



A Guide To Diagnostic Insulation Testing Above 1 kV

Megger[®]

Test Equipment Depot - 800.517.8431 - 99 Washington Street Melrose, MA 02176 - TestEquipmentDepot.com

The word "Megger" is a registered trademark

WHY A 10 KV INSULATION TESTER?

Megger invented insulation testing before the beginning of the 20th century and has continued to lead the market in innovation and technological advancement. So, why did we develop a 10 kV model when all other suppliers stopped at 5 kV? The answer is in the IEEE standards. Megger developed a 10 kV unit to meet the new testing recommendations outlined by the IEEE. Megger has offered a 10 kV insulation resistance tester since 2001.

In March 2000, The IEEE-SA Standards Board approved a revision to IEEE Std 43-1974. The "IEEE Recommended Practice for Testing Insulation Resistance of Rotating Machinery," Std 43-2000, emphasizes the need for upgrading current practices to accommodate changes and improvements in insulating materials and the value of higher voltage testing that reveals otherwise hidden flaws.

Following is a brief summary of the highlights of the standard:

- Test voltages up to 10 kV are recommended for windings rated greater than 12 kV.
- Both the Insulation Resistance test and the Polarization Index test are recommended.
- Test results should be compared to historical values to identify changes.
- In lieu of historical records, minimum acceptable values (based on the type of equipment) for both tests are indicated.
- Depending on the machine rating, the readings for one or both tests should exceed the minimum acceptable values.
- If the readings are below the minimum acceptable values, the winding is not recommended for an over voltage test or for operation.

IEEE Std 43-2000 recommends a procedure for measuring insulation resistance of armature and field windings in rotating machines rated 1 hp, 750 W or greater and applies to synchronous machines, induction machines, dc machines and synchronous condensers. It does not apply to fractional horsepower machines. It also recommends the insulation test voltage (based on winding rating) and minimum acceptable values of insulation resistance for ac and dc rotating machine windings.

For more information on the IEEE Standard, please turn to page 25 in the booklet.

WHY A 15 KV INSULATION TESTER?

15 kV insulation testers are now in demand as engineers experience earlier degradation detection and better fault detection on high voltage equipment. Many power utilities in South America have already incorporated 15 kV testing into their procedures and this trend is now spreading into Europe, the Middle East and Asia. In the US NETA standards specify 15 kV test voltage. The NETA Pearl reconditioning standard / NETA MTS-1997 specifies 15 kV testing on equipment with a maximum voltage rating of 35 kV and above. Motors tested to NETA ATS 2007 with 34,500 V or above on their name plate also require testing at 15 kV

Introduction	2	Ramped Voltage Test.....	18
What is Insulation?	2	Dielectric Discharge Test.....	19
What Causes Insulation to Degrade?.....	3	Different Problems/Different Tests	21
Electrical Stress.....	3	Appendices	22
Mechanical Stress.....	3	Potential Sources of Error/Ensuring Quality Test Results.....	22
Chemical Attack.....	3	Test Leads.....	22
Thermal Stress.....	3	Making Measurements above 100 GΩ	22
Environmental Contamination	3	Accuracy Statements.....	22
How Can Predictive Maintenance Help Me?	3	Delivery of Stated Voltage.....	22
The Benefit of New Technology.....	4	Interference Rejection	23
How Insulation Resistance is Measured	4	Rules on Testing and Comparing.....	23
How an Insulation Resistance Tester Operates	4	CAT Rating.....	24
Components of Test Current	4	CAT Rating Guidelines.....	24
Capacitive Charging Current.....	4	The Importance of a CAT Rating	24
Absorption or Polarization Current.....	4	Some CAT Rating Basic Statistics.....	25
Surface Leakage Current.....	5	Testing at High Altitudes.....	25
Conduction Current.....	5	Testing Insulation Resistance of Rotating Machinery.....	25
Connecting your Insulation Tester	6	Effects of Temperature	26
Selected Typical Connections	6	Effects of Humidity	27
Shielded Power Cable.....	6	Ingress Protection.....	27
Circuit Breaker/Bushings.....	6	High Potential Testing	29
Power Transformer	6	Current (nA) Readings vs. Resistance (MΩ) Readings.....	29
AC Generator	7	Burn Capability.....	29
Insulation Resistance Tester Scale	7	Drying Out Electrical Equipment.....	29
Voltage Characteristics	8	Test Item Discharge.....	30
The Guard Terminal	9	Charging Time for Large Equipment	31
Introduction.....	9	Motor Driven Insulation Testers.....	31
How the Guard Terminal Works	10	Test Lead Design	31
Guard Terminal Performance.....	10	Significant Safety Enhancements.....	32
Comparing Results.....	11	Things to Consider for Safe Operation.....	32
The Guard Terminal as a Diagnostic Tool	11	Safety Warnings	33
Guard Terminal Protection.....	11	Instrument Case Design	33
Final Words	12	Fire Retardant Safety	33
Evaluation and Interpretation of Results	13	Megger Insulation Testers	35
Interpretation of the Infinity Reading.....	13	MIT515, MIT525, MIT1025, MIT1525	35
Diagnostic High Voltage Insulation Tests	14	S1-568, S1-1068, S1-1568.....	35
Spot Reading Test	14	Models MJ15 and BM15.....	36
Time vs. Resistance Test	15	Test Leads	36
Polarization Index Test	16		
Step Voltage Test	17		

INTRODUCTION

Electrical insulation degrades over a period of time because of various stresses, which are imposed upon it during its normal working life. The insulation has been designed to withstand these stresses for a period of years, which would be regarded as the working life of that insulation. This often runs into decades.

Abnormal stresses can bring about an increase in this natural aging process that can severely shorten the working life of the insulation. For this reason it is good practice to perform regular testing to identify whether increased aging is taking place and, if possible, to identify whether the effects may be reversible or not.

The purpose of diagnostic insulation testing is:

- To identify increased aging.
- To identify the cause of this aging.
- To identify, if possible, the most appropriate actions to correct the situation.

In its simplest form, diagnostic testing takes the form of a "Spot Test." Most electrical maintenance professionals have made spot tests where a voltage is applied to the insulation and a resistance is measured. The diagnosis in this case is limited to "the insulation is good" or "the insulation is bad." But having made this diagnosis what do we do about it? It's a bit like going to the doctor with a bad cough and the doctor simply telling you, "You've got a bad cough." You wouldn't be happy to come away with only that information. You expect the doctor to examine you, carry out a few tests, and tell you why you have a bad cough and what to do about it to cure the cough.

In insulation testing, a spot test on its own is the equivalent of the doctor telling you that you are well or you are sick. It's minimal information. This is the sort of test that is typically applied to low-voltage circuits where the cost of a failure is low and equipment can be replaced easily and inexpensively. Since the equipment being tested is low voltage equipment, these tests are typically performed using a 500 or 1000 V test voltage and will be familiar to all electrical maintenance personnel.

However, if the doctor records the results of his examination and compares them with those from previous visits, then a trend might be apparent which could lead to medication being prescribed. Similarly, if insulation resistance readings are recorded and compared with previously obtained readings, it may be possible to see a trend and to prescribe remedial actions if such are called for.

Diagnostic insulation testing at voltages above 1 kV is an area that is less familiar to many electrical maintenance personnel. The purpose of this booklet, therefore, is to:

- Acquaint the reader with making diagnostic insulation resistance tests.
- Provide guidelines for evaluating the results of these diagnostic insulation resistance tests.
- Introduce the benefits of multi-voltage testing at higher voltages.

A series of appendices are included at the end of the booklet to provide the reader with additional information related to diagnostic insulation testing.

This booklet is based on the principles established in the booklet "A Stitch in Time... The Complete Guide to Electrical Insulation Testing" first published in 1966 by the James G. Biddle Company.

WHAT IS INSULATION?

Every electric wire in a facility, whether it's in a motor, generator, cable, switch, transformer, or whatever, is covered with some form of electrical insulation. While the wire itself is a good conductor (usually made of copper or aluminum) of the electric current that powers electrical equipment, the insulation must resist current and keep the current in its path along the conductor. Understanding Ohm's Law, which is expressed in the following equation, is the key to understanding insulation testing:

$$E = I \times R$$

where,

E = voltage in volts

I = current in amperes

R = resistance in ohms

For a given resistance, the higher the voltage, the greater the current. Alternatively, the lower the resistance of the wire, the more current that flows for the same voltage.

No insulation is perfect (has infinite resistance), so some current does flow along the insulation or through it to ground. Such a current may be insignificantly small for most practical purposes but it is the basis of insulation testing equipment.

So what is "good" insulation? "Good" means a relatively high resistance to current flow. When used to describe an insulation material, "good" also means "the ability to maintain a high resistance." Measuring resistance can tell you how "good" the insulation is.

What Causes Insulation to Degrade?

There are five basic causes for insulation degradation. They interact with each other and cause a gradual spiral of decline in insulation quality.

Electrical Stress

Insulation is designed for a particular application. Overvoltages and undervoltages cause abnormal stresses within the insulation, which can lead to cracking or delamination of the insulation.

Mechanical Stress

Mechanical damage such as hitting a cable while digging a trench is fairly obvious but mechanical stresses also may occur from running a machine out of balance or frequent stops and starts. The resulting vibration from machine operation may cause defects within the insulation.

Chemical Attack

While you would expect insulation to be affected by corrosive vapors, dirt and oil can also operate to reduce the effectiveness of insulation.

Thermal Stress

Running a piece of machinery in excessively hot or cold conditions will cause over expansion or contraction of the insulation which might result in cracks and failures. However, thermal stresses are also incurred every time a machine is started or stopped. Unless the machinery is designed for intermittent use, every stop and start will adversely affect the aging process of the insulation.

Environmental Contamination

Environmental contamination covers a multitude of agents ranging from moisture from processes, to humidity on a muggy day, and even to attack by rodents that gnaw their way into the insulation.

Insulation begins to degrade as soon as it is put in service. The insulation in any given application will have been designed to provide good service over many years under normal operating conditions. However, abnormal conditions may have a damaging effect which, if left unchecked, will speed up the rate of degradation and will ultimately cause a failure in the insulation. Insulation is deemed to have failed if it fails to adequately prevent electrical current from flowing in undesirable paths. This includes current flow across the outer or inner surfaces of the insulation (surface leakage current), through the body of the insulation (conduction current) or for a variety of other reasons.

For example, pinholes or cracks can develop in the insulation or moisture and foreign matter can penetrate the surface(s). These contaminants readily ionize under the effect of an applied voltage providing a low resistance path for surface leakage current which increases compared with dry uncontaminated surfaces. Cleaning and drying the insulation, however, will easily rectify the situation.

Other enemies of insulation may produce deterioration that is not so easily cured. However, once insulation degradation has started, the various initiators tend to assist each other to increase the rate of decline.

How Can Predictive Maintenance Help Me?

While there are cases where the drop in insulation resistance can be sudden, such as when equipment is flooded, it usually drops gradually, giving plenty of warning if tested periodically. These regular checks permit planned reconditioning prior to service failure and/or a shock condition.

Without a periodic testing program all failures will come as a surprise, unplanned, inconvenient and quite possibly very expensive in time and resources and, therefore, money to rectify. For instance, take a small motor that is used to pump material, which will solidify if allowed to stand, around a processing plant. Unexpected failure of this motor will cost tens, maybe even hundreds of thousands, of dollars to rectify if downtime of the plant is also calculated. However, if diagnostic insulation testing had been included in the preventive maintenance program it may have been possible to plan maintenance or replacement of the failing motor at a time when the line was inactive, thereby minimizing costs. Indeed, it may have been that the motor could have been improved while it was still running.

If advanced insulation degradation goes undetected there is an increase in the possibility of electrical shock or even death for personnel; there is an increase in the possibility of electrically induced fires; the useful life of the electrical equipment can be reduced and/or the facility can face unscheduled and expensive downtime. Measuring insulation quality on a regular basis is a crucial part of any maintenance program as it helps predict and prevent electrical equipment breakdown.

This is particularly appropriate now when we consider that large parts of the electrical network in the USA and Europe were installed in the 1950s in a burst of postwar investment. Some equipment is approaching the end of its design life, while some has already exceeded it but is still operating satisfactorily.

Since diagnostic testing is generally reserved for more critical items, we normally, but not always, find that diagnostic testers have voltage outputs of 5 or 10 kV. These voltages are more suitable for testing the assets which themselves are usually medium voltage machines, cables, transformers, etc.

The Benefit of New Technology

Insulation testers date back to the early 20th century when Sidney Evershed and Ernest Vignoles developed their first insulation tester (which evolved in 1903 into the Megger[®] range of testers).

In the early days, most instruments were hand-cranked. This limited their ability to carry out tests which took an extended time to complete, and limited the voltage stability to the operator's ability to crank steadily. Later, these same instruments were capable of having an external motor drive added which helped with long duration tests but did very little to improve the voltage stability. However, the range of these instruments rarely exceeded 1000 MΩ. The analog movements were very heavy and actually served to damp out any transient events.

The appearance of electronics and the development of battery technology revolutionized the design of insulation testers. Modern instruments are line- or battery-powered and produce very stable test voltages under a wide variety of conditions. They are also able to measure very small currents so that their insulation resistance measuring range is extended several thousandfold into the teraohm (TΩ) range. Some can even replace the pencil, paper and stopwatch, which were formerly used to manually collect results, by recording data in memory for later download and analysis. It is fortunate that these astonishing enhancements were made since the manufacturers of insulating material have been working hard also, with the result that modern insulating materials now exhibit much higher resistances than those in the early 20th century.

Newer technology offers enhanced performance so that established procedures can yield greater insights and new methods can be made available. Modern instruments deliver stable voltage over their full resistance range, with microprocessor sensitivity in the measuring circuit enabling measurements in the TΩ range. The combination of stable voltage and enhanced sensitivity enables the tester to measure the minuscule amounts of current that are passed by quality insulation in new, capital equipment. Accordingly, sophisticated procedures that rely on precise measurement have been developed and may be easily implemented.

Now that the insulation tester isn't limited to values associated with faulty or aged equipment, it can be used to pinpoint the test item's position anywhere along its aging curve. The "infinity" indication that is a delight to the repair technician represents a void to the diagnostician. Some instruments have diagnostic tests preprogrammed into their software and can run them automatically, filling that void with valuable analytical data.

HOW INSULATION RESISTANCE IS MEASURED

How an Insulation Resistance Tester Operates

The Megger[®] insulation tester is a portable instrument that provides a direct reading of insulation resistance in ohms, megohms, gigohms, or teraohms (depending on the model chosen) regardless of the test voltage selected. For good insulation, the resistance usually reads in the megohm or higher range. The Megger insulation tester is essentially a high-range resistance meter (ohmmeter) with a built-in dc generator.

The instrument's generator, which can be hand-cranked, battery- or line-operated, develops a high dc voltage that causes several small currents through and over surfaces of the insulation being tested. The total current is measured by the ohmmeter, which has an analog indicating scale, digital readout or both.

Components of Test Current

If we apply a test voltage across a piece of insulation, then by measuring the resultant current and applying Ohm's Law ($R=E/I$), we can calculate the resistance of the insulation. Unfortunately, more than one current flows, which tends to complicate matters.

Capacitive Charging Current

We are all familiar with the current required to charge the capacitance of the insulation being tested. This current is initially large but relatively short lived, dropping exponentially to a value close to zero as the item under test is charged. Insulating material becomes charged in the same way as a dielectric in a capacitor.

Absorption or Polarization Current

Absorption current is actually made up of up to three components, which decay at a decreasing rate to a value close to zero over a period of several minutes.

The first is caused by a general drift of free electrons through the insulation under the effect of the electric field.

The second is caused by molecular distortion whereby the imposed electric field distorts the negative charge of the electron shells circulating around the nucleus toward the positive voltage.

The third is due to the alignment of polarized molecules within the electric field applied, see figure 1. This alignment is fairly random in a neutral state, but when an electric field is applied, these polarized molecules line up with the field to a greater or lesser extent.

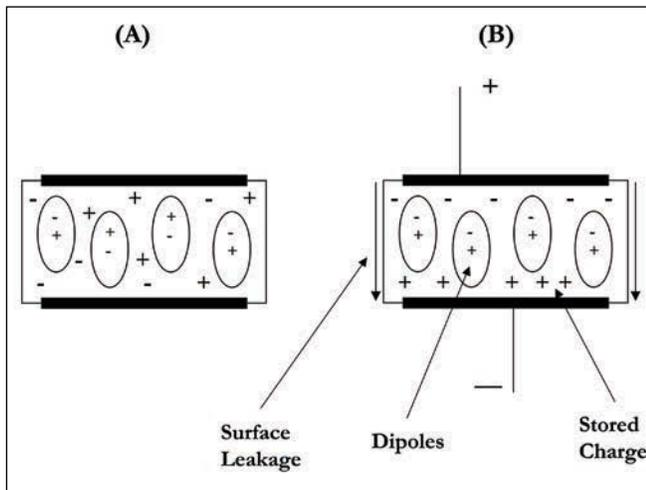

Figure 1: Alignment of Polarized Molecules

The three currents are generally considered together as a single current and are mainly affected by the type and condition of the bonding material used in the insulation. Although the absorption current approaches zero, the process takes much longer than with capacitive current.

Orientational polarization is increased in the presence of absorbed moisture since contaminated materials are more polarized. This increases the degree of polarization. Depolymerization of the insulation also leads to increased absorption current.

Not all materials possess all three components and, indeed, material such as polyethylene exhibits little, if any, polarization absorption.

Surface Leakage Current

The surface leakage current is present because the surface of the insulation is contaminated with moisture or salts. The current is constant with time and depends on the degree of ionization present, which is itself dependent on temperature. It is often ignored as a separate current, being included with the conduction current below as the total leakage current.

Conduction Current

Conduction current is steady through the insulation and is usually represented by a very high value resistor in parallel with the capacitance of the insulation. It is a component of the Leakage Current, which is the current that would be measured when the insulation is fully charged and full absorption has taken place. Note that it includes surface leakage, which can be reduced or eliminated by the use of the guard terminal (to be discussed later).

The graph in figure 2 shows the nature of each of the components of current with respect to time.

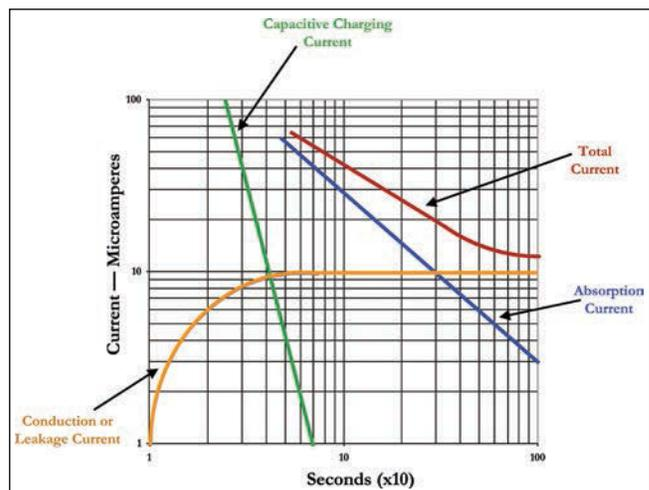

Figure 2: Components of Test Current

The total current is the sum of these components. (Leakage current is shown as one current.) It is this current that can be measured directly by a microammeter or, in terms of megohms, at a particular voltage by means of a Megger insulation tester. Some instruments offer the alternatives of displaying a measurement in terms of current or as a resistance.

Because the total current depends upon the time that the voltage is applied, Ohm's Law ($R = E/I$) only holds, theoretically, at an infinite time (that implies waiting forever before taking a reading). It is also highly dependent upon starting from a base level of total discharge. The first step in any insulation test is, therefore, to ensure that the insulation is completely discharged.

Please note: The charging current disappears relatively rapidly as the equipment under test becomes charged. Larger units with more capacitance will take longer to be charged. This current is stored energy and, for safety reasons, must be discharged after the test. Fortunately, the discharge of this energy takes place relatively quickly. During testing, the absorption current decreases at a relatively slow rate, depending upon the exact nature of the insulation. This stored energy, too, must be released at the end of a test, and requires a much longer time to discharge than the capacitance charging current.

Connecting your Insulation Tester

With modern insulating materials there is little, if any, difference in the reading obtained, regardless of which way the terminals are connected. However, on older insulation, a little-known phenomenon called electroendosmosis causes the lower reading to be obtained with the positive terminal connected to the grounded side of the insulation being tested. If testing an underground cable, the positive terminal would normally be connected to the outside of the cable since this will be grounded by contact with the soil, as shown in figure 3. Please note that you do not connect directly to the insulation but rather to the cable's neutral or ground.

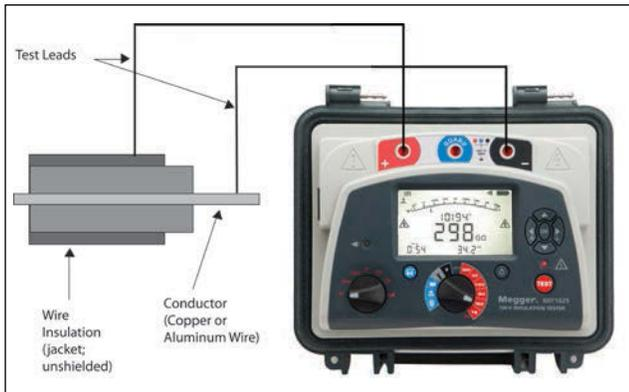

Figure 3: Simplistic Connection to a Cable

Selected Typical Connections

Shielded Power Cable

Connected to measure the insulation resistance between one conductor and ground.

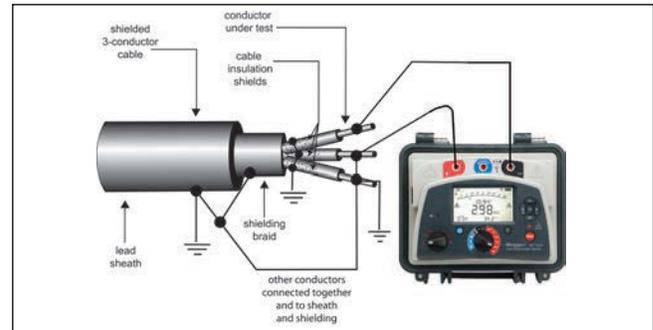

Figure 4: Connection to a Shielded Power Cable

Circuit Breaker/Bushings

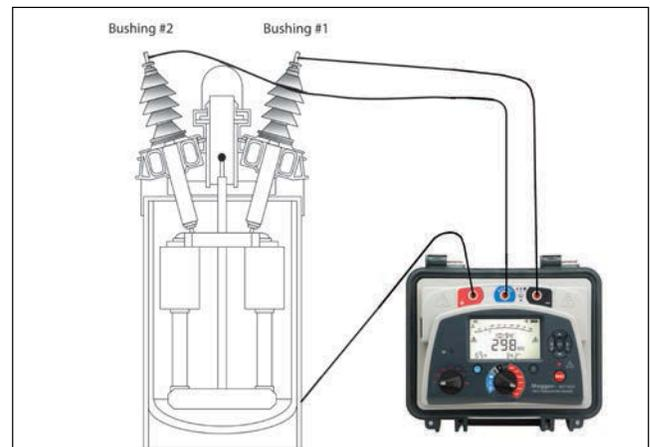

Figure 5: Connection to a Circuit Breaker

Power Transformer

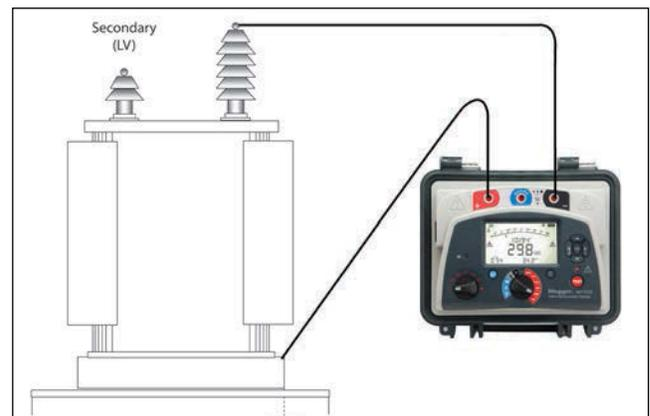

Figure 6: Connection to a Power Transformer

AC Generator

Keen observers will note that the hookup to measure the circuit breaker bushing included the connection of the third, or Guard, terminal. The use of this terminal is explained in greater detail later in this booklet.

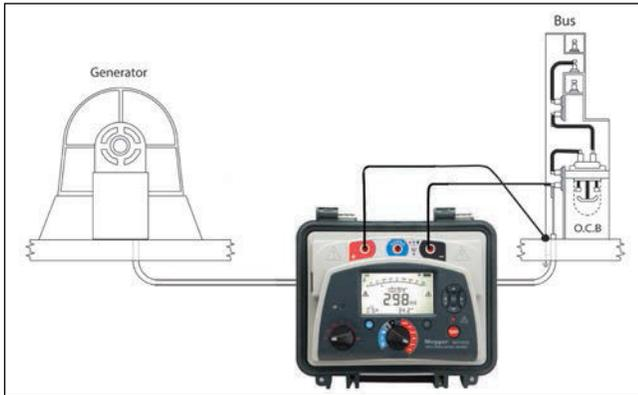

Figure 7: Connection to an AC Generator

Insulation Resistance Tester Scale

Most modern insulation testers offer displays that provide the operator with both a digital readout of the result and some form of analog movement or pointer travel. Figure 8 shows the top panel and display of the Megger MIT1025.



Figure 8: Megger MIT1025 top panel and screen display

When an insulation tester is “hooked up” to the item to be tested, and a test is started, several things occur. The three different currents, capacitive charging, dielectric absorption, and conduction/leakage are flowing. The sum of these three currents will cause the instrument display to vary, with the reading increasing, initially quickly and then more slowly with time.

With an analog display, the movement of the pointer may provide information to an experienced operator. Is the pointer traveling smoothly, or “stuttering”? Is it rising steadily or intermittently dropping back? This valuable supplementary information would be difficult or

nearly impossible to discern from the dancing digits of an LCD. A few examples are listed here:

- As the test voltage increases and the item under test approaches breakdown, corona discharge will cause the pointer to “jitter,” indicating to the operator that the maximum voltage that the item can withstand is being approached. This warning happens in time to terminate the test before actual breakdown, and possible damage, occurs.
- To the experienced operator, the speed at which the pointer travels imparts information on the capacitance of the item under test. This is a useful property in high-voltage cable testing, and relates to the theoretical basis of the more sophisticated dielectric discharge test that is described elsewhere in this booklet.
- If the pointer alternately rises and drops back, it could indicate arcing in the item under test that is too small to cause the automatic shutdown of the tester. Such information helps direct the operator in pinpointing a problem.
- Observing a pointer as it slows to an apparent halt (it may still be moving, but at a “speed” likened to that of a clock hand) can be more agreeable to taking a quick or spot reading than trying to decide when a digital display has reasonably stabilized. No digital display “freezes” on a precise number without at least some fluctuation of the least significant digit.

This kind of detail is difficult or impossible for the eye to extract from the scrolling digits on an electronic display. But whereas pointer travel may be desirable, when it stops, the operator is left to interpolate the reading between the scale markings, introducing an element of judgment, which can be a source of error. Digital models present no such problem, as they inform the operator exactly (within the unit’s accuracy specification) what measurement has been taken. And remember, most will give you a value of capacitance at the end of the test.

Most Megger insulation testers above 1 kV come with an analog/digital display. One of the advantages of this display is that the analog portion of the meter will sway and oscillate, indicating to the operator that the item under test has not yet reached a steady state and is still under the influence of the absorption and charging current. This indication means that the item should be tested longer or that there is a problem. When the analog portion of the display becomes steady, the instrument displays the result in an unambiguous digital direct reading form, with no multipliers or math to perform.

Unlike the analog/digital display mentioned above, an “average sensing” bar graph meter does not provide a real-time indication of insulation resistance. Some instruments offer a curved bar graph in place of a genuine logarithmic arc, in which the low end of the scale is expanded relative to the high end. The bar graph takes readings over time, performs calculations and then displays the results. The problem with this type of meter is its principal of operation. If an event occurs when the bar graph is not taking readings, it will be missed and not shown on the display. Additionally, bar graph simulations of pointer travel may not appear to the eye the same as the familiar pointer travel and may not replicate a mechanical movement to the expected degree.

When doing insulation testing, the more the operator knows about the results (during and after the test), the better his/her decision on how to correct the problem, if one exists. If something is missed during a test because the instrument had a bargraph-style meter, important information could also be missed.

Voltage Characteristics

The output voltage of an insulation tester depends on the resistance it is measuring. At low resistances, say tens of ohms, the output voltage will be close to zero, maybe a few volts. As the resistance load is increased so the test voltage will increase until it reaches the requested voltage. As the resistance increases further, the test voltage will slowly increase until a steady value is reached. This value will probably be slightly in excess of the requested nominal voltage (e.g. 5104 V when 5000 V was selected).

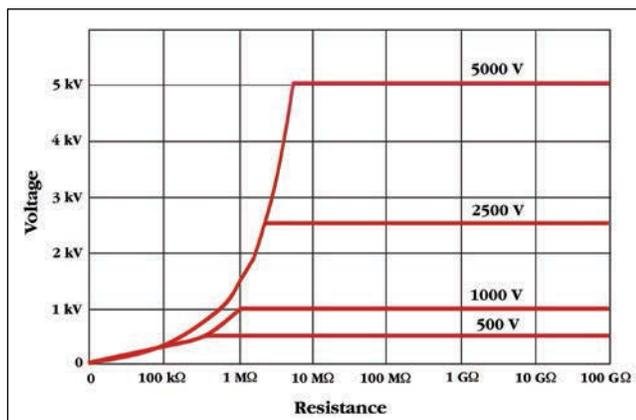

Figure 9: Good Load Curve

You should always ensure that an insulation tester is provided with a “load graph” that indicates output voltage characteristics against load resistance or, alternatively, an integral voltmeter that actually measures the terminal voltage during a test and displays it continuously. By this means you can ensure that an adequate voltage is produced over the resistance range of interest.

A quality insulation tester will have a voltage characteristic that exhibits a sharp rise in voltage up to a level of resistance commensurate with good insulation. A fast rise time ensures an effective measurement. The voltage characteristic shown in figure 9 represents a good characteristic. In this example, the output voltage will have reached 500 V at a load as low as 500 kΩ and 1000 V by 1 MΩ. These values are legislated by international standards for testing wiring in houses, shops, etc. While this is hardly a common use for typical diagnostic insulation testers, it does provide a good benchmark for the serious manufacturer. Similar figures would apply at higher voltages. Voltage should rise sharply up to anywhere from one to five megohms, depending on the voltage selection, and maintain that voltage at all higher resistances.

With lower quality insulation testers, voltage ramp is far slower. The instruments typified by the poor curve shown in figure 10 do not produce the rated voltage until much higher resistances have been reached. Thus tests could produce results that provide pass levels of insulation but have only been subjected to half the desired test voltage.

Note: Beware of instruments that do not have published load curves.

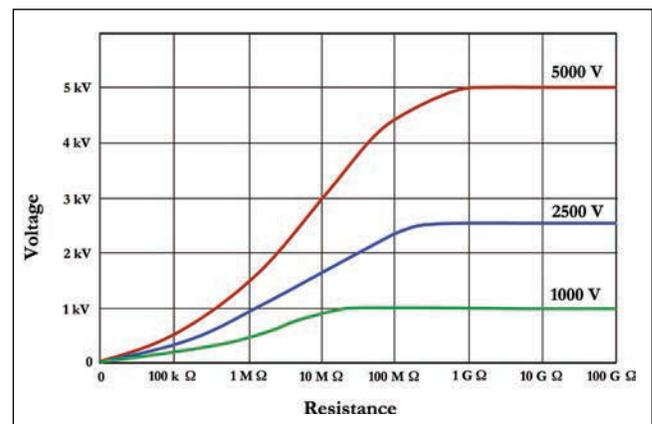

Figure 10: Poor Load Curve

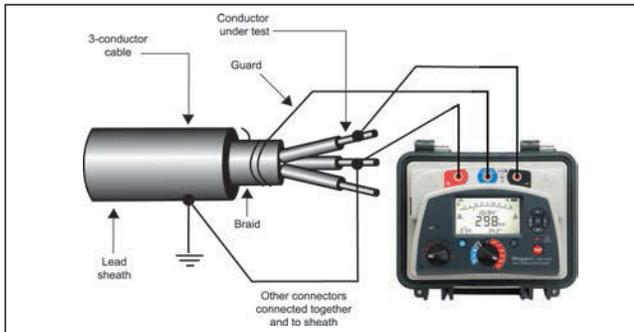

Figure 11: Use of the Guard Terminal on a Power Cable

THE GUARD TERMINAL

Introduction

When making an insulation test, we are often so preoccupied with the resistance of the actual insulator that we forget the resistance path on the outer surface of the insulating material. This resistance path can be very much part of our measurement and can dramatically affect the results.

As a refresher, the total current that flows during an insulation resistance test is made up of three main components:

1. The charging current, which is charging up the object's capacitance.
2. An absorption current, which is the current that is being drawn into the insulation by the polarizing of the electrons; initially high but drops over time (at a rate slower than the charging current).
3. The conduction or leakage current, which is the small, steady state current that divides into two parts:
 - a. The conduction path through the insulation.
 - b. The current flowing over the insulation's surface.

The current flowing over the surface is the component of current that we do not want to measure if we want to measure the insulation resistance of the material. Surface leakage introduces errors into the measurement of insulation resistance. Removing the surface leakage from the measurement becomes more critical the higher the expected insulation resistance values.

Some insulation testers have two terminals, others have three. As these are dc testers, two of the terminals are the + and -. The third (if present) is a guard. It does not have to be used and many operators use insulation

testers satisfactorily without ever employing the guard. However, it affords the operator an extra function for diagnosis of equipment problems. The guard is a shunt circuit that diverts surface leakage current around the measurement function. If parallel leakage paths exist, a guard connection will eliminate those from the measurement, and give a more precise reading of the leakage between the remaining elements.

Surface leakage is essentially a resistance in parallel with the true insulation resistance of the material being tested. When making a two-terminal measurement, this resistance path is very much part of the measurement and can affect the readings dramatically. A three-terminal measurement, which includes the use of the guard terminal, ignores the surface leakage. This can be quite important when testing high voltage components like insulators, bushings and cables where high resistance values are expected.

As an example, dirt and moisture on a transformer bushing will promote surface leakage between the + and - connections, thereby bringing down the reading and possibly giving a false impression that the bushing is defective. Connecting the guard to a bare wire wrapped around the bushing will intercept this current and yield a measurement based predominantly upon leakage through defects in the ceramic.

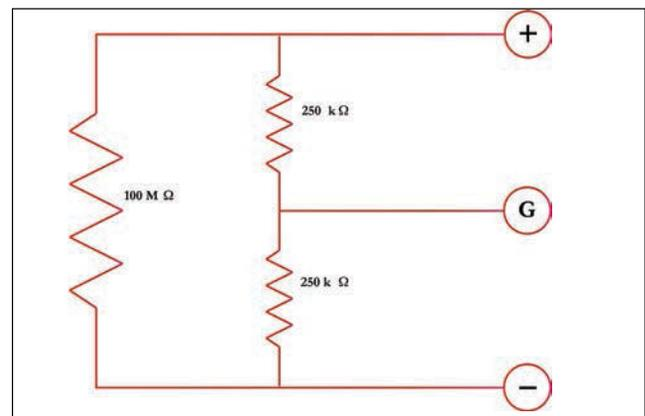

Figure 12: Guard Terminal Diagram

It is most important not to confuse the guard with a ground. Connecting the guard and return lead to the same element of the test item only shunts the current that is supposed to be measured, and thereby short-circuits the measurement function. When selecting a tester, consider:

- The goals of testing (basic installation checks don't generally require a guard).
- The electrical composition of the items to be tested (motors and transformers can be tested for leakage between windings, with ground leakage eliminated).
- The possible effects of surface leakage (wire and cable can carry current across the surface, via dirt and moisture, as well as through the insulating material).
- The degree to which results must be analyzed (are "bad" items merely to be replaced or discarded, or will it be necessary to localize faults for possible repair).

How the Guard Terminal Works

The following high voltage bushing example shows a typical application for the guard terminal. In the first graphic, the guard terminal is not used and the leakage currents flowing through the bushing and across the surface are combined and measured together by the instrument. In the second graphic, wire has been wrapped around the bushing and connected to the guard terminal so that the surface leakage flows to the guard terminal. Current flowing into the guard terminal is not measured by the instrument, meaning that it is ignored in the insulation resistance measurement.

To better understand what is actually happening within the instrument, consider figure 14. The insulation tester has three main elements; the high voltage dc current source, the high voltage voltmeter and the current meter. The insulation resistance measurement is simply Ohm's Law, measured voltage divided by the measured current. The guard terminal allows leakage current to bypass the current measurement and be ignored.

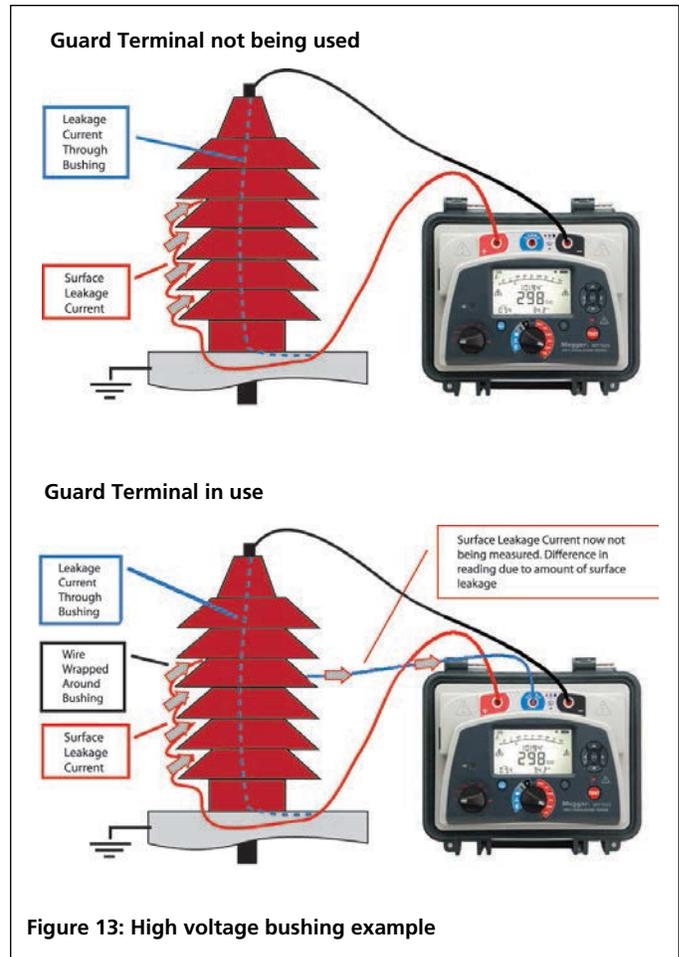

Figure 13: High voltage bushing example

Guard Terminal Performance

Testers with guards generally cost a bit more than two-terminal models, but in many applications, a two-terminal model won't be imparting the full spectrum of information that can be accrued by insulation testing.

Something that is often forgotten is the difference in the capabilities of the guard circuit. Guard terminal performance is often hidden in the instrument datasheet or left out altogether. The guarding capability of the insulation tester is much more important when measuring leaky insulation than the usually quoted measurement accuracy figure, which may be 5%.

Surface leakage is part of the uncertainty of the measurement. The more surface leakage bypassing the current measurement means less left to measure. When measuring high voltage electrical components, the better the performance of the guard terminal, the more accurate the insulation resistance measurement. Effective predictive maintenance depends on reliable trending of test results to provide early indication of failure. Faulty readings due to surface leakage not being properly guarded can skew a maintenance program.

Consider the following example, an extreme case where the surface leakage path is 200 times less than the resistance of the insulation.

Here we show an insulator of value 100 MΩ that we wish to measure. It is dirty and contaminated and so it has a surface leakage path of 500 kΩ. If we apply our test voltage from the positive and negative terminals without guarding the circuit, 20 times as much current will flow through the surface leakage compared with the current flowing through the insulation we wish to measure and we will read a resistance of only 497 kΩ.

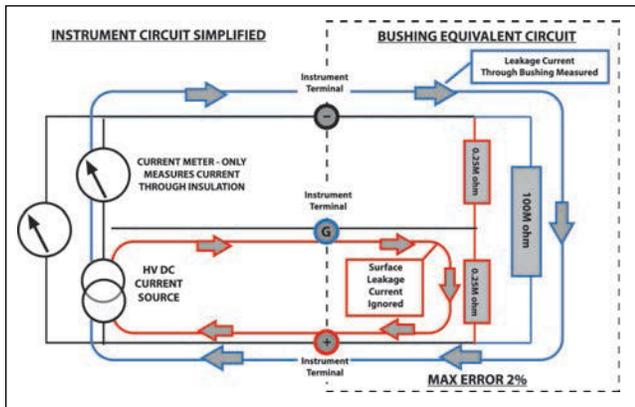

Figure 14: Instrument circuit simplified

If we “guard” the sample, here shown as being guarded such that we split the leakage resistance equally on either side of the guard connection, we will be able to eliminate the effect of the surface leakage to a certain extent. How much we eliminate the effect of the surface leakage is based on the guard circuitry of the insulation tester used. Depending on the instrument chosen, this error level can range from less than 1.0% to more than 80.0%. If you intend to use the guard terminal, investigate the error level before purchasing an instrument.

This is a classic example of the need to compare tests on a like to like basis. An unguarded measurement and a guarded measurement yield very different results. How is an operator to know whether the guard terminal was previously used unless the test records record this seemingly unimportant detail?

Comparing Results

A way to check guard terminal performance is to compare results with and without the guard terminal in use on a calibration box with a known leakage value added to the circuit (to be guarded out). A top quality instrument (and guard terminal) will provide the same

result before the leakage value is added to the circuit (measured unguarded) and after it is added to the circuit (and measured guarded). In addition, the test voltage will remain at the selected level.

Instruments with poor guard terminals can show a variance (error) of upwards of 95% in the reading with the guard terminal in use. In addition, they often show a significant drop in the delivered voltage from the selected voltage level. Even units with more accurate guard terminals can still show a significant drop in delivered test voltage, making the measured result questionable.

Following are some results from actual instruments, using the 1 TΩ position on a calibration box and then introducing 5 MΩ leakage to be guarded out. The names and model numbers of all but the Megger unit have been removed. This data is being used to show how much error can be introduced into the readings by a poor guard terminal.

Instrument	Reading without guard	Delivered voltage without guard	Added leakage	Reading with guard	Delivered voltage with guard
Megger MIT525	978 MΩ	5090 V	5 MΩ	978 MΩ	5001 V
Instrument 1	1.01 TΩ	5010 V	5 MΩ	37.6 MΩ	3287 V
Instrument 2	975 MΩ	5103 V	5 MΩ	961 MΩ	3757 V
Instrument 3	978 MΩ	5269 V	5 MΩ	746 MΩ	3680 V

The Guard Terminal as a Diagnostic Tool

The user can quickly identify when surface leakage is present and how much by performing two tests, one with the guard terminal and one without. If the instrument gives the option of looking at the measurement in leakage current rather than resistance, the user simply subtracts the measured value with the guard terminal in use from the value without the guard terminal. The result shows exactly how much current is surface leakage.

Poor insulation resistance measurements can lead to expensive remedial action like replacing a bushing. It may be that all the bushing needed was a good clean. Using the guard terminal helps identify this type of situation and saves money.

Note: Beware of specs that provide input impedance.

Guard Terminal Protection

The guard terminal is an important part of a >1kV insulation tester. The guard terminal not only has to perform well, but also has to be well protected. The performance is its ability to efficiently remove the effects of surface or unwanted leakage from an

insulation measurement. The protection is against the inadvertent application of voltage or transients as required by the specified safety CAT rating from IEC61010.

The Megger MIT and S1 families of 5 kV and 10 kV insulation testers have a unique specification for the performance of their guard terminals. The specification means the instrument has the ability to take IR measurements when the guarded leakage current is 200 times the magnitude of the measured insulation leakage current and have no more than an additional 2% error in accuracy.

To achieve this and still provide the required safety protection to meet IEC61010 is of course important. However, the most common approach used by some instrument manufacturers is to employ a higher input impedance to provide the required protection. This will effectively destroy the measurement performance of the guard terminal.

To understand this effect let's take a case study of an instrument manufacturer that has highlighted the benefits of a guard terminal protected with 200 kΩ input impedance.

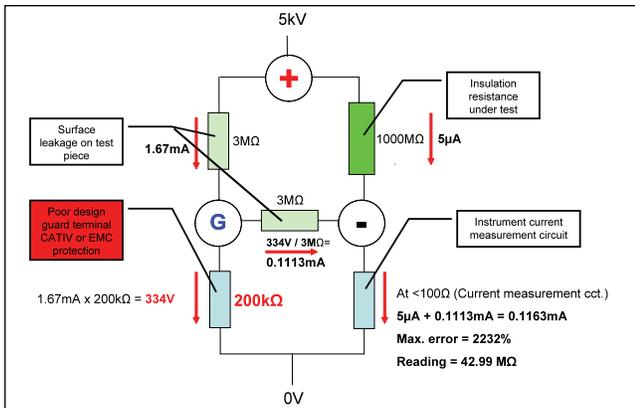

Figure 15: Measurement circuit "protected" by high impedance guard

Figure 15 above shows an equivalent circuit of a 1000 MΩ insulation resistance being measured with a surface leakage of 6 MΩ across it. The surface leakage has been connected to the guard terminal to ensure it is not measured. However this instrument is protected with a 200 kΩ input impedance. The result is a measured value of about 43 MΩ, over 2000% away from the 1000 MΩ that should have been measured.

In a Megger insulation tester the guard deploys effective protection but the input impedance remains at an acceptable level as shown in the example below in figure 16.

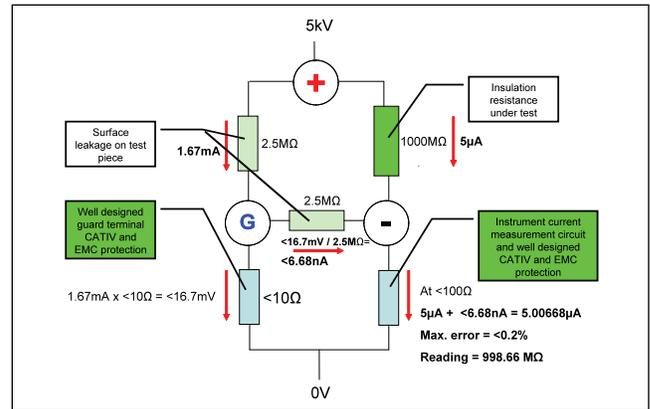

Figure 16: Measurement circuit with low-impedance high-accuracy guard

In figure 16 the Megger guard terminal input protection is low impedance but still protects to the requirements of IEC61010. The importance of the low impedance protection is evident with the additional error introduced to the guarded measurement being no more than 0.2% in this calculated example.

It is important when selecting a 5 kV or 10 kV insulation tester to ensure the instrument is properly protected on all terminals including the guard terminal, but also to ensure the protection used has not destroyed the instrument's performance as an insulation tester. Megger will not make compromises.

Final Words

Clearly, the guard terminal is a very useful feature, but a few words of caution are necessary. The presence of the guard terminal alone does not guarantee that an insulation test set will give accurate results in the presence of high levels of surface leakage. In particular, it is difficult to maintain the performance of the guard terminal if the instrument is also to offer a CAT IV 600V safety rating. Make sure the insulation tester is able to achieve its CAT rating without compromising the guard terminal performance.

There can be many reasons why some instruments achieve poor guard terminal performance, but one of the most obvious is that, with a guard terminal, the instrument not only has to supply the current needed for the actual insulation test, but also the diverted current that flows via the guard terminal. If the voltage generator in the test set has insufficient capacity — effectively having a high internal resistance — the result will be that the test voltage falls, giving inaccurate results. This is a very important consideration because the current in the guard terminal circuit can be ten or more times greater than that in the test circuit itself.

The stability of the test set also has an effect on the accuracy of the results obtained when the guard terminal is in use, as does leakage on the surface of the test leads used. There are instruments currently available that can give results that are in error by as much as 80% when the guard terminal is in use. Such huge errors, of course, nullify the benefits of the guard terminal. In fact, they do worse than this because, by delivering spurious results, they may mask real problems. So what can purchasers of high-voltage insulation test sets do to avoid problems of this type?

Fortunately, the answer is straightforward. All that's necessary is to ask the instrument manufacturer, before making a purchase, to confirm the accuracy that the instrument will deliver when the guard terminal is used. Any reluctance to provide this information will enable the obvious conclusions to be drawn, and the appropriate purchasing decisions made!

High-voltage insulation testing is invaluable both in fault diagnosis and in condition monitoring. The quality of the results obtained, however, depends on the quality of the test equipment used. Three-terminal test sets, which incorporate a guard terminal, are invariably a little more expensive than their two-terminal equivalent.

As we've seen, however, the small extra cost is money well spent, provided that using the guard terminal doesn't destroy the instrument's accuracy. Do not forget to ask for those accuracy figures before making a purchase.

EVALUATION AND INTERPRETATION OF RESULTS

Interpretation of the Infinity Reading

One of the most important features of an insulation tester is the range that the instrument can measure. Testing goals determine whether basic function is all that is needed, or enhanced range is recommended. Simple proofing applications, such as an electrician signing off a job, can be met with a basic range of a thousand megohms (MΩ). Admittedly, new equipment, if not defective or damaged during installation, will over-range all but the most advanced testers; however, this is okay. In such cases, the electrician is not looking for an actual value, but rather wants to see a high value and "infinity" certainly meets that criterion. However, "infinity" is not a measurement; it is an indication that the insulation being tested has a resistance that exceeds the measuring capabilities of the tester and should always be recorded as "greater than 1000 MΩ" or whatever is the highest available number on your insulation tester. Usually this is adequate since the minimum acceptable value of resistance is likely to be much lower than the maximum reading available.

But for maintenance of capital equipment, a tester with only a limited range is "shortchanging" the operator. For preventive/predictive maintenance, infinity readings are of no use. The operator knows that the test item is "good", but not much more. Testers with extended range, up into teraohms (1 TΩ = 1,000,000 MΩ), afford actual measurements right from the time of installation, thereby establishing a long time line that gives the maintenance professional plenty of "breathing room."

Significant changes in insulation quality can occur at high levels of insulation resistance, beyond the range of more limited instruments, as shown by graph in figure 17.

In this example, a limited-range tester would not capture this valuable data. We can clearly see that, although the last recorded insulation value is in excess of 10 GΩ, the rate of decline is increasing; something is wrong. An instrument with a range limited to 2000 MΩ would miss this totally. By the time the readings had degraded into the instrument's range, the maintenance person would be left with comparatively little time to schedule routine off-line maintenance. (It may even be too late to rectify the fault condition.)

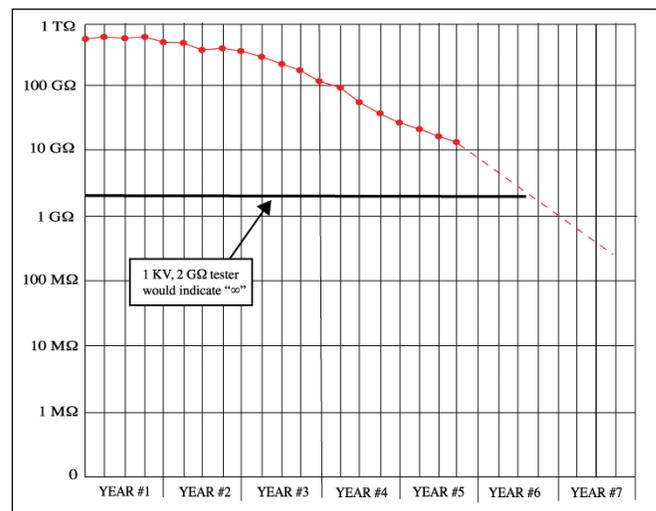

Figure 17: Changes in Insulation Resistance at High Values

DIAGNOSTIC HIGH VOLTAGE INSULATION TESTS

Diagnostic insulation tests electrically stimulate the insulation and measure the response. Dependent upon that response, we can draw some conclusions about the condition of the insulation.

Diagnostic insulation testing covers a very wide range of techniques, some of which involve portable equipment

and some that require considerable fixed equipment. Here we shall consider only those tests that may be performed with a readily portable dc insulation tester. These are:

- Trending spot tests
- Time constant
- Polarization Index (PI)
- Step Voltage (SV)
- Ramp test
- Dielectric Discharge (DD)

Each test gives a different view, or window, into the condition of the insulation; the whole picture is only available when all required tests have been completed.

Spot Reading Test

The spot reading test is the simplest of all insulation tests and the one most associated with lower voltage insulation testers; the test voltage is applied for a short, specific period of time (typically 60 seconds as usually any capacitive charging current will have decayed by this time) and a reading is then taken. The reading can then be compared to the minimum installation specifications. Unless the result is catastrophically low, it is best used when trended against previously obtained values.

However, insulation resistance is highly temperature dependent, and thus the results should be corrected to a standard temperature, usually 40° C. While temperature effects will be covered later, a good rule of thumb is that for every 10° C increase in temperature, the current doubles (resistance halves). The key to making the spot reading test valuable is consistent timekeeping, effective record keeping, and trending of results.

As noted previously, the increased sensitivity available in microprocessor-based diagnostic insulation testers allows the operator to identify insulation problems in their early stages rather than when those problems become catastrophic. In many cases, the trend is far more important than the absolute value.

Compare the two traces in figure 18. Apparatus "A" shows a high insulation resistance while Apparatus "B" shows a low value. However, when the trend is examined, Apparatus "B" shows little cause for concern; it has been around the same value for several years and shows every prospect of continuing in the same vein for many years to come. Conversely, the curve for Apparatus "A" is diving dramatically and the apparatus will, if nothing is done to prevent it, fail within the next few years.

While Apparatus "A" has much higher absolute resistance values than Apparatus "B," the trend is quite worrying. Apparatus "B" has a fairly consistent flat trend, indicating that the insulation quality is probably acceptable.

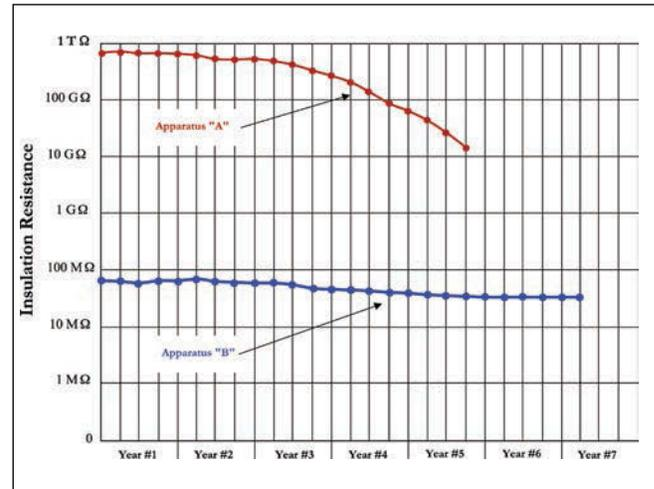

Figure 18: Comparison of Trended Test Results

Insulation resistance readings should be considered relatively rather than absolutely. They can vary widely for one motor or machine tested three days in a row, yet not mean bad insulation. As mentioned, the important information is the trend in readings over a time period, showing lessening resistance and warning of coming problems. Periodic testing is, therefore, critical to preventive maintenance of electrical equipment. The interval between tests (monthly, twice a year, once a year, etc.) depends upon the type, location, and importance of the equipment. Evaluating a series of readings taken over a number of months or years moves the operator toward being a diagnostician.

Periodic tests should be made in the same way each time. Use the same test connections and apply the same test voltage for the same length of time. Tests should also be made at about the same temperature, or the operator must correct them to the same temperature. A record of the relative humidity near the equipment at the time of the test is helpful in evaluating the reading and trend as low temperatures and high humidity might suggest condensation on the surface of the insulation. For this reason it is essential to ensure that equipment to be tested is at a temperature in excess of the dew point, as otherwise, condensation will form which will distort the readings unless the measurement is well "guarded."

The following table contains some general observations about how to interpret periodic insulation resistance tests and what should be done with the result.

Condition	What To Do
a) Fair to high values and well maintained	<ul style="list-style-type: none"> No cause for concern, well maintained.
b) Fair to high values but showing a constant tendency towards lower values	<ul style="list-style-type: none"> Locate and remedy the cause and check the downward trend.
c) Low but well maintained	<ul style="list-style-type: none"> Condition is probably all right but cause of low values should be checked. May simply be the type of insulation in use.
d) So low as to be unsafe	<ul style="list-style-type: none"> Clean, dry out, or otherwise raise the values before placing equipment in service (test wet equipment while drying out).
e) Fair or high values previously well maintained but showing sudden lowering	<ul style="list-style-type: none"> Make tests at frequent intervals until the cause of low values is located and remedied or, Until the values have become steady at a lower level but safe for operation or, Until values become so low that it is unsafe to keep the equipment in operation.

Time vs. Resistance Test

Familiar, standardized test procedures that have been employed for years benefit from the improved capabilities of enhanced diagnostic testing. Most basic of these is the time-resistance method. A valuable property of insulation, but one that must be understood, is that it “charges” during the course of a test thanks to the movement of electrons as explained previously. This movement of electrons constitutes a current.

Its value as a diagnostic indicator is based on two opposing factors; the current dies away as the structure reaches its final orientation, while “leakage” promoted by moisture or deterioration passes a comparatively large, constant current. The net result is that with “good” insulation, leakage current is relatively small and resistance rises continually as current decreases from the effects of charging and dielectric absorption. Deteriorated insulation will pass relatively large amounts of leakage current at a constant rate for the applied voltage, which will tend to mask the charging and absorption effects.

Graphing the resistance reading at time intervals from initiation of the test yields a smooth rising curve for “good” insulation, but a “flat” graph for deteriorated equipment. The concept of the time resistance test is to take successive readings at specified times. It is based on the relative magnitudes of leakage and absorption currents in clean, dry insulation compared to that of moist or contaminated insulation. Good insulation shows a continual increase in resistance over time. With contaminated insulation, the leakage current is much larger and the effects of the absorption current are, therefore, much less apparent.

The benefits of the time resistance test are that it is relatively independent of temperature and can give conclusive information without the records of past tests.

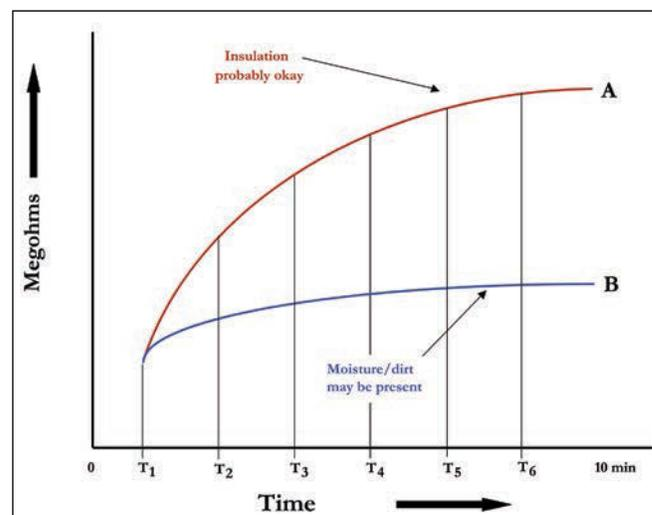

Figure 19: Time Resistance Test Graph

Polarization Index Test

The simplest implementation of the time resistance test for solid insulation is represented by the popular Polarization Index (PI) test, which requires only two readings followed by a simple division; the one-minute reading is divided into the ten-minute reading to provide a ratio. The result is a pure number and can normally be considered independent of temperature since the thermal mass of the equipment being tested is usually so great that the overall cooling which takes place during the 10 minutes of the test is negligible.

In general, a low ratio indicates little change, hence poor insulation, while a high ratio indicates the opposite. References to typical PI values are common in the literature, which makes this test very easy and readily employed. However, we say “in general” because as

mentioned previously there are materials that exhibit very little or no dielectric absorption. Carrying out a test on these materials would then produce a result very close to 1.

Note that resistance readings alone are difficult to work with, as they may range from enormous values in new equipment down to a few megohms just before removal from service.

A test like the PI is particularly useful because it can be performed on even the largest equipment, and yields a self-contained evaluation based on relative readings rather than absolute values. But no PI can be calculated with a tester of limited range, because "infinity" is not a number! Advanced testers reach the teraohm range, and therefore, do not run off the graph. The largest and newest capital equipment can be readily tested to yield repeatable data for recording and subsequent trend evaluation. The following chart highlights selected PI values and what they mean to the operator.

Polarization Index	Insulation Condition
<1	Poor
1-2	Questionable
2-4	Okay
>4	Good

Values above 4 indicate excellent equipment for which no action is likely to be necessary within the immediate maintenance schedule. The operator may be called upon to make critical judgments, however. Some high values of PI (above 5) could indicate brittle or cracked insulation; this should be fairly obvious. A sudden increase in PI greater than 20%, without any maintenance having been performed, should serve as a warning; insulation may hold its value for long periods, but is not likely to dramatically improve all by itself.

A benefit of the PI test is that it can provide an indication of insulation quality in ten minutes on very large pieces of equipment that might take an hour or more to fully charge, see figure 20. With a spot reading test, the operator would have to wait until the reading stabilized. For this reason it is normal to conduct a PI test at relatively low voltage before applying the high voltages typically applied for a withstand test.

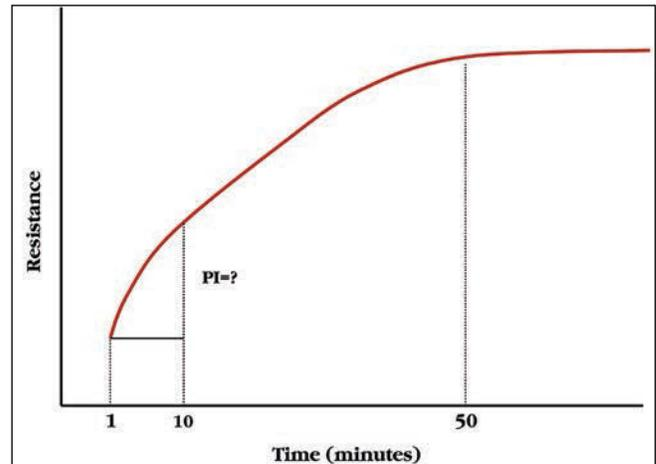

Figure 20: Benefit of the Polarization Test for Large Equipment

Although the PI value table has been used for many years and is well accepted, PI readings can occasionally be encountered which are exceptional. Many years ago the freshly cooked stator of a 3750 kVA generator was tested and a PI of 13.4 was obtained. The stator had cooled down and no doubt was still in its curing phase. Subsequent tests yielded reducing PI values until it stabilized around 4.7. During routine maintenance, PI values do not reach these heady heights.

It is also interesting to note that many people have tried to use the PI test on oil-filled transformers and cannot understand why a known good transformer gives them results close to 1. The answer is simple. PI testing is not appropriate for oil-filled transformers. The concept depends on the relatively rigid structures of solid insulating materials, where absorption energy is required to reconfigure the electronic structure of comparatively fixed molecules against the applied voltage field. Because this process can go to a theoretical state of completion (at "infinite time," which obviously cannot be achieved in the practical field, but can be reasonably approximated), the result is a steady diminution of current as molecules reach their "final" alignment. Because the PI test is defined by this phenomenon, it cannot be successfully applied to fluid materials since the passage of test current through an oil-filled sample creates convection currents that continually swirl the oil, resulting in a chaotic lack of structure that opposes the basic premise upon which the PI test rests.

Step Voltage Test

Since good insulation is resistive, an increase in test voltage will lead to an increase in current with a result that the resistance remains constant. Any deviation from this could signify defective insulation. At lower test voltages, say 500 V or 1000 V, it is quite possible that these defects might be unobserved, but as the voltage rises we reach a point where ionization can take place within cracks or cavities, resulting in an increase in current, and therefore a reduction in the insulation resistance. Note that it is not necessary to reach the design voltage of the insulation for these defects to become apparent, since we are simply looking for ionization in the defect.

The Step Voltage test follows exactly this principle and can be employed usefully at voltages reaching 2500 V and upwards. The Step Voltage test may be employed as an undervoltage or overvoltage test. However, it must be remembered that an overvoltage test can lead to a catastrophic failure if the insulation breaks down because high voltage test sets (i.e. high-pots) have a lot of power available. An undervoltage test carried out by an insulation tester has relatively little power available and it is therefore far less likely to result in a destructive test.

A recognized standard procedure is to increase voltage in five equal steps at one-minute increments and record the final insulation resistance at each level. Any marked or unusual resistance reduction is an indication of incipient weakness. Modern electronics allows these readings to be captured automatically.

Following are some possible results from a Step Voltage test on a motor from 500 to 2500 volts and what they mean to the operator:

- No appreciable difference in values - Insulation is in reliable condition.
- Appreciable difference in values - Insulation requires more thorough reconditioning.
- Insulation fails at 2,500 V - Motor is in question; would most likely fail in service even if an attempt were made to recondition it on the basis of low-voltage tests only.

The graphs in figure 21 are taken from a motor that was damp and dirty (lower trace) and after cleaning and drying (upper trace).

In general, if a deviation of 25% in resistance

measurements is observed over the range of successive voltages, it is an indication of the presence of moisture or other contamination. Localized physical damage may be further revealed by breakdown or arcing. A "stuttering" or "jittery" pointer movement can anticipate this condition as the breakdown voltage is neared. It may be desirable to terminate the test at such point before insulation breakdown further deteriorates the condition of the test item.

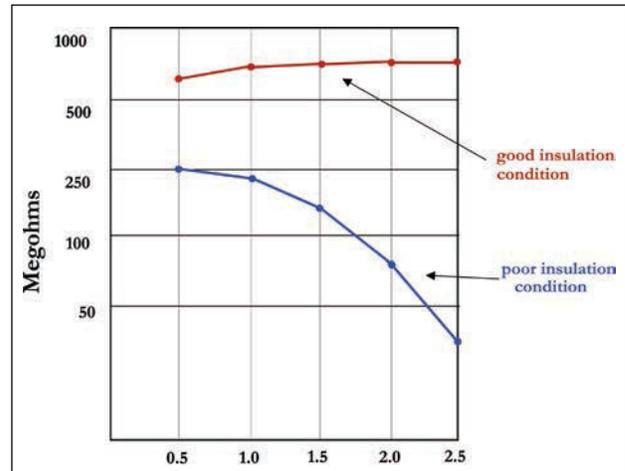

Figure 21: Step Voltage Graph

Like the PI test, the Step Voltage test is a repeatable, self-evaluating test that, because of its short duration, is free of extraneous influences like temperature effect.

Ramped Voltage Test

The ramped voltage test is endorsed in IEEE95-2002 as part of the recommended practice for insulation testing of AC electric machinery (2300 V and above) with high direct voltage. When using this test method, the test voltage is gradually increased (ramped) at a set rate to a final level, which results in an increase in the current. Any variations in current compared to the increase in applied test voltage can provide useful diagnostic information about the condition of the insulation. Commonly used on rotating machinery, this test helps diagnose various insulation defects and forms of deterioration such as:

- Cracks or fissures
- Surface contamination
- Uncured resin
- Moisture absorption
- Delamination

- Voids

This test is recommended by the US Bureau of Reclamation on a wide range of rotating machines with polyester, asphalt and epoxy-mica insulations. Another possible application for the ramp test is to test voltage suppression devices by monitoring the applied voltage at a specified current.

The ramp test offers better control of the applied test voltage compared to the step voltage test, providing a better warning of impending insulation breakdown, and therefore an opportunity to avoid insulation damage. In addition the rate of voltage increase is typically 1000 V per minute whereas the greater rate of voltage rise during a step increase is typically 1000 V per second. The slower rate of voltage increase is also less likely to result in insulation damage.

In addition the ramp test allows the user to separate the leakage current from the capacitive and polarization currents. This means small defects in insulation can be detected more easily.

The ramped voltage test, like the step voltage test, requires the operator to interpret the test results and make a determination of insulation condition from graphs produced. Following is a quick guide to what the graphical display of results indicates:

- Windings in good condition should produce a smooth, almost linear rising current curve versus the applied voltage.
- Any deviation from a smooth curve should be viewed as a warning that the insulation test could be approaching a possible breakdown (deviations could be obtained as close as 5% below the breakdown voltage).
- An imminent breakdown is usually indicated in a sudden increase in current.
- An abrupt drop in current is rare, but if it happens when the test voltage is above the peak operating voltage of the winding it can also be

an indication of impending breakdown.

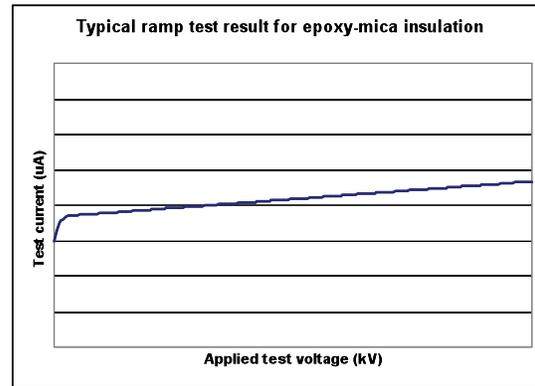

Figure 22: Typical ramp test result for epoxy-mica insulation

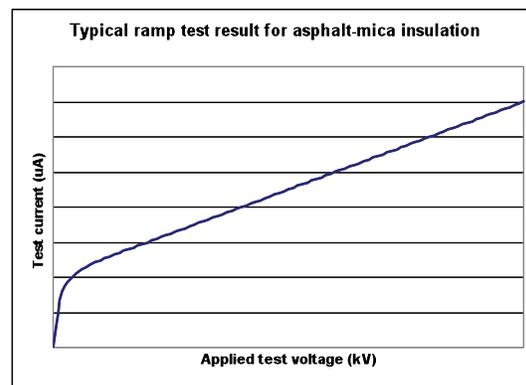

Figure 23: Typical ramp test result for asphalt-mica insulation

Comparing the results of epoxy-mica insulation in figure 22, to asphalt-mica insulation in figure 23, the difference is due to the level of absorption current present. Asphalt-mica insulation has a much higher level of absorption current relative to the conduction leakage current. This results in a much steeper slope. However both insulations diagnosed as being in good condition because of the linear response.

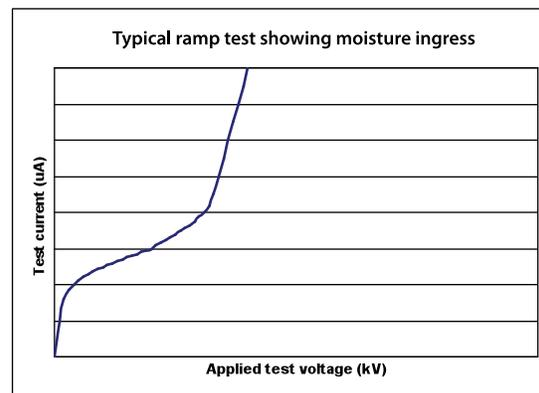

Figure 24: Typical ramp test showing moisture ingress

Figure 24 is the response from insulation with absorbed moisture. This could be caused by a long period of disuse for example. This test, due to the sudden increase in current, would have been stopped to prevent breakdown occurring.

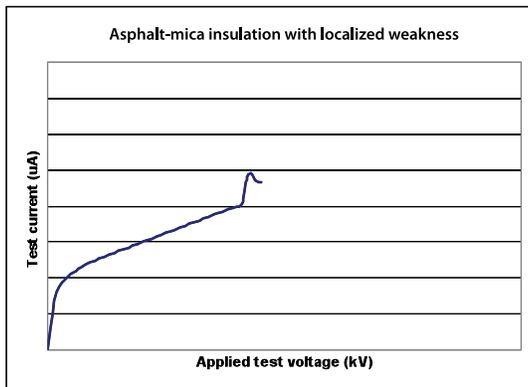

Figure 25: Asphalt-mica insulation with localized weakness

Old asphalt insulation may provide a slightly non-linear response and can show very small deviations, or blips in the current graph. Significant localized weaknesses will show a much larger, sudden increase in current, as seen in figure 25. In this case the test has been terminated as the graph was approaching vertical; breakdown would have been imminent in this case

Cracks in the ground wall insulation will also show a sudden near vertical current response, often preceded by small spikes before breakdown finally occurs. Figure 26 shows a typical response which in this case is an epoxy-mica insulation.

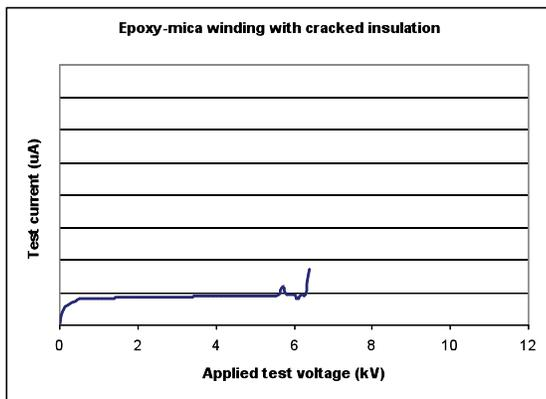

Figure 26: Epoxy-mica winding with cracked insulation

The current curves from different phases can also be compared. All three windings should provide comparable results. A phase that shows a different response, such as shown in figure 27 will usually indicate a problem with the insulation condition.

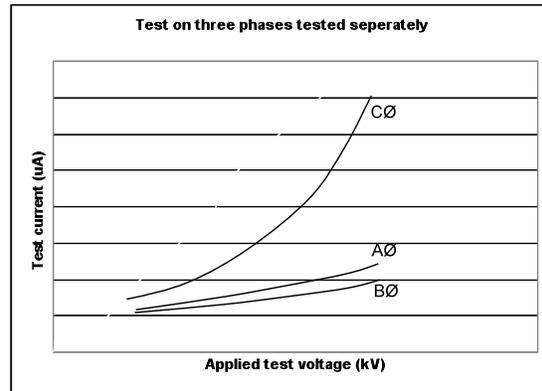

Figure 27: Test on three phases tested separately

The graphs shown are examples of the type of faults that can be diagnosed with the ramp test. Referring to IEEE95-2002 will provide much more detail of the test's diagnostic capability.

Dielectric Discharge Test

The Dielectric Discharge test (DD) is a relatively new test method that was developed by EdF, the national power utility of France, and based on years of research. While the other methods mentioned measure the currents flowing during the charging process, the DD test measures the current that flows during discharge of the test sample. As such, it is not a pure insulation resistance test but rather an adjunct to traditional insulation tests. The charge that is stored during an insulation test is automatically discharged at the end of the test when the insulation tester's discharge resistors are switched across the terminals.

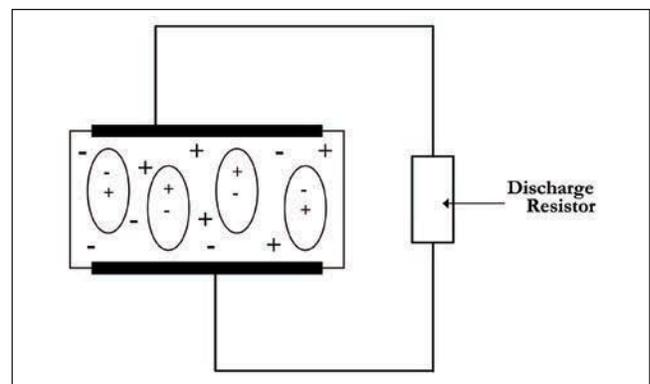

Figure 28: Discharge of Test Item's Stored Charge

The rate of discharge depends only on the discharge resistors and the amount of stored charge from the insulation. However, the capacitive charge is discharged rapidly until the voltage across the insulation has reduced to almost zero. At that time, the effect of leakage currents will be negligible. So only the reversal of dielectric absorption is left. This is known as dielectric reabsorption and is a mirror image of the dielectric absorption.

The capacitive current quickly decays from a high value with a relatively short time constant (a few seconds). The absorption (or reabsorption during a discharge) current always starts at a high level but has a much longer time constant (up to many minutes). It is caused by the dipoles randomizing their alignment within the insulation and the electron shell returning to an undistorted shape. This has the effect of a current flowing if the discharge circuit is still connected, or a voltage reappearing on the sample if it is left open circuit. Rapidly removing the effects of leakage and capacitive currents allows the possibility of interpreting the degree of polarization of the insulation and relating it to moisture and other polarization effects.

The test item is first charged for anywhere from 10 to 30 minutes at high voltage until full absorption has taken place. (The Megger insulation testers that automate this test charge the test sample for 30 minutes.) At this time, capacitance is fully charged and the dielectric absorption is essentially complete. Only leakage current continues to flow. At this point the test voltage is removed and the insulation is discharged through the instrument's internal discharge resistors to quickly dissipate the capacitive charge. After 60 seconds of discharge, any remaining current flow is measured. At this time, the capacitance has been discharged and the voltage has collapsed so that the charge stored in the dipoles can be viewed independently of the "masking" currents that are dominant during the charging phase of an insulation test.

The measured results are then entered into the following formula and an index is calculated.

$$\frac{\text{Current flowing after 1 minute (nA)}}{\text{Test Voltage (V) x Capacitance (\mu F)}}$$

The measurement is temperature dependent, so it is important to test at a reference temperature or to

record the temperature.

Insulation in high voltage equipment often consists of layers, each having its own capacitance and associated leakage resistance. When insulation is built up in this way, the aim is to make each layer such that the voltage stress is shared equally between layers. When the insulator is discharged, each layer's charge will decrease equally until there is no voltage remaining.

When a layer is faulty between good layers, its leakage resistance will decrease while capacitance is likely to remain the same. A standard insulation test will be determined by the good layers, and not likely to reveal this condition. But during dielectric discharge, the time constant of the faulty layer will mismatch the others to yield a higher DD value. A low DD value indicates that reabsorption current is decaying quickly, and the time constant of each layer is similar. A high value indicates that reabsorption exhibits long relaxation times, which may point to a problem.

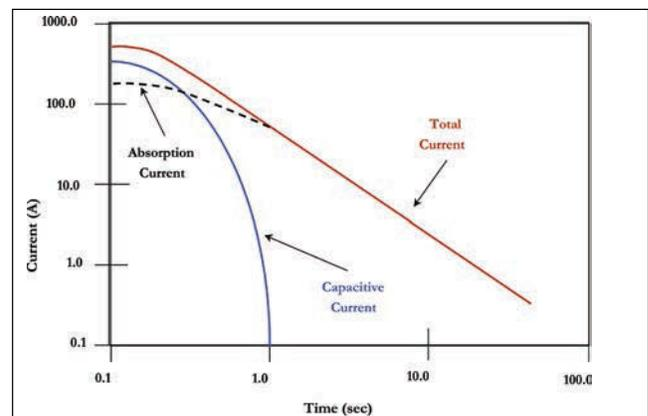

Figure 29: Reabsorption Currents

Typical conditions from practical research, primarily carried out on generators by EdF, arrived at the figures of merit in the following table. This technique was developed for high voltage generators but has application on any multilayered insulation.

D Value (in mA V ⁻¹ F ⁻¹)	Insulation Condition
> 7	Bad
4 - 7	Poor
2 - 4	Questionable
< 2	OK

Different Problems/Different Tests

As we have just seen, the Dielectric Discharge Test can be used to identify problems in a single layer of multilayer insulation. Other test methods might not point to problems on this specific type of insulating structure. Similarly, the Polarization Index test is particularly valuable in revealing moisture ingress, oil soaks, and similar pervasive contamination. These invading contaminants provide convenient paths for electrical leakage, which damages the surrounding insulation and eventually burns through as a “short.” This type of problem is revealed at almost any test voltage and will appear as a characteristically “flat” PI. Moisture and contaminants will also bring down the readings, but this requires a previous value for comparison; the PI test has the advantage of making an internal comparison.

However, other problems may seem to “pass” a PI or simple Spot Reading test by yielding high resistance values at a given voltage. Such problems include localized physical damage like pinholes or dry, brittle insulation in aged equipment. Step voltage tests reveal such problems. Increasing numbers of imperfections will pass current as higher and higher voltage is applied, and be reflected in a declining resistance. Higher voltage will pull arcs across small air gaps, thereby providing an “early warning” of an incipient problem. As equipment ages, such gaps can narrow by accumulation of dirt and moisture until a short to ground develops.

APPENDICES

Potential Sources of Error/Ensuring Quality Test Results

The following section identifies several areas of potential error in insulation testing above 1 kV. These factors may be of less importance in 1 kV testing, but increased voltages and sensitivities make them critical for higher voltage testing.

Test Leads

Beware of instruments with low quality leads whose voltage rating is less than the test voltages employed. It is extremely important that the only leakage currents during a measurement are those that are developed by the insulation under test. If the leads themselves produce leakage, you may be measuring lead insulation resistance rather than the item under test.

All leads supplied with Megger insulation testers are high quality leads, which have been tested to withstand voltages well above the highest test voltage generated by the particular instrument. Even then, it is important to reduce stray leakage by preventing the leads from contacting each other, the ground and particularly water.

Additional information on the design and the importance of operating safely can be found on page 31.

Making Measurements above 100 GΩ

Measurements up to 100 GΩ can be made without any special precautions, assuming that the leads are reasonably clean and dry. The guard can be used to remove the effects of surface leakage if necessary. Greater precautions are required when measuring resistances above 100 GΩ as stray leakage current can spoil the quality of the readings taken. Be aware of the following:

- Test leads should not be allowed to touch each other or any other object since this will induce leakage paths.
- Sharp points at the test lead connections should be avoided since this will encourage corona discharge.
- Instrument test jacks should be deep so that unwanted leakage does not occur between the terminals.

Accuracy Statements

Pay close attention to an insulation tester's accuracy statement. Do not accept a mere plus/minus percentage for digital units. The statement must also include plus/minus a number of digits, as no digital display can fix its last digit (least significant digit, or l.s.d.) to a single number. Accuracies specified as "percent of reading" indicate the same error at all points on the scale.

Analog statements listed as "percent of scale" or "full scale deflection" (f.s.d.) can be deceptive. Because the accuracy interval is based on the full-scale length, it translates into an increasing percentage error as the readings rise against a logarithmic scale. In other words, the same number of pointer widths on the expanded low end of the scale will account for only a few megohms, while on the contracted upper end, this will be hundreds of megohms. Therefore, when meeting a desired or required accuracy spec, don't stop at the percentage statement but also examine the terms.

Accuracy statements can also be misleading if not explained carefully. Be sure to check the range covered by the accuracy statement in the datasheet, as it can vary dramatically among different instruments. There is a significant difference in an instrument that shows 5% accuracy up to 40 GΩ or 100 GΩ and one that shows 5% accuracy up to 1 TΩ. Some instruments show an accuracy statement but do not give the applicable range. Always ask about the range for a specific accuracy if it is not specified.

Note: Beware of instruments that do not have published load curves.

Delivery of Stated Voltage

Voltage regulation is indicated for an insulation tester with a load graph in the instruction manual showing the output voltage against resistance load. The load curve ensures that, at typical insulation resistance values, the insulation tester is delivering full rated test voltage to the test item. While this may appear to be obvious, it is not necessarily the case unless so stated by the manufacturer of a given tester. A poorly-regulated tester may load down under a high-resistance load so that the insulation of the test item may actually be experiencing only a fraction of the rated test voltage, which the transformer can output only under maximum conditions. Such instrumentation is not likely to come provided with a load curve.

It was this condition that inspectors from specifying agencies, like UL®, discovered among “testers” that were “jury-rigged” from on-hand transformers and other components at job sites to perform high potential tests. The inadequacies of such systems led to the highly specific language pertaining to output voltage that now commonly appears in the standards literature. Megger insulation testers conform by delivering and maintaining the rated test voltage once a minimum load commensurate with typical insulation values (generally 1 to 10 MΩ, depending on model and voltage selection) is applied. Test voltage is typically a few volts above rated, but should not drop below it, maintaining the integrity of the test and the repeatability when performing scheduled preventive maintenance. If exceptionally precise reporting data is mandated, some models display the actual test voltage in addition to the selected voltage and this information is included among the data provided at the conclusion.

Interference Rejection

Interference is the electrical noise produced at a variety of frequencies, which can appear in the sample being tested. It is usually induced currents or voltages from adjacent equipment and is very common in substations, particularly high voltage substations where power frequencies predominate. This electrical noise superimposes an ac signal on the dc test current and can cause considerable variations in readings and may prevent the operator getting a reading at all if it is beyond the capabilities of your instrument. As an example, 4 mA of 50/60 Hz noise is fairly typical of the electrical noise that can be encountered in large substations (400+ kV).

Be aware of the capability of the insulation tester being used to cancel out the effects of this ac noise effectively, resulting in the ability to make measurements in increasingly more difficult conditions. Not all noise is limited to power frequencies, however. To accommodate other frequencies some top of the range instruments incorporate further software filters that can eliminate the effects of this noise. It is important that the instrument you use is matched to the level of interference anticipated.

Rules on Testing and Comparing

Comparison of results in order to determine rates of degradation is key to the whole preventive/predictive maintenance concept. However, it must be emphasized that this concept applies to readings taken at discrete maintenance intervals. Even then, strict standardization of test procedure and conditions is imperative. Comparison of “on-the-spot” readings is a whole different scenario and fraught with potential error.

It is tempting to try to back up tests with additional readings. You may make some adjustment to the test item or setup, or someone else may have difficulty accepting the result and wish to verify it. But an insulation tester is not like a multimeter! High-voltage testing behaves very much like the Heisenberg Uncertainty Principle (you cannot know both the speed and position of an electron) applied to insulation. That is to say, the act of measuring affects the item being measured, so that subsequent readings are not being taken on precisely the same item.

As has been described, the act of applying an insulation test polarizes the insulating material. This effectively changes its electrical configuration and dielectric properties. Because insulating material is, by design, a poor conductor, it can take considerable time for “relaxation,” or the return to random configuration, to occur. Immediately upon termination of a test, the item under test is not precisely the same piece of equipment that it was before the test. An immediate follow-up test will be affected, sometimes considerably, by the charge left from the first test. Which measurement is correct? They both are! They each can be expected to give a correct measurement of the condition of the insulation at the time of test. Furthermore, industry-standard discharge procedures are not sufficient for the institution of a repeat test. Such procedures are aimed at personnel safety, not qualification of the test item. Residual charges can remain for hours, or even days, that may be below human perception yet enormous to a sensitive meter. Equipment should be left grounded for several hours, or preferably until the next day, before additional testing is done. And then, external factors, especially temperature, must not be overlooked.

This does not mean that on-the-spot retesting should never be performed. For relative information, it may be quite valuable. But it must be kept in perspective. Do not expect the readings to agree.

Two different operators may also not observe the same degree of detail with respect to procedure. Temperature is one factor. If the equipment is turned on, perhaps to check performance, then retested, the second test is not necessarily comparable to the first. Time of test is also readily overlooked. One operator may rigidly time the test while another merely waits for stabilization of the reading. This can result in measurements being taken at different points on the time-resistance curve (as has been illustrated under the “Spot-Reading” test), and again the two results will not be comparable.

If this seems like excessive attention to detail, consider the standards agencies. Organizations like UL® and ASTM® do not write procedures that say, in effect, “hook up a meter and take a reading.” Rather, they specify every variable, including setup, procedure, and characteristics of the test instrument, before results can be considered in conformance. Standard maintenance procedures deserve no less diligence.

CAT Rating

In addition to the obvious performance specifications, instrumentation should also be evaluated according to various quality standards. Paramount among these is safety. One of the most recognized and respected safety standards has been established by the International Electrotechnical Commission (IEC) in EN61010-1:2001. This standard defines the requirements that test instruments must meet in order to be safe from arc flash and arc blast in specific environments. It is not enough to simply determine that an instrument is “CAT rated”, as it is commonly termed. The CAT rating must be understood, as it rigorously describes where in the electrical environment a given piece of equipment can and cannot be safely employed.



Figure 30: Megger MIT models ensure CAT rating applies to all terminals for safety purposes. Some instruments on the market today are misleading.

CAT Rating Guidelines

“CAT rating” is rendered in two parameters: one indicating system level and the other specifying rated operating voltage. A designation of “CAT IV 600 V” means that the unit is safe to operate in any electrical environment up to and including CAT IV, on cable or apparatus rated up to 600 volts phase to ground. Beware of products that specify the CAT rating while failing to list the voltage level. This is incomplete information and the absence can be costly in terms of safe operation. The CAT rating defines the level of transient (spike or surge) that the instrument has been designed to withstand. Transients vary in size and duration depending on the source. A transient may be several kV in amplitude but its duration is notably short, a typical interval being 50 µsec (microseconds). Its principle danger is that when

it rides on top of the sinusoidal voltage it can initiate an arc, which will continue until the end of the cycle. In a CAT IV environment, the available short circuit current can exceed 1000 amps. Inside an instrument that happens to be testing the circuit, this can generate hundreds of kilowatts of heat in a small space for a few milliseconds. The rapid expansion of air can cause the instrument to disintegrate or explode. Fire, burns, and dangerous flying pieces are the consequence.

Instruments designed to a category rating have sufficient clearance between critical parts to prevent an arc from creating the initial breakdown when a transient occurs. IEC61010 defines the design requirements in order for instruments to declare a specific category rating and specifies both the electrical and physical requirements (called creepage and clearance distances) that make up the circuitry and casework.

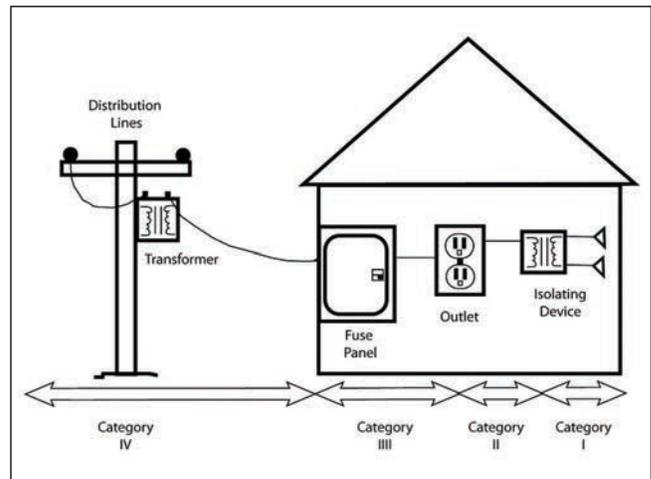

Figure 31: Electrical supply broken down into categories

The Importance of a CAT Rating

CAT rating is determined by distance downstream of the transformer servicing the premise. The overhead or underground transmission lines constitute the CAT IV environment because the energy available from the supply is much higher near the transformer. This is the most dangerous environment and requires the highest degree of protection. As voltage passes through the fuse panel into the building, the circuit impedance is higher and transients are damped, reducing the available energy in the transient. This process of progressive damping, lower energy and reduced hazard continues through the remaining categories. Downstream of

the service entrance is the CAT III environment. From the socket or outlet the rating becomes CAT II, and inside of equipment (photocopiers, televisions, etc) isolated by an internal transformer the environment is CAT I. This attenuation is the reason appliances are not known to explode, but a multimeter may. The voltage measurement range on a multimeter may include the rating for the CAT IV environment, thereby creating an incorrect impression that the tester can be used there.

Some CAT Rating Basic Statistics

Do not confuse working or steady state voltage with transient voltages. The tester must be able to safely withstand transients of several multiples of the rated voltage. For example, to be rated as safe on a 300 Vrms phase-to-neutral line in a CAT IV environment, the tester must be able to withstand an impulse of 4 kV!

The Megger MIT and S1 series with 5 kV and 10 kV maximum output are rated at CATIV 600V, which means they are able to withstand an impulse of 8kV. The recently introduced 15 kV instruments, the MIT1525 and S1-1568 are rated at CATIV 1000V, these are capable of withstanding 12 kV impulses.

What is the actual risk of such occurrences? Small transients of a few hundred volts occur on most days, but fortunately, large transients (5 to 12 kV) do not occur often. But that does not mean that they can be discounted. Working with a correctly rated instrument, the chances of a dangerous breakdown are on the order of one in a million per hour connected to the supply. But reduce the protection by one category and the chances of an accident increase by a factor of about 30. This means that of 100 operators using instruments of the wrong category on live systems for one hour per day, 200 days per year, a dangerous situation is likely to occur every 18 months.

Testing at high altitudes

The International Electrotechnical Commission (IEC) standard EN61010-1:2001, specifies that the CAT rating must be valid up to an altitude of 2000m. This is because as the altitude increases the density of the air decreases and therefore so does its insulating properties. This is a problem for locations such as open cast mines in chili where altitudes could be around 4000m, which mean the CAT rating of most instruments become invalid. In fact many instruments will breakdown internally under their own test voltage at these altitudes.

The introduction of the latest range of MIT and S1 series instruments saw the introduction of CAT ratings specified to higher altitudes, exceeding the standard requirement of EN61010-1:2001. The MIT515, MIT525 and MIT1025 can operate and maintain their safety category rating to 3000m and the S1-568, S1-1068 and S1-1568 can maintain their safety category rating to 4000m altitude.

Testing Insulation Resistance of Rotating Machinery

In March 2000, the IEEE-SA Standards Board approved a revision of IEEE Std 43-1974 by the Electric Machinery Committee of the IEEE Power Engineering Society. This revision is IEEE Std 43-2000, the "IEEE Recommended Practice for Testing Insulation Resistance of Rotating Machinery." Changes made to the types of insulation used in electric rotating machines have resulted in different insulation resistance characteristics, and therefore, required a substantial revision to the IEEE standard. According to the IEEE, the standard is intended for:

- Individuals/organizations that manufacture rotating machines.
- Individuals/organizations that are responsible for the acceptance of new rotating machines.
- Individuals/organizations that test and maintain rotating machines.
- Individuals/organizations that operate rotating machines.

Megger recommends that anyone involved in testing and/or maintaining rotating machinery review this standard in detail. We will provide some of the highlights.

IEEE Std 43-2000 recommends a procedure for measuring insulation resistance of armature and field windings in rotating machines rated 1 hp, 750 W or greater and applies to synchronous machines, induction machines, dc machines and synchronous condensers. It does not apply to fractional horsepower machines. It also recommends the insulation test voltage (based on winding rating) and minimum acceptable values of insulation resistance for ac and dc rotating machine windings.

The following chart provides guidelines for the dc voltage to be applied during an insulation resistance test. Note that voltages up to 10 kV are recommended for windings rated at greater than 12 kV.

*Winding Rated Voltage (V)	Insulation Resistance Test Direct Voltage (V)
<1000	500
1000-2500	500-1000
2501-5000	1000-2500
5001-12,000	2500-5000
>12,000	5000-10,000

* Rated line-to-line voltage for three-phase ac machines, line-to-ground voltage for single-phase machines, and rated direct voltage for dc machines or field windings

The standard recommends that each phase be isolated and tested separately (if feasible) as this approach allows comparisons to be made between phases. The two phases not being tested should be grounded to the same ground as the stator core or rotor body. When all phases are tested simultaneously, only the insulation to ground is tested. Insulation resistance measurements should be made with all external equipment (cables, capacitors, surge arresters, etc.) disconnected and grounded as these items may influence the resistance reading. A common ground should be used to prevent stray losses in the ground circuit that could affect the test results.

The standard calls out both the insulation resistance test and the polarization index test (PI), and recommends that both tests be made (if possible). It indicates that testing history should be used to track changes. If history is not available, the standard provides minimum values for both tests that can be used to estimate the suitability of the winding. These are the lowest values at which a winding is recommended for an overvoltage test or for operation.

The recommended minimum values for PI are based on the thermal class of the insulating materials and apply to all insulating materials regardless of application per IEC 60085-01: 1984. The PI test is not applicable to noninsulated field windings. Be aware that a very high PI (greater than 8) for varnished cambric, shellac mica-folium, or asphaltic stator windings may indicate that the insulation has been thermally aged and may be at risk of failure. Physical inspection can be used to confirm if the insulation is dry and brittle.

Thermal Class Rating	Minimum PI Value
Class A	1.5
Class B	2.0
Class F	2.0
Class H	2.0

The recommended minimum insulation resistance after one minute at 40° C can be determined from the following chart. The minimum resistance of one phase of a three-phase armature winding tested with the other two grounded should be approximately twice that of the entire winding. If each phase is tested separately (with guard circuits being used on the phases not under test), the observed minimum resistance should be three times the entire winding.

Minimum Insulation Resistance (MΩ)	Test Specimen
kV* + 1	For most windings made before about 1970, all field windings, and others not described below.
100	For most dc armature and ac windings built after about 1970 (form-wound coils).
5	For most machines with random-wound stator coils and form-wound coils rated below 1 kV.

* kV is the rated machine terminal-to-terminal voltage in rms kV.

The rating of the machine determines whether the motor windings must achieve the minimum value for either the insulation resistance test or PI test, or must achieve the minimum for both tests.

Machine Rating	Evaluation Criteria
10,000 kVA or less	Should have EITHER a value of the PI test or a value of the insulation resistance test (at 40° C) above the minimum recommended values.
Above 10,000 kVA	Should have BOTH a value of the PI test or a value of the insulation resistance test (at 40° C) above the minimum recommended values.

Effects of Temperature

Temperature variations can have a significant effect on insulation resistance readings. Resistance drops markedly with an increase in temperature for the same piece of apparatus. Each type of insulating material has a different degree of resistance change with temperature. Temperature correction factor tables have been developed for various types of electrical apparatus and can be acquired from the manufacturer. Failing that, it is recommended that you develop

your own correction factor tables by recording two resistance values for the same piece of equipment at two different temperatures. A graph may then be plotted of resistance (on a logarithmic scale) against temperature (on a linear scale). The graph is a straight line and may be extrapolated to any temperature so that correction factors may be read directly.

In lieu of detailed data, the “rule-of-thumb” is that for every 10° C increase in temperature, halve the resistance; or for every 10° C decrease in temperature, double the resistance. For example, a 100 GΩ resistance at 20° C becomes 25 GΩ at 40° C.

Why is temperature correction important? Consider the example in the following table of a motor tested at various times of the year at differing temperatures (all within a 15° band). The temperature adjustments were made using the rule-of-thumb correction.

Date	Insulation Resistance (MΩ)	Temperature °F	Temp. Adjusted Insulation Resistance (MΩ)
Jan-01	15,000	68	14,990
Jun-01	9,000	80	14,276
Jan-02	14,500	68	14,490
Jun-02	8,500	82	14,562
Jan-03	14,300	68	14,290
Jun-03	8,700	81	14,341
Jan-04	14,500	68	14,490
Jun-04	8,900	81	14,671
Jan-05	14,200	69	14,748
Jun-05	8,900	80	14,117
Jan-06	13,600	68	13,591
Jun-06	8,900	78	13,071
Jan-07	13,500	66	12,491
Jun-07	7,500	80	11,896
Jan-08	11,300	68	11,292
Jun-08	6,500	80	10,310
Jan-09	8,000	67	7,693

The readings taken create confusion if they are not corrected for temperature. When plotted, they produce a chart that is of limited use in determining a trend. If the same data is corrected for temperature and plotted, the graph begins to provide a valuable picture of the deterioration of the insulation.

Temperature correction is particularly important when testing with higher voltages and at higher levels of sensitivity.

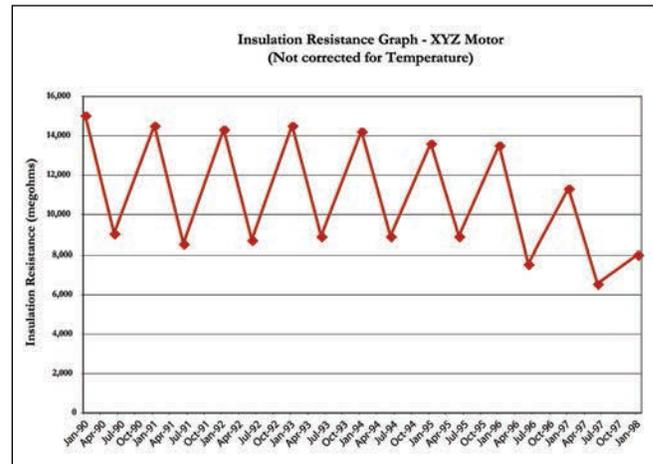

Figure 32: Insulation Resistance Graph Not Corrected for Temperature

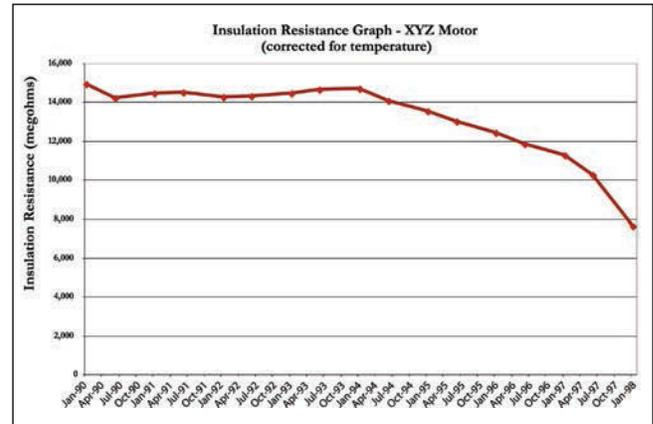

Figure 33: Insulation Resistance Graph Corrected for Temperature

Effects of Humidity

Humidity (moisture content) has an effect upon insulation resistance, but it cannot be quantified as neatly as can temperature effect because different types of insulation will absorb moisture to varying degrees, as will varying ages and conditions of the same type. The best that can be said is that humidity is a factor that should not be overlooked when evaluating test results. Unlike temperature, humidity's effect is not a constant gradient and as long as the temperature remains above the dew point, humidity will not appreciably affect insulation readings.

Increasing humidity in the surrounding (ambient) air can affect insulation resistance to varying degrees. If equipment operates regularly above the dew-point temperature (the temperature at which the moisture

vapor in air condenses as a liquid), the test reading will not be affected much by the humidity. Even if the equipment to be tested is idle, the same is true — so long as its temperature is kept above the dew point (and the insulation surfaces are free of contaminants, such as certain lints and acids or salts, which have the property of absorbing moisture).

In electrical equipment, we're concerned primarily with the conditions on the exposed surfaces where moisture condenses and affects the overall resistance of the insulation. Studies show, however, that dew will form in the cracks and crevices of insulation before it is visibly evident on the surface. Dew-point measurements will provide a clue as to whether such invisible conditions might exist, altering the test results.

Humidity effects require greater attention as test voltages increase because the higher voltages can promote ionization much more readily than at low voltages. As a result, humidity that doesn't produce a noticeable effect at 1 kV may produce perplexingly low readings at 5 kV. This is not necessarily a problem. The difference in response at two different voltages can be used to detect moisture and tests carried out guarded and unguarded can be used to detect surface moisture or internal moisture.

Ingress Protection

Somewhere in the fine print of most test equipment product bulletins is an IP rating, a number that gives the operator vital information. In fact, the IP rating lets the operator know whether a piece of test equipment is suited for his/her application and test environment.

"IP" stands for "ingress protection." That is the degree to which the instrument can withstand invasion by foreign matter. The IP rating system has been established by the IEC (International Electrotechnical Commission), in their Standard 529, and is used as a guide to help the operator protect the life of the instrument. It also can help the operator make a more informed purchase decision by ensuring that the piece of test equipment is designed to work in the environment(s) that he/she faces.

The IP rating is comprised of two digits, each signifying a separate characteristic. The designation indicates how well the item is sealed against invasion by foreign matter, both moisture and dust (the higher the number(s), the better the degree of protection). What would a typical rating of IP54 tell a buyer about the application capabilities of a model? If you want to sound thoroughly knowledgeable, that's IP five-four, not fifty-four. Each digit relates to a separate rating, not to each other.

The first digit refers to particulate ingress, reflecting the degree to which solid objects can penetrate the enclosure. A level of "5" indicates "dust protected" as well as protected from invasion with a wire down to 1.0 mm. There is only one higher category: "dust tight." The second digit refers to moisture. A rating of "4" means resistance to "splashing water, any direction." The higher ratings of 5 through 8 indicate "jetting water" and "temporary" or "continuous" immersion.

So what? Well, suppose an instrument under consideration was rated only to IP43. What would that tell the operator about its usability? Could it be thoroughly utilized in a quarry or cement plant? Hardly! The particulate rating 4 indicates "objects equal or greater than 1 mm." That's a boulder in comparison to particles typically produced by industrial processes. Flying dust could put the unit out of commission.

Suppose the unit is rated at IP42. A moisture rating of 2 indicates dripping water. Therefore, it would not be resistant to flying spray. Acquiring an instrument for an environment that exceeds its IP capabilities likely means that the operator will need another very soon. What about a rating of IP40? A moisture rating of 0 means that the unit is not protected against any liquid ingress.

The following charts provide a guide to various IP ratings and what they mean to the operator:

Protection Against Access to Hazardous Parts (First Digit)	
Number	Description
0	Non-protected
1	Protected against access with back of hand (50 mm)
2	Protected against access with jointed finger (12 x 80 mm)
3	Protected against access with a tool (2.5 mm)
4, 5, 6	Protected against access with a wire (1.0 mm)

Protection Against Ingress of Solid Foreign Objects (First Digit)	
Number	Description
0	Non-protected
1	Objects equal or greater than 50 mm
2	Objects equal or greater than 12.5 mm
3	Objects equal or greater than 2.5 mm
4	Objects equal or greater than 1 mm
5	Dust protected
6	Dust tight

Protection against Ingress of Liquids (Second Digit)	
Number	Description
0	Non-protected
1	Water dripping vertically
2	Water dripping, enclosure tilted up to 15°
3	Spraying water, up to 60° angle from vertical
4	Splashing water, any direction
5	Jetting water, any direction
6	Powerful jetting water, any direction
7	Temporary immersion in water
8	Continuous immersion in water

High Potential Testing

There is no truly singular definition of the “high potential” test. It is commonly used, but its definition is situational, in the “eye of the beholder” it might be said. Basically, a high potential test is an electrical stress test conducted at a voltage two or more times rated voltage and sometimes known as a Withstand or Proof Test.

Since the test is conducted at a voltage considerably higher than the rated voltage of the equipment being tested, it is known as an overvoltage test unlike the high voltage insulation test, which is generally applied at a voltage below the rated voltage of the equipment. The act of overvoltage testing creates abnormal stresses in the test sample and can contribute to the acceleration of aging in insulation. Indeed, some standards require the voltage to be increased until the test sample breaks down.

If an overvoltage test is to be applied, it is normal practice to apply an undervoltage PI test beforehand to pre-qualify the insulation.

High potential tests may be carried out with ac or dc voltages, as appropriate. Samples with considerable capacitance will appear as a short circuit to an ac test, requiring a test set with very large power capabilities to overcome the capacitive charging currents. In situations such as this, it is quite normal to apply a dc test with the equivalent peak.

Current (nA) Readings vs. Resistance (MΩ) Readings

Insulation testers measure current and then convert it into a resistance reading. Why do we do this? Well, predominantly, it’s tradition. Good insulation produces a high reading while poor insulation produces a low

reading. Also, good insulation is predominantly resistive. If we double the test voltage, we double the current flowing but the resistance remains constant. However, sometimes it is easier to diagnose problems by considering the actual currents that flow.

The choice is yours because many modern insulation testers are capable of presenting their measurements in either unit.

Burn Capability

Full-function insulation testers above 1 kV often include a “burn” mode. It is a feature that may never be used; yet it does have a viable function within a narrow range of application.

Insulation testers will generate high voltages into significant resistances. However, if a breakdown occurs within the insulation, the resistance drops, the current increases, and the voltage drops. If left to its own devices this would cause the breakdown arc to extinguish, the resistance to increase, and the voltage to increase which in turn causes breakdown and so on. This continuing cycle does not allow the measurement of resistance and indeed could open pinholes or enlarge burn tracks. Rather than cause further damage, most insulation testers will shut down.

However, if you want to find the location of the breakdown this may be extremely inconvenient. For this reason some instruments offer an operator selectable “burn” mode; the automatic shutdown is overridden and a low current arc is maintained. It must be understood, however, that the instrument’s short circuit limitation is still in effect. The tester will not provide a “dead” short. The function enables the operator to localize or identify the fault by looking for a spark or wisp of smoke or perhaps by use of an ionization detector. Pinholes in windings can be identified, covered with insulating varnish, and the equipment returned to service. In cable maintenance, a high potential tester with much higher currents than insulation testers is used to “break down” a high-resistance fault, converting it to an “open” that is much more easily recognized by arc reflection techniques.

Drying Out Electrical Equipment

Electricity and water do not form a happy partnership and so it is often necessary to “dry out” insulation. This may be done to remove surface moisture or perhaps to drive moisture from the internals of the insulation. Indeed some pieces of equipment have in-built heater coils which can be used for this purpose. However, several other methods are also available for drying electrical equipment.

The most satisfactory solution to the problem involves placing the windings in an oven with suitable temperature control and proper air circulation. Banks of infrared lamps may be used when this is not possible, or a suitable housing may be built around the machine, using steam coils or electric resistance type units for a source of heat. Openings must be provided for the free circulation of air as otherwise the expulsion of moisture would simply result in an increasing humidity inside the drying chamber. Blowers may be used to increase the air movement.

Vacuum drying has also been effectively used to expedite the return of equipment to service, but this method requires extra precautions and should only be undertaken by experienced personnel.

Another method often used is to circulate low-voltage current through the windings. This method should not be used, however, until the insulation resistance has reached a value of at least 100 MΩ. The current should be limited to only a fraction of nameplate amperes, and a careful check must be maintained on maximum temperatures on the insulated parts. Maximum drying temperatures on windings should not exceed 194° F (90° C) as measured by a thermometer. This will prevent not only the rapid thermal deterioration of the insulation but damage from the high vapor pressures that would be obtained if steam were produced.

If drying is required, records help determine when the insulation is moisture free. As an example of the importance of past readings, consider a motor that's been flooded. After a cleanup, a spot reading with the Megger tester shows 15 MΩ. If past records showed the insulation resistance to run from 10 to 20 MΩ, the motor would be in good shape. If, on the other hand, past records showed the normal resistance values to run from 100 to 150 MΩ, the operator would know that moisture was still present in the motor windings.

During drying operations, when insulation resistance values are used as an indicator of the suitability of windings for service or for application of test potential, the drying must be continued for a sufficient time to make sure that the values are reliable. Often the resistance curve will take one or more sharp dips before leveling off or continuing to increase in a positive direction. This is due to moisture working out of the windings. When the machine is completely dried out, further work is required to remove any remaining dust. This may be done through the use of dry compressed air at pressure not exceeding 40 psi.

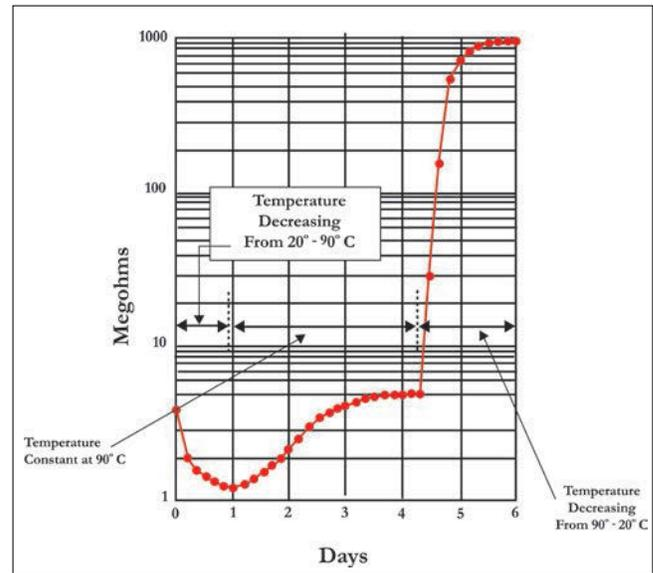

Figure 34: Typical Drying-out Resistance Graph

Figure 34 shows a typical drying-out curve for a dc motor armature, which shows how insulation resistance changes. During the first part of the run, the resistance decreases because of the higher temperature. Then it rises at a constant temperature as drying proceeds. Finally, it rises to a high value, as room temperature (20° C) is reached.

There is a significant caveat when testing wet insulation with an insulation tester; wet equipment is susceptible to voltage breakdown. If windings have absorbed a lot of moisture even low voltages can puncture insulation. Therefore, the operator should be very careful before applying high voltages. More advanced Megger insulation testers allow the test voltage to be set at anything from a low of 25 volts to a high of 5000 volts in 25-volt increments.

Test Item Discharge

Perhaps you were taught to discharge a capacitor and then to store the capacitor with the terminals shorted together. Did you ever wonder why, since you have discharged the capacitor and maybe had checked that there was no voltage across the terminals, you needed to short the terminals?

The reason is the dielectric absorption current. If the terminals are left unshorted, the energy stored by dielectric absorption will slowly release with negative charge migrating to one terminal and positive charge to the positive terminal. Over a period of time this charge can build up to a dangerous level, as high as the original

test voltage, and with a considerable amount of energy to back it up. This energy can kill.

At the end of an insulation test the test sample closely resembles a charged capacitor; there remains a considerable amount of energy stored within the insulation dielectric.

There is an important “rule of thumb” on charging and discharging items under test. This rule suggests that the operator discharge the item under test for five times as long as it was tested. If the operator performs a 10-minute PI test, he/she should allow the unit to discharge for 50 minutes.

A good quality instrument will automatically discharge the test sample as soon as a test is completed or interrupted. Some lower quality instruments have a separate discharge selection knob, or switch, which adds a step to a test. If this step is forgotten, the test item can be deadly for the next person who handles it.

Megger insulation testers also detect the voltage across the test sample during the discharge phase and will show this voltage until it has fallen to a safe level. At this point, the item is safe to handle.

However, all we have discharged at this point is the stored capacitive charge. As explained at the start of this booklet, any capacitance is charged relatively quickly at the start of a test. Similarly, the capacitive charge is discharged relatively quickly at the end of a test. But the dielectric absorption current takes much longer to go in and also takes much longer to come out.

Thus while the sample is immediately safe to handle, if the terminals are not shorted they will gradually acquire charge and become dangerous once again. So, unless the equipment is going back into service, ensure that the terminals are shorted and grounded.

Charging Time for Large Equipment

One question we are often asked is, “How long will it take to charge a particular piece of equipment?” The answer is, “We don’t know!”

Why not? Well, the answer depends on the actual configuration of the particular piece of equipment concerned. For example, the Megger S1-5010 specifies a charging rate of “less than 5 seconds per microfarad with 2 mA short circuit current” and “2.5 seconds per microfarad with 5 mA short circuit current.” Thus, if you know the capacitance of the test sample you can work out the charging time; it doesn’t matter if it is a motor, a cable, or just a slab of insulating material.

Motor Driven Insulation Testers

Another question we are frequently asked is “What happened to the old wooden box motor driven insulation testers?” Some people seemed to think that they set the standard for insulation testing and still do.

These motor driven wooden boxes, with an external motor, were produced between 1910 and 1972 and used the original Evershed patented “Cross Coils Ohmmeter.” This was a large heavy movement that, as the name suggests, had two coils set at an angle to each other. This was the first “true ohmmeter.” The construction of the movement had benefits and drawbacks.

The main benefit was, because of the weight of the movement, it had considerable inertia and was, therefore, quite insensitive to interference or transient events. This resulted in a very smooth motion. Unfortunately, the sheer weight of the movement made it fairly delicate and so the instruments needed to be handled with care. Furthermore, the instruments needed to be leveled before use and were, therefore, supplied with a spirit level on the scale and adjustable feet. The movements were also fairly insensitive with maximum resistance capabilities that could be measured in high megohms or low gigohms.

Alternative power sources were developed. The old generator was big and heavy as anyone who has tried to hand crank one of these old instruments will attest; you certainly wouldn’t want to do a PI test while hand cranking, but if you lacked a mains supply there was no alternative.

Technology advances meant that “electronic movements” could be used which were more rugged and more accurate. New low-voltage generators were developed which made hand cranking much easier and then ultimately battery technology enabled pure battery power to be employed. This resulted in the long term, very stable power supplies that we see today.

The use of electronics has resulted in lighter, more rugged, more accurate instruments that respond more quickly. They can provide more information, which results in us seeing transient events that were previously totally hidden by the relative instability of the power supply and the inertia of the movement.

Which is better? The decision is yours.

TEST LEAD DESIGN

The design of the test lead sets is intended to facilitate connection to a variety of de-energized systems for the purpose of making insulation resistance measurements. In all cases it is the responsibility of the user to employ safe working practices and verify that the system is safe before connection. Even electrically isolated systems may exhibit significant capacitance which will become highly charged during the application of the insulation test. This charge can be lethal and connections, including the leads and clips, should never be touched during the test. The system must be safely discharged before touching connections.

Test leads are a key component of any precision instrument and that safety, long life, and the ability to provide reliable connections to the wide variety of test pieces found in real applications are of utmost importance.

Careful design ensures repeatable connections, which are practical and safe to use. Only the best materials and most appropriate materials should be used to provide the essential blend of performance and safety. As an example the careful specification of the cable ensures it remains flexible in all conditions and has extremely good insulation properties which will not affect the measurements made.

Using a double-insulated silicon cable will ensure reliable and safe measurements. Testing with poor or electrically leaky leads can provide misleading measurements and may result in perfectly good insulation being diagnosed faulty, wasting both time and money on unnecessary repairs. This is especially so when using long test leads.

Significant Safety Enhancements

The international standard IEC 61010-031 details the safety requirements for hand-held probe assemblies for electrical measurement and test. A number of amendments were made to the standard, in particular: prevention of hazard from arc flash and short circuits.

Two hazards are considered: (1) the dangers of a probe tip or crocodile clip temporarily bridging two high energy conductors, and (2) the dangers of a contact being broken while current is flowing.

These hazards are particularly applicable to many of the environments in which 5kV and 10kV insulation resistance testers are used. Should a probe or clip momentarily short out two high energy conductors during connection, an extremely high current will flow heating the metal and melting insulation. This itself may

cause serious burns to the operator or bystander near the clip or probe. Additionally, should the contact be broken while current is flowing, arcing may occur leading to an extremely serious situation known as arc-flash.

The standard describes the danger of arcing as follows: "The arcing will ionize the air in the vicinity of the arc, permitting continued current flow in the vicinity of the probe tip or crocodile clip. If there is sufficient available energy, then the ionization of the air will continue to spread and the flow of current through the air continues to increase. The result is an arc flash, which is similar to an explosion, and can cause injury or death to an operator or a bystander."

IEC 61010-031:2008 requires probe tips and crocodile clips to be constructed to mitigate the risk of arc flash and short circuits, and this requirement applies to all crocodile clips or clamps that are rated to Installation Category III or IV (CATIII or CATIV). The outer surfaces of crocodile clips must not, therefore, be conductive and no metal parts should be accessible (as defined by the standard) with the clip closed.

During design phase, detailed measurement and test procedures are used to assess the electrical creepage and clearance paths, to assure compliance with the standard. Accessibility of conductive metalwork is assessed using an IEC standard test finger.

Things to Consider for Safe Operation

In electrical test environments, safe working practices are essential to ensure the safety of operators. Insulation testing in high-voltage, high-energy environments poses a number of unique hazards listed below:

1. Maintaining practicality with a fully insulated clip

If a clip's added insulation impedes the operation and ability to make reliable connection to the wide variety of bus bars, wires and terminals that are needed, the design is useless and the operator may be tempted to remove the additional insulation to make connection.

2. Protection from charged capacitance of long cables

Locked high-voltage plugs at the instrument end reduce the likelihood of a plug losing connection or pulling out which could result in the load inadvertently remaining lethally charged at the end of a test and the instrument to incorrectly report that no voltage was present. The lock facility is simple to use and prevents "plug end" disconnection and helps ensure the integrity of load discharge after a test.

3. Protection from high voltage in a CATIV 600V or CATIV1000V environment

As a connection is made to more upstream supply systems, (Overvoltage Category IV relates to incoming supplies of industrial premises), increased protection is required from overvoltages. These are transients that naturally occur on the supply, which are typically caused by switching actions or distant lightning strikes and present the connected equipment, test leads, clips etc with impulses of many thousands of volts. Such equipment must provide protection to the operator during the process of connection. A clip rated for use on a 600V supply in overvoltage category CATIV must be able to withstand such impulses up to 8kV.

A clip rated for use on a 1000V supply in overvoltage category CATIV must be able to withstand such impulses up to 12kV

Clips that are molded from a high dielectric strength-insulating polymer with carefully defined dimensions ensure electrical creepage and clearance distances are maintained even under adverse conditions.

4. Protection from instrument output (5 kV, 10 kV or 15 kV)

Many people fear the electrical output from their insulation tester may be 5, 10 or even 15 kV. However, in reality the current available from the instrument is generally limited to a few milliamperes and in itself presents a relatively low hazard.

The danger here is not so much the output of the instrument but more the working environment. If the connected load is capacitive, this can provide very significant energy when charged to high voltage by the instrument, and can be lethal if touched. Additionally, when testing insulation in many HV environments, it is not uncommon to have to climb ladders to reach connections on equipment such as transformers, with associated risks of working at height. In such situations, an otherwise harmless electrical impulse may cause the user to react automatically, with a potentially serious injury from a fall. Fully insulated clips help minimize the risk.

Safety Warnings

The circuit under test must be switched off, de-energized, isolated and checked to be safe before insulation test connections are made. Make sure the

circuit is not reenergized while the instrument is connected. Circuit connections must not be touched during an insulation test.

After completing a test, capacitive circuits must be completely discharged before disconnecting the test leads. Capacitive charges can be lethal.

Tested items should be firmly shorted out with a shorting link, after discharge, until required for use. This is to guard against any stored dielectric absorption charge subsequently being released, thereby raising the voltage to potentially dangerous levels.

Test leads, including crocodile clips, must be in good condition, clean, dry, and free of broken or cracked insulation. The lead set should not be used if any part of it is damaged.

INSTRUMENT CASE DESIGN

5-kV to 15-kV insulation testers are used in a multitude of environments from motor testing in a workshop to testing of power lines and switchgear in high voltage switchyards. The nature of the work undertaken requires ultimate portability and ruggedness. Unlike the majority of equipment found in switchyards where durability and safety comes from sturdy metal cases bonded to earth, insulation testers must be small and lightweight, enabling work to be undertaken in all locations and altitudes. To achieve this, instrument manufacturers typically adopt injection molded plastic, typically ABS or similar material, providing a lightweight and durable enclosure.

To ensure maximum safety for users, products should meet the stringent requirements of the international standard IEC61010 (Safety of Electrical Equipment for Measurement, Control and Laboratory use).

Insulation testers are not only designed to measure insulation resistance on de-energized systems but also to undertake voltage measurements on energized systems up to 600 V ac. (phase to earth). In both these situations it is necessary to ensure the instrument can handle not only the applied voltage but also any transients which may occur elsewhere on the system and be propagated down to the connected instrument. In external locations

involving power distribution systems such transients can be significant, carrying a very large amount of energy and providing a significant danger to the user. Even during an insulation test when the connected circuit is de-energized, a switching operation elsewhere on the network or a distant lightning strike can induce a large transient voltage in the un-energized system which the instrument must safely survive to protect the user.

Fire Retardant Safety

IEC61010 categorizes such transients into different severities depending upon the location and supply voltage within the distribution system. Increasingly severe transients are encountered as we move upstream along the distribution system. Instruments for connection to external systems must be rated to Category IV, (CATIV). Instruments rated to CATIV 600 V, for example, must be able to safely withstand transients of 8,000 V.

Should a fault develop when connected to such a system and the transient cause flashover within the instrument, the local ionization of the air may create an effective short circuit across what could potentially be a very high-energy supply, presenting a significant danger to the user. As a result, IEC61010-2-030 requires instruments to remain safe when such transients occur.

In addition, Part 1 of IEC61010 requires that there will be no spread of fire outside the equipment in the event of a single fault occurring within the instrument, for example a faulty battery. There are two routes to check compliance: first, perform "single-fault" testing within the instrument, and second, simply fit a fire retardant case. The safest instruments include both routes of compliance.

Unfortunately, while the injection-molded materials suitable for case manufacture are ideal for their lightweight and durability properties, they are generally not fire retardant and will not provide adequate protection in the event of a fault. Materials with fire retardant additives are available but suffer from reduced durability, so will not withstand the rigors of everyday use as well. This conundrum creates a serious challenge for instrument manufacturers.

Megger has adopted a unique design approach by forming a dual case design where the inner layer provides essential fire protection leaving the outer case uncompromised in its ruggedness and durability.

MEGGER INSULATION TESTERS

Megger 5-kV, 10-kV and 15 kV insulation testers are designed for industrial and utility applications. All Megger insulation testers are robust and reliable for high performance use. They offer up to CAT IV 1000 V safety rating on all terminals and are housed in a rugged polypropylene case with full protection to IP65 when being transported. A unique dual case design on all units allows for fire-retardant protection while maintaining ruggedness.

The 10 kV instruments offer full compliance with the IEEE 43-2000 standard "Recommended Practice for Testing Insulation Resistance of Rotating Machinery". This allows the user to effectively test any existing engine. The 15 kV instrument offer full compliance with NETA requirements for testing equipment rated above 35 kV.

MIT515, MIT525, MIT1025, MIT1525

The MIT Series is comprised of four instruments: two 5-kV models, one 10-kV unit and one 15-kV unit. The series is designed for industrial and power distribution. The MIT515 (5-kV model) can be used to perform both simple go-no-go insulation tests and basic diagnostic insulation tests such as polarization index (PI). Two new advanced models, MIT1025 (10-kV model), and MIT1525 (15-kV model) offer memory and diagnostic insulation testing. The MIT1025 and MIT1525 are suited to more rigorous testing of higher voltage equipment.

The MIT units have a fully specified guard terminal/circuit to allow accurate results in a wide range of test situations. Tests can be performed from battery or from ac power and benefit from a long battery life and a rapid recharge time. To assist with storing and trending results, the MIT525, MIT1025 and MIT1525 include memory and download to PC via USB, as well as additional diagnostic tests such as step voltage (SV) and ramp test.

Some of the features of the MIT Series are:

- Intuitive operation with rotary switch dial
- Line supply or battery operation
- Easy battery replacement
- Ramp test

S1-568, S1-1068 and S1-1568

The S1 Series consists of three models, 5-kV, 10kV and 15kV models (S1-568, S1-1068 and S1-1568 respectively). The S1 units are specially designed for utilities, particularly in transmission and generation applications where higher electrical noise and long cable runs are encountered, and service companies. All S1 models are equipped with high output power rated at 6 mA to deal with capacitive loads and increased electrical noise immunity to handle the most challenging substation environments, transmission voltage environments.

The S1 units have five diagnostic tests, including PI, SV and Ramp tests. The instruments can store and download results through their USB ports and via bluetooth. In addition the S1 range can be remotely controlled via USB and Power DB Lite software for additional confidence and convenience.

Some of the S1 Series features are:

- 6mA output current provides fast charging and testing of capacitive loads
- 8mA noise immunity for stable measurements in EHV environments
- Measurement range to 15 T Ω (5-kV models) and 35 T Ω (10-kV and 15-kV models)
- USB and Bluetooth streaming of live test data and download of stored results
- On board memory for results storage
- Remote operation via USB



Models MJ15 and BM15

5-kV Insulation Testers

- Pass/fail overlays for rapid go/no go testing
- Insulation resistance to 20 GΩ
- Voltage range to 600 V indicates auto discharge

The BM15 and MJ15 are compact 5-kV insulation testers that are simple to use and provide a quick, accurate reading of insulation resistance. Both instruments offer four test voltages (500 V, 1 kV, 2.5 kV, 5 kV), analog scales, and measurement sensitivity to 20 GΩ.

The BM15 is powered by 8 “AA” or rechargeable alkaline batteries while the MJ15 includes a hand-crank generator in addition to battery power.

Test Leads

Megger provides a full line of test lead sets that are designed to provide safety isolation in compliance with IEC 16010-031:2008. They provide double insulation where practical. However, at higher voltages where the large physical dimensions would render this impractical for a usable clip, single insulation is provided. Safe working practices must be used, and clips and connections must not be touched while energized.



Your “One Stop” Source for all your electrical test equipment needs

- Battery test Equipment
- Cable Fault Locating Equipment
- Circuit Breaker Test Equipment
- Data Communications Test Equipment
- Fiber Optic test Equipment
- Ground Resistance test Equipment
- Insulation Power Factor (C&DF) Test Equipment
- Insulation Resistance Test Equipment
- Line Testing Equipment
- Low Resistance Ohmmeters
- Motor & Phase Rotation Test Equipment
- Multimeters
- Oil Test Equipment
- Portable Appliance & Tool Testers
- Power Quality Instruments
- Recloser Test Equipment
- Relay Test Equipment
- TDR Test Equipment
- Transformer Test Equipment
- Watthour Meter Test Equipment
- STATES® Terminal Blocks & Test Switches
- Professional Hands-On Technical and Safety
- Training Programs

Megger is a world leading manufacturer and supplier of test and measurement instruments used within the electrical power, building wiring and telecommunication industries.

With research, engineering and manufacturing facilities in the USA, England and Sweden, combined with sales and technical support in most countries, Megger is uniquely placed to meet the needs of its customers worldwide.

Megger®

