



OM-240 712E

2011-09

Processes



MIG (GMAW) and Pulsed MIG (GMAW-P) Welding

Description



Arc Welding Power Source

AlumaPowerTM 350 MPa Auto-LineTM

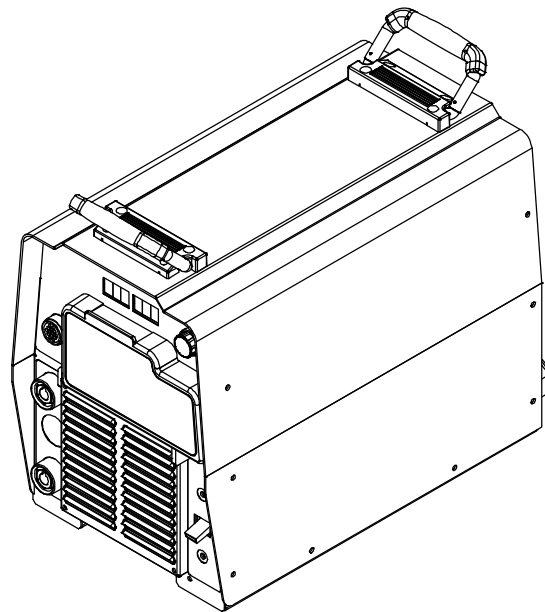

Visit our website at
www.MillerWelds.com

OWNER'S MANUAL

File: MIG (GMAW)



From Miller to You

Thank you and congratulations on choosing Miller. Now you can get the job done and get it done right. We know you don't have time to do it any other way.

That's why when Niels Miller first started building arc welders in 1929, he made sure his products offered long-lasting value and superior quality. Like you, his customers couldn't afford anything less. Miller products had to be more than the best they could be. They had to be the best you could buy.

Today, the people that build and sell Miller products continue the tradition. They're just as committed to providing equipment and service that meets the high standards of quality and value established in 1929.

This Owner's Manual is designed to help you get the most out of your Miller products. Please take time to read the Safety precautions. They will help you protect yourself against potential hazards on the worksite.

We've made installation and operation quick and easy. With Miller you can count on years of reliable service with proper maintenance. And if for some reason the unit needs repair, there's a Troubleshooting section that will help you figure out what the problem is. The parts list will then help you to decide the exact part you may need to fix the problem. Warranty and service information for your particular model are also provided.



Miller is the first welding equipment manufacturer in the U.S.A. to be registered to the ISO 9001 Quality System Standard.

Miller Electric manufactures a full line of welders and welding related equipment. For information on other quality Miller products, contact your local Miller distributor to receive the latest full line catalog or individual specification sheets. **To locate your nearest distributor or service agency call 1-800-4-A-Miller, or visit us at www.MillerWelds.com on the web.**



Working as hard as you do – every power source from Miller is backed by the most hassle-free warranty in the business.



TABLE OF CONTENTS

SECTION 1 – SAFETY PRECAUTIONS - READ BEFORE USING	1
1-1. Symbol Usage	1
1-2. Arc Welding Hazards	1
1-3. Additional Symbols For Installation, Operation, And Maintenance	3
1-4. California Proposition 65 Warnings	4
1-5. Principal Safety Standards	4
1-6. EMF Information	4
SECTION 2 – CONSIGNES DE SÉCURITÉ – LIRE AVANT UTILISATION	5
2-1. Symboles utilisés	5
2-2. Dangers relatifs au soudage à l'arc	5
2-3. Dangers supplémentaires en relation avec l'installation, le fonctionnement et la maintenance	7
2-4. Proposition californienne 65 Avertissements	8
2-5. Principales normes de sécurité	9
2-6. Informations relatives aux CEM	9
SECTION 3 – INTRODUCTION	11
3-1. Specifications	11
3-2. Features And Benefits	11
3-3. Arc Controls	11
3-4. Duty Cycle And Overheating	12
SECTION 4 – INSTALLATION	13
4-1. Serial Number And Rating Label Location	13
4-2. Dimensions And Weight	13
4-3. Selecting a Location	13
4-4. Weld Output Receptacles And Selecting Cable Sizes	14
4-5. Remote 14 Receptacle Information	15
4-6. Optional 115 Volts AC Duplex Receptacle And Supplementary Protectors	15
4-7. Electrical Service Guide	16
4-8. Connecting 1-Phase Input Power	17
4-9. Connecting 3-Phase Input Power	18
SECTION 5 – GENERAL OPERATION	19
5-1. Front Panel	19
5-2. Configuration Option Menu	20
SECTION 6 – GMAW/GMAW-P	22
6-1. Typical Connection For Remote Control Feeder GMAW/GMAW-P	22
6-2. MIG Welding Mode - GMAW	23
6-3. MIG - Wire and Gas Selection Table	24
6-4. Pulsed MIG Welding Mode - GMAW-P Process	25
6-5. Pulsed MIG - Wire and Gas Selection Table	26
6-6. Remote Process Select	27
SECTION 7 – MAINTENANCE & TROUBLESHOOTING	28
7-1. Routine Maintenance	28
7-2. Blowing Out Inside Of Unit	28
7-3. Help Displays	29
7-4. Troubleshooting	30
SECTION 8 – ELECTRICAL DIAGRAM	32
SECTION –9 – PARTS LIST	34
WARRANTY	

SECTION 1 – SAFETY PRECAUTIONS - READ BEFORE USING

som 2011-01

 Protect yourself and others from injury — read and follow these precautions.

1-1. Symbol Usage

 **DANGER!** – Indicates a hazardous situation which, if not avoided, will result in death or serious injury. The possible hazards are shown in the adjoining symbols or explained in the text.

 Indicates a hazardous situation which, if not avoided, could result in death or serious injury. The possible hazards are shown in the adjoining symbols or explained in the text.

NOTICE – Indicates statements not related to personal injury.

 Indicates special instructions.



This group of symbols means Warning! Watch Out! ELECTRIC SHOCK, MOVING PARTS, and HOT PARTS hazards. Consult symbols and related instructions below for necessary actions to avoid the hazards.

1-2. Arc Welding Hazards

 The symbols shown below are used throughout this manual to call attention to and identify possible hazards. When you see the symbol, watch out, and follow the related instructions to avoid the hazard. The safety information given below is only a summary of the more complete safety information found in the Safety Standards listed in Section 1-5. Read and follow all Safety Standards.

 Only qualified persons should install, operate, maintain, and repair this unit.

 During operation, keep everybody, especially children, away.



ELECTRIC SHOCK can kill.

Touching live electrical parts can cause fatal shocks or severe burns. The electrode and work circuit is electrically live whenever the output is on. The input power circuit and machine internal circuits are also live when power is on. In semiautomatic or automatic wire welding, the wire, wire reel, drive roll housing, and all metal parts touching the welding wire are electrically live. Incorrectly installed or improperly grounded equipment is a hazard.

- Do not touch live electrical parts.

- Wear dry, hole-free insulating gloves and body protection.
- Insulate yourself from work and ground using dry insulating mats or covers big enough to prevent any physical contact with the work or ground.
- Do not use AC output in damp areas, if movement is confined, or if there is a danger of falling.
- Use AC output ONLY if required for the welding process.
- If AC output is required, use remote output control if present on unit.
- Additional safety precautions are required when any of the following electrically hazardous conditions are present: in damp locations or while wearing wet clothing; on metal structures such as floors, gratings, or scaffolds; when in cramped positions such as sitting, kneeling, or lying; or when there is a high risk of unavoidable or accidental contact with the workpiece or ground. For these conditions, use the following equipment in order presented: 1) a semiautomatic DC constant voltage (wire) welder, 2) a DC manual (stick) welder, or 3) an AC welder with reduced open-circuit voltage. In most situations, use of a DC, constant voltage wire welder is recommended. And, do not work alone!
- Disconnect input power or stop engine before installing or servicing this equipment. Lockout/tagout input power according to OSHA 29 CFR 1910.147 (see Safety Standards).
- Properly install and ground this equipment according to its Owner's Manual and national, state, and local codes.

- Always verify the supply ground – check and be sure that input power cord ground wire is properly connected to ground terminal in disconnect box or that cord plug is connected to a properly grounded receptacle outlet.
- When making input connections, attach proper grounding conductor first – double-check connections.
- Keep cords dry, free of oil and grease, and protected from hot metal and sparks.
- Frequently inspect input power cord for damage or bare wiring – replace cord immediately if damaged – bare wiring can kill.
- Turn off all equipment when not in use.
- Do not use worn, damaged, undersized, or poorly spliced cables.
- Do not drape cables over your body.
- If earth grounding of the workpiece is required, ground it directly with a separate cable.
- Do not touch electrode if you are in contact with the work, ground, or another electrode from a different machine.
- Do not touch electrode holders connected to two welding machines at the same time since double open-circuit voltage will be present.
- Use only well-maintained equipment. Repair or replace damaged parts at once. Maintain unit according to manual.
- Wear a safety harness if working above floor level.
- Keep all panels and covers securely in place.
- Clamp work cable with good metal-to-metal contact to workpiece or worktable as near the weld as practical.
- Insulate work clamp when not connected to workpiece to prevent contact with any metal object.
- Do not connect more than one electrode or work cable to any single weld output terminal.

SIGNIFICANT DC VOLTAGE exists in inverter welding power sources AFTER removal of input power.

- Turn Off inverter, disconnect input power, and discharge input capacitors according to instructions in Maintenance Section before touching any parts.



HOT PARTS can burn.

- Do not touch hot parts bare handed.
- Allow cooling period before working on equipment.
- To handle hot parts, use proper tools and/or wear heavy, insulated welding gloves and clothing to prevent burns.



FUMES AND GASES can be hazardous.

Welding produces fumes and gases. Breathing these fumes and gases can be hazardous to your health.

- Keep your head out of the fumes. Do not breathe the fumes.
- If inside, ventilate the area and/or use local forced ventilation at the arc to remove welding fumes and gases.
- If ventilation is poor, wear an approved air-supplied respirator.
- Read and understand the Material Safety Data Sheets (MSDSs) and the manufacturer's instructions for metals, consumables, coatings, cleaners, and degreasers.
- Work in a confined space only if it is well ventilated, or while wearing an air-supplied respirator. Always have a trained watch-person nearby. Welding fumes and gases can displace air and lower the oxygen level causing injury or death. Be sure the breathing air is safe.
- Do not weld in locations near degreasing, cleaning, or spraying operations. The heat and rays of the arc can react with vapors to form highly toxic and irritating gases.
- Do not weld on coated metals, such as galvanized, lead, or cadmium plated steel, unless the coating is removed from the weld area, the area is well ventilated, and while wearing an air-supplied respirator. The coatings and any metals containing these elements can give off toxic fumes if welded.



ARC RAYS can burn eyes and skin.

Arc rays from the welding process produce intense visible and invisible (ultraviolet and infrared) rays that can burn eyes and skin. Sparks fly off from the weld.

- Wear an approved welding helmet fitted with a proper shade of filter lenses to protect your face and eyes from arc rays and sparks when welding or watching (see ANSI Z49.1 and Z87.1 listed in Safety Standards).
- Wear approved safety glasses with side shields under your helmet.
- Use protective screens or barriers to protect others from flash, glare and sparks; warn others not to watch the arc.
- Wear protective clothing made from durable, flame-resistant material (leather, heavy cotton, or wool) and foot protection.



WELDING can cause fire or explosion.

Welding on closed containers, such as tanks, drums, or pipes, can cause them to blow up. Sparks can fly off from the welding arc. The flying sparks, hot workpiece, and hot equipment can cause fires and explosions. Accidental contact of electrode to metal objects can cause sparks, explosion, overheating, or fire. Check and be sure the area is safe before doing any welding.

- Remove all flammables within 35 ft (10.7 m) of the welding arc. If this is not possible, tightly cover them with approved covers.
- Do not weld where flying sparks can strike flammable material.
- Protect yourself and others from flying sparks and hot metal.
- Be alert that welding sparks and hot materials from welding can easily go through small cracks and openings to adjacent areas.
- Watch for fire, and keep a fire extinguisher nearby.
- Be aware that welding on a ceiling, floor, bulkhead, or partition can cause fire on the hidden side.
- Do not weld on closed containers such as tanks, drums, or pipes, unless they are properly prepared according to AWS F4.1 (see Safety Standards).
- Do not weld where the atmosphere may contain flammable dust, gas, or liquid vapors (such as gasoline).
- Connect work cable to the work as close to the welding area as practical to prevent welding current from traveling long, possibly unknown paths and causing electric shock, sparks, and fire hazards.
- Do not use welder to thaw frozen pipes.

- Remove stick electrode from holder or cut off welding wire at contact tip when not in use.
- Wear oil-free protective garments such as leather gloves, heavy shirt, cuffless trousers, high shoes, and a cap.
- Remove any combustibles, such as a butane lighter or matches, from your person before doing any welding.
- After completion of work, inspect area to ensure it is free of sparks, glowing embers, and flames.
- Use only correct fuses or circuit breakers. Do not oversize or bypass them.
- Follow requirements in OSHA 1910.252 (a) (2) (iv) and NFPA 51B for hot work and have a fire watcher and extinguisher nearby.

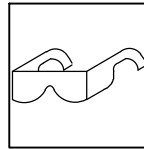

FLYING METAL or DIRT can injure eyes.

- Welding, chipping, wire brushing, and grinding cause sparks and flying metal. As welds cool, they can throw off slag.
- Wear approved safety glasses with side shields even under your welding helmet.



BUILDUP OF GAS can injure or kill.

- Shut off compressed gas supply when not in use.
- Always ventilate confined spaces or use approved air-supplied respirator.

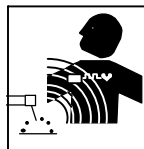

ELECTRIC AND MAGNETIC FIELDS (EMF) can affect Implanted Medical Devices.

- Wearers of Pacemakers and other Implanted Medical Devices should keep away.
- Implanted Medical Device wearers should consult their doctor and the device manufacturer before going near arc welding, spot welding, gouging, plasma arc cutting, or induction heating operations.

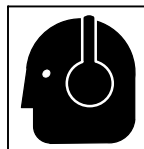

NOISE can damage hearing.

Noise from some processes or equipment can damage hearing.

- Wear approved ear protection if noise level is high.

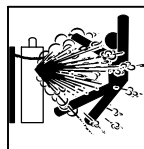

CYLINDERS can explode if damaged.

Compressed gas cylinders contain gas under high pressure. If damaged, a cylinder can explode. Since gas cylinders are normally part of the welding process, be sure to treat them carefully.

- Protect compressed gas cylinders from excessive heat, mechanical shocks, physical damage, slag, open flames, sparks, and arcs.
- Install cylinders in an upright position by securing to a stationary support or cylinder rack to prevent falling or tipping.
- Keep cylinders away from any welding or other electrical circuits.
- Never drape a welding torch over a gas cylinder.
- Never allow a welding electrode to touch any cylinder.
- Never weld on a pressurized cylinder – explosion will result.
- Use only correct compressed gas cylinders, regulators, hoses, and fittings designed for the specific application; maintain them and associated parts in good condition.
- Turn face away from valve outlet when opening cylinder valve.
- Keep protective cap in place over valve except when cylinder is in use or connected for use.
- Use the right equipment, correct procedures, and sufficient number of persons to lift and move cylinders.
- Read and follow instructions on compressed gas cylinders, associated equipment, and Compressed Gas Association (CGA) publication P-1 listed in Safety Standards.

1-3. Additional Symbols For Installation, Operation, And Maintenance



FIRE OR EXPLOSION hazard.

- Do not install or place unit on, over, or near combustible surfaces.
- Do not install unit near flammables.
- Do not overload building wiring – be sure power supply system is properly sized, rated, and protected to handle this unit.



FALLING EQUIPMENT can injure.

- Use lifting eye to lift unit only, NOT running gear, gas cylinders, or any other accessories.
- Use equipment of adequate capacity to lift and support unit.
- If using lift forks to move unit, be sure forks are long enough to extend beyond opposite side of unit.
- Keep equipment (cables and cords) away from moving vehicles when working from an aerial location.
- Follow the guidelines in the Applications Manual for the Revised NIOSH Lifting Equation (Publication No. 94-110) when manually lifting heavy parts or equipment.

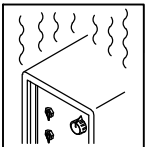

OVERUSE can cause OVERHEATING

- Allow cooling period; follow rated duty cycle.
- Reduce current or reduce duty cycle before starting to weld again.
- Do not block or filter airflow to unit.

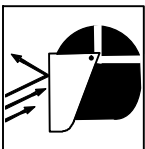

FLYING SPARKS can injure.

- Wear a face shield to protect eyes and face.
- Shape tungsten electrode only on grinder with proper guards in a safe location wearing proper face, hand, and body protection.
- Sparks can cause fires — keep flammables away.

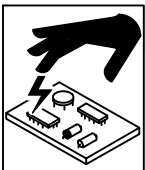

STATIC (ESD) can damage PC boards.

- Put on grounded wrist strap BEFORE handling boards or parts.
- Use proper static-proof bags and boxes to store, move, or ship PC boards.



MOVING PARTS can injure.

- Keep away from moving parts.
- Keep away from pinch points such as drive rolls.



WELDING WIRE can injure.

- Do not press gun trigger until instructed to do so.
- Do not point gun toward any part of the body, other people, or any metal when threading welding wire.



MOVING PARTS can injure.

- Keep away from moving parts such as fans.
- Keep all doors, panels, covers, and guards closed and securely in place.
- Have only qualified persons remove doors, panels, covers, or guards for maintenance and troubleshooting as necessary.
- Reinstall doors, panels, covers, or guards when maintenance is finished and before reconnecting input power.

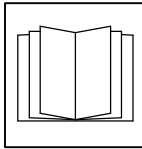

READ INSTRUCTIONS.

- Read and follow all labels and the Owner's Manual carefully before installing, operating, or servicing unit. Read the safety information at the beginning of the manual and in each section.
- Use only genuine replacement parts from the manufacturer.
- Perform maintenance and service according to the Owner's Manuals, industry standards, and national, state, and local codes.

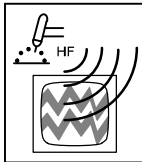

H.F. RADIATION can cause interference.

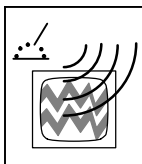

- High-frequency (H.F.) can interfere with radio navigation, safety services, computers, and communications equipment.
- Have only qualified persons familiar with electronic equipment perform this installation.
- The user is responsible for having a qualified electrician promptly correct any interference problem resulting from the installation.
- If notified by the FCC about interference, stop using the equipment at once.
- Have the installation regularly checked and maintained.
- Keep high-frequency source doors and panels tightly shut, keep spark gaps at correct setting, and use grounding and shielding to minimize the possibility of interference.



ARC WELDING can cause interference.

- Electromagnetic energy can interfere with sensitive electronic equipment such as computers and computer-driven equipment such as robots.
- Be sure all equipment in the welding area is electromagnetically compatible.
- To reduce possible interference, keep weld cables as short as possible, close together, and down low, such as on the floor.
- Locate welding operation 100 meters from any sensitive electronic equipment.
- Be sure this welding machine is installed and grounded according to this manual.
- If interference still occurs, the user must take extra measures such as moving the welding machine, using shielded cables, using line filters, or shielding the work area.

1-4. California Proposition 65 Warnings

-  **Welding or cutting equipment produces fumes or gases which contain chemicals known to the State of California to cause birth defects and, in some cases, cancer. (California Health & Safety Code Section 25249.5 et seq.)**
-  **Battery posts, terminals and related accessories contain lead and lead compounds, chemicals known to the State of California to cause cancer and birth defects or other reproductive harm. *Wash hands after handling.***
-  **This product contains chemicals, including lead, known to the state of California to cause cancer, birth defects, or other reproductive harm. *Wash hands after use.***

For Gasoline Engines:

-  **Engine exhaust contains chemicals known to the State of California to cause cancer, birth defects, or other reproductive harm.**

For Diesel Engines:

-  **Diesel engine exhaust and some of its constituents are known to the State of California to cause cancer, birth defects, and other reproductive harm.**

1-5. Principal Safety Standards

Safety in Welding, Cutting, and Allied Processes, ANSI Standard Z49.1, from Global Engineering Documents (phone: 1-877-413-5184, website: www.global.ihs.com).

Safe Practices for the Preparation of Containers and Piping for Welding and Cutting, American Welding Society Standard AWS F4.1, from Global Engineering Documents (phone: 1-877-413-5184, website: www.global.ihs.com).

National Electrical Code, NFPA Standard 70, from National Fire Protection Association, Quincy, MA 02269 (phone: 1-800-344-3555, website: www.nfpa.org and www.sparky.org).

Safe Handling of Compressed Gases in Cylinders, CGA Pamphlet P-1, from Compressed Gas Association, 4221 Walney Road, 5th Floor, Chantilly, VA 20151 (phone: 703-788-2700, website: www.cganet.com).

Safety in Welding, Cutting, and Allied Processes, CSA Standard W117.2, from Canadian Standards Association, Standards Sales, 5060 Spectrum Way, Suite 100, Ontario, Canada L4W 5N5 (phone: 800-463-6727, website: www.csa-international.org).

Safe Practice For Occupational And Educational Eye And Face Protection, ANSI Standard Z87.1, from American National Standards Institute,

25 West 43rd Street, New York, NY 10036 (phone: 212-642-4900, website: www.ansi.org).

Standard for Fire Prevention During Welding, Cutting, and Other Hot Work, NFPA Standard 51B, from National Fire Protection Association, Quincy, MA 02269 (phone: 1-800-344-3555, website: www.nfpa.org).

OSHA, Occupational Safety and Health Standards for General Industry, Title 29, Code of Federal Regulations (CFR), Part 1910, Subpart Q, and Part 1926, Subpart J, from U.S. Government Printing Office, Superintendent of Documents, P.O. Box 371954, Pittsburgh, PA 15250-7954 (phone: 1-866-512-1800) (there are 10 OSHA Regional Offices—phone for Region 5, Chicago, is 312-353-2220, website: www.osha.gov).

U.S. Consumer Product Safety Commission (CPSC), 4330 East West Highway, Bethesda, MD 20814 (phone: 301-504-7923, website: www.cpsc.gov).

Applications Manual for the Revised NIOSH Lifting Equation, The National Institute for Occupational Safety and Health (NIOSH), 1600 Clifton Rd, Atlanta, GA 30333 (phone: 1-800-232-4636, website: www.cdc.gov/NIOSH).

1-6. EMF Information

Electric current flowing through any conductor causes localized electric and magnetic fields (EMF). Welding current creates an EMF field around the welding circuit and welding equipment. EMF fields may interfere with some medical implants, e.g. pacemakers. Protective measures for persons wearing medical implants have to be taken. For example, access restrictions for passers-by or individual risk assessment for welders. All welders should use the following procedures in order to minimize exposure to EMF fields from the welding circuit:

1. Keep cables close together by twisting or taping them, or using a cable cover.
2. Do not place your body between welding cables. Arrange cables to one side and away from the operator.
3. Do not coil or drape cables around your body.

4. Keep head and trunk as far away from the equipment in the welding circuit as possible.
5. Connect work clamp to workpiece as close to the weld as possible.
6. Do not work next to, sit or lean on the welding power source.
7. Do not weld whilst carrying the welding power source or wire feeder.

About Implanted Medical Devices:

Implanted Medical Device wearers should consult their doctor and the device manufacturer before performing or going near arc welding, spot welding, gouging, plasma arc cutting, or induction heating operations. If cleared by your doctor, then following the above procedures is recommended.

SECTION 2 – CONSIGNES DE SÉCURITÉ – LIRE AVANT UTILISATION

fre_som_2010-03

 Se protéger et protéger les autres contre le risque de blessure — lire et respecter ces consignes.

2-1. Symboles utilisés

 **DANGER!** – Indique une situation dangereuse qui si on l'évite pas peut donner la mort ou des blessures graves. Les dangers possibles sont montrés par les symboles joints ou sont expliqués dans le texte.

 Indique une situation dangereuse qui si on l'évite pas peut donner la mort ou des blessures graves. Les dangers possibles sont montrés par les symboles joints ou sont expliqués dans le texte.

NOTE – Indique des déclarations pas en relation avec des blessures personnelles.

 Indique des instructions spécifiques.



Ce groupe de symboles veut dire Avertissement! Attention! DANGER DE CHOC ELECTRIQUE, PIECES EN MOUVEMENT, et PIECES CHAUDES. Consulter les symboles et les instructions ci-dessous y afférant pour les actions nécessaires afin d'éviter le danger.

2-2. Dangers relatifs au soudage à l'arc

 Les symboles représentés ci-dessous sont utilisés dans ce manuel pour attirer l'attention et identifier les dangers possibles. En présence de l'un de ces symboles, prendre garde et suivre les instructions afférentes pour éviter tout risque. Les instructions en matière de sécurité indiquées ci-dessous ne constituent qu'un sommaire des instructions de sécurité plus complètes fournies dans les normes de sécurité énumérées dans la Section 2-5. Lire et observer toutes les normes de sécurité.

 Seul un personnel qualifié est autorisé à installer, faire fonctionner, entretenir et réparer cet appareil.

 Pendant le fonctionnement, maintenir à distance toutes les personnes, notamment les enfants de l'appareil.



UNE DÉCHARGE ÉLECTRIQUE peut entraîner la mort.

Le contact d'organes électriques sous tension peut provoquer des accidents mortels ou des brûlures graves. Le circuit de l'électrode et de la pièce est sous tension lorsque le courant est délivré à la sortie. Le circuit d'alimentation et les circuits internes de la machine sont également sous tension lorsque l'alimentation est sur Marche. Dans le mode de soudage avec du fil, le fil, le dérouleur, le bloc de commande du rouleau et toutes les parties métalliques en contact avec le fil sont sous tension électrique. Un équipement installé ou mis à la terre de manière incorrecte ou impropre constitue un danger.

- Ne pas toucher aux pièces électriques sous tension.
- Porter des gants isolants et des vêtements de protection secs et sans trous.
- S'isoler de la pièce à couper et du sol en utilisant des housses ou des tapis assez grands afin d'éviter tout contact physique avec la pièce à couper ou le sol.
- Ne pas se servir de source électrique à courant électrique dans les zones humides, dans les endroits confinés ou là où on risque de tomber.
- Se servir d'une source électrique à courant électrique UNIQUEMENT si le procédé de soudage le demande.
- Si l'utilisation d'une source électrique à courant électrique s'avère nécessaire, se servir de la fonction de télécommande si l'appareil en est équipé.
- D'autres consignes de sécurité sont nécessaires dans les conditions suivantes : risques électriques dans un environnement humide ou si l'on porte des vêtements mouillés ; sur des structures métalliques telles que sols, grilles ou échafaudages ; en position coincée comme assise, à genoux ou couchée ; ou s'il y a un risque élevé de contact inévitable ou accidentel avec la pièce à souder ou le sol. Dans ces conditions, utiliser les équipements suivants, dans l'ordre indiqué : 1) un poste à souder DC à tension constante (à fil), 2) un poste à souder DC manuel (électrode) ou 3) un poste à souder AC à tension à vide réduite. Dans la plupart des situations, l'utilisation d'un poste à souder DC à fil à tension constante est recommandée. En outre, ne pas travailler seul !
- Couper l'alimentation ou arrêter le moteur avant de procéder à l'installation, à la réparation ou à l'entretien de l'appareil. Déverrouiller l'alimentation selon la norme OSHA 29 CFR 1910.147 (voir normes de sécurité).
- Installer le poste correctement et le mettre à la terre convenablement selon les consignes du manuel de l'opérateur et les normes nationales, provinciales et locales.
- Toujours vérifier la terre du cordon d'alimentation. Vérifier et s'assurer que le fil de terre du cordon d'alimentation est bien raccordé à la borne de terre du sectionneur ou que la fiche du cordon est raccordée à une prise correctement mise à la terre.
- En effectuant les raccordements d'entrée, fixer d'abord le conducteur de mise à la terre approprié et contre-vérifier les connexions.
- Les câbles doivent être exempts d'humidité, d'huile et de graisse; protégez-les contre les étincelles et les pièces métalliques chaudes.
- Vérifier fréquemment le cordon d'alimentation afin de s'assurer qu'il n'est pas altéré ou à nu, le remplacer immédiatement s'il l'est. Un fil à nu peut entraîner la mort.
- L'équipement doit être hors tension lorsqu'il n'est pas utilisé.
- Ne pas utiliser des câbles usés, endommagés, de grosseur insuffisante ou mal épissés.
- Ne pas enrouler les câbles autour du corps.
- Si la pièce soudée doit être mise à la terre, le faire directement avec un câble distinct.
- Ne pas toucher l'électrode quand on est en contact avec la pièce, la terre ou une électrode provenant d'une autre machine.
- Ne pas toucher des porte électrodes connectés à deux machines en même temps à cause de la présence d'une tension à vide doublée.
- N'utiliser qu'un matériel en bon état. Réparer ou remplacer sur-le-champ les pièces endommagées. Entretenir l'appareil conformément à ce manuel.
- Porter un harnais de sécurité si l'on doit travailler au-dessus du sol.
- S'assurer que tous les panneaux et couvercles sont correctement en place.
- Fixer le câble de retour de façon à obtenir un bon contact métal-métal avec la pièce à souder ou la table de travail, le plus près possible de la soudure.
- Isoler la pince de masse quand pas mis à la pièce pour éviter le contact avec tout objet métallique.
- Ne pas raccorder plus d'une électrode ou plus d'un câble de masse à une même borne de sortie de soudage.

Il reste une TENSION DC NON NÉGLIGEABLE dans les sources de soudage onduleur UNE FOIS l'alimentation coupée.

- Arrêter les convertisseurs, débrancher le courant électrique et décharger les condensateurs d'alimentation selon les instructions indiquées dans la partie Entretien avant de toucher les pièces.



LES PIÈCES CHAUDES peuvent provoquer des brûlures.

- Ne pas toucher à mains nues les parties chaudes.
- Prévoir une période de refroidissement avant de travailler à l'équipement.
- Ne pas toucher aux pièces chaudes, utiliser les outils recommandés et porter des gants de soudage et des vêtements épais pour éviter les brûlures.



LES FUMÉES ET LES GAZ peuvent être dangereux.

Le soudage génère des fumées et des gaz. Leur inhalation peut être dangereux pour votre santé.

- Eloigner votre tête des fumées. Ne pas respirer les fumées.
- À l'intérieur, ventiler la zone et/ou utiliser une ventilation forcée au niveau de l'arc pour l'évacuation des fumées et des gaz de soudage.
- Si la ventilation est médiocre, porter un respirateur anti-vapeurs approuvé.
- Lire et comprendre les spécifications de sécurité des matériaux (MSDS) et les instructions du fabricant concernant les métaux, les consommables, les revêtements, les nettoyants et les dégraissants.
- Travailler dans un espace fermé seulement s'il est bien ventilé ou en portant un respirateur à alimentation d'air. Demander toujours à un surveillant dûment formé de se tenir à proximité. Des fumées et des gaz de soudage peuvent déplacer l'air et abaisser le niveau d'oxygène provoquant des blessures ou des accidents mortels. S'assurer que l'air de respiration ne présente aucun danger.
- Ne pas souder dans des endroits situés à proximité d'opérations de dégraissage, de nettoyage ou de pulvérisation. La chaleur et les rayons de l'arc peuvent réagir en présence de vapeurs et former des gaz hautement toxiques et irritants.
- Ne pas souder des métaux munis d'un revêtement, tels que l'acier galvanisé, plaqué en plomb ou au cadmium à moins que le revêtement n'ait été enlevé dans la zone de soudure, que l'endroit soit bien ventilé, et en portant un respirateur à alimentation d'air. Les revêtements et tous les métaux renfermant ces éléments peuvent dégager des fumées toxiques en cas de soudage.



LES RAYONS DE L'ARC peuvent provoquer des brûlures dans les yeux et sur la peau.

Le rayonnement de l'arc du procédé de soudage génère des rayons visibles et invisibles intenses (ultraviolets et infrarouges) susceptibles de provoquer des brûlures dans les yeux et sur la peau. Des étincelles sont projetées pendant le soudage.

- Porter un casque de soudage approuvé muni de verres filtrants appropriés pour protéger visage et yeux pour protéger votre visage et vos yeux pendant le soudage ou pour regarder (voir ANSI Z49.1 et Z87.1 énuméré dans les normes de sécurité).
- Porter des lunettes de sécurité avec écrans latéraux même sous votre casque.
- Avoir recours à des écrans protecteurs ou à des rideaux pour protéger les autres contre les rayonnements les éblouissements et les étincelles ; prévenir toute personne sur les lieux de ne pas regarder l'arc.
- Porter des vêtements confectionnés avec des matières résistantes et ignifuges (cuir, coton lourd ou laine) et des bottes de protection.



LE SOUDAGE peut provoquer un incendie ou une explosion.

Le soudage effectué sur des conteneurs fermés tels que des réservoirs, tambours ou des conduites peut provoquer leur éclatement. Des étincelles peuvent être projetées de l'arc de soudage. La projection d'étincelles, des pièces chaudes et des équipements chauds peut provoquer des incendies et des brûlures. Le contact accidentel de l'électrode avec des objets métalliques peut provoquer des étincelles, une explosion, un surchauffement ou un incendie. Avant de commencer le soudage, vérifier et s'assurer que l'endroit ne présente pas de danger.

- Déplacer toutes les substances inflammables à une distance de 10,7 m de l'arc de soudage. En cas d'impossibilité les recouvrir soigneusement avec des protections homologués.
- Ne pas souder dans un endroit où des étincelles peuvent tomber sur des substances inflammables.
- Se protéger et d'autres personnes de la projection d'étincelles et de métal chaud.
- Des étincelles et des matériaux chauds du soudage peuvent facilement passer dans d'autres zones en traversant de petites fissures et des ouvertures.
- Surveiller tout déclenchement d'incendie et tenir un extincteur à proximité.
- Le soudage effectué sur un plafond, plancher, paroi ou séparation peut déclencher un incendie de l'autre côté.
- Ne pas effectuer le soudage sur des conteneurs fermés tels que des réservoirs, tambours, ou conduites, à moins qu'ils n'aient été préparés correctement conformément à AWS F4.1 (voir les normes de sécurité).
- Ne soudez pas si l'air ambiant est chargé de particules, gaz, ou vapeurs inflammables (vapeur d'essence, par exemple).
- Brancher le câble de masse sur la pièce la plus près possible de la zone de soudage pour éviter le transport du courant sur une longue distance par des chemins inconnus éventuels en provoquant des risques d'électrocution, d'étincelles et d'incendie.
- Ne pas utiliser le poste de soudage pour dégeler des conduites gelées.
- En cas de non utilisation, enlever la bague d'électrode du porte-électrode ou couper le fil à la pointe de contact.
- Porter des vêtements de protection dépourvus d'huile tels que des gants en cuir, une chemise en matériau lourd, des pantalons sans revers, des chaussures hautes et un couvre chef.
- Avant de souder, retirer toute substance combustible de vos poches telles qu'un allumeur au butane ou des allumettes.
- Une fois le travail achevé, assurez-vous qu'il ne reste aucune trace d'étincelles incandescentes ni de flammes.
- Utiliser exclusivement des fusibles ou coupe-circuits appropriés. Ne pas augmenter leur puissance; ne pas les ponter.
- Une fois le travail achevé, assurez-vous qu'il ne reste aucune trace d'étincelles incandescentes ni de flammes.
- Utiliser exclusivement des fusibles ou coupe-circuits appropriés. Ne pas augmenter leur puissance; ne pas les ponter.
- Suivre les recommandations dans OSHA 1910.252(a)(2)(iv) et NFPA 51B pour les travaux à chaud et avoir de la surveillance et un extincteur à proximité.

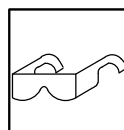

DES PIÈCES DE METAL ou DES SALETES peuvent provoquer des blessures dans les yeux.

- Le soudage, l'écaillage, le passage de la pièce à la brosse en fil de fer, et le meulage génèrent des étincelles et des particules métalliques volantes. Pendant la période de refroidissement des soudures, elles risquent de projeter du laitier.
- Porter des lunettes de sécurité avec écrans latéraux ou un écran facial.



LES ACCUMULATIONS DE GAZ risquent de provoquer des blessures ou même la mort.

- Fermer l'alimentation du gaz comprimé en cas de non utilisation.
- Veiller toujours à bien aérer les espaces confinés ou se servir d'un respirateur d'adduction d'air homologué.



Les CHAMPS ÉLECTROMAGNÉTIQUES (CEM) peuvent affecter les implants médicaux.

- Les porteurs de stimulateurs cardiaques et autres implants médicaux doivent rester à distance.
- Les porteurs d'implants médicaux doivent consulter leur médecin et le fabricant du dispositif avant de s'approcher de la zone où se déroule du soudage à l'arc, du soudage par points, du gougeage, de la découpe plasma ou une opération de chauffage par induction.

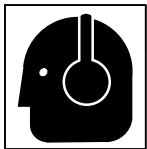

LE BRUIT peut endommager l'ouïe.

Le bruit des processus et des équipements peut affecter l'ouïe.

- Porter des protections approuvées pour les oreilles si le niveau sonore est trop élevé.

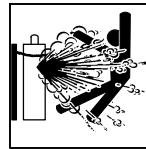

LES BOUTEILLES peuvent exploser si elles sont endommagées.

Les bouteilles de gaz comprimé contiennent du gaz sous haute pression. Si une bouteille est endommagée, elle peut exploser. Du fait que les bouteilles de gaz font normalement partie du procédé de soudage, les manipuler avec précaution.

- Protéger les bouteilles de gaz comprimé d'une chaleur excessive, des chocs mécaniques, des dommages physiques, du laitier, des flammes ouvertes, des étincelles et des arcs.
- Placer les bouteilles debout en les fixant dans un support stationnaire ou dans un porte-bouteilles pour les empêcher de tomber ou de se renverser.
- Tenir les bouteilles éloignées des circuits de soudage ou autres circuits électriques.
- Ne jamais placer une torche de soudage sur une bouteille à gaz.
- Une électrode de soudage ne doit jamais entrer en contact avec une bouteille.
- Ne jamais souder une bouteille pressurisée – risque d'explosion.
- Utiliser seulement des bouteilles de gaz comprimé, régulateurs, tuyaux et raccords convenables pour cette application spécifique; les maintenir ainsi que les éléments associés en bon état.
- Détourner votre visage du détendeur-régulateur lorsque vous ouvrez la soupape de la bouteille.
- Le couvercle du détendeur doit toujours être en place, sauf lorsque la bouteille est utilisée ou qu'elle est reliée pour usage ultérieur.
- Utiliser les équipements corrects, les bonnes procédures et suffisamment de personnes pour soulever et déplacer les bouteilles.
- Lire et suivre les instructions sur les bouteilles de gaz comprimé, l'équipement connexe et le dépliant P-1 de la CGA (Compressed Gas Association) mentionné dans les principales normes de sécurité.

2-3. Dangers supplémentaires en relation avec l'installation, le fonctionnement et la maintenance



Risque D'INCENDIE OU D'EXPLOSION.

- Ne pas placer l'appareil sur, au-dessus ou à proximité de surfaces inflammables.
- Ne pas installer l'appareil à proximité de produits inflammables.
- Ne pas surcharger l'installation électrique – s'assurer que l'alimentation est correctement dimensionnée et protégée avant de mettre l'appareil en service.

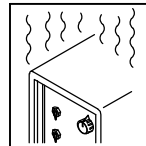

L'EMPLOI EXCESSIF peut SURCHAUFFER L'ÉQUIPEMENT.

- Prévoir une période de refroidissement ; respecter le cycle opératoire nominal.
- Réduire le courant ou le facteur de marche avant de poursuivre le soudage.
- Ne pas obstruer les passages d'air du poste.



LA CHUTE DE L'ÉQUIPEMENT peut provoquer des blessures.

- Utiliser l'anneau de levage uniquement pour soulever l'appareil, NON PAS les chariots, les bouteilles de gaz ou tout autre accessoire.
- Utiliser un équipement de levage de capacité suffisante pour lever l'appareil.
- En utilisant des fourches de levage pour déplacer l'unité, s'assurer que les fourches sont suffisamment longues pour dépasser du côté opposé de l'appareil.
- Tenir l'équipement (câbles et cordons) à distance des véhicules mobiles lors de toute opération en hauteur.
- Suivre les consignes du Manuel des applications pour l'équation de levage NIOSH révisée (Publication N°94-110) lors du levage manuel de pièces ou équipements lourds.

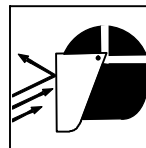

LES ÉTINCELLES PROJETÉES peuvent provoquer des blessures.

- Porter un écran facial pour protéger le visage et les yeux.
- Affûter l'électrode au tungstène uniquement à la meuleuse dotée de protecteurs. Cette manœuvre est à exécuter dans un endroit sûr lorsque l'on porte l'équipement homologué de protection du visage, des mains et du corps.
- Les étincelles risquent de causer un incendie – éloigner toute substance inflammable.

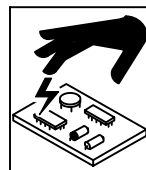

LES CHARGES ÉLECTROSTATIQUES peuvent endommager les circuits imprimés.

- Établir la connexion avec la barrette de terre avant de manipuler des cartes ou des pièces.
- Utiliser des pochettes et des boîtes antistatiques pour stocker, déplacer ou expédier des cartes de circuits imprimés.



Les PIÈCES MOBILES peuvent causer des blessures.

- Ne pas s'approcher des organes mobiles.
- Ne pas s'approcher des points de coincement tels que des rouleaux de commande.



LES FILS DE SOUDAGE peuvent provoquer des blessures.

- Ne pas appuyer sur la gâchette avant d'en avoir reçu l'instruction.
- Ne pas diriger le pistolet vers soi, d'autres personnes ou toute pièce mécanique en engageant le fil de soudage.



Les PIÈCES MOBILES peuvent causer des blessures.

- S'abstenir de toucher des organes mobiles tels que des ventilateurs.
- Maintenir fermés et verrouillés les portes, panneaux, recouvrements et dispositifs de protection.
- Lorsque cela est nécessaire pour des travaux d'entretien et de dépannage, faire retirer les portes, panneaux, recouvrements ou dispositifs de protection uniquement par du personnel qualifié.
- Remettre les portes, panneaux, recouvrements ou dispositifs de protection quand l'entretien est terminé et avant de rebrancher l'alimentation électrique.

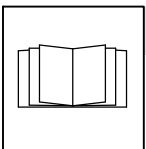

LIRE LES INSTRUCTIONS.

- Lire et appliquer les instructions sur les étiquettes et le Mode d'emploi avant l'installation, l'utilisation ou l'entretien de l'appareil. Lire les informations de sécurité au début du manuel et dans chaque section.
- N'utiliser que les pièces de rechange recommandées par le constructeur.
- Effectuer l'entretien en respectant les manuels d'utilisation, les normes industrielles et les codes nationaux, d'état et locaux.

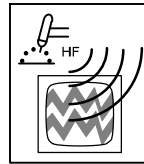

LE RAYONNEMENT HAUTE FRÉQUENCE (H.F.) risque de provoquer des interférences.

- Le rayonnement haute fréquence (H.F.) peut provoquer des interférences avec les équipements de radio-navigation et de communication, les services de sécurité et les ordinateurs.

- Demander seulement à des personnes qualifiées familiarisées avec des équipements électroniques de faire fonctionner l'installation.
- L'utilisateur est tenu de faire corriger rapidement par un électricien qualifié les interférences résultant de l'installation.
- Si le FCC signale des interférences, arrêter immédiatement l'appareil.
- Effectuer régulièrement le contrôle et l'entretien de l'installation.
- Maintenir soigneusement fermés les portes et les panneaux des sources de haute fréquence, maintenir les éclateurs à une distance correcte et utiliser une terre et un blindage pour réduire les interférences éventuelles.

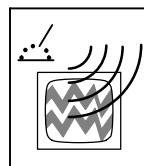

LE SOUDAGE À L'ARC risque de provoquer des interférences.

- L'énergie électromagnétique risque de provoquer des interférences pour l'équipement électronique sensible tel que les ordinateurs et l'équipement commandé par ordinateur tel que les robots.

- Veiller à ce que tout l'équipement de la zone de soudage soit compatible électromagnétiquement.
- Pour réduire la possibilité d'interférence, maintenir les câbles de soudage aussi courts que possible, les grouper, et les poser aussi bas que possible (ex. par terre).
- Veiller à souder à une distance de 100 mètres de tout équipement électronique sensible.
- Veiller à ce que ce poste de soudage soit posé et mis à la terre conformément à ce mode d'emploi.
- En cas d'interférences après avoir pris les mesures précédentes, il incombe à l'utilisateur de prendre des mesures supplémentaires telles que le déplacement du poste, l'utilisation de câbles blindés, l'utilisation de filtres de ligne ou la pose de protecteurs dans la zone de travail.

2-4. Proposition californienne 65 Avertissements

⚠ Les équipements de soudage et de coupage produisent des fumées et des gaz qui contiennent des produits chimiques dont l'État de Californie reconnaît qu'ils provoquent des malformations congénitales et, dans certains cas, des cancers. (Code de santé et de sécurité de Californie, chapitre 25249.5 et suivants)

⚠ Les batteries, les bornes et autres accessoires contiennent du plomb et des composés à base de plomb, produits chimiques dont l'État de Californie reconnaît qu'ils provoquent des cancers et des malformations congénitales ou autres problèmes de procréation. Se laver les mains après manipulation.

⚠ Ce produit contient des produits chimiques, notamment du plomb, dont l'État de Californie reconnaît qu'ils provoquent

des cancers, des malformations congénitales ou d'autres problèmes de procréation. *Se laver les mains après utilisation.*

Pour les moteurs à essence :

⚠ Les gaz d'échappement des moteurs contiennent des produits chimiques dont l'État de Californie reconnaît qu'ils provoquent des cancers et des malformations congénitales ou autres problèmes de procréation.

Pour les moteurs diesel :

⚠ Les gaz d'échappement des moteurs diesel et certains de leurs composants sont reconnus par l'État de Californie comme provoquant des cancers et des malformations congénitales ou autres problèmes de procréation.

2-5. Principales normes de sécurité

Safety in Welding, Cutting, and Allied Processes, ANSI Standard Z49.1, de Global Engineering Documents (téléphone : 1-877-413-5184, site Internet : www.global.ihc.com).

Safe Practices for the Preparation of Containers and Piping for Welding and Cutting, American Welding Society Standard AWS F4.1, de Global Engineering Documents (téléphone : 1-877-413-5184, site internet : www.global.ihc.com).

National Electrical Code, NFPA Standard 70, de National Fire Protection Association, Quincy, MA 02269 (téléphone : 800-344-3555, site Internet : www.nfpa.org et www.sparky.org).

Safe Handling of Compressed Gases in Cylinders, CGA Pamphlet P-1, de Compressed Gas Association, 4221 Walney Road, 5th Floor, Chantilly, VA 20151 (téléphone : 703-788-2700, site Internet : www.cganet.com).

Safety in Welding, Cutting, and Allied Processes, CSA Standard W117.2, de Canadian Standards Association, Standards Sales, 5060 Spectrum Way, Suite 100, Ontario, Canada L4W 5N5 (téléphone : 800-463-6727, site internet : www.csa-international.org).

Safe Practice For Occupational And Educational Eye And Face Protection, ANSI Standard Z87.1, de American National Standards Institute,

25 West 43rd Street, New York, NY 10036 (téléphone : 212-642-4900, site Internet : www.ansi.org).

Standard for Fire Prevention During Welding, Cutting, and Other Hot Work, NFPA Standard 51B, de National Fire Protection Association, P.O. Box 9101, Quincy, MA 02269-9101 (téléphone : 617-770-3000, site Internet : www.nfpa.org).

OSHA, Occupational Safety and Health Standards for General Industry, Title 29, Code of Federal Regulations (CFR), Part 1910, Subpart Q, and Part 1926, Subpart J, de U.S. Government Printing Office, Superintendent of Documents, P.O. Box 371954, Pittsburgh, PA 15250-7954 (téléphone : 1-866-512-1800) (il y a 10 bureaux régionaux—le téléphone de la région 5, Chicago, est 312-353-2220, site Internet : www.osha.gov).

U.S. Consumer Product Safety Commission (CPSC), 4330 East West Highway, Bethesda, MD 20814 (téléphone : 301-504-7923, site internet : www.cpsc.gov).

Applications Manual for the Revised NIOSH Lifting Equation, The National Institute for Occupational Safety and Health (NIOSH), 1600 Clifton Rd, Atlanta, GA 30333 (téléphone : 1-800-232-4636, site internet: www.cdc.gov/NIOSH).

2-6. Informations relatives aux CEM

Le courant électrique qui traverse tout conducteur génère des champs électromagnétiques (CEM) à certains endroits. Le courant de soudage crée un CEM autour du circuit et du matériel de soudage. Les CEM peuvent créer des interférences avec certains implants médicaux comme des stimulateurs cardiaques. Des mesures de protection pour les porteurs d'implants médicaux doivent être prises: par exemple, des restrictions d'accès pour les passants ou une évaluation individuelle des risques pour les soudeurs. Tous les soudeurs doivent appliquer les procédures suivantes pour minimiser l'exposition aux CEM provenant du circuit de soudage:

1. Rassembler les câbles en les torsadant ou en les attachant avec du ruban adhésif ou avec une housse.
2. Ne pas se tenir au milieu des câbles de soudage. Disposer les câbles d'un côté et à distance de l'opérateur.
3. Ne pas courber et ne pas entourer les câbles autour de votre corps.

4. Maintenir la tête et le torse aussi loin que possible du matériel du circuit de soudage.
5. Connecter la pince sur la pièce aussi près que possible de la soudure.
6. Ne pas travailler à proximité d'une source de soudage, ni s'asseoir ou se pencher dessus.
7. Ne pas souder tout en portant la source de soudage ou le dévidoir.

En ce qui concerne les implants médicaux :

Les porteurs d'implants doivent d'abord consulter leur médecin avant de s'approcher des opérations de soudage à l'arc, de soudage par points, de gougeage, du coupage plasma ou de chauffage par induction. Si le médecin approuve, il est recommandé de suivre les procédures précédentes.

SECTION 3 – INTRODUCTION

3-1. Specifications

Input Power	Rated Output	Voltage Range in CV Mode	Amperage Range in CC Mode	Max. Open-Circuit Voltage	RMS Amps Input at Rated Load Output, 60 Hz 3-Phase at NEMA Load Voltages and Class I Rating					KVA	KW
					208 V	230 V	400 V	460 V	575 V		
3-Phase	350 A at 34 VDC, 60% Duty Cycle	10–38 V	5–425 A	75 VDC	40.4	36.1	20.6	17.8	14.1	14.2	13.6
1-Phase	300 A at 32 VDC, 60% Duty Cycle*				60.8	54.6	29.7	25.4	19.9		

*See Section 3-4 for Duty Cycle Rating.

3-2. Features And Benefits

Auto-Line™ Power Management Technology is circuitry that automatically adapts the power source to the primary voltage being applied (see Sections 4-8 and 4-9).

LVC™ Line Voltage Compensation is circuitry that keeps the power source output constant regardless of input power fluctuation.

Wind Tunnel Technology™ circulates air over components that require cooling, not over electronic circuitry, which reduces contaminants and improves reliability in harsh welding environments.

Fan-On-Demand™ cooling system operates only when needed, reducing noise, energy use and the amount of contaminants pulled through the machine.

Thermal Overload Protection automatically shuts down the unit, only when necessary to prevent damage to internal components if the duty cycle is exceeded or air flow and cooling are restricted (see Section 3-4).

Auto Remote Sense enables the unit to automatically sense the connection of a remote control.

Synergic Pulsed MIG Operation allows single knob control of the arc. As wirefeed speed is increased or decreased, the pulsed parameters increase or decrease matching the power output to the wire speed (see Section 5-2).

3-3. Arc Controls

Inductance influences the arc stiffness, bead width and appearance, and puddle fluidity in MIG Welding Mode (see Section 6-2).

SharpArc™ optimizes the size and shape of the arc cone, bead width and appearance, and puddle fluidity in Pulsed MIG Welding Mode (see Section 6-4).

3-4. Duty Cycle And Overheating



Duty Cycle is percentage of 10 minutes that unit can weld at rated load without overheating.

If unit overheats, output stops, a Help message is displayed and cooling fan runs. Wait fifteen minutes for unit to cool. Reduce amperage or voltage, or duty cycle before welding.

Single Phase Operation: The unit is supplied with a 8 AWG power cord. The rated output with 8 AWG is 300 amps, 32 volts at 40% duty cycle. To achieve 60% duty cycle change cord to 6 AWG.

NOTICE – Exceeding duty cycle can damage unit and void warranty.

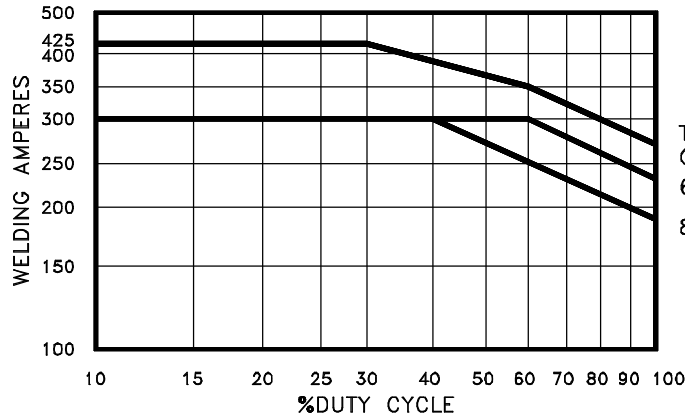

THREE PHASE OPERATION

6AWG POWER CORD

8AWG POWER CORD

SINGLE PHASE OPERATION

60% Duty Cycle

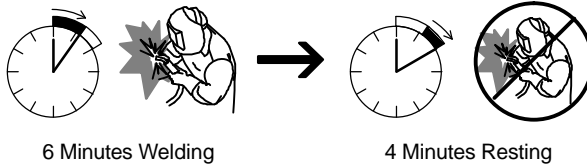

Overheating

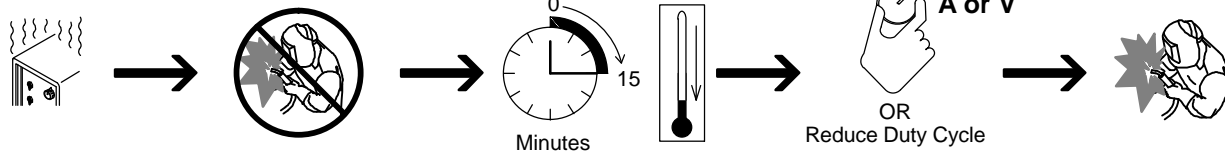

Ref. 216 568-A

SECTION 4 – INSTALLATION

4-1. Serial Number And Rating Label Location

The serial number and rating information for this product is located on the rear panel. Use rating label to determine input power requirements and/or rated output. For future reference, write serial number in space provided on back cover of this manual.

4-2. Dimensions And Weight

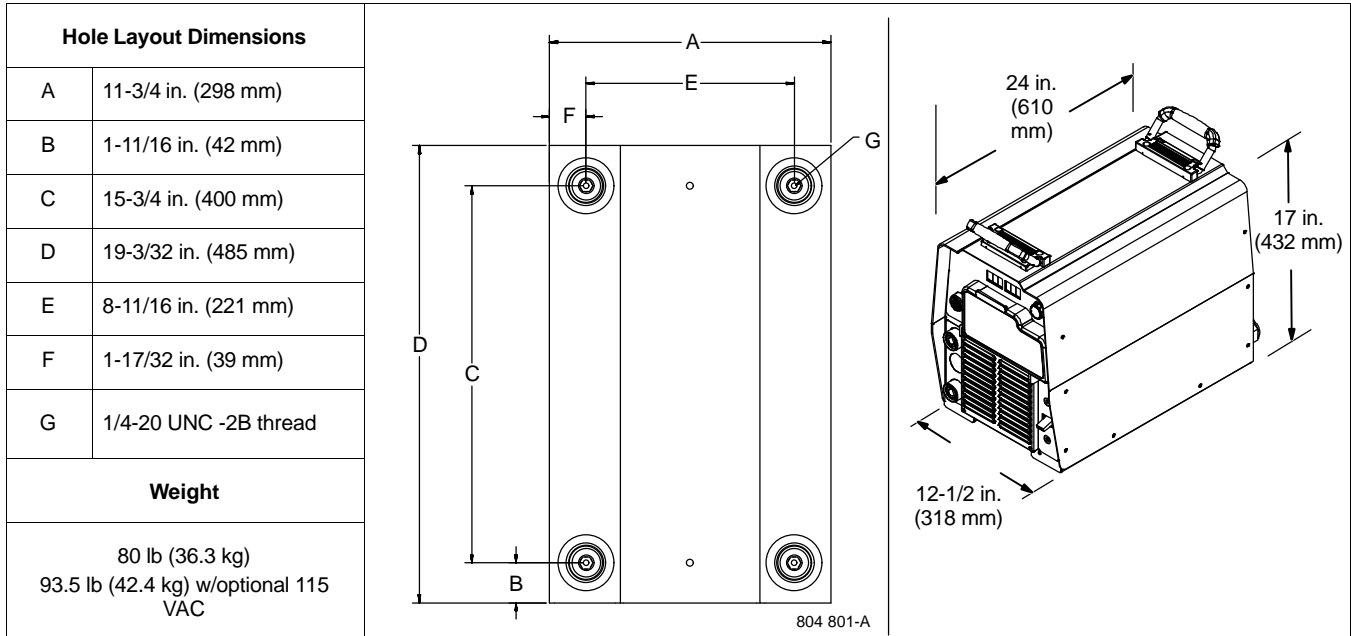

4-3. Selecting a Location

Do not move or operate unit where it could tip.

Movement

- 1 Lifting Handles
Use handles to lift unit.
- 2 Hand Cart
Use cart or similar device to move unit.
- 3 Line Disconnect Device
Locate unit near correct input power supply.

⚠ Special installation may be required where gasoline or volatile liquids are present – see NEC Article 511 or CEC Section 20.

Location

4-4. Weld Output Receptacles And Selecting Cable Sizes

NOTICE – The Total Cable Length in Weld Circuit (see table below) is the combined length of both weld cables. For example, if the power source is 100 ft (30 m) from the workpiece, the total cable length in the weld circuit is 200 ft (2 cables x 100 ft). Use the 200 ft (60 m) column to determine cable size.

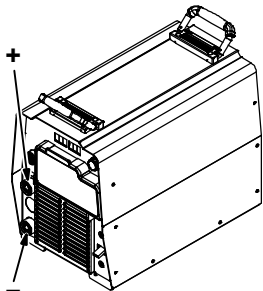
 <p>Weld Output Terminals</p> <p>⚠ Turn off power before connecting to weld output terminals.</p> <p>⚠ Do not use worn, damaged, undersized, or poorly spliced cables.</p>	Weld Cable Size** and Total Cable (Copper) Length in Weld Circuit Not Exceeding***									
	Welding Amperes	10 – 60% Duty Cycle AWG (mm²)	60 – 100% Duty Cycle AWG (mm²)	100 ft (30 m) or Less	150 ft (45 m)	200 ft (60 m)	250 ft (70 m)	300 ft (90 m)	350 ft (105 m)	400 ft (120 m)
				10 – 100% Duty Cycle AWG (mm²)						
 <p>Output Receptacles</p>	100	4 (20)	4 (20)	4 (20)	3 (30)	2 (35)	1 (50)	1/0 (60)	1/0 (60)	
	150	3 (30)	3 (30)	2 (35)	1 (50)	1/0 (60)	2/0 (70)	3/0 (95)	3/0 (95)	
	200	3 (30)	2 (35)	1 (50)	1/0 (60)	2/0 (70)	3/0 (95)	4/0 (120)	4/0 (120)	
	250	2 (35)	1 (50)	1/0 (60)	2/0 (70)	3/0 (95)	4/0 (120)	2x2/0 (2x70)	2x2/0 (2x70)	
	300	1 (50)	1/0 (60)	2/0 (70)	3/0 (95)	4/0 (120)	2x2/0 (2x70)	2x3/0 (2x95)	2x3/0 (2x95)	
	350	1/0 (60)	2/0 (70)	3/0 (95)	4/0 (120)	2x2/0 (2x70)	2x3/0 (2x95)	2x3/0 (2x95)	2x4/0 (2x120)	
	400	1/0 (60)	2/0 (70)	3/0 (95)	4/0 (120)	2x2/0 (2x70)	2x3/0 (2x95)	2x4/0 (2x120)	2x4/0 (2x120)	
	500	2/0 (70)	3/0 (95)	4/0 (120)	2x2/0 (2x70)	2x3/0 (2x95)	2x4/0 (2x120)	3x3/0 (3x95)	3x3/0 (3x95)	
	600	3/0 (95)	4/0 (120)	2x2/0 (2x70)	2x3/0 (2x95)	2x4/0 (2x120)	3x3/0 (3x95)	3x4/0 (3x120)	3x4/0 (3x120)	

* This chart is a general guideline and may not suit all applications. If cable overheats, use next size larger cable.

**Weld cable size (AWG) is based on either a 4 volts or less drop or a current density of at least 300 circular mils per ampere.
() = mm² for metric use

***For distances longer than those shown in this guide, call a factory applications rep. at 920-735-4505 (Miller) or 1-800-332-3281 (Hobart).

Ref. S-0007-J 2011-07

4-5. Remote 14 Receptacle Information

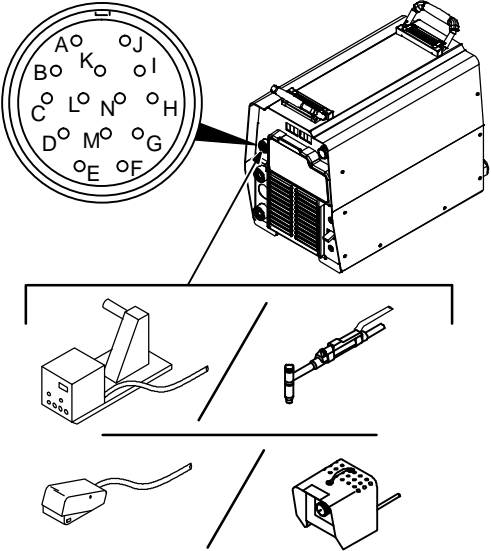
	REMOTE 14	Socket*	Socket Information
	24 VOLTS AC OUTPUT (CONTACTOR)	A	24 volts AC. Protected by supplementary protector or CB2.
B		Contact closure to A completes 24 volts AC contactor control circuit.	
115 VOLTS AC OUTPUT (CONTACTOR)	I	115 volts AC. Protected by supplementary protector CB1.	
	J	Contact closure to I completes 115 volts AC contactor control circuit.	
REMOTE OUTPUT CONTROL	C	Output to remote control; 0 to +10 volts DC, +10 volts DC in MIG mode.	
	D	Remote control circuit common.	
	E	0 to +10 volts DC input command signal from remote control.	
	L	Wirefeed speed command, 0 to +10 volts DC output signal from wire feeder.	
	M	CC/CV Select; 0 to +10 volts DC.	
	N	Wirefeed speed common.	
A/V AMPLERAGE VOLTAGE	F	Current feedback; +1 volt DC per 100 amperes.	
	H	Voltage feedback; +1 volt DC per 10 output receptacle volts.	
GND	G	Circuit common for 24 and 115 volts AC circuits.	
	K	Chassis common.	

*The remaining sockets are not used.

4-6. Optional 115 Volts AC Duplex Receptacle And Supplementary Protectors

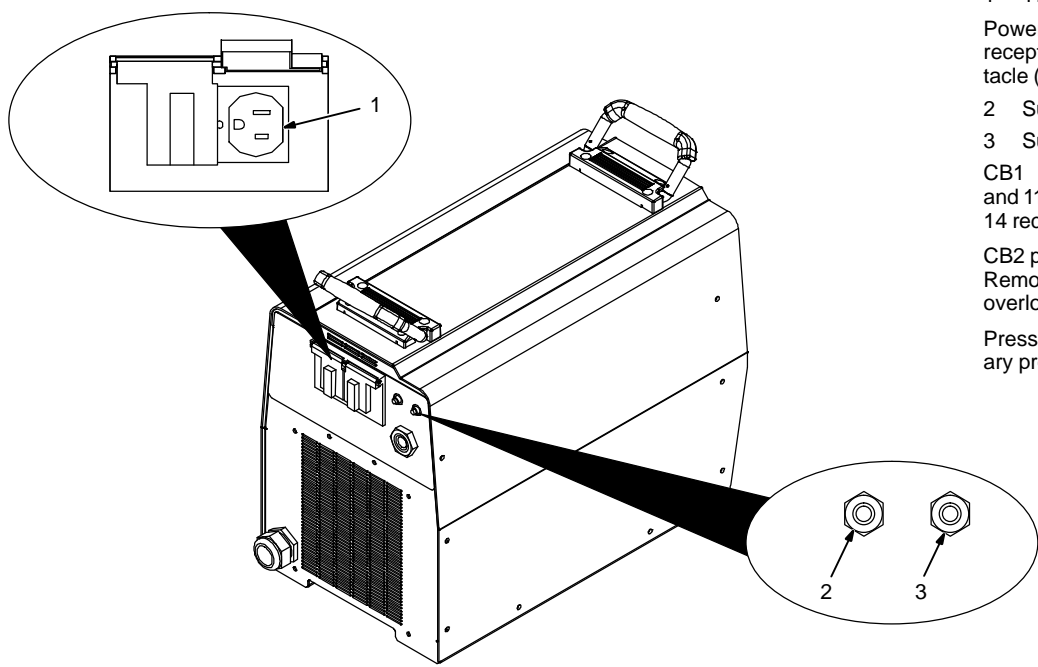

1 115 V 10 Amp AC Receptacle
Power is shared between duplex receptacle and Remote 14 receptacle (see Section 4-5).

2 Supplementary Protector CB1
3 Supplementary Protector CB2
CB1 protects duplex receptacle and 115 volts AC portion of Remote 14 receptacle from overload.
CB2 protects 24 volts AC portion of Remote 14 receptacle from overload.

Press button to reset supplementary protector.

803 691-C

4-7. Electrical Service Guide

NOTICE – INCORRECT INPUT POWER can damage this welding power source. Phase to ground voltage shall not exceed +10% of rated input voltage.

NOTICE – Actual input voltage should not be 10% less than minimum and/or 10% more than maximum input voltages listed in table. If actual input voltage is outside this range, output may not be available.

⚠ Failure to follow these electrical service guide recommendations could create an electric shock or fire hazard. These recommendations are for a dedicated circuit sized for the rated output and duty cycle of the welding power source.

In dedicated circuit installations, the National Electrical Code (NEC) allows the receptacle or conductor rating to be less than the rating of the circuit protection device. All components of the circuit must be physically compatible. See NEC articles 210.21, 630.11, and 630.12.

	Single-Phase				
Input Voltage (V)	208	230	400	460	575
Input Amperes (A) At Rated Output	60.8	54.6	29.7	25.4	19.9
Max Recommended Standard Fuse Rating In Amperes ¹					
Time-Delay Fuses ²	70	60	35	30	25
Normal Operating Fuses ³	80	80	45	40	30
Min Input Conductor Size In AWG/Kcmil ⁴	8	8	10	12	12
Max Recommended Input Conductor Length In Feet (Meters)	72 (22)	89 (27)	176 (54)	140 (43)	219 (67)
Min Grounding Conductor Size In AWG/Kcmil ⁴	8	8	10	12	12

	Three-Phase				
Input Voltage (V)	208	230	400	460	575
Input Amperes (A) At Rated Output	40.4	36.1	20.6	17.8	14.1
Max Recommended Standard Fuse Rating In Amperes ¹					
Time-Delay Fuses ²	45	40	25	20	15
Normal Operating Fuses ³	60	50	30	25	20
Min Input Conductor Size In AWG/Kcmil ⁴	8	10	12	14	14
Max Recommended Input Conductor Length In Feet (Meters)	119 (36)	96 (29)	175 (53)	150 (46)	234 (71)
Min Grounding Conductor Size In AWG/Kcmil ⁴	10	10	12	14	14

Reference: 2011 National Electrical Code (NEC) (including article 630)

¹ If a circuit breaker is used in place of a fuse, choose a circuit breaker with time-current curves comparable to the recommended fuse.

² "Time-Delay" fuses are UL class "RK5". See UL 248.

³ "Normal Operating" (general purpose - no intentional delay) fuses are UL class "K5" (up to and including 60 amps), and UL class "H" (65 amps and above).

⁴ Conductor data in this section specifies conductor size (excluding flexible cord or cable) between the panelboard and the equipment per NEC Table 310.15(B)(16). If a flexible cord or cable is used, minimum conductor size may increase. See NEC Table 400.5(A) for flexible cord and cable requirements.

4-8. Connecting 1-Phase Input Power

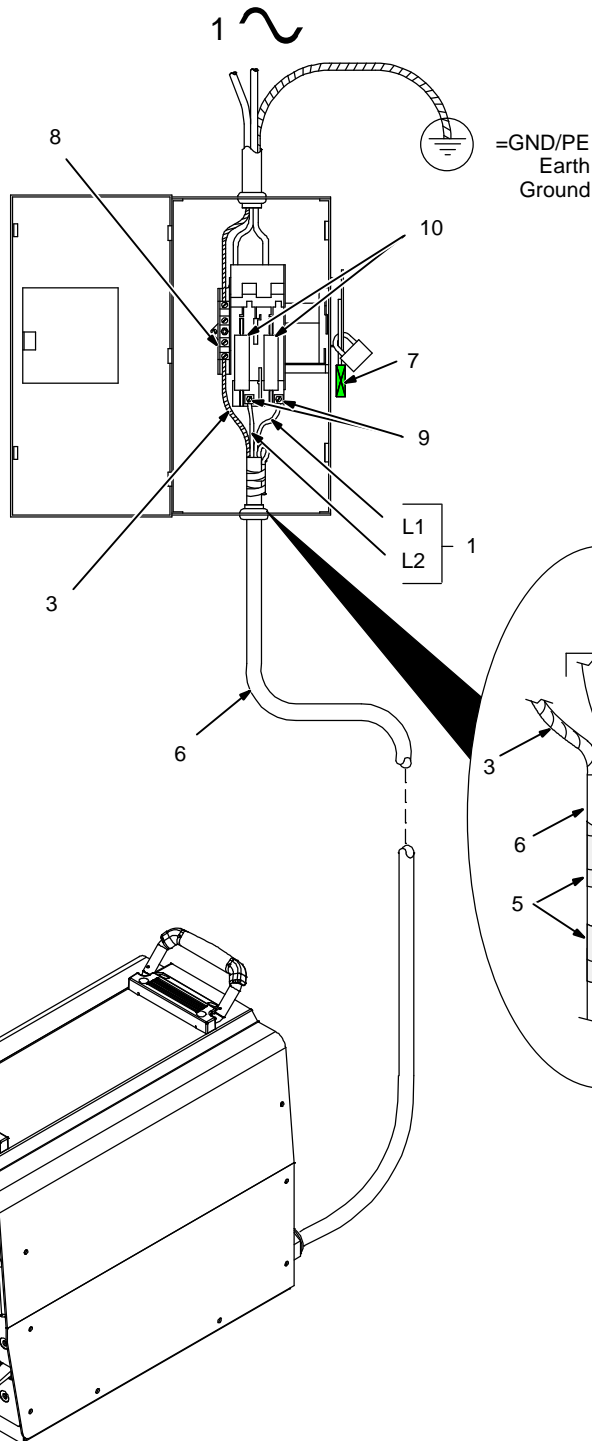

- ⚠** Installation must meet all National and Local Codes – have only qualified persons make this installation.
- ⚠** Disconnect and lockout/tagout input power before connecting input conductors from unit.
- ⚠** Always connect green or green/yellow conductor to supply grounding terminal first, and never to a line terminal.

ℹ The Auto-Line circuitry in this unit automatically adapts the power source to the primary voltage being applied. Check input voltage available at site. This unit can be connected to any input power between 208 and 575 VAC without removing cover to relink the power source.

See rating label on unit and check input voltage available at site.

- 1 Black And White Input Conductor (L1 And L2)
- 2 Red Input Conductor
- 3 Green Or Green/Yellow Grounding Conductor
- 4 Insulation Sleeving
- 5 Electrical Tape

Insulate and isolate red conductor as shown.

- 6 Input Power Cord.
- 7 Disconnect Device (switch shown in the OFF position)
- 8 Disconnect Device Grounding Terminal
- 9 Disconnect Device Line Terminals

Connect green or green/yellow grounding conductor to disconnect device grounding terminal first.

Connect input conductors L1 and L2 to disconnect device line terminals.

- 10 Overcurrent Protection

Select type and size of overcurrent protection using Section 4-7 (fused disconnect switch shown).

Close and secure door on disconnect device. Remove lockout/tagout device, and place switch in the On position.

Tools Needed:



input1 2011-03 – 803 766-C

4-9. Connecting 3-Phase Input Power

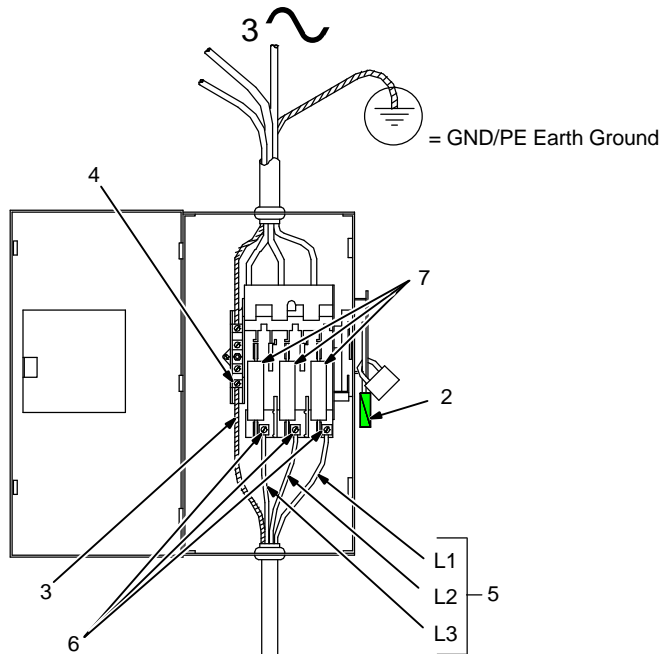

⚠ Installation must meet all National and Local Codes – have only qualified persons make this installation.

⚠ Disconnect and lockout/tagout input power before connecting input conductors from unit.

⚠ Always connect green or green/yellow conductor to supply grounding terminal first, and never to a line terminal.

ℹ The Auto-Line circuitry in this unit automatically adapts the power source to the primary voltage being applied. Check input voltage available at site. This unit can be connected to any input power between 208 and 575 VAC without removing cover to relink the power source.

See rating label on unit and check input voltage available at site.

For Three-Phase Operation

- 1 Input Power Cord.
- 2 Disconnect Device (switch shown in the OFF position)
- 3 Green Or Green/Yellow Grounding Conductor
- 4 Disconnect Device Grounding Terminal
- 5 Input Conductors (L1, L2 And L3)
- 6 Disconnect Device Line Terminals

Connect green or green/yellow grounding conductor to disconnect device grounding terminal first.

Connect input conductors L1, L2, and L3 to disconnect device line terminals.

7 Overcurrent Protection

Select type and size of overcurrent protection using Section 4-7 (fused disconnect switch shown).

Close and secure door on disconnect device. Remove lockout/tagout device, and place switch in the On position.

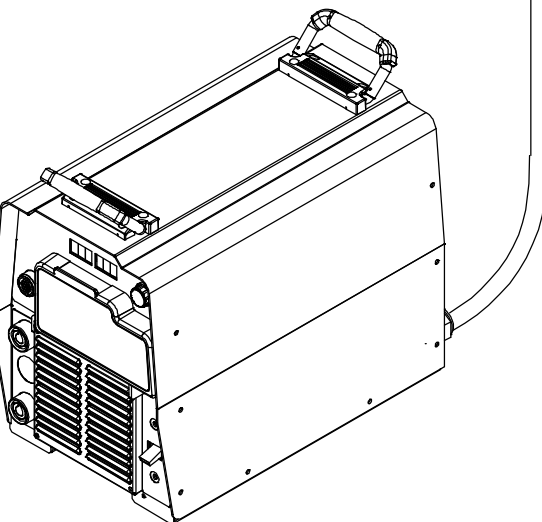

Tools Needed:

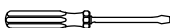

SECTION 5 – GENERAL OPERATION

5-1. Front Panel

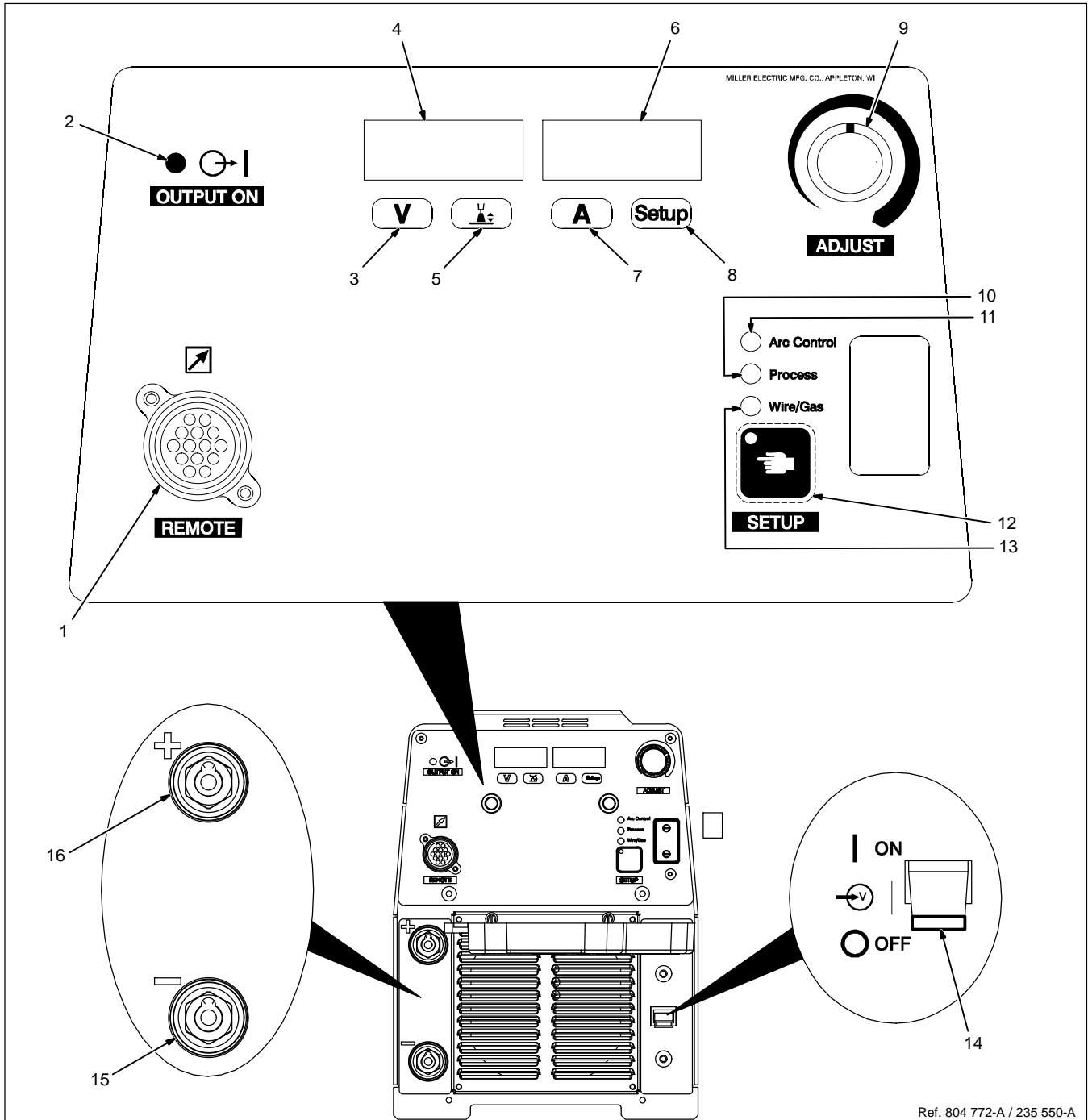

Ref. 804 772-A / 235 550-A

☞ Weld process operation sections describe functionality of the identified items.

- 1 Remote 14 Receptacle
- 2 Output ON Indicator Light
- 3 Volts Indicator
- 4 Left Display
- 5 Arc Length Indicator

- 6 Right Display

☞ The meters display the actual weld output values after arc initiation and remains displayed for approximately three seconds after the arc is broken.

- 7 Amps Indicator
- 8 Setup Indicator
- 9 Adjust Control

- 10 Process Indicator

- 11 Arc Control Indicator
- 12 Setup Button
- 13 Wire/Gas Type Indicator
- 14 Power Switch
- 15 Weld Output Terminal (-)
- 16 Weld Output Terminal (+)

5-2. Configuration Option Menu

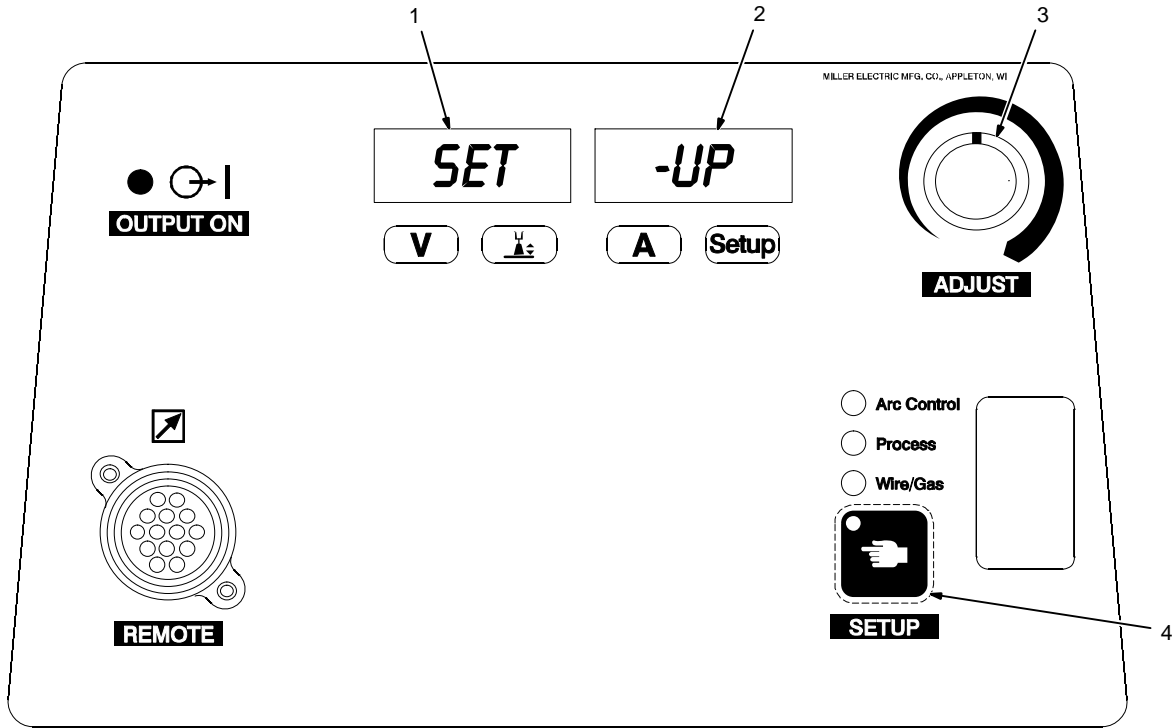

Ref. 235 550-A

- 1 Left Display
- 2 Right Display
- 3 Adjustment Control
- 4 Setup Button

Setup

The Configuration Option Menu provides a

means to customize some machine features for desired operation.

To enter the Configuration Option Menu, hold the Setup Button down during power up while the unit is displaying 8888 on the Left and Right Displays. *SET-UP* will be displayed momentarily.

Configuration options are displayed in the Left Display. Settings are displayed in the Right Display. Settings can be changed by turning the Adjust Control. If a setting does not change when the Adjust Control is turned, the option is not configurable. Pressing the Setup Button moves to the next configuration option.

Notes

5-2 Configuration Option Menu (Continued)

PULS

AUTO

Pulsed MIG Manual/Auto Control

This option sets the Pulsed MIG control as manual (*PULS MAN*) or Auto (*PULS AUTO*) operation. When set to manual operation, the arc length setting on power source and wire speed setting on wire feeder need to be adjusted independently to achieve the desired arc length. When set to Auto operation, once arc length is determined it is not necessary to change the arc length value with changes in wirefeed speed.

The AlumaPower 350 MPa and synergic feeders allow single knob control of the arc. As wirefeed speed is increased or decreased, the pulse parameters increase or decrease matching the power output to the wire speed.

☞ Auto Operation will only work with synergic wire feeders. All other wire feeders will only operate as manual control. Even when Auto is displayed, operation will be manual when any other feeder is connected. See product literature for a list of compatible synergic wire feeders.

PULS

ARC.L

Pulsed MIG Adjustment

This option allows adjusting the Pulsed MIG process in units of Arc Length (*PULS ARC.L*) or preset voltage (*PULS VOLT*).

WFS

IPM

Wire Feed Speed And Wire Diameter Units

WFS IPM:
WFS is displayed in inches per minute
Diameter is displayed in inches

WFS MPM:
WFS is displayed in meters per minute
Diameter is displayed in millimeters

INFO

NO

Revision Information

This option identifies the unit's weld library (*INFO LIB*) and firmware revision (*INFO REV*).

Press the Setup Button while the unit is displaying *INFO LIB* to identify the unit's weld library.

Press the Setup Button while the unit is displaying *INFO REV* to identify the unit's firmware revision.

Pressing the Setup Button while the unit is displaying *INFO NO* will move to the next configuration option.

EXIT

NO

Exit Configuration Option Menu

Press the Setup Button while the unit is displaying *EXIT NO* to return to the first configuration option. Press the Setup Button while the unit is displaying *EXIT YES* to exit the Configuration Option Menu.

*☞ The Configuration Option Menu can be exited at any time by turning the unit off. Only if the unit is turned off after *EXIT NO* is displayed will configuration option changes be saved.*

SECTION 6 – GMAW/GMAW-P

6-1. Typical Connection For Remote Control Feeder GMAW/GMAW-P

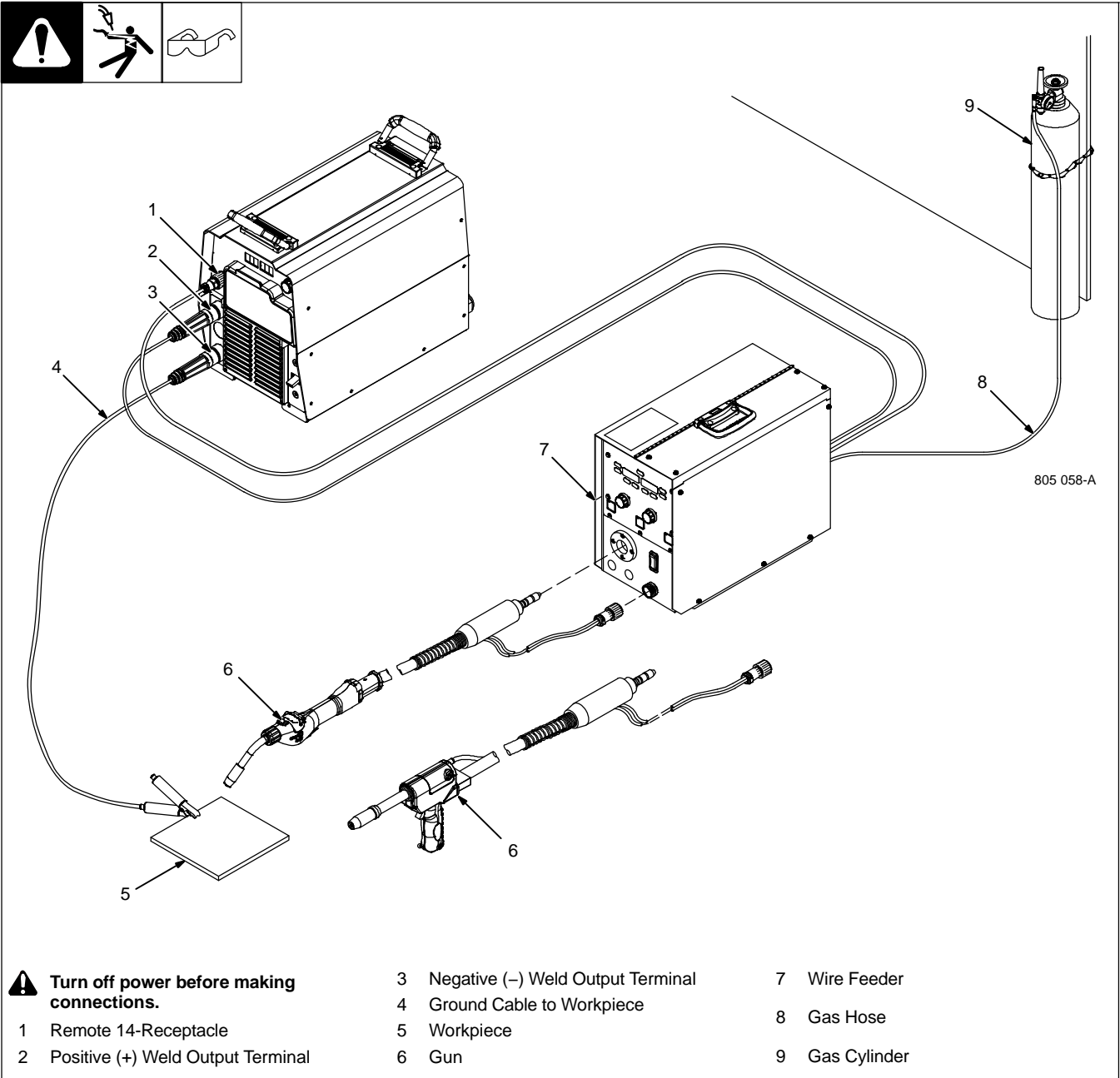

6-2. MIG Welding Mode - GMAW

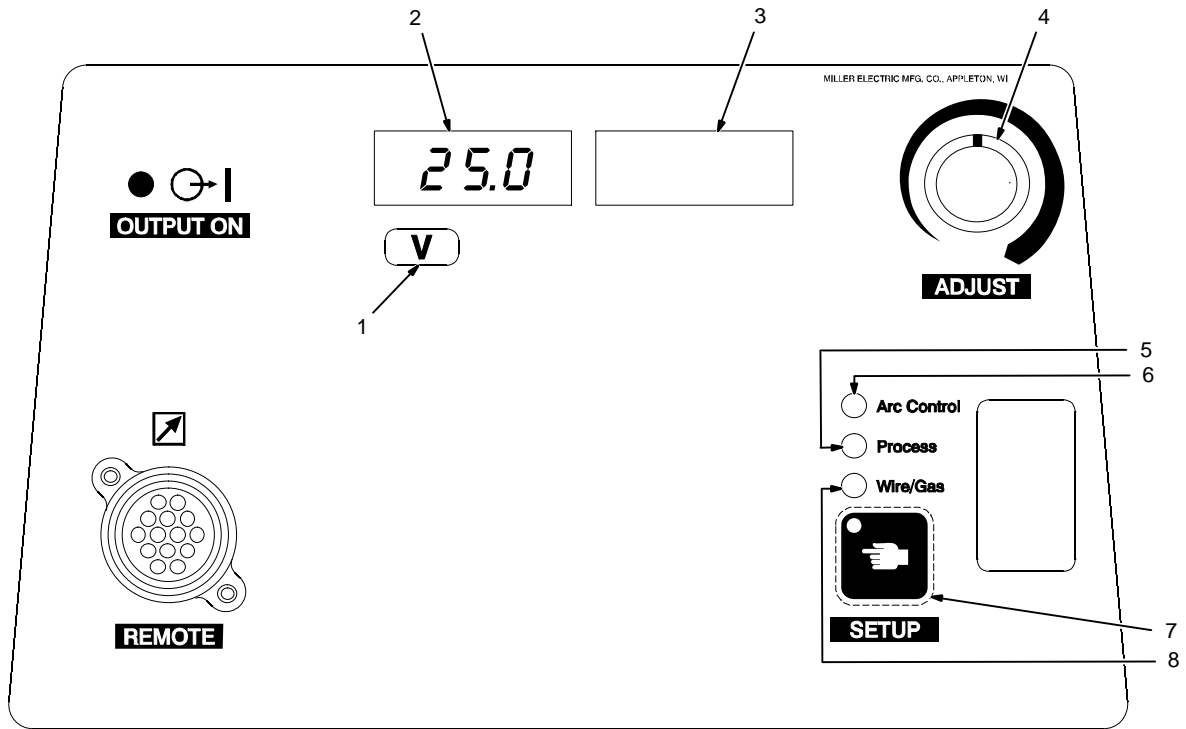

Ref. 235 550-A

⚠ Weld terminals are energized through the remote control in MIG welding mode.

- 1 Volts Indicator
- 2 Left Display
- 3 Right Display
- 4 Adjust Control
- 5 Process Indicator
- 6 Arc Control Indicator
- 7 Setup Button
- 8 Wire/Gas Indicator

Setup

For typical system connections refer to Section 6-1.

Press Setup Button twice. The Process Indicator will be lit. Rotate Adjust Control to select MIG.

Press the Setup Button again. The Wire/Gas Indicator will be lit. The active wire type will appear in the Left and Right Display.

Rotate Adjust Control to select desired wire.

Press the Setup Button again. Wire/Gas Indicator is lit. The active gas type will appear in the Left and Right Display.

Rotate Adjust Control to select desired gas.

Press the Setup Button to confirm the selection. The unit will acknowledge a change of wire and gas information by displaying *PROG LOAD* momentarily.

☞ For best results, select the appropriate Wire and Gas Type to match the actual wire and gas being used. Refer to the MIG – Wire and Gas Selection Table for available wires and gases (see Section 6-3).

Operation

While the Volts Indicator is lit under the Left Display, the Adjust Control is used to set desired preset voltage.

☞ The preset voltage can be adjusted remotely at the wire feeder if the feeder has a voltage control. This voltage control will override the Adjust Control of preset voltage on the welding power source.

Pressing the Setup Button allows adjustment of Arc Control, Wire Type, Gas Type and preset voltage.

Arc Control (Inductance)

Press the Setup Button until the Arc Control Indicator is lit. *INDU* appears on the Left Display, and the corresponding inductance setting appears on the Right Display.

Rotate Adjust Control to select desired inductance setting from 0 to 100. Use lower inductance settings to stiffen the arc and reduce puddle fluidity. Use higher inductance settings to soften the arc and increase puddle fluidity.

Refer to the MIG – Wire and Gas Selection Table (see Section 6-3) for suggested inductance setting for the specific wire and gas being used.

Press the Setup Button to return to adjustment of preset voltage.

☞ Each Wire and Gas Type combination has independent preset voltage and inductance settings. These settings are preserved when the unit is turned off.

6-4. Pulsed MIG Welding Mode - GMAW-P Process

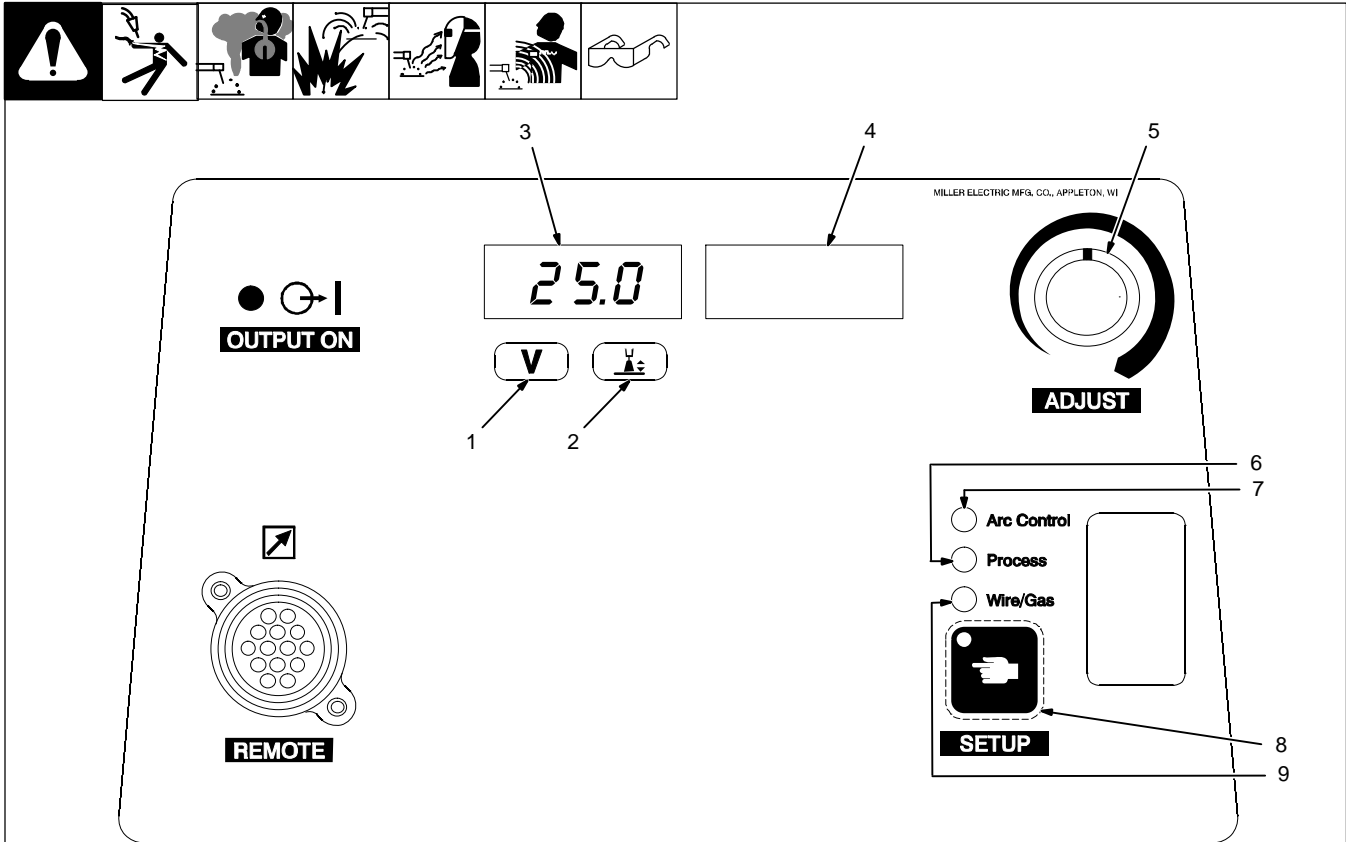

Ref. 235 550-A

⚠ Weld terminals are energized through the remote control in Pulsed MIG welding mode.

- 1 Volts Indicator
- 2 Arc Length Indicator
- 3 Left Display
- 4 Right Display
- 5 Adjust Control
- 6 Process Indicator
- 7 Arc Control Indicator
- 8 Setup Button
- 9 Wire/Gas Indicator

Setup

For typical system connections refer to Section 6-1.

Press Setup Button twice. The Process Indicator will be lit. Rotate Adjust Control to select *PULS*.

Press the Setup Button until the Wire/Gas Indicator is lit. The active wire type will appear in the Left and Right Display.

Rotate Adjust Control to select desired wire.

Press the Setup Button again. Wire/Gas Indicator is lit. The active gas type will appear in the Left and Right Display.

Rotate Adjust Control to select desired gas.

Press the Setup Button again to confirm the selection. The unit will acknowledge a change of wire and gas information by displaying *PROG LOAD* momentarily.

For best results, select the appropriate Wire and Gas Type to match the actual

wire and gas being used. Refer to Pulsed MIG – Wire and Gas Selection Table for available wires and gases (see Section 6-5).

Operation

While the Arc Length Indicator is lit under the Left Display, the Adjust Control is used to set the desired arc length setting.

The arc length will be adjusted remotely at the wire feeder if the feeder has a voltage control. This voltage control will override the Adjust Control of arc length on the welding power source.

Arc Control (SharpArc)

Press the Setup Button until the Arc Control Indicator is lit. *SHRP* appears on the Left Display, and the corresponding SharpArc setting appears on the Right Display.

Rotate Adjust Control to select desired SharpArc setting from 0 to 50, default is 25. Adjusting the SharpArc setting changes the welding arc cone. Lower settings widen the arc cone, increases puddle fluidity and flattens the weld bead appearance.

Higher settings narrow the arc cone, reduces puddle fluidity and crowns the weld bead appearance.

Each Wire and Gas Type combination has independent Arc Length and SharpArc settings. These settings are preserved when the unit is turned off.

Arc Length - Pulsed MIG Manual Control (see Section 5-2)

Arc length corresponds to the level of energy needed to burn off the welding electrode.

As wire feed speed increases, a higher arc length setting is required to burn off the additional wire. The arc length setting appears in the Left Display when the Arc Length Indicator is lit. Arc length can be adjusted from 0 to 100.

After the welding output terminals are energized, but prior to arc initiation, the unit displays the letter "R" and a reference wire speed (IPM) on the Right Display. The reference wire speed can be used as a starting point for the wire speed setting at the feeder. The wire speed and arc length setting can then be further adjusted to achieve the desired arc length.

The Configuration Option Menu (see Section 5-2) can be used to change the arc length setting (0 to 100) to average arc voltage. Average arc voltage can be used as an alternative method to set the Pulsed MIG welding arc with the same parameters (voltage and wire speed) as a conventional MIG arc. Lower voltage settings correspond to tighter arc lengths while higher voltage settings correspond to longer arc lengths. If the voltage mode is selected, the average voltage preset will be displayed on the Left Display with the Volts Indicator lit.

Arc Length - Pulsed MIG Auto Control (see Section 5-2)

In Auto operation the arc length setting is 0-100. The programs have been developed at 50 arc length setting. Increasing or decreasing the arc length setting from 50 will change the arc length. It is not necessary to change the arc length value when changing wire feed speed settings.

6-6. Remote Process Select



This power source can be used with wire feeders that support Remote Process Select. This feature allows the operator to switch the active welding process between MIG and Pulsed MIG at the wire feeder. To determine if the welding system is Remote Process Select capable, connect the wire feeder to the power source and review the power source display variations shown below.

 *When used with an XMT power source, the Process Select knob must be set to Pulsed MIG for Remote Process Select to be active.*

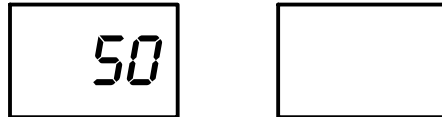

Power Source Display – Wire Feeder with Remote Process Select Not Detected

When the power source Right Display is blank, a wire feeder with Remote Process Select is not detected. Set the active weld process at the power source.



Power Source Display – Wire Feeder with Remote Process Select Detected

When the power source Right Display is MIG, a wire feeder with Remote Process Select is detected and set for MIG operation. The active weld process can **only** be changed at the wire feeder.



Power Source Display – Wire Feeder with Remote Process Select Detected and Set for Pulsed MIG

When the power source Right Display is PULS, a Remote Process Select wire feeder is detected and is set for Pulsed MIG operation. The active weld process can **only** be changed at the wire feeder.

Using a Dual Wire Feeder with Remote Process Select

When using a dual wire feeder with Remote Process Select, different weld programs for the left and right side can be selected. The power source MIG and Pulsed MIG programs for the left side of wire feeder are selected with the left side of the wire feeder active. The power source MIG and Pulsed MIG programs for the right side are selected with the right side of the wire feeder active. When the right side of the wire feeder is active, the power source Right Display will show a decimal point in the lower right hand corner as shown.

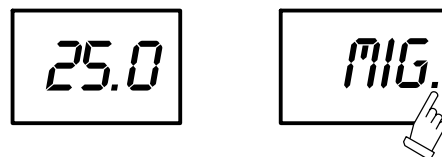

Decimal point indicates wire feeder right side is active.

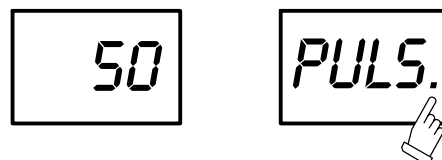

Decimal point indicates wire feeder right side is active.

Power Source Display – Dual Wire Feeder with Right Side Active and Set for MIG

Power Source Display – Dual Wire Feeder with Right Side Active and Set for Pulsed MIG

SECTION 7 – MAINTENANCE & TROUBLESHOOTING

7-1. Routine Maintenance

		Disconnect power before maintaining.		<i>Maintain more often during severe conditions.</i>	
3 Months					
				Replace Damaged Or Unreadable Labels	
				Repair Or Replace Cracked Cables	
		Replace Cracked Torch Body			
				Repair Or Replace Cracked Cables And Cords	
				Clean And Tighten Weld Connections	
6 Months					
		Blow Out Inside			

7-2. Blowing Out Inside Of Unit

<p>⚠ Do not remove case when blowing out inside of unit.</p> <p>To blow out unit, direct airflow through front and back louvers as shown.</p>			
Ref. 803 691-C			

7-3. Help Displays

 All directions are in reference to the front of the unit. All circuitry referred to is located inside the unit.

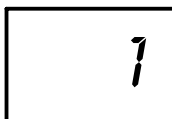

Help 1 Display

Indicates a malfunction in the primary power circuit. If this display is shown, contact a Factory Authorized Service Agent.

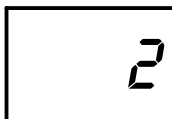

Help 2 Display

Indicates a malfunction in the thermal protection circuitry. If this display is shown, contact a Factory Authorized Service Agent.

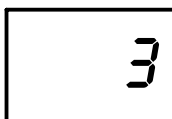

Help 3 Display

Indicates the left side of the unit has overheated. The unit has shut down to allow the fan to cool it (see Section 3-4). Operation will continue when the unit has cooled.

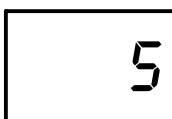

Help 5 Display

Indicates the right side of the unit has overheated. The unit has shut down to allow the fan to cool it (see Section 3-4). Operation will continue when the unit has cooled.

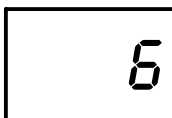

Help 6 Display

Indicates operation at maximum input current. The unit has a maximum allowable input current limit. As the line voltage decreases, the required input current increases. If the line voltage is too low, the output power is limited by the input current. When this limit is reached, the unit automatically reduces output power to continue operation. If this display is shown, have a qualified electrician check the input voltage.

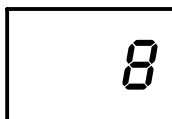

Help 8 Display

Indicates a malfunction in the secondary power circuit of the unit. If this display is shown, contact a Factory Authorized Service Agent.



Help 25 Display

Indicates machine has reached duty cycle limits (see Section 3-4). Unit must be left on to power the fan for cooling. Operation will continue when unit has cooled.

SECTION 8 – ELECTRICAL DIAGRAM

	WARNING
	<ul style="list-style-type: none"> Do not touch live electrical parts. Disconnect input power or stop engine before servicing. Do not operate with covers removed. Have only qualified persons install, use, or service this unit.
ELECTRIC SHOCK HAZARD	

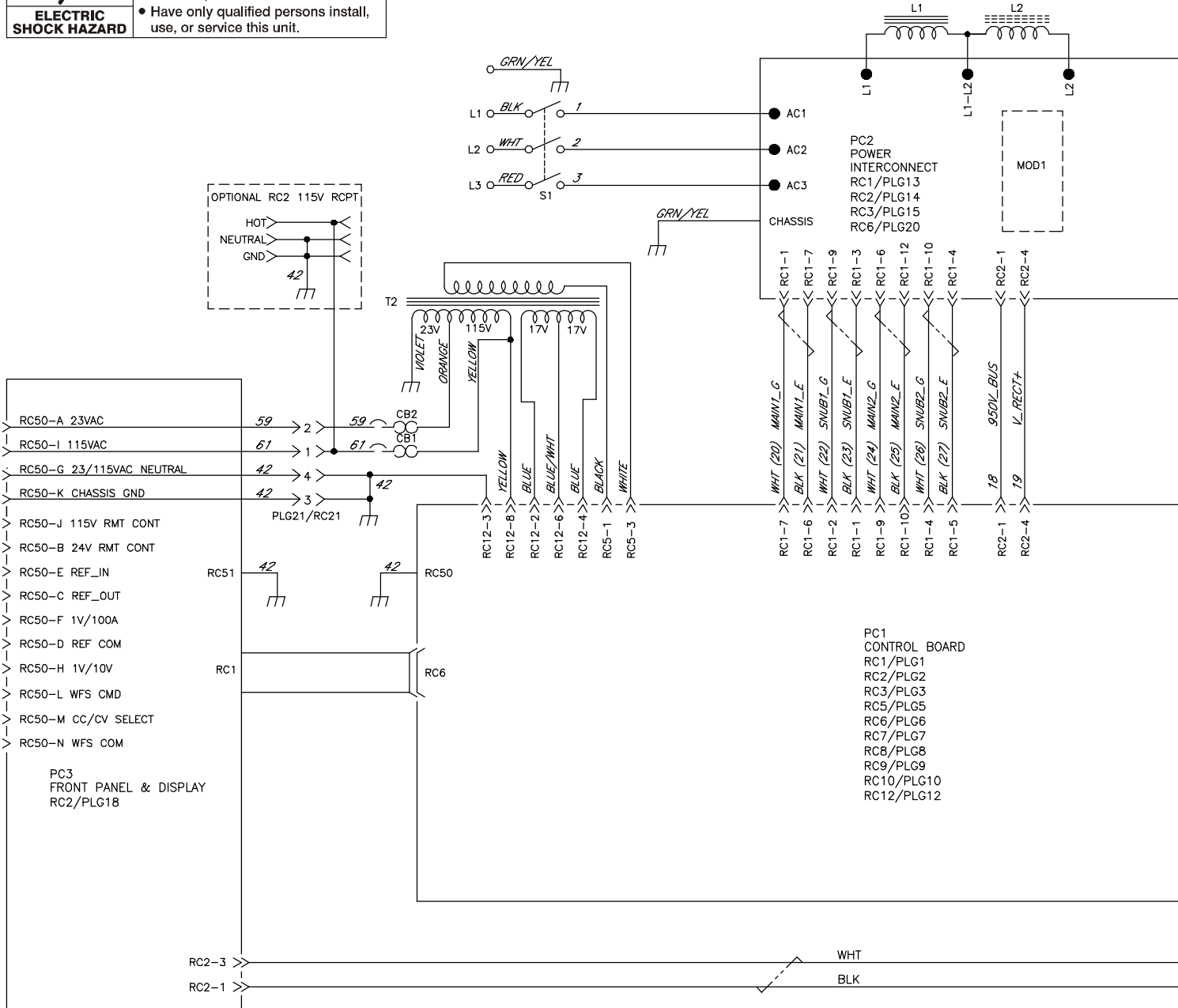
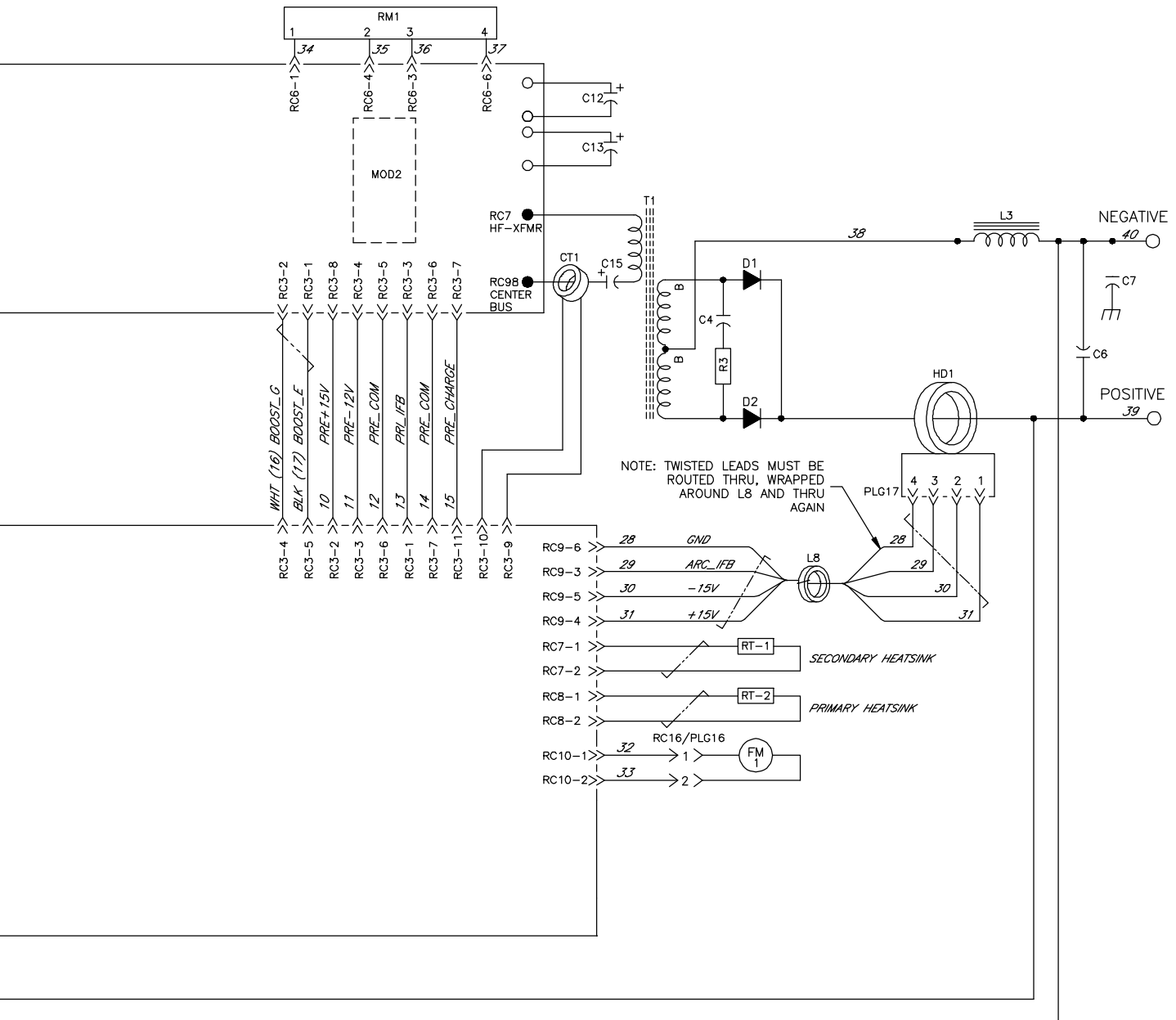

Figure 8-1. Circuit Diagram



SECTION -9 - PARTS LIST

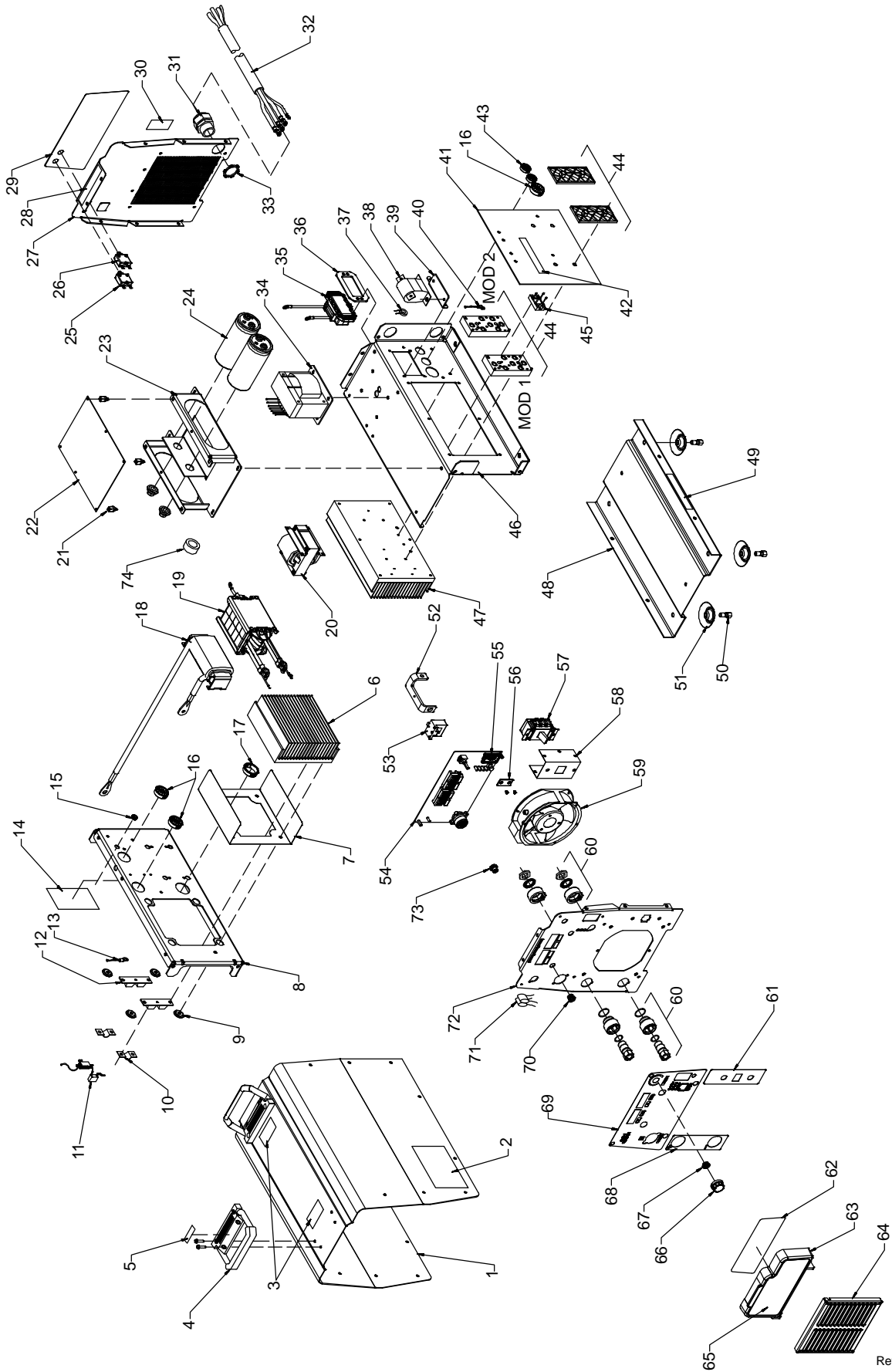

Figure 9-1. Parts Assembly

Item No.	Dia. Mkgs.	Part No.	Description	Quantity
----------	------------	----------	-------------	----------

Figure 9-1. Parts Assembly

...	1	216 034	.. Wrapper (Includes Insulators and Safety Labels)	1
.....		175 256	.. Insulator, Side Rh (Not Shown)	1
.....		178 551	.. Insulator, Side (Not Shown)	1
...	2	134 327	.. Label, Warning General Precautionary Static & Wire Feed	2
...	3	138 442	.. Label, Caution Falling Equip Can Cause Injury	2
...	4	195 585	.. Handle, Rubberized Carrying	2
...	5	135 483	.. Label, Important Remove These Two Handle Screws	2
...	6	225 097	.. Heat Sink, Lh Rect	1
...	7	211 503	.. Insulator, Heat Sink	1
...	8	+212 207	.. Windtunnel, Lh	1
...	9	196 355	.. Insulator, Screw	4
...	10	199 840	.. Bus Bar, Diode	2
...	11	R3/C4	233 052 .. Resistor/Capacitor	1
...	12	D1,D2	201 531 .. Kit, Diode Power Module	2
...	13	RT1	199 798 .. Thermistor, NTC 30K Ohm @ 25 Deg C 18In Lead	1
...	14	227 127	.. Label, Warning Electric Shock/Exploding Parts	1
...	15	107 983	.. Blank, Snap-in Nyl .500 Mtg Hole Black	1
...	16	179 276	.. Bushing, Snap-In Nyl 1.000 Id X 1.375 Mtg Hole Cent	3
...	17	170 647	.. Bushing, Snap-In Nyl 1.312 Id X 1.500 Mtg Hole	1
...	18	L3	212 150 .. Inductor, Output	1
...	19	T1	228 382 .. XFMR, HF Litz/Litz	1
...	20	L1	212 091 .. Inductor, Input	1
...	21	083 147	.. Grommet, Scr No 8/10 Panel Hole .312 Sq .500 High	4
...	22	PC1	242 812 .. Circuit Card Assy, Control W/Program	1
...	22	PC1	◆242 341 .. Circuit Card Assy, Control/Aux Power W/Program	1
.....		216 113	.. Stand-Off Support, PC Card .187 Dia W/P&I .375	2
.....		PLG1	115 091 .. Housing Plug+Pins (Service Kit) RC1	1
.....		PLG2	201 665 .. Housing Plug+Pins (Service Kit) RC2	1
.....		PLG3	131 056 .. Housing Plug+Pins (Service Kit) RC3	1
.....		PLG5	131 204 .. Housing Plug+Pins (Service Kit) RC5	1
.....		PLG7	131 054 .. Housing Plug+Pins (Service Kit) RC7	1
.....		PLG8	131 054 .. Housing Plug+Pins (Service Kit) RC8	1
.....		PLG9	115 093 .. Housing Plug+Pins (Service Kit) RC9	1
.....		PLG10	115 094 .. Housing Plug+Pins (Service Kit) RC10	1
.....		PLG12	115 092 .. Housing Plug+Pins (Service Kit) RC12	1
...	23	212 072	.. Bracket, Mtg Capacitor/PC Board	1
...	24	C12,13	219 930 .. Kit, Capacitor Elctlt Replacement	1
.....		RC2	◆604 176 .. Rcpt, Str Dx Grd 2P3W 15A 125V *5-15R	1
...	25	CB2	083 432 .. Supplementary Protector, Man Reset 1P 10A 250VAC Frict	1
...	26	CB1	089 807 .. Supplementary Protector, Man Reset 1P 2.5A 250VAC Frict	1
...	26	CB1	◆083 432 .. Supplementary Protector, Man Reset 1P 10A 250VAC Frict	1
...	27	+212 071	.. Panel, Rear Standard	1
...	27	◆+212 202	.. Panel, Rear	1
...	28	126 026	.. Label, Warning Electric Shock Can Kill Significant	1

+When ordering a component originally displaying a precautionary label, the label should also be ordered.

◆Part of 115V Aux Power Option.

BE SURE TO PROVIDE MODEL AND SERIAL NUMBER WHEN ORDERING REPLACEMENT PARTS.

Item No.	Dia. Mkgs.	Part No.	Description	Quantity
29			Nameplate, Rear (Order by Model and Serial Number)	1
29		◆	Nameplate, Rear Aux (Order by Model and Serial Number)	1
		◆217 297	Cover, Receptacle Weatherproof Duplex Rcpt	1
30		217 480	Label, Warning Incorrect Connections	1
31		215 980	Bushing, Strain Relief .709/.984 Id X1.375 Mtg Hole	1
32		219 487	Cable, Power 12 Ft 8Ga 4C (Non-Stripped End)	1
33		234 126	Nut, Conduit 1.000 Npt Knurled	1
34	T2	211 109	XFMR, Control 665V 336Va Syn Aux Pwr	1
34	T2	◆211 968	XFMR, Control Toroidal 665 VAC Pri 1536 Va 60 Hz	1
		◆212 947	Plate, Mtg Toroid XFMR	1
35	L2	218 018	Inductor, Pre-Regulator	1
36		218 566	Gasket, Inductor Mounting	1
37	CT1	196 231	XMFR, Current Sensing 200/1	1
38	C15	196 143	Capacitor, Polyp Met Film 16. Uf 400 VAC 10%	1
39		216 117	Bracket, Mtg Capacitor Series	1
40	RT2	199 798	Thermistor, Ntc 30K Ohm @ 25 Deg C 18in Lead	1
41	PC2	225 442	Circuit Card Assy, Interconnect W/Label & Clips (Includes)	1
42		126 026	Label, Warning Electric Shock Can Kill Significant	1
		223 343	Clip, Wire Stdf .40-.50 Bndl .156Hole .031-.078Thk	2
43		153 403	Bushing, Snap-In Nyl .750 Id X 1.000 Mtg Hole Cent	2
44		217 625	Kit, Input/Pre-Regulator And Inverter Module (Includes)	1
			MOD 1, SKiip 83 HEC	1
			MOD 2, SKiip 83 EC	1
	PLG13	130 203	Housing Plug+Pins (Service Kit) RC1	1
	PLG14	201 665	Housing Plug+Pins (Service Kit) RC2	1
	PLG15	115 092	Housing Plug+Pins (Service Kit) RC3	1
	PLG20	115 093	Housing Plug+Pins (Service Kit) RC6	1
45	RM1	205 751	Module, Power Resistor W/Plug	1
46		212 206	Windtunnel, Rh	1
47		196 330	Heat Sink, Power Module	1
48		+175 132	Base	1
49		153 178	Label, Warning Exploding Parts Can Serious Injury	1
50		176 736	Screw, Mtg Foot	4
51		229 325	Foot, Mtg Unit	4
52		212 074	Bus Bar, Output	1
53	HD1	182 918	Transducer, Current 400A Module Supply V +/- 15V	1
54	PC3	243 610	Circuit Card Assy, Front Panel & Display W/Program	1
	PLG18	131 204	Housing Plug+Pins (Service Kit) RC2	1
	RC50	210 233	Rcpt, W/Pins (Service Kit)	1
	PLG21	212 088	Plug, W/Leads	1
	RC21	167 640	Housing Plug+Pins (Service Kit)	1
55		230 943	Enclosure, Connector DB-9	1
56		230 944	Cover, Enclosure Connector DB-9	1
57	S1	244 920	Switch, Tgl 3pst 40a 600vac Scr Term Wide Tgl	1
58		176 226	Insulator, Switch Power	1
59	FM1	196 313	Fan, Muffin 115V 50/60Hz 3000 RPM 6.378 Mtg Holes	1
	PLG16	131 054	Housing Plug+Pins (Service Kit)	1
	RC16	135 635	Housing Plug+Pins (Service Kit)	1

+When ordering a component originally displaying a precautionary label, the label should also be ordered.

◆Part of 115V Aux Power Option.

BE SURE TO PROVIDE MODEL AND SERIAL NUMBER WHEN ORDERING REPLACEMENT PARTS.

Item No.	Dia. Mkgs.	Part No.	Description	Quantity
----------	------------	----------	-------------	----------

Figure 9-1. Parts Assembly (Continued)

... 60		208 967	.. Rcpt Assy, Tw Lk Insul Fem (Dinse Type) 50/70 Series (Includes)	... 2
		208 968	... Rcpt, Tw Lk Insul W/O-Ring	1
		185 712	... Insulator, Bulkhead Front	1
		185 713	... Insulator, Bulkhead Rear	1
		185 714	... Washer, Tooth 22Mmid X 31.5Mmod 1.310-1Mmt Intern	1
		185 717	... Nut, M20-1.5 1.00Hex .19H Brs Locking	1
		185 718	... O-Ring, 0.989 Id X 0.070 H	1
		186 228	... O-Ring, 0.739 Id X 0.070 H	1
... 61			Nameplate, Power (Order by Model and Serial Number)	1
... 62		240 874	.. Label, Process	1
... 63		218 041	.. Door, W/Quick Access Ball Fasteners	1
... 64		175 138	.. Box, Louver	1
... 65			Label, (Order by Model and Serial Number)	1
... 66		174 991	.. Knob, Pointer 1.250 Dia X .250 Id W/Spring Clip-.21	1
... 67		231 469	.. Nut, 500-28 .69Hex .28H Brs Conical Knurl	1
... 68			Nameplate, Connection (Order by Model and Serial Number)	1
... 69			Nameplate (Order by Model and Serial Number)	1
... 70		216 112	.. Fastener, Panel Receptacle Quick Access	2
... 71	C6,7	214 749	.. Capacitor Assy, W/Plug And Leads (Voltage Feedback)	1
... 72		235 549	.. Panel, Front W/Knockout	1
... 73		231 470	.. Nut, Adapter Encoder Shaft Mtg 375-32 To 500-28	1
... 74	L8	241 027	.. Core, Toroidal	1

+When ordering a component originally displaying a precautionary label, the label should also be ordered.

◆Part of 115V Aux Power Option.

BE SURE TO PROVIDE MODEL AND SERIAL NUMBER WHEN ORDERING REPLACEMENT PARTS.

Notes

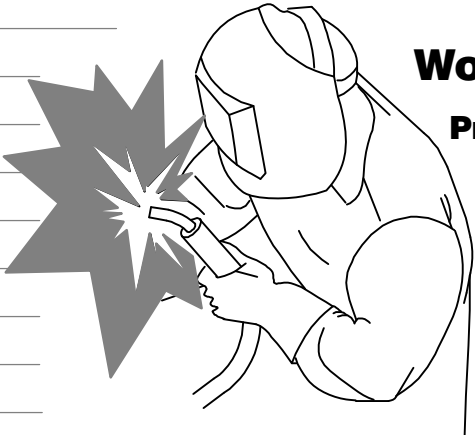

Work like a Pro!

Pros weld and cut safely. Read the safety rules at the beginning of this manual.

TRUE BLUE[®]

WARRANTY

Effective January 1, 2011

(Equipment with a serial number preface of MB or newer)

This limited warranty supersedes all previous Miller warranties and is exclusive with no other guarantees or warranties expressed or implied.

Warranty Questions?

Call
1-800-4-A-MILLER
for your local
Miller distributor.

Your distributor also gives
you ...

Service

You always get the fast,
reliable response you
need. Most replacement
parts can be in your
hands in 24 hours.

Support

Need fast answers to the
tough welding questions?
Contact your distributor.
The expertise of the
distributor and Miller is
there to help you, every
step of the way.

LIMITED WARRANTY – Subject to the terms and conditions below, Miller Electric Mfg. Co., Appleton, Wisconsin, warrants to its original retail purchaser that new Miller equipment sold after the effective date of this limited warranty is free of defects in material and workmanship at the time it is shipped by Miller. THIS WARRANTY IS EXPRESSLY IN LIEU OF ALL OTHER WARRANTIES, EXPRESS OR IMPLIED, INCLUDING THE WARRANTIES OF MERCHANTABILITY AND FITNESS.

Within the warranty periods listed below, Miller will repair or replace any warranted parts or components that fail due to such defects in material or workmanship. Miller must be notified in writing within thirty (30) days of such defect or failure, at which time Miller will provide instructions on the warranty claim procedures to be followed.

Miller shall honor warranty claims on warranted equipment listed below in the event of such a failure within the warranty time periods. All warranty time periods start on the delivery date of the equipment to the original end-user purchaser, and not to exceed one year after the equipment is shipped to a North American distributor or eighteen months after the equipment is shipped to an International distributor.

1. 5 Years Parts — 3 Years Labor
 - * Original main power rectifiers only to include SCRs, diodes, and discrete rectifier modules
2. 3 Years — Parts and Labor
 - * Engine Driven Welding Generators
(NOTE: Engines are warranted separately by the engine manufacturer.)
 - * Inverter Power Sources (Unless Otherwise Stated)
 - * Plasma Arc Cutting Power Sources
 - * Process Controllers
 - * Semi-Automatic and Automatic Wire Feeders
 - * Smith 30 Series Flowgauge and Flowmeter Regulators (No Labor)
 - * Transformer/Rectifier Power Sources
 - * Water Coolant Systems (Integrated)
3. 2 Years — Parts
 - * Auto-Darkening Helmet Lenses (No Labor)
4. 1 Year — Parts and Labor Unless Specified
 - * Automatic Motion Devices
 - * CoolBelt and CoolBand Blower Unit (No Labor)
 - * External Monitoring Equipment and Sensors
 - * Field Options
(NOTE: Field options are covered for the remaining warranty period of the product they are installed in, or for a minimum of one year — whichever is greater.)
 - * Flowgauge and Flowmeter Regulators (No Labor)
 - * RFCS Foot Controls (Except RFCS-RJ45)
 - * Fume Extractors
 - * HF Units
 - * ICE Plasma Cutting Torches (No Labor)
 - * Induction Heating Power Sources, Coolers, and Electronic Controls/Recorders
 - * Load Banks
 - * Motor Driven Guns (w/exception of Spoolmate Spoolguns)
 - * PAPR Blower Unit (No Labor)
 - * Positioners and Controllers
 - * Racks
 - * Running Gear/Trailers
 - * Spot Welders
 - * Subarc Wire Drive Assemblies
 - * Water Coolant Systems (Non-Integrated)
 - * Weldcraft-Branded TIG Torches (No Labor)
 - * Wireless Remote Foot/Hand Controls and Receivers
 - * Work Stations/Weld Tables (No Labor)

5. 6 Months — Parts
 - * Batteries
 - * Bernard Guns (No Labor)
 - * Tregaskiss Guns (No Labor)

6. 90 Days — Parts
 - * Accessory (Kits)
 - * Canvas Covers
 - * Induction Heating Coils and Blankets, Cables, and Non-Electronic Controls
 - * M-Guns
 - * MIG Guns and Subarc (SAW) Guns
 - * Remote Controls and RFCS-RJ45
 - * Replacement Parts (No labor)
 - * Roughneck Guns
 - * Spoolmate Spoolguns

Miller's True Blue[®] Limited Warranty shall not apply to:

1. **Consumable components; such as contact tips, cutting nozzles, contactors, brushes, relays, work station table tops and welding curtains, or parts that fail due to normal wear. (Exception: brushes and relays are covered on all engine-driven products.)**
2. Items furnished by Miller, but manufactured by others, such as engines or trade accessories. These items are covered by the manufacturer's warranty, if any.
3. Equipment that has been modified by any party other than Miller, or equipment that has been improperly installed, improperly operated or misused based upon industry standards, or equipment which has not had reasonable and necessary maintenance, or equipment which has been used for operation outside of the specifications for the equipment.

MILLER PRODUCTS ARE INTENDED FOR PURCHASE AND USE BY COMMERCIAL/INDUSTRIAL USERS AND PERSONS TRAINED AND EXPERIENCED IN THE USE AND MAINTENANCE OF WELDING EQUIPMENT.

In the event of a warranty claim covered by this warranty, the exclusive remedies shall be, at Miller's option: (1) repair; or (2) replacement; or, where authorized in writing by Miller in appropriate cases, (3) the reasonable cost of repair or replacement at an authorized Miller service station; or (4) payment of or credit for the purchase price (less reasonable depreciation based upon actual use) upon return of the goods at customer's risk and expense. Miller's option of repair or replacement will be F.O.B., Factory at Appleton, Wisconsin, or F.O.B. at a Miller authorized service facility as determined by Miller. Therefore no compensation or reimbursement for transportation costs of any kind will be allowed.

TO THE EXTENT PERMITTED BY LAW, THE REMEDIES PROVIDED HEREIN ARE THE SOLE AND EXCLUSIVE REMEDIES. IN NO EVENT SHALL MILLER BE LIABLE FOR DIRECT, INDIRECT, SPECIAL, INCIDENTAL OR CONSEQUENTIAL DAMAGES (INCLUDING LOSS OF PROFIT), WHETHER BASED ON CONTRACT, TORT OR ANY OTHER LEGAL THEORY.

ANY EXPRESS WARRANTY NOT PROVIDED HEREIN AND ANY IMPLIED WARRANTY, GUARANTY OR REPRESENTATION AS TO PERFORMANCE, AND ANY REMEDY FOR BREACH OF CONTRACT TORT OR ANY OTHER LEGAL THEORY WHICH, BUT FOR THIS PROVISION, MIGHT ARISE BY IMPLICATION, OPERATION OF LAW, CUSTOM OF TRADE OR COURSE OF DEALING, INCLUDING ANY IMPLIED WARRANTY OF MERCHANTABILITY OR FITNESS FOR PARTICULAR PURPOSE, WITH RESPECT TO ANY AND ALL EQUIPMENT FURNISHED BY MILLER IS EXCLUDED AND DISCLAIMED BY MILLER.

Some states in the U.S.A. do not allow limitations of how long an implied warranty lasts, or the exclusion of incidental, indirect, special or consequential damages, so the above limitation or exclusion may not apply to you. This warranty provides specific legal rights, and other rights may be available, but may vary from state to state.

In Canada, legislation in some provinces provides for certain additional warranties or remedies other than as stated herein, and to the extent that they may not be waived, the limitations and exclusions set out above may not apply. This Limited Warranty provides specific legal rights, and other rights may be available, but may vary from province to province.





Owner's Record

Please complete and retain with your personal records.

Model Name

Serial/Style Number

Purchase Date

(Date which equipment was delivered to original customer.)

Distributor

Address

City

State

Zip



For Service

Contact a **DISTRIBUTOR** or **SERVICE AGENCY** near you.

Always provide Model Name and Serial/Style Number.

Contact your Distributor for:

Welding Supplies and Consumables

Options and Accessories

Personal Safety Equipment

Service and Repair

Replacement Parts

Training (Schools, Videos, Books)

Technical Manuals (Servicing Information and Parts)

Circuit Diagrams

Welding Process Handbooks

To locate a Distributor or Service Agency visit www.millerwelds.com or call 1-800-4-A-Miller

Contact the Delivering Carrier to:

File a claim for loss or damage during shipment.

For assistance in filing or settling claims, contact your distributor and/or equipment manufacturer's Transportation Department.

Miller Electric Mfg. Co.

An Illinois Tool Works Company
1635 West Spencer Street
Appleton, WI 54914 USA

International Headquarters—USA

USA Phone: 920-735-4505 Auto-Attended
USA & Canada FAX: 920-735-4134
International FAX: 920-735-4125

For International Locations Visit
www.MillerWelds.com

