

Owner's Manual

2020 NSX



WARNING

California Proposition 65 Warning

Operating, servicing and maintaining a passenger vehicle or off-highway motor vehicle can expose you to chemicals including engine exhaust, carbon monoxide, phthalates, and lead, which are known to the State of California to cause cancer and birth defects or other reproductive harm. To minimize exposure, avoid breathing exhaust, do not idle the engine except as necessary, service your vehicle in a well-ventilated area and wear gloves or wash your hands frequently when servicing your vehicle. For more information go to www.P65Warnings.ca.gov/passenger-vehicle.

Event Data Recorders

This vehicle is equipped with an event data recorder (EDR).

The main purpose of an EDR is to record, in certain crash or near crash-like situations, such as an air bag deployment or hitting a road obstacle, data that will assist in understanding how a vehicle's systems performed. **The EDR is designed to record data related to vehicle dynamics and safety systems for a short period of time, typically 30 seconds or less. The EDR in this vehicle is designed to record such data as:**

- **How various systems in your vehicle were operating;**
- **Whether or not the driver and passenger safety belts were buckled/fastened;**

- **How far (if at all) the driver was depressing the accelerator and/or brake pedal; and,**
- **How fast the vehicle was traveling.**

These data can help provide a better understanding of the circumstances in which crashes and injuries occur. NOTE: EDR data are recorded by your vehicle only if a non-trivial crash situation occurs; no data are recorded by the EDR under normal driving conditions and no personal data (e.g., name, gender, age, and crash location) are recorded. However, other parties, such as law enforcement, could combine the EDR data with the type of personally identifying data routinely acquired during a crash investigation.

To read data recorded by an EDR, special equipment is required, and access to the vehicle or the EDR is needed. In addition to the vehicle manufacturer, other parties, such as law enforcement, that have the special equipment, can read the information if they have access to the vehicle or the EDR.

The data belongs to the vehicle owner and may not be accessed by anyone else except as legally required or with the permission of the vehicle owner.

Service Diagnostic Recorders

This vehicle is equipped with service-related devices that record information about powertrain performance. The data can be used to verify emissions law requirements and/or help technicians diagnose and solve service problems. It may also be combined with data from other sources for research purposes, but it remains confidential. Some diagnostic and maintenance information is uploaded to Acura upon vehicle start up.

California Perchlorate Contamination Prevention Act

The airbags, seat belt tensioners, and CR type batteries in this vehicle may contain perchlorate materials - special handling may apply. See www.dtsc.ca.gov/hazardouswaste/perchlorate/

As you read this manual, you will find information that is preceded by a **NOTICE** symbol. This information is intended to help you avoid damage to your vehicle, other property, or the environment.

Software End User License Agreement

Your vehicle comes equipped with software, which is governed by the End User License Agreement in Owner's Manual, and which contains a binding arbitration clause. Please refer to the End User License Agreement for the terms and conditions governing your use of the installed software, as well as the applications, services, functions, and content provided through the software. Your use of the installed software will serve as your consent to the terms and conditions of the End User License Agreement.

You may opt out within 30 days of your initial use of the Software by sending a signed, written notice to ACURA at American Honda Motor Co., Inc. Acura Client Relations Mail Stop 100-5E-8F, 1919 Torrance Blvd. Torrance, CA 90501-2746.

Privacy Notice

This vehicle may share location and usage information. To manage this setting, visit www.acuralink.com/vehicle-data-choices.

A Few Words About Safety

Your safety, and the safety of others, is very important. And operating this vehicle safely is an important responsibility.

To help you make informed decisions about safety, we have provided operating procedures and other information on labels and in this manual. This information alerts you to potential hazards that could hurt you or others.

Of course, it is not practical or possible to warn you about all the hazards associated with operating or maintaining your vehicle. You must use your own good judgment.

You will find this important safety information in a variety of forms, including:

- **Safety Labels** - on the vehicle.
- **Safety Messages** - preceded by a safety alert symbol  and one of three signal words: **DANGER**, **WARNING**, or **CAUTION**. These signal words mean:

 **DANGER**

You **WILL** be **KILLED** or **SERIOUSLY HURT** if you don't follow instructions.

 **WARNING**

You **CAN** be **KILLED** or **SERIOUSLY HURT** if you don't follow instructions.

 **CAUTION**

You **CAN** be **HURT** if you don't follow instructions.

- **Safety Headings** - such as Important Safety Precautions.
- **Safety Section** - such as Safe Driving.
- **Instructions** - how to use this vehicle correctly and safely.

This entire book is filled with important safety information - please read it carefully.

This owner's manual should be considered a permanent part of the vehicle and should remain with the vehicle when it is sold.

This owner's manual covers all models of your vehicle. You may find descriptions of equipment and features that are not on your particular model.

Images throughout this owner's manual (including the front cover) represent features and equipment that are available on some, but not all, models. Your particular model may not have some of these features.

This owner's manual is for vehicles sold in the United States and Canada.

The information and specifications included in this publication were in effect at the time of approval for printing. Honda Motor Co., Ltd. reserves the right, however, to discontinue or change specifications or design at any time without notice and without incurring any obligation.

➤ Safe Driving P. 31

For Safe Driving P. 32

Seat Belts P. 36

Airbags P. 43

➤ Instrument Panel P. 69

Indicators P. 70

Gauges and Displays P. 95

➤ Controls P. 103

Clock P. 104

Locking and Unlocking the Doors P. 105

Operating the Switches Around the Steering Wheel P. 127

Climate Control System P. 155

➤ Features P. 161

Audio System P. 162

Audio System Basic Operation P. 166

Customized Features P. 244

HomeLink® Universal Transceiver P. 267

➤ Driving P. 309

Before Driving P. 310

Towing a Trailer P. 320

Multi-View Rear Camera P. 369

➤ Maintenance P. 375

Before Performing Maintenance P. 376

Maintenance Minder™ P. 379

Checking and Maintaining Wiper Blades P. 404

Climate Control System Maintenance P. 419

➤ Handling the Unexpected P. 431

Tools P. 432

If a Tire Goes Flat P. 433

Overheating P. 450

Indicator, Coming On/Blinking P. 452

When You Cannot Open the Hatch P. 464

➤ Information P. 467

Specifications P. 468

Identification Numbers P. 470

Emissions Testing P. 473

Warranty Coverages P. 475

Contents

Child Safety P. 58

Exhaust Gas Hazard P. 67

Safety Labels P. 68

Opening and Closing the Hatch P. 119
Adjusting the Mirrors P. 141

Security System P. 122
Adjusting the Seats P. 144

Opening and Closing the Windows P. 125
Interior Convenience Items P. 149

Audio Error Messages P. 223
Bluetooth® HandsFreeLink® P. 270

General Information on the Audio System P. 226
AcuraLink®* P. 304

When Driving P. 321
Refueling P. 371

Braking P. 357
Fuel Economy and CO₂ Emissions P. 373

Parking Your Vehicle P. 364

Maintenance Under the Hood and Hatch P. 385
Checking and Maintaining Tires P. 407
Cleaning P. 420

12-Volt Battery P. 417
Accessories and Modifications P. 426

Replacing Light Bulbs P. 401
Remote Transmitter Care P. 418
Storage P. 428

Power System Won't Start P. 445
Fuses P. 457
Refueling P. 465

Jump Starting P. 448
Emergency Towing P. 462 When You Cannot Unlock the Fuel Fill Door P. 463

Devices that Emit Radio Waves P. 471
Authorized Manuals P. 477

Reporting Safety Defects P. 472
Client Service Information P. 478

Quick Reference Guide P. 4

Safe Driving P. 31

Instrument Panel P. 69

Controls P. 103

Features P. 161

Driving P. 309

Maintenance P. 375

Handling the Unexpected P. 431

Information P. 467

Index P. 479

Visual Index

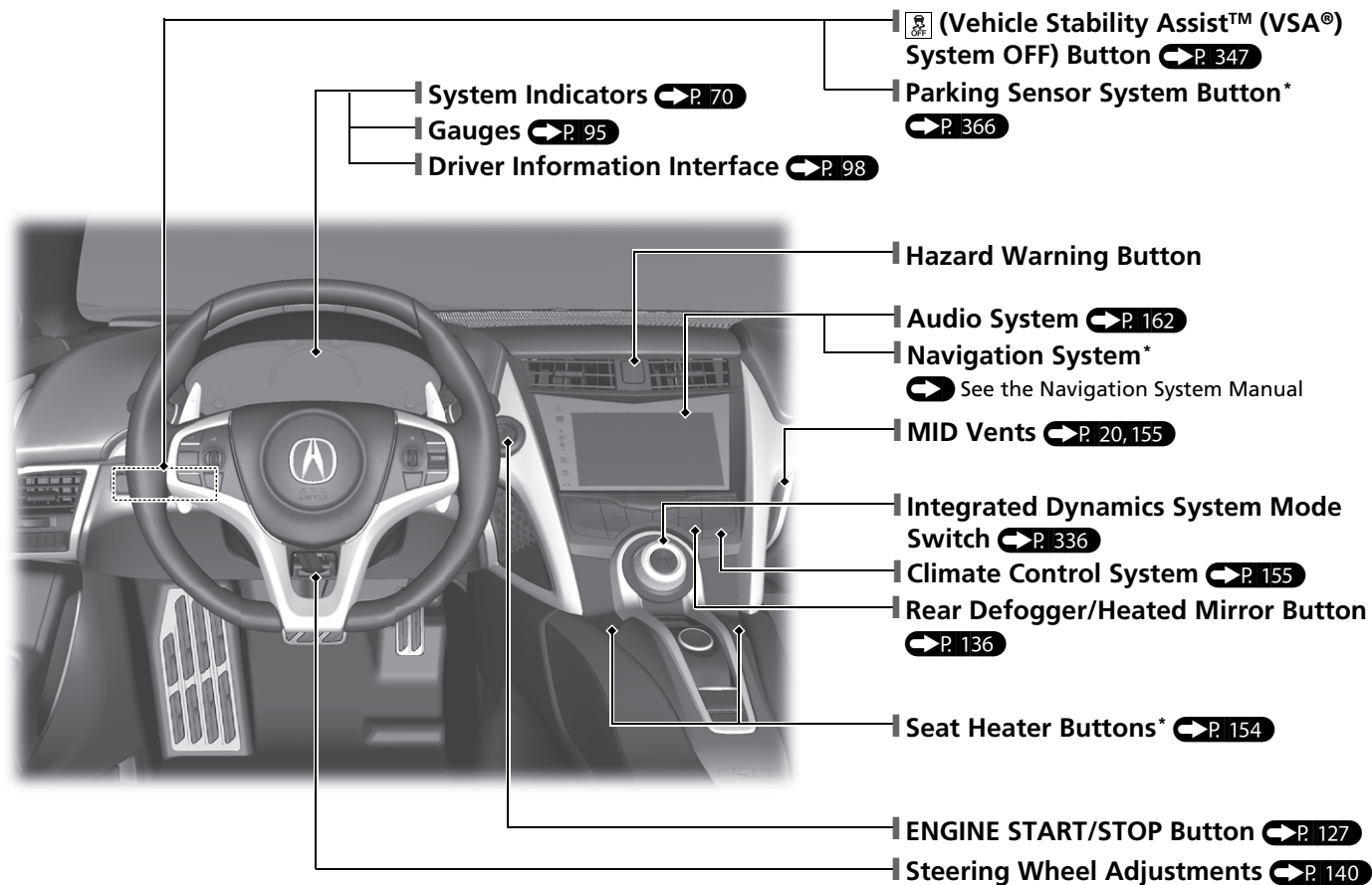

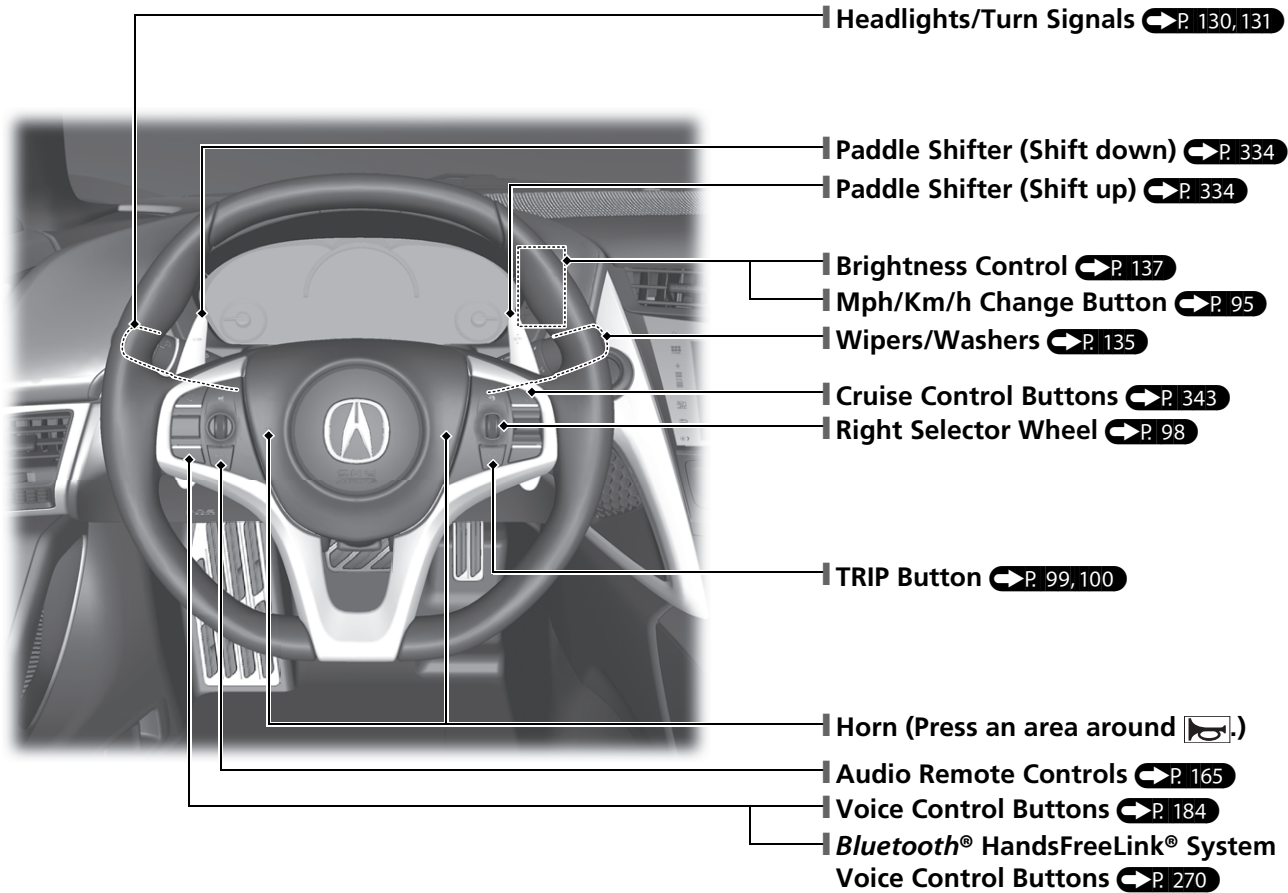

Visual Index

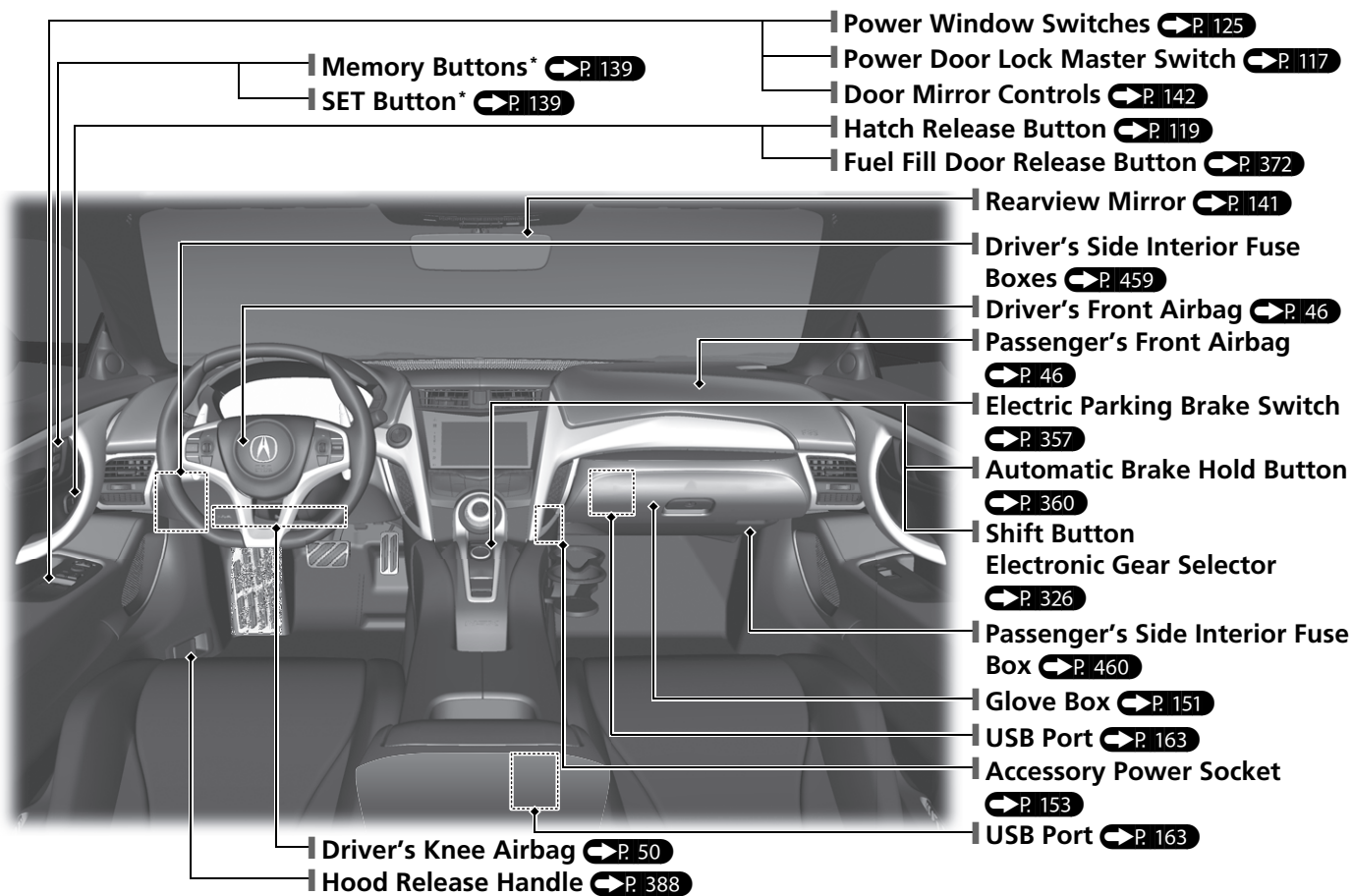

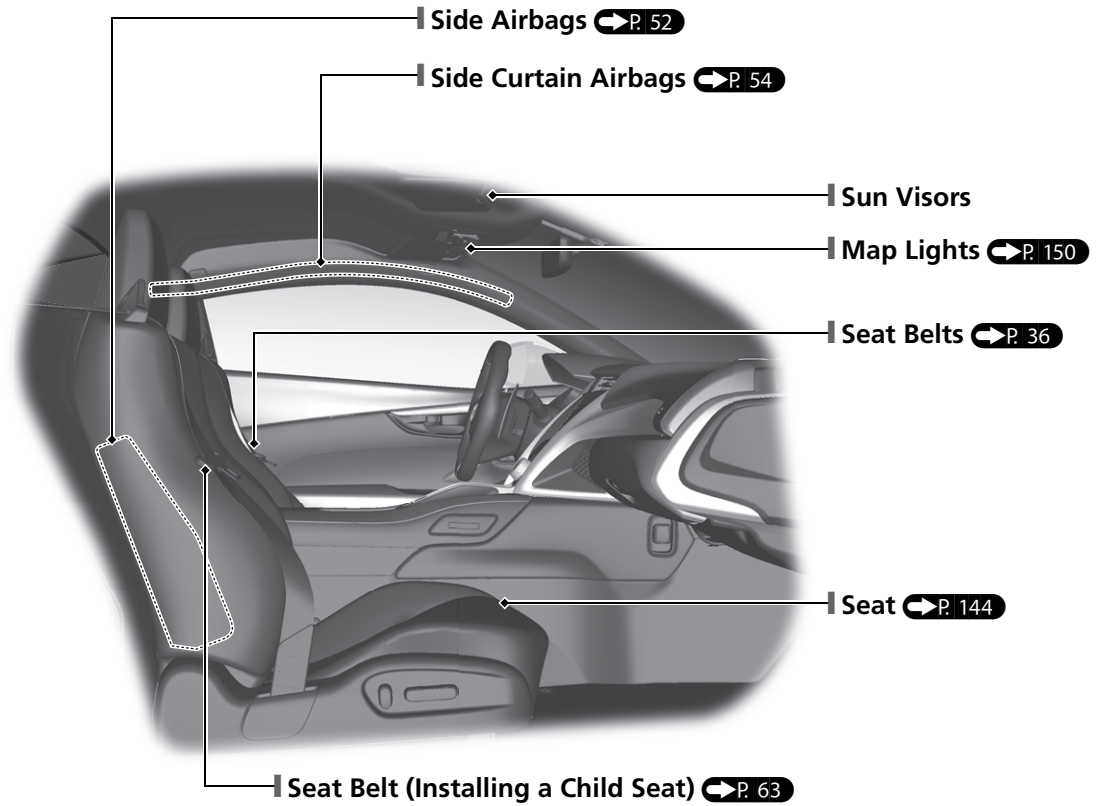

Visual Index

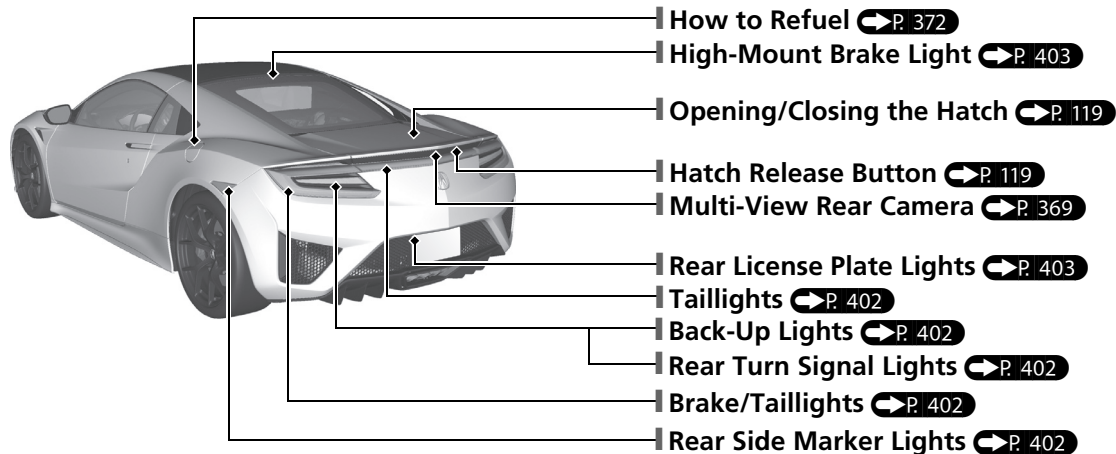
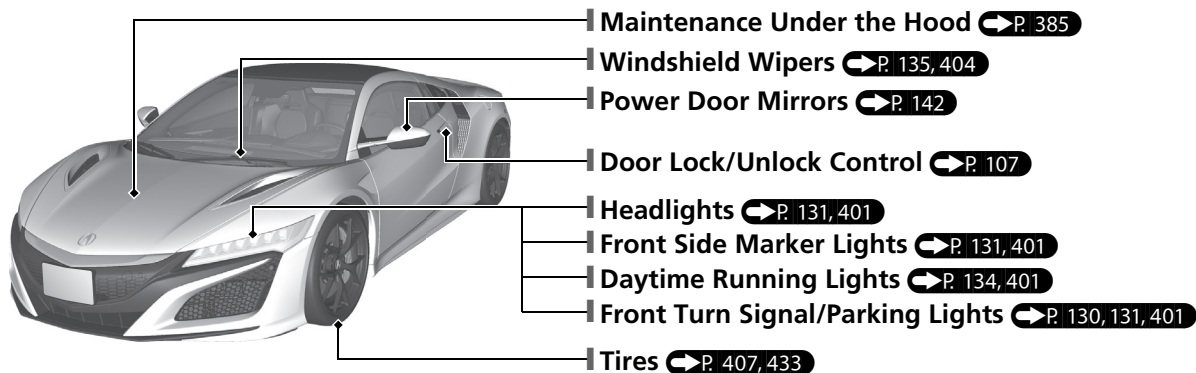

SPORT HYBRID Super Handling All-Wheel-Drive™ (SPORT HYBRID SH-AWD®)

Your SPORT HYBRID SH-AWD® vehicle uses a Twin Motor Unit, Direct Drive Motor, and a gasoline engine as propulsion sources, with electric motors receiving electricity from an internal High Voltage battery.

Operating mode	EV Launch*	Engine Drive	EV Cruising*	Power Acceleration
Vehicle Speed	Launch Acceleration: • Front Motor Drive	Gentle Acceleration: • Engine Drive	Low Speed Cruise: • Front Motor Drive	Aggressive Acceleration: • Engine Drive • Motor Assist
Twin Motor Unit	Drive	-	Drive	Drive
Direct Drive Motor	Stopped	Generate / -	Stopped	Generate / Drive
Engine	Stopped	Running	Stopped	Running
High Voltage battery	Discharges	Charges/Discharges	Discharges	Discharges

*: When Integrated Dynamics System is in **SPORT+** mode or **TRACK** mode, EV Launch and EV Cruising cannot be operated.

*: Operating paddle shifters when the gear position is in **D** cancels EV Launch and EV Cruising.

Operating mode	Engine Cruising	Regeneration	AWD Mode
Vehicle Speed	High Speed Cruise: • Engine Drive	Deceleration: • Front & Rear Regeneration	Slippery Condition: • Engine Drive • Front Motor Drive
Twin Motor Unit	-	Regenerate	Drive
Direct Drive Motor	Generate/Drive	Stopped	Generate/Drive
Engine	Running	Running/Stopped	Running
High Voltage battery	Charges/Discharges	Charges	Charges/Discharges

Energy Efficiency

As with a gasoline-powered vehicle, hybrid vehicle fuel efficiency and driving range is most impacted by your driving style. Aggressive acceleration and high-speed driving can easily trigger the system to switch the propulsion source to the gasoline-powered engine. In addition, heavy climate control system use negatively affects vehicle range and efficiency. Either of these use patterns will more quickly reduce the High Voltage battery's state of charge.

Battery Types

There are two types of batteries used in this vehicle; a standard 12-volt battery that powers the airbags, the interior and exterior lights, and other standard 12-volt systems; and a High Voltage battery that is used to power the propulsion motors and recharge the 12-volt battery.

Regenerative Energy and Regenerative Braking

When decelerating without the accelerator being depressed or the brake pedal being applied, or while driving downhill, the electric motors act as generators that a portion of the electrical energy that was used to accelerate the vehicle. This regenerative braking slows the vehicle in a manner similar to engine braking in a gasoline-powered vehicle.

Auto Engine Stop/Start

Your vehicle's gasoline engine will automatically stop and start during vehicle operation as needed to meet driving and battery conditions. These are some examples that could cause the gasoline engine to automatically start.

In the following cases, however, Auto Engine Stop may not activate.

- When the Integrated Dynamics System is in SPORT+ mode or TRACK mode.
- The vehicle momentarily needs additional power for aggressive acceleration, or driving uphill or at high speed.
- The climate control system is in heavy use.
- The High Voltage battery temperature is high or low.
- The High Voltage battery state of charge is low.
- The engine coolant temperature is low.
- When the door is opened after releasing seatbelt.
- When the shift position is in **M** (Manual) mode.

About Your Vehicle's Limited Operating Temperature

If the outside temperature is about -4°F (-20°C), some operation might be limited.

The limited operation is listed below:

- High Voltage Battery → P. 90
- Dual Clutch Transmission → P. 325
- Shifting → P. 326

Sounds Unique to the SPORT HYBRID SH-AWD® System

When you first start driving this vehicle, you likely will hear some unfamiliar sounds, particularly when you first turn on the power system, while driving, and just after parking. Some of these sounds are unique to this vehicle's powertrain, fuel, and climate control systems; others are similar to sounds generated by conventional automobiles that typically are masked by louder noises absent from a vehicle of this design. These sounds are not a cause for concern, and you will soon recognize them as normal and thus be able to detect any new or unusual noise should one develop.

About a system to cool the High Voltage battery using the climate control system.

- The system will not be activated when the defroster is ON.
- When the outside temperature is in extreme hot or cold condition, the system may not provide sufficient cooling performance to the High Voltage battery due to the protection of the electric A/C compressor.
- When the system is active, the climate control system may not work sufficiently.

Safety Precautions

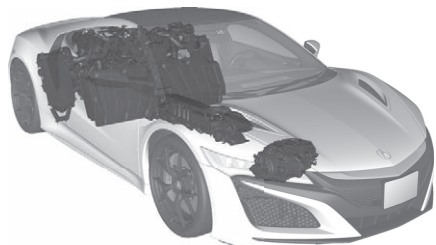

Do not touch the High Voltage system

Attempting to take a High Voltage system component apart or disconnect one of its wires can cause severe electrical shock. If the High Voltage system needs maintenance or repair, it should be performed at an authorized Acura NSX dealer.

If a crash occurs

- Be careful of electric shock hazard.
 - ▶ If a severe crash damages your vehicle's High Voltage system, there is a possibility of electrical shock due to exposed High Voltage components or wires. If this happens, do not touch any of the High Voltage system components or any of its orange wires.
- Avoid contact with High Voltage battery fluid.
 - ▶ The High Voltage battery contains a flammable electrolyte that could leak as a result of a severe crash. Avoid any skin or eye contact with the electrolyte as it is corrosive. If you accidentally touch it, flush your eyes or skin with a large quantity of water for at least five minutes, and seek medical attention immediately.
- Use a fire extinguisher for an electrical fire.
 - ▶ Attempting to extinguish an electrical fire with even a small quantity of water, from a garden hose for instance, can be dangerous.
- Anytime the vehicle is damaged in a crash, have it repaired by an authorized Acura NSX dealer.

Emergency Shutdown System for the High Voltage System

The emergency shutdown system may activate when the vehicle is impacted by some incident such as a crash. When this system activates, the High Voltage system automatically shuts down, and your vehicle no longer will move under its own power. To return the High Voltage system back to normal operation, consult an authorized Acura NSX dealer.

Acura collects and recycles High Voltage batteries used in its vehicles – consult an authorized Acura NSX dealer for more information.

Safe Driving P. 31

Airbags P. 43

- Your vehicle is fitted with airbags to help protect you and your passenger during a moderate-to-severe collision.

Child Safety P. 58

- Your vehicle is **not recommended for child passengers**. If you decide to disregard our recommendations and transport a child passenger, the child should be properly restrained. Never put a rear-facing child seat in the passenger's seat.

Exhaust Gas Hazard P. 67

- Your vehicle emits dangerous exhaust gases that contain carbon monoxide. Do not run the engine in confined spaces where carbon monoxide gas can accumulate.

Seat Belts P. 36

- Fasten your seat belt and sit upright well back in the seat.
- Check that your passenger is wearing their seat belt correctly.



Fasten your lap belt as low as possible.

Before Driving Checklist P. 35

- Before driving, check that the seats, steering wheel, and mirrors have been properly adjusted.

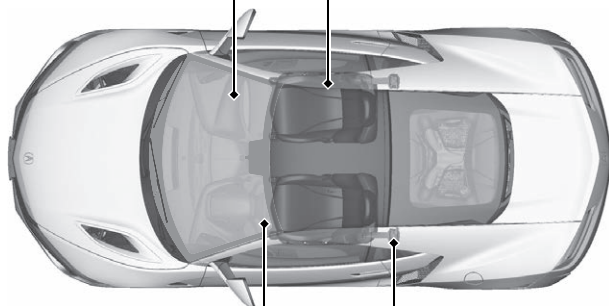















Instrument Panel P. 69

Gauges  P. 95 / Driver Information Interface  P. 98 / System Indicators  P. 70



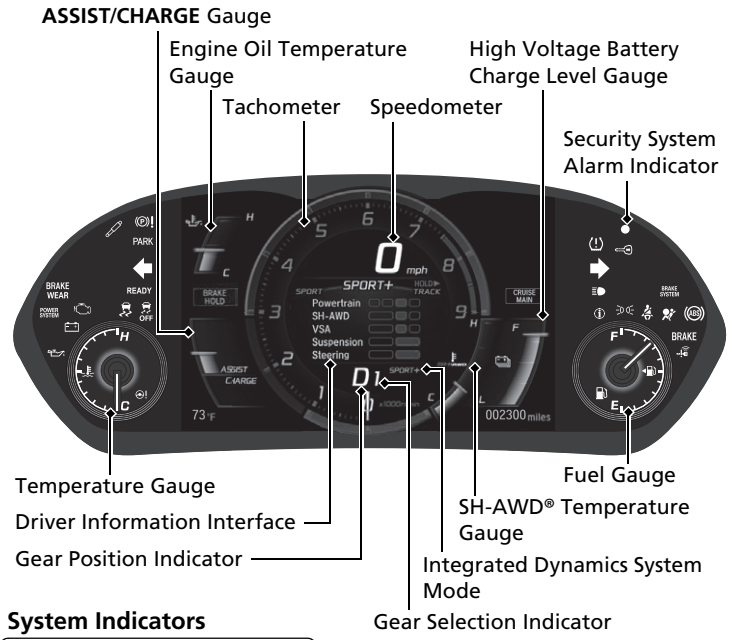

Quick Reference Guide

System Indicators



-  Electric Power Steering (EPS) System Indicator
-  Malfunction Indicator Lamp
-  Low Oil Pressure Indicator
-  Immobilizer System Indicator
-  12-Volt Battery Charging System Indicator
-  Automatic Brake Hold System Indicator
-  U.S. Automatic Brake Hold Indicator
-  Canada
-  Electric Parking Brake System Indicator
-  U.S. Electric Parking Brake Indicator
-  Canada
-  Active Damper System Indicator
-  U.S. Brake Wear Indicator*
-  Canada















System Indicators

-  Vehicle Stability Assist™ (VSA®) System Indicator
-  VSA® OFF Indicator
-  Low Tire Pressure/TPMS Indicator
-  System Message Indicator

Lights Indicators

-  Lights On Indicator
-  High Beam Indicator

System Indicators

-  Turn Signal and Hazard Warning Indicators
-  Supplemental Restraint System Indicator
-  Anti-lock Brake System (ABS) Indicator
-  BRAKE U.S. Brake System Indicator (Red)
-  Canada BRAKE SYSTEM U.S. Brake System Indicator (Amber)
-  Canada
-  Low Fuel Indicator
-  Seat Belt Reminder Indicator
-  READY READY Indicator
-  POWER SYSTEM POWER SYSTEM Indicator
-  CRUISE MAIN CRUISE MAIN Indicator
-  CRUISE CONTROL CRUISE CONTROL Indicator
-  Keyless Access System Indicator

Controls P. 103



Clock P. 104

Models with navigation system

The navigation system receives signals from GPS satellites, updating the clock automatically.

You can also adjust the time manually.



- 1 Select the  (HOME) icon, then select **Settings**.
- 2 Select **Clock/Info**, then **Clock Adjustment**.
- 3 Touch the  icon to adjust the numbers up or down.
- 4 Select **OK**.

ENGINE START/STOP Button P. 127

Press the button to changes the vehicle's power mode.

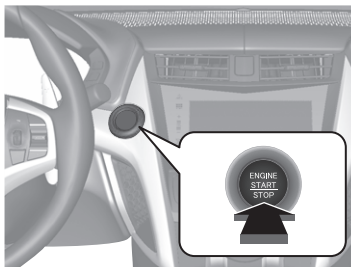

Turn Signals P. 130

Turn Signal Control Lever

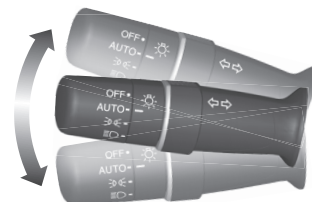

Lights P. 131

Light Control Switches

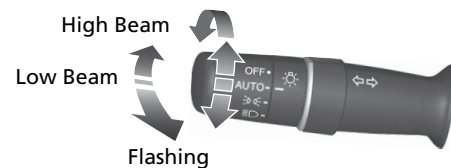

Wipers and Washers

➔ P. 135

Wiper/Washer Control Lever

Adjustment Ring

- ☾ : Lower speed, fewer sweeps
- ☿ : Higher speed, more sweeps

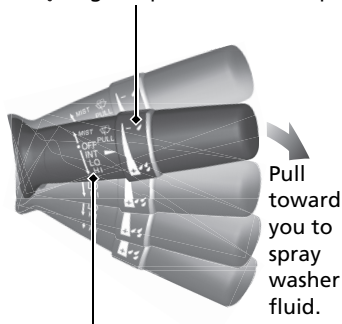

MIST
OFF

INT: Low speed with intermittent

LO: Low speed wipe

HI: High speed wipe

Steering Wheel ➔ P. 140

To adjust, push the adjustment lever down, adjust to the desired position, then lock the lever back in place.

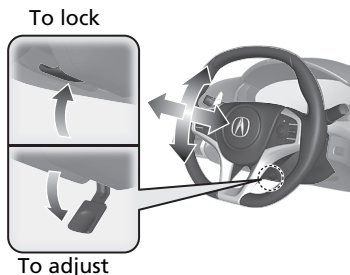

Unlocking the Doors from the Inside ➔ P. 115

- Pull either inner door handle to unlock and open it in one motion.

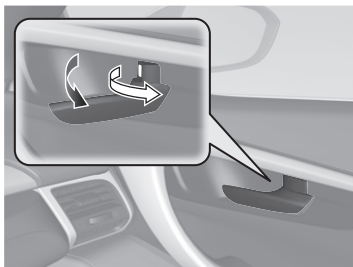

- Unlocking and opening the driver's door from the inner handle unlocks the passenger's door.

Hatch ➔ P. 119

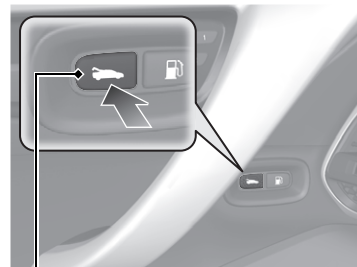

Hatch Release Button

- To unlock and open the hatch:
- Press the hatch release button on the driver's door.
- Press the hatch release button on the keyless access remote.
- Press the hatch release button on the hatch.

Power Door Mirrors

➔ P. 142

- With the power mode in ON, move the selector switch to L or R.
- Push the appropriate edge of the adjustment switch to adjust the mirror.

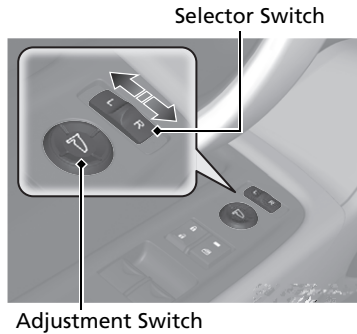

Power Windows ➔ P. 125

- With the power mode in ON, open and close the power windows.
- If the power window lock button is in the off position, the passenger's window can be opened and closed with its own switch.
- If the power window lock button is in the on position (indicator on), the passenger's window switch is disabled.

Power Window Lock Button Indicator

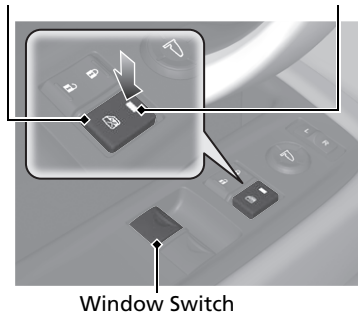

Climate Control System P. 155

- Press the **AUTO** button to activate the climate control system.
- Press the button to turn the system on or off.
- Press the button to defrost the windshield.

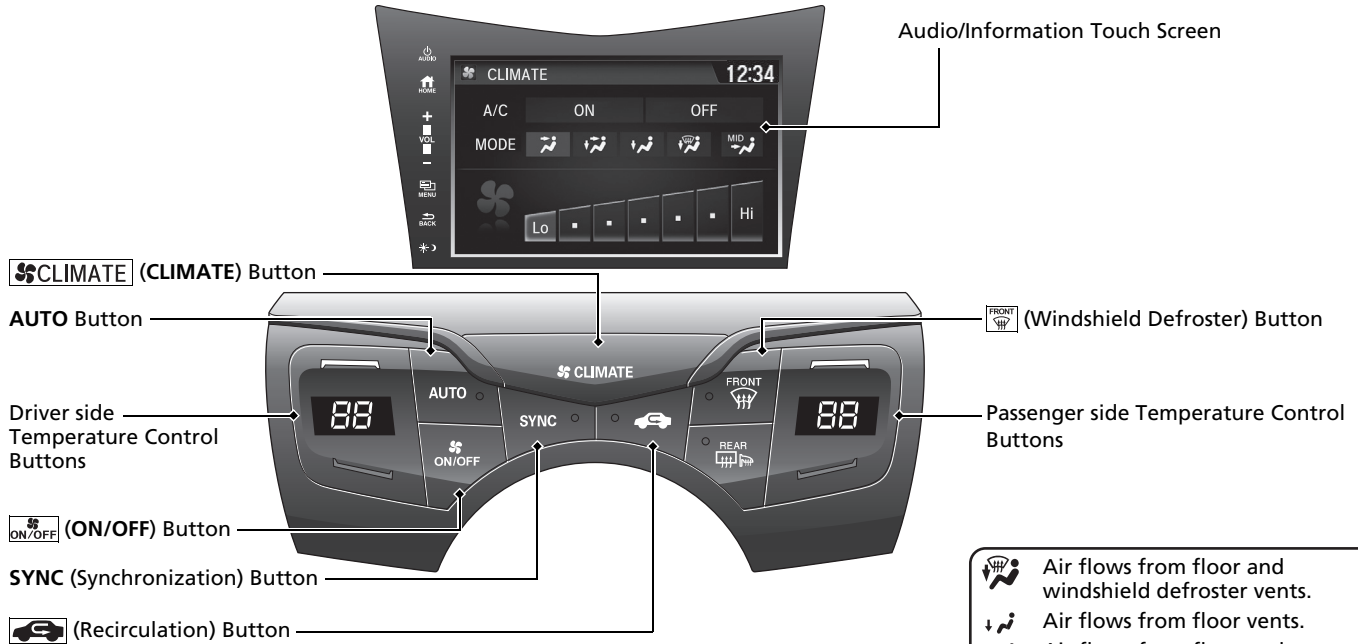

- Air flows from floor and windshield defroster vents.
- Air flows from floor vents.
- Air flows from floor and dashboard vents.
- Air flows from dashboard vents.
- MID vents provide supplemental air to the lower body of the occupant(s). MID vents can be used together with any other vent mode.

Features P. 161

Audio system P. 166

For navigation system operation  See the Navigation System Manual

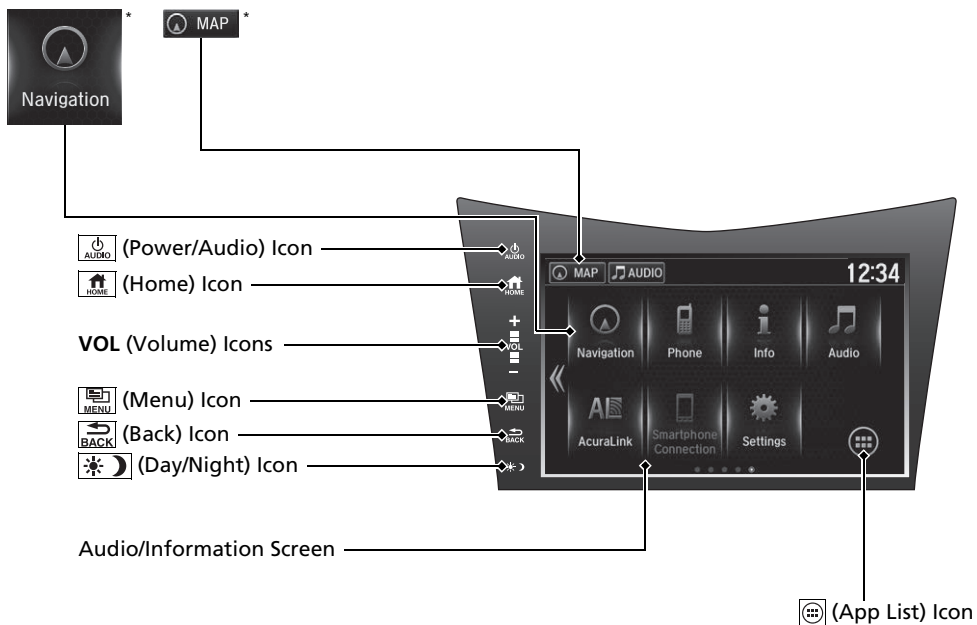

Audio Remote Controls

➔ P. 165

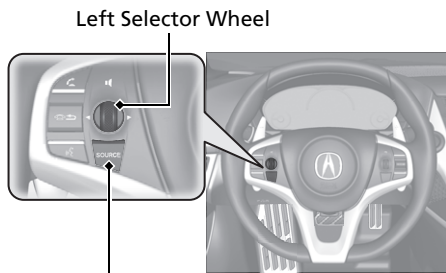

SOURCE Button

- **SOURCE** Button
Press to change the audio mode: FM/
SiriusXM®*/USB/iPod/Pandora®*/Apps*/
Bluetooth® Audio/Audio Apps*.
- **Left Selector Wheel**
Roll to adjust the volume up/down.
Radio: Move right or left to change the
preset station.
Move and hold to select the next
or previous strong station.
USB device:
Move right or left to skip to the
beginning of the next song or
return to the beginning of the
current song.
Move and hold to change a folder.

Driving ↔ P. 309

Electronic Gear Selector ↔ P. 326

- Select **[P]** and depress the brake pedal when turning on the power.
- Gear selection

Gear Position Indicator/Gear Selection Indicator
The gear position indicator, the gear selection indicator and the shift button indicator indicate the current gear selection.



Gear Position Indicator
Gear Selection Indicator

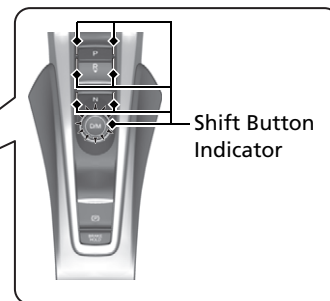
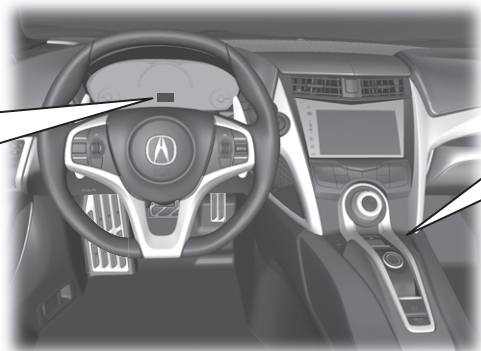

P

Park

Press the **[P]** button.

Used when parking or before turning the power on or off.
Transmission is locked.

R

Reverse

Press back the **[R]** button.

Used when reversing.

N

Neutral

Press the **[N]** button.

Used to keep the transmission disengaged from the engine and motor.

D/M

Drive/Manual

Each time you press the **[D/M]** button, the mode switches between D (drive) and M (manual) mode.

D (Drive)

- Normal driving (gears change between 1st and 9th automatically)
- Temporarily driving in the sequential mode

M (Manual)

- Driving in the sequential mode

Paddle Shifters P. 334

Paddle shifters allow you to shift gears much like a manual transmission (1st through 9th). This is useful for regenerative braking. You cannot shift up or down while in EV mode.

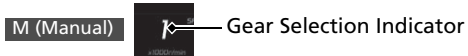
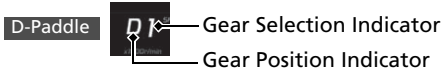
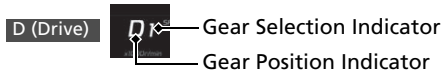

Shift Down 
Paddle Shifter



Shift Up 
Paddle Shifter

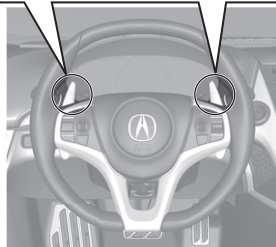

When the transmission is in **D** (D-paddle shift mode)

The vehicle will go into the sequential mode momentarily, and the gear selection indicator becomes more prominent.

The sequential mode is automatically canceled and the gear selection indicator returns to ordinary display under the following conditions.

- Hold the  paddle shifter for a few seconds.
- Once you start traveling at a constant speed.
- The vehicle comes to a complete stop.
- When you change to another Integrated Dynamics System mode.

The sequential mode automatically shifts under following condition

- Accelerator pedal depressed beyond the click.
- Engine speed reaches near the tachometer's red zone.
- Engine speed reaches idle speed while deceleration.

When the transmission is in **M** (Manual) mode

The vehicle will go into the sequential mode, and the gear position indicator goes off and only the gear selection indicator is displayed.

You can cancel this mode by pressing the **D/M** button, pulling the  paddle shifter for a few seconds or changing Integrated Dynamics System mode to **QUIET**. When the sequential mode is canceled, the display is changed from only the gear selection indicator to both of the gear position indicator and the gear selection indicator.

The transmission automatically shifts up from 1st to 2nd and does not automatically shift up between 2nd and 9th gear.

VSA® On and Off P. 347

- The Vehicle Stability Assist™ (VSA®) system helps stabilize the vehicle during cornering, and helps maintain traction while accelerating on loose or slippery road surfaces.
- VSA® comes on automatically every time you turn on the power system.

Tire Pressure Monitoring System (TPMS) P. 352

- The TPMS monitors tire pressure.
- The TPMS is turned on automatically every time you turn on the power system.

Refueling P. 371

Fuel requirement:

Unleaded premium gasoline with a pump octane number 91 or higher

Fuel tank capacity: 15.6 US gal (59.0 liters)

- 1** Press the fuel fill door release button.

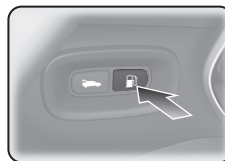

- 2** After refueling, wait for about five seconds before removing the filler nozzle.

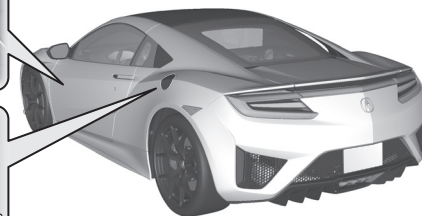
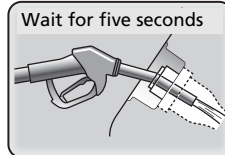

Maintenance P. 375

Under the Hatch P. 386

- Check engine oil and engine coolant.
Add when necessary.

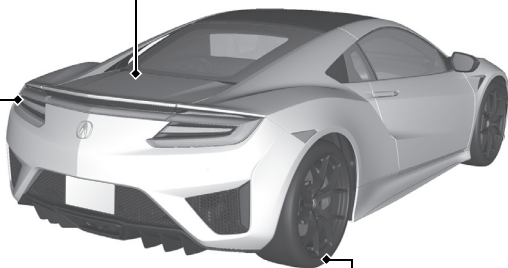

Lights P. 401

- Inspect all lights regularly.

Tires P. 407

- Inspect tires and wheels regularly.
 - Check tire pressures regularly.
 - Install winter tires for winter driving.
- Handling Summer Only tires and Ultra High Performance (UHP) tires in low ambient temperatures.

 **Cold Weather Driving**  P. 416

Press the hatch release button on the driver's door.

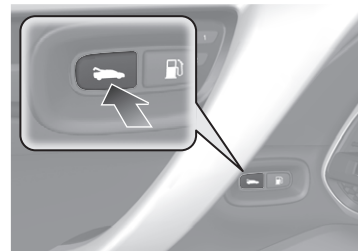

Under the Hood P. 385

- Check inverter coolant.
- Check brake fluid.
- Check the 12-volt battery condition monthly.

Wiper Blades P. 404

- Replace blades if they leave streaks across the windshield.

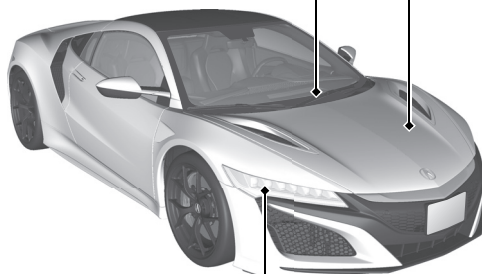

Lights P. 401

- Inspect all lights regularly.

- 1** Pull the hood release handle under the corner of the dashboard.

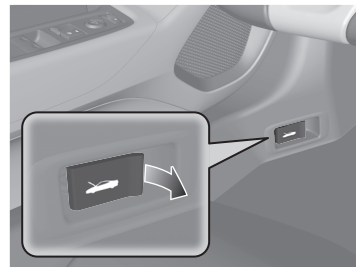

- 2** Locate the hood latch lever, pull it up, and then raise the hood. Once you have raised the hood slightly, you can release the lever.

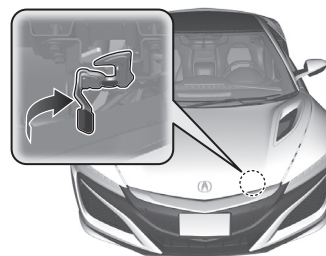

- 3** When finished, close the hood and make sure both right and left latches are firmly locked in place.

Handling the Unexpected P. 431

Flat Tire P. 433

- Park in a safe location and repair the flat tire using the temporary tire repair kit.



Power System Won't Start P. 445

- If the 12-volt battery is dead, jump start using a booster battery.



Overheating P. 450

- Park in a safe location. If you do not see steam under the hatch, open the hatch, and let the power system and the engine cool down.



Indicators Come On P. 452

- Identify the indicator and consult the owner's manual.

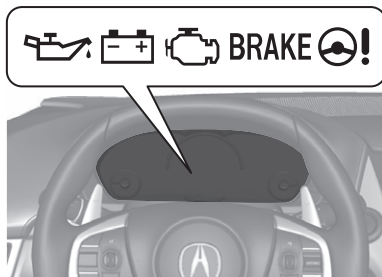

Blown Fuse P. 457

- Check for a blown fuse if an electrical device does not operate.

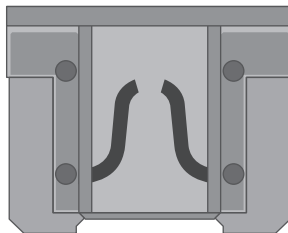

Emergency Towing P. 462

- Call a professional towing service if you need to tow your vehicle.

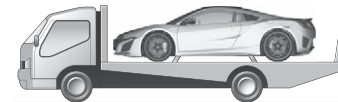

What to Do If

Q Why do the doors lock after I unlocked the doors?

A If you do not open the doors within 30 seconds, the doors are relocked automatically for security.

Q Why does the beeper sound when I open the driver's door?

A The beeper sounds when:

- The power mode is in ACCESSORY.
- The exterior lights are left on.

Q Why does the beeper sound when I start driving?

A The beeper sounds when the driver and/or passenger are not wearing their seat belts.

Q **Models with iron brake discs**
Why do I hear a screeching sound when I apply the brake pedal?

A The brake pads may need to be replaced. Have your vehicle inspected by an authorized Acura NSX dealer.

Q Pressing the electric parking brake switch does not release the parking brake. Why?

A Press the electric parking brake switch with the brake pedal depressed.

Q Depressing the accelerator pedal does not release the parking brake automatically. Why?

A

- Fasten the driver's seat belt.
- Check if the transmission is in **P** or **N**. If so, select any other position.

Q Why does the gear position automatically change to **P** when I open the driver's door to check for parking space lines when reversing?

A

- Fasten the driver's seat belt.
- Close the driver's door and manually change the gear position.
▶ When opening the driver's door **➔ P. 329**

Q I'm seeing an amber indicator of a tire with an exclamation point. What is that?

A The Tire Pressure Monitoring System (TPMS) needs attention. Check tire pressure.
🔍 If the Low Tire Pressure/TPMS Indicator Comes On or Blinks **➔ P. 455**

Safe Driving

You can find many safety recommendations throughout this chapter, and throughout this manual.

For Safe Driving

Important Safety Precautions.....	32
Your Vehicle's Safety Features.....	34
Safety Checklist	35

Seat Belts

About Your Seat Belts.....	36
Fastening a Seat Belt.....	39
Seat Belt Inspection.....	42

Airbags

Airbag System Components.....	43
Types of Airbags.....	46
Front Airbags (SRS)	46

Driver's Knee Airbag.....	50
Side Airbags.....	52
Side Curtain Airbags.....	54
Airbag System Indicators.....	55
Airbag Care	57

Child Safety

Protecting Child Passengers	58
Safety of Infants and Small Children...	60
Safety of Larger Children	65

Exhaust Gas Hazard

Carbon Monoxide Gas.....	67
--------------------------	----

Safety Labels

Label Locations	68
-----------------------	----

The following pages explain your vehicle's safety features and how to use them properly. The safety precautions below are ones that we consider to be among the most important.

Important Safety Precautions

■ Always wear your seat belt

A seat belt is your best protection in all types of collisions. Airbags are designed to supplement seat belts, not replace them. So even though your vehicle is equipped with airbags, make sure you and your passenger always wear your seat belts, and wear them properly.

■ Your vehicle is not recommended for child passengers

The National Highway Traffic Safety Administration and Transport Canada recommend that all children ages 12 and under be properly restrained in a back seat. Since this vehicle does not have a back seat, we strongly recommend that you do not carry any child who is not large enough and mature enough to ride in front.

■ Be aware of airbag hazards

While airbags can save lives, they can cause serious or fatal injuries to occupants who sit too close to them, or are not properly restrained. Infants, young children, and short adults are at the greatest risk. Be sure to follow all instructions and warnings in this manual.

■ Don't drink and drive

Alcohol and driving don't mix. Even one drink can reduce your ability to respond to changing conditions, and your reaction time gets worse with every additional drink. So don't drink and drive, and don't let your friends drink and drive, either.

☒ Important Safety Precautions

Some states, provinces and territories prohibit the use of cell phones other than hands-free devices by the driver while driving.

Never carry an infant in a rear-facing child seat in this vehicle.

If an older child must ride in this vehicle, follow all child safety instructions and warnings in this manual.

☒ **Child Safety** P. 58

■ Pay appropriate attention to the task of driving safely

Engaging in cell phone conversation or other activities that keep you from paying close attention to the road, other vehicles, and pedestrians could lead to a crash. Remember, situations can change quickly, and only you can decide when it is safe to divert some attention away from driving.

■ Control your speed

Excessive speed is a major factor in crash injuries and deaths. Generally, the higher the speed, the greater the risk, but serious injuries can also occur at lower speeds. Never drive faster than is safe for current conditions, regardless of the maximum speed posted.

■ Keep your vehicle in safe condition

Having a tire blowout or a mechanical failure can be extremely hazardous. To reduce the possibility of such problems, check your tire pressures and condition frequently, and perform all regularly scheduled maintenance.

■ Do not leave children unattended in the vehicle

Children, pets and people needing assistance left unattended in the vehicle may be injured if they activate one or more of the vehicle controls. They may also cause the vehicle to move, resulting in a crash in which they and/or another person(s) can be injured or killed. Also, depending on the ambient temperature, the temperature of the interior may reach extreme levels, which can result in harm or death. Even if the climate control system is on, never leave them in the vehicle unattended as the climate control system can shut off at any time.

Your Vehicle's Safety Features

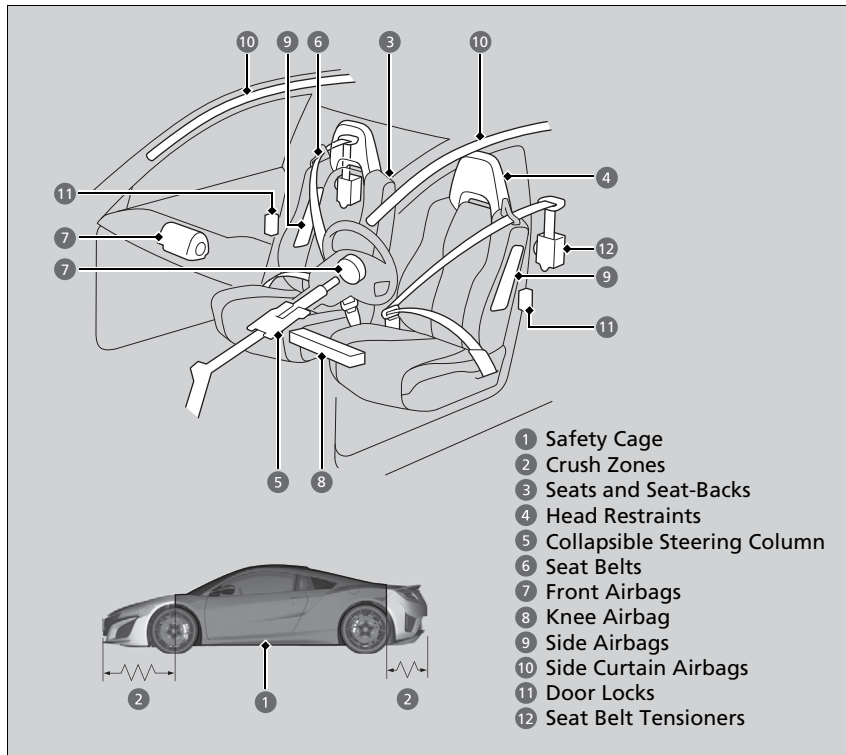

The following checklist will help you take an active role in protecting yourself and your passenger.

▣ Your Vehicle's Safety Features

Your vehicle is equipped with many features that work together to help protect you and your passenger during a crash.

Some features do not require any action on your part. These include a strong framework that forms a safety cage around the passenger compartment, front and rear crush zones, a collapsible steering column, and tensioners that tighten the seat belts in a sufficient crash.

However, you and your passenger cannot take full advantage of these features unless you remain seated in the correct position and always wear your seat belts. In fact, some safety features can contribute to injuries if they are not used properly.

Safety Checklist

For the safety of you and your passenger, make a habit of checking these items each time before you drive.

- After everyone has entered the vehicle, be sure both doors are closed and locked. Locking the doors helps prevent an occupant from being ejected and an outsider from unexpectedly opening a door.
 - **Locking/Unlocking the Doors from the Inside** P. 115
- Adjust your seat to a position suitable for driving. Be sure the seats are adjusted as far to the rear as possible while allowing the driver to control the vehicle. Sitting too close to a front airbag can result in serious or fatal injury in a crash.
 - **Adjusting the Seats** P. 144
- Always wear your seat belt, and make sure you wear it properly. Confirm that any passenger is properly belted as well.
 - **Fastening a Seat Belt** P. 39
- If you choose to ignore our warnings and carry a child in this vehicle, make every effort to protect them by properly using a seat belt or a child seat according to the child's age, height, and weight.
 - **Child Safety** P. 58

☒ Safety Checklist

If the **Door Open** or **Door And Trunk Open** message appears on the driver information interface, a door and/or the trunk (hatch) is not completely closed. Close both doors and the trunk (hatch) tightly until the message disappears.

➤ **Driver Information Interface Warning and Information Messages** P. 88

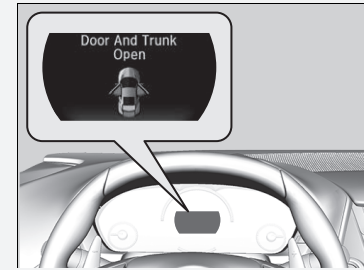

About Your Seat Belts

Seat belts are the single most effective safety device because they keep you connected to the vehicle so that you can take advantage of many built-in safety features. They also help keep you from being thrown against the inside of the vehicle, against any passenger, or out of the vehicle. When worn properly, seat belts also keep your body properly positioned in a crash so that you can take full advantage of the additional protection provided by the airbags.

In addition, seat belts help protect you in almost every type of crash, including:

- frontal impacts
- side impacts
- rear impacts
- rollovers

■ Lap/shoulder seat belts

Both seating positions are equipped with lap/shoulder seat belts with emergency locking retractors. In normal driving the retractor lets you move freely while keeping some tension on the belt. During a collision or sudden stop the retractor locks to restrain your body. The passenger's seat belt has a lockable retractor that must be properly activated when using a forward-facing child seat, should you choose to disregard our recommendations and install one.

➤ **Installing a Child Seat** P. 63

➤ About Your Seat Belts

WARNING

Not wearing a seat belt properly increases the chance of serious injury or death in a crash, even though your vehicle has airbags.

Be sure you and your passenger always wear seat belts and wear them properly.

Seat belts cannot completely protect you in every crash. But in most cases, seat belts can reduce your risk of serious injury.

Most states and all Canadian provinces and territories require you to wear seat belts.

If you extend the seat belt too quickly, it will lock in place. If this happens, slightly retract the seat belt, then extend it slowly.

■ Proper use of seat belts

Follow these guidelines for proper use:

- All occupants should sit upright, well back in the seat, and remain in that position for the duration of the trip. Slouching and leaning reduce the effectiveness of the belt and can increase the chance of serious injury in a crash.
- Never place the shoulder part of a lap/shoulder seat belt under your arm or behind your back. This could cause very serious injuries in a crash.
- Two people should never use the same seat belt. If they do, they could be very seriously injured in a crash.
- Do not put any accessories on the seat belts. Devices intended to improve comfort or reposition the shoulder part of a seat belt can reduce the protective capability and increase the chance of serious injury in a crash.

■ Seat Belt Reminder



The seat belt system includes an indicator on the instrument panel to remind the driver or a passenger or both to fasten their seat belts. If you set the power mode to ON and a seat belt is not fastened, a beeper will sound and the indicator will blink. After a few seconds, the beeper will stop and the indicator will come on and remain illuminated until the seat belt is fastened.

The beeper will periodically sound and the indicator will blink while the vehicle is moving until the seat belt is fastened.

▣ About Your Seat Belts

If your passenger moves around and extends the seat belt, the lockable retractor may activate. If this happens, release the retractor by unfastening the seat belt and allow the belt to retract completely. Then refasten the belt.

▣ Seat Belt Reminder

The indicator will also come on if a passenger does not fasten their seat belt within six seconds after the power mode is set to ON. When no one is sitting in the passenger's seat, or a child is riding there, the indicator will not come on and the beeper will not sound.

■ Automatic Seat Belt Tensioners

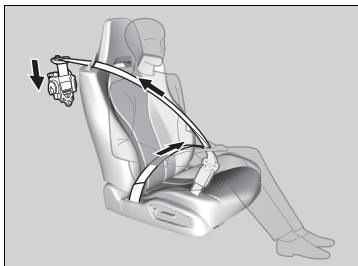

The driver's and passenger's seats are equipped with automatic seat belt tensioners to enhance safety.

The tensioners automatically tighten the seat belts during a moderate-to-severe frontal collision, sometimes even if the collision is not severe enough to inflate the front airbags or the driver's knee airbag.

⌘ Automatic Seat Belt Tensioners

The seat belt tensioners can only operate once. If a tensioner is activated, the SRS indicator will come on. Have an authorized Acura NSX dealer replace the tensioner and thoroughly inspect the seat belt system as it may not offer protection in a subsequent crash.

During a moderate-to-severe side impact, the tensioner on that side of the vehicle also activates.

Fastening a Seat Belt

After adjusting your seat to the proper position, and while sitting upright and well back in the seat:

🔧 **Adjusting the Seats** P. 144

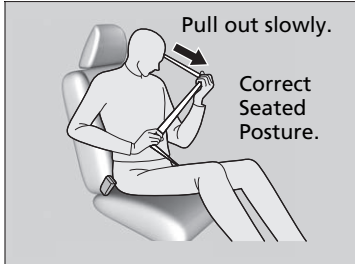

1. Pull the seat belt out slowly.

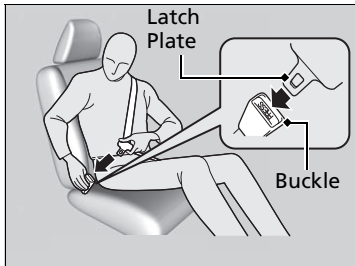

2. Insert the latch plate into the buckle, then tug on the belt to make sure the buckle is secure.

▶ Make sure that the belt is not twisted or caught on anything.

🔧 Fastening a Seat Belt

No one should sit in a seat with an inoperative seat belt or one that does not appear to be working correctly. Using a seat belt that is not working properly may not protect the occupant in a crash. Have an authorized Acura NSX dealer check the belt as soon as possible.

Never insert any foreign objects into the buckle or retractor mechanism.

If the seat belt appears to be locked in a fully retracted position, firmly pull out on the shoulder belt once, then push it back in.

Then smoothly pull it out of the retractor and fasten. If you are unable to release the seat belt from a fully retracted position, do not allow anyone to sit in the seat, and take your vehicle to a dealer for repair.

🔧 **About Your Seat Belts** P. 36

🔧 **Seat Belt Inspection** P. 42



3. Position the lap part of the belt as low as possible across your hips, then pull up on the shoulder part of the belt so the lap part fits snugly. This lets your strong pelvic bones take the force of a crash and reduces the chance of internal injuries.
4. If necessary, pull up on the belt again to remove any slack, then check that the belt rests across the center of your chest and over your shoulder. This spreads the forces of a crash over the strongest bones in your upper body.

Fastening a Seat Belt

WARNING

Improperly positioning the seat belts can cause serious injury or death in a crash.

Make sure all seat belts are properly positioned before driving.

To release the belt, push the red **PRESS** button and then guide the belt by hand until it has retracted completely.

When exiting the vehicle, be sure the belt is properly stowed so that it will not get caught in the closing door.

Advice for Pregnant Women

If you are pregnant, the best way to protect yourself and your unborn child when driving or riding in a vehicle is to always wear a seat belt and keep the lap part of the belt as low as possible across the hips.

Wear the shoulder belt across the chest avoiding the abdomen.



Wear the lap part of the belt as low as possible across the hips.

Advice for Pregnant Women

Each time you have a checkup, ask your doctor if it is okay for you to drive.

To reduce the risk of injuries to both you and your unborn child that can be caused by an inflating front airbag:

- When driving, sit upright and adjust the seat as far back as possible while allowing full control of the vehicle.
- When sitting in the passenger's seat, adjust the seat as far back as possible.

Seat Belt Inspection

Regularly check the condition of your seat belts as follows:

- Pull each belt out fully, and look for frays, cuts, burns, and wear.
- Check that the latch plates and buckles work smoothly and the belts retract easily.
 - ▶ If a belt does not retract easily, cleaning the belt may correct the problem. Only use a mild soap and warm water. Do not use bleach or cleaning solvents. Make sure the belt is completely dry before allowing it to retract.

Any belt that is not in good condition or working properly will not provide proper protection and should be replaced as soon as possible.

A belt that has been worn during a crash may not provide the same level of protection in a subsequent crash. Have your seat belts inspected by an authorized Acura NSX dealer after any collision.

▶▶ Seat Belt Inspection

WARNING

Not checking or maintaining seat belts can result in serious injury or death if the seat belts do not work properly when needed.

Check your seat belts regularly and have any problem corrected as soon as possible.

Airbag System Components

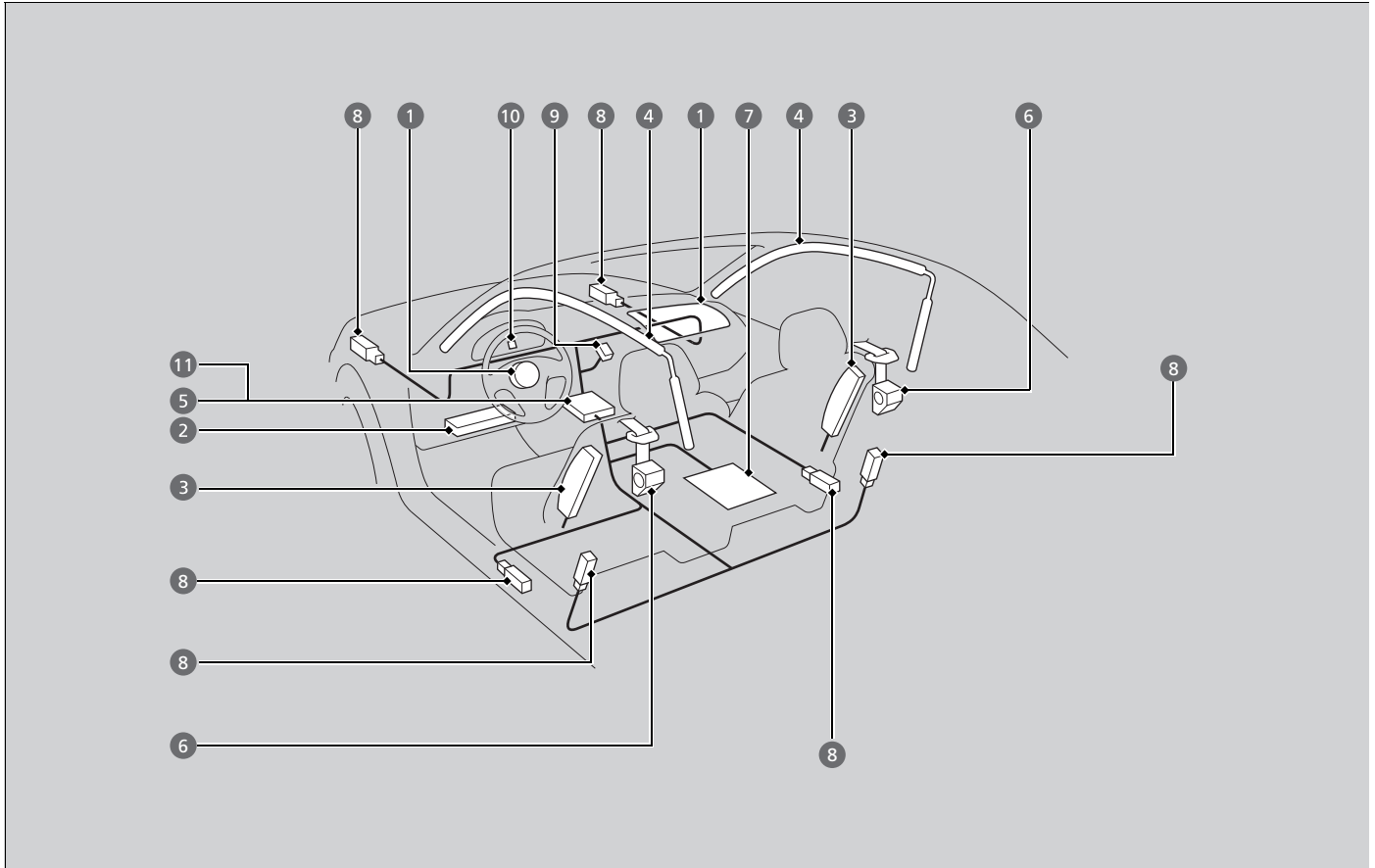

The front, driver's knee, side, and side curtain airbags are deployed according to the direction and severity of impact. Both side curtain airbags are deployed in a rollover. The airbag system includes:

- ❶ Two SRS (Supplemental Restraint System) front airbags. The driver's airbag is stored in the center of the steering wheel; the passenger's airbag is stored in the dashboard. Both are marked **SRS AIRBAG**.
- ❷ Driver's knee airbag. The knee airbag is stored under the steering column. It is marked **SRS AIRBAG**.
- ❸ Two side airbags, one for the driver and one for a passenger. The airbags are stored in the outer edges of the seat-backs. Both are marked **SIDE AIRBAG**.
- ❹ Two side curtain airbags, one for each side of the vehicle. The airbags are stored in the ceiling, above the side windows. The front and rear pillars are marked **SIDE CURTAIN AIRBAG**.
- ❺ An electronic control unit that, when the power system is on, continually monitors information about the various impact sensors, seat and buckle sensors, rollover sensor, airbag activators, seat belt tensioners, and other vehicle information. During a crash event the unit can record such information.
- ❻ Automatic seat belt tensioners. In addition, the driver's and passenger's seat belt buckles incorporate sensors that detect whether or not the belts are fastened.
- ❼ Weight sensors in the passenger's seat. The passenger's airbag will be turned off if the weight on the seat is approximately 65 lbs (29 kg) or less (the weight of an infant or small child).
- ❽ Impact sensors that can detect a moderate-to-severe front or side impact.
- ❾ An indicator on the dashboard that alerts you that the passenger's front airbag has been turned off.
- ❿ An indicator on the instrument panel that alerts you to a possible problem with your airbag system or seat belt tensioners.
- ⓫ A rollover sensor that can detect if your vehicle is about to roll over and signal the control unit to deploy both side curtain airbag.

■ Important Facts About Your Airbags

Airbags can pose serious hazards. To do their job, airbags must inflate with tremendous force. So, while airbags help to save lives, they can cause burns, bruises, and other minor injuries, sometimes even fatal ones if occupants are not wearing their seat belts properly and sitting correctly.

What you should do: Always wear your seat belt properly, and sit upright and as far back from the steering wheel as possible while allowing full control of the vehicle. A passenger should move their seat as far back from the dashboard as possible.

Remember, however, that no safety system can prevent all injuries or deaths that can occur in a severe crash, even when seat belts are properly worn and the airbags deploy.

Do not place hard or sharp objects between yourself and a front airbag.

Carrying hard or sharp objects on your lap, or driving with a pipe or other sharp object in your mouth, can result in injuries if your front airbag inflates.

Do not attach or place objects on the front and driver's knee airbag covers.

Objects on the covers marked **SRS AIRBAG** could interfere with the proper operation of the airbags or be propelled inside the vehicle and hurt someone if the airbags inflate.

▣ Important Facts About Your Airbags

Do not attempt to deactivate your airbags. Together, airbags and seat belts provide the best protection.

When driving, keep hands and arms out of the deployment path of the front airbag by holding each side of the steering wheel. Do not cross an arm over the airbag cover.

Types of Airbags

Your vehicle is equipped with four types of airbags:

- **Front airbags:** Airbags in front of the driver's and passenger's seats.
- **Driver's knee airbag:** Airbag under the steering column.
- **Side airbags:** Airbags in the driver's and passenger's seat-backs.
- **Side curtain airbags:** Airbags above the side windows.

Each is discussed in the following pages.

Front Airbags (SRS)

The front SRS airbags inflate in a moderate-to-severe frontal collision to help protect the head and chest of the driver and/or passenger.

SRS (Supplemental Restraint System) indicates that the airbags are designed to supplement seat belts, not replace them. Seat belts are the occupant's primary restraint system.

Housing Locations

The front airbags are housed in the center of the steering wheel for the driver, and in the dashboard for the passenger. Both airbags are marked **SRS AIRBAG**.

Types of Airbags

The airbags can inflate whenever the power mode is in ON.

After an airbag inflates in a crash, you may see a small amount of smoke. This is from the combustion process of the inflator material and is not harmful. People with respiratory problems may experience some temporary discomfort. If this occurs, get out of the vehicle as soon as it is safe to do so.

Front Airbags (SRS)

During a frontal crash severe enough to cause one or both front airbags to deploy, the airbags can inflate at different rates, depending on the severity of the crash, whether or not the seat belts are latched, and/or other factors. Frontal airbags are designed to supplement the seat belts to help reduce the likelihood of head and chest injuries in frontal crashes.

■ Operation

Front airbags are designed to inflate during moderate-to-severe frontal collisions. When the vehicle decelerates suddenly, the sensors send information to the control unit which signals one or both front airbags to inflate.

A frontal collision can be either head-on or angled between two vehicles, or when a vehicle crashes into a stationary object, such as a concrete wall.

■ How the Front Airbags Work

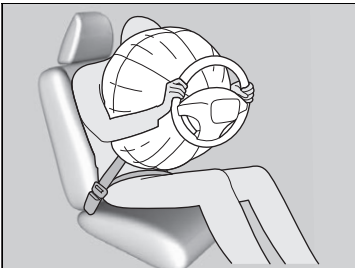

While your seat belt restrains your torso, the front airbag provides supplemental protection for your head and chest.

The front airbags deflate immediately so that they won't interfere with the driver's visibility or the ability to steer or operate other controls.

The total time for inflation and deflation is so fast that most occupants are not aware that the airbags deployed until they see them lying in front of them.

▣ How the Front Airbags Work

Although the driver's and passenger's airbags normally inflate within a split second of each other, it is possible for only one airbag to deploy. This can happen if the severity of a collision is at the margin, or threshold that determines whether or not the airbags will deploy. In such cases, the seat belt will provide sufficient protection, and the supplemental protection offered by the airbag would be minimal.

■ When front airbags should not deploy

Minor frontal crashes: Front airbags were designed to supplement seat belts and help save lives, not to prevent minor scrapes, or even broken bones that might occur during a less than moderate-to-severe frontal crash.

Side impacts: Front airbags can provide protection when a sudden deceleration causes a driver or passenger to move toward the front of the vehicle. Side airbags and side curtain airbags have been specifically designed to help reduce the severity of injuries that can occur during a moderate-to-severe side impact which can cause the driver or passenger to move toward the side of the vehicle.

Rear impacts: Head restraints and seat belts are your best protection during a rear impact. Front airbags cannot provide any significant protection and are not designed to deploy in such collisions.

Rollovers: In a rollover, your best form of protection is a seat belt or, if your vehicle is equipped with a rollover sensor, both a seat belt and a side curtain airbag. Front airbags, however, are not designed to deploy in a rollover as they would provide little if any protection.

■ When front airbags deploy with little or no visible damage

Because the airbag system senses sudden deceleration, a strong impact to the vehicle framework or suspension might cause one or more of the airbags to deploy. Examples include running into a curb, the edge of a hole, or other low fixed object that causes a sudden deceleration in the vehicle chassis. Since the impact is underneath the vehicle, damage may not be readily apparent.

■ When front airbags may not deploy, even though exterior damage appears severe

Since crushable body parts absorb crash energy during an impact, the amount of visible damage does not always indicate proper airbag operation. In fact, some collisions can result in severe damage but no airbag deployment because the airbags would not have been needed or would not have provided protection even if they had deployed.

Advanced Airbags

The passenger's airbag have advanced features to help reduce the likelihood of airbag related injuries to a smaller occupant.

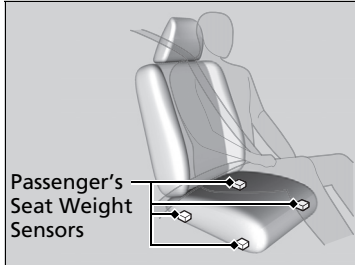

The passenger's advanced airbag system has weight sensors.

We advise against allowing a child age 12 or under to ride in the passenger's seat.

However, **if you do allow a child age 12 or under to ride in the passenger's seat**, note that the system will automatically turn off the passenger's airbag if the sensors detect that the child is approximately 65 lbs (29 kg) or less.

Advanced Airbags

For the passenger's advanced front airbag to work properly:

- Do not spill any liquid on or under the seat.
- Do not put any object under the passenger's seat.
- Make sure any objects are positioned properly on the floor. Improperly positioned objects can interfere with the advanced airbag sensors.
- An occupant should sit upright and wear their seat belts properly.
- Do not cover the passenger's side dashboard with a cloth, towel, cover, etc.

➤ **Passenger Front Airbag Off Indicator** P. 56

Driver's Knee Airbag

The driver's knee SRS airbag inflates in a moderate-to-severe frontal collision to help keep the driver in the proper position and to help maximize the benefit provided by the vehicle's other safety features.

SRS (Supplemental Restraint System) indicates that the airbag is designed to supplement seat belts, not replace them. Seat belts are the occupant's primary restraint system.

Housing Locations

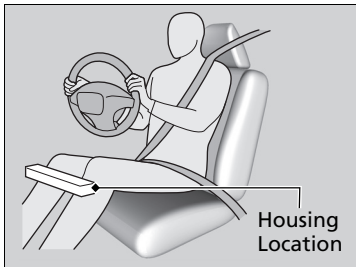

The driver's knee airbag is housed under the steering column.

The airbag is marked **SRS AIRBAG**.

Operation

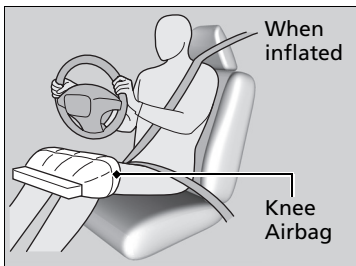

When the driver's front airbag inflates, the driver's knee airbag also inflates.

Even if the collision is not severe enough to deploy the front airbag, the knee airbag may inflate alone.

Driver's Knee Airbag

Do not attach accessories on or near a knee airbag as they can interfere with the proper operation of the airbag, or even hurt someone if the airbag inflates.

The driver should not store any items under the seat or behind their feet. The items can interfere with proper airbag deployment in the event of a moderate to severe frontal collision and may result in inadequate protection.

■ When driver's knee airbag deploys with little or no visible damage

Because the airbag system senses sudden deceleration, a strong impact to the vehicle framework or suspension might cause one or more of the airbags to deploy. Examples include running into a curb, the edge of a hole, or other low fixed object that causes a sudden deceleration in the vehicle chassis. Since the impact is underneath the vehicle, damage may not be readily apparent.

■ When driver's knee airbag may not deploy, even though exterior damage appears severe

Since crushable body parts absorb crash energy during an impact, the amount of visible damage does not always indicate proper airbag operation. In fact, some collisions can result in severe damage but no airbag deployment because the airbags would not have been needed or would not have provided protection even if they had deployed.

Side Airbags

The side airbags help protect the torso and pelvis of the driver or a passenger during a moderate-to-severe side impact.

Housing Locations

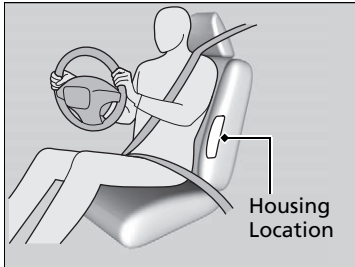

The side airbags are housed in the outside edge of the driver's and passenger's seat-backs.

Both are marked **SIDE AIRBAG**.

Operation

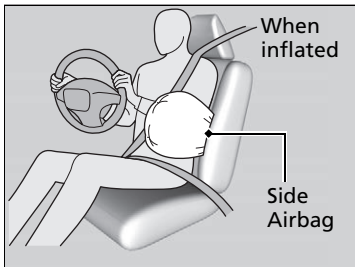

When the sensors detect a moderate-to-severe side impact, the control unit signals the side airbag on the impact side to immediately inflate.

Side Airbags

Make sure you and your passenger always sit upright. Leaning into the path of a side airbag can prevent the airbag from deploying properly and increases your risk of serious injury.

Do not attach accessories on or near the side airbags. They can interfere with the proper operation of the airbags, or hurt someone if an airbag inflates.

Do not cover or replace the seat-back covers without consulting an authorized Acura NSX dealer. Improperly replacing or covering seat-back covers can prevent your side airbags from properly deploying during a side impact.

■ When a side airbag deploys with little or no visible damage

Because the airbag system senses sudden acceleration, a strong impact to the side of the vehicle's framework can cause a side airbag to deploy. In such cases, there may be little or no damage, but the side impact sensors detected a severe enough impact to deploy the airbag.

■ When a side airbag may not deploy, even though visible damage appears severe

It is possible for a side airbag not to deploy during an impact that results in apparently severe damage. This can occur when the point of impact was toward the far front or rear of the vehicle, or when the vehicle's crushable body parts absorbed most of the crash energy. In either case, the side airbag would not have been needed nor provided protection even if it had deployed.

Side Curtain Airbags

The side curtain airbags help protect the heads of the driver and any passengers during a moderate-to-severe side impact. The side curtain airbags equipped in this vehicle are also designed to help reduce the likelihood of partial and complete ejection of vehicle occupants through side windows in crashes, particularly rollover crashes.

Housing Locations

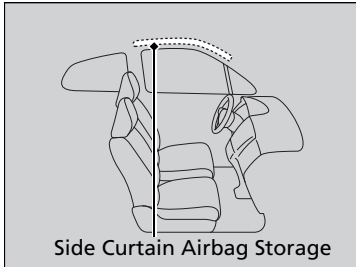

The side curtain airbags are located in the ceiling above the side windows on both sides of the vehicle.

Operation

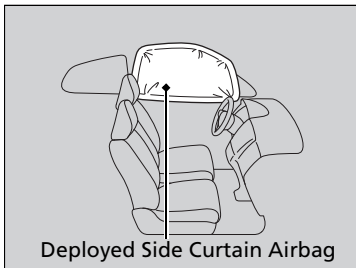

The side curtain airbag is designed to deploy in a rollover or a moderate-to-severe side impact.

Side Curtain Airbags

If the SRS control unit senses that your vehicle is about to rollover, it immediately deploys both side curtain airbags and activates both seat belt tensioners.

If the impact is on the passenger's side, the passenger's side curtain airbag deploys even if there is no occupant on that side of the vehicle.

To get the best protection from the side curtain airbags, occupants should wear their seat belts properly and sit upright and well back in their seats.

Do not attach any objects to the side windows or roof pillars as they can interfere with the proper operation of the side curtain airbags.

■ When side curtain airbags deploy in a frontal collision

One or both side curtain airbags may also inflate in a moderate-to-severe angled frontal collision.

Airbag System Indicators

If a problem occurs in the airbag system, the SRS indicator will come on and a message appears on the driver information interface.

■ Supplemental Restraint System (SRS) Indicator

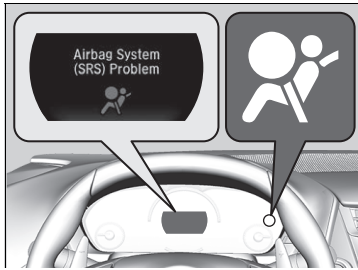

■ When the power mode is set to ON

The indicator comes on for a few seconds, then goes off. This tells you the system is working properly.

If the indicator comes on at any other time, or does not come on at all, have the system checked by an authorized Acura NSX dealer as soon as possible. If you don't, your airbags and seat belt tensioners may not work properly when they are needed.

▶▶ Supplemental Restraint System (SRS) Indicator

⚠ WARNING

Ignoring the SRS indicator can result in serious injury or death if the airbag systems or tensioners do not work properly.

Have your vehicle checked by an authorized Acura NSX dealer as soon as possible if the SRS indicator alerts you to a possible problem.

■ Passenger Front Airbag Off Indicator

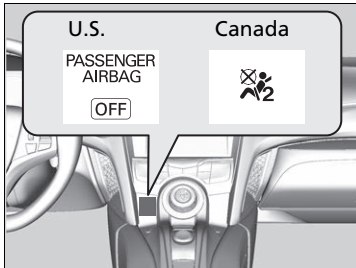

■ When the passenger front airbag off indicator comes on

The indicator comes on to alert you that the passenger's front airbag has been turned off. This occurs when the weight sensors detect about 65 lbs (29 kg) or less, the weight of an infant or small child, on the seat.

Your vehicle is not recommended for child passengers. Never put a rear-facing child seat in this vehicle.

If you decided to disregard our recommendations and transport a small child, they should be properly restrained.

➔ **Child Safety** P. 58

Objects placed on the seat can also cause the indicator to come on.

If the passenger's seat is empty, the passenger's front airbag will not deploy and the indicator will not come on.

⊠ Passenger Front Airbag Off Indicator

If the indicator comes on with no passenger and no objects on the passenger's seat, or with an adult riding there, something may be interfering with the weight sensor, such as:

- An object hanging on the seat.
- An object pressing the rear of the seat-back.
- The seat or seat-back is forced back against cargo on the rear trays or floor behind it.
- An object placed under the passenger's seat.

If none of these conditions exist, have your vehicle checked by an authorized Acura NSX dealer as soon as possible.

The passenger front airbag off indicator may come on and go off repeatedly if the total weight on the seat is near the airbag cutoff threshold.

Airbag Care

You do not need to, and should not, perform any maintenance on or replace any airbag system components yourself. However, you should have your vehicle inspected by an authorized Acura NSX dealer in the following situations:

■ When the airbags have deployed

If an airbag has inflated, the control unit and other related parts must be replaced. Similarly, once an automatic seat belt tensioner has been activated, it must be replaced.

■ When the vehicle has been in a moderate-to-severe collision

Even if the airbags did not inflate, have an authorized Acura NSX dealer inspect the following: the weight sensors in the passenger's seat, seat belt tensioners, and each seat belt that was worn during the crash.

■ Do not remove or modify a seat without consulting an authorized Acura NSX dealer

This would likely disable or affect the proper operation of the weight sensors in the passenger's seat. If it is necessary to remove or modify a seat to accommodate a person with disabilities, contact an authorized Acura NSX dealer, or for U.S. vehicles, Acura Client Relations at 1-844-682-2872 and for Canadian vehicles, Acura Client Service at 1-888-9-ACURA-9 or 1-844-9-MYNSX-9 (NSX-specific).

✘ Airbag Care

We recommend against the use of salvaged airbag system components, including the airbag, tensioners, sensors, and control unit.

Protecting Child Passengers

Each year, many children are injured or killed in vehicle crashes because they are either unrestrained or not properly restrained. In fact, vehicle crashes are the number one cause of death of children ages 12 and under.

To reduce the number of child deaths and injuries, every state, Canadian province and territory requires that children be properly restrained when they ride in a vehicle.

Since this vehicle does not have a back seat, we recommend that you do not carry a child, age 12 or under, as a passenger. This is because:

- An inflating front or side airbag can injure or kill a child sitting in the passenger's seat.
- A child in the passenger's seat is more likely to interfere with the driver's ability to safely control the vehicle.
- Statistics show that children of all sizes and ages are safer when they are properly restrained in a rear seat. Because this vehicle does not have a rear seat, we recommend that you do not carry a child age 12 or under in this vehicle.

Protecting Child Passengers

WARNING

Children who are unrestrained or improperly restrained can be seriously injured or killed in a crash.

Any child too small for a seat belt should be properly restrained in a child seat. A larger child should be properly restrained with a seat belt, using a booster seat if necessary.

The National Highway Traffic Safety Administration and Transport Canada recommend that all children ages 12 and under be properly restrained in a rear seat. Some states or provinces/territories have laws restricting where children may ride.

Never put a rear-facing child seat in this vehicle.

- Any child who is too small to wear a seat belt correctly must be restrained in an approved child seat that is properly secured to the vehicle using the lap belt portion of the lap/shoulder belt.
- Never hold a child on your lap because it is impossible to protect them in the event of a collision.
- Never put a seat belt over yourself and a child. During a crash, the belt would likely press deep into the child and cause serious or fatal injuries.
- Never let two children use the same seat belt. Both children could be very seriously injured in a crash.
- Do not allow children to operate the doors, windows or seat adjustments.
- Do not leave children in the vehicle unattended, especially in hot weather when the inside of the vehicle can get hot enough to kill them. They could also activate vehicle controls causing it to move unexpectedly.

▶▶ Protecting Child Passengers

⚠ WARNING

Allowing a child to play with a seat belt or wrap one around their neck can result in serious injury or death.

Instruct children not to play with any seat belt.

To deactivate a lockable retractor, release the buckle and allow the seat belt to wind up all the way.

To remind you of the passenger's front airbag hazards and child safety, your vehicle has warning labels on the dashboard (U.S. models) and on the front visors. Please read and follow the instructions on these labels.

▶ **Safety Labels** P. 68

Safety of Infants and Small Children

■ Protecting Infants

An infant must be properly restrained in a rear-facing, reclining child seat until the infant reaches the seat manufacturer's weight or height limit for the seat, and the infant is at least one year old. **Because rear-facing child seats should not be used in this vehicle, you should never carry an infant in this vehicle.**

▣ Protecting Infants

WARNING

Placing a rear-facing child seat in the passenger's seat can result in serious injury or death during a crash.

Never install a rear-facing child seat in this vehicle.

Rear-facing child seats should never be installed in a forward-facing position.

Protecting Smaller Children

Since this vehicle does not have a back seat, we recommend that you do not carry a child, age 12 or under, as a passenger.

This is because placing a forward-facing child seat in the passenger's seat can be hazardous, even with advanced front airbags that automatically turn the passenger's front airbag off.

If you choose to ignore our warnings and transport a small child in this vehicle, be sure to move the passenger seat as far to the rear as possible, and follow the instructions and guidelines in the following pages.

Protecting Smaller Children

⚠ WARNING

Placing a forward-facing child seat in the passenger's seat can result in serious injury or death if the front airbag inflates.

If you must place a forward-facing child seat in passenger's seat, move the vehicle seat as far back as possible, and properly restrain the child.

Educate yourself about the laws and regulations regarding child seat use where you are driving, and follow the child seat manufacturer's instructions.

A child seat must be secured to the vehicle with the lap part of a lap/shoulder belt. A child whose seat is not properly secured to the vehicle can be endangered in a crash.

■ Selecting a Forward-facing Child Seat

■ Important consideration when selecting a child seat

Make sure the child seat meets the following three requirements:

- The child seat is the correct type and size for the child.
- The child seat is the correct type for the seating position.
- The child seat is compliant with Federal Motor Vehicle Safety Standard 213 or Canadian Motor Vehicle Safety Standard 213.

■ Installing a Child Seat

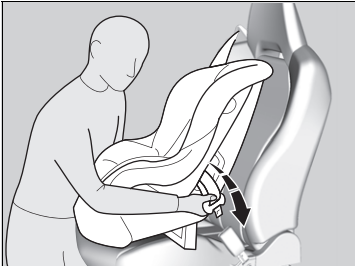

1. Move the passenger seat to the rearmost position.

2. Place the child seat on the passenger seat.

3. Route the seat belt through the child seat according to the seat manufacturer's instructions, and insert the latch plate into the buckle.

▶ Insert the latch plate fully until it clicks.

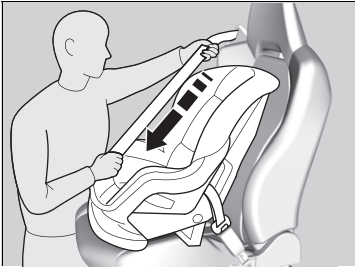

4. Slowly pull the shoulder part of the belt all the way out until it stops. This activates the lockable retractor.

5. Let the seat belt completely wind up into the retractor, then try to pull it out to make sure the retractor is locked.

▶ If you are able to pull the shoulder belt out, the lockable retractor is not activated. Pull the seat belt all the way out, and repeat steps 3 – 5.

6. Grab the shoulder part of the seat belt near the buckle, and pull up to remove any slack from the lap part of the belt.

▶ When doing this, place your weight on the child seat and push it into the vehicle seat.

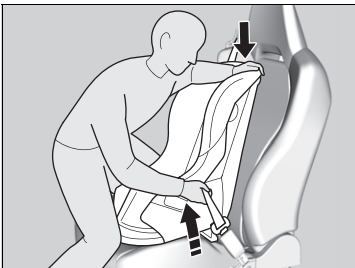

▣ Installing a Child Seat

A child seat must be secured to the vehicle with the lap part of a lap/shoulder belt.

For your child's safety, when using a child seat installed using the vehicle's seat belt system, check that the seat is properly secured to the vehicle.

Continued

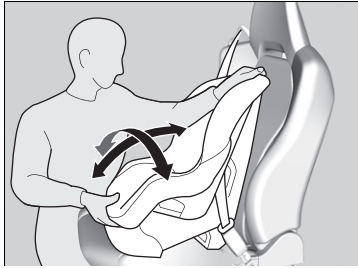

7. Make sure the child seat is firmly secured by rocking it forward and back and side to side; less than one inch of movement should occur near the seat belt.

■ Adding Security with a Tether

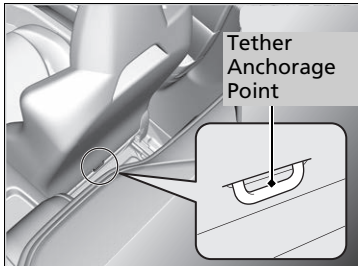

A tether anchorage point is provided behind the passenger seat. A child seat with a tether can be installed, so long as the base of the child seat is secured using a seat belt.

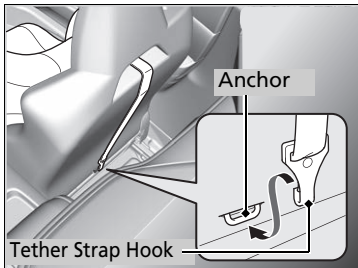

1. Move the seat forward.
 ► **Adjusting the Seat Positions** P. 144
2. Route the tether strap through the hole between head restraint and seat-back. Make sure the strap is not twisted.
3. Secure the tether strap hook to the anchor.
4. Tighten the tether strap as instructed by the child seat manufacturer.
5. Move the seat to the rearmost position.

►► Installing a Child Seat

A child seat that is not properly secured will not adequately protect a child in a crash and may cause injury to the child or another vehicle occupant.

To deactivate a lockable retractor, release the buckle and allow the seat belt to wind up all the way.

►► Adding Security with a Tether

Since a tether can provide additional security to the lap/shoulder seat belt installation, we recommend using a tether whenever one is available.

Safety of Larger Children

■ Protecting Larger Children

Since this vehicle does not have a back seat, we recommend that you do not carry a child age 12 or under as a passenger. This is because children who have outgrown child seats are also at risk of being injured or killed by an inflating passenger's front airbag. If a larger child must ride in this vehicle, the information in the following pages provides guidelines to help you decide when a given child may ride in this vehicle, and how to properly protect the child.

■ Checking Seat Belt Fit

When a child is too big for a child seat, secure the child in the passenger's seat using the lap/shoulder seat belt. Have the child sit upright and all the way back, then answer the following questions.



■ Checklist

- Do the child's knees bend comfortably over the edge of the seat?
- Does the shoulder belt cross between the child's neck and arm?
- Is the lap part of the seat belt as low as possible, touching the child's thighs?
- Will the child be able to stay seated like this for the whole trip?

If you answer yes to all these questions, the child is ready to wear the lap/shoulder seat belt correctly. If you answer no to any question, the child needs to ride on a booster seat until the seat belt fits properly without a booster seat.

» Safety of Larger Children

⚠ WARNING

Allowing a child age 12 or under to sit in the vehicle can result in injury or death if the passenger's front airbag inflates.

If a larger child must ride in the vehicle, move the vehicle seat as far to the rear as possible, have the child sit up properly and wear the seat belt properly, using a booster seat if needed.

■ Booster Seats

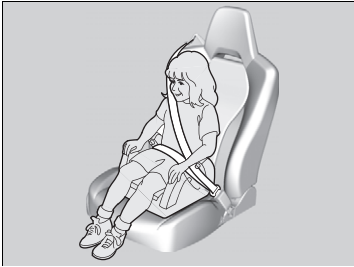

If a lap/shoulder seat belt cannot be used properly, position the child in a booster seat in the passenger's seating position. For the child's safety, check that the child meets the booster seat manufacturer's recommendations.

▣ Booster Seats

When installing a booster seat, make sure to read the instructions that came with it, and install the seat accordingly.

There are high- and low-type booster seats. Choose a booster seat that allows the child to wear the seat belt correctly.

Some U.S. states, and Canadian provinces and territories require children to use a booster seat until they reach a given age or weight (e.g. six years or 60 lbs). Be sure to check current laws in the state or province, or territory where you intend to drive.

■ Protecting Larger Children-Final Checks

If you decide that a child can safely ride in this vehicle:

- Make sure you read and fully understand the instructions and safety information in this manual.
- Move the passenger seat as far back as possible.
- Have the child sit upright and well back in the seat.
- Check that the seat belt is properly positioned so that the child is secure in the seat.

■ Monitoring a child passenger

We strongly recommend that you keep an eye on a child passenger. Even older, more mature children sometimes need to be reminded to fasten their seat belts and sit up properly.

Carbon Monoxide Gas

The engine exhaust from this vehicle contains carbon monoxide, a colorless, odorless, and highly toxic gas. As long as you properly maintain your vehicle, carbon monoxide gas will not get into the interior.

■ Have the exhaust system inspected for leaks whenever

- The exhaust system is making an unusual noise.
- The exhaust system may have been damaged.
- The vehicle is raised for an oil change.

☒ Carbon Monoxide Gas

WARNING

Carbon monoxide gas is toxic.

Breathing it can cause unconsciousness and even kill you.

Avoid any enclosed areas or activities that expose you to carbon monoxide.

An enclosed area such as a garage can quickly fill up with carbon monoxide gas. Do not turn the power system on with the garage door closed. Even when the garage door is open, drive out of the garage immediately after turning the power system on.

Label Locations

These labels are in the locations shown. They warn you of potential hazards that can cause serious injury or death. Read these labels carefully.

If a label comes off or becomes hard to read (except for the U.S. dashboard label which may be removed by the owner), contact an authorized Acura NSX dealer for a replacement.

Dashboard

U.S. models only

This Vehicle is Equipped with Advanced Air Bags

Even with Advanced Air Bags Children can be killed or seriously injured by the air bag, never put a rear-facing child seat in the front. Always use seat belts and child restraints. See owner's manual for more information about air bags. To be removed by owner only.

Sun Visors

U.S. models

WARNING
EVEN WITH ADVANCED AIR BAGS

- Children can be killed or seriously injured by the air bag.
- Always use appropriate child seat in the front.
- Always use seat belts and child restraints.
- See owner's manual for more information about air bags.

Canadian models

WARNING

- To avoid serious injury in all types of crashes, you must always wear your safety belt.
- Do not install rearward-facing child seats in any front passenger seat position.
- Do not sit or lean unnecessarily close to the air bag.
- Do not place any objects over the air bag or between the air bag and yourself.
- See this owner's manual for further information and explanations.

ATTENTION

- Pour éviter des blessures graves maximale lors d'une collision boucliez toujours votre ceinture de sécurité.
- N'installez jamais un siège pour enfants faisant face à l'arrière sur le siège du passager avant.
- Nie vous appuyez pas et ne vous assoyez pas près du coussin gonflable.
- Nie déposez aucun objet sur le coussin gonflable ou entre le coussin gonflable et vous.
- Lisez le guide utilisateur pour de plus amples renseignements.

High Voltage System Components

U.S. models

WARNING

HIGH VOLTAGE

- You can be killed or hurt.
- Do not remove this cover.
- No customer serviced parts inside.

Canadian models

WARNING

HIGH VOLTAGE

- You can be killed or hurt.
- Do not remove this cover.
- No customer serviced parts inside.

ATTENTION

HAUTE TENSION

- Vous pouvez être blessé ou tué.
- Nie pas enlever ce couvercle.
- Aucune pièce à l'intérieur que le client peut réparer.

Inverter Coolant Filler Tank Cap

DANGER WARNING
危険 危険

NEVER OPEN WHEN HOT. HOT COOLANT WILL BURN YOU.
N'OUVREZ PAS QUAND CHAUD. VOTRE LIQUIDE RÉFROIDISSANT PEUT ÊTRE TRÈS CHAUD. NE PAS OUVRIRE LORSQU'IL EST TRÈS CHAUD. NE PAS OUVRIRE LORSQU'IL EST TRÈS CHAUD.

Engine Coolant Reserve Tank Cap

DANGER WARNING
危険 危険

NEVER OPEN WHEN HOT. HOT COOLANT WILL BURN YOU.
N'OUVREZ PAS QUAND CHAUD. VOTRE LIQUIDE RÉFROIDISSANT PEUT ÊTRE TRÈS CHAUD. NE PAS OUVRIRE LORSQU'IL EST TRÈS CHAUD. NE PAS OUVRIRE LORSQU'IL EST TRÈS CHAUD.

Air Conditioner System

U.S. models

WARNING

Flammable Refrigerant
CAUTION SYSTEM CONTAINS REFRIGERANT R-1234yf UNDER HIGH PRESSURE. TO BE SERVICED ONLY BY QUALIFIED PERSONNEL. Follow instructions in the service manual.

AIR CONDITIONER SYSTEM REFRIGERANT : R-1234yf (SAE J2810, J2842, J2845)

REC. CHARGE : MAX 0.455kg MIN 0.405kg

OIL TYPE : ND-OIL11 (POE)

T6N Honda Motor Co., Ltd.

Canadian models

WARNING

R-1234yf



Instrument Panel





This chapter describes the buttons, indicators, and gauges that are used while driving.

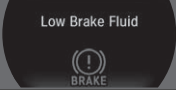
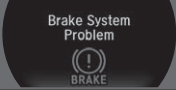





Indicators	70
Driver Information Interface Warning and Information Messages.....	83
Gauges and Displays	95
Gauges.....	95
Driver Information Interface	98





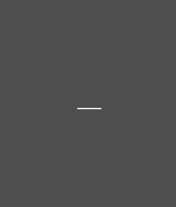



Indicators



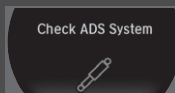
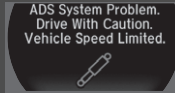

Indicator	Name	On/Blinking	Explanation	Message
	Brake System Indicator (Red)	<ul style="list-style-type: none"> Comes on for a few seconds when you set the power mode to ON, then goes off. Comes on when the brake fluid level is low. Comes on if there is a problem with the brake system. 	<ul style="list-style-type: none"> Comes on while driving - Check the brake fluid level. <ul style="list-style-type: none"> ➤ What to do when the indicator comes on while driving P. 453 Comes on along with the brake system indicator (amber) - Immediately stop in a safe place. Contact an authorized Acura NSX dealer for repair. The brake pedal becomes harder to operate. Depress the pedal further than you normally do. Comes on along with the ABS indicator - Have your vehicle checked by an authorized Acura NSX dealer. <ul style="list-style-type: none"> ➤ If the Brake System Indicator (Red) Comes On P. 453 	 
	Low Oil Pressure Indicator	<ul style="list-style-type: none"> Comes on when you set the power mode to ON, and goes off when the power system starts. Comes on when the engine oil pressure is low. Comes on if there is a problem with the engine oil pressure system. 	<ul style="list-style-type: none"> Comes on while driving - Immediately stop in a safe place and set the power mode to VEHICLE OFF, then contact an authorized Acura NSX dealer. 	









Indicator	Name	On/Blinking	Explanation	Message
	Electric Parking Brake Indicator	<ul style="list-style-type: none"> • Comes on when the parking brake is applied, and goes off when it is released. • Comes on for about 15 seconds then goes off when you pull the electric parking brake switch with the power mode in OFF. • Comes on for about 15 seconds then goes off when you set the power mode to OFF with the parking brake applied. 	<ul style="list-style-type: none"> • Blinks and the electric parking brake system indicator comes on at the same time - There is a problem with the electric parking brake system. The parking brake may not be set. 	
	Electric Parking Brake System Indicator	<ul style="list-style-type: none"> • Comes on for a few seconds when you set the power mode to ON, then goes off. • Comes on if there is a problem with the electric parking brake system. 	<ul style="list-style-type: none"> • Comes on while driving - Avoid using the parking brake and have your vehicle checked by an authorized Acura NSX dealer immediately. <ul style="list-style-type: none"> ▶ If the Electric Parking Brake System Indicator Comes On P. 454 	
		<ul style="list-style-type: none"> • Comes on when you press the electric parking brake switch without depressing the brake pedal. 	<ul style="list-style-type: none"> • Depress the brake pedal to release the parking brake. <ul style="list-style-type: none"> ▶ Parking Brake P. 357 	







Indicator	Name	On/Blinking	Explanation	Message
	Automatic Brake Hold System Indicator	<ul style="list-style-type: none"> Comes on when the automatic brake hold system is on. 	<p>➤ Automatic Brake Hold P. 360</p>	
	Automatic Brake Hold Indicator	<ul style="list-style-type: none"> Comes on for a few seconds when you set the power mode to ON, then goes off. Comes on when the automatic brake hold is activated. 	<p>➤ Automatic Brake Hold P. 360</p>	





Indicator	Name	On/Blinking	Explanation	Message
	Brake System Indicator (Amber)	<ul style="list-style-type: none"> • Comes on for a few seconds when you set the power mode to ON, then goes off. • Comes on if there is a problem with a system related to braking other than the conventional brake system. • Comes on if there is a problem with the cooperative control with regenerative braking, the electric servo brake system, or the hill start assist system. 	<ul style="list-style-type: none"> • Comes on while driving - Have your vehicle checked by an authorized Acura NSX dealer. • Stays on constantly - Avoid high speeds and sudden braking. Take the vehicle to an authorized Acura NSX dealer immediately. • With this indicator on, your vehicle still has normal braking ability. 	



Indicator	Name	On/Blinking	Explanation	Message
	POWER SYSTEM Indicator	<ul style="list-style-type: none"> Comes on for a few seconds when you set the power mode to ON, then goes off. Comes on if there is a problem with the electric vehicle system. 	<ul style="list-style-type: none"> Comes on while driving - Have your vehicle checked by an authorized Acura NSX dealer immediately. 	
	READY Indicator	<ul style="list-style-type: none"> Comes on when the vehicle is ready to drive. 	<ul style="list-style-type: none"> ➤ Turning on the Power P. 321 	
	Active Damper System Indicator	<ul style="list-style-type: none"> Comes on for a few seconds when you change the power mode to ON, then goes off. Comes on if there is a problem with the Active Damper System. The speed of the vehicle will be limited. 	<ul style="list-style-type: none"> Stays on constantly - Have the vehicle checked by an authorized Acura NSX dealer. With this indicator on, your vehicle has normal damping ability without the active damper feature. ➤ Integrated Dynamics System P. 336 	 
 	Brake Wear Indicator*	<ul style="list-style-type: none"> Comes on for a few seconds when you change the power mode to ON, then goes off. Comes on if a worn brake pad is detected. 	<ul style="list-style-type: none"> Comes on while driving - The brake pads may need to be replaced. Have your vehicle inspected by an authorized Acura NSX dealer. 	 

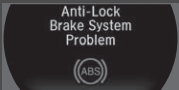

Indicator	Name	On/Blinking	Explanation	Message
	Malfunction Indicator Lamp	<ul style="list-style-type: none"> • Comes on when you set the power mode to ON, and goes off either when the power system is on or after several seconds if the power system did not turn on. If “readiness codes” have not been set, it blinks five times before it goes off. • Comes on if there is a problem with the emissions control system. • Blinks when a misfire in the engine’s cylinders is detected. 	<ul style="list-style-type: none"> • Readiness codes are part of the on board diagnostics for the emissions control systems. <ul style="list-style-type: none"> ▶ Testing of Readiness Codes P. 473 • Comes on while driving - Have your vehicle checked by an authorized Acura NSX dealer. • Blinks while driving - Stop in a safe place where there are no flammable objects. Stop the power system for 10 minutes or more, and wait for it to cool down. Then, take the vehicle to an authorized Acura NSX dealer. <ul style="list-style-type: none"> ▶ If the Malfunction Indicator Lamp Comes On or Blinks P. 452 	
		<ul style="list-style-type: none"> • Comes on if there is a problem with the gear shift mechanism. 	<ul style="list-style-type: none"> • Comes on and gear position indicator blinks at the same time - Have your vehicle checked by an authorized Acura NSX dealer. 	
	12-Volt Battery Charging System Indicator	<ul style="list-style-type: none"> • Comes on when you set the power mode to ON, and goes off when the power system is on. • Comes on when the 12-volt battery is not charging. 	<ul style="list-style-type: none"> • Comes on while driving - Turn off the climate control system and rear defogger in order to reduce electricity consumption. <ul style="list-style-type: none"> ▶ If the 12-Volt Battery Charging System Indicator Comes On P. 452 	



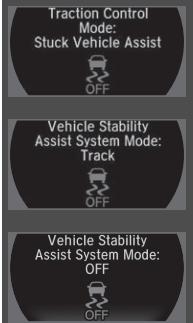

Indicator	Name	On/Blinking	Explanation	Message
	Gear Position Indicator	<ul style="list-style-type: none"> Indicates the current gear selection. 	<ul style="list-style-type: none">  Shifting P. 326 	—
	Transmission System Indicator	<ul style="list-style-type: none"> The indicated current gear selection blinks if there is a problem with the transmission system. 	<ul style="list-style-type: none"> Avoid sudden start and acceleration, and stop in a safe place immediately. Have your vehicle checked by an authorized Acura NSX dealer. 	
		<ul style="list-style-type: none"> All the gear positions may light for several seconds, and go off. 	<ul style="list-style-type: none"> When all the gear positions light, immediately stop your vehicle in a safe place. Indicators go off if there is no problem. However, even if they go off, take your vehicle to an authorized Acura NSX dealer for inspection. 	—
		<ul style="list-style-type: none"> The indicated current gear selection or all the gear positions blink if there is a problem with the transmission system. 	<ul style="list-style-type: none"> Immediately stop in a safe place.  Emergency Towing P. 462 Have your vehicle checked by an authorized Acura NSX dealer. 	
		<ul style="list-style-type: none"> The indicated current gear selection or all the gear positions blink if you cannot select P due to the transmission system failure. 	<ul style="list-style-type: none"> The power system can be activated as a temporary measure.  If the Transmission System Indicator Blinks along with the Warning Message P. 456 Set the parking brake when parking. Have your vehicle checked by an authorized Acura NSX dealer immediately. 	



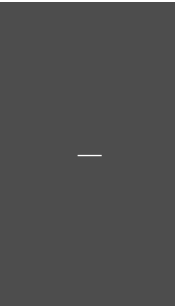

Indicator	Name	On/Blinking	Explanation	Message
	Seat Belt Reminder Indicator	<ul style="list-style-type: none"> • Comes on and the beeper sounds if you are not wearing a seat belt when you set the power mode to ON. • If the passenger is not wearing a seat belt, the indicator comes on a few seconds later. • Blinks while driving if either you or the passenger has not fastened a seat belt. The beeper sounds and the indicator blinks at regular intervals. 	<ul style="list-style-type: none"> • The beeper stops and the indicator goes off when you and the passenger fasten their seat belts. • Stays on after you or the passenger has fastened the seat belt - A detection error may have occurred in the sensor. Have your vehicle checked by an authorized Acura NSX dealer.  Seat Belt Reminder P. 37 	<div data-bbox="1310 295 1487 385"> Fasten Seatbelt  </div> <div data-bbox="1310 400 1487 490"> Fasten Passenger's Seatbelt  </div>
	Low Fuel Indicator	<ul style="list-style-type: none"> • Comes on when the fuel reserve is running low (approximately 2.4 U.S. gal/8.9 Liter left). • Blinks if there is a problem with the fuel gauge. 	<ul style="list-style-type: none"> • Comes on - Refuel your vehicle as soon as possible. • Blinks - Have your vehicle checked by an authorized Acura NSX dealer. 	<div data-bbox="1310 586 1487 687"> Fuel Low  </div> <div data-bbox="1310 703 1487 804"> Fuel Gauge System Problem  </div>

Indicator	Name	On/Blinking	Explanation	Message
	Anti-lock Brake System (ABS) Indicator	<ul style="list-style-type: none"> • Comes on for a few seconds when you set the power mode to ON, then goes off. • If it comes on at any other time, there is a problem with the ABS. 	<ul style="list-style-type: none"> • Stays on constantly - Have your vehicle checked by an authorized Acura NSX dealer. With this indicator on, your vehicle still has normal braking ability but no anti-lock function. ➤ Anti-lock Brake System (ABS) P. 362 	
	Supplemental Restraint System Indicator	<ul style="list-style-type: none"> • Comes on for a few seconds when you set the power mode to ON, then goes off. • Comes on if a problem with any of the following is detected: <ul style="list-style-type: none"> - Supplemental restraint system - Side airbag system - Side curtain airbag system - Knee airbag system - Seat belt tensioner 	<ul style="list-style-type: none"> • Stays on constantly or does not come on at all - Have your vehicle checked by an authorized Acura NSX dealer. 	
	Electric Power Steering (EPS) System Indicator	<ul style="list-style-type: none"> • Comes on when you set the power mode to ON, and goes off when the power system is on. • Comes on if there is a problem with the EPS system. 	<ul style="list-style-type: none"> • Stays on constantly or does not come on at all - Have your vehicle checked by an authorized Acura NSX dealer. ➤ If the Electric Power Steering (EPS) System Indicator Comes On P. 453 	

Indicator	Name	On/Blinking	Explanation	Message
	Vehicle Stability Assist™ (VSA®) System Indicator	<ul style="list-style-type: none"> • Comes on for a few seconds when you set the power mode to ON, then goes off. • Blinks when VSA® is active. • Comes on if there is a problem with the VSA® system. 	<ul style="list-style-type: none"> • Stays on constantly - Have your vehicle checked by an authorized Acura NSX dealer. <ul style="list-style-type: none"> ➤ Vehicle Stability Assist™ (VSA®), aka Electronic Stability Control (ESC), System P. 346 	
	Vehicle Stability Assist™ (VSA®) OFF Indicator	<ul style="list-style-type: none"> • Comes on for a few seconds when you set the power mode to ON, then goes off. • Comes on when you press the VSA® OFF button to change VSA® mode. • Comes on when you select TRACK mode by the Integrated Dynamics System mode switch. 	<ul style="list-style-type: none"> ➤ VSA® On and Off P. 347 ➤ Integrated Dynamics System P. 336 	

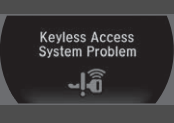
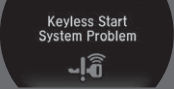

Indicator	Name	On/Blinking	Explanation	Message
	<p>Low Tire Pressure/TPMS Indicator</p>	<ul style="list-style-type: none"> • Comes on for a few seconds when you set the power mode to ON, then goes off. • Comes on if the tire pressure of any of the tires becomes significantly low. • Blinks for about one minute, and then stays on if there is a problem with the TPMS. 	<ul style="list-style-type: none"> • Comes on while driving - Stop in a safe place, check tire pressures, and inflate the tire(s) if necessary. • Blinks and remains on - Have your vehicle checked by an authorized Acura NSX dealer. 	
	<p>System Message Indicator</p>	<ul style="list-style-type: none"> • Comes on for a few seconds when you set the power mode to ON, then goes off. • Comes on along with a beep when a problem is detected. A system message on the driver information interface appears at the same time. 	<ul style="list-style-type: none"> • While the indicator is on, roll the right selector wheel to see the message again. • Refer to the Indicators information in this chapter when a system message appears on the driver information interface. Take the appropriate action for the message. • The driver information interface does not return to the normal screen unless the warning is canceled, or the right selector wheel is rolled. 	



Indicator	Name	On/Blinking	Explanation	Message
	Turn Signal and Hazard Warning Indicators	<ul style="list-style-type: none"> Blinks when you operate the turn signal lever. Blink if you press the hazard warning button. 	<ul style="list-style-type: none"> Does not blink or blinks rapidly - Have your vehicle checked by an authorized Acura NSX dealer.  Replacing Light Bulbs P. 401, 402 	—
	High Beam Indicator	<ul style="list-style-type: none"> Comes on when the high beam headlights are on. 	—	—
	Lights On Indicator	<ul style="list-style-type: none"> Comes on whenever the light switch is on, or in AUTO when the exterior lights are on. 	<ul style="list-style-type: none"> If you set the power mode to VEHICLE OFF while the exterior lights are on, a chime sounds when the driver's door is opened. 	—
	Immobilizer System Indicator	<ul style="list-style-type: none"> Comes on briefly when you set the power mode to ON, then goes off. Comes on if the immobilizer system cannot recognize the key information. 	<ul style="list-style-type: none"> Blinks - You cannot start the power system. Set the power mode to VEHICLE OFF, then select the ON mode again. Repeatedly blinks - The system may be malfunctioning. Have your vehicle checked by an authorized Acura NSX dealer. Do not attempt to alter this system or add other devices to it. Electrical problems can occur. 	—



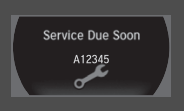

Indicator	Name	On/Blinking	Explanation	Message
 Indicator	Security System Alarm Indicator	<ul style="list-style-type: none"> Blinks when the security system alarm has been set. 	<p>➤ Security System Alarm P. 122</p>	—
	Keyless Access System Indicator	<ul style="list-style-type: none"> Comes on for a few seconds when you set the power mode to ON, then goes off. Comes on as soon as a problem is detected in the keyless access system or keyless starting system. 	<ul style="list-style-type: none"> Have your vehicle checked by an authorized Acura NSX dealer. 	 
	CRUISE MAIN Indicator	<ul style="list-style-type: none"> Comes on when you press the CRUISE button. 	<p>➤ Cruise Control P. 343</p>	—
	CRUISE CONTROL Indicator	<ul style="list-style-type: none"> Comes on if you have set a speed for cruise control. 	<p>➤ Cruise Control P. 343</p>	—



Driver Information Interface Warning and Information Messages

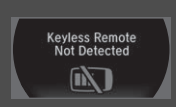
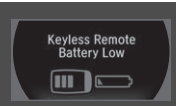

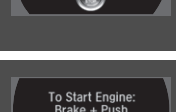

The following messages appear only on the driver information interface. Roll the right selector wheel to see the message again with the system message indicator on.

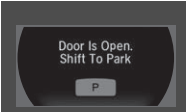
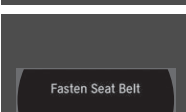

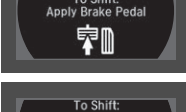
Message	Condition	Explanation
 <p>Washer Fluid Low</p>	<ul style="list-style-type: none"> Appears when the washer fluid is low. 	<ul style="list-style-type: none"> Refill the washer fluid. <ul style="list-style-type: none"> ► Refilling Window Washer Fluid P. 400
 <p>Service Due Soon A12345</p>	<ul style="list-style-type: none"> Appears when the scheduled maintenance is due soon. Consequently, Service Due Now and Service Past Due follow. 	<ul style="list-style-type: none"> ► Maintenance Minder Messages on the Driver Information Interface P. 381
 <p>Transmission Temperature Near Limit. Performance May Be Reduced</p>	<ul style="list-style-type: none"> Appears when the temperature of the transmission is starting to get too hot. The performance of the vehicle may be reduced. 	<ul style="list-style-type: none"> It may not be possible to use the paddle shifters. Until the message disappears, reduce your speed and allow the system to cool down.
 <p>Stop Driving When Safe. Transmission Temperature Too Hot</p>	<ul style="list-style-type: none"> Appears when the transmission system temperature is too high. The vehicle does not operate properly. 	<ul style="list-style-type: none"> You may find it difficult to accelerate, or to start the vehicle on uphill. Immediately stop in a safe place in P. Let the engine idle until the message disappears.



Message	Condition	Explanation
	<ul style="list-style-type: none"> Appears when there is a problem with the sensor on the 12-volt battery. 	<ul style="list-style-type: none"> Have your vehicle checked by an authorized Acura NSX dealer. ➤ Checking the 12-Volt Battery P. 417
	<ul style="list-style-type: none"> Appears after the driver's door is opened when the power mode is in ACCESSORY. 	<ul style="list-style-type: none"> Press the ENGINE START/STOP button twice with your foot off the brake pedal to change the power mode to VEHICLE OFF.
	<ul style="list-style-type: none"> Appears when the power mode is in ACCESSORY. 	<p>—</p>



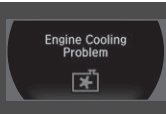
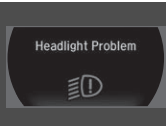

Message	Condition	Explanation
	<ul style="list-style-type: none"> Appears when you close the door with the power mode in ON without the keyless access remote inside the vehicle. 	<ul style="list-style-type: none"> Disappears when you bring the keyless access remote back inside the vehicle and close the door. <ul style="list-style-type: none"> ➤ Keyless Access Remote Reminder P. 129
	<ul style="list-style-type: none"> Appears when the keyless access remote battery becomes weak. 	<ul style="list-style-type: none"> Replace the battery as soon as possible. <ul style="list-style-type: none"> ➤ Replacing the Button Battery P. 418
	<ul style="list-style-type: none"> Appears if the keyless access remote battery is too weak to turn on the power system or the key is not within operating range to turn on the power system. A beeper sounds six times. 	<ul style="list-style-type: none"> Bring the keyless access remote in front of the ENGINE START/STOP button to be touched with. <ul style="list-style-type: none"> ➤ If the Keyless Access Remote Battery is Weak P. 446
	<ul style="list-style-type: none"> Appears three seconds after you bring the keyless access remote in front of the ENGINE START/STOP button when To Start, Hold Remote Near Start Button appears. To Start Engine: Brake + Push appears sequentially. 	<ul style="list-style-type: none"> Unless you bring the keyless access remote in front of the ENGINE START/STOP button, this message does not appear. <ul style="list-style-type: none"> ➤ If the Keyless Access Remote Battery is Weak P. 446
	<ul style="list-style-type: none"> Appears when you set the power mode to ACCESSORY or ON. 	<ul style="list-style-type: none"> ➤ Turning on the Power P. 321
	<ul style="list-style-type: none"> Appears if you press the ENGINE START/STOP button while the vehicle is moving. 	<ul style="list-style-type: none"> The message will disappear after six seconds or when the power mode is set to VEHICLE OFF.

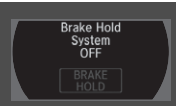
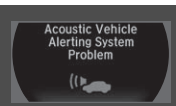

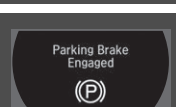

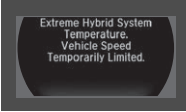

Message	Condition	Explanation
	<ul style="list-style-type: none"> Appears when you turn the power system on with the transmission not in P. 	<ul style="list-style-type: none"> Press the P button.
	<ul style="list-style-type: none"> Appears when you try to change the gear position after the position has automatically been changed to P with the driver's door open and the driver's seat belt unfastened. 	<ul style="list-style-type: none"> Press the P button if you leave the vehicle.
	<ul style="list-style-type: none"> Appears when you set the power mode to ON without fastening the driver's seat belt. Appears when you change the gear position after P has been automatically selected with the driver's door open, the driver's seat belt unfastened, then the brake pedal is released. 	<ul style="list-style-type: none"> Fasten the seat belt properly before you start to drive. <ul style="list-style-type: none"> ► Shift Operation P. 328
	<ul style="list-style-type: none"> Appears when you try to change the gear position without depressing the brake pedal. 	<ul style="list-style-type: none"> Depress the brake pedal, then select a shift button.
	<ul style="list-style-type: none"> Appears when you try to change the gear position without releasing your foot off the accelerator pedal. 	<ul style="list-style-type: none"> Release your foot from the accelerator pedal, depress the brake pedal, then select a gear.





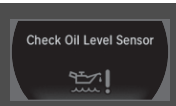

Message	Condition	Explanation
	<ul style="list-style-type: none"> Appears when the park button is pressed while the vehicle is moving. Appears if you change the gear position to R while the vehicle is moving forward, or to D or M while the vehicle is reversing. 	<ul style="list-style-type: none"> Make sure that the vehicle comes to a stop before operating the select button.
	<ul style="list-style-type: none"> Appears if you depress the accelerator pedal when the transmission is in N. 	<ul style="list-style-type: none"> Release the accelerator pedal. After that, depress the brake pedal and change the transmission position.
	<ul style="list-style-type: none"> Appears when the shift is repeatedly changed between P and any other position. 	<ul style="list-style-type: none"> Wait for a while then change the shift position.
	<ul style="list-style-type: none"> Appears if there is a problem with the electric system. Appears when you set the power mode to OFF while driving. 	<ul style="list-style-type: none"> Immediately stop in a safe place and set the parking brake. Continue driving if the message goes off soon after. If there is a problem with the transmission system, the transmission system indicator comes on. <ul style="list-style-type: none"> ► Transmission System Indicator P. 76
	<ul style="list-style-type: none"> Appears when you change to N, and press the ENGINE START/STOP button within five seconds. 	<ul style="list-style-type: none"> The gear position remains in N for 15 minutes, then automatically switches to P. <ul style="list-style-type: none"> ► If you want to keep the transmission in N position (car wash mode) P. 329
	<ul style="list-style-type: none"> Appears when the vehicle is stopped with the driver's seat belt unfastened and there is a chance that the vehicle may roll unintentionally. 	<ul style="list-style-type: none"> Press the P button before release the brake pedal when idling, parking or exiting the vehicle. <ul style="list-style-type: none"> ► Shift Operation P. 328

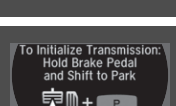
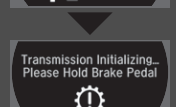
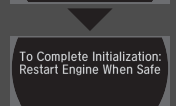
Message	Condition	Explanation
	<ul style="list-style-type: none"> • Appears if any door or the trunk (hatch) is not completely closed. • Appears if any door or the trunk (hatch) is opened while driving. The beeper sounds. 	<ul style="list-style-type: none"> • Goes off when all doors and the trunk (hatch) are closed.
	<ul style="list-style-type: none"> • Appears if there is a problem with the radiator system. 	<ul style="list-style-type: none"> • Drive slowly to prevent overheating and have your vehicle checked by an authorized Acura NSX dealer as soon as possible.
	<ul style="list-style-type: none"> • Appears when there is a problem with the headlights. 	<ul style="list-style-type: none"> • Appears while driving - The low beam headlights may not be on. When conditions allow you to drive safely, have your vehicle checked by an authorized Acura NSX dealer as soon as possible.
<p>Models with parking sensor system</p> 	<ul style="list-style-type: none"> • Appears if there is a problem with the parking sensor system. 	<ul style="list-style-type: none"> • Check if the area around the sensor(s) is covered with mud, ice, snow, etc. If the indicator(s) stays on even after you clean the area, have the system checked by an authorized Acura NSX dealer.

Message	Condition	Explanation
	<ul style="list-style-type: none"> Appears if the automatic brake hold is automatically canceled while it is in operation. 	<ul style="list-style-type: none"> Immediately depress the brake pedal.
	<ul style="list-style-type: none"> Appears when the automatic brake hold system is turned off. 	<ul style="list-style-type: none"> ➤ Automatic Brake Hold P. 360
	<ul style="list-style-type: none"> Appears if there is a problem with the acoustic vehicle alerting system. 	<ul style="list-style-type: none"> Have your vehicle checked by an authorized Acura NSX dealer.
	<ul style="list-style-type: none"> Appears when the automatic brake hold button is pressed without wearing the driver's seat belt. 	<ul style="list-style-type: none"> Fasten the driver's seat belt. ➤ Automatic Brake Hold P. 360
	<ul style="list-style-type: none"> Appears when the automatic brake hold button is pressed without depressing the brake pedal while the automatic brake hold is in operation. 	<ul style="list-style-type: none"> Press the automatic brake hold button with the brake pedal depressed. ➤ Automatic Brake Hold P. 360
	<ul style="list-style-type: none"> Appears when the parking brake is applied automatically while it is in operation. 	<ul style="list-style-type: none"> ➤ Automatic Brake Hold P. 360 ➤ Parking Brake P. 357

Message	Condition	Explanation
	<ul style="list-style-type: none"> Appears after the 12-volt battery charging system indicator comes on. 	<ul style="list-style-type: none"> Your vehicle has less ability to accelerate and may be harder to start on an incline. Contact an authorized Acura NSX dealer immediately.
	<ul style="list-style-type: none"> Appears when the transmission temperature is too low to operate (approx. -13°F [-25°C] or below). 	<ul style="list-style-type: none"> You can start the engine and use the climate control system to warm up the interior, which will also warm the transmission enough for you to drive the vehicle. The engine speed does not increase even if you fully depress the accelerator pedal.
	<ul style="list-style-type: none"> Appears when the High Voltage battery temperature is extremely low (-4°F [-20°C]). 	<ul style="list-style-type: none"> Contact an authorized Acura NSX dealer immediately. To prevent the message to come on, store the vehicle in the garage or drive in advance to warm up the High Voltage battery. The minimum operation guarantee environmental temperature is -4°F [-20°C].
	<ul style="list-style-type: none"> Appears when the twin motor unit fluid temperature is extremely low. 	<ul style="list-style-type: none"> Vehicle speed is limited to 109 mph (175 km/h) until twin motor unit fluid warms up.
	<ul style="list-style-type: none"> Appears if the AWD system has a problem due to a hybrid system or power distribution control failure. 	<ul style="list-style-type: none"> Drives with the rear wheels only in this state. Have your vehicle checked by an authorized Acura NSX dealer.

Message	Condition	Explanation
	<ul style="list-style-type: none"> Appears when the engine is running and indicates that the engine oil level is low. 	<ul style="list-style-type: none"> Appears while driving - Immediately stop in a safe place.  If the Low Oil Level Symbol Appears P. 456
	<ul style="list-style-type: none"> Appears when the engine is running and indicates that there is a problem with the oil level sensor. 	<ul style="list-style-type: none"> Have your vehicle checked by an authorized Acura NSX dealer as soon as possible.
	<ul style="list-style-type: none"> Appears if the engine coolant temperature is abnormally high. 	<ul style="list-style-type: none">  Overheating P. 450
	<ul style="list-style-type: none"> Appears if there is a problem with the fuel system. Engine performance will be limited. 	<ul style="list-style-type: none"> Immediately stop in a safe place and set the power mode to VEHICLE OFF, then select the ON mode again. Have your vehicle checked by an authorized Acura NSX dealer if the message appears again.
	<ul style="list-style-type: none"> Appears if there is a temporary problem with the gear shift mechanism and initialization is necessary. 	<ul style="list-style-type: none"> Depress the brake pedal and shift to P.
	<ul style="list-style-type: none"> Appears when the transmission is undergoing initialization. 	<ul style="list-style-type: none"> Keep the brake pedal depressed.
	<ul style="list-style-type: none"> Appears when a temporary problem is fixed. 	<ul style="list-style-type: none"> Initialization will be completed when the engine is restarted.

Message	Condition	Explanation
 <p>Transmission Problem Reverse Gear Not Available</p>	<ul style="list-style-type: none"> Appears when a problem with the transmission prevents a gear from changing to R. 	<ul style="list-style-type: none"> Have your vehicle checked by an authorized Acura NSX dealer.
 <p>High Voltage Battery Charge Too Low. Vehicle Cannot Start.</p>	<ul style="list-style-type: none"> Appears when the High Voltage battery is extremely low and cannot start the power system. 	<ul style="list-style-type: none"> Have your vehicle checked by an authorized Acura NSX dealer.
 <p>Power System Problem. Stop Driving When Safe.</p>	<ul style="list-style-type: none"> Appears when the vehicle cannot be driven by the engine. 	<ul style="list-style-type: none"> Stop your vehicle in a safe place and contact an authorized Acura NSX dealer.
 <p>REV Limit Reduced Engine Temp Too Low</p>	<ul style="list-style-type: none"> Appears when the engine speed exceeds reduced REV LIMIT while engine temperature is low. 	<ul style="list-style-type: none"> Continue driving at a low engine speed until the engine temperature becomes warm.
 <p>Slow Down! Reduced Stopping Power</p>	<ul style="list-style-type: none"> Appears when braking ability is reduced due to increased fluid consumption in the braking system. 	<ul style="list-style-type: none"> Slow Down and drive carefully. The message will disappear once the brakes have cooled and the system has returned to normal operating condition.
 <p>Tire Pressure Too Low For High Speed Driving</p>	<ul style="list-style-type: none"> Appears if you are driving at an extremely high speed and one or more tires are underinflated. 	<ul style="list-style-type: none"> Decelerate and drive your vehicle until the message disappears.

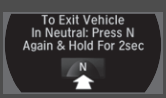
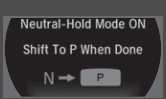
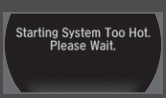
Message	Condition	Explanation
	<ul style="list-style-type: none"> • Appears for a few seconds if you have not pressed the N button long enough to initiate Neutral-Hold mode. 	<ul style="list-style-type: none"> ➤ If you want to keep the transmission in N position (car wash mode) P. 329
	<ul style="list-style-type: none"> • Appears when you press and hold N button for more than 2 seconds. 	<ul style="list-style-type: none"> • Disappears when you set the gear position to other than N. ➤ If you want to keep the transmission in N position (car wash mode) P. 329
	<ul style="list-style-type: none"> • Appears when the device for starting the vehicle is too hot. 	<ul style="list-style-type: none"> • Wait until message disappears.

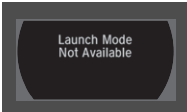
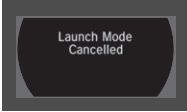
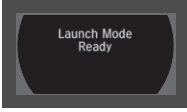
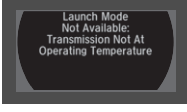
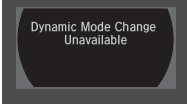
Message	Condition	Explanation
	<ul style="list-style-type: none"> Appears when launch control cannot be used due to the condition of your vehicle. 	➤ Launch Control P. 341
	<ul style="list-style-type: none"> Appears if you shift the gear or do anything else after Launch Mode is ready. 	➤ Launch Control P. 341
	<ul style="list-style-type: none"> Appears when Launch Mode is ready. 	➤ Launch Control P. 341
	<ul style="list-style-type: none"> Appears when the temperature of the transmission is not in the operable range for launch control. 	➤ Launch Control P. 341
	<ul style="list-style-type: none"> Appears if the Integrated Dynamics System mode cannot be changed due to certain situations, such as a system error or adverse driving conditions. 	➤ Integrated Dynamics System P. 336

Gauges

Gauges include the speedometer, tachometer, fuel gauge, temperature gauge, High Voltage battery charge level gauge, **ASSIST/CHARGE** gauge, **SH-AWD**[®] temperature gauge, and related indicators. They are displayed when the power mode is in ON.

■ Speedometer

Displays your driving speed in mph or km/h.

■ Tachometer

Shows the number of engine revolutions per minute.

■ Engine speed red-zone indication

Alerts you when the engine speed is near the tachometer's red zone.

When the engine speed exceeds 7,000 rpm, the outer ring of the tachometer flashes in red.

To protect the engine from damage, never drive with the tachometer in its red zone.

■ Fuel Gauge

Displays the amount of fuel left in the fuel tank.

» Speedometer

Press and hold the mph/km/h change button until you hear a beep.

The speedometer reading and the displayed measurements switch between mph and km/h.

» Fuel Gauge

NOTICE

You should refuel when the needle approaches **E**. Running out of fuel can cause the engine to misfire, damaging the catalytic converter.

The actual amount of remaining fuel may differ from the fuel gauge reading.

■ Temperature Gauge

Displays the temperature of the engine coolant.

■ High Voltage Battery Charge Level Gauge

Shows the remaining High Voltage battery charge level.

■ ASSIST/CHARGE Gauge

■ Electric motor

The degree to which the electric motor is being powered is displayed by the readings on the **ASSIST** side.

■ Battery charge in progress

The degree to which the High Voltage battery is being charged is displayed by the readings on the **CHARGE** side.

⌘ Temperature Gauge

Driving with the temperature gauge pointer in the upper zone can cause serious engine damage. Pull safely to the side of the road and allow engine temperature to return to normal.

➤ **Overheating** P. 450

⌘ High Voltage Battery Charge Level Gauge

The High Voltage battery charge level may decrease under the following conditions:

- When the 12-volt battery has been replaced.
- When the 12-volt battery has been disconnected.
- When the High Voltage battery control system corrects its reading.

The charge level reading will be corrected automatically while driving.

Changes in the temperature of the High Voltage battery can increase or decrease the battery's charging capacity. If temperature changes cause the battery's capacity to change, the number of indicators in the battery charge level gauge may also change, even if the amount of charging remains the same.

■ SH-AWD® Temperature Gauge

Displays the temperature of the SH-AWD® system.

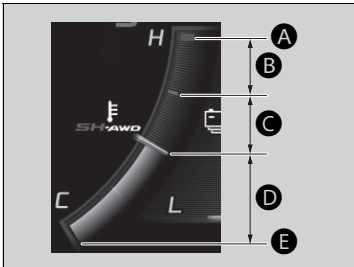

A: System performance is severely limited due to extreme operating temperature. Stop your vehicle in a safe place and contact an authorized Acura NSX dealer.

B: System performance is limited due to high operating temperature.

C: System is operating at optimum performance.

D: System performance is limited due to low operating temperature.

E: System is not warm enough for vehicle to drive.

■ Engine Oil Temperature Gauge

Displays the temperature of the engine oil when the Integrated Dynamics System is in **SPORT+** mode and **TRACK** mode.

Since the actual oil temperature is not measured, the temperature displayed here may differ from the actual temperature.

🔧 **Integrated Dynamics System** P. 336

▣ SH-AWD® Temperature Gauge

If the temperature reaches the red zone, stop your vehicle in a safe place and allow the system to cool down. After that, change the power mode to VEHICLE OFF and set the power mode to ON again. Even though the system has cooled down, the **POWER SYSTEM** indicator will stay on. Have your vehicle inspected by an authorized Acura NSX dealer.

▣ Engine Oil Temperature Gauge

Driving with the temperature gauge pointer in the upper zone can cause serious engine damage. Pull safely to the side of the road and allow engine temperature to return to normal.

Driver Information Interface

The driver information interface shows the odometer, trip meter, outside temperature indicator, and other gauges. It also displays important messages such as warnings and other helpful information.

Switching the Display

Roll the right selector wheel to change the display.

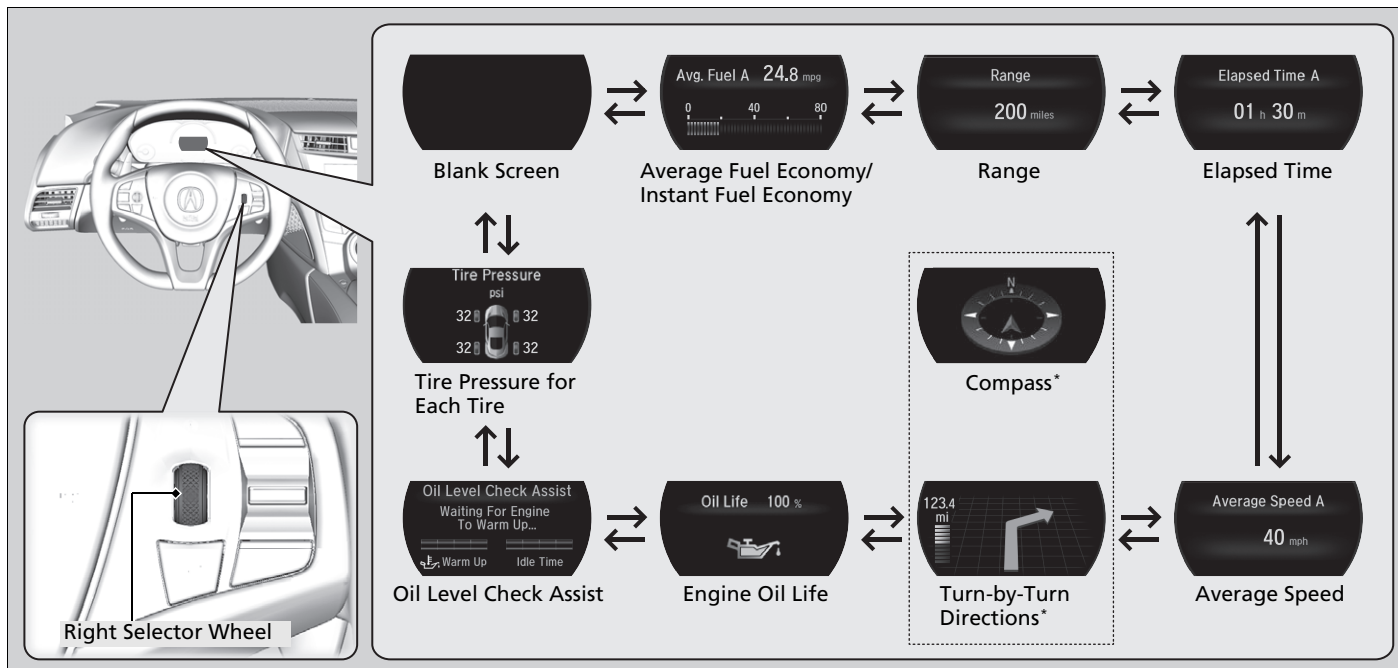

Press the **TRIP** button to change the display.

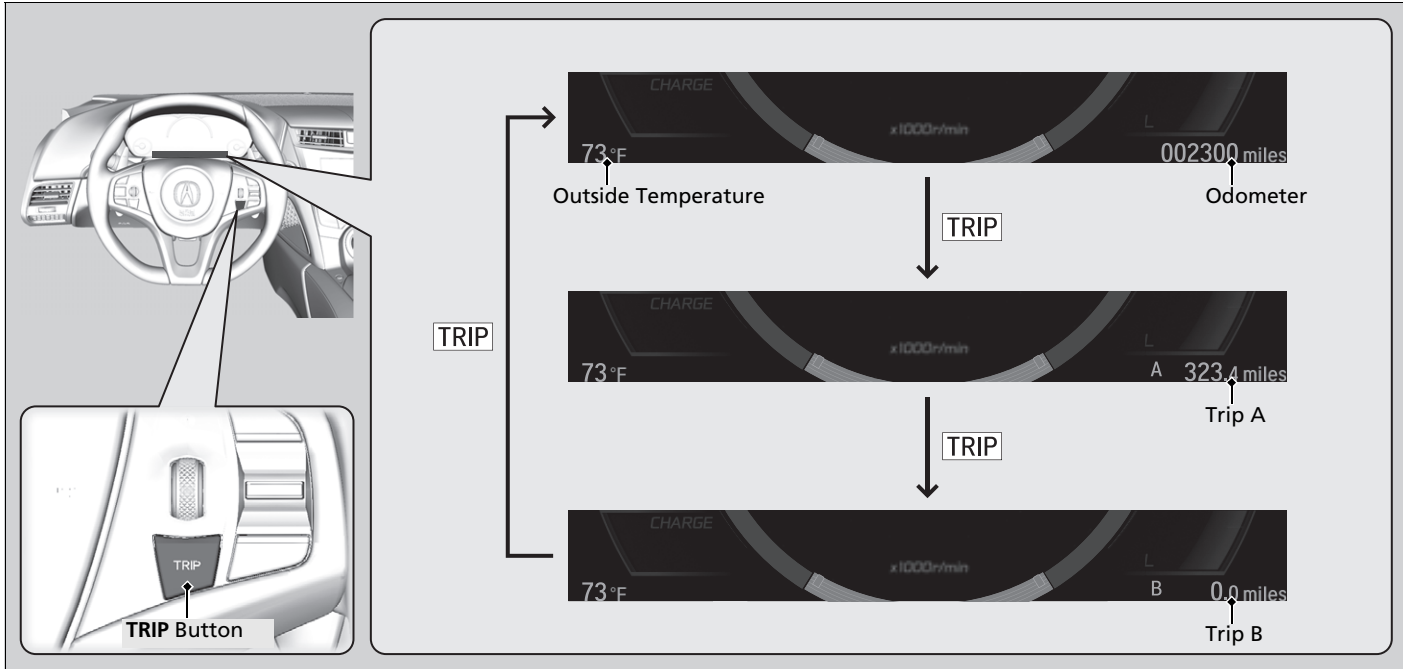

■ Odometer

Shows the total number of miles or kilometers that your vehicle has accumulated.

■ Trip Meter

Shows the total number of miles or kilometers driven since the last reset. Meters A and B can be used to measure two separate trips.

■ Resetting a trip meter

To reset a trip meter, display it, then press and hold the **TRIP** button. The trip meter is reset to **0.0**.

When a trip meter is reset, the average fuel economy, the elapsed time, and the average speed are also reset.

■ Outside Temperature

Shows the outside temperature in Fahrenheit (U.S.) or Celsius (Canada).

■ Adjusting the outside temperature display

Adjust the temperature reading up to $\pm 5^{\circ}\text{F}$ or $\pm 3^{\circ}\text{C}$ if the temperature reading seems incorrect.

▶▶ Trip Meter

Switch between trip meter A and trip meter B by pressing the **TRIP** button.

▶▶ Outside Temperature

The temperature sensor is in the front bumper. Road heat and exhaust from another vehicle can affect the temperature reading when your vehicle speed is less than 19 mph (30 km/h).

It may take several minutes for the display to be updated after the temperature reading has stabilized.

Use the audio system's customized features to correct the temperature.

▶▶ **Customized Features** P. 244

■ Average Fuel Economy

Shows the estimated average fuel economy of each trip meter in mpg or l/100 km. The display is updated at set intervals. When a trip meter is reset, the average fuel economy is also reset.

■ Instant Fuel Economy

Shows the instant fuel economy as a bar graph in mpg or l/100 km.

■ Range

Shows the estimated distance you can travel on the remaining power and fuel. This distance is estimated from the fuel economy of your previous trips.

■ Elapsed Time

Shows the time elapsed since Trip A or Trip B was reset.

■ Average Speed

Shows the average speed in mph or km/h since Trip A or Trip B was reset.

⌘ Average Fuel Economy

You can change when to reset the average fuel economy.

➤ **Customized Features** P. 244

⌘ Range

The displayed range may change even when the vehicle is stationary.

⌘ Elapsed Time

You can change when to reset the elapsed time.

➤ **Customized Features** P. 244

⌘ Average Speed

You can change when to reset the average speed.

➤ **Customized Features** P. 244

■ Navigation *

■ Compass

Shows the compass screen.

■ Turn-by-Turn Directions

When driving guidance is provided by the navigation system or Android Auto, turn-by-turn directions to your destination appear.

➤ **Refer to the Navigation System Manual**

➤ **Android Auto™** P. 219

■ Engine Oil Life

Shows the remaining oil life and Maintenance Minder™.

➤ **Maintenance Minder™** P. 379

■ Oil Level Check Assist

Shows the engine oil level check assist display.

➤ **Oil Check** P. 391

■ Tire Pressure Monitor

Shows each tire's pressure.

➤ **Tire Pressure Monitoring System (TPMS)** P. 352

⌘ Navigation *

You can select whether to have the turn-by-turn display come on or not during the route guidance.

➤ **Customized Features** P. 244

Controls

This chapter explains how to operate the various controls necessary for driving.

Clock	104	Immobilizer System	122	Driving Position Memory System *	138
Locking and Unlocking the Doors		Security System Alarm.....	122	Adjusting the Steering Wheel	140
Key	105	Opening and Closing the Windows	125	Adjusting the Mirrors	141
Low Keyless Access Remote Signal		Operating the Switches Around the		Interior Rearview Mirror	141
Strength.....	106	Steering Wheel		Power Door Mirrors	142
Locking/Unlocking the Doors from the		ENGINE START/STOP Button.....	127	Adjusting the Seats	144
Outside	107	Turn Signals	130	Interior Convenience Items	149
Locking/Unlocking the Doors from the		Light Switches.....	131	Climate Control System	155
Inside	115	Daytime Running Lights	134	Using Automatic Climate Control	155
Auto Door Locking/Unlocking	118	Wipers and Washers	135	Automatic Climate Control Sensors.....	159
Opening and Closing the Hatch	119	Rear Defogger/Heated Door Mirror Button	136		
Security System	122	Brightness Control	137		

* Not available on all models

Adjusting the Clock





Models without navigation system

You can adjust the time in the clock display with the power mode in ON.

Adjusting the Time



Using the Settings menu on the audio/information screen

1. Select **Settings**.
2. Select **Clock/Info**.
3. Select **Clock Adjustment**.
4. Select  or  to change hour.
5. Select  or  to change minute, then select **OK**.

Adjusting the Clock

Models with navigation system

The clock is automatically updated through the audio system, so the time does not need to be adjusted.

Models with Display Audio

You cannot adjust the time while the vehicle is moving.

Using the Settings menu on the audio/information screen

Models with Display Audio

You can customize the clock display to show the 12 hour clock or 24 hour clock.





 **Customized Features** P. 244

The clock display is set to on by factory default. You can turn the clock display on and off.

 **Customized Features** P. 244

The clock is automatically updated when your smartphone is connected to the audio system.

You can also adjust the clock by touching the clock displayed on the upper right corner of the display.

1. Touch the clock on the display for a few seconds.
2. Select **Clock Adjustment**.
3. Select  or  to change hour.
4. Select  or  to change minute, then select **OK**.

Key

This vehicle comes with the following key:



Use the keyless access remote to turn on and off the power system, to lock and unlock the doors and to open the hatch.

Built-in Key

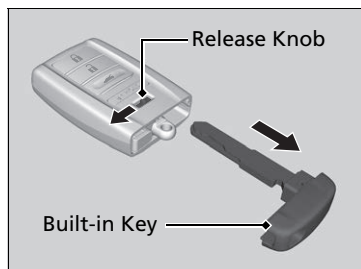

The built-in key can be used to lock or unlock the doors when the keyless access remote battery becomes weak and the power door lock/unlock operation is disabled.

To remove the built-in key, slide the release knob and then pull out the key. To reinstall the built-in key, push the built-in key into the keyless access remote until it clicks.

Key

All the keys have an immobilizer system. The immobilizer system helps to protect against vehicle theft.

Immobilizer System P. 122

Follow the advice below to prevent damage to the keys:

- Do not leave the keys in direct sunlight, or in locations with high temperature or high humidity.
- Do not drop the keys or set heavy objects on them.
- Keep the keys away from liquids, dust and sand.
- Do not take the keys apart except for replacing the battery.

If the circuits in the keys are damaged, the power system may not activate, and the keyless access system may not work.

If the keys do not work properly, have them inspected by an authorized Acura NSX dealer.

■ Key Number Tag

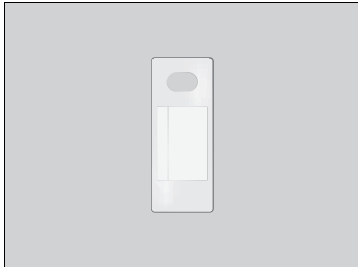

Contains a number that you will need if you purchase a replacement key.

Low Keyless Access Remote Signal Strength

The vehicle transmits radio waves to locate the keyless access remote when locking/unlocking the doors, opening the hatch, or to activate the power system.

In the following cases, locking/unlocking the doors, opening the hatch, or activating the power system may be inhibited or operation may be unstable:

- Strong radio waves are being transmitted by nearby equipment.
- You are carrying the keyless access remote together with telecommunications equipment, laptop computers, cell phones, or wireless devices.
- A metallic object is touching or covering the keyless access remote.

☒ Key Number Tag

Keep the key number tag separate from the key in a safe place outside of your vehicle. If you wish to purchase an additional key, contact an authorized Acura NSX dealer.

If you lose your key and you cannot activate the power system, contact an authorized Acura NSX dealer.

☒ Low Keyless Access Remote Signal Strength

Communication between the keyless access remote and the vehicle consumes the keyless access remote's battery.

Battery life is about two years, but this varies depending on regularity of use.

The battery is consumed whenever the keyless access remote is receiving strong radio waves. Avoid placing it near electrical appliances such as televisions and personal computers.

Locking/Unlocking the Doors from the Outside

■ Using the Keyless Access System

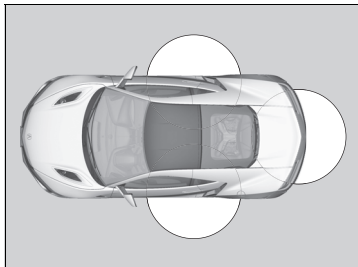

When you carry the keyless access remote, the outer door handles automatically pop in/out and you can lock/unlock the doors and open the hatch.

Outer door handles automatically pop in/out within about 6 feet (2 m) radius of the outside door handle.

You can lock/unlock the doors within a radius of about 32 inches (80 cm) of the outside door handle. You can open the hatch within about 32 inches (80 cm) radius from the hatch release button.

■ Locking the vehicle

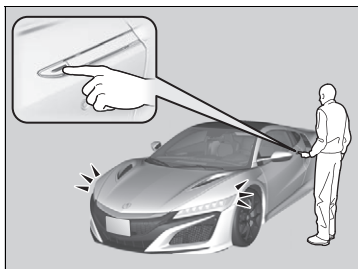

Press the door lock button on either door.

- ▶ Some exterior lights flash; the beeper sounds; both doors lock; both outer door handles pop in if they are popped out; and the security system sets.

▣ Using the Keyless Access System

If you do not open a door within 30 seconds of unlocking the vehicle, the doors will automatically relock and the outer handles of the doors will automatically pop back in.

You can lock or unlock doors using the remote transmitter or keyless access system only when the power mode is in VEHICLE OFF.

- Do not leave the keyless access remote in the vehicle when you get out. Carry it with you.
- Even if you are not carrying the keyless access remote, you can lock/unlock the doors while someone else with the remote is within range.
- The door may be unlocked if the door handle is covered with water in heavy rain or in a car wash if the keyless access remote is within range.
- If you grip either door handle wearing gloves, the door sensor may be slow to respond or may not respond by unlocking the doors.
- The door may not open if you pull it immediately after gripping the door handle. Grip the handle again and confirm that the door is unlocked before pulling the handle.
- Even within the 32 inches (80 cm) radius, you may not be able to lock/unlock the doors with the keyless access remote if it is above or below the outside handle.
- The keyless access remote may not operate if it is too close to the door and door glass.

■ Unlocking the vehicle

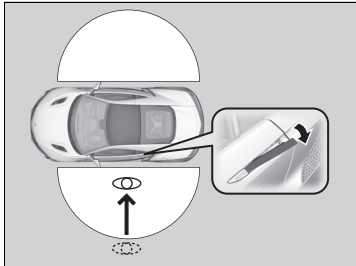

When you walk to the vehicle while carrying the keyless access remote, the outer door handles will automatically pop out. The auto pop-out function activates when both doors are closed, and the keyless access remote is within a 6-foot (2 m) radius of the outside door handle.

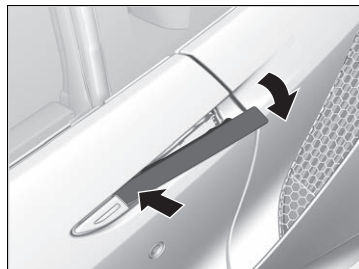

Pushing out the door handle

To push out the outer door handle manually, push the front side inwards.

Using the Keyless Access System

If you lock the doors and then keep the keyless access remote within the detection range for more than 2 minutes, the auto pop-out function will be disabled. If the function is disabled, pop out the handle manually or use the unlock button on the keyless access remote.

If you walk away from the vehicle when the power system is on, the auto pop-out function will not work.

If you close the doors and take the keyless access remote out of the 6-foot (2m) detection range and then bring it back into the range within 10 seconds, the pop-out function will not work. In this case, pop out the door handle manually or use the remote transmitter.

If, however, you bring the remote back into range after 10 seconds, the handles will automatically pop out.

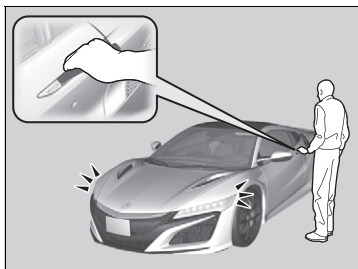

Grab the driver's door handle:

- ▶ The driver's door unlocks.
- ▶ Some exterior lights flash twice and the beeper sounds twice.

Grab the front passenger's door handle:

- ▶ Both doors unlock.
- ▶ Some exterior lights flash twice and the beeper sounds twice.

✘ Using the Keyless Access System

If the passenger's door is not opened, the outer handle of the passenger's door will pop back in 30 seconds after the driver's door is closed or when the gear position is moved out of **P**.

If the vehicle is left for more than 8 days, the auto pop-out function will not work. In this case, unlock the vehicle using the remote transmitter.

✘ **Auto Pop-Out Main Switch** P. 111

If the outer handle of a door is popped out and the keyless access remote is taken out of the 6-foot (2m) detection range, the handle will pop back in after 18 to 30 seconds.

The light flash, beep and unlock settings can be customized using the audio/information screen.

✘ **Customized Features** P. 244

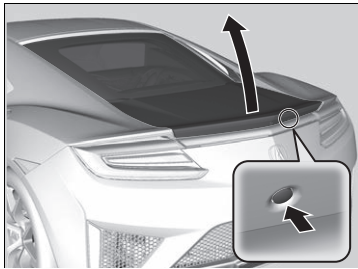

Press the hatch release button:

- ▶ The hatch unlocks and opens.
- ▶ The beeper sounds.
- ▣ **Using the Hatch Release Button** P. 119

■ Auto Pop-Out Main Switch

By switching the auto pop-out main switch to OFF, you can disable the auto pop-out function. For the purpose of safety and to prevent damaging the vehicle, disable this function and manually operate the handle, especially when the vehicle is:

- being shipped by train, truck, or boat.
- going through a car wash.
- having maintenance performed on it.

■ To temporarily deactivate the auto pop-out function:

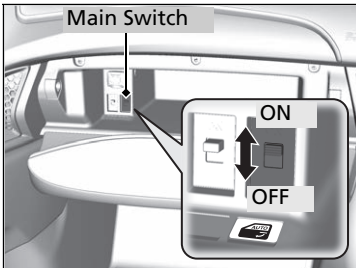

Turn off the auto pop-out main switch in the glove box.

☒ Auto Pop-Out Main Switch

The auto pop-out function is deactivated in the following situations:

- The auto pop-out main switch is turned off.
- The keyless access remote is not within a 6-foot (2m) radius of the outside door handle.
- The keyless access remote is in the vehicle.
- The power mode is in ACCESSORY or ON.

■ Using the Remote Transmitter

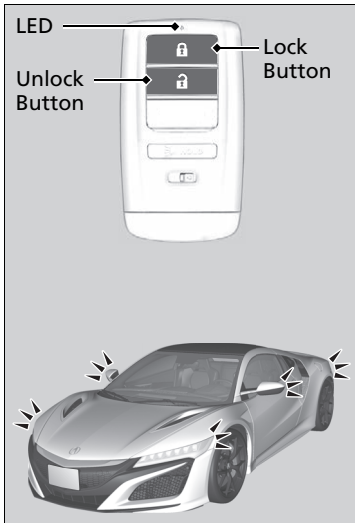

■ Locking the doors

Press the lock button.

Once:

- ▶ Some exterior lights flash, both doors lock, both outer door handles pop in, and the security system sets.

Twice (within five seconds after the first push):

- ▶ The beeper sounds and verifies the security system is set.

▣ Using the Remote Transmitter

If you do not open a door within 30 seconds of unlocking the vehicle with the remote transmitter, the doors will automatically relock and the outer handles of the doors will automatically pop back in. You can change the relock timer setting.

▣ **Customized Features** P. 244

If the interior light switch is in the door activated position, the interior lights come on when you press the unlock button.

No doors opened: The lights fade out after 30 seconds.

Doors relocked with the remote: The lights go off immediately.

▣ **Interior Lights** P. 149

The remote transmitter uses low-power signals, so the operating range may vary depending on the surroundings.

The remote will not lock the vehicle when a door is open.

■ Unlocking the doors

Press the unlock button.

Once:

- ▶ Some exterior lights flash twice, the driver's door unlocks and the driver's outer door handle pops out.

Twice:

- ▶ The passenger's door unlocks and the passenger's outer door handle pops out.

☒ Using the Remote Transmitter

If the distance at which the remote transmitter works varies, the battery is probably low.

If the LED does not come on when you press a button, the battery is dead.

☒ **Replacing the Button Battery** P. 418

You can customize the door unlock mode setting.

☒ **Customized Features** P. 244

If the passenger's door is not opened, the outer handle of the passenger's door will pop back in 30 seconds after the driver's door is closed or when the gear position is moved out of **P**.

To pop out the outer handle of the passenger's door when the gear position is in **P**, press the unlock button on the remote transmitter or press the master door unlock switch.

■ Locking/Unlocking the Doors Using a Key

If the lock or unlock button of the remote does not work, use the key instead. Fully insert the key and turn it.



▶▶ Locking/Unlocking the Doors Using a Key

When you lock the driver's door with a key, the passenger's door locks at the same time. When unlocking, the driver's door unlocks first. Turn the key a second time within a few seconds to unlock the passenger's door.

If you unlock the doors with the key, the alarm goes off when you open the hood or select other than **P** before the power mode is set to ON.

You can customize the door unlock mode setting. **▶▶ Customized Features** P. 244

■ Locking a Door Without Using a Key

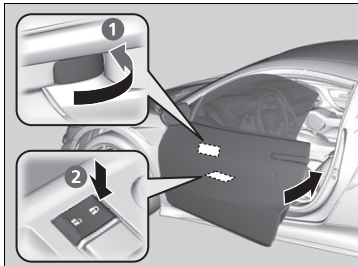

If you do not have the key on you, or if for some reason you cannot lock a door using the key, you can lock the door without it.

■ Locking the doors

Push the lock tab forward **1** or push the master door lock switch in the lock direction **2**, and close the door.

▶▶ Locking a Door Without Using a Key

When you lock the driver's door, the passenger's door locks at the same time. Before locking a door, make sure that the key is not inside the vehicle.

■ Lockout prevention system

The doors cannot be locked when the keyless access remote is inside the vehicle.

Locking/Unlocking the Doors from the Inside

■ Using the Lock Tab

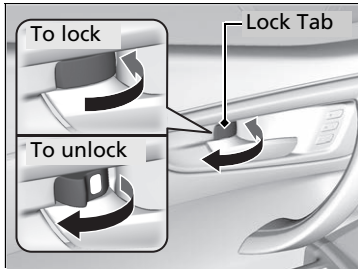

■ **Locking a door**
Push the lock tab forward.

■ **Unlocking a door**
Pull the lock tab rearward.

☒ Using the Lock Tab

When you lock the door using the lock tab on the driver's door, both doors lock at the same time. When you unlock the door using the lock tab on the driver's door, only the driver's door will unlock.

Continued

■ Unlocking Using the Inner Handle

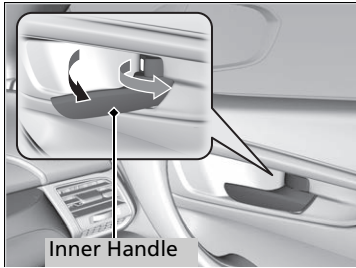

Pull the either door inner handle.

- ▶ The door unlocks and opens in one motion.

Unlocking and opening the driver's door with the inner handle unlocks both doors.

To avoid both doors to be unlocking, use the lock tab on the driver's door to unlock, then lock again before opening the door.

- ▶ This setting works for one time only. If you do not want both doors to be unlocked all the time, customize the **Auto Door Unlock** setting to **Off** using the audio/information screen.

▣ Unlocking Using the Inner Handle

The inner door handles are designed to allow occupants to open the door in one motion. However, this feature requires that occupants never pull an inner handle while the vehicle is in motion.

■ Using the Master Door Lock Switch

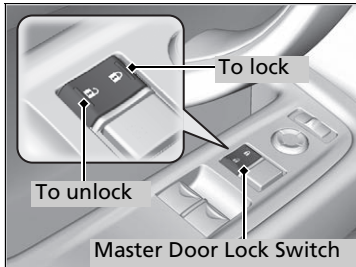

Press the master door lock switch in as shown to lock or unlock both doors.

☒ Using the Master Door Lock Switch

When you lock/unlock the driver's door using the master door lock switch, the passenger's door locks/unlocks at the same time.

Auto Door Locking/Unlocking

Your vehicle locks and unlocks both doors automatically when a certain condition is met.

■ Auto Door Locking

■ Drive lock mode

Both doors lock when the vehicle's speed reaches about 10 mph (15 km/h).

■ Auto Door Unlocking

■ Driver's door open mode

Both doors unlock when the driver's door is opened.

☒ Auto Door Locking/Unlocking

You can turn off or change to another auto door locking/unlocking setting using the audio/information screen.

☒ **Customized Features** P. 244

Precautions for Opening/Closing the Hatch

■ Opening the hatch

Open the hatch all the way.

- ▶ If it is not fully opened, the hatch may begin to close under its own weight.

■ Closing the hatch

Keep the hatch closed while driving to:

- ▶ Avoid possible damage.
- ▶ Prevent exhaust gas from leaking into the vehicle.

☒ **Exhaust Gas Hazard** P. 67

Using the Hatch Release Button

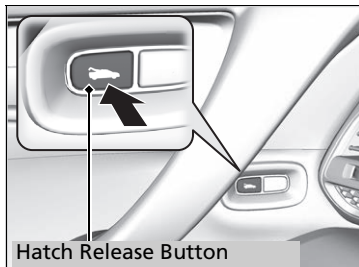

Press the hatch release button on the driver's door unlocks and opens the hatch.

☒ **When You Cannot Open the Hatch** P. 464

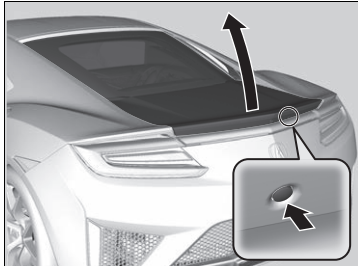

Push the release button on the hatch after the doors are unlocked.

➤ **When You Cannot Open the Hatch** P. 464

Even if the hatch is locked, you can open the hatch if you carry the keyless access remote.

▶ The beeper sounds.

Using the Remote Transmitter

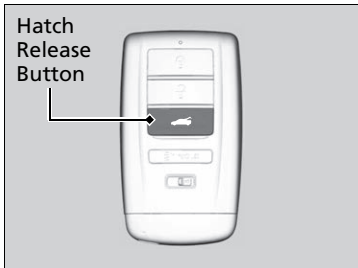

Press the hatch release button for approximately one second to unlock and open the hatch.

Using the Hatch Release Button

- If you forget the remote inside, the beeper will sound and the hatch will not close.
- A person who is not carrying the keyless access remote can unlock the hatch if a person who is carrying it is within range.
- If the beeper sounds after close the hatch, move the keyless access remote away from the trunk and close again.
- The keyless access remote may not operate if it is too close to the hatch.

Hatch Main Switch

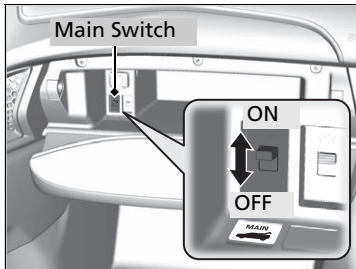

The hatch main switch disables the hatch release button on the remote transmitter, the hatch release button on the hatch and the hatch release button on the driver's door to protect luggage in the trunk.

1. Turn off the hatch main switch in the glove box.
2. Lock the glove box.

Emergency Hatch Opener

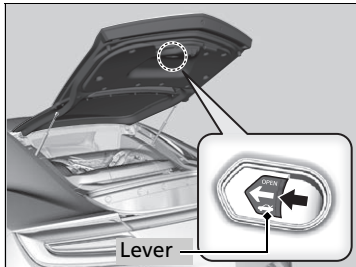

The hatch release lever allows you to open the hatch from inside for your safety.

Slide the release lever in the direction of the arrow.

▣ Hatch Main Switch

If you need to give the key to someone else, remove the built-in key from the keyless access remote by sliding the release knob, and give the remote as a valet key.

▣ Emergency Hatch Opener

Parents should decide if their children should be shown how to use this feature.

Immobilizer System

The immobilizer system prevents a key that has not been pre-registered from starting the power system. Each key contains electronic transmitters that use electronic signals to verify the key.

Pay attention to the following when pressing the **ENGINE START/STOP** button:

- Do not allow objects that emit strong radio waves near the **ENGINE START/STOP** button.
- Make sure the key is not covered by or touching a metal object.
- Do not bring a key from another vehicle's immobilizer system near the **ENGINE START/STOP** button.
- Do not put the key near magnetic items. Electronic devices, such as a televisions and audio systems emit strong magnetic fields. Note that even a key chain can become magnetic.

Security System Alarm

The security system alarm activates when the hood, hatch or doors are forcibly opened. The alarm does not go off if the hatch or doors are opened with the key, remote transmitter or keyless access system.

However, the alarm goes off when a door is opened with the key, then select other than **[P]** or the hood is opened before the power mode is set to ON.

■ When the security system alarm activates

The horn sounds intermittently, and some exterior lights flash.

■ To deactivate the security system alarm

Unlock the vehicle using the remote transmitter or keyless access system, or the power mode is set to ON. The system, along with the horn and flashing lights, is deactivated.

ⓘ Immobilizer System

NOTICE

Leaving the keyless access remote in the vehicle can result in theft or accidental movement of the vehicle. Always take the remote with you whenever you leave the vehicle unattended.

Do not alter the system or add other devices to it. Doing so may damage the system and make your vehicle inoperable.

ⓘ Security System Alarm

The security alarm continues for a maximum of two minutes until the security system deactivates.

■ Setting the security system alarm

The security system alarm automatically sets when the following conditions have been met:

- The power mode is set to VEHICLE OFF.
- The hood and hatch are closed.
- Both doors are locked from outside with the key, remote transmitter or keyless access system.

■ When the security system alarm sets

The security system indicator in the instrument panel blinks. When the blinking interval changes after about 15 seconds, the security system is set.

■ To cancel the security system alarm

The security system is canceled when the vehicle is unlocked using the remote transmitter, keyless access system, or when the power mode is set to ON. The security system indicator goes off at the same time.

☒ Security System Alarm

Do not set the security system alarm when someone is in the vehicle or a window is open. The system can accidentally activate when:

- The door is unlocked with the lock tab.
- The hatch is opened with the hatch release button on the driver's door or with the emergency hatch opener.
- The gear position is shifted out of **[P]**.
- The hood is opened with the hood release.

If the 12-volt battery goes dead after you have set the security system alarm, the security alarm may go off once the 12-volt battery is recharged or replaced. If this occurs, deactivate the security system alarm by unlocking a door using the remote transmitter or keyless access system.

Do not alter the system or add other devices to it. Doing so may damage the system and make your vehicle inoperable.

Do not open the hatch with the key unless it is an emergency. Opening the hatch with the key will trigger the security system.

☒ **When You Cannot Open the Hatch** P. 464

■ Panic Mode

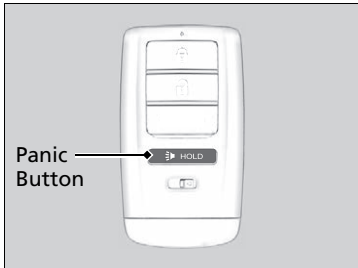

■ The panic button on the remote transmitter

If you press the panic button for approximately one second, the following will occur for about 30 seconds:

- The horn sounds.
- Some exterior lights flash.

■ Canceling panic mode

- Press any button on the remote transmitter.
- Set the power mode to ON.

Opening/Closing the Power Windows

The power windows can be opened and closed when the power mode is in ON, using the switches on the doors. The driver's side switches can be used to open and close both windows.

The power window lock button on the driver's side must be switched off (not pushed in, indicator off) to open and close the passenger's window from the passenger's side.

When the power window lock button is pushed in, the indicator comes on and you can only operate the driver's window. Turn the power window lock button on if a child is in the vehicle.

Opening/Closing the Windows with Auto-Open/Close Function

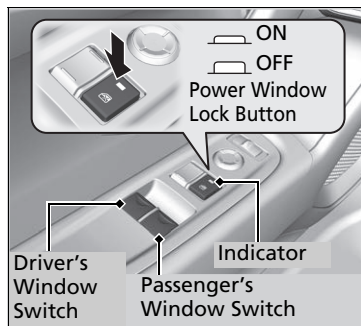

Automatic operation

To open: Push the switch down firmly.

To close: Pull the switch up firmly.

The window opens or closes completely. To stop the window at any time, push or pull the switch briefly.

Manual operation

To open: Push the switch down lightly, and hold it until the desired position is reached.

To close: Pull the switch up lightly, and hold it until the desired position is reached.

Opening/Closing the Power Windows

WARNING

Closing a power window on someone's hands or fingers can cause serious injury.

Make sure your passenger is away from the windows before closing them.

The power windows can be operated for up to 10 minutes after you set the power mode to VEHICLE OFF.

Opening either door cancels this function.

Auto Reverse

If a power window senses resistance when closing automatically, it stops closing and reverses direction.

The driver's window auto reverse function is disabled when you continuously pull up the switch.

The auto reverse function stops sensing when the window is almost closed to ensure that it fully closes.

■ Opening the Windows with the Remote

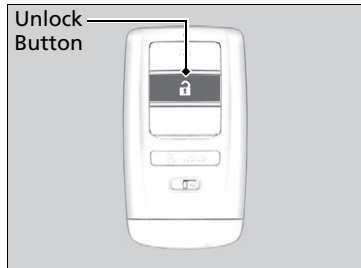

To open: Press the unlock button, and then within 10 seconds, press it again and hold it. If the windows stop midway, repeat the procedure.

■ Opening/Closing the Windows with the Key

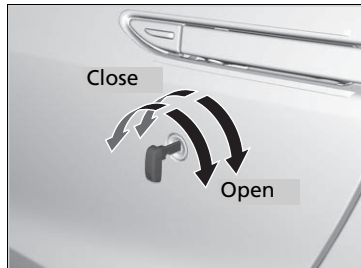

To open: Unlock the driver's door with the key. Within 10 seconds of returning the key to the central position, turn the key in the unlock direction and hold it there.

To close: Lock the driver's door with the key. Within 10 seconds of returning the key to the central position, turn the key in the lock direction and hold it there.

Release the key to stop the windows at the desired position. If you want further adjustment, repeat the same operation.

ENGINE START/STOP Button

Changing the Power Mode

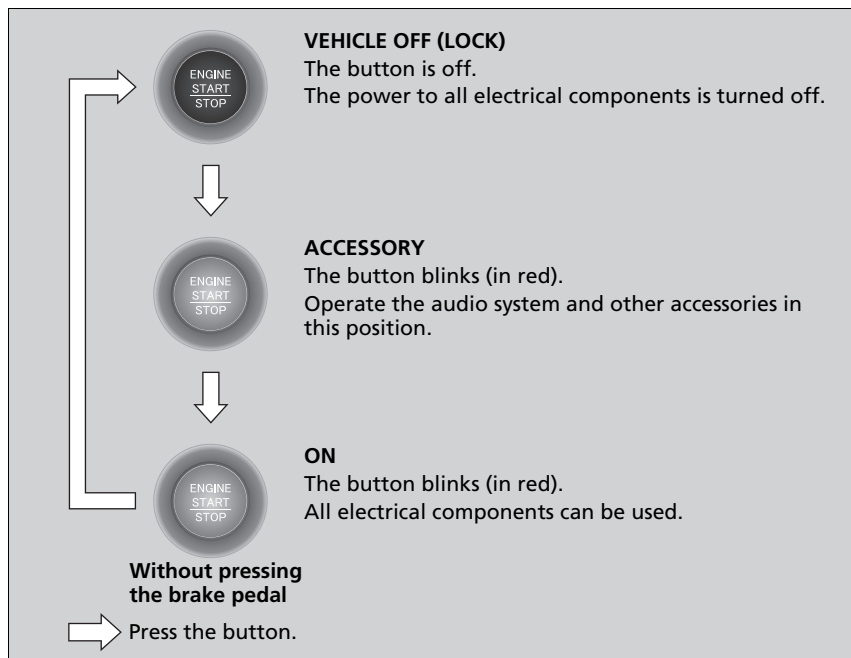

ENGINE START/STOP Button

ENGINE START/STOP Button Operating Range

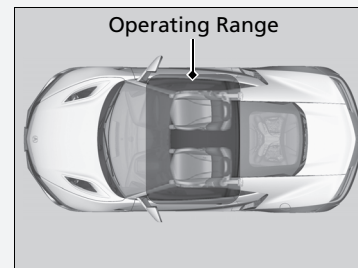

You can start the power system when the keyless access remote is inside the vehicle. The power system may also start if the keyless access remote is close to the door or window, even if it is outside the vehicle.

If the battery of the keyless access remote is getting low, the power system may not start when you push the **ENGINE START/STOP** button. If the power system does not start, refer to the following link.

➤ If the Keyless Access Remote Battery is Weak P. 446

Do not leave the power mode in ACCESSORY or ON when you get out.

■ Automatic Power Off

If you leave the vehicle for more than 30 minutes with the transmission in **P** and the power mode in ACCESSORY, the vehicle will automatically go into VEHICLE OFF (LOCK) mode to prevent draining the 12-volt battery.

■ Power Mode Reminder

If you open the driver's door when the power mode is set to ACCESSORY, a warning buzzer will sound.

■ Keyless Access Remote Reminder

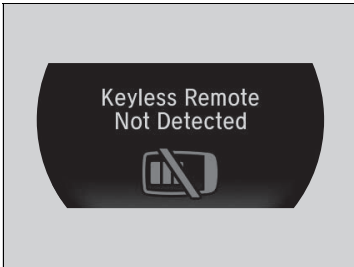

When the power mode is set to any mode other than OFF and you remove the keyless access remote from the vehicle and shut the door, an alarm will sound. If the alarm continues to sound, place the keyless access remote in another location.

■ When the power mode is in ACCESSORY

The alarm will sound from outside the vehicle.

■ When the power mode is in ON

An alarm will sound both inside and outside the vehicle. In addition, a warning indicator will appear on the instrument panel.

⊠ Keyless Access Remote Reminder

When the keyless access remote is within the system's operational range, and both doors are closed, the warning function cancels.

If the keyless access remote is taken out of the vehicle after the power system has been turned on, you can no longer change the **ENGINE START/STOP** button mode or restart the power system. Always make sure if the remote is in your vehicle when you operate the **ENGINE START/STOP** button.

Removing the keyless access remote from the vehicle through a window does not activate the warning buzzer.

Do not put the keyless access remote on the dashboard or in the glove box. It may cause the warning buzzer to go off. Under some other conditions that can prevent the vehicle from locating the remote, the warning buzzer may also go off even if the remote is within the system's operational range.

Turn Signals

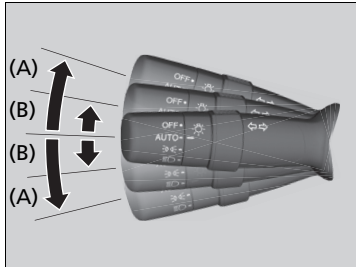

The turn signals can be used when the power mode is in ON.

■ (A): Turn signal

Push the lever up or down based on the direction you want to turn, and the turn signal will blink.

■ (B): One-touch turn signal

When you lightly push the lever up or down and release it, the turn signal will blink 3 times.

▶▶ Turn Signals

The turn signal indicator on the instrument panel will blink when the external turn signal blinks.

▶ Indicators P. 70

Light Switches

Manual Operation

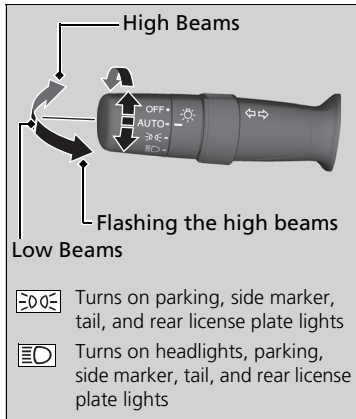

Rotating the light switch turns the lights on and off, regardless of the power mode setting.

High beams

Push the lever forward until you hear a click.

Low beams

When in high beams, pull the lever back to return to low beams.

Flashing the high beams

Pull the lever back, and release it.

Lights off

Turn the lever to **OFF** either when:

- The transmission is in **P**.
- The parking brake is applied.

To turn the lights on again, turn the lever to **OFF** to cancel the lights off mode. Even if you do not cancel the lights off mode, the lights come on automatically when:

- The gear position is changed out of **P**.
- The parking brake is released.
- The vehicle starts to move.

Light Switches

If you leave the power mode in VEHICLE OFF while the lights are on, a chime sounds when the driver's door is opened.

When the lights are on, the lights on indicator in the instrument panel will be on.

Lights On Indicator P. 81

If you sense that the level of the headlights is abnormal, have your vehicle inspected by an authorized Acura NSX dealer.

Do not leave the lights on when the power system is off because it will cause the 12-volt battery to discharge.

■ Automatic Operation (automatic lighting control)



Automatic lighting control can be used when the power mode is in ON.

When the light switch is in **AUTO**, the headlights and other exterior lights will switch on and off automatically depending on the ambient brightness.

The headlights come on when you unlock a door in dark areas with the headlight switch in **AUTO**.

- ▶ Once you lock the door, the headlights will go off.

▶▶ Automatic Operation (automatic lighting control)

We recommend that you turn on the lights manually when driving at night, in a dense fog, or in dark areas such as long tunnels or parking facilities.

The light sensor is in the location shown below. Do not cover this light sensor with anything; otherwise, the automatic lighting system may not work properly.

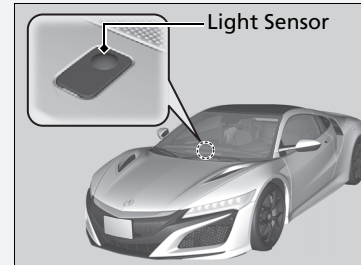

U.S. models

Adjust the auto light sensitivity as follows:

Setting	The exterior lights come on when the ambient light is at
MAX	Bright
HIGH	
MID	
LOW	
MIN	

▶▶ Customized Features P. 244

■ Headlight Integration with Wipers

The headlights automatically come on when the wipers are used several times within a certain interval with the headlight switch in **AUTO**.

The headlights automatically go off a few minutes later if the wipers are stopped.

■ Automatic Lighting Off Feature

The headlights, all other exterior lights, and the instrument panel lights turn off 15 seconds after you set the power mode to VEHICLE OFF, take the remote with you, and close the driver's door.

If you set the power mode to VEHICLE OFF with the headlight switch on, but do not open the door, the lights turn off after 10 minutes (3 minutes, if the switch is in the **AUTO** position).

The lights turn on again when you unlock or open the driver's door. If you unlock the door, but do not open it within 15 seconds, the lights go off. If you open the driver's door, you will hear a lights on reminder chime.

⌘ Headlight Integration with Wipers

This feature activates when the headlights are off in **AUTO**.

The instrument panel brightness does not change when the headlights come on.

At dark ambient light levels, the automatic lighting control feature turns on the headlights, regardless of the number of wiper sweeps.

You can turn the headlight integration with wipers function on and off.

➤ **Customized Features** P. 244

⌘ Automatic Lighting Off Feature

You can change the headlight auto off timer setting.

➤ **Customized Features** P. 244

Daytime Running Lights

The daytime running lights come on when the following conditions have been met:

- The power mode is in ON.
- The headlight switch is in **AUTO**.
- The parking brake is released.

The daytime running lights are off the headlight switch is turned on, or when the headlight switch is in **AUTO** and it is getting darker outside.

» Daytime Running Lights

U.S. models

The brightness of the daytime running lights is lower when the headlight switch is in **OFF** than when it is in **AUTO**. When it is in **AUTO**, the low-beam headlights come on once the level of ambient light is very low.

Wipers and Washers

■ Windshield Wiper/Washer

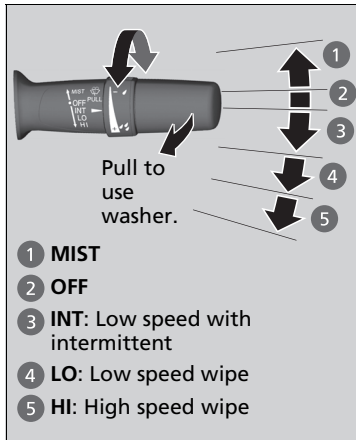

The windshield wipers and washers can be used when the power mode is in ON.

■ MIST

The wipers run at high speed until you release the lever.

■ Wiper switch (OFF, INT, LO, HI)

Change the wiper switch setting according to the amount of rain.

■ Adjusting wiper operation

Turn the adjustment ring to adjust wiper operation.

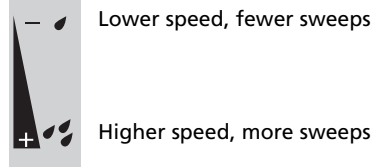

■ Washer

Sprays while you pull the lever toward you. When you release the lever for more than one second, the spray stops, the wipers sweep two or three more times to clear the windshield, then stop.

» Wipers and Washers

NOTICE

Do not use the wipers when the windshield is dry. The windshield will get scratched, or the rubber blades will get damaged.

NOTICE

In cold weather, the blades may freeze to the windshield. Operating the wipers in this condition may damage wipers. Use the defroster to warm the windshield, then turn the wipers on.

If the vehicle speeds up while the wipers are operating intermittently, the length of the wipe interval shortens. When the vehicle speeds up, the wiper operation's shortest delay setting (4) and the LO setting become the same.

Turn the washers off if no washer fluid comes out. The pump may get damaged.

The wiper motor may stop motor operation temporarily to prevent an overload. Wiper operation will return to normal within a few minutes, once the circuit has returned to normal.

If the wipers stop operating due to any obstacle such as the build-up of snow, park the vehicle in a safe place.

Rotate the wiper switch to **OFF**, and set the power mode to ACCESSORY or VEHICLE OFF, then remove the obstacle.

Rear Defogger/Heated Door Mirror Button

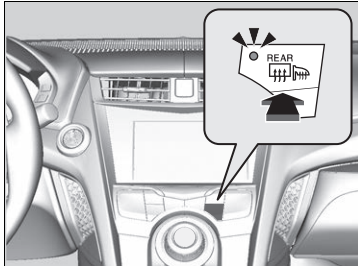

Press the rear defogger and heated door mirror button to defog the rear window and mirrors when the power mode is in ON.

The rear defogger and heated door mirrors automatically switch off after 10-30 minutes depending on the outside temperature.

However, if the outside temperature is 32°F (0°C) or below, they do not automatically switch off.

⊠ Rear Defogger/Heated Door Mirror Button

This system consumes a lot of power, so turn it off when the window has been defogged. Also, do not use the system for a long time while the power system is stopped. This may weaken the 12-volt battery, making it difficult to turn the power system on.

When the outside temperature is below 41°F (5°C), the heated door mirror may activate automatically for 10 minutes when you set the power mode to ON.

Brightness Control

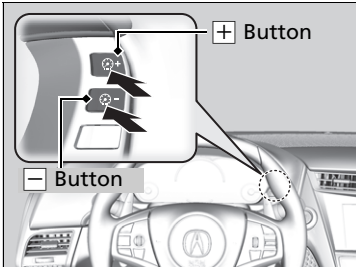

When the power mode is in ON, you can use the **+** or **-** button to adjust instrument panel brightness.

To brighten: Press the **+** button.

To dim: Press the **-** button.

You will hear a beep when the brightness reaches minimum or maximum. Several seconds after you have adjusted the brightness, you will be returned to the previous screen.

■ Brightness level indicator

The brightness level is shown on the driver information interface while you are adjusting it.

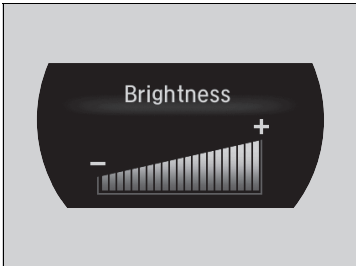

☒ Brightness Control

The brightness of the instrument panel will be reduced when the following conditions:

- The power mode is in ON.
- The light switch is in any position other than off and it is dark outside.

When it is bright outside and the headlight integration with the wiper is activated, the instrument panel brightness does not change.

The brightness can be set differently for when the exterior lights are on, and when they are off.

Driving Position Memory System*

You can store two driver's seat (except for power lumbar) and outside door mirrors position with the driving position memory system.

When you unlock and open the driver's door with a remote transmitter, or keyless access system, door mirrors adjust to one of the two preset positions and the seat adjusts to retracted positions of one of the two preset positions automatically.

The seat will move to the stored position when you set the power mode to ACCESSORY.

When you enter the vehicle, the driver information interface briefly shows you which remote transmitter you used to unlock the vehicle.

- **DRIVER 1** transmitter is linked to memory button 1.
- **DRIVER 2** transmitter is linked to memory button 2.

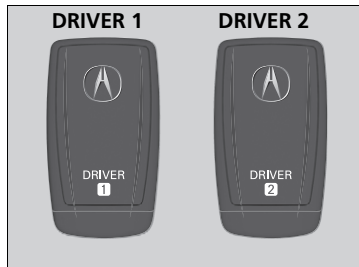

The driver's seat moves rearward depending on the set seating position once you

- Stop the vehicle.
- Put the transmission in **P**.
- Set the power mode to VEHICLE OFF.
- Then open the driver's door.

Once the power mode is in the ACCESSORY position, the driver's seat moves to the **DRIVER 1** or **2** preset position.

►► Driving Position Memory System*

Using the audio/information screen, you can disable the automatic seat and door mirrors adjustment function.

► **Customized Features** P. 244

The driver's seat easy exit feature:

- Will tilt slightly forward and then move rearward to allow you to more easily exit the vehicle.
- Can be turned ON/OFF.

► **Customized Features** P. 244

System Operation

The system will not operate if:

- The vehicle speed is above 3 mph (5 km/h).
- Either memory position button is pressed while the seat or the outside mirror is in motion.
- The seat or the outside mirror position is adjusted while in operation.
- The memory 1 or 2 position is set fully to the rear.

■ Storing a Position in Memory

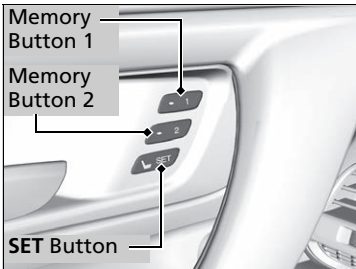

1. Set the power mode to ON. Adjust the driver's seat and the door mirrors to the desired position.
2. Press the **SET** button.
 - ▶ You will hear the beeper, and the memory button indicator light will blink.
3. Press memory button **1** or **2** within five seconds of pressing the **SET** button.
 - ▶ Once the seat and the outside mirrors position have been memorized, you will hear the beeper twice, and the indicator light on the button you pressed stays on.

■ Recalling the Stored Position

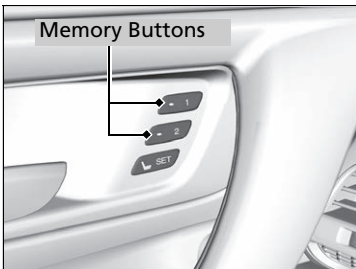

1. Put the transmission into **P**.
2. Apply the parking brake.
3. Press a memory button (**1** or **2**).
 - ▶ You will hear the beep, and the indicator light will blink.

The seat and the door mirrors will automatically move to the memorized positions. When it has finished moving, you will hear the beeper twice, and the indicator light stays on.

⌘ Storing a Position in Memory

After you press the **SET** button, the storing operation will be canceled when:

- You do not press the memory button within five seconds.
- You readjust the seat or the outside mirror position before the double-beep.
- You set the power mode to any position except ON.

⌘ Recalling the Stored Position

The seat and door mirrors will stop moving if you:

- Press the **SET** button, or a memory button (**1** or **2**).
- Adjust the seat position or door mirrors.
- Put the transmission into a position other than **P**.

Adjusting the Steering Wheel

The steering wheel height and distance from your body can be adjusted so that you can comfortably grip the steering wheel in an appropriate driving posture.

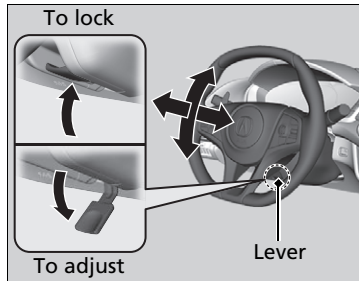

1. Push the steering wheel adjustment lever down.
 - ▶ The steering wheel adjustment lever is under the steering column.
2. Move the steering wheel up or down, and in or out.
 - ▶ Make sure you can see the instrument panel gauges and indicators.
3. Pull the steering wheel adjustment lever up to lock the steering wheel in position.
 - ▶ After adjusting the position, make sure you have securely locked the steering wheel in place by trying to move it up, down, in, and out.

Adjusting the Steering Wheel

WARNING

Adjusting the steering wheel position while driving may cause you to lose control of the vehicle and be seriously injured in a crash.

Adjust the steering wheel only when the vehicle is stopped.

Interior Rearview Mirror

Adjust the angle of the rearview mirror when you are sitting in the correct driving position.

Automatic Dimming Rearview Mirror

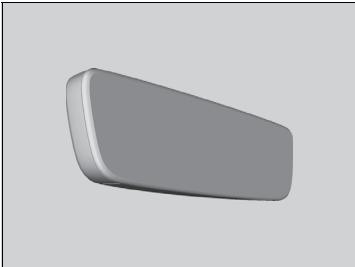

When you are driving after dark, the automatic dimming rearview mirror reduces the glare from headlights behind you, based in inputs from the mirror sensor. This feature is always active.

Adjusting the Mirrors

Keep the inside and outside mirrors clean and adjusted for best visibility.

Adjust the mirrors before you start driving.

➤ **Adjusting the Seat Positions** P. 144

Automatic Dimming Rearview Mirror

The auto dimming function cancels when the transmission is in **R**.

Power Door Mirrors

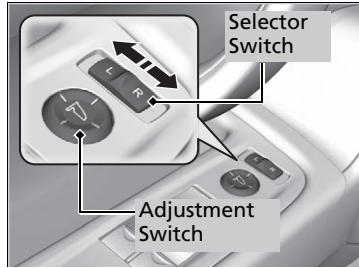

You can adjust the door mirrors when the power mode is in ON.

■ Mirror position adjustment

L/R selector switch: Select the left or right mirror. After adjusting the mirror, return the switch to the center position.

Mirror position adjustment switch: Press the switch left, right, up, or down to move the mirror.

Reverse Tilt Door Mirror



Models with driving position memory system

If activated, either side door mirror automatically tilts downward when you press back the **R** button; this improves close-in visibility on the selected side of the vehicle when backing up. The mirror automatically returns to its original position when you take the transmission out of **R**.

To activate this feature, set the power mode to ON and slide the selector switch to the left or right side.

Models without driving position memory system

If activated, passenger side door mirror automatically tilts downward when you press back the **R** button; this improves close-in visibility on the passenger side of the vehicle when backing up. The mirror automatically returns to its original position when you take the transmission out of **R**.

To activate this feature, set the power mode to ON and slide the selector switch to the passenger side.

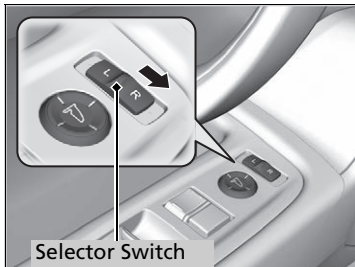

Adjusting the Seats

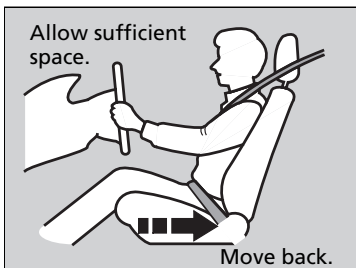

Adjust the driver's seat as far back as possible while allowing you to maintain full control of the vehicle. You should be able to sit upright, well back in the seat and be able to adequately depress the pedals without leaning forward, and grip the steering wheel comfortably. The passenger's seat should be adjusted in a similar manner, so that it is as far back from the front airbag in the dashboard as possible.

Adjusting the Seat Positions

Adjusting the power seats*



Adjusting the Seats

WARNING

Sitting too close to a front airbag can result in serious injury or death if the front airbags inflate.

Always sit as far back from the front airbags as possible while maintaining control of the vehicle.

The National Highway Traffic Safety Administration and Transport Canada recommend that drivers allow at least 10 inches (25 cm) between the center of the steering wheel and the chest.

Always make seat adjustments before driving.

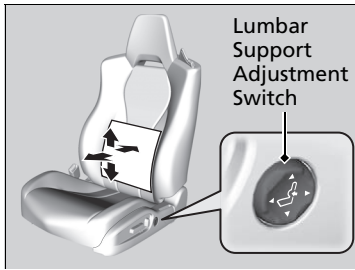

■ Lumbar Support Adjustment Switch*

Press the top: To move the lumbar support up.

Press the bottom: To move the lumbar support down.

Press the front: To increase the entire lumbar support.

Press the rear: To decrease the entire lumbar support.

■ Adjusting the manual seats*



▶▶ Adjusting the manual seats*

Once a seat is adjusted correctly, rock it back and forth to make sure it is locked in position.

■ Adjusting the Seat-Backs

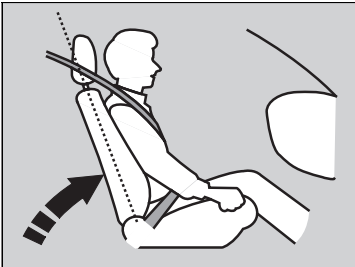

Adjust the driver's seat-back to a comfortable, upright position, leaving ample space between your chest and the airbag cover in the center of the steering wheel.

The passenger should also adjust their seat-back to a comfortable, upright position.

Reclining a seat-back so that the shoulder part of the belt no longer rests against the occupant's chest reduces the protective capability of the belt. It also increases the chance of sliding under the belt in a crash and being seriously injured. The farther a seat-back is reclined, the greater the risk of injury.

▣ Adjusting the Seat-Backs

⚠ WARNING

Reclining the seat-back too far can result in serious injury or death in a crash.

Adjust the seat-back to an upright position, and sit well back in the seat.

Do not put a cushion, or other object, between the seat-back and your back. Doing so may interfere with proper seat belt or airbag operation.

If you cannot get far enough away from the steering wheel and still reach the controls, we recommend that you investigate whether some type of adaptive equipment may help.

Maintain a Sitting Proper Position

After all occupants have adjusted their seats and put on their seat belts, it is very important that they continue to sit upright, well back in their seats, with their feet on the floor, until the vehicle is safely parked and the power system is off.

Sitting improperly can increase the chance of injury during a crash. For example, if an occupant slouches, lies down, turns sideways, sits forward, leans forward or sideways, or puts one or both feet up, the chance of injury during a crash is greatly increased.

In addition, an occupant who is out of position in the seat can be seriously or fatally injured in a crash by striking interior parts of the vehicle or being struck by an inflating front airbag.

▶ Maintain a Sitting Proper Position

WARNING

Sitting improperly or out of position can result in serious injury or death in a crash.

Always sit upright, well back in the seat, with your feet on the floor.

Interior Lights

Interior Light Switches

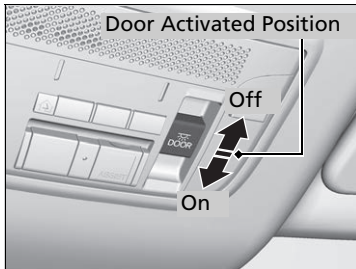

■ ON

The interior lights come on regardless whether the doors are open or closed.

■ Door activated

The interior lights come on in the following situations:

- When either of the doors are opened.
- You unlock the driver's door.
- When the power mode is set to VEHICLE OFF.

■ OFF

The interior lights remain off regardless whether the doors are open or closed.

Interior Light Switches

In the door activated position, the interior lights fade out and go off about 30 seconds after the doors are closed.

The lights go off after about 30 seconds in the following situations:

- When you unlock the driver's door but do not open it.
- When you set the power mode to VEHICLE OFF but do not open a door.

You can change the interior lights dimming time.

➤ **Customized Features** P. 244

The interior lights go off immediately in the following situations:

- When you lock the driver's door.
- When you close the driver's door in ACCESSORY mode.
- When you set the power mode to ON.

To avoid draining the 12-volt battery, do not leave the interior light on for an extended length of time when the power system off.

If you leave either door open in VEHICLE OFF mode, the interior lights go off after about 15 minutes.

■ Map Lights

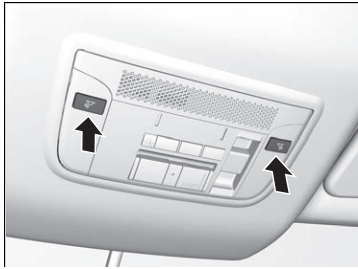

The map lights can be turned on and off by pressing the  (map light) button.

▣ Map Lights

When the ceiling light switch is in the door activated position and either door is open, the map light will not go off when you press the  (map light) button.

Storage Items

■ Glove Box

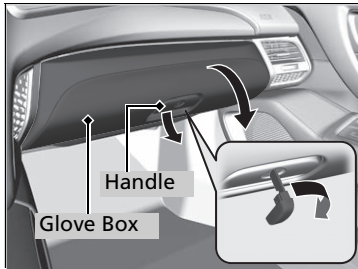

Pull the handle to open the glove box. You can lock the glove box with the built-in key.

■ Console Compartment

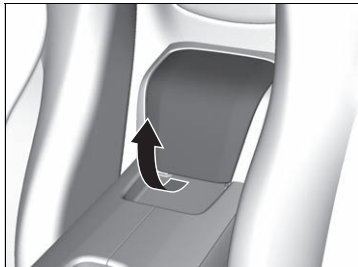

Pull the lid to open the console compartment.

☒ Glove Box

⚠ WARNING

An open glove box can cause serious injury to your passenger in a crash, even if the passenger is wearing the seat belt.

Always keep the glove box closed while driving.

■ Beverage Holders

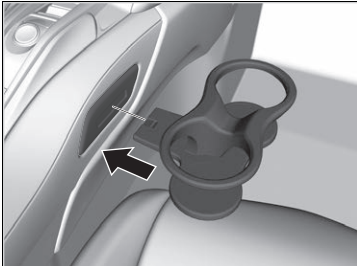

Insert the beverage holders into the passenger side of the center console.

▣ Beverage Holders

NOTICE

Spilled liquids damage the upholstery, carpeting, and electrical components in the interior.

Other Interior Convenience Items

■ Accessory Power Socket

The accessory power socket can be used when the power mode is in ACCESSORY or ON.

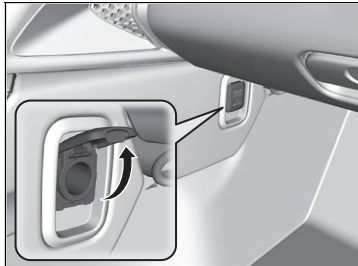

■ Accessory power socket

Open the cover to use it.

⌘ Accessory Power Socket

NOTICE

Do not insert an automotive type cigarette lighter element.

The accessory power socket can overheat.

The accessory power socket is designed to supply power for 12-volt DC accessories that are rated 180 watts (15 amps) or less.

To prevent draining the 12-volt battery, use the accessory power socket only when the power system on.

When the accessory power socket is not in use, close the cover to prevent any small foreign objects from getting into the accessory power socket.

■ Seat Heaters*

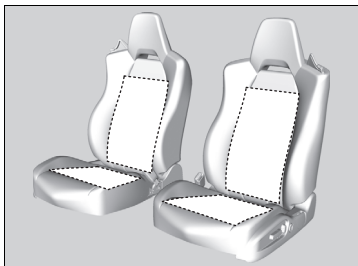

The power mode must be in ON to use the seat heaters.

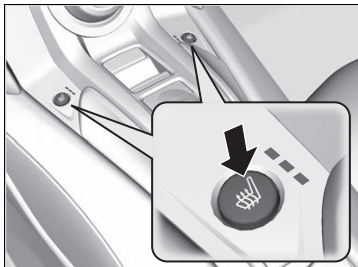

Press the seat heater button:

Once - The HI setting (three indicators on)

Twice - The MID setting (two indicators on)

Three times - The LO setting (one indicator on)

Four times - The OFF setting (no indicators on)

When the power mode is turned on after it is turned off, the previous setting of seat heaters is maintained.

▣ Seat Heaters*

⚠ WARNING

Heat induced burns are possible when using seat heaters.

Persons with a diminished ability to sense temperature (e.g., persons with diabetes, lower-limb nerve damage, or paralysis) or with sensitive skin should not use seat heaters.

Do not use the seat heaters even in LO when the power system is off. Under such conditions, the 12-volt battery may be weakened, making the power system difficult to start.

Using Automatic Climate Control

The automatic climate control system maintains the interior temperature you select. The system also selects the proper mix of heated or cooled air to raise or lower the interior temperature to your preference as quickly as possible.

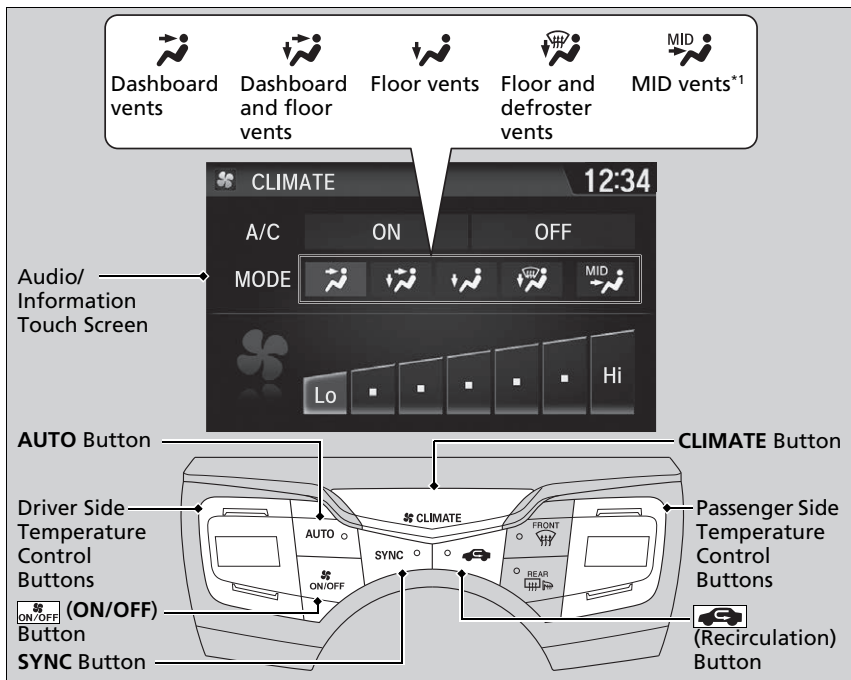

Use the system when the power mode is ON.

1. Press the **AUTO** button.
2. Adjust the interior temperature using the driver's side or passenger's side control buttons.
3. Press the button to cancel.

Using Automatic Climate Control

Press the **CLIMATE** button to display A/C, MODE, fan control information on the audio/information screen for several seconds. Select icon to turn on or off A/C, change the vent mode, or change the fan speed.

If any buttons are pressed while using the climate control system in auto, the function of the button that was pressed will take priority.

The **AUTO** indicator will go off, but functions unrelated to the button that was pressed will be controlled automatically.

To prevent cold air from blowing in from outside, the fan may not start immediately when the **AUTO** button is pressed.

If the interior is very warm, you can cool it down more rapidly by partially opening the windows, turning the system to AUTO, and setting the temperature to low. Change the fresh mode to recirculation mode until the temperature cools down.

When you set the temperature to the lower or upper limit, **Lo** or **Hi** is displayed.

Pressing the button switches the climate control system on or off. When turned on, the system returns to your last selection.

*1: MID vents provide supplemental air to the lower body of the occupant(s). MID vents can be used together with any other vent mode.

Continued

■ Switching between the recirculation and fresh air modes

Press the  (recirculation) button and switch the mode depending on environmental conditions.

Recirculation mode (indicator on): Recirculates air from the vehicle's interior through the system.

Fresh air mode (indicator off): Maintains outside ventilation. Keep the system in fresh air mode in normal situations.

■ Defrosting the Windshield and Windows

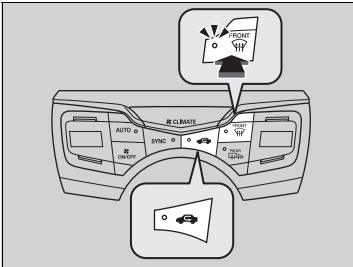

Pressing the  (windshield defroster) button turns the air conditioning system on and automatically switches the system to fresh air mode.

Press the  button again to turn off, the system returns to the previous settings.

■ To rapidly defrost the windows

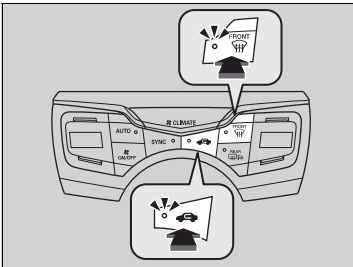

1. Press the  button.
2. Press the  button.

▣ Defrosting the Windshield and Windows

For your safety, make sure you have a clear view through all the windows before driving.

Do not set the temperature near the upper or lower limit.

When cold air hits the windshield, the outside of the windshield may fog up.

If the side windows fog up, adjust the vents so that the air hits the side windows.

▣ To rapidly defrost the windows

After defrosting the windows, switch over to fresh air mode. If you keep the system in recirculation mode, the windows may fog up from humidity. This impedes visibility.

■ Synchronization Mode

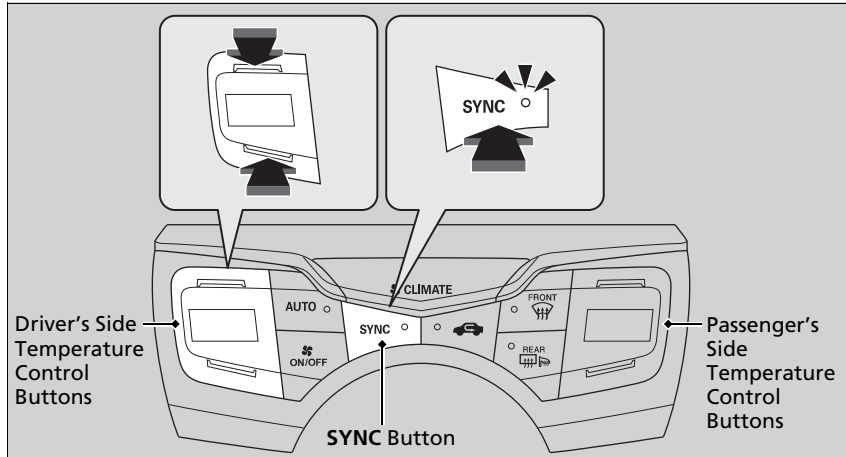

You can set the temperature synchronously for the driver's side and the passenger's side in synchronization mode.

1. Press the **SYNC** button.
 - The system switches to synchronization mode.
2. Adjust the temperature using the driver's side temperature control buttons.

Press the **SYNC** button to return to dual mode.

☞ Synchronization Mode

When the system is in dual mode, the driver's side temperature and the passenger's side temperature can be set separately.

Automatic Climate Control Sensors

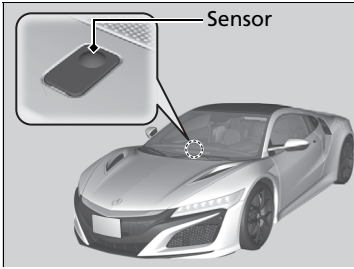

The automatic climate control system is equipped with sensors. Do not cover or spill any liquid on them.

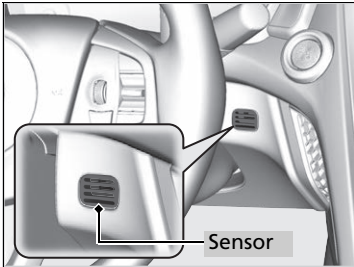

Features

This chapter describes how to operate technology features.

Audio System

About Your Audio System	162
USB Ports	163
Audio System Theft Protection	164
Audio Remote Controls	165
Audio System Basic Operation	166
Audio/Information Screen	167
Adjusting the Sound	181
Display Setup	182
Voice Control Operation	184
Playing FM Radio	188
Playing SiriusXM® Radio*	192
Playing an iPod	199

Song By Voice™ (SBV)	202
Playing Pandora®*1	206
Playing a USB Flash Drive	208
Playing <i>Bluetooth</i> ® Audio	211
Wi-Fi Connection	213
Siri® Eyes Free	215
Apple CarPlay™	216
Android Auto™	219

Audio Error Messages

iPod/USB Flash Drive	223
Pandora®*1	224
Android/Apps	225
General Information on the Audio System	
SiriusXM® Radio Service*	226

Compatible iPod, iPhone, and USB Flash Drives	227
Honda App License Agreement	228
Legal Information on Apple CarPlay/Android Auto	240
About Open Source Licenses	242
License Information	243
Customized Features	244
Defaulting All the Settings	266
HomeLink® Universal Transceiver ...	267
<i>Bluetooth</i>® HandsFreeLink®	
Using HFL	270
HFL Menus	273
AcuraLink®*	304

***1: Available only on U.S. models.**

* Not available on all models

About Your Audio System

The audio system features FM radio and SiriusXM® Radio service*. It can also play USB flash drives, and iPod, iPhone and *Bluetooth*® devices.

You can operate the audio system from the icons on the touchscreen interface or the remote controls on the steering wheel.

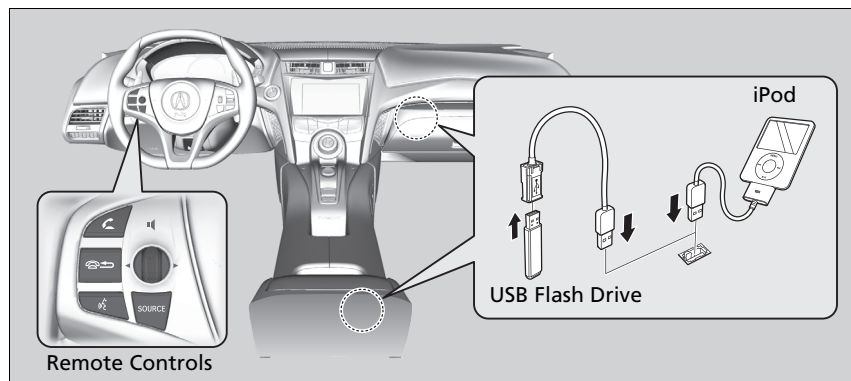

>About Your Audio System

SiriusXM® Radio* is available on a subscription basis only. For more information on SiriusXM® Radio, contact an authorized Acura NSX dealer.

General Information on the Audio System P. 226

SiriusXM® Radio* is available in the United States and Canada, except Hawaii, Alaska, and Puerto Rico.

SiriusXM®* is a registered trademark of SiriusXM Radio, Inc.

iPod, iPhone and iTunes are trademarks of Apple Inc.

State or local laws may prohibit the operation of handheld electronic devices while operating a vehicle.

USB Ports

Install the iPod USB connector or the USB flash drive to the USB port.

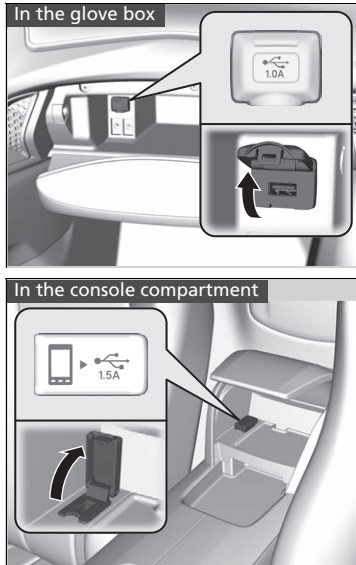

■ In the glove box

The USB port (1.0A) is for playing audio files on a USB flash drive and connecting a cellular phone and charging device.

■ In the console compartment

The USB port (1.5A) is for charging devices, playing audio files and connecting compatible phones with Apple CarPlay or Android Auto.

- ▶ To prevent any potential issues, be sure to use an Apple MFi Certified Lightning Connector for Apple CarPlay, and for Android Auto, the USB cables should be certified by USB-IF to be compliant with USB 2.0 Standard.

▣ USB Ports

- Do not leave the iPod or USB flash drive in the vehicle. Direct sunlight and high temperatures may damage it.
- We recommend using an extension cable with the USB port.
- Do not connect the iPod or USB flash drive using a hub.
- Do not use a device such as a card reader or hard disk drive, as the device or your files may be damaged.
- We recommend keeping your data backed up before using the device in your vehicle.
- Displayed messages may vary depending on the device model and software version.

If the audio system does not recognize the iPod, try reconnecting it a few times or reboot the device. To reboot, follow the manufacturer's instructions provided with the iPod or visit www.apple.com/ipod.

▣ USB charge

The USB port can supply up to 1.0A/1.5A of power. It does not output 1.0A/1.5A unless requested by the device.

For amperage details, read the operating manual of the device that needs to be charged.

Set the power mode to ACCESSORY or ON first.

Under certain conditions, a device connected to the port may generate noise in the radio you are listening to.

Audio System Theft Protection

The audio system is disabled when it is disconnected from the power source, such as when the 12-volt battery is disconnected or goes dead. In certain conditions, the system may display a code entry screen. If this occurs, reactivate the audio system.

■ Reactivating the audio system

1. Set the power mode to ON.
2. Turn on the audio system.
3. Select and hold the  (power/audio) icon for more than two seconds.
 - ▶ The audio system is reactivated when the audio control unit establishes a connection with the vehicle control unit. If the control unit fails to recognize the audio unit, you must go to an authorized Acura NSX dealer and have the audio unit checked.

Audio Remote Controls

Allows you to operate the audio system while driving.

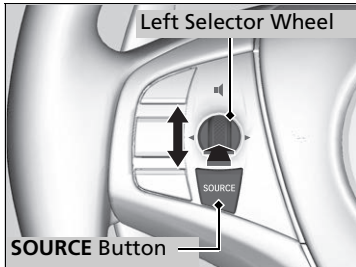

SOURCE Button

Cycles through the audio modes as follows:
 FM→SiriusXM®→USB→iPod→Pandora®→
 Apps*→Bluetooth® Audio→Audio Apps*

Left Selector Wheel

Roll Up: To increase the volume.

Roll Down: To decrease the volume.

Push: To mute. Push again to unmute.

- When listening to the radio
 - Move to the right:** To select the next preset radio station.
 - Move to the left:** To select the previous preset radio station.
 - Move to the right and hold:** To select the next strong station.
 - Move to the left and hold:** To select the previous strong station.
- When listening to an iPod, USB flash drive, or Bluetooth® Audio
 - Move to the right:** To skip to the next song.
 - Move to the left:** To go back to the beginning of the current or previous song.
 - Move to the right and hold:** To skip to the next folder.
 - Move to the left and hold:** To go back to the previous folder.
- When listening to Pandora®*
 - Move to the right:** To skip to the next song.
 - Move to the right and hold:** To select the next station.
 - Move to the left and hold:** To select the previous station.

Audio Remote Controls

Some mode appears only when an appropriate device or medium is used.

* Not available on all models

To use the audio system function, the power mode must be in ACCESSORY or ON.

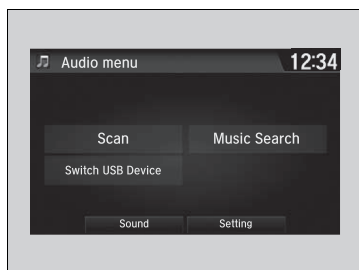
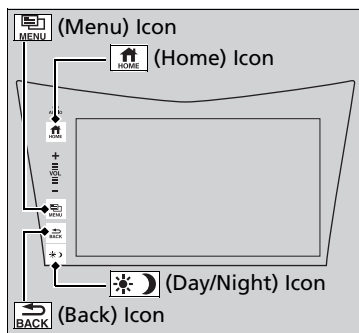

: Select to go to the home screen.

➤ **Switching the Display** P. 167





: Select to display available options including **Sound, View Radio Text, Music Search**, and playback modes.



: Select to go back to the previous screen.



: Select to change the audio/information screen brightness.

Select  once and select  or  to make an adjustment.

▶ Each time you select , the mode switches among the daytime mode, nighttime mode and off mode.

Audio System Basic Operation

Audio Menu Items

- **Station List** P. 189, 191
- **Music Search List** P. 200, 209
- **Scan** P. 190, 191, 198, 210
- **Play Mode** P. 201, 210

Audio/Information Screen

Displays the audio status and wallpaper. From this display, you can go to various setup options.

Switching the Display

Using the audio/information screen

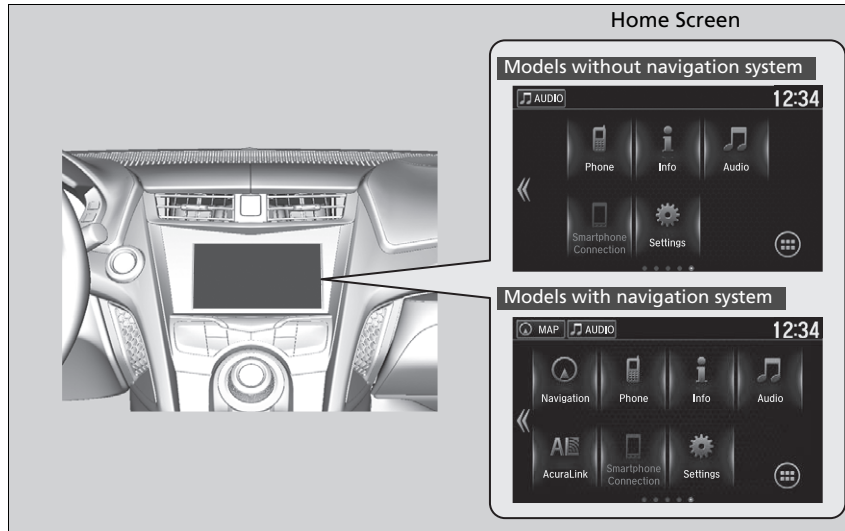

Select  to go to the home screen.

Select **Phone**, **Info**, **Audio**, **Settings**, **Navigation***, **AcuraLink***, **Smartphone Connection** (Apple CarPlay, Android Auto), or  (app list).

Using the audio/information screen

Touchscreen operation

- Use simple gestures - including touching, swiping and scrolling - to operate certain audio functions.
- Some items may be grayed out during driving to reduce the potential for distraction.
- You can select them when the vehicle is stopped or use voice commands.
- Wearing gloves may limit or prevent touchscreen response.
- You can use the microfiber cleaning cloth included in your owner's kit to remove dust or fingerprints from the touchscreen.

■ Phone

Displays the HFL information.

➔ **Bluetooth® HandsFreeLink®** P. 270

■ Info

Displays **Trip Computer** or **Clock/Wallpaper**. Select  on the **Info Menu** screen to see all available options: **Trip Computer**, **Voice Info**, **Clock/Wallpaper** and **System/Device Information**.

Trip Computer:

- **Current Drive** tab: Displays the current trip information.
- **History of Trip A** tab: Displays information for the three previous drives. The information is stored every time you reset Trip A.
To delete the history manually, select **Delete History** on the **History of Trip A** tab. The confirmation message appears on the screen, then select **Yes**.

Voice Info: Displays a list of all voice commands.

Clock/Wallpaper: Displays the clock and wallpaper.

System/Device Information:

- **System Info**: Displays the software version of the audio system.
- **USB Info**: Displays the memory usage of the USB device.

■ Audio

Displays the current audio information.

■ Settings

Enters the customizing menu screen.

➔ **Customized Features** P. 244

■ Navigation*

Displays the navigation screen.

➤ **Refer to the Navigation System Manual**

■ AcuraLink*

Is a subscription-based service that can provide convenient features such as voice communication if an airbag deploys, online security, and one-on-one operator assistance.

➤ **AcuraLink®** P. 304

■ Smartphone Connection

Displays Apple CarPlay or Android Auto.

➤ **Apple CarPlay™** P. 216

➤ **Android Auto™** P. 219

■ App List

Adds or removes apps or widgets on the home screen.

➤ **Home Screen** P. 173

■ Changing the Home Screen Icon Layout



1. Select .
2. Select and hold an icon.
 - ▶ The screen switches to the customization screen.
3. Drag and drop the icon to where you want it to be.
4. Select **OK**.
 - ▶ The screen will return to the home screen.

Wallpaper Setup

You can change, store, and delete the wallpaper on the audio/information screen.

Import wallpaper

You can import up to five images, one at a time, for wallpaper from a USB flash drive.

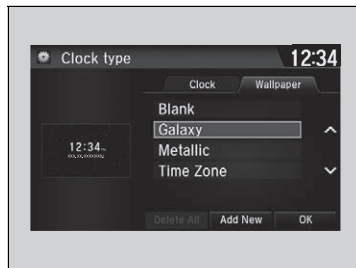

1. Connect the USB flash drive to the USB port.
▶ **USB Ports** P. 163
2. Select **Settings**.
3. Select **Clock/Info**.
4. Select **Clock/Wallpaper Type**, then open the **Wallpaper** tab.
5. Select **Add New**.
▶ The picture name is displayed on the list.
6. Select a desired picture.
▶ The preview is displayed on the left side on the screen.
7. Select **Start Import** to save the data.
▶ The display will return to the wallpaper list.

Wallpaper Setup

The wallpaper you set up on **Clock/Wallpaper Type** cannot be displayed on the driver information interface.

- When importing wallpaper files, the image must be in the USB flash drive's root directory. Images in a folder cannot be imported.
- The file name must be fewer than 64 characters.
- The file format of the image that can be imported is BMP (bmp) or JPEG (jpg).
- The individual file size limit is 5 MB.
- The maximum image size is 4,096 × 4,096 pixels. If the image size is less than 800 × 480 pixels, the image is displayed in the middle of the screen with the extra area appearing in black.
- If the USB flash drive does not have any pictures, the **No files detected** message appears.

Continued

■ Select wallpaper

1. Select **Settings**.
2. Select **Clock/Info**.
3. Select **Clock/Wallpaper Type**, then open the **Wallpaper** tab.
 - ▶ The screen changes to the wallpaper list.
4. Select a desired wallpaper.
 - ▶ The preview is displayed on the left side on the screen.
 - ▶ The pop-up menu appears on the screen.
5. Select **Set**.
 - ▶ The display will return to the wallpaper list.

■ To view wallpaper once it is set

1. Select .
2. Select **Info**.
3. Select .
4. Select **Clock/Wallpaper**.

■ Delete wallpaper

1. Select **Settings**.
2. Select **Clock/Info**.
3. Select **Clock/Wallpaper Type**, then open the **Wallpaper** tab.
 - ▶ The screen changes to the wallpaper list.
4. Select a wallpaper that you want to delete.
 - ▶ The preview is displayed on the left side on the screen.
 - ▶ The pop-up menu appears on the screen.
5. Select **Delete**.
 - ▶ A confirmation message appears on the screen.
6. Select **Yes** to delete completely.
 - ▶ The display will return to the wallpaper list.

▶▶ Wallpaper Setup

From the pop-up menu, select **Preview** to see a preview at full-size screen.

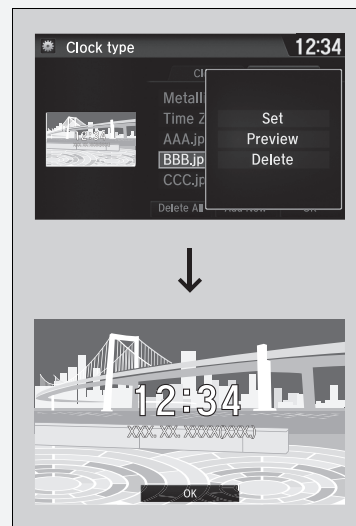

To go back to the previous screen, select **OK**, or select .



When the file size is large, it takes a while to be previewed.

To delete all wallpapers you add, select **Delete All**, then **Yes**.

■ Home Screen

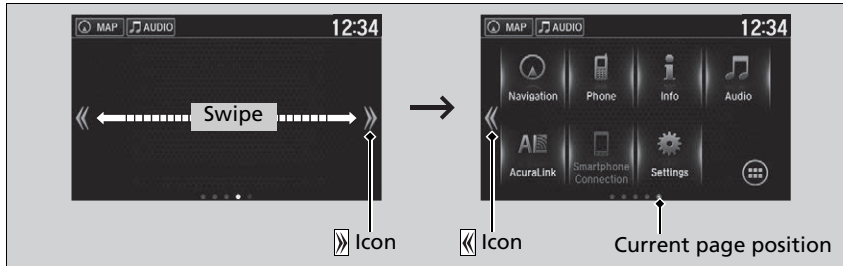
■ To change to a next screen



Selecting  or , or swiping the screen left or right changes to the next screen.



▶▶ Home Screen

The home screen has 5 pages (fixed). You cannot add any more pages.

Select  to go directly back to the first page of the home screen from any page.

■ To use apps or widgets



1. Select .
2. Select  (app list) icon.
▶ The **Apps** screen appears.
3. Select the app or widget you want to use.

Pre-installed app list:

- **Browser:** Displays the web browser utilized by smartphone and Wi-Fi connection.
- **Calculator:** Displays Calculator.
- **Downloads:** Displays the data downloaded from the web browser and so on.
- **Install USB:** Installs the driver for the USB flash drive.
- **Search:** Displays various retrieval screen.
- **Settings:** Displays the Android setting screen.

▶▶ To use apps or widgets

Select and hold a selected app or widget to add that app's or widget's shortcut on the home screen.

Pre-installed apps may not start up normally. If this occurs, you need to reset the system.

▶ **Defaulting All the Settings** P. 266

If you perform **Factory Data Reset**, it may reset all the settings to their factory default.

▶ **Defaulting All the Settings** P. 266

In case those apps still do not startup normally even after **Factory Data Reset**, contact an authorized Acura NSX dealer.

There is a possibility that a browser is shut down in the situation of the use. In that situation, the screen will return to before the browser startup.



You can delete user installed apps by the following procedure.

1. Select .
2. Select **Settings**.
3. Select **System**.
4. Select the **Others** tab.
5. Select **Detail Information**.
6. Select **Apps**.
7. Select an app that you want to delete.
8. Select **Delete**.

Pre-installed apps cannot be deleted.

■ To add app or widget icons on the home screen

App or widget icons can be added on the home screen.

1. Select .
2. Select .
3. Select and hold empty space on the home screen.
 - ▶ The pop-up menu appears on the screen.
4. Select **Add App** or **Add Widget**.
 - ▶ The **Apps/Widgets** screen appears.

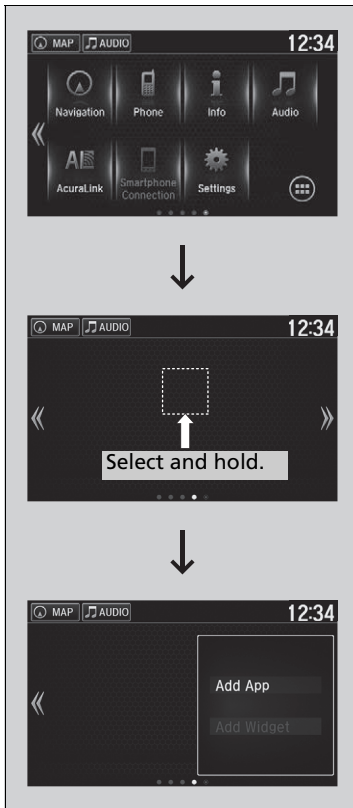

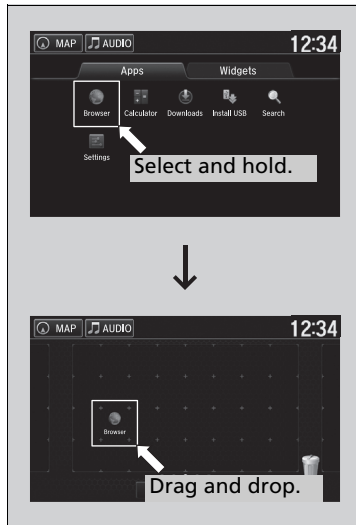

5. Select and hold an app or widget icon you want to add.
 - ▶ The screen switches to the customization screen.
6. Drag and drop the icon to where you want it to be.
7. Select **OK**.
 - ▶ The screen will return to the home screen.

■ To move icons on the home screen

You can change location on the home screen.

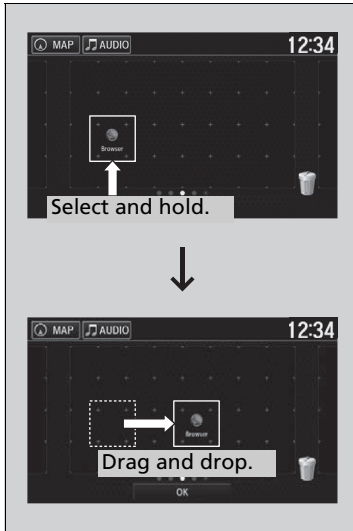

1. Select and hold an icon.
 - ▶ The screen switches to the customization screen.
2. Drag and drop the icon to where you want it to be.
3. Select **OK**.
 - ▶ The screen will return to the home screen.

☒ To move icons on the home screen

You can also move the **Phone, Info, Audio, Settings, Navigation**^{*}, **AcuraLink**^{*}, **Smartphone Connection**, and  (app list) icons in the same manner.

* Not available on all models

■ To remove icons from the home screen

You can delete the icons on the home screen.

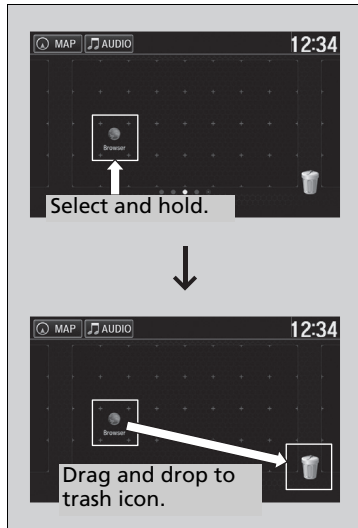

1. Select and hold an icon.
 - ▶ The screen switches to the customization screen.
2. Drag and drop the icon you want to remove to the trash icon.
 - ▶ The icon is removed from the home screen.
3. Select **OK**.
 - ▶ The screen will return to the home screen.



▶▶ To remove icons from the home screen

You cannot delete the **Phone, Info, Audio, Settings, Navigation^{*}, AcuraLink^{*}, Smartphone Connection,** and  (app list) icons.

Apps or widgets will not be deleted by deleting the icon on the home screen.

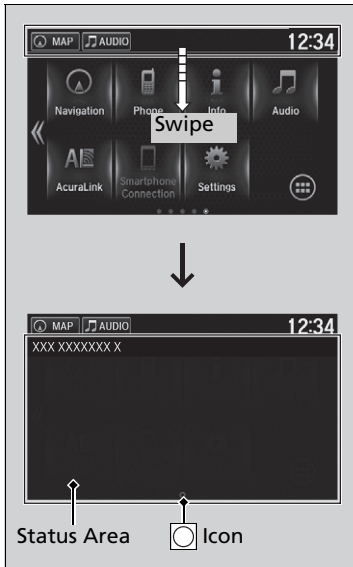
Status Area



1. Swipe the upper area of the screen.
 - ▶ The status area appears.
2. Select an item to see the details.
3. Select  or swipe up the  icon to close the area.

■ Closing Apps

You can close specific apps running in the background on the system.

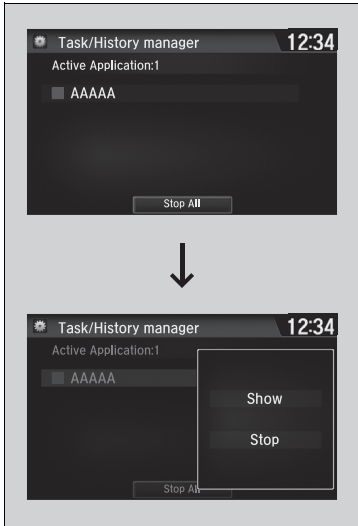

1. Select and hold .
2. Select an app you want to close.
3. Select **Stop**.
 - ▶ The display will return to the app list.

▶▶ Closing Apps

If you have a number of apps running in the background and something goes wrong with the audio system, some of those apps may not work properly. If this happens, close all the apps and re-launch the app/apps that you want to use.

To close all apps on the system, select **Stop All**, then **Yes**.

You cannot close the Garmin* apps.

Adjusting the Sound

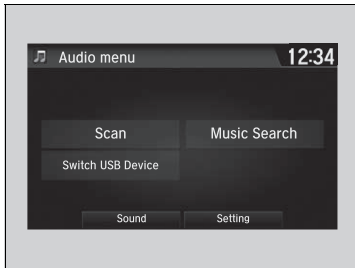

1. Select .
2. Select **Audio**.
3. Select .
4. Select **Sound**.

Select a tab from the following choices:

- **BAS-TRE**: Bass, Treble
- **FAD-BAL**: Fader, Balance
- **CTR*-SUBW**: Center*, Subwoofer
- **SVC-Neural***: Speed Volume Compensation, DTS Neural Surround™*

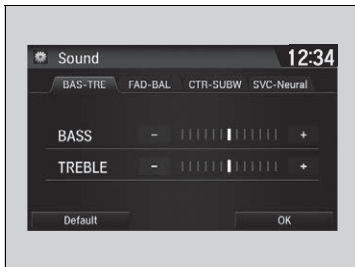

Adjusting the Sound

The SVC has four modes: **Off**, **Low**, **Mid**, and **High**. SVC adjusts the volume level based on the vehicle speed. As you go faster, audio volume increases. As you slow down, audio volume decreases.

You can also adjust the sound the following procedure.

1. Select .
2. Select **Settings**.
3. Select **Audio**.
4. Select **Sound**.

* Not available on all models

Display Setup

You can change the brightness or color theme of the audio/information screen.

■ Changing the Screen Brightness

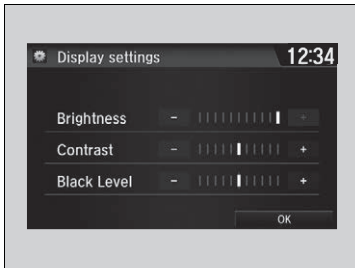



1. Select .
2. Select **Settings**.
3. Select **System**.
4. Select the **Display** tab.
5. Select **Display Settings**.
6. Select the setting you want.
7. Select **OK**.

☒ Changing the Screen Brightness

You can change the **Contrast** and **Black Level** settings in the same manner.

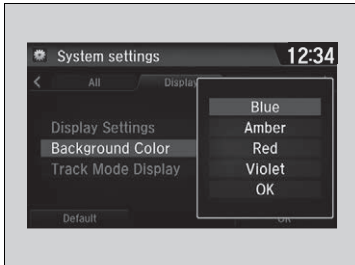
■ Changing the Screen's Color Theme



1. Select .
2. Select **Settings**.
3. Select **System**.
4. Select the **Display** tab.
5. Select **Background Color**.
6. Select the setting you want.
7. Select **OK**.

☒ Changing the Screen's Color Theme

When the vehicle is in **SPORT+** or **TRACK** mode, the background color of the screen automatically changes to red.

■ Selecting an Audio Source

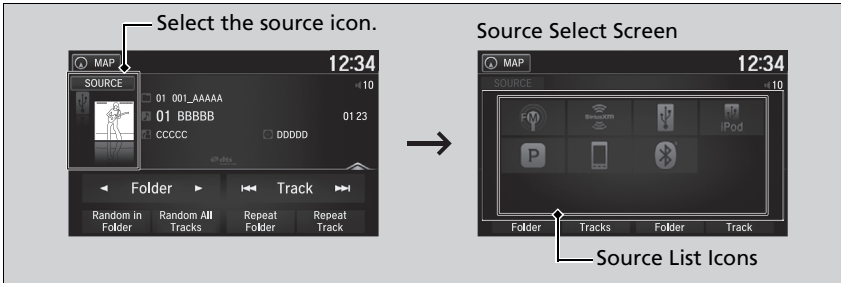

Select the current source icon, then select an icon on the source list to switch the audio source.

■ Limitations for Manual Operation

Certain manual functions are disabled or inoperable while the vehicle is in motion. You cannot select a grayed-out option until the vehicle is stopped.

▶▶ Selecting an Audio Source

If you startup pre-installed audio apps, **AUDIO Apps** is displayed on the lower right of the screen. These pre-installed apps cannot be displayed on the source select screen.

You can startup those audio apps from **AUDIO Apps**.

Pandora® is available only in the U.S.

▶▶ Limitations for Manual Operation



When the vehicle is in **TRACK** mode, the following screen is displayed and the audio system becomes inoperable. To return to the normal screen, touch any part of the audio/information screen. You can turn the limitation on and off.

▶ **Customized Features** P. 244





Voice Control Operation

Your vehicle has a voice control system that allows hands-free operation.

The voice control system uses the  (Talk) and  (hang-up/back) buttons on the steering wheel and a microphone near the map lights on the ceiling.

▶▶ Voice Control Operation

When you press the  button, a helpful prompt asks what you would like to do. Press and release the  button again to bypass this prompt and give a command.

▶▶ Voice Recognition

The voice control system can only be used from the driver's seat because the microphone unit removes noises from the front passenger's side.

■ Voice Recognition

To achieve optimum voice recognition when using the voice control system:

- Make sure the correct screen is displayed for the voice command that you are using.

The system recognizes only certain commands. Available voice commands.

 **Voice Portal Screen** P. 185

- Close the windows.
- Adjust the dashboard and side vents so air does not blow onto the microphone on the ceiling.
- Speak clearly in a natural speaking voice without pausing between words.
- Reduce any background noise if possible. The system may misinterpret your command if more than one person is speaking at the same time.

Voice Portal Screen

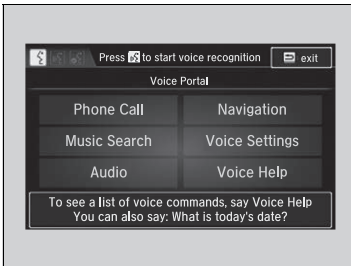

When the  (Talk) button is pressed, available voice commands appear on the screen.

For a complete list of commands, say “Voice Help” after the beep or select **Voice Help**.

You can see the list of commands in **Voice Info** on the **Info menu** screen. Select **Info**, then select .

The system only recognizes the commands on the following pages, at certain screens. Free form voice commands are not recognized.

*1: Models with navigation system

*2: Available only on U.S. models.

* Not available on all models

Phone Call

This can be only used when the phone is connected. When the system recognizes the *Phone call* command, the screen will change to the voice recognition screen for phone commands.

- *Dial by number*
- *Call history*
- *Redial*
- *Call <Your Contact Name>*
- *Call <Phone Number>*
- *Call Police*
- *Call 911*

Phone Call commands are not available if using Apple CarPlay.

Music Search*1

This can be only used when the iPod or USB device is connected.

Climate Control*1

When the system recognizes the *Climate Control* command, the screen will change the dedicated screen to the climate control voice recognition screen.

 **Climate Control Commands*1** P. 187

Audio*1

When the system recognizes the *Audio* command, the screen will change to the audio voice recognition screen.

- *Audio On*
- *Audio Off*
- *Radio FM*
- *Radio SXM**
- *Pandora*2*
- *iPod*
- *USB*
- *Other Sources*

Pandora®*2 cannot be used while Android Auto is active.

Navigation*1

The screen changes to the navigation screen.

 **Refer to the Navigation System Manual**

Voice Setting

The screen changes to the **Voice Recog** tab on the **System settings** screen.

■ Voice Help

You can see a list of the available commands on the screen.

- *Useful Commands*
- *Phone Commands*
- *Audio Commands**¹
- *On Screen Commands*
- *Music Search Commands**¹
- *General Commands*
- *Climate Control Commands**¹

■ Useful Commands

The system accepts these commands on the voice portal top screen.

- *Call <Phone Number>*
- *Call <Your Contact Name>*
- *What time is it?*
- *What is today's date?*

*1: Models with navigation system

*2: Available only on U.S. models.

* Not available on all models

■ Phone Commands

The system accepts these commands on the dedicated screen for the voice recognition of the phone.

- *Call by Number*
- *Call by Name*
- *Call <Phone Number>*
- *Call <Your Contact Name>*

■ Audio Commands*¹

The system accepts these commands on the dedicated screen for the voice recognition of the audio.

■ Radio FM Commands

- *Radio tune to <87.7-107.9> FM*
- *Radio tune to <87.7 -107.9> HD <1-8> FM*
- *Radio FM preset <1-12>*

■ Radio SXM Commands*

- *SXM channel <1-999>*
- *SXM channel <channel name, category name, traffic and weather city name, sports team name>*
- *Radio SXM preset <1-12>*

■ Pandora Commands*²

- *Pandora play*

■ iPod Commands

- *iPod play*
- *iPod play track <1-30>*
- *Music Search*
- *What album is this?*
- *What am I listening to?*

■ USB Commands

- *USB play*
- *USB play track <1-30>*
- *Music Search*
- *What album is this?*
- *What am I listening to?*

■ Bluetooth® Audio Commands

- *Bluetooth® Audio play*

NOTE:

Bluetooth® Audio commands may not work on some phones or *Bluetooth®* Audio devices.

■ On Screen Commands

When **On Screen Commands** is selected, the explanation screen is displayed.

■ Music Search Commands*1

The system accepts these commands on the **Music Search** screen.

■ Using Song By Voice

Song By Voice™ is a feature that allows you to select music from your iPod or USB device using Voice Commands. To activate this mode, you must push the talk switch and say: "Music search".

■ Song By Voice Commands

- *What am I listening to?*
- *Who am I listening to?*
- *Who is this?*
- *What's playing?*
- *Who's playing?*
- *What album is this?*

■ Play Commands

- *Play artist <Name>*
- *Play track/song <Name>*
- *Play album <Name>*
- *Play genre/category <Name>*
- *Play playlist <Name>*
- *Play composer <Name>*

■ List Commands

- *List artist <Name>*
- *List album <Name>*
- *List genre/category <Name>*
- *List playlist <Name>*
- *List composer <Name>*

■ General Commands

- *What time is it?*
- *What is today's date?*

■ Climate Control Commands*1

- *Climate Control on*
- *Climate Control off*
- *Fan Speed <1-7>*
- *Temperature max heat*
- *Temperature max cool*
- *Temperature <57-87> degrees*
- *Defrost on*
- *Defrost off*
- *Air conditioner on*
- *Air conditioner off*
- *More*
- *Climate control automatic*
- *Vent*
- *Dash and floor*
- *Fan speed up*
- *Fan speed down*
- *Floor vents*
- *Floor and defrost*
- *Temperature up*
- *Temperature down*

*1: Models with navigation system

Playing FM Radio

The diagram shows a central 'Audio/Information Screen' displaying 'SOURCE', 'FM', '80.0 MHz', and a frequency list: 'Scan', 'Tune', 'Seek', '80.0', '85.1', '90.2', '95.3', '100.4', '105.5'. To the left is a vertical toolbar with icons for AUDIO, HOME, VOL (+/-), MENU, and BACK. To the right is a secondary toolbar with an Open/Close icon and Seek icons (left and right arrows). Arrows connect these icons to their respective text descriptions.

Audio/Information Screen

(Power/Audio) Icon
Select to turn the audio system on and off.

VOL (Volume) Icons
Select to adjust the volume.

(Menu) Icon
Select to display the menu items.

(Back) Icon
Select to go back to the previous display.

Scan Icon
Select to scan each station with a strong signal.

Tune Icons
Select ◀ or ▶ to tune the radio frequency.

Open/Close Icon*1
Displays/hides the detailed information.

Seek Icons
Select ▶▶ or ◀◀ to search the selected band up or down for a station with a strong signal.

Preset Icons
Tune the preset radio frequency. Select and hold the preset icon to store that station. Select 7 to display preset 7 onwards.

*1:Some or all of the lists may not be displayed.

■ Preset Memory

To store a station:

1. Tune to the selected station.
2. Select and hold the preset number for the station you want to store.

You can also store a preset station by the following procedure.

1. Tune to the selected station.
2. Select the open/close icon to display a list.
3. Select the **Preset** tab.
4. Select and hold the preset number for the station you want to store.

■ Station List

Lists the strongest stations on the selected band.

1. Select the open/close icon to display a list.
2. Select the **Station List** tab.
3. Select the station.

■ Manual update

Updates your available station list at any time.

1. Select the open/close icon to display a list.
2. Select the **Station List** tab.
3. Select **Refresh**.

▶▶ Preset Memory

The **ST** indicator appears on the display indicating stereo FM broadcasts.

Switching the Audio Mode

Press the **SOURCE** button on the steering wheel or select **SOURCE** on the screen.

▶▶ **Audio Remote Controls** P. 165

You can store 12 FM stations into preset memory.

HD Radio Technology manufactured under license from iBiquity Digital Corporation. U.S. and Foreign Patents. HD Radio™ and the HD, HD Radio, and "Arc" logos are proprietary trademarks of iBiquity Digital Corp.



■ Scan

Samples each of the strongest stations on the selected band for 10 seconds. To turn off scan, select **Cancel** or .

■ HD Subchannel

Displays the subchannel list when an HD Radio™ station is selected while listening to an FM station.

1. Select .
2. Select **HD Radio Subchannel**.
3. Select the channel number.

■ Radio Data System (RDS)

Provides text data information related to your selected RDS-capable FM station.

■ To find an RDS station from Station List

1. Select the open/close icon to display a list while listening to an FM station.
2. Select the **Station List** tab.
3. Select the station.

■ Manual update

Updates your available station list at any time.

1. Select the open/close icon to display a list while listening to an FM station.
2. Select the **Station List** tab.
3. Select **Refresh**.

■ Radio text

Displays the radio text information of the selected RDS station.

1. Select .
2. Select **View Radio Text**.

■ Scan

Samples each of the strongest stations on the selected band for 10 seconds.

To turn off scan, select **Cancel** or .

☒ Radio Data System (RDS)

When you select an RDS-capable FM station, the RDS automatically turns on, and the frequency display changes to the station name. However, when the signals of that station become weak, the display changes from the station name to the frequency.

Playing SiriusXM® Radio *

(Power/Audio) Icon
Press to turn the audio system on and off.

VOL (Volume) Icons
Select to adjust the volume.

(Menu) Icon
Select to display the menu items.

(Back) Icon
Select to go back to the previous display.

Scan Icon
Select to scan each channel.

Category Icons
Select ◀ or ▶ to display and select a SiriusXM® Radio category.

Channel Icons
Select ◀◀ or ▶▶ to the previous or next channel.
Select and hold to rapidly skip 10 channels at a time.

Audio/Information Screen

Station Art

Open/Close Icon*¹
Displays/hides the detailed information.

Preset Icons
Tune the preset radio station. Select and hold the preset icon to store that station. Select 7 to display preset 7 onwards.

Skip Icons
Select ◀◀ or ▶▶ to change section in the channel. Select and hold to move rapidly within the section.

*1: Some or all of the lists may not be displayed.

■ To Change the Tune Mode

1. Select .
2. Select **Tune Mode**.
3. Select **Channel Mode** or **Category Mode**.

▶▶ Playing SiriusXM® Radio*

In the channel mode, all available channels are selectable. In the category mode, you can select a channel within a category (Jazz, Rock, Classical, etc.).

There may be instances when SiriusXM® Radio does not broadcast all the data fields (artist name, title). This does not indicate a problem with your audio system.

SiriusXM® Radio stations load in ascending order, which can take about a minute. Once they have loaded you will be able to scroll up or down to make your selections.

Switching the Audio Mode

Press the **SOURCE** button on the steering wheel or select **SOURCE** on the screen.

 **Audio Remote Controls** P. 165

Tune Start:

When you change to a preset channel, a song being played on that channel restarts from the beginning with this function. This can be turned on or off from the **Audio settings** screen.

 **Customized Features** P. 244

■ Preset Memory

To store a channel:

1. Tune to the selected channel.
2. Press and hold the preset number for the station you want to store.
3. Select **Replace**.

You can also store a channel by the following procedure.

1. Tune to the selected channel.
2. Select the open/close icon to display a list.
3. Select the **Preset** tab.
4. Select and hold the preset number for the station you want to store.

■ Multi-channel preset (for music channels only)

You can store up to five of your preferred music channels per preset.



1. Tune a station.
2. Select the open/close icon to display a list.
3. Select the **Preset** tab.
4. Select and hold the preset number you want to add a music channel.
 - ▶ A message appears if there are no available presets.
5. Select **Combine**.

▶▶ Playing SiriusXM® Radio*

You can store 12 SiriusXM® channels into the preset memory.

■ Listening to Featured Channels

Suggested channel listing received from SiriusXM® can be displayed and selected.

1. Select the open/close icon to display a channel list.
2. Select the **Channel List** tab.
3. Select the featured channel list title you want to listen to.
 - ▶ The selected channel list of the title is displayed.
4. Select the channel.

☒ Listening to Featured Channels

Up to three featured channels by SiriusXM® can be displayed.

Featured channel lists are at the top of the channel list.

Continued

■ Replay Function

The system can record up to the last 60 minutes of your currently tuned channel's broadcast, as well as the last 30 minutes of your preset channel's broadcast, starting from the moment you turn the vehicle on. If you tuned to a preset channel, the system records up to 60 minutes of a broadcast instead of up to 30 minutes. You can rewind and replay the last 30 or 60 minutes of a broadcast.

1. Select .
2. Select **Playback Position**.
3. Move the time marker to the position you want to replay.

To play or pause on playback mode:

1. Select .
2. Select **Play/Pause**.

■ Returning to real-time broadcast

1. Select .
2. Select **Play Live Broadcast**.

▶▶ Replay Function

The system starts storing broadcast in memory when the power mode is turned ON. You can go back to the program from that point.

You can no longer replay any program once the power mode is turned off as it erases memory. You can check how long the program has been stored in memory from the audio/information screen.

After 30 or 60 minutes of recording the system will automatically start deleting the oldest data.

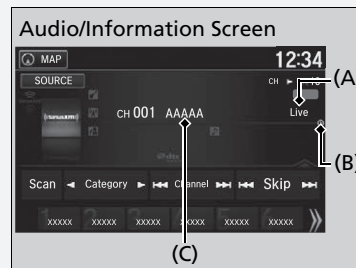



- (A): Shows how much time the replayed segment is behind the real-time broadcast
- (B): Replayed segment
- (C): Length stored in memory

■ Live Sports Alert

While listening to other channels, you can receive sports alerts such as scores from the games of your favorite teams.

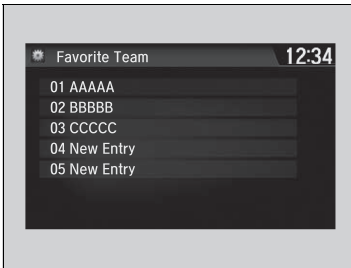
■ To set up a favorite team



1. Select .
2. Select **Settings**.
3. Select **Audio**.
4. Select the **SXM** tab.
5. Select **SportsFlash Setup(Favorite Team)**.
6. Select a team.

■ To set up an alert message

1. Select .
2. Select **Settings**.
3. Select **Audio**.
4. Select the **SXM** tab.
5. Select **SportsFlash Setup(Interrupt)**.
6. Select **On(one time)** or **On(continue)**.

☒ Live Sports Alert

The sports alert function is available in SiriusXM® mode only.

☒ To set up a favorite team

Sports alerts cut in only when SiriusXM® mode is on. Selecting **On(one time)** from the customized settings disables the alert feature next time you turn the power mode to ON.

 **Customized Features** P. 244

You can also set up a favorite team by the following procedure.

1. Select **Audio**.
2. Select .
3. Select **Setting**.
4. Select **SportsFlash Setup(Favorite Team)**.

■ To set up an alert beep

1. Select .
2. Select **Settings**.
3. Select **Audio**.
4. Select the **SXM** tab.
5. Select **SportsFlash Setup(Interrupt Beep)**.
6. Select **On**.

■ Traffic and Weather Information

You can receive traffic and weather information.

1. Select .
2. Select **Settings**.
3. Select **Audio**.
4. Select the **SXM** tab.
5. Select **Traffic & Weather Setup**.
6. Select the region.
 - ▶ When you do not want to receive the information, select **Unset**.

■ Scan

Sample each channel on the selected mode for 10 seconds.

1. Select **Scan**.
2. Select **Scan Channels**.
 - ▶ You can select the desired channel by songs using **Scan Songs in Presets**.

To turn off scan, select **Cancel**.

▶▶ To set up an alert beep

You can also set up a alert beep by the following procedure.

1. Select **Audio**.
2. Select .
3. Select **Setting**.
4. Select **SportsFlash Setup(Interrupt Beep)**.

▶▶ Traffic and Weather Information

The traffic and weather information function in SiriusXM® mode only.

You can also set up the traffic and weather information by the following procedure.

1. Select **Audio**.
2. Select .
3. Select **Setting**.
4. Select **Traffic & Weather Setup**.

▶▶ Scan

The “Scan Songs in Preset” function is based on TuneScan™ technology of SiriusXM®.

The “Featured Channels” function is based on Featured Favorites™ technology of SiriusXM®.

TuneScan™ and Featured Favorites™ are registered trademarks of SiriusXM® Radio, Inc.

Playing an iPod

Connect the iPod using your dock connector to the USB port, then select the iPod mode.

 **USB Ports** P. 163

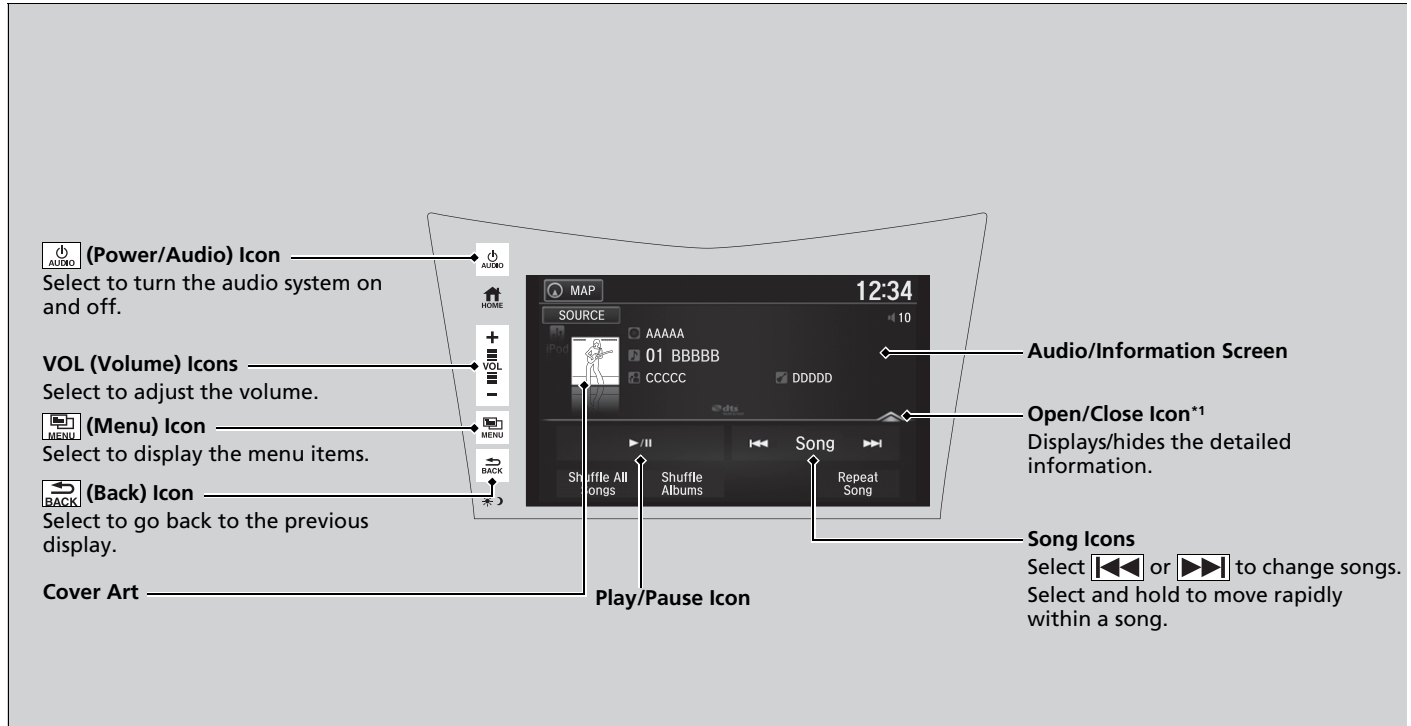

*1: Some or all of the lists may not be displayed.

■ How to Select a Song from the Music Search List

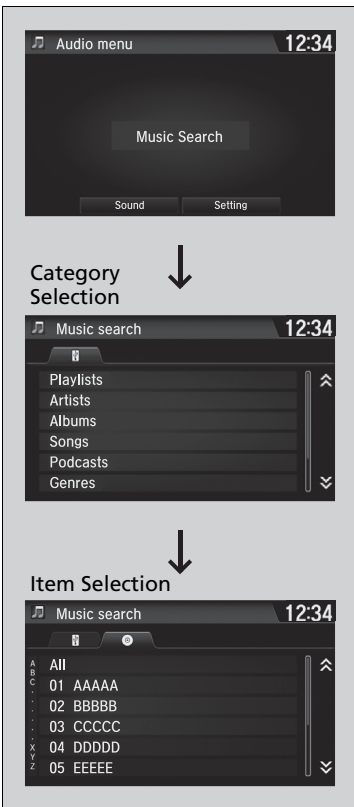

1. Select  and select **Music Search**.

2. Select the items on that menu.

▶▶ Playing an iPod

Available operating functions vary on models or versions. Some functions may not be available on the vehicle's audio system.

If there is a problem, you may see an error message on the audio/information screen.

 **iPod/USB Flash Drive** P. 223

If you operate any music app on your iPhone/iPod while the phone is connected to the audio system, you may no longer be able to operate the same app on the audio/information screen. Reconnect the device if necessary.

If an iPhone is connected via Apple CarPlay, the iPod/USB source is unavailable and audio files on the phone can only be played within Apple CarPlay.

How to Select a Play Mode

You can select shuffle and repeat modes when playing a file.

Select a play mode.

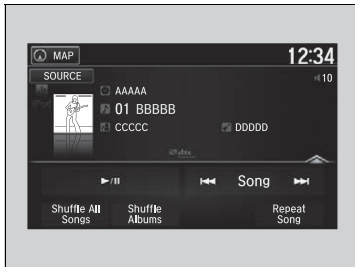

To turn off a play mode

Select the mode you want to turn off.

How to Select a Play Mode

Play Mode Menu Items:

Shuffle All Songs: Plays all available files in a selected list (playlists, artists, albums, songs, podcasts, genres, composers, or audiobooks) in random order.

Shuffle Albums: Plays all available albums in a selected list (playlists, artists, albums, songs, podcasts, genres, composers, or audiobooks) in random order.

Repeat Song: Repeats the current track.

Models with navigation system

Song By Voice™ (SBV)

Use SBV to search for and play music from your USB flash drive or iPod using voice commands.

■ To enable SBV

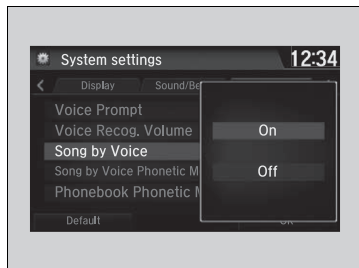

1. Select .
2. Select **Settings**.
3. Select **System**.
4. Select the **Voice Recog** tab.
5. Select **Song by Voice**.
6. Select **On** or **Off**.



▶▶ Song By Voice™ (SBV)

Setting options:

- **On** (factory default): Song By Voice™ commands are available.
- **Off**: Disable the feature.

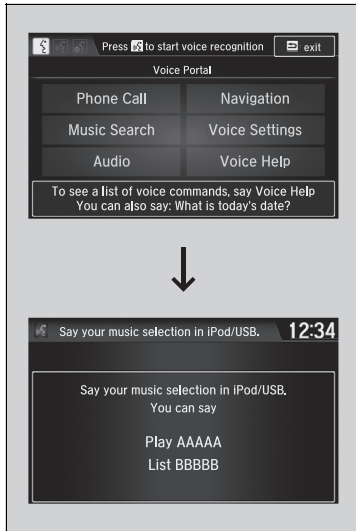
■ Searching for music using SBV



1. Set the **Song by Voice** setting to **On**.
2. Press the  (Talk) button and say "Music Search" to activate the SBV feature for the USB flash drive and iPod.
3. Then, say the next command.
 - ▶ Example 1: Say "(List) 'Artist A'" to view a list of songs by that artist. Select the desired song to start playing.
 - ▶ Example 2: Say "Play 'Artist A'" to start playing songs by that artist.
4. To cancel SBV, press the  (hang-up/back) button on the steering wheel. The selected song continues playing.

Once you have canceled this mode, you need to press the  button and say "Music Search" again to re-activate this mode.

▶▶ Searching for music using SBV

Song By Voice™ Commands List

▶ **Song By Voice Commands** P. 187

NOTE:

Song By Voice™ commands are available for tracks stored on the USB flash drive or iPod.

You can add phonetic modifications of difficult words so that it is easier for SBV to recognize artists, songs, albums, and composers in voice commands.

▶ **Phonetic Modification** P. 204

SBV is not available when using Apple CarPlay. Use Siri Eyes Free instead.

Continued

■ Phonetic Modification

Add phonetic modifications of difficult or foreign words so that it is easier for SBV to recognize artists, songs, albums, and composers in voice commands when searching for music on the USB flash drive or iPod.

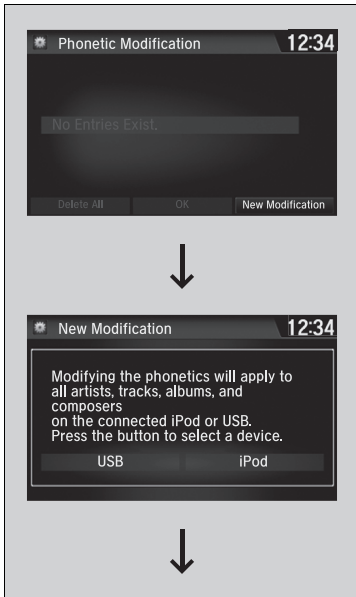

1. Select .
2. Select **Settings**.
3. Select **System**.
4. Select the **Voice Recog** tab.
5. Select **Song by Voice Phonetic Modification**.
6. Select **New Modification**.
7. Select **USB** or **iPod**.

▶▶ Phonetic Modification

Song by Voice Phonetic Modification is grayed out when **Song by Voice** is set to **Off**.

You can store up to 2,000 phonetic modification items.

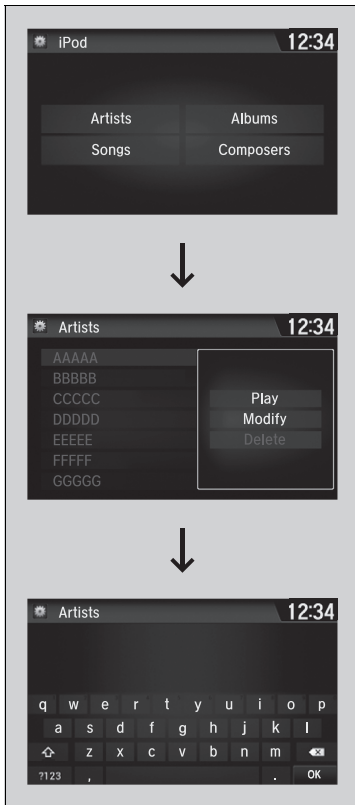

8. Select the item to modify (e.g., **Artists**).

▶ The list of the selected item appears on the screen.

9. Select an entry to modify.

▶ The pop-up menu appears on the screen.

▶ To listen to the current phonetic modification, select **Play**.

▶ To delete the current phonetic modification, select **Delete**.

10. Select **Modify**.

11. Select the phonetic spelling you want to use (e.g., "Artist A") when prompted.

12. Select **OK**.

▶ The artist "No Name" is phonetically modified to "Artist A." When in the SBV mode, you can press the  (Talk) button and use the voice command "Play 'Artist A'" to play songs by the artist "No Name."

Playing Pandora®*1

Your audio system allows you to listen to music from the Pandora® app on a compatible smartphone.

This function is available when the phone is paired and connected to the vehicle's *Bluetooth*® HandsFreeLink® (HFL) system, or with an iPhone, you can connect using your USB cable to the USB port.

▶ **Phone Setup** P. 278

▶ **USB Ports** P. 163

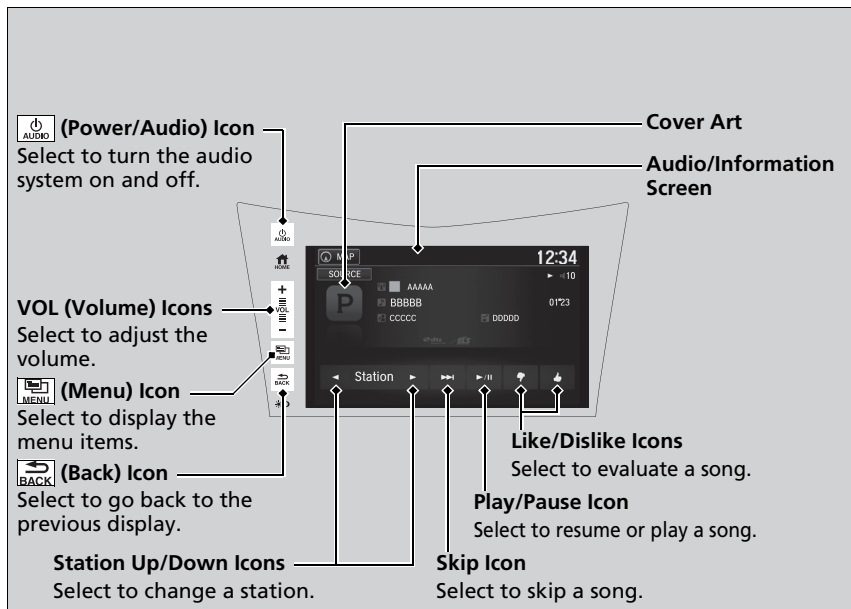

*1: Available only on U.S. models.

▶▶ Playing Pandora®*1

Pandora®, the Pandora logo, and the Pandora trade dress are trademarks or registered trademarks of Pandora Media, Inc., used with permission. Pandora is only available in certain countries. Visit the Pandora website for more information.

To find out if your phone is compatible with this feature, visit www.acura.com/handsfreelink, or call 1-888-528-7876.

To use this service in your vehicle, the Pandora® app must first be installed on your phone. Visit www.pandora.com for more information.

Pandora® is free, personalized radio that plays music and comedy you'll love. Just start with the name of one of your favorite artists, songs, comedians or composers and Pandora® will create a custom station that plays similar tracks. Pandora® also features hundreds of genre stations ranging from Dubstep to Smooth Jazz to Power Workout.

If you cannot operate Pandora® through the audio system, it may be streaming through *Bluetooth*® Audio. Make sure Pandora® mode on your audio system is selected.

If your phone is connected to Android Auto, Pandora is only available through the Android Auto interface. Visit the Android Auto website to check compatibility.

Pandora® Menu

You can operate some of the Pandora® menu items from your vehicle's audio system. The available items are:

- **Bookmark**
- **Station List**
- **New Station**
- **Sound**
- **Setting**

■ Operating a menu item

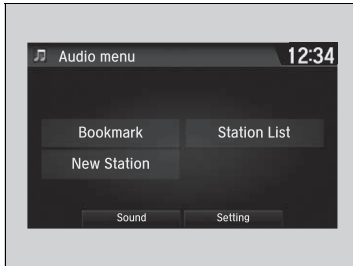

1. Select .
2. Select an item.

▶▶ Pandora® Menu

Available operating functions vary on software versions. Some functions may not be available on the vehicle's audio system.

If there is a problem, you may see an error message on the audio/information screen.

▶ **Pandora®*1** P. 224

Pandora® may limit the total number of skips allowed on the service. If you dislike a track after the skip limit has been reached, your feedback will be saved but the current track will continue to play.

To change stations, activate the Pandora® menu, select **Station List**, and then select a new station. It also changes stations on the main Pandora® screen.

Playing a USB Flash Drive

Your audio system reads and plays sound files on a USB flash drive in either MP3, WMA, or AAC*1 format.

Connect your USB flash drive to the USB port, then select the USB mode.

➤ **USB Ports** P. 163

The diagram shows a car's audio system display with several callouts pointing to specific icons and functions:

- (Power/Audio) Icon:** Select to turn the audio system on and off.
- VOL (Volume) Icons:** Select to adjust the volume.
- (Menu) Icon:** Select to display the menu items.
- (Back) Icon:** Select to go back to the previous display.
- Folder Icons:** Select to skip to the next folder, and to skip to the beginning of the previous folder.
- Audio/Information Screen:** Shows the current track information, including the track name (01 BBBB), time (01'23), and volume level (10).
- Open/Close Icon*2:** Displays/hides the detailed information.
- Track Icons:** Select or to change files. Select and hold to move rapidly within a track.

*1: Only AAC format files recorded with iTunes are playable on this unit.

*2: Some or all of the lists may not be displayed.

How to Select a File from the Music Search List

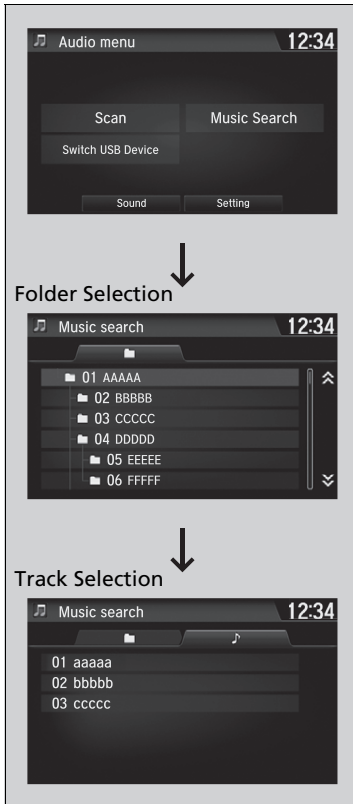

1. Select  and select **Music Search**.

2. Select a folder.

3. Select a track.

▶▶ Playing a USB Flash Drive

Use the recommended USB flash drives.

▶ **General Information on the Audio System**
P. 226

WMA files protected by digital rights management (DRM) cannot be played.

The audio system displays **Unplayable File**, then skips to the next file.

If there is a problem, you may see an error message on the audio/information screen.

▶ **iPod/USB Flash Drive** P. 223

Select **Switch USB Device** in the **Audio menu** to switch another USB device.

Continued

■ How to Select a Play Mode

You can select scan, repeat, and random modes when playing a file.

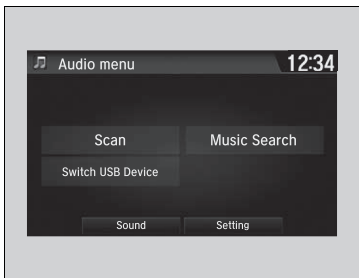

■ Scan

1. Select .
2. Select **Scan**.
3. Select a play mode.

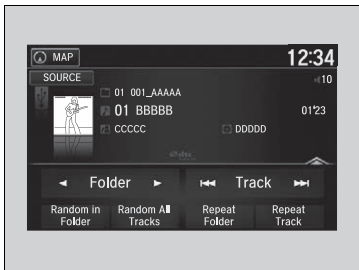

■ Random/Repeat

Select a play mode.

■ To turn off a play mode

To turn off **Scan**, select  or **Cancel**.

To turn off **Random/Repeat**, select the mode again.

▶▶ How to Select a Play Mode

Play Mode Menu Items:

Scan

Scan Folders: Provides 10-second sampling of the first file in each of the main folders.

Scan Tracks: Provides 10-second sampling of all files in the current folder.

Random/Repeat

Random in Folder: Plays all files in the current folder in random order.

Random All Tracks: Plays all files in random order.

Repeat Folder: Repeats all files in the current folder.

Repeat Track: Repeats the current file.

Playing *Bluetooth*® Audio

Your audio system allows you to listen to music from your *Bluetooth*-compatible phone.

This function is available when the phone is paired and connected to the vehicle's *Bluetooth*® HandsFreeLink® (HFL) system.

📄 **Phone Setup** P. 278

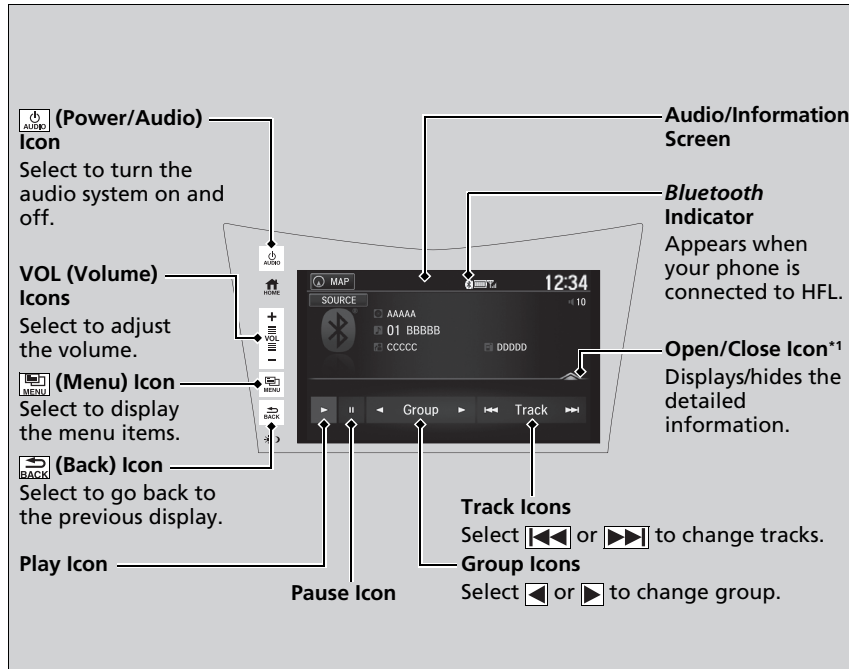

*1: Depending on the *Bluetooth*® device you connect, some or all of the lists may not be displayed.

▶▶ Playing *Bluetooth*® Audio

Not all *Bluetooth*-enabled phones with streaming audio capabilities are compatible with the system. For a list of compatible phones:

- U.S.: Visit www.acura.com/handsfreelink, or call 1-888-528-7876.
- Canada: For more information on smartphone compatibility, call 1-888-528-7876.

It may be illegal to perform some data device functions while driving.

Only one phone can be used with HFL at a time. When there are more than two paired phones in the vehicle, the first paired phone the system finds is automatically connected.

The connected phone for *Bluetooth*® Audio can be different.

If more than one phone is paired to the HFL system, there may be a delay before the system begins to play.

In some cases, the name of the artist, album, or track may not appear correctly.

Some functions may not be available on some devices.

If a phone is currently connected via Apple CarPlay or Android Auto, *Bluetooth*® Audio from that phone is unavailable. However, a second previously paired phone can stream *Bluetooth*® Audio by selecting **Connect**  from the **Bluetooth Device List**.

📄 **Phone Setup** P. 278

■ To Play *Bluetooth*® Audio Files

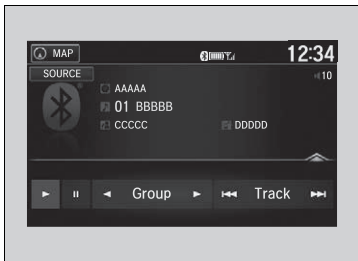

1. Make sure that your phone is paired and connected to the system.

▶ **Phone Setup** P. 278

2. Select the *Bluetooth*® Audio mode.

If the phone is not recognized, another HFL-compatible phone, which is not compatible for *Bluetooth*® Audio, may already be connected.

■ To pause or resume a file

Select the play icon or pause icon.

■ Searching for Music

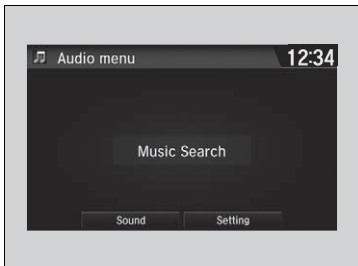

1. Select .

2. Select **Music Search**.

3. Select a search category (e.g., Albums).

4. Select an item.

▶ The selection begins playing.

▶▶ To Play *Bluetooth*® Audio Files

To play the audio files, you may need to operate your phone. If so, follow the phone maker's operating instructions.

Switching to another mode pauses the music playing from your phone.

You can change the connected phone in the *Bluetooth*® settings on the **Audio menu** screen by the following procedure.

1. Select .
2. Select **Setting**.

▶▶ Searching for Music



Depending on the *Bluetooth*® device you connect, some or all of the lists may not be displayed.

Wi-Fi Connection

You can connect the audio system to the Internet using Wi-Fi and browse websites or use online services on the audio/information screen. If your phone has wireless hotspot capabilities, the system can be tethered to the phone. Use the following steps to setup.

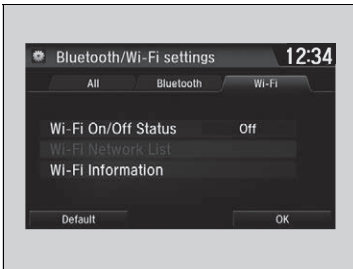
Wi-Fi mode (setting for the first time)



1. Select .
2. Select **Settings**.
3. Select **Bluetooth/Wi-Fi**.
4. Select the **Wi-Fi** tab.
5. Select **Wi-Fi On/Off Status**, then **On**.
6. Select **Wi-Fi Network List**.
 - ▶ Make sure your phone's Wi-Fi setting is in access point (tethering) mode.
 - ▶ Select the phone you want to connect to the system.
 - ▶ If you do not find the phone you want to connect in the list, select **Scan**.
7. Select **Connect**.
 - ▶ If needed, enter a password for your phone and select **OK**.
 - ▶ When the connection is successful, the  icon is displayed on the top of the screen.
8. Select  to go back to the home screen.

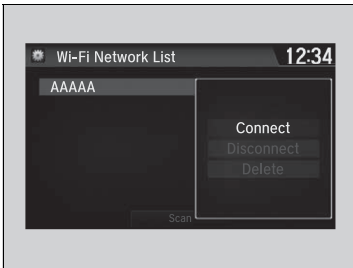

Wi-Fi mode (setting for the first time)

You cannot go through the setting procedure while a vehicle is moving. Park in a safe place to setup the Wi-Fi connection.

Some cell phone carriers charge for tethering and smartphone data use. Check your phone's data subscription package.

Check your phone manual to find out if the phone has Wi-Fi connectivity.

You can confirm whether Wi-Fi connection is on or off with the  icon on **Wi-Fi Network List**. Network speed will not be displayed on this screen.

Continued

■ Wi-Fi mode (after the initial setting has been made)

Make sure your phone's Wi-Fi setting is in access point (tethering) mode.

▶▶ Wi-Fi mode (after the initial setting has been made)

iPhone users

You may need to go through an initial setup for Wi-Fi connection again after you boot your phone.

Siri® Eyes Free

You can talk to Siri using the  (Talk) button on the steering wheel when your iPhone is paired to the *Bluetooth*® HandsFreeLink® (HFL) system.

 **Phone Setup** P. 278

■ Using Siri Eyes Free

(Hang-up/back) Button

Press to deactivate Siri Eyes Free.

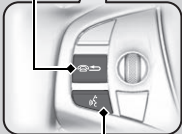
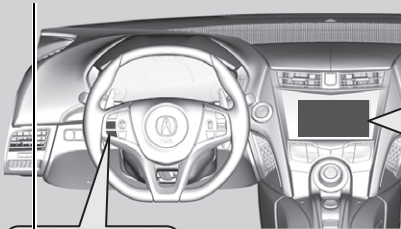

(Talk) Button

Press and hold until the display changes as shown.

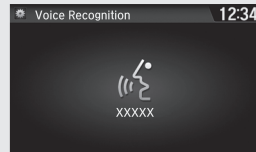

Appears when Siri is activated in Siri Eyes Free

While in Siri Eyes Free:
The display remains the same.
No feedback or commands appear.

Siri® Eyes Free

Siri is a trademark of Apple Inc.

Check Apple Inc. website for features available for Siri.

We recommend against using Siri other than in Siri Eyes Free mode while operating a vehicle.

Using Siri Eyes Free

Some commands work only on specific phone features or apps.

Apple CarPlay™

If you connect an Apple CarPlay-compatible iPhone to the system via USB, you can use the audio/information screen, instead of the iPhone display, to make a phone call, listen to music, view maps (navigation), and access messages.

➤ **USB Ports** P. 163

Apple CarPlay™

Only iPhone 5 or newer versions with iOS 8.4 or later are compatible with Apple CarPlay.

Park in a safe place before connecting your iPhone to Apple CarPlay and when launching any compatible apps.

To use Apple CarPlay, connect the USB cable to the USB port located in the console compartment. The USB port located in the glove box will not enable Apple CarPlay operation.

➤ **USB Ports** P. 163

To directly access the Apple CarPlay phone function, select **Phone** on the home screen. While connected to Apple CarPlay, calls are only made through Apple CarPlay. If you want to make a call with HandsFreeLink, turn Apple CarPlay OFF or detach the USB cable from your iPhone.

➤ **Setting Up Apple CarPlay** P. 217

When your iPhone is connected to Apple CarPlay, it is not possible to use the *Bluetooth*® Audio or *Bluetooth*® HandsFreeLink®. However, other previously paired phones can stream audio via *Bluetooth*® while Apple CarPlay is connected.

➤ **Phone Setup** P. 278

For details on countries and regions where Apple CarPlay is available, as well as information pertaining to function, refer to the Apple homepage.

Apple CarPlay Menu

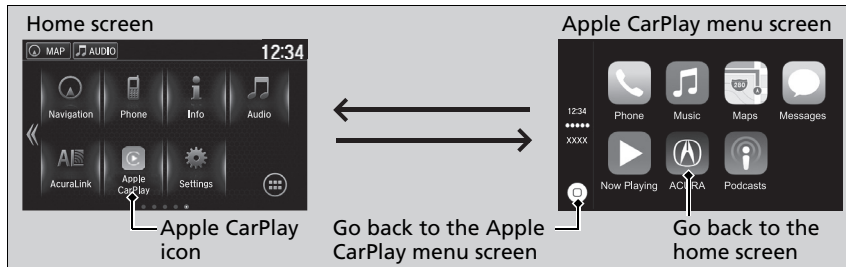

Phone

Access the contact list, make phone calls, or listen to voice mail.

Messages

Check and reply to text messages, or have messages read to you.

Music

Play music stored on your iPhone.

■ Maps

Display Apple CarPlay map and use the navigation function just as you would on your iPhone.

Models with navigation system

Only one navigation system (pre-installed navigation or Apple CarPlay) can give directions at a time. When you are using one system, directions to any prior destination set on the other system will be canceled, and the system you are currently using will direct you to your destination.

■ Setting Up Apple CarPlay

After you have connected your iPhone to the system via USB, use the following procedure to set up Apple CarPlay. Use of Apple CarPlay will result in the transmission of certain user and vehicle information (such as vehicle location, speed, and status) to your iPhone to enhance the Apple CarPlay experience. You will need to consent to the sharing of this information on the audio/information screen.

■ Enabling Apple CarPlay

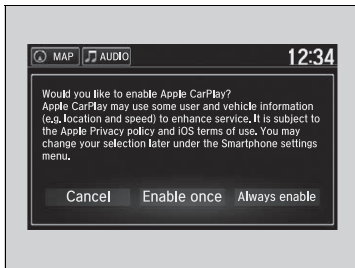

Enable once: Allows only once. (Prompt shows again next time.)

Always enable: Allows anytime. (Prompt does not show again.)

Cancel: Does not allow this consent.

You may change the consent settings under the **Smartphone** settings menu.

▶▶ Apple CarPlay™

Apple CarPlay Operating Requirements & Limitations

Apple CarPlay requires a compatible iPhone with an active cellular connection and data plan. Your carrier's rate plans will apply.

Changes in operating systems, hardware, software, and other technology integral to providing Apple CarPlay functionality, as well as new or revised governmental regulations, may result in a decrease or cessation of Apple CarPlay functionality and services. Acura cannot and does not provide any warranty or guarantee of future Apple CarPlay performance or functionality.

It is possible to use 3rd party apps if they are compatible with Apple CarPlay. Refer to the Apple homepage for information on compatible apps.

▶▶ Setting Up Apple CarPlay

You can also use the method below to set up Apple CarPlay:

Select  → Settings → Smartphone → Apple CarPlay

Use of user and vehicle information

The use and handling of user and vehicle information transmitted to/from your iPhone by Apple CarPlay is governed by the Apple iOS terms and conditions and Apple's Privacy Policy.

Continued

■ Operating Apple CarPlay with Siri Eyes Free

Press and hold the talk button to activate Siri Eyes Free.



▶▶ Operating Apple CarPlay with Siri Eyes Free

Below are examples of questions and commands for Siri Eyes Free.

- What movies are playing today?
- Call dad at work.
- What song is this?
- How's the weather tomorrow?
- Read my latest email.
- Find a table for four tonight in Chicago.

For more information, please visit www.apple.com/ios/siri.

Android Auto™

When you connect an Android phone to the audio system via USB, Android Auto is automatically initiated. When connected via Android Auto, you can use the audio/information screen to access the Phone, Google Maps (Navigation), Google Play Music, and Google Now functions. When you first use Android Auto, a tutorial will appear on the screen.

We recommend that you complete this tutorial while safely parked before using Android Auto.

➤ **USB Ports** P. 163

➤ **Auto Pairing Connection** P. 221

Android Auto™

To use Android Auto, you need to download the Android Auto app from Google Play to your smartphone.

Only Android 5.0 (Lollipop) or later versions are compatible with Android Auto. Bluetooth A2DP cannot be used on your phone while connected to Android Auto.

Park in a safe place before connecting your Android phone to Android Auto and when launching any compatible apps.

To use Android Auto, connect the USB cable to the USB port located in the console compartment. The USB port in the glove box will not enable Android Auto operation.

➤ **USB Ports** P. 163

When your Android phone is connected to Android Auto, it is not possible to use the *Bluetooth*® Audio. However, other previously paired phones can stream audio via *Bluetooth*® while Android Auto is connected.

➤ **Phone Setup** P. 278

■ Android Auto Menu

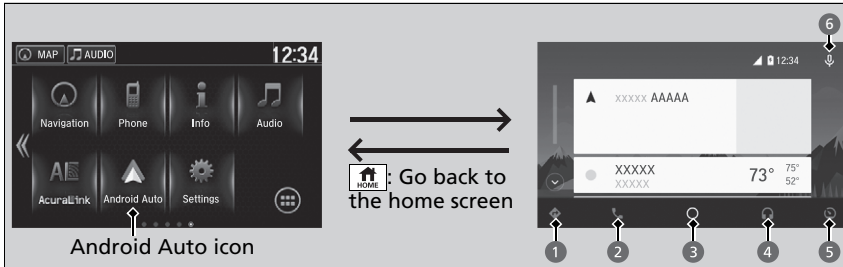

1 Maps (Navigation)

Display Google Maps and use the navigation function just as you would with your Android phone. When the vehicle is in motion, it is not possible to make keyboard entries. Stop the vehicle in a safe location to undertake a search or provide other inputs.

Models with navigation system

Only one navigation system (pre-installed navigation or Android Auto) can give directions at a time. When you are using one system, directions to any prior destination set on the other system will be canceled, and the system you are currently using will direct you to your destination.

The audio/information screen shows you turn-by-turn driving directions to your destination.

2 Phone (Communication)

Make and receive phone calls as well as listen to voicemail.

3 Google Now (Home screen)

Display useful information organized by Android Auto into simple cards that appear just when they're needed.

▶▶ Android Auto™

For details on countries and regions where Android Auto is available, as well as information pertaining to function, refer to the Android Auto homepage.

Android Auto Operating Requirements & Limitations

Android Auto requires a compatible Android phone with an active cellular connection and data plan. Your carrier's rate plans will apply.

Changes in operating systems, hardware, software, and other technology integral to providing Android Auto functionality, as well as new or revised governmental regulations, may result in a decrease or cessation of Android Auto functionality and services. Acura cannot and does not provide any warranty or guarantee of future Android Auto performance or functionality.

It is possible to use 3rd party apps if they are compatible with Android Auto. Refer to the Android Auto homepage for information on compatible apps.

4 Music and audio

Play Google Play Music and music apps that are compatible with Android Auto. To switch between music apps, press this icon.

5 Go back to the Home Screen.**6 Voice**

Operate Android Auto with your voice.

Auto Pairing Connection

When you connect an Android phone to the unit via USB, Android Auto is automatically initiated.

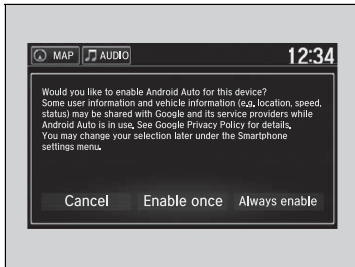
Enabling Android Auto

Enable once: Allows only once. (Prompt shows again next time.)

Always enable: Allows anytime. (Prompt does not show again.)

Cancel: Does not allow this consent.

You may change the consent settings under the **Smartphone** settings menu.

Enabling Android Auto

Only initialize Android Auto when you are safely parked. When Android Auto first detects your phone, you will need to set up your phone so that auto pairing is possible. Refer to the instruction manual that came with your phone.

You can use the method below to change Android Auto settings after you have completed the initial setup:

Select  → Settings → Smartphone → Android Auto

Use of user and vehicle information

The use and handling of user and vehicle information transmitted to/from your phone by Android Auto is governed by Google's Privacy Policy.

■ Operating Android Auto with Voice Recognition

Press and hold the talk button to operate Android Auto with your voice.

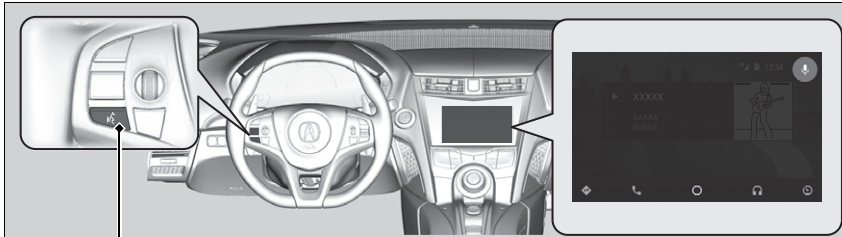

(Talk) button:

Press and hold to operate Android Auto with your voice.

Press again to deactivate voice recognition.

Press and release to activate standard voice recognition system.

▶▶ Operating Android Auto with Voice Recognition

Below are examples of commands you can give with voice recognition:

- Reply to text.
- Call my wife.
- Navigate to Acura.
- Play my music.
- Send a text message to my wife.
- Call flower shop.

For more information, please refer to the Android Auto homepage.

You can also activate the voice recognition function by pressing the  icon in the upper-right corner of the screen.

iPod/USB Flash Drive

If an error occurs while playing an iPod or USB flash drive, you may see the following error messages. If you cannot clear the error message, contact an authorized Acura NSX dealer.

Error Message	Solution
USB Error	Appears when there is a problem with the audio system. Check if the device is compatible with the audio system.
The connected USB device has a problem. See Owner's Manual	Appears when an incompatible device is connected. Disconnect the device. Then turn the audio system off, and turn it on again. Do not reconnect the device that caused the error.
Unsupported Version	Appears when an unsupported iPod is connected. If it appears when a supported iPod is connected, update the iPod software to the newer version.
Connect Retry	Appears when the system does not acknowledge the iPod. Reconnect the iPod.
Unplayable File	Appears when the files in the USB flash drive are copyright protected or an unsupported format. This error message appears for about three seconds, then plays the next song.
No Data	iPod Appears when the iPod is empty.
	USB flash drive Appears when the USB flash drive is empty or there are no MP3, WMA, or AAC files in the USB flash drive.
	iPod and USB flash drive Check that compatible files are stored on the device.
Unsupported	Appears when an unsupported device is connected. If it appears when a supported device is connected, reconnect the device.

Pandora®*1

If an error occurs while playing Pandora®, you may see the following error messages.

If you cannot clear the error message, contact an authorized Acura NSX dealer.

Error Message	Solution
To begin listening, select a station from the Stations list.	Appears when there is no station list on the device. Use the device to create a station.
Unable to rate track. Please try again. Skip limit reached.	Appears when you try to skip a song or select Like/Dislike over the predetermined number of times in an hour.
Unable to play Pandora. Please try again later. Unable to retrieve a track explanation. Please try again later. Unable to create bookmark. Please try again later.	Appears when the commanded operation fails. Try again later.
No Data	Appears when no data is available with Pandora® activated. Reboot the app and reconnect the device.
Pandora App version is not supported	Appears when Pandora® version is not supported. Update Pandora® to the latest version.
Unable to complete the operation. Please try again later.	Appears when the Pandora® server is in maintenance. Try again later.
Unable to connect Pandora. When stopped, check your mobile phone	Appears when Pandora® is unable to play music. Check your device.
Unable to connect Pandora. When stopped, check your mobile phone	Appears when Pandora® app is not installed on your device. Install Pandora® app to your device.

*1: Available only on U.S. models.

Android/Apps

If an error occurs while using the audio system or apps, you may see the following error messages. If you cannot clear the error message, contact an authorized Acura NSX dealer.

Error Message* ¹	Solution
Unfortunately, **** has stopped.	Error has occurred within app, select OK on the screen to close the app.
**** is not responding. Would you like to close it?	App is not responding. Select Wait if you can wait for a response from app a little longer. If it does not respond even if you keep waiting, select OK to close the app and start it up. If the error message continues, perform Factory Data Reset .  Defaulting All the Settings P. 266

*1:****part is variable characters, and will change depending upon where an error occurs.

SiriusXM® Radio Service*

■ Subscribing to SiriusXM® Radio

1. You need your radio ID ready before registering for subscription. To see the ID on the screen, select **Channel 0**.
2. Have your radio ID ready, and either call SiriusXM® or visit the SiriusXM® website to subscribe.

■ Receiving SiriusXM® Radio

Switch to the SiriusXM® mode by using the **SOURCE** button on the steering wheel, or through the audio/information screen, and stay in this mode for about 30 minutes until the service is activated. Make sure your vehicle is in an open area with good reception.

■ SiriusXM® Radio Display Messages

Channel Not Subscribed:

You are not subscribed to the channel selected.

Subscription Update:

SiriusXM® radio is receiving information update from the network.

Channel Not Available:

No such channel exists, or the artist or title information is unavailable.

No Signal:

The signal is too weak in the current location.

Antenna Disconnected:

The SiriusXM® antenna is disconnected. Contact an authorized Acura NSX dealer.

☒ Subscribing to SiriusXM® Radio

Contact Information for SiriusXM® Radio:

- U.S.: SiriusXM® Radio at www.siriusxm.com/subscribe-now, or 1-877-447-0011
- Canada: SiriusXM® Canada at www.siriusxm.ca/subscribe-now, or 1-877-209-0079

☒ Receiving SiriusXM® Radio

The SiriusXM® satellites are in orbit over the equator; therefore, objects south of the vehicle may cause satellite reception interruptions. Satellite signals are more likely to be blocked by tall buildings and mountains the farther north you travel from the equator.

You may experience reception problems under the following circumstances:

- In a location with an obstruction to the south of your vehicle.
- In tunnels
- On the lower level of a multi-tiered road
- Large items carried on the roof rack

Compatible iPod, iPhone, and USB Flash Drives

■ iPod and iPhone Model Compatibility

Model
iPod (5th generation)
iPod classic 80GB/160GB (launch in 2007)
iPod classic 120GB (launch in 2008)
iPod classic 160GB (launch in 2009)
iPod nano (1st to 7th generation) released between 2005 and 2012
iPod touch (1st to 5th generation) released between 2007 and 2012
iPhone 3G/iPhone 3GS/iPhone 4/iPhone 4S/iPhone 5/iPhone 5c/iPhone 5s/iPhone 6/iPhone 6s/iPhone 6 Plus/iPhone 6s Plus

■ USB Flash Drives

- A USB flash drive of 256 MB or higher is recommended.
- Some digital audio players may not be compatible.
- Some USB flash drives (e.g., a device with security lockout) may not work.
- Some software files may not allow for audio play or text data display.
- Some versions of MP3, WMA, or AAC formats may be unsupported.

⌘ iPod and iPhone Model Compatibility

This system may not work with all software versions of these devices.

⌘ USB Flash Drives

Files on the USB flash drive are played in their stored order. This order may be different from the order displayed on your PC or device.

Honda App License Agreement

■ END USER LICENSE AGREEMENT

PLEASE CAREFULLY READ THIS END USER LICENSE AGREEMENT (THIS “AGREEMENT”) WHICH GOVERNS YOUR USE OF THE SOFTWARE INSTALLED ON YOUR HONDA OR ACURA VEHICLE (YOUR “VEHICLE”) AS WELL AS THE APPLICATIONS, SERVICES, FUNCTIONS, AND CONTENT PROVIDED THROUGH THE SOFTWARE (COLLECTIVELY, THE “SERVICES”). YOUR USE OF THE SOFTWARE OR SERVICES WILL SERVE AS YOUR CONSENT TO THE TERMS OF THIS AGREEMENT. THE SOFTWARE IS OWNED (OR LICENSED), PROVIDED, AND/OR OPERATED BY AMERICAN HONDA MOTOR CO. INC., (“HONDA,” “US,” “WE,” OR “OUR”), WITH ITS BUSINESS ADDRESS AT 1919 TORRANCE BLVD., TORRANCE, CA 90501. REFERENCE TO “HONDA” IN THIS AGREEMENT INCLUDES HONDA’S PARENT COMPANY AND ITS AFFILIATES AND DESIGNATED AGENTS. THE SERVICES ARE OWNED (OR LICENSED), PROVIDED, AND/OR OPERATED BY HONDA OR A THIRD-PARTY SERVICE PROVIDER (A “PROVIDER”). REFERENCE TO A “PROVIDER” IN THIS AGREEMENT INCLUDES SUCH PROVIDER’S PARENT COMPANY, AFFILIATES, AND DESIGNATED AGENTS.

A. Description of the Software. The SOFTWARE includes the software, firmware and the like, installed and executing on your VEHICLE during manufacture, and thereafter updated from time to time by HONDA, you or an authorized HONDA dealer (a “DEALER”). The SOFTWARE allows you to access and use a variety of SERVICES, including but not limited to: (a) HONDA applications, services, and content provided through the SOFTWARE (together, “HONDA SERVICES”); and (b) PROVIDER applications, services, and content provided through the SOFTWARE (together, “PROVIDER SERVICES”), each of which may provide access to various information, media, content, and services.

B. SOFTWARE Licensing and Intellectual Property.

1. SOFTWARE. This AGREEMENT grants you a non-exclusive, limited, and revocable license to use the SOFTWARE and SERVICES solely (a) as installed on your VEHICLE by HONDA, (b) as updated on your Vehicle by HONDA, you (but only as and when directed by HONDA), or a DEALER and (c) as permitted under the terms of this AGREEMENT.

2. HONDA Services. The SOFTWARE may provide you with access to various HONDA SERVICES. Installation, activation, or use of HONDA SERVICES may require your consent to additional terms, conditions, and privacy policies applicable to those HONDA SERVICES (the “HONDA TERMS”). You acknowledge and agree that any collection, use, sharing of data generated by your VEHICLE or your use of your VEHICLE, and your use of the HONDA SERVICES shall be subject to this AGREEMENT and any additional HONDA TERMS that may be specifically applicable to such HONDA SERVICES or data generation. The HONDA SERVICES may collect, use, and share such data while you are using the SOFTWARE.

3. Open-Source Software. The SOFTWARE and SERVICES may incorporate software licensed to HONDA under free or open-source licenses which govern HONDA's distribution and your use of such software. HONDA and the third-party authors, licensors, and distributors of such software disclaim all warranties and all liability arising from any and all use or distribution of the software. To the extent such software is provided under terms that differ from the applicable free or open-source licenses, those terms are offered by HONDA alone. Additional information regarding free and open-source software incorporated in the SOFTWARE and SERVICES is available in this manual or within the SOFTWARE.

4. Provider Services. The SOFTWARE may provide you with access to various PROVIDER SERVICES. Installation or use of such PROVIDER SERVICES may require your consent to additional terms, conditions, and privacy policies of the applicable PROVIDER (the "PROVIDER TERMS"). This AGREEMENT restricts the manner in which you can install and use PROVIDER SERVICES but does not grant you a license or permission to use such PROVIDER SERVICES. Your permission to use PROVIDER SERVICES is limited and subject to any license grants, conditions, and limitations included in the PROVIDER TERMS. You acknowledge that any collection, use, sharing of your information, targeted advertising practices by PROVIDERS, and your use of the PROVIDER SERVICES shall be subject to both this AGREEMENT and any applicable PROVIDER TERMS. The PROVIDER SERVICES may collect, use, and share such information while you are using the SOFTWARE.

5. License Limitations and Restrictions on Use.

(a) Limited License. You understand and agree that the SOFTWARE and SERVICES are licensed, not sold, to you solely for use in accordance with this AGREEMENT and any applicable PROVIDER TERMS, and any documentation for the VEHICLE made available to you by HONDA (any "DOCUMENTATION"). HONDA and its licensors reserve all rights in the SOFTWARE and HONDA SERVICES not expressly granted to you under this AGREEMENT. PROVIDERS and their licensors reserve all rights in the PROVIDER SERVICES not expressly granted to you under the applicable PROVIDER TERMS.

(b) Restrictions on Use. The licenses granted under this AGREEMENT do not permit you to use the SOFTWARE or SERVICES on a device other than your VEHICLE. As a condition of using the SOFTWARE and SERVICES, you agree that you may not and will not:

- (1) copy, download, distribute, modify, publish, sell, rent, lease, lend, license, sublicense, reuse, or create derivative works of the SOFTWARE or SERVICES or any of the content or other material within the SOFTWARE or SERVICES, including without limitation, HONDA or PROVIDER names, logos, or any other trademarks of HONDA or PROVIDERS or used in association with the SOFTWARE or any SERVICES, except as required to use the SOFTWARE or SERVICES in accordance with this AGREEMENT, any applicable PROVIDER TERMS, and the DOCUMENTATION;
- (2) access or use the SOFTWARE or SERVICES in any manner intended to damage or impair the operation of the SOFTWARE or SERVICES or interfere with anyone else's use and enjoyment of the SOFTWARE or SERVICES;
- (3) access or attempt to access any system or server on which the SOFTWARE or SERVICES is hosted or modify or alter the SOFTWARE or SERVICES in any way;
- (4) use the SOFTWARE or SERVICES for any unlawful purpose, or in violation of any third party rights;
- (5) use the SOFTWARE or SERVICES in violation of any applicable traffic regulations, rules or laws, including but not limited to any driver distraction laws, rules or regulations;
- (6) violate the terms of this AGREEMENT, any HONDA TERMS, any PROVIDER TERMS or other applicable third-party terms, conditions, and privacy policies; or
- (7) reverse engineer, decompile, disassemble, attempt to derive the source code of, nor permit others to reverse engineer, decompile, or disassemble, or attempt to derive the source code of the SOFTWARE or SERVICES, except and only to the extent that such activity is expressly permitted (a) by applicable law notwithstanding this limitation or (b) the terms of applicable free or opensource software licenses.

6. Intellectual Property Rights. All title and intellectual property rights in and to the SOFTWARE and SERVICES, the accompanying DOCUMENTATION, and all copies of the SOFTWARE or SERVICES are owned by HONDA, PROVIDERS, or their suppliers or licensors. This AGREEMENT does not grant you any rights in connection with any trademarks or service marks of HONDA, PROVIDERS, or their licensors, affiliates, or suppliers.

7. Export Restrictions: You acknowledge that the SOFTWARE and SERVICES are subject to U.S., European Union, and other export jurisdictions. You agree to comply with all applicable international and national laws that apply to the SOFTWARE and SERVICES, including the U.S. Export Administration Regulations, as well as end-user, end-use, and destination restrictions issued by the U.S. and other governments.

C. SOFTWARE Operation

- 1.** HONDA reserves the right to suspend or terminate your access to and use of the SOFTWARE or SERVICES if you are found to be in violation of this AGREEMENT or as reasonably deemed necessary by HONDA.
- 2. Eligibility/Registration/Activation.** The SOFTWARE is intended for and available to individuals who (a) are of legal age of majority in their jurisdiction of residence (and at least 18 years of age), or are younger than 18 years of age and possess a valid driver's license issued by their jurisdiction of residence, and (b) own or have permissive access to a compatible VEHICLE. We do not knowingly collect any information, including personal information, from children under 13. If we learn or are notified that we have collected personal information of a child under 13, we will immediately take steps to delete such information.
- 3. Use of PROVIDER SERVICES through the SOFTWARE.** Certain PROVIDER SERVICES made available through the SOFTWARE may require that you register or otherwise have an account with the PROVIDER and agree to PROVIDER TERMS. Any use of any of such PROVIDER SERVICES within the SOFTWARE is subject to this AGREEMENT and the applicable PROVIDER TERMS. HONDA does not exercise control over such PROVIDER SERVICES and is not responsible or liable for the availability, security, or content of such PROVIDER SERVICES, and the inclusion of any PROVIDER SERVICES does not imply a referral from, the approval of, or the endorsement by HONDA of such PROVIDER SERVICES. HONDA is not responsible or liable, directly or indirectly, for any damage relating to or resulting from your use of the PROVIDER SERVICES.
- 4. Links to Third Party Sites:** The SOFTWARE may provide you with the ability to access third-party sites and content through the use of the SOFTWARE or SERVICES. The third-party sites and content are not under the control of HONDA. HONDA is not responsible or liable, directly or indirectly, for such third-party websites and their content or for any damage relating to or resulting from your access or use of such websites and content.

5. Unauthorized Use and Abuse. You are responsible for ensuring your (and any authorized third parties') use of the SOFTWARE and SERVICES remains in compliance with this AGREEMENT and all other applicable HONDA TERMS and PROVIDER TERMS. You acknowledge and agree that any use of the SOFTWARE or SERVICES occurring through your VEHICLE will be deemed your actions and that HONDA and PROVIDERS may rely upon such actions. You agree to immediately notify us if you suspect fraudulent or abusive activity involving the SOFTWARE or SERVICES. If you so notify us or if we otherwise suspect fraudulent or abusive activity, you agree to cooperate with us in any fraud investigation and to use any fraud prevention measures we prescribe. Your failure to immediately notify us or cooperate to use such measures will result in your liability for all fraudulent usage or abusive activity associated with your VEHICLE.

6. SOFTWARE Updates. The SOFTWARE and SERVICES may be updated when your VEHICLE is serviced by a DEALER or remotely, over-the-air, by HONDA from time to time; such updates may occur with or without further notice or your future consent. The SOFTWARE may be updated at HONDA's discretion and for any purpose including, without limitation, to patch or otherwise improve the SOFTWARE or SERVICES functionality, security, or stability. All updates to the SOFTWARE and SERVICES are subject to this AGREEMENT and any other applicable HONDA TERMS and PROVIDER TERMS.

7. Uninstalling, Removing, and Replacing the SOFTWARE. Replacing SOFTWARE or HONDA SERVICES with software or firmware not provided and installed by HONDA or a DEALER will render all representations and warranties for the SOFTWARE, HONDA SERVICES, and VEHICLE functionality reliant upon the SOFTWARE or HONDA SERVICES null and void.

D. SOFTWARE Operational Notices and Warnings

1. Vehicle Geolocation Information. You acknowledge that your VEHICLE may be equipped with certain traffic and map features. The traffic feature will automatically collect and transmit, through GPS technology, your Vehicle's current location (longitude and latitude), travel direction and speed ("VEHICLE GEOLOCATION INFORMATION") to HONDA and PROVIDERS. The VEHICLE GEOLOCATION INFORMATION is used by HONDA and PROVIDERS to provide traffic and navigation-related information to you, but may also be used to provide other SERVICES or offers to you. HONDA will not use such VEHICLE GEOLOCATION INFORMATION for its own marketing efforts, or provide such information to unaffiliated third parties for their own purposes, without your express consent.

2. Potential Map Inaccuracy and Route Safety. Maps used by this system may be inaccurate because of changes in roads, traffic controls, routing, or driving conditions. Always use good judgment and common sense when following suggested routes. Do not follow the route suggestions if doing so would result in an unsafe or illegal driving maneuver, if you would be placed in an unsafe situation, or if you would be directed into an area that you consider unsafe. Do not rely on any navigation features included in the system to route you to emergency services. Not all emergency services such as police, fire stations, hospitals, or clinics are likely to be contained in the map database for such navigation features. Ask local authorities or an emergency services operator for such locations and routes. The driver is ultimately responsible for the safe operation of the vehicle and therefore, must evaluate whether it is safe to follow the suggested directions. Any navigation features are provided only as an aid. Make your driving decisions based on your observations of local conditions and existing traffic regulations. Navigation features are not a substitute for your personal judgment. Any route suggestions made by the SOFTWARE or SERVICES should never replace any local traffic regulations or your personal judgment or knowledge of safe driving practices.

3. Speech Recognition: You acknowledge and understand that HONDA and PROVIDERS may record, retain, and use voices commands when you use the speech recognition components of the SOFTWARE or SERVICES. You and all VEHICLE operators and passengers (a) consent to the recording and retention of voice commands in support of providing speech recognition components and (b) release HONDA and PROVIDERS from all claims, liabilities, and losses that may result from any use of such recorded voice commands. Recognition errors are inherent in speech recognition. It is your responsibility to monitor any speech recognition functions included in the system and address any errors. Neither HONDA nor PROVIDERS will be liable for any damages arising out of errors in the speech recognition process.

4. Distraction Hazards. Navigation features may require manual (non-verbal) input or setup. Attempting to perform such set-up or insert data while driving can seriously distract your attention and could cause a crash or other serious consequences; the ability to undertake such interactions may also be limited by state or local law, which laws you are responsible to know and follow. Even occasional short scans of the screen may be hazardous if your attention has been diverted away from your driving at a critical time. Pull over and stop the vehicle in a safe and legal manner before attempting to access a function of the system requiring prolonged attention. Do not raise the volume excessively. Keep the volume at a level where you can still hear outside traffic and emergency signals while driving. Driving while unable to hear these sounds could result in a crash.

E. Information Collection and Storage

1. Information Collection, Use, Transmission and Storage of Data. Consent to Use of Data. You agree that HONDA and PROVIDERS may collect and use your information gathered in any manner as part of product support services related to the SOFTWARE or related services. HONDA may share such information with third parties, including, without limitation, PROVIDERS, third party software and services suppliers, their affiliates and/or their designated agents, solely to improve their products or to provide services or technologies to you. HONDA, third party software and systems suppliers, their affiliates and/or their designated agent may disclose this information to others, but not in a form that personally identifies you.

2. Information Storage. Depending on the type of multimedia system you have in your VEHICLE, certain information may be stored for ease of use of the SOFTWARE including, without limitation, search history, location history in certain applications, previous and saved destinations, map locations within certain applications, and device numbers and contact information.

(a) Vehicle Health Information. Your VEHICLE may remotely transmit information regarding the status and health of your VEHICLE (“VEHICLE INFORMATION”) to HONDA without notification to you. VEHICLE INFORMATION may contain VEHICLE maintenance and malfunction status that is derived from VEHICLE diagnostic data and includes, but is not limited to, status of powered doors and windows, battery life data, battery charging data, VEHICLE speed, coolant temperature, air compressor revolution, output power, warning codes, diagnostic trouble codes, fuel injection volume, and engine rotations per minute. VEHICLE HEALTH INFORMATION may be used by HONDA for research and development, to deliver HONDA SERVICES and information to you, and to contact you, and is retained only for a period of time necessary to fulfill these goals.

(b) VEHICLE Geolocation Data (non-navigation/map based). If you opt-in to geolocation-based SERVICES, your vehicle’s geolocation data (latitude and longitude) will be automatically sent from your VEHICLE to HONDA and PROVIDERS.

(c) You understand that the inputting or uploading of information to your VEHICLE’s multimedia system or the SOFTWARE or SERVICES is at your own risk and that HONDA is not responsible for unauthorized access to or use of any personal or other information. All information uploaded to the SOFTWARE and SERVICES may be stored on your VEHICLES’s multimedia system and you understand that the security and safety of your VEHICLE’s multimedia system is your sole responsibility.

F. NO WARRANTY. You understand and agree that your use of the SOFTWARE and SERVICES are solely at your own risk and that you will be solely responsible for any damage to your VEHICLE's multimedia system or any other equipment or any loss of data that may result from your use of the SOFTWARE or SERVICES. THE SOFTWARE AND SERVICES ARE PROVIDED ON AN "AS IS" AND "AS AVAILABLE" BASIS WITHOUT ANY WARRANTY OF ANY KIND, EXPRESSED, IMPLIED OR STATUTORY. WE SPECIFICALLY DISCLAIM ANY IMPLIED WARRANTIES OF MERCHANTABILITY, FITNESS FOR A PARTICULAR PURPOSE, AND NON-INFRINGEMENT. HONDA makes no warranties that the SOFTWARE or SERVICES will meet your requirements, or that the SOFTWARE or SERVICES will be uninterrupted, timely, secure, non-infringing or error free. You understand and agree that you are responsible for any and all charges, costs or expenses associated with your use of the SOFTWARE or SERVICES. Advice or information, whether oral or written, obtained by you from us or through the SOFTWARE or SERVICES are provided for informational purposes only and will not create any warranty not expressly made herein. You should not rely on any such information or advice. We assume no liability or responsibility for any errors or omissions in the SOFTWARE or SERVICES. We do not make any warranty or representation that your use of the material displayed on, or obtained through, the SOFTWARE or SERVICES is non-infringing of any rights of any third party. Any decision or action taken by you on the basis of information or content provided via the application is at your sole discretion and risk. HONDA and PROVIDERS are not responsible or liable for any such decision, or for the accuracy, completeness, usefulness, or availability of any content or information displayed, transmitted, or otherwise made available via the SOFTWARE or SERVICES. To the extent jurisdictions do not allow the exclusion of certain warranties, some of the above exclusions may not apply to you.

G. LIMITATIONS ON LIABILITY. You and HONDA are each waiving important rights.

1. Limitations on YOUR liability. HONDA cannot recover from you any consequential, indirect, incidental, or special damages, or attorney's fees in connection with your use of the SOFTWARE or HONDA SERVICES. HONDA WAIVES TO THE FULLEST EXTENT ALLOWED BY LAW ANY CLAIM FOR DAMAGES OTHER THAN DIRECT, COMPENSATORY DAMAGES AS LIMITED IN THIS AGREEMENT.

2. Limitation on HONDA and PROVIDER liability. Neither HONDA nor PROVIDERS will be liable to you or any other party for consequential, indirect, incidental, special, or punitive damages (including without limitation lost profits) in connection with your use of the SOFTWARE or SERVICES, even if HONDA or PROVIDERS are aware of the possibility of such damages. These limitations apply to all claims, including, without limitation, claims in contract and tort (such as negligence, product liability and strict liability). To the extent that a jurisdiction does not permit the exclusion or limitation of liability as set forth herein our liability is limited to the maximum extent permitted by law in such states. If HONDA or PROVIDERS are found liable to you for any reason, you agree that the aggregate liability of all these parties to you for any claim is limited to ten U.S. dollars (US \$10.00). Neither HONDA nor any PROVIDER would have agreed to provide the SOFTWARE or SERVICES to you if you did not agree to this limitation. This amount is the sole and exclusive liability of HONDA and PROVIDERS to you, and is payable as liquidated damages and not as a penalty. Except where prohibited by law, you may not bring any claim against HONDA or any third-party beneficiary more than two (2) years after the claim arises. We do not have any liability for SOFTWARE or SERVICES interruptions of any length.

(a) **Release of HONDA and PROVIDERS** For yourself and anyone else claiming under you, you agree to release and discharge HONDA, PROVIDERS, their respective officers, directors, and employees, and each third-party beneficiary from all claims, liabilities and losses in connection with the SOFTWARE or SERVICES, including, but not limited to claims for personal injury or property damage arising from the total or partial failure of performance of the SOFTWARE or SERVICES, even if caused by or based upon the negligence, gross negligence, strict products liability, Deceptive Trade Practices Act violations, bad faith, or breach of warranty of us or the malfunction of the SOFTWARE or SOFTWARE SERVICES. YOU AGREE TO WAIVE TO THE FULLEST EXTENT ALLOWED BY LAW, ANY CLAIM FOR DAMAGES OTHER THAN DIRECT, COMPENSATORY DAMAGES AS LIMITED IN THIS AGREEMENT. YOU HEREBY RELEASE AND DISCHARGE HONDA AND ITS LICENSORS AND CONTRACTORS (INCLUDING ANY THIRD PARTIES PROVIDING ALL OR PART OF THE SOFTWARE OR SERVICES) FROM AND AGAINST ANY CLAIMS, DAMAGES, EXPENSES AND LIABILITY ARISING FROM OR RELATED TO ANY INJURIES, DAMAGES, OR LOSSES TO ANY PERSON (INCLUDING DEATH) OR PROPERTY OF ANY KIND RESULTING IN WHOLE OR PART, DIRECTLY OR INDIRECTLY, FROM YOUR USE OF THE SOFTWARE OR SERVICES.

H. Survival. You agree that the limitations of liability and indemnities in this AGREEMENT will survive even after the AGREEMENT has ended. These limitations of liability apply not only to you, but to anyone using the SOFTWARE or SERVICES via your VEHICLE, to anyone making a claim on your behalf, and to any claims made by your family, employees, customers, or others arising out of or relating to your VEHICLE, the SOFTWARE, or SERVICES.

I. Availability/Interruption. The SOFTWARE and certain SERVICES are made available through your VEHICLE's compatible multimedia system when the VEHICLE is turned on. Certain SERVICES may be available only through your compatible mobile device when it is within the operating range of the VEHICLE and a wireless carrier. The availability of the SOFTWARE and SERVICES may be subject to transmission limitation or interruption, including but not limited to technical obsolescence or sunset of the hardware, software or firmware, inside of or external to the Vehicle, required for data transmission or receipt. HONDA does not guarantee that the SOFTWARE, SERVICES, or any portion thereof will be available at all times or in all areas. You acknowledge and agree that HONDA is not responsible for performance degradation, interruption or delays. You acknowledge that HONDA shall not be liable to you if the SOFTWARE or SERVICES in a given location are not available. If the SOFTWARE or SERVICES are not available within your intended location, you agree that your sole remedy shall be to cease using the SOFTWARE and SERVICES.

J. PRODUCT SUPPORT: Product support for the SOFTWARE is provided by HONDA. For product support, please refer to HONDA instructions provided in the DOCUMENTATION. Should you have any questions concerning this AGREEMENT, or if you desire to contact HONDA for any other reason, please refer to the HONDA contact information provided in the DOCUMENTATION.

K. Termination and Transfer.

1. Termination. This AGREEMENT is effective until terminated by you or US. WE may terminate this AGREEMENT for any or no reason, and with or without notice to you. Your rights under this AGREEMENT will terminate automatically without notice from US if you fail to comply with any term of this AGREEMENT. Upon termination of this AGREEMENT, you shall cease all use of the SOFTWARE and SERVICES.

2. Transfer: You may permanently transfer your rights under this AGREEMENT only as part of a sale or transfer of the VEHICLE, provided you retain no copies, you transfer all of the SOFTWARE and HONDA SERVICES (including all component parts, the media and printed materials, and any upgrades), and the recipient agrees to the terms of this AGREEMENT. You agree to notify HONDA upon the sale or transfer of the VEHICLE. To contact HONDA, please refer to the HONDA contact information provided in the DOCUMENTATION.

L. Changes to the SOFTWARE or SERVICES. WE may change, modify, or update the SOFTWARE or SERVICES from time to time. Unless explicitly stated otherwise, any new features or services that augment or enhance the SOFTWARE or SERVICES in the future shall respectively be considered part of the SOFTWARE or SERVICES and subject to this AGREEMENT. WE reserve the right at any time and from time to time to interrupt, restrict, modify, suspend, discontinue, temporarily or permanently, the SOFTWARE or SERVICES (or any portion thereof), with or without notice to you, and you agree that HONDA shall not be liable to you or to any third party for any modification, suspension or discontinuance of the SOFTWARE or SERVICES.

M. ARBITRATION:

PLEASE READ THIS ARBITRATION PROVISION CAREFULLY TO UNDERSTAND YOUR RIGHTS. YOU AGREE THAT ANY CLAIM THAT YOU MAY HAVE IN THE FUTURE MUST BE RESOLVED THROUGH BINDING ARBITRATION. YOU WAIVE THE RIGHT TO HAVE YOUR DISPUTE HEARD IN COURT AND WAIVE THE RIGHT TO BRING CLASS CLAIMS. YOU UNDERSTAND THAT DISCOVERY AND APPEAL RIGHTS ARE MORE LIMITED IN ARBITRATION.

Arbitration is a method of resolving a claim, dispute or controversy without filing a lawsuit. By agreeing to arbitrate, the right to go to court is waived and instead claims, disputes or controversies are submitted to binding arbitration. This provision sets forth the terms and conditions of our agreement. YOU and HONDA agree and acknowledge that this Agreement affects interstate commerce and the Federal Arbitration Act ("FAA") applies. By using the Software, Vehicle, or Services, YOU elect to have disputes resolved by arbitration. YOU, HONDA or any involved third party may pursue a Claim. "Claim" means any dispute between YOU, HONDA, or any involved third party relating to your use of the Software, the Vehicle, or the Services, this Agreement, or our relationship, including any representations, omissions or warranties. "Claim" does not include personal injury or wrongful death claims. YOU or HONDA may seek remedies in small claims court or provisional judicial remedies without arbitrating. In addition, notwithstanding anything herein to the contrary, YOU or HONDA may seek equitable relief in a court of competent jurisdiction.

YOU or HONDA may select arbitration with American Arbitration Association, JAMS or National Arbitration and Mediation. Contact these sponsors for their rules. The hearing will be in the federal district where YOU reside. If agreed, it may be by telephone or written submissions. Filing and arbitrator fees to be paid per the sponsor rules. You may contact the sponsor for a fee waiver. If no fee waivers, HONDA will pay filing and arbitrator fees up to \$5,000, unless law requires more. Each party is responsible for other fees. Arbitrator may award costs or fees to prevailing party, if permitted by law. HONDA will not seek fees, unless the claims are frivolous.

Arbitrator shall be an attorney or current or retired judge familiar with automotive or consumer software. The arbitrator shall follow substantive law, statute of limitations and decide all issues relating to the interpretation, construction, enforceability and applicability of this provision. The arbitrator may order relief permitted by law. This provision is governed and enforceable by the FAA. An award shall include a written opinion and be final, subject to appeal by the FAA.

This provision survives termination of this Agreement or relationship, bankruptcy, assignment or transfer. If part of this provision is unenforceable, the remainder remains in effect. If unenforceability allows arbitration as a class action, then this provision is entirely unenforceable. YOU may opt out within 30 days of your initial use of the Software by sending a signed, written notice to HONDA at Honda Financial Services, P.O. Box 165007, Irving, TX 75016. HONDA reserves the right to make changes to this provision after providing written notice and an opportunity to opt out.

N. Miscellaneous: You may not assign this AGREEMENT without HONDA's prior written consent. This AGREEMENT and any additional HONDA TERMS and PROVIDER TERMS represents the entire agreement between you and US. HONDA may amend the terms of this AGREEMENT by providing you with notices of such updated terms. If you do not consent to be bound by the updated terms, your sole remedy will be to cease using the SOFTWARE and SERVICES. If any part of this AGREEMENT is found invalid, void, or unenforceable, the balance of the AGREEMENT will remain valid and enforceable according to its terms. To the fullest extent permitted by law, and except as explicitly provided otherwise, this AGREEMENT and any disputes arising out of or relating to it will be governed by the laws of the State of California, except that California laws concerning choice of law or conflicts shall not apply if they would cause the substantive law of another jurisdiction to apply. Notwithstanding the foregoing, Section M shall be governed by the Federal Arbitration Act and the laws of the State of California, as applicable, as set forth therein. The failure to enforce any term of this AGREEMENT on one occasion shall not prevent enforcement on any other occasion or the enforcement of any other term. Headings and captions shall not be considered included for purposes of interpretation or application hereof, but are for convenience only.

Legal Information on Apple CarPlay/Android Auto

■ OWNER'S MANUAL LICENSE/LIABILITY STATEMENTS

USE OF APPLE CARPLAY IS SUBJECT TO YOUR AGREEMENT TO THE CARPLAY TERMS OF USE, WHICH ARE INCLUDED AS PART OF THE APPLE iOS TERMS OF USE. IN SUMMARY, THE CARPLAY TERMS OF USE DISCLAIM APPLE AND ITS SERVICE PROVIDERS' LIABILITY IF THE SERVICES FAIL TO PERFORM CORRECTLY OR ARE DISCONTINUED, STRICTLY LIMIT APPLE AND ITS SERVICE PROVIDERS' OTHER LIABILITIES, DESCRIBE THE KINDS OF USER INFORMATION (INCLUDING, FOR EXAMPLE, VEHICLE LOCATION, VEHICLE SPEED, AND VEHICLE STATUS) BEING GATHERED AND STORED BY APPLE AND ITS SERVICE PROVIDERS, AND DISCLOSE CERTAIN POSSIBLE RISKS ASSOCIATED WITH THE USE OF CARPLAY, INCLUDING THE POTENTIAL FOR DRIVER DISTRACTION. SEE APPLE'S PRIVACY POLICY FOR DETAILS REGARDING APPLE'S USE AND HANDLING OF DATA UPLOADED BY CARPLAY.

USE OF ANDROID AUTO IS SUBJECT TO YOUR AGREEMENT TO THE ANDROID AUTO TERMS OF USE WHICH MUST BE AGREED TO WHEN THE ANDROID AUTO APPLICATION IS DOWNLOADED TO YOUR ANDROID PHONE. IN SUMMARY, THE ANDROID AUTO TERMS OF USE DISCLAIM GOOGLE AND ITS SERVICE PROVIDERS' LIABILITY IF THE SERVICES FAIL TO PERFORM CORRECTLY OR ARE DISCONTINUED, STRICTLY LIMIT GOOGLE AND ITS SERVICE PROVIDERS' OTHER LIABILITIES, DESCRIBE THE KINDS OF USER INFORMATION (INCLUDING, FOR EXAMPLE, VEHICLE LOCATION, VEHICLE SPEED, AND VEHICLE STATUS) BEING GATHERED AND STORED BY GOOGLE AND ITS SERVICE PROVIDERS, AND DISCLOSE CERTAIN POSSIBLE RISKS ASSOCIATED WITH THE USE OF ANDROID AUTO, INCLUDING THE POTENTIAL FOR DRIVER DISTRACTION. SEE GOOGLE'S PRIVACY POLICY FOR DETAILS REGARDING GOOGLE'S USE AND HANDLING OF DATA UPLOADED BY ANDROID AUTO.

DISCLAIMER OF WARRANTIES; LIMITATION ON LIABILITY

YOU EXPRESSLY ACKNOWLEDGE AND AGREE THAT USE OF APPLE CARPLAY OR ANDROID AUTO (“THE APPLICATIONS”) IS AT YOUR SOLE RISK AND THAT THE ENTIRE RISK AS TO SATISFACTORY QUALITY, PERFORMANCE, ACCURACY AND EFFORT IS WITH YOU TO THE MAXIMUM EXTENT PERMITTED BY APPLICABLE LAW, AND THAT THE APPLICATIONS AND INFORMATION ON THE APPLICATIONS IS PROVIDED “AS IS” AND “AS AVAILABLE,” WITH ALL FAULTS AND WITHOUT WARRANTY OF ANY KIND, AND HONDA HEREBY DISCLAIMS ALL WARRANTIES AND CONDITIONS WITH RESPECT TO THE APPLICATIONS AND INFORMATION ON THE APPLICATIONS, EITHER EXPRESS, IMPLIED OR STATUTORY, INCLUDING, BUT NOT LIMITED TO, THE IMPLIED WARRANTIES AND/OR CONDITIONS OF MERCHANTABILITY, SATISFACTORY QUALITY, FITNESS FOR A PARTICULAR PURPOSE, ACCURACY, QUIET ENJOYMENT, AND NON-INFRINGEMENT OF THIRD PARTY RIGHTS. NO ORAL OR WRITTEN INFORMATION OR ADVICE GIVEN BY HONDA OR AN AUTHORIZED REPRESENTATIVE SHALL CREATE A WARRANTY. AS EXAMPLES, AND WITHOUT LIMITATION, HONDA DISCLAIMS ANY WARRANTY REGARDING THE ACCURACY OF DATA PROVIDED BY THE APPLICATIONS, SUCH AS THE ACCURACY OF DIRECTIONS, ESTIMATED TRAVEL TIME, SPEED LIMITS, ROAD CONDITIONS, NEWS, WEATHER, TRAFFIC, OR OTHER CONTENT PROVIDED BY APPLE, GOOGLE, THEIR AFFILIATES, OR THIRD PARTY PROVIDERS; HONDA DOES NOT GUARANTEE AGAINST LOSS OF APPLICATION DATA, WHICH MAY BE LOST AT ANY TIME; HONDA DOES NOT GUARANTEE THAT THE APPLICATIONS OR ANY SERVICES PROVIDED THROUGH THEM WILL BE PROVIDED AT ALL TIMES OR THAT ANY OR ALL SERVICES WILL BE AVAILABLE AT ANY PARTICULAR TIME OR LOCATION. FOR EXAMPLE, SERVICES MAY BE SUSPENDED OR INTERRUPTED WITHOUT NOTICE FOR REPAIR, MAINTENANCE, SECURITY FIXES, UPDATES, ETC., SERVICES MAY BE UNAVAILABLE IN YOUR AREA OR LOCATION, ETC. IN ADDITION, YOU UNDERSTAND THAT CHANGES IN THIRD PARTY TECHNOLOGY OR GOVERNMENT REGULATION MAY RENDER THE SERVICES AND/OR APPLICATIONS OBSOLETE AND/OR UNUSABLE.

TO THE EXTENT NOT PROHIBITED BY LAW, IN NO EVENT SHALL HONDA OR ITS AFFILIATES BE LIABLE FOR PERSONAL INJURY, OR ANY INCIDENTAL, SPECIAL, INDIRECT OR CONSEQUENTIAL DAMAGES WHATSOEVER, INCLUDING, WITHOUT LIMITATION, DAMAGES FOR LOSS OF PROFITS, CORRUPTION OR LOSS OF DATA, FAILURE TO TRANSMIT OR RECEIVE ANY DATA, BUSINESS INTERRUPTION OR ANY OTHER COMMERCIAL DAMAGES OR LOSSES, ARISING OUT OF OR RELATED TO THE APPLICATIONS OR YOUR USE OF OR INABILITY TO USE THE APPLICATIONS OR INFORMATION ON THE APPLICATIONS, HOWEVER CAUSED, REGARDLESS OF THE THEORY OF LIABILITY (CONTRACT, TORT OR OTHERWISE) AND EVEN IF HONDA WERE ADVISED OF THE POSSIBILITY OF SUCH DAMAGES. SOME STATES AND JURISDICTIONS DISALLOW THE EXCLUSION OR LIMITATION OF LIABILITY FOR DAMAGES, SO THESE LIMITATIONS AND EXCLUSIONS MAY NOT APPLY TO YOU. IN NO EVENT SHALL HONDA’S TOTAL LIABILITY TO YOU FOR ALL DAMAGES (OTHER THAN AS MAY BE REQUIRED BY APPLICABLE LAW IN CASES INVOLVING PERSONAL INJURY) EXCEED THE AMOUNT OF FIVE DOLLARS (\$5.00). THE FOREGOING LIMITATIONS WILL APPLY EVEN IF THE ABOVE STATED REMEDY FAILS OF ITS ESSENTIAL PURPOSE.

About Open Source Licenses

To see the open source license information, follow these steps.

1. Select .
2. Select **Settings**.
3. Select **System**.
4. Select the **Others** tab.
5. Select **Detail Information**.
6. Select **About device**.
7. Select **Legal information**.
8. Select **Open source licenses**.

License Information

■ DTS

For DTS patents, see <http://patents.dts.com>. Manufactured under license from DTS Licensing Limited. DTS, the Symbol, & DTS and the Symbol together are registered trademarks, and DTS Neural Surround is trademark of DTS, Inc. © DTS, Inc. All Rights Reserved.



Use the audio/information screen to customize certain features.

■ How to customize

While the vehicle is at a complete stop with the power mode in ON, select , and **Settings**, then select a setting item.

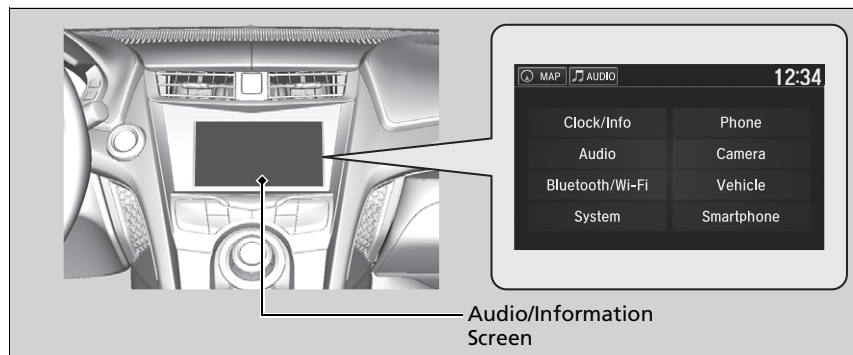

▶ Customized Features

When you customize settings, make sure that the vehicle is at a complete stop and shift to **P**.

To customize other features, select **Settings**.

▶ **List of customizable options** P. 252

■ Customization flow

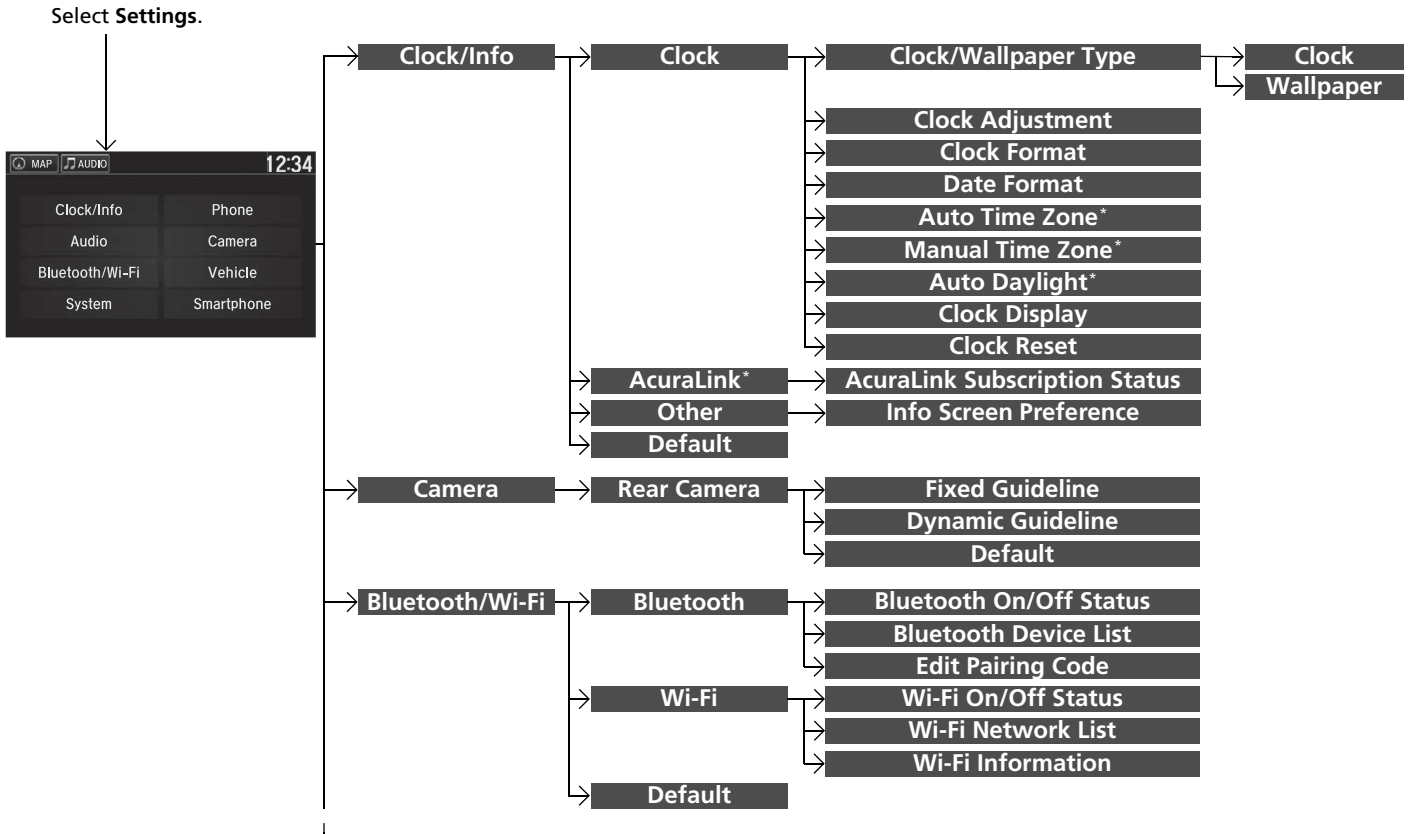

Features

* Not available on all models

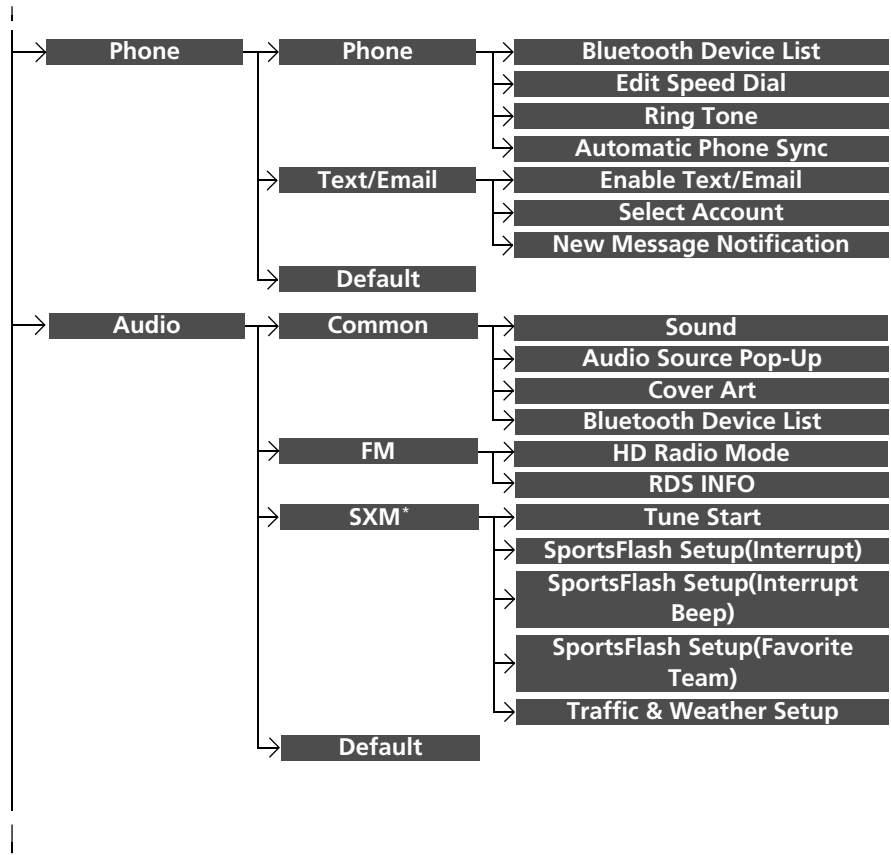

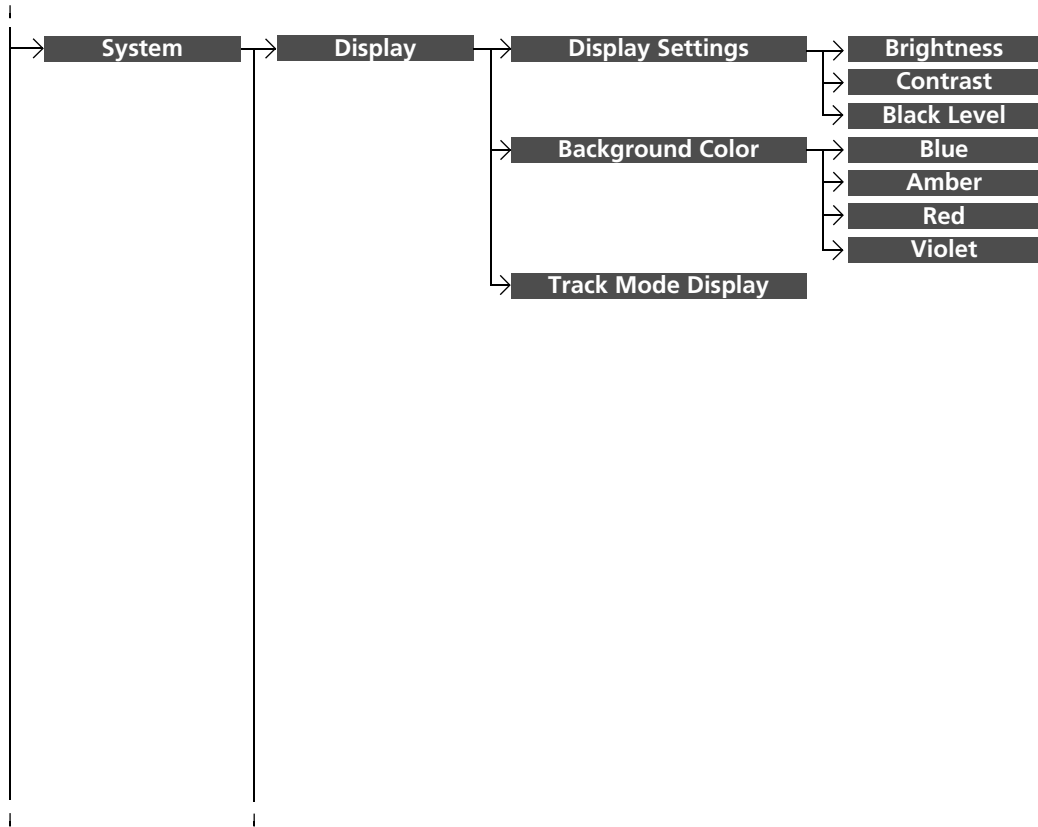

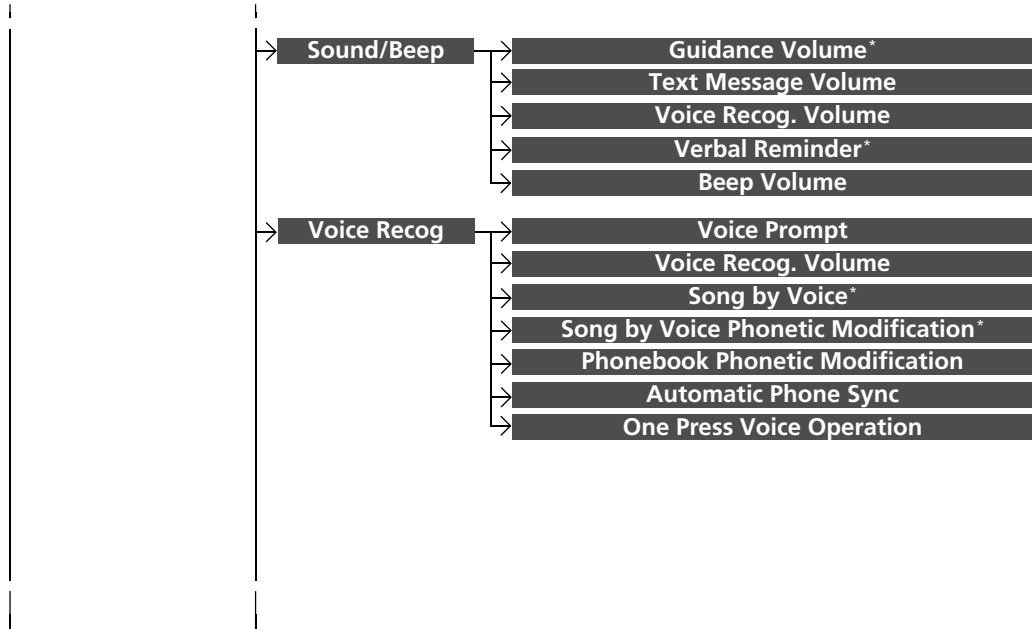

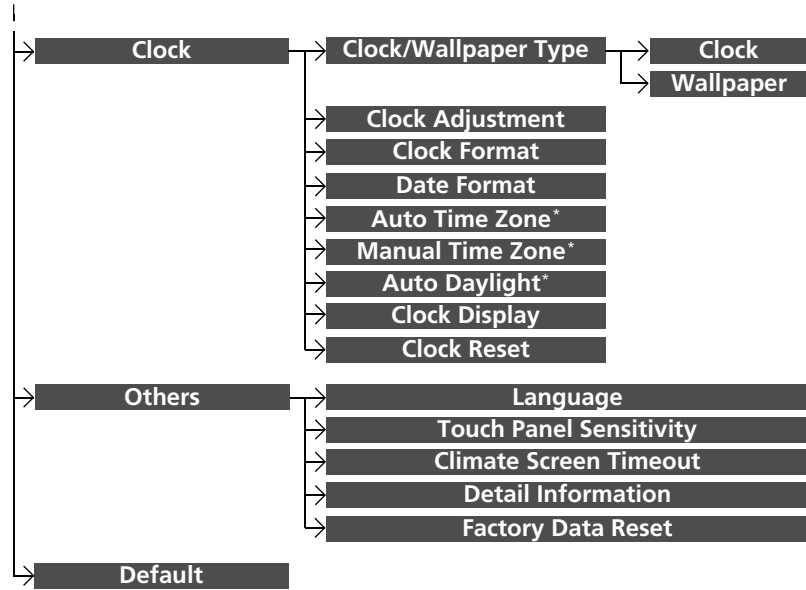

* Not available on all models

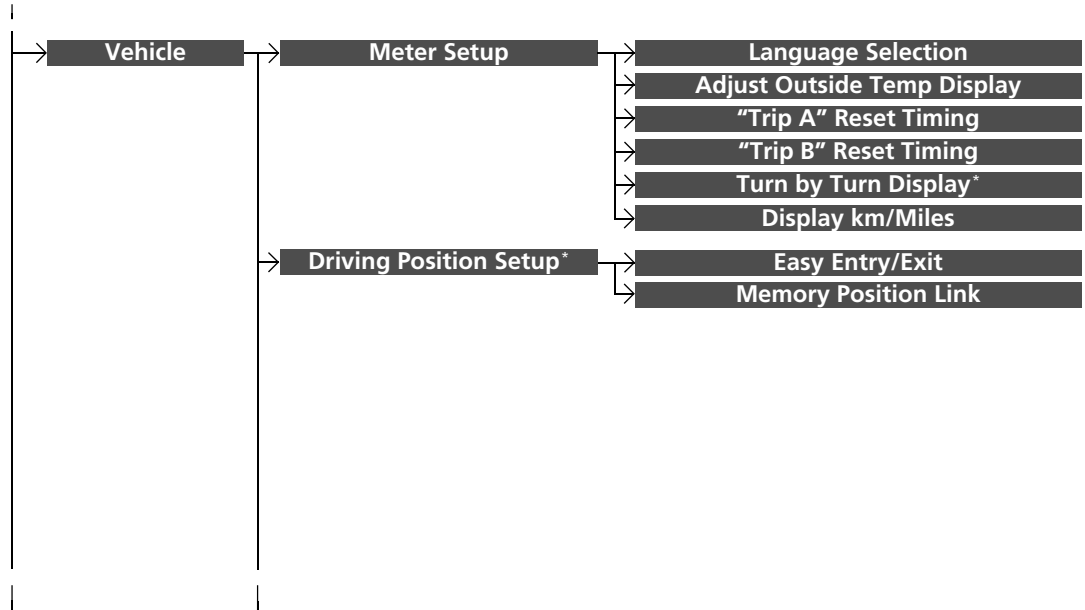

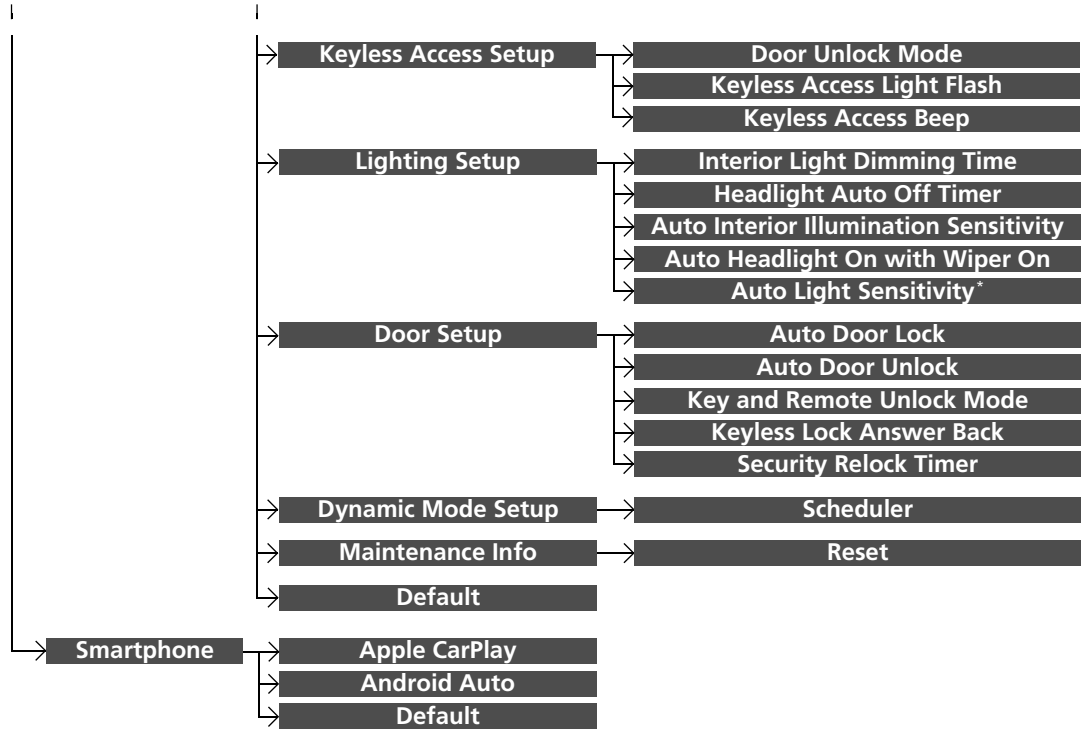

Features



* Not available on all models

■ List of customizable options

Setup Group	Customizable Features	Description	Selectable Settings	
Clock/ Info	Clock/ Wallpaper Type	Clock	Changes the clock display type. Analog/Digital^{*1}/ Small Digital/Off	
		Wallpaper	<ul style="list-style-type: none"> • Changes the wallpaper type. • Imports an image file for a new wallpaper. • Deletes an image file for a wallpaper. Blank/Galaxy^{*1}/ Metallic/Time Zone	
		Clock Adjustment	Adjusts Clock.	—
		Clock Format	Selects the digital clock display from 12H to 24H.	12H^{*1}/24H
		Date Format	Changes the date display type.	YYYY/MM/DD, MM/ DD/YYYY^{*1}, DD/ MM/YYYY
		Auto Time Zone[*]	Automatically adjusts the clock when driving through different time zones.	On^{*1}/Off
		Manual Time Zone[*]	Changes the time zone manually.	—
		Auto Daylight[*]	Select On to have the GPS automatically adjust the clock to daylight savings time. Select Off to cancel this function.	On^{*1}/Off
		Clock Display	Selects whether the clock display comes on.	On^{*1}/Off
		Clock Reset	Resets the clock settings to the factory default.	Yes/No

*1:Default Setting

* Not available on all models

Setup Group	Customizable Features	Description	Selectable Settings
Clock/ Info	AcuraLink* AcuraLink Subscription Status	Displays your current AcuraLink subscription status.	—
	Other Info Screen Preference	Changes the information screen type. <ul style="list-style-type: none"> • Info Top- A brief menu pops up. • Info Menu- A full menu pops up. • Off- A menu does not pop up. 	Info Top/Info Menu*¹/Off
	Default	Cancels/Resets all customized items in the Clock/Info group as default.	Yes/No
Camera	Rear Camera Fixed Guideline	Selects whether the fixed guidelines come on the rear camera monitor.  Multi-View Rear Camera P. 369	On*¹/Off
	Dynamic Guideline	Selects whether the guidelines adjust to the movement of the steering wheel.  Multi-View Rear Camera P. 369	On*¹/Off
	Default	Cancels/Resets all customized items in the Rear Camera setting group as default.	Yes/No

*1:Default Setting

Setup Group	Customizable Features	Description	Selectable Settings	
Bluetooth /Wi-Fi	Bluetooth On/Off Status	Changes the <i>Bluetooth</i> ® status.	On^{*1}/Off	
	Bluetooth	Pairs a new phone to HFL, edits or deletes a paired phone. ➤ Phone Setup P. 278	—	
	Edit Pairing Code	Edits a pairing code. ➤ To change the pairing code setting P. 279	Random/Fixed^{*1}	
	Wi-Fi On/Off Status	Changes the Wi-Fi mode.	On/Off^{*1}	
	Wi-Fi	Wi-Fi Network List	Connects, disconnects, or deletes the Wi-Fi device.	—
		Wi-Fi Information	Shows the Wi-Fi information of the head unit.	—
Default		Cancels/Resets all customized items in the Bluetooth/Wi-Fi group as default.	Yes/No	

*1:Default Setting

Setup Group	Customizable Features	Description	Selectable Settings
Phone	Bluetooth Device List	Pairs a new phone to HFL, connects or disconnects a paired phone. ▶ Phone Setup P. 278	—
	Edit Speed Dial	Edits, adds or deletes a speed dial entry. ▶ Speed Dial P. 284	—
	Ring Tone	Selects the ring tone.	Fixed/Mobile Phone *1
	Automatic Phone Sync	Sets phonebook and call history data to be automatically imported when a phone is paired to HFL.	On *1/ Off
	Enable Text/Email	Turns the text/e-mail message function on and off.	On *1/ Off
	Select Account	Selects a text or e-mail message account.	—
	New Message Notification	Selects whether a pop-up alert comes on the screen when HFL receives a new text/e-mail message.	On/Off *1
Default	Cancels/Resets all customized items in the Phone settings group as default.	Yes/No	

*1:Default Setting

Setup Group	Customizable Features	Description	Selectable Settings
Audio	Sound	Adjusts the settings of the audio speakers' sound. ▶ Adjusting the Sound P. 181	-6~0*1~+6 (BASS and TREBLE), RR9~0*1~FR9 (FADER) , L9~0*1~R9 (BALANCE) , -6~0*1~+6 (Center* and Subwoofer), Off/Low/Mid*1/High (Speed Volume Compensation), Off*1/On (Neural*)
	Common		
	Audio Source Pop-Up	Selects whether the list of selectable audio sources comes on when Audio is selected on the home screen.	On/Off*1
	[Your selected media] Cover Art	Turns the cover art display on and off.	On*1/Off
	Bluetooth Device List	Pairs a new phone to HFL, edits or deletes a paired phone. ▶ Phone Setup P. 278	—
	FM mode FM		
	HD Radio Mode	Selects whether the audio system automatically switches to the digital radio waves or receives the analog waves only.	Auto*1/Analog
	RDS INFO	Turns on and off the RDS information.	On*1/Off

*1: Default Setting

* Not available on all models

Setup Group	Customizable Features	Description	Selectable Settings
Audio	Tune Start	Turns on and off, starts the song from the beginning as you change preset stations.	On^{*1}/Off
	SportsFlash Setup(Interrupt)	Turns on and off the sports alert function.	Off^{*1}/On(one time)/ On(continue)
	SiriusXM[®] mode SXM[*] SportsFlash Setup(Interrupt Beep)	Causes the system to beep when the sports alert is notified.	On^{*1}/Off
	SportsFlash Setup(Favorite Team)	Selects your favorite sports teams. ▶ Live Sports Alert P. 197	—
	Traffic & Weather Setup	Selects the region you want to receive the information.	—
Default		Cancels/Resets all customized items in the Audio settings group as default.	Yes/No

*1:Default Setting

Setup Group	Customizable Features	Description	Selectable Settings
System	Display	Brightness	Changes the brightness of the audio/information screen. 0~5~10^{*1} (Daytime mode) 0~5^{*1}~10 (Nighttime mode)
		Contrast	Changes the contrast of the audio/information screen. -5~0^{*1}~+5
		Black Level	Changes the black level of the audio/information screen. -5~0^{*1}~+5
	Background Color	Changes the background color of the audio/information screen. Blue^{*1}/Amber/Red/Violet	
	Track Mode Display	Turns the limitation screen for the TRACK mode on and off. ☒ Limitations for Manual Operation P. 183	On^{*1}/Off
	Sound/Beep	Guidance Volume[*]	Changes the sound volume. Adjusts the guidance volume of the navigation system.
Text Message Volume		Changes the text/e-mail message reading volume.	1~6^{*1}~11

*1:Default Setting

Setup Group	Customizable Features	Description	Selectable Settings	
System	Sound /Beep	Voice Recog. Volume	Changes the volume of the voice prompt.	1~6*1~11
		Verbal Reminder*	Turns the verbal reminders on and off.	On*1/Off
		Beep Volume	Changes the beep volume.	Off*1/1/2/3
		Voice Prompt	Turns the voice prompt on and off.	On*1/Off
		Voice Recog. Volume	Changes the volume of the voice prompt.	1~6*1~11
		Song by Voice*	Turns the Song By Voice™ on and off.	On*1/Off
	Voice Recog	Song by Voice Phonetic Modification*	Modifies a voice command for music stored in the system or an iPod/iPhone. ▶ Phonetic Modification P. 204	—
		Phonebook Phonetic Modification	Modifies a voice command for the phonebook. ▶ Phonebook Phonetic Modification P. 287	—
		Automatic Phone Sync	Sets phonebook and call history data to be automatically imported when a phone is paired to HFL.	On*1/Off
		One Press Voice Operation	Changes the setting of the  (Talk) button operation when using the voice operation.	On*1/Off

*1:Default Setting

Setup Group	Customizable Features	Description	Selectable Settings			
System	Clock <hr/> Clock/ Wallpaper Type <hr/> Clock Adjustment <hr/> Clock Format <hr/> Date Format <hr/> Auto Time Zone* <hr/> Manual Time Zone* <hr/> Auto Daylight* <hr/> Clock Display <hr/> Clock Reset	See Clock/Info on P. 252				
			Others	Language	Change the display language.	English*¹/Français/ Español
				Touch Panel Sensitivity	Sets the sensitivity of the touch panel screen.	High*¹/Low

*1:Default Setting

Setup Group	Customizable Features	Description	Selectable Settings
System	Others		
	Climate Screen Timeout	Changes the length of time the climate control display stays on when you press the CLIMATE button.	Never/5 Seconds/10 Seconds*¹/20 Seconds
	Detail Information	Displays the details of the head unit and operating system information.	—
	Factory Data Reset	Resets all the settings to their factory default. <input checked="" type="checkbox"/> Defaulting All the Settings P. 266	Yes/No
Default		Cancels/Resets all customized items in the System group as default.	Yes/No

*1:Default Setting

Setup Group	Customizable Features	Description	Selectable Settings
Vehicle Meter Setup	Language Selection	Changes the displayed language on the driver information interface.	English^{*1}/Français/Español
	Adjust Outside Temp Display	Adjusts the temperature reading by a few degrees.	-5°F ~ ±0°F^{*1} ~ +5°F (U.S.) -3°C ~ ±0°C^{*1} ~ +3°C (Canada)
	"Trip A" Reset Timing	Changes the setting of how to reset trip meter A and average fuel economy A.	With Refuel/IGN Off/Manually Reset^{*1}
	"Trip B" Reset Timing	Changes the setting of how to reset trip meter B and average fuel economy B.	With Refuel/IGN Off/Manually Reset^{*1}
	Turn by Turn Display*	Selects whether the turn-by-turn display comes on during the route guidance.	On^{*1}/Off
	Display km/Miles	Selects the trip computer units.	Auto^{*1}/km/Miles

*1:Default Setting

Setup Group	Customizable Features	Description	Selectable Settings	
Vehicle	Driving Position Setup*	Easy Entry/Exit	Moves the seat rearward when you get in/get out of the vehicle. Changes the setting for this feature.	On* ¹ /Off
		Memory Position Link	Turns the driving position memory system on and off.	On* ¹ /Off
	Keyless Access Setup	Door Unlock Mode	Changes which doors unlock when you grab the driver's door handle.	Driver Door Only* ¹ / All Doors
		Keyless Access Light Flash	Causes some exterior lights to flash when you unlock/lock the doors.	On* ¹ /Off
		Keyless Access Beep	Causes the beeper to sound when you unlock/lock the doors.	On* ¹ /Off
	Lighting Setup	Interior Light Dimming Time	Changes the length of time the interior lights stay on after you close the doors.	60 sec/30 sec* ¹ /15 sec
		Headlight Auto Off Timer	Changes the length of time the exterior lights stay on after you close the driver's door.	60 sec/30 sec/15 sec* ¹ /0 sec
		Auto Interior Illumination Sensitivity	Changes the sensitivity of the brightness of the instrument panel when the headlight switch is in the AUTO position.	Min/Low/Mid* ¹ /High/ Max

*1:Default Setting

* Not available on all models

Setup Group	Customizable Features	Description	Selectable Settings	
Vehicle	Lighting Setup	Auto Headlight On with Wiper On	Changes the settings for the wiper operation when the headlights automatically come on while the headlight switch is in the AUTO position.	On ^{*1} /Off
		Auto Light Sensitivity*	Changes the level of ambient light that causes the headlights to come on in AUTO position.	Max/High/Mid ^{*1} / Low/Min
	Door Setup	Auto Door Lock	Used to change the setting for when the doors automatically lock.	With Vehicle Speed^{*1}/Shift from P/Off
		Auto Door Unlock	Changes the setting for when the doors unlock automatically.	All Doors with Driver's Door Opens^{*1}/All Doors with Shift to P/All Doors with IGN Off/Off
		Key And Remote Unlock Mode	Sets up the driver's door or all the doors to unlock on the first push of the remote.	Driver Door^{*1}/All Doors
		Keyless Lock Answer Back	LOCK/UNLOCK- The exterior lights flash. LOCK (2nd push)- The beeper sounds.	On ^{*1} /Off
		Security Relock Timer	Changes the time it takes for the doors to relock and the security system to set after you unlock the vehicle without opening either door.	90 sec/60 sec/30 sec^{*1}

*1:Default Setting

* Not available on all models

Setup Group	Customizable Features	Description	Selectable Settings
Vehicle	Dynamic Mode Setup Scheduler	Changes the Integrated Dynamics System mode schedule. The vehicle starts in the QUIET or SPORT mode according to the selected item or time schedule.	OFF/Always Sport^{*1}/ Always Quiet/Last Start/Quiet: 12am-6am/Quiet: 12am-8am
	Maintenance Info Reset	Used to reset the engine oil life display when the maintenance service has been performed.	—
	Default	Cancels/Resets all customized items in the Vehicle group as default.	Yes/No
Smart-phone	Apple CarPlay	Sets up the Apple CarPlay connection.	—
	Android Auto	Sets up the Android Auto connection.	—
	Default	Cancels/Resets all customized items in the Smartphone group as default.	Yes/No

*1:Default Setting

Defaulting All the Settings

Reset all the menu and customized settings as the factory defaults.

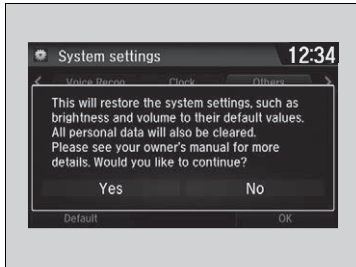

1. Select .
2. Select **Settings**.
3. Select **System**.
4. Select the **Others** tab.
5. Select **Factory Data Reset**.
 - A confirmation message appears on the screen.
6. Select **Yes** to reset the settings.
7. Select **Yes** again to reset the settings.
 - A confirmation message appears on the screen. Select **OK**.
 - After selecting **OK**, the system will reboot.

►► Defaulting All the Settings

When you transfer the vehicle to a third party, reset all settings to default and delete all personal data.

If you perform **Factory Data Reset**, it will reset the pre-installed apps to their factory default.

The HomeLink® Universal Transceiver can be programmed to operate up to three remote controlled devices around your home, such as garage doors, lighting, or home security systems.

■ Important Safety Precautions

Refer to the safety information that came with your garage door opener to test that the safety features are functioning properly. If you do not have the safety information, contact the manufacturer.

Before programming HomeLink, make sure that people and objects are out of the way of the garage or gate to prevent potential injury or damage.

When programming a garage door opener, park just outside the garage door's path.

⌘ HomeLink® Universal Transceiver

Before programming HomeLink to operate a garage door opener, confirm that the opener has an external entrapment protection system, such as an "electronic eye," or other safety and reverse stop features. If it does not, HomeLink may not be able to operate it.

Training HomeLink

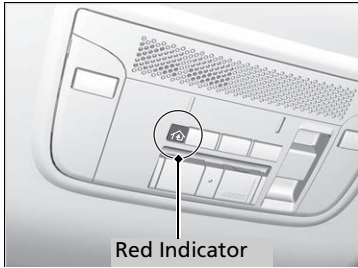

If it is necessary to erase a previously entered learned code:

- Press and hold the two outside buttons for about 20 seconds, until the red indicator blinks. Release the buttons, and proceed to step 1.
- If you are training the second or third button, go directly to step 1.

The instructions on the next page should work for most gate or garage openers, but may not work for all. For detailed instructions about your specific remote opener, visit <http://www.homelink.com> or call (800) 355-3515.

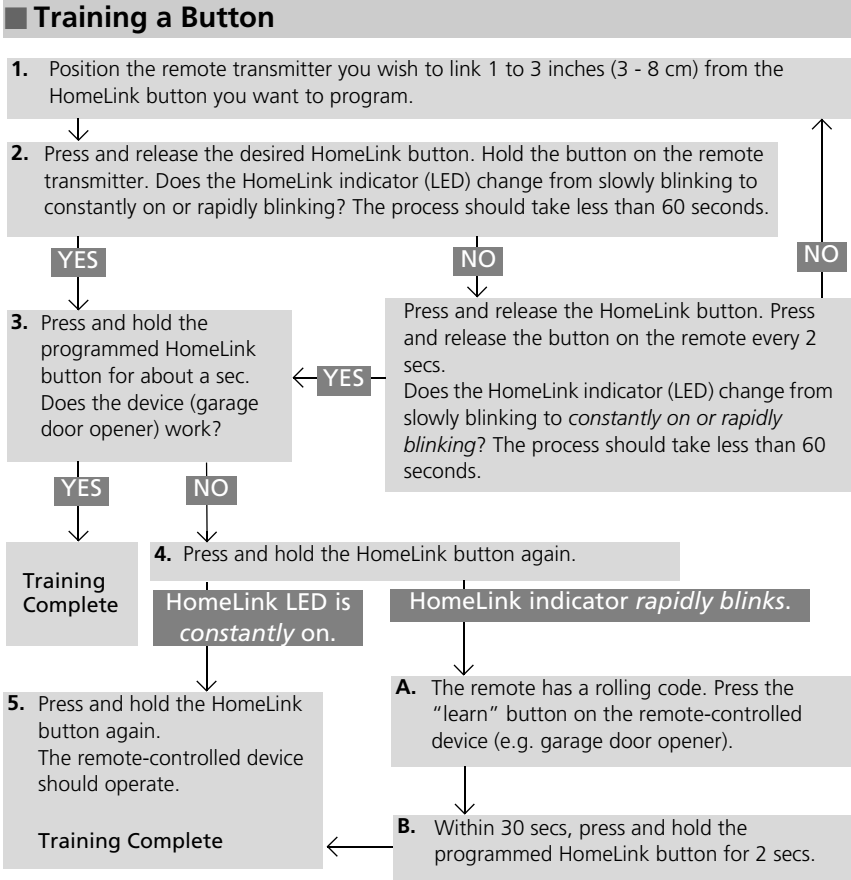

Training HomeLink

Retraining a Button

If you want to retrain a programmed button for a new device, you do not have to erase all button memory. You can replace the existing memory code using this procedure:

- Press and hold the desired HomeLink button until the HomeLink indicator begins to blink.

Standard transmitter Indicator remains on for about 25 secs.	Rolling code transmitter Indicator remains on for about 25 secs.
--	--
- Quickly release the HomeLink button and follow steps 1 - 3 under "Training a Button." You do not need to press and release the HomeLink button again in step 2.

Erasing Codes

To erase all the codes, press and hold the two outside buttons until the HomeLink indicator begins to blink (about 10 to 20 secs). You should erase all codes before selling the vehicle.

If you have any problems, see the device's instructions, visit www.homelink.com, or call HomeLink at (800) 355-3515.

HomeLink® is a registered trademark of Gentex Corporation.

Bluetooth® HandsFreeLink® (HFL) allows you to place and receive phone calls using your vehicle's audio system, without handling your cell phone.

Using HFL

HFL Buttons

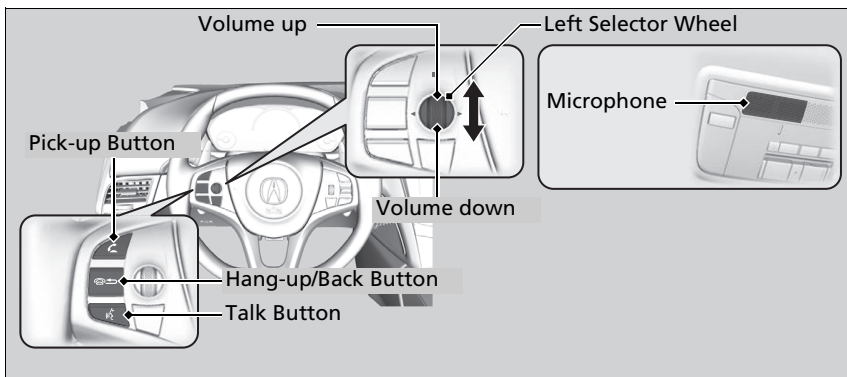

Bluetooth® HandsFreeLink®

Place your phone where you can get good reception.

To use HFL, you need a *Bluetooth*-compatible cell phone. For a list of compatible phones, pairing procedures, and special feature capabilities:

- U.S.: Visit www.acura.com/handsfreelink, or call 1-888-528-7876.
- Canada: For more information on smartphone compatibility, call 1-888-528-7876.

To use the system, the **Bluetooth On/Off Status** setting must be **On**. If there is an active connection to Apple CarPlay, HFL is unavailable.

➤ **How to customize** P. 244

Voice control tips

- Aim the vents away from the ceiling and close the windows, as noise coming from them may interfere with the microphone.
- Press the  button when you want to call a number using a stored voice tag, a phonebook name, or a number. Speak clearly and naturally after a beep.
- If the microphone picks up voices other than yours, the command may be misinterpreted.
- To change the volume level, select the audio system's **VOL** (Volume) or use the remote audio controls on the steering wheel.

Up to five speed dial entries can be displayed among a total of 20 that can be entered.

➤ **Speed Dial** P. 284

Up to five previous calls can be displayed at a time among a total of 20 that can be entered. If there is no call history, Call History is disabled.

 **(Pick-up) button:** Press to go to the **Speed Dial/Call History** on the driver information interface, or to answer an incoming call.

 **(Hang-up/back) button:** Press to end a call, go back to the previous command, cancel a command, or clear the phone information on the driver information interface.

 **(Talk) button:** Press to access Voice Portal.



Left selector wheel:

Move to the right or left to select the **Speed Dial** or **Call History** on the driver information interface.

Roll up or down to select an item displayed on the **Speed Dial/Call History** display.

Push to call a number listed in the selected item on the **Speed Dial/Call History** display.

To go to the **Phone menu** screen:

1. Select .
2. Select **Phone** to switch the display to the phone screen.
3. Select .

▶▶ Bluetooth® HandsFreeLink®

Bluetooth® Wireless Technology

The *Bluetooth®* word mark and logos are registered trademarks owned by *Bluetooth SIG, Inc.*, and any use of such marks by Honda Motor Co., Ltd., is under license. Other trademarks and trade names are those of their respective owners.

HFL Limitations

An incoming call on HFL will interrupt the audio system when it is playing. It will resume when the call is ended.

■ HFL Status Display

The audio/information screen notifies you when there is an incoming call.

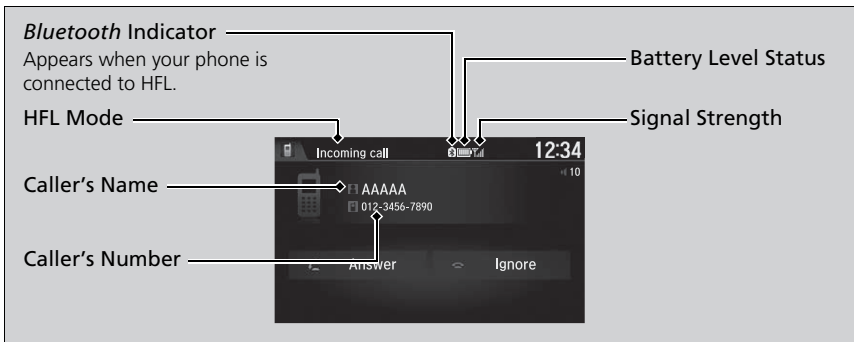

■ Limitations for Manual Operation

Certain manual functions are disabled or inoperable while the vehicle is in motion. You cannot select a grayed-out option until the vehicle is stopped.

Only previously stored speed dial entries with voice tags, phonebook names, or numbers can be called using voice commands while the vehicle is in motion.

▶ **Speed Dial** P. 284

▶ HFL Status Display

The information that appears on the audio/information screen varies between phone models.

You can change the system language.

▶ **How to customize** P. 244

HFL Menu

The power mode must be in ACCESSORY or ON to use HFL.

■ Phone settings screen

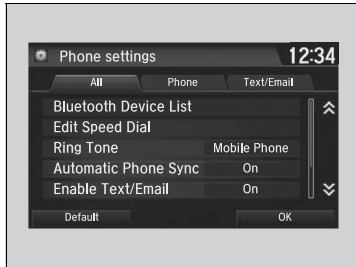

1. Select .
2. Select **Settings**.
3. Select **Phone**.

▶▶ HFL Menu

To use HFL, you must first pair your *Bluetooth*-compatible cell phone to the system while the vehicle is parked.

Some functions are limited while driving.

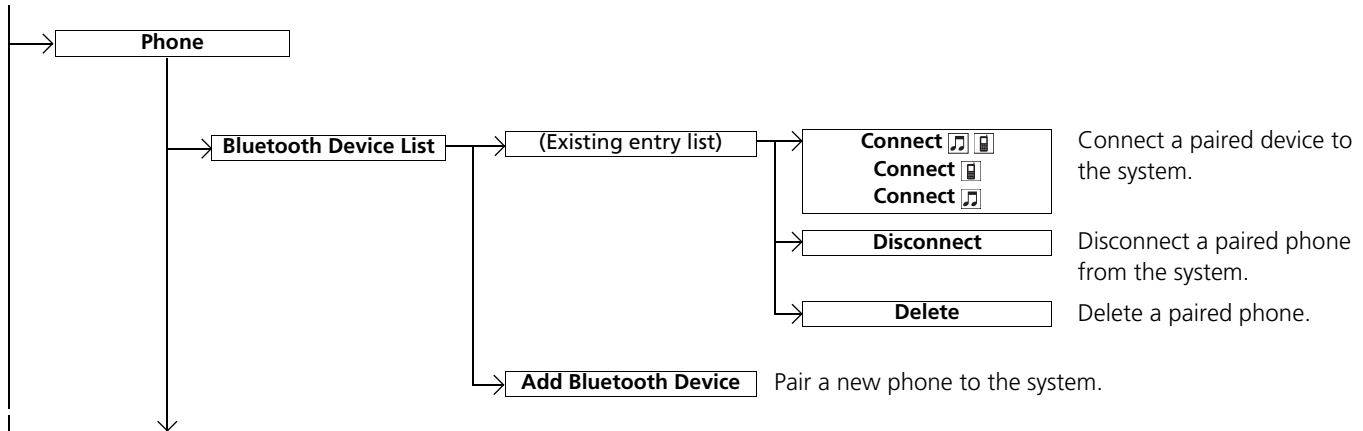

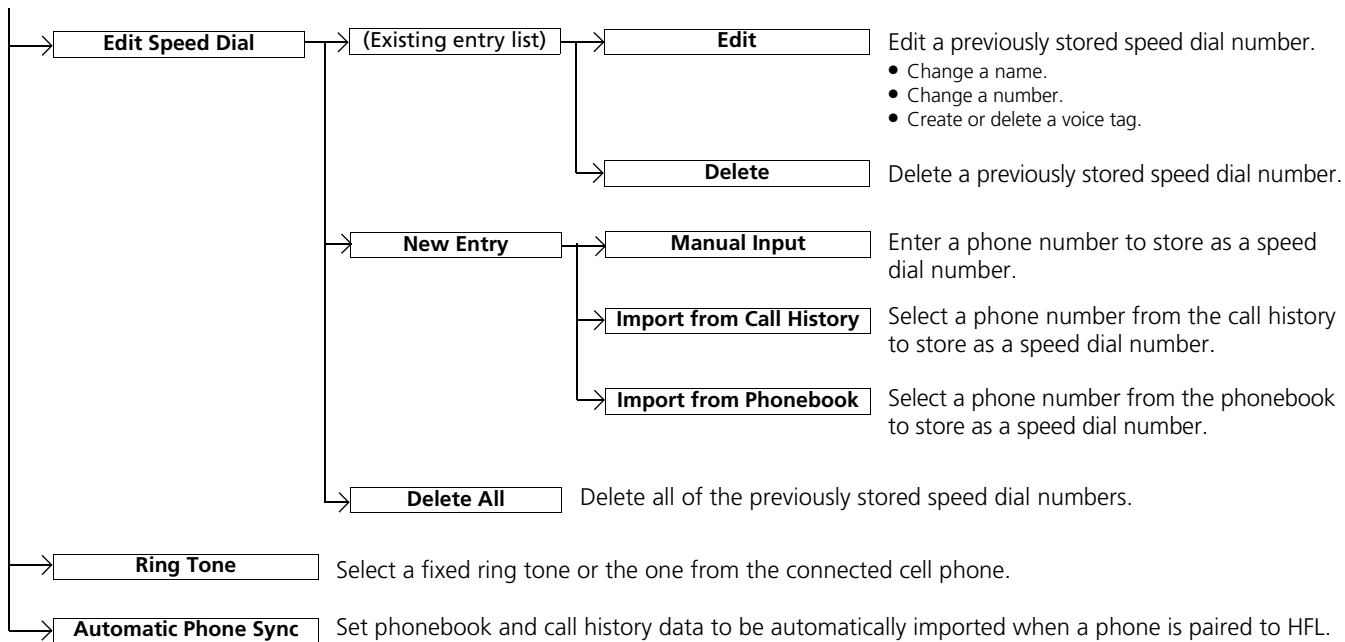

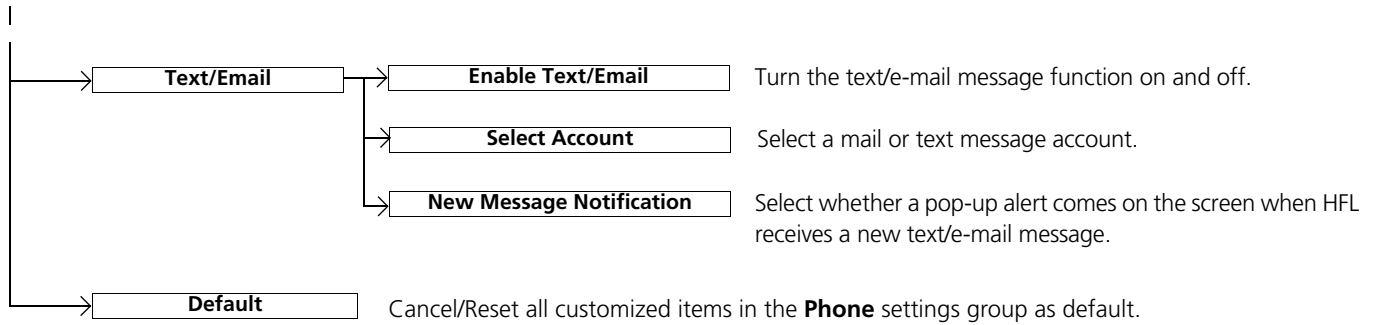

■ Phone menu screen

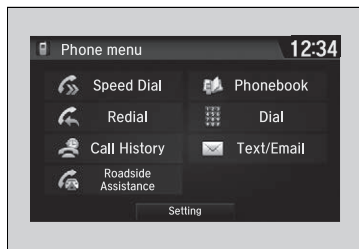

1. Select .
2. Select **Phone**.
3. Select .

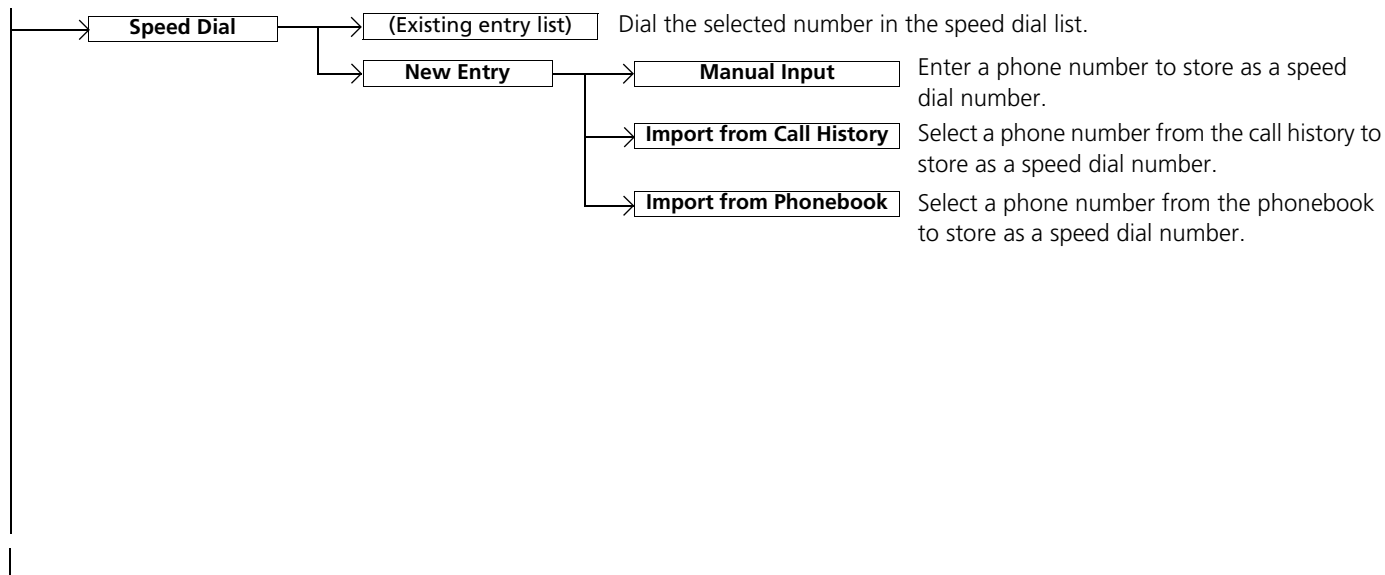

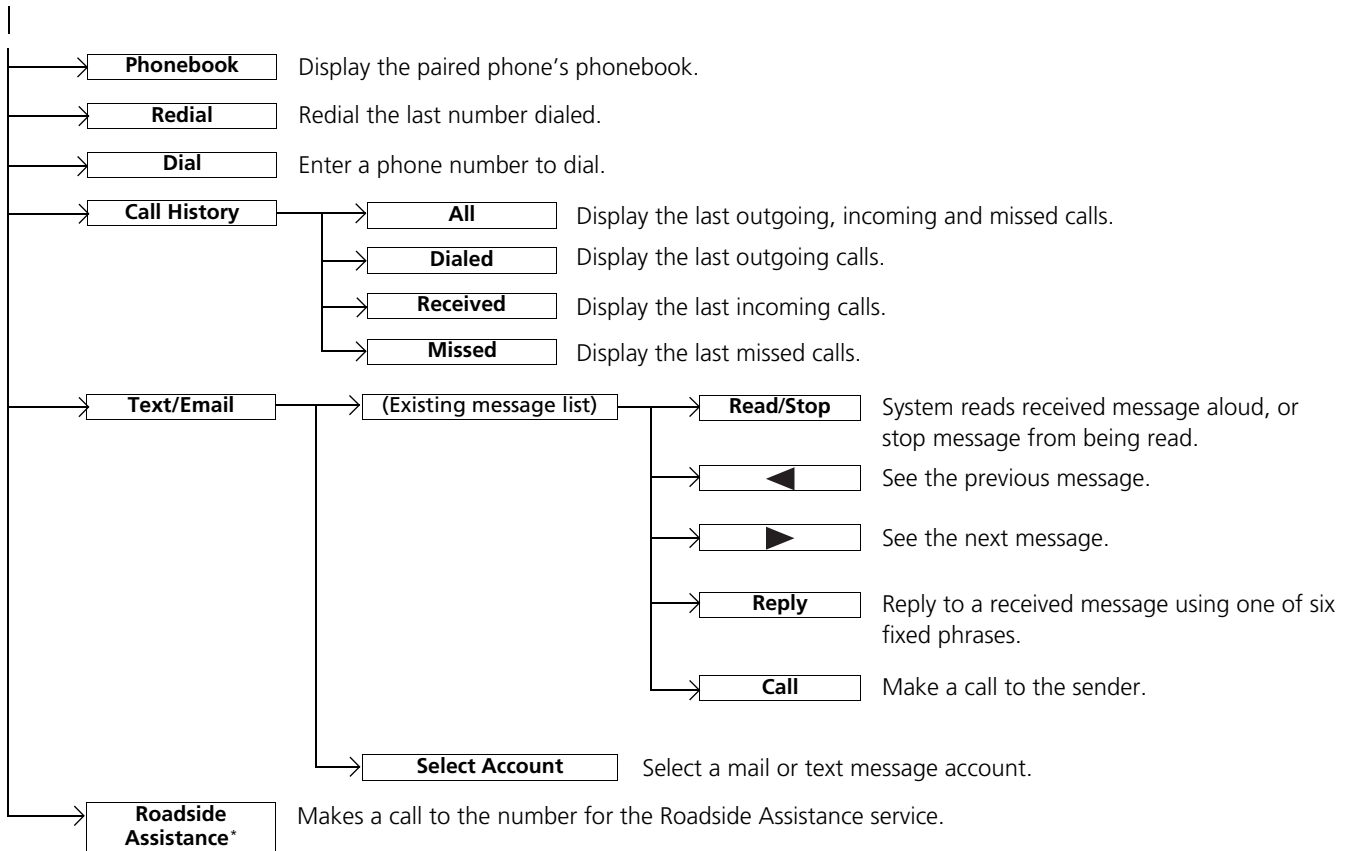

* Not available on all models

Phone Setup

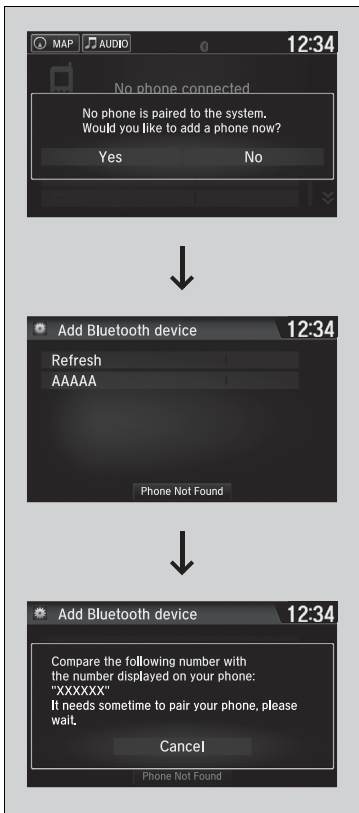

■ To pair a cell phone (when there is no phone paired to the system)

1. Select **Phone**.
2. Select **Yes**.
3. Make sure your phone is in search or discoverable mode, then select **Continue**.
 - ▶ HFL automatically searches for a *Bluetooth*® device.
4. Select your phone when it appears on the list.
 - ▶ If your phone does not appear, you can select **Refresh** to search again.
 - ▶ If your phone still does not appear, select **Phone Not Found** and search for *Bluetooth*® devices using your phone. From your phone, search for **HandsFreeLink**.
5. The system gives you a pairing code on the audio/information screen.
 - ▶ Confirm if the pairing code on the screen and your phone match. This may vary by phone.

☞ Phone Setup



Your *Bluetooth*-compatible phone must be paired to the system before you can make and receive hands-free calls.

Phone Pairing Tips:

- You cannot pair your phone while the vehicle is moving.
- Up to six phones can be paired.
- Your phone's battery may drain faster when it is paired to the system.
- If your phone is not ready for pairing or not found by the system within three minutes, the system will time out and return to idle.

Once you have paired a phone, you can see it displayed on the screen with one or two icons on the right side.



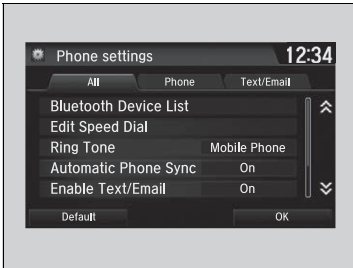

These icons indicate the following:

- : The phone can be used with HFL.
- : The phone is compatible with *Bluetooth*® Audio.

If there is an active connection to Apple CarPlay, pairing of additional *Bluetooth*-compatible devices is unavailable and **Add Bluetooth Device** is grayed out from the **Bluetooth Device List** screen.



■ **To change the currently paired phone**

1. Go to the phone settings screen.
 - ▶ **Phone settings screen** P. 273
2. Select **Bluetooth Device List**.
3. Select a phone to connect.
 - ▶ HFL disconnects the connected phone and starts searching for another paired phone.
4. Select **Connect**  , **Connect** , or **Connect** .

■ **To change the pairing code setting**

1. Select .
 2. Select **Settings**.
 3. Select **Bluetooth/Wi-Fi**.
 4. Select the **Bluetooth** tab.
 5. Select **Edit Pairing Code**.
6. Select **Random** or **Fixed**.

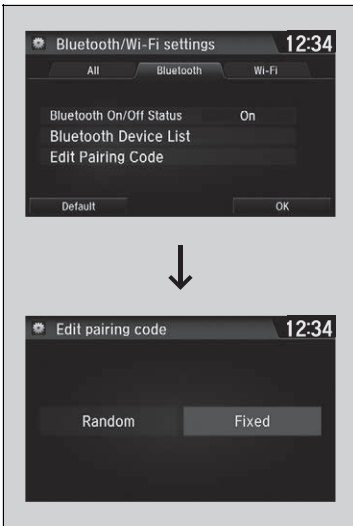

☒ **To change the currently paired phone**

If no other phones are found or paired when trying to switch to another phone, HFL will inform you that the original phone is connected again.

To pair other phones, select **Add Bluetooth Device** from the **Bluetooth device list** screen.

☒ **To change the pairing code setting**

The default pairing code is **0000** until you change the setting.

To create your own, select **Fixed**, and delete the current code, then enter a new one.

For a randomly generated pairing code each time you pair a phone, select **Random**.

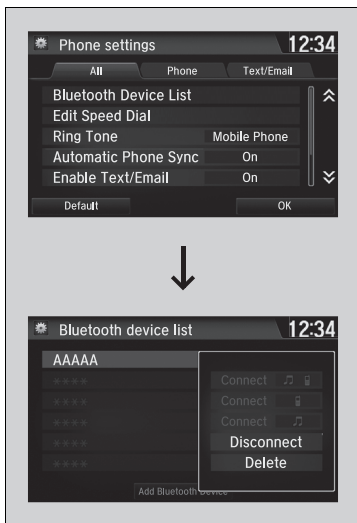

■ **To delete a paired phone**

1. Go to the phone settings screen.
 - ▶ **Phone settings screen** P. 273
2. Select **Bluetooth Device List**.
3. Select a phone you want to delete.
4. Select **Delete**.
5. A confirmation message appears on the screen. Select **Yes**.

■ To Set Up Text/E-mail Message Options

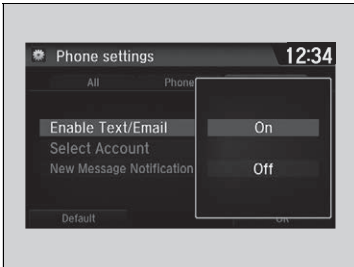

■ To turn on or off the text/e-mail function

1. Go to the phone settings screen.
 ▶ **Phone settings screen** P. 273
2. Select the **Text/Email** tab, then **Enable Text/Email**.
 ▶ A pop-up menu appears on the screen.
3. Select **On** or **Off**.

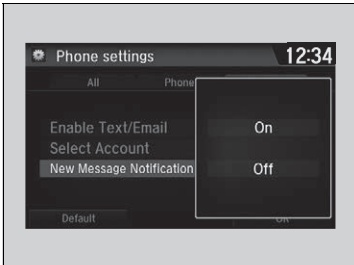

■ To turn on or off the text/e-mail notice

1. Go to the phone settings screen.
 ▶ **Phone settings screen** P. 273
2. Select the **Text/Email** tab, then **New Message Notification**.
 ▶ A pop-up menu appears on the screen.
3. Select **On** or **Off**.

☒ To Set Up Text/E-mail Message Options

To use the text/e-mail message function, it may be necessary to set up on your phone.

☒ To turn on or off the text/e-mail notice

- On:** A pop-up notification comes on every time you receive a new message.
- Off:** The message you receive is stored in the system without notification.

■ Ring Tone

You can change the ring tone setting.



1. Go to the phone settings screen.
 - **Phone settings screen** P. 273
2. Select **Ring Tone**.
3. Select **Fixed** or **Mobile Phone**.

☒ Ring Tone

Fixed: The fixed ring tone sounds from the speakers.

Mobile Phone: For certain connected phones, the ring tone stored in the phone sounds from the speakers.

Automatic Import of Cellular Phonebook and Call History

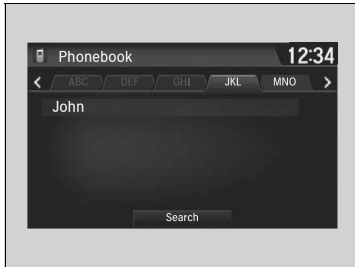

■ When Automatic Phone Sync is set to On:

When your phone is paired, the contents of its phonebook and call history are automatically imported to the system.

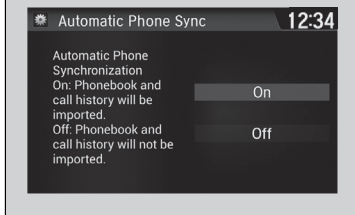
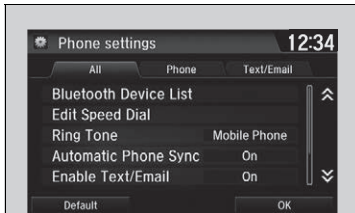

■ Changing the Automatic Phone Sync setting

1. Go to the phone settings screen.
▶ Phone settings screen P. 273
2. Select **Automatic Phone Sync**.

3. Select **On** or **Off**.

⊞ Automatic Import of Cellular Phonebook and Call History

When you select a name from the list in the cellular phonebook, you can see up to three category icons. The icons indicate what types of numbers are stored for that name.

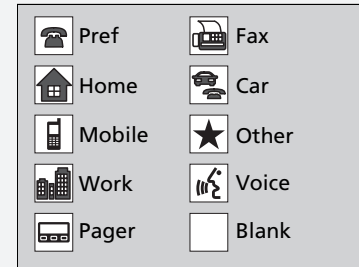

On some phones, it may not be possible to import the category icons to the system.

The phonebook is updated after every connection. Call history is updated after every connection or call.

■ Speed Dial

Up to 20 speed dial numbers can be stored per phone.

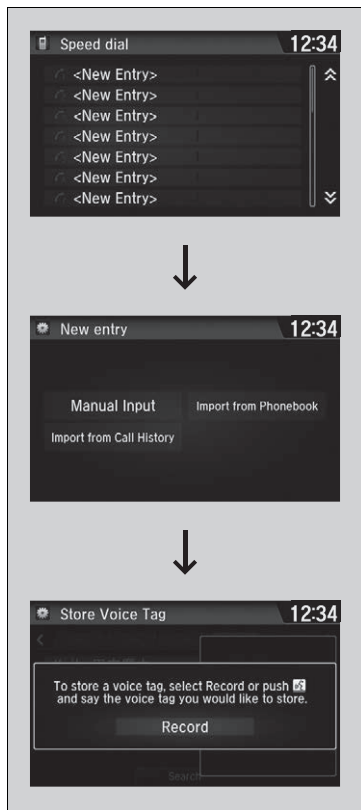

To store a speed dial number:

1. Go to the **Phone menu** screen.
 - ▶ **Phone menu screen** P. 276
2. Select **Speed Dial**.
3. Select **New Entry**.
 - From **Import from Call History**:
 - ▶ Select a number from the call history.
 - From **Manual Input**:
 - ▶ Input the number manually.
 - From **Import from Phonebook**:
 - ▶ Select a number from the connected cell phone's imported phonebook.
4. When the speed dial is successfully stored, you are asked to create a voice tag for the number. Select **Yes** or **No**.
5. Select **Record**, or use the [voice tag icon] button and follow the prompts to complete the voice tag.

▶▶ Speed Dial

When a voice tag is stored, press the [voice tag icon] button to call the number using the voice tag. Say the voice tag name.

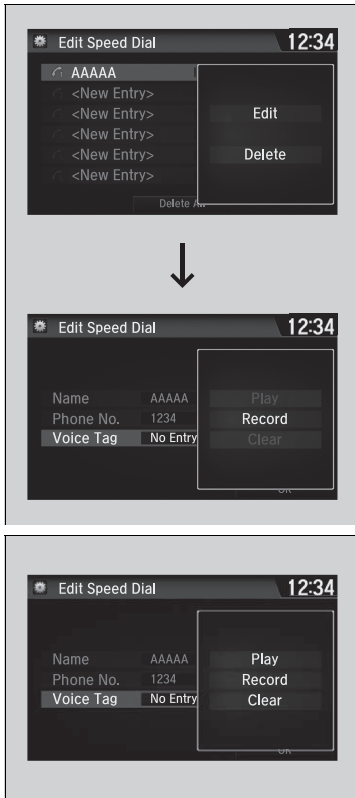

■ **To add a voice tag to a stored speed dial number**

1. Go to the phone settings screen.
▶ **Phone settings screen** P. 273
2. Select **Edit Speed Dial**.
3. Select an existing speed dial entry.
▶ From the pop-up menu, select **Edit**.
4. Select **Voice Tag**.
▶ From the pop-up menu, select **Record**.
5. Select **Record**, or use the  button and follow the prompts to complete the voice tag.

■ **To delete a voice tag**

1. Go to the phone settings screen.
▶ **Phone settings screen** P. 273
2. Select **Edit Speed Dial**.
3. Select an existing speed dial entry.
▶ From the pop-up menu, select **Edit**.
4. Select **Voice Tag**.
▶ From the pop-up menu, select **Clear**.
5. A confirmation message appears on the screen. Select **Yes**.

☞ Speed Dial

Avoid using duplicate voice tags.
Avoid using "home" as a voice tag.
It is easier for the system to recognize a longer name.
For example, use "John Smith" instead of "John."

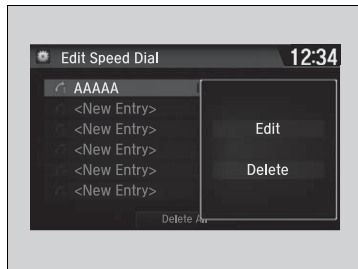

■ To edit a speed dial

1. Go to the phone settings screen.
 - ▶ **Phone settings screen** P. 273
2. Select **Edit Speed Dial**.
3. Select an existing speed dial entry.
 - ▶ From the pop-up menu, select **Edit**.
4. Select a setting you want.

■ To delete a speed dial

1. Go to the phone settings screen.
 - ▶ **Phone settings screen** P. 273
2. Select **Edit Speed Dial**.
3. Select an existing speed dial entry.
 - ▶ From the pop-up menu, select **Delete**.
4. A confirmation message appears on the screen. Select **Yes**.

Phonebook Phonetic Modification

Add phonetic modifications or a new voice tag to the phone's contact name so that it is easier for HFL to recognize voice commands.

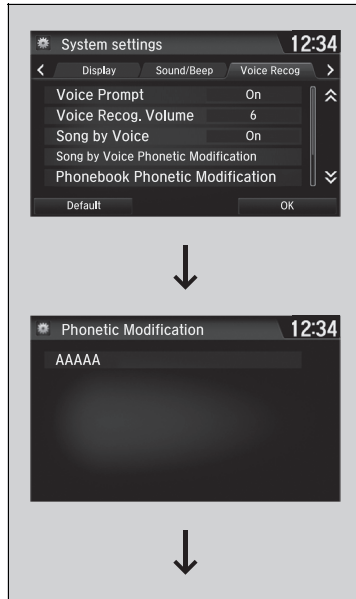

To add a new voice tag

1. Select .
2. Select **Settings**.
3. Select **System**.
4. Select the **Voice Recog** tab.
5. Select **Phonebook Phonetic Modification**.
6. Select the phone you want to add the phonetic modification to.

Phonebook Phonetic Modification

You can store up to 20 phonetic modification items.



7. Select **New Voice Tag**.

8. Select a contact name you want to add to.

▶ The pop-up menu appears on the screen.



9. Select **Modify**.

10. Using **Record** or the  button, follow the prompts to complete the voice tag.

11. You will receive a confirmation message on the screen, then select **OK**.



■ To modify a voice tag

1. Select .
2. Select **Settings**.
3. Select **System**.
4. Select the **Voice Recog** tab.
5. Select **Phonebook Phonetic Modification**.
6. Select the phone for which you want to modify the voice tag.
7. Select a contact name you want to modify.
 - ▶ The pop-up menu appears on the screen.
8. Select **Modify**.
9. Using **Record** or the  button, follow the prompts to complete the voice tag.
10. You will receive a confirmation message on the screen, then select **OK**.

☒ Phonebook Phonetic Modification

You can only modify or delete contact names for the currently connected phone.

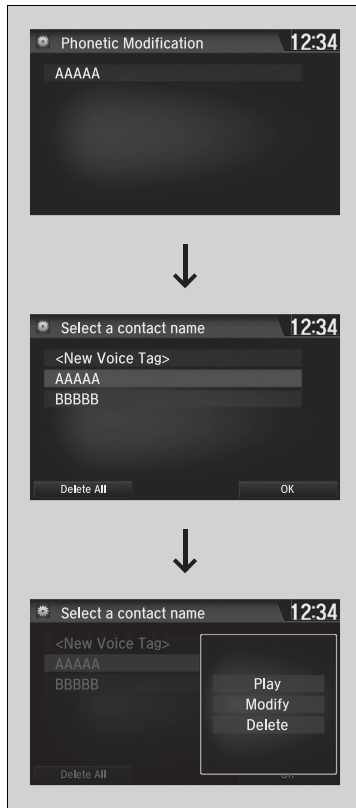

■ **To delete a modified voice tag**

1. Select .
2. Select **Settings**.
3. Select **System**.
4. Select the **Voice Recog** tab.
5. Select **Phonebook Phonetic Modification**.
6. Select the phone from which you want to delete the phonetic modification.
7. Select a contact name you want to delete.
 - ▶ The pop-up menu appears on the screen.
8. Select **Delete**.
 - ▶ The selected contact name has been selected.
9. Select **OK**.

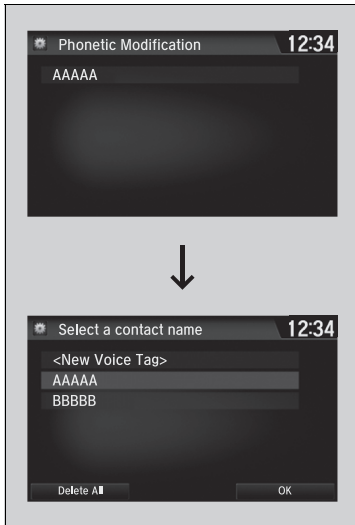

■ To delete all modified voice tags

1. Select .
2. Select **Settings**.
3. Select **System**.
4. Select the **Voice Recog** tab.
5. Select **Phonebook Phonetic Modification**.
6. Select the phone from which you want to delete the phonetic modifications.
 - ▶ The contact name list appears.
7. Select **Delete All**.
8. You will receive a confirmation message on the screen, then select **Yes**.

■ Making a Call

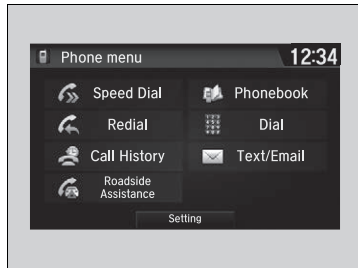

You can make calls by inputting any phone number, or by using the imported phonebook, call history, speed dial entries, or redial.

▶▶ Making a Call

Any voice-tagged speed dial entry can be dialed by voice from most screens.

Press the  button and say the voice tag name.

Once a call is connected, you can hear the voice of the person you are calling through the audio speakers.

While there is an active connection with Apple CarPlay, phone calls cannot be made with HandsFreeLink® and are only made from Apple CarPlay.

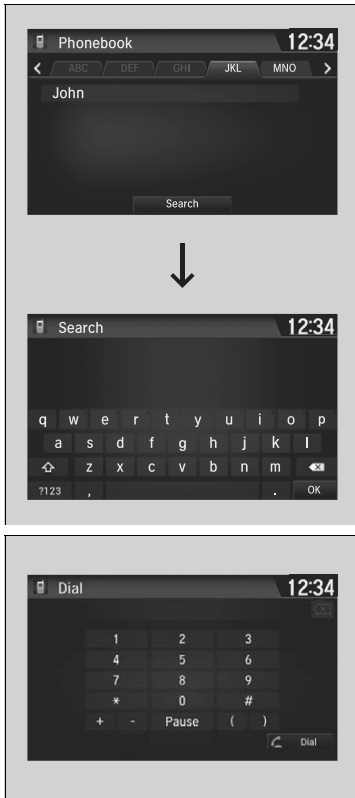

■ **To make a call using the imported phonebook**

1. Go to the **Phone menu** screen.
 ▶ **Phone menu screen** P. 276
2. Select **Phonebook**.
3. Select a name.
 ▶ You can also search by letter. Select **Search**.
 ▶ Use the keyboard on the touch screen for entering a name. If multiple numbers exist, select a number.
4. Select a number.
 ▶ Dialing starts automatically.

■ **To make a call using a phone number**

1. Go to the **Phone menu** screen.
 ▶ **Phone menu screen** P. 276
2. Select **Dial**.
3. Select a number.
 ▶ Use the keyboard on the touch screen for entering numbers.
4. Select  **Dial**.
 ▶ Dialing starts automatically.

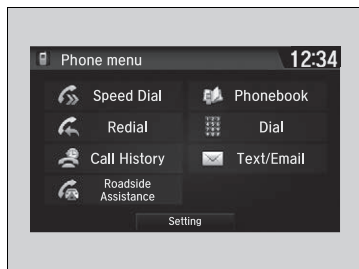

■ **To make a call using redial**

1. Go to the **Phone menu** screen.
 - ▶ **Phone menu screen** P. 276
2. Select **Redial**.
 - ▶ Dialing starts automatically.

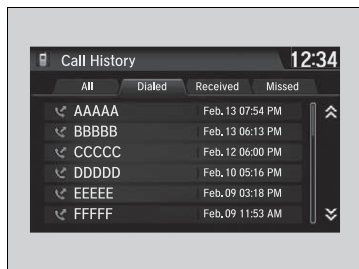

■ **To make a call using the Call History**

Call history is stored by **All**, **Dialed**, **Received**, and **Missed**.

1. Go to the **Phone menu** screen.
 - ▶ **Phone menu screen** P. 276
2. Select **Call History**.
3. Select **All**, **Dialed**, **Received**, or **Missed**.
4. Select a number.
 - ▶ Dialing starts automatically.



■ **Steering switches**

1. Press the button.
2. Move the left selector wheel right to select **Call History**.
3. Roll the left selector wheel to select a number.
4. Push the left selector wheel or the button.
 - ▶ Dialing starts automatically.

▶▶ **To make a call using redial**

Press and hold the button to redial the last number dialed.

▶▶ **To make a call using the Call History**

The call history displays the last 20 all, dialed, received, or missed calls. (Appears only when a phone is connected to the system.)

These icons next to the number indicate the following:

- : Dialed calls.
- : Received calls.
- : Missed calls.

■ **Steering switches**

The call history displays the last 12 dialed, received, or missed calls.

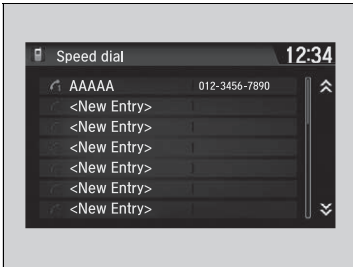

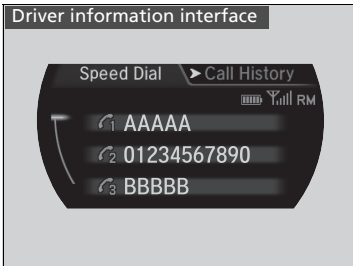

■ To make a call using a Speed Dial entry

1. Go to the **Phone menu** screen.
 - ▶ **Phone menu screen** P. 276
2. Select **Speed Dial**.
3. Select a number.
 - ▶ Dialing starts automatically.



■ Steering switches

1. Press the  button.
2. Move the left selector wheel left to select **Speed Dial**.
3. Roll the left selector wheel to select a number.
4. Push the left selector wheel or the  button.
 - ▶ Dialing starts automatically.

▶ To make a call using a Speed Dial entry

When a voice tag is stored, press the  button to call the number using the voice tag.

- ▶ **Speed Dial** P. 284

Any voice-tagged speed dial entry can be dialed by voice from any screen. Press the  button and follow the prompts.



■ Steering switches

The speed dial displays the 20 speed dial entries.

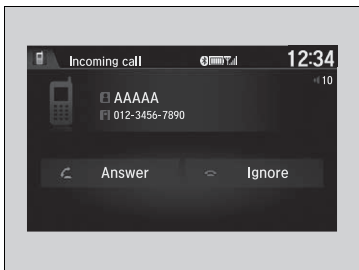
■ Receiving a Call



When there is an incoming call, an audible notification sounds (if activated) and the **Incoming call** screen appears.

Press the  button to answer the call.
 Press the  button to decline or end the call.

■ Options During a Call

The following options are available during a call.

Mute: Mute your voice.

Transfer: Transfer a call from the system to your phone.

Touch Tones: Send numbers during a call. This is useful when you call a menu-driven phone system.

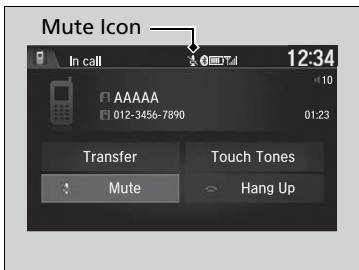

The available options are shown on the lower half of the screen.

Select the option.

- ▶ The mute icon blinks when **Mute** is selected. Select **Mute** again to turn it off.

▶▶ Receiving a Call



Call Waiting

Press the  button to put the current call on hold to answer the incoming call.

Press the  button again to return to the current call.

Select **Ignore** to ignore the incoming call if you do not want to answer it.

Press the  button if you want to hang up the current call.

You can select the icons on the audio/information screen instead of the  and  buttons.

▶▶ Options During a Call

Touch Tones: Available on some phones.

You can select the icons on the audio/information screen.

Receiving a Text/E-mail Message

HFL can display newly received text or e-mail messages as well as 20 of the most recently received messages on a linked cell phone. Each received message can be read aloud and replied to using a fixed common phrase.

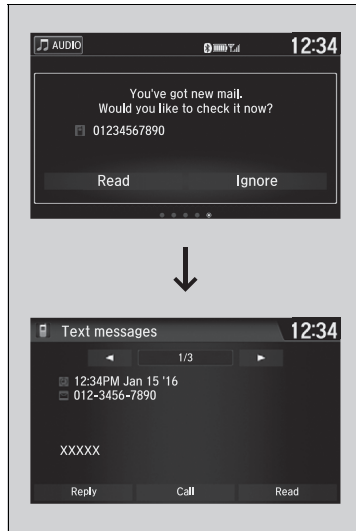

1. A pop-up appears and notifies you of a new text or e-mail message.
2. Select **Read** to listen to the message.
 - ▶ The text or e-mail message is displayed. The system automatically starts reading out the message.
3. To discontinue the message read-out, select **Stop**.

Receiving a Text/E-mail Message

The system does not display any received messages while you are driving. You can only hear them read aloud.

The system can only receive messages that are sent as text (SMS) messages. Messages sent using data services will not be displayed in the list.

With some phones, you may be able to display up to 20 most recent text and e-mail messages.

State or local laws may limit your use of the HFL text /e-mail message feature. Only use the text /e-mail message feature when conditions allow you to do so safely.

When you receive a text or e-mail message for the first time since the phone is paired to HFL, you are asked to turn the **New Message Notification** setting to **On**.

- ▶ **To turn on or off the text/e-mail notice**
P. 281

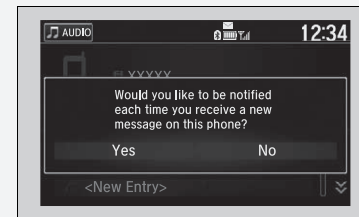

Continued

■ Selecting a Mail Account

If a paired phone has text or mail message accounts, you can select one of them to be active and receive notifications.

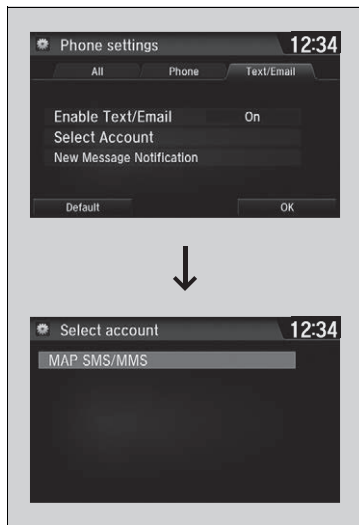

1. Go to the phone settings screen.
▶ **Phone settings screen** P. 273
2. Select the **Text/Email** tab, then **Select Account**.
▶ A pop-up menu appears on the screen.
3. Select **Text Messages** or an e-mail account you want.

▶▶ Selecting a Mail Account

You can also select a mail account from the folder list screen or the message list screen.

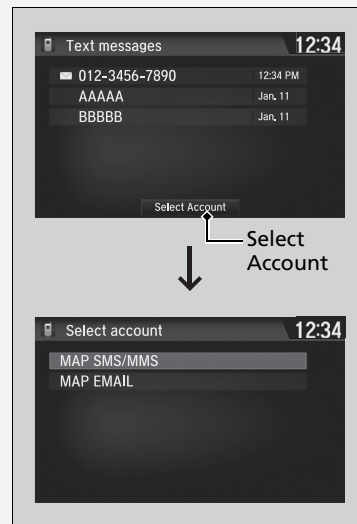

You can only receive notifications from one text or mail message account at a time.

Displaying Messages

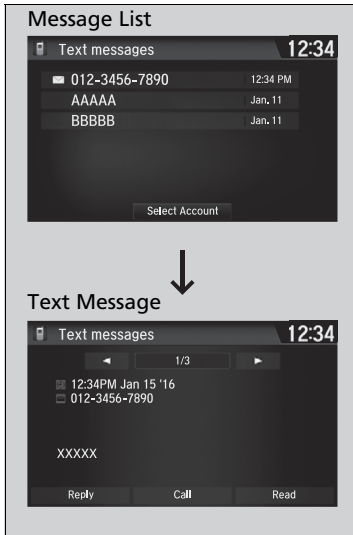

■ Displaying text messages

1. Go to the **Phone menu** screen.
 ▶ **Phone menu screen** P. 276
2. Select **Text/Email**.
 ▶ Select account if necessary.
3. Select a message.
 ▶ The text message is displayed. The system automatically starts reading the message aloud.

☒ Displaying Messages

The ☒ icon appears next to an unread message.

If you delete a message on the phone, the message is also deleted in the system. If you send a message from the system, the message goes to your phone's outbox.

To see the previous or next message, select ◀ (previous) or ▶ (next) on the message screen.

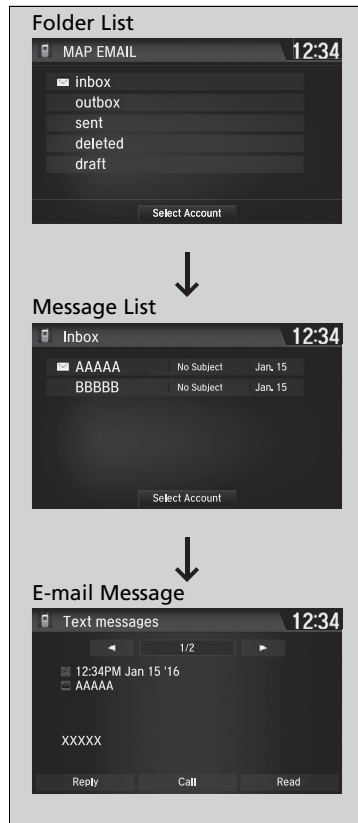

■ Displaying e-mail messages

1. Go to the **Phone menu** screen.
 - ▶ **Phone menu screen** P. 276
2. Select **Text/Email**.
 - ▶ Select **Select Account** if necessary.
3. Select a folder.
 - ▶ Select a message.
4. Select a message.
 - ▶ The e-mail message is displayed. The system automatically starts reading the message aloud.

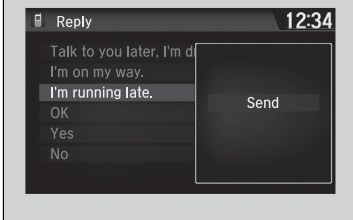
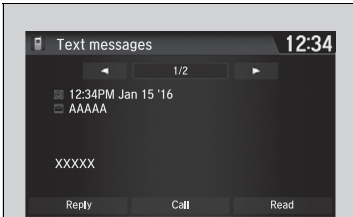
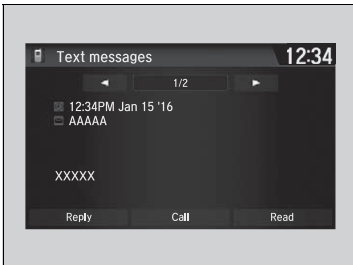

■ Read or Stop reading a message

1. Go to the text or e-mail message screen.
 - ▶ The system automatically starts reading the message aloud.
 - ▣ **Displaying Messages** P. 299
2. Select **Stop** to stop reading. Select **Read** again to start reading the message from the beginning.

■ Reply to a message

1. Go to the text or e-mail message screen.
 - ▶ The system automatically starts reading the message aloud.
 - ▣ **Displaying Messages** P. 299
2. Select **Reply**.
3. Select the reply message.
 - ▶ The pop-up menu appears on the screen.
4. Select **Send** to send the message.
 - ▶ **Complete** appears on the screen when the reply message was successfully sent.

▣ Reply to a message

The available fixed reply messages are as follows:

- **Talk to you later, I'm driving.**
- **I'm on my way.**
- **I'm running late.**
- **OK**
- **Yes**
- **No**

You cannot add, edit, or delete reply messages.

Only certain phones receive and send messages when paired and connected. For a list of compatible phones:

- U.S.: Visit www.acura.com/handsfreelink/, or call 1-888-528-7876.
- Canada: For more information on smartphone compatibility, call 1-888-528-7876.

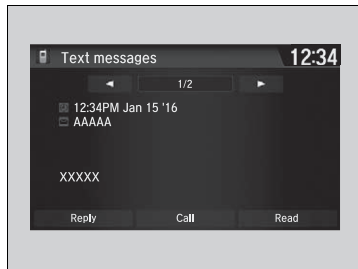

■ **Making a call to a sender**

1. Go to the text message screen.
2. Select **Call**.

Roadside Assistance*

Provides a nationwide service for unexpected incidents. You can call for assistance using a phone paired and connected to *Bluetooth*® HandsFreeLink®.



1. Go to the **Phone menu** screen.
 ▶ **Phone menu screen** P. 276
2. Select **Roadside Assistance**.
3. Select a phone number.
 ▶ Dialing starts automatically.

⌘ Roadside Assistance*

If you are subscribed to a paid AcuraLink package, you can call roadside assistance (1-844-682-2872) using the **LINK** button instead of your phone. If you need to contact Acura Client Relations, call 1-800-382-2238.

▶ **AcuraLink**®* P. 304

* Not available on all models

Is a subscription-based service that provides convenient features such as voice communication in case of an airbag deployment, online security, and one-on-one operator assistance. For information on traffic rerouting and traffic information updates, provided by the AcuraLink server, see the Navigation System Manual.

In Case of a Crash

Automatic collision notification

If your vehicle's airbags deploy or if the unit detects that the vehicle is severely impacted, your vehicle will automatically attempt to connect to the AcuraLink operator. Once connected, information about your vehicle, its positioning, and its condition will be sent to the operator; you also can speak to the operator when connected.

AcuraLink®*

AcuraLink also provides services you can operate from the Internet or your smartphone.

To subscribe to AcuraLink, or to get more information about all of its features, contact an authorized Acura NSX dealer, or visit owners.acura.com (in U.S.) or www.acura.ca (in Canada).

In Case of a Crash

Your vehicle may not be able to connect to the operator if the battery level is low, the line is disconnected or you do not have adequate cellular coverage.

You cannot use the Assist services when:

- You travel outside the AcuraLink service coverage areas.
- There is a problem with the connecting devices, such as the **ASSIST** button, microphone, speakers, or the unit itself.
- You are not subscribed to the service or your subscription is no longer valid.

You cannot operate other navigation- or phone-related functions using the screens while talking to the operator.

Only the operator can terminate the connection to your vehicle.

Automatic collision notification

If the unit fails to connect to the operator, it repeatedly tries until it succeeds.

■ Manual operator connection

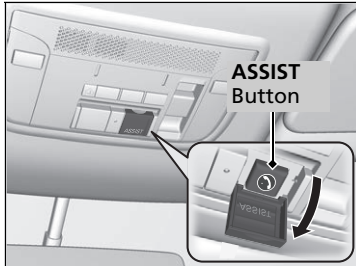

If you need to talk to the AcuraLink operator in a situation where no airbag has deployed, you can manually connect to them by pressing the **ASSIST** button with the power mode in ACCESSORY or ON.

1. Open the cover attached to the ceiling console.
2. Press the **ASSIST** button.
 - ▶ You are connected to the AcuraLink operator.

Manual operator connection

Do not press the button while driving. When you need to contact the operator, park the vehicle in a safe place.

If the unit fails to connect to the operator, it automatically cancels the action after three minutes.

If necessary, the cover can be broken to access the **ASSIST** button.

■ Security Features

Your subscribed telematics service provider can track your vehicle's location, remotely lock or unlock doors, and help you find your vehicle.

To use these features, you need your user ID and personal identification number (PIN).

■ Stolen vehicle tracking

This feature searches and tracks down your vehicle position even if it is on the move. If you believe that your vehicle has been stolen, contact the police as well as the provider. Tracking requests must be initiated by the police.

■ Remote door lock/unlock

The provider can remotely lock or unlock doors upon your request.

■ Vehicle finder

This feature is convenient to use when trying to locate your vehicle in large areas, such as a crowded parking lot. If you cannot locate your vehicle after using the remote transmitter's answerback function, you can contact the provider which can then flash your vehicle's exterior lights and sound the horn.

■ Security alarm notification

If the security system in your vehicle detects an abnormal condition, such as someone tampering with the lock on your vehicle, the provider notifies you by email or SMS.

▣ Security Features

The contact information of your provider, your user ID and PIN will be given when you subscribe to AcuraLink. If you forget any of the above, contact an authorized Acura NSX dealer, or go to owners.acura.com (in U.S.) or www.acura.ca (in Canada).

You can also activate the remote door lock/unlock and vehicle finder features from the Internet or using your smartphone app. Ask an authorized Acura NSX dealer, or visit owners.acura.com (in U.S.) or www.acura.ca (in Canada) for details.

▣ Vehicle finder

The lights will stop flashing and horn will stop sounding under the following conditions:

- When 30 seconds have elapsed.
- You unlock the doors using the remote transmitter.
- You unlock the doors using the keyless access system.
- You unlock the doors using the built-in key.
- The power mode is set to ACCESSORY or ON.

Operator Assistance

Connect to the AcuraLink operator when trying to find a destination or for roadside assistance.

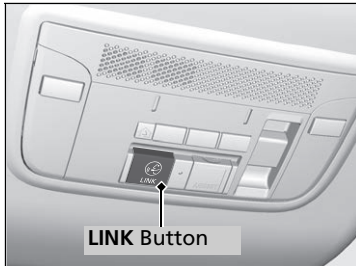

1. Press the **LINK** button.
 - ▶ Connection to the operator begins.
2. Talk to the operator.
 - ▶ To disconnect, select **End Call** on the audio/information screen or press the  button on the steering wheel.

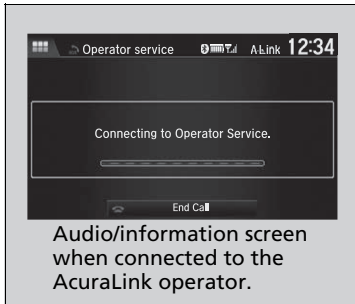

Audio/information screen when connected to the AcuraLink operator.

Operator Assistance

Remain attentive to road conditions and driving during operator assistance.



Driving

This chapter discusses driving and refueling.

Before Driving

Driving Preparation	310
Maximum Load Limit.....	313
High-Performance Driving	315

Towing a Trailer

Towing Your Vehicle	320
---------------------------	-----

When Driving

Turning on the Power	321
Precautions While Driving.....	324
Dual Clutch Transmission	325
Shifting	326
Acoustic Vehicle Alerting System.....	335

Integrated Dynamics System	336
Launch Control	341
Cruise Control	343
Vehicle Stability Assist™ (VSA®), aka Electronic Stability Control (ESC), System	346
Agile Handling Assist	350
SPORT HYBRID Super Handling All-Wheel- Drive™ (SPORT HYBRID SH-AWD®).....	351
Tire Pressure Monitoring System (TPMS).....	352
Tire Pressure Monitoring System (TPMS) - Required Federal Explanation	354
High Voltage Battery.....	356

Braking

Brake System	357
Anti-lock Brake System (ABS).....	362
Brake Assist System	363

Parking Your Vehicle

When Stopped	364
Parking Sensor System *	365

Multi-View Rear Camera.....

Refueling

Fuel Information	371
How to Refuel	372

Fuel Economy and CO₂ Emissions....

Turbo Engine Vehicle

* Not available on all models

Driving Preparation

Check the following items before you start driving.

Exterior Checks

- Make sure there are no obstructions on the windows, door mirrors, exterior lights, or other parts of the vehicle.
 - ▶ Remove any frost, snow, or ice.
 - ▶ Remove any snow on the roof, as this can slip down and obstruct your field of vision while driving. If frozen solid, remove ice once it has softened.
 - ▶ When removing ice from around the wheels, be sure not to damage the wheel or wheel components.
- Make sure the hood is securely closed.
 - ▶ If the hood opens while driving, your front view will be blocked.
- Make sure the tires are in good condition.
 - ▶ Check air pressures, and check for damage and excessive wear.
 - ✦ **Checking and Maintaining Tires** P. 407
- Make sure there are no people or objects behind or around the vehicle.
 - ▶ There are blind spots from the inside.
- Check the front bumper ducts and side intercooler ducts for mud, leaves, and road debris that could build up and prevent proper cooling performance.

Exterior Checks

NOTICE

When doors are frozen shut, use warm water around the door edges to melt any ice. Do not try to force them open, as this can damage the rubber trim around the doors. When done, wipe dry to avoid further freezing.

Do not pour warm water into the key cylinder. You will be unable to insert the key if the water freezes in the hole.

Heat from the engine and exhaust can ignite flammable materials left under the hatch, causing a fire. If you've parked your vehicle for an extended period, inspect and remove any debris that may have collected, such as dried grass and leaves that have fallen or have been carried in for use as a nest by a small animal.

Also check under the hatch for leftover flammable materials after you or someone else has performed maintenance on your vehicle.

Interior Checks

- Store or secure all items on board properly.
 - ▶ Carrying too much cargo, or improperly storing it, can affect your vehicle's handling, stability, stopping distance, and tires, and make it unsafe.
 - ✦ **Maximum Load Limit** P. 313
- Do not pile items higher than the seat height.
 - ▶ They can block your view and may be thrown forward in the event of sudden braking.
- Do not place anything in the seat footwells. Make sure to secure the floor mat.
 - ▶ An object or unsecured floor mat can interfere with your brake and accelerator pedal operation while driving.
- If you have any animals on board, do not let them move around in the vehicle.
 - ▶ They may interfere with driving and a crash could occur.
- Securely close and lock both doors and the hatch.
 - ✦ **Locking/Unlocking the Doors from the Inside** P. 115
- Adjust your seating position properly.
 - ✦ **Adjusting the Seats** P. 144
- Adjust the mirrors and steering wheel properly.
 - ▶ Adjust them while sitting in the proper driving position.
 - ✦ **Adjusting the Mirrors** P. 141
 - ✦ **Adjusting the Steering Wheel** P. 140

Interior Checks

The headlight aim is set by the factory, and does not need to be adjusted. However, if you regularly carry heavy items in the trunk have the aiming readjusted at an authorized Acura NSX dealer or by a qualified technician.

- Be sure items placed on the floor behind the driver's and passenger's seats cannot roll under the seats.
 - ▶ They can interfere with the driver's ability to operate the pedals, the operation of the seats, or the operation of the sensors under the seats.
- Everyone in the vehicle must fasten their seat belt.
 - 📌 **Fastening a Seat Belt** P. 39
- Make sure that the indicators in the instrument panel come on when you start the vehicle, and go off soon after.
 - ▶ Always have an authorized Acura NSX dealer check the vehicle if a problem is indicated.
 - 📌 **Indicators** P. 70

Maximum Load Limit

The maximum load for your vehicle is 507 lbs (230 kg).
 The maximum load for the cargo area is 100 lbs (45 kg).
 See the Tire and Loading Information label attached to the driver's doorjamb.

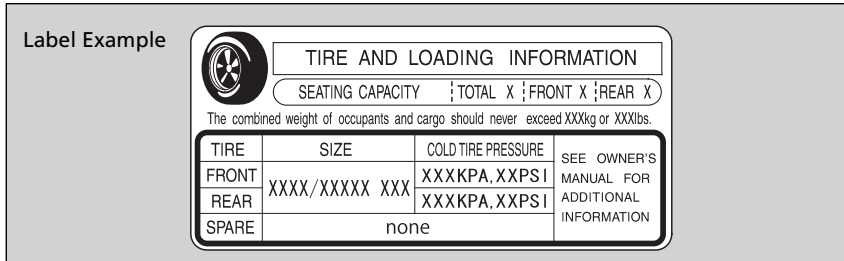

This figure includes the total weight of all occupants, cargo, and accessories, and the tongue load if you are towing a trailer.

Steps for Determining Correct Load Limit -

- (1) Locate the statement "The combined weight of occupants and cargo should never exceed XXX kg or XXX lbs." on your vehicle's placard.
- (2) Determine the combined weight of the driver and passengers that will be riding in your vehicle.
- (3) Subtract the combined weight of the driver and passengers from XXX kg or XXX lbs.
- (4) The resulting figure equals the available amount of cargo and luggage load capacity. For example, if the "XXX" amount equals 1,400 lbs. and there will be five 150 lb. passengers in your vehicle, the amount of available cargo and luggage load capacity is 650 lbs. (1,400 - 750 (5 x 150) = 650 lbs.)

Continued

Maximum Load Limit

⚠ WARNING

Overloading or improper loading can affect handling and stability and cause a crash in which you can be hurt or killed.

Follow all load limits and other loading guidelines in this manual.

Gross Vehicle Weight Rating (GVWR):
 The maximum allowable weight of the vehicle, all occupants, all accessories and all cargo.

➤ Specifications P. 468

Gross Axle Weight Rating (GAWR):
 The maximum allowable weight of the vehicle axle.

➤ Specifications P. 468

- (5) Determine the combined weight of luggage and cargo being loaded on the vehicle. That weight may not safely exceed the available cargo and luggage load capacity calculated in step 4.
- (6) If your vehicle will be towing a trailer, load from your trailer will be transferred to your vehicle. Consult this manual to determine how this reduces the available cargo and luggage load capacity of your vehicle.

In addition, the total weight of the vehicle, all occupants, accessories, cargo, and trailer tongue load must not exceed the Gross Vehicle Weight Rating (GVWR) or the Gross Axle Weight Rating (GAWR). Both are on a label on the driver's doorjamb.







▶▶ Maximum Load Limit

Towing a Trailer:

See Towing a Trailer to determine whether your vehicle is designed to tow a trailer.

▶▶ **Towing a Trailer** P. 320

Load Limits Example

<p>Example 1</p>  <p>Max Load 507 lbs (230 kg)</p>	\geq		<p>+</p>	
		<p>Passenger Weight 150 lbs x 1 + 257 lbs = 407 lbs (68 kg x 1 + 117 kg = 185 kg)</p>		<p>Maximum Cargo Weight 100 lbs (45 kg)</p>
<p>Example 2</p>  <p>Max Load 507 lbs (230 kg)</p>	\geq		<p>+</p>	
		<p>Passenger Weight 150 lbs x 2 + 107 lbs = 407 lbs (68 kg x 2 + 49 kg = 185 kg)</p>		<p>Maximum Cargo Weight 100 lbs (45 kg)</p>

High-Performance Driving

Your Acura NSX is designed, built and equipped with systems and features to provide you with exceptional driving performance, including the ability to engage in high-performance driving. However, due to the risks to both you and other road users, including the risk of injury or death from a high-speed loss of control or crash, if you engage in high-performance driving, Acura recommends you only do so where conditions are controlled, such as at a track or other closed-course venue. When driving on public roads you should always obey the posted speed limits and other traffic laws, reduce speed as needed for traffic and environmental conditions, and not engage in driving behaviors (including, for instance, use of Launch Control) that may create heightened risks for yourself and any other road users who may be present (even if you are unaware of them).

NSX **TRACK** mode, Launch Control and other systems are designed for increased performance, both in terms of acceleration and handling, up to near-performance-limit conditions. They are most appropriately used on closed courses and they should not be used on public roads. Use of these systems may delay the intervention of vehicle safety systems designed to minimize the risk of a loss of traction or steering control, and can cause the NSX to handle differently than you might expect or would experience under normal driving conditions. Use of these systems will not make up for a lack of appropriate driver experience and skill, and will not allow the driver to overcome risks created by:

- A lack of proper vehicle maintenance
- Less than ideal road conditions and/or unfamiliarity with the driving environment
- Other traffic or road users

High-Performance Driving

NOTICE

The NSX warranty does not cover any damage or failure resulting from high-performance driving, racing, competitive driving of any sort whatsoever, or use on a track or similar-type venue. See warranty book for details.

➤ **TRACK Mode** P. 340

➤ **Launch Control** P. 341

High-performance driving requires special skills, knowledge and experience, as the safety risks are greatly increased when the NSX is operated at its upper performance abilities. As a responsible NSX driver, you should not drive above your skill limits or training, even if the NSX's performance levels would otherwise allow you to do so. If you intend to engage in high-performance driving, Acura strongly recommends that:

- You first obtain appropriate, professional training
- Turn off any devices or systems that may distract you from the driving task

High-performance driving in general, and the use of **TRACK** mode and Launch Control in particular, puts very high loads on the NSX and its components, and results in greater wear and tear on the vehicle. Because of these high loads, if your NSX is not in top condition or if certain components, such as the brakes or tires, have undue wear, those components could experience a loss of performance, or fail, when engaging in high-performance driving. Therefore, Acura highly recommends that you undertake more proactive and frequent maintenance than that required under normal use and have your vehicle inspected at an authorized Acura NSX dealer (and all necessary repairs or adjustments made) before you engage in any high-performance driving. In addition to any required maintenance, there are certain NSX specific items and protocols that you should pay special attention to before, during and after engaging in any high-performance driving. Ultimately, the decision whether to engage in high-performance driving is yours, and depending on your NSX's condition and prior usage, the items and protocols listed below may or may not be sufficient to ensure a safe driving experience.

BEFORE DRIVING

- With the vehicle parked on level ground, properly bleed brake system after replacing with Acura Heavy Duty Brake Fluid DOT 4 or equivalent
- Inspect brake pad thickness and replace if 6.0 mm or less

- Burnish the brake pads shortly before high-performance driving so that they have the performance characteristics necessary to repeatedly and quickly slow the NSX when it is being operated at significantly high speeds. (While the NSX's brake pads are properly burnished for the demands expected in ordinary day-to-day driving, high-performance driving puts unique demands on the brake system which require further burnishing.)
- Inspect ALL cooling openings to confirm they are open and free of debris such as leaves, etc. Cooling openings include engine undercover ducts, heat resistance ducts, brake ducts, radiators, and intercoolers
- Remove Tire Repair Kit from the trunk, along with any other cargo area contents
- Check tire wear and tire pressure, and make certain wheel lug bolts are properly torqued, as driving at high speed puts additional strain on tires and wheels. Never use slick tires, and do not use Summer Only tires and Ultra High Performance tires if temperatures will be lower than 45°F (7°C)
- If you anticipate sustained driving at speeds greater than 168 mph/270 km/h, adjust the cold tire pressure as shown on the driver door jamb warning label. This will help avoid heat build-up and sudden tire failure

High-Performance Driving

⚠ WARNING

Use of slick tires/racing slicks may subject the chassis and body components to higher dynamic loads than they were designed for. Higher than intended dynamic loads could result in component failure, loss of control, and serious injury or death to you or others. Do not install slick tires on the NSX.

U.S. models

⚠ WARNING		
If driving at high speeds (over 168mph/270km/h), adjust cold tire pressure as shown below to avoid excess heat buildup and sudden tire failure.		
		2D AAAA
DRIVING SPEED	TIRE	COLD TIRE PRESSURE
OVER	FRONT	260K PA, 38 PSI
168 mph / 270 km/h	REAR	260K PA, 38 PSI

Canadian models

⚠ WARNING		⚠ ATTENTION	
If driving at high speeds (over 168mph/270km/h), adjust cold tire pressure as shown below to avoid excess heat buildup and sudden tire failure.		Pour conduire à grande vitesse (plus de 168 mph / 270 km/h) ajuster la pression des pneus à froid, comme indiqué ci-dessous, afin d'éviter l'accumulation excessive de chaleur et une défaillance soudaine du pneu.	
DRIVING SPEED	TIRE/PNEU	COLD TIRE PRESSURE	
VITESSE DE CONDUITE		PRESSION DES PNEUS À FROID	
OVER/ PLUS DE	FRONT/AVANT	260 KPA, 38 PSI	
168 mph / 270 km/h	REAR/ ARRIERE	260 KPA, 38 PSI	
		2D AAAA	

Continued

- Inspect all exhaust mounts for cracks or signs of wear
- Inspect tailpipe active exhaust valves to ensure they are functioning correctly. You can do this by cycling the Integrated Dynamics System mode switch between **SPORT** and **TRACK** modes, while the engine is idling

WHILE DRIVING

- You may see a brake warning message in the Driver Information Interface (and warning message chime) and/or experience increased brake pedal stroke. If either occurs, immediately slow down and allow for increased stopping distances. The message will disappear once the brakes have cooled and the system has returned to normal operating condition



- After high-performance driving, it is critical to allow your vehicle to properly cool down. Do not immediately stop your vehicle. Instead, continue driving at reduced speeds, allowing for increased braking distances until your vehicle returns to normal operating temperatures. Once you stop and safely park the NSX, open the hatch to aid cooling. If the engine oil temperature reaches the **H** mark during high-performance driving, have your NSX inspected by an authorized Acura NSX dealer

AFTER DRIVING

- Check your NSX, and each of its relevant components, to make sure that it still is in a safe operating condition (example: wheel lug bolt torque, tire pressure, etc.). We recommend repeating the BEFORE DRIVING protocol, and if any item shows excessive wear or appears to be in an unusual condition, have it replaced, or exercise appropriate caution when driving and see your authorized Acura NSX dealer

For more information, please contact your authorized Acura NSX dealer, and/or Acura Client Relations.

📄 **Client Service Information** P. 478

Your vehicle is not designed to tow a trailer. Attempting to do so can void your warranties.

Towing Your Vehicle

Your vehicle is not designed to be towed behind a motor home. If your vehicle needs to be towed in an emergency, refer to the emergency towing information.

➤ **Emergency Towing** P. 462

Turning on the Power

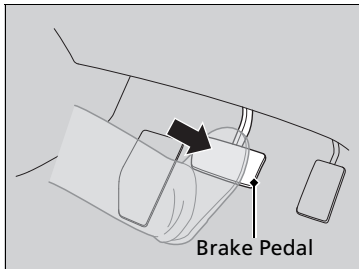

1. Make sure the parking brake is applied.
 - ▶ The electric parking brake indicator comes on for 15 seconds when you pull up the electric parking brake switch.
2. Depress the brake pedal.

Turning on the Power

Keep your foot firmly on the brake pedal when starting the power system.

The engine is harder to start in cold weather and in thinner air found at altitudes above 8,000 feet (2,400 meters).

When turning on the power system in cold weather, turn off all electrical accessories such as the lights, climate control system, and rear defogger in order to reduce 12-volt battery drain.

If the exhaust system sounds abnormal or you can smell exhaust gas inside the vehicle, have your vehicle checked by an authorized Acura NSX dealer. There may be a problem with the engine or exhaust system.

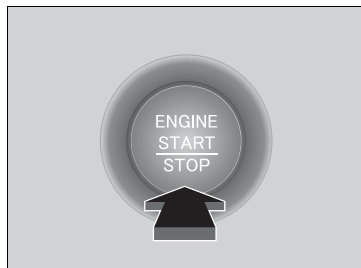

3. Press the **ENGINE START/STOP** button without depressing the accelerator pedal.
 - ▶ The **Ready To Drive** message appears on the driver information interface.
 - ▶ When the ambient temperature is extremely low, the vehicle does not move until certain conditions are met. A warning message appears instead of **Ready To Drive**.
 - ▶ **Driver Information Interface Warning and Information Messages** P. 90

When the Integrated Dynamics System is in QUIET mode

- ▶ If the High Voltage battery is fully charged, the gasoline engine may not start.
- ▶ The gasoline engine starts either according to the temperature of the engine or when the High Voltage battery charge level is low.

When the Integrated Dynamics System is in SPORT mode

- ▶ Regardless of the High Voltage battery charge level, the gasoline engine always starts.
- ▶ Gasoline engine starts with a louder sound than **QUIET** mode. When engine temperature or High Voltage battery temperature are low, or when High Voltage battery charge level is low, gasoline engine starts at the same sound level as **QUIET** mode.

■ Stopping the Power System

You can turn the power system off when the vehicle is completely stopped.

1. Select **P**.
2. Press the **ENGINE START/STOP** button.

▶▶ Turning on the Power

The immobilizer system protects your vehicle from theft. If an improperly coded key (or other device) is used, the power system does not activate.

▶ **Immobilizer System** P. 122

Bring the keyless access remote close to the **ENGINE START/STOP** button if the battery in the keyless access remote is weak.

▶ **If the Keyless Access Remote Battery is Weak** P. 446

The power system may not activate if the keyless access remote is subjected to strong radio waves.

Do not hold the **ENGINE START/STOP** button to start the power system.

If the power system does not start, wait at least 30 seconds before trying again.

You can set the Integrated Dynamics System mode to be selected when you set the power mode to ON.

▶ **Customized Features** P. 244

Starting to Drive

1. Change the gear position to **D/M**. Select **R** when reversing.
2. With the parking brake applied, release the brake pedal and gently depress the accelerator pedal.
 - ▶ Make sure the electric parking brake indicator goes off.
3. Gradually release the brake pedal and gently depress the accelerator pedal to pull away.

Hill Start Assist System

Hill start assist keeps the brake engaged briefly to help prevent the vehicle from rolling on inclines as you move your foot from the brake pedal to the accelerator.

Change to **D/M** when facing uphill, or **R** when facing downhill, then release the brake pedal.

Starting to Drive

You can also release the parking brake by pressing the electric parking brake switch while depressing the brake pedal.

When facing downhill, you can start your vehicle more smoothly by manually releasing it with the electric parking brake switch than by releasing it with the accelerator pedal.

Hill Start Assist System

Hill start assist may not prevent the vehicle from rolling downhill on a very steep or slippery slope, and does not operate on small inclines.

Hill start assist is not a replacement for the parking brake.

Precautions While Driving

In Rain

Avoid driving in deep water and on flooded roads. This can damage the power system or driveline, or cause electrical component failure.

The vehicle is equipped with ultra high performance summer tires that, due to their decreased tread depth, are at greater risk of hydroplaning on wet roads compared to regular tires. Exercise caution when driving on wet surfaces.

In Snow and Ice

The vehicle is equipped with ultra high performance summer tires. These tires are designed for optimum performance and handling in warm climates, and are not suitable for below freezing, snowy or icy weather conditions. If you drive under these circumstances, use of winter tires is recommended and may be mandatory, depending on your region, province or territory.

➤ **Winter Tires** P. 415

➤ **Cold Weather Driving** P. 416

Due to limitations of the Lithium-ion High Voltage battery, the minimum starting temperature for the vehicle is -4°F (-20°C).

Inability to start the vehicle and/or decreased performance is expected if the vehicle is operated at temperatures below -4°F (-20°C).

Precautions While Driving

NOTICE

Do not select a shift button while pressing the accelerator pedal.

NOTICE

The following can damage the under spoiler, under covers, front bumper, rear diffuser, brake cooling components, and side sill:

- Parking the vehicle by a parking block
- Parallel parking along the road shoulder
- Driving toward the bottom of a hill
- Driving up or down to a different surface level (such as a road shoulder)
- Driving on a rutted or bumpy road
- Driving on a road with potholes
- Driving over speed bump

NOTICE

If you repeatedly turn the steering wheel at an extremely low speed, or hold the steering wheel in the full left or right position for a while, the electric power steering (EPS) system heats up. The system goes into a protective mode, and limits its performance. The steering wheel becomes harder and harder to operate. Once the system cools down, the EPS system is restored. Repeated operation under these conditions can eventually damage the system.

If the power mode is set to ACCESSORY while driving, the power system will shut down and all steering and brake power assist functions will stop, making it difficult to control the vehicle.

Driving in snow or icy conditions may accumulate ice on the brake disk surface, reducing braking power.

Other Precautions

If there is a strong impact with something under the vehicle, stop in a safe location. Check the underside of the vehicle for damage or any fluid leaks. If any of these components are damaged or loose, the stability, handling, and powertrain cooling performance of the vehicle may be adversely affected.

Dual Clutch Transmission

Creeping

As with a conventional gasoline-powered vehicle with an automatic transmission, this vehicle will creep. Keep the brake pedal firmly depressed when stopped.

Kickdown

The accelerator pedal features a kickdown switch. Quickly depressing the accelerator pedal while driving may cause the transmission to drop to a lower gear, subsequently increasing vehicle speed. Depress the accelerator pedal carefully, especially when driving uphill, on slippery roads, and curves.

Precautions While Driving

Do not press the **N** button, as you will lose regenerative braking (and acceleration) performance.

Models with iron brake discs

Avoid hard braking for the first 200 miles (300 km). You should also follow this recommendation when the brake pads are replaced.

Dual Clutch Transmission

The DCT will not operate when it is extremely cold. If the vehicle has been parked in extremely cold conditions, after you start the engine, wait until it gets warm. Keep your vehicle parked until the **READY** indicator comes on.

Shifting

Change the gear position in accordance with your driving needs.

■ Shift button positions



P **Park**
Used when parking or before turning the power on or off.
Transmission is locked.

R **Reverse**
Used when reversing

N **Neutral**
Used to keep the transmission disengaged from the engine and motor.

D/M **Drive/Manual**
Each time you press the **D/M** button, the mode switches between D (drive) and M (manual) mode.

Used for:

D (Drive)

- Normal driving (gears change between 1st and 9th automatically)
- Temporarily driving in the sequential mode

M (Manual)

- Driving in the sequential mode

▶▶ Shifting

⚠ WARNING

The vehicle can roll away if left unattended without confirming that Park is engaged.

A vehicle that rolls away could cause a crash resulting in serious injury or death.

Always keep your foot on the brake pedal until you have confirmed that **P** is shown on the gear position indicator.

While the High Voltage battery charge level is full, or the High Voltage battery temperature is low, regenerative braking may become less effective.

To prevent malfunction and unintended engagement:

- Do not spill any liquids on or around shift buttons.
- Do not place or drop any objects on or around shift buttons.
- Do not let passenger or children operate the shift buttons.

You may occasionally find that it takes longer than usual for the vehicle to start moving when you select **R**, release the brake pedal, and/or depress the accelerator pedal. This may occur when the High Voltage battery charge level is extremely low; in this circumstance, it does not indicate a vehicle malfunction.

■ P (park) button

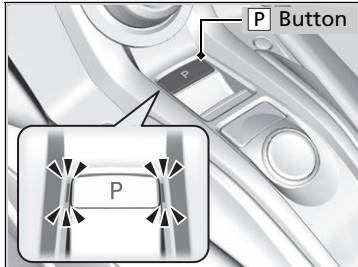

The gear position changes to **P** when you press the **P** button while the vehicle is parked with the power mode in ON. The indicators on the sides of the **P** button come on.

☒ Shifting

The beeper sounds when you depress the accelerator pedal with the gear position in **N** while in EV mode or while gear position changed to **N** without direct shifter selection in any mode.

Change the gear position to **D/M** or **R** with the brake pedal depressed.

When shifting gears in extremely low temperatures (-22°F/-30°C), there may be a short delay before the shift is indicated in the display. Always confirm you are in the correct gear before driving.

Continued

■ Shift Operation

Tachometer's red zone

EV **D** ← Gear Position Indicator

D (Drive) **D1** ← Gear Selection Indicator
 ← Gear Position Indicator

D-Paddle **D1** ← Gear Selection Indicator
 ← Gear Position Indicator

M (Manual) **1** ← Gear Selection Indicator

P Press the **P** button.

R Press back the **R** button.

N Press the **N** button.

D/M Press the **D/M** button.
 Each time you press the **D/M** button, the mode switches between D (drive) and M (manual) mode.

Shift Button Indicator

▶ Shift Operation

NOTICE

Before you change **D/M** to **R** and vice versa, come to a complete stop and keep the brake pedal depressed. Operating the shift button before the vehicle has come to a complete standstill may damage the transmission.

Use the gear position indicator and the shift button indicator to check the gear position before selecting a shift button.

If the indicator of the currently selected gear position, or all gear position indicators, are blinking simultaneously, there is a problem with the transmission. Avoid sudden acceleration and have the transmission checked by an authorized Acura NSX dealer as soon as possible.

The fuel supply may be cut off if you drive at engine speeds in or over the tachometer's red zone (engine speed limit). If this happens, you may experience a slight jolt.

When the engine speed is increased while the transmission is in **N**, **P** or **R**, the fuel supply may be cut off even without the engine speed entering the tachometer's red zone.

The beeper sounds once when you change to **R**.

■ When opening the driver's door

If you open the driver's door under the following conditions, the gear position automatically changes to **P**.

- The vehicle is in stationary with the power mode in ON, or moving at 1 mph (2 km/h) or slower.
- The transmission is in other than **P**.
- You have unfastened the driver side seat belt.
 - ▶ If you manually change the gear position from **P** with the brake pedal depressed, the gear position will automatically return to **P** once you release the brake pedal.

■ When turning off the power mode

If you turn the power system off while the vehicle is stationary, and the transmission is in other than **P**, the gear position automatically changes to **P**.

■ If you want to keep the transmission in **N position (car wash mode)**

With the engine running:

1. Press and hold the brake pedal.
2. Press **N**. Within two seconds press and hold **N** for two seconds.
3. Within five seconds press the **ENGINE START/STOP** button.
 - ▶ This puts the vehicle in car wash mode which must be used when your vehicle is pulled through a conveyor type automatic car wash where you or an attendant do not remain in the vehicle.
 - ▶ The gear position remains in **N** with the power mode in ACCESSORY for 15 minutes, then, it automatically changes to **P** and the power mode changes to OFF.

Manually changing to **P** cancels ACCESSORY mode. The **P** indicator comes on and the power mode changes to OFF.

ⓘ When opening the driver's door

While the system is designed to automatically change the gear position to **P** under the described conditions, in the interest of safety you should always select **P** before opening the driver's door. Make sure to park the vehicle in a safe place.

🔒 When Stopped P. 364

If you want to drive the vehicle after the gear position has automatically changed to **P** under the described conditions, close the door, fasten the seat belt, depress the brake pedal, then change the gear position.

If you leave the vehicle, turn off the power system and lock the doors.

■ Restriction on selecting a gear position

You cannot select a gear position under certain circumstances that may lead to a crash.

When the transmission is in:	1. Under the circumstances of that:	2. You cannot select:	3. The gear position remains in/changes to:	How to change the gear position
P	The brake pedal is not depressed. The accelerator pedal is depressed.	Other gear position	P	Release the accelerator pedal and depress the brake pedal.
N	The vehicle is moving at low speed without the brake pedal depressed. The vehicle is moving at low speed with the accelerator pedal depressed.		N	
N or D/M	The vehicle is moving forward.		R	Park your vehicle in a safe place.
R or N	The vehicle is moving backward.		D/M	
R , N , or D/M	The vehicle is moving.		P	
P or N	The READY indicator is not on.		A gear position other than P or N	P or N
N or D/M	The brake pedal is not depressed.	R	N	Depress the brake pedal.

Sequential Mode

Use the paddle shifters to change between 1st and 9th gears without removing your hands from the steering wheel. The transmission will switch to the sequential mode.

■ When the transmission is in **D** (D-paddle shift mode):

The vehicle will go into the sequential mode momentarily, and the gear selection indicator becomes more prominent.

The sequential mode is automatically canceled and the gear selection indicator returns to ordinary display under the following conditions.

- Hold the **+** paddle shifter for a few seconds.
- Once you start traveling at a constant speed.
- The vehicle comes to a complete stop.
- When you change to another Integrated Dynamics System mode.

The sequential mode automatically shifts under following condition

- Accelerator pedal depressed beyond the click.
- Engine speed reaches near the tachometer's red zone.
- Engine speed reaches idle speed while deceleration.

Sequential Mode



When sequential mode is selected, the gasoline engine powers the vehicle.



■ **When the transmission is in M (Manual) mode:**

The vehicle will go into the sequential mode, and the gear position indicator goes off and only the gear selection indicator is displayed.

You can cancel this mode by pressing the **D/M** button, pulling the **+** paddle shifter for a few seconds or changing Integrated Dynamics System mode to **QUIET**. When the sequential mode is canceled, the display is changed from only the gear selection indicator to both of the gear position indicator and the gear selection indicator.

The transmission automatically shifts up from 1st to 2nd and does not automatically shift up between 2nd and 9th gear.

Transmission Control Mode [Displayed on Instrument Panel] (Y = Yes/N= No)	Auto Mode 	D-Paddle Mode 	Manual Mode 
Activation Method ▶	Initial Startup	Use Shift Paddle While in EV or Auto Mode	Press [D/M] Button
Automatically Upshift	Y	N	N
Automatically Downshift	Y	N	N
Kickdown Shift beyond click	Y	Y	N
Deceleration Downshift	Y	Y	Y
Automatic Upshift at Redline	Y	Y	N

Transmission Control Mode [Displayed on Instrument Panel] (Y = Yes/N= No)		D-Paddle Mode 	Manual Mode 
Activation Method ▶		Use Shift Paddle While in EV or Auto Mode	Press [D/M] Button
To return to Auto Mode	Automatically after cruising	Y	N
	Pull & hold [+] Shift paddle for a few seconds	Y	Y
	Vehicle come to complete stop	Y	N
	Integrated Dynamics System mode change to other mode	Y	Return to Auto mode only when QUIET mode is selected.

■ Sequential Mode Operation

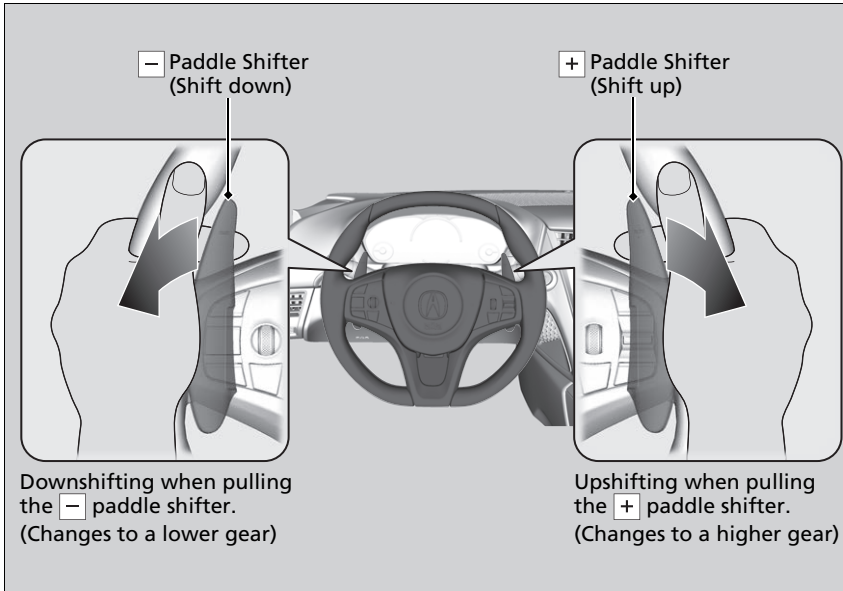

▣ Sequential Mode Operation

Each paddle shift operation makes a single gear change.

To change gears continuously, release the paddle shifter before pulling it again for the next gear.

If the sequential mode gear selection indicator blinks when you try to shift up or down, this means your vehicle speed is not in its allowable gear range. Slightly accelerate to shift up and decelerate to shift down while the indicator is blinking.

In Manual mode, to prioritize the engine performance enhancement, the transmission may not allow for shifting up while the engine speed is low.

Acoustic Vehicle Alerting System

Alerts pedestrians when the vehicle transmission is in a position other than **P** and is traveling at speeds of 22 mph (36 km/h) or less.

Integrated Dynamics System

Constantly controls your vehicle's engine, transmission, High Voltage battery, EPS, dampers, brakes, VSA® and SH-AWD® according to the mode you select. You can choose between four modes, **QUIET** mode, **SPORT** mode, **SPORT+** mode and **TRACK** mode by turning the switch on the center console. Current mode is displayed on the Driver Information Interface, and each mode will appear differently.

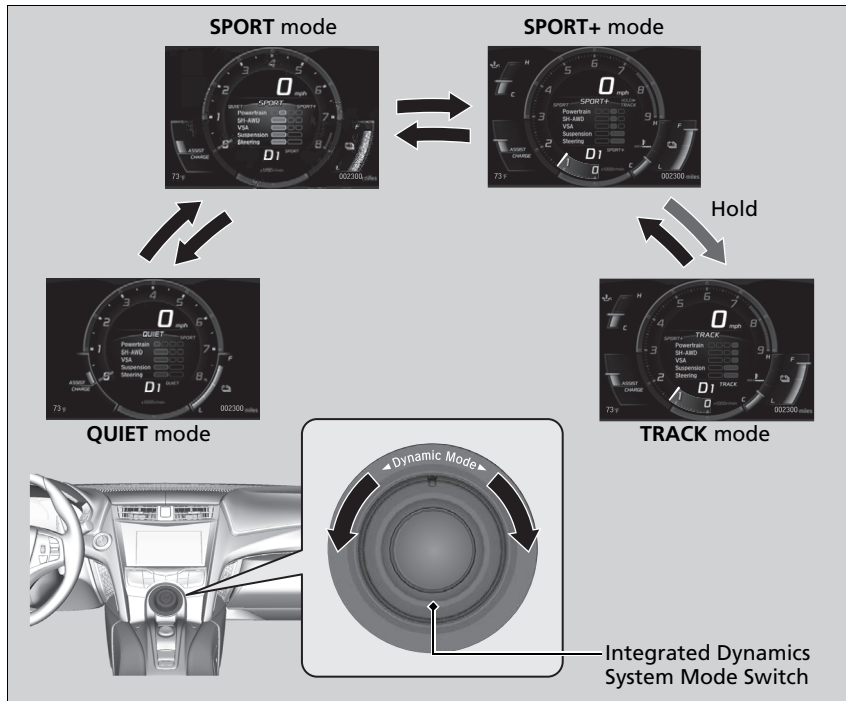

Integrated Dynamics System

You can set the mode to be selected when you set the power mode to ON.

▶ **Customized Features** P. 244

The mode may not be able to be changed under some driving conditions. If mode change is necessary, reduce speed or cornering speed. This message will also be shown if you try to change modes when any vehicle systems have failed.

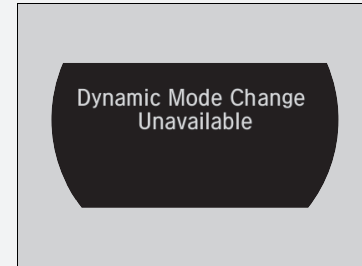

Category		QUIET	SPORT	SPORT+	TRACK
Information Display	Driver Information Interface	Minimized and not intrusive.	Easy to read information for every day driving.	Information for more aggressive driving is added (engine oil temp, SH-AWD® system temp, tachometer position prioritizes high engine speed).	
	Steering	Steering effort is balanced for city and highway use.		Increased steering effort for driver feedback.	
	Suspension Damping	Damping is set for balanced use in every day driving.		Damping is set for higher body control and performance in a performance driving environment.	
Chassis Control	Braking	Feel settings are balanced for operation on all public road environments.			Feel setting is calibrated for high temperature operation on track.
	VSA®	Balanced calibration for VSA® and Traction control in all environments.		Enhanced control for Agile Handling Assist, VSA®, and Traction Control during performance driving.	Track oriented control allowing increased freedom for the driver.

Category	QUIET	SPORT	SPORT+	TRACK
Powertrain Start-up	EV operation is prioritized, starts quietly.	Powerful start-up sound.		
Powertrain Sound	Minimum sound for quiet driving.	Balanced sound for city and highway use.	Emotional sound for increased feedback.	Maximum sound for driving on race track with helmet on.
Hybrid Battery Management	Efficiency and smooth quiet operation are prioritized.	Balanced management for response and efficiency.	Maximum electric assist for acceleration.	Battery charge is managed to give consistent lap time during track use.
Hybrid Battery A/C Cooling	Battery A/C cooling is not used in this mode.	Battery A/C cooling is active however cabin cooling is prioritized.		Battery A/C cooling is active and may compromise cabin cooling.
EV Operation	Available	Available	Not available	Not available
Driving Force Character	Ease of force modulation for comfortable operation.	Balanced tuning of drive force request for all driving scenarios.	Maximum response.	Linear response for ease of cornering line control.
DCT Shift Map/ Response	Comfortable/low engine speed priority.	Balanced tuning for all driving scenarios.	Quick downshifts on request, lower gears are held for maximum response.	Gears are held to maximize performance on track. Shifts are very fast.
SH-AWD®	Quiet and comfortable operation.	Balanced setting for secure every day use in any condition.	Traction and response are prioritized for performance on winding roads.	Settings are optimized for dry surface, high cornering load with neutral handling attitude.

QUIET Mode

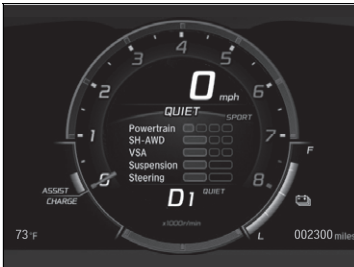

QUIET mode prioritizes quiet and relaxed driving. The powertrain prioritizes EV operation, quiet sound, and low engine speed in all driving situations including start-up.

- The engine speed is limited to 4,000rpm.
- The vehicle speed is limited to approximately 120 mph (193 km/h).

SPORT Mode

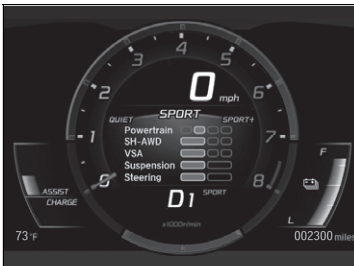

SPORT mode gives the driver an everyday New Sports eXperience. The dynamic systems function to balance sport and touring driving performance.

■ SPORT+ Mode

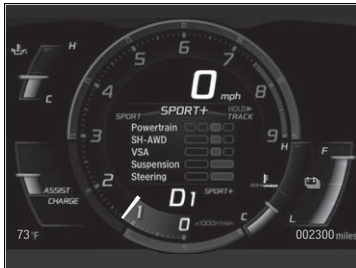

SPORT+ mode optimizes dynamic response from all powertrain and chassis systems - perfect for your favorite winding road.

- EV operation is eliminated while operating in **SPORT+**.

■ TRACK Mode

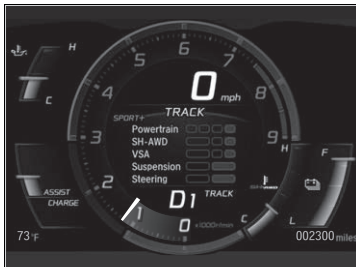

TRACK mode gives maximum, consistent performance from dynamic systems during track day lapping sessions. Hybrid battery charge is maintained for consistent performance.

- VSA® OFF indicator is illuminated in **TRACK** mode indicating reduced stability control. This allows more body side slip and wheel spin before VSA® begins to operate.
- Integrated Dynamics switch must be turned and held to the right for several seconds to engage **TRACK** mode.

▶▶ TRACK Mode

Before choosing the **TRACK** mode, carefully read the information about high performance driving.

▶ **High-Performance Driving** P. 315

During **TRACK** mode, the climate control system may weaken its function to prioritize cooling the High Voltage battery.

Launch Control

Your vehicle controls the engine and transmission response to maximize acceleration from standstill.

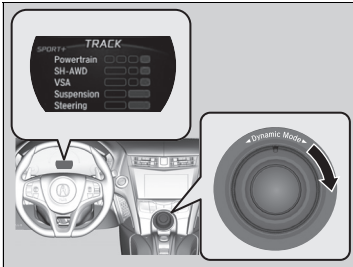

1. Use the Integrated Dynamics System mode switch to set the Integrated Dynamics System mode to **TRACK**.

➤ **Integrated Dynamics System** P. 336

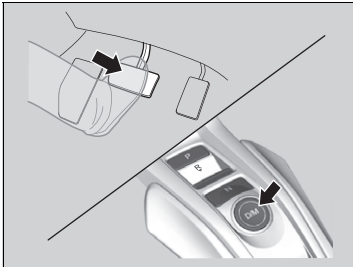

2. Depress the brake pedal firmly and change the gear position to **D/M**.



3. Release the parking brake.

Launch Control

⚠ WARNING

Using this system on public roads that are used by other vehicles and pedestrians can result in a collision involving serious injury or death.

Do not use this system when driving on wet or slippery surfaces as you may lose control of the vehicle.

The system puts a tremendous load on the engine and transmission. Frequent use of this system may lead to reduced vehicle life.

The system does not function when:

- VSA® is off.
- The vehicle is not at standstill.
- The gear position is not in **D/M**.
- A gear other than 1st gear is selected when the system is in manual mode.
- The parking brake is applied.
- The vehicle is facing uphill or downhill on a steep slope.
- The transmission temperature is too cold or too hot.
- There is a problem with a vehicle system.

Continued

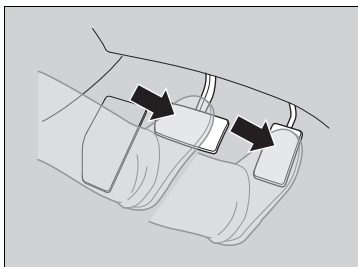

4. While keeping the brake pedal firmly depressed, depress the accelerator pedal all the way, beyond the point when the transmission downshifts.

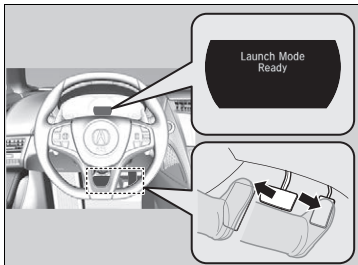

5. When **Launch Mode Ready** is displayed in the driver information interface, release the brake pedal at once.

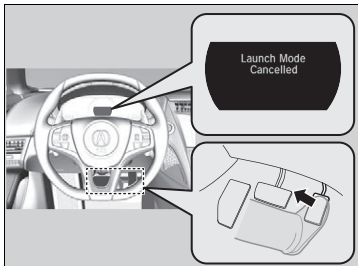

6. To cancel launch mode, take your foot off the accelerator pedal. **Launch Mode Cancelled** is displayed in the driver information interface.

Cruise Control

Maintains a constant vehicle speed without having to keep your foot on the accelerator. Use cruise control on freeways or open roads where you can travel at a constant speed with little acceleration or deceleration.

When to use

- Vehicle speed for cruise control:
Desired speed in a range above roughly 25 mph (40 km/h) ~
- Gear positions for cruise control:
In D (Drive) or M (Manual)
- Integrated Dynamics System modes for cruise control: **QUIET**, **SPORT**, **SPORT+** mode

Always keep sufficient distance between you and the vehicle in front of you.



How to use

- Press the **CRUISE** button on the steering wheel.

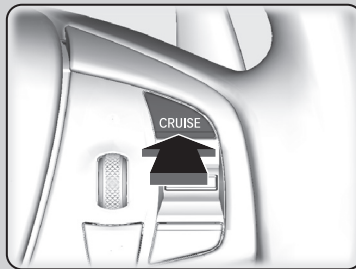

CRUISE MAIN is on in the instrument panel. Cruise control is ready to use.

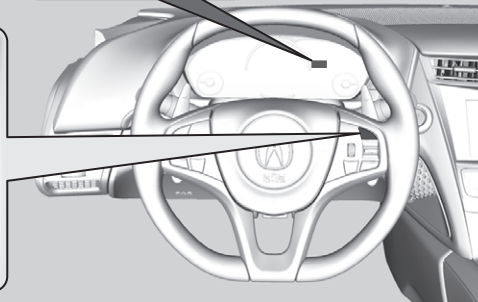

⊗ Cruise Control

⚠ WARNING

Improper use of the cruise control can lead to a crash.

Use cruise control only when traveling on open highways in good weather.

It may not be possible to maintain a constant speed when driving uphill or downhill.

When not using cruise control: Turn off cruise control by pressing the **CRUISE** button.

Continued

■ To Set the Vehicle Speed

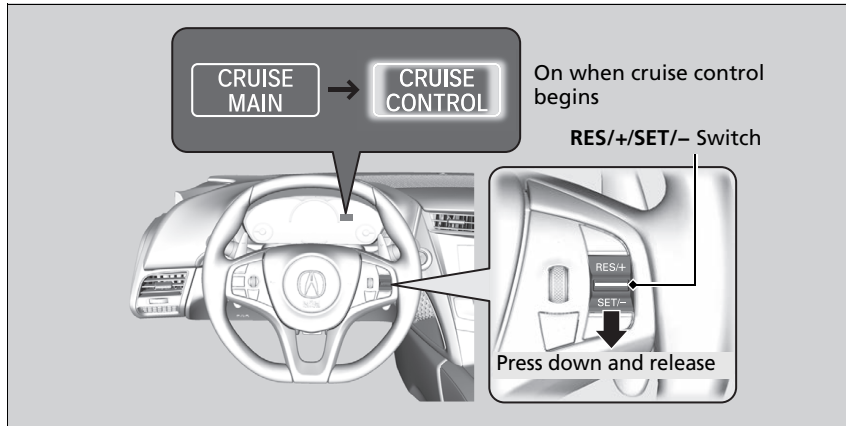

Take your foot off the pedal and press the **RES/+ / SET / -** switch down when you reach the desired speed.

The moment you release the **RES/+ / SET / -** switch, the set speed is fixed, and cruise control begins. The **CRUISE CONTROL** indicator comes on.

■ To Adjust the Vehicle Speed

Increase or decrease the vehicle speed using the **RES/+**/**SET/-** switch on the steering wheel.

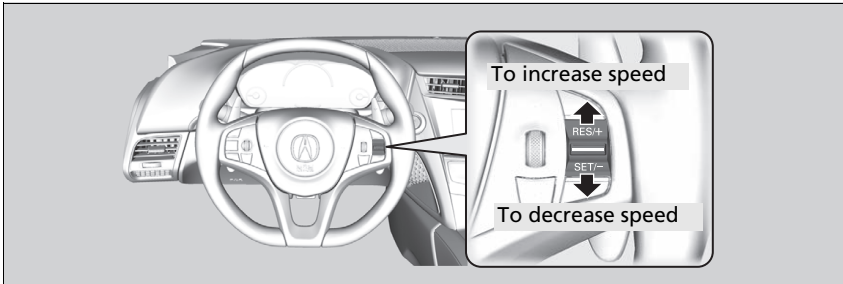

- Each time you press the switch up or down, the vehicle speed is increased or decreased by about 1 mph (1.6 km/h).
- If you keep the switch pressed up or down, the vehicle speed increases or decreases until you release it. This speed is then set.

■ To Cancel

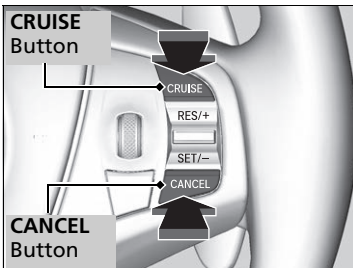

To cancel cruise control, do any of the following:

- Press the **CANCEL** button.
- Press the **CRUISE** button.
- Depress the brake pedal.

The **CRUISE CONTROL** indicator goes off.

☒ To Adjust the Vehicle Speed

You can set the vehicle speed pressing the **RES/+**/**SET/-** switch down on the steering wheel when adjusting the speed with the accelerator and brake pedals.

☒ To Cancel

Resuming the prior set speed:

After cruise control has been canceled, you can still resume the prior set speed by pressing the **RES/+**/**SET/-** switch up while driving at a speed of at least 25 mph (40 km/h) or more.

You cannot set or resume in the following situations:

- When vehicle speed is less than 25 mph (40 km/h)
- When the **CRUISE** button is turned off

At vehicle speeds of 22 mph (35 km/h) or less, cruise control is canceled automatically.

Vehicle Stability Assist™ (VSA®), aka Electronic Stability Control (ESC), System

VSA® helps to stabilize the vehicle during cornering if the vehicle turns more or less than what was intended. It also assists in maintaining traction on slippery surfaces. It does so by regulating engine and motor output and selectively applying the brakes.

■ VSA® Operation

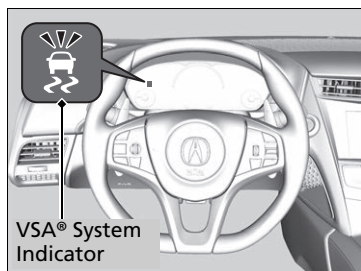

When VSA® activates, you may notice that the engine and motor do not respond to the accelerator. You may also notice some noise from the hydraulic system. You will also see the indicator blink.

▣ Vehicle Stability Assist™ (VSA®), aka Electronic Stability Control (ESC), System

VSA® may not function properly if tire type and size are mixed. Make sure to use the same size and type of tire, and the air pressures as specified.

➤ **Tire and Wheel Replacement** P. 413

When the VSA® system indicator comes on and stays on while driving, there may be a problem with the system. While this may not interfere with normal driving, have your vehicle checked by an authorized Acura NSX dealer immediately.

VSA® cannot enhance stability in all driving situations and does not control the entire braking system. You still need to drive and corner at speeds appropriate for the conditions and always leave a sufficient margin of safety.

The main function of the VSA® system is generally known as Electronic Stability Control (ESC). The system also includes a traction control function.

■ VSA® On and Off

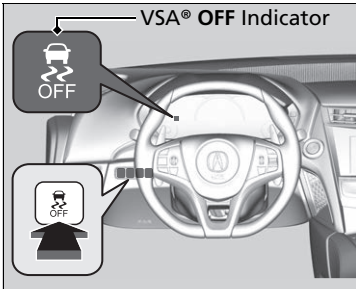

This button is on the driver side control panel. This button is used to change VSA® modes. See below for more information.

VSA® is turned on every time you turn the power system on, even if you press the button the last time you drove the vehicle.

■ When the Integrated Dynamics System mode is in QUIET mode, SPORT mode, or SPORT+ mode



To enter **Stuck Vehicle Assist** mode, press the VSA® OFF button until a single beep is heard and the VSA® OFF indicator illuminates.

▶ This message appears on the driver information interface for a few seconds.

If the Integrated Dynamics System mode is changed, VSA® will remain in **Stuck Vehicle Assist** mode.

To exit **Stuck Vehicle Assist** mode, press the VSA® OFF button until a single beep is heard and the VSA® OFF indicator extinguishes.

▶▶ Vehicle Stability Assist™ (VSA®), aka Electronic Stability Control (ESC), System

In **Stuck Vehicle Assist** mode, your vehicle will have normal braking and cornering ability, but VSA® traction and stability enhancement becomes less effective.

In certain unusual conditions when your vehicle gets stuck in shallow mud or fresh snow, it may be easier to free it with **Stuck Vehicle Assist** mode.

In **Stuck Vehicle Assist** mode, the traction control function becomes less effective. This allows for the wheels to spin more freely at low speed. You should only attempt to free your vehicle with the  button pressed if you are not able to free it without.

Immediately after freeing your vehicle, be sure to press the button again. We do not recommend driving your vehicle with **Stuck Vehicle Assist** mode.

You may hear a motor sound coming from the front of the vehicle while system checks are being performed immediately after turning the power system on or while driving. This is normal.

■ When the Integrated Dynamics System mode is in TRACK mode

When you set the Integrated Dynamics System mode to **TRACK**, the VSA® system switches to **Track** mode and the VSA® **OFF** indicator comes on. The VSA® features do not stop, but the thresholds for them to activate become higher. Additional care should be used while driving in **TRACK** mode, and **TRACK** mode should only be used while driving on closed circuits.



To enter **Stuck Vehicle Assist** mode, press the VSA® OFF button until a single beep is heard.

- ▶ This message appears on the driver information interface for a few seconds.

If the Integrated Dynamics System mode is changed, VSA® will remain in **Stuck Vehicle Assist** mode.



To exit **Stuck Vehicle Assist** mode, press the VSA® OFF button until a single beep is heard.

- ▶ This message appears on the driver information interface.

▶▶ When the Integrated Dynamics System mode is in TRACK mode

In **OFF** mode, your vehicle will have normal braking and cornering ability, but it will not have VSA® traction and stability enhancement.

When the VSA® system is off, the traction control system and agile handling assist system are also off.

We do not recommend driving your vehicle with the VSA®, traction control system, and agile handling assist system switched off.

If the low tire pressure/TPMS indicator comes on or blinks, the VSA® system comes on automatically. In this case, you can select **Stuck Vehicle Assist** mode to free a stuck vehicle, but you cannot select the VSA® **OFF** mode by pressing the  button.



To completely disable VSA®, the VSA® must be in **TRACK** mode (it cannot be in **Stuck Vehicle Assist** mode). Press and hold the VSA® OFF button until you hear a single beep, then later two more beeps.

- ▶ This message appears on the driver information interface.



To resume VSA® full function, press the VSA® OFF button until a single beep is heard. The VSA® will return to **Track** Mode.

- ▶ This message appears on the driver information interface.

If VSA® **OFF** mode is selected, and Integrated Dynamics System is changed to a mode other than **TRACK**, VSA® full function will resume, and the VSA® **OFF** indicator will go off.

Agile Handling Assist

Lightly brakes each of the front and rear wheels, as needed, when you turn the steering wheel, and helps support the vehicle's stability and performance during cornering.

ⓘ Agile Handling Assist

The agile handling assist cannot enhance stability in all driving situations. You still need to drive and corner at speeds appropriate for the conditions and always leave a sufficient margin of safety.

When the VSA® system indicator comes on and stays on while driving, the agile handling assist does not activate.

You may hear a sound coming from the front of the car while the agile handling assist is activated. This is normal.

SPORT HYBRID Super Handling All-Wheel-Drive™ (SPORT HYBRID SH-AWD®)

The system controls and transfers varying amounts of motor and/or engine torque to each wheel in accordance with the driving conditions.

SPORT HYBRID SH-AWD® helps to enhance driving stability, and lets you handle situations like slippery surfaces better than when driving with standard two wheel drive. However, the system does not help to enhance braking. Be cautious about the following:

- It is still your responsibility to drive safely when you steer, accelerate, and apply brakes.
- Leave a sufficient margin when braking on slippery surfaces.

⚠ SPORT HYBRID Super Handling All-Wheel-Drive™ (SPORT HYBRID SH-AWD®)

Do not drive through deep water.

The SPORT HYBRID SH-AWD® system may not function properly if tire type and size are mixed. Make sure to use the same size and type of tire, and the air pressures as specified.

➡ **Tire and Wheel Replacement** P. 413

Tire Pressure Monitoring System (TPMS)

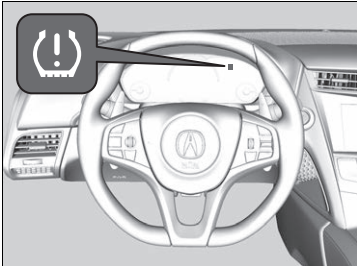

Monitors the tire pressure while you are driving. If your vehicle's tire pressure becomes significantly low, the low tire pressure/TPMS indicator comes on and a message appears on the driver information interface.

▶▶ Tire Pressure Monitoring System (TPMS)

Conditions such as low ambient temperature and altitude change directly affect tire pressure and can trigger the low tire pressure/TPMS indicator to come on.

▶ **If the Low Tire Pressure/TPMS Indicator Comes On or Blinks** P. 455

Tire pressure checked and inflated in:

- Warm weather can become under-inflated in colder weather.
- Cold weather can become over-inflated in warmer weather.

The low tire pressure/TPMS indicator will not come on as a result of over inflation.

■ Tire Pressure Monitor



To select the tire pressure monitor, set the power mode to ON, and roll the right selector wheel until you see the tire pressure screen.

The pressure for each tire is displayed in PSI (U.S.) or kPa (Canada).



Tire Pressures Low is displayed when a tire has significantly low pressure. The specific tire is displayed on the screen.



Tire Pressure Too Low For High Speed Driving is displayed when driving at an extremely high speed and one or more tires are underinflated.

- ▶ Decelerate and drive your vehicle until the message disappears.

▣ Tire Pressure Monitor

The pressure displayed on the driver information interface can be slightly different from the actual pressure as measured by a gauge. If there is a significant difference between the two values, or if the low tire pressure/TPMS indicator and the message on the driver information interface do not go off after you have inflated the tire to the specified pressure, have the system checked by an authorized Acura NSX dealer.

Tire Pressure Monitor Problem may appear on the driver information interface if there is a problem with the TPMS. Please have the system checked by an authorized Acura NSX dealer.

Tire Pressure Monitoring System (TPMS) - Required Federal Explanation

Each tire, including the spare (if provided), should be checked monthly when cold and inflated to the inflation pressure recommended by the vehicle manufacturer on the vehicle placard or tire inflation pressure label.

(If your vehicle has tires of a different size than the size indicated on the vehicle placard or tire inflation pressure label, you should determine the proper tire inflation pressure for those tires.)

As an added safety feature, your vehicle has been equipped with a tire pressure monitoring system (TPMS) that illuminates a low tire pressure telltale



when one or more of your tires is significantly under-inflated.

Accordingly, when the low tire pressure telltale illuminates, you should stop and check your tires as soon as possible, and inflate them to the proper pressure.

Driving on a significantly under-inflated tire causes the tire to overheat and can lead to tire failure. Under-inflation also reduces fuel efficiency and tire tread life, and may affect the vehicle's handling and stopping ability.

Please note that the TPMS is not a substitute for proper tire maintenance, and it is the driver's responsibility to maintain correct tire pressure, even if under-inflation has not reached the level to trigger illumination of the TPMS low tire pressure telltale.

Your vehicle has also been equipped with a TPMS malfunction indicator to indicate when the system is not operating properly. The TPMS malfunction indicator is combined with the low tire pressure telltale. When the system detects a malfunction, the telltale will flash for approximately one minute and then remain continuously illuminated. This sequence will continue upon subsequent vehicle start-ups as long as the malfunction exists.

When the malfunction indicator is illuminated, the system may not be able to detect or signal low tire pressure as intended.

TPMS malfunctions may occur for a variety of reasons, including the installation of replacement or alternate tires or wheels on the vehicle that prevent the TPMS from functioning properly.

Always check the TPMS malfunction telltale after replacing one or more tires or wheels on your vehicle to ensure that the replacement or alternate tires and wheels allow the TPMS to continue to function properly.

High Voltage Battery

The High Voltage battery gradually discharges when the vehicle is not in use. As a result, if your vehicle is parked for an extended period of time, the battery level may get low. Keeping the High Voltage battery's charge level low can shorten its life.

To maintain the High Voltage battery, drive your vehicle for more than 30 minutes to recharge it at least once every three months. Also, try to park in shaded areas instead of direct sunlight.

 **Storage** P. 428

Brake System

■ Parking Brake

Use the parking brake to keep the vehicle stationary when parked. When the parking brake is applied, you can manually or automatically release it.



■ To apply

The electric parking brake can be applied any time the vehicle has battery, no matter which power mode the vehicle is in.

Pull the electric parking brake switch up gently and securely.

- ▶ The parking brake indicator comes on.

■ To release

The power mode must be in the ON position to release the electric parking brake.

1. Depress the brake pedal.
2. Press the electric parking brake switch.

- ▶ The parking brake indicator goes off.

Manually releasing the parking brake using the switch helps your vehicle start slowly and smoothly when facing downhill on steep hills.



⊗ Brake System

When you depress the brake pedal, you may hear a whirring sound from the engine compartment. This is because the brake system is in operation, and it is normal.

⊗ Parking Brake

You may hear the electric parking brake system motor operating from the rear wheel area when you apply or release the parking brake.

You cannot apply or release the parking brake if the 12-volt battery goes dead.

- ▶ **Jump Starting** P. 448

If you pull up and hold the electric parking brake switch while driving, the brakes on all four wheels are applied by the electric servo brake system until the vehicle comes to a stop. The electric parking brake then applies, and the switch should be released.

■ To release automatically

Depressing the accelerator pedal releases the parking brake.

Use the accelerator pedal to release the brake when you are starting the vehicle facing uphill, or in a traffic jam.

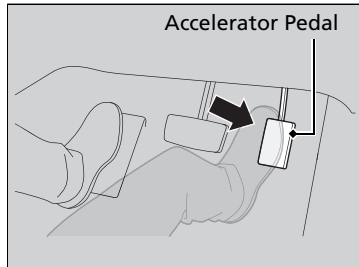

Gently depress the accelerator pedal.

When on a hill, it may require more accelerator input to release.

- The electric parking brake indicator goes off.

You can release the parking brake automatically when:

- You are wearing the driver's seat belt.
- The power system is on.
- The transmission is not in **P** or **N**.

▣ Parking Brake

In the following situations, the parking brake automatically operates.

- When the vehicle stops with the automatic brake hold system activated for more than 10 minutes.
- When the driver's seat belt is unfastened while your vehicle is stopped and brake hold is applied.
- When the power system is turned off while brake hold is applied.
- When there is a problem with the Brake Hold System.

If the parking brake cannot be released automatically, release it manually.

The parking brake cannot be released automatically while the following indicators are on:

- Malfunction indicator lamp
- Transmission system indicator

The parking brake may not be released automatically while the following indicators are on:

- Electric parking brake system indicator
- VSA® system indicator
- **ABS** indicator
- Supplemental restraint system indicator

Foot Brake

Your vehicle is equipped with disc brakes at all four wheels. The brake assist system increases the stopping force when you depress the brake pedal hard in an emergency situation. The anti-lock brake system (ABS) helps you retain steering control when braking very hard.

➤ **Brake Assist System** P. 363

➤ **Anti-lock Brake System (ABS)** P. 362

Models with iron brake discs

■ Brake squeal

To satisfy the performance under a wide range of driving conditions, a high-performance braking system is equipped on your vehicle. You may hear the brake squeal under certain conditions, such as vehicle speed, deceleration, humidity, and so on. This is not a malfunction.

⌘ Foot Brake

Check the brakes after driving through deep water, or if there is a buildup of road surface water. If necessary, dry the brakes by lightly depressing the pedal several times.

Models with iron brake discs

If you hear a continuous metallic friction sound when applying the brakes, this is caused by the brake wear indicator rubbing on the brake rotor and indicates that the brake pads need to be replaced. Have your vehicle checked by an authorized Acura NSX dealer. If you hear only an occasional squeak or squeal when you initially apply the brake pedal, this may be normal and caused by high frequency vibration of the brake pads against the rotating brake disc.

Constantly using the brake pedal while going down a long hill builds up heat, which reduces the brake effectiveness. Apply regenerative braking by taking your foot off the accelerator pedal and downshifting to a lower gear.

Do not rest your foot on the brake pedal while driving, as it will lightly apply the brakes and cause them to lose effectiveness over time and reduce pad life. It will also confuse drivers behind you.

■ Automatic Brake Hold

Keeps the brake applied after releasing the brake pedal until the accelerator pedal is pressed. Use this system only while the vehicle is temporarily stopped, like at traffic lights and in heavy traffic.

► Automatic Brake Hold

⚠ WARNING

Activating the automatic brake hold system on steep hills or slippery roads may still allow the vehicle to move if you remove your foot from the brake pedal.

If a vehicle unexpectedly moves, it may cause a crash resulting in serious injury or death.

Never activate the automatic brake hold system or rely on it to keep a vehicle from moving when stopped on a steep hill or slippery roads.

⚠ WARNING

Using the automatic brake hold system to park the vehicle may result in the vehicle unexpectedly moving.

If a vehicle moves unexpectedly, it may cause a crash, resulting in serious injury or death.

Never leave the vehicle when braking is temporarily kept by automatic brake hold and always park the vehicle by putting the transmission in **P** and applying the parking brake.

■ Turning on the system



Automatic Brake Hold Button



Fasten your seat belt properly, then start the power system. Press the automatic brake hold button.

- The automatic brake hold system indicator comes on. The system is turned on.

■ Activating the system

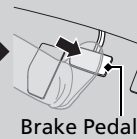

Brake Pedal



Depress the brake pedal to come to a complete stop. The transmission must be in **D/M** or **N**.

- The automatic brake hold indicator comes on. Braking is kept for up to 10 minutes.
- Release the brake pedal after the automatic brake hold indicator comes on.

■ Canceling the system

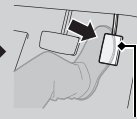

Accelerator Pedal

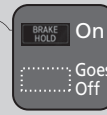

Depress the accelerator pedal while the transmission is in **D/M** or **R**. The system is canceled and the vehicle starts to move.

- The automatic brake hold indicator goes off. The system continues to be on.

■ **The system automatically cancels when:**

- You depress the brake pedal and change to **P** or **R**.
- You engage the parking brake.

Under the following conditions, the system automatically cancels, and the parking brake is applied:

- Braking is kept for more than 10 minutes.
- The driver's seat belt is unfastened.
- The power system is turned off.
- **Brake Hold System Problem** appears on the driver information interface.

■ **Turning off the automatic brake hold system**

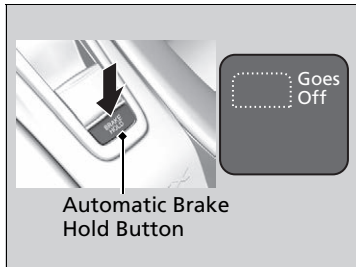

While the system is on, press the automatic brake hold button again.

- ▶ The automatic brake hold system indicator goes off.

If you want to turn off automatic brake hold while the system is in operation, press the automatic brake hold button with the brake pedal depressed.

⌘ Automatic Brake Hold

While the system is activated, you can turn off the power system or park the vehicle through the same procedure as you normally do.

⌘ **When Stopped** P. 364

Whether the system is on, or the system is activated, the automatic brake hold turns off once the power system is off.

Make sure to turn off the automatic brake hold system before using an automated car wash.

You may hear an operating noise if the vehicle moves while the automatic brake hold system is in operation. The system generates sound while holding the vehicle and it moves.

Anti-lock Brake System (ABS)

■ ABS

Helps prevent the wheels from locking up, and helps you retain steering control by pumping the brakes rapidly, much faster than you.

The electronic brake distribution (EBD) system, which is part of the ABS, also balances the front-to-rear braking distribution according to vehicle loading.

You should never pump the brake pedal. Let the ABS work for you by always keeping firm, steady pressure on the brake pedal. This is sometimes referred to as “stomp and steer.”

■ ABS operation

You may hear an operating noise when the ABS is working. Depress the brake pedal and keep holding the pedal firmly down. On dry pavement, you will need to press on the brake pedal very hard before the ABS activates. However, you may feel the ABS activate immediately if you are trying to stop on snow or ice.

ABS may activate when you depress the brake pedal when driving on:

- Wet or snow covered roads.
- Roads paved with stone.
- Roads with uneven surfaces, such as potholes, cracks, manholes, etc.

When the vehicle speed goes under 6 mph (10 km/h), the ABS stops.

ⓘ Anti-lock Brake System (ABS)

NOTICE

The ABS may not function correctly if you use an incorrect tire type and size.

When the **ABS** indicator comes on while driving, there may be a problem with the system. While normal braking is not affected, there is a possibility of the ABS not operating. Have your vehicle checked by an authorized Acura NSX dealer immediately.

The ABS does not reduce the time or distance it takes to stop the vehicle. It only helps with steering control during hard braking.

In the following cases, your vehicle may need more stopping distance than a vehicle without the ABS:

- When driving on rough road surfaces, including when driving on uneven surfaces, such as gravel or snow.
- When tire chains are installed.

The following may be observed with the ABS system:

- Motor sounds coming from the engine compartment when the brakes are applied, or when system checks are being performed after the engine has been started and while vehicle is accelerates.

These sounds are normal to ABS systems and are no cause for concern.

Brake Assist System

■ Brake Assist System

Designed to assist the driver by generating greater braking force when you depress the brake pedal hard during emergency braking.

■ Brake assist system operation

Press the brake pedal firmly for more powerful braking.

When brake assist operates, an operating noise may be heard. This is normal. Keep holding the brake pedal firmly down.

When Stopped

1. Depress the brake pedal firmly.
2. With the brake pedal depressed, pull up the electric parking brake switch slowly, but fully.
3. Change the gear position to **P**.
4. Turn off the power system.
 - ▶ The electric parking brake indicator goes off in about 15 seconds.

Always confirm the electric parking brake is set, in particular if you are parked on an incline.

When the Integrated Dynamics System mode is in QUIET mode or SPORT mode

During Auto Engine Stop, the gear position changes to **P** and the engine restarts automatically under the following conditions:

- You unfasten the driver side seat belt and open the door.

▣ Parking Your Vehicle

WARNING

The vehicle can roll away if left unattended without confirming that Park is engaged.

A vehicle that rolls away could cause a crash resulting in serious injury or death.

Always keep your foot on the brake pedal until you have confirmed that **P** is shown on the gear position indicator.

Do not park your vehicle near flammable objects, such as dry grass, oil, or timber. Heat from the exhaust can cause a fire.

▣ When Stopped

NOTICE

The following can damage the driveline:

- Depressing the accelerator and brake pedals simultaneously.
- Changing to **P** before the vehicle stops completely.

When facing uphill, do not hold the vehicle by depressing the accelerator pedal. Doing so may cause the power system to overheat and fail.

In extremely cold temperatures, the parking brake may freeze up if applied. If such temperatures are expected, do not apply the parking brake. If parking on a slope, either turn the steering wheel so one of the front tires will contact the curb or block the wheels to keep the vehicle from moving. If you do not take either precaution, the vehicle may roll unexpectedly, leading to a crash.

Parking Sensor System*

The corner and center sensors monitor obstacles around your vehicle, and the beeper and audio/information screen let you know the approximate distance between your vehicle and the obstacle.

■ The sensor location and range

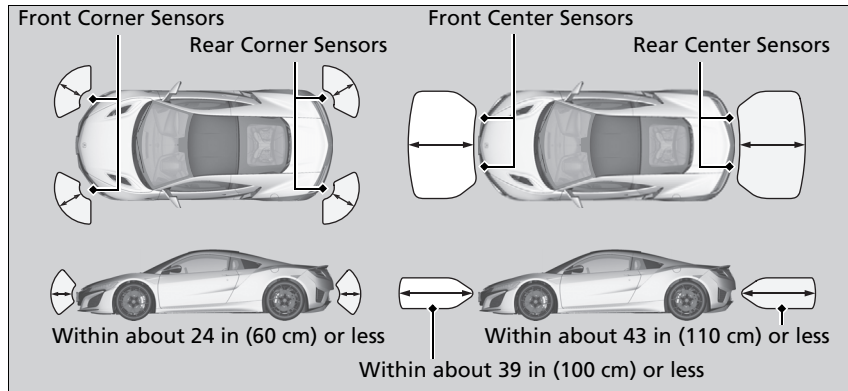

▣ Parking Sensor System*

Even when the system is on, always confirm if there is no obstacle near your vehicle before parking.

The system may not work properly when:

- The sensors are covered with snow, ice, mud or dirt.
- The vehicle is on uneven surface, such as grass, bumps, or a hill.
- The vehicle has been out in hot or cold weather.
- The system is affected by devices that emit ultrasonic waves.
- Driving in bad weather.

The system may not sense:

- Thin or low objects.
- Sonic-absorptive materials, such as snow, cotton, or sponge.
- Objects directly under the bumper.

Do not put any accessories on or around the sensors.

* Not available on all models

■ Parking sensor system on and off

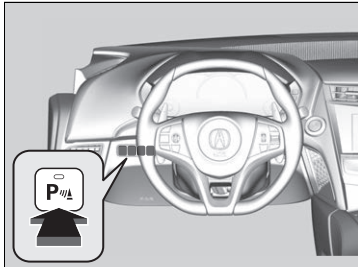

With the power mode in ON, press the parking sensor system button to turn the system on or off. The indicator in the button comes on when the system is on.

The rear center and corner sensors start to detect an obstacle when the transmission is in **R**, and the vehicle speed is less than 5 mph (8 km/h).

The front center and corner sensors start to detect an obstacle when the transmission is not in **P**, and the vehicle speed is less than 5 mph (8 km/h).

■ When the distance between your vehicle and detected obstacles becomes shorter

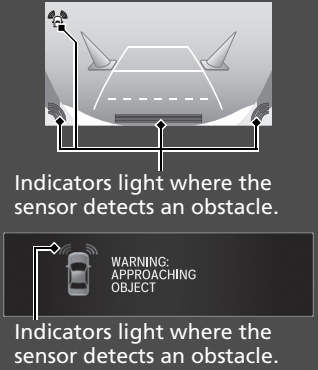
Length of the intermittent beep	Distance between the Bumper and Detected Obstacle		Indicator	Audio/information screen
	Corner Sensors	Center Sensors		
Moderate	—	Front: About 39-24 in (100-60 cm) Rear: About 43-24 in (110-60 cm)	Blinks in Yellow*1	 <p>Indicators light where the sensor detects an obstacle.</p> <p>Indicators light where the sensor detects an obstacle.</p>
Short	About 24-18 in (60-45 cm)	About 24-18 in (60-45 cm)	Blinks in Amber	
Very short	About 18-14 in (45-35 cm)	About 18-14 in (45-35 cm)		
Continuous	About 14 in (35 cm) or less	About 14 in (35 cm) or less	Blinks in Red	

*1: At this stage, only the center sensors detect obstacles.

■ Turning Off All Rear Sensors

1. Make sure that the parking sensor system is not activated. Set the power mode to VEHICLE OFF.
2. Press and hold the parking sensor system button, and set the power mode to ON.
3. Keep pressing the button for ten seconds. Release the button when the indicator in the button blinks.
4. Press the button again. The indicator in the button goes off.
 - ▶ The beeper sounds twice. The rear sensors are now turned off.

To turn the rear sensors on again, follow the above procedure. The beeper sounds three times when the rear sensors come back on.

⌘ Turning Off All Rear Sensors

When you select [R], the indicator in the parking sensor system button blinks as a reminder that the rear sensors have been turned off.

About Your Multi-View Rear Camera

The audio/information screen can display your vehicle's rear view. The display automatically changes to the rear view when the gear position is changed to **R**.

Multi-View Rear Camera Display Area

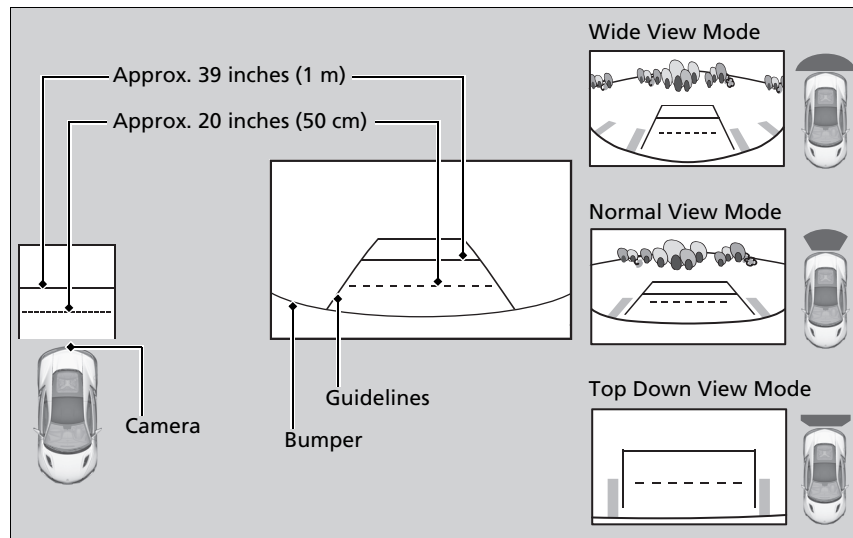

About Your Multi-View Rear Camera

The rear camera view is restricted. You cannot see the corner ends of the bumper or what is underneath the bumper. Its unique lens also makes objects appear closer or farther than they actually are.

Visually confirm that it is safe to drive before backing up. Certain conditions (such as weather, lighting, and high temperatures) may also restrict the rear view. Do not rely on the rearview display which does not give you all information about conditions at the back of your vehicle.

If the camera lens is covered with dirt or moisture, use a soft, moist cloth to keep the lens clean and free of debris.

You can change the **Fixed Guideline** and **Dynamic Guideline** settings.

➤ **Customized Features** P. 244

Fixed Guideline

On: Guidelines appear when you select **R**.

Off: Guidelines do not appear.

Dynamic Guideline

On: Guidelines move according to the steering wheel direction.

Off: Guidelines do not move.

You can view three different camera modes on the rearview display. Touch the appropriate icon to switch the mode.

: Wide view mode

: Normal view mode

: Top down view mode

- If the last used viewing mode was Wide or Normal view mode, the same mode is selected the next time you put the transmission into **R**.
- If Top down view mode was last used before you turned off the power system, Wide view mode is selected next time you turn the power system on and put the transmission into **R**.
- If Top down view mode was last used more than 10 seconds after you change from **R**, Wide view mode is selected the next time you put the transmission into **R**.

Fuel Information

■ Fuel requirement

Unleaded premium gasoline, pump octane number 91 or higher

Use of lower octane gasoline can cause occasional metallic knocking noise in the engine and will result in decreased engine performance.

We recommend that you use a pump octane of 93 or higher to maximize the performance of the engine.

Use of gasoline with a pump octane less than 91 can lead to engine damage.

■ Top tier detergent gasoline

Because the level of detergency and additives in gasoline vary in the market, Acura endorses the use of "TOP TIER Detergent Gasoline" where available to help maintain the performance and reliability of your vehicle. TOP TIER Detergent Gasoline meets a new gasoline standard jointly established by leading automotive manufacturers to meet the needs of today's advanced engines.

Qualifying gasoline retailers will, in most cases, identify their gasoline as having met "TOP TIER Detergent Gasoline" standards at the retail location. This fuel is guaranteed to contain the proper level of detergent additives and be free of metallic additives. The proper level of detergent additives, and absence of harmful metallic additives in gasoline, help avoid build-up of deposits in your engine and emission control system.

For further important fuel-related information for your vehicle, or on information on gasoline that does not contain MMT, visit Acura Owners at owners.acura.com. In Canada, visit www.acura.ca for additional information on gasoline. For more information on top tier gasoline, visit www.toptiergas.com.

■ Fuel tank capacity: 15.6 US gal (59.0 liters)

⌘ Fuel Information

NOTICE

We recommend quality gasoline containing detergent additives that help prevent fuel system and engine deposits. In addition, in order to maintain good performance, fuel economy, and emissions control, we strongly recommend the use of gasoline that does NOT contain harmful manganese-based fuel additives such as MMT, if such gasoline is available.

Use of gasoline with these additives may adversely affect performance, and cause the malfunction indicator lamp on your instrument panel to come on. If this happens, contact an authorized Acura NSX dealer for service.

Some gasoline today is blended with oxygenates such as ethanol. Your vehicle is designed to operate on oxygenated gasoline containing up to 15% ethanol by volume. Do not use gasoline containing methanol. If you notice any undesirable operating symptoms, try another service station or switch to another brand of gasoline.

How to Refuel

Your fuel tank is not equipped with a fuel fill cap. You can insert the filler nozzle directly into the filler neck. The tank seals itself again when you pull out the filler nozzle.

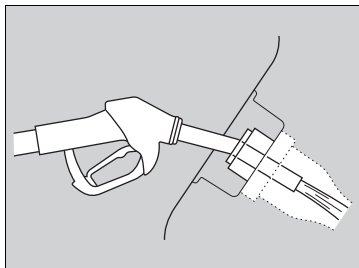
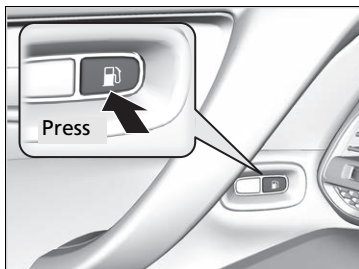

1. Stop your vehicle with the service station pump on the left side of the vehicle in the rear.
 - ▶ The fuel fill door opens.
2. Turn off the power system.
3. Press the fuel fill door release button.
 - ▶ The fuel fill door opens.
4. Place the end of the filler nozzle on the lower part of filler opening, then insert it slowly and fully.
 - ▶ Make sure that the end of the filler nozzle goes down along with the filler pipe.
 - ▶ Keep the filler nozzle level.
 - ▶ When the tank is full, the filler nozzle will click off automatically.
 - ▶ After filling, wait about five seconds before removing the filler nozzle.
5. Shut the fuel fill door by hand.

How to Refuel

⚠ WARNING

Gasoline is highly flammable and explosive. You can be burned or seriously injured when handling fuel.

- Turn the power system off, and keep heat, sparks, and flame away.
- Handle fuel only outdoors.
- Wipe up spills immediately.

The fuel filler opening is designed to accept only service station filler nozzles for refueling. Use of smaller diameter tubes (e.g., to siphon fuel for other uses) or other non-service station devices can damage the area in and around the filler opening.

The filler nozzle automatically stops to leave space in the fuel tank so that fuel does not overflow as a result of changes in air temperature.

Do not continue to add fuel after the nozzle has automatically stopped. Additional fuel can exceed the full tank capacity.

If the fuel nozzle keeps turning off when the tank is not full, there may be a problem with the pump's fuel vapor recovery system. Try filling at another pump. If this does not fix the problem, consult an authorized Acura NSX dealer.

If you have to refuel your vehicle from a portable container, use the funnel provided with your vehicle.

▶ **Refueling from a Portable Fuel Container** P. 465

Improving Fuel Economy and Reducing CO₂ Emissions

Achieving fuel economy and reducing CO₂ emissions is dependent on several factors, including driving conditions, load weight, idling time, driving habits, and vehicle condition. Depending on these and other factors, you may not achieve the rated fuel economy of this vehicle.

Maintenance and Fuel Economy

You can optimize your fuel economy with proper maintenance of your vehicle. Always maintain your vehicle in accordance with the messages displayed on the driver information interface.

- Use the recommended viscosity engine oil.
- Maintain the specified tire pressure.
- Do not load the vehicle with excess cargo.
- Keep your vehicle clean. A buildup of snow or mud on your vehicle's underside adds weight and increases wind resistance.

Improving Fuel Economy and Reducing CO₂ Emissions

Direct calculation is the recommended method to determine actual fuel consumed while driving.



In Canada, posted fuel economy numbers are established following a simulated test. For more information on how this test is performed, please visit <http://oee.nrcan.gc.ca/>

Handling Precautions

The turbocharger is a high-precision device designed to obtain greater horsepower by delivering a large volume of compressed air into the engine using a turbine driven by the engine's exhaust gas pressure.

- **When the engine is cold just after starting, avoid hard or sudden acceleration.**
- **Always replace the engine oil and engine oil filter according to the Maintenance Minder™.**

The turbine rotates at very high speeds over 100,000 rpm and its temperature reaches over 1,292°F (700°C). It is lubricated and cooled by engine oil.

If you fail to replace the engine oil and filter at the scheduled distance or interval, deteriorated engine oil may cause failure such as sticking and abnormal noise of the turbine bearing.

☞ Turbo Engine Vehicle

The scheduled maintenance intervals for replacing the engine oil and filter is indicated on the Maintenance Minder™. Follow the information of when to replace them.

☞ **Maintenance Minder™** P. 379

☞ **Recommended Engine Oil** P. 390

The temperature gauge needle is at the **H** mark when you restart the engine after driving under high load conditions such as at high speed or in hilly terrain. This is normal. The gauge needle goes down after you idle or drive the vehicle for about one minute.

Maintenance

This chapter discusses basic maintenance.



Before Performing Maintenance		
Inspection and Maintenance	376	
Safety When Performing Maintenance	377	
Parts and Fluids Used in Maintenance		
Service	378	
Maintenance Minder™	379	
Maintenance Under the Hood and Hatch		
Maintenance Items Under the Hood and		
Hatch	385	
Opening the Hatch	387	
Opening the Hood	388	
Engine Compartment Cover	389	
Recommended Engine Oil	390	
Oil Check	391	
Adding Engine Oil	394	
Cooling System	396	
Inverter Coolant	398	
Transmission Fluids	399	
Brake Fluid	400	
Refilling Window Washer Fluid	400	
Replacing Light Bulbs	401	
Checking and Maintaining Wiper Blades	404	
Checking and Maintaining Tires		
Checking Tires	407	
Tire and Loading Information Label	408	
Tire Labeling	408	
DOT Tire Quality Grading (U.S. Vehicles)	410	
Wear Indicators	412	
Tire Service Life	412	
Tire and Wheel Replacement	413	
Tire Rotation	414	
Winter Tires	415	
Cold Weather Driving	416	
12-Volt Battery	417	
Remote Transmitter Care		
Replacing the Button Battery	418	
Climate Control System Maintenance	419	
Cleaning		
Interior Care	420	
Exterior Care	422	
Accessories and Modifications		
Accessories	426	
Modifications	427	
Storage	428	

Inspection and Maintenance

For your safety, perform all listed inspections and maintenance to keep your vehicle in good condition. If you become aware of any abnormality (noise, smell, insufficient brake fluid, oil residue on the ground, etc.), have your vehicle inspected by an authorized Acura NSX dealer. (Note, however, that service at an authorized Acura NSX dealer is not mandatory to keep your warranties in effect.) Refer to the separate maintenance booklet for detailed maintenance and inspection information.

Types of Inspection and Maintenance

■ Daily inspections

Perform inspections before long distance trips, when washing the vehicle, or when refueling.

■ Periodic inspections

- Check the brake fluid level monthly.
 - **Brake Fluid** P. 400
- Check the tire pressure monthly. Examine the tread for wear and foreign objects.
 - **Checking and Maintaining Tires** P. 407
- Check the operation of the exterior lights monthly.
 - **Replacing Light Bulbs** P. 401
- Check the condition of the wiper blades at least every six months.
 - **Checking and Maintaining Wiper Blades** P. 404

Inspection and Maintenance

U.S. models

Maintenance, replacement, or repair of emissions control devices and systems may be done by any automotive repair establishment or individuals using parts that are "certified" to EPA standards.

According to state and federal regulations, failure to perform maintenance on the maintenance main items marked with # will not void your emissions warranties. However, all maintenance services should be performed in accordance with the intervals indicated by the driver information interface.

➤ **Maintenance Service Items** P. 382

If you want to perform complex maintenance tasks that require more skills and tools, you can purchase a subscription to the Service Express website at www.techinfo.honda.com.

➤ **Authorized Manuals** P. 477

If you want to perform maintenance yourself, make sure that you have the necessary tools and skills first. After performing maintenance, update the records in the separate maintenance booklet.

Safety When Performing Maintenance

Some of the most important safety precautions are given here. However, we cannot warn you of every conceivable hazard that can arise in performing maintenance. Only you can decide whether you should perform a given task.

Maintenance Safety

- To reduce the possibility of fire or explosion, keep cigarettes, sparks, and flames away from the 12-volt battery, all High Voltage system, and all fuel related parts.
- Never leave rags, towels, or other flammable objects under the hood and hatch.
 - ▶ Heat from the engine and exhaust can ignite them, causing a fire.
- To clean parts, use a commercially available degreaser or parts cleaner, not gasoline.
- Wear eye protection and protective clothing when working with the 12-volt battery or compressed air.
- Engine exhaust contains carbon monoxide, which is poisonous and can kill you.
 - ▶ Only operate the engine if there is sufficient ventilation.

Vehicle Safety

- The vehicle must be in a stationary condition.
 - ▶ Make sure your vehicle is parked on level ground, the parking brake is set, and the power system is turned off.
- Be aware that hot parts can burn you.
 - ▶ Make sure to let the power system, including the engine and exhaust system, cool thoroughly before touching vehicle parts.
- Be aware that moving parts can injure you.
 - ▶ Do not activate the power system unless instructed, and keep your hands and limbs away from moving parts. When the power system is on, the engine can automatically start, or the radiator fan may start operating without the engine running.

⚠ Safety When Performing Maintenance

⚠ WARNING

Improperly maintaining this vehicle or failing to correct a problem before driving can cause a crash in which you can be seriously hurt or killed.

Always follow the inspection and maintenance recommendations according to the schedules in this owner's manual.

⚠ WARNING

Failure to properly follow maintenance instructions and precautions can cause you to be seriously hurt or killed.

Always follow the procedures and precautions in this owner's manual.

Parts and Fluids Used in Maintenance Service

The use of Acura genuine parts and fluids is recommended when maintaining and servicing your vehicle. Acura genuine parts are manufactured according to the same high quality standards used in Acura vehicles.

Select the Maintenance Minder to see maintenance items that are due soon and to see the percentage of life remaining in the engine oil.

When the engine oil life is less than 15%, a Maintenance Minder message will appear every time you set the power mode to ON, reminding you to bring your vehicle to an authorized Acura NSX dealer for service.

To Use Maintenance Minder™

■ Displaying the Engine Oil Life and Maintenance Items

Certain maintenance items due soon, along with the estimated remaining oil life, appear on the driver information interface.

You can view them on the Maintenance Minder screen at any time.

1. Set the power mode to ON.
2. Roll the right selector wheel until the engine oil life appears on the driver information interface.

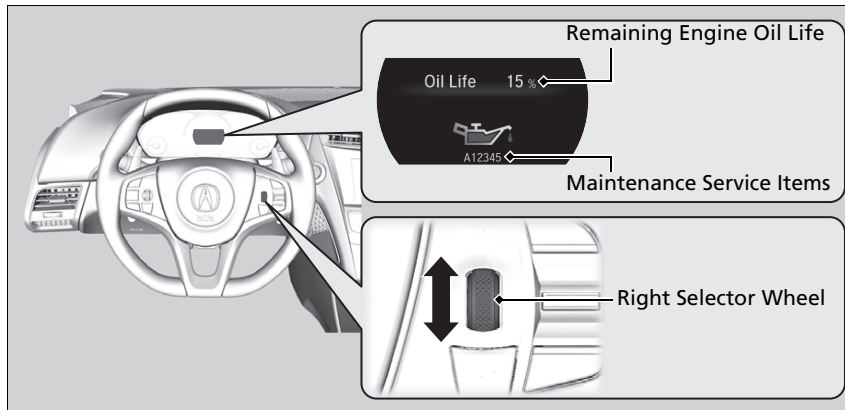

►► Displaying the Engine Oil Life and Maintenance Items



Based on the engine operating conditions and oil age, the remaining engine oil life is calculated and displayed as a percentage.

Displayed Engine Oil Life (%)	Calculated Engine Oil Life (%)
100	100 to 91
90	90 to 81
80	80 to 71
70	70 to 61
60	60 to 51
50	50 to 41
40	40 to 31
30	30 to 21
20	20 to 16
15	15 to 11
10	10 to 6
5	5 to 1
0	0

There is a list of maintenance main and sub items you can view on the driver information interface.

► **Maintenance Service Items** P. 382

Maintenance Minder Messages on the Driver Information Interface

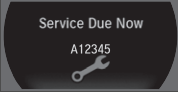
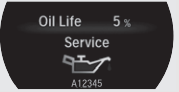
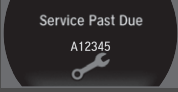
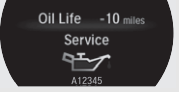
Maintenance Message	Oil Life Display	Explanation	Information
<p>Service Due Soon</p> 	<p>15 %</p> 	<p>The engine oil life indicator starts to appear along with other due-soon maintenance item codes when the remaining oil life drops to 15 percent. Once you switch the display by rolling the right selector wheel, this message will go off.</p>	<p>The engine oil is approaching the end of its service life.</p>
<p>Service Due Now</p> 	<p>5 %</p> 	<p>The remaining engine oil life is 5 to 1 percent. Roll the right selector wheel to switch to another display.</p>	<p>The engine oil has almost reached the end of its service life, and the maintenance items should be inspected and serviced as soon as possible.</p>
<p>Service Past Due</p> 	<p>Negative Distance</p> 	<p>The engine oil life has passed its service life, and a negative distance appears after driving over 10 miles (U.S. models) or 10 km (Canadian models). Roll the right selector wheel to switch to another display.</p>	<p>The engine oil life has passed. The maintenance items must be inspected and serviced immediately.</p>

The system message indicator (ⓘ) comes on along with the Maintenance Minder message.

Maintenance Service Items

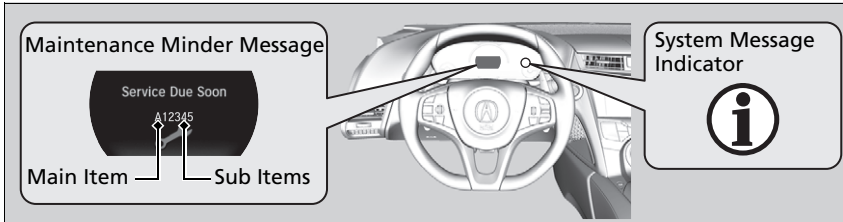

Maintenance Service Items

- Independent of the Maintenance Minder information, replace the brake fluid every 3 years.
- Adjust the valves during services A, B, 1, 2, or 3 if they are noisy.
- Inspect direct injection + port injection fuel system every 3 years or service item B is indicated.
- Inspect tire condition every 3,100 miles (5,000 km).

CODE	Maintenance Main Items
A	<ul style="list-style-type: none"> • Replace engine oil*1
B	<ul style="list-style-type: none"> • Replace engine oil*1 and oil filter • Inspect front and rear brakes • Check expiration date for temporary tire repair kit bottle • Inspect tie rod ends, steering gearbox, and boots • Inspect suspension components • Inspect driveshaft boots • Inspect brake hoses and lines (Including ABS/VSA®) • Inspect all fluid levels and condition of fluids • Inspect exhaust system# • Inspect fuel lines and connections# • Inspect direct injection + port injection fuel system

CODE	Maintenance Sub Items
1	<ul style="list-style-type: none"> • Inspect tire condition
2	<ul style="list-style-type: none"> • Replace air cleaner element*2 • Replace dust and pollen filters*3
3	<ul style="list-style-type: none"> • Replace transmission fluid*4 • Replace clutch fluid*4
4	<ul style="list-style-type: none"> • Replace spark plugs • Inspect valve clearance • Inspect Active Exhaust Valve function • Replace Intake Sound Control
5	<ul style="list-style-type: none"> • Replace engine coolant
6	<ul style="list-style-type: none"> • Replace Twin Motor Unit fluid*5

*1: If a message **SERVICE** does not appear more than 12 months after the display is reset, change the engine oil every year.

: See information on maintenance and emissions warranty.

*2: If you drive in dusty conditions, replace the air cleaner element every 15,000 miles (24,000 km).

*3: If you drive primarily in urban areas that have high concentrations of soot in the air from industry and from diesel-powered vehicles, replace the dust and pollen filters every 15,000 miles (24,000 km) or every year.

*4: Driving in mountainous areas at very low vehicle speeds results in higher transmission temperature. This requires transmission fluid and clutch fluid changes more frequently than recommended by the Maintenance Minder. If you regularly drive your vehicle under this condition, have the transmission fluid and clutch fluid changed every 20,000 miles (32,000 km).

*5: Driving in mountainous areas at very low vehicle speeds results in higher level of mechanical (Shear) stress to fluid. This requires Twin Motor Unit fluid changes more frequently than recommended by the Maintenance Minder. If you regularly drive your vehicle under these conditions, have the Twin Motor Unit fluid changed at 7,500 miles (12,000 km), then every 15,000 miles (24,000 km).

Resetting the Display

Reset the Maintenance Minder display if you have performed the maintenance service.

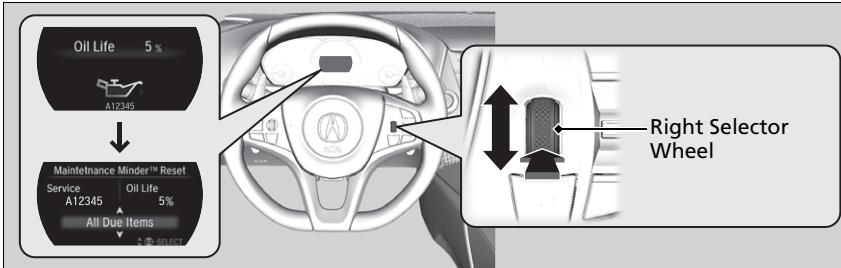

Using the driver information interface

1. Set the power mode to ON.
2. Roll the right selector wheel until the engine oil life appears on the driver information interface.
3. With all doors closed, press and hold the right selector wheel for more than 10 seconds to enter the reset mode.
4. Select **All Due Items** with the right selector wheel, then press the right selector wheel.
 - ▶ The displayed maintenance items disappear, and the engine oil life display returns to **100%**.

To cancel the oil life reset mode, select **Cancel** with the right selector wheel, then press the right selector wheel.

Resetting the Display

NOTICE

Failure to reset the Maintenance Minder™ display after a maintenance service results in the system showing incorrect maintenance intervals, which can lead to serious mechanical problems.

An authorized Acura NSX dealer will reset the Maintenance Minder™ display after completing the required maintenance service. If someone other than an authorized Acura NSX dealer performs maintenance service, reset the Maintenance Minder™ display yourself.

Using the audio/information screen

1. Set the power mode to ON.
 2. Select  on the audio/information screen.
 3. Select **Settings**.
 4. Select **Vehicle**, then **Maintenance Info**.
 5. Select **Reset**.
 - A confirmation message appears on the screen.
 6. Select **Reset**.
 - The engine oil life display returns to **100%**.
- To cancel the oil life reset mode, select **Cancel**.

Maintenance Items Under the Hood and Hatch

Hood

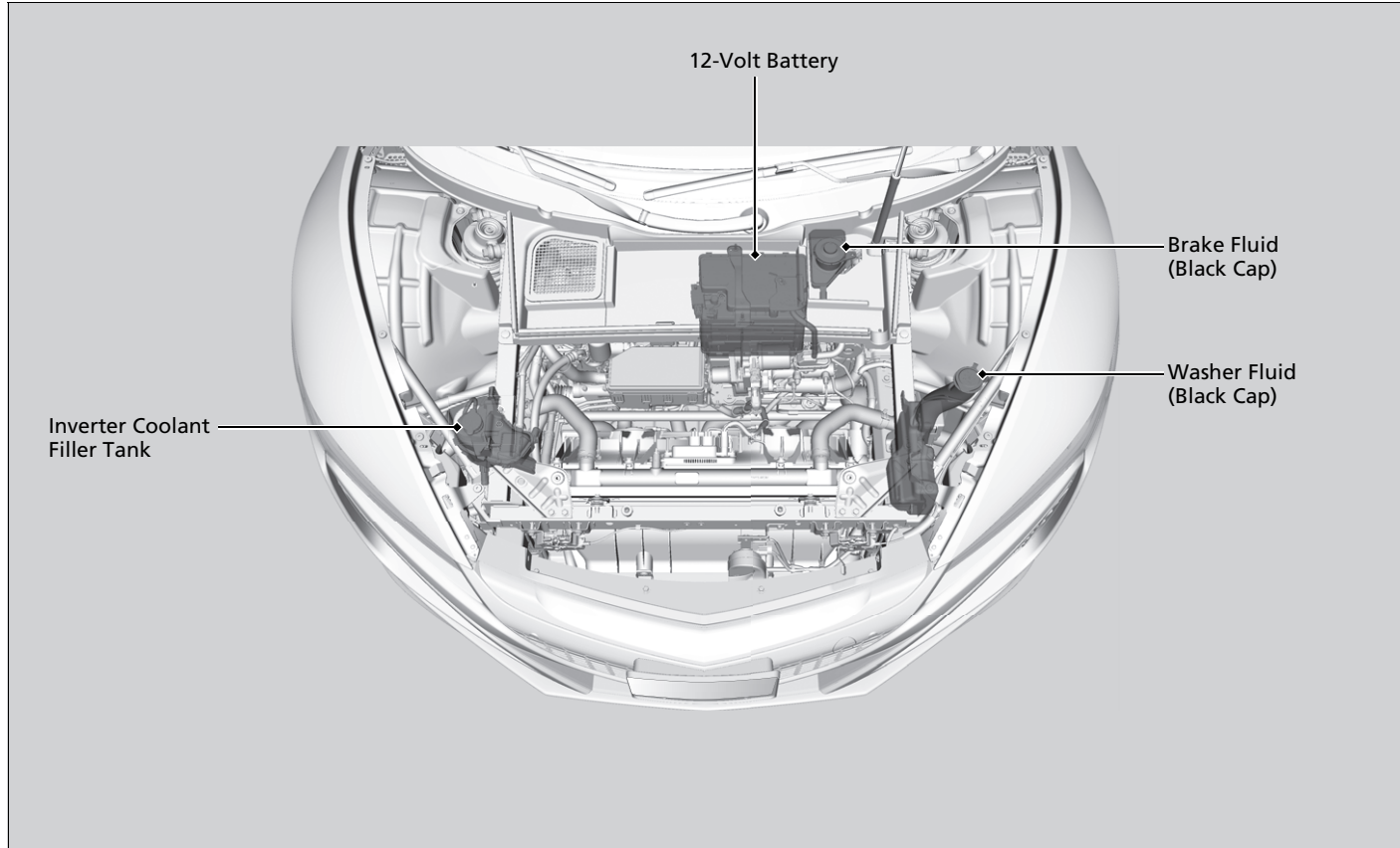

Hatch

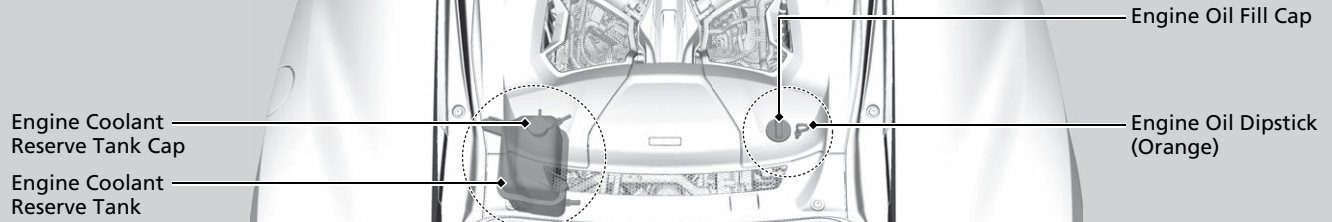

Opening the Hatch

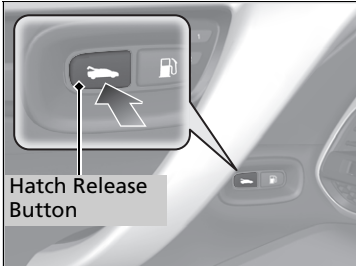

1. Park the vehicle on a level surface, and set the parking brake.
2. Press the hatch release button on the driver's door.

3. Lift the hatch up most of the way.
 - ▶ The hydraulic supports will lift it up the rest of the way and hold it up.

When closing, press down firmly with your hands.

✘ Opening the Hatch

When closing the hatch, check that the hatch is securely latched.

The hatch can be opened by pressing the release button on the hatch.

➤ **Using the Hatch Release Button** P. 119

Opening the Hood

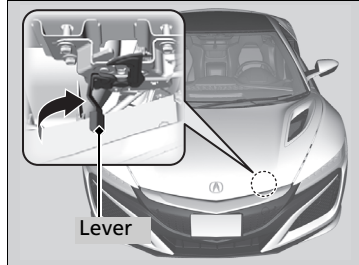
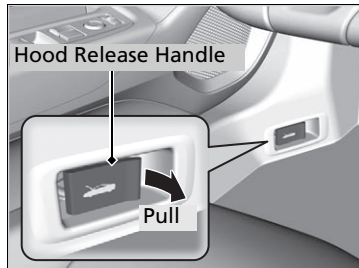

1. Park the vehicle on a level surface, and set the parking brake.
2. Pull the hood release handle under the driver's side lower corner of the dashboard.
 - The hood will pop up slightly.
3. Pull up the hood latch lever (located under the front edge of the hood to the center) and raise the hood. Once you have raised the hood slightly, you can release the lever.
4. Lift the hood up most of the way.
 - The hydraulic support will lift it up the rest of the way and hold it up.

When closing, lower it to approximately 12 inches (30 cm), then press down firmly with your hands, and make sure both right and left latches are firmly locked in place.

Opening the Hood

NOTICE

Do not open the hood when the wiper arms are raised. The hood will strike the wipers, resulting in possible damage to the hood and/or the wipers.

When closing the hood, check that both right and left latches are securely latched.

If the hood latch lever moves stiffly, or if you can open the hood without lifting the lever, the latch mechanism should be cleaned and lubricated.

Engine Compartment Cover

The component parts in the engine compartment are protected by covers. You may need to remove the cover when you perform certain maintenance work. Pull up on the engine compartment cover, remove it from the pins.

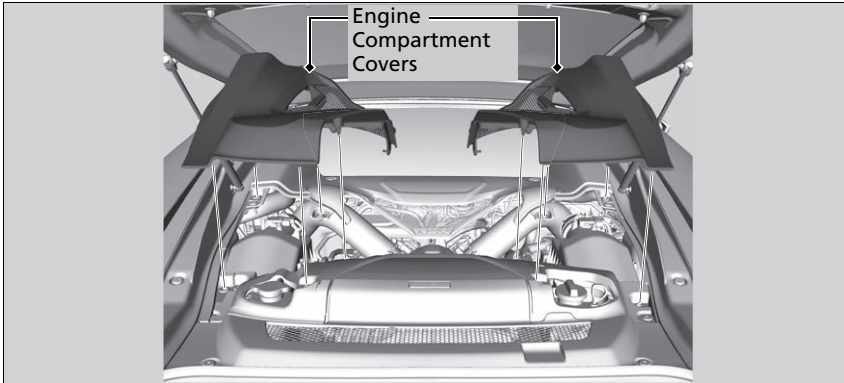

Recommended Engine Oil

Under normal ambient temperature and driving conditions, Acura NSX specifications require full synthetic, 0W-40 motor oil such as Ultimate Full Synthetic Motor Oil, Type 3, 0W-40, available at your authorized Acura NSX dealer. Contact your authorized Acura NSX dealer for more details.

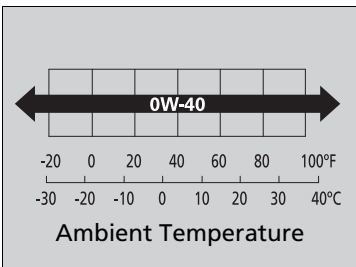

Oil is a major contributor to your engine's performance and longevity. If you drive the vehicle with insufficient or deteriorated oil, the engine may fail or be damaged.

Recommended Engine Oil

NOTICE

Acura cannot ensure proper engine operation and durability if other engine oil is used.

Oil Check

We recommend that you check the engine oil level every time you refuel.

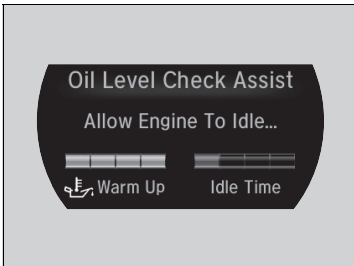

1. Bring up the **Oil Level Check Assist** display on the driver information interface.
 - **Driver Information Interface** P. 98
2. Warm up the engine until all the bars in the **Warm Up** gauge light up.
3. When the bars turn green, park the vehicle on level ground and select **P**.
4. Allow the engine to continue idling until all the bars in the **Idle Time** gauge in the engine **Oil Level Check Assist** display light up.
 - Do not depress the accelerator pedal while the engine is idling, as this will reset the **Idle Time**.

Oil Check

NOTICE

Do not open a door or the hatch before the **Ready To Check Oil Level** message appears. If a door or the hatch is open, the corresponding warning message will be given priority, and the **Oil Level Check Assist** will not be displayed.

Continued

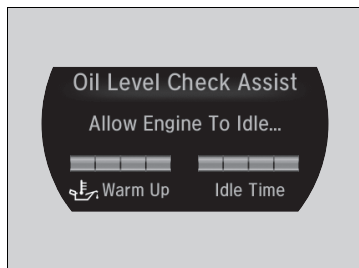

5. When all the bars in the **Idle Time** gauge light up, **Ready To Check Oil Level** message appears.

6. Change the display in the driver information interface to any display other than the **Oil Level Check Assist** display.
➤ **Driver Information Interface** P. 98

7. Change the power mode to VEHICLE OFF.

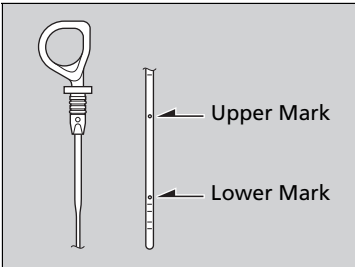
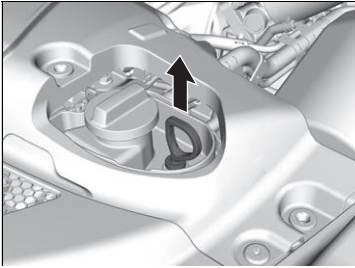

8. Open the hatch.
 - **Opening the Hatch** P. 387
9. Remove the right engine compartment cover.
 - **Engine Compartment Cover** P. 389
10. Remove the dipstick (orange).
11. Wipe the dipstick with a clean cloth or paper towel.
12. Insert the dipstick back all the way into its hole.
13. Remove the dipstick again, and check the level. It should be between the upper and lower marks.
 - The engine oil level should be checked after two minutes after changing the power mode to VEHICLE OFF.
 - Add oil if necessary.
 - When engine oil is added, recheck the engine oil level using steps 1 - 14.
14. After checking the engine oil level, make sure to select a display other than the **Oil Level Check Assist** display.
 - **Driver Information Interface** P. 98

► Oil Check

For a proper oil level reading, the dipstick must be inserted with the flat side of the dipstick handle facing the oil fill cap.

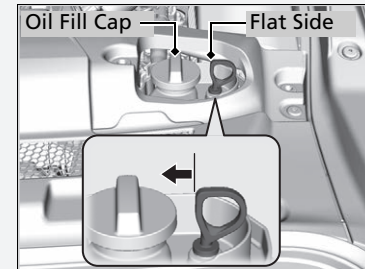

The amount of oil consumed depends on how the vehicle is driven and the climatic and road conditions encountered. The rate of oil consumption can be up to 1.05 US quart (1 liter) per 625 miles (1000 km). Consumption is likely to be higher when the engine is new.

Adding Engine Oil

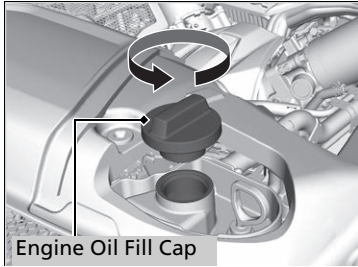

1. Unscrew and remove the engine oil fill cap.
2. Add oil slowly.
3. Reinstall the engine oil fill cap, and tighten it securely.
4. Recheck the engine oil level.
 - ❏ **Oil Check** P. 391

► Adding Engine Oil

NOTICE

Do not fill the engine oil above the upper mark. Overfilling the engine oil may result in leaks and engine damage.

If any oil spills, wipe it away immediately. Spilled oil may damage the engine compartment components.

Changing the Engine Oil and Oil Filter

You must change the engine oil and oil filter regularly in order to maintain the engine's lubrication. The engine may be damaged if they are not changed regularly.

Specialized equipment and procedures are required to change the engine oil and oil filter. Have an authorized Acura NSX dealer replace them.

Do not attempt to change the engine oil and oil filter yourself.

Cooling System

Specified coolant: Acura Long Life Antifreeze/Coolant Type 2

This coolant is premixed with 50% antifreeze and 50% water. Do not add any straight antifreeze or water.

We recommend you check the engine coolant level every time you refuel. Check the reserve tank. Add the engine coolant accordingly.

Checking the Coolant

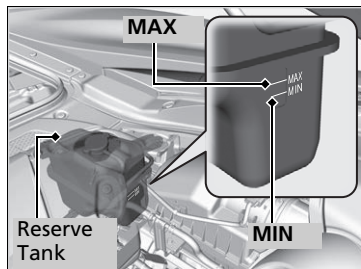

1. Make sure the engine and radiator are cool.

2. Open the hatch.

► **Opening the Hatch** P. 387

3. Remove the left engine compartment cover.

► **Engine Compartment Cover** P. 389

4. Check the amount of coolant in the reserve tank.

► If the coolant level is below the **MIN** mark, add the specified coolant until it reaches the **MAX** mark.

5. Inspect the cooling system for leaks.

►► Cooling System

⚠ WARNING

Removing the reserve tank cap while the engine is hot can cause the coolant to spray out, seriously scalding you.

Always let the engine and radiator cool down before removing the reserve tank cap.

NOTICE

Genuine Acura engine coolant is a 50/50 mixture of antifreeze and water that can withstand freezing at temperatures as low as about -31°F (-35°C). If your vehicle is consistently subjected to temperatures below this, the concentration of antifreeze in the coolant should be increased. Consult an authorized Acura NSX dealer for details.

If Acura antifreeze/coolant is not available, you may use another major brand of non-silicate coolant as a temporary replacement. Check that it is a high quality coolant recommended for aluminum engines. Continued use of any non-Acura coolant can result in corrosion, causing the cooling system to malfunction or fail. Have the cooling system flushed and refilled with Acura antifreeze/coolant as soon as possible.

Do not add rust inhibitors or other additives to your vehicle's cooling system. They may not be compatible with the coolant or with the engine components.

■ Adding the Coolant

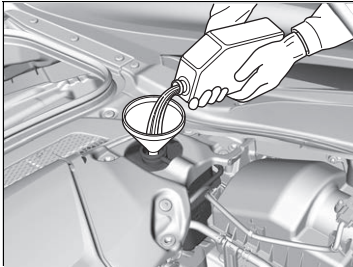
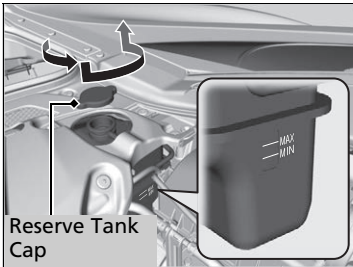

1. **Make sure the engine and radiator are cool.**
2. Turn the reserve tank cap 1/8 turn counter-clockwise and relieve any pressure in the cooling system.
3. Push down and turn the reserve tank cap counter-clockwise to remove it.
4. Pour coolant into the reserve tank until it reaches the **MAX** mark.
5. Put the reserve tank cap back on, and tighten it fully.

▶▶ Adding the Coolant

NOTICE

Pour the fluid slowly and carefully so you do not spill any. Clean up any spills immediately; they can damage components in the engine compartment.

Inverter Coolant

Specified coolant: Acura Long Life Antifreeze/Coolant Type 2

This coolant is premixed with 50% antifreeze and 50% water. Do not add any straight antifreeze or water.

We recommend you check the inverter coolant level every time you refuel.

Have an authorized Acura NSX dealer replace the inverter coolant.

Checking the Coolant

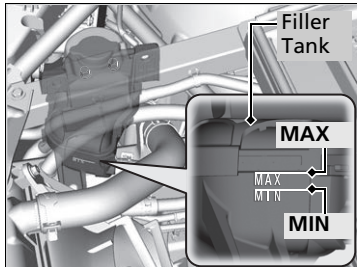

1. Open the hood.
 - **Opening the Hood** P. 388
2. Check the fluid level in the tank.
3. If the coolant level has dropped below the **MIN** level, have your vehicle serviced at an authorized Acura NSX dealer.
 - Only a properly trained technician can refill the coolant and check the system for leaks.

ⓘ Inverter Coolant

NOTICE

Genuine Acura engine coolant is a 50/50 mixture of antifreeze and water that can withstand freezing at temperatures as low as about -31°F (-35°C). If your vehicle is consistently subjected to temperatures below this, the concentration of antifreeze in the coolant should be increased. Consult an authorized Acura NSX dealer for details.

If Acura antifreeze/coolant is not available, you may use another major brand non-silicate coolant as a temporary replacement. Check that it is a high quality coolant recommended for aluminum engines. Continued use of any non-Acura coolant can result in corrosion, causing the cooling system to malfunction or fail. Have the cooling system flushed and refilled with Acura antifreeze/coolant as soon as possible.

Do not add rust inhibitors or other additives to your vehicle's cooling system. They may not be compatible with the coolant or with the motor components.

Transmission Fluids

Dual Clutch Transmission Fluids

Specified fluids:

Clutch

Acura Automatic Transmission Fluid ATF DW-1

Transmission

Acura Gear Oil GO-Type 2.0

Have an authorized Acura NSX dealer check the fluid level and replace if necessary.

Do not attempt to check or change the dual clutch transmission fluids yourself.

Twin Motor Unit Fluid

Specified fluid:

Acura Automatic Transmission Fluid ATF DW-1

Have an authorized Acura NSX dealer check the fluid level and replace if necessary.

Do not attempt to check or change the twin motor unit fluid yourself.

⌘ Dual Clutch Transmission Fluids

NOTICE

Do not mix Acura ATF DW-1 with other transmission fluids.

Using a transmission fluid other than Acura ATF DW-1 may adversely affect the operation and durability of your vehicle's transmission, and damage the transmission.

Any damage caused by using a transmission fluid that is not equivalent to Acura ATF DW-1 is not covered by Acura's new vehicle limited warranty.

⌘ Twin Motor Unit Fluid

NOTICE

Do not mix Acura ATF Type DW-1 with other transmission fluids.

Using a transmission fluid other than Acura ATF DW-1 may adversely affect the operation and durability of your vehicle's twin motor unit, and damage the twin motor unit.

Any damage caused by using a transmission fluid that is not equivalent to Acura ATF DW-1 is not covered by Acura's new vehicle limited warranty.

Brake Fluid

Specified fluid: Acura Heavy Duty Brake Fluid DOT 4

■ Checking the Brake Fluid

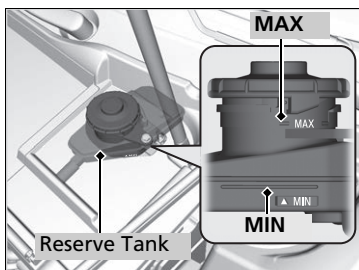

The fluid level should be between the **MIN** and **MAX** marks on the side of the reserve tank.

» Brake Fluid

NOTICE

Brake fluid marked DOT 5 is not compatible with your vehicle's braking system and can cause extensive damage.

If the specified brake fluid is not available, you should use only DOT 4 fluid from a sealed container as a temporary replacement.

Using any non-Acura brake fluid can cause corrosion and decrease the longevity of the system. Have the brake system flushed and refilled with Acura Heavy Duty Brake Fluid DOT 4 as soon as possible.

If the brake fluid level is at or below the **MIN** mark, have an authorized Acura NSX dealer inspect the vehicle for leaks or worn brake pads as soon as possible.

» Refilling Window Washer Fluid

NOTICE

Do not use engine antifreeze or a vinegar/water solution in the windshield washer reservoir. Antifreeze can damage your vehicle's paint. A vinegar/water solution can damage the windshield washer pump.

Use only commercially available windshield washer fluid. Avoid prolonged use of hard water to prevent lime scale build up.

Refilling Window Washer Fluid

If the washer fluid is low, a message appears on the driver information interface. Pour the washer fluid carefully. Do not overflow the reservoir.

Headlights

Headlights are LED type. Have an authorized Acura NSX dealer inspect and replace the light assembly.

Front Turn Signal/Parking Lights

Front turn signal/parking lights are LED type. Have an authorized Acura NSX dealer inspect and replace the light assembly.

Front Side Marker Lights

Front side marker lights are LED type. Have an authorized Acura NSX dealer inspect and replace the light assembly.

Side Turn Signal/Emergency Indicator Lights

Door mirror side turn lights are LED type. Have an authorized Acura NSX dealer inspect and replace the light assembly.

Daytime Running Lights

Daytime running lights are LED type. Have an authorized Acura NSX dealer inspect and replace the light assembly.

Headlights

The headlight aim is set by the factory, and does not need to be adjusted. However, if you regularly carry heavy items in the trunk, have the aiming readjusted at an authorized Acura NSX dealer or by a qualified technician.

Rear Turn Signal Lights

Rear Turn Signal lights are LED type. Have an authorized Acura NSX dealer inspect and replace the light assembly.

Brake/Taillights

Brake/Taillights are LED type. Have an authorized Acura NSX dealer inspect and replace the light assembly.

Rear Side Marker Lights

Rear side marker lights are LED type. Have an authorized Acura NSX dealer inspect and replace the light assembly.

Taillights

Taillights are LED type. Have an authorized Acura NSX dealer inspect and replace the light assembly.

Back-Up Lights

Back-up lights are LED type. Have an authorized Acura NSX dealer inspect and replace the light assembly.

Rear License Plate Lights

Rear license plate lights are LED type. Have an authorized Acura NSX dealer inspect and replace the light assembly.

High-Mount Brake Light

High-mount brake light is LED type. Have an authorized Acura NSX dealer inspect and replace the light assembly.

Checking Wiper Blades

If the wiper blade rubber has deteriorated, it will leave streaks and the hard surfaces of the blade may scratch the window glass.

Changing the Wiper Blade Rubber



1. While holding the wiper switch in the **MIST** position, change the power mode to VEHICLE OFF.
2. Wiper arms will move into service position.

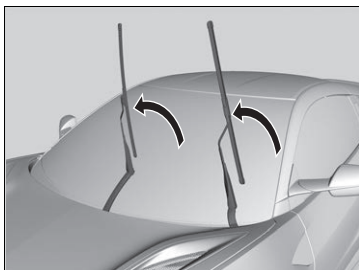

3. Lift both wiper arms.

Changing the Wiper Blade Rubber

NOTICE

Avoid dropping the wiper arm onto the windshield, it may damage the wiper arm and/or the windshield.

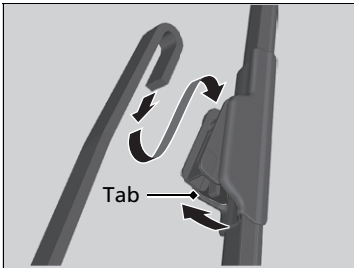

4. Press up on and hold the tab, then slide the holder off the wiper arm.

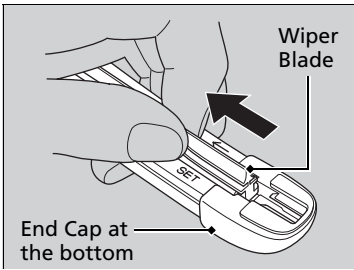

5. Pull the end of the wiper blade in the direction of the arrow in the image until it is out of the holder's end cap.

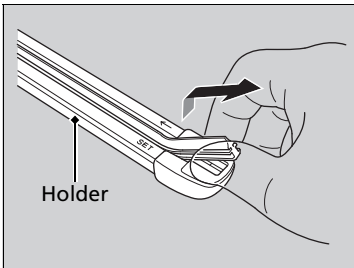

6. Pull the wiper blade in the opposite direction to slide it out of the holder.

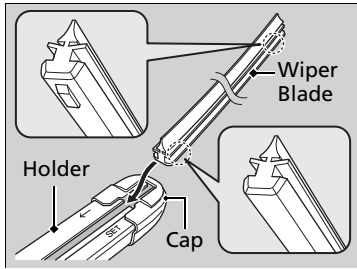

7. Insert the flat side of the new wiper blade onto the bottom part of the holder. Insert the blade all the way.
8. Install the end of the wiper blade into the cap.
9. Slide the wiper blade onto the wiper arm until it locks.
10. Lower both wiper arms.
11. Set the power mode to ON and hold the wiper switch in the **MIST** position until both wiper arms return to the standard position.

Checking Tires

To safely operate your vehicle, your tires must be of the proper type and size, in good condition with adequate tread, and properly inflated.

■ Inflation guidelines

Properly inflated tires provide the best combination of handling, tread life, and comfort. Refer to the driver's doorjamb label or specifications page for the specified pressure.

Underinflated tires wear unevenly, adversely affect handling and fuel economy, and are more likely to fail from overheating.

Overinflated tires make your vehicle ride harshly, are more prone to road hazards, and wear unevenly.

Every day before you drive, look at each of the tires. If one looks lower than the others, check the pressure with a tire gauge.

At least once a month or before long trips, use a gauge to measure the pressure in all tires. Even tires in good condition can lose 1 – 2 psi (10 – 20 kPa, 0.1 – 0.2 kgf/cm²) per month.

■ Inspection guidelines

Every time you check inflation, also examine the tires and valve stems. Look for:

- Bumps or bulges on the side or in the tread. Replace the tire if you find any cuts, splits, or cracks in the side of the tire. Replace it if you see fabric or cord.
- Remove any foreign objects and inspect for air leaks.
- Uneven tread wear. Have an authorized Acura NSX dealer check the wheel alignment.
- Excessive tread wear.

➤ **Wear Indicators** P. 412

- Cracks or other damage around valve stem.

☒ Checking Tires

⚠ WARNING

Using tires that are excessively worn or improperly inflated can cause a crash in which you can be seriously hurt or killed.

Follow all instructions in this owner's manual regarding tire inflation and maintenance.

Measure the air pressure when tires are cold. This means the vehicle has been parked for at least three hours, or driven less than 1 mile (1.6 km). If necessary, add or release air until the specified pressure is reached.

If checked when hot, tire pressure can be as much as 4 – 6 psi (30 – 40 kPa, 0.3 – 0.4 kgf/cm²) higher than if checked when cold.

Have an authorized Acura NSX dealer check the tires if you feel a consistent vibration while driving. New tires and any that have been removed and reinstalled should be properly balanced.

Tire and Loading Information Label

The label attached to the driver’s doorjamb provides necessary tire and loading information.

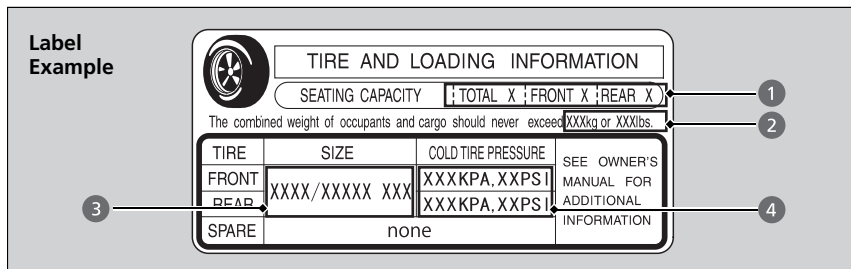

▶ Tire and Loading Information Label

The tire and loading information label attached to the driver’s doorjamb contains:

- 1 The number of people your vehicle can carry.
- 2 The total weight your vehicle can carry. Do not exceed this weight.
- 3 The original tire sizes for front, rear, and spare, if equipped.
- 4 The proper cold tire pressure for front, rear, and spare, if equipped.

Tire Labeling

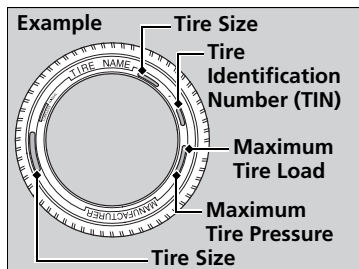

The tires that came on your vehicle have a number of markings. Those you should be aware of are described as follows.

▶ Tire Sizes

Following is an example of tire size with an explanation of what each component means.

245/40R19 98W

- 245: Tire width in millimeters.
- 40: Aspect ratio (the tire’s section height as a percentage of its width).
- R: Tire construction code (R indicates radial).
- 19: Rim diameter in inches.
- 98: Load index (a numerical code associated with the maximum load the tire can carry).
- W: Speed symbol (an alphabetical code indicating the maximum speed rating).

■ Tire Sizes

Whenever tires are replaced, they should be replaced with tires of the same size, load index and speed rating.

■ Tire Identification Number (TIN)

The tire identification number (TIN) is a group of numbers and letters that look like the example in the side column. TIN is located on the sidewall of the tire.

■ Glossary of Tire Terminology

Cold Tire Pressure – The tire air pressure when the vehicle has been parked for at least three hours or driven less than 1 mile (1.6 km).

Load Rating – Means the maximum load that a tire is rated to carry for a given inflation pressure.

Maximum Inflation Pressure – The maximum tire air pressure that the tire can hold.

Maximum Load Rating – Means the load rating for a tire at the maximum permissible inflation pressure for that tire.

Recommended Inflation Pressure – The cold tire inflation pressure recommended by the manufacturer.

Treadwear Indicators (TWI) – Means the projections within the principal grooves designed to give a visual indication of the degrees of wear of the tread.

☒ Tire Identification Number (TIN)

DOT B97R FW6X 2209

DOT: This indicates that the tire meets all requirements of the U.S. Department of Transportation.

B97R: Manufacturer's identification mark.

FW6X: Tire type code.

22 09: Date of manufacture.

22 ——— Year
 09 ——— Week

DOT Tire Quality Grading (U.S. Vehicles)

The tires on your vehicle meet all U.S. Federal Safety Requirements. All tires are also graded for treadwear, traction, and temperature performance according to Department of Transportation (DOT) standards. The following explains these gradings.

■ Uniform Tire Quality Grading

Quality grades can be found where applicable on the tire sidewall between tread shoulder and maximum section width.

■ Treadwear

The treadwear grade is a comparative rating based on the wear rate of the tire when tested under controlled conditions on a specified government test course. For example, a tire graded 150 would wear one and one-half (1 1/2) times as well on the government course as a tire graded 100. The relative performance of tires depends upon the actual conditions of their use, however, and may depart significantly from the norm due to variations in driving habits, service practices and differences in road characteristics and climate.

▣ Uniform Tire Quality Grading

For example:

Treadwear 200
Traction AA
Temperature A

All passenger car tires must conform to Federal Safety Requirements in addition to these grades.

■ Traction

The traction grades, from highest to lowest, are AA, A, B, and C. Those grades represent the tire's ability to stop on wet pavement as measured under controlled conditions on specified government test surfaces of asphalt and concrete. A tire marked C may have poor traction performance.

■ Temperature

The temperature grades are A (the highest), B, and C, representing the tire's resistance to the generation of heat and its ability to dissipate heat when tested under controlled conditions on a specified indoor laboratory test wheel. Sustained high temperature can cause the material of the tire to degenerate and reduce tire life, and excessive temperature can lead to sudden tire failure. The grade C corresponds to a level of performance which all passenger car tires must meet under the Federal Motor Vehicle Safety Standard No. 109. Grades B and A represent higher levels of performance on the laboratory test wheel than the minimum required by law.

⌘ Traction

Warning: The traction grade assigned to this tire is based on straight-ahead braking traction tests, and does not include acceleration, cornering, hydroplaning, or peak traction characteristics.

⌘ Temperature

Warning: The temperature grade for this tire is established for a tire that is properly inflated and not overloaded. Excessive speed, underinflation, or excessive loading, either separately or in combination, can cause heat buildup and possible tire failure.

Wear Indicators

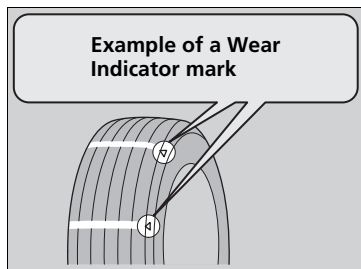

The groove where the wear indicator is located is 1/16 inch (1.6 mm) shallower than elsewhere on the tire. If the tread has worn so that the indicator is exposed, replace the tire. **Worn out tires have poor traction on wet roads.**

Tire Service Life

The life of your tires is dependent on many factors, including driving habits, road conditions, vehicle loading, inflation pressure, maintenance history, speed, and environmental conditions (even when the tires are not in use).

In addition to regular inspections and inflation pressure maintenance, it is recommended that you have annual inspections performed once the tires reach five years old. All tires should be removed from service after 10 years from the date of manufacture, regardless of their condition or state of wear.

Checking Tires

High speed driving

We recommend that you do not drive on public roads faster than the posted speed limits and conditions allow. If you intend to drive at sustained high speeds (over 168 mph or 270 km/h), such as at a track or other closed course venue, adjust the cold tire pressures as shown below to avoid excessive heat build up and sudden tire failure.

Tire Size	Front:
	245/35ZR19 (93Y)
Pressure	Rear:
	305/30ZR20 (103Y)
Pressure	Front:
	38 psi (260 kPa, 2.6 kgf/cm ²)
Pressure	Rear:
	38 psi (260 kPa, 2.6 kgf/cm ²)

Tire and Wheel Replacement

Replace your tires with radials of the same size, load range, speed rating, and maximum cold tire pressure rating (as shown on the tire's sidewall). Using tires of a different size or construction can cause certain vehicle systems such as the ABS and Vehicle Stability Assist™ (VSA®) system to work incorrectly.

It is best to replace all four tires at the same time.

If you replace a wheel, only use TPMS specified wheels approved for your vehicle. Make sure that the wheel's specifications match those of the original wheels.

⚠ Tire and Wheel Replacement

⚠ WARNING

Installing improper tires on your vehicle can affect handling and stability. This can cause a crash in which you can be seriously hurt or killed.

Always use the size and type of tires recommended in this owner's manual.

Tire Rotation

The front and rear tire sizes are different and they are directional tires.

Due to tire sizes and directional tires, the tires on this vehicle cannot be rotated.

▶▶ Tire Rotation

Directional tires should be mounted with the rotation indication mark facing forward, as shown below.

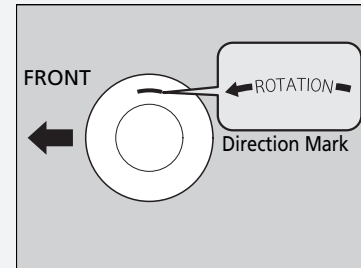

Winter Tires

If driving on snowy or frozen roads, mount all-season marked **M+S** tires, snow tires, or tire chains; reduce speed; and maintain sufficient distance between vehicles when driving.

Be particularly careful when operating the steering wheel or brakes to prevent skidding.

Use tire chains, snow tires, or all-season tires when necessary or according to the law.

When mounting, refer to the following points.

For winter tires:

- Mount the tires to all four wheels.

Recommended Winter Tires:

- **Michelin Alpin PA4**
Front: 245/35R19 (93W)
Rear: 295/30R20 (97V)
- **Pirelli SottoZero 3**
Front: 245/35R19 (93W)
Rear: 305/30R20 (103W)

For tire chains:

- Install them on the rear tires only.
- Because your vehicle has limited tire clearance, we strongly recommend using the chains listed below:

- **Auto-trac 232405***1
- **K-Summit K-44***2

*1: Tire chains to be used only on optional 295/30R20 winter tires.

*2: Tire chains to be used only on optional 305/30R20 winter tires.

- Follow the chain manufacturer's instruction when installing. Mount them as tightly as you can.
- Check that the chains do not touch the brake lines or suspension.
- Drive slowly.

⚠ Winter Tires

⚠ WARNING

Using the wrong chains, or not properly installing chains, can damage the brake lines and cause a crash in which you can be seriously injured or killed.

Follow all instructions in this owner's manual regarding the selection and use of tire chains.

NOTICE

Traction devices that are the wrong size or improperly installed can damage your vehicle's brake lines, suspension, body, and wheels. Stop driving if they are hitting any part of the vehicle.

When tire chains are mounted, follow the chain manufacturer's instructions regarding vehicle operational limits.

If your vehicle is equipped with summer tires, be aware that these tires are not designed for winter driving conditions. For more information, contact an authorized Acura NSX dealer.

Cold Weather Driving

Summer Only tires and Ultra High Performance (UHP) tires are very sensitive to ambient temperatures and are designed to be used at temperatures above 45°F (7°C). If the vehicle is operated with Summer Only tires or UHP tires at temperatures below 45°F (7°C), the tires will provide decreasing amounts of grip and other performance attributes. If the vehicle is operated with Summer Only tires or UHP tires at temperatures below -4°F (-20°C), the tire tread may lose their elasticity and become brittle, resulting in permanent damage to the tread. A damaged tire may fail during use. Therefore, if you operate the vehicle when ambient temperatures are below 45°F (7°C), we recommend that you install other tires (e.g., mud+snow, winter) that are designed to provide appropriate performance attributes under the anticipated conditions.

❗ Cold Weather Driving

⚠️ WARNING

Use of Summer Only tires or Ultra High Performance tires at temperatures below 45°F (7°C) may lead to a loss of performance and control, which could result in a crash, serious injury or death.

Checking the 12-Volt Battery

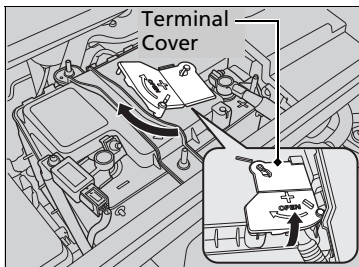
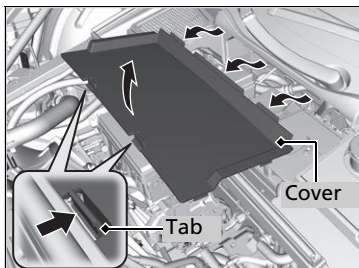

Check the battery terminals for corrosion monthly.

The battery is protected by a cover. Remove the cover by pressing the tabs.

Slide the terminal cover on your vehicle's 12-volt battery positive \oplus terminal.

The battery condition is monitored by the sensor on the negative terminal. If there is a problem with the sensor, the warning message on the driver information interface will let you know. Have your vehicle checked by an authorized Acura NSX dealer.

If your vehicle's battery is disconnected or goes dead:

- The audio system is disabled.
 - **Reactivating the audio system** P. 164
- The clock resets.
 - **Clock** P. 104

Charging the AGM Battery

AGM labeled batteries can be damaged if improperly charged. For more information on how to charge an AGM battery, consult an authorized Acura NSX dealer.

12-Volt Battery

⚠ WARNING

The battery gives off explosive hydrogen gas during normal operation.

A spark or flame can cause the battery to explode with enough force to kill or seriously hurt you.

When conducting any battery maintenance, wear protective clothing and a face shield, or have a skilled technician do it.

WARNING: Battery post, terminals, and related accessories contain lead and lead compounds.
Wash your hands after handling.

When you find corrosion, clean the battery terminals by applying a baking powder and water solution. Clean the terminals with a damp towel. Cloth/towel dry the battery. Coat the terminals with grease to help prevent future corrosion.

When replacing the battery, the replacement must be of the same specifications. Consult an authorized Acura NSX dealer for more information.

Replacing the Button Battery

If the indicator does not come on when the button is pressed, replace the battery.

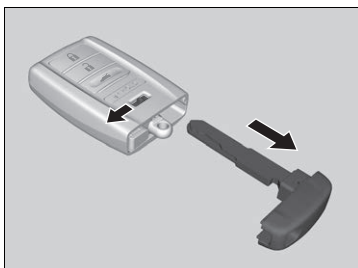

Battery type: CR2032

1. Remove the built-in key.
2. Remove the upper half of the cover by carefully prying on the edge with a coin.
 - ▶ Remove carefully to avoid losing the buttons.
 - ▶ Wrap a coin with a cloth to prevent scratching the keyless access remote.
3. Make sure to replace the battery with the correct polarity.

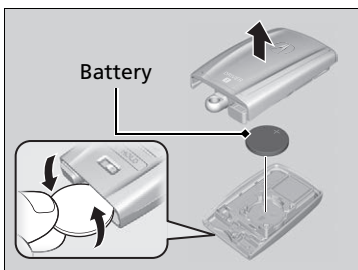

Replacing the Button Battery

WARNING

CHEMICAL BURN HAZARD

The battery that powers the remote transmitter can cause severe internal burns and can even lead to death if swallowed. Keep new and used batteries away from children.

If you suspect that a child has swallowed the battery, seek medical attention immediately.

NOTICE

An improperly disposed of battery can damage the environment. Always confirm local regulations for battery disposal.

Replacement batteries are commercially available or at an authorized Acura NSX dealer.

Air Conditioning

To ensure proper and safe operation, the Society of Automotive Engineers (SAE J2845) recommends that the refrigerant system only be serviced by trained and certified technicians.

Never repair or replace the air conditioning evaporator (cooling coil) with one removed from a used or salvaged vehicle.

New replacement mobile air conditioning evaporators must be certified (and labeled) as meeting SAE Standard J2842.

Dust and Pollen Filters

The climate control system is equipped with dust and pollen filters that collect pollen, dust, and other debris in the air. The Maintenance Minder™ messages will let you know when to replace the filters.

We recommend that you replace the dust and pollen filters sooner when using your vehicle in areas with high concentrations of dust.

Air Conditioning

NOTICE

Vented refrigerant is harmful to the environment. To avoid refrigerant from venting, never replace the evaporator with one removed from a used or salvaged vehicle.

Refrigerant in your vehicle's air conditioning system is flammable and can be ignited during servicing if proper procedures are not followed.

The air conditioner label is found under the hood:

➤ **Safety Labels** P. 68

➤ **Specifications** P. 468

Canadian models



 : Caution

 : Flammable Refrigerant

 : Requires Registered Technician to Service

 : Air Conditioning System

Dust and Pollen Filters

If the airflow from the climate control system deteriorates noticeably, and the windows fog up easily, the filters may need to be replaced. Please contact an authorized Acura NSX dealer for replacement.

Interior Care

Use a damp cloth with a mixture of mild detergent and warm water to remove dirt.
Use a clean cloth to remove detergent residue.

Cleaning Seat Belts

Use a soft brush with a mixture of mild soap and warm water to clean the seat belts.
Let the belts air dry.

Cleaning the Window

Wipe using a glass cleaner.

Interior Care

Do not spill liquids inside the vehicle. Electrical devices and systems may malfunction if liquids are splashed on them.

Do not use silicone based sprays on electrical devices such as audio devices and switches. Doing so may cause the items to malfunction or cause a fire inside the vehicle.

If a silicone based spray is inadvertently used on electrical devices, consult an authorized Acura NSX dealer.

Depending on their composition, chemicals and liquid aromatics may cause discoloration, wrinkles, and cracking to resin-based parts and textiles. Do not use alkali solvents or organic solvents such as benzene or gasoline.

After using chemicals, make sure to gently wipe them away using a dry cloth.

Do not place used cloths on top of resin based parts or textiles for long periods of time without washing.

Cleaning the Window

Wires are mounted to the inside of the hatch glass. Wipe along the same direction as the wires with a soft cloth so as not to damage them.

■ Floor Mats

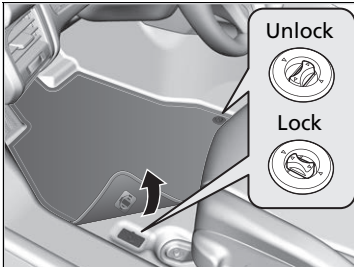

The floor mats hook over the floor anchors, which keep the mats from sliding forward. To remove the mats for cleaning, turn the anchor knobs to the unlock position. When reinstalling the mats after cleaning, turn the knobs to the lock position.

Do not put additional floor mats on top of the anchored mat.

■ Maintaining Genuine Leather

To properly clean leather:

1. Use a vacuum or soft dry cloth first to remove any dirt or dust.
2. Clean the leather with a soft cloth dampened with a solution comprised of 90% water and 10% neutral soap.
3. Wipe away any soap residue with a clean damp cloth.
4. Wipe away residual water and allow leather to air dry in the shade.

■ Carbon Fiber Meter Visor and Steering Wheel

Do not use abrasive cleaners.

▣ Floor Mats

If you use any floor mats that were not originally provided with your vehicle, make sure they are designed for your specific vehicle, fit correctly, and are securely anchored by the floor anchors.

▣ Maintaining Genuine Leather

It is important to clean or wipe away dirt or dust as soon as possible. Spills can soak into leather resulting in stains. Dirt or dust can cause abrasions in the leather. In addition, please note that some dark colored clothing can rub onto the leather seats resulting in discoloration or stains.

Exterior Care

Dust off the vehicle body after you drive. Regularly inspect your vehicle for scratches on painted surfaces. A scratch on a painted surface can result in body rust. If you find a scratch, promptly repair it.

■ Washing the Vehicle

Wash the vehicle regularly. Wash more frequently when driving in the following conditions:

- If driving on roads with road salt.
- If driving in coastal areas.
- If tar, soot, bird droppings, insects, or tree sap are stuck to painted surfaces.

■ Using an Automated Car Wash

Do not use an automated car wash.

■ Using High Pressure Cleaners

- Keep sufficient distance between the cleaning nozzle and the vehicle body.
- Take particular care around the windows. Standing too close may cause water to enter the vehicle interior.
- Do not spray high pressure water directly into the engine compartment. Instead, use low pressure water and a mild detergent.

✎ Washing the Vehicle

Do not spray water into the air intake vents. It can cause a malfunction.

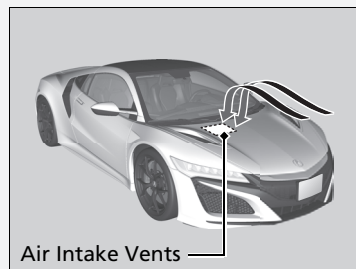

Do not spray water onto the capless unit when the fuel fill door is open. It can cause damage to the fuel system or engine.

If you need to lift the wiper arms away from the windshield, first set the wiper arms to the maintenance position.

✎ **Changing the Wiper Blade Rubber** P. 404

■ Applying Wax

A good coat of automotive body wax helps protect your vehicle's paint from the elements. Wax will wear off over time and expose your vehicle's paint to the elements, so reapply as necessary.

■ Maintaining the Bumpers and Other Resin Coated Parts

If you get gasoline, oil, engine coolant, or battery fluid on resin coated parts, they may be stained or the coating may peel. Promptly wipe it away using a soft cloth and clean water.

■ Cleaning the Window

Wipe using a glass cleaner.

■ Maintaining Aluminum Wheels

Aluminum is susceptible to deterioration caused by salt and other road contaminants. When necessary, as early as possible use a sponge and mild detergent to wipe away these contaminants. Do not use a stiff brush or harsh chemicals (including some commercial wheel cleaners). These can damage the protective finish on aluminum alloy wheels, resulting in corrosion. Depending on the type of finish, the wheels also may lose their luster or appear burnished. To avoid water stains, wipe the wheels dry with a cloth while they are still wet.

▣ Applying Wax

NOTICE

Chemical solvents and strong cleaners can damage the paint, metal, carbon fiber*, and plastic on your vehicle. Wipe away spills immediately.

▣ Maintaining the Bumpers and Other Resin Coated Parts

Ask an authorized Acura NSX dealer about the correct coating material when you want to repair the painted surface of the parts made of resin.

* Not available on all models

■ Fogged Exterior Light Lenses

The inside lenses of exterior lights (headlights, brake lights, etc.) may fog temporarily if you have driven in the rain. Dew condensation also may build up inside the lenses when there is a significant enough difference between the ambient and inside lens temperatures (similar to vehicle windows fogging up in rainy conditions). These conditions are natural processes, not structural design problems in the exterior lights.

Lens design characteristics may result in moisture developing on the light lens frame surfaces. This also is not a malfunction.

However, if you see large amounts of water accumulation, or large water drops building up inside the lenses, have your vehicle inspected by an authorized Acura NSX dealer.

■ Cast Iron Brakes *

Keep brake pads and rotors free of substances that are either abrasive or oil based, as these substances can reduce brake system performance.

NSX brake pads and disks have a high metallic content. Under certain conditions these pad and disks may rust to varying degrees, which may cause a clunk noise or rubbing sound if parked when brakes become wet. This is normal for brakes with high friction pads and it does not affect operation of the brakes.

To prevent the iron contained in the brake pads and rotors from rusting and sticking, brakes should be dried before parking the vehicle after driving on wet roads or after washing the vehicle (especially before long-term storage). To dry the brake pads and rotors, drive the vehicle at a low speed and apply the brakes several times.

By regularly applying strong pressure to the brakes, you can reduce corrosion buildup on the brake pads and rotors.

🔧 Brake Maintenance

Brake maintenance requires specialized knowledge. We recommend maintenance to be carried out by an authorized Acura NSX dealer.

🔧 Maintenance of Brake Surfaces

Brakes can be dried by driving on a dry road for few miles/kilometers, and applying the brake pedal normally, based on traffic and road conditions. These steps help maintain brake system performance.

■ Carbon Ceramic Brakes *

Keep the brake pads and rotors free of substances that are either abrasive or oil based, as these substances can reduce braking power. After driving in the presence of salt and/or sand, briefly wash the rotor/pad surfaces with low-pressure water, then allow the brake system to dry. To dry the brake pads and rotors, drive the vehicle at a low speed and apply the brakes several times.

■ Painting the Vehicle

Refer to the color code label and the temperature notice label affixed to the underside of the hood before painting the vehicle.

▶▶ Painting the Vehicle

U.S. models

NOTICE

High temperature may damage the high-voltage battery used to power the electric motor. When drying paint in a heated paint booth, make sure the temperature does not exceed 150°F(65°C).



Canadian models

NOTICE

High temperature may damage the high-voltage battery used to power the electric motor. When drying paint in a heated paint booth, make sure the temperature does not exceed 150°F(65°C).

AVIS

Des températures importantes pourraient endommager la batterie haute tension qui alimente le moteur électrique de la voiture. Lors du séchage de la peinture, s'assurer que la température dans la cabine de peinture chauffante ne dépasse pas 150°F(65°C).



* Not available on all models

Accessories

When installing accessories, check the following:

- Do not install accessories on the windshield. They can obstruct your view and delay your reaction to driving conditions.
- Do not install any accessories over areas marked **SRS AIRBAG**, on the sides or backs of the seats, on front or side pillars, or near the side windows. Accessories installed in these areas may interfere with proper operation of the vehicle's airbags or may be propelled into you or another occupant if the airbags deploy.
- Be sure electronic accessories do not overload electrical circuits or interfere with proper operation of your vehicle.
 - **Fuses** P. 457
- Before installing any electronic accessory, have the installer contact an authorized Acura NSX dealer for assistance. If possible, have an authorized Acura NSX dealer inspect the final installation.

Accessories and Modifications

WARNING

Improper accessories or modifications can affect your vehicle's handling, stability, and performance, and cause a crash in which you can be seriously hurt or killed.

Follow all instructions in this owner's manual regarding accessories and modifications.

WARNING

Use of improperly designed, engineered or manufactured high-voltage battery assemblies could cause a fire in your vehicle.

A vehicle fire could result in a crash or injury.

Only use a genuine Acura high-voltage battery assembly, or its equivalent, in your vehicle.

Modifications

Do not modify your vehicle in a manner that may affect its handling, stability, or reliability, or install non-genuine Acura parts or accessories that may have a similar effect.

Even minor modifications to vehicle systems can affect overall vehicle performance. Always make sure all equipment is properly installed and maintained, and do not make any modification to your vehicle or its systems that might cause your vehicle to no longer meet federal, state, province, territory, and local regulations.

The on-board diagnostic port (OBD-II/SAE J1962 connector) installed on this vehicle is intended to be used with automobile system diagnostic devices or with other devices that Acura has approved. Use of any other type of device may adversely affect the vehicle's electronic systems or allow them to be compromised, possibly resulting in a system malfunction, drained battery, or other unexpected problems.

Do not modify or attempt to repair your vehicle's high-voltage hybrid power system or otherwise modify vehicle electrical systems. Disassembling or modifying electrical equipment can result in a crash or a fire.

If you ever need to replace your vehicle's high-voltage battery assembly outside of warranty coverage, we highly recommend that you only use a genuine Acura high-voltage battery assembly. Genuine Acura high-voltage battery assemblies are designed to work with your vehicle's hybrid power system and have been designed, engineered and manufactured to avoid overcharging situations. Non-genuine high-voltage battery assemblies may not have been similarly designed, engineered and manufactured, and installation of such assemblies could result in overcharging, fires, loss of power, or other conditions that may increase the likelihood of a crash or injury.

Vehicle Storage

If you need to park your vehicle for an extended period (more than one month), there are several things you should do to prepare it for storage. This helps reduce possible deterioration of vehicle components and overall condition, which allows you to get the vehicle back on the road with minimal delay. These are:

- If possible, store your NSX in a garage or enclosed area.
- Fill the fuel tank completely.
- Change the engine oil and filter.
- Wash and dry the exterior completely.
- Clean the interior. Make sure the carpeting, floor mats, etc., are completely dry.
- Put the transmission in **P**.
Release the parking brake.
- Leave one window open slightly (if the vehicle is being stored indoors).
- To maintain the low-voltage 12-volt battery, connect it to an accessory battery charger. For more information on how to maintain your 12-volt battery, consult an authorized Acura NSX dealer.
 - **Checking the 12-Volt Battery** P. 417
- If the vehicle is to be stored for a longer period of time, it should be supported on jack stands to raise the tires off the ground to prevent tire flat spotting.
 - **Handling of the Jack** P. 444
- Support the front wiper blade arms with a folded towel or rag so they do not touch the windshield.
- Cover the vehicle with a “breathable” cover, one made from a porous material such as cotton. Nonporous materials (such as plastic sheeting) may trap moisture, which can damage the paint.
- If possible, remove the vehicle from the garage or enclosed area, remove covering, and periodically run the engine until it reaches full operating temperature (the cooling fan cycles on and off twice).
Preferably, do this once a month.

- To maintain the High Voltage battery, drive your vehicle for more than 30 minutes at least once every three months.

If road conditions are not suitable or desirable for driving, the following alternate procedure can be used to maintain the vehicle's High Voltage battery if local idling by-laws permit:

1. Remove the vehicle from the garage or enclosed area to prevent carbon monoxide accumulation.

📄 **Carbon Monoxide Gas** P. 67

2. Depress the brake pedal and press the **ENGINE START/STOP** button as you normally would to start the vehicle.
3. Allow the vehicle to run for 30 minutes. Time spent at idle stop still counts as part of this 30-minute run.

Handling the Unexpected

This chapter explains how to handle unexpected troubles.



Tools

Types of Tools..... 432

If a Tire Goes Flat

Temporarily Repairing a Flat Tire..... 433

Handling of the Jack 444

Power System Won't Start

Checking the Procedure 445

If the Keyless Access Remote Battery is

Weak 446

Emergency Power System Off..... 447

Jump Starting..... 448

Overheating

How to Handle Overheating..... 450

Indicator, Coming On/Blinking

If the 12-Volt Battery Charging System

Indicator Comes On 452

If the Malfunction Indicator Lamp Comes

On or Blinks 452

If the Brake System Indicator (Red) Comes

On 453

If the Electric Power Steering (EPS) System

Indicator Comes On 453

If the Electric Parking Brake System

Indicator Comes On 454

If the Low Tire Pressure/TPMS Indicator

Comes On or Blinks..... 455

If the Transmission System Indicator Blinks

along with the Warning Message... 456

If the Low Oil Level Symbol Appears..... 456

Fuses

Fuse Locations 457

Inspecting and Changing Fuses..... 461

Emergency Towing..... 462

When You Cannot Unlock the Fuel Fill

Door..... 463

When You Cannot Open the Hatch..... 464

Refueling

Refueling from a Portable Fuel Container 465

Types of Tools

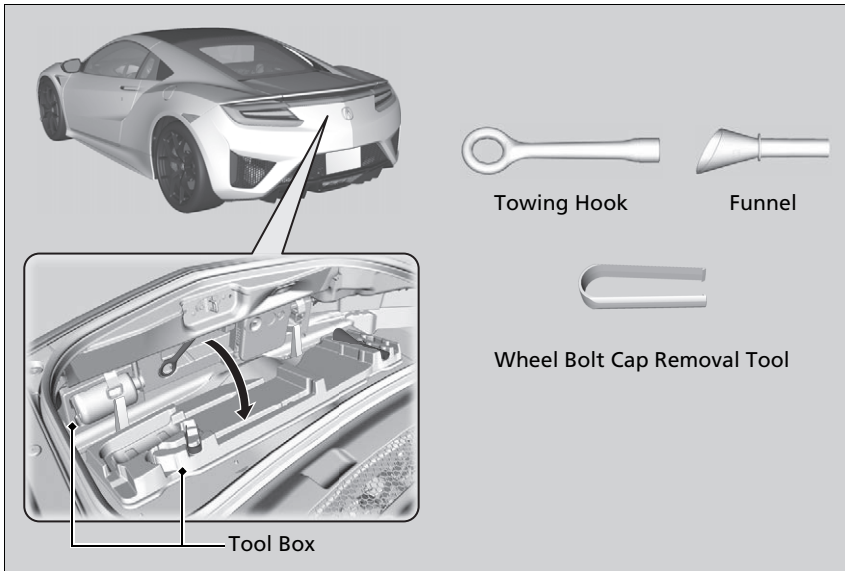

Types of Tools

The tools are stored in the trunk.

Temporarily Repairing a Flat Tire

If the tire has a large cut or is otherwise severely damaged, you will need to have the vehicle towed. If the tire only has a small puncture, from a small nail for instance, you can use the temporary tire repair kit so that you can drive to the nearest service station for a more permanent repair.

If a tire goes flat while driving, grasp the steering wheel firmly, and brake gradually to reduce speed. Then stop in a safe place.

1. Park the vehicle on a firm, level, and non-slippery surface. Apply the parking brake.
2. Put the transmission into **P**.
3. Turn on the hazard warning lights and set the power mode to VEHICLE OFF.

Temporarily Repairing a Flat Tire

The kit should not be used in the following situations. Instead, contact an authorized Acura NSX dealer or a roadside assistant to have the vehicle towed.

- The tire sealant has expired.
- More than one tire is punctured.
- The puncture or cut is larger than 3/16 inch (4 mm).
- The tire side wall is damaged or the puncture is outside the contact area.



When the puncture is:	Kit Use
Smaller than 3/16 inch (4 mm)	Yes
Larger than 3/16 inch (4 mm)	No

- Damage has been caused by driving with the tire extremely under inflated.
- The tire bead is no longer seated.
- The rim is damaged.

Do not remove a nail or screw that punctured the tire. If you remove it from the tire, you may not be able to repair the puncture using the kit.

NOTICE

Do not use a puncture-repairing agent other than the one provided in the kit that came with your vehicle. If a different agent is used, you may permanently damage the tire pressure sensor.

■ Getting Ready to Temporarily Repair the Flat Tire

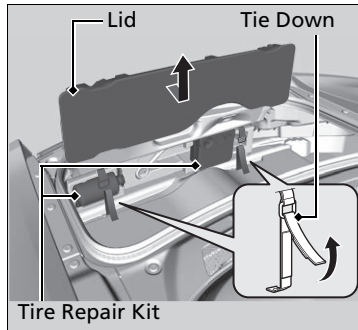
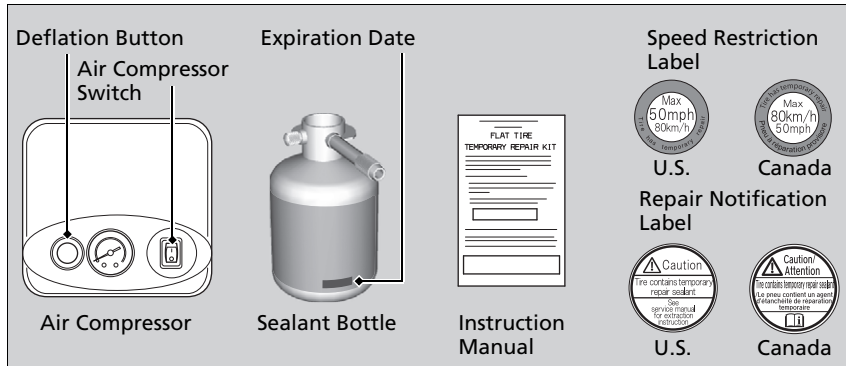

1. Open the hatch.
2. Loosen tool box tie downs.
3. Remove tool box lid.
4. Take the kit out of the tool box.
5. Place the kit face up, on flat ground near the flat tire, and away from traffic. Do not place the kit on its side.

▶▶ Getting Ready to Temporarily Repair the Flat Tire

When making a temporary repair, carefully read the instruction manual provided with the kit.

Injecting Sealant and Air

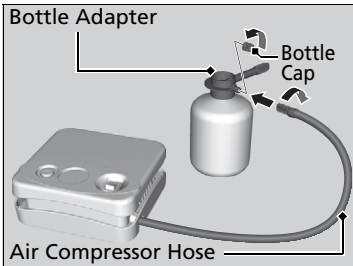
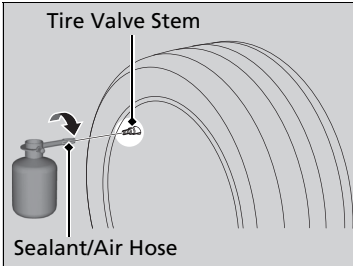
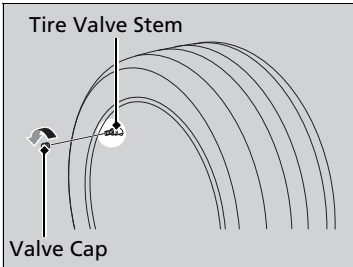

1. Remove the valve cap from the tire valve stem.
2. Shake the sealant bottle.
3. Attach the sealant/air hose onto the tire valve stem. Screw the sealant/air hose until it is tightly connected to the valve stem.
 - Make sure the bottle remains upright to ensure all the sealant flows into the tire.
4. Remove the bottle cap from the bottle adapter.
5. Attach the air compressor hose onto the bottle adapter. Screw the air compressor hose until it is tightly connected to the bottle adapter.

Injecting Sealant and Air

⚠ WARNING

Tire sealant contains substances that are harmful and can be fatal if swallowed.

If accidentally swallowed, do not induce vomiting. Drink plenty of water and get medical attention immediately.

For skin or eye contact, flush with cool water and get medical attention if necessary.

Keep the sealant bottle out of the reach of children. Do not shake the bottle after the bottle cap is removed. If you shake the bottle after the cap is removed, it may spill sealant.

In cold temperatures, the sealant may not flow easily. In this situation, warm it up for five minutes before using.

The sealant is latex based and can permanently stain clothing and other materials. Be careful during handling and wipe up any spills immediately.

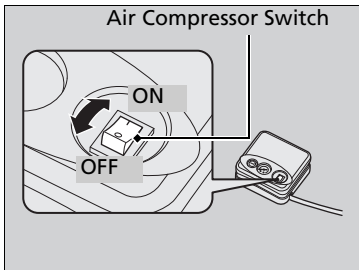
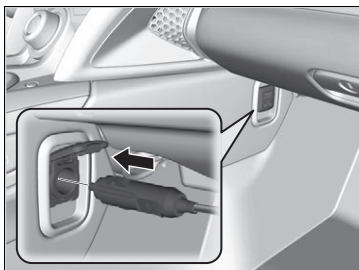

6. Plug in the compressor to the accessory power socket.
 - ▶ Be careful not to pinch the cord in a door or window.
 - **Accessory Power Socket** P. 153
7. Turn the power system on.
 - ▶ Keep the power system on while injecting sealant and air.
 - **Carbon Monoxide Gas** P. 67
8. Turn the air compressor on to inflate the tire.
 - ▶ The compressor starts injecting sealant and air into the tire.
9. After the air pressure reaches 32 psi (220 kPa), turn off the compressor.

➤ Injecting Sealant and Air

⚠ WARNING

Running the engine with the vehicle in an enclosed or even partly enclosed area can cause a rapid build-up of toxic carbon monoxide.

Breathing this colorless, odorless gas can cause unconsciousness and even death. Only run the engine to power the air compressor with the vehicle outdoors.

NOTICE

Do not operate the temporary tire repair kit compressor for more than 15 minutes. The compressor can overheat and become permanently damaged.

Until the sealant injection is complete, the pressure shown on the pressure gauge will appear higher than actual. After the sealant injection is complete the pressure will drop and then begin to rise again as the tire is inflated with air. This is normal. To accurately measure the air pressure using the gauge, turn the air compressor off only after the sealant injection is complete.

If the required air pressure is not reached within 15 minutes, the tire may be too severely damaged for the kit to provide the necessary seal and your vehicle will need to be towed.

See an authorized Acura NSX dealer for a replacement sealant bottle and proper disposal of an empty bottle.

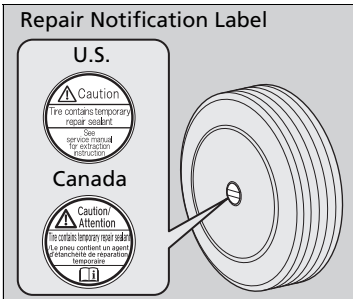
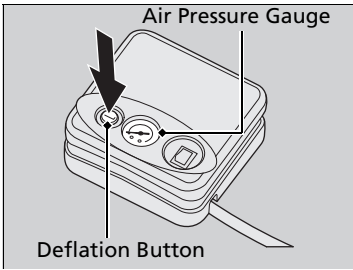

10. Unplug the kit from the accessory power socket.
11. Unscrew the sealant/air hose from the tire valve stem. Reinstall the valve cap.
12. Push the deflation button until the gauge returns 0 psi (0 kPa).
13. Apply the repair notification label to the flat surface of the wheel.
 - ▶ The wheel surface must be clean to ensure the label adheres properly.

■ Distributing the Sealant in the Tire

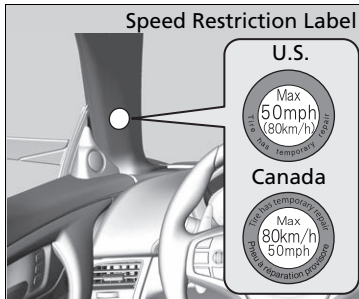

1. Apply the speed restriction label to the location as shown.
2. Drive the vehicle for about five minutes.
 - ▶ Do not exceed 50 mph (80 km/h).
3. Stop the vehicle in a safe place.

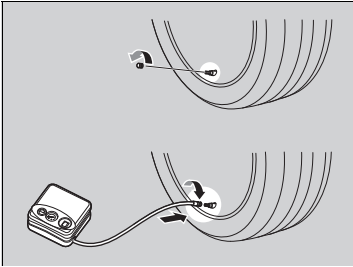

4. Recheck the air pressure using the gauge on the air compressor.
 - Do not turn the air compressor on to check the pressure.
5. If the air pressure is:
 - Less than 19 psi (130 kPa):
Do not add air or continue driving. The leak is too severe. Call for help and have your vehicle towed.
 - ▣ **Emergency Towing** P. 462
 - 32 psi (220 kPa) or more:
Continue driving for another five minutes or until you reach the nearest service station if less than five minutes away. Do not exceed 50 mph (80 km/h).
 - Stop and check the air pressure again. If the air pressure does not go down after the five minute drive, you do not need to check the pressure any more. Drive to the nearest service station to fix or replace the tire.

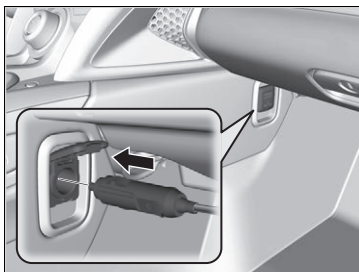

Air Compressor Switch

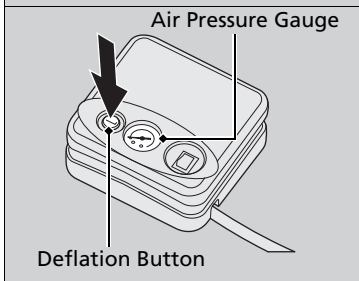
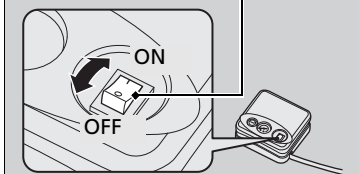

- Greater than 19 psi (130 kPa), but less than 32 psi (220 kPa):
Turn the air compressor on to inflate the tire until the tire pressure reaches 32 psi (220 kPa).
 ▶ **Injecting Sealant and Air** P. 435
Then drive carefully for five more minutes or until you reach the nearest service station if less than five minutes away.
Do not exceed 50 mph (80 km/h).
 ▶ You should repeat this procedure as long as the air pressure is within this range.

▶▶ Distributing the Sealant in the Tire

⚠ WARNING

Running the engine with the vehicle in an enclosed or even partly enclosed area can cause a rapid build-up of toxic carbon monoxide.

Breathing this colorless, odorless gas can cause unconsciousness and even death. Only run the engine to power the air compressor with the vehicle outdoors.

Refer to the driver's doorjamb label for the specified pressure.

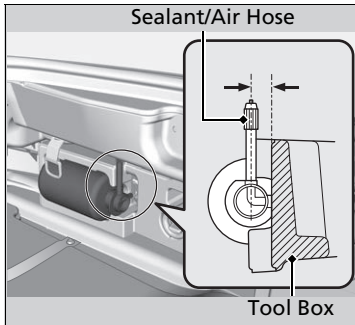

6. Repackage and properly stow the kit.
 - ▶ Ensure the sealant bottle is inserted with the sealant/air hose parallel to the tool box to prevent the bottle/hose damage.

■ Inflating an Under-inflated Tire

You can use the kit to inflate a non-punctured under-inflated tire.

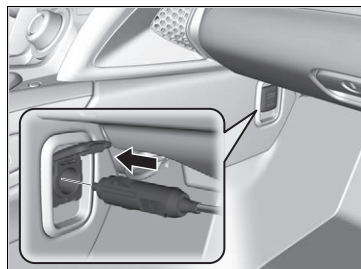
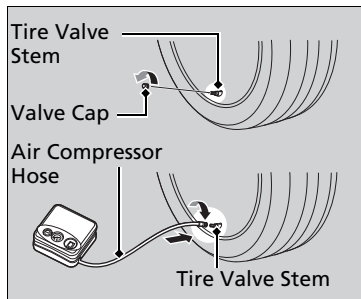

1. Take the kit out of the box.
 - **Getting Ready to Temporarily Repair the Flat Tire** P. 434
2. Place the kit, face up, on flat ground near the flat tire, away from traffic. Do not place the kit on its side.
3. Remove the valve cap from the tire valve stem.
4. Attach the air compressor hose onto the tire valve stem.
Screw the air compressor hose until it is tightly connected to the valve stem.
5. Plug in the compressor to the accessory power socket.
 - ▶ Be careful not to pinch the cord in a door or window.
 - **Accessory Power Socket** P. 153
6. Turn the power system on.
 - ▶ Keep the power system on while injecting air.
 - **Carbon Monoxide Gas** P. 67

▶▶ Inflating an Under-inflated Tire

⚠ **WARNING**

Running the engine with the vehicle in an enclosed or even partly enclosed area can cause a rapid build-up of toxic carbon monoxide.

Breathing this colorless, odorless gas can cause unconsciousness and even death. Only run the engine to power the air compressor with the vehicle outdoors.

NOTICE
Do not operate the temporary tire repair kit compressor for more than 15 minutes. The compressor can overheat and become permanently damaged.

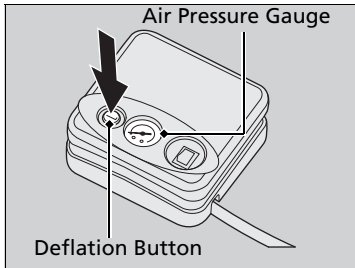
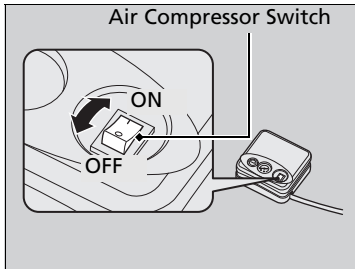

7. Turn the air compressor switch on to inflate the tire.
 - ▶ The compressor starts to inject air into the tire.
 - ▶ If you have turned the power system on, keep the power system on while injecting air.
8. Inflate the tire to the specified air pressure.
9. Turn off the kit.
 - ▶ Check the pressure gauge on the air compressor.
 - ▶ If overinflated, press the deflation button.
10. Unplug the kit from the accessory power socket.
11. Unscrew the air hose from the tire valve stem. Reinstall the valve cap.
12. Push the deflation button until the gauge returns 0 psi (0 kPa).
13. Repackage and properly stow the kit.

Handling of the Jack

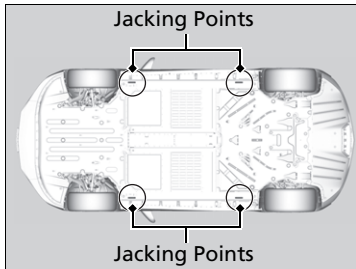

Your vehicle has jacking points as shown. When replacing your tires, consult an authorized Acura NSX dealer.

Handling of the Jack

Many types of jacks and jack stands, as well as improper lifting procedures, may cause side sill and underbody damage. Please consult an authorized Acura NSX dealer about proper lifting equipment and methods.

Checking the Procedure

When the **READY** indicator does not come on and the **Ready To Drive** message does not appear on the driver information interface, check the following items and take appropriate action.

☒ Checking the Procedure

If you must start the vehicle immediately, use an assisting vehicle to jump start it.

☒ **Jump Starting** P. 448

Checklist	Condition	What to Do
Check if the related indicator or driver information interface messages come on.	The Temperature Is Too Cold For Vehicle To Operate message appears.	☒ Driver Information Interface Warning and Information Messages P. 83
	The To Start, Hold Remote Near Start Button message appears. ▶ Make sure the keyless access remote is in its operating range. ☒ ENGINE START/STOP Button Operating Range P. 127	
	The POWER SYSTEM indicator comes on.	Have your vehicle checked by an authorized Acura NSX dealer.
	The transmission system indicator blinks and Transmission Problem Apply Parking Brake When Parked message appears.	The power system can be activated as a temporary measure. ☒ If the Transmission System Indicator Blinks along with the Warning Message P. 456
Check the brightness of the interior lights.	The interior lights are dim or do not come on at all.	Have the 12-volt battery checked by an authorized Acura NSX dealer.
	The interior lights come on normally.	Check all fuses, or have your vehicle checked by an authorized Acura NSX dealer. ☒ Inspecting and Changing Fuses P. 461
Check the gear position.	The transmission is not in P .	Put the transmission into P .
Check the immobilizer system indicator.	When the immobilizer system indicator is blinking, the power system cannot be turned on.	☒ Immobilizer System Indicator P. 81

If the Keyless Access Remote Battery is Weak

If the beeper sounds, the **ENGINE START/STOP** button flashes, and the **READY** indicator does not come on.

The **To Start, Hold Remote Near Start Button** message appears on the driver information interface.

Turn on the power system as follows.

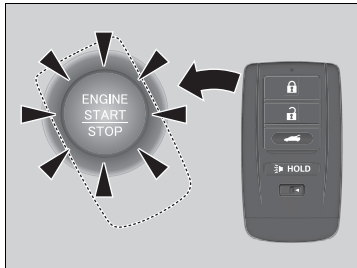

1. Touch the center of the **ENGINE START/STOP** button with the **A** logo on the keyless access remote while the **ENGINE START/STOP** button is flashing. The buttons on the keyless access remote should be facing you.

▶ The **ENGINE START/STOP** button flashes for about 30 seconds.

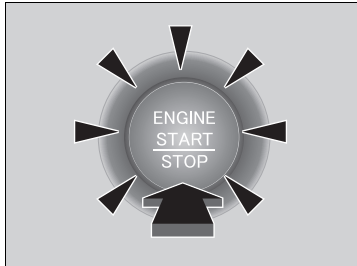

2. Depress the brake pedal and press the **ENGINE START/STOP** button within 10 seconds after the beeper sounds and the **ENGINE START/STOP** button changes from flashing to on.

▶ If you don't depress the pedal, the mode will change to **ACCESSORY**.

Emergency Power System Off

The **ENGINE START/STOP** button may be used to turn the power system off due to an emergency situation even while driving. If you must turn the power system off, do either of the following operations:

- Press and hold the **ENGINE START/STOP** button for about two seconds.
- Firmly press the **ENGINE START/STOP** button three times.

The steering wheel will not lock. However, because turning off the engine disables the power assist the engine provides to the steering and braking systems, it will require significantly more physical effort and time to steer and slow the vehicle. Use both feet on the brake pedal to slow down the vehicle and stop immediately in a safe place.

The gear position automatically changes to **P** after the vehicle comes to a complete stop. Then, the power mode changes to VEHICLE OFF.

⊠ Emergency Power System Off

Do not press the button while driving unless it is absolutely necessary for the power system to be turned off.

Jump Starting Procedure

Turn off the power to electric devices, such as audio and lights. Turn off the power system, then open the hood.

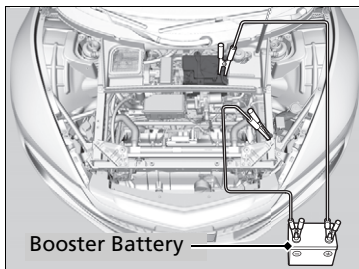
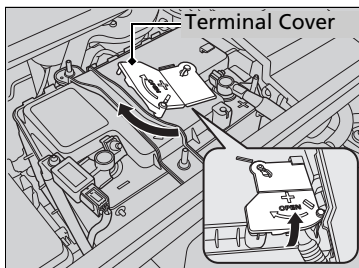

1. Remove the maintenance cover.
➤ **Checking the 12-Volt Battery** P. 417
2. Slide the terminal cover on your vehicle's 12-volt battery positive \oplus terminal as shown.
3. Connect the first jumper cable to your vehicle's 12-volt battery \oplus terminal.
4. Connect the other end of the first jumper cable to the booster battery \oplus terminal.
 - ▶ If you use a booster battery, only use a 12-volt booster battery.
 - ▶ When using an automotive battery charger, select a charging voltage lower than 15-volts. Check the charger manual for the proper setting.
5. Connect the second jumper cable to the booster battery \ominus terminal.

Jump Starting

⚠ WARNING

A 12-volt battery can explode if you do not follow the correct procedure, seriously injuring anyone nearby.

Keep all sparks, open flames, and smoking materials away from the 12-volt battery.

Securely attach the jumper cable clips so that they do not come off when the engine vibrates. Also be careful not to tangle the jumper cables or allow the cable ends to touch each other while attaching or detaching the jumper cables.

12-volt battery performance degrades in cold conditions and may prevent the engine from starting.

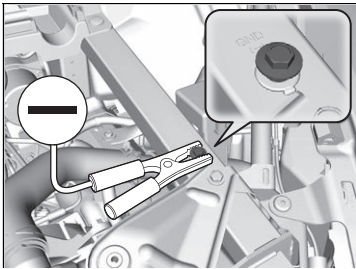

6. Connect the other end of the second jumper cable to the front frame as shown. Do not connect this jumper cable to any other part.
7. If your vehicle is connected to another vehicle, start the assisting vehicle's engine and increase its rpm slightly.
8. Attempt to start your vehicle's engine. If it turns over slowly, check that the jumper cables have good metal-to-metal contact.

■ What to Do After the Engine Starts

Once your vehicle's engine has started, remove the jumper cables in the following order.

1. Disconnect the jumper cable from your vehicle's ground.
2. Disconnect the other end of the jumper cable from the booster battery ⊖ terminal.
3. Disconnect the jumper cable from your vehicle's 12-volt battery ⊕ terminal.
4. Disconnect the other end of the jumper cable from the booster battery ⊕ terminal.

Have your vehicle inspected by a nearby service station or an authorized Acura NSX dealer.

How to Handle Overheating

Overheating symptoms are as follows:

- The temperature gauge pointer is at the **H** mark or the engine suddenly loses power.
- Steam or spray comes out of the engine compartment.

■ First thing to do

1. Immediately park the vehicle in a safe place.
 - ▶ Put the transmission into **P** and set the parking brake.
2. Turn off all accessories and turn on the hazard warning lights.
 - ▶ **No steam or spray present:** Keep the power system on and open the hatch.
 - ▶ **Steam or spray is present:** Turn off the power system and wait until it subsides. Then open the hatch.

🔗 How to Handle Overheating

⚠️ WARNING

Steam and spray from an overheated engine can seriously scald you.

Do not open the hatch if steam is coming out.

NOTICE

Continuing to drive with the temperature gauge pointer at the **H** mark may damage the engine.

■ Next thing to do

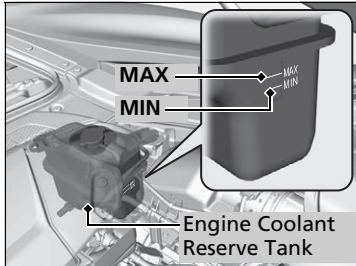

1. Check that the cooling fan is operating and turn the power system off once the temperature gauge pointer comes down.
 - ▶ If the cooling fan is not operating, immediately turn the power system off.
2. Once the engine has cooled down, inspect the coolant level and check the cooling system components for leaks.
 - ✘ **Checking the Coolant** P. 396
 - ▶ If the coolant level in the reserve tank is low, or no coolant in the tank, check that the radiator is cool. Cover the reserve tank cap with a heavy cloth and open the cap. Add coolant until it reaches the **MAX** mark, and put the cap back on.

■ Last thing to do

Once the engine has cooled sufficiently, turn the power system on and check the temperature gauge. If the temperature gauge pointer has gone down, resume driving. If it has not gone down, contact an authorized Acura NSX dealer for repairs.

▶▶ How to Handle Overheating

⚠ WARNING

Removing the reserve tank cap while the engine is hot can cause the coolant to spray out, seriously scalding you.

Always let the engine and radiator cool down before removing the reserve tank cap.

If the coolant is leaking, contact an authorized Acura NSX dealer for repairs.

Use water as an emergency/temporary measure only. Have an authorized Acura NSX dealer flush the system with proper antifreeze as soon as possible.

If the 12-Volt Battery Charging System Indicator Comes On



■ Reasons for the indicator to come on

Comes on when the 12-volt battery is not being charged.

■ What to do when the indicator comes on

Turn off the climate control system, rear defogger, and other electrical systems, and immediately contact an authorized Acura NSX dealer for repairs.

If the Malfunction Indicator Lamp Comes On or Blinks



■ Reasons for the indicator lamp to come on or blink

- Comes on when there is a problem with the engine emissions control system.
- Blinks when engine misfiring is detected.

■ What to do when the indicator lamp comes on

Avoid high speeds and immediately get your vehicle inspected at an authorized Acura NSX dealer.

■ What to do when the indicator lamp blinks

Park the vehicle in a safe place with no flammable items and wait at least 10 minutes or more with the engine stopped until it cools.

ⓘ If the 12-Volt Battery Charging System Indicator Comes On

If you need to stop temporarily, do not turn off the power system. Restarting the power system may rapidly discharge the battery.



ⓘ If the Malfunction Indicator Lamp Comes On or Blinks

NOTICE

If you drive with the malfunction indicator lamp on, the emissions control system and the engine could be damaged.

If the malfunction indicator lamp blinks again when restarting the engine, drive to the nearest authorized Acura NSX dealer at 31 mph (50 km/h) or less. Have your vehicle inspected.

If the Brake System Indicator (Red) Comes On

- U.S.  **■ Reasons for the indicator to come on**
- The brake fluid is low.
 - There is a malfunction in the brake system.
- Canada  **■ What to do when the indicator comes on while driving**
- Depress the brake pedal lightly to check pedal pressure.
- If normal, check the brake fluid level the next time you stop.
 - If abnormal, take immediate action. If necessary, downshift the transmission to slow the vehicle using regenerative braking.

If the Electric Power Steering (EPS) System Indicator Comes On

-  **■ Reasons for the indicator to come on**
- Comes on if there is a problem with the EPS system.
- What to do when the indicator comes on**
- Stop the vehicle in a safe place and turn on the power system again. If the indicator comes on and stays on, immediately have your vehicle inspected by an authorized Acura NSX dealer.

▶▶ If the Brake System Indicator (Red) Comes On

Have your vehicle repaired immediately. It is dangerous to drive with low brake fluid. If there is no resistance from the brake pedal, stop immediately in a safe place. If necessary, downshift the gears.

If the brake system indicator and **ABS** indicator come on simultaneously, the electronic brake distribution system is not working. This can result in vehicle instability under sudden braking.

Have your vehicle inspected by an authorized Acura NSX dealer immediately.

If both red and amber brake system indicators come on, stop the vehicle in a safe place and have it inspected by an authorized Acura NSX dealer immediately.

If the Electric Parking Brake System Indicator Comes On



■ Reasons for the indicator to come on

Comes on when there is a problem with the electric parking brake system.

■ What to do when the indicator comes on

Avoid using the parking brake and immediately get your vehicle inspected at an authorized Acura NSX dealer.

■ What to do when the electric parking brake indicator comes on or blinks at the same time.

Release the parking brake.

🔧 Parking Brake P. 357

- If the electric parking brake indicator remains on or blinks even after releasing the parking brake, immediately stop the vehicle in a safe place, and call an authorized Acura NSX dealer.
 - ▶ To prevent your vehicle from moving unexpectedly, put the transmission into **P**.
- If only the electric parking brake indicator goes off, immediately get your vehicle inspected at an authorized Acura NSX dealer.

⚠️ If the Electric Parking Brake System Indicator Comes On

If you apply the parking brake, it may not release.

If the electric parking brake indicator turns on, the parking brake is still applied.

When the electric parking brake indicator blinks at the same time as the electric parking brake system indicator, the system must be checked. The parking brake may not operate under these conditions.

If the Low Tire Pressure/TPMS Indicator Comes On or Blinks



■ Reasons for the indicator to come on or blink

Tire pressure is significantly low in one or more of the tires. If there is a problem with the TPMS, the indicator blinks for about one minute, and then stays on.

■ What to do when the indicator comes on

Drive carefully, avoid abrupt or sharp cornering, and hard braking. Stop your vehicle in a safe place. Check the tire pressure and adjust the pressure to the specified level. The specified tire pressure is on a label on the driver's side doorjamb.

■ What to do when the indicator blinks

Have the tire inspected by an authorized Acura NSX dealer as soon as possible.

▶▶ If the Low Tire Pressure/TPMS Indicator Comes On or Blinks

NOTICE

Driving on an extremely underinflated tire can cause it to overheat. An overheated tire can fail. Always inflate your tires to the prescribed level.

If the Transmission System Indicator Blinks along with the Warning Message



■ Reasons for the indicator to blink

The transmission is malfunctioning.

■ What to do when the indicator blinks

- Immediately have your vehicle inspected by an authorized Acura NSX dealer.
- Put the transmission into **N** when you turn the power system on.
 - ▶ Check to verify the **N** position on the instrument panel is selected and if the indicator on the **N** button is illuminating or blinking.
 - ▶ The power system cannot be turned on unless the parking brake is set.

🔧 **Turning on the Power** P. 321



🔧 If the Transmission System Indicator Blinks along with the Warning Message

You may not be able to turn on the power system.

Make sure to set the parking brake when parking your vehicle.

Call a professional towing service if you need to tow your vehicle.

🔧 **Emergency Towing** P. 462

If the Low Oil Level Symbol Appears



■ Reasons for the symbol to appear

Appears when the engine oil level is low.

■ What to do as soon as the symbol appears

1. Immediately park the vehicle on level ground in a safe place.
2. If necessary, turn the hazard warning lights on.

■ What to do after parking the vehicle

Check the oil level.

🔧 **Oil Check** P. 391

🔧 If the Low Oil Level Symbol Appears

NOTICE

Running the engine with a low oil level can cause serious mechanical damage almost immediately.

This system activates after the engine warms up. If the outside temperature is extremely low, you may have to drive for a long time until the system senses the engine oil level.

If the symbol appears again, turn the power system off, and contact an authorized Acura NSX dealer for repairs immediately.

Fuse Locations

If any electrical devices are not working, set the power mode to VEHICLE OFF, and check to see if any applicable fuse is blown.

Hood Fuse Box

There are two fuse boxes under the hood. Fuse locations are shown on the fuse box cover. Locate the fuse in question by the fuse number and box cover number.

Fuse box A

Located near the radiator. Push the tabs to open the box.

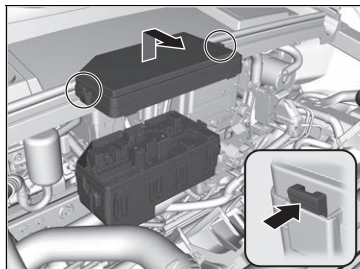

Circuit protected and fuse rating

	Circuit Protected	Amps
1	EPS	70 A
	Cooling Fan	50 A
	ABS/VSA Motor	40 A
	ABS/VSA FSR	20 A
	AS F/B Main	30 A
	Main Fuse	200 A
	–	(50 A)
2	F/B Main 1	60 A
	–	(60 A)
	–	(50 A)
	Left Electric Parking Brake Motor	30 A
	Right Electric Parking Brake Motor	30 A
	–	(40 A)
	Heater Motor 2	30 A
	Heater Motor 1	30 A
	–	(40 A)
	–	(40 A)
3	E-OP	30 A
	–	(30 A)
	ADS	30 A
	AMP*	(30 A)
4	Parking Light	10 A
5	IGPS PCS	7.5 A
6	Left Headlight High Beam	10 A
7	VFP2	7.5 A

	Circuit Protected	Amps
8	Left Headlight Low Beam	10 A
9	Right Headlight High Beam	10 A
10	Right Headlight Low Beam	10 A
11	IGPS Fan	7.5 A
12	FI Main	15 A
13	FI Sub	20 A
14	Back Up	7.5 A
15	SBW ECU	7.5 A
16	DBW1	15 A
17	IG Coil	15 A
18	DBW2	15 A
19	Parking Light & Headlight Main	20 A
20	Rear Defroster	20 A
21	Front Washer	20 A
22	ISC	15 A
23	–	–
24	ACC/IG2 Main	10 A
25	Daytime Running Lights	10 A
26	Horn	10 A
27	Interior Lights	7.5 A
28	IGP2	15 A
29	Audio	10 A

* Not available on all models

■ **Fuse box B**

Located near the 12-volt battery. Remove the maintenance cover, then push the tabs to open the box.

☒ **Checking the 12-Volt Battery** P. 417

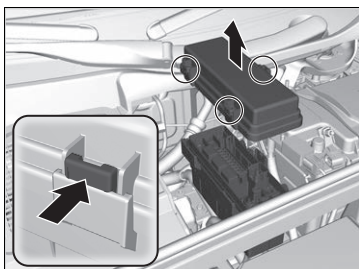

Handling the Unexpected

■ **Circuit protected and fuse rating**

	Circuit Protected	Amps
1	SBW	60 A
	–	–
	F/B Main 2	60 A
	Wiper	30 A
	Passenger Power Window	30 A
	IG Main 1	30 A
2	Driver Power Window	30 A
	ESB	40 A
3	IG Main 2	30 A
4	IMA Motor	20 A
5	BMS	7.5 A
6	Stop	7.5 A
7	Turbo W/G	20 A
8	Hazard	7.5 A
9	A/C W/P	10 A
10	–	–
11	AEV	7.5 A
12	FI-ECU Backup	7.5 A
13	–	–
14	–	–
15	–	–
16	–	–
17	IMA Motor	10 A

■ Driver's Side Interior Fuse Box

Located under the dashboard.

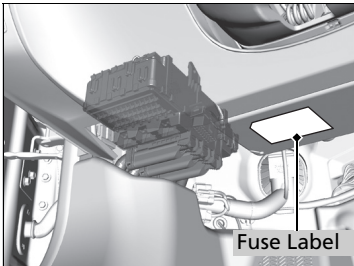

Fuse locations are shown on the label on the under panel.

Locate the fuse in question by the fuse number and label number.

■ Circuit protected and fuse rating

	Circuit Protected	Amps
1	Passenger's Door Handle	10 A
2	Door Lock	15 A
3	SMART	7.5 A
4	–	–
5	Front Accessory Power Socket	20 A
6	Fuel Pump	20 A
7	MISS SOL	15 A
8	ENG	7.5 A
9	VSA/ABS	7.5 A
10	SRS	10 A
11	Power System 2	10 A
12	–	–
13	Power System 1	10 A
14	Fuel Lid	7.5 A
15	Driver's Power Seat Reclining*	(20 A)
16	–	(7.5 A)
17	Seat Heater*	(20 A)
18	Driver's Door Handle	10 A
19	–	–
20	Passenger's Side Door Unlock	7.5 A
21	Daytime Running Lights	7.5 A
22	Key Lock	7.5 A
23	Air Conditioning	7.5 A

	Circuit Protected	Amps
24	Feed Back IG1a	7.5 A
25	Instrument Panel Lights	7.5 A
26	Power Lumbar Support*	(7.5 A)
27	Parking Lights	7.5 A
28	Sub Main	15 A
29	Meter	10 A
30	DR2	7.5 A
31	Sub Fuel Pump	15 A
32	SRS	10 A
33	Passenger's Side Door Lock	7.5 A
34	Driver's Door Lock	7.5 A
35	Driver's Door Unlock	7.5 A
36	Driver's Power Seat Sliding*	(20 A)
37	Right Daytime Running Light	7.5 A
38	Left Daytime Running Light	7.5 A
39	Feed Back IG1b	7.5 A
40	ACC	7.5 A
41	–	–
42	–	–

* Not available on all models

■ Passenger's Side Interior Fuse Box

Located inside the passenger's side under cover. Remove the clips using a Phillips-head screwdriver, then open the under cover.

Fuse locations are shown on the label on the under cover.

Locate the fuse in question by the fuse number and label number.

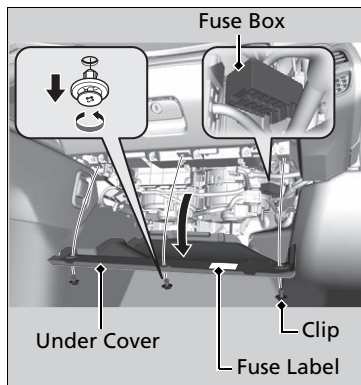

■ Circuit protected and fuse rating

	Circuit Protected	Amps
a	Passenger's Power Seat Sliding*	(20 A)
b	Passenger's Power Seat Reclining*	(20 A)
c	–	(10 A)
d	–	–
e	Wiper	7.5 A
f	EPS	7.5 A
g	DR1	7.5 A
h	Power System 3	7.5 A

■ Rear Side Interior Fuse Box

Located near the rear center speaker. Fuse locations are shown on the hood fuse box A cover.

Have an authorized Acura NSX dealer inspect and replace the fuse.

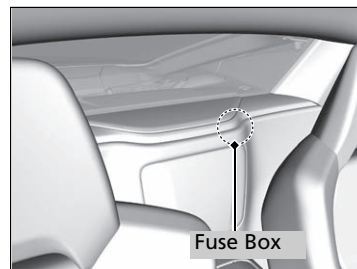

■ Circuit protected and fuse rating

	Circuit Protected	Amps
1	HCA-2	20 A
2	–	–
3	–	–
4	–	–
5	HCA-1	20 A
6	DI-INJ	20 A
7	–	–
8	TCU	30 A

Inspecting and Changing Fuses

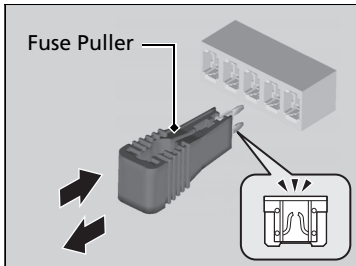
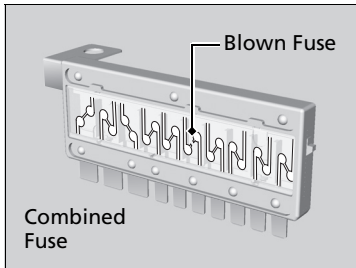

1. Set the power mode to VEHICLE OFF. Turn headlights and all accessories off.
2. Remove the fuse box cover.
3. Check the large fuse in the hood.
 - If the fuse is blown, use a Phillips-head screwdriver to remove the screw and replace it with a new one.
4. Inspect the small fuses in the hood and the vehicle interior.
 - If there is a burned out fuse, remove it with the fuse puller and replace it with a new one.

Inspecting and Changing Fuses

NOTICE

Replacing a fuse with one that has a higher rating greatly increases the chances of damaging the electrical system.

Replace fuse with a spare fuse of the same specified amperage.

Use the charts to locate the fuse in question and confirm the specified amperage on the fuse label.

► **Fuse Locations** P. 457

There is a fuse puller on the back of the hood fuse box A cover.

Call a professional towing service if you need to tow your vehicle.

■ Flat bed equipment

The operator loads your vehicle on the back of a truck.

This is the only way you can safely transport your vehicle.

Any other towing method will damage the vehicle's drive system.

» Emergency Towing

NOTICE

Trying to lift or tow your vehicle by the bumpers will cause serious damage. The bumpers are not designed to support the vehicle's weight.

NOTICE

Improper towing such as towing behind a motorhome or other motor vehicle can damage the transmission.

Never tow your vehicle with a rope or chain. It is very dangerous since ropes or chains may shift from side to side or break. You will also damage the vehicle's drive system.

■ What to Do When Unable to Unlock the Fuel Fill Door

If you cannot unlock the fuel fill door, use the following procedure.

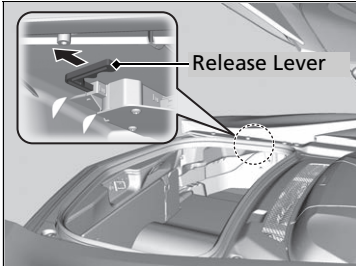

1. Open the hatch.
2. Pull the release lever toward you.
 - ▶ The release lever unlocks the fuel fill door when it is pulled.

⌘ When You Cannot Unlock the Fuel Fill Door

After taking these steps, contact an authorized Acura NSX dealer to have your vehicle checked.

■ What to Do When Unable to Open the Hatch

If you cannot open the hatch, use the following procedure.

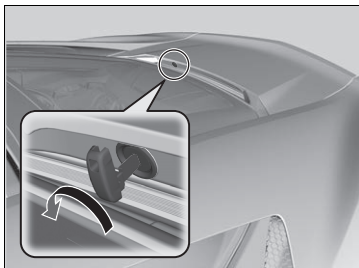

1. Remove the built-in key.
2. Fully insert the key and turn it.

☞ When You Cannot Open the Hatch

After taking these steps, contact an authorized Acura NSX dealer to have your vehicle checked.

If the security system alarm is set and open the hatch with the built-in key, the alarm goes off.

☑ **Security System Alarm** P. 122

Refueling from a Portable Fuel Container

If you have run out of fuel and need to refuel your vehicle from a portable fuel container, use the funnel provided with your vehicle.

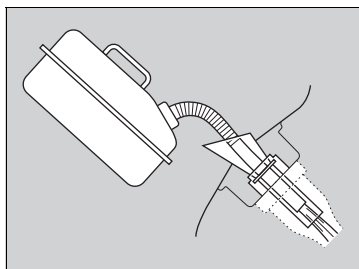
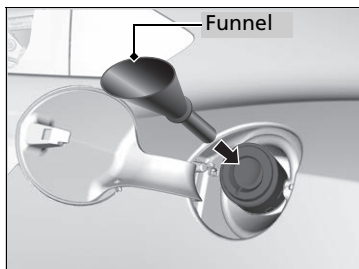

1. Turn off the power system.
2. Press the fuel fill door release button.
 - ▶ The fuel fill door opens.
3. Take the funnel out of the tool box in the trunk.
 - ▶ **Types of Tools** P. 432
4. Place the end of the funnel on the lower part of filler opening, then insert it slowly and completely.
 - ▶ Make sure that the end of the funnel goes down along with the filler pipe.
5. Fill the tank with fuel from the portable fuel container.
 - ▶ Pour fuel carefully so you do not spill any.
6. Remove the funnel from the filler neck.
 - ▶ Wipe up any fuel from the funnel before storing it.
7. Shut the fuel fill door by hand.

Refueling from a Portable Fuel Container

WARNING

Gasoline is highly flammable and explosive. You can be burned or seriously injured when handling fuel.

- Turn the power system off, and keep heat, sparks, and flame away.
- Handle fuel only outdoors.
- Wipe up spills immediately.

NOTICE

Do not insert the nozzle of a portable fuel container or any funnel other than the one provided with your vehicle. Doing so can damage the fuel system. Do not try to pry open or push open the filler opening with foreign objects. This can damage the filler opening and its seal.

Make sure the fuel in the portable fuel container is gasoline before you refuel.

Information

This chapter includes your vehicle's specifications, locations of identification numbers, and other information required by regulation.

Specifications	468
Identification Numbers	
Vehicle Identification Number (VIN), Engine Number, Motor Number, and Transmission Number.....	470
Devices that Emit Radio Waves	471
Reporting Safety Defects	472
Emissions Testing	
Testing of Readiness Codes.....	473
Warranty Coverages	475
Authorized Manuals	477
Client Service Information	478

■ Vehicle Specifications

Model	Acura NSX
No. of Passengers:	
Front	2
Rear	0
Total	2
Weights:	
Gross Vehicle Weight Rating	See the certification label on the driver's doorjamb
Gross Axle Weight Rating (Front)	See the certification label on the driver's doorjamb
Gross Axle Weight Rating (Rear)	See the certification label on the driver's doorjamb

■ Air Conditioning

Refrigerant Type	HFO-1234yf (R-1234yf)
Charge Quantity	14.3 - 16.0 oz (405 - 455 g)
Lubricant Type	ND-OIL 11
Quantity	6.1 - 7.0 cu-in (100 - 115 cm ³)

■ Engine Specifications

Displacement	213 cu-in (3,493 cm ³)	
Spark Plugs	NGK	SILZKAR8F7S

■ Fuel

Type	Unleaded premium gasoline, Pump octane number of 91 or higher	
Fuel Tank Capacity	15.6 US gal (59.0 L)	

■ Washer Fluid

Tank Capacity	2.6 US qt (2.5 L)	
---------------	-------------------	--

■ Light Bulbs

Headlights (Low Beam)	LED
Headlights (High Beam)	LED
Front Turn Signal/Parking Lights	LED
Front Side Marker Lights	LED
Side Turn Signal Lights (on Door Mirrors)	LED
Daytime Running Lights	LED
Rear Turn Signal Lights	LED
Brake/Taillights	LED
Rear Side Marker Lights	LED
Taillights	LED
Back-Up Lights	LED
Rear License Plate Lights	LED
High-Mount Brake Light	LED
Interior Lights	
Map Lights	LED
Ambient Lights	LED
Door Courtesy Lights	LED
Glove Box Light	LED
Trunk Light	LED

■ **Brake Fluid**

Specified	Acura Heavy Duty Brake Fluid DOT 4
-----------	------------------------------------

■ **Dual Clutch Transmission Fluid**

Clutch

Specified	Acura Automatic Transmission Fluid ATF DW-1
Capacity	Change 2.75 US qt (2.6 L)

Transmission

Specified	Acura Gear Oil GO-Type 2.0
Capacity	Change 4.86 US qt (4.6 L)

■ **Twin Motor Unit Fluid**

Specified	Acura Automatic Transmission Fluid ATF DW-1
Capacity	Change 2.56 US qt (2.42 L)

■ **Engine Oil**

Recommended	Ultimate Full Synthetic Motor Oil, Type3, 0W-40
	Change 7.7 US qt (7.3 L)
Capacity	Change including filter 8.3 US qt (7.9 L)

■ **Engine Coolant**

Specified	Acura Long Life Antifreeze/Coolant Type2
Ratio	50/50 with distilled water
Capacity	4.1 US gal (15.5 L) (change including the remaining 0.34 US gal (1.29 L) in the reserve tank and heater)

■ **Inverter Coolant**

Specified	Acura Long Life Antifreeze/Coolant Type2
Ratio	50/50 with distilled water
Capacity	0.50 US gal (1.90 L) (change including the remaining 0.12 US gal (0.46 L) in the reserve tank)

■ **Tire**

Regular	Size	Front	245/35ZR19 (93Y)
		Rear	305/30ZR20 (103Y)
Regular	Pressure psi (kPa [kgf/cm ²])	Front	32 (220 [2.2])
		Rear	32 (220 [2.2])
Wheel Size	Regular	Front	19 X 8 1/2J
		Rear	20 X 11J

Vehicle Identification Number (VIN), Engine Number, Motor Number, and Transmission Number

Your vehicle has a 17-digit vehicle identification number (VIN) used to register your vehicle for warranty purposes, and for licensing and insuring your vehicle. The locations of your vehicle's VIN, engine number, motor number, and transmission number are shown as follows.

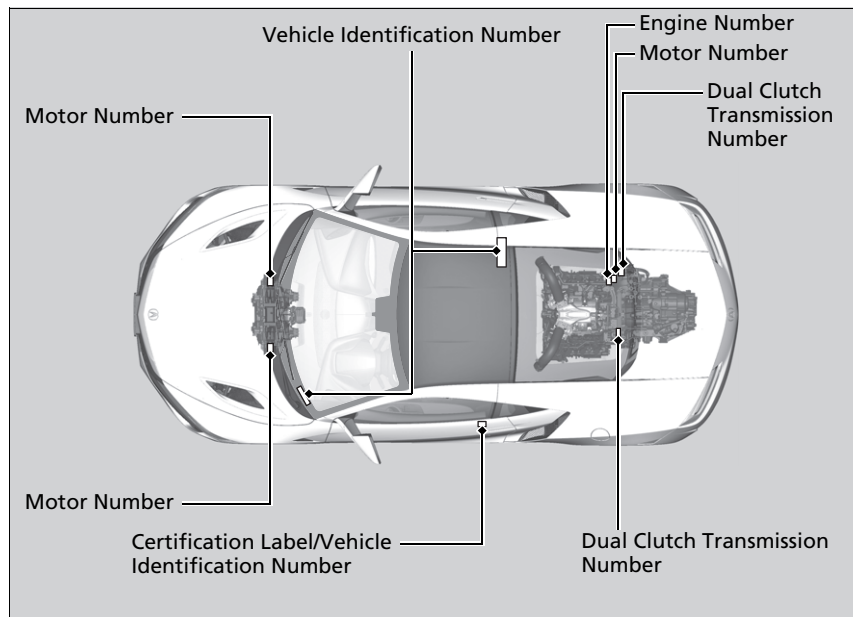

Vehicle Identification Number (VIN), Engine Number, Motor Number, and Transmission Number

The interior vehicle identification number (VIN) is located under the cover.

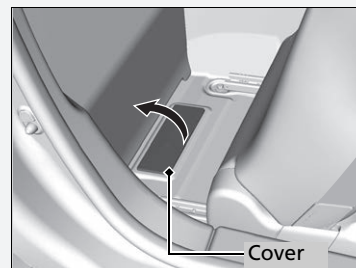

Each radio frequency device installed in the vehicle conforms to the requirements and standards of the regulation listed below:

As required by the FCC:

This device complies with Part 15 of the FCC rules. Operation is subject to the following two conditions: (1) This device may not cause harmful interference, and (2) this device must accept any interference received, including interference that may cause undesired operation.

Changes or modifications not expressly approved by the party responsible for compliance could void the user's authority to operate the equipment.

This device complies with industry Canada licence-exempt RSS standard(s). Operation is subject to the following two conditions: (1) this device may not cause interference, and (2) this device must accept any interference, including interference that may cause undesired operation of the device.

In the U.S.

If you believe that your vehicle has a defect which could cause a crash or could cause injury or death, you should immediately inform the National Highway Traffic Safety Administration (NHTSA) in addition to notifying American Honda Motor Co., Inc.

If NHTSA receives similar complaints, it may open an investigation, and if it finds that a safety defect exists in a group of vehicles, it may order a recall and remedy campaign. However, NHTSA cannot become involved in individual problems between you, your dealer, or American Honda Motor Co., Inc.

To contact NHTSA, you may call the Vehicle Safety Hotline toll-free at 1-888-327-4236 (TTY: 1-800-424-9153); go to <http://www.safercar.gov>; or write to: Administrator, NHTSA, 1200 New Jersey Avenue, SE., Washington, DC 20590. You can also obtain other information about motor vehicle safety from <http://www.safercar.gov>.

In Canada

If you believe that your vehicle has a defect which could cause a crash or could cause injury or death, you should immediately inform Honda Canada Inc. and you may also inform Transport Canada.

If Transport Canada receives similar complaints, it may open an investigation, and if it finds that a safety defect exists in a group of vehicles, it may lead to a recall and remedy campaign. However, Transport Canada cannot become involved in individual problems between you, your dealer, or Honda Canada Inc.

To contact Transport Canada's Defect Investigations and Recalls Division, you may call 1-800-333-0510. For more information on reporting safety defects or about motor vehicle safety, go to <http://www.tc.gc.ca/roadsafety>.

Testing of Readiness Codes

Your vehicle has readiness codes as part of the onboard self diagnostic system. Some States use these codes for testing to verify whether your vehicle's emissions components are working properly. The codes may not be read properly if testing is performed just after the 12-volt battery has gone dead or been disconnected.

To check if they are set, set the power mode to ON, without turning the power system on. The malfunction indicator lamp will come on for several seconds. If it then goes off, the readiness codes are set. If it blinks five times, the readiness codes are not set.

If you are required to have your vehicle tested before the readiness codes are ready, prepare the vehicle for retesting by doing the following:

1. Fill the gas tank to approximately 3/4 full.
2. Park the vehicle and leave the power system off for six hours or more.
3. Make sure the ambient temperature is between 40°F and 95°F (4°C and 35°C).
4. Start the engine without touching the accelerator pedal, and let it idle for 20 seconds.
5. Keep the vehicle in **P**. Increase the engine speed to 2,000 rpm, and hold it there for about three minutes.
6. Let the engine idle with your foot off the accelerator for 20 seconds.

Testing of Readiness Codes

The readiness codes are erased when the 12-volt battery is disconnected, and set again only after several days of driving under a variety of conditions.

If a testing facility determines that the readiness codes are not set, you may be requested to return at a later date to complete the test.

If the testing facility determines the readiness codes are still not set, see an authorized Acura NSX dealer.

7. Select a nearby, lightly traveled major highway where you can maintain a speed of 50 mph (80 km/h) over for at least 20 minutes. Drive on the highway in **D** with SPORT mode. Do not use cruise control.
8. Drive in city or suburban traffic for at least 10 minutes. When traffic conditions allow, let the vehicle coast for several seconds without using the accelerator pedal or the brake pedal.
9. Park the vehicle and leave the power system off for 40 minutes.

■ U.S. Owners

Your new vehicle is covered by these warranties:

New Vehicle Limited Warranty – covers your new vehicle, except for the emissions control systems and accessories, against defects in materials and workmanship.

Emissions Control Systems Defects Warranty and Emissions Performance Warranty – these two warranties cover your vehicle's emissions control systems. Time, mileage, and coverage are conditional. Please read your warranty booklet for exact information.

Seat Belt Limited Warranty – a seat belt that fails to function properly is covered by a limited warranty. Please read your warranty booklet for details.

Rust Perforation Limited Warranty – all exterior body panels are covered against rusting from the inside out for the specified time period, regardless of mileage.

Accessory Limited Warranty – Acura accessories are covered under this warranty. Time and mileage limits depend on the type of accessory and other factors. Please read your warranty booklet for details.

Replacement Parts Limited Warranty – covers all Acura replacement parts against defects in materials and workmanship.

Replacement 12-Volt Battery Limited Warranty – provides prorated coverage for a replacement battery purchased from an authorized Acura NSX dealer.

Replacement Muffler Lifetime Limited Warranty – provides coverage for as long as the purchaser of the muffler owns the vehicle.

Restrictions and exclusions apply to all these warranties. Please read the Acura warranty information booklet that came with your vehicle for precise information on warranty coverages. Your vehicle's original tires are covered by their manufacturer. Tire warranty information is in a separate booklet.

■ **Canadian Owners**

Please refer to the warranty manual that came with your vehicle.

■ **EPA Contact Information**

An owner may obtain further information concerning emission warranties or report violations of the terms of the emission warranties by contacting:

Director,
Light-Duty Vehicle Center,
U.S. Environmental Protection Agency,
Attention: Warranty Claim
2000 Traverwood Drive,
Ann Arbor, MI 48105;
complianceinfo@epa.gov

■ Service Express

For electronic copies of service publications, you can purchase a subscription to Service Express. Visit www.techinfo.honda.com for pricing and options.

■ For U.S. Owners

Manuals can be purchased from Helm Incorporated. You can order a manual by phone at 1 (800) 782-4356 (credit card orders only), or online at www.helminc.com.

■ For Canadian Owners

Please contact an authorized Acura NSX dealer to order any manuals that you may require.

Authorized Acura NSX dealership personnel are trained professionals who should be able to deal with any problems you may encounter with your vehicle. If, however, you are faced with a problem that they cannot resolve to your satisfaction, contact Acura Client Relations/Services.

U.S. Owners

American Honda Motor Co., Inc.
Acura Client Relations
Mail Stop 100-5E-8F
1919 Torrance Blvd.
Torrance, CA 90501-2746
Tel: 1-844-68-ACURA
(1-844-682-2872)

Canadian Owners

Honda Canada Inc.
Acura Client Services
180 Honda Boulevard
Markham, ON
L6C 0H9
Tel: 1-888-9-ACURA-9
1-844-9-MYNSX-9 (NSX-
specific)
Fax: 1-877-939-0909
E-mail: acura_cr@ch.honda.com

In Puerto Rico and the U.S. Virgin Islands

Bella International
P.O. Box 190816
San Juan, PR 00919-0816
Tel: 1 (787) 620-7546

Client Service Information

When you call or write, please give us the following information:

- Vehicle Identification Number
 - **Vehicle Identification Number (VIN), Engine Number, Motor Number, and Transmission Number** P. 470
- Date of purchase
- Odometer reading of your vehicle
- Your name, address, and telephone number
- A detailed description of the problem
- Name of the authorized Acura NSX dealer who sold the vehicle to you

Numbers

12-Volt Battery Charging System

Indicator 75, 452

A

AAC 208

ABS (Anti-lock Brake System) 362

Accessories and Modifications 426

Accessory Power Socket 153

Acoustic Vehicle Alerting System 335

Active Damper System Indicator 74

AcuraLink 304

Adding the Coolant 397

Additives

Coolant 396, 398

Washer 400

Adjusting

Mirrors 141

Seats 144

Steering Wheel 140

Temperature 100

Agile Handling Assist System 350

Air Conditioning System (Climate Control

System) 155

Changing the Mode 156

Defrosting the Windshield and

Windows 157, 158

Dust and Pollen Filters 419

Recirculation/Fresh Air Mode 156

Sensors 159

Using Automatic Climate Control 155

Air Pressure 408, 469

Airbags 43

Advanced Airbags 49

Airbag Care 57

Driver's Knee Airbag 50

Event Data Recorder 0

Front Airbags (SRS) 46

Indicator 55, 78

Passenger Front Airbag Off Indicator 56

Sensors 43

Side Airbags 52

Side Curtain Airbags 54

Android Auto 219

Anti-lock Brake System (ABS) 362

Indicator 78

Apple CarPlay 216

Audio Remote Controls 165

Audio System 162

Adjusting the Sound 181

Changing the Home Screen Icon

Layout 170

Closing Apps 180

Error Messages 223

General Information 226

Home Screen 173

iPod 199

Limitations for Manual Operation 183

MP3/WMA/AAC 208

Reactivating 164

Recommended Devices 227

Remote Controls 165

Security Code 164

Selecting an Audio Source 183

Status Area 179

Theft Protection 164

USB Flash Drives 227

USB Ports 163

Wallpaper Setup 171

Audio/Information Screen 167

Authorized Manuals 477

Auto Door Locking/Unlocking 118

Auto Engine Stop/Start 13

Automatic Brake Hold 360

Indicator 72, 360

Automatic Brake Hold System

Indicator 72, 360

Automatic Operation (automatic lighting

control) 132

Average Fuel Economy 101

Average Speed 101

B**Battery**

12-Volt	417
12-Volt Battery Charging System	
Indicator	75, 452
Charging (AGM Battery)	417
High Voltage	356
Jump Starting	448
Maintenance (Checking the 12-Volt Battery).....	417
Maintenance (Replacing).....	418
Battery Types	12
Belts (Seat)	36
Beverage Holders	152
Bluetooth® Audio	211
Bluetooth® HandsFreeLink®	270
Booster Seats (For Children)	66
Brake System	357
Anti-lock Brake System (ABS).....	362
Automatic Brake Hold.....	360
Brake Assist System	363
Fluid	400
Foot Brake	359
Parking Brake	357
Brake System (Amber)	
Indicator.....	73
Brake System (Red)	
Indicator.....	70, 453
Brake Wear	
Indicator.....	74

Bulb Replacement	401
Back-Up Lights	402
Daytime Running Lights.....	401
Front Side Marker Lights.....	401
Front Turn Signal/Parking Lights	401
Headlights.....	401
High-Mount Brake Light.....	403
Rear License Plate Lights.....	403
Rear Side Marker Lights.....	402
Rear Turn Signal Lights	402
Side Turn Signal/Emergency Indicator Lights	401
Taillights.....	402
Bulb Specifications	468

C

Carbon Monoxide Gas	67
Carrying Cargo	311, 313
Certification Label	470
Changing Bulbs	401
Charging System Indicator	75, 452
Child Safety	58
Emergency Hatch Opener.....	121
Child Seat	58
Booster Seats	66
Child Seat for Infants.....	60
Child Seat for Small Children.....	61
Installing a Child Seat.....	63
Larger Children	65
Selecting a Forward-facing Child Seat.....	62

Using a Tether	64
Cleaning the Exterior	422
Cleaning the Interior	420
Client Service Information	478
Climate Control System	155
Defrosting the Windshield and Windows	157, 158
Dust and Pollen Filters.....	419
Recirculation/Fresh Air Mode.....	156
Sensors	159
Using Automatic Climate Control.....	155
Clock	104
Cold Weather	416
Console Compartment	151
Controls	103
Coolant (Engine)	396
Adding the Coolant	397
Checking the Coolant.....	396
Overheating.....	450
Coolant (Inverter)	398
Creeping (Dual Clutch Transmission)	325
Cruise Control	343
CRUISE CONTROL Indicator	82
CRUISE MAIN Indicator	82
Cup Holders	152
Customized Features	244

D

Daytime Running Lights	134
Dead Battery (12-Volt)	448

Defrosting the Windshield and Windows	157, 158
Devices that Emit Radio Waves	471
Dimming	
Headlights	131
Rearview Mirror	141
Dipstick (Engine Oil)	386, 393
Directional Signals (Turn Signal)	130
Door Mirrors	142
Doors	105
Auto Door Locking	118
Auto Door Unlocking	118
Door Open Message	35
Keys	105
Locking/Unlocking the Doors from the Inside	115
Locking/Unlocking the Doors from the Outside	107
Lockout Prevention System	114
DOT Tire Quality Grading	410
Driver Information Interface	98
Driver's Knee Airbag	50
Driving	309
Braking	357
Cold Weather	416
Cruise Control	343
Dual Clutch Transmission	325
Shifting Gear	326
Turning on the Power	321
Driving Position Memory System	138

Dual Clutch Transmission	325
Creeping	325
Fluids	399, 469
Kickdown	325
Operating the Shift Button	23, 328
Shifting	326
Dust and Pollen Filters	419

E

Elapsed Time	101
Electric Parking Brake	357
Indicator	71
Electric Parking Brake System	
Indicator	71, 454
Electric Power Steering (EPS) System	
Indicator	78, 453
Electronic Stability Control (ESC)	346
Emergency	462
Emergency Hatch Opener	121
Emissions Testing (Readiness Codes)	473
Energy Efficiency	12
Engine	470
Coolant	396, 469
Jump Starting	448
Oil	390, 469
Engine Compartment Cover	389
Engine Coolant	396
Adding the Coolant	397
Checking the Coolant	396
Overheating	450

Engine Oil

Adding	394
Changing	395
Checking	391
Displaying Oil Life	380
Low Oil Level Symbol	456
Low Oil Pressure Indicator	70
Recommended Engine Oil	390
Temperature Gauge	97
EPS (Electric Power Steering) System	78
Exhaust Gas Hazard (Carbon Monoxide)	67
Exterior Care (Cleaning)	422
Exterior Mirrors	142

F

Features	161
Filters	
Dust and Pollen	419
Oil	395
Flat Tire	433
Floor Mats	421
Fluids	
Brake	400, 469
Dual Clutch Transmission	399, 469
Engine Coolant	396, 469
Inverter Coolant	398, 469
Twin Motor Unit	399, 469
Windshield Washer	400, 468
FM Radio	188

Foot Brake	359
Front Airbags (SRS)	46
Fuel	25, 371
Economy	373
Gauge	95
Instant Fuel Economy	101
Low Fuel Indicator	77
Range	101
Refueling	371
Requirement	371, 468
Fuel Economy	373
Fuel Fill Door	25, 372
Fuses	457
Inspecting and Changing	461
Locations	457, 459, 460
G	
Gasoline (Fuel)	
Economy	373
Gauge	95
Information	371
Instant Fuel Economy	101
Low Fuel Indicator	77
Refueling	371
Gauges	95
Gear Position Indicator	76, 328
Gear Shift Positions	
Dual Clutch Transmission	326
Glass (care)	420, 423
Glove Box	151

H	
Handling the Unexpected	431
HandsFreeLink® (HFL)	270
Automatic Import of Cellular Phonebook and Call History	283
Displaying Messages	299
HFL Buttons	270
HFL Menus	273
HFL Status Display	272
Limitations for Manual Operation	272
Making a Call	292
Options During a Call	296
Phone Setup	278
Phonebook Phonetic Modification	287
Receiving a Call	296
Receiving a Text/E-mail Message	297
Ring Tone	282
Roadside Assistance	303
Selecting a Mail Account	298
Speed Dial	284
To Set Up Text/E-mail Message Options	281
Hatch	119
Unable to Open	464
Hazard Warning Button	4
Headlights	131
Aiming	401
Automatic Operation (automatic lighting control)	132
Dimming	131, 134
Operating	131
Heaters (Seat)	154

HFL (HandsFreeLink®)	270
High Beam Indicator	81
High Voltage Battery	356
High-Performance Driving	315
Hill Start Assist System	323
HomeLink® Universal Transceiver	267
Honda App License Agreement	228
Hybrid Vehicle	
SPORT HYBRID Super Handling All-Wheel-Drive™ (SPORT HYBRID SH-AWD®)	9
I	
Identification Numbers	
Engine, Motor, and Transmission	470
Vehicle Identification	470
Immobilizer System	122
Indicator	81
Indicators	70
12-Volt Battery Charging System	75, 452
Active Damper System	74
Anti-lock Brake System (ABS)	78
Automatic Brake Hold	72, 360
Automatic Brake Hold System	72, 360
Brake System (Amber)	73
Brake System (Red)	70, 453
Brake Wear	74
CRUISE CONTROL	82, 344
CRUISE MAIN	82, 343
Door and Trunk (Hatch) Open	35
Electric Parking Brake	71

Electric Parking Brake System	71, 454	Interior Lights	149	Lights On Indicator	81
Electric Power Steering (EPS)		Interior Rearview Mirror	141	Turn Signals	130
System	78, 453	Inverter Coolant	398, 469	Load Limits	313
Gear Position	76			Locking/Unlocking	105
High Beam	81			Auto Door Locking/Unlocking.....	118
Immobilizer System	81	J		From Inside	115
Keyless Access System.....	82	Jump Starting	448	From Outside	107
Lights On	81			Keys	105
Low Fuel	77	K		Using a Key	114
Low Oil Pressure	70	Key Number Tag	106	Lockout Prevention System	114
Low Tire Pressure/TPMS	80, 352, 354, 455	Keyless Access System	107	Low Battery Charge (12-Volt)	452
Malfunction Indicator Lamp	75, 452	Keyless Lockout Prevention	114	Low Fuel Indicator	77
POWER SYSTEM	74	Keys	105	Low Keyless Access Remote Signal	
READY	74	Lockout Prevention	114	Strength	106
Seat Belt Reminder.....	37, 77	Number Tag	106	Low Oil Level	456
Security System Alarm.....	82	Remote Transmitter	112	Low Oil Pressure Indicator	70
Supplemental Restraint System	55, 78	Kickdown (Dual Clutch Transmission)	325	Luggage (Maximum Load Limit)	313
System Message	80			Lumbar Support	145
Transmission System	76				
Turn Signal	81	L			
Vehicle Stability Assist™ (VSA®)		Language (HFL)	272	M	
System	79, 346	Launch Control	341	Maintenance	375
VSA® OFF.....	79, 347	Lights	131, 401	12-Volt Battery.....	417
Information	467	Automatic Operation (automatic lighting		Brake Fluid	400
Instant Fuel Economy	101	control).....	132	Cleaning	420
Instrument Panel	69	Bulb Replacement.....	401	Climate Control System.....	419
Integrated Dynamics System	336	Daytime Running Lights.....	134	Coolant.....	396, 398
QUIET Mode	339	High Beam Indicator	81	Cooling System	396
SPORT Mode.....	339	Interior	149	Inverter Coolant	398
SPORT+ Mode	340	Light Switches	131	Maintenance Minder™	379
TRACK Mode	340			Oil.....	391

- Precautions..... 376
 - Remote Transmitter 418
 - Replacing Light Bulbs..... 401
 - Safety..... 377
 - Service Items..... 382
 - Tires 407
 - Transmission Fluids..... 399
 - Under the Hood and Hatch..... 385
 - Malfunction Indicator Lamp** 75, 452
 - Map Lights** 150
 - Maximum Load Limit**..... 313
 - Meters, Gauges**..... 95
 - Mirrors**..... 141
 - Adjusting..... 141
 - Door..... 142
 - Exterior..... 142
 - Interior Rearview..... 141
 - Modifications (and Accessories)**..... 426
 - MP3**..... 208
 - Multi-View Rear Camera** 369
- N**
- Numbers (Identification)** 470
- O**
- Odometer**..... 100
 - Oil (Engine)** 390, 469
 - Adding 394
 - Checking..... 391
 - Displaying Oil Life..... 380
 - Low Oil Level Symbol..... 456
 - Low Oil Pressure Indicator 70
 - Recommended Engine Oil 390, 469
 - Viscosity 390, 469
 - Open Source Licenses**..... 242
 - Opening**
 - Hatch..... 119, 387, 464
 - Opening/Closing**
 - Hatch..... 119, 387
 - Hood..... 388
 - Power Windows 125
 - Operating the Switches Around the Steering Wheel**..... 127
 - Outside Temperature Display**..... 100
 - Overheating**..... 450
- P**
- Paddle Shifters (Sequential Mode)**..... 334
 - Pandora®** 206
 - Panic Mode**..... 124
 - Parking**..... 364
 - Parking Brake** 357
 - Parking Sensor System** 365
 - Passenger Front Airbag Off Indicator** 56
 - Passing Indicators**..... 131
 - POWER Button** 127
 - Power System**
 - Turning on 321
 - POWER SYSTEM Indicator**..... 74
 - Power Windows** 125
 - Precautions While Driving**
 - In Snow and Ice 324
 - Rain 324
 - Pregnant Women**..... 41
 - Puncture (Tire)** 433
- R**
- Radio (FM)**..... 188
 - Radio (SiriusXM®)**..... 192
 - Radio Data System (RDS)** 191
 - Range**..... 101
 - RDS (Radio Data System)** 191
 - Readiness Codes (Emissions Testing)** 473
 - READY Indicator** 74
 - Rear Defogger/Heated Door Mirror Button**..... 136
 - Rearview Mirror**..... 141
 - Refueling** 371
 - Fuel Gauge 95
 - Gasoline 371, 468
 - Low Fuel Indicator..... 77
 - Regenerative Energy and Regenerative Braking** 12
 - Regulations** 354, 410, 471
 - Remote Transmitter**..... 112
 - Replacement**
 - Battery..... 418
 - Bulbs 401
 - Fuses 457, 459, 460

Tires.....	413
Wiper Blade Rubber.....	404
Reporting Safety Defects.....	472
Resetting a Trip Meter.....	100
Reverse Tilt Door Mirror.....	143
Right Selector Wheel.....	98

S

Safe Driving.....	31
Safety Check.....	35
Safety Labels.....	68
Safety Message.....	1
Seat Belts.....	36
Automatic Seat Belt Tensioners.....	38
Checking.....	42
Fastening.....	39
Installing a Child Seat.....	63
Pregnant Women.....	41
Reminder.....	37, 77
Warning Indicator.....	37, 77
Seat Heaters.....	154
Seats.....	144
Adjusting.....	144
Seat Heaters.....	154
Security System.....	122
Immobilizer System Indicator.....	81
Security System Alarm Indicator.....	82
Selecting a Forward-facing Child Seat.....	62
Sequential Mode.....	331
Sequential Mode Operation.....	334

Setting the Clock.....	104
Shift Button.....	23, 326
Operation.....	328
Shifting (Transmission).....	23, 326
Side Airbags.....	52
Side Curtain Airbags.....	54
Siri Eyes Free.....	215
SiriusXM® Radio.....	192
Snow Tires.....	415
Sounds Unique to the SPORT HYBRID SH-AWD® System.....	13
Spark Plugs.....	468
Specifications.....	468
Specified Fuel.....	371, 468
SPORT HYBRID Super Handling All-Wheel-Drive™ (SPORT HYBRID SH-AWD®).....	351
SRS Airbags (Airbags).....	46
Steering Wheel.....	
Adjusting.....	140
Stopping.....	364
Storage.....	428
Summer Tires.....	415
Supplemental Restraint System (SRS).....	46
Switches (Around the Steering Wheel).....	4, 5, 127
System Message Indicator.....	80

T

Temperature.....	
Gauge.....	96

Temperature Sensor.....	159
Temporary Tire Repair Kit.....	433
Time (Setting).....	104
Tire Pressure Monitoring System (TPMS).....	352
Indicator.....	80, 455
Tires.....	407
Air Pressure.....	408, 469
Chains.....	415
Checking and Maintaining.....	407
Flat Tire (Puncture).....	433
Inspection.....	407
Labeling.....	408
Regulations.....	410
Rotation.....	414
Summer.....	415
Temporary Tire Repair Kit.....	433
Wear Indicators.....	412
Winter.....	415
Tools.....	432
Towing a Trailer.....	320
Towing Your Vehicle.....	320
Emergency.....	462
TPMS (Tire Pressure Monitoring System).....	352
Transmission.....	23, 326
Dual Clutch.....	23, 325, 326
Fluids.....	399, 469
Gear Position Indicator.....	76, 328
Number.....	470
Sequential Mode.....	331

TRIP Button	99
Trip Meter	100
Troubleshooting	431
Blown Fuse	457, 459, 460
Buzzer Sounds When Opening Door	29
Emergency Towing	462
Flat Tire/Puncture	433
Noise When Braking	29
Overheating	450
Power System Won't Start	445
Premium Gasoline	371, 468
Warning Indicators	70
Trunk	
Light Bulb	468
Turn Signals	130
Indicators (Instrument Panel)	81
Turn-by-Turn Directions	102
Turning on the Power	321
Does Not Activate	445
Jump Starting	448
Twin Motor Unit	
Fluid	399, 469

U

Unlocking the Doors	107
Unlocking the Doors from the Inside	115
USB Flash Drives	227
USB Ports	163
Using the Keyless Access System	107

V

Vehicle Identification Number	470
Vehicle Stability Assist™ (VSA®)	346
Off Button	347
Off Indicator	79, 347
System Indicator	79, 346
Vehicle Storage	428
Viscosity (Oil)	390, 469
Voice Control Operation	
Audio Commands	186
Climate Control Commands	187
General Commands	187
Music Search Commands	187
On Screen Commands	187
Phone Commands	186
Useful Commands	186
Voice Portal Screen	185
Voice Recognition	184
VSA® (Vehicle Stability Assist™)	346

W

Wallpaper	171
Warning and Information Messages	83
Warning Indicator On/Blinking	452
Warning Labels	68
Warranties (Warranty Manual provided separately)	475
Watts	468
Wear Indicators (Tire)	412
Wi-Fi Connection	213

Window Washers	135
Adding/Refilling Fluid	400
Switch	135
Windows (Opening and Closing)	125
Windshield	
Cleaning	420, 423
Defrosting/Defogging	136, 157
Washer Fluid	400, 468
Wiper Blades	404
Wipers and Washers	135
Winter Tires	
Snow Tires	415
Tire Chains	415
Wipers and Washers	135
Checking and Replacing Wiper Blades	404
WMA	208
Worn Tires	407



31T6N630
OM-12728
00X31-T6N-6300

owners.acura.com (U.S.)
acura.ca (Canada)

2020 Acura NSX Owner's Manual
© 2019 Honda Motor Co., Ltd. — All Rights Reserved

Printed in U.S.A.