



Fortus® 380mc 3D Production System

User Guide

Part No. 821358-0001 Rev. A

Liability Statement

The information in this document is subject to change without notice. Stratasys, Inc. shall not be liable for errors contained herein or for incidental or consequential damages in connection with the furnishing, performance, or use of this material. Stratasys, Inc. makes no warranty of any kind with regard to this material, including, but not limited to, the implied warranties of merchantability and fitness for a particular purpose. It is the responsibility of the system owner/material buyer to determine that the Stratasys material is safe, lawful, and technically suitable for the intended application as well as identify the proper disposal (or recycling) method consistent with local environmental regulations. Except as provided in Stratasys' standard conditions of sale, Stratasys shall not be responsible for any loss resulting from any use of its products described herein.

Copyright Statement

This document is protected by copyright. All rights reserved. Its use, disclosure, and possession are restricted by an agreement with Stratasys per software copyright. No part of this document may be photocopied, reproduced or translated into another language without the prior written consent of Stratasys, Inc.

All drawings and information herein are the property of Stratasys Inc. All unauthorized use and reproduction is prohibited.

Trademark Acknowledgments

Stratasys, FORTUS (Fortus) and FDM are registered trademarks of Stratasys, Inc. FORTUS 380mc, Insight, Control Center, FDM Technology, SR-30, SR-100, SR-110, and ABS-ESD7 are trademarks of Stratasys, Inc.

Windows 7 is a registered trademark of Microsoft Corporation.

Novus Plastics Polish #1 and #2 are registered trademarks of Novus International.

All other product names and trademarks are the property of their respective owners, and Stratasys assumes no responsibility with regard to the selection, performance, or use of these non-Stratasys products. Product specifications subject to change without notice.

Stratasys Incorporated

7665 Commerce Way
Eden Prairie, MN 55344 USA
952.937.3000
Fax: 952.937.0070
www.stratasys.com

© Copyright 2014 Stratasys Inc. All rights reserved.
Printed in the United States of America

About the FORTUS 380mc Printer

Welcome to the Fortus 380mc™ 3D Production System which is referred to throughout this User Guide as the 380mc. This printer incorporates the latest in innovative technologies to provide you with precise prototypes from a CAD design. Stratasys' Fused Deposition Modeling (FDM) technology provides prototype parts, including internal features, that can be used to field-test form, fit, and function. Direct Digital Manufacturing (DDM) allows for the creation of customized end-use parts straight from 3D CAD data. The 380mc printer features a servo/belt driven XY gantry with multiple high temperature modeling material capability.

Components of the 380mc

- The 380mc Printer
- Modeling Material
- Support Material
- Insight Software Package
- A Computer Workstation (not sold by Stratasys)

Printer Highlights

- Envelope Size: 14 x 12x 12 inch (355.6 x 304.8 x 304.8mm)
- Material Canister Bays: 1 model, 1 support
- Touchscreen Graphical User Interface

Available Material Options

Two material options are available for the 380mc. Option details are as follows:

Option	Option Details
Standard	ABS-M30 (all colors), ABS-M30i, ABS-ESD7, and ASA (natural and black) model material with SR-30 support material.
Engineering	PC, PC-ISO, and Nylon12 model material with associated PC_S, SR-100 and SR-110 support materials.



Note: See “Tip Compatibility & Selection” on page 37 for detailed material/tip compatibility information.

About This Guide

This guide is your introduction to building prototypes and end-use parts using a Stratasys 3D production, rapid prototype system. It is designed as a learning and reference tool that explains system operation in an easy to understand, step-by-step, process.

How to Use This Guide

This guide is divided into easy-to-follow chapters. You can read this guide chapter by chapter or use the Table of Contents when you need to quickly find specific information. Keeping this guide close to your printer will efficiently allow you to troubleshoot and maintain the printer.

Conventions Used in This Guide

The following conventions are used in this guide:

- When you see text in **this font**, it indicates a button being pressed via the User Interface touchscreen. For example, press the **Queue** button within the Navigation Bar.
- When you see text in [blue](#), it indicates that the text is a linked reference to a specific figure, table, heading, or page number.
- Standard **bold text** is used to emphasize items within instructional sequences or indicate a navigational path you must follow to locate/start a software application, open or save a file on your workstation PC, or perform an operation when working with Insight. The > character is used to separate items within a navigational path. For example, navigate to **File > Open** from the Main Menu.

Revision Log

Revision	Date	Description of Changes
821358-0001_REV_A	October 2014	First release of this document.

Table of Contents

1	Service and Support	1
	Service	1
	Software Support	1
	Safety Instructions	2
	Hazard Types	2
	Product Safety Signs	2
	Product Safety Label Locations	3
	Potential Safety Hazard Areas	6
	Door Locks	7
	General Safety Practices	8
	Environmental Requirements	8
2	Setup and Installation	9
	General Information	9
	Welcome Kit Contents	9
	Prepare Your Facility for Installation	13
	Identifying Your Printer	13
	Basic Setup	14
	Making the Network Connection	14
	Connecting the Power Cable	14
	AC Circuit Breaker	14
	Configuring the Network	15
	Setting the Printer's Date and Time	18
	Licensing the Printer	19
3	System Components	20
	Printer Overview	20
	Access Doors and Panels	20
	Touchscreen User Interface	22
	Oven Components	23
	Oven Door	23
	Oven Lights	24

Platen	25
Tip Wipe Assembly	26
Canister Bay Enclosure Components	27
Canister Bay	28
Canister Drives and Canister Release Knobs	28
Canister Status LED Indicators	29
Tip Wipe Height Adjustment Wheels	29
Purge Bin	30
Storage Area	30
Gantry	31
Gantry Assembly	31
Head Assembly	32
Head Maintenance Bracket	33
Vacuum and Air Dryer Systems	35
On Board Vacuum System	35
On Board Air Dryer System	35
Modeling Materials and Tips	36
Materials Used	36
Canister Memory Chip	36
Liquefier Tips	37
Software	41
Controller Software	41
Insight Software	41
FDM Control Center Software	42
4 User Interface	43
Overview	43
Information Bar	44
Dashboard	45
Display Area	50
Navigation Bar	50
Working with the Build Page	52
Viewing Print Job Information	53
Selecting a Print Job from the Build Page	53
Print Job Status	54
Print Job Controls	59
Working with the Queue Page	61
About the Job Queue	62
About the Sample Queue	65
Working with the Tips Page	66
Tips/Materials Status	67

Canister Load Status	70
Material Load Controls	71
Tips Controls	73
Working with the Calibration Page	78
Viewing Calibration Status	79
Calibration Controls	79
XYZ Tip Offset Calibration	80
Touchscreen Calibration	81
Find Z Home	81
Find XY Home	81
Working with the Settings Page	82
Settings Page Navigation	83
Printer Settings	85
Network Settings	88
Display Settings	91
.....	91
Service Settings	91
Working with the Maintenance Page	92
Maintenance Page Navigation	93
Head Settings	94
Bay Settings	95
Gantry/Stage Settings	97
Chamber Settings	101
System Settings	105
5 Operating the Printer	110
Basic User Operations	110
Powering ON the Printer	110
Powering OFF the Printer	111
Material, Canisters, and Liquefier Tips	112
Loading Material to the Liquefier Tips	112
Unloading Material from the Liquefier Tips	118
Removing Canisters	120
Handling/Storing Canisters	122
Changing Tips or Material Type	123
Using the Tip Change Wizard	123
Changing Tips within the Top Cover	156
Adjusting Tip Wipe Heights	159
Basic Job Build Tasks	161
Before a Build	161
Preparing the Printer	161
Selecting a Job to Build	162
Information Available During a Build	164

Build Warnings	165
Pausing a Build	166
Aborting a Build	166
After a Build is Complete	168
Changing Printer Defaults	170
Display Units	170
Job Storage.....	170
Oven Temperature Control	171
Part Build Location.....	172
Touchscreen Display Brightness	172
Printer Status	173
Tip Odometer Status	173
Materials Status	175
Temperature Status	177
Software Version	180
6 Calibration	181
XYZ Tip Offset Calibration.....	182
Touchscreen Calibration.....	199
XY Home Calibration.....	201
Z Zero Calibration	201
7 Maintenance	202
Add Printer to Control Center	202
Install/Update Material License	205
Controller Software.....	209
Updating Controller Software - Web Method	209
Updating Controller Software - CD Method	216
Maintenance Schedule	221
Daily Maintenance	222
Clean the Platen	222
Empty the Purge Bin.....	223
Weekly Maintenance.....	224
Vacuum the Build Envelope.....	224
Clean/Inspect Tip Wipe Assembly	224
Quarterly Maintenance.....	229
Clean the Tip Sensor Plunger	229
As Needed Maintenance	230
Replace an Oven Bulb	230
Clean the Printer	231

8 Troubleshooting	234
Getting Help	234
Warnings and Errors	235
Warnings at Build Start	235
Errors Preventing a Build from Starting.....	237
Load Errors	239
Build Pause Warnings.....	241
Build Abort Warnings.....	243
Finding a Remedy	245

1 Service and Support

This chapter provides information on service and support for the 380mc as well as safety information and safety label locations.

Service

If you have a problem with your printer that is not covered in this guide, please contact Stratasys Customer Support:

Region	Phone	Email
North America / Latin America	+1 800-801-6491 (7:00 AM - 5:00 PM)	support@stratasys.com
Asia Pacific	+852 3944-8888 (9:00 AM - 6:00 PM)	support.ap@stratasys.com
Europe, Middle East, & Africa	+49 7229-7772-644 (9:00 AM - 5:00 PM)	support.emea@stratasys.com

When calling in for service, always have your printer's software version (see "Software Version" on page 180) and hardware serial number available (see "Identifying Your Printer" on page 13). You may also need access to your Insight workstation to provide a diagnostic file from your hardware.

Software Support

If you have a software problem that is not covered in this guide, please contact Stratasys Customer Support:

Region	Phone	Email
North America / Latin America	+1 800-801-6491 (7:00 AM - 5:00 PM)	support@stratasys.com
Asia Pacific	+852 3944-8888 (9:00 AM - 6:00 PM)	support.ap@stratasys.com
Europe, Middle East, & Africa	+49 7229-7772-644 (9:00 AM - 5:00 PM)	support.emea@stratasys.com

When calling in for service, always have your printer's software version (see "Software Version" on page 180) and hardware serial number available (see "Identifying Your Printer" on page 13). You may also need access to your Insight workstation to provide a diagnostic file from your hardware.

Safety Instructions

The following basic safety tips are given to ensure safe installation, operation, and maintenance of Stratasys equipment and are not to be considered as comprehensive on matters of safety. The Fortus 380mc printer is designed to be a safe and reliable rapid prototyping printer. Access to areas of the printer are potentially dangerous.

Hazard Types

Stratasys recommends that all services be performed by qualified personnel. All personnel working on or around this printer should be knowledgeable of what the following hazard classifications mean throughout this guide.

- **Warnings and Cautions** precede the paragraph to which they pertain.



Warning: Indicates a potentially hazardous situation which, if not avoided, may result in injury or death.



Caution: Indicates a situation which, if not avoided, could result in damage to equipment.

- **Notes** follow the relative paragraph.



Note: Indicates additional information relative to the current topic.

Product Safety Signs



Note: Always read and adhere to safety statements, and be aware of the following safety signs when you see them on the printer.

We make every effort to ensure that our printers are safe and reliable at all times. However, there will be times when you must access areas of the printer where potentially high voltages, hot temperatures, and/or moving mechanical components could cause severe injury.



High Voltage: The high voltage sign indicates the presence of high voltages. Always stay away from any exposed electrical circuitry. It is recommended that all jewelry be removed.



Hot Surface: The hot surface sign indicates the presence of devices with high temperatures. Always use extra care when working around heated components. Always wear the safety gloves provided in the Welcome Kit.

Head temperatures in the printer can exceed 450° C (800° F).



Gloves: The gloves sign indicates that if you enter the area specified by the symbol you must wear safety gloves (provided in the Welcome Kit) which have been approved for high temperatures.



Crushed Hand: The crushed hand sign indicates that a hazard exists where you could get your hand crushed between two objects. One or more objects move in the area that you are working.

Product Safety Label Locations

Figure 1-1: Head safety label locations

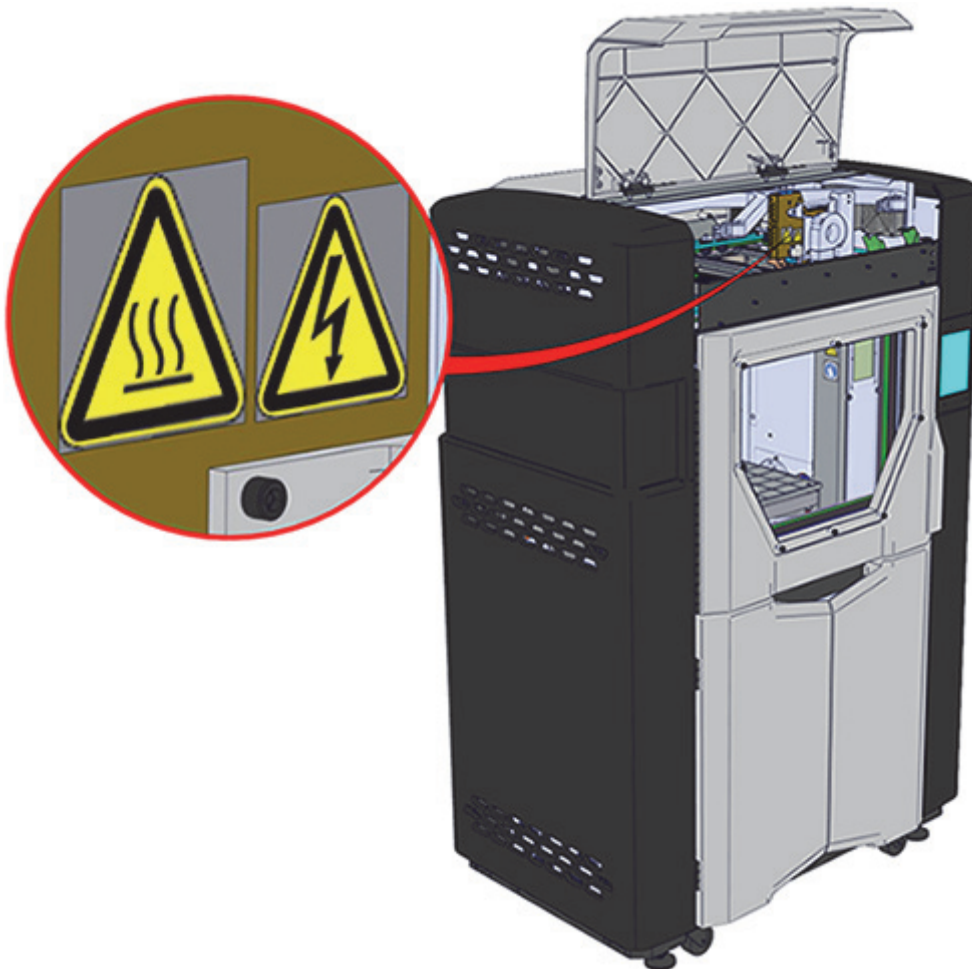

Figure 1-2: Oven safety label locations

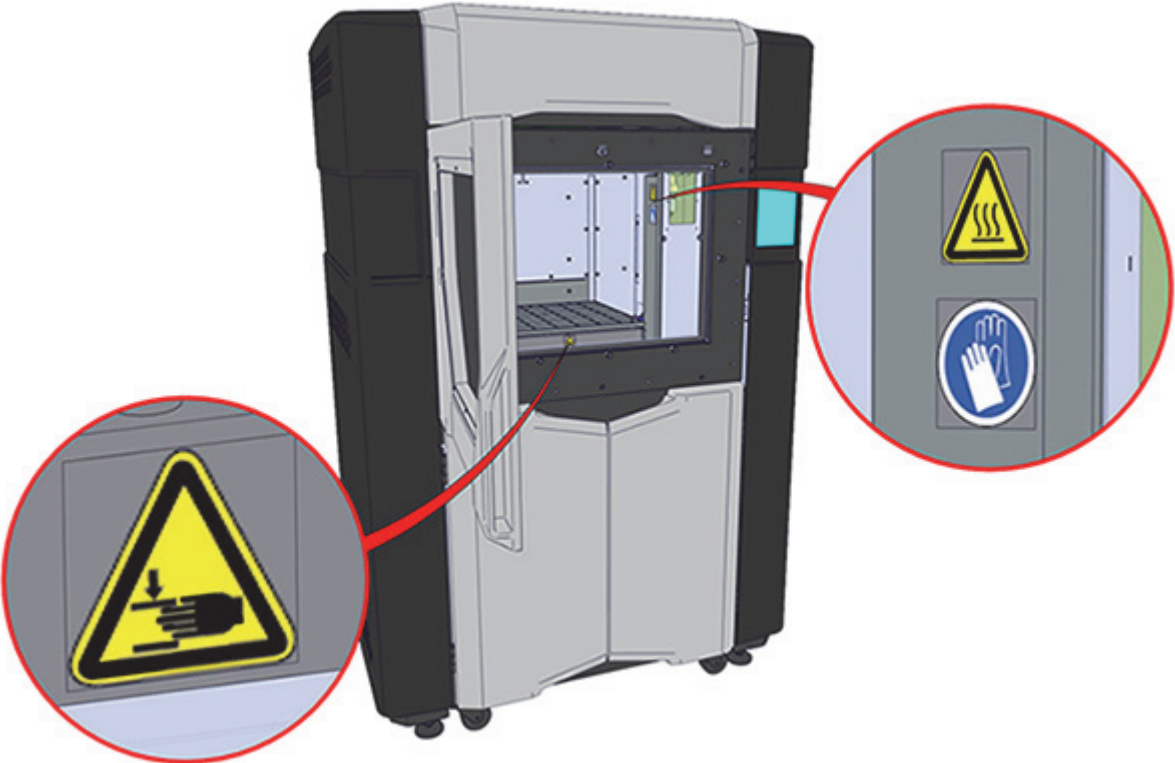

Figure 1-3: Z Stage safety label locations

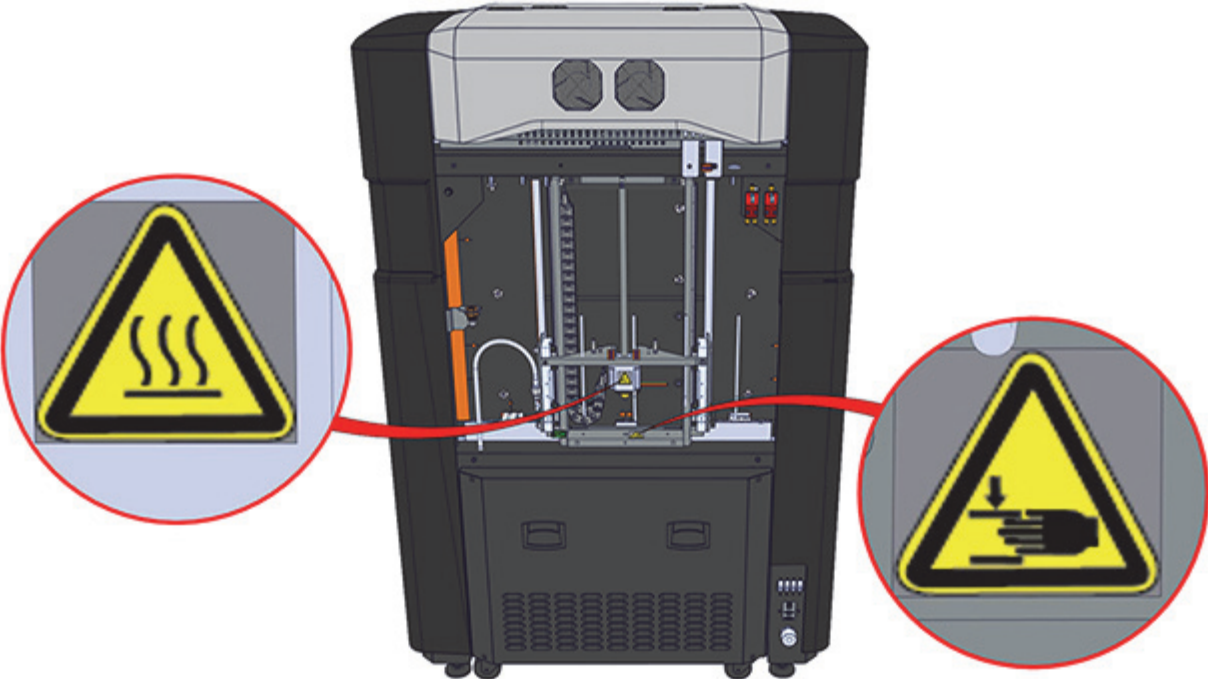

Figure 1-4: Air system safety label locations

Compressed Air System



Vacuum System



Figure 1-5: Rear safety label locations

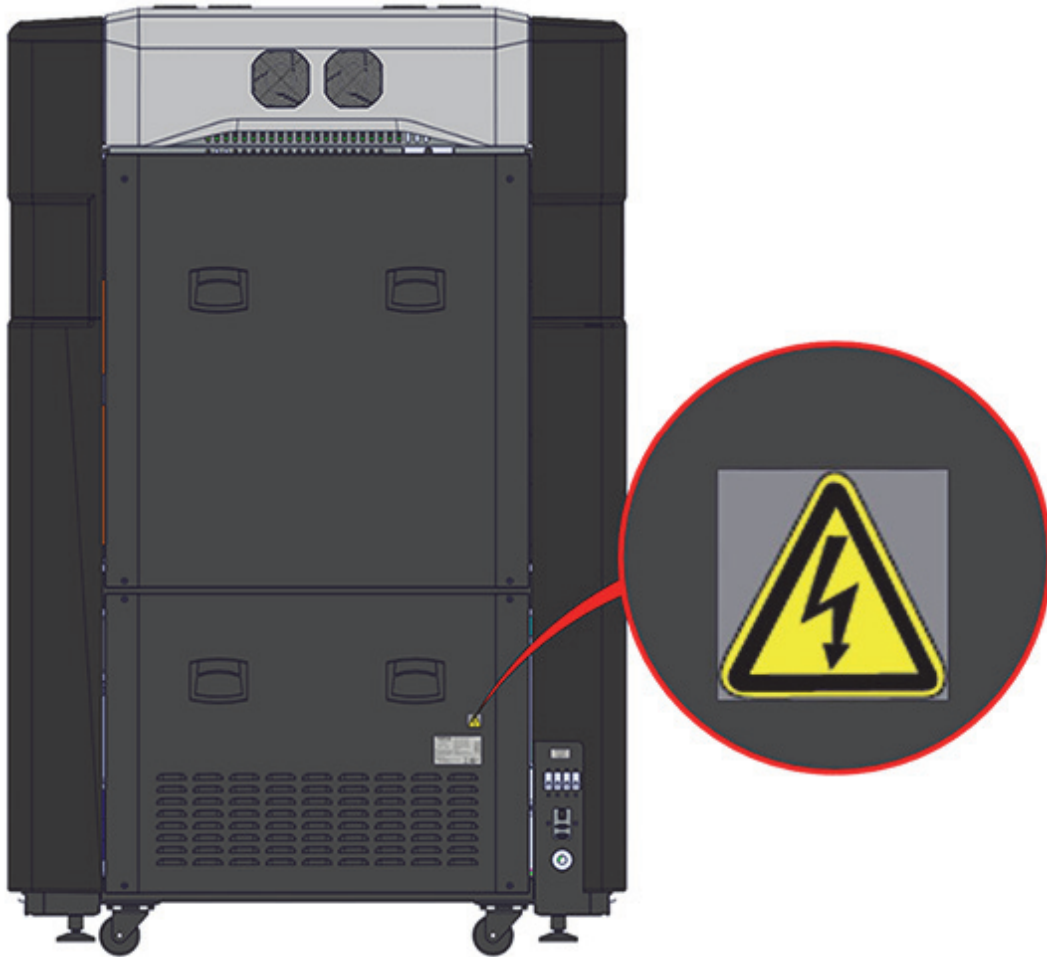

Potential Safety Hazard Areas

The following components and areas of the printer are highlighted as potential safety hazards that may cause system failure or reliability problems if proper safety procedures are not followed.

Oven



Warning: Always wear safety gloves and long sleeves when working inside the oven. Components are hot.

The oven temperature is extremely hot. The oven temperature is controlled by a safety thermostat that shuts the printer off when temperatures reach 370° C (698° F).



Note: Opening the oven door shuts the oven heaters off.

Gantry



Warning: Never wear a tie, loose clothing or dangling jewelry when working around moving components of the printer.

Beneath the top cover of the printer is the gantry. This area houses the mechanical drive components of the X and Y axes. Use extreme caution whenever accessing this area of the printer. The servo drive system, including the motors, pulleys and belts are extremely powerful, and care must be taken.



Note: The printer's servo motors are disabled when the oven door and/or top cover are open. The XY pinch hazard between the timing belts and pulleys is minimized by locking the oven door and top cover while building and disabling the motors when the oven door and top cover are open. The oven door and top cover automatically lock when the printer is building and cannot be opened while the printer is building. You cannot start a build if the oven door or top cover are open.

Z Stage



Warning: Never wear a tie, loose clothing or dangling jewelry when working around moving components of the printer.

The drive belt, pulleys and Z stage servo motor can cause severe injury. The Z stage crushing hazard is minimized by locking the oven door during Z stage moves and disabling the Z motor when the oven door is open.

Head temperatures in the printer can exceed 450° C (800° F).

Door Locks

Sensors are used to communicate the status of the oven door and the top cover to the printer. For safety reasons, the oven door and top cover must be closed before the X, Y, and Z motors will operate. Electromagnetic locks ensure that the oven door and top cover remain securely closed when the printer is building.

General Safety Practices

Abide by these general safety practices when working with this printer.



High Voltage: High voltage is present in the printer.



Warning: Only use an OSHA or CE approved step stool when accessing the area under the top cover of the printer.



Warning: Always wear safety gloves and long sleeves when working in the oven, with the head, or liquefier tips. These components are very hot.

Environmental Requirements

- The 380mc is for indoor use only.
- Operating temperature shall be in the range of 65°F to 86°F (18°C to 30°C), with relative humidity range of 30% to 70% non-condensing.
- Storage temperature shall be in the range of -40°F to 129.2°F (-40°C to 54°C), with relative humidity range of 10% to 85% non-condensing.
- Altitude shall not exceed 6561.68 feet (2000 m).
- Material storage shall be in the range of 55°F to 75°F (13°C to 24°C), with relative humidity range of 20% to 50%.

2 Setup and Installation

This chapter describes basic setup and installation of the 380mc.

General Information

Welcome Kit Contents

The printer's Welcome Kit contains the Welcome Insert document, software CDs, the common tools you will need to maintain the printer, and a variety of replacement parts. Use the following figures and tables to identify the contents of the Welcome Kit.

Figure 2-1: Welcome Kit Contents - CD, Drives and Cables

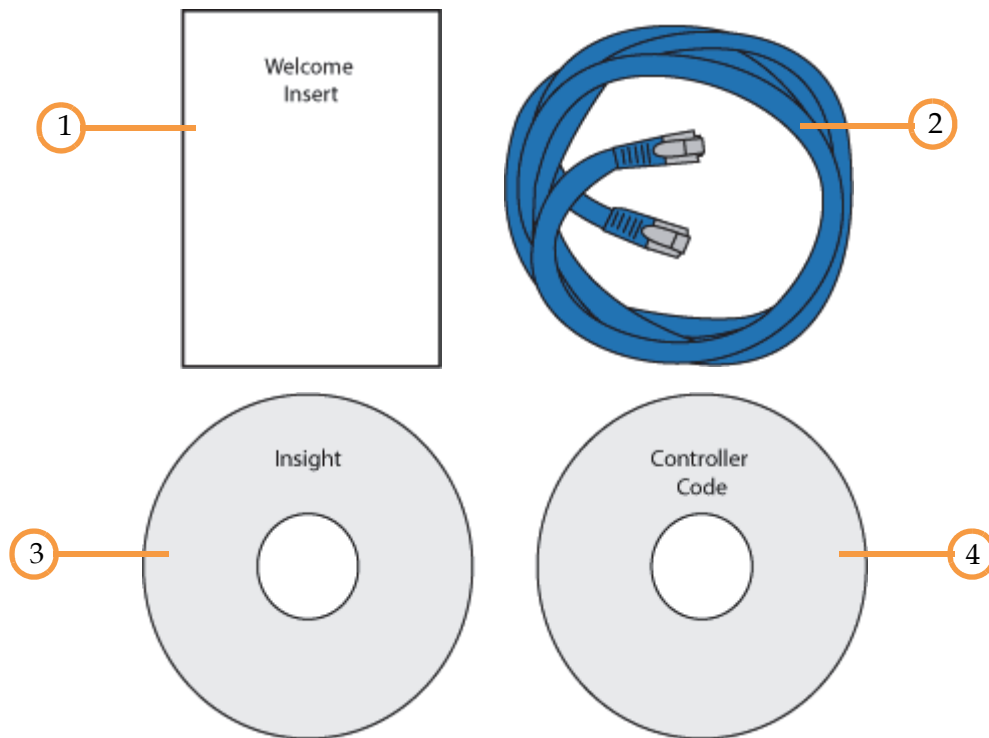

Table 2-1: Key for Figure 2-1

1	Welcome Insert Document	Contains instructions for downloading the 380mc User Guide (this document).
2	RJ45 Cable	This cable is used to establish a network connection between the 380mc and your Ethernet network. Job files are transferred to the printer via this connection. See “Making the Network Connection” on page 14 .
3	Controller Software CD	This CD is a back-up copy of Controller Software which is the software used to control the printer. See “Software” on page 41 for more information.
4	Insight CD	This CD is used to load Insight software (as well as FDM Control Center software) onto your workstation PC. Insight is the software used to process files and then transfer them to the printer to be built. See “Software” on page 41 for more information.

Figure 2-2: Welcome Kit Contents - Tools



Table 2-2: Key for Figure 2-2

1	Leather Safety Gloves	Printer components may be extremely hot. To prevent burns or other injuries, these gloves should be worn any time you see the gloves safety sign throughout this document. See “Product Safety Signs” on page 2.
2	Magnetic Handle Pick Set	Occasionally, you may need to use these picks to aid in the removal of breakaway supports (see “Removing a Part from the Printer” on page 169) or clearing debris which have accumulated on the head and/or tips.
3	Platen Dusting Brush	This tool is used to brush away material debris when cleaning the platen. Always ensure that the platen is clean before starting a build, as debris on the platen will affect vacuum quality. See “Clean the Platen” on page 222 for instructions.
4	Hex Ball End Driver (9/64)	This is used throughout the process of changing the printer’s tips. See “Changing Tips or Material Type” on page 123. The Welcome Kit contains two of these tools to provide you with a spare in the event that you misplace one.
5	10x Lighted Magnifier	This tool is included to aid you with performing an XYZ Tip Offset Calibration which requires you to view small toolpath relationships. Batteries for this item (2 C batteries) are not included. See “6 Calibration” on page 181.
6	5" Cutters	These are used to cut a canister’s filament when unloading and removing materials from the printer. See “Material, Canisters, and Liquefier Tips” on page 112.
7	Needle Nose Pliers (7 1/8)	Occasionally, you may need to use pliers to aid in the removal of breakaway supports (see “Removing a Part from the Printer” on page 169) or clearing debris which have accumulated on the head and/or tips.

Figure 2-3: Welcome Kit Contents - Spare Parts

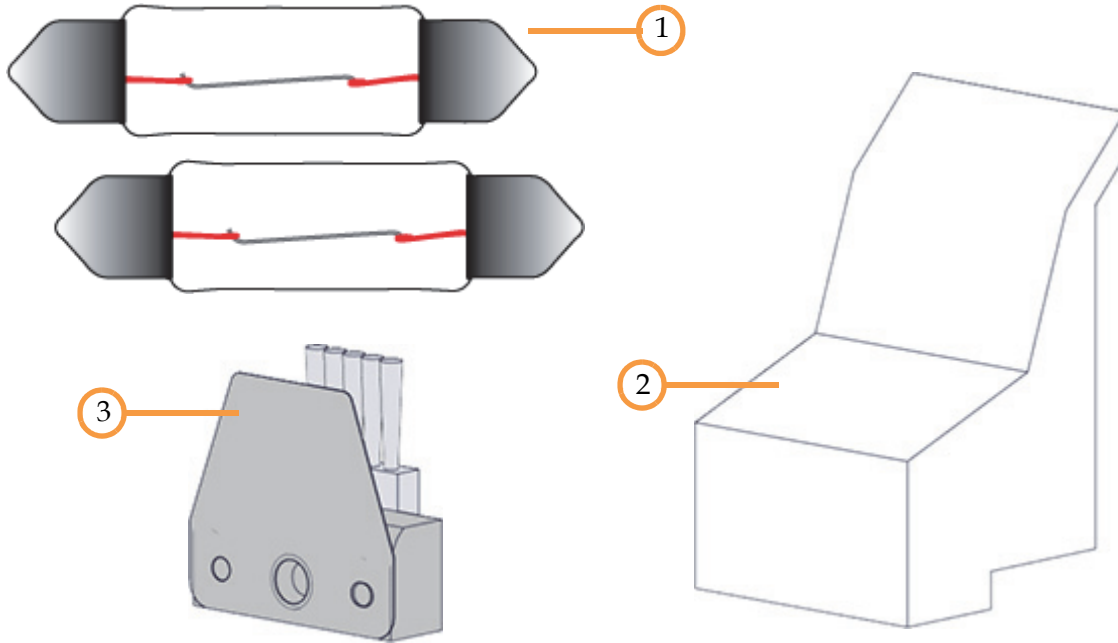

Table 2-3: Key for Figure 2-3

1	Oven Bulbs Replacement Kit	<p>Periodically you may need to replace an oven bulb. Bulbs generally burn out in pairs. The Welcome Kit contains oven bulb replacement kits, with 2 replacement Festoon bulbs per kit. See “Replace an Oven Bulb” on page 230 for instructions.</p> <p>Once replacements are depleted, you will need to order additional bulb replacement kits. See Table 7-2 on page 221 for replacement consumable part numbers.</p>
2	Purge Ledge	<p>The Welcome Kit contains replacement purge ledges (4). The purge ledge is part of the tip wipe assembly which should be inspected once a week. Purge ledges should be replaced whenever excessive buildup has accumulated on the ledge's surface. See “Clean/Inspect Tip Wipe Assembly” on page 224 for instructions.</p> <p>Once replacements are depleted, you will need to order additional replacement purge ledges. See Table 7-2 on page 221 for replacement consumable part numbers.</p>
3	Flicker and Brush Assembly	<p>The Welcome Kit contains replacement flicker/brush assemblies (4). The flicker and brush are components of the tip wipe assembly and keep the liquefier tips free of debris and material buildup. They should be inspected once a week and replaced as needed. See “Clean/Inspect Tip Wipe Assembly” on page 224 instructions and explanations of wear.</p> <p>Once replacements are depleted, you will need to order additional replacement assemblies. See Table 7-2 on page 221 for replacement consumable part numbers.</p>

Figure 2-4: Welcome Kit Contents - Cleaning Supplies

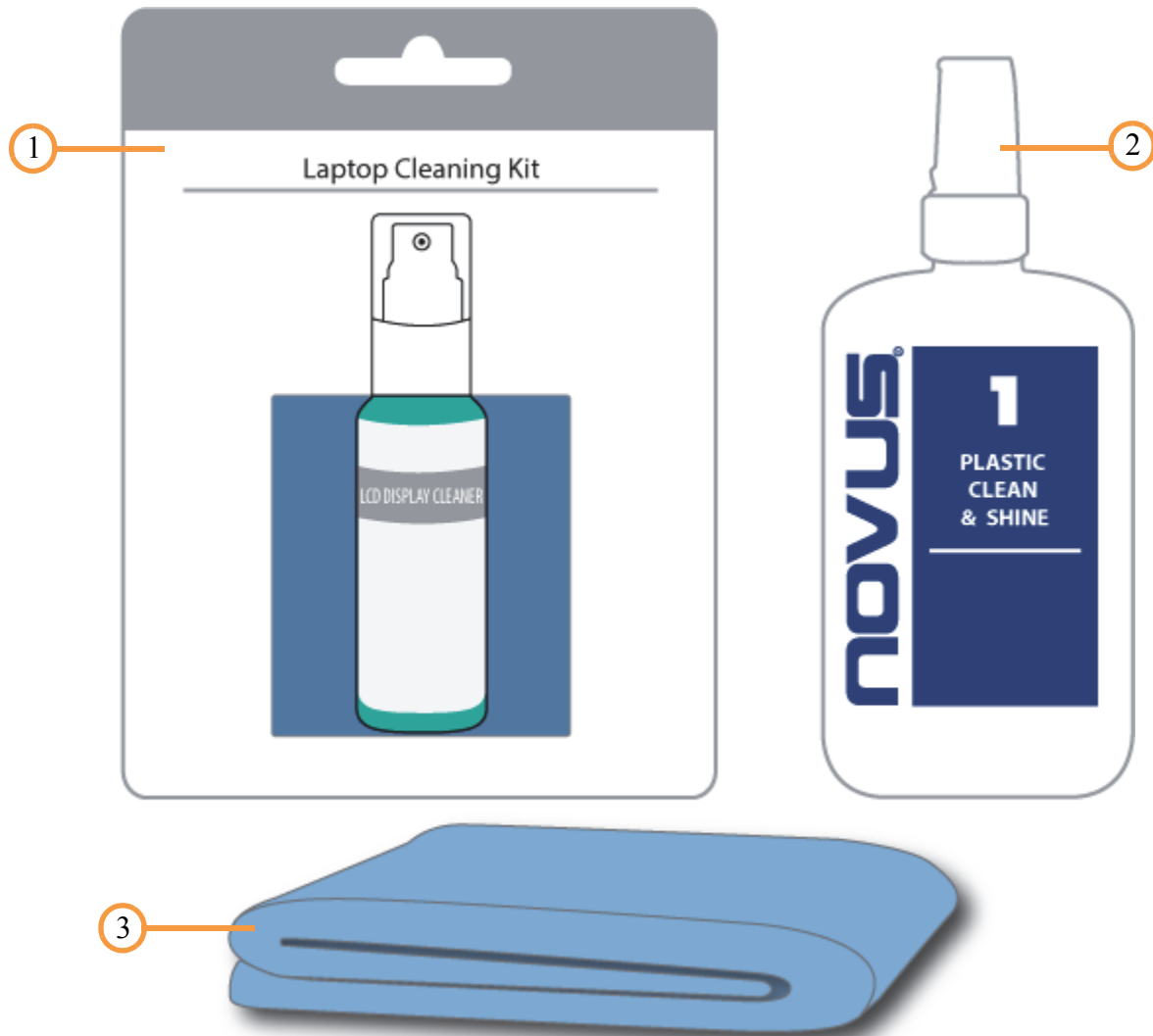

Table 2-4: Key for Figure 2-4

1	Touchscreen Cleaning Kit	From repeated use, the touchscreen may become dirty and occasionally need to be cleaned. Only use suitable LCD cleaning agents when cleaning the touchscreen. See “Cleaning the Touchscreen Display” on page 233 for cleaning instructions.
2	Oven Glass Cleaning Kit	The oven door's window may occasionally need to be cleaned. This window is comprised of a polycarbonate panel and a pane of tempered glass. Only use Novus 1 plastic cleaner when cleaning the oven door's polycarbonate panel. The oven door's tempered glass pane can be cleaned using a slightly soapy warm water solution and a microfiber cloth. See “Cleaning the Oven Door Glass/Window” on page 231 for cleaning instructions.
3	Microfiber Cloth	Various components of the printer may become dirty and occasionally need to be cleaned. Only use a suitable microfiber cloth to clean these components. See “Clean the Printer” on page 231 for cleaning instructions using this cloth.

Prepare Your Facility for Installation

Follow the Site Preparation Guide to ensure that your facility is effectively and safely prepared for printer installation.

Identifying Your Printer

Use the following tags to identify your printer:

- Serial Number Tag - Refer to this number when requesting service.
- Model Tag - The printer’s model number, part number and power requirements are given on this tag. This tag also lists all patent numbers associated with the printer, some FCC compliance information, voltage warnings and the Stratasys web address.

Both tags are located on the back side of the printer near the bottom, and are typically placed near the printer’s power connection. Use the information on these tags when identifying your printer with Customer Support.

Figure 2-5: ID Tag Locations

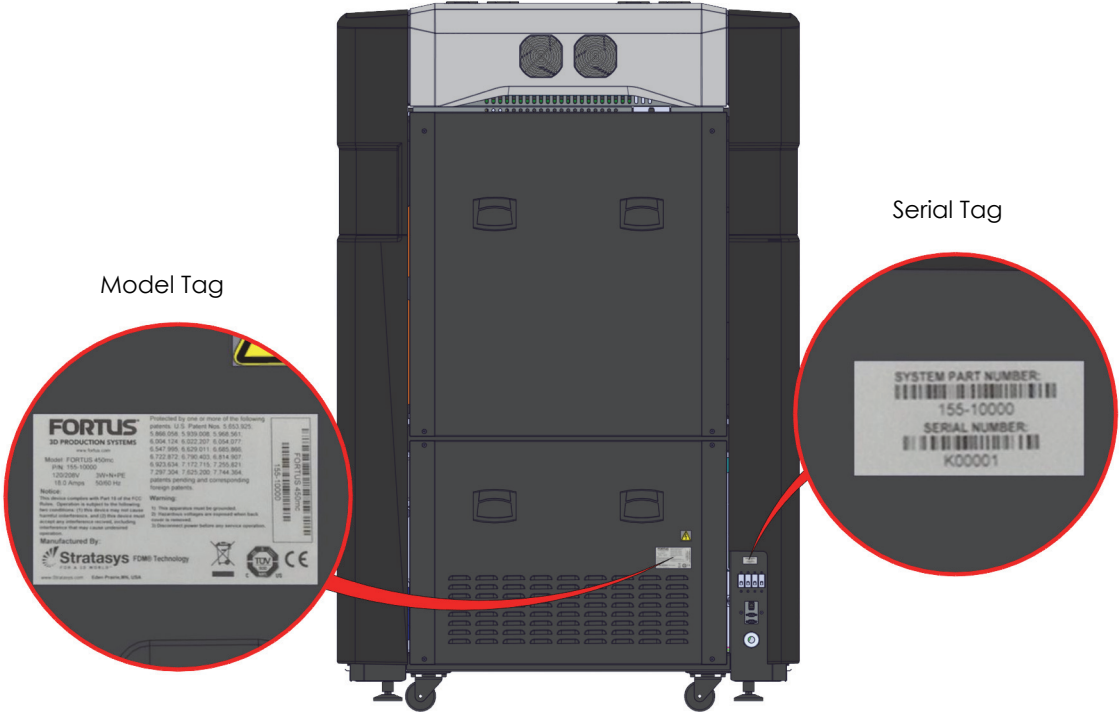

Basic Setup



Note: See [Figure 2-6](#) for all rear connections.

Making the Network Connection

Processed job files are transferred to the 380mc through your facility's Ethernet network. An RJ45 network connector is located on the right, rear corner of the printer (as viewed from the rear) for the network connection (see [Figure 2-6](#)).

Connecting the Power Cable



Warning: A licensed electrician must perform all facility AC wiring installations, including connecting system power.

AC Circuit Breaker

The printer's AC circuit breaker is located on the right, rear corner of the printer (as viewed from the rear). When the AC circuit breaker handle is pushed up (ON position), power is applied to the printer.

If the printer encounters a high current surge, the AC circuit breaker trips, protecting the printer's electrical and electronic components. When the AC circuit breaker trips, the circuit breaker handle flips downward (toward the OFF position) and is no longer in the fully upward position.

To return the printer to operation, reset the AC circuit breaker. This is accomplished by pushing the AC circuit breaker handle fully upward (to the ON position).



Note: When the AC circuit breaker is tripped, the circuit breaker handle doesn't always end up in the fully downward (OFF) position. Any time the AC circuit breaker is tripped the handle will flip to a downward position and no longer be in the fully upward (ON) position. When resetting the AC circuit breaker, always push the AC circuit breaker handle to the fully downward (OFF) position before pushing the handle to the fully upward (ON) position.

Figure 2-6: Rear Connections

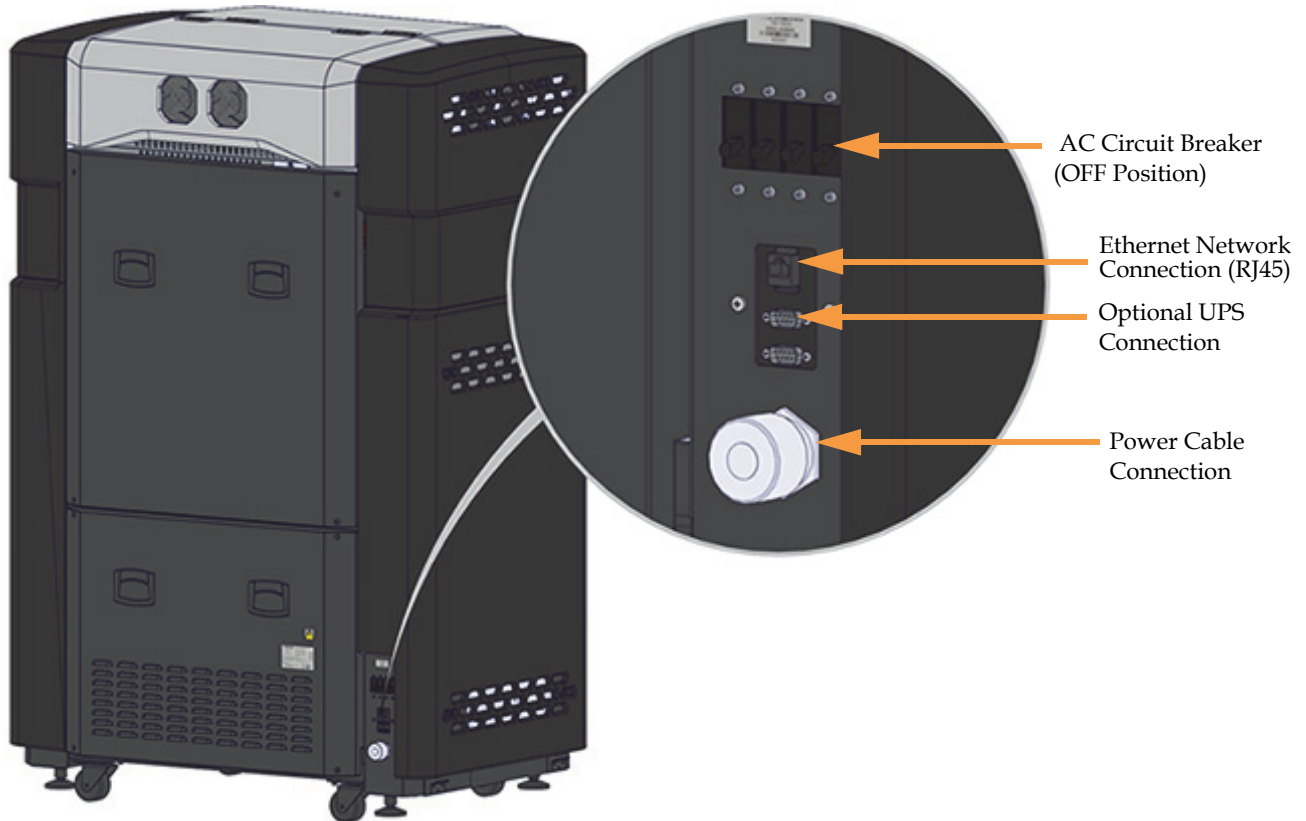

Configuring the Network

This section is provided in case you need to change your network settings.

The printer's network address type can be set to DHCP (Dynamic) or Static.

- DHCP (Dynamic) address - a network server or PC will generate an IP address for the printer. A different IP address may be generated from time to time by the server or PC.
- Static address - you must enter an IP address, network mask, and gateway address for the printer (provided by the system administrator). Once entered, the address will not change.

In addition to configuring the IP address, you can set the UPnP configuration for the printer.

- UPnP On - the printer will broadcast its Unique Device Name (UDN) address across the network. This allows Insight software to automatically detect the IP address of the printer for communication.
- UPnP Off - the printer will not broadcast its IP address across the network. Insight software will need to be manually configured to communicate with the printer.

UPnP Configuration

To configure your printer's UPnP settings:

1. Power ON the printer, see [“Powering ON the Printer”](#) on page 110.
2. Press the **Settings** button within the Navigation Bar (see [Table 4-5](#) on page 51).
3. Locate the **UPnP** option within the Network portion of the Settings page (see [“UPnP”](#) on page 90).
4. A sliding button is displayed which allows you to turn UPnP off and on (On is selected by default); adjust this setting as needed by touching this button on the screen and sliding the button to the left (Off) or right (On).

Network Address Configuration

To configure your printer's network address settings:

1. Power ON the printer, see [“Powering ON the Printer”](#) on page 110.
2. Press the **Settings** button within the Navigation Bar (see [Table 4-5](#) on page 51).
3. A grouping of network address information can be found in the first row of the Network portion of the Settings page. This grouping contains Address Type, IP Address, Netmask, and Gateway Address fields, with the field's corresponding address displayed in the right side of the row (see [“Network Address Information”](#) on page 90).
4. To adjust the printer's network address information, press the right arrow graphic displayed within the Network row. This will open your printer's Network Settings Details page (see [“Network Settings”](#) on page 88).
5. A sliding button is displayed to the right of the **Address Type:** field which allows you to select a DHCP (Dynamic) or Static address type (DHCP is selected by default). Adjust this setting as needed by touching this button on the screen and sliding the button to the left (DHCP) or right (Static).
 - A. If DHCP is selected, no additional configuration is necessary. Press the **Settings** button in the upper-left corner of the page to exit the printer's Network Settings Details page and return to the Settings page.
 - B. If Static is selected, the Enter Network Settings pop-up dialog will be displayed. Within this dialog you must manually configure the IP Address, Network Mask, and Gateway fields using the keypad displayed. Simply touch a field on the screen to select it and then use the keypad to enter address information.

Figure 2-7: Enter Network Settings Dialog

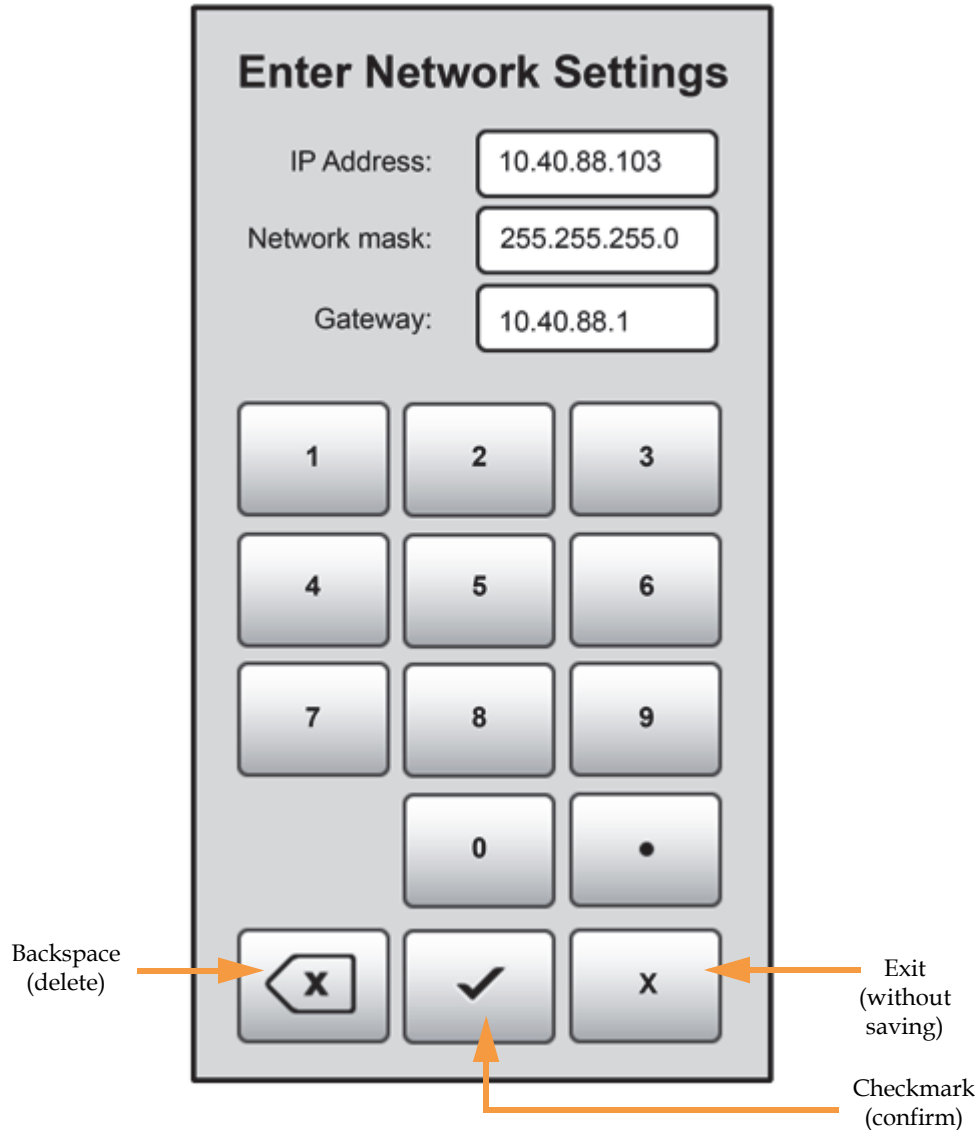

- Use the **number keys** to enter address digits.
- Use the **backspace** key to delete entries digit by digit.
- Use the **checkmark** key to confirm entries and exit the dialog with saving.
- Use the **x** key to exit the dialog without saving.



Note: See your network administrator if you do not know the IP address, Network mask, or Gateway address.

6. After configuring your network settings and exiting the Enter Network Settings dialog you will be returned to the printer's Network Settings Details page. Press the **Settings** button in the upper-left corner of the dialog to exit the Network Settings Details page and return to the Settings page.

Setting the Printer's Date and Time

In order to ensure accurate build times, the printer's clock must be set. This is done within the FDM Control Center application which was installed on your workstation PC as part of the installation process (see "FDM Control Center Software" on page 42). Perform the following steps to set the 380mc's date and time:

1. Open FDM Control Center by navigating to **All Programs > Insight (installed version) > Control Center (installed version)** or double-clicking the Control Center shortcut (if available).
2. Select the Services tab, and ensure that your 380mc is selected from the Name: drop-down menu. If your printer is not available from the drop-down menu, you will need to add the printer within Control Center, see "Add Printer to Control Center" on page 202 for instructions.
3. Click the **System Time** button.

Figure 2-8: System Time Button Location

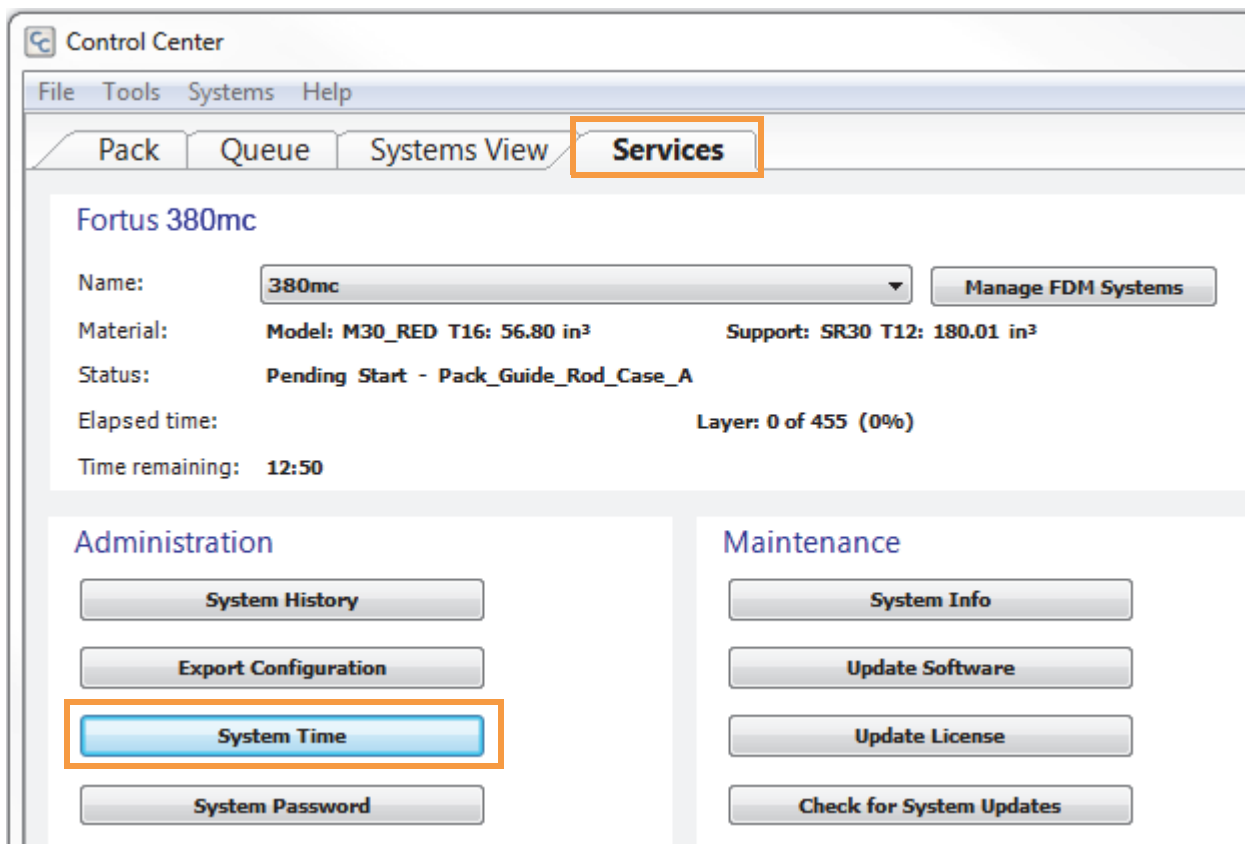

4. The Change 380mc Date and Time dialog will be displayed. The date and time settings within this dialog are automatically configured based on the workstation PC's date and time settings.
5. Adjust the date and/or time setting if needed, then click **OK** to close the dialog. Your printer's date and time settings will be configured and are displayed within the Information Bar portion of the User Interface (see "Information Bar" on page 44).

Figure 2-9: Change Date and Time Dialog

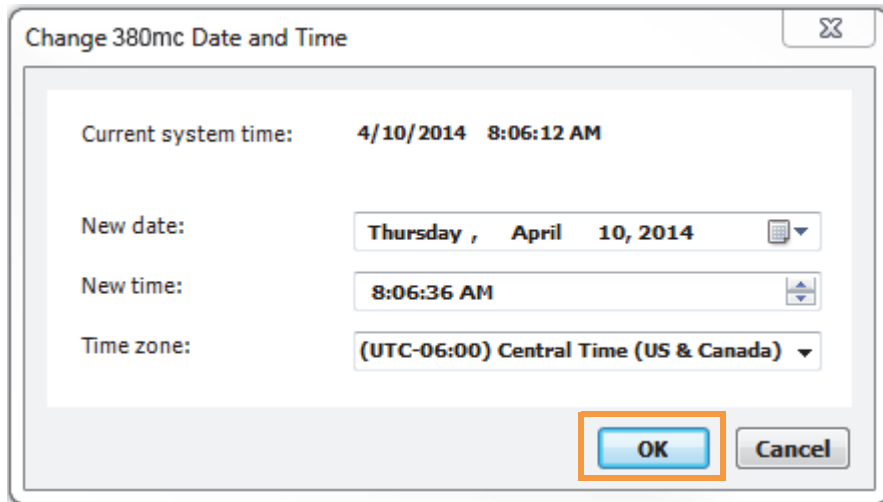

Licensing the Printer

The printer must be licensed before it can be used to build parts. The process of licensing the printer involves putting the printer into a mode which allows for material license upgrades, and then installing the printer's material license file. This file contains the details of the printer's materials configuration (see [Available Material Options](#) for details) and determines which model and support materials can be used to build parts on the printer. The printer should have been licensed as part of its initial installation and setup (performed by your authorized service representative). However, if after installing and loading material canisters your printer does not recognize these canisters and will not allow you to initiate a build, you may need to license the printer. Follow the steps within "Install/Update Material License" on page 205 to license your printer.

3 System Components

This chapter describes the components of the 380mc. Information regarding the materials and tips that can be used by the printer is also included in this chapter.

Printer Overview

Access Doors and Panels



Warning: The right and left upper and lower side panels, as well as the upper and lower rear panels, should only be removed by an authorized service representative. These components are indicated in the following figures for reference purposes only.

This printer has been designed to allow easy access to the most frequently accessed areas on the system. Doors and panels are highlighted in [Figure 3-1](#) and [Figure 3-2](#).

Figure 3-1: Access Doors and Panels - Front View

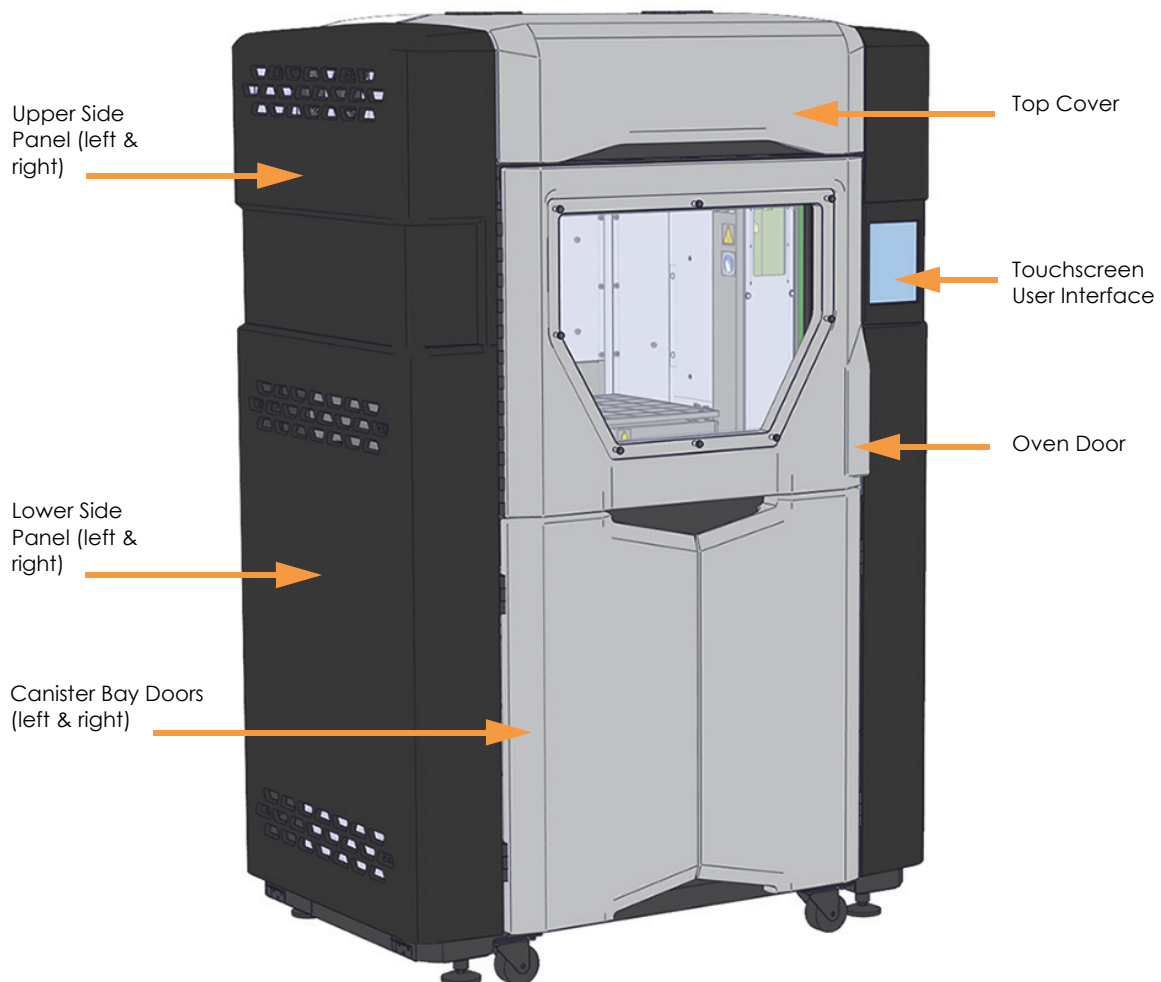
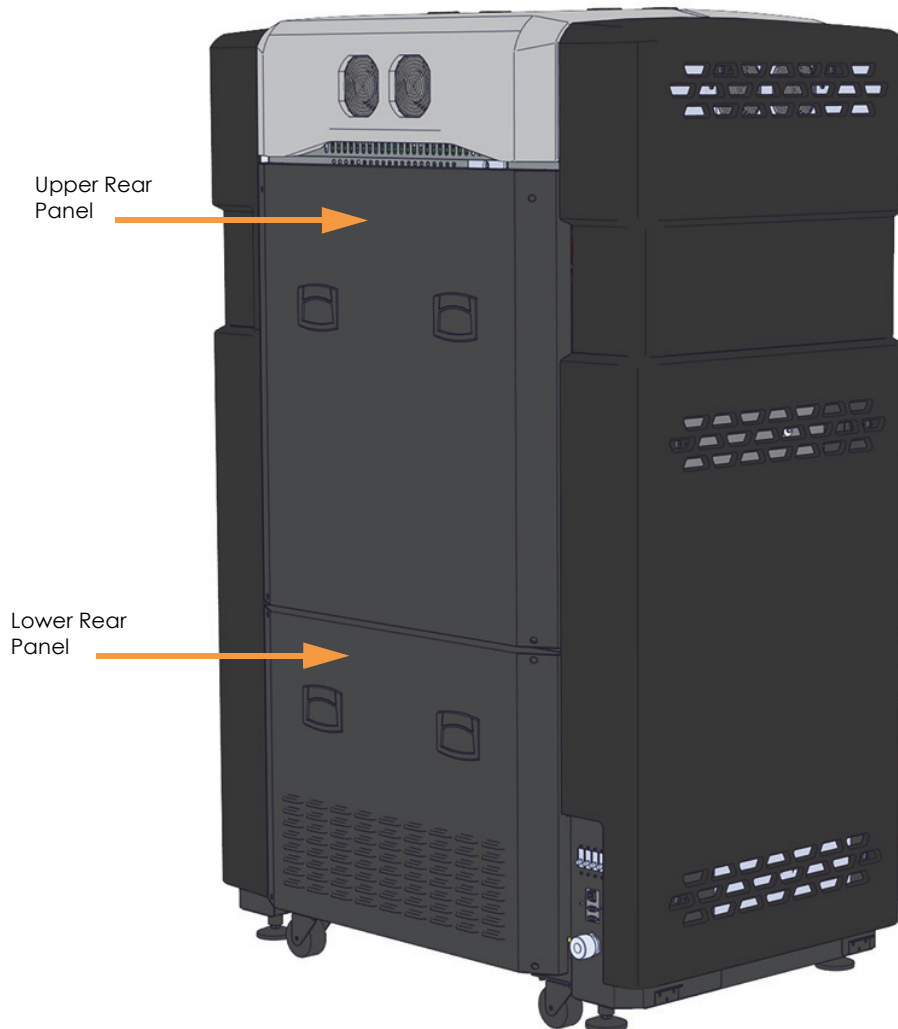

Figure 3-2: Access Doors and Panels - Rear View



Top Cover

Allows access to the gantry and head assembly.

Six fans are used to cool this area of the printer. The two fans on the left and the two fans on the right draw cool air into the gantry area, while the two fans on the rear draw warm air out of the gantry area.

Oven Door

Allows access to the platen, tip wipe assembly, and completed parts for removal.

Canister Bay Doors

Allows access to the canister bay enclosure and its components (material canisters, canister release knobs, and canister status LEDs), as well as the power switch, tip wipe height adjustment wheels, purge bin, and storage area.

Right & Left Side Panels



Warning: The right and left upper and lower side panels should only be removed by an authorized service representative.

Upper & Lower Rear Panels



Warning: The upper and lower rear panels should only be removed by an authorized service representative.

Touchscreen User Interface

Allows for user control of the printer. From the User Interface you can access various screens to select jobs for building, control jobs in the process of being built, change materials and tips, perform calibrations, and configure your printer's settings and maintenance options. The touchscreen visually displays the operational state of the printer as well as any warning information available.

See ["4 User Interface"](#) on page 4-43 for detailed information on the components and pages of the User Interface.

Oven Components

The oven is comprised of the oven door and everything that you see through the oven door window, including the platen and the tip wipe assembly. The oven is where parts are built.

Figure 3-3: Oven Components

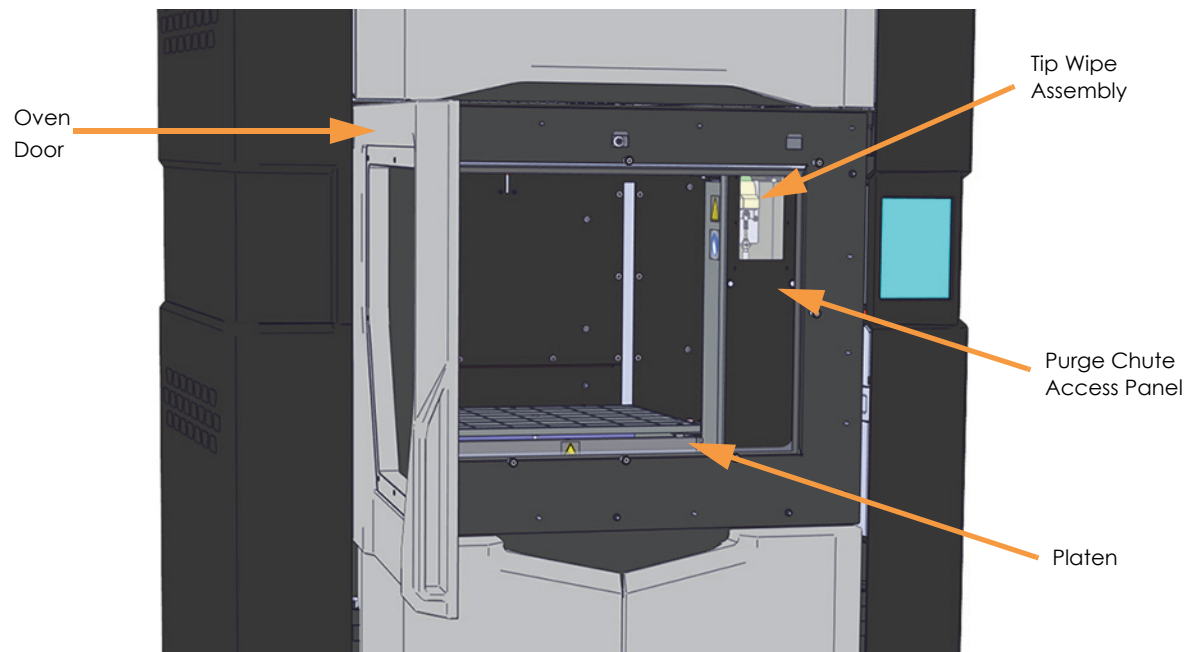

Oven Door

The oven door utilizes an electromagnetic lock. The oven door remains locked while the printer is building and automatically unlocks when it is safe for you to access the components of the oven; the oven door cannot be opened when the printer is building. The top cover will automatically unlock in conjunction with the oven door, allowing you to manually open the top cover.

The oven door window is comprised of 2 components, an interior pane of glass and an exterior polycarbonate panel. The interior pane is tempered glass which is designed to withstand extremely high temperatures, as this pane is in direct contact with the oven. The exterior polycarbonate panel is removable and features an anti-scratch coating on the exterior side of the panel (i.e. the surface aligned with the exterior of the printer). The interior surface of this panel does not feature this anti-scratch coating.



Note: Although the polycarbonate exterior panel features an anti-scratch coating, certain materials can still damage/scratch the panel's surface. Use extreme care to avoid any activity which may scratch the panel's exterior surface.

Very specific cleaning procedures must be followed when cleaning the interior glass pane and the polycarbonate panel. See [“Cleaning the Oven Door Glass/Window”](#) on page 231 for details.

Oven Lights



Hot Surface: Bulbs are hot. Never touch bulbs when the oven light is turned on. Bulbs should only be removed/replaced when the oven light is turned off. See “[Replace an Oven Bulb](#)” on page 230 for bulb replacement instructions.

There are four Festoon bulbs ([Figure 3-4](#)) mounted on the front upper edge of the oven, two per side, which illuminate the oven. Each bulb is rated at 12 volts.

The Oven Light Control button within the Dashboard indicates the current state of the oven light and allows you to manually turn the light ON or OFF. (See “[Oven Light Control Button](#)” on page 49 for more information.)

[Figure 3-4:](#) Bulb Locations

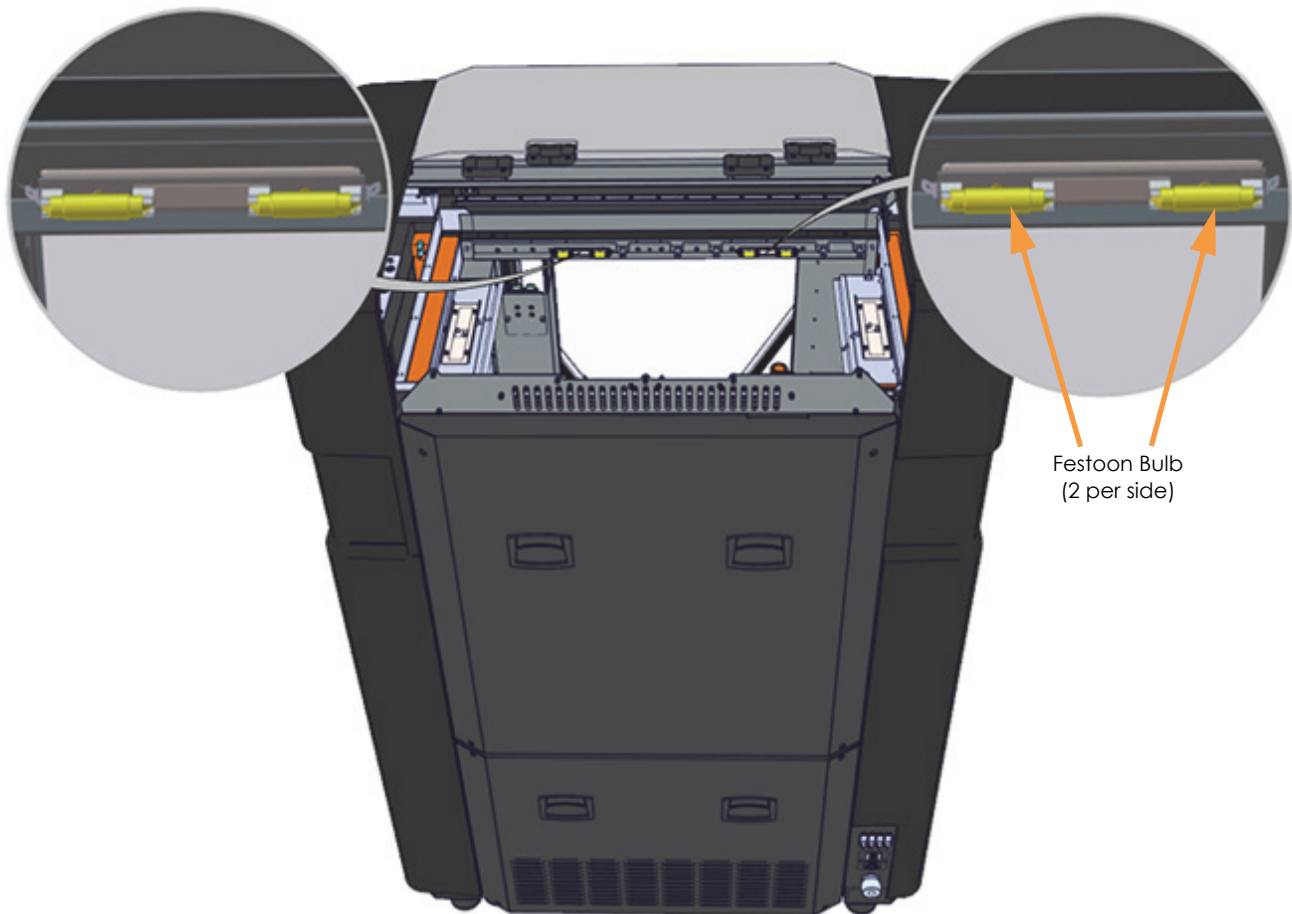

Platen

The steel platen provides the level surface on which parts are built. A build sheet is securely affixed to the platen by the vacuum source (see [“On Board Vacuum System”](#) on page 35 for details). A checkerboard pattern is machined into the top surface of the platen which allows vacuum to be evenly distributed across the entire surface. Always ensure that the platen is clean before starting a build, as debris on the platen will affect vacuum quality (see [“Clean the Platen”](#) on page 222 for instructions).

A debris screen (not a customer removal part) is placed across the vacuum port, located at the center of the platen. This screen prevents material particles from entering the vacuum lines. You should inspect the debris screen often to ensure that it does not become clogged with debris.

The tip sensor, located on the front right corner of the platen, is used by the printer to determine tip placement relative to the surface of the build sheet. The printer will utilize the tip sensor to determine placement during a Z Zero Calibration (performed automatically when a build is started) and when determining the Z offset between model and support tips after they have been changed (during an XYZ Tip Offset Calibration).



Note: The platen is mounted to the Z stage cross beams with three leveling jack screws; this allows the platen to be leveled. Platen leveling should be performed by an authorized service representative only.

Figure 3-5: Platen Components

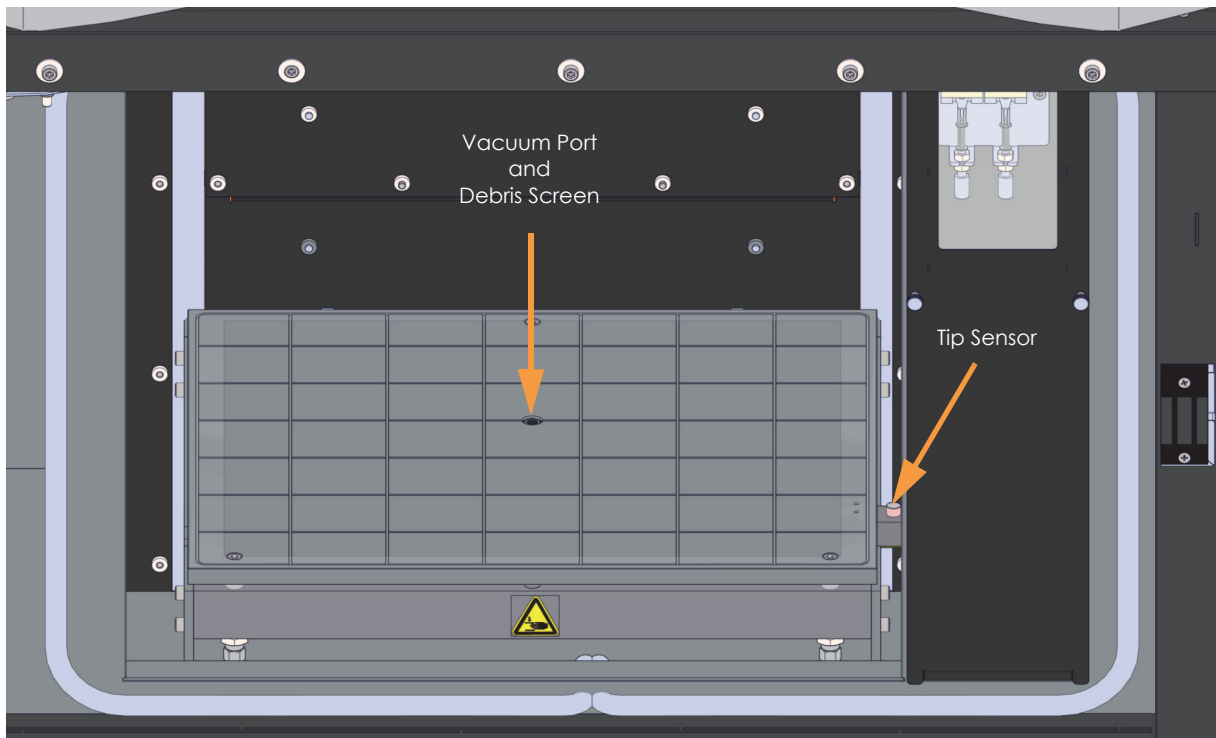

Tip Wipe Assembly

The tip wipe assembly is located on the front, right side of the oven. The assembly consists of two flicker/brush assemblies (one for each tip), two purge ledges (one for each tip), and a purge chute. The assembly is housed behind the purge chute access plate. The flicker/brush assemblies keep the printer's tips and tip shields free of purged material debris and material buildup.

The head is positioned directly above the purge ledge when material is being purged from a tip. When material is purging, it gets balled up on the purge ledge. After material is purged from a tip, the tip passes across the flicker/brush assembly. The flicker cuts the purged material from the end of the tip and knocks it into the purge chute. The brush cleans the tip and tip shield. The purge chute directs purged material into the purge bin located within the canister bay enclosure.

Tip wipes can be manually adjusted using the tip wipe height adjustment wheels located within the canister bay enclosure. See "Tip Wipe Height Adjustment Wheels" on page 29.

Figure 3-6: Tip Wipe Assembly

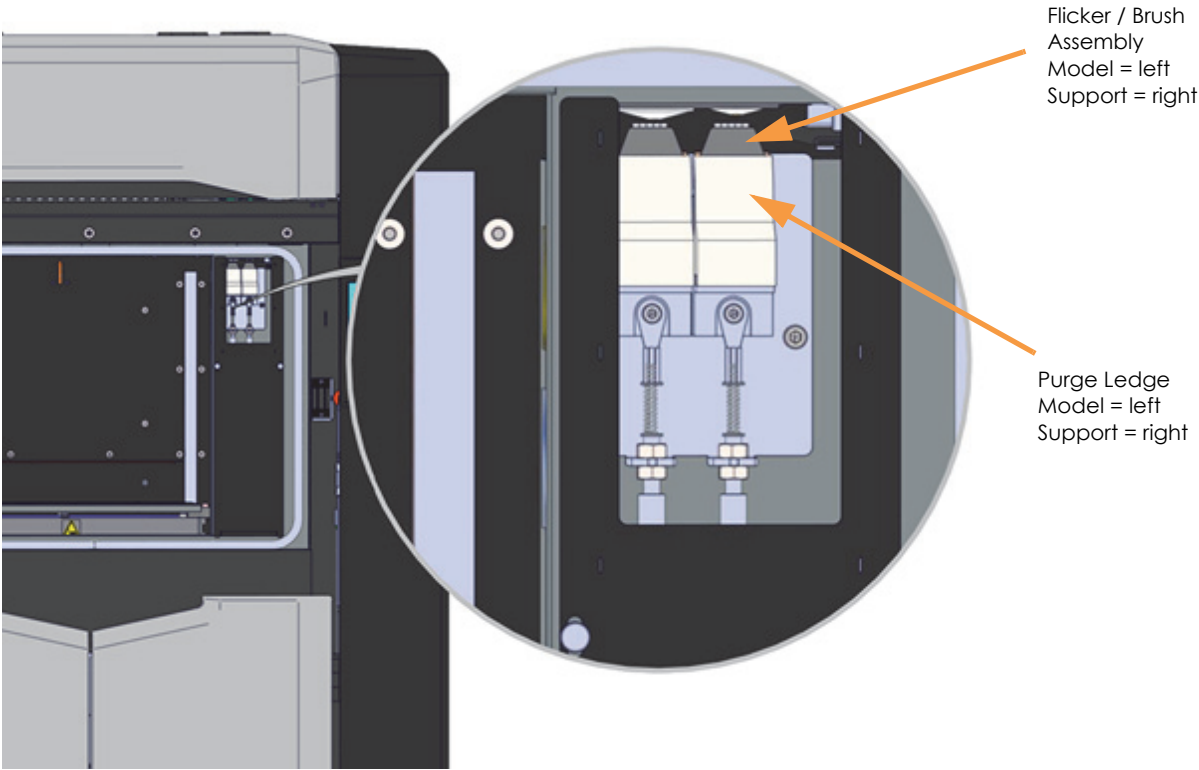

Canister Bay Enclosure Components

The model and support material canister bays are accessed by opening the canister bay doors on the front of the printer. The canister bay doors do not contain electromagnetic locks and can therefore be opened while the printer is building.

Figure 3-7: Canister Bay Enclosure Components

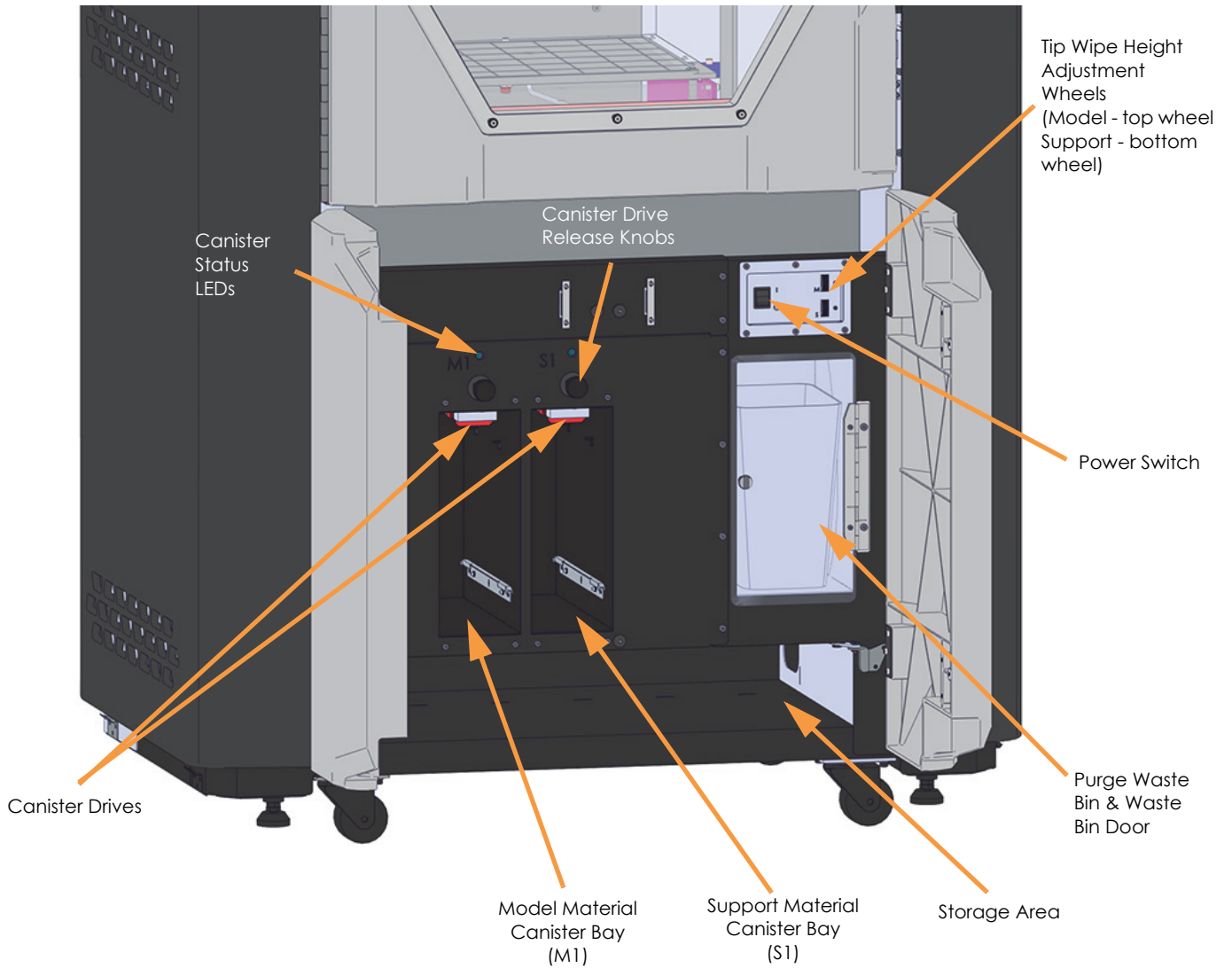

Canister Bay

The 380mc has two operating material canister bays - one model and one support. The left-most bay (M1) holds model material while the right-most bay (S1) holds support material.

While building, one model and one support canister will be active. An active canister has material filament loaded to the head, as indicated by a steady green LED above the canister and a status of “Loaded” displayed on the User Interface (see “Materials Status” on page 175 for more information). You can replace inactive canisters without pausing the printer.

Canister Drives and Canister Release Knobs

Each individual canister bay has a canister drive and a canister release knob. The canister drive feeds filament from a canister to the head.

- The canister drive is located within the canister bay (directly above the canister when installed) and contains a small DC motor which drives filament up to the head.
- The canister drive is spring loaded and moves up and down on guide pins. Two springs provide positive pressure for the canister drive against the top of the canister.
- The canister drive contains a filament present switch which detects the presence of material within the canister drive.

A canister release knob is used to engage (and disengage) the canister drive with the canister.

Figure 3-8: Canister Drive Details

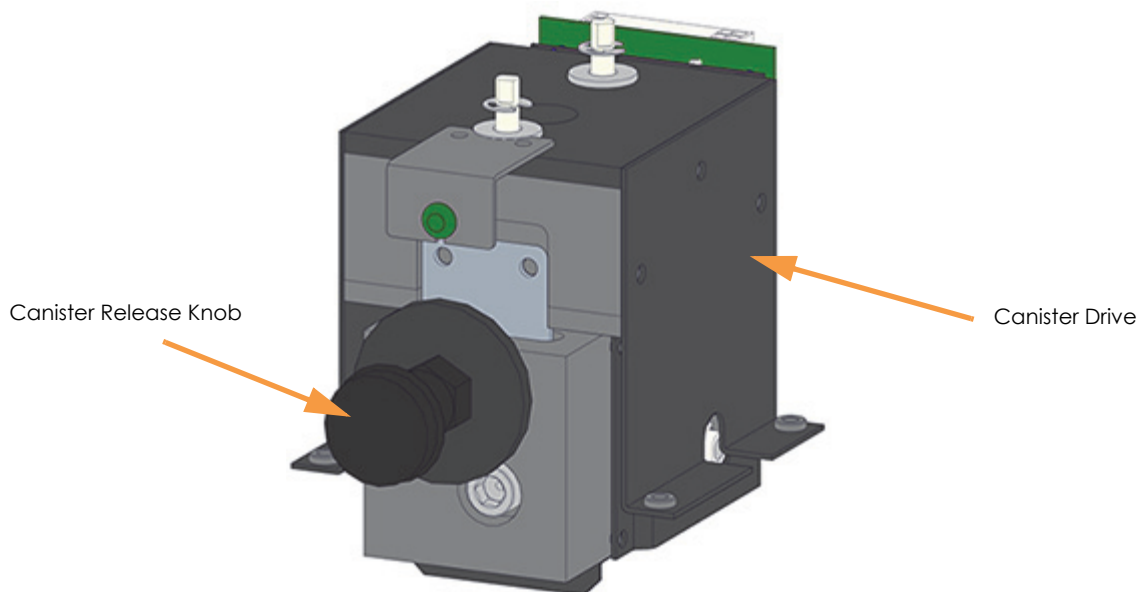

Canister Status LED Indicators

There is one colored status LED above each canister. This LED indicates the canister condition for each canister bay (Figure 3-7). LEDs states are as follows:

- Off: No canister detected, or a canister is present but filament has not been fed into the canister drive.
- Green – Slow Flashing (ready state): Filament has been fed into the canister drive but is not loaded to the head; canister can be unloaded if necessary.
- Green – Rapid Flashing (loading state): Filament has been fed into the canister drive and is in the process of loading to the head; canister cannot be removed.
- Green – Steady: Filament is loaded to the head; canister cannot be removed.
- Red – Flashing: Canister load/unload failure or canister memory chip read/write failure has occurred; canister should be removed.
- Red – Steady: Empty canister; canister should be removed.

Tip Wipe Height Adjustment Wheels

The canister bay enclosure contains adjustment wheels for both the model and support tip wiper. These wheels allow you to manually adjust tip wipe heights to ensure proper placement. After replacing a tip you must adjust that tip's tip wipe height using the tip's corresponding adjustment wheel. See [“Adjusting Tip Wipe Heights”](#) on page 159 for instructions.

Figure 3-9: Tip Wipe Height Adjustment Wheel Locations

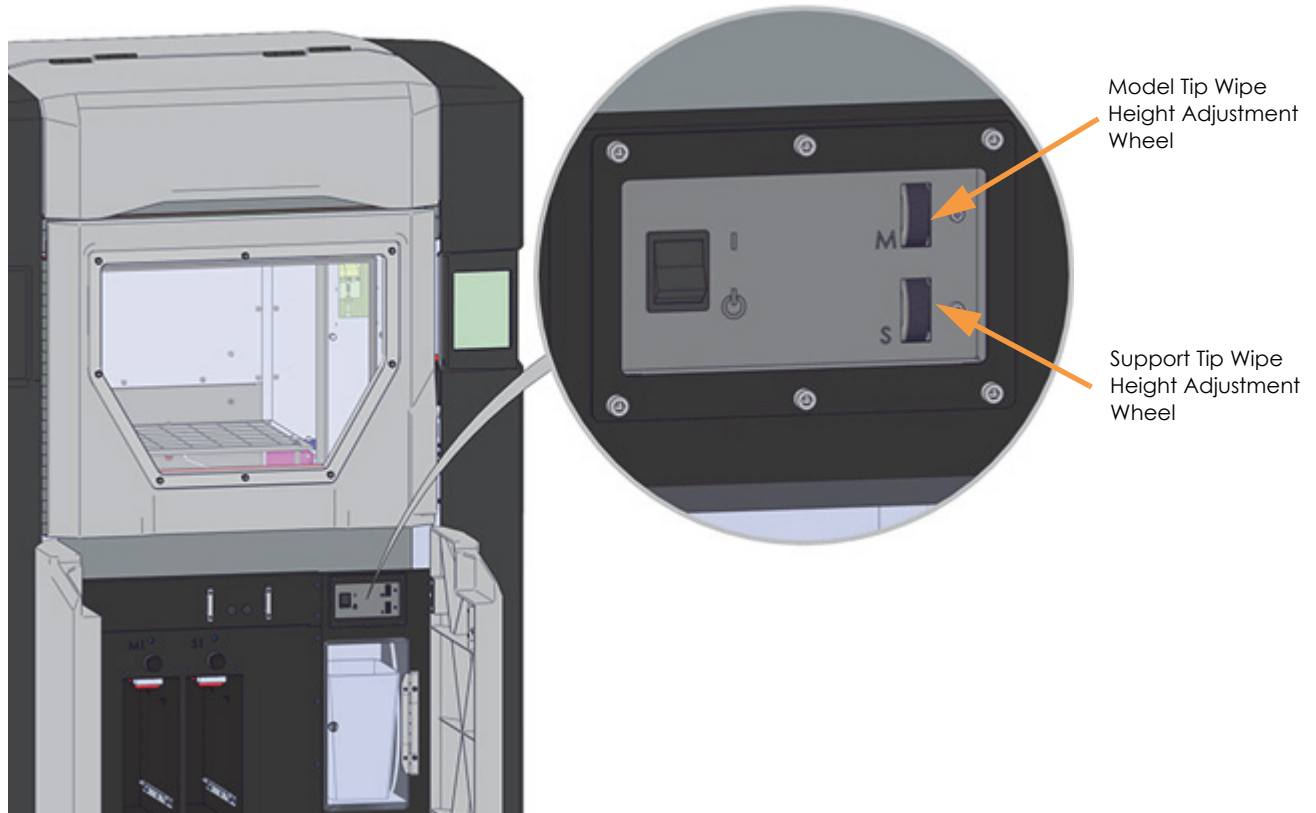

Purge Bin

The canister bay enclosure contains a purge bin. This bin collects purged material debris passed down from the flicker/brush assemblies via the purge chute.

The purge bin is equipped with its own door which is spring loaded. The purge bin door should be closed whenever the printer is building. The purge bin should be emptied on a daily basis, see “Empty the Purge Bin” on page 223 for instructions.

Figure 3-10: Purge Bin Location

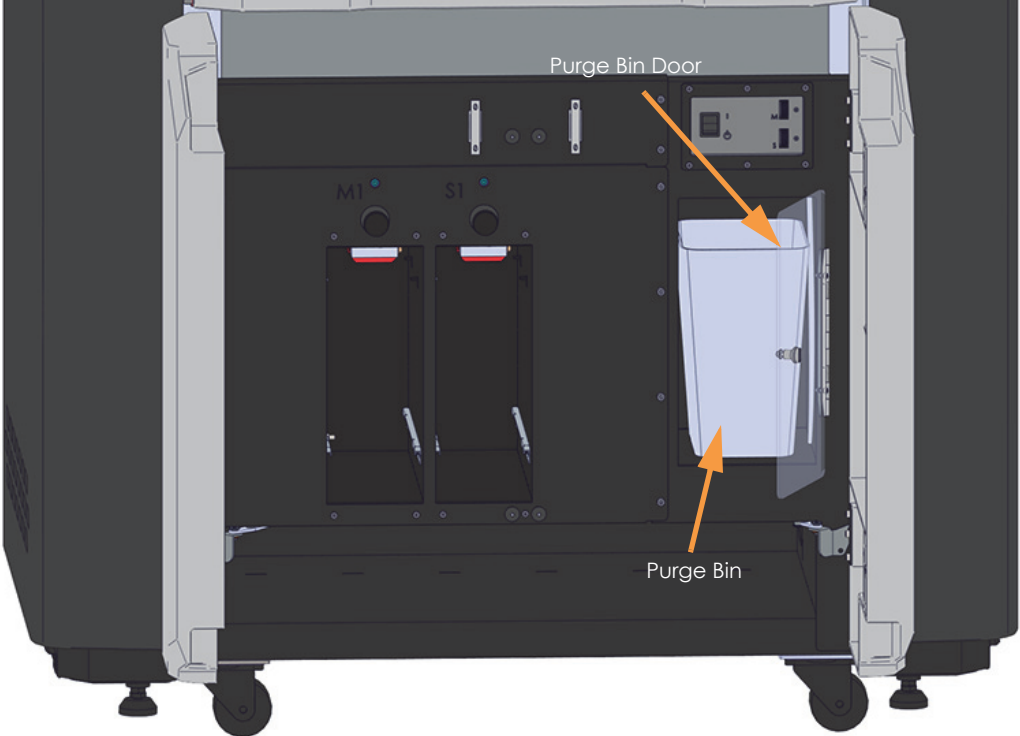

Storage Area

Directly below the four canister drives is a storage area which can be used to store spare parts or tools, as needed.

Figure 3-11: Storage Area

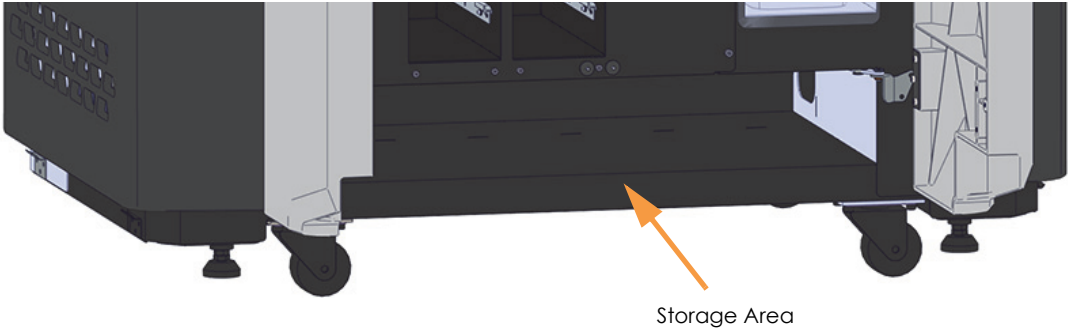

Gantry

To access the gantry or the head, you must first open the top cover. The top cover utilizes an electromagnetic lock. The top cover remains locked while the printer is building and automatically unlocks when it is safe for you to access the components within this area of the printer; the top cover cannot be opened when the printer is building. The oven door will automatically unlock in conjunction with the top cover. The printer cannot resume building if the top cover is open.

Gantry Assembly

The gantry moves the head in the X and Y directions when building a part. The gantry assembly is located under the top cover. The entire gantry is outside of the oven; only the bottom of the head protrudes into the oven. The gantry and its drive motors are thermally shielded from the oven via flexible heat shields. To move the head, the gantry utilizes one X and one Y servo motor attached to timing belts.

Figure 3-12: Gantry Assembly

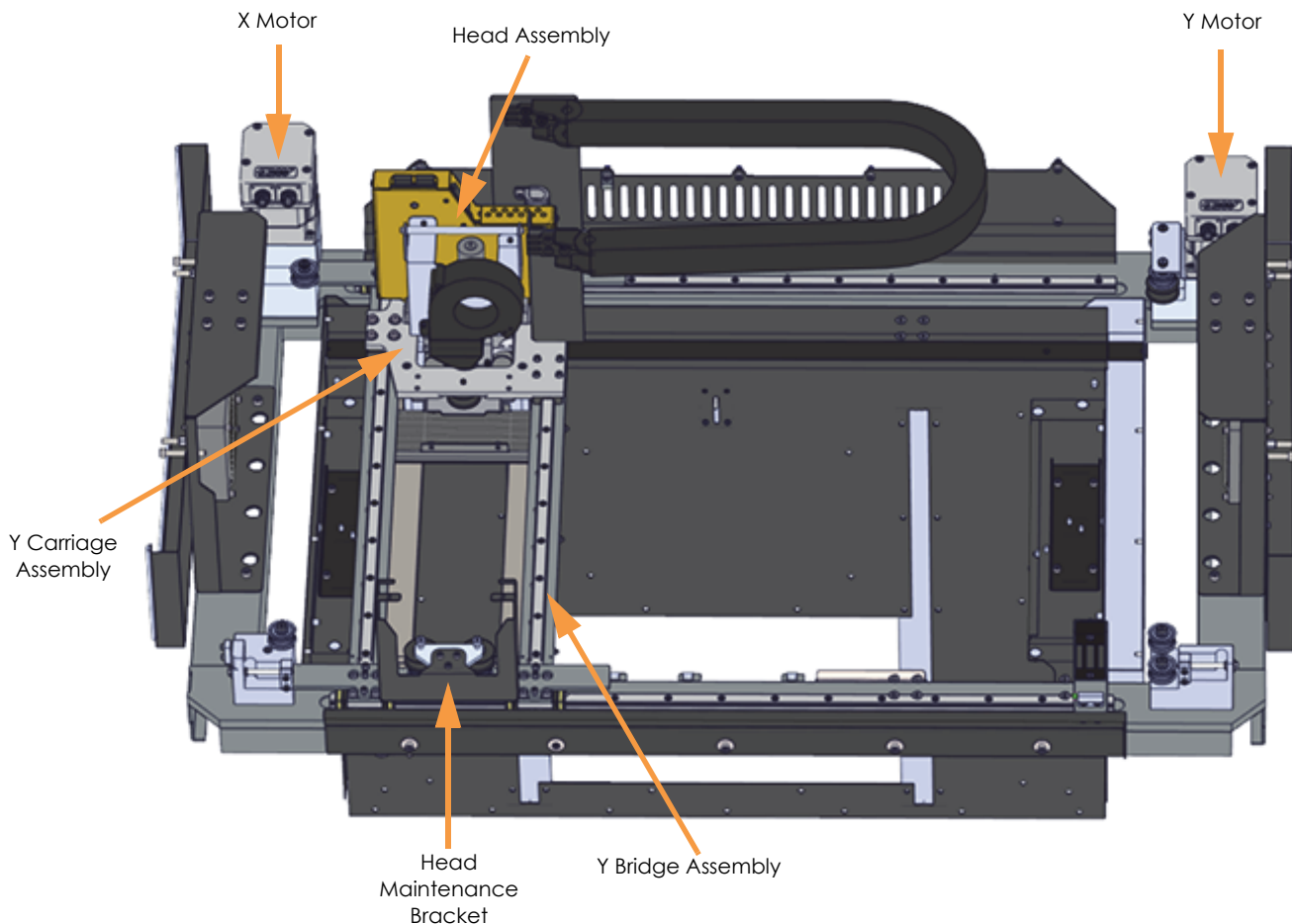

Head Assembly

The head assembly has been designed for use with a wide range of modeling materials. The board inside the head provides direct heater. The head extrudes model material and support material with two identical liquefiers. The support liquefier moves up and down via a drive motor. The liquefier tips are clamped directly between the liquefier heater blocks with two screws. A single blower fan is mounted above the tip liquefier entrances to cool the incoming material and the liquefier entrances.

Figure 3-13: Head Assembly

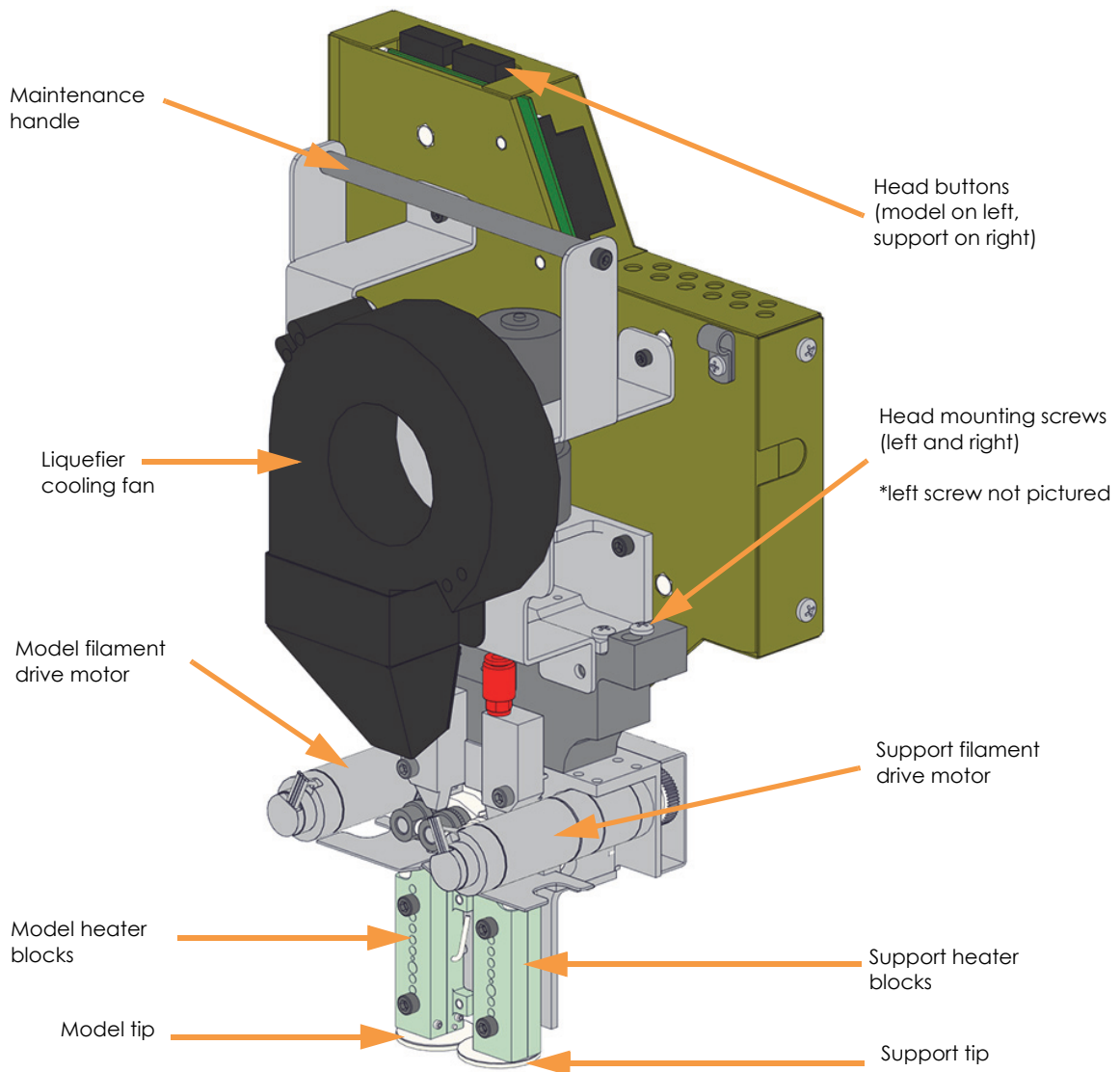

Head Maintenance Bracket

The 380mc is equipped with a head maintenance bracket which places the head in a convenient location for many head maintenance tasks, such as changing tips (see “Changing Tips within the Top Cover” on page 156).

Placing Head into Maintenance Bracket

When necessary, perform the following steps to place the head into the maintenance bracket:

1. Ensure that the printer is stopped and not building.
2. Open the top cover and manually move the head to the front-center of the gantry area using the maintenance handle.
3. Loosen but do not remove the two head mounting screws.

Note: The retaining screws are ‘captured’. They should not be completely removed from the head.

Figure 3-14: Head Mounting Screw Locations

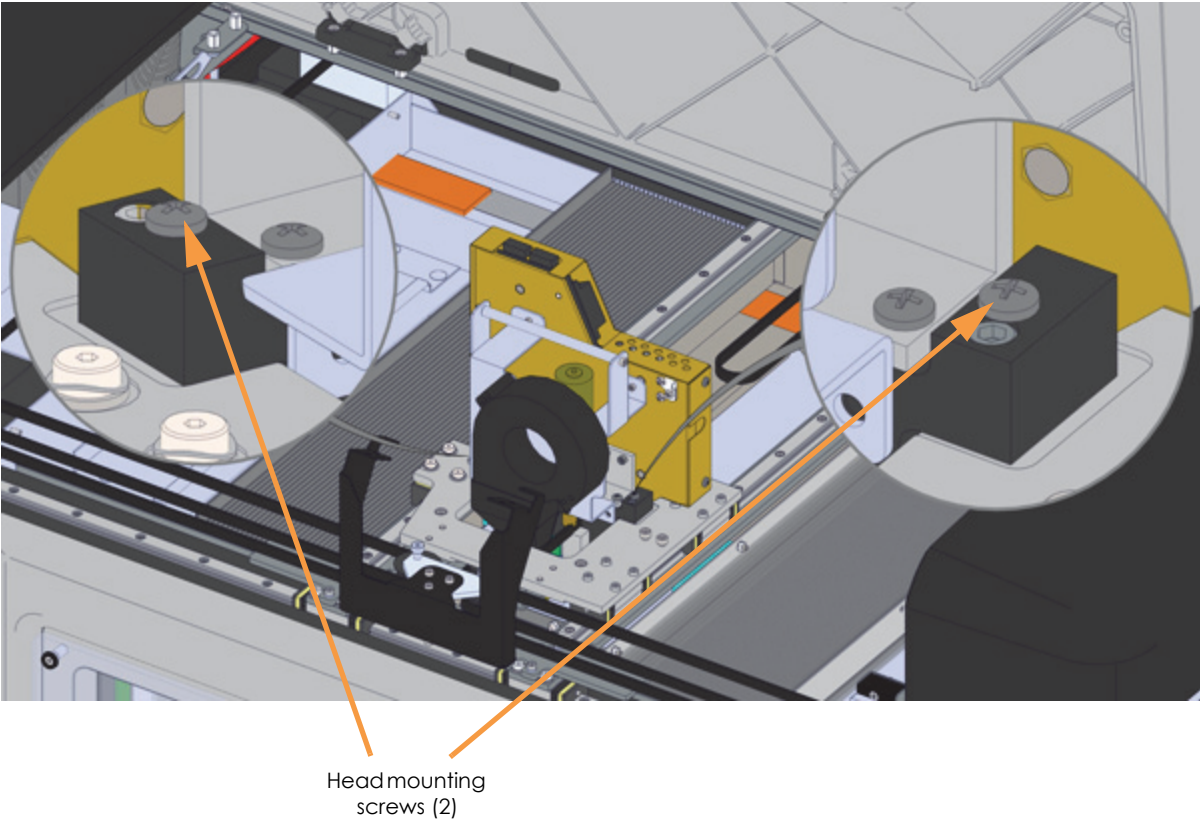

4. While firmly grasping the maintenance handle, lift the head and place it into the head maintenance bracket.

Figure 3-15: Head in Maintenance Bracket

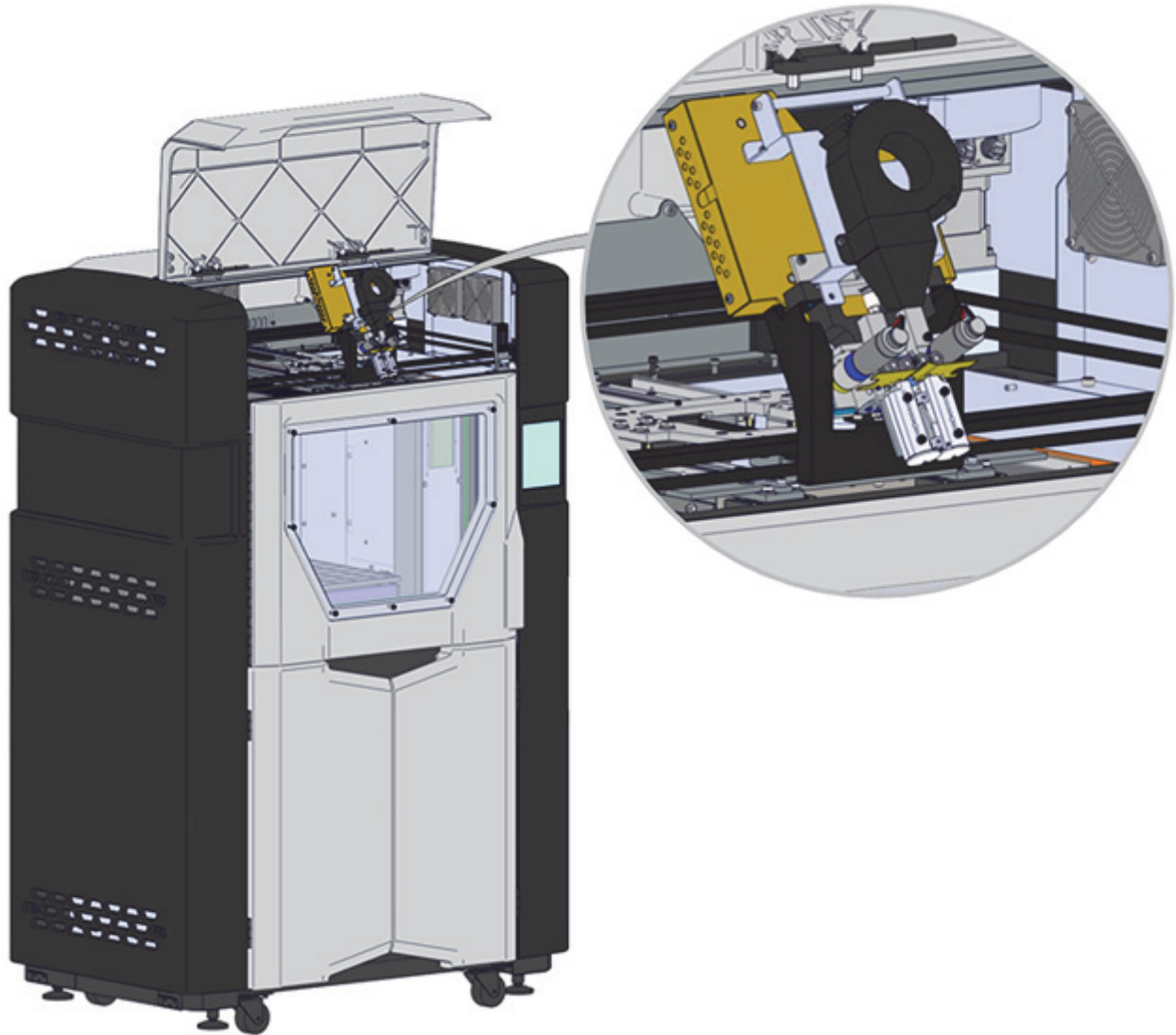

Removing Head from Maintenance Bracket

After performing any necessary head maintenance tasks, perform the following steps to remove the head from the head maintenance bracket and replace it within the gantry:

1. While firmly grasping the maintenance handle, remove the head from the head maintenance bracket and return head to its initial position within the gantry.
2. Secure the head to the head mounting plate using the two head mounting screws (see Figure 3-14).
3. Ensure that the head cable is not kinked in a position where it will rub on the top cover and then close the top cover.

Vacuum and Air Dryer Systems

On Board Vacuum System

The vacuum pump generates the vacuum used to hold the build sheet to the platen. When sufficient vacuum is achieved, the build sheet automatically affixes to the platen and the red X over the top of the Vacuum Status Indicator (within the Information Bar) will disappear (see “[Information Bar](#)” on page 44). The vacuum system also contains an in-line vacuum filter (to remove debris from the vacuum system) and a vacuum switch (which prevents the printer from operating if vacuum is not present).

On Board Air Dryer System

The material drying system is designed to help keep loaded material filament dry. An air compressor is used to force dry air through the filament tubes. The compressed air is pushed through a regenerating dryer where it is dried. The dried air is diverted between two dryer elements every 30 seconds. The pressure and flow of the dried, compressed air is controlled by a pressure regulator and a separate air flow meter. Excess water is diverted to an evaporation tray within the printer, and debris is captured by a filter element.

Modeling Materials and Tips

Materials Used

The 380mc can use a variety of material types:

- High strength polycarbonate (PC) model material used with PC_S breakaway support or SR-100 soluble support.
- PC-ISO model material used with PC_S breakaway support.
- ABS-M30, ABS-M30i, ABS-ESD7, and ASA model material used with SR-30 soluble support.
 - SR-30 is ductile and dissolves rapidly.
- Nylon 12, which is the first semi-crystalline Fused Deposition Modeling (FDM) thermoplastic, used with SR-110 support material.

The types of materials (model and support) available for use on your printer are dependent upon the material license option purchased with the printer (see the [Available Material Options](#) section for details regarding material options available to the 380mc). You have the ability to upgrade your printer's material options if needed. This upgrade can be done via the Materials setting within the Maintenance page (see "[System Settings](#)" on page 105 for details).

Printer material compatibility information can be found in "[Tip Compatibility & Selection](#)" on page 37.

Canister Memory Chip

Each material canister contains a memory chip which tracks the canister's volume. The 380mc utilizes a different canister memory chip than other Fortus canisters and as a result, only 380mc compatible canisters can be used to build parts on the printer. These canisters exhibit a black canister snout and plastic plug (see [Figure 5-5 on page 116](#) for details).

Figure 3-16: Canister Memory Chip Location

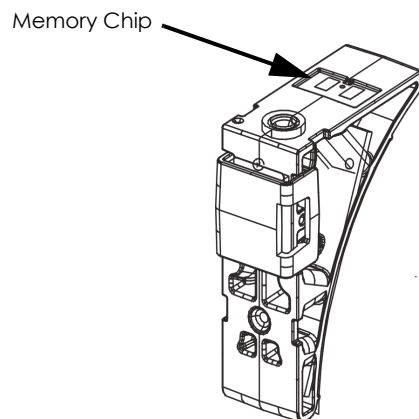

When a canister is installed, its memory chip is read and the canister's information is reported to the printer. The canister's material type and volume are displayed on the User Interface within the Dashboard (see "[Dashboard](#)" on page 45 for more information) as well as the Tips page (see "[Working with the Tips Page](#)" on page 66).

When initiating a build, the printer compares the material requirements (model and support) of the build file to the printer's current materials configuration. If materials do not match, the User Interface prompts you to change materials to the appropriate type.



Note: You can choose to continue the build with mis-matched material(s), but part build quality will be unpredictable.

The build file also contains an estimate of the amount of model and support material required to complete the build. This estimate is compared to the amount of material available within each canister. If there is not enough material available to complete the build, you will be warned and given the option to change canisters or install additional canisters before starting the build.



Note: A specific prompt will only be displayed if a canister volume related issue is detected.

Liquefier Tips

Liquefier Tips and Slice Heights

Two types of liquefier tips are available. Standard tips are used for all modeling materials and for Break-Away Support Structures (BASS), while soluble tips are used for soluble support materials (see [“Tip Identification” on page 40](#) for more information). When modeling with materials that use soluble release support material (SR), use the T12SR30 or T12SR100 tip for the support material.

There are six tips available for use with the 380mc: T10, T12, T12SR30, T12SR100, T16, and T20. Tips are a replaceable consumable item and must be changed whenever the printer's material type is changed or when a tip reaches its odometer limit. When changing tips, if a tip is removed that may be re-installed at a later time, be sure to record the tip's odometer reading and store this information with the removed tip. See [“Changing Tips or Material Type” on page 123](#) for detailed instructions on changing tips.

Tip Compatibility & Selection

[Table 3-1](#) lists the materials available for use with the 380mc and their corresponding tips.

[Table 3-2](#) lists the slice heights for each model tip.

[Table 3-3](#) provides approximate tip life based upon the amount of material used.

The printer tracks tip use and automatically prompts you, via the User Interface, when a tip should be replaced. Worn tips are prone to clogs and reduce part quality. See [“Tip Odometer Status” on page 173](#) for more information on viewing tip use status.

When changing tips, the printer will guide you through the process of resetting tip odometers using the Tip Change Wizard (see [“Using the Tip Change Wizard”](#) on page 123.)

Table 3-1: Available Tips

Model Material	Model Tip	Support Material	Support Tip
ABS-M30 ABS-M30i	T10, T12,T16, T20	SR-30	T12SR30
ABS-ESD7	T12, T16	SR-30	T12SR30
ASA	T10, T12,T16, T20	SR-30	T12SR30
Nylon 12	T12, T16, T20	SR-110	T12SR100
PC	T10, T12, T16	SR-100	T12SR100
PC PC-ISO	T12	PC_S	T12
PC/PC-ISO	T16, T20	PC_S	T16

Table 3-2: Slice Height

Model Tip	Slice Height (in)	Slice Height (mm)
T10	0.005	0.127
T12	0.007	0.178
T16	0.010	0.254
T20	0.013	0.330

Table 3-3: Tip Life

Model ^a Material	Model Tip	Model Tip Life ^b			Support Tip	Support Tip Life ^b		
		cu. in.	cu. cm.	Canisters		cu. in.	cu. cm.	Canisters
ABS-M30 ABS-M30i	T10	620	10160	6.5	T12SR30	270	4420	3.0
ABS-M30 ABS-M30i	T12	770	12620	8.5	T12SR30	550	9010	6.0
ABS-M30 ABS-M30i	T16	920	15080	10.0	T12SR30	640	10550	7.0
ABS-M30 ABS-M30i	T20	920	15080	10.0	T12SR30	640	10550	7.0
ABS-ESD7	T12	770	12620	8.5	T12SR30	550	9010	6.0
ABS-ESD7	T16	920	15080	10.0	T12SR30	640	10550	7.0
ASA	T10	620	10160	6.5	T12SR30	270	4420	3.0
ASA	T12	770	12620	8.5	T12SR30	550	9010	6.0
ASA	T16	920	15080	10.0	T12SR30	640	10550	7.0
ASA	T20	920	15080	10.0	T12SR30	640	10550	7.0
Nylon 12	T12	491	8050	5.3	T12SR100	550	9010	6.0
Nylon 12	T16	552	9010	6.0	T12SR100	664	10880	7.1
Nylon 12	T20	552	9010	6.0	T12SR100	664	10880	7.1
PC	T10	620	10160	6.67	T12SR100	270	4420	3.0
PC	T12	740	12060	8.0	T12 T12SR100	370 550	6030 9010	4.0 6.0
PC	T16	830	13570	9.0	T16 T12SR100	460 644	7540 10553	5.0 7.0
PC-ISO	T12	740	12060	8.0	T12	370	6030	4.0
PC-ISO	T16	830	13570	9.0	T16	460	7540	5.0
PC-ISO	T20	830	13570	9.0	T16	460	7540	5.0

a. ABS-M30, ABS-M30i, ABS-ESD7, and ASA model materials use SR-30 support material. Use the T12SR30 tip for SR-30 material (regardless of model tip size).
PC model material uses either SR-100 or PC_S support material. When using PC_S the support tip matches model tip size for T12 and T16, while T20 uses a T16 support tip. When using SR-100 use the T12SR100 support tip (regardless of model tip size).
PC-ISO model material uses PC_S support material. Support tip matches model tip size for T12 and T16, while T20 uses a T16 support tip.
Nylon 12 model material uses SR-110 support material. Use the T12SR100 support tip (regardless of model material tip size).

b. Tip Life is directly related to the amount of material that passes through the tip. The amounts listed above are approximates of how much material will pass through a tip before the tip will need to be replaced. Since other factors can also affect tip life, the material amounts are only approximates.

Tip Identification

Figure 3-17: Tip Identification

All unused model and support tips are interchangeable EXCEPT for Soluble Release support tips. Once a tip is used, it is committed to that material type and is no longer interchangeable.

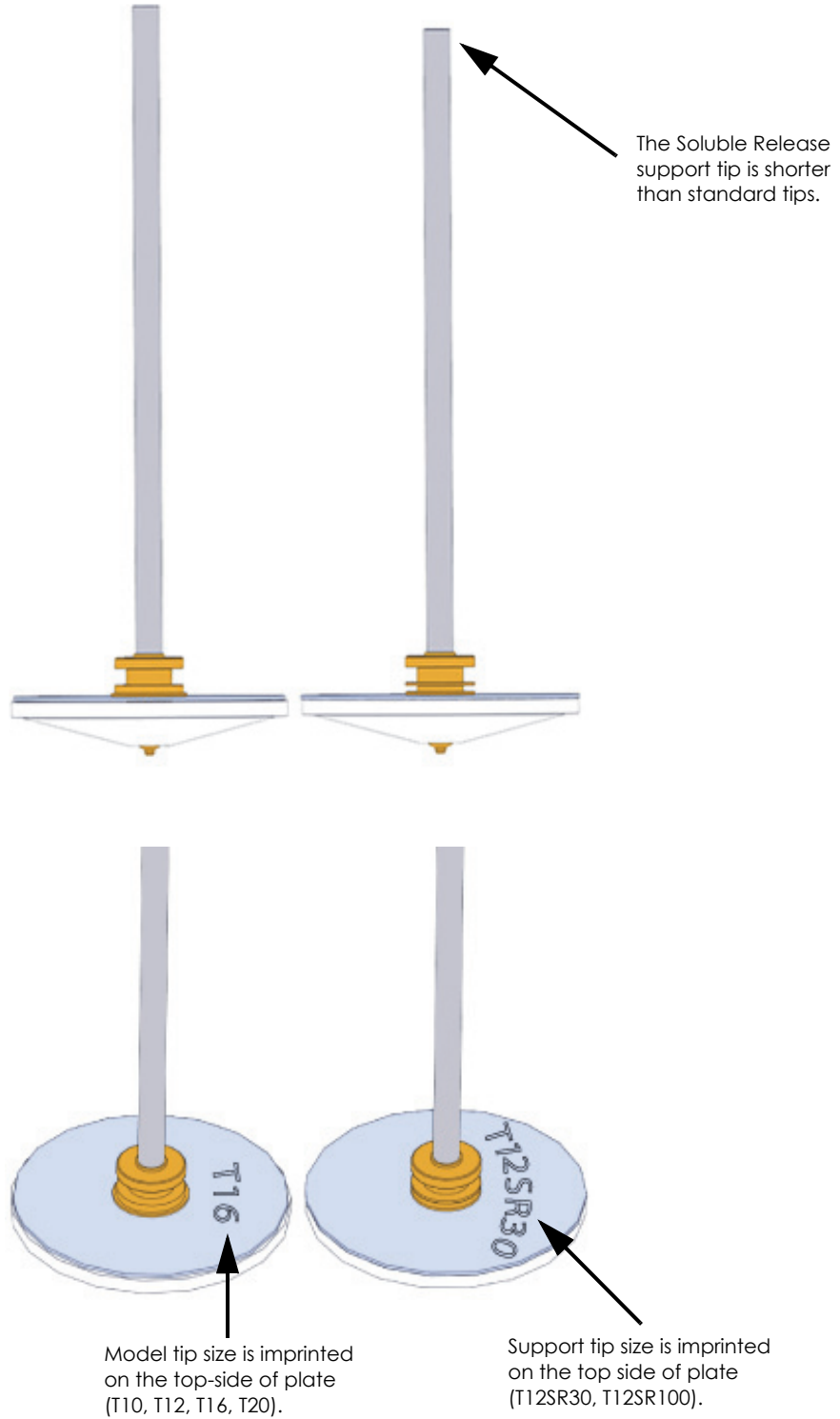

Software

Controller Software

Controller Software is installed on your printer's hard drive during the manufacturing process, and can be updated as new versions become available (see [“Updating Controller Software - Web Method”](#) on page 209 for instructions). Controller Software is the software used to control the printer. A CD copy of this software is provided in the Welcome Kit. This copy should be kept as a back-up in the event that you need to reload Controller Software on the printer.

Insight Software



Note: For detailed information and instructions on using Insight, see the associated Help file within the Insight application (available by selecting the Help option within the Insight toolbar).

Insight software is installed on your workstation PC (using the CD provided in your Welcome Kit) as part of the initial installation and setup process (performed by your authorized service representative). Insight is the software used to process job files and then transfer them to the printer to be built. The 380mc builds parts by processing the original STL job file into a Stratasys CMB file that is downloaded to the printer. To build a job, you must send the job file to the 380mc using the Insight application.



Note: FDM Control Center is an application that connects with Insight software to send jobs to the printer to be built. For detailed information about using FDM Control Center, use the associated Help file within the application.

Jobs are sent to the printer in CMB format and are placed into the Job Queue (stored on the printer's hard drive). (See [“Working with the Queue Page”](#) on page 61 for information on the Job Queue.) The header of the CMB file contains the processed job's basic information (material type, approximate material amounts required for the build, tip size, etc.). This information is used to verify job compatibility with the printer's materials/tips configuration.

To start Insight, navigate to **All Programs > Insight (installed version) > Insight (installed version)** from your workstation's Start Menu or double-click on the Insight desktop shortcut (if available).

Insight STL file processing consists of:

1. Configuring the modeler (printer).
2. Orienting the STL model.
3. Slicing the STL model.
4. Creating support curves (defining where temporary supports will be built).
5. Creating toolpath fill for model and support curves.
6. Saving a toolpath file (CMB file).
7. Downloading the toolpath file to the modeler (printer), via FDM Control Center, to be built.

FDM Control Center Software

FDM Control Center is an application that connects with Insight software to send jobs to the printer to be built. Control Center is designed to be used with your network-based Stratasys printer. Insight performs the model processing to prepare a CMB file and Control Center connects to the printer to build the job and monitor the printer's status.



Note: For detailed information about using FDM Control Center, see the associated Help file within the application (available by selecting the Help option within the Control Center toolbar).

Control Center software is packaged together with Insight software, and is installed on your workstation PC as part of the initial installation and setup process (performed by your authorized service representative). During the software installation process, your printer's network information should have been configured within Control Center allowing you to send CMB files to the printer. If you find that you are unable to select your 380mc from the drop-down menu within Control Center, you will need to add your modeler (printer) to your list of available FDM systems, see ["Add Printer to Control Center"](#) on page 202 for instructions.

4 User Interface

This chapter provides an overview of the 380mc User Interface (UI). Specific printer operation information and procedures can be found in “5 Operating the Printer” on page 110. You must power ON the printer prior to using the touchscreen, see “Powering ON the Printer” on page 110 for instructions.

Overview

The 380mc User Interface is comprised of a touchscreen located on the front right face of the printer (see Figure 3-1 on page 20). The touchscreen has four main areas of functionality; these items are highlighted in Figure 4-1.

Figure 4-1: User Interface Overview

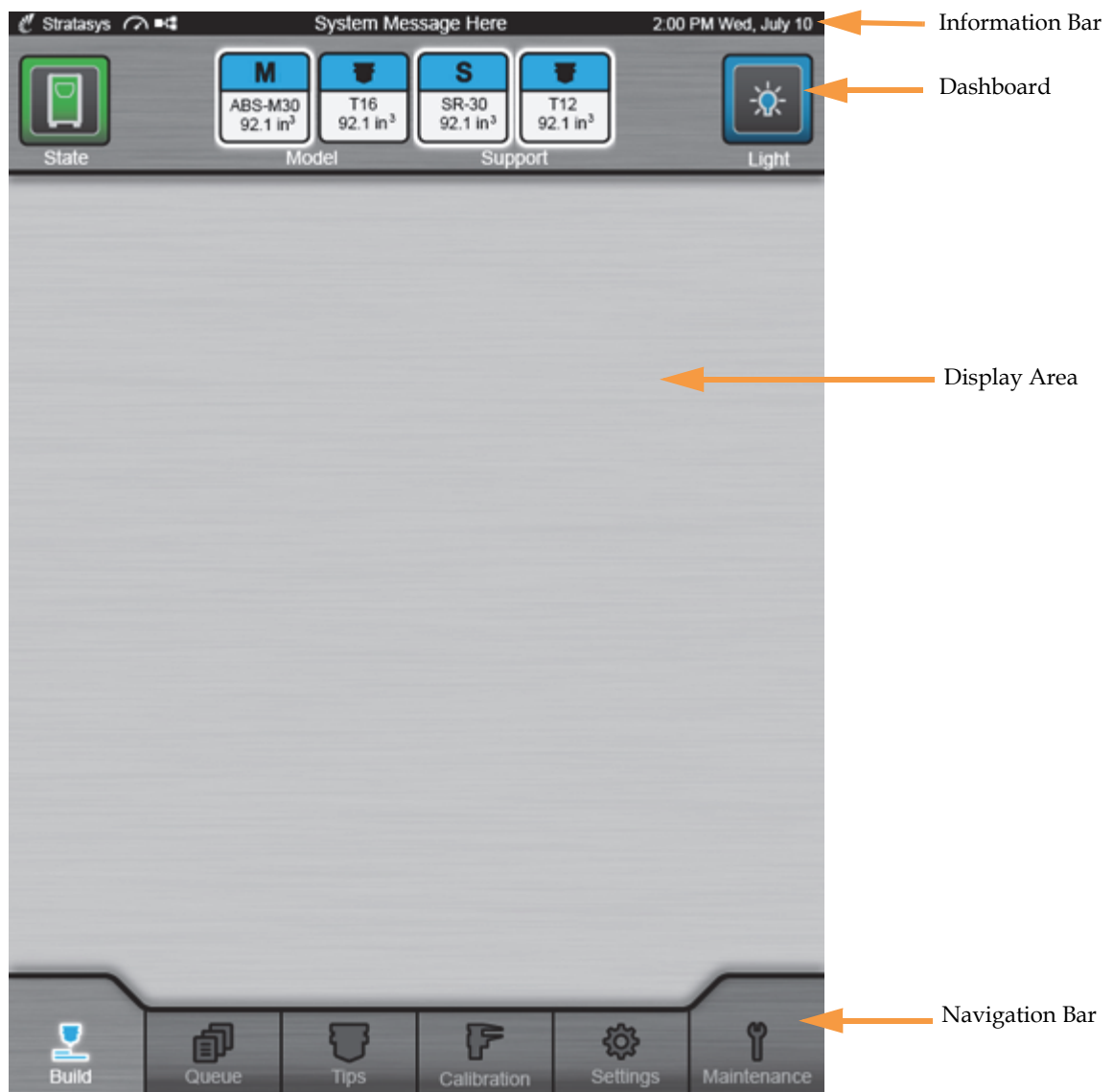

The touchscreen is designed to reduce glare; therefore, it is best to view the touchscreen when standing in front of the printer with the screen to your right. Viewing the touchscreen from any other angle may inhibit a clear view of the screen's display. The touchscreen is easy to use and allows you to:

- Access material load, unload and calibration functions.
- Monitor printer status.
- Monitor materials/tips statuses (types loaded/installed, canister volumes, tip odometers, etc.) and change materials and/or tips when necessary.
- Monitor build progress (name of job being built, materials usage information, estimated completion time, etc.).
- Access network configuration information and change printer defaults.
- Access the Job Queue and Sample Queue.

Information Bar

The Information Bar is docked at the top of the touchscreen display, and appears on every page of the User Interface. A variety of information is displayed within the Information Bar including the System Status Indicator (printer's "heartbeat"), Stratasys logo, Vacuum Status Indicator, Network Status Indicator, high level system messages, and current date/time.

Figure 4-2: Information Bar

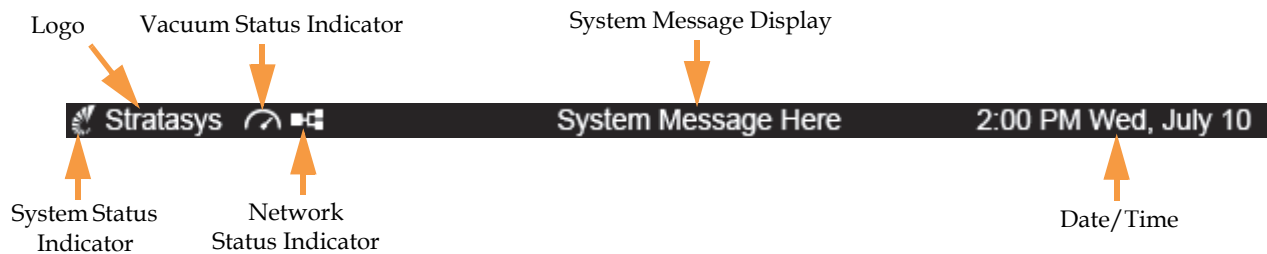

The System Status Indicator (nautilus shell icon) acts as the printer's "heartbeat"; when the printer is functioning correctly, the indicator will slowly flash on and off.

The Vacuum Status Indicator is always displayed within the Information Bar. If a red X is displayed over the top of this indicator, sufficient vacuum has not been achieved. Once sufficient vacuum has been achieved and a build sheet is securely affixed to the platen, the red X will disappear.

The Network Status Indicator is always displayed within the Information Bar. If a red X is displayed over the top of this indicator, a network connection is not present and job files cannot be sent to the printer (see ["Making the Network Connection"](#) on page 14). Once the printer establishes a connection with the Ethernet network, the red X will disappear.

The center portion of the Information Bar displays high level system messages (e.g. "Shutting Down", "Building", etc.). Whenever the state of the printer changes (i.e. switches from "Idle" to "Building", etc.) the system message portion of the Information Bar will update to reflect the change.

The current date and time are displayed within the right-most portion of the Information Bar. If this information is inaccurate see ["Setting the Printer's Date and Time"](#) on page 18 for instructions on changing your printer's date and time information.

Dashboard

The Dashboard is docked just beneath the Information Bar and appears on every page of the User Interface. The Dashboard displays the printer's build state (button), material statuses and canister volumes (model and support), tip statuses and odometer amounts (model and support tip), and oven light control (button).



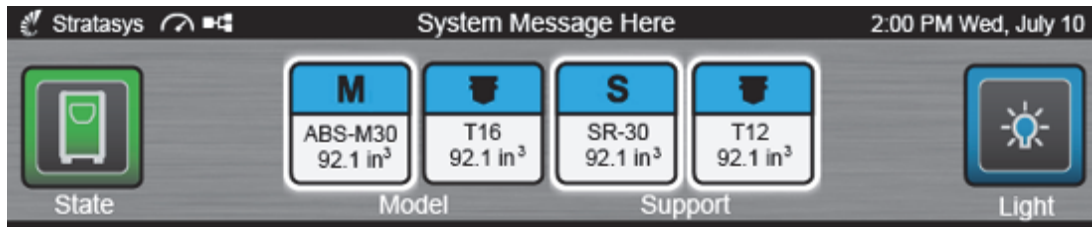



Figure 4-3: Dashboard



Build State Button

The printer's build state reflects the current state of the physical system, without regard for a particular job. The Build State button will appear as follows depending on the state of the printer:

Table 4-1: Build State Button - Button States

Button State		Description
 Green, unselected (no white highlighted border)	 Green, selected (white highlighted border)	Printer is building or is idle but physically able/ready to build (i.e. material loaded, valid tips below odometer limit, job selected, etc.).
 Yellow, unselected (no white highlighted border)	 Yellow, selected (white highlighted border)	Printer is functional but not currently able to build because certain conditions are not met (e.g. oven door or top cover open, no vacuum, out of material or no material loaded to head, tip exceeds odometer limit, etc.). This includes the printer being manually or automatically paused. Condition(s) must be resolved in order to start/resume a build. See "Build Warnings" on page 165 for details.
 Red, unselected (no white highlighted border)	 Red, selected (white highlighted border)	Printer is not functional and not able to build due to a system error (e.g. motion error) or has an internal system error that leads to a build being aborted (not a user initiated abort). A dialog will be displayed indicating the reason(s) for this state. Contact Customer Service for help correcting the error in order to restore the printer to a buildable state.

Pressing the Build State button will open a dialog indicating the reason(s) for the current build state (see “Warnings and Errors” on page 235 for explanations of warnings displayed on this page). Once all warnings have been corrected, press the checkmark button to exit the dialog.



Note: It is good practice to press the Build State button prior to starting each job.

Figure 4-4: Build State Example

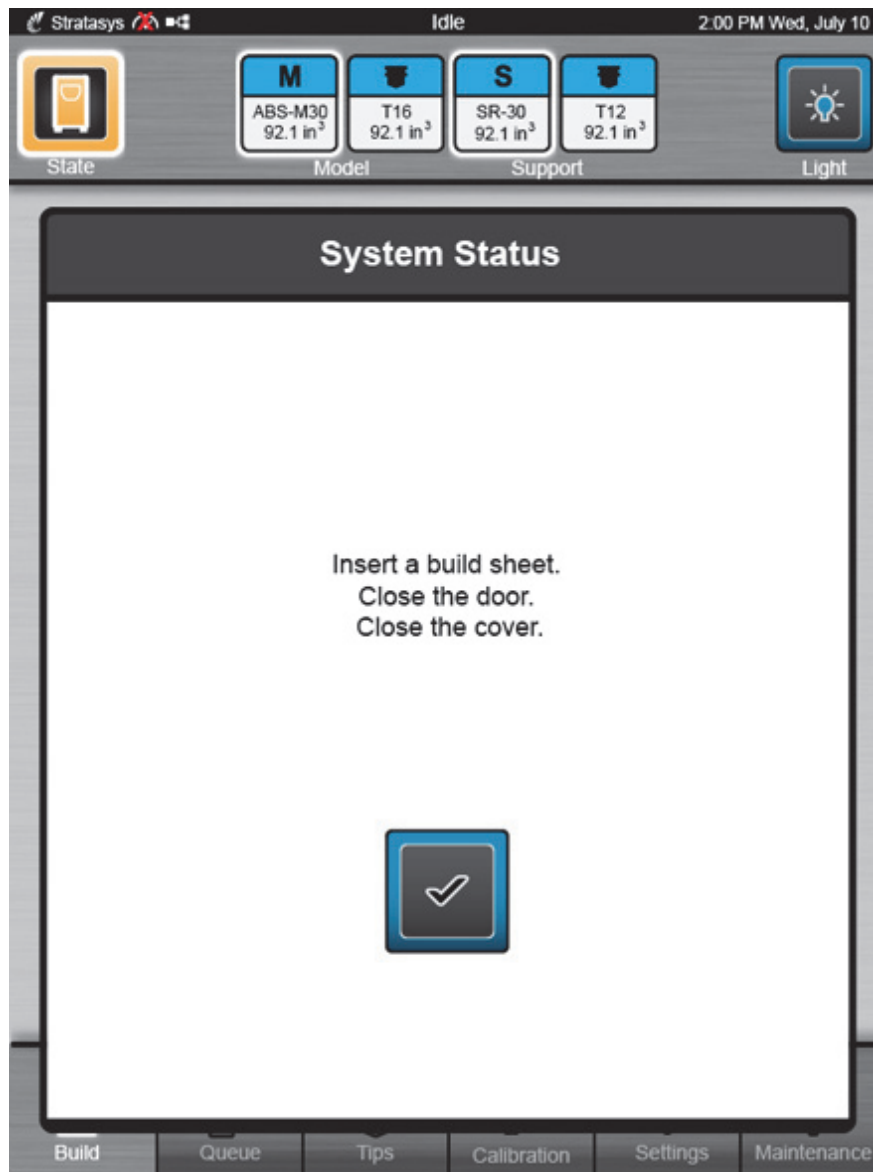

Materials/Tips Status

The center section of the Dashboard contains four icons pertaining to the status of the printer's current materials and tips.





Note: Icons are display only and are not buttons.



The information displayed within these icons is meant to be used as a quick reference of the printer's current configuration. (See ["Modeling Materials and Tips"](#) on page 36 for detailed materials/tips information and configurations.)

Material Status Icons

The Dashboard contains icons representing the model (M) and support (S) canister within the printer. Each icon displays the associated material's canister bay (e.g. M), the name of the material currently installed in that bay (e.g. ABS-M30), and the current volume of material in that canister (e.g. 83.4 in³/1366.7 cm³). The Material Status Icons can appear in the following states (color usage, highlighting, and descriptions apply to both icons):

Table 4-2: Material Status Icons - Icon States

Icon State	Description
 Blue (no white highlighted border)	Valid canister inserted into bay, material name and current volume displayed. Material from canister is not loaded to the head. See "Loading Material to the Liquefier Tips" on page 112 for instructions.
 Blue (white highlighted border)	Valid canister loaded into bay, material name and current volume displayed. Material from canister is loaded to the head and canister is selected to be used for building.
 Yellow (no material information)	-- indicates that a canister is not loaded in the corresponding canister bay - user action required to insert canister. See "Loading Material to the Liquefier Tips" on page 112 and "Canister Installation" on page 115 for instructions.



Icon State	Description
 Yellow (empty canister)	<p>Canister is empty - material name and empty volume displayed, user action required to remove empty canister.</p> <p>See “Unloading Material from the Liquefier Tips” on page 118 and “Removing an empty canister” on page 120 for instructions.</p>
 Yellow	<p>Valid canister installed in canister bay, but material does not match the current material configuration of the printer and/or the material currently loaded to the head.</p> <p>User action required to replace mismatched material or an existing build will pause once the currently loaded canister empties. See “Changing Tips or Material Type” on page 123 for instructions.</p> <p>Mismatched materials will not prevent you from starting a build. Upon initiation of the build you will be warned of the material mismatch, and if you choose to continue with the build, the mismatched materials will be used to print the selected job.</p>
 Flashing Red	<p>Invalid or unreadable canister present in bay - user action required to remove canister.</p> <p>See “Unloading Material from the Liquefier Tips” on page 118 and “Removing Canisters” on page 120 for instructions.</p>

Tip Status Icons

The Dashboard contains two icons which represent the printer’s model and support tips. Each icon displays the tip’s size (e.g. T10) and current odometer value (e.g. 58.3 in³/955.4 cm³). The model and support Tip Status Icons will appear in the following states (color usage and descriptions apply to both icons):

Table 4-3: Tip Status Icons - Icon States



Icon State	Description
 Blue (no white highlighted border)	<p>Valid tip, tip size, and current odometer for this tip is displayed.</p> <p>Tip is below odometer limit for associated material.</p>

 <p>Blue (white highlighted border)</p>	<p>Valid tip, tip size, and current odometer for this tip is displayed.</p> <p>Tip is below odometer limit for associated material and is currently in position to be used for building.</p> <p>While building, highlighting will switch between the model and support icon to indicate which tip is currently active.</p>
 <p>Yellow</p>	<p>Valid tip, tip size, and current odometer for this tip is displayed.</p> <p>Tip is within 10% of or has reached the odometer limit for the associated material (see Table 3-3 on page 39 for approximate tip life information).</p> <p>Printer is still able to build with this tip, but you will be warned before starting a build that the tip's odometer limit has been reached and part quality may be negatively affected. User action is required to replace tip. See “Changing Tips or Material Type” on page 123 for instructions.</p>
 <p>Flashing Red</p>	<p>Invalid tip/mismatch with currently loaded material, or tip has exceeded the odometer limit for the associated material and no further builds can be started.</p> <p>See “Tip Compatibility & Selection” on page 37 for material and tip compatibility information and “Changing Tips or Material Type” on page 123 for instructions on changing tips.</p>

Oven Light Control Button

The Oven Light Control button within the Dashboard indicates the current state of the oven light (ON/OFF), and allows for user control of the oven light. The Oven Light Control button can appear as follows:

Table 4-4: Oven Light Control Button - Button States

Icon State	Description
 <p>Dark Blue (no white highlighted border)</p>	<p>Oven light is OFF.</p> <p>Selecting the Oven Light Control button in this state will turn the oven light ON.</p>
 <p>Light Blue (white highlighted border)</p>	<p>Oven light is ON.</p> <p>Selecting the Oven Light Control button in this state will turn the oven light OFF.</p>

Display Area

The buttons/icons and information shown within the Display Area of the touchscreen will vary depending on which main page of the User Interface is selected.

- When powered ON, a representation of the printer's current state is displayed.
- After pressing the Build State button within the Dashboard, the Display Area will refresh and text describing the reason(s) for the current build state will be displayed. (See [Figure 4-4](#).)
- After selecting a button from the Navigation Bar, the Display Area will refresh and the main page corresponding to the selected button will be displayed.
- When working with a wizard, the Display Area will refresh as you navigate through each page of the wizard.

Navigation Bar

The Navigation Bar appears on each main page of the User Interface, and provides one-touch access to the Build, Queue, Tips, Calibration, Settings, and Maintenance functions of the printer. The User Interface is broken up into several pages of related functionality. Selecting a button from the Navigation Bar will open the button's corresponding page, allowing you to perform tasks within that page.

If a page contains sub-pages or wizards, additional buttons corresponding to these items will be displayed just above the Navigation Bar within the page's Display Area.











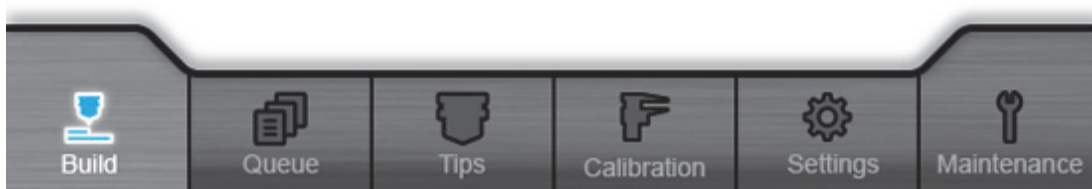

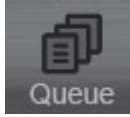
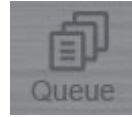

 **Note:** The Navigation Bar is hidden whenever you are working within a wizard (a multi-step activity that is altering the system state and cannot be interrupted via general navigation). Wizards are defined within the context of their main page (i.e. the Tip Change Wizard is within the Tips page).

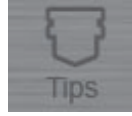
Figure 4-5: Navigation Bar

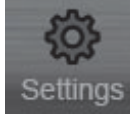
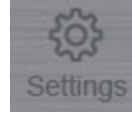

The buttons in the Navigation Bar are mutually exclusive, meaning only one button may be selected at any given time. In some instances, all of the buttons in the Navigation Bar will be disabled. Buttons can appear as follows:

Table 4-5: Navigation Bar - Button States

Button Name	Selected State	Unselected State	Disabled State
Build Button			
Queue Button			
Tips Button			
Calibration Button			
Settings Button			
Maintenance Button			

Working with the Build Page

The Build page is comprised of the four main areas of functionality that are necessary for selecting and building parts on the printer; these items are highlighted in [Figure 4-6](#). Within the Build page you can select a job, see how a selected job matches the printer's current configuration, view build time and materials usage estimates for the selected job, start, pause, and abort a job, and see status and estimated action points for the currently building job.

To access the Build page, press the **Build** button within the Navigation Bar; a screen similar to the one in [Figure 4-6](#) will be displayed.

Figure 4-6: Build Page

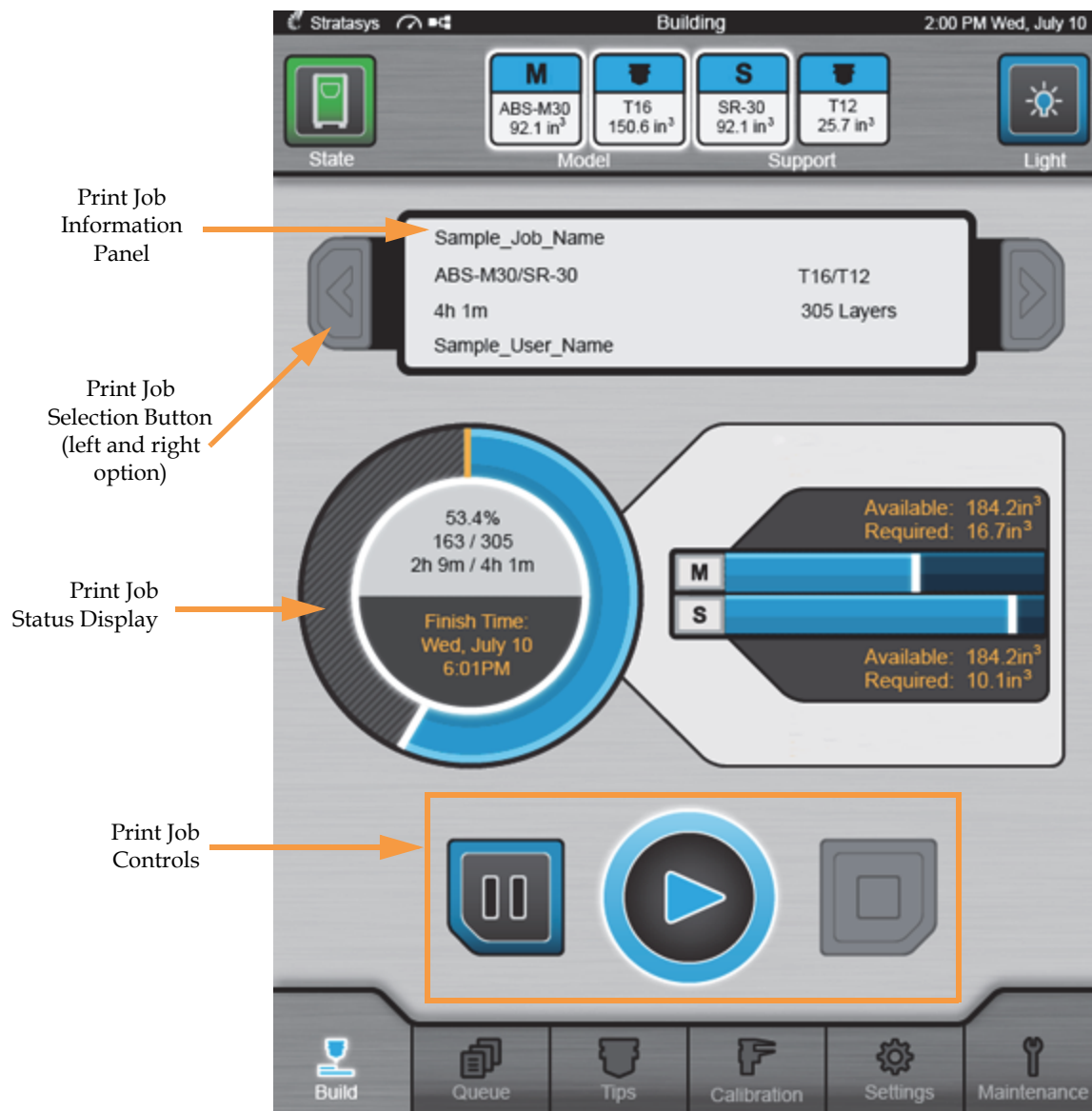

Viewing Print Job Information

Information pertaining to a selected job is displayed at the top of the Build page within the Print Job Information Panel. This information is static and represents the details of the job as submitted to the printer from the Insight application on your workstation PC.

Figure 4-7: Print Job Information Panel

A rectangular panel with a black border containing job details. The text is arranged in four rows: the first row has 'Sample_Job_Name'; the second row has 'Model_Material/Support_Material' and 'Model_Tip/Support_Tip'; the third row has '0h 5m' and '5 Layers'; the fourth row has 'Sample_User_Name'.

Sample_Job_Name	
Model_Material/Support_Material	Model_Tip/Support_Tip
0h 5m	5 Layers
Sample_User_Name	

Information displayed within this panel for a selected job includes:

- Name of the job.
- Model and support materials associated with the job.
- Estimated build time for the job.
- Name of the user that submitted the job.
- Tip sizes associated with the job.
- Number of layers in the job.

Selecting a Print Job from the Build Page

When the printer is idle you can navigate through the Job Queue directly within the Build page (rather than navigating to the Queue page) using the left and right Print Job Selection buttons. (See “Working with the Queue Page” on page 61 for more information). The left Print Job Selection button allows you to view the job previous to the currently selected job, while the right Print Job Selection button allows you to view the next job in the queue. If the [Keep Previous Job](#) setting is turned ON for your printer, the previously built job is stored within the Job Queue and the left Print Job Selection button is the only way you can access this job in order to print it again.

Figure 4-8: Print Job Selection Buttons Enabled

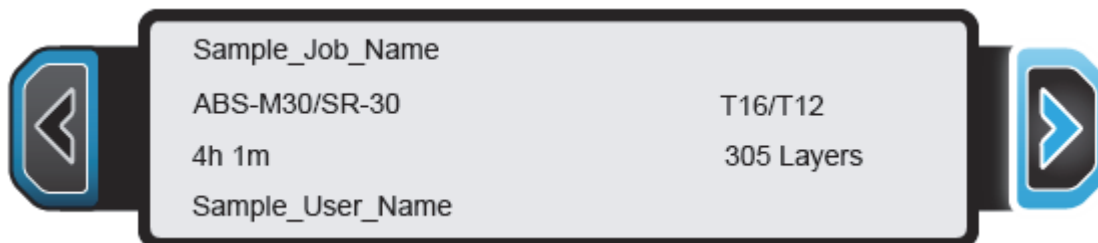

As you scroll through the jobs in the queue, the Print Job Information Panel will refresh and display information pertaining to the previous or next job in the queue. Jobs are displayed in the same order as they appear in the Job Queue. When a job is selected, the rest of the Build page will update to reflect the build time, layer information, materials needs, and configuration match of the selected job as compared to the printer’s current configuration. If the Job Queue is empty, only the text “Queue Empty” will be displayed.

A Print Job Selection button that is available for selection is indicated by a blue border with no white outline, as in the left button in Figure 4-8. When you select the left or right button, it will momentarily indicate the selection by showing a white outline, as in the right button in Figure 4-8. If the end of the queue is reached in either direction, the button for navigating further in that direction will be disabled, as in either button in Figure 4-9.

If the job shown in the Print Job Information Panel is from the Sample Queue, the left and right Print Job Selection buttons still step through the Job Queue, starting at the top of the queue, and the information for the sample job is replaced. The left and right Print Job Selection buttons do not step through the jobs in the Sample Queue at any time.

When the printer is building, the Print Job Selection buttons are disabled as shown in Figure 4-9. This is also how the Print Job Selection buttons will appear if there are no jobs in the Job Queue.

Figure 4-9: Print Job Selection Buttons Disabled

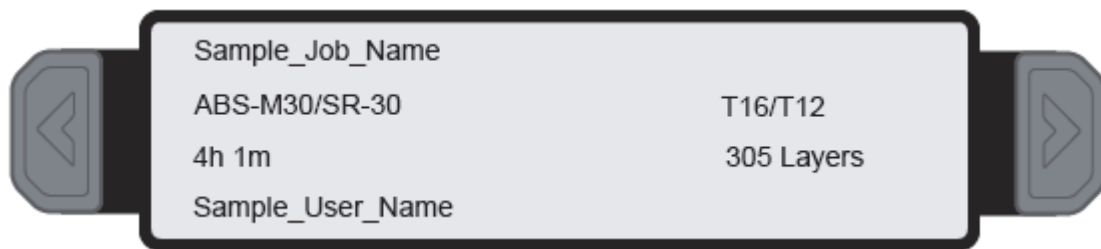

Print Job Status

The Print Job Status section of the Build page is comprised of a two-part graphic which provides information on a selected and/or building job. The information displayed will vary depending on the state of the printer.

- The Build Status portion of this graphic displays the build's percentage of completion, number of completed layers as compared to total number of layers, elapsed build time as compared to total build time, expected build completion information, and build progress ring.
- The Materials Status portion of this graphic displays detailed material status information, for both model and support material, as it pertains to a selected job.

Figure 4-10: Print Job Status Overview

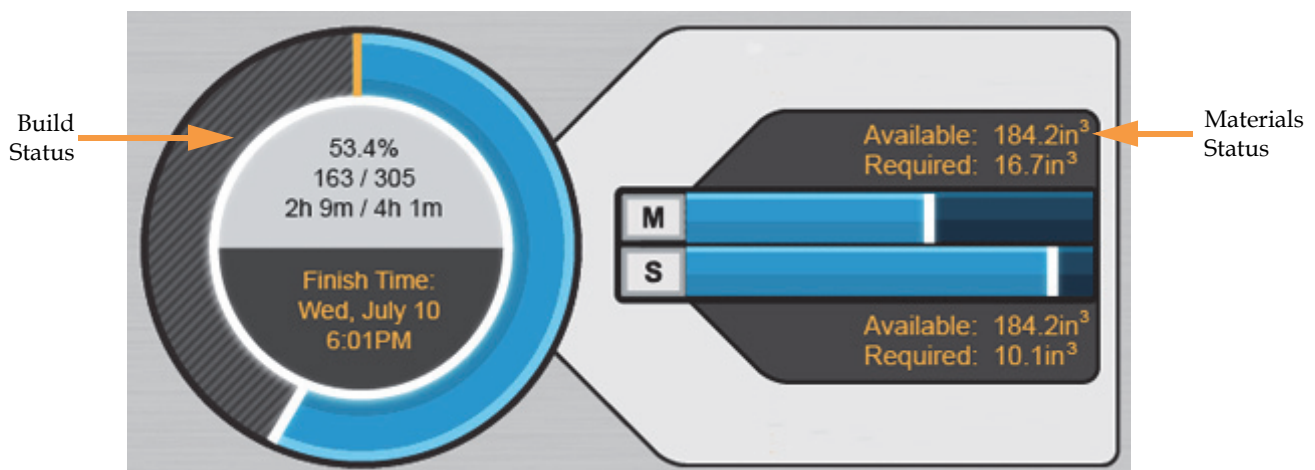

Build Status Display

The upper portion of the Build Status Display shows the following build information:

- The build's percentage of completion is displayed as a numerical percentage just above the build's layer completion information.
- The number of completed layers as compared to the total number of layers in the build is displayed just below the build's percentage of completion.
- Elapsed build time as compared to total build time is displayed just below the build's layer completion information.

The finish time displayed within the lower portion of the Build Status Display will vary slightly depending on whether the printer is idle or building:

- When idle, the estimated completion date and time if the job were started immediately is displayed.
- When building, the build's estimated completion date and time is displayed.

The outer build progress ring will vary depending on whether the printer is idle or building:

- When idle, no progress is indicated within the build progress ring.
- As build progress is made, the build's percentage of completion is displayed by radially filling in the outer progress ring, in a clockwise direction. This percentage will coincide with the numerical percentage displayed within the upper portion of the Build Status Display.

Figure 4-11: Build Status Display Details

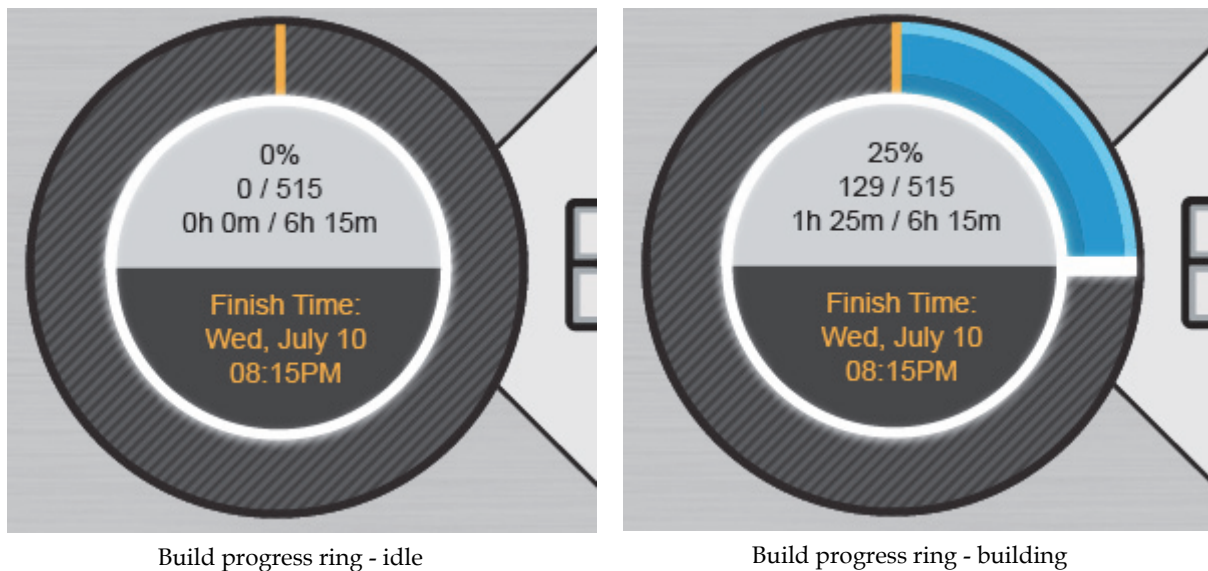

As you scroll through jobs in the queue, information within the Build Status Display will update to reflect the selected job. (See [“Selecting a Print Job from the Build Page”](#) on page 53 for more information.) Once a job is selected and a build is started, the information within the Build Status Display will update frequently to indicate build progress.

Materials Status Display

Materials related information is displayed within three areas of the Materials Status Display.

Information pertaining to model material is displayed within the upper portion of the Materials Status Display.

- The Available: field displays the total amount of model material loaded within the printer (in^3 or cm^3 depending on your printer's configuration).
- The Required: field displays the amount of model material required to complete the build (in^3 or cm^3 depending on your printer's configuration).

Figure 4-12: Materials Status Display Details - Model Material Requirements

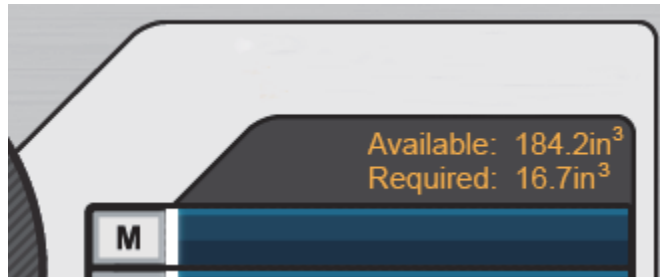

Information pertaining to support material is displayed within the lower portion of the Materials Status Display.

- The Available: field displays the total amount of support material loaded within the printer (in^3 or cm^3 depending on your printer's configuration).
- The Required: field displays the amount of support material required to complete the build (in^3 or cm^3 depending on your printer's configuration).

Figure 4-13: Materials Status Display Details - Support Material Requirements

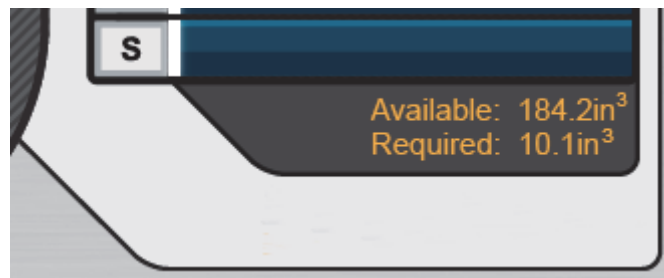

As you scroll through jobs in the queue, the model and support Required: fields will update to reflect the amount of model and support material required to complete the selected job. The model and support values displayed within the two Required: fields will stay the same regardless of whether the printer is idle or building; these fields do not update as build progress is made. A value of 0.0in^3 (0.0cm^3) is only displayed within the two Required: fields if the Job Queue is empty and a job can therefore not be selected.

The center portion of the Materials Status Display provides a graphical representation of whether there is enough material in the printer to complete the selected job. The graphics displayed will vary slightly depending on whether the printer is idle or building. As you scroll through jobs in the queue, this portion of the display will update to reflect the amount of model and support material required to complete the selected job.

In Figure 4-14, there is sufficient material in the printer to complete the build if it were started. The model and support progress bars are shown in dark blue.

Figure 4-14: Materials Status Display Details - Idle, Sufficient Materials

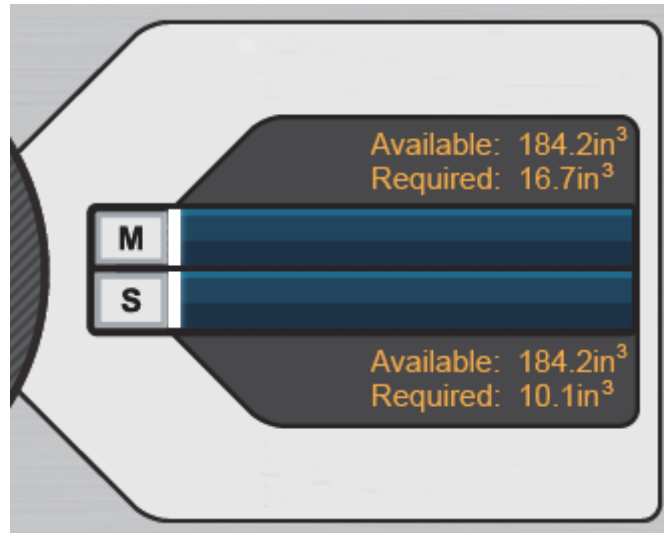

In Figure 4-15, there is not sufficient material in the printer to complete the build if it were started. The model and support progress bars indicate the amount of available material (in dark blue), and the amount of additional material required to complete the build (in hashed-grey). If you attempt to start a build with insufficient materials you will receive a warning indicating that there is not enough material installed to complete the build. You can proceed with the build, but you will need to install additional material or the build will pause once the printer runs out of material.

Figure 4-15: Materials Status Display Details - Idle, Insufficient Materials

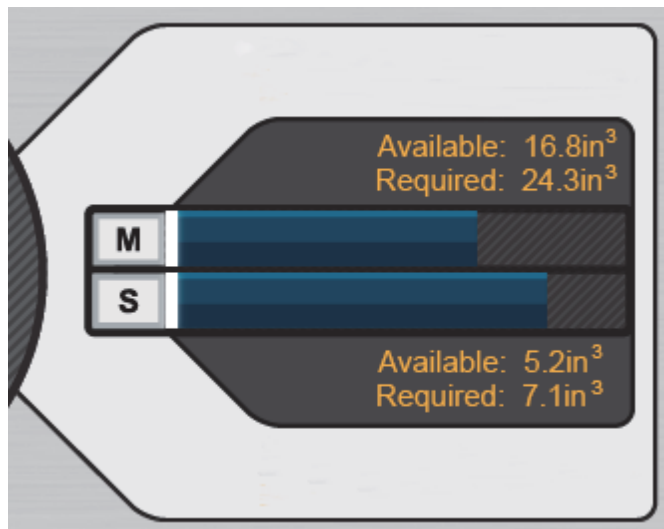

When the printer is building an additional progress bar is displayed for both the model and support fields. This light blue bar indicates build progress and reflects the amount of material used so far during the build.

In Figure 4-16, the light blue progress bars indicate the amount of model and support material used so far. The dark blue progress bars indicate the remaining amount of model and support required to complete the build. There is sufficient material in the printer to complete this build, so no indication of additional material required (in hashed-grey) is displayed.

Figure 4-16: Materials Status Display Details - Building, Sufficient Materials

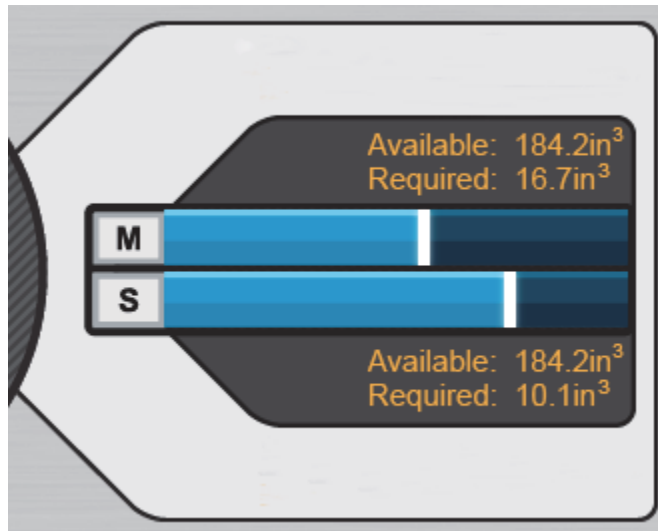

In Figure 4-17, the light blue progress bars indicate the amount of model and support material used so far; however, there is not sufficient material in the printer to complete this build. The dark blue progress bars indicate the remaining amount of model and support available in the printer while the additional material required to complete the build is indicated in hashed-grey.

Figure 4-17: Materials Status Display Details - Building, Insufficient Materials

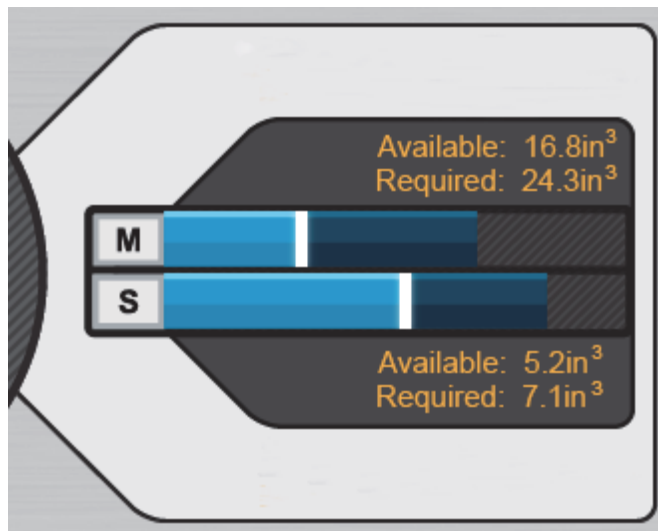

Print Job Controls

Three buttons are displayed at the bottom of the Build page (just beneath the Print Job Status Display). These buttons are used to start, pause, and abort a build.



Figure 4-18: Print Job Controls



Build (play) Button

The Build button, which resembles the “Play” control for a media device, allows you to start a build (see “[Selecting a Job to Build](#)” on page 162 for more information). The Build (play) button can appear in the following states:



Table 4-6: Print Job Controls - Build (play) Button States

Button State	Description
 Blue (no white highlighted border)	Printer is in a buildable state AND a selected job is available to build OR printer is currently paused or aborted. Selecting the Build (play) button will begin/resume the build.
 Blue (white highlighted border)	Printer is actively building. Selecting the Build (play) button in this state has no effect.
	Build (play) button is disabled and not selectable. Printer is not in a buildable state OR a job is not selected/available to build (e.g. queue is empty). To troubleshoot this issue, press the Build State button within the Dashboard. This will open a dialog allowing you to view the reason(s) for the current build state, including any issues impeding your ability to start a build (i.e. no vacuum, no build sheet, etc.). See “ Warnings at Build Start ” on page 235 and “ Errors Preventing a Build from Starting ” on page 237 for more information.

Pause Button

The Pause button allows you to pause an active build. The Pause button can appear in the following states:



Table 4-7: Print Job Controls - Pause Button States

Button State	Description
 <p>Blue (no white highlighted border)</p>	<p>Printer is actively building. Selecting the Pause button in this state will pause the build.</p> <p>When the printer is paused the Build State button will turn yellow. Pressing this button will open a dialog indicating the reason(s) for the pause condition. See “Build Warnings” on page 165 and “Build Pause Warnings” on page 241 for more information.</p>
 <p>Blue (white highlighted border)</p>	<p>The build is paused.</p> <p>Selecting the Pause button in this state will have no effect. Selecting the Build (play) button will resume a paused build.</p>
	<p>Pause button is disabled and not selectable.</p> <p>There is no job currently building on the printer.</p>

Abort Button

The Abort button allows you to abort a build. You must first pause the build before it can be aborted. The Abort button can appear in the following states:

Table 4-8: Print Job Controls - Abort Button States

Button State	Description
 <p>Blue (no white highlighted border)</p>	<p>The Abort button is only selectable when a build is paused (i.e. after pressing the Pause button).</p> <p>Pressing the Abort button will display a prompt asking you to confirm the abort.</p> <ul style="list-style-type: none"> - If confirmed, the build will be aborted. - If canceled, the build will be unaffected (i.e. revert to its previous build/pause state).
 <p>Blue (white highlighted border)</p>	<p>The build has been aborted as the result of a manual abort, or the printer automatically aborting the build due to an error. Pressing the Build State button will open a dialog indicating the reason for the abort condition. See “Build Warnings” on page 165 and “Build Abort Warnings” on page 243 for more information.</p> <p>Button will remain in this state until the aborted part is removed from the printer (see “Removing a Part from the Printer” on page 169).</p>
	<p>Abort button is disabled and not selectable.</p> <p>There is no job currently building on the printer.</p>

Working with the Queue Page

There are two, separate queues available on the 380mc: the Job Queue and the Sample Queue. From the Queue page you can view, edit, sort and select jobs from the Job Queue or Sample Queue. To access these queues, press the **Queue** button within the Navigation Bar; the Job Queue will be displayed by default.

Figure 4-19: Queue Page - Job Queue Displayed



Toggling between the Job Queue and the Sample Queue can be done by selecting the corresponding tab within the Queue page. The selected queue's tab will be blue.

Figure 4-20: Job Queue/Sample Queue Tabs



About the Job Queue

The Job Queue contains the list of files (jobs) downloaded to the printer from the Control Center application on your workstation PC. By default, jobs are added to the Job Queue in the order they were submitted to the printer via Control Center. Individual jobs are listed in rows, with columns indicating job name (Job Name), estimated build time (Est. Build), model tip (Tip) associated with the job, and type of model material (Material) associated with the job. Please note that this information is static and represents the details of the job as submitted to the printer via the Control Center.

Up to 7 jobs are displayed within the Job Queue list at a given time. If the queue contains more than 7 jobs, use the scrollbar (to the right of the queue) to scroll up or down through the list of available jobs.

To select a job, simply touch the corresponding row in the list; the row will turn blue. Once you've selected a job, navigate back to the Build page (by pressing the **Build** button within the Navigation Bar). The details of the job you selected will be displayed within the Build page and the job will be queued for building.

Figure 4-21: Job Queue

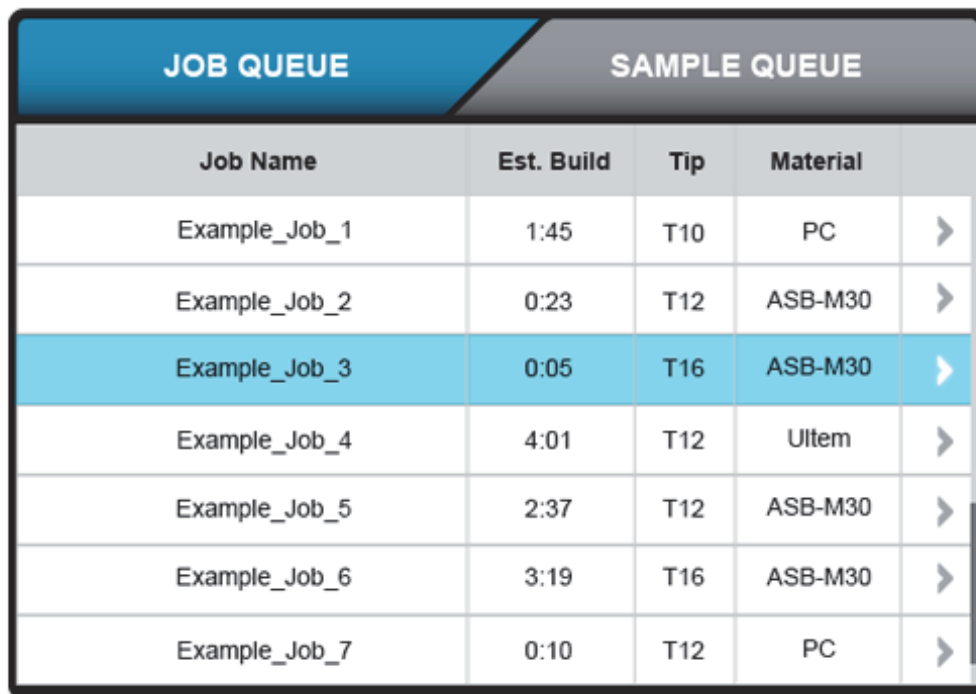

JOB QUEUE		SAMPLE QUEUE		
Job Name	Est. Build	Tip	Material	
Example_Job_1	1:45	T10	PC	>
Example_Job_2	0:23	T12	ASB-M30	>
Example_Job_3	0:05	T16	ASB-M30	>
Example_Job_4	4:01	T12	Ultem	>
Example_Job_5	2:37	T12	ASB-M30	>
Example_Job_6	3:19	T16	ASB-M30	>
Example_Job_7	0:10	T12	PC	>

Job Queue Controls





There are four buttons displayed directly below the Job Queue list which can be used to rearrange the print jobs listed in the queue. These buttons are disabled for the Sample Queue.

Figure 4-22: Job Queue Controls



These buttons have the following functionality:

Table 4-9: Job Queue Control Buttons

Icon	Name	Description
	Move to Top	Moves the selected job to the top of the Job Queue list.
	Move Up	Moves the selected job up one position in the Job Queue list.
	Move Down	Moves the selected print job down one position in the Job Queue list.
	Delete	Removes the selected job from the Job Queue list. You will be asked to confirm this action prior to the job being deleted from the queue.

Job Queue Sorting

By default, jobs are added to the Job Queue in the order they were submitted to the printer via the Control Center application on your PC. Jobs can be sorted by selecting the various column headers (Job Name, Est. Build, Tip, and Material) displayed. Sorting jobs in this manner can help you identify jobs that match the printer's current materials/tips configuration or find a job that can be printed within a desired time frame.

Viewing Job Details

To view additional details regarding a particular job in the Job Queue or Sample Queue, select the right arrow displayed for that job.

Figure 4-23: View Job Details

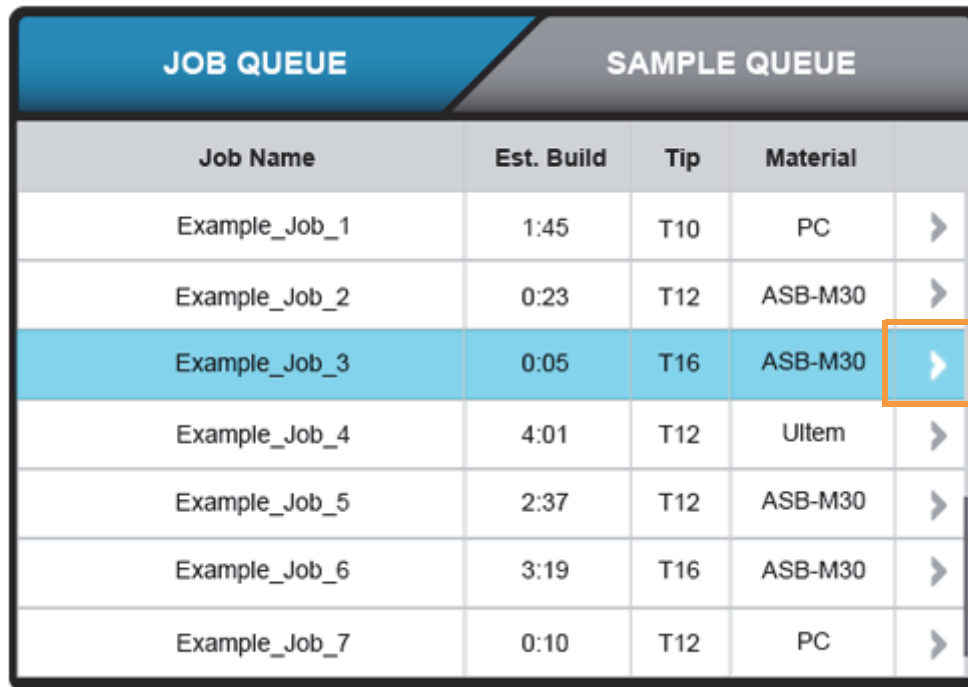

Job Name	Est. Build	Tip	Material	
Example_Job_1	1:45	T10	PC	➤
Example_Job_2	0:23	T12	ASB-M30	➤
Example_Job_3	0:05	T16	ASB-M30	➤
Example_Job_4	4:01	T12	Ultem	➤
Example_Job_5	2:37	T12	ASB-M30	➤
Example_Job_6	3:19	T16	ASB-M30	➤
Example_Job_7	0:10	T12	PC	➤

This will open the job's Job Details page which displays additional information such as the name of the user who submitted the job, the number of layers in the job, the support material and support tip associated with the job, and the size of the job. To close this page and return to the main queue, select the Queue button within the header of the page.

Figure 4-24: Close Job Details

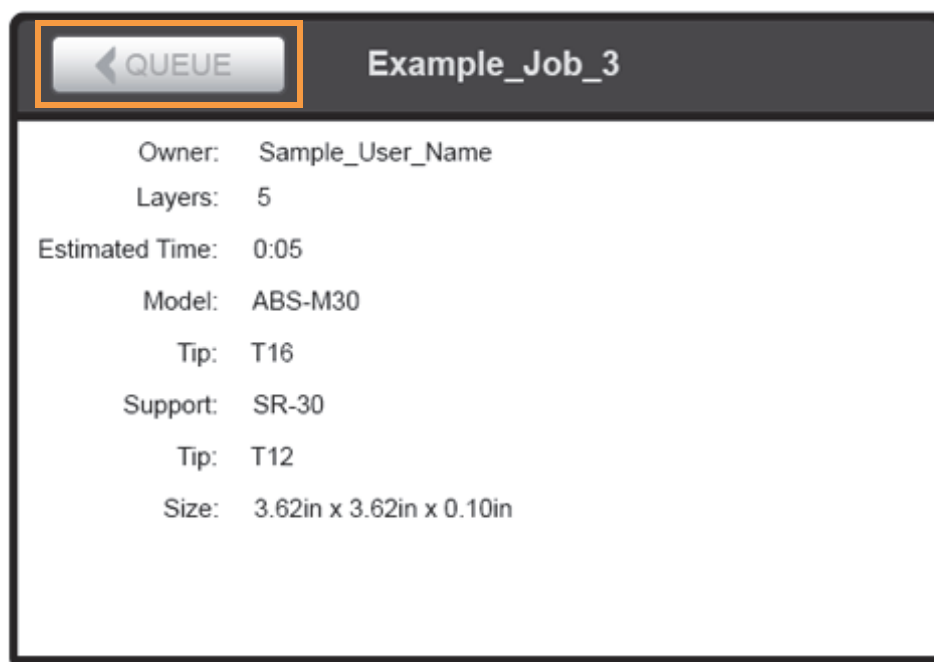

← QUEUE Example_Job_3

Owner: Sample_User_Name
Layers: 5
Estimated Time: 0:05
Model: ABS-M30
Tip: T16
Support: SR-30
Tip: T12
Size: 3.62in x 3.62in x 0.10in

About the Sample Queue

The 380mc comes with several sample job files permanently installed on the printer. These files are accessible via the Sample Queue only. This queue is comprised of a few sample part files as well as a variety of other files that are helpful for testing the printer. The majority of the files within the Sample Queue will be utilized only by authorized service representatives when performing maintenance on the printer.

Overall, the functionality of the Sample Queue is the same as that of the Job Queue:

- Individual jobs are listed in rows with columns indicating Job Name, Estimated Build Time, Material Tip associated with the job, and Material type associated with the job. Please note that this information is static and represents the details of the job as submitted to the printer via the Insight application on your PC.
- Up to 7 jobs are displayed within the Sample Queue list at a given time. If the queue contains more than 7 jobs, use the scrollbar (to the right of the queue) to scroll up or down through the list of available jobs.
- To select a job, simply touch the corresponding row in the list; the row will turn blue. Once you've selected a job, navigate back to the Build page (by pressing the **Build** button within the Navigation Bar). The job you selected will be displayed on the Build page and be queued for building.
- Additional details for a job can be viewed by opening the job's Job Details page (see "Viewing Job Details" on page 64).

However, the following functionality differences exist for the Sample Queue:

- [Job Queue Controls](#) are disabled for the Sample Queue, and therefore these job files cannot be deleted.
- Jobs in the Sample Queue cannot be sorted (as described within the [Job Queue Sorting](#) section).

Working with the Tips Page

The Tips page displays a detailed representation of the printer's current materials and tips configuration. Two Tip Status Icons and two Material Status Icons (similar to the icons within the [Dashboard](#)) represent the tips and model/support material loaded/installed within the printer. These icons will take on a variety of colors and highlighted states depending on their status.

Within this page you can view the current configuration of the printer including model and support tip size and odometer values, current and set point tip temperatures and model and support material types, view canister volumes and load statuses, load and unload materials, access the [Tip Change Wizard](#) and Tip Wipe Adjust Wizard, and perform a variety of tip maintenance functions.

To access the Tips page, press the **Tips** button within the Navigation Bar; a screen similar to the one in [Figure 4-25](#) will be displayed.

Figure 4-25: Tips Page

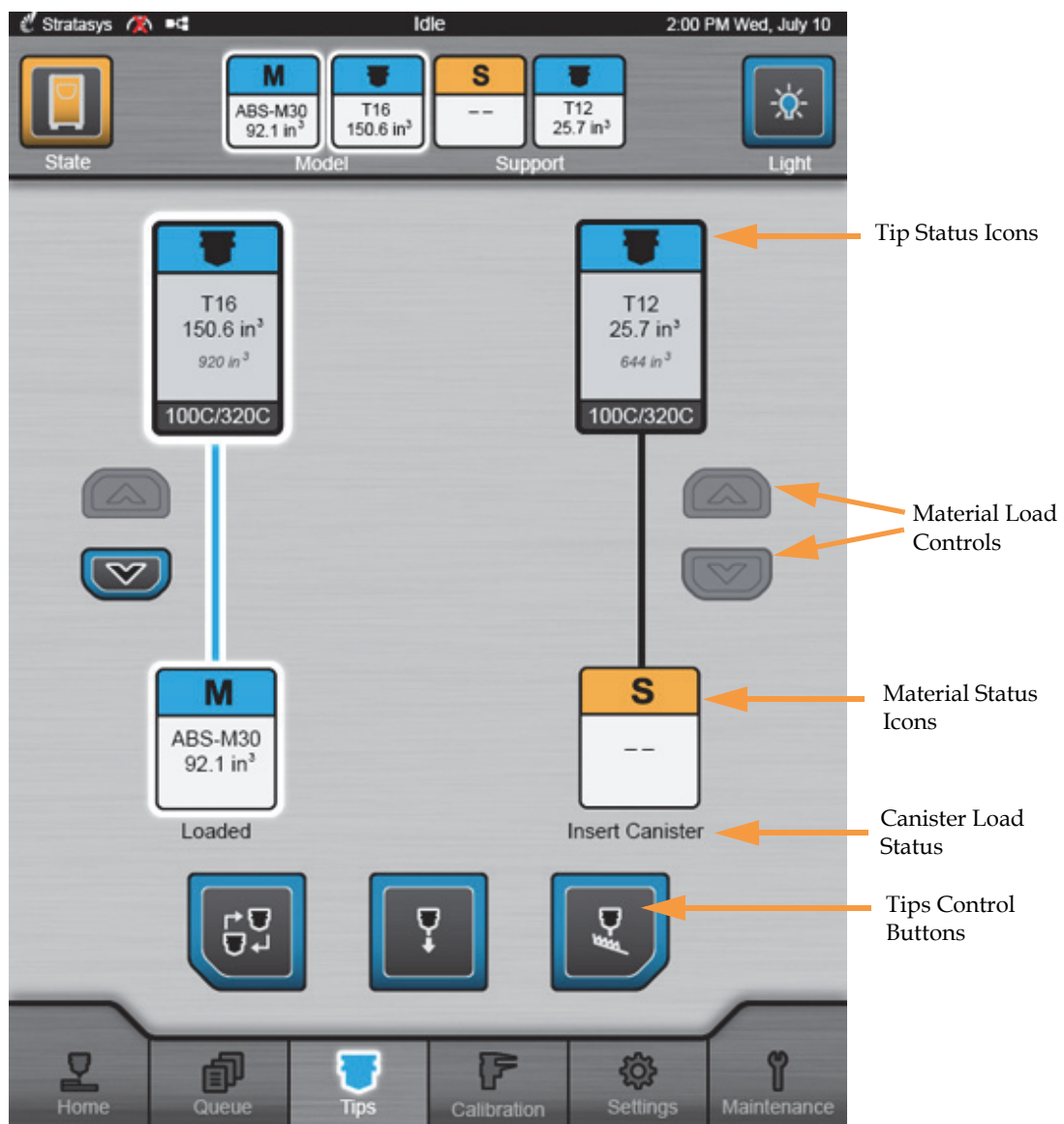

Tips/Materials Status

The Tips page contains four icons pertaining to the status of the printer's current materials and tips. Two **Tip Status Icons** and two **Material Status Icons** (similar to the icons within the **Dashboard**) represent the tips and model/support material loaded/installed within the printer. These icons will take on a variety of colors and highlighted states depending on their status. Canisters selected for use for building, and whose material is loaded to the head, are indicated by a white highlighted border.





Note: These icons are display only and are not buttons.

Tip Status Icons

The two Tip Status Icons within the upper portion of the page represent the printer's model and support tips. The left icon represents the model tip while the right icon represents the support tip. Each icon displays the tip's size (e.g. T10) and current odometer value (e.g. 258.0 in³/4227.9 cm³) within the upper portion of the icon. The tip's approximate tip life, based upon the amount of material used, is displayed within the center portion of the icon (i.e. maximum odometer limit for the tip). The tip's current temperature as compared to its set point temperature is displayed within the lower portion of the icon. The model and support Tip Status Icons will appear in the following states (color usage and descriptions apply to both icons):

Table 4-10: Tip Status Icons - Icon States

Icon State	Description
 <p>Blue (no white highlighted border)</p>	<p>Valid tip, tip size, current odometer, and approximate tip life for this tip is displayed.</p> <p>Tip is below odometer limit for associated material.</p>
 <p>Blue (white highlighted border)</p>	<p>Valid tip, tip size, current odometer, and approximate tip life for this tip is displayed.</p> <p>Tip is below odometer limit for associated material and is currently in position to be used for building.</p> <p>While building, highlighting will switch between the model and support icon to indicate which tip is currently active.</p>

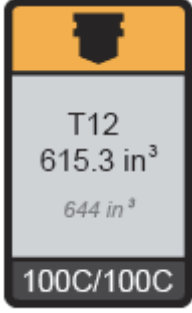
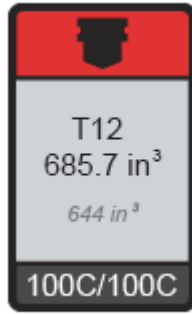



Icon State	Description
 <p>Yellow</p>	<p>Valid tip, tip size, current odometer, and approximate tip life for this tip is displayed.</p> <p>Tip is within 10% of or has reached the odometer limit for the associated material (see Table 3-3 on page 39 for approximate tip life information).</p> <p>Printer is still able to build with this tip, but you will be warned before starting a build that the tip's odometer limit has been reached and part quality may be negatively affected. User action is required to replace tip. See “Changing Tips or Material Type” on page 123 for instructions.</p>
 <p>Flashing Red</p>	<p>Invalid tip/mismatch with currently loaded material, or tip has exceeded the odometer limit for the associated material and no further parts can be started.</p> <p>See “Tip Compatibility & Selection” on page 37 for material and tip compatibility information and “Changing Tips or Material Type” on page 123 for instructions on changing tips.</p>

Material Status Icons

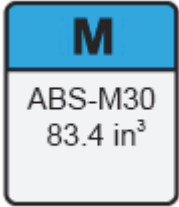
The two Material Status Icons within the page represent the model and support canisters installed/inserted in the printer. Each icon displays the associated material's canister bay (M or S), the name of the material currently installed in that bay (e.g. ABS-M30), and the current volume of material in that canister (e.g. 83.4 in³/1366.7 cm³). The Material Status Icons can appear in the following states (color usage, highlighting, and descriptions apply to both icons):

Table 4-11: Material Status Icons - Icon States

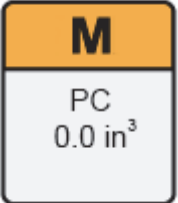
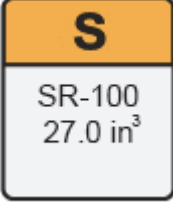
Icon State	Description
 <p>Blue (no white highlighted border)</p>	<p>Valid canister inserted into bay, material name and current volume displayed.</p> <p>Material from canister is not loaded to the head. See “Loading Material to the Liquefier Tips” on page 112 for instructions.</p>

Icon State	Description
 <p data-bbox="318 449 542 506">Blue (white highlighted border)</p>	<p data-bbox="566 216 1338 273">Valid canister loaded into bay, material name and current volume displayed.</p> <p data-bbox="566 302 1354 359">Material from canister is loaded to the head and canister is selected to be used for building.</p>
 <p data-bbox="318 751 542 808">Yellow (no material information)</p>	<p data-bbox="566 520 1338 577">- - indicates that a material canister is not loaded in the corresponding canister bay - user action required to insert canister.</p> <p data-bbox="566 606 1279 663">See “Loading Material to the Liquefier Tips” on page 112 and “Canister Installation” on page 115 for instructions.</p>
 <p data-bbox="347 1060 513 1117">Yellow (empty canister)</p>	<p data-bbox="566 829 1354 886">Canister is empty - material name and empty volume displayed, user action required to remove empty canister.</p> <p data-bbox="566 915 1347 972">See “Unloading Material from the Liquefier Tips” on page 118 and “Removing an empty canister” on page 120 for instructions.</p>
 <p data-bbox="391 1365 470 1388">Yellow</p>	<p data-bbox="566 1138 1346 1215">Valid canister installed in canister bay, but material does not match the current material configuration of the printer and/or the material currently loaded to the head.</p> <p data-bbox="566 1245 1338 1335">User action required to replace mismatched material or an existing build will pause once the currently loaded canister empties. See “Changing Tips or Material Type” on page 123 for instructions</p> <p data-bbox="566 1365 1360 1476">Mismatched materials will not prevent you from starting a build. Upon initiation of the build you will be warned of the material mismatch, and if you choose to continue with the build, the mismatched materials will be used to print the selected job.</p>
 <p data-bbox="358 1724 501 1755">Flashing Red</p>	<p data-bbox="566 1493 1360 1549">Invalid or unreadable canister present in bay - user action required to remove canister.</p> <p data-bbox="566 1579 1347 1635">See “Unloading Material from the Liquefier Tips” on page 118 and “Removing Canisters” on page 120 for instructions.</p>

Canister Load Status

A variety of canister load status messages are displayed directly beneath each Material Status Icon, indicating the current activity of each canister and/or the canister's filament. Throughout the process of loading and unloading material these statuses will update frequently, giving you an indication of the progress being made. (See [“Loading Material to the Liquefier Tips”](#) on page 112 and [“Unloading Material from the Liquefier Tips”](#) on page 118 for detailed information.)

Figure 4-26: Canister Load Status Locations

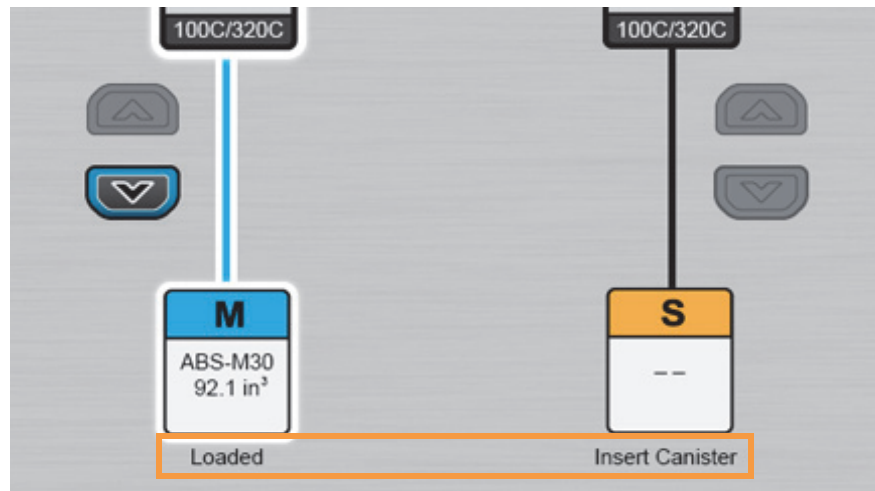

The various canister load statuses displayed are as follows:

- Loading - this status is displayed while filament is being loaded to the liquefiers within the head, which can only be done when the printer is stopped (idle) and is not building.
- Loaded - this status is displayed once filament is loaded to the liquefiers, indicating that the canister can be used to build a selected job.
- Unloading - this status is displayed while filament is being unloaded from the liquefiers, which can only be done when the printer is stopped (idle) and is not building.
- Advance Filament - (displayed during the material loading process only) this status is displayed for canisters that have been properly installed, but have not had their filament pre-loaded to the printer's drive wheels.
- Not Loaded - this status is displayed after a canister's filament contacts the filament present switch, but before filament begins being loaded to the liquefiers. Once the Load Material button is pressed (see [Figure 4-27](#) on page 71), this status switches to "Loading".
- Insert Canister - indicates that a canister is not present in the material's corresponding canister bay (see [“Canister Installation”](#) on page 115 for instructions).
- Remove Canister - indicates that a canister's filament has been completely unloaded from the printer (or the canister is empty), and the canister can be removed from the canister bay (see [“Removing Canisters”](#) on page 120 for instructions).

In the event that a load error occurs, the canister load status text will indicate this error (typically displaying "Load Error"). A second line of text will be displayed indicating the cause of the load error. [“Load Errors”](#) on page 239 provides detailed descriptions of the various load errors you may encounter, as well as instructions for correcting the error condition.

Material Load Controls

The Tips page contains Material Load Control buttons which are used to load and unload material to the liquefier tips within the head. A Load Material (up arrow) and Unload Material (down arrow) button is displayed for each material canister; however, the selectability of these buttons is dependent upon the canister's load status. See [Table 4-12 on page 71](#) for button state information.

Figure 4-27: Material Load Controls - Button Locations

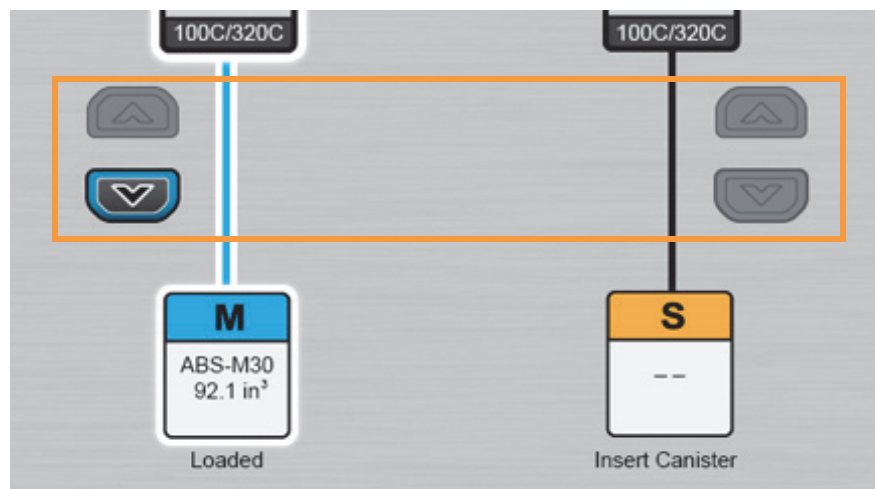

The Unload Material button (unselected state) will be selectable for all canisters with a “Loaded” status. The “Loaded” status is displayed for canisters whose filament is loaded to the corresponding liquefier tip in the head. Pressing this button will instruct the printer to begin the process of unloading material (see [“Unloading Material from the Liquefier Tips” on page 118](#) for details).

The Load Material button (unselected state) will be selectable for all canisters with a “Not Loaded” status, given that another canister's material is not already loaded to the corresponding liquefier tip in the head. If the corresponding tip is already loaded with material, the Load Material button will appear in its disabled state. The “Not Loaded” status is displayed for canisters whose filament has contacted the filament present switch, but is not yet loaded to the liquefier tip. Pressing this button will instruct the printer to begin the process of loading material (see [“Loading Material to the Liquefier Tips” on page 112](#) for details).

For all other canister statuses, the Load Material and Unload Material buttons will be disabled.

Table 4-12: Material Load Control Buttons - Button States

Button Name	Selected State	Unselected State	Disabled State
Load Material Button			
Unload Material Button			

As materials are loaded and unloaded, the pathway between the material and tip status icons will become blue with a white highlighted border, and will fill in the direction that the canister's filament is traveling.

Material load progress will display the same functionality regardless of whether a model or support canister is being loaded. Once a canister's material is loaded to the head, the pathway between the canister's Material Status Icon and the corresponding Tip Status Icon will be fully (solid) highlighted and the canister's load status will update to "Loaded". This indicates that the canister is selected and in position to be used to build parts on the printer. The Unload Material button (down arrow) will become selectable, indicating that the canister can be unloaded, if needed.

Material unload progress will display the same functionality regardless of whether a model or support canister is being unloaded. Once a canister's material is unloaded from the head the pathway between the canister's Material Status Icon and the corresponding Tip Status Icon will be solid black, and the canister's load status will update to "Not Loaded". The Load Material button (up arrow) will become selectable, indicating that the canister can be reloaded, if needed.

Figure 4-28: Material Load Progress Indicator

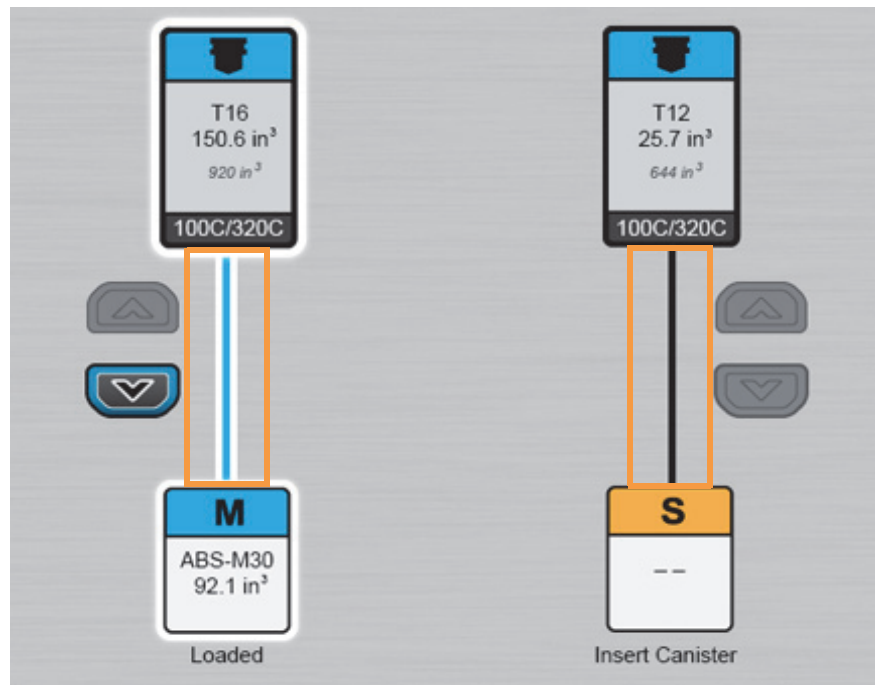

Tips Controls

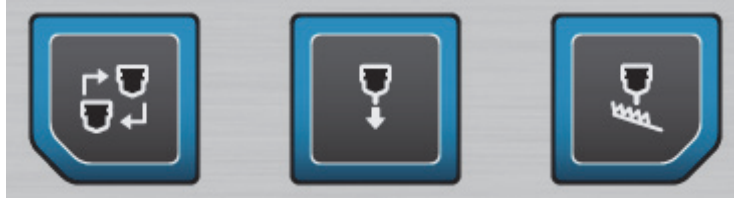

Three buttons are displayed at the bottom of the Tips page (just above the Navigation Bar). These buttons are used to initiate a variety of tip related functions.

Figure 4-29: Tips Controls



These buttons have the following functionality:

Table 4-13: Tips Controls Buttons

Icon	Name	Description
	Tip Change (Wizard)	Opens the Tip Change Wizard. The Tip Change Wizard is a guided wizard which allows you to change the printer's model and/or support materials and tips. See “ Tip Change Wizard ” for overview information and “ Using the Tip Change Wizard ” on page 123 for detailed instructions.
	Tip Purge/Unplug	Opens the Tip Maintenance Page. Within this page you can: - Initiate a tip unplug routine - Perform a tip purge - Enable/disable a tip's head button - View model and support tip temperature information
	Tip Wipe Adjustment	Opens the Tip Wipe Adjustment Page. Within this page you can: - Set the printer to its standby temperature - Set the printer to its build temperature - Move the head to the purge position - Wipe tips

Tip Change Wizard

The Tip Change Wizard is designed to streamline the process of changing model and/or support materials and tips. You will use this wizard any time you change material type or tips on the printer.



Caution: If material type is changed, tips must be changed. Any time you are changing material type and tips you must follow the steps within “[Changing Tips or Material Type](#)” on page 123. You cannot enter tip odometer information outside of the Tip Change Wizard.

To access the Tip Change Wizard, press the **Tip Change (Wizard)** button within the Tips page. A screen will be displayed showing the current configuration of your printer.



Note: The Navigation Bar is hidden within the Tip Change Wizard.

A detailed walk through of the Tip Change Wizard can be found in [“Using the Tip Change Wizard” on page 123](#). The example within this section outlines the necessary steps for changing material type (model and support) as well as changing tips. The intent of this example is to help familiarize you with the functionality of the Tip Change Wizard. As you navigate through this example, observe the state of the icons within the Dashboard.

Tip Purge/Unplug

Pressing the **Tip Purge/Unplug** button will open the Tip Maintenance page. Within this page you can:

- Initiate a tip unplug routine
- Perform a tip purge
- Enable/disable a tip’s head button
- View model and support tip temperature information

Two groupings of buttons are displayed within the body of the page, one for the model tip and one for the support tip. The buttons within these groupings have the same functionality, but control each tip separately. The corresponding tip’s current temperature as compared to its set point temperature is displayed beneath the tip’s button grouping.

Figure 4-30: Tip Maintenance Page



Unplug

Pressing the **Unplug** button initiates an automated tip unplug routine. This button should be pressed if you encounter a paused build due to the “Model filament clogged in tip” or “Support filament clogged in tip” warning (see “[Build Pause Warnings](#)” on page 241). Ensure that you press the Unplug button corresponding to the plugged tip (i.e. press the Unplug button under the Support heading to resolve a clogged support tip).

During the unplug routine the printer runs a series of purges and retries while monitoring following error. Following error is the failure of a motor to reach its commanded position. This routine also includes a sequence wherein the head fan is turned off for a period of time to allow the tip to heat up further. This increase in temperature allows clogged material to liquefy further in order to eliminate the clogged tip.

Purge

Pressing the **Purge** button instructs the printer to perform a long purge. After pressing this button, the head will move to the purge position and the corresponding tip will heat to a predetermined set point temperature. Once the tip’s temperature reaches this set point, material will be purged from the tip for about 10 seconds. When changing to or from colored material it is beneficial to perform multiple purges as this will remove all material remaining within the liquefier tips and/or tubes to ensure that color mixing doesn’t occur.

Enable Head Button

The head features two buttons, one for the model tip and one for the support tip, which can be used to purge material from the corresponding tip or move filament away from the corresponding tip.

Figure 4-31: Head Button Location

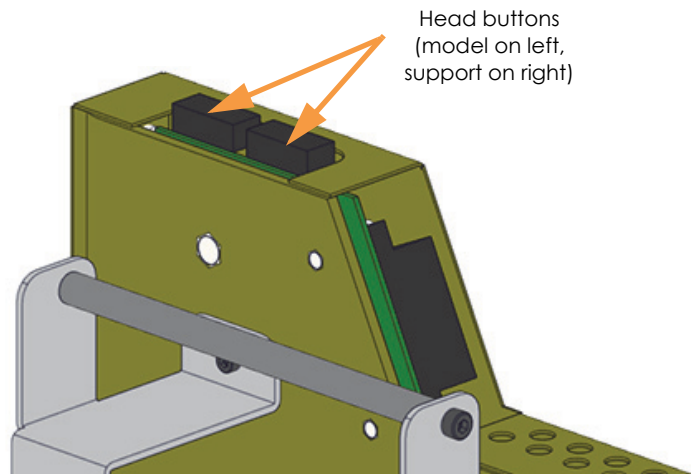

Pressing the **Enable Head Button** button within the Tip Maintenance page makes the corresponding tip’s head button active. After pressing this button the tip will begin to heat to a predetermined set point temperature. Once the tip reaches temperature, open the top cover and begin using the tip’s head button.

- Pushing the button toward “LOAD” runs a long purge.
- Pushing the button toward “UNLOAD” moves filament away from the tip.

After the tip reaches temperature, there’s a timeout of roughly 2 minutes before the tip is cooled again. The timer is reset every time one of the head buttons is pushed or material is purged. This ensures that the tips will not be cooled and the buttons will not be disabled unless no activity is sensed for that period of time.

Tip Wipe Adjustment

Pressing the **Tip Wipe Adjustment** button will open the Tip Wipe Adjust Wizard page. Within this page you can:

- Instruct the printer to set to its standby or build temperature
- Command the head to move to the purge position
- Initiate a tip wipe

The printer's current chamber temperature as compared to its standby temperature is displayed at the top of the page.

Figure 4-32: Tip Wipe Adjust Page

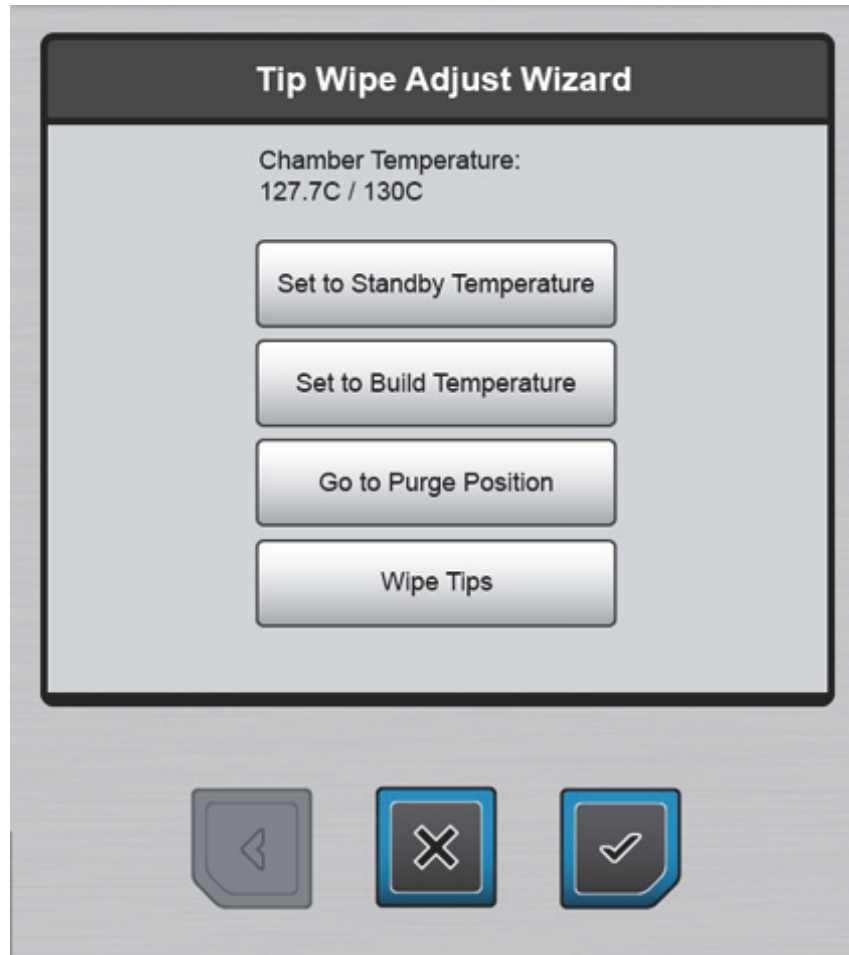

Set to Standby Temperature

Pressing the **Set to Standby Temperature** button instructs the printer to set to its standby temperature. The Chamber Temperature field will update to indicate temperature change progress.

Set to Build Temperature

Pressing the **Set to Build Temperature** button instructs the printer to set to its build temperature. Build temperatures are material specific. The Chamber Temperature field will update to indicate temperature change progress.

Go to Purge Position

Pressing the **Go to Purge Position** button will instruct the head to move to the purge position (directly above the purge ledge). This button must be pressed before the Wipe Tips button will become selectable, as the head must be in the purge position before tips can be wiped.

Wipe Tips

After pressing the Go to Purge Position button the Wipe Tips button becomes selectable. Pressing the **Wipe Tips** button will initiate a tip wipe. After pressing this button the head will begin to move back and forth, slowly passing the model and support tips over the flicker/brush assemblies. The head will make 4 passes. With each pass, the head gradually moves horizontally across the flicker to ensure proper adjustment and even wear.

You will need to access this button when adjusting tip wipe heights using the Tip Wipe Height Adjustment Wheels, see [“Adjusting Tip Wipe Heights” on page 159](#) for instructions.



Note: You must manually adjust tip wipe heights each time you change a tip. This will ensure proper placement of the flicker/brush assemblies in relation to tips/tip shields.

Working with the Calibration Page



Note: This section provides an overview of the Calibration page and its features, but does not go into detail regarding calibration procedures. See “6 Calibration” on page 181 for detailed calibration procedure information and instructions.

The Calibration page allows you to perform a variety of calibration procedures on the printer, including:

- XYZ Tip Offset Calibration
- Touchscreen Calibration
- Find XY Home
- Find Z Home

To access the Calibration page, press the **Calibration** button within the Navigation Bar; a screen similar to the one in [Figure 4-33](#) will be displayed.

Figure 4-33: Calibration Page

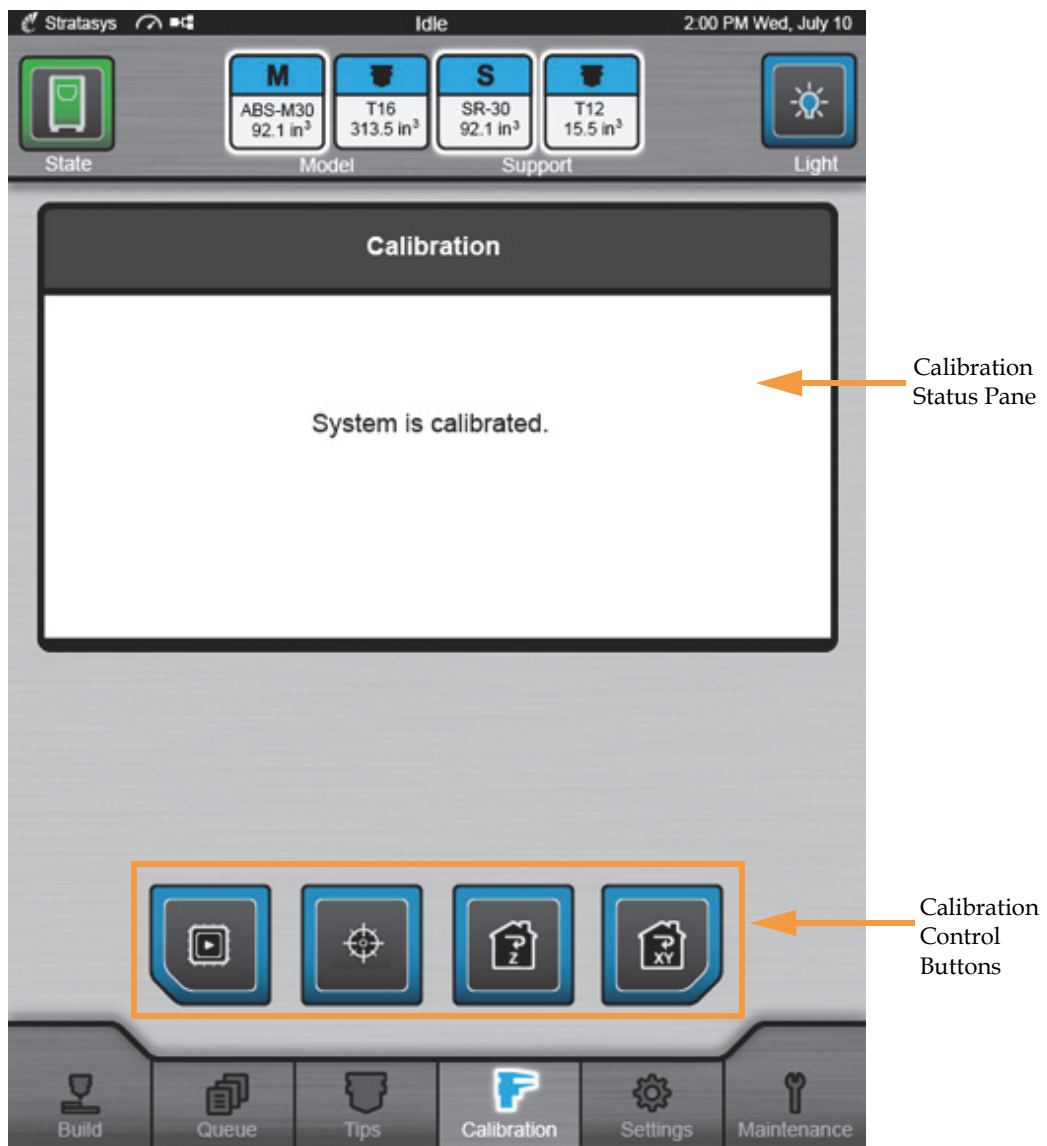

Viewing Calibration Status

Your printer's calibration status is displayed within the upper portion of the page. The text displayed within the Calibration Status Pane reflects the overall calibration status of the printer. If your printer is calibrated (i.e. XYZ Tip Offset Calibration has been completed), information similar to what is shown in [Figure 4-33](#) will be displayed. If the printer needs to be calibrated or if you skipped the task of performing an XYZ Tip Offset Calibration after changing tips, the text within this pane will reflect the printer's uncalibrated state and prompt you to take the necessary steps to calibrate the printer's tips. You cannot build parts on the printer until the printer's tips are calibrated.

Calibration Controls

Four buttons are displayed at the bottom of the Calibration page (just above the Navigation Bar). These buttons are used to initiate a variety of calibration related functions.

[Figure 4-34](#): Calibration Controls

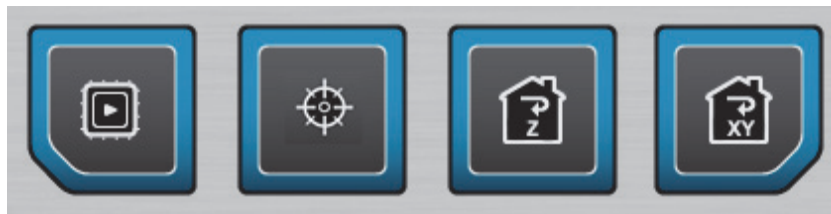

These buttons have the following functionality:

[Table 4-14](#): Calibration Control Buttons

Icon	Name	Description
	XYZ Tip Offset Calibration	Opens a page which allows you to initiate an XYZ Tip Offset Calibration and/or build a calibration part. Once you've made your selections the XYZ Tip Offset Calibration Wizard will walk you through the process of calibrating your printer's tips. Tips must be calibrated each time they are changed. See "Changing Tips or Material Type" on page 123.
	Touchscreen Calibration	Allows you to perform a touchscreen calibration. See "Touchscreen Calibration" on page 199 for instructions.
	Z Home	Instructs the printer to find its Z Home location.
	XY Home	Instructs the printer to find its X and Y Home locations. See "XY Home Calibration" on page 201 for instructions.

XYZ Tip Offset Calibration

Pressing the **XYZ Tip Offset Calibration** button will open a page which allows you to initiate an XYZ Tip Offset Calibration and/or build a calibration part. See “[XYZ Tip Offset Calibration](#)” on page 182 for detailed instructions.

An XYZ Tip Offset Calibration must be performed each time the printer’s tips are changed. Although the Tip Change Wizard provides instructions for performing this calibration directly within the wizard, the XYZ Tip Offset Calibration can be performed outside of the Tip Change Wizard using this button.

Figure 4-35: XYZ Tip Offset Calibration Page

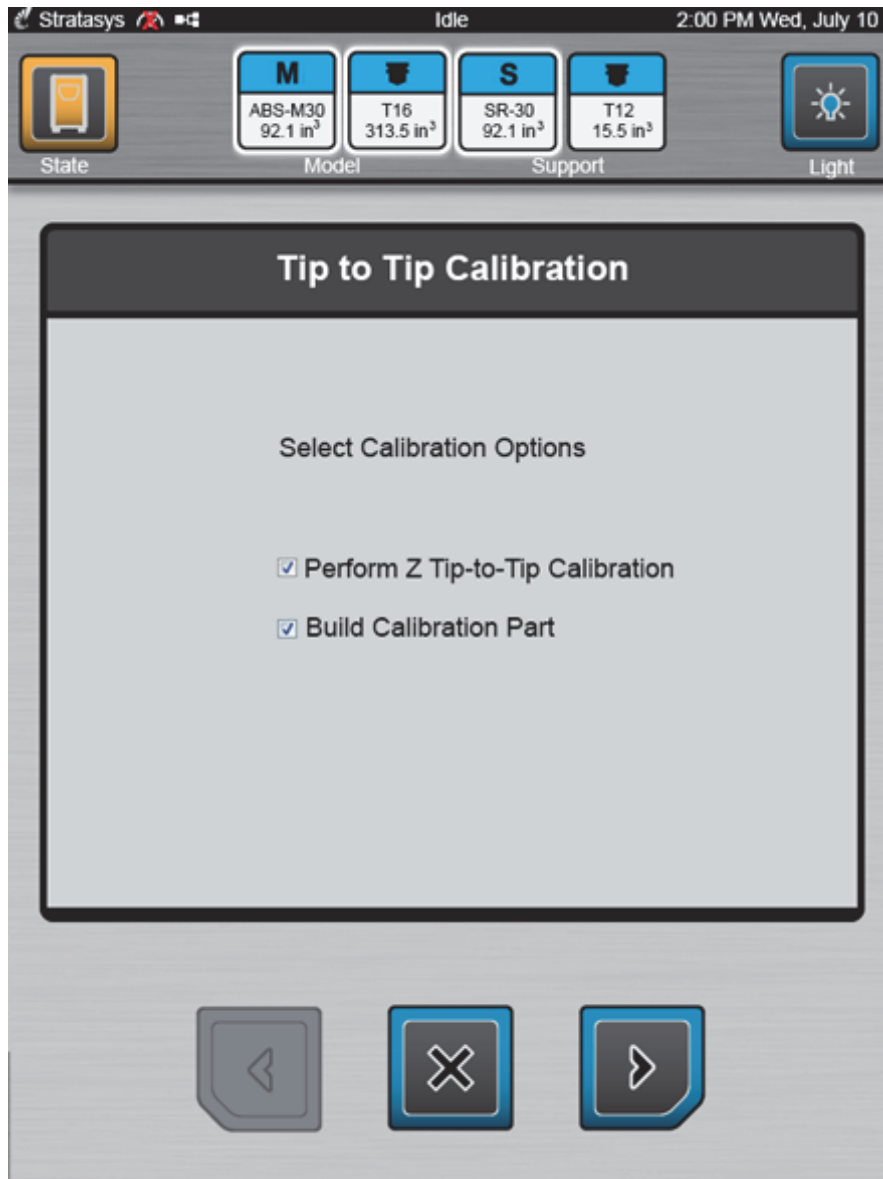

Touchscreen Calibration

Pressing the **Touchscreen Calibration** button will open a dialog allowing you to recalibrate the touchscreen display. See [“Touchscreen Calibration” on page 199](#) for detailed instructions.

Figure 4-36: Recalibrate Screen Confirmation Page

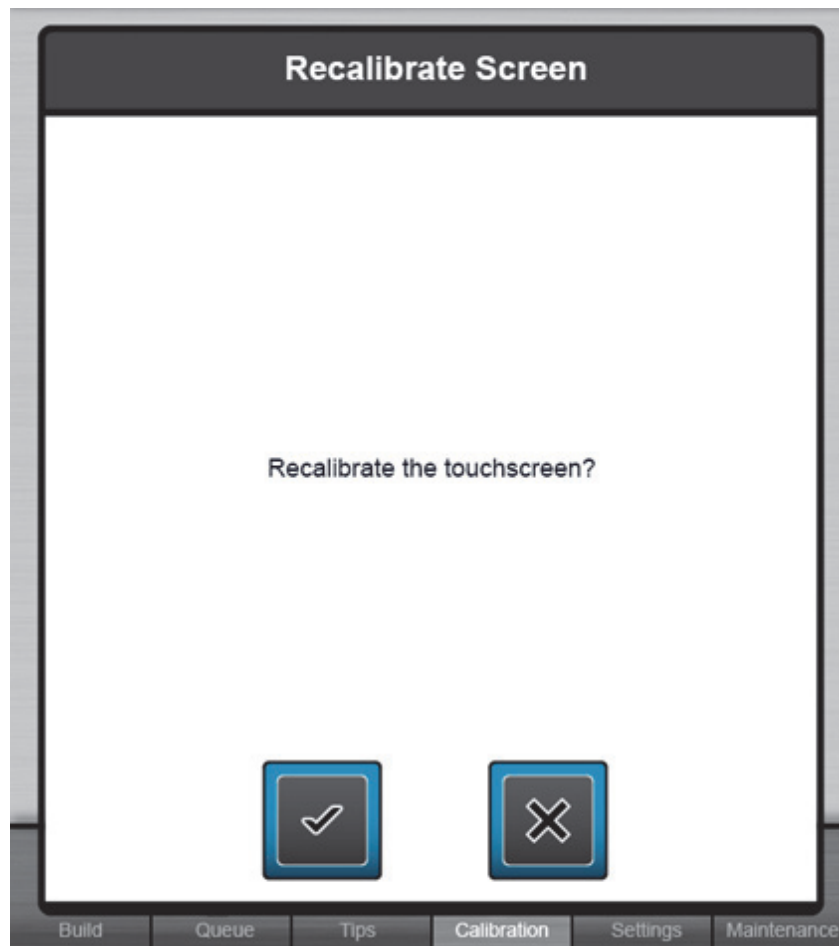

Find Z Home

Pressing the **Z Home** button instructs the printer to find its home location for the Z axis.



Note: This button can also be found within the Gantry/Stage Details page. See [“Gantry/Stage Settings” on page 97](#) for more information.

Find XY Home

Pressing the **XY Home** button instructs the printer to find its X and Y Home locations. See [“XY Home Calibration” on page 201](#) for more information.



Note: This button can also be found within the Gantry/Stage Details page. See [“Gantry/Stage Settings” on page 97](#) for more information.

Working with the Settings Page

The options within the Settings page are organized into groupings of related functionality. Within each grouping, printer information can be viewed and individual printer settings and preferences can be configured. Within this page you can turn a variety of printer settings on/off (including UPnP, part placement, auto cooldown, etc.), select your printer's address type (dynamic or static) and manually configure an IP address, network mask, and gateway address (if needed), and adjust the brightness of the touchscreen display. As a part of its initial installation and setup (performed by your authorized service representative), your printer's network settings will be configured within this page (as described within "[Configuring the Network](#)" on page 15). Once those settings are configured you may need to occasionally access this page in order to adjust printer preferences.

To access the Settings page, press the **Settings** button within the Navigation Bar; a screen similar to the one in [Figure 4-37](#) will be displayed.

Figure 4-37: Settings Page



Settings Page Navigation

To scroll up and down within the Settings page simply touch the screen and pull the list of options in the direction you'd like to scroll. A small scrollbar is displayed along the right-hand side of the page, indicating the direction in which you're scrolling. The options within the Settings page are organized into 3 main categories: Printer, Network, and Service. Main categories are distinguished by a bold heading.

Each main category contains a variety of settings and preferences that can be configured. Items are organized into individual rows within the page. The name of the setting/preference to be configured is displayed within the left side of the row. For some items, current configuration information is displayed within the row (for reference purposes). The graphic displayed within the right side of a row will vary depending on the configuration options available for that row.

Figure 4-38: Settings Page Content List

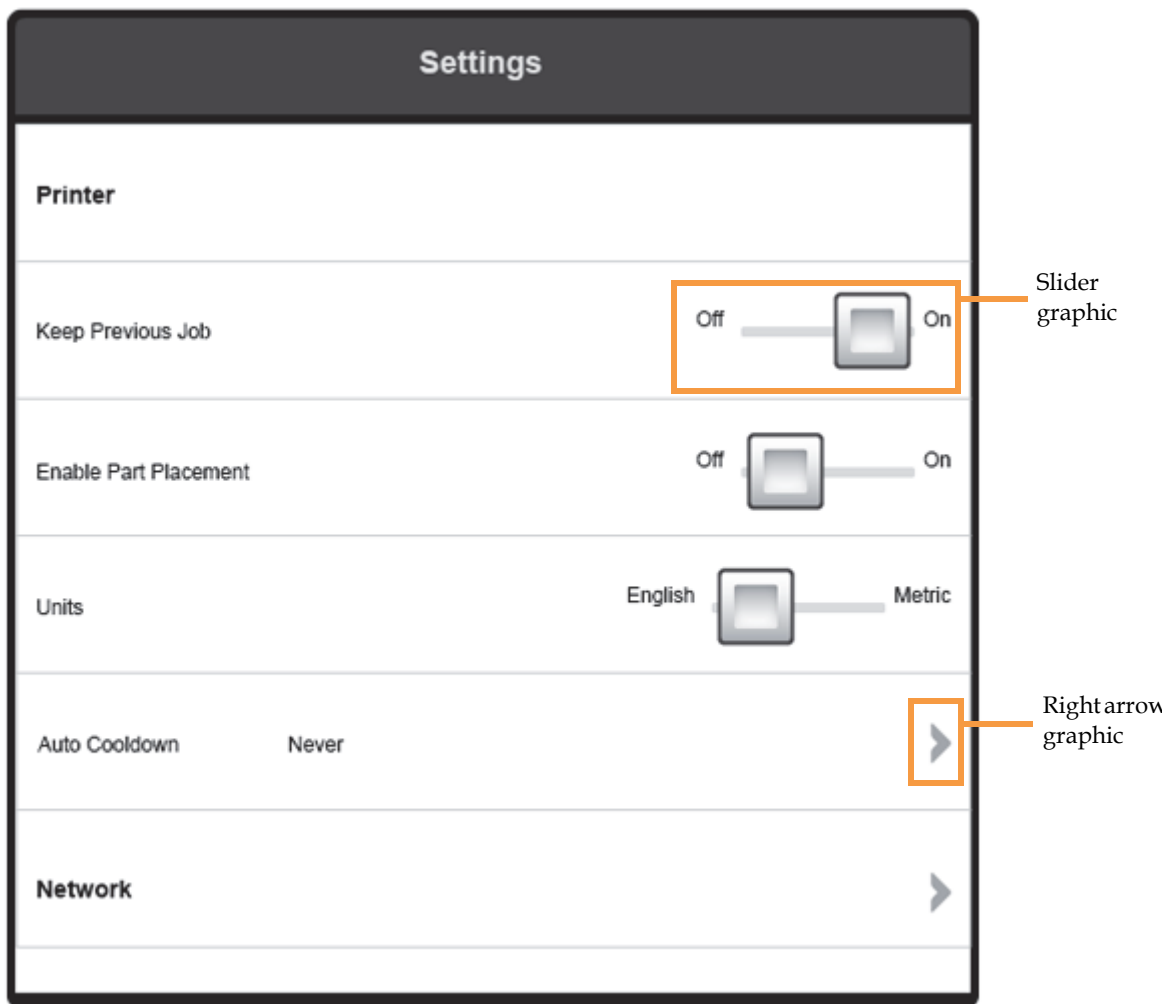

Rows containing a slider graphic (see [Figure 4-38](#)) allow you to configure a particular setting, typically turning the setting Off and On, directly within the Settings page. Simply touch the slider on the screen and move it to the left or right to adjust its setting.

Rows containing a right arrow graphic (see [Figure 4-38](#)) will open a new page allowing you to configure that row's settings/preferences; this new page is referred to as the item's details page (i.e. Network Settings Details page).

After making the necessary adjustments to a row's settings/preferences within a details page, press the Settings button in the upper-left corner of the page (see [Figure 4-39](#)) to exit the details page and return to the Settings page.

Figure 4-39: Settings Details Page - Back Button Location



Printer Settings

Within the Printer category of the Settings page you can configure a variety of printer functionality preferences.



Note: The printer's date and time settings are not configured within the Settings page. Instead, this information is configured within the FDM Control Center application which was installed on your workstation PC as part of the initial installation and setup process. See [“Setting the Printer's Date and Time” on page 18](#) for instructions.

Keep Previous Job

For privacy reasons, you have the option of choosing whether or not the printer's previous job is stored within the Job Queue. If you're concerned about other users of your printer seeing what you've built, this setting allows you to prevent other users from accessing the printer's previous job. When this setting is set to On, the printer will store its previous job file making it available for re-selection within the Job Queue. When this setting is set to Off, the printer's previous job file will be deleted from the Job Queue upon completion of the build. The job's file will need to be resent to the printer in order to be built again.

To configure this setting, use the slider graphic to turn the setting On and Off as needed; On is selected by default.

Figure 4-40: Keep Previous Job



Enable Part Placement

The Enable Part Placement setting gives you the ability to select a job's placement on a build sheet. By default, single part jobs are built in the center of a build sheet while packs are built according their selected placement within Control Center. Therefore, when this setting is set to Off, single part jobs will automatically be built in the center of the build sheet and packs will be built according their selected placement within Control Center. To configure this setting, use the slider graphic to turn the setting On and Off as needed.

Figure 4-41: Enable Part Placement



When this setting is set to On, you will be able to select a job's location on the build sheet prior to starting the build (see [“Selecting a Job to Build” on page 162](#)). At the start of a build a dialog will be displayed asking you to select the part's build location (see [Figure 4-42](#)). The dialog will contain a graphic representing your printer's platen as well as a blue bounding box graphic (the imaginary box surrounding the part).

You can select the part's build location by dragging and dropping the bounding box on the touchscreen; the bounding box cannot be placed outside the limits of the platen. Pressing the checkmark button will confirm your selected placement and start a build.

"Ghost box" graphics are also displayed; a "ghost box" represents the location where a part was built previously. Clicking the Delete (trash can) button will clear the display, removing all "ghost box" items.

Figure 4-42: Part Placement Dialog

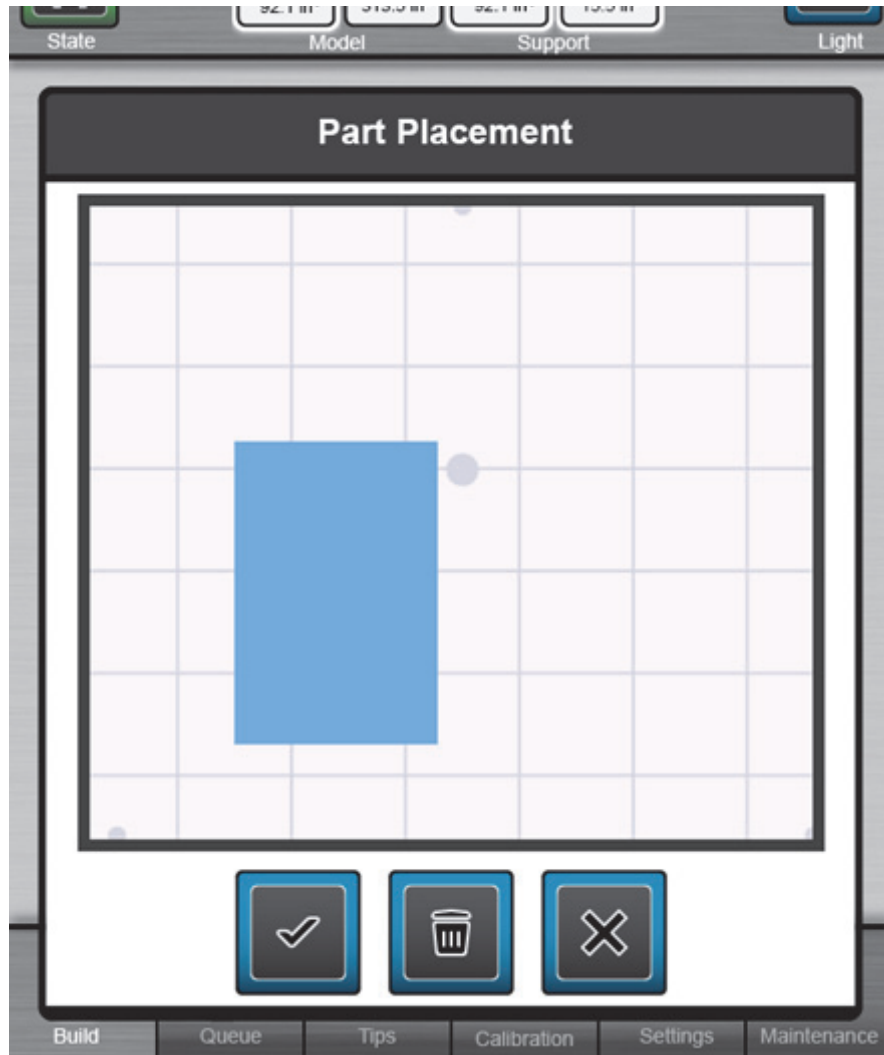

Units

The Units row displays the type of units the printer is configured for, English or Metric. To configure this setting, use the slider graphic to select between English and Metric units; English is selected by default.

Figure 4-43: Units



Auto Cooldown

The Auto Cooldown row displays the printer's auto cooldown setting. Pressing the right arrow graphic within this row will open a page allowing you to adjust this setting.

Figure 4-44: Auto Cooldown



Oven modeling temperature is determined by the material type (model and support) loaded within the printer. It is controlled by the printer's software and cannot be modified; however, you do have control of some oven temperature functions. The Auto Cooldown setting allows you to configure the printer's auto cooldown function.

The printer's oven is designed to cool incrementally until the printer controlled standby temperature is reached. This functionality acts as an energy saving feature. Auto Cooldown can be set to:

- Never - the printer is never auto-cooled. After every job is complete, oven temperature will stay at the material's build temperature. This is the default setting.
- Always - the printer is always auto cooled. After every job is complete and auto-cooled, oven temperature will stay at the material's standby temperature.
- Next Build Only - after the next job is complete and auto-cooled, auto cooldown mode will automatically reset to Never.

To configure this setting, touch the row corresponding to the auto cooldown option you want to select (Never, Always, or Next Build Only), the row will turn blue when selected. Press the **Settings** button within the heading of the page to exit the Auto Cooldown Details page and return to the Settings page.

Figure 4-45: Auto Cooldown Details Page

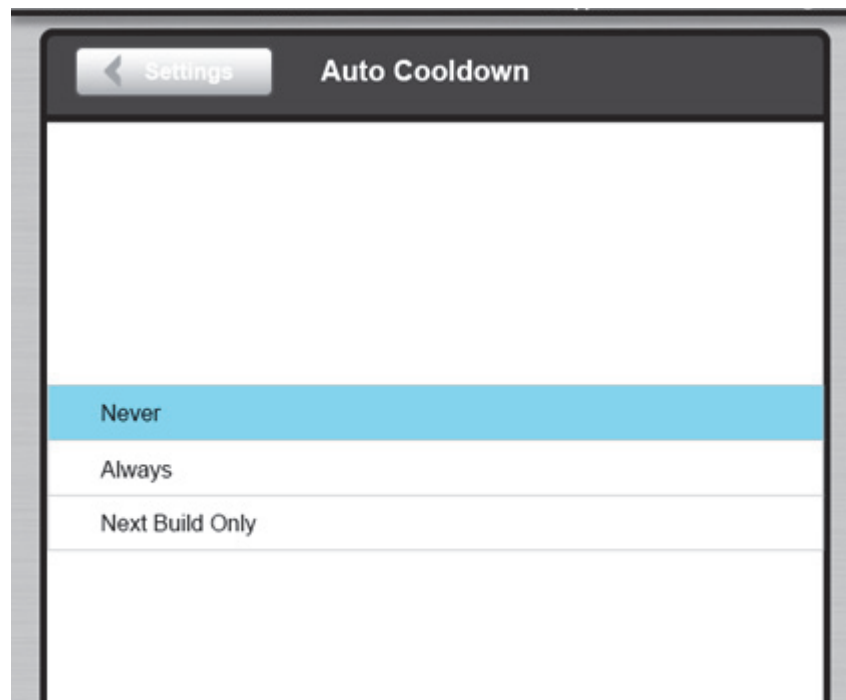

Network Settings

Within the Network Settings category of the Settings page you can configure your printer's UPnP and network address information.



Note: Your printer was configured for your network as a part of its initial installation and setup (see “Configuring the Network” on page 15). The information within this section is provided to help you understand the functionality of the Network Settings portion of the Settings page.

Pressing the right arrow graphic within the Network row will open your printer's Network Settings Details page.

Figure 4-46: Open Network Settings Details Page



Within this page you can set your printer's address type to DHCP (dynamic) or Static; DHCP is selected by default. To configure this setting, use the slider graphic to select DHCP or Static. Press the **Settings** button in the upper-left corner of the dialog to exit the Network Settings Details page and return to the Settings page.

Figure 4-47: Network Settings Details Page

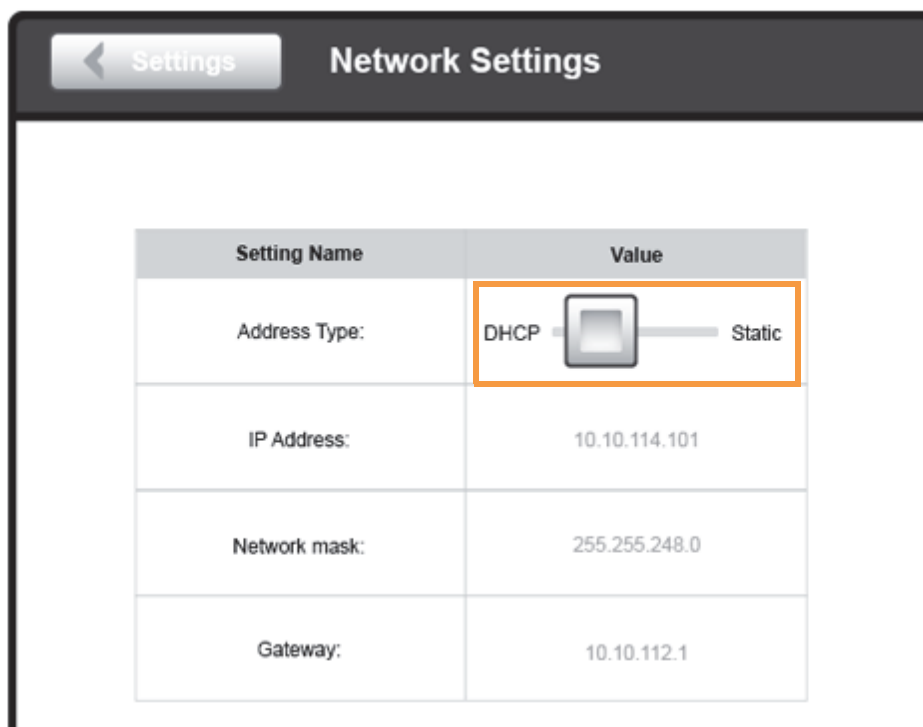

DHCP Configuration

When the Address Type is set to **DHCP**, a network server or PC will generate an IP address for the printer. A different IP address may be generated from time to time by the server or PC. The generated IP address will be displayed within the IP Address: field, and corresponding network mask and gateway address information will also be displayed.

Static Configuration

When the Address Type is set to **Static** you must enter an IP address, network mask, and gateway address for the printer (provided by the system administrator). Once entered, the address will not change.



Note: See your system administrator if you do not know the IP address, Network mask, or Gateway address.

When Static is selected the Enter Network Settings pop-up dialog will be displayed. Within this dialog you must manually configure the IP Address, Network mask, and Gateway fields using the keypad displayed. Simply touch a field on the screen to select it and then use the keypad to enter address information.

Figure 4-48: Enter Network Settings Dialog

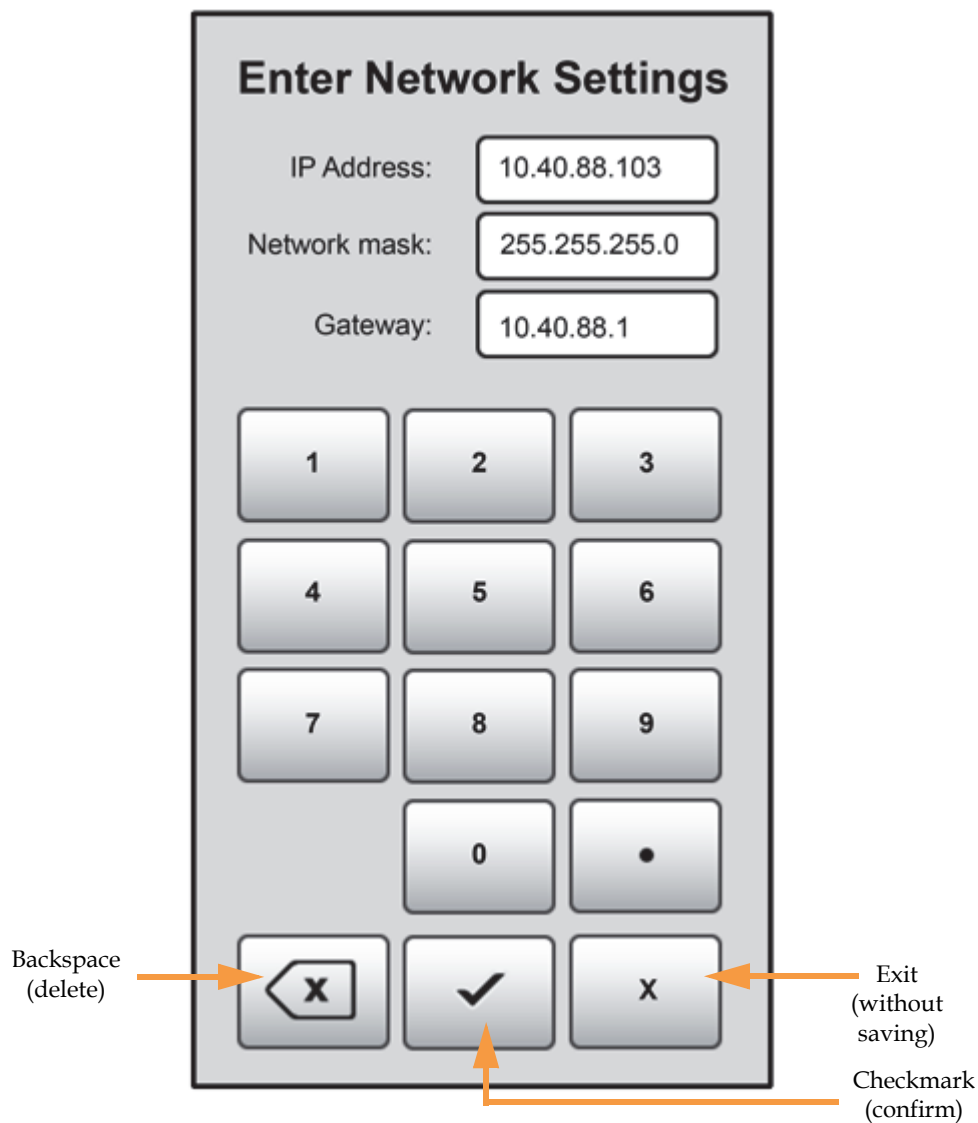

- Use the **number keys** to enter address digits.
- Use the **backspace** key to delete entries digit by digit.
- Use the **checkmark** key to confirm entries and exit the dialog with saving.
- Use the **x** key to exit the dialog without saving.

Network Address Information

The printer's network address information is displayed directly below the Network row. The printer's Address Type, IP Address, Netmask, and Gateway Address are displayed within the right side of the row. Any configuration changes made within the Network Settings Details page will be reflected within this row.

Figure 4-49: Network Address Configuration

Address Type	DHCP
IP Address	10.10.114.101
Netmask	255.255.248.0
Gateway Address	10.10.112.1

UPnP

UPnP allows the printer to broadcast its Unique Device Name (UDN) address across the network. When this setting is set to On, the printer will broadcast its UDN across the network allowing Insight to automatically detect the IP address of the printer for communication. When this setting is set to Off, the printer will not broadcast its IP address across the network and Insight will need to be manually configured to communicate with the printer.

To configure this setting, use the slider graphic to turn the setting On and Off as needed. UPnP is set to On by default.

Figure 4-50: UPnP



Display Settings

Adjust Brightness

The Adjust Brightness slider graphic allows you to adjust the brightness of the touchscreen display.

To configure this setting, use the slider graphic to adjust as needed; sliding to the right will increase brightness, while sliding to the left will dim brightness.

Figure 4-51: Adjust Brightness

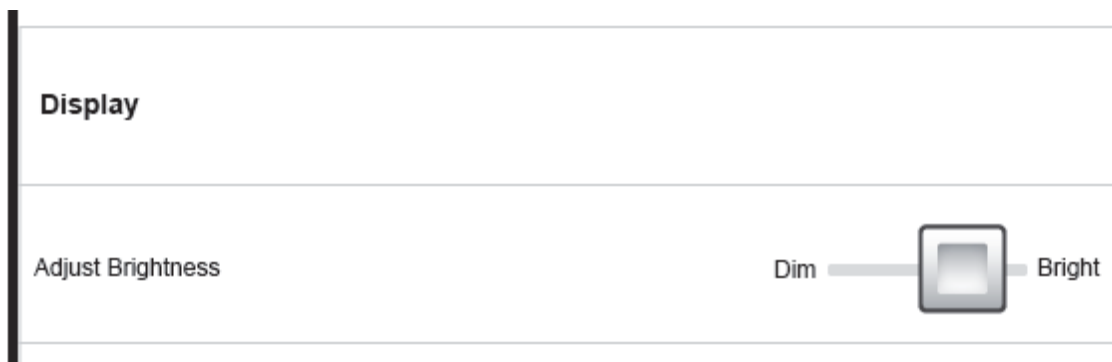

Service Settings

Service Mode

The Service Mode slider graphic allows an authorized service representative to put the printer into Service Mode in order to perform service procedures. Only authorized service representatives can put the printer into Service Mode using this setting, as a password is required to put the printer into this mode.

Figure 4-52: Service Mode



Working with the Maintenance Page

 **Note:** This section provides an overview of the Maintenance page and its features, but does not go into detail regarding printer maintenance procedures. See “7 Maintenance” on page 202 for detailed maintenance information.

The options within the Maintenance page are organized into groupings of related functionality. Within each grouping, maintenance related printer information can be viewed and individual maintenance settings and preferences can be configured. From this page you can upgrade your printer’s material license and/or software version, perform a variety of maintenance procedures on the printer, and view diagnostic/printer state information. Please note that advanced maintenance must be performed by an authorized service representative only.

To access the Maintenance page, press the **Maintenance** button within the Navigation Bar; a screen similar to the one in [Figure 4-53](#) will be displayed.

Figure 4-53: Maintenance Page

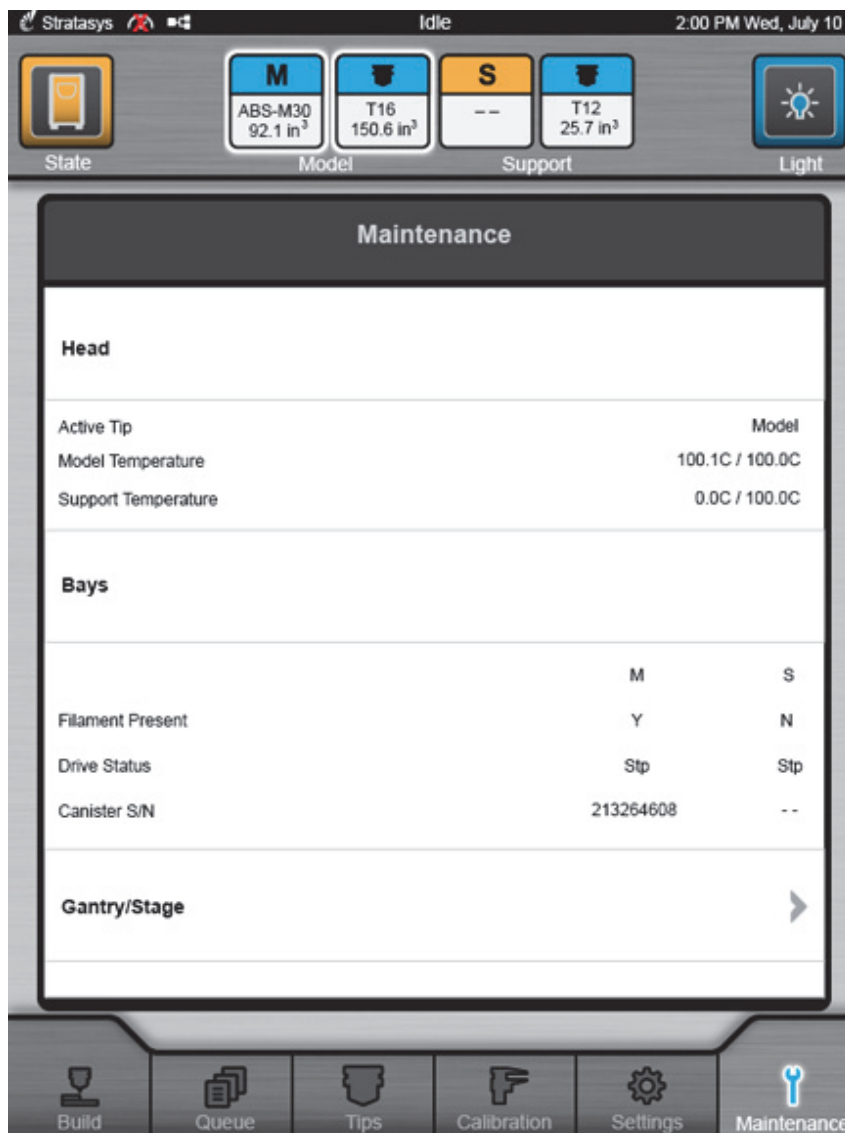

Maintenance Page Navigation

To scroll up and down within the Maintenance page simply touch the screen and pull the list of options in the direction you'd like to scroll. A small scrollbar is displayed along the right-hand side of the page, indicating the direction in which you're scrolling. The options within the Maintenance page are organized into 5 main categories: Head, Bays, Gantry/Stage, Chamber, and System. Main categories are distinguished by a bold heading.

Each main category contains a variety of settings and preferences that can be configured. Items are organized into individual rows within the page. The name of the setting/preference to be configured is displayed within the left side of the row. For most items, current configuration information is displayed within the center and/or right side of the row (for reference purposes).

Rows containing a right arrow graphic (see [Figure 4-54](#)) will open a new page allowing you to adjust the printer's gantry/stage positioning, update the printer's Controller Software version or materials configuration, or restart the printer.

[Figure 4-54](#): Maintenance Page Content List

Maintenance		
System		
Serial Number		K00028
Software Version		2.0.4418.0
Update Software		➤
Materials	Engineering High Performance Standard	➤
Restart		➤

Head Settings

Active Tip

The Active Tip row indicates which tip is currently active on the printer (i.e. extruding material to create a part). This setting updates automatically to coincide with the status of the printer's tips while building and will match the selected tip icon indicated within the Dashboard. Whenever material is being extruded from the model tip "Model" will be displayed, and whenever material is being extruded from the support tip "Support" will be displayed.

Figure 4-55: Active Tip

Active Tip	Model
Model Temperature	100.1C / 100.0C
Support Temperature	0.0C / 100.0C

Model Temperature

The Model Temperature row displays the model tip's current temperature as compared to its set point temperature.

Figure 4-56: Model Temperature

Active Tip	Model
Model Temperature	100.1C / 100.0C
Support Temperature	0.0C / 100.0C

Support Temperature

The Support Temperature row displays the support tip's current temperature as compared to its set point temperature.

Figure 4-57: Support Temperature

Active Tip	Model
Model Temperature	100.1C / 100.0C
Support Temperature	0.0C / 100.0C

Bay Settings

Filament Present

Each individual canister bay has a canister drive containing a filament present switch (see “Canister Drives and Canister Release Knobs” on page 28). This switch detects the presence of material within the canister drive. The Filament Present row displays status information pertaining to the filament loaded in a canister drive; status information for each of the canister drives is displayed. “Y” indicates that a canister’s filament is detected by the filament present switch within the canister drive, while “N” indicates that filament is not detected.

Figure 4-58: Filament Present

	M	S
Filament Present	Y	N
Drive Status	Stp	Stp
Canister S/N	213264608	--

Drive Status

The Drive Status row displays status information pertaining to a canister drive motor’s drive wheels. Status information for the drive wheels within each of the canister drives is displayed. This information will update as material is loaded to and unloaded from the head.

- “Stp” indicates that the drive wheels are stopped.
- “Fwd” indicates that the drive wheels are driving material forward (toward the head).
- “Bk” indicates that the drive wheels are driving material backward (toward the canister).

Figure 4-59: Drive Status

	M	S
Filament Present	Y	N
Drive Status	Stp	Stp
Canister S/N	213264608	--

Canister S/N

The Canister S/N row displays the serial number of the model and support canisters installed in the printer's canister bays. The printer automatically reads this number off of the canister's memory chip when it is inserted into a canister bay. If a canister bay is empty "--" will be displayed in place of a serial number.

Figure 4-60: Canister S/N

	M	S
Filament Present	Y	N
Drive Status	Stp	Stp
Canister S/N	213264608	--

Gantry/Stage Settings

Pressing the right arrow graphic within the Gantry/Stage row will open your printer's Gantry/Stage Details page ([Figure 4-62 on page 98](#)). Within this page you can move the platen (Z) up or down and the head in the X and Y axis.

[Figure 4-61](#): Open Gantry/Stage Details Page



The **Z Home** and **XY Home** buttons are displayed within the lower portion of the page (just above the Navigation Bar). These buttons have the same functionality as the buttons displayed within the Calibration page (see "[Calibration Controls](#)" on page 79). The left-most button (Z Home) instructs the printer to find its home location for the Z axis (see "[Find Z Home](#)" on page 81). The right-most button (XY Home) instructs the printer to find its home location for the X and Y axes (see "[Find XY Home](#)" on page 81).

Upon opening the Gantry/Stage Details page the X axis is selected by default (as in [Figure 4-62](#)). The current position of each axis is displayed within the upper-left portion of the page. If you make placement adjustments for an axis, the information displayed for that axis will update within this portion of the page.

The graphic within the center of the page represents the X, Y and Z axes. A grey bar with one or more blue arrows indicates which axis is selected. As you switch from one axis to the next using the Axis Selection buttons, this graphic will update to reflect the selected and unselected axes (see [Figure 4-63](#) and [Figure 4-64](#)).



Note: You may need to perform a Z Home calibration, using the Z Home button, before the Z axis is available for selection.

Pressing a blue arrow will cause an incremental movement of the head or platen from its current position. The Incremental Movement Distance buttons allow you to specify the distance of this movement in units of 1 (1.0), 10ths (0.1), 100ths (0.01) or 1000ths (0.001) of an inch (or equivalent units in millimeters - 25.0, 10.0, 1.0, 0.1). To initiate an incremental movement, select the desired Incremental Movement Distance button and then use the Axis Selection buttons to select an axis. After selecting the desired axis, press the blue arrow pointing in the direction you want the incremental movement to take place. Depending on the selected axis, the platen or head will then move from its current position by the distance specified by the selected Incremental Movement Distance button, and in the direction of the selected blue arrow.

The Absolute Movement buttons will vary depending on which axis is selected. These buttons are used to move the head or platen to a predefined location within the selected axis' range of travel. To initiate an absolute movement, use the Axis Selection buttons to select an axis and then press the desired Absolute Movement button. Depending on the selected axis, the head or platen will then move from its current position to a predefined location within its range of travel.

Pressing the Maintenance button in the upper-left corner of the page will close the Gantry/Stage Details page (returning you to the Maintenance page).

In Figure 4-62 the X axis is selected; absolute movements can be made to the Left, Mid (middle) or Right of travel.

Figure 4-62: Gantry/Stage Details Page - X Axis Selected

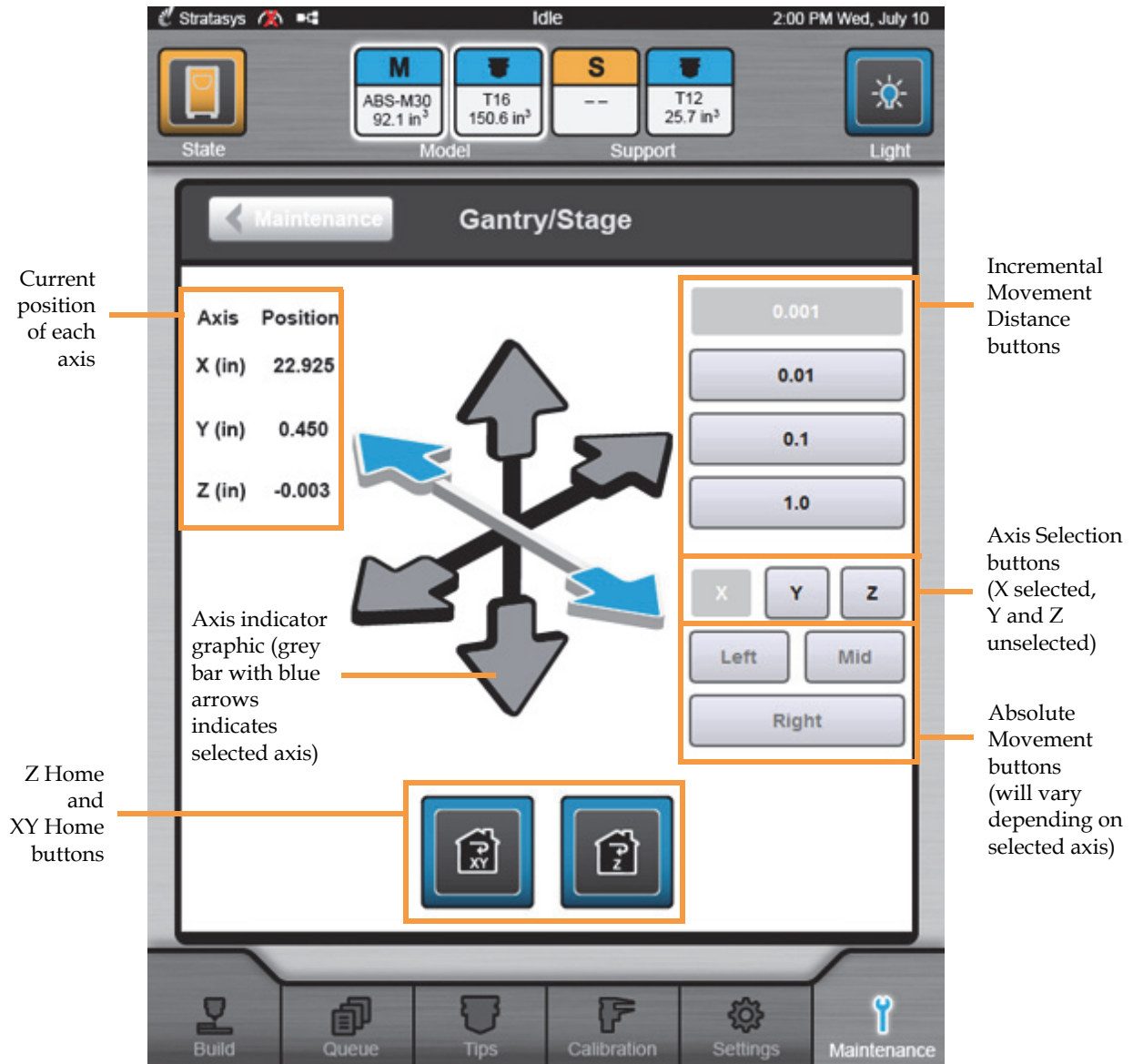

In Figure 4-63 the Y axis is selected; absolute movements can be made to the Back, Mid (middle) or Front of travel.

Figure 4-63: Gantry/Stage Details Page - Y Axis Selected

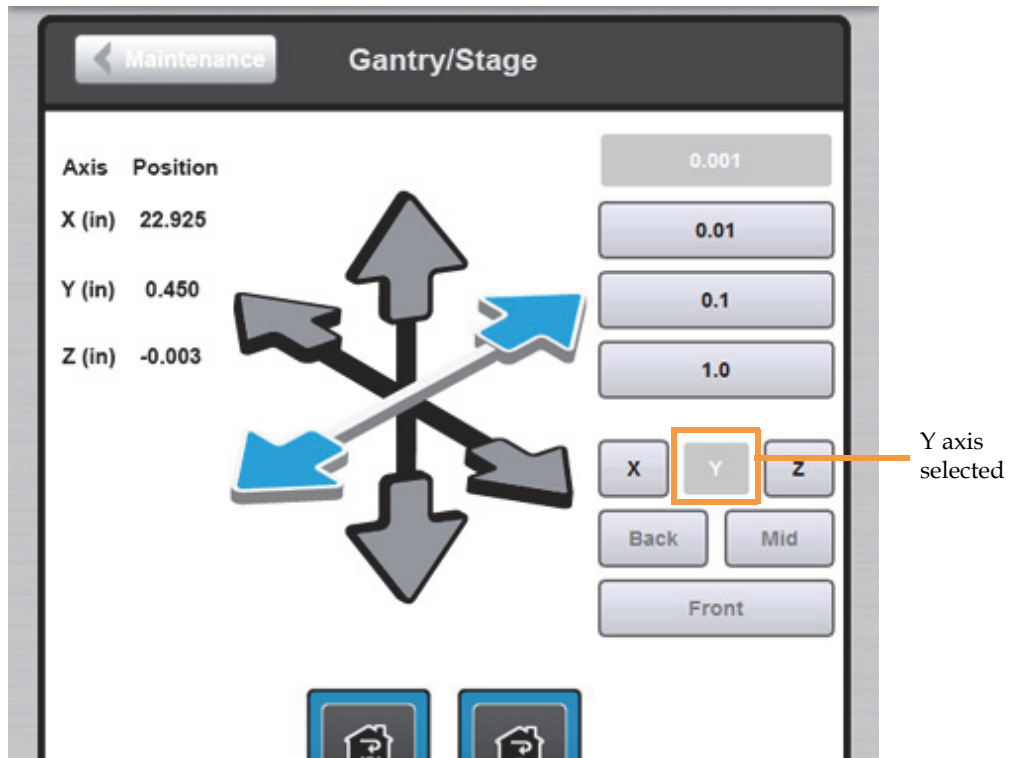

In Figure 4-64 the Z axis is selected; absolute movements can be made to the Mid (middle) or Bottom of travel.

Figure 4-64: Gantry/Stage Details Page - Z Axis Selected

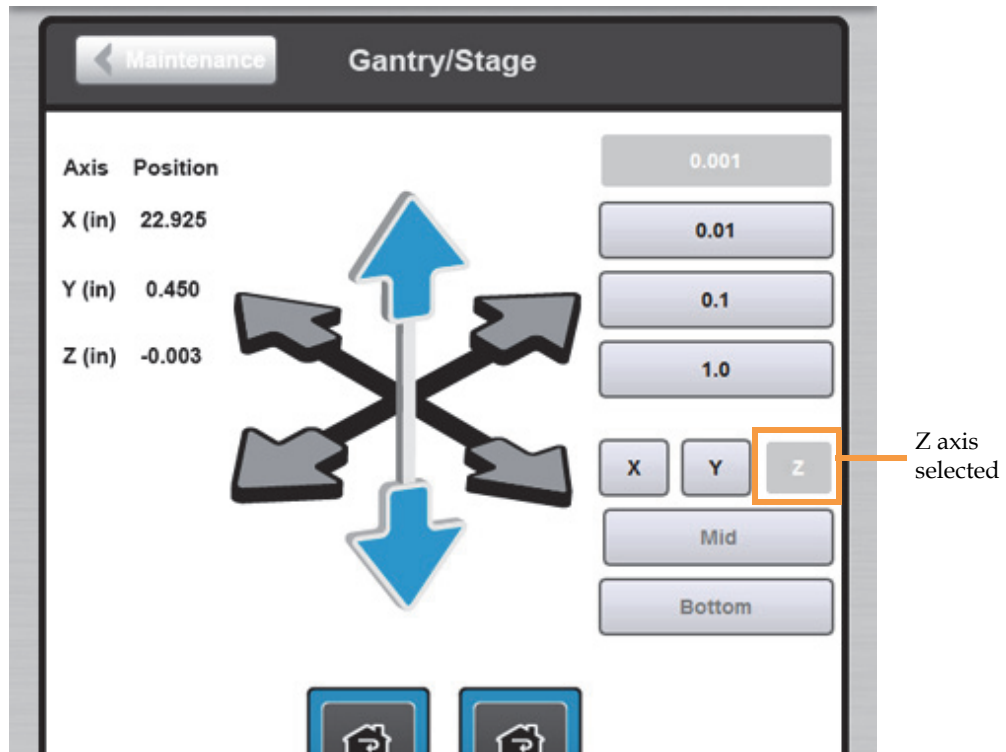

X, Y, Z Position

Position information for the X, Y and Z axes is displayed within the X, Y, Z Position row. This information is the same as what is displayed within the Gantry/Stage Details page. The position information displayed within this row will update to reflect changes made within the Gantry/Stage Details page.

Figure 4-65: X, Y, Z Position

X Position	22.925 in
Y Position	0.450 in
Z Position	-0.003 in

Z Tip Sensor



Warning: It is possible for the tips to collide with the Z tip sensor if moving in X or Y when the Z stage is very high up in its range of travel. Always leave the Z stage at mid or bottom of travel when moving XY.

The Z Tip Sensor row displays whether the tip is currently sensed at the sensor. “Off” will be displayed whenever the tip is not sensed at the sensor, and “On” will be displayed whenever the tip is sensed at the sensor (i.e. the tip is in current contact with and touching the sensor). During normal printer operation “Off” should always be displayed. A status of “On” while the printer is idle or building a part indicates a problem with the tip sensor. Do not manually move the Z stage to activate the Z tip sensor as it can damage the sensor.

Figure 4-66: Z Tip Sensor

Z Tip Sensor	Off
--------------	-----

Chamber Settings

Oven Temperature

The Oven Temperature row displays the oven's current temperature as compared to its set point temperature.



Note: Small offsets (1-3C) between actual and set point temperatures are normal, particularly oven temperatures above 150C.

Figure 4-67: Oven Temperature

Oven Temperature	127.7C / 130C
Vacuum Enable	Off
Vacuum Status	Low
Dryer Status	Good
Door Lock	Unlocked
Door Status	Closed
Cover Status	Closed

Vacuum Enable

The Vacuum Enable row displays whether the printer's vacuum capability is on or off. This row updates automatically. "On" will be displayed when vacuum is enabled, and "Off" will be displayed when vacuum is disabled.

Figure 4-68: Vacuum Enable

Oven Temperature	127.7C / 130C
Vacuum Enable	Off
Vacuum Status	Low
Dryer Status	Good
Door Lock	Unlocked
Door Status	Closed
Cover Status	Closed

Vacuum Status

The Vacuum Status row displays status information pertaining to the printer's vacuum system. "Low" is displayed if vacuum pressure is below threshold. In this instance, a build sheet will not affix to the platen as sufficient pressure is not present to hold the build sheet to the platen's surface. "Good" is displayed when sufficient vacuum pressure is present. In this instance, a build sheet should affix to the platen within 5 minutes of installation.

Figure 4-69: Vacuum Status

Oven Temperature	127.7C / 130C
Vacuum Enable	Off
Vacuum Status	Low
Dryer Status	Good
Door Lock	Unlocked
Door Status	Closed
Cover Status	Closed

Dryer Status

The Dryer Status row displays status information pertaining to the printer's dryer system. "Low" is displayed when the pressure in the dryer system (determined by a sensor near the compressor) is below threshold. "Good" is displayed when sufficient dryer pressure is present. During normal printer operation "Good" should always be displayed.

Figure 4-70: Dryer Status

Oven Temperature	127.7C / 130C
Vacuum Enable	Off
Vacuum Status	Low
Dryer Status	Good
Door Lock	Unlocked
Door Status	Closed
Cover Status	Closed

Door Lock

The Door Lock row displays whether or not the printer's door is locked. Whenever the oven door can be opened (i.e. the printer is not building and it is therefore safe for you to open the oven door) "Unlocked" will be displayed. Whenever the oven door's lock is engaged and the door cannot be opened (i.e. the printer is building a part) "Locked" will be displayed.

Figure 4-71: Door Lock

Oven Temperature	127.7C / 130C
Vacuum Enable	Off
Vacuum Status	Low
Dryer Status	Good
Door Lock	Unlocked
Door Status	Closed
Cover Status	Closed

Door Status

The Door Status row displays the status of the printer's oven door. "Open" will be displayed when the oven door is open, and "Closed" will be displayed when the oven door is closed.

Figure 4-72: Door Status

Oven Temperature	127.7C / 130C
Vacuum Enable	Off
Vacuum Status	Low
Dryer Status	Good
Door Lock	Unlocked
Door Status	Closed
Cover Status	Closed

Cover Status

The Cover Status row displays the status of the printer's top cover. "Open" will be displayed when the top cover is open, and "Closed" will be displayed when the top cover is closed.

Figure 4-73: Cover Status

Oven Temperature	127.7C / 130C
Vacuum Enable	Off
Vacuum Status	Low
Dryer Status	Good
Door Lock	Unlocked
Door Status	Closed
Cover Status	Closed

System Settings

Serial Number

The Serial Number row displays the printer's unique serial number. This number can also be found on the label on the exterior surface of the printer (see [Figure 2-5 on page 13](#) for label placement).

Figure 4-74: Serial Number



Software Version

The Software Version row displays the version of Controller Software installed on the printer.

Figure 4-75: Software Version



Update Software

Pressing the right arrow graphic within the Update Software row will open the Update Software page.

Figure 4-76: Update Software



The Update Software page (see [Figure 4-76](#)) lists a variety of version information pertaining to the printer. Pressing the Upgrade System Software button within this page will open a new page and automatically put the printer into Software Upgrade Mode (see [Figure 4-77](#)). When the printer is in Software Upgrade Mode you can send software upgrade files to the printer in order to upgrade its version of Controller Software. See [“Updating Controller Software - Web Method” on page 209](#) for more information.

Figure 4-77: Update Software Page



Figure 4-78: Upgrade Software Page

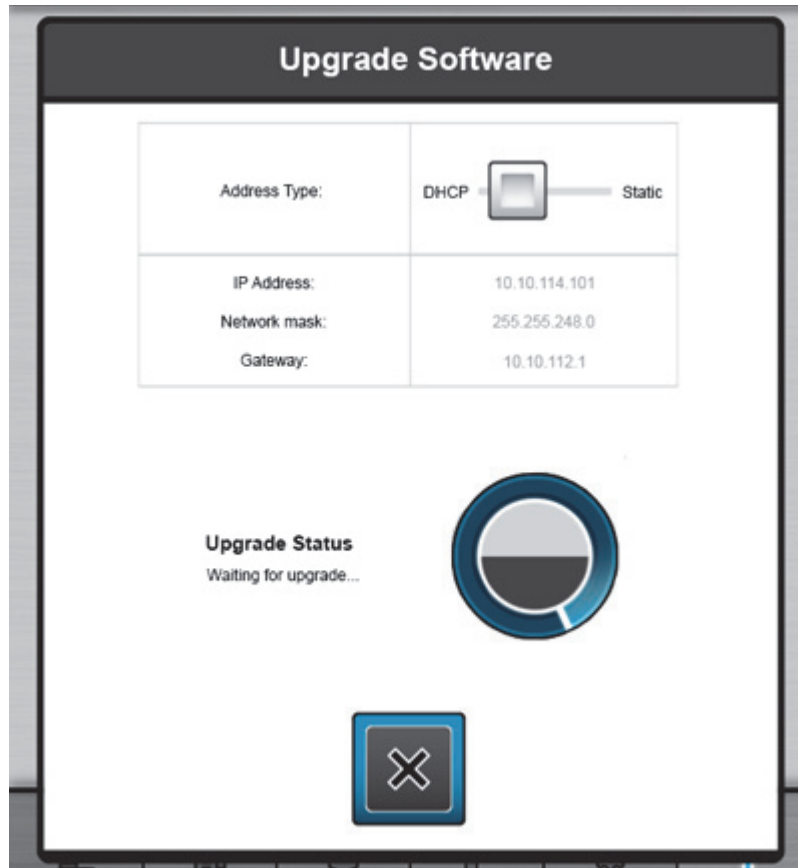

Materials

The Materials row displays the printer's materials configuration information (see [Available Material Options](#) for details). This information is based on the material license purchased for the printer. The printer's material license determines the types of materials (model and support) that can be used to build parts on the printer. The printer is licensed as part of its initial installation and setup process (performed by your authorized service representative).

Pressing the right arrow graphic within the Materials row will open the Materials Details page.

Figure 4-79: Materials



The Materials Details page displays a list of the material types configured for use on the printer, and allows you to put the printer into License Upgrade Mode. Pressing the **Add License** button within this page will open a new page and put the printer into License Upgrade Mode. To close this page and return to the Maintenance page, press the **Maintenance** button within the header of the page.

Figure 4-80: Materials Details Page

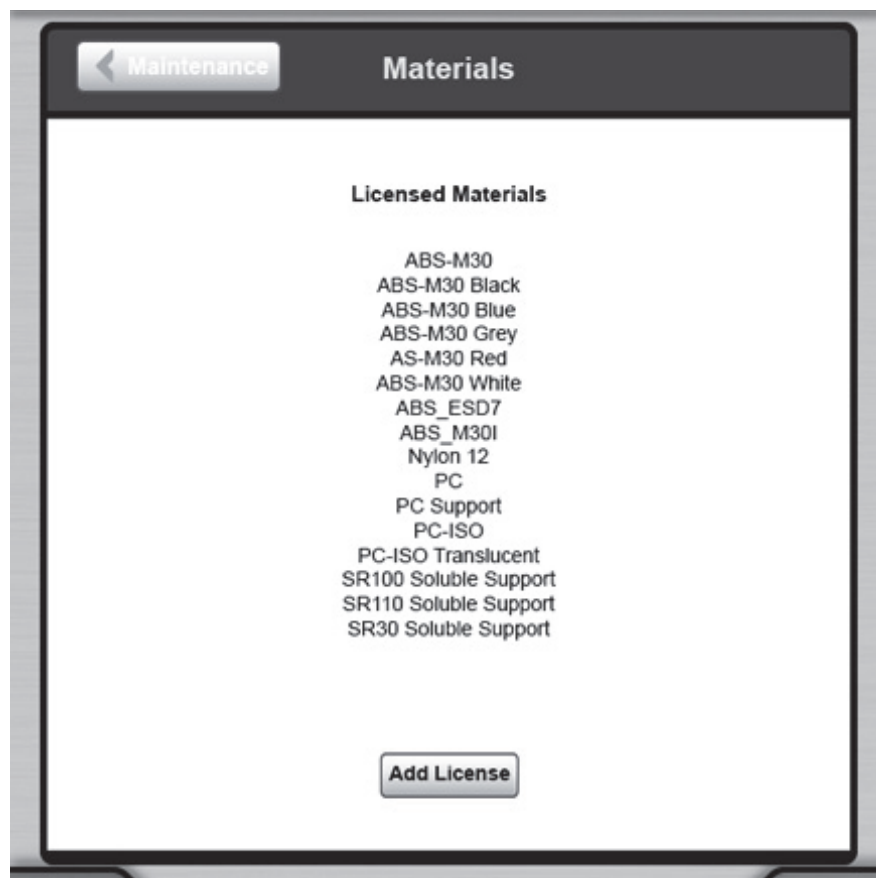

If you find that the printer's materials configuration no longer meets your needs, you can purchase a different material option and upgrade the printer's material license. Pressing the Add License button within the Materials Details page puts the printer into License Upgrade Mode, and opens the Add Material License page. When the printer is in License Upgrade Mode you can send license files to the printer in order to upgrade its materials configuration. See ["Install/Update Material License" on page 205](#) for more information. Selecting the **X (Cancel)** button will close the page and return you to the Materials Details page.

Figure 4-81: Add Material License Page

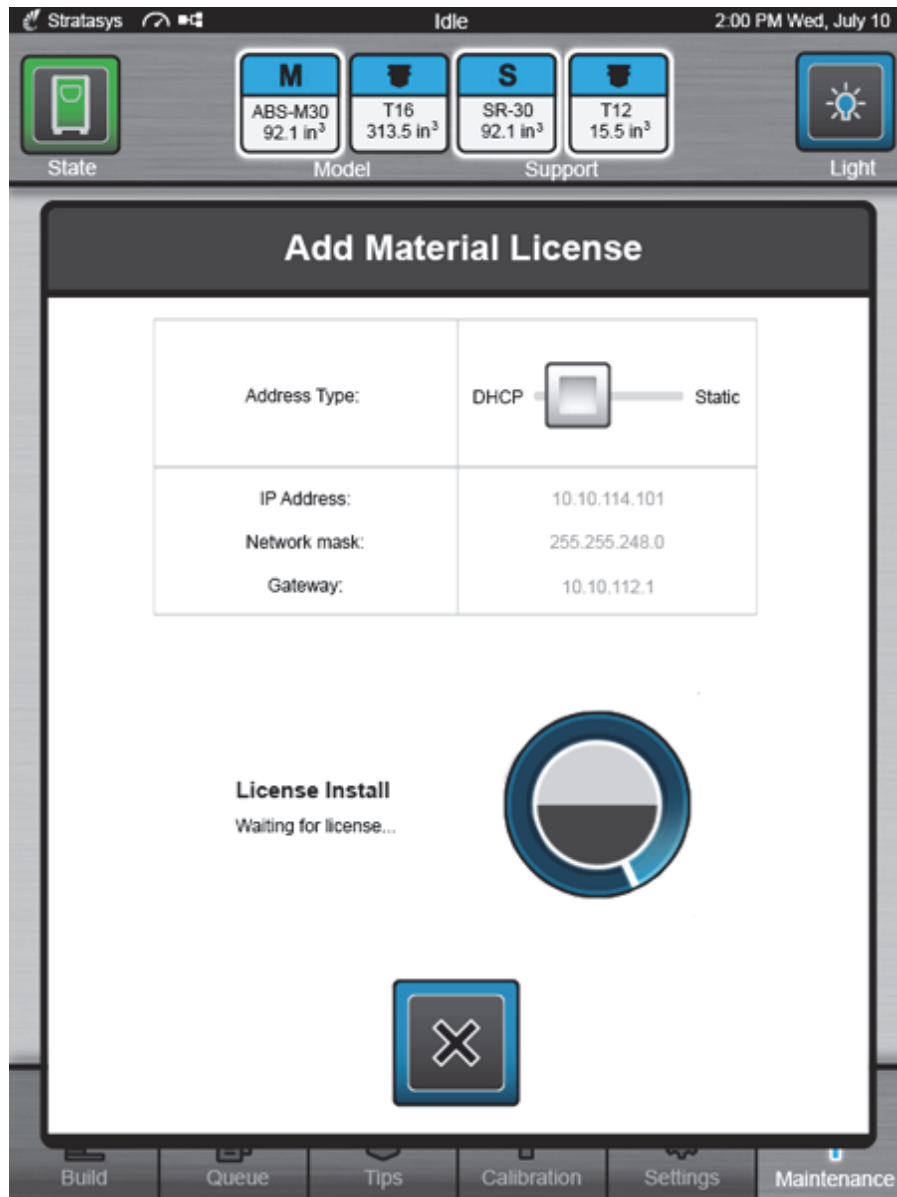

Restart

Pressing the right arrow graphic within the Restart row will open a dialog allowing you to manually restart the printer.

Figure 4-82: Restart



Pressing the **checkmark** button within this dialog will cause the printer to restart automatically. Selecting the **X (Cancel)** button within this dialog will close the dialog.

Figure 4-83: Restart

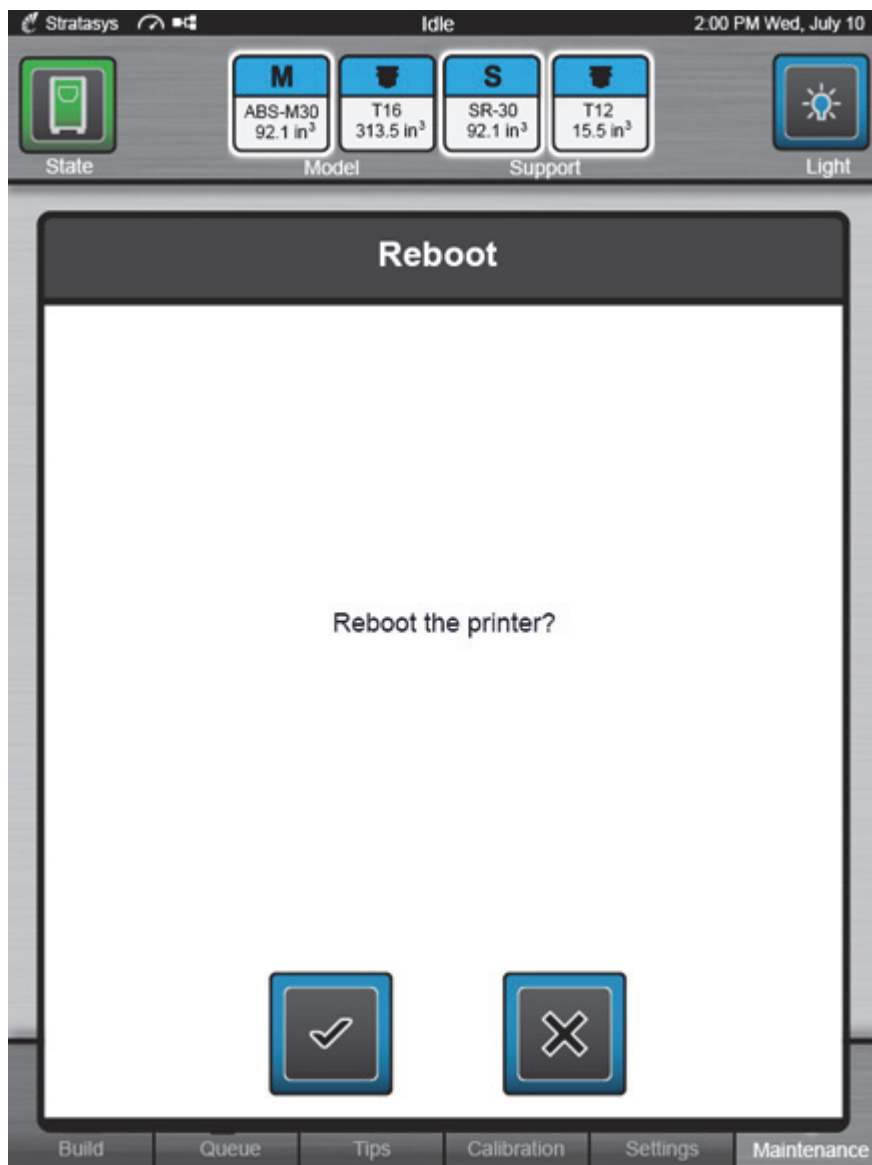

5 Operating the Printer

This chapter explains basic steps in operating the 380mc.

Basic User Operations

Powering ON the Printer

To power the printer ON:

1. Ensure that the AC circuit breaker is in the ON (I) position. (See [Figure 2-6 on page 15](#) for AC circuit breaker location.)
2. Open the canister bay doors. Within the canister bay area, flip the power switch to the ON (I) position.
3. The printer will begin to boot. The touchscreen will turn on and the Stratasys logo followed by start-up code will be displayed for a brief period.

[Figure 5-1: Power Switch Location](#)

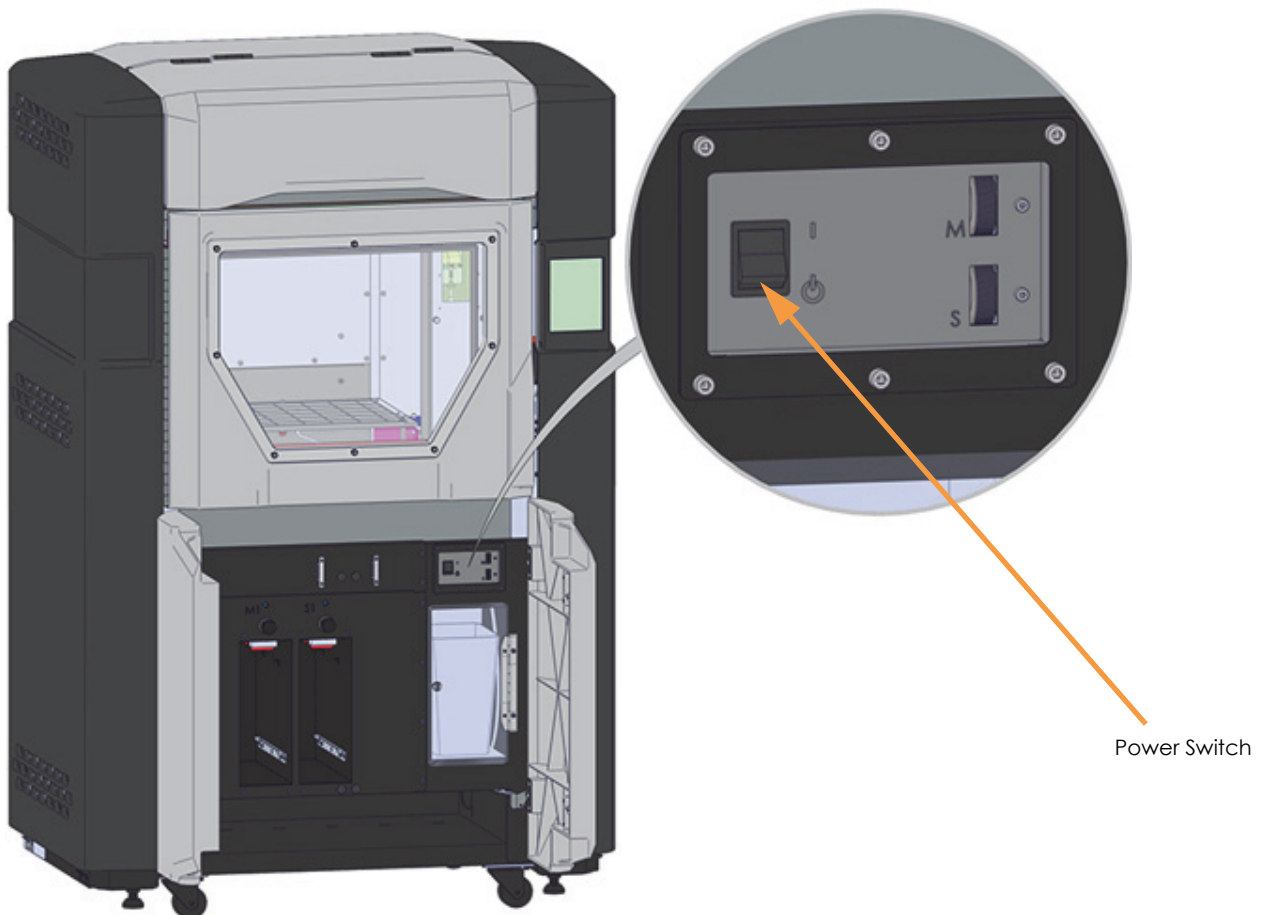

4. Once the printer boots up “Initializing” will be displayed on the touchscreen, followed by “Starting”. The icons within the Dashboard will be blank until this process is complete.

Figure 5-2: Initializing Start Up Screen

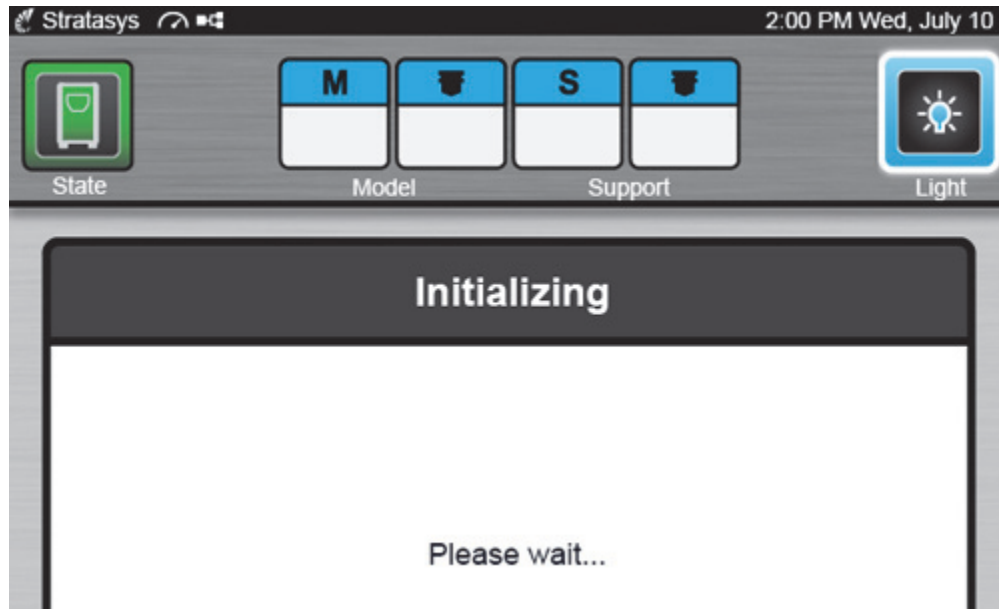

5. After the initialization and start up process is complete, the printer will automatically perform an XY Home Calibration.
6. Once calibration is complete, the Dashboard will refresh and display the printer's current configuration (materials and tips) information. If this is the first time you've powered up the printer, all material and tip status icons will be yellow indicating that tips and material canisters need to be installed.

Powering OFF the Printer

To power the printer OFF:

1. Ensure that the printer is stopped (idle) and is not building.
2. Open the canister bay doors. Within the canister bay area, flip the power switch to the OFF (O) position. (See [Figure 5-1](#) for power switch location.)
3. The oven light and User Interface will turn off, and after a couple of minutes the printer will shutdown.

Please note that this procedure only powers down the electronics. To completely disengage power to the printer, you must flip the AC circuit breaker to the OFF position. (See [Figure 2-6 on page 15](#) for AC circuit breaker location.)

Material, Canisters, and Liquefier Tips

Loading Material to the Liquefier Tips



Caution: Any time the printer's material type is changed, tips must also be changed. The following information does not contain steps for changing the printer's tips. Any time you are changing material type and tips you must follow the steps within "[Changing Tips or Material Type](#)" on [page 123](#). You cannot enter tip odometer information outside of the Tip Change Wizard.

The information within this section will walk you through the process of loading material to the liquefier tips. As you complete the required steps, be sure to observe the status information displayed on the touchscreen.



Note: Loading filament to the liquefiers can only be done when the printer is stopped (idle) and is not building.

The [Canister Installation](#) section outlines the procedure for installing a material canister which will be used to build parts on the printer. The 380mc utilizes two material canister bays - one model and one support. In order to build, one model and one support canister must be installed. It is recommended that you properly store canisters (see "[Handling/ Storing Canisters](#)" on [page 122](#)) that are not in use in order to safeguard against moisture exposure.

Once you've properly installed a canister, you will [Pre-load filament to the drive wheels](#) which places a canister's filament into position to be loaded to the liquefier tips within the head. Once filament is pre-loaded to the drive wheels, it can then be completely loaded to the liquefier tips.

1. To begin, ensure that the printer is stopped (idle) and is not building.
2. Select the **Tips** button from the Navigation Bar; a screen similar to [Figure 5-3](#) will be displayed. The information displayed represents the current configuration of your printer.

Figure 5-3: Current Configuration - Load Material

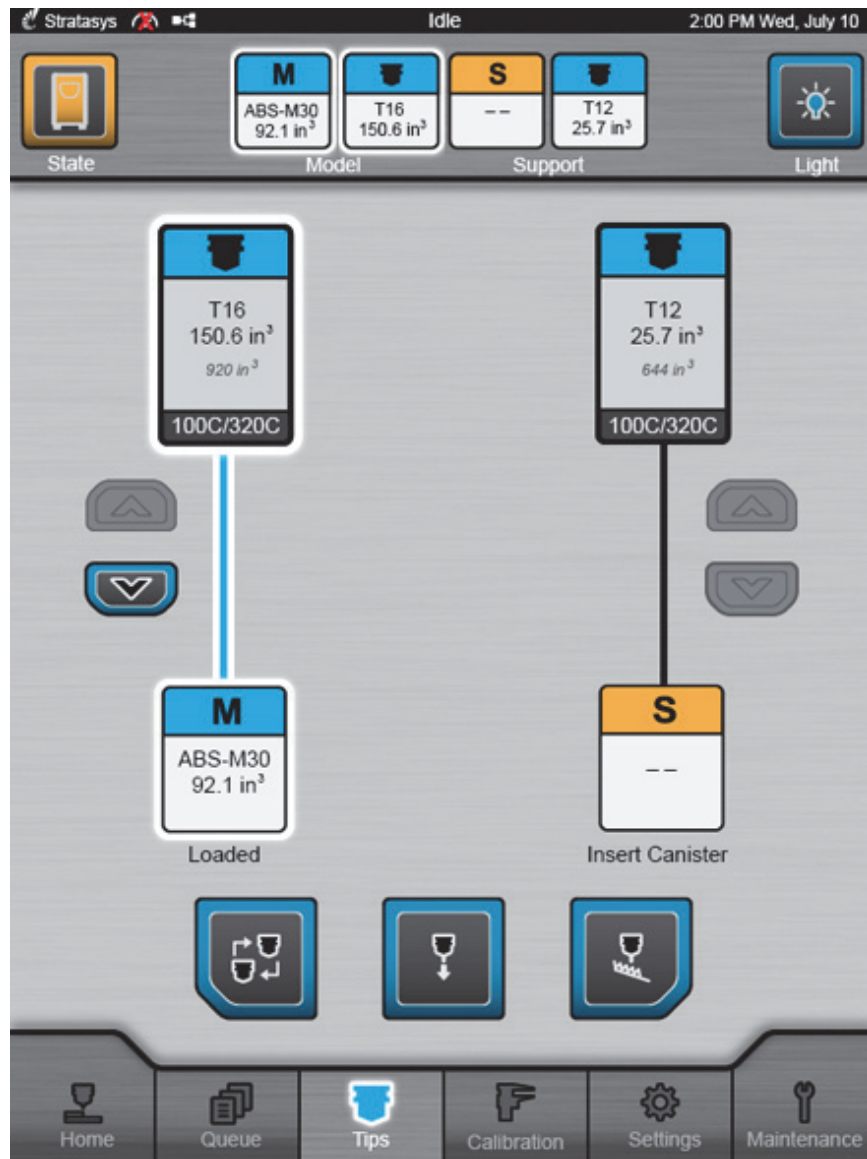

3. Observe the status information displayed below the model and support canister icons. The "Insert Canister" status indicates that a canister is not present in the material's corresponding canister bay.
4. Insert the canister you'd like to load into its appropriate canister bay. See "Canister Installation" on page 115 for detailed instructions.
5. Feed filament into the drive mechanism by pressing in and down on the canister's thumbwheel. Turn the thumbwheel until you feel the drive motor pull the filament and the canister status LED begins to flash green. See "Pre-load filament to the drive wheels" on page 117 for detailed instructions.
 - Filament needs to be advanced approximately 2 inches (50.8 mm) to reach the drive motor drive wheels.

6. The printer automatically completes the process of pre-loading filament.
 - The drive motor advances filament until it contacts the filament present sensor. Once filament is detected, the drive motor stops and the canister status LED begins to flash green.
 - A status of "Advance Filament" is displayed until filament is detected by the filament present sensor. Once filament is detected, status is updated to "Not Loaded".



Caution: Make sure that the thumbwheel door is closed after filament pre-load is accomplished.

- Close the thumbwheel door.
7. The Load Material (up arrow) button should be selectable for all materials needing to be loaded. Press the **Load Material** button corresponding to the material canister you want to load.

Figure 5-4: Load Material Button



Note: Only one material can be loaded at a time.

Model and support materials must be compatible. If a selected material is incompatible with a loaded material, a material mis-match load error will occur and the selected material will not be loaded. See [Table 3-1 on page 38](#) for material compatibility information.

8. Material begins to load to the liquefier; the canister status LED flashes green. The material's status is updated to "Loading" and the pathway displayed between the canister's material icon and the corresponding tip icon becomes highlighted to indicate load progress (see [Figure 4-28 on page 72](#)).
 - The head warms up to the material operating temperature (automatic - based on canister memory chip data). This step also sets the oven temperature to the correct value for the material being loaded. (See [Table 18 on page 147](#) for oven stabilization information.)
 - The drive motor starts to push filament to the liquefier tips.
 - For some materials, the order of these steps is reversed.
 - When filament reaches the head, it enters the liquefier tip and the tip purges a small amount of material.
9. Once material is loaded, the canister status LED is solid green and the material's status is updated to "Loaded".

If you changed material type, you must also change tips. See [“Changing Tips within the Top Cover” on page 156](#) for instructions. Otherwise, see [“Basic Job Build Tasks” on page 161](#) for information on selecting and starting a job.

Canister Installation

The process for installing a new, unopened canister varies slightly from the process for installing a previously used canister. The following instructions will guide you through the process of installing a canister, noting the steps which only apply to new (unopened) canisters. Refer to [Figure 5-5](#) for referenced item numbers.

1. For new, unopened canisters:
 - A. Remove the canister from its packing container.
 - B. Peel back the foil tape (item 1) on the side of the canister.
 - C. Remove and discard the anti-rotation plug (item 2).
 - D. Reseal the canister hole with the reusable foil tape by pressing it firmly against the canister to establish an airtight seal.
2. Open the canister bay doors. Pick up the canister by grasping the black plastic snout (item 4).
3. Rest the canister on the edge of the bay - do not push the canister fully into the bay.



Caution: Do not remove the plastic plug until you are ready to pre-load filament.

4. Remove the plastic plug (6A) on top of the snout.
5. Snap the plastic plug into the storage slot (6B).
6. For new canisters, prepare the filament (5) for loading:
 - A. Open the thumbwheel (3) door on the front of the canister.
 - B. Roll a small amount of material out of the canister by pressing in and down on the thumbwheel.
 - C. Cut the filament below its bend (using the 5" cutters supplied in the Welcome Kit) so that the filament end is flush with the top filament outlet of the snout.
 - D. Close the thumbwheel door (do not remove foam center from gasket yet).
7. Push canister all the way into the canister bay.

Figure 5-5: Canister Installation

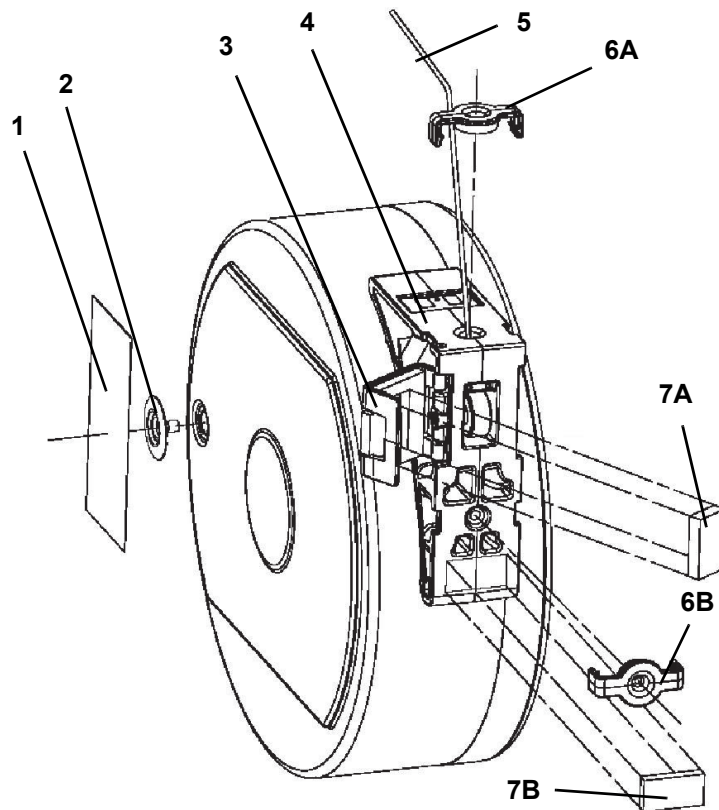

Table 5-1: Key to Figure 5-5

Item	Description	Item	Description
1	Foil Tape	6A	Plastic Plug (operating position)
2	Anti-Rotation Plug	6B	Plastic Plug (storage position)
3	Thumbwheel Door	7A	Foam Gasket (operating position)
4	Canister Snout	7B	Foam Gasket (storage position)
5	Filament		

8. Drop the canister drive down onto the canister by pulling out the canister release knob. (Figure 5-6)
 - Verify that the canister drive is aligned with the filament exit.
 - The canister status LED is OFF at this point and a canister status of "Advance Filament" will be displayed.
 - After about five seconds, the printer reads the canister's memory chip (see "Canister Memory Chip" on page 36 for details) and the canister drive motor starts turning.

The canister is now installed into its canister bay, and filament is ready to be pre-loaded to the drive wheels. If following the "Loading Material to the Liquefier Tips" procedure return to page 113 and proceed with step 5. Otherwise, proceed to "Pre-load filament to the drive wheels" on page 117.

Figure 5-6: Pre-loading Filament

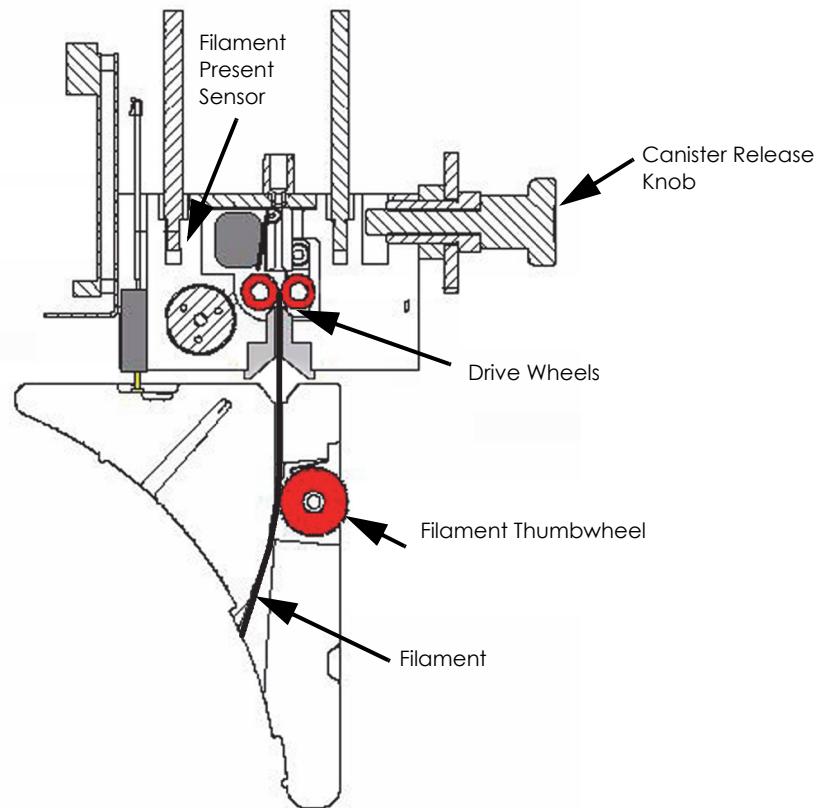

Pre-load filament to the drive wheels

Pre-loading filament to the drive wheels places a canister's filament into position to be loaded to the liquefier tips within the head. To pre-load filament to the drive wheels:

1. Open the thumbwheel door.
2. Remove the square foam gasket on the inside of the thumbwheel door (7A in Figure 5-5).
3. Stick the gasket onto the canister, placing it into its storage position (7B in Figure 5-5).
 - The square foam gasket prevents the thumbwheel from moving.
 - The gasket must only be removed when the canister is installed in the printer.
 - Reuse the gasket if the canister is to be stored.
4. Feed filament into the drive mechanism by pressing in and down on the thumbwheel. (Figure 5-6)
5. Turn the thumbwheel until you feel the drive motor pull the filament and the canister status LED begins to flash green.
 - Filament needs to be advanced approximately 2 inches (50.8 mm) to reach the drive motor drive wheels.

6. The printer automatically completes the process of pre-loading filament.
 - The drive motor advances filament until it contacts the filament present sensor. Once filament is detected, the drive motor stops and the canister status LED begins to flash green.
 - A status of "Advance Filament" is displayed until filament is detected by the filament present sensor. Once filament is detected, status is updated to "Not Loaded".



Caution: Make sure that the thumbwheel door is closed after filament pre-load is accomplished.

7. Close the thumbwheel door.

Filament is now in position to be loaded to the liquefier tips in the head. If following the “Loading Material to the Liquefier Tips” procedure return to [page 114](#) and proceed with step 6.

Unloading Material from the Liquefier Tips



Caution: Any time the printer’s material type is changed, tips must also be changed. The following information does not contain steps for changing the printer’s tips. Any time you are changing material type and tips you must follow the steps within “Changing Tips or Material Type” on [page 123](#). You cannot enter tip odometer information outside of the Tip Change Wizard.

Perform the following steps to unload material from the liquefier tips:



Note: If you are changing to a different material type or changing tips, follow the procedure outlined in “Changing Tips or Material Type” on [page 123](#).

1. Ensure that the printer is stopped (idle) and is not building.
2. Select the **Tips** button from the Navigation Bar; a screen similar to [Figure 5-7](#) will be displayed. The information displayed represents the current configuration of your printer.

Figure 5-7: Current Configuration - Unload Material

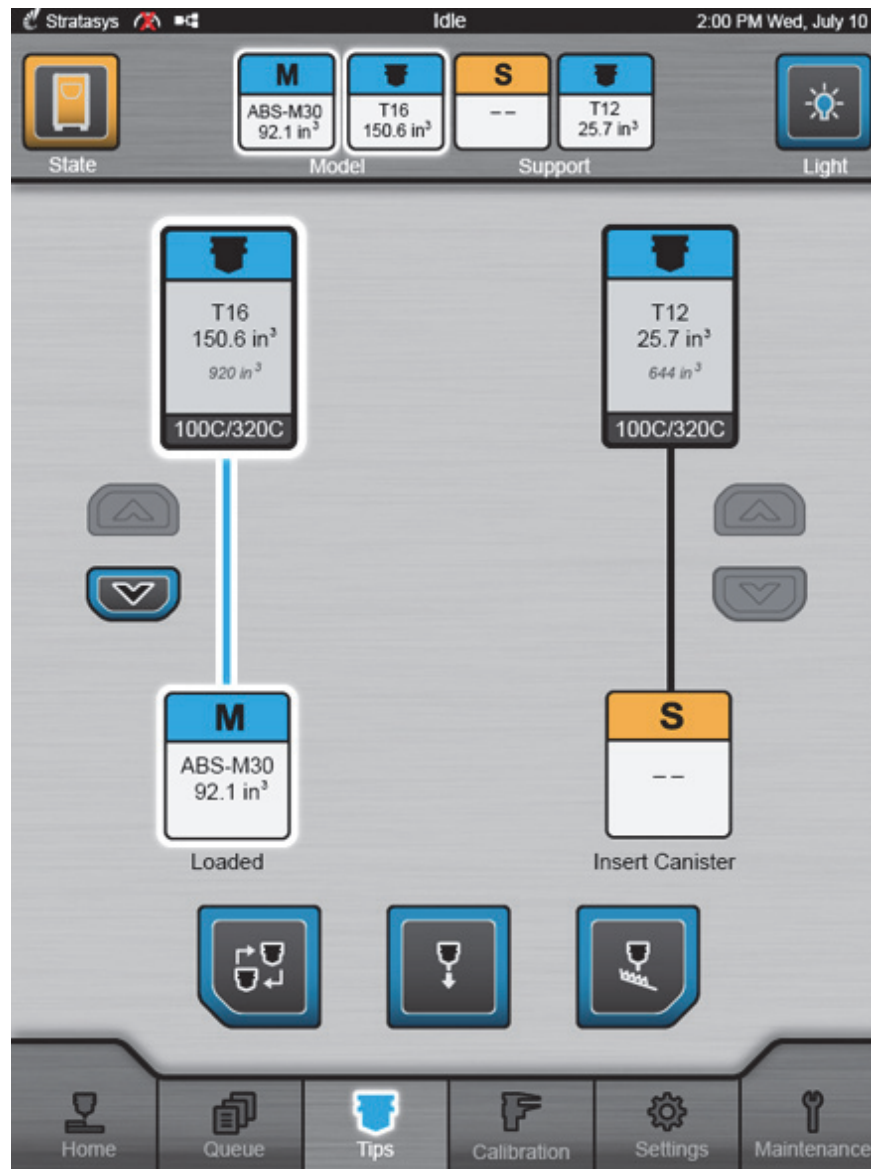

3. Observe the status information displayed below each of the model and support canister option icons. A "Loaded" status indicates currently loaded material.
4. The Unload Material (down arrow) button should be selectable for all loaded materials. Press the **Unload Material** button corresponding to the material canister you want to unload.

Figure 5-8: Unload Material Button





Note: Only one material can be unloaded at a time.

-
5. Material begins to unload from the liquefier. The material's status is updated to "Unloading" and the canister status LED rapidly flashes green. The pathway displayed between the canister's material icon and the corresponding tip icon becomes highlighted to indicate unload progress (see [Figure 4-28 on page 72](#)).



Note: The unload process will take several minutes.

-
6. Once unloaded, the material's status is updated to "Remove Canister" indicating that the canister can be removed from the canister bay. See ["Removing Canisters" on page 120](#) for detailed instructions. The canister status LED turns to a slower flashing green (same flash rate as used to indicate canister Ready condition).
 7. The canister status LED stops flashing once the unloaded canister is removed from the canister bay. The canister's Material Status Icon turns yellow and a canister load status of "Insert Canister" is displayed indicating that a canister is not present in that canister bay.
 8. Replace the canister as needed. Refer to ["Canister Installation" on page 115](#), and ["Handling/Storing Canisters" on page 122](#) for more information.

If you changed material type, you must also change tips. See ["Changing Tips within the Top Cover" on page 156](#) for instructions. Otherwise, see ["Basic Job Build Tasks" on page 161](#) for information on selecting and starting a job.

Removing Canisters

The process for removing an empty canister as opposed to a partially used canister varies slightly.

Removing an empty canister

1. Raise the canister drive off the canister by lifting the canister release knob.
2. Pull the canister out of the bay.



Note: Empty canisters have a small, unusable volume of material remaining. The leftover material allows for manufacturing tolerances.

-
3. There will be a piece of material, approximately 2 inches (50.8 mm) in length, that extends beyond the filament exit hole.
 4. Discard the empty canister as it is no longer usable.

Removing a partially used canister



Note: Refer to [Figure 5-5](#) for referenced item numbers.

1. Unload filament from the liquefiers (see “[Unloading Material from the Liquefier Tips](#)” on page 118).
 2. Once the material’s status is displayed as "Remove Canister", open the canister thumbwheel door (item 3).
 3. Re-insert the square foam gasket (item 7A) into the thumbwheel door.
 4. Close the thumbwheel door.
 5. Raise the canister drive off the canister by lifting the canister release knob.
-



Caution: IMMEDIATELY pull the canister from the bay after lifting the canister release knob. A delay may allow filament to be forced into the canister. If filament is forced into canister, cross winding is likely, making the entire canister unusable.

6. Immediately pull the canister out of the bay (within ten seconds of lifting the canister release knob).
 - When the canister release knob is raised, the drive motor runs in reverse and pulls material from the printer.
-



Caution: Discard material pulled from printer. Do not attempt to rewind material in canister. If filament is forced into canister, cross winding will most likely occur, making the entire canister unusable.

- The excess material accumulates in the empty canister bay.
 - As the end of the filament exits the filament present sensor, the drive motor stops.
7. Using the 5” cutters (included in the Welcome Kit), cut the filament flush with the top of the canister snout.
 8. Remove the plastic plug from its storage location (item 6B) and insert it into the filament outlet hole of the canister snout (item 4 & 6A).
 9. Pull remaining filament from the canister drive and discard all accumulated material in the canister bay.
-



Note: If following the “[Unloading Material from the Liquefier Tips](#)” procedure return to [page 120](#) and proceed with [step 5](#).

10. Install another canister as needed, see “[Canister Installation](#)” on page 115 for instructions.

Handling/Storing Canisters

Stratasys FDM thermoplastic materials will maintain proper product performance over an extended period of time, when handled and stored according to recommended procedures. Like other thermoplastics, the filament within canisters can absorb moisture when exposed to ambient humidity. Stratasys canisters are designed to minimize moisture exposure while unopened and opened. When a canister's filament absorbs moisture a finished part's surface quality, seam quality and overall part aesthetics can be affected. Care should be taken to ensure filament remains dry by following the steps below.



Caution: Material storage shall be in the range of 55°F to 75°F (13°C to 24°C), with relative humidity range of 20% to 50%.

Each standard canister holds 92 in³ (1510 cc) of filament material, while 2X canisters hold double that amount (184 in³ / 3015 cc). Canisters also contain desiccant material; the desiccant is designed to maintain proper moisture levels for an unopened canister. Once the desiccant is exposed to ambient air, it can become saturated and ineffective for moisture control. Proper handling of the canister after it has been opened is essential to maximizing canister life.

A removable plastic cap and a thumbwheel door provide an airtight seal to keep moisture from entering the canister while stored.



Caution: Make sure that you insert the square foam gasket under the thumbwheel door and place the plastic cap over the filament outlet hole when storing a canister. In less than one hour, in an unsealed canister, filament can absorb enough moisture to become unusable.

If a canister containing material is removed from the printer, or remains in the printer in a non-ready state (canister status LED is OFF), it should be stored as follows (refer to [Figure 5-5](#) for referenced item numbers):



Note: When the filament is in a ready or loaded state (flashing green or steady green canister status LED) and the canister door is closed, the printer's air-dryer system constantly purges moisture from the canister.

1. Open the thumbwheel door (item 3 of [Figure 5-5](#)) and insert the square foam gasket (item 7A) (stored on the canister - item 7B) into its thumbwheel door location.
2. Close the thumbwheel door - make sure that it is completely closed.
3. Remove the plastic cap from its stowed position (item 6B) and insert it into the filament outlet hole of the canister snout (item 4 & 6A).
4. Store canisters in an upright position, do not lay them flat.

Changing Tips or Material Type

The information within this section is meant to guide you through the process of changing materials and tips. The Tips page includes a Tip Change Wizard designed to streamline the process of changing the printer’s model and/or support materials and tips. The [Using the Tip Change Wizard](#) section contains a detailed example which will guide you through the process of changing material types and tips using the wizard.



Whenever the printer’s material type is changed, tips must also be changed. The Tip Change Wizard contains a step which will instruct you to change tips when necessary; [“Changing Tips within the Top Cover” on page 156](#) provides instructions for changing the printer’s tips.

After changing one or both tips and exiting the wizard, you must manually adjust tip wipe heights to ensure proper placement of the printer’s flicker/brush assemblies in relation to tips/tip shields. The final page of the wizard will prompt you to perform this adjustment.

Using the Tip Change Wizard

The following example will walk you through the process of switching from PC model (T12 tip) and PC_S support (T12 tip) material to ABS-M30 model (T16 tip) and SR-30 support (T12 tip) material, to help familiarize you with the functionality of the Tip Change Wizard. As you navigate through this example, observe the state of the icons within the Dashboard. Throughout the wizard, three buttons are displayed at the bottom of the screen in place of the Navigation Bar, which is hidden when working within the wizard. These buttons have the following functionality:

Table 5-2: Tip Change Wizard Controls

Icon	Name	Description
	Previous	When colored (selectable) - allows you to return to the previous page of the wizard. No functionality when gray (disabled).
	Stop	When colored (selectable) - allows you to stop and exit the wizard. No functionality when gray (disabled).
	Next	When colored (selectable) - allows you to proceed to the next page of the wizard. No functionality when gray (disabled).

1. To access the Tip Change Wizard, press the **Tip Change (Wizard)** button within the Tips page.
2. From the list of material options displayed, select the model material you'd like to switch to (ABS-M30 in this case). The newly selected model material will be indicated. Press the **Next** button to proceed with the wizard.



- From the list of tip options displayed, select the model tip you'd like to switch to (T16 in this case). The newly selected model tip will be indicated. Press the **Next** button to proceed with the wizard.



Note: When selecting the tip you'd like to switch to you are given a “current” (i.e. T12 (current)) and “new” (i.e. T12 (new)) option for the tip size currently installed in the printer (if applicable). If the currently installed tip is compatible with the material type you're switching to you can reuse the tip; however, you may only reuse one tip. For example, if you choose to reuse the currently installed model tip (i.e. selecting T12(current) below) you must select a new support tip in [step 5](#).



- Based on the model material you selected in [step 2](#), a list of support material options will be displayed. From the list of material options displayed, select the support material you'd like to switch to (SR-30 in this case).

In this case, only one material option is displayed (and is selected by default) as only one support material is compatible with the model material selected previously. See [“Tip Compatibility & Selection” on page 37](#) for material and support compatibility information. Press the **Next** button to proceed with the wizard.



- Based on the support material you selected in the previous step, a list of compatible support tip options will be displayed. From the list of support tip options displayed select the support tip you'd like to switch to (T12(current) in this case). Press the **Next** button to proceed with the wizard.



Note: When selecting the tip you'd like to switch to you are given a "current" (i.e. T12 (current)) and "new" (i.e. T12 (new)) option for the tip size currently installed in the printer (if applicable). If the currently installed tip is compatible with the material type you're switching to you can reuse the tip; however, you may only reuse one tip. For example, if you chose to reuse the currently installed model tip in [step 3](#) you must select a new support tip.



6. Verify that the material and tip selections displayed are correct. If you need to change your material and/or support tip selections, press the **Previous** button and make changes as needed. Ensure that a part is not on the platen and then press the **Next** button to proceed with the wizard.

A screen will be displayed briefly informing you that the platen is moving to the oven cleaning location.



Caution: Pressing the Next button will instruct the platen to move to the oven cleaning location; the platen will raise upward to the top of the oven. If a part is left on the platen it can get smashed or damaged during this process, and potentially cause damage to the printer. Always remove parts from the platen when instructed.

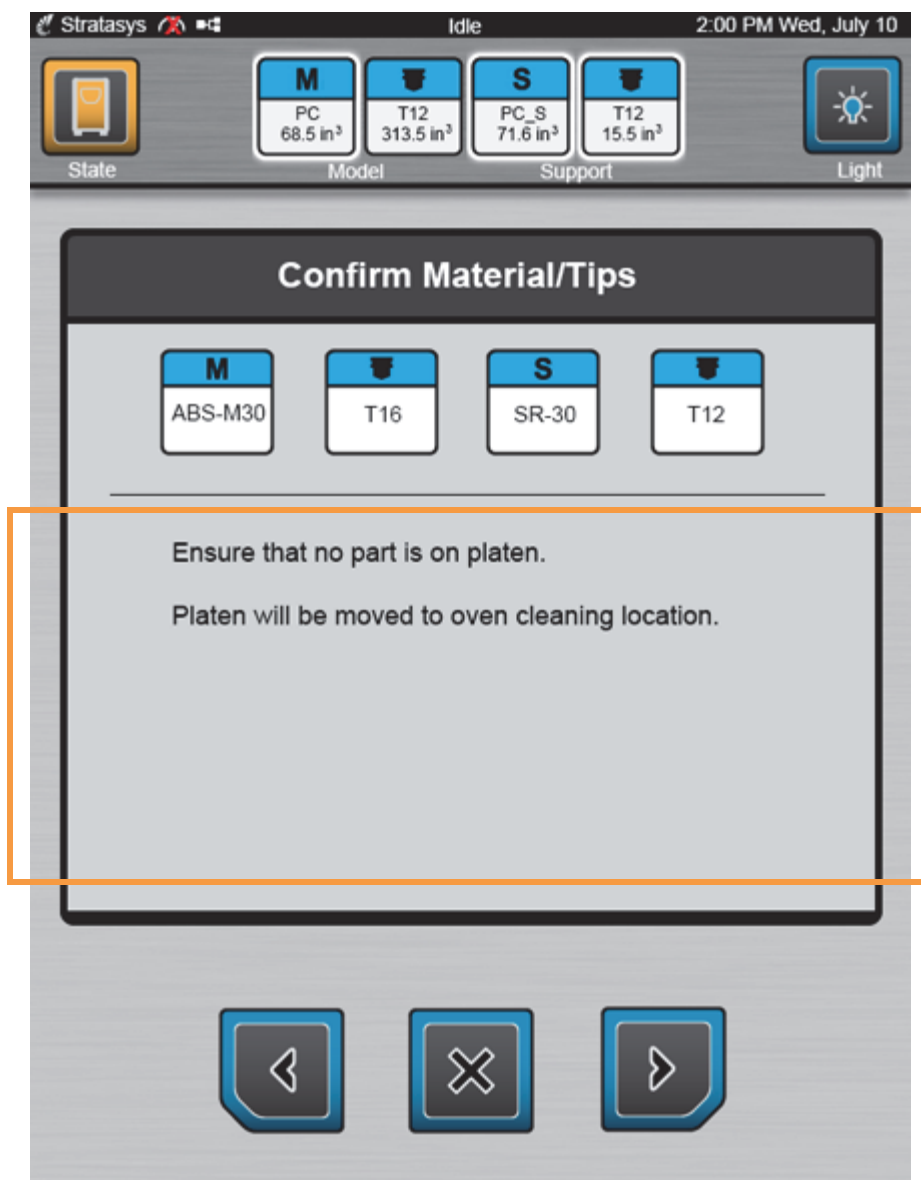

7. Once the platen moves to the oven cleaning location perform the steps displayed within the page. When finished, press the **Next** button to proceed with the wizard.



Note: Please be aware of the warning(s) indicated within the page.

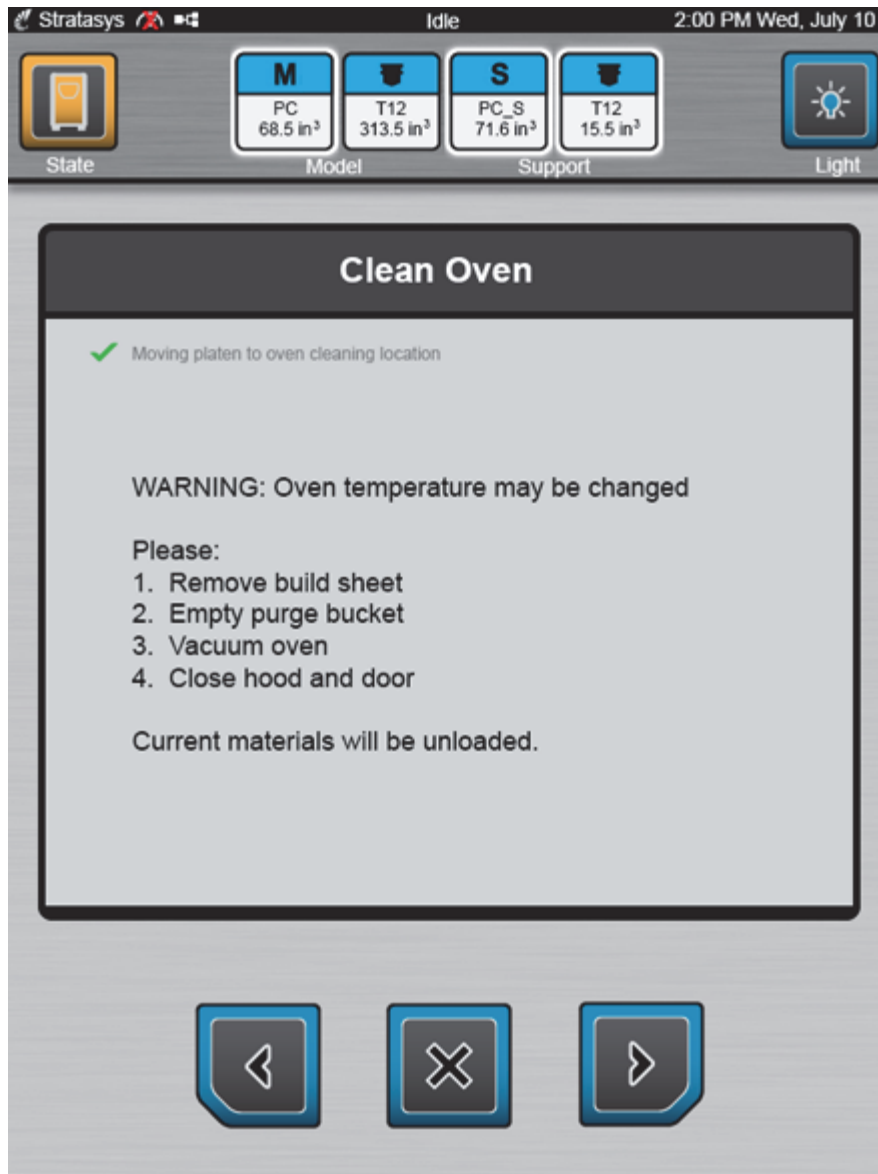

8. The model and support material currently loaded in the printer (PC and PC_S in this case) will start to unload (model material will unload first followed by support material). A two-part radial progress graphic displays the amount of time remaining until this process is complete (12 minutes in this case). Material unload percentage of completion is represented by radially filling in the outer progress ring of this graphic, in a clockwise direction.



- A. As material unload progress is made, the radial progress graphic will be updated. A green checkmark will be displayed indicating that material has been completely unloaded from the printer.



9. Once the material unload process is complete, you will be prompted to remove unloaded canisters (as appropriate). Remove unloaded canisters (see “[Removing Canisters](#)” on page 120) and then press the **Next** button to proceed with the wizard.

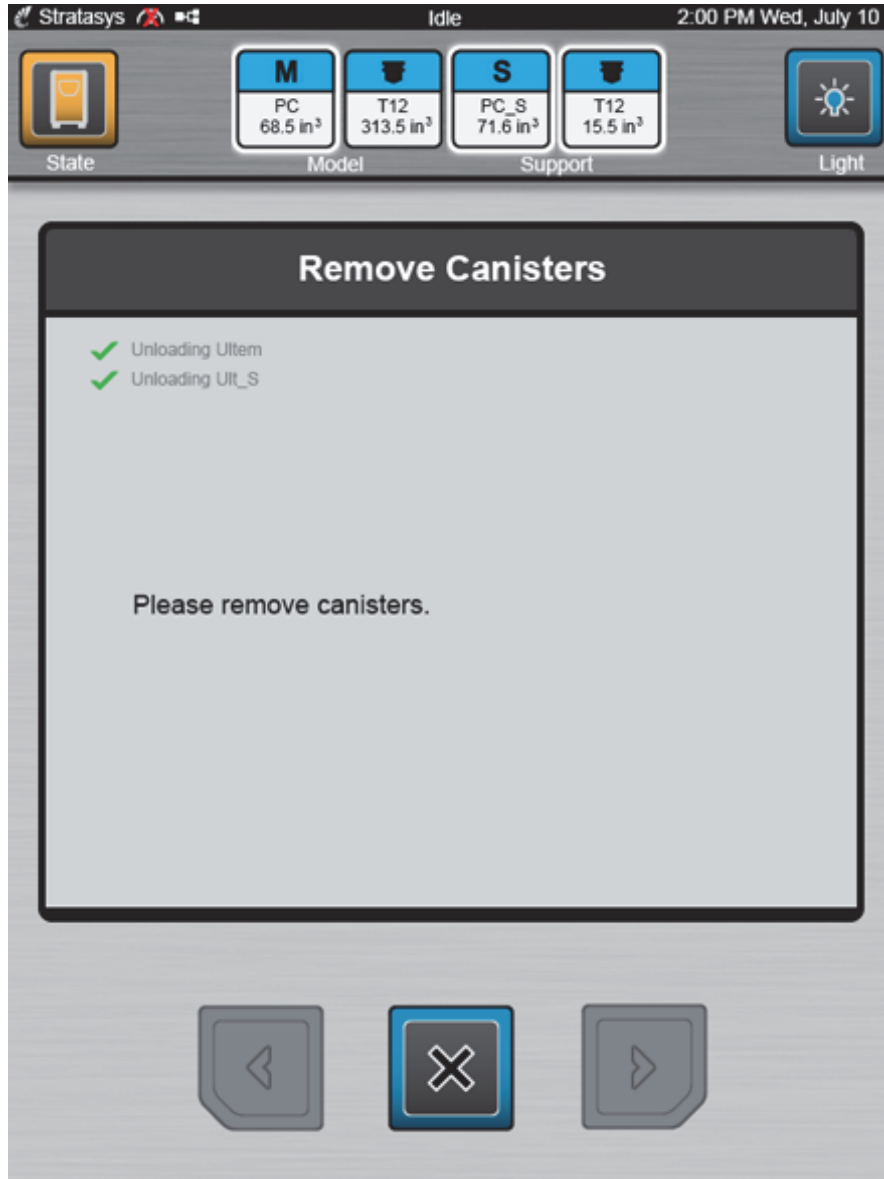



Caution: Discard material pulled from printer. Do not attempt to rewind material in canister. If filament is forced into canister, cross winding will most likely occur, making the entire canister unusable.

- A. Once canisters have been removed, the printer will clear the filament remaining within the filament tubes. Excess material accumulates in the empty canister bay; discard this material and then press the **Next** button to proceed with the wizard.



Note: The Material Status Icons for the unloaded canisters will update to reflect their now empty state.



10. Confirm that the material and tip selections displayed are correct and then press the **Next** button to proceed with the wizard.



Note: Please be aware of the warnings associated with your selections. A tip and/or material type change will require calibration. If you proceed past this page of the wizard and exit the wizard without performing an XYZ Tip Offset Calibration, your printer will not be calibrated. You will not be able to build parts until you calibrate the printer by performing an XYZ Tip Offset Calibration.

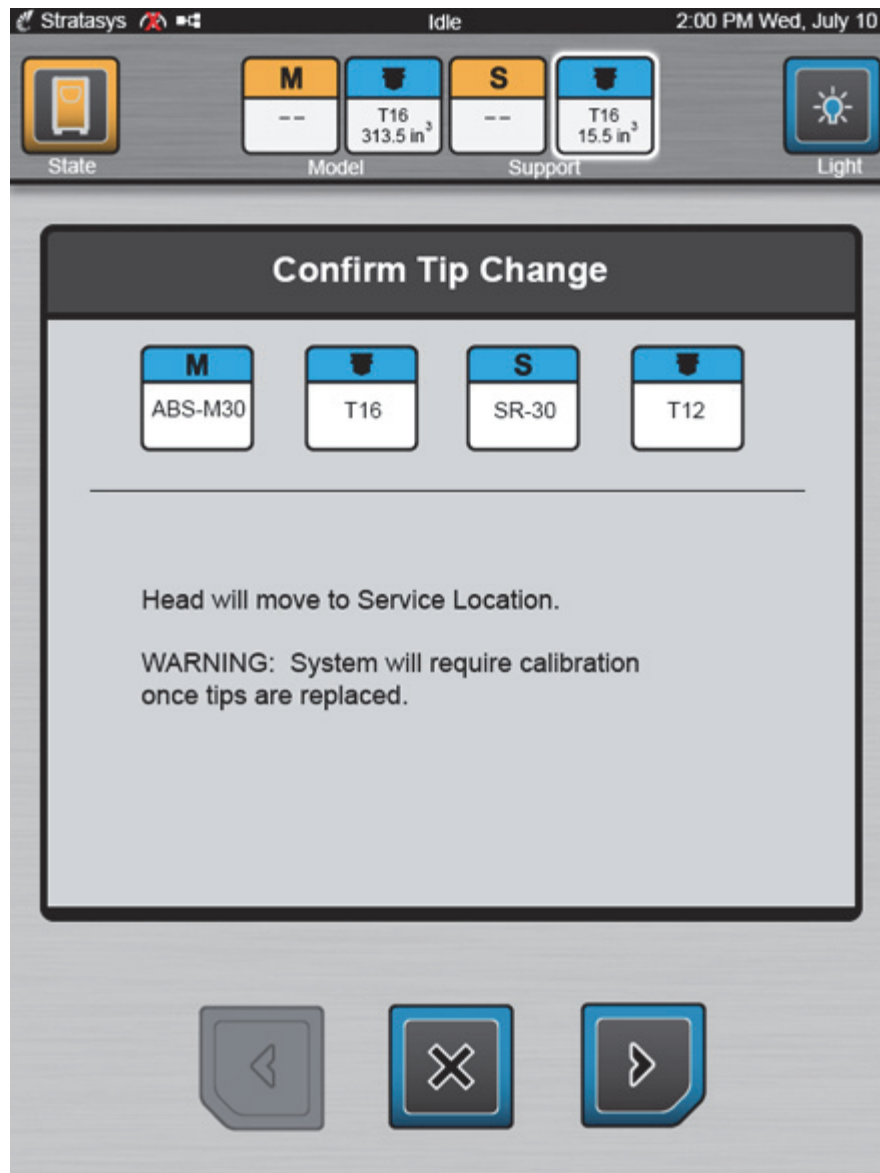

Note: If the printer's head is not currently in the Service Location, a screen will be displayed briefly informing you that the head is moving to the Service Location.

11. A screen will be displayed momentarily indicating that the printer is preparing to have its tip(s) replaced. Perform the necessary steps to replace model and/or support tips. See “[Changing Tips within the Top Cover](#)” on page 156 for detailed instructions on changing tips.

If a tip is removed that may be re-installed at a later time, be sure to record the tip’s odometer reading (item 4 in the image below) and store this reading with the removed tip. Once a new model and/or support tip is installed, press the **Next** button to proceed with the wizard.

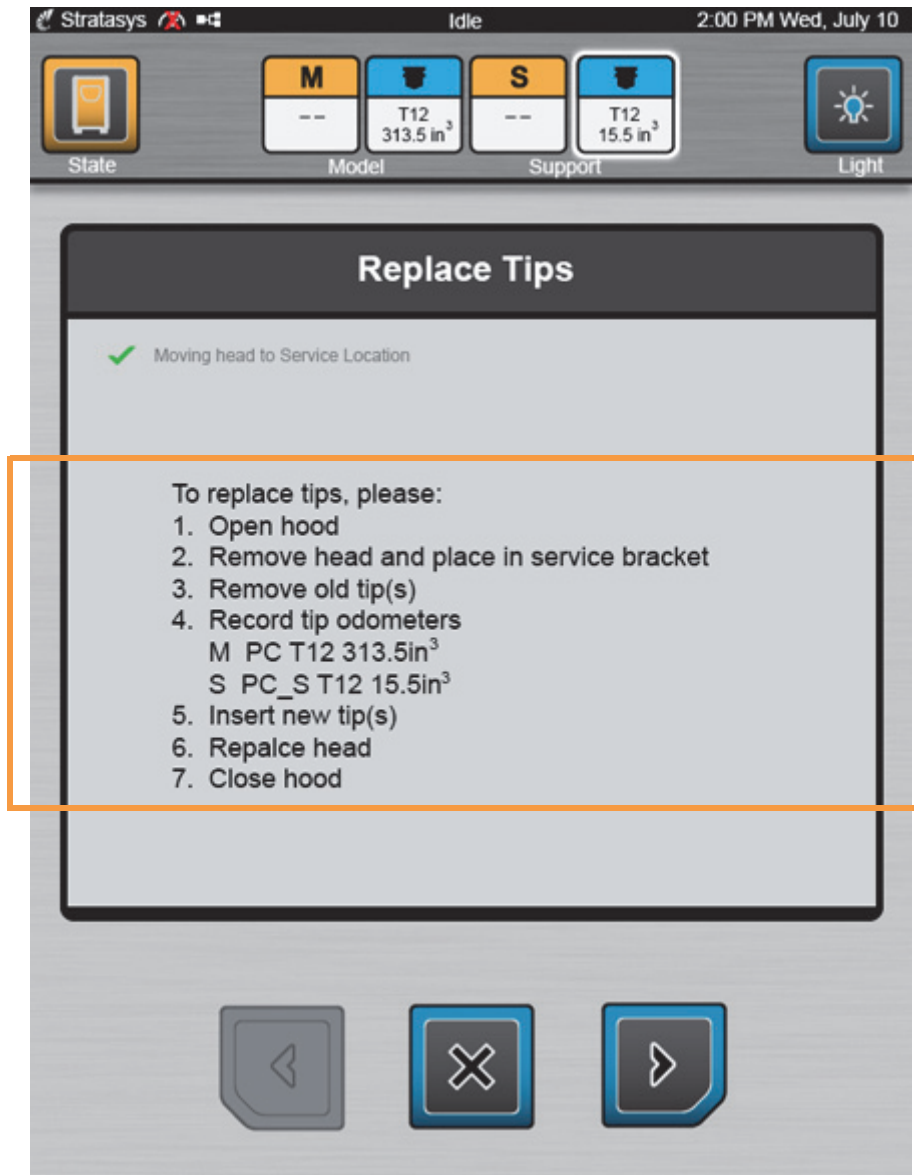

12. A default odometer value of 0.0 (in³) is automatically populated for the newly installed model and support tip; update tip odometer information as needed.
- If you are using brand new (unused) tips, no configuration is necessary. Simply accept the default values, press the **Next** button, and then proceed to [step 13](#).
 - If you are using previously used tips, follow the sub-steps listed below. For this example we are using one previously used tip (support) and one brand new tip (model). Therefore, we will update the support tip's odometer information to reflect previous usage, and accept the default odometer value for the model tip.



Note: The image below will vary depending on whether you are changing one or both tips. If you are only changing one tip, only the field for that tip's odometer will be displayed (i.e. if you're only changing the support tip, the model field will not be displayed).

- A. Press the touchscreen anywhere within the Model field. When selected, the field will turn blue.
- B. Using the keypad, enter the odometer value corresponding to your model tip; if necessary, use the delete key to erase a field's default value. For this example, we will accept the default value of 0.0 (in³).
- C. Repeat steps A. and B. as needed to update the support tip's odometer information. For this example, we will use the keypad to enter a value of 15.5 (in³) for the support tip.
- D. Confirm that the tip odometer information you entered is correct and then press the **Next** button to proceed with the wizard.

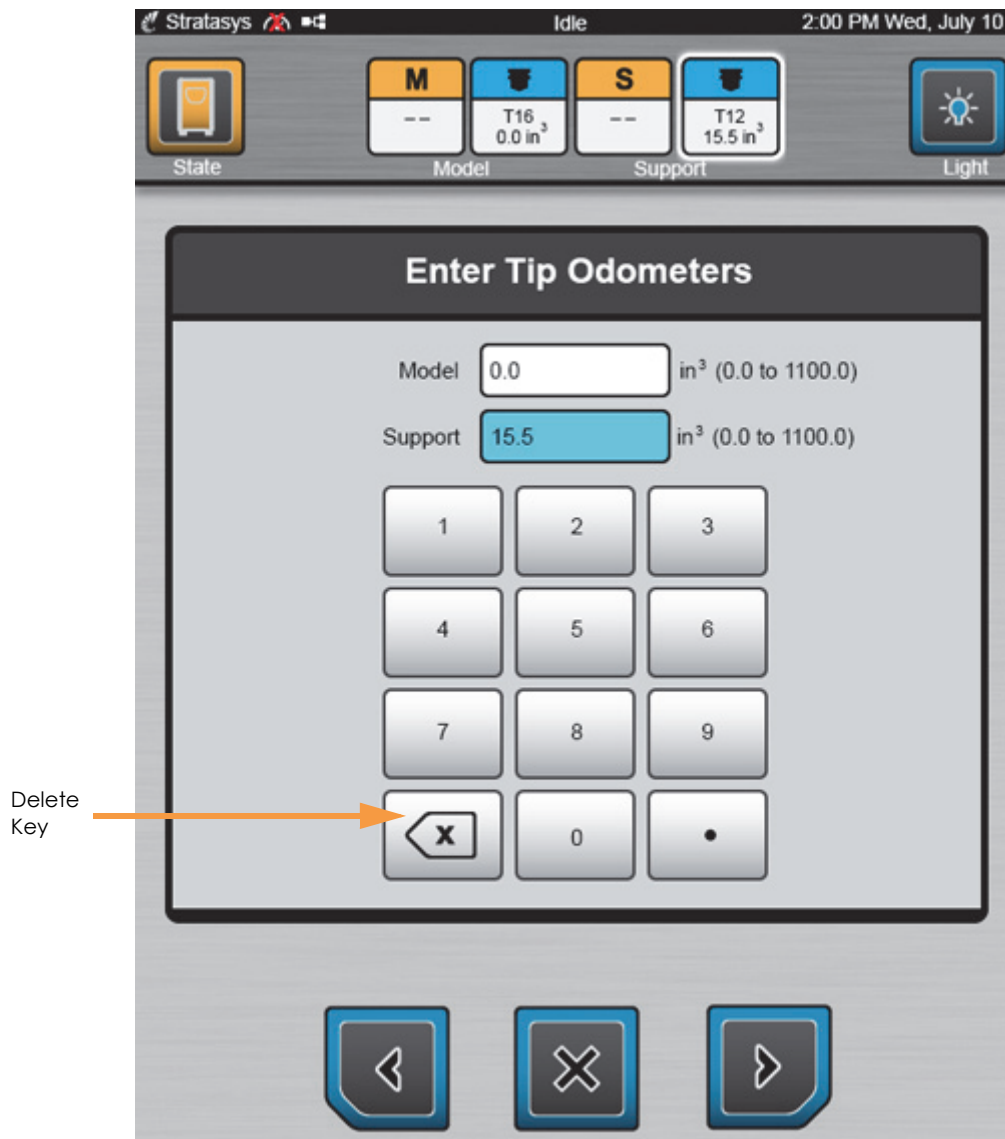

Note: Depending on the printer's current oven temperature, oven temperature may need to stabilize following this step.

13. Your materials and/or tip changes will be saved and the odometer values entered in the previous step will be displayed within the Tip Status Icons of the Dashboard.

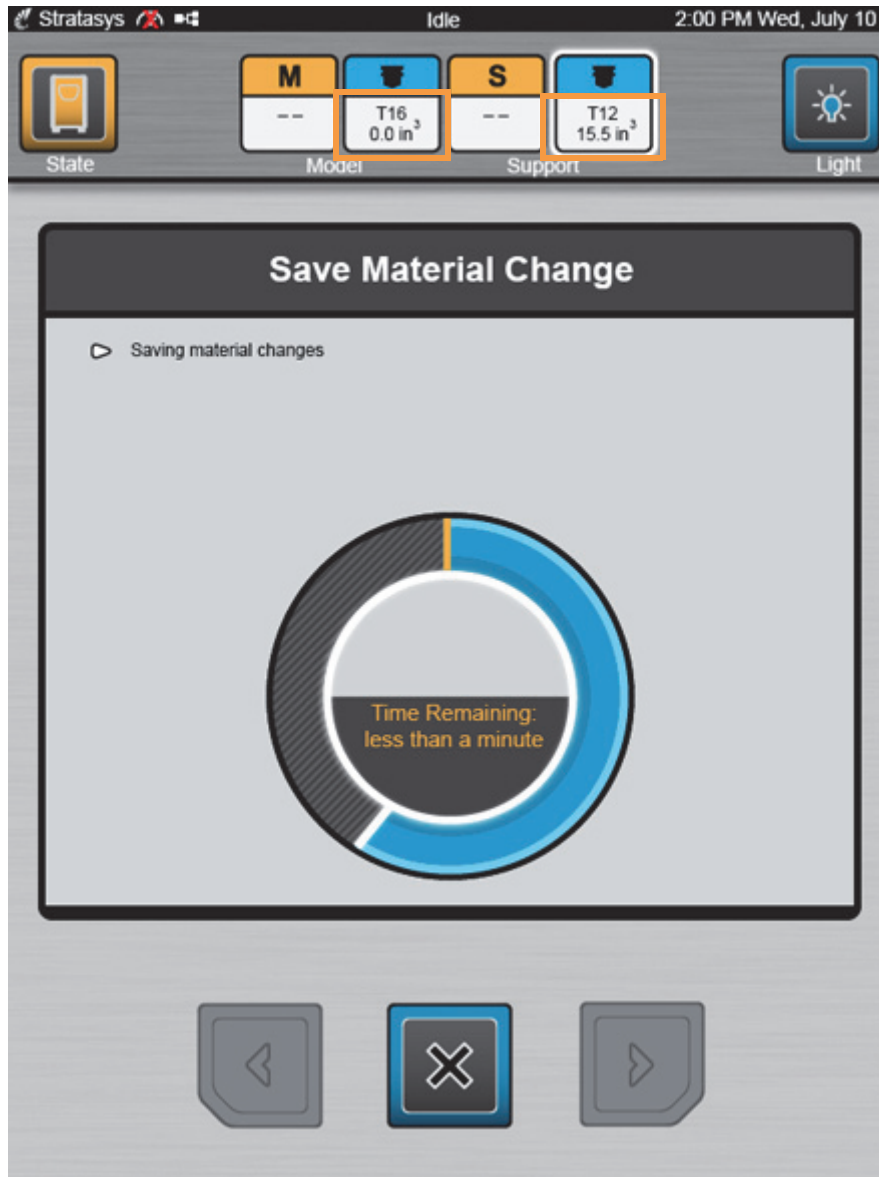

14. Perform the necessary steps to prepare for tip calibration.
- A. Install a build sheet - make sure the build sheet is as centered as possible when placed onto the platen.
 - B. Verify vacuum - within about 5 minutes the printer should attain sufficient vacuum to secure the build sheet to the platen. The red X over the top of the Vacuum Status Indicator will disappear once sufficient vacuum is achieved (see “[Information Bar](#)” on page 44).
 - C. Install canisters (see “[Canister Installation](#)” on page 115) and then pre-load the canister’s filament to the drive wheels (see “[Pre-load filament to the drive wheels](#)” on page 117). About five seconds after installation the printer reads the canister’s memory chip and the canister’s information will be displayed within the Material Status Icons of the Dashboard.
 - D. Once finished, press the **Next** button to proceed with the wizard.

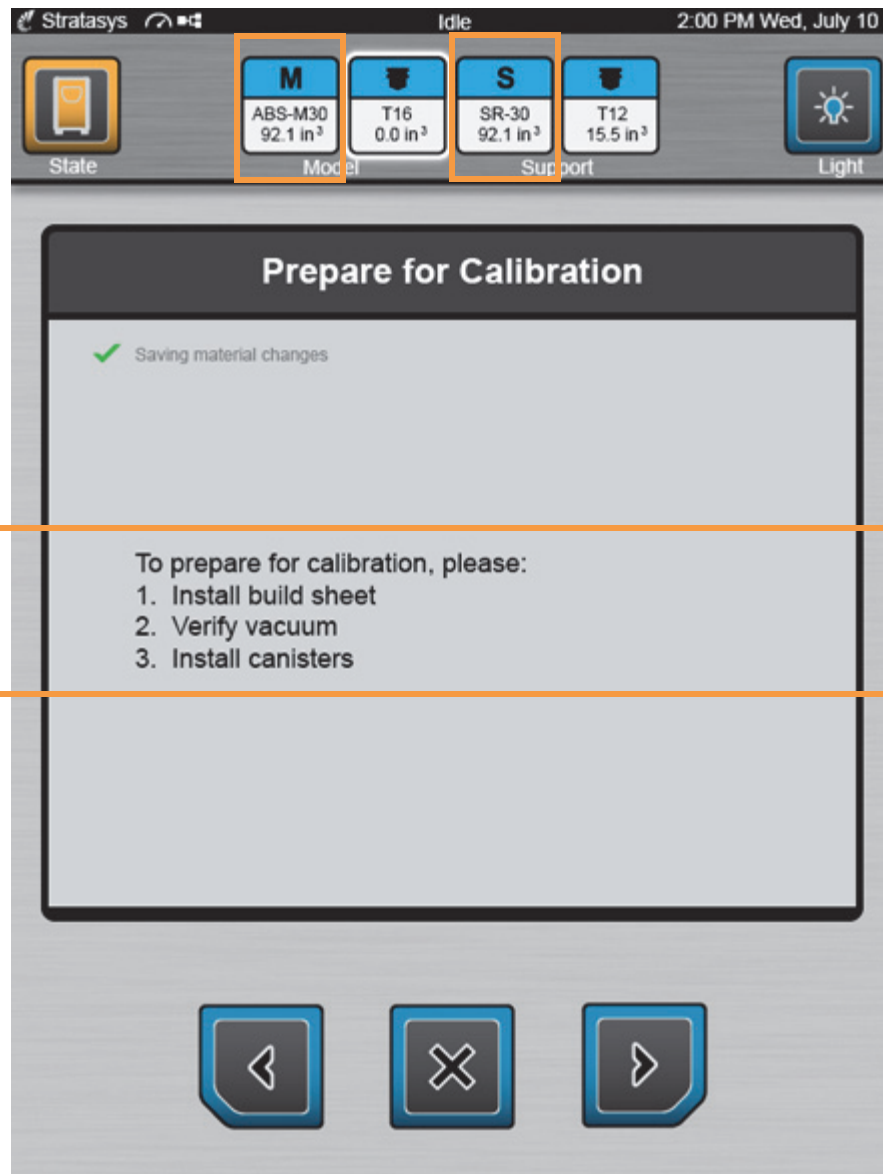

15. Select the model and support canisters to be loaded during the calibration sequence by pressing the corresponding row on the touchscreen (if they are not already selected by default). When selected, the row will be blue. Selected canisters are indicated by a white outline encasing the canister's icon. Press the **Next** button to proceed with the wizard.



16. A screen will be displayed allowing you to select the calibration part's location on the build sheet prior to starting the build. The screen contains a graphic representing your printer's platen as well as a blue bounding box graphic (the imaginary box surrounding the part). Select the calibration part's build location by dragging and dropping the bounding box on the touchscreen; the bounding box cannot be placed outside the limits of the platen. Press the **Next** button to proceed with the wizard.



Note: The Select Calibration Part Location page is displayed regardless of your printer's Enable Part Placement setting configuration (see "Enable Part Placement" on page 85 for details).

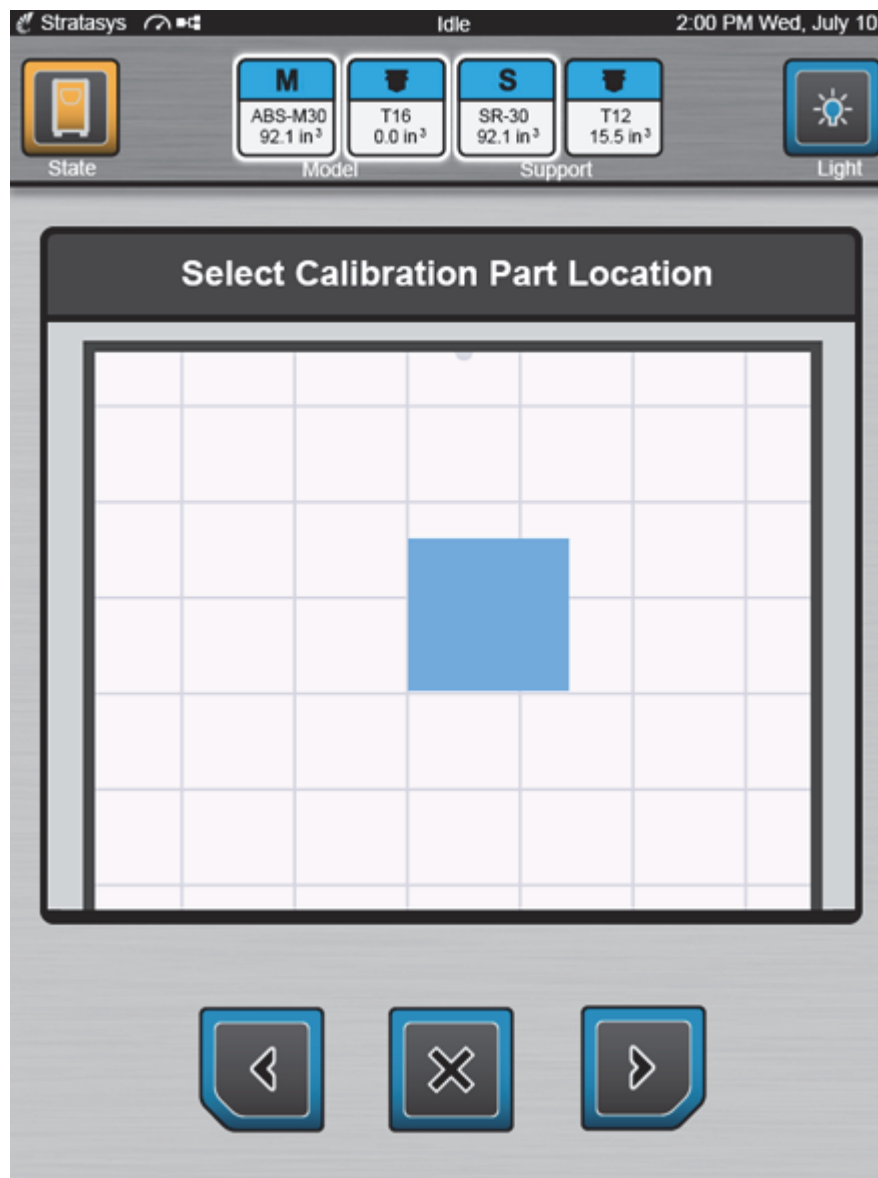

17. The printer will begin the process of building a calibration part. This process includes allowing oven temperature to stabilize (see Table 5-3 for stabilization times), performing a Z tip-to-tip calibration, loading model material, loading support material, and then building the calibration part. The status of each task is indicated on the screen. A green checkmark will be displayed once a task is completed and the page's header will update to reflect the task currently in process.

A two-part radial progress graphic is displayed within the center of the page. This graphic displays the amount of time remaining until the entire process is complete (18 minutes in this case). Completion percentage is represented by radially filling in the outer progress ring of this graphic, in a clockwise direction. As each task is completed, the progress graphic will be updated.

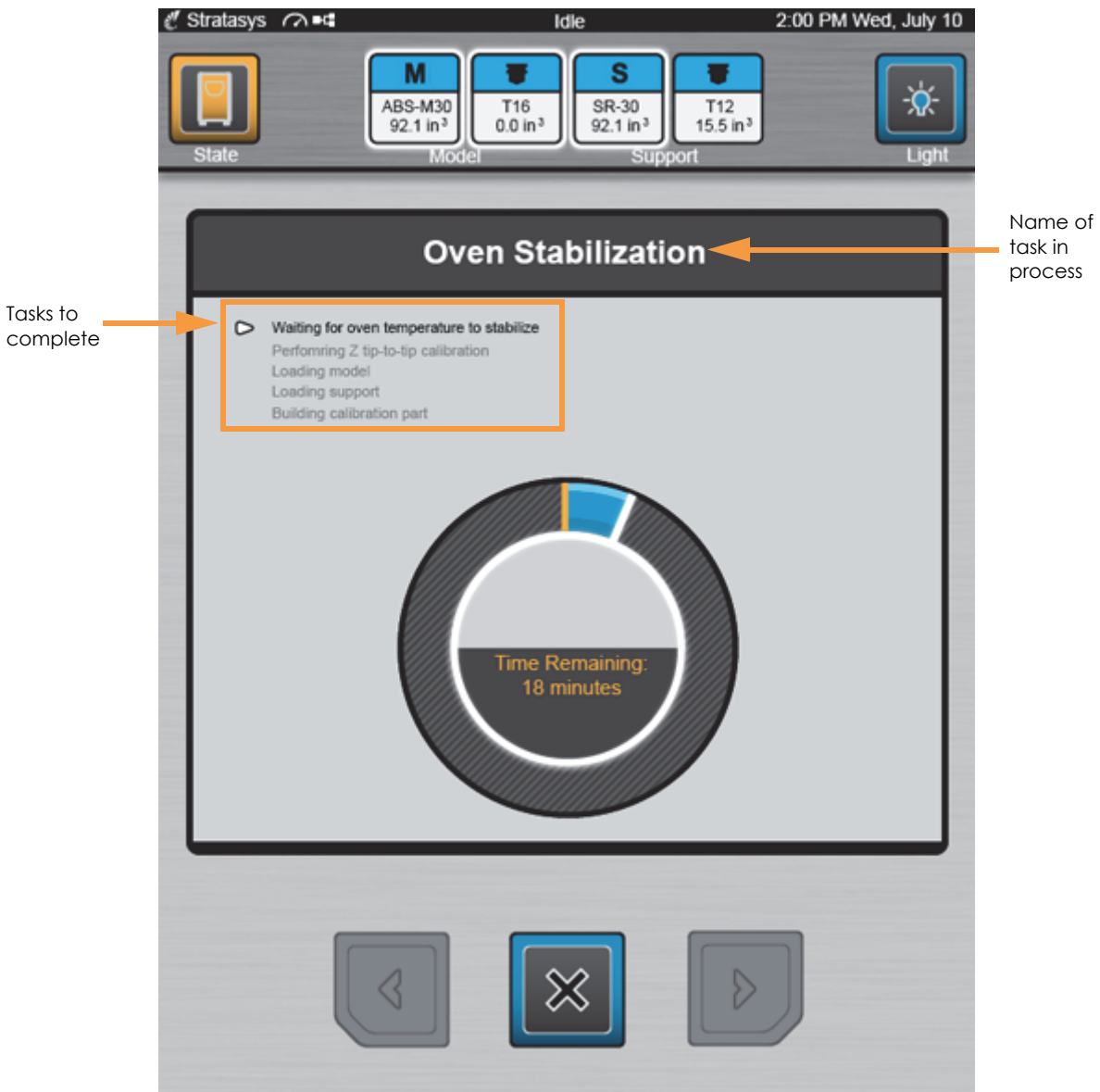
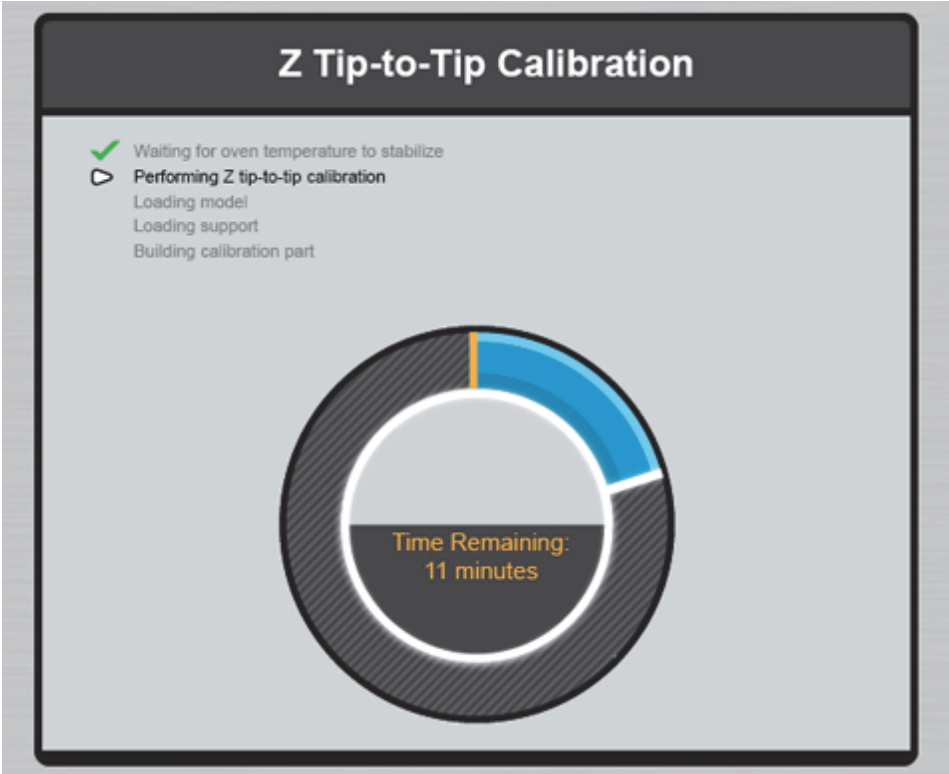

Table 5-3: Oven Stabilization Times (in hours)

Current Oven Temp.	Material Type Being Installed				
	ABS-M30 ABS-M30i	ABS-ESD7	ASA	Nylon 12	PC PC-ISO
Room temp.	2	2	2	2	3
ABS-M30, ABS-M30i Auto Cool-Down	---	---	---	---	2
ABS-ESD7	---	---	---	---	2
ASA	---	---	---	---	2
Nylon 12	---	---	---	---	2
PC/PC-ISO	2	2	2	2	---

- A. The screen will update as the printer:
- Performs a Z tip-to-tip calibration.



- Loads model material, and then loads support material.

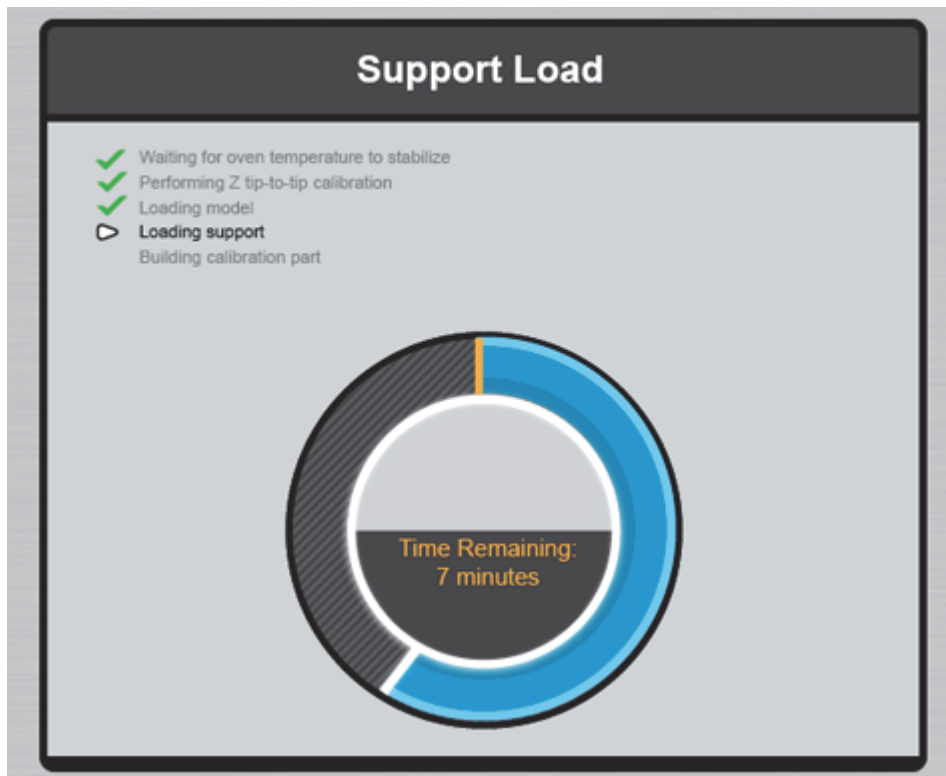
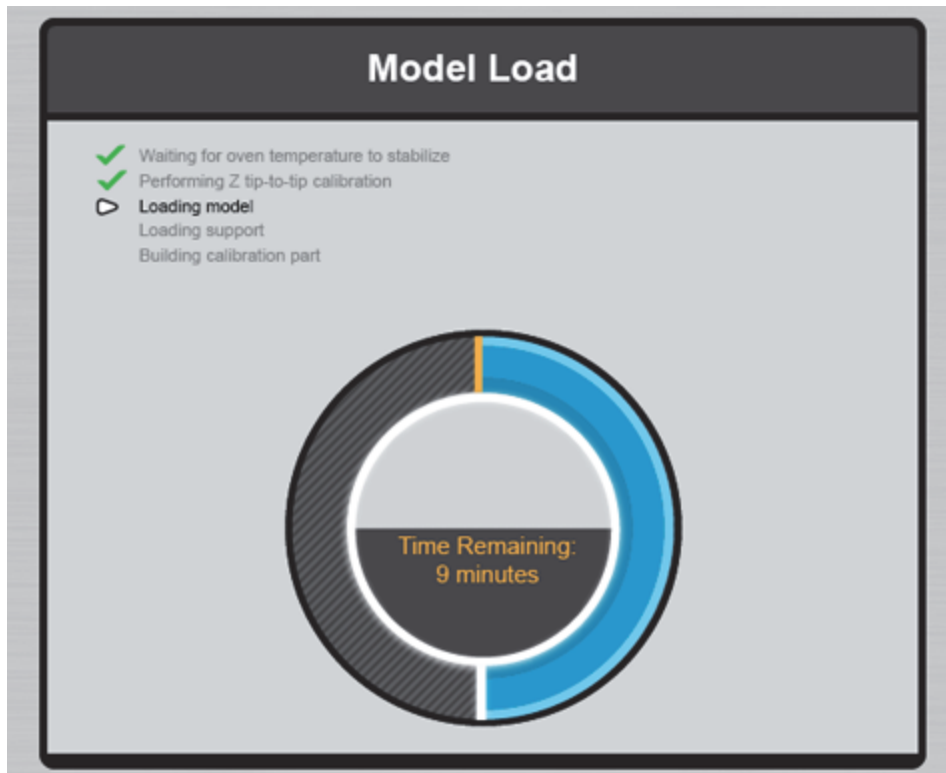

- B. In addition to the screen updating, the Information Bar and the Build State button will update to indicate when the printer is building the calibration part.



- C. Once the calibration part is complete you will be prompted to remove the part from the printer. Remove the completed part and then press the **Next** button to proceed with the wizard.

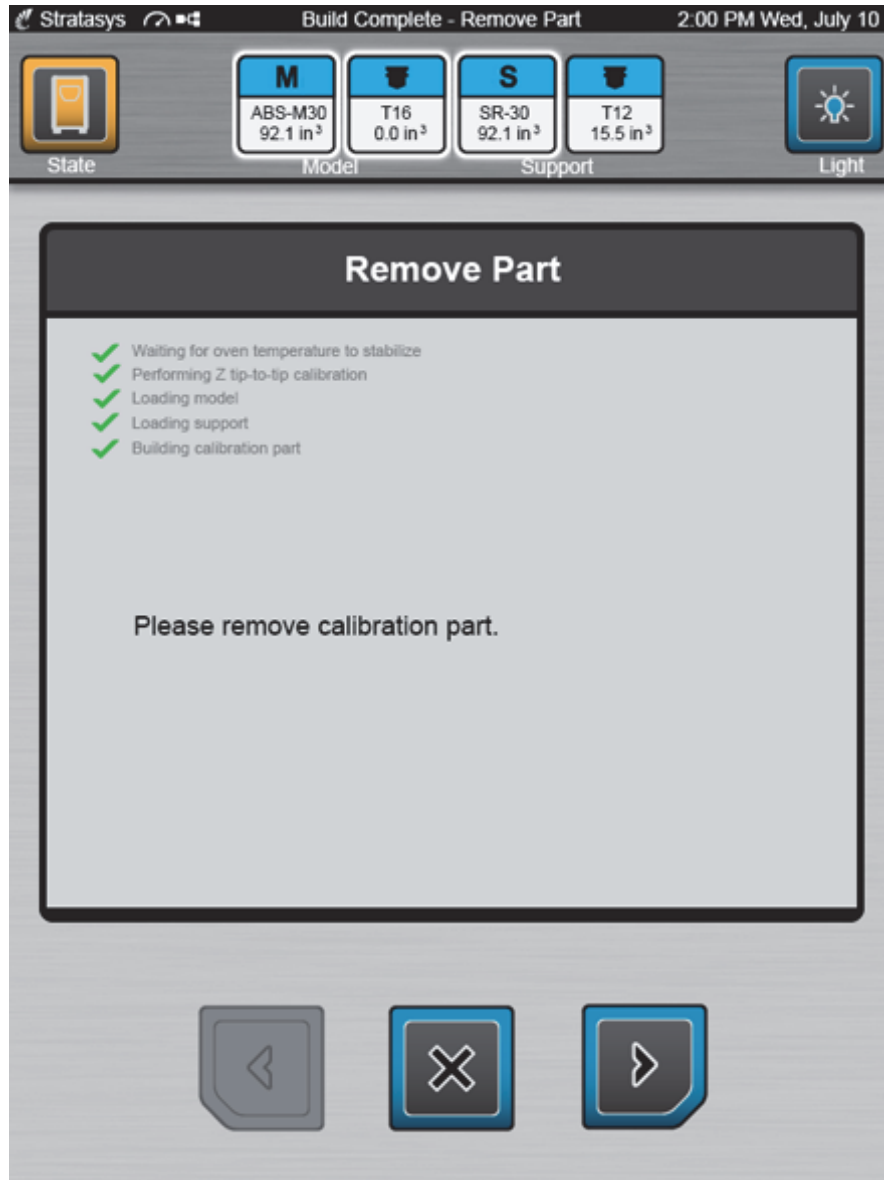

18. The Adjust XYZ Calibration page will open; this page will vary slightly depending on the type of units that the printer is configured for (see “Units” on page 86 for details). The icons and buttons within this page will allow you to make XYZ tip offset adjustments based on an analysis of the calibration part. The Material Thickness field displays the slice height for the model tip installed in the printer. The information within step 19 and step 20 will guide you through the process of analyzing the calibration part and making XYZ tip offset corrections, if needed (see “XYZ Tip Offset Calibration” on page 182 for additional information).

Adjust XYZ Calibration page - English units

Adjust XYZ Calibration page - Metric units

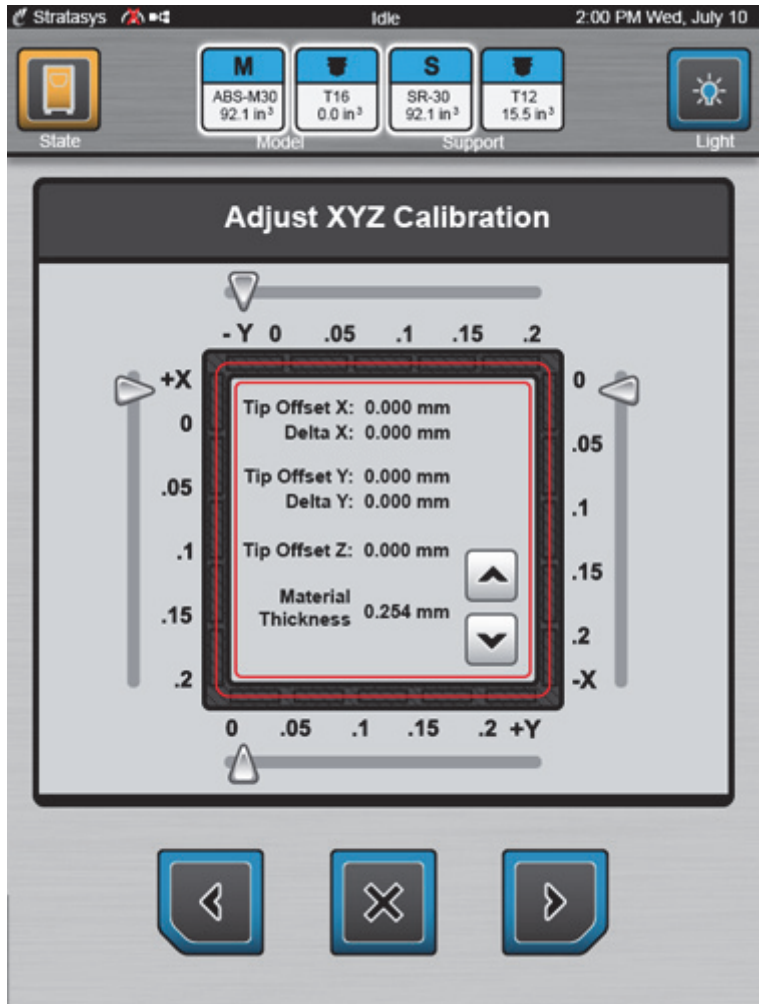
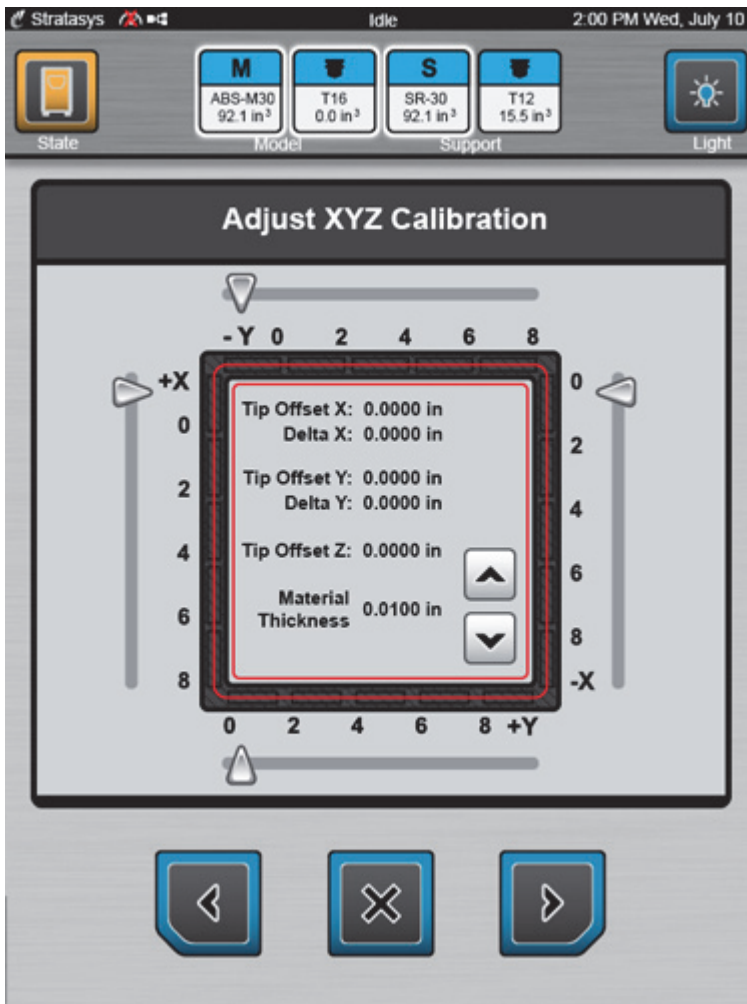

19. Determine the XY Offset Adjustment needed for your printer.
- Using a magnifier (included in the Welcome Kit), view the relationship between the support calibration toolpath and the alignment indicators to determine the X and Y axis calibration.
 - Holding the build sheet up to the light, a contrasting-colored wall, or a contrasting-colored piece of paper may make it easier to view this toolpath.

- B. Determine where on each axis the support toolpath is most centered between the X-Y alignment indicators (see Figure 5-9 and Figure 5-10 for English units, and Figure 5-11 and Figure 5-12 for Metric units). The numbers on the calibration part represent thousandths of an inch (e.g., 4 = 0.004 in. (0.1mm)).

Figure 5-9: Calibration Part - No Adjustment Needed (English units)

Magnified single side of a calibration part with a reading of 0.

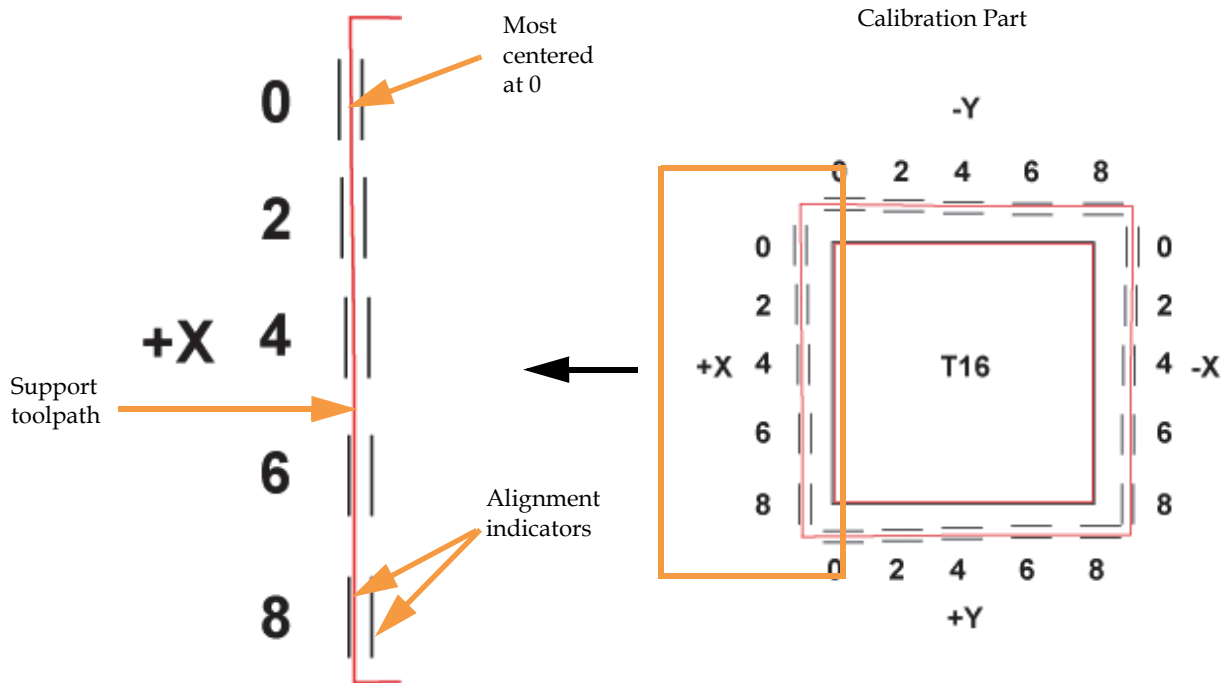

Figure 5-10: Calibration Part - Adjustment Needed (English units)

Support toolpath is most centered between the alignment indicators at the 4, indicating an adjustment of $+X = 0.004$

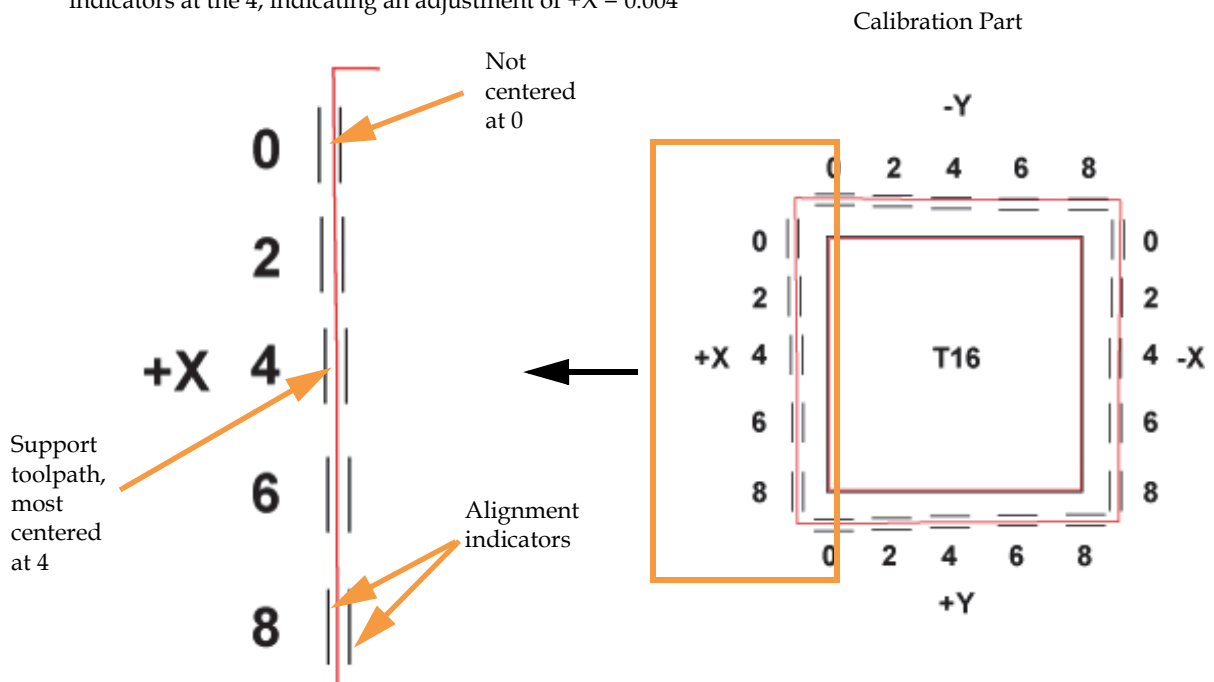

Figure 5-11: Calibration Part - No Adjustment Needed (Metric units)

Magnified single side of a calibration part with a reading of 0.

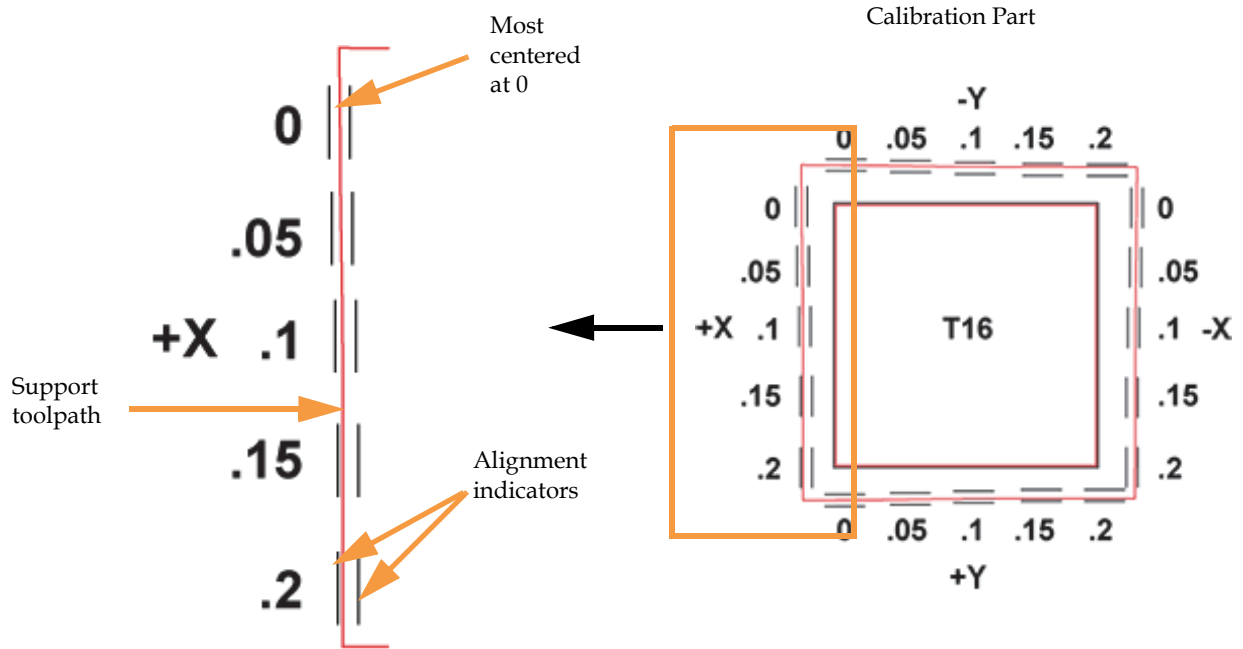
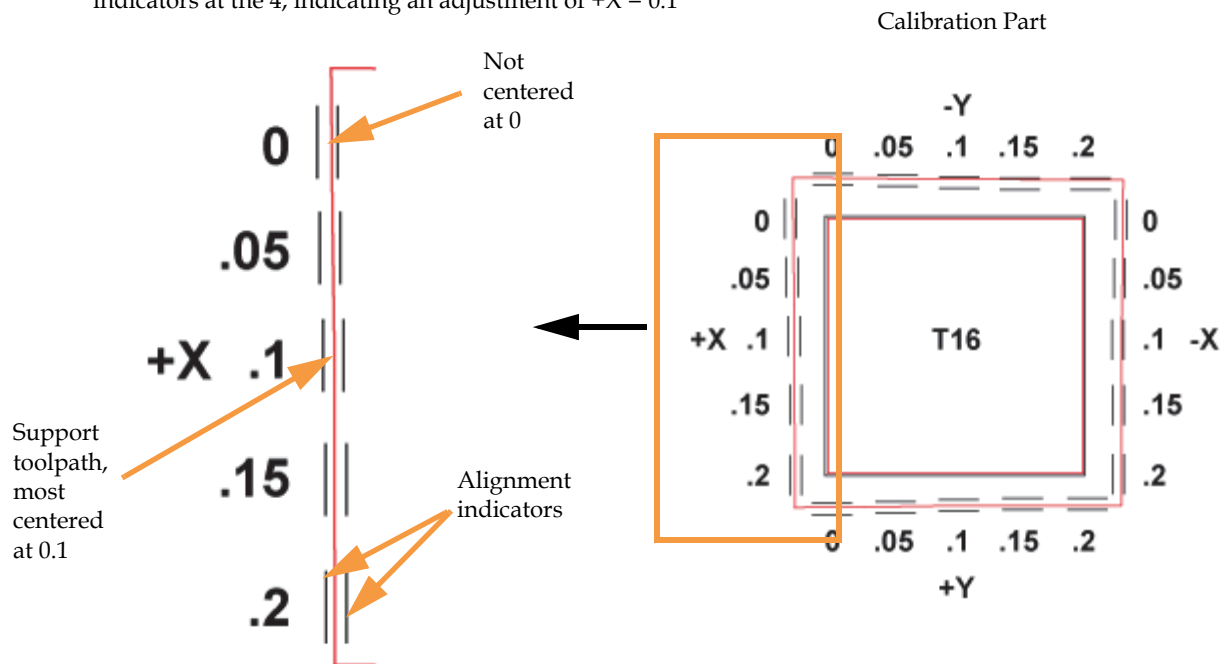

Figure 5-12: Calibration Part - Adjustment Needed (Metric units)

Support toolpath is most centered between the alignment indicators at the .1, indicating an adjustment of $+X = 0.1$



- C. Within the Adjust XYZ Calibration page, slide the scale icons on the screen to match where the support toolpath is most centered between the alignment indicators. The Delta X and Delta Y fields will reflect adjustments made.



Note: Only one offset value can be selected for each axis, (i.e., an adjustment of $+X = 2$ (0.002 in. (0.05mm)) and $-X = 4$ (-0.004 in. (0.1 mm)) is not allowed).

To be within tolerance, the X and Y values found on the calibration part must be at or under 2 or 0.002 in. (0.05 mm). Therefore any reading within the range of 0 to 2 (0 to 0.05mm) for an axis is acceptable, although a reading of 0 is preferable.

- If the support toolpath is most centered at 2 (0.05 mm) or less (as in [Figure 5-9](#) and [Figure 5-11](#)), the printer is calibrated for that axis and an adjustment is not required. The following figure shows an XY offset requiring no adjustments. If the support toolpath for your calibration part is most centered at 2 (0.05 mm) or less for both the X and Y axis, proceed to [step 20](#).

Figure 5-13: XY Offset - No Adjustment

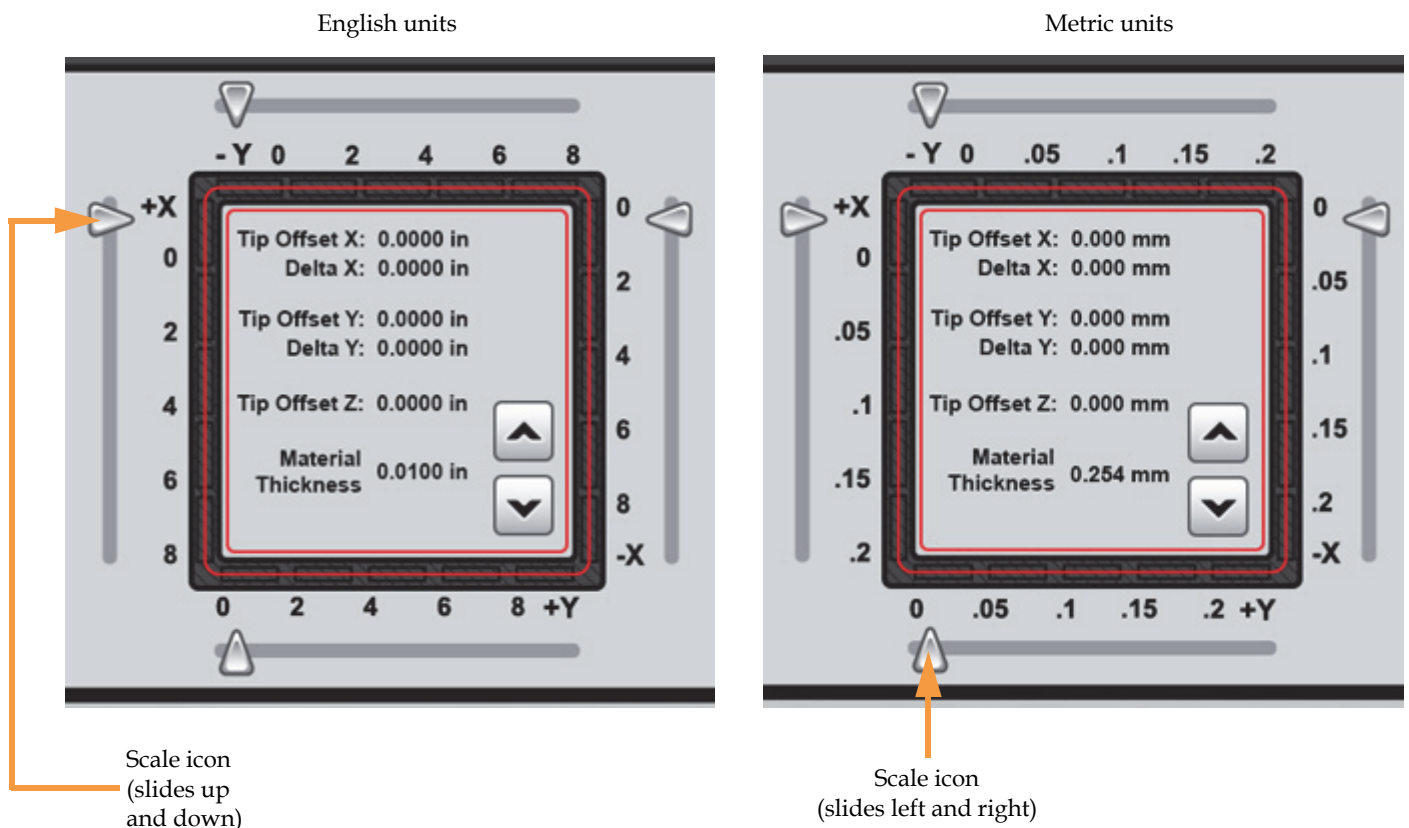

- If the support toolpath is not centered at 2 (0.05 mm) or less (as in [Figure 5-10](#) and [Figure 5-12](#)) an offset adjustment is needed. The following figure shows a +X adjustment of 4 or 0.004 in. (0.1 mm). The +X scale icon has been moved downward to the 4 (0.1) and the Delta X value reflects this adjustment (0.0040 in./ 0.100 mm).

Figure 5-14: XY Offset - +X Adjustment

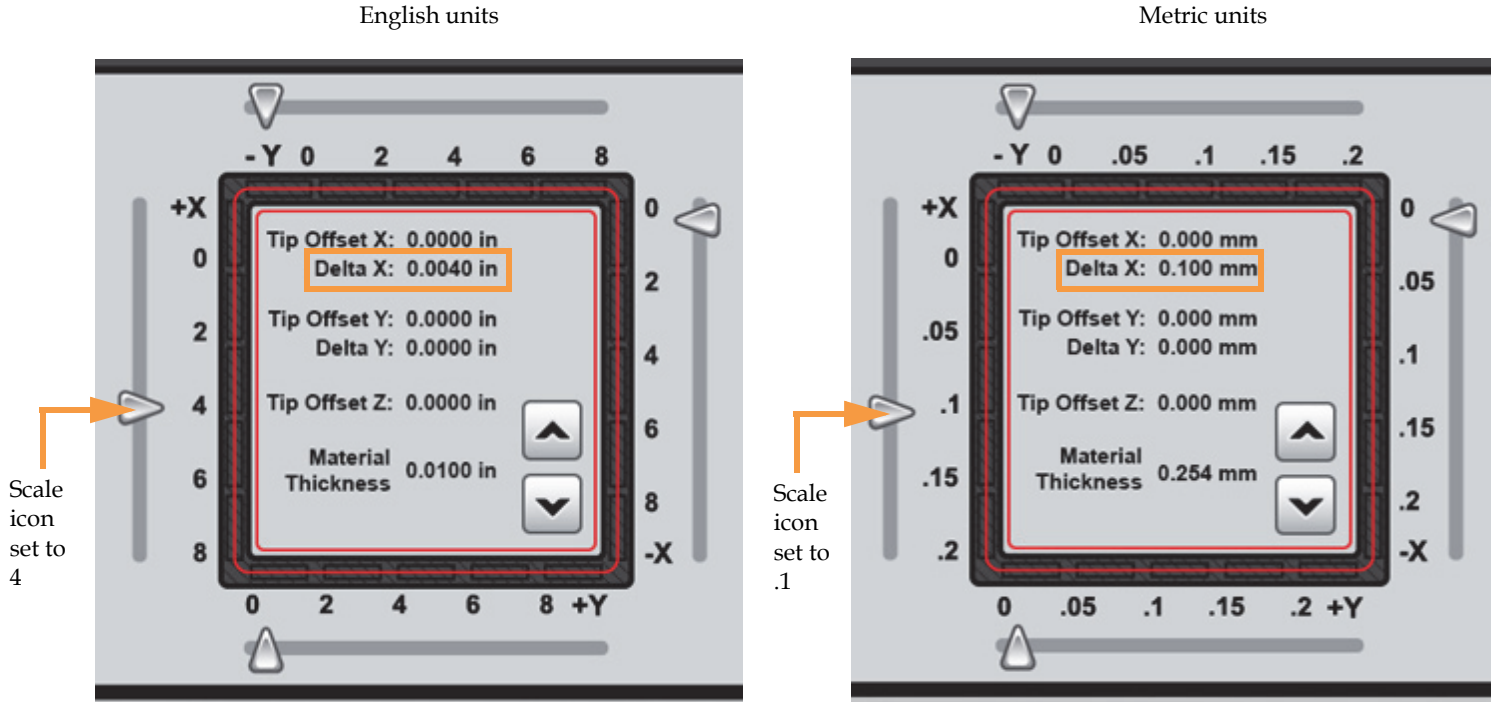

- D. If an adjustment value for either axis is required you will need to rebuild the calibration part. To do so:
- After entering your adjustment value(s), press the **Next** button within the Adjust XYZ Calibration screen.
 - The Finish Calibration screen will be displayed; press the **XYZ Tip Offset Calibration** button within this screen.

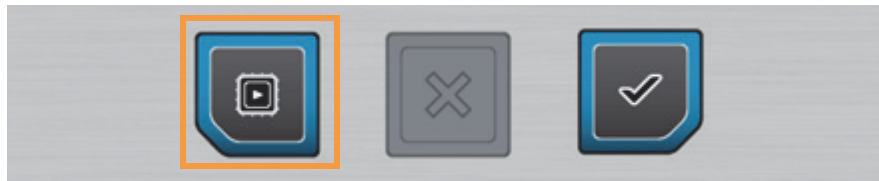

Note: Do not press the checkmark button as this will close the wizard. If you closed the wizard before properly calibrating your printer's tips, see "[XYZ Tip Offset Calibration](#)" on page 182 for instructions on completing the calibration process. You cannot build parts on the printer until the printer's tips are calibrated.

- The Prepare for Calibration screen will be displayed (see [step 14](#)). Perform the steps indicated on the screen making sure to install a build sheet, and then press the **Next** button.
- Within the Select Calibration Part Location screen (see [step 16](#)) select the calibration part's location on the build sheet and then press the **Next** button.

- The Build Calibration Part screen will be displayed (see [step 17 B.](#)) and the calibration part will begin building. A two-part radial progress graphic displays time remaining for the build as well as the build's percentage of completion. Once the calibration part is complete you will be prompted to remove the part from the printer (see [step 17 C.](#)). Remove the completed part and then press the **Next** button.
 - Repeat the instructions in [step 19.](#) Continue to check and adjust for XY offset. Readjusting until the calibration toolpath is centered at 0 for the X and Y axis is preferable. However, readjusting until the calibration toolpath for X and Y is within tolerance, which is at or under 2 or 0.002 in. (0.05 mm) for an axis, is acceptable.
- E. Proceed to the Z offset adjustment ([step 20](#)) once the calibration toolpath for X and Y is within tolerance.

20. Determine the Z Offset Adjustment.



Note: Do not measure for Z until the calibration part shows the XY offset to be at 2 (0.05 mm) for less or the X and Y axis (see [step 19](#) for details).

- Peel the support layer from the inner square of the calibration part.
- Measure the thickness of the support layer on each side of the square with a caliper or micrometer. Measure in the center of each side; measuring near the corners will result in inaccurate values.
- Take the average value of the four measurements; this is the number you will enter for the Z offset adjustment.

Figure 5-15: Remove and Measure Support Layer

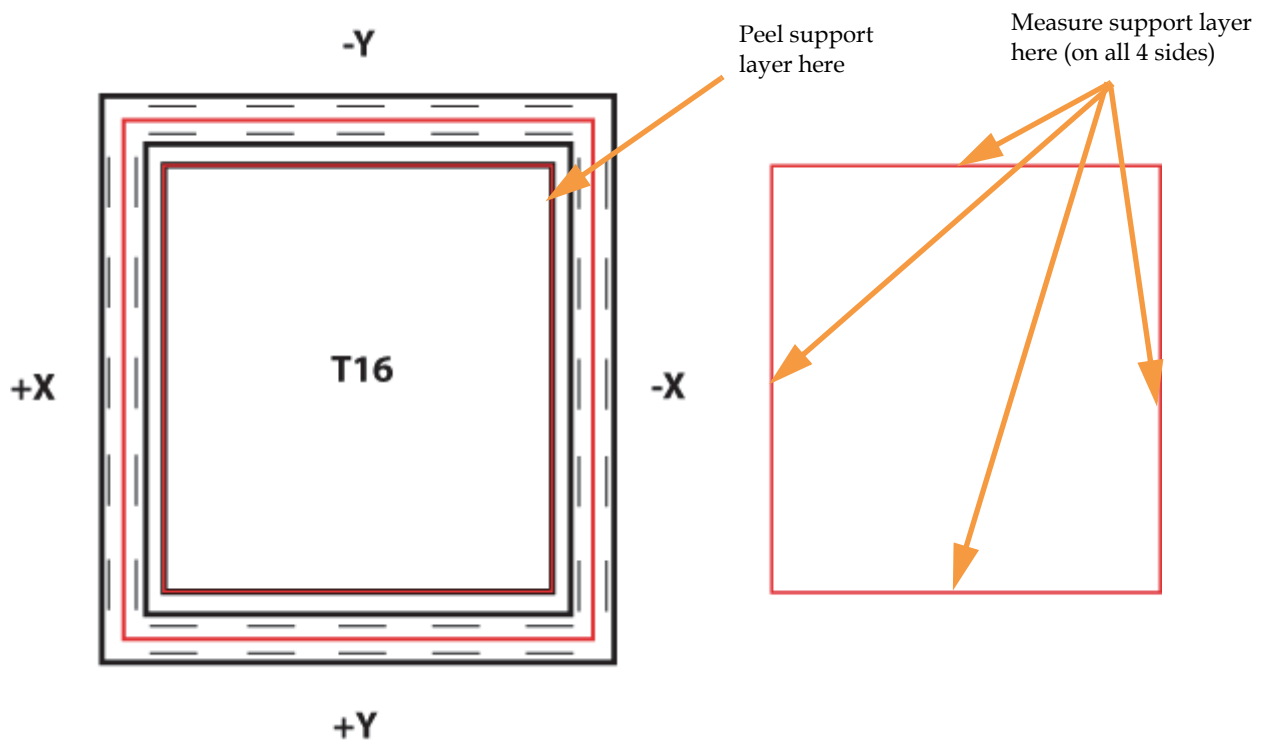

D. Refer to [Table 5-4](#) and determine the slice height for the model tip installed in your printer.

Table 5-4: Model Tip Slice Heights

Model Tip	Slice Height (in)	Slice Height (mm)
T10	0.005	0.127
T12	0.007	0.178
T16	0.010	0.254
T20	0.013	0.330

- E. If the value measured in [step C](#) is within ± 0.0005 in. (0.01 mm) of the model tip's slice height (see [Table 5-4](#)) the printer is calibrated for the Z axis and an adjustment is not required. Proceed to [step 21](#).
- F. If the value measured in [step C](#) is not within ± 0.0005 in. (0.01 mm) of the model tip's slice height (see [Table 5-4](#)), you will need to enter a Z offset adjustment using the Up and Down buttons within the Adjust XYZ Calibration page. Each button press equates to one ten thousandths of an inch.
- Use the **Down** button to enter the value obtained in [step C](#) if this value is less than the tip's slice height. For example, if you measured an average of 0.008 in. (0.203 mm) for a tip with a slice height of 0.010 in. (0.254 mm), press the Down button until 0.0080 (0.203) is displayed within the Material Thickness field.

Figure 5-16: Z Offset Adjustment

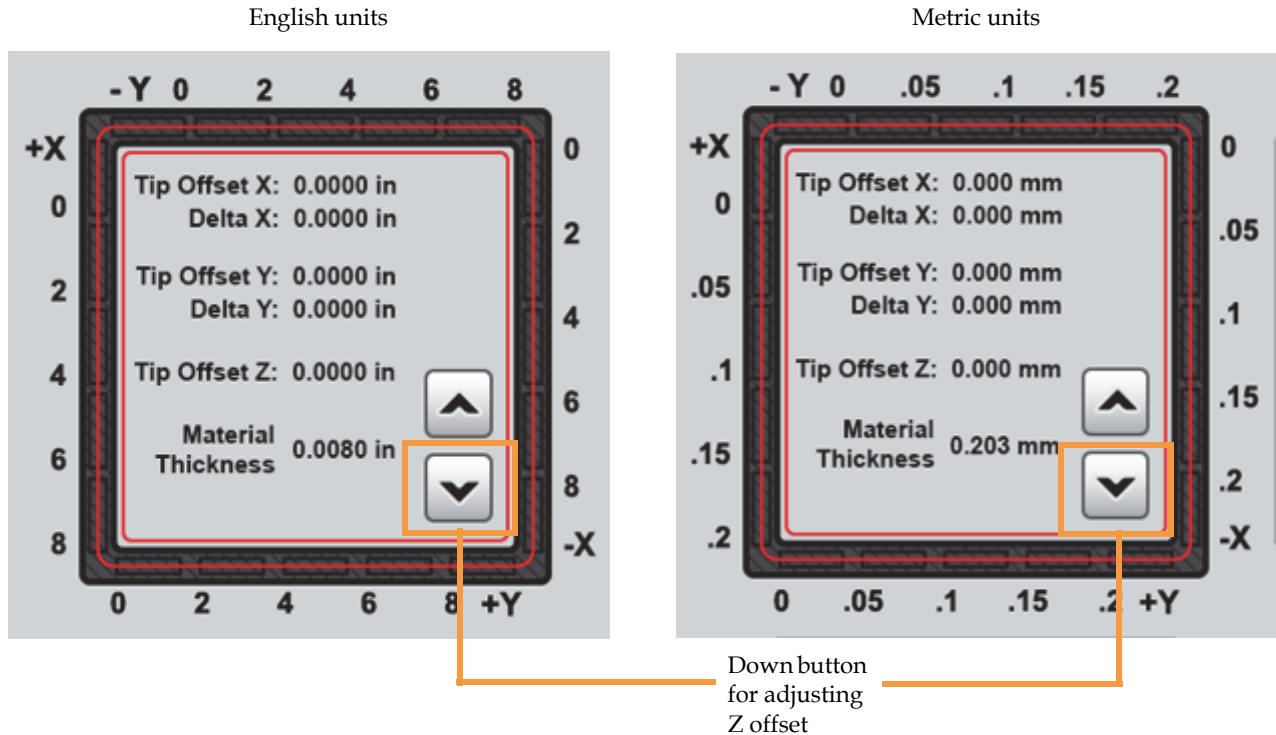

- Use the **Up** button to enter the value obtained in [step C](#) if this value is greater than the tip's slice height. For example, if you measured an average of 0.012 in. (0.305 mm) for a tip with a slice height of 0.010 in. (0.254 mm), press the Up button until 0.0120 (0.305) is displayed within the Material Thickness field.

Figure 5-17: Z Offset Adjustment

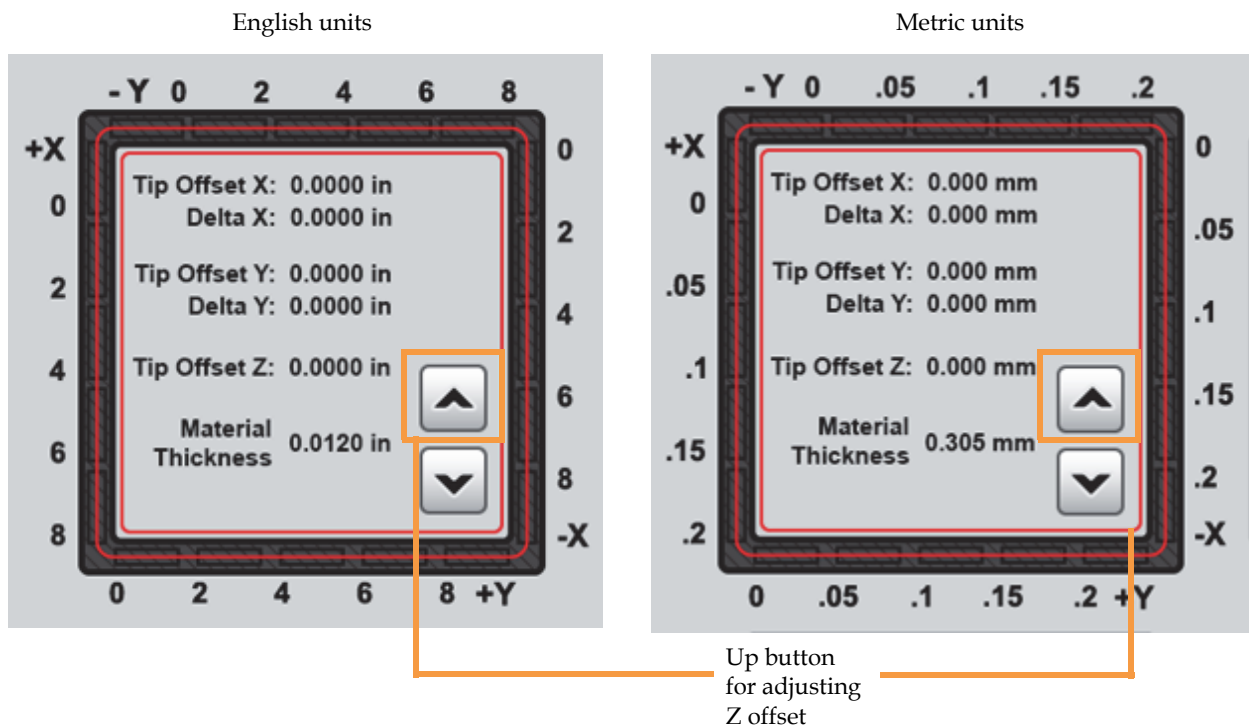

- G. If a Z offset adjustment is required you will need to rebuild the calibration part. To do so:
- After entering your adjustment value(s), press the **Next** button within the Adjust XYZ Calibration screen.
 - The Finish Calibration screen will be displayed; press the **XYZ Tip Offset Calibration** button within this screen.



Note: Do not press the checkmark button as this will close the wizard. If you closed the wizard before properly calibrating your printer's tips, see ["XYZ Tip Offset Calibration"](#) on page 182 for instructions on completing the calibration process. You cannot build parts on the printer until the printer's tips are calibrated.

- The Prepare for Calibration screen will be displayed (see [step 14](#)). Perform the steps indicated on the screen making sure to install a build sheet, and then press the **Next** button.
- Within the Select Calibration Part Location screen (see [step 16](#)) select the calibration part's location on the build sheet and then press the **Next** button.

- The Build Calibration Part screen will be displayed (see [step 17 B.](#)) and the calibration part will begin building. A two-part radial progress graphic displays time remaining for the build as well as the build's percentage of completion. Once the calibration part is complete you will be prompted to remove the part from the printer (see [step 17 C.](#)). Remove the completed part and then press the **Next** button.
 - Repeat the instructions in [step 20.](#) Continue to check and adjust for Z offset until the support layer matches the model tip slice height ± 0.0005 in. (0.01 mm).
21. Once you're finished adjusting for XYZ offsets, press the **Next** button to proceed with the wizard. Your calibration adjustment(s) will be saved.
 22. Once calibration is complete, a screen similar to the following is displayed on the touchscreen. Press the **checkmark** button to exit the wizard. Upon exiting the Tip Change Wizard, your printer's materials/tips configuration information will reflect the changes made throughout the wizard.
 23. After exiting the wizard you must immediately adjust tip wipe height, for both the model and support tip, as improper tip height can significantly impact part quality. See "[Adjusting Tip Wipe Heights](#)" on [page 159](#) for detailed instructions.

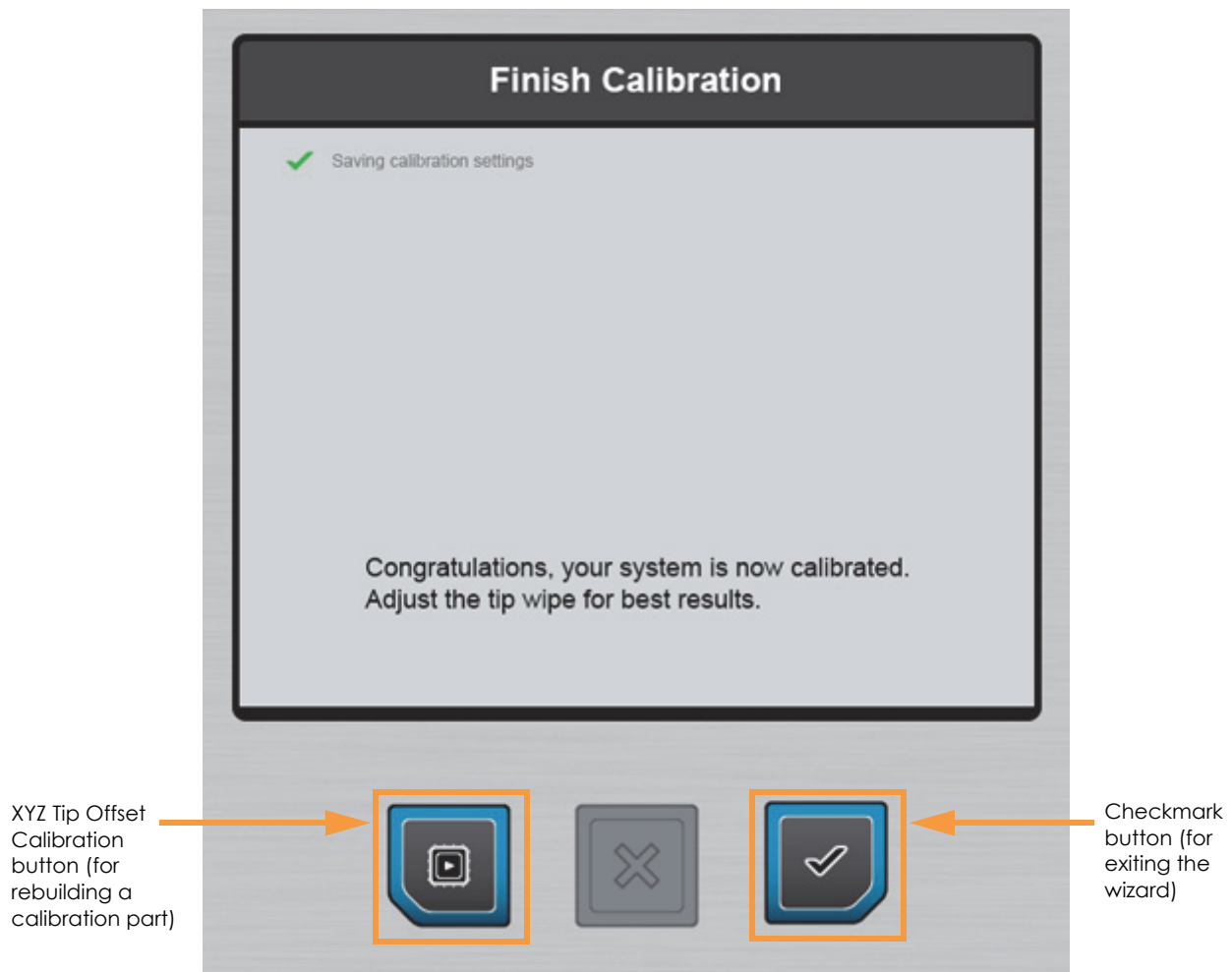

Changing Tips within the Top Cover

Any time the printer's material type is changed, tips must also be changed. If you are following the steps outlined within ["Using the Tip Change Wizard"](#), complete the steps below to change tips, and then return to [step 11 on page 135](#) and proceed with the wizard.



Warning: Always use an approved ladder or step stool when working with components under the top cover.



Gloves: Liquefier tips can be hot. You must wear safety gloves (provided in the Welcome Kit) when replacing tips.

1. Open the top cover.
2. Place the head in the head maintenance bracket. Refer to ["Head Maintenance Bracket"](#) on page 33 for instructions.

Figure 5-18: Head in Maintenance Bracket

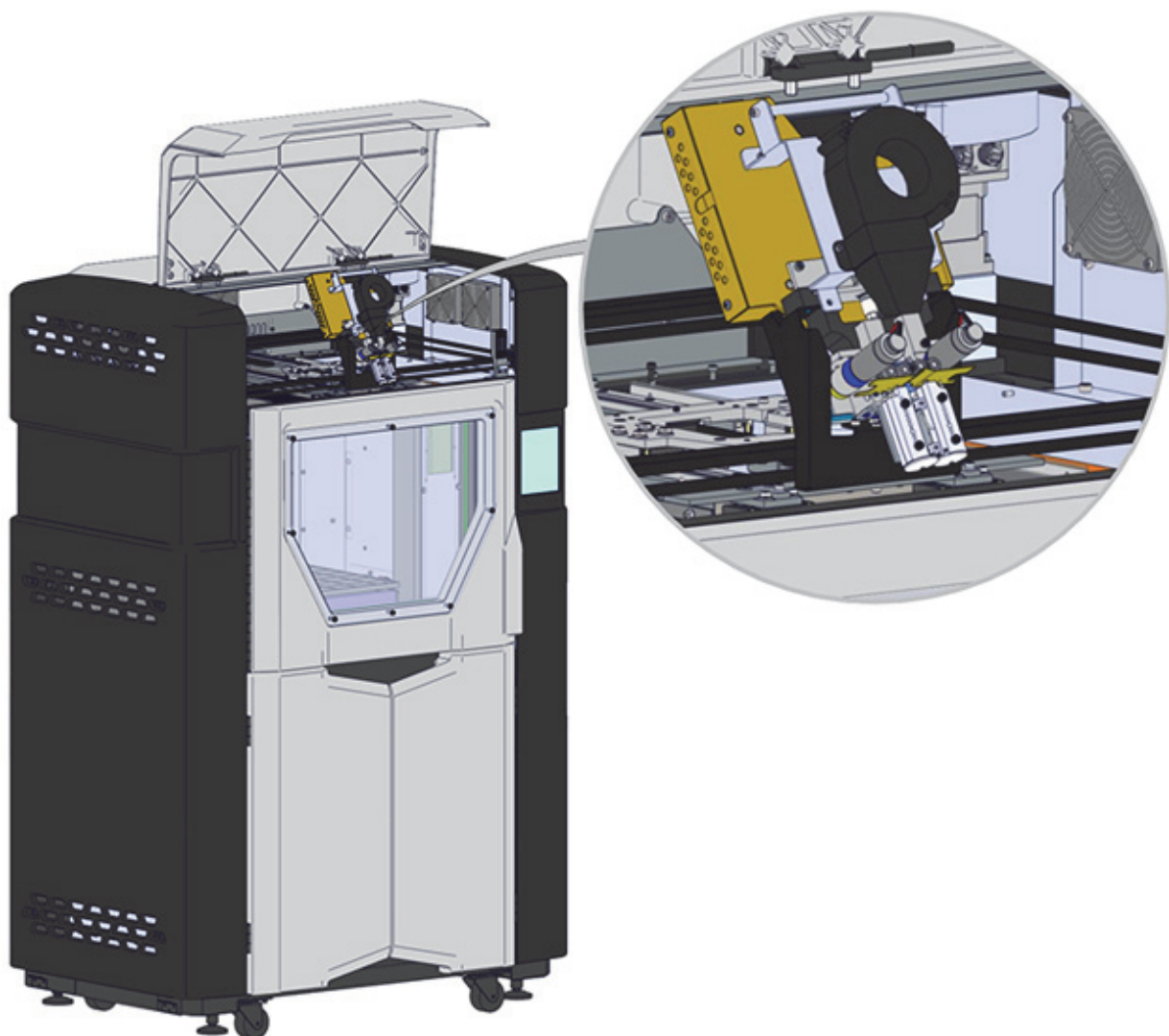

- Using the 9/64 Hex Ball End Driver tip change tool (provided in the Welcome Kit), loosen the two (2) liquefier retaining screws which clamp the liquefier tip in place.
- Remove the desired tip from the head by gently grasping the tip's tip shield and pulling the tip downward and out of the printer. If a tip is removed that may be re-installed at a later time, record the tip's odometer reading and store this reading with the removed tip. Odometer information is displayed within the two Tip Status Icons of the Dashboard (see "Materials/Tips Status" on page 47).

Figure 5-19: Tip Removal

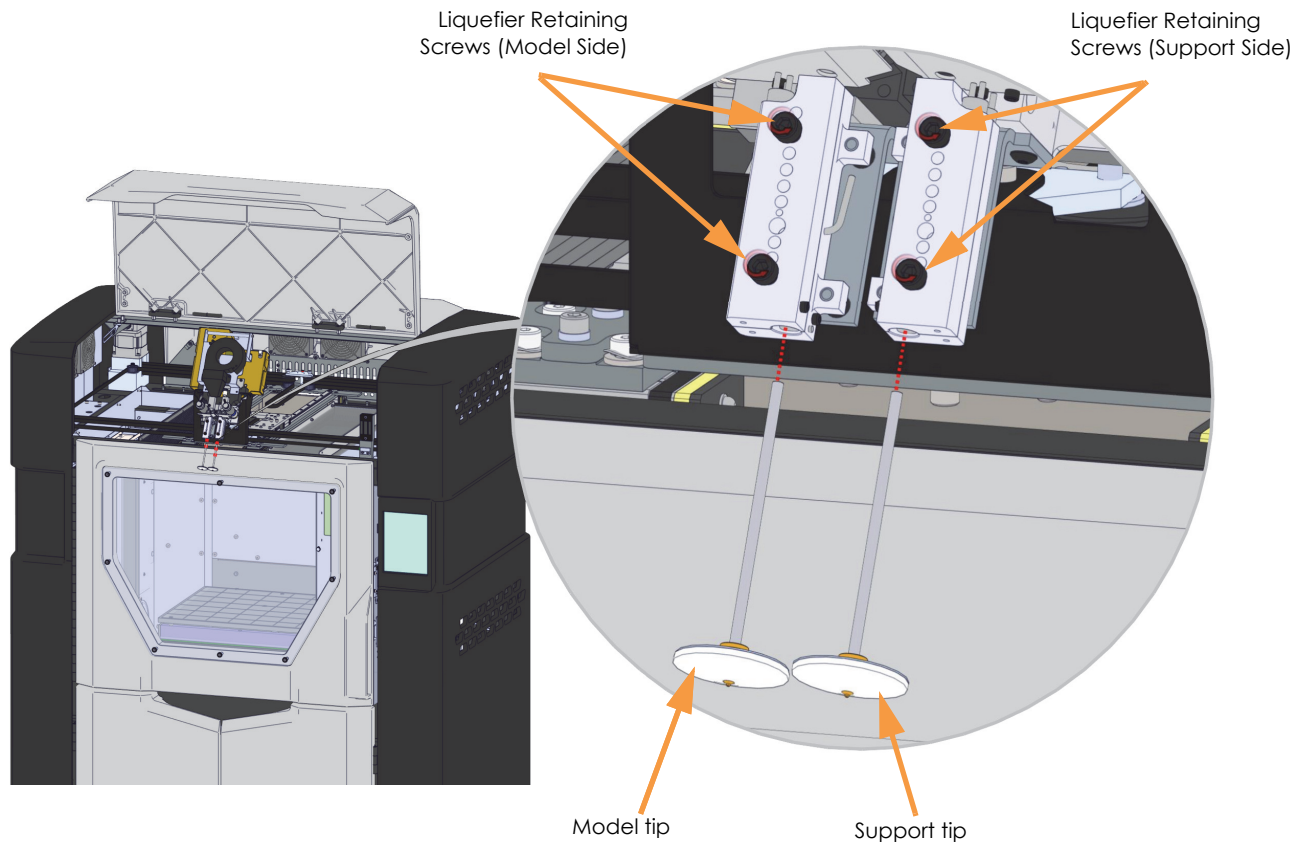

- Install a new tip into the head (see "Tip Compatibility & Selection" on page 37 for tip/material compatibility information) and then tighten the two (2) liquefier retaining screws using the 9/64 Hex Ball End Driver tip change tool.



Note: There is a small notch within the tip's pathway inside the heater block, which can impede tip insertion. Make sure the tip is fully inserted into the heater block before tightening the liquefier retaining screws (Figure 5-20). When correctly inserted, tip shield should be flush with the bottom of the heater block.

Figure 5-20: Tip Installation

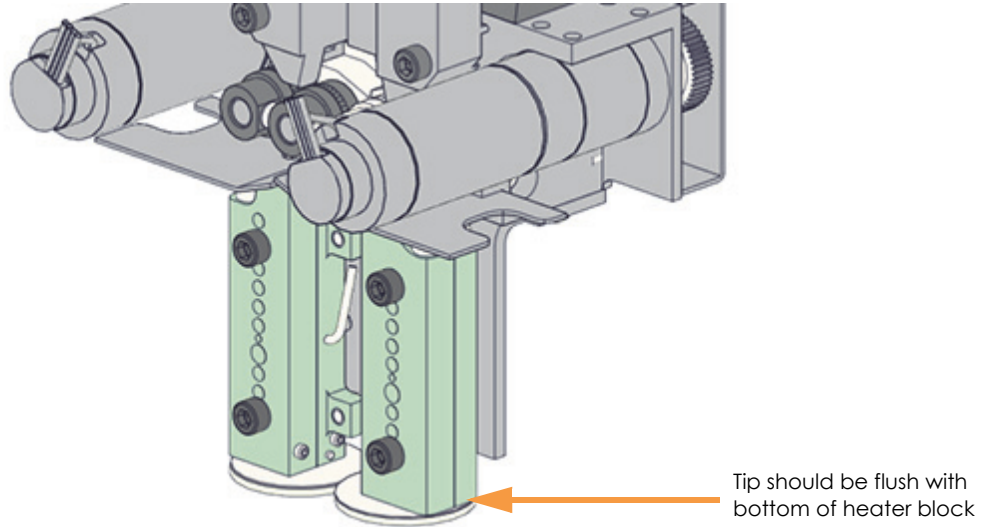

6. Repeat steps 3 - 5 if an additional tip needs to be changed.
7. Remove the head from the head maintenance bracket and return head to its initial position. Secure the head to the head mounting plate using the two (2) head mounting screws. Refer to "[Head Maintenance Bracket](#)" on page 33 for instructions.
8. Close the top cover.



Note: Make sure the filament tubes, umbilical cable, and air hose are not tangled and are routed correctly.

9. After changing one or both tips, you must manually adjust tip wipe heights to ensure proper placement of the printer's flicker/brush assemblies in relation to tips/tip shields. Adjust tip wipe heights as needed, see "[Adjusting Tip Wipe Heights](#)" on page 159 for instructions.

Adjusting Tip Wipe Heights

The tip wipe assembly contains two flicker/brush assemblies which are used to keep tips and tip shields free of purged material debris and buildup. The flicker cleans the tip's opening, while the brush cleans the tip shield. After changing one or both tips, you must manually adjust tip wipe heights to ensure proper placement of the flicker/brush assemblies in relation to tips/tip shields.

1. Open the canister bay doors and stand facing the front of the printer so that you can see the tip wipe assembly through the purge chute access plate window.
2. Press the **Tip Wipe Adjustment** button within the Tips page; the Tip Wipe Adjustment page will open (see "[Tip Wipe Adjustment](#)" on page 76).
3. Press the **Go to Purge Position** button; the head will move to the purge position.
4. Press the **Wipe Tips** button. After a few seconds the head will begin to move back and forth, slowly passing the model and support tips over the flicker/brush assemblies.
 - The head will make 4 passes. With each pass, the head gradually moves horizontally across the flicker to ensure proper adjustment and even wear.
5. Observe placement via the purge chute access plate window and using the Tip Wipe Height Adjustment Wheels, adjust tip wipe height for the replaced tip(s).
 - Top wheel corresponds to model tip, bottom wheel corresponds to support tip.
 - Rolling a wheel down will move the corresponding flicker/brush assembly downward (away from tip/tip shield) and vice versa.



Note: It is recommended that you first move the flicker/brush assembly upward, until extreme contact with the tip shield is made. Then, gradually move the flicker/brush assembly downward until proper placement is achieved.

Figure 5-21: Tip Wipe Height Adjustment Wheel Locations

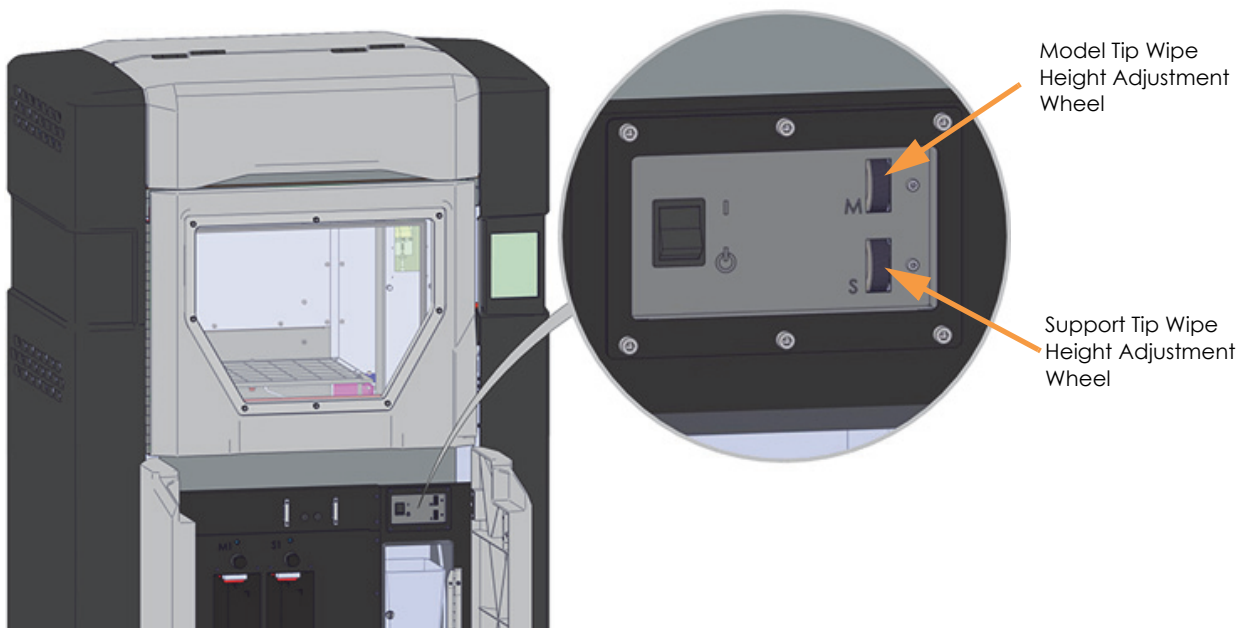



Note: As needed, press the **Wipe Tips** button again to initiate an additional 4 passes of the head.

6. Once you believe you have achieved proper placement (as shown in [Figure 5-22](#)), press the **Wipe Tips** button and observe placement via the purge chute access plate window. When properly adjusted:
 - The tip's opening should slightly graze the top edge of the flicker. The flicker should not have any contact with the tip shield.
 - If placement is too high, extreme resistance will occur when the tip passes over the flicker, which may cause damage to the flicker/brush assembly.

Figure 5-22: Proper Tip Wipe Placement

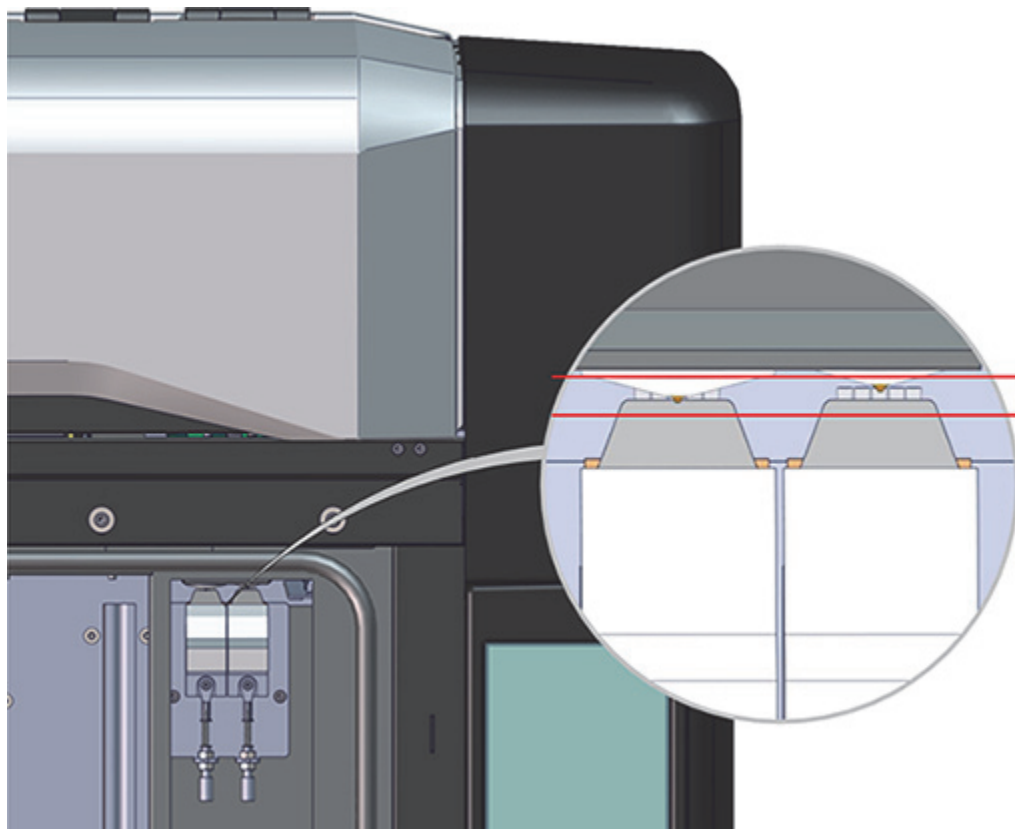

7. If additional adjustments are needed readjust height using the Tip Wipe Height Adjustment Wheels. When finished, close the canister bay doors.

Basic Job Build Tasks

Before a Build

To build a job, you must first send the job file to the printer from the Control Center application installed on your workstation PC. Jobs are sent in CMB format and placed in the Job Queue (stored on the printer's hard drive). The header of the CMB file contains the processed job's basic information (material type, approximate material amount required for the build, tip size, etc.). This information is used to verify job compatibility with the printer's existing configuration.

For information on using Insight, see the associated Help file within the Insight application.

Preparing the Printer

To prepare the printer for a build:

1. Power ON the printer (see [“Powering ON the Printer”](#) on page 110 for instructions).
2. Install a new build sheet.



Warning: Wear proper safety equipment when handling items inside the oven. Surfaces in the build chamber can be very hot.

- A. Remove the plastic wrap from both sides of the build sheet.
-



Note: Always use a new build sheet when building a job; the build sheet is intended for one-time use. Do not turn a build sheet over and place it on the platen. Material residue on the sheet can adhere to the platen or interfere with the build sheet vacuum.



Note: Using build sheets not provided by Stratasys may impact part quality and printer reliability.



Note: ABS, ASA and PC parts use a clear build sheet. Nylon 12 parts use a green tinted build sheet.

- B. Open the oven door and place the build sheet onto the platen.
- Make sure the build sheet is as centered as possible when placed onto the platen.
 - If the oven is hot, the build sheet will curl when placed on the platen. As the build sheet warms up, it will flatten and adhere to the platen. Some adjustment of the build sheet may be necessary to seal it against the platen.
 - Within about 5 minutes the printer should attain sufficient vacuum to secure the build sheet to the platen. The red X over the top of the Vacuum Status Indicator will disappear once sufficient vacuum is achieved (see [“Information Bar”](#) on page 44). The Build State button will remain yellow at this point.
3. Make sure that the tip wipe assembly's brushes as well as the printer's tips are clean and that the purge bin is empty.

Selecting a Job to Build

1. Select the **Queue** button within the Navigation Bar. The Queue page will open, and the Job Queue tab will be selected by default (see [Figure 4-19 on page 61](#)).
2. Within the Job Queue, select the job you wish to build by touching its entry in the list; the job's row will turn blue. After selecting a job the Build State button will turn green.
 - If you wish to select a job from the Sample Queue, toggle to the Sample Queue by touching its header within the Queue page and then selecting the job you wish to build by touching its entry in the list.
3. Return to the Build page by selecting the **Build** button from the Navigation Bar. The details of the job you selected will be displayed within the Print Job Selection Panel. (See [“Viewing Print Job Information” on page 53](#).)
4. Compare the materials/tips requirements of the selected job to the printer's current configuration. Ensure that loaded materials match the material requirements of the selected job, and installed tips match the tips required by the selected job.
 - If the model and/or support materials loaded in the printer do not match the materials required to complete the build you will receive a warning (see [“Errors Preventing a Build from Starting” on page 237](#)). Change material type/tips if necessary (see [“Tip Compatibility & Selection” on page 37](#) for materials compatibility information and [“Changing Tips or Material Type” on page 123](#) for instructions on changing materials/tips).
5. Ensure that the active model and support canister bays have filament loaded to the head (steady green canister status LED and Material Status Icon is blue with a white highlighted border). (See [“Loading Material to the Liquefier Tips” on page 112](#) for details.) Also ensure that the printer contains enough model and support material to complete the build (see [“Materials Status Display” on page 56](#)).
 - If there is not enough material loaded in the printer to complete the build, you will receive a warning (see [“Errors Preventing a Build from Starting” on page 237](#)).
6. Press the **Build (play)** button within the Build page to start the build. Depending on your printer's part placement setting configuration a dialog may be displayed (see [“Printer Settings” on page 85](#)).
 - If the Enable Part Placement setting is set to Off (default setting), a dialog will not be displayed and the job will automatically be built in the center of the build sheet.
 - If you set the Enable Part Placement setting to On, a dialog will be displayed allowing you to select the job's build location. The dialog contains a graphic representing your printer's platen as well as a blue bounding box graphic (the imaginary box surrounding the part). Select the job's build location by dragging and dropping the bounding box on the touchscreen. When finished, press the **checkmark** button to confirm your selected placement and start the build.

Figure 5-23: Part Placement Dialog

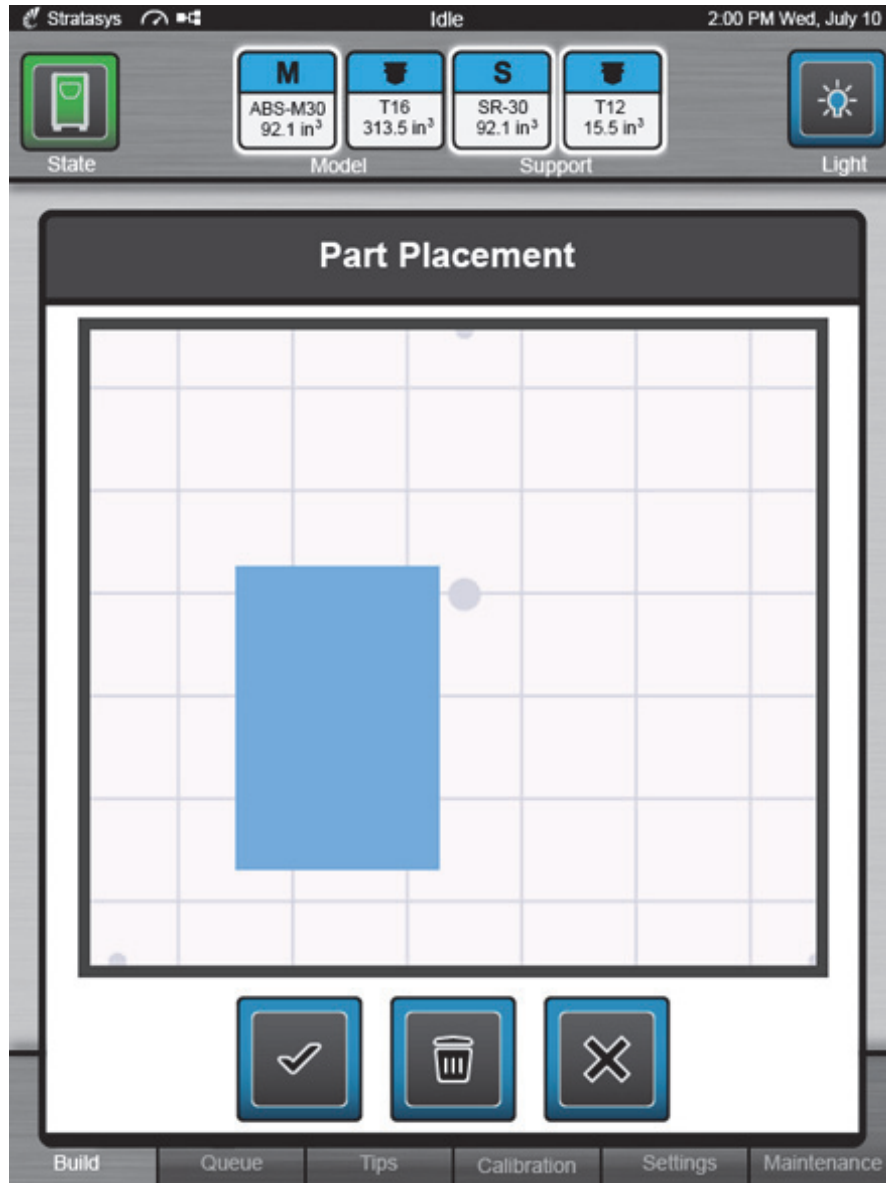

7. "Heating Oven and Tips" is displayed within the Information Bar. The oven will begin to heat to a set point temperature determined by the material types specified for the job. Please be patient.
8. After the oven and liquefier tips reach temperature "Finding Z Zero" is displayed within the Information Bar, and the printer performs a Z Zero Calibration.
9. Once Z Zero Calibration is complete the printer begins building the job. "Starting Part Build" is momentarily displayed within the Information Bar. "Building" is displayed within the Information Bar as the part is being built, and build progress is displayed within the Build page (see ["Information Available During a Build"](#) on page 164).
10. When finished, "Build Complete - Remove Part" is displayed within the Information Bar indicating that the completed part can be removed from the printer (see ["After a Build is Complete"](#) on page 168).

Information Available During a Build

During a build, information pertaining to that build is displayed within two areas of the Build page:

The Print Job Information Panel displays the details of a job, as submitted to the printer from the workstation PC. This information is static and is for reference purposes only. See “Viewing Print Job Information” on page 53 for detailed information.

Figure 5-24: Print Job Information Panel - Building

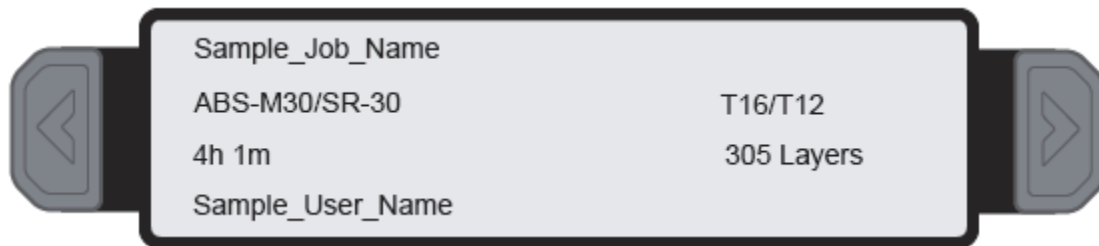

Information displayed within this panel for a selected job includes:

- Name of the job.
- Model and support materials associated with the job.
- Estimated build time for the job.
- Name of the user that submitted the job.
- Tip sizes associated with the job.
- Number of layers in the job.

The Print Job Status section of the Build page is comprised of a two-part graphic which provides information on a building job. See “Build Status Display” on page 55 for detailed information.

- The Build Status portion of this graphic displays the build’s percentage of completion, number of completed layers as compared to total number of layers, elapsed build time as compared to total build time, expected build completion information, and build progress ring.
- The Materials Status portion of this graphic displays detailed material status information, for both model and support material, as it pertains to a selected job.

Figure 5-25: Print Job Status Overview

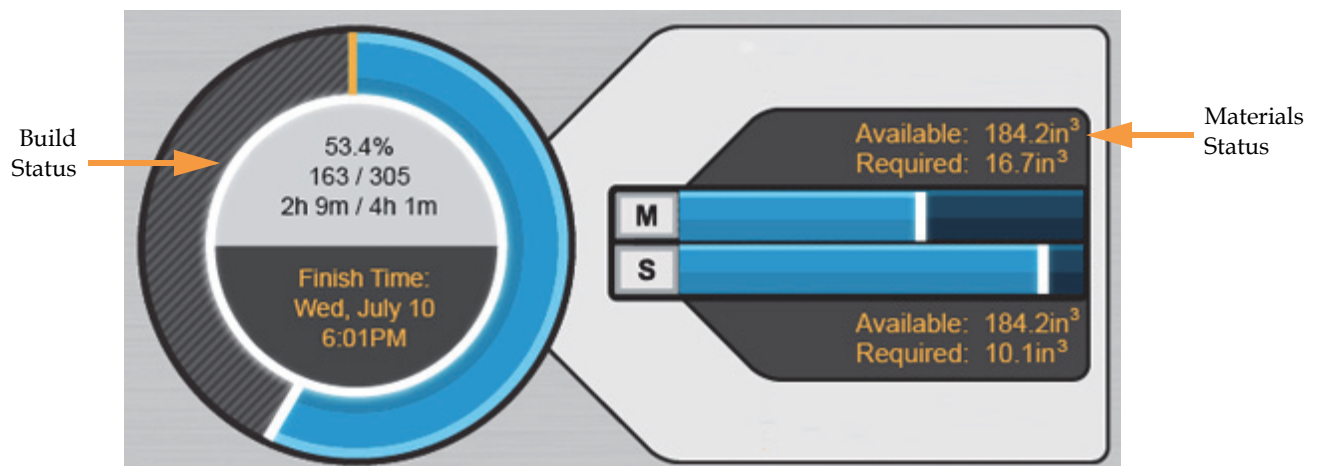

Build Warnings

If the printer detects an issue that may affect a build, it will be indicated within the [Dashboard](#). The Build State button will turn yellow or red depending on the severity of the warning. Pressing the Build State button will open a dialog indicating the reason(s) for the warning/error. The body of the dialog will contain information related to the cause of the warning/error. Depending on the type of warning, the canister load status text displayed beneath each Material Status Icon of the Tips page also provides information indicating the cause of a warning/error (see [“Canister Load Status” on page 70](#)).

- When loading and unloading materials you may encounter load related warnings which need to be resolved prior to starting a build.
- When starting a build you may encounter a variety of warnings pertaining to the printer’s current materials and tips configuration. If the printer’s tips have not been calibrated, the materials/tips installed within the printer do not match the requirements of the build, or the printer does not contain enough material to complete the build, you will receive a warning instructing you to resolve this issue.



Note: You can choose to ignore the warning and continue the build, but part build quality will be unpredictable. A warning generated from a mis-match of model/support material or from low/no vacuum cannot be bypassed.

- In some cases, the warning will prevent you from starting a build and will need to be corrected before the printer can build a part.
- While the printer is building, various pause and abort related warnings may be displayed. Some of these warnings may be due to a manual pause or abort, while others may be the result of the printer automatically pausing or aborting a build. Depending on the severity of the warning you may or may not be able to resume building.

See [“Warnings and Errors” on page 235](#) for a detailed list of the warnings you may encounter, and instructions on how to correct them.

Pausing a Build

During a build the Pause button within the Build page becomes selectable (see “[Pause Button](#)” on page 60 for details). The printer can pause automatically, or be manually paused using this button:

- An automatic pause occurs when a canister runs out of material, a failure is detected, etc.
- A manual pause occurs whenever the **Pause** button is pressed.

When the printer is directed to pause:

1. The current toolpath is completed, the Z stage is lowered slightly, and then the head is parked. “Build Paused” is displayed within the Information Bar.
 - If an automatic pause occurs, pressing the Build State button will open a dialog indicating the reason for the pause condition (i.e. empty canister). Correct this condition and then press the **checkmark** button to exit the dialog. (See “[Build Pause Warnings](#)” on page 241 for a list of pause related warnings/errors and resolution instructions.)
2. To resume building, press the **Build (play)** button within the Build page. A resume command will be sent to the printer instructing it to resume the build.



Note: The printer will not resume building instantaneously, please be patient.

If the oven door or top cover are open, or if vacuum is not present, the part will not resume building immediately. Press the Build State button to check for any errors in order to troubleshoot this situation.

3. “Resuming” will be displayed within the Information Bar and the Pause button will be shown in its selected state (see [Table 4-7 on page 60](#)). Once the build resumes, “Building” will be displayed within the Information Bar and the Pause button will revert to its unselected state (see [Table 4-7 on page 60](#)).

Aborting a Build

When the printer is paused, you have the option of aborting the build. To do so:

1. If it is not already, pause the printer by pressing the **Pause** button within the Build page. If the printer was paused automatically proceed to [step 3](#).
2. A pause command will be sent to the printer, and the User Interface will change to indicate the paused condition. “Build Paused” will be displayed within the Information Bar.
3. The Abort button within the Build page will be selectable (see “[Abort Button](#)” on page 60 for details), press the **Abort** button.
4. A dialog will be displayed allowing you to confirm or cancel the abort; press the **checkmark** button within the dialog to confirm the abort.

Figure 5-26: Abort Confirmation Dialog

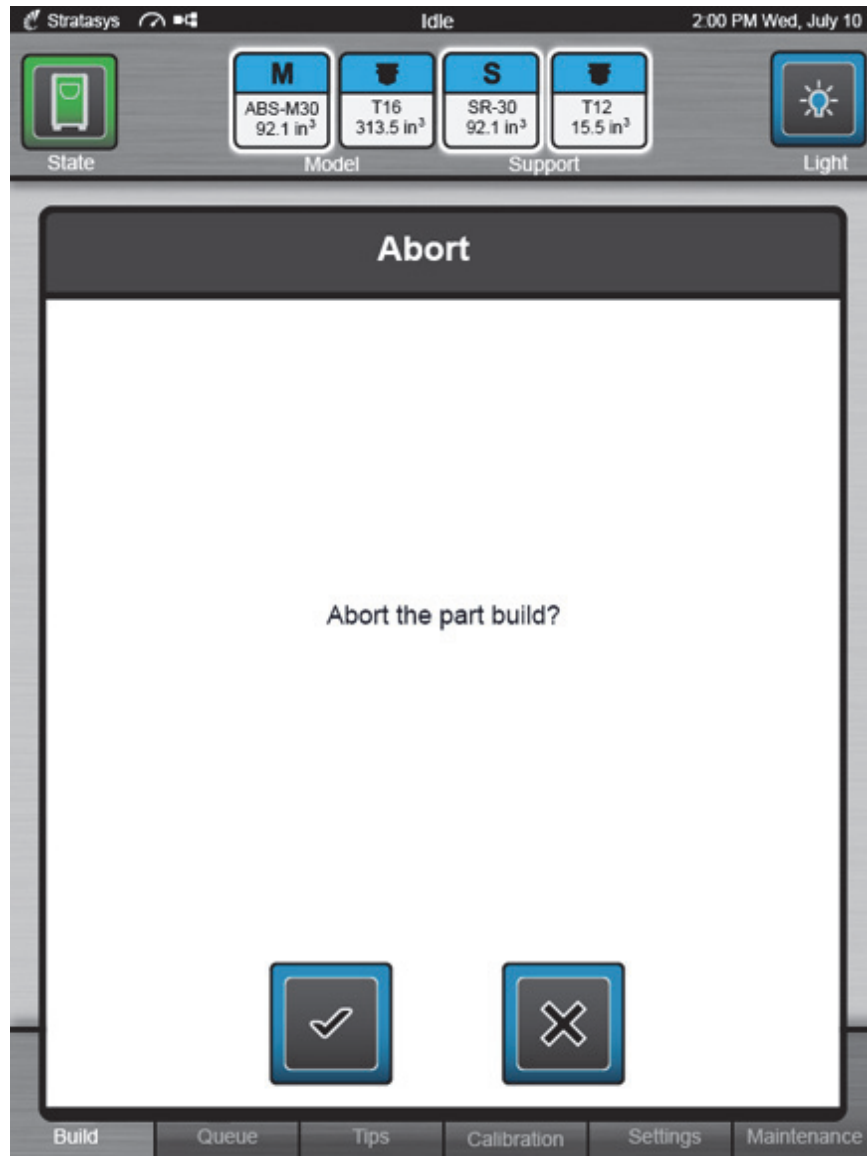

5. An abort command will be sent to the printer and the dialog will close.
6. The Z stage will move to its end of travel and "Aborting" will be displayed within the Information Bar.
7. Once the Z stage reaches its end of travel "Build Aborted - Remove Part" is displayed within the Information Bar prompting you to remove the aborted build.

After a Build is Complete

After the completion of a build, the printer performs the following actions:

- The Z stage is lowered and the head is parked.
- Depending on your printer's auto cooldown configuration, the oven may or may not begin to cool (see ["Auto Cooldown"](#) on page 87 for details).
- "Build Complete - Remove Part" is displayed within the Information Bar.
- The Build Status Display graphic shows the build's percentage of completion as 100% and the outer progress ring is completely filled (see ["Build Status Display"](#) on page 55).
- The Build State button turns yellow indicating a warning. Pressing this button will display a dialog prompting you to remove the finished part ([Figure 5-27](#)).



Note: If the build was terminated abnormally, press the Build State button to view the reason(s) for the termination. See ["Build Abort Warnings"](#) on page 243 for a list of abort related warnings/errors and resolution instructions.

Figure 5-27: Remove Part Dialog

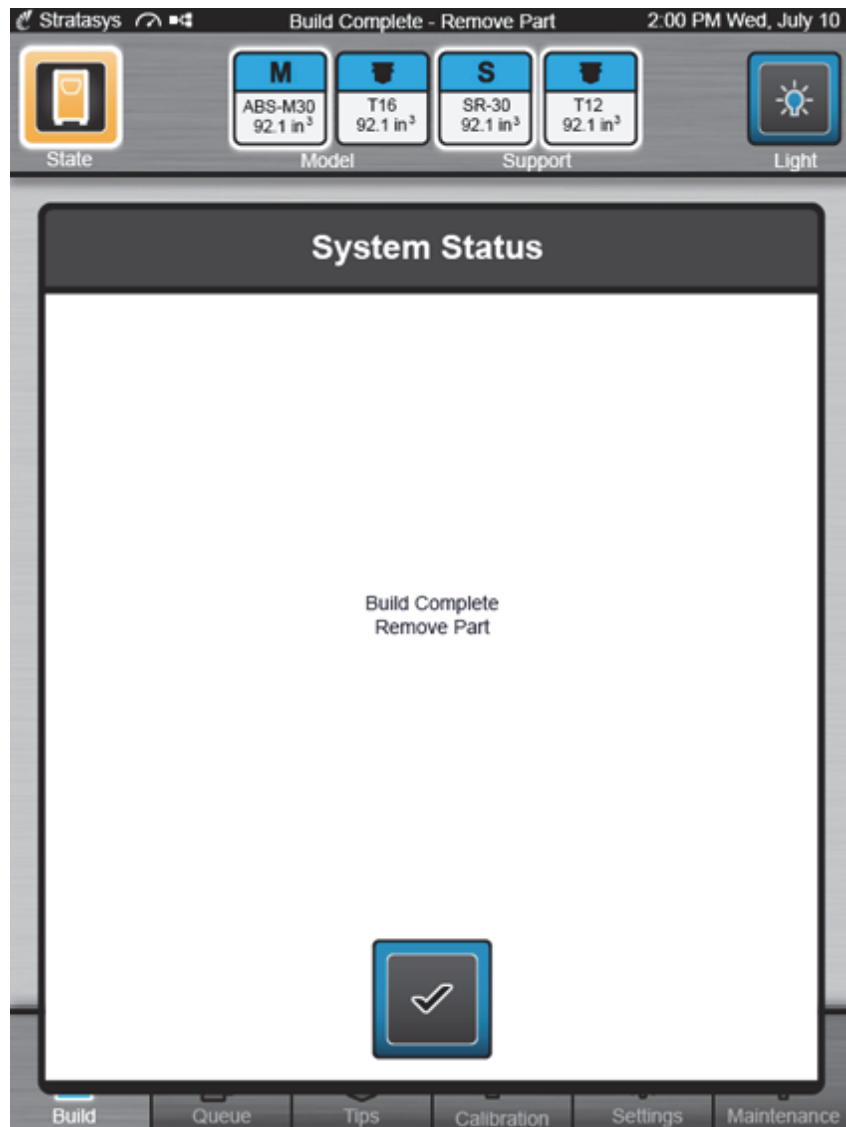

Removing a Part from the Printer



Warning: Wear proper safety equipment when handling items inside the oven as surfaces within the oven can be very hot.

To remove a part from the printer:



Note: If your printer's Auto Cooldown setting is set to Always, allow the oven to cool to the standby temperature before removing the part (see [“Auto Cooldown” on page 87](#)).

1. Open the oven door.
2. Push up on the edge of the build sheet to release the vacuum grip. A red X will be displayed over the top of the Vacuum Status Indicator.



Caution: Do not attempt to remove a part from the build sheet while the build sheet is on the platen. Damage to the platen or platen level may occur.

3. Remove the build sheet from the platen.



Caution: Use extreme care when cleaning the platen. If using a brush, brush away from the vacuum port in the center of the platen. If debris falls into the vacuum port, it can cause loss of vacuum, resulting in poor build sheet adhesion. (See [“Clean the Platen” on page 222](#) for cleaning related instructions.)

4. Remove debris that may have fallen onto the platen - use a vacuum or the Platen Dusting Brush (included in the Welcome Kit).
5. Carefully peel the part from the build sheet.
 - If the part does not peel easily, use a metal scraper to carefully pry the part from the build sheet.
6. Remove supports from the completed part (material specific information and instructions can be found on the Stratasys Website and Customer Extranet).
 - PC and PC-ISO materials use break-away supports, called BASS. This support material must be removed manually; material should break away with relative ease. If necessary, use needle nose pliers or a pick (included in the Welcome Kit) to remove supports.
 - Soluble Release support material is used with ABS-M30/ ABS-M30i, ABS-ESD7, ASA, PC, and Nylon 12 material. After building a part, you can remove supports using an Ultrasonic or Circulation Tank containing a solution of water and WaterWorks soluble solution. For more information on WaterWorks, refer to the WaterWorks User Guide located on Stratasys' Customer Extranet.

Changing Printer Defaults

Factory presets can be changed via the Settings page. To access this page, press the **Settings** button within the Navigation Bar.

Display Units

By default the printer is configured to display English (imperial) units (inches). However, you can adjust this setting as needed to have the printer display metric units.

The Units setting determines the type of units that the printer is configured for, English or Metric. To configure this setting, use the slider graphic to select between English and Metric units.

Figure 5-28: Units



Job Storage

The Keep Previous Job setting determines whether or not the printer's previous job is stored within the Job Queue once a build is complete (see ["Keep Previous Job" on page 85](#)). If you're concerned about other users of your printer seeing what you've built, this setting will prevent the printer's previous job from being accessible after the build is complete. By default this setting is set to On meaning that the printer's previous job file is stored within the Job Queue making it available for re-selection upon completion of the build.

When this setting is set to Off, the printer's previous job file will be deleted from the Job Queue upon completion of the build. The job's file will need to be resent to the printer in order to be built again.

To configure this setting, use the slider graphic to turn the setting On and Off as needed.

Figure 5-29: Keep Previous Job



Oven Temperature Control

Oven modeling temperature is determined by the material type (model and support) loaded within the printer. It is controlled by the printer's software and cannot be modified; however, you do have control of some oven temperature functions. The Auto Cooldown setting allows you to configure the printer's auto cooldown function (see "Enable Part Placement" on page 85).

The printer's oven is designed to cool incrementally until the printer controlled standby temperature is reached. This functionality acts as an energy saving feature. Auto Cooldown can be set to:

- Never - the printer is never auto-cooled. After every job is complete, oven temperature will stay at the material's build temperature. This is the default setting.
- Always - the printer is always auto-cooled. After every job is complete and auto-cooled, oven temperature will stay at the material's standby temperature.
- Next Build Only - after the next job is complete and auto-cooled, auto cooldown mode will automatically reset to Off.

To configure this setting, open the Auto Cooldown Details page by pressing the right arrow graphic within the Auto Cooldown row of the Settings page.

Figure 5-30: Auto Cooldown



Within the Auto Cooldown Details page touch the row corresponding to the auto cooldown option you want to select (Never, Always, or Next Build Only), the row will turn blue when selected. Press the **Settings** button within the heading of the page to exit the Auto Cooldown Details page and return to the Settings page.

Figure 5-31: Auto Cooldown Details Page

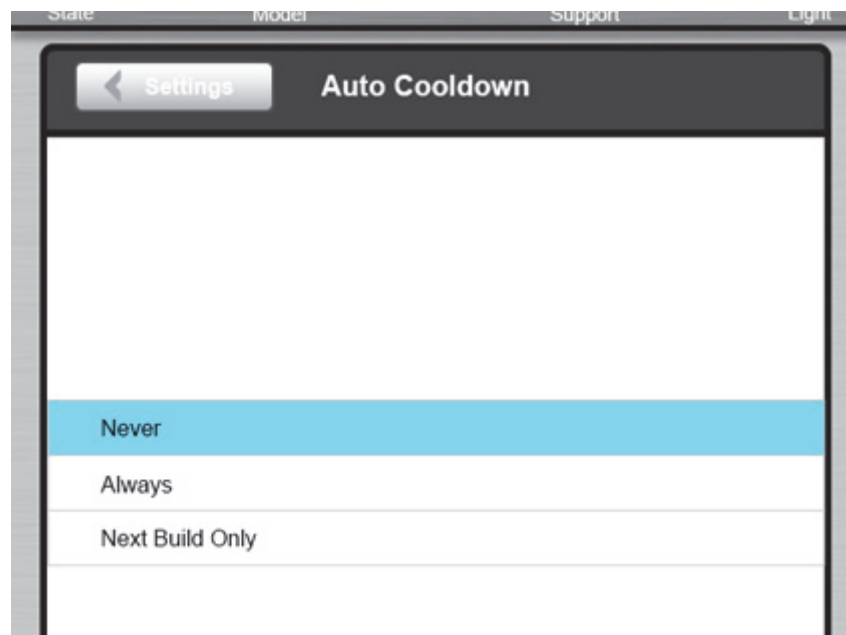

Part Build Location

The Enable Part Placement setting determines whether or not you can select a job's placement on a build sheet prior to starting the build (see ["Network Settings" on page 88](#)). By default this setting is set to Off and single part jobs are built in the center of a build sheet while packs are built according their selected placement within Control Center.

When this setting is set to On, you will be able to select a job's location on the build sheet prior to starting the build (see ["Selecting a Job to Build" on page 162](#)). At the start of a build a dialog will be displayed asking you to select the part's build location (see [Figure 5-23](#)). The dialog will contain a graphic representing your printer's platen as well as a blue bounding box graphic (the imaginary box surrounding the part). You can select the part's build location by dragging and dropping the bounding box on the touchscreen; the bounding box cannot be placed outside the limits of the platen. Pressing the checkmark button will confirm your selected placement and start a build.

To configure this setting, use the slider graphic to turn the setting On and Off as needed.

[Figure 5-32: Enable Part Placement](#)



Touchscreen Display Brightness

The Adjust Brightness setting allows you to adjust the brightness of the touchscreen display (see ["Adjust Brightness" on page 91](#)). By default, the touchscreen display is configured to be slightly more bright than dim.

Use the slider graphic to adjust brightness as needed; sliding to the right (towards Bright) will increase brightness, while sliding to the left (towards Dim) will dim brightness.

[Figure 5-33: Adjust Brightness](#)

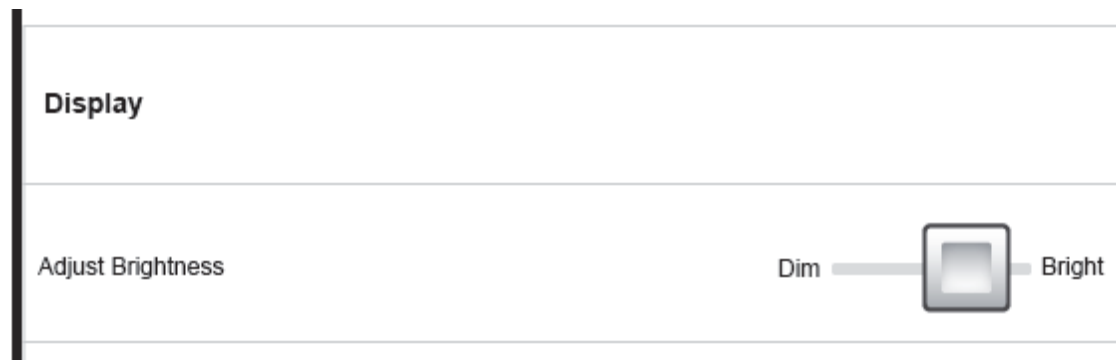

Printer Status

The various pages of the User Interface display each of the following:

- Odometer status
- Material status
- Temperature status
- Software version
- Other printer information

Tip Odometer Status

The printer tracks and displays the total amount of material extruded through a liquefier tip since it was last replaced. Tip odometer values can be determined via two methods:

1. The Dashboard contains two Tip Status Icons, one corresponding to the printer's model tip and the other to the printer's support tip (see ["Materials/Tips Status" on page 47](#) for details). These icons display tip size (e.g. T16) followed by the tip's current odometer value (e.g. 150.6 in³ / 2467.9 cm³).
2. Pressing the **Tips** button within the Navigation Bar will open the Tips page. The upper portion of this page's display area contains two icons, one corresponding to the printer's model tip and the other to the printer's support tip (see ["Tips/Materials Status" on page 67](#) for details). These icons display tip size (e.g. T16) followed by the tip's current odometer value (e.g. 150.6 in³ / 2467.9 cm³).

Figure 5-34: Tip Odometer Status Locations

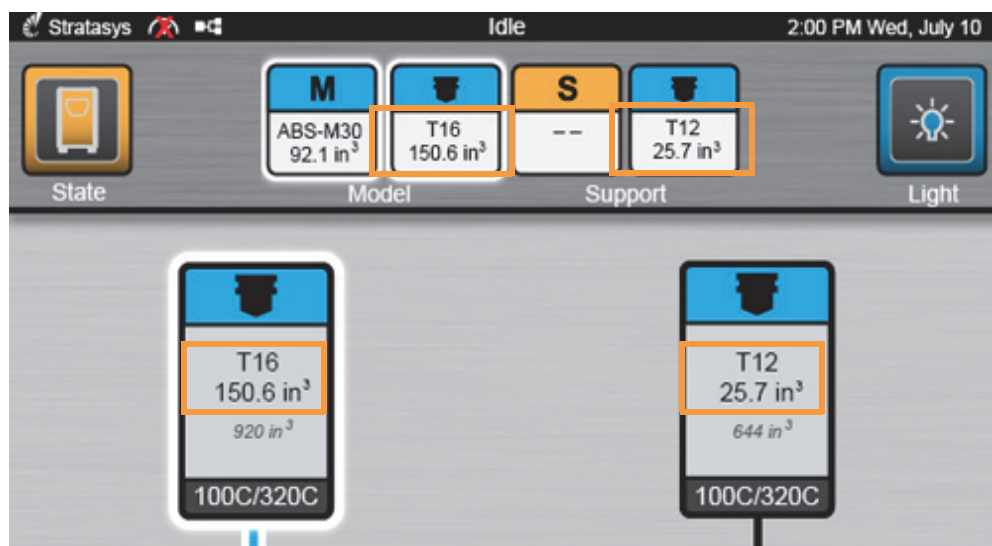

Tip Life Status

In addition to the odometer status information displayed, approximate tip life information can also be found within the Tips page. Tip life is the maximum amount of material that can be extruded through a tip. Approximate tip life information is displayed within the two tips icons, directly beneath the tip's current odometer value (e.g 920 in³/15,080 cm³). This information is material dependent and is determined based off of the amount of material that has already been extruded using a particular tip, for a particular material type. See [Table 3-3 on page 39](#) for approximate tip life information.

When a tip is within 10% of or has reached its odometer limit for an associated material, you will receive a warning and the tip's icon will turn yellow (within the Dashboard and Tips page). You can continue to build using the tip, but part quality will be unpredictable.

When a tip exceeds its odometer limit for an associated material, you will receive a warning and the tip's icon will turn red (within the Dashboard and Tips page). You cannot continue to build with a tip that has exceeded its odometer limit. The tip should be changed immediately (see ["Changing Tips or Material Type" on page 123](#) for instructions).

Figure 5-35: Tip Life Status Location



Materials Status

You can find the current status of each of the canisters installed/inserted in the printer via two methods:

1. The Dashboard contains two Material Status Icons, one corresponding to the printer's model canister (M) and one corresponding to the printer's support canister (S). (See "[Materials/Tips Status](#)" on page 47 for details). Each icon displays the material's associated canister bay (e.g. M), the name of the material currently installed in that bay (e.g. ABS-M30), and the current volume of material in that canister (e.g. 92.1 in³/1509.2 cm³).
2. Selecting the **Tips** button within the Navigation Bar will open the Tips page. Two Material Status Icons, one corresponding to the printer's model canister (M) and one corresponding to the printer's support canister (S) are displayed within the lower portion of the page (see "[Tips/Materials Status](#)" on page 67 for details). Each of these icons displays the material's associated canister bay (e.g. M), the name of the material currently installed in that bay (e.g. ABS-M30), and the current volume of material in that canister (e.g. 92.1 in³/1509.2 cm³).

Figure 5-36: Materials Status Locations

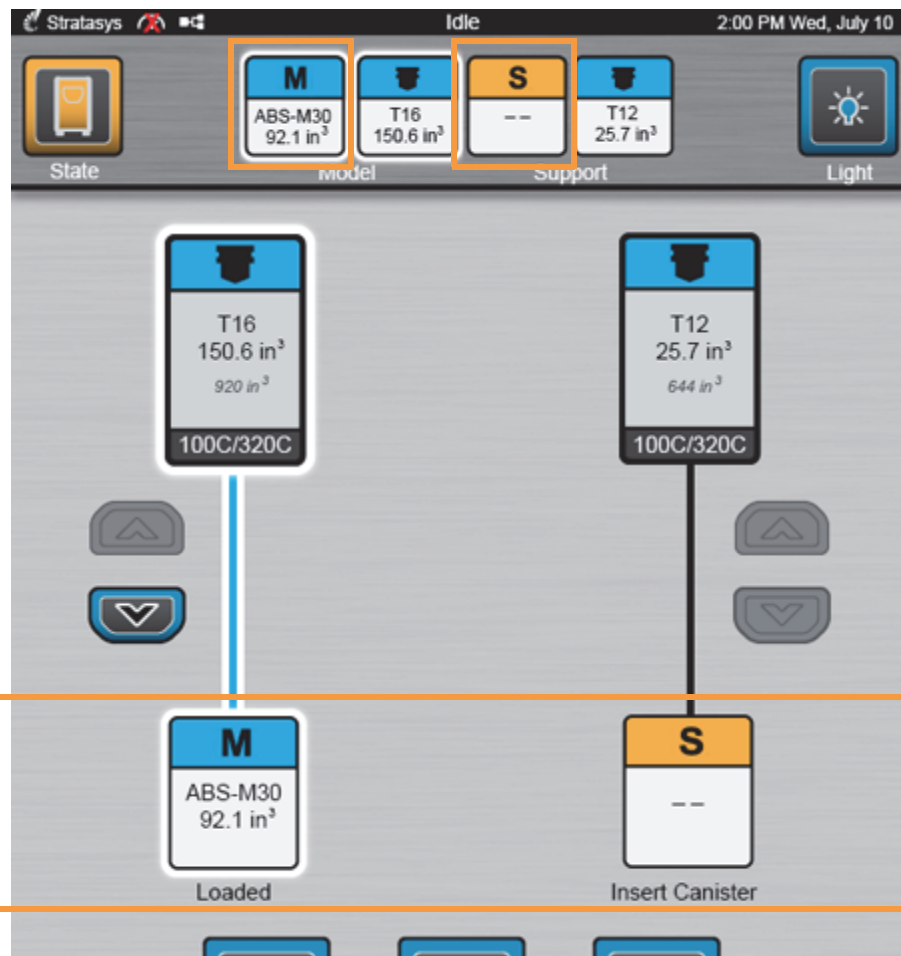

Regardless of whether you are viewing these icons within the Dashboard or the Tips page, icons will take on a variety of colors, depending on their status (see

Table 4-2 on page 47 for detailed status explanations):

- Blue - an icon with blue coloring indicates that a valid canister is inserted into the corresponding canister bay; the canister's material type and current volume are displayed within the icon. A blue icon with a white highlighted border indicates that material from the canister is loaded to the head and is selected to be used for building.
- Yellow - an icon with yellow coloring indicates a canister related issue/warning (see ["Warnings and Errors" on page 235](#) for more information). A yellow icon with a white highlighted border indicates that the corresponding canister is selected to be used for building.
 - When "- -" is displayed within a yellow icon it indicates that a canister is not loaded into the corresponding canister bay.
 - A canister volume of 0 in³ / 0 cm³ accompanying a material name means that the corresponding canister has run out of material and is empty.
 - Any other yellow icon indicates that a valid canister is installed within the corresponding canister bay, but the material within that canister does not match the printer's current configuration.
- Red - an icon with red coloring indicates that an invalid or unreadable canister is present in the corresponding canister bay. To resolve this condition the canister should be removed and replaced with a valid canister.

Detailed canister load status information as well as a graphical representation of this information can also be found within the Tips page:

- A variety of canister load status messages are displayed directly beneath each Material Status Icon, indicating the current activity of each canister and its filament. These statuses will update frequently throughout the material loading and unloading process, giving you an indication of the progress being made (see ["Canister Load Status" on page 70](#) for more information).
- As materials are loaded and unloaded, the pathway between the material and tip status icons will become blue with a white highlighted border, and will fill in the direction that the canister's filament is traveling (see [Figure 4-28](#)).

Temperature Status

Current and set point temperature information for the oven and liquefier tips can be found within the Tips and Maintenance pages.

Oven Temperature

To view the oven's temperature information within the Maintenance page:

1. Press the **Maintenance** button within the Navigation Bar; the Maintenance page will be displayed.
2. Locate the Chamber section of the page. The Oven Temperature row displays the printer's current and set point oven temperatures.

Figure 5-37: Maintenance Page Oven Temperature

Oven Temperature	127.7C / 130C
Vacuum Enable	Off
Vacuum Status	Low
Dryer Status	Good
Door Lock	Unlocked
Door Status	Closed
Cover Status	Closed

To view the oven's temperature information within the Tips page:

1. Press the **Tips** button within the Navigation Bar; the Tips page will be displayed.
2. Press the **Tip Wipe Adjustment** button; the Tip Wipe Adjust Wizard page will be displayed. The Chamber Temperature field displays the printer's current oven temperature as compared to its set point temperature.

Figure 5-38: Tips Page Oven Temperature



Tip Temperature

To view temperature information pertaining to the model and support tips within the Maintenance page:

1. Press the **Maintenance** button within the Navigation Bar; the Maintenance page will be displayed.
2. Locate the Head section of the page. The Model Temperature row displays temperature information for the model tip while the Support Temperature row displays temperature information for the support tip.

Figure 5-39: Maintenance Page Tip Temperatures

Active Tip	Model
Model Temperature	100.1C / 100.0C
Support Temperature	0.0C / 100.0C

To view temperature information pertaining to the model and support tips within the Tips page:

1. Open the Tips page by selecting the **Tips** button within the Navigation Bar. A screen representing your printer's current configuration will be displayed.
2. The two large icons within the upper portion of the page represent your printer's tips (model on the left and support on the right). The tip's current temperature as compared to its set point temperature is displayed within the lower portion of the icon.

Figure 5-40: Tips Page Tip Temperatures



3. Tip temperature information can also be found within the Tip Maintenance page:
 - A. To open this page, press the **Tip Purge/Unplug** button within the Tips page. The page is divided into two groupings, one for the model tip and one for the support tip.
 - B. The tip's current temperature as compared to its set point temperature is displayed at the bottom of its grouping.

Figure 5-41: Tip Maintenance Page Tip Temperatures

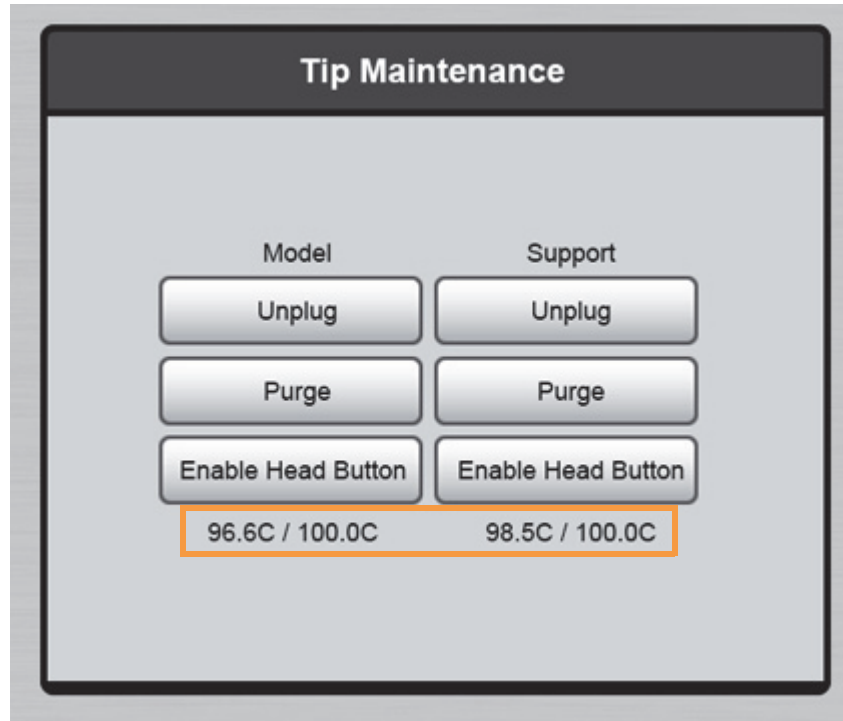

Software Version

Version information for the software used to control the printer (Controller Software) can be accessed via the Maintenance page:



Note: Controller Software is installed on the printer's hard drive and should not be confused with Insight software, which is installed on the workstation PC.

1. To access the Maintenance page, press the **Maintenance** button within the Navigation Bar.
2. Locate the System section within the page.
3. The Software Version row displays the printer's Controller Software version information.

Figure 5-42: Controller Software Version Information

The screenshot shows a 'System' section with a table of printer details. The 'Software Version' row is highlighted with an orange border. Below the table is an 'Update Software' button with a right-pointing arrow.

System	
Serial Number	K00028
Software Version	2.0.4418.0
Update Software	



Note: See “Controller Software” on page 209 for instructions on updating your printer's software version.

6 Calibration

This chapter describes basic calibration procedure for the 380mc. The buttons/pages described within this chapter are accessible via the Calibration page (see “Working with the Calibration Page” on page 78).

To open the Calibration page, press the **Calibration** button within the Navigation Bar; a screen similar to the one in Figure 6-1 will be displayed. Your printer’s calibration status will be displayed within the top of the page.

Figure 6-1: Calibration Page

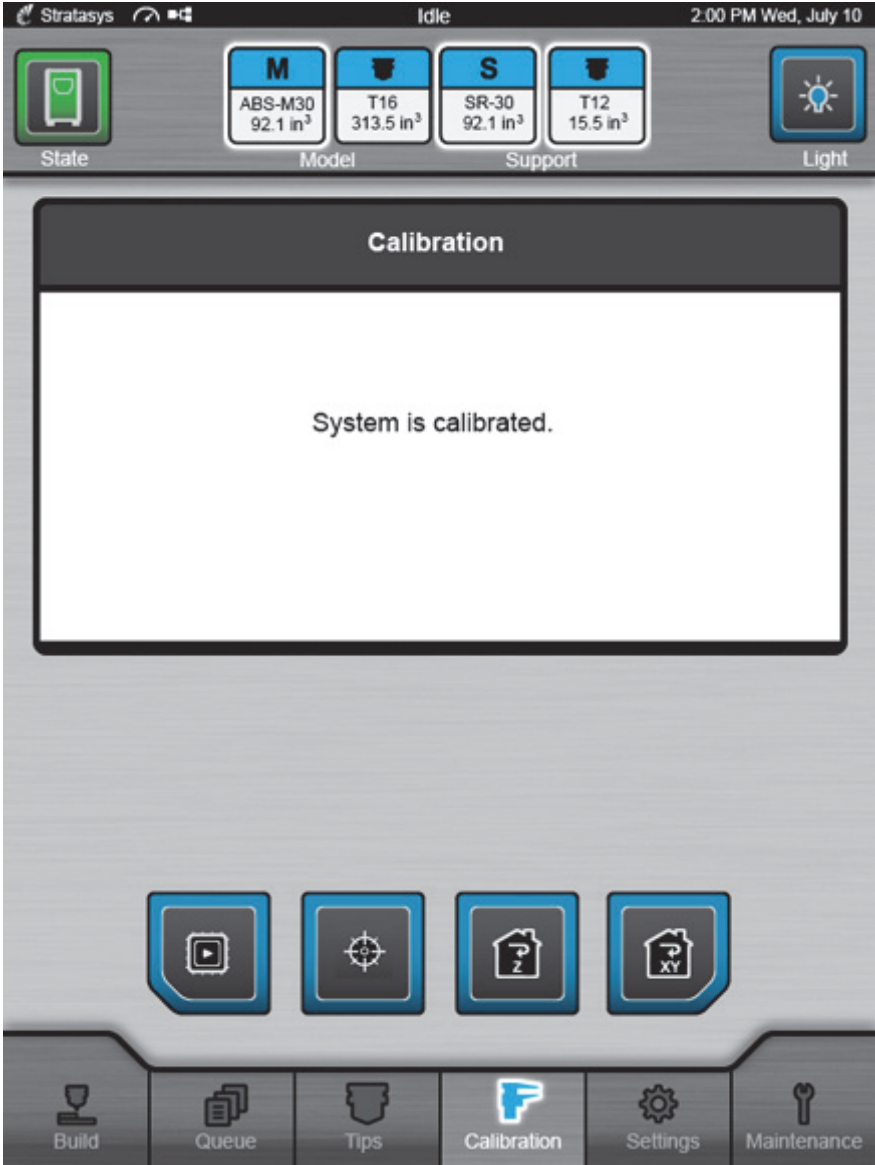



XYZ Tip Offset Calibration

Tip offset values are the distance between the model and support tips in the X, Y and Z directions. Accurate tip offset values ensure that support toolpaths are accurately located in reference to model toolpaths. Inaccurate tip offset values can cause part quality issues such as support material embedded in a part or improperly supported parts.

The XYZ Tip Offset Calibration registers the support tip relative to the model tip. This calibration requires you to analyze a calibration part once it's built, and supply the printer with correction values as needed. An XYZ Tip Offset Calibration must be performed each time the printer's tips are changed. The Tip Change Wizard includes a step for performing this calibration; however, the steps below can be used to calibrate the printer's tips outside of the Tip Change Wizard.

The XYZ Tip Offset Calibration is delivered as a wizard which will walk you through the steps required to calibrate your printer's tips. While working within the wizard, three buttons are displayed at the bottom of the screen in place of the Navigation Bar (which is hidden when working within a wizard). These buttons have the following functionality:

Table 6-1: Tip Calibration Wizard Controls

Icon	Name	Description
	Previous	When colored (selectable) - allows you to return to the previous page of the wizard. No functionality when gray (disabled).
	Stop	When colored (selectable) - allows you to stop and exit the wizard. No functionality when gray (disabled).
	Next	When colored (selectable) - allows you to proceed to the next page of the wizard. No functionality when gray (disabled).

1. Open the Calibration page by pressing the **Calibration** button within the Navigation Bar.
2. Press the **XYZ Tip Offset Calibration** button within the Calibration page.

Figure 6-2: XYZ Tip Offset Calibration Button Location

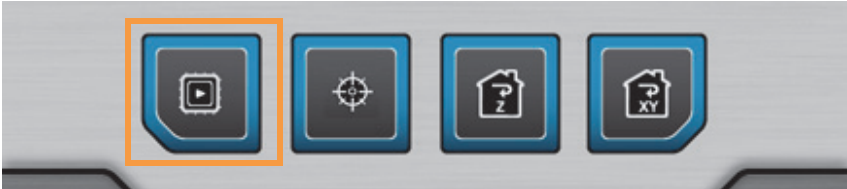

3. The Tip to Tip Calibration page will be displayed. Within this page you have the option of performing a Z Tip-to-Tip Calibration and/or building a calibration part; the checkbox for each option is selected by default. Touching a checkbox on the screen will allow you select and deselect options as needed. Ensure that both options are selected and press the **Next** button to proceed with the wizard.

 **Note:** Whenever the “Perform Z Tip-to-Tip Calibration” option is selected a new Z Tip-to-Tip Calibration will be initiated, and any Z offset correction values stored previously will be reset.

Figure 6-3: Tip to Tip Calibration Page



4. Perform the necessary steps to prepare for tip calibration and then press the **Next** button to proceed with the wizard.
 - A. Install a build sheet - make sure the build sheet is as centered as possible when placed onto the platen.
 - B. Verify vacuum - within about 5 minutes the printer should attain sufficient vacuum to secure the build sheet to the platen. The red X over the top of the Vacuum Status Indicator will disappear once sufficient vacuum is achieved (see “Information Bar” on page 44).

Figure 6-4: Prepare for Calibration Page

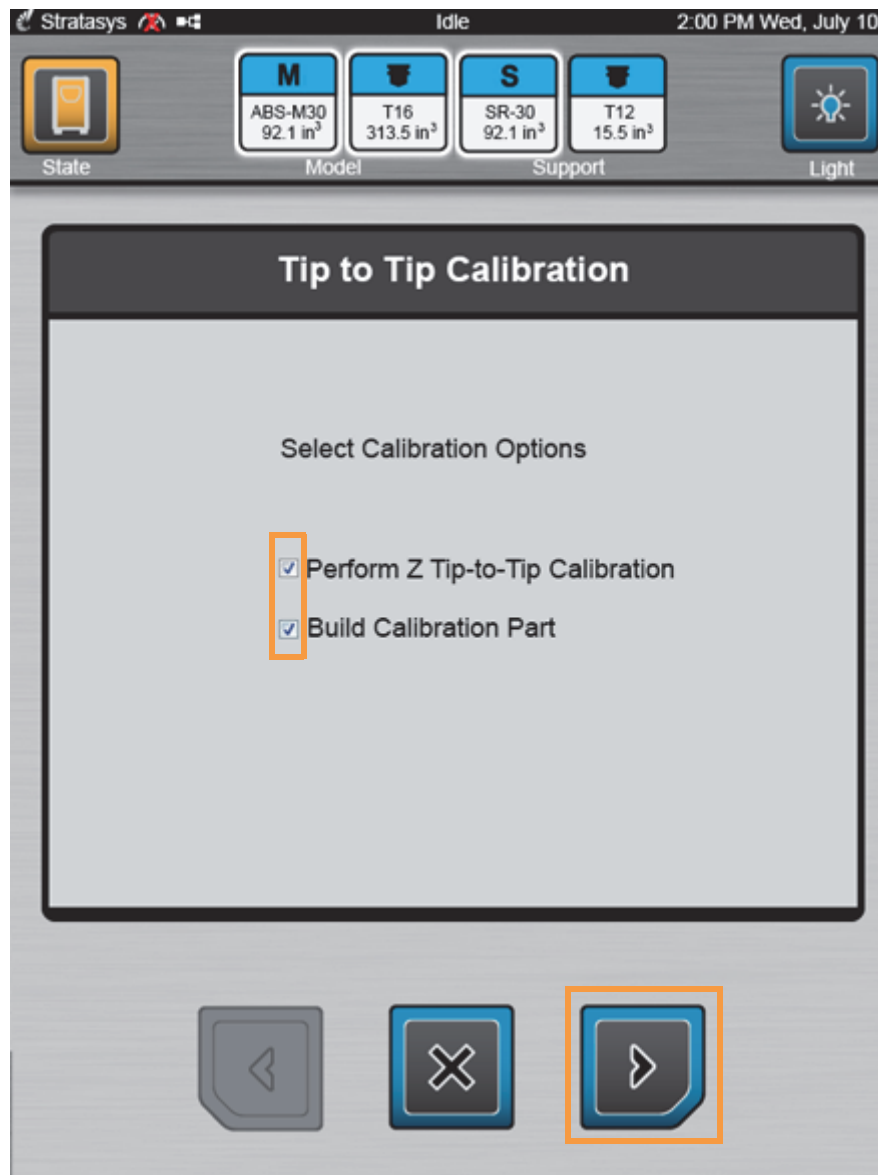
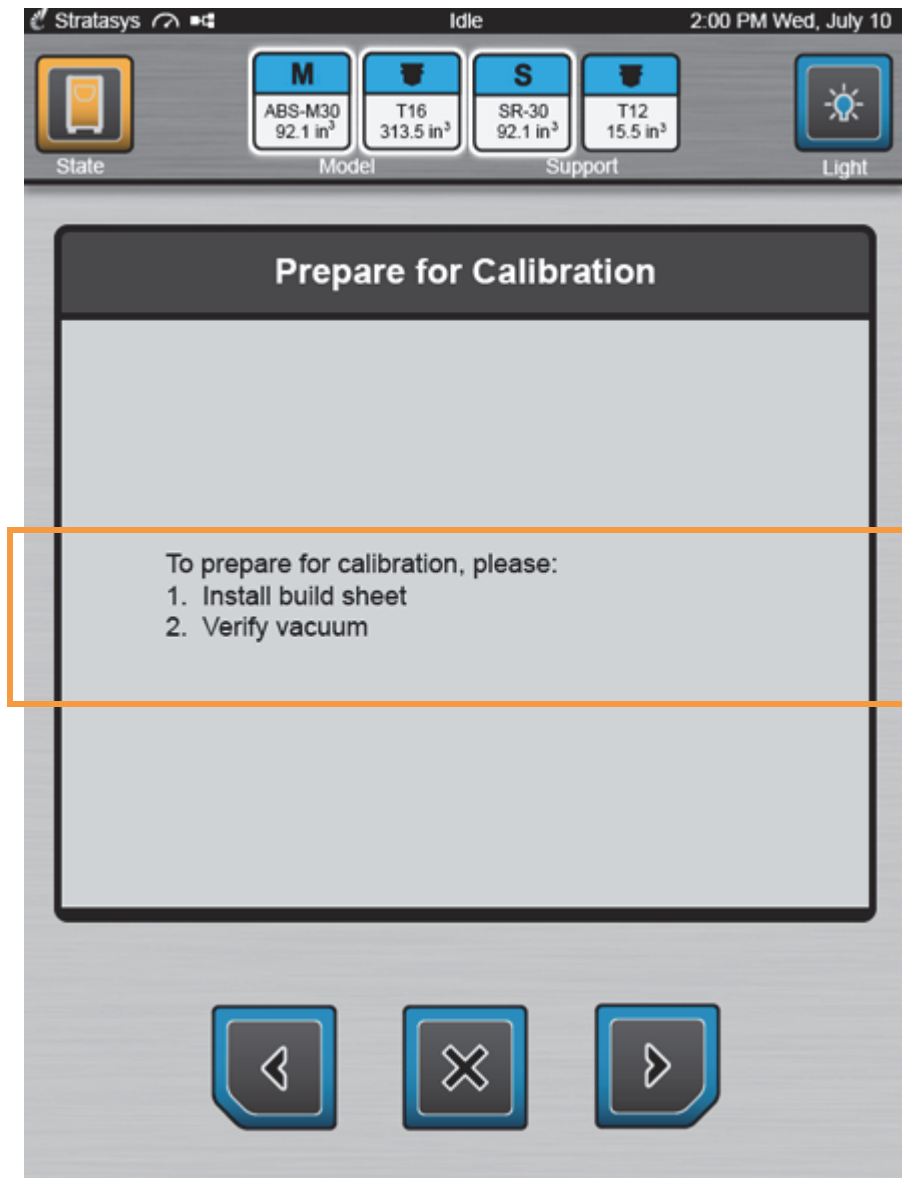

5. A screen will be displayed allowing you to select the calibration part's location on the build sheet prior to starting the build. The screen contains a graphic representing your printer's platen as well as a blue bounding box graphic (the imaginary box surrounding the part). Select the calibration part's build location by dragging and dropping the bounding box on the touchscreen; the bounding box cannot be placed outside the limits of the platen. Press the **Next** button to proceed with the wizard.

 **Note:** The Select Calibration Part Location page is displayed regardless of your printer's Enable Part Placement setting configuration (see ["Enable Part Placement"](#) on page 85 for details).

Figure 6-5: Select Calibration Part Location Page



- The printer will begin the process of building a calibration part. Since both options were selected in [step 3](#), this process includes performing a Z tip-to-tip calibration and then building the calibration part. The status of each task is indicated on the screen. A green checkmark will be displayed once a task is completed and the page's header will update to reflect the task currently in process. The tasks displayed will vary depending on which calibration options are selected/deselected within the Tip to Tip Calibration page ([Figure 6-3](#)).

A two-part radial progress graphic is displayed within the center of the page. This graphic displays the amount of time remaining until the entire process is complete (9 minutes in this case). Completion percentage is represented by radially filling in the outer progress ring of this graphic, in a clockwise direction. As each task is completed, the progress graphic will be updated.

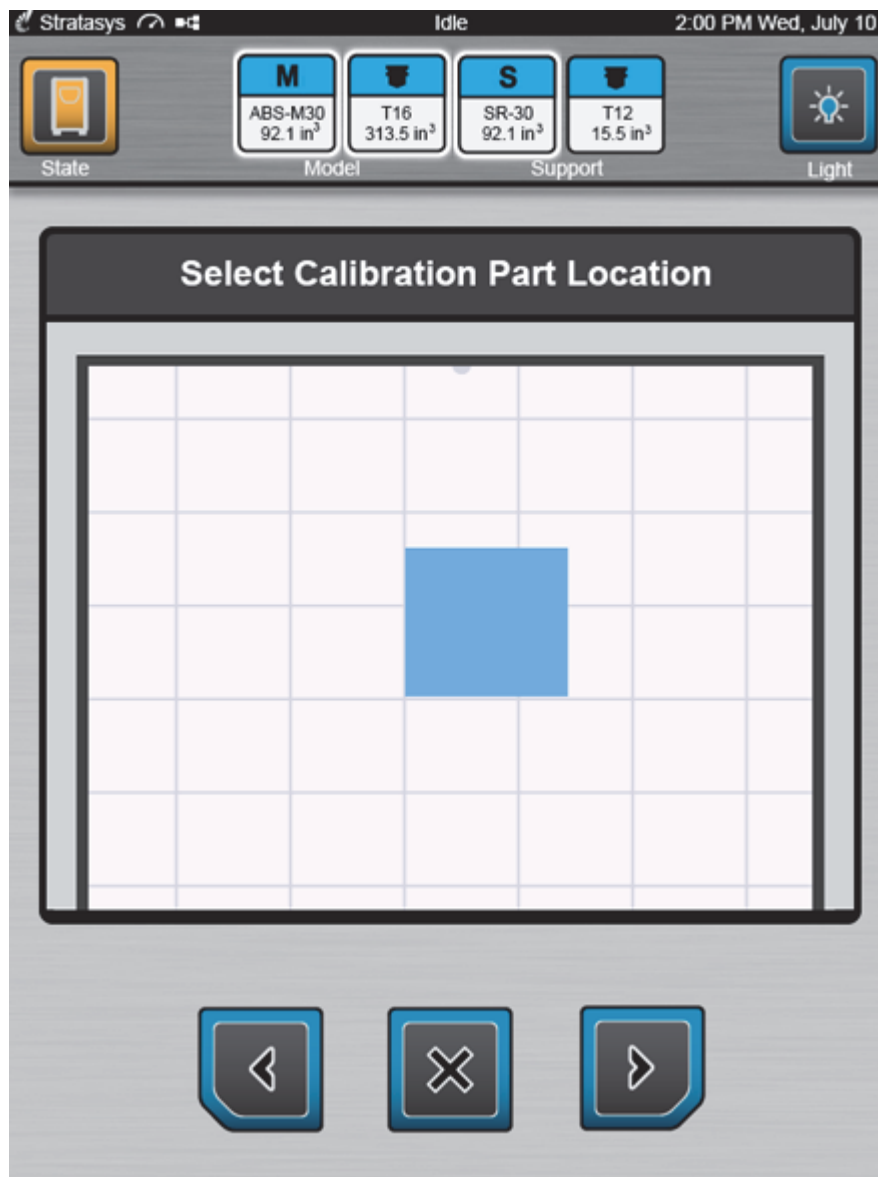
Figure 6-6: Z Tip-to-Tip Calibration Page

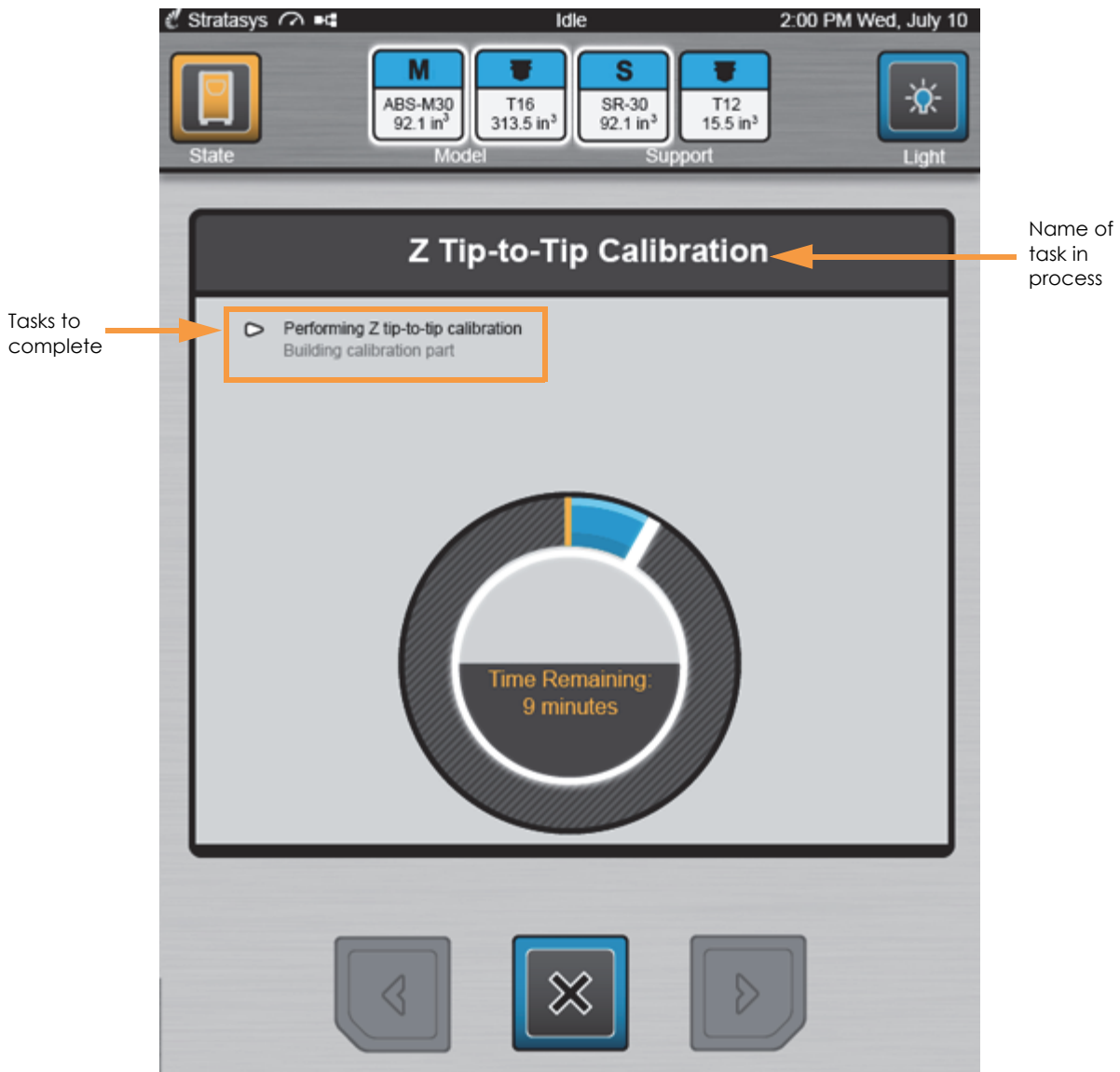

- A. In addition to the screen updating, the Information Bar and the Build State button will update to indicate when the printer is building the calibration part.

Figure 6-7: Build Calibration Part Page



- B. Once the calibration part is complete you will be prompted to remove the part from the printer. Remove the build sheet from the platen and allow it to cool and then press the **Next** button to proceed with the wizard.

Figure 6-8: Remove Calibration Part Page

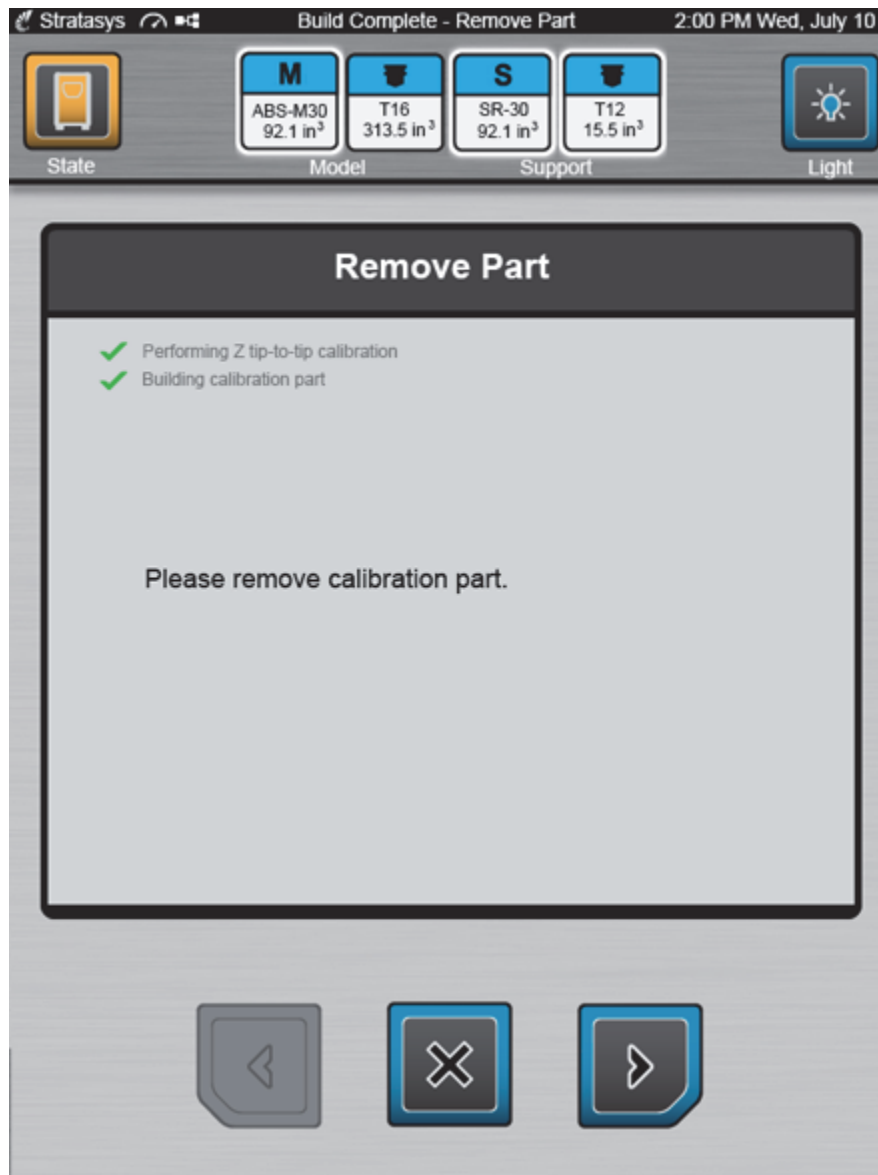

7. The Adjust XYZ Calibration page will open. The buttons within this page will allow you to make XYZ tip offset adjustments based on an analysis of the calibration part. The Material Thickness field displays the slice height for the model tip installed in the printer (see Table 6-2 for slice height information).

Figure 6-9: Adjust XYZ Calibration Page

Adjust XYZ Calibration page - English units

Adjust XYZ Calibration page - Metric units

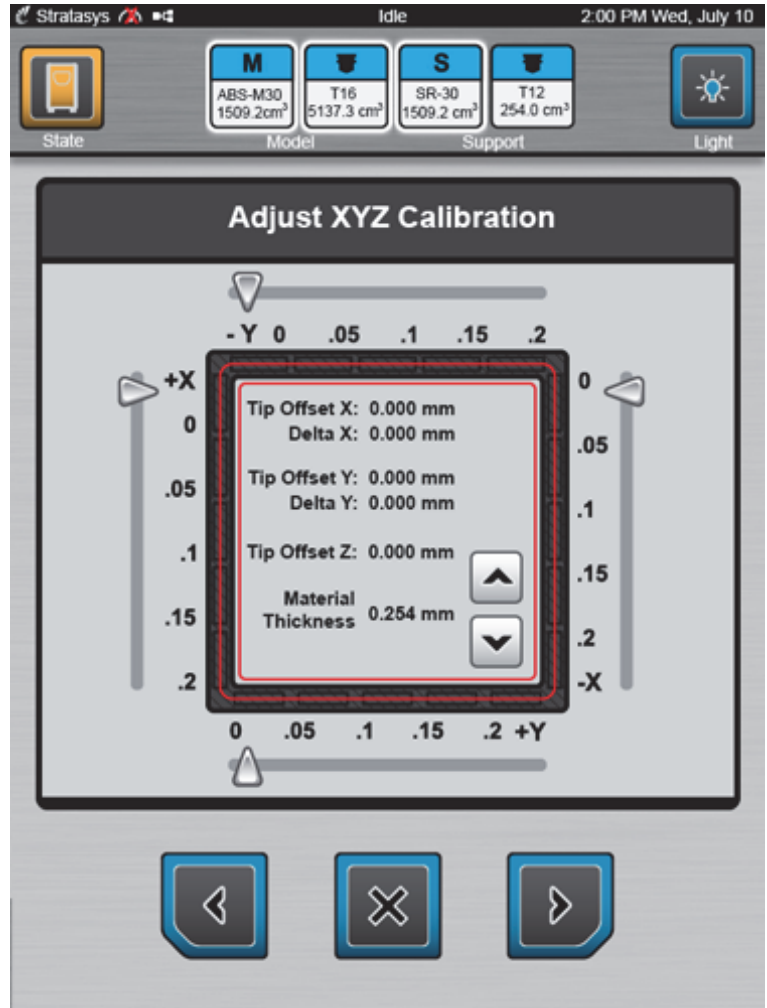
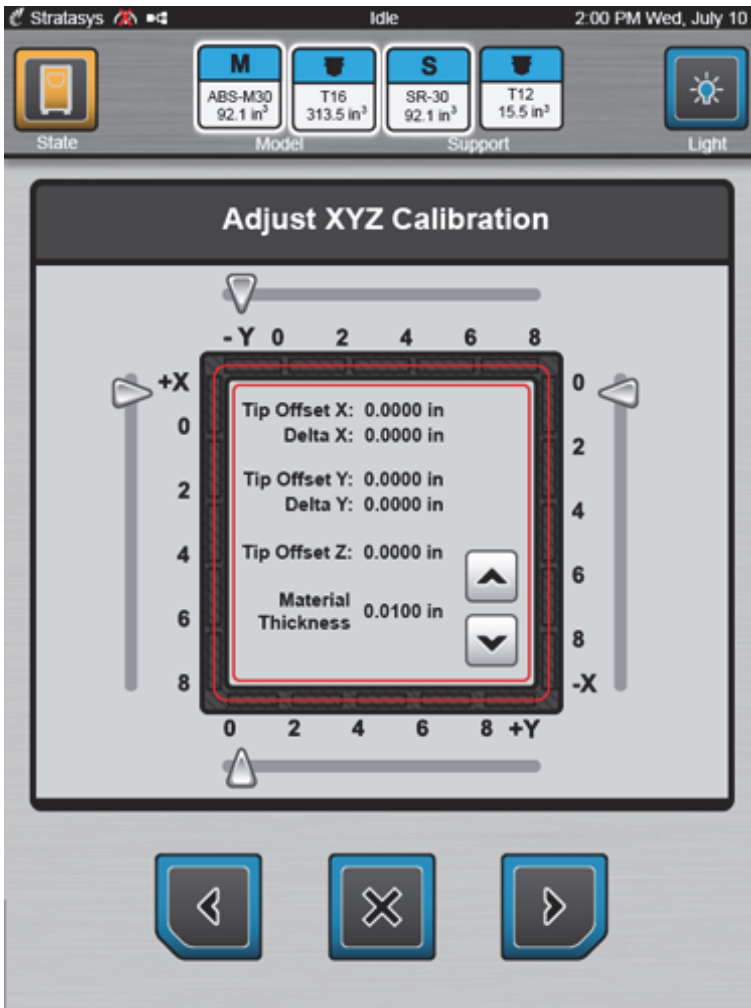

8. Determine the XY Offset Adjustment needed for your printer.
 - A. Using a magnifier (included in the Welcome Kit), view the relationship between the support calibration toolpath and the alignment indicators to determine the X and Y axis calibration.
 - Holding the build sheet up to the light, a contrasting-colored wall, or a contrasting-colored piece of paper may make it easier to view this toolpath.

- B. Determine where on each axis the support toolpath is most centered between the X-Y alignment indicators (see Figure 6-10 or Figure 6-11 for English units, and Figure 6-12 and Figure 6-13 for Metric units). The numbers on the calibration part represent thousandths of an inch (e.g., 4 = 0.004 in.).

Figure 6-10: Calibration Part - No Adjustment Needed (English units)

Magnified single side of a calibration part with a reading of 0.

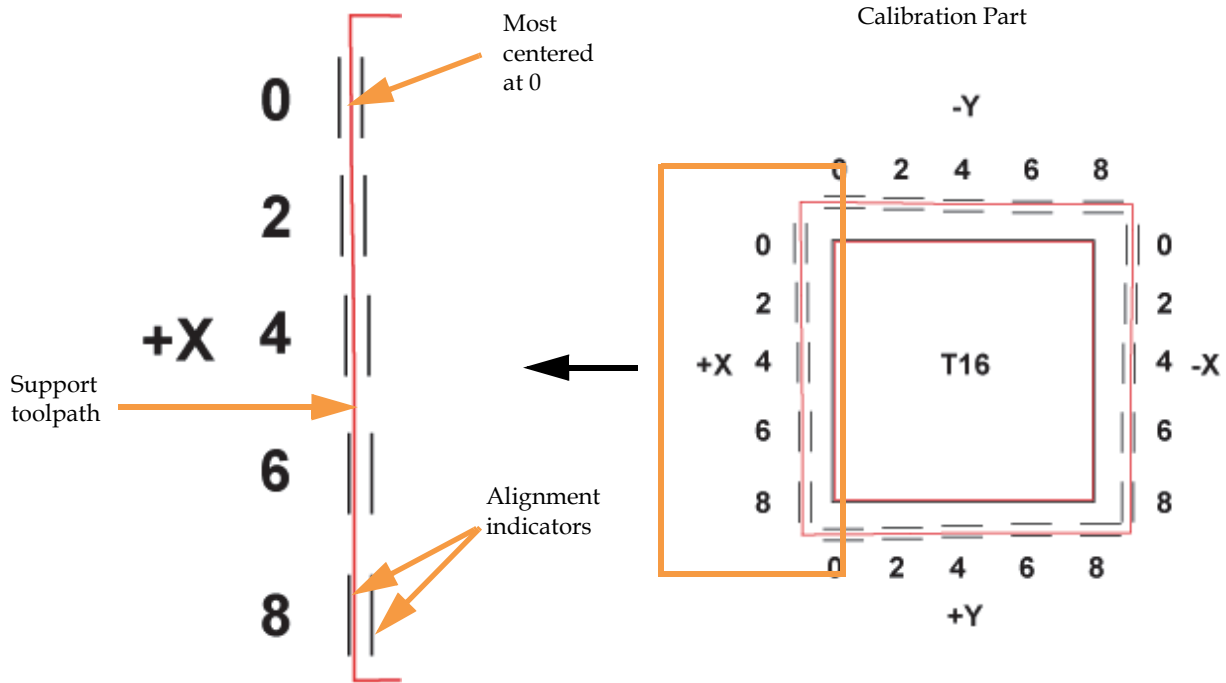

Figure 6-11: Calibration Part - Adjustment Needed (English units)

Support toolpath is most centered between the alignment indicators at the 4, indicating an adjustment of $+X = 0.004$

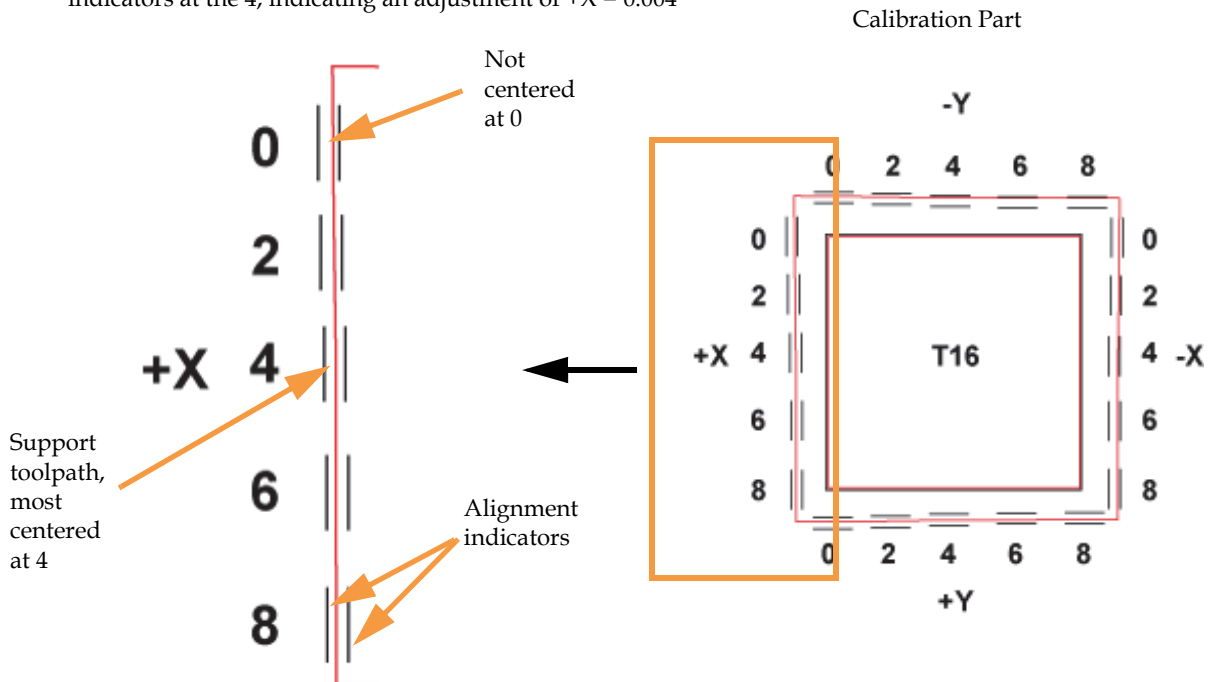

Figure 6-12: Calibration Part - No Adjustment Needed (Metric units)

Magnified single side of a calibration part with a reading of 0.

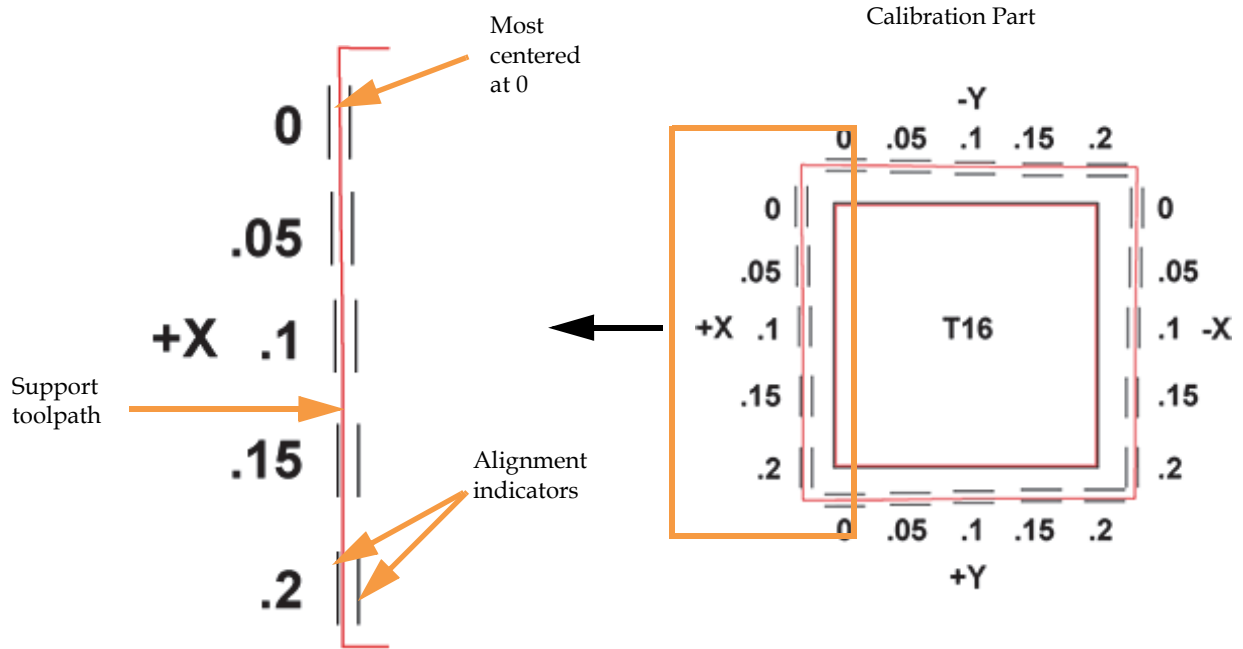
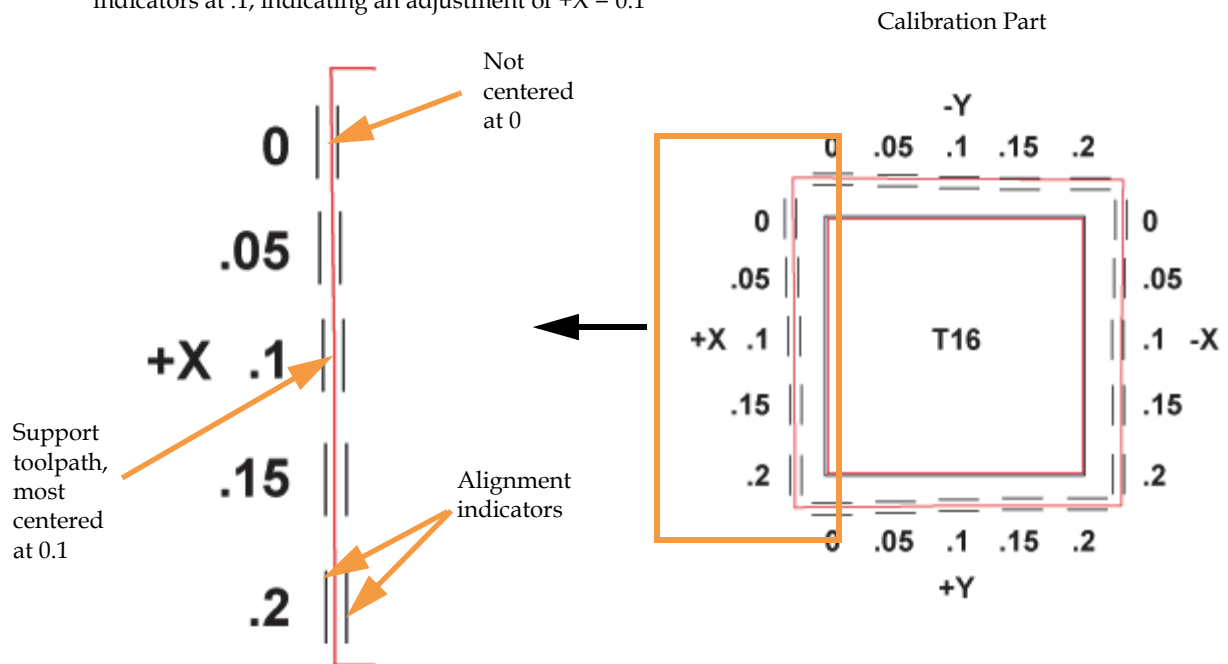

Figure 6-13: Calibration Part - Adjustment Needed (Metric units)

Support toolpath is most centered between the alignment indicators at .1, indicating an adjustment of $+X = 0.1$



- C. Within the Adjust XYZ Calibration page, slide the scale icons on the screen to match where the support toolpath is most centered between the alignment indicators. The Delta X and Delta Y fields will reflect adjustments made.



Note: Only one offset value can be selected for each axis, (i.e., an adjustment of $+X = 2$ (0.002 in. (0.05mm)) and $-X = 4$ (-0.004 in. (0.1 mm)) is not allowed).

To be within tolerance, the X and Y values found on the calibration part must be at or under 2 or 0.002 in. (0.05 mm). Therefore any reading within the range of 0 to 2 (0 to 0.05mm) for an axis is acceptable, although a reading of 0 is preferable.

- If the support toolpath is most centered at 2 (0.05mm) or less (as in [Figure 6-10](#) and [Figure 6-12](#)), the printer is calibrated for that axis and an adjustment is not required. The following figure shows an XY offset requiring no adjustments. If the support toolpath for your calibration part is most centered at 2 (0.05mm) or less for both the X and Y axis, proceed to [step 9](#).

Figure 6-14: XY Offset - No Adjustment

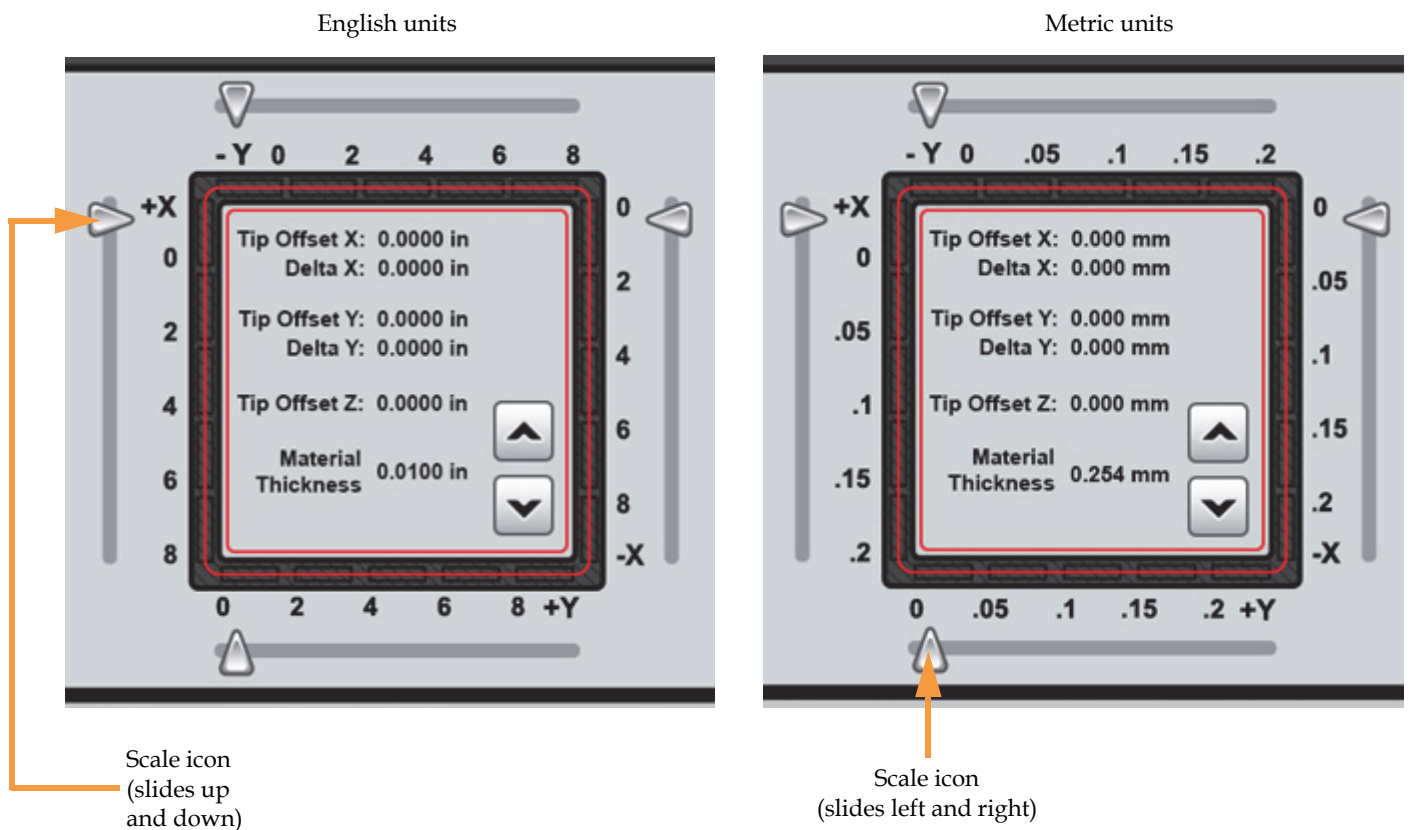

- If the support toolpath is not centered at 2 (0.05mm) or less (as in [Figure 6-11](#) and [Figure 6-13](#)) an offset adjustment is needed. The following figure shows a +X adjustment of 4 or 0.004 in. (0.1 mm). The +X scale icon has been moved downward to the 4 (0.1) and the Delta X value reflects this adjustment (0.0040 in./ 0.100mm).

Figure 6-15: XY Offset - +X Adjustment

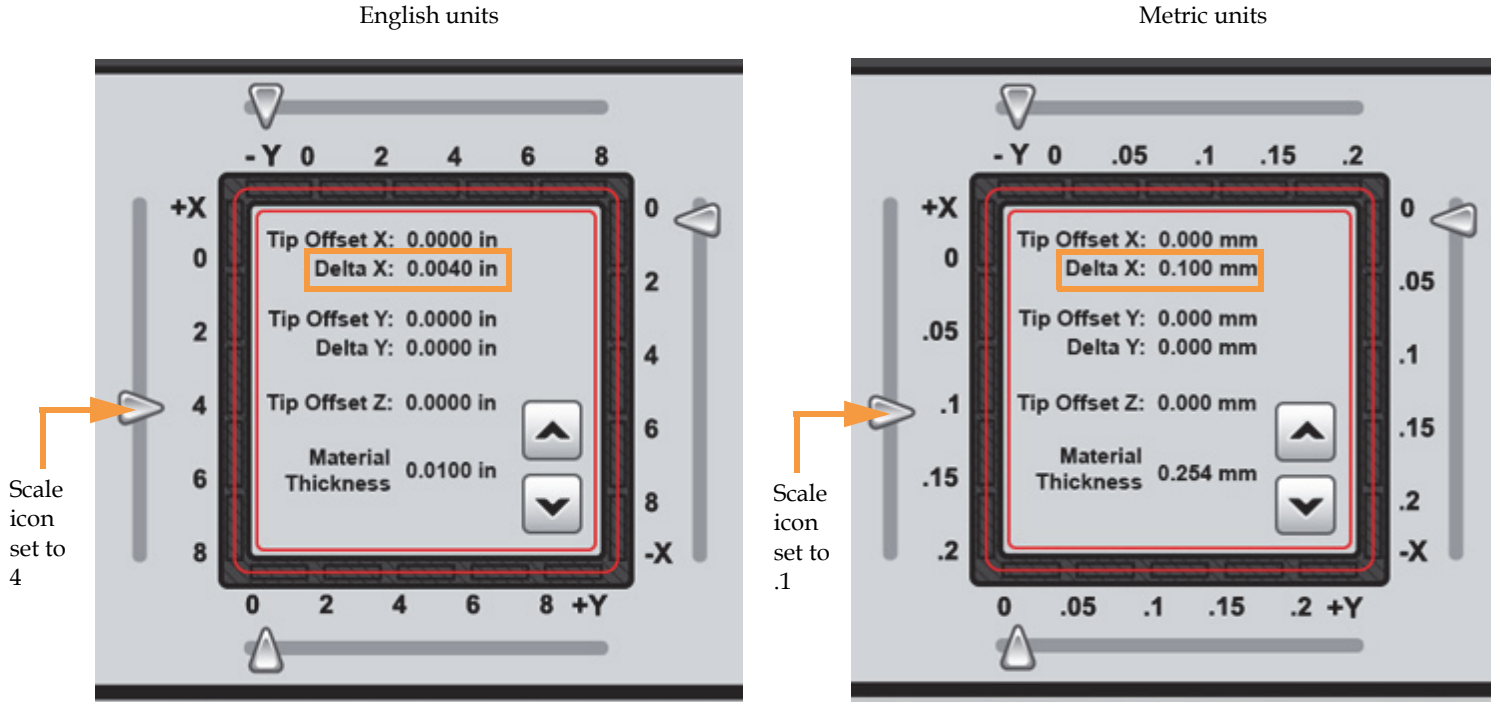

- D. If an adjustment value for either axis is required you will need to rebuild the calibration part. To do so:
- After entering your adjustment value(s) press the **Next** button within the Adjust XYZ Calibration page. Your calibration adjustment(s) will be saved.
 - The Finish Calibration page will be displayed (see [Figure 6-19](#)); press the **XYZ Tip Offset Calibration** button within this page.

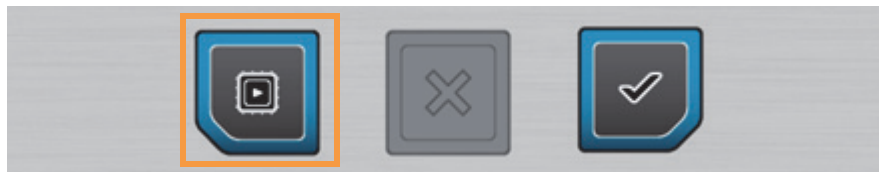

Note: Do not press the checkmark button as this will close the wizard.

- If you closed the wizard before properly calibrating your printer's tips:
- Press the **XYZ Tip Offset Calibration** button within the Calibration page to reopen the wizard (see [step 2](#)).
 - Ensure that **only** the "Build Calibration Part" option is selected within the Tip to Tip Calibration page (see [Figure 6-3](#)) and then press the **Next** button. If the "Perform Z Tip-to-Tip Calibration" option is also selected, a new Z Tip-to-Tip Calibration will be initiated, and the correction values entered previously will be reset.
 - Proceed with the wizard starting from [step 4](#).

- The Prepare for Calibration page will be displayed (Figure 6-4). Perform the steps indicated on the screen, making sure to install a build sheet, and then press the **Next** button.
 - Within the Select Calibration Part Location page (Figure 6-5) select the calibration part's location on the build sheet and then press the **Next** button.
 - The Build Calibration Part screen will be displayed (Figure 6-7) and the calibration part will begin building (a Z tip-to-tip calibration will not be performed).
 - Once the calibration part is complete you will be prompted to remove the part from the printer (Figure 6-8). Remove the completed part and then press the **Next** button.
 - Repeat the instructions in [step 7](#). Continue to check and adjust for XY offset. Readjusting until the calibration toolpath is centered at 0 for the X and Y axis is preferable. However, readjusting until the calibration toolpath for X and Y is within tolerance, which is at or under 2 or 0.002 in. (0.05 mm) for an axis, is acceptable.
- E. Proceed to the Z offset adjustment ([step 9](#)) once the calibration toolpath for X and Y is within tolerance.
9. Determine the Z Offset Adjustment.



Note: Do not measure for Z until the calibration part shows the XY offset to be at 2 (0.05 mm) or less for the X and Y axis (see [step 7](#) for details).

- A. Peel the support layer from the inner square of the calibration part.
- B. Measure the thickness of the support layer on each side of the square with a caliper or micrometer. Measure in the center of each side; measuring near the corners will result in inaccurate values.
- C. Take the average value of the four measurements, this is the number you will enter for the Z offset adjustment.

Figure 6-16: Remove and Measure Support Layer

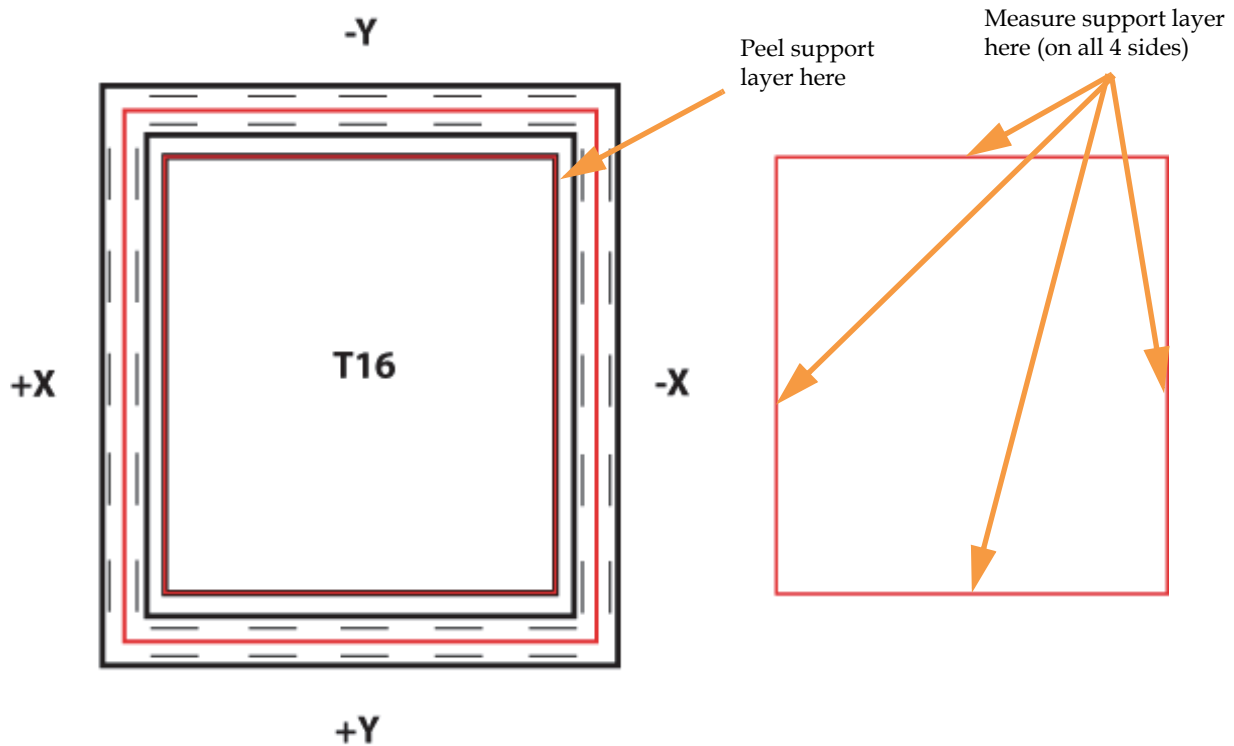

- D. Refer to [Table 6-2](#) and determine the slice height for the model tip installed in your printer.

Table 6-2: Model Tip Slice Heights

Model Tip	Slice Height (in)	Slice Height (mm)
T10	0.005	0.127
T12	0.007	0.178
T16	0.010	0.254
T20	0.013	0.330

- E. If the value measured in [step C](#) is within ± 0.0005 in. (0.01 mm) of the model tip's slice height (see [Table 6-2](#)) the printer is calibrated for the Z axis and an adjustment is not required. Proceed to [step 10](#).
- F. If the value measured in [step C](#) is not within ± 0.0005 in. (0.01 mm) of the model tip's slice height (see [Table 6-2](#)), you will need to enter a Z offset adjustment using the Up and Down buttons within the Adjust XYZ Calibration page ([Figure 6-9](#)). Each button press equates to one ten thousandths of an inch.
- Use the **Down** button to enter the value obtained in [step C](#) if this value is less than the tip's slice height. For example, if you measured an average of 0.008 in. (0.203 mm) for a tip with a slice height of 0.010 in. (0.254 mm), press the Down button until 0.0080 (0.203) is displayed within the Material Thickness field.

Figure 6-17: Z Offset Adjustment

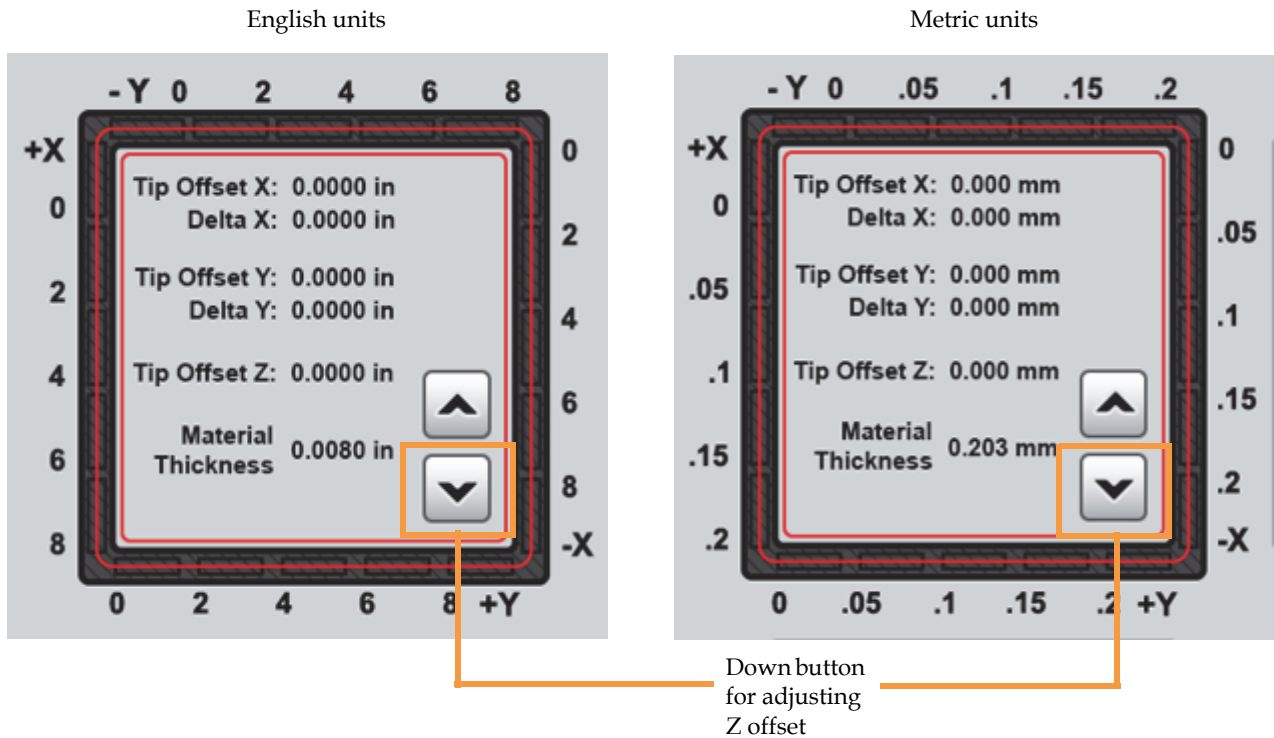

- Use the **Up** button to enter the value obtained in **step C** if this value is greater than the tip's slice height. For example, if you measured an average of 0.012 in. (0.305 mm) for a tip with a slice height of 0.010 in. (0.254 mm), press the Up button until 0.0120 (0.305) is displayed within the Material Thickness field.

Figure 6-18: Z Offset Adjustment

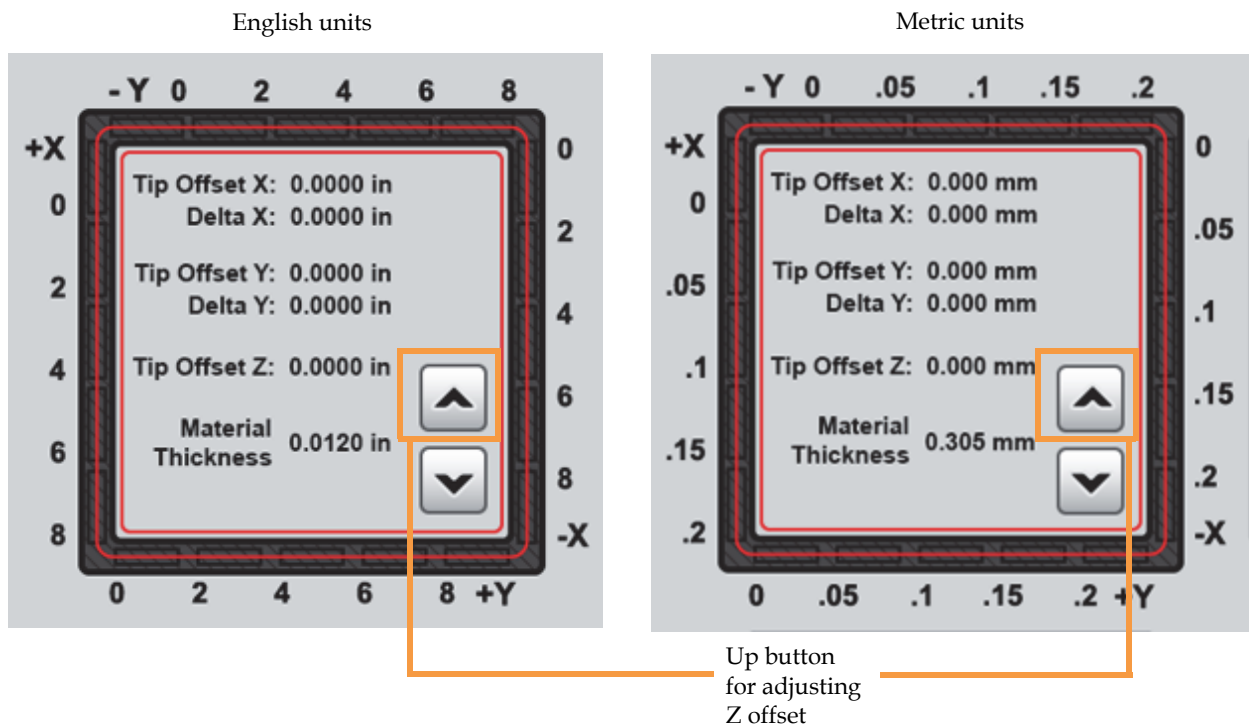

- G. If a Z offset adjustment is required you will need to rebuild the calibration part. To do so:
- After entering your Z offset adjustment press the **Next** button within the Adjust XYZ Calibration page. Your Z offset adjustment will be saved.
 - The Finish Calibration page will be displayed (see [Figure 6-19](#)); press the **XYZ Tip Offset Calibration** button within this page.



Note: Do not press the checkmark button as this will close the wizard.

If you closed the wizard before properly calibrating your printer's tips:

- Press the **XYZ Tip Offset Calibration** button within the Calibration page to reopen the wizard (see [step 2](#)).
- Ensure that **only** the "Build Calibration Part" option is selected within the Tip to Tip Calibration page (see [Figure 6-3](#)) and then press the **Next** button. If the "Perform Z Tip-to-Tip Calibration" option is also selected, a new Z tip-to-Tip Calibration will be initiated, and the correction values entered previously will be reset.
- Proceed with the wizard starting from [step 4](#).

- The Prepare for Calibration page will be displayed ([Figure 6-4](#)). Perform the steps indicated on the screen making sure to install a build sheet, and then press the **Next** button.
 - Within the Select Calibration Part Location page ([Figure 6-5](#)) select the calibration part's location on the build sheet and then press the **Next** button.
 - The Build Calibration Part screen will be displayed ([Figure 6-7](#)) and the calibration part will begin building (a Z tip-to-tip calibration will not be performed).
 - Once the calibration part is complete you will be prompted to remove the part from the printer ([Figure 6-8](#)). Remove the completed part and then press the **Next** button.
 - Repeat the instructions in [step 9](#). Continue to check and adjust for Z offset until the support layer matches the model tip slice height ± 0.0005 in. (0.01 mm).
10. Once you're finished adjusting for XY and Z, press the **Next** button within the Adjust XYZ Calibration page. Your calibration adjustment(s) will be saved.

11. The Finish Calibration page will be displayed. Press the **checkmark** button within the Finish Calibration page to exit the wizard. You will be returned to the Calibration page, and “System is calibrated” should be displayed within the Calibration Status Pane (Figure 4-33).

After exiting the wizard you must immediately adjust tip wipe height, for both the model and support tip, as improper tip height can significantly impact part quality. See “Adjusting Tip Wipe Heights” on page 159 for detailed instructions.

Figure 6-19: Finish Calibration Page

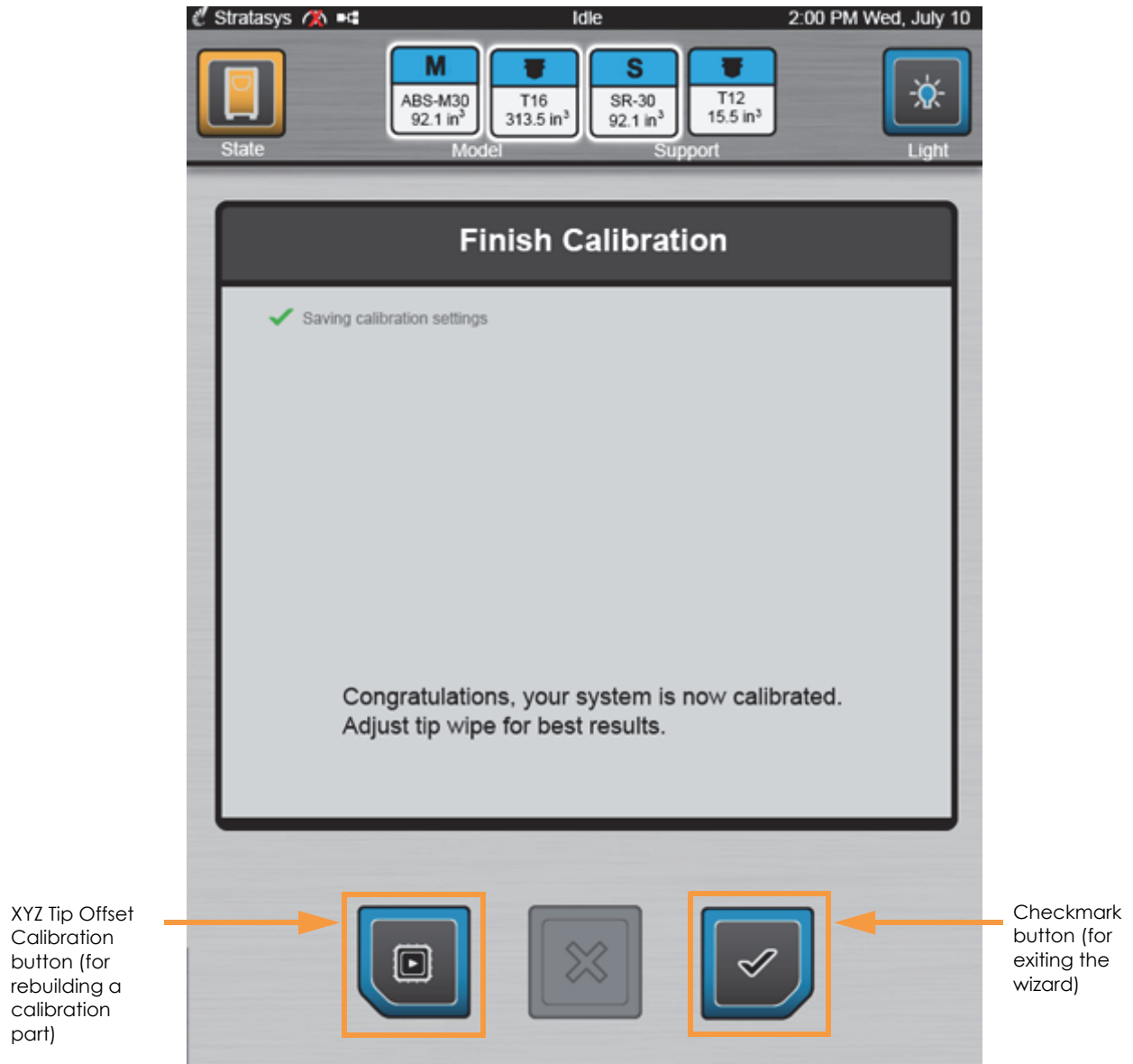

Touchscreen Calibration



Caution: A stylus pen should be used when performing this calibration to ensure precise calibration. Do not use your fingertip to perform this calibration. If a stylus pen is not available, a pencil eraser may be used.

You have the option of recalibrating the printer's touchscreen display. Extreme care must be taken when performing this calibration as an improperly calibrated touchscreen can lead to button accuracy issues.

To recalibrate the touchscreen:

1. Open the Calibration page by pressing the **Calibration** button within the Navigation Bar.
2. Press the **Touchscreen Calibration** button within the Calibration page.
3. A dialog will be displayed asking you if you want to recalibrate the touchscreen, press the **checkmark** button to confirm.

Figure 6-20: Recalibrate Screen Confirmation Page

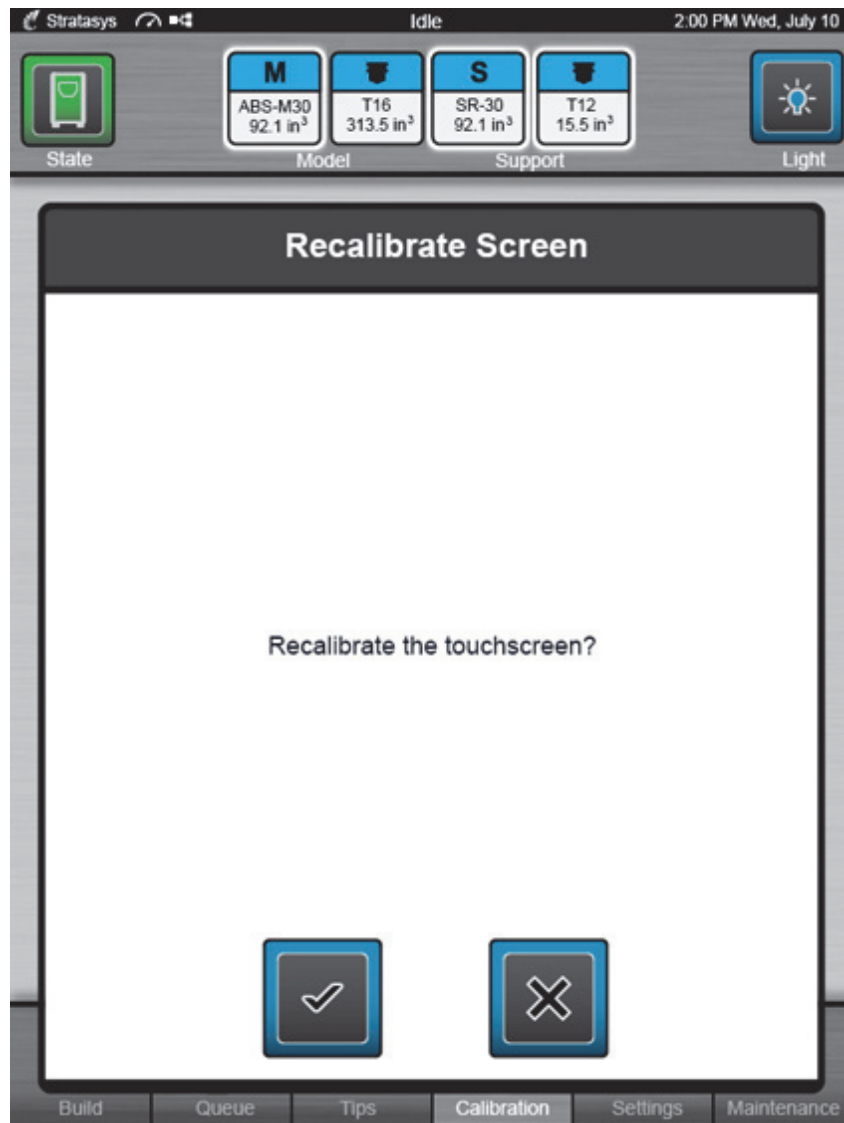

4. A dialog is displayed with instructions for recalibrating the touchscreen. Using a stylus, touch the screen in the center of the calibration point displayed. Repeat this process for the remaining calibration points (1 point for each of the 4 corners of the screen).



Note: The graphic displayed within the center of the dialog represents the time remaining before the touchscreen calibration times out. The black portion will fill the perimeter of the grey circle in a clockwise direction. You must touch the calibration point displayed within the screen before the black portion of the graphic completes a full circle. The timer will reset for each of the 4 calibration points displayed. If you wish to exit the page without calibrating the screen simply wait until the black portion of the graphic completes a full circle; the dialog will close and you will be returned to the Calibration page.

5. Once finished, your calibration settings will be saved and the dialog will close. You will be returned to the Calibration page.

Figure 6-21: Touchscreen Calibration Procedure

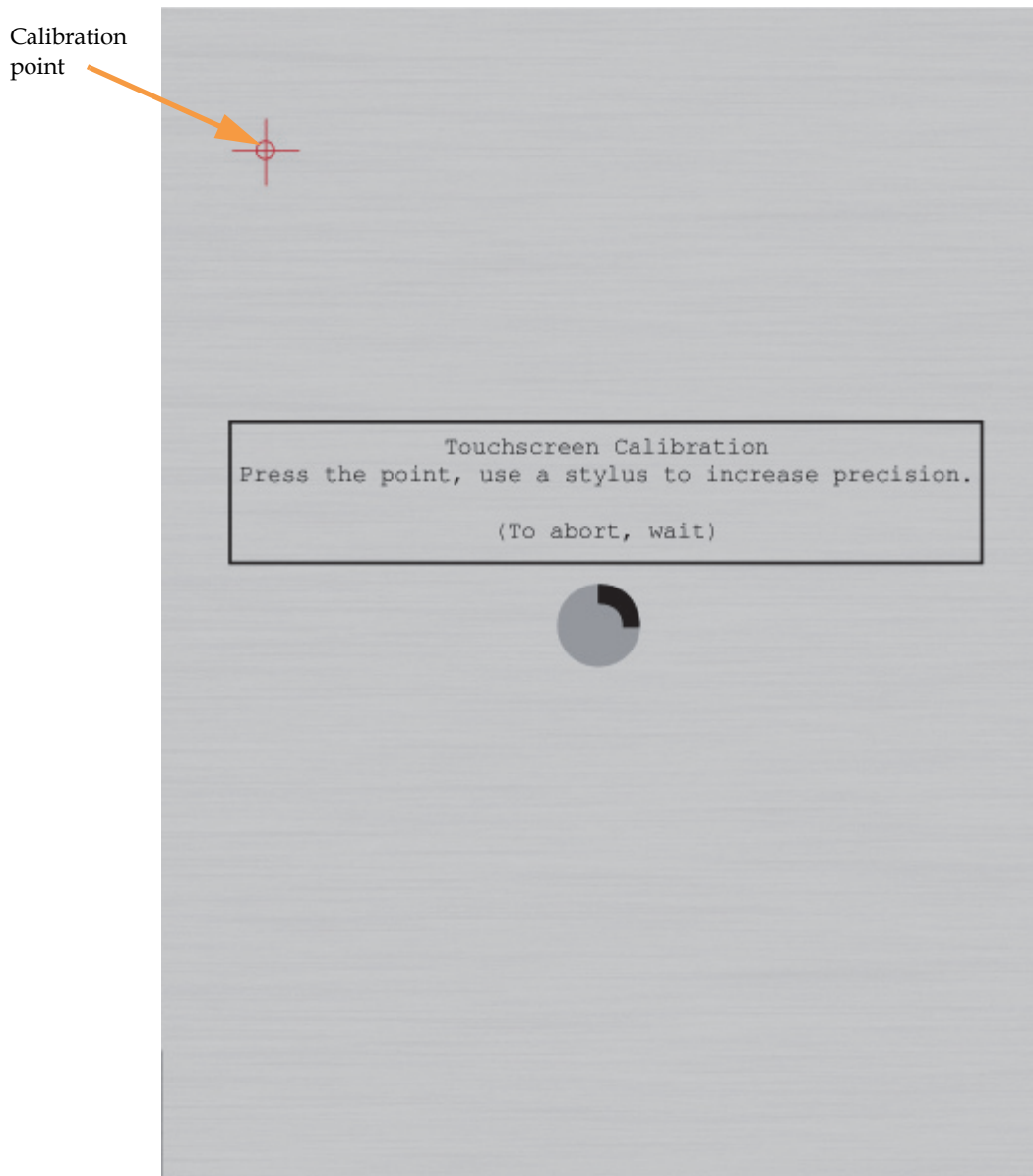

XY Home Calibration

The printer is designed to automatically perform an XY Home Calibration as part of its initialization and startup process. Each time the printer is powered on, it will automatically perform this calibration. The XY Home Calibration is responsible for finding the home position for the X and Y axes. The home position is a set location the system references for all movements.



Note: You can manually perform this calibration using the XY Home button (see “Calibration Controls” on page 79).

The XY Home Calibration requires no user interaction. When homing XY the printer will:

- Find its Z home limit switch
- Find its X and Y travel limits
- Return to the head parked position

Z Zero Calibration

The printer automatically initiates a Z Zero Calibration before each job is built; “Finding Z Zero” will be displayed within the Information Bar while this process is occurring. This calibration sets the reference point between the model tip and the build sheet to ensure proper positioning for the first layer of a build.

This calibration requires no user interaction. When performing the Z Zero Calibration, the printer will find the Z end of travel sensor at the bottom of travel and will then find the tip sensor using the model tip. Based on this positioning the printer knows the reference distance between the tip sensor and the build sheet.

7 Maintenance

This chapter describes various maintenance tasks that will routinely need to be performed on the 380mc.

Add Printer to Control Center

Control Center software is packaged together with Insight software (see “Software” on page 41), and is installed on your workstation PC as part of the initial installation and setup process (performed by your authorized service representative). During the software installation process, your printer’s network information should have been configured within Control Center allowing you to send CMB files to the printer. This section is provided in case you need to reconfigure your printer within Control Center.

1. Open the Settings page by pressing the **Settings** button within the Navigation Bar.

Figure 7-1: Settings Button Location



2. Within the Network portion of the page a row containing network address information can be found. Locate the IP Address field within this row, and record your printer’s IP address.

Figure 7-2: Locate IP Address

Address Type	DHCP
IP Address	10.10.114.101
Netmask	255.255.248.0
Gateway Address	10.10.112.1

- From the workstation's Start Menu, navigate to **All Programs > Insight (installed version) > Control Center (installed version)** or double-click the Control Center shortcut (if available).

Figure 7-3: Open Control Center

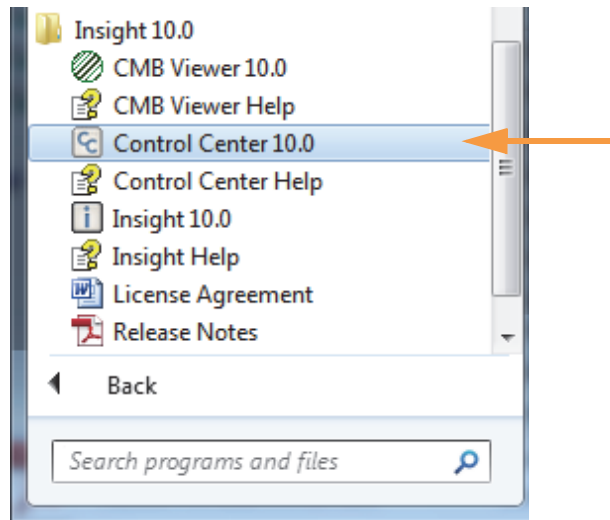

- Within Control Center, select the **Services** tab and then click the **Manage FDM Systems** button.

Figure 7-4: Manage FDM Systems Button Location

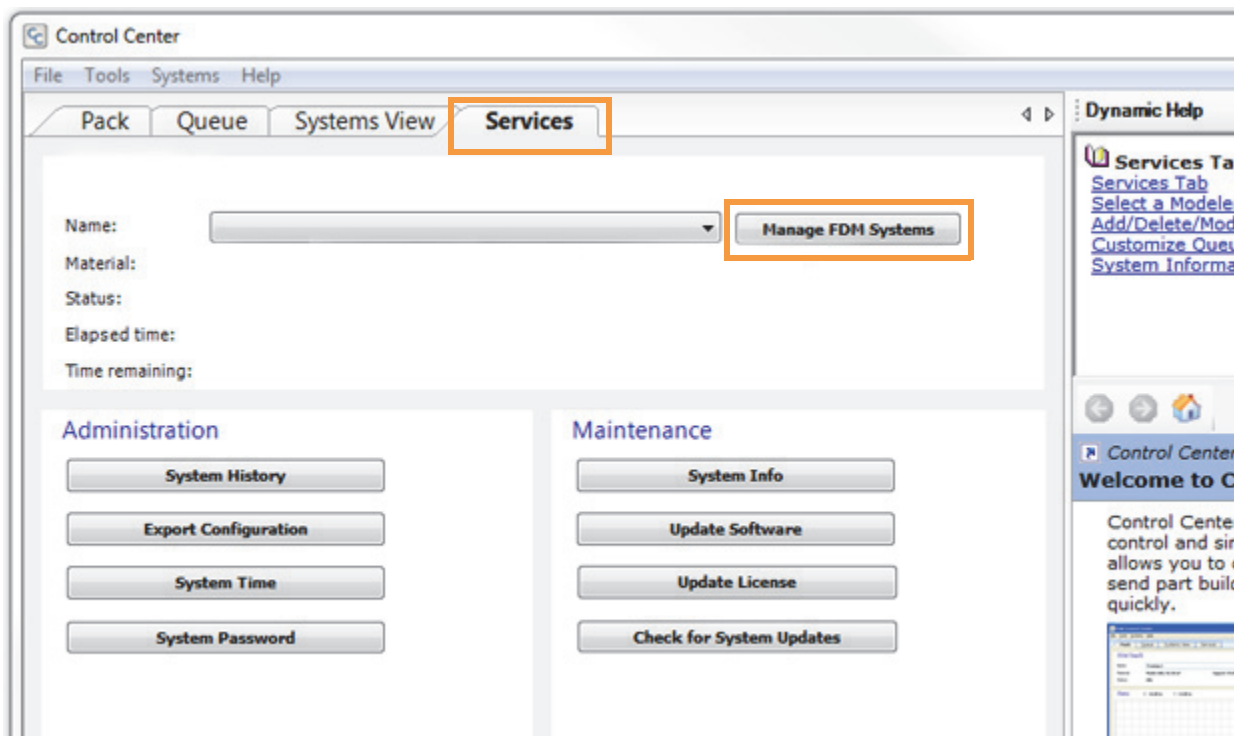

- Click the **Add Manually...** button within the dialog displayed.

6. The Add FDM System dialog will be displayed. Configure the following information within this dialog:
 - Enter a unique identifying name into the Name: field. This field is optional, but will help you quickly locate your printer in the event that you have several printer's configured.
 - Enter the printer's location into the Location: field. This field is optional.
 - Enter the IP address recorded in [step 2](#) into the IP Address: field.
 - Select Fortus 380mc from the Type: drop-down menu.
7. Click the **Add System** button when finished. A dialog will be displayed informing you that Control Center is verifying the connection to the printer as well as the printer type.

Figure 7-5: Add FDM System Dialog

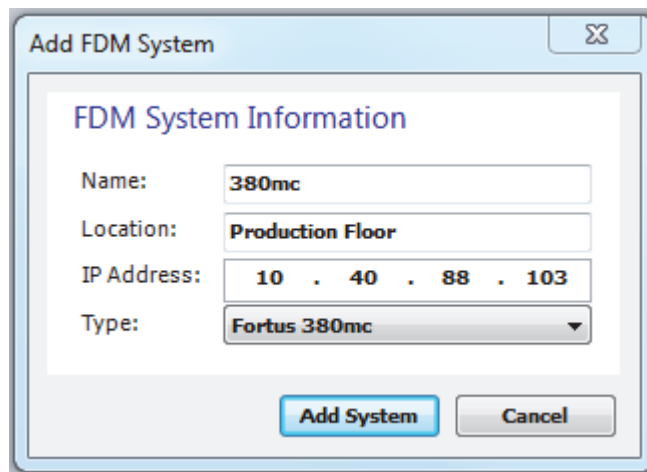

The screenshot shows a dialog box titled "Add FDM System". Inside the dialog, there is a section titled "FDM System Information" with the following fields:

- Name: 380mc
- Location: Production Floor
- IP Address: 10 . 40 . 88 . 103
- Type: Fortus 380mc (selected from a dropdown menu)

At the bottom of the dialog, there are two buttons: "Add System" and "Cancel".

8. Once verification is complete, a dialog will be displayed informing you that the printer is connected and your printer will be added to the list displayed. Click the **Close** button.
9. Within Control Center, select the **Services** tab and then select your 380mc printer from the drop-down menu to make it your active printer (see [Figure 7-4](#) on page 203 for menu location).

Install/Update Material License

The printer's material license determines the types of materials (model and support) that can be used to build parts on the printer (see [Available Material Options](#) for material option details). The printer should have been licensed as part of its initial installation and setup process (performed by your authorized service representative). However, if you determine that the printer was not licensed properly, the steps within this section will guide you through the process of licensing your printer. Similarly, if you find that the printer's material option configuration no longer meets your needs, you can purchase a different material package and upgrade your printer's material license by following the steps below.

Perform the following steps to install or update your printer's material license:

1. Save the 380mc license file to a known location on the workstation PC.
2. Open the Maintenance page by pressing the **Maintenance** button within the Navigation Bar.
3. Locate the Materials row within the page and press the right arrow graphic within the row to open the Materials Details page. This page displays a list of the material types configured for use on the printer, and allows you to put the printer into License Upgrade Mode.
4. Press the **Add License** button located beneath the list of licensed materials. This will open a new page and automatically put the printer into License Upgrade Mode, allowing it to accept the new material license.

Figure 7-6: Materials Details Page - Add License Button Location

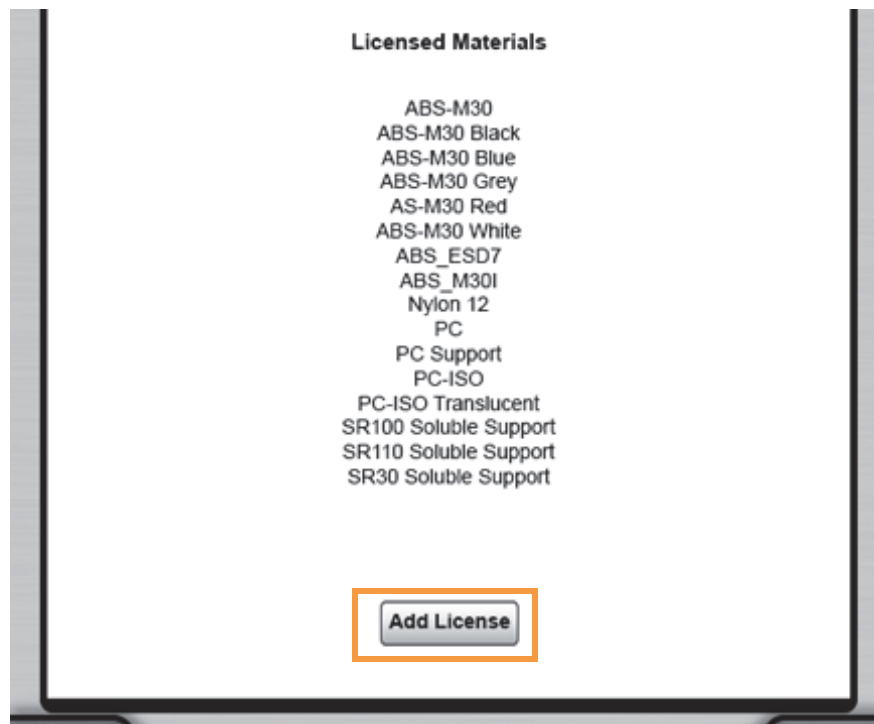

- The Add Material License page will open. A radial progress graphic is displayed within the lower portion of the page, indicating that the printer is in License Upgrade Mode and waiting to receive the material license upgrade. The text displayed within this section of the page will update as license upgrade progress is made.

Figure 7-7: Add Material License Page - License Upgrade Mode

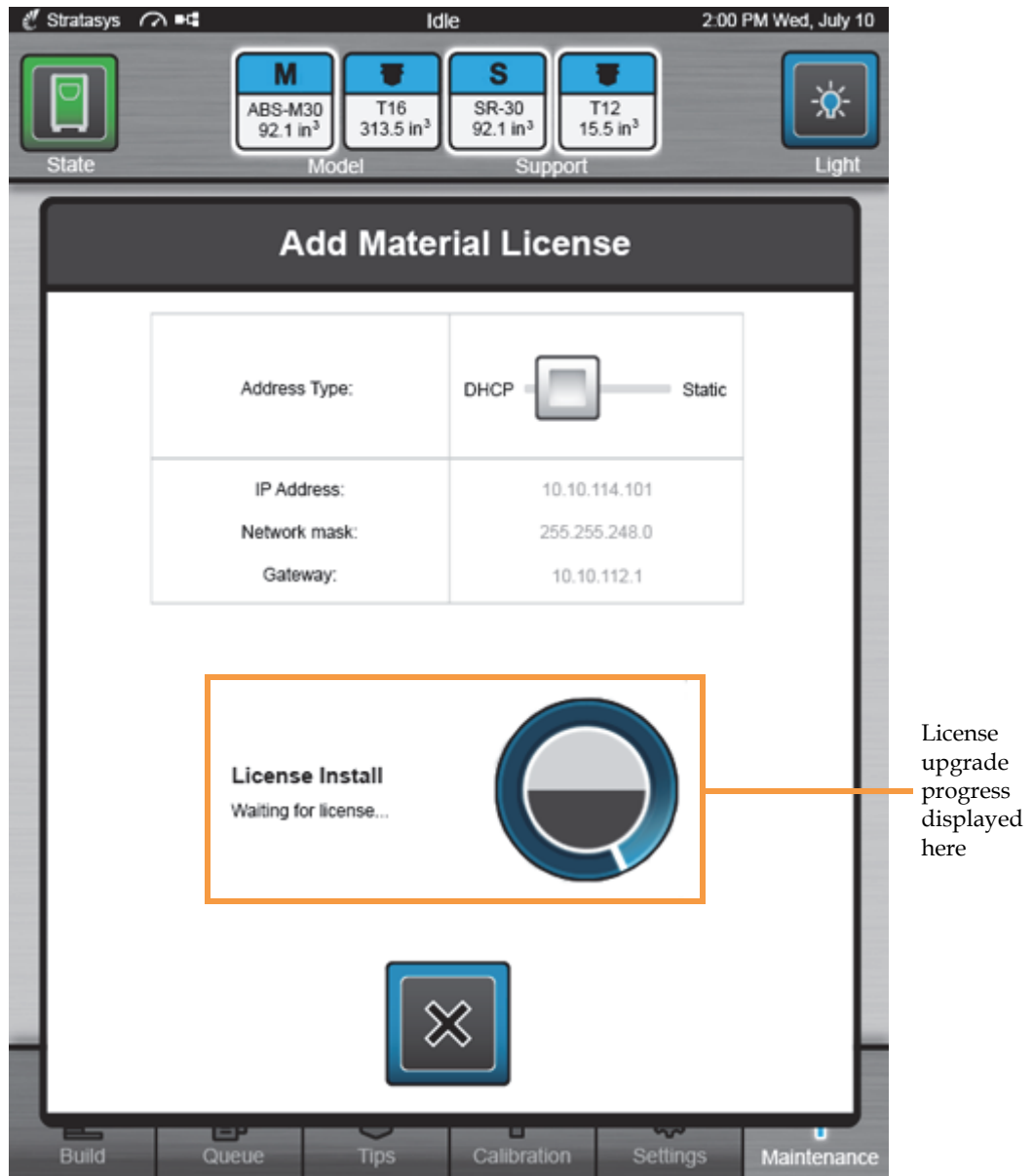

- From the workstation's Start Menu, navigate to **All Programs > Insight (installed version) > Control Center (installed version)** or double-click the Control Center shortcut (if available). See Figure 7-3 on page 203.

7. Within Control Center, select the **Services** tab. Ensure that your 380mc printer is selected from the drop-down menu and then click the **Update License** button. (See “Add Printer to Control Center” on page 202 if you cannot select your printer from the drop-down menu.)

Figure 7-8: Update License Button Location

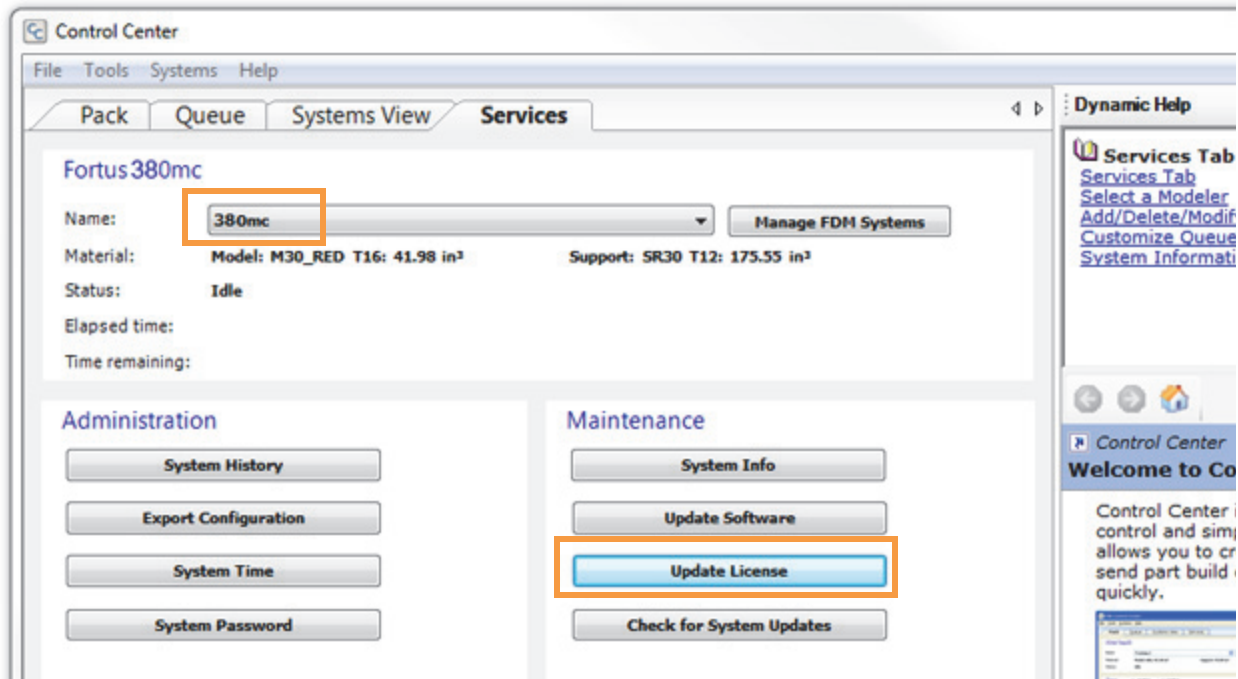

8. Control Center will begin establishing a connection with the printer. Once a connection is established, the workstation PC's file explorer will open.
9. Browse to the location of the 380mc license file that was transferred in step 1.
10. Select the license file and then click **Open**. Control Center will begin sending the new material license to the printer; “Downloading license” and then “Verifying license” will be displayed on the touchscreen.
11. Once the material license is successfully downloaded to the printer an indicator will be displayed within the bottom of the Control Center window.

Figure 7-9: License Successfully Downloaded

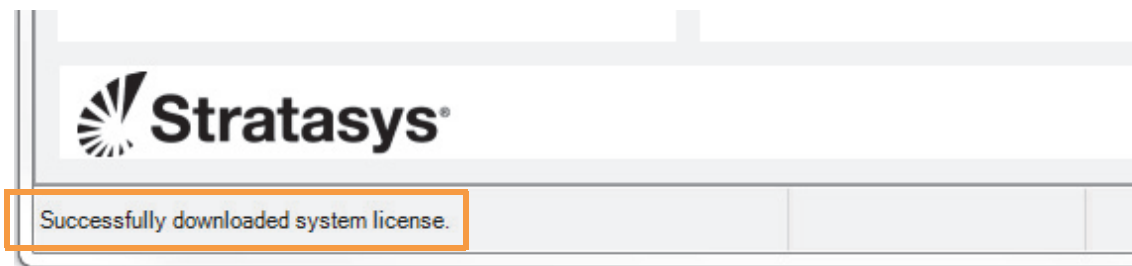

12. The following dialog will be displayed on the touchscreen once the license update is received. Press the **checkmark** button to finish installing the new material license; “Installing license” will be displayed on the touchscreen.

Figure 7-10: Complete License Install Dialog

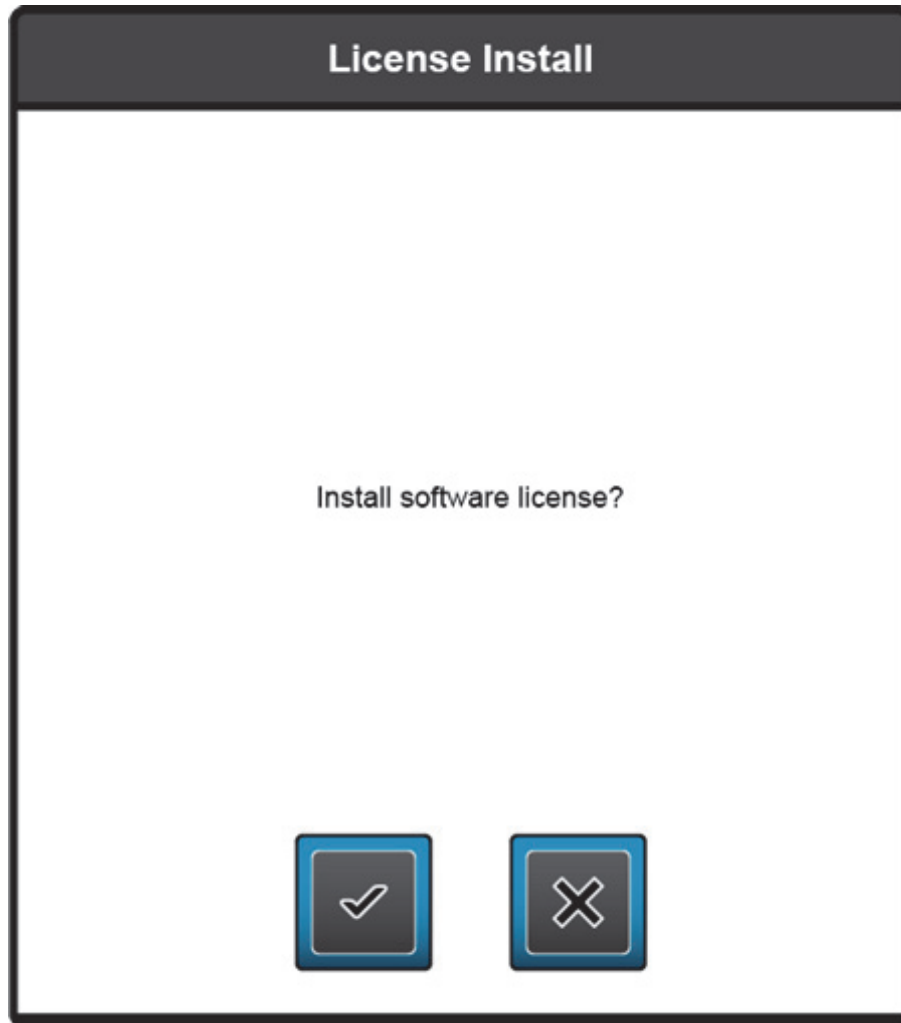

13. Once the license install is complete you will be returned to the Materials Details page (Figure 7-6); the licensed materials listed will reflect the material license upgrade. Press the **Maintenance** button within the header of the page to return to the Maintenance page.

Controller Software

Controller Software can be updated using either of the methods described below; however, the Web Method is the preferred update method:



Note: Updating Controller Software will erase all job files from the Job Queue (files within the Sample Queue are retained). After completing the software update, you will need to resend jobs to the printer.

Updating Controller Software - Web Method

Perform the following steps to update your printer's Controller Software version:

1. Open the Maintenance page by pressing the **Maintenance** button within the Navigation Bar.

Figure 7-11: Maintenance Button Location

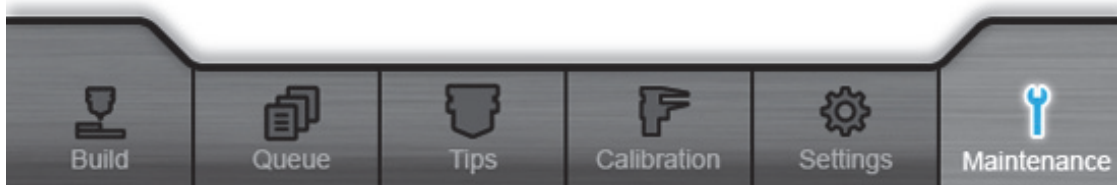

2. Locate the Update Software row within the page. Press the right arrow graphic within the row to open the Update Software page.



3. The Update Software page lists a variety of version information. The Controller Version field lists the version of Controller Software currently installed on the printer. Press the **Upgrade System Software** button; this will open a new page and automatically put the printer into Software Upgrade Mode, allowing it to accept the software update.

Figure 7-12: Update Software Page



- The following is displayed on the touchscreen while the printer is in Software Upgrade Mode. A radial progress graphic is displayed within the lower portion of the page, indicating that the printer is in Software Upgrade Mode and waiting to receive the software upgrade. The text displayed within this section of the page will update as upgrade progress is made.

Figure 7-13: Software Upgrade Mode



Note: All recent calibration data (i.e. tip offset values), printer settings/configurations and material license information are automatically retained during the software update process. Files sent to the Job Queue are not retained.

- From the workstation's Start Menu, navigate to **All Programs > Insight (installed version) > Control Center (installed version)** or double-click the Control Center shortcut (if available). See [Figure 7-3 on page 203](#).
- Within Control Center, select the **Services** tab. Ensure that your 380mc printer is selected from the drop-down menu then click the **Check for System Updates** button. (See [“Add Printer to Control Center” on page 202](#) if you cannot select your printer from the drop-down menu.)

Figure 7-14: Check for System Updates Button Location

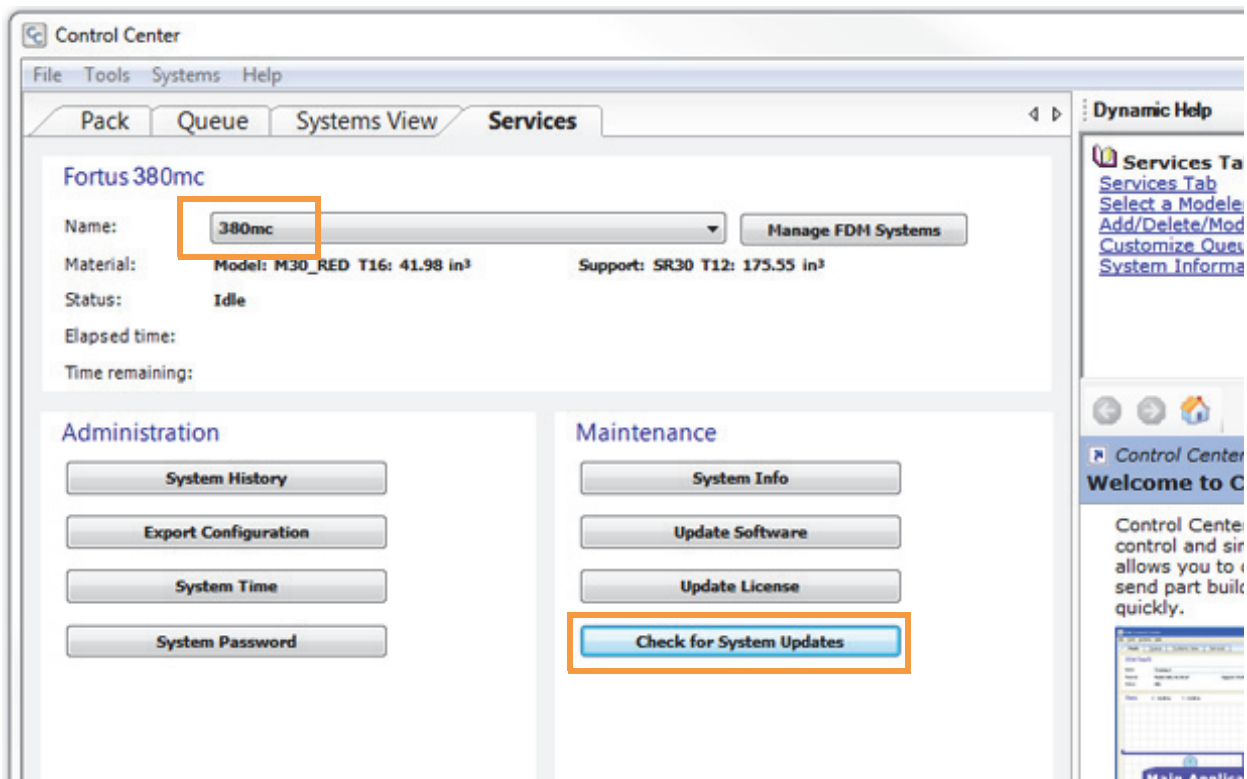

7. The Stratasys Update Manager application will open and will automatically check to see if your Controller Software version is current. If an update is available, it will be indicated on the screen.
8. Click the **Update** button to apply the software update.

Figure 7-15: Stratasys Update Manager

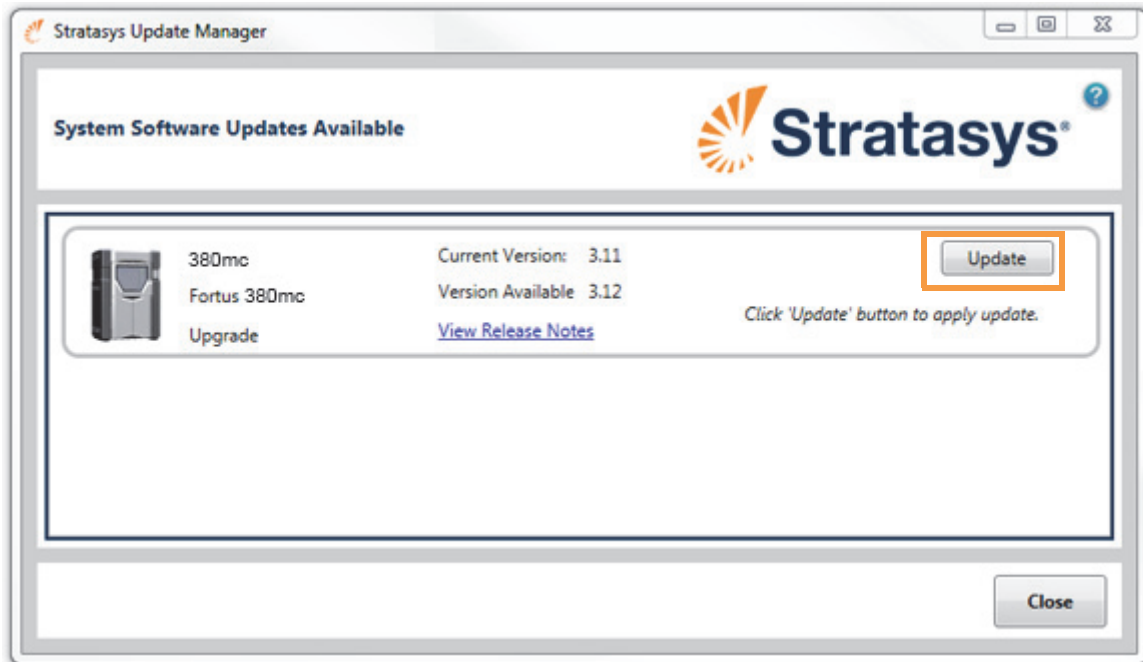

9. The application will begin sending software to the printer. Once the software download is complete, you will need to reboot the printer to complete the update.

Figure 7-16: Software Update Progress



10. The following dialog will be displayed on the touchscreen once the software update is received. Press the **checkmark** button to install the software update and reboot the printer.

Figure 7-17: Upgrade Confirmation Dialog



11. Controller Software will begin to boot on the printer. The following will be displayed on the touchscreen while the software update is booting on the printer.



Note: This process may take up to 15 minutes, please be patient.

Figure 7-18: Printer Upgrading

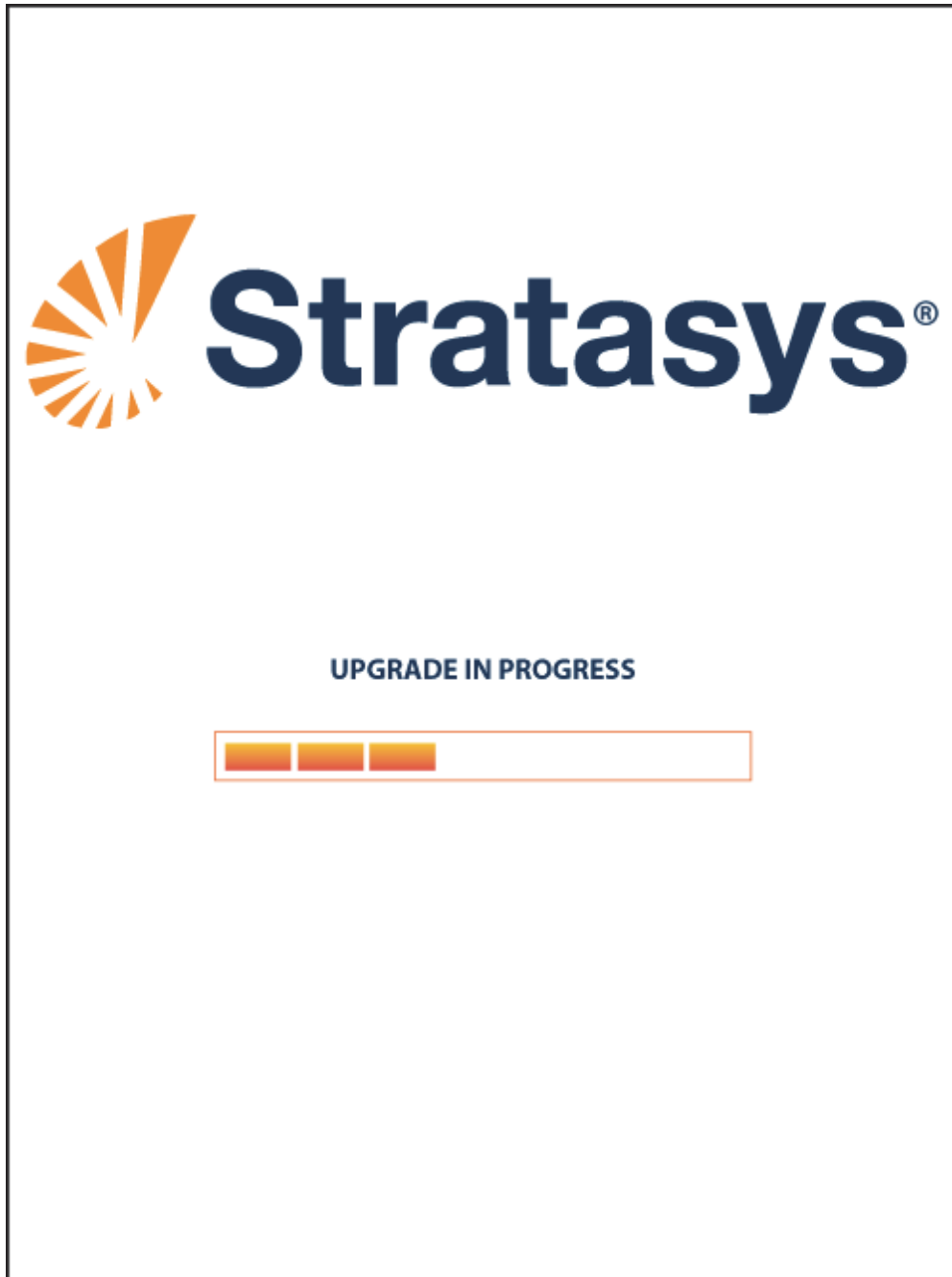

12. Once The printer reboots it will conduct its regular startup process and automatically perform an XY Home Calibration (see [“Powering ON the Printer”](#) on page 110 for details).

Updating Controller Software - CD Method

If the printer has a weak network connection or does not allow for automatic updates, you can manually download Controller Software updates by performing the following steps:

1. Open the Maintenance page by pressing the **Maintenance** button within the Navigation Bar (see [Figure 7-11 on page 209](#)).
2. Locate the Update Software row within the page. Press the right arrow graphic within the row to open the Update Software page (see [Figure 7-11 on page 209](#)).
3. Press the **Upgrade System Software** button within the Update Software page (see [Figure 7-13 on page 211](#)). This will automatically put the printer into Software Upgrade Mode, allowing it to accept the software update.
4. The following is displayed on the touchscreen while the printer is in Software Upgrade Mode.

Figure 7-19: Software Upgrade Mode





Note: All recent calibration data (i.e. tip offset values), printer settings/configurations and material license information are automatically retained during the software update process. Files sent to the Job Queue are not retained.

5. Insert the Controller Software Update CD into the workstation PC and then transfer the .upg file to a known location on the workstation's hard drive.
6. From the workstation's Start Menu, navigate to **All Programs > Insight (installed version) > Control Center (installed version)** or double-click the Control Center shortcut (if available). See [Figure 7-3 on page 203](#).
7. Within Control Center, select the **Services** tab. Ensure that your 380mc printer is selected from the drop-down menu then click the **Update Software** button. (See ["Add Printer to Control Center"](#) on page 202 if you cannot select your printer from the drop-down menu.)

Figure 7-20: Update Software Button Location

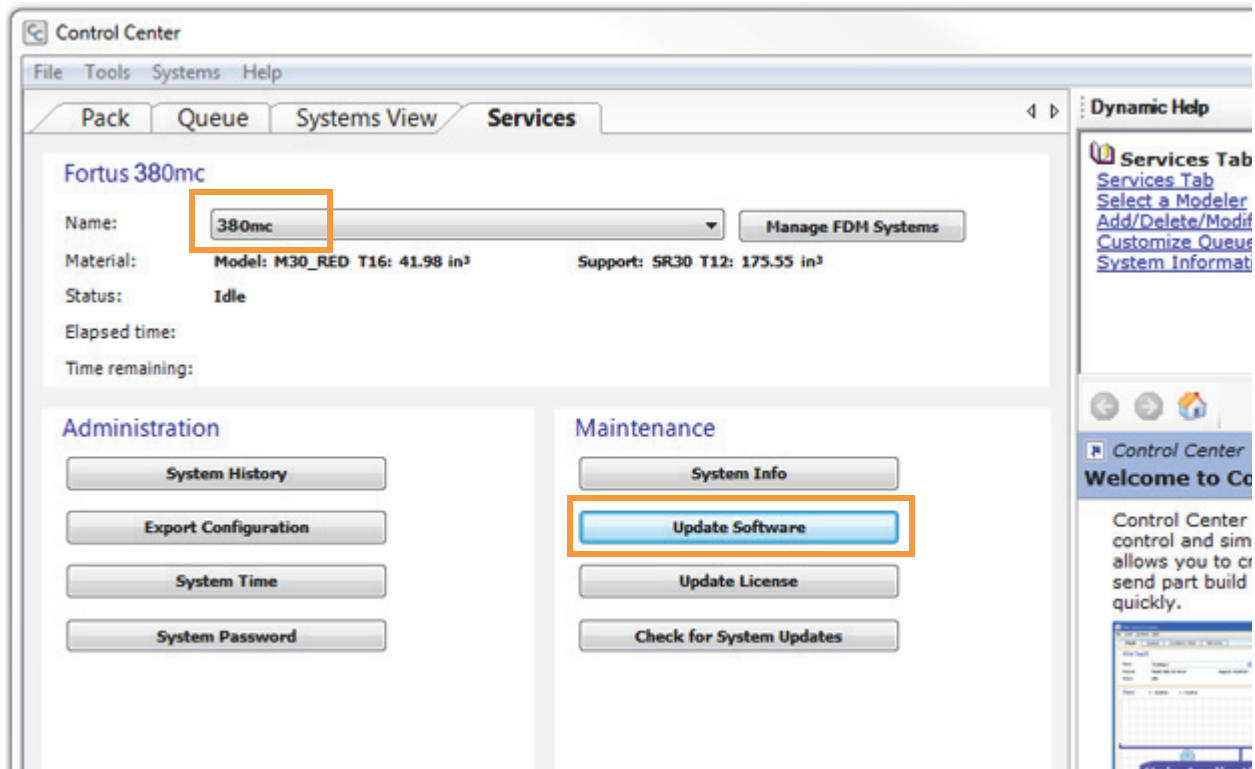

8. Control Center will begin establishing a connection with the printer. Once a connection is established, the workstation PC's file explorer will open.

9. Browse to the location of the .upg software update file that was transferred in step 5.
10. Select the .upg file to be downloaded and then click **Open**. Control Center will begin sending software to the printer. Progress is indicated within the bottom of the Control Center window.

Figure 7-21: Software Download Progress

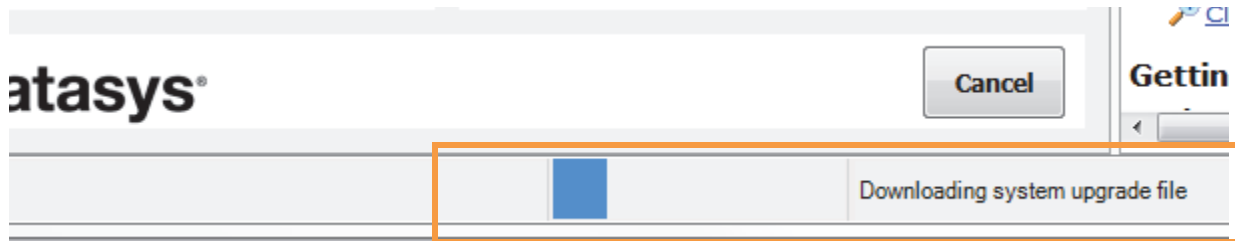

11. Once the software update is successfully downloaded to the printer an indicator will be displayed within the bottom of the Control Center window.

Figure 7-22: Software Upgrade Successfully Downloaded

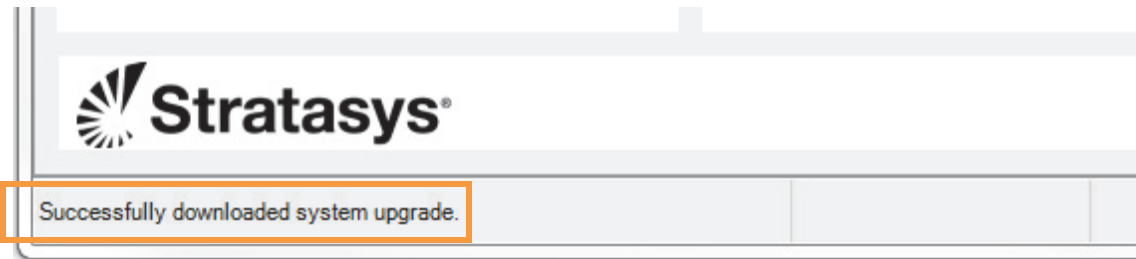

12. The following dialog will be displayed on the touchscreen once the software update is received. Press the **checkmark** button to install the software update and reboot the printer.

Figure 7-23: Upgrade Confirmation Dialog



13. Controller Software will begin to boot on the printer. The following will be displayed on the touchscreen while the software update is booting on the printer.



Note: This process may take up to 15 minutes, please be patient.

Figure 7-24: Printer Upgrading

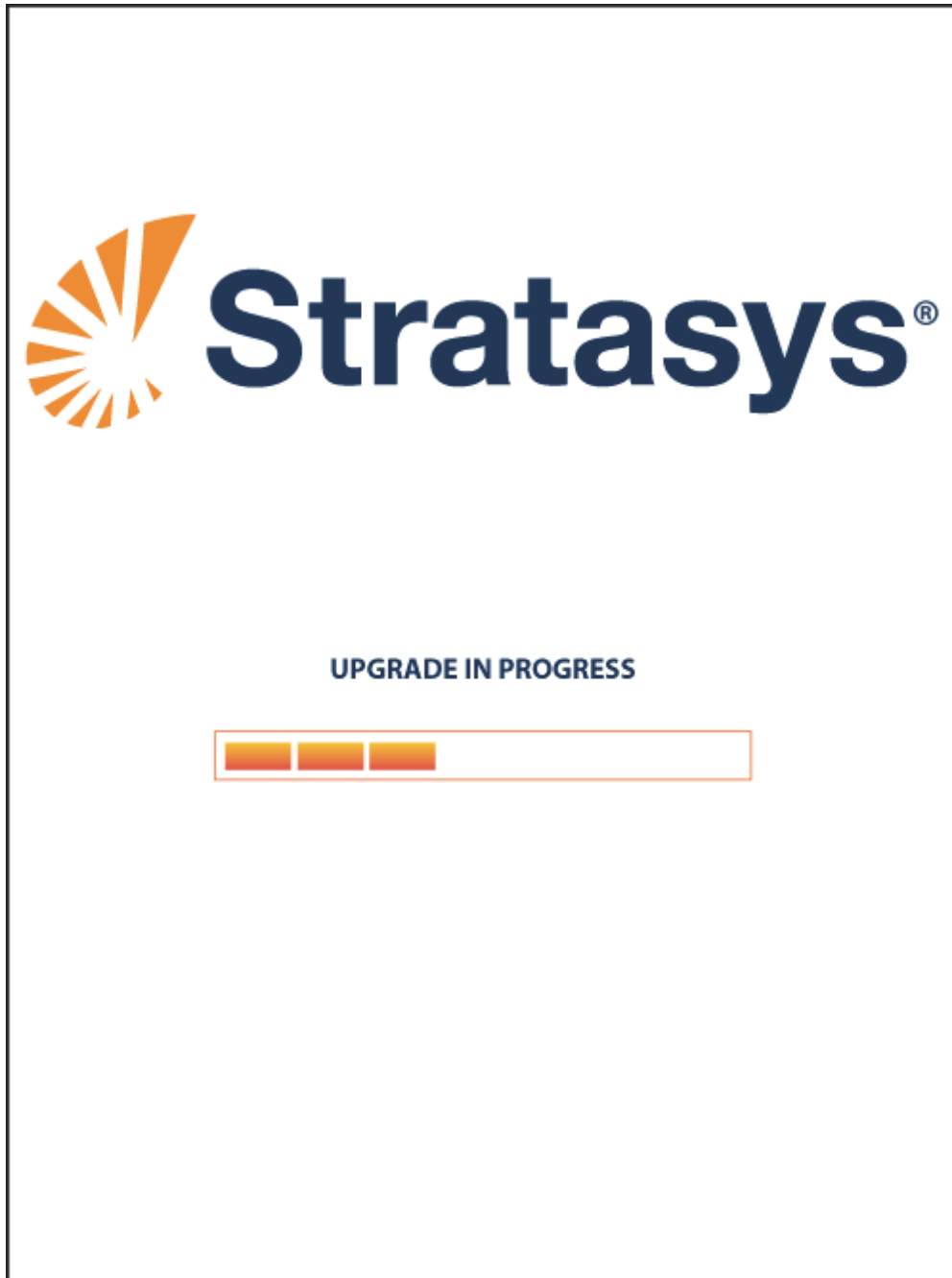

14. Once The printer reboots it will conduct its regular startup process and automatically perform an XY Home Calibration (see [“Powering ON the Printer”](#) on page 110 for details).

Maintenance Schedule



Warning: The right and left upper and lower side panels, as well as the upper and lower rear panels, should only be removed by an authorized service representative.



Warning: Always wear proper heat protective clothing when working inside the oven.

Maintenance tasks must be performed on a regular basis in order to maintain optimal system operation. [Table 7-1](#) outlines the general maintenance schedule for the 380mc. Detailed instructions for each task make up the rest of this chapter.

[Table 7-2](#) lists part numbers for various replacement consumable items. A limited amount of replacement oven bulbs, flicker/brush assemblies and purge ledges are included in the Welcome Kit (see [Table 2-3 on page 11](#)). Once replacements are depleted, you will need to order additional replacement items from Stratasys or your regional Stratasys office. Use the part numbers listed in this table when ordering replacement parts

Table 7-1: Maintenance Schedule

Daily	Weekly	Quarterly	As Needed	Maintenance Task
X				“Clean the Platen” on page 222
X				“Empty the Purge Bin” on page 223
	X			“Vacuum the Build Envelope” on page 224
	X			“Clean/Inspect Tip Wipe Assembly” on page 224
		X		“Clean the Tip Sensor Plunger” on page 229
			X	“Replace an Oven Bulb” on page 230
			X	“Clean the Printer” on page 231

Table 7-2: Replacement Consumables

Part Number	Description
310-05000	2-pack of oven bulbs (see “Replace an Oven Bulb” on page 230).
511-00200	4-pack of flicker/brush assemblies (see “Clean/Inspect Tip Wipe Assembly” on page 224).
511-00700	4-pack of purge ledges (see “Clean/Inspect Tip Wipe Assembly” on page 224).

Daily Maintenance

Clean the Platen

The steel platen provides the level surface on which parts are built (see [Figure 3-5 on page 25](#) for platen overview). A build sheet is securely affixed to the platen by the vacuum source. If debris collects on the platen, it can adversely affect vacuum quality.

1. Remove the build sheet from the platen.
 - Lift a corner of the build sheet to break the vacuum holding it to the platen.
 - Slide the build sheet from the platen.
2. Carefully remove purged material debris that have fallen into the channels of the platen.
 - Vacuum or use the Platen Dusting Brush (included in the Welcome Kit) to clean the platen.
 - If the dusting brush is used, brush away from the vacuum port in the center of the platen.
 - If debris falls into the vacuum port it can cause a loss of vacuum, resulting in poor adhesion of the build sheet to the platen which can result in the loss of a build.



Note: Do not attempt to remove the vacuum port screen. It is not a customer replaceable item. Contact Stratasys Customer Support or your regional Stratasys office (see [“Service” on page 1](#) for contact information) if an excessive amount of material debris has fallen into the vacuum port.

Empty the Purge Bin

The purge bin is located inside the canister bay. It catches the material that has been purged or wiped from the liquefiers and liquefier tips. The purge bin should be emptied daily, to do so:

1. Open the canister bay doors.
2. Open the purge bin door.
3. Pull the purge bin from the printer.
4. Empty waste material from the purge bin.
5. Reinstall the bin by inserting it into the opening.
6. Close the purge bin door and then close the canister bay doors.

Figure 7-25: Purge Bin

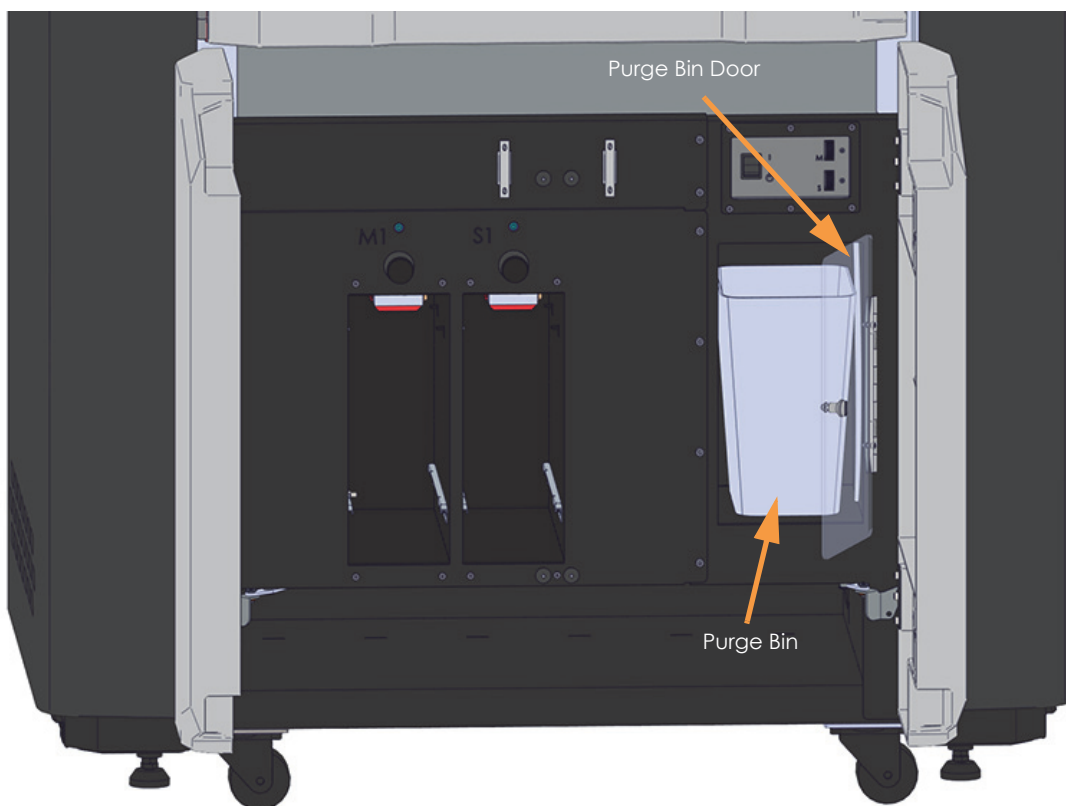

Weekly Maintenance

Vacuum the Build Envelope

The purge chute is designed to catch purged material debris and pass debris into the purge bin for disposal. However, some excess material debris may fall into the bottom of the build envelope. Do not allow excess material debris to accumulate in the build envelope as this could cause damage to the printer. Vacuum the build envelope on a weekly basis to remove build material debris and dust.

Clean/Inspect Tip Wipe Assembly

You should clean the tip wipe assembly once a week. While cleaning the assembly, inspect the flicker/brush assemblies and purge ledges for wear and replace parts as necessary when wear is detected.

The flicker/brush assembly is replaced as a single unit. Once material is purged from a tip, the flicker portion of the flicker/brush assembly passes across the tip's opening, cutting purged material off in small segments. The brush portion of the flicker/brush assembly then passes across the tip's opening cleaning the tip and its tip shield. As a result, the flicker will wear at the location where the tip contacts its surface and eventually develop a notch large enough for the tip to completely pass through the flicker; a notched flicker cannot properly cut purging material. Similarly, material can become embedded within the bristles of the brush resulting in clumping; clumped bristles cannot properly clean a tip or its tip shield. The flicker should be replaced once a significant notch develops, and the brush should be replaced whenever bristle clumping (which cannot be removed with a brush) is apparent.

A purge ledge is replaced as a single unit; you do not need to replace a model side purge ledge and support side purge ledge together. Segments of purged material that have been knocked away from a tip's opening by the flicker drop onto the purge ledge. Purged material is then balled up by the purge ledge, and transported through the purge chute into the purge waste bin. As a result, material buildup will accumulate on the surface of the purge ledge. A purge ledge should be replaced whenever excessive buildup has accumulated on the ledge's surface.

To clean the tip wipe assembly and inspect its components:

1. Ensure that the printer is stopped (idle) and is not building.
2. Open the oven door.



Hot Surface: Depending on how long the oven has been allowed to cool, components may be hot. If the printer's thumbscrews are hot, wear the safety gloves provided in the Welcome Kit to perform all remaining steps.

3. Remove the two thumbscrews securing the purge chute access plate.
4. Carefully remove the purge chute access plate by pulling it up and out of its slot within the oven frame.



Note: The glass pane within the purge chute access plate is loose and may potentially break. Use caution when removing the purge chute access plate to ensure that the glass pane does not fall from its slot.

Figure 7-26: Purge Chute Access Plate Removal

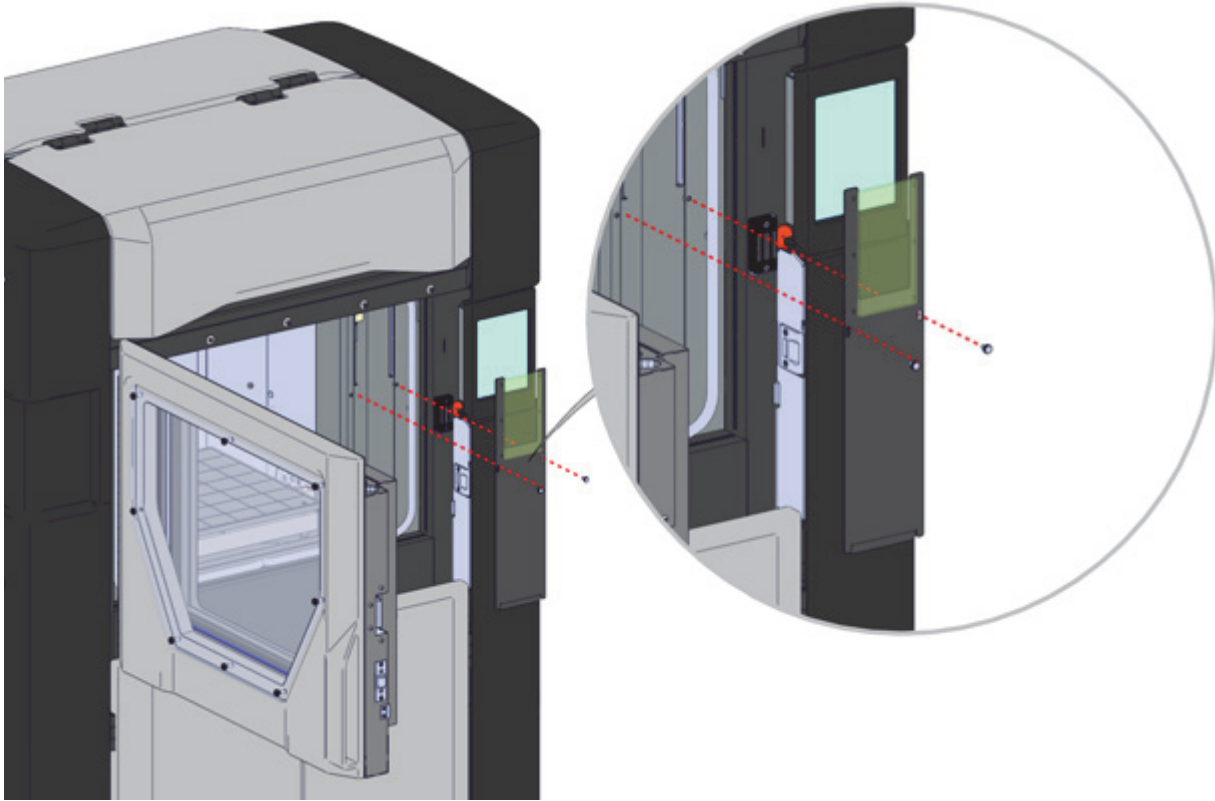

5. Remove the model side purge ledge by lifting it upward until it clears its locating pin.
6. Repeat step 5 to remove the support side purge ledge.

Figure 7-27: Purge Ledge Removal

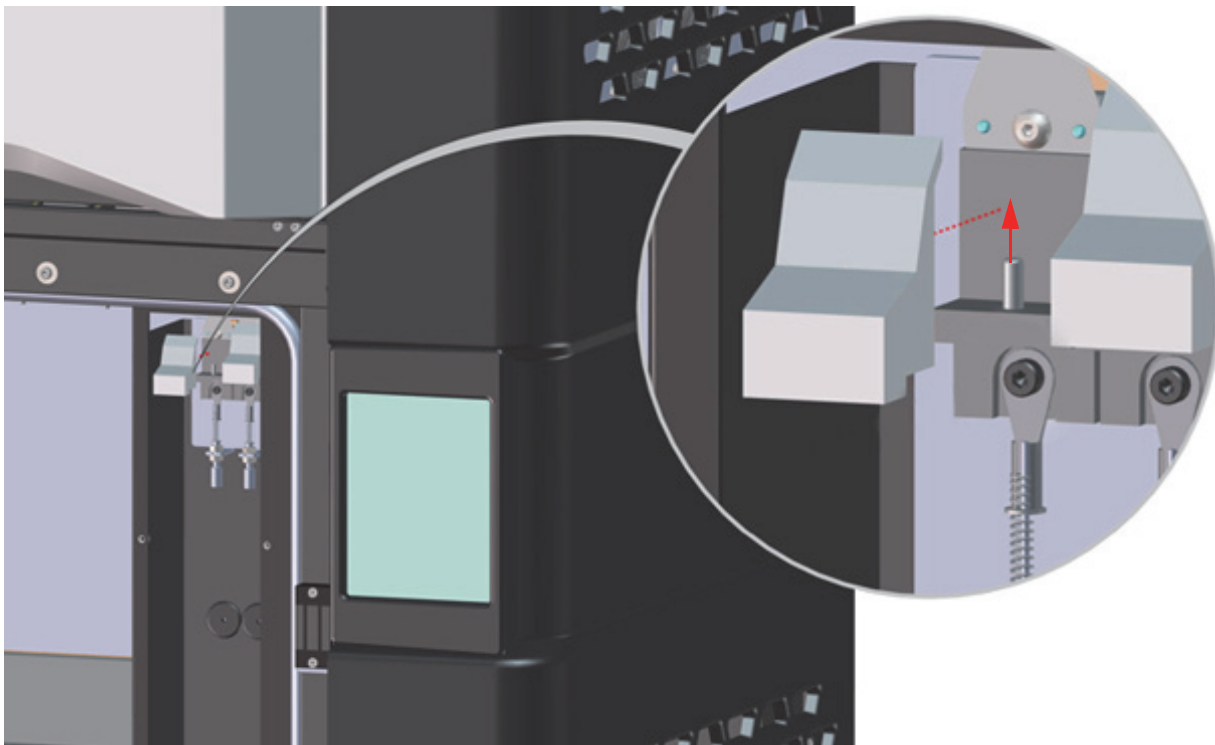

7. Remove the model side flicker/brush assembly by lifting it upward until it clears its locating pins.
8. Repeat [step 7](#) to remove the support side flicker/brush assembly.



Note: If the head is positioned above the purge area it may impede your ability to remove the flicker/brush assemblies. Open the top cover and manually move the head backwards and away from the purge area.

Figure 7-28: Flicker/Brush Assembly Removal

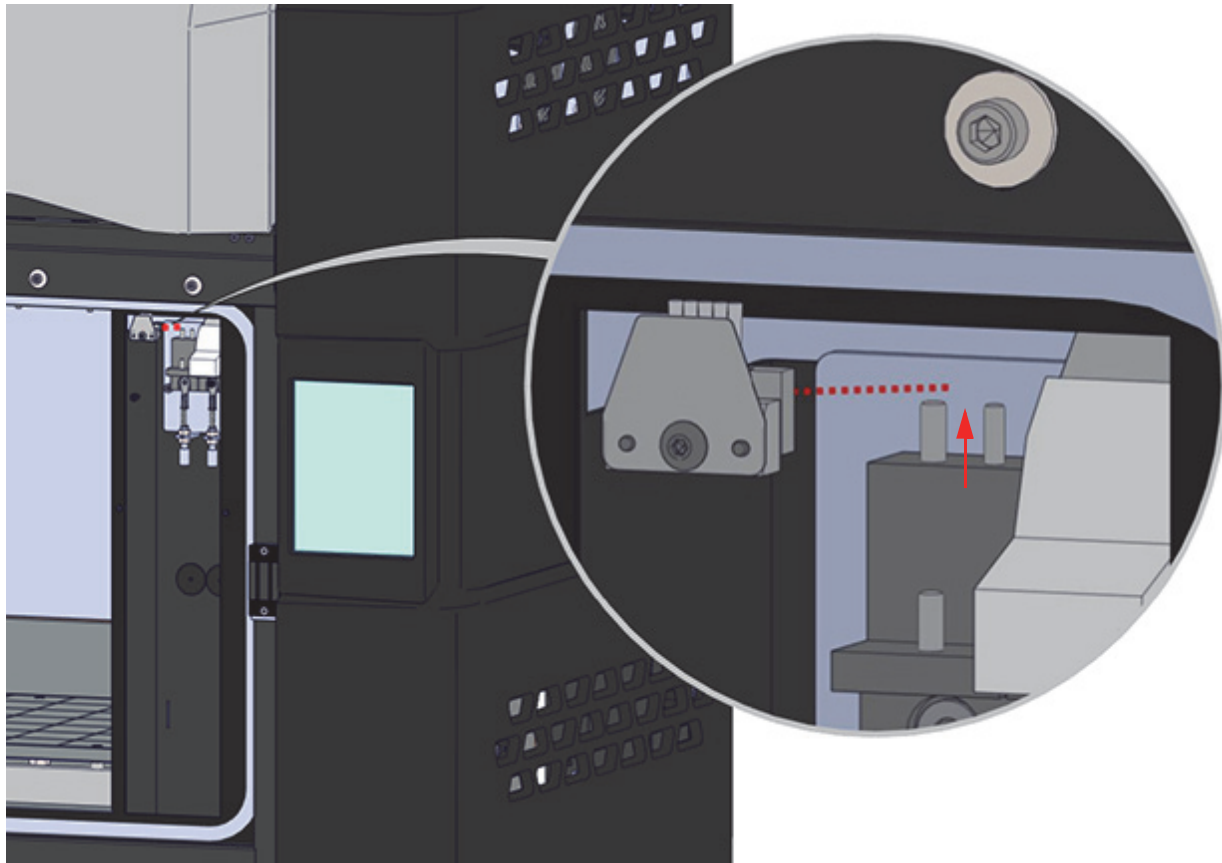

9. Clean and inspect the surface around the locating pins. Make sure that the purge ledges and flicker/brush assemblies can sit flush on the surface.
10. Inspect the purge ledges. Purge surfaces should be free from irregularities and excessive material buildup.
 - Clean the purge ledges if they are to be reinstalled.
 - Replace the purge ledge(s) if excessive buildup has accumulated on the ledge's surface. Replacement purge ledges are supplied within the Welcome Kit. Once these replacements are depleted you will need to order additional replacement purge ledges.

11. Inspect the flicker portion of the flicker/brush assemblies. The top edge of the flicker should be straight and must not contain excessive notching/wear. A small amount of wear is acceptable (see [Figure 7-29](#)).

[Figure 7-29](#): Flicker with Unacceptable Wear

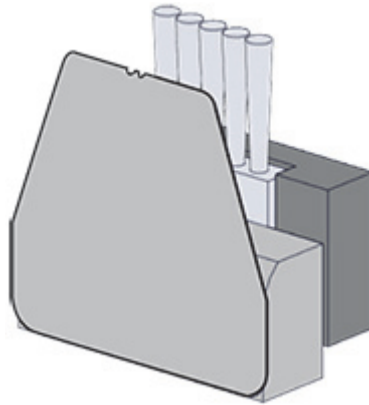

12. Inspect the brush portion of the flicker/brush assemblies. Brush bristles must not show evidence of wear (i.e. no notches in bristle pattern) and should not contain significant bristle clumping. Frayed bristles are acceptable as long as the top edge is even across all of the bristles.

13. Replace one or both of the flicker/brush assemblies if excessive wear is present. Replacement assemblies are supplied within the Welcome Kit. Once these replacements are depleted you will need to order additional replacement assemblies.

- The components of the assembly cannot be replaced individually. The entire flicker/brush assembly must be replaced if excessive wear is present on the flicker or the brush.

[Figure 7-30](#): Tip Wipe Assembly Details

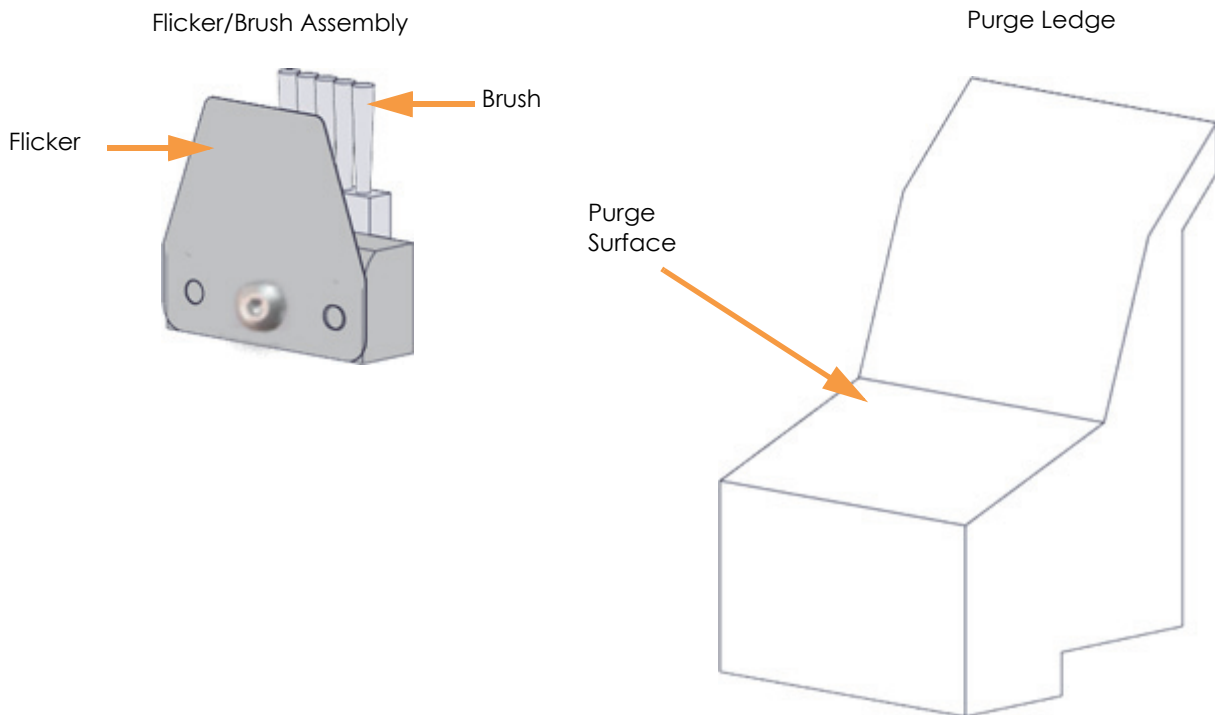

14. Reinstall the support side flicker/brush assembly by placing the assembly onto its locating pins and sliding the assembly downward.
15. Repeat [step 14](#) to reinstall the model side flicker/brush assembly.
16. Reinstall the support side purge ledge by placing the purge ledge onto its locating pin and sliding the purge ledge downward.
17. Repeat [step 16](#) to reinstall the model side purge ledge.
18. Reinstall the purge chute access plate and secure using the two thumbscrews.
19. Adjust tip wipe assembly heights to ensure proper placement. See "[Adjusting Tip Wipe Heights](#)" on [page 159](#) for instructions.

Quarterly Maintenance

Clean the Tip Sensor Plunger



Hot Surface: Components can be hot; never touch the tip sensor plunger with your bare hands.

It is recommended that you remove/replace the tip sensor plunger when the printer is powered OFF or has been allowed to cool thoroughly.

Material debris can occasionally accumulate on the top of the tip sensor plunger. Excessive buildup can affect part build quality. To clean the tip sensor plunger:

1. Remove the plunger by gently pulling it up and out.
2. Remove material residue on the top of the plunger.
3. Replace the plunger in the sensor bracket - make sure the larger flat surface faces upward.

Figure 7-31: Tip Sensor Removal

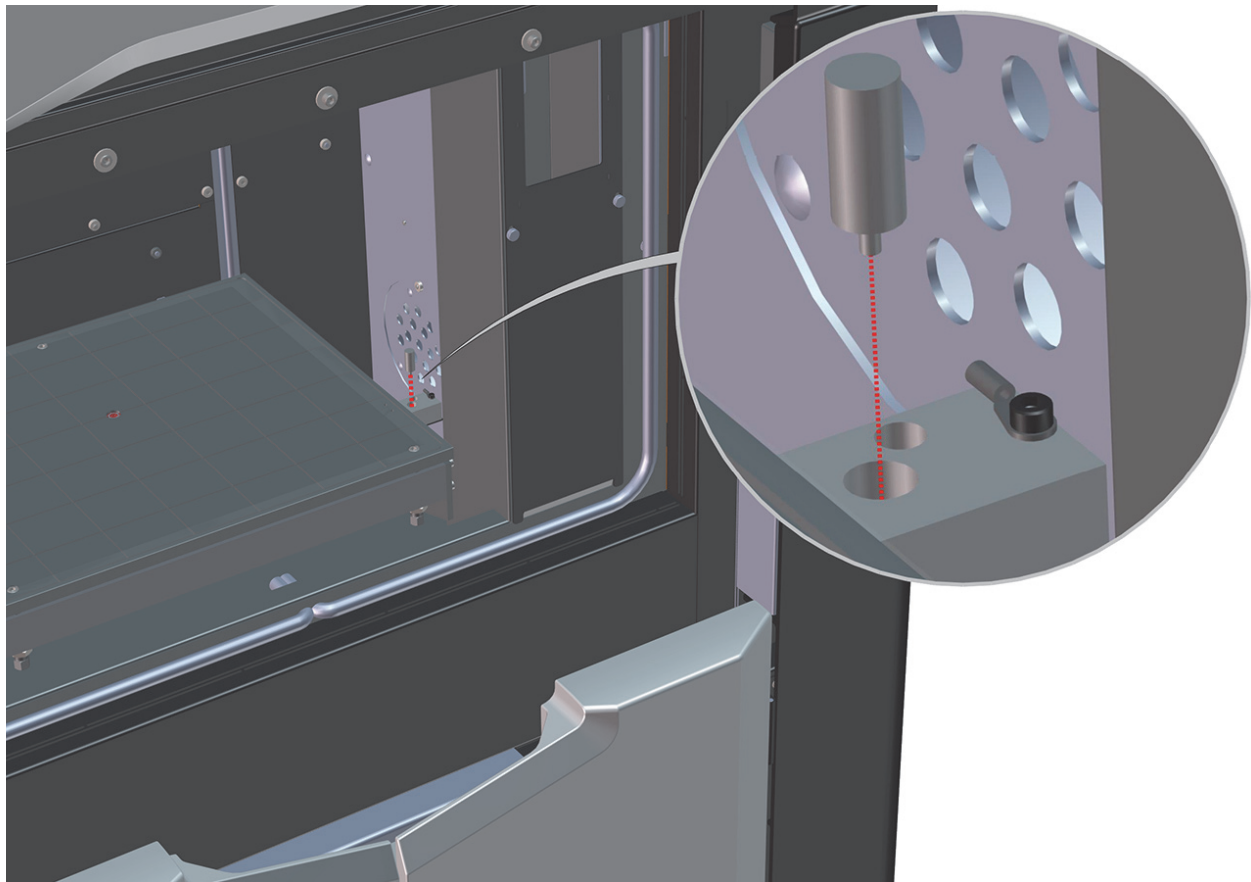

As Needed Maintenance

Replace an Oven Bulb



Hot Surface: Bulbs are hot; never touch bulbs with your bare hands. Always wear safety gloves (provided in the Welcome Kit) when changing bulbs.

It is recommended that bulbs be removed/replaced when the printer is powered OFF.

There are four festoon bulbs mounted on the front upper edge of the oven, two per side, which illuminate the oven. Bulbs will periodically burn out and require replacement. Bulbs generally will burn out in pairs. Use the following steps to replace an oven bulb:

1. With the oven light turned ON, take note of which bulb needs to be replaced.
2. Turn the oven light OFF using the [Oven Light Control Button](#) within the Dashboard.
3. Open the oven door. Ensure that you are wearing safety gloves and remove the burnt out bulb by gently pulling it out of the clamps securing it to the edge of the oven.

Figure 7-32: Bulb Locations

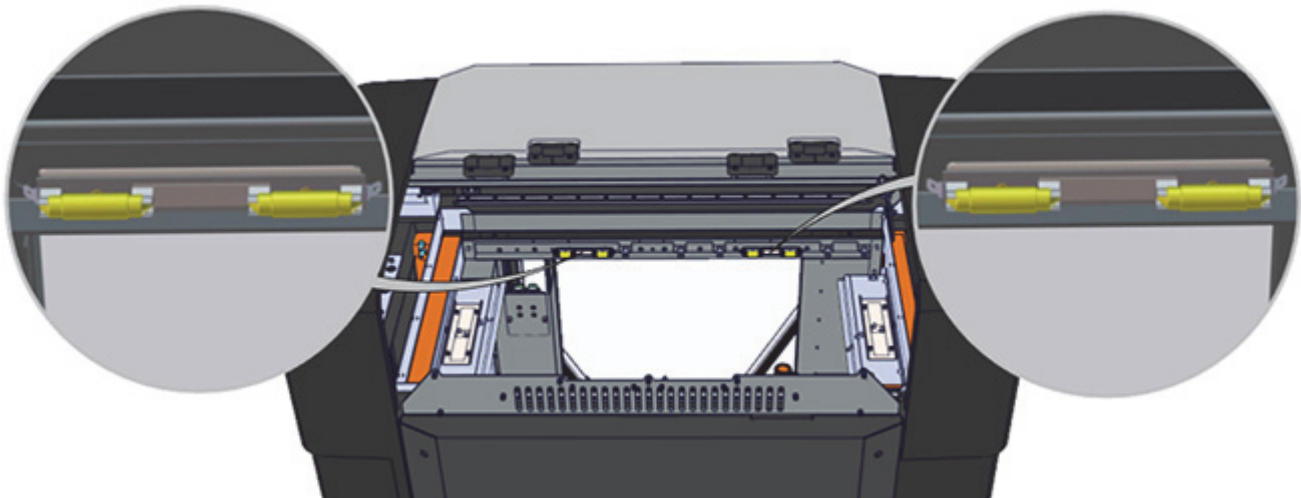

4. Install a replacement bulb by gently pressing it into place within the securing clamps.



Note: Replacement bulb kits are supplied in the Welcome Kit. Once these replacements are depleted you will need to order additional replacement bulb kits.

5. Repeat [step 3](#) and [step 4](#) if additional bulbs need to be replaced. When finished close the oven door.
6. Verify that the new bulb is operating by turning the oven light on using the [Oven Light Control Button](#).

Clean the Printer

Cleaning the Exterior Surface of the Printer

The printer's exterior surfaces (doors and panels) may accumulate dust and periodically require cleaning. Exterior doors and panels, with the exception of the oven window and touchscreen display, can be cleaned using a slightly damp microfiber cloth (supplied in the Welcome Kit). The cloth should be only slightly damp to ensure that water does not enter the printer. Excess water can cause damage to interior components.

Cleaning the Oven Door Glass/Window



CAUTION: Using a cleaner which contains ammonia and/or alcohol can damage the printer's glass/window and cause yellowing. Only suitable cleaning solutions (Novus 1) and a microfiber cloth (included in the Welcome Kit) should be used to clean the oven door's polycarbonate panel.

The oven door's tempered glass pane can be cleaned using a slightly soapy warm water solution, and a microfiber cloth (included in the Welcome Kit).

The oven door window is comprised of an interior pane of glass as well as an exterior polycarbonate panel (see "[Oven Door](#)" on page 23 for details). The exterior polycarbonate panel is removable allowing you to clean both surfaces of the panel, as well as access both surfaces of the glass pane. Perform the following steps to remove the polycarbonate panel and clean the surfaces of the panel and glass pane:



CAUTION: The polycarbonate exterior panel features an anti-scratch coating on its exterior surface. However, certain materials can still damage/scratch the panel's surface. Use extreme care when removing this panel to avoid any activity which may scratch the panel's exterior surface.

1. Turn power OFF by flipping the power switch to the OFF (O) position (see "[Powering OFF the Printer](#)" on page 111). Allow the printer to cool or wear gloves to perform the remainder of the following steps.
2. Turn the AC circuit breaker switch to the off position. (See [Figure 2-6](#) on page 15 for AC circuit breaker location.)
3. Remove the eight (8) thumbscrews securing the polycarbonate panel to the oven door (see [Figure 7-33](#)).
4. Gently lift the polycarbonate panel from the oven door and set aside. When placed aside, panel should be laid flat with the exterior surface of the panel (which features the anti-scratch coating) facing upward.

Figure 7-33: Removing Oven Window

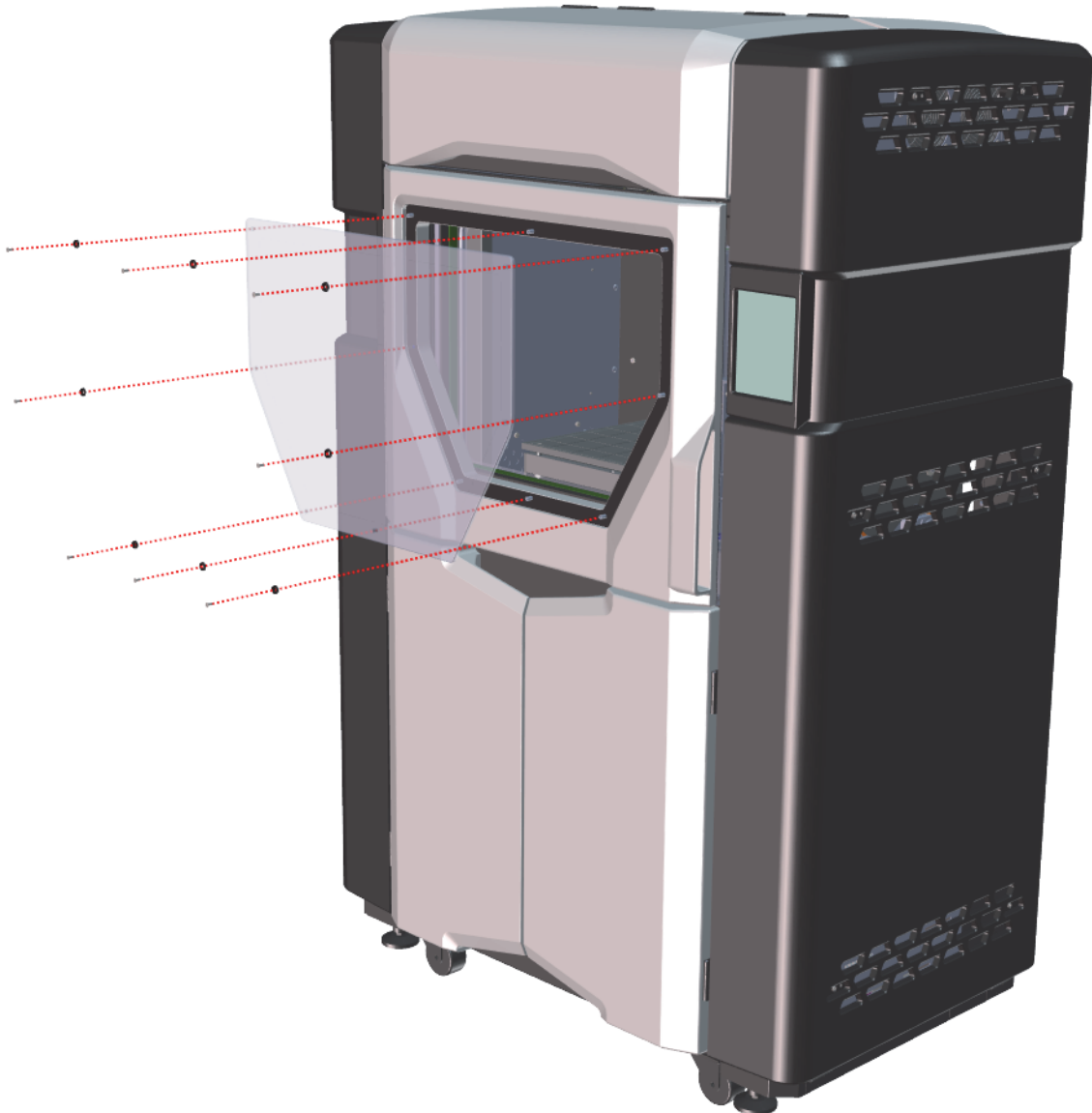

5. Gently clean the exterior surface of the tempered glass pane using a slightly soapy warm water solution, and a microfiber cloth (supplied in the Welcome Kit).
6. Open the oven door and repeat [step 5](#) to clean the interior surface of the tempered glass pane. When finished close the oven door.
7. Apply an adequate amount of approved cleaning solution (Novus 1, supplied in the Welcome Kit) to a microfiber cloth (supplied in the Welcome Kit) and gently clean the interior surface of the polycarbonate panel (surface that does not feature the anti-scratch coating).
8. Replace the polycarbonate panel within the oven door and secure using eight (8) thumbscrews ([Figure 7-33](#)).
9. Apply an adequate amount of approved cleaning solution (Novus 1, supplied in the Welcome Kit) to a microfiber cloth (supplied in Welcome Kit) and gently clean the exterior surface of the polycarbonate panel (surface featuring the anti-scratch coating).

Cleaning the Touchscreen Display



CAUTION: Using a cleaner which contains ammonia and/or alcohol can damage the touchscreen. Only a suitable LCD cleaning solution and microfiber cloth (included in the Welcome Kit) should be used to clean the touchscreen display.

As needed, to remove smudge marks and buildup, clean the touchscreen display using the LCD cleaner and microfiber cloth provided in the Welcome Kit.

Apply an adequate amount of LCD cleaning solution to the provided microfiber cloth and then gently wipe the exterior surface of the touchscreen display to clean its surface. It is recommended that you apply LCD cleaner to the microfiber cloth rather than applying cleaner directly to the touchscreen display, as excess moisture may damage the display.

Cleaning the Liquefier Tips

The printer automatically cleans the tips before and during each part build, using the tip wipe assembly. However, material that cannot be removed during the auto-cleaning process may occasionally accumulate on the tips. The brass, wooden-handled brush (included in the Welcome Kit) should be used to remove excess material manually.

Cleaning the Purge Chute

Occasionally, purged material debris can catch within the purge chute and impede the passage of purged material debris into the purge bin. The purge chute access plate can be removed to allow for cleaning of the purge chute. To remove the purge chute access plate for cleaning:

1. Turn power OFF by flipping the power switch to the OFF (O) position. (See “Powering OFF the Printer” on page 111.)
2. Turn the AC circuit breaker switch to the off position. (See [Figure 2-6 on page 15](#) for AC circuit breaker location.)
3. Open the oven door.



Hot Surface: Depending on how long the oven has been allowed to cool, components may be hot. If the printer’s thumbscrews are hot, wear the safety gloves provided in the Welcome Kit to loosen and remove thumbscrews.

4. Remove the two (2) thumbscrews securing the purge chute access plate.
5. Carefully remove the purge chute access plate by pulling it up and out of its slot within the oven frame (see [Figure 7-26 on page 225](#)).



Note: The glass pane within the purge chute access plate is loose and may potentially break. Use caution when removing the purge chute access plate to ensure that the glass pane does not fall from its slot.

6. Clean the purge chute as needed to remove accumulated material debris.
7. Reinstall the purge chute access plate and secure using the two (2) thumbscrews.

8 Troubleshooting

This chapter describes troubleshooting steps that can be performed to correct basic problems with the 380mc.

Getting Help

If you have a problem with your printer or the printer's materials that is not covered in this guide, or if you need to order replacement parts, please contact Customer Support for your region:

Region	Phone	Email
North America / Latin America	+1 800-801-6491 (7:00 AM - 5:00 PM)	support@stratasys.com
Asia Pacific	+852 3944-8888 (9:00 AM - 6:00 PM)	support.ap@stratasys.com
Europe, Middle East, & Africa	+49 7229-7772-644 (9:00 AM - 5:00 PM)	support.emea@stratasys.com

If needed, you can write to Customer Support North America at:

Stratasys, Inc.
Customer Support
7665 Commerce Way
Eden Prairie, MN 55344 USA

Before calling for service or supplies, always have the following information ready:

- Your printer's software version (see "Software Version" on page 180 for instructions on obtaining this information).
- Your printer's serial number (see Figure 2-5 on page 13 for serial number tag placement).
- Access to your Insight workstation in order to provide a diagnostic file, if necessary.

Warnings and Errors

If the printer detects an issue that may affect a build, it will be indicated within the [Dashboard](#). The Build State button will turn yellow or red depending on the severity of the warning/error. Pressing the Build State button will open a dialog indicating the reason(s) for the warning/error. The body of the dialog will contain information related to the cause of the warning/error. Depending on the type of issue, the canister load status text displayed beneath each Canister Status Icon of the Tips page also provides information indicating the cause of a warning/error (see [“Canister Load Status”](#) on page 70 for details).



Note: You can choose to ignore the warning and continue the build, but part build quality will be unpredictable. A warning generated from a mis-match of model/support material or from low/no vacuum cannot be bypassed.

Warnings at Build Start

Run tip offset calibration

- The printer’s model and support tips were not calibrated after being changed (within the Tip Change Wizard or otherwise).
- Correct condition - calibrate the printer’s tips by performing an XYZ Tip Offset Calibration. See [“XYZ Tip Offset Calibration”](#) on page 182 for instructions.

Insufficient model material for part build

- The amount of model material currently installed in the printer is not sufficient for the selected build.
- Correct condition - install additional model material into the printer, see [“Loading Material to the Liquefier Tips”](#) on page 112 for instructions.

Insufficient support material for part build

- The amount of support material currently installed in the printer is not sufficient for the selected build.
- Correct condition - install additional support material into the printer, see [“Loading Material to the Liquefier Tips”](#) on page 112 for instructions.

Model material does not match selected job

- The type of model material loaded in the printer does not match the model material required to build the selected job.
- Correct condition - change the model material loaded in the printer to the type of model material required to build the job. See [“Changing Tips or Material Type”](#) on page 123 for instructions.

Support material does not match selected job

- The type of support material loaded in the printer does not match the support material required to build the selected job.
- Correct condition - change the support material loaded in the printer to the type of support material required to build the job. See [“Changing Tips or Material Type” on page 123](#) for instructions.

Model tip does not match selected job

- The currently installed model tip does not match the model tip configuration of the selected job.
- Correct condition - change tips by removing the incorrect model tip and installing a model tip matching the job’s tip configuration. See [“Changing Tips or Material Type” on page 123](#) for instructions.

Support tip does not match selected job

- The currently installed support tip does not match the support tip configuration of the selected job.
- Correct condition - change tips by removing the incorrect support tip and installing a support tip matching the job’s tip configuration. See [“Changing Tips or Material Type” on page 123](#) for instructions.

Model tip extrusion volume near limit

- The printer’s model tip is near its odometer limit (see [Table 3-3 on page 39](#) for approximate tip life information). This limit is material dependent and is displayed within the two Tip Status Icons found within the Tips page (see [“Tip Status Icons” on page 67](#)).
- Correct condition - you are still able to build using this tip, but part quality may be affected. Once the tip’s odometer limit is reached, you will be prompted to change the tip and will no longer be able to build using the tip (see [“Using the Tip Change Wizard” on page 123](#) and [“Changing Tips within the Top Cover” on page 156](#) to change tips).

Support tip extrusion volume near limit

- The printer’s support tip is near its odometer limit (see [Table 3-3 on page 39](#) for approximate tip life information). This limit is material dependent and is displayed within the two Tip Status Icons found within the Tips page (see [“Tip Status Icons” on page 67](#)).
- Correct condition - you are still able to build using this tip, but part quality may be affected. Once the tip’s odometer limit is reached, you will be prompted to change the tip and will no longer be able to build using the tip (see [“Using the Tip Change Wizard” on page 123](#) and [“Changing Tips within the Top Cover” on page 156](#) to change tips).

Errors Preventing a Build from Starting

Close the door

- Indicates that the oven door is open.
- Correct condition - close the oven door.

Close the cover

- Indicates that the top cover is open.
- Correct condition - close the top cover.

Load model material

- Model material has not been loaded into the printer.
- Correct condition - load model material. See [“Loading Material to the Liquefier Tips” on page 112](#) for instructions.

Load support material

- Support material has not been loaded into the printer.
- Correct condition - load support material. See [“Loading Material to the Liquefier Tips” on page 112](#) for instructions.

Replace empty model canister

- Model material canister has run out of material.
- Correct condition - remove the empty canister and replace with a new canister. See [“Removing an empty canister” on page 120](#) for instructions.

Replace empty support canister

- Support material canister has run out of material.
- Correct condition - remove the empty canister and replace with a new canister. See [“Removing an empty canister” on page 120](#) for instructions.

Change model tip

- The model tip has reached its odometer limit (see [Table 3-3 on page 39](#) for approximate tip life information). You are unable to continue building using this tip and must change it prior to starting a build.
- Correct condition - remove the tip and replace it with a new one (see [“Using the Tip Change Wizard” on page 123](#) and [“Changing Tips within the Top Cover” on page 156](#) to change tips).

Change support tip

- The support tip has reached its odometer limit (see [Table 3-3 on page 39](#) for approximate tip life information). You are unable to continue building using this tip and must change it prior to starting a build.
- Correct condition - remove the tip and replace it with a new one (see [“Using the Tip Change Wizard” on page 123](#) and [“Changing Tips within the Top Cover” on page 156](#) to change tips).

Select a job

- Indicates that a job has not been selected for building.
- Correct condition - select the job you'd like to build from either the Job Queue or Sample Queue. See [“Selecting a Job to Build” on page 162](#) for instructions.

Remove part

- Indicates that the completed part from the previously built job is still in the printer's oven.
- Correct condition - open the oven door and remove the completed part. See [“Removing a Part from the Printer” on page 169](#) for instructions.

Insert a build sheet

- Indicates that a build sheet has not been placed onto the platen.



Note: Once a build sheet has been placed onto the platen this warning will be displayed until the printer achieves sufficient vacuum to securely affix the build sheet to the platen. The red X over the top of the Vacuum Status Indicator (within the Information Bar) will disappear once sufficient vacuum is achieved.

- Correct condition - open the oven door and place a build sheet onto the platen (see [“Before a Build” on page 161](#) for more information).
 - If a build sheet has already been placed onto the platen but sufficient vacuum hasn't been achieved, this is often the result of a poorly positioned build sheet. Ensure that the platen is free of material debris and then reposition the build sheet on the platen. Wait for the printer to achieve sufficient vacuum. If you are still unable to achieve sufficient vacuum, install a new build sheet. Contact Stratasys Customer Support or your regional Stratasys office if after performing these steps you are still unable to achieve sufficient vacuum (see [“Getting Help” on page 234](#) for contact information).

Check dryer system

- Dry air pressure is below minimum requirement for printer operation.
- Correct condition - contact Stratasys Customer Support or your regional Stratasys office (see [“Getting Help” on page 234](#) for contact information).

Tip sensor error

- The tip sensor is sensing the tip when it should not be.
- Correct condition - contact Stratasys Customer Support or your regional Stratasys office (see [“Getting Help” on page 234](#) for contact information).

Load Errors

Filament broken in head

- The printer believes that material is not loaded within the tips.
- Correct condition - unload model and support material (see [“Unloading Material from the Liquefier Tips” on page 118](#)) and then reload these materials (see [“Loading Material to the Liquefier Tips” on page 112](#)). Once loaded, verify that material purges from the tips by performing a manual purge of each tip using the purge buttons within the Tip Maintenance page (see [“Purge” on page 75](#)).

Purge failed

- Indicates that filament is currently in the head, but the load failed.
- Correct condition - unload model and support material (see [“Unloading Material from the Liquefier Tips” on page 118](#)) and then reload these materials (see [“Loading Material to the Liquefier Tips” on page 112](#)). Once loaded, verify that material purges from the tips by performing a manual purge of each tip using the purge buttons within the Tip Maintenance page (see [“Purge” on page 75](#)).

Filament broken

- Indicates that filament appears to be broken at the canister drive.
- Correct condition - remove the canister and clear all filament from the filament tubes (see [“Removing Canisters” on page 120](#)). Reload the canister (see [“Loading Material to the Liquefier Tips” on page 112](#)). If the error persists, contact Stratasys Customer Support or your regional Stratasys office (see [“Getting Help” on page 234](#) for contact information).

Load timed out

- Indicates that filament was not detected at the head within 5 minutes of a load’s initiation.
- Correct condition - remove the canister and ensure that it is properly prepared for installation and load (i.e. anti-rotation plug has been removed, etc.). See [“Removing Canisters” on page 120](#) and [“Canister Installation” on page 115](#) for details. Reload the canister (see [“Loading Material to the Liquefier Tips” on page 112](#)).

Load incomplete

- Indicates that filament has reached the head, but the printer does not think the tip was loaded.
- Correct condition - remove the canister and clear all filament from the filament tubes (see [“Removing Canisters” on page 120](#)). Reload the canister (see [“Loading Material to the Liquefier Tips” on page 112](#)). If the error persists, contact Stratasys Customer Support or your regional Stratasys office (see [“Getting Help” on page 234](#) for contact information).

Filament detected in head too soon

- Indicates that the printer’s controller is detecting filament in the head too soon, possibly due to a piece of broken filament within the filament tubes.
- Correct condition - remove the canister (see [“Removing Canisters” on page 120](#)) and reload the canister (see [“Loading Material to the Liquefier Tips” on page 112](#)). If the error persists, contact Stratasys Customer Support or your regional Stratasys office (see [“Getting Help” on page 234](#) for contact information).

No filament detected at canister bay

- Indicates that the switch in the canister drive is not detecting filament. This could indicate that the canister is empty or filament became broken during the load process.
- Correct condition - remove the canister and clear all filament from the filament tubes (see [“Removing Canisters” on page 120](#)). Reload the canister (see [“Loading Material to the Liquefier Tips” on page 112](#)). If the error persists, contact Stratasys Customer Support or your regional Stratasys office (see [“Getting Help” on page 234](#) for contact information).

Failed to load filament to head

- Indicates that filament is not loaded to the head and the printer does not think the tip was loaded.
- Correct condition - remove the canister and clear all filament from the filament tubes (see [“Removing Canisters” on page 120](#)). Reload the canister (see [“Loading Material to the Liquefier Tips” on page 112](#)). If the error persists, contact Stratasys Customer Support or your regional Stratasys office (see [“Getting Help” on page 234](#) for contact information).

Auto purge detection failed

- Indicates that the printer was unable to detect a stable tip temperature.
- Correct condition - unload model and support material (see [“Unloading Material from the Liquefier Tips” on page 118](#)) and then reload these materials (see [“Loading Material to the Liquefier Tips” on page 112](#)). Once loaded, verify that material purges from the tips by performing a manual purge of each tip using the purge buttons within the Tip Maintenance page (see [“Purge” on page 75](#)).

Build Pause Warnings



Note: For all pause related warnings, attempt to resume the build (by pressing the **Build (play)** button within the Build page) prior to performing the step(s) for correcting the pause condition.

Out of model material

- The printer has run out of model material. If 2 model material canisters are installed, this warning indicates that both canisters are empty.
- Correct condition - remove the empty canister(s) and replace as needed. See [“Removing an empty canister” on page 120](#) and [“Canister Installation” on page 115](#) for instructions.

Out of support material

- The printer has run out of support material. If 2 support material canisters are installed, this warning indicates that both canisters are empty.
- Correct condition - remove the empty canister(s) and replace as needed. See [“Removing an empty canister” on page 120](#) and [“Canister Installation” on page 115](#) for instructions.

Model canister removed during build

- Indicates that the printer lost contact with the canister’s memory chip or the canister drive inadvertently lifted.
- Correct condition - ensure that the canister is seated correctly within the canister drive. If so, remove the canister and then reinstall it (see [“Removing Canisters” on page 120](#) and [“Canister Installation” on page 115](#)). If this does not correct the error, remove the canister and install a new canister.

Support canister removed during build

- Indicates that the printer lost contact with the canister’s memory chip or the canister drive inadvertently lifted.
- Correct condition - ensure that the canister is seated correctly within the canister drive. If so, remove the canister and then reinstall it (see [“Removing Canisters” on page 120](#) and [“Canister Installation” on page 115](#)). If this does not correct the error, remove the canister and install a new canister.

Detected end of model filament

- Indicates that the canister may have run out of model material (is empty) or filament may have broken within the filament tubes.
- Correct condition - remove the empty canister(s) and replace as needed. See [“Removing an empty canister” on page 120](#) and [“Canister Installation” on page 115](#) for instructions.

Detected end of support filament

- Indicates that the canister may have run out of support material (is empty) or filament may have broken within the filament tubes.
- Correct condition - remove the empty canister(s) and replace as needed. See [“Removing an empty canister” on page 120](#) and [“Canister Installation” on page 115](#) for instructions.

User inserted pause

- Indicates that a pause was inserted within the job's file.
- Correct condition - resume the build by pressing the **Build (play)** button within the Build page.

Model filament clogged in tip

- The printer has detected excessive torque needed to extrude model material.
- Correct condition - if this error occurs during the first few layers of a build, Contact Stratasys Customer Support or your regional Stratasys office (see [“Getting Help” on page 234](#) for contact information). If this error occurs during the middle or end of a build, check the build for part curl and ensure that over-fill is not occurring.

Support filament clogged in tip

- The printer has detected excessive torque needed to extrude support material.
- Correct condition - if this error occurs during the first few layers of a build, Contact Stratasys Customer Support or your regional Stratasys office (see [“Getting Help” on page 234](#) for contact information). If this error occurs during the middle or end of a build, check the build for part curl and ensure that over-fill is not occurring.

Vacuum pressure lost

- Printer unexpectedly lost vacuum.
- Correct condition - often the result of a poorly positioned build sheet. Ensure that the platen is free of material debris and then reposition the build sheet on the platen. Wait for the printer to achieve sufficient vacuum; the red X over the top of the Vacuum Status Indicator (within the Information Bar) will disappear once sufficient vacuum is achieved. If you are still unable to achieve sufficient vacuum, install a new build sheet. Contact Stratasys Customer Support or your regional Stratasys office if after performing these steps you are still unable to achieve sufficient vacuum (see [“Getting Help” on page 234](#) for contact information).

Dryer pressure lost

- Printer unexpectedly lost dryer pressure.
- Correct condition - contact Stratasys Customer Support or your regional Stratasys office (see [“Getting Help” on page 234](#) for contact information).

Build Abort Warnings



Note: For all abort related warnings, attempt to resume the build (see [“Aborting a Build” on page 166](#)) prior to performing the step(s) for correcting the abort condition.

Z home failure

- Indicates that the Z stage failed to find its home position.
- Correct condition - verify that the tip sensor plunger is present and properly installed, see [“Clean the Tip Sensor Plunger” on page 229](#) for instructions.

Move compiler failure

- An error occurred when attempting to translate the CMB file into commands for the printer.
- Correct condition - often the result of a corrupted or outdated CMB file. Ensure that your printer’s software version is up to date (see [“Updating Controller Software - Web Method” on page 209](#)) and that you are using the correct version of Insight software. Reprocess, reorient, and resend the job file to the printer using Insight (see [“Insight Software” on page 41](#)) and then restart the build (see [“Basic Job Build Tasks” on page 161](#) for instructions).

Toolpath data feed failure

- Printer unexpectedly lost job information during the build.
- Correct condition - reprocess, reorient, and resend the job file to the printer using Insight (see [“Insight Software” on page 41](#)). If you encounter the same error when rebuilding with the reprocessed file, attempt to build a different file to see if the error occurs again. If so, contact Stratasy Customer Support or your regional Stratasy office (see [“Getting Help” on page 234](#) for contact information).

Canister removed

- Indicates that the printer lost contact with the canister’s memory chip or the canister drive inadvertently lifted.
- Correct condition - ensure that the canister is seated correctly within the canister drive. If so, remove the canister and then reinstall it (see [“Removing Canisters” on page 120](#) and [“Canister Installation” on page 115](#)). If this does not correct the error, remove the canister and install a new canister.

No job file

- Indicates that a job file has not been selected for building.
- Correct condition - select the job you’d like to build from either the Job Queue or Sample Queue. See [“Selecting a Job to Build” on page 162](#) for instructions.

Vacuum pressure lost

- Printer unexpectedly lost vacuum.
- Correct condition - often the result of a poorly positioned build sheet. Ensure that the platen is free of material debris and then reposition the build sheet on the platen. Wait for the printer to achieve sufficient vacuum; the red X over the top of the Vacuum Status Indicator (within the Information Bar) will disappear once sufficient vacuum is achieved. If you are still unable to achieve sufficient vacuum, install a new build sheet. Contact Stratasy Customer Support or your regional Stratasy office if after performing these steps you are still unable to achieve sufficient vacuum (see [“Getting Help” on page 234](#) for contact information).

Dryer pressure lost

- Printer unexpectedly lost dryer pressure.
- Correct condition - contact Stratasys Customer Support or your regional Stratasys office (see [“Getting Help” on page 234](#) for contact information).

Unknown abort

- An unexpected error occurred in which the printer was unable to map the cause of the error to a known abort reason.
- Correct condition - attempt to restart the build, see [“Basic Job Build Tasks” on page 161](#) for instructions. If the error persists, contact Stratasys Customer Support or your regional Stratasys office (see [“Getting Help” on page 234](#) for contact information).

Finding a Remedy

The following table lists various troubleshooting scenarios you may encounter when operating the 380mc and methods for resolving these scenarios.

Condition	Possible Cause	Remedy
Canister will not load	Anti-rotation plug not removed from canister.	Remove plug (see Figure 5-5 on page 116).
	Rubber thumbwheel insert not removed from thumbwheel door.	Remove thumbwheel insert (see Figure 5-5 on page 116).
	Empty canister (zero volume).	Remove and replace empty canister (see “Removing Canisters” on page 120 and “Canister Installation” on page 115).
	Filament stuck in canister.	Remove canister from printer and pull out about 8 feet (2 meters) of material. Ensure filament pulls out freely. See “Unloading Material from the Liquefier Tips” on page 118 and “Removing Canisters” on page 120 .
	Incorrect canister type installed.	The 380mc utilizes a different canister memory chip than other Fortus canisters. As a result, only 380mc canisters can be used to build parts on the printer. Ensure that a 380mc canister is installed - these canisters exhibit a black canister snout and plastic plug (see Figure 5-5 on page 116 for referenced items).
	Canister drive not fully lowered onto canister.	Reset canister drive onto canister (see “Canister Installation” on page 115).
	Canister memory chip circuit failed.	View canister status within the Dashboard. If the canister's icon is red, there may be an issue with the canister's memory chip. Unload and then reload the canister. If the error persists, replace the canister with a new one. See “Unloading Material from the Liquefier Tips” on page 118 , “Removing Canisters” on page 120 , and “Loading Material to the Liquefier Tips” on page 112 .
	Incorrect tip size displayed on the touchscreen (within a Tips Status Icon)	Verify that installed tips match the tip configuration of the selected job (see “Viewing Print Job Information” on page 53). If one or both installed tips do not match the job's tip configuration, change tip(s) to match the requirements of the selected job (see “Changing Tips or Material Type” on page 123).
Filament does not reach head (load time-out reached)	Remove canister and replace with a new canister (see “Removing Canisters” on page 120 and “Loading Material to the Liquefier Tips” on page 112). If the error persists, contact Customer Support or your regional Stratasys office (see “Getting Help” on page 234 for contact information).	

Condition	Possible Cause	Remedy
Loss of extrusion (head will not extrude material)	Filament stuck in canister	Remove canister from printer and pull out about 8 feet (2 meters) of material. Ensure filament pulls out freely. (See “ Unloading Material from the Liquefier Tips ” on page 118 and “ Removing Canisters ” on page 120.)
	Canister drive is too slow	Verify that load time from the canister to the head switch is less than 5 minutes.
	Plugged Tips	Verify that the size of the installed tip matches the tip size displayed within the Dashboard. See Table 3-1 on page 38. Verify that tip life has not exceeded maximum tip odometer. See Table 3-3 on page 39. Verify tips were installed correctly. See “ Changing Tips within the Top Cover ” on page 156. Verify that material purges by initiating a purge using the model and/or support purge buttons. See “ Tip Purge/Unplug ” on page 74. Replace tip with new tip and recalibrate. See “ Using the Tip Change Wizard ” on page 123.
	Printer not calibrated	Perform an XYZ Tip Offset Calibration. See “ XYZ Tip Offset Calibration ” on page 182.
	Low vacuum caused build sheet to shift and may have plugged tip.	See “Low vacuum” in this table.
Low vacuum	The build sheet is not properly installed.	Move the build sheet until it overlaps the platen equally on all sides.
	There is filament debris on the platen.	Remove the build sheet and clean the top surface of the platen (see “ Clean the Platen ” on page 222.)
	A small piece of material may have been sucked into the vacuum line.	Contact Customer Support or your regional Stratasys office (see “ Getting Help ” on page 234 for contact information).
	The vacuum port's debris screen may be plugged.	Clean the debris screen (see “ Clean the Platen ” on page 222). Do NOT remove the screen - it is not a customer replaceable item.
	The exhaust port on the vacuum pump may be clogged, or the vacuum pump may require replacing.	Contact Customer Support or your regional Stratasys office (see “ Getting Help ” on page 234 for contact information).
Low air pressure	This scenario is not operator adjustable.	Contact Customer Support or your regional Stratasys office (see “ Getting Help ” on page 234 for contact information).
Support material is difficult to remove from part	Support material is embedded in the vertical surfaces of the part.	Adjust the tip to tip calibration. See “ XYZ Tip Offset Calibration ” on page 182.
Model material surface finish is poor on downward facing surfaces	The tip to tip calibration is not set correctly.	Repeat tip to tip calibration. See “ XYZ Tip Offset Calibration ” on page 182.
Support material removes too easily		

Condition	Possible Cause	Remedy
Material oozing	Dryer failure.	Contact Customer Support or your regional Stratasys office (see “Getting Help” on page 234 for contact information).
	Moisture in the canister.	Contact Customer Support or your regional Stratasys office (see “Getting Help” on page 234 for contact information).
Oven not maintaining temperatures	Heater failure.	Contact Customer Support or your regional Stratasys office (see “Getting Help” on page 234 for contact information).
	Oven door open.	Close the oven door; the heater turns off while the door is open.
	Oven door not sealing.	<p>Check oven door seal and verify that it is securely affixed to oven door frame and does not exhibit cuts/tears.</p> <p>If excessive wear is visible, Contact Customer Support or your regional Stratasys office (see “Getting Help” on page 234 for contact information).</p>