



# BATCH WEIGH HOPPER SYSTEM WITH BIN SITE AUTOMATION



## Operators Manual

Software Release U-TREAT v2.0.0



## **INTRODUCTION**

Thank you for choosing USC, LLC for your equipment needs. We appreciate your business and will work diligently to ensure that you are satisfied with your choice.

### **OVERVIEW**

The purpose of this manual is to provide you with the basic information needed to operate and maintain the USC Batch Weigh Hopper System. It does not hold USC, LLC liable for any accidents or injuries that may occur.

### **OPERATOR RESPONSIBILITIES**

As the purchaser/owner/operator of this equipment and control system, you have an obligation to install, operate, and maintain the equipment in a manner that minimizes the exposure of people in your care to any potential hazards inherent in using this equipment. It is critical that the owner of this equipment:

- Has a clear and documented understanding of the process this machine is being used in and of any resulting hazards or special requirements arising from this specific application.
- Allow only properly trained and instructed personnel to install, operate, or service this equipment.
- Maintain a comprehensive safety program involving all who work with this machine and other associated process equipment.
- Establish clear areas of staff responsibility (e.g. operation, setup, sanitation, maintenance, and repairs).
- Provide all personnel with necessary safety equipment.
- Periodically inspect the equipment to insure that the doors, covers, guards, and safety devices are in place and functioning, that all safety instructions and warning labels are intact and legible, and that the equipment is in good working order.
- In addition to the operating instructions, observe and enforce the applicable legal and other binding regulations, national and local codes.

As the person with the most to gain or lose from working safely, it is important that you work responsibly and stay alert. By following a few simple rules, you can prevent an accident that could injure or kill you or a co-worker.

- Disconnect, lockout, and tagout electrical and all other energy sources before inspecting, cleaning, servicing, repairing, or any other activity that would expose you to the hazards of electrical shock.

*BATCH WEIGH HOPPER SYSTEM*

- Do not operate, clean, or service this equipment until you have read and understood the contents of this manual. If you do not understand the information in this manual, bring it to the attention of your supervisor, or call your local USC dealer for assistance.
- Any operator who is known or suspected to be under the influence of alcohol or drugs should not be allowed to operate the equipment.
- Understand and follow the safety practices required by your employer and this manual.
- **PAY ATTENTION** to what you and other personnel are doing and how these activities may affect your safety.
- **Failure to follow these instructions may result in serious personal injury or death.**

**RECEIVING YOUR EQUIPMENT**

As soon as the equipment is received, it should be carefully inspected to make certain that it has sustained no damage during shipment and that all items listed on the packing list are accounted for. If there is any damage or shortages, the purchaser must immediately notify your USC dealer. Ownership passes to purchaser when the unit leaves the USC, LLC. premises. The purchaser is responsible for unloading all components of the equipment.

Document the serial number of the machine for future reference. Below is a picture showing where the serial number is located.



*Batch Weigh Hopper  
Serial Number*

**BATCH WEIGH HOPPER SERIAL NUMBER:** \_\_\_\_\_

# TABLE OF CONTENTS

<u>Section</u>	<u>Contents</u>	<u>Page #</u>
<b>Section A</b>	<b>Safety Instructions .....</b>	<b>5</b>
<b>Section B</b>	<b>Installation &amp; Setup .....</b>	<b>12</b>
<b>Section C</b>	<b>Mechanical Operation .....</b>	<b>16</b>
	Batch Weigh Hopper Main Control Panel Overview .....	16
	Batch Weigh Hopper Overview .....	17
	Bin Site System Overview .....	18
	Bin Slide Gates, Pro Box Hopper, Transfer Conveyor .....	20
	Underbin Conveyor, Underbin Conveyor Encoder .....	20
	Batch Weigh Hopper, Slide Gate & Scale Head .....	21
	Scale Fill Conveyor, Diverter .....	21
<b>Section D</b>	<b>Electrical Operation .....</b>	<b>22</b>
	Main Screen .....	24
	H-O-A Screen .....	29
	Utilities Screen .....	33
	Security Screen .....	35
	Tools & Options Screen .....	37
<b>Section E</b>	<b>Calibration &amp; Operation .....</b>	<b>44</b>
	Determining Seed Cup Weight .....	44
	Loading Seed Into Bins .....	45
	Setting The Seed Flow Rate .....	47
	Scale Fill From Bin .....	48
	Calling in Seed From Pro Boxes .....	50
	Batch Weigh Hopper Calibration .....	52
	Underbin Operation In Reverse Mode .....	53
	Editing & Printing Reports .....	54
	Downloading Reports .....	56
<b>Section F</b>	<b>Troubleshooting &amp; Alarms .....</b>	<b>60</b>
	Troubleshooting .....	60
	System Alarms - Faults .....	62
	System Messages .....	64
<b>Section G</b>	<b>Maintenance .....</b>	<b>65</b>
<b>Section H</b>	<b>Storage .....</b>	<b>72</b>
<b>Section I</b>	<b>Mechanical Drawings .....</b>	<b>74</b>
<b>Section J</b>	<b>Limited Warranty .....</b>	<b>85</b>

# SAFETY INSTRUCTIONS

## SECTION A

Every year accidents in the work place maim, kill, and injure people. Although it may be impossible to prevent all accidents, with the right combination of training, operating practices, safety devices, and operator vigilance, the number of accidents can be significantly reduced. The purpose of this section is to educate equipment users about hazards, unsafe practices, and recommended hazard avoidance techniques.

### SAFETY WORDS AND SYMBOLS

It is very important that operators and maintenance personnel understand the words and symbols that are used to communicate safety information. Safety words, their meaning and format, have been standardized for U.S. manufacturers and published by the American National Standards Institute (ANSI). The European Community (E.C.) has adopted a different format based on the International Standards Organization (I.S.O.) and applicable machinery directives. Both formats are presented below. Graphic symbols are not standardized, but most manufacturers will use some variation of the ones seen in this manual.



Indicates an imminently hazardous situation which, if not avoided, **will** result in death or serious injury.



Indicates a potentially hazardous situation which, if not avoided, **could** result in death or serious injury.



Indicates a potentially hazardous situation which, if not avoided, **may** result in minor or moderate injury and/or property damage.



Provides additional information that the operator needs to be aware of to avoid a potentially hazardous situation.



**Mandatory Lockout Power Symbol.** Disconnect, lockout, and tagout electrical and other energy sources before inspecting, cleaning, or performing maintenance on this panel.



**International Safety Alert Symbol.** The exclamation point (!) surrounded by a yellow triangle indicates that an injury hazard exists. However, it does not indicate the seriousness of potential injury. The exclamation point (!) is also used with the DANGER, WARNING, and CAUTION symbols so the potential injury is indicated.



**Electrocution Hazard Symbol.** This symbol indicates that an electrocution hazard exists. Serious injury or death could result from contacting high voltage.



**International Electrocution Hazard.** This symbol indicates that an electrocution hazard exists. Serious injury or death could result from contacting high voltage.



**Mandatory Read Manual Action Symbol.** (I.S.O. format) This symbol instructs personnel to read the Operators Manual before servicing or operating the equipment.



**Mandatory Read Manual Action Symbol.** This symbol instructs personnel to read the Operators Manual before servicing or operating the equipment.

**NOTICE**

Notice is used to notify people of important installation, operation or maintenance information which is not hazard related.

## **LOCKOUT / TAGOUT PROCEDURES**

Lockout/Tagout is the placement of a lock/tag on an energy isolating device in accordance with an established procedure. When taking equipment out of service to perform maintenance or repair work, always follow the lockout/tagout procedures as outlined in ANSI Z344.1 and/or OSHA Standard 1910.147. This standard “requires employers to establish a program and utilize procedures for affixing appropriate lockout devices or tagout devices to energy isolating devices and to otherwise disable machines or equipment to prevent unexpected energizing, start-up, or release of stored energy in order to prevent injury to employees.”

## **EMERGENCY STOP**



There are two Emergency Stop push buttons. There is one on the Main Control Panel and one on the Bin Site Control Panel. Actuators of emergency stop shall be colored RED. The background immediately around the device actuator shall be colored YELLOW. The actuator pushbutton-operated device shall be of the palm or mushroom head type.

## **CONTROLLED STOP**

This is the stopping of machine motion by reducing the electrical command signal to 0 (zero) once the stop signal has been recognized. The operator initiates this stop by pressing the “PAUSE” button at the bottom of the main screen.

## **HAZARD REVIEW**

### **Electrocution Hazard**



Electrocution accidents are most likely to occur during maintenance of the electrical system or when working on or near exposed high voltage wiring. This hazard does not exist when the electrical power has been disconnected, properly locked, and tagged out.

### **Automatic Start Hazard**



This seed treating system is usually controlled by an automated system and may start without warning. Failure to properly disconnect, lockout, and tagout all energy sources of remotely controlled equipment creates a very hazardous situation and could cause injury or even death. PLEASE STAY CLEAR AND BE ALERT.

**YOU** are responsible for the **SAFE** operation and maintenance of your USC, LLC Batch Weigh Hopper System. **YOU** must ensure that you and anyone else who is going to operate, maintain, or work around the Batch Weigh Hopper System be familiar with the operating and maintenance procedures and related **SAFETY** information contained in this manual. This manual will take you step-by-step through your working day and alert you to good safety practices that should be adhered to while operating the Batch Weigh Hopper System.

Remember, **YOU** are the key to safety. Good safety practices not only protect you, but also the people around you. Make these practices a working part of your safety program. Be certain that **EVERYONE** operating this equipment is familiar with the recommended operating and maintenance procedures and follows all the safety precautions. Most accidents can be prevented. Do not risk injury or death by ignoring good safety practices.

- Batch Weigh Hopper System owners must give operating instructions to operators or employees before allowing them to operate the machine, and at least annually thereafter per OSHA (Occupational Safety and Health Administration) regulation 1928.57.
- The most important safety device on this equipment is a **SAFE** operator. It is the operator's responsibility to read and understand **ALL** Safety and Operating instructions in the manual and to follow them. All accidents can be avoided.
- A person who has not read and understood all operating and safety instructions is not qualified to operate the machine. An untrained operator exposes himself and bystanders to possible serious injury or death.
- Do not modify the equipment in any way. Unauthorized modification may impair the function and/or safety and could affect the life of the equipment.
- Think SAFETY! Work SAFELY!

### **GENERAL SAFETY**

1. Read and understand the Operator's Manual and all safety signs before operating, maintaining, adjusting or unplugging the Batch Weigh Hopper System.
2. Only trained persons shall operate the Batch Weigh Hopper System. An untrained operator is not qualified to operate the machine.
3. Have a first-aid kit available for use should the need arise, and know how to use it.



*BATCH WEIGH HOPPER SYSTEM*

4. Provide a fire extinguisher for use in case of an accident. Store in a highly visible place.
5. Do not allow children, spectators or bystanders within hazard area of machine.
6. Wear appropriate protective gear. This includes but is not limited to:

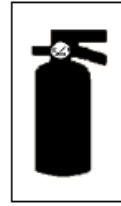

- A hard hat
- Protective shoes with slip resistant soles
- Protective goggles
- Heavy gloves
- Hearing protection
- Respirator or filter mask



7. Place all controls in neutral or off, stop motor, and wait for all moving parts to stop. Then disable power source before servicing, adjusting, repairing, or unplugging.



8. Review safety related items annually with all personnel who will be operating or maintaining the Batch Weigh Hopper System.

**OPERATING SAFETY:**

1. Read and understand the Operator's Manual and all safety signs before using.
2. Disconnect and disable electrical supply completely and wait for all moving parts to stop before servicing, adjusting, repairing or unplugging.
3. Clear the area of bystanders, especially children, before starting.
4. Be familiar with the machine hazard area. If anyone enters hazard area, shut down machine immediately. Clear the area before restarting.
5. Keep hands, feet, hair and clothing away from all moving and/or rotating parts.
6. Stay away from overhead obstructions and power lines during operation and transporting. Electrocution can occur without direct contact.
7. Do not operate machine when any guards are removed.
8. Inspect welds and repair if needed.

### **PLACEMENT SAFETY**

1. Move only with the appropriate equipment
2. Stay away from overhead power lines when moving any components of the Batch Weigh Hopper System. Electrocutation can occur without direct contact.
3. Be familiar with machine hazard area. If anyone enters hazard areas, shut down machine immediately. Clear the area before restarting.
4. Operate the Batch Weigh Hopper System on level ground free of debris. Anchor the equipment to prevent tipping or upending.



Before placement of any equipment, be sure that ground is reasonably level. The equipment may topple or work improperly if the ground is too uneven, damaging the equipment and/or causing personal injury.

### **MAINTENANCE SAFETY**

1. Review the Operator's Manual and all safety items before working with, maintaining or operating the bin site system.
2. Place all controls in neutral or off, stop motors, disable power source, and wait for all moving parts to stop before servicing, adjusting, repairing or unplugging.
3. Follow good shop practices:  
Keep service area clean and dry.  
Be sure electrical outlets and tools are properly grounded.  
Use adequate light for the job at hand.
4. Keep hands, feet, hair and clothing away from all moving and/or rotating parts.
5. Clear the area of bystanders, especially children, when carrying out any maintenance and repairs or making any adjustments.
6. Before resuming work, install and secure all guards when maintenance work is completed.
7. Keep safety signs clean. Replace any sign that is damaged or not clearly visible.



## SAFETY SIGNS

1. Keep safety signs clean and legible at all times.
2. Replace safety signs that are missing or have become illegible.
3. Replaced parts that displayed a safety sign should also display the current sign.
4. Safety signs are available from your Authorized Dealer.

### How to Install Safety Signs:

- Be sure that the installation area is clean and dry.
- Be sure temperature is above 50°F (10°C).
- Decide on the exact position before you remove the backing paper.
- Remove the smallest portion of the split backing paper.
- Align the sign over the specified area and carefully press the small portion with the exposed sticky backing in place.
- Slowly peel back the remaining paper and carefully smooth the remaining portion of the sign in place.
- Small air pockets can be pierced with a pin and smoothed out using the piece of sign backing paper.



Located on the USC equipment you will find safety labels. Always be sure to read and follow all directions on the labels.



Part # 09-02-0001



Part # 09-02-0002



Guards provided with USC equipment are to remain in place during operation.

**SECTION  
B**

**INSTALLATION & SETUP**



**HIGH VOLTAGE** ~ Always disconnect the power source before working on or near the control panel or lead wires.



**HIGH VOLTAGE** ~ Use insulated tools when making adjustments while the controls are under power.



Permanent installation may require additional electrical cords, liquid hose, and air lines, since each installation is unique.

**SET-UP**

The following steps outline the initial set-up of your USC Batch Hopper System:

1. Confirm all equipment has been received and then contact USC, LLC or your dealer to setup a time for an installation crew to install your Batch Weigh Hopper System.
2. A USC trained install crew will arrive on site and perform the necessary steps for installation of the equipment.



Based on your particular Batch Weigh Hopper System, some additional equipment may be required to install the Batch Weigh Hopper System (i.e. fork lift(s), crane, etc.



USC requires that all touch screen control panels be set up inside a building or in a covered structure to protect the machine from weathering.

3. Have a certified electrician provide power to the Batch Weigh Hopper System and wire in all necessary “customer supplied” wiring, including Ethernet cables as listed in your provided Batch Weigh Hopper schematics. Provide convenient shutdown switches and comply with local electrical codes. The USC Batch Weigh Hopper System must be connected to the same electrical requirements as specified in the main control panel on the power requirement tag and the electrical schematic shipped with the piece of equipment. USC recommends that flexible conduit be used wherever possible. Attach 110V power to the Batch Weigh Hopper System and touch screen control panels.

 Seed Treating <b>Solutions</b>	
Mfg. By: USC, LLC	
Max voltage: 208-230V, 1PH, 60 HZ	
Total FLA: 59	
Largest Motor FLA: 28	
Schematic number: CBWH1204N10N1	
Enclosure rating: UL type 1	
Short Circuit Current Rating: 5ka RMS Sym, 600V Max	
<p style="text-align: center;"><b>WARNING</b></p> To maintain over current, short-circuit and ground fault protection, the manufacturer's instruction for selection of overload and short circuit protection must be followed to reduce the risk of fire or electrical shock.	
<p style="text-align: center;"><b>WARNING</b></p> If an overload or a fault current interruption occurs, circuits must be checked to determine the cause of the interruption. If a fault condition exists, the current-carrying components should be examined and replaced if damaged, and the integral current sensors must be replaced to reduce the risk of fire or electrical shock.	
Panel 1 of 1 See schematic number:CBWH1204N10N1 for interconnections.	
Fuse Replacement	
Fuse	Line Size Type
FU8050	8050 4 amp SB TL 150VDC CERM
FU8072	8072 1 amp T SB/TD GMD-1-R
FU8117	8117 1 amp T SB/TD GMD-1-R
<p style="text-align: center;"><b>!! WARNING !!</b></p> 208-230Volts/ 1Phase/60 Hertz supply only. L1to Neutral voltage must not exceed 120 Volts!!	

- 4. Connect a dedicated analog phone line to the modem located in the top left portion of the control panel. This will allow USC remote access to the Batch Weigh Hopper System.

Analog Phone Line Hooked Up Here



- 5. A service port located on the side of the main control panel will allow the operator to connect a printer and an Ethernet connection to the unit. The printer connection will allow the user to print reports directly from the reports screen.

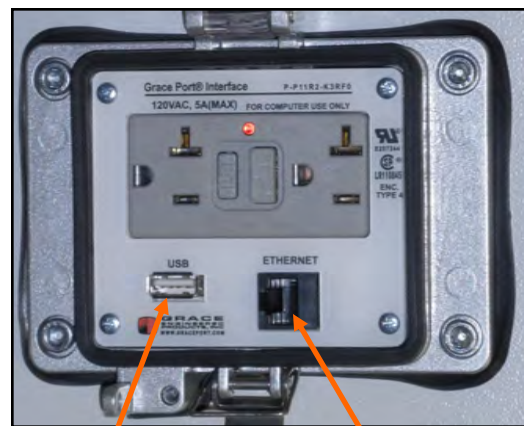

USB Connection

Ethernet Connection

- 6. Supply approximately 100-110 psi of air pressure at two locations. It is required that this air supply have an in-line customer supplied air dryer to protect the air system from contamination. From the dryer, one line goes to the bottom of the solenoid group on the side of the Bin Site Control Panel. (right) The other line goes from the dryer to operate the bin slide gates under the Batch Hopper.
- 7. Contact USC, LLC or your dealer to setup a startup and training session(s) before using your Batch Weigh Hopper System.
- 8. Have the scales calibrated by a state certified professional scale technician after the USC, LLC trained technician has performed a startup session on your site.



Connect Air Line Here

9. Setup the Main Control Panel at a place that is convenient to the operator. This may include attaching the automated Main Control Panel to a wall or to the control panel stand that will require anchoring.
10. Connect the gray cable with light blue ends to one of PJCAN connections on the bottom of the Main Control Panel to the Treater Control panel (if applicable) then on to the Bin Site Control Panel.
11. Connect the red cable to the PJESTOPA on the Main Control Panel to the PJESTOPB on the Treater Control Panel (if applicable) then on to the Bin Site Control Panel. This cable must run from an A connection to a B connection (never A to A or B to B). Connect the two red plugs into each of the remaining open PJESTOP connections.

### MAIN CONTROL PANEL

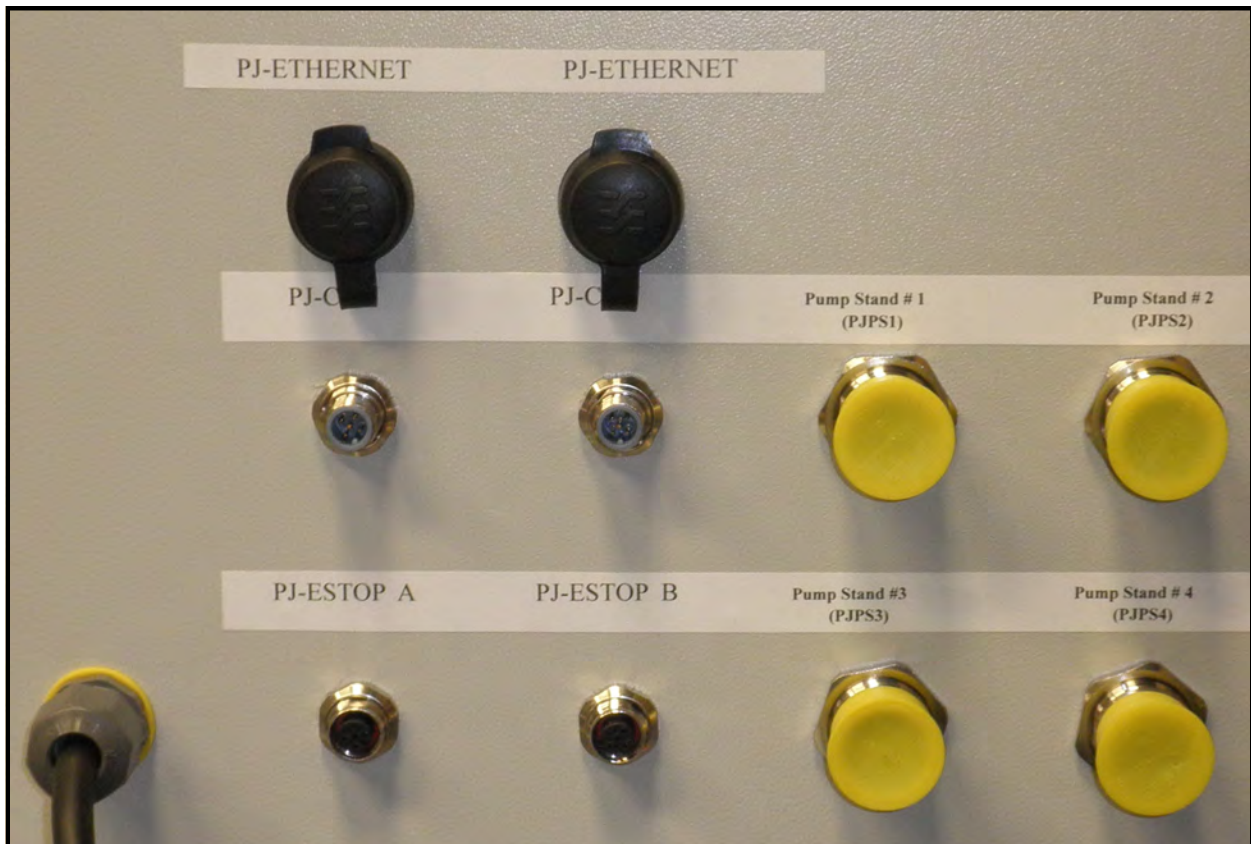

**BIN SITE CONTROL PANEL**



SECTION  
C

**MECHANICAL OPERATION**

**BATCH WEIGH HOPPER MAIN CONTROL PANEL OVERVIEW**

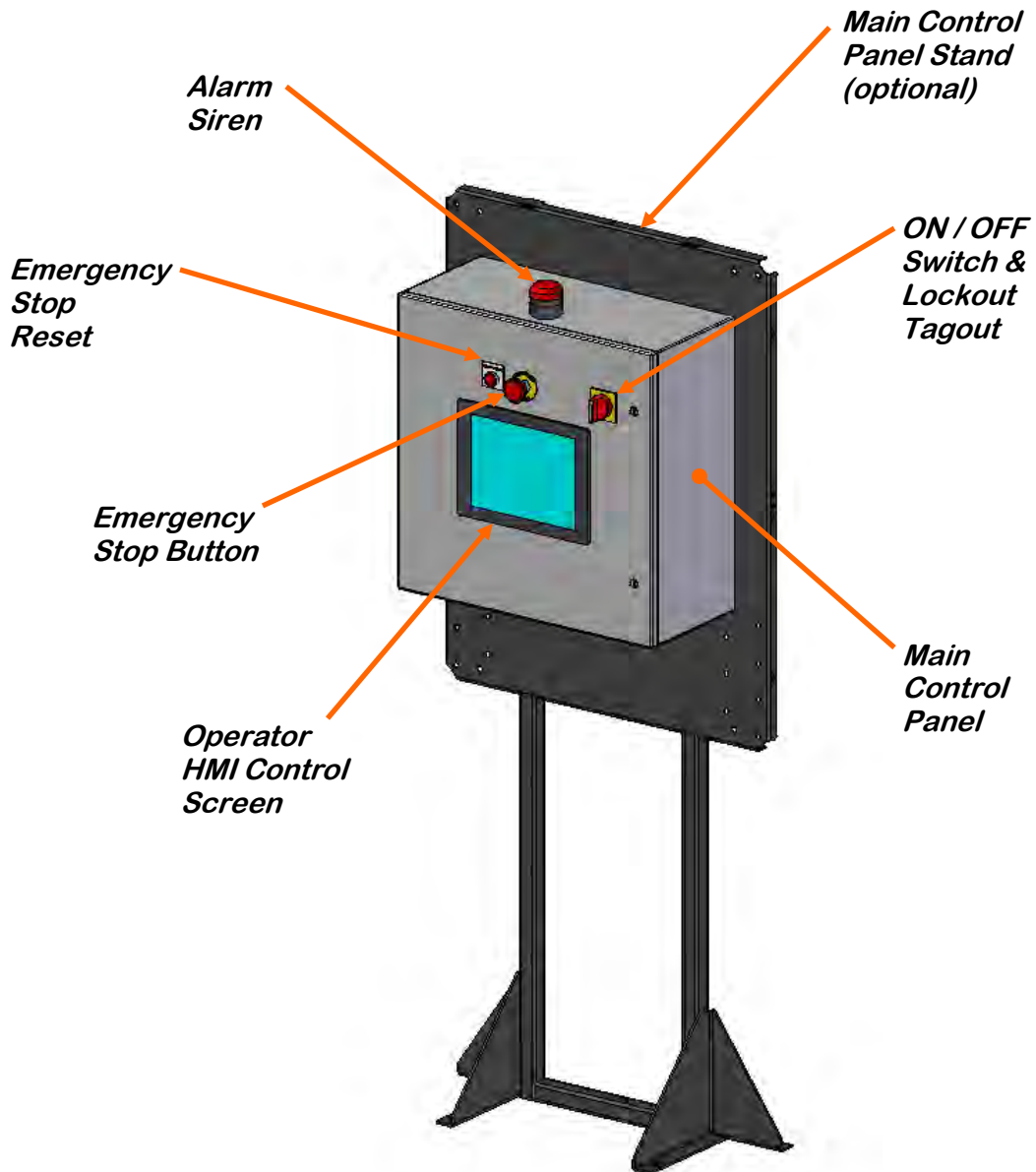

**BATCH WEIGH HOPPER OVERVIEW**

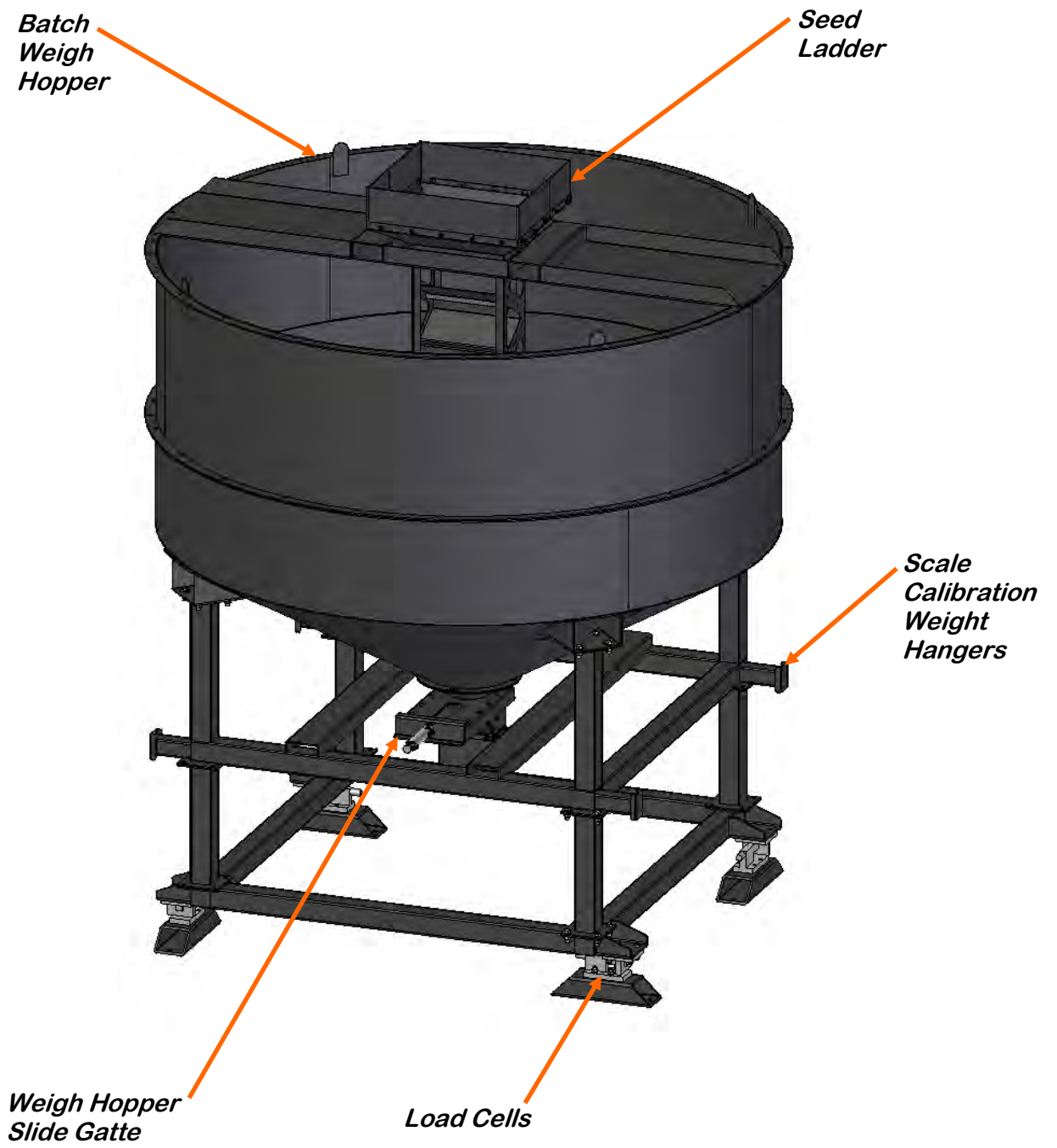

**BIN SITE SYSTEM OVERVIEW**

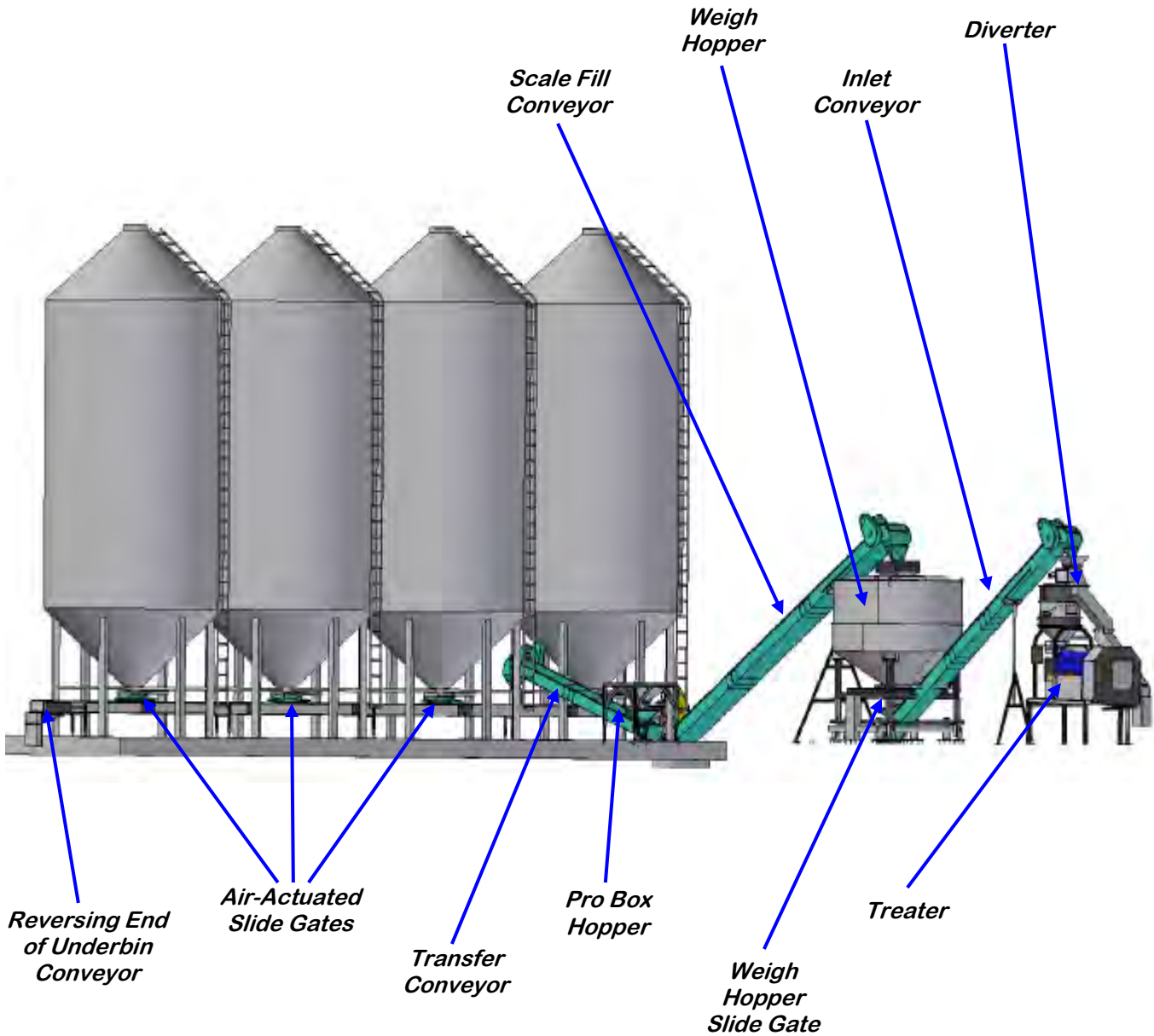

**BIN SITE SYSTEM OVERVIEW**

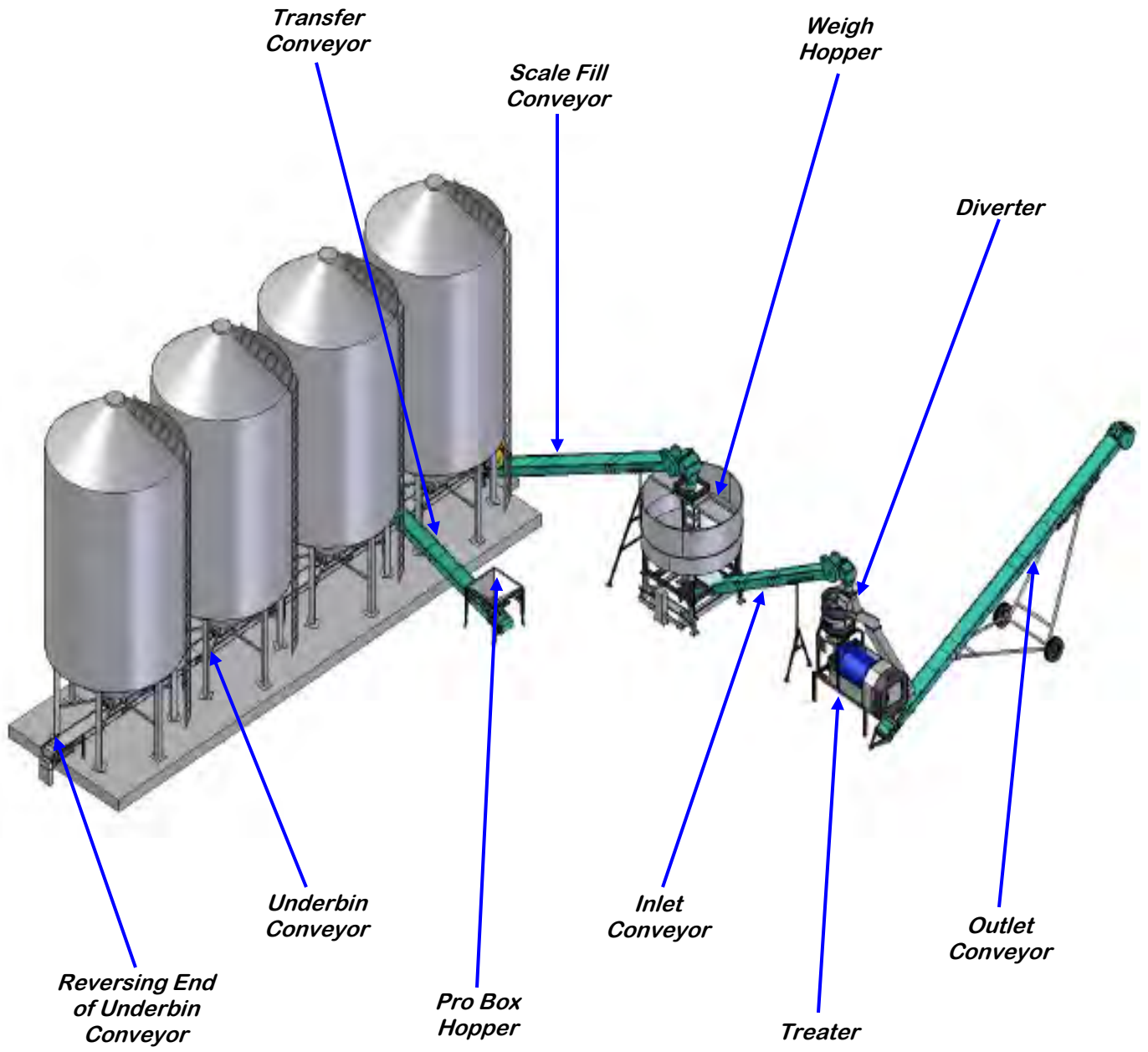

### **BIN SLIDE GATES**

An air-actuated slide gate attaches to the bottom of each bin. The slide gate sits below the manual crank gate on the bin. The flow rate of seed passing through the gate is adjusted by moving the collar on the rod that exits out of the back of the bin slide gate. Moving the collar further away from the bin slide gate will allow the gate to open more and increase seed flow. It is recommended that the manual gate be opened all the way. The system calibrates seed flow through a timing mechanism that tells the air gate to close after a given amount of time. During each run of seed, the system will constantly perform an automatic calibration. that is flow rate specific. If the manual gate or the collar is adjusted, recalibration of the seed flow will need to be done (see page 52).

---

### **PRO BOX HOPPER (optional)**

The pro box hopper is an inverted pyramid shaped hopper that is used as a means of running seed straight from a pro box into the weigh hopper system. This hopper includes an adjustable slide gate for metering the flow of seed and adjustable legs for changing the height of the hopper.

---

### **TRANSFER CONVEYOR (optional)**

The transfer conveyor is the conveyor that connects the pro box hopper to the rest of the system. This conveyor is located so that its intake hopper is directly under the pro box hopper and its discharge end is feeding into the underbin or scale fill conveyor. This conveyor can be run in the AUTO mode or be run manually via the weigh hopper H-O-A screen.

---

### **UNDERBIN CONVEYOR**

The underbin conveyor sits directly below each of the air-actuated slide gates that are in turn positioned directly under the manual slide gates of the bulk bins. The conveyor transports seed forward to the scale fill conveyor. The underbin conveyor may also include an option so that it can run in reverse for clean out purposes. Seed is moved inside the underbin conveyor via a crescent belt. An adjustment for the tracking of this belt is located at both the head and tail section of the conveyor. The head section also includes a viewing window and the tail section has a removable cover to help with proper alignment of the underbin conveyor belt. An encoder is located in the tail section of the underbin conveyor. The encoder is used to verify that the conveyor is running without any slippage at the belt.

---

### **UNDERBIN CONVEYOR ENCODER**

The underbin conveyor encoder is an electronic device that is connected to a non-drive shaft on the underbin conveyor. This is usually the rear conveyor shaft. The encoder sends an electrical signal to the weigh hopper system whenever the shaft is spinning. That signal allows the weigh hopper system to know that the belt on the underbin conveyor is traveling at the correct speed and that no slippage is occurring. This process allows the weigh hopper system to perform correct auto-calibrations during each run of seed.

## **SCALE FILL CONVEYOR**

The scale fill conveyor is a fixed conveyor that is used to transport seed from the discharge end of the underbin conveyor to the top of the weigh hopper. This conveyor's intake hopper will sit directly under the discharge portion of the underbin conveyor and the discharge end of the scale fill conveyor will be directly above the center of the weigh hopper. The scale fill conveyor is commonly used as the device that brings seed from outside of the treater building to the inside.

---

## **WEIGH HOPPER, SLIDE GATE & SCALE HEAD**

Once seed exits the discharge end of the scale fill conveyor, it will fall down into a fixed seed ladder that is located in the center of the weigh hopper (There is no seed ladder on the 100 unit hopper). Seed will then come to rest above the slide gate as it waits to be weighed. The weigh hopper sits atop a scale assembly. The system uses a Cardinal series 205 scale head to display the current weight of the seed in the weigh hopper. The scale head communicates with the system via an Ethernet cable. When the system finishes shutting down each of the conveyors, it will then look to the scale head to get the current weight of the seed in the weigh hopper for calibration purposes.

**NOTICE** The Cardinal series 205 scale head will require calibration by a state certified calibration specialist in order for it to be legal for trade.

Located below the weigh hopper is an air-actuated slide gate. This slide gate has two magnetic sensors that are positioned to read whether or not the slide gate is currently in the open or closed position. This is done to ensure an accurate scale reading will always be achieved. Directly below the air actuated slide gate is a manual gate that can be positioned to control the flow of seed from the weigh hopper.

---

## **DIVERTER (optional)**

The diverter is an air actuated gate that is located above the seed wheel and below the weigh hopper. The diverter gate will sit in one of two positions; Treat or Bypass. When the gate is in the treat position, seed will flow into the treater to have chemical applied to it. When the gate is in the bypass position, seed will not enter the treater but instead will be carried away through a separate chute to a conveyor or holding device. The diverter can be manually actuated by pressing and holding the Treat or Bypass button in the lower right corner of the weigh hopper H.O.A. screen.

SECTION  
D

## ELECTRICAL OPERATION



**HIGH VOLTAGE** ~ Always disconnect the power source before working on or near the control panel or lead wires.



**HIGH VOLTAGE** ~ Use insulated tools when making adjustments while the controls are under power.



**AUTHORIZED PERSONNEL** only shall work on the control panel. Never allow anyone who has not read and familiarized themselves with the owner's manual to open or work on the control panel.

This section provides a general overview and description of the operator controls for the Batch Weigh Hopper System.

### General Panel Descriptions

This system consists of two panels:

- The Bin Site Control Panel (BSCP) is a 36 x 30 x 10 inch enclosure that contains the bulk of the electrical control components. The air solenoid bank that controls the Batch Hopper slide gate valve and the bin slide gate valves is located on the side of this panel and hardwired to the BSCP.
- The Main Control Panel (MCP) is the moveable enclosure that contains the PLC and touch screen HMI. This is where the operator will control all the functions of the Batch Weigh Hopper System. The MCP is connected to the BSCP with two sets of cables. The MCP may also be connected to a Treater panel using these same types of cables. The first set are red braided Emergency Stop cables and the second set are grey CANBUS cables handling all of the I/O communications. (see pages 14 and 15)

**HMI - Main Control Panel**

The following pages explain the function of the touch screen controls.

**USC STARTUP SCREEN**

This screen is the first screen the operator will see after the system receives power. Touch this screen to allow the operator to advance to the Main screen.



**MAIN SCREEN**

This screen informs the operator of the status of all system motors and electrical devices and allows for control / adjustment of system operations.

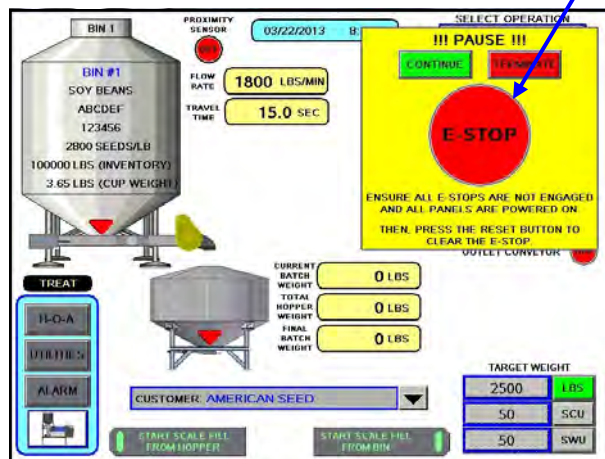
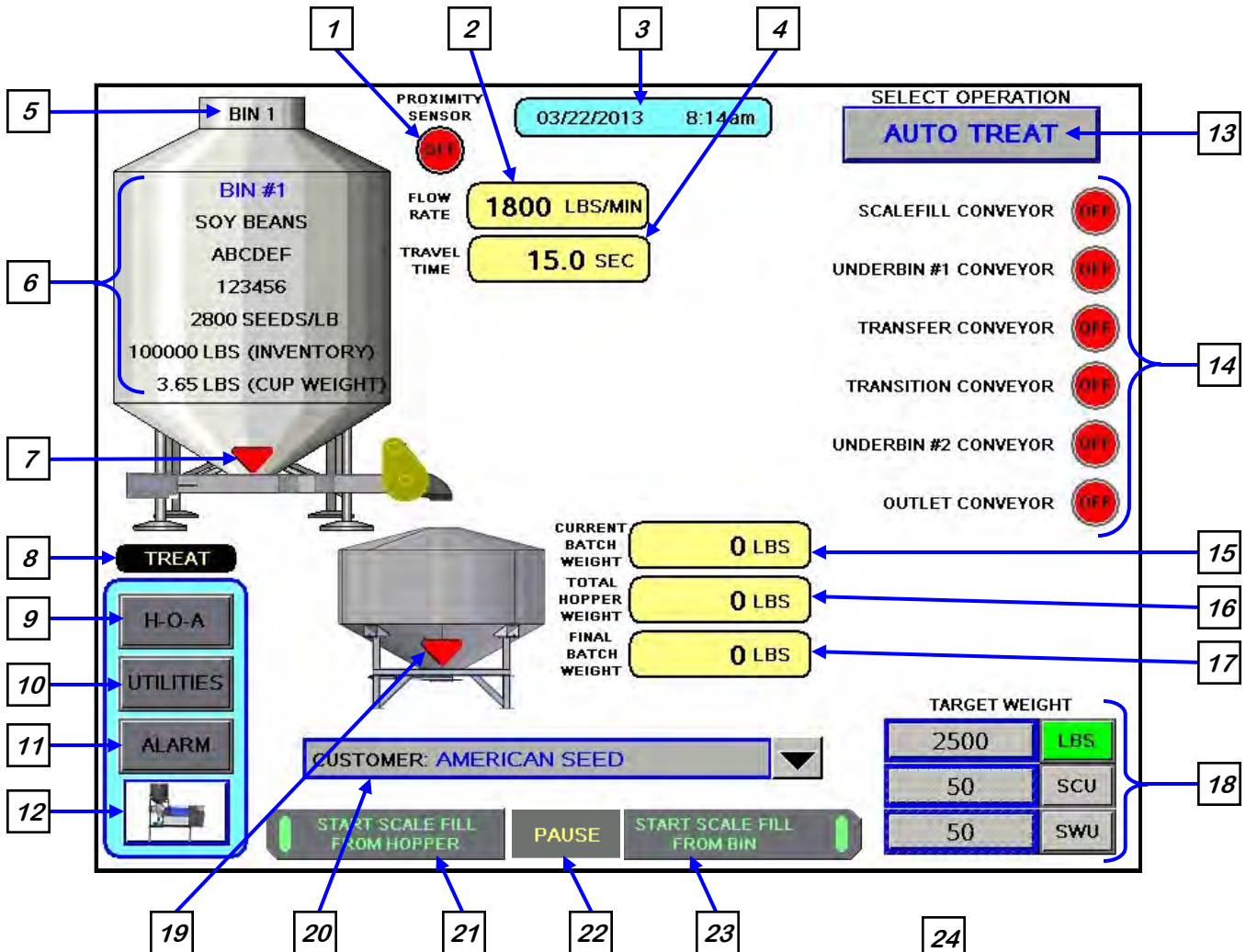

### **Main Screen Button Descriptions**

**1. INLET HOPPER PROXIMITEY SWITCH INDICATOR:** Informs the operator of the status of the proximity switch located in the supply hopper on the treater. If the switch is ON (green) it is detecting seed. If it is OFF (red) it is not detecting seed.

**2. FLOW RATE DISPLAY:** Informs the operator of the flow rate of seed from the currently selected bin.

**3. CURRENT DATE and TIME DISPLAY.**

**4. TRAVEL TIME DISPLAY:** Informs the operator of the amount of time seed takes to flow from the currently selected bin to the batch hopper.

**5. CURRENT BIN SELECTED:** Indicates the currently selected bin.

**6. CURRENT BIN INFO:** Displays the bin information that has been entered into the currently selected bin. Includes seed type, seed variety, lot number, seeds/lb, amount in inventory and cup weight.

**7. BIN SLIDE GATE INDICATOR:** Informs the operator as to whether the currently selected bin slide gate is in the open or closed position.

**8. DIVERTER INDICATOR (optional):** Informs the operator if the diverter is currently in the treat or bypass position. This indicator will only be present if the batch hopper system has a diverter.

**9. H-O-A (Hand-Off-Auto) BUTTON:** This button advances the operator to the H-O-A screen (page 29).

**10. UTILITIES BUTTON:** This button advances the operator to the UTILITIES screen (page 33).

**11. ALARM BUTTON:** This button advances the operator to the ALARMS screen (page 62).

**12. TREATER BUTTON (optional):** This button advances the operator to the treater main screen. This button is only available if the batch hopper system is being operated in conjunction with a PLC controlled seed treater.

**13. SELECT OPERATION BUTTON:** Pressing this button allows the operator to choose between the auto treat and the manual treat / bypass modes of operation (right). This option is only available if the batch hopper is operating in conjunction with a USC, PLC controlled seed treater. If you are not, this button will not be present on the Main screen. In auto treat mode the operator would select the bin they want to pull seed from and enter a target weight for the run. Then press the start scale fill from bin if a standard bin was chosen or start scale fill from hopper if pulling seed from a manual hopper.

(continued on page 26)

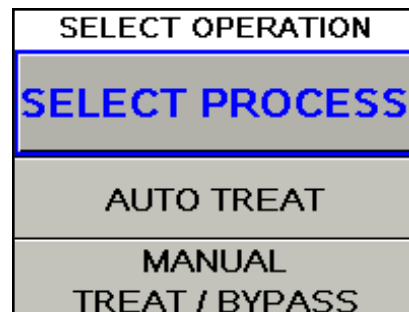

### **Main Screen Button Descriptions**

**13. (Continued):** This starts the conveyors in the pre-determined order defined on the H.O.A. screen, opens the bin slide gate and begins to fill the batch hopper. When the batch hopper is filled and weighed it will begin to empty. Once the proximity switch on the treater detects the presence of seed it will start the treating process. In manual treat / bypass mode the operator has two options. Manual treat works the same as auto treat except the treater must be manually started on the main treater screen. Bypass mode is used when you do not want to treat the seed but still use the batch hopper system to weigh and record the amount of seed retrieved (This is only possible if the treater is equipped with the treater diverter option). To bypass the treater the operator must go to the H.O.A. screen and press the bypass button in the lower right corner. This switches the diverter to bypass mode allowing the seed emptying from the batch hopper to go directly to the outlet conveyor instead of the treater.

**14. CURRENT CONVEYOR MOTOR STATUS INDICATOR:** Informs the operator if a particular conveyor motor is on or off.

**15. CURRENT BATCH WEIGHT DISPLAY:** Informs the operator of the current running total of seed that has entered the batch hopper system for this particular run of seed.

**16. TOTAL HOPPER WEIGHT DISPLAY:** Informs the operator of the current running total of seed that has entered the batch hopper when the operator is using multiple runs to achieve the total target weight.

**17. FINAL BATCH WEIGHT DISPLAY:** Informs the operator of the weight of seed that has been recorded by the scale printer and has exited the batch hopper system.

**18. TARGET WEIGHT MODULE:**

Pressing this button brings up a numerical key pad (right). This allows the operator to enter the amount of seed that is to be pulled in from the selected bin. The operator can also select to call in seed via seed count units (SCU) or seed weigh units (SWU). If SCU is selected, the system will base the units upon the seed count defined for each product on the Edit Product Names screen. That number will vary depending on the type of seed. If SWU is selected, the system will base the units upon 50 lbs/unit.



**19. BATCH WEIGH HOPPER SLIDE GATE INDICATOR:** Informs the operator of the status of the air-actuated slide gate located at the bottom of the batch hopper. Green indicating the open position and red for the closed position

**Main Screen Button Descriptions**

**20. CUSTOMER BUTTON:** There are two ways to use this button. First, select the main field and a pop-up keyboard allows you to type a customers name. Second, you may select the down arrow to the right of the button and bring up a pop-up window that gives you multiple options. Option one is to select Enter Search Name at the top and the same pop-up keyboard appears. Option two is to use the up or down arrows to scroll to the customers name and option three is to select the file cabinet icon that takes you to the Customer Info page so you may create a new entry. (See page 41)

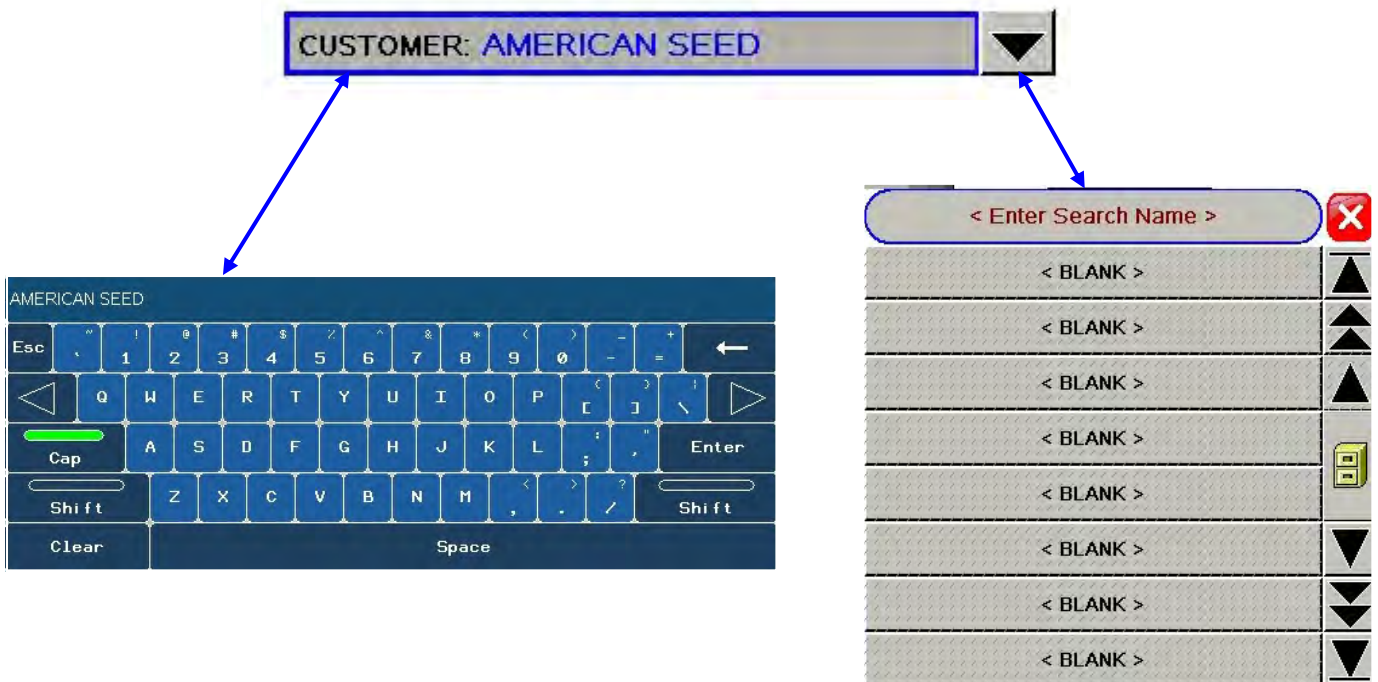

**21. START SCALE FILL FROM HOPPER BUTTON:**

Allows the operator to run seed in the auto mode from a Pro Box hopper. When the operator presses the Start Scale Fill from Manual Hopper button a verification screen (right) appears to allow them to modify any of the Pro Box information for that particular run.

BIN NAME:	MANUAL HOPPER
SEED TYPE:	SOY BEANS
SEED VARIETY:	ABCDEF
LOT NUMBER:	123456
SEEDS / LB:	2800
CUP WEIGHT:	3.65 LBS
<b>MANUAL HOPPER FILL</b>	
<b>START</b>	<b>CANCEL</b>
* By pressing *START* the system will automatically set:	
*NO SEED FLOW* = 10 minutes & *TARGET WEIGHT* = 1,000,000.	

## Main Screen Button Descriptions

**22. PAUSE BUTTON:** Allows the operator to pause the ongoing process in the event of a set-up error or an alarm situation. Pushing this button will activate the pause screen (top). Once the issue is resolved push continue to re-start the process. Or use the terminate button.

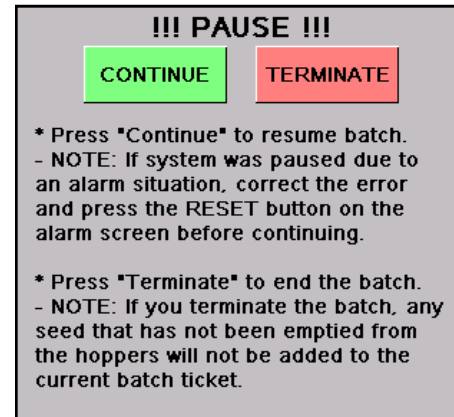

**23. START SCALE FILL FROM BIN BUTTON:** Allows the operator to run seed in the auto mode from a bin. A verification screen (bottom) appears to verify the operator has a truck or trailer in place to receive the seed before they press START to continue the process.



**24. EMERGENCY STOP INDICATOR:** This blinking display is activated when the system's E-Stop button is activated.

### “H-O-A” (HAND-OFF-AUTO) SCREEN

Hand-Off-Auto controls are provided for most of the automated devices in the system, and are accessed on this screen.



These H-O-A buttons force the selected component to be energized HAND, de-energized OFF or automatically energized by the normal logic sequence AUTO. The HAND function will cause the component to operate independent of whatever else the system is trying to do automatically. These functions should not normally be used if the automated sequencing is active. **Be sure to understand the impact of energizing or de-energizing a component with the HAND/OFF settings before using them. These commands are not a substitute for lockout/tagout procedures when working on or near this machine. Use proper lockout/tagout procedures to disable the equipment before servicing it.**

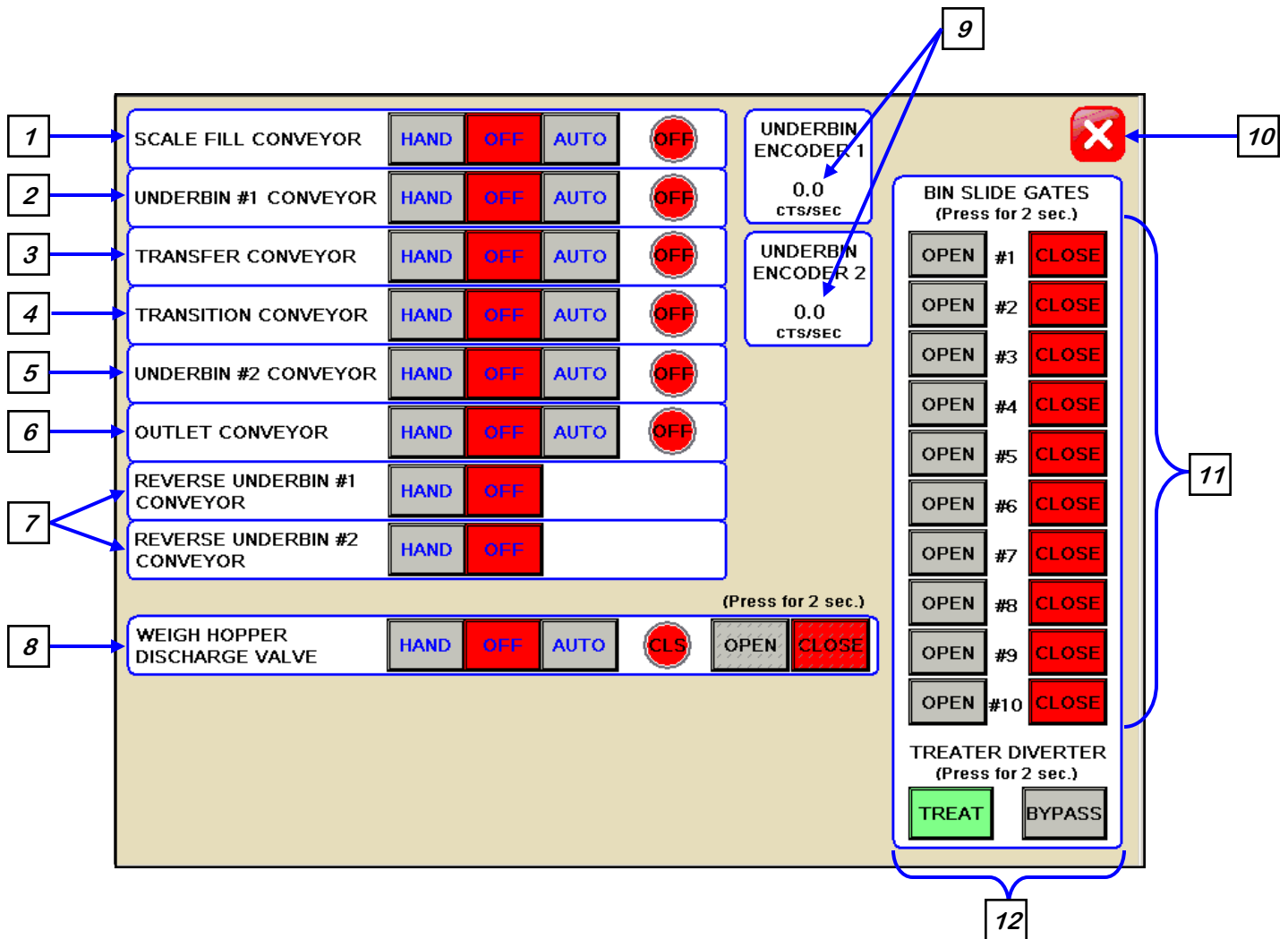

## **H-O-A Button Descriptions**

**1. SCALE FILL CONVEYOR CONTROL MODULE:** This module controls the function of the scale fill conveyor. The HAND button will place the scale fill conveyor in the manual mode of operation. The OFF button will turn the associated device in the OFF mode of operation. The AUTO button will place the device in the automatic mode of operation. The motor will not operate in this mode unless all other needed devices are in the AUTO mode and the START SCALE FILL button is pressed on the Main screen.

**2. UNDERBIN #1 CONVEYOR CONTROL MODULE:** This module controls the function of the underbin #1 conveyor. The HAND button will place the underbin #1 conveyor in the manual mode of operation. The OFF button will turn the associated device in the OFF mode of operation. The AUTO button will place the device in the automatic mode of operation. The motor will not operate in this mode unless all other needed devices are in the AUTO mode and the START SCALE FILL button is pressed on the Main screen.

**3. TRANSFER CONVEYOR CONTROL MODULE (optional):** This module controls the function of the transfer conveyor. The HAND button will place the transfer conveyor in the manual mode of operation. The OFF button will turn the associated device in the OFF mode of operation. The AUTO button will place the device in the automatic mode of operation. The motor will not operate in this mode unless all other needed devices are in the AUTO mode and the START SCALE FILL button is pressed on the Main screen. This button will only be present if the batch hopper system has a transfer conveyor.

**4. TRANSITION CONVEYOR CONTROL MODULE (optional):** This module controls the function of the transition conveyor. The HAND button will place the transition conveyor in the manual mode of operation. The OFF button will turn the associated device in the OFF mode of operation. The AUTO button will place the device in the automatic mode of operation. The motor will not operate in this mode unless all other needed devices are in the AUTO mode and the START SCALE FILL button is pressed on the Main screen. This button will only be present if the batch hopper system has a transition conveyor.

## **H-O-A Button Descriptions**

**5. UNDERBIN #2 CONVEYOR” CONTROL MODULE (optional):** This module controls the function of the underbin #2 conveyor. The HAND button will place the underbin #2 conveyor in the manual mode of operation. The OFF button will turn the associated device in the OFF mode of operation. The AUTO button will place the device in the automatic mode of operation. The motor will not operate in this mode unless all other needed devices are in the AUTO mode and the START SCALE FILL button is pressed on the Main screen. This button will only be present if the batch hopper system has a second underbin conveyor.

**6. OUTLET CONVEYOR CONTROL MODULE:** This module controls the function of the outlet conveyor. The HAND button will place the outlet conveyor in the manual mode of operation. The OFF button will turn the associated device in the OFF mode of operation. The AUTO button will place the device in the automatic mode of operation. The motor will not operate in this mode unless all other needed devices are in the AUTO mode and the START SCALE FILL button is pressed on the Main screen.

**7. REVERSE UNDERBIN CONVEYOR CONTROL MODULE (optional):** This module operates in the manual mode only. Pressing the HAND button allows the operator to run the underbin conveyor in reverse. **ALWAYS ENSURE THE BELT IS IMMEDIATELY AND PROPERLY ALIGNED WHEN RUNNING IN REVERSE! BELTS WILL OFTEN SHIFT ALIGNMENT WHEN THEIR DIRECTION OF TRAVEL IS REVERSED. BE SURE TO RE-CHECK THE ALIGNMENT AFTER IT IS RETURNED TO THE FORWARD DIRECTION.** This module will only be present if the bin site system has the reversing option for the underbin conveyor.

**8. WEIGH HOPPER DISCHARGE VALVE CONTROL MODULE:** This module controls the function of the hopper discharge valve located at the bottom of the batch hopper. The HAND button will place the discharge valve in the manual mode of operation. By pressing and holding for two seconds the OPEN or CLOSED button the operator can manually open or close the hopper discharge gate. The round indicator displays the valve status. CLS in red for closed and OPN in green for open. The OFF button will turn the associated device in the OFF mode of operation. The AUTO button will place the device in the automatic mode of operation and would then be controlled by the batch hopper PLC program.

## **H-O-A Button Descriptions**

**9. COUNTS PER SECOND DISPLAY (optional):** This display shows the current counts per second that the underbin encoder is reading. This allows the bin site system to be sure that the underbin conveyor is running properly and that the belt is not slipping. This display will only be present if the bin site system has an underbin encoder on the underbin conveyor. If not working correctly, calibration of the seed flow will be effected.

**10. SCREEN EXIT BUTTON:** This button is used to exit back to the previous screen. Its functionality is the same throughout the HMI display.

**11. BIN SLIDE GATES CONTROL MODULE:** This module allows the operator to manually control the operation of the slide gates that are located underneath each bin. The bin slide gates will be opened and closed automatically when the operator presses the START SCALE FILL button on the Main screen.

**12. DIVERTER CONTROL MODULE (optional):** This module controls the function of the diverter. The module allows the operator to choose if the diverter is in the treat or bypass mode. In treat mode seed will be run through the treater and in bypass mode seed will be diverted so that it does not pass through the treater. This module will only be present if the batch hopper system has a diverter.

**UTILITIES SCREEN**

This screen allows the operator to set various system parameters and gives access to the Bin Site Reports, Alarms, Security and Customer Info screens.

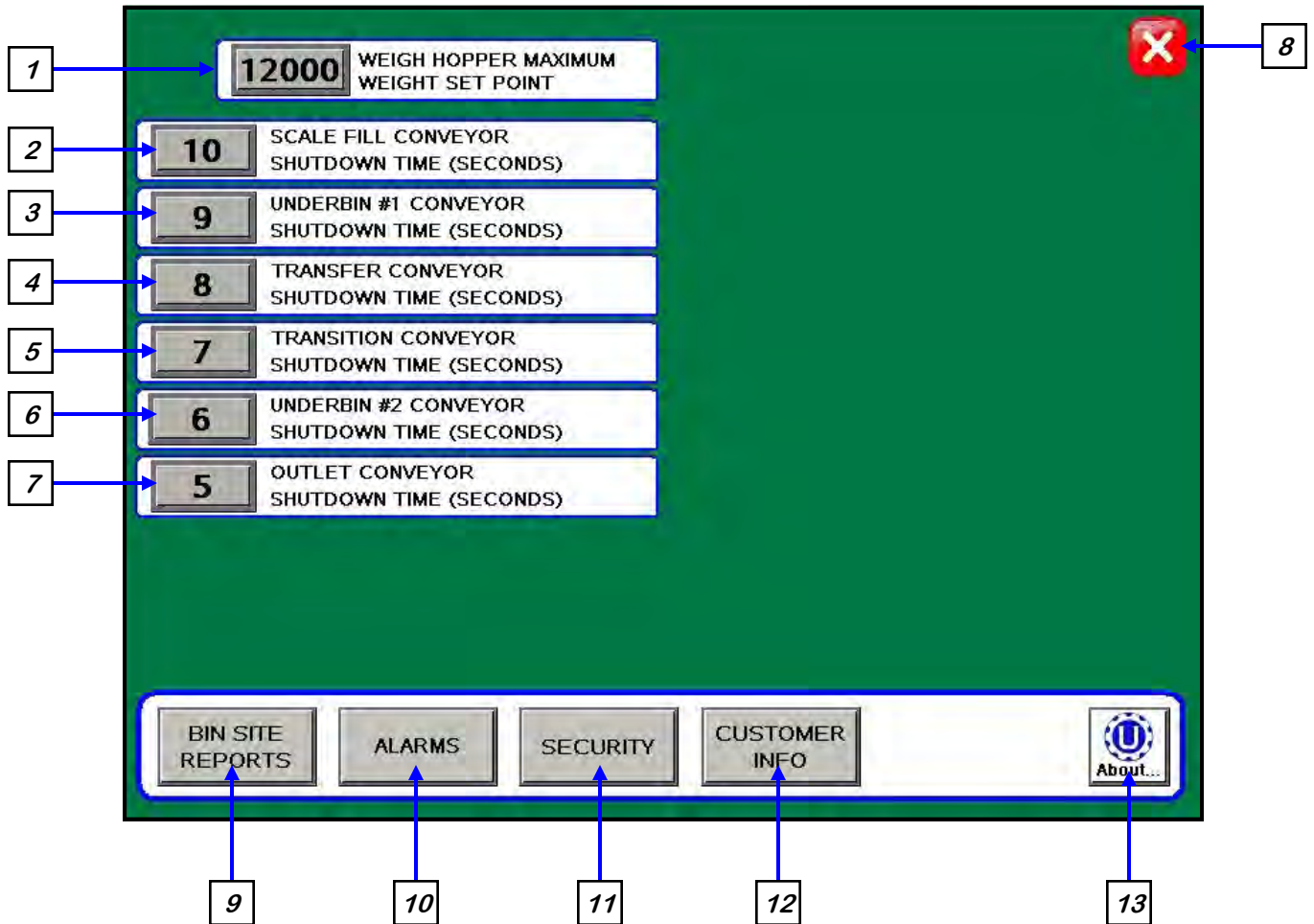

**NOTICE**

When buttons 1-7 are pressed, a numeric touch pad (right) will appear allowing the operator to enter in a number for that particular parameter.

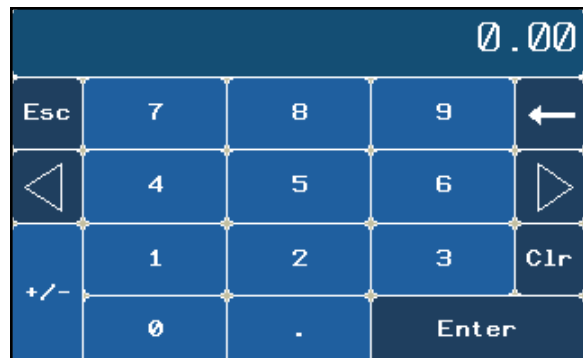

## Utilities Screen Button Descriptions

**1. MAXIMUM SCALE WEIGHT:** Pressing this button allows the operator to adjust the maximum amount of seed that the scale can hold.

**2. SCALE FILL CONVEYOR SHUTDOWN TIME:** Pressing this button allows the operator to adjust the shutdown time of the scale fill conveyor.

**3. UNDERBIN #1 CONVEYOR SHUTDOWN TIME:** Pressing this button allows the operator to adjust the shutdown time of the underbin #1 conveyor. This timer will begin once the bin slide gate has closed and will allow the underbin conveyor to clean itself out.

**4. TRANSFER CONVEYOR SHUTDOWN TIME (optional):** Pressing this button allows the operator to adjust the shutdown time of the transfer conveyor. This timer will allow the Pro Box hopper to clean itself out. This button will only be present if the Pro Box hopper is being used.

**5. TRANSITION CONVEYOR SHUTDOWN TIME (optional):** Pressing this button allows the operator to adjust the shutdown time of the transition conveyor. This timer will allow the transition conveyor to clean itself out.

**6. UNDERBIN #2 CONVEYOR SHUTDOWN TIME (optional):** Pressing this button allows the operator to adjust the shutdown time of the underbin #2 conveyor. This timer will begin once the batch is finished and will allow the underbin conveyor to clean itself out. This button will only be present if the batch hopper system has a second underbin conveyor.

**7. OUTLET CONVEYOR SHUTDOWN TIME:** Pressing this button allows the operator to adjust the shutdown time of the outlet conveyor. This timer will always be set to the longest shutdown time to be sure all other conveyors and the treater have cleared themselves of seed and shutdown down.

**8. SCREEN EXIT BUTTON:** Pressing this button is used to exit back to the previous screen. Its functionality is the same throughout the HMI display.

**9. BIN SITE REPORTS BUTTON:** Pressing this button advances the operator to the Bin Site Reports screen.

**10. ALARMS BUTTON:** Pressing this button advances the operator to the Alarms screen.

**11. SECURITY BUTTON:** Pressing this button advances the operator to the Security screen.

**12. CUSTOMER INFO BUTTON:** Pressing this button advances the operator to the Customer Information Screen.

**13. ABOUT USC BUTTON:** Pressing this button allows the operator see what software release is installed in the system.

## SECURITY SCREEN

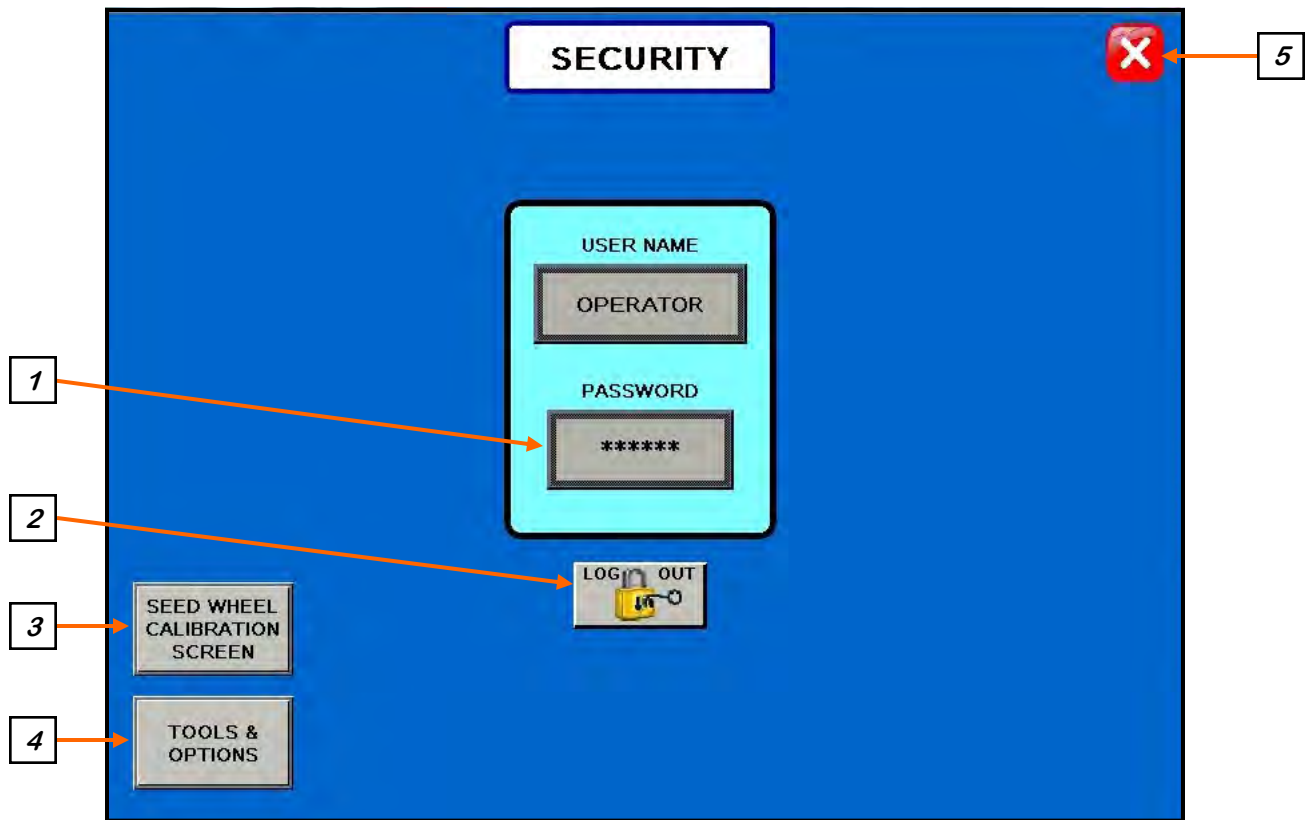

### Security Screen Button Descriptions

**1. PASSWORD ENTRY:** The operator uses this input to obtain access to all options on this screen. When this button is pressed a keypad (below) will appear on the screen. The password is **USC** and should only be made accessible to personnel qualified to operate the batch hopper system. The User Name will stay OPERATOR.



### Security Screen Button Descriptions

**2. LOGOUT BUTTON:** Pressing this button will log the operator out of the Security screen. However, the operator will be automatically logged out after 5 minutes of inactivity on the touch screen.

**3. SEED WHEEL CALIBRATION SCREEN (Optional):** Pressing this button will advance the operator to the Seed Wheel Calibration screen (below). This option only appears if the batch hopper system is working in conjunction with a USC PLC based seed treater.

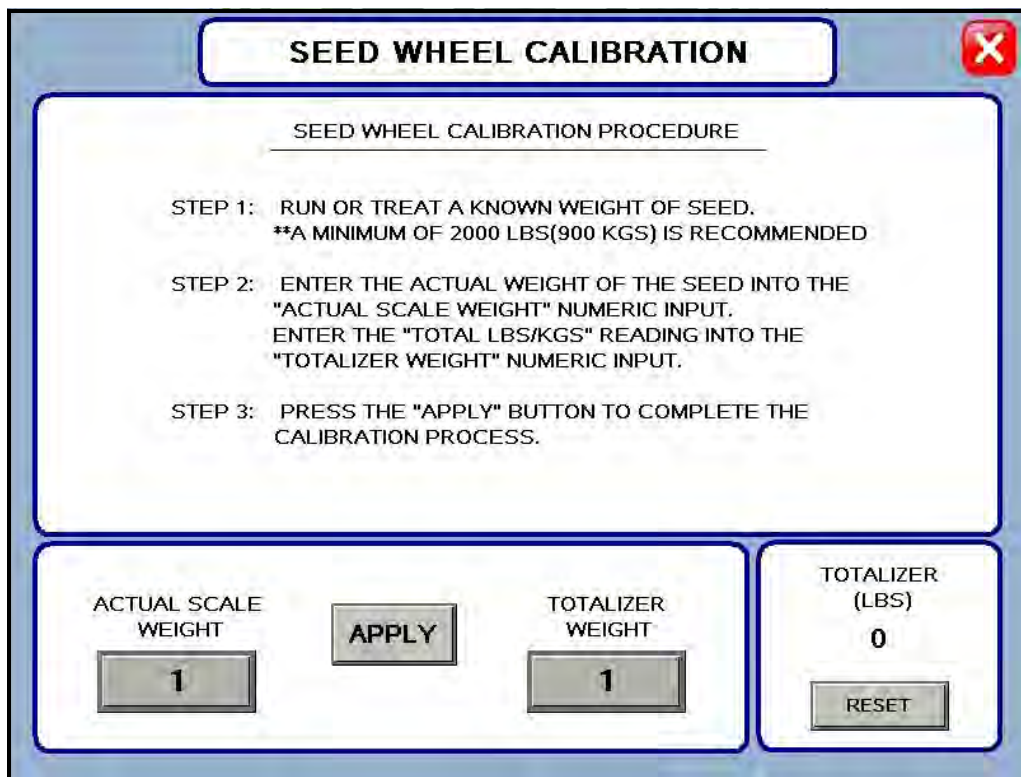

**4. TOOLS & OPTIONS:** Pressing this button will advance the operator to the Tools & Options screen.

**5. SCREEN EXIT BUTTON:** Pressing this button is used to exit back to the previous screen. Its functionality is the same throughout the HMI display.

**TOOLS & OPTIONS SCREEN**

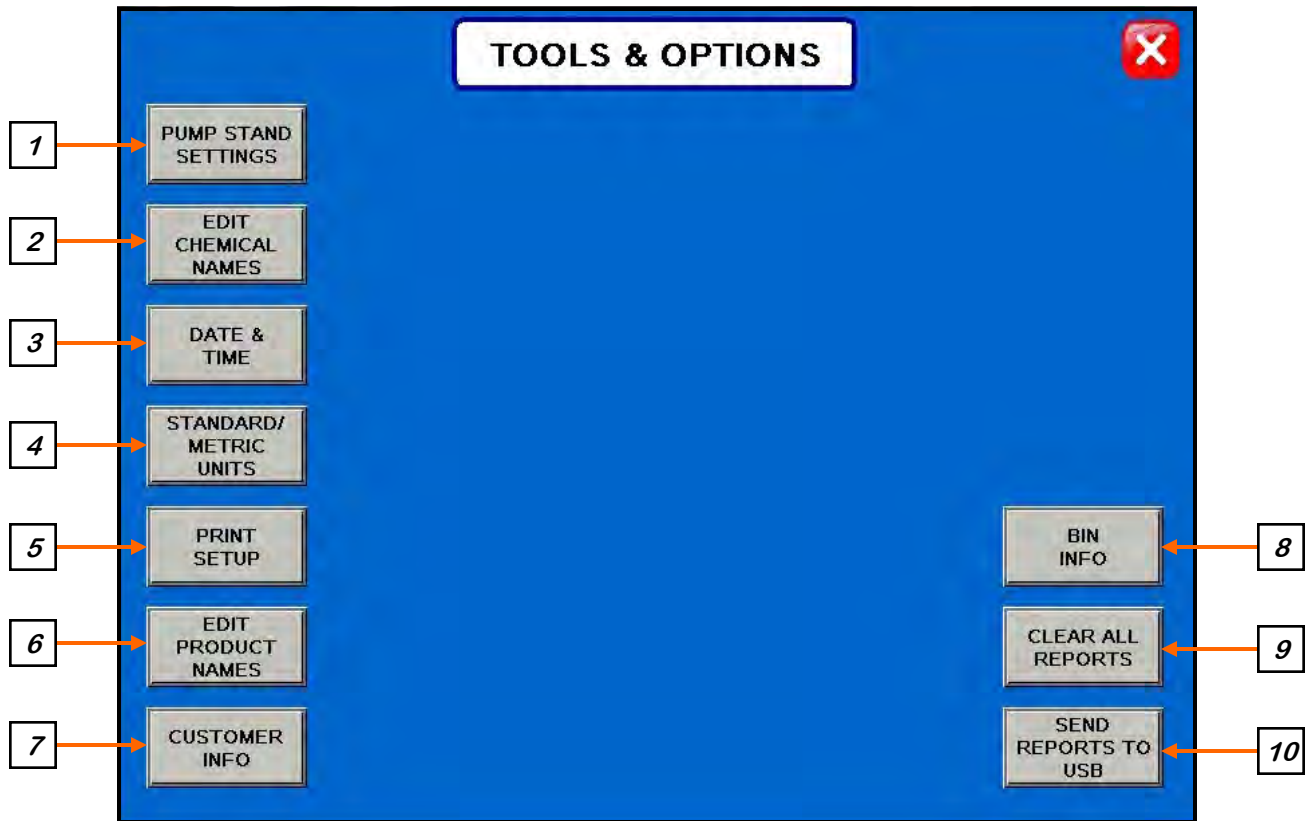

**Tools & Options Screen Button Descriptions**

**1. PUMP STAND SETTINGS:** This button advances the operator to the Pump Stand Settings screen where the Flow Rate Entry Type can be set for cut weight or seed count units and the Flow Rate Display can be set for ounces per minute or ounces per cut weight for each individual Pump Stand.

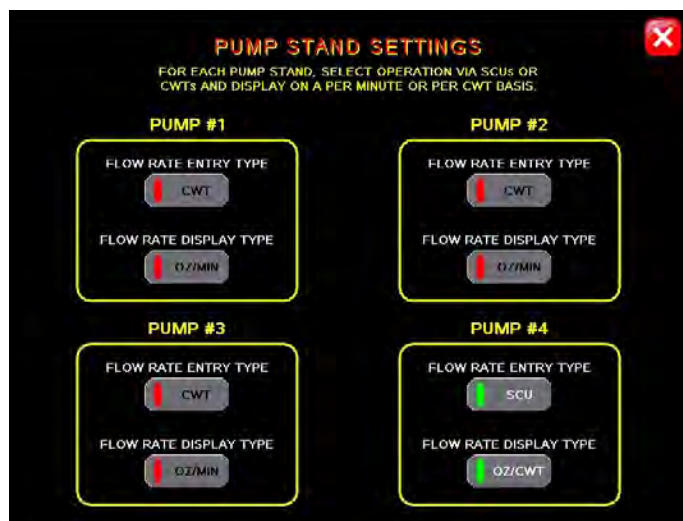

**Tools & Options Screen Button Descriptions**

**2. EDIT CHEMICAL NAMES:** Allows the operator to change the chemical names to better fit their needs. Pressing this button will advance the operator to the Edit Chemical Name screen (top) . Selecting one of the Chemical buttons brings up an alpha numeric screen to enter the desired name. Pressing the CALC button for that chemical name brings up the Chemical Factor Calculator window (bottom left). From this screen the operator can determine the chemical multiplier by entering the Calibration Tube amount and the Totalizer amount. Press save and the multiplier is automatically calculated and entered. Another window will prompt the operator to verify this information on the main screen Pump Stand module (bottom right).

*Chemical Name*

*Press this button to bring up the Chemical Factor Calculator*

## Tools & Options Screen Button Descriptions

**2. EDIT CHEMICAL NAMES (continued):** Selecting the light bulb help button in the upper left corner brings up the Flow Meter Calibration instructions.

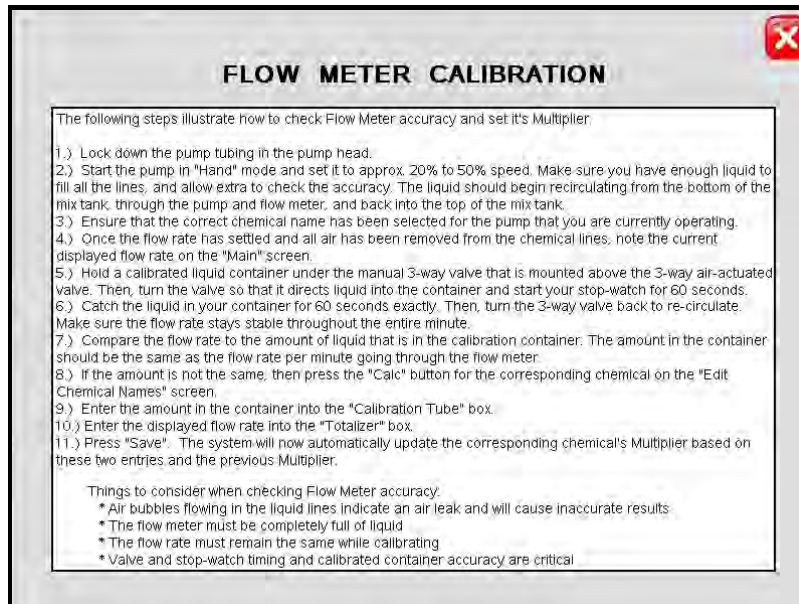

**3. DATE & TIME:** Allows the operator to set the date and time.

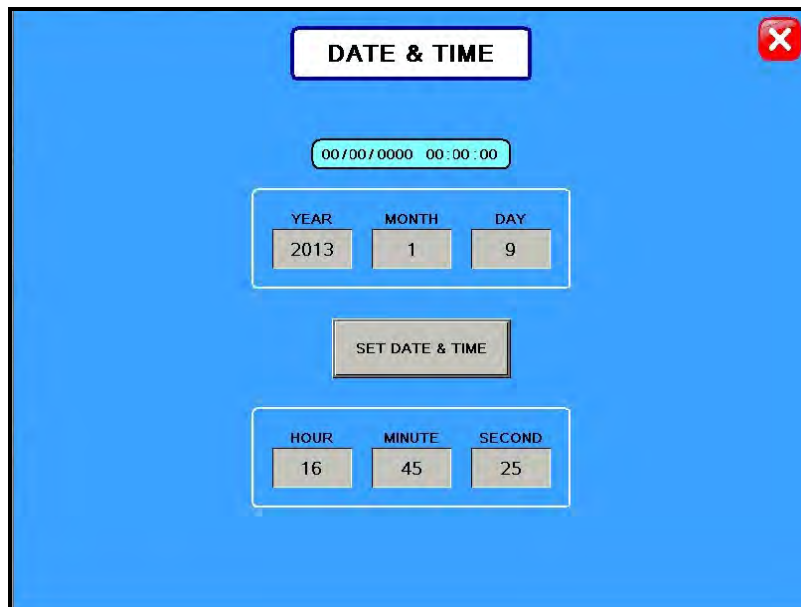

**Tools & Options Screen Button Descriptions**

**4. STANDARD/METRIC UNITS:** Allows the operator to switch between Standard or Metric units of measurement. When this button is pressed a window will appear which will allow the operator to select the desired units of measurement.

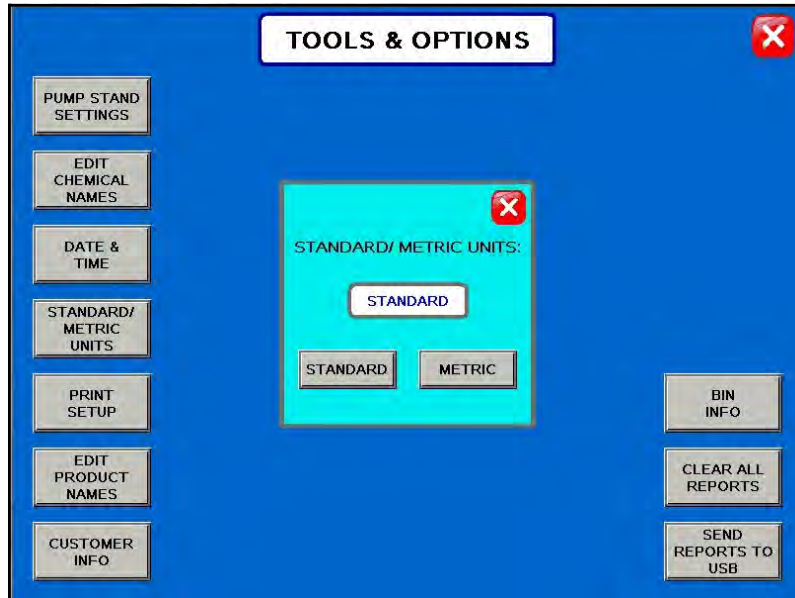

**5. PRINT SETUP:** Allows the operator to set up their personal company information which will be printed at the top of each report. Pressing the button will advance the operator to the screen below. The company information can be entered by selecting the blank space under each heading. The operator may also check the Auto Print box to print a report for a customer every time a report is generated as well as how many copies the customer requires.

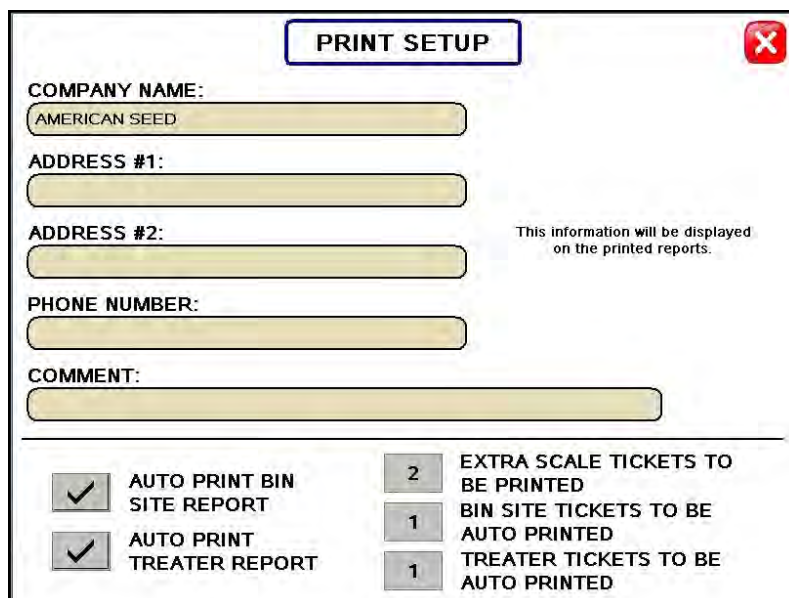

**Tools & Options Screen Button Descriptions**

**6. EDIT PRODUCT NAMES:** Pressing the button will advance the operator to the Edit Product screen (top). Select one of the product name buttons and an alpha numeric popup will appear allowing the operator to change the name. Also, you may enter a value if you are using the Seed Count Unit of measurement.

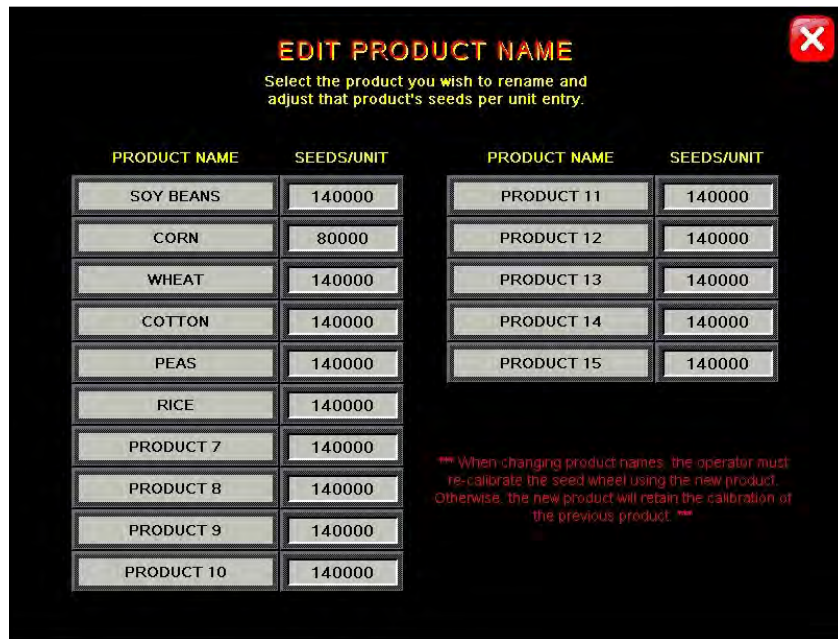

**7. CUSTOMER INFO:** Pressing the button will advance the operator to the Customer Info screen (bottom left). If you are looking for a specific customer you may press the < ENTER SEARCH NAME > button and key in the name or use the arrows to scroll through the listing. Selecting the CREATE NEW ENTRY button (bottom, right) allows the operator to create a new customer listing.

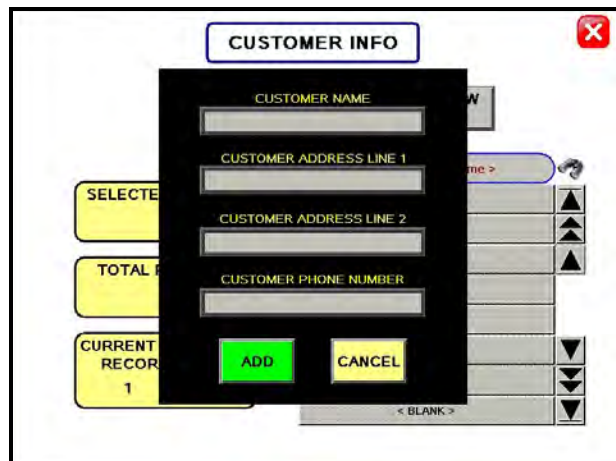
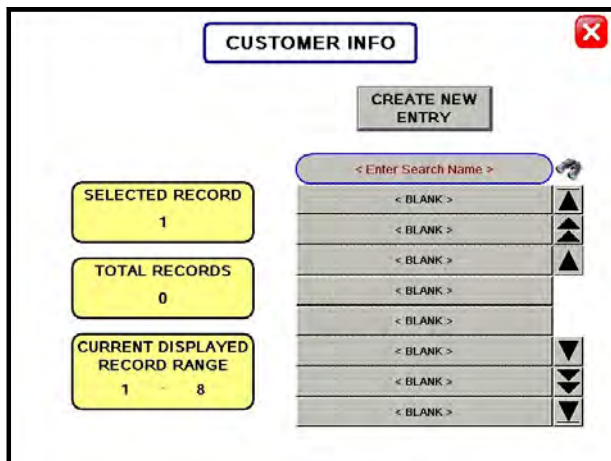

**Tools & Options Screen Button Descriptions**

**8. BIN INFO:** Pressing this button will advance the operator to the Bin Info screen. This screen allows the operator to select a particular bin and the information that is to be entered for it. The information to be entered is seed type, seed variety, lot number, seeds per pound, and cup weight of the seed in the selected bin. A keypad will appear when the button next to any of these options is pressed. After entering this information the SAVE button must be pressed for the bin site system to retain the information. The inventory of the bin may also be entered on this screen. Enter the amount of inventory that is to be added or subtracted into the Amount to Adjust Inventory box and then press and hold the “+” or the “-” box for 3 seconds. The total amount of inventory in the bin will be displayed in the white box above the amount to be adjusted.

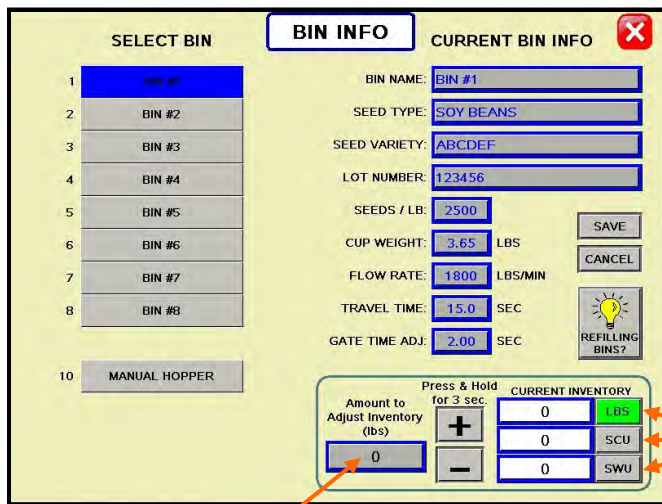

*Displays the total inventory in the selected bin*

*Enter the amount of seed that is to be added here.*

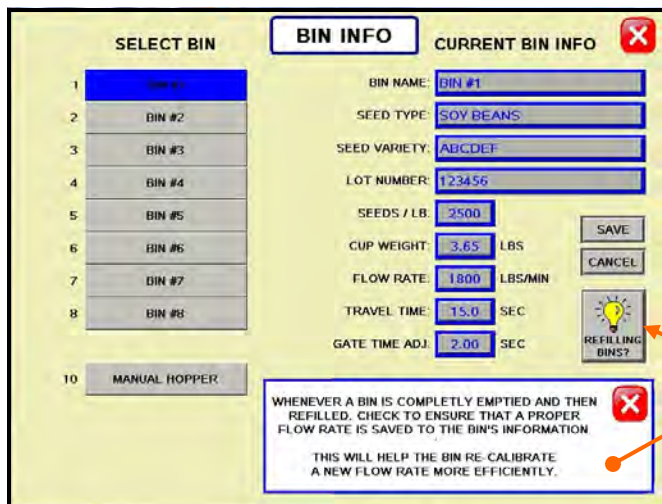

*Select for helpful information Regarding Bin Refill*

## Tools & Options Screen Button Descriptions

**9. CLEAR ALL REPORTS:** Pressing this button will open a window which will ask the operator if they want to clear all the saved reports. If YES is pressed then the reports will be permanently erased. The operator **MUST NOT** leave the screen until all files have been cleared out.

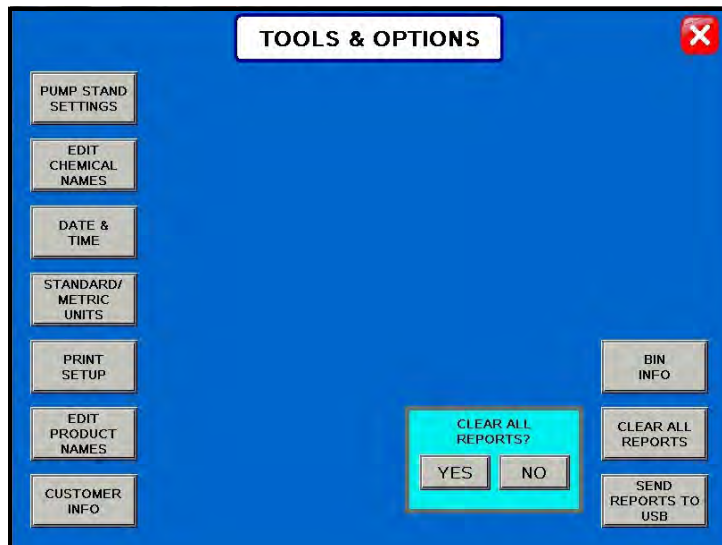

**10. SEND REPORTS TO USB:** Pressing this button will open a window which will ask the operator if they want to send reports to a USB device. Insert a compact flash device into the USB port on the left side of the control panel. The device must be in the FAT32 format. Press YES and the reports will be downloaded.

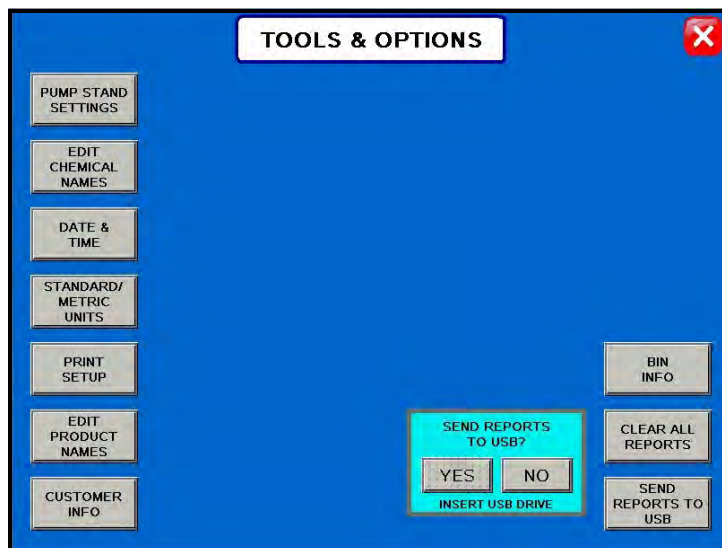

**SECTION  
E**

**CALIBRATION & OPERATION**

**DETERMINING SEED CUP WEIGHT**

The following is a list of steps to use when determining seed cup weight. A seed calibration cup, funnel, stand and scale are required.

1. Set the empty seed calibration cup on the scale and zero out the weight of the cup.
2. Place the funnel and stand in the seed to be treated or a separate container (figure 1). This will help to avoid any unnecessary clean-up while filling and leveling the top of the seed calibration cup.
3. Place your hand under the bottom of the funnel and fill the funnel up with seed.
4. Place the calibration cup under the funnel stand and remove your hand from the bottom of the funnel, and allow the cup to be filled. (figure 1)
5. After the cup has been filled, strike off the top of the seed calibration cup with a straight edge. (figure 2)



*Seed Calibration Cup*

**NOTICE** Do not shake the cup.

6. Weigh the sample of seed. (figure 3)

**NOTICE** A typical weight of the sample of seed will be anywhere between 2.8 to 4.0 lbs. Anything over or under this range could be caused by not zeroing out the weight of the cup, or the scale may be set on the wrong units.

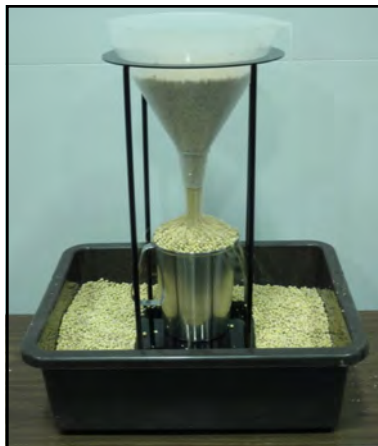

*Figure 1*



*Figure 2*



*Figure 3*

## **LOADING SEED INTO BINS**

Before seed is pulled out of the bins and run through the batch hopper system, all the applicable information about the seed that was loaded into each individual bin must first be entered into the batch hopper system. If the same seed was loaded into multiple bins the same information still needs to be loaded into each bin separately.

The following is a list of steps to perform to enter the bin information for each bin once seed has been loaded into that bin:

1. Load the seed into the bin. Take a seed sample for the cup weight of each bin at this time. Also, note the seed type, seed variety, lot number, seed weight and total inventory weight of the seed that is loaded into the bin. The seed weight can be defined in either pounds, seed count units or seed weight units.
2. Press the UTILITIES button in the lower left corner of the Bin Site main screen.
3. Press the SECURITY button on the bottom of the Utilities screen.
4. Press the PASSWORD box, then from the popup keyboard enter the letters USC and press enter.
5. Press the TOOLS & OPTIONS button in the lower left hand corner of the Security screen.
6. Press the BIN INFO button on the Tools & Options screen.

Enter the letters  
**USC** here.

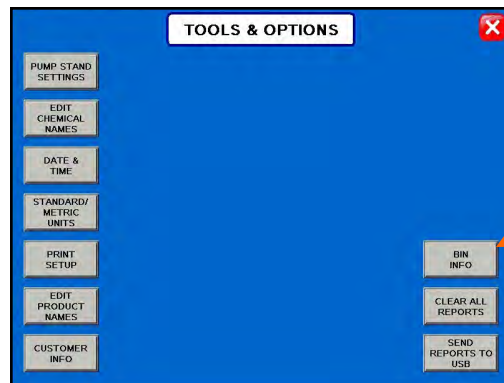
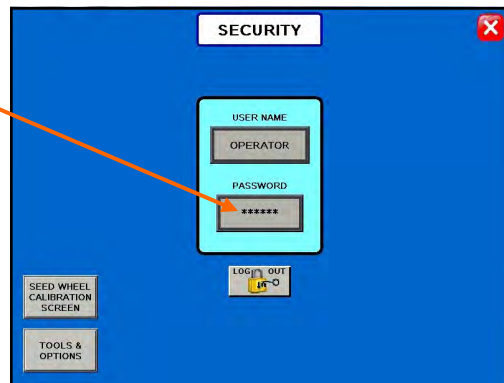

Press this button  
to enter the Bin  
Info screen.

### **LOADING SEED INTO BINS**

7. Select the desired bin to enter information into from the select bin list..
8. Enter the seed type, seed variety, lot number, seeds per pound and cup weight of the seed in the bin into their respective box under the Current Bin Info.
9. Enter in the total weight of seed that was added to the bin into the bin inventory section on the lower portion of the screen. The system will automatically subtract inventory after each run. Press the save button when all the information has been entered.
10. When finished, exit back to the Main screen.

SELECT BIN	BIN INFO	CURRENT BIN INFO
1 <b>BIN #1</b>	BIN NAME: BIN #1	
2 BIN #2	SEED TYPE: SOY BEANS	
3 BIN #3	SEED VARIETY: ABCDEF	
4 BIN #4	LOT NUMBER: 123456	
5 BIN #5	SEEDS / LB: 2500	SAVE
6 BIN #6	CUP WEIGHT: 3.65 LBS	CANCEL
7 BIN #7	FLOW RATE: 1800 LBS/MIN	REFILLING BINS?
8 BIN #8	TRAVEL TIME: 15.0 SEC	
	GATE TIME ADJ: 2.00 SEC	
10 MANUAL HOPPER		

Amount to Adjust Inventory (lbs)	Press & Hold for 3 sec.	CURRENT INVENTORY
0	+	0 LBS
	-	0 SCU
		0 SWU

## **SETTING THE SEED FLOW RATE**

The following is a list of steps for setting the seed flow rate. This must be completed before running the batch hopper system. Repeat steps 1 & 2 for each bin.

1. Set the manual gate on the bin to the fully open position. Once opened, this gate should be set in place and not moved through out the entire season. If this gate is adjusted during a run or between runs then it will effect the calibration of the system and the system will need to be re-calibrated. (page 52)
2. Set the stop for the air actuated slide gate on the bin. This stop controls how far the slide gate will open and the flow rate at which seed can exit the bin. To set the stop, adjust the position of the collar on the rod that exits the slide gate opposite of the air valve (below). Placing the collar closer to the slide gate will restrict flow and farther away from the slide gate will increase seed flow for the system. Once a collar location has been selected, use the hitch pin to lock the collar in place. If the stop is adjusted between runs then it will effect the calibration of the system and the system will need to be re-calibrated. (page 52)

### **NOTICE**

It is recommended to initially place the collar closer to the slide gate and then move it farther away from the slide gate one hole at a time to increase the flow rate of the system. This will protect against overloading the underbin conveyer with seed.

3. Finally, set the position of the manual slide gate that is located under the weigh hopper. This gate will control the flow of seed out of the weigh hopper by restricting the size of the opening from the weigh hopper. The more open the gate is, the faster seed will exit the weigh hopper. To set this gate, simply loosen the three nuts on the gate. Then adjust the gate to the desired position, and retighten the nuts.

Move the position of the collar along this rod to adjust the flow of seed through the bin slide gate.

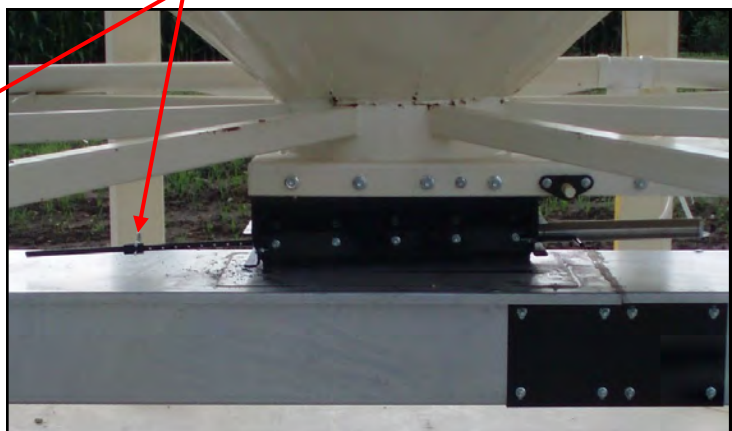
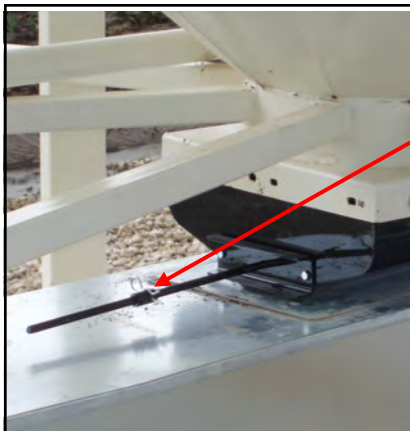

## SCALE FILL FROM BIN

The following is a list of steps to use when running the batch hopper system in the Scale Fill From Bin mode of operation. This allows the operator to automatically fill the scale from the bin.

1. Select the bin that you wish to call seed from by pressing the image of the bin on the Main screen and then select the bin from the pop-up menu . (right)
2. Press SELECT PROCESS and then select either AUTO TREAT or MANUAL TREAT / BYPASS mode of operation depending upon what you plan to do with the seed once it has been pulled from the bin and weighed by the batch hopper system.

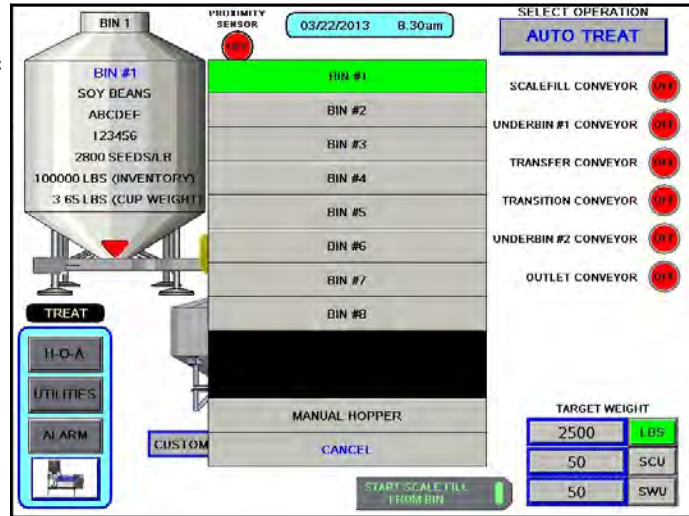

3. On the Main screen, in the box labeled TARGET WEIGHT enter the amount of weight that is to be brought into the batch hopper on this run. (right)
4. Press the box labeled CUSTOMER at the bottom of the Main screen and enter in the current customer's name and any other applicable information.
5. Under the H-O-A screen place all necessary conveyors into the AUTO mode of operation. (below left) Ensure that the diverter is in the appropriate position as well.
6. Under the Utilities screen, ensure that all settings are appropriate. (below right)

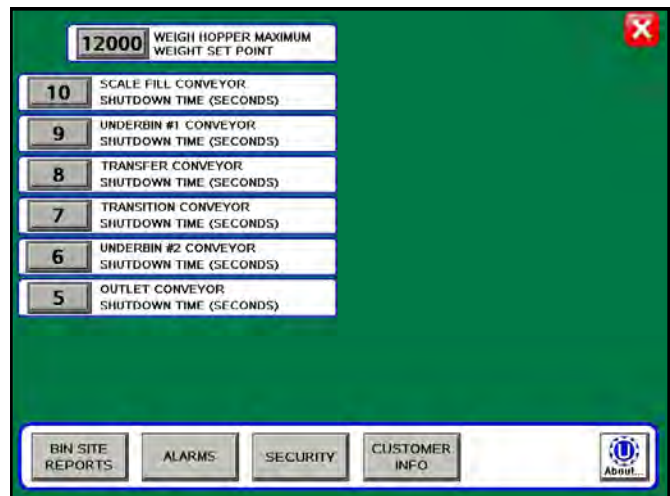
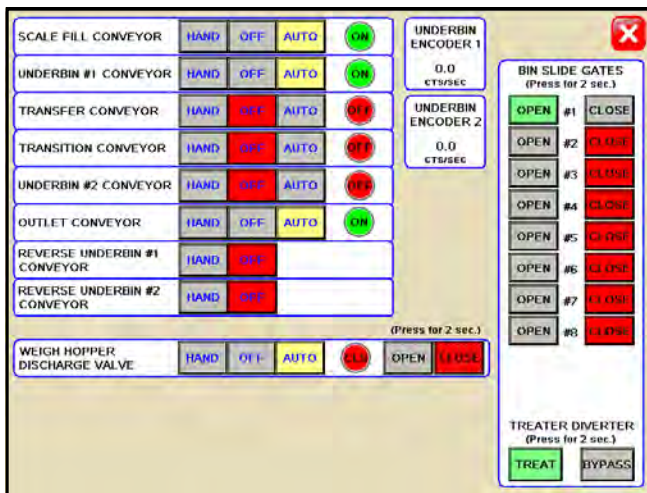

**SCALE FILL FROM BIN**

7. Return to the Main screen and press the START SCALE FILL FROM BIN button at the bottom of the screen. Then press START from the pop-up screen. This toggles the button to CANCEL SCALE FILL FROM BIN and activates the PAUSE button. The system will first turn on the scale fill conveyor and then the underbin conveyor. Once all needed conveyors are running, the slide gate for the selected bin will open and seed will flow through the conveyors to the batch hopper. (left)
8. As the batch hopper system is running, the main screen will display the total pounds of seed in the weigh hopper, and the status of the conveyor motors.
9. The slide gate on the bin will automatically close once the target weight in seed passes through the slide gate. Once the gate closes, a window will appear notifying the operator that the batch is finishing. It will then be replaced with another window indicating amount of time before the system shuts down. If operating in the Manual Treat mode the treater will have to be turned on and off separately. The system will then shutdown the conveyors in reverse order of startup. This will ensure the conveyors have an opportunity to clean out any product from them. (right)
10. There are two ways the seed will be removed from the hopper. If the system is running in the AUTO TREAT mode the hopper gate will open automatically at the appropriate time. In the MANUAL TREAT / BYPASS mode the operator must go to the H.O.A. screen, place the Weigh Hopper Discharge Valve in the HAND mode and press and hold the OPEN button.
11. If the operator chose a target weight that is greater than the maximum scale weight setting, the system will start the entire process over until the target weight is met. Two conditions must be met before this process will re-start. The scale has to be empty and remain empty for at least five seconds and the weigh hopper slide gate must be in the closed position.

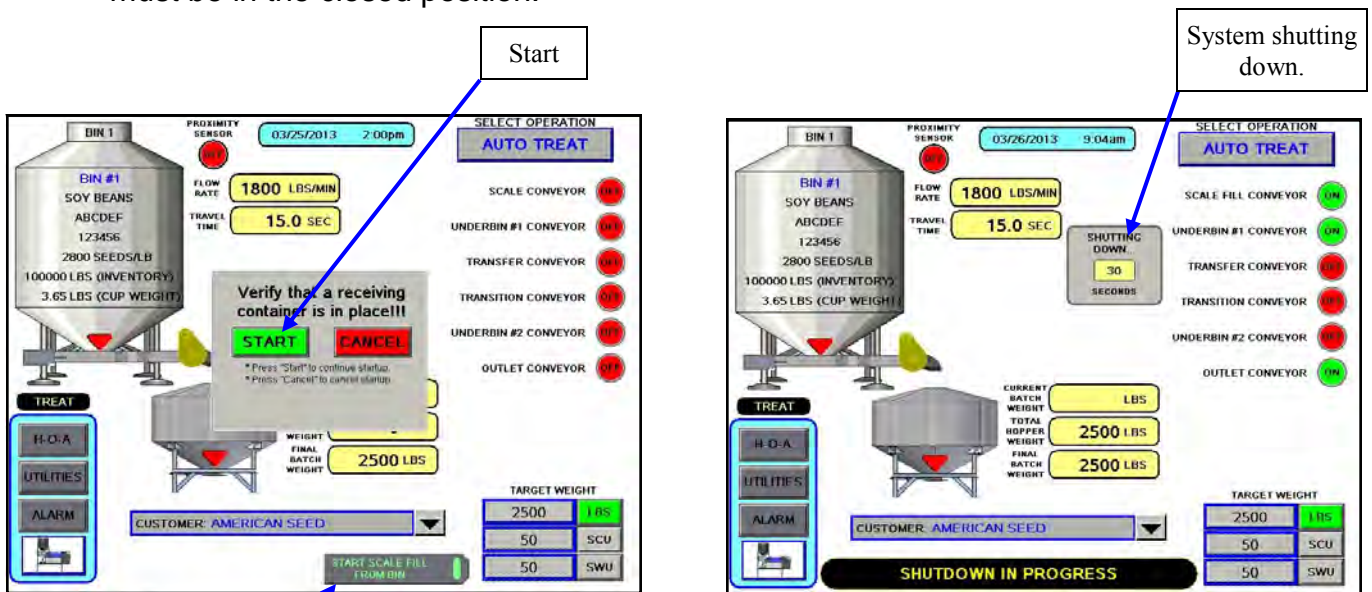

Start scale fill from bin.

**CALLING IN SEED FROM PRO BOXES**

The following is a list of steps to use when running the batch hopper system using the START SCALE FILL FROM HOPPER button. This button will automatically move seed from the manual hopper, via the transfer conveyor, to the scale. The START SCALE FILL FROM HOPPER button is only available if the batch hopper system has a manual hopper.

1. Under the H-O-A screen place all necessary conveyors into the AUTO mode of operation. Depending upon the setup of the equipment, some bin sites will require only the transfer conveyor or the scale fill conveyor to be in AUTO mode and some sites will require the transfer, underbin and scale fill conveyors to all be in the AUTO mode. Ensure that the diverter is in the appropriate position as well.
2. Under the Utilities screen, ensure that all settings are appropriate.
3. Press the image of the bin and select MANUAL HOPPER from the pop-up screen. (top)
4. Press SELECT PROCESS and then select either AUTO TREAT or MANUAL TREAT / BYPASS mode of operation depending upon what you plan to do with the seed once it has been pulled from the Pro Box and weighed by the batch hopper system.
5. Press START SCALE FILL FROM HOPPER button at the bottom of the screen. Then press START from the pop-up screen. This toggles the button to FINISH SCALE FILL FROM HOPPER and activates the PAUSE button. (page 51) The system will first turn on the scale fill conveyor, the underbin conveyor, then the transfer conveyor (If applicable) and the outlet conveyor (If applicable). (bottom)

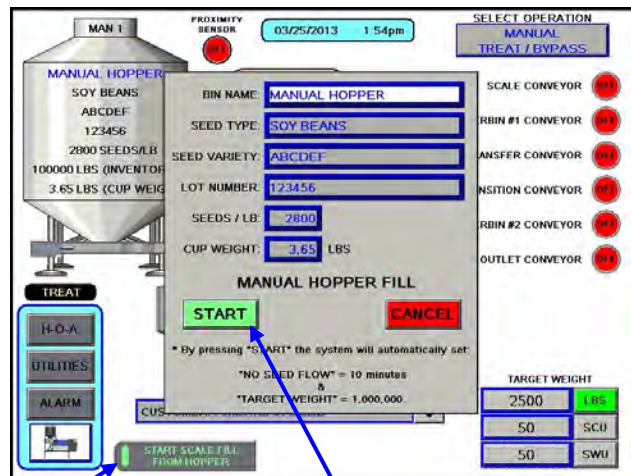
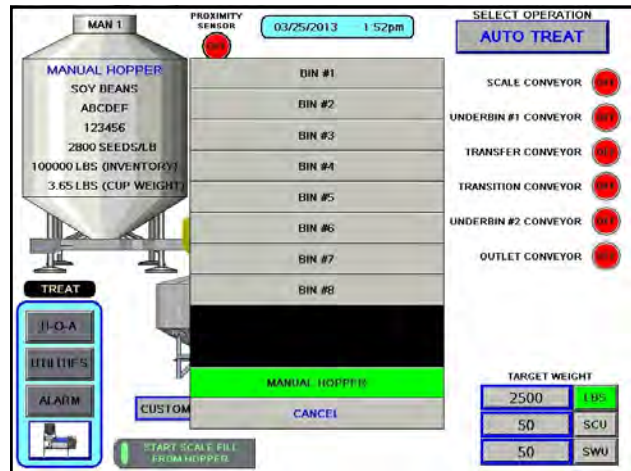

Start scale fill from hopper

Start

**CALLING IN SEED FROM PRO BOXES**

6. As the batch hopper system is running, the Main screen will display the total pounds of seed in the batch hopper. If the system needs to be stopped for a moment because of a problem, the PAUSE button can be pressed to halt the process. When ready to begin again, the CONTINUE button is pressed.
7. Once all of the seed has passed from the manual hopper, through the conveyors and through the weigh hopper, press the FINISH SCALE FILL FROM HOPPER button. At this point, the conveyors will shutdown in reverse order of startup.
8. The system will automatically print the report for the run from the scale head printer.

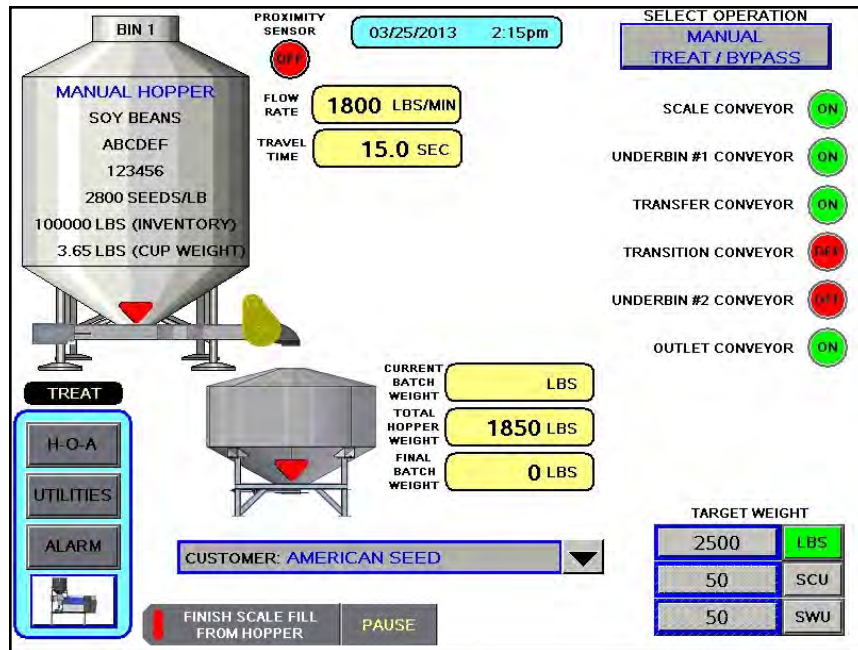

## BATCH HOPPER CALIBRATION

Once the initial calibration is established, the system continuously updates the seed flow rate. The calibration is based upon time and weight. The system first calculates the amount of time it takes for the seed to travel from the bin slide gate to the weigh hopper. This is called the travel time. Then the system calculates how long it takes to fill the weigh hopper. This allows the system to calculate the seed flow rate of pounds per minute. Finally, the system uses the travel time and seed flow rate to calculate the amount of seed in the conveyors at any given time. Once this weight is known, it will automatically close the bin gate at the appropriate time to reach the target weight of seed that the operator has entered.

Initial calibration procedure:

1. Set the bin collar in the fourth hole from the end of the rod in. This sets the Flow Rate at approximately 1200 pounds. Adjust as needed (each hole adjusts up or down by approximately 200 pounds). These figures are based on Soybeans.
2. From the main screen check the Flow Rate to verify it is at the default setting of 1800 lbs/min and the Travel Time is at it's default of 15.0 sec. Then set your Target Weight at 2000 pounds. At the end of the run the Final Batch Weight must be 1500 pounds. These values are recommended but not necessary depending on the setup. After the run, check to see if the Flow Rate and Travel Time have changed from the default settings. If they have the system has been successfully calibrated. Each bin must be individually calibrated. If running a small batch there may not be enough seed run to have the flow rate updating in real time during the run. As long as there have been no pauses or alarms the system will re-calculate and update the flow rate display after the run is complete.

**NOTE: If you change the location of the bin collar or the bin runs out of seed before the Target Weight is reached the system will need to be re-calibrated.**

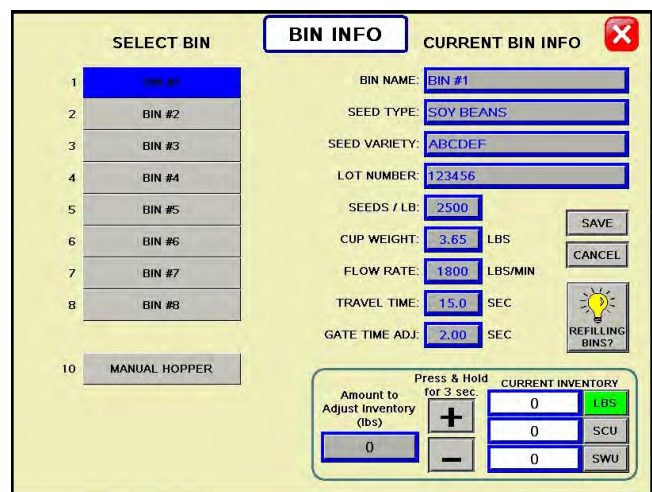
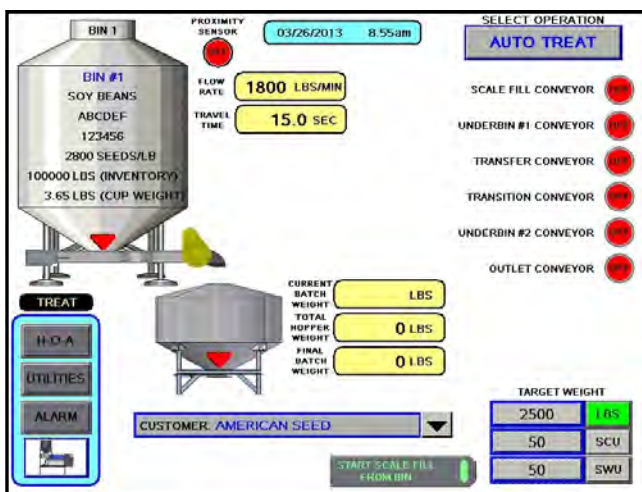

**UNDERBIN OPERATION IN REVERSE MODE**

The following is a list of steps to use when running the batch hopper system using the REVERSE mode. This mode of operation will allow the operator to clean out the underbin conveyor and to remove any excess seed from the bins at the end of the treating season. **ALWAYS ENSURE THE BELT IS IMMEDIATELY AND PROPERLY ALIGNED WHEN RUNNING IN REVERSE! BELTS WILL OFTEN SHIFT ALIGNMENT WHEN THEIR DIRECTION OF TRAVEL IS REVERSED.**

The REVERSE UNDERBIN CONVEYOR for the underbin conveyor will only be present if the batch hopper system has the reversing option for the underbin conveyor.

1. Place a conveyor and seed storage container under the reversing end of the underbin conveyor to catch seed as it exits the underbin conveyor. Turn that conveyor motor on.
2. Under the H-O-A screen place the REVERSE UNDERBIN CONVEYOR operation in the HAND mode. (top) Ensure that the belt on the underbin conveyor is correctly aligned.
3. Then, manually place the desired bin slide gate to the OPEN position. (top)
4. The batch hopper main screen will show the underbin conveyor on and the bin slide gate in the open position. (bottom)
5. Once all seed has passed through the underbin conveyor and into the seed container, place the open bin slide gate back to the CLOSED position.
6. Allow the underbin conveyor to run for at least 15 seconds. This will allow the underbin conveyor to clean itself out. Then place the underbin conveyor motor back to the OFF position.

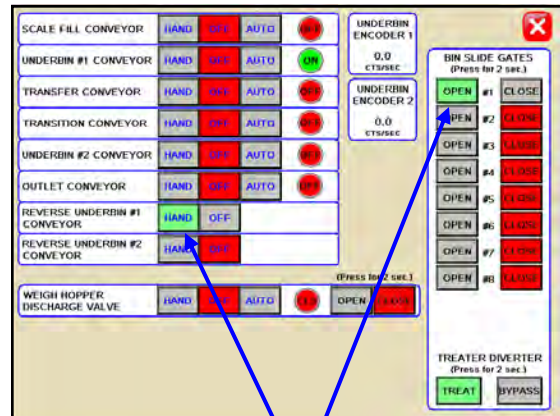

Press the "HAND" button and then place the bin slide gate to the "OPEN" position.

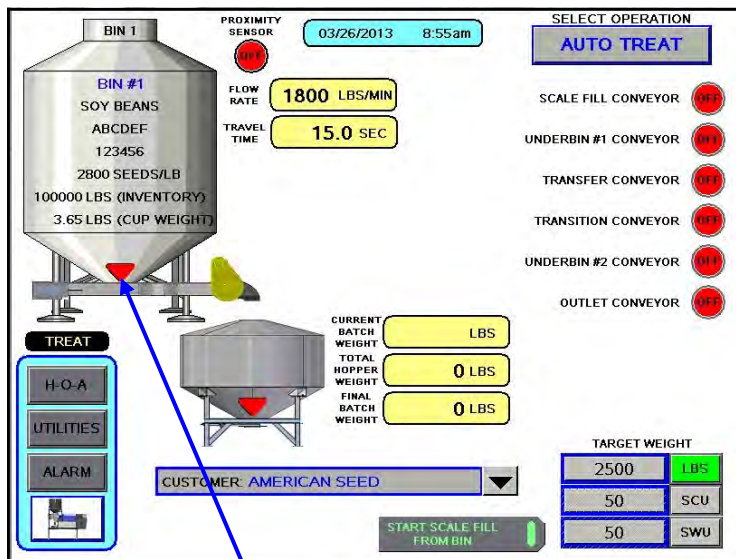

Slide Gate Indicator.

## EDITING & PRINTING REPORTS

The following steps explain how reports are entered after a run has been completed.

1. After the SHUTDOWN button has been pressed a dialog box will appear (right), notifying the operator that the data from the run is being saved.



2. Once the data has been saved, the operator may access it from the BIN SITE REPORTS screen (top). Under the reports screen, the customers information and seed information can be recorded and saved for later use. Press the EDIT button and go to the EDIT BIN SITE REPORTS screen (bottom). From this screen you may change the customer name. Pressing the customer name will bring up a keypad to enter the name with. Or you may select the arrow to the right of the name to scroll to the customers name. When finished the operator can press the OK button to save the data.



**EDITING - PRINTING REPORTS**

3. Press the PRINT button and a popup window appears. From this screen you can enter the number of reports to print for the customers records. Then press the X in the top right corner of the screen to exit back to the main screen.

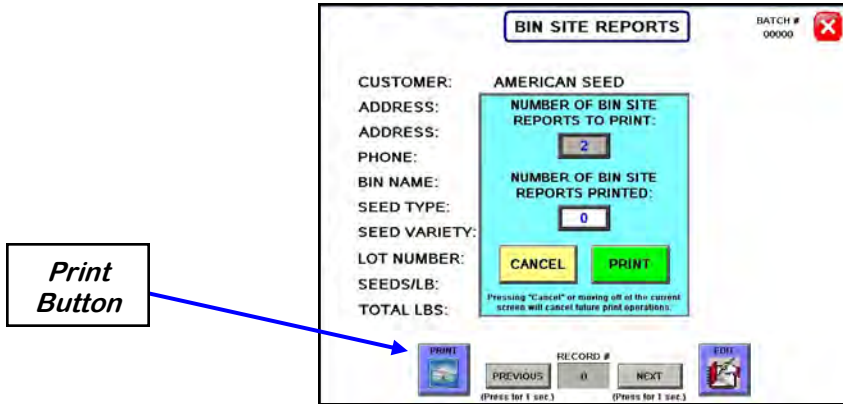

4. If the Auto Print Bin Site Report has been activated on the Print Set-up screen (see page 40) steps 2 and 3 will not be required. The print verification screen will appear and automatically print the number of reports specified.



5. Once the data has been saved, the reports can be accessed later by pressing the REPORTS button on the UTILITIES screen. If you would like to erase the reports, press the SECURITY button under the UTILITIES screen to advance to the security screen. Enter the password **USC** and then press the TOOLS & OPTIONS button. From this screen press the CLEAR ALL REPORTS button. A confirmation window will appear allowing the operator to erase all saved reports.

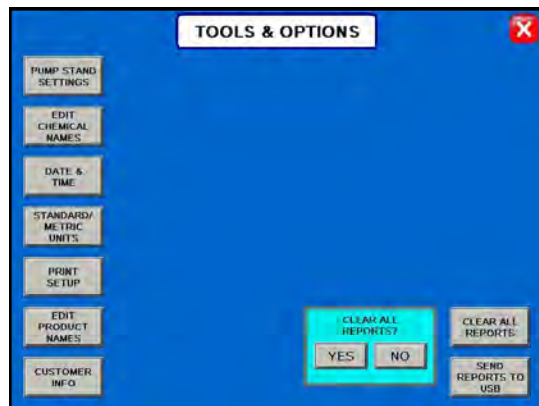

## DOWNLOADING REPORTS

The USB port located on the side of the operator control panel allows the operator to download reports to a compact flash device.

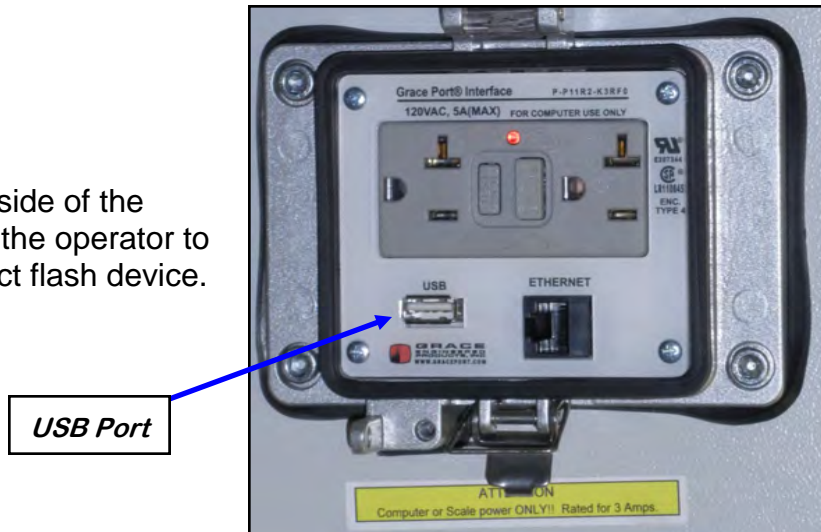

Use the following steps to download reports to a computer.

1. Insert a Compact Flash device into the USB port. The Flash device must be in Fat 32 format.
2. Advance to the Tools & Options screen.
3. Press the SEND BIN SITE REPORT TO USB button. A confirmation window will appear. Press the YES button and all the reports will automatically copy to the compact flash device.
4. Remove the compact flash device from the control panel and insert into your computer.

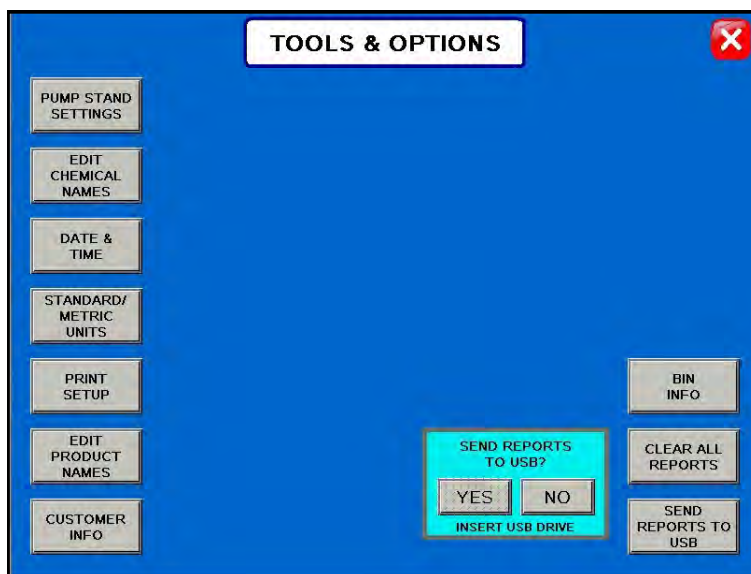

## **DOWNLOADING REPORTS**

5. Start Microsoft Office Excel. From the top menu select DATA then FROM TEXT.
6. From the Input Text File screen select the appropriate external drive. Then select the folders USR / LOG. Change the file type to ALL FILES. Select the file you want to work with and the Text Import Wizard window will open.

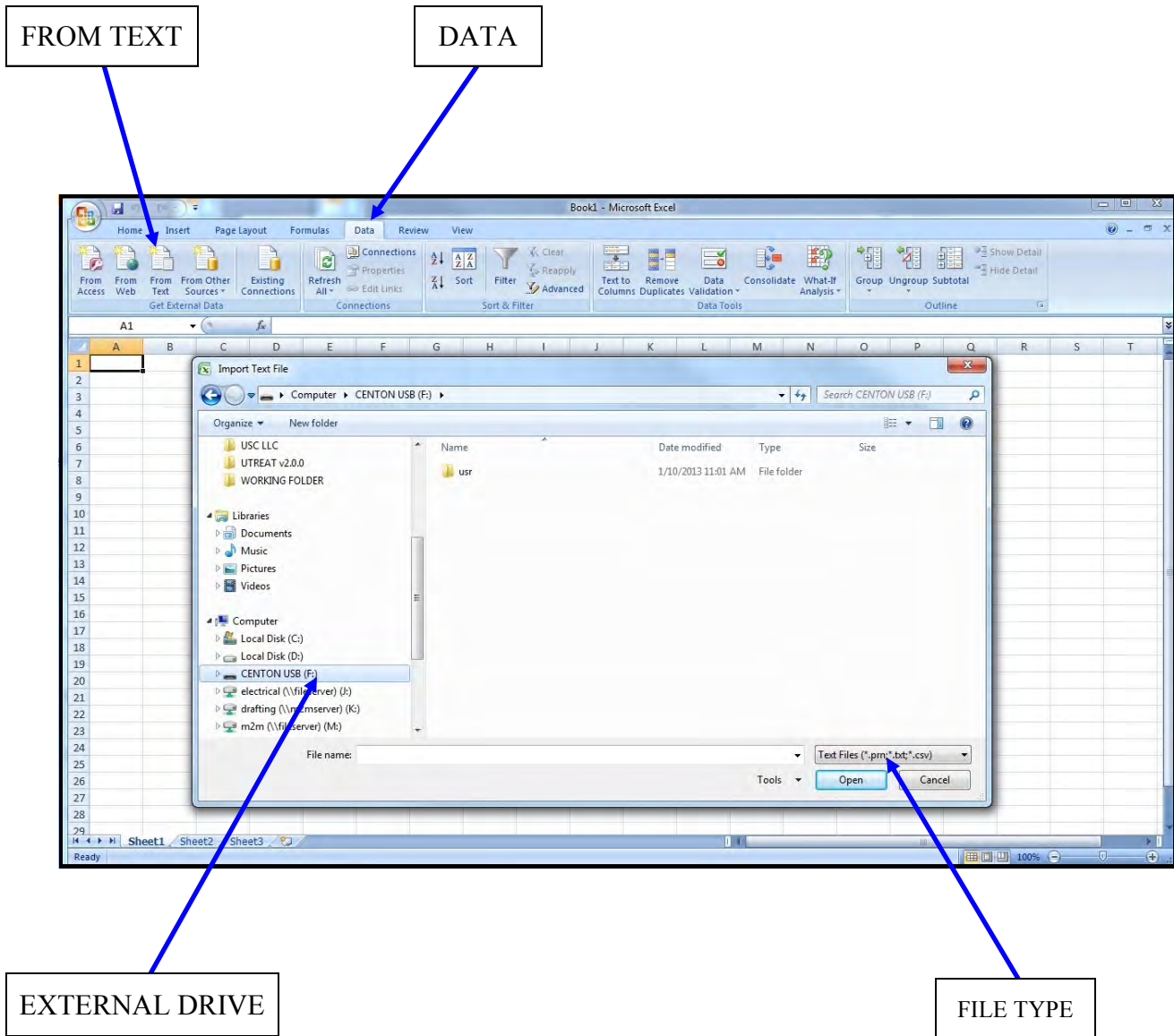

## DOWNLOADING REPORTS

7. Under Original data type select Delimited. Change Start import row to 3, then click Next.

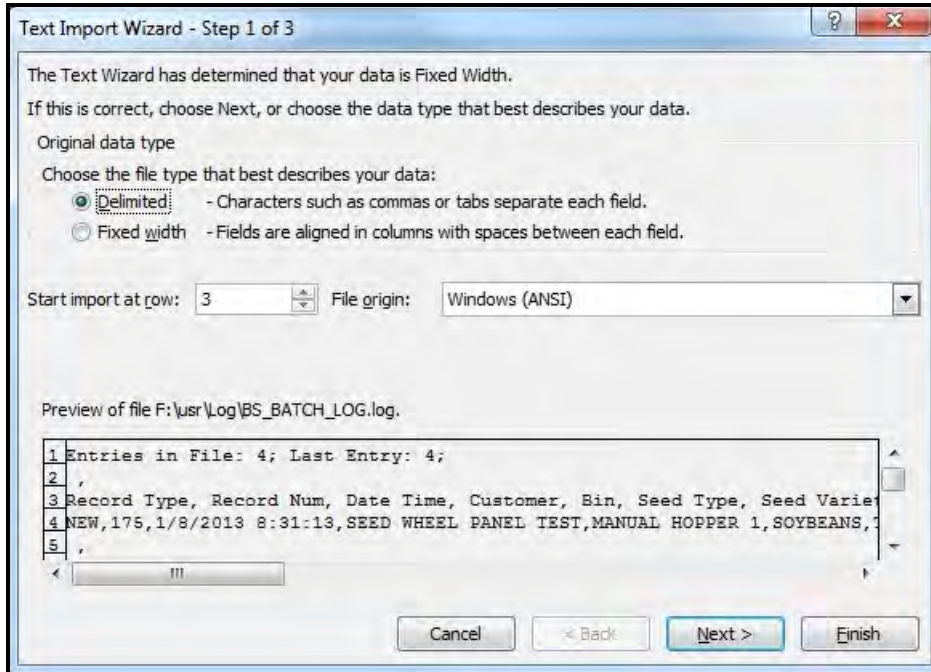

8. Under Delimiters deselect Tab and select Comma. Then click Next.

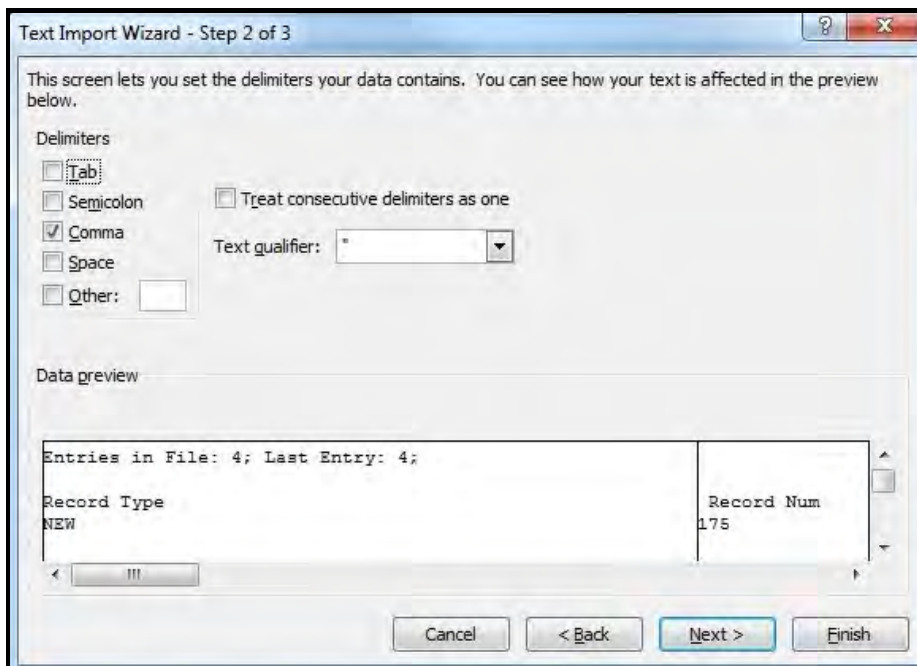

## DOWNLOADING REPORTS

9. Click Finish and the Import Data window appears. Click OK.

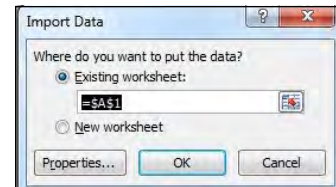
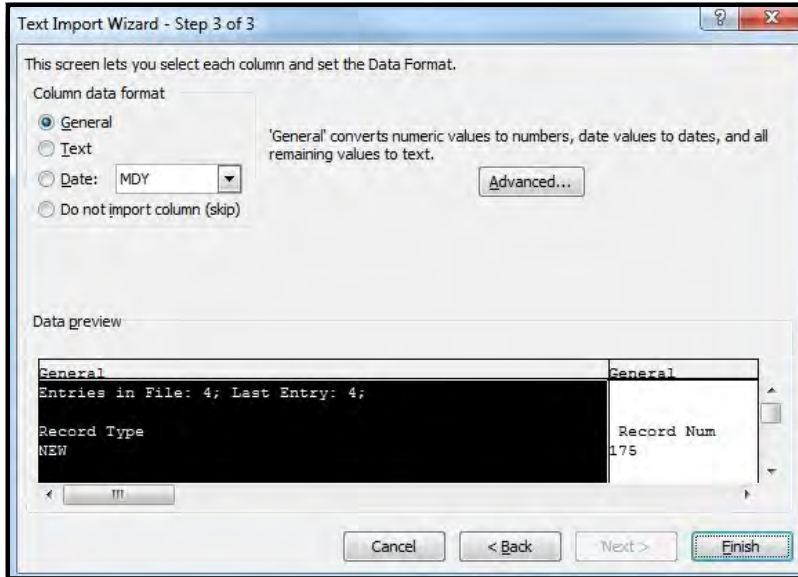

10. The Report conversion process is complete. In the File menu, click Save As and file the report.

	A	B	C	D	E	F	G	H	I	J	K	L	M	N	O	P	Q	R
1	Time	Date	Message															
2	11:45:40	4/17/2012	196	4/17/2012 11:37:59	USC	MANUAL HOPPER	SOYBEANS				2800	1832						
3	11:51:59	4/17/2012	197	4/17/2012 11:46:15	USC	MANUAL HOPPER	SOYBEANS				2800	1834						
4	14:58:45	4/17/2012	201	4/17/2012 14:56:8	USC	BIN 4	SOYBEANS	AG2232	2521PH4T9		2650	969						
5	15:03:02	4/17/2012	202	4/17/2012 14:59:20	USC	MANUAL HOPPER	SOYBEANS				2800	1057						
6	15:21:33	4/17/2012	205	4/17/2012 15:16:49	USC	MANUAL HOPPER	SOYBEANS				2800	1149						
7	15:26:04	4/17/2012	206	4/17/2012 15:22:8	USC	BIN 4	SOYBEANS	AG2232	2521PH4T9		2650	1467						
8	16:32:48	4/17/2012	207	4/17/2012 15:26:39	USC	MANUAL HOPPER	SOYBEANS				2800	1932						
9	17:04:45	4/17/2012	208	4/17/2012 16:33:23	USC	MANUAL HOPPER	SOYBEANS				2800	1863						
10	10:44:10	4/18/2012	210	4/18/2012 10:9:3	USC	MANUAL HOPPER	SOYBEANS				2800	1581						
11	10:54:16	4/18/2012	211	4/18/2012 10:44:46	USC	MANUAL HOPPER	SOYBEANS				2800	1932						
12	11:00:54	4/18/2012	212	4/18/2012 10:54:52	USC	MANUAL HOPPER	SOYBEANS				2800	1932						
13	11:12:20	4/18/2012	213	4/18/2012 11:1:30	USC	MANUAL HOPPER	SOYBEANS				2800	2064						
14	11:20:22	4/18/2012	214	4/18/2012 11:12:56	USC	MANUAL HOPPER	SOYBEANS				2800	2249						
15	11:48:08	4/18/2012	215	4/18/2012 11:20:58	USC	MANUAL HOPPER	SOYBEANS				2800	1754						
16	11:55:10	4/18/2012	216	4/18/2012 11:48:44	USC	MANUAL HOPPER	SOYBEANS				2800	1799						
17	12:10:34	4/18/2012	217	4/18/2012 11:55:46	USC	MANUAL HOPPER	SOYBEANS				2800	1754						
18	13:13:27	4/18/2012	218	4/18/2012 12:11:10	USC	MANUAL HOPPER	SOYBEANS				2800	1797						
19	13:28:54	4/18/2012	219	4/18/2012 13:14:4	USC	MANUAL HOPPER	SOYBEANS				2800	1796						
20	13:40:19	4/18/2012	220	4/18/2012 13:29:30	USC	MANUAL HOPPER	SOYBEANS				2800	1607						
21	13:50:50	4/18/2012	221	4/18/2012 13:40:55	USC	BIN 4	SOYBEANS	AG2232	2521PH4T9		2650	2102						
22	14:05:33	4/18/2012	222	4/18/2012 13:51:26	USC	MANUAL HOPPER	SOYBEANS				2800	871						
23	14:11:59	4/18/2012	223	4/18/2012 14:6:9	USC	BIN 4	SOYBEANS	AG2232	2521PH4T9		2650	1242						
24	14:19:52	4/18/2012	224	4/18/2012 14:12:35	USC	MANUAL HOPPER	SOYBEANS				2800	1227						
25	14:25:29	4/18/2012	225	4/18/2012 14:20:28	USC	BIN 4	SOYBEANS	AG2232	2521PH4T9		2650	879						

**SECTION  
F**

**TROUBLESHOOTING**

**TROUBLESHOOTING**

Below is a table describing the most frequent problems and solutions with the USC Batch Weigh Hopper System. For further assistance, contact your local USC dealer.

Problem	Possible cause	Solution
System is not consistently calibrating correctly.	<ol style="list-style-type: none"> <li>1. Bin slides gates or manual gates have been moved.</li> <li>2. Underbin conveyor belt is slipping.</li> <li>3. Bin slide gate is not consistently opening to the same point.</li> <li>4. The operator is pressing the "Cancel Scale Fill" button before the run ends.</li> <li>5. System is being paused during the run.</li> </ol>	<ol style="list-style-type: none"> <li>1. Ensure that the slide gate collar and manual gate is locked into place. Then recalibrate.</li> <li>2. Tighten the underbin conveyor belt.</li> <li>3. Check for any obstruction that may be restricting the movement of the slide gate.</li> <li>4. Allow the system to shutdown on its own.</li> <li>5. Make another run without pausing system.</li> </ol>
System calibration for currently selected bin is incorrect.	<ol style="list-style-type: none"> <li>1. System is too far out of calibration to recalibrate automatically.</li> </ol>	<ol style="list-style-type: none"> <li>1. Recalibrate the system. (see page 52)</li> </ol>
Weight display not reading steady (Bouncing)	<ol style="list-style-type: none"> <li>1. Bad load cell.</li> </ol>	<ol style="list-style-type: none"> <li>1. Replace load cell.</li> </ol>
No scale reading on the weigh hopper indicator on the touch screen.	<ol style="list-style-type: none"> <li>1. Ethernet cable is disconnected.</li> <li>2. Scale head is unplugged.</li> </ol>	<ol style="list-style-type: none"> <li>1. Check all Ethernet cables for connectivity and damage.</li> <li>2. Ensure that the scale head has power and is turned on.</li> </ol>
Scale is reading incorrect weight.	<ol style="list-style-type: none"> <li>1. Something is touching the scale.</li> <li>2. Scale needs recalibrated.</li> <li>3. Ethernet cable may be damaged or receiving electrical interference</li> </ol>	<ol style="list-style-type: none"> <li>1. Ensure that the area around the scale is clean and that nothing is leaning on or resting on the hopper.</li> <li>2. Zero scale. If still incorrect, have a professional scale technician recalibrate the scale.</li> <li>3. Ensure that Ethernet cable is not located directly next to any electrical lines.</li> </ol>

BATCH WEIGH HOPPER SYSTEM

Problem	Possible Cause	Solution
No bin slide gates will open or close when their corresponding button is pressed on the touch screen.	<ol style="list-style-type: none"> <li>1. No air or not enough air is being supplied to the solenoid bank on the side of the bin site control panel.</li> <li>2. The bin site PLC may be off.</li> </ol>	<ol style="list-style-type: none"> <li>1. Ensure that at least 100 psi of air is being supplied to the solenoid bank.</li> <li>2. Ensure that the bin site control panel has power to it, is "on" and that all of the breakers inside the panel are "on" as well.</li> </ol>
Air gate will not close fully.	<ol style="list-style-type: none"> <li>1. Something is obstructing the air gate from closing.</li> <li>2. Air pressure to the gate is not strong enough.</li> </ol>	<ol style="list-style-type: none"> <li>1. Remove obstruction.</li> <li>2. Ensure that the bin slide gate has at least 100 psi of air being supplied to it.</li> </ol>
Air gate is opening when it should be closing and vice versa.	<ol style="list-style-type: none"> <li>1. Air lines to the air gate are reversed.</li> </ol>	<ol style="list-style-type: none"> <li>1. Exchange air line for the proper solenoid on the back of the solenoid bank.</li> </ol>
Diverter is leaking seed through bypass side while in "treat" mode of operation.	<ol style="list-style-type: none"> <li>1. Too low of air pressure to actuate the diverter.</li> <li>2. An obstruction in the diverter is stopping correct placement of the diverter plate.</li> </ol>	<ol style="list-style-type: none"> <li>1. Ensure that at least 100 psi of air pressure is present at the diverter.</li> <li>2. Remove obstruction.</li> </ol>
Solenoids are making a buzzing sound when air gates are actuated.	<ol style="list-style-type: none"> <li>1. Moisture in the air system.</li> <li>2. Electric actuator on solenoid bank may be faulty.</li> </ol>	<ol style="list-style-type: none"> <li>1. Remove moisture from the air lines.</li> <li>2. Replace the electronic actuator on the solenoid.</li> </ol>
The touch screen has warning triangles on each button.	<ol style="list-style-type: none"> <li>1. The bin site PLC may be off.</li> </ol>	<ol style="list-style-type: none"> <li>1. Ensure that the bin site control panel has power to it, is "on" and that all of the breakers inside the panel are "on" as well.</li> </ol>
Conveyor will not start in "HAND" or "AUTO" mode.	<ol style="list-style-type: none"> <li>1. Conveyor motor starter is tripped.</li> <li>2. Conveyor is clogged.</li> </ol>	<ol style="list-style-type: none"> <li>1. Reset motor starter.</li> <li>2. Remove obstruction or debris.</li> </ol>

**SYSTEM ALARMS - FAULTS**

The table below and on the following pages provides a general description of all the system alarms (faults & warnings) of the Batch Weigh Hopper System. When a fault or warning condition is detected by the system, the Alarms screen will pop-up describing the cause of the Alarm or Fault. Any motor fault will activate the alarm screen on the operator control panel. If running, the system will then progress to the Pause state. A warning will alert the operator of a system condition which needs attention or correction. The alarms are reset when the fault condition is cleared and the “Reset Alarm” button is pressed. The horn is silenced by pressing the “Silence Alarm” button on the Alarms screen. For further assistance, contact your local USC dealer.

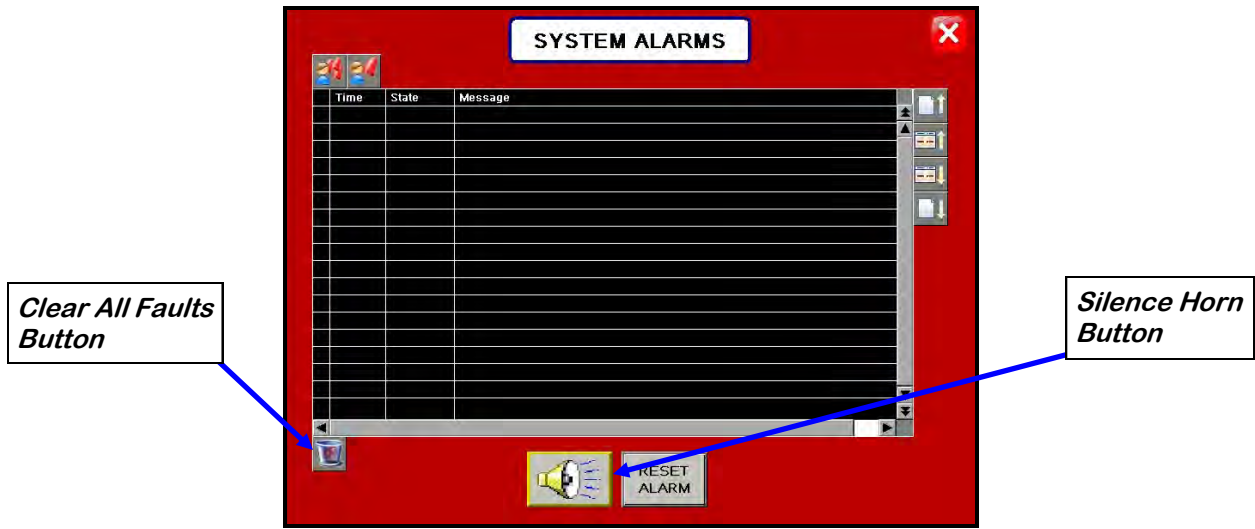

Alarm - Fault	Possible Cause	Solution
Weigh Hopper Reached Max Capacity	The current weight in the Weigh Hopper is above the number entered into the maximum scale weight in the “Utilities” screen.	Verify the number entered into the maximum scale weight box is correct. If yes, then recalibrate and rerun system.
Bin Site SURGE SUPPRESSOR-FAILED!!!	1. L1 of the Surge protector will no longer protect the electrical panel against voltage surges.	1. Replace the Surge Protector.
Underbin Conveyor - check for belt slippage/check speed sensor	1. Underbin Conveyor belt is slipping. 2. Underbin Conveyor Speed encoder is not working correctly.	1. Tighten and adjust the Underbin Conveyor belt as necessary. 2. Verify that sensor is tight to shaft and wiring is correct. If yes to both, then replace sensor.

BATCH WEIGH HOPPER SYSTEM

Alarm - Fault	Possible Cause	Solution
Conveyor #1 Motor Fault	<ol style="list-style-type: none"> <li>1. Conveyor #1 motor auxiliary contact was not sensed after being energized to run.</li> <li>2. Conveyor #1 motor has been shutdown while in Auto mode of operation.</li> </ol>	<ol style="list-style-type: none"> <li>1. Verify that the motor starter has power, is turned on and that the overload is not tripped.</li> <li>2. Verify that the Conveyor #1 was not turned "Off" while the system was in Auto mode of operation.</li> </ol>
Conveyor #2 Motor Fault	<ol style="list-style-type: none"> <li>1. Conveyor #2 motor auxiliary contact was not sensed after being energized to run.</li> <li>2. Conveyor #2 motor has been shutdown while in Auto mode of operation.</li> </ol>	<ol style="list-style-type: none"> <li>1. Verify that the motor starter has power, is turned on and that the overload is not tripped.</li> <li>2. Verify that the Conveyor #2 was not turned "Off" while the system was in Auto mode of operation.</li> </ol>
Conveyor #3 Motor Fault	<ol style="list-style-type: none"> <li>1. Conveyor #3 motor auxiliary contact was not sensed after being energized to run.</li> <li>2. Conveyor #3 motor has been shutdown while in Auto mode of operation.</li> </ol>	<ol style="list-style-type: none"> <li>1. Verify that the motor starter has power, is turned on and that the overload is not tripped.</li> <li>2. Verify that the Conveyor #3 was not turned "Off" while the system was in Auto mode of operation.</li> </ol>
Conveyor #4 Motor Fault	<ol style="list-style-type: none"> <li>1. Conveyor #4 motor auxiliary contact was not sensed after being energized to run.</li> </ol>	<ol style="list-style-type: none"> <li>1. Verify that the motor starter has power and is turned on.</li> </ol>
Weigh Hopper Gate - Not Open	<ol style="list-style-type: none"> <li>1. "Open" slide gate sensor is not positioned properly.</li> <li>2. "Open" slide gate solenoid failed to actuate.</li> </ol>	<ol style="list-style-type: none"> <li>1. Verify that the "open" slide gate sensor is properly positioned.</li> <li>2. Check air supply and signal to solenoid.</li> </ol>
Weigh Hopper Gate - Not Closed	<ol style="list-style-type: none"> <li>1. "Closed" slide gate sensor is not positioned properly.</li> <li>2. "Closed" slide gate solenoid failed to actuate.</li> </ol>	<ol style="list-style-type: none"> <li>1. Verify that the "Closed" slide gate sensor is properly positioned.</li> <li>2. Check air supply and signal to solenoid.</li> </ol>

**SYSTEM MESSAGES**

The table below provides a general description of all the system messages that could occur. When a warning condition is detected, a window will appear (below) notifying the operator that the system will not start because of a certain condition. When the condition has been corrected, the “START SCALE FILL FROM BIN” button can be pressed to start the system.

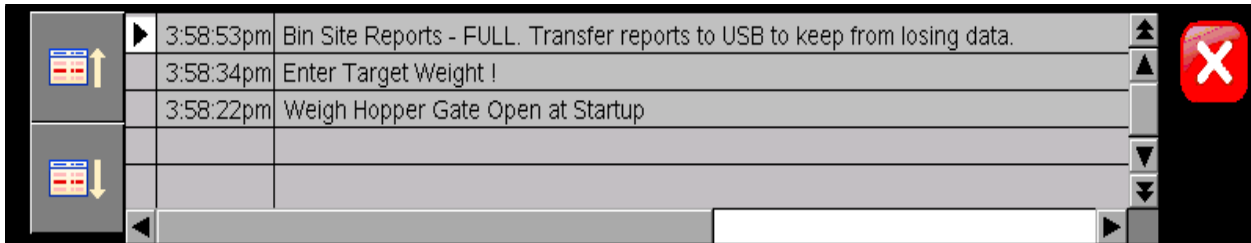

Message
Scale Fill Conveyor Not In Auto For Startup
Transition Conveyor Not In Auto For Startup:
Underbin Conveyor Not In Auto For Startup
Diverter in Treat position at Startup
Weigh Hopper Gate Open at Startup
Enter Target Weight!
Scale Unstable - Stabilize scale to continue operation.
Diverter in Bypass Position at Startup
Bin Site Reports - FULL. Transfer Reports to USB to keep from losing data.
Treater Auto Start Failed - Correct problem and press the Treater Startup button.
BIN SITE SYSTEM CONFIGURATION ERROR. Please contact USC tech support.
Transfer Conveyor Not in Auto For Startup.
Please select desired Bin for Startup.
Scale Fill Manual in Operation.

**MAINTENANCE****SECTION  
G**

Proper maintenance of your Batch Weigh Hopper System is critical for peak performance, reliability and accuracy of this system. The following is a guideline for the type of maintenance and servicing that should be performed on this unit. Your environment and uses may require additional maintenance and service beyond this list to assure a reliable and safe unit. The operator of this unit has ultimate responsibility to identify areas of concern and rectify them before they become a hazard or safety issue. There is no substitute for a trained, alert operator.



Do not put this unit into operation with any questionably maintained parts. Poor performance or a hazard may occur.

**BIN SLIDE GATES**

- Inspect all welds and structural components for bends, cracks and damage.
- Test slide gates for proper actuation with control panel.
- Remove air to gates and manually open and close gates. Check for any friction while gate is sliding.

**UNDERBIN CONVEYOR**

- Inspect all welds and structural components for bends, cracks and damage.
- Clean out any build up of debris from the clean out door.
- Check the conveyor belt tension and alignment. (page 69)
- Check the drive belt tension and alignment. (page 71)
- Grease all necessary bearings. (page 67)
- Remove yellow guard and check chain tension.
- Check for proper operation of conveyor while in reverse mode. Align if necessary.
- Check encoder for tightness to shaft and proper signal to control panel.

**SCALE FILL CONVEYOR**

- Inspect all welds and structural components for bends, cracks and damage.
- Clean out any build up of debris from the clean out door.
- Check the conveyor belt tension and alignment. (page 69)
- Check the drive belt tension and alignment. (page 71)
- Grease all necessary bearings. (page 67)
- Remove yellow guard and check chain tension.

### **WEIGH HOPPER, SLIDE GATE & SCALE HEAD**

- Inspect all welds and structural components for bends, cracks and damage.
  - Check for binding on scale components.
  - Check wiring from scale to scale head for any damage or kinks.
  - Test slide gate for proper actuation with control panel.
  - Check slide gate sensors for correct positioning and signal.
  - Have scale professionally re-calibrated as necessary.
- 

### **CONTROL PANEL & AIR SYSTEM**

- Drain water from compressor daily.
  - Drain air dryer every 40 hours of operation.
  - Test all air solenoids for correct actuation.
  - Inspect all exterior wiring for any kinks or damage.
- 

### **PRO BOX HOPPER & TRANSFER CONVEYOR (optional)**

- Inspect all welds and structural components for bends, cracks, and damage.
  - Clean out any build up of debris from the clean out door.
  - Check the conveyor belt tension and alignment. (page 69)
  - Check the drive belt tension and alignment. (page 71)
  - Grease all necessary bearings. (page 67)
  - Remove yellow guard and check chain tension.
- 

### **DIVERTER (optional)**

- Inspect all welds and structural components for bends, cracks, and damage.
  - Test diverter gate for proper actuation with control panel.
  - Clean diverter tubing of any obstructions.
  - Grease all necessary bearings.
- 

### **TRANSFER CONVEYOR (optional)**

- Inspect all welds and structural components for bends, cracks and damage.
- Clean out any build up of debris from the clean out door.
- Check the conveyor belt tension and alignment. (page 69)
- Check the drive belt tension and alignment. (page 71)
- Grease all necessary bearings. (page 67)
- Remove yellow guard and check chain tension.

## **CONVEYOR MAINTENANCE**

Proper maintenance of the USC Conveyors is critical for peak performance, reliability and accuracy of this system. The following is a guideline for the type of maintenance and servicing that should be performed on these units. Your environment and uses may require additional maintenance and service beyond this list to assure a reliable and safe unit. The operator of this unit has ultimate responsibility to identify areas of concern and rectify them before they become a hazard or safety issue. There is no substitute for a trained, alert operator.



Do not put this unit into operation with any questionably maintained parts. Poor performance or a hazard may occur.

## **FLUIDS AND LUBRICANTS**

### **Grease**

Use an SAE multipurpose high temperature grease with extreme pressure (EP) performance. Also acceptable is an SAE multipurpose lithium-based grease.

### **Storing Lubricants**

Your machine can operate at top efficiency only if clean lubricants are used. Use clean containers to handle all lubricants. Store them in an area protected from dust, moisture and other contaminants.

## **GREASING**

Use a Maintenance Checklist to keep record of all scheduled maintenance.

1. Use a hand-held grease gun for all greasing.
2. Wipe grease fitting with a clean cloth before greasing to avoid injecting dirt and grit.
3. Replace and repair broken fittings immediately.

**NOTICE** If fittings will not take grease, remove and clean thoroughly. Also clean lubricant passageway. Replace fitting if necessary.

## **CONVEYOR SERVICING INTERVALS**

### **Every 40 hours or Weekly**

1. Check the conveyor belt tension and alignment.
2. Grease conveyor bearings.
  - Two bolt flanged bearings, tail roller bearings right and left (2 locations).
  - Two bolt flanged bearings, drive roller bearings right and left (2 locations).
  - Two bolt flanged bearings, jackshaft bearings right and left (2 locations).

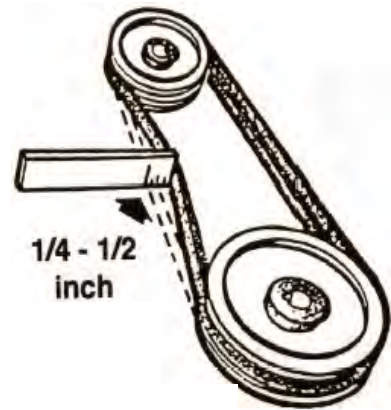

3. Remove guard and check the drive belt tension and alignment. The belts will deflect approximately 1/4 to 1/2 inch when properly tensioned. (right)



---

### **Every 200 hours or Annually**

1. Repack wheel bearings.
2. Wash machine.
3. Check pulley bushing for wear. To inspect pulley:
  - Lower the conveyor to its lowest position.
  - When the conveyor has reached the lowest position, it will stop on the hinge support.
  - Loosen and remove the bolt.
  - Inspect the bushing on the pulley for wear.
  - Reverse steps 1-4 for re-assembly.

## **CONVEYING BELT TENSION AND ALIGNMENT - TAIL END**

A contoured belt with molded flights is used to convey material along the frame. The tension and alignment of the belt should be checked weekly, or more often if required, to be sure that it does not slip or run to one side. A properly tensioned belt will not slip when it is operating. Operating the belt with less slippage will increase the belt life and causes less stress on bearings, pulleys and shafts.



Although it is acceptable to align the belt from either the Head or the Tail (Intake) end. Tightening the belt may only be done from the Tail end of the conveyor

To maintain the belt, follow this procedure:



Place all controls in neutral or off, stop motor and disable power source before working on belt.

1. Use the take-up bolt located at the tail to set the tension of the belting.
2. If the belt needs to be tightened to prevent slippage, use the take-up adjustments on the tail end.
3. The belt is tightened by turning both take-up adjustments an **equal** number of turns.
4. Use the drive roller to check the alignment. The belt should be centered.
5. Turn the belt 1/2 revolution when the belt is new and check the drive and tail roller. If out of alignment, the belt will move to the loose side. Loosen the jam nut and use the bearing position bolts to set the position. Tighten jam nut.
6. Run and check again. Check frequently during the first few minutes of operation and then several times during the first 10 hours. The belt normally seats itself during the first 10 hours of operation and can be checked weekly after that.
7. The belt is properly aligned when the belt runs in the center of the head and tail rollers.

*Use this bolt to tighten the belt or to adjust the tracking*



*Tighten jam nut after adjustment*

### **CONVEYING BELT ALIGNMENT-HEAD END**

1. A misaligned belt will track toward the loose side. Set the tracking by loosening the jam nut on the tight side and using the bearing position bolt to move the end of the head roller toward the tail. Tighten the jam nut when the belt is centered on the head roller.
2. Run the belt and check the tracking again. Loosen the tight side slightly again if required. Repeat the adjusting and checking procedure until the belt centers on the input end roller and remains centered when running.
3. Always repeat this aligning procedure when installing a new belt. Check frequently during the first 10 hours of operation. After 10 hours, the belt is normally seated and checking the alignment can be done less frequently.

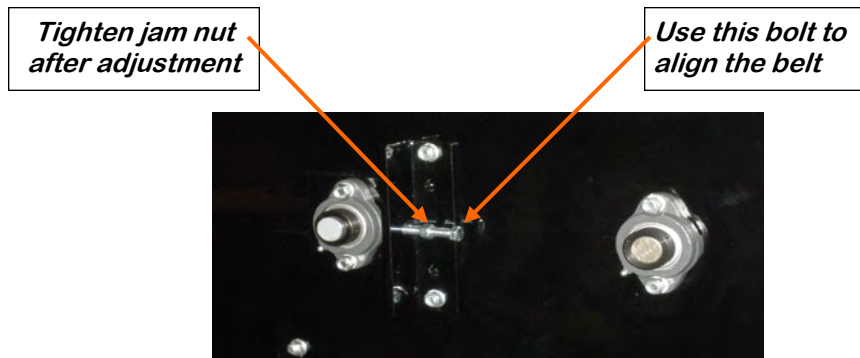

### **BELT REPLACEMENT**

1. Rotate the belt until the seam is visible.
2. Move the tail roller to its loosest position.
3. Pull all the slack to the seam area.
4. Remove the wire connector and open the belt.
5. Attach one end of the replacement belt to the belt end being removed.
6. Pull the old belt out and the new belt will be threaded into place.
7. Disconnect the old belt.
8. Connect the ends of the new belt together and secure.
9. Set the belt tension.
10. Check and set the belt alignment

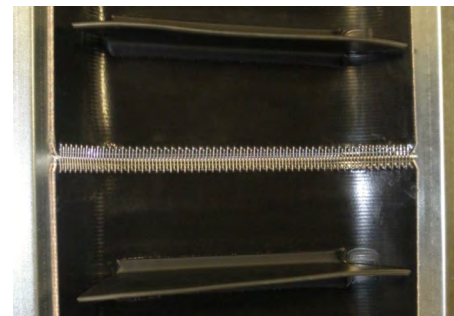

*Belt Seam*



## **DRIVE BELT TENSION & ALIGNMENT**

Power to the conveying belt is transmitted through a V-belt. The V-belt drive system must be maintained at the proper belt tension and pulley alignment to obtain the desired performance and life. When maintaining the belt drive system follow this procedure:

**NOTICE** Turn motor off and unplug power cord or turn off power and lock out the master panel before starting maintenance on drive belt system.

### **Belt Tension Drive**

1. Push on the center of the belt span with a force of approximately 5 to 10 lbs.
2. The belts will deflect approximately 1/4 to 1/2 inch when properly tensioned.
3. Move the motor up, using the adjustment bolts, to set drive belt tension (top right).
4. Close and secure guards.



*Motor base adjustment*

### **Drive Belt Alignment**

1. Lay a straightedge across the pulley faces to check the alignment (bottom right).
2. Use the pulley hub or the motor mounting plate slots to move the pulley to the required position for alignment.
3. Tighten hub bolts to secure pulley on shaft.
4. Check belt tension
5. Close and secure guards.



*Lay a straightedge across*

### **Drive Belt Replacement**

1. Lower motor to its loosest position.
2. Remove old belt and replace with a new one.
3. Raise motor to set the belt tension.
4. Check pulley alignment. Adjust if required.
5. Close and secure guards.

## SECTION H STORAGE

When storing the Batch Weigh Hopper System for long periods of time, the following procedures must be followed to reduce the chance of rust, corrosion and fatigue of the Batch Weigh Hopper System. You can also use these steps when storing the machine for the winter.



A dust mask and protective rubber gloves shall be used when cleaning the machine.

---

### UNDERBIN CONVEYOR

1. Disconnect power.
2. Thoroughly wash the entire machine to remove all dirt, mud, debris or residue.
3. Remove yellow covers and remove any debris or build-up.
4. Remove clean out doors and thoroughly remove any debris or build-up inside of the conveyor. Ensure that the bottom pan of the underbin conveyor is free of seed.
5. Lubricate all grease fittings and chain. Make sure that all grease cavities have been filled with grease to remove any water residue from the washing. This also protects the bearing seals.
6. Re-connect power and run the underbin conveyor to help remove any additional debris. Compressed air can be used to blow out any foreign material.

---

### WEIGH HOPPER & SLIDE GATE

1. Thoroughly clean the weigh hopper to remove all residue from the equipment.
2. Clean the slide gate of any seed or residue that may have built up.

---

### SCALE FILL CONVEYOR

1. Disconnect power.
2. Thoroughly wash the entire machine to remove all dirt, mud, debris or residue.
3. Remove yellow covers and remove any debris or build-up.
4. Remove clean out doors and thoroughly remove any debris or build-up inside of the conveyor.

### **SCALE FILL CONVEYOR**

5. Lubricate all grease fittings and chain. Make sure that all grease cavities have been filled with grease to remove any water residue from the washing. This also protects the bearing seals.
  6. Re-connect power and run the scale fill conveyor to help remove any additional debris. Compressed air can be used to blow out any foreign material.
  7. Cover the electric motor with a water proof tarpaulin and tie securely in place.
- 

### **PRO BOX HOPPER & TRANSFER CONVEYOR (optional)**

1. Disconnect power.
  2. Thoroughly wash the entire machine to remove all dirt, mud, debris or residue.
  3. Remove yellow covers and remove any debris or build-up.
  4. Remove clean out doors and thoroughly remove any debris or build-up inside of the conveyor.
  5. Lubricate all grease fittings and chain. Make sure that all grease cavities have been filled with grease to remove any water residue from the washing. This also protects the bearing seals.
  6. Re-connect power and the transfer conveyor to help remove any additional debris. Compressed air can be used to blow out any foreign material.
  7. Cover the electric motor with a water proof tarpaulin and tie securely in place.
  8. Tarp or place the cover on top of the pro box hopper to keep out any dirt or unwanted pests.
- 

### **FINAL**

1. Store all portable components of the Batch Weigh Hopper System inside a protective building to keep them from being exposed to the weather.
2. Disconnect power to the machine and all of the components.
3. Ensure all moisture has been removed from the airlines.
4. Disconnect the supply air line to the bottom of the solenoid bank and place a plug in the fitting to keep moisture out of the system.

SECTION  
I

**MECHANICAL DRAWINGS**

**100 - 200 UNIT WEIGH HOPPER BASE ASSEMBLY (05-07-0296)**

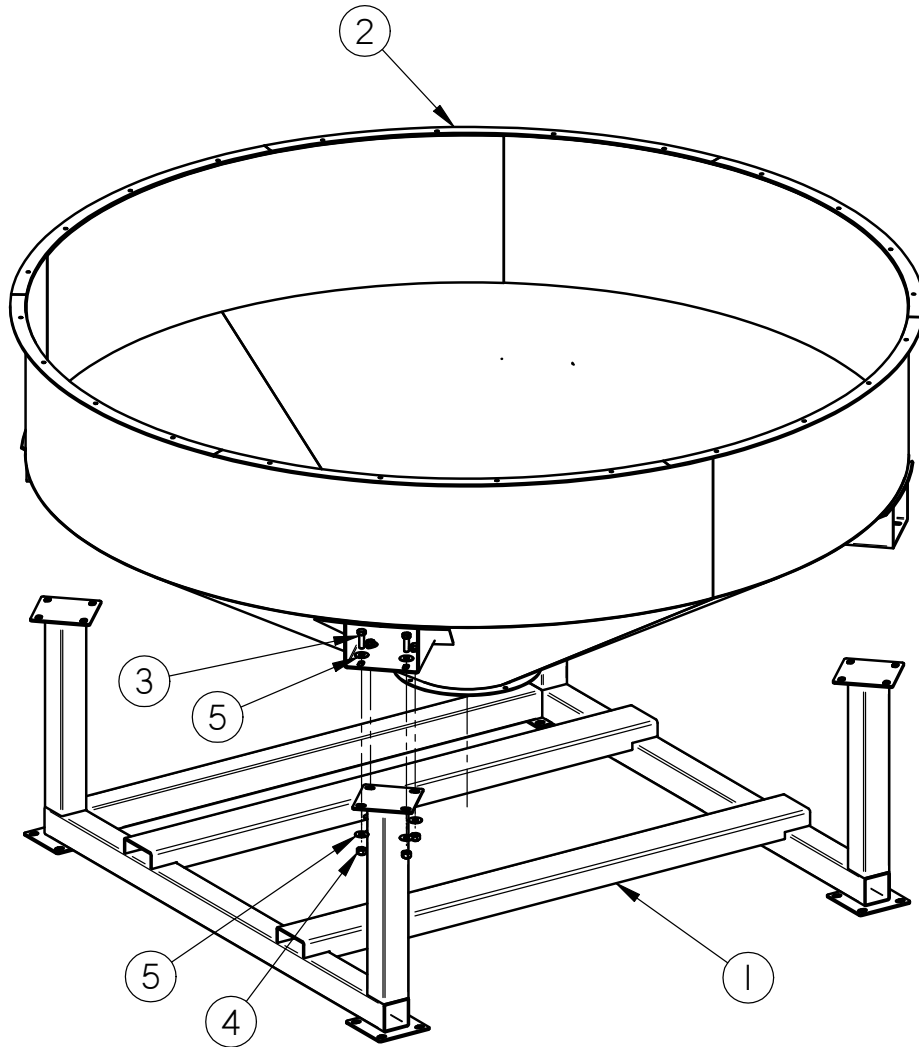

Item #	Part #	Description	Qty
1	05-03-0577	WDMT BASE FR WEIGH HPR 300 1 SD OPN	1
2	05-03-0794	WDMT WEIGHT HOPP 8 OTLT	1
3	06-01-0032	BOLT, .625 X 11 X 2" UNC ZP GRADE 5	16
4	06-03-0005	NUT NYL LOCK .625-11 ZP	16
5	06-05-0006	WASHER, .625 FLAT ZP	32

**300 UNIT WEIGH HOPPER BASE ASSEMBLY (05-07-0297)**

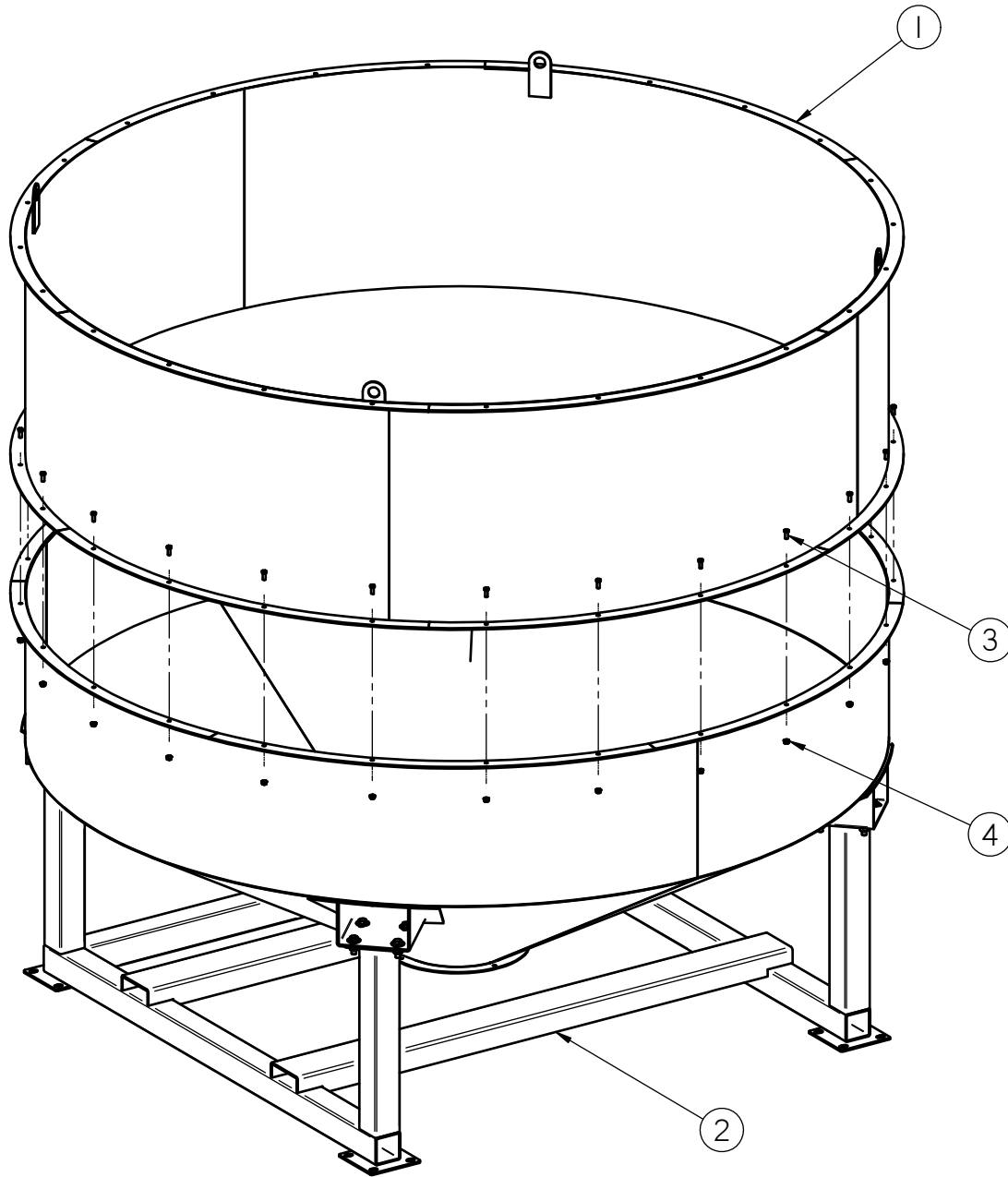

Item #	Part #	Description	Qty
1	05-03-0656	WDMT WEIGHT HOPR 300 UNIT	1
2	05-07-0296	ASSY WEIGHT HOPP 100-200 UNIT SLGT	1
3	06-01-0016	BOLT .375-16 X 1.00 ZP GR5	24
4	06-03-0014	NUT LOCK FLG .375-16 ZP GR5	24

**SEED LADDER ASSEMBLY (05-03-0613)**

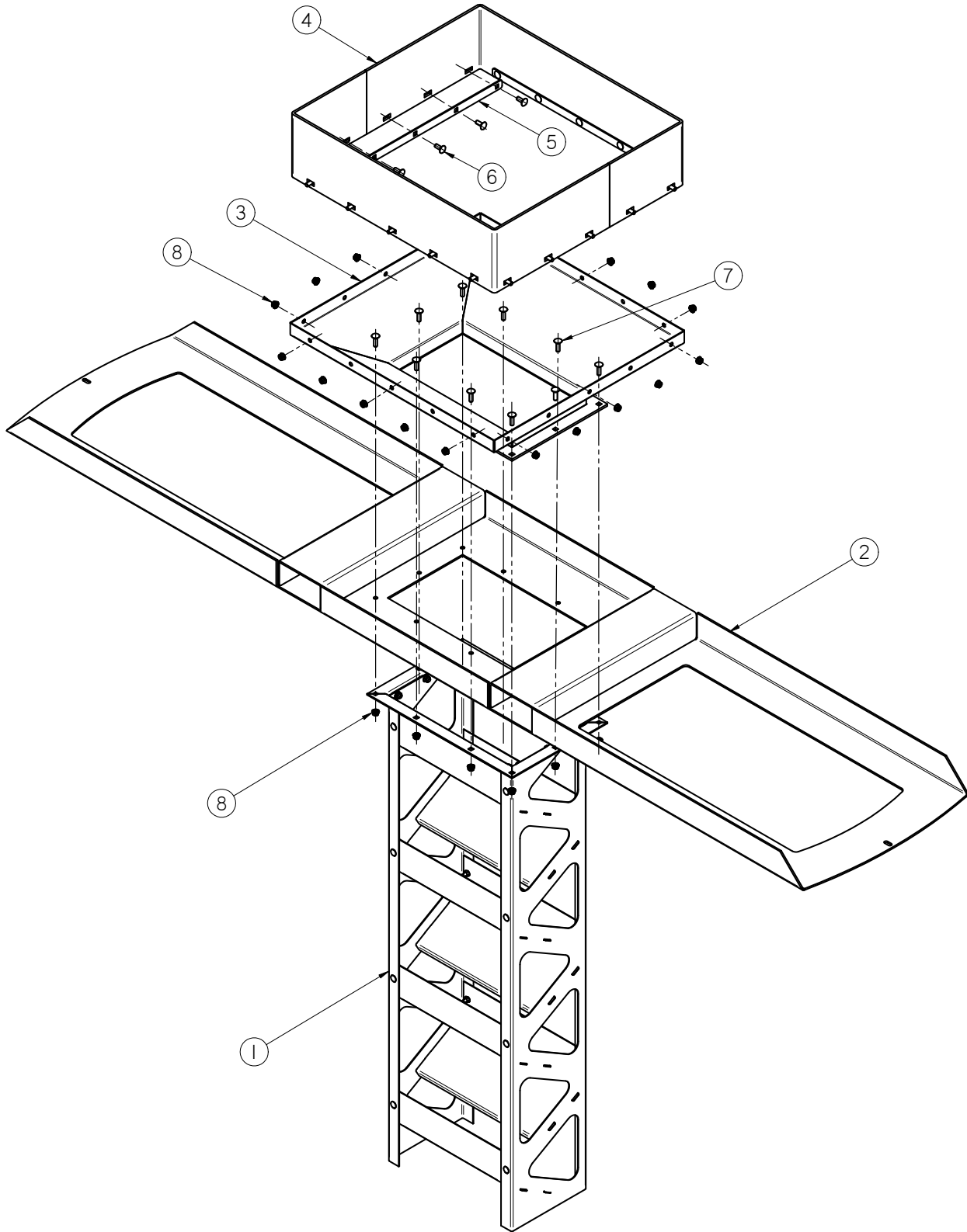

BATCH WEIGH HOPPER SYSTEM

**SEED LADDER ASSEMBLY (05-03-0613)**

Item #	Part #	Description	Qty
1	05-03-0662	ASSY SEED LADDER 300UNIT	1
2	05-03-0667	WDMT MNT PLT REMV SEED LADDER	1
3	05-03-0668	WDMT REMV SEED LADDER HOPP	1
4	05-10-3296	PLT REMV SEED LADDER HOPP EXT RBRR	2
5	05-10-3308	PLT REMV SEED LADDER HOPP EXT HLDR	4
6	06-01-0115	BOLT CRG .375-16 X 1.00 ZP GR5	20
7	06-01-0127	BOLT, CARRIAGE, .375-16 X 1 1/4 ZP G5	10
8	06-03-0014	NUT LOCK FLG .375-16 ZP GR5	30

**WEIGH HOPPER SLIDE GATE ASSEMBLY (12-04-0017)**

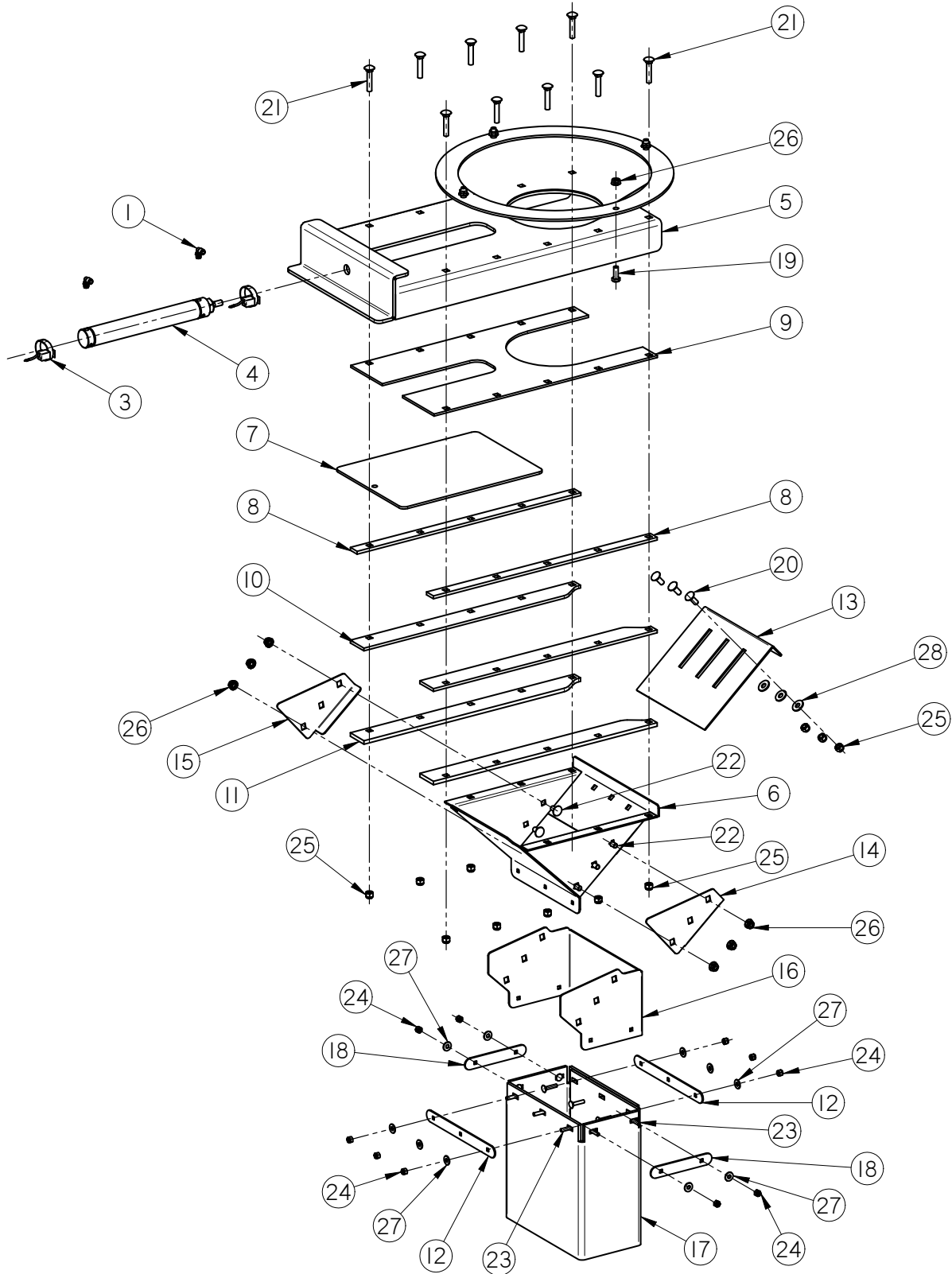

BATCH WEIGH HOPPER SYSTEM

**WEIGH HOPPER SLIDE GATE ASSEMBLY (12-04-0017)**

Item #	Part #	Description	Qty
1	02-16-0046	FTTG PUSH 90 DEG .250 OD X .125 NPT	2
2	03-17-0046	CLEVIS ASSY BIMBA D-8311-A	1
3	03-17-0047	SW MAG REED MRS-.087-PBL-17	2
4	03-17-0067	CYL AIR 9"STROKE 1.5 IN BORE DBL	1
5	05-03-0776	WDMT SLIDE GATE WEIGH HOPP 8 OPEN	1
6	05-07-0295	ASSY SLIDE GATE CS CHUTE 8.00	1
7	05-10-3456	PLT SLIDE 8 SLIDE GATE	1
8	05-10-3457	PLT UHMW 8 SLIDE GATE SIDE	2
9	05-10-3458	PLT UHMW STRIPPER SLIDE GATE 8.00	1
10	05-10-3459	PLT UHMW BRG SLIDE GATE 8.00	2
11	05-10-3460	PLT CS BRG SUPT SLIDE GATE 8.00	2
12	05-10-3474	PLT SLIDEGATE CLAMP 2 12-04-0012	2
13	05-10-3479	PLT DUMP HOPP SLIDE CS 2	1
14	05-10-3480	PLT DUMP HOPP SLIDE 8 CS	1
15	05-10-3481	PLT DUMP HOPP SLIDE 8 CS	1
16	05-10-3482	PLT SLIDEGATE CHUTE HANGER	1
17	05-10-3483	PLT SLIDEGATE CHUTE	1
18	05-10-3484	PLT SLIDEGATE CLAMP 2 12-04-0012	2
19	06-01-0016	BOLT .375-16 X 1.00 ZP GR5	4
20	06-01-0115	BOLT CRG .375-16 X 1.00 ZP GR5	3
21	06-01-0136	BOLT CRG .375-16 X 2.00 ZP GR5	10
22	06-01-0153	BOLT CRG .375-16X.750 ZP SHORT NECK	6
23	06-01-0159	BOLT CRG .25-20 X 1.25 ZP GR5	10
24	06-03-0001	NUT,LOCK, .250-20 ZP G5 NYLON INSERT	10
25	06-03-0003	NUT NYL LOCK .375-16 ZP GR5	13
26	06-03-0014	NUT LOCK FLG .375-16 ZP GR5	10
27	06-05-0001	WASHER, FLAT .250	10
28	06-05-0004	WSHR FLAT .375 ZP	3

**100 - 200 UNIT WEIGH HOPPER FINAL ASSEMBLY (05-07-0456)**

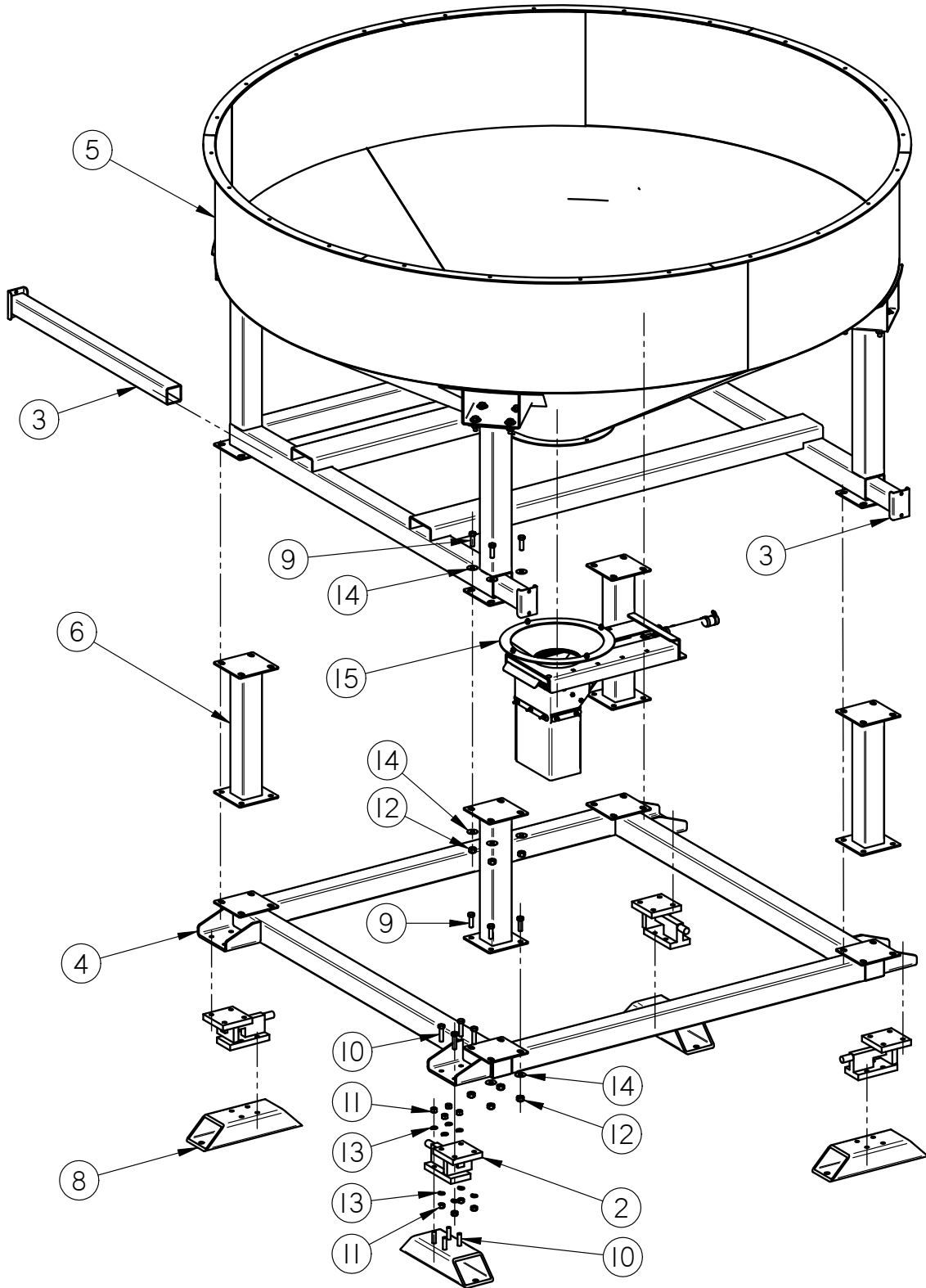

BATCH WEIGH HOPPER SYSTEM

**100 - 200 UNIT WEIGH HOPPER FINAL ASSEMBLY (05-07-0456)**

Item #	Part #	Description	Qty
1	03-19-0030	DIGITAL INDICATOR CARDINAL 205	1
2	03-19-0036	LDCL 5000LB X4 KIT	1
3	05-03-0810	WDMT SCL WEIGHT HANGER	4
4	05-03-0870	WDMT BASE FR LDCL MNT 76IN CTRS	1
5	05-07-0296	ASSY WEIGHT HOPP 100-200 UNIT SLGT	1
6	05-07-0307	ASSY WEIGH HOPP FR 24 OAL FS-3	1
7	05-08-0153	SHIM KIT WEIGH HOPPER LDCL	1
8	05-11-0285	BASE MNT LDCL WGH HOPP FR	4
9	06-01-0032	BOLT, .625 X 11 X 2" UNC ZP GRADE 5	32
10	06-01-0075	BOLT, .625 X 11 X 2.50" UNC ZP GRADE 5	32
11	06-02-0005	NUT, .625-11 UNC ZP GRADE 5	32
12	06-03-0005	NUT NYL LOCK .625-11 ZP	32
13	06-04-0005	WASHER, .625 LOCK ZP	32
14	06-05-0006	WASHER, .625 FLAT ZP	48
15	12-04-0017	SLIDE GATE WEIGHT HOPP 8.00	1

**300 UNIT WEIGH HOPPER FINAL ASSEMBLY (05-07-455)**

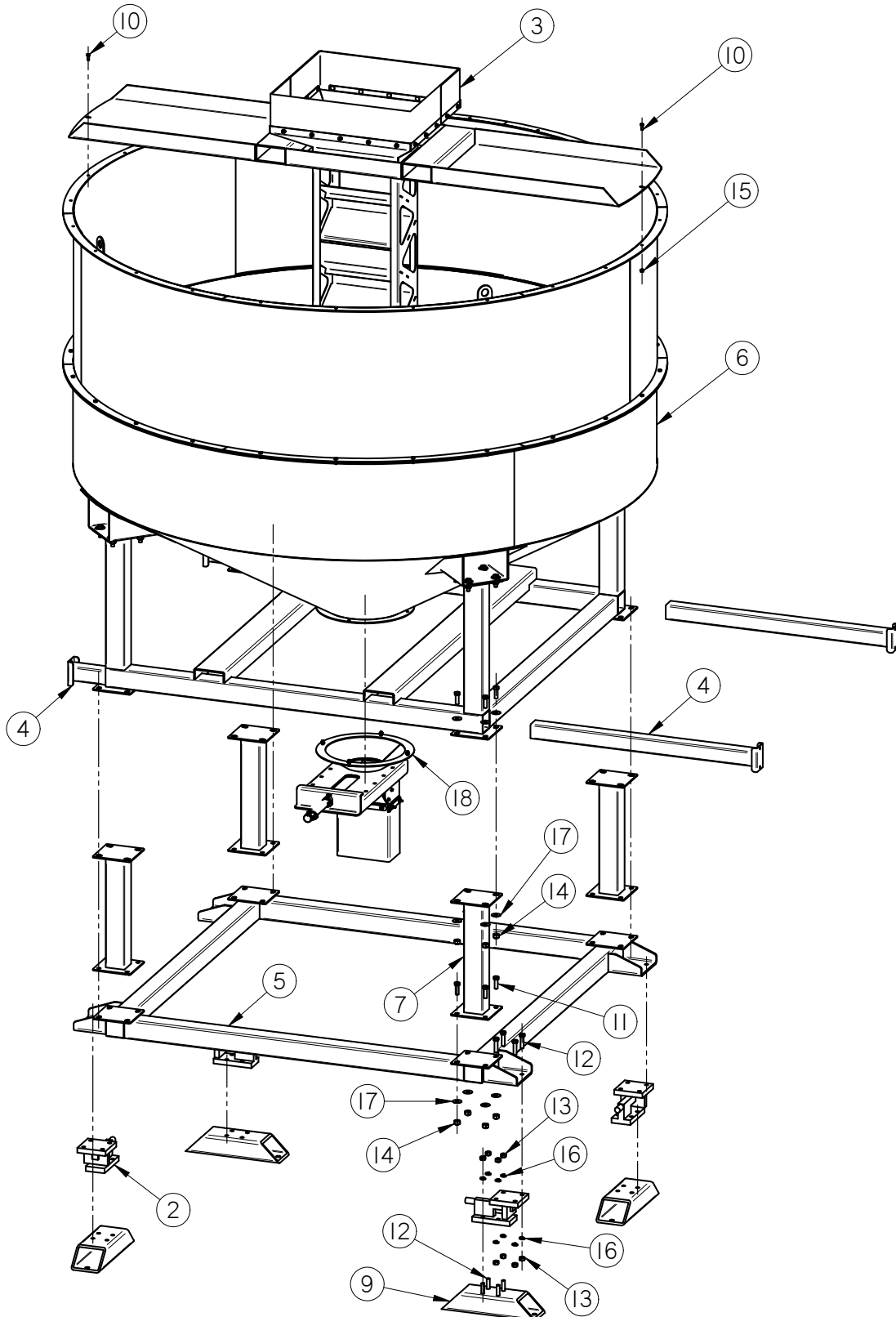

**300 UNIT WEIGH HOPPER FINAL ASSEMBLY (05-07-0455)**

Item #	Part #	Description	Qty
1	03-19-0030	DIGITAL INDICATOR CARDINAL 205	1
2	03-19-0036	LDCL 5000LB X4 KIT	1
3	05-03-0613	ASSY SEED LADDER FORKLIFT REMOVABLE	1
4	05-03-0810	WDMT SCL WEIGHT HANGER	4
5	05-03-0870	WDMT BASE FR LDCL MNT 76IN CTRS	1
6	05-07-0297	ASSY WEIGHT HOPP 300 UNIT SLGT	1
7	05-07-0307	ASSY WEIGH HOPP FR 24 OAL FS-3	1
8	05-08-0153	SHIM KIT WEIGH HOPPER LDCL	1
9	05-11-0285	BASE MNT LDCL WGH HOPP FR	4
10	06-01-0016	BOLT .375-16 X 1.00 ZP GR5	2
11	06-01-0032	BOLT, .625 X 11 X 2" UNC ZP GRADE 5	32
12	06-01-0075	BOLT, .625 X 11 X 2.50" UNC ZP GRADE 5	32
13	06-02-0005	NUT, .625-11 UNC ZP GRADE 5	32
14	06-03-0005	NUT NYL LOCK .625-11 ZP	32
15	06-03-0014	NUT LOCK FLG .375-16 ZP GR5	2
16	06-04-0005	WASHER, .625 LOCK ZP	32
17	06-05-0006	WASHER, .625 FLAT ZP	48
18	12-04-0017	SLIDE GATE WEIGHT HOPP 8.00	1

**NOTES**

# USC LIMITED WARRANTY

## SECTION J

USC, LLC, (Manufacturer) warrants its seed treating equipment as follows:

1. **Limited Warranty:** Manufacturer warrants that the Products sold hereunder will be free from defects in material and workmanship for a period of 18 months from date of shipment. If the Products do not conform to this Limited Warranty during the warranty period, Buyer shall notify Manufacturer in writing of the claimed defects and demonstrate to Manufacturer satisfaction that said defects are covered by this Limited Warranty. If the defects are properly reported to Manufacturer within the warranty period, and the defects are of such type and nature as to be covered by this warranty, Manufacturer shall, at its expense, furnish replacement Products or, at Manufacturer's option, replacement parts for the defective products. Shipping and installation of the replacement Products or replacement parts shall be at the Buyer's expense.

2. **Other Limits:** THE FOREGOING IS IN LIEU OF ALL OTHER WARRANTIES, EXPRESSED OR IMPLIED, INCLUDING BUT NOT LIMITED TO THE IMPLIED WARRANTIES OF MERCHANTABILITY AND FITNESS FOR A PARTICULAR PURPOSE. Manufacturer does not warrant against damages or defects arising from improper installation (where installation is by persons other than Manufacturer), against defects in products or components not manufactured by Manufacturer, or against damages resulting from such non-Manufacturer made products or components. Manufacturer passes on to the Buyer the warranty it received (if any) from the maker of such non-Manufacturer made products or components. This warranty also does not apply to Products upon which repairs and/or modifications have been effected or attempted by persons other than pursuant to written authorization by Manufacturer. Manufacturer does not warrant against casualties or damages resulting from misuse and/or abuse of product(s), acts of nature, effects of weather, including effects of weather due to outside storage, accidents, or damages incurred during transportation by common carrier.

3. **Exclusive Obligation:** THIS WARRANTY IS EXCLUSIVE. The sole and exclusive obligation of Manufacturer shall be to repair or replace the defective Products in the manner and for the period provided above. Manufacturer shall not have any other obligation with respect to the Products or any part thereof, whether based on contract, tort, strict liability or otherwise. Under no circumstances, whether based on this Limited Warranty or otherwise, shall Manufacturer be liable for incidental, special, or consequential damages.

4. **Other Statements:** Manufacturer's employees or representatives' oral or other written statements do not constitute warranties, shall not be relied upon by Buyer, and are not a part of the contract for sale or this limited warranty.

5. **Return Policy:** Approval is required prior to returning goods to USC, LLC. A restocking fee will apply.

6. **Entire Obligation:** This Limited Warranty states the entire obligation of Manufacturer with respect to the Products. If any part of this Limited Warranty is determined to be void or illegal, the remainder shall remain in full force and effect.



**USC, LLC**

2320 124th road

Sabetha, Ks 66534

PHONE: (785) 431-7900

FAX: (785) 431-7950

EMAIL: [sales-team@uscllc.com](mailto:sales-team@uscllc.com)

WEB: [www.uscllc.com](http://www.uscllc.com)

---