





KIPFold 1800 User Guide Ver 1.1



KIPFold 1800 User Guide

Safety

Read these safety instructions completely before operating the folder and keep this manual for future reference close to the folder. Carefully observe all warnings, precautions and instructions on the folder or the ones described in the operating instructions. In order to guarantee hazard-free operations all maintenance and repairs are only to be carried out by trained personnel.

<p>WARNING: Indicates a potentially hazardous situation which, if not avoided, COULD result in death or serious injury.</p>	 Warning
<p>CAUTION: Indicates a potentially hazardous situation which, if not avoided, MAY result in minor or moderate injury.</p>	

Maintenance and Modifications

<p>To avoid the risk of introducing hazards, all modifications and maintenance activities are strictly reserved to properly qualified and trained service technicians. In daily use, any electrical equipment may be subject to parts wear and eventual failure. In order to maintain safety and reliability, the Customer Engineer (hereafter called CE) must perform regular maintenance inspections.</p>	
---	---

General

<p>Make sure that the folder is placed on a level, horizontal surface of sufficient strength. See the respective specifications sheet for the weight of the equipment Always use materials for the respective folder. Materials not approved can cause faults in the folder. Do not use the folder when it is emitting unusual sounds. Remove the plug from the power socket or turn off the fixed connection to the electricity grid and contact Customer Service. Do not use the folder in rooms which are subject to excessive vibration. Move the folder careful and slow using two persons. Set the adjustable feet on the ground when the folder is in the desired position</p>	
---	---



KIPFold 1800 User Guide

Main connection cable

Do not use different connector cables, other than supplied with the folder. When replacement of the power supply cable is required because of damage or defect, contact your CE for proper replacement of this power supply cable.



Mains connection

Do not use an extension cable to connect the machine.
This machine is not designed for connection to an IT power supply system. An IT power system is voltage network in which the neutral wire is not connected to earth.
When the machine is connected through a wall-socket, place the machine near a wall-socket that is easily accessible.
When the machine is connected through a fixed connection to the electricity grid, the disconnect device in the fixed connection must be easily accessible.
The machine must be connected to an earth (grounded) outlet.



Measures to take in case of an accident

1. If an accident has occurred, the distributor who has been notified first must immediately take emergency measures to provide relief to affected persons and to prevent further damage.
2. If a report of a serious accident has been received from a customer, an onsite evaluation must be carried out quickly by an authorised person.
3. To determine the cause of the accident, conditions and materials must be recorded through direct on-site checks, in accordance with instructions.
4. For reports and measures concerning serious accidents, follow the regulations specified by the distributor.



Disclaimer

These safeguards have been compiled to the best of our knowledge. They are intended as a compact guide to the safe handling of the product. We reserve the right to revise specification data sheets, as new information becomes available. It is the user's responsibility to determine the suitability of this information for the adoption of safety precautions as may be necessary. It is the user's responsibility to ensure that the specification data sheets are the latest ones issued. If and in so far as limitation of liability is permitted under the applicable laws, we do not accept liability for any inaccuracy that may occur in this information.



KIPFold 1800 User Guide

Machine Dimensions (Metric)

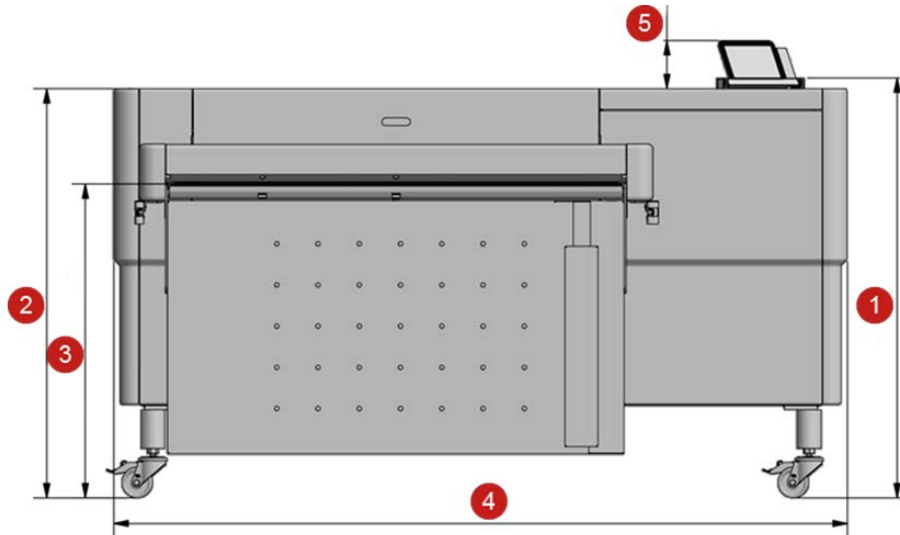

1. 1019mm (shipment height)
2. 899mm - 1040mm (no riser), 1119mm - 1260mm (220mm riser)
3. 665mm - 806mm (no riser), 885mm - 1026mm (220mm riser)
4. 1778mm
5. 26mm - 126mm (depending on the angle of the tablet)

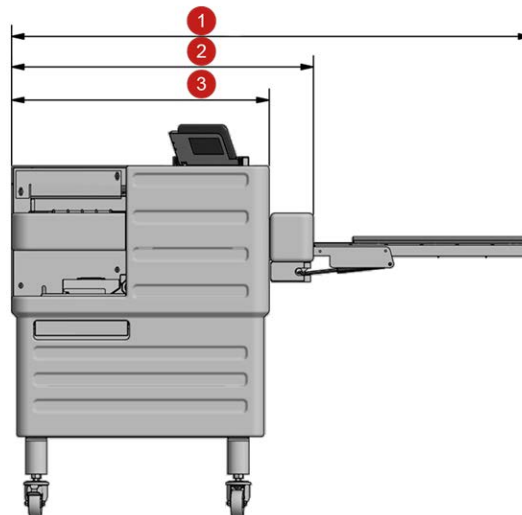

1. 1465mm
2. 852mm
3. 727mm



KIPFold 1800 User Guide

Conveyor tray extension

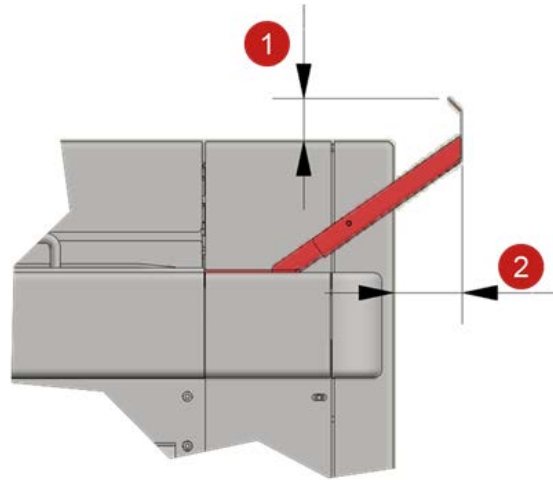

1. 43mm
2. 69mm



KIPFold 1800 User Guide

Machine Dimensions (Inch)

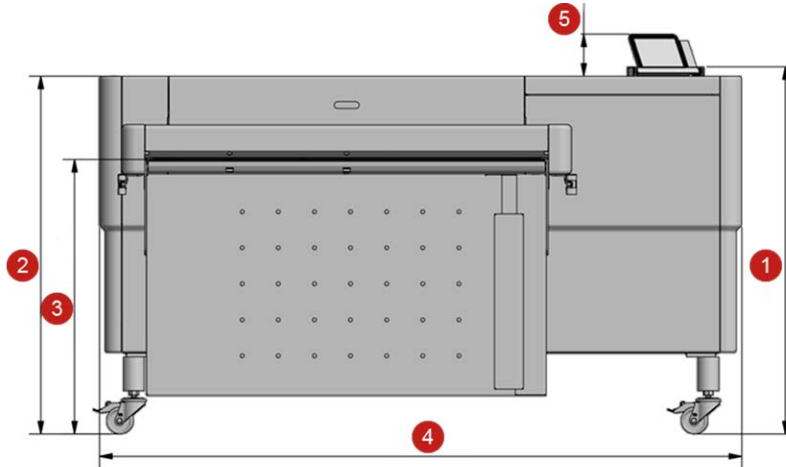

1. 40.12" (shipment height)
2. 35.39" - 40.94" (no riser), 44.06" - 49.61" (8.66" riser)
3. 26.18" - 31.73" (no riser), 34.84" - 40.39" (8.66" riser)
4. 70"
5. 1.02" - 4.96" (depending on the angle of the tablet)

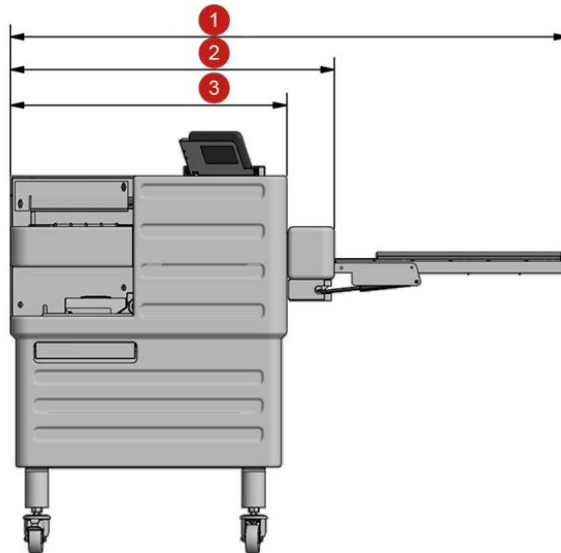

1. 57.68"
2. 33.54"
3. 28.62"



KIPFold 1800 User Guide

Conveyor tray extension

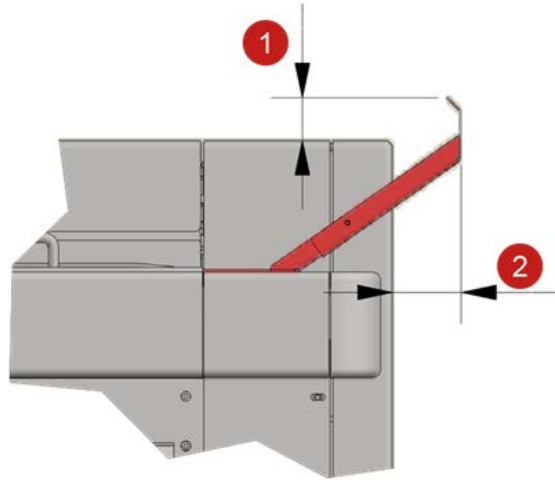

1. 1.69"
2. 2.7"



KIPFold 1800 User Guide

Machine Specifications (Metric)

Cross Fold Tray Performance	<ul style="list-style-type: none"> • 80 mixed documents at 80gr/sqm • 20 A0 at 80/sqm
Min. document length	<ul style="list-style-type: none"> • 210mm as unfolded cover sheet • 420mm to be folded
Max. document length Fan fold only	<ul style="list-style-type: none"> • 28 layers with 80 gsm paper • absolute document length depends on panel width (approx. 28 x panel width)
Max document length Fan and cross fold	<ul style="list-style-type: none"> • 12 layers with 80gsm paper • 17 layers with stacking capacity limited to 3 packages • absolute document length depends on panel width (approx. 12 x panel width)
Min. document width Max. document width	<ul style="list-style-type: none"> • 279mm • 914mm
Paper weight best quality with	<ul style="list-style-type: none"> • 60g/m² - 110g/m² • 75g/m² - 80g/m²
Panel width fan folder Panel width cross fold Margin	<ul style="list-style-type: none"> • 170 - 230mm • 250 - 320mm • 0 - 40mm
Folding speed	<ul style="list-style-type: none"> • 2,5 - 10m/min
Fold programs	<ul style="list-style-type: none"> • 255 – editable
Temperature	<ul style="list-style-type: none"> • 15°C - 35°C
Humidity	<ul style="list-style-type: none"> • 20% - 80%
Power supply	<ul style="list-style-type: none"> • 100V – 120V 50/60Hz • 200V – 240V 50/60Hz
Main Fuse	<ul style="list-style-type: none"> • 10A
Consumption standby Consumption max.	<ul style="list-style-type: none"> • 50W • 400W
Weight	<ul style="list-style-type: none"> • 332kg



KIPFold 1800 User Guide

Machine Specifications (Inch)

Cross Fold Tray Performance	<ul style="list-style-type: none"> • 80 mixed documents at 20lb • 20 E-size at 20lb
Min. document length	<ul style="list-style-type: none"> • 8.5" or 9" as cover sheet • 16.5 to be folded
Max. document length Fan fold only	<ul style="list-style-type: none"> • 28 layers with 20lb paper • absolute document length depends on panel width (approx. 28 x panel width)
Max document length Fan and cross fold	<ul style="list-style-type: none"> • 12 layers with 20lb paper • 17 layers with stacking capacity limited to 3 packages • absolute document length depends on panel width (approx. 12 x panel width)
Min. document width Max. document width	<ul style="list-style-type: none"> • 11" • 36"
Paper weight best quality with	<ul style="list-style-type: none"> • 16lb - 30lb • 20lb - 24lb
Panel width fan folder Panel width cross fold Margin	<ul style="list-style-type: none"> • 6.70" - 9.00" • 10.00" - 12.0 0" • 0" - 1.1/2"
Folding speed	<ul style="list-style-type: none"> • 8.2 - 32.8 ft/min
Fold programs	<ul style="list-style-type: none"> • 255 – editable
Temperature	<ul style="list-style-type: none"> • 59°F - 95°F
Humidity	<ul style="list-style-type: none"> • 20% - 80%
Power supply	<ul style="list-style-type: none"> • 100V – 120V 50/60Hz • 200V – 240V 50/60Hz
Main Fuse	<ul style="list-style-type: none"> • 10A
Consumption standby Consumption max.	<ul style="list-style-type: none"> • 50W • 400W
Weight	<ul style="list-style-type: none"> • 732lb



KIPFold 1800 User Guide

Power & Switch On



Please use only the power cable supplied with the folder.

100 - 240 VAC 50/60Hz 10A

Do not use multi plug extension cords!

These cords will not stand the power consumption of printer and folder.

- The power supply box is at the folder's right bottom side.
- The main switch of the machine is next to the power cable connector.
- Find the folders serial number on the rating plate next to the switch.
- The machine can be completely switched off by disconnecting the power cable.
 - This area must be accessible at all times





KIPFold 1800 User Guide

Basic Screens on the Folder

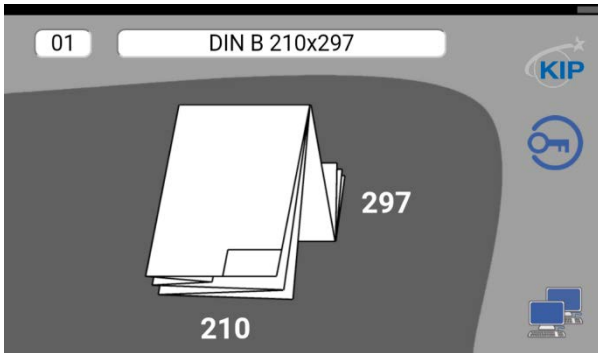

The folder runs a self-test of the system.

The standard start screen appears in the display, if the test runs without any problem.

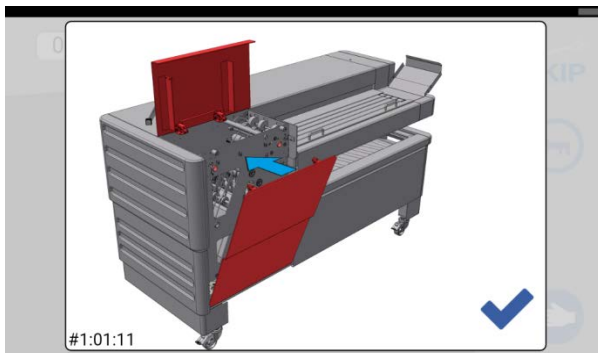

In case a problem is detected during the self-test, the screen shows an error code.

Please refer to the Trouble Shooting for more information.



When Connected to the KIP Printer, if this image is displayed on the Folder Screen the KIP Printer is controlling the folder in an online condition. In order to put the folder into an Offline state, at the touch screen of the printer select the **Folder Offline** button.



KIPFold 1800 User Guide

Main Folder Screen – Offline Mode

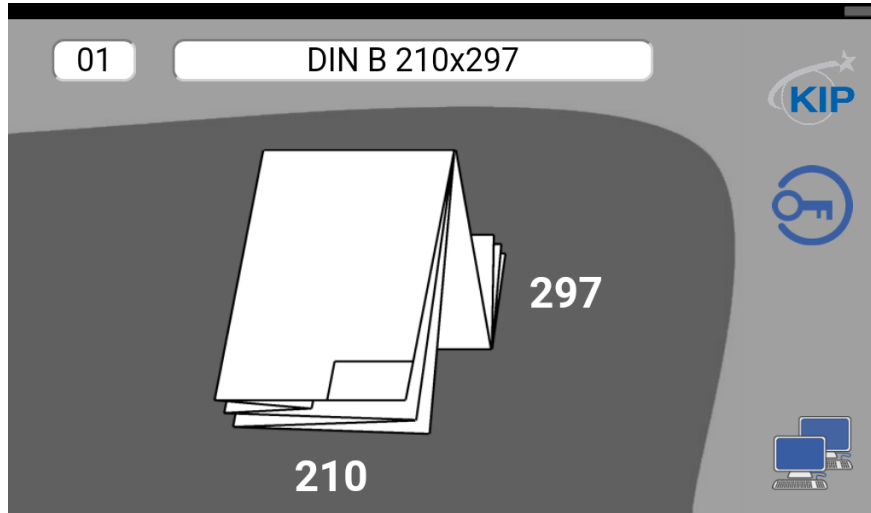

	<p>Shows the contact information of the technical service</p>
	<p>Program editor / Service Mode</p>
<p>DIN B 210x297</p>	<p>Opens a list of available folding programs.</p>



KIPFold 1800 User Guide

Media and formats

<u>Format limits</u>	
Fan Folder	All documents with length from 210 mm (8.5") up to 6.000 mm (19,6 ft) (80 gr. Paper) or unlimited length (option) and width up to max. 914 mm (36").
Cross Folder	Maximum paper length of 2500 mm. Longer copies will not be transported into the cross folder but deployed fan folded off to the left side of the folder.
<u>Recommended media</u>	
The paper weight should not be less than 60 g/m ² (18#) and not more than 110 g/m ² .(24#)	
For application media types, please contact your dealer.	
	Film or materials with glossy shiny surfaces are not suitable.



KIPFold 1800 User Guide

Select and customise programs

Select a folding program for offline function by pressing on the name of the fold currently selected.

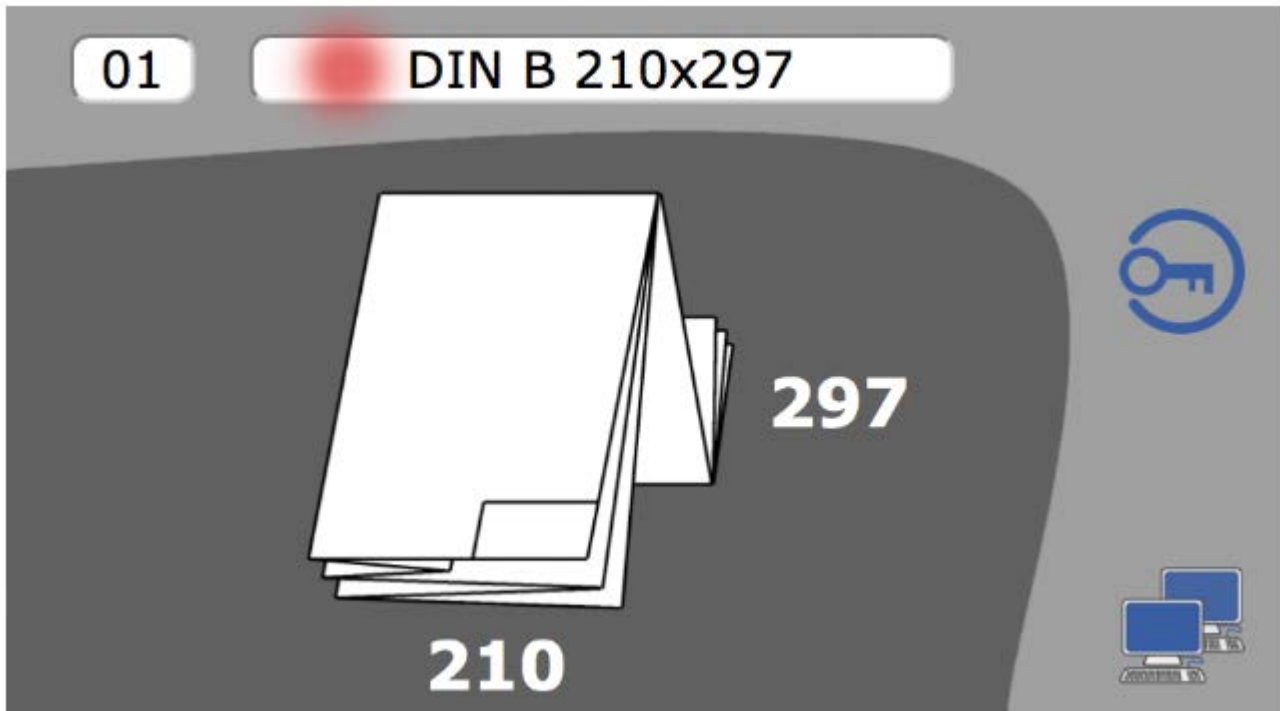

Select the desired program.





KIPFold 1800 User Guide

Online Folding



In most cases the title block (legend) has to be on the leading edge of the document entering the folder. The title block position has to be set in the KIP software you are using.

If the printer reports the size of the copy, it is possible to print A1 and A2 (C-size and D-size) in landscape orientation. In this case the title block has to be at the leading edge for A1 or D-size and on the trailing edge for A2 or C-size

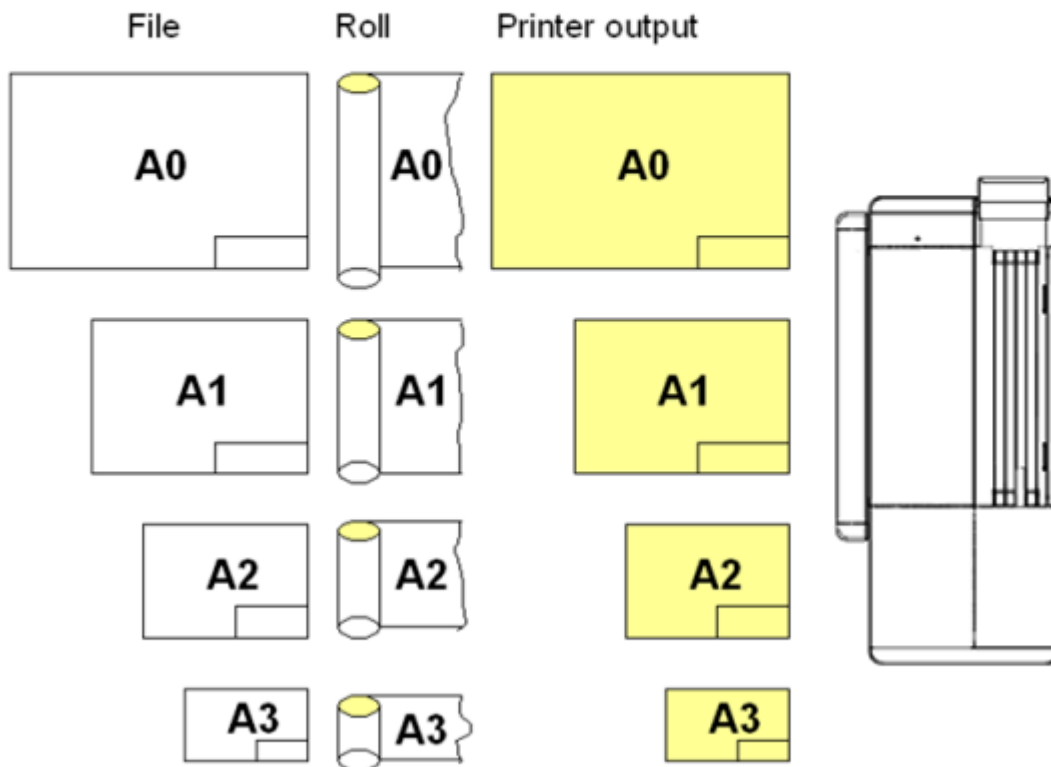



KIPFold 1800 User Guide

Using the KIPFold 1800 with KIP Print Management Suite

KIP System K applications allow either the selection of a folder preset packet and/or the creation of customised folder presets

KIP Applications/Function:

- KIP PrintPro Creation & Selection
- KIP PrintPro.Net Creation & Selection
- KIP Windows Driver Selection Only
- KIP AutoCAD Driver Selection Only

KIP ImagePro and Folding

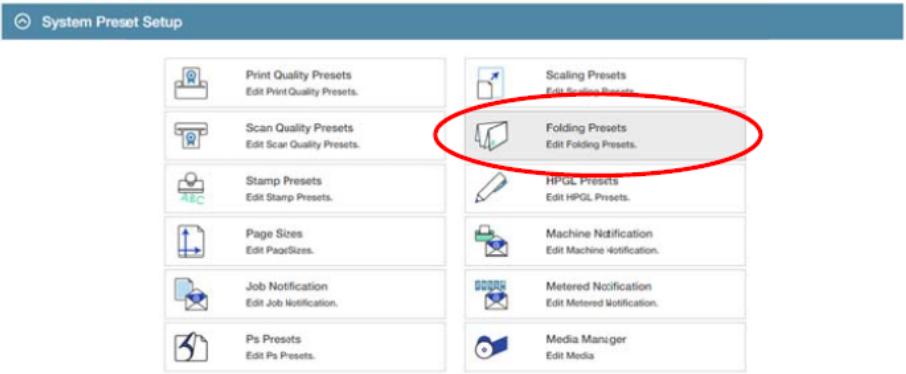

Folder Preset Creation

Component	Function
1. System Preset Setup	 <p>The screenshot shows the 'System Preset Setup' window with a grid of preset categories. The 'Folding Presets' category is highlighted with a red oval. The categories and their sub-options are:</p> <ul style="list-style-type: none">Print Quality Presets (Edit Print Quality Presets.)Scan Quality Presets (Edit Scan Quality Presets.)Stamp Presets (Edit Stamp Presets.)Page Sizes (Edit Page Sizes.)Job Notification (Edit Job Notification.)Ps Presets (Edit Ps Presets.)Scaling Presets (Edit Scaling Presets.)Folding Presets (Edit Folding Presets.)HPGL Presets (Edit HPGL Presets.)Machine Notification (Edit Machine Notification.)Metered Notification (Edit Metered Notification.)Media Manager (Edit Media)



KIPFold 1800 User Guide

To create a folding Preset follow these steps.

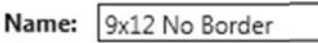
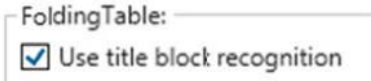
Step	Action	Illustration
1.	Select the Folding Presets button from the Printer Information page.	 A blue button with a white icon of a folded sheet of paper. The text on the button reads "Folding Presets" and "Edit Fdding Presets." (Note the typo in the image).
2.	Select the New Button	 A small blue icon of a document with a plus sign, followed by the text "New".
3.	Name – This is the name that will be displayed in the Preset list of names and will be displayed on the main screen.	 The text "Name:" followed by a text input field containing the text "9x12 No Border".
4.	Use Title Block Recognition – Checking this box enables Auto Title Block Recognition/Location.	 The text "FoldingTable:" followed by a horizontal line, and below it a checked checkbox with the text "Use title block recognition".



KIPFold 1800 User Guide

Step	Action	Illustration
5.	Folding Table – This area is where all settings for the Fold Parameters are made.	
<p>The Folding Table Icon Explained:</p> <ol style="list-style-type: none">1. Media Width2. Fold Packet3. Title Block Location (Used when Title Block Recognition is checked)4. Alignment – Used to shift the image Left, Centre, Right when the image is smaller than the paper size.5. Rotation – For Portrait View6. Rotation – For Landscape View7. Minimum Width / Short Edge (see note)8. Maximum Width / Short Edge (see note)9. Minimum Length/ long Edge (see note)10. Maximum Length / Long Edge (see note)11. Snap to Cut Length – Add blank paper to the trailing edge of the copy.12. Inter Copy Delay – in tenth of a second for fast printers or when tab applicator option is used. <p>Note: For #'s 7, 8, 9 and 10 – This configures the Minimum & Maximum for X&Y so that the software knows what size the drawing is and what roll size/fold packet/alignment/rotation/snap length/inter-copy delay are applied.</p>		



KIPFold 1800 User Guide

Step	Action	Illustration
6.	<p>Media Width – Select the desired Media Width to be used.</p>	
7.	<p>Fold Packet – Allows for the selection of the fold packet to be used.</p>	
8.	<p>Title Block Location – Allows for the selection of the title block Location.</p> <p>Note: when Use title block recognition is selected it is necessary to indicate where you want the title block to be.</p>	

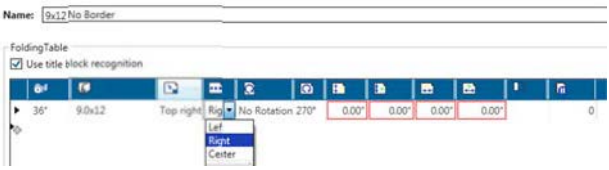
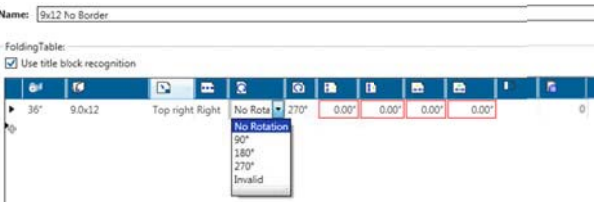
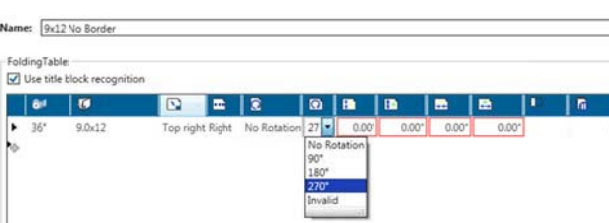
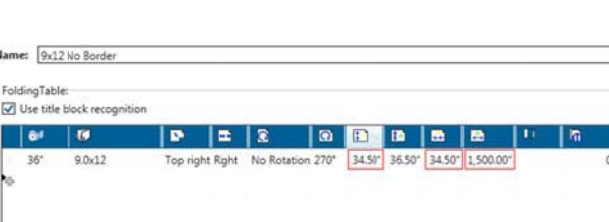

KIPFold 1800 User Guide

<p>9.</p>	<p>Alignment – Allows for the selection of Left, Right or Centre for alignment.</p>	
<p>10.</p>	<p>Rotation for Portrait – allows for the setting of a rotation for Portrait documents.</p>	
<p>11.</p>	<p>Rotation for Landscape – allows for the setting of a rotation for Landscape documents.</p>	
<p>12.</p>	<p>Minimum width or short edge Maximum width or short edge Minimum Length or long edge Maximum Length or long edge</p> <p>Note: This configures the Minimum & Maximum for X&Y so that the software knows what size the drawing is and what roll size/fold packet/alignment/rotation/snap length/inter-copy delay are applied.</p>	



KIPFold 1800 User Guide

<p>13.</p>	<p>Snap to Cut Length - Add blank paper to the trailing edge of the copy.</p> <p>Note: For this example this setting is not used.</p>	
<p>14.</p>	<p>Inter Copy Delay - in tenth of a second for fast printers or when tab applicator option is used.</p> <p>Note: For this example this setting is not used.</p>	
<p>15.</p>	<p>Reset, Save, Save (activated) –</p> <p>If the settings are not correct select “Reset” to start over.</p> <p>Select “Save” to save the settings.</p> <p>Select “Save (activated)” to save the settings and have them be active and available for use.</p>	
<p>16.</p>	<p>New Fold Preset – the new fold Preset will now be displayed in the left hand column under Custom.</p>	



KIPFold 1800 User Guide

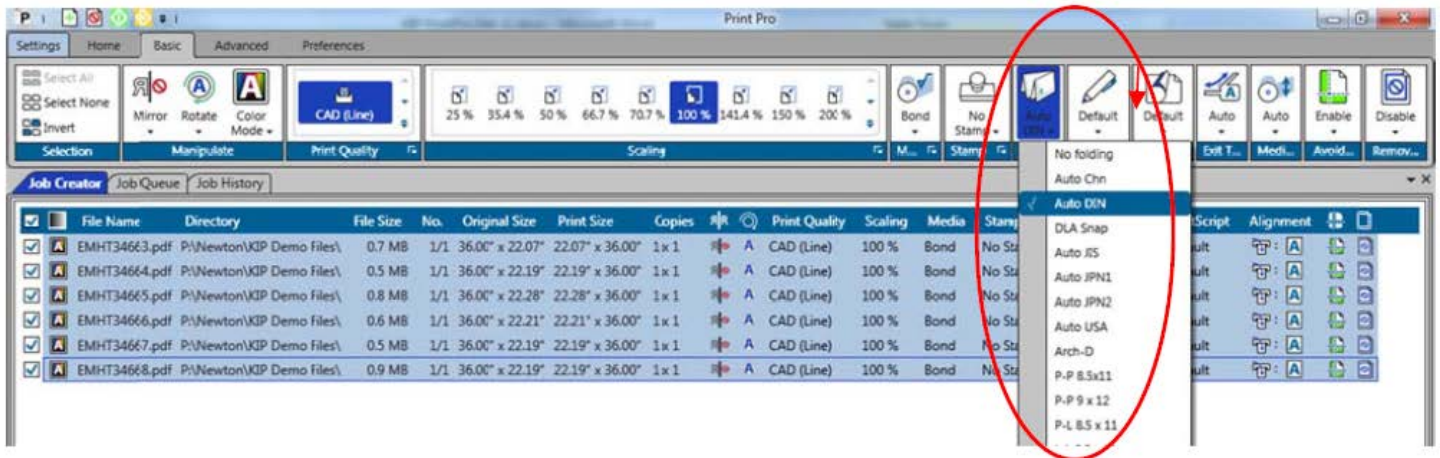

Method 2

Selected File – The folding column will display the selected Fold Pattern being applied.

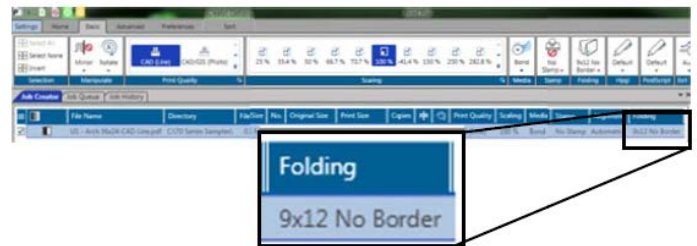

Folder Preset Selection

Method 1

In this method the fold packet to be used will be selected first by clicking the Fold button in the Basic tab ribbon bar. Once here select the desired Folder Packet setting to be applied to the entire job. Doing this procedure prior to selecting the files to be printed will then apply the selected fold packet to all selected files making everything in the job ticket print and fold the same way.



KIPFold 1800 User Guide

Method 2

In this method files will be added to the job ticket in the usual manner Home tab, (Add Files, Browse for and select files, add them to the job to be printed). Once the files to be printed have been added, go to the Basic tab and using the dropdown menu in the Fold column, each file can be given a different fold packet. This method can be used when a job has to be folded in a very specific way.

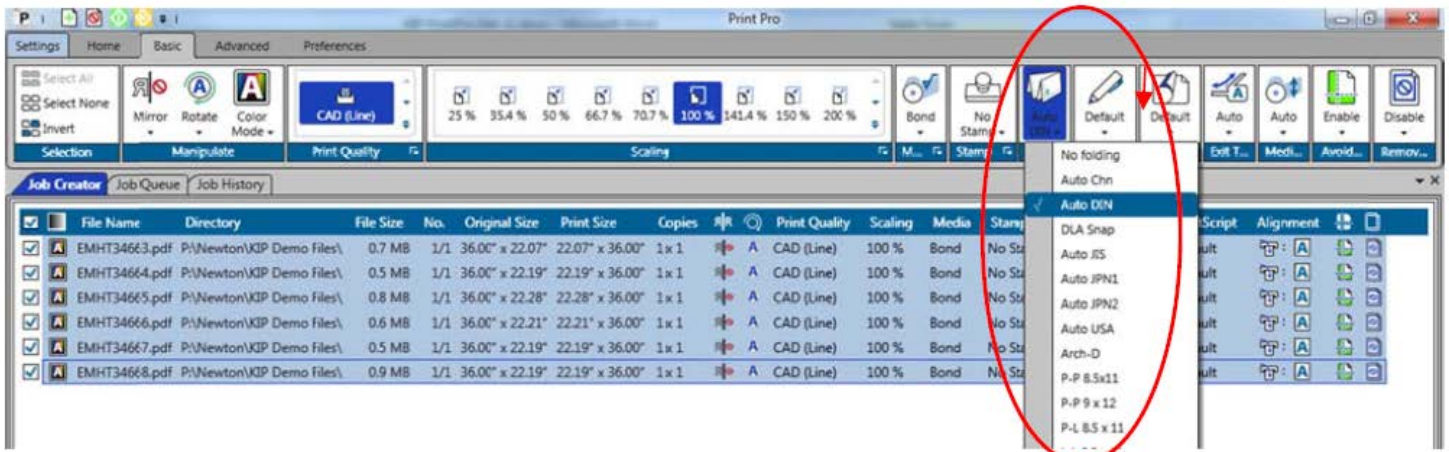





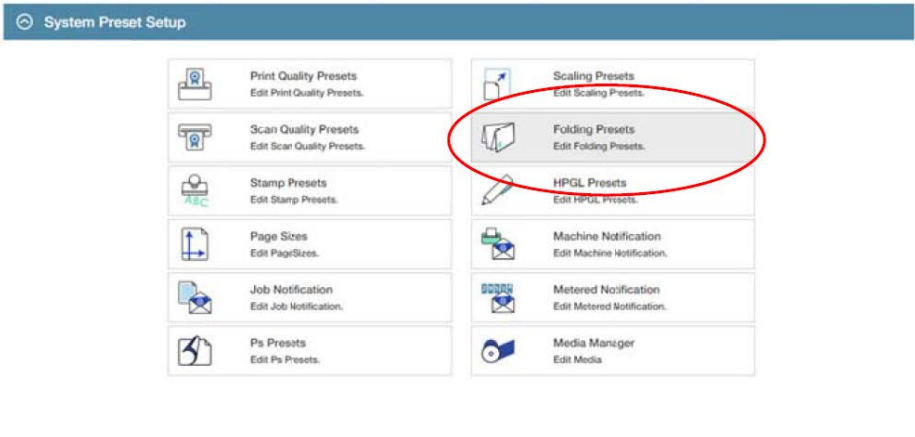

KIPFold 1800 User Guide

KIP PrintPro.Net and Folding

Folder Preset Creation

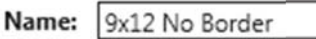
Component	Function
1. System Preset Setup	 <p>Template setup has many functions within this section. These are explained individually here.</p>

Step	Action	Illustration
1	Select the Folding Presets button from the Printer Information page.	
2.	Select the New Button	
3.	Name – This is the name that will be displayed in the Preset list of names and will be displayed on the main screen.	
4.	Use Title Block Recognition – Checking this box enables Auto Title Block Recognition/Location.	



KIPFold 1800 User Guide

Step	Action	Illustration
	<p>Folding Table – This area is where all settings for the Fold Parameters are made.</p>	
	<p>The Folding Table Icon Explained:</p> <ol style="list-style-type: none"> 1. Media Width 2. Fold Packet 3. Title Block Location (Used when Title Block Recognition is checked) 4. Alignment – Used to shift the image Left, Centre, Right when the image is smaller than the paper size. 5. Rotation – For Portrait View 6. Rotation – For Landscape View 7. Minimum Width / Short Edge (see note) 8. Maximum Width / Short Edge (see note) 9. Minimum Length/ long Edge (see note) 10. Maximum Length / Long Edge (see note) 11. Snap to Cut Length – Add blank paper to the trailing edge of the copy. 12. Inter Copy Delay – in tenth of a second for fast printers or when tab applicator option is used. <p>Note: For #'s 7, 8 9, 10 – This configures the Minimum & Maximum for X&Y so that the software knows what size the drawing is and what roll size/fold packet/alignment/rotation/snap length/inter-copy delay are applied.</p>	



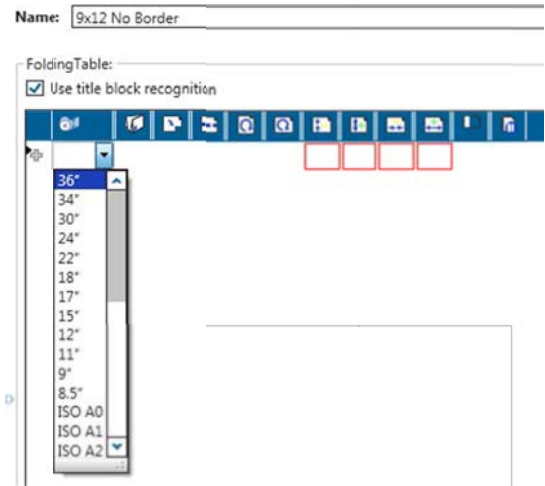
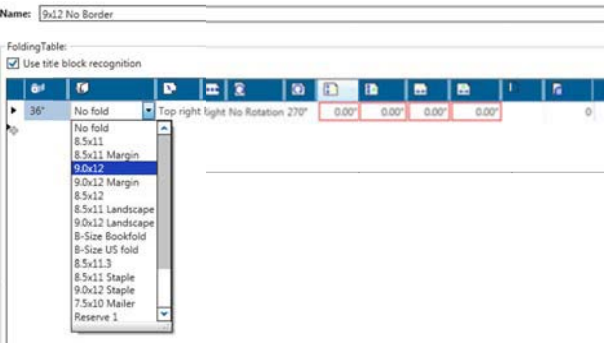
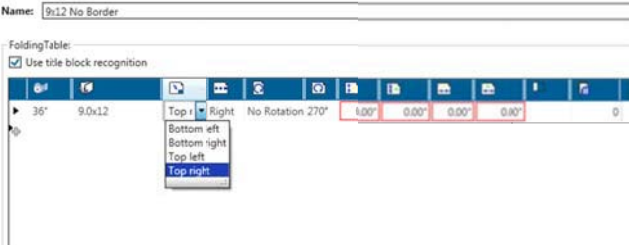

KIPFold 1800 User Guide

Step	Action	Illustration
1.	Media Width – Select the desired Media Width to be used.	
2.	Fold Packet – Allows for the selection of the fold packet to be used.	
3.	Title Block Location – Allows for the selection of the title block Location. Note: when Use title block recognition is selected it is necessary to indicate where you want the title block to be.	



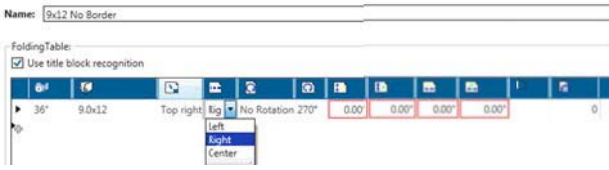

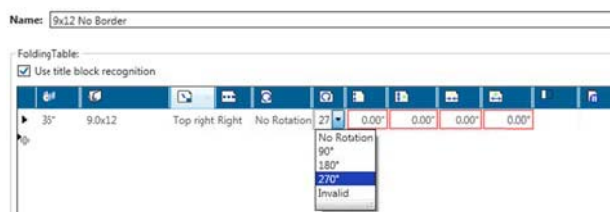
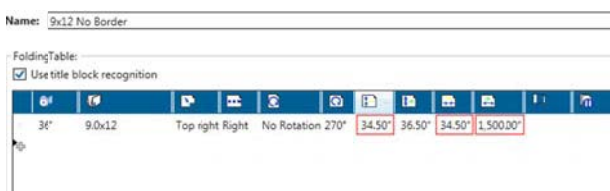

KIPFold 1800 User Guide

4.	Alignment – Allows for the selection of Left, Right or Centre for alignment.	
Step	Action	Illustration
1.	Rotation for Portrait – allows for the setting of a rotation for Portrait documents.	
2.	Rotation for Landscape – allows for the setting of a rotation for Landscape documents.	
3.	Minimum width or short edge Maximum width or short edge Minimum Length or long edge Maximum Length or long edge Note: This configures the Minimum & Maximum for X&Y so that the software knows what size the drawing is and what roll size/fold packet/alignment/rotation/snap length/inter-copy delay are applied.	

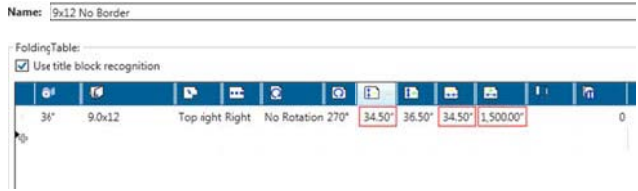
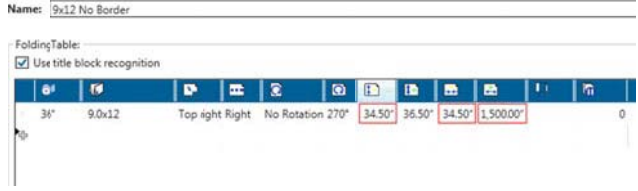

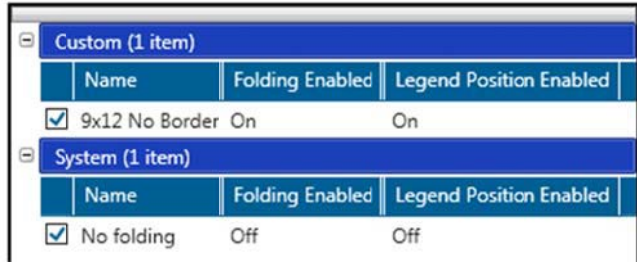
KIPFold 1800 User Guide

<p>4.</p>	<p>Snap to Cut Length - Add blank paper to the trailing edge of the copy.</p> <p>Note: For this example this setting is not used.</p>	
<p>5.</p>	<p>Inter Copy Delay - in tenth of a second for fast printers or when tab applicator option is used.</p> <p>Note: For this example this setting is not used.</p>	
<p>6.</p>	<p>Reset, Save, Save (activated) –</p> <p>If the settings are not correct select “Reset” to start over.</p> <p>Select “Save” to save the settings.</p> <p>Select “Save (activated)” to save the settings and have them be active and available for use.</p>	
<p>7.</p>	<p>New Fold Preset – the new fold Preset will now be displayed in the left hand column under Custom.</p>	
<p>8.</p>	<p>Folding from KIP ImagePro – Once the Folding Preset has been created and saved as active it can be selected and applied to jobs. Select the drop down arrow in the Folding button and pick the 9x12 No Border that was just created.</p>	



KIPFold 1800 User Guide

1. **Selected File** – The folding column will display the selected Fold Pattern being applied.

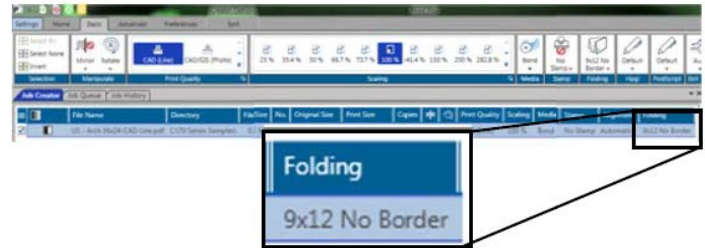

Folder Preset Creation

In PrintPro.Net there are two methods for printing and selecting fold presets using the KIPFold 1800.

Method 1

In this method the fold packet to be used will be selected first by clicking the Fold button in the Basic tab ribbon bar. Once here select the desired Folder Packet setting to be applied to the entire job. Doing this procedure prior to selecting the files to be printed will then apply the selected fold packet to all selected files making everything in the job ticket print and fold the same way.

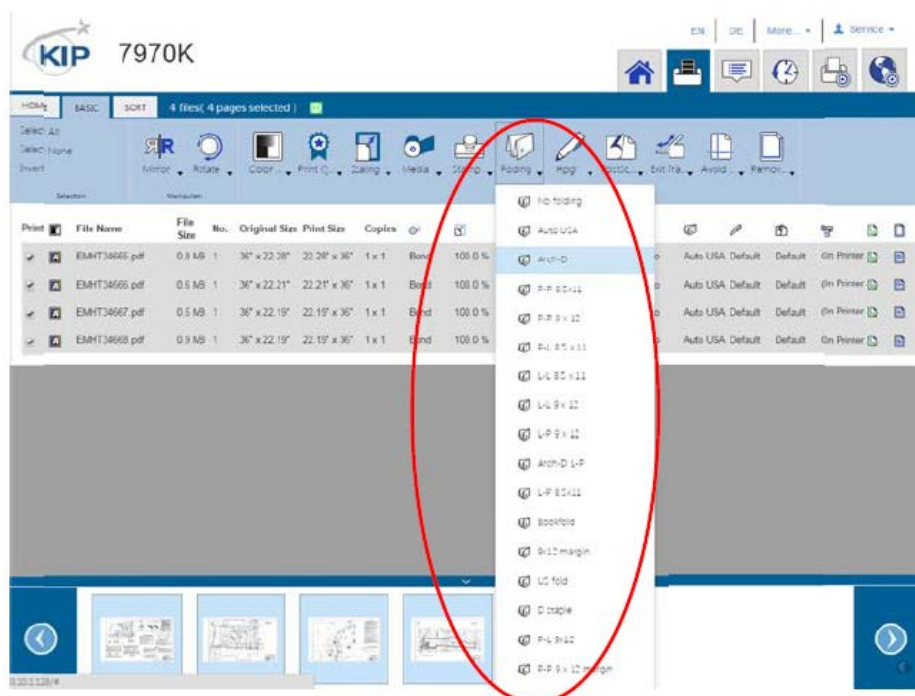

No part of this publication may be copied, reproduced or distributed in any form without express written permission from KIP. © KIP. All references subject to change without notice



KIPFold 1800 User Guide

Method 2

In this method files will be added to the job ticket in the usual manner Home tab, (Add Files, Browse for and select files, add them to the job to be printed). Once the files to be printed have been added, go to the Basic tab and using the dropdown menu in the Fold column, each file can be given a different fold packet. This method can be used when a job has to be folded in a very specific way.

The screenshot shows the KIP software interface for job 7970K. The 'BASIC' tab is active, and four files are selected. The 'Folding' option in the 'Other Options' toolbar is highlighted with a red circle. In the file list, the 'Arch-D' option in the 'Fold' column is also highlighted with a red circle.

Print	File Name	File Size	No.	Original Size	Print Size	Copies												
<input checked="" type="checkbox"/>	EMHT34665.pdf	0.8 MB	1	36' x 22.28'	22.28' x 36'	1 x 1	Bond	100.0 %			CAD (Line)	No Stamp Auto	Arch-D	Default	Default	On Printer		
<input checked="" type="checkbox"/>	EMHT34666.pdf	0.6 MB	1	36' x 22.21'	22.21' x 36'	1 x 1	Bond	100.0 %			CAD (Line)	No Stamp Auto	Auto USA	Default	Default	On Printer		
<input checked="" type="checkbox"/>	EMHT34667.pdf	0.5 MB	1	36' x 22.19'	22.19' x 36'	1 x 1	Bond	100.0 %			CAD (Line)	No Stamp Auto	Auto USA	Default	Default	On Printer		
<input checked="" type="checkbox"/>	EMHT34668.pdf	0.9 MB	1	36' x 22.19'	22.19' x 36'	1 x 1	Bond	100.0 %			CAD (Line)	No Stamp Auto	Auto USA	Default	Default	On Printer		



KIPFold 1800 User Guide

KIP Windows Driver and Folding

When using the KIP Windows Driver to print and fold files follow these steps:

1. Select the file to be printed in the appropriate application. For this example Adobe is being used.
2. Go to File and select Print
3. When the Print window opens select the installed KIP Windows Driver and then select the Properties button.
4. When the Properties button opens select the finishing button.

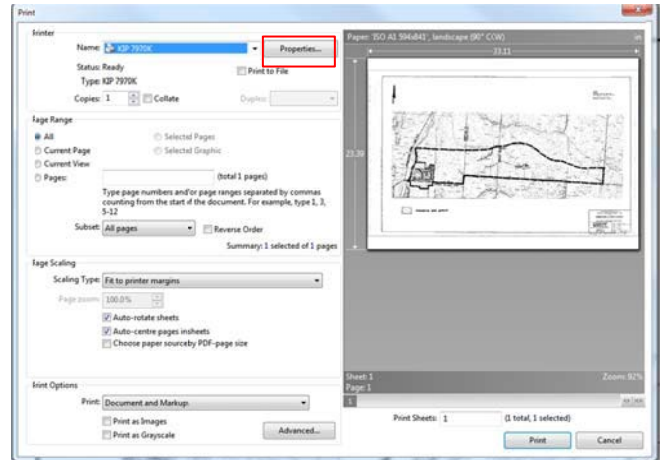

5. Under Finishing use the pull down to select one of the available Presets
6. Select the Desired Fold Packet.

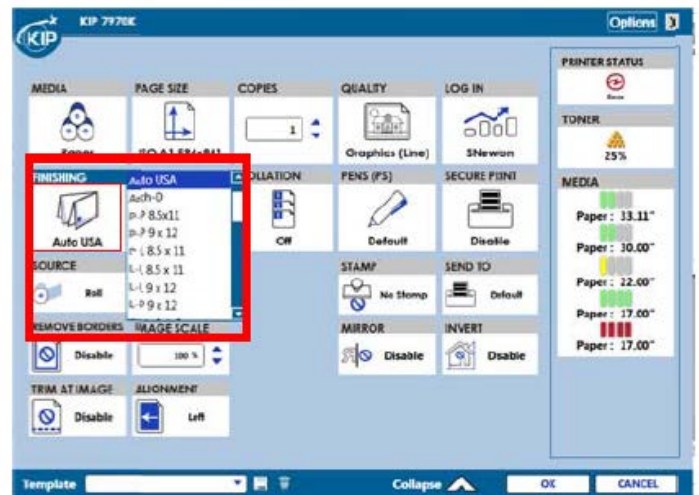

No part of this publication may be copied, reproduced or distributed in any form without express written permission from KIP. © KIP. All references subject to change without notice



KIPFold 1800 User Guide

KIP AutoCAD and Folding

When using the KIP AutoCAD Driver to print and fold files follow these steps:

1. From within AutoCAD go to File and then print.
2. Double click the installed KIP AutoCAD driver.

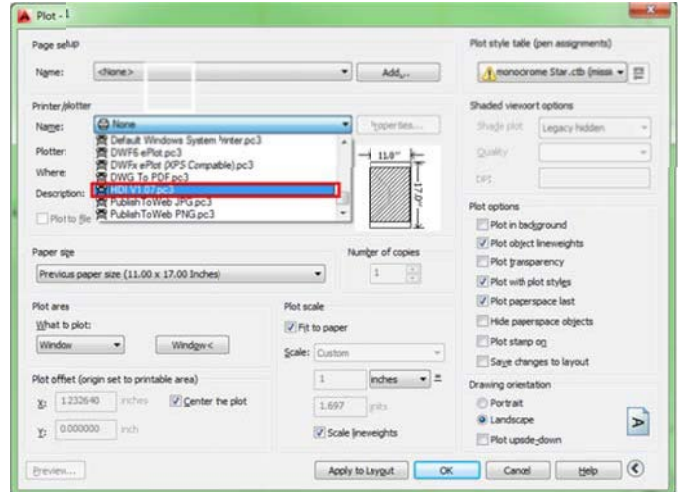

3. This will open the Plotter Configuration Editor
4. Select the Device and Document Settings Tab
5. Select the Custom Properties option
6. Select the Custom Properties button

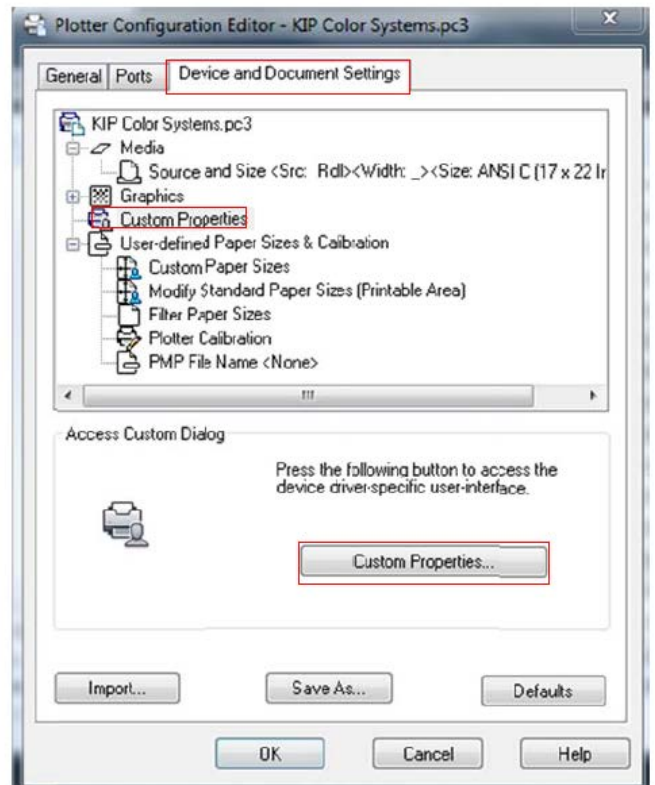



KIPFold 1800 User Guide

- Once the custom properties window opens under Media Options select the Folder Button.
- Select any of the available presets to apply that setting to the files being printed.

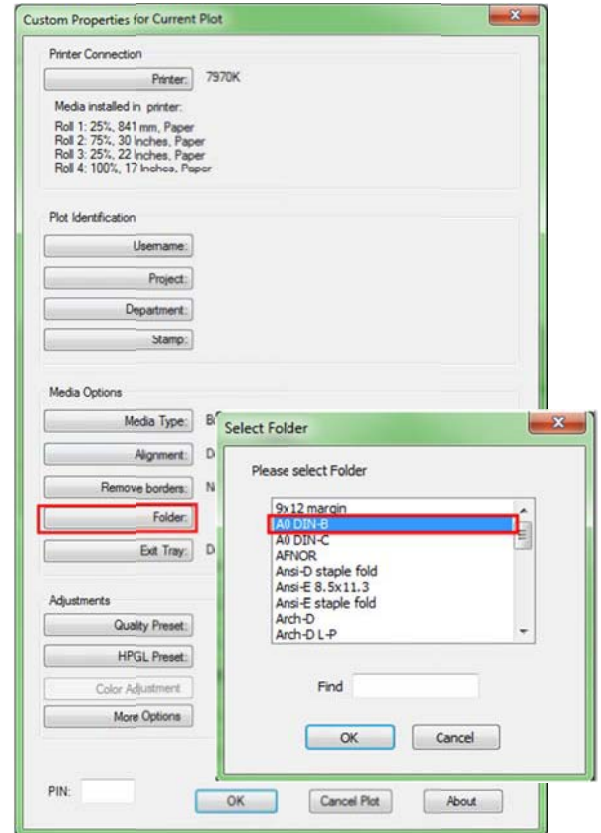

- Select OK to set this
- Select OK again to return to the print screen and submit the file.

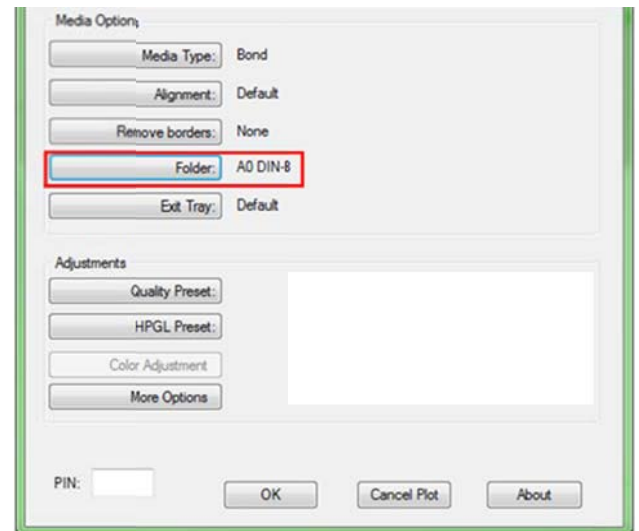



KIPFold 1800 User Guide

Troubleshooting

In case an issue occurs, an error code will be shown on the tablet screen

This could be a open cover or a paper jam

If there is remaining paper pinched between fold rollers or other turning parts close the covers and press the purge button **(2)**. All transport belts and rollers will be switched on until you press the button again.

After taking out the jammed paper or closing the cover, the folder needs to be restarted by clicking on the exit button **(3)**

The folder will reboot now and check the paper path again.
This takes approx. 20 seconds. Thereafter, the folder will be ready.

The "key" button **(1)** gives the technician the possibility to enter the service menu.





KIPFold 1800 User Guide

How To clean start-up errors 22:xx / 82:xx

After a start-up error has occurred you have to make sure that no paper is still located inside the machine.

Such errors could be for example:

- 22:xx - for Fan Folder start-up errors
- 82:xx - for Cross Folder start-up errors

Always use the purge function before you remove any paper remains by hand.

In case of Fan Folder errors open the red highlighted cover **(2)** and remove every piece of paper between the fold rollers and from the paper path. Close the cover.

In case of Cross Folder errors open cover **(1)** and remove every piece of paper between the transport belts, inside the Tilt Tray and below it. Close the cover. Also lift the fan unit **(3)** and remove the paper under it.





KIPFold 1800 User Guide

How to purge

- Do not open the bridge and do not remove the prints manually
- Use purge every time at first



- On the screen of the folder, there is an error message with “Sensor S-XX cut”.
- The purge function is placed at the upper right corner.



- Press and hold the purge button!
- If the cleaning phase is passed, you can stop to hold its.
- Finally check the folder. It should be empty of any packages.



KIPFold 1800 User Guide



The Color of KIP IS GREEN

KIP IS COMMITTED TO PRODUCT DESIGNS THAT PROMOTE ENVIRONMENTAL HEALTH AND SUSTAINABILITY. OUR GOAL IS TO CONSISTENTLY IMPROVE AND REFINED THE TECHNOLOGIES IN KIP PRODUCTS THAT KEEP OUR PLANET GREEN.

The greatest environmental benefit of KIP products is through the actual operation of our products and solutions. We improve the customer experience by integrating environmental considerations into our business strategy – resulting in superior products.

Customers increasingly value environmental aspects of products, such as energy efficiency, emissions reduction and the ability to recycle exhausted supply containers. We differentiate our products by integrating such features to deliver a low total cost of ownership and an improved user experience.

- Energy Star Qualified • ROHS Compliance • ISO 14001 Standards
- Ozone Emissions Filters • UL/UL-C Approved • 100% Toner Efficiency – No Waste Toner • Organic, Recyclable Photoreceptors • Recyclable Toner Containers • Prints on Recycled Paper • Automatic Image Rotation and Media Selection Ensure Minimal Paper Waste



ENVIRONMENTAL RESPONSIBILITY



WWW.KIP.COM