



## User Manual

# Digi-Sense<sup>®</sup> TC9500 Advanced Multiparameter Temperature Controller with Thermocouple, Thermistor, and RTD Inputs Models 89800-03 and 89800-04



**Test Equipment  
Depot**  
1-800-517-8431

99 Washington Street  
Melrose, MA 02176  
Phone 781-665-1400  
Toll Free 1-800-517-8431

 Visit us at [www.TestEquipmentDepot.com](http://www.TestEquipmentDepot.com)

THE STANDARD IN PRECISION MEASUREMENT



## Table of Contents

Introduction.....	3
Unpacking .....	3
Controller Description—Front Panel.....	4
Controller Description—Back Panel.....	5
Controller Description—Active Display Screen .....	6
Setup and Operation .....	7
Initial Setup .....	7
Basic Operation Setup.....	7
Auto Tune Setup .....	7
PID Control Mode Setup (Default Mode).....	8–16
ON/OFF Control Mode Setup.....	17–24
Ramp & Soak Control Mode Setup .....	25–33
Ramp Rate Control Mode Setup .....	25–33
Data Acquisition Software .....	34–37
Safety .....	38
Specifications for Controller Models.....	39–40
Specifications for Sensor Inputs .....	41
Screen Flow Charts.....	42–43
General Setup Flow Chart .....	42
Advanced Menu Setup Flow Chart .....	43
RTD Wiring Instructions .....	44
Ferrite Clip Installation.....	44
Alternative Power Cords—for Various Countries .....	45
Output Cord Adapters—for Various Countries .....	46
Approvals .....	47
Maintenance.....	48

## **Introduction**

The Digi-Sense TC9500 Advanced Multiparameter Temperature Controller (Models 89800-03 and 89800-04) is designed to regulate a user-defined set point temperature. The Ramp/Soak and Ramp Rate features allow up to a 40-step profile using; time, hold, soak and end. Which allows you to create the ideal profile for your process. The microprocessor control uses a PID algorithm that provides precise heating/cooling tolerances for demanding applications in the laboratory or industrial settings. Advanced features include a USB communication port, audible alarm, external alarm relay output, detachable power cord. and grid support bracket that is ideal for fume hood mounting to maximize bench space.

The TC9500 is a microprocessor-based, digital indicating, single-loop temperature controller. It has a single output located on the back of the controller. It features an auto-tuning function that allows automatic configuration of the PID parameters with minimum user configuration required. The TC9500 has multiple inputs that accept thermocouple, RTD, and thermistor sensors.

The controller automatically sets the PID parameters through a "learning" sequence in the Tune mode. PID parameters include proportional band, reset/integral, and rate/derivative. The user-friendly LED display is to aid in monitoring and setup of the controller. The controller automatically store all user parameters in nonvolatile memory.

## **Unpacking**

Check individual parts against the list of items below. If anything is missing or damaged, please contact your instrument supplier immediately.

1. Temperature controller
2. Grid support bracket (attached to the back of the controller)
3. 6-ft (3-m) detachable IEC power cord. Model 89800-03 comes standard with a US 120 VAC plug; Model 89800-04 comes standard with a US 220 VAC plug.  
See page 45 for additional cords.
4. Electrical noise canceling ferrite clip (connects to sensor input; see page 44 for reference)
5. User manual
6. Quick-start guide

# Controller Description - Front Panel



## 1. RUN/STOP Button

Pressing RUN/STOP once will start the control process if the Temperature Controller is stopped, or stop the control process if the Temperature Controller is running. If the Temperature Controller is running, “Heat” and “Cool” on-screen indicators will illuminate appropriately in the “Alarm/Action Display”.

## 2. TUNE Button

Pressing TUNE once will start the AUTO TUNE cycle. AUTO TUNING must be enabled in the setup mode for this key to function. (See page 14, Screen 16)

## 3. ALARM Button

In an ALARM situation, the screen will display either “WARNING” or “ERROR” with the corresponding message. A “WARNING” will not stop the control process. An “ERROR” will stop the control process.

A. *MANUAL RESET* mode: Pressing ALARM once will silence the audible alarm and clear the on-screen alarm message. If the alarm situation is still presents the “Alarm/Action Display” will remain illuminated. The alarm and on-screen message will not clear automatically, even if the system is no longer in an alarm situation.

B. *AUTO RESET* mode: Pressing ALARM once will silence the audible alarm and clear the on-screen alarm message. If the alarm situation is still present, the “Alarm/Action Display” will remain illuminated. If the system leaves an alarm situation, the system will automatically silence the alarm and clear the on-screen alarm message.

## 4. SELECT Button

Pressing SELECT once will cycle through user-configurable control set points. All user-configurable set points will be underlined with a greyed out line. The selected Set Point will be underlined. Change the set point with the UP and DOWN arrow buttons.

## 5. MENU Button

The MENU button provides access to all user-configurable setup parameters of the controller. Pressing this key once will scroll through parameter options. Pressing and holding this key will exit to the home screen, saving any changes made up to that point.

## 6. UP, DOWN, LEFT Arrow Buttons

The UP and DOWN arrow buttons will increase or decrease the value of the set point selected (underlined). Pressing the UP or DOWN arrow keys will increase or decrease *numerical* entries by the least significant digit. The rate of acceleration will increase as shown in the table below, starting from the least significant digit. Pressing and holding the UP or DOWN arrow key will increase or decrease *text* entries without an acceleration factor. The LEFT arrow button moves backwards through the General and Advanced Setup Menus. To exit to the main screen from either menu, press and hold the MENU button.

Numbers...	Increase/Decrease by...
0.0 – 0.9	0.1
0 – 9	1
10 – 100	10
100 +	50
Table 1. Acceleration Factor Table	

## 7. HEAT, COOL, AND TUNE Indicators

When any of these modes are active they will have a block indicator on the display showing they are active. **Example:** When the control is in the heat mode and it is applying power to the heater output there will be an indicator block on the display to show the heater output is active.

## Controller Description — Back Panel

Heater/Cooler output based on model

**5-15R ,115 VOLT**  
Model 89800-03



**IEC 60320 C19, 230 VOLT**  
(Image shows this receptacle)  
Model 89800-04



1. IEC power cord connection (see page 45 for additional cords)
2. Heater/cooler output (see pages 46-47 for optional cord adapters dependent on country)
3. Power switch
4. Grid support bracket
5. External alarm output
6. USB port
7. Thermistor input: accepts type 400 and 700 with Digi-Sense phone plug connector
8. Thermocouple input: accepts type J, K, N, R, S, T, B, and E with mini-connector
9. RTD input: accepts type Alpha 0.003850 and Alpha 0.003916 with ANSI 3 blade connector. (RTD probes with ANSI connectors purchased from Cole-Parmer or Davis Instruments before May of 2013 will need the wiring in the probe connector modified. See page 44 for wiring instructions.)
10. RTD input: accepts Digi-Sense 3-pin round connector
11. Fuse

# Controller Description — Active Display Screen

## MAIN SCREENS

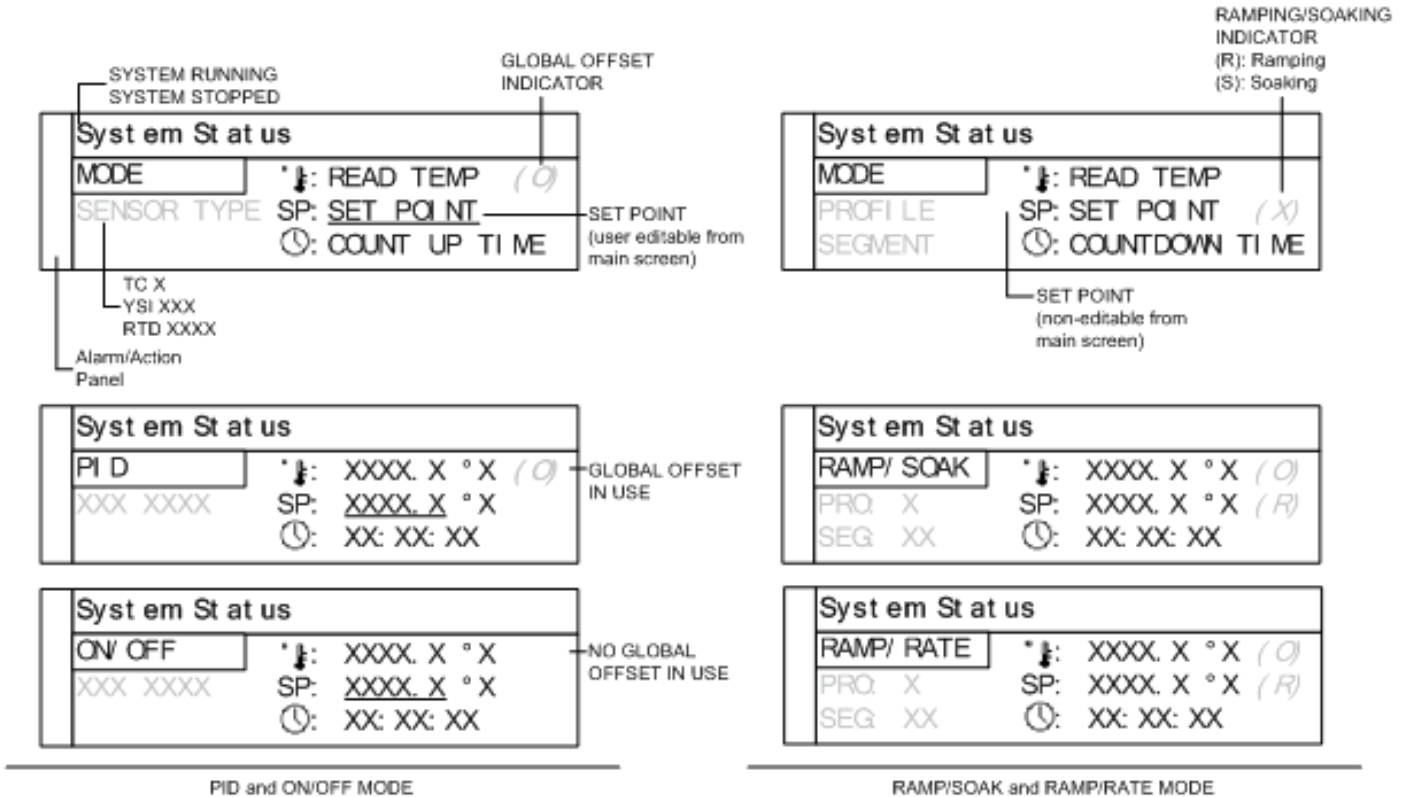

## ALARM ACTION PANEL

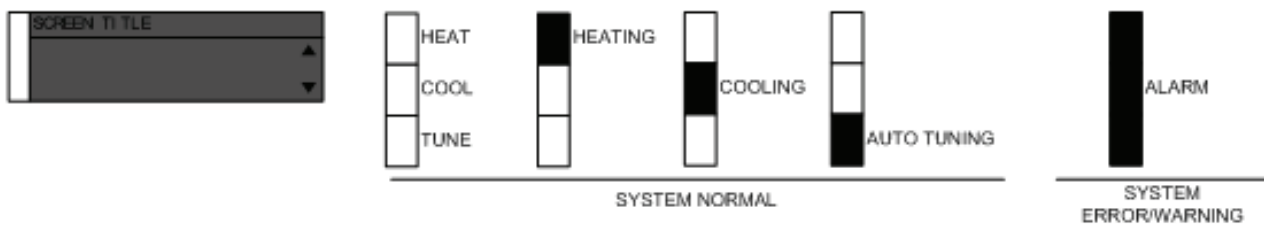

## NAVIGATION



# **Setup and Operation**

## **Initial Setup**

- Install controller in a safe operating area.
- Plug the heating or cooling device (sold separately) into the output connector, located on the back of the controller.
- Connect input sensor into the proper connection input on the back of the controller.
- Place the ferrite clip over lead wire of sensor (see page 44 for reference picture of installation).
- Connect external alarm output to the controller (optional).
- Connect USB cable to the USB connector, located on the back of the controller (optional).
- Plug supplied AC cord into the IEC input connector, located on the back of the controller.

## **Basic Operation Setup**

- Turn power switch ON, located on the back of controller.
- Follow the instructions on the “welcome” screen.
  - Press SELECT key to read a brief description of each key on the front of controller.
  - Press the MENU key to skip the instructions and enter into the main operation screen.
- Press the SELECT key to make a user-editable field active. A line will appear under the field when the field is active for editing.
- Use the UP/DOWN arrow keys to adjust the value that is active in a user-editable field.
- Enter the user-configurable setup by pressing the MENU key from the system status screen.
- Use the MENU key to advance through each menu setting.
- Depending on process operation, follow the directions to set up the controller for the proper operation of your process:
  - PID (factory default) on pages 8-16
  - ON/OFF on pages 17-24
  - Ramp & Soak on pages 25-33
  - Ramp Rate on pages 25-33
- All changed settings will be retained in memory when returning to the System Status screen.
- Use the screen flow charts (see pages 42-43) to have a visual of the controls menu layout.

## **Auto Tune Operation**

- Set up your process as noted in the initial setup.
- Verify that the Auto Tune feature is enabled in the menu settings.
- From the main operation screen set the set point temperature.
- Press the TUNE button and the indicators showing Heat and Tune will be illuminated on display.
- The Set Point value can not be altered after the Tune process has started. The value is locked until the Tune process is complete or aborted by the user.
- Stopping the Tune operation prior to it finishing will cause the PID settings to be returned to factory default values.
- PID values will be saved in nonvolatile memory.

## **PID Control Mode Setup:** (FACTORY DEFAULT MODE)

### **Screen # 1 - Selecting Sensor Type**

- Press the MENU key one time to select sensor input type.
- Use UP/DOWN arrow keys to change sensor type.
- Press MENU key when complete.

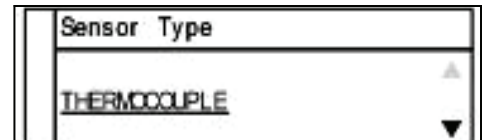

### **Screen # 2 - Selecting Sensor Type**

- If **Thermocouple** is selected on screen # 1:
- Use the UP/DOWN arrow keys to select the desired thermocouple type: J, K, N, R, S, T, B, or E.
- Press MENU key to advance to screen #3 after selection has been made.



- If **Thermistor** is selected on screen # 1:
- Use UP/DOWN arrow keys to select the desired thermistor type: 400 or 700.
- Press MENU key to advance to screen #3 after selection has been made.



- If **RTD** is selected on screen # 1:
- Use UP/DOWN arrow keys to select the desired RTD type: Alpha 003850 or 003916.
- Press MENU key to advance to screen #3 after selection has been made.



### **Screen # 3 - Selecting Temperature Scale**

- Use the UP/DOWN keys to select the desired temperature scale: Celsius °C, Fahrenheit °F, Kelvin K, Reaumur °Ré, or Rankine °Ra.
- Press MENU key to advance to screen # 4 after selection has been made.





## PID Control Mode Setup:

### Screen # 4 - Selecting Alarm Setting

- Use the UP/DOWN arrow keys to change between Auto Reset, Manual Reset and Off.
- Press MENU key to advance to next screen.
  - If Auto or Manual is selected, the controller will advance to screen # 5.
  - If selection is OFF, the controller will advance to screen # 9.



### Screen # 5 - Selecting Alarm Mode

- Use the UP / DOWN arrow keys to select alarm mode.
- Selectable alarm modes:
  - **Process High:** The alarm will be activated if the temperature rises above the user set alarm value.
  - **Process Low:** The alarm will be activated if the temperature goes below the user set alarm value.
  - **Process High/Low:** The alarm will be activated if the temperature goes above or below the high and low temperature levels set by user.
  - **Deviation High:** Alarm activation point that changes with the change of the process set point.  
**Example:** The user sets deviation high alarm at 30°C and has a process set point of 100°C. If the temperature reaches 130°C, the alarm will be activated. The user changes process set point to 60°C. If process temperature reaches 90°C, the alarm will be activated.
  - **Deviation Low:** Alarm activation point that changes with the change of the process set point.  
**Example:** The user sets the deviation low alarm at 30°C and the process set point is 100°C. If the process temperature is 70°C or less, the alarm will be activated. If the process set point temperature is set at 70°C, then if the process temperature is 40°C or less, it will activate the alarm.
  - **Deviation High/Low:** Same as Deviation High and Deviation Low alarms. It has the capability of having an alarm activate when the set point temperature goes above or below a set point temperature.
  - **Deviation Band:** Allows the user to set the alarm to be activated within a specified temperature range.
- Press the MENU key to advance to screen # 6 after selecting alarm mode.



# PID Control Mode Setup:

## Screen # 6 - Setting Alarm Mode Variables

- This screen reflects the variable settings for the selected alarm mode from screen # 5.

### -Set Point—Process High

- Press the UP/DOWN arrow keys to adjust the temperature value.
- When complete, press MENU key to advance to screen # 7.

Process High
HIGH <u>XXXX.X</u> °X

### -Set Point—Process Low

- Press the UP/DOWN arrow keys to adjust the temperature value.
- When complete, press MENU key to advance to screen # 7.

Process Low
LOW <u>XXXX.X</u> °X

### -Set Point—Process High/Low

- Press the UP/DOWN arrow keys to adjust the temperature value.
- Press the SELECT key to toggle between High and Low. There will be a line below the active field.
- When complete, press MENU key to advance to screen # 7.

Process High/Low
High: <u>XXXX.X</u> °X
Low: <u>XXXX.X</u> °X

### -Set Point—Deviation High

- Press the UP/DOWN arrow keys to adjust the temperature value.
- When complete, press MENU key to advance to screen # 7.

Deviation High
HIGH <u>XXXX.X</u> °X

### -Set Point—Deviation Low

- Press the UP/DOWN arrow keys to adjust the temperature value.
- When complete, press MENU key to advance to screen # 7.

Deviation Low
LOW <u>XXXX.X</u> °X

## PID Control Mode Setup:

### **-Set Point—Deviation High/Low**

- Press the UP/DOWN arrow keys to adjust the temperature value.
- Press the SELECT key to toggle between the High and Low. There will be a line below the active field.
- When complete, press MENU key to advance to screen # 7.

Deviation High/Low	
High: <u>XXXX.X</u> °X	▲
Low: <u>XXXX.X</u> °X	▼

### **-Set Point—Deviation Band**

- Press the UP/DOWN arrow keys to adjust the temperature value.
- When complete, press MENU key to advance to screen # 7.

Deviation Band	
BAND: <u>XXXX.X</u> °X	▲
	▼

## PID Control Mode Setup:

### Screen # 7 - Setting Hysteresis Alarm

- Use the UP/DOWN arrow keys to adjust value.
- The user-defined value when the alarm will exit an alarm condition. **Example:** User has a Process High alarm programmed with a value of 150°C and has set the Alarm Hysteresis of 1°C. The alarm has been activated after the temperature reached 160°C. When temperature reaches 149°C, the alarm condition will not be active.
- When complete, press MENU key to advance to screen # 8.

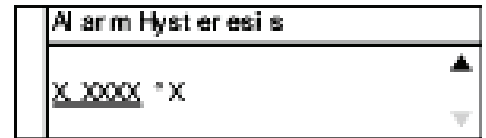

### Screen # 8 - Setting Audible Alarm

- Use UP/DOWN arrow keys to change value to either ON audible alarm or OFF audible alarm.
- When complete, press MENU key to advance to screen # 9.



### Screen # 9 - Advanced Menu Gateway

- Use the UP/DOWN arrow keys to change selection to ENTER.
- When complete, press MENU key to advance to screen # 10.
- The following screens are in the advance portion of the setup menu:



Screen # 10 - Calibration Gateway

Screen # 11 - Global Sensor Offset

Screen # 12 - Over Temperature Stop

Screen # 13 - Loop Break Stop

Screen # 14 - Control Action

Screen # 15 - Control Mode

Screen # 16 - Auto Tune

Screen # 17 - Proportional Band Setup

Screen # 18 - Proportional Gain Setup

Screen # 19 - Integral Time Setup

Screen # 20 - Integral Gain Setup

Screen # 21 - Derivative Rate Setup

Screen # 22 - Derivative Rate Gain Setup

Screen # 23 - Power Rate Control

Screen # 24 - Run Time

Screen # 25 - Power Failure Control

## PID Control Mode Setup:

### Screen # 10 - Calibration Gateway

- Screen will default to SKIP Calibration Setup.
- **WARNING:** Do not enter the calibration gateway unless you have the proper calibration equipment to calibrate the sensor inputs associated with this controller. Changing calibration settings in the controller can cause errors in sensor temperature readings and operation of the control. For instructions on how to use the calibration functions, contact your instrument supplier.
- With SKIP selected, press the MENU key to advance to screen # 11.



### Screen # 11 - Global Sensor Offset Calibration

- Use the UP/DOWN arrow keys to change the offset value.
- The use of another temperature device is required to determine the correct offset needed.
- Adjusting this value is offsetting the sensor input temperature being displayed.
- When complete, press MENU key to advance to screen # 12.



### Screen # 12 - Over Temperature Stop

- Use UP/DOWN arrow keys to change the value.
- When sensor temperature goes above this value, the output device will be turned off.
- When complete, press MENU key to advance to screen # 13.

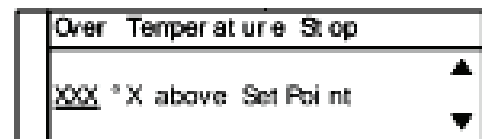

### Screen # 13 - Loop Break Stop

- Default value is ENABLED. Use UP/DOWN arrow keys to change the value.
- Loop Break Stop is a feature that will stop the process output while the controller is in the run mode. If the controller senses there is no change in temperature in a user set amount of time, the output will be turned off and error message will be displayed on the screen along with an audible alarm.
- Set to DISABLED if this function is not required.
- When complete, press MENU key to advance to screen # 14.



## PID Control Mode Setup:

### Screen # 14 - Control Action

- Use UP/DOWN arrow keys to change the value.
- Set for the process that is being performed: Heat or Cool
- When complete, press MENU key to advance to screen # 15.



### Screen # 15 - Control Mode

- Use UP/DOWN arrow keys to change the value.
- Default value is PID mode. (If different, select PID mode)
- When complete, press MENU key to advance to screen # 16.



### Screen # 16 - Auto Tune

- Default value is ENABLED. Use UP/DOWN arrow keys to toggle between ENABLED and DISABLED.
- Select ENABLED to use the Tune key on the front panel to activate the Auto Tune function. This function needs to remain ENABLED until the controller has been properly tuned to the user's particular application.
- When complete, press MENU key to advance to screen # 17.

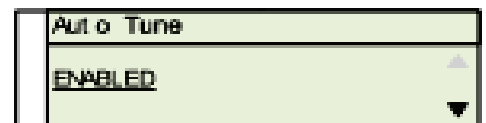

### Screen # 17 - Proportional Band Setup

- Use UP/DOWN arrow keys to change the value.
- **WARNING:** Do not change these values unless you have experience in manual setup of PID (Proportional, Integral, and Derivative) of this controller. These values are derived from running the auto tune function. Altering the value after auto tune has been completed will affect the performance of the system.
- When complete, press MENU key to advance to screen # 18.



### Screen # 18 - Proportional Gain Setup

- Use UP/DOWN arrow keys to change the value.
- **WARNING:** Do not change these values unless you have experience in manual setup of PID (Proportional, Integral, and Derivative) of this controller. These values are derived from running the auto tune function. Altering the value after auto tune has been completed will affect the performance of the system.
- When complete, press MENU key to advance to screen # 19.



## PID Control Mode Setup:

### Screen # 19 - Integral Time Setup

- Use UP/DOWN arrow keys to change the value.
- **WARNING:** Do not change these values unless you have experience in manual setup of PID (Proportional, Integral, and Derivative) of this controller. These values are derived from running the auto tune function. Altering the value after auto tune has been completed will affect the performance of the system.
- When complete, press MENU key to advance to screen # 20.

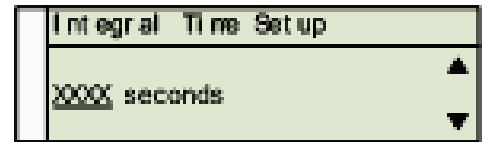

### Screen # 20 - Integral Gain Setup

- Use UP/DOWN arrow keys to change the value.
- **WARNING:** Do not change these values unless you have experience in manual setup of PID (Proportional, Integral, and Derivative) of this controller. These values are derived from running the auto tune function. Altering the values after auto tune has been completed will affect the performance of the system.
- When complete, press MENU key to advance to screen # 21.



### Screen # 21 - Derivative Rate Setup

- Use UP/DOWN arrow keys to change the value.
- **WARNING:** Do not change these values unless you have experience in manual setup of PID (Proportional, Integral, and Derivative) of this controller. These values are derived from running the auto tune function. Altering the value after auto tune has been completed will affect the performance of the system.
- When complete, press MENU key to advance to screen # 22.



### Screen # 22 - Derivative Rate Gain Setup

- Use UP/DOWN arrow keys to change the value.
- **WARNING:** Do not change these values unless you have experience in manual setup of PID (Proportional, Integral, and Derivative) of this controller. These values are derived from running the auto tune function. Altering the value after auto tune has been completed will affect the performance of the system.
- When complete, press MENU key to advance to screen # 23.



## PID Control Mode Setup:

### Screen # 23 - Power Output Control

- Use UP/DOWN arrow keys to change the value.
- Default value is 100 percent.
- This feature allows the user to reduce the output power to the output heating device—useful in applications where temperature overshoot is occurring after auto tune has been completed.
- Experimenting with this value will be necessary because every process setup is different.
- When complete, press MENU key to advance to screen # 24.



### Screen # 24 - Run Time

- Use UP/DOWN arrow keys to change the value.
- Use SELECT key to toggle between the HR and MIN fields.
- Run Time is a safety feature while the control is in the ON/OFF or PID mode. The user can set a timer to have the output turned OFF if the time expires.
- When complete, press MENU key to advance to screen # 25.

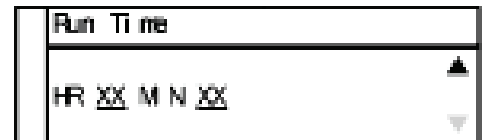

### Screen # 25 - Power Failure Control

- Use UP/DOWN arrow keys to change the value.
- Default value is STOP:
  - *STOP* — If the controller loses power while in the run mode, it will not resume the process once the power has been restored.
  - *RESUME* — If the controller loses power while in the run mode, it will resume the operating process once the power has been restored.
- When complete, press MENU key to advance to screen # 26.



### Screen # 26 - Advanced Menu Exit

- Setup is complete.
- Automatically exit to the main operation screen.



## ON/OFF Control Mode Setup:

### Screen # 1 - Selecting Sensor Type

- Press the MENU key one time to select sensor input type.
- Use UP/DOWN arrow keys to change sensor type.
- When complete, press MENU key to advance to next screen.

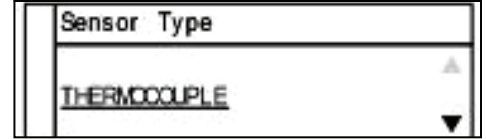

### Screen # 2 - Selecting Sensor Type

- If **Thermocouple** is selected on screen # 1:
- Use the UP/DOWN arrow keys to select the desired thermocouple type: J, K, N, R, S, T, B, or E.
- Press MENU key to advance to screen #3 after selection has been made.



- If **Thermistor** is selected on screen # 1:
- Use UP/DOWN arrow keys to select the desired thermistor type: 400 or 700.
- Press MENU key to advance to screen #3 after selection has been made.



- If **RTD** is selected on screen # 1:
- Use UP/DOWN arrow keys to select the desired RTD type: Alpha 003850 or 003916.
- Press MENU key to advance to screen #3 after selection has been made.



### Screen # 3 - Selecting Temperature Scale

- Use the UP/DOWN keys to select the desired temperature scale: Celsius °C, Fahrenheit °F, Kelvin K, Reaumur °Ré, or Rankine °Ra.
- Press MENU key to advance to screen # 4 after selection has been made.



## ON/OFF Control Mode Setup:

### Screen # 4 - Selecting Alarm Setting

- Use the UP/DOWN arrow keys to change between Auto Reset, Manual Reset ,and Off.
- Press MENU key to advance to next screen:
  - If Auto or Manual is selected, the controller will advance to screen # 5.
  - If selection is OFF, the controller will advance to screen # 9.



### Screen # 5 - Selecting Alarm Mode

- Use the UP/DOWN arrow keys to select alarm mode.
- Selectable alarm modes:
  - **Process High:** The alarm will be activated if the temperature rises above the user set alarm value.
  - **Process Low:** The alarm will be activated if the temperature goes below the user set alarm value.
  - **Process High/Low:** The alarm will be activated if the temperature goes above or below the high and low temperature levels set by user.
  - **Deviation High:** Alarm activation point that changes with the change of the process set point. **Example:** The user sets deviation high alarm at 30°C and has a process set point of 100°C. If the temperature reaches 130°C, the alarm will be activated. The user changes process set point to 60°C. If process temperature reaches 90°C, the alarm will be activated.
  - **Deviation Low:** Alarm activation point that changes with the change of the process set point. **Example:** User sets the deviation low alarm 30°C and the process set point is 100°C. If the process temperature is 70°C or less, the alarm will be activated. If the process set point temperature is set at 70°C, then if the process temperature is 40°C or less, it will activate the alarm.
  - **Deviation High/Low:** Same as Deviation High and Deviation Low alarms. It has the capability of having an alarm activate when the set point temperature goes above or below a set point temperature.
  - **Deviation Band:** Allows the user to set the alarm to be activated within a specified temperature range.
- Press the MENU key to advance to screen # 6 after selecting alarm mode.



# ON/OFF Control Mode Setup:

## Screen # 6 - Setting Alarm Mode Variables

- This screen reflects the variable settings for the selected alarm mode from screen # 5.

### -Set Point—Process High

- Use UP/DOWN arrow keys to adjust the temperature value.
- When complete, press MENU key to advance to screen # 7.

Process High	▲
HIGH XXXX.X °X	▼

### - Set Point—Process Low

- Use UP/DOWN arrow keys to adjust the temperature value.
- When complete, press MENU key to advance to screen # 7.

Process Low	▲
LOW XXXX.X °X	▼

### - Set Point—Process High/Low

- Use UP/DOWN arrow keys to adjust the temperature value.
- Press the SELECT key to toggle between High and Low.  
There will be a line below the active field.
- When complete, press MENU key to advance to screen # 7.

Process High/Low	▲
High: XXXX.X °X	▼
Low: XXXX.X °X	

### - Set Point—Deviation High

- Use UP/DOWN arrow keys to adjust the temperature value.
- When complete, press MENU key to advance to screen # 7.

Deviation High	▲
HIGH XXXX.X °X	▼

### - Set Point—Deviation Low

- Use UP/DOWN arrow keys to adjust the temperature value.
- When complete, press MENU key to advance to screen # 7.

Deviation Low	▲
LOW XXXX.X °X	▼

## ON/OFF Control Mode Setup:

### **-Set Point—Deviation High/Low**

- Use UP/DOWN arrow keys to adjust the temperature value.
- Press the SELECT key to toggle between High and Low.  
There will be a line below the active field.
- When complete, press MENU key to advance to screen # 7.

Deviation High/Low	
High: <u>XXXX.X</u> °X	▲
Low: <u>XXXX.X</u> °X	▼

### **- Set Point—Deviation Band**

- Use UP/DOWN arrow keys to adjust the temperature value.
- When complete, press the key to advance to screen # 7.

Deviation Band	
BAND: <u>XXXX.X</u> °X	▲
	▼

## ON/OFF Control Mode Setup:

### Screen # 7 - Setting Hysteresis Alarm

- Use the UP/DOWN arrow keys to adjust value.
- The user-defined value when the alarm will exit an alarm condition. **Example:** The user has a Process High alarm programmed with a value of 150°C and has set the Alarm Hysteresis of 1°C. The alarm has been activated after the temperature reached 160°C. When temperature reaches 149°C, the alarm condition will not be active.
- When complete, press MENU key to advance to screen # 8.

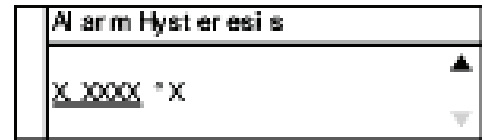

### Screen # 8 - Setting Audible Alarm

- Use UP/DOWN arrow keys to change value to either ON audible alarm or OFF audible alarm.
- When complete, press MENU key to advance to screen # 9.



### Screen # 9 - Advanced Menu Gateway

- Use UP/DOWN arrow keys to change selection to ENTER.
- When complete, press MENU key to advance to screen # 10.
- The following screens are in the advance portion of the setup menu:

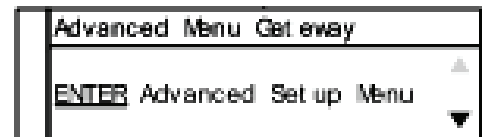

**Screen # 10 - Calibration Gateway**

**Screen # 11 - Global Sensor Offset**

**Screen # 12 - Over Temperature Stop**

**Screen # 13 - Loop Break Stop**

**Screen # 14 - Control Action**

**Screen # 15 - Control Mode**

**Screen # 16 - On/Off Control**

**Screen # 17 - Power Output Control**

**Screen # 18 - Run Time**

**Screen # 19 - Power Failure Control**

## ON/OFF Control Mode Setup:

### Screen # 10 - Calibration Gateway

- Screen will default to SKIP Calibration Setup.
- **WARNING:** Do not enter the calibration gateway unless you have the proper calibration equipment to calibrate the sensor inputs associated with this controller. Changing calibration settings in the control can cause errors in sensor temperature readings and operation of the control. For instructions on how to use the calibration functions, contact your instrument supplier.
- With SKIP selected, press the MENU key to advance to screen # 11.



### Screen # 11 - Global Sensor Offset Calibration

- Use the UP/DOWN arrow keys to change the offset value.
- The use of another temperature device is required to determine the correct offset needed.
- Adjusting this value is offsetting the sensor input temperature being displayed.
- When complete, press MENU key to advance to screen # 12.



### Screen # 12 - Over Temperature Stop

- Use the UP/DOWN arrow keys to change the value.
- When sensor temperature goes above this value, the output device will be turned off.
- When complete, press MENU key to advance to screen # 13.

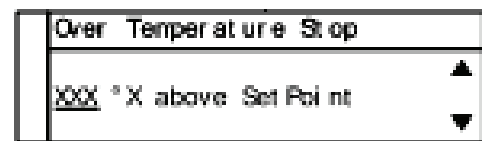

### Screen # 13 - Loop Break Stop

- Default value is ENABLED. Use the UP/DOWN arrow keys to change the value.
- Loop Break Stop is a feature that will stop the process output while the control is in the run mode. If the control senses there is no change in temperature in a user set amount of time the output will be turned off and error will be displayed on the screen along with a audible alarm.
- Set to DISABLED if this function is not required.
- When complete, press MENU key to advance to screen # 14.



## ON/OFF Control Mode Setup:

### Screen # 14 - Control Action

- Use the UP/DOWN arrow keys to change the value from Heat to Cool.
- Set for the particular process that is being performed.
- When complete, press MENU key to advance to screen # 15.



### Screen # 15 - Control Mode

- Use UP/DOWN arrow keys to change the value from the default mode of PID to On/Off.
- When complete, press MENU key to advance to screen # 16.

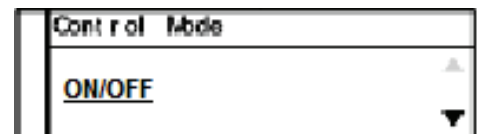

### Screen # 16 - ON/OFF Control

- Use the UP/DOWN arrow keys to adjust value.
- Cycle time is the rate that the output cycles on and off. The recommended time is 1 second.
- If a mechanical relay is being used from the output, it is recommended that the time be increased to more than 1 second. Mechanical relays are slower than solid-state relays and require more time to operate correctly. Damage to the relay and control can occur if not set correctly.
- When complete, press MENU key to advance to screen # 17.

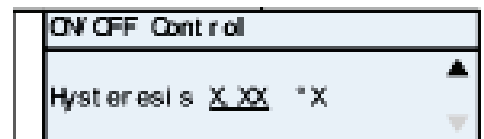

### Screen # 17 - Power Output Control

- Use UP/DOWN arrow keys to change the value.
- Default value is 100 percent.
- This feature allows the user to reduce the output power to the output heating device—useful in applications where temperature overshoot is occurring after Auto Tune has been completed.
- Experimenting with this value will be necessary because every process setup is different.
- When complete, press MENU key to advance to screen # 18.

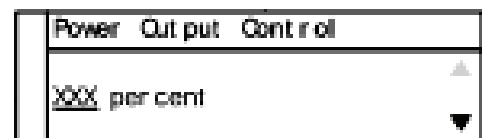

## ON/OFF Control Mode Setup:

### Screen # 18 - Run Time

- Use the UP/DOWN arrow keys to change the value.
- Use the SELECT key to toggle between HR and MIN fields.
- Run Time is a safety feature while the control is in the On/Off or PID mode. The user can set a timer to have the output turned OFF if the time expires.
- When complete, press MENU key to advance to screen # 19.



### Screen # 19 - Power Failure Control

- Use the UP/DOWN arrow keys to change the value.
- Default value is STOP:
  - STOP* — If the controller loses power while in the run mode, it will not resume the process once the power has been restored.
  - RESUME* — If the controller loses power while in the run mode, it will resume the operating process once the power has been restored.
- When complete, press MENU key to advance to screen # 20.



### Screen # 20 - Advanced Menu Exit

- Setup is complete.
- Automatically will exit to the main operation screen.



## Ramp & Soak or Ramp Rate Mode Setup:

### Screen # 1 - Selecting Sensor Type

- Press the MENU key one time to select sensor input type.
- Use UP/DOWN arrow keys to change sensor type.
- Press MENU key when complete.

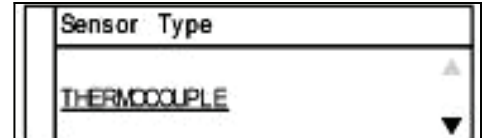

### Screen # 2 - Selecting Sensor Type

- If **thermocouple** is selected on screen # 1:
- Use UP/DOWN arrow keys to select the desired thermocouple type: J, K, N, R, S, T, B, or E.
- Press MENU key to advance to screen # 3 after selection has been made.



- If **thermistor** is selected on screen # 1:
- Use UP/DOWN arrow keys to select the desired thermistor type: 400 or 700.
- Press MENU key to advance to screen # 3 after selection has been made.



- If **RTD** is selected on screen # 1:
- Use UP/DOWN arrow keys to select the desired RTD type: Alpha 003850 or 003916.
- Press menu to advance to screen # 3 after selection has been made.



### Screen # 3 - Selecting Temperature Scale

- Use the UP/DOWN keys to select the desired temperature scale: Celsius °C, Fahrenheit °F, Kelvin K, Reaumur °Ré, or Rankine °Ra.
- Press MENU key to advance to screen # 4 after selection has been made.



## Ramp & Soak or Ramp Rate Mode Setup:

### Screen # 4 - Selecting Alarm Setting

- Use the UP/DOWN arrow keys to change between Auto Reset and Manual Reset.
- Press MENU key to advance to next screen:
  - If Auto Reset or Manual Reset was selected, continue to screen # 5.
  - If selection is OFF, skip to screen # 9.



### Screen # 5 - Alarm Mode

- Use the UP/DOWN arrow keys to select alarm mode.
- Selectable alarm modes:
  - **Process High:** The alarm will be activated if the temperature rises above the user set alarm value.
  - **Process Low:** The alarm will be activated if the process value goes below the user set alarm value.
  - **Process High/Low:** The alarm will be activated if the temperature goes above or below a high and low temperature set by user.
  - **Deviation High:** Alarm activation point that changes with the change of the process set point. Example: The user sets deviation high alarm at 30°C and has a process set point of 100°C. If the temperature reaches 130°C the alarm will be activated. The user changes process set point to 60°C. If process temperature reaches 90°C the alarm will be activated.
  - **Deviation Low:** Alarm activation point that changes with the change of the process set point. Example: The user sets the deviation low alarm 30°C and the process set point is 100°C. If the process temperature is 70°C or less, the alarm will be activated. If the process set point temperature is set at 70°C, then if the process temperature is 40°C or less it will activate the alarm.
  - **Deviation High/Low:** Same as Deviation High and Deviation Low alarms. It has the capability of having an alarm activate when the set point temperature goes above or below a set point temperature.
  - **Deviation Band:** Allows the user to set the alarm to be activated within a specified temperature range.
- Press the menu key to advance to screen # 6 after selecting alarm mode.

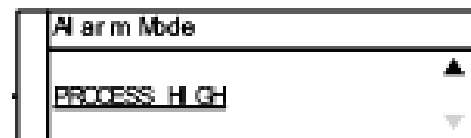

## Ramp & Soak or Ramp Rate Mode Setup:

### Screen # 6 - Setting Alarm Mode Variables

- This screen reflects the variable settings for the selected alarm mode from screen # 5.

#### -Set Point—Process High

- Use UP/DOWN arrow keys to adjust the temperature value.
- When complete, press MENU key to advance to screen # 7.

Process High	▲
HIGH <u>XXXX.X</u> °X	▼

#### - Set Point—Process Low

- Use UP/DOWN arrow keys to adjust the temperature value.
- When complete, press MENU key to advance to screen # 7.

Process Low	▲
LOW <u>XXXX.X</u> °X	▼

#### - Set Point—Process High/Low

- Use UP/DOWN arrow keys to adjust the temperature value.
- Press the SELECT key to toggle between High and Low.  
There will be a line below the active field.
- When complete, press MENU key to advance to screen # 7.

Process High/Low	▲
High: <u>XXXX.X</u> °X	▼
Low: <u>XXXX.X</u> °X	

#### - Set Point—Deviation High

- Use UP/DOWN arrow keys to adjust the temperature value.
- When complete, press MENU key to advance to screen # 7.

Deviation High	▲
HIGH <u>XXXX.X</u> °X	▼

#### - Set Point—Deviation Low

- Use UP/DOWN arrow keys to adjust the temperature value.
- When complete, press MENU key to advance to screen # 7.

Deviation Low	▲
LOW <u>XXXX.X</u> °X	▼

## Ramp & Soak or Ramp Rate Mode Setup:

### **-Set Point—Deviation High/Low**

- Use UP/DOWN arrow keys to adjust the temperature value.
- Press the SELECT key to toggle between High and Low.  
There will be a line below the active field.
- When complete, press MENU key to advance to screen # 7.

Deviation High/Low	
High: <u>XXXX.X</u> °X	▲
Low: <u>XXXX.X</u> °X	▼

### **- Set Point—Deviation Band**

- Use UP/DOWN arrow keys to adjust the temperature value.
- When complete, press the key to advance to screen # 7.

Deviation Band	
BAND: <u>XXXX.X</u> °X	▲
	▼

## Ramp & Soak or Ramp Rate Mode Setup:

### Screen # 7 - Setting Hysteresis Alarm

- Use the UP/DOWN arrow keys to adjust value.
- The user-defined value when the alarm will exit an alarm condition. **Example:** The user has a Process High alarm programmed with a value of 150°C and has set the Alarm Hysteresis of 1°C. The alarm has been activated after the temperature reached 160°C. When temperature reaches 149°C, the alarm condition will not be active.
- When complete, press MENU key to advance to screen # 8.

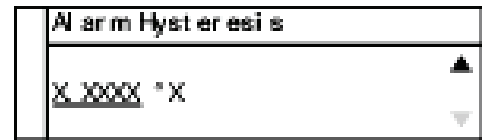

### Screen # 8 - Setting Audible Alarm

- Use UP/DOWN arrow keys to change value to either ON audible alarm or OFF audible alarm.
- When complete, press MENU key to advance to screen # 9.



### Screen # 9 - Advanced Menu Gateway

- Use UP/DOWN arrow keys to change selection to ENTER.
- When complete, press MENU key to advance to screen # 10.
- The following screens are in the advanced portion of the setup menu:

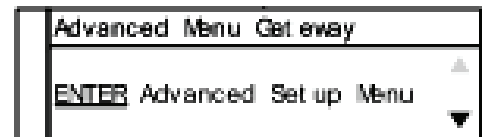

Screen # 10 - Calibration Gateway

Screen # 21- Power Output Control

Screen # 11 - Global Sensor Offset

Screen # 22- Run Time

Screen # 12 - Over Temperature Stop

Screen # 23 - Power Failure Control

Screen # 13 - Loop Break Stop

Screen # 24 - Advanced Menu Exit

Screen # 14 - Control Action

Screen # 15 - Control Mode

Screen # 16 - Ramp & Soak Profile

Screen # 17 - Assured Soak

Screen # 18 - Segment Definition Setup

Screen # 19 - Control Parameter Setup

Screen # 20 - Control Parameter Gain Setup

## Ramp & Soak or Ramp Rate Mode Setup:

### Screen # 10 - Calibration Gateway

- Screen will default to SKIP Calibration Setup.
- **WARNING:** Do not enter the calibration gateway unless you have the proper calibration equipment to calibrate the sensor inputs associated with this controller. Changing calibration settings in the control can cause errors in sensor temperature readings and operation of the control. For instructions on how to use the calibration functions, contact your instrument supplier.
- With SKIP selected, press the MENU key to advance to screen # 11.



### Screen # 11 - Global Sensor Offset Calibration

- Use the UP/DOWN arrow keys to change the offset value.
- The use of another temperature device is required to determine the correct offset needed.
- Adjusting this value is offsetting the sensor input temperature being displayed.
- When complete, press MENU key to advance to screen # 12.



### Screen # 12 - Over Temperature Stop

- Use the UP/DOWN arrow keys to change the value.
- When sensor temperature goes above this value, the output device will be turned off.
- When complete, press MENU key to advance to screen # 13.

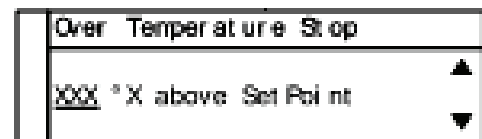

### Screen # 13 - Loop Break Stop

- Default value is ENABLED. Use the UP/DOWN arrow keys to change the value.
- Loop Break Stop is a feature that will stop the process output while the control is in the run mode. If the control senses there is no change in temperature in a user set amount of time the output will be turned off and error will be displayed on the screen along with a audible alarm.
- Set to DISABLED if this function is not required.
- When complete, press MENU key to advance to screen # 14.



## Ramp & Soak or Ramp Rate Mode Setup:

### Screen # 14 - Control Action

- Use the UP/DOWN arrow keys to change the value from Heat to Cool.
- Set for the particular process that is being performed.
- When complete, press MENU key to advance to screen # 15.

Control Action
HEAT

### Screen # 15 - Control Mode

- Use UP/DOWN arrow keys to change the value from the default mode of PID to On/Off.
- When complete, press MENU key to advance to screen # 16.

Control Mode
PLD

### Screen # 16 - Ramp & Soak Profile

- Use UP/DOWN arrow keys to change the profile number.
- Profiles # 1 through # 9 are available to set up for different processes.
- When complete, press MENU key to advance to screen # 17.

Ramp & Soak Profile
Profile X

### Screen # 17 - Assured Soak

- Use UP/DOWN arrow keys to change value.
- If Assured Soak is set to YES, the profile will not advance to the next step until it reaches a certain temperature set in the profile. If set to NO, the profile will continue on even if the soak temperature has not been met.
- When complete, press MENU key to advance to screen # 18.

Assured Soak
YES

## Ramp & Soak or Ramp Rate Mode Setup:

### Screen # 18 - Segment Definition Setup

- Use UP/DOWN arrow keys to change the value.
- Use the SELECT key to change between user-defined sections:
  - **SEG (Segment):** There are 1 to 16 programmable segments per profile.
  - **Temp (Temperature):** Controller is expected to meet this temperature within a user-defined time. Two user-editable fields: HR (Hour) and MIN (Minutes).
  - **End Time:** Time control is expected to complete segment.
  - **Rate (Ramp Rate Mode):** Temperature value that is expected to be met by user-defined end time.
  - **Control Parameter (Ramp & Soak Mode):** Default value is AUTO and the system will use the systems auto tuned values. There are 1 to 9 storable segments to manually input/save PID control values. The PID values can be determined by experimentation with your process set up.
- Press Menu key to advance to next screen.

#### Ramp & Soak

Segment Set up	
SEG XX	XXXX.X °X
End Time: HR XX MIN XX	
Control Parameter: X	

#### Ramp Rate

Segment Set up	
SEG XX	XXXX.X °X
End Time: HR XX MIN XX	
Rate: XXXX.X	

### Screen # 19 - Control Parameter Setup

- This function is only available if control parameter 1 to 9 was selected in screen # 18 Segment Definition Setup.
- Selectable fields: P (Proportional), I (Integral), and D (Derivative)
- Use the UP/DOWN arrow keys to adjust value in each field.
- Use the SELECT key to change between editable fields.

Control Parameter Set up	
Control Parameter XX	
P: X.XX	I: X.XX
D: X.XX	

### Screen # 20 - Control Parameter Gain Setup

- This function is only available if control parameter 1 to 9 was selected in screen # 18 Segment Definition Setup.
- Selectable fields: P (Proportional), I (Integral), and D (Derivative)
- Use the UP/DOWN arrow keys to adjust value in each field.
- Use the SELECT key to change between editable fields.

Control Parameter Gain Set up	
Control Parameter XX	Gain
P: X.XX	I: X.XX
D: X.XX	



## Ramp & Soak or Ramp Rate Mode Setup:

### Screen # 21 - Power Output Control

- Use UP/DOWN arrow keys to change the value.
- Default value is 100 percent.
- This feature allows the user to reduce the output power to the output heating device—useful in applications where temperature overshoot is occurring after Auto Tune has been completed.
- Experimenting with this value will be necessary because every process setup is different.
- When complete, press MENU key to advance to screen # 22.



### Screen # 22 - Run Time

- Use the UP/DOWN arrow keys to change the value.
- Use the SELECT key to toggle between HR and MIN fields.
- Run Time is a safety feature while the control is in the On/Off or PID mode. The user can set a timer to have the output turned OFF if the time expires.
- When complete, press MENU key to advance to screen # 23.

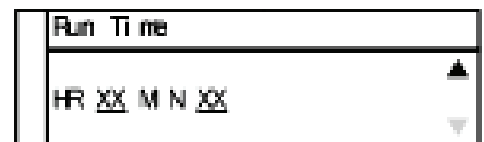

### Screen # 23 - Power Failure Control

- Use the UP/DOWN arrow keys to change the value.
- Default value is STOP:
  - *STOP* — If the controller loses power while in the run mode, it will not resume the process once the power has been restored.
  - *RESUME* — If the controller loses power while in the run mode, it will resume the operating process once the power has been restored.
- When complete, press MENU key to advance to screen # 24.



### Screen # 24 - Advanced Menu Exit

- Setup is complete.
- Automatically will exit to the main operation screen.

# Data Acquisition Software Installation

1. Download software from Cole-Parmer website. Search for product 89800-03 or 89800-04.
2. Data Acquisition software is located in Technical Resources section of the product page.
3. Extract the downloaded file after download is complete. To install the software execute the setup.exe file.



4. Press the Next button to continue with the installation of software.

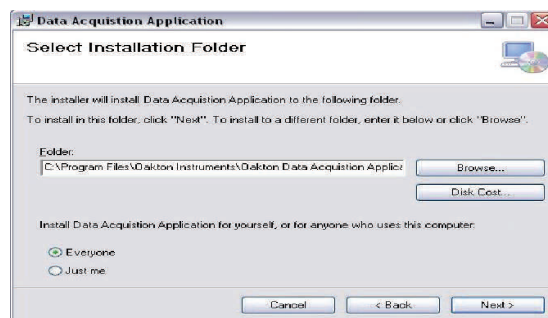

5. Press the Next button or make any changes needed for your installation.



6. Press the Next button to confirm the installation of the software.

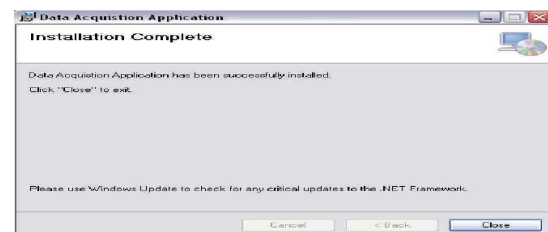

7. Installation is complete. Press the Close button to finish installation.
8. Software will be located in Digi-Sense folder
9. Start software by clicking on the Digi-Sense Data Acquisition Icon.

# Data Acquisition Software COM Port Setup

1. Connect USB cable between the Digi-Sense TC9500 controller and your computer.
2. Turn the controller ON.
3. Start the Data Acquisition software.
4. Click the COM Port Settings button in the software and select the appropriate COM port.

COM Port Settings...

5. If you do not know the COM port the controller is using, follow these steps to select correct port:
  - Go into Device Manager. To enter device manager, go to the START button and type the word device manager.
  - Click on Device Manager
  - In Device Manager, find the option POTS (COM & LPT), then click on the plus symbol.
  - Find the associated port that has been assigned by the computer to the controller.

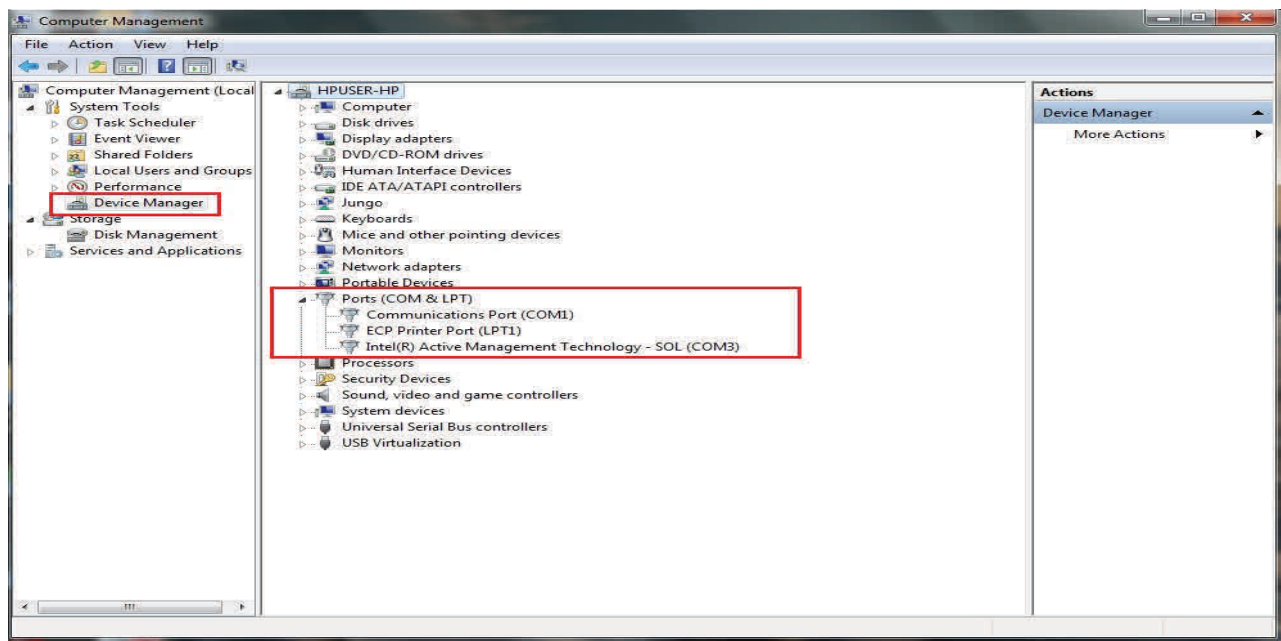

6. After COM port has been determined, press the Connect button.

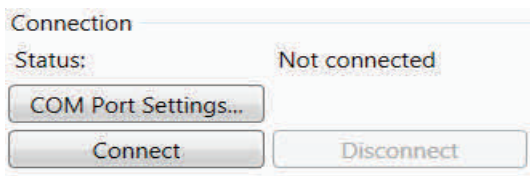

7. If connection is successful, the sensor temperature will appear in the current temp location and status will change to connected.

# Data Acquisition Software Setup

Main operation screen:

The screenshot displays the 'Oakton Data Acquisition Utility' software interface. The window title is 'Oakton Data Acquisition Utility' and it has a menu bar with 'File', 'Edit', 'Tools', and 'Help'. The interface is divided into several sections:

- Device Section:** Contains 'Current Temp:' and 'Set Temp:' fields, both set to '°C'. There are 'Up' and 'Down' buttons next to the 'Current Temp' field, and 'Set' and 'Down' buttons next to the 'Set Temp' field. Below these are radio buttons for '°F' and '°C'. A red box highlights the 'Up' and 'Down' buttons, with an annotation: **Sensor Temperature**. Another red box highlights the 'Set' and 'Down' buttons, with an annotation: **Control Temperature Set Point**.
- Connection Section:** Shows 'Status: Not connected'. There is a 'COM Port Settings...' button. Below are 'Connect' and 'Disconnect' buttons. A red box highlights the 'COM Port Settings...' button, with an annotation: **Status of USB connection with control**. Another red box highlights the 'Connect' and 'Disconnect' buttons, with an annotation: **Press button to change COM port**. A third red box highlights the 'Connect' and 'Disconnect' buttons, with an annotation: **Use these buttons to Connect or Disconnect USB communications to the computer**.
- Logging Section:** Contains 'Current logging file:' with a text box and a browse button (...). Below is 'Logging Interval:' set to '1.00'. There is a checked checkbox for 'Enable graph'. Below these are 'Start' and 'Stop' buttons. At the bottom of this section are 'Read File' and 'Clear Graph' buttons. A red box highlights the 'Current logging file:' text box, with an annotation: **Enter file name and location for data log file**. Another red box highlights the 'Logging Interval:' text box, with an annotation: **Rate the data is saved. Defaults at 1.0 second intervals**. A red box highlights the 'Start', 'Stop', 'Read File', and 'Clear Graph' buttons, with an annotation: **Buttons associated with logging**.
- Graph Section:** A large graph area on the right side of the window. The y-axis ranges from 0.0 to 1.2 with major ticks every 0.2. The x-axis has several '01' labels. A yellow box at the bottom of the graph area contains the text **LIVE GRAPH AREA**. A red box highlights the 'Enable graph' checkbox, with an annotation: **Live graph function**.

# Data Acquisition Software Setup

## Setting Temperature Set Point

- Use the UP and DOWN buttons beside Set Temp to adjust temperature set point.
- The user can also manually type in the temperature by placing the mouse pointer in Set Temp box. Then type in set point value and press the Set button.
- This will update the temperature on the Digi-Sense controller.

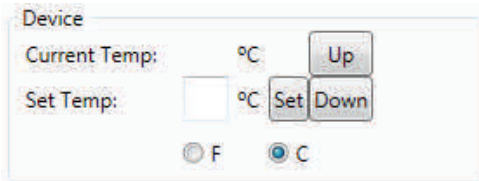

## Data Logging Setup

1. Enter file name into Current logging file. Press the button to change file directory path.

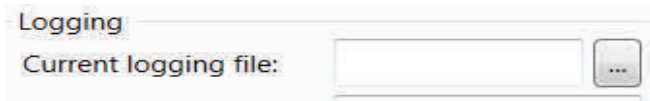

2. Data logging interval defaults at 1.00 seconds. Change the value by left-clicking with pointer located inside the box.
3. Type in new interval time and left-click with mouse in the graph area.

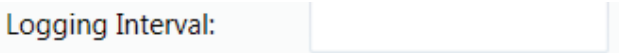

4. Enable Graph will have a check in the box as the default setting. If the live graph is not wanted, left-click with mouse pointer over the box to turn off the feature.

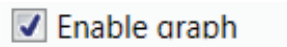

5. Start/stop data logging and graphing function:

*Start* button — Select this button to start graphing and data logging.

*Stop* button — Stops the data logging and graphing when the Start button is active.

*Read File* button — Loads a previous data file for viewing on graph.

*Clear Graph* button — Clears all data on the graph.



## Safety Precautions



**DANGER: DO NOT REMOVE COVER! HIGH VOLTAGE IS PRESENT IN THE CONTROL. Contact vendor for service.**



**DANGER: If high voltage is present on external temperature sensor from outside source, high voltage will be present at the control.**



**DANGER: Fire protection and control damage: Replace all fuses with the correct fuse replacement. Reference page 39 for model 89800-03 and page 40 for model 89800-04.**



**WARNING: Specifications for the power cord: see page 39 for model 89800-03 and page 40 for model 89800-04 for proper replacement cord. Additional input power cords for various countries are listed on page 45.**



**WARNING: Use of separate temperature limit control is recommended were a fault condition could occur and result in a fire or other hazardous condition.**

## **Specifications for TC9500 Controller — Model 89800-03**

**Power input:** 120 VAC  $\pm 10\%$ , 50/60 Hz  $\pm 3\%$ , 15 amp, 1800 watts max load

**Operating environment:** 32 to 77°F (0 to 25°C); 90% RH, noncondensing

**Maximum altitude:** 2187 yd (2000 m)

**Pollution degree:** 2 (normally only nonconductivity pollution occurs)

**Installation category II:** local level (connect to branch circuit and not directly to a main circuit, such as a fuse panel)

**Storage:** 32 to 140°F (0 to 60°C); 5 to 80% RH, noncondensing

**Fuse:** 250 volt, 15 amp rated (fast-acting)

**AC line cord:** SJT-14-3 14 AWG, 15 amp, 125 VAC, less than 9 ft (3 m) in length

**Heater/cooler output:** max voltage: 120 VAC  $\pm 10\%$ , 15 amp, 50/60 Hz  $\pm 3\%$ , 1800 watts max load

**External alarm output:** SPDT relay — 24 VAC/VDC, 1 amp

**Process memory:** data retention upon power failure via nonvolatile memory

**Dimensions (W x H x D):** 8" x 3.75" x 9" (20.3 x 9.5 x 22.9 cm)

## **Specifications for TC9500 Controller — Model 89800-04**

**Power input:** 230 VAC  $\pm 10\%$ , 50/60 Hz  $\pm 3\%$ , 10 amp, 2300 watts max load

**Operating environment:** 32 to 77°F (0 to 25°C); 90% RH, noncondensing

**Maximum altitude:** 2187 yd (2000 m)

**Pollution degree:** 2 (normally only nonconductivity pollution occurs)

**Installation category II:** local level (connect to branch circuit and not directly to a main circuit, such as a fuse panel)

**Storage:** 32 to 140°F (0 to 60°C); 5 to 80% RH, noncondensing

**Fuse:** 250 volt, 10 amp rated (fast-acting)

**AC line cord:** SJT-14-3 14 AWG, 15 amp, 240 VAC, less than 9 ft (3 m) in length

**Heater/cooler output:** max voltage: 240 VAC  $\pm 10\%$ , 15 amp, 50/60 Hz  $\pm 3\%$ , 3600 watts max load

**External alarm output:** SPDT relay — 24 VAC/VDC, 1 amp

**Process memory:** data retention upon power failure via nonvolatile memory

**Dimensions (W x H x D):** 8" x 3.75" x 9" (20.3 x 9.5 x 22.9 cm)



## **Specifications for Sensor Input**

- Thermocouple (grounded or nongrounded), RTD (Type Alpha 0.003850 and Alpha 0.003916), and Thermistor (Type 400 and 700)
- Automatic cold junction compensation and break protection for sensor

### **Ranges**

<b>Thermocouples</b>	
<b>Type J</b>	<b>-310 to 1832°F (-190 to 1000°C)</b>
<b>Type K</b>	<b>-328 to 2502°F (-200 to 1372°C)</b>
<b>Type N</b>	<b>-328 to 2372°F (-200 to 1300°C)</b>
<b>Type R</b>	<b>32 to 3214°F (0 to 1768°C)</b>
<b>Type S</b>	<b>32 to 3214°F (0 to 1768°C)</b>
<b>Type T</b>	<b>-328 to 752°F (-200 to 400°C)</b>
<b>Type B</b>	<b>392 to 3272°F (200 to 1800°C)</b>
<b>Type E</b>	<b>-328 to 1832°F (-200 to 1000°C)</b>
<b>RTDs</b>	
<b>Type 0.003850 100Ω</b>	<b>-328 to 1472°F (-200 to 800°C)</b>
<b>Type 0.003916 100Ω</b>	<b>-328 to 680°F (-200 to 630°C)</b>
<b>Thermistors</b>	
<b>Type 400</b>	<b>-22 to 212°F (-30 to 100°C)</b>
<b>Type 700</b>	<b>5 to 212°F (-15 to 100°C)</b>

### **Sensor accuracy for thermocouples and RTDs**

Calibration accuracy

Thermocouple types J, K, T, E, N,  $\pm 0.1\%$  of span or  $\pm 1^\circ\text{C}$

Thermocouple types B, R, S,  $\pm 0.2\%$  of span or  $\pm 2^\circ\text{C}$

RTD;  $\pm 0.1\%$  of span

Accuracy span is 1000°F (540°C) minimum

### **Sensor accuracy for thermistors**

Calibration accuracy

Thermistors:  $\pm 0.4\%$  of span or  $\pm 0.5^\circ\text{C}$

Accuracy span is 266°F (130°C) minimum

# Screen Flow Charts

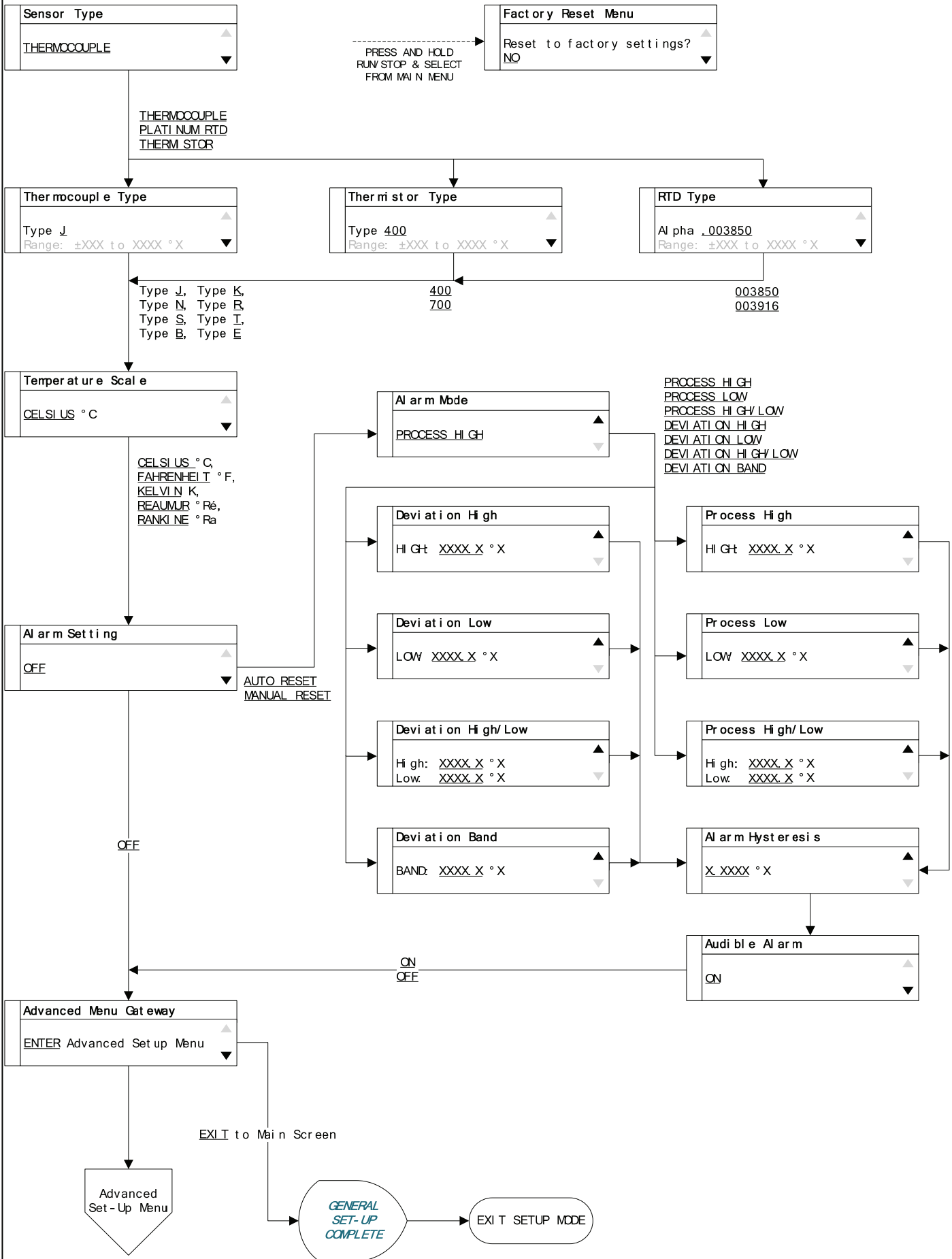

# Screen Flow Charts

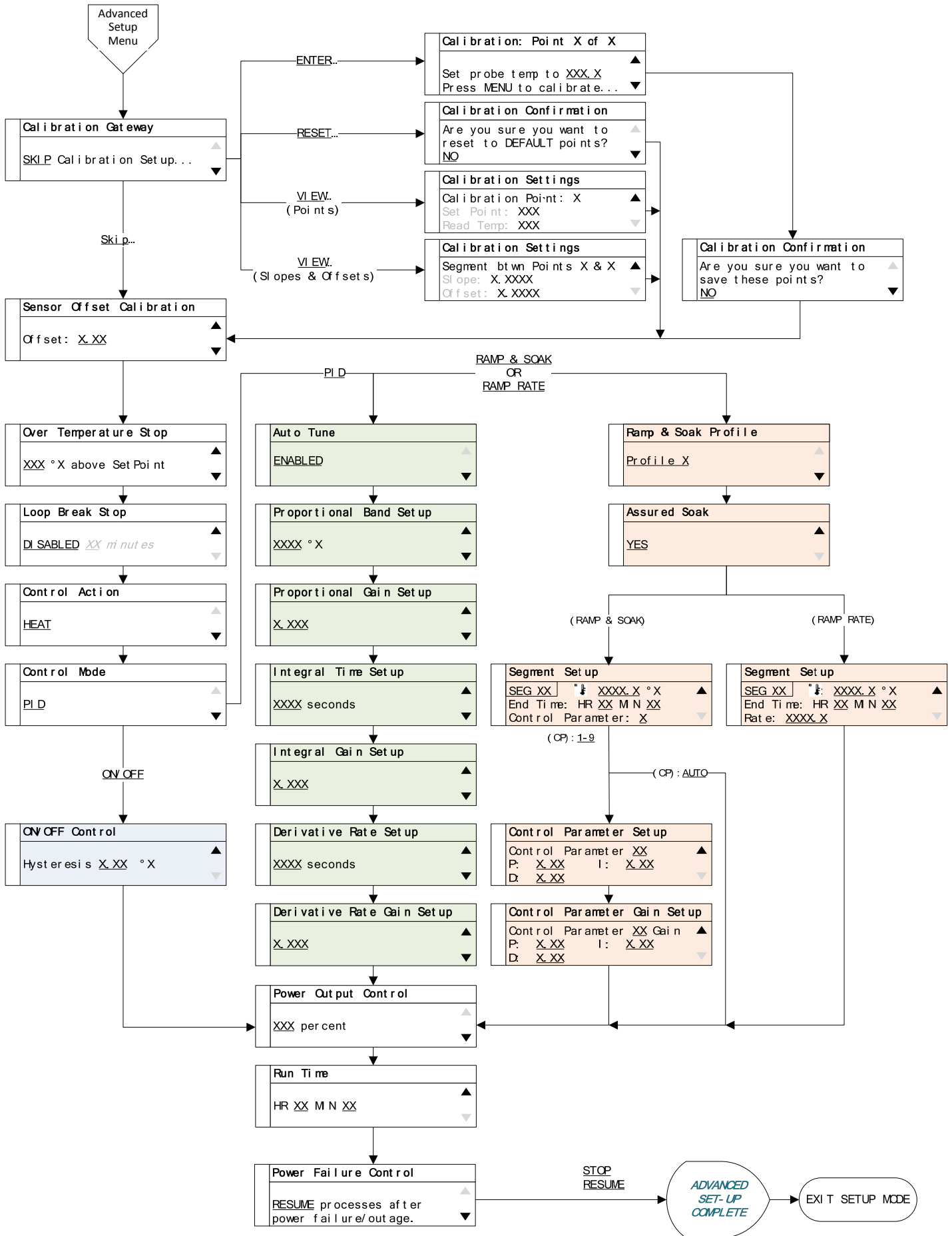

## Correct Wiring of ANSI (3-Blade) RTD Probe

- If the controller shows an “open” sensor alarm when using an RTD sensor with an ANSI Style 3-blade connector:
  - Please verify that the probe is wired correctly to industry standards.
  - Open the connector of the probe and confirm the wiring is per the picture below.
  - If the wirings does not match, please rewire as shown.

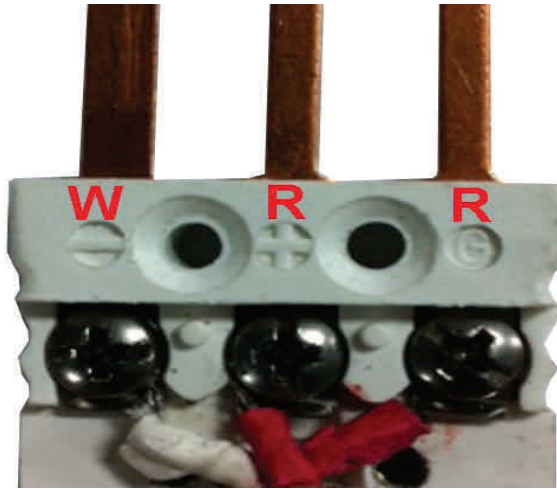

## Ferrite Clip Installation



Example picture Digi-Sense Temperature Controller TC9500 Model 89800-03

## Alternative Power Cords — for Various Countries

A detachable cord/plug set is automatically included with both models of the temperature controller:

- Model 89800-03 includes a US 120 VAC plug
- Model 89800-04 includes a US 220 VAC plug

Below is a ordering table for the available cord/plug sets. Cord/plug sets feature a country-specific male plug on one end and an IEC 320 female plug on the other end. Order a cord/plug set to replace a lost or damaged set or to use your temperature controller in another country.

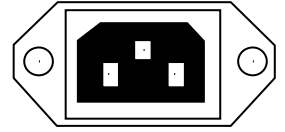

IEC 320 socket

Illustration	Country	Catalog number
	US Standard	50001-68
	Australia, Japan	50001-60
	Denmark	50001-62
	India	50001-64
	Israel	50001-69
	Europe	50001-70
	England	50001-72
	Switzerland	50001-74
	Italy	50001-76
	US (NEMA)	50001-78

## Output Cord Adapters – for Various Countries

A detachable cord set is not included with the temperature controller:

- Model 89800-03 includes a US 120 VAC female plug
- Model 89800-04 includes a IEC 60320 C19, 230 VAC female plug

Below is a ordering table for the available cord sets. Cord sets feature a country-specific female plug on one end and an IEC 360320 C19 male plug on the other end that will plug into the controller.. Order a cord set to use your heating or cooling devices with your 230 VAC temperature controller in another country. Each cord set is 12 in ((30.5 cm) in length.



IEC 60320 C19

Illustration	Country	Catalog number
	Australia, Japan	80800-24
	Denmark	80800-21
	India	80800-23
	Israel	80800-28
	Europe	89800-19
	England	89800-22
	Switzerland	80800-26
	Italy	80800-27
	US (NEMA)	80800-29

## **CE Approval**

*Conforms to the following Product Specifications:*

EMC: EC Directive 204/108/EC  
Using the following: EN 61326-1-2006  
EN 55011 : 2009 ISM RADIO FREQUENCY EQUIPMENT, CLASS B  
EN 61000-3-2:2006 (IEC 61000-3-2 : 2005) HARMONICS  
En 61000-3-3:2008 (IEC 6100-3-3:2008) FLICKER  
Immunity Test:  
EN 61000-4-2: 2001-4 ESD  
EN 61000-4-3: 2006-02 RADIATED RF SUSCEPTIBILITY  
EN 61000-4-4:2004-07 ELECTRICAL FAST TRANSIENT / BURST  
EN 61000-4-5:2001-04 SURGE  
EN 61000-4-6:2004-11 RF CONDUCTED SUSCEPTIBILITY, COMMON MODE  
EN 61000-4-11:2004-03 VOLTAGE DIPS AND INTERRUPTIONS

Safety: 2006/95/EC using EN61010-1

## **UL Approval—File E207546, Vol.**

**Standard:** UL 61010-1, 3rd Edition, 2012-04-17 (ELECTRICAL EQUIPMENT FOR MEASUREMENT, CONTROL, AND LABORATORY USE - Part 1: General Requirements)  
CAN/CSA-C22.2 No. 61010-1, 3rd Edition, 2012-04, (ELECTRICAL EQUIPMENT FOR MEASUREMENT, CONTROL, AND LABORATORY USE - Part 1: General Requirements)

**Certification Type:** Listing

**CCN:** OGTK, OGTK7 (Laboratory Use Electrical Equipment)

## **Maintenance**

- Simple preventive maintenance steps include keeping the controller clean. Protect it from overload, excessive dirt, oil and corrosion.
- Cleaning: If cleaning is necessary, use only a damp cloth with water only. Wipe only the exterior of the control chassis.

CATALOG NUMBERS **89800-03 and 89800-04**

SERIAL NUMBER \_\_\_\_\_

DATE OF PURCHASE \_\_\_\_\_

**Test Equipment Depot**  
  
1-800-517-8431

99 Washington Street  
Melrose, MA 02176  
Phone 781-665-1400  
Toll Free 1-800-517-8431

 Visit us at [www.TestEquipmentDepot.com](http://www.TestEquipmentDepot.com)