

June 9, 1961

electronics

A McGraw-Hill Publication
75 Cents

A
SPECIAL
REPORT
about

**ELECTRONICS
IN EUROPE**

ROLAND KISSLER
BOX 956
MOSES LAKE WASH

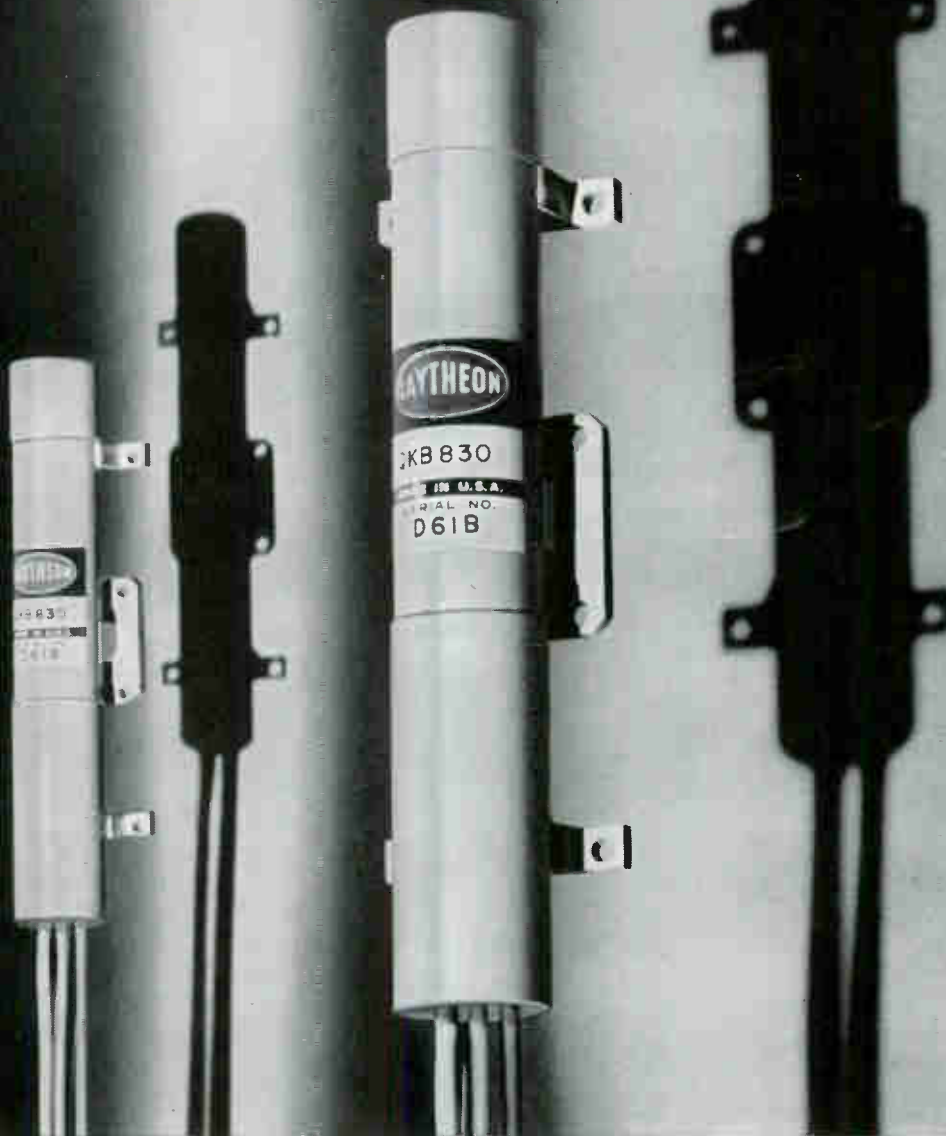

QKB 830 O-TYPE BWO is 1¼ inches in diameter; weighs only 1½ lbs.

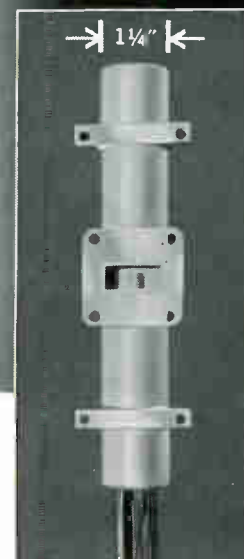

Electrostatically focused BWO provides smaller, lighter X-band signal source

New Raytheon tube combines advantages of backward wave oscillators in rugged compact package ideal for airborne and missile use.

The QKB 830 is especially suitable for local oscillator service in airborne, shipboard, or ground-based equipment such as anti-jam radar receivers. A wide-range tube, it can be tuned from 8.5 to 9.6 kMc by varying a single electrode voltage.

The small size and low voltages of the QKB 830 permit its use as a direct replacement for mechanically tuned klystrons in existing systems. It is also adaptable to many other applications requiring a voltage tunable source having provision for low-voltage pulsed or amplitude modulation.

Write today for technical data or application service to Microwave and Power Tube Division, Raytheon Company, Waltham 54, Massachusetts. In Canada: Waterloo, Ontario.

QKB 830 GENERAL CHARACTERISTICS (Typical CW Operation)

Power Output	15-30mW
Frequency	8.5-9.6 kMc
Voltage Requirements	
Tuning Voltage	150-250 Vdc
Focus Voltage	300 Vdc
Filament Voltage	6.3 V
Shock	50 G's
Cooling	convection
Overall Length	7.5 in.
Weight	1.5 lb. Max.

RAYTHEON COMPANY

MICROWAVE AND POWER TUBE DIVISION

RAYTHEON

electronics

A McGraw-Hill Publication 75 Cents



W. W. MacDONALD, Editor

J. M. CARROLL, Managing Editor

SENIOR ASSOCIATE EDITORS: Samuel Weber, Roland J. Charest. ASSOCIATE EDITORS: Frank Leary, Michael F. Tomaino, Sylvester P. Carter, William P. O'Brien, John F. Mason, William E. Bushor, Thomas Emma, Sy Vogel, Leslie Salomon, M. M. Perugini, George J. Flynn. ASSISTANT EDITORS: Michael F. Wolff, Nilo Lindgren, Stanley Froud, Stephen B. Gray, Roy J. Bruun, George V. Novotny, Leon H. Dulberger.

REGIONAL EDITORS: Harold C. Hood (Pacific Coast, Los Angeles), Thomas Maguire (New England, Boston), Cletus M. Wiley (Midwest, Chicago). BUYERS' GUIDE EDITOR: George Sideris. ART DIRECTOR: Harry Phillips; Howard R. Berry. PRODUCTION EDITOR: John C. Wright, Jr. EDITORIAL ASSISTANTS: Gloria J. Meurer, Bernice Duffy, Lorraine Rossi, Virginia T. Bastian, Lynn Emery, Avis Pomeranz, Florence Hajaistran, Laura W. Smith, Bette H. Snyder.

JAMES GIRDWOOD, Publisher

BUSINESS

Will the Laser Succeed Sonar for Undersea Electronics?	24
Data Logging and Process Control Highlight French Show	26
Ultrasonics Improves Grinding Economy and Quality	28
Polaris Sub Crews Get Navigation Simulator	30
Teaching Machines Draw Overflow Crowd, Get EIA Section	32
Crosstalk	4
Financial	20
Comment	6
25 Most Active Stocks	21
Electronics Newsletter	9
Meetings Ahead	34
Washington Outlook	14

ENGINEERING

Microwave relay tower of the German Postal Ministry, on the Frauenkopf near Stuttgart. (<i>Standard Elektrik Lorenz</i>) See p 65	COVER
Electronics in Europe. Special on-the-spot report gives penetrating analysis of an entire continent's business climate, industrial plant, labor-management relations, professional education and latest technical developments. By W. W. MacDonald	65
Modifying Vidicon Camera Chain for Slow-Scan Television Systems. Decrease bandwidth and power requirements of transmitters. By F. F. Martin and C. T. Shelton	101
Semiconductors Improve Reliability of Steel-Mill Control Equipment. Transistors, silicon-controlled rectifiers and photocells. By T. E. DeViney	104
Neon Diode-Resistor Matrix Controls Electronic Typewriter. Uses type wheel with thyatron drive. By M. Ruderfer	108
Servo Filter and Gain Control Improve Automatic Direction Finder. Light weight and low cost. By P. V. Sparks	110
One-Shot Gating Circuit Generates Sinewaves for Testing Counters. Operates at 32 Mc. By V. Kenn	114
Comparing Resistances With Oscillator and Oscilloscope. Electronic switch displays decay waveforms sequentially. By A. Kislovsky	118

DEPARTMENTS

Research and Development. Boosting Strobotron Power	120
Components and Materials. Power Rectifiers	124
Production Techniques. Making Modules Compact	128
New on the Market	132
Thumbnails	152
Literature of the Week	148
People and Plants	156
New Books	150
Index to Advertisers	169

Shallcross

precision
circuit
news



**Delay-to-
Rise-Time
Ratio in
Only 6 in³**

Total Delay	1.5 μ sec
Rise Time	0.03 μ sec
Impedance	500 ohms
PRF	2.5 mc
Attenuation	1 db
Distortion	5%
TC	+150 ppm, ± 15 ppm (-10°C to $+50^{\circ}\text{C}$)

Some of the toughest performance specs we've seen in 12 years of delay line engineering are crammed into the $\frac{1}{2}$ " x 2" x 6" case of this lumped constant line. Used by a data processing equipment manufacturer, the unit requires uncommon care in component selection and in circuit layout to achieve the desired 50 to 1 delay-to-rise-time ratio in the space allowed.

Special cores and toroidal winding techniques promote maximum Q, and, when coupled with custom miniature capacitors, desired LC characteristics are obtained within the specified space. An ingenious termination further reduces distortion at tapped outputs and appreciably enhances the pulse time characteristic.

Even if your delay line requirements are not so critical, this same Shallcross ingenuity may pay big dividends in reducing size, cost, or circuit complexity for you. Why not outline your needs to us?

DELAY LINES



VARIABLE DELAY

Continuously adjustable delays from 0 to 0.5 μ sec with 0.005 μ sec resolution are attainable in this typical Shallcross unit. Maximum rise time is 0.06 μ sec at maximum delay.



DISTRIBUTED CONSTANT



LUMPED CONSTANT

Shallcross' family of distributed constant and lumped constant lines utilize the latest refinements in inductors, capacitors, winding, trimming and packaging techniques.



STEPPING ACCURATELY

Typical of longer Shallcross delay lines, this variable lumped constant unit provides a total delay of 24.65 μ sec in 15 steps calibrated to 0.05 μ sec accuracy. Delay-to-rise-time is 100:1—and in a hermetically-sealed package measuring only 2" x 4" x 7 $\frac{1}{4}$ ".

Of course variations can be made for your requirements—in impedance, taps, rise time, attenuation and so forth. These are regular occurrences with the many hundred designs produced by Shallcross delay line specialists.

Shallcross Manufacturing Co. Selma, North Carolina

Precision wirewound resistors, Switches, Instruments, Delay lines, Resistance networks, Audio attenuators.

LAMBDA

Convection Cooled

Transistorized Regulated Power Supplies

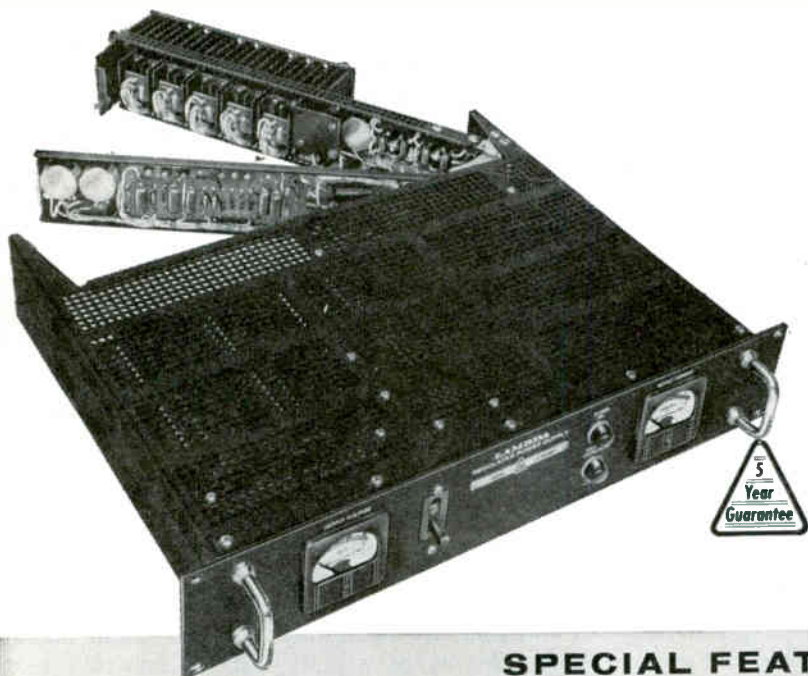

LA SERIES

0- 34 VDC	5 AMP
0- 34 VDC	10 AMP
0- 34 VDC	20 AMP
20-105 VDC	2 AMP
20-105 VDC	4 AMP
20-105 VDC	8 AMP
75-330 VDC	0.8 AMP
75-330 VDC	1.5 AMP
75-330 VDC	3 AMP

SPECIAL FEATURES

- Convection Cooled—No internal blowers or filters—maintenance free
- Ambient 50°C
- No Voltage Spikes or overshoot on "turn on, turn off," or power failure
- Short Circuit Proof
- Remote programming over Vernier band
- Hermetically-sealed transformer designed to MIL-T-27A
- Easy Service Access
- Constant Current Operation—Consult Factory
- Guaranteed 5 years

CONDENSED DATA

DC OUTPUT (Regulated for line and load)

Model	Voltage Range ⁽¹⁾	Vernier Band ⁽²⁾	Current Range ⁽³⁾	Price ⁽⁴⁾
LA 50-03A	0- 34 VDC	4 V	0- 5 AMP	\$ 395
LA100-03A	0- 34 VDC	4 V	0-10 AMP	510
LA200-03A	0- 34 VDC	4 V	0-20 AMP	795
LA 20-05A	20-105 VDC	10 V	0- 2 AMP	350
LA 40-05A	20-105 VDC	10 V	0- 4 AMP	495
LA 80-05A	20-105 VDC	10 V	0- 8 AMP	780
LA 8-08A	75-330 VDC	30 V	0- 0.8 AMP	395
LA 15-08A	75-330 VDC	30 V	0- 1.5 AMP	560
LA 30-08A	75-330 VDC	30 V	0- 3 AMP	860

(1) The DC output voltage for each model is completely covered by four selector switches plus vernier range.

(2) Center of vernier band may be set at any of 16 points throughout voltage range.

(3) Current rating applies over entire voltage range.

(4) Prices are for unmetred models. For metred models add the suffix "M" and add \$30.00 to the price.

Regulation (line) Less than 0.05 per cent or 8 millivolts (whichever is greater). For input variations from 100-130 VAC.

Regulation (load) Less than 0.10 per cent or 15 millivolts (whichever is greater). For load variations from 0 to full load.

Ripple and Noise Less than 1 millivolt rms with either terminal grounded.

Temperature Coefficient Less than 0.025%/°C.

AC INPUT 100-130 VAC, 60 ± 0.3 cycle(s)

(5) This frequency band apply covers standard commercial power line tolerances in the United States and Canada. For operation over wider frequency band, consult factory.

Size
 LA 50-03A, LA20-05A, LA 8-08A 3½" H x 19" W x 14¾" D
 LA100-03A, LA40-05A, LA15-08A 7" H x 19" W x 14¾" D
 LA200-03A, LA80-05A, LA30-08A 10½" H x 19" W x 16½" D

Send for new Lambda Catalog 61

LA118



LAMBDA ELECTRONICS CORP.

515 BROAD HOLLOW ROAD, HUNTINGTON, L. I., NEW YORK 516 MYRTLE 4-4200

Published weekly, with Electronics Buyers' Guide and Reference Issue, as part of the subscription, by McGraw-Hill Publishing Company, Inc. Founder: James H. McGraw (1860-1948).

Title registered U.S. Patent Office; Copyrighted 1961, McGraw-Hill Publishing Company, Inc. All rights reserved, including the right to reproduce the contents of this publication, in whole or in part.

Executive, editorial, circulation and advertising offices McGraw-Hill Building, 330 West 42nd Street, New York 36, N. Y. Telephone Longacre 4-3000. Teletype TWX N.Y. 1-1636. Cable McGrawhill, N. Y. Printed in Albany, N. Y.; second class postage paid.

OFFICERS OF THE PUBLICATIONS DIVISION: Nelson L. Bond, President; Shelton Fisher, Wallace F. Traendly, Senior Vice Presidents; John R. Callahan, Vice President and Editorial Director; Joseph H. Allen, Vice President and Director of Advertising Sales; A. R. Venezian, Vice President and Circulation Coordinator.

OFFICERS OF THE CORPORATION: Donald C. McGraw, President; Joseph A. Gerardi, Hugh J. Kelly, Harry L. Waddell, Executive Vice Presidents; L. Keith Goodrich, Vice President and Treasurer; John J. Cooke, Secretary.

Subscriptions are solicited only from those actively engaged in the field of the publication. Position and company connection must be indicated on orders. Subscription rates: United States and Possessions, \$6.00 one year; \$9.00 two years; \$12.00 three years. Canada, \$10.00 one year. All other countries \$20.00 one year. Single Copies, United States and Possessions and Canada 75¢; Buyers' Guide \$3.00; Single Copies all other countries \$1.50; Buyers' Guide \$10.00.

The Publisher, upon written request from any subscriber to our New York Office, agrees to refund that part of the subscription price applying to copies not yet mailed.

Subscribers: Please address all correspondence, change of address notices, subscription orders or complaints to Fulfillment Manager, Electronics, at above address. Change of address notices should provide old as well as new address, including postal zone number if any. If possible, attach address label from recent issue. Allow one month for change to become effective.

Postmaster: Please send Form 3579 to Fulfillment Manager, Electronics, 330 West 42nd Street, New York 36, New York.



Audited Paid Circulation

CROSSTALK

WHY NOT STANDARDIZE MICROWAVE BANDS? What you mean by Q-band isn't necessarily what I mean by Q-band and neither of us may agree with what the other guy means by Q-band.

Although some general agreement exists on what frequencies are in what microwave bands, the conversation comes to a grinding stop when someone mentions "... the upper end of K band ..." or "... around the middle of S band ...". These are the same engineers that specify component values to decimal places.

Like Topsy, identification of microwave bands by letter designation just grew from what was a wartime security device to keep the enemy from learning specific radar frequencies. Going through some present-day catalogs and ads for microwave gear, it would seem that we are still operating under wartime wraps.

Talks with microwave equipment and component manufacturers indicate that they would very much like to see standardization in this area. Says Weismann of PRD "... standards have never been established, although there is some general agreement between manufacturers ..." Sonnen-schein of Polarad feels "... some people may not agree with the standards as set down, but industry will gain by avoiding confusion and eventually reducing costs ...".

And Hensperger of Narda Microwave says "... (standardization of frequency band letters) is something that is sorely needed in the microwave industry ... this matter should be brought up before the EIA Standardization Committee for their action. Wholey of Hewlett-Packard thinks "... any standardization could do nothing but help the industry ... (but) I believe that you would find a great amount of inertia from various companies to change over to a standardized system."

The microwave letter-frequency chart presented last week (ELECTRONICS, p 58, June 2) was compiled from many sources. Some manufacturers and engineers may not agree with it, but we feel that a start towards standardization must be made.

LASER - - - WHAT NEXT? Undersea light beams, generated by lasers operating in the blue-green spectrum, may one day rival sonar for undersea applications. In detection, light provides high definition compared to pulsed sound. For control and communication a needle-like, hard-to-intercept light beam could realize a high level of privacy.

Systems techniques, developed with available optical equipment, are discussed on p 24, with the probability of laser developments leading to one suitable for use undersea.

Coming In Our June 16 Issue

NEW SPEAKER SYSTEM. For many years, loudspeaker designers have been seeking a speaker with a transient response as close to the ideal as possible and with uniform frequency response free from resonance effects across the audio range.

In our next issue, S. R. Rich of Bogen and Rich, Inc. in Yonkers, N. Y. describes an electrodynamic loudspeaker that has a totally active surface. Using a non-resonant, pneumatically-loaded bass unit together with a distributed current carrying sheet located within a magnetic field for higher frequencies, system is said to have an almost ideal transient and wide-range frequency response, free from excessive dips and peaks.

IN ADDITION. Interesting feature material to appear next week includes: a heart sound discriminator for medical diagnosis by R. Weiss of Seattle University; a microwave isolator combining the Hall effect and tunnel diodes by C. H. Hubbard, L. A. LoSasso and E. Rousso of Airborne Instruments Laboratory; wideband video distribution amplifiers by H. H. Naidich of ITT Federal Laboratories.

FILMISTOR® 'C'

METAL FILM RESISTORS OFFER 5 DISTINCT TEMPERATURE COEFFICIENTS TO MEET ALL CIRCUIT REQUIREMENTS

**RUGGED END-CAP
CONSTRUCTION
FOR LONG TERM
STABILITY**

• • •

**EXCEPTIONAL
RESISTANCE TO
MOISTURE AND
MECHANICAL DAMAGE**

• • •

**SURPASS MIL-R-10509
PERFORMANCE
REQUIREMENTS**

Providing close accuracy, reliability and stability with low controlled temperature coefficients, these molded case metal-film resistors outperform precision wirewound and carbon film resistors. Prime characteristics include minimum inherent noise level, negligible voltage coefficient of resistance and excellent long-time stability under rated load as well as under severe conditions of humidity.

Close tracking of resistance values of 2 or more resistors over a wide temperature range is another key performance characteristic of molded-case Filmistor "C" Resistors. This is especially important where they are used to make highly accurate ratio dividers.

Filmistor "C" Resistors are automatically spiralled to desired resistance values by exclusive Sprague equipment. The metallic resistive film, deposited by high vacuum evaporation, bonds firmly to special ceramic cores. Noble metal terminals insure low contact resistance.

The resistance elements, complete with end caps and leads attached are molded in dense, high temperature thermosetting material to form a tough molded shell for maximum protection against mechanical damage, moisture penetration and repeated temperature cycling.

Filmistor "C" Resistors, in 1/8, 1/4, 1/2 and 1 watt ratings, surpass stringent performance requirements of MIL-R-10509C, Characteristic C. Write for Engineering Bulletin No. 7025 to: Technical Literature Section, Sprague Electric Co., 35 Marshall Street, North Adams, Mass.

*For application engineering assistance write:
Resistor Division, Sprague Electric Co.
Nashua, New Hampshire*



SPRAGUE COMPONENTS

RESISTORS
CAPACITORS
MAGNETIC COMPONENTS
TRANSISTORS

INTERFERENCE FILTERS
PULSE TRANSFORMERS
PIEZOELECTRIC CERAMICS
PULSE-FORMING NETWORKS

HIGH TEMPERATURE MAGNET WIRE
CERAMIC-BASE PRINTED NETWORKS
PACKAGED COMPONENT ASSEMBLIES
FUNCTIONAL DIGITAL CIRCUITS



'Sprague' and 'C' are registered trademarks of the Sprague Electric Co.

COMPACT AiResearch 60 cycle Actuators for ground use . . .



Inexpensive, lightweight 60 cycle motor driven actuators with integral magnetic brakes* are now being manufactured by AiResearch for ground radar, ground support and shipboard use.

Unequaled in 60 cycle performance, these extremely compact, lightweight actuators range from fractional hp motor size up to any desired hp in single phase, two phase and three phase design for a wide variety of applications.

The above-pictured actuator is used in a ground radar system. It is driven by a single phase 60 cycle ac fractional hp electric motor and can be furnished with a feedback potentiometer for use in servo applications. The entire unit weighs only 2½ lb. and is rated at 200 lb. operating load.

OTHER ELECTROMECHANICAL COMPONENTS AND SYSTEMS

A C and D C Motors, Generators and Controls • Static Inverters and Converters • Linear and Rotary Actuators • Power Servos • Hoists • Temperature and Positioning Controls • Sensors • Programmers • Missile Launchers • Radar Positioners • Power Supplies • Williamsgrip Connectors

Your inquiries are invited.

* patented 60 cycle operated magnetic brake



AiResearch Manufacturing Division

Los Angeles 45, California

COMMENT

Computers Today

. . . I have just spent an hour leafing through your April 28th special report "Computers Today" (p 63) with considerable interest. I think that most technically oriented layman would get a very good overall orientation in the state of the computer art by reading it . . .

I have enjoyed my entire association with the production of this report from our first meeting and discussion to this final reading. I am grateful for the opportunity of having my small message ride on the back of your large vehicle . . .

DOUGLAS C. ENGELBART
STANFORD RESEARCH INSTITUTE
MENLO PARK, CALIF.

We consider researcher Engelbart more a pillar than a passenger. Not only was his interesting disquisition "Computers and the Challenges of Man" a definitive contribution to the concept of the report, but also his advice, encouragement and the results of his own researches were in great measure responsible for its success.

Patent Legislation

May 5 ELECTRONICS' "Patent Bills in Senate Opposed by EIA" (p 11) stresses the industry arguments for retention, by government contractors, of patent rights growing out of R&D work paid for by the government. "Inventions cannot be contracted for, since they are incidental to contract performance, thus cannot be predicted in advance of signing the contract," argues EIA.

When, however, companies make employment contracts with individual engineers and scientists, they completely reverse themselves and use the government's arguments. These company-employee contracts require assignment of employee inventions to the company, the consideration being usually one dollar and the employee's salary. In some cases such con-

tracts may extend the assignment period to five or so years after employment terminates.

The EIA claim that "a major stimulant to electronics industry growth would be lost due to the title-claiming legislation, and that firms doing both government and commercial work would not put into the government-sponsored research their best and newest patentable ideas," is also completely opposite to their own policies with respect to the inventions of their employees . . .

If retention of patent rights is a "major stimulant" for invention, and if putting "in . . . their best and newest patentable ideas" is so important to these companies when they work for the government, why do they not provide such stimuli for their inventive employees in their nongovernmental R&D activities? If they practiced the policies they now preach, their own growth would be stimulated by purchase of employee inventions; these employees would not be tempted to hold back valuable ideas; and the very marked and costly employee turnover rate would surely be greatly reduced.

B. F. MEISSNER
MEISSNER INVENTIONS INC.
MIAMI SHORES, FLA.

Companies hire engineers and scientists with the foreknowledge that inventions may and should emerge from the work financed and directed by the corporation; that they then become mesne assignors for patent rights is a logical step that does not have a parallel in the contractual relationships obtaining between the government and its suppliers. Many firms reward talented inventors with something more than the legally required \$1 consideration. If something like the employee assignment contract executed by the postulant engineer were to be executed by a contractor with the government prior to the signing of a contract, then the company would as clearly surrender primary rights to the exploitation of the invention as the engineer now willingly does.

Max. MegW/cu. in.



ITT CERAMIC HYDROGEN THYRATRONS AND DIODES FOR MAXIMUM POWER/SIZE RATIO

No other hydrogen thyatron and diode line offers this wide choice of high-power types in the smallest possible tube envelopes. Made by ITT Kuth Laboratories, most experienced maker of hydrogen-filled tubes, these ceramic thyratrons and diodes are the most complete line on the market today, with each type immediately available from production. The high-power thyratrons are designed to operate at high repetition rates and high temperatures; the high-power diodes may be used as hold-off diodes, inverse clippers and backswing clippers. Also available is an equally comprehensive line of glass thyratrons. The entire ITT hydrogen thyatron and diode program is aimed at the most demanding applications, particularly where long life and ruggedness are mandatory.

THYRATRONS	KU 70	KU 71	KU 72	KU 73	KU 74	KU 274
Performance Factor ($\times 10^3$)	1.0	4.0	7.0	20.0	40.0	45.0
Peak Power Output, Megawatts	0.2	1.0	3.50	12.50	33.0	50.0
Forward Anode Voltage, Kilovolts	6.0	10.0	20.0	25.0	33.0	50.0
Peak Anode Current, Amperes	90	200	350	1000	2000	2000
Average Anode Current, Amperes	.100	200	.300	1.5	4.0	4.0
Height, Inches	1.70	2.25	3.00	5.75	11.0	12.0
Diameter, Inches	1.15	1.37	1.75	3.00	4.50	4.50

DIODES	KU 92	KU 93	KU 94
Peak Inverse Voltage, Clipper, Kilovolts	25.0	33.0	33.0
Peak Forward Current, Clipper, Amperes	300	500	2000
Max. Average Current, Clipper, Amperes	.200	.500	2.0
Peak Inverse Voltage, Rectifier, Kilovolts	15.0	20.0	20.0
Peak Forward Current, Rectifier, Amperes	2.0	8.0	16.0
Max. Average Current, Rectifier, Amperes	.50	2.0	4.0
Height, Inches	3.00	6.00	8.25
Diameter, Inches	1.75	3.00	4.50

Write for information on the complete line of ITT hydrogen thyratrons and diodes. Application assistance is available for your specific requirements.

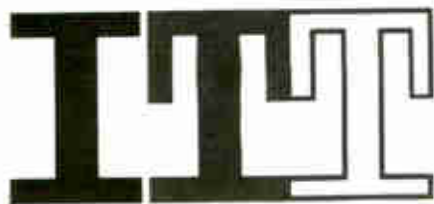

ELECTRON TUBE DEPARTMENT ■ COMPONENTS DIVISION
INTERNATIONAL TELEPHONE AND TELEGRAPH CORPORATION, CLIFTON, NEW JERSEY

ITT COMPONENTS DIVISION PRODUCTS: POWER TUBES • IATRON STORAGE TUBES • HYDROGEN THYRATRONS
TRAVELING WAVE TUBES • SELENIUM RECTIFIERS • SILICON DIODES AND RECTIFIERS • TANTALUM CAPACITORS

CIRCLE 7 ON READER SERVICE CARD

BUSS and FUSETRON FUSES

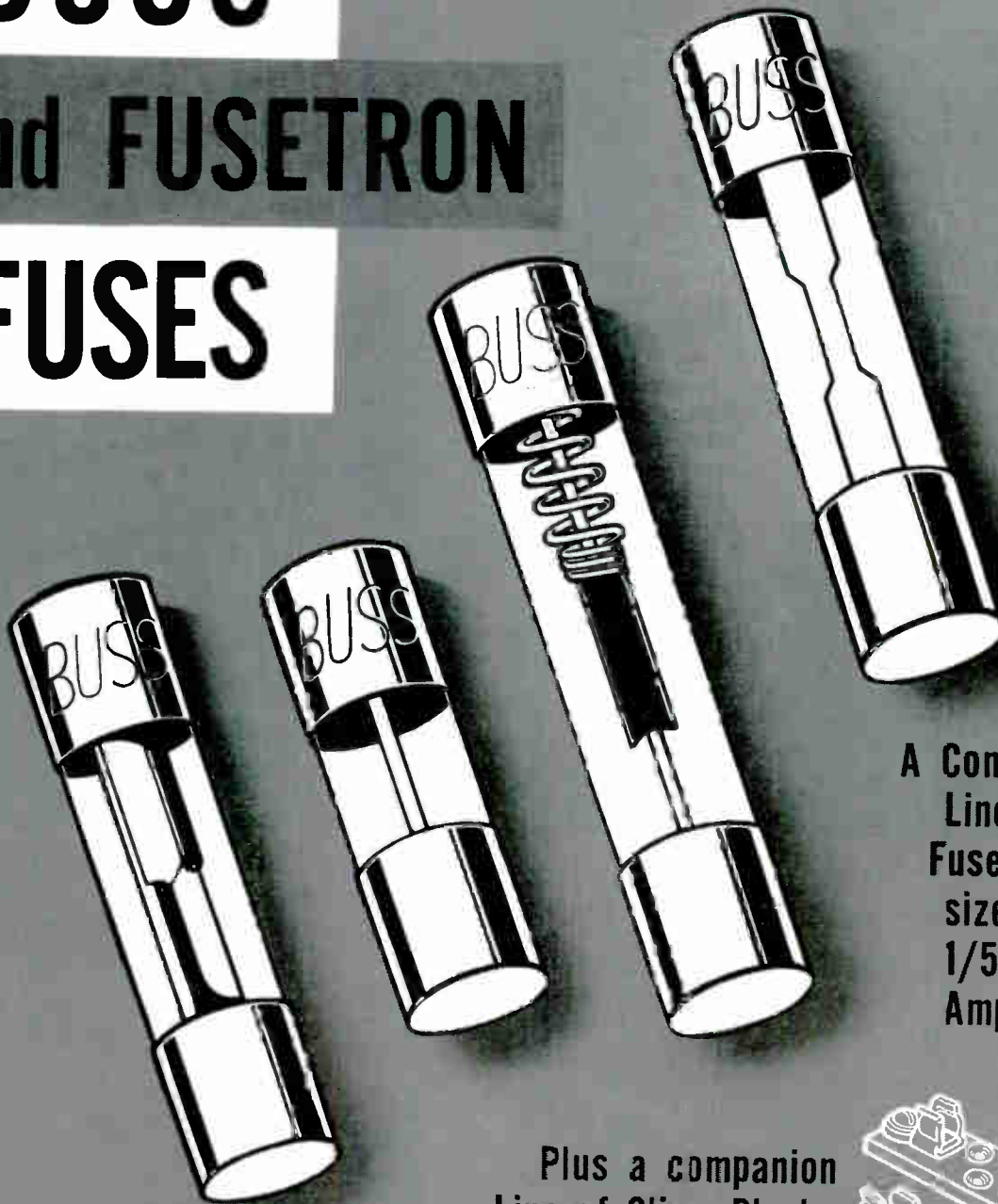

A Complete
Line of
Fuses in
sizes from
1/500
Amps. up

Plus a companion
Line of Clips, Blocks
and Holders

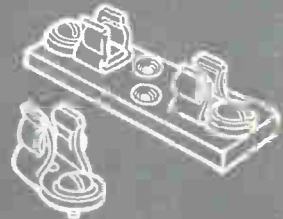

When you specify BUSS and FUSETRON fuses you can be sure of safe, dependable, trouble-free protection for your equipment under all service conditions.

Every BUSS and FUSETRON fuse is tested in a sensitive electronic device that automatically rejects any fuse not correctly calibrated, properly constructed and right in all physical dimensions.

Chances are you will find in the complete BUSS line the fuse and fuse mounting to fit your requirements — but if your protection problem is unusual, let our engineers work with you and save you engineering time.

To get full data for your files, write for BUSS bulletin on small dimension fuses and fuseholders. Form SFB.

561

BUSSMANN MFG. DIVISION, McGraw-Edison Co., UNIVERSITY AT JEFFERSON, ST. LOUIS 7, MO.

ELECTRONICS NEWSLETTER

Navy Discloses Details On Artemis Project

SOME DETAILS on Project Artemis—the long-range surveillance and ranging sonar system being planned for antisubmarine defense by the Navy—were released to the press last week. The story on Artemis was first broken by **ELECTRONICS** on Jan. 13 (p 26). Among new material released:

The *USNS Mission Capistrano*, a modified tanker, is being used as a test vessel to carry the 5-story-high transducer, which weighs hundreds of tons. The transmitter sends out a low-frequency thump which carries for hundreds of miles; sensitive receiving stations in the vicinity of Bermuda and ranging south to the Bahamas are running tests on reception. Power used by the transducer would light a town of 50,000 persons, the Navy says.

Some 30 university, government and industrial scientific research groups are involved in various aspects of Artemis, which is sponsored by Office of Naval Research and heavily funded from various of the Navy's many pockets. Hudson laboratories of Columbia University is coordinating the research effort. University of Michigan's Institute of Science & Technology is working out special data-processing techniques. IBM's federal systems division is developing a mathematical model of the characteristics of underwater sound under various ocean conditions. General Atronics of Bala-Cynwyd, Pa., is performing theoretical and experimental studies relating to signal-enhancement problems of the project.

Communications Meet Stresses New Systems

NEW HORIZONS in electronics was the theme of the meeting of the Armed Forces Communications & Electronics Association meeting which closed yesterday in Washington, D. C. One highlight: the demonstration and discussion by Bell

Labs' B. H. Oliver—AFCEA's president—of a coherent light generator, a c-w gas maser in the visible spectrum. Oliver noted that optical maser systems could handle 100 color tv channels and still leave lots of room for data transmission and telephony. He also postulated: optical radar systems that could identify aircraft shapes; space communications links—earth to moon or satellite, satellite to satellite—and even ground communications through conduits.

Industrial and military exhibitors numbered over 200, with the accent on new systems. Among them: Army Signal Corps and Sylvania Electric both had exhibits dealing with Advent. Navy displayed details of its space surveillance system. AT&T exhibited working models of satellite and earth stations for space transmission of live tv. Radio Engineering Labs showed the klystron carriage from a 75-Kw power amplifier used in tropo scatter. Development Engineering Co. exhibited a model of the ionospheric research facility now abuilding at Arecibo, P. R., which will include the world's largest radioastronomy antenna—1,000 ft in diameter.

Rocket Antenna Breakdown Investigated by Air Force

INVESTIGATION of the mechanisms of voltage breakdown in rocket antennas is being undertaken by the Air Force. Series of Nike-Cajun firings at the Gulf Test Range, Eglin AFB, Fla., recently produced definite evidence of voltage breakdown in slot antennas at 250 Mc. Breakdowns, which have plagued rocket and space programs, occur in the upper altitudes because of loss of air insulation.

Breakdown produces r-f noise, alters input impedance, decreases radiated power, modifies radiation pattern, distorts pulse shapes. Signals measured in the Eglin tests show breakdowns starting at 50,000 ft to 300,000 ft in vhf, uhf and microwave spectra. Correlation of data is expected to help the Air Force predict occurrence. Instru-

mentation for the Eglin tests was designed at Stanford Research Institute for USAF's Cambridge Research Labs.

Navy Instruments Pigeon To Check His Navigation

OFFICE OF NAVAL RESEARCH has begun following pigeons around to find out how they navigate so accurately over unfamiliar terrain. The answer might result in small navigation and detection systems for naval aircraft.

A bird-tracking system developed for ONR by American Electronic Laboratories in Philadelphia includes a miniature radio-beacon transmitter carried by the unsuspecting pigeon on his back. The transmitter weighs less than an ounce including power supply, puts out a milliwatt; power is supplied by three mercury button cells that can drive the unit for 20 hours. A half-wave dipole trails about 40 in. behind and below the bird in flight; first eight inches are encased in a glass-fiber rod to keep the pigeon from getting tangled with the trailing antenna.

Sensitive beacon receiver can pick up the transmitter's signal up to about 20 miles as long as the bird is 40 ft above the ground or more. The receiver antenna is a high-gain Yagi array with a narrow beamwidth. Two receiving stations are set up along the bird's probable course; they record azimuth information at time intervals determined in advance.

Two Stations On Mark At Stereo Starting Gate

TWO F-M STATIONS—in Schenectady, N. Y., and Chicago—were toeing the line at the start of the race to get stereo stations on the air the moment the Federal Communications Commission okay took effect 12:01 a.m. June 1. A technical point—the time-zone difference—put the Schenectady station on the air first.

WGFM, the f-m outlet owned by GE in Schenectady, began its pioneer broadcast with the equipment used by GE to demonstrate its f-m stereo system to the National

Stereophonic Radio Committee. WEFM Chicago, owned by Zenith Radio Corp., was next out of the starting gate. Zenith and GE systems were jointly authorized by the FCC's April 20 ruling.

A third entry was left at the gate. WFKM Chicago was delayed by complications involving the multiplexing of background music channel, hit the air later in the week, expects to be on an all-stereo programming schedule by Fall.

Both GE and Zenith are rushing stereo receivers into production. In Chicago, Zenith promised stereo table models in time for Christmas.

Air Agency Proposes Rule On Distance-Measuring Gear

FEDERAL AVIATION AGENCY is proposing a rule that would require all U. S. civil aircraft over 12,500 pounds to be equipped with distance-measuring equipment when operating under instrument flight rules. Deadline under the proposed rule would be January 1964. Government-industry conference in March produced agreement that DME was valuable as a safety navigation instrument. FAA's follow-up proposal would require installation of DME on turbojets by July 1, '62, turboprops by Jan. 1, '63, pressurized piston-engine craft by July 1 '63 and all other craft with a maximum weight of 12,500 pounds or more by Jan. 1, '64. Comments must be submitted by August 1.

FAA plan anticipates discontinuing all low-frequency airways facilities and replacing them with Vortac (vhf omnirange with Tacan-compatible DME) by 1965.

Savings-Bank Computer to Use Magnetic-Card Memory

NEW RECORDKEEPING SYSTEM developed by National Cash Register for large savings banks is an on-line system using an NCR 315 computer accessed from teller inquiry units; it stores depositor records on CRAM (card random-access memory) units. The NCR-developed memory units are made up of decks of plastic cards coated, like magnetic tape, with magnetically susceptible coating. New system will be in-

stalled in New York's Greenwich Savings Bank, will be able to handle 12,000 teller transactions an hour, produce net cash figures on demand, and provide reports such as analysis of depositors by age group and area, size and activity of accounts. Leased telephone lines will connect remote teller units to the central NCR 315.

FCC Requires Seal To Guarantee Radiation Limit

FEDERAL COMMUNICATIONS COMMISSION is reiterating a warning that all f-m and tv sets manufactured after Dec. 31, '57 and operated in the U. S. must carry a seal or label stating that the set meets FCC requirements for permissible level of r-f radiation. Owner of the set is responsible for observance of this noninterference regulation, but since users generally do not have test gear to determine compliance the FCC says "it feels that the manufacturer or distributor should assume this obligation to his customers and affix the required seal so that the purchaser of the set is assured that it conforms with radiation requirements."

Ruling applies alike to sets of domestic or foreign manufacture.

CBS, Philco Dropping Entertainment Tubes

CBS ELECTRONICS AND PHILCO CORP. have disclosed plans this week to get out of the entertainment tube business. CBS will pull out by the end of this month, while Philco plans to phase out over the remainder of 1961.

Philco vp W. J. Peltz, who manages the Philco-Lansdale division which will end tube manufacture, says the main reason for his company's action was due to economic factors brought on by a rising use of transistors and a decline in entertainment tube use. The company plans to retrain many workers.

From CBS word is that Raytheon will buy the biggest part of the inventory at the two tube plants at Danvers and Newburyport, Mass.; the tubes will be marketed through CBS dealers.

CBS will concentrate on indus-

trial and military electronics, build high-performance tubes, semiconductors, microelectronic devices. Company headquarters move to the new CBS plant in Lowell, Mass. The move, which will throw about 1,000 people onto the labor market, emphasizes New England's concentration on military and industrial electronics and the minor role played by consumer goods there.

Raytheon's purchase of the inventory signals an aggressive move for a big share of the independent (noncaptive) market for entertainment tubes. A company spokesman says the tubes were snapped up to prevent short-term depression in prices that dumping would cause, and to allow the company to stock up on replacement tubes currently in demand. The replacement market, Raytheon thinks, is about to be sparked by "the imminent opening of color-tv market;" also "the stereo f-m market is about to expand greatly." Market for entertainment-type tubes is now divided about 60-40, with the larger part sold to original-equipment manufacturers.

Air Force Extends Dew-Line Capability

AIR FORCE announced last week that its distant early-warning radar network will begin operating over the North Atlantic on July 1 as four new sites in Greenland go into operation. The opening of the four will signal the closing of nine other sites—three major installations and six gap-filler radars—in the Canadian Arctic and the Labrador-Newfoundland region.

In another development, Army awarded a \$19-million contract to Western Electric for work on a secure worldwide command support communications network. The contract specifically affects the switching and terminal facilities, will fund the manufacture of a working engineering test net.

Navy gave the Bendix Corp. a \$670,000 dispatch contract to get to work on development of a shipboard communications terminal for use in Army's Advent satellite communications program. Bendix already has a \$17-million contract to develop the overall communications system for Advent.

GOODYEAR

ADVANCED WEAPONS TRAINING: Another Prime Capability of Goodyear Aircraft

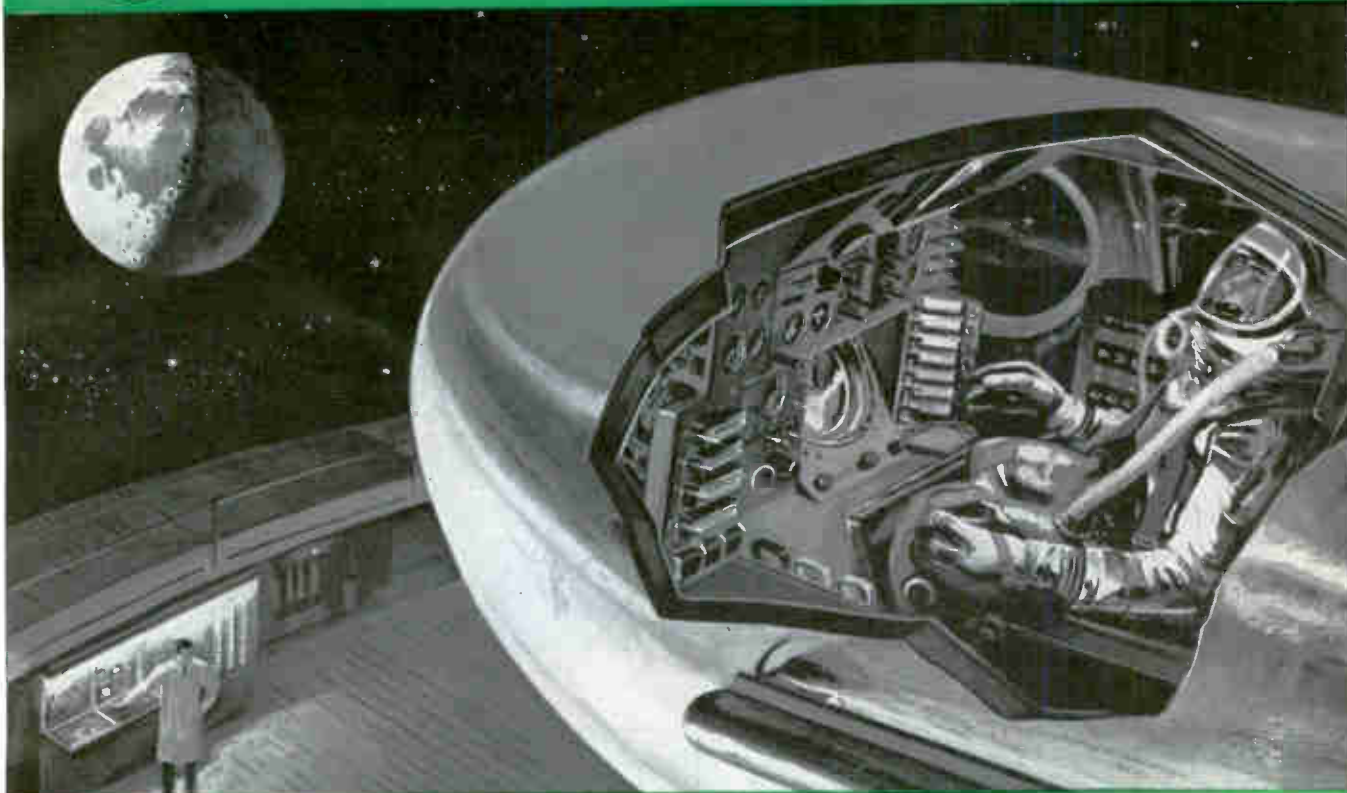

Inside Look at Outer Space: GAC has the capability to design a trainer which simulates an outer-space environment for tomorrow's astronaut.

DRESS REHEARSAL FOR THE BIGGEST SHOW ABOVE EARTH!

Prepare an astronaut for the experiences of space flight before launch? It is possible at Goodyear Aircraft Corporation (GAC). For at GAC can be found the skills to design and develop the most advanced weapon system trainers, the facilities to produce them, the experience to perfect them.

Today, working with the U.S. Naval Training Device Center, these skills, facilities, and experience factors are being utilized in building weapon system trainers for two of the Navy's most advanced aircraft—the A2F Intruder and the W2F Hawkeye.

Tomorrow we expect to be called upon to produce trainers for other complex systems. Whether the training is for missions below the seas, above the earth, or in the outer reaches of space, you'll find GAC ready.

Creative Engineers and Scientists—if you are looking for a challenge in these fields contact Mr. Charles G. Jones, Director of Technical and Scientific Personnel

GOODYEAR

GOODYEAR AIRCRAFT CORPORATION
Plants in Litchfield Park, Arizona, and Akron, Ohio



GAC is one of the prime suppliers of classroom radar trainers—similar to the one depicted here—for the U.S. Navy.



GAC-designed simulator-trainer for Navy's A2F Intruder duplicates flight and tactics characteristics.

New!
TYPE
280-A

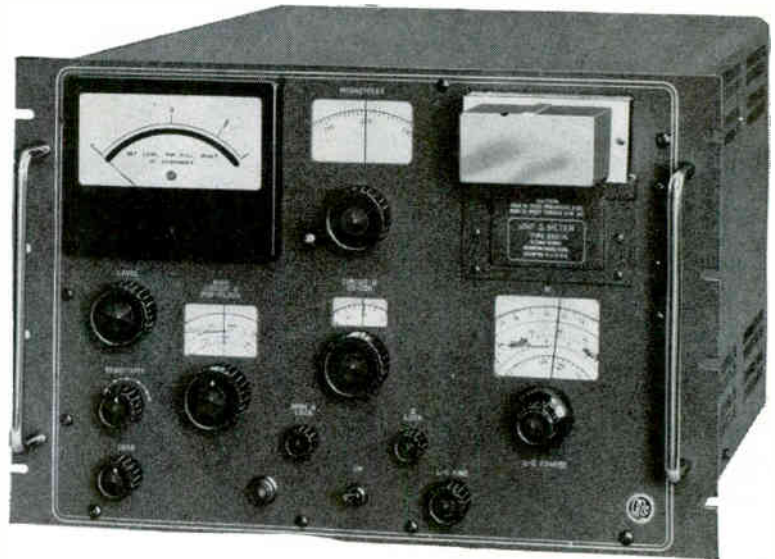

UHF Q METER 210-

— measures **COMPONENTS,**
CAVITIES, SEMI-CONDUCTORS

Description

The new UHF Q Meter Type 280-A is a unique self-contained instrument for measuring the RF characteristics of components in the UHF range. The instrument consists of a specially designed oscillator, Q measuring circuit, and resonance indicator and, in application, is similar to its counterparts in the lower frequency ranges. In addition to performing conventional Q Meter measurements, in which the unknown component is resonated with the internal calibrated capacitor, the output of the oscillator and the input of the resonance indicator are available externally for directly measuring the Q of self-resonant devices.

The UHF Q Meter differs from conventional Q Meters in that it measures the actual percentage bandwidth of the resonance curve and, from this data, computes and reads out circuit Q. The test circuit is first tuned to resonance by adjusting oscillator frequency and/or resonating capacitance. The circuit is then detuned from the half-power point on one side of the resonance curve to the opposite half-power point by adjusting a calibrated dial, coupled to the oscillator frequency control, which directly reads out circuit Q.

Precision Electronic Instruments
since 1934



BOONTON RADIO

BOONTON, NEW JERSEY • Tel. DEERFIELD 4-3200

- 10-25,000 TOTAL Q RANGE
- SELF-CORRECTING UHF RESONATING CAPACITOR
- DIRECT-READING INDUCTANCE SCALE
- 25 MV RF MEASURING LEVEL
- MEASURES "IN-CIRCUIT" Q OF SELF-RESONANT CIRCUITS

= 610 MC

by



Specifications

Radio Frequency Characteristics

RF RANGE: 210 to 610 MC
 RF ACCURACY: $\pm 3\%$
 RF CALIBRATION: Increments of approximately 1%
 RF MONITOR OUTPUT: 10 mv. minimum into 50 ohms*
 *at frequency monitoring jack

Q Measurement Characteristics

Q RANGE:
 Total Range: 10 to 25,000*
 High Range: 200 to 25,000*
 Low Range: 10 to 200
 *10 to approx. 2,000 employing internal resonating capacitor
 Q ACCURACY: $\pm 20\%$ of indicated Q
 Q CALIBRATION:
 High Q Scale: Increments of 1—5% up to 2,000
 Low Q Scale: Increments of 3—5%

Inductance Measurement Characteristics

L RANGE: 2.5 to 146 m μ h*
 *actual range depends upon measuring frequency
 L ACCURACY: ± 11 to 15%*
 *accuracy depends upon resonating capacitance
 L CALIBRATION: Increments of approx. 5%

Resonating Capacitor Characteristics

CAPACITOR RANGE: 4 to 25 μ f
 CAPACITOR ACCURACY: $\pm (5\% + 0.2 \mu$ f)
 CAPACITOR CALIBRATION:
 0.05 μ f increments, 4-5 μ f
 0.1 μ f increments, 5-15 μ f
 0.2 μ f increments, 15-25 μ f

Measurement Voltage Level

RF LEVELS: 25, 40, 80, 140, 250 mv. nominal*
 *across measuring terminals

Physical Characteristics

MOUNTING: Cabinet for bench use; by removal of end covers, suitable for 19" rack mounting.
 FINISH: Gray wrinkle, engraved panel (other finishes available on special order).
 DIMENSIONS: Height: 12-7/32" Width: 19"
 Depth: 17"
 WEIGHT: Net: 72 lbs.

Power Requirements

280-A : 105-125/210-250 volts, 60 cps, 140 watts
 280-AP: 105-125/210-250 volts, 50 cps, 140 watts

Price: 280-A: \$2,375.00 280-AP: \$2,375.00
 F.O.B. Boonton, N. J.

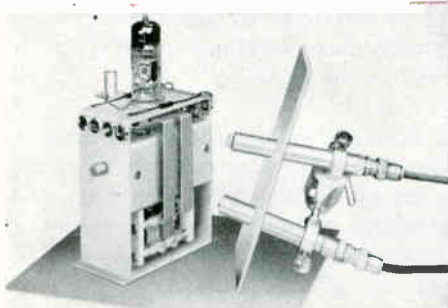

"IN-CIRCUIT" Q MEASUREMENT

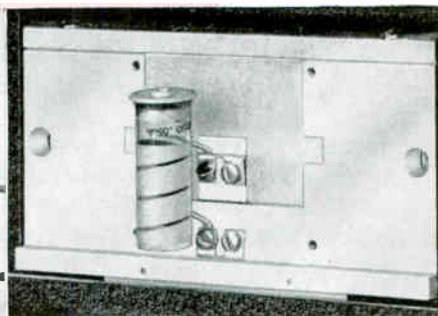

COIL MEASUREMENT

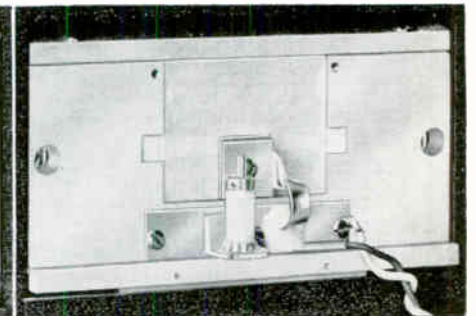

DIODE MEASUREMENT

CORPORATION

TWX: BOONTON, NEW JERSEY 866 • CABLE ADDRESS: BOONRACO

June 9, 1961



A Subsidiary of
 Hewlett-Packard Company

CIRCLE 13 ON READER SERVICE CARD 13

FOR STANDARDS LABORATORIES



MODEL AS-1

PRECISION ATTENUATOR SET

This set contains eight Weinschel precision coaxial attenuators in a solid walnut, velvet-lined case. Included in the set are Weinschel Model 210 attenuators and Weinschel Model 50 attenuators, in attenuation values of 3, 6, 10, and 20 db. The set covers the frequency range of DC to 12.4 kmc. All eight attenuators are made with Weinschel's own stable film resistors, and have stainless steel bodies and stainless steel connectors which give maximum life with minimum wear.

CERTIFICATE OF CALIBRATION

A Certificate of Calibration showing calibration data for each attenuator is supplied with the set. The certificate gives DC resistance and insertion loss at three frequencies for each attenuator.

WEINSCHTEL ENGINEERING
4081 METROPOLITAN AVENUE
BENNINGTON, MARYLAND

Certificate of Calibration

MODEL AS-1 SERIAL NO. 1
Insertion Loss in 50 Ohm System at 20°C ± 2°C, 1 Milliwatt CW Input Power Maximum

MODEL 210 ATTENUATORS				Insertion Loss			
Serial Number	Nominal Value	DC Resistance in Ohms		Source and Load VSWR			
		Female To Male	Male To Ground	< 1.01	< 1.02	< 1.10	
20089	3 db	34.46	3.00 ± 0.04	X	3.1 ± .11	2.2 ± .14	
24489	6 db	67.70	5.85 ± 0.01	X	6.0 ± .14	6.0 ± .14	
23247	10 db	115.00	9.05 ± 0.04	X	10.0 ± .17	10.1 ± .14	
23408	20 db	228.40	X	18.6 ± .21	19.6 ± .27	20.6 ± .14	

MODEL 50 ATTENUATORS				Insertion Loss			
Serial Number	Nominal Value	DC Resistance in Ohms		Source and Load VSWR			
		Female To Male	Male To Ground	DC	± 0.04	± 0.04	
22109	3 db	17.18	1.10	151.10	3.05 ± 0.01	3.05 ± .01	3.10 ± .02
22630	6 db	32.69	81.35	81.25	6.10 ± 0.01	6.10 ± .01	6.10 ± .01
22727	10 db	61.99	61.04	61.00	9.05 ± 0.01	9.05 ± .01	10.00 ± .01
24210	20 db	102.20	11.28	81.16	20.05 ± 0.01	20.05 ± .01	20.10 ± .01

Date: August 16, 1960
Witnessed Eng. Job No. 0-4368 Test Engineer: _____
CALIBRATION STANDARDS AS APPLICABLE ARE TRACEABLE TO NATIONAL BUREAU OF STANDARDS 2162-1-5/61

Write today for complete specifications.



KENSINGTON, MARYLAND
Phone: Lockwood 4-0121

TWX: KENS 446

WASHINGTON OUTLOOK

A VAST new astrophysics market has been firmed up as a result of Washington's decision to place this nation into a race with the Soviet Union to land a man on the moon.

Aside from the super-booster phases of the program, top priority will now go to Project Apollo to develop the manned spacecraft and associated guidance, communications and navigation systems. NASA's latest budget boost earmarks an additional \$531 million for the project.

Feasibility studies on Project Apollo have already been submitted to NASA by Martin, General Electric and General Dynamics. Hardware development contracts will be awarded later this year or early in 1962. No decision has been made yet as to whether to select a single prime contractor or whether to award prime contracts to several companies for major systems and for system management.

Competition for Apollo contracts is expected to be heated. As is frequently the case on projects of this type, selection of contractors will range beyond the factors of technical competency and plant and managerial capacities. The political ingredient is rated high in the negotiations.

Some companies reveal confidentially that they are deliberately not bidding on other space projects at this time so that their staffs and facilities will be available when the time comes for NASA to award Apollo contracts.

MARITIME ADMINISTRATION is plumping for automation in operation of merchant ships. The agency is awarding a research contract to Sperry Rand Corp.'s Sperry-Piedmont division for construction of a prototype bridge control systems console. The project will probably run about 18 months.

Objective is to simplify the operation of merchant vessels by providing deck officers with continuous information on such matters as the ship's position, effects of the weather and the sea, communications within the vessel and to other ships, and the vessel's stability.

FCC HAD ADDED NEW FUEL to the commercial communications satellite question with a decision favoring ownership by international common carrier communications companies, declaring this would best serve the public interest.

On the surface, the decision appears to rule out equipment manufacturers as part owners of the system. Several aerospace and electronic firms have sought to participate in a joint communications satellite venture with the common carriers.

But the Justice Department, in a brief to FCC, advised the agency that ownership in the system should not be restricted to common carrier communications companies. The equipment makers intend to carry the fight all the way to Congress if efforts fail at the FCC.

DEFENSE DEPARTMENT is getting a stronger voice in deciding what electronic goods and other general material can be exported to Iron Curtain countries. President Kennedy has set up a three-member export control review board to decide on controversial shipments to the Soviet bloc. Each of the members—the Secretaries of Commerce, Defense and State—will have virtual veto power over any given shipment.

In the past, the Commerce Department has been the final authority and has taken a more liberal view on exports than Pentagon advisers. Although only a small amount of electronics equipment is being shipped to the Soviet Union and satellite countries—mostly electron tubes, magnetic tape and some radio-tv parts—the decision to put the Defense Department on a par with Commerce is expected to work against any prospect of loosening the ban on other electronic goods.

New 1 mv to 1,000 v Null Voltmeter—

null meter,
dc voltmeter,
amplifier...
*in one versatile
instrument!*

1 mv end-scale sensitivity!
10 to 200 megohm input impedance!
Low noise, low drift, unique ac rejection!

Here's real measurement versatility—a null meter, a dc voltmeter and a high-gain amplifier—all in one compact instrument!

To provide for high sensitivity, high input impedance, low noise and drift, high ac rejection, *plus* superlative resolution and stability, the new Φ 413A employs the Φ -pioneered photoconductor chopper and other precise circuitry of the popular Φ 412A Voltmeter-Ohmmeter-Ammeter.

As a dc voltmeter, Φ 413A offers high input impedance and input isolation from ground that allows operation up to 500 volts dc or 130 volts ac from ground potential. It measures from 1 mv to 1,000 volts end scale in 13 zero-center voltage ranges, providing 2% accuracy and virtually drift-free operation. The 413 is especially useful in resistance bridge measurement.

As an amplifier, the Φ 413A provides an output proportional to meter deflection, offering gain from 0.001 to 1,000 in 13 steps. Extreme linearity, high stability and low noise make it ideal as an indicating and control device. Typical application is for amplifying the output of a thermocouple in control systems, the zero set establishing an arbitrary reference.

Moderate price plus Hewlett-Packard superior engineering and manufacturing standards, make the Φ 413A today's best value for flexible null and voltage measurement, and amplification requirements.



Φ 413A Null Voltmeter

Specifications

VOLTMETER

Ranges: Positive and negative voltages, 1 mv to 1,000 v end scale, 13 zero-center ranges.

Accuracy: $\pm 2\%$ of end scale value

Input Impedance: 10 megohms on 1, 3 and 10 mv ranges
30 megohms on 30 mv range
100 megohms on 100 mv range
200 megohms on 300 mv range and above

AC Rejection: A voltage at power line or twice power line frequency 40 db greater than full scale affects reading less than 1%. Peak voltage must not exceed 1,500 v.

AMPLIFIER

Voltage Gain: 0.001 to 1,000 in 13 steps

Gain Accuracy: $\pm 1\frac{1}{2}\%$

Gain Linearity: $\pm 0.2\%$

Noise: Less than 0.1% (rms) of end scale on any range

Output: 1 volt for end scale deflection, same polarity as input. End scale corresponds to 1.0 on upper scale. Max. load current, 1 ma.

AC Rejection: Approx. 3 db at 1 cps, 80 db at 50, 60 cps

Input Isolation: Greater than 100 megohms shunted by 0.1 μ f to instrument case (power line ground)

Common Signal Rejection: May be operated up to 500 v dc, or 130 v ac above ground

Dimensions: 11 $\frac{1}{2}$ " high, 7 $\frac{1}{2}$ " wide, 10" deep (cabinet); 5 $\frac{1}{4}$ " high, 19" wide, 7 $\frac{1}{2}$ " deep behind panel (rack mount)

Price: Φ 413A, \$350.00 (cabinet); Φ 413AR, \$355.00 (rack mount)

HEWLETT-PACKARD COMPANY

1078A Page Mill Road Palo Alto, Calif., U.S.A.
Cable "HEWPACK" Davenport 6-7000

Sales representatives in all principal areas

HEWLETT-PACKARD S. A.

Rue du Vieux Billard No. 1 Geneva, Switzerland
Cable "HEWPACKSA" Tel. No. (022) 26. 43. 36



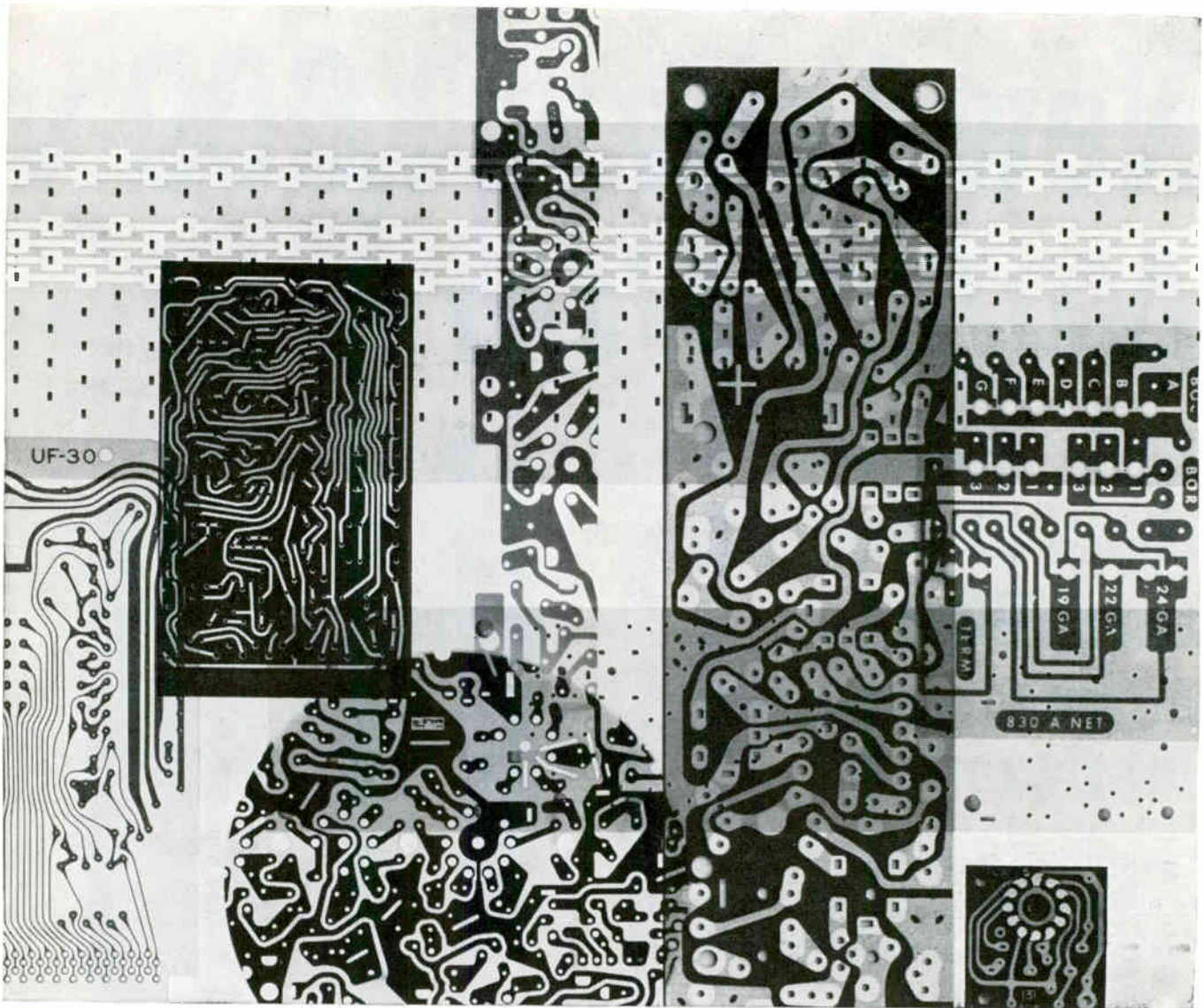

Your profits suffer for the pennies you pinch on printed circuits

Normally, the cost of the copperclad laminate in a printed circuit is peanuts compared to the cost of the product in which it is used.

So whether you produce your own boards, or buy them already punched and etched for assembly, a review of the specific laminates you are now using could uncover an important new benefit.

Perhaps a dollar benefit . . . fewer rejects due to poor cold-punching qualities, unsatisfactory foil bond strength, poor dip soldering performance, or dimensional instability. Or perhaps dollars saved in reduced servicing of circuit failures in installed equipment. Keep in mind, the laminate is only a fraction of your loss.

You might turn up a new product benefit. Greater reliability, and assurance for your customer that your equipment will measure up to the trouble-free performance he expects. Maybe you will find that a *flame retardant* printed circuit will give your product a selling edge, or reduce the danger of fire and severe damage to expensive equipment.

Start a review of your copperclad laminates with a call to the nearby NVF Sales Office, or write for samples and literature. Dept. HH-4, Wilmington, Delaware.

116 Choices: One Source This is the latest count of the different plastics and grades NVF can offer in your search for the *one best material*. Add to this total *the one special grade* that can be developed from scratch to meet your particular need. This full range of materials is backed by complete engineering services . . . from application assistance up to and including the delivery of 100% usable, precision-fabricated parts . . . in any quantity, on time! Call the NVF Sales Office near you. It's a direct line to single-source help on your current materials problem.



NATIONAL VULCANIZED FIBRE COMPANY
WILMINGTON 99, DELAWARE
In Canada: NATIONAL FIBRE COMPANY OF CANADA, LTD., Toronto-3, Ontario



FEATURING

4 dimensions in precision electronic instruments

EASE-OF-OPERATION • ACCURACY • RELIABILITY • LONG LIFE

CHECK THESE JF INSTRUMENTS FOR YOUR PARTICULAR APPLICATION . . .

1 DIFFERENTIAL VOLTMETERS (0-500V)

MODEL NO.	ACCURACY	MAXIMUM METER RESOLUTION	INPUT IMPEDANCE AT NULL (0-500V)	REFERENCE	PRICE
800	±0.05% DC	5MV	Infinite	Standard Cell Standard Cell (Zener available at extra cost)	\$ 385.00
801	±0.05% DC	50uV	Infinite		485.00
801H	±0.05% DC	5uV	Infinite		555.00
803	±0.05% DC	50uV	Infinite		875.00
	±0.2% AC (30cps-5KC)		1 Meg, 25uufd		
8011A (militarized)	±0.05% DC	50uV	Infinite	Zener	1745.00

2 POWER SUPPLIES

(*all percentages are plus or minus)

MODEL NO.	TYPE	RANGE		CALIBRATION* ACCURACY	STABILITY*	REGULATION*		PRICE
		VOLTAGE	CURRENT			LINE	LOAD	
301C	Precision constant voltage calibrator (chopper stabilized against std. cell ref.)	1.02-1012V	0-400MA	0.1%	0.005%/hr. 0.01%/day	0.005%	0.005%	\$ 985.00
301E		1.02-512V	0-300MA	0.1%		0.005%	0.005%	695.00
334A		0-3111V	0-400MA	0.05%		0.005%	0.005%	2650.00
351A	Precision constant current calibrator (chopper stabilized against std. cell ref.)	0-100V	1uA-100MA	0.05%	0.005%/hr. 0.01%/day	0.01%	0.01%	845.00
406	general purpose	0-530V	0-100MA	3% (full scale meter reading)	0.01%/hr. 0.05%/day	0.01%	0.01%	285.00
407	general purpose	0-555V	0-300MA	0.5%	0.01%/hr. 0.05%/day	0.01%	0.01%	335.00
417A	general purpose	0-500V	0-500MA	3% (full scale meter reading)	0.005%/hr. 0.03%/day	0.001%	0.001%	795.00
402M	HIGH VOLTAGE	500-1600V	0-1MA	0.5%	0.005%/hr. 0.05%/day	0.03%	0.03%	320.00
405	HIGH VOLTAGE	600-3100V	0-15MA	0.25%	0.005%/hr. 0.05%/day	0.01%	0.005%	595.00
408A	HIGH VOLTAGE	500-6010V	0-20MA	0.25%	0.005%/hr. 0.05%/day	0.01%	0.01%	695.00
409A	HIGH VOLTAGE	170-1530V	0-3MA	2%	0.02%/day	0.01%	0.4% for 1MA load change	335.00
410A	HIGH VOLTAGE	1000-10,010V	0-10MA (20MA below 6000V)	0.25%	0.005%/hr. 0.05%/day	0.01%	0.01%	1095.00
412A	HIGH VOLTAGE	500-2010V	0-15MA	0.25%	0.005%/hr. 0.05%/day	0.01%	0.01%	455.00

3 UNIVERSAL IMPEDANCE BRIDGE

MODEL NO.	RESISTANCE	CAPACITANCE	INDUCTANCE	ACCURACY	FREQUENCY	PRICE
710A	0.1m ohm-12 Meg.	0.1uuf-1200ufd	0.1uh-1200h	R=±0.1%, C=±0.2%, L=±0.3%	100CPS-10KC	\$525.00

4 VAW METER

MODEL NO.	VOLTAGE (full scale)	CURRENT (full scale)	POWER	POWER FACTOR RANGE	FREQUENCY RESPONSE	ACCURACY	INPUT IMPEDANCE	PRICE
102	1.5-600V	1.5ma-30A	225 uw to 18 KW	1.0 0.1 0.1	20CPS-100KC 20CPS-20KC 20KC-40KC	3% 3% 5%	1 Meg. 25uufd	\$555.00

ADDITIONAL SPECIFICATIONS AND APPLICATION NOTES ARE AVAILABLE

Write us direct or contact our engineering representative in your area.

All prices F.O.B. Factory, Seattle, Washington
Prices and data subject to change without notice



JOHN FLUKE MFG. CO., INC.
P. O. Box 7428 Seattle 33, Washington



OSCILLOSCO

Latest additions to the **PHILIPS** range

To give the user the fullest benefit, every PHILIPS oscilloscope is supplied with a complete set of accessories.

Depending on the type the range of accessories may vary from simple connection cables or a rubber viewing hood to attenuator probes or DC-coupled cathode follower probes.

Always included is a manual with operating and service instructions.

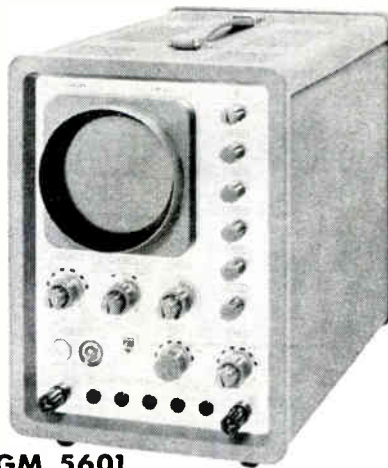

GM 5601

Portable HF Oscilloscope

10 cm C.R.T. with 3 kV E.H.T.

Vertical Amplifier

Bandwidth: 0 - 5 Mc/s

Deflection factor: 100 mV/cm - 15 V/cm

Accuracy: 3%

Time base

Sweep speeds: 0.5 μ sec/cm - 0.2 sec/cm

Accuracy: 3%, Magnifier: x5

Triggering: up to 1 Mc/s on 5 mm amplitude, adjustable trigger level

Dimensions: 30 x 21 x 40 cm

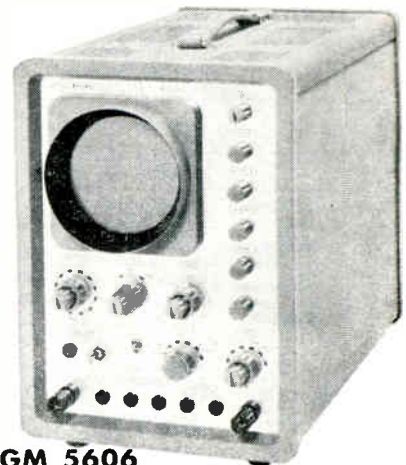

GM 5606

Portable LF Oscilloscope

10 cm C.R.T. with 3 kV E.H.T.

Vertical Amplifier

Bandwidth: 0 - 200 kc/s

Deflection factor: 10 mV/cm - 150 V/cm

Accuracy: 3%

Time base

Sweep speeds: 2.5 μ sec/cm - 1 sec/cm

Accuracy: 3%, Magnifier: x5

Triggering: up to 200 kc/s on 5 mm amplitude, adjustable trigger level

Dimensions: 30 x 21 x 40 cm

PHILIPS *electronic measuring*

Sold and serviced by Philips Organizations all over the world

Further information will gladly be supplied by:

N.V. Philips' Gloeilampenfabrieken, EMA-Department, Eindhoven, the Netherlands

For Canada: Philips Electronics Ind. Ltd., 116 Vanderhoof Ave., Toronto 17, Ont.

O P E S



GM 5600

Compact HF Oscilloscope

7 cm C.R.T. with 1.6 kV E.H.T.

Vertical Amplifier

Bandwidth: 0 - 5 Mc/s

Deflection factor: 50 mV/cm - 50 V/cm

Accuracy: 4%

Time base

Sweep speeds: 0.5 μ sec/cm - 180 msec/cm

Triggering: up to 1 Mc/s on 10 mm amplitude, adjustable trigger level with preset position

Dimensions: 25 x 16 x 34 cm



GM 5602

General purpose Oscilloscope

10 cm C.R.T. with 4 kV E.H.T.

Vertical Amplifier

Bandwidth: 0 - 14 Mc/s

Deflection factor: 50 mV/cm - 10 V/cm

Accuracy: 3%

Time base

Sweep speeds: 0.2 μ sec/cm - 1 sec/cm

Accuracy: 3%, Magnifier: x5

Triggering: up to 2 Mc/s on 5 mm amplitude, adjustable trigger level

Dimensions: 37 x 27 x 53 cm



GM 5639

X-Y Oscilloscope

10 cm C.R.T. with 2 kV E.H.T.

Amplifiers

Bandwidth: 0 - 1 Mc/s

Deflection factor: 100 mV/cm - 150 V/cm

Accuracy: 3%, Relative phase shift < 2°

Time base

Sweep speeds: 2 μ sec/cm - 0.5 sec/cm

Accuracy: 5%

Triggering: up to 1 Mc/s on 5 mm amplitude, adjustable trigger level

Dimensions: 30 x 21 x 45 cm



GM 5603

Wide band Oscilloscope

13 cm C.R.T. with 10 kV E.H.T.

Vertical amplifier (differential)

Bandwidth: 0-14 Mc/s

Deflection factor: 50 mV/cm - 10 V/cm

Accuracy: 3%, Rejection ratio: 1000

Time base

Sweep speeds: 0.2 μ sec/cm - 1 sec/cm

Accuracy: 3%

Triggering: up to 2 Mc/s on 5 mm amplitude, adjustable trigger level

Dimensions: 40 x 30 x 60 cm

instruments: quality tools for industry and research



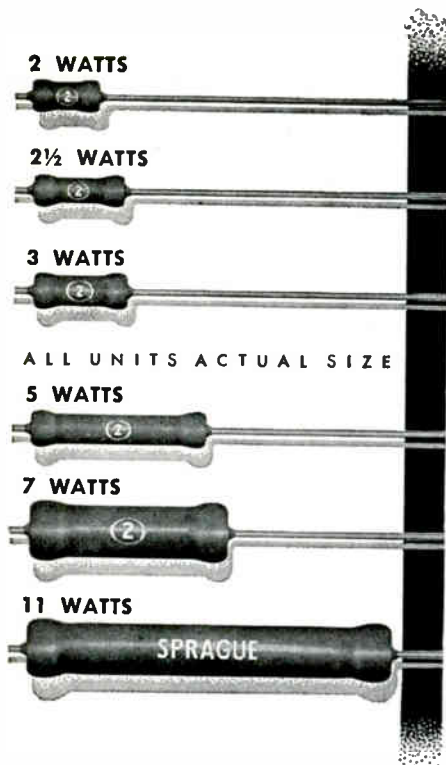

NEXT TIME ... USE TINY *Blue Jacket* WIREWOUND RESISTORS

Sprague builds reliability... efficiency... economy right into minified Blue Jackets with these important features:

- * All-welded end-cap construction with special vitreous-enamel coating for total protection against humidity, mechanical damage, heat, corrosion gives long-term dependability under severe environmental conditions
- * Available in resistance tolerances as close as $\pm 1\%$
- * Low in cost... quick and easy to install

Tiny axial-lead Blue Jackets are specially designed for use with conventional wiring or on printed boards in miniature electronic assemblies. Write for complete technical data in Sprague Engineering Bulletin 7410B.

SPRAGUE ELECTRIC COMPANY
35 Marshall Street, North Adams, Mass.



FINANCIAL

Companies Announce New Mergers

STOCKHOLDER MEETINGS of several electronics companies have resulted in approval of merger plans. Among the announcements are:

AMPHENOL-BORG ELECTRONICS CORP., Broadview, Ill., stockholders have approved the merger of FXR, INC. with their company. A separate meeting of FXR stockholders in Woodside, N. Y. also approved the merger. According to M. L. Devine, A-B president, the New York company will continue to operate as a separate division. FXR president Henry Feldman was elected a director of Amphenol-Borg. The Illinois company says its interest in the acquisition stems from a belief in the growth of the microwave industry. FXR manufactures microwave gear, waveguide components, high power pulse modulators and test equipment.

C-E-I-R, Washington, D. C. and ARB SURVEYS, INC., New York City, announce they have agreed in principle to have the Washington firm acquire ARB Surveys in the near future. C-E-I-R specializes in electronic data processing and business services. The company operates computer service centers in Arlington, Va.; New York; Boston; Hartford, Conn.; Houston, Tex.; Los Angeles; San Francisco and London, England. ARB Surveys is an independent affiliate of the American Research Bureau. The company specializes in market research surveys. Its operations are currently running at about \$250,000 per year.

CURTISS-WRIGHT CORP., Wood Ridge, N. J. has announced acquisition of two electronics facilities and purchase of a substantial interest in a nuclear equipment company. The first of the two electronics acquisitions was made by purchase of ABRAMS INSTRUMENT CORP., Lansing, Mich. The company, established in 1938, makes radar cameras, depth charge computers, plotting machines and other instrumentation for aircraft, rockets and missiles. The second facility C-W has acquired was brought about by

establishment of a new plant in Needham, Mass. to conduct research and development and produce prototypes of miniaturized electronic circuit components. It is called ADVANCED MINIATURIZED ELECTRONICS INC. and will operate as a wholly owned subsidiary. The TARGET ROCK CORP., Hempstead, N. Y. specializes in manufacture of nuclear handling equipment and makes core handling devices, transfer units and other nuclear support mechanisms.

FAIRCHILD CAMERA AND INSTRUMENT CORP. has acquired the assets of two Los Angeles companies, CIRCLE WELD MANUFACTURING and CURTIS LABORATORIES. Circle Weld, which manufactures precision metal bellows equipment, will operate as a department of Fairchild's Special Products division. Curtis Products, which develops and manufactures specialized optical gear, will function as a department of Fairchild's Defense Products division.

CRYOGENICS, INC., Stafford, Va., manufacturer of instruments and systems for low temperature applications, has acquired WAKIT INSTRUMENTS CORP., Falls Church, Va., for an undisclosed amount of stock. Wakit makes equipment for cryogenic applications including transfer tubes for liquid helium and hydrogen as well as other hardware for low temperature environments. The Falls Church company will operate as a wholly owned subsidiary of Cryogenics.

TEXAS GAS TRANSMISSION CORP., Owensboro, Ky., has acquired a controlling interest in KENTUCKY ELECTRONICS, INC. in the same city. The newly acquired company makes special-purpose precision wire for use in transmitter and receiver equipment, electron tubes and semiconductor. The company also manufactures stamped and drawn parts for cathode-ray guns.

ESTEY ELECTRONICS, INC., Torrance, Calif., and ORGAN CORP. OF AMERICA, West Hempstead, N. Y. have been

merged. Under terms of the agreement the 440,000 shares of Organ Corp. stock now outstanding will be converted into new Estey stock on a one-per-one basis. Present Estey stockholders will receive one share of stock in the new company (which will continue under the Estey name) for each 20 shares of their stock presently held. The combined assets of Estey and Organ Co. total \$2,897,518. Although both companies are primarily engaged in manufacturing electronic organs both for institutional and home use, company executives say they are exploring government electronics in military and space to see if this field would be suitable for their company facilities and abilities.

GIANNINI CONTROLS CORP., Duarte, Calif., has consolidated with CRAMER CONTROLS CORP., Centerbrook, Conn. The transaction was based on exchange of 83,000 shares of Giannini stock for the Cramer assets and business. The Connecticut company makes timing controls and instrument motors. It is anticipated the Cramer division will add approximately \$4 million to Giannini's sales volume. Cramer will function as an operating division of its new parent company. P. F. Brophy, former president of the Centerbrook firm, has been made general manager of the division.

25 MOST ACTIVE STOCKS

	WEEK ENDING MAY 26, 1961			
	SHARES (IN 100's)	HIGH	LOW	CLOSE
Gen Tel & Elec	1,379	28	27 ¹ / ₈	27 ¹ / ₄
Ampex	1,180	24 ¹ / ₂	22 ¹ / ₈	23 ¹ / ₄
Avco Corp	1,132	19 ⁵ / ₈	18 ¹ / ₄	19 ³ / ₈
General Elec	1,109	68	64 ³ / ₈	65 ⁷ / ₈
Transitron	1,079	33 ¹ / ₈	28 ¹ / ₂	29 ⁵ / ₈
Avnet Elec	1,075	53 ¹ / ₂	47 ³ / ₄	52
Sperry Rand	902	33 ¹ / ₈	31 ³ / ₈	32 ³ / ₈
Lockheed Aircraft	883	43 ⁷ / ₈	41 ⁵ / ₈	43 ¹ / ₈
Westinghouse Elec	756	44	42	42
Dynamics Corp of Am	746	18 ¹ / ₈	16 ¹ / ₈	18 ¹ / ₈
Universal Control	737	14 ⁵ / ₈	13 ¹ / ₄	13 ³ / ₄
Gen Dynamics	670	38	36 ¹ / ₂	37 ¹ / ₈
Martin Co	664	38 ¹ / ₂	37	38
Gen Inst Co	602	49 ³ / ₄	44 ¹ / ₂	49 ³ / ₄
Pentron Elec	547	7 ¹ / ₂	6 ⁵ / ₈	7 ¹ / ₂
Collins Radio	531	42 ³ / ₄	38 ¹ / ₂	42 ¹ / ₂
Reeves Soundcraft	529	10 ¹ / ₈	9	9 ¹ / ₂
Waltham Precision	525	4 ¹ / ₄	3 ⁵ / ₈	4 ¹ / ₈
RCA	519	65 ¹ / ₈	62 ³ / ₈	62 ³ / ₈
IBM	494	479	453 ¹ / ₂	478
Nuclear Corp of Am	473	7 ¹ / ₂	6 ⁵ / ₈	7 ¹ / ₂
Hycon Mfg Co	416	6 ¹ / ₈	5 ⁵ / ₈	6
Burroughs	407	33 ¹ / ₂	31 ⁵ / ₈	32 ³ / ₈
Sonotone	406	14	13 ³ / ₈	13 ³ / ₄
Elec & Mus Ind	399	6 ³ / ₄	6 ³ / ₈	6 ³ / ₈

The above figures represent sales of electronics stocks on the New York and American Stock Exchanges. Listings are prepared exclusively for ELECTRONICS by Ira Haupt & Co., investment bankers.

MAG AMPS

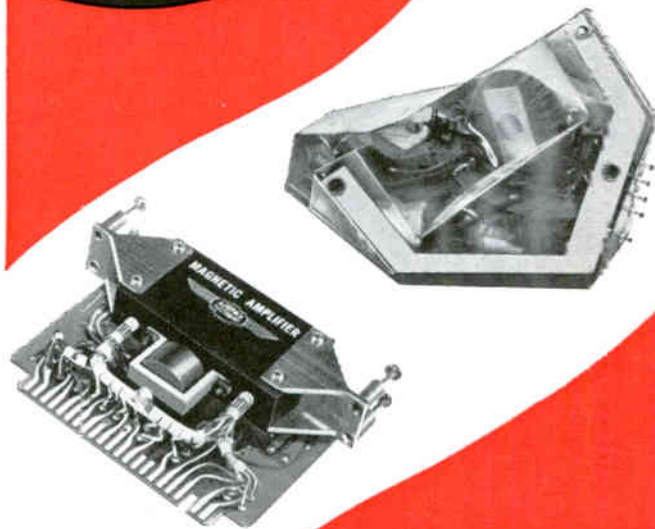

**Confidence
in a
quality product**

The fast response, wide dynamic range, high gain and light weight of an Airpax MAG AMP provide the systems engineer with that extra degree of versatility which permits a successful design rather than a marginal system.



SEMINOLE DIVISION • FT. LAUDERDALE, FLA.

DELCO'S 2N174 PROVED IN MINUTEMAN

... and Polaris and Talos and Atlas and Jupiter and Thor and Titan and Bomarc and Zeus and Pershing and hundreds of other military and industrial applications.

For Delco Radio's highly versatile family of 2N174 power transistors meet or exceed the most rigid electrical and extreme environmental requirements.

Over the past five years since Delco first designed its 2N174, no transistor has undergone a more intensive testing program both in the laboratory and in use, in applications from mockups for commercial use to missiles for the military. And today, as always, no Delco 2N174 leaves our laboratories without passing at least a dozen electrical tests and as many environmental tests before and after aging.

This 200 per cent testing, combined with five years of refinements in the manufacturing process, enables us to mass produce these highly reliable PNP germanium transistors with consistent uniformity. And we can supply them to you quickly in any quantity at a low price.

For complete information or applications assistance on the Military and Industrial 2N174's or other application-proved Delco transistors, just write or call our nearest sales office.

Union, New Jersey
324 Chestnut Street
MURdock 7-3770

Santa Monica, California
726 Santa Monica Blvd.
UPton 0-8807

Chicago, Illinois
5750 West 51st Street
PORTsmouth 7-3500

Detroit, Michigan
57 Harper Avenue
TRinity 3-6560



DELCO
DEPENDABILITY
RADIO
RELIABILITY

Division of General Motors • Kokomo, Indiana

MEASURE FREQUENCY, 200 MC to 12.4 GC,

*with COUNTER
ACCURACY!*

*Faster
More accurate
More useful
Microwave frequency
measurements*

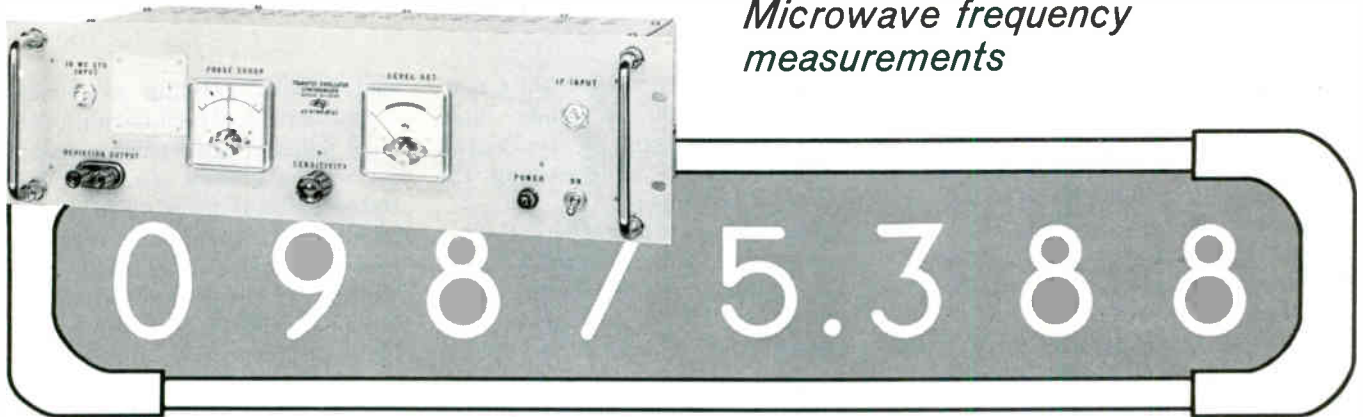

Introduce counter accuracy to your microwave frequency measurements with the unique Dymec Transfer Oscillator Synchronizer! Model DY-5796, used with a Hewlett-Packard Transfer Oscillator and an Φ Counter, permits high-accuracy automatic frequency measurements, even on varying signals, all the way to 12.4 GC.

With the Φ 540A/B Transfer Oscillator and Φ 524/525B Frequency Counter, the DY-5796 Synchronizer provides positive locking of the transfer oscillator to the signal frequency . . . thus giving you measurement accuracy equal to that of the counter time base. Higher accuracies can be achieved with an external frequency standard, such as the Φ Model 103A Quartz Oscillator, which provides short term stability better than 5 parts in 10^{10} . The Φ 524C and 525B Frequency Converter covers 100 to 220 MC, and the Φ 540A (with external Φ 934A Harmonic Mixer) or 540B (with the mixer built in) extends your measuring range to 12.4 GC.

By keeping the transfer oscillator and the signal frequency in permanent synchronization, the DY-5796 also permits long term measurements of low drift rates at microwave frequencies. FM deviations up to 0.2% of the carrier frequency can be measured with the addition of a VTVM and/or oscilloscope. Further, this instrument and the associated equipment greatly simplify determination of the harmonic number and microwave frequency.

The DY-5796 Synchronizer is available from Dymec for use with your present Φ Transfer Oscillator* and Counter—or you can use the Dymec 5854 Frequency Measuring System composed of the Synchronizer and the optimum related Φ equipment mounted in only 52½" of rack space.

SPECIFICATIONS

DY-5796 Transfer Oscillator Synchronizer

Frequency Range: 200 MC to 12.4 GC
Lock-on Range: $\pm 0.2\%$ of signal frequency, maximum*
Price: \$685.00

*With Modification Kit 9200-0028 for 540A/B Oscillator. \$65.00

DY-5854 Frequency Measuring System

Includes synchronizer, modified transfer oscillator, electronic counter with frequency converter, digital recorder with analog output, cabinet and interconnecting cables.



Frequency Range: 200 MC to 12.4 GC
Lock-on Range: $\pm 0.2\%$ of signal frequency, maximum
Accuracy: ± 1 count \pm stability
Stability: $3/10^8$ short term, $5/10^8$ per week with 524C/D internal time base. May be used with external frequency standard, e.g., Φ 103AR, for greater accuracy.
Registration: 9 places: first 2 on converter dial, next 7 on counter.
Printout: Full readout of counter printed on paper tape.
Analog Output: For Potentiometer Recorder: 0-100 mv. Minimum load resistance 0.5M. Calibrate control. For Galvanometer Recorder: 0-1 ma into 5000 ohms or less. Zero and calibrate controls.

FM Measurement: Deviations up to 0.2% of signal frequency at rates to 1 kc. Above 1 kc, max. deviation limit reduced at 20 db/decade to max. of 0.001% at 200 kc.

Price: \$6,405.00.

Data subject to change without notice.

Prices f.o.b. factory.

Write to your Dymec/Hewlett-Packard representative or contact us directly for complete information.

DYMEC
 A division of HEWLETT-PACKARD COMPANY



DEPT. E - 9. 395 PAGE MILL ROAD, PALO ALTO, CALIFORNIA • DAVenport 6-1755 • Area Code 415

TWX-117-U

Will the Laser Succeed Sonar for Undersea

By LEON H. DULBERGER,
Assistant Editor

UNDERSEA EXPERIMENTS with lasers may lead to communication, control and detection systems for submerged military and commercial marine objects; operating over distances of miles.

Pulse sonar methods for the same tasks face inherent limitations. Complex design is needed to avoid interception of the sonar beam or to obtain high-definition detection.

Lasers, (Light Amplification by Stimulated Emission of Radiation) designed to operate in the blue-green spectral region are being researched by the Trident Corp., a subsidiary of Avien, Inc., N. Y., as devices to produce high-power collimated beams for penetrating sea water. The needle-like beam would afford privacy in communication and high-definition in detection.

The company has worked out a multistage program to study basic properties of light in sea water, with emphasis on improving the range of equipment.

The firm ascribes attenuation in underwater light transmission to absorption by materials in water, scattering by suspended particle matter and variation in optical density along the light path. Scattering also causes high background light levels making targets difficult to distinguish. This amounts to a low signal-to-noise ratio. It is the major cause of short range in underwater optical systems today; not lack of sensitivity in receivers.

Trident Corp. is pursuing a series of experiments using available optical and electrical hardware. They feel a solid-state laser suitable for undersea use should follow when design criteria and system philosophy evolve from re-

search with existing components.

Different ocean conditions determine whether absorption or scatter causes the greater problem. Some water contains more scattering material than other water, and temperature has a marked effect. Methods of reducing effects of scatter by control of optical characteristics in projecting and receiving equipment are to be tested.

Early investigations will employ a 250-watt mercury-arc lamp with light output formed into a narrow beam by a parabolic reflector. The receiver will consist of a second parabolic reflector focusing received light on a multiplier photo tube. Estimated maximum one-way range is 3,000 feet. Reflectivity tests would be made by bouncing light off a flat-disk target. These checks would best be done in the relatively clear waters of the Arctic.

Ruby laser (left) is beamed through eight feet of green dyed water at Avien-Trident in measurement of small angle backscatter, beam spreading and attenuation. Tanks have known attenuation, can be connected optically in series

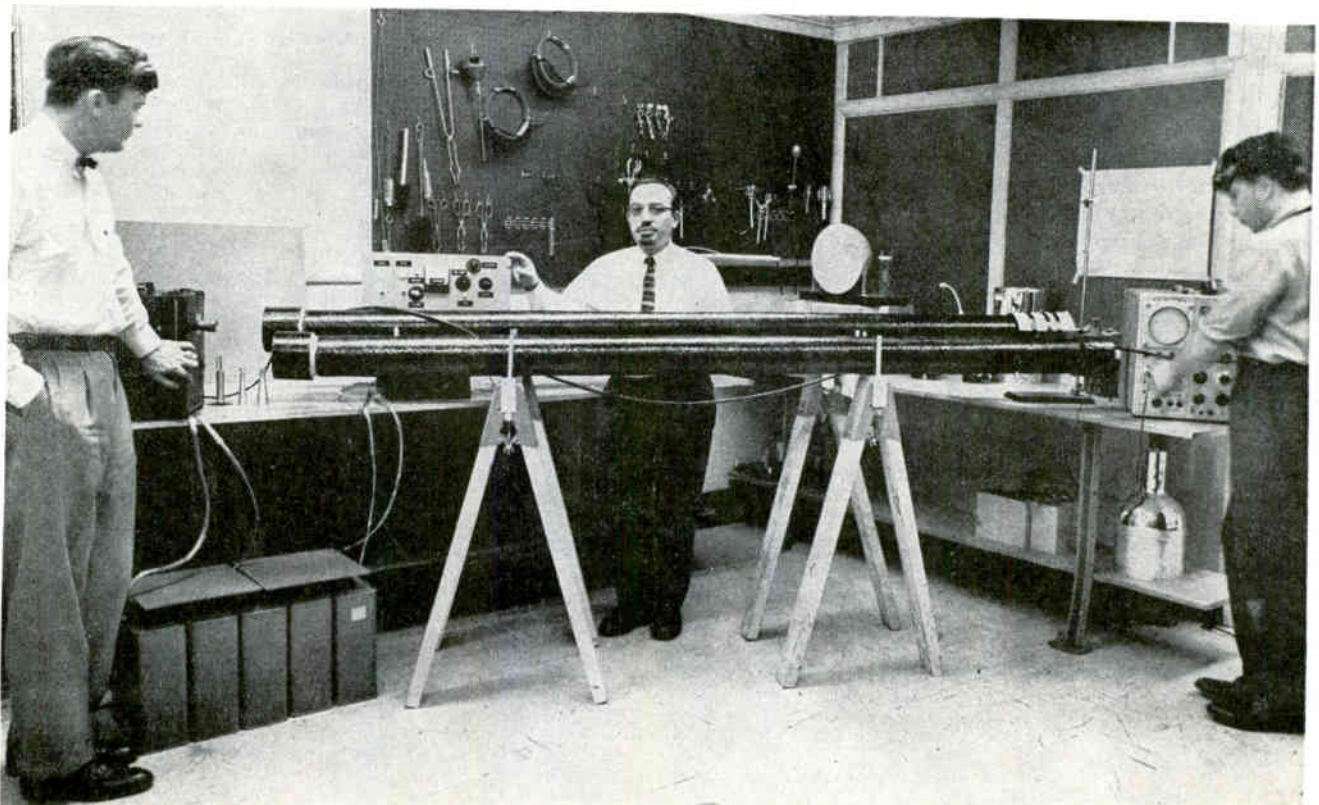

Electronics?

HOW ONE FIRM'S INTEREST BEGAN

In developing a helicopter-dropped, unmanned submersible decoy, using a low-noise, chemical engine of proprietary design, Avien, Inc. realized need for undersea control of the vehicle to achieve maximum usefulness. Sonar techniques exhibited shortcomings in military applications, and led to consideration of light operated systems.

The firm's Trident subsidiary, which produces a line of high accuracy finished laser crystals with polished reflectors, studied the possibilities from a system and components standpoint.

They have submitted proposals to naval agencies. Their approach is outlined in this article, along with work by some other firms active in the undersea laser field

Observations of underwater light transmission for 2,500 feet have already been recorded in scientific marine journals.

The next step would be development of an active scanning unit to overcome scatter problems. The system will use a flying-spot illuminator, synchronized with it a flying-spot scanner as receiver. The pick up device would be a multiplier phototube.

Use of a narrow beam of controlled focus to illuminate a small area of the target at a time, is planned. This will reduce scatter caused by flooding large areas of water with light. The receiver will view only the area lighted by the narrow-beam. Input will be through a pinhole aperture to reduce background clutter. The scanning pattern may be a spiral. Additionally, spectral control of the received signal by a filter will take advantage of the fact that light near the receiver is of a slightly different color than near the target. Narrow-band spectral filters of less than one angstrom bandwidth and narrow angular view have already been designed by the firm.

Reflected light from targets will

show a sharp gradient of bright and dark areas. It is possible that a differentiating circuit in the receiving system's light amplifier could be developed to emphasize sharp intensity gradients.

Improvements in target distinguishing ability as compared to a simple illuminating and detecting light system, might approach a million to one.

Consider that a conventional tv system, using natural illumination, has detected targets at about 150 yards.

Finally, the development of a solid-state blue-green laser, using special materials, will be accomplished. This high-brilliance source would produce a needle-narrow beam at wavelengths where the sea has maximum transparency. Experiments to date have been performed with a ruby laser and a tank of water containing molecular absorbing and particulate scattering material.

Results are encouraging in spite of improper spectral qualities of the laser's output.

The Trident suggested acronym for a system of undersea optical detection is Vedar—for Visible

Energy Detection And Ranging.

Several other firms plan or already have programs for development of undersea lasers and related systems.

For example, Hughes Aircraft Co., Calif., has presented a proposal to Office of Naval Research. They plan to apply experience with laser materials in developing a unit with output in the visible light range. The firm has undersea systems background, will design a coherent light receiver for use with undersea laser systems.

Loral Electronics Corp., N. Y. will enter this field, and Raytheon Co., Mass. is investigating its possibilities. American Optical Co., N. Y. has expressed an interest in underwater lasers.

Melpar, Inc., Va., is now building gaseous and solid-state lasers for undersea applications, and doing related systems work.

Technical Research Group, Inc., N. Y., is investigating gaseous and solid-state lasers, both pulsed and continuous, in work leading to a unit with output in the blue-green region. They are also developing system concepts for applying the devices underwater.

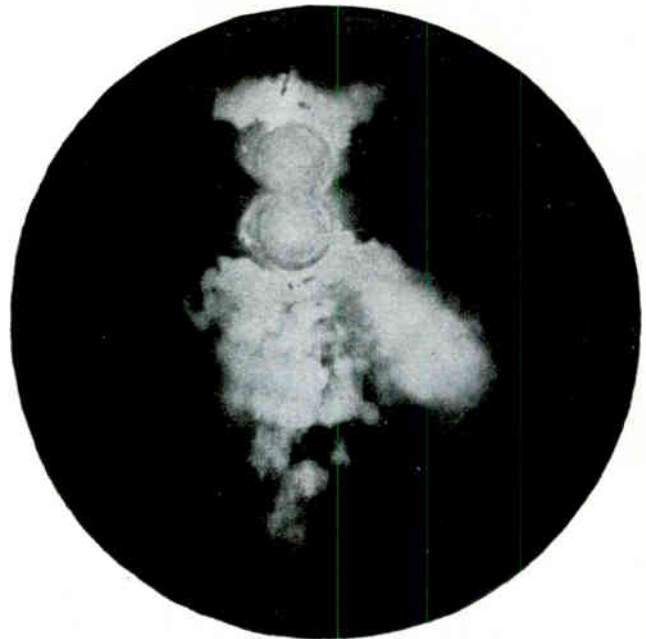

Laser output from Avien-Trident unit seen through eight feet of green dyed water. Reflection at air water interface causes double image

Mesucora was held at the Centre National des Industries et des Techniques exposition palace. Exhibitor lineup showed 391 French companies and 339 foreign

Labinal Electronique's Delta 500 differential analyzer

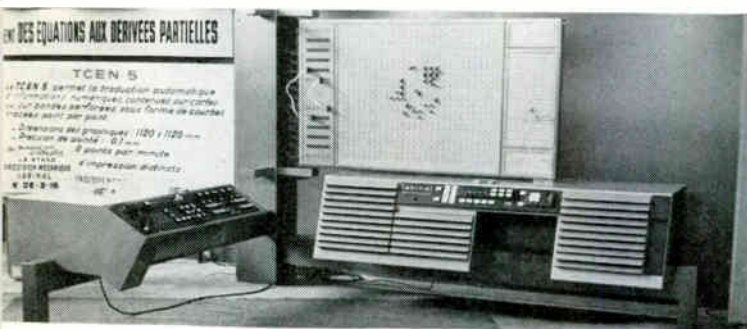

Data Logging and Computer Process Control Highlight French Instrumentation Show

By ARTHUR ERIKSON,
McGraw-Hill World News

PARIS—A growing tendency of European instrumentation and control manufacturers to design and market similar equipment showed up recently at the Mesucora show here. It points up a growing and homogeneous industrial electronics marketplace embracing the entire continent.

Mesucora is a word coined by the French from the words: *mesure*, *contrôle*, *regulation et automatisme*. Along with 391 French manufacturers, 339 firms from 17 other countries put their wares on display. There were 110 German exhibitors, 87 U.S., 60 British and 38 Swiss. Show attendance was 85,000; one quarter from outside France.

Data logging, the show revealed, is a French strong point. Compagnie Generale de Telegraphie sans Fil de Paris introduced a data logger that makes in just 65 seconds the rounds of 100 transducers—pressure gages, flowmeters, temperature gages and the like. The transistor equipment converts transducer output into a four-digit decimal number with an accuracy of four parts in 10,000.

In process control computers, the

French have achieved strength through union with U. S. companies. Compagnie Europeenne d'Automatisme Electronique of Paris, a joint effort by two French firms and Thompson Ramo Wooldridge, showed the RW-300 computer.

CAE is installing RW-300's for fuel-cladding rupture-detection systems at the Chinon nuclear power station and for computation of specific fuel consumption at a 250 Mw thermal power station now under construction on the outskirts of Paris.

Another French firm, Compagnie des Competurs of Montrouge, expects to get into the chemical-process control market with the Packard Bell PB 250 computer. CdC will build it under license. CdC also attracted attention with its endless tape programming unit for an automatic conveyor loading system.

French exhibitors displayed an imposing array of nuclear instrumentation equipment. The French are far enough along in this field that several manufacturers showed transistor counting equipment with resolution of 0.1 μ sec.

Tube manufacturer La Radio-technique of Paris is readying an 8-in. diameter multiplier phototube

with gain of 10^6 , transit time spread or 2×10^{-9} , and 60 microamp per lumen sensitivity for use with Cerenkov detectors or large-surface scintillators.

Another nuclear item was the electrostatic relay that the French Atomic Energy Commission developed. The unit picks up outputs as low as 10^{-11} coulomb from radiation detection devices. The output charges are stored on a blade until the electrostatic force reaches a present value at which the force is enough for the blade to be attracted to a magnet, closing the contacts and resetting the blade to zero.

Precision of the calibration is 0.5×10^{-3} , repeatability 2 percent, contact life in the order of 10^6 operations. CSF will manufacture the relay.

Five French contenders in the static-switching market turned up with transistor logic elements, hinting that activity in that sector will perk up. One manufacturer estimated his static switching business this year will triple last year's; another expects his sales will double.

Mesucora reflected relative French indifference toward numerical machine-tool control. Only one new system was displayed and that a prototype for a government re-

TA-300 Data Logger by CSF

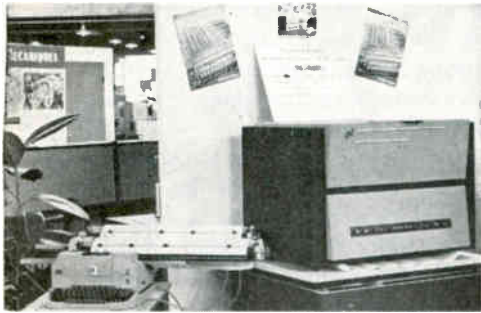

search laboratory. The equipment is all electromechanical. Its developers say it may sell for \$3,000.

Here are some other items that attracted attention:

Measurement by microwave: equipment by Philips-Industrie of Bobigny permits simultaneous measurement of eccentricity and surface irregularities or vibrations on rotating components under dynamic conditions. It sets up a system of standing waves in a waveguide by reflection on the piece being checked out; the waveguide does not have to touch the piece, which acts as a variable short circuit.

Displacement of the piece, and a surface irregularity represents a displacement, causes a shift in the standing-wave pattern. The shift is detected by a crystal whose output is fed to an oscilloscope calibrated to readout surface irregularities and eccentricity of 1 micron.

Epicyclic motor: this component for servo systems runs at speeds as low as 10 rpm but has no gear train in it. To get low output speed directly, the rotor is mounted on two rubber-surfaced wheels slightly smaller in diameter than the stator bore. The rotor wheels run around the inside of the stator at 3,000 rpm and as they do the rotor slowly describe a circle about the axis of the motor.

This slow rotation is picked off through an elastic linkage to drive the output shaft. The speed depends on the difference in diameter between the rotor wheels and the

In jeder Sprache, wo auch immer,

ist die Bedeutung die gleiche. Präzision oder Precision, als Wort und als Handelsmarke, ist der Schlüssel zu den höchsten Wertmasstäben in der Magnetbandaufzeichnung. Precision Bandgeräte bieten beispiellose Genauigkeit, Verlässlichkeit und Vielseitigkeit in der Aufzeichnung von wissenschaftlichen Daten und benötigen dennoch bei weitem weniger Platz, Strom und Fürsorge als gewöhnliche Bandgeräte. Fordern Sie Einzelheiten an—in jeder Sprache!

Vertreter erwarten Ihre Anfrage in allen grösseren Städten der Welt.

Quel que soit le lieu et l'idiome,

la définition est la même. Le mot, le marque Précision est synonyme des plus hauts standards d'opération en enregistrement sur bande magnétique. Les enregistreurs "Précision" offrent une exactitude, une sûreté et une souplesse hors-concours dans l'acquisition de données scientifiques. Pourtant les exigences d'encombrement, de puissance ou d'entretien sont moindre que des appareils d'enregistrement conventionnels. Demandez-nous des détails, en n'importe quelle langue!

Nos représentants sont établis à travers le monde.



In qualunque lingua, in qualunque luogo,

il significato è lo stesso. Precision, tanto la parola quanto il nome, è la chiave ai più alti gradi d'effettualità per registratori magnetici a nastro. I registratori Precision offrono esattezza impareggiabile, fedeltà, ed adattabilità nel registrare dati scientifici, però richiedono molto meno spazio, energia, e mantenimento che i registratori convenzionali a nastro. Chiedere per iscritto particolari—in qualunque lingua!

Rappresentanti si trovano nelle principali città del mondo.

In any language, anywhere,

the meaning is the same. Precision, both as a word and as a name, is the key to the highest standards of performance in instrumentation magnetic tape recording. Precision recorders offer unmatched accuracy, reliability, and flexibility in capturing scientific data, yet require far less space, power, or maintenance than conventional tape machines. Write for details—in any language!

Representatives in principal cities throughout the world.



P. I. Invites inquiries from senior engineers seeking a challenging future.

PRECISION INSTRUMENT COMPANY

1011 Commercial Street • San Carlos • California
Cable: PRINCO, San Carlos, Calif. TWX: SCAR BEL 30

Paris . . .

stator bore; standard models have speeds of 10, 30, 60 or 100 rpm. The motor measures slightly under 6 in. in diameter, develops starting torque of 370 oz-in., starts, stops or reverses in 1/100 second, says manufacturer SFAIRE.

Numerical-analog differential analyzer: Labinal Electronique's (Paris) Delta 600 solves partial differential equations by using both numerical and analog methods simultaneously. It can be linked to perforated card equipment or a curve tracer.

Drilled ferrite-plate memory: each plate in a stack of 40 has 256 holes; the ferrite around each hole acts as a conventional ferrite toroid. The material in the plates has conductivity low enough to permit printing the readout circuit

directly on the plate. With 40 matrices of 256 holes each, capacity of the unit is 10,240 bits. It was developed by the Centre National d'Etudes des Telecommunications of Issy-les-Moulineaux.

Low-voltage amplifier with neg-

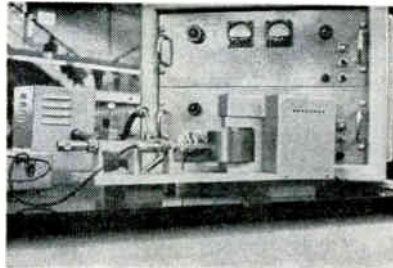

Microwave equipment by Philips-Industrie measures surface irregularities and eccentricity with an accuracy of 1 micron. The piece being checked (right) is placed in front of a waveguide to create a standing wave pattern

ligible drift: intended for strain gage, thermocouple and similar measurement applications, Sexta's (Bogneau) all-transistor amplifier never strays more than a few microvolts with zero input. The unit handles a-c or d-c inputs from 1 mv to 1 volt, responds within 100 microseconds, stays linear within 1 percent or better.

Automatic transistor wafer sorter: this \$8,000 machine by EAM of Clamart measures by a capacitance bridge the deviation to the nearest 0.5 micron of wafer thickness from a nominal value. It then sends the wafer on to join its dimensional class—one of the 11 good (0 and out to plus or minus 2.5 microns in 0.5 micron increments) or the two bad (above or below the 2.5 micron limit). Wafers are fed to the measuring head by a vibrating bowl; capacity is 3,600 wafers an hour.

Ultrasonics Improves Grinding Economy and Quality

ULTRASONIC REMOVAL of metal embedded on grinding-wheel surfaces during grinding operations is claimed by Cavitron Corp.

The device performing this function is trade named Ever-Grind and was on exhibit at the recent New York show put on by the American Society of Tool and Manufacturing Engineers.

Ultrasonic vibrations cause cavitation in the grinding coolant liquid so that bubbles rapidly form and implode with a force sufficient to remove surface-adhering substances.

Ever-Grind uses ultrasonic energy in the 20,000 to 40,000-cps range to prevent deposition of metal between the abrasive particles on the grinding wheel. A magnetostrictive transducer is the source of ultrasonic vibrations. Attached to the end of the vibrating transducer is an aluminum tool head the size of a cigarette package which has built-in multiple conduits for coolant.

With the tool head positioned 0.002 inch above the grinding

wheel, the coolant flows through the head onto the rotating wheel. Cavitation is thus caused to act upon metal particles adhering to the wheel.

According to Cavitron spokesmen, a complex of physical conditions is brought about by the reciprocating tool head, cavitating

coolant, structure geometry and rotating wheel. Field force created causes metal particles to be attacked 20,000 times a second with terrific distributed impact so that they are torn off and carried away in the coolant, which is filtered-cleaned and recirculated to the head and the wheel surface.

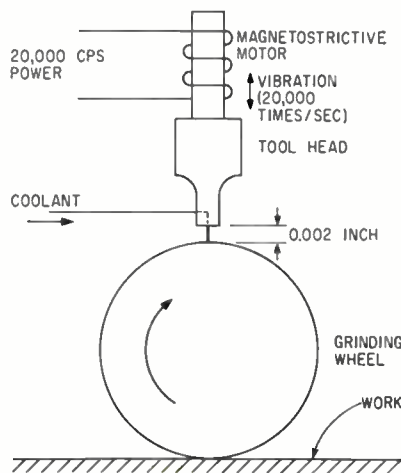

This is the basic setup for the ultrasonic removal of embedded metal particles

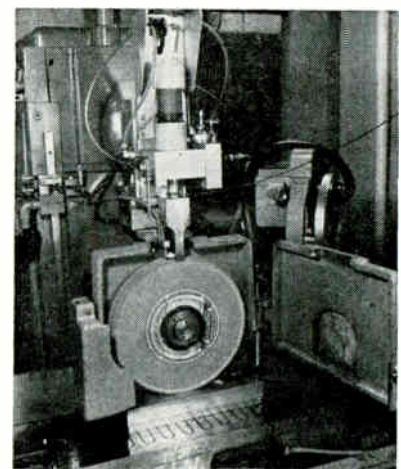

Ever-Grind equipment and grinder. Note coolant ducts and micrometer adjustment

VITRAMON, INC. *Develops Dramatically Improved Dielectric Material*



**SOLID STATE
PORCELAIN
CAPACITORS**

with **NEW #155 "FRIT"**

**ASSURE 10 TIMES BETTER PERFORMANCE
AFTER A LIFE TEST 10 TIMES MORE DEMANDING!**

Three years of intensive product research, and the desire to impose a more exacting quality control during production, have resulted in the development of a new porcelain "frit." Completely formulated and produced within our own plant, this high quality dielectric material, utilized for the improved "VY" Porcelain Capacitors, has produced dramatic results.

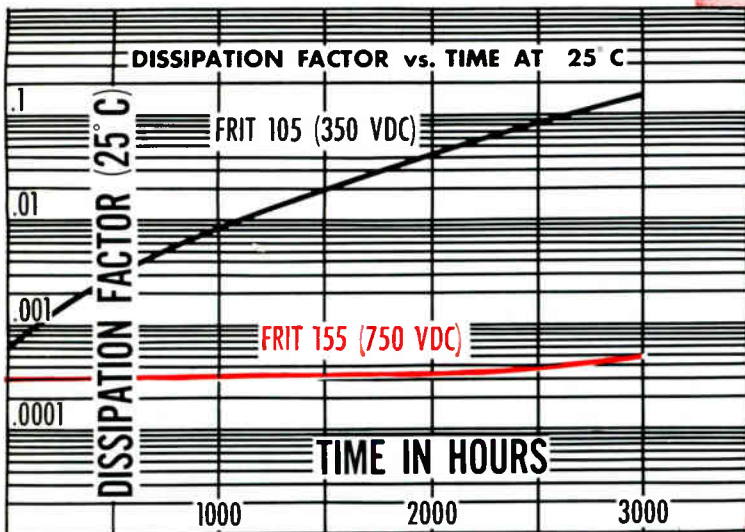

NOTE: Offered Exclusively For MIL-C-11272B Requirements.

© Vitramon, Inc.

Axial Series
(Conforms with MIL-C-11272B)

Axial-Radial Series
(Conforms with MIL-C-11272B)

Radial Series

End Radial Series

When tested at 125°C with more than twice previous test voltages applied (750 VDC vs 350 VDC and 450 VDC vs 200 VDC) and with the time extended to 2000 hours (more than 10 times as stringent a test) post-test dissipation factor is .002 max. and insulation resistance is greater than 100,000 megohms (10 times better)!

Vitramon[®]
INCORPORATED
Box 544, Bridgeport 1, Conn.

make Springs
in Seconds!

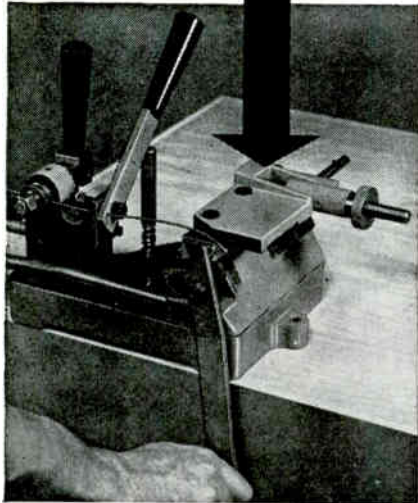

Save Costly Special Orders
With the NEW

DI-ACRO* Spring Winder

This unique machine eliminates costly special spring orders, saves valuable waiting time. Winds compression and extension springs to 1½" O.D. Handles round, flat and rectangular wire to ¼" dimension. Note exclusive features in the hand operated Di-Acro Spring Winder which assure accurate tension and fast operation without special experience or skill.

new TENSION CONTROL—Simply adjust to desired tension—the control keeps it uniform, for winding one spring or hundreds, and releases when each spring is wound.

new WIRE CUT-OFF—After spring is wound, release tension and use cut-off lever to quickly cut end of spring to desired length.

new CAM LOCK—Simply feed wire under cam, turn handle and wire is securely locked to arbor while spring is wound. No threading required.

FREE ENGINEERING SERVICE



Send us your spring forming problems—samples or dimension sketches—together with sufficient test material, and let us wind some sample springs for you free of charge. No obligation.

Quick Facts Folder gives details on all Di-Acro Precision Machines. Consult the yellow pages of your phone book under Machinery, Machine Tools, for the name of your Di-Acro distributor or write.

*pronounced Die-ack-ro

di-acro
PRECISION
METALWORKING
MACHINES

DI-ACRO CORPORATION
formerly O'Neil-Irwin
Mfg. Co.
436 8th Ave., Lake City, Minn.

Polaris Crews Get Control Simulator

FLEET BALLISTIC MISSILE crews are now "navigating submarines" in a new \$1-million electronic simulator at the U. S. Navy Subschool, New London, Conn. Navy is expected to award contracts for two more soon.

Developed and built by Reflectone Electronics (soon to merge with Universal Match) in association with Electric Boat, the trainer is a reproduction of the navigational and ships control center in the SSB(N) *George Washington*. The trainer can be operated either alone or with diving and missile launching simulators.

The navigational trainer consists of the navigation center, instructor's console and computer room.

The navigation center contains actual and simulated equipment and mockups. Included are control consoles, Sins (the Ship's Inertial Navigation System), Navdac control (Navigation Data Assimilation Computer), periscopes and controls and recorders. Radio aids, transmitters and receivers, plotters, chronometer and loran C are part of the systems, as well as duplications of all indicator lights.

The instructor's console contains equipment for controlling parameters of the training problem such as latitude and longitude errors for each of the three Sins, and positioning controls for initial inputs of latitude and longitude of the sub-

marine. Panels on the console control malfunction situations, periscopes and simulated errors in the radio aids and loran C system. The instructor can also insert ocean-current velocity and directional information.

The computer room houses the logic equipment that supplies information parameters, compares relationships and feeds data to the navigation center. These equipments include computers to develop latitude, longitude, ships ground speed and ocean-current velocity.

Tied in with the artificial star sky are a star selection computer and data selector for the type 8 periscope. A star azimuth and altitude computer, latitude resolver, local hour angle (LHA) computer and Aries computers are employed for the type 11 periscope.

Additional computation equipment provides sky information and precise star position data, with specific error computers related to each.

One big problem was achieving accurate simulation of the ship's main navigation system, Sins. Each sub carries three separate Sins. Each provides slightly different readings. The operator must compare results and select the Sins he thinks most accurate since the Navdac computer will accept only one Sins result at a time.

An important element of the



Officer gives instructions to fire Polaris missile at simulator control panel

trainer is the course generator which provides an actual position of the vessel for use in the navigation problem against which the system errors can be measured. The instructor gets the correct position while the student is given readings with the errors he will normally encounter in operation.

The course generator is an analog system using velocity servos. Speed through the water is inserted as a voltage, the magnitude of which is a function of the speed. Heading is set into an analog resolver and ocean currents are introduced as a voltage.

The course generator also feeds information into the several other pieces of navigational equipment with the data degraded by realistic errors.

For celestial navigation, the trainer provides an artificial sky maneuverable by astrocomputers to present 50 to 60 navigable stars for any time, past or future, for any location. Equipment includes the type 8 periscope for celestial observation and a type 11 star-tracking persicope.

Color Tv Intrigues Montreux Festival

COLOR TELEVISION systems caught most of the interest at the International Festival of Television Arts & Sciences, held recently at Montreux in Switzerland.

Ampex demonstrated its small color Videotape; Telechrome Mfg. and RCA both exhibited compatible color studio equipment.

A "robot" tv studio operated by one man was among exhibits which drew a great deal of attention. Tv broadcasters from both sides of the Iron Curtain attended the Festival; only France, Germany, Japan, Switzerland and the U. S. exhibited.

Fifty papers—including 16 by U. S. authors—were presented at the symposium. Subjects included satellite communications vehicles, discussed by L. Jaffe of the National Aeronautics & Space Administration; synchronous communications satellites, which was the subject of a paper by R. P. Haviland of GE; and the use of satellites for tv relay, discussed by J. R. Pierce of Bell Telephone Labs.

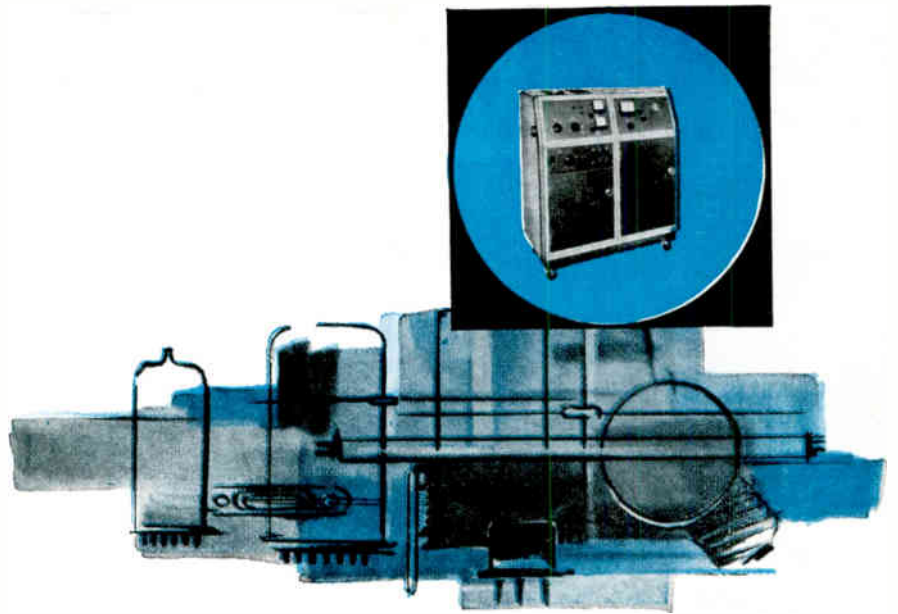

**MASS SPECTROMETER
LEAK DETECTOR***
**...100 TIMES MORE SENSITIVE
THAN OTHER HELIUM
ACTUATED UNITS**

Sensitivity of 10^{-12} cc/sec. (S.T.P.) permits critical vacuum testing, providing an important increase in operating reliability and shelf life of hermetically sealed and pressurized devices. The competitively-priced Crosby-Teletronics Model 600, an outgrowth of the recently-introduced ultra sensitive Model 700 (sensitivity of 10^{-13} cc/sec), incorporates a double magnetic analyzer and a newly developed ion source and detector unit. This new machine takes its place with other advance-design hardware developed by Crosby-Teletronics, a leader in test equipment, long range communications and

vacuum research



Crosby-Teletronics Corporation • 54 Kinkel Street • Westbury, Long Island, New York *pat. pend.

300% FASTER ULTRASONIC CLEANING*



WITH THE NEW SELF TUNING AUTOSONIC BY POWERTRON

Powertron Autosonics are the only cleaners that continuously tune themselves electronically to give you peak cleaning efficiency. Regardless of load changes, liquid level, liquid temperature, or operator inattention, you get top cleaning performance hour after hour with no controls other than a single switch.

The Powertron self tuning feature is available in a complete line of Autosonic tank units, consoles, cabinet models, immersible transducers, and vapor degreasers that...

ELIMINATE OPERATOR TRAINING AND MONITORING
IMPROVE QUALITY
REDUCE REJECTS
CUT LABOR AND SOLVENT COSTS

*Case histories on file show up to 900% faster cleaning consistently and savings as high as \$3,000 a month in labor costs under ideal conditions.



Send for Powertron's free booklet 60-1, "How to Clean Ultrasonically with Self Tuning."

POWERTRON
ULTRASONICS CORPORATION
DEPT. E-6 • PATTERSON PL., ROOSEVELT FIELD
GARDEN CITY, L.I., N.Y. • PIONEER 1-3220

Teaching Machines Draw Overflow Crowd, Get Special EIA Section

CHICAGO—Electronic teaching machines can share in a potential billion-dollar market for teaching machines of all types, Hugh C. Bream of U.S. Industries told an overflow crowd recently during a special conference at the 37th annual EIA convention.

Electronic teaching devices could solve a share of the skilled manpower problem pointed out by Jerome Wiesner following the award to him of the 10th annual EIA medal of honor for distinguished service contributing to advancement of electronics industry. Wiesner is Presidential Assistant for Science and Technology.

The U.S.S.R. is educating engineers at double and triple our rate, Bream told the conference.

A. J. Platt, RCA, was named chairman of a new education-institution section within the EIA Industrial Electronics Division to collect and disseminate market data and other information on development, standardization and other requirements for teaching machines.

A special task force is working on a symposium that would bring together manufacturers and groups of educators to chart mutual problems and requirements.

Retraining and reeducation of unemployed in the wake of the rapid growth of automation is a most

promising area for expanding use of teaching machines, said Bream.

While schools and colleges look like the biggest long-term market, the military, with requirements for quick training, is most likely to make most immediate use of such devices, he added.

Teachers report machines save time. A private tutor function permits student to pace himself and to accelerate the pace of learning. Feedback control allows the student to make optimum use of his time, according to Norman Crowder, who is a colleague of Bream at U.S. Industries.

Thomas Cheatham, Litton Systems, Inc., predicted foreign languages will be the first academic subjects to be taught by machine, partly because of the advantage of audio reinforcement. He said prices of machines are likely to drop from a third to a half as they become widely accepted.

In other EIA developments, Edward Taylor, Motorola, chairman of Consumer Products Division, reported the group will drop costly and difficult effort to gather retail statistics and will add statistical reports on stereo f-m.

L. M. Sandwick, Pilot Radio, and G. B. Mallory of Mallory, were named new members of the EIA board of directors.

Metal Interface Amplifier

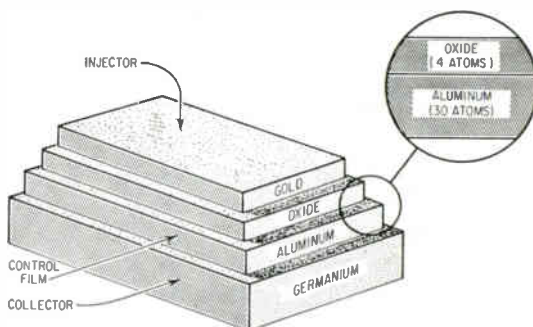
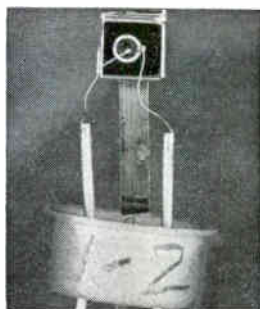

Philco's metal interface amplifier, shown under four-diameter magnification in photo, has a metal injector and control film corresponding to the emitter and base of a transistor. Electron current through base, however, is majority carrier flow.

Here's a new "twist" for the specialized application:

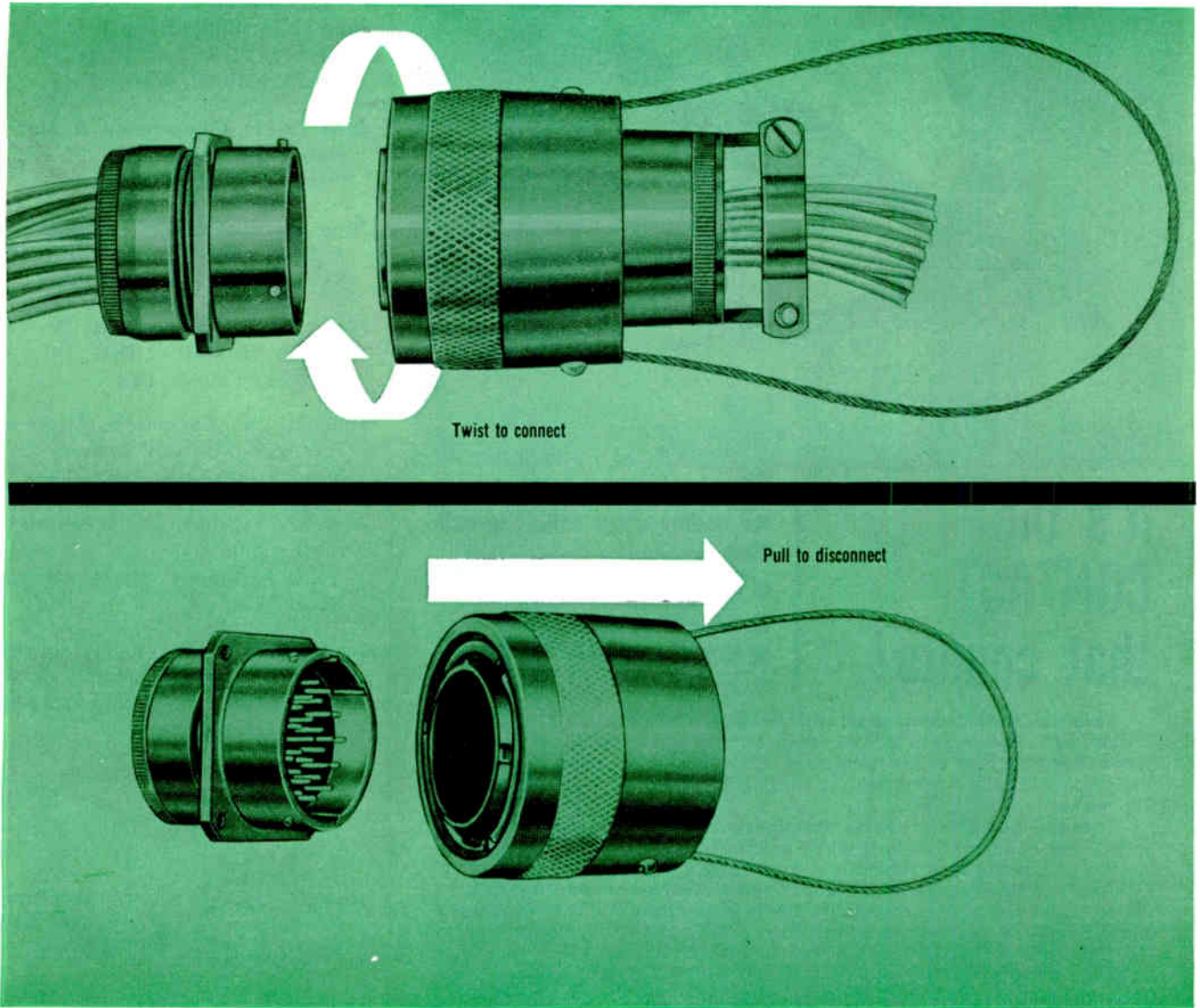

Bendix "TWIST / PULL" Pygmy Electrical Connector

This new Bendix® Pygmy® Electrical Connector uniquely combines positive coupling and pull-to-disconnect features. It is connected by a twist; disconnected either by hand or, remotely, by lanyard.

Complete intermateability with PT receptacles is achieved through use of standard Pygmy PT plug shells, five-key polarization, and three-point bayonet lock coupling. The "twist/pull" design assures inter-facial sealing and meets the performance requirements of MIL-C-26482.

Resilient inserts assure extreme vibration resistance and provide support for size 20 or 16 gold-plated Pygmy contacts of either the solder or removable crimp type. Plating options for the aluminum shell components are: cadmium with an olive drab chromate after treatment, or alumilite hard anodic coating.

Write today for your copy of our informative technical bulletin SL-102, giving complete information on shell sizes and arrangements, as well as helpful design and dimensional data.

Scintilla Division

SIDNEY, NEW YORK



Canadian Affiliate: Aviation Electric, Ltd., 200 Laurentien Blvd., Montreal 9, Quebec. Export Sales & Service: Bendix International, 205 E. 42nd St., New York 17, N. Y.

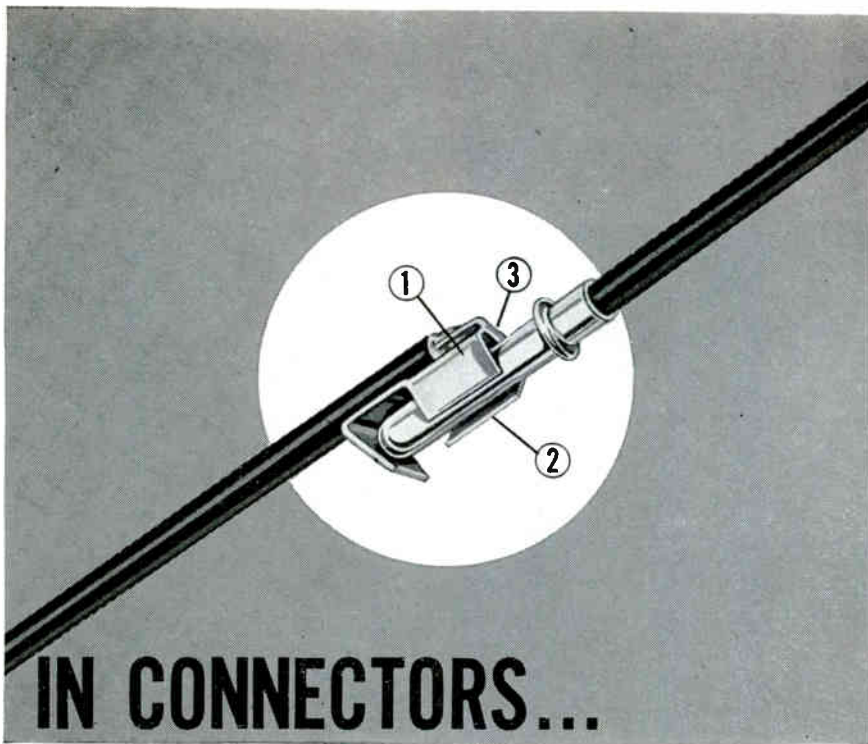

IN CONNECTORS...

it's the
CONTACT
that counts!

3 positive contact surfaces on each Alden top-connected contact give you:

- More reliable electrical contact
- More secure mechanical grip
- Minimum electrical resistance

Each lead has individual strain relief because wire is doubled back through contact tab. Punch press contact design permits rapid heat transfer — eliminates unreliable cold solder joints as in screw machine contacts. Danger of insulation pull back is eliminated by bringing wire insulation right into molded clip pocket.

These unique Alden molding techniques in connector design drastically reduce the number of parts required and make possible multi-contact connectors of amazing basic simplicity and reliability.

Resilient Alden contacts can be included in any type of molded insulation for any combination of contacts. Hundreds of standard off-the-shelf designs are quickly available — with or without leads — or as part of unit-molded cables.

Our Customer Department will work closely with you on any connecting or cabling problems. A letter with description or sketch will enable us to provide recommendations or samples at once.

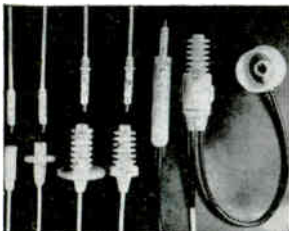

New, flameproof, high voltage connectors now available in high-density, flame-retardant polyethylene. Light, compact connectors for applications up to 30 KVDC and up to 250° F without distortion.

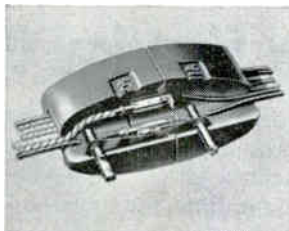

First major advance in connector reliability since potting offers fool-proof, tamper-proof connections for trouble-free operation. Alden "IMI" connectors and cables (wires, contacts, or other inserts) are integrally molded in a single hot shot of insulation so that material forming the connectors and covering the wires forms a single continuous, bonded insulation.

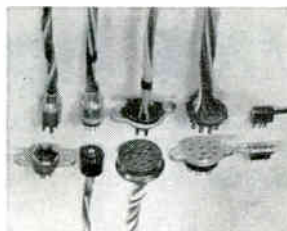

Standard assembled connectors in non-interchangeable layouts with from 2 to 11 contacts; miniature connectors, plain or shielded, for carrying power or signal; miniature plugs and sockets; signal connectors; and CRT connectors are all available for fast delivery.

ALDEN

PRODUCTS COMPANY

6127 N. MAIN STREET, BROCKTON, MASS.

MEETINGS AHEAD

June 11-16: Electronic Representatives Management Inst., ERA & Univ. of Ill; Robert Allerton Park, Univ. of Ill., Urbana, Ill.

June 12-13: Radio Frequency Interference, PGRFI of IRE; Sheraton-Park Hotel, Wash., D. C.

June 12-17: Components & Materials Conf., Institution of Electrical Engineers; London.

June 14-15: Product Engineering & Production, PGPEP of IRE; Sheraton Hotel, Philadelphia.

June 19-20: Broadcast & Tv Receivers, B&TVR of IRE; O'Hare Inn; Des Plaines, Ill.

June 22-23: Computers & Data Processing, Univ. of Denver; Elkhorn Lodge, Estes Park, Colo.

June 22-23: Air Lines Communications Administrative Council; AEEC; Saxony Hotel, Miami Beach, Fla.

June 26-27: Vacuum Metallurgy Conf., American Vacuum Society; New York Univ. Heights Campus, New York City.

June 26-28: Military Electronics, National Convention, PGME of IRE; Shoreham Hotel, Wash., D. C.

June 26-30: Aero-Space Electricity, Concepts & Design, AIEE; Ben Franklin Hotel, Philadelphia.

June 26-July 1: International Measurement Conf. and Instrument Show, IMEKO, IMIS; Engineering Societies Bldg., Budapest.

Aug. 22-25: WESCON, L.A. & S.F. Sections of IRE, WCEMA; Cow Palace, San Francisco.

Sept. 11-15: Instrument-Automation Conf. and Exhibit, ISA; Sports Arena, Los Angeles.

Oct. 9-11: National Electronics Conf., IRE, AIEE, EIA, SMPTE; Int. Amphitheatre, Chicago.

Nov. 14-16: Northeast Research & Engineering Meeting, NEREM; Commonwealth Armory and Somerset Hotel, Boston.

NRC's Packaged Pumping Systems Produce and Measure "Clean"

Vacuum to

10⁻⁶ Torr

Here's what you get with the
NRC Series 3300 line of
portable pumping systems:



- * **Lightweight, rugged frame design** for "functional" operation, easier maintenance and reliable vacuum performance.
- * **Fractionating type diffusion pumps**, for dependable top speed pumping performance, even at lower pressure ranges.
- * **High conductance, straight-through pumping**—Gate type main valve has 100% full opening, least restrictive vacuum valve available; no elbow cold traps or angle valves to restrict flow rate; result—more useful pumping speed available.
- * **Portable gauge control**—The NRC Model 710 Vacuum Gauge Control assures accuracy and reliability; box mounted, normally rests on shelf in system frame; can be easily moved to any remote location for convenient reading.
- * **Wide choice of sizes available**; built around 2", 4", 6" and 10" diffusion pumps; all systems complete and performance tested; wide choice of accessory base plates, bell jars, feed-throughs, power supplies, etc., also available.

Featured in the Series 3300 Systems are NRC's new "HS" fractionating diffusion pumps, producing ultra-high-speed over a wide pressure range. Their extremely low backstreaming rates, in combination with the "optically opaque" baffle cold traps, result in vacuums that can truly be termed "clean".

These complete systems combine such features as fractionating diffusion pumps, conductance slide valves, and full-flow combination baffle cold traps, provide "functional" pumping systems that outperform any other systems available.

The new Series 3300 packaged pumping systems assure you of high vacuum pumping and measurement. All they need for operation are power, water, and a suitable vacuum work or test chamber. Use them whenever you need pressures from 10⁻³ Torr or lower. Can easily be moved from job to job or as a building block for a high performance vacuum installation. Write today for complete data sheet and specifications on the Series 3300 Systems.



A Subsidiary of National Research Corporation

160 Charlemont Street, Dept. 4F
Newton 61, Massachusetts
DEcatur 2-5800

Here is a plan to help you

REDUCE SUFFERING AND TRAGEDY

With it, your company can **SAVE PRECIOUS LIVES**, while **CUTTING COSTS DUE TO ABSENTEEISM** by as much as $\frac{1}{3}$ to $\frac{1}{2}$!

Together, American management and labor have done a remarkable job of reducing the incidence of industrial accidents. In-plant safety campaigns have been so effective that today it is *nonwork accidents* that cause the bulk of lost lives and manhours in our economy.

The National Safety Council has developed a plan to reduce these accidents. Not only will it save lives and prevent crippling injuries, but it will add significantly to the efficiency and net profits of companies which put it into operation.

Let's say you're an average company or corporate unit doing \$1 million in sales a year. Your net is around \$73,000. National Safety Council figures show that the average nonwork accident costs employers about \$72. (You can determine *your* costs with the Council's new nonwork accident report system.) Ten such accidents can cost \$720—or about 1% of your net profit. Prevent those accidents and you can add 1% to your net! Prevent twenty—and add 2% to net!

Experience shows that a reduction of nonwork accidents

by 30% is possible! One large company with an excellent in-plant safety record has *cut nonwork accidents by $\frac{1}{3}$* with its off-the-job safety program! It's employee's rate for motor vehicle fatalities stands 85% below rate for all U.S. workers! And its already low in-plant accident rate came down 50 per cent!

Here is a rewarding endeavor that pays immeasurable dividends in human and employee relations—as well as an important untapped source for cost control. You can institute this kind of program in your company. Send the coupon for a copy of our booklet "The Challenge to Management of Off-the-Job Accidents." It will show you how to determine your non-work accident costs, as well as many tested ways to reduce this steady waste of lives and profits. Send the coupon today.



HOWARD PYLE
President, The National Safety Council



Published to save lives
in cooperation with
The Advertising Council and
The National Safety Council



**SUPPORT YOUR LOCAL
SAFETY ORGANIZATION**

THE NATIONAL SAFETY COUNCIL
425 NORTH MICHIGAN AVENUE, CHICAGO 11, ILL.
Please send me a copy of your booklet "The Challenge to Management of Off-the-Job Accidents." I want to learn how my company can save lives while cutting costs.

NAME _____

TITLE _____

COMPANY _____

ADDRESS _____



GEC INDUSTRIAL
R. F. GENERATORS

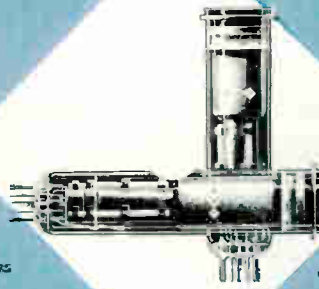

GEC VIDICONS



GEC SCAN
CONVERSION
TUBES



GEC SCAN
CONVERTERS

ADVANCED

ELECTRONIC DEVELOPMENTS FROM G E C

ELECTRONIC TUBES . . .

Vidicons with unsurpassed light sensitivity and low lag responding to all parts of the spectrum including near and far infrared.

FEATURES:

- 1 in. and larger sizes
- Electrostatic and magnetic focus and deflection
- Low power heaters
- Patented internal construction allows operation in any position

Scan Conversion Tubes provide controllable storage of input signal with simultaneous reading and writing.

GEC's Capability includes the design and development of a wide range of pickup, conversion and display tubes.

SCAN CONVERSION SYSTEMS . . .

Transistorized Scan Converters convert from any scanning format into another. One basic unit uses plug-in functional modules to provide required conversion. Modules presently available are: TV Control, PPI Control, and Slow Scan Control.

FEATURES:

- Translation of video information from one scanning mode to another
- Storage and Integration of video information
- Time-Coordinate Transformation providing expansion or reduction of bandwidth
- Rack-mounted requiring 36 $\frac{3}{4}$ in. of panel space
- Power consumption only 1.5 amp at 115 Vac, 60 cps
- No external power supplies are needed

GEC Monoscope Cameras, Radar Target Simulators and other system equipment are available for operating scan conversion systems.

INDUSTRIAL R. F. GENERATORS . . .

Induction and dielectric heating R. F. Generators are available in the very highest powers. GEC's extensive radio-frequency engineering is available to assist customers in special applications of R. F. Generators.

For additional information about your specific R & D needs, contact . . .

. advanced electronics at work



GENERAL ELECTRODYNAMICS CORPORATION

4430 FOREST LANE • GARLAND, TEXAS • BROADWAY 5-1161

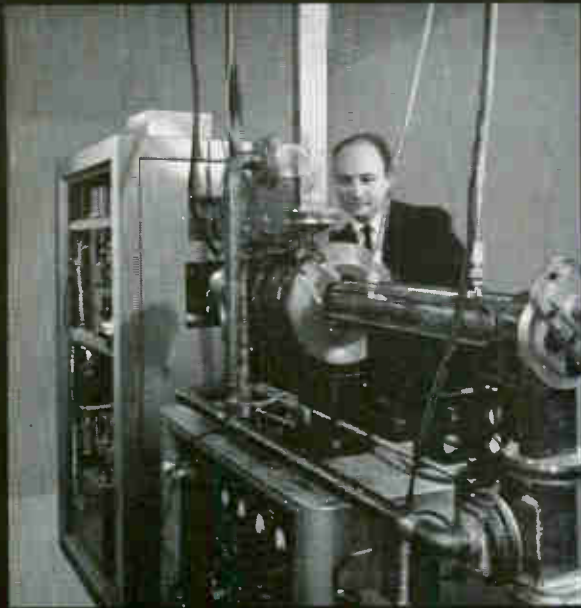

Research LINAC

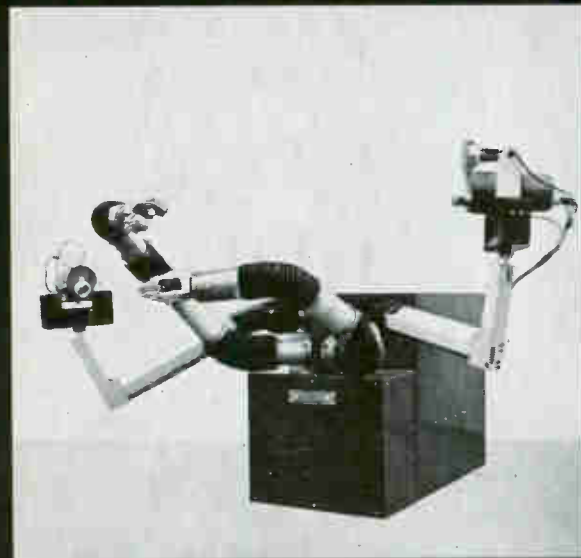

Radiation Handler—Mobot® Mark II

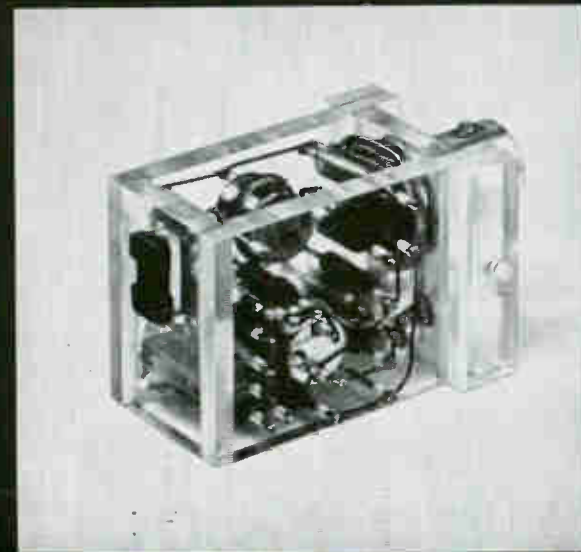

Detector—Preamplifier

Opportunities in basic research
or development engineering
in our expanding

nuclear electronics laboratory

programs: Operating in a radiation environment is a many faceted problem that offers challenge and growth to many kinds of engineers and scientists in our Nuclear Electronics Laboratory. They are contributing to such projects as: simulating radiation environment to study the radiation resistance of electronic components and systems; the design of LINACS, producing either electron beams, gamma rays or neutron pulses, uniquely adapted to current needs in radiation research, effects testing, medical therapy, sterilization, industrial processing and radiography; radiation detection and measurement with such devices as the Hughes charged particle detector; and mobile remote handling equipment, such as the MOBOT®.

facilities: The laboratory's research and test facilities include a 1 Mev beam generator, an underground LINAC installation and a 500-curie cobalt radiator. An improved 10 Mev LINAC is being constructed. The unexcelled facilities of the Hughes Aircraft Company, which include 5 million square feet of research development and manufacturing area, support the technical competence of a staff which is a demonstrated leader in electronic system and component development.

openings: Physicists, Electronic Engineers and Mechanical Engineers to participate in the development of High Power Particle Acceleration, Solid State Radiation Detectors and associated data processing equipment or mobile remote handling systems.

If you are a graduate electronic engineer, physicist, mechanical engineer or metallurgist and have experience which is applicable to the above programs, please airmail your resume to:

Mr. Robert A. Martin, Supervisor, Scientific Employment, Hughes Aerospace Engineering Division, 11940 W. Jefferson Blvd., Culver City 41, California.

WE PROMISE YOU A REPLY WITHIN ONE WEEK

At Hughes, all qualified applicants will receive consideration for employment without regard to race, creed, color or national origin.

Creating a new world with Electronics

HUGHES

HUGHES AIRCRAFT COMPANY
AEROSPACE ENGINEERING DIVISION

NO DERATING

with IRC Resisteg Coated Power Resistors

Exclusive RESISTEG COATING accounts directly for the ability of IRC Power Resistors to operate at full rated power—even at high resistance values. Resisteg Coating is cured at less than 205°F. This is more than 1000° lower than is required for other power resistor coatings.

With Resisteg low-temperature curing there is no tendency for wire turns to shift, no necessity for tight windings, no hot spots from arcing-over, no appreciable change in temperature coefficient or resistance.

Resisteg Coating permits the use of close spacing, large wire diameter, and maximum number of turns. This increases the transfer of heat from the interior of the IRC resistor to the terminals—providing a safety margin for surges and minimizing any need to derate at high ambient temperatures. Request Bulletin C-1C. International Resistance Co., 401 N. Broad St., Phila. 8, Pa.

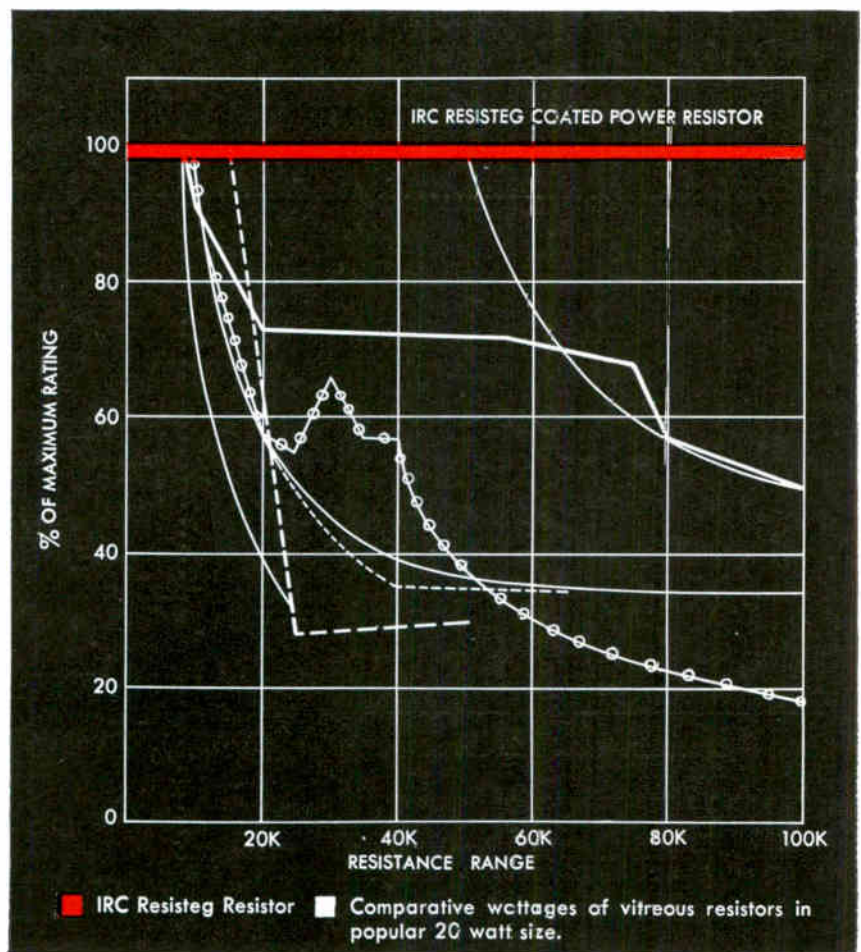

COMPLETE LINE OF POWER RESISTORS • STOCKED BY IRC MAJOR INDUSTRIAL DISTRIBUTORS



Leading supplier to manufacturers of electronic equipment

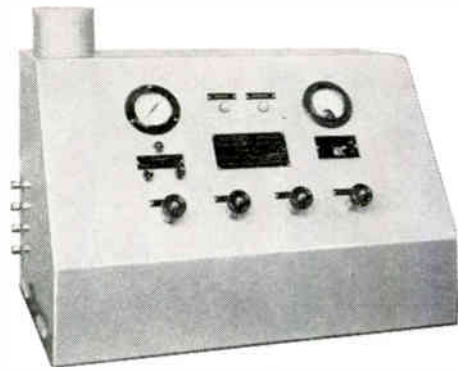

ENGELHARD HYDROGEN DIFFUSION PURIFIER

This Hydrogen Purifier removes all impurities (including oxygen, nitrogen, argon, water vapor, hydrocarbons, etc.) from hydrogen gas streams. Produces hydrogen of highest purity obtainable from dissociated ammonia, steam reformed natural gas or propane, commercial hydrogen purchased in cylinders and other hydrogen containing gas streams. *No trace of impurities detectable in purified gas.* Ultra-pure product hydrogen obtained at lowest cost. • Available in standard sizes: 100 c.c. per hour, 20 SCFH, 75 SCFH, and 150 SCFH. Larger sizes custom built to requirements. Write for literature.

INDUSTRIAL EQUIPMENT DIVISION
GAS EQUIPMENT SECTION
113 ASTOR STREET • NEWARK, N. J.

A GAS GENERATOR FOR THE MOST EFFICIENT AND ECONOMICAL PRODUCTION OF N₂ H₂ FORMING GAS MIXTURES

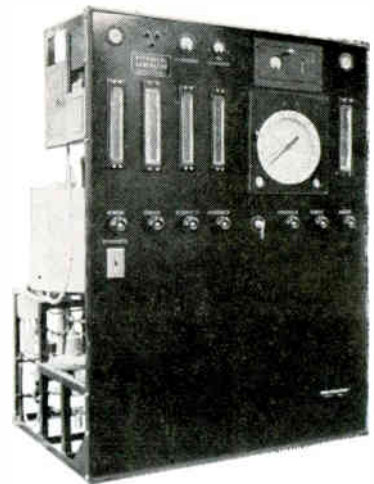

... provides the most economical and efficient method for the production of pure nitrogen—completely free of oxygen—with a hydrogen content precisely controlled at any desired percentage between 0.5% and 25%. Gas mixtures are supplied at a fraction of cylinder supply cost. • The Nitroenal Generator is automatic except for startup, with no need for operating personnel. The unit performs instantly, efficiently anywhere in the range of from 25% to 100% of rated capacity. Installation requires only a 110 volt line, water, air, ammonia lines and drain facilities. . . . The catalyst lasts indefinitely—minimum maintenance costs.

INDUSTRIAL EQUIPMENT DIVISION
GAS EQUIPMENT SECTION
113 ASTOR STREET • NEWARK, N. J.



HERMACH-ENGELHARD MULTI-RANGE TRANSFER VOLT-AMMETERS FOR LAB STANDARD ACCURACY

Hermach-Engelhard multi-range transfer volt ammeters provide laboratory standard accuracy in reading voltages or current with an error not exceeding 0.05% through a frequency range from d-c to 50,000 cps. These readings are obtained without the use of correction factors directly from the instrument itself. Bureau of Standards certificates are provided on request. Write for complete technical data.

INDUSTRIAL EQUIPMENT DIVISION
INSTRUMENTS AND SYSTEMS SECTION
850 PASSAIC AVENUE • E. NEWARK, N. J.

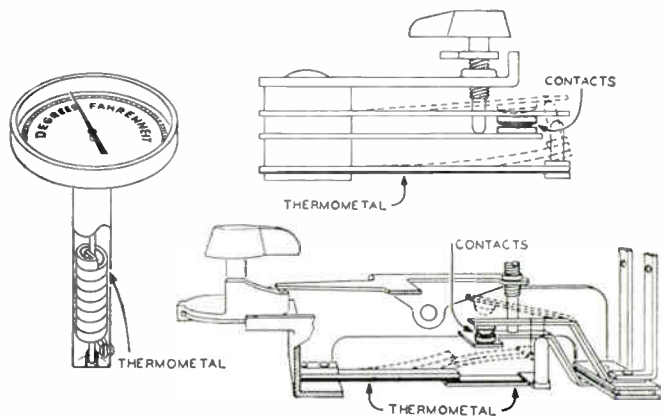

CONTROL TEMPERATURE, CURRENT AND VOLTAGE WITH THERMOMETAL®

Leading manufacturers rely on the dependable performance of Wilco Thermometal in electrical appliances, thermal cutouts, heating controls and many other applications involving the indication and accurate control of temperatures, electrical currents, voltages, etc. Thermometal is supplied in strip form, rolled and slit to close tolerances and tempered to specification. Thermometal elements and sub-assemblies are also supplied to specifications, with or without contacts attached. Send for literature.

H. A. WILSON DIVISION
U.S. HIGHWAY 22 • UNION, N. J.

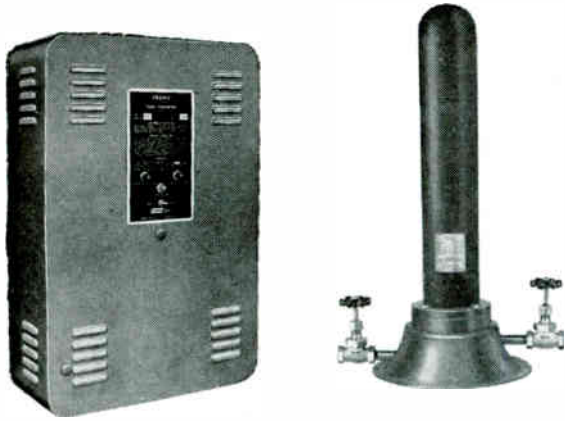

FOR LOW COST PURIFICATION AND DRYING OF HYDROGEN AND OTHER GASES

The Deoxo Catalytic Purifier removes oxygen to less than one part per million from hydrogen gas. It can also be used with other gases such as Nitrogen, Nitrogen-Hydrogen Mixture, Argon, Helium, and Carbon Dioxide. • A combination unit, the Deoxo Dual Puridryer, contains the Deoxo Catalytic Purifier plus an extremely efficient automatically operated drying unit. Removes oxygen to less than 1 PPM from hydrogen and dries the purified gas to a low point of minus 100°F. It will also purify and dry other gases in a similar manner.

INDUSTRIAL EQUIPMENT DIVISION
GAS EQUIPMENT SECTION
113 ASTOR STREET • NEWARK, N. J.

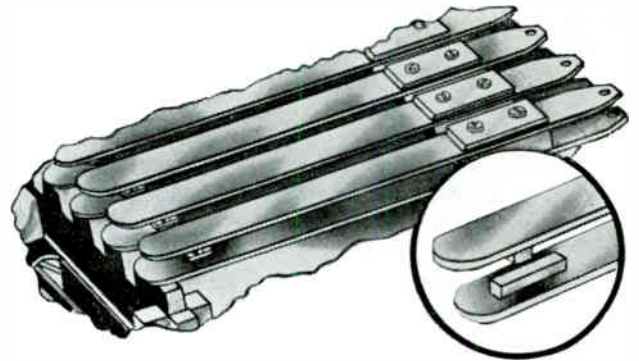

ECONOTAPE CONTACTS ARE MOST EFFICIENT FOR ELECTRICAL RELAYS

High reliability welded contacts and contact assemblies available for your relays. Weld strength guaranteed. • Overall contact height held within $\pm .00025$. Assemblies are available in gold, platinum, palladium, silver and their various alloys—both solid and laminated. Single contact usable for various contact ratings, for wet and dry circuitry—assemblies protected for shelf life and handling. Designs for attachment to header by welding or brazing. Complete electrical and mechanical design services available.

D. E. MAKEPEACE DIVISION
PINE & DUNHAM STREET • ATTLEBORO, MASS.

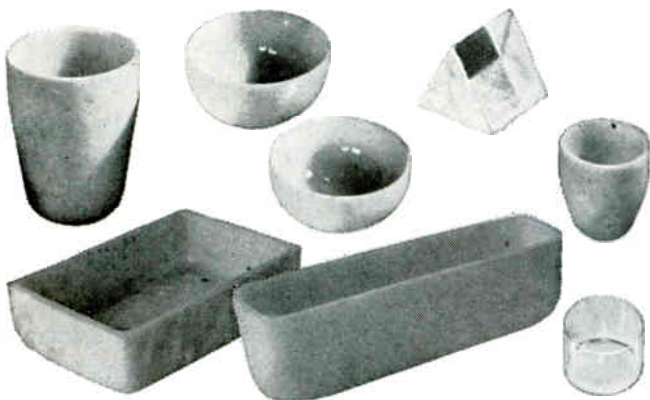

LOOK TO AMERSIL FOR ALL HIGH PURITY FUSED QUARTZ REQUIREMENTS

Amersil manufactures and fabricates high purity fused quartz for ultraviolet transmission application, laboratory ware and production equipment. These products include standard apparatus, plain tubing in many intricate fabrications, crucibles, trays, cylindrical containers and piping in a full range of sizes up to 25" in diameter. Ingots and plates are available in general commercial quality as well as in special optical grades. Amersil engineers are also prepared to assist in developing fused quartz and silica equipment for special requirements.

AMERSIL QUARTZ DIVISION
685 RAMSEY AVENUE • HILLSIDE, N. J.

ENGELHARD

INDUSTRIES, INC.

EXECUTIVE OFFICES:

113 ASTOR STREET • NEWARK 2, NEW JERSEY

SALES OFFICES: CHICAGO • DALLAS • DETROIT • HOUSTON • LOS ANGELES • NEW YORK • ORLANDO • PROVIDENCE • SAN FRANCISCO • WASHINGTON, D. C.

Please send literature as indicated below, addressed to my attention:

- | | |
|--|--|
| <input type="checkbox"/> Deoxo Purifier—Puridryer | <input type="checkbox"/> Econotape |
| <input type="checkbox"/> High Diffusion Purifier | <input type="checkbox"/> Thermometal |
| <input type="checkbox"/> Fused Quartz | <input type="checkbox"/> Nitroenal Generator |
| <input type="checkbox"/> Hermach-Engelhard Volt-Ammeters | |

NAME.....

TITLE.....

FIRM.....

STREET.....

CITY..... ZONE..... STATE.....

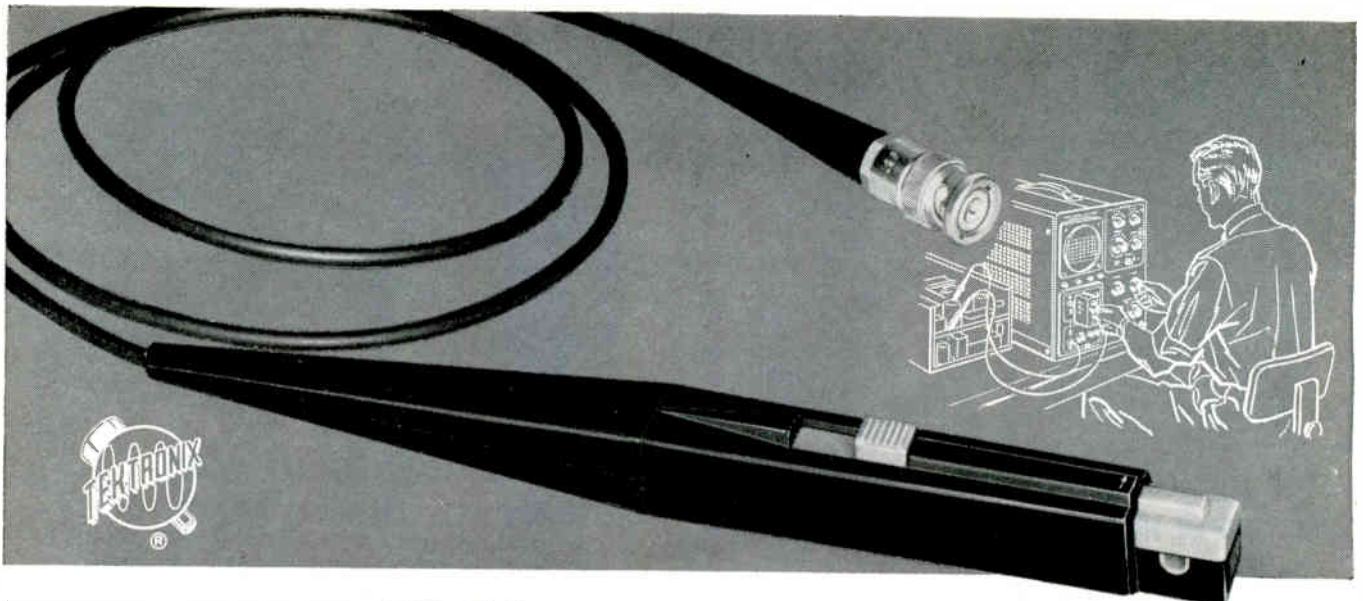

NEW HIGH-FREQUENCY CURRENT PROBE

for Your Tektronix Oscilloscope

SPECIFICATIONS P6016 and TYPE 131 SYSTEM



Sensitivity with 50 mv/div Oscilloscope Input:

1 ma/div basic sensitivity. Ten-position switch provides calibrated steps of 1, 2, 5, 10, 20, and 50 ma/div . . . 0.1, 0.2, 0.5, and 1 amp/div, accurate within 3%. Continuous uncalibrated adjustment is possible by using variable control on the oscilloscope.

Noise:

Equivalent to a 100-microampere peak-to-peak input signal.

Risetime (with Type K or L Plug-In Unit in a Type 540-Series Oscilloscope):

20 nanoseconds (approximately 17 mc at 3 db down).

Low-frequency Response:

50 cps at 3 db down.

Maximum Current Rating:

15 amperes peak-to-peak.

Power Requirements:

105-125 volts ac, approximately 1/2 watt at 117 v.

P6016 and PASSIVE TERMINATION SYSTEM

Sensitivity:

Either 2 or 10 milliamps per millivolt of oscilloscope sensitivity, accurate within 3%.

Risetime (with Type K or L Plug-In Unit in a Type 540-Series Oscilloscope):

18 nanoseconds (approximately 20 mc at 3 db down).

Low-Frequency Response:

At 2 ma/mv—about 850 cps at 3 db down (5% tilt of 10 microsecond square pulse).



At 10 ma/mv—about 230 cps at 3 db down (5% tilt of 35 microsecond square pulse).

Maximum Current Rating:

15 amperes peak-to-peak.

COMMON TO BOTH SYSTEMS

Direct Current Saturation

Threshold:

1/2 ampere.

Maximum Breakdown Voltage

Rating:

600 volts, with thumb slide closed.

Insertion Impedance:

About 0.003 Ω at 1 kc—increasing as a function of frequency—with typically 1 pf capacitance between the conductor and probe case.

TYPE P6016 and TYPE 131 SYSTEM	\$235
TYPE P6016 and PASSIVE TERMINATION SYSTEM	\$ 90
Type P6016, purchased separately	\$ 75
Type 131, purchased separately	\$160
Passive Termination, purchased separately	\$ 15
f.o.b. factory	

The P6016 AC Current Probe and Type 131 Amplifier constitute a current-detecting system for use with your Tektronix Oscilloscope. This system provides accurate displays for observation and measurement of current waveforms. Current range extends from less than one milliamp to 15 amps. Passband, with a 30-mc oscilloscope, is 50 cps to approximately 17 mc.

A second system comprises the P6016 AC Current Probe with a Passive Termination. Although less versatile, this system provides for observation and measurement of current waveforms at frequencies to approximately 20 mc with a 30-mc oscilloscope.

Long narrow shape and convenient thumb control make the P6016 easy to use. Just place probe slot over conductor and close slide with thumb—no direct electrical connection is required. Wiping action keeps core surfaces clean. Loading introduced is so light that it can almost always be disregarded.

CAREER OPPORTUNITIES now exist at Tektronix in the following fields: Instrument design, Circuit design and engineering, Cathode-ray tubes, Electron physics, Solid state and semiconductor devices. For information write to Irving Smith, Professional Placement.

Tektronix, Inc.

P. O. Box 500 • Beaverton, Oregon
Phone Mitchell 4-0161 • TWX—BEAV 311 • Cable: TEKTRONIX

TEKTRONIX FIELD OFFICES: Albuquerque, N. Mex. • Atlanta, Ga. • Baltimore (Towson) Md. • Boston (Lexington) Mass. • Buffalo, N.Y. • Chicago (Park Ridge) Ill. • Cleveland, Ohio • Dallas, Texas • Dayton, Ohio • Denver, Colo. • Detroit (Lathrup Village) Mich. • Endicott (Endwell) N.Y. • Greensboro, N.C. • Houston, Texas • Indianapolis, Ind. • Kansas City (Mission) Kan. • Los Angeles, Calif. Area (East Los Angeles, Encino • West Los Angeles) • Minneapolis, Minn. • Montreal, Quebec, Canada • New York City Area (Alburtson, L.I., N.Y. • Stamford, Conn. • Union, N.J.) • Orlando, Fla. • Philadelphia, Pa. • Phoenix (Scottsdale) Ariz. • Poughkeepsie, N.Y. • San Diego, Calif. • San Francisco (Palo Alto) Calif. • St. Petersburg, Fla. • Syracuse, N.Y. • Toronto (Willowdale) Ont., Canada • Washington, D.C. (Annandale, Va.).

TEKTRONIX ENGINEERING REPRESENTATIVES: Hawthorne Electronics, Portland, Oregon • Seattle, Washington. Tektronix is represented in twenty overseas countries by qualified engineering organizations. In Europe please write Tektronix Inc., Victoria Ave., St. Sampsons, Guernsey C.I., for the address of the Tektronix Representative in your country.

NEVER BEFORE POSSIBLE...ultra-fast silicon diodes that combine 2 nanosec speed, 100 mA conductance, .025 μ A leakage and 2 pf capacitance

The new General Instrument 'SP' series offers a combination of electrical characteristics never before possible in ultra-fast switching silicon diodes. The complete line, including the popular IN914, IN916 and IN903 series, are immediately available in production quantities. They all feature nanosecond switching speeds, coupled with either high conductance, low leakage current or low capacitance. Check the chart. Then call the General Instrument sales office or franchised distributor nearest you for complete specs. Or write today to General Instrument Semiconductor Division, 65 Gouverneur Street, Newark 4, New Jersey.

TYPE	Breakdown [ⓐ] Voltage (BV)	Maximum Reverse Current (μ A)			Forward Current (Min. mA @ 1V)	Reverse Recovery Max. (m μ sec) [ⓑ]	Capacitance [Ⓒ] at $V_R=0$ (pf) [ⓓ]	Rectification [ⓔ] Efficiency
		25°C	150°C	Test Voltage [ⓔ]				
SP100	75	0.1	100	50	10	2	45%	
SP101	30	.025	50	20	100	2	45%	
SP106	125	.025	50	100	100	2	45%	
IN914A	100	.025	50	20 [ⓔ]	20	4	45%	
IN916A	100	.025	50	20 [ⓔ]	20	2	45%	

[ⓐ] Breakdown Voltage at 100 μ A. [ⓑ] Voltage at which Reverse Current measurements were taken. [Ⓒ] Switching $I_F=10$ mA to $V_R=6.0$ V $R_L=100$ ohms recovery to 1 mA. [ⓓ] Measured at 1 megacycle. [ⓔ] Measured at 100 megacycles using MIL-STD-19500 test circuit. [ⓕ] Reverse leakage when measured at -75 Volts and 25°C shall not exceed 5 μ A.

ACTUAL SIZE

GENERAL INSTRUMENT CORPORATION

WE ARE PLEASED TO ANNOUNCE THAT WE HAVE BEEN APPOINTED
 SOLE DISTRIBUTORS IN THE UNITED STATES FOR THE COMPLETE
 LINE OF RECEIVING, INDUSTRIAL AND SCOPE TUBES
 MADE BY
 BRIMAR, LTD. OF SIDCUP, KENT, ENGLAND
 WHICH ARE WORLD FAMOUS AS THE STANDARD OF QUALITY
 IN THE ELECTRONICS INDUSTRY

INDUSTRIAL ELECTRONIC HARDWARE CORPORATION
 Manufacturers of Wiring Devices for the Electronics Industry
 109 Prince Street, New York 12, N. Y.



CIRCLE 200 ON READER SERVICE CARD

GLASS BEADS BY THE BILLIONS AT SUBSTANTIAL SAVINGS

Recently perfected, new production techniques have resulted in a superior glass product at significantly lower cost to you. Quality of bead cut assures more uniform glass-to-metal seal. Parts supplied clean, ready for production line use.

O.D. — .049 to .055
 I. D. — .021 to .025
 LENGTH — .062 ± .005
 MATERIAL: Soft Glass - KG - 12
 or G - 12 Glass

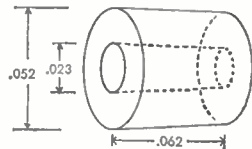

PRICE: \$1.25/M (F.O.B. Destination U.S.A.)

OTHER QUALITY GLASS PRODUCTS
 ALSO AVAILABLE FROM THIS
 RELIABLE WEST COAST SOURCE

Hanibal offers a complete range of semiconductor glass housings. Prompt quotations will be supplied on glass parts fabricated to your custom specifications. Brochures covering the full range of Hanibal's precision glass housing are available on request.



hanibal
 GLASS, INCORPORATED

3025 South Kilson Drive
 Santa Ana, California
 Kimberly 9-0371

PRECISION
 DRAWN GLASS
 TUBING
 AND ROD





To
pinpoint
a NASA
payload



on
the
moon...

requires
Motorola
systems
reliability

CALTECH'S JPL RANGER,
to carry research instrument packages
to the moon, will rely upon precision
design, construction, testing and
performance of Motorola electronic
equipment. Comprehensive measurements
of operational and navigational data
aboard will be assembled for transmission
by its Flight Data Encoder. An all
solid state Transponder generates
the telemetry carrier, receives ground
commands, and translates carrier
frequencies for two-way Doppler velocity
measurements. ☆ In laboratories and
at launch site, Payload Test Sets will check
out the spacecraft RF communications
system. At NASA's transmitter and receiver
sites, Calibration Beacons will check
command transmitter performance and radiate
precise signals to test telemetry receivers.
☆ Motorola's participation in Ranger lunar
probes demonstrates its space communications
capabilities for frontier programs.

Military Electronics Division



MOTOROLA

*Qualified technical personnel
are invited to apply*

CHICAGO 51, Illinois, 1450 North Cicero Avenue
SCOTTSDALE, Arizona, 8201 East McDowell Road
RIVERSIDE, California, 8330 Indiana Avenue

CIRCLE 45 ON READER SERVICE CARD

Elcor's Current Indicator & Integrator
is praised highly in government, university
and industrial labs around the world.



The use of Elcor pioneered Isoplys (Isolated Power Supplies) helps make this instrument unique . . . and highly reliable. Circuitry is advanced. Sensitivity and accuracy are high. Drift is low. Features are many: Internal calibrating current source—Digital read-out—Pre-set control—Versatile external circuit controls.

Although originally designed for use with high-voltage particle accelerators such as the Van de Graaf generator, Elcor's Model A309A Current Indicator and Integrator is ideally suited for other applications: Monitoring and integrating electron or positive-ion beam current—Measuring radiation intensity and total radiation exposure—Integrating any quantity such as nuclear radiation, temperature, displacement, absorption, etc., that can be converted into a proportional current or voltage. Write for full information.



ELCOR Incorporated

*Subsidiary of Welex Electronics Corporation
Sales / R & D Laboratory / Manufacturing
1225 W. Broad Street / Falls Church, Virginia
JEfferson 2-8850*

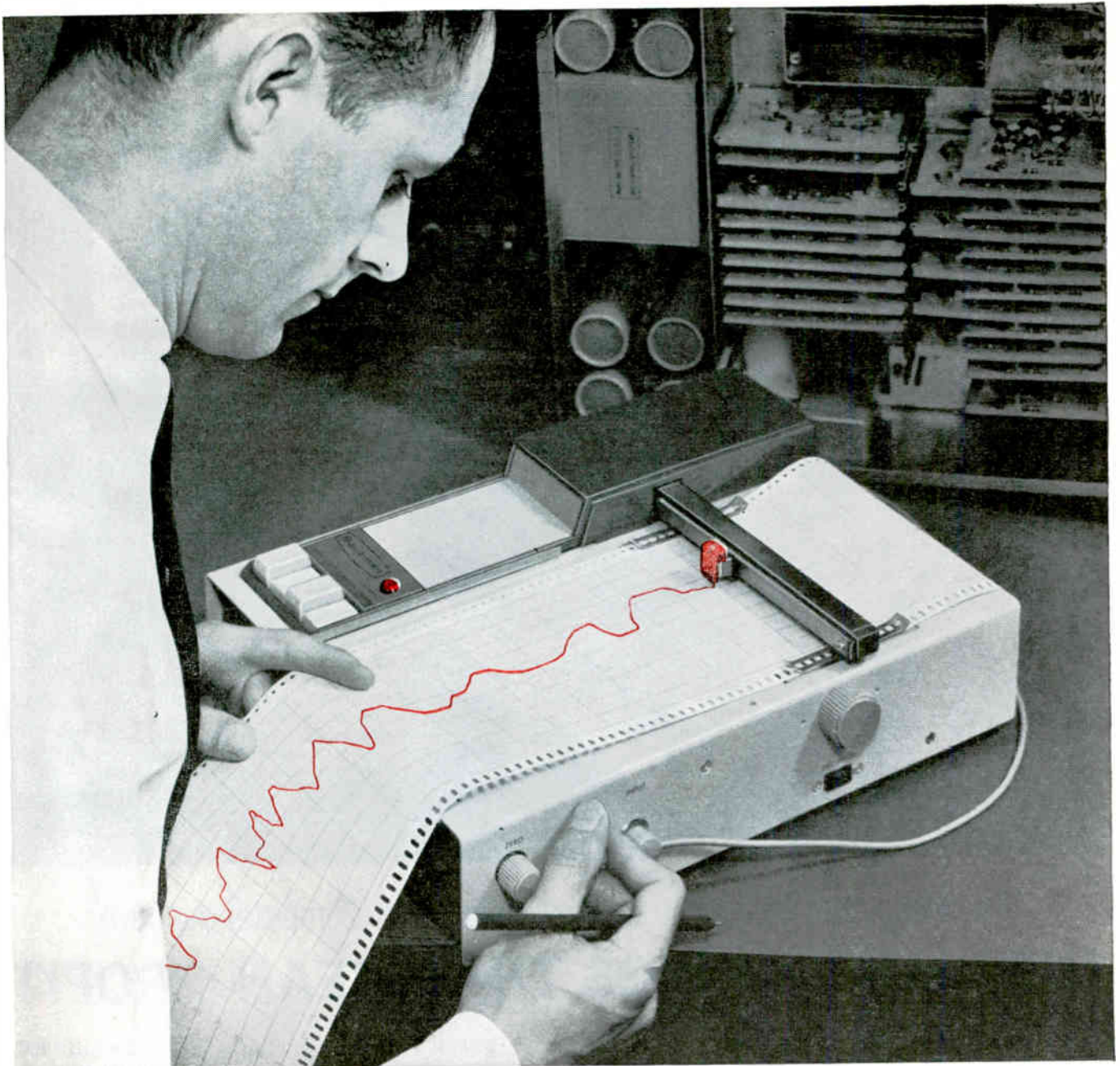

AWARD-WINNING* Beckman Potentiometric Recorder

Exclusive design features assure greatly improved performance and flexibility beyond any recorder in its price class. Pen movement, for example, is virtually free of backlash and maintenance because the drive is a toothed Nylon belt—instantly responsive, smooth and accurate. A wide variety of chart-drive speeds are obtainable with a simple flip-of-a-switch; or by just plugging-in small, auxiliary drive units. Centralized, pushbutton controls offer added convenience. Recorder is easily adaptable for use of special purpose strip or polar co-ordinate charts and is tailored for quick and easy addition of Limit Switch Controls without adding bulk.

PRICE \$500. For a comprehensive explanation, ask for Brochure A93500.

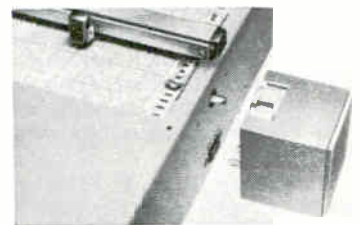

Recorder shown with compact auxiliary, outboard drive unit. Brief specs: Input 10-100 mv; limit of error 1% fs; response 1 second fs.

T40

Beckman[®]

INSTRUMENTS INC.
BERKELEY DIVISION
RICHMOND, CALIFORNIA

*Received Award of Excellence for design at 1960 WESCON.

June 9, 1961

CIRCLE 47 ON READER SERVICE CARD 47

From General Ceramics Division of
INDIANA GENERAL CORPORATION

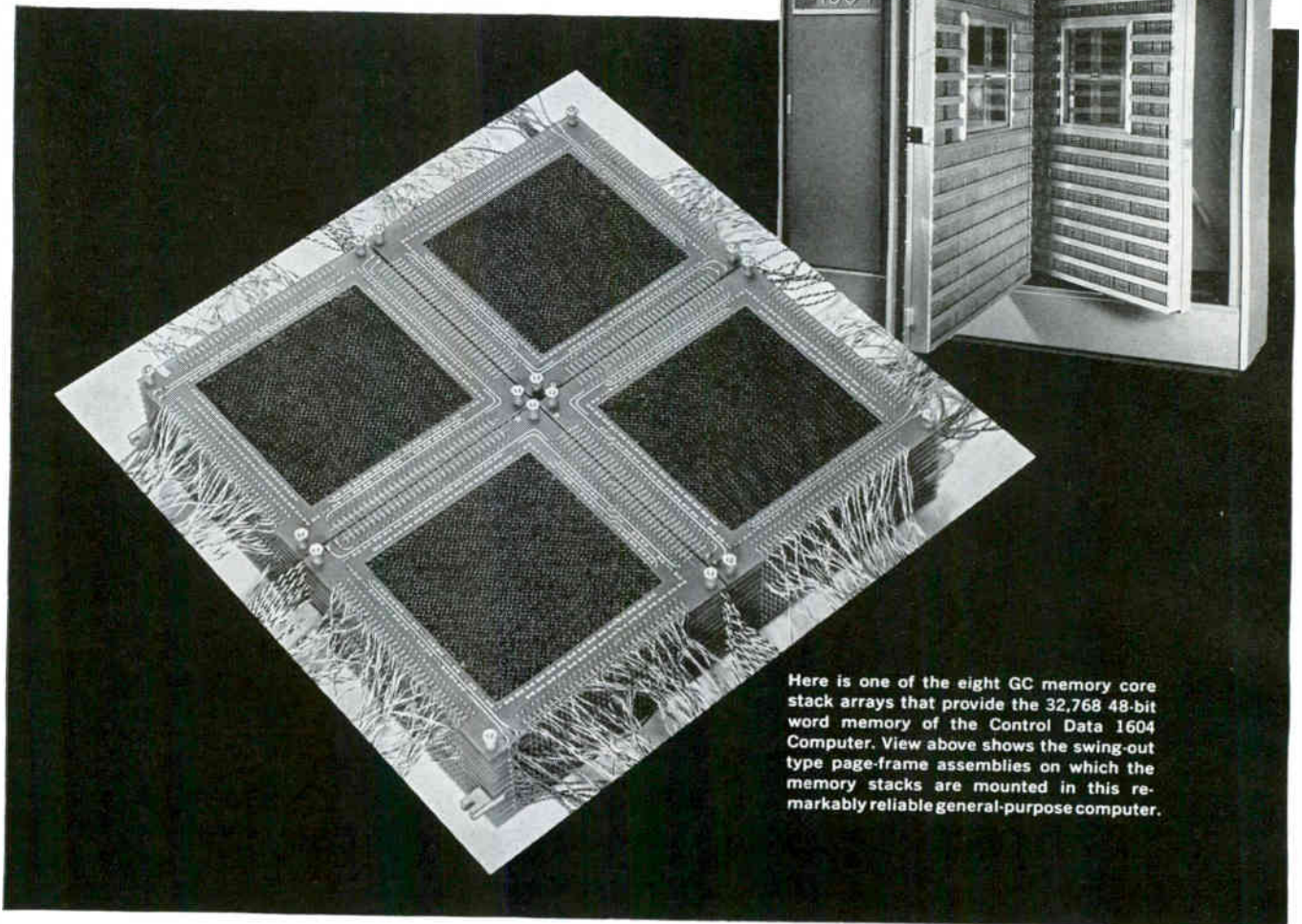

Here is one of the eight GC memory core stack arrays that provide the 32,768 48-bit word memory of the Control Data 1604 Computer. View above shows the swing-out type page-frame assemblies on which the memory stacks are mounted in this remarkably reliable general-purpose computer.

Reliability that Helps the Control Data 1604 Computer Achieve "UPTIME" RATINGS THAT MEAN PROFIT

General Ceramics, the originator of the square loop ferrite, offers a complete line of job-proven cores, planes, stacks and memory systems — proven in many computer and control system applications where the ultimate in reliability is demanded.

A good example is Control Data's advanced, large-scale, solid state 1604 Computer which has set new reliability standards for the industry, maintaining one of the highest over-all average "uptime" ratings ever achieved for machines in its class. This high performance requires fail-proof output from every component, including the over 1.6 million GC cores wired into the memory stacks of the 1604.

According to W. F. Harrison, Control Data's Manager of Engineering Services, "GC was chosen on the basis of a careful evaluation which included criteria ranging from the supplier's reputation and background through his proven ability to produce required quantities with consistent quality."

General Ceramics reliability is assured through 100% quality control at all levels — beginning with mechanical and electrical testing of each individual core and continuing with both visual and electrical inspections at all stages of assembly. This means, for example, the meticulous microscope-checking of over 175,000 soldered connections alone in the eight banks of stacks used in each Control Data 1604 Computer.

Advanced techniques such as ultrasonic cleaning, automatic 12-per-second core testing and other electronic functional checks performed on specifically designed equipment provide that extra edge of quality which customers, such as Control Data Corporation, have come to expect from General Ceramics.

Compare GC with your present source — write, wire or phone today.



APPLIED LOGICS DEPARTMENT

GENERAL CERAMICS

Phone VALley 6-5100 • Direct Distance Dialing Code 201

KEASBEY, NEW JERSEY, U.S.A.

TECHNICAL CERAMICS, FERRITES AND MEMORY PRODUCTS

48 CIRCLE 48 ON READER SERVICE CARD

electronics

For TV and Hi-Fi circuits . . . Four new tubes from **RAYTHEON**

Four new tubes recently added to the Raytheon line offer improved performance, savings in space and costs, and increased reliability in video and high-fidelity audio circuits.



6JF8 Horizontal Amplifier and Damper

Especially designed for portable TV, the 6JF8 combines the characteristics of 6DQ6B and 6AX4GTB. Save space and reduce manufacturing costs by using one tube for two functions.



6HB6 Wide-Band Amplifier

Unique grid design improves deflection linearity making the 6HB6 ideal for TV vertical and oscilloscope deflection circuits. High sensitivity and high output. $G_m=25,000 \mu\text{mhos}$.

Improve performance...save space...cut costs



5DN4 Full-Wave Power Rectifier

The greater reliability and higher power of the 5DN4 permit lower costs in circuits of TV "combination" consoles. 415 mA maximum output current. Dual filament leads reduce heating effect. Dual anode leads improve anode cooling. Functionally replaces 5U4GB, 5V3B, and 3DG4.



6JB8 High-Fidelity Triode Pentode

A high-gain pentode amplifier and triode phase inverter, designed specifically for audio use, featuring low-cost, highly reliable construction and controlled for low hum and microphonic levels.

For complete technical data on these new tubes, please write: Raytheon, Industrial Components Division, 55 Chapel Street, Newton 58, Massachusetts.

RAYTHEON COMPANY

INDUSTRIAL COMPONENTS DIVISION

RAYTHEON

ELECTRONICS AT GRUMMAN



...THE CAR POOL

There are no vital statistics but it is obvious from the Grumman experience that many A-1 engineering ideas have been born under the unexpected stimulation of a ride to work. Total involvement seems to be characteristic of the Grumman engineer.

The elastic approach to work and absence of rigid protocol is the norm at Grumman. The engineer moves in the direction his talents take him, whether this be theoretical analysis, translating concepts to finished hardware, equipment development, checking systems compatibility or seeing the system through' to laboratory testing.

Engineers who find flexibility necessary for their own 'modus operandi' are cordially urged to consider the following immediate positions.

Digital Computer Systems Engineer—BSEE with a minimum of 4 years experience in the analysis design and development of digital computers. Will participate in the integration of digital computer into a complex weapons system. A significant part of the effort will be devoted to extensive laboratory and flight development programs.

Electronics Support Equipment Engineer—Electronic Engineer experienced with digital computers, radar & communications who welcome an opportunity to utilize their present skills while they extend their technical background to new areas. Will analyze complex weapons systems to establish test logic & techniques involved in a comprehensive automatic test program utilizing ground support equipment. BSEE with a minimum of 3 years experience.

Data Processing Engineer—Background in digital data processing, logic circuit design, memory devices, R-F modulation techniques and related digital techniques required. Opportunity to participate in advanced design of systems concepts and hardware development. BSEE or BS in Physics with a minimum of 3 years' applicable experience.

Radar Development Engineer—BSEE with a minimum of 4 years experience in the analysis, design and development of airborne radar systems. Should be capable of analyzing the radar system with the end view of integrating the equipment into a complex weapons system. Will fully participate in laboratory and flight development programs conducted in the finest facilities available in a professional atmosphere.

To arrange an immediate interview, send your resume to Mr. W. Brown, Manager Engineering Employment, Dept. GR-76



GRUMMAN

AIRCRAFT ENGINEERING CORPORATION
Bethpage · Long Island · New York

All qualified applicants considered regardless of race, creed, color or national origin.

Shrinking test pattern demonstration proves CBS ultrahigh-resolution c.r.t. resolves 2,600 TV lines per inch

A standard E.I.A. test pattern diminished to 0.41" width without loss of detail proves that CBS UHR tubes achieve the highest resolution available—2,600 TV lines per inch. This unique capability resulting from the 0.77 mil spot size generates a great number of optical elements on the screen—up to 26 million on a 7" tube.

Other significant facts about these extraordinary tubes:

- **EXCELLENT LINEARITY**—Linearity of spot displacement on the tube face, with deflection current, is 2.5%: 1.0% available at extra cost.
- **UNIFORM RESOLUTION**—With optimum focusing, maximum loss of resolution is only 15% from center to edge.
- **ZERO ORTHOGONALITY**—With CBS adjustable deflection coils, orthogonality can be readily adjusted to zero.
- **NEGLIGIBLE DEFOCUSING**—Only 2.5% at edge of screen; can be reduced to near zero by dynamic focusing.

Available in 27 off-the-shelf models, CBS UHR tubes provide opportunities to advance the state of the art in several important fields. In strip radar, for example, ten times the capabilities of present systems can be achieved. For information retrieval, these UHR tubes can read out an 8½x11" document photographically reduced 200 times to 0.043x0.055". Other exciting possibilities are in photoreconnaissance, TV microscopy, navigational aids, advanced radars, computer readout, data storage and transmission.

Associated video amplifiers and sweep systems can be supplied on a custom basis to make possible maximum resolution. CBS Electronics also offers you expert application assistance in ultrahigh resolution techniques for your special requirements. Write or call today.

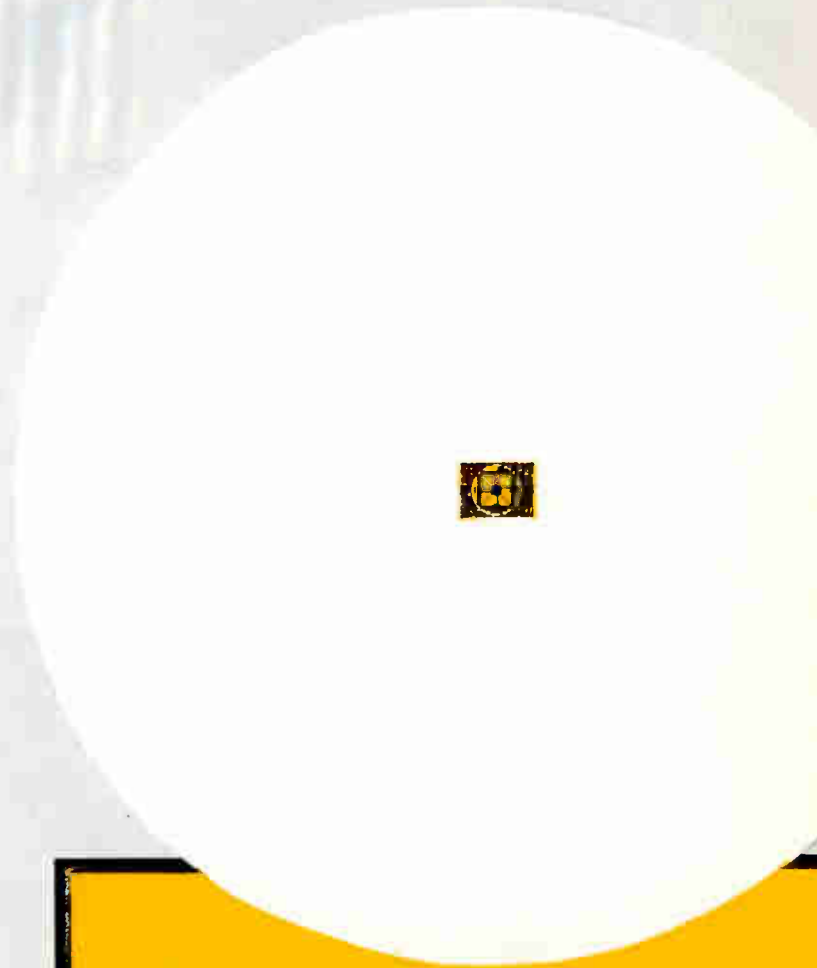

HOW SHRINKING TEST PATTERN DEMONSTRATION IS MADE

A standard E.I.A. test pattern with an aspect ratio of 4:3 is reduced to the point where the 800-line wedge is barely perceptible in the horizontal. If this occurs in a 0.41" wide raster, as illustrated above, then the resolution is 800 divided by 0.41", or 1,950 TV lines per inch. Correction for the 4:3 aspect ratio gives 2,600 TV lines per inch.

Since this printed page allows for maximum resolution of only 110 optical lines per inch, the diminished test pattern is represented here as a line engraving with a minimum line thickness of 0.005". In an actual demonstration, all details of the test pattern are visible (through a microscope, of course).



CBS ELECTRONICS

Danvers, Massachusetts

A Division of Columbia Broadcasting System, Inc.

TUBES • SEMICONDUCTORS • MICROELECTRONICS • AUDIO COMPONENTS

Sales Offices: Danvers, Mass., 100 Endicott St., SP 4-2360 • Newark, N. J., 231 Johnson Ave., TA 4-2450
Melrose Park, Ill., 1990 N. Mannheim Rd., FS 9-2100 • Los Angeles, Calif., 2120 S. Garfield Ave., RA 3-9081.

*Never
before!*

A Complete Line of Coaxial Circulators Combining these Outstanding Features:



**Complete coverage,
200 MC to 8 KMC**

Ultra-low insertion loss

Small, compact, lightweight

Broad band coverage

Performance-proved Low cost, high value



Check the table below for the field-proved specifications of a few typical Melabs Circulator models, available now for off-the-shelf delivery. Nowhere else can you find such a complete line of circulators to meet so many of your requirements with such high performance standards.

Here are Specifications that Speak for Themselves!

Band Model Series	HF—		HU—	HL—		HS—		HC—
Frequency	200-600 mc		600-1000 mc	1.0-1.7 kmc		1.7-4.0 kmc		4.0-8.0 kmc
Typical Model	HF-400	HF-420	HU-935	HL-130	HL-145	HS-225	HS-280	HC-565
Frequency	380-420	405-445	890-960	1.25-1.35	1.4-1.5	2.2-2.3	2.7-2.9	5.4-5.9
Insertion Loss:								
Max. (at band ends)	0.6	0.5	0.4	0.3	0.3	.3	.3	.4
Typical/center	0.4	0.35	0.2	.2	.2	.2	.2	.2
Isolation:								
Min. (at band ends)	17 db	17 db	18 db	18 db	18 db	20 db	20 db	20 db
Typical/center	25 db	25 db	25 db	25 db	25 db	25 db	25 db	25 db
VSWR (outputs terminated)								
Max. (at band ends)	1.3	1.3	1.3	1.3	1.3	1.3	1.3	1.3
Typical/center	1.1	1.1	1.1	1.1	1.1	1.1	1.1	1.1
*Diameters (max. excluding connectors)	5¼"	5¼"	3 11/16"	3"	3"	3"	3"	2"
*Height	1⅞"	1⅞"	1⅞"	1¾"	1¾"	1⅞"	1⅞"	1⅞"
*Weight (approx.)	4 lbs.	4 lbs.	1½ lbs.	1¼ lbs.	1¼ lbs.	8 oz.	8 oz.	6 oz.
**Connectors (female)	Type N	Type N	Type N	Type N	Type N	Type N	Type N	Type N
Power:								
Average	100 w	100 w	5 w	5 w	5 w	5 w	5 w	5 w
***Peak	5 kw	5 kw	5 kw	5 kw	5 kw	5 kw	5 kw	5 kw
Price:	\$400.00		\$350.00	\$310.00		\$240.00		\$225.00

*All units can, on request, be further miniaturized to meet your specifications. Size and weight reductions of 2 to 1 have been obtained for the S and C band units.

**These circulators can, on request, be provided with High Power or TNC Connectors.

***Rated with Type N Connectors.



**(pronounced MEL-LABS), Dept. E-6,
3300 Hillview Avenue, Palo Alto, California
DAvenport 6-9500**

In addition to standard, temperature-stable units listed above, Melabs offers many circulator models to meet special requirements. Electronically tunable models HF, HU, HL Series are available with 300-500 MC tunable bandwidths. High-speed switchable models can be made to order for signal transfer or radiometer applications. Also available on special order are higher power models and individual units covering broader frequency bands. Simple modification converts these circulators to isolators with the same superior specifications.

Data subject to change without notice. Prices f.o.b. factory.



It's no
secret . . .
**EMCOR
ENCLOSURES
HAVE
A NEW
ADDRESS**

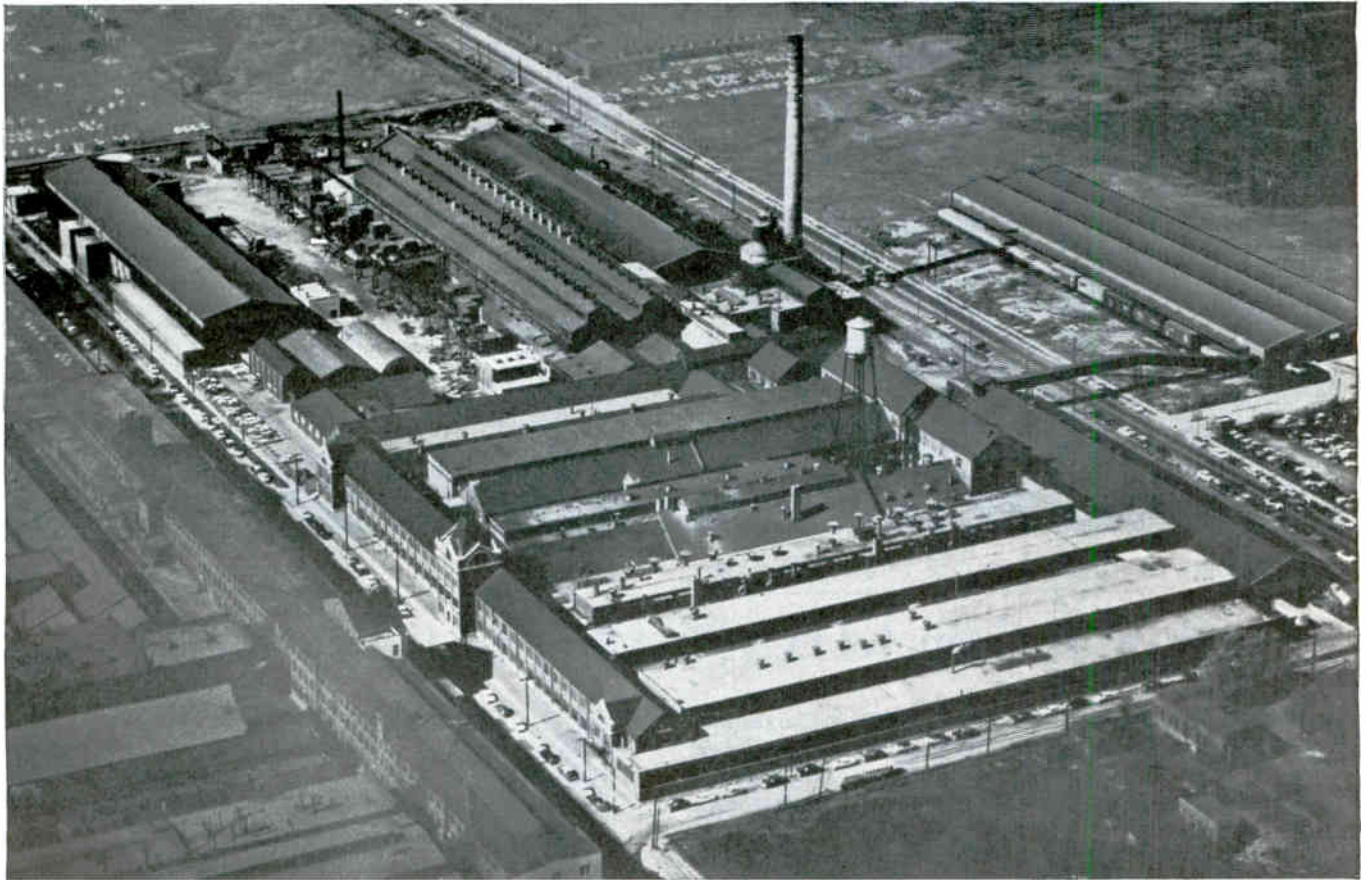

Because of increased production demands for EMCOR Enclosures, we have outgrown our two plant facilities in Elgin, Illinois. To meet these increased demands, we are in the process of moving our complete operation to the Ingersoll Products main plant at 1000 West 120th Street, Chicago. Over 75 percent of the EMCOR operation has already been transferred to the new address. The transition has been so smooth and so well planned that EMCOR engineering, sales and production have gone on uninterrupted. We are moving from our present facilities of 50,000 square feet to our new address which boasts nearly one million square feet of manufacturing space. Our new location offers fully automated manufacturing equipment and additional skilled craftsmen that meet production demands for EMCOR Enclosures. In making this gigantic move to our new address, we assure our customers of sustained and recognized EMCOR leadership in serving the needs of industrial, mechanical, electronics, instrumentation and electro-mechanical engineers.

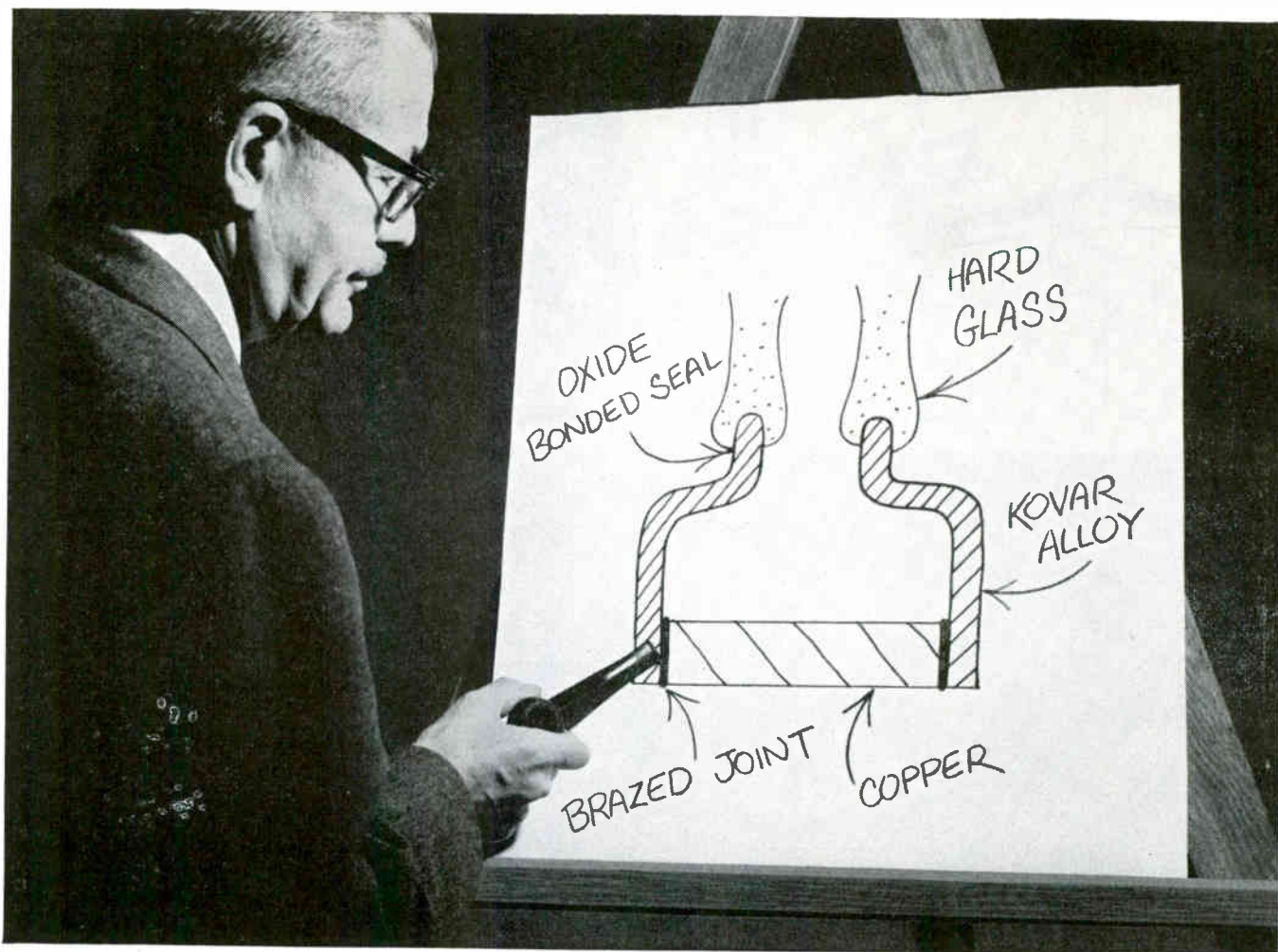

Photo above shows the new press brake line for EMCOR Enclosures, just a portion of the new production facilities at our new address.

**All factory sales and engineering
offices located at 1000 W. 120th St.,
Chicago 43, Ill. Phone CO 4-7800**



EMCOR - The Original Modular Enclosure System By
INGERSOLL PRODUCTS
Division of Borg-Warner Corporation
1000 W. 120th ST. • DEPT. 1242 • CHICAGO 43, ILL.



Engineering hints from Carborundum

How to Join KOVAR® Alloy to Other Metals

KOVAR, the original iron-nickel-cobalt alloy, has a thermal expansion curve which matches almost perfectly that of several hard glasses. It is a widely accepted answer to the problem of producing vacuum and pressure tight glass-to-metal seals.

Most applications involve joining Kovar Alloy by either welding, brazing or soldering to other metals. Ordinary joining methods require variations and refinements to meet special characteristics or conditions—with such considerations as these:

1. KOVAR ALLOY has a considerably lower expansivity than most other metals.
2. WELDED AND BRAZED JOINTS WITH KOVAR ALLOY are frequently made in close proximity to a glass seal.
3. FOR HIGH VACUUM APPLICATIONS it is essential that no brazing alloy is used which contains a high vapor pressure constituent, such as cadmium, zinc or lead.

For example, to avoid stress corrosion on silver brazed Kovar joints we advise the following precautions:

1. BRAZING SURFACE to be free of longitudinal scratches.
2. ANNEAL KOVAR PARTS before brazing.
3. PLATE THE BRAZING SURFACE with copper or nickel.
4. DESIGN THE JOINT to avoid tensional stressing of the Kovar Alloy during the brazing operation. If the higher expansion member is on the inside, allow sufficient clearance between the parts.

5. USE A EUTECTIC BRAZING ALLOY, such as 72% silver, 28% copper.
6. THE BRAZING TEMPERATURE should be applied uniformly, such as in an atmosphere controlled furnace or high frequency induction heating.

New Technical Bulletin 100EB2A, available on request, gives additional information on welding, brazing, and soldering of Kovar Alloy to other metals. Individual engineering reports are also furnished on specific customer problems on Kovar Alloy joints.

Kovar Alloy, either oxide bonded to hard glass, or brazed to metallized ceramic insulators, makes a rugged permanent seal . . . even under the most severe conditions of temperature, vibration and handling. Technical service is available to help you solve processing and application problems. Contact the Carborundum Company, Refractories Division, Dept. E-61, Latrobe Plant, Latrobe, Pa.

THERE IS NO TRUE SUBSTITUTE FOR KOVAR® ALLOY . . . supplied only by CARBORUNDUM

KOVAR's superiority in making all types of glass-to-metal and ceramic-to-metal seals — and its ability to be easily formed, welded, soldered and brazed — is the result of a stringently controlled manufacturing process based on over 25 years continuous production experience. KOVAR is an alloy of unique and rigidly maintained characteristics. Stock and custom forms, together with complete technological advisory service, are available only through Carborundum.

CARBORUNDUM®

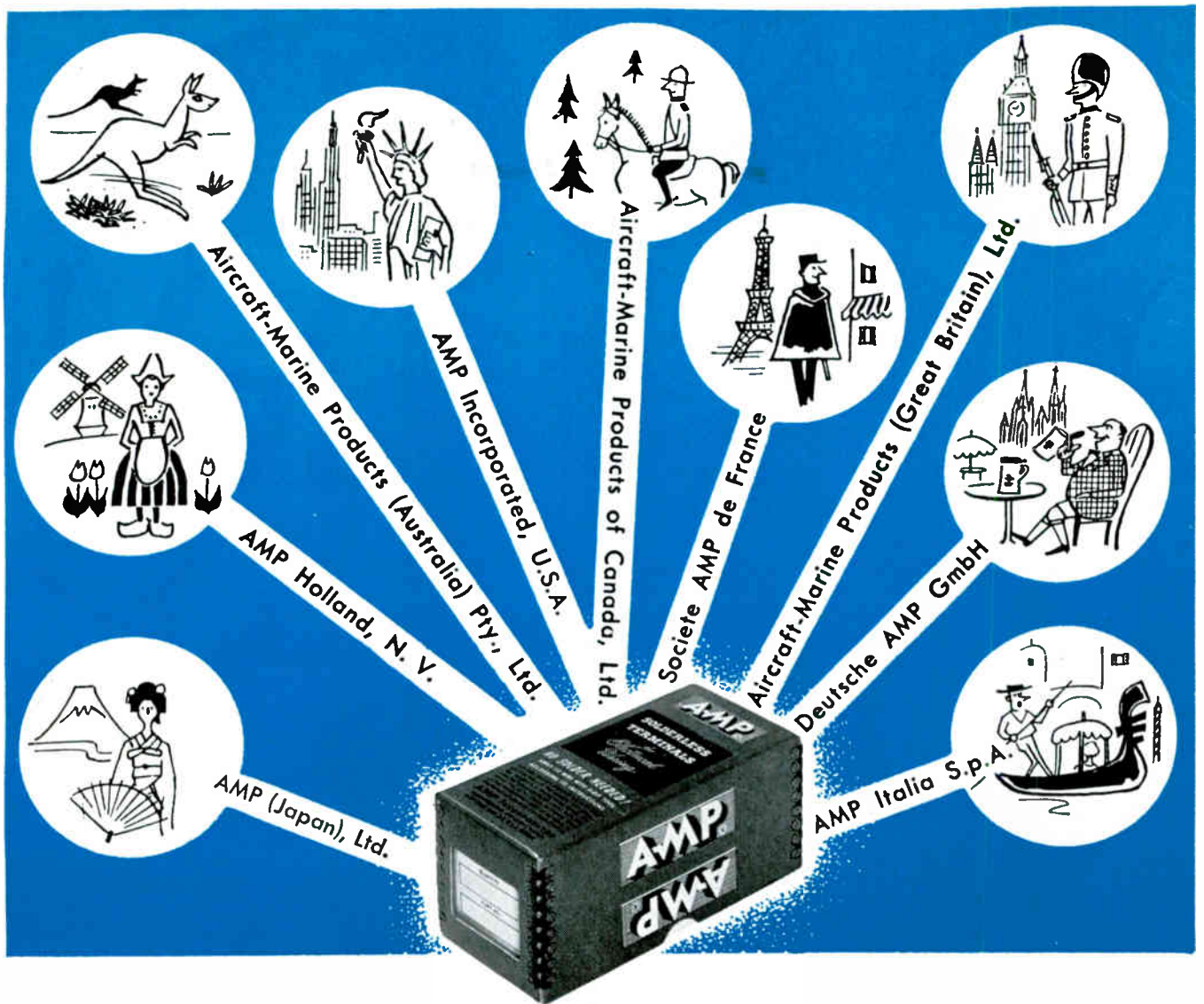

We speak the language . . .

anywhere in Europe . . . everywhere in the world!

In the common language of expressed needs for solderless terminals of unquestioned reliability, AMP INCORPORATED enjoys perfect communications with the electronics industry everywhere.

From its world-wide network of centrally located facilities, AMP makes available products and services to help manufacture and maintain electronic equipment of every size, type and description.

Wherever you are and no matter where your equipment may be, you can depend on AMP's more than 15,000 different solderless terminals and extensive experience in solderless termination techniques to help you with production, installation and maintenance problems.

Write for the AMP story . . . in your language—Italian, French, Spanish, German or English—today!

AMP INCORPORATED

GENERAL OFFICES: HARRISBURG, PENNSYLVANIA

AMP products and engineering assistance are available through subsidiary companies in: Australia • Canada • England • France • Holland • Italy • Japan • Mexico • West Germany

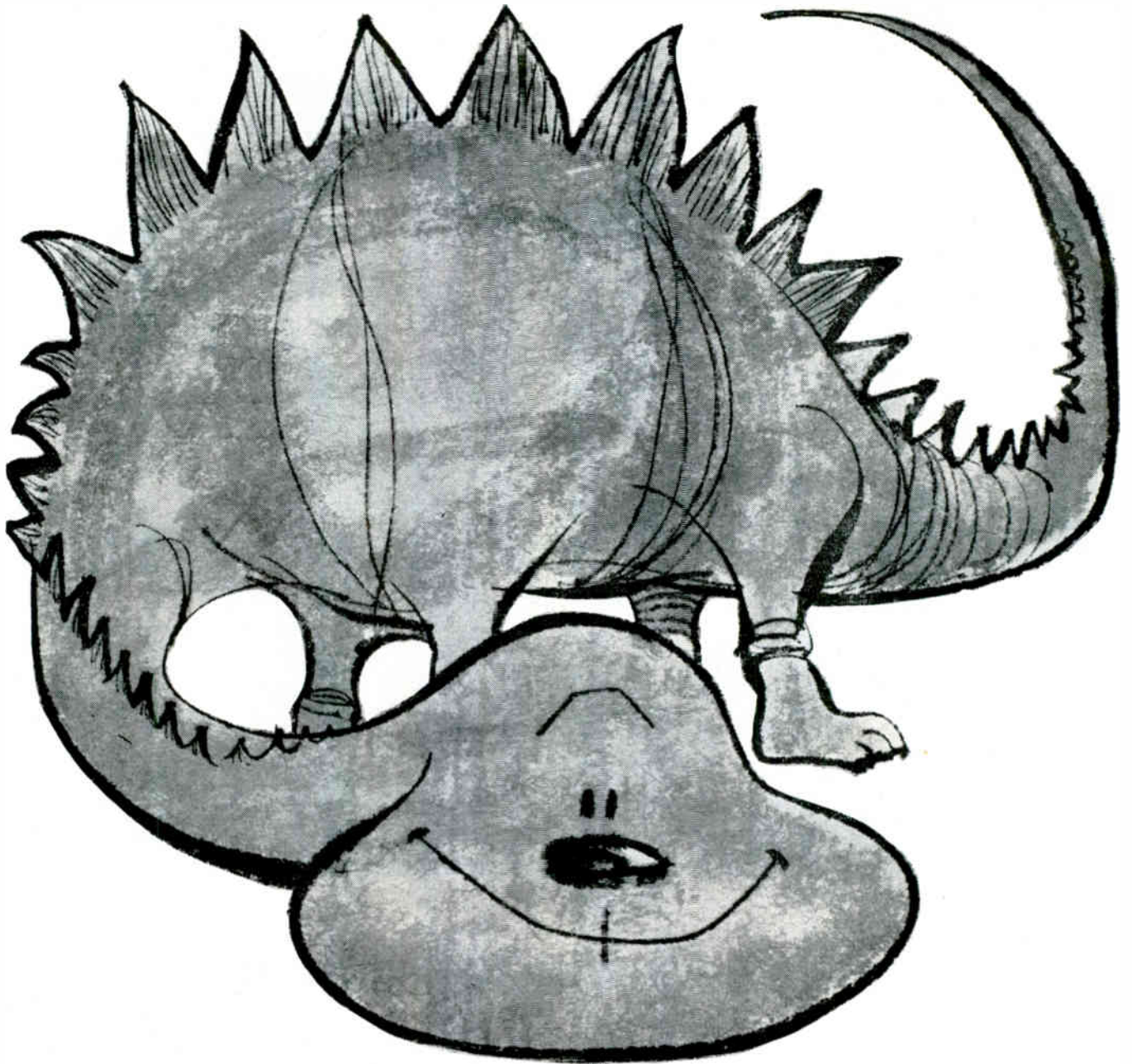

That it is, friend Dyna-Soar, for your orbital research flights, or for any number of other space applications. This "cordwood" system is an example of EECO's welded matrix packaging technique for digital systems. It's called MiniWeld... a total system concept which utilizes *standard components* but packs them like cordwood into the greatest possible density. MiniWeld systems meet or exceed MIL-E-5400C, Class I or II specifications... withstand extreme temperatures... endure shock of 50g and vibration of 30g (50 cps to 3000 cps). MiniWeld is established hardware with 152 compatible

FOR ME?

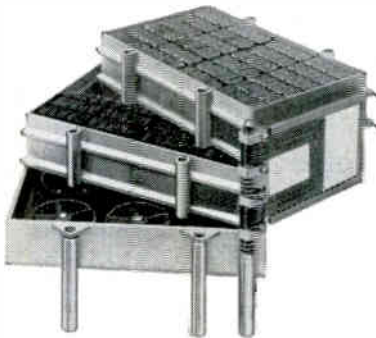

Cordwood technique used in MiniWeld construction selected by Miniaturization Award Committee as a packaging breakthrough in high-density electronic systems.

digital circuits catalogued... up to 200 circuits may be cordwood-stacked in a single frame. Mini-Circuits are interconnected with welded ribbon matrix... wire-wrap techniques tie the Mini-Circuit and cable modules together into a system that could go to the moon — and work.

Digital equipment has been an EECO specialty since 1947. So have time code generators, tape search and control systems and timing system complexes with full auxiliary equipment. Is your project mired in the tarpits because of a spaceborne timing and equipment problem? Let EECO help you out. Write for MW-1 data.



Electronic Engineering Company of California 1601 East Chestnut Avenue, Santa Ana, California

Kimberly 7-5501 • TWX: S ANA 5263

EE 1-30

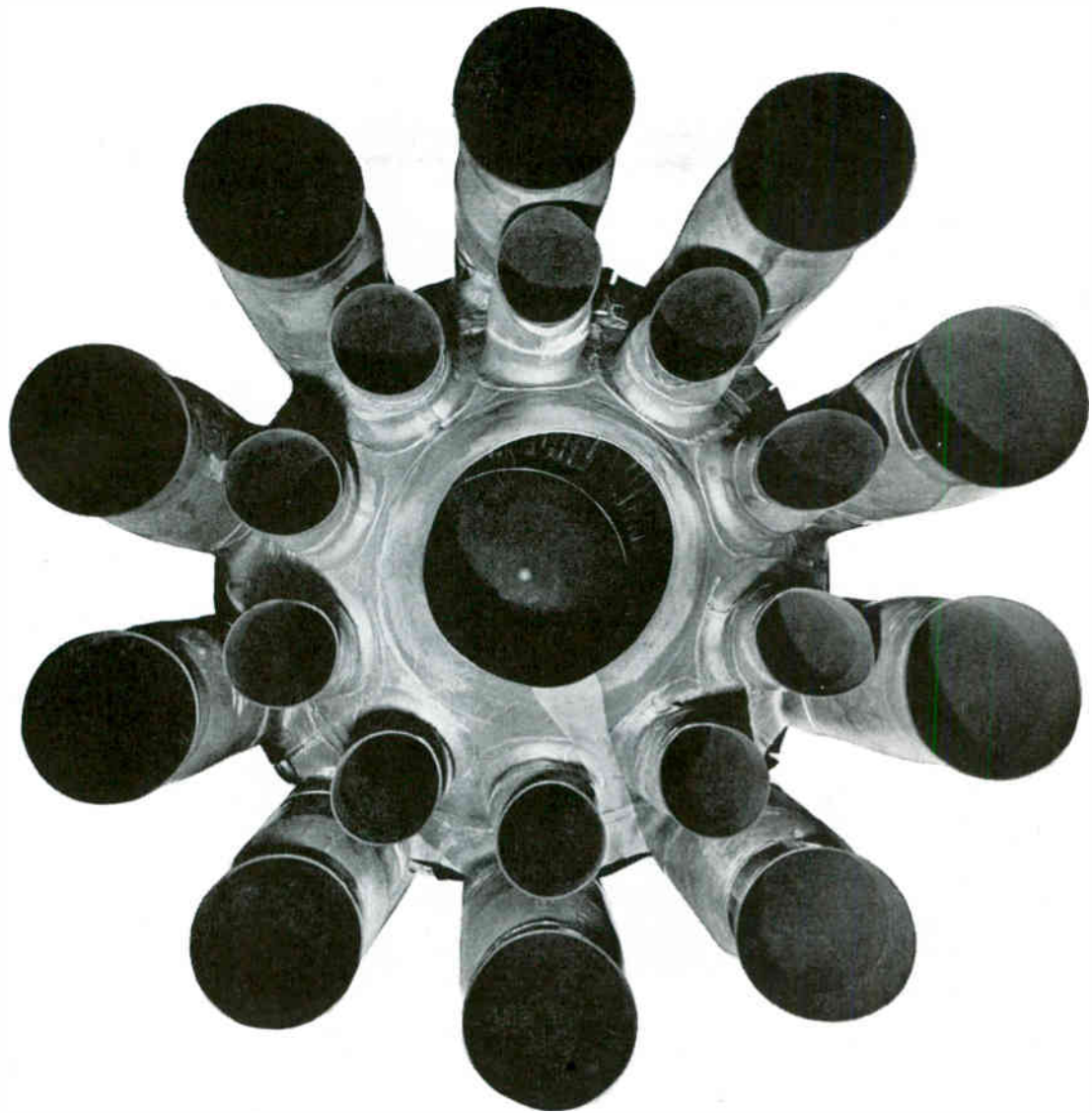

what!—counters on jets? Lots of them. **Kollsman** puts them there. KOLLSMAN INSTRUMENT CORP. And Veeder-Root supplies Kollsman, providing jet pilots with direct read-out—immediate indication of the vital data necessary for controlling aircraft travelling at jet speeds. Can Veeder-Root help your performance? Better find out. Write to Instrument Section, Veeder-Root Incorporated, Hartford 2, Connecticut. **count on...Veeder-Root**



Modern thrustmeter—one of many special Instruments which uses Veeder-Root counting ingenuity—shows pilots the power conditions necessary for safe take-off.

ULTRA-SHORT PULSE MEASUREMENT

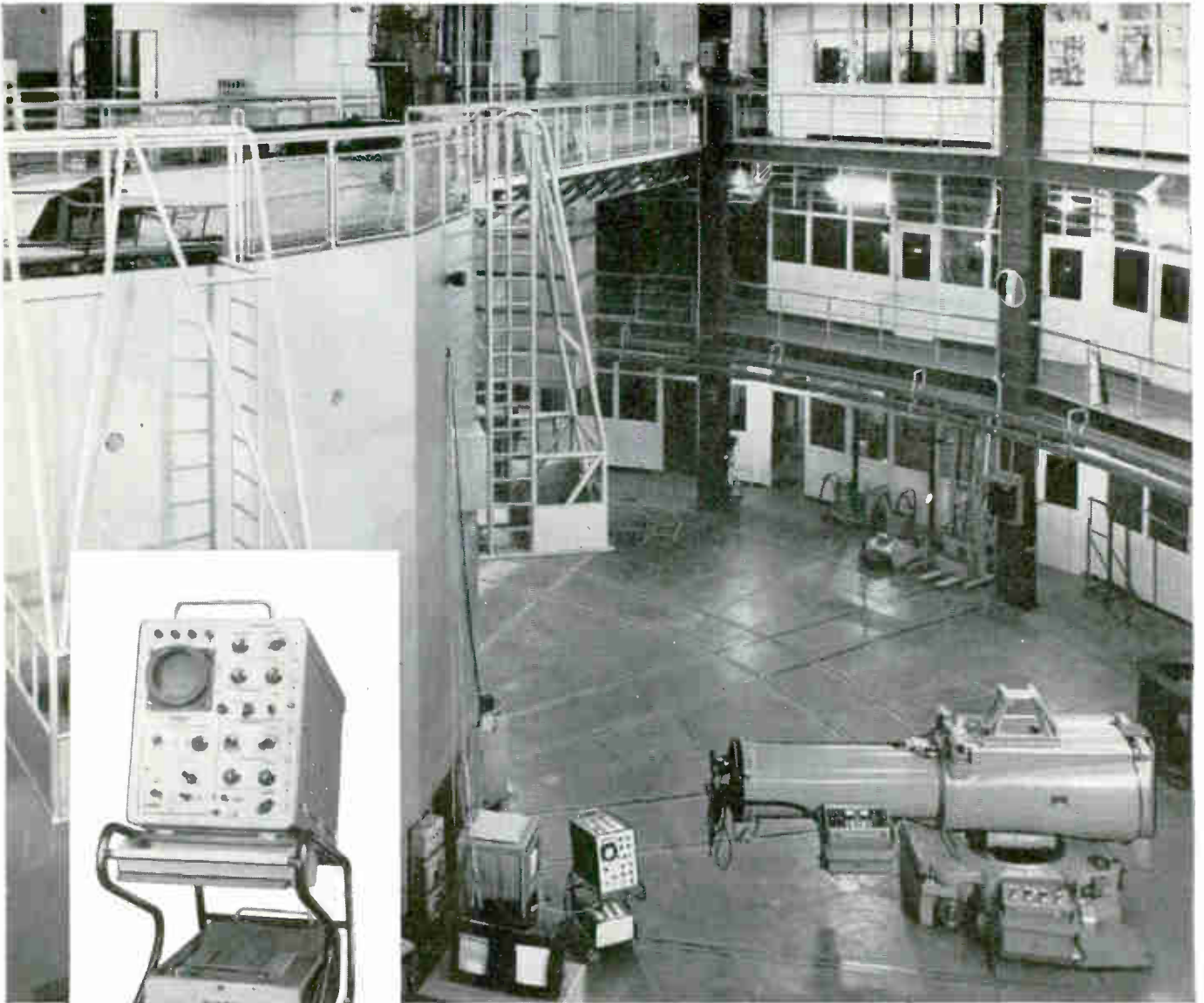

The EL 3 pile at the SACLAY CENTRE for NUCLEAR RESEARCHES.



Inter plans
4 3 1 0

OSCILLOSCOPE 204 A

From DC up to 50 MHz

In EL 3 works, the Ribet-Desjardins 204 A synchroscope, able to observe phenomena lasting for $1/100.000.000$ th of a second, ensures control of the electronic equipment on which all experiments in nuclear physics rely.

Vertical amplifier :
Bandwidth: from DC to 50 MHz (3 dB $\pm 0,5$)
Sensitivity : 25 mV/cm.
Rise time : 0,007 μ s.
Input impedance : 1 m Ω and 35 pF.
PC probe and Cathode follower probe.
Sweep system :
free running, triggered and single sweep operation.

Delay time multiplier : from 2 s/cm to 0,5 μ s/cm. Accuracy: 2 %.
Main sweep rates : from 5 ms/cm to 5 m μ s/cm. 100 MHz marker.
Selection of triggering level.
Cathode ray tube :
Accelerating potential : 10 and 20 KV.
Diameter : 125 mm.

RIBET-DESJARDINS

DÉPARTEMENT MESURE-CONTRÔLE
13-17, Rue Périier - MONTROUGE (Seine)

TÉL : ALEsia 24-40 +

Teleg : Pilacelect - Montrouge - Seine (France)

North America (Canada) : ELECTROLINE TELEVISION EQUIPMENT INC. Room 114, 5757 Decelles Avenue - MONTREAL
Other areas : addresses sent on request.

“ Trouble is,
we've been hiding
our Tape Recorders
under
somebody
else's
nose
cone! ”

**FACT
FILE**

BORG-WARNER CONTROLS MINIATURE TAPE RECORDERS

...for missile and space applications
FIVE YEARS OF SUCCESSFUL RECORDER DEVELOPMENTS

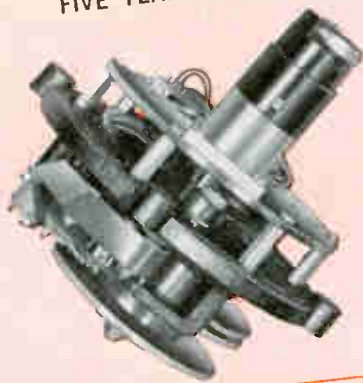

Reliable performance at 1000 or more G's of sustained acceleration... up to seven tracks of information, plus a timing track, on 1/2-in. wide magnetic tape... low maintenance and re-use costs are some of the features which have placed these rugged recorders in most major nose cone recovery and re-entry programs.

*AVCO equips recoverable data cassettes
with BORG-WARNER CONTROLS' Recorders to
preserve vital ICBM test data.*

Borg-Warner Controls' miniature tape recorders are among those supplied for use on Titan and Atlas ICBM re-entry vehicles, developed by Avco Corporation's Research and Advanced Development Division. The tape recorder preserves vital test data during the radio transmission "black-out" period at the critical point of re-entry.



For Engineering Aid... or Data Sheets—Contact:

BORG-WARNER CONTROLS
DIVISION OF BORG-WARNER CORPORATION



P. O. Box 1679
Santa Ana, California
Phone Kimberly 5-5581
Teletype S Ana 5291

ICBM TEST DATA

CLASSIFIED

Acme Electric

CONSTANT VOLTAGE STABILIZERS

PROTECT THEMSELVES AGAINST OVERLOAD!

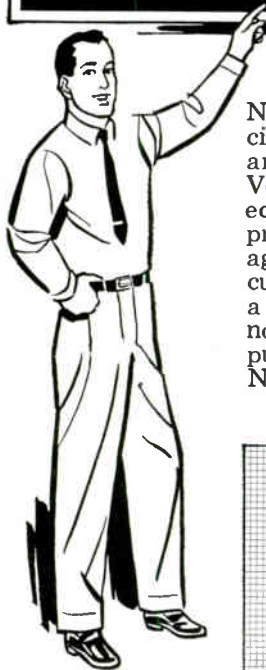

No need to "fuse" the output circuit against overload when an Acme Electric Constant Voltage Stabilizer is part of the equipment. These stabilizers provide automatic protection against overload or short circuit. When load current reaches a critical point in excess of normal operating load, the output voltage is reduced to zero. No voltage — no current.

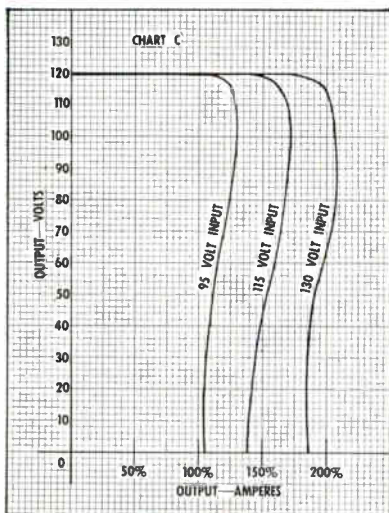

Chart shows performance curves under various voltage inputs and current overload conditions. This current limiting is accomplished automatically.



If you have ever observed the "quickness" of two cycles, 1/30 second, then you'll appreciate the speed with which these stabilizers respond to a fluctuation in line voltage.

Available in sizes from 15 to 2000 VA. Input voltage ranges 95/130, 190/260. Output voltages stabilized at 6.3, 120, 240 volts. Write for catalog 09-B01.

ACME ELECTRIC CORPORATION

316 Water St. Cuba, N.Y.
 In Canada: Acme Electric Corp. Ltd., 50 Northline Rd., Toronto, Ont.

SAA3515/1967

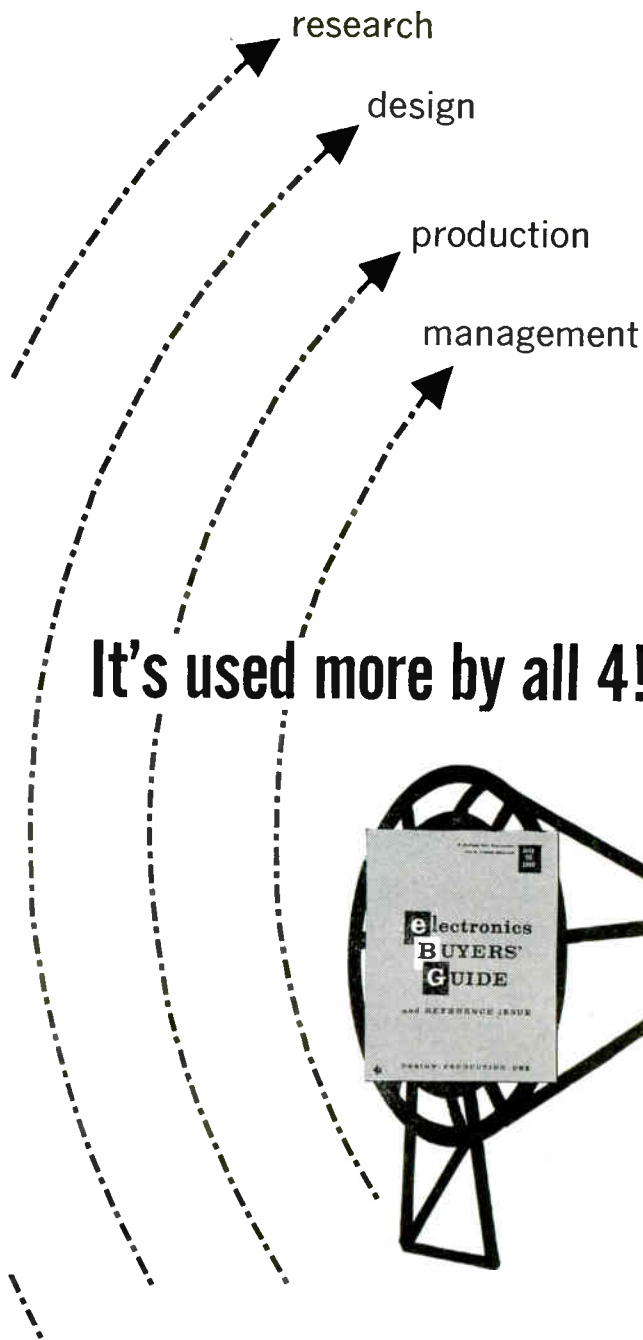

Because a BUYERS' GUIDE must contain *more* than product listings. The 26-man editorial staff of **electronics** has boiled down over-all marketing, materials, specifying, and design data pertinent to the entire industry into a valuable 64-page Reference Section available in no other electronic buying guide or directory. It gives a broad picture of who buys what, and where, in the electronics industry . . . an exclusive in electronic directories.



RECENT RAYTHEON DEVELOPMENTS
IN MICROWAVE FERRITE DEVICES

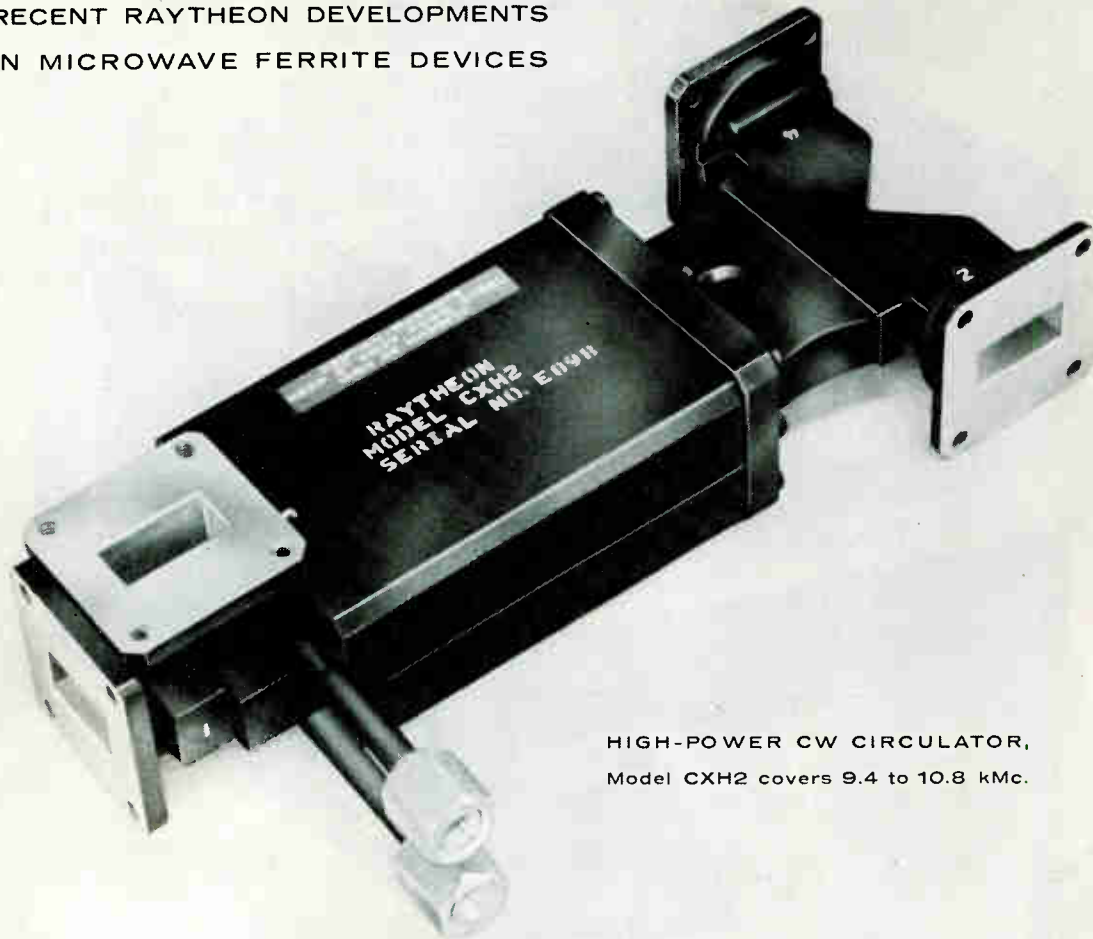

HIGH-POWER CW CIRCULATOR,
Model CXH2 covers 9.4 to 10.8 kMc.

Versatile X-band circulators handle cw power in excess of 10kW

New high-power ferrite device provides over 20 db isolation; can be used as isolator with suitable auxiliary loads.

An advanced line of Raytheon high-power circulators keeps abreast of new X-band tube developments.

Typical of these compact units is the CXH2 covering 9.4 to 10.8 kMc with a continuous power rating of 10kW. Isolation is 20 db minimum, insertion loss is 0.2 db maximum and VSWR is 1.15 maximum.

Used as an isolator—in conjunction with suitable auxiliary loads—the CXH2 will handle continuous power levels to 10 kilowatts with a back-to-front ratio greater than 100:1. Similar units are available for use at high peak power levels.

For complete details on this and other significant developments in high-power microwave ferrite devices, please write to Special Microwave Devices Operation, Raytheon Company, Waltham Industrial Park, Waltham 51, Massachusetts.

TYPICAL SPECIFICATIONS • MODEL CXH2

Frequency	9.4—10.8 kMc
Power	10kW (cw)
Isolation	20 db min.
Insertion loss	0.2 db max.
VSWR	1.15 max.
Length	9 3/16 in.
Flanges	UG 39/U
Waveguide	RG 52/U
Weight	Less than 4 lbs.
Water cooled	0.75 gpm.

RAYTHEON

RAYTHEON COMPANY

SPECIAL MICROWAVE DEVICES OPERATION

The new 906C timing system is here

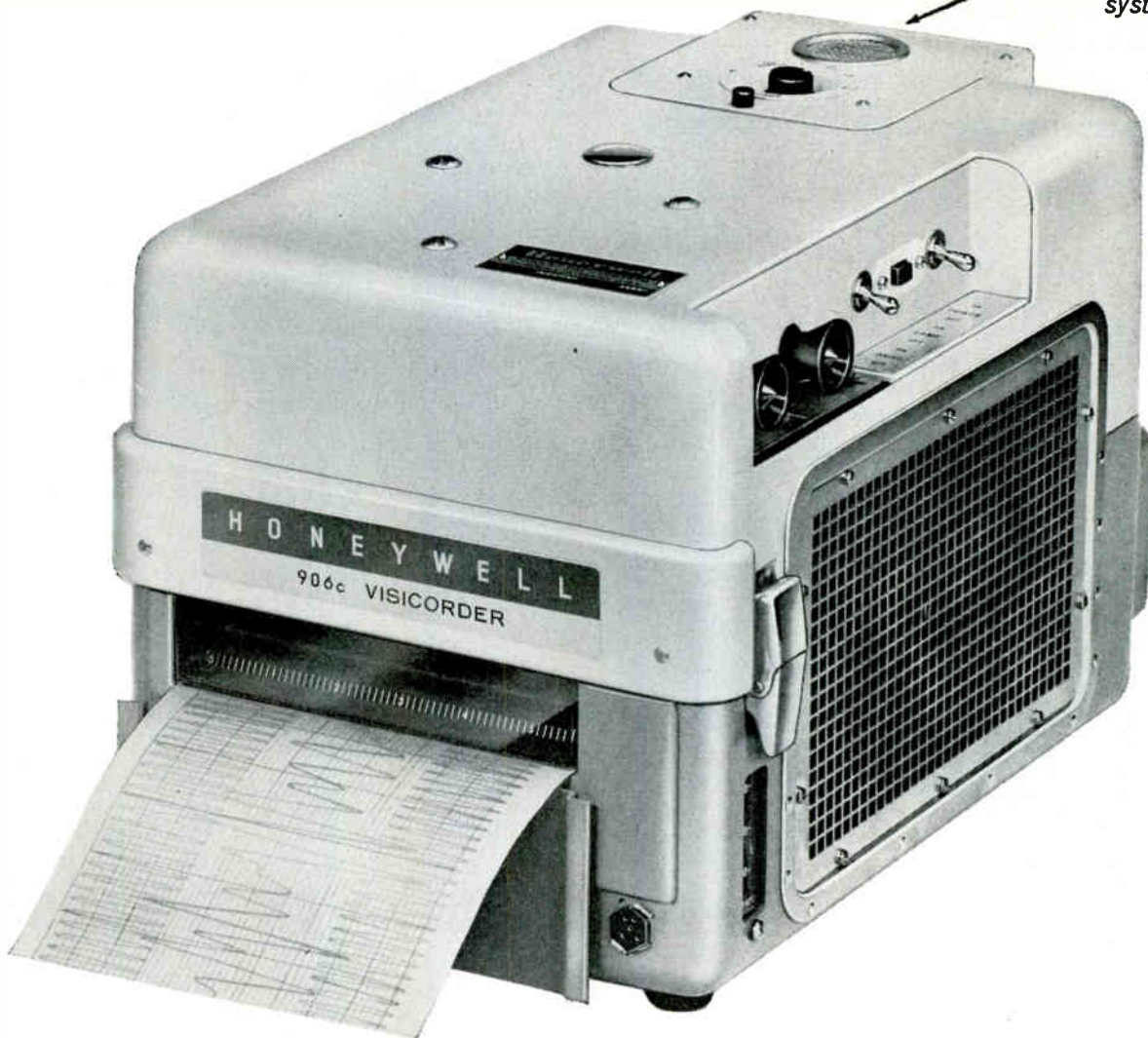

What's *different* about the NEW 906C VISICORDER OSCILLOGRAPH?

At first glance you may see no difference at all. Just the same functional lines and compact size that you have come to recognize in the Visicorder.

They have not changed since 1956, when the Visicorder principle of oscillography made immediate readout of high frequency data possible for the first time.

Until now, all the improvements that have maintained the Visicorder's record of leadership have been internal:

- increased capacity to 14 channels
- higher frequency response (0-5000 cps)
- simultaneously recorded grid lines
- self-starting lamp for remote operation

But the 906C has a new feature you *can* see, (look carefully at the back of the case) and one that represents still another breakthrough; a built-in flash tube timing system which not only generates its own time base, but which can also be triggered *externally*. You can, in other words, use the 906C's

timing system to record time lines simultaneously with data. Or you can trigger the timing circuit externally—either by supplying a pulsing voltage of only +10v into 20K ohms impedance, or simply by causing impedance to drop to 100 ohms or less through shorting-out or other means.

Thus your "time" signal may actually be an event marker related to shaft rotation, belt movement, or any other effect which might be more conveniently fed to the timing circuit than to a galvanometer.

(Owners of Visicorders 906, 906A, and 906B will be glad to know that only a *field-change* is necessary to economically and easily add this timing system to their instruments).

Write today for full information on the brand-new 906C Visicorder. Ask for Catalog HC-906C. Or call us at SKYline 6-3681, Direct Distance Dialing Code 303.

Minneapolis-Honeywell, Heiland Division
5200 East Evans Avenue, Denver 22, Colorado

HONEYWELL INTERNATIONAL

Sales and Service offices in all principal cities of the world. Manufacturing in United States, United Kingdom, Canada, Netherlands, Germany, France, Japan.

Honeywell



First in Control
SINCE 1885

How Does Your Present Source for Electronic Components Compare with Avnet?

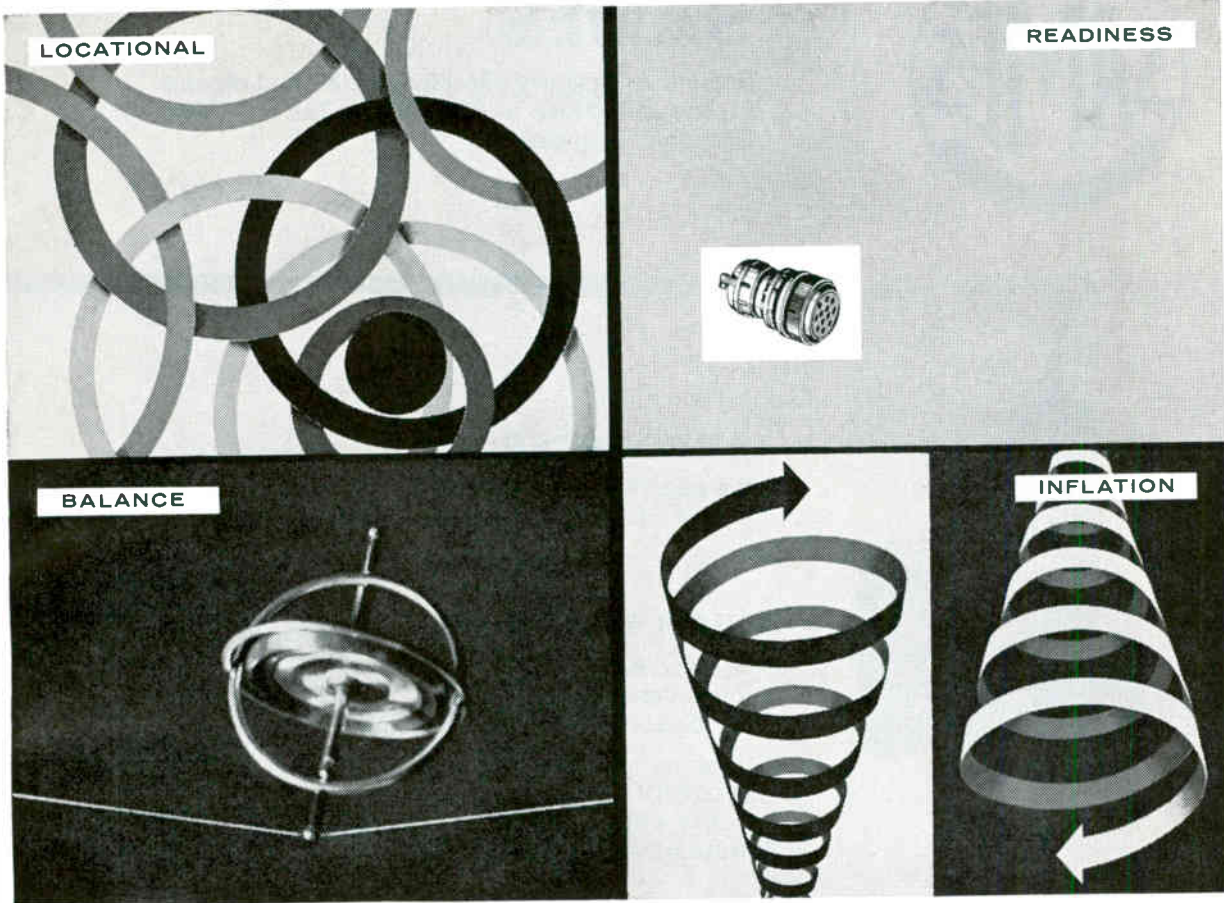

The Avnet System embodies many Exclusive Marketing Techniques

a new concept—LOCATIONAL.

(LOCAL plus NATIONAL becomes LOCATIONAL) The Avnet System, for the 1st time, combines benefits of a National Network (price, trained men, inventory, multiple Headquarters) with the benefits of a local source (speed, personal service, on-the-spot quality control, nearby prototype assembly facilities).

a new concept—BALANCE.

Avnet's inventory is balanced 5 ways: 1. satisfy daily demand. 2. stock future demand. 3. proper variance of type, size, function. 4. multiplied by 8 for Avnet's 8 Stocking Facilities. 5. added, subtracted, divided and multiplied by the 15 major lines marketed by Avnet. This takes delicate balancing, checks and counterchecks, hourly tabulations.

an old concept—READINESS.

The grey pattern above is made up of 70,000 dots. Avnet's Assembly Facilities enable them to supply over 70,000 different types of connectors in any quantities. This flexibility, depth and breadth is Readiness. It is exclusive with, and 5 years old at, Avnet. This experience cannot be bought anywhere, at any price. But it's Free to Avnet's customers.

a change of concept—INFLATION.

Avnet can't control the nation's price structures. But Avnet can, and does, control its own value structure. Avnet probably gives more lead time, more reliability, more application information, more selection, more service than any other source. Simply, Avnet gives *more* for the *same* price.

The Avnet System is a complete method of Marketing with many more techniques than shown here. Avnet is the largest, the smallest, the only organization of its kind. But being the largest is meaningless unless it benefits the customer. And it is meaningless for you to change from your present source to Avnet unless you *can* get more value for the same price.

AVNET



THE AVNET SYSTEM
Men / Methods / Materials / Management
AVNET ELECTRONICS CORP.

LOS ANGELES, CAL. • SUNNYVALE, CAL. • SEATTLE, WASH. • SALT LAKE CITY, UTAH • PHOENIX, ARIZ. • CHICAGO, ILL. • DAYTON, OHIO • WESTBURY, L. I. • BURLINGTON, MASS.

BENDIX SCINTILLA CONNECTORS	MECHANICAL PRODUCTS	SPERRY SEMICONDUCTORS	BABCOCK RELAYS	CONTROL SWITCH DIVISION	RHEEM SEMICONDUCTORS	GREMAR CONNECTORS
ROBERTSON SPLICE & CONNECTOR CASES	SPRAGUE CAPACITORS	KING SUBMINI-TEMP CERAMIC CAPACITORS	TIC PRECISION TRIMMERS	U. S. SEMCOR SEMICONDUCTORS	SANGAMO CAPACITORS	MICROBOT CONNECTORS
CLARE RELAYS	AVNET AUTO. CONNECTOR AND CABLE TESTER	AVO MULTI-RANGE METERS	WIDNEY DORLEC CONSTRUCTIONAL SYSTEM	GENALEX TUBES	SULLIVAN PRECISION MEASURING APPARATUS	SERVO DESIGN AND TESTING EQUIPMENT

Mail me information on the components circled at left.

NAME: _____

TITLE: _____

(Clip this bottom section to your letterhead, mail to The Avnet System, Publications Section, 70 State Street, Westbury, Long Island, N. Y. Your request will be expedited within 90 minutes of receipt.)



SAMES

Société Anonyme de Machines Électrostatiques
21, rue Jean Macé B. P. 150 Tél. : 44-77-64
Grenoble, France.



ANNOUNCES

the opening of the Office of the U.S. Representative for
United States sales of :

HIGH VOLTAGE POWER SUPPLIES

50 kV to 600 kV, 0,2 to 14 ma
Regulation from 3 to 0,001 %
Electrostatic Generator Principle

Used for
ELECTRON OPTICS
X-RAY THERAPY & METALLOGRAPHY
INSULATION & CABLE TESTING

PARTICLE ACCELERATORS FOR NEUTRON GENERATION

150 kV, 300 kV and 600 kV, 0,6 to 2 ma
ion or electron beam currents, constant or pulsed

Used for
ACTIVATION ANALYSIS
NUCLEAR RESEARCH
NUCLEAR TEACHING



EUROPEAN SALES AGENTS OF SAMES ARE :

Austria : AUSTRONIK, Salzburg
Belgium : GENTRONICS, Brussels
Chinese People's Republic :
Cie OLIVIER, Paris
Denmark : DANSK SCIENTA,
Copenhagen
Great Britain : MILESHIVOLT LTD,
Shoreham by Sea
Italy : SECI, Milan
Netherlands :
PROJECTO, Amsterdam

Norway : LEHMKUHL, Oslo
Portugal : A. G. M. E., Lisbon
Spain : CRESA, Barcelona
Sweden : SCIENTA SCANDIA,
Gothenburg
Switzerland : OMNIRAY, Zurich
Western Germany :
DR. NAMUR, Darmstadt
Bulgaria, Czechoslovakia,
Eastern Germany, Hungary, Poland,
Rumania, U.R.S.S. : CIFAL, Paris.

For further information in the United States,
please write or call :
Dlgbly 4-1286



Office of the U. S. Representative, Room 3701,
30, Broad Street,
New-York 4, New-York.

ELECTRONICS IN EUROPE

By W. W. MacDONALD, Editor

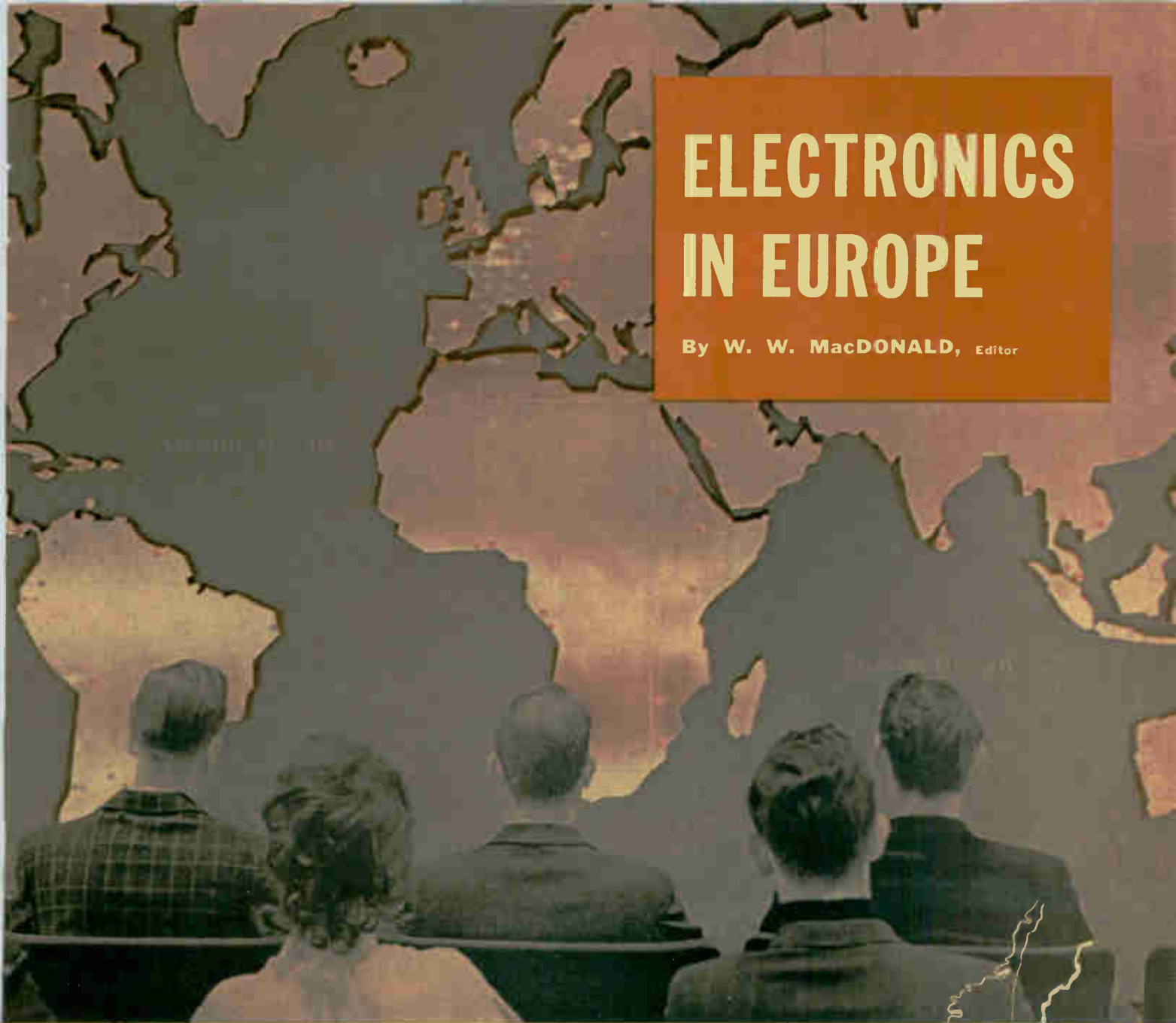

L. M. ERICSSON, Stockholm

PURELY PERSONAL



REPRINTS
AVAILABLE
SEE
READER SERVICE CARD

Electronics in Europe

IF YOU HAVE NEVER BEEN in Europe, or if you have not been there in the last five years, forget most of what you have heard and much of what you have seen. It is different now.

BUSINESS IS BOOMING

THERE ARE NEW PLANTS EVERYWHERE

SEVERE LABOR SHORTAGES ARE DEVELOPING

THE WORK DAY IS SHORTENING AND WAGES ARE RISING

THE STANDARD OF LIVING IS UP

TARIFF BARRIERS ARE DISAPPEARING

EUROPE IS NEARLY SELF-SUFFICIENT

ITS TONGUE IS NO LONGER HANGING OUT FOR AMERICAN MERCHANDISE

AMONG CONCLUSIONS that may save you time and money, reached after a great deal of preliminary digging followed by three months of intensive personal checking on the ground, are these:

- Europe as a whole is as big a potential market as the U.S.A., and less saturated
- It is no longer a question of "if" the two common markets will come closer together, but "when and how"
- International thinking and action, rather than an "export" concept, is necessary for effective trade with the continent; there will be no more selling of beads to Indians
- Our domestic market interests many European manufacturers less than other markets
- Linkages between companies, and those of other countries, are so extensive and complex that a diagram of them would look like the web of an inebriated spider
- If you are just now thinking of "getting into Europe" it is almost too late

- European managers can use American know-how, but too much influence is as bad as too little
- Foremen are hard to find and harder to train, particularly for production control
- Nationals, properly directed, make the best salesmen
- Good service is especially important on the continent, often more so than increased sales power
- We manufacture some specialties for our military and space programs that it does not yet pay Europeans to make
- Our current sales "edge" on more conventional products is the ability to deliver quickly

SOME OF THESE STATEMENTS need qualification. Many need amplification. And there are many technical developments to report. You'll find all three in the pages that follow

Why Business Is Booming

WHEN THE WAR ENDED, Europe had vast internal hungers of many kinds to satisfy. It couldn't satisfy them all quickly because manufacturing capacity was exhausted and plants had been bombed out or their contents carried away to the East. Financial help poured in from the West but it has taken until now to get the economic and physical machinery geared up for mass production and distribution.

Radio sets and television receivers and communications apparatus which constitute the continent's major electronics business have been flooding into the market for some time, providing profit for the development of other products, with the result that many countries are running out of help. This is particularly true in Holland, where many Belgian workers are brought north across the border in busses each morning and returned to their homes each night, and in West Germany, which imports labor from southern Italy and from Spain each

summer only to have much of it go home at the approach of cold weather.

Northern Italy itself is beginning to feel the pinch of a labor shortage. So is Switzerland. In France the housing shortage is so severe in the vicinity of Paris that new factories and radical expansion of old ones is not permitted; at least two manufacturers are building down on the Riviera near Nice, where labor is easier and they hope they can attract engineers. There are depressed areas, such as Northern Ireland, Scotland and Portugal, but they are the exception rather than the rule and could change quickly.

Another reason why business is good is that most European manufacturers consider all of the continent, rather than just their own country, their home market. They have natural advantages of many kinds when selling within their own borders but in many instances also make items that can successfully compete in surrounding countries. The British, for example, do well with radar and navigation devices on which military needs gave them a head start. France and Italy, needing microwave communications systems not only to cover

the mountainous parts of their respective countries but also to reach North Africa, sell a good deal of related equipment across national borders. The West Germans are giving them a run for their money in this area, and two Italian manufacturers of conventional radio receivers volunteer the information that they may soon stop making such sets and shift to more specialized electronics products because the Germans can apparently undersell them in their own country.

On top of all this domestic and continental business, many European manufacturers are doing a good business with South America, Africa, the near East and other distant places that might indeed still be thought of as export markets. They find it increasingly difficult to sell in the United States because of the wide variety of products available locally and higher tariff barriers.

The Netherlands, West Germany and Italy, members of the European Economic Community or so-called "inner six" along with France, Belgium and Luxemburg, have enough business on the books so that the three successive tariff reductions by the group to date is probably more insurance for the future than cur-



PURELY PERSONAL

SAID GOODBYE to wellwishers on the ground at New York's International Airport, in code via blinker on a flashlight borrowed from a Pan-Am stewardess, as the plane rolled out on the runway; 36 years of amateur radio has not been entirely wasted.

Speaking of airplanes, one enters a Caravelle ingloriously, through the rear. As if to compensate for this indignity, Swissair calls attention to the removable armrest between seats, says "this is considered a great convenience by honeymooners." Italian Steamship Line is even more solicitous of the passenger's welfare, says "if your every personal need is not fulfilled call our social director."

The English put ice in their orange juice, none in the whisky. Elsewhere in Europe, if the orange juice looks like tomato juice don't put salt and pepper in it before tasting; blood oranges have the same color.

In Glasgow, two small boys asked me the way to Argyll street; so much for the dress and mannerisms of natives.

Book matches encountered in many countries of the continent are scored so that when you pull at one it snaps out; it also falls out occasionally in your pocket.

The Louvre has the Venus de Milo and other art treasures inside. Outside, vendors sell other forms of

rently needed as a stimulant. The extent to which France is currently profiting is hard to tell, but it is fairly clear that Belgium and Luxembourg do not yet produce enough electronics products for the arrangement to make any immediate difference.

In the European Free Trade Association or so-called "outer seven" consisting of Austria, Denmark, Norway, Portugal, Sweden, Switzerland and the United Kingdom business is supporting a growing economy but it is also generally recognized that the heart of the continent's market is represented by the other group and, in England particularly, many manufacturers think the two markets must soon merge to some extent if their current moderate prosperity is to last. Few members of either economic community expect the decline in U. S. fortunes in the early part of this year to be quickly reflected in their own sales potentials. Some Germans do think reduction of American financial support to other countries could bring reduced business for them after a time delay of a couple of years, not so much because of reduced aid to West Germany but because there might be less money in the hands of some of Germany's customers.

The prosperity of Europe's electronics industry cannot be attributed to any great extent to either military or space business; there is not yet much of either by our standards and there is not likely to be in the immediate future. Figures printed early this year (ELECTRONICS, January 6, 1961) indicate how well the West is doing nevertheless, and here are some more unearthed while overseas:

Britain's electronics business reached \$1.3 billion in 1959, with about \$580 million of this in consumer goods, and is currently adding sales at the rate of approximately \$90 million per year. Exports accounted for \$275 million worth of the total. France produced \$650 million worth of goods in our field during 1960, up 25 percent over the previous year. Export of what the French call "materiel professionnel", which includes everything except consumer goods,

rose 30 percent to \$32.5 million, and about two thirds of this was sold outside the franc zone. Holland's electrical and electronics business, from which electronics alone cannot be separated, rose from \$370 million in 1951 to \$556 million in 1959, with the export portion moving from 51 percent to 58 percent.

West Germany is doing about a \$1-billion business, exporting perhaps 25 percent of its products. Italy turned out \$175 million worth of electronic equipment in 1960; \$10 million of it was in industrial apparatus. Switzerland exported approximately \$75 million worth of gear last year. Finland did a \$13 million business, exporting around 2 percent of its production. Norway's electrical, electronic and telephone figures are difficult to separate but it looks like electronics may account for \$55 million.

Export Honeymoon Is Over

Europe is nearly self sufficient in electronics for a number of reasons. In the first place, it has had to develop conventional component-part production capacity to produce its own radio and television sets, and many of these parts can be used without change or in modified form in the construction of other apparatus. If a sufficient quantity cannot readily be produced within a country it can often be obtained from one next door. Italy, for example, is constantly being urged by the Germans, Swiss and others to boost its parts exports and to make more sophisticated types. So, to some extent, is France. Transistors are being successfully manufactured at Palermo, down in Sicily, and soon will be also on the Côte d'Azur. In both cases U. S. money is involved.

Many European companies are closely linked with others, either through joint ownership, subsidiary operation, licenses, patents or other links. Thus there is no lack of know how, including American,

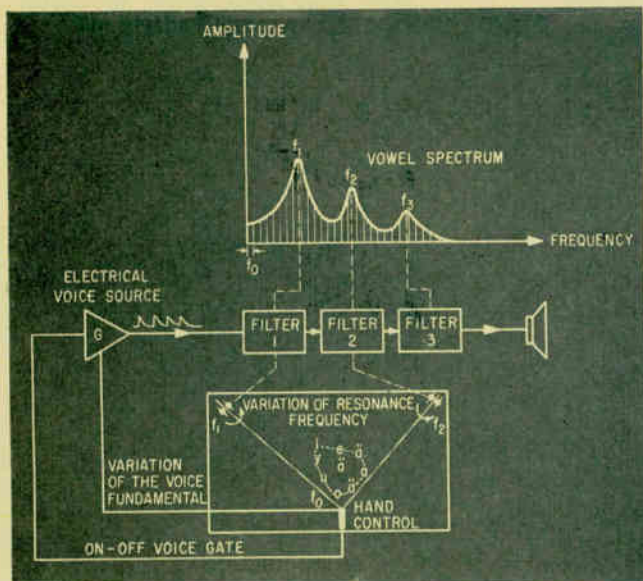

SPEECH SYNTHESIZER—Move a device resembling an Ouija board around the desk and it talks (R.I.T.)

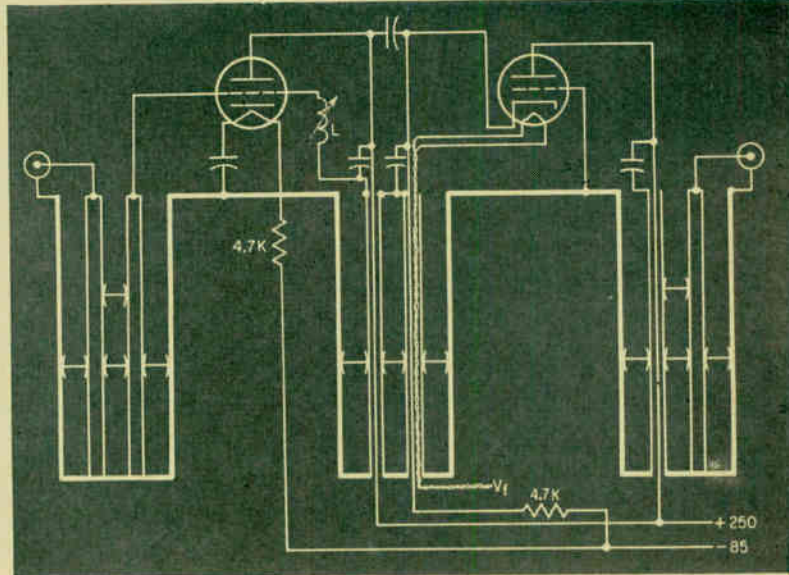

RADIO ASTRONOMY—High frequency amplifier circuit employed in a recent experimental system (Philips)

when truly sophisticated component parts are needed. In general, however, those developed for many military and space projects which either do not exist or are small overseas do not at this time particularly interest the average manufacturer because needed quantities are small. It costs too much to make them in the absence of heavy government support, so they are often imported in small quantities from the United States.

This is true too of highly refined electronic instruments of many types; England has a fine instrument business but does not yet offer a wide variety of types. More or less the same thing is true of Holland. Germany had a good reputation in this field before the war, and is just beginning to renew it, but will take some time to make a dent in the market due to preoccupation with production of other items. The Swiss seem surprisingly slow to extend their substantial electrical business into the electronics field, and the Italians are not yet far enough along the road of supplying more fundamental electronics needs to be a factor in the instrument business.

It is particularly important to understand that while Europe, considered as a whole, represents a big and growing market the volume of business that can be obtained on

certain electronics items is not like that of the United States. Thus systems used for military and related purposes are frequently imported and will continue to be. But competition on the continent, from countries on the continent, is becoming very keen indeed. It is equally keen in nonmilitary items such as commercial radar, navigation equipment and air traffic-control devices. Competition for computer business is of a somewhat different nature, since it comes not only from competent companies native to the various countries themselves but also from many with close U. S. affiliations and not a few with headquarters in the new world.

Old-line business machine makers are, in fact, among those companies with the most experience not only in manufacturing on the continent but also in doing business in the continental manner. There are a number of instances in which plants were set up in several countries of Europe either to get the business in those specific countries or to hedge against possible contingencies within the two European markets. Today most of them specialize in the production of just part of a computer, and the various units such as input devices, memory and output devices come together wherever there is an order.

These companies have become truly international in character, rather than national.

Commercial communications apparatus, including radio and television broadcast stations and antenna systems, point-to-point and microwave including scatter, is highly developed in Europe. Development went hand in hand with the consumer goods business with which the continent's postwar commercial renaissance began. So Europe is in a good position to supply most of its own needs in the area and even to export. Here, too, it is late to consider establishing representation of any kind on the continent because close affiliations have already been formed by many manufacturers, particularly those with telephone interests, and there are not too many companies lying around loose for acquisition or affiliation. Go to Europe seeking such affiliations and you will use a lot of expense-account money, shoe leather and perspiration before you hit pay dirt.

In most areas the day of the quick deal is over. Take West Germany, for example. Right after the war the Germans, like most other Europeans, needed electronic equipment so badly that they would buy it from the only source of supply, the United States, almost without regard to the price, delivery and

PLANTS



Part of the Philips complex at Eindhoven



A headquarters office in Berlin



Texas Instruments' new plant at Bedford, England

MORE EXAMPLES

in ITALY



ARE BIG AND MODERN



How Siemens' instrument shop looked when the war ended,

and the new labs at Munich

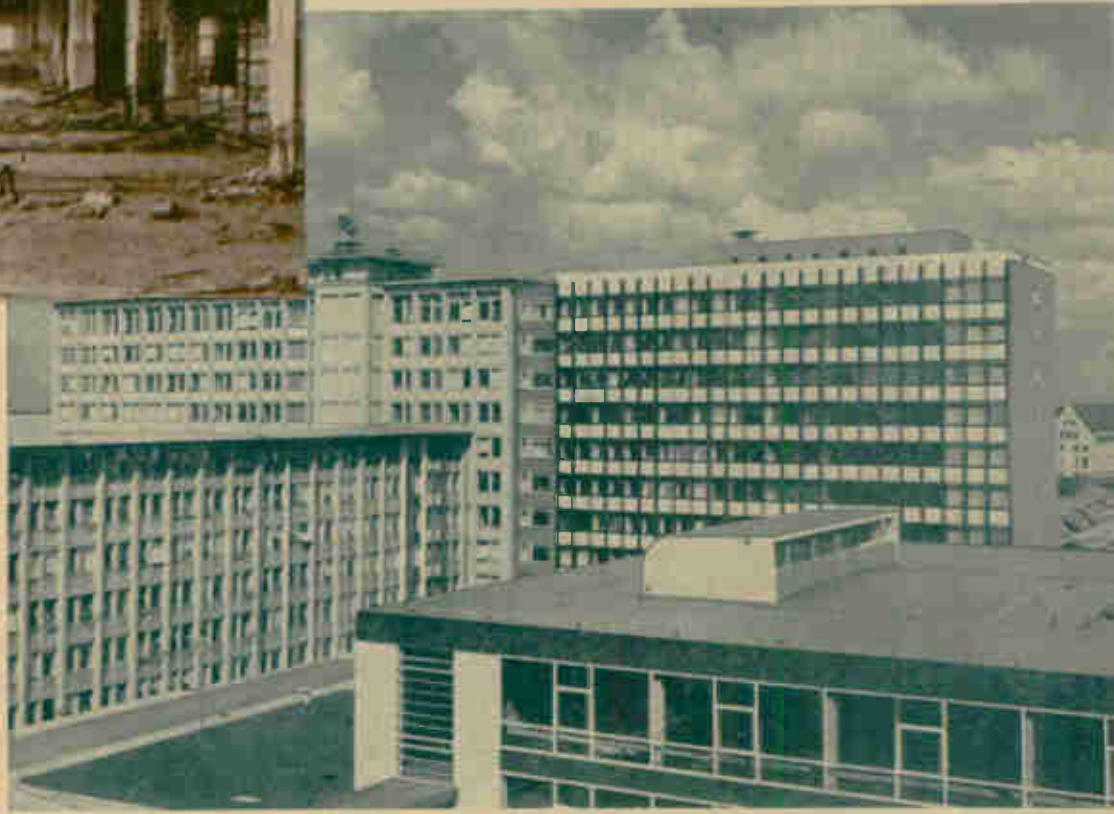

in SWITZERLAND



in FRANCE



in SICILY



in SWEDEN

art. Solicited in broken English, one can answer in equally broken Spanish, and the man usually goes away slightly puzzled.

"All Americans are tall, have crew cuts and big smiles."

Butter by Michaelangelo: You rarely see it in plain ordinary pats. The moulds give it all kinds of artistic shapes, the most common being that of a curled leaf.

Only Americans eat with one hand.

To look like an American in Holland carry a briefcase at arm's length and keep the brim of your hat turned down. To look like a Dutchman carry the briefcase under your arm and snap the hatbrim up.

In the older buildings of some European countries certain facilities tax aging or unaccustomed leg muscles.

The shower is frequently installed in a modern European hotel as a concession to foreigners and rarely used otherwise. That's why it is sometimes found over a bathtub in company with a glass partition that only protects half the area and a drain is installed in the floor to take care of the resulting flood.

In Amsterdam I encountered a dog that obeyed when spoken to in Dutch.

Typical American life as portrayed by a movie playing in Holland: "The Purple Gang."

Electric razor adapter worked everywhere in Europe except one or two places in England. Funny, too, because that's where it was made.

It's a wonder Germans do not have permanently curved backs. Their hotels usually place a bolster and two pillows at the head of the bed and it is not unusual also to find one at the foot.

When a Dutchman or a German wishes to express polite interest, especially more of the polite than the interest, he says "Ah, Zo!"

Flughaven, seen on the signposts

specifications. Now the Germans are beginning to say it is easier to do business with other Europeans who know and speak their language. In particular, they are becoming critical of the specifications found in our technical literature, say it may have meaning to an advertising man but often omits related factors without which there is not much meaning to an engineer. All over Europe we were told that performance of delivered products should be what the promotion promises, and that service after the sale had to be more than conversational service, that is, "That's the way it is supposed to work."

The export honeymoon is over but American manufacturers can continue to lead a mutually profitable married life with Europeans in product areas where government purchases permit volume production not achievable overseas, where highly sophisticated products are developed with money from the same source and where volume can be achieved in certain specialties because of the more advanced state of our commercial economy. And, momentarily, U. S. manufacturers have one more edge. Because of our large production capacity and the lull in business here, we can actually make delivery on many products considerably faster than Europeans can supply themselves, particularly if shipment can be made by air.

How They Do Business

There are not many wholesalers or distributors in the field of electronics in Europe in the American sense, and the few there are often owned outright or in part by a factory. Frequently the factory sells direct to dealers in the case of consumer goods, or direct to the ultimate user in the case of commercial and industrial goods, and it is not uncommon for the factory to handle all subsequent service with a substantial field crew. More

particularly, there are relatively few independent manufacturers' representatives and when you do find them they rarely handle products made within their own country. The tendency of manufacturers selling across national borders appears to be toward use of their own full-time representatives.

Europeans resist the idea that they have to be satisfied with a product or the service they receive in connection with it after the sale because "other brands are just as bad." This explains why management planning, operating procedures and customer relations encountered in some of the countries visited seemed in several instances to be better than that achieved by a parent company or affiliate back in the United States. They also exhibit a marked preference for doing business with nationals, or with other Europeans who understand their way of life, so much so that many U. S. companies that know the ropes overseas do have enough Americans around in high places to keep a company or affiliate up to date with respect to desired over-all policy and to keep operations moving somewhat faster than might be the European custom but are today careful not to load the personnel roles so heavily as to make them seem foreign. There are several instances in which foreign-owned firms in Europe have European presidents, with an American nearby in an advisory capacity.

Down the line, salesmen are usually European, and sales managers are either Europeans who have close and frequent contacts with an overseas counterpart or Americans who have lived long enough in Europe to know European ways. Top engineers are usually native, as are most of those at lower echelons, and visit the United States in surprisingly large numbers and with considerable frequency. Or are kept fully informed concerning American practices through technical correspondence and the reading of technical journals.

Toughest men to find and to train in, for instance, Germany, are those needed for quality control and as foremen. Quality control and production control as we know

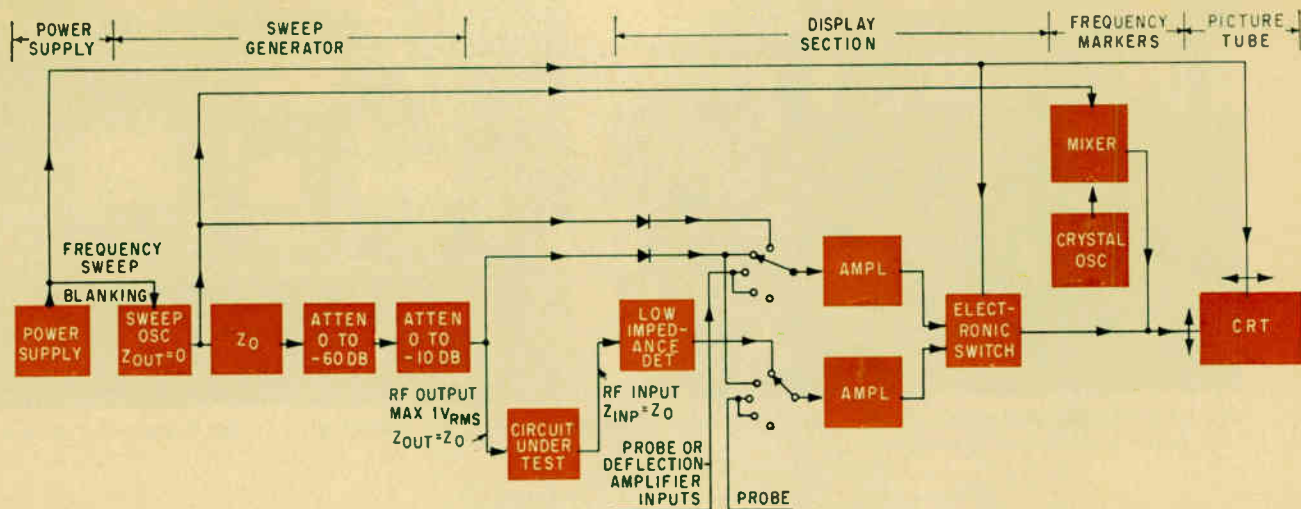

TEST INSTRUMENT—Two channel frequency response display for two and four-terminal network measurements (Rhode & Schwarz)

them have to be taught in many cases because the volumes Europeans are accustomed to handling have not until now been great enough to warrant such methods. There are plenty of expert workers who would make good foremen but many resist leaving a specific job either because they take pride in working on precision equipment with their hands or feel that a supervisory job is less secure or both. If they do become foremen many must learn to get the most out of their crew by a proper combination of orders, persuasion, leadership and encouragement. Otherwise they may be completely dictatorial or, if cautioned about it, flounder around and exert no leadership at all.

Technical Men Are Different

Top engineering talent sufficient for Europe's needs in the field of electronics is available, with the usual provision that there are never too many around anywhere who function to perfection in key management positions. Supporting technical personnel is another story; the continent does not have them in anything like the number found in the more middle-class United States, it is harder for those in this group to move upward and even the schools run by many of the larger manufacturers are hard put to develop the manpower needed.

Yet in many ways the European technical man has a fine education. It may not be possible to move him directly from school to a specific and specialized job in industry and have him gear in with the speed of his American counterpart, but his scientific background is broad enough and thorough enough so that he can be useful in many areas or specialize in a sticky one once he gets the feel of commercial life. To understand why this is so something must be known about the European educational system.

In Sweden, which is much like

the United States in many respects, youngsters go to elementary school for seven years and then those heading for college have from three to five years in a junior high plus three to four in senior high. University or college then takes four years or a little more for an engineering degree, plus many more for the higher degrees. Teaching of English begins in the fifth grade of the elementary school, German in junior high, and French is optional in the last grade. Senior high has English, German and French as alternatives, plus optionals such as Latin, Greek, Spanish or Russian. Vocational training goes along with schooling in many instances and, like most other Europeans, the Swedes put in long hours. In England, for example, children go to school six days a week and a recent referendum suggesting that it be cut to five was defeated either by parents sincerely interested in thorough education or those who value the luxury of having the home to themselves on Saturday.

Electronics was one of the fields barred to West Germany up to 1955 so most of the engineers there have electrical backgrounds and are men who have defected to the latest branch of the art in recent years. German schools do not yet have clearly defined electronics courses. The electronic engineering degree is quite recent in Italy but the

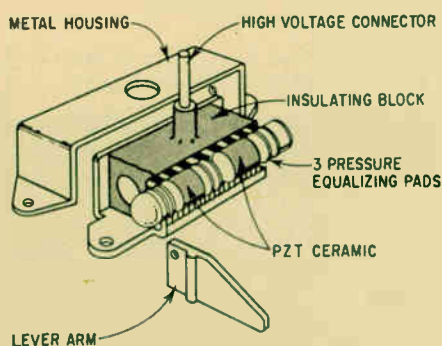

SPARK PUMP—Pressure can be translated to high-voltage impulses for automobile ignition systems and other applications (Brush Crystal, Ltd.)



Black-coated girls assemble potentiometers in a Mial plant at Milan. White-coated girls in the Rome plant of a subsidiary make polystyrene capacitors.



Subminiature diodes and rectifiers in production at TI, Bedford.

**PRODUCTION
FACILITIES
ARE GOOD,
OFTEN NOVEL**

Waxheating sets glue fast in Van Der Helm tv cabinets:
Glue is applied to unwired part . . .



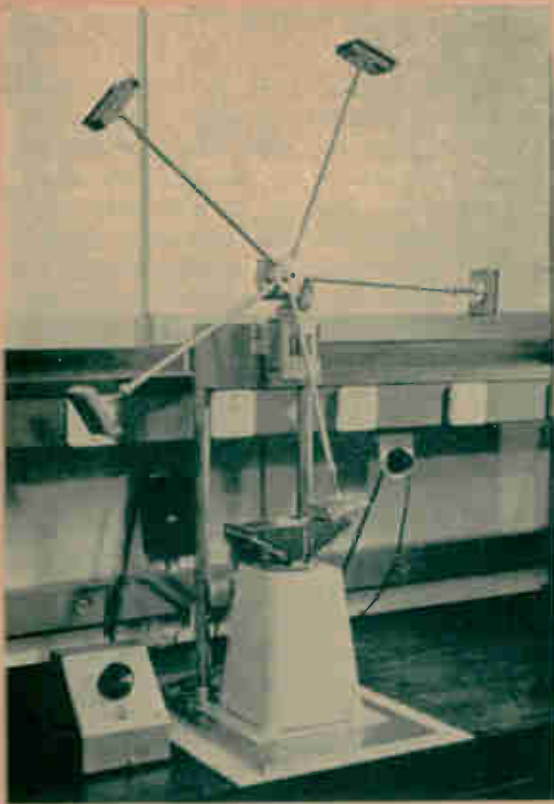

Experimental "Ferris wheel" ultrasonic dip-soldering setup at Mullard's in England

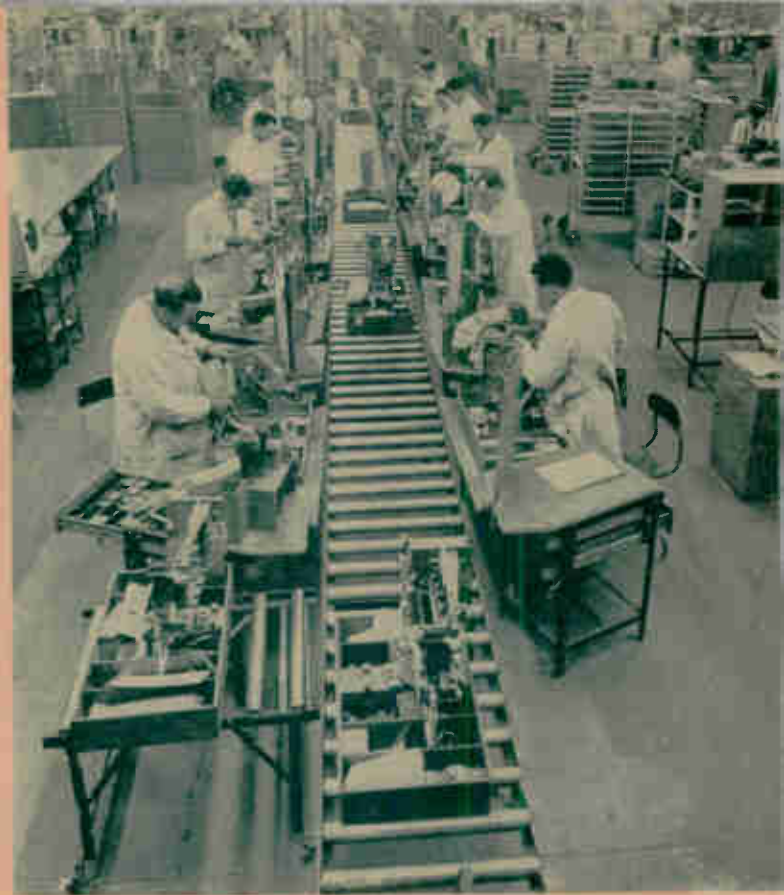

A Honeywell line at Motherwell, near Glasgow



Telefunken transistor manufacturing

wire is drawn into groove in other part . . . the two parts are placed together . . . current is passed through the wire



at many German crossroads, is definitely not a German town.

"As rare as a girdle in Germany."

Feminine shoes in the hall of a European hotel, waiting to be shined, seem slightly indecent to the uninitiated.

There are three types of Swedish beer, light, medium and heavy alcoholic content. Said a native when asked what the light tasted like: "Atlantic water."

Italian farms and some others appear to employ women, oxen, horses and tractors in that order. The women swing a mattock with a motion not unlike that used when making a chip shot to the green.

Italians do not pick up pizza. And you won't easily find vichyssoise or French dressing in France.

KEYS

EUROPEAN HOTELKEEPERS don't lose many keys. They are six inches long and weigh half a pound. Or they are lashed to a plastic stand you can't get in your pocket. Or to an object that resembles an outside handball. Or they have a metal crossbar that makes the setup look like a child's giant jack. Or a weathervane.

About the only thing you won't find fastened to a key is a dumbbell, or a five-pound anchor.

French automobile drivers take aim. If an Italian hits you in a pedestrian zone he is legally responsible. Many of them around Rome wear dark glasses even at night, as if to insure it.

The worst way to get answers is from an American who has lived too long in Europe, or from a European who has lived too long in America.

The small change purse, for coins, is a European institution.

Some of the older plants, especially those that have acquired adjacent buildings around an inner courtyard, require that you have either radar or a seeing-eye dog to find

theoretical instruction useful in any science is good. Physical equipment for teaching in the colleges still leaves much to be desired. Swiss education is still more electrical than electronic, with the result that men gravitating toward the latter field after graduation put in a great deal of time extending their education after they get their first job in the industry and, for this reason, usually hang on to that first job for at least two or three years like grim death in order to pay the bill. A government institute in Zurich provides the instruction at night for many of them, and does it so well that of the 6,000 students currently registered for courses in many fields nearly half are not Swiss.

Salaries paid to engineers after graduation do not mean much unless the cost of living is known, and this information is hard to come by and has many variables such as the precise location within a country in which the man works; it is

Earnings of course increase with experience. A man just out of school can earn about \$2,460 in France but can move up from there fairly rapidly. A good man may earn \$7,000 and, here as in several other countries, the opportunity to move into management is no less than in the United States. Statistically, there are more men in top spots who started along the technical route. Italy is paying experienced electronics engineers between \$4,200 and \$6,000 to start.

Prestige of the engineer is high, with only a few exceptions. Men down the line may mentally click their heels and remain silent when in the presence of their bosses but the bosses encourage them collectively to the maximum extent consistent with their old-world idea of a proper social status. Have yourself escorted around any plant or laboratory by top management and you will see them go far out of their way to properly introduce department heads and project leaders

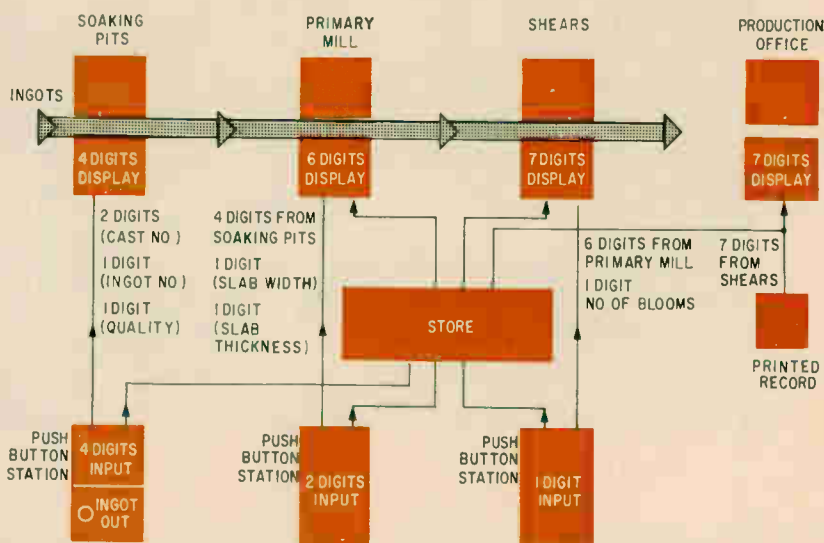

ROLLING MILL RUNNING RECORD—As work proceeds down the processing line its progress is signaled to the next station, and the production office winds up with a printed record (British Iron & Steel Research)

considerably lower in Europe with the possible exception of Sweden. One of England's major electronics equipment makers currently pays engineering and science graduates straight out of school \$1,960 at age 21, \$2,030 at 22 and \$2,100 at 23 for a 38½-hour work week; \$2,144, \$2,184 and \$2,254 for 42 hours.

and almost invariable leave it to these people to explain what is going on under their direction.

Titles are more meaningful than on our side of the water and, depending upon where you are, there may be a considerable difference between the word doctor and the word engineer. Sometimes these

are found in combination and there are instances in which a man may legitimately sign a technical paper Dr.Dr.Ing. without being verbally crucified by his fellows thereafter. It is quite common to hear a man introduced as Engineer Brown, and the phrase Herr Doktor is an everyday greeting.

Professors may be just as poorly paid as they are in U. S. but they are almost universally considered upper crust in Europe. A high percentage of them not only teach but also run a research project which may be financed either by the government or industry. They are frequently on the payroll of a university and also on that of a manufacturer or manufacturing group, not under cover or even by special dispensation but as an accepted thing that is believed to benefit both employers as well as the individual.

Research, Development and Design

Research and development in the field of electronics is handicapped by lack of financial support comparable to that stemming from the military and space programs in the United States but this is compensated for to a considerable extent by other factors. The breadth of the education possessed by many of Europe's researchers fits them well for work which requires detailed knowledge of many interlocking sciences. This same broad technical education leads them strongly toward studies of basic phenomena rather than hardware, or what the English call iron-mongery. Lack of money limits the use of project teams but it is being demonstrated once again that there is more than one way to skin a cat; one man with background, brains, energy, a burning desire to solve a problem and freedom of action can often run a committee a respectable race to results.

The whole atmosphere in which

many Europeans habitually work lends itself to a considerable degree to the development of things which can have great significance in the middle and long-range distance rather than those that merely return a quick buck. Designs that pay current bills have a way of coming along in sufficient number anyway and need comparatively little stimulation beyond that automatically generated by economic pressures. There is less distinction between research and development and design than in America. The fact that the first two are not unduly sacrificed to the last is plainly indicated by a report covering research and development going on overseas which appeared a little over a year ago (ELECTRONICS, February 12, 1960). And a good way to indicate the intermixture of all three is to report in the following paragraphs

or in the illustrations within these pages a random sample of just a few of the technical problems and projects and products encountered in Europe, more or less in the order of laboratories visited:

ENGLAND—*Marconi's* is putting a lot of research effort into air-traffic control, using a digital approach, and is working on a method of generating characters electronically that may have uses here and in other applications. Continuous-wave doppler altimeters are being further developed for commercial as contrasted to military use. For measurement of radiation in the vicinity of high-power directive radio or radar systems there are portable hazard monitors using thermistors. These are effective in fields that range from 0.5 to 40 milliwatts per square centimeter. Op-

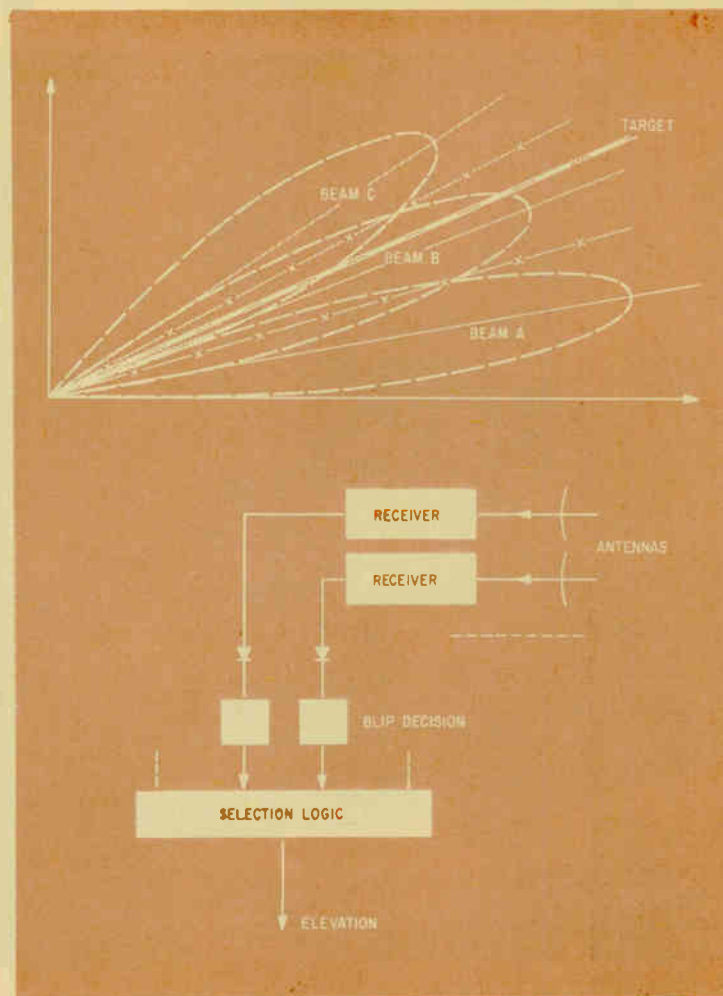

3-D MULTIBEAM RADAR—One of several methods under consideration in Europe (Compagnie Francaise Thomson-Houston)

In-Plant Training Combats

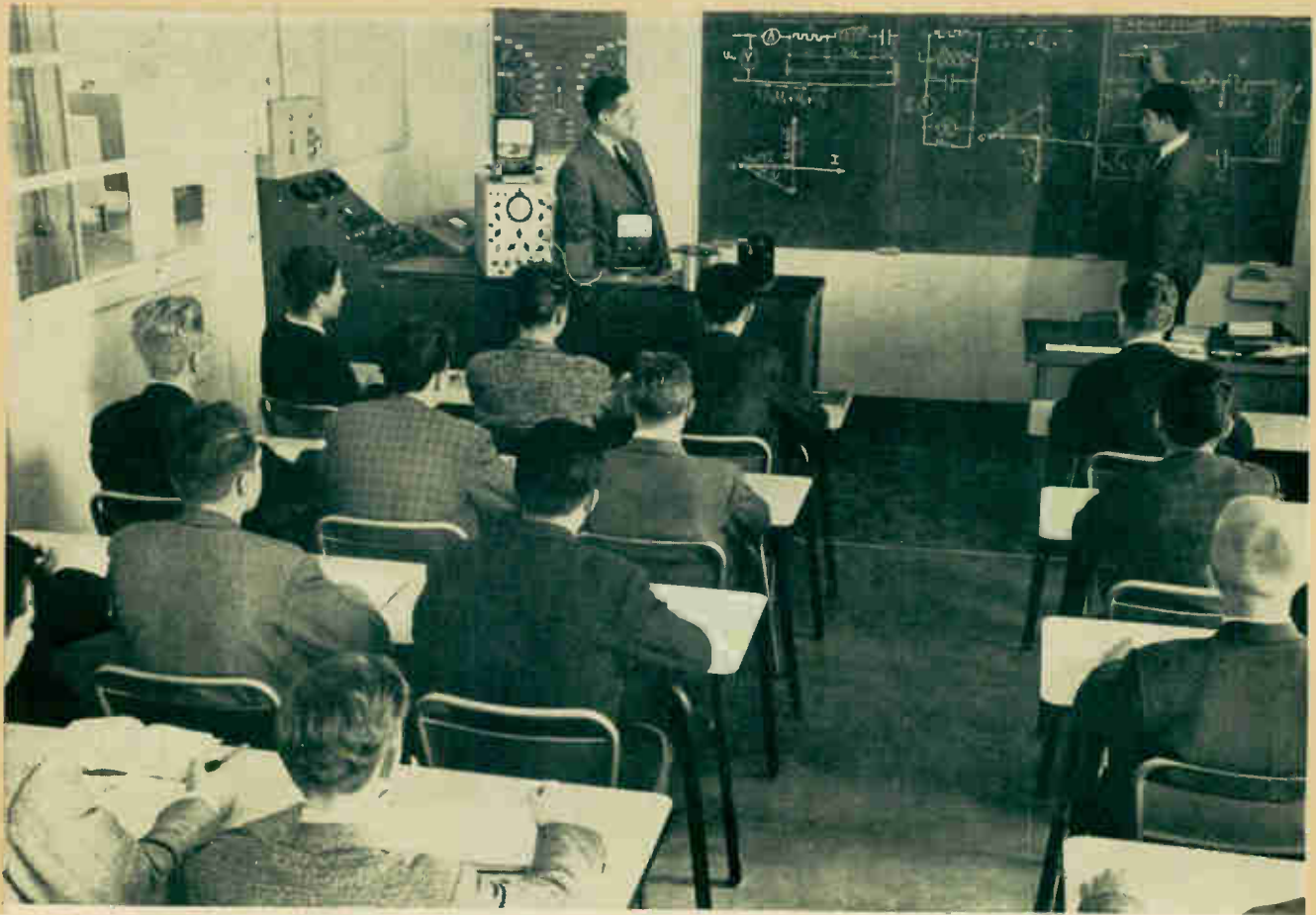

A class for technicians at IBM's factory in Essonnes, France

erating frequency has recently been raised to cover 10,000 megacycles and work is in progress to develop broad-band antennas covering the 2,000 to 10,000 megacycle range. Both cone and disk types are under study, and spiral types are being etched on a printed-circuit board.

An automatic radio compass for high-speed aircraft uses a fixed loop and a crystal-controlled tuning system, providing accurate tuning in 0.5-kilocycle steps over the bands 100 to 419.5 and 490 to 1,999.5 Kc (see diagram). The receiver local oscillator is successively mixed in the decade converter chain with the output of three crystal-controlled oscillators so that the output at the discriminator is always 55 kilocycles when the local oscillator is tuned to the desired frequency. Selection of a frequency on the decade dials at the controller operates the crystal-selection motor,

which selects the correct combination of hundreds, tens and units crystals. Simultaneously, the tuning motor chooses the desired frequency band and drives the tuning mechanism to the lowest frequency. The tuning mechanism reverses and the local oscillator sweeps up the band at high speed until a 45-kilocycle signal is received at the output of the decade converter chain. The 45-kilocycle output is rectified and operates a magnetic clutch which reduces the tuning speed to 1/25 normal. The slow speed scan continues until a 55-kilocycle signal is received by the crystal gate. The rectified 55-kilocycle output de-clutches the motor and operates a magnetic brake to lock the tuning system. Simultaneously, the crystal gate is converted to a crystal frequency discriminator which drives a reactance tube to stabilize the local oscillator to the correct

frequency. The 0.5-kilocycle steps are provided by using two alternative crystal frequencies in the frequency discriminator so that the discriminator operates at either 55 or 55.5 kilocycles. Under normal conditions tuning accuracy is better than plus or minus 50 cycles and under extreme environmental conditions does not exceed 200. Maximum time taken for the tuning cycle is five seconds, the average being three.

Nearly \$3 million was spent last year on research by *Mullard*. A good deal of this went into studies of basic computer techniques and into thin films and semiconductors. Work on cryogenic devices has shifted from the Crewe storage cell, found too sensitive to small changes in device characteristics, to the cryotron. Magnetic thin film switching characteristics are faster than ferrites and faster than logic cir-

Growing Labor Shortages

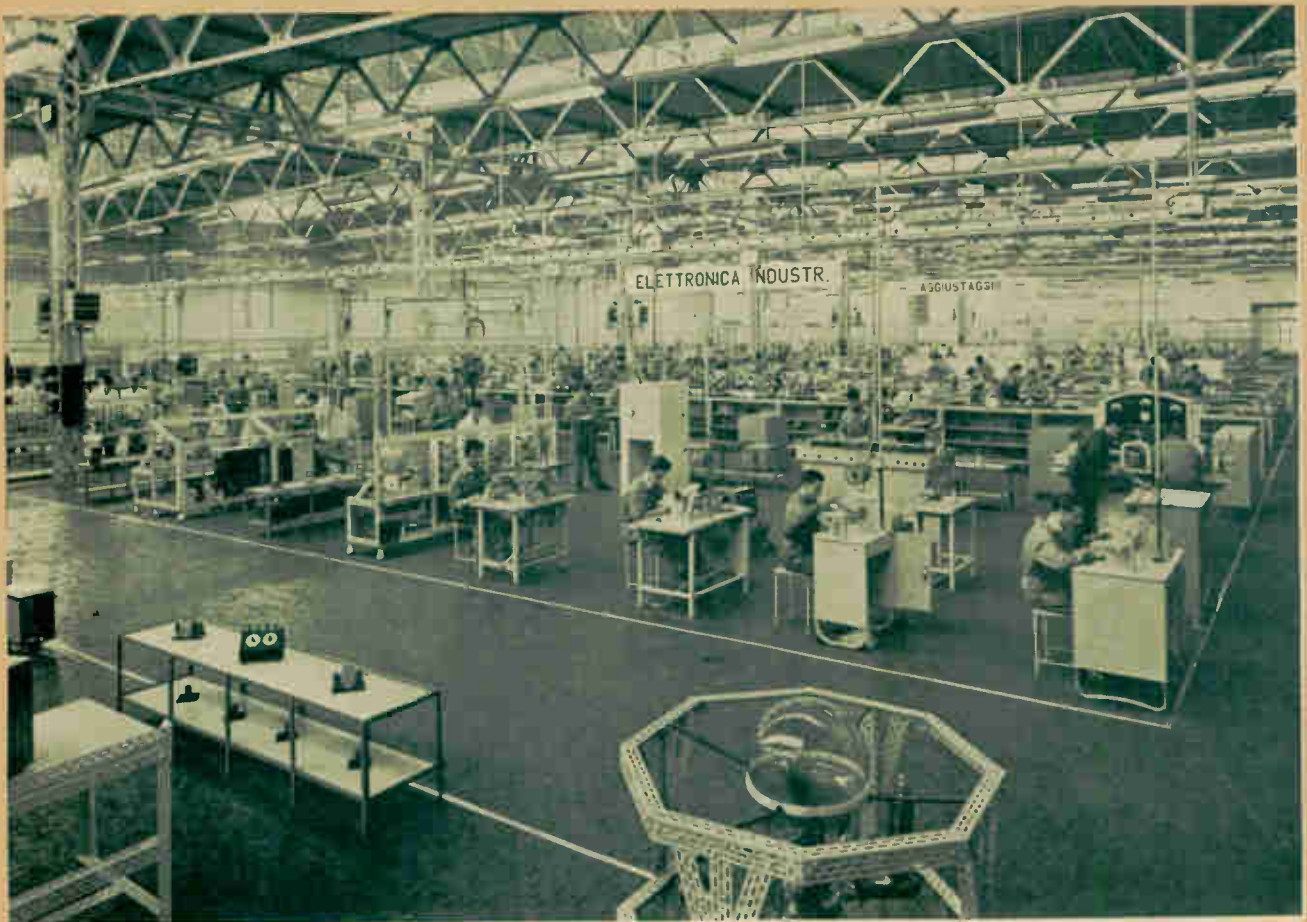

Electronics school at Fiat, Turin, is one of several in this plant

circuits can use, so there is work going on here to speed up the logic. Temperature dependence of tunnel diodes is being studied. So is the current distribution within transistors designed for vhf and the capacitance in the collector-depletion area of uhf types. Use of alloy-diffusion techniques for vhf transistor production is giving production efficiencies of around 60 percent. A method of alloying aluminum to silicon bases gives low saturation resistance. Transistorizing of television receiver front ends is under way. Recent experiments indicate some promise that it may be possible to use ultrasonic methods of modulating radio frequencies. Ultrasonic drilling, dip tinning, soldering and welding are receiving much attention (see photos).

An Association, *British Iron & Steel Research*, is experimenting

with scattered light, photocells, d-c amplifiers and oscilloscope indicators to detect scratches in tin plate during high-speed production. In another area, the group thinks fatigued metals may emit energy of the order of one electron volt, perhaps because oxide is formed by fatigue, and that this energy might be detected with a multiplier amplifying to about 10^6 .

Products underway at *General Electric* include a high-frequency drift transistor and a subminiature point-contact diode.

Despite the fact that *Decca* is up to here in commercial radar business and looking ahead to such things as daylight viewing and possible combinations of pulse and c-w navigation systems that are strictly up its alley, there has been time to think of related things; maybe ships will also need computers on the bridge. There was some talk

about data-handling systems being about 10-percent computer and 90-percent buffer, and that many applications should use real time instead of all that buffer. Also, a constructional concept for transistor electronic equipment called environment stabilization is being investigated. Circuit elements are isolated from external ambient conditions and maintained at constant temperature and humidity. They are mounted in thermally insulated glass-fiber containers so as to minimize shock and vibration. Printed wiring boards on which transistors and other components are mounted employ a general-purpose pattern, with coding eyelets inserted to suit particular circuits. The boards are mounted in metal frames which also house preset controls and monitor points. Liquid cooling is used, and a conventional domestic refrigerator compressor extracts heat

your man. This is assuming you find the plant, sometimes unmarked.

In England, very small boys buss and hop around the hotels.

The French get liver trouble, not heart.

European children are still seen, rather than heard.

It is against the law to play a portable radio in Paris streets.

The concierge in some Italian apartment buildings charges admission, and turnstiles are not unknown.

The only way you can park a car in crowded Paris is to wait until someone else pulls out.

Citroen's Deux Cheval car looks like it is about to keel over when it turns a corner. But it doesn't.



French telephone bells would wake the dead.

An English lawyer, or his clerk, carries a red plush bag containing wig and gown by a gold tassel, is slightly reminiscent of Santa Claus.

In Scotland it is just Haig, not Haig & Haig. May be because a Scot can say it faster.

Yellow sugar is common in London, powdered lump sugar in Stockholm.

Europeans frequently have bread that tastes like bread.

A Turkish rug looks good, and

from the oil coolant. The company has also found time to develop an electronic system designed for offshore surveying, under test by the Swedes and soon to be demonstrated to the U. S. Corps of Engineers.

A conventional automobile constitutes the cockpit of a driving trainer, made by *General Precision Systems*, that by optical and electronic means produces on a large screen a realistic picture of the road ahead; since cars, poles and other objects along the simulated road are enlarged small models, if you "hit" one it actually falls over.

Honeywell, with a plant up in Scotland, has a financial interest in a company in London specializing in electronic medical equipment. "Computer diagnosis" could someday come from the work of companies of this kind. *EMI* seeks to convert some of its experience with scintillation counters for nuclear work to commercial applications, employs a consultant specialized in cybernetics. *Pye* says differential phase characteristics of most transistors make them difficult to use in transmitters designed for color work, thinks price reductions on suitable types may permit their use in a year or so, is one of the few manufacturers in England recommending production of television receivers using 625 lines as well as sets employing the 405-line U.K. standard.

FRANCE—A spokesman for *French Army Telecommunications* put his finger on several preoccupations peculiar to the country's needs, preoccupations that steer its research, development and design efforts to a considerable degree, when he indicated a continuing desire for higher power and higher frequency communications systems, search radar with longer range, passive detection equipment and more compact transistorized portable gear.

At *LCT* it was demonstrated that direct dialing of long-distance telephone calls is very advanced, but use of semiconductors for switching is not progressing as fast as with consumer goods because systems have to be compatible and cost

is still high. A considerable number of loudspeaking telephone instruments that are transistorized and even omit the conventional bell have been installed experimentally; they require 100 milliwatts, and a combination of various signal frequencies rather than power is used for operation. A new ground surveillance radar detects vehicles or pedestrians even if they are moving in the vicinity of fixed echoes 10,000 times larger.

Technical management at *CSF* called attention to a recently introduced droppable radio beacon with a nominal range of 60 miles, said their present 4,000 megacycle six-watt link equipment now handles 600 channels and might handle 900 next year and as many as 1,800 in three years. Tubes under development include high-power 30-megacycle klystrons for linear accelerators, wideband high-frequency tubes whose design is at present classified, carcinotrons developing 620 watts at 4,000 megacycles or 25 to 50 kilowatts at lower frequencies essentially for jamming applications, and high-power tubes useful for the production of plasmas. The research lab thinks the achievement of energies in the vicinity of 1.3 Bev could be obtained within a year, is seeking to develop neutral beams of organized ions and electrons and is also interested in ion-propulsion methods.

A sequential-memory color-television system for which relative freedom from noise troubles and elimination of tint or hue controls at the receiver is claimed is being refined; it uses an f-m subcarrier. The French, by the way, think a European color standard may come before the end of 1961. In the industrial field, there is an experimental model of a microwave surface checker that uses six rotating antenna heads to scan the surface.

At *CdC* considerable attention is being devoted to studies of the moisture in various gasses, with cooling obtained through conventional refrigeration units, liquid air and, more recently, Peltier effect. Magnetic earth-field detectors have been produced for some time and are undergoing further refinement. A cesium-antimony photocell

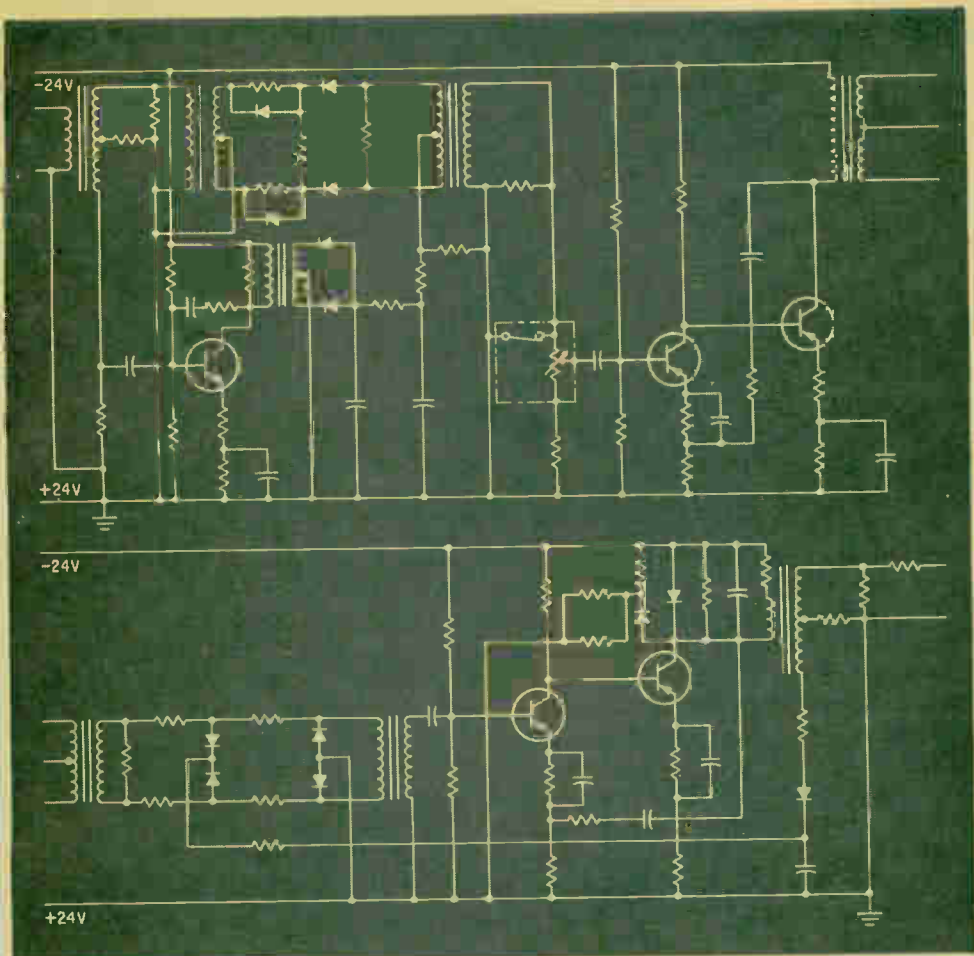

POWER LINE CARRIER—Basic circuits of transistorized Italian equipment (CEA Perego)

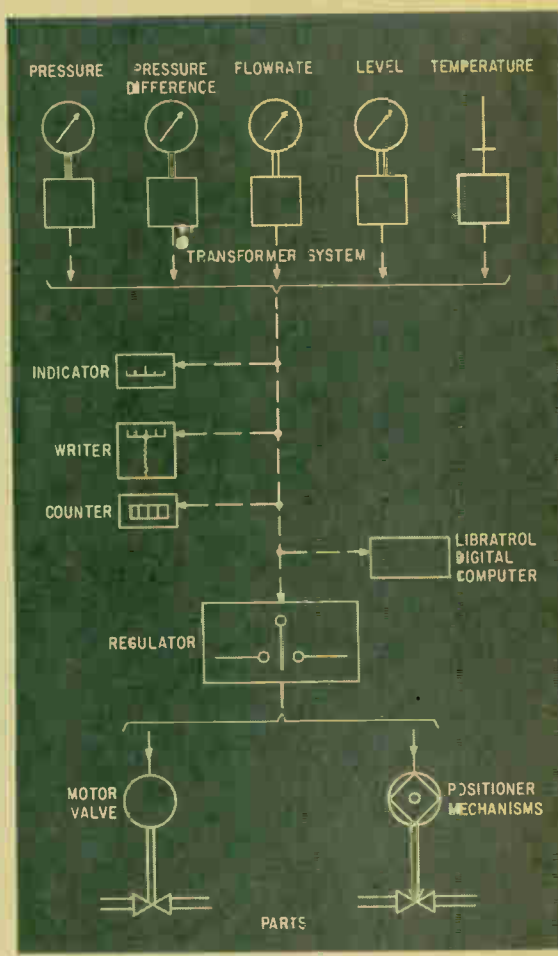

INDUSTRIAL REGULATOR SYSTEM—Heart of the device is a digital computer (Schoppe & Faeser)

is being used to measure the time delay in light pulses with equipment intended to determine cloud heights. There is also work going on in the development of slow-scan industrial television, and some in character recognition. Among other things, SACM research is working on transistorizing of broadcast studio amplifiers, the delta system of pulse code modulation, sonar and a railway signal system.

Single-sideband transmitters and other sophisticated communications equipment have been in production for some time at CFTH, so radar is currently getting more research and development effort. Five and 30-megawatt klystrons are already available and components for 100-megawatt units are being designed; the output tube may take a little time to debug, but a ring duplexer is coming along fast. An S-band

five-megawatt radar fights spot jammers in the following manner: A random frequency pilot feeds a signal to the amplifier unit, along with a local oscillator signal to the receiving circuits. The main part of this pilot is an amplifier fitted with a carcinotron which defines the local-oscillator frequency. The carcinotron oscillates at a different frequency at each repetition period, during the whole of the repetition period. The oscillation frequency is defined by a random step generator which feeds the stage at a suitable voltage chosen among a high number of voltage levels. The distribution probability of each frequency is approximately uniform in the bandwidth of the amplifying chain. The carcinotron signal feeds directly to the mixer circuits of the receiver along with a transposition stage where, by

beating with a fixed-frequency oscillator, corresponding to the r-f value, it is transposed to the transmitting frequency. The transposed signal, properly filtered, is pulse modulated and applied to the input of the transmitter amplifying chain. The amplifying chain consists of triode and klystron amplifying stages which bring the pilot signal level of a few milliwatts to the 10 kilowatts needed to drive the power klystron. The power klystron itself has its cavities tuned for the required wide band. It is pulse fed by a modulator having a pulse length near that of the r-f pulse fed by the preceding stages. The modulator is a standard delay line and thyatron type.

An air target indicator system developed by this same company rotates the antenna at twice the speed used for conventional ppi. The an-

COMMUNICATIONS EQUIPMENT IS STILL EUROPE'S STRONG SUIT



TRT's antenna on the Pic de Midi de Bigorre in the Pyrenees is the starting point for a tropo scatter system that relays French tv programs to Algeria by way of Mallorca



Television tower just outside Stuttgart. The five-ringed structure below the antenna is a restaurant; in some German installations they slowly rotate around the concrete support

Reps Are Rare But Up To Date



New building and service department of Stockholm operation supported almost entirely by U.S. instrument imports

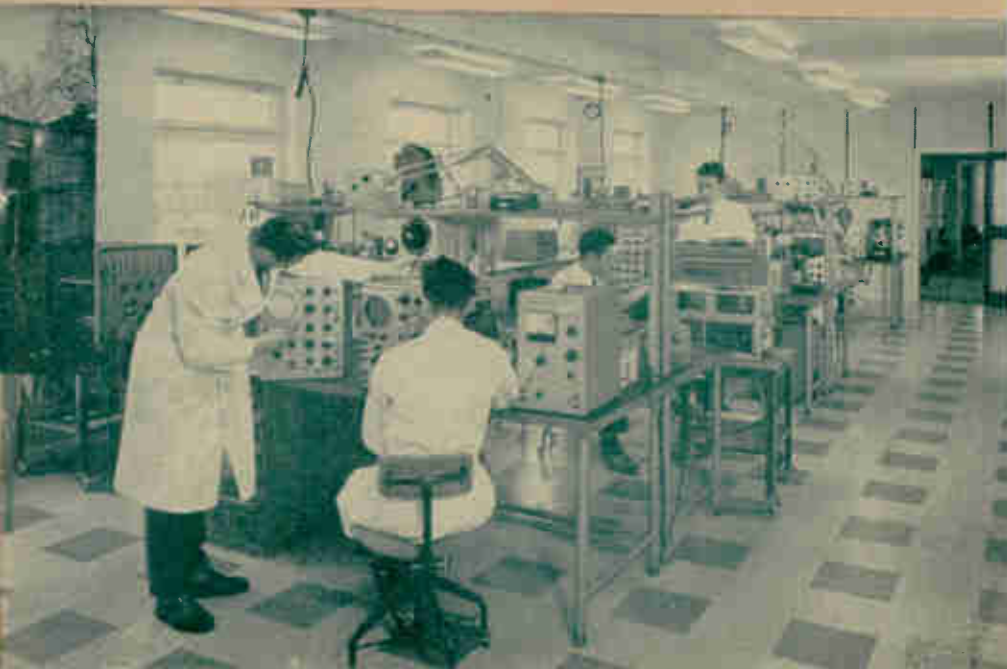



No matter where you are in Copenhagen's new airport building you see on slides, by DISA closed-circuit television, announcements of plane arrivals and departures. You also see and hear the girl who transmits these and other messages

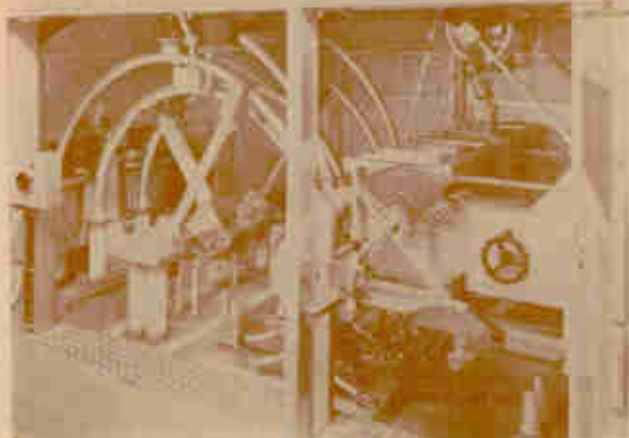

Final amplifier of a high-power Brown Boveri transmitter

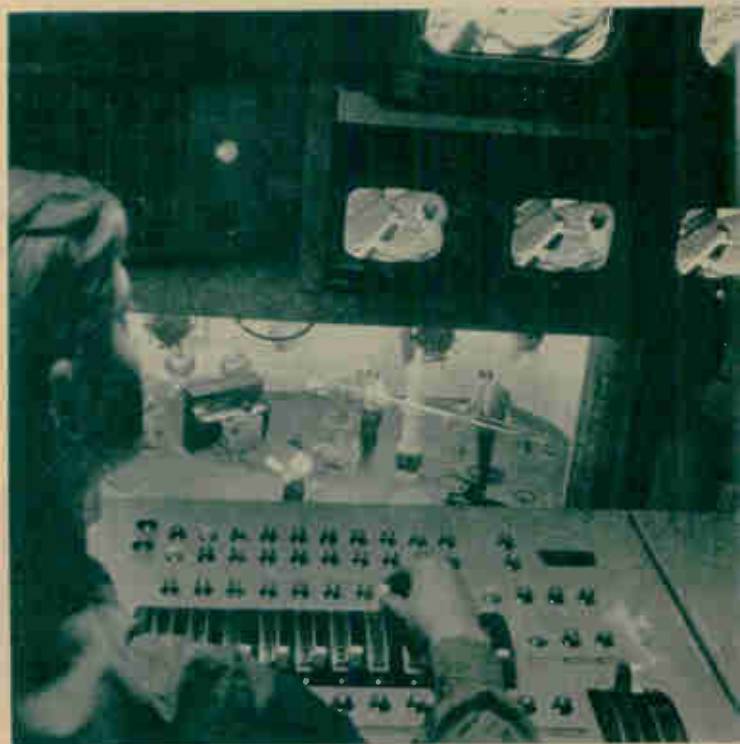

A British console with lever controls and a 44-inch image-orthicon camera with skew-type motor-selected lenses, by the same maker



Marconi's mobile wireless station

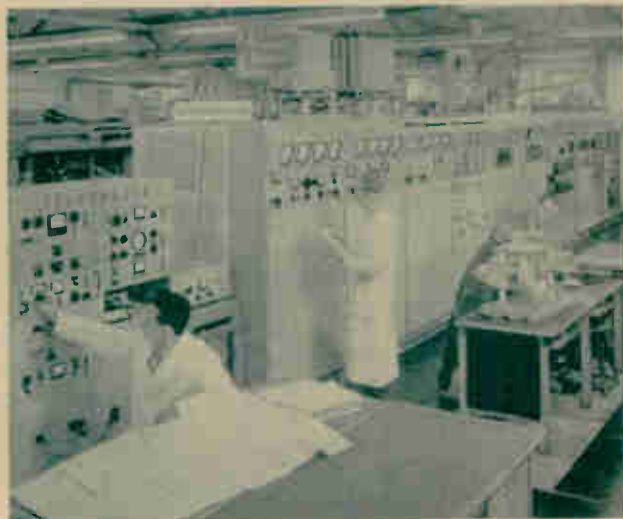

A 100-Kw Telefunken transmitter under construction

works good, on a cocktail table.

Spirits are rated in percent, not proof.

EUROPEANS ARE OLD FASHIONED BUT—

MOST AIRLINES and many other kinds of transportation use Navy time, i.e. 1200 is noon. And there is no need to confirm on domestic flights.

- Most countries have nationally uniform automobile driving rules and regulations.

- You blink your lights to pass in many places, and some cars have a switch that transfers the horn button to the lights for this purpose.

- In Germany and in Switzerland trucks, except those carrying perishables or emergency equipment, are barred from the roads on Saturday afternoon and Sunday to give pleasure cars a break.

- Plastic inserts in rear car windows prevent fogging; standard in several makes.

- The metric system is just about universally used.

- Outdoor vending machines sell many more things in Holland and Sweden.

- If you snap on the light switch just inside the door of a good hotel and then forget to turn it out when you hit the sack there is no need to get up. There is another one beside the headboard, possibly one on each side, and it is not unusual to have still others on the remaining walls. And separate switches or buttons are by your side to call the waiter, the maid or a bellhop. Several hotels patronized while doing this stint of work had magnetic door latches that could be operated from bedside, and a couple also had electrically operated do-not-disturb signs.

- In many of the top hotels you can get wet four ways. You can stretch out in water, sit in it, have it shower down at you or direct the spray with a flexible hose. In some cases the shower mixer is calibrated in degrees so you know what the temperature will be before subjecting your hide to it. Warmed towel bars are common.

- The French deliver local Paris mail from and to various substations by fast pneumatic tubes. In Italy there are mailboxes on some of the trolley cars to move it downtown faster.

- The Germans shove a vertical

tenna is a dual primary source that generates two separate beams, overlapping in a region where the radiation field of each beam is not less than two db below the maximum. The two beams are fed alternatively and automatically every 375 degrees of antenna rotation by a microwave waveguide switch. No dead sector or mismatching occurs during the 1/20 second switching time. To minimize rain echoes the dual primary source employs linear and circular polarization. Permanent echo suppression is accomplished by taking advantage of the fact that in a two stacked beam system the upper beam can be shaped so that it beams past fixed ground obstacles surrounding the radar without illuminating them, while targets flying just above receive sufficient power to give a good paint on the scope.

The firm of *Schneider* has automatic television set checkers at the end of its production line that turn sets, with all tubes in place, on for an hour, then off for an hour, for 24 hours. Alignment is done after.

Government-supported *CNET* is investigating basic problems in semiconductor physics, including recombinations in materials such as germanium with nickel, is doing considerable work with electroluminescence and the effects of various temperatures and pressures upon switching and memory action. The laboratory is also studying the theoretical possibilities of masers, looking at ion levels, fermi levels. It thinks lasers might provide highly monochromatic and directional reception at levels between 10 and 1,000 microns and provide a new tool in spectroscopy. It also thinks the technitron may provide fast bistable switching, though not as fast as the tunnel diode.

Over at *Bull*, preoccupation with a big data-processing system introduced just a year or so ago has not been so great that other things have not also come along. There is a fully electronic desk calculator in the works. Engineers are experimenting with a low-frequency parametric amplifier and ferrite-coil combination that could handle modulation at low noise levels. Frequently working with optics as

well as electronics, this company has done some experimental work with a tv camera having two pickup tubes and channels; a divided diaphragm and constant focus is involved. A 10-inch multiplier phototube is also contemplated.

At *LEP* some interesting work is going on with solar cells, types operating at about 11-percent efficiency for missiles and similar applications that justify high cost and types turning out from five to seven-percent efficiency that might be made for one tenth the cost. *TRT* has recently developed 12-volt battery-operated telemetering equipment suitable for oil operations in the Sahara; in this equipment the transmitter draws power only when, in effect, the receiver asks for it. Some of this firm's high-frequency radio-link equipment continues to use triodes in parallel in the final r-f stage to give some measure of reliability should a single tube fail and, what is more interesting, if the entire final fails there is sufficient feed-through from preceding stages to give some communication.

HOLLAND—Philips is involved in so many research, design and development projects, ranging from radio and television through anything you'd care to mention to electron microscopes, that it would be easier to report what this company is not delving into than what it is working on even if you knew. Here are just a few of the things presented to our ears and eyes while in the central laboratories:

As Europe heads toward color television standards there is considerable conviction at Eindhoven that assigned bandwidth is of greater importance than the number of lines; differences in line standards around the continent, it is felt, can be resolved through the use of converters. Sulphide phosphors appear to give color television picture tubes considerable brightness, and less trailing with motion, and there appears to be only slightly less saturation of greens than when using conventional phosphors; reds still require improvement. Computing techniques have captured the engineer-

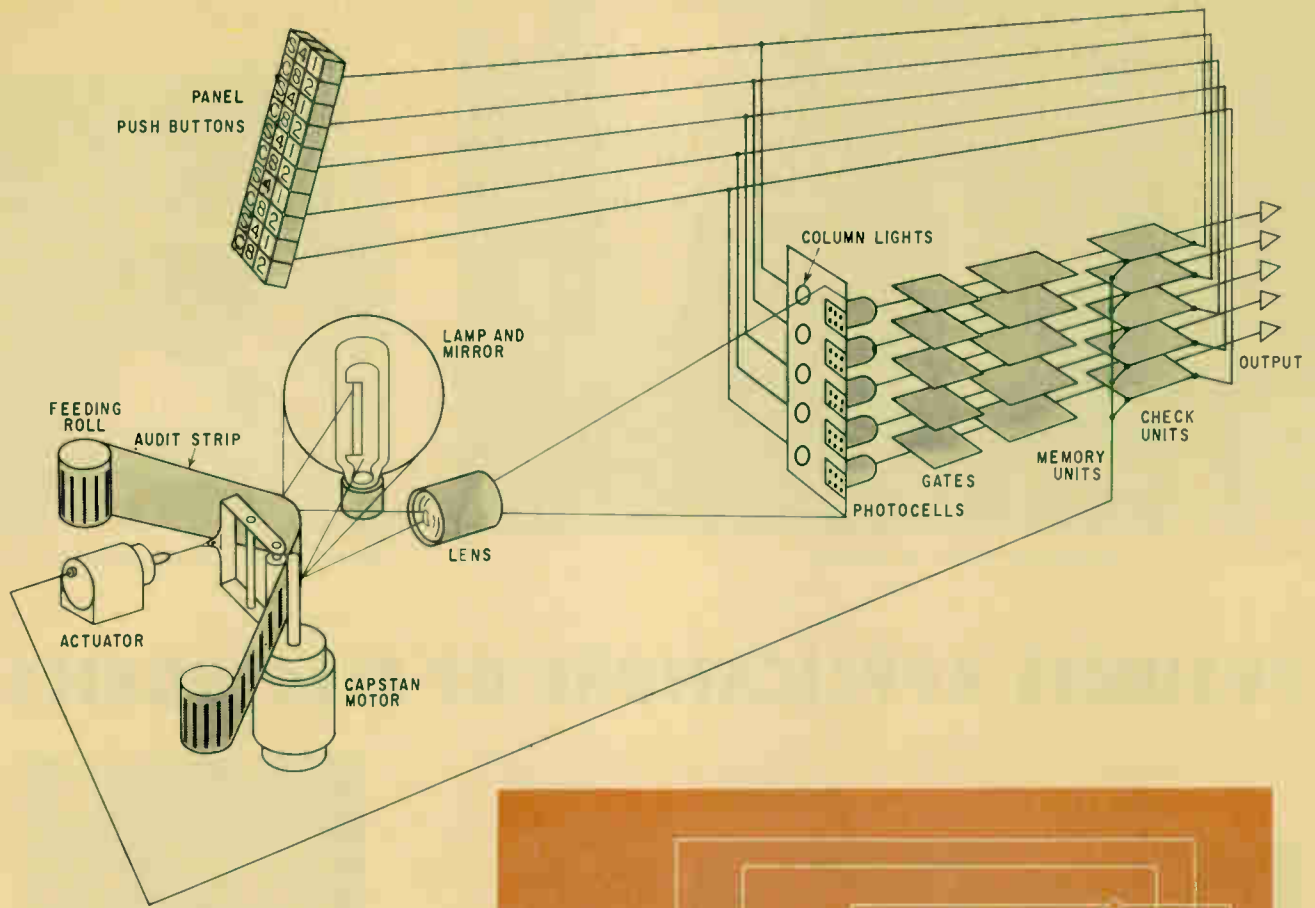

PHOTOELECTRIC READER — Audit strips produced by information originating in cash registers may be deciphered (Sweda)

ing fancy to such an extent that there is some speculation as to whether it might not some day be possible to build computer-coded radios and television sets that would self-select particular program types. With respect to more conventional application of computers it is felt that there will be a long-term market for both separate and centralized types; to avoid long waits at the various input points of the latter type there may be some virtue in remote storage and automatic load-switching systems.

In this big company there is a considerable degree of separation between research and commercial design, leading to byproducts that are not always in the field of electronics. Studies of the effect of radiation upon various materials, for example, led to the formation of a pharmaceutical business now

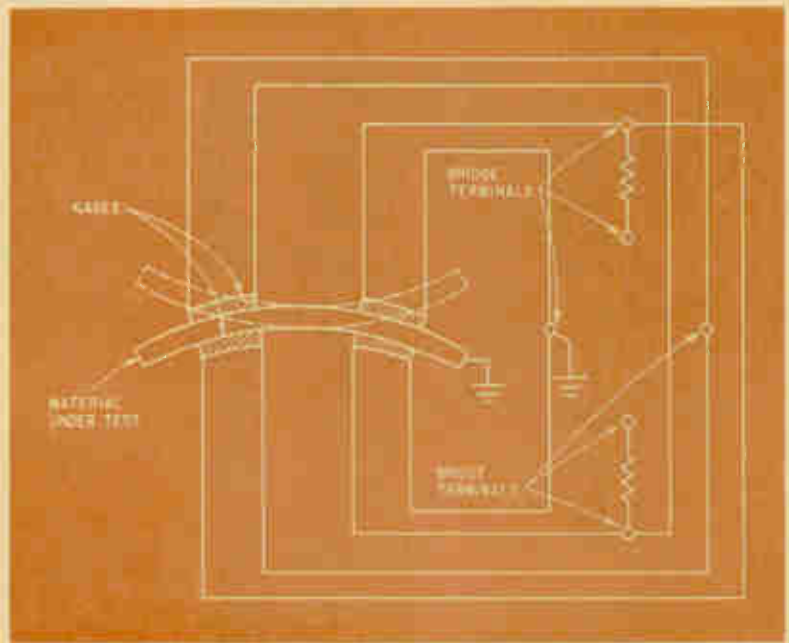

MEASUREMENT OF BENDING—Four strain gages compensate against temperature influences (Peekel, Rotterdam)

producing vitamin D.

Rubber-based strain gages made by Peekel measure 20-percent stretch or compression in such things as plastics, work fine for static measurements but require some special manipulation and interpretation when used for dynamic tests with this company's line of measurement apparatus.

There is also a sound-spectrum meter and a recording audiometer in the present instrument line and a multioctave variable-bandpass filter that is considered unusual. Equipped with built in amplifiers and attenuators, this device makes it possible arbitrarily to shape the passband from 15 to 16,000 cycles. The range is divided into eight con-



National-Elliott processing center in London



Facit computer center in Gothenburg, Sweden

BUSINESS APPLICATIONS OF ELECTRONICS



Fixed ferrite memory of a Ferranti high-speed computer under test in England



French magnetic memory of CdeC's design





Bull computer installation in Paris

ARE INCREASING



Electronic display for airports, by Ayrtohen



Decca is investigating type of construction in which all circuit elements are isolated from external ambients



whip on top of the television antenna and use it for regular radio reception.

• Quaint old-world music? Yeh, if you can hear it through the stereophonic juke boxes playing American rock and roll.

In Holland you can sell any kind of a cigarette, so long as it is labeled "American type".

If pea soup is at the top of the menu, and it is Thursday, you are in Sweden. It's an old army custom.

Laplanders put salt in their coffee; the snow from which they make it contains none.

Swedish hatracks seem very high.

The boss' office in many European plants has a double door.

Stamped steel radiators are found everywhere, take up less room than the cast kind.

Copenhagen airline stewardesses ride leg-powered scooters around the new terminal building, it is that large.

ELEVATORS

DON'T WAIT in front of the door for a European elevator without a catcher's mask; most of them open outward.

Don't lean casually against a wall once you get inside because two or more of the walls may move when the thing gets started. This assumes, in France and Italy particularly, that you do get inside. Four people make some elevators quite intime. And each door latch on the automatic types seems to operate in a different way. There may even be two additional little swinging doors inside. And if any of the latches on any of the doors are not firmly closed the machine may refuse to respond to button pushing until the concierge shows up.

In Germany, beware the "Pater-noster" unless you fancy your foot-work. These are constantly moving doorless elevators that operate like a Ferris wheel. Assuming that you want to go up, the first man jumps down, the second man steps nimbly

tigious bands, and the associated filters can be adjusted individually, with each linear attenuator calibrated in db. All filters can be used simultaneously, and the arrangement of front-panel controls forms a frequency-attenuation coordinate system that can be read directly.

Product diversification is proceeding rapidly at *Van Der Heem*. Among the latest interests here are underwater sound simulators that can be taken aboard a ship for training, a transistor marine receiver designed for standby or monitoring service, a panoramic unit that contains just five tubes, and single-sideband equipment. *Electrologica* is refining equipment that permits its computer to handle magnetic tape as well as punched-card input.

SWEDEN—The *Royal Institute of Technology* is directly or indirectly involved in many research projects of interest to both government and industry, as are other paraeducational institutions. High on the list of subjects being studied is the production and control of plasma; recent reports cover confinement of charged particles by a magnetic field, energy balance and confinement of a magnetized plasma, the motion of charged particles in a rotating plasma and diffusion processes in a plasma column within a longitudinal magnetic field. Ex-

periments with magnetic bottles or mirror machines in the United States have been closely watched, and construction of a multistage device of this kind is under consideration.

Acoustic analysis and synthesis of speech is of particular interest. It has been proposed that studies through 1963 cover the physical characteristics of speech waves and establish codes relating this structure to the units of speech messages and to speech production and perception. Following earlier lines of approach, special attention will be given to the prediction of speech wave characteristics from a knowledge of speech production data. This approach has been found fruitful as a means of deriving minimum redundancy schemes for speech-wave descriptions.

Other areas under study include the action of microwaves in plasmas, the possible use of plasmas as circuit elements including antennas, semiconductors and cryotrons, methods of producing longer-life electron tubes, methods of compressing intelligence to conserve bandwidth, methods of coding data fed to information storage systems.

At *Ericsson*, where legend has it that a man out in the shop devised the first telephone handset in the country by lashing a microphone and a receiver to opposite ends of a cut-off broomstick for his own

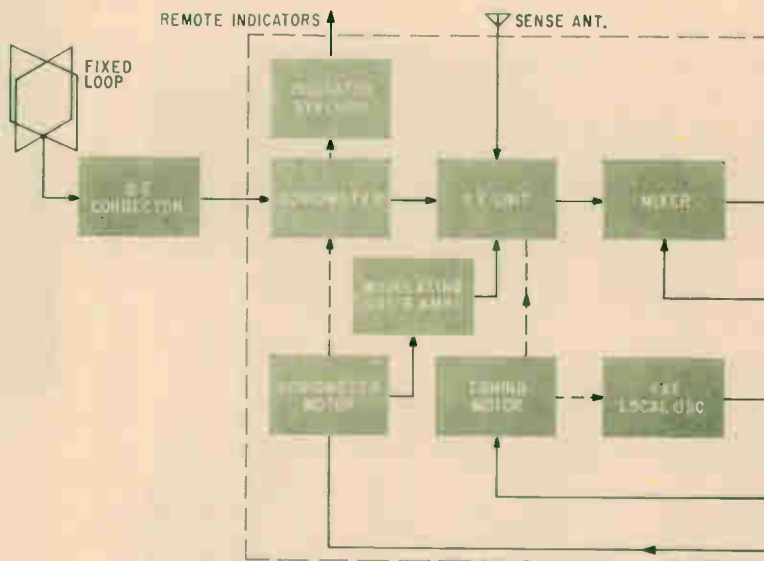

AIRCRAFT ADF — Crystal controlled tuning system permits

convenience, development of an electronic exchange to handle traffic from an airforce helicopter fleet is underway; when this work has been completed the equipment will be built and installed overseas by an affiliate. Deliveries are just starting on a fast-dialing 12-mega-cycle carrier system. A time-division multiplexing system using computer principles and transistors and ferrite memories is under development in the lab.

Latest version of the company's one-piece loudspeaking telephone instrument uses semiconductor diodes and transistor amplifiers. It is voice operated, that is the direction of speech is determined by the relative voice levels of the people at each end of the line. Under idle conditions the gain is low, and the attenuation is about 20 db below the working level for both amplifiers. When one amplifier comes up to the working level the other is further suppressed. Four pads are used in the voice-control bridge, two causing diminishing attenuation with increasing current and two causing increasing attenuation with increasing current. There was no feedback, and no clipping of speech that could be attributed to one way operation was noted in normal conversation.

In addition to price tag and tape punches, *Sweda* now also offers an electronic reader for printed audit

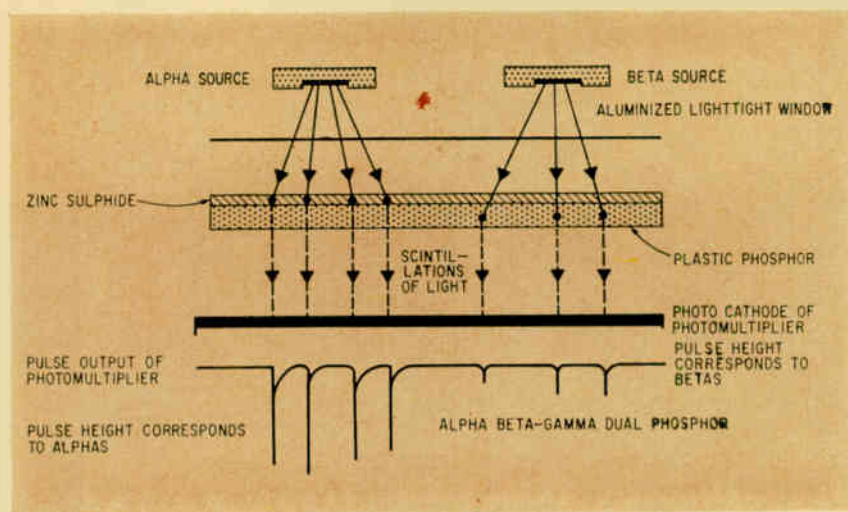

DUAL PURPOSE SCINTILLATION COUNTER—Two kinds of radiation are measured simultaneously (EMI Electronics, Ltd.)

strips. *Facit*, working on a special-purpose data-processing machine designed to work as a simulator for the test and final development of an electronic defense system needed by the air force, has further improved its "carousel" memory, previously reported in these columns, and should be introducing a new computer model about the time this special report goes into the mails. *Saab*, continuing to gravitate toward our business as an outgrowth of its use of electronics in the automobile and aircraft field, is making fire control gear, an infrared gunsight, a hit

indicator. There is also growing interest in numerical control of machine tools, although applications to date have been largely for internal use, and the production of electronic instruments for commercial applications has proceeded to the point of releasing preliminary sales information. *ABN* has a new loudspeaking hand-free telephone design. As a side activity, several of its people are studying possible use of computers to diagnose common diseases; they think that by asking 10,000 patients 250 questions on a printed form it might be possible to program so that perhaps 75 diseases could be narrowed down to give doctors a choice of three probables for personal diagnosis. They also think the approach might lend itself to mental as well as physical ailments.

WEST GERMANY — Speaking generally, preoccupation with production could easily cause this highly prosperous country to fall behind in its research and development and affect business in future years. Interesting work is, nevertheless, going on in widely scattered places, decentralization of industry being one of the first things noted about this partitioned land.

Management at *Minneapolis-Honeywell* expects to build a new plant soon to take care of an order for F 104 flight-control equip-

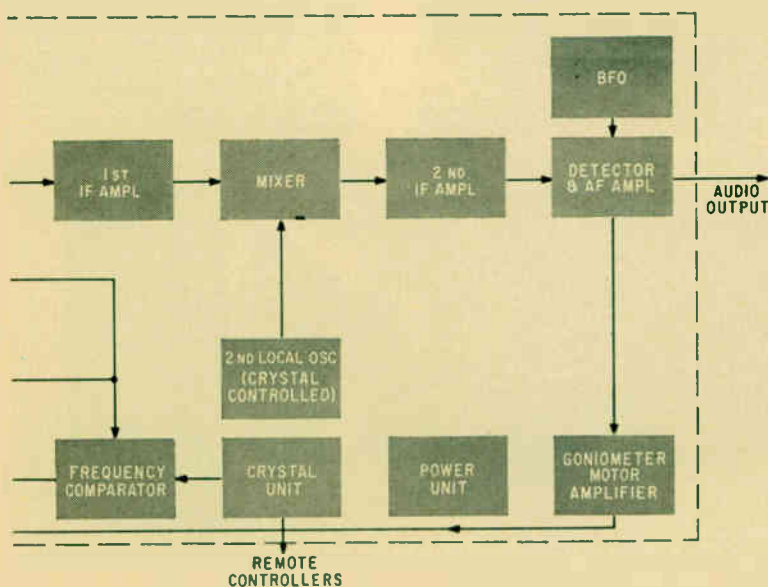

rapid frequency selection in 0.5-Kc steps (Marconi's)

INDUSTRIAL

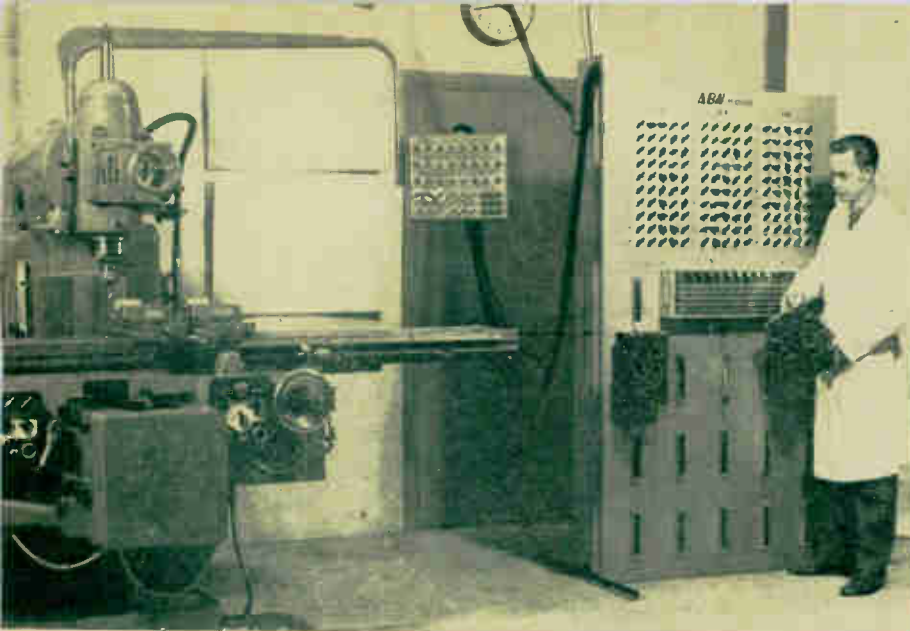

Swedish ABN's milling machine control, and a piece that formerly took two hours now turned out in 18 minutes



ment, thinks it will also soon be producing more U. S.-designed data processing equipment abroad. *Hartmann & Braun* is becoming interested in using transistors, particularly silicon types, in its broad instrument line, but thinks they must have life guaranteed as long as the tubes now in use for widespread industrial application. Controls for reactors also intrigue this firm.

At *Rohde & Schwarz*, where one of the principals is an engineer's engineer and says he wants to do more business to get more money so he can hire more engineers, has just finished designing a self-tuning vtm covering from 10 to 1,200 megacycles. The company is shipping a device that gives a two-channel frequency response display for two and four-terminal network measurements. In principle, there is in the sweep-signal generator section an oscillator which is frequency modulated from the power supply, producing a swept-frequency signal. The center frequency of the band swept through is adjustable in five subranges covering a total of 0.5 to 400 megacycles, the sweep width about the center frequency being continuously variable between plus or minus 0.2 and plus or minus 50

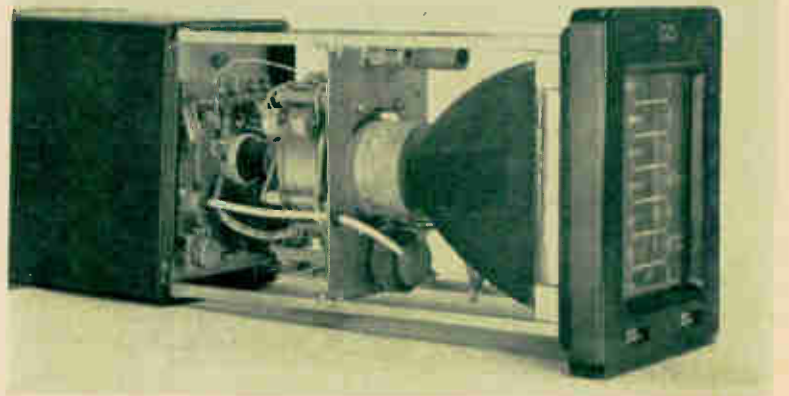

Boiler water level indicator designed by CdeC and currently coming into use in France

and **MEDICAL APPLICATIONS SLOWLY GROW**

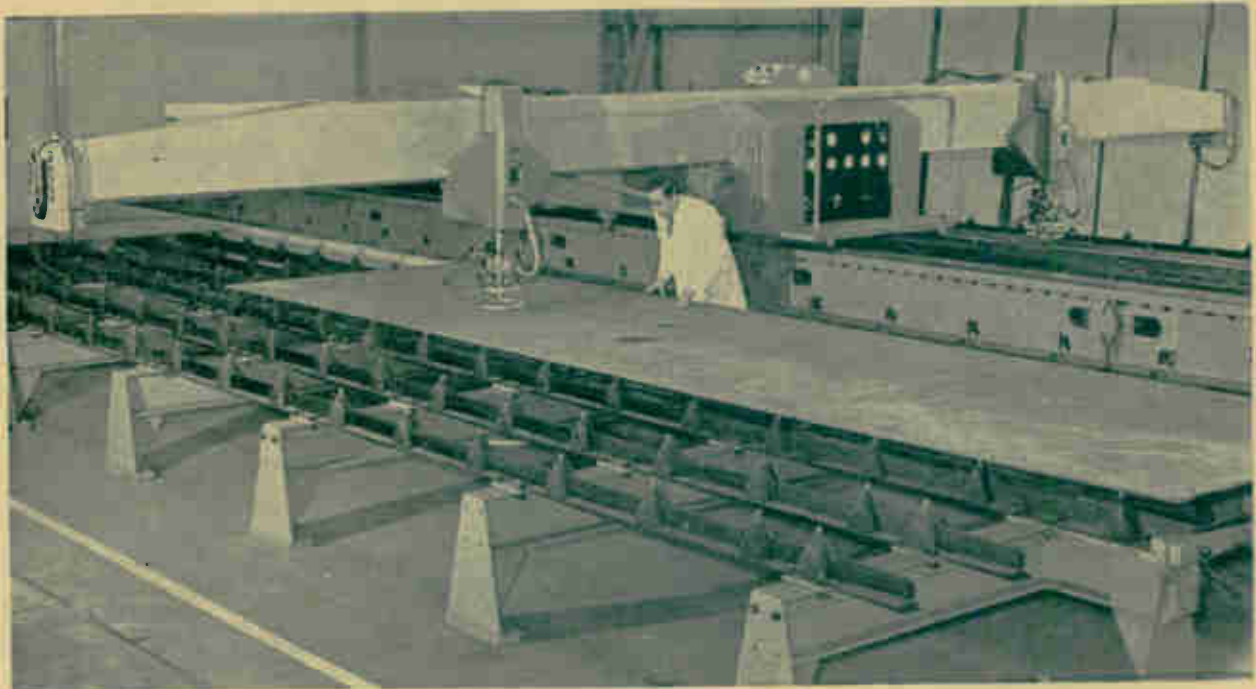

Magnetic-tape computer controlled oxyacetylene ship plate cutter developed by British Oxygen with help of Ferranti

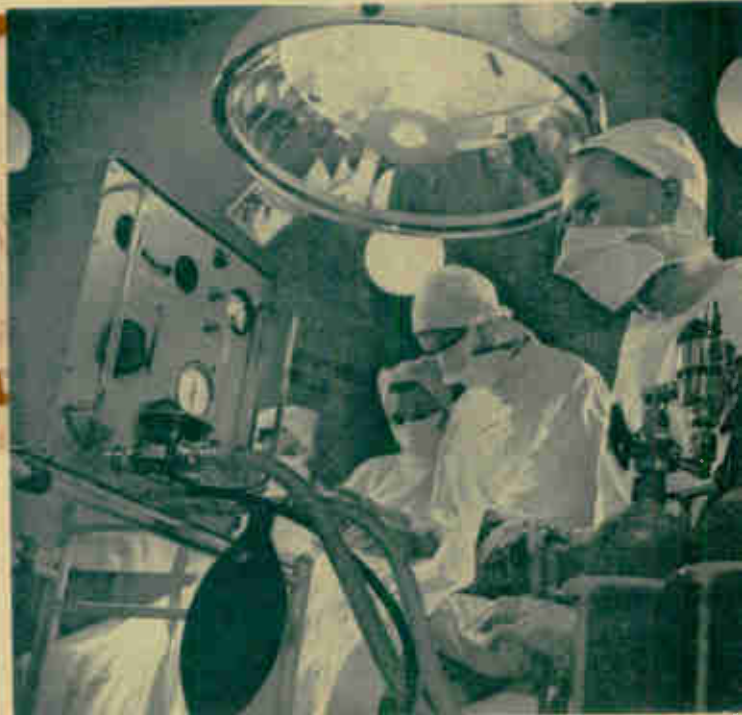

Portable electronic lung developed by Pye, and an electronic stethoscope



Stimulator designed by Peekel of Holland to assist in the breeding of cattle

across as the lift comes level and the third jumps up while keeping a weather eye upon the rapidly approaching ceiling.

In Spain, don't try to ride down in an elevator, ever. It is against the law.

The word Perron, seen on a Dutch railway station, does not mean that's the name of the town.

Europeans, with the possible exception of Italians, smoke less than we do; part of the reason is the very high cost of cigarettes.

Dutch gin is an acquired taste; tabs are often saved for tax deduction.

In Holland, the trains show pictures of the country's beauty spots, not ads.

Koln is Cologne, Munchen is Munich, Bayern is Bavaria; I wonder why they had to be Anglicized.

American ease in any kind of company is sometimes taken for arrogance.

If you rent a German apartment you put in your own lighting fixtures, shelves, closets and water heater; yet the newer ones are extremely modern otherwise.

A paper doily slotted around the stem of a beer glass prevents drip.

Salted butter is virtually unknown in Europe.

Cigarettes come in tens as well as twenties; probably also a matter of price.

If a car overtakes your Volks in Germany it is probably a Mercedes.

German office buildings and factories often rise many stories despite lots of available land outside; the law requires so many square feet of natural lighting per worker and you gotta have glass to comply.

Einstein was born in Ulm, on the Danube or, more properly, the Donau.

Ski's are often carried to and from the mountains in a rack on the back of the car that makes the set-up look like a papoose.

When a car cuts you off on the Autobahn, or any German road for

megacycles. The source impedance is automatically adjusted to zero. And attenuator permits adjustment of the generator output voltage in 10 decibel and 1 decibel steps between 100 microvolts and one volt. The voltages of interest at the input, interior or output of a circuit under test are applied to two identical channels which constitute the display section, are variable in gain and switched at power-supply frequency. Passed on to a large-screen picture tube, these voltages are displayed as a function of frequency, as two patterns over a horizontal frequency axis. Crystal controlled or external frequency markers of selectable density provide a frequency scale whose length corresponds to the sweep width of the sweep signal generator. The vertical scale, a replaceable clear plastic graticule with linear subdivisions, is calibrated by reducing the test voltage in accurately known steps, using the attenuator of the sweep signal generator.

At *Standard Elektric Lorenz* development investment continues to go heavily into further refinement of multichannel radio links, including antenna systems. Semiconductors are under close study as possible replacements for conventional relays. Components to go with transistors are likely to be made here soon. *Hewlett-Packard* is starting to manufacture some of the simpler instruments in the parent company's line, and local management hopes to build enough income in this manner to support original development of other types

it thinks are of particular interest to Europeans.

The range of research and development at *Siemens* has been and is so extensive that it can only be highlighted here: Organic plastic capacitors are under study, and so are organic semiconductors. Magnetic materials, particularly ferrites, are being materially improved. Two approaches to miniaturization and microminiaturization are being tried, one using stacked wafers shaped like the nicely nested cells in a honeycomb and the other employing deposited semiconductors, capacitors, resistors and other circuit elements arranged as a homogenous mass; the first is well along, the second just getting started. Mesa-type transistors are in preproduction, tunnel diodes good to 10,000 megacycles are already being made at the rate of about 2,000 per month for the company's own use. Magnetic films of between 500 and 1,000 angstroms are being examined under an electron microscope, using newly developed measurement techniques. Latest thin-film studies are working toward nanoseconds instead of microseconds. On the equipment side, single-sideband transmissions are being tried in connection with multichannel equipment operating around 400 megacycles; problems with selective fading are noted when using ssb in scatter systems.

Diversification has been proceeding rapidly at *Telefunken* since 1958. There may soon be some offerings in the missile control field. Talk about color television across

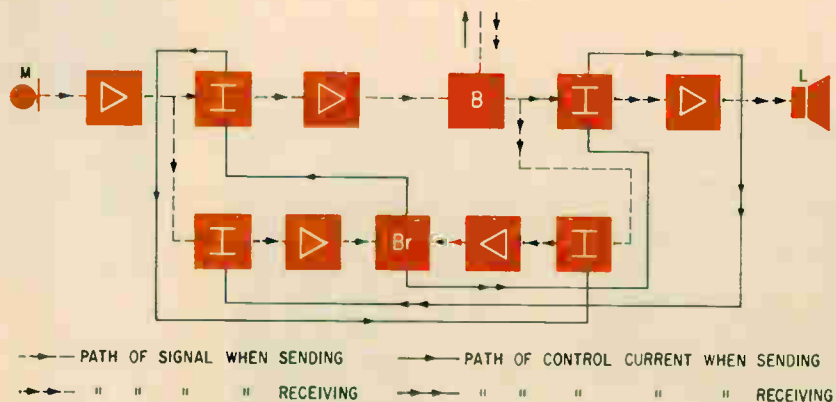

LOUDSPEAKING TELEPHONE—Voice-operated unit controls gain of two amplifiers to avoid feedback (Ericsson)

the border to the East is forcing attention to design in this area to meet a possible demand in the West. Scatter transmission systems were built and operated successfully by brute force before the principles of operation were fully known; now researchers are backtracking and learning the reasons. Mechanical filters, available for some time, are now being miniaturized. They use connecting bars under torsion between elements, are piezoelectric in principle, the individual elements can be pretuned in production and are not materially affected with respect to frequency by subsequent welding and assembly operations. Transistorized laboratory instruments for radiation measurement will soon constitute a specialized line, may lead to development of a broader line of electronic instruments. New direction-finding techniques, lending themselves to operation close to the East-West border, are being sought by this company.

More explosion-proof controls are needed for critical industries such as the coal industry; German specs are stiffer than U. S. for such uses. So *Schoppe & Faeser* is putting much of its effort into such controls. There is also a lot of work going into continuous control of industrial processes, and the firm is beginning to use transistor amplifiers. One new instrument is entirely electronic in operation. *Valvo*, making a widely diversified line of tubes, says c-w magnetrons for higher power are under development, thinks these will be needed in increasing quantity for electronic cooking and the drying of such things as fibers, salt, soya beans. Increasing application of magnetrons in medicine and industry is also expected, so there is some effort going here, too.

SWITZERLAND—Electrical and electronic items including component parts must meet fairly stiff tests before they can be sold in this country, and *Swiss Electrical Testing Institute* does the testing. They are especially rough on devices that cause radio interference between 150 and 1,500 kilocycles and the government has recently extended its interest to performance of receivers designed for f-m

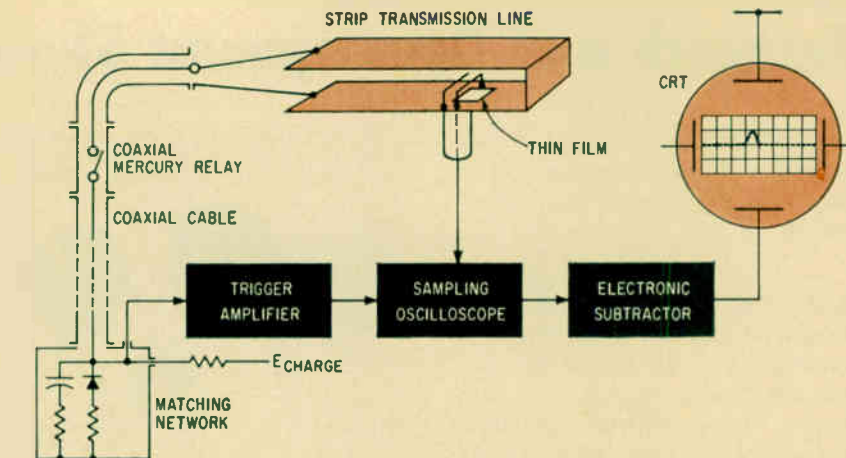

Setup for measuring fast switching times in thin magnetic films (IBM, Switzerland)

service. Signal-to-noise ratio must be greater than 35 db with an antenna input of five microvolts. Distortion factor must be less than three percent with antenna input voltages between 10 and 100 microvolts for all modulation frequencies between 60 cycles and 10 kilocycles. There must be maximum attenuation of two db for a frequency deviation of plus or minus 300 kilocycles. Signal-to-noise ratio must be at least 40 db when the desired input signal of 150 microvolts is mixed with a 10-microvolt adjacent channel signal. Image frequency attenuation must be greater than 40 db and i-f attenuation greater than 100 db. A one-to-20,000 change in amplitude-modulated input signal from five to 100 microvolts should not alter the audio output voltage by more than four db. With a signal of 250 microvolts at the input and a noise pulse train of one microvolt amplitude and 10^{-7} sec pulse width, the signal-to-noise ratio at the loudspeaker terminals should be better than 30 db. The oscillator frequency should not change by more than 20 kilocycles during five minutes of operation with outside temperature changing from 15 to 30 degrees C or plus or minus 10 percent in power-line voltage or a change of antenna input voltage of 60 db. Radiation from the oscillator should be less than three microvolts per meter measured at a distance of three meters from the receiver.

At *Brown Boveri* new techniques will be based largely on semicon-

ductors, but single-cavity turbomagnetrans, which are velocity-modulated magnetrons, are also being refined and now turn out up to one kilowatt. New machine-tool controls use analog-digital converters. Microwave link equipment has automatic frequency control fast enough to handle frequencies as low as 30 cycles with pumping effects.

Basic research, coupled with advanced research in only a few cases and entirely divorced from commercial activities, is the role of *IBM's* research center. Under particularly close study at this time is the fundamental behavior of magnetic films down to five angstroms in thickness. Involved are electron spin characteristics, rotation that might permit shifts in time of the order of 10^{-9} second with perhaps five oersteds of magnetic switching force, behavior of block walls, environmental effects. Application of thin films is also being studied in connection with microwaves, detection devices, radiation and pressure transducers. A mechanical filter is under development. And a group has just been formed to do basic research in semiconductors.

A new plant nearly completed and already partially occupied by *Autophon* will turn out radio-link equipment, a portable uhf transmitter-receiver, selective calling systems for mobile use. The company is also becoming more active in the design and production of numerical signaling and communication equipment, has auxiliary

Research and Development Shows Great Promise

equipment almost ready for shipment to a major American airport that already has some gear in operation.

ITALY—*C.G.E.* has set up a specialized electronics department, is starting to build industrial controls employing transistors to supplement the magnetic amplifiers made for some time. It is also designing a punched-tape positioning control for European machines it thinks may require greater precision than is offered by systems currently available; some U.S. controls are considered fine where large volume with moderate precision is the major requirement. *International Rectifier* is sponsoring a plant to make semiconductors this coming fall.

The firm of *Mial*, a major component parts manufacturer, is expanding in the southern part of the

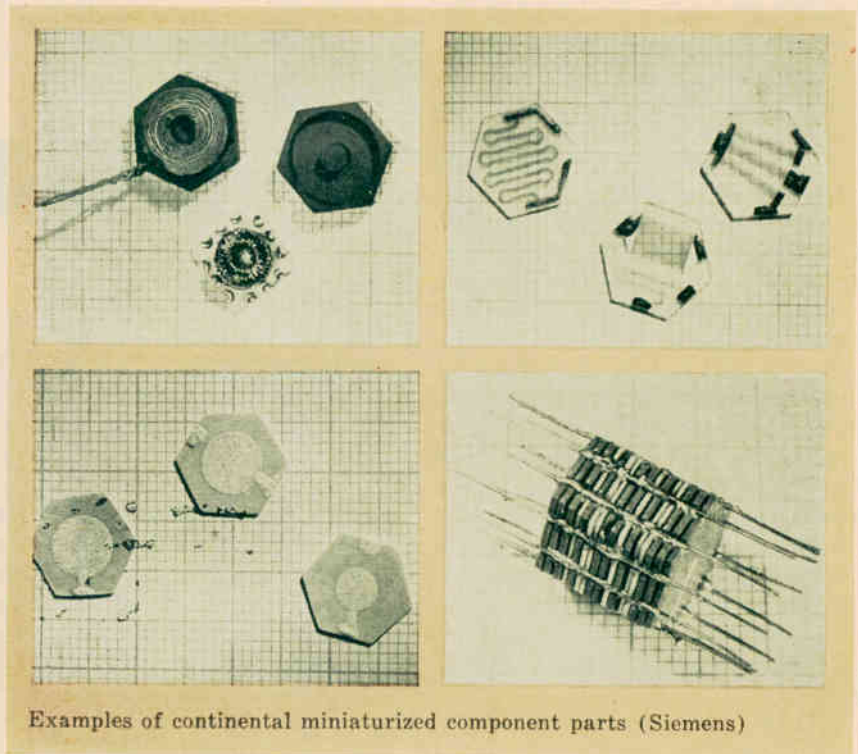

Examples of continental miniaturized component parts (Siemens)

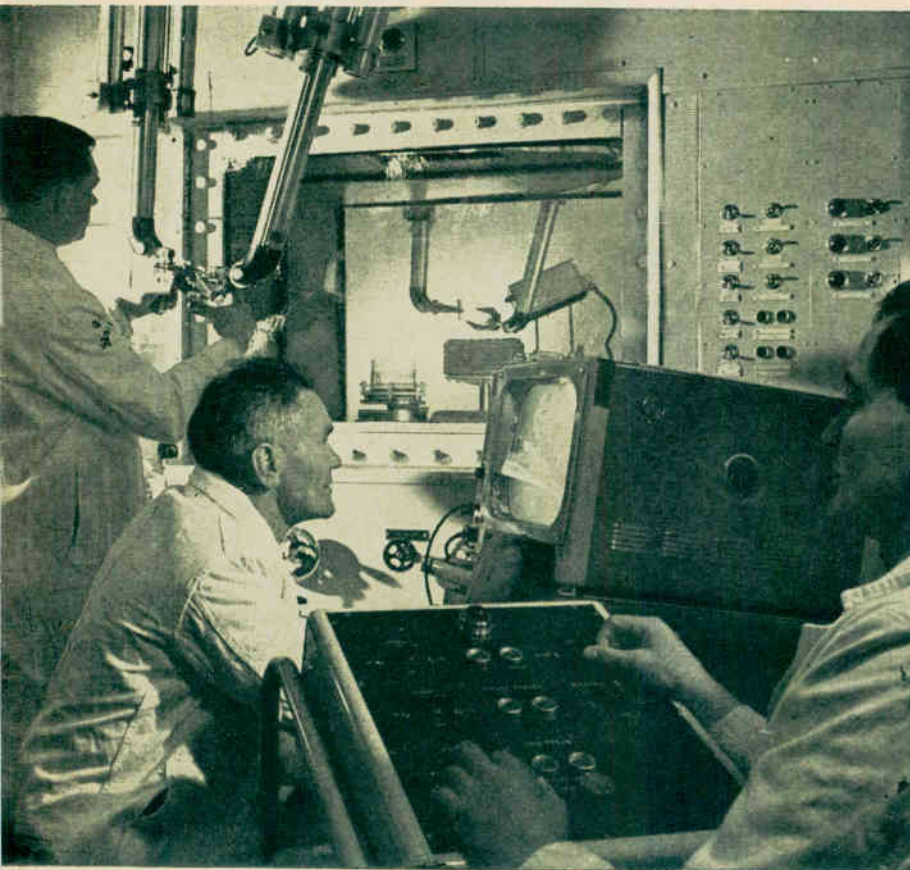

Electronic manipulators of a breeder reactor in England

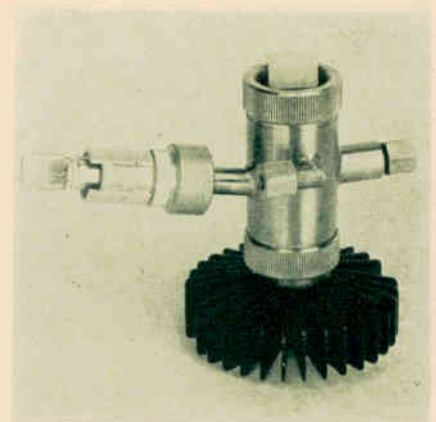

CdC condensation type hygrometer with mirror cooling achieved by Peltier effect through n-p semiconductors

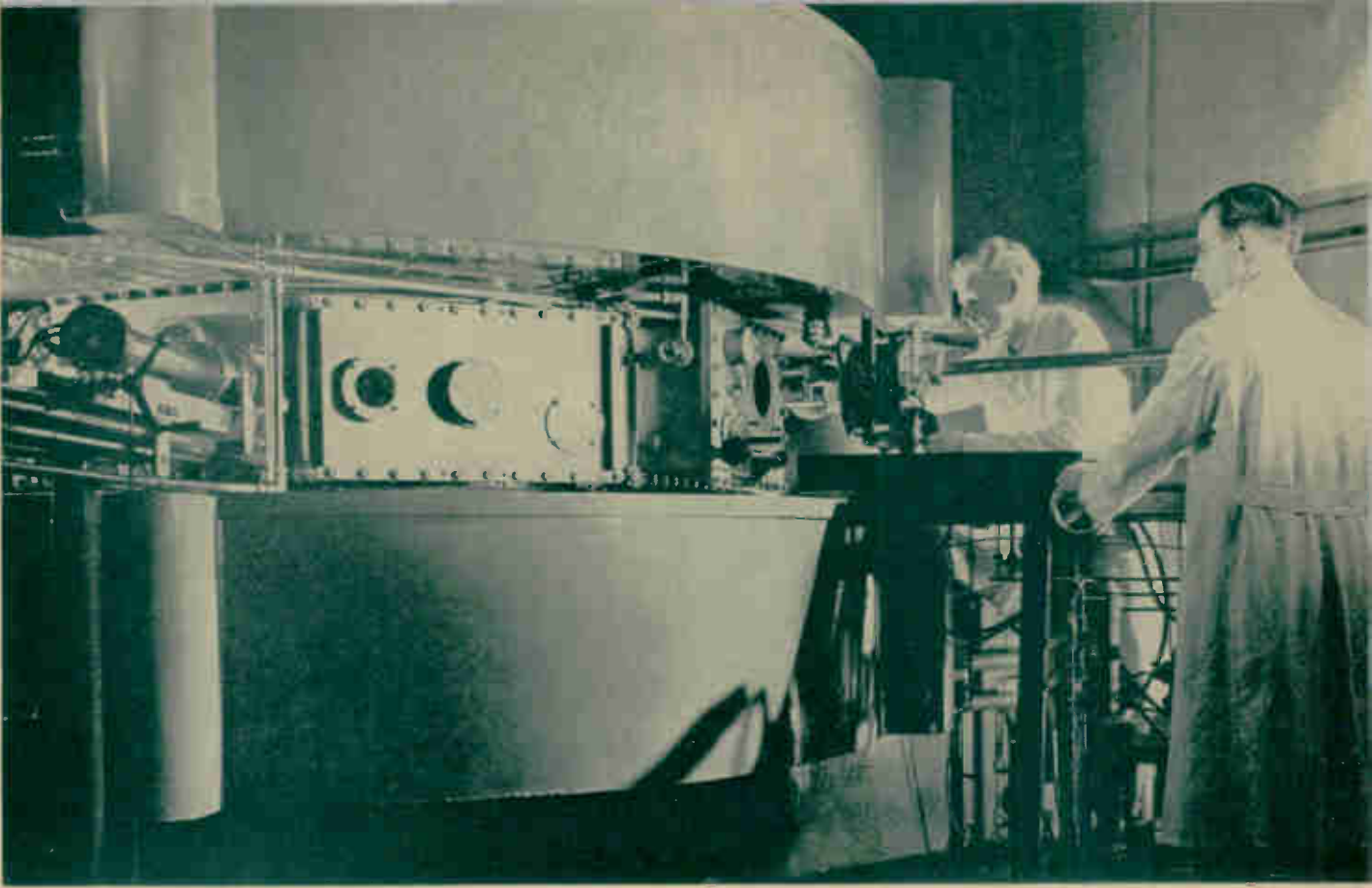

Adjusting a European synchrocyclotron

CSF linear accelerator at Orsay Faculty of Science

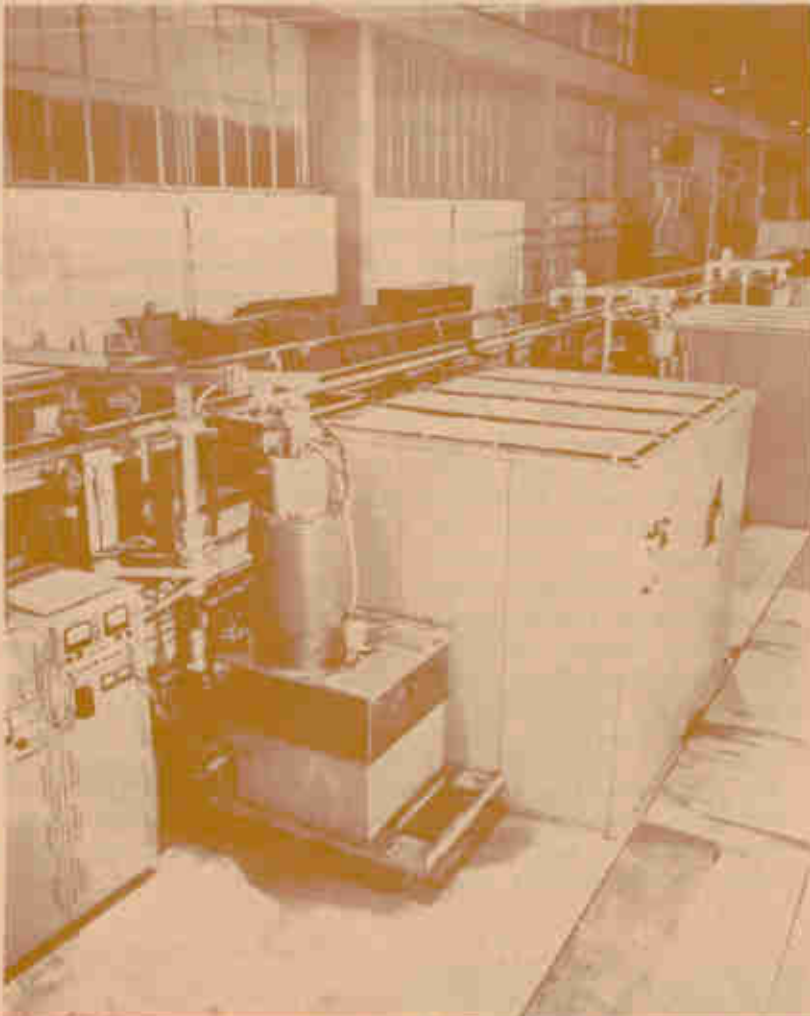

Explosion of a firecracker, pictured with the aid of a Mullard image converter tube

that matter, you waggle your index finger at it and look disgusted.

Community eating around one large restaurant table is common in Munchen, and many other towns in South Germany.

Germany bars Russian and other caviar containing boric acid.

Around some Swiss plants you will find slots in the stone curbs to hold up bicycles.

High poles outlining the entire shape of a building you are planning to erect in Switzerland warn the neighbors; if too many object to obstruction of their view you don't build.

Swiss schoolteachers are elected.

Many secretaries make more than many engineers.

The Swiss export complete chalets.

In Italy, try the faucet marked "C" before you plunge; it may mean caldo, or hot.

Much of Europe has waiters to wait on the waiters.

Nobody asked me but . . . to fix it so that nobody will: The most universal word in any language appears to be 'Allo. Wander off main street in almost any European city and you'll hear it spoken, gently. The only way to avoid foreign entanglement is to have a very strong character. Or to be my age.



country, says the trick in converting agricultural workers down there into good factory help is to feed them heavily and well and not worry too much about breaking the habit of taking the middle of the day off; steady incomes soon have the whole family enthusiastic about the changeover but it takes time and patience to accomplish it. Production efficiency is then greater than in the north. Factory equipment must be complete and self sufficient; tools and services and materials cannot yet be quickly found right around the corner.

Study of vacuum techniques in the manufacture of semiconductors is starting at *C.I.S.E.* Pulse height analyzers of the type used in nuclear work are being used to study noise in semiconductors. An industrial tv unit has been built to watch operation of a van de Graaff generator and there is some thought that the output of a radiation counter might be used to automatically focus the camera. *CEA-Perego* is developing semiconductor types to go with its magnetic controls, is further refining digital data logging equipment for industrial plants, has just transistorized its carrier communication and remote switching line. A slave manipulator for nuclear work has been completed.

At *Olivetti* the application of parametrons and tunnel diodes to computers is being closely studied. Interest is currently high in development of small and medium-size computers that can be sold at a low price. *Marelli* has increased the capacity of its high-frequency link equipment to handle 400 channels, hopes to have 20,000-channel equipment soon, is pushing radio versus coaxial cables to avoid damage by earthquake and avalanche. New links, using some passive repeaters, are under development for an additional tv channel; they'll be up around 2,000 megacycles. A shell-type microwave antenna is in the works. *Fiat* is working on electronic ignition systems, logic circuits for computers, a proximity sensor, a d-c chopper amplifier and numerical control for machines.

European customers often ask for products with better than U.S. Mil-specs, according to *Selenia*. Specializing in radar and microwave communications equipment,

this company is taking a flyer at other things. Among them are railway signaling systems, some missile work, meteorological devices, sine-wave-output high-power inverters. Work is also in progress on a digital data-handling system for a radar net.

The *Institute of Telecommunications* is studying data transmission, color television, semiconductors for computers, use of analogs for the solution of general engineering problems. *Autovox* is making radiosondes and portable transmitters in addition to its broad line of consumer goods.



From the above random samples it should be evident that European electronics is well along in development, although not necessarily along precisely the same lines as in America. There is a distinct impression after three months on the ground that continental engineers may be unnecessarily modest about the state of their art and that at least part of this feeling can be attributed to the fact that they have known much more about what is going on on our side of the ocean than we have known about what is going on on theirs. Among the reasons why this is so is the relative freedom and speed with which new U.S. developments are disclosed in the technical press, which is closely followed overseas.

ELECTRONICS itself has been responsible for the dissemination of much knowledge concerning American developments abroad, and has also recently described some of the things that are going on in other countries such as Czechoslovakia (February 3, 1961) and Hungary (February 17). Similar information will soon be forthcoming concerning Norway, Finland, and Spain. In addition, the overflow of material from this special report and, particularly, receipt of more detailed technical material solicited while gathering material for it in Europe, will in the months ahead add further to the international flavor.

**FIRST
PORTABLE
LOW COST**

DUAL GUN OSCILLOSCOPE

Featuring ★ DC to 5 Mc Bandwidth ★ 1 mv/cm sensitivity ★

AT HALF THE EXPECTED PRICE **\$495**

Available now for the first time — the only light weight, 5 Mc dual gun oscilloscope with all these features:

VERTICAL AMPLIFIERS: DC to 5 Mc bandwidth (3 db); 70 nanoseconds rise time; 100 v/cm to 100 mv/cm on both amplifiers, 1 mv/cm preamplifier on lower amplifier.

INPUT IMPEDANCE: (each channel) 30 picofarads across 1 Megohm.

HORIZONTAL SWEEP: 1 microsecond/cm to 1 second/cm in 5 steps.

TRIGGER: Internal; free running, or with 0.5 cm excursion by either beam; External; ± 0.5 v to 2.5 v ; TV frame and TV line.

WEIGHT: 22 pounds **SIZE:** 9½" x 8½" x 13"

Price: Model 5Mc-2 Oscilloscope with 2 Probes \$495.00 Immediate delivery. All prices are quoted f.o.b. Los Angeles, and are subject to change without notice.

For complete information and demonstration contact nearest representative.

Anderson-Stone Engineering, Newton, Mass.
Brogan Associates, Mineola, Long Island; Syracuse, New York
J. E. Cuesta Company, Paoli, Pennsylvania
Datronics, Houston, Dallas, Fort Worth, Texas
Kittleson Company, Los Angeles, Palo Alto, California
S. S. Lee Associates, Washington, D.C.; Baltimore, Maryland;
Winston-Salem, North Carolina; Orlando, Florida
Pivan Engineering, Chicago, Illinois; Indianapolis, Indiana



Packard Bell Electronics
ENGINEERING BEYOND THE EXPECTED

12333 West Olympic Boulevard, Los Angeles 64, California

Highly Reliable

HITACHI "SEMI-CONDUCTORS"

For Industrial Use
Switching Transistors and Diodes

2SA13
2SA41
2SA42
2SA85
2SA208
2SA209
2SA210
2SB63
2SB67
2SB68
2SB81
2SB82
2SC89
2SC90
2SC91

Hitachi semi-conductors provide the basis for the excellent capacity of the Hitachi Electronic Computer HITAC 103.

1N34A
1N35
1N38A
1N55A
1N60
1S77
1S78
1S79
1S84



Back of HITAC 103.



Hitachi, Ltd.

Tokyo Japan

Cable Address: "HITACHY" TOKYO

NEW THIN FILM NRC VACUUM COATER

- * *A complete research or production unit for thin film deposition*
- * *Increases scope and flexibility in research programs*

Here's a newly-designed vacuum evaporation system for research and development in electronics, optics, infrared and semi-conductor products.

Films of many kinds of materials can be deposited — such as metals (including refractories), alloys, dielectrics, salts and organics. This evaporator is a versatile tool in the development of semi-conductor devices, micro-miniaturization, molecular electronics, epitaxial growth. It also has application for computer memory devices, infrared and interference layers in the optic field, space environmental testing, crystal growing, zone refining, vacuum leak testing, degassing of materials and low-temperature drying.

The Model 3166 is complete. Easy to operate. Merely connect power and water supply. Write or call for data sheet and prices.



* *Exclusive Features for Greater Value . . .*

NEW ELECTRIC HYDRAULIC HOIST for fast, effortless raising and lowering of bell jar.

NEW 6" fractionating 4-stage diffusion pump (Model HS 6-1500) rated 1550 liters/sec., 750 micron forepressure tolerance. Unaffected by line voltage and cooling water variations.

ALL CONTROLS ON FRONT PANELS for easy reading and operation, and less floor space required.

FULL OPENING, straight-through gate valve for high pumping conductance.

NEW CIRCULAR CHEVRON BAFFLE COLD TRAP. Coolant reservoir centrally located for more even cooling of chevron plates, prevents backstreaming and cryogenically pumps condensable vapors.

LARGE BASE PLATE has 17 electric and mechanical feed-through seals all identically sized (1" diameter) for greater flexibility and possible different arrangements of feed-through in base plate — either 18" or 24" diameter bell jar can be used interchangeably.



A Subsidiary of National Research Corporation

160 Charlemont Street, Dept. 4FF
Newton 61, Massachusetts
DEcatur 2-5800



FOR
MILITARY
REQUIREMENTS
BE SURE OF MAXIMUM
RELIABILITY...SPECIFY
PHILCO
TRANSISTORS

Look to the pioneer producer of *many millions of Military transistors* for your critical applications. Philco has been the symbol of reliability from one of the industry's first JAN types (2N128) to the present broad Military line.

The enviable record of ultra-reliable performance has resulted in the use of Philco transistors in many Military programs. The following types are available to existing Military specifications:

TYPE NO.	APPLICATION	MILITARY SPEC. NO.
2N128	High frequency amplifier	MIL-T-19500/9A
2N240	High speed switch	MIL-S-19500/25A
2N393	High speed switch	MIL-S-19500/77A (Sig C)
2N495	Medium frequency amplifier (Silicon)	MIL-T-19500/54A (Sig C)
2N496	Medium speed switch (Silicon)	MIL-S-19500/85 (Sig C)
2N499	VHF amplifier	MIL-S-19500/72A (Sig C)
2N501A	Very high speed switch	MIL-T-19500/62 (Sig C)
2N502A	VHF amplifier	MIL-S-19500/112 (Sig C)
2N599	Medium speed switch	MIL-S-19500/166 (Navy)
2N1118	Medium frequency amplifier (Silicon)	MIL-S-19500/138 (Sig C)
2N1119	Medium speed switch (Silicon)	MIL-S-19500/139 (Sig C)
2N1158A	VHF oscillator	MIL-S-19500/113 (Sig C)
2N1199A	High speed switch	MIL-S-19500/131 (Sig C)
2N1200	HF amplifier (Silicon)	MIL-S-19500/105 (Sig C)
2N1201	HF amplifier (Silicon)	MIL-S-19500/101 (Sig C)
2N1411	High speed switch	MIL-S-19500/133 (Sig C)
2N1499A	High speed switch	MIL-S-19500/170 (Sig C)
2N1500	Very high speed switch	MIL-S-19500/125 (Sig C)

For information on any of the above types, write Dept. E6961.

PHILCO[®]



Famous for Quality the World Over

LANSDALE DIVISION

• LANSDALE, PENNSYLVANIA

OFFICIAL U.S. AIR FORCE PHOTO





Typical slow-scan tv transmitter with mechanical shutter attached to lens weighs 6 lb and occupies 80 cubic inches

Modifying Vidicon Camera Chain For Slow-Scan Television Systems

Reducing tv scan rates allows use of a low-power, narrow-band transmitter. However, there are drawbacks in such systems. This article analyzes a typical camera and explains how the problems were overcome

By F. F. MARTIN
C. T. SHELTON,
Defense Electronic Products
RCA, Camden, New Jersey

THE INCREASED SPEED of modern warfare requires faster more efficient transmission of reconnaissance data. A photo-transmission system and the use of television pickup tubes as the primary sensors have been proposed. Conventional television using scan rates requiring bandwidths of approximately 6 Mc requires high-powered transmitters with penalties in weight and volume. One solution is based on slowing down the scanning rate of a vidicon electron beam, thus

reducing the video bandwidth. This concept has been proved in satellite experiments.

Slow-scan television has a narrow bandwidth which reduces transmitting link requirements and simplifies video recording. Figure 1A shows video bandwidth plotted against active line time for a 800-horizontal-line number. Assuming typical system parameters, three points are marked on the curve. These correspond to conventional scan rate, 4-second frame-time scan rate (used in this experimental slow-scan camera) and one-minute frame time. The latter rate is selected to show a range of values and does not imply a limitation. At these points the video bandwidth

becomes 5.4 Mc, 44 Kc and 2.9 Kc respectively. Slowing the scan rate further would decrease the video bandwidth to a frequency that permits telephone lines to be used for transmitting a closed-loop tv picture.

The effect of video bandwidth on r-f transmitting power is shown in Fig. 1B, which shows the r-f power required as a function of bandwidth to transmit a video picture 250 miles. Locating the three bandwidth points on the graph shows r-f power requirements of 10,000 watts, 100 watts and 6 watts.

Assuming 30-percent transmitter efficiency, input power requirements would be 34,000 watts, 340

watts and 20 watts respectively. A most significant factor is heat dissipation—24,000 watts, 240 watts and 14 watts respectively.

A second advantage of slow-scan rates is that increased resolution can be realized from vidicon pickup tubes. This results because as the scan time is slowed down, more time is available to discharge the scene. Increasing discharge time permits lower beam current. When the beam current is reduced, the scanning aperture (or beam size) is reduced and since the resolution of a vidicon pickup tube is limited by the beam size, the resolution is increased as the beam size is decreased.

A third advantage of slow scan is that the image is immobilized for the duration of the scanning time. Thus, motion is stopped and the observer has more time to interpret a scene before another is presented.

The design of the camera is based on study of the operating characteristics of vidicons at slow scanning rates¹. It was shown during these studies that the vidicon would operate satisfactorily and give good images at reduced scanning rates, but that several of its properties must be taken into account.

Changes in vidicon operating characteristics are a result of increased storage time between readout scans. With increased storage time, a greater target charge is accumulated between scans at a given light level. This fact, coupled with the reduction in bandwidth of the resulting video, gives in-

creased sensitivity. In most system applications the increased storage time cannot be allowed because of the smearing that would result from the continuously moving scene. Therefore, a 1/50-second mechanical shutter is used to make the storage time for incoming light approximately that of a vidicon camera operated at a conventional scanning rate.

Unfortunately, target dark current does have an increased storage time therefore at scanning rates as low as four seconds, there is an increase of dark current in the signal. At conventional scanning rates, dark current is no more than 10-percent of the video signal but in this slow-scan camera it is approximately 50 percent. The effect of this dark current is to provide a pedestal on which the video appears.

Fortunately, vidicon manufacturing techniques give good uniformity of dark current, so that serious shading patterns are not obtained and only slight shading effects are visible. Another problem with dark current is that it is temperature dependent and therefore requires compensation to keep video level constant.

During the original development of slow-scan systems, some problems were anticipated with resolution at longer storage times. The anticipated lateral leakage of target charge had a negligible effect at rates as low as four seconds per frame. At the same time, the lower beam currents required to give target discharge resulted in a finer beam. The net effect is that the

camera exhibits about 30-percent more resolution than a conventional vidicon camera.

Another problem is that the image is not completely erased with each scan. In a system application where each picture is of an appreciably different area from the preceding one, this effect could result in double images. Image lag tests indicated that with a continuous scan rate of four seconds, there would be 40-percent carry-over of images from frame to frame when operating with normal light levels.

This carry-over would then decrease the usefulness of images. To reduce this effect, a one-second erase scan is used between the 4-second readout scans. During erase, the horizontal scan rate of 100 lines per second is left constant and the vertical rate is changed from four seconds to one second. This resulted in a 10-percent carry-over from frame to frame. This amount of carry-over is in most cases unnoticeable.

Microphonic signals occur when operating vidicons at slow scanning rates. The landing-mesh electrode, spaced approximately $\frac{1}{16}$ of an inch behind the target, vibrates inducing a spurious signal into the target output circuit. At conventional scanning rates, this microphonic signal is unnoticeable. However, at four seconds per frame, the signal output current is reduced 200:1 while the microphonic signal remains the same. In some cases, the microphonic signal could be three or four times greater than the useful signal.

The performance of the 7263 one-inch vidicon was greatly improved for this application. Starting with the military version of the one-inch vidicon, modifications were made to reduce the vibration of the mesh electrode. Selected 7263 vidicons using the improved design gave few microphonic signals during the vibration tests.

The slow-scan camera shown in the photograph is packaged in two units. The pickup unit includes the lens and shutter, the modified 7263 vidicon and the preamplifier. The control unit contains the remainder of the circuits. These two units form the complete camera and require only input power. The video output goes through a BNC con-

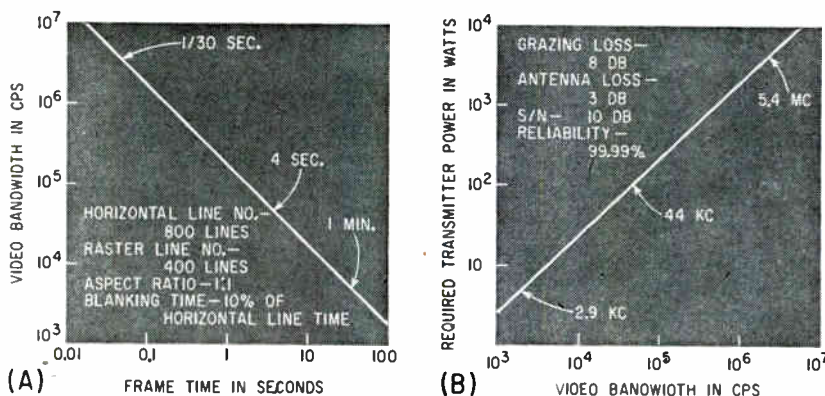

FIG. 1—Video bandwidth as a function of total scan time (A). Power requirements as a function of bandwidth (B)

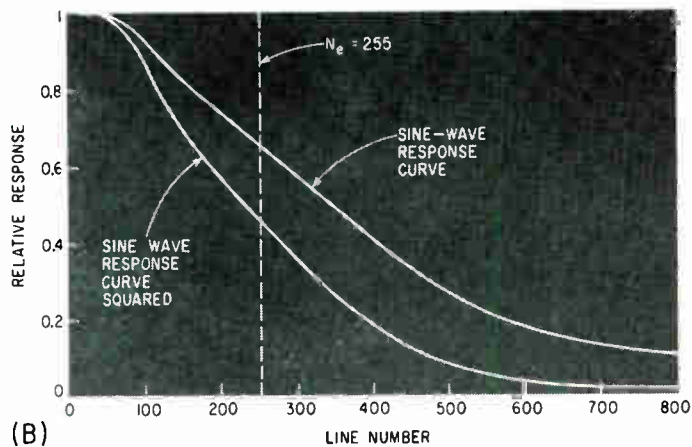
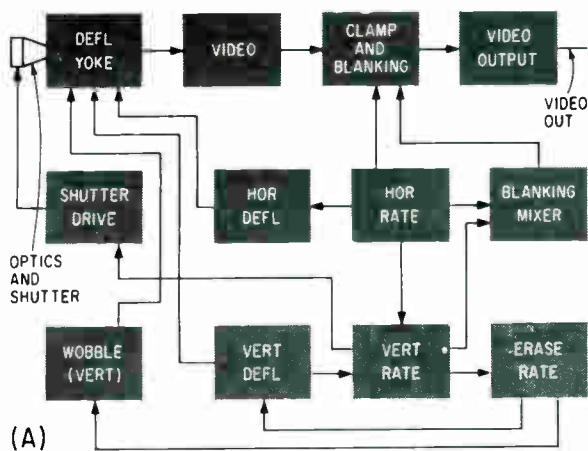

FIG. 2—Functional block diagram of experimental camera (A). Aperture response with Wollensak 25 mm $f/1.25$ Rapitar lens at $f/2.0$ (B)

nector. Set-up controls are provided by screw-driver adjustments on one side of the control unit.

The functional block diagram of the camera is shown in Fig. 2A. The deflection timing system starts with a horizontal-rate generator operating at 100 lines per second. This triggers a vertical-rate generator which generates the 4-second sweep time and triggers the erase-rate generator to generate the one-second erase sweep time. The vertical-rate and erase-rate generators generate a one-second sawtooth followed by the 4-second vertical-deflection sawtooth. The vertical-rate generator also provides a pulse to operate the shutter drive just after the erase sweep and before the start of the readout sweep.

Initial tests showed that the erase raster, which is a 100-line raster as opposed to the 400-line readout raster, produced a 100-line charge pattern on the target that caused noticeable interference in the readout picture. This problem was solved by adding an 80-Kc wobble current to the vertical-deflection coil during erase sweep. This current spreads the electron beam vertically causing the erase-raster lines to overlap thus eliminating the 100-line pattern.

The video circuit is conventional, consisting of linear transistor amplifiers using feedback for stability. The bandwidth of the video amplifier is approximately 40 Kc. The d-c component of the signal is restored with a keyed clamp after which horizontal- and vertical-

blanking pulses are added.

During the period of the vertical blanking pulse interval, horizontal blanking pulses are added to the signal at a reduced level in order to maintain the horizontal synchronization during the one-second erase period.

Since the vidicon dark-current pedestal varies with target temperature, compensation has been added in the clamp circuit so that the video level will remain constant as temperature changes.

The problems encountered in the adjustment of a slow-scan camera are slightly different from those found in adjusting conventional tv cameras. Beam setting is critical. The beam must be adequate to discharge the target but if excessive beam is used, a heavy, spurious pattern results. In some cases, this type of spurious pattern causes serious deterioration of the image. On the other hand, if the beam is set just at its critical value, it might not give full discharge if slight drifts in bias voltage or changes in light level or dark current occur. It is necessary to set the control grid of the vidicon approximately 5 to 10 volts above the critical value to insure stable target discharge under all conditions. If the spurious pattern is to be avoided at this setting, careful beam alignment must be used. Special low-current alignment coils were designed for the deflection yoke that provided proper alignment while minimizing power-supply drain. With proper alignment, it was found that no mesh pattern

was observed with the excess beam current. Vidicon exposure to scenes of low contrast results in the useful part of the signal current being only a fraction of the total signal and dark current. If the vidicon is underexposed, the useful signal current is even smaller. Overexposure results in beam bending due to excessive target charge, causing reduced resolution and image distortion.

The curve shown in Fig. 2B shows the camera's aperture response curve^{2,3} to a sine wave frequency input. The curve was obtained by using a series of sine wave optical patterns placed at the center of the field of view. With each pattern, the peak-to-peak voltage signal was recorded. From this curve the equivalent resolution of the camera (N_e) was determined to be 250 lines. This resolution compared favorably with conventional-rate vidicon cameras which generally have an equivalent resolution of no greater than 175 lines.

The authors acknowledge the work of D. E. Townsend and L. Arlan in perfecting the camera circuits.

REFERENCES

- (1) C. T. Shelton and H. W. Stewart, Pickup Tube Performance With Slow Scanning Rates, *Journal SMPTE*, 67, July, 1958.
- (2) Otto H. Schade, Image Gradation, Gaininess, and Sharpness in Television and Motion Picture Systems, Pub. ST-592-I, II, III, IV, RCA Tube Div., Harrison, New Jersey.
- (3) Otto H. Schade, A New System of Measuring and Specifying Image Deflection, Pub. ST-652, RCA Tube Div., Harrison, New Jersey.

Semiconductors Improve Reliability

Solid-state circuit for controlling motors on a steel strip welding and coiling line replaces environment-sensitive electromechanical devices with transistors, silicon controlled rectifiers and photocells

By T. E. DeVINEY, Systems Development, Square D Co., Cleveland, Ohio

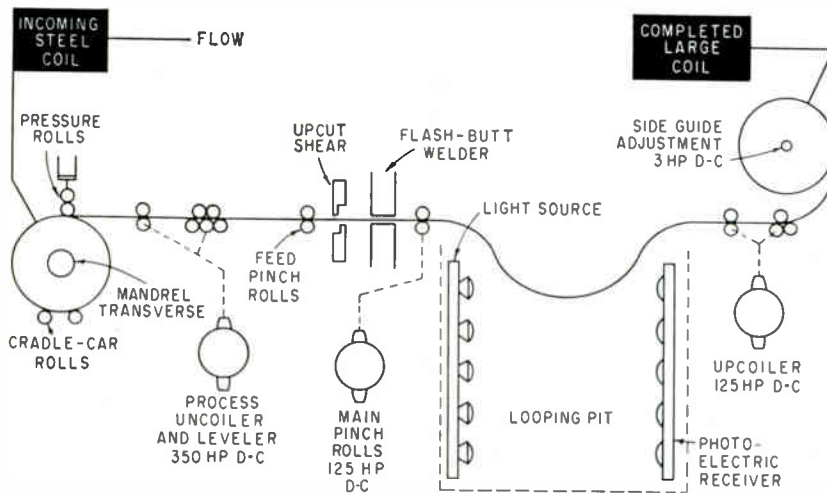

FIG. 1—On this steel strip-welding and coiling line, the photoelectric receiver controls the field strength of the up-coiler motor and thus regulates loop depth

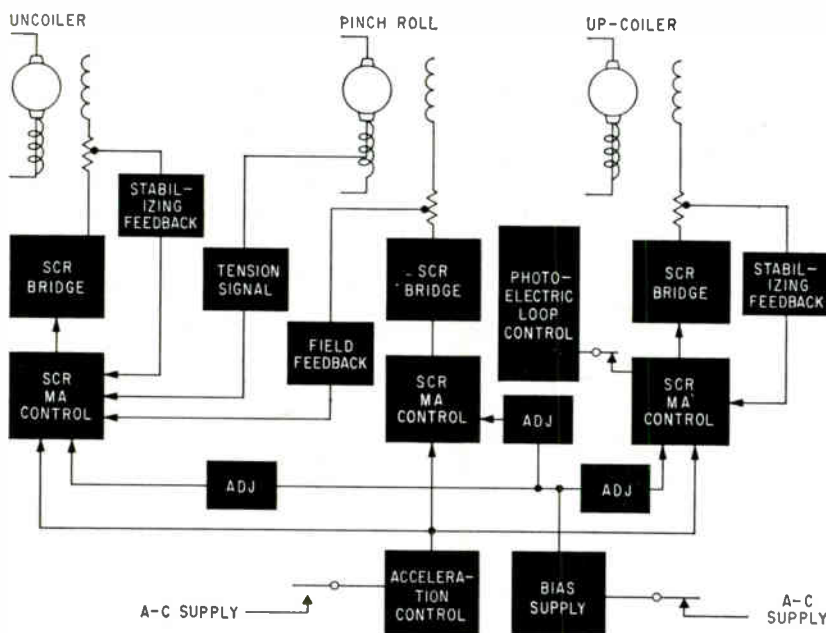

FIG. 2—System block diagram. Speed control of the d-c motors from 400 to 1,200 rpm is by field weakening

ENVIRONMENTAL CONDITIONS for heavy-industry control equipment are often detrimental to electromechanical devices, especially in corrosive atmospheres and conductive dusts. With power semiconductors, it is now possible to accomplish statically, and thus more reliably, many functions that were previously accomplished with electromechanical devices. Power semiconductors are used in several of the static circuits of the loop and tension controller described here.

This control was designed for a steel strip welding and coiling line (Fig. 1). The processing line welds small coils together to produce larger ones. Three large d-c drive motors are used: one to drive the processor which uncoils and straightens the incoming strip; the second to drive a set of tension rolls to create tension and establish line speed; and the third to drive an up-coiler, which recoils the combined welded strip. A looping pit allows slack in the strip for decoupling the pinch roll from the up-coiler. A photoelectric loop control regulates the depth of the loop. Light is directed across the pit striking the photodetector. The loop intercepts this light, thereby determining the quantity of light striking the photo detector.

The system block diagram (Fig. 2) shows three large d-c motors which are accelerated from zero to base speed (400 rpm) by removing resistances in series with their armatures with their fields fully excited. Speed control of the motors from 400 rpm to 1,200 rpm is by field weakening. The circuits shown in the block diagram control the motors in the field weakening range.

Each shunt field of the three large d-c motors is supplied by a separate silicon controlled rectifier bridge and its magnetic amplifier firing circuit. All control functions are accomplished in the control windings of the magnetic amplifiers at low power levels where the signals can remain electrically isolated.

Two signals, common to all three

Of Steel-Mill Control Equipment

field supplies, set the operating point of the system. The bias supply with its individual adjustment resistors makes it possible to adjust the field currents of the three d-c motors to operating levels below base speed. Acceleration above base speed, and well as the final speed, is controlled by a common signal supplied from the acceleration and deceleration control. These two signals directly determine pinch-roll motor speed and line speed.

Exact tension was not required for the material between the pinch roll and uncoiler; therefore, no mechanical indication of tension was included, and all signals for regulating tension were obtained from the motor characteristics themselves. Fortunately, most of the output of the pinch-roll motor is used in supplying tension to the strip between the pinch roll and uncoiler. Thus, the armature current of the pinch-roll motor is a good indication of the tension in the strip. A signal was obtained from the voltage across a commutating winding in series with the armature of the pinch-roll motor which was then fed back to the field supply of this uncoiler.

This signal controls the uncoiler load, thereby maintaining a constant pinch-roll motor armature current. This would be satisfactory tension control if the pinch-roll motor field flux remained constant and the motor was run at one speed. Because the field is weakened to obtain higher speeds, the armature current of the pinch-roll motor must be allowed to increase by the same ratio to keep the tension in the strip constant. It would be desirable to have a signal proportional to the field flux of the pinch-roll motor, but this is not convenient. Instead, a voltage proportional to the field current is modified by a nonlinear circuit to represent field flux. This signal modifies the armature current feedback signal so that the armature current of the pinch-roll motor increases in proportion to the line speed.

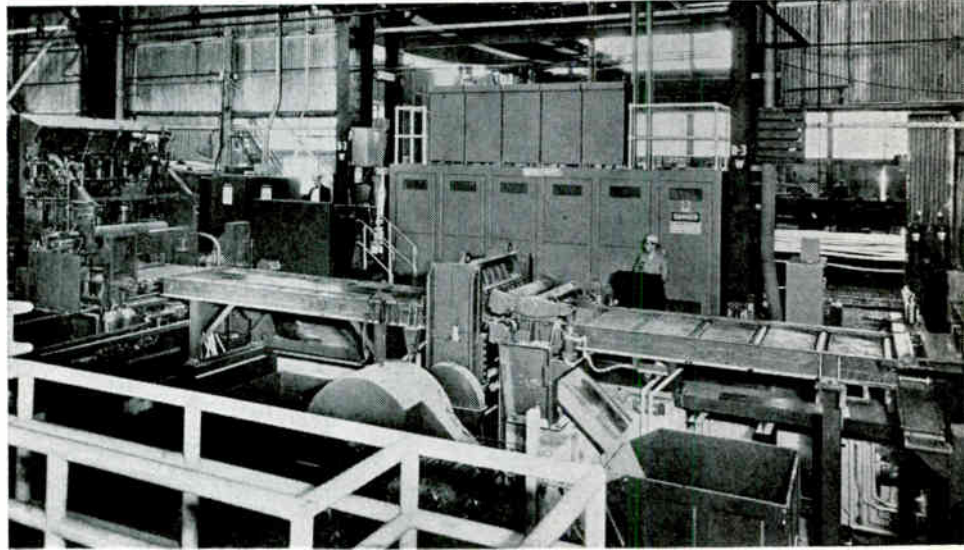

In heavy-industry equipment such as this steel mill coiling line, replacement of electromechanical control devices with solid-state static controls results in greater reliability and life expectancy and reduced maintenance

The material looping into the pit intercepts the light and determines the quantity of light striking the photodetector. Receiver output is directly proportional to the quantity of light striking it. This regulates the loop depth by controlling field strength of the up-coiler motor. If the depth of the loop increases, more light is intercepted and the output of the photoelectric loop control decreases, which weakens the field of the up-coiler and increases the speed of that motor. This regulates the depth of the loop.

Silicon controlled rectifiers were chosen for the adjustable d-c field supplies because of their comparative speed of response, size, and cost. As shown in Fig. 3, a single phase bridge contains two silicon controlled rectifiers (Q_1 and Q_2) and two conventional silicon rectifiers (D_1 and D_2). The two conventional rectifiers provide a discharge path for the inductive load current so that no external discharge path is required. This discharge path allows the inductive discharge current to bypass the silicon controlled rectifiers so that they may regain control during each cycle.

To control this bridge, a mag-

netic amplifier firing circuit was designed (Fig. 3). It contains two half-wave magnetic amplifiers, an input transformer and a transistor emitter follower used as a clipper for each half-wave output. Supply voltage for the firing circuit is taken from the same source as that of the silicon controlled rectifier bridge and is transformed to a lower voltage. This voltage is large compared to the desired 3.5 volts output of the firing circuit. The magnetic amplifier determines what portion of each half cycle of the transformer output voltage is applied to the clipper. The peak of this voltage is limited by the clipper so that the output appears as a square wave with steep leading and trailing edges. Clipping action takes place in the emitter followers by the transistors Q_3 and Q_4 with Zener diodes D_3 and D_4 .

One problem became apparent in using this firing circuit where the control signals were large enough to drive the magnetic amplifier far into cut-off. As with all magnetic amplifiers, there is a back slope (Fig. 4A) where the load current increases with an increase in negative control current. This is a result of the control ampere turns

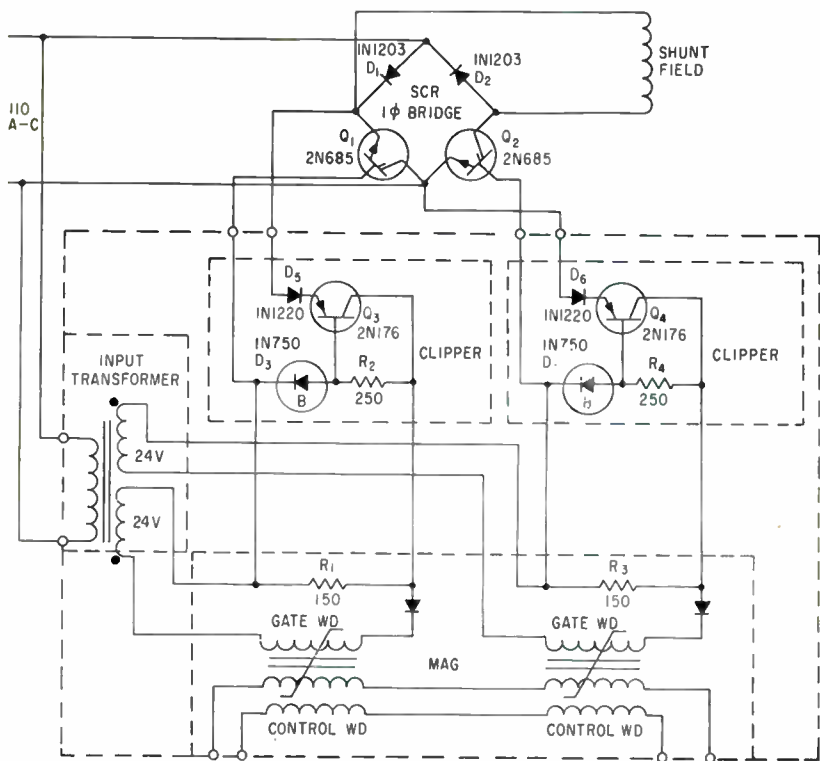

FIG. 3—For this power supply, silicon controlled rectifiers were chosen because of their comparative speed of response, size and cost

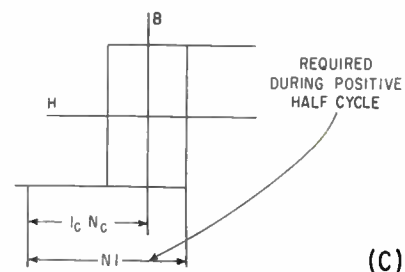
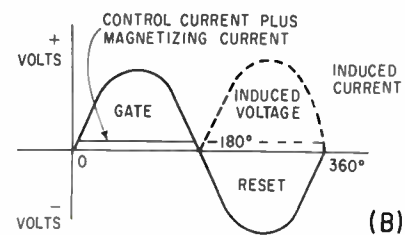
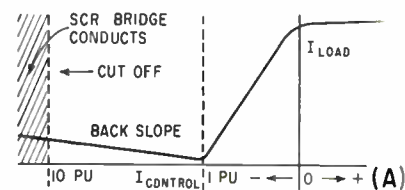

FIG. 4—Self saturating magnetic amplifier transfer curve (A); magnetic amplifier applied voltages (B); and B-H curve (C)

being large enough to induce a voltage (Fig. 4B) which is large enough to overcome the supply voltage and cause a positive current to flow during the negative half cycle of the gate supply voltage.

The gate then provides ampere turns during its positive half cycle to overcome the control ampere turns plus the amount for magnetization (Fig. 4C). The difficulty arises from the current which flows during the positive half cycle of the gate supply. At this time the current flowing through resistors R_1 and R_2 (Fig. 3) cause voltage drops that can become large enough to fire the silicon controlled rectifiers for full output. The OFF to ON ratio is defined as the ratio of the control ampere turns between turn off and turn on in the negative direction to the control ampere turns required for proportional control. To obtain the desired minimum OFF to ON ratio of 10 to 1, it was necessary to add silicon diodes D_5 and D_6 whose forward drop minimizes the effect of the positive half cycle leakage currents.

All the desirable features for system design have been obtained

with fast response, high gain and a convenient way of combining electrically isolated control signals at a low power level. This controlled rectifier bridge and firing circuit is the basic power and regulating element of the control.

In applying the silicon controlled rectifier bridges for more than one motor field, a problem of interaction may exist. It was thought that all three bridges could be powered from the same transformer, but because of the rapid firing of the controlled rectifiers, large pulse disturbances are created in the supply. These pulses can cause the other silicon controlled rectifier bridges to fire so that independent control is not obtained. Two causes for misfiring due to the pulses were: the interelement capacitance of the silicon controlled rectifiers that allowed pulses directly from the line to reach the gate; and the component capacitances or normal transformer action of the firing circuit that pass the pulses thereby giving false firing signals.

It was not enough to separate the bridges with independent transformers because the capacitance between windings passed the steep

wavefront pulses. Capacitors were then placed across the secondaries of these transformers and satisfactory isolation was obtained.

In the past, motor driven rheostats were used to provide acceleration and deceleration control. Generally they were large, cumbersome, and fairly expensive when used to control total power to motor fields. Where automatic regulation has been supplied, additional control elements have been introduced in the field circuits to modulate the reference set up by the motor driven rheostat. The functions of a motor driven rheostat are: to control the drive motor field current resulting in the change of motor speed; and, with feedback systems, to reduce system gain to offset the increased gain in the field circuit that is obtained when the motor field is weakened.

The static circuit performs the first function but not the second. Therefore, in using this circuit, the system must be able to accommodate the increase in gain and remain stable, or some other means must be provided for accomplishing part two.

The acceleration or deceleration signal of the static circuit (Fig. 5)

is obtained from the charging or discharging of capacitor C_1 , whose rate of charge and discharge is controlled by two separate transistor circuits. The ultimate potential to which capacitor C_1 is charged is determined by the setting of the potentiometer R_7 , which is a voltage divider across a d-c supply. Transistors Q_1 and Q_2 are in series with the charging potential and the capacitor to control the amount of current that flows into or out of capacitor C_1 . Transistor Q_1 controls the charging current and transistor Q_2 controls the discharging current. Direction of capacitor current is dependent on which voltage is greater, that across the capacitor or that at the setting on R_7 .

The transistors are controlled by a feedback signal taken from the field current of the motor being controlled. The path for this control current is through the emitter-to-base junctions of Q_1 and Q_2 connected in series, as shown by the dotted line. When the field current is high, the feedback signal is large and causes a high rate of charge or discharge of capacitor C_1 . The opposite occurs when the field current is low. It accomplishes the first function of a motor driven rheostat which for this control is to accelerate or decelerate at a constant rate of change of motor speed.

The rate of the acceleration ad-

justment was made possible by negative feedback resistor R_2 . The charging characteristic of capacitor C_1 is suitable for acceleration, but the discharge characteristic is opposite to that desirable for deceleration. Resistor R_1 , rectifier D_1 , and resistor R_3 shape the discharge curve for deceleration. At low field currents, the feedback current through the emitter base circuit of Q_2 is low and the high value negative feedback resistor R_5 limits this current to an even lower value.

This low emitted-to-base current results in slow discharge of capacitor C_1 . As the field current increases, the feedback current increases slowly until the voltage across resistor R_3 reaches 0.6 volt after which the voltage across resistor R_3 is limited by rectifier D_1 . This eliminates the negative feedback effect and allows the field feedback signal to increase more rapidly. Resistor R_4 makes this a smooth transition. The increase of the discharge rate of capacitor C_1 results in a discharge curve that approaches the desired deceleration signal. Advantages of this circuit over a motor driven rheostat are reduced size, lower cost and long maintenance-free life expectancy.

The most common mechanical loop depth sensing device is a dancer roll with its linkages and transducer. Many photoelectric systems have been developed to replace this type of mechanical system. In

general, the signal output of these systems is incremental. The more components used, the smaller the increments and the closer the output comes to being continuous. The system described required the photoelectric output to be continuous. A new system was developed to meet this requirement based on measuring the quantity of light striking the sensing device.

A Plexiglass lens was devised that accepts light only from the light source and provides the additional function of condensing this light into a smaller area. Surfaces that are not used for reflecting are painted a dull black to absorb light. The light that enters the window perpendicular to the window surface will be reflected by the 45 degree clear surface and the light rays will appear at the output end. Light rays 3 degrees or more from being perpendicular in one horizontal direction will not be reflected by the 45 degree surface while light rays 8 degrees or more in the opposite horizontal direction will be absorbed by black surfaces. Light rays not perpendicular in a vertical direction will not register on the output cell.

At the output of the lens, two selenium photosensitive strips produce a voltage proportional to the quantity of light striking them. The result is a continuous output that is insensitive to external light. This low voltage output is amplified by a silicon transistor. In this amplifier the silicon transistor, having a relatively low leakage current, was temperature stabilized by a single diode compensation and a negative feedback resistor. The diode provides a voltage to the transistor to bias it to the point of conduction. Any additional voltage provided by the selenium photocells causes a current to flow from base to emitter which is amplified by the transistor to produce a signal current in a magnetic amplifier control winding.

Automobile head lights were used as the light source. For every two feet of loop depth, three light bulbs and two sensing units and their amplifiers were used. A decided advantage is gained by using this system over one that has an incremental output. Without a large number of components, a continuous signal is obtained.

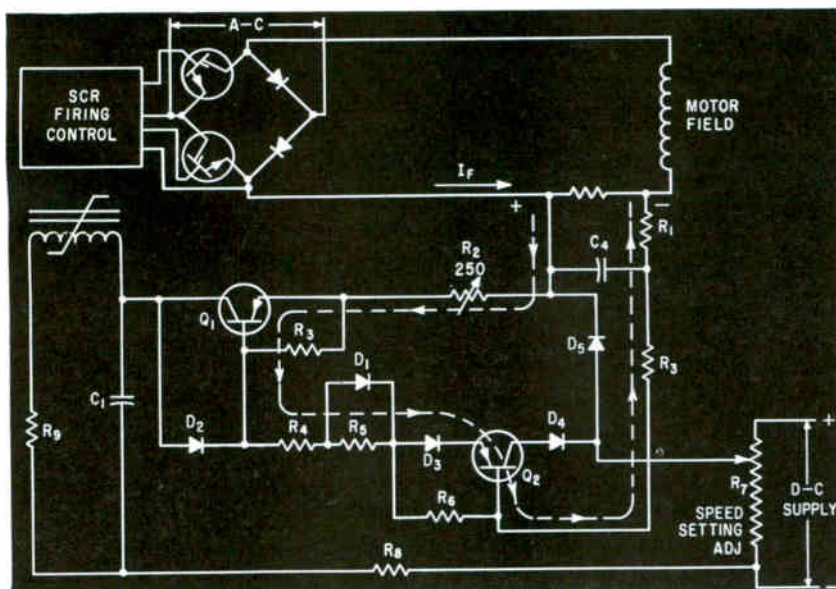

FIG. 5—In this acceleration circuit, the acceleration or deceleration signal is obtained from the charging or discharging of capacitor C_1 , whose rate of charge or discharge is controlled by two separate transistor circuits

Control matrix feeds a thyatron drive circuit.

Use of type wheel

offers advantages over

conventional

electric typewriters

By MARTIN RUDERFER,

Dimensions, Inc.,
Brooklyn, New York

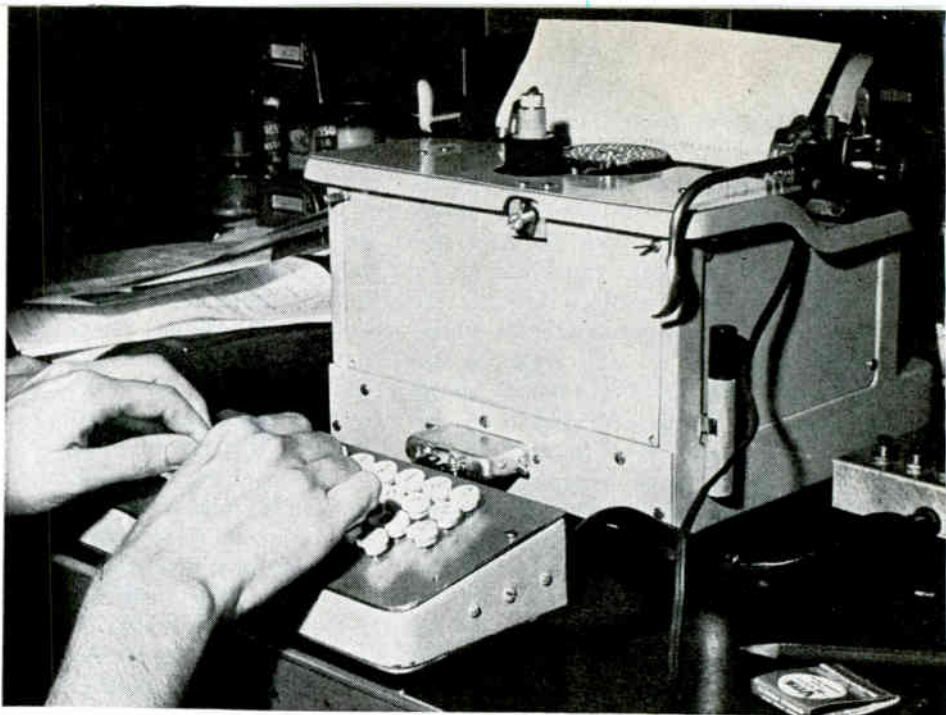

Working model employs conventional carriage and frame

Neon Diode-Resistor Matrix Controls Electronic Typewriter

ELECTRONIC CONTROLS can be combined with a printing type wheel to produce the improved typewriting mechanism shown in the photograph.¹ The type wheel itself gives such advantages as reduction in number of parts, rapid interchangeability of the entire set of type faces, ribbonless printing, increase in number of type faces that may be simultaneously carried, pre-aligned type faces, inherently high maximum speeds and small and light construction. Electronic control of the typewheel gives additional advantage of ease of automatic operation, provides a movable keyboard for positioning, permits quick conversion to nonstandard but more efficient keyboard arrangements and affords ease of electronically interlocking the keyboard. Reliability is achieved by modular construction, reduction in moving parts, and protection from erasure grits, while owing to its type-wheel operation, the typewriter cannot be jammed. Such features of present electric typewriting devices as auto-

matic carriage return, light touch and adjustable blow, may also be retained.

The electronically controlled type wheel can be used as a standard or portable typewriter, or as a special typewriter using the standard complement of type plus scientific, music or any set of symbols. Further applications include teletypewriter, data-phone printer, automatic typewriter, computer printer, printing intercommunicator and composing machine.

Present automatic printers require two costly code-bar matrices (incoming and outgoing) or a solenoid and switch for each key. These devices are replaced in this typewriter by a resistor-diode matrix. This matrix is reciprocal, working from line to machine and keyboard to line. Typing speed may be higher in automatic operation because there are no type bars to jam and limit speed.

A simplified drawing of the printing mechanism is shown in Fig. 1. The 1/70 hp induction motor drives

the type wheel through a pinion and gear. The motor also drives the rotor of an electric clutch. When the clutch is operated by a current, the clutch stator rotates the entire type wheel assembly around the motor shaft, driving the type wheel toward the platen. Clutch power is discontinued before the type wheel reaches the platen and the type wheel assembly rebounds from the platen. Thus, printing is done on the fly. An impact absorber, which is in effect a heavy spring, absorbs most of the momentum of the type wheel assembly. This action minimizes the time of contact between type face and platen and makes depth of penetration independent of type face area. The result is a quality print with no signs of blurring. The return spring, which returns and maintains the type wheel assembly against a reference stop, absorbs proportionally little energy during the printing operation.

The clutch is timed and operated by the circuit in Fig. 2. The keyboard is an assembly of electrical

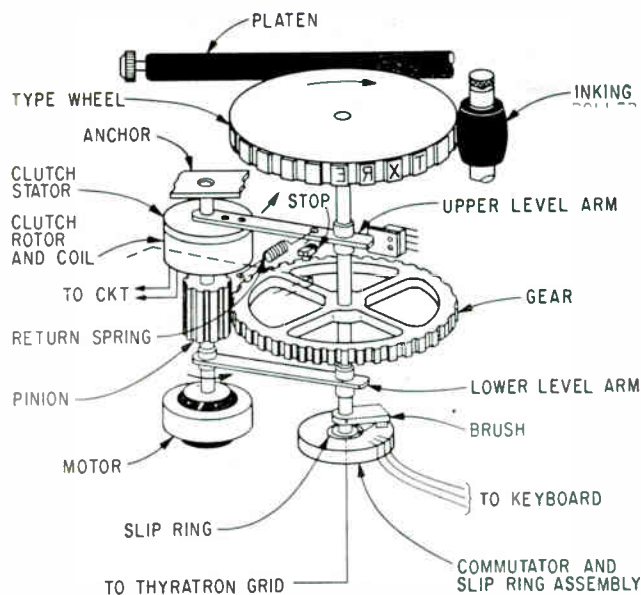

FIG. 1—Mechanical construction is uncomplicated

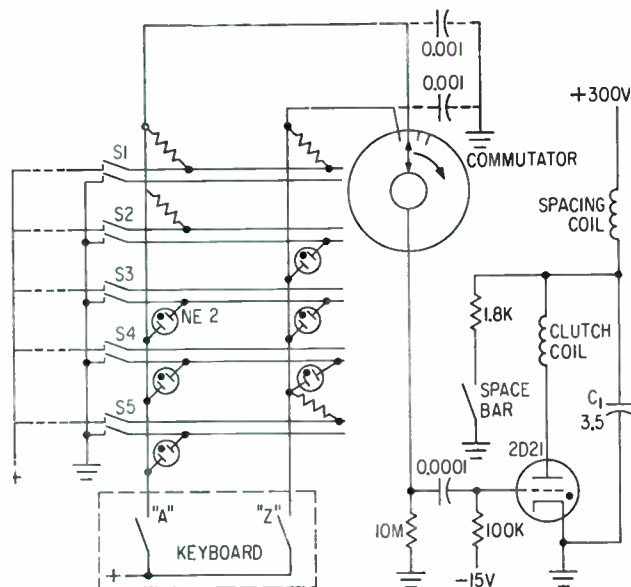

FIG. 2—Control circuit uses thyatron to engage clutch

switches. When a key is depressed, the thyatron is triggered by the rotating brush contacting the commutator segment connected to that selected key. Capacitor C_1 , which is initially charged, discharges through the clutch coil and thyatron, producing a pulse of current that momentarily turns on the clutch and causes a print. The current pulse is initially sinusoidal because of the resonance between C_1 and the inductance of the clutch coil. At the end of a half cycle C_1 is completely discharged and the clutch inductance attempts to recharge the capacitor. This automatically shuts off the thyatron. Capacitor C_1 recharges through the coil of the spacing solenoid which unlatches the spacing mechanism, allowing the carriage to advance one space. The circuit is now ready for another printing operation. A *pnpn* transistor or silicon controlled rectifier may be used in place of the thyatron.

For manual operation each key must be held down for at least one revolution of the type wheel to insure a print and for less than two revolutions of the type wheel to prevent a double print. If two keys are operated in rapid succession, the second letter may be printed first and result in an inversion of type. Circuit additions can eliminate these possibilities. A capacitor connected from each commutator segment to ground, as shown by the dotted

lines, permits a key to be operated for less than the period of one wheel rotation. The capacitor acts as a short-time memory and is discharged at printing. Nonrepeat operation is obtainable by interlocking the circuit electronically with a bistable device, such as a transistor, to give one print trigger per key stroke. This interlock can be extended to prevent the introduction of a second print pulse before the first is printed out. For automatic operation, these additions may not be required because the equivalent functions are often inherent in the device feeding the printer.

The electrical keyboard is advantageous for automatic operation from parallel input, as provided by punched tape, data-phone or computer. The diode-resistor matrix incorporated in the keyboard converts from the parallel input to the individual key lines connecting to the commutator, as shown in Fig. 2. Neon diodes, used for economy, have satisfactory speed characteristics for this application. Either a resistor or a diode is connected at the intersection of each key line with each pair of conductors representing an incoming line. The combination of resistors and diodes comprising the five components on each key line determines the code for that character and initiates printing for only one operated combination of switches S_1 through S_5 . These switches, which are manual in the

model, may be the outputs of a tape reader, data-phone line or computer. The code shown is the Baudot, but it may be readily extended to 6 or more digits. A serial-to-parallel converter feeding the incoming lines permits operation on teletypewriter lines. The matrix is reciprocal, that is if switches S_1 through S_5 are connected, manual operation of the keyboard may provide a parallel coded signal to a tape punch or directly to outgoing lines.

Coding is accomplished by inserting an adapter or switch between keyboard and commutator to reconnect the key lines to different commutator segments. This gives a new arrangement of the keys. Key arrangements more desirable than the present 85-year-old inefficient keyboard can thereby be inexpensively introduced with a multiple-keyboard machine.

A 350-rpm wheel printer approximately matches the speed characteristics of conventional typewriters. However, in conventional machines type-bar interference sets a maximum practical speed limit. In a continuously rotating wheel printer, the limitation is one of time rather than space and may be overcome by increasing the rotational speed of the wheel.

REFERENCE

- (1) M. Ruderfer, U. S. Patent 2,675,108, Apr. 13, 1954; additional patent pending

Servo Filter and Gain Control

IMPROVE AUTOMATIC DIRECTION FINDER

Synchronous servo filter at the receiver output separates the servomotor drive voltage from voice frequencies. Automatic gain control provides uniform receiver response over a wide range of input levels without clipping signal at high modulation levels

By PAUL V. SPARKS,

Motorola Aviation Electronics, Inc.,
Santa Monica, Calif.

A FIXED LOOP ANTENNA, sense antenna, superheterodyne receiver, servo amplifier and gonio-indicator are the major components of an airborne radio navigation system called the T-12 automatic direction finder.

In the automatic direction finder (adf) mode, the system combines signals from the fixed loop antenna and sense antenna. The resultant signal positions a motor-driven pointer to indicate the bearing of the transmitting station. In the receiver mode the sense antenna alone is used, and the system operates as a conventional low-frequency communications receiver.

Functionally, the T-12 is a position servo system (Fig. 1A). Error input to the system is generated in the r-f resolver in response to the intersection of a transmitted wave with the cross-wound coils of the fixed-loop antenna. The servo loop nulls by driving the resolver rotor winding to the position where the

receiver indicates zero response. At this point, the indicator needle points to the bearing of the transmitting station, on an azimuth card calibrated in 5-deg increments.

The receiver covers the frequency range of 190 through 1,750 Kc in three overlapping bands. Optional equipment includes a 1,000-cps oscillator, tuning meter and push-pull loudspeaker amplifier. The 1,000-cps oscillator allows the reception of c-w transmissions and also aids tuning in weak or distant stations.

The system operates from a 13.75 or 27.5 volt (nominal) d-c supply. Current drain is a maximum of 1.2 amp at 13.75 v; 0.9 amp at 27.5 v. The receiver and servo amplifier use temperature-stabilized transistor stages in removable modules. Temperature stability is such that minimum performance requirements are maintained through the range -30 to $+55$ C. Etched circuits are used extensively and the total weight of the system fully installed is less than 11 pounds. All operating controls are on the front panel of the receiver. The preferred mounting location for the servo

amplifier is directly to the rear of the gonio-indicator. The fixed loop antenna is designed for top or bottom mounting on the aircraft fuselage. The loop antenna has a built-in 7.5-deg quadrantal error compensation factor that simplifies system installation and calibration.

Figure 1B illustrates how the fixed-loop antenna and r-f resolver produce the error input voltage. The fixed loop is mounted with the plane of one coil parallel to the longitudinal axis of the aircraft and the plane of the other coil parallel to the lateral axis of the aircraft. The r-f resolver consists of two distributed stator windings inside a cylindrical form, with the two coil axes at right angles to each other, similar to the cross-wound coils of the fixed-loop antenna. A secondary winding is carried on a cylindrical rotor that is free to rotate through 360 deg relative to the two stators. The resolver rotor is driven by a two-phase servomotor through reduction gears.

The vertically polarized wavefront of the transmitted wave in-

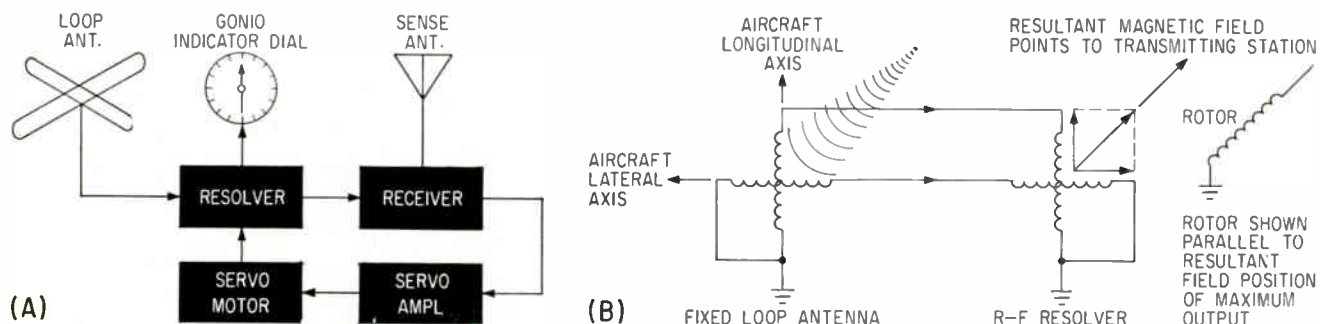
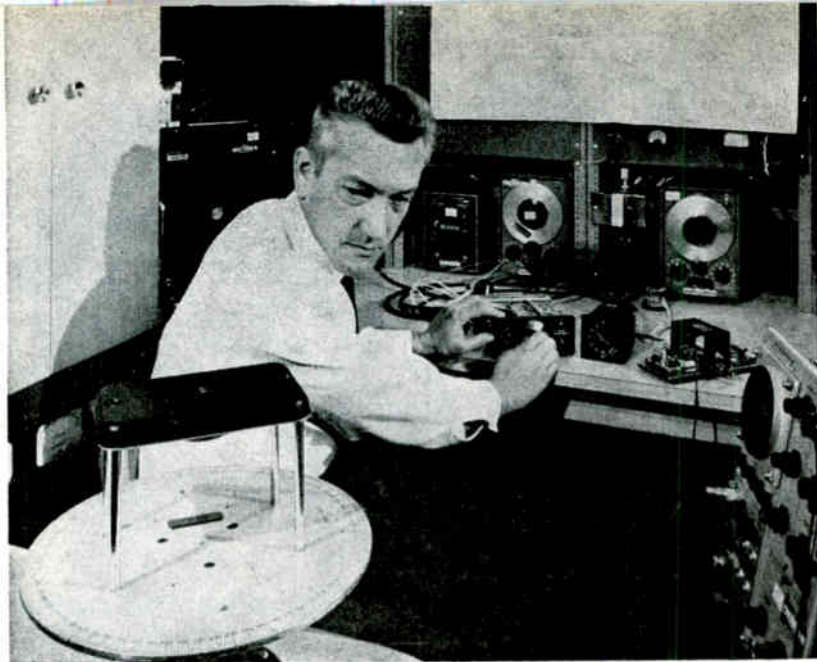

FIG. 1—Block diagram of position servo system (A); illustration of generating error input voltage to the system (B)

tercepts the two coils of the fixed loop and induces voltages in each of them. These voltages are proportional in amplitude and phase to the lateral and longitudinal coordinates of the transmitting station in relation to the longitudinal axis of the aircraft. The coils of the fixed-loop antenna are each connected in series with one of the cross-wound stator windings of the r-f resolver. The current flow through the stator windings creates magnetic fields around each of them which combine vectorially to form a resultant field. The angular relationship of this resultant field to the cross-wound resolver stators is the same as that of the transmitting station to the cross-wound coils of the fixed-loop antenna.

The magnetic field links with the resolver rotor coil and induces a voltage in it that is a measure of the angular displacement between the axis of the resolver rotor and the vector of the resultant field. The resolver rotor replaces the rotating loop of the conventional adf system. As in the rotating loop system, there are two positions of the resolver rotor coil that produce minimum output voltage. These nulls occur when the axis of the rotor is at right angles to the vector of the resultant field, that is, at displacement angles of 90 and 270 deg, which represent the bearing of the transmitting station and its reciprocal. One of these nulls is selected as the true null and the indicator pointer is synchronized to point to the bearing when the rotor attains this position. The receiving equipment must be capable of sensing which side of the true null position the rotor is on, and of producing a low-frequency motor control voltage to drive the rotor to the null position. These requirements are fulfilled by the balanced modulator stage and the nondirectional sense antenna.

The resolver rotor signal is applied to the input of the balanced modulator from the loop amplifier, as shown by the phase relationships in Fig. 2. The sense antenna signal is coupled in series with the output of the balanced modulator. When the resolver rotor is to the left of the null position, the rotor voltage is in phase with the sense antenna voltage. When the re-



Screen room test of fixed loop antenna and goniometer indicator of automatic direction finder

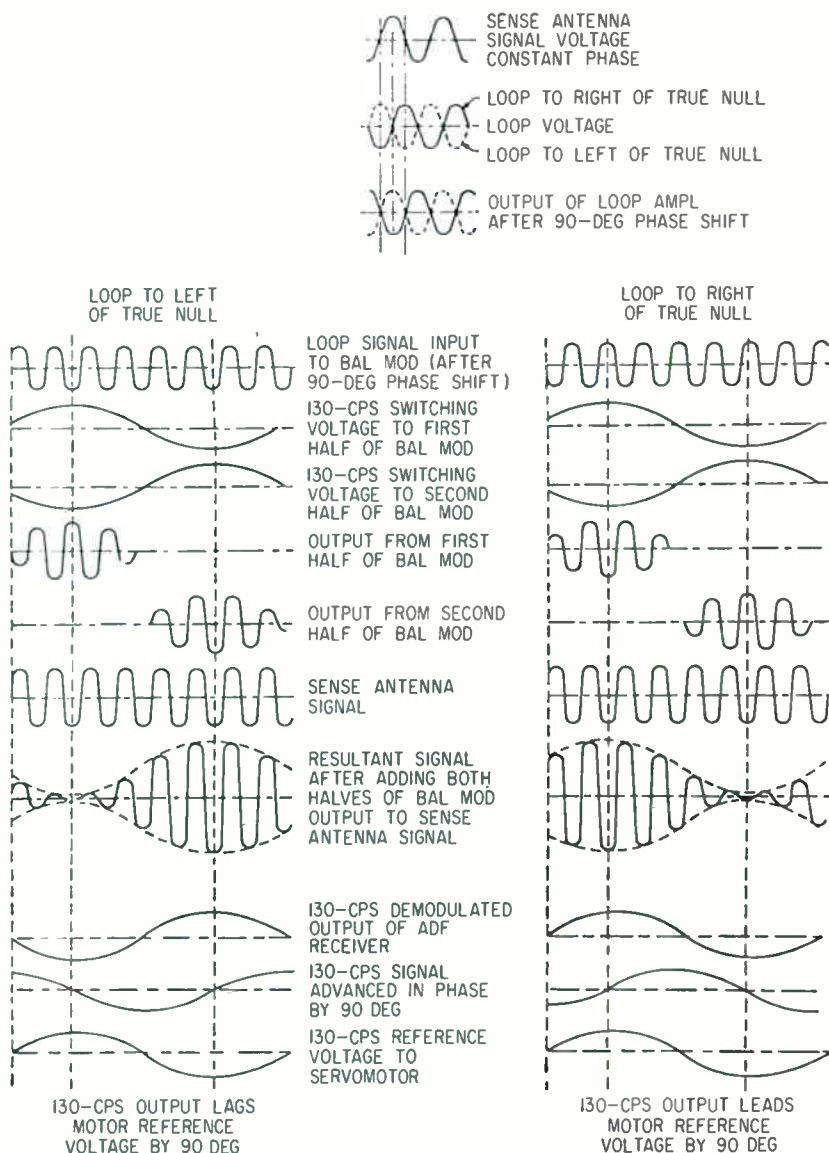

FIG. 2—Phase relationships in adf operation

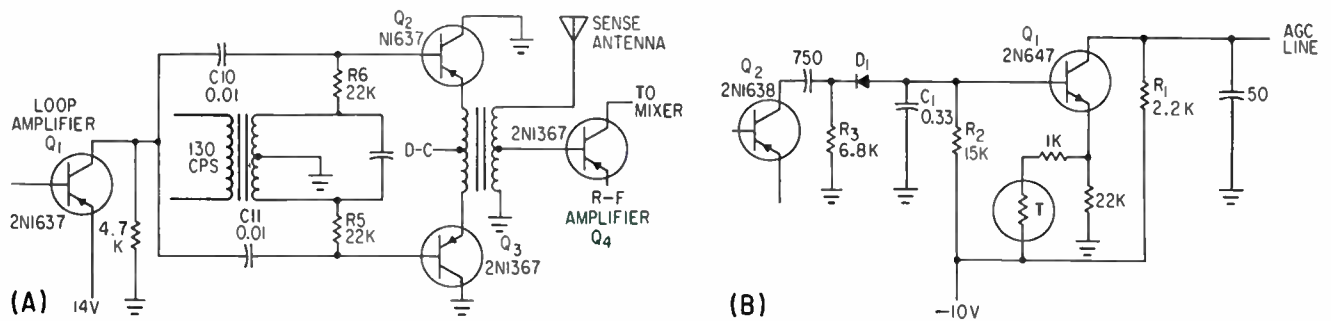

FIG. 3—Balanced modulator (A) and agc amplifier (B) in receiver

resolver rotor is to the right of the correct null position, the rotor voltage is 180 deg out of phase with the sense antenna voltage. The balanced modulator consists of two transistors (Fig. 3A) connected in the common collector configuration. A 130-cps switching voltage is applied to the bases of the transistors from opposite ends of a centertapped transformer winding. The transistors conduct alternately during each half-cycle of the switching voltage. When one transistor conducts, the other is cut off. The r-f rotor signal is applied to the bases of the two transistors in parallel. The emitters of the two transistors are connected to opposite ends of the centertapped primary winding of a coupling transformer.

During each half-cycle of the switching voltage r-f current flows in opposite directions through each half of the coupling transformer primary winding. This produces an r-f voltage across the secondary of the coupling transformer that undergoes a 180-deg phase reversal during each half-cycle of the switching voltage (about every 4 msec). The constant-phase sense antenna signal is in series with the secondary of the coupling transformer, and adds to the in-phase r-f current while cancelling the out-of-phase r-f current during successive half-cycles of the switching voltage. The result is a 130-cps modulated r-f signal, in which the 130-cps modulation envelope is either in phase or 180 deg out of phase with the 130-cps switching voltage, depending on whether the resolver rotor is to the left or right of the null position.

The remaining circuits of the re-

ceiver recover the 130-cps modulation envelope from the r-f rotor signal. The signal is amplified and shifted in phase by 90 deg in the servo amplifier and then applied to the variable phase winding of the servomotor in the goniometer. The reference phase winding of the servomotor is excited from the same 130-cps source that actuates the balanced modulator. The 90-deg phase shift, introduced in the servo amplifier, changes the in-phase or 180-deg out-of-phase relationship of the two signals to the quadrature relationship required to drive the motor.

The circuits of the superheterodyne and the servo amplifier, with two exceptions, are conventional. The two exceptions are the agc circuit in the receiver and the synchronous filter in the servo amplifier.

The agc system provides uniform receiver response over a wide dynamic range of input signal levels without the attendant disadvantage of signal clipping at high modulation levels inherent with positive-bias base control of *pn*p transistors. The agc amplifier Q_1 (Fig. 3B) is an *npn* transistor, which under quiescent conditions is forward-biased toward maximum conduction. The large collector current flowing through load resistor R_1 develops a voltage drop that opposes the regulated 10-v d-c supply. The agc line assumes the potential difference between the 10-v d-c supply and the voltage drop across R_1 , which under zero-signal conditions is about 3 v d-c.

The output of the third i-f amplifier Q_2 is applied across agc diode D_1 . The negative-going half cycles of the i-f signal tend to discharge

capacitor C_1 , which under quiescent conditions maintains the base of Q_1 at the forward bias voltage developed at the junction of resistor R_2 and diode D_1 , which together with resistor R_3 form a voltage divider across the regulated 10-v d-c line.

As capacitor C_1 discharges, the forward bias on Q_1 is reduced. This causes a corresponding reduction in the voltage drop across resistor R_1 , so that the voltage level of the agc line increases toward the 10-v d-c of the regulated line.

The carrier-proportional positive agc voltage is applied to the bases of the first and second i-f amplifiers, mixer stage and r-f amplifier stage through separate filter networks. These stages employ *pn*p transistors, which require negative forward bias for conduction. The effect of the increasing positive agc bias caused by an increasing i-f signal, is to reduce the forward bias and hence the gain of the controlled stages.

To avoid signal clipping at high signal levels, the agc bias controls negative current feedback in each of the controlled stages. Figure 4A illustrates this procedure for the first i-f amplifier Q_3 , which is representative of the other controlled stages. As the carrier level increases, the positive agc increases and reduces the forward bias and the gain of Q_3 . If the forward bias falls below the peak value of the signal, clipping results. To avoid this, diode D_2 is connected between the emitter of Q_3 and the junction of the voltage divider formed by resistors R_4 and R_5 .

Under quiescent conditions, D_2 is forward biased and conducting. As the forward bias on Q_3 is re-

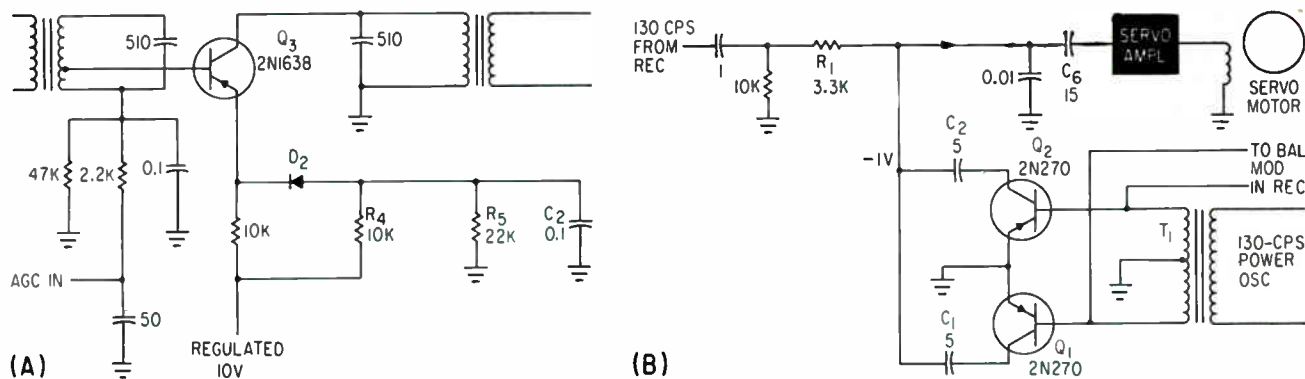

FIG. 4—Automatic gain controlled stage in receiver (A) and synchronous filter in servo amplifier (B)

duced due to the increasing agc voltage, the positive d-c voltage on the emitter of Q_3 increases until eventually D_2 becomes reverse-biased and nonconducting. This transition is gradual, due to the characteristic of D_2 . As a result, emitter bypass capacitor C_2 is gradually removed from the circuit, providing proportional negative current feedback to the input. This extends the dynamic range of the agc characteristic, without clipping of the input signal at high levels.

In addition, by varying the values of the diode voltage-dividers on each stage, the signal level at which the respective diode becomes reverse-biased is staggered. The sequence in which each of the controlled stages becomes degenerative is as follows: r-f amplifier, first i-f amplifier, mixer and second i-f amplifier.

Separation of the 130-cps motor-drive voltage from the audio voice frequencies in the receiver output is accomplished by a synchronous filter circuit at the input of the 3-stage servo amplifier. The filter features high rejection of unwanted frequencies without introducing phase shift in the signal, and permits the use of a wide-tolerance oscillator (frequency range 120 to 180 cps) as the low-frequency modulating source for the system. The filter also compensates for any phase shift that may be present in the receiver, and in addition provides a degree of wave-shape restoration.

The synchronous filter consists of transistors Q_1 and Q_2 and associated components as shown in Fig. 4B. The nominal 130-cps output of the power oscillator is applied to the bases of Q_1 and Q_2

from opposite ends of the center-tapped secondary winding of transformer T_1 . Because the power oscillator also provides the 130-cps modulation component to the r-f signal by the balanced modulator stage in the receiver, perfect synchronism always exists between the 130-cps output of the receiver and the 130-cps switching voltage applied to the bases of Q_1 and Q_2 ; a change in oscillator frequency affects both signals equally.

The 130-cps switching voltage causes transistors Q_1 and Q_2 to conduct alternately on successive half-cycles, when the bases of the transistors are driven negative with respect to their emitters. Transistors, Q_1 and Q_2 operate as an automatic single-pole double-throw switch, in which the pole moves from one contact to the other during each cycle of the 130-cps switching voltage.

The 130-cps output of the receiver constitutes the desired input signal to the servo amplifier, and is either in phase or 180 deg out of phase with the 130-cps switching voltage applied to the bases of Q_1 and Q_2 . If the incoming signal is going positive when Q_1 is grounded, capacitor C_1 will acquire a small positive charge. The charge is small due to the relatively long time constant of R_1 and C_1 , compared to the duration of the positive half-cycle of the 130-cps signal. During the next half-cycle of the input voltage, Q_2 is grounded, and capacitor C_2 acquires a small negative charge. As long as the input signal exists this process continues, until capacitor C_1 is charged positively to the peak level of the positive half-cycle of the input voltage, and capacitor C_2 is charged

negatively to the peak level of the negative half-cycle of the input signal. The base of voltage amplifier Q_3 in the servo amplifier (not shown) is connected alternately to capacitors C_1 and C_2 during successive half-cycles of the switching voltage. Once the capacitors are charged, the servo amplifier input sees a perfect squarewave regardless of the waveshape of the receiver output. The receiver output serves to restore the charge on the capacitors, dissipated in the input impedance of the servo amplifier.

The filtering action of the circuit is clarified by considering the case of a second harmonic component. Assume that the input signal is twice the frequency of the switching voltage (260-cps) and that when the input signal is going positive, Q_1 is grounded. As a result capacitor C_1 acquires a small charge. During the negative half-cycle of the input signal C_1 loses the charge it just gained. During the succeeding cycle of the applied voltage, the same effect occurs with capacitor C_2 . The net change in charge stored in C_1 and C_2 for the two cycles of applied voltage is zero. In effect, R_1 , C_1 and R_2 , C_2 behave as low-impedance filters for the higher frequency, while functioning as integrators at the switching frequency. Any input wave form with a low form factor during one half cycle of the switching voltage will suffer attenuation, while waveforms with a high form factor will experience negligible attenuation. The circuit is analogous to a high-Q parallel-tuned circuit, without the disadvantage of phase-shift in the signal due to changes in frequency of the power oscillator.

One-Shot Gating Circuit Generates

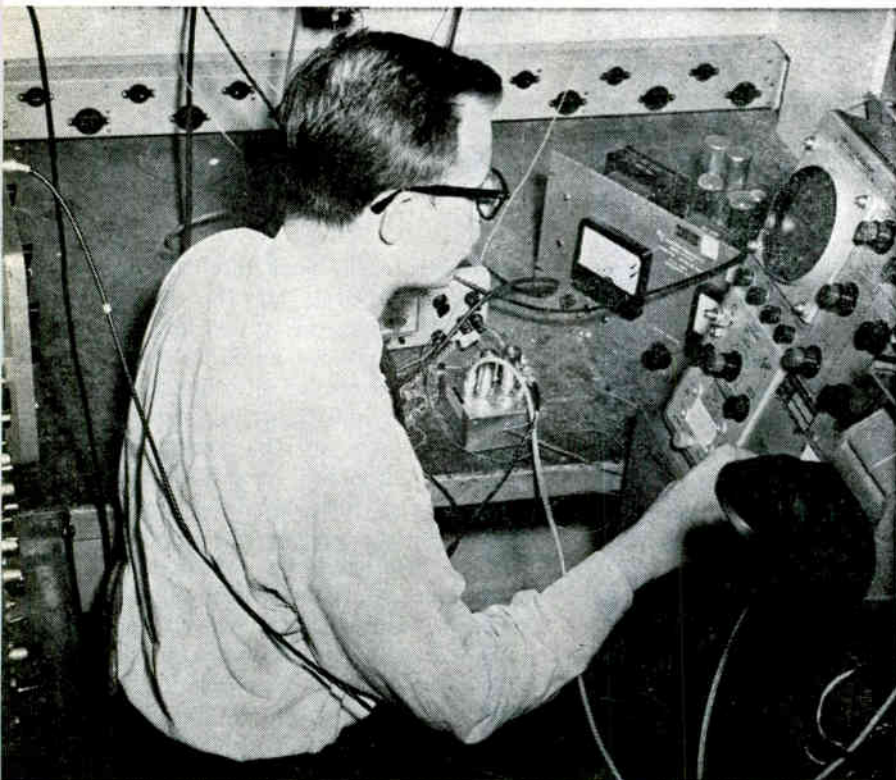

Author checks breadboard of frequency generator

By VLADIMIR KENN,

Sylvania Electronic Systems,
Division of General Telephone and
Electronics Corp., Waltham, Mass.

IN CHECKING the operation of high-speed counters, it is sometimes necessary to generate an accurately known number of high-frequency sinewaves. In particular, to check the counting and read-out performance of a 5-bit 32-Mc binary counter, it is required to generate a known number (between 0 and 32) of 32-Mc sinewaves on a manually initiated basis.

This system generates a group of precounted 32-Mc sinewaves on depressing a pushbutton. The number and frequency of the sinewaves are preset and adjustable.

The system (Fig. 1A) is composed of pulse generator, frequency generator, 32-Mc transmission gate, one-shot logic and one-shot pushbutton.

A Rutherford 2A pulse generator

is recommended. The negative output from the pulse generator is adjusted to about 15 v and its width is set by observing the number of sinewaves on an oscilloscope at the output of the frequency generator, point B, Fig. 1B. The repetition rate is adjusted to any convenient number to permit observation of the frequency generator output. The sync and delayed sync outputs of the pulse generator are used in the one-shot logic. Rise time of the negative pulse on line A should be 10 nanoseconds or less for maximum output of the frequency generator.

The frequency generator generates a number of sinewaves each time a negative pulse from the pulse generator is introduced at its input, the number of cycles being a function of the width of the input negative pulse. The 32-Mc transmission gate permits these bursts of 32 Mc to pass through only when

enabled by the one-shot logic.

The frequency generator (Fig. 1B) is a ringing oscillator that produces sinewaves at the resonant frequency of the tank circuit at the cathode of V_1 . The number of sinewaves is controlled by the input pulse width.

Between pulses, V_1 operates at zero bias, and current I , the zero-bias plate current for both halves of the 5687, flows in L , producing a magnetic field which has energy stored in it according to $\frac{1}{2} LI^2$.

The leading edge of the negative input pulse cuts off the tube and the inductor current flows into the tank capacitor in a direction that makes the cathode voltage negative, thereby starting oscillations at the tank resonant frequency. At the end of the pulse, the tube conducts again, and a second oscillation is excited, but is quickly damped out because the tube is now a low resistance in shunt with the tank. The amplitude of oscillation is a function of L and I and the first negative voltage peak is $E = I \sqrt{L/C}$. Tube V_2 is a cathode follower that permits driving a 91-ohm load and provides energy, fed back by the 9-pf capacitor, to replace the tank circuit losses so that the oscillations will be constant in amplitude.

The 32-Mc transmission gate (Fig. 1B) is a six-diode gate composed of fast planar silicon diodes, type FD-100. Low forward impedance, low capacitance and fast switching speed make this diode suitable at this frequency. About 10 ma are passed through diodes D_5 , D_6 , D_1 , and D_2 to provide optimum forward conduction characteristics.

The gate is opened and closed by gating voltages at D_1 and D_6 , as indicated in Figs. 1B and 2.

The one-shot logic enables the transmission gate to pass the first complete burst of 32-Mc signal that occurs after actuation of the pushbutton. After this burst is completed, the logic is automatically

Sinewaves for Testing Counters

reset, and closes the gate until the next actuation of the pushbutton.

The one-shot logic (Fig. 1C) uses the repetitive output of the frequency generator and gates through the first and only the first complete burst after actuation of the momentary contact pushbutton. This is done with two gates, two flip-flops and a one-shot pushbutton using the sync and delayed sync outputs of the pulse generator.

Gate 1 is opened by setting flip-flop 1 to its ONE state, and this occurs only if a positive trigger arrives on line L. A positive trigger on line C will set flip-flop 1 to its ZERO state and thus close gate 1. If flip-flop 1 is already in its ZERO state (gate 1 closed), triggers arriving on line C will have no effect.

While gate 2 is closed, triggers arriving periodically on line D cannot pass to line L and, therefore, gate 1 remains closed, and there is no 32-Mc output at H until the one-shot pushbutton is actuated.

Assume now that the one-shot pushbutton is actuated, even during a burst of 32-Mc. The one-shot pushbutton, provides one and only one positive pulse per push. When the pushbutton is actuated, a positive trigger is produced on line E, flip-flop 2 is set to its ONE state and gate 2 opens. When the next trigger arrives on line D, it can pass to line L and set flip-flop 1 to its ONE state, thereby opening gate 1 and allowing the next complete burst of 32-Mc to pass to the output H. This burst of 32-Mc is the first of these bursts to appear at H. The next pulse that arrives on line C, at some time before the next burst of 32-Mc occurs, sets flip-flop 1 to its ZERO state, which closes gate 1 and thus prevents the following bursts of 32-Mc from passing through to H. The trailing edge, or positive-going portion of waveform G, is differentiated as gate 1 closes and sets flip-flop 2 to its ZERO state, thus closing gate 2 and preventing further triggers on line D from affecting flip-flop 1. This con-

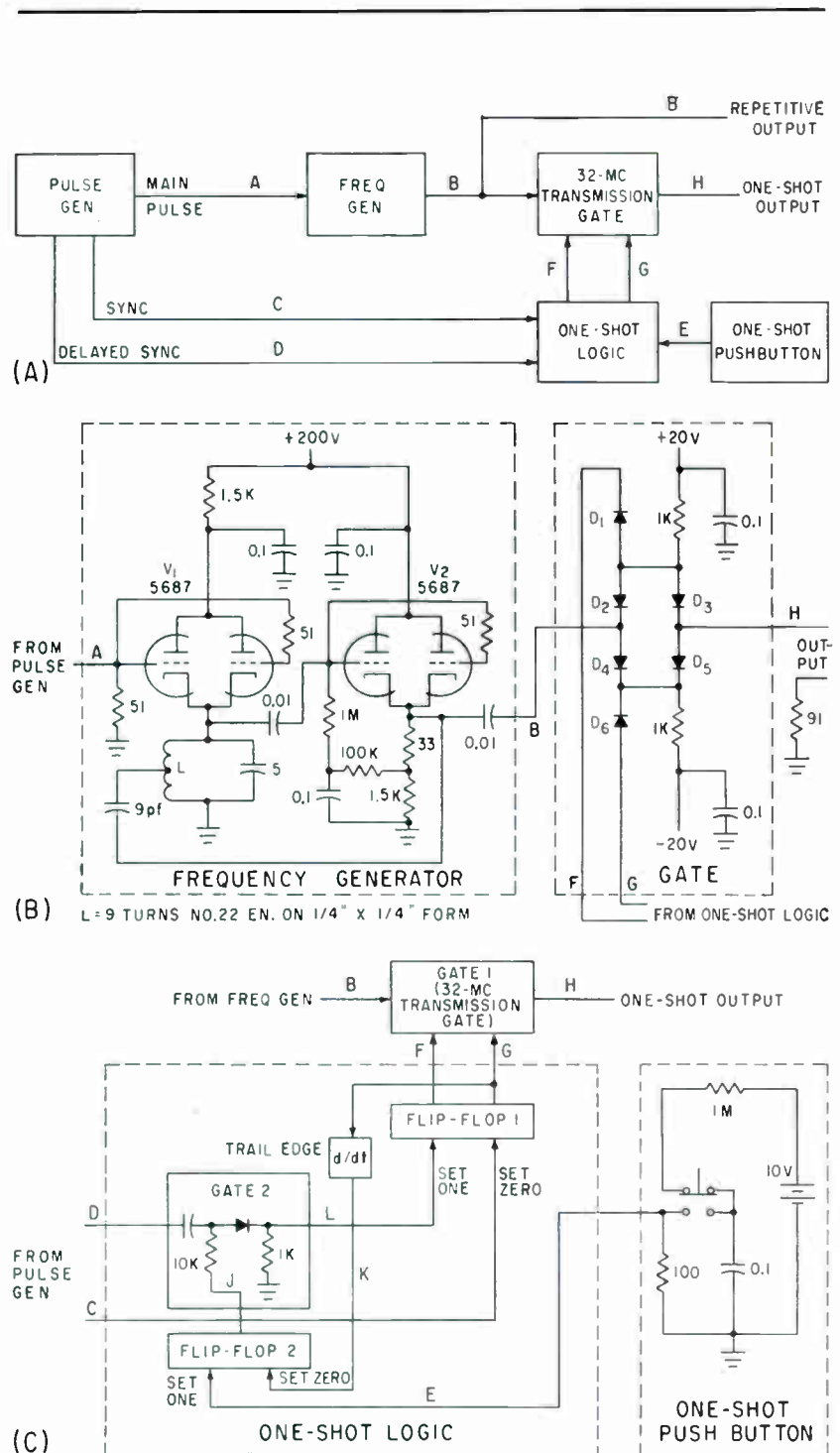

FIG. 1—Block diagram of system (A); schematic of frequency generator and 32-Mc transmission gate (B); and diagram of one-shot logic and one-shot pushbutton (C). The gate 2 diode in (C) is a 1N38B or 1N270, and is not critical

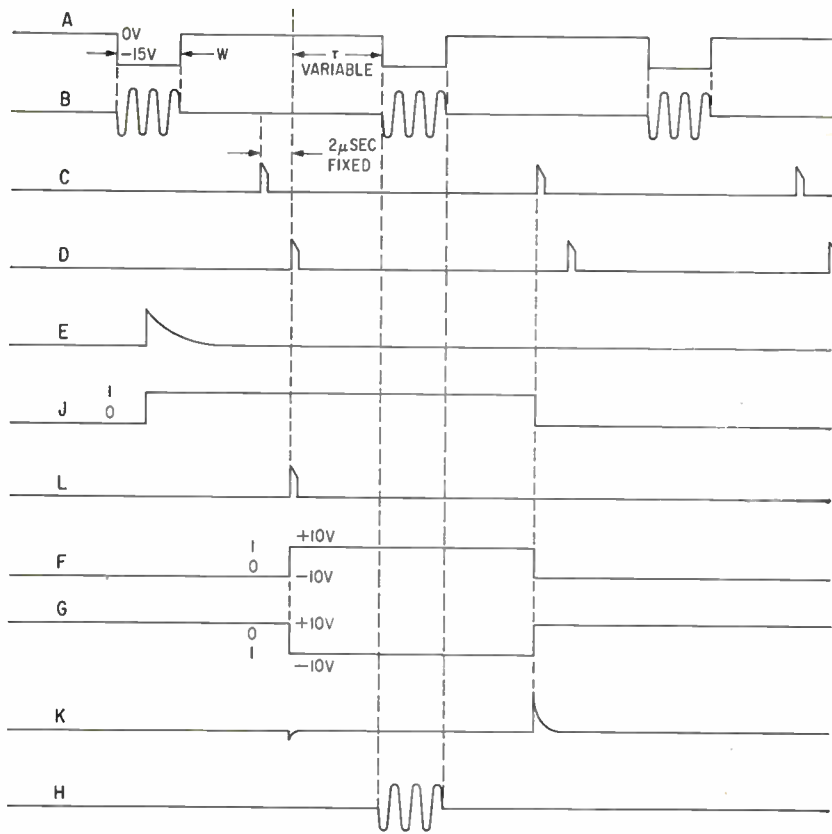

FIG. 2—Waveforms and timing diagram, with the letters indicating the waveforms present on the similarly lettered lines in Fig. 1

dition is now identical with the original state and no action can take place until the pushbutton is again actuated. The differentiating circuit consists of an $0.01\text{-}\mu\text{f}$ capacitor and the input impedance of flip-flop 2. This circuit is not necessary if the waveform at G is capacitively coupled into flip-flop 2.

The one-shot button on the pulse generator would accomplish the same results; however, it is difficult to adjust the pulse width of the pulse generator to obtain the desired number of sinewaves on a one-shot basis since the output of the frequency generator cannot be observed on an oscilloscope by this method. Therefore, the pulse width of the pulse generator would have to be set by observing the frequency generator output on a repetitive basis, and then switching to one-shot operation.

The difficulty is that the pulse width and amplitude of the output of the pulse generator is dependent on repetition rate, and there would be no guarantee that the number of sinewaves displayed on a repetitive

basis would hold for the one-shot operation.

This limitation of the pulse generator would probably apply to any other pulse generator with the same rise time and output amplitude capabilities. Even if a special design for a pulse generator of variable pulse width and one-shot operation were undertaken, it is doubtful that the required tolerance on pulse width could be maintained when switching from repetitive operation to one-shot operation. At 32 Mc, a pulse width change of as little as 15 nanoseconds might cause a problem of ambiguity when the equipment is used to check high-speed counter performance.

This system generates a train of sinewaves, with number and frequency variable by adjustments of pulse width and tank resonance frequency and feeds them into a 90-ohm load on either a repetitive or one-shot basis.

For this choice of tubes and circuit configuration, the maximum frequency is somewhere around 40

to 50 Mc, depending on the amplitude requirements. For higher frequencies the 5-pf capacitor across the tank can be removed to reduce the inductance of L . Reducing L will reduce the output amplitude to below the present 4-v peak-to-peak into 90 ohms.

The lowest number of sinewaves possible with this system is about two at 32 Mc, dictated by minimum pulse width out of the pulse generator.

The highest number is limited to the number that can conveniently be counted by observing the oscilloscope presentation on a repetitive basis.

Although the one-shot logic method of obtaining single bursts of sinewaves appears cumbersome, it is the only means of insuring an accurate and unambiguous count of the number of sine waves in the one-shot burst. This is of prime importance when testing the operation of a counter, since the counter itself usually has a built-in ambiguity of one count.

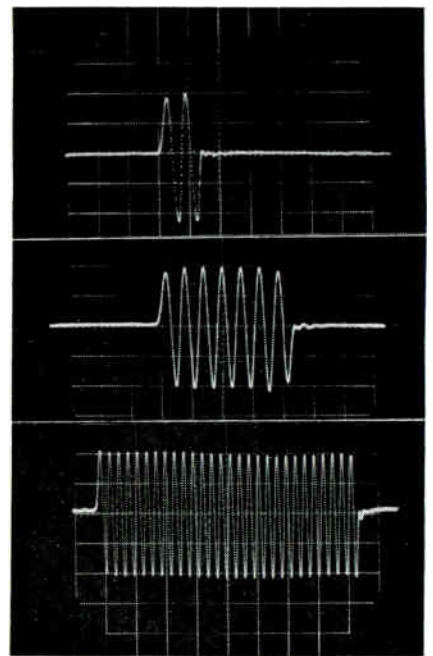
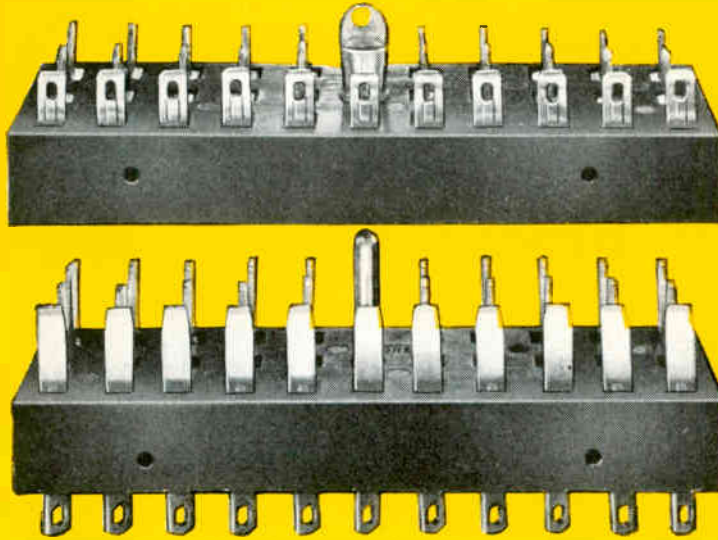

FIG. 3—Oscillograms of various numbers of integral 32-Mc oscillations, taken with a reversing mirror so that time runs from right to left. Vertical scale is 1 volt per cm, horizontal scale is 50 nsec per cm for the first two and 100 nsec per cm for the third waveform

AN IMPROVEMENT



THE NEW JONES MONOBLOC 300 SERIES CONNECTORS

- Simpler . . . sturdier • Easy insertion and withdrawal
- Eliminates Moisture traps (No back plates)

Completely interchangeable with the equivalent sizes of the standard 300 Series.

Can be supplied with hardware for either chassis mounting or cable application.

Insulation material is G.P. black . . . pins are of cadmium plated brass . . .

Contacts are of cadmium-plated phosphor bronze.

For further information, contact the Cinch sales office in your area.

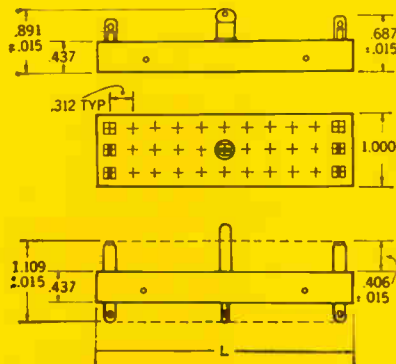

DIMENSIONAL DATA				
Plug Part No.	Receptacle Part No.	No. of Pins or Contacts	Eyelet or Polarizing Pin Position	Dimension "L"
261 31 15 000	261 32 15 000	15	—	1.625
261 31 18 000	261 32 18 000	18	—	1.937
261 31 21 000	261 32 21 000	21	—	2.250
261 31 24 000	261 32 24 000	23	#14	2.562
261 31 27 000	261 32 27 000	26	#14	2.875
261 31 30 000	261 32 30 000	29	#14	3.187
261 31 33 000	261 32 33 000	32	#17	3.500

SPECIFICATIONS	
Recommended Withstanding Voltage:	
A. Adjacent terminals (Sea level)	2540 Volts (AC RMS)
B. To ground (Sea level)	3750 Volts (DC)
	2250 Volts (AC RMS)
	3300 Volts (DC)
Current rating	4.5 Amps.
Contact resistance	.016 Dhms (max.)
Insulation resistance	1,000 Megohms (min.)



Jones

HOWARD B. JONES DIVISION
CINCH MANUFACTURING COMPANY

1026 South Homan Avenue, Chicago 24, Illinois



Division of United-Carr Fastener Corporation, Boston, Massachusetts

Centrally located plants at Chicago, Illinois; Shelbyville, Indiana; City of Industry, California, and St. Louis, Missouri

CIRCLE 117 ON READER SERVICE CARD

Author measuring input and output impedance of 4-terminal network. Superimposed oscillations can just be discerned (left).



Comparing Resistances With Oscillator and Oscilloscope

By ANDREI KISLOVSKY,

Electrotechnical Faculty,
University of Belgrade, Yugoslavia

A METHOD of comparing two resistances, or two resistance-capacitance combinations, is to observe their damping effect on a shock-excited oscillator. An advantage of the technique is that it provides unambiguous scope readout. The technique can be used to determine the value of unknown components or to adjust variable elements to agree with a standard.

The circuit will measure resistances of 100 to 100,000 ohms, with an accuracy of 5 percent or better. The upper limit can be increased by using a coil with a higher Q.

The oscillator, V_{2B} , is shocked by V_{2A} at a rate determined by the input driving frequency from V_1 . The known and unknown resistances

are alternately connected across the oscillator by the relay, causing oscillations to decay at different exponential rates. Oscillator output is viewed on a scope, with the two alternate oscillations superimposed. When the envelopes of the two oscillations merge into one, their impedances are equal; when the frequencies of the two signals are the same, their capacitive reactances are also equal.

When the input signal allows V_{2A} to conduct, oscillations are cut off and energy is stored in the coil. When V_{2A} is driven to cutoff, the oscillator is free to run. A flip-flop frequency divider drives a fast-acting relay that connects first one impedance across the tank, then the other. For resistances from 100 to 2,500 ohms, the load is placed across C_1 rather than the whole tank.

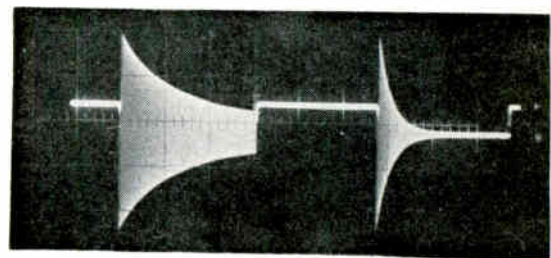

Timebase frequency is adjusted to show two decaying oscillations separately

Measurement error is given by $\Delta u/u$ where u is the amplitude of oscillation at a given point in the decay.

The oscillation under observation occurs $k\tau$ seconds after the beginning of the trains of oscillations, where τ is the time constant of the envelope of the train that is damped with the unknown resistance.

In the time $k\tau$ there are two oscillations, with amplitudes $u = U \exp(-k)$ and $u' = u + \Delta u = U \exp[-k(1 + \Delta\tau/\tau)]$.

Assuming $\Delta u/u$ is small, $\Delta\tau/\tau = (\Delta u/u) / [k + \Delta u/u (k/2 - 1)]$.

If $k = 1$ (the comparison is made when the amplitudes of oscillation have decreased e times from their initial values), and $\Delta u/u$ is assumed to be 5 percent, $\Delta\tau/\tau$ is approximately 5 percent. But if $k = 2$, $\Delta\tau/\tau$ will be only 2.5 percent.

Considering also the regeneration loop, to minimize error it is necessary to set τ as large as possible and compare amplitudes for $k \geq 2$. The two conditions are in contradiction, because the time interval during which V_{2A} does not conduct is limited. A compromise is to adjust damping so that oscillation amplitude falls to approximately 5 percent (e^{-3}) of its initial value. Thus the comparison of amplitudes should be made in the last third of the oscillation.

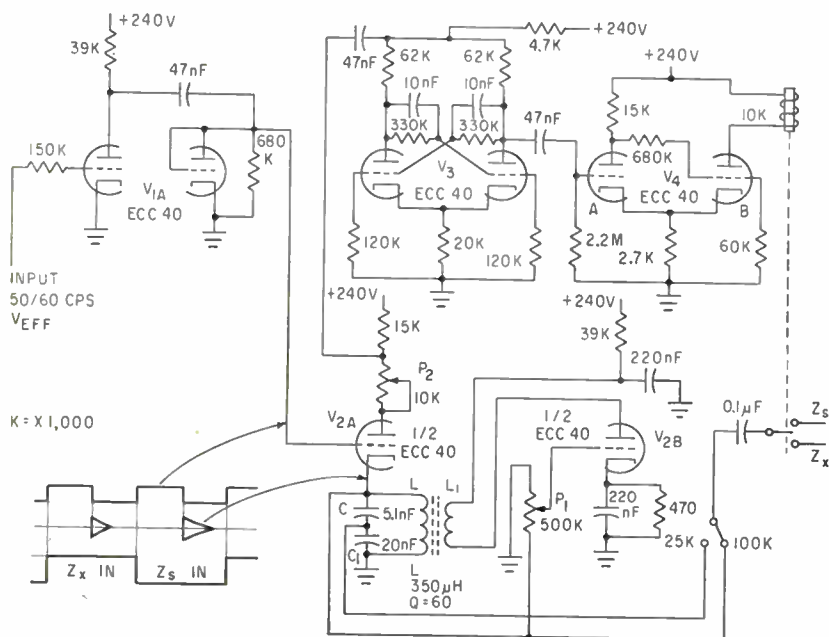

Oscillator, V_{2B} , is damped alternately by known and unknown impedance. Flip-flop frequency divider drives relay at one-half input frequency

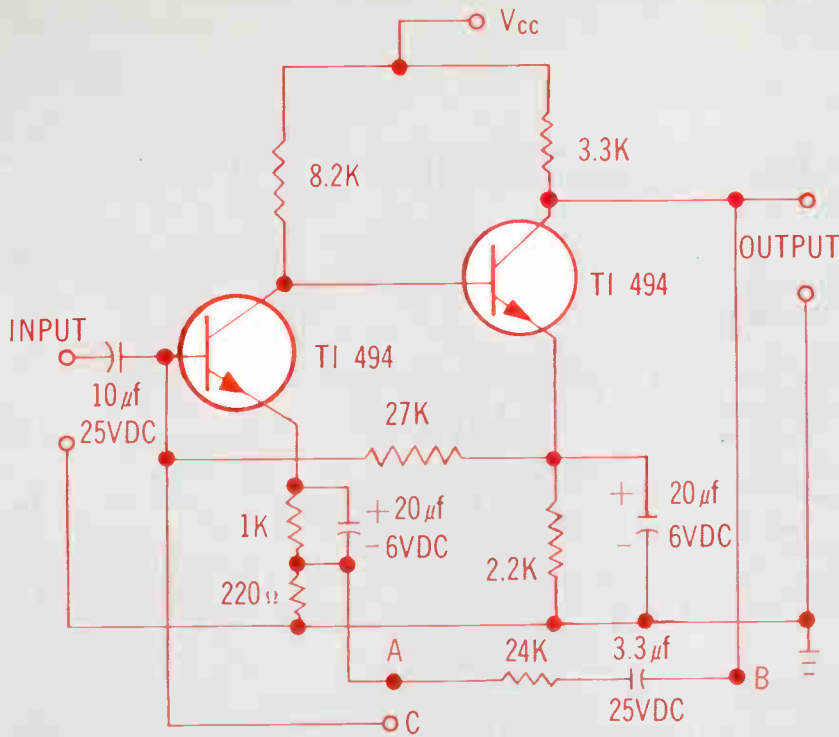

Multipurpose Industrial Amplifier



Typical Characteristics:

Voltage Amplification	40 db (nominal)
Frequency Response	± 3 db from 10 cps to 1 mc
Input Impedance	20KΩ @ 1 kc
Output Impedance	less than 50 ohms @ 1 kc
Max Input Voltage	80 mv (rms)
Supply Voltage	10 to 25 volts dc
Temperature Range	-20°C to +100°C

Versatility—

The basic amplifier circuit also may be utilized as a sensitive a-c voltmeter, tuned amplifier or tuned oscillator simply by employing different networks between terminals A and B or C and B.

HOW TO GET HIGH TEMPERATURE STABILITY AND INDUSTRIAL ECONOMY

With New TI Low-Cost Silicon Industrial Transistors...

You can assure your customers optimum circuit performance up to 125°C when you design-in new, low-cost TI silicon industrial transistors. Priced comparable to lower-temperature industrial devices, these new TI silicon industrial units provide the high performance your industrial designs require.

Get greater margins of operational safety by applying these new silicon industrial transistors to your process control, communication, aviation system, electronic instrumentation, and computer applications today.

CHARACTERISTICS					APPLICATIONS					
TYPE	MIN BV _{CB0}	DC Beta Range	MAX I _{CB0} @ 100°C	f _{αb} (typ)	Servo and Relay Driver	Audio Amplifier Medium-Speed Switcher *	Audio Amplifier Medium-Speed Switcher †	High-Speed Switcher	RF Amplifier (to 40 mc)	VHF Amplifier (to 100 mc)
TI 480	50 v	9-36* @ 5 ma	50 μa @ 30 v	1 mc	TI 480					
TI 481	80 v	9-36* @ 5 ma	50 μa @ 30 v	1 mc	TI 481					
TI 482	20 v	>20 @ 30 & 150 ma	50 μa @ 10 v†	60 mc			TI 482		TI 482	
TI 483	40 v	20-60 @ 150 ma	50 μa @ 30 v†	60 mc			TI 483		TI 483	
TI 484	40 v	40-120 @ 150 ma	50 μa @ 30 v†	60 mc			TI 484		TI 484	
TI 485	20 v	15-60 @ 10 ma	20 μa @ 15 v†	200 mc				TI 485		TI 485
TI 492	40 v	15-45* @ 1 ma	50 μa @ 30 v	8 mc		TI 492				
TI 493	40 v	15-45 @ 10 ma	50 μa @ 20 v	20 mc		TI 493				
TI 494	40 v	40-125 @ 10 ma	50 μa @ 20 v	20 mc		TI 494				
TI 495	40 v	120-250 @ 10 ma	50 μa @ 20 v	20 mc		TI 495				

*AC Beta † I_{CB0} @ 125°C

†100 μa to 20 ma

‡20 ma to 300 ma



SEMICONDUCTOR COMPONENTS
DIVISION
PLANTS IN DALLAS, TEXAS
BEDFORD, ENGLAND
AND NICE, FRANCE



**TEXAS INSTRUMENTS
INCORPORATED**
13500 N. CENTRAL EXPRESSWAY
P. O. BOX 5012 DALLAS 22, TEXAS

Thyratron Actuator Boosts Strobotron Power

By RONALD L. IVES,
Palo Alto, Calif.

ELECTROMECHANICAL devices requiring high power can now be operated in strobotron circuits. A self-resetting thyratron actuator overcomes the limitations imposed by the strobotron tubes.

Small relays, counters, solenoid valves and similar devices are often operated by recharge current in the strobotron circuit. Within the power and frequency limits of the strobotron tube, performance is completely satisfactory in a wide variety of control, measuring and counting applications. However, power available to the load is usually limited to that available from a 4- μ f capacitor charged to 300 volts.

The strobotron actuation circuit is unsatisfactory at higher power levels because strobotrons cannot usually be operated in parallel. Also, life of the strobotron tube is shortened markedly by overloads.

Dependable operation of heavy electromechanical loads from pulse inputs is possible with the circuit in the figure. With a suitable choice of tubes, this circuit can be arranged to handle loads from a few milliamperes to several amperes and at voltages from about 50 to more than 500 volts. Operation at even higher voltages and currents is theoretically possible although it was not actually attempted.

When the circuit is energized but no input pulse is provided to the grid of thyratron V_1 , the thyratron does not conduct. However, vacuum tube triode V_2 does conduct because its grid is at the same potential as its cathode. Conduction in V_2 charges capacitor C_1 to plate supply potential. Charging rate is determined by the resistances of V_2 and R_1 . Resistor R_1 is provided solely to limit current in V_2 to a safe value.

When a positive pulse having sufficient amplitude to overcome the hold-off bias is applied to the grid

of V_1 , the thyratron conducts. Capacitor C_1 discharges through V_1 , actuating the electromechanical load device. Because of diode D_1 , voltage drop across the load lowers the potential on capacitor C_2 . Thus voltage at the grid of V_2 is negative with respect to that at the cathode, which cuts off the tube and prevents C_1 from recharging.

As C_1 discharges, current through the load decreases and voltage drop across it is reduced. However, diode D_1 blocks current in the direction that would permit voltage across C_2 to become more positive. Thus an increase in voltage at the grid of V_2 is delayed by the R-C circuit consisting of R_2 and C_2 .

Plate voltage at V_1 is reduced as the positive voltage on C_1 is discharged until conduction can no longer be sustained. After V_1 has been cut off, C_2 discharges through R_2 , increasing grid voltage of V_2 toward cathode potential. The triode conducts again, recharging C_1 and making the circuit ready for the next cycle.

Minimum time delay in the grid circuit of V_2 is slightly longer than that required for V_1 to de-ionize. In practice, V_2 must be kept from conducting after the load has been de-energized until all parts of the magnetic load circuit have come to rest. The return of a spring-loaded plunger or armature in an electromagnetic actuator can induce high voltages in the load coil. In several cases, these voltages have produced systemic oscillations. Time delay can be reduced only if very effective flyback absorbers, such as adequate reverse diodes, are connected across the load.

When operating frequency of the electromechanical device does not require rapid recharging of C_1 , plate supply voltage can be a-c. In such a case, V_2 functions as a grid-controlled rectifier.

Experience indicates that only one thyratron can be used. Connecting more than one gas tube in parallel to increase current handling

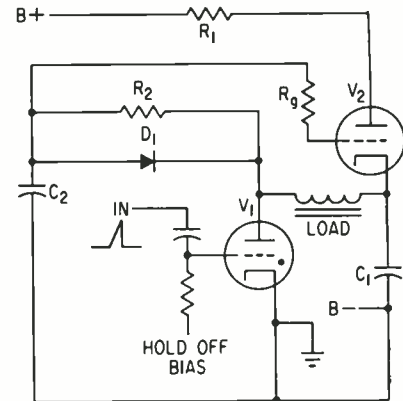

After C_1 discharges through triggered thyratron and energizes load, thyratron is cut off and capacitor recharges through triode

capability is almost always unsatisfactory. However, several vacuum triodes can be operated in parallel if each has a current limiting resistor that ensures each tube providing equal power to the load.

Usually the triode should have a separate filament circuit with the center tap at approximately the same potential as the cathode. Otherwise, it must be established that the peak heater to cathode voltage rating of the tube is never exceeded during current surges.

Adequate shielding of the thyratron will make the circuit more dependable in military and industrial environments. Shielding is particularly important in the presence of strong magnetic fields or high beta-gamma backgrounds. In these environments, close differential operation of the tube is not recommended.

Oscilloscope Displays Magnetic Film Curves

PERFORMANCE of thin magnetic film elements in storage applications can be predicted directly from an oscilloscope display. The method provides the critical curve of switching properties for on-the-spot examination after the elements have been fabricated. These curves



Audio, telemetry and low frequency oscillators

Pictured here are six of the most widely used oscillators in electronics. All employ the highly stable, dependable, accurate resistance-capacity circuit. They require no zero setting. Output is constant, distortion is low and frequency range is wide. Scales are logarithmic for easy reading; all are compact, rugged and broadly useful basic instruments. Brief specifications are given below; call your ϕ rep for demonstration or write direct for complete data on any instrument.

Model	Frequency Range	Calibration Accuracy	Output to 600 ohms	Recommended Load	Maximum Distortion	Max. Hum & Noise \ddagger	Input Power	Price
200AB	20 cps to 40KC (4 bands)	$\pm 2\%$	1 watt (24.5 v)	600 ohms	1% 20 cps to 20 KC 2% 20 KC to 40 KC	0.05%	70 watts	\$165.00
200CD	5 cps to 600 KC (5 bands)	$\pm 2\%$	160 mw 10 volts	600 ohms*	0.5% below 500 KC 1% 500 KC and above	0.1%	75 watts	\$195.00
200J	6 cps to 6 KC (6 bands)	$\pm 1\% \dagger$	160 mw 10 volts	600 ohms*	0.5%	0.1%	110 watts	\$350.00
200T	250 cps to 100 KC (5 bands)	$\pm 1\% \dagger$	160 mw 10 volts	600 ohms*	0.5%	0.03%	160 watts	\$500.00
201C	20 cps to 20 KC (3 bands)	$\pm 1\% \dagger$	3 watts (42.5 v)	600 ohms**	0.5% \ddagger	0.03%	75 watts	\$250.00
202C	1 cps to 100 KC (5 bands)	$\pm 2\%$	160 mw 10 volts	600 ohms*	0.5% \S	0.1%	75 watts	\$300.00

*Internal impedance is 600 ohms. Frequency and distortion unaffected by load resistance. Balanced output with amplitude control at 100. Use line matching transformer for other control settings. **Internal impedance approximately 600 ohms with output attenuator at 10 db or more. Approximately 75 ohms below 5000 cps with attenuator at zero. \dagger Internal, non-operating controls permit precise calibration of each band. \ddagger 0.5%, 50 cps to 20 KC at 1 watt output. 1.0% over full range at 3 watts output. \S 0.5%, 10 cps to 100 KC. 1.0%, 5 to 10 cps. 2.0% at 2 cps. 3.0% at 1 cps. \parallel Measured with respect to full rated output.

HEWLETT-PACKARD COMPANY

1015A Page Mill Road • Palo Alto, California, U.S.A.

Cable "HEWPACK" • Davenport 5-4451

Hewlett-Packard S.A., Rue du Vieux Billard No. 1, Geneva, Switzerland

Cable "HEWPACKSA" • Tel. No. (022) 26. 43. 36

Field representatives in all principal areas

6036



ϕ 200AB
Audio Oscillator



ϕ 200CD
Wide Range
Oscillator



ϕ 200J
Interpolation
Oscillator



ϕ 200T
Telemetry
Oscillator



ϕ 201C
Audio
Oscillator



ϕ 202C
Low Frequency
Oscillator



pioneered the world-famous resistance-capacity oscillator circuit



COAXIAL BROAD BAND FERRITE ISOLATORS

IN SIZES FOR EVERY APPLICATION

Now—from Kearfott, a new and broader line of Ferrite Isolators to satisfy the most exacting requirements of band width and isolation. Combining low unit loss characteristics with compactness and light weight, this new series of Kearfott Coaxial Isolators is available from present stock. Immediate selection and faster delivery is assured . . . *precision performance proven.*

A FEW OF THE TYPICAL SPECIFICATIONS				
MODEL	FREQUENCY	ISOLATION	INSERTION LOSS	VSWR
C991100-402	1.2—2.6 KMC	10 DB Min.	1.0 DB Max.	1.20
C992100-405	2.0—2.5 KMC	30 DB Min.	.8 DB Max.	1.20
C992100-404	2.0—4.0 KMC	10 DB Min.	1.0 DB Max.	1.20
C992100-407	3.0—3.5 KMC	35 DB Min.	.8 DB Max.	1.20
C993100-401	4.0—8.0 KMC	10 DB Min.	1.0 DB Max.	1.20
C994100-403	7.0—9.0 KMC	25 DB Min.	.8 DB Max.	1.20

Complete information on these or all of the models is available by directing inquiries to: 14844 Oxnard Street, Van Nuys, California, or the sales office in your area.



**KEARFOTT DIVISION
GENERAL PRECISION, INC.**

Little Falls, New Jersey

SALES OFFICES SEATTLE, WASH. VAN NUYS, CALIF. PHOENIX, ARIZ. DAYTON, OHIO CLIFTON, N.J.
PALO ALTO, CALIF. SAN DIEGO, CALIF. DALLAS, TEX. CHICAGO, ILL. WASHINGTON, D.C.

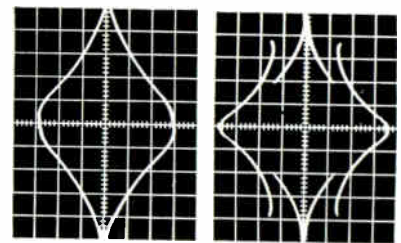

(A)

(B)

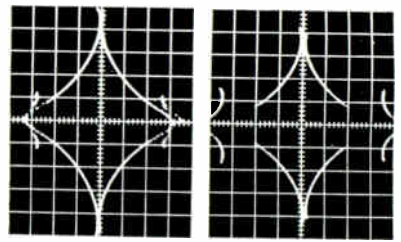

(C)

(D)

Trace at (A) shows desired curve alone while all others include curve caused by domain wall movement

of flux reversal resulting from rotation of magnetization in thin magnetic films are usually plotted from point-by-point measurements.

The procedure for displaying the curves was evolved by W. Kolb of Siemens in Munich, Germany. He expects a more detailed description of the method to appear in *Elektronischen Rechenanlagen* (Electronic Computer Notes).

The thin magnetic film elements of interest are usually in the form of a disk several millimeters in diameter and 1,000 angstrom units thick. They generally consist of about 80 percent nickel and 20 percent iron and are formed by evaporation in a high vacuum on a glass plate.

Suitability of thin magnetic films for storage circuits depends on their anisotropy. This single-axis characteristic in which there is an easy direction of magnetization is closely related to flux reversal in the presence of controlling magnetic fields. The critical curve represents flux reversal in relation to intensity and direction of controlling magnetic fields.

For coherent rotation of magnetization, switching of the thin magnetic film is theoretically fastest when the critical curve takes the shape of a hypocycloid with four cusps. In practice, however, the curve departs from the hypocycloid.

To display the critical curve, a 500-cps sinusoidal voltage is applied to the horizontal input of the oscilloscope. At the same time, an alternating magnetic field proportional to the voltage is applied in the easy direction of magnetization to the thin magnetic film element.

Vertical input to the oscilloscope is a 10-cps symmetrical sawtooth voltage. A magnetic field proportional to this voltage is applied in the hard direction of magnetization.

The two magnetic fields control the switching element as shown in the figure. Flux in the easy direction of magnetization is reversed by the sinusoidally varying magnetic field. However, the points during each cycle at which switching occurs are affected by the magnetic field applied in the hard direction of magnetization.

A pick-off coil is used to detect switching of the element. As flux is reversed, the voltage induced in the pick-off coil is used to intensity modulate the oscilloscope trace forming the critical curve.

In the photographs of the display, the desired curve is shown at (A). A second curve produced by movement of the domain walls appears in all the remaining photographs. The two curves may merge as at (B) or have common peaks as at (C). At (D), they are completely separated with the inner curve taking the shape of a hypocycloid.

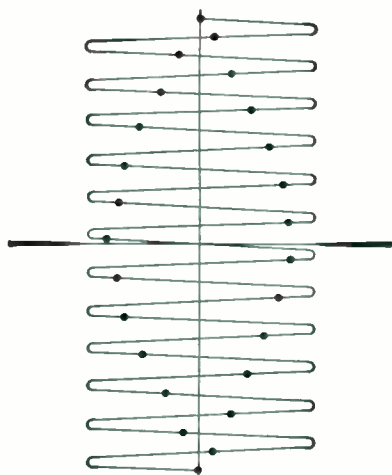

Switching magnetic films intensity modulates trace swept by voltages proportional to controlling magnetic fields

SHOWN 3 TIMES NORMAL SIZE

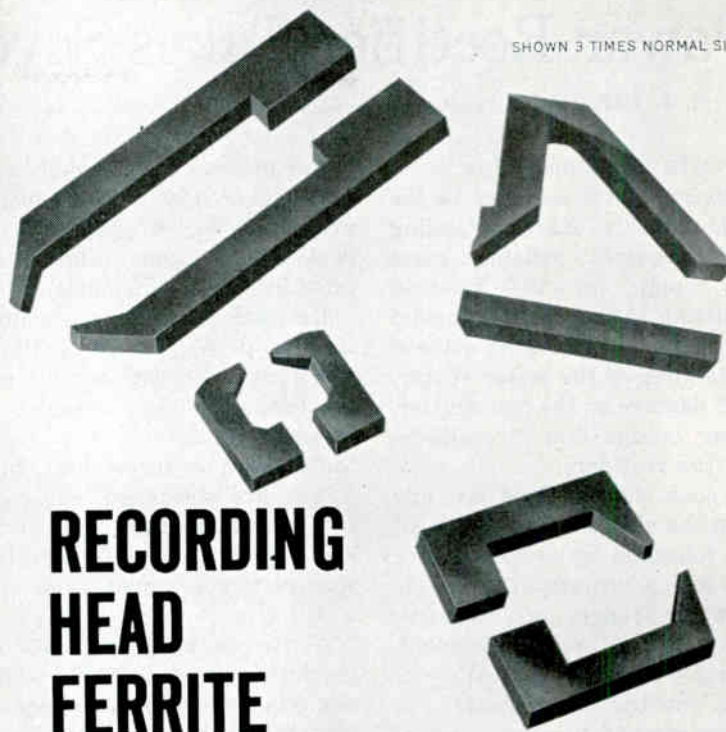

RECORDING HEAD FERRITE

Kearfott's new CN-20 nickel-ferrite, specifically developed for recording head applications, is a sintered material which operates most efficiently in the 10 kc to 750 kc frequency range. CN-20 imparts superior magnetic and mechanical properties, is insensitive to mechanical stresses of potting compound during curing, is magnetically stable under temperature variation and has uniform magnetic properties. CN-20 heads have negligible deviations in inductance to temperatures as high as 160°F, using gaps of .0010 or .0015 inches.

Production quantities of complex shapes are immediately available. Dimensional tolerances of 0.0001 inch and finishes of 16 to 32 micro-inches are standard... electroplated surfaces for unusual wear resistance also available.

TYPICAL CHARACTERISTICS

Initial Permeability at 100 kc	800
Saturation Magnetization (DC) at 16 oersteds	3680 gauss
Residual Magnetization	2565 gauss
Coercive Force	0.19 oersteds
Temperature Coefficient of Initial Permeability (-20°C to +100°C)	1.0% °C
Curie Temperature	150°C
Resistivity	10 ⁴ ohm-cm

All magnetic properties are held within a tolerance of ±15%

Write for complete data



**KEARFOTT DIVISION
GENERAL PRECISION, INC.**

Little Falls, New Jersey

Power Rectifier Takes Severe Environment

By E. J. DIEBOLD, Director of Corporate Engineering, International Rectifier Corp., El Segundo, Calif.

HIGH POWER RADAR operating in severe environments, as used in the Ballistic Missile Early Warning System, requires reliable beam power supply for the klystron transmitting tubes. Environmental extremes must be tolerated without direct failures of the power supply, indirect damage to the transmitter, or power outage due to malfunction of the rectifiers.

For such installations at any point on the globe, the environment is best tolerated by semiconductor devices which operate over a wide temperature range, are hermetically sealed, position independent, static, rigid and symmetrical or reversible (having no filament).

An assignment to meet a set of unusually rigid requirements was tackled as an engineering challenge. And a successful design was accepted and proved by the approving agencies.

In this design, see photos, the power rectifier elements contain a large number of identical silicon rectifier cells connected in series. This arrangement allows continued operation with a plurality of failed individual elements without detriment to the operative cells, except by the proportional increase of the mean voltage applied per cell. Hence the overall reliability is higher than the reliability of the individual units.

To facilitate storage, replacement and transportation, a self-contained, hermetically sealed unitary structure was provided, of manageable size, suitable proportions for installment and electrical reversibility, to be used at any part of the rectifier circuit.

The design of the rectifier elements assures voltage division for any distribution of failed cells by an elastic voltage divider network consisting of resistors and capacitors. Rectifier cells and hardware are combined into a rectifier module which is assembled and in-line tested as one component. Assembly into the complete structure is performed with a minimum of stress on the modules (bolted joints).

For a beam power supply of 30,000 volts, 9 amps, rectifier elements are rated 70,000 volts, 400 amp peak. These higher values are dictated by the environment.

Rectifier elements are contained in slim, prismatic (16 × 16 × 60 in.) tanks, entirely metallic except for two symmetric terminals with ceramic insulation. Six identical tanks form a three-phase bridge. Tanks are grounded, self-cooling, self-supporting and able to withstand shake tests, and operating or storage temperatures from -65 C to 105 C.

Active parts are immersed in an insulating fluid, askarel, which is nonflammable and a good heat transfer medium. Internally, heat moves by natural convection of the askarel. This oily fluid flows freely through the electrostatic shield from the hot, active parts to the cold grounded tank walls. At full load, the temperature rise of the live parts over ambient air (without forced cooling) is not more than 40 C.

Active parts are mounted on a strong epoxy-fiberglass tube which is held between large ceramic, high-strength insulators. A large steel spring keeps the entire internal structure under an axial compression which is larger than the highest dynamic force applied to all these parts. The electrostatic screen is maintained under a tensile force of equal magnitude. Thus the structure cannot move under shock or vibration, although displacements due to thermal expansion are allowed without undue stress.

Electrical influences are governed by the power source, the load (pulse forming network and klystron) and the protective system for the tube (crowbar tube and vacuum circuit breakers). Rectifiers create environmental problems for each other and for the other parts of the system (commutation-switching transients).

The beam power supply has a very low impedance, yet it must be short-circuited instantly whenever the klystron draws a fault current.

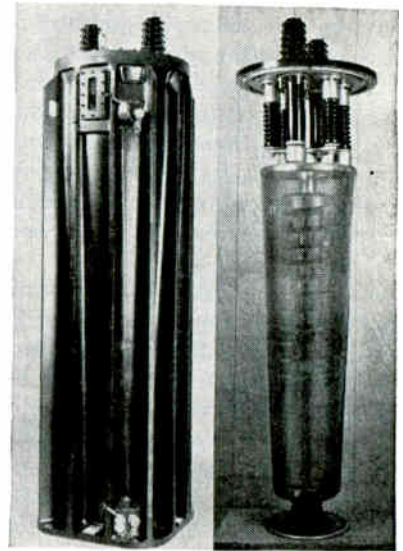

Complete rectifier element (left) rated 70,000 volts, 400 amp peak. Level gage indicates operating temperature by liquid expansion. Internal structure (right) shows rectifier modules on a helix around the central insulating cylinder. Anode connection on upper end of central cylinder, cathode connection on Faraday screen

This is achieved by firing a crowbar tube and removing the resulting short circuit by operating a vacuum circuit breaker. Crowbaring causes a heavy overcurrent in the rectifiers. Interruption of the vacuum switches causes switching voltage transients. Spark-gaps clip excessive transients. Recurrent voltage transients are caused by the reverse recovery current clipping action of the semiconductor junctions.

High surge currents with subsequent high surge voltages constitute the most severe stress on the rectifiers. Current surges cause sudden localized overheating of the semiconductor junctions and possibly excessive reverse current under immediately following overvoltages. The temperature induced reverse current is then a further source of heat and temperature rise. To prevent this type of failure, the silicon rectifier cells are made from alloyed junctions, 0.06 sq in., able to carry 40 times the

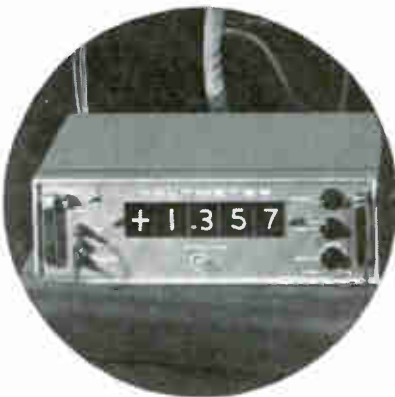
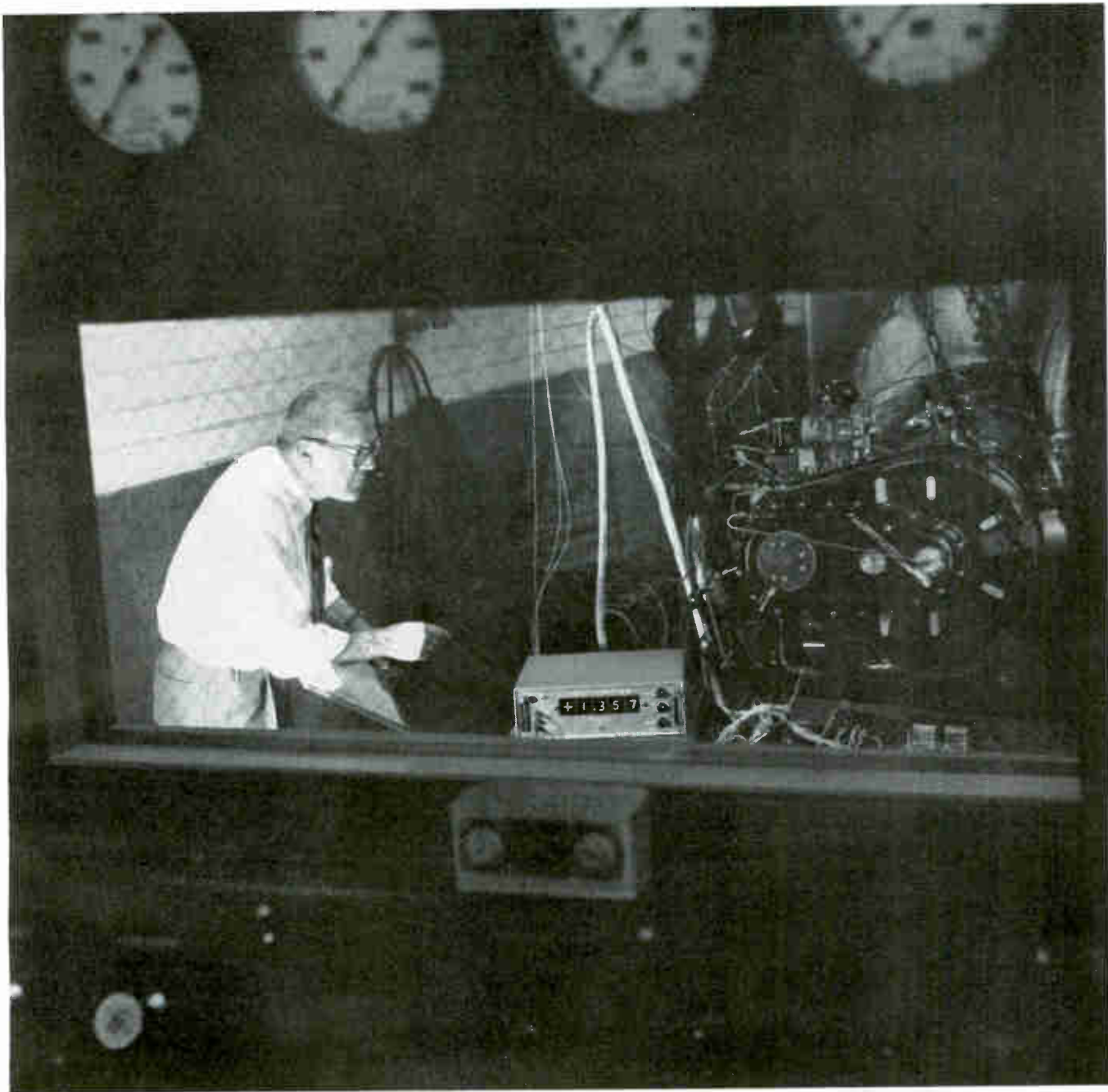

NO STEPPING SWITCHES IN THIS ULTRA-RELIABLE DVM:

Cubic announces a new digital voltmeter design that eliminates stepping switches and, with them, the need for periodic maintenance. The new Cubic V-70 uses the same ultra-reliable reed relays developed for submarine cables. These reed relays are sealed in glass and have practically unlimited life. They are noiseless and completely unaffected by operating position.

Accurate: The V-70 reads any d-c voltage from 0.001 to 999.9 volts with an absolute accuracy of 0.01% plus or minus 1 digit. The Cubic V-70 Digital Voltmeter provides these and other premium features at a cost of only \$1,580. For details, write to Dept. E-105, Industrial Division, Cubic Corporation, San Diego 11, Calif. (in Europe: Cubic Europa S. p. A., Via Archimede 185, Rome).

Cubic manufactures a complete line of quality digital instruments, including a-c and d-c voltmeters, ohmmeters, ratiometers, scanners and printer controls.



INDUSTRIAL DIVISION
SAN DIEGO, CALIF., U.S.A. ROME, ITALY



Hughes cuts fancy figures in silicon. Reports "Airbrasive is the only tool capable of handling the process!"

Hughes Aircraft uses the Industrial Airbrasive linked to a pantograph to cut intricate patterns and shapes in semiconductor wafers. And what's more they are doing it accurately and with *complete safety to the fragile part.*

The secret of this unique tool is a superfine jet of abrasive particles and dry gas, directed through a carbide nozzle. The resulting cutting action in hard brittle materials is cool, rapid, precise, and completely shockless.

The Airbrasive is being used to solve hundreds of seemingly impossible jobs... precision deburring... to remove surface deposits... form and adjust microminiaturized circuits... cut glass, germanium, tungsten, ferrites, and others.

Low in cost too. For under \$1,000.00 you can set up your own Airbrasive cutting unit!

Send us samples of your "impossible" jobs and we will test them for you at no cost.



SEND FOR BULLETIN 6006...complete information.

International Representatives

UNITED KINGDOM
Elliott Brothers (London) Limited
Century Works
Lewisham, S. E. 13, England
Tideway 3232

BELGIUM—LUXEMBURG
Regulation-Mesure S.P.R.L.,
22 Rue Saint Hubert
Bruxelles 15, Belgium
Bruxelles 70-79-89

JAPAN
Hakuto Company Limited
Toranomon-Sangyo Building
1, Kotohira-Cho, Shiba, Minato-Ku
Tokyo, Japan
(501) 5301-9

FRANCE
Elliott Automation (France)
23-25 Rue de Lisbonne
Paris 8, France
Le Borde 3847

**SWITZERLAND—WEST GERMANY
AUSTRIA—ITALY**
Sorensen-Ardag
Eichstrasse 29
Zurich 3/45, Switzerland
051/273060

S.S. White

S. S. White Industrial Division
Dept. EU, 10 East 40th Street, New York 16, N. Y.

New dual
Model D1

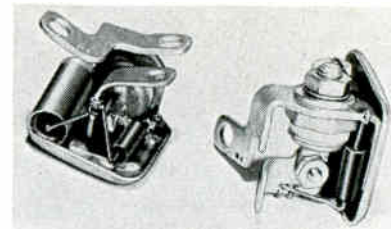

Rectifier module contains one silicon rectifier cell, voltage dividing capacitor and damping resistor, mounted on metallic shield which acts as cooling fin and cathode connector. Anode connector bracket connects to following module. Bolted joints are used for interconnections. Internal wiring with soldered joints, minimum length wires and large cross section conductors minimizes inductance

rated current for 50 milliseconds without affecting the voltage recovery. All rectifier cells are in-line tested for this property. Mounting, cooling and interconnections are designed to carry this surge current, not only for the much smaller rated current.

Transient voltages appearing in the blocking direction between terminals are equally divided among all the series-connected devices, to avoid failure. From the overall systems layout, it is apparent that voltage transients will not have rise times of less than 0.2 μ sec, rising to a peak of 70,000 volts; or a rate of rise of 3.5×10^{11} volt per second. This constitutes a very severe stress in magnitude and rate of rise. Ordinary rectifier stacks cannot cope with such a fast rise.

Extremely high voltage silicon rectifier junctions must be excluded from this application because they show an excessive increase of reverse current at the surge-current induced over-temperature. Accordingly, the units are made with cells of a mean rated voltage of only 400 v, tested at high temperature and a substantial voltage to guarantee performance under these conditions.

Requiring 176 cells in series, voltage division is achieved by designing the stack as a short-circuited transmission line with a cutoff frequency of more than 10 Mc. To achieve this, a tapered-cylinder, high-conductivity Faraday screen is applied around a cylindrical stack, the rectifier modules positioned in an even helix along the axis of the cylinder. Each

module contains a rectifier cell, shunting capacitor, shunting resistor and coupling capacitor plate (acting also as a cooling fin) which couples to the screen. Self- and mutual inductance are controlled by the size of conductors.

Shunting capacitor and resistor compensate for reverse switching properties of semiconductor junctions, furthermore, they are dimensioned to obtain the desired frequency of the transmission line^{1, 2}. The tapered shield gives a gradual modification of the shunt capacitance. The narrow lower end is held fixed at the cathode potential, with the screen acting as a return current carrier. Voltages appearing between rectifier modules and ambient are limited to less than the voltage between terminals. The screen eliminates ground or ambient voltage influences.

Electromagnetic waves coming from outside the tank are shielded by heavy aluminum walls, their residue is shielded by the screen. Rectifier modules at the open end of the transmission line are subjected to higher voltage stresses, similar to a transformer winding. Hence, the cells of the first turn of the helix are made with a voltage rating of 150 percent, and those in the next three turns with a rating of 125 percent of remaining cells.

High voltage effects, such as local discharge, creepage, arcs and thermal breakdown due to electric gradients are eliminated by using the capacitors and resistors in the rectifier modules as a voltage dividing ladder, to which all metallic parts are tied. Thus all electric gradients are held very low.

Electric stresses applied between ground and active parts are localized to the insulating space between tank and Faraday screen, the ceramic support insulators and feed-through insulators. These parts are designed to withstand voltages above 180,000 volts. The outside flashover voltage is much lower, thus eliminating internal failures.

REFERENCES

(1) E. J. Diebold, Voltage Division of Series-Connected Semiconductor Devices, Part I: Properties of Semiconductor Devices Affecting Voltage Division, International Rectifier Corp., *Rectifier News*, Winter, 1959. Part II: Properties of Rectifier Systems and Means to Improve Voltage Division, *ibid*, Spring, 1960.

(2) E. J. Diebold, Semiconductor Diode Strings under Voltage Transients, *Solid State Journal*, vol 2, No. 4, April, 1961; and vol 2, No. 5, May 1961.

DATA RECORDERS EXPENSIVE?

not any more!



now...

0.2% precision
in a complete,
easy-to-use
4-channel
analog tape
recording
system... only

\$2,950

Also available:
Model 102A—
2-channel system
\$1390

MNEMOTRON model 204

Record /Reproduce System

complete with Tape Transport

Now, you can afford the data recording facilities you need . . . as few as 2 channels, as many as 4, 6, 7 on 1/4" tape; or 14 on 1/2" tape.

Mnemotron pioneers this **price-plus-precision** breakthrough with a unique pulsed FM principle and fully transistorized, self-contained, interchangeable modules. Precise, economical and portable Mnemotron is ideal for these applications in industry, research and medicine: • Data acquisition, storage, analysis and reduction • Time scale contraction and expansion • Dynamic Simulation • Programming • Computer Read In and Read Out.

With Mnemotron, you can do more with paper recorders, too . . . expanding frequency response and channel capacity, saving you from being "snowed" with data, letting you look at the same data at different time scales.

When the data you want is analog, record and reproduce it with greater accuracy and much lower cost with Mnemotron. Write, wire, phone today for complete details on this new concept in instrumentation tape recording.

MNEMOTRON

CORPORATION

37 South Main Street, Pearl River, N. Y. • Pearl River 5-4015 (914) • Cables: Mnemotron
Precision Analog Data Tape Recorders and Biological Computers

Model 204 features:
Any 2 of these
speeds:

1 1/2, 3 3/4, 7 1/2, 15 ips

Frequency Response:

DC-800 cps @ 15 ips

DC-400 cps @ 7 1/2 ips

Linearity: 0.2% full scale

Noise: Less than
-50 db full scale

Crosstalk:
below 70 db

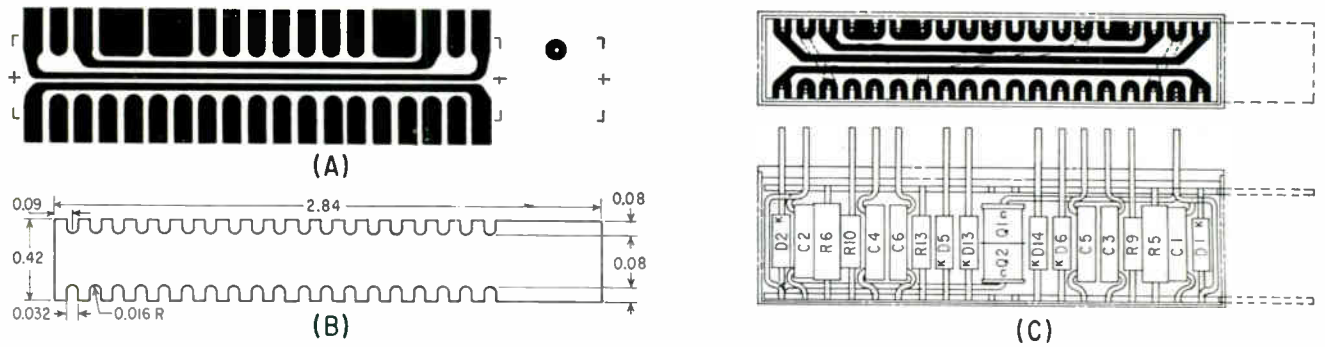

FIG. 1—Artwork for a single board side (A), board blank dimensions (B) and a portion of an assembly layout (C)

Notched Boards Make Modules Compact

By E. P. FITZGERALD Senior Systems Engineer, Vought Electronics, Chance Vought Corp., Arlington, Texas

MINIATURIZING CIRCUITRY without resorting to expensive microminiature components is, for the design engineer, a challenging and ever-present problem. This report describes a unique three-dimensional module packaging system for digital circuitry which solves this problem. Standard, off-the-shelf components are used and, since circuit board blanks, etching procedure and encapsulation are standardized, modules can be massproduced.

Components are mounted by their leads in notches on two opposing double-sided circuit boards. Board width and spacing between notches enable standard miniature capacitors and quarter-watt resistors to be mounted without touching each other. The board blanks are cut to size and notched in advance in a single operation on a die press.

Design, fabrication and system subassembly of a flip-flop module will illustrate the techniques. This module's packaging density is 83,500 parts per cubic foot, compared to 30,000 to 50,000 parts for other packaging methods with similar components. The encapsulated modules have been tested at extreme conditions of humidity, vibration, acceleration, shock and temperature without a failure.

Environmental and producibility tests led to selection of $\frac{3}{4}$ -inch epoxy-paperbase boards. Position of each component on the boards and the etched circuit layout was determined. The layout was prepared by a three-dimension projection method which accurately positioned

the wiring on both sides of each board and permitted high circuit density. A special feature of the artwork is the fullness and length of the land areas. This facilitates etching because alignment of the film positives to board blank is not critical. Before etching, the 38 notches on each board were plated.

Fig. 1 illustrates these steps. Fig. 1A shows the artwork for one of the four board sides; Fig. 1B, a board blank. The distance between notch centerlines is 0.120 inch. The unnotched area at the end, which allows the board to be grasped in a holding fixture during hand assem-

bly, is cut off before encapsulation. Fig. 1C indicates the type of pictorial assembly layout used. A complete layout includes both sides (with all components and leads numbered to correspond to the schematic) and both boards (with all notch positions numbered).

A small number of modules were hand-assembled to investigate fabrication improvements before setting up for mass production. The holding fixture shown in the photograph was used. Prototypes showed that solder flowed onto land areas and into notches around the component leads, giving good physical

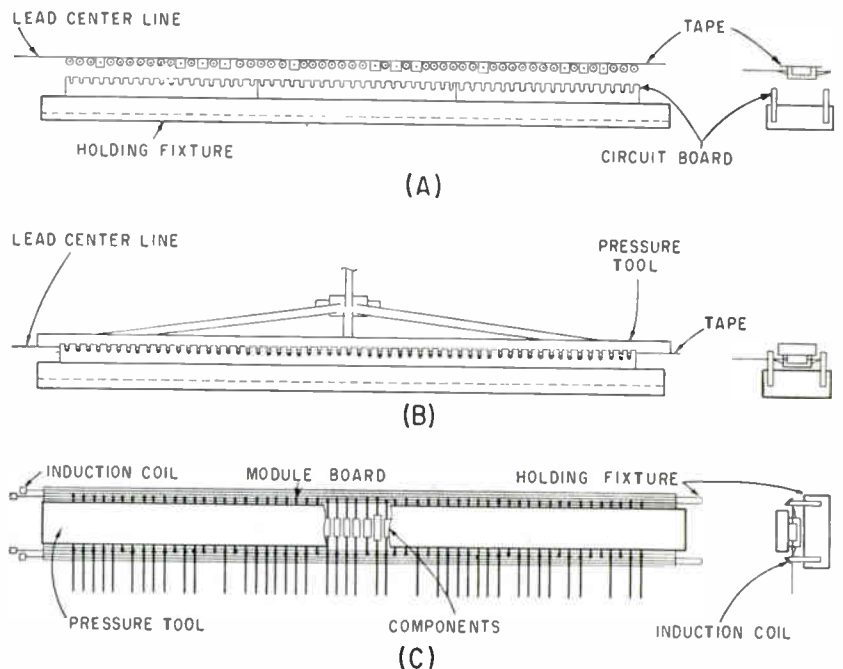
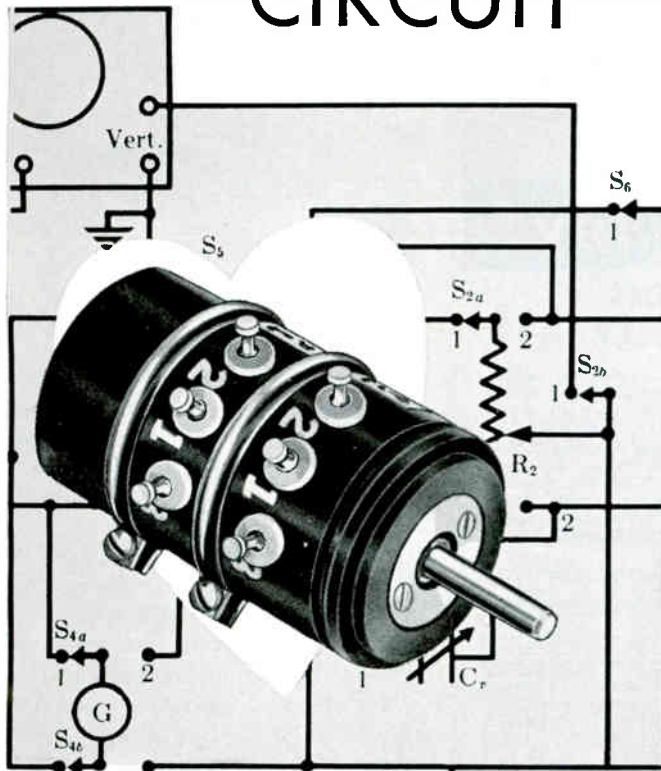

Fig. 2—Mass-production method will position tape-mounted components over boards (A), press components in place (B) and solder leads (C)

HEART OF THE CIRCUIT



PRECISION POTENTIOMETERS

by *New England Instrument*

WIRE WOUND — CONDUCTIVE PLASTIC

Whatever your potentiometer requirement may be, N.E.I. has the answer. Since we produce both wire wound and conductive plastic types our engineers can impartially evaluate your problem and come up with the proper solution.

CONDUCTIVE PLASTIC

- Infinite resolution
- Unsurpassed reliability
- Negligible noise level
- Standard resistance values 1K, 2K, 5K, 10K and 20K, 0.5 linearity.
- Specials from 500 ohms to 1 megohm — 0.1% linearity
- Single or multigang construction.

WIRE WOUND

- Meet performance specs of MIL5272A, and NAS710 and applicable portions of JANR-19
- Maintain excellent characteristics from -55° to 150° C
- Available from $\frac{1}{2}$ " single and 10 turn types to 3"
- Standard resistances from 1K to 100K, special designs from 25 ohm to 250K
- Single or multigang construction.



SEND FOR COMPLETE CATALOG



New England Instrument Company
39 Green Street, Waltham, Massachusetts

CIRCLE 202 ON READER SERVICE CARD

June 9, 1961

In RF connectors

GREMAR

is **FIRST** in

VERSATILITY!

MOST COMPLETE LINE!

Greomar makes more series of RF connectors and components than are available from any other source . . . and, then some! Greomar exclusives include *Red Line* miniature RF connectors for use with MIL-type sub-miniature coaxial cables; power dividers; impedance transformers . . . and others.

MOST COMPLETE STOCKS!

Greomar always has more than 750,000 assembled RF connectors of more than 2000 types on the shelf . . . plus over 8,000,000 component parts always ready for speedy assembly of standard connectors or quick adaptation to your special requirements.

MOST COMPLETE SERVICE!

Because Greomar connectronics® concentrates engineering, production and quality control on RF connectors and components only, you can depend on Greomar to solve your design, delivery and reliability problems quickest. Try us and see. Address your inquiry to:



descriptive literature available on request



GREMAR

MANUFACTURING COMPANY, INC.

RELIABILITY THROUGH QUALITY CONTROL

Dept. A

Wakefield, Mass., CRystal 9-4580

CIRCLE 129 ON READER SERVICE CARD

129

Specify



STANDARD DEPOSITED CARBON RESISTORS

RESISTORS for reliability!

GOLD SEAL CARBON FILM RESISTORS ARE "RELIABILITY TESTED" INDIVIDUALLY

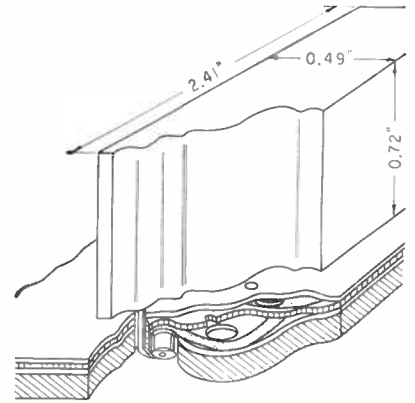

FIG. 3—Mounting technique permits module removal from board

Rugged, Sub-Miniature Gold Seal Carbon Film Resistors are available in three complete lines, standard, moulded and hermetically sealed. With completely uniform carbon coating applied to special ceramic core material, these resistors offer unsurpassed reliability. Calibrated at 25°C to tolerance specified, they are available in plus or minus ½%, 1%, 2%, or 5% tolerances. When 2.5 times rated wattage but not more than 2 times max. rated voltage is applied for 5 seconds, there is an average change of .05% with max. permanent change of .1%. Subjected to temperature of -65°C for 24 hours, average change is below .25%. Meet or surpass applicable MIL specs.

DISTRIBUTED NATIONALLY BY AVNET CORPORATION

STANDARD DEPOSITED CARBON RESISTORS (40°C. AMBIENT TEMP. AT FULL LOAD)

TYPE	MIL-R	RATING WATT	CONT. VDC	RESISTANCE RANGE							
				½%		1%		2%		5%	
				MIN	MAX	MIN	MAX	MIN	MAX	MIN	MAX
S-2	RN-30	2	750	15 Ω	10 Meg.	15 Ω	50 Meg.	15 Ω	60 Meg.	15 Ω	100 Meg.
S-1	RN-25	1	500	10 Ω	5 Meg.	10 Ω	20 Meg.	10 Ω	30 Meg.	10 Ω	60 Meg.
SX-12		½	350	10 Ω	3.9 Meg.	10 Ω	10 Meg.	10 Ω	15 Meg.	10 Ω	20 Meg.
S-12	RN-20	½	350	5 Ω	2 Meg.	2 Ω	5 Meg.	2 Ω	10 Meg.	2 Ω	10 Meg.
SX-14		¼	300	5 Ω	1 Meg.	2 Ω	2.5 Meg.	2 Ω	5 Meg.	2 Ω	10 Meg.
S-14	RN-10	¼	300	5 Ω	1 Meg.	5 Ω	2.5 Meg.	5 Ω	5 Meg.	5 Ω	10 Meg.
S-14A		¼	300	5 Ω	1 Meg.	5 Ω	2.5 Meg.	5 Ω	5 Meg.	5 Ω	10 Meg.
SX-18		¼	250	2 Ω	500K	2 Ω	1 Meg.	2 Ω	2 Meg.	2 Ω	3 Meg.
S-18		¼	250	2 Ω	500K	2 Ω	1 Meg.	2 Ω	2 Meg.	2 Ω	3 Meg.
S-110		1/10	150	20 Ω	250K	20 Ω	250K	20 Ω	500K	20 Ω	500K

MOLDED DEPOSITED CARBON RESISTORS (70°C. AMBIENT TEMP AT FULL LOAD)

TYPE	MIL-R	RATING WATT	CONT. VDC	RESISTANCE RANGE							
				½%		1%		2%		5%	
				MIN	MAX	MIN	MAX	MIN	MAX	MIN	MAX
SM-2	RN-80	2	750	15 Ω	10 Meg.	15 Ω	50 Meg.	15 Ω	60 Meg.	15 Ω	100 Meg.
SM-1	RN-75	1	500	10 Ω	5 Meg.	10 Ω	20 Meg.	10 Ω	30 Meg.	10 Ω	60 Meg.
SM-12	RN-70	½	350	10 Ω	2 Meg.	10 Ω	5 Meg.	10 Ω	10 Meg.	10 Ω	10 Meg.
SM-14	RN-65	¼	300	10 Ω	1 Meg.	10 Ω	2.5 Meg.	10 Ω	5 Meg.	10 Ω	10 Meg.
SM-18	RN-60	¼	250	10 Ω	500K	10 Ω	1 Meg.	10 Ω	2 Meg.	10 Ω	2 Meg.

HERMETICALLY SEALED DEPOSITED CARBON RESISTORS (70°C. AMB. TEMP. AT FULL LOAD)

TYPE	MIL-R	RATING WATT	CONT. VDC	RESISTANCE RANGE							
				½%		1%		2%		5%	
				MIN	MAX	MIN	MAX	MIN	MAX	MIN	MAX
SH-2	RN-80	2	750			50 Ω	20 Meg.	50 Ω	20 Meg.	50 Ω	20 Meg.
SH-1	RN-75	1	500			10 Ω	10 Meg.	10 Ω	10 Meg.	10 Ω	10 Meg.
SH-12	RN-70	½	350			10 Ω	5 Meg.	10 Ω	5 Meg.	10 Ω	5 Meg.
SH-14	RN-65	¼	300			10 Ω	2.5 Meg.	10 Ω	2.5 Meg.	10 Ω	2.5 Meg.
SH-18	RN-60	¼	250			10 Ω	1 Meg.	10 Ω	1 Meg.	10 Ω	1 Meg.

WIRE WOUND FIXED RESISTORS ARE AVAILABLE IN TWO SERIES

SERIES M micro-miniature and sub-miniature resistors are non-inductive, vacuum impregnated, absolutely tension-free wound to assure maximum stability, and all connections are microscopically welded. Temperature coefficient is .002% per °C over the range of -65°C to +150°C. Use of a new high-heat epoxy encapsulating material assures high temperature thermo stability. Resistance tolerances are: 1%; .5%; .25%; 1%. Special tolerances may be obtained. Lead size can be varied. Complete environmental tests available. Diameter x length dimensions from .080" x .210" to .210" x .465"; max. wattage from .04 to .25; max. voltage from 50 to 300; max. resistance from 100 K to 2 Meg.; and min. resistance from 1 K to .1 ohm.

SERIES 600 are vacuum impregnated, encapsulated and surpass MIL-spec requirements. All Lug types and Radial types have axial mounting hole for #6 screw. Lead wire size #20, other sizes available. Diameter x length dimensions from .250" x .500" to 1.000" x 2.125"; com. wattage from .25 to 2.5; and max. ohms from 2 meg. to 25 meg. Special application resistors per customer specifications.

Reliability is inherent through design and craftsmanship in their manufacture.

Standard or non-standard values available for prompt delivery. Field engineers will gladly assist you with technical recommendations.

For additional data write for descriptive literature.

TECHNOLOGY INSTRUMENT CORPORATION

863 WASHINGTON STREET, CANTON, MASS. • CANTON 6-3338
850 LAWRENCE DRIVE, NEWBURY PARK, CALIF. • HUDSON 5-2165

and electrical connections. There was no excess solder buildup. Since all soldering is on the external edges of the boards, faulty connections are easily seen. Lead material need not be standardized; it need only be solderable and no greater in diameter than the notches. The notches are wide enough after plating to accommodate the leads of standard quarter-watt resistors.

A method of mass-producing the assemblies is shown in Fig. 2. Component leads are precut and components are placed on a tape in the proper order and spacing for the assembly. At station 1 (Fig. 2A), the module boards are held rigidly on edge in a holding fixture with the tape in position above the notches. At station 2 (Fig. 2B), pressure is applied to the tape, forcing the leads to the bottom of the proper notches. At station 3 (Fig. 2C) pressure is applied uniformly to the components by the holding fixture while leads are soldered in the notches by localized induction heating. The notches are dip soldered or tinned in advance.

Some of the larger components' lead positions do not match the required component centerline. These leads are preformed before the component is placed on the tape.

Prototype modules were encapsulated by potting in a mold. In mass production, each module will be placed in a standard, prestamped, bathtub type case made from the potting compound. The case will remain as part of the encapsulation.

Different types of modules were assembled into logic units on function cards, which in turn were assembled to mother boards. Again, for design studies, prototypes were

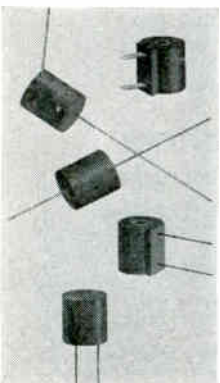
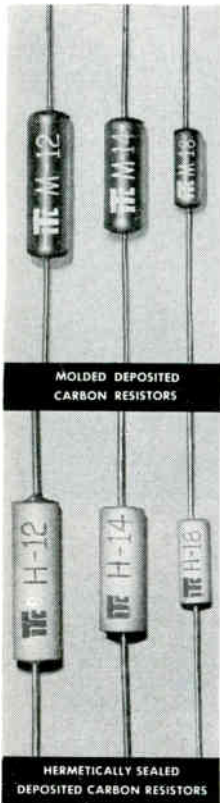

hand-assembled to the cards.

In mass production, multilayer circuitry will be used, as in Fig. 3. External leads will pass through the clearance holes in the function cards and will be soldered to pads. Each pad will be connected through an eyelet to the multilayer circuitry. This method of attachment allows removal of a module without damage to the module or function card. All the module leads will be wiped, after insertion through clearance holes, in one operation and dip soldered to the pads.

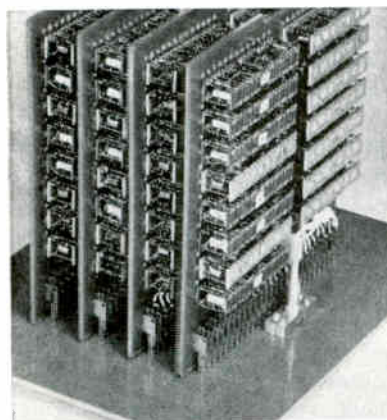
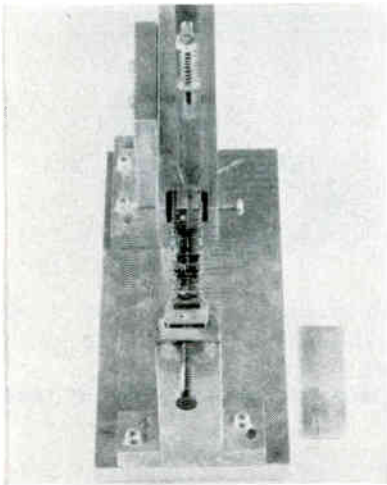
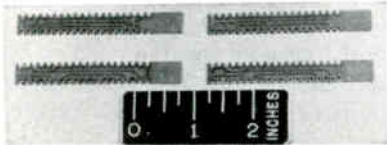

Prototype production steps are (top to bottom): preparation of boards, assembly in holding fixture, potting, assembly of functional cards and mother board

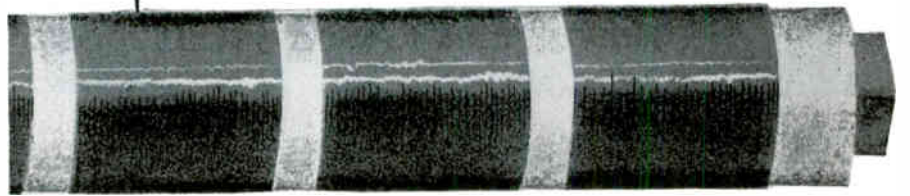
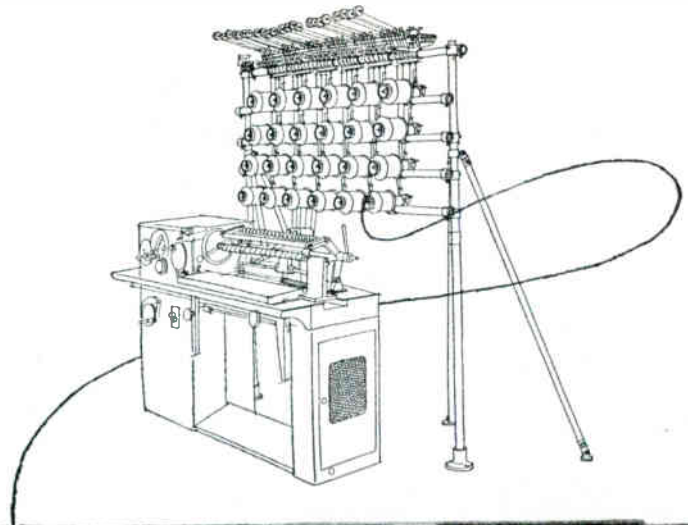

Produces more...more accurately The No. 108 Coil Winder

Quick set ups...30-coil simultaneous winding capacity (short or long runs)...finger tip control...make the LEESONA No. 108 today's most productive semi-automatic coil winder. Versatile — handles wire from No. 19 to No. 44 (B & S) and finer. Modern design eliminates operator fatigue. Write LEESONA CORPORATION, P.O. Box 6088, Providence 4, Rhode Island.

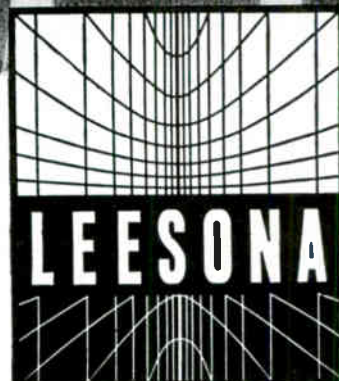
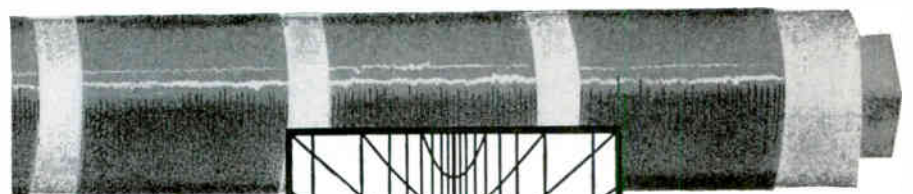

23B.1.4

New On The Market

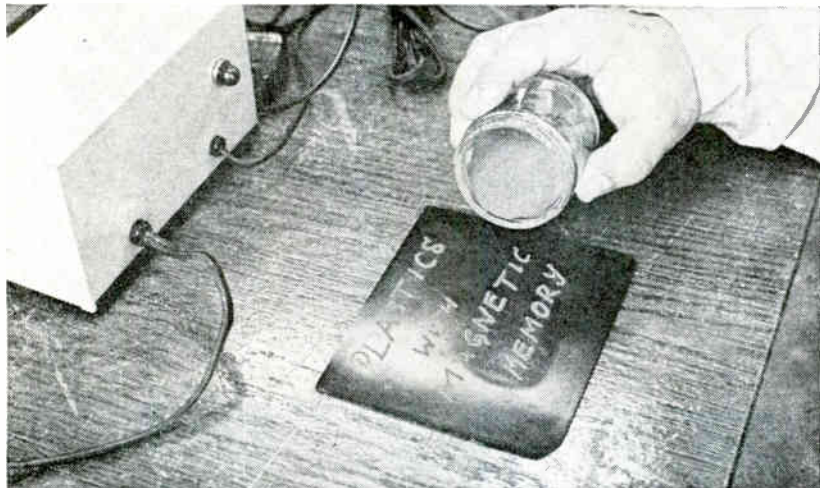

Thermosetting Plastic CAN BE SPOT-MAGNETIZED

THERMOSETTING plastic that can be spot-magnetized to provide practically any pattern is announced by Mesa Plastics Co., 12270 Nebraska Ave., Los Angeles 25, Calif. The compound, which has been tested beyond 400 F, includes nonconduc-

tive ferrite power fillers. Applications include memory drums, d-c motors, relays, transducers and instruments. Limited quantities are available.

CIRCLE 301 ON READER SERVICE CARD

Six-Channel Scope FIVE-GUN CRT

OSCILLOSCOPE provides six channels, has proved valuable in the design of static converters and inverters and in the design and servicing of digital computers.

Presentation is on a Memotron memory tube and a 5-inch, square-face five-gun crt. Each channel has its own amplifier and crt gun. Photographs may be taken of tran-

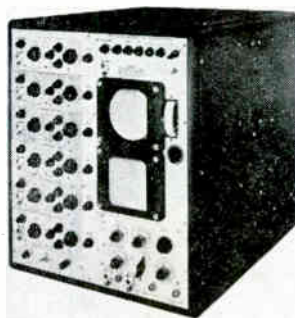

sient conditions on all channels. The Memotron channel allows storage when photography is not needed. Amplifier for each channel has a rise time of about 50 ns, is about 3 db down at 10 Mc. Input

impedance is 1 megohm in parallel with 40 pf. Overall size is 25 high x 20 wide x 22 inches deep; manufacturer is Clifton Technical Physics, 3329 Doris Ave., Wanamassa, N. J.

CIRCLE 303 ON READER SERVICE CARD

Reflex Klystron

100 TO 120 GC

REFLEX KLYSTRON operates over 100 to 120 Gc range with 10 mw minimum power output and minimum life of 250 hours. An integral-cavity type, the QKK971 has smooth vernier tuning and uses anode voltage of 1,700, with anode current of 50 ma. Price is \$3,500,

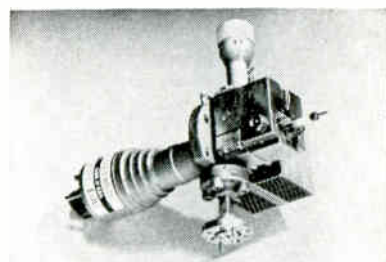

with availability in 90 days, from Raytheon Co., Foundry Ave., Waltham 54, Mass.

CIRCLE 304 ON READER SERVICE CARD

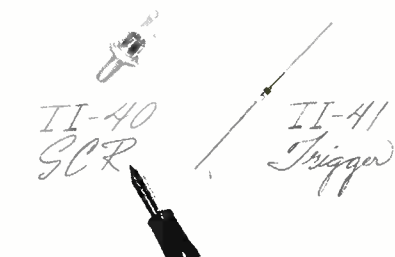

SCR and Trigger LOWER COST

LOW-COST TI-40 scr is intended for consumer devices and industrial controls. Forward current rating of the silicon controlled rectifier is 3 amp, and forward and reverse ratings are 200 volts. Consistent parameters and uniform junction planes are obtained with diffusion process manufacturing. The TI-41 *pnpn* silicon trigger device is rated for a forward breakover voltage of 30 ± 6 v, with a maximum breakover current of 100 μ a, and maximum forward drop of 5 v at $I_F = 100$ ma. The units are available off-the-shelf from distributors; manufacturer is Texas Instruments Inc., 13500 N. Central Expwy, Dallas, Tex.

CIRCLE 302 ON READER SERVICE CARD

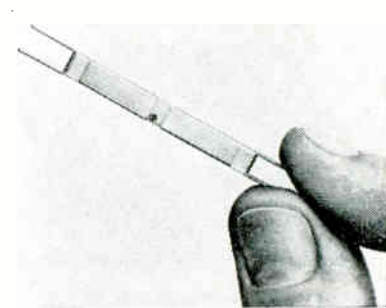

Fast Heating Cathode

100 MILLISEC WARM UP

HARP CATHODE, by Amperex Electronic Corp., 230 Duffy Ave., Hicksville, L. I., N. Y., delivers full power in 100 ms. Cathode will be incorporated in line of tubes for r-f power output stages in mobile and airborne equipment. Warmup is so short that standby current can be eliminated. The directly heated cathode consists of a rectangular frame with many fine wires strung parallel like the strings on a harp. Because of its many parallel wires, the cathode has low inductance and low hum, and operates at 1.6 v. The

why use two?
when one will do!

JFD LC tuner



WHY USE TWO...?

a trimmer capacitor and inductor
when one JFD LC Tuner will do!

When your tuned circuit "package" calls for higher stability, greater economy, finer tuning — it's time for the versatile JFD LC Tuner.

This unique package combines the characteristics of a precision variable capacitor and a metalized inductor in one compact tuneable LC circuit. It improves performance, simplifies specifying, speeds assembly, and enhances high frequency capability.

JFD LC Tuners are available in 16 different standard panel and printed circuit types. The inductance, capacitance range, Q and other parameters can be designed to

suit individual circuit requirements. Performance characteristics can also be varied by using other core materials or other lead configurations, by having the piston grounded or ungrounded, and by various types of loading.

For complete information, contact your local JFD Field office or your local JFD franchised Industrial Distributor, or write direct for Bulletins 216 and 216-1.

FEATURES: Rugged shock-proof, vibration-proof electro-mechanical construction. • Glass or quartz dielectric and invar assures low temperature coefficient • No derating at high temperature. • Precisely repeatable tuning—no reversals. • Single resonating frequency for each adjust screw setting.

Model	Self-Resonating Freq. Range, Mc.		Nominal Q of Inductor Over Tuning Range	Nominal Inductance uh.	
	Min.	Max.		Min.	Max.
LC 303	400	725	170-200	.025	.028

JFD

JFD ELECTRONICS CORPORATION

Components Division • 6101 16th Avenue • Phone DEwey 1-1000 • TWX-NY25040

JFD WESTERN
P. O. Box 3416
7311 Van Nuys Blvd.
Van Nuys, Calif
Phone STate 1-3530

JFD MIDWESTERN
6414 W. Higgins Ave.
Chicago, Illinois
Phone: SPring 4-4175

JFD NEW ENGLAND
Ruth Drive
Marlboro, Mass.
Phone: HUntley 5-7311

JFD CANADA
51 McCormack Street
Toronto, Ontario, Canada
Phone: ROger 9-1129

VARIABLE TRIMMER PISTON CAPACITORS • FIXED METALIZED INDUCTORS • LC TUNERS • DIPLEXERS
FIXED AND VARIABLE, DISTRIBUTED AND LUMPED CONSTANT DELAY LINES • PULSE FORMING NETWORKS

cathode, which has withstood over 30,000 switchings, has been incorporated into tube type 8042, a fast warmup version of type 6146. The

8042 (25 watts diss; 175 Mc; ICAS) is available in preproduction quantities.

CIRCLE 305 ON READER SERVICE CARD

and digital computers, coordinate converters, radars and other analog devices.

CIRCLE 308 ON READER SERVICE CARD

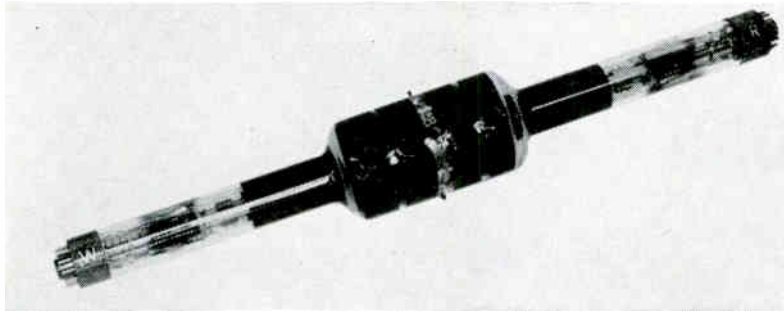

Double-Ended Storage Tube SCAN CONVERTER

TWO-IN-ONE storage tube converts one type of scan to another. Type K2070 is a nondestructive readout, double-ended, electrical-input electrical-output storage tube. Resolution is in excess of 1,000 tv lines at 50-percent modulation. Information can be retained for hours, erased in a second, or caused to decay at a controlled rate. The device can be used for converting from one scan frequency to another, as

in wide to narrow bandwidth transmission and radar ppi to tv scan. Integrating characteristics enable build-up of repetitive signals, with signals submerged in noise recovered in gradual steps. The tube, which uses two opposed, on-axis electron guns for writing and reading, is manufactured by Allen B. Du Mont Labs, 750 Bloomfield Ave., Clifton, N. J.

CIRCLE 306 ON READER SERVICE CARD

Shield Chamber NOISE-FREE TESTING

PORTABLE SHIELD chamber for making electrically quiet measurements has been developed by Topaz Transformer Products, Inc., 4995 Weeks Ave., San Diego 10, Calif. The device encloses and tests sensitive electronic circuits. Complete electrostatic shielding and maximum isolation from noise sources, including the power line, is obtained. The chamber also provides 40 db electromagnetic shielding. The

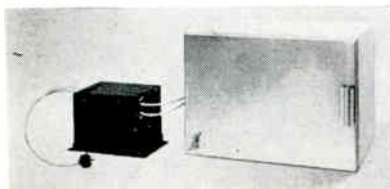

shield chamber is available in three sizes and can be purchased with or without magnetic shielding.

CIRCLE 307 ON READER SERVICE CARD



Plotting Board VERTICAL/HORIZONTAL

MILGO ELECTRONIC CORP., 7620 N. W. 36th Ave., Miami 47, Fla., has designed a vertical/horizontal plotting board that provides two simultaneous plots of any four independent voltages against time and is capable of tilting to a horizontal or vertical position. Model 1587 is designed to operate with analog

D-C Amplifier DELIVERS 100 WATTS

POWER AMPLIFIER delivers 100 watts from d-c to 25 Kc. The instrument delivers 200 volts open circuit, 1.0 ampere short circuit, and has drift of less than 10 mv at a gain of 10. The amplifier requires 8 3/4 inches of panel space in a 19-inch rack. Uses include driving solenoid or voice-coil actuators (such as shakers), and as an earth's field coil modulator for magnetometer experiments. Manufacturer is Micro Gee Products, Inc., 6319 W. Slauson Ave., Culver City, Calif.

CIRCLE 309 ON READER SERVICE CARD

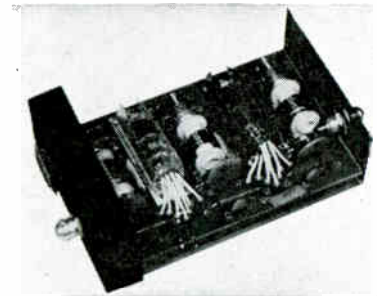

I-F Preamplifiers MODULAR UNITS

ORION ELECTRONIC CORP., 108 Columbus Ave., Tuckahoe, N. Y. Series H modular i-f preamplifiers furnish the low noise operation essential in designing any receiving system for optimum sensitivity. Units can be furnished with either a balanced or unbalanced input. Output impedance of all is 50 ohms. The tube units operate from -50 C to +85 C; the germanium transistor preamplifiers, from -20C to +50C.

CIRCLE 310 ON READER SERVICE CARD

Liquid Dip Coating FOR MODULES, P-C BOARDS

TECHNICAL RESEARCH CO., 13535 Monster Road, Seattle 88, Wash. Designed for use as a low viscosity, long pot life, encapsulating material for electronic and electric p-c boards and modular assemblies,

New... LOW COST

PRODUCTION EYELET MACHINES

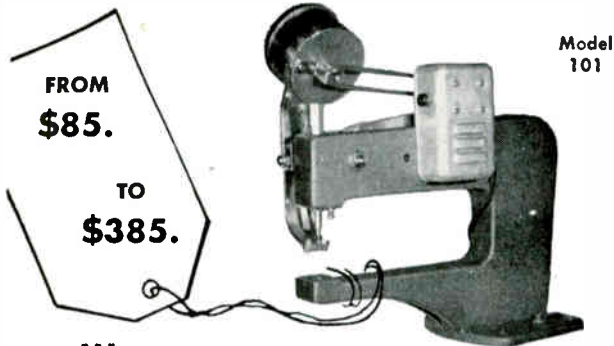

We specialize in production machines for electrical and electronic needs. Used by leading makers of PW boards for setting funnel flange, standardized, and special eyelets, from smallest sizes to $\frac{3}{8}$ ". Best value on the market.

Model 101 air-operated machine automatically adjusts to various thicknesses. Cuts damage when setting plastics, ceramics, PW boards, glass, leather, etc.

FREE BULLETIN NO. AE100



Solve your eyelet machine problems fast — Write today.

EYELET TOOL CO.
INCORPORATED

31 Carleton Street, Cambridge, Mass.
CIRCLE 203 ON READER SERVICE CARD



it's read more
by all 4!

electronics magazine gives you the latest engineering developments. Government trends, military applications, and markets are technically interpreted. Get it first with your own subscription. Mail the reader service card (postpaid) to electronics, the magazine that helps you to know and grow! Rates: three years for \$12, one year for \$6; Canadian, one year for \$10; foreign, one year for \$20. Annual electronics BUYERS' GUIDE (single issue price \$3.00) included with every subscription.

subscribe today to **electronics**

June 9, 1961

INTRODUCING



New Unitized
Sonic Energy Cleaner
compact—reliable—new low price

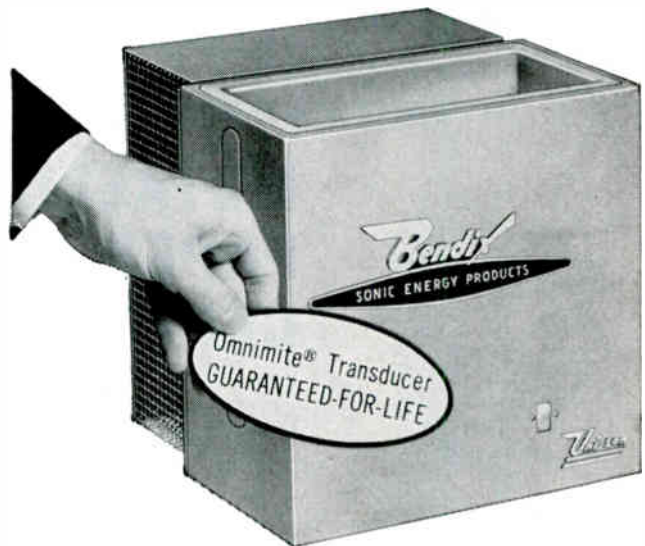

For superior cleaning on a sustained production basis, Bendix Uni-son utilizes a solid state generator, fixed tuning, and Omnimite®, the guaranteed-for-life magnetostrictive transducer. Flexibility, full warranty, compact size and low price make Uni-son the most economical sonic cleaner to own, operate, and maintain.

And it's from Bendix—pioneer and largest producer of sonic energy cleaning equipment. That's your best assurance of all-around quality and dependability.



**Pioneer-Central Division
The Bendix Corporation
Davenport, Iowa**

SONIC ENERGY CLEANING

Please send complete details on Bendix Uni-son.
 Please send details on complete Bendix cleaning systems.

Name _____
Address _____
City _____ Zone _____ State _____

CIRCLE 135 ON READER SERVICE CARD 135

AEROVOX CAPACIBILITY*

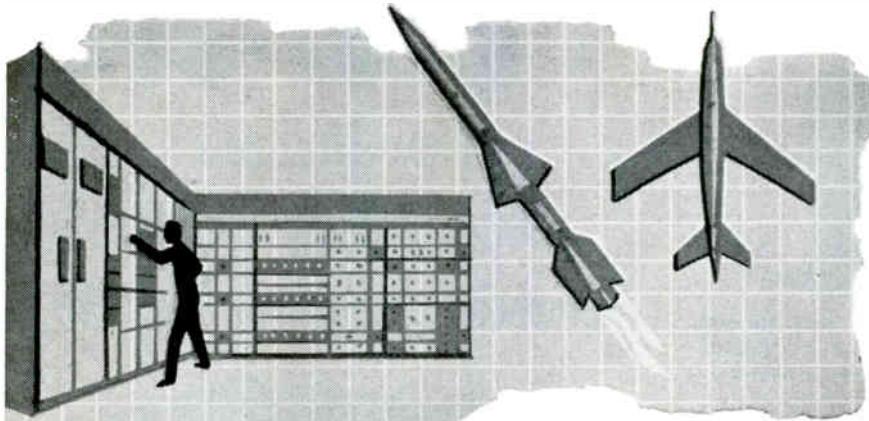

HIGH-TEMPERATURE

METALLIZED PAPER CAPACITORS

P123ZN
—
rated at 50 VDC. Full voltage rating to $+100^{\circ}\text{C}$. Rated from 150 VDC to 600 VDC. Full voltage to 100°C and to $+125^{\circ}\text{C}$ at 75% of voltage rating.

P323ZN
—
full rated voltage to 125°C .

P30ZN
(bathtub) and **P09ZN**
(rectangular). Full rated voltage to 125°C .

P09ZNR

Designed specifically to meet critical operating requirements, Aerovox metallized paper capacitors offer many important advantages, including minimum size for space-tight applications...reliability and long service life...low radio frequency impedance...and a wide range of case styles for operation to $+125^{\circ}\text{C}$ without voltage derating.

Aerolene® impregnated units are available in the temperature ranges shown at left:

Want complete technical data? Call your nearest Aerovox representative... or write today for your free copy of catalog 131B8.

*Capacibility An Aerovox characteristic. Capability to design, develop, and manufacture capacitors to best meet customers' requirements.



Tereco No. 141 was developed to meet the stringent requirements of missile borne equipment. Technical specifications and price list are available.

CIRCLE 311 ON READER SERVICE CARD

Epoxy Adhesive

ALLACO PRODUCTS, 238 Main St., Cambridge 42, Mass. Epoxy adhesive cures in 60 sec at room temperature or 45 sec with the aid of infrared heat.

CIRCLE 312 ON READER SERVICE CARD



Card Assemblies

REDUCE P-C COMPLEXITY

COMPUTER TECHNIQUES INC., 3300 Northern Blvd., L. I. C. 1, N. Y. Three typical card assemblies are shown. A BCD to decimal decoder capable of storing parallel BCD data and converting it to decimal form. An accumulator card containing five full adder sections coupled together to form a cumulative carry, parallel five bit accumulator with all input gating facilities provided on card. A decade counter card containing two full decimal digits of serial counters.

CIRCLE 313 ON READER SERVICE CARD

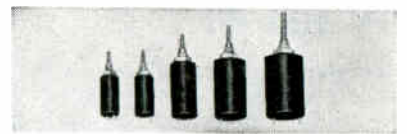

R-F Coils

TUNABLE

RELCOIL PRODUCTS CORP., Windsor Locks, Conn. The RC and RCP (plug-in) series provide a wide range of precision r-f tunable coils in the medium and high Q areas. The inductance values range from $0.1\mu\text{h}$ to $15,000\mu\text{h}$, in overlapping standard tuning ranges. They yield reliable operation over a temperature range of -65°C to $+125^{\circ}\text{C}$,



AEROVOX CORPORATION
NEW BEDFORD DIVISION NEW BEDFORD, MASS.

Technical Leadership - Manufacturing Excellence

and will adequately meet military requirements.

CIRCLE 314 ON READER SERVICE CARD



P-C Facsimile System USES TRANSISTORS

FAIRCHILD CAMERA AND INSTRUMENT CORP., 580 Midland Ave., Yonkers, N. Y., introduces a transistor-printed circuit facsimile system for transmission of graphic data. Two speeds of transmission: standard rate for high definition reproduction; a higher rate can be used when less resolution is acceptable. Material such as large blueprints can be cut into strips and supplied continuously into the flat feed transmitting unit, saving time against the conventional method of placing sections one at a time on a drum.

CIRCLE 315 ON READER SERVICE CARD

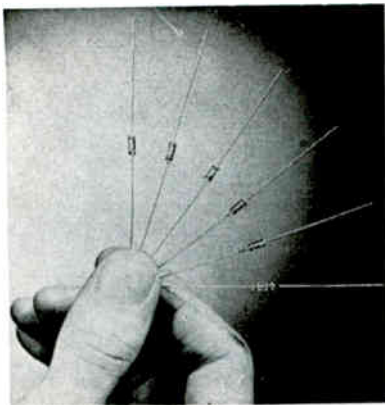

Germanium Diodes MILITARY TYPE

OHMITE MFG. CO., 3667 Howard St., Skokie, Ill., is now producing all

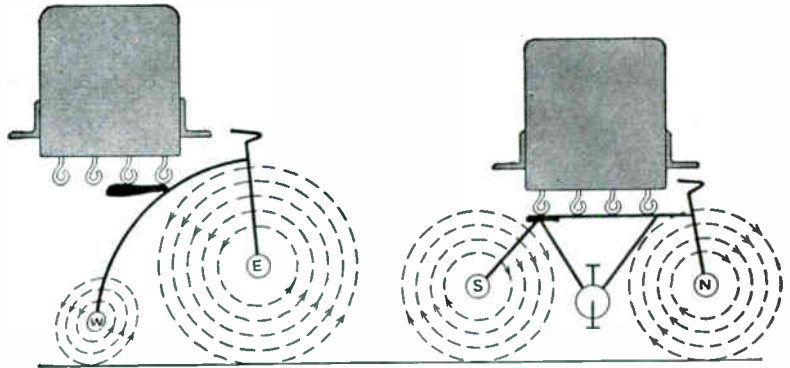

some relays are quite differential from others

If you want something to happen when a predetermined difference exists between two signals, gather 'round. Almost every* available subminiature dual coil "differential" relay we know of must have the "trip" signal applied to a specific coil and consequently the "reset" signal to the other coil. The dilemma stems from the lack of symmetry between the two flux paths or magnetic circuits of such a dual coil relay (the total pole gap changes with armature position). In a situation like this it takes more power to move the armature in one direction than the other, and when normal safety margins are added to operating power levels the disproportion becomes extreme. If you've found yourself with a relay that is this choosy about how and whether it transfers its contacts, you know you have anything but "true differential operation".

32 DPDT dual coil magnetic latching relay. The moment there's 100 milliwatts more on one coil than the other — regardless of how gradually the differential has taken place — the contacts transfer synchronously and completely. Hang up, blackout and those other monstrous contact mistakes often brought on by "sliding current" signals are neatly avoided by the design and adjustment of the "32". Its magnetic circuits and flux paths are as symmetrical as grapefruit halves, the gap remains constant no matter what the armature position, and essentially 100% cancellation occurs between coils. The 30 g to 5000 cycles vibration (operating or non-operating), 100 g shock and constant acceleration, and -65° to $+125^{\circ}$ C. operating temperature ratings all hold true for the stated 100-milliwatt sensitivity. Safety margins needn't be added just to make the specs hold true in practice.

* * *

In typical and magnanimous fashion, we will now present *THE SOLUTION*, hoping that in due course it will also sell some of our relays. For true differential operation, without the pitfalls, we commend to your attention our subminiature Series



If you've never used two collector circuits of a bistable what's-it to drive a dual coil polarized relay differentially, who knows what joys may await you? Write to Sigma today, telling us your differential troubles.

*Except ours, of course.



SIGMA

SIGMA INSTRUMENTS, INC.
62 PEARL ST., SO. BRAintree 85, MASS.

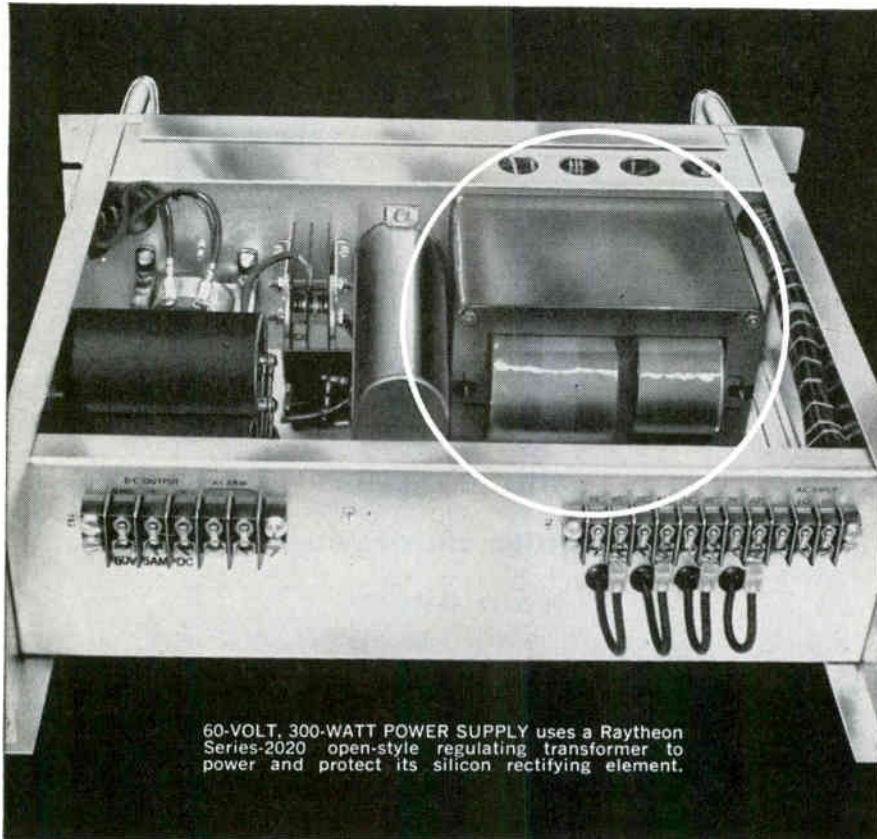

**POWER • PROTECTION • REGULATION
ALL THREE
IN ONE TRANSFORMER!**

Does your power transformer protect semiconductor rectifiers?

How do you protect the silicon and germanium rectifiers in that advanced design power supply? Do you use elaborate circuitry or —like many power supply designers—are you using a Raytheon 2020 Voltage Regulating Transformer?

These versatile units provide stabilized voltages within $\pm 1\%$ and are available in any of 2,020 standard models for solid-state and vacuum-tube rectifiers. You match your exact requirement from a full range of standard designs and ratings from 10 to 10,000 VA.

Write today for Catalog 4-265 with convenient Selection Guide and Power Supply Design Data. Raytheon Company, Commercial Apparatus & Systems Division, Keeler Avenue, South Norwalk, Connecticut.

RAYTHEON

RAYTHEON COMPANY

COMMERCIAL APPARATUS & SYSTEMS DIVISION

Raytheon voltage regulators are also available from your local Raytheon distributor

eight germanium diodes called for under military specifications MIL-E-1D and MIL-S19500B. They are of the gold-bonded type in a sub-miniature, hermetically sealed glass envelope. Further information is given in bulletins 158 and 164.

CIRCLE 320 ON READER SERVICE CARD

Nylon Clamp

WECKESSER CO., INC., 5701 Northwest Highway, Chicago 46, Ill. Nylon clamps can be used for both temporary and permanent cable assemblies.

CIRCLE 321 ON READER SERVICE CARD

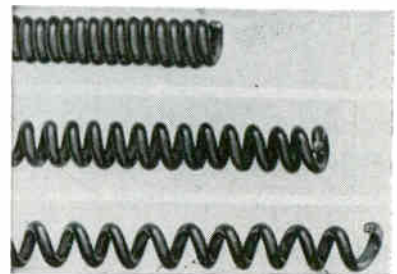

Retractable Coil Cords NEOPRENE JACKETED

ALPHA WIRE CORP., 200 Varick St., New York, N. Y., announces a line of retractile coil cords—electric cords that are permanently coiled into a spring shape. The neoprene jackets are designed to withstand constant heavy duty use, prolong useful life, and resist oil and weather damage. Cords are available from stock as power cords, power cord sets, shielded communication cords and retractile test lead wire.

CIRCLE 322 ON READER SERVICE CARD

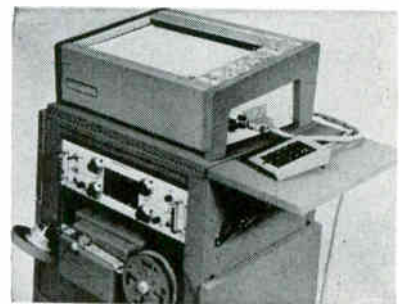

Digital Plotter COMPACT UNIT

ELECTRONIC ASSOCIATES, INC., Long Branch, N. J. Able to accept analog

as well as digital inputs, the 3100 Dataplotter provides accuracies up to 0.175 percent of full scale on 11 by 17 in. X-Y plots of digital data and permits plotting speeds up to 80 points per minute. The low-cost unit is equipped with transistorized control circuitry.

CIRCLE 323 ON READER SERVICE CARD

Crystal Detectors FOR K AND R BANDS

HEWLETT-PACKARD CO., 1501 Page Mill Road, Palo Alto, Calif. Crystal detectors that combine high sensitivity and flat frequency response with accurate square-law characteristics are now available for K and R band waveguide systems.

CIRCLE 324 ON READER SERVICE CARD

Adhesive

RADIATION APPLICATIONS INC., 36-40 37th St., Long Island City 1, N. Y. Adhesive offers high electrical resistance, low thermal conductivity, and may be used under temperatures up to 1,000 F.

CIRCLE 325 ON READER SERVICE CARD



Battery Substitute LOW-NOISE

ELCOR, INC., Falls Church, Va. The A4S series of Isoplays (isolated power supplies) are ideal low-noise battery substitutes. High degree of isolation achieved suits them for use in bridge circuits, bootstrapped circuits, floating bias or reference circuits and direct-coupled d-c amplifier circuits. Noise

OVER 100 BILLION BITS WITHOUT A DROPOUT ! RELIABILITY WITH POTTER HIGH DENSITY RECORDING

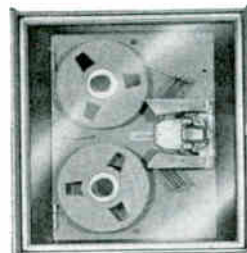

906 II HIGH SPEED DIGITAL
MAGNETIC TAPE HANDLER

TYPICAL CAPABILITIES OF POTTER HIGH DENSITY SYSTEMS

High Density Systems by Potter can include such outstanding characteristics as:

- RELIABILITY:**
 Transient error rate... 1 in 10^6 to 10^8 max. at 1500 ppi
 Permanent error rate... 1 in 10^8 to 10^9 max. at 1500 ppi
 Reread time to recover transient errors... less than .005% of "on-line" time at 1500 ppi
- BIT DENSITIES** up to 2,000/inch
TAPE SPEED up to 150 ips
- NUMBER OF CHANNELS**
 up to 20 per inch of tape width
- INTERCHANNEL TIME**
DISPLACEMENT
 Less than 0.2 microsecond at buffer output
- INTERBLOCK GAP**
 May be as short as 0.3"; 0.75" typical for dual read/write operation at 100 ips
- ERROR DETECTION**
 Parity channel provides single error detection
- ERROR CORRECTION**
 Single parity channel makes possible single error correction
- AND MANY OTHERS**
 write for details

For more than 40 hours of continuous operation, Potter High Density systems have recorded 100 billion bits without a single dropout. And — they've done it at the fantastic rate of 240,000 decimal characters per second. Only with the revolutionary new recording technique do you get this combination of extreme capacity with ultimate reliability.

In the 40-hour test, less than 2 seconds re-read time were required to recover information lost through transient error. More than 20,000 passes of the tape can be made without losing information or significantly increasing the reading error rate.

Tested and proven in computer systems, Potter High Density Recording is presently available in the Potter 906II High Speed Digital Magnetic Tape Handler, and will be available in other Potter Tape Systems.

Write today for details on how High Density Recording can be applied to your data handling problem.

POTTER INSTRUMENT COMPANY, INC. • SUNNYSIDE BOULEVARD, PLAINVIEW, NEW YORK

AC Instrument Calibration to 0.05% ACCURACY

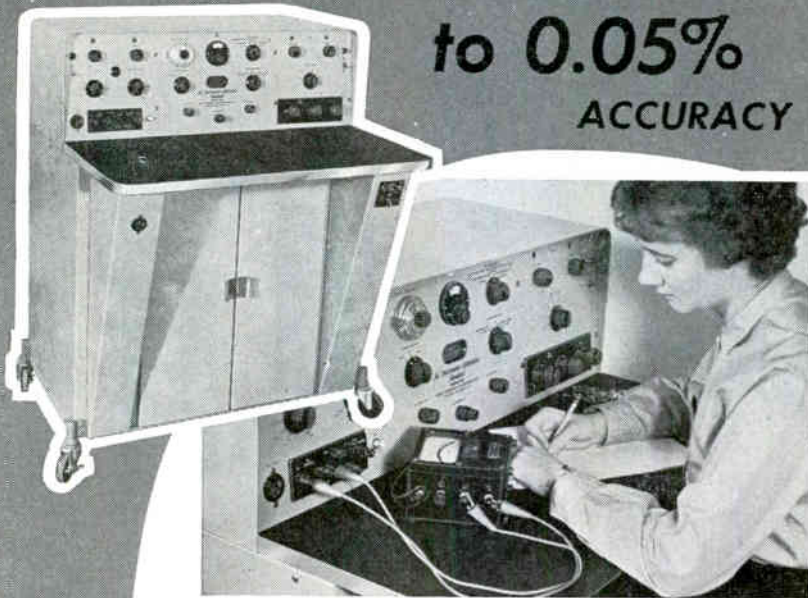

Voltmeters and ammeters, plus wattmeters, are quickly calibrated over frequencies from 50 to 2400 cps by one operator.

The Model 1967 Semi-Automatic AC Instrument Calibration Standard provides, in a single convenient console, a precise and rapid means for standardizing and calibrating alternating current wattmeters, expanded scale, digital, indicating and recording voltmeters and ammeters.

Basic accuracy is maintained by an AC reference source consisting of a servo amplifier, thermal transfer circuit and a sensitive light beam galvanometer all balanced against a $\pm 0.01\%$ laboratory type standard cell. Resistive components are made of selected manganin properly heat-treated, aged for six months and adjusted to $\pm 0.01\%$ of absolute value. The thermoelement is unaffected by waveform errors, has flat frequency response and is protected against overloads.

MODEL 1967 CALIBRATION RANGES			
AC VOLTAGE		AC CURRENT	
RANGE	MIN. LOAD RESISTANCE	RANGE	MAX. LOAD RESISTANCE
0-.5 MV	20,000 ohms	0-15 μ A	10,000 ohms
0-3.0 MV	20,000 ohms	0-30 μ A	10,000 ohms
0-7.5 MV	20,000 ohms	0-75 μ A	10,000 ohms
0-15 MV	20,000 ohms	0-150 μ A	10,000 ohms
0-30 MV	20,000 ohms	0-300 μ A	10,000 ohms
0-75 MV	20,000 ohms	0-750 μ A	10,000 ohms
0-150 MV	20,000 ohms	0-1.5 MA	1,000 ohms
0-3.0 MV	20,000 ohms	0-3.0 MA	1,000 ohms
0-7.5 MV	20,000 ohms	0-7.5 MA	1,000 ohms
0-1500 MV	1,000 ohms	0-15 MA	1,000 ohms
RANGE	MAXIMUM LOAD	RANGE	MAXIMUM LOAD
0-1.5 Volts	2 VA	0-0.15 Amp	10 VA
0-3.0 Volts	3 VA	0-0.3 Amp	10 VA
0-7.5 Volts	5 VA	0-0.75 Amp	10 VA
0-15 Volts	10 VA	0-1.5 Amp	10 VA
0-30 Volts	15 VA	0-3.0 Amp	10 VA
0-75 Volts	15 VA	0-7.5 Amp	10 VA
0-150 Volts	15 VA	0-15 Amp	10 VA
0-300 Volts	15 VA	0-30 Amp	10 VA
0-750 Volts	15 VA	0-75 Amp	10 VA
0-1500 Volts	15 VA		

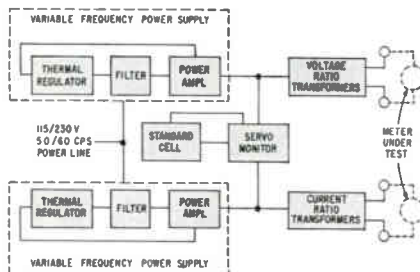

We are specialists in the design and manufacture of instrument calibration consoles — offering more types than any other source in the world. Accuracy of all units is certificated and traceable to primary standards maintained by the National Bureau of Standards.

*Performance is rigidly guaranteed.
Prices are f.o.b. Boonton, N.J.
and subject to change without notice.*



**Radio Frequency
LABORATORIES, INC.**
Boonton, New Jersey, U.S.A.



SEND
FOR
TECH.
DATA

For additional information, including application data, write or phone DE 4-3100. Demonstrations available by local representatives.

introduced by these units into the circuits to which they are connected is less than 10 μ v peak-to-peak per kilohm impedance to ground.

CIRCLE 326 ON READER SERVICE CARD



Telemetry Filters IN SMALL CASE

PCA ELECTRONICS, INC., 16799 Schoenborn St., Sepulveda, Calif., has developed a series of passive telemetry filters designed for application with f-m discriminators. They are synthesized by the use of modern network concepts and are optimized with regard to performance and size. Emphasis has been placed on minimizing time delay variations and maximizing the rejection of adjacent channels.

CIRCLE 327 ON READER SERVICE CARD

Temperature Sensor

ROSEMOUNT ENGINEERING CO., 4900 West 78th St., Minneapolis 24, Minn. Resistance temperature sensor for nuclear applications withstands a radiation level of 500 rad/hour.

CIRCLE 328 ON READER SERVICE CARD



Spark Gaps TRIGGERED UNITS

EDGERTON, GERMESHAUSEN & GRIER, INC., 160 Brookline Ave., Boston 15,

MICO Precision Apparatus

NEW HEAVY
DUTY 2 & 3
DIMENSIONAL
ENGRAVER



FOR
Engraving
Nameplates
Fine Routing Work
Profiling Small
Objects
Making Small Dies
and Molds

UHF COAXIAL
WAVEMETERS



2-75
Centimeter
Range

Send for Illustrated Catalogs.

MICO INSTRUMENT CO.

77 Trowbridge St.

Cambridge 38, Mass.

CIRCLE 206 ON READER SERVICE CARD

FASTENERS FROM



DIE CAST
ZINC ALLOY

ZINC ALLOY

WING NUTS



Wing Nuts



Cap Nuts



Thumb Nuts



Thumb & Wing Screws



Screws



Hex Nuts



Washers



Screw Insulators



washer base



high wing



senior series



low wing

widest range of types, thread & blank sizes FROM STOCK

GRC's WING NUT types include senior, junior and economy series—exclusive washer base, high, low, extra low, capped and round wing styles. Patented recessed wings, smooth-acting washer-like bosses simplify assembly, improve appearance. Available in thread and blank sizes from #4 thru 1/2".

GRC's exclusive methods—die casting zinc alloy or molding Nylon and Delrin fasteners in one high speed automatic operation—assure high quality at lowest possible cost.

Write, wire, phone TODAY for SAM- PLES prices, your copy of GRC's NEW INDUSTRIAL FASTENER CATALOG



GRIES REPRODUCER CORP.

World's Foremost Producer of Small Die Castings

151 Beechwood Ave. • New Rochelle, N. Y.

Phone: NEw Rochelle 3-8600

CIRCLE 207 ON READER SERVICE CARD

Did you know that your 1960 electronics BUYERS' GUIDE includes . . . Missiles in Production — p. R5, List of Military Procurement Locations and Personnel — p. R7, Characteristics of Plastics — p. R34, Characteristics of Laminates — p. R36, Wire, Tape and Foam Specifications—p. R38, Symbols Dictionary—p. R42, List of Industry Organizations, Services and Standards — p. R47, Military Standards — p. R50, Military Nomenclature — p. R53.

The only directory in the electronics industry with a Reference Section. It contains Market Data, Materials for Components, Specifications and Services, Design Data.

First choice of all 4!



gives more to all 4!

electronics BUYERS' GUIDE
and REFERENCE ISSUE

WHAT
do
you need to know
about...

PURE
FERRIC
OXIDES
MAGNETIC
IRON
OXIDES
MAGNETIC
IRON
POWDERS
?

Since final quality of your production of ferrites, electronic cores, and magnetic recording media depends on proper use of 3 specialized groups of magnetic materials . . . you'll find it mighty helpful to have all the latest, authoritative technical data describing the physical and chemical characteristics of each. This information is available to you just for the asking. Meanwhile, here are highlights of each product group.

PURE FERRIC OXIDES—For the production of ferrite bodies, we manufacture a complete range of high purity ferric oxide powders. These are available in both the spheroidal and acicular shapes, with average particle diameters from 0.2 to 0.8 microns. Impurities such as soluble salts, silica, alumina and calcium are at a minimum.

MAGNETIC IRON OXIDES—For magnetic recording—audio, video, instrumentation etc.—we produce a group of special magnetic oxides with a range of controlled magnetic properties. Both the black ferroso-ferric and brown gamma ferric oxides are available.

MAGNETIC IRON POWDERS—For the fabrication of magnetic cores in high-frequency, tele-communication, and other magnetic applications, we make a series of high purity iron powders.

If you have problems involving any of these materials, please let us go to work for you. We maintain fully equipped laboratories for the development of new and better inorganic materials. Write . . . stating your problem . . . to C. K. Williams & Co., Dept. 25, 640 N. 13th St., Easton, Penna.

WILLIAMS
COLORS & PIGMENTS

C. K. WILLIAMS & CO.
EAST ST. LOUIS, ILL. • EASTON, PA.
EMERYVILLE, CAL.

CIRCLE 141 ON READER SERVICE CARD

141

yes

Gamewell made a pot that will trip a microswitch

This $\frac{7}{8}$ " 100,000 ohm pot has a microswitch attached. The cam-shaped shaft can actuate the switch precisely at the chosen point. A simple solution — yes, but the answer to a special problem.

Gamewell's YES service — Your Engineered Specials service — is amazingly capable at designing simple answers to special pot problems. Why not put it to the test? Write for the facts.

***your
Engineered
Specials service**



BLISS
Gamewell

THE GAMEWELL COMPANY, POTENTIOMETER DIVISION,
1409 CHESTNUT STREET, NEWTON UPPER FALLS 64,
MASS. A SUBSIDIARY OF E. W. BLISS COMPANY.



GUDELACE®...



the lacing tape with a NON-SKID tread

You can't see it, but it's there! Gudelace is built to grip—Gudebrod fills flat braided nylon with just the right amount of wax to produce a non-skid surface. Gudelace construction means no slips—so no tight pulls to cause strangulation and cold flow.

But Gudelace is soft and flat—stress is distributed evenly over the full width of the tape. No worry about cut thru or harshness to injure insulation . . . or fingers.

Specify Gudelace for *real* economy—faster lacing with fewer rejects.

Write for free Data Book.
It shows how Gudelace and other Gudebrod lacing materials fit your requirements.



GUDEBROD BROS. SILK CO., INC.

ELECTRONICS DIVISION
225 West 34th Street
New York 1, New York

EXECUTIVE OFFICES
12 South 12th Street
Philadelphia 7, Pa.

CIRCLE 208 ON READER SERVICE CARD

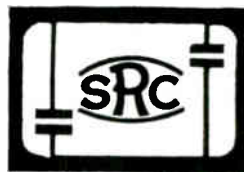

silvered mica capacitors

The "English Mica"

WAX-COATED TYPE (FOR FILTER NETWORKS)

Flat wafer construction, the routine availability of close tolerances, high stability and notably low cost, make the SRC Silvered Mica Capacitor the foremost choice for filter networks.

Capacitance range $2\mu\text{F}$ to $0.1\mu\text{F}$, temperature rating, encapsulated, -60 to $+135^\circ\text{C}$, axial or radial leads, electrical specifications equivalent to Mil. C 5A (F) or better.

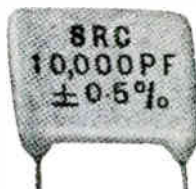

CEMENT-INSULATED TYPE

Of similar construction, the cement coating of this range suits it to both open and encapsulated uses. Capacitance range $2\mu\text{F}$ to $0.01\mu\text{F}$. Grid spaced radial leads for conventional or printed circuits.

Regular weekly air shipments are received from London with close co-ordination of deliveries. Specifications and prices FOB Washington from

B.R.E.L.
PRECISION ELECTRONIC COMPONENTS
B.R.E.L.

British Radio Electronics Ltd.
1833 Jefferson Place, N.W., Washington 6, D. C.
Telephone: FEderal 8-1520

CIRCLE 209 ON READER SERVICE CARD
electronics

Mass., has developed spark gaps for use in electronic crowbar applications and for high energy switching functions. They eliminate many of the disadvantages of hot cathode hydrogen thyratrons and mercury vapor ignitrons, such as limited h-v holdoff, limited peak current, filament power requirement, close temperature regulation, restricted mounting position, complex triggering and large size.

CIRCLE 329 ON READER SERVICE CARD

Sweep Generator

TELONIC INDUSTRIES, INC., Beech Grove, Ind. Both center frequency range and sweep width of the r-f generator are 5 Mc to 1,200 Mc.

CIRCLE 330 ON READER SERVICE CARD

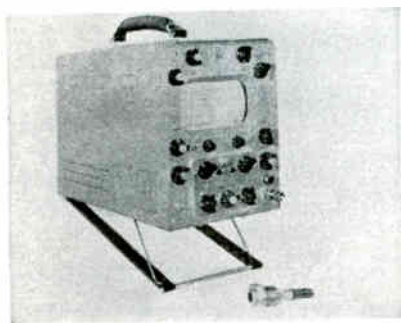

Flaw Detector DRY-COUPLED

CIRCO CORP., 51 Terminal Drive, Clark, N. J. The Metalloradar is an ultrasonic flaw detector that operates without the liquid coupling usually required. The ultrasonically-vibrating crystal in the device is intimately coupled to the object being tested, through the medium of a synthetic membrane that fits tightly over the transducer. Basic price is \$2,750.

CIRCLE 331 ON READER SERVICE CARD

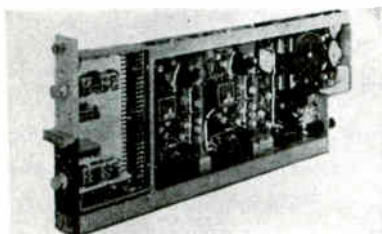

D-C Amplifier SOLID STATE DESIGN

PACKARD BELL COMPUTER CORP., 1905 Armacost Ave., Los Angeles 25,

June 9, 1961

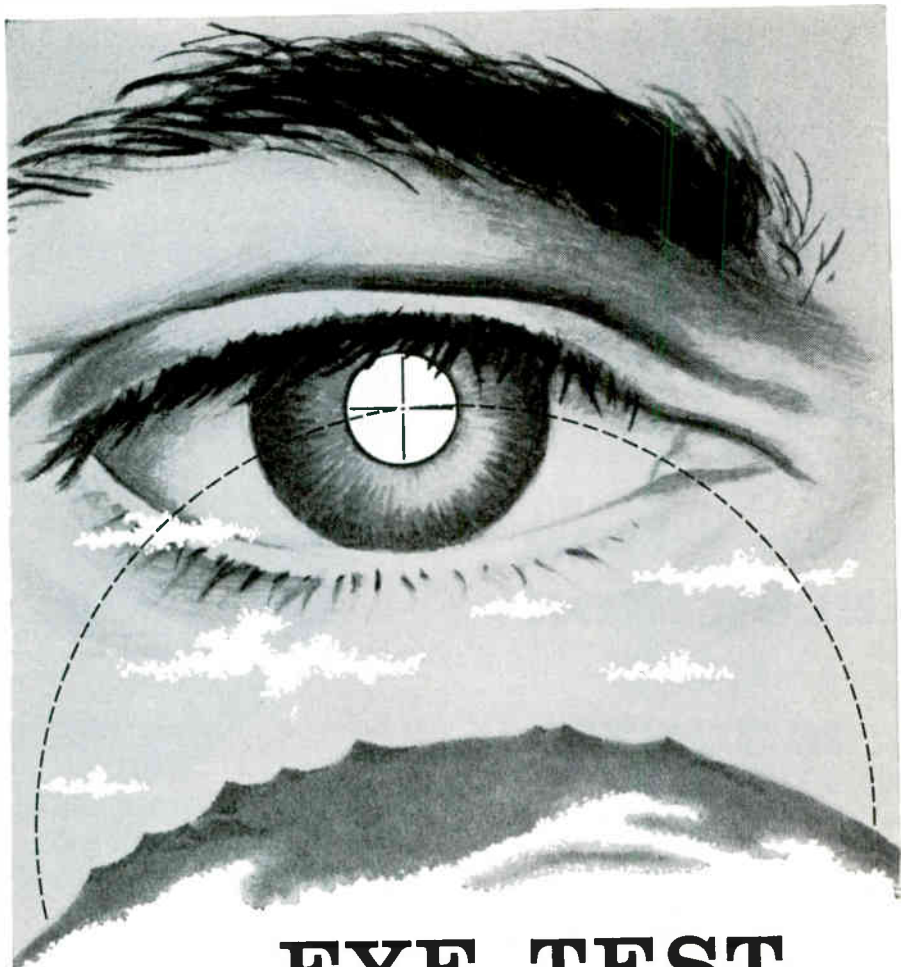

EYE TEST FOR RADAR

B&L optical-electronic-mechanical capabilities assure accuracy in missile tracking system

The strength of our missile defense program depends in part on extreme accuracy of radar tracking.

Bausch & Lomb has developed a camera lens for boresighting a radar antenna—in essence, this lens checks the performance of radar just as one's vision is checked in an eye examination.

Accuracy of this lens system easily meets the most extreme requirements.

The same skills that made possible this missile track radar camera lens are available to assist on your project. Write us for full details. Bausch & Lomb Incorporated, Military Products Division, 61418 Bausch St., Rochester 2, N. Y.



CIRCLE 143 ON READER SERVICE CARD

143

APPROVED
INTERNATIONALLY



**SUPERIOR
ELECTRON
GUN
MOUNTS**

Superior Electronics Corporation, oldest and largest exclusive manufacturer of Electron Gun Mounts, manufactures a complete line of standard Electron Gun Mounts for television, commercial and industrial application as well as prototypes and special purpose guns for the military and for research and development.

Superior Electronics has a full complement of engineers whose professional skills are at your service. Samples, catalogs and prices are available on request.

**SUPERIOR
ELECTRONICS CORP.**

Dept. EL-60 • 208 Piaget Ave.
Clifton, N. J. • GRegory 2-2500



Model
1313

\$590

1/4% ACCURACY WANTED?

This new Universal Bridge adds to the wide variety from which an engineer must choose. But Model 1313 has both 1/4% Accuracy and Direct Readout; combines high discrimination with exceptional ease of use. Detector AGC, variable frequency operation and functional styling are all plus features.

L: 1 μ H to 110H, 7 decades
C: 1 μ F to 110 μ F, 7 decades
R:01 Ω to 110M Ω , 8 Decades
Accuracy: 1/4%
Discrimination: 5000 div'ns/Decade
Frequency: 1Kc, 10Kc, 100 cps to 20Kc
with ext. osc.
Readout: . . . Direct—no multiplying factors

MAKE NO MISTAKE
MEASURE WITH :



MARCONI
INSTRUMENTS



111 CEDAR LANE • ENGLEWOOD, NEW JERSEY

Main Plant: St. Albans, England

CIRCLE 210 ON READER SERVICE CARD

This is not an offer of these securities for sale. The offer is made only by the Prospectus.

NEW ISSUE

\$15,000,000

Aerojet-General Corporation

5 1/4% Sinking Fund Debentures due May 1, 1981

Price 100% and accrued interest

Copies of the Prospectus may be obtained in any State in which this announcement is circulated from only such of the underwriters, including the undersigned, as may lawfully offer these securities in such State.

Kidder, Peabody & Co.

Blyth & Co., Inc.	Eastman Dillon, Union Securities & Co.	Glore, Forgan & Co.
Goldman, Sachs & Co.	Harriman Ripley & Co. <small>Incorporated</small>	Lazard Frères & Co. Lehman Brothers
Smith, Barney & Co. <small>Incorporated</small>	Stone & Webster Securities Corporation	White, Weld & Co. Dean Witter & Co.
Auchincloss, Parker & Redpath	Hornblower & Weeks	Paine, Webber, Jackson & Curtis
A. C. Allyn and Company <small>Incorporated</small>	Bache & Co.	A. G. Becker & Co. <small>Incorporated</small>
Drexel & Co.	Francis I. duPont & Co.	Clark, Dodge & Co. <small>Incorporated</small>
R. W. Pressprich & Co.	Hayden, Stone & Co.	Dominick & Dominick
Reynolds & Co., Inc.	Hemphill, Noyes & Co.	W. E. Hutton & Co.
Shearson, Hammill & Co.	Shields & Company	

May 16, 1961.

Calif. Model 500 is a single ended d-c amplifier for instrumentation applications. Among its features are adjustable gains from 10 to 1,000 and adjustable bandwidth from 10 cps to 100 Kc; also, an input impedance of more than 1,000 megohms and output capability of ± 10 v at 100 ma. Unit contains two single ended amplifiers in one package using a common power supply.

CIRCLE 332 ON READER SERVICE CARD



VOR Instrumentation LIGHTWEIGHT UNIT

COLLINS RADIO CO., Cedar Rapids, Iowa, offers a transistorized vor instrumentation unit for instrument landing system services. The 344D-2 provides vor and localizer indication, to-from information, reciprocal bearing, left-right vor, vor course selection, glidescope needle and warning flags. List price is \$1,185.

CIRCLE 333 ON READER SERVICE CARD

Trimmer Potentiometer

CTS CORP., Elkhart, Ind. Single turn commercial composition trimmer potentiometers measure $\frac{7}{8}$ in. by $\frac{1}{2}$ in.

CIRCLE 334 ON READER SERVICE CARD



Voltage Divider COMPACT SIZE

GENERAL RESISTANCE, INC., 430 Southern Blvd., New York 55, N. Y. Dial-A-Vider provides an easy-to-read, small size, reliable decade



Bristol choppers help first U.S. Astronaut maneuver space capsule

Four Bristol Syncroverter* choppers formed a vital part of the infrared horizon sensors manufactured by Barnes Engineering Company, Stamford, Conn., and carried aloft in NASA's MERCURY capsule by the first U.S. astronaut to reach outer space.

The Bristol choppers function as sensitive phase detectors in the sensors as they establish a horizontal reference plane for the vehicle.

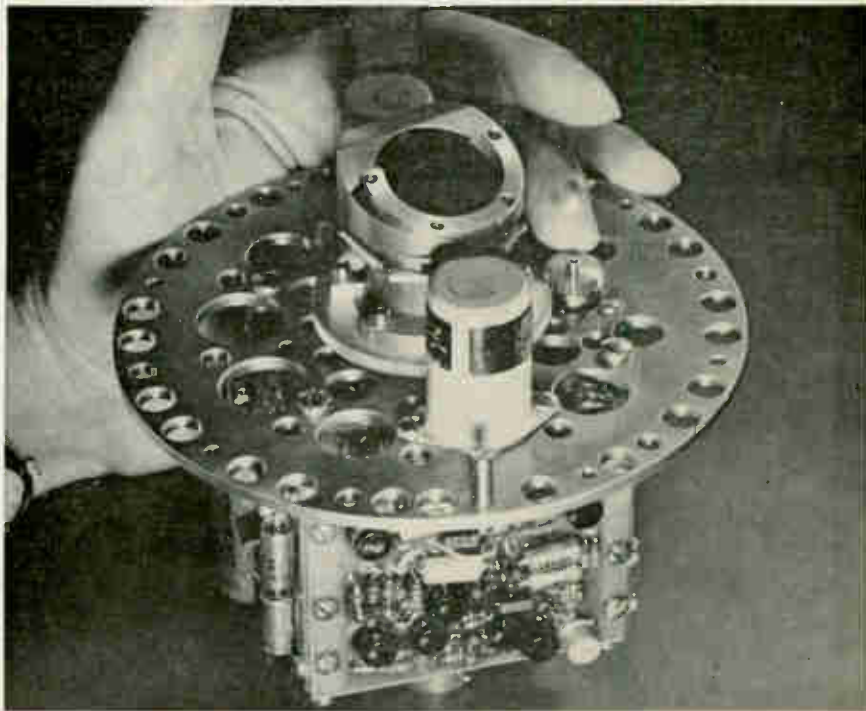

Infrared Horizon Sensor undergoes rigorous optical, mechanical, and electrical checks at Barnes Engineering Co. One Bristol chopper is located in foreground, in front of gear.

Bristol Syncroverter* choppers, noted for low noise, long life and high reliability, are finding a vital place in more and more missile guidance systems, as well as in analog computers, d-c amplifiers, and test equipment for industrial applications. More than 200 models available. Write for complete details.

**The Bristol Company, Aircraft Equipment Division,
152 Bristol Road, Waterbury 20, Conn.**

A Subsidiary of American Chain & Cable Company, Inc.

*T.M. Reg. U.S. Pat. Off. 1.4

BRISTOL... engineers for precision, builds for reliability







NOW! IRIG TIME CODE GENERATOR

Output Signals in 7 Convenient Forms



The Hermes all solid-state Time Code Generator, Model 275 Type B, provides precision time signals (Days, Hours, Minutes, Seconds) in conformance with IRIG (Inter-Range Instrumentation Group) Recommendation No. 104-60, Formats B and C. Model 275 Types A and C, generate similar signals for other data recording and computer applications.

The chart (below) shows the types of time code data available and the seven forms of output presentation. Typical applications are illustrated.

FORMS OF OUTPUT PRESENTATION	TYPES OF DATA PRESENTED			TYPICAL APPLICATIONS
	30 bit 100 pps	28 bit 2 pps	42 bit each ms	
(Serial) AM on 1 kc/s Carrier, 3-to-1 ratio	✓			High Speed Analog Tape Recorder 
(Serial) AM on 100cps carrier, 3-to-1 ratio		✓		Tape Recorders with speeds less than 7½ ips 
(Serial) D-C Pulse Width Code	✓	✓		Oscillograph 
(Serial) Neon Driver	✓	✓		Data Recording Cameras 
Parallel BCD			✓	Digital Acquisition Systems 

Pulse repetition rates of 1pps, 10pps, 100pps and 1,000pps are also provided.

The seven outputs of the Model 275 (6 serial, 1 parallel) are based on a built-in precision oscillator which is stable to 1 part in 10^8 per day. For those applications requiring even greater stability, the Hermes Ultra Stable Oscillator, Model 105A* may be switched in as an external frequency source. Circuits for automatic WWV synchronization with time preset are included. Also provided is a front panel Visual Decimal Display, synchronized with the output signals.

*Stable to 5 parts in 10^{10} per day!

Write for Technical Bulletin 275

Hermes



ELECTRONICS CO.

75 CAMBRIDGE PARKWAY, CAMBRIDGE 42, MASS.

A DIVISION OF

Itel

type voltage divider. Three models are available, all having constant 10,000 ohms input impedance and varying output impedances depending on setting and model. Resolution ranges are from 0.001, 0.0001, and 0.000001. Phase angle at 10 Kc is less than 0.1 deg. Matched precision resistors in each unit provide rigid temperature stability.

CIRCLE 335 ON READER SERVICE CARD

High Power TWT

VARIAN ASSOCIATES, 611 Hansen Way, Palo Alto, Calif. A 3-Mw pulse amplifier traveling wave tube has 500 Mc bandwidth, rated at 5 Kw average power, and has a frequency range of 5.4 to 5.9 Gc.

CIRCLE 336 ON READER SERVICE CARD



Crystal Discriminator ULTRALINEAR

ELECTRONIC LABORATORIES CORP., 4221 Spencer St., Torrance, Calif., announces the CD-106B crystal discriminator. Package configuration, measuring 1.000 by 1.250 by 0.750 in., allows use of two crystals in a lightweight device suitable for aircraft and mobile narrow band f-m communications equipment. With a center frequency of 10.7 Mc and excellent linearity over a range of ± 5.0 Kc, distortion is held to less than 1.5 percent.

CIRCLE 337 ON READER SERVICE CARD

Breadboard Socket

POMONA ELECTRONICS CO., INC., 1500 E. Ninth St., Pomona, Calif. Surface mounted transistor breadboard socket for use with Jetec 30 type transistors is applicable for laboratory and R & D work.

CIRCLE 338 ON READER SERVICE CARD

DOUBLE FACED GLOVE BOXES

provide just the right atmosphere for sweet music . . . controlled, of course



This double faced glove box, in spite of its versatility, is standard equipment. And, as the cartoon is supposed to convey, it is designed with tandem viewing panels, glove ports and lighting fixtures thus permitting two operators to work simultaneously. K · S · E's 32 page catalog clearly portrays these double faced boxes and the many other types of Safety Enclosures available.

**No comment! . . . Dopey's just fiddling around*

For complete information,
call or write

K · S · E

KEWAUNEE
SCIENTIFIC
EQUIPMENT
ADRIAN,
MICHIGAN

4015 LOGAN STREET
CIRCLE 212 ON READER SERVICE CARD

You Get Things Done With Boardmaster Visual Control

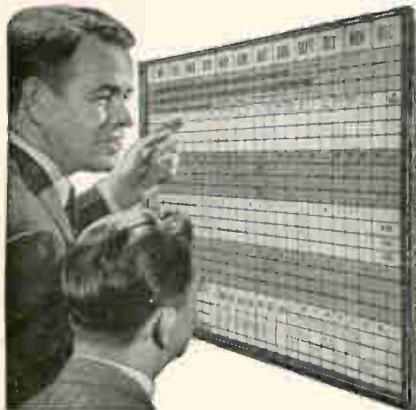

- ☆ Gives Graphic Picture of Your Operations—Spotlighted by Color
- ☆ Facts at a glance—Saves Time, Saves Money, Prevents Errors
- ☆ Simple to operate—Type or Write on Cards, Snaps in Grooves
- ☆ Ideal for Production, Traffic, Inventory, Scheduling, Sales, Etc.
- ☆ Made of Metal. Compact and Attractive. Over 500,000 in Use

Full price **\$49.50** with cards

FREE 24-PAGE BOOKLET NO. C-10
Without Obligation

Write for Your Copy Today

GRAPHIC SYSTEMS
Yanceyville, North Carolina

CIRCLE 213 ON READER SERVICE CARD
June 9, 1961

FIELD PROVEN!

MODEL
3240

WITH



ROBOTEC
overload and
short protection
and



HEATRAN
electronic
dissipation
control

\$349.50

FOB FACTORY
Other Models
Available. Write
for Catalog

Power Designs inc.

1700 SHAMES DRIVE, WESTBURY, NEW YORK
Edgewood 3-6200 (LD Area Code 516)

CIRCLE 214 ON READER SERVICE CARD



SEMICONDUCTORIZED
POWER SUPPLY

**1-32 VOLTS
0-4.0 AMP**

High efficiency, stabilized solid state DC power supply with .05% regulation, 1 millivolt ripple, .01 ohm source impedance, 50 microvolt response time, 55-440 cycle input.

IMMEDIATE DELIVERY

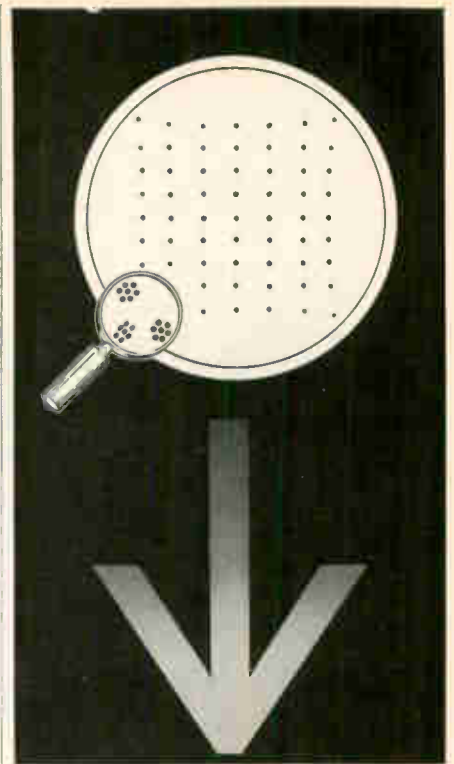

WHY

MAJOR C. R. TUBE MFGRS.
RECOMMEND
SYNTRONIC YOKES

Exceptional manufacturing uniformity. Achieved by unique pepperpot tube testing—the most comprehensive method known for precise measurement for spot uniformity . . . to attain extremely accurate focusing. For technical details, request ELECTRONIC INDUSTRIES reprint #6-57 from Syntronic Instruments, Inc.

Call your nearest **SYNTRONIC REP** today

Boston-New Eng.:	NORwood 7-3164
New York Area:	OXford 5-0255
Phila. Area:	MOhawk 4-4200
Wash.-Balt. Area:	APpleton 7-1023
Indianapolis:	VIctor 6-0359
Los Angeles:	CUMberland 3-1201

syntronic
INSTRUMENTS, INC!

100 Industrial Road, Addison, Illinois
Phone: Kingswood 3-6444

The Industry's broadest yoke line . . . already tooled for quantity production. Or, yokes can be custom designed to your precise requirement.



CIRCLE 147 ON READER SERVICE CARD

147

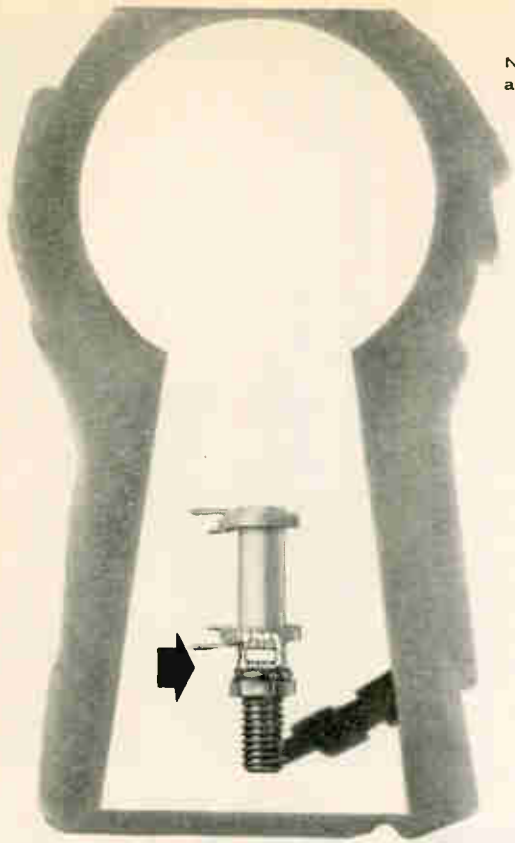

New advanced coil forms
and internal PERMA-TORQ®

RELIABILITY... locked in and guaranteed

Working on the problems plaguing electronic systems design, CAMBION® engineers developed a new device to keep coils and coil forms in proper adjustment.

This exclusive development is the CAMBION internal PERMA-TORQ, a miniaturized, constant tensioning unit located completely within the CAMBION ceramic coil form. Allowing tuning cores to be locked while still tunable, it considerably reduces harmonics, provides increased stability and decreases oscillation in high gain IF strips. Reliability under all conditions keynotes the performance.

New Internal PERMA-TORQ is available in coil forms with the normal yellow, red, green and white slugs — (range: 0.2-300 MC) and with purple slugs (range: 2-40 MC) and blue slugs (range: 40-300 MC). Mechanically, PERMA-TORQ is very easy to adjust. Only a special tuning tool is needed.

CAMBION makes more than 1500 coil forms with varying collar-and-terminal arrangements — including ceramic, phenolic and shielded forms for conventional and printed circuits. All are guaranteed to meet your specifications.

The broad CAMBION line includes plugs and jacks, solder terminals, insulated terminals, terminal boards, capacitors, shielded coils, coil forms, panel hardware, digital computer components. For a catalog, for design assistance or for both, write to Cambridge Thermionic Corporation, 437 Concord Ave., Cambridge 38, Massachusetts. In Europe contact Maitland Engineering, Ltd., 50 Heaton Moor Rd., Stockport, England, or Uni-Office, N.V., P.O. Box 1122 Rotterdam, The Netherlands.

CAMBRIDGE THERMIONIC CORPORATION
CAMBION®
The guaranteed electronic components



Literature of

CROSSGUIDE COUPLERS Microwave Development Laboratories, Inc., 15 Strathmore Road, Natick, Mass. Catalog XT-61 contains applications and specifications for a line of directional crossguide couplers.

CIRCLE 339 ON READER SERVICE CARD

SWITCHING TRANSISTOR General Electric Co., Liverpool, N.Y. A 6-page specification sheet deals with the 2N396A *pnp* germanium alloy transistor for use in medium speed industrial and military switching circuits.

CIRCLE 340 ON READER SERVICE CARD

D-C POWER SUPPLIES Electronic Measurements Co. of Red Bank, Eatontown, N. J., has issued a catalog of more than 80 models of Regatran semiconductor d-c power supplies.

CIRCLE 341 ON READER SERVICE CARD

CUP PROCESSING Electronic Production & Development, Inc., 138 Nevada St., El Segundo, Calif., has available data sheets on processing techniques for the use of its electronic encapsulation cups.

CIRCLE 342 ON READER SERVICE CARD

ACCELEROMETERS Donner Scientific Co., a subsidiary of Systron-Donner Corp., Concord, Calif. An 8-page brochure describes the firm's transistorized 0.1 percent linear force balance servo-accelerometers.

CIRCLE 343 ON READER SERVICE CARD

F-M DISCRIMINATORS Data-Control Systems, Inc., 39 Rose St., Danbury, Conn. An 8-page brochure covers f-m discriminators and associated equipment for research data systems.

CIRCLE 344 ON READER SERVICE CARD

HIGH VOLTAGE CATALOG Peshel Electronics, Inc., Patterson, N.Y. An 8-page catalog of h-v test sets and h-v power supplies is available.

CIRCLE 345 ON READER SERVICE CARD

INDICATOR LIGHTS Transistor Electronics Corp., 3357 Republic

the Week

Ave., Minneapolis 26, Minn. The concept of transistorized indicators (Tec-Lites) and their function in modern semiconductor circuitry is contained in bulletin 137.

CIRCLE 346 ON READER SERVICE CARD

THERMOCOUPLES Baldwin-Lima-Hamilton Corp., 42 Fourth Ave., Waltham 54, Mass. A line of microminiature thermocouples — fast and accurate temperature sensors—is described in bulletin No. 4336.

CIRCLE 347 ON READER SERVICE CARD

SILICON RECTIFIERS Raytheon Co., 215 First Ave., Needham, Mass. Catalog describes more than 150 different silicon diffused rectifiers ranging from 50 to 600 v piv and from 250 ma to 22 amperes.

CIRCLE 348 ON READER SERVICE CARD

RELAY BULLETIN Universal Relay Corp., 42 E. White St., New York 13, N.Y. A 20-page bulletin lists and describes relays, steppers, Sensitrols etc., most of which are carried in stock in production quantities.

CIRCLE 349 ON READER SERVICE CARD

MAGNETIC CLUTCHES FAE Instrument Corp., 16 Norden Lane, Huntington Station, N.Y. A 12-page catalog covers a line of precision miniature magnetic clutches, clutch-brakes and brakes in BuOrd frame sizes 8, 11 and 18.

CIRCLE 350 ON READER SERVICE CARD

GERMANIUM TRANSISTORS Texas Instruments Inc., P. O. Box 5012, Dallas 22, Texas. Forward and reverse agc characteristics of vhf germanium mesa transistors are contained in a recent issue of *Application Notes*.

CIRCLE 351 ON READER SERVICE CARD

TUBING AND SLEEVING Suflex Corp., 33-40 57th St., Woodside, N.Y., has available a selector card designed to assist users of insulating tubing and sleeving in determining proper types and sizes for particular applications. Samples are included.

CIRCLE 352 ON READER SERVICE CARD



**John
Gregorio
can
show
you...**

how to measure ac ratios to one part per million... at a sensible price

In fact, any of North Atlantic's field engineering representatives can quickly demonstrate how the Models RB-503 and -504 Ratio Boxes will meet all your requirements for high accuracy at lowest cost.

Designed for either bench or rack mounting, both models provide rated accuracy over their full ratio range, with six-digit, in-line window readout for best readability. Both incorporate heavy duty switches with transient suppression, fold-away legs, easily removeable end plates and voltage dividing transformers to MIL-T-27A. Abridged specifications are given below:

	RB-503	RB-504
Ratio Range	0.000000 to 1.111110	-0.111110 to +1.111110
Accuracy Of Ratio For All Ratios (at 400 cps)	$\pm \left[0.001 + \frac{0.0001}{(\text{Ratio})} \right] \%$	$\pm \left[0.0001 + \frac{0.000025}{(\text{Ratio})} \right] \%$
Frequency Range (Useful)	50 to 10,000 cps	50 to 10,000 cps
Nominal Input Impedance (at 400 cps)	50K-60K	> 250K
Max. Input Voltage	0.5f, Volts, (f in cps) (not to exceed 350 V.)	1.0f, Volts, (f in cps) (not to exceed 350 V.)
Max. Effective Series Resistance	3.5 ohms	8 ohms
Resolution	5 decades plus 1 turn potentiometer	5 decades plus 1 turn potentiometer
Size	13½" h. x 19" w. x 8" d.	3½" h. x 19" w. x 8" d.
Price	\$295.00	\$450.00

Also from North Atlantic: Model RB-510 for high precision at 10 kc and RB-520 for MIL Spec applications.

If you're up against critical jobs of ac ratio measurement — in the laboratory, on the production line, or in the field — it will pay you to talk to the North Atlantic man in your area. For his name, call or write today. Or request Bulletin RB 503-504 for complete data.



NORTH ATLANTIC industries, inc.
TERMINAL DRIVE, PLAINVIEW, L. I., NEW YORK • Overbrook 1-8600

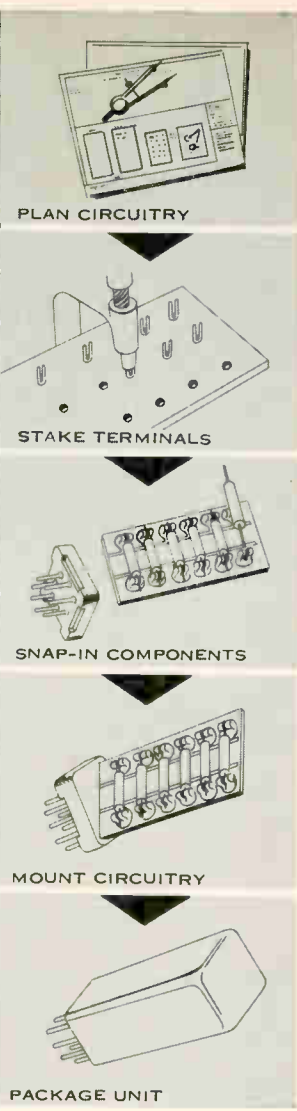
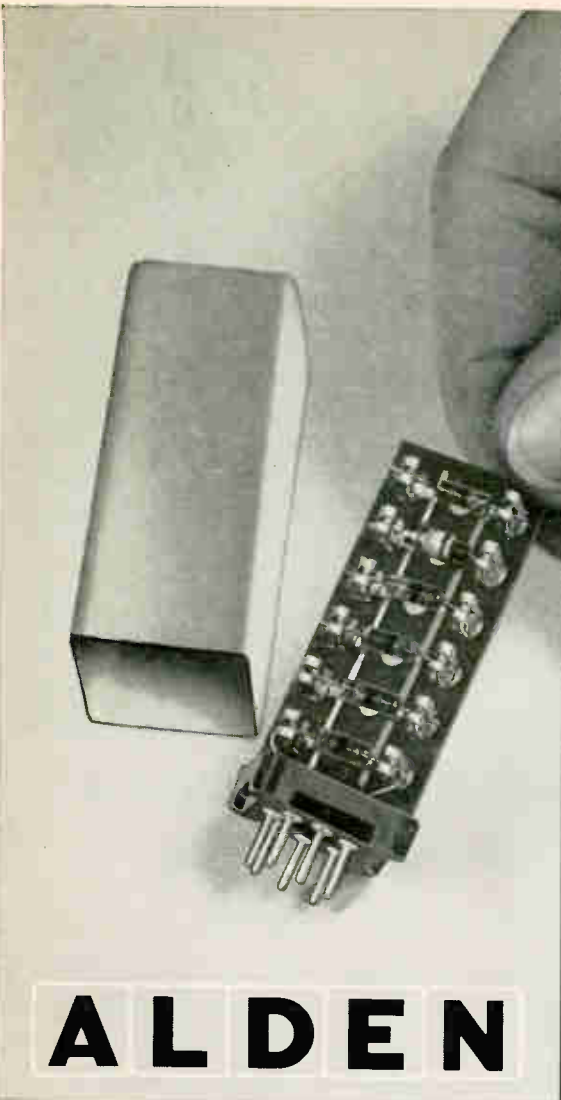

ALDEN

miniature packaging modules

Off-the-shelf building block components to simplify assembly and servicing of smaller circuits. Alden miniature plug-ins are simple to install, can be knocked down and swiftly reassembled, and allow for 30-second replacement by handy spares. Their greatest virtue: elimination of costly downtime. But they have other special assets:

- standard 7 or 9-pin off-the-shelf components
- space-saving "maximum density" package
- extra light-weight aluminum housings
- accommodates tremendous variety of circuits
- snap-in terminal setting and connecting
- open type construction for easy accessibility to components
- specially designed terminals give faster heat dissipation
- jumper strip eliminates need for leads

Alden furnishes everything you need — including planning sheets for slick, quick, layout. Ask about our plug-in module package kit. For complete information, including new micromodules, write:

ALDEN

PRODUCTS COMPANY
6127 N. Main Street, Brockton, Mass.



Model 196G Germanium Transistor Amplifier by Taber Instrument Corporation — Its miniature size, light weight and ruggedness adapt it to portable and airborne instrumentation.

NEW BOOKS

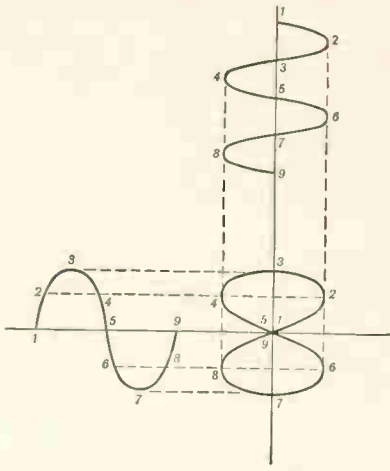

Construction of Lissajous figure.

International Dictionary of Applied Mathematics

W. F. FREIBERGER, Editor in Chief
D. Van Nostrand Company, Inc., Princeton N. J., 1173 p., \$25.

EVERY specialized dictionary faces a dilemma: it must cover the greatest possible number of entries with utmost brevity. As a result, often the explanations become so terse that they are understandable only to the expert who does not need them, and not to the layman who does.

In this case a good compromise was reached in that most of the entries are intelligible to the graduate engineer with a modicum of mathematical equipment. A very wide field is covered: many physical and engineering terms and concepts, as well as mathematical ones, are quantitatively defined, though more basic mathematical terms are not included, being outside the scope of the dictionary.

A feature of this volume, likely to prove very useful to the mathematician, is a set of four glossaries, in French, German, Spanish and Russian, listing alphabetically terms corresponding to all entries. While this will be a great help in reading foreign papers, these terms might also have been included after each English-language entry, so as to enable two-way translation. Standard metric terms nano-, tera-, giga-, and the like are not listed, instead terms such as micromicro —are used.

In a time when every engineer has to deal with many branches of

mathematics, this is a most useful reference volume.—G.V.N.

High Frequency Applications of Ferrites

By J. ROBERTS

D. Van Nostrand Co., Inc., Princeton, N. J., 1961, 166 p, \$4.85.

UNLIKE many materials texts, which frequently attempt to survey a material's applications in several fields, this little book is pleasantly compact and to the point. It hews to its title, concentrating on providing an understanding of basic ferrite properties and the application of these to inductor and transformer cores, microwave devices, and computers and data processors. Permanent magnets are discussed, for example, as parts of pulse transformer cores. The book is intended for advanced students and physicists or engineers designing or using electronic devices.—G.S.

Electronic Business Machines

Edited by J. H. LEVESON

Philosophical Library, Inc., New York, 272 p, \$15.

ALTHOUGH attempts are made to instruct the reader in the art of programming, the main use of this book will be as a guide to management people who have no computer experience and are contemplating the installation of a machine. The basic philosophy of a stored-memory computer is presented and different types of applications to business problems are discussed. This is a book to be read for general background information, but does not seem to justify its price in terms of information content. —LEONORE R. BUSHOR, *Computer Consultant, West Islip, N. Y.*

Introductory System Analysis

By W. A. LYNCH and J. G. TRUXAL

McGraw-Hill Book Co., New York, 1961, 445 p, \$7.50.

WHILE primarily a textbook for a sophomore course, this book is also

SOME TIMERS DO ALL THEY ARE DESIGNED FOR—AND MORE. Others just make claims. A.W. Haydon's record speaks for itself. Behind each: 101 "pros" pooling their timing technology...so-phisticated test labs to assure peak performance...built-in reliability reflecting years of experience. ■ A.W. Haydon makes them all: timing motors, time delay relays, elapsed time indicators and the like—electronic marvels from Culver City, electromechanical wonders from Waterbury. Shown: microminiature ETI—actual size. Literature on request. ■ If you need a reliable timing device—miniature for aircraft or microminiature for rocketry—member, A. W. Haydon timers meet or exceed all MIL specs. When it's a matter of time, choose A.W. Haydon reliability.



PERFORMANCE OUTWEIGHS CLAIMS

THE AWHAYDON COMPANY
235 NORTH ELM STREET, WATERBURY 20, CONNECTICUT

**POWER,
CONTROL,
SIGNAL
CIRCUITS...**

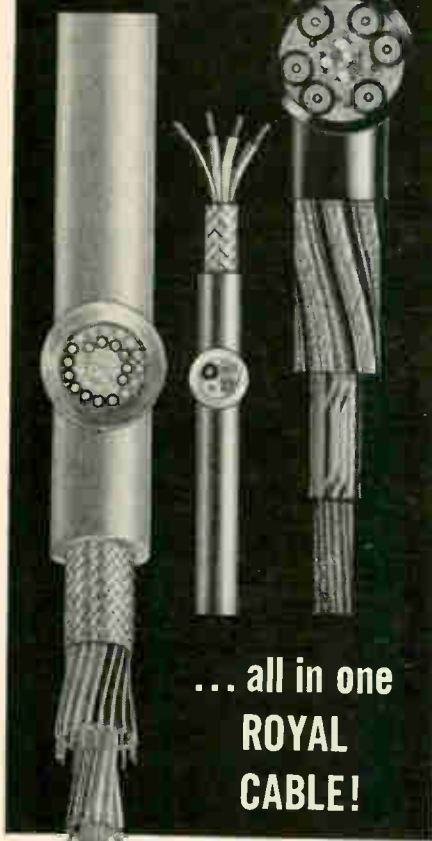

**... all in one
ROYAL
CABLE!**

ROYAL MULTI-CONDUCTOR CABLES are designed, manufactured and quality-controlled to your exact specifications . . . for a myriad of uses . . . for simple or complex applications. Cable elements and materials may be combined to include signal, control and power circuits into one construction and within one jacket. Royal is equipped and experienced to provide a finished cable that will assure predictable, dependable on-the-job performance. And remember, Royal is ready . . . to quote . . . to supply . . . to satisfy.

Write for new Catalog No. 4C-61 . . . (includes charts on Royal RG and special application cables, physical characteristics, test procedures, engineering tables, etc.)

ROYAL ELECTRIC CORPORATION
301 Saratoga Ave., Pawtucket, R. I.
In Canada: Royal Electric Company
(Quebec) Ltd., Pointe Claire, Quebec

ROYAL
ELECTRIC 
... an associate of

written as an introduction to systems and analog engineering for nonelectrical engineers, and as a handbook of linear system analysis for the graduate engineer. The main areas treated are the model concept, the transfer function, and analog simulation and computation. A unified approach includes mechanical and hydraulic as well as electrical systems, tending to make it easier to associate new ideas with familiar mechanical concepts. A large number of problems and a bibliography for further study are included with each chapter.—G.V.N.

**Professional Manpower
and Education in
Communist China**

By LEO A. ORLEANS

*National Science Foundation,
Washington, D. C., 1961, 259 p, \$2.*

DESPITE the all-inclusive sounding title, no information is given on Chinese manpower breakdown in engineering or in the other professions. Nor is any mention made as to what specific areas in electronics, physics, and so on are being pursued and as to how these pursuits are organized. Consequently, the content would probably be of slight interest to engineers, scientists, and managers in electronics and other technological industries. Possibly, historians and economists would be interested in the broad philosophical implications, but as the author admits the substantiating statistical data are quite shaky and therefore almost meaningless. The general impression given is that Communist China is in a much greater technological muddle at all levels than is the U. S. and will be for many years to come.—R.J.B.

THUMBNAIL REVIEWS

Using Transistors. By D. J. W. Sjobema. Philips Technical Library, Centrex, Eindhoven, Netherlands, (Available from the Macmillan Co., New York), 118 p, \$2.10. This is one of the best of the many recent books about transistors. Popular and qualitative, it is written for the student or hobbyist rather than engineer. After describing transistors and transistor



**LOOKING
FOR
THE
IDEAL
TERMINAL
SETTER?**

STOP. You've found it. A Black & Webster Electropunch or full automatic Electroset can solve your terminal setting problems **\$135⁰⁰**
—for as little as

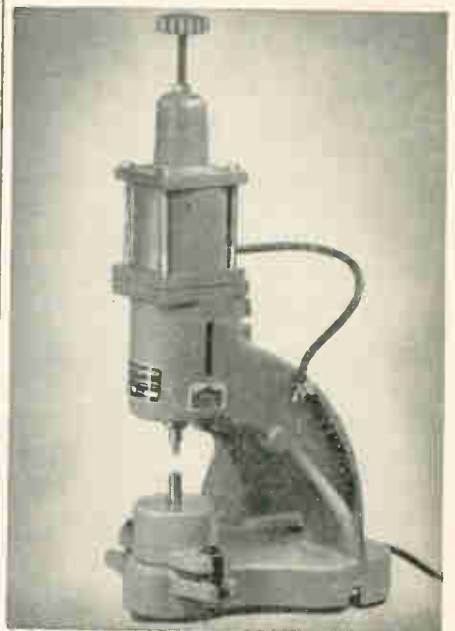

SHORT RUNS: Electropunch — sets hand fed terminals twice as fast as conventional methods. All electric. Foot switch operated.

LONG RUNS: Electroset — automatically feeds and sets terminals up to 3600 per hour. All electric. Customized to your needs.



WHAT'S YOUR PROBLEM?
Black & Webster can help.
Send sample terminal and requirements.

Write today for free 12-page catalog describing our complete line of production tools.

BLACK & WEBSTER, INC.

Dept. E, 570 Pleasant St.
Watertown 72, Mass.

CIRCLE 215 ON READER SERVICE CARD
electronics

The all-new, all solid-state Philbrick P2 amplifier

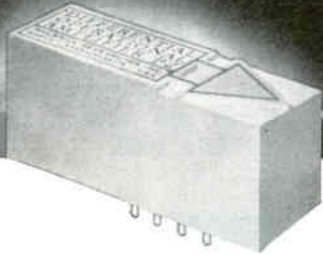

NO TUBES, NO CHOPPERS, NOTHING BUT PERFORMANCE. An ingenious arrangement of all solid-state components endows this operational amplifier with the most remarkable and versatile characteristics. But let's let them speak for themselves. *Full differential input:* truly floating with respect to ground. *No common mode error.* *Low input current:* typically 10^{-11} amps. *Low noise:* typically under 10 microvolts in the dc to 1 kc range. *Sub millivolt long term stability:* less than 100 microvolts drift per day. *Cool running:* typically 330 milliwatt dissipation. *Wide band pass:* typically 75 kc as a unity gain follower. *High open loop gain:* typically 30,000. **\$210.**
Truly low cost.

Use the P2 for instrumentation, analog computation, and other applications requiring high reliability and accuracy. Discover its marvelous versatility and convenience. Add, integrate, scale, invert with it. Take advantage of its differential inputs to perform very high impedance voltage following (or amplification), precise current driving, and many other useful applications. The P2's output delivers 1 ma at ± 10 volts. The cast aluminum housing fits right in your hand.

Please write for further information to:

GEORGE A.
PHILBRICK
RESEARCHES, INC.

127 CLARENDON ST. BOSTON 16, MASS.
COMMONWEALTH 6-5375. TWX: BS 1032. FAX: BSN
REPRESENTATIVES IN PRINCIPAL CITIES
EXPORT OFFICE: 240 W. 17TH ST., N. Y. 11, N. Y.
TEL. CHELSEA 3-3200. CABLE: TRILRUSH

CIRCLE 216 ON READER SERVICE CARD

June 9, 1961

circuits in general terms, it introduces a number of practical circuits that can be built by the "amateur experimenter". As in all books in this series, European symbols and transistor types are used; this however should present no difficulty.

Technical Writing Techniques for Engineers. By Joseph Racker, Prentice-Hall, Inc., Englewood Cliffs, N. J., 234 p, \$6.95. An interesting approach is used here: simple writing tips are dressed in engineering clothes (diagrams, charts, tables). So this makes the book easy to meet and a helpful acquaintance. This book gives a specific set of rules for writing in the engineering field. Depending on your level of development, the book provides a good beginning or timely checklist.

Basic Mathematics for Electronics. By N. Cooke, McGraw-Hill Book Co., Inc., New York, 679 p, \$10.75. An expanded and updated edition of the "Mathematics for Electricians and Radiomen" (1942), this book is aimed at those with at most a high-school background in mathematics. It should be of no use to a graduate engineer, since it is concerned with extremely elementary mathematics and their application in basic electricity. Good use is made of the inside covers for much-used tables.

Fundamentals of Semiconductors. By M. G. Scroggie, Gernsback Library Inc., New York, 160 p, \$2.95. Deals in conversational way with basic semiconductor principles and uses words, not mathematics, to describe the various actions. Major advantage of the book is that it brings a wide range of semiconductor phenomena, from transistors to the Hall and electroluminescent effects, under a single roof.

Rare Metals Handbook. Edited by Clifford A. Hampel, Reinhold Pub. Corp., New York, 1961, 715 p, \$20. This second edition, put together by 44 experts, lists 55 of the less-common metals. Six are new in this edition: secium, chromium, plutonium (recently declassified), rubidium, and yttrium. Also, separate chapters have been assembled on columbium and tantalum. The reference format is functional, the illustrations profuse and informative. Production statistics, occurrence, derivation, economics, alloys and applications are given. Handy engineering information on so many vital structural materials.

New Philbrick 6033 solid-state power supply



BALANCED OUTPUTS, COMPUTING GRADE. The 6033 is the latest addition in the distinguished line of Philbrick power supplies. It will energize at least 10 Philbrick P2 amplifiers and other transistorized electronic equipment. Like the P2, its remarkable characteristics speak for themselves. *Low internal impedance:* less than 2 milliohms. *Low noise and hum:* guaranteed less than 150 microvolts rms (0.001%). *Highly regulated outputs:* against load, less than 300 microvolts; against line, less than 200 microvolts. *Low long term drift:* typically 0.1%. *Short transient recovery time:* no load to full load, less than 1 millisecond. *Unique short circuit overload protection:* inherent in the 6033's design with no extra circuitry to deteriorate performance. *Truly low cost:* about half that of supplies with comparable performance. **\$285.**

Operates from 115 volt, 50-400 cycles, providing up to 150 ma at plus AND minus 15 volts, slaved to a common reference. Conveniently packaged, cool running, and highly reliable. Available as bench model or modular plug-in. Bench model dimensions: $3\frac{1}{2}$ " h x $5\frac{1}{2}$ " w x $7\frac{1}{2}$ " d. Also available with 300 ma output.

Complete facts are waiting for you. Please write:

GEORGE A.
PHILBRICK
RESEARCHES, INC.

127 CLARENDON ST. BOSTON 16, MASS.
COMMONWEALTH 6-5375. TWX: BS 1032. FAX: BSN
REPRESENTATIVES IN PRINCIPAL CITIES
EXPORT OFFICE: 240 W. 17TH ST., N. Y. 11, N. Y.
TEL. CHELSEA 3-3200. CABLE: TRILRUSH

CIRCLE 155 ON READER SERVICE CARD

155

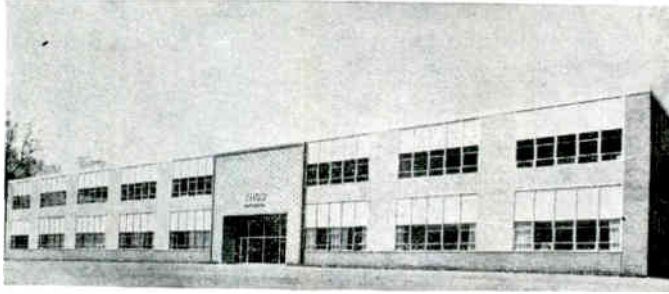

Arco Electronics Moves Headquarters

ARCO ELECTRONICS, INC., sales and marketing agency for manufacturers of electronic products, and itself a manufacturer of complementary components, has moved its headquarters from Manhattan to a new plant in the Lake Success Business and Professional Park, Great Neck, N. Y.

Arco's new plant contains 46,000 sq ft of space, nearly twice the former quarters. The building houses production, laboratory and warehousing facilities for Arco's PFC division, which produces a complete line of precision film capacitors, capacitor standards, R-C networks and related products for industrial, military and space markets.

Albert I. Rothenstein, company president, says the move provides Arco with the room and facilities "to carry through our growth and expansion programs."

He adds that the improved and enlarged facilities will result in a more efficient operation of Arco's sales and marketing programs that provide off-the-shelf delivery of components on a 24-hour basis to distributors in the U. S. and Canada.

Arco is exclusive sales and marketing agency to distributors for the standard line of miniaturized transistor transformers and other types produced by the HST division of Dresser Electronics. For this assignment, Arco maintains a network of some 50 industrial distributors.

The company performs a similar function for the Elmenco line of capacitors produced by Electro Motive Mfg. Co. Arco stocks large in-

ventories of 500 different values of the complete Elmenco line for immediate delivery throughout the country.

Rothenstein says Arco is negotiating with other electronics manufacturers for additional products to handle on an exclusive national basis, as part of the company's expanding program.

Arco expanded its manufacturing operations last year with the acquisition of a production facility in Terryville, Conn. The plant produces a new line of electrolytic capacitors, fabricated of 99.99 percent pure aluminum foil and premium grade capacitor paper.



Appoint S. L. Glaspell Chemonics President

LANCER INDUSTRIES, INC., Mineola, N. Y., has announced the appointment of Spencer L. Glaspell as president of Chemonics Corp., Pasadena, Calif., wholly owned electronics subsidiary.

Glaspell was formerly sales manager of Graphik Circuits Division of Cinch Mfg. Corp. He is a former chairman of the Printed Circuits Group of the Electronic Industries

Association and past president of the Western Association of Circuit Manufacturers.

Robert Honer Joins Electro Instruments

ROBERT E. HONER, formerly manager of electronics for the Convair Division of General Dynamics Corp., in San Diego, has joined Electro Instruments, Inc. as vice president-operations, a newly-created position. Honer has been a Convair executive since 1953.



Ling Electronics Names Tweedie Vice President

WILLIAM A. TWEEDIE has been promoted to vice president and general manager of Ling Electronics, division of Ling-Temco Electronics, Inc., Anaheim, Calif.

Tweedie joined Ling Electronics in the fall of 1960, coming from the Stanford Research Institute where he had been an executive for several years.



Gorham Corporation Elects Brown

ELECTION of Gordon Stanley Brown to the board of directors of the Gor-



Wide Range PULSE and SQUARE WAVE GENERATOR PSG-1

Broad Range of Frequencies and Pulse Widths

- Frequency—1 cycle to 1 mc
- Pulse Width—.1 μ sec. to .3 seconds
- Rise and Fall Time—.02 μ sec. for 10 v, 100 ohm output
- Rise and Fall Time—.1 μ sec. for 50 v, 500 ohm output

DOUBLE PULSE ADAPTER • PSG-1/DG Price \$135.00

Pulse and Square Wave Generator — Rack Mounted PSG-1/RM Price \$740.00

Double Pulse Adapter — Rack Mounted PSG-1/DG/RM Price \$145.00



Variable Width PULSE GENERATOR PG-10

The Pulse Generator, PG-10, generates variable width pulses in the frequency range 1 megacycle per second to 20 megacycles per second. It is especially useful where high repetition rates and narrow pulses are required. Price \$1250.00

- Frequency range: 1-20 mcps (3 overlapping ranges)
- Rise and fall time less than .006 μ sec.
- Minimum pulse width approximately .02 μ sec. at 50% amplitude
- Can be externally synchronized

Very Low Frequency SPECTRUM ANALYZER SA-11

This analyzer system is designed for use wherever real time, accurate, high-resolution analysis of the very low frequencies is required. Some typical fields of application are:

- Seismology
- Underwater acoustics
- Heartbeat analysis
- Speech analysis
- Shock and vibration analysis

Frequency range—

0.0025-1000 cps (real time basis) seven scales

Analysis time—

1.6 seconds for maximum selectivity

3DB Selectivity

1 cycle scale: 0.0037 cps
1000 cycle scale: 3.75 cps

Transistorized models SA-12 and SA-14 will provide frequency ranges up to 5000 cps and, with GASL auxiliary equipment, offer power density and normal density capability



Visit us at our plant for a demonstration, or call our Marketing Department at EDgewood 3-6960 to arrange for analysis of one of your sample tapes.

All prices subject to change without notice.

CIRCLE 217 ON READER SERVICE CARD



Transistorized LOGIC MODULES

For systems containing dynamic and static type digital logic as well as analog computation devices.

FHS-1	High Speed Flip Flop (2)	\$82	MG-1	Multiplexer Gate (6 gates)	\$59
FMS-1	Dual Medium Speed Flip Flop (2)	69	OA-1	Summing Amplifier	71
DG-1	Digital Gate (4)	51	SA-1	Servo Amplifier	87
DM-1	Delay Multivibrators (3)	62	CDX-1	Card Extender	30
ND-1	Nixie Driver	58	BCP-1	Bucket—27 card capability—wired for power	357
BO-1	Blocking Oscillator (3)	88	BC-1	Bucket—27 card capability—not wired for power	241
OS-1	Clock Oscillator	77	TLG-1	2 Leg Gate (8 gates)	69
CPA-1	Clock Pulse Amplifier (4)	105	LD-1	Light Driver (4)	42
AE-1	Active Element	61	ST-1	Schmidt Trigger (2)	68
DL-1	Delay Line Card	89	MSC-1	Special Circuit Card	25
CG-1	Computer Gate Card	49			
MDL-1	Magnetostrictive Delay Line	522			

FIRST CHOICE OF ALL 4!

RESEARCH — DESIGN — PRODUCTION — MANAGEMENT

There is no mystery about who gets and uses the **electronics BUYERS' GUIDE**. It is part of the paid subscription to regular weekly issues of **electronics**, and is available and used by the more than 52,000 identified subscribers of the magazine.

Only the **electronics BUYERS' GUIDE** is compiled to satisfy the basic buying needs of all four key segments of the industry — research, design, production, management.

GIVES MORE TO ALL 4!

electronics BUYERS' GUIDE
and REFERENCE ISSUE



where stability and miniaturization are primary

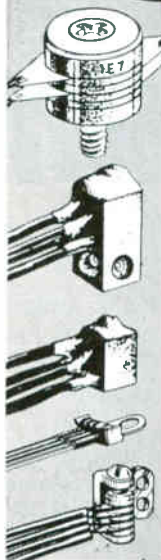

SEMICONDUCTORS
COPPER OXIDE
AND SELENIUM

INSTRUMENT RECTIFIERS
RING MODULATORS
HIGH-VOLTAGE RECTIFIERS
VOLTAGE REGULATORS
SWITCHED RECTIFIERS
CHOPPERS
SPECIAL PURPOSE UNITS
LIST PRICES FROM .42c

5 COPPER OXIDE CELL STYLES FROM .080" to .500" DIA. ACTIVE AREAS .0012 to .125 SQ. IN.

SELENIUM CELL SIZES FROM .080" round TO 2" SQUARE. .020" TO .045" THICK.

Write for Free Bulletins Dept. 20

CONANT LABORATORIES
LINCOLN, NEBRASKA

MINIATURE SNAP ACTION LOW COST Time Delay Relays

For commercial use, economical Curtiss-Wright thermal time delay relays, hermetically sealed in glass, are a compact and reliable design for many control, switching and timing applications. Precision built for high performance and long life. Ambient temperature compensated. Conservatively rated, these new rugged, small sized units are preset for time delays from 3 to 60 seconds.



Write for latest complete components catalog #503

Electronics Division
CURTISS-WRIGHT CORPORATION
East Paterson, New Jersey

AD NO 4509

ham Corp., Providence, R. I., is announced.

Currently the dean of engineering at MIT, Brown's extensive background in technology and electronics is expected to be of vital help to Gorham, particularly in its diversification program.



Control Electronics Advances Magenheim

BERTRAM MAGENHEIM has been named chief engineer of Control Electronics Co., Inc., Huntington Station, N. Y. In this capacity, he will direct all of the engineering activities of the company in the microwave, delay line, audio filter and instrument fields.

Prior to this promotion, Magenheim was head of the company's microwave division.



Bulova Labs Assigns Systems Post

ARNOLD S. GREENHUT was recently named to the new post of management engineer for Bulova Research & Development Laboratories, Woodside, N. Y. His assignment will include developing improved administrative systems and procedures, and management control and manufacturing engineering methods.

Before joining Bulova, Greenhut had been employed for 9 years in a similar capacity with Republic

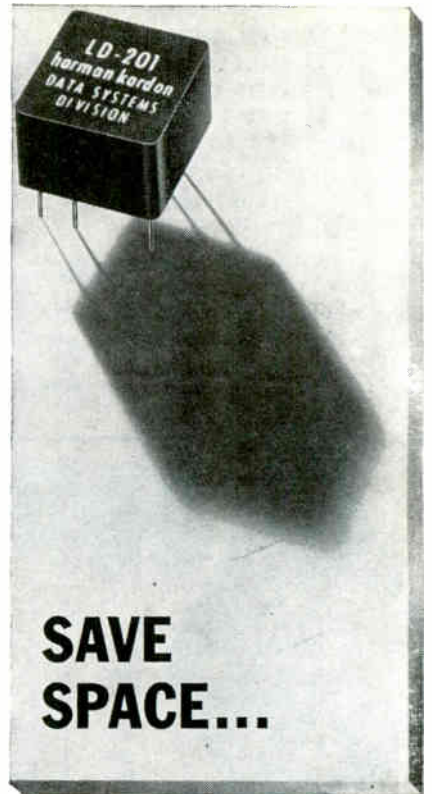

**SAVE
SPACE...**

INCREASE RELIABILITY

with
**Harman-Kardon encapsulated
digital logic modules...
proven components...proven
circuits...proven packaging**

These fully encapsulated modules offer increased reliability—afford a high density, fully protected package with better heat dissipation. And, you will find the cost competitive with open card construction.

The modularized Series 200 logic circuits are available now—from stock—in a variety of logic configurations for operation up to 250 Kc. Higher speed units, too, are on the way!

The application engineering staff of the Data Systems Division stands ready to serve you in the implementation of your system block diagrams.

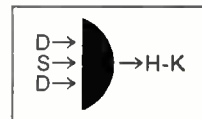

Data Systems Division

harman kardon

INCORPORATED
Plainview, N.Y.

CIRCLE 219 ON READER SERVICE CARD
electronics

electronics fills you in on every phase of the electronics industry each week featuring engineering and technical data every issue. Latest economic trends, technically interpreted, to help you make sound plans. Facts you'll want to file and keep. Subscribe now. Mail the reader service card (postpaid) to **electronics**, the magazine that helps you to know and to grow! Rates: three years for \$12, one year for \$6; Canadian, one year for \$10; foreign, one year for \$20. Annual **electronics BUYERS' GUIDE** (single issue price \$3.00) included with every subscription.

it's read
more by
all 4!



RESEARCH



DESIGN



PRODUCTION



MANAGEMENT

SUBSCRIBE TODAY TO
electronics!

June 9, 1961

Aviation, and for 5 years as industrial engineer and production manager for Presto Electric and Presto Electric Co. of Canada.



**Dynex Industries
Names Mamon V-P**

MICHEL MAMON, a specialist in magnetic amplifiers for instrumentation and automatic control, and a designer of transistor circuitry, has been appointed vice president in charge of engineering for Dynex Industries, Inc., Syosset, N. Y. He was formerly with ITT Labs.



**Robert Fano Elected
To Adcole Board**

ROBERT M. FANO, professor of electrical communication at the Massachusetts Institute of Technology, has been elected to the board of directors of Adcole Corp., Cambridge, Mass., manufacturer of electronic systems.

Fano has been on the staff at MIT since 1941 and has served as leader of the radar techniques group of Lincoln Laboratory.

**Microwave Associates
Hires Senior Engineers**

MICROWAVE ASSOCIATES, INC., Burlington, Mass., announces the appointment of Kenneth R. Evans,

**Instant Reset
Voltage Compensated
Vibration Resistant**



**Thermal Time
Delay Relays**

Precision-built Curtiss-Wright thermal time delay relays reset instantly when de-energized — provide the same delay period for each succeeding cycle. Compensated for wide voltage variations. Available in either 28V DC or 115V AC, 60 or 400 cps. Chatter-free operation, under severe shock and vibration conditions. Small sized, hermetically sealed, temperature compensated for precise, reliable operation and long life. Preset time delays from 10 to 180 seconds with SPST, SPDT or DPDT snap action contacts.



Write for latest complete components catalog #504

TIME DELAY RELAYS • DELAY LINES • ROTARY SOLENOIDS • DIGITAL MOTORS • TIMING DEVICES • DUAL RELAYS • SOLID STATE COMPONENTS

Electronics Division
CURTISS-WRIGHT CORPORATION
East Paterson, New Jersey



NEW

TRANSISTORIZED PRINTER RELAY

Type 237
Model 1

- replaces electro-mechanical signal relays
- eliminates associated local DC power supplies
- eliminates electro-mechanical maintenance problems
- Isolates the reactance of printer selector magnet
- presents resistive termination to the signal loop

Pace-Setters in Quality Communication Equipment

NORTHERN RADIO COMPANY, inc.
147 WEST 22nd ST., NEW YORK 11, NEW YORK
In Canada: Northern Radio Mfg. Co., Ltd., 1950 Bank St., Billings Bridge, Ottawa, Ontario.

WRITE ON YOUR LETTERHEAD TO DEPT. E-6
CIRCLE 221 ON READER SERVICE CARD

Leonard T. King and Meyer Gilden as senior engineers in the Electron Tube and Device Division.

Both Evans and King, formerly with Varian Associates, Palo Alto, Calif., will be working on traveling-wave tube and backward-wave oscillator developments. Gilden formerly with Stanford Research Institute, Menlo Park, Calif., will be engaged in plasma physics research.



Kahle Engineering Appoints Engel

KAHLE ENGINEERING CO., Union City, N. J., designer and builder of machinery for the glass working and electronics industry, announces that William T. Engel has been appointed chief engineer, in charge of the engineering and design department.

Engel has spent almost forty years in the field of design and development of automatic machinery, about half of this time with RCA.



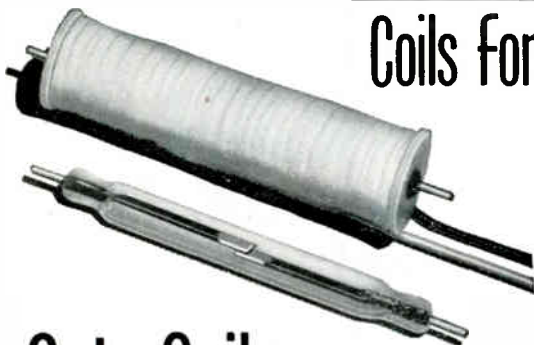

Quantatron Elects Richard B. Leng

RICHARD B. LENG has been elected executive vice president, chairman of the executive committee, and a director of Quantatron, Inc., Santa Monica, Calif. Firm is engaged in the development and production of microwave components and ad-



Coils for Contact Capsules

TYPE	DC-V	Ohms	Nom. Watts	Nom. Amp/Turns
S 	6	100	.40	250
	12	360		
	24	1400		
M 	6	50	.70	250
	12	175		
	24	820		
T 	6	100	.35	125
	12	400		
	24	1600		
	32	2800		
	48	4600		

Coto-Coils

COTO-COIL CO., INC.
65 Pavilion Avenue
Providence 5, R. I.

Write for Bulletin and Prices
CIRCLE 222 ON READER SERVICE CARD

Is your advertising selling the same four key buyers your salesmen call on? Competition demands it! Only advertising in electronics reaches and sells the electronics man *wherever* he is: in *Research,*

TODAY YOU MUST SELL ALL FOUR!

Design, Production, and Management. Put your advertising where it works *hardest...*

in **electronics**

vanced electronic instruments.

Leng was previously group vice president, industrial and defense products, and a member of the board of directors of Packard Bell Electronics.

Budd-Stanley Co. Moves To New Plant

THE BUDD-STANLEY CO., producer of microwave test instruments and components, has moved manufacturing facilities from Long Island City to a recently completed plant in Syosset, N. Y. The structure's 40,000 sq ft capacity is expected to enable the company to triple present production.

PEOPLE IN BRIEF

Robert L. McGrath of General Dynamics/Electronics moves up to production control manager in the military products division. Donald E. Kaplan leaves Burroughs Corp. to join the mechanical engineering staff of International Resistance Co. Melvin L. Morgan, formerly with Avco Manufacturing, appointed application engineer in Datex Corp.'s sales dept. H. Edward Rice, ex-General Electric, named vice president in charge of operations for Philco Corp.'s government and industrial group. Frank J. Kocsis advances at Servo Corp. of America to the defense systems department staff. A. L. Hammerschmidt, previously with the National Broadcasting Co., appointed chief engineer of RCA's missile and surface radar division. Walter Ostrom of Volkert Stampings promoted to chief designer. Elliot F. Linsky transfers from Technitrol Engineering Co. to Auerbach Electronic's air traffic control data processing program. Martin Cooperstein advances to manager of the programming and analysis laboratory at Sylvania's data systems operations. Stanley W. Dublin of NYU's engineering research division elected research director and secretary of the Newark College of Engineering Research Foundation. Warren D. Blumberg, ex-Technical Electronics Co., joins Babcock Relays as head of component reliability.

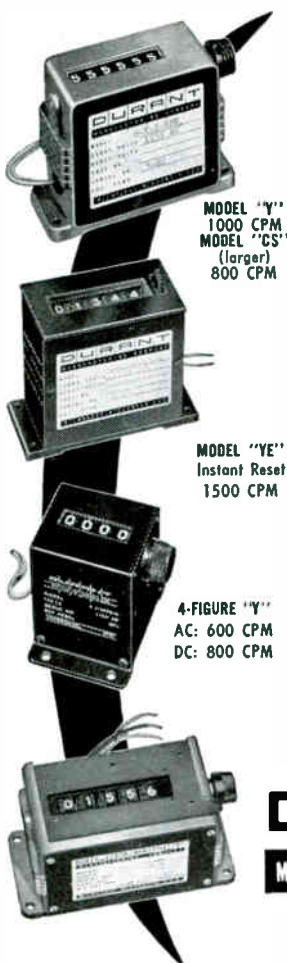

MODEL "Y"
1000 CPM
MODEL "CS"
(larger)
800 CPM

MODEL "YE"
Instant Reset
1500 CPM

4-FIGURE "Y"
AC: 600 CPM
DC: 800 CPM

DURANT

Electric Counters

COMPLETE LINE for HIGH SPEED, ACCURATE ELECTRIC COUNTING in INDUSTRIAL PLANTS

There's a DURANT electrically-actuated COUNTER designed just for your needs. Dependable, easy to read, easy to install on individual production equipment, or as original equipment on your new product. Get accurate counts at high, low, or intermediate speeds.

Durant Counters will give trouble-free service for many years, even under the most severe operating conditions.



PANEL MOUNT Mounting plate with knurled reset knob or tumbler lock reset — can be set in panel from front. Ideal for remote control.

Model SP-MF PREDETERMINED (lower left) May be pre-set to any number; when desired figure reached, an electric signal stops a machine, lights a light, or sets off an alarm. 600 CPM.

Send for CATALOG 55

DURANT

MANUFACTURING COMPANY

1912 N. Buffum Street
Milwaukee 1, Wisconsin

72 Thurbers Avenue
Providence 5, R. I.

CIRCLE 223 ON READER SERVICE CARD

Suppress
lead wire
errors
with
REC's new



TRIPLE BRIDGE UNIT

Check these advantages in resistance temperature measurement applications:

- Suppresses large lead resistance changes (up to 5 ohms)
- Suppresses variable lead resistances at null and when unbalanced
- Suppresses unequal lead resistances
- Trims out calibration differences
- Multiple temperature ranges
- Standardized 10 mv. DC output
- Full line of auxiliary equipment

This precision-made, plug-in unit permits convenient change of full-scale temperature and corrects known calibration errors of sensor. Basic 10-channel unit provides 10 temperature ranges for each of 10 sensors.

Write for Bulletin 86012



**ROSEMOUNT
ENGINEERING
COMPANY**

4900 West 78th Street, Minneapolis 24, Minnesota

CIRCLE 224 ON READER SERVICE CARD

EICO 1961

KITS AND WIRED

STEREO
AND MONO
HIGH FIDELITY
TEST INSTRUMENTS
HAM EQUIPMENT
CITIZENS TRANSCEIVERS
RADIOS

LABORATORY PRECISION AT LOWEST COST
Easy assembly kit for home

Send for
FREE
New 1961
EICO Electronics Catalog

EICO, 3300 N. Blvd., L.I.C. 1, N. Y. E-6A
 Send free 32-page catalog & dealer's name
 Send new 36-page Guidebook to HI-FI for which I enclose 25¢ for postage & handling.

Name
 Address
 City Zone State

EICO 3300 N. Blvd., L.I.C. 1, N. Y.
 ...praised by the experts
35 BEST BUYS IN ELECTRONICS

CIRCLE 161 ON READER SERVICE CARD

161

electronics

WEEKLY QUALIFICATION FORM FOR POSITIONS AVAILABLE

ATTENTION: ENGINEERS, SCIENTISTS, PHYSICISTS

This Qualification Form is designed to help you advance in the electronics industry. It is unique and compact. Designed with the assistance of professional personnel management, it isolates specific experience in electronics and deals only in essential background information.

The advertisers listed here are seeking professional experience. Fill in the Qualification Form below.

STRICTLY CONFIDENTIAL

Your Qualification form will be handled as "Strictly Confidential" by ELECTRONICS. Our processing system is such that your form will be forwarded within 24 hours to the proper executives in the companies you select. You will be contacted at your home by the interested companies.

WHAT TO DO

1. Review the positions in the advertisements.
2. Select those for which you qualify.
3. Notice the key numbers.
4. Circle the corresponding key number below the Qualification Form.
5. Fill out the form completely. Please print clearly.
6. Mail to: D. Hawksby, Classified Advertising Div., ELECTRONICS, Box 12, New York 36, N. Y. (No charge, of course).

COMPANY	SEE PAGE	KEY #
AIRCRAFT ARMAMENTS INC. Cockeysville, Maryland	164	1
THE BENDIX CORPORATION Kansas City Division Kansas City, Missouri	88*	2
BROOKHAVEN NATIONAL LAB. Upton, New York	80*	3
CORNELL ASSOCIATES Chicago, Illinois	88*	4
ERIE ELECTRONICS DIV. Erie Resistor Corp. Erie, Pa.	88*	5
ESQUIRE PERSONNEL Chicago, Illinois	166	6
GENERAL ELECTRIC CO. Defense Systems Dept. Syracuse, New York	164	7
GRUMMAN AIRCRAFT ENGINEERING CORP. Bethpage, L. I., New York	50	8
HEATH COMPANY Benton Harbor, Michigan	88*	9
IBM CORPORATION New York, New York	163	10
NATIONAL SCIENTIFIC LABS., INC. Washington, D. C.	166	11
PERKIN-ELMER CORP. Norwalk, Connecticut	164	12
REPUBLIC AVIATION Farmingdale, L. I., New York	166	13
SCIENTISTS, ENGINEERS & EXECUTIVES INC. Washington, D. C.	166	14
SIKORSKY AIRCRAFT Div. of United Aircraft Corp. Stratford, Connecticut	165	15
WHO'S HIRING WHO Washington, D. C.	88*	16
P-6754	166	17

* These advertisements appeared in the 6/2/61 issue.

(cut here)

(cut here)

electronics WEEKLY QUALIFICATION FORM FOR POSITIONS AVAILABLE

Personal Background

NAME

HOME ADDRESS.....

CITY..... ZONE..... STATE.....

HOME TELEPHONE.....

Education

PROFESSIONAL DEGREE(S).....

MAJOR(S)

UNIVERSITY

DATE(S)

FIELDS OF EXPERIENCE (Please Check)

691

- | | | |
|--|--|---------------------------------------|
| <input type="checkbox"/> Aerospace | <input type="checkbox"/> Fire Control | <input type="checkbox"/> Radar |
| <input type="checkbox"/> Antennas | <input type="checkbox"/> Human Factors | <input type="checkbox"/> Radio-TV |
| <input type="checkbox"/> ASW | <input type="checkbox"/> Infrared | <input type="checkbox"/> Simulators |
| <input type="checkbox"/> Circuits | <input type="checkbox"/> Instrumentation | <input type="checkbox"/> Solid State |
| <input type="checkbox"/> Communications | <input type="checkbox"/> Medicine | <input type="checkbox"/> Telemetry |
| <input type="checkbox"/> Components | <input type="checkbox"/> Microwave | <input type="checkbox"/> Transformers |
| <input type="checkbox"/> Computers | <input type="checkbox"/> Navigation | <input type="checkbox"/> Other |
| <input type="checkbox"/> ECM | <input type="checkbox"/> Operations Research | <input type="checkbox"/> |
| <input type="checkbox"/> Electron Tubes | <input type="checkbox"/> Optics | <input type="checkbox"/> |
| <input type="checkbox"/> Engineering Writing | <input type="checkbox"/> Packaging | <input type="checkbox"/> |

CATEGORY OF SPECIALIZATION

Please indicate number of months
experience on proper lines.

	Technical Experience (Months)	Supervisory Experience (Months)
RESEARCH (pure, fundamental, basic)
RESEARCH (Applied)
SYSTEMS (New Concepts)
DEVELOPMENT (Model)
DESIGN (Product)
MANUFACTURING (Product)
FIELD (Service)
SALES (Proposals & Products)

CIRCLE KEY NUMBERS OF ABOVE COMPANIES' POSITIONS THAT INTEREST YOU

1 2 3 4 5 6 7 8 9 10 11 12 13 14 15 16 17 18 19 20 21 22 23 24 25

IBM



capturing the spirit of research...

This is IBM's new research laboratory dedicated on April 25, 1961, as the Thomas J. Watson Research Center. It is the headquarters for IBM's world-wide research activities, and is the largest laboratory in the world devoted to computer research.

Functional design and bold use of natural materials achieve unity of site and structure in the rolling countryside of Yorktown, New York. Inside this facility, IBM scientists pursue programs in the physical sciences, mathematics, engineering sciences, and the evolution of experimental systems and machines. The constructive thinking and the scientific

achievements of our research staff will provide the basis for new and improved IBM products, and will contribute to the body of knowledge so vital to the scientific community-at-large.

If you sense a personal challenge to your own talents, and wish to consider joining IBM, we would like to hear from you. Write, outlining briefly your background and experience, to: Manager of Professional and Technical Employment, Dept. 554F1, IBM Corporation, 590 Madison Avenue, New York, N. Y. Applications will be considered without regard to race, creed, color or national origin.

$$0 = \frac{dx^2}{dt^2} + \frac{x}{r^3} + \frac{\partial R}{\partial x}$$

$$0 = \frac{dy^2}{dt^2} + \frac{y}{r^3} + \frac{\partial R}{\partial y}$$

$$0 = \frac{dz^2}{dt^2} + \frac{z}{r^3} + \frac{\partial R}{\partial z}$$

PLOTTING PATHWAYS IN SPACE

A special group of engineering-oriented mathematicians (and mathematics-oriented engineers) at DSD is exclusively concerned with both theoretical and practical sides of astrodynamics and celestial mechanics. Space probes...near-earth satellites...lunar satellites and missiles...all fall within their range of interests. In addition, the statistical problems of data interpretation and mathematical techniques of vehicle guidance are under investigation.

The group operates in an informal, academic atmosphere. Staff members enjoy direct access to the best computation equipment available - including an IBM 7090, a 300 amplifier analog computer, a complete telemetry station, and the finest microwave instrumentation in the free world (MISTRAM).

Although many contracts are in progress, strong encouragement is also given to a wide latitude of independent investigations. (One of the results of this policy was the creation of GESE - General Electric Electronic System Evaluator.)

You are cordially invited to look into the immediate opportunities in our expanding astrodynamics group...or, if you are an experienced electronics engineer interested in broad systems assignments, we'll be glad to discuss current openings in several other equally challenging program areas at DSD.

All qualified applicants will receive consideration for employment without regard to race, creed, color or national origin.

Write informally, or forward your resume to
Mr. P. W. Christos, Box 69-WW.



DSD DEFENSE SYSTEMS DEPARTMENT
A Department of the Defense Electronics Division

GENERAL  ELECTRIC

Northern Lights Office Building, Syracuse, New York

A stimulating challenge to

COMPETENT ENGINEERS

AAI's continued growth offers exceptional opportunities to qualified engineers who want the freedom of creative thinking and have the ability to work as a team. Right now we're looking for this kind of talent to add to our staff:

ELECTRONIC ENGINEERS

...with experience in digital systems design, digital analysis and design, pulse circuitry, simulation and telemetry.

...to work on computers, test equipment and instrumentation.

ELECTROMECHANICAL ENGINEERS

...with experience in servos, relays, switches and analog computers.

...to work on trainers and simulators.

If your experience is in any of these areas and you are interested in moving ahead with us, send your resume to Mr. D. J. Wishart.



AIRCRAFT ARMAMENTS, INC.
Cockeysville, Maryland
(Suburban Baltimore)

All qualified applicants will receive consideration for employment without regard to race, creed, color or national origin.

COMMERCIAL INSTRUMENT DEVELOPMENT

Project Engineer

Excellent opportunity for EE or Physics graduate to design and build complex electro-optical laboratory instruments.

Position requires interest in development of new scientific instruments plus sound theoretical background and at least 5 years' experience in producing scientific instruments.

Excellent salary and fringe benefits program.

Send resume to
Howard M. Moran

Perkin-Elmer

Corporation

MAIN AVE. • ROUTE 7 • NORWALK, CONN.

All qualified applicants will be considered regardless of race, creed, color or national origin.

helitronics... new avenues of creative engineering at Sikorsky Aircraft

Within the scope of Sikorsky's long-range programs is an area of important developments which we term *helitronics*... an area that embraces the significant blending of two modern technologies: *helicopters* and *electronics*. Specifically, helitronics means the integration of guidance and navigation systems, specialized electronic search and detection equipment to enhance the mission capability of the helicopter; specialized sensors and automatic controls to increase its versatility as an optimum military weapon system or commercial carrier.

To satisfy the demands of more sophisticated electronic systems, Sikorsky now has openings for competent electronic engineers with particular skills in design, instrumentation, test, development, air-borne systems, production and service support equipment, trainers and simulators.

Unusually interesting openings also exist for men with E.E. degrees to function as Field Service Representatives (with advanced electronics training and experience) and Avionics Instructors (with electronics and aircraft maintenance experience and a desire to teach).



pioneer and leading manufacturer of rotary wing aircraft

For further information, submit your resume or make inquiry to J. L. Purfield, Personnel Department.

All qualified applicants will receive consideration for employment without regard to race, creed, color or national origin.

SIKORSKY AIRCRAFT

Division of United Aircraft Corporation

STRATFORD • CONNECTICUT

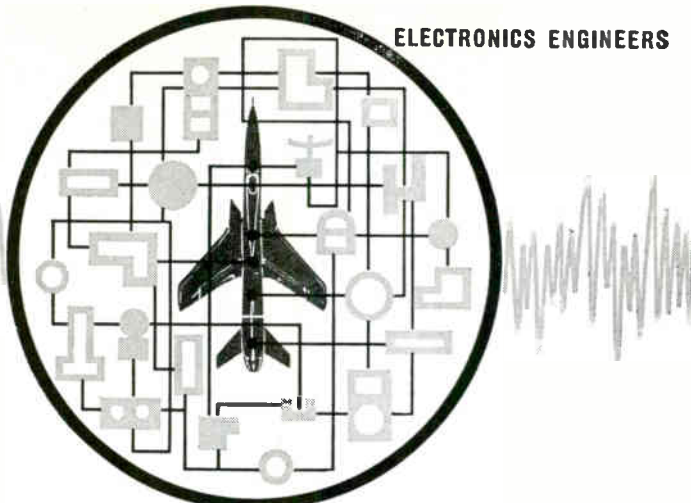

ELECTRONIC SYSTEMS INTEGRATION

FOR TODAY'S MOST ADVANCED MANNED WEAPON SYSTEM

Republic's F105D, all-weather Mach 2 weapon system with nuclear capability, is known as the first "electronic airplane." An integrated complex of sophisticated electronic systems permits its lone pilot to be fighter-pilot, bombardier, navigator, gunner, and radar operator in one.

Integration of the many electronic subsystems and components is a task offering distinct professional challenge. Assignments involve these areas:

- | | |
|---|--|
| Radar (front & side looking) | High Speed Tape Recorders |
| Fire Control Systems | Antenna & Radome Design |
| Flight Control Systems | Data Link |
| Infrared Systems | (doppler & inertial) Navigation |
| Digital Computer Design | Communications |
| Analog Computer Design | Servomechanisms |

► If you have an EE or Physics degree and 3 or more years experience in one of the above areas, we invite you to write in confidence to: Mr. George R. Hickman, Technical Employment Manager, Dept. 11F-1.

All qualified applicants will receive consideration for employment without regard to race, creed, color, or national origin.



FIELD ENGINEERS

For assignments in the United States and overseas. Must possess experience in the design of systems installation and maintenance in one of the following fields:

- COMMUNICATIONS**
- MICROWAVE**
- FIXED PLANT RADIO**
- RADAR, GROUND OR AIRBORNE**
- MISSILE CONTROL SYSTEMS**

Please send resume to
I. F. MARKHAM
National Scientific Laboratories, Inc.
2010 Massachusetts Avenue, N. W.
Washington 6, D. C.

Wanted: Electronic Meter Engineers

Young and aggressive meter manufacturing firm has opening for two experienced meter engineers. Design and development and production background important. Salary open. Advance with this dynamic firm in its all new plant. All replies will be held in strictest confidence.
P 6754 Electronics
645 N Michigan Ave., Chicago 11, Ill.



MANUFACTURERS' REPRESENTATIVES

IN THE ELECTRONIC INDUSTRY

SAMUEL K. MACDONALD, INC.
manufacturers representatives over 25 years
1531 SPRUCE STREET, PHILA. 2, PA.
Territory: Pennsylvania • New Jersey
Delaware • Maryland
Virginia • West Virginia
District of Columbia
Other Offices: Pittsburgh
Baltimore
Washington, D.C.

WHAT ARE YOU - A PLASMA PHYSICIST-or "Something"?

We want to hear from you in either case, if you are interested in being considered confidentially for exceptional openings with our numerous clients. The "Something" applies to all levels in the varied fields of modern technology. Send your Resume.

Scientists, Engineers & Executives, Inc.
1026-17th St., N. W. Washington 6. D. C.

ELECTRONIC SYSTEMS SPECIALIST \$16,000 PER YEAR

Analysis of electronic communications and control systems. Broad background desired and background experience in the field of military R&D contracts is very desirable. Company client assumes all employment expense. Send resume in complete confidence.
ESQUIRE PERSONNEL
202 S. State Street Chicago 4, Illinois

SEARCHLIGHT SECTION

(Classified Advertising)

BUSINESS OPPORTUNITIES
EQUIPMENT - USED or RESALE

DISPLAYED RATE

The advertising rate is \$24.75 per inch for all advertising appearing on other than a contract basis. Contract rates quoted on request. AN ADVERTISING INCH is measured 3/8 inch vertically on one column, 3 columns—30 inches—to a page. EQUIPMENT WANTED or FOR SALE ADVERTISEMENTS acceptable only in Displayed Style.

UNDISPLAYED RATE

\$2.40 a line, minimum 3 lines. To figure advance payment count 5 average words as a line.
PROPOSALS, 2.40 a line an insertion. BOX NUMBERS count as one line additional in undisplayed ads.
DISCOUNT OF 10% if full payment is made in advance for four consecutive insertions of undisplayed ads (not including proposals).

SUB-CONTRACT WORK WANTED

- COMPLETE FACILITIES AVAILABLE
- ENGINEERING "KNOW-HOW"
- TECHNICAL AID

Engineering supervision—specializing in miniature component

- | | |
|------------|-------------|
| ASSEMBLING | • WIRING |
| PLATING | • SOLDERING |
| BRAZING | • CASTING |
| STAMPING | • GRINDING |

TOOL WORK

Experienced in Precious & Non-Precious Pure and Alloyed Metals—Precision Work and Controls—

FREE... Descriptive Literature Available On Request
— Plants on Eastern Seaboard —

AMERITRON ELECTRONICS, INC.
377 Fifth Avenue • New York 16, N. Y.
LEhigh 2-2618

CIRCLE 461 ON READER SERVICE CARD

Warren Paley
of
**TALLYMASTER,
INC.**
calls . . .
UNIVERSAL!



RELAYS



WARREN PALEY
President—E. E.

"If it's a relay—I call UNIVERSAL. I have always managed to get the relay I needed . . . regardless of brand name. Their tremendous inventory of current and hard-to-get relays has enabled me to get what I want — when I wanted it."

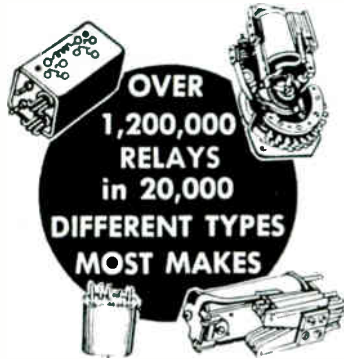

- PRODUCTION QUANTITIES IN STOCK
- DELIVERY ON OFF-THE-SHELF ITEMS WITHIN 48 HOURS. DELIVERY WITHIN ONE WEEK ON RELAYS REQUIRING ASSEMBLY AND/OR ADJUSTMENT.

**WE DELIVER RELAYS
NOT PROMISES**



FREE...

Send for
**NEW
catalog**
"E"

Universal RELAY CORP.

42A White St., N. Y. 13, N. Y. Walker 5-9257
CIRCLE 462 ON READER SERVICE CARD

June 9, 1961

SPECIAL PURPOSE TUBES

OA2	.80	4-1000A	85.00	242C	10.00	807WA	5.00	5841	3.25
OA2WA	2.00	4AP10	10.00	244A	1.25	808	.75	5842/417A	7.50
OA3	.85	4B31	12.50	245A	2.50	809	4.75	5844	.60
OB2	.60	4C35	12.50	249B	10.00	810	12.50	5845	4.50
OB2WA	2.00	4D32	15.00	249C	5.00	811	2.50	5852	2.25
OB3	.70	4E27	6.00	250R	10.00	811A	3.50	5854	1.00
OC3	.50	4J30-61	6.00	PUR 251A	50.00	813	12.50	5879	1.00
OD3	.30	4J52	25.00	252A	4.75	814	2.50	5881/6L6WGB	2.00
CIA	6.50	4PR60A	60.00	254A	2.00	815	1.00	5886	3.00
IAD4	1.50	4X150A	15.00	257A	2.50	816	1.85	5896	.75
C1B	1.50	4X150D	15.00	FG-258A	75.00	828	8.50	5902	2.50
1B24A	8.50	4X250B	20.00	259A	2.50	829B	9.50	5915	.85
1B35	1.85	5BP1A	9.50	262B	2.50	832	2.00	5930/2A3W	2.0
1B35A	3.00	5C22	12.50	FP-265	5.00	832A	6.75	5932/6L6WGA	2.
1B58	20.00	5CP7A	9.50	267B	5.00	833A	35.00	5933/807W	1.2
1B59/R1130B	7.50	5CP11A	9.50	271A	9.00	836	1.00	5933WA	5.00
1B63A	10.00	5J26	25.00	272A	2.75	837	.80	5948/1754	75.00
1C/3B22	3.50	5LP1	7.50	274A	2.00	838	1.00	5949/1907	50.00
CIK	5.00	5R4GY	1.00	275A	3.00	842	5.00	5956/E36A	9.00
1P21	30.00	5R4WGB	5.00	276A	4.00	845	7.50	5962/B5101	3.00
1P22	7.00	5R4WGY	2.75	283A	2.50	850	12.50	5963	1.10
1P25	8.00	5RP1A	9.50	287A	1.85	866A	1.75	5964	.75
1P29	2.25	5RP11A	25.00	293A	2.50	869B	50.00	5965	1.00
2-01C	10.00	5SP1	25.00	HF-300	25.00	872A	3.50	5977/6K4A	1.25
2AP1A	5.00	5SP7	25.00	300B	5.00	884	1.25	5979/B51	4.00
2BP1	7.50	6AC7W	.35	304TH	30.00	885	.65	5980/B52	6.00
2C36	22.50	6AG7Y	.75	204TL	35.00	913	8.50	5987	7.50
2C39	3.50	6AK5W	.90	309A	2.50	918	.65	5992	2.00
2C39A	8.50	6AN5	1.75	310A	2.50	920	2.50	5993	4.00
2C39B	18.75	6AR6	.75	311A	2.25	927	1.00	6005/6AQ5W	1.00
2C40	7.00	6A56	.85	313C	1.00	931A	3.00	6012	3.50
2C42	3.00	6A57G	2.50	323A	5.00	959	.50	6021A	2.00
2C43	7.50	6B4G	2.50	328A	2.25	1000T	80.00	6032	10.00
2C50	4.00	6BL6	30.00	336A	2.00	CK-1006	2.00	6037/QK-243	15.00
2C51	1.50	6BM6	30.00	337A	2.25	1237	2.00	6044	3.50
2C52	1.50	6BM6A	30.00	347A	1.00	1500T	125.00	6045	1.15
2D21	.50	6C4W	2.50	348A	2.00	1614	2.75	6050	1.00
2D21W	1.00	6C21	10.00	349A	1.50	1616	.50	6072	1.50
2E22	2.50	C6J	10.00	350A	3.50	1619	.20	6073	.75
2E24	2.50	C6J/A	15.00	350B	1.00	1620	3.50	6074	1.50
2E26	2.50	C6J/K	20.00	352A	6.00	1624	.35	6080	2.50
2E30	2.50	6J4WA	1.00	354A	7.50	1625	50.00	6080WA	4.00
2J21-50	PUR	6J6W	.75	355A	7.50	1846	1.25	6080WB	10.00
2J42	60.00	C6L	2.00	393A	5.00	2050	1.25	6082	3.00
2J51	40.00	6L6GAY	.75	394A	2.50	2050W	1.50	6087/SY3WGTB	3.00
2K22	20.00	6L6WGA	2.00	395A	2.00	5 45	10.00	6098	5.00
2K25	8.50	6L6WGB	2.00	396A/2C51	1.50	5550	30.00	6099	.75
2K26	30.00	6Q5G	2.50	398A/5603	3.00	5586	100.00	6100/6C4WA	1.00
2K28	25.00	65C7GTY	1.00	401A/5590	1.00	5641	1.75	6101/6J6WA	.85
2K29	25.00	65J7WGT	1.25	403A/6AK5	.65	5642	1.75	6108/B5213	2.50
2K30	50.00	65L7WGT	.75	403B/5591	2.75	5643	3.00	6109/B5404	1.00
2K34	75.00	65N7W	.50	404A/5847	7.50	5644	2.50	6111A	2.00
2K35	250.00	65N7WGT	.75	407A	3.50	5647	3.50	6112	2.00
2K41	12.50	65N7WGT/A	2.50	408A/6028	2.75	5651	.75	6115/QK-351	40.00
2K42	125.00	65U7GTY	.75	409A/6A56	1.00	5654/6AK5W	1.00	6130/3C45	5.00
2K43	125.00	6V6GTY	.75	416B/6280	25.00	5654/6AK5W	1.40	6135	1.35
2K44	125.00	6X4W	.75	417A/5842	7.50	6096	2.50	6136/6AU6WA	1.35
2K45	20.00	6X5WGT	1.00	418A	10.00	5656	2.50	6137/6SK7WA	1.50
2K47	125.00	7AK7	1.50	420A/5755	3.75	5663	.75	6146	3.00
2K48	50.00	7BP7A	5.00	421A/5998	7.50	5670	1.00	6147	2.25
2K50	75.00	10KP7	17.50	429A	6.50	5675	8.50	6161	50.00
2K54	10.00	10KP7	15.00	GL-434A	5.00	5678	1.25	6186/6AG5WA	1.35
2K55	15.00	12AT7WA	1.25	450TH	40.00	5686	1.85	6189/12AU7WA	1.35
2P21	40.00	12A V7	1.00	450TL	40.00	5687	1.50	6197	1.50
2X2A	.80	12DP7	7.50	CK-503AX	.75	5691	5.00	6198	85.00
3AP1	2.00	12GP7	12.50	CK-510AX	1.00	5692	2.00	6201/12AT7WA	1.75
3B23/RK-22	2.00	16F	10.00	576	12.50	5693	3.50	6202/6X4WA	1.50
3B24	.35	16J	20.00	577	12.50	5696	.75	6211	.75
3B24W	2.50	FG-17	5.00	578	5.00	5702	1.50	6216	2.50
3B24WA	5.00	HK-24	2.00	KU-610	4.00	5703	.85	6236	150.00
3B25	2.50	25T	10.00	NL-623	8.50	5718	.60	6252	15.00
3B26	2.25	25Z6WGT	1.50	KU-627	4.00	5719	.60	6263	9.00
3B28	3.00	26Z5W	1.50	631-P1	4.00	5721	125.00	6264	9.00
3B29	5.00	FG-27A	20.00	673	12.50	5725/6A56W	1.00	6265/6BH6W	2.75
3BP1	2.50	FG-32	6.00	676	25.00	5726/6AL5W	.60	6282/BL-11	65.00
3C/4B24	4.00	FG-33	17.00	677	27.50	5727/2D21W	1.00	6293	4.50
3C22	15.00	35T	5.00	701A	3.00	5749/6BA6W	.75	6299	37.50
3C23	5.00	35TG	1.25	707B	.75	5750/6BE6W	1.50	6322/BL-25	12.50
3C24/24G	4.00	FG-41	50.00	NL-710	10.00	5751/12AX7W	1.50	6336	9.00
3C45	3.00	FP-54	100.00	714AY	10.00	5751WA	1.60	6345	3.50
3D21A	2.50	FG-57	6.00	715B	2.50	5763	1.50	6350	1.75
3D22	8.00	RK-60/1641	.85	715C	12.50	5768	35.00	6352	8.50
3E22	3.00	RK-61	2.35	719A	7.50	5777	125.00	6364	150.00
3E29	6.00	FG-67	3.85	720AY-EY	20.00	5778	125.00	6390	150.00
3GP1	1.50	HY-69	2.00	721A	.35	5783	2.00	6438	5.00
C3J	8.50	RK-73	.25	721B	3.75	5787	2.00	6463	1.00
C3J/A	10.00	BL-75	3.00	723A/B	2.85	5796	10.00	6517/QK358	250.00
3J21	35.00	RK-75/307A	.35	725A	5.00	5799/VX-21	3.00	6533	5.00
3J31	50.00	FG-81A	4.00	726A	2.00	5800/VX-41	7.50	6550	3.50
3K21	125.00	FG-95	17.50	726B	3.00	5801/VX-33A	2.25	6807	20.00
3K22	125.00	FG-104	25.00	726C	8.50	5802/VX-32B	2.25	6897	20.00
3K23	250.00	FG-105	10.00	750TL	87.50	5803/VX-55	2.25	6907	15.00
3K27	150.00	F-123A	4.00	NL-760	20.00	5814A	1.25	7025	.75
3K30	50.00	F-128A	25.00	BL-800A	50.00	5822A	55.00	8005	7.50
3KP1	7.50	HF-200	10.00	802	4.50	5828	3.00	8013A	3.00
3X3000A1	148.00	203A	2.50	803	2.50	5829	.75	8014A	25.00
4-65A	9.00	211	1.00	804	12.50	5836	60.00	8020	2.00
4-125A	20.00	212E	25.00	805	3.50	5837	60.00	8025A	6.00
4-250A	27.50	231D	.90	807	1.25	5839	3.00	9002	.25
4-400A	30.00	FG-235	40.00	807W	1.25	5840	1.50	9005	3.00

ALL TUBES ARE NEW, INDIVIDUALLY CARTONED, FULLY GUARANTEED

Prices are FOB
shipping point

western engineers

Orders for less than
\$10 cannot be
processed

ELK GROVE, CALIFORNIA
SUPPLIERS OF ELECTRON TUBES SINCE 1932

CIRCLE 463 ON READER SERVICE CARD

ANTENNA PEDESTAL SCR 584—MP 61B

Full azimuth and elevation sweeps. 360 degrees in azimuth. 210 degrees in elevation. Accurate to 1 mil. or better over system. Complete for full tracking response. Angle acceleration rate: AZ, 9 degrees per second squared EL. 4 degrees per second squared. Angle slowing rate: AZ 20 degrees per sec. EL. 10 degrees per sec. Can mount up to a 20 ft. dish. Angle tracking rate: 10 degrees per sec. Includes pedestal drives, sleds, potentiometers, drive motors, control amplifiers. Excellent condition. Quantity in stock for immediate shipment. Ideal for missile & satellite tracking, antenna pattern ranges. Complete description in McGraw-Hill Radiation Laboratory Series, Volume 1, page 284 and page 209, and Volume 26, page 233.

MIT MODEL 9 PULSER 1 MEGAWATT-HARD TUBE

Output pulse power 25 KV at 40 amp. Max. duty ratio: .002. Uses 6C21 pulse tube. Pulse duration .25 to 2 microsec. Input 115 volts 60 cycle AC. Includes power supply in separate cabinet and driver. Fully guaranteed as new condition. Full Desc. MIT. Rad. Lab. series "Pulse Generators."

AN/TPS-1D RADAR

500kw. 1220-1359mc. 160 nautical mile search range. P.P.L. and A Scopes. MTI. thraxton mod. 5J26 magnetron. Like new. Complete system incl. spare parts and gas generator.

MIT MODEL 3 PULSER

Output: 144kw (12kv at 12 amp). Duty ratio: .001 max. Pulse duration: .5 1 and 2 micro sec. Input: 115v 400 to 2000 cps and 24vdc. \$325 ea. Full desc. Vol. 5 MIT Rad. Lab. series pg. 140.

AN/TPS-10D HEIGHT FINDER

200kw. Xband. Range: 60, 120 miles. Height coverage —5000 to +60,000 ft. with 360 degree azimuth coverage. Complete set in stock.

WE MICROWAVE LINK TD-2 FREQ. MULTIPLIER CHAIN

Basic crystal oscillator multiplying thru 2037 cavities and 416K cavities with crystal stability output 3700-4200 MC/S. New.

SCR 584 RADARS AUTOMATIC TRACKING RADAR

Our 584s in like new condition, ready to go, and in stock for immediate delivery. Ideal for research and development, airway control, GCA, missile tracking, balloon tracking, weather forecasting, antiaircraft defense, tactical air support. Write us. Fully Desc. MIT Rad. Lab. Series, Vol. 1, pps. 207-210, 298 284-286.

RADIO RESEARCH INSTRUMENT CO.
550 FIFTH AVE.
NEW YORK
JUDSON
6-4691

CIRCLE 464 ON READER SERVICE CARD

lab grade TEST EQUIPMENT for sale
standard brands—military surplus
(new or professionally reconditioned)
experienced problem solvers and budget-cutters

ENGINEERING ASSOCIATES
434 Patterson Road Dayton 19, Ohio

CIRCLE 465 ON READER SERVICE CARD

BROADBAND RELIABLE MICROWAVES

L Band:	QK241	\$990.00	X Band:	6229	\$240.00
	6BL6	32.50		2K45	60.00
S Band:	2J33	45.00	Ku Band:	3J31	100.00
	2K41	100.00		QK246	495.00
C Band:	4J57	150.00	K Band:	6841	400.00
	SAC47	2100.00		QK463	270.00
	Ka Band:	QK389			\$1000.00
		QK791			300.00

These are representative selections . . . thousands more in stock . . . plus the regular POWER & INDUSTRIAL types. All material FOB-NYC, subject to prior sale and price change. 24-hour telephones: CORtlandt 7-4245.

PAGE ELECTRONICS 136 Liberty Street, NYC 6, NY

CIRCLE 468 ON READER SERVICE CARD

"TAB", SILICON 750MA* DIODES

Factory Tested Gtd.!

GENERAL PURPOSE SPECIAL 35c each 400 PIV at 300 MA 20 for \$6

rms/piv 17/25 10c	rms/piv 35/50 14c	rms/piv 70/100 24c	rms/piv 140/200 29c
rms/piv 210/300 39c	rms/piv 280/400 50c	rms/piv 350/500 64c	rms/piv 420/600 74c
rms/piv 490/700 87c	rms/piv 560/800 93c	rms/piv 630/900 \$1.10	rms/piv 700/1000 \$1.50

Low Priced ★ T200 SILICON DIODES
rated 380piv/268rms @ 200Ma @ 100°K
36¢ each: 10 for \$3.25; 100 for \$27; 1000 for \$230

CAPACITOR INPUT DERATE 20%:
POWER DIODES • STUDS 50PIV/35 Rms
FACTORY TESTED — GTD!

1.5 Amp 430 @ .100 for \$27, 1000 for \$225
3.0 Amp 450 @ .100 for \$45, 1000 for \$390
6.0 Amp \$1.50 @ .100 for \$100, 250 for \$200
12 Amp \$1.15 @ .100 for \$175, 250 for \$225
35 Amp \$2.30 @ .100 for \$200, 250 for \$400
70 Amp \$3.90 @ .50 for \$175, 100 for \$300
240 Amp \$4.50 @ .50 for \$220, 100 for \$3.75

* Derate 20% for Capacitive & Battery Load!
Amp Ratings for Studs on Heat Sink!!!

"TAB" FOR TEST EQUIPMENT SPECIALS!

TEKTRONIX #511A Scope Cal Sweep.....\$300
DUMONT #279 Dual Beam Scope.....\$245
LFE #401 LAB 15Mv/PtoP L.N.....\$315
ADVANCE ELECTRONICS #404A PHASEMETER
\$150
INET Magnivolt Regulated P/Sup.....\$225
LAMBDA #35 Regulated P/S, 100-200VDC @ 300
Ma\$100
W. E. TD2 Microwave System Generator.....\$81
MEASUREMENTS 78E Sig Gen 40-75 Mc's.....\$39
TS14/AP S-Band Test Set Sig Gen.....\$45
BC221—Sig Corps Record! New Book & Calib. L.N.
\$125
Baird Atomic TS 3, TP 4 Transistor T/set.....\$2.75
Sperry SAC 19 Microwave Klystron.....\$250
WE BUY SELL & TRADE!!

TERMS: Money Back Guarantee!
Our 17th year. \$2 min. order
F.O.B. N.Y.C. Add shpg charges
or for C.O.D. 25% Dep. Prices
shown subject to change.
111-EJ LIBERTY ST., N.Y. 6, N.Y.

Send 25¢ for Catalog

PHONE: RECTOR 2-6245
CIRCLE 466 ON READER SERVICE CARD

if you purchase TUBES & SPECIALIZED ELECTRONIC COMPONENTS . . .

THE 1961 BARRY GREENSHEET IS A MUST!

Circle Reader Service Card No. 466 for your copy.
* A Complete 48 Page Electronics Buyers' Guide

BARRY ELECTRONICS CORP.
512 Broadway • New York 12, N. Y. • Walker 5-7000
Cable: Barrytel, NY • Teletype: NY 1-3731

CIRCLE 460 ON READER SERVICE CARD

GLASS TUBING
PYREX - NONEX - URANIUM
BULB & CYLINDERS
WRITE FOR FREE MONTHLY LIST
HOUE GLASS COMPANY
PHONE COLFAX 4-4800
P.O. Box 206 Keyport, N. J.

CIRCLE 467 ON READER SERVICE CARD

Wilgreen

can deliver Amphenol
Bendix
Cannon
CONNECTORS
FITTINGS & CLAMPS

We stock more than 5,000,000 MS/AN CONNECTORS . . . of 50,000 variations! In PRODUCTION QUANTITIES . . . we sell BELOW "O.E.M." PRICE . . . and offer IMMEDIATE "OFF-THE-SHELF" DELIVERY!

FREE . . . Send for latest brochure . . . and list price chart

WILGREEN INDUSTRIES, Inc.
100 Warren Street, New York 7, N. Y.
Worh 4-2490-1-2 Wire: FXK

CIRCLE 469 ON READER SERVICE CARD

KLYSTRON SPECIAL

726 B. C.	\$15.00	2K50	\$72.00
5721	125.00	2K54	15.00
6115	50.00	2K55	25.00
6116	75.00	2K56	50.00
6390	175.00	3K21	150.00
2K22	22.50	QK185	35.00
2K23	22.50	QK290	350.00
2K25	9.00	QK291	350.00
2K28	27.50	QK292	350.00
2K29	27.50	QK293	350.00
2K33A	200.00	QK294	350.00
2K33B	300.00	QK295	450.00
2K39	170.00	V23	450.00
2K41	75.00	V27	600.00
2K42	150.00	V28	975.00
2K43	144.00	V45	450.00
2K44	100.00	V270	125.00
2K45	25.00	VA94	350.00
2K48	50.00	X12	475.00

LIBERTY ELECTRONICS, Inc.
582 Broadway New York 12, N. Y.
Walker 5-6000 Cables: TELSER SUP

CIRCLE 470 ON READER SERVICE CARD

GET IT from GOODHEART!

0.1% SORENSEN Line Voltage Regulator

#50005, Brand new at low surplus price! Input 95-130 V. 1 ph., with taps for 50 or 60 cy. Use for any power up to 5000 watts. Output adjustable 110-120 V. and holds to ±0.1% at line frequency, or to ±0.25% if line frequency drifts 5%. Regulates against line changes of 95-130V and against load changes from 0 to 5 KVA. Maximum harmonics less than 3%! Recovery time 0.15 seconds. Input to the control section can be moved to the point where you will use the power, thus compensating for line drop. In rack cabinet 28" h, 22" wd, 13" dp. Net wt 190 lbs. Shpg wt 285 lbs FOB Utica, N. Y. In original factory pack suitable for export, including SPARE PARTS group. Sorenson catalog net price is \$695.00 \$349.50 less spares. Our price, WITH SPARES. . . .



#10,0005, same as above but 10 kva, factory-reconditioned, fob Norwalk, Conn., \$595.00. #1000-25, 190-260 V 1 ph to 230 V, fob Los Ang., \$179.50

Write us, stating your specific needs in Line Voltage Regulators, Receivers, Signal Generators, Transmitters, Tuning-Fork Frequency Standards, Graphic Recorders, etc., all at low surplus prices, all certified and guaranteed unconditionally.

R. E. GOODHEART CO.
P. O. Box 1220-E Beverly Hills, Calif.

CIRCLE 471 ON READER SERVICE CARD

Write us, stating your specific needs in Line Voltage Regulators, Receivers, Signal Generators, Transmitters, Tuning-Fork Frequency Standards, Graphic Recorders, etc., all at low surplus prices, all certified and guaranteed unconditionally.

R. E. GOODHEART CO.
P. O. Box 1220-E Beverly Hills, Calif.

"SEARCHLIGHT"

IS
Opportunity Advertising

—to help you get what you want—to help you sell what you no longer need.

Take Advantage Of It
"Think Searchlight First"
For Every Business Want

INDEX TO ADVERTISERS



Audited Paid Circulation

*AMP Incorporated	55	*Gamewell Co., The.....	142
*Acme Electric Corp.....	60	Garrett Corporation, The	
Aerovox Corporation	136	Air Research Mfg. Div.....	6
*Airtax Electronics, Inc.....	21	General Applied Science Laboratories	157
*Alden Products Co.....	34, 150	*General Ceramics Division of Indiana	
Avnet Corporation	63	General Corp.	48
		*General Electrodynamics Corporation	37
Bausch & Lomb, Inc.....	143	*General Instrument Corp.....	43
*Beckman Instruments, Inc.		Goodyear Aircraft Corp.....	11
Berkley Division	47	Graphic Systems, Inc.....	147
*Bendix Corporation		*Gremar Mfg. Co.....	129
Scintilla Division	33	Gries Reproducer Corp.....	141
Pioneer-Control Division	135	Grumman Aircraft Engineering Corp.	50
Black & Webster, Inc.....	152	*Gudebrod Bros. Silk Co., Inc.....	142
*Boonton Radio Corp.....	12, 13		
Borg-Warner	59	Hanibal Glass, Incorporated.....	44
Bristol Company, The.....	145	Harman Kardon Inc.....	158
British Radio Electronics Ltd.....	142	Haydon Co., A. W.....	151
*Bussmann Mfg. Co.....	8	Heiland Division, Minneapolis-	
		Honeywell Regulator Co.....	62
CBS Electronics	51	Hermes Electronics Co.....	146
*Cambridge Thermionic Corp.....	148	*Hewlett-Packard Company	15, 121
*Carborundum Company, The.....	54	Hitachi, Ltd.	98
Conant Laboratories	157	*Hughes Aircraft Co.....	38
*Coto-Coil Co., Inc.....	160		
*Crosby-Teletronics Corporation	31	Industrial Electronic Hardware Corp.	44
Cubic Corp.	125	Ingersoll Products, Division of Borg-	
*Curtiss-Wright Corp.	158, 159	Warner Corp.	53
		International Resistance Co.....	39
Delco Radio	22	*IT&T Electron Tube Dept., Compon-	
Di-Acro Corporation	30	ents Division, International Tele-	
Durant Manufacturing Co.....	161	phone and Telegraph.....	7
*Dymec, A Division of Hewlett-			
Packard Co.	23	*J F D Electronics Corp.....	133
		Jones, Howard B., Division of Cinch	
Elcor Incorporated	46	Mfg. Co.	117
Electronic Engineering Co.....	56		
*Electronic Instrument Co., Inc.		*Kearfott Div., General Precision	
(EICO)	161	Inc.	122, 123
Englehard Industries, Inc.....	40, 41	Keweenaw Scientific Equipment....	147
Eyelet Tool Co.....	135	Kidder-Peabody	144
Fluke Mfg. Co., Inc., John.....	17	Lambda Electronics Corp.....	3
		Leesona Corp.	131

* See Advertisement in the July 20, 1960 issue of Electronics Buyers' Guide for complete line of products or services.

TUBING QUALITY ...PLUS



● Quality in small tubing starts with the careful selection of redrawing stock. It must be of the correct analysis and free of flaws throughout.

Next, quality depends on applied know-how. UNIFORM's craftsmanship meets extremely close tolerances on O.D., I.D. or wall dimensions—down to ± 0.00025 inches. UNIFORM's skill provides fine finish, exact temper, square-cut ends free of burrs or distortion, and perfectly straight tubing protected during shipment by modern packaging. Then, if tubular parts are to be fabricated "at the mill," tubing quality is maintained through unusual ingenuity in the design and construction of special jigs, fixtures and production equipment providing intricate conformations with precision.

Quality is paramount at UNIFORM TUBES. Whether you need tubing to meet standard specifications or have special requirements, come to UNIFORM for the answer in both tubing and fabricated parts supplied in many alloys of steel, copper, nickel, aluminum and the precious metals. Send us your specifications for quotation.



**UNIFORM TUBES,
INC. COLLEGEVILLE 2, PA.**

HUxley 9-7276 TWX-CGVL 1044

*Marconi Instruments Ltd.....	144
Melabs	52
*Mico Instrument Co.....	141
Mnemotron Corporation	127
*Motorola, Inc. Military Electronics Division....	45

NRC, A Subsidiary of National Research Corporation	35, 99
National Vulcanized Fibre Company..	16
New England Instrument Company..	129
*North Atlantic Industries, Inc.....	149
*Northern Radio Co., Inc.....	160

Packard Bell Electronics.....	97
*Philbrick Research, Inc., George A..	155
*Philco Corporation Lansdale Division	100
Philips Gloeilampfabrieken, N.V.	18, 19
Potter Instrument Co., Inc.....	139
*Power Designs, Inc.....	147
Powertron Ultrasonics Corp.....	32
Precision Instrument Co.....	27

*Radio Corporation of America..	4th Cover
*Radio Frequency Laboratories, Inc..	140
*Raytheon Company.....	2nd Cover, 49 61, 138
*Ribet-Desjardins	58
Rosemount Engineering Co.....	161
Royal Electric Corp.....	152

SAMES	64
*Shallerross Mfg. Co.....	2
*Sigma Instruments, Inc.....	137
Sprague Electric Co.....	5, 20
Superior Electronics Corp.....	144
*Syntronic Instruments, Inc.....	147

*Technology Instrument Corporation.	130
Tektronix, Inc.	42
*Texas Instruments Incorporated Semiconductor-Components Division.	119

Uniform Tubes, Inc.....	169
-------------------------	-----

*Varian Associates.....	3rd Cover
*Veeder-Root, Inc.	57
*Vitramon, Inc.	29

Weinschel Engineering	14
White, S. S.....	126
*Williams & Co., C. K.....	141
■	
Manufacturers' Representatives MacDonald Inc., Samuel K.....	166

CLASSIFIED ADVERTISING
F. J. Eberle, Business Mgr.

EMPLOYMENT OPPORTUNITIES.	163-166
SPECIAL SERVICES	
Contract Work	166
EQUIPMENT	
(Used or Surplus New)	
For Sale	167-168

ADVERTISERS INDEX

Aircraft Armaments, Inc.....	164
Ameritron Electronics Inc.....	166
Barry Electronics Corp.....	168
Engineering Associates	168

* See Advertisement in the July 20, 1960 issue of Electronics Buyers' Guide for complete line of products or services.

Esquire Personnel	168
General Electric, Defense Systems Dept...	164
Goodheart Co., R. E.....	168
Houde Supply Co.....	168
International Business Machines Corp....	163
Liberty Electronics Inc.....	168
National Scientific Labs Inc.....	166
Page Electronics	168
Perkin-Elmer Corp.	164
Radio Research Instrument Co.....	168
Republic Aviation	166
Scientists, Engineers & Executives.....	166
Sikorsky Aircraft, Div. of United Aircraft Corp.	165
TAB	168
Universal Relay Corp.....	167
Western Engineers	167
Wilgreen Industries, Inc.....	168

This index and our Reader Service Numbers are published as a service. Every precaution is taken to make them accurate, but ELECTRONICS assumes no responsibilities for errors or omissions.

electronics



Audit Bureau
of Circulations



Associated Business
Publications

Audited Paid Circulation

BRUCE A. WINNER
Advertising Sales Manager

R. S. QUINT, Assistant Publisher Buyers' Guide and Business Manager; FRED STEWART, Promotion Manager; B. ANELLO, Marketing Service Manager; RICHARD J. TOMLINSON, Production Manager; GEORGE E. POMEROY, Classified Manager; HUGH J. QUINN, Circulation Manager.

HOUSTON Joseph A. Page; DALLAS Robert T. Wood, Frank LeBeau; LONDON Edward E. Schirmer; FRANKFURT Stanley R. Kimes; GENEVA Michael R. Zeynel.

BRANCH OFFICES: National Press Bldg., Washington 4, D.C.; McGraw-Hill Bldg., Copley Square, Boston 16; Four Gateway Center, Pittsburgh 22; Six Penn Center Plaza, Philadelphia 3; 645 North Michigan Avenue, Chicago 11; 55 Public Square, Cleveland 13; 255 California Street, San Francisco 11; 1125 West Sixth St., Los Angeles 17; 1740 Broadway, Denver 2; 1301 Rhodes-Haverty Bldg., Atlanta 3; 901 Vaughn Bldg., Dallas 1; Prudential Bldg., Holcombe Blvd., Houston 25; McGraw-Hill Publishing Co., Ltd., 34 Dover Street, London, England; 85 Westendstrasse, Frankfurt/Main; 2 Place de Port, Geneva.

ADVERTISING REPRESENTATIVES: NEW YORK Donald H. Miller, Henry M. Shaw, George F. Werner; BOSTON William S. Hodgkinson, Donald R. Furth; PITTSBURGH David M. Watson; PHILADELPHIA Warren H. Gardner, William J. Boyle; CHICAGO Harvey W. Wernecke, Martin J. Gallay; CLEVELAND P. T. Fegley; SAN FRANCISCO T. H. Carmody, R. C. Alcorn; LOS ANGELES Marshall Freeman; DENVER J. Patten; ATLANTA M. Miller;



HOW THE WORD GETS AROUND... Problem: Build a 4,000-mile military communications network for 15 NATO countries. Bounce microwave messages off the troposphere, hurdle mountain ranges, reach over the curvature of the earth to span a continent from the Arctic Circle to Turkey. Tall order! But NATO is doing it, with Project Ace High: an international forward-scatter communications system.

The first link in Ace High, a four-station system called Hot Line, was installed in Norway in 1958. Varian's VA-800C amplifier klystrons are the heart of the system. Tube life to date is averaging over 5,000 hours. What's more, the average improves every day; two-thirds of the tubes are still operational. In fact, two tubes are over 13,000 hours.

Do you require such exemplary tube performance? Technical data? Just write Tube Division.



VARIAN associates
PALO ALTO 1, CALIFORNIA

- BOMAC LABORATORIES, INC.
- VARIAN ASSOCIATES OF CANADA, LTD.
- S-F-D LABORATORIES, INC.
- SEMICON ASSOCIATES, INC.
- SEMICON OF CALIFORNIA, INC.
- VARIAN A.G. (SWITZERLAND)

VA-800C • 2.16 to 2.40 kMc • 10 kW CW

RCA PRESENTS A NEW MICROWAVE FAMILY

Integral-Cavity Pencil Tubes Shown Actual Size, Approximately

RCA Pencil Tubes provide the vital voice-communications link in the Satellite Communications System of Project Mercury

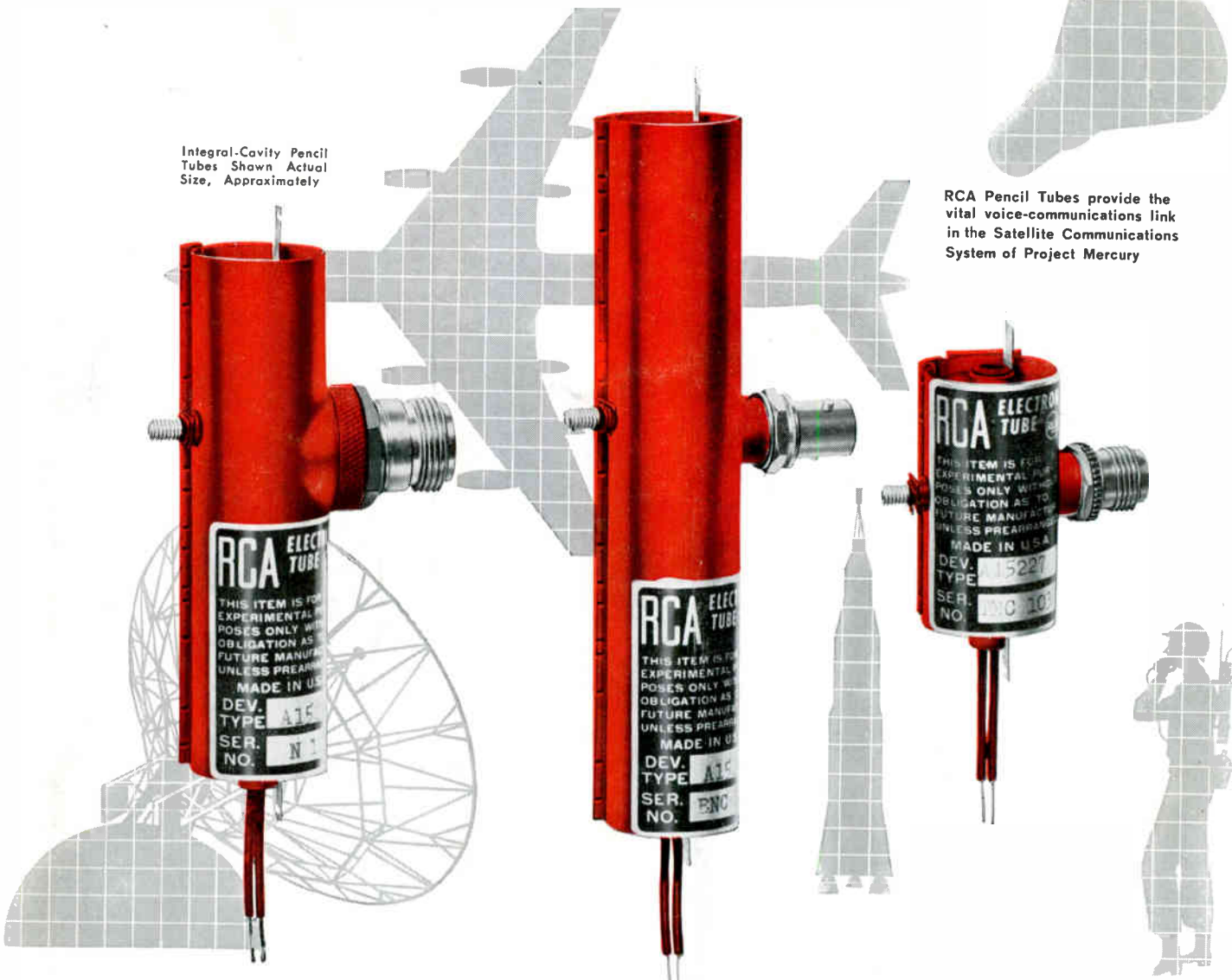

Integral-Cavity

PENCIL-TUBE OSCILLATORS

- From 900-3400 Mc
- Low-cost
- Includes RF Circuitry
- Compact

OVERALL RF PERFORMANCE ASSURED

Now, RCA offers the recognized performance-advantages of the famous coaxial pencil tube . . . in a design which combines the pencil tube with a mechanically-tuned cavity—to produce a single-unit, compact, low-cost microwave oscillator.

Wherever circuit compactness and gross weight are major considerations in microwave designs, RCA Integral-Cavity Pencil Tubes hold intrinsic possibilities—for CW, plate-pulse, or cathode-pulse work. There's a choice

of over 20 types. And note this: RCA's Applications Engineering group is available to discuss special Integral-Cavity Pencil Tubes "tailored" to your specific requirements.

For information on RCA Integral-Cavity Pencil Tubes—and other integral cavity developments such as amplifiers, harmonic generators, voltage-tuned oscillators, get in touch with your RCA Field Representative. Or write: Microwave Marketing, Building 55, RCA Electron Tube Division, Harrison, N. J.

TYPICAL PERFORMANCE OF REPRESENTATIVE OSCILLATORS

RCA-Dev. Type	Power Output (Watts)	Duty Cycle	Freq. (Mc)	Input Pulse Voltage
A-15132	500 (Peak)	0.001	1100	50
A-15228	300 (Peak)	0.001	2000	50
A-15234	100 (Peak)	0.001	3000	50
A-15221	1	CW	1100	—
A-15227	0.3	CW	2000	—
A-15233	0.1	CW	3000	—

Important Technical Data for Microwave Designs

• RCA MICROWAVE TUBES and SOLID-STATE OSCILLATORS and AMPLIFIERS (ICE-180C). 16 pages of characteristics on nearly 100 RCA Microwave Devices. Please request on company letterhead.



• RCA PENCIL TUBES (ICE-219). 28-page book on Pencil Tube theory, application, characteristics curves, operating data. Price 50 cents. Please remit with order.

Send your order to—Section F-19-Q-2, Commercial Engineering, RCA Electron Tube Division, Harrison, N. J.



The Most Trusted Name in Electronics
RADIO CORPORATION OF AMERICA

RCA ELECTRON TUBE DIVISION FIELD OFFICES. . . Industrial Product Sales: NEWARK 2, N. J., 744 Broad St., HU 5-3900 • CHICAGO 54, ILL., Suite 1154, Merchandise Mart Plaza, WH 4-2900 • LOS ANGELES 22, CALIF., 6801 E. Washington Blvd., RA 3-8361 • BURLINGAME, CALIF., 1838 El Camino Real, OX 7-1620 • Government Sales: HARRISON, N. J., 415 South Fifth St., HU 5-3900 • DAYTON 2, OHIO, 224 N. Wilkinson St., BA 6-2366 • WASHINGTON 7, D.C., 1725 "K" St., N.W., FE 7-8500