



**D-Link**

**D-LINK™ DGS-3100 SERIES  
GIGABIT STACKABLE MANAGED SWITCH**

**USER MANUAL**

**V3.0**

**Information in this document is subject to change without notice.**

**© 2009 D-Link Computer Corporation. All rights reserved.**

Reproduction in any manner whatsoever without the written permission of D-Link Computer Corporation is strictly forbidden.

Trademarks used in this text: D-Link and the D-Link logo are trademarks of D-Link Computer Corporation; Microsoft and Windows are registered trademarks of Microsoft Corporation.

Other trademarks and trade names may be used in this document to refer to either the entities claiming the marks and names or their products. D-Link Computer Corporation disclaims any proprietary interest in trademarks and trade names other than its own.

### **FCC Warning**

This equipment has been tested and found to comply with the limits for a Class A digital device, pursuant to Part 15 of the FCC Rules. These limits are designed to provide reasonable protection against harmful interference when the equipment is operated in a commercial environment. This equipment generates, uses, and can radiate radio frequency energy and, if not installed and used in accordance with this user's guide, may cause harmful interference to radio communications. Operation of this equipment in a residential area is likely to cause harmful interference in which case the user will be required to correct the interference at his own expense.

### **CE Mark Warning**

This is a Class A product. In a domestic environment, this product may cause radio interference in which case the user may be required to take adequate measures.

### **Warnung!**

Dies ist ein Produkt der Klasse A. Im Wohnbereich kann dieses Produkt Funkstoerungen verursachen. In diesem Fall kann vom Benutzer verlangt werden, angemessene Massnahmen zu ergreifen.

### **Precaución!**

Este es un producto de Clase A. En un entorno doméstico, puede causar interferencias de radio, en cuyo case, puede requerirse al usuario para que adopte las medidas adecuadas.

### **Attention!**

Ceci est un produit de classe A. Dans un environnement domestique, ce produit pourrait causer des interférences radio, auquel cas l'utilisateur devrait prendre les mesures adéquates.

### **Attenzione!**

Il presente prodotto appartiene alla classe A. Se utilizzato in ambiente domestico il prodotto può causare interferenze radio, nel cui caso è possibile che l'utente debba assumere provvedimenti adeguati.

### **VCCI Warning**

この装置は、クラスA情報技術装置です。この装置を家庭環境で使用すると電波妨害を引き起こすことがあります。この場合には使用者が適切な対策を講ずるよう要求されることがあります。

August, 2009 P/N

# Table of Contents

PREFACE .....	i
System Overview .....	ii
Viewing the Device .....	iii
DGS-3100 Series Front Panel .....	iii
DGS-3100-24TG Front Panel .....	iii
Device Management Methods.....	iv
User Guide Overview.....	v
Intended Audience .....	vi
Notes, Notices, and Cautions .....	vii
Safety Cautions .....	viii
General Precautions for Rack-Mountable Products .....	ix
GETTING STARTED.....	1
Accessing the Boot/Startup Menu Functions .....	2
Downloading Software.....	2
Set Terminal Baud-Rate.....	2
Defining Stacking Units.....	3
Using the Web-Based User Interface .....	4
Understanding the D-Link Embedded Web Interface .....	5
Using the Tool Menu .....	7
Displaying the Stack Status.....	7
Locating Devices.....	7
Backing up and Restoring Configuration Files .....	8
Resetting the Device .....	9
Downloading the Firmware.....	10
Rebooting the System .....	12
View/Add/Update/Delete User Accounts Using the Web System Components.....	13
'User' Level Support on the WEB .....	14
CONFIGURING BASIC CONFIGURATION .....	15
Viewing Device Information.....	16
Defining System Information.....	18
Defining IP Addresses .....	19
Managing Stacking .....	20
Managing Stacking Modes.....	20
Advanced Stacking .....	20
Stack Startup Process .....	22
Building Stacks – Quick Start .....	24
Stack Management Examples .....	25
Configuring Stacking .....	31
Defining Ports .....	32
Configuring Port Properties .....	32
Viewing Port Properties .....	34
ARP Settings.....	35
Configuring User Accounts.....	36
Managing System Logs.....	38
Configuring SNTP .....	40
Configuring Daylight Savings Time .....	42

Configuring SNMP .....	46
Defining SNMP Views .....	47
Defining SNMP Groups .....	48
Defining SNMP Users .....	50
Defining SNMP Communities .....	52
Defining SNMP Host Table .....	53
Defining SNMP Engine ID .....	55
Enabling SNMP Traps .....	56
DHCP Relay .....	57
DHCP Auto Configuration .....	58
Dual Image Services .....	59
Firmware Information .....	59
Config Firmware Image .....	60
Telnet Setting .....	61
CONFIGURING L2 FEATURES .....	62
Enabling Jumbo Frames .....	63
Configuring VLANs .....	64
Understanding IEEE 802.1p Priority .....	64
VLAN Description .....	64
Notes about VLANs on the DGS-3100 Series .....	64
IEEE 802.1Q VLANs .....	64
802.1Q VLAN Tags .....	66
Port VLAN ID .....	67
Tagging and Untagging .....	67
Ingress Filtering .....	67
Default VLANs .....	68
VLAN and Trunk Groups .....	68
VLAN Status .....	68
Defining VLAN Properties .....	69
Defining Asymmetric VLAN .....	71
Configuring GVRP .....	73
Defining Trunking .....	75
Defining VLAN Trunking .....	77
Traffic Segmentation .....	79
Configuring LACP .....	80
Defining IGMP Snooping .....	81
Defining MLD Snooping .....	85
Configuring Port Mirroring .....	89
Configuring Spanning Tree .....	91
Defining Spanning Tree Global Parameters .....	92
Defining STP Port Settings .....	94
Defining Multiple Spanning Tree Configuration Identification .....	96
Defining MSTP Port Information .....	97
Defining Forwarding and Filtering .....	99
Defining Unicast Forwarding .....	99
Defining Multicast Forwarding .....	100
Defining Multicast Filtering .....	101
Defining DLF Filtering .....	102

Configuring LLDP .....	104
Defining LLDP Global Settings .....	104
Defining LLDP Port Settings .....	105
Defining LLDP Basic TLV Settings .....	107
Defining LLDP Dot3 TLV Settings .....	108
Viewing LLDP Local Port Information .....	109
Viewing LLDP Remote Port Information .....	111
CONFIGURING QUALITY OF SERVICE .....	116
Understanding QoS .....	118
Defining Bandwidth Settings .....	119
Configuring Storm Control .....	121
Mapping Ports to Packet Priorities .....	122
Mapping Priority to Classes (Queues) .....	123
Configuring QoS Scheduling Mechanism .....	124
Defining Multi-Layer CoS Settings .....	125
SECURITY FEATURES .....	126
Configuring Safeguard Engine .....	127
Configuring Trust Host .....	128
Configuring Port Security .....	129
Configuring Guest VLANs .....	131
Configuring Port Authentication 802.1X .....	132
Configuring MAC Authentication (by using Guest VLAN, 802.1X and Radius pages) .....	137
Defining RADIUS Settings .....	140
Defining EAP Forwarding Settings .....	142
Configuring Secure Socket Layer Security .....	143
Configuring Secure Shell Security .....	145
Defining SSH Algorithm Settings .....	146
Defining Application Authentication Settings .....	148
Configuring Authentication Server Hosts .....	149
Defining Login Methods .....	150
Defining Enable Methods .....	152
Configuring Local Enable Password .....	154
Defining Arp Spoofing Prevention Settings .....	155
MONITORING THE DEVICE .....	156
Viewing Stacking Information .....	157
Viewing CPU Utilization .....	158
Viewing Port Utilization .....	159
Viewing Packet Size Information .....	160
Viewing Received Packet Statistics .....	161
Viewing UMB_cast Packet Statistics .....	162
Viewing Transmitted Packet Statistics .....	163
Viewing RADIUS Authenticated Session Statistics .....	165
Viewing ARP Table .....	166
Viewing MLD Router Ports .....	167
Viewing Router Ports .....	168
Viewing Session Table .....	169
Viewing IGMP Group Information .....	170

Viewing MLD Group Information.....	171
Defining Dynamic and Static MAC Addresses.....	172
Viewing System Log.....	174
MANAGING POWER OVER ETHERNET DEVICES.....	175
Defining PoE System Information.....	176
Displaying and Editing PoE System Information.....	178
DEFINING ACCESS PROFILE LISTS.....	179
ACL Configuration Wizard.....	180
Defining Access Profile Lists.....	182
Defining Access Rules Lists.....	195
Finding ACL Rules.....	198
Defining Time Ranges.....	201
CONNECTORS AND CABLES.....	205
Pin Connections for the 10/100/1000 Ethernet Interface.....	206
RJ-45 Ports Pinout.....	206
Pin Connections for the HDMI Connector.....	207
HDMI Ports Pinout.....	207
SYSLOG ERRORS.....	208
TECHNICAL SUPPORT.....	252

# Preface

This preface provides an overview to the guide, and includes the following sections:

- System Overview
- Viewing the Device
- Device Management Methods
- User Guide Overview
- Intended Audience
- Notes, Notices, and Cautions
- Safety Cautions
- General Precautions for Rack-Mountable Products

## System Overview

The DGS-3100 series and the DGS-3100-24TG Gigabit Ethernet Switches enhance networks by providing a powerful switch that eliminates network bottlenecks, enabling network administrators to fine tune network configurations.

The DGS-3100 series and the DGS-3100-24TG are perfect for departmental and enterprise connections, and are ideal for backbone and server connections.



## Viewing the Device

The devices described in this section are stackable Gigabit Ethernet Managed Switches. Device management is performed using an Embedded Web Server (EWS) or through a Command Line Interface (CLI). The device configuration is performed via an RS-232 interface. This section contains descriptions for the following:

- DGS-3100 series Front Panel
- DGS-3100-24TG Front Panel

### DGS-3100 Series Front Panel

The DGS-3100 series provides 24/48 high performance 1000BASE-T ports. The 1000Base-T ports operate at 10/100/1000, and connect to backbones, end-stations, and servers. The DGS-3100 series also provides 4 Mini-GBIC (SFP) combo ports which connect fiber optic media to switches, servers, or network backbone. The DGS-3100 series provides an additional RS-232 port (console port) for managing the switch via a console terminal or PC with a Terminal Emulation Program.

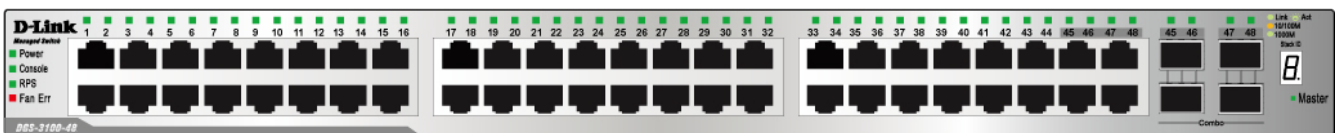

Figure 1. DGS-3100 Series 48 Port Front Panel

### DGS-3100-24TG Front Panel

The DGS-3100-24TG provides eight high performance 1000BASE-TX ports. The ports operate at 10/100/1000, and connect to backbones, end-stations, and servers. The DGS-3100-24TG also provides 16 Mini-GBIC (SFP) ports which connect fiber optic media to switches, servers, or network backbone. The DGS-3100-24TG provides an additional RS-232 port (console port) for managing the switch via a console terminal or PC with a Terminal Emulation Program.

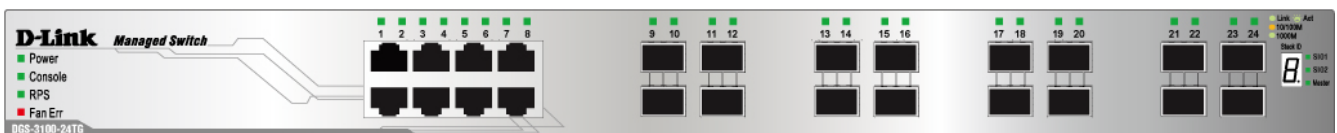

Figure 2. DGS-3100-24TG Front Panel

## Device Management Methods

The DGS-3100 series and DGS-3100-24TG provide different methods for managing the device including:

- Web Based Management Interface
- SNMP-Based Management
- Command Line Console

### Web Based Management Interface

Once the device is installed, network managers can configure the switch, monitor the LED panel, and display statistics graphically via a web browser, including:

- Netscape Navigator (version 7.0 and higher)
- Microsoft® Internet Explorer (version 5.0).
- Mozilla Firefox (version 2.0)

### SNMP-Based Management

The system also supports SNMPv1, SNMPv2c, and SNMPv3. The SNMP agent decodes the incoming SNMP messages, and replies to requests with MIB objects stored in the database. The SNMP agent updates the MIB objects to generate statistics and counters.

### Command Line Console

The device also supports device configuration using the *Command Line Interface*. A terminal is connected to device via the serial console port.

## User Guide Overview

This section provides an overview to the DGS-3100 series and the DGS-3100-24TG Switch Manual, including the guide structure and a chapter overview:

- **Section 1, Getting Started** — Provides general background for understanding and using the Boot/Startup Menu and the Embedded Web System, including an explanation of the interface buttons and general system functions.
- **Section 2, Defining the Basic Device Configuration** — Provides information for viewing system information, defining IP addresses, managing stacking, defining ports, configuring SNMP management, and defining the system time settings.
- **Section 3, Configuring L2 Features** — Provides information for enabling and configuring Jumbo frames, VLANs, Trunks (LAGs), Traffic Segmentation, Multicast forwarding, Spanning Tree and LLDP.
- **Section 4, Configuring Quality of Service** — Provides information for ability to implement QoS and priority queuing within a network.
- **Section 5, Security Features** — Provides information for enabling and configuring device security.
- **Section 6, Monitoring the Device** — Provides information for monitoring the device.
- **Section 7, Managing Power over Ethernet Devices** — Provides information configuring the PoE function.
- **Section 8, Defining Access Profile Lists** — Provides information for configuring the ACL.

## **Intended Audience**

The DGS-3100 series/DGS-3100-24TG User Guide contains information for configuring and managing the DGS-3100 series/DGS-3100-24TG Switches. This guide is intended for network managers familiar with network management concepts and terminology.

## Notes, Notices, and Cautions



NOTE: A NOTE indicates important information that helps you make better use of your device.



NOTICE: A NOTICE indicates **either** potential damage to hardware or loss of data and tells you how to avoid the problem.



CAUTION: A CAUTION indicates a potential for property damage, personal injury, or death.

## Safety Cautions

Use the following safety guidelines to ensure your own personal safety and to help protect your system from potential damage. Throughout this safety section, the caution icon (⚠) is used to indicate cautions and precautions that you need to review and follow.

To reduce the risk of bodily injury, electrical shock, fire, and damage to the equipment, observe the following precautions.

- Do not service any product except as explained in your system documentation. Opening or removing covers that are marked with the triangular symbol with a lightning bolt may expose you to electrical shock. Only a trained service technician should service components inside these compartments.
- If any of the following conditions occur, unplug the product from the electrical outlet and replace the part or contact your trained service provider:
  - The power cable, extension cable, or plug is damaged.
  - An object has fallen into the product.
  - The product has been exposed to water.
  - The product has been dropped or damaged.
  - The product does not operate correctly when you follow the operating instructions.
- Keep your system away from radiators and heat sources. Also, do not block the cooling vents.
- Do not spill food or liquids on your system components, and never operate the product in a wet environment. If the system gets wet, see the appropriate section in your troubleshooting guide or contact your trained service provider.
- Do not push any objects into the openings of your system. Doing so can cause a fire or an electric shock by shorting out interior components.
- Use the product only with approved equipment.
- Allow the product to cool before removing covers or touching internal components.
- Operate the product only from the type of external power source indicated on the electrical ratings label. If you are not sure of the type of power source required, consult your service provider or local power company.
- To help avoid damaging your system, be sure the voltage selection Switch (if provided) on the power supply is set to match the power available at your location:
  - 115 volts (V)/60 hertz (Hz) in most of North and South America and some Far Eastern countries such as South Korea and Taiwan
  - 100 V/50 Hz in eastern Japan and 100 V/60 Hz in western Japan
  - 230 V/50 Hz in most of Europe, the Middle East, and the Far East
- Also be sure that attached devices are electrically rated to operate with the power available in your location.
- Use only approved power cable(s). If you have not been provided with a power cable for your system or for any AC-powered option intended for your system, purchase a power cable that is approved for use in your country. The power cable must be rated for the product and for the voltage and current marked on the product's electrical ratings label. The voltage and current rating of the cable should be greater than the ratings marked on the product.
- To help prevent an electric shock, plug the system and peripheral power cables into properly grounded electrical outlets. These cables are equipped with three-prong plugs to help ensure proper grounding. Do not use adapter plugs or remove the grounding prong from a cable. If you must use an extension cable, use a 3-wire cable with properly grounded plugs.
- Observe extension cable and power strip ratings. Make sure that the total ampere rating of all products plugged into the extension cable or power strip does not exceed 80 percent of the ampere ratings limit for the extension cable or power strip.
- To help protect your system from sudden, transient increases and decreases in electrical power, use a surge suppressor, line conditioner, or uninterruptible power supply (UPS).
- Position system cables and power cables carefully; route cables so that they cannot be stepped on or tripped over. Be sure that nothing rests on any cables.
- Do not modify power cables or plugs. Consult a licensed electrician or your power company for site modifications. Always follow your local/national wiring rules.

- When connecting or disconnecting power to hot-pluggable power supplies, if offered with your system, observe the following guidelines:
  - Install the power supply before connecting the power cable to the power supply.
  - Unplug the power cable before removing the power supply.
  - If the system has multiple sources of power, disconnect power from the system by unplugging all power cables from the power supplies.

Move products with care; ensure that all casters and/or stabilizers are firmly connected to the system. Avoid sudden stops and uneven surfaces.



## General Precautions for Rack-Mountable Products

Observe the following precautions for rack stability and safety. Also refer to the rack installation documentation accompanying the system and the rack for specific caution statements and procedures.

Systems are considered to be components in a rack. Thus, "component" refers to any system as well as to various peripherals or supporting hardware.



**CAUTION:** Installing systems in a rack without the front and side stabilizers installed could cause the rack to tip over, potentially resulting in bodily injury under certain circumstances. Therefore, always install the stabilizers before installing components in the rack.

After installing system/components in a rack, never pull more than one component out of the rack on its slide assemblies at one time. The weight of more than one extended component could cause the rack to tip over and may result in serious injury.

- Before working on the rack, make sure that the stabilizers are secured to the rack, extended to the floor, and that the full weight of the rack rests on the floor. Install front and side stabilizers on a single rack or front stabilizers for joined multiple racks before working on the rack.

Always load the rack from the bottom up, and load the heaviest item in the rack first.

Make sure that the rack is level and stable before extending a component from the rack.

Use caution when pressing the component rail release latches and sliding a component into or out of a rack; the slide rails can pinch your fingers.

After a component is inserted into the rack, carefully extend the rail into a locking position, and then slide the component into the rack.

Do not overload the AC supply branch circuit that provides power to the rack. The total rack load should not exceed 80 percent of the branch circuit rating.

Ensure that proper airflow is provided to components in the rack.

Do not step on or stand on any component when servicing other components in a rack.



**NOTE:** A qualified electrician must perform all connections to DC power and to safety grounds. All electrical wiring must comply with applicable local or national codes and practices.



**CAUTION:** Never defeat the ground conductor or operate the equipment in the absence of a suitably installed ground conductor. Contact the appropriate electrical inspection authority or an electrician if you are uncertain that suitable grounding is available.



**CAUTION:** The system chassis must be positively grounded to the rack cabinet frame. Do not attempt to connect power to the system until grounding cables are connected. Completed power and safety ground wiring must be inspected by a qualified electrical inspector. An energy hazard will exist if the safety ground cable is omitted or disconnected.

#### Protecting Against Electrostatic Discharge

Static electricity can harm delicate components inside your system. To prevent static damage, discharge static electricity from your body before you touch any of the electronic components, such as the microprocessor. You can do so by periodically touching an unpainted metal surface on the chassis.

You can also take the following steps to prevent damage from electrostatic discharge (ESD):

1. When unpacking a static-sensitive component from its shipping carton, do not remove the component from the antistatic packing material until you are ready to install the component in your system. Just before unwrapping the antistatic packaging, be sure to discharge static electricity from your body.
2. When transporting a sensitive component, first place it in an antistatic container or packaging.
3. Handle all sensitive components in a static-safe area. If possible, use antistatic floor pads and workbench pads and an antistatic grounding strap.

#### Battery Handling Reminder



**CAUTION:** This is danger of explosion if the battery is incorrectly replaced. Replace only with the same or equivalent type recommended by the manufacturer. Discard used batteries according to the manufacturer's instructions.



---

# GETTING STARTED

To begin managing the device, simply run the browser installed on the management station and point it to the IP address defined for the device. For example, <http://123.123.123.123>. Please note that the proxy for session connection should be turned off.



**NOTE:** The Factory default IP address for the Switch is 10.90.90.90.

## Accessing the Boot/Startup Menu Functions

The following configuration functions are performed from the Boot (Startup) menu:

- Downloading Software
- Set Terminal Baud-Rate
- Defining Stacking Units

To display the Startup menu:

1. During the boot process, after the first part of the POST is completed press Ctrl+shift+ (-) within 2 seconds after the following message is displayed:

```
Autoboot in 2 seconds -press RETURN or Esc. to abort
and enter prom.#
```

2. Press Enter, to access the Startup menu.
3. The Startup menu is displayed and contains the following configuration functions.

```
Startup Menu
```

```
[1] Download Software
[2] Set Terminal Baud-Rate
[3] Stack menu
[4] Back
```

```
Enter your choice or press 'ESC' to exit:
```

The following sections describe the Startup menu options. If no selection is made within 25 seconds (default), the switch times out and the device continues to load normally.

## Downloading Software

Use the software download option when a new software version must be downloaded to replace corrupted files, update, or upgrade the system software. It is recommended to set the Baud Rate to 38400 prior to downloading software, therefore allowing the software download to be faster. See *Set Terminal Baud-Rate*.

To download software from the Startup menu:

1. On the Startup menu, press “1”.

The following prompt is displayed:

```
Downloading code using XMODEM
```

2. When using HyperTerminal, click **Transfer** on the HyperTerminal menu bar.
3. From the Transfer menu, click **Send File**. The **Send File** window is displayed.
4. Enter the file path for the file to be downloaded.
5. Ensure the protocol is defined as Xmodem.
6. Click **Send**.

The software is downloaded. Software downloading takes several minutes. The terminal emulation application, such as HyperTerminal, may display the progress of the loading process. After software downloads, the device reboots automatically. Refer to the *Set Terminal Baud-Rate* section to define the Terminal Baud-Rate.

## Set Terminal Baud-Rate

Use the Set Terminal Baud-Rate option to define the Baud-Rate. The Baud-Rate is the serial bit rate used to communicate with the management host. The Baud-Rates values are: 2400, 4800, 9600, 19200, 38400. The default Baud-Rate value is 9600.

To set the terminal Baud-Rate:

1. On the Startup menu, press “2”.

The following prompt is displayed:

**Set new device Baud rate: \_**

2. Press Enter to apply changes.

## Defining Stacking Units

Use the Stack menu option to display the current stack unit ID list and define an alternative unit ID (stack membership number). Unit ID 0 is allocated for auto-numbering, which is the factory default. Refer to *Managing Stacking* for further reference.

To access the stack menu:

1. On the Startup menu, press “3”.

The following prompt is displayed:

**Stack menu**

**[1] Show unit stack id**

**[2] Set unit stack id**

**[3] Back**

**Enter your choice or press ‘ESC’ to exit:**

2. To display the current unit stack ID list, press “1”.

The following prompt is displayed:

**Stack menu**

**[1] Show unit stack id**

**[2] Set unit stack id**

**[3] Back**

**Enter your choice or press ‘ESC’ to exit:**

**Current working mode is stacking.**

**Unit stack id set to 0.**

**==== Press Enter to Continue ====**

3. To change the unit ID (stack membership number), press “2”.

The following prompt is displayed:

**Stack menu**

**[1] Show unit stack id**

**[2] Set unit stack id**

**[3] Back**

**Enter your choice or press ‘ESC’ to exit:**

**Enter unit stack id [0-6]:**

## Using the Web-Based User Interface

This section contains information on starting the D-Link Embedded Web Interface. To access the D-Link user interface:

1. Open an Internet browser. Ensure that pop-up blockers are disabled. If pop-up blockers are enabled, edit, add, and device information messages may not open.
2. Enter the device IP address in the address bar and press *Enter*.

The user interface provides access to various switch configuration and management windows, allows you to view performance statistics, and permits you to graphically monitor the system status. The screen captures in this Guide represent the DGS-3100-48 48 port device. The Web pages in the 24 port and the DGS-3100-24TG devices may vary slightly.

# Understanding the D-Link Embedded Web Interface

The D-Link Embedded Web Interface Device Information Page contains the following information:

View	Description
<b>Tree View</b>	Displays the different system features, and configuration options.
<b>Zoom View</b>	Located at the top of the home page, the port LED indicators provide a visual representation of the ports on the D-Link front panel.
<b>Menu Information View</b>	Located below the Zoom View, displays <i>Save</i> , <i>Tool</i> menu, <i>Stack ID</i> , and <i>Logout</i> buttons. Also displays Up Time information and User Loggin Identification.
<b>Device Information View</b>	Located in the main part of the home page, the device view provides a view of the device, an information or table area, and configuration instructions.
<b>Stacking Status View</b>	Located at the bottom left corner of the home page, the stacking status view provides a graphic representation of the stacking links and ports status.

**Table 1-1. Web Interface Views**

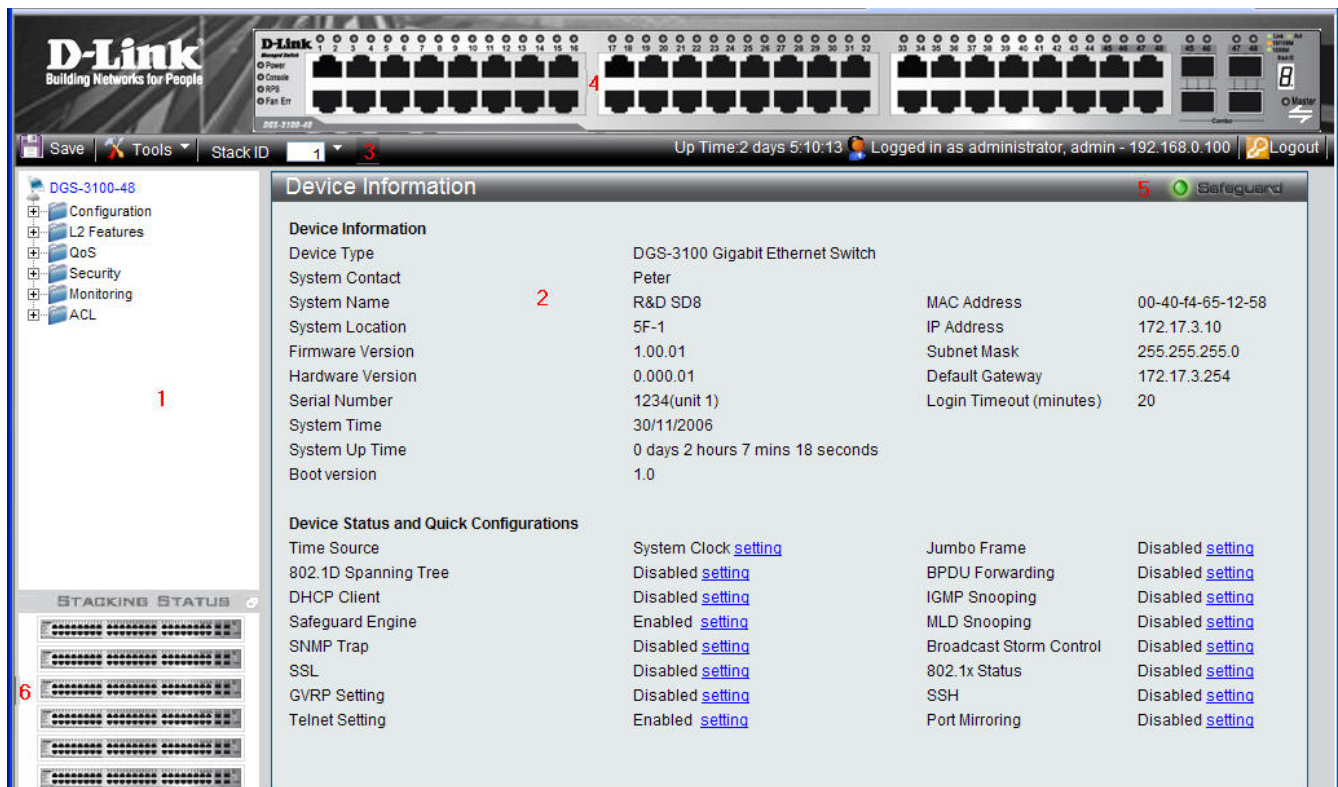

**Figure 1-1. Device Information Page**

The following table describes the main 6 areas on the Device Information Page:

View	Description
<b>1. Tree View</b>	Select the folder or window to be displayed. The folder icons can be opened to display the hyperlinked menu buttons and subfolders contained within them.
<b>2. Device Information View</b>	Presents Switch information based on the selection and the entry of configuration data
<b>3. Menu Information View</b>	Presents the <i>Save</i> button, a menu for accessing device tools, and a menu for Stack ID selection. The current Up Time and current User Loggin information is reported. The <i>Logout</i> button is also here.
<b>4. Zoom View</b>	Presents a graphical near real-time image of the front panel of the Switch. This area displays

<b>View</b>	<b>Description</b>
	the Switch's ports and expansion modules, showing port activity, duplex mode, or flow control, depending on the specified mode. Various areas of the graphic can be selected for performing management functions, including port configuration
<b>5 Device Application Buttons</b>	Provides access to the device logout, and provides information about the Safe Guard mode currently enabled on the device.
<b>6 Stacking Status View</b>	Provides a graphic representation of the stacking links and ports status.

**Table 1-2. Main Areas**

## Using the Tool Menu

The tool menu contains menu options for:

- Displaying the Stack Status
- Locating Devices
- Backing up and Restoring Configuration Files
- Resetting the Device
- Downloading the Firmware
- Rebooting the System

## Displaying the Stack Status

The *Stacking Information Page* provides specific information for stacked devices. For more information regarding the stacking setup, see *Managing Stacking* section.

## Locating Devices

The *Device Locator Page* enables locating system devices by activating LED locators. To locate devices:

1. Click  > **Device Locator**. The *Device Locator Page* opens.

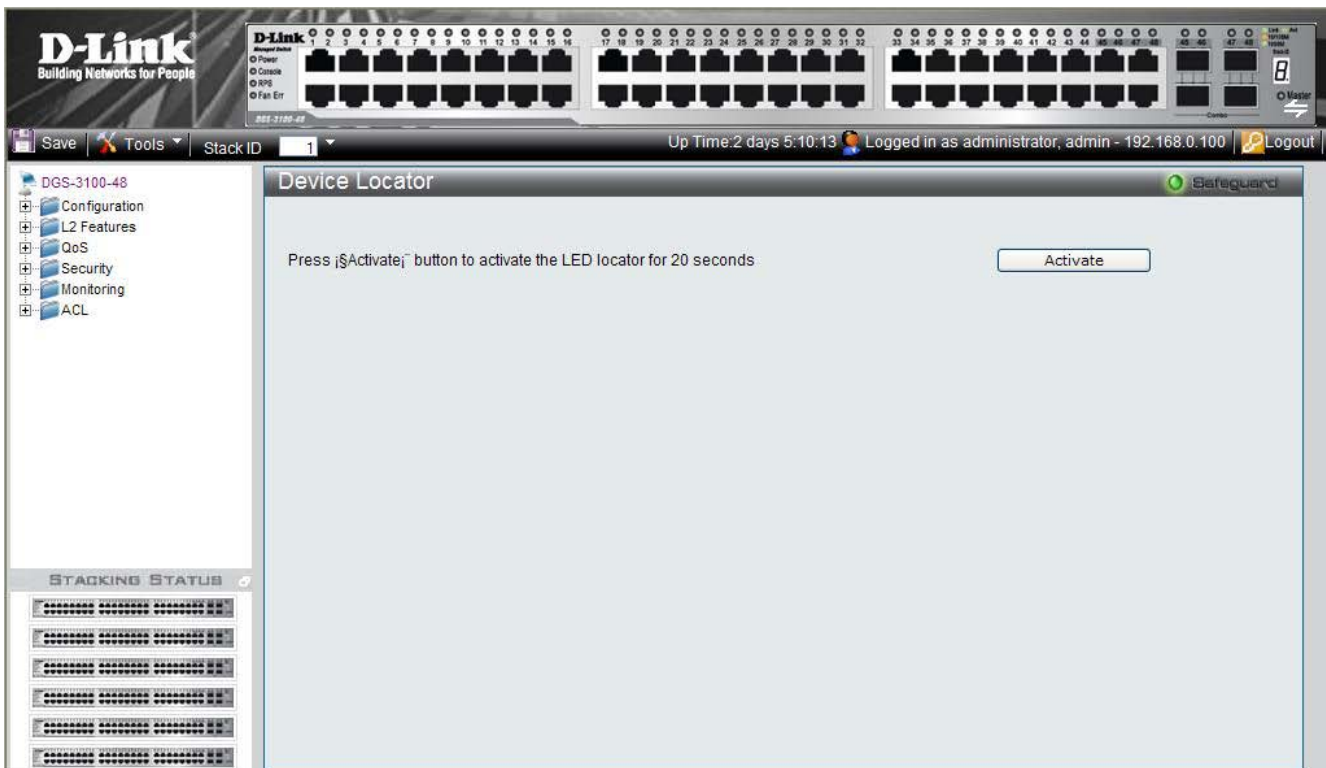



Figure 1-2. Device Locator Page

2. Click . The LED locator is activated for 20 seconds. On which the letter “L” will flash on the master unit.

## Backing up and Restoring Configuration Files

The *Config Backup and Restore Page* contains fields for downloading and uploading the configuration file from the device through HTTP or TFTP server. To back up and restore configuration files:

1. Click  > **Config Backup & Restore**. The *Config Backup and Restore Page* opens.

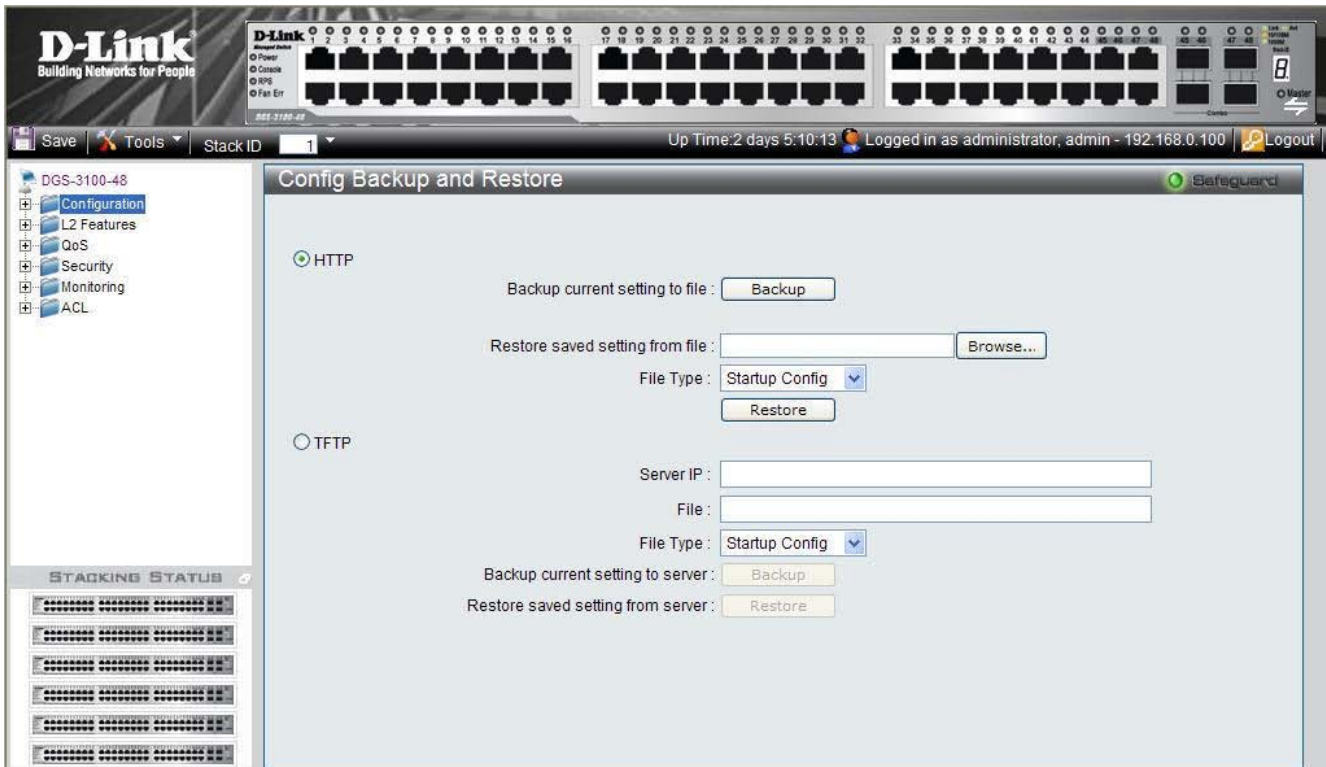

**Figure 1-3. Config Backup and Restore Page**

The Config Backup and Restore Page contains the following fields:

Field	Description
<b>Http</b>	<p>Indicates that the system files are backed up or restored via an HTTP server. The possible field values are:</p> <p><i>Backup current setting to file</i> — Backs up the current configuration files via the HTTP server.</p> <p><i>Restore saved setting from file</i> — Restores the current configuration files via the HTTP server.</p> <p><i>File Type</i> — Specifies the current configuration file type. The possible field values are <i>Startup Config</i> and <i>Running Config</i>.</p>
<b>TFTP</b>	<p>Indicates that the system files are backed up or restored via an TFTP server. The possible field values are:</p> <p><i>Server IP</i> — Specifies the TFTP Server IP Address to which files are backed up or from which they are restored.</p> <p><i>File</i> — Indicates the file that is backed up or restored.</p> <p><i>File Type</i> — Specifies the current configuration file type. The possible field values are <i>Startup Config</i> and <i>Running Config</i>.</p> <p><i>Backup current setting to server</i> — Backs up the current configuration files via the TFTP server.</p> <p><i>Restore saved setting from server</i> — Restores the current configuration files via the TFTP server.</p>



2. Select *HTTP* or *TFTP* field.
3. Define the selected server method fields.

To backup files, click

To restore files, click

## Resetting the Device

The *Factory Reset Page* restores the factory defaults. To restore the device to the factory default settings:

1. Click  > **Reset**. The *Factory Reset Page* opens:

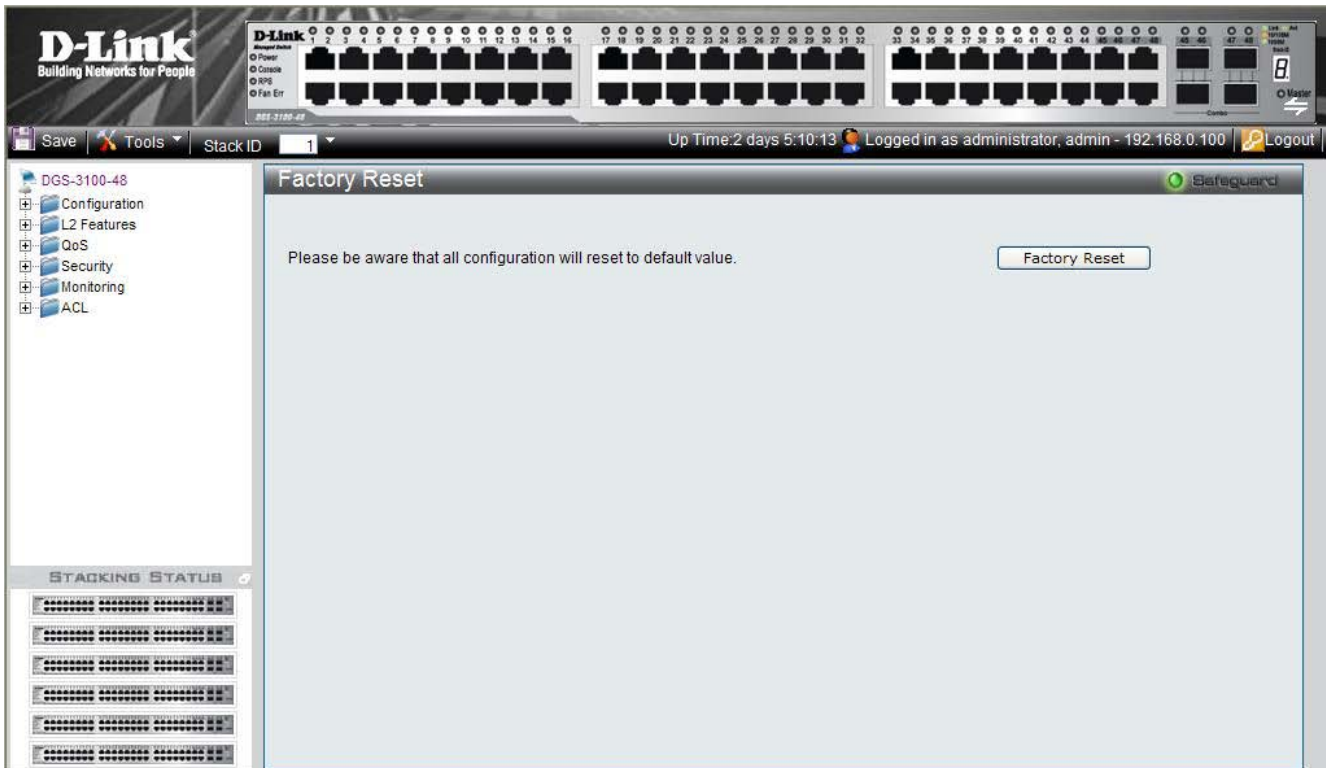

Figure 1-4. Factory Reset Page

2. Click . The factory default settings are restored once it completely reloaded, and the device is updated.

## Downloading the Firmware

The 'Firmware Download' web page is used to download the firmware files that will be used to manage the device.



**NOTE:** Firmware version 1.x.x supports 4 SKUs of DGS-3100 series: DGS-3100-24, DGS-3100-24P, DGS-3100-48 and DGS-3100-48P, Firmware version 2.x.x supports in addition the 5<sup>th</sup> SKU: DGS-3100-24TG.

Firmware version 2.x.x includes as well additional features comparing to version 1.x.x, for more details, please refer to the Release Notes.

When upgrading firmware from version 1.x.x to version 2.x.x on the switch, the user should upgrade the boot software as well from version 1.0.0.3 to version 1.0.0.4

### Upgrade Procedure – Important Notes:

**ACL backward compatibility issue** - In firmware 1.x.x, TCP/UDP ports of access profile are in hexadecimal instead of decimal values. In version 2.x.x, TCP/UDP port value entries are in decimal value. However - if the user upgrades the switch firmware from version 1.x.x to version 2.x.x, the value will be retained as hexadecimal value.

**ACLs access rules priority** did not work in firmware version 1.x.x. In firmware version 2.x.x, the priority is supported and it is not allowed two identical access rules priority from different access profiles. If the user download configuration file from version 1.x.x which including ACLs which has more than one rule, it might not work and there will be an error message. The user can delete and create the ACLs again if he encountered a problem.

**Tacacs/Radius backwards compatibility issue** - In firmware version 1.x.x, it is possible to configure up to 4 Tacacs /Radius servers. In firmware version 2.x.x, it is possible to configure up to 3 servers from each type. In addition to that it was not required to configure priority to Tacacs servers in 1.x.x while in 2.x.x it is required. If the user configured 4 servers in version 1.x.x and try to download the configuration to firmware 2.x.x, he will get an error message, the same event will happened because of the Tacacs priority.

The *Firmware Download Page* enables downloading files either via an HTTP or a TFTP server. To download Firmware:

1. Click  > **Firmware Download**. The *Firmware Download Page* opens:

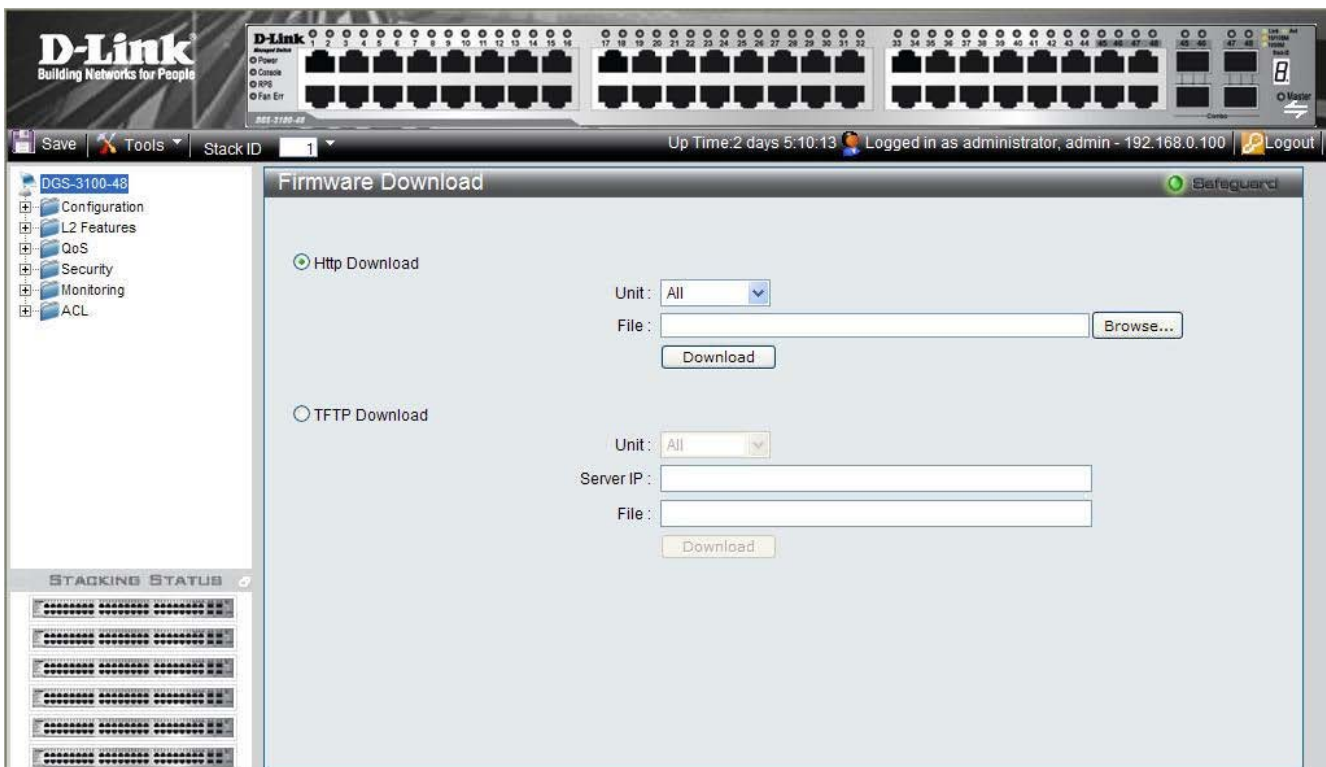

Figure 1-5. Firmware Download Page

The *Firmware Download Page* contains the following fields:

Field	Description
<b>HTTP Download</b>	Indicates that the Firmware file is downloaded via an HTTP server. <i>Unit</i> — Indicates if the Firmware file is downloaded to a specific stacking member or to All stacking members. <i>File</i> — Indicates the Firmware file that is downloaded to the stack or specific device.
<b>TFTP Download</b>	Indicates that the Firmware file is downloaded via a TFTP server. <i>Unit</i> — Indicates if the Firmware file is downloaded to a specific stacking member or to All stacking members. <i>Server IP Address</i> — Specifies the TFTP Server IP Address from which files are downloaded. <i>File</i> — Indicates the Firmware file that is downloaded to the stack or specific device.

2. Select *HTTP* or *TFTP* Download field.
3. Define the *Unit* field.
4. For *Http* download, define the *File* field, or alternatively, browse to select the file.
5. Click  . The Firmware is downloaded, and the device is updated.

## Rebooting the System

The *System Reboot Page* provides a method for selecting one, or all of the units to be rebooted. To reboot the system:

1. Click  > **System Reboot**. The *System Reboot Page* opens:

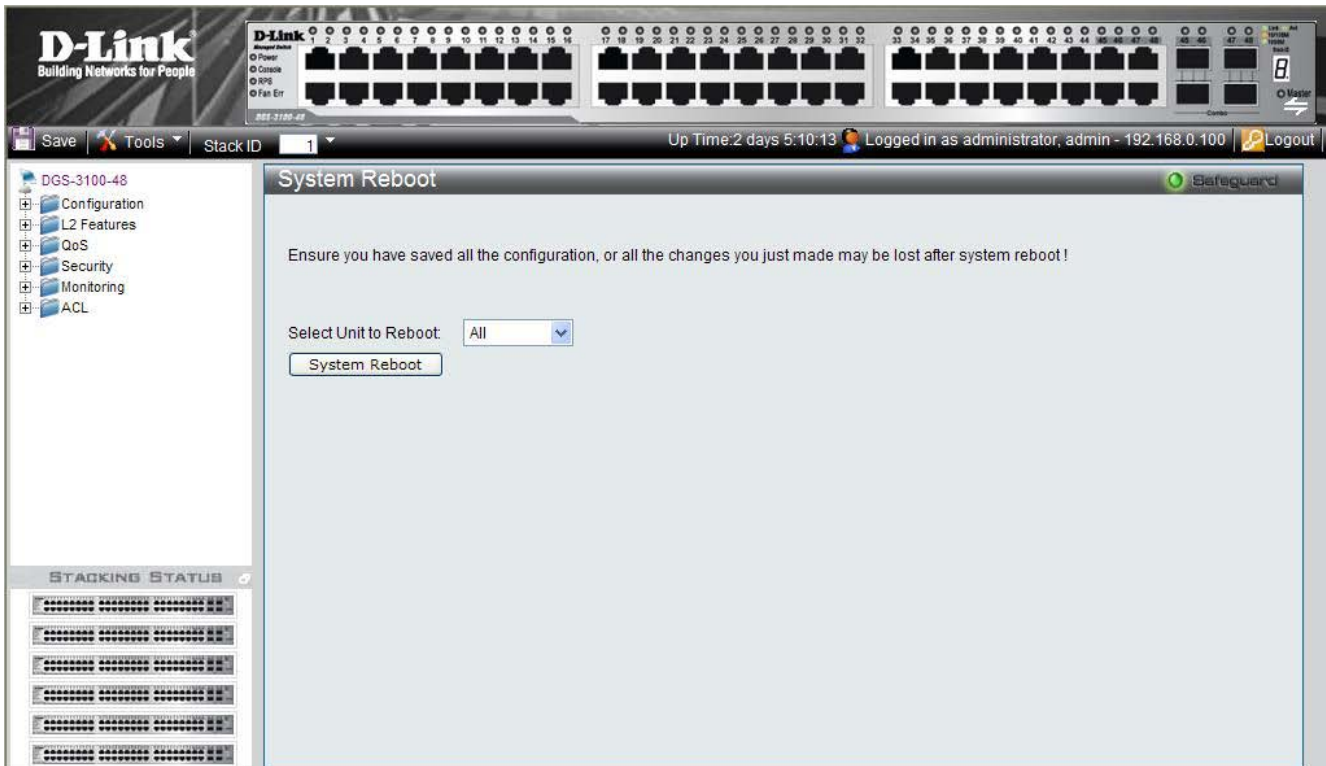

**Figure 1-6. System Reboot Page**



The System Reboot Page contains the Select Unit to Reboot field. The possible values are:

Value	Description
All	Reboots all stacking members.
01 - 06	Reboots the specific stack member.

2. Define the *Select Unit to Reboot* field.
3. Click . The selected unit(s) is/are rebooted.

## View/Add/Update/Delete User Accounts Using the Web System Components

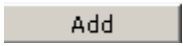
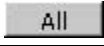
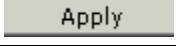
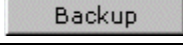
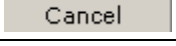
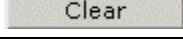
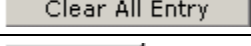
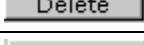
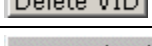
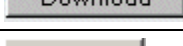
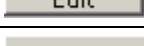
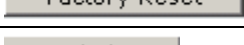
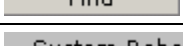
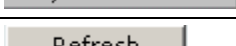
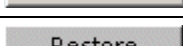
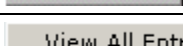
The following table contains information regarding the list of buttons:

Component	Name	Description
	Activate	Activates field commands
	Add	Adds selected items
	ALL	Selects all
	Apply	Applies field settings
	Backup	Evokes backup
	Cancel	Cancels settings
	Clear	Clears selected settings and fields
	Clear All	Clears all settings and fields
	Delete	Deletes selected fields
	Delete VID	Deletes VLAN Identification
	Download	Starts downloading system files.
	Edit	Modifies configuration Information
	Factory Reset	Resets the factory defaults
	Find	Finds a table entry.
	System Reboot	Reboot the system
	Refresh	Refreshes device information.
	Restore	Restores the specific configuration file.
	View All Entry	Displays table entries.

**Table 1-3. User Interface Buttons**

## 'User' Level Support on the WEB

R3.0 firmware release will support additional user level (in addition to "Operator" and "Admin") on the WEB GUI. The new level will be 'User' (level 1).

'User' will have access as reader without possibility to change configuration to most of the web pages, except the pages that controls the following functionality that will be blocked to 'user' level:

- Update Firmware
- Modify/Delete startup configuration
- Factory Reset
- View/Add/Update/Delete User Accounts

If the 'User' is trying to modify any configuration by pressing the 'Apply' button, the 'Access Denied' page will be displayed.

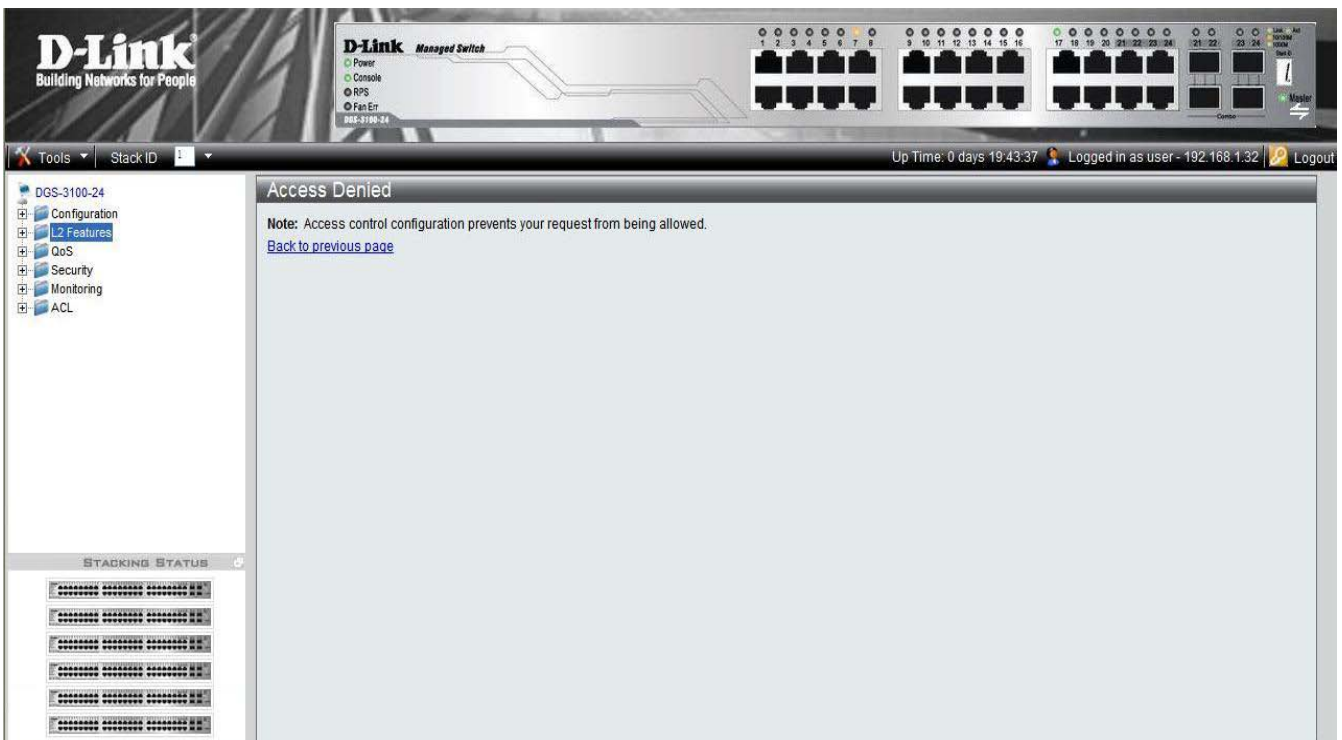

Figure 1-7. Access Denied Page

---

## CONFIGURING BASIC CONFIGURATION

This section contains information for viewing device information, defining IP addresses, managing stacking, defining port parameters, configuring system user accounts, configuring and managing system logs, defining the system time, and configuring SNMP system management. This section contains the following topics:

- Viewing Device Information
- Defining System Information
- Defining IP Addresses
- Managing Stacking
- Defining Ports
- ARP Settings
- Configuring User Accounts
- Managing System Logs
- Configuring Sntp
- Configuring SNMP
- DHCP Auto Configuration
- Dual Image Services
- Telnet Setting

## Viewing Device Information

The *Device Information Page* contains parameters for configuring general device information, including the system name, location, and contact, the system MAC Address, System Up Time, and MAC addresses, and both software, boot, and hardware versions.

In addition the *Device Information Page* provides shortcuts to device feature pages. To define the general system information:

- Click **DGS-3100-xx** in the Tree View. The *Device Information Page* opens:

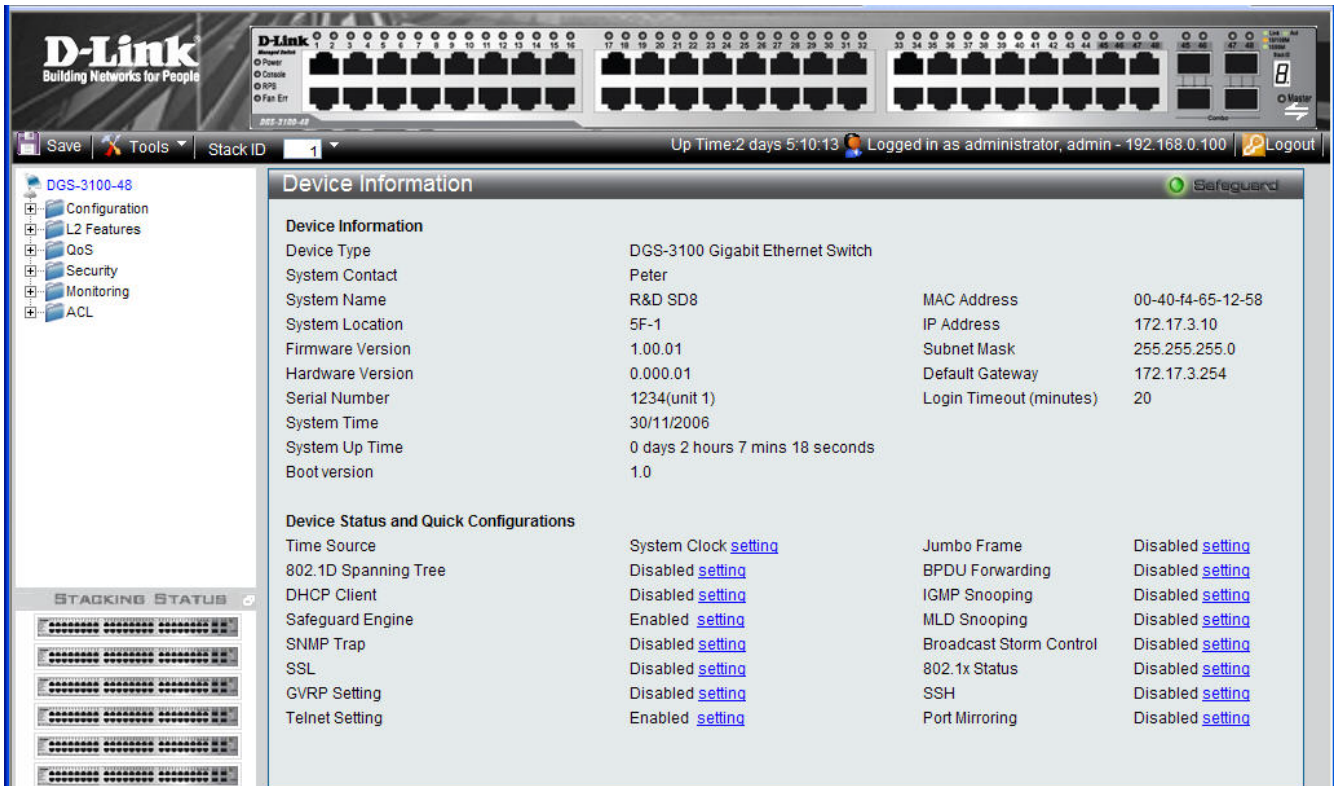

**Figure 2-1. Device Information Page**

The Device Information Page contains the following fields:

Field	Description
<b>Device Type</b>	Displays the factory defined device name and type.
<b>System Contact</b>	Displays the name of the contact person. The field range is 0-31 characters.
<b>System Name</b>	Displays the user-defined system name. The field range is 0-31 characters.
<b>System Location</b>	Displays the location where the system is currently running. The field range is 0-31 characters.
<b>Firmware Version</b>	Displays the installed software version number.
<b>Hardware Version</b>	Displays the installed device hardware version number.
<b>Serial Number</b>	Displays the installed device serial number.
<b>System Time</b>	Displays the system time. The field format is Day/Month/Year.
<b>System Up Time</b>	Displays the amount of time since the most recent device reboot. The system time is displayed in the following format: Days, Hours, Minutes, and Seconds. For example, 41 days, 2 hours, 22 minutes and 15 seconds.
<b>Boot Version</b>	Displays the installed device boot version number.



Field	Description
<b>MAC Address</b>	Displays the MAC address assigned to the device.
<b>IP Address</b>	Displays the IP address assigned to the device.
<b>Subnet Mask</b>	Displays the subnet mask assigned to the device.
<b>Default Gateway</b>	Displays the device default gateway assigned to the device.
<b>Login Timeout (minutes)</b>	Indicates the amount of time after which if no user activity occurs, the device times out. The default is 10 minutes.
<b>Time Source</b>	Provides a shortcut to viewing the system clock settings.
<b>802.1D Spanning Tree</b>	Indicates if STP is enabled on the device, and provides a shortcut to viewing the STP settings.
<b>DHCP Client</b>	Indicates if DHCP Client is enabled on the device, and provides a shortcut to viewing the DHCP Client settings.
<b>Safeguard Engine</b>	Indicates if the Safeguard Engine is enabled on the device, and provides a shortcut to viewing the Safeguard Engine settings.
<b>SNMP Trap</b>	Indicates if SNMP Traps are enabled on the device, and provides a shortcut to viewing the SNMP Traps settings.
<b>SSL</b>	Indicates if Secure Socket Layer (SSL) is enabled on the device, and provides a shortcut to viewing the SSL settings.
<b>GVRP Setting</b>	Indicates if Group VLAN Registration Protocol is enabled.
<b>Telnet Setting</b>	Indicates if Telnet is enabled.
<b>Jumbo Frame</b>	Indicates if Jumbo Frames are enabled on the device, and provides a shortcut to viewing the Jumbo Frames settings.
<b>BPDU Forwarding</b>	Indicates if BPDU Forwarding is enabled on the device, and provides a shortcut to viewing the BPDU Forwarding settings.
<b>IGMP Snooping</b>	Indicates if IGMP Snooping is enabled on the device, and provides a shortcut to viewing the IGMP Snooping settings.
<b>MLD Snooping</b>	Indicates if MLD Snooping is enabled on the device, and provides a shortcut to viewing the MLD Snooping settings.
<b>Broadcast Storm Control</b>	Indicates if Broadcast Storm Control is enabled on the device, and provides a shortcut to viewing the Broadcast Storm Control settings.
<b>802.1X Status</b>	Indicates if 802.1X is enabled on the device, and provides a shortcut to viewing the 802.1X settings.
<b>SSH</b>	Indicates if Secure Shell Protocol (SSH) is enabled on the device, and provides a shortcut to viewing the SSH settings.
<b>Port Mirroring</b>	Indicates if Port Mirroring is enabled.

To view settings for a device feature:

1. Select a device feature under the *Device Status* and *Quick Configuration Section*.
2. Click setting next to the feature name. The configuration page for the selected device feature opens.

## Defining System Information

The *System Information Page* provides device information about specific stacking members. To view system information:

1. Click **Configuration > System Information**. The *System Information Page* opens:

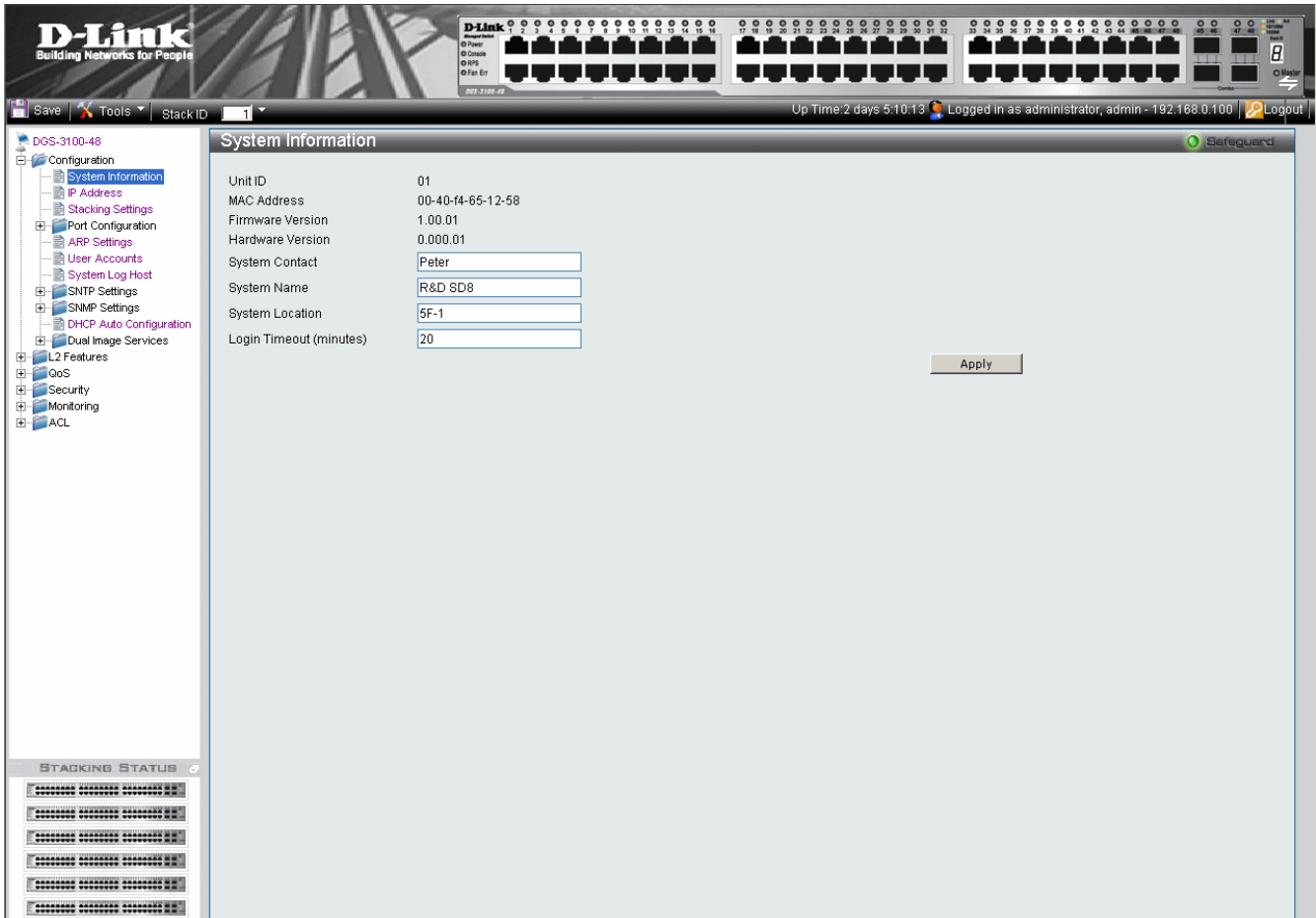

**Figure 2-2. System Information Page**

The System Information Page contains the following fields:

Field	Description
<b>Unit ID</b>	Displays the stack unit ID.
<b>MAC Address</b>	Displays the MAC address assigned to the device
<b>Firmware Version</b>	Displays the stacking member's software version number.
<b>Hardware Version</b>	Displays the stacking member's hardware version number.
<b>System Contact</b>	Defines the name of the contact person. The field range is 0-160 characters.
<b>System Name</b>	Defines the user-defined system name.
<b>System Location</b>	Defines the location where the system is currently running. The field range is 0-160 characters.
<b>Login Timeout (minutes)</b>	Defines the amount of time the device times out when no user activity occurs. The default is 10 minutes.

2. Define the *System Name* field.
3. Define the *System Location* and *Login Timeout (minutes)* fields.
4. Click **Apply**. The system information is defined, and the device is updated.

## Defining IP Addresses

The *IP Address Page* contains fields for assigning IP addresses. Packets are forwarded to the default IP when frames are sent to a remote network via the *Default Gateway*. The configured IP address must belong to the same IP address subnet of one of the IP interfaces. The *Dynamic Host Configuration Protocol (DHCP)* assigns dynamic IP addresses to devices on a network. DHCP ensures that network devices can have a different IP address every time the device connects to the network.

1. Click **Configuration > IP Address**. The *IP Address Page* opens:

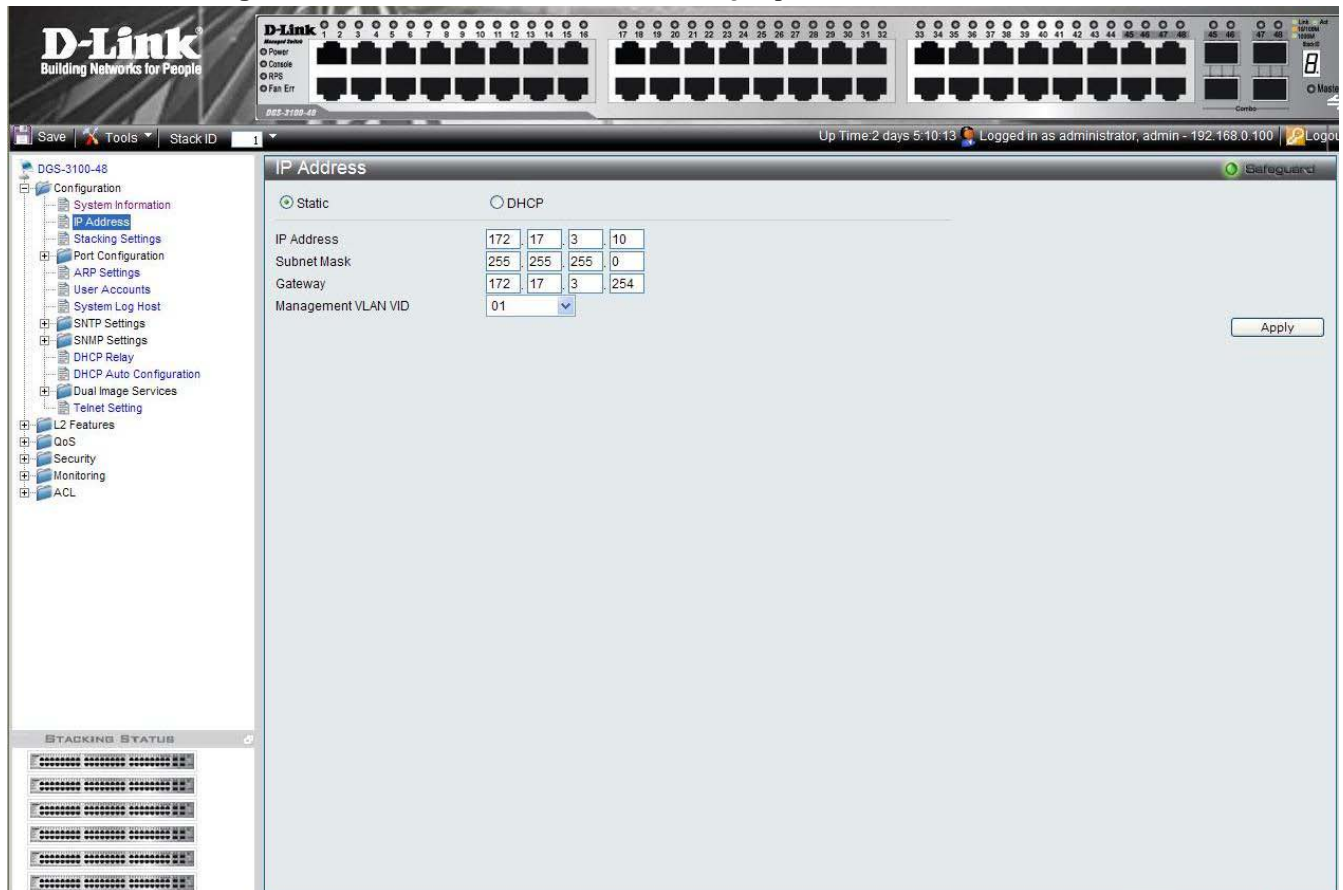

**Figure 2-3. IP Address Page**

The IP Address Page contains the following fields:

Field	Description
<b>Static</b>	When selected, the IP address is static and user-defined in the <i>IP Address</i> field. This is the default value.
<b>DHCP</b>	When selected, the IP address is retrieved from a DHCP server.
<b>IP Address</b>	Defines the IP address. This field is active if the IP address is static.
<b>Subnet Mask</b>	Defines the address mask that manages sub-netting on the network. The default value is 255.0.0.0.
<b>Gateway</b>	Defines the default gateway. The default gateway manages connections to other subnets and other networks.
<b>Management VLAN VID</b>	Defines the management VLAN's VID.

2. Select the IP address type in either the Static or DHCP fields.
3. If *Static* is the defined IP address type, define the *IP Address* field.
4. Define the *Subnet Mask*, *Gateway*, and *Management VLAN VID* fields.
5. Click **Apply**. The IP address information is defined, and the device is updated.

## Managing Stacking

Stacking enhances network flexibility by building virtual switches with more ports than are available in a single device. Stacks are managed by stacking member which called *Stack Master*. All other stacking members serve as ports only.

The following paragraphs provide a stacking explanation for DGS-3100 series and include the following topics:

- Managing Stacking Modes
- Advanced Stacking
- Building Stacks – Quick Start
- Stack Management Examples
- Configuring Stacking

## Managing Stacking Modes

A switch operates in the following modes:



NOTE: The DGS-3100 series family stacking connections have two HX ports.

- **Stacking** - Switches operating in Stack mode run as organized group of switches known as a Stack. A stack consists of one Stack Master, a Backup Master, and up to four Stack Member Switches. However, in specific scenarios, a single unit can be considered a *Stack of One*. A *Stack of One* is a single unit which is not connected to any other stacking members.

If the unit is reset to the factory defaults, the unit is reloaded in stacking Auto-Numbering mode.

## Advanced Stacking

This section provides information for understanding advanced stacking concepts, including:

- Unit ID and how they are allocated
- Stacking member start up process.

This section contains the following topics:

- Allocating Unit IDs
- Assigning Unit IDs

### Allocating Unit IDs

Switches are shipped from the factory without a Unit ID and in *Auto Assign* mode. All switches must be assigned a Unit ID before switches can operate as stacking members. More than one stacking member cannot receive the same Unit ID. Unit IDs are assigned by:

- Assigned by the system administrator. Unit IDs that are assigned by the system administrator and can only be changed manually by the system administrator.
- If the system administrator does not set the Unit IDs manually, the Auto Assign initializes the switches when they are powered up. From the switches who are automatically assigned a Unit ID, one of the stacking members is assigned the Unit ID 1. That stacking member is the Stack Master. If there were more than one switch in the stack, there is a Master Election and Backup Master Election process. Following the Master Election process, the other stacking members are assigned a Unit ID by the stack Master. For more information on the Master Election process, please see *Electing a Stacking Master*.

Stacking members maintain the assigned Unit ID even after the stacking member is rebooted. The Stack Master may reallocate IDs during system initialization to resolve duplicate ID conflicts. Manually assigned IDs cannot be changed by the Stack Master, even if there is a conflict.

Unit ID assignments or modifications are effective only during system initialization, and do not occur during the system up-time.

Stacking members do not have to be numbered in sequence, and can be interconnected, as long as each stacking has a unique ID, and at least, one stacking member serves as the Stack Master.

## Assigning Unit IDs

Each stacking member has an assigned unique Unit ID. Unit ID numbers are assigned as follows:

- **Unit ID 1** - Assigned to the Stack Master. The Stack Master is indicated by the Master LED on front which is lit solid green.
- **Unit ID 2** - Assigned to the Backup Master
- **Unit ID 3, 4, 5, and 6** - Assigned to Stacking members.



NOTE: There are cases in which a unit to which Unit ID 1 is assigned is not the stack Master but a Backup Master.

•

This section contains the following topics:

- Defining a Stacking Master
- Defining a Stacking Back Up Master
- Defining Stacking Members
- Master Enabled Stacking Members
- Electing a Stacking Master

### Defining a Stacking Master

The stacking member assigned the Unit ID1 operates as the *Stack Master*.

The Stack Master provides a single point of control, configuration, and management for the entire stack. In addition, the Stack Master stores all stack member configuration. The individual stacking members do not store any configuration information.

### Defining a Stacking Back Up Master

The stacking member assigned the Unit ID 2 is defined as the stack's Backup Master.

In addition to being a stack member, Backup Master serves as a backup in case the Stack Master fails or disconnected. If the Stack Master fails or disconnected, the Backup Master takes over as the Stack Master.

The Stack Master stores an active configuration which copied on the Backup Master. The active configuration copy is used if the Backup Master takes over for the Stack Master. Only the configuration file is copied. Any dynamically filled tables, for example, learnt address, are not copied from the Stack Master to the Backup Master. If the Backup Master takes over the role of Stack Master, the Backup Master builds new dynamic tables.

### Defining Stacking Members

Switches assigned the Unit IDs 3,4,5,6 are called stacking members. The Stack Master (or Backup Master if the Stack Master fails) manages the stack members operation. Stacking members cannot be directly managed or configured. If neither the Stack Master nor the Backup Master were operating, the stacking members cannot function.

### Master Enabled Stacking Members

Only Stacking members assigned to Unit ID 1 or 2 are called Master Enabled stacking members. Only the Master Enabled stacking members participate in the Master Election process, and therefore can become master or backup master (that means the s with assigned IDs of 3, 4, 5 and 6 can never become neither a master nor a backup master unless their ID is changed by the system administrator or reset to the factory default firstly).

### Electing a Stacking Master

Whenever a stacking member (or more than one) comes up, one of the stacking members is elected to be the stack Master. The Stack Master is selected as follows:

- If one of the master enabled stacking members in the stack was set to *Force Master* by the system administrator (through the GUI – Stacking Master selector), that master enabled stacking member is the Stack Master. Stacking

members which are defined as *Force Master* stacking members are manually selected as the Stack Master. Only a master enabled stacking member can be selected as the *Force Master*.

- If the stack contains more than one stacking member whose Unit ID is either 1 or 2, then one of the stacking members are elected the Stack Master. It does not matter if the Unit ID was originally automatically or manually assigned. These stacking members are called *Master Enabled*. If there is only one stacking member, that stacking member is selected as the Stack Master, even if the stacking member's Unit ID is 2. If there is a stacking member Unit ID 2 which up-time is 30 minutes and Unit ID 1's uptime is 19 minutes. The difference is 11, which is greater than 10 minutes, thus the Unit ID 2 is the elected Stack Master.
- If there are more than one stacking members, the two stacking members decide which stacking member is elected Stack Master by checking:
  - Which stacking member has been running for a longer time. The up-time is measured in increments of 10 minutes. The stacking member running the longest is the elected Stack Master.
  - If they have been running for the same amount of time, the stacking member with the Unit ID 1 is the stack Master.
  - If both stacking members have been running for the same amount of time, and both stacking members have the same Unit ID, the stacking members with the lowest MAC address is selected as the Stack Master. The other unit is rebooted and is assigned the Unit ID 2.
  - If the stack contains one or more stacking members set to the factory default states, and there is no Unit ID assigned to a stacking member, then the Stack Master is one of these stacking members. The stacking member selected to be the Master is the stacking member running for the longest time. If all stacking members are running the same amount of time, the stacking member with the lowest MAC address is selected as the Stack Master.

The Master Election results in an elected Stack Master. The Stack master has a Unit ID of 1 and the Backup Master has a Unit ID of 2 (if a Backup Master was included in the stack).

If a Master Enabled stacking member, a Unit ID of 1 or 2, is added to a stack and powered on, the newly added switch invokes Master Election process. The Master Election process occurs even though the stack has an elected master. However, the newly added switch loses in the election process (lower up-time) and joins the stack as a stacking member or Backup Master.

## Stack Startup Process

When a stacking member is initialized, either powered up or rebooted, the stacking member goes through the same exact process including:

- Discovering the Stacking Master.
- Allocating Unit IDs/Resolving Unit ID Conflicts
- Unit and Stacking Port Configuration

### Discovering the Stacking Master

When a stacking member is initialized in stack mode, the stacking member's behavior depends on its Unit ID.

- If the stacking member does not have a current Unit ID the stacking member operates in *Factory Default* mode. If there is a Stacking Master, the stacking member is assigned a Unit ID through Unit ID Allocation. The stacking members receive a Unit ID from the Stacking Master. If the stack does not have a Stacking master then the switch participates in Master-Election, and may be elected either the new Stacking Master or Backup Master.
- If the stacking member's current Unit ID is 1 or 2, the stacking member participates in the Master Election. For example, the Unit ID was previously allocated, or the stacking member was in a different stack.
- If the stacking member has a current Unit ID the stacking members attempts to use the Unit ID in the new stack. If the stacking member current ID is 3, 4, 5, or 6, then the stacking members attempts to connect to the running Stack Master. The new stacking member does not proceed to the next stage until there is contact with the Stack Master. These stacking members do not participate in the *Master Election* process, and if no Stack Master is present, the stacking members' network ports are shut down. Only the stacking ports are operational.

Both the Stack Master and all other stacking members carry out a continuous process of *Master Discovery* by frequently exchanging stack control messages. This allows the stacking members to discover when a stacking member fails or is unreachable.

## Allocating Unit IDs/Resolving Unit ID Conflicts

Once the Stack Master is elected, it allocates the Unit IDs to the stacking members that do not have a Unit ID. Stacking members that do not have a Unit ID operate in the *Factory Default* mode.

In addition, the stack Master attempts to resolve all duplicate Unit IDs occurrences among stacking members. The Stack Master reallocates the duplicate Unit ID if there are available Unit IDs.

If two stacks are merged, stacking units that were initially in the Stack Master's sub-group retain their Unit ID. New stacking member are allocated new Unit IDs.

If a conflict occurs after the stacking members are rebooted, the following occurs:

- If both duplicate stacking members are in *Auto Assign* mode, then the Unit ID is assigned by the MAC address. The stacking member with the lowest MAC address maintains its Unit ID. The other stacking member is assigned a new Unit ID.
- If one of the stacking members with duplicate Unit IDs is in *Auto Assign* mode and the other stacking member is in manual mode, the stacking member in *Manual* mode maintains its Unit ID, The other stacking member is assigned a new Unit ID. .

Stacking members are shut down if:

- If both duplicate stacking members are in *Manual* mode then both stacking members are *shut down*.
- If the Stack Master is able to allocate a Unit ID to each stacking member, then all stacking members operate as a stack. If the Stack Master is unable to allocate a Unit ID to any stacking member, that stacking member is effectively *shut down* and does not participate in the stack.
- Stacking members with a conflicting manually set ID are shut down as the Stack Master cannot override the system administrator's Unit ID assignment to resolve the conflict.
- If there are more stacking members than the maximum number allowed in a stack, and the incoming stacking members are already in *Factory Default* mode, the Stack Master is elected following *Master Discovery* and *Master Election* processes. All other stacking members are shut down in some extreme cases, due to during the boot process, where some stacking members may be connected and join the stack. If the new stacking members are already assigned a Unit, then the new stacking members cannot join the stack. The switches are remains shut down.

If a stacking member is shut down, the stacking members stacking links are inactive. Moreover, if the stacking members are connected in a chain topology, the shut down of one stacking member breaks the chain. This may cause other stacking members to be disconnected and shut down if the stacking members have no active link to the Stack Master.

## Unit and Stacking Port Configuration

Each stacking member has a Unit ID; one of the stacking members is the stack Master, and, possibly, one of the stacking members serves as Backup Master. The Stack Master now configures each stacking member according to the Configuration file stored on the Stack Master.

If the stack has a Backup Master the Configuration file are also be copied to the Backup Master.

Once all the stacking members are configured, the stack proceeds to a normal operational mode. If any change is made to the system configuration, the change is stored by the stack Master and is copied to the Backup Master.

## Building Stacks – Quick Start

The DGS-3100 series supports the following stacking scenarios:

- Building a new stack from scratch
- Increasing the stack by adding units to an existing stack

This section contains the following topics:

- Stack Resiliency
- Managing a Self-Ordered Stack
- Managing a New Manually Ordered Stack

### Stack Resiliency

Topologies of stack can be either Ring or Chain. Best practice is to configure the stack in Ring topology, due to the high resiliency in case of unit failure or stacking link failure.

Additionally, in case of redundant power supply usage it is recommended to make sure that Master and Backup Master s are connected to a redundant power supply.

### Managing a Self-Ordered Stack

This section describes managing a self-ordered stack. Self-ordered stacks are automatically assigned Unit IDs by the system through the Master Election process. This section contains the following topics:

- Building a New Self-Ordered Stack
- Adding Members to a Self Ordered Running Stack

#### Building a New Self-Ordered Stack

To build a self ordered stack:

1. Connect the units physically through the stacking ports.
2. Turn on the units. After a short interval the stack will become operational with one of the units selected as the Master of the stack. The Master and Backup selection is known as *Master Election*. Master Election takes place if there are one or more eligible candidates contending to be the Master unit. The Master Unit is indicated by the green Master LED on the front panel. The Master LED is located near the Unit ID LEDs. If a serial console is connected, the serial cable must be connected to the Stack Master console port since the only operational console port in the stack is the one of the Master unit.



**NOTE:** To reset the stacking members to the factory defaults, press the Reset button for at least 5 seconds.

#### Adding Members to a Self Ordered Running Stack

1. Reset the new stacking units to the factory defaults by pressing the Reset button (optional).
2. Connect the stacking members physically to the stack.
3. Turn on the switches, the new units will become stacking members.

### Managing a New Manually Ordered Stack

System administrator can also manually assign Unit IDs to stacking members. System administrator has to assign a unique Unit ID from 1 to 6 to each stack member.

A Unit ID that is manually assigned is not subject to automatic numbering. The Unit IDs are assigned as follows:

- **Unit ID 1** – Assigned to the Stacking Master. The Stack Master is indicated by the Master LED on front which is lit solid green.
- **Unit ID 2** - Assigned to the Backup Master



- **Unit ID 3 4, 5, 6** –Assigned to the Stacking member.

This section contains the following topics:

- Building New Manually Ordered Stacks
- Adding Stacking Members to an Existing Manually Ordered Stack

### Building New Manually Ordered Stacks

To build new a self ordered stack:

1. Connect the units physically through the stacking ports.
2. Turn on the units, one at a time.
3. Assign the Stack Master the Unit ID of 1 using a Stack Management Interfaces either the console port, Telnet, or Embedded Web Interface.
4. Assign the Backup Master the Unit ID of 2 using a Stack Management Interfaces either the console port, Telnet, or Embedded Web Interface.
5. Assign the remaining stacking members using a Stack Management Interfaces either the console port, Telnet, or Embedded Web Interface.
6. Ensure that none of the stacking members have the same Unit ID.
7. Reboot all the stack units.

### Adding Stacking Members to an Existing Manually Ordered Stack

To add units to an existing manually ordered stack:

1. Reset the new stacking units to the factory defaults by pressing the *Reset* button.
2. Connect the stacking members physically to the stack.
3. Turn on the switches, the new units become stacking members, but with automatically assigned Unit IDs.
4. Reassign the Unit ID manually to each of the newly added stacking members using a Stack Management Interfaces either the console port, Telnet, or Embedded Web Interface. This step is optional, and the stack is operational even if some unit IDs were manually configured while others are self-assigned.
5. Reboot the stacking members to ensure the Unit ID is permanent.

## Stack Management Examples

This section contains information for troubleshooting stacking, and includes the following topics:

- Replacing Failed Stacking-Members in a Running Stack
- Replacing a Failed Stack Master
- Dividing Stacks
- Merging Stacks
- Stacking Cable Failure
- Inserting Excess Stacking Members

### Replacing Failed Stacking-Members in a Running Stack

This example assumes that a stacking member, other than master, has failed in a running stack, when the system administrator is notified of the system failure the stacking member is removed and replaced with a new switch.

When the stacking member fails, the Stack Master identifies the failed stacking member using the *Master Discovery* process. The Stack Master recognizes that the stacking member no longer responds. If the stack topology was ring topology, the Stack Master directs all other stack members to route traffic around the failed stacking member. At the same time the Stack Master notifies the system administrator of the failure using SYSLOG messages and SNMP traps.

When the failed stacking member is disconnected from the stack, all traffic is routed around the failed stacking member as stated above. As long as all other stacking connections are intact, the stack continues to run.

When a new stacking member is inserted and the stack is powered up, the following occurs:

- The new stacking member which is in stacking mode, performs the *Master Discovery* process, and perhaps participates in a *Master Election* .For more information on the Master Election process, see *Electing a Stacking Master*.

- If the new stacking member has a Unit ID of 1 or 2, i.e. the stacking member is a master enabled unit, the new stacking member initiates the Master Election process. However, since the running Stack Master has a longer up-time, it remains the Stack Master and the new stacking member does not become a new Stack Master.
- If the new stacking member has a Unit ID of 3 to 6, the new unit attempts to become a stacking member, and is subject to the already running Stack Master. The Master Election process does not occur.
- The Stack Master performs a Unit ID Allocation and Conflict Resolution process.
  - If the new stacking member was in Factory Default mode (the unit does not have an assigned Unit ID). The new stacking member is assigned the lowest available Unit ID by the Stack Master. It is strongly recommended that automatic assigned Unit ID mode be used since it provides improved stack resiliency.
  - If the new stacking member already has an assigned Unit ID, and that Unit ID is unused in the current stack, the new stacking member retains its assigned Unit ID. The Stack Master applies any configuration relevant to that Unit ID.
  - If the new stacking member already has an assigned Unit ID, and that Unit ID conflicts with an existing Unit ID the Stack Master reallocates a new Unit ID to the new stacking member. , The lowest available Unit ID is applied to the new stacking member. This occurs only if new stacking member does not have a manually assigned Unit ID, which the Stack Master cannot change.
  - If the new stacking member cannot be assigned an available Unit ID, then the new stacking member is effectively shut down and cannot join the stack. For example, the stacking member replacement can only occur if the new stacking member has a manually assigned Unit ID.
- The Stack Master now performs *Unit and Stacking Port Configuration* for the new stacking member.
- Any configuration information which the Stack Master stores that is relevant to the Unit ID is assigned to the new stacking member. If the new stacking member was assigned the same Unit ID of the replaced stacking member, then the new stacking member receives the same configuration as the failed stacking member. If the new stacking member is identical to the replaced stacking member, the entire configuration of the replaced stacking member is applied to the new stacking member. The stack reverts to the stacking state it was running in before stacking member failed. However, sometimes the new stacking member is not identical to the failed stacking member. The Stack Master applies the configuration as follows:
- If a 24-port switch replaces a failed 48-port switch, then the new stacking member's ports are configured according first 24 ports configuration of the failed stacking member.



NOTE: The 48 port configuration of the failed stacking member is recorded, even though only the first 24 port configuration is currently applied. If a 48 port switch is inserted and assigned the same Unit ID, the switch is configured with the port configuration of the original 48 port stacking member.

- If a 48-port stacking member replaces a 24-port stacking member, then the first 24 ports of the new stacking member are configured according failed stacking member's ports configuration. The remaining new stacking member ports are configured with the switch's default settings.

## Replacing a Failed Stack Master

This example assumes that a stacking member acting as the Stack Master has failed in a running stack. When the system administrator is notified of the Stack Master failure and replaces existing Stack Master with a new switch.

When the Stack Master fails, the stack's Backup Master recognizes the failure and that the Stack Master no longer responds and assumes the role of Stack Master. The Backup Master uses Master Discovery process to identify the failure. In case of Ring topology the Backup Master directs all other stack members to route traffic around the failed stacking member. At the same time the Backup Master notifies the system administrator of the failure using SYSLOG messages and SNMP traps.

When the failed stacking member is disconnected from the stack, all traffic is already routed around the failed stacking member. If all other stacking connections are left intact, the stack keeps running. When a new stacking member is inserted and powered up, the following occurs:

- The new stacking member performs *Master Discovery* process, and participates in a Master Election process. For more information on the Master Election, see *Electing a Stacking Master*.
  - If the new stacking member has a Unit ID of 1 or 2, i.e. the stacking member is a master enabled; Master Election process is initiated. Since the running stack Backup Master has a longer run time and if the Backup Master has been running for more than 10 minutes, the Backup Master remains the elected Stack Master. The new stacking member does not become the new Stack Master. This may result in new stacking member using

Unit ID 1, and serving as the stack Backup master, while the already running stacking member with Unit ID 2 remains the active Stack Master.

- The Stack Master performs Unit ID Allocation and Conflict Resolution process.
  - If the new stacking member is in the *Factory Default* mode, the new stacking member is assigned the lowest available Unit ID by the Stack Master. It is strongly recommended that *Auto Assign* mode is used to assign the Unit ID. The *Auto Assign* mode provides better stack resiliency.
  - If the new stacking member already has an assigned Unit ID, and that Unit ID is unused in the current stack, the incoming stacking member is assigned Unit ID. The Stack Master applies any device configuration to the new stacking member.
  - If the new stacking member already has an assigned Unit ID, and that UnitID conflicts with an existing Unit ID the Stack Master reallocates a new Unit ID to the new stacking member. The lowest available Unit ID is applied to the new stacking member. This occurs only if new stacking member does not have a manually assigned Unit ID, which the Stack Master cannot change.
  - If the new stacking member cannot be assigned an available Unit ID, then the new stacking member is effectively shut down and cannot join stack. For example, if stacking member replacement that can only occur if the new stacking member has a manually assigned Unit ID.
- The Stack Master performs Unit *and Stacking Port Configuration* for the new stacking member.
- Any configuration information the Stack Master retains that is relevant to the Unit ID of the new stacking member is applied. If the new stacking member was assigned the same Unit ID of the replaced stacking member, then the new stacking member receives the same switch configuration as the failed stacking member, described in *Replacing Failed Stacking-Members in a Running Stack*.

## Dividing Stacks

This example assumes that a working stack is divided into two groups. The stack is divided either by a failed stacking link connected to two stacking members in the stack or by a failed stacking members in a chain topology which causes disconnection between two units in the stack. In this case we should consider each sub-group as an independent running stack configuration. For each sub-group we should consider three sub options:

- Both the Stack Master and the Backup Master are part of the sub-group.
- Either the Stack Master or the Backup Master is part of the sub-group.
- Neither the Stack Master nor the Backup Master is part of the sub-group.

When a stack is split into two parts, the following occurs in each partial stack according to the following scenario:

Both the Stack Master and the Backup Master are part of the sub-group.

Nothing changes, except the Stack Master recognizes the missing stacking members as removed stacking members and routes traffic around them.

Since both the Stack Master and Backup Master are in this stacking section, this section is operating and the other section cannot operate.

The following occurs when the stack is divided and both the Master and Backup master are in the sub-group:

- The Master Discovery, Master Election and Unit ID Allocation & Duplicate Unit ID Conflict Resolution processes are performed, resulting in the following:
  - Any configuration information stored by Stack Master, which remained in the group, that is relevant to the stacking members remains unchanged.
  - Topology information, inter-stacking member forwarding information for transmitting traffic to any other stacking member, managed by the Stack Master includes only stacking members that remain connected after the stack is divided.
  - The divided stack continues to operate normally, the only difference is there are less stacking members than prior to the stack division.
  - No Unit ID changes are performed in each divided stack.
  - The Stack Master notifies the system administrator using SYSLOG messages and SNMP traps of the removed stacking members. In addition the Stack Master also notifies the system administrator whichd ports belong to unreachable stacking members and are reported as *Not Present*.
- Either the Stack Master or the Backup Master remain in the divided group

- If the Stack Master remains in this sub-group, the behavior is the same as described above. If the Backup Master remains in this sub group the behavior is the same as described in 0 - *Replacing a Failed Stack Master* .



**NOTE:** If a stack is divided into two parts with one section which containing the Stack Master, and the other section - Backup Master was operate.

The following occurs if either the Stack Master or the Backup Master remains in the divided group:

- The *Master Discovery*, *Master Election* and *Unit ID Allocation & Duplicate Unit ID Conflict Resolution* processes are performed, resulting in the following:
  - When the stack is divided and if the Stack Master remains in the split stack, the Stack Master recognizes that the stacking units were no longer responds. This occurs using the *Master Detection Process*. The Stack Master notifies the system administrator using SYSLOG messages and SNMP traps of the removed stacking members. In addition the Stack Master also notifies the system administrator whichd ports belong to unreachable stacking members and are reported as *Not Present*.
  - if the Backup Master remains in the split stack, when the stack is divided, the Backup Master identifies this as of the Stack Master failing. The Backup Master takes over and manages the remaining stacking members as a stack. The Backup Master retains the same Unit ID as before the stack was divided. Since the Backup Master was not acting as the Stack Master prior to the split, the Back Master initiates a Topology Database and port learning process. Traffic can be halted for a short period until the stack is synchronized, i.e., stacking member and port configuraiton is completed. New stacking members are learnt by the Backup Master are notified to the system administrator using SYSLOG messages and SNMP traps.
  - The divided stack continues to operate normally, the only difference is there are less stacking members than prior to the stack division.No Unit ID changes are performed in each the divided stacks.
  - Even if each stacking section has a Stack Master, one section retains the Stack Master and the other section the Backup Master, both stacks have the same configuration and the same IP address.



**NOTE:** If both stacks have the same IP Address, this can lead to network problem. There is no way for users to connect to any stacks through the stack IP address

If neither the Stack Master nor the Backup Master remain in the divided group.

- This is identical to failed Stack Master, where no backup is available.
- Stacking members whose Unit IDs are 3, 4, 5 or 6 in original stack do not renumber themselves. The stacking members' network ports remains shut down until a Stack Master is enabled, is connected and is operating as the Stack Master .The Master-Discovery process recognized that the Stack Master has been separated from the stack.
- The stacking members lose connection with the Stack Master. Since the stacking members started as a running stack, and the stacking members are not in the *Factory Default Mode*, the stacking members are not reassigned Unit IDs. Resetting the stacking members will initiate Unit ID auto-assignment. No Unit ID changes are performed in each one of the two stacking sections of the original stacks.



**NOTE:** None of the stacking members in either stacking sections can remember themselves.

## Merging Stacks

This example assumes that the user would like to merge two working stacks. This creates one stack from two separate stacks. There are two scenarios:

If new stacking members are powered down during insertion and then powered up

- This is identical to insert stacking members into a running stack, see *Replacing Failed Stacking-Members in a Running Stack*. The only difference is that an additional stacking member is inserted into the stack. Therefore, for each stacking member inserted the same process occurs.

If stacks being merged are connecting via stacking cables and, both stacks are running the following occurs:

- If each of the joined stacks has a Stack Master, both Stack Masters perform the *Master Discovery* process. Both Stack Masters participate in the *Master Election* process. One Stack Master is selected as the Stack Master. The criteria for selecting a Stack Master in a merged stack as follows:
  - Force Master
  - System Up Time
  - Lowest Unit ID
  - Lowest MAC Address
- The process of master selection between two Stack Masters is as follows:
  - If Force Master is enabled, then the Stack Master which was forced is selected.
  - The *System Up Time* is measured in increments of 10 minutes. The Stack Master with longest System Up Time is selected as Stack Master.
  - If both Stack Masters have the same *Up Time*, the Stack Master with the lowest Unit ID is selected as Stack Master.
  - If both Stack Master Unit IDs are equal the Stack Master with the lowest MAC address is selected.
  - The Master Election process assigns a dynamically allocated Unit ID. Reassignment of Unit ID to the other Stack Master and is performed by the new Stack Master. The switch is either allocated as a stack member or the Backup Master. There cannot be two stacking members with the same Unit ID at the process end.
  - The Stacking Master that loses the Master election process is shut down if the Unit ID was manually allocated. It is recommended that the administrator configure the switch to *Auto Assign* mode before reconnecting the switch to the stack.
  - When two stacks are combined, all of the configuration information for one of the stacks is lost. After the discovery/election process is completed, only the new Stack Master maintains its configuration information.
  - If one of the merged stacks had neither a Stack Master unit nor a Backup Master, then stacking members belonging to this group are inserted into the stack as in *Replacing Failed Stacking-Members in a Running Stack*. The Stack Master either connects stacking members to the stack using the current Unit IDs or reallocates the Unit IDs necessary. For more information see *Replacing Failed Stacking-Members in a Running Stack*.

If two stacks are merged into one stack, both stack configuration cannot be maintained. All stacking member's dynamic information that belong to the portion of the stack that was not reelected is lost and the new Stack Master relearns the information.

## Stacking Cable Failure

This example assumes that *Stacking Connection Cables* failed and caused the stack to split, as described in *Dividing Stacks*. When the stacking cable connection is fixed and stacking members are reconnected, it results in merging two stacks as described in *Merging Stacks*.

This can be occurred only if the topology of the stack is *Chain* topology. Single stacking cable failure does not cause a stack split if a *Ring* topology is used.

## Inserting Excess Stacking Members

This example assumes that the user attempts to insert too many stacking members into a stack.

- All stacking members (existing and newly inserted) are powered on at the same time:
  - A Stack Master is elected following *Master Discovery* and *Master Election* processes.
  - All excess stacking members are shutdown.

- A running stacking member group is added to an existing stack, assuming each one of the stack groups has an elected Stack Master. The total of existing stacking members and new stacking members exceeds the maximum allowed number of stacking members in a stack, which is 6 stacking members:
  - *Master Detection* and *Master Election* processes determine the master out of one of two combined stacking groups.
  - When switches are added to a running stack, the *Unit ID Allocation and Duplicate ID Conflict Resolution* process detects an error if too many switches are present in the stack, and no changes are to stacking members that originally belonged to the group managed by the newly elected master. The original switches retain their ID assignments and configurations. The stacking members that originally belonged to the group managed by the Stack Master that lost the Master Election process are shut down.

## Configuring Stacking

The *Stacking Settings Page* allows network managers to execute force master and to change each and every unit its own unit ID. To complete the changing process the user need to reboot the unit.

1. Click **Configuration > Stacking Settings**. The *Stacking Settings Page* opens:

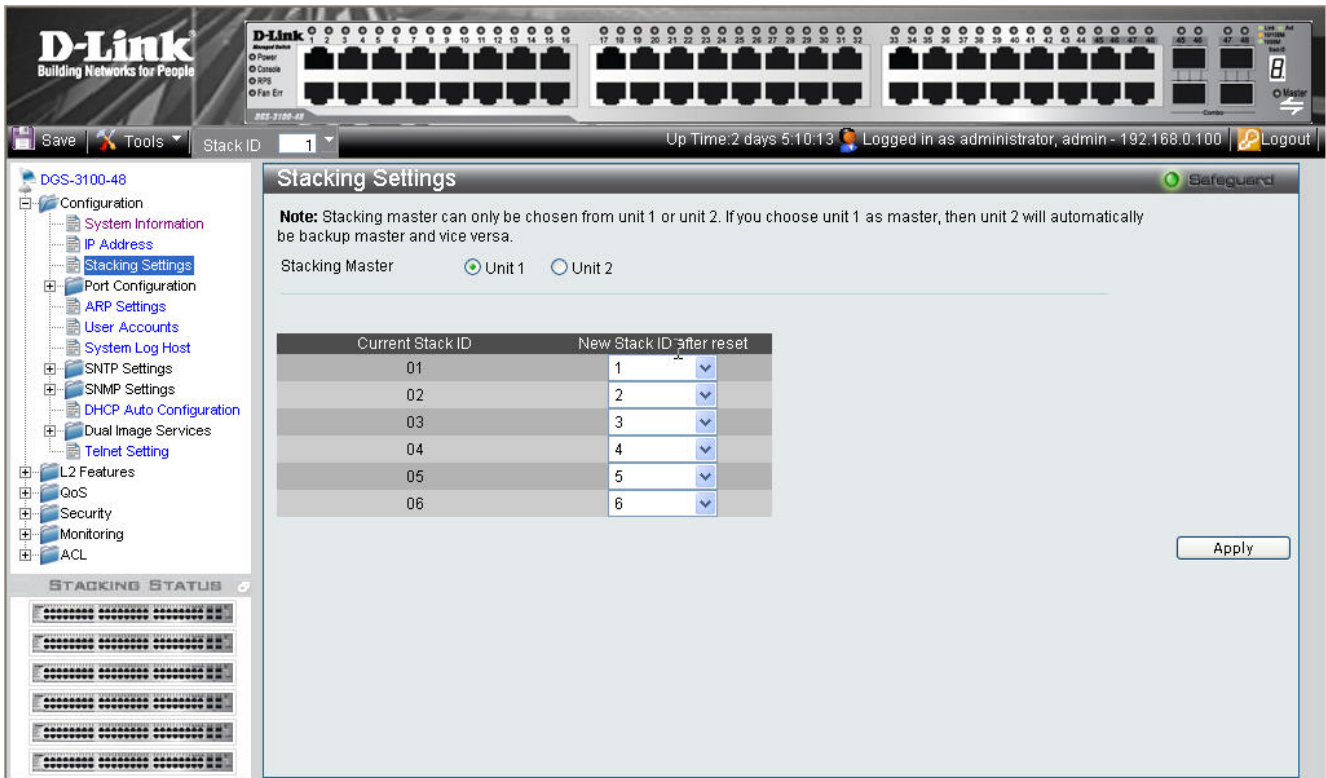

**Figure 2-4. Stacking Settings Page**

The Stacking Settings Page contains the following fields:

Field	Description
<b>Stacking Master</b>	Defines the stacking member with either stacking ID of 1 or 2 as the Stacking Master. The possible field values are:  <i>Unit 1</i> — Defines the member with the Unit ID 1 as the Stacking Master if unit ID 2 will be selected unit ID 1 will be reboot and ID 2 will become stack master.  <i>Unit 2</i> — Defines the member with the Unit ID 2 as the Stacking Master if unit ID 1 will be selected unit ID 2 will be reboot and ID 1 will become stack master.
<b>Current Stack ID</b>	Displays the Stacking Member ID that the new Unit ID will replace after the device is reboot.
<b>New Stack ID after reset</b>	Defines the unit ID assigned to the Stacking Member after the device reboot.

2. Select the Stacking Master in the *Stacking Master* field.
3. Select a Unit ID in the *New Stack ID after reboot* field.
4. Click **Apply**. If force master was selected then current master will be rebooted. If unit ID was change then the changes will be applied and occur after the reboot.

## Defining Ports

- Configuring Port Properties
- Viewing Port Properties

## Configuring Port Properties

The *Port Setting Page* contains parameters for configuring port or LAG properties. Gigabit ports operate in full duplex mode only, and take on certain characteristics that are different from the other choices listed. The copper ports also support auto MDI/MDIX for cross over cables.

To define port parameters:

1. Click **Configuration > Port Configuration > Port Setting**. The *Port Setting Page* opens:

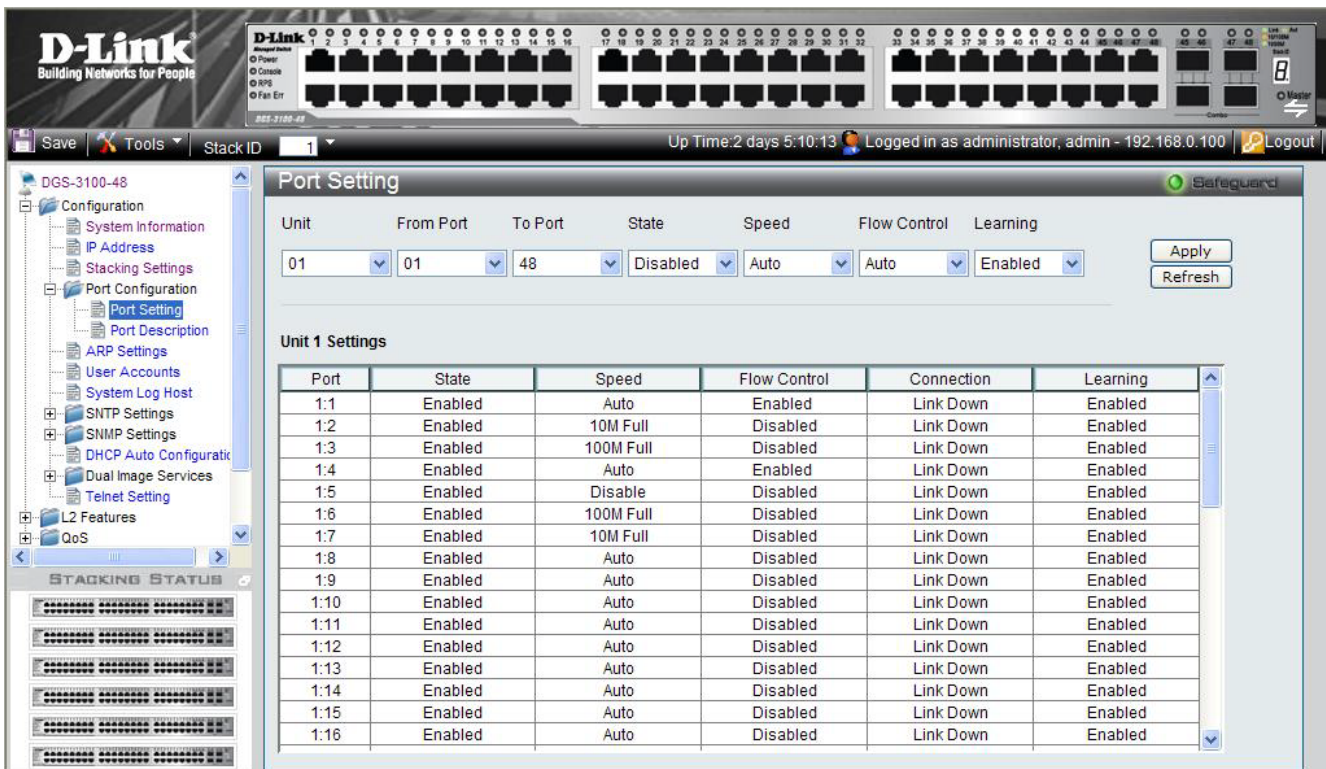

Figure 2-5. Port Setting Page

The Port Setting Page contains the following fields:

Field	Description
<b>Unit</b>	Defines the stacking member or LAG for which the port settings are displayed.
<b>From Port</b>	Defines the port number from which the port configuration will apply.. This field appears only if a unit number is selected in the Unit field.
<b>From LAG</b>	Defines the LAG number from which the port configuration will apply. This field appears only if LAG is selected in the Unit field.
<b>To Port</b>	Defines the port number to which ports the configuration will apply. This field appears only if a unit number is selected in the Unit field.
<b>To LAG</b>	Defines the LAG number to which the port configuration will apply. This field appears only if LAG is selected in the Unit field.
<b>State</b>	Defines whether the interface interface is currently operational or non-operational. The possible field values are:



Field	Description
	<p><i>Enabled</i> — Indicates that the interface is currently receiving and transmitting traffic.</p> <p><i>Disabled</i> — Indicates that the interface is currently not receiving and not transmitting traffic. This is the default value.</p>
<b>Speed</b>	<p>Defines the configured rate for the interface. The port rate determines what speed setting options are available. The possible field values are:</p> <p><i>10M/Full</i> — Indicates the interface is currently operating at 10 Mbps and full duplex mode.</p> <p><i>10M/Half</i> — Indicates the interface is currently operating at 10 Mbps and half duplex mode.</p> <p><i>100M/Full</i> — Indicates the interface is currently operating at 100 Mbps and full duplex mode.</p> <p><i>100M/Half</i> — Indicates the interface is currently operating at 100 Mbps and half duplex mode.</p> <p><i>1000M/Full</i> — Indicates the interface is currently operating at 1000 Mbps and full duplex mode.</p> <p><i>Auto</i> — Indicates the interface is automatically configured to the fastest network traffic the interface can manage.</p>
<b>Flow Control</b>	<p>Defines the flow control scheme used for the various port configurations. Interface configured for full-duplex use 802.3x flow control, half-duplex interfaces use backpressure flow control, and <i>Auto</i> interfaces use an automatic selection of the two. The default is <i>Disabled</i>.</p>
<b>Learning</b>	<p>Defines whether MAC address learning is enabled on the ports. The possible field values are:</p> <p><i>Enabled</i> — Enables MAC address learning on the interface. If MAC address learning is enabled, the source and destination MAC address are recorded in the Forwarding Table. (This is the default value)</p> <p><i>Disabled</i> — Disables MAC address learning..</p>

2. Define the *Unit*, *From Port* or *From LAG t*, *To Port* or *To LAG*, *State*, *Speed*, *Flow Control*, and *Learning* fields.
3. Click . The port configuration is saved, and the device is updated.

## Viewing Port Properties

The *Port Description Page* allows network managers provide a description of device ports. To define a port description:

1. Click **Configuration > >Port Configuration > Port Description**. The *Port Description Page* opens:

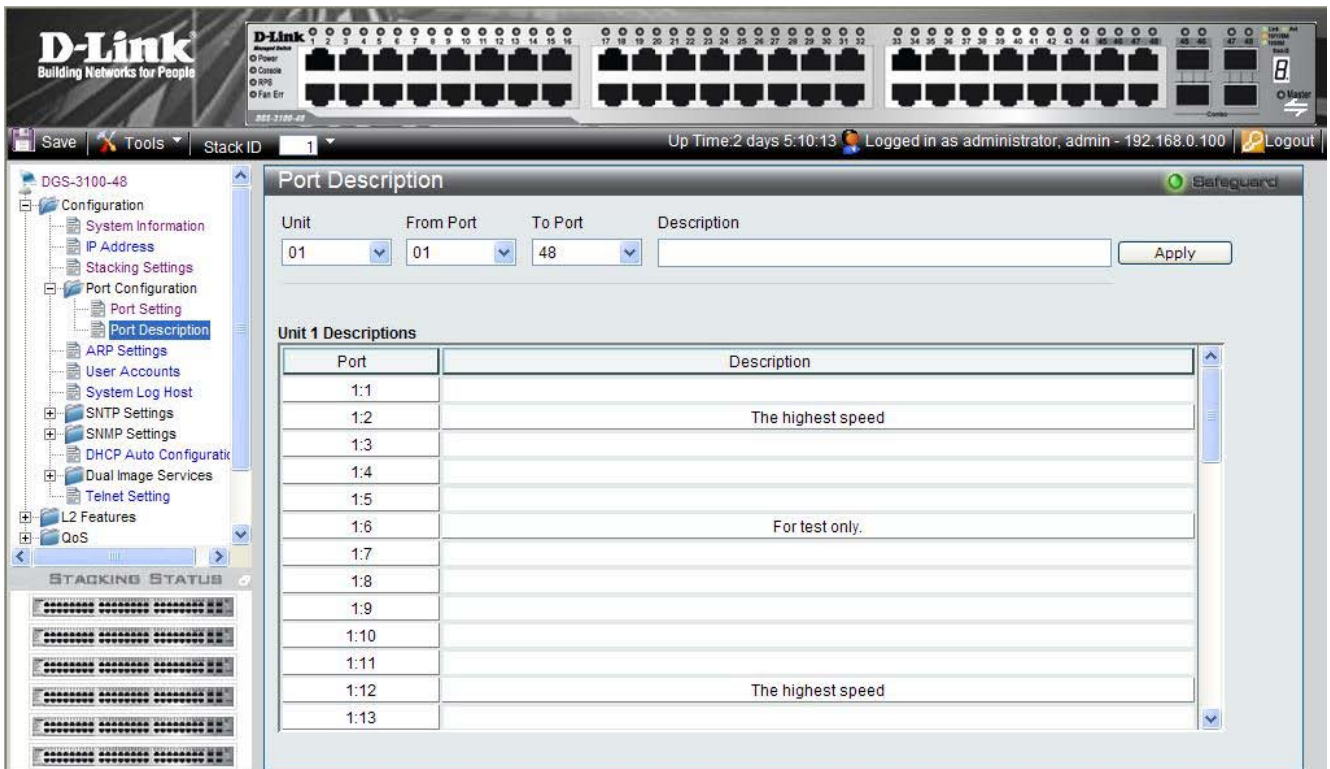

**Figure 2-6. Port Description Page**

The Port Description Page contains the following fields:

Field	Description
<b>Unit</b>	Defines the stacking member for which the port settings are displayed.
<b>From Port</b>	Defines the port number from which the port parameters are configured.
<b>To Port</b>	Defines the port number to which the port parameters are configured.
<b>Description</b>	Defines a user-defined port description.

2. Define the *Unit*, *From Port*, *To Port*, and *Description* fields.
3. Click **Apply**. The port description is saved, and the device is updated.

# ARP Settings

The *Address Resolution Protocol* (ARP) converts IP addresses into physical addresses and maps the IP address to a MAC address. ARP allows a host to communicate with other hosts only when the IP addresses of its neighbors are known. To define ARP information:

1. Click **Configuration > ARP Settings**. The *ARP Settings Page* opens:

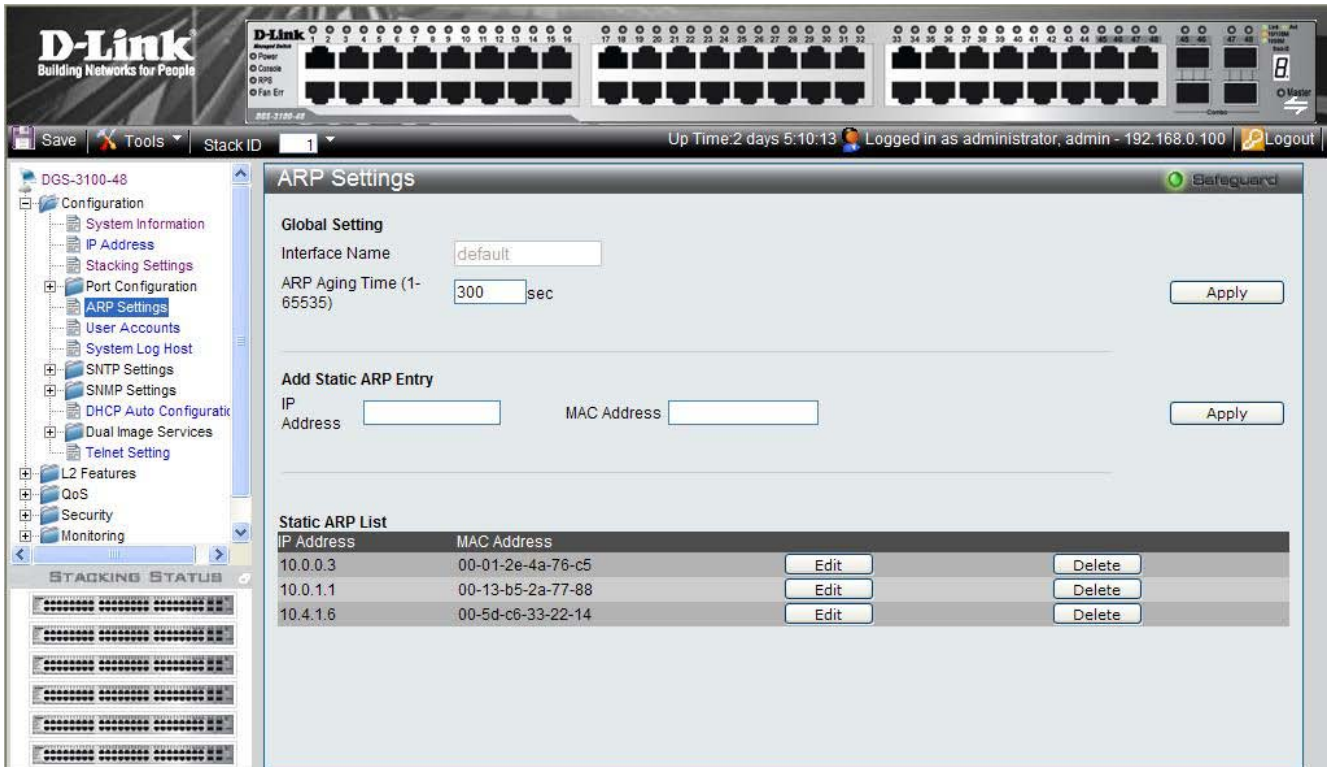

**Figure 2-7. ARP Settings Page**

The ARP Settings Page contains the following fields:

Field	Description
<b>Interface Name</b>	Defines the interface (VLAN) name.
<b>ARP Aging Time (1-65535)</b>	Defines the amount of time (in seconds) that passes between <i>ARP Table</i> entry requests. Following the <i>ARP Entry Age</i> period, the entry is deleted from the table. The range is 1 - 65535. The default value is 300 seconds.
<b>IP Address</b>	Defines the station IP address associated with the MAC address.
<b>MAC Address</b>	Defines the station MAC address associated in the ARP table with the IP address.
<b>Static ARP Settings</b>	Displays current static ARP settings table, detailing the user-defined interface name, IP address, and MAC address of each entry.

2. Define the *Interface Name* and *ARP Aging Time* fields.
3. Click **Apply**. The ARP global setting is updated.
4. Define the *IP Address* and *MAC Address* fields.
5. Click **Apply**. The ARP settings are saved, and the device is updated.

## Configuring User Accounts

User accounts including user passwords and access rights are defined on the *User Accounts Page*. To define user account information:

1. Click **Configuration > User Accounts**. The *User Accounts Page* opens:

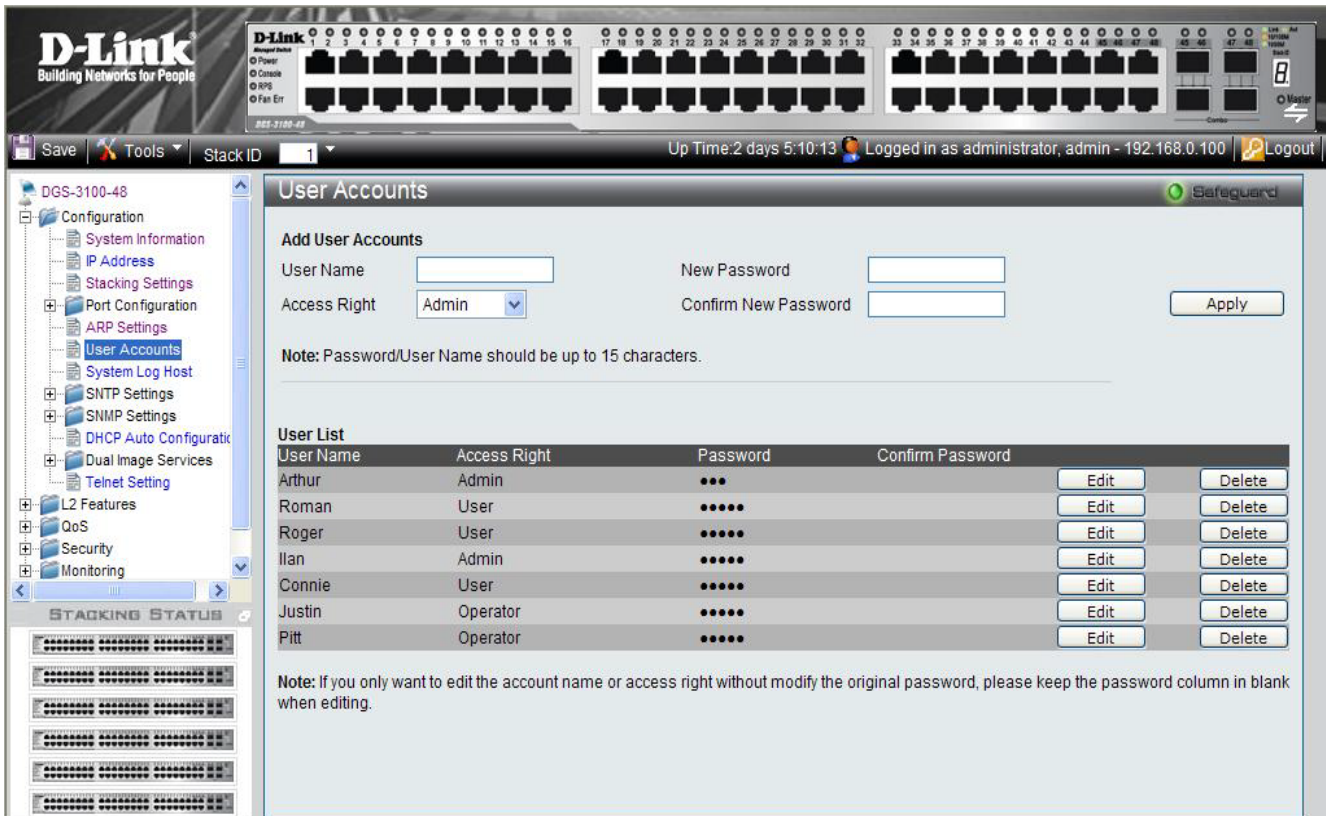

**Figure 2-8. User Accounts Page**

The User Accounts Page contains the following fields:

Field	Description
<b>User Name</b>	Defines the user name. The user name can contain up-to <b>15</b> characters.
<b>New Password</b>	Defines the password assigned to the user account. The password can contain up-to <b>15</b> characters.
<b>Access Right</b>	Displays the user access level. The possible field values are: <ul style="list-style-type: none"> <li><i>Admin</i> — Assigns the user full administrative access through both the Web Interface and the CLI.</li> <li><i>Operator</i> — Assigns the user operator-level access, which is similar to Admin access except that the operator cannot update the firmware, startup configuration, user accounts, or restore factory reset.</li> <li><i>User</i> — Assigns the user read-only access through both the Web Interface and the CLI. The Following limitations appear on the Web Interface:               <ul style="list-style-type: none"> <li>• The ‘Save’ navigation tree button does not appear and only ‘Show Stack Status’ feature appears under the ‘Tools’ button in the Web Interface.</li> <li>• An ‘Access Denied’ window is displayed, if the user clicks Apply. In order to return to the Web Interface, the user has to go back to the previous page or access a different page by using the navigation bar.</li> </ul> </li> </ul>
<b>Confirm New Password</b>	Confirms the user password.

2. Define the *User Name* field.
3. Select the user access level in the *Access Right* field.
4. Enter a new password in the *New Password* field and then re-enter it again in the *Confirm New Password* field.
5. Click . The new user accounts, passwords, and access rights are defined and the device is updated.

To edit the User Accounts Page:

1. Select a name on the *User List*;
2. Click .
3. Define the value.
4. Click . The new access rights are saved, and device is updated.

To delete a User Accounts Page entry:

1. Select an entry.
2. Click . The user account is deleted, and the device is updated.

## Managing System Logs

System Logs record and manage events and report errors and informational messages. Event messages have a unique format, as per the Syslog protocols recommended message format for all error reporting. For example, Syslog and local device reporting messages are assigned a severity code, and include a message mnemonic, which identifies the source application generating the message. Messages are filtered based on their urgency or relevancy. Each message severity determines the set of event logging devices that are sent per each event message.

1. Click **Configuration > System Log Host**. The *System Log Host Page* opens:

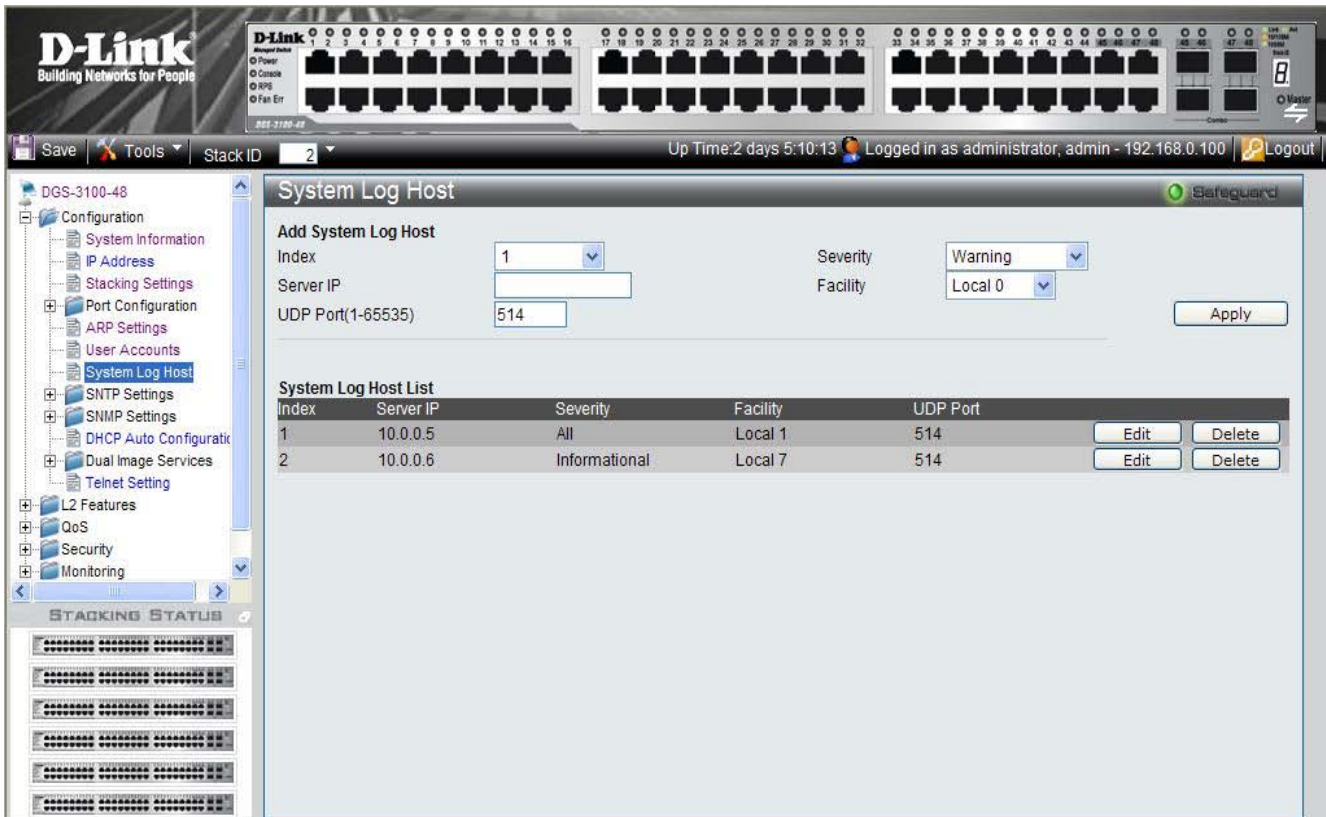

**Figure 2-9. System Log Host Page**

The System Log Host Page contains the following fields:

Field	Description
<b>Index</b>	Defines syslog host index, 1 out of 4
<b>Severity</b>	Defines the minimum severity from which warning logs are sent to the server. There are two levels. – warning (high) and informational (low): <i>Warning</i> —The device is functioning, but an operational problem has occurred. <i>Informational</i> — Provides device information through system logs. <i>All</i> — Sends system logs for all levels of system logs.
<b>Server IP</b>	Displays the IP address of the Log Server Host.
<b>Facility</b>	Defines an application from which system logs are sent to the remote server. Only one facility can be assigned to a single server. If a second facility level is assigned, the first facility is overridden.
<b>UDP Port(514 or 1-65535)</b>	Defines the UDP port to which the server logs are sent. The possible range is 1 - 65535. The default value is 514.

2. Define the *Index*, *Severity*, *Server IP*, *Facility*, and *UDP Port* fields.
3. Click **Apply**. The System Log Host is defined, and the device is updated.

To delete a log entry:

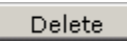
1. Select the entry.
2. Click . The entry is deleted, and the device is updated.

## Configuring SNTP

The device supports the *Simple Network Time Protocol* (SNTP). SNTP assures accurate network device clock time synchronization up to the millisecond. Time synchronization is performed by a network SNTP server. The device operates only as an SNTP client, and cannot provide time services to other systems. The device polls Unicast type servers for the server time.

Time sources are established by stratum. Stratum define the accuracy of the reference clock. The higher stratum (where zero is the highest), the more accurate the clock. The device receives time from stratum 1 and above.

The following is an example of stratum:

Stratum	Example
<b>Stratum 0</b>	A real time clock (such as a GPS system) is used as the time source.
<b>Stratum 1</b>	A server that is directly linked to a Stratum 0 time source is used as the time source. Stratum 1 time servers provide primary network time standards
<b>Stratum 2</b>	The time source is distanced from the Stratum 1 server over a network path. For example, a Stratum 2 server receives the time over a network link, via NTP, from a Stratum 1 server.

Information received from SNTP servers is evaluated based on the Time level and server type. SNTP time definitions are assessed and determined by the following time levels:

Time level	SNTP Time Definition
<b>T1</b>	The time at which the original request was sent by the client.
<b>T2</b>	The time at which the original request was received by the server.
<b>T3</b>	The time at which the server sent the client a reply.
<b>T4</b>	The time at which the client received the server's reply.



Polling for Time Information

SNTP is used to poll time information from SNTP server. Using SNTP enables accurate system clock.

The *Time Settings Page* allows network managers to enable and configure the SNTP time settings on the device. To enable SNTP:

1. Click **Configuration > SNTP Settings > Time Settings**. The *Time Settings Page* opens:

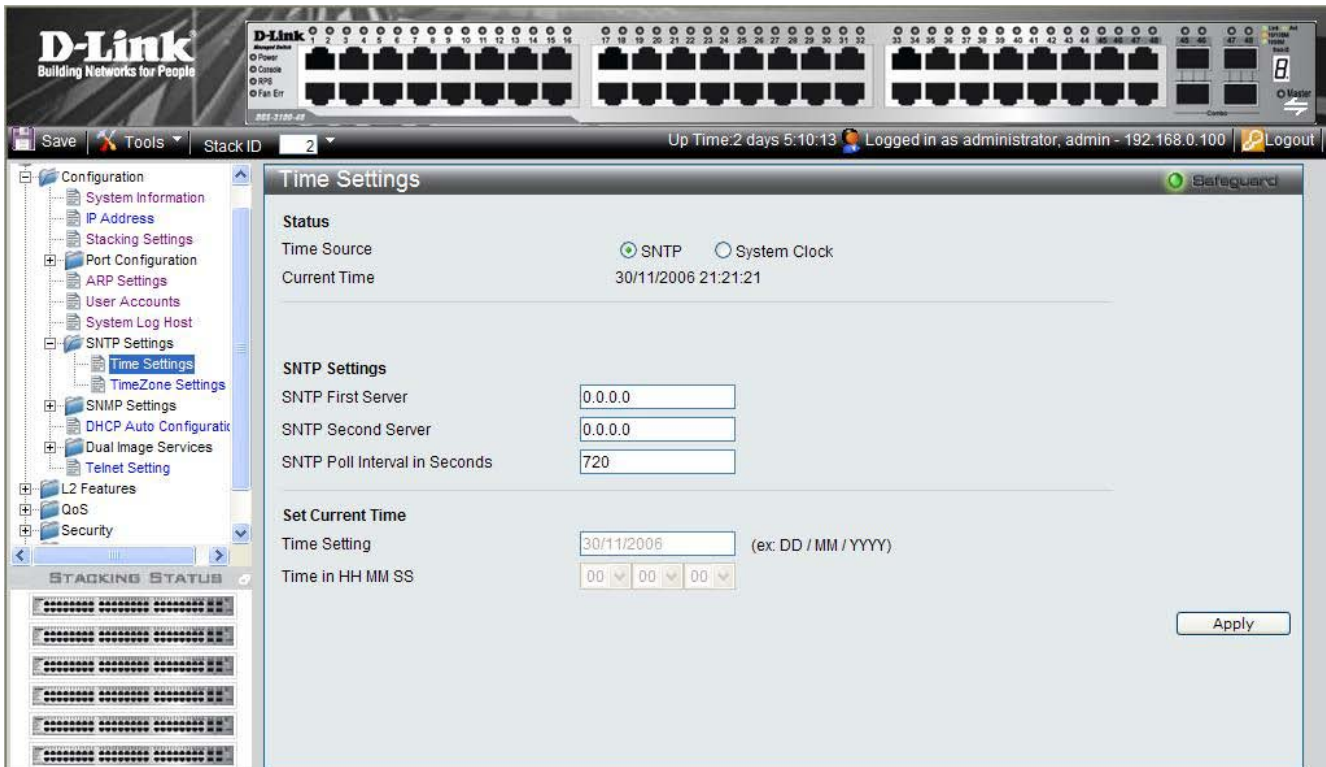

Figure 2-10. Time Settings Page

The Time Settings Page contains the following fields:

Status

Field	Description
<b>Time Source</b>	Defines the time source by which the system time is set. The possible field values are: <i>SNTP</i> — Indicates that the system time is retrieved from a SNTP server. <i>System Clock</i> — Indicates that the system time is set locally by the device.
<b>Current Time</b>	Displays the current date and time.

SNTP Settings Section

Field	Description
<b>SNTP First Server</b>	Defines the IP address of primary SNTP server from which the system time is retrieved.
<b>SNTP Second Server</b>	Defines the IP address of secondary SNTP server from which the system time is retrieved.
<b>SNTP Poll Interval in Seconds</b>	Defines the interval (in seconds) at which the SNTP server is polled for Unicast information. The range is 60-86400 seconds. The Poll Interval default is 1024 seconds.

Set Current Time

Field	Description
<b>Time Setting</b>	Defines the current system date. The field format is Day/Month/Year.
<b>Time in HH MM SS</b>	Defines the current system time. The field format is HH:MM:SS based on the 24-hour clock (Military Time) For example, 9:00PM is configured as 21:00:00.

2. Select a time source in the *Time Source* field.
3. Define the fields.
4. Click . The SNTP settings are defied, and the device is updated.

## Configuring Daylight Savings Time

The *TimeZone Settings Page* contains fields for defining system time parameters for both the local hardware clock and the external SNTP clock. If the system time is kept using an external SNTP clock, and the external SNTP clock fails, the system time reverts to the local hardware clock. Daylight saving times can be enabled on the device.

The following is a list of *daylight savings* start and end times in specific countries:

- **Albania** — From the last weekend of March until the last weekend of October.
- **Australia** — From the end of October until the end of March.
- **Australia - Tasmania** — From the beginning of October until the end of March.
- **Armenia** — From the last weekend of March until the last weekend of October.
- **Austria** — From the last weekend of March until the last weekend of October.
- **Bahamas** — From April to October, in conjunction with daylight savings in the United States.
- **Belarus** — From the last weekend of March until the last weekend of October.
- **Belgium** — From the last weekend of March until the last weekend of October.
- **Brazil** — From the third Sunday in October until the third Saturday in March. Clocks go forward one hour in most areas of southeast Brazil for daylight savings.
- **Chile** —Easter Island: from March 9 until October 12. The rest of the country, from the first Sunday in March, or after March 9.
- **China** — China does not use daylight saving time.
- **Canada** — From the first Sunday in April until the last Sunday of October. Daylight saving times are usually regulated by provincial and territorial governments. Exceptions may exist in certain municipalities.
- **Cuba** — From the last Sunday of March to the last Sunday of October.
- **Cyprus** — From the last weekend of March until the last weekend of October.
- **Denmark** — From the last weekend of March until the last weekend of October.
- **Egypt** — From the last Friday in April until the last Thursday in September.
- **Estonia** — From the last weekend of March until the last weekend of October.
- **Finland** — From the last weekend of March until the last weekend of October.
- **France** — From the last weekend of March until the last weekend of October.
- **Germany** — From the last weekend of March until the last weekend of October.
- **Greece** — From the last weekend of March until the last weekend of October.
- **Hungary** — From the last weekend of March until the last weekend of October.
- **India** — India does not use daylight saving time.
- **Iran** — From Farvardin 1 until Mehr 1.
- **Iraq** — From April 1 until October 1.
- **Ireland** — From the last weekend of March until the last weekend of October.
- **Israel** — Varies year-to-year.
- **Italy** — From the last weekend of March until the last weekend of October.
- **Japan** — Japan does not use daylight saving time.
- **Jordan** — From the last weekend of March until the last weekend of October.
- **Latvia** — From the last weekend of March until the last weekend of October.
- **Lebanon** — From the last weekend of March until the last weekend of October.
- **Lithuania** — From the last weekend of March until the last weekend of October.
- **Luxembourg** — From the last weekend of March until the last weekend of October.

- **Macedonia** — From the last weekend of March until the last weekend of October.
- **Mexico** — From the first Sunday in April at 02:00 to the last Sunday in October at 02:00.
- **Moldova** — From the last weekend of March until the last weekend of October.
- **Montenegro** — From the last weekend of March until the last weekend of October.
- **Netherlands** — From the last weekend of March until the last weekend of October.
- **New Zealand** — From the first Sunday in October until the first Sunday on or after March 15.
- **Norway** — From the last weekend of March until the last weekend of October.
- **Paraguay** — From April 6 until September 7.
- **Poland** — From the last weekend of March until the last weekend of October.
- **Portugal** — From the last weekend of March until the last weekend of October.
- **Romania** — From the last weekend of March until the last weekend of October.
- **Russia** — From the last weekend of March until the last weekend of October.
- **Serbia** — From the last weekend of March until the last weekend of October.
- **Slovak Republic** - From the last weekend of March until the last weekend of October.
- **South Africa** — South Africa does not use daylight saving time.
- **Spain** — From the last weekend of March until the last weekend of October.
- **Sweden** — From the last weekend of March until the last weekend of October.
- **Switzerland** — From the last weekend of March until the last weekend of October.
- **Syria** — From March 31 until October 30.
- **Taiwan** — Taiwan does not use daylight saving time.
- **Turkey** — From the last weekend of March until the last weekend of October.
- **United Kingdom** — From the last weekend of March until the last weekend of October.
- **United States of America** — From the second Sunday in March at 02:00 to the first Sunday in November at 02:00.

To configure the system time:

- Click **Configuration > SNMP Settings > TimeZone Settings**. The *TimeZone Settings Page* opens:

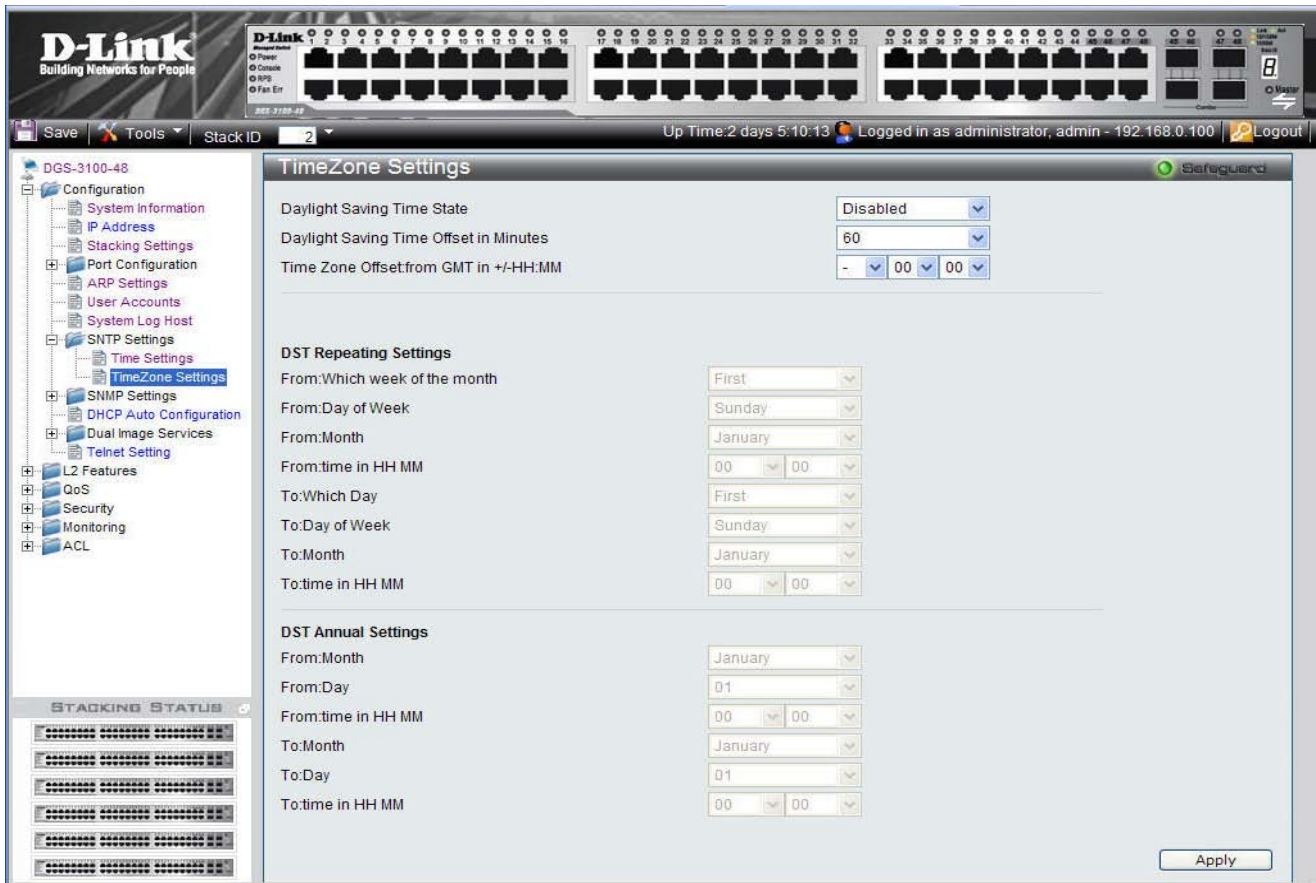

**Figure 2-11. TimeZone Settings Page**

The *TimeZone Settings Page* contains the following fields:

Field	Description
<b>Daylight Savings Time State</b>	Defines type of DST enabled on the device. The possible field values are: Disable — Disables DST on the device. This is the default values. Repeating — Enables setting repeating DST. This option requires defining begin and end times by specific date and hour. Annual — Enables setting annual DST. This option requires defining begin and end times by the specific dates.
<b>Daylight Saving Time Offset in Minutes</b>	Defines the local DST offset in minutes. The default time is 60 minutes. The possible field values are: 30 — Defines the local offset for 30 minutes. 60 — Defines the local offset for 60 minutes. 90 — Defines the local offset for 90 minutes. 120 — Defines the local offset for 120 minutes.
<b>Time Zone Offset:from GMT</b>	Indicates the difference between <i>Greenwich Mean Time</i> (GMT) and local time. For example, the Time Zone Offset for Paris is GMT +1, while the Time Zone Offset for New York is GMT -5.

DST Repeating Settings Sections

The *Repeating Mode* enables setting repeating DST. This option requires defining begin and end times by specific day and hour. For example, the network administrator defines that DST begins the second Saturday during April and ends on the last Sunday in October.

Field	Description
<b>From Which Week of the Month</b>	Defines which numeric week of the month DST begins. The possible field values are: <i>First</i> — Indicates the first week of a month. <i>Second</i> — Indicates the second week of a month. <i>Third</i> — Indicates the third week of a month. <i>Fourth</i> — Indicates the fourth week of a month.
<b>From Day of Week</b>	Defines the week day DST starts. The field range is Sunday–Saturday.
<b>From Month</b>	Defines the month DST starts. The field range is January–December.
<b>From time in HH MM</b>	Defines the time of day DST starts. The field format is Hour:Minutes based on the 24-hour clock (Military Time). For example, 9:00PM is configured as 21:00.
<b>To Which Week of the Month</b>	Defines which numeric week of the month DST ends. The possible field values are: <i>First</i> — Indicates the first week of a month. <i>Second</i> — Indicates the second week of a month. <i>Third</i> — Indicates the third week of a month. <i>Fourth</i> — Indicates the fourth week of a month.
<b>To Day of Week</b>	Defines the week day DST ends. The field range is Sunday–Saturday.
<b>To Month</b>	Defines the month DST ends. The field range is January–December.
<b>To time in HH MM</b>	Defines the time of day DST ends. The field format is Hour:Minutes based on the 24-hour clock (Military Time). For example, 9:00PM is configured as 21:00.

#### DST Annual Settings Section

The *Annual Mode* enables setting a DST seasonal time adjustment. This option requires defining *begin* and *end* times by the specific dates. For example, the network administrator defines that DST begins April 3 and ends October 14.

Field	Description
<b>From:Month</b>	Defines the month of the year that DST starts. The field options are January-December.
<b>From:Day</b>	Defines the date on which DST starts. The field options are 1-31.
<b>From:Time</b>	Defines the time at which DST starts. The field format is HH:MM based on the 24-hour clock (Military Time) For example, 9:00PM is configured as 21:00.
<b>To:Month</b>	Defines the month of the year in which DST ends. The field options are January-December.
<b>To:Day</b>	Defines the date on which DST ends. The field options are 1-31.
<b>To:Time</b>	Defines the time at which DST ends. The field format is HH:MM based on the 24-hour clock (Military Time) For example, 9:00PM is configured as 21:00.

1. Select a daylight savings time source in the *Daylight Saving Time State* field.
2. Define the fields.
3. Click . Daylight Savings Time is configured, and the device is updated.

## Configuring SNMP

*Simple Network Management Protocol* (SNMP) provides a method for managing network devices. The device supports the following SNMP versions:

- SNMP version 1
- SNMP version 2c
- SNMP version 3

### SNMP v1 and v2c

The SNMP agents maintain a list of variables used to manage the device. The variables are defined in the *Management Information Base* (MIB). The SNMP agent defines the MIB specification format, as well as the format used to access the information over the network. Access rights to the SNMP agents are controlled by access strings.

### SNMP v3

SNMP v3 applies access control and a new traps mechanism. In addition, *User Security Model* (USM) parameters are defined for SNMPv3, including:

Parameters	Description
<b>Authentication</b>	Provides data integrity and data origin authentication.
<b>Privacy</b>	Prevents message content disclosure. <i>Cipher Block-Chaining</i> (CBC) is used for encryption. Either authentication is enabled on a SNMP message, or both authentication and privacy are enabled on an SNMP message. However, privacy cannot be enabled without authentication.
<b>Key Management</b>	Defines key generation, key updates, and key use.

The device supports SNMP notification filters based on *Object IDs* (OIDs). OIDs are used by the system to manage device features. SNMP v3 supports the following features:

- Security
- Feature Access Control
- Traps

## Defining SNMP Views

SNMP views provide or block access to device features or aspects of features. For example, a view can be defined to show that SNMP view A has *included* access to Multicast groups, while SNMP view B has *excluded* access to Multicast groups. Feature access is granted via the MIB name or MIB Object ID.

1. Click **Configuration > SNMP Settings > SNMP View Table**. The *SNMP View Table Page* opens:

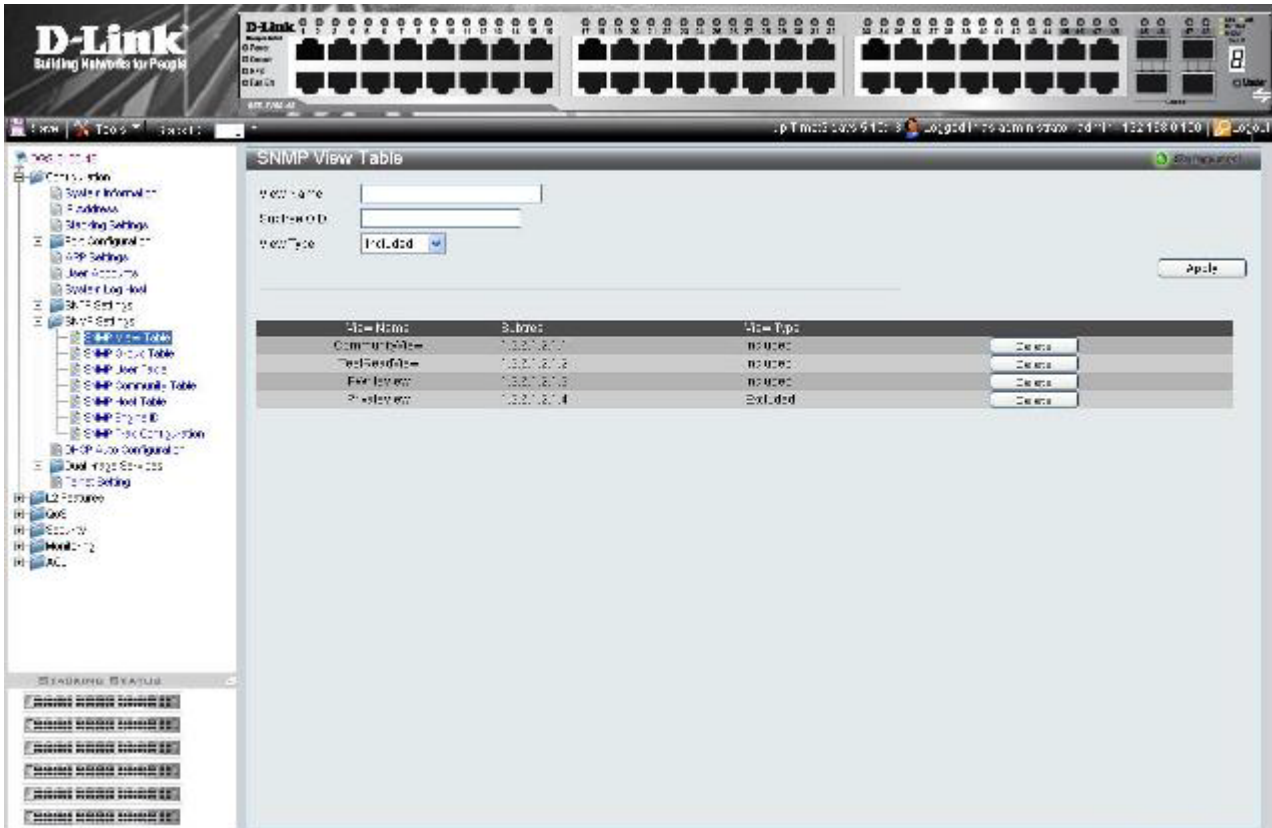

Figure 2-12. SNMP View Table Page

The SNMP View Table Page contains the following fields:

Field	Description
<b>View Name</b>	Defines the <i>view</i> name (limited to 30 alphanumeric characters).
<b>Subtree OID</b>	Defines the OID included in, or excluded from, the selected SNMP view.
<b>View Type</b>	Defines whether the defined OID branch will be included in, or excluded from, the selected SNMP view.

2. Define the *View Name*, *Subtree OID* and *View Type* fields.
3. Click **Apply**. The SNMP View Table is defined, and the device is updated.

To delete a view from the SNMP View Table Page:

1. Select an entry on the list.
2. Click **Delete**. The entry is deleted, and the device is updated.

## Defining SNMP Groups

The *SNMP Group Table Page* provides information for creating SNMP groups and assigning SNMP access control privileges to SNMP groups. Groups enable network managers to assign access rights to specific device features or feature aspects. To define SNMP groups:

1. Click **Configuration > SNMP Settings > SNMP Group Table**. The *SNMP Group Table Page* opens:

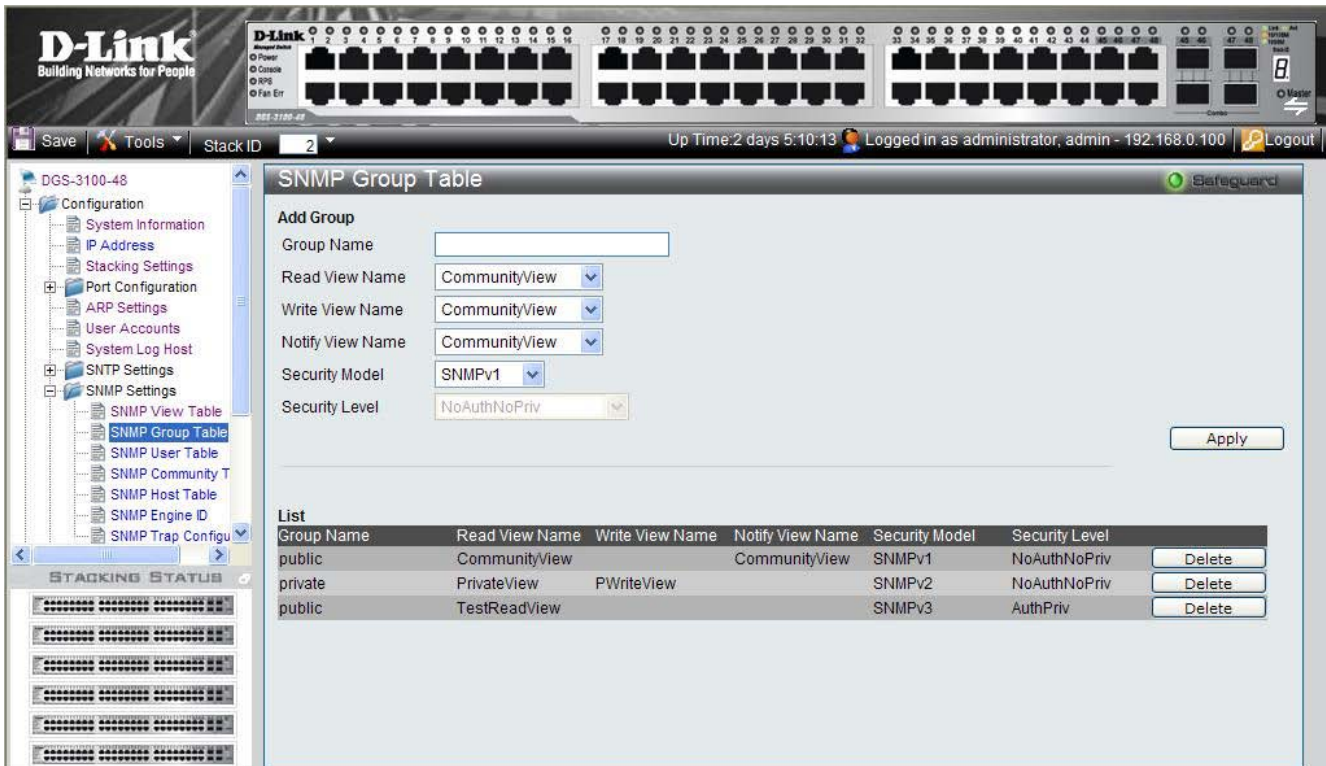

**Figure 2-13. SNMP Group Table Page**

The SNMP Group Table Page contains the following fields:

Field	Description
<b>Group Name</b>	Defines the user-defined group name to which access control rules are applied (limited to 30 alphanumeric characters).
<b>Read View Name</b>	Defines a Read Only view. The Read Only view management access is restricted to read-only, and changes cannot be made to the assigned SNMP view. The possible values are: <i>CommunityView</i> <i>TestReadView</i> <i>PWriteView</i> <i>PrivateView</i>
<b>Write View Name</b>	Defines a Write view. The Management view access is read/write, and changes can be made to the assigned SNMP view. The possible values are: <i>CommunityView</i> <i>TestReadView</i> <i>PWriteView</i> <i>PrivateView</i>



Field	Description
<b>Notify View Name</b>	Defines a Notify view. The Notify view sends traps for the assigned SNMP view. This is applicable for SNMPv3 only. The possible values are: <i>CommunityView</i> <i>TestReadView</i> <i>PWriteView</i> <i>PrivateView</i>
<b>Security Model</b>	Defines the SNMP version attached to the group. The possible field values are: <i>SNMPv1</i> — Defines SNMPv1 as the security model for the group. <i>SNMPv2</i> — Defines SNMPv2 as the security model for the group. <i>SNMPv3</i> — Defines SNMPv3 as the security model for the group.
<b>Security Level</b>	Defines the security level attached to the group. Security levels apply to SNMPv3 only. The possible field values are: <i>NoAuthNoPriv</i> — Defines that neither the Authentication nor the Privacy security levels are assigned to the group. <i>AuthNoPriv</i> — Authenticates SNMP messages, and ensures that the SNMP message's origin is authenticated. <i>AuthPriv</i> — Encrypts SNMP messages.

2. Define the *Group Name*, *Read View Name*, *Write View Name*, and *Notify View Name* fields.
3. Select a security model from the *Security Model* list.
4. Click **Apply**. The SNMP groups are defined, and the device is updated.

To delete a Group Name from the SNMP Group Table Page List:

1. Select a Group Name.
2. Click **Delete**. The Group Name is deleted, and the device is updated.

## Defining SNMP Users

The *SNMP User Table Page* enables assigning system users to SNMP groups and defining the user authentication method. To assign system users:

1. Click **Configuration > SNMP Settings > SNMP User Table**. The *SNMP User Table Page* opens:

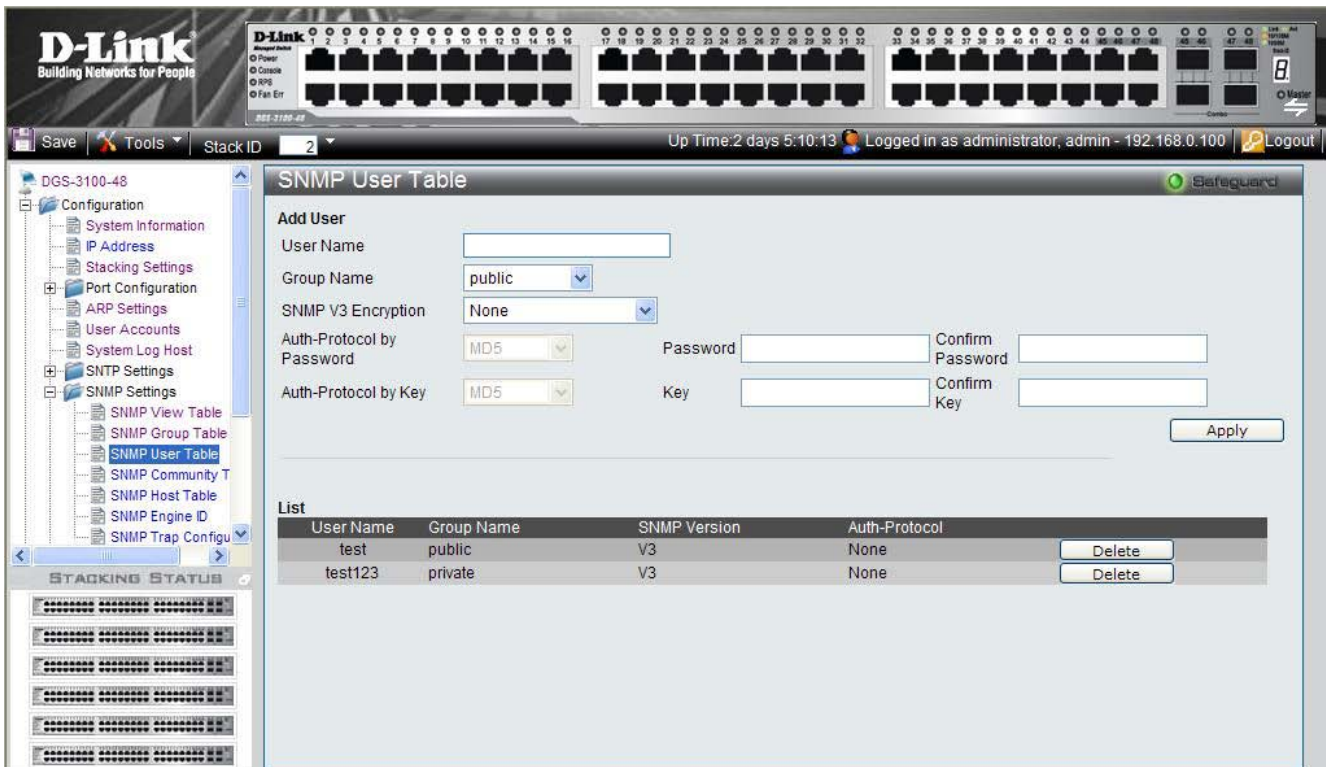

Figure 2-14. SNMP User Table Page

The *SNMP User Table Page* contains the following fields:

Field	Description
<b>User Name</b>	Defines the SNMP user name included in the SNMP user group.
<b>Group Name</b>	Defines the SNMP group and assigned to a user.
<b>SNMP V3 Encryption</b>	Defines the SNMPv3 user authentication method. The possible field values are: <i>None</i> — No user authentication is used. <i>Password</i> — Provides user authentication via the HMAC-SHA-96 authentication level password or HMAC-MD5-96 password. <i>Key</i> — Provides user authentication via the HMAC-MD5 algorithm or the HMAC-SHA-96 authentication level.
<b>Auth-Protocol by Password</b>	Selects the authentication password type used to authenticate users. The possible field values are: <i>MD5</i> — Defines that HMAC-MD5-96 password is used for authentication. <i>SHA</i> — Defines that HMAC-SHA-96 authentication level password is used for authentication.
<b>Password</b>	Defines the password used for authentication. (1-32 digits).
<b>Confirm Password</b>	Confirms the password used for authentication. (1-32 digits).

Field	Description
<b>Auth-Protocol by Key</b>	Selects the authentication key type used to authenticate users. The possible field values are: <i>MD5</i> — Defines that users are authenticated via a HMAC-MD5 algorithm key. <i>SHA</i> — Defines that users are authenticated via a HMAC-SHA-96 authentication level key.
<b>Key</b>	Defines the authentication key for authentication (MD5 – 32 or 64 digits), (SHA – 40 or 70 digits).
<b>Confirm Key</b>	Confirms the authentication key for authentication.

2. Define the *User Name*, *Group Name*, and *SNMP V3 Encryption* fields.
3. Define the authentication password or authentication key.
4. Click . The SNMP authentication method is defined, and the device is updated.

## Defining SNMP Communities

Access rights are managed by defining communities, using the *SNMP Community Table Page*. When the community names are changed, access rights are also changed. SNMP communities are defined only for SNMP v1 and SNMP v2c. To define SNMP communities:

1. Click **Configuration > SNMP Settings > SNMP Community Table**. The *SNMP Community Table Page* opens:

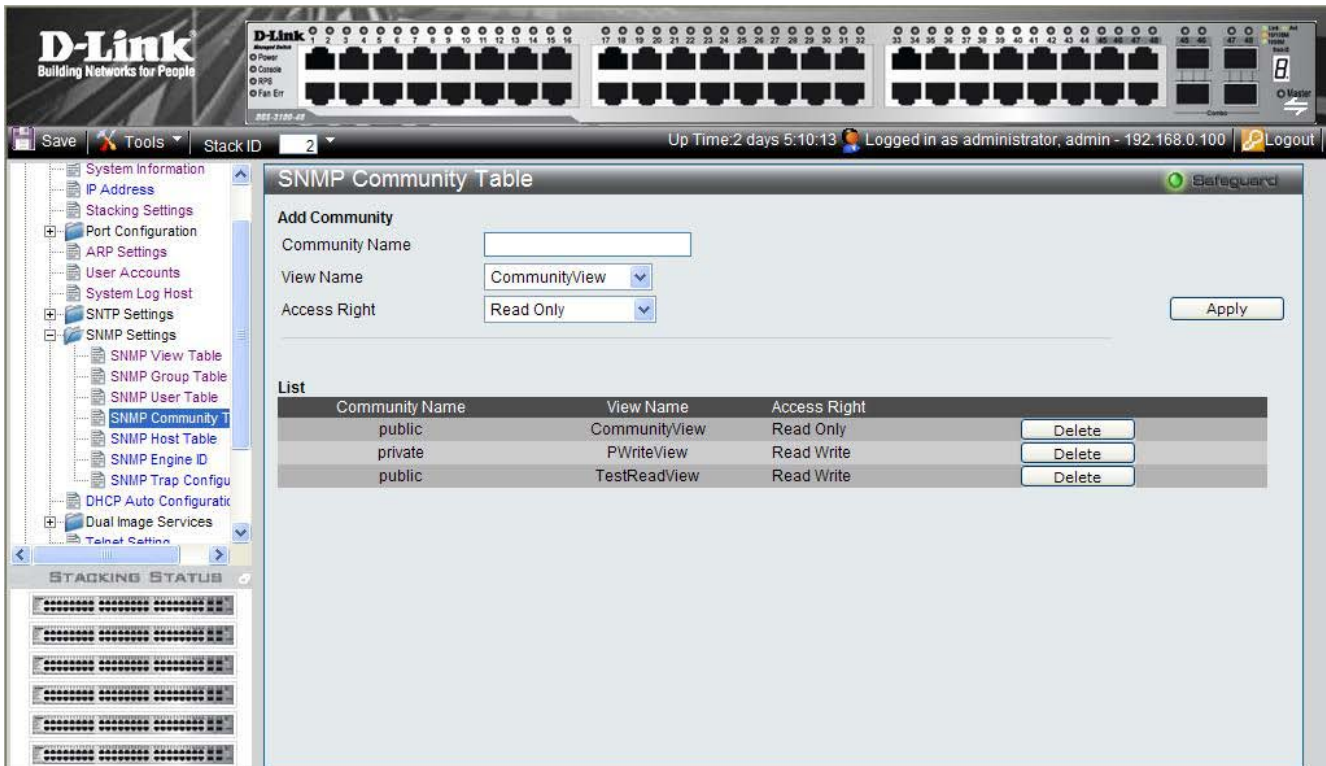

**Figure 2-15. SNMP Community Table Page**

The *SNMP Community Table Page* contains the following fields:

Field	Description
<b>Community Name</b>	Defines advanced SNMP community name (limited to 20 alphanumeric characters).
<b>View Name</b>	Defines the group of MIB objects that a remote SNMP manager is allowed to access on the switch.
<b>Access Rights</b>	Defines the access rights of the community. The possible field values are: <i>Read Only</i> — Management access is restricted to read only, and changes cannot be made to the community. <i>Read Write</i> — Management access is read/write and changes can be made to the device configuration, but not to the community.

2. Define the *Community Name*, and *View Name*, *Access Right* fields.
3. Click . The SNMP Community Table is defined, and the device is updated.

To delete a SNMP Community Table Page List entry:

1. Select a Community Name.
2. Click . The entry is deleted, and the device is updated.

## Defining SNMP Host Table

The *SNMP Host Table Page* contains information for defining filters that determine whether traps are sent to specific host, as well as the trap type sent.

To define the *SNMP Host Table Page*:

1. Click **Configuration > SNMP Settings > SNMP Host Table**. The *SNMP Host Table Page* opens:

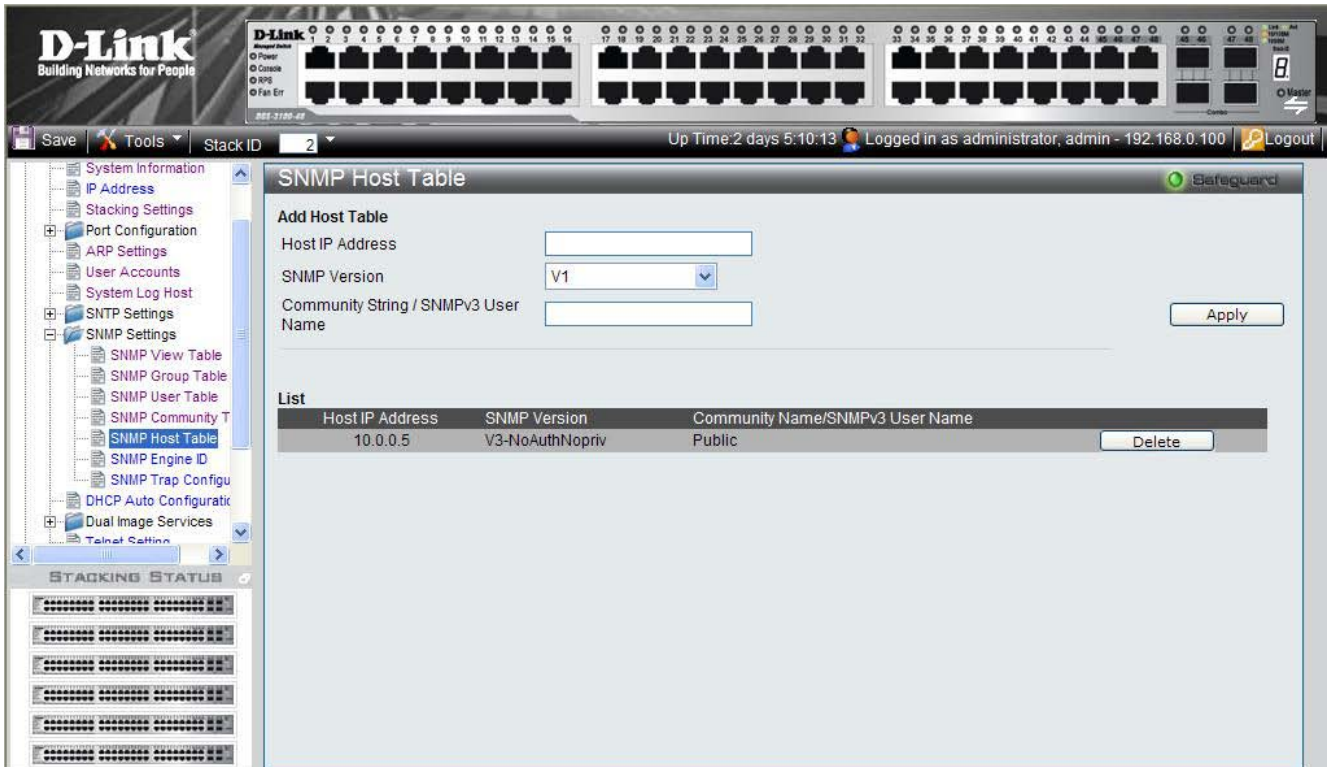

Figure 2-16. SNMP Host Table Page

The *SNMP Host Table Page* contains the following fields:

Field	Description
<b>Host IP Address</b>	Defines the IP address to which the traps are sent.
<b>SNMP Version</b>	Defines the trap type. The possible field values are: <i>SNMPV1</i> — Indicates that SNMP Version 1 traps are sent. <i>SNMPV2c</i> —Indicates that SNMP Version 2 traps are sent. <i>SNMPV3-NoAuth-NoPriv</i> — Indicates that the SNMP version 3 is assigned with a NoAuth-NoPriv security level and traps of that level will be sent <i>SNMPV3-Auth-NoPriv</i> — Indicates that the SNMP version 3 is assigned with an Auth-NoPriv security level and traps of that level will be sent <i>SNMPV3-Auth-Priv</i> — Indicates that the SNMP version 3 is assigned with an Auth-Priv security level and traps of that level will be sent
<b>Community String / SNMPv3 User Name</b>	Defines the community string or assigned to the SNMP V3 user.

2. Define the Host IP Address field.
3. Select the trap type in the SNMP Version field.
4. Define the Community String / SNMPv3 User Name field.
5. Click . The SNMP Host Table is defined, and the device is updated.

To delete a SNMP Host Table Page List entry:

1. Select an entry.
2. Click . The entry is deleted, and the device is updated.

## Defining SNMP Engine ID

The Engine ID is a unique identifier used for SNMP V3 implementations. This is an alphanumeric string used to identify the SNMP engine on the switch. To define the SNMP Engine ID:

1. Click **Configuration > SNMP Settings > SNMP Engine ID**. The *SNMP Engine ID Page* opens:

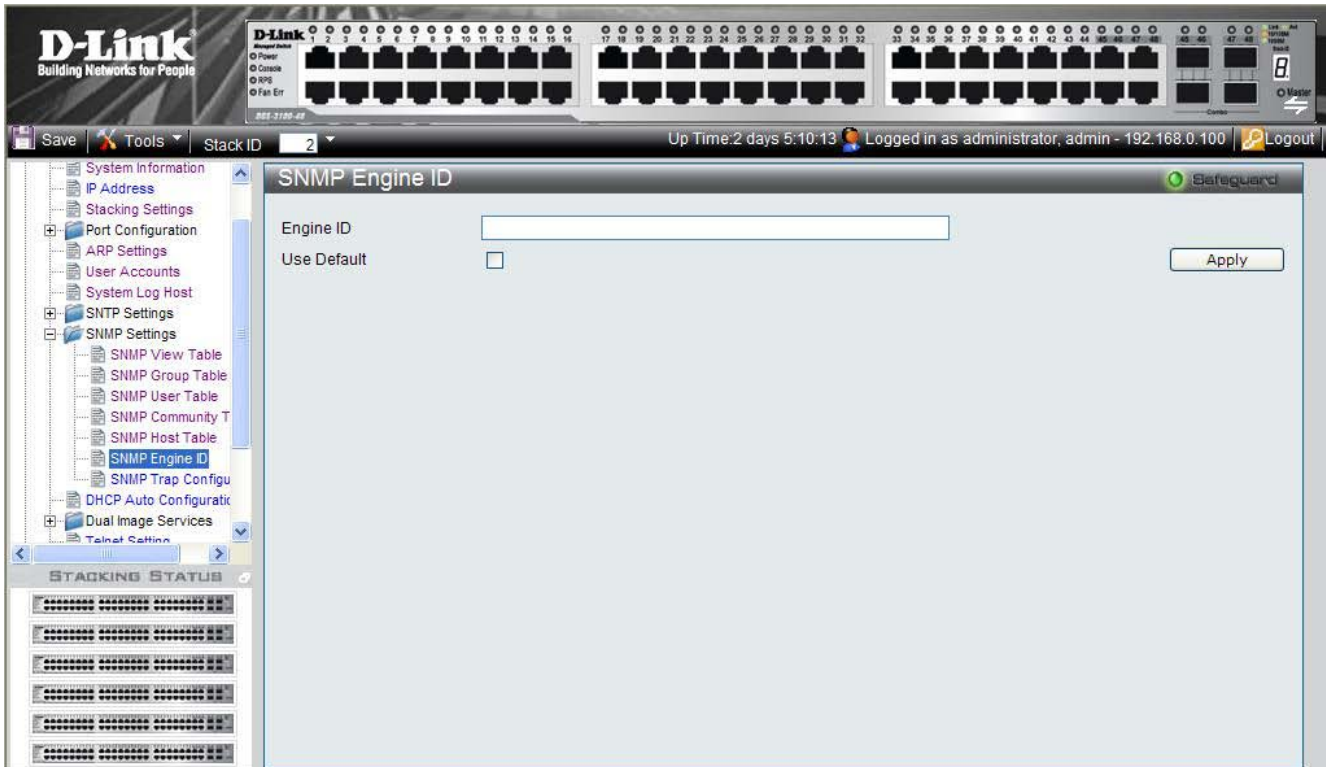

**Figure 2-17. SNMP Engine ID Page**

The *SNMP Engine ID Page* contains the following fields:

Field	Description
<b>Engine ID</b>	Defines the local device Engine ID. The field value is a hexadecimal string. Each byte in hexadecimal character strings is two hexadecimal digits. Each byte can be separated by a period or a colon. The Engine ID must be defined before SNMPv3 is enabled. Select a default Engine ID that is comprised of an Enterprise number and the default MAC address.
<b>Use Default</b>	When selected, provides the device-generated Engine ID. The default Engine ID is based on the device MAC address and is defined per standard as: <i>First 4 octets</i> — first bit = 1, the rest is IANA Enterprise number. <i>Fifth octet</i> — Set to 3 to indicate the MAC address that follows. <i>Last 6 octets</i> — MAC address of the device.

2. Define the *Engine ID* or *Use Default* checkbox.
3. Click **Apply**. The SNMP Engine ID is defined, and the device is updated.

## Enabling SNMP Traps

The *SNMP Configuration Trap Page* contains parameters for defining SNMP notification parameters. To enable SNMP notifications: To enable SNMP Traps:

1. Click **Configuration > SNMP Settings > SNMP Trap Configuration**. The *SNMP Configuration Trap Page* opens:

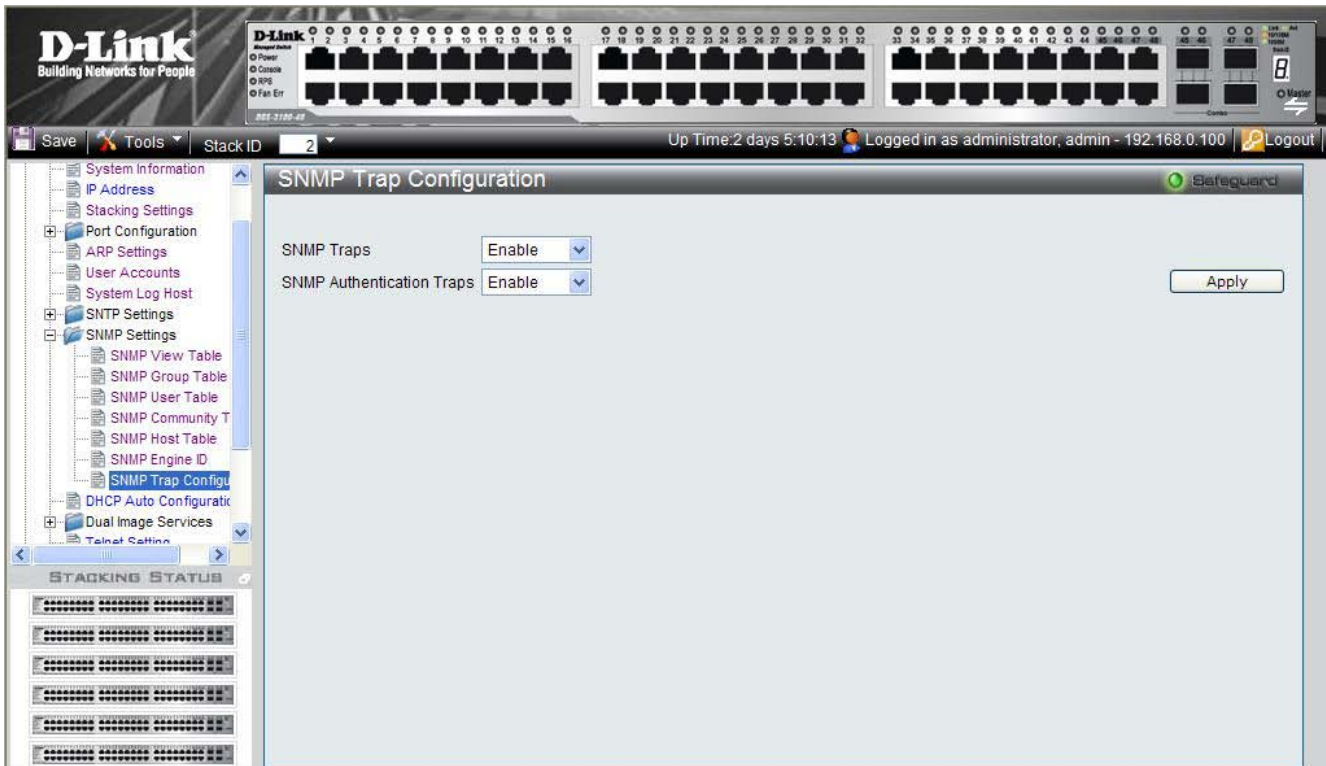

**Figure 2-18. SNMP Configuration Trap Page**

The *SNMP Configuration Trap Page* contains the following fields:

Field	Description
<b>SNMP Traps</b>	Specifies whether the device can send SNMP notifications. The possible field values are: <i>Enable</i> — Enables SNMP notifications. This is the default value. <i>Disable</i> — Disables SNMP notifications.
<b>SNMP Authentication Traps</b>	Specifies whether the device can send traps upon <i>authentication failure</i> notification. <i>Enable</i> — Enables the device to send authentication failure notifications. This is the default value. <i>Disable</i> — Disables the device from sending authentication failure notifications.

2. Define the SNMP Traps and SNMP Authentication Traps fields.
3. Click **Apply**. The SNMP trap status is modified, and the device is updated.



# DHCP Relay

The *DHCP Relay Page* allows the user to enable DHCP relay and define DHCP relay servers on the device.

The Relay agent information option known as Option 82 is part of the DHCP protocol and allows a DHCP relay agent to send additional client information upon requesting an IP address. A DHCP relay agent detects DHCP broadcasts from DHCP clients and relays those broadcasts to DHCP servers on different subnets.

In addition, when client ingress VLAN information differs from the VLAN on which DHCP servers are connected, Option 82 information is added to the packets relayed to DHCP server. Option 82 specifies the relaying switch’s MAC address, the port identifier, and specifies the VLAN forwarding the packet.

To define DHCP Relay Server Information:

1. Click **Configuration > DHCP Relay**. The *DHCP Relay Page* opens:

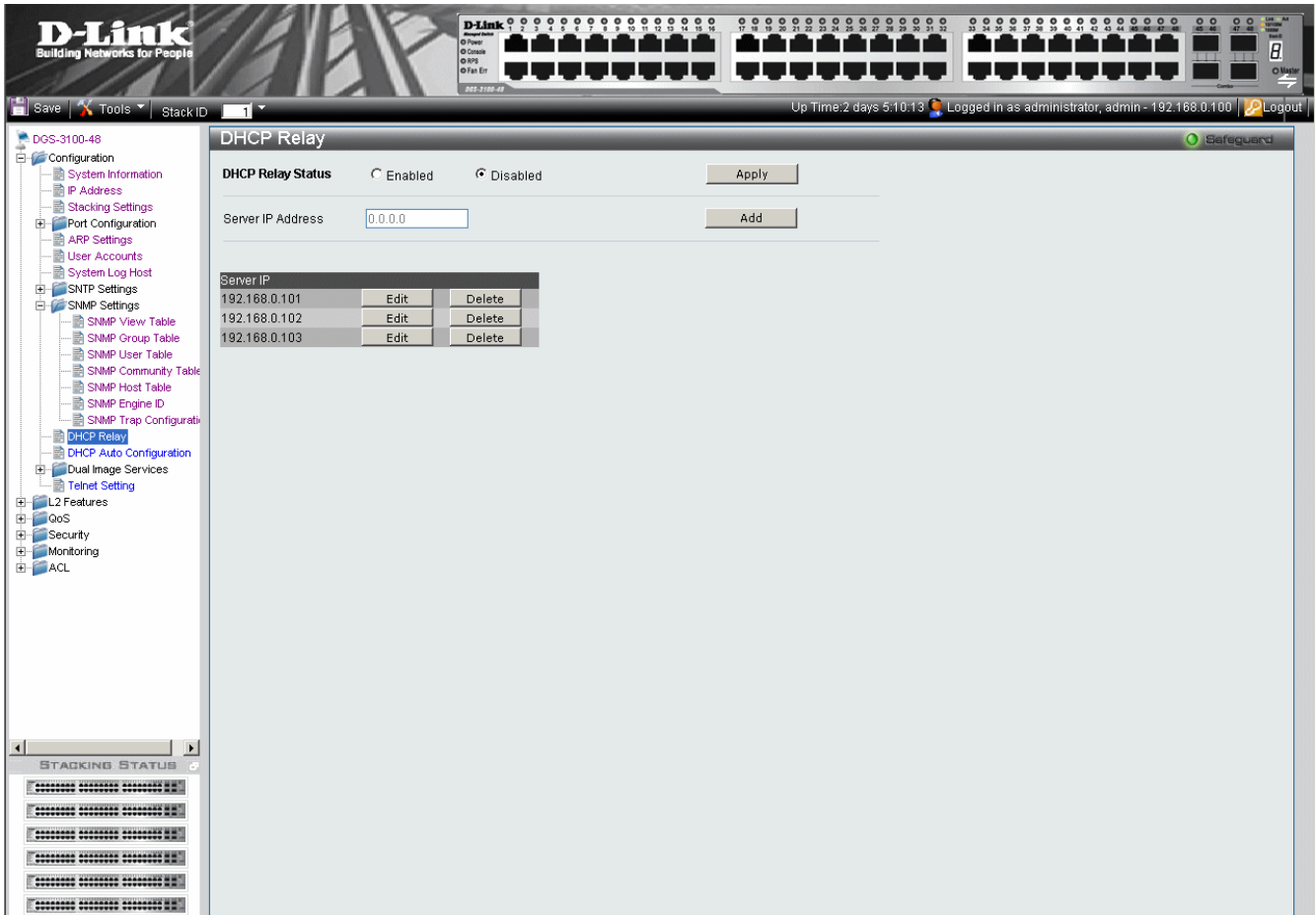

**Figure 2-19. DHCP Relay Page**

The DHCP Relay Page contains the following fields:

Field	Description
<b>DHCP Relay Status</b>	Specifies whether the DHCP is enabled on the device. The possible field values are: <ul style="list-style-type: none"> <li>• <i>Enabled</i> — Enables DHCP Relay on the device.</li> <li>• <i>Disabled</i> — Disables DHCP Relay on the device. This is the default value.</li> </ul>
<b>Server IP Address</b>	Defines the DHCP relay server’s IP address
<b>Server IP</b>	Display the list of user-defined DHCP Relay servers.

2. Select Enabled to enable DHCP Relay. Disabled is the default.
3. Click **Apply**. The DHCP Relay servers are defined, and the device is updated..

## DHCP Auto Configuration

In the DHCP Auto Configuration Page, users can enable or disable automatic download of the latest image and configuration files from the DHCP server. During reboot, if DHCP Auto Configuration is enabled, the device polls the TFTP Server. From the DHCP server, the device receives the following, if necessary:

- **IP address** – The device will receive IP from the DHCP server regardless of current IP configuration (whether static or dynamic). If the device already has a DHCP-defined IP address, it will retain the current address. If Static IP is present in the configuration file, it will be ignored.
- **Image file** – If an updated image file is available on the network, and the DHCP server's latest instruction file refers to it, the device downloads the image file.
- **Configuration file** – If an updated configuration file is available on the network, and the DHCP server's latest instruction file refers to it, the device downloads the file as its new Running Configuration, and also saves it as the Startup Configuration. If Static IP is present in the configuration file, it will be ignored.

To enable DHCP Auto Configuration:

1. Click **Configuration > DHCP Auto Configuration**. The *DHCP Auto Configuration Page* opens:

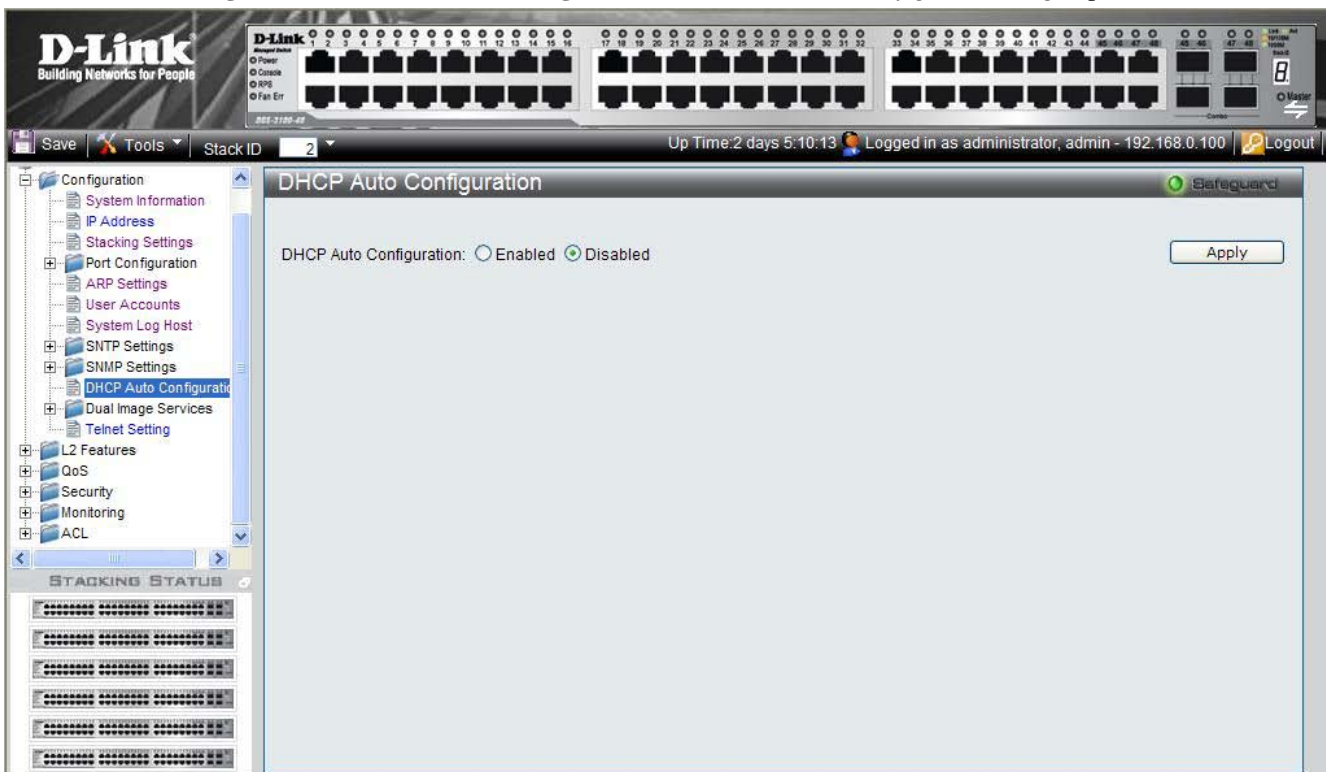

**Figure 2-20. DHCP Auto Configuration Page**

The *DHCP Auto Configuration Page* contains the following fields:

Field	Description
<b>DHCP Auto Configuration</b>	Specifies whether the device gets an updated image file, and updated configuration file through the DHCP Server whenever the device reboots. The DHCP server maintains the TFTP Server IP address, where the files are saved. The possible field values are: <ul style="list-style-type: none"> <li>• <i>Enabled</i> — Enables automatic updates from the DHCP server.</li> <li>• <i>Disabled</i> — Disables automatic updates from the DHCP server. This is the default value.</li> </ul>

2. Select **Enabled** to turn on DHCP Auto configuration or **Disabled** to turn it off. **Disabled** is the default.
3. Click . The DHCP automatic configuration update is modified, and the device is updated.

## Dual Image Services

The device contains two software images in its flash memory, one is for reboot and the other one is for backup. When a software download is successfully completed, the new image automatically becomes the new reboot file, unless the user manually configures the other file to be active. In a stacked system, the user can define the active image file for every unit in the stack.

When the user is downloading a new image, it will always be downloaded to the location of the second image. It means that if image1 is the currently running image, the new firmware will be always downloaded as image2, nothing else will happen until the next reboot.

By default, the newly downloaded image will be marked as the next image which will run after the reboot. However, the user can identify the next image which will run after reboot by viewing the page: 'Dual Image Services/Firmware Information' and change the next image that will run after reboot if user config the page: 'Dual Image Services/Config Firmware Image'.

This feature includes two screens:

- Firmware Information
- Config Firmware Image

## Firmware Information

The *Firmware Information Page* contains information about the image files stored for the device, or in case of a stacked system, for all devices in the stack. To view the list of device images:

- Click **Configuration > Dual Image Services > Firmware Information**. The *Firmware Information Page* opens:

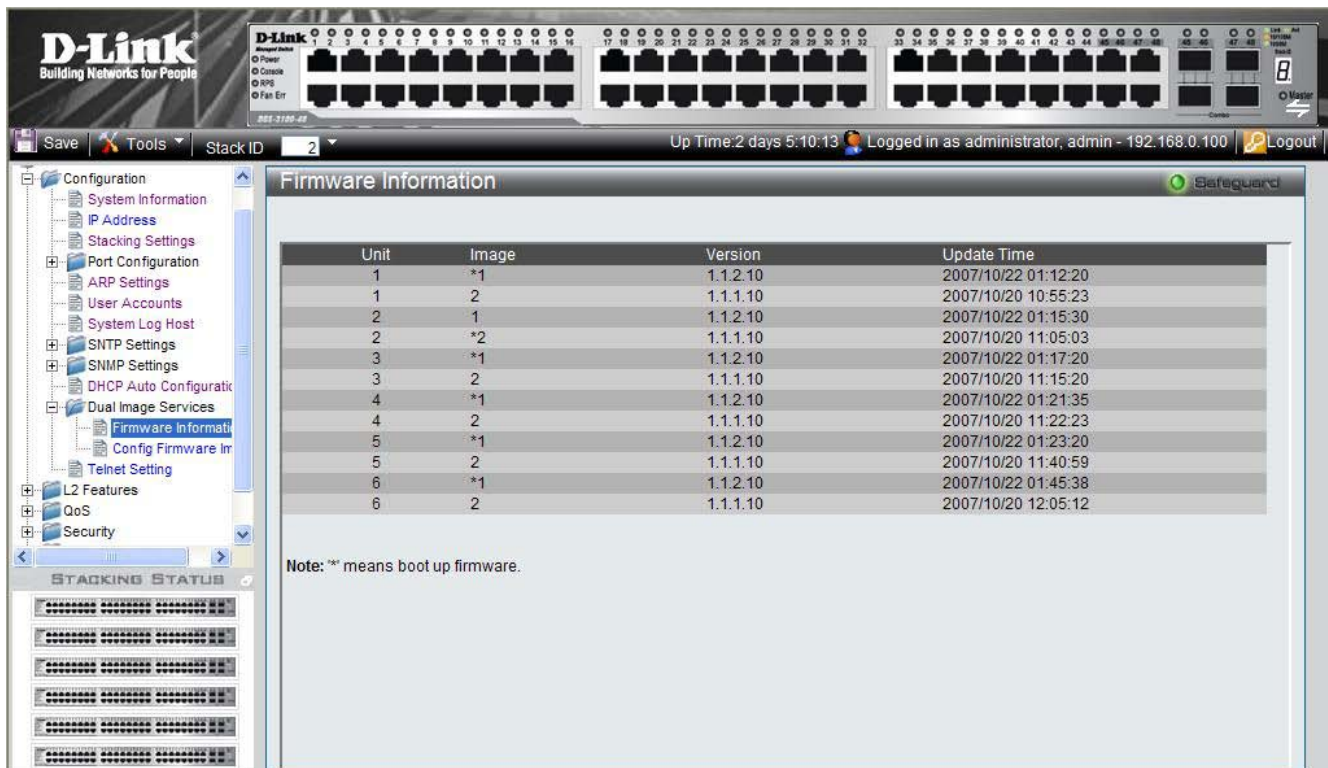

**Figure 2-21. Firmware Information Page**

The *Firmware Information Page* contains the following fields:

Field	Description
<b>Unit</b>	Displays the stacking member for which the firmware image information is displayed.
<b>Image</b>	Each device has two image files, one for reboot and one for backup. Upon software upgrade download, the downloaded image file is designated for reboot, although users can modify this in the Config Firmware Image page.

Field	Description
	An "*" indicates that this image file is used for reboot.
Version	Displays the image file's version number.
Update Time	Displays the time and date which the software was saved to the server.

## Config Firmware Image

The *Config Firmware Image Page* allows users to change each device's image file. To change the reboot file:

1. Click **Configuration > Dual Image Services > Config Firmware Image**. The *Config Firmware Image Page* opens:

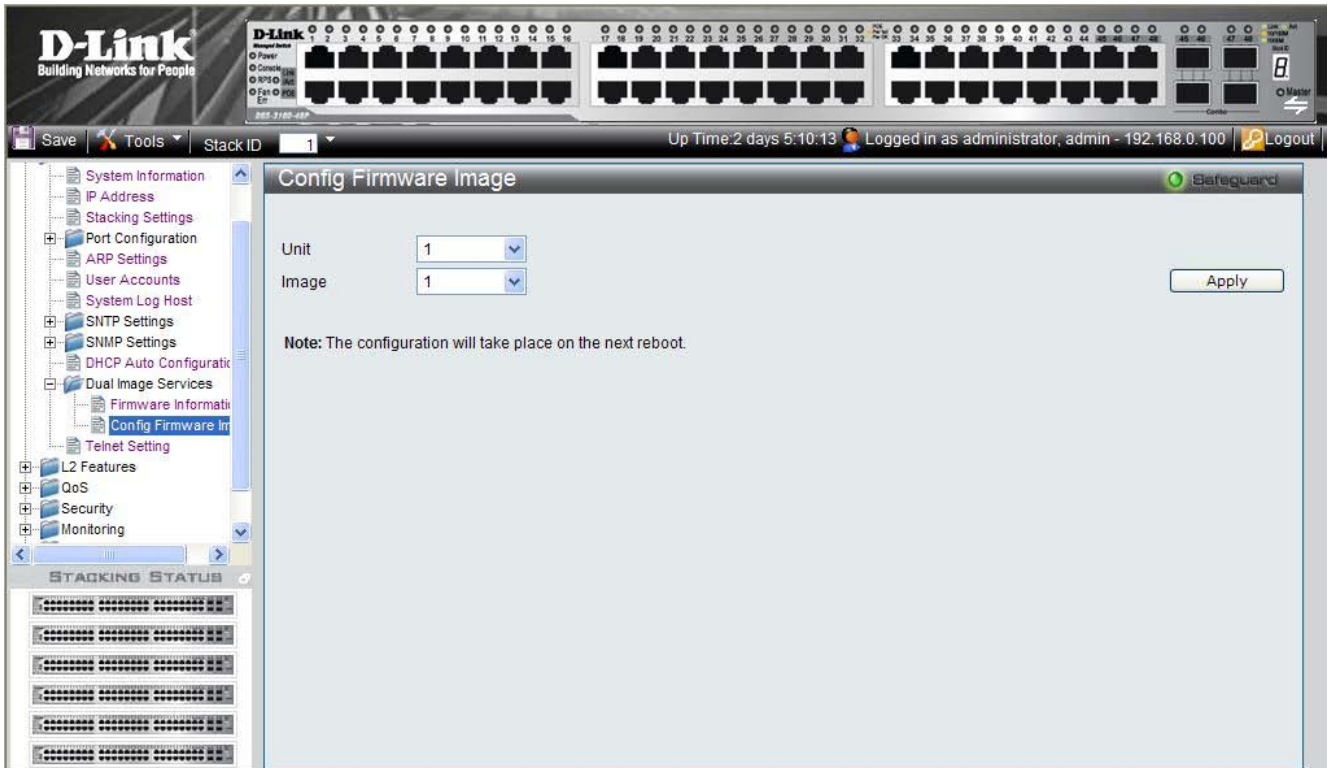

**Figure 2-22. Config Firmware Image Page**

The *Config Firmware Image Page* contains the following fields:

Field	Description
Unit	Defines the stacking member for which the reboot image file is defined.
Image	Defines the image file used for reboot. The possible values are: <ul style="list-style-type: none"> <li>• 1 – Image-1 is the latest downloaded image file.</li> <li>• 2 – Image-2 is the previously downloaded image file.</li> </ul>

2. Select the **Unit** and choose its reboot **Image** file.
3. Click **Apply**. The device will use the defined image file to reboot next time.

# Telnet Setting

The *Telnet Setting* allows users to enable or disable Telnet on the device. To enable or disable Telnet:

1. Click **Configuration > Telnet Setting**. The *Telnet Setting* opens:

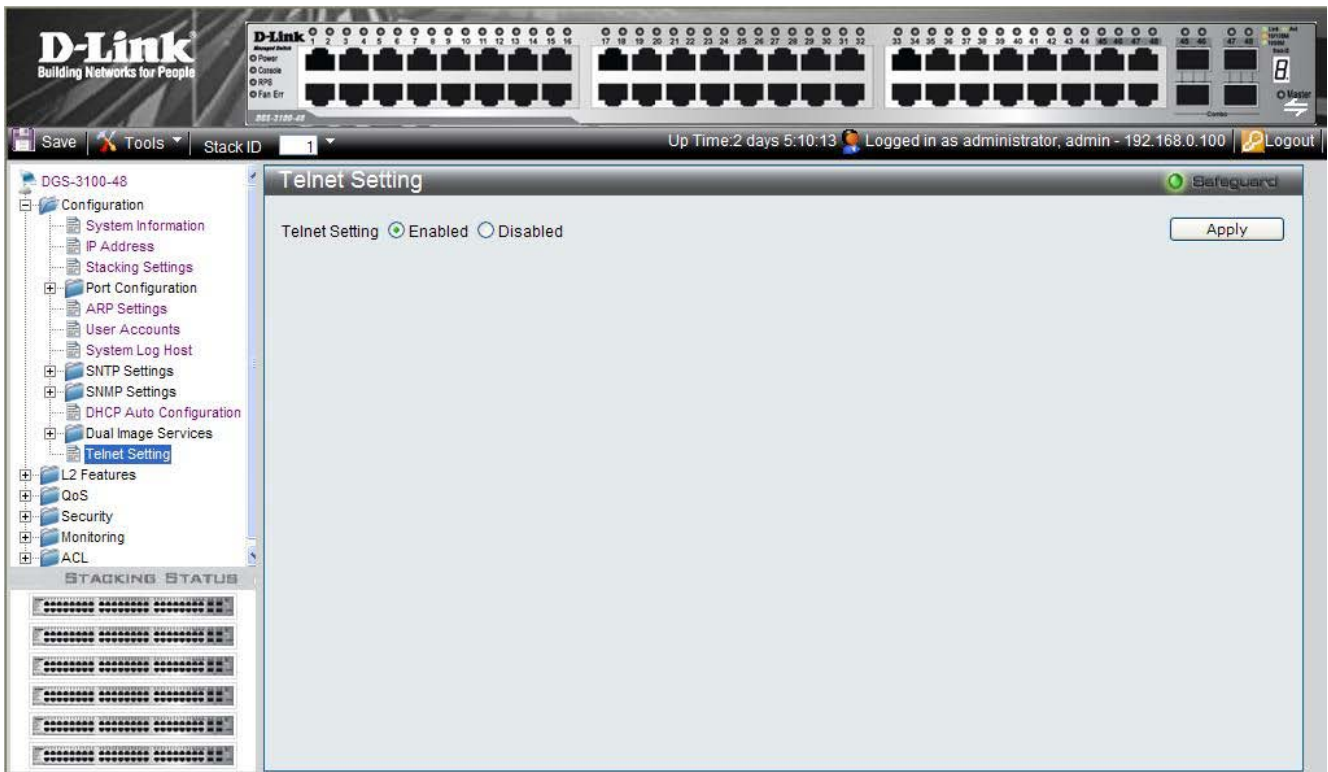

**Figure 2-23. Telnet Setting Page**

The *Telnet Setting* contains the following fields:

Field	Description
<b>Telnet Setting</b>	Defines the Telnet status on the device. The possible values are: <ul style="list-style-type: none"> <li>• <i>Enabled</i> – Enables Telnet.</li> <li>• <i>Disabled</i> – Disables Telnet.</li> </ul>

2. Select the **Telnet Setting**.
3. Click . The Telnet setting on the device is updated.

---

## CONFIGURING L2 FEATURES

This section contains information for enabling and configuring L2 Features. This section contains the following topics:

- Enabling Jumbo Frames
- Configuring VLANs
- Configuring GVRP
- Defining Trunking
- Traffic Segmentation
- Configuring LACP
- Defining IGMP Snooping
- Defining MLD Snooping
- Configuring Port Mirroring
- Configuring Spanning Tree
- Defining Forwarding and Filtering
- Configuring LLDP

## Enabling Jumbo Frames

Jumbo Frame support is designed to enhance Ethernet networking throughput and significantly reduce the CPU utilization of large file transfers like large multimedia files or large data files by enabling more efficient larger payloads per packet. The *Jumbo Frame Page* allows network managers to enable Jumbo Frames on the device.

1. Click **L2 Features** > **Jumbo Frame**. The *Jumbo Frame Page* opens:

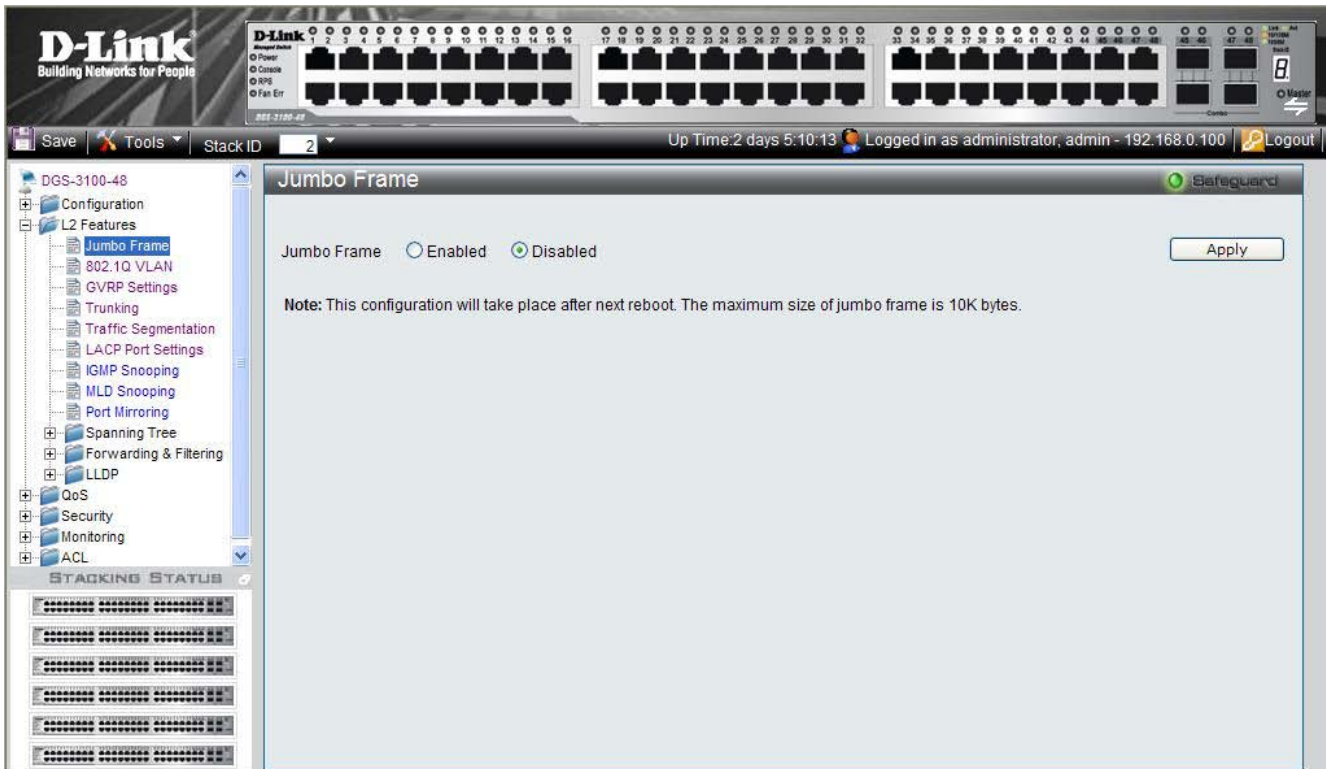

**Figure 3–1. Jumbo Frame Page**

The *Jumbo Frame Page* contains the following field:

Field	Description
<b>Jumbo Frame</b>	Defines whether Jumbo Frames are enabled on the device. The possible field values are: <i>Enabled</i> — Enables Jumbo Frames on the device. <i>Disabled</i> — Disables Jumbo Frames on the device. This is the default value.

2. Select *Enable* in the *Jumbo Frames* field. Jumbo Frames are enabled only after the configuration is saved and the device is rebooted.
3. Click **Apply**. Jumbo Frames are enabled after the device is reset.

# Configuring VLANs

## Understanding IEEE 802.1p Priority

Priority tagging is an IEEE 802.1p defined standard function designed to provide a means of managing traffic on networks where many different types of data are transmitted simultaneously. It is intended to alleviate problems associated with the delivery of time-critical data over congested networks. The quality of applications dependent on such data, such as video conferencing, can be severely and adversely affected by even very small delays in transmission.

IEEE 802.1p standard-compliant network devices recognize the priority level of data packets and can assign priority labels or tags to packets, as well as strip priority tags from packets. The priority tag determines the packet's degree of expeditiousness and the queue to which it is assigned.

Priority tags are assigned values from 0 to 7, with 0 being assigned to the lowest priority data, and 7 to the highest. Generally, tag 7 is used for data associated with video or audio applications, sensitive to even slight delays, or for data from specified end users whose data transmissions warrant special consideration.

The switch enables increased definition for handling priority tagged data packets on the network. Using queues to manage priority tagged data enables user-specification for the data's relative priority to suit the needs of the network. Circumstances can arise where it is advantageous to group two or more differently tagged packets into the same queue. Generally, however, it is recommended that the highest priority queue, Queue 3, be reserved for data packets with a priority value of 7.

A weighted round robin system is employed on the switch to determine the rate at which the queues are emptied of packets. The ratio used for clearing the queues is 8:1. This means that the highest priority queue, Queue 3, clears eight packets for every one packet cleared from Queue 0.

It is important that the priority queue settings on the switch are for all ports, and all devices connected to the switch are affected. The priority queuing system is especially beneficial for networks that employ priority tag assignment capable switches.

## VLAN Description

A Virtual Local Area Network (VLAN) is a network topology configured according to a logical scheme rather than the physical layout. VLANs can be used to combine any collection of LAN segments into an autonomous user group that appears as a single LAN. VLANs also logically segment the network into different broadcast domains so that packets are forwarded only between ports within the VLAN. Typically, a VLAN corresponds to a particular subnet, although not necessarily.

VLANs can enhance performance by conserving bandwidth, and improve security by limiting traffic to specific domains.

A VLAN is a collection of end nodes grouped by logic instead of physical location. End nodes that frequently communicate with each other are assigned to the same VLAN, regardless of where they are physically on the network. Logically, a VLAN can be equated to a broadcast domain, because broadcast packets are forwarded to only members of the VLAN on which the broadcast was initiated.

## Notes about VLANs on the DGS-3100 Series

No matter what basis is used to uniquely identify end nodes and assign these nodes VLAN membership, packets cannot cross VLANs without a network device performing a routing function between the VLANs.

The DGS-3100 series supports IEEE 802.1Q VLANs. The port untagging function can be used to remove the 802.1Q tag from packet headers to maintain compatibility with devices that are tag-unaware.

The switch's default is to assign all ports to a single 802.1Q VLAN named 'default.'

The 'default' VLAN has a VID = 1.

## IEEE 802.1Q VLANs

Some relevant terms:

Term	Description
Tagging	The act of putting 802.1Q VLAN information into the header of a packet.



Term	Description
<b>Untagging</b>	The act of stripping 802.1Q VLAN information out of the packet header.
<b>Ingress port</b>	A port on a switch where packets are flowing into the switch and VLAN decisions must be made.
<b>Egress port</b>	A port on a switch where packets are flowing out of the switch, either to another switch or to an end station, and tagging decisions must be made.

IEEE 802.1Q (tagged) VLANs are implemented on the switch. 802.1Q VLANs require tagging, which enables them to span the entire network (assuming all switches on the network are IEEE 802.1Q-compliant).

VLANs allow a network to be segmented in order to reduce the size of broadcast domains. All packets entering a VLAN are only forwarded to the stations (over IEEE 802.1Q enabled switches) that are members of that VLAN, and this includes broadcast, multicast and unicast packets from unknown sources.

VLANs can also provide a level of security to a network. IEEE 802.1Q VLANs only deliver packets between stations that are members of the VLAN.

Any port can be configured as either tagged or untagged. The untagging feature of IEEE 802.1Q VLANs allows VLANs to work with legacy switches that don't recognize VLAN tags in packet headers. The tagging feature allows VLANs to span multiple 802.1Q-compliant switches through a single physical connection and allows Spanning Tree to be enabled on all ports and work normally.

The IEEE 802.1Q standard restricts the forwarding of untagged packets to the VLAN in which the receiving port is a member.

The main characteristics of IEEE 802.1Q are as follows:

- Assigns packets to VLANs by filtering.
- Assumes the presence of a single global spanning tree.
- Uses an explicit tagging scheme with one-level tagging.
- 802.1Q VLAN Packet Forwarding

Packet forwarding decisions are made based upon the following three types of rules:

- Ingress rules - rules relevant to the classification of received packets belonging to a VLAN.
- Forwarding rules between ports - decides whether to filter or forward the packet.
- Egress rules - determines if the packet must be sent tagged or untagged.

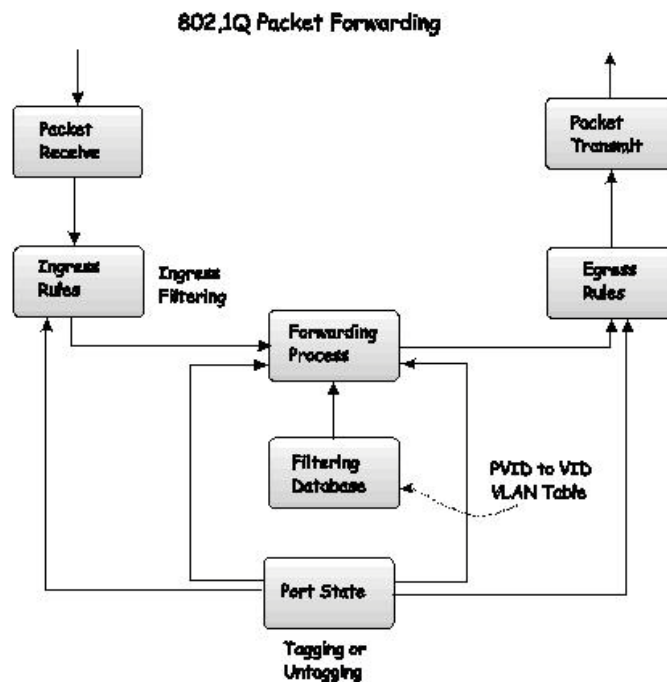

Figure 3–2. IEEE 802.1Q Packet Forwarding

## 802.1Q VLAN Tags

The figure below shows the 802.1Q VLAN tag. There are four additional octets inserted after the source MAC address. Their presence is indicated by a value of 0x8100 in the EtherType field. When a packet's EtherType field is equal to 0x8100, the packet carries the IEEE 802.1Q/802.1p tag. The tag is contained in the following two octets and consists of 3 bits of user priority, 1 bit of Canonical Format Identifier (CFI - used for encapsulating token ring packets so they can be carried across Ethernet backbones), and 12 bits of VLAN ID (VID). The 3 bits of user priority are used by 802.1p. The VID is the VLAN identifier and is used by the 802.1Q standard. Because the VID is 12 bits long, 4094 unique VLANs can be identified.

The tag is inserted into the packet header making the entire packet longer by 4 octets. All of the information originally contained in the packet is retained.

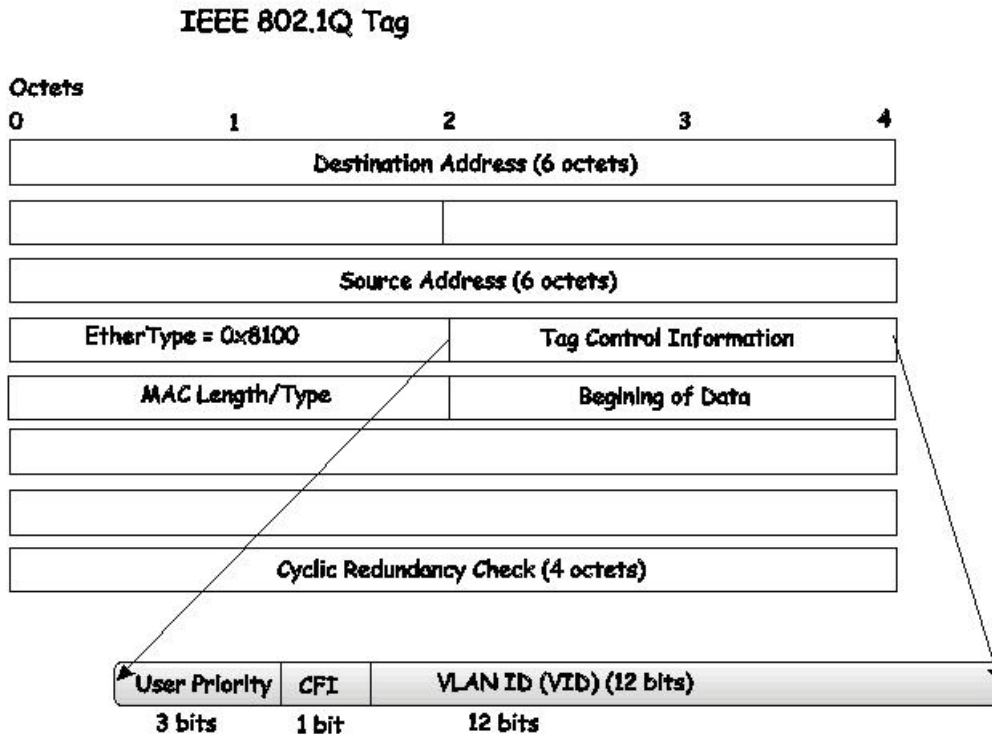

Figure 3–3. IEEE 802.1Q Tag

The EtherType and VLAN ID are inserted after the MAC source address, but before the original EtherType/Length or Logical Link Control. Due to the packet now being a bit longer than it was originally, the Cyclic Redundancy Check (CRC) must be recalculated.

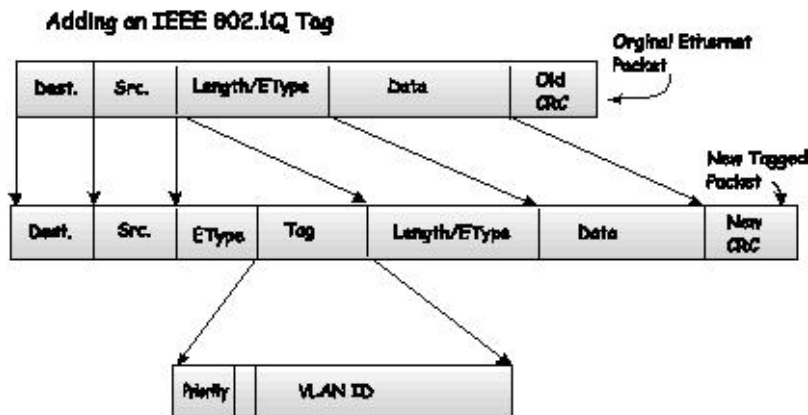

Figure 3–4. Adding an IEEE 802.1Q Tag

## Port VLAN ID

Tagged packets (carrying the 802.1Q VID information) can be transmitted from one 802.1Q compliant network device to another with the VLAN information intact. This allows 802.1Q VLANs to span network devices (and the entire network, providing all network devices are 802.1Q compliant).

Not all network devices are 802.1Q compliant. Such devices are referred to as tag-unaware. 802.1Q devices are referred to as tag-aware.

Prior to the adoption of 802.1Q VLANs, port-based and MAC-based VLANs were in common use. These VLANs relied upon a Port VLAN ID (PVID) to forward packets. A packet received on a given port would be assigned that port's PVID and then be forwarded to the port that corresponds to the packet's destination address (found in the switch's forwarding table). If the PVID of the port receiving the packet is different from the PVID of the port that is to transmit the packet, the switch drops the packet.

Within the switch, different PVIDs mean different VLANs (remember that two VLANs cannot communicate without an external router). So, VLAN identification based upon the PVIDs cannot create VLANs that extend outside a given switch (or switch stack).

Every physical port on a switch has a PVID. 802.1Q ports are also assigned a PVID, for use within the switch. If no VLANs are defined on the switch, all ports are then assigned to a default VLAN with a PVID equal to 1. Untagged packets are assigned the PVID of the port on which they were received. Forwarding decisions are based upon this PVID, in so far as VLANs are concerned. Tagged packets are forwarded according to the VID contained within the tag. Tagged packets are also assigned a PVID, but the PVID is not used to make packet forwarding decisions, the VID is.

Tag-aware switches must keep a table to relate PVIDs within the switch to VIDs on the network. The switch compares the VID of a packet to be transmitted to the VID of the port that is to transmit the packet. If the two VIDs are different, the switch drops the packet. As a result of the existence of the PVID for untagged packets, and the VID for tagged packets, tag-aware and tag-unaware network devices can coexist on the same network.

A switch port can only have one PVID, but it can have as many VIDs that the switch's memory storage capacity has in its VLAN table, to store them.

As some devices on a network may be tag-unaware, a decision must be made at each port on a tag-aware device before packets are transmitted; Should the packet to be transmitted have a tag or not? If the transmitting port is connected to a tag-unaware device, the packet should be untagged. If the transmitting port is connected to a tag-aware device, the packet should be tagged.

## Tagging and Untagging

Every port on an 802.1Q compliant switch can be configured as tagged or untagged.

Tagging enabled ports put the VID number, priority, and other VLAN information into the header of all packets that flow into and out of it. If a packet has previously been tagged, the port does not alter the packet, thus keeping the VLAN information intact. The VLAN information in the tag is then used by other 802.1Q compliant devices on the network to make packet-forwarding decisions.

Ports with untagging enabled strip the 802.1Q tag from all packets flowing into and out of those ports. If the packet doesn't have an 802.1Q VLAN tag, the port does not alter the packet. As a result, all packets received by and forwarded by an untagging port have no 802.1Q VLAN information (as the PVID is only used internally within the switch). Untagging is used to send packets from an 802.1Q-compliant network device to a non-compliant network device.

## Ingress Filtering

A port on a switch where packets are flowing into the switch, and VLAN decisions must be made, is referred to as an ingress port. If ingress filtering is enabled for a port, the switch examines the VLAN information in the packet header (if present) and decides whether or not to forward the packet.

If the packet is tagged with VLAN information, the ingress port first determines if the ingress port itself is a member of the tagged VLAN. If it is not, the packet is dropped. If the ingress port is a member of the 802.1Q VLAN, the switch determines if the destination port is a member of the 802.1Q VLAN. If it is not, the packet is dropped. If the destination port is a member of the 802.1Q VLAN, the packet is forwarded and the destination port transmits it to its attached network segment.

If the packet is not tagged with VLAN information, the ingress port tags the packet with its own PVID as a VID (if the port is a tagging port). The switch then determines if the destination port is a member of the same VLAN (has the same VID) as

the ingress port. If it does not, the packet is dropped. If it has the same VID, the packet is forwarded and the destination port transmits it on its attached network segment.

This process is referred to as ingress filtering, and is used to conserve bandwidth within the switch, by dropping packets that are not on the same VLAN as the ingress port at the point of reception. This eliminates the subsequent processing of packets that is just dropped by the destination port.

## Default VLANs

The switch initially configures one VLAN, VID = 1, called 'default.' The factory default setting assigns all ports on the switch to the 'default.'

Ports can't be removed from the default VLAN, If a port is configured as Untagged member to other VLAN it will be automatically removed from the default VLAN.

Packets cannot cross VLANs. If a member of one VLAN wants to connect to another VLAN, the link must be through an external router.



**NOTE:** If no VLANs are configured on the switch, then all packets are forwarded to any destination port. Packets with unknown source addresses are flooded to all ports. Broadcast and multicast packets are also flooded to all ports.

An example is presented in this table:

VLAN Name	VID	Switch Ports
System (default)	1	5, 6, 7, 8, 21, 22, 23, 24
Engineering	2	9, 10, 11, 12
Marketing	3	13, 14, 15, 16
Finance	4	17, 18, 19, 20
Sales	5	1, 2, 3, 4

Table 3-1. VLAN Example - Assigned Ports

## VLAN and Trunk Groups

Trunk Groups (LAGs) can be added as member to a VLAN (similar to ports).

The members of a trunk group have the same VLAN setting. Any VLAN setting on trunk group members applies to the other member ports.



**NOTE:** In order to use VLAN segmentation in conjunction with port trunk groups, the port trunk group(s) can first be set, and then the VLAN settings may be configured. Changing the port trunk grouping with VLANs already in place doesn't require reconfiguration of the VLAN settings after changing the port trunk group settings. VLAN settings automatically change in conjunction with the change of the port trunk group settings.

## VLAN Status

The VLAN List displays VLANs, VLAN membership and membership type. This window displays the ports on the switch that are currently Egress or Tag ports. To view the following table, open the L2 features->VLAN folder and click the VLAN Status Link.

This section contains the following topics:

- Defining VLAN Properties
- Configuring GVRP

## Defining VLAN Properties

The *VLAN Configuration Page* provides information and global parameters for configuring and working with VLANs.

1. Click **L2 Features > 802.1Q VLAN**. The *VLAN Configuration Page* opens:

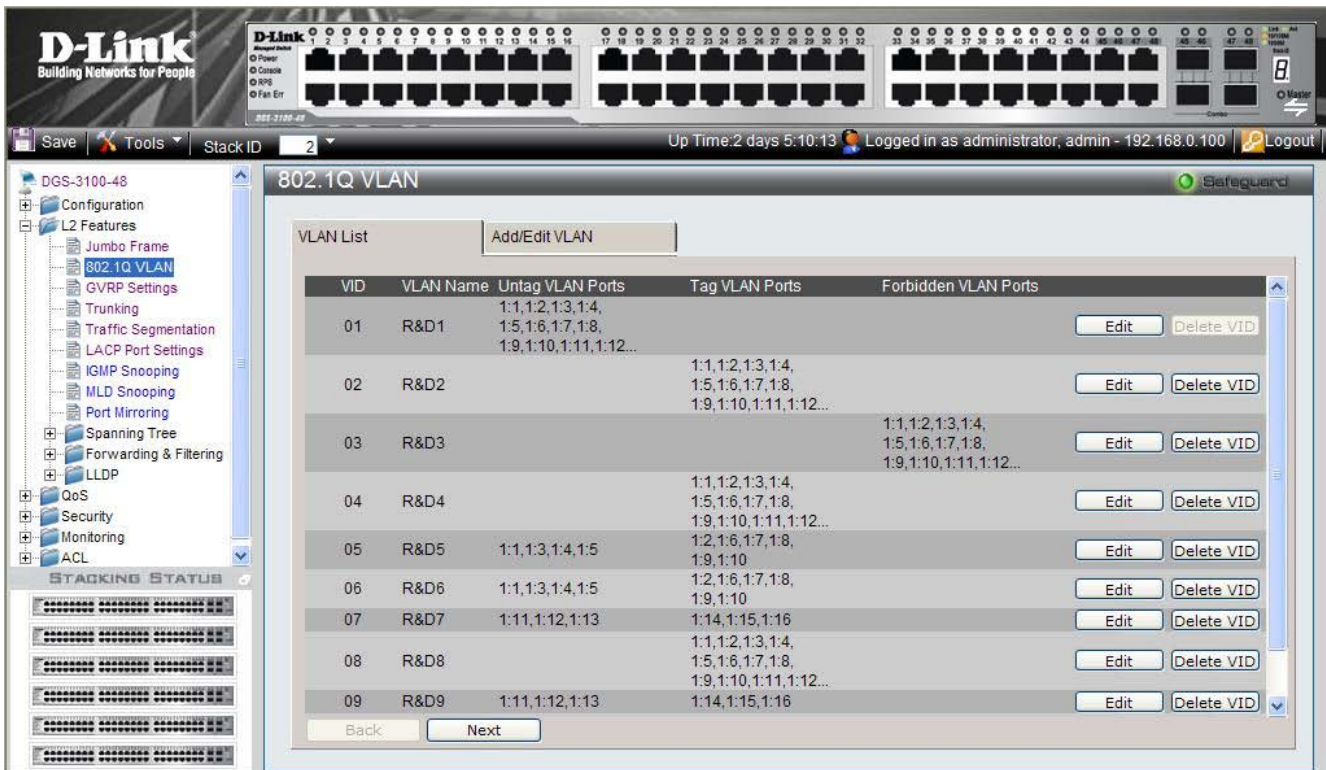

**Figure 3–5. VLAN Configuration Page**

The *VLAN Configuration Page* contains the following fields:

Field	Description
<b>VID</b>	Defines the VLAN ID.
<b>VLAN Name</b>	Defines the user-defined VLAN name. The field ranges is 1-32 characters.
<b>Untag VLAN Ports</b>	Defines the interface is an untagged VLAN member. Packets forwarded by the interface are untagged.
<b>Tag VLAN Ports</b>	Defines the interface is a tagged member of a VLAN. All packets forwarded by the interface are tagged. The packets contain VLAN information.
<b>Forbidden VLAN Ports</b>	Defines the interface VLAN membership, even if GVRP indicates the port is to be added.



**NOTE:** The Guest VLAN should be disabled before deleting the VLAN which was defined as the Guest VLAN..



**NOTE:** On the Default VLAN, the user can define ports as ‘Untagged’ or ‘Tagged’ but not as ‘Forbidden’ or ‘Not Member’.

2. Click the **Add/Edit VLAN** tab. The *Add/Edit VLAN Information Page* opens:

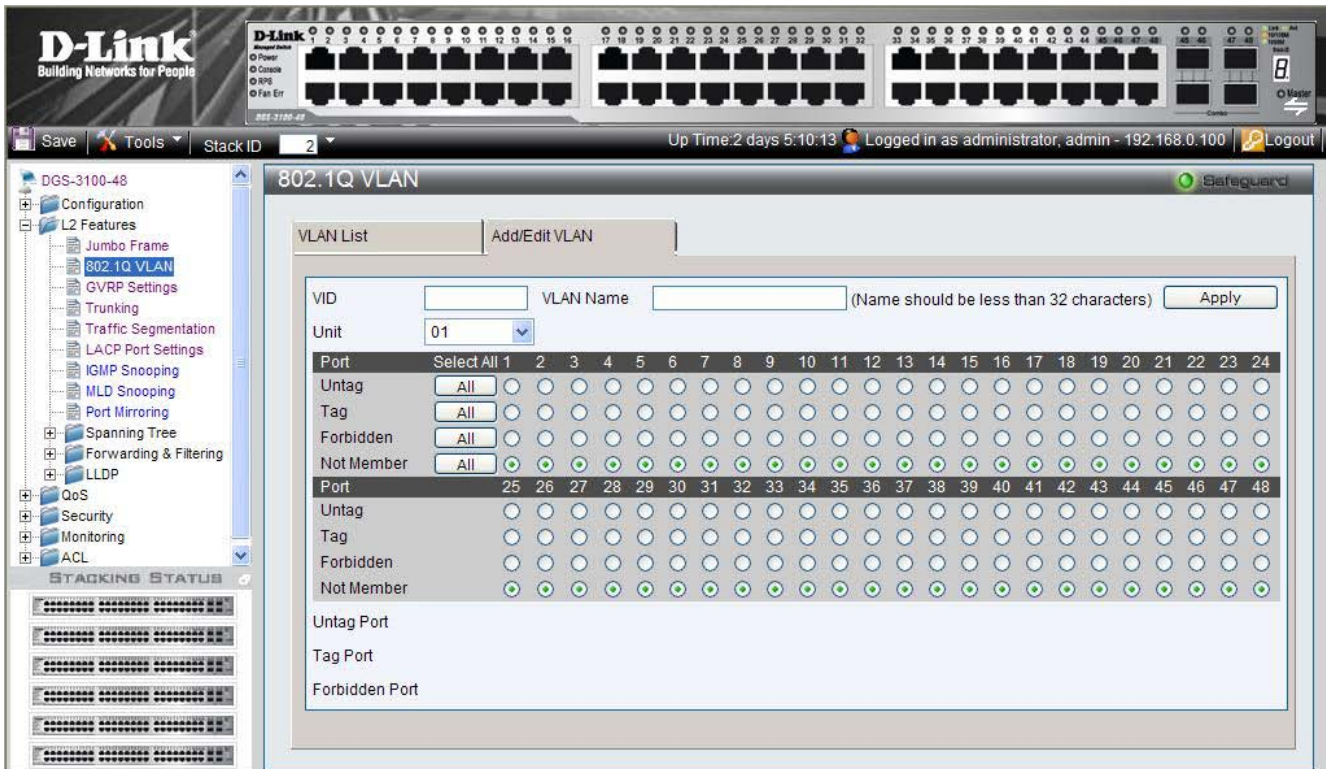

**Figure 3–6. Add/Edit VLAN Information Page**

The *Add/Edit VLAN Information Page* contains the following fields:

Field	Description
<b>VID</b>	Defines the VLAN ID.
<b>VLAN Name</b>	Defines the user-defined VLAN name. The field ranges up to 32 characters.
<b>Unit</b>	Defines the stacking member for which the VLAN parameters are displayed.
<b>Untag Port</b>	Defines the interface is an untagged VLAN member. Packets forwarded by the interface are untagged.
<b>Tag Port</b>	Defines the interface is a tagged member of a VLAN. All packets forwarded by the interface are tagged. The packets contain VLAN information.
<b>Forbidden Port</b>	Defines the interface VLAN membership, even if GVRP indicates the port is to be added.
<b>Not Member</b>	Indicates that the interface is not a member of the VLAN.
<b>Port Select All</b>	Selects all ports and either untags, tags, excludes, or removes the VLAN membership.

3. Define the *VID*, *VLAN Name*, and *port-related* fields.
4. Select the *Tagged*, *Untagged*, and *Forbidden* ports.
5. Click **Apply**. The VLAN is saved, and the device is updated.

To modify a VLAN:

1. Click **L2 Features > 802.1Q VLAN**. The *VLAN Configuration Page* opens:
2. Select a VLAN in the VLAN Table.
3. Click **Edit**. The configured VLAN parameters are displayed in the *Add/Edit VLAN Information* section.
4. Modify the VLAN parameters.
5. Click **Apply**. The VLAN information is modified, and the device is updated.

## Defining Asymmetric VLAN

The device configuration allows a port to be defined as an untagged member only in one VLAN and tagged in multiple VLANs. By enabling Asymmetric VLAN on the device, a port is defined as an untagged member in multiple VLANs. This allows ports from separate VLANs access to a remote server without accessing other hosts.

When Asymmetric VLAN is enabled, if a port is an untagged member in VLAN #1, VLAN #1 must be the PVID.

The following scenerio illustrates the feature:

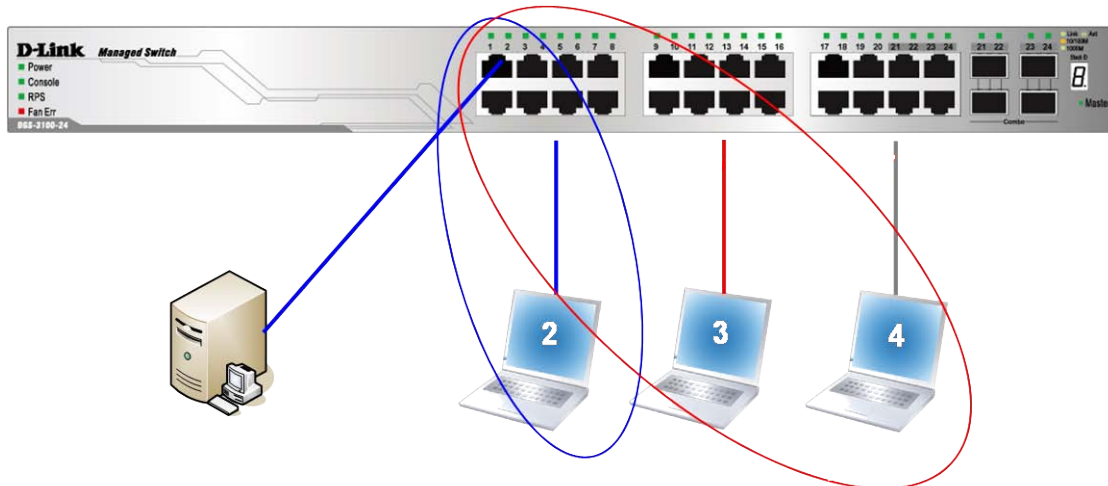

Figure 3–7. Asymmetric VLAN scenerio

Port 1 connect to Server; port 1, port 3, port 9 and port 17 are untagged ports; PC3 & PC4 are in the same VLAN#3; port 1 is a untagged member of VLAN#2 and VLAN#3 (untagged member overlap). Then the server can talk with VLAN#2, VLAN#3; PC3 and PC4 can talk to the server and to each other; PC2 can talk to the Server; VLAN#2 can't communicate with VLAN3.

In this example port 1 need to be untagged member in VLAN#2 & VLAN#3, so Asymmetric VLAN should be enabled.



**NOTE:** In order to support this network scenerio, the user will need to activate also 'DLF Filtering' feature which will be released in DGS-3100-xx R3.0 as well

1. Click **L2 Features** > **Asymmetric VLAN**. The *Asymmetric VLAN Page* opens:

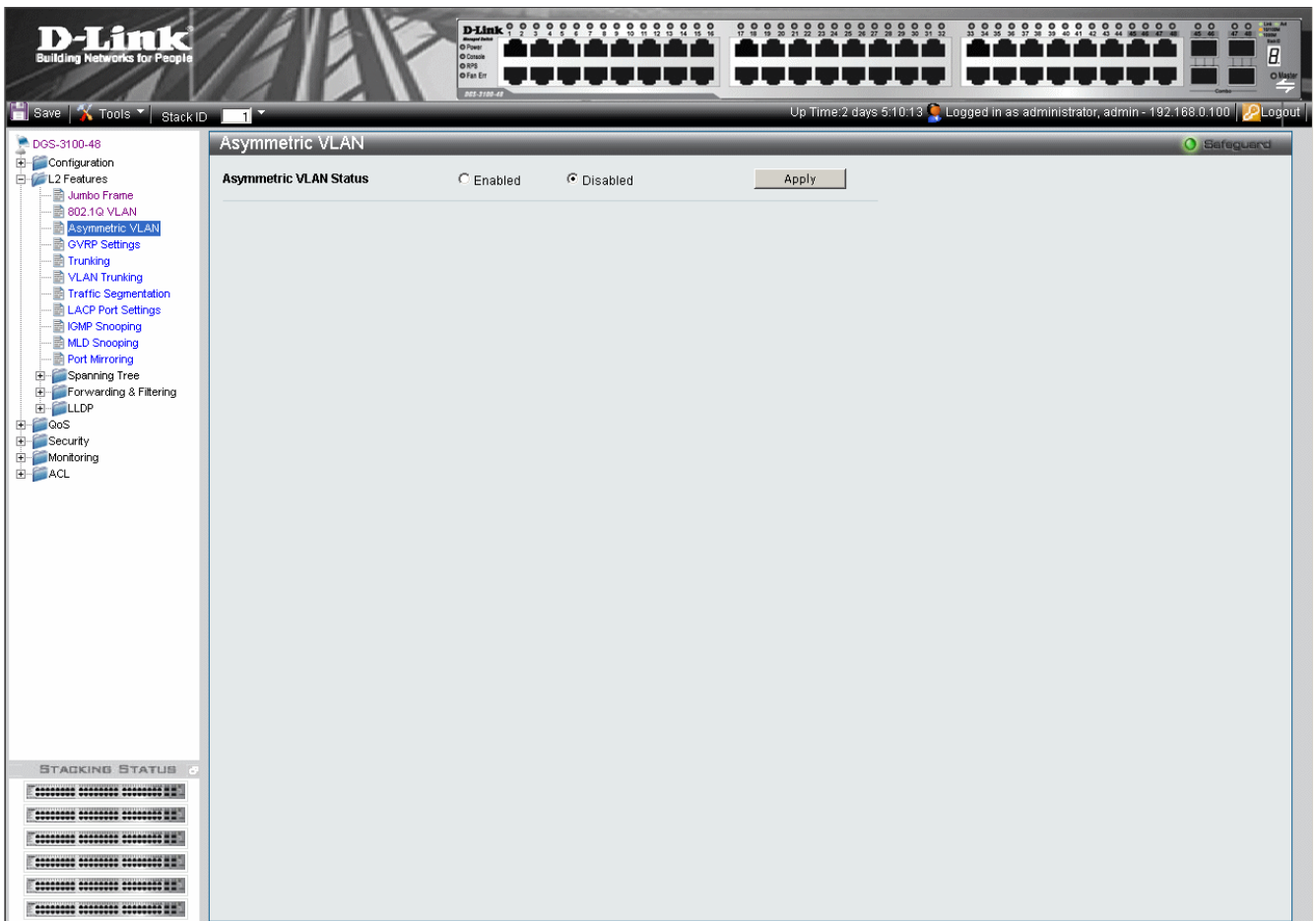

Figure 3–8.Asymmetric VLAN Page

The *Asymmetric VLAN Page* contains the following fields:

Field	Description
<b>Asymmetric VLAN Status</b>	Defines whether Asymmetric VLAN is enabled on the device. The possible field values are: <i>Enabled</i> — Enables Asymmetric VLAN on the device. <i>Disabled</i> — Disables Asymmetric VLAN on the device. This is the default value.

2. Select Enabled/Disabled in the *Asymmetric VLAN Status* field.
3. Select Enable in the DLF Filtering (see *Defining DLF Filtering*).
4. Click **Apply**. The Asymmetric VLAN option is enabled, and the device is updated.



## Configuring GVRP

GVRP timers need to be in the default values on all Layer 2-connected devices. If the GVRP timers are set differently on the Layer 2-connected devices, the GVRP application does not operate successfully.

GARP VLAN Registration Protocol (GVRP) is specifically provided for automatic distribution of VLAN membership information between VLAN-aware bridges. GVRP allows VLAN-aware bridges to automatically learn VLANs to bridge port mapping without requiring the individual configuration of each bridge and register VLAN membership. To define GVRP on the device:

1. Click **L2 Features > GVRP Settings**. The *GVRP Setting Page* opens:

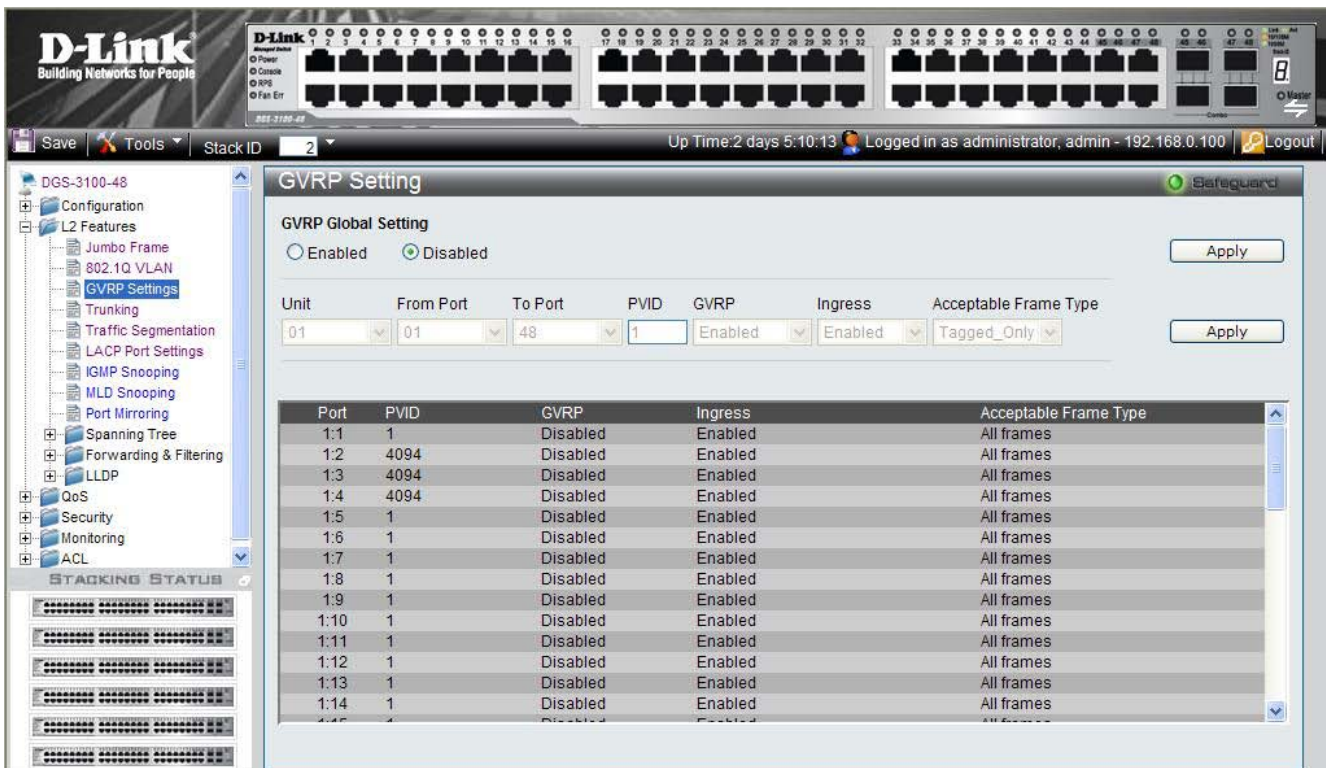

Figure 3–9. GVRP Setting Page

The *GVRP Setting Page* contains the following fields:

Field	Description
<b>GRVP Global Setting</b>	Defines whether GRVP is enabled on the device. The possible field values are: <i>Enabled</i> — Enables GRVP on the device. <i>Disabled</i> — Disables GRVP on the device. This is the default value.
<b>Unit</b>	Defines the stacking member's Unit ID and LAGs for which GVRP parameters are displayed.
<b>From Port</b>	Defines the first port number that is displayed to which GVRP are assigned.
<b>To Port</b>	Defines the last port number that is displayed to which GVRP are assigned.
<b>PVID</b>	Defines the PVID assigned to the port.
<b>GVRP</b>	Defines whether GVRP is enabled on the port. The possible field values are: <i>Enabled</i> — Enables GVRP on the selected port. <i>Disabled</i> — Disables GVRP on the selected port. (This is the default value).
<b>Ingress</b>	Defines whether Ingress filtering is enabled on the device. The possible field values are: <i>Enabled</i> — Enables Ingress filtering on the device. Ingress filtering compares an incoming VID tag packet with the PVID number assigned to the port. If the PVIDs vary, the port drops the packet. (This is the default value). <i>Disabled</i> — Disables Ingress filtering on the device.
<b>Acceptable Frame Type</b>	Defines the packet type accepted on the port. The possible field values are: <i>Admit Tagged Only</i> — Only tagged packets are accepted on the port. <i>Admit All</i> — Both tagged and untagged packets are accepted on the port. (This is the default value).

2. Select a stacking member in the *Unit* field.
3. Select the ports to and from which the GVRP parameters are displayed in the *From/To Port* fields.
4. Define the *PVID*, *GVRP*, *Ingress*, and *Acceptable Frame Type* fields.
5. Click . The GVRP is enabled, and the device is updated.

## Defining Trunking

The *Trunking Configuration Page* contains information for assigning ports to LAGs and defining LAG parameters. To assign ports to LAGs:

1. Click **L2 Features > Trunking**. The *Trunking Configuration Page* opens:

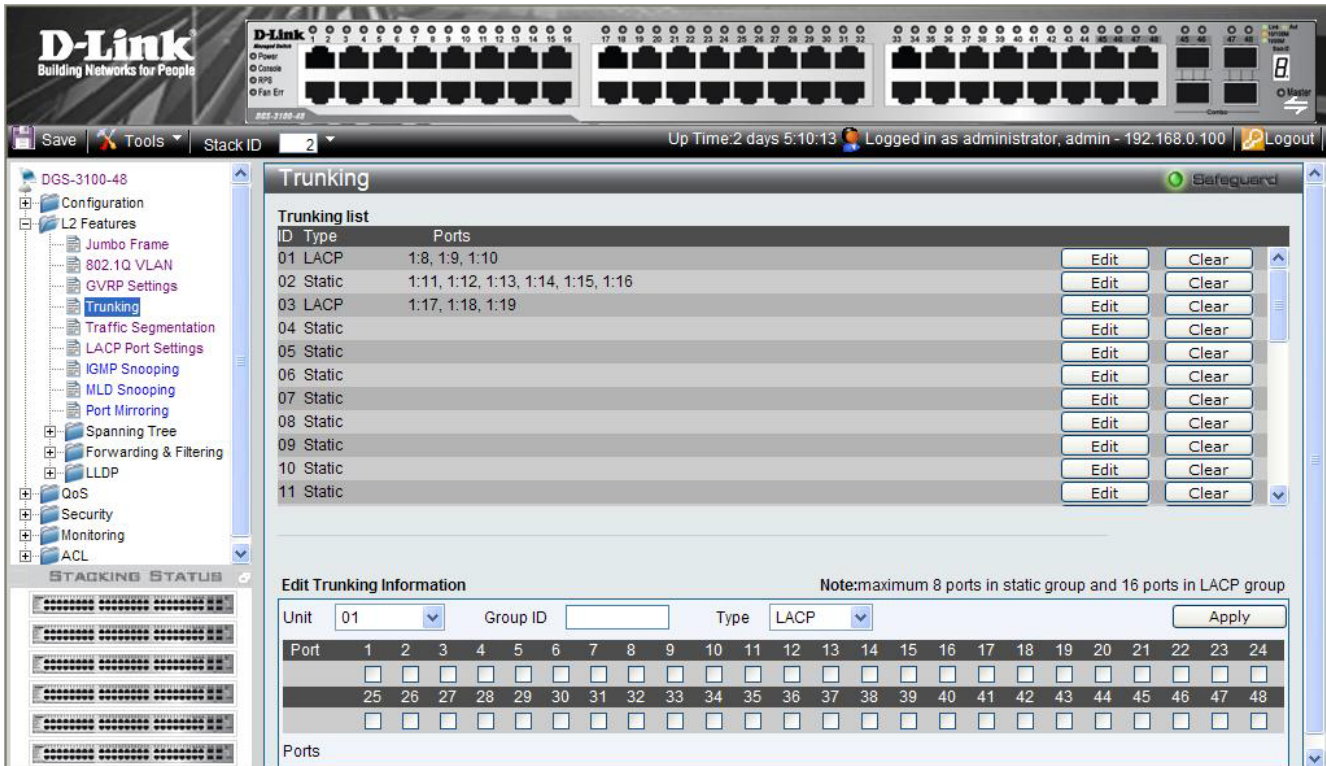

**Figure 3–10. Trunking Configuration Page**

The *Trunking Configuration Page* contains the following fields:

Field	Description
<b>Unit</b>	Defines the stacking member's Unit ID for which LAG parameters are displayed.
<b>Group ID</b>	Displays the LAG number.
<b>Type</b>	Defines the LAG type. The possible field values are: <i>Static</i> — The LAG is static; LACP is disabled on the LAG. (This is the default value). <i>LACP</i> — LACP is enabled on the device..
<b>Ports</b>	Displays the ports which are included in the LAG.

2. Select a stacking unit in the *Unit* field.
3. Define the *Group ID* and *Type* fields.
4. Check the ports to be added to the LAG. The port numbers are displayed in the *Ports* field.
5. Click **Apply**. The LAG settings are saved, and the device is updated.

## Notes about Trunking on the DGS-3100 Series

DGS-3100 series supports up to 32 LAGs per device (or stack).



**NOTE:** A port must belong to the default VLAN when the user is adding the port to a LAG, After adding the port to the LAG, the LAG itself can be joined to other VLAN.

When a port is added to a LAG, the port's configuration is stopping to be active, this configuration will return to be active only after the port will be removed from the LAG.

## Defining VLAN Trunking

VLAN Trunking allows frames belonging to unknown VLAN groups to pass through the switch. VLAN Trunking is activated by enabling VLAN Trunking on the device and defining up to 48 ports as “Uplink” ports. In addition, Ingress Filtering must be enabled on all ports (see GVRP Setting Page ).

The following limitations are applied to the user-defined Uplink ports:

- The Uplink ports can be defined only on Units 1-2 on a stacking device.
- The Uplink ports can not be added to a LAG.
- The Port Lock option is disabled on both ports.
- Port Mirroring is disabled on both ports.

The pass through functionality applies to all VLANs that were not created on the switch, for example if only VLAN #1 is defined on the switch, VLANs 2-4094 will pass traffic between the Uplink ports.

In the example below, the user defined ‘VLAN Trunking’ ports (Uplinks) are ports 23 and 24. In this case, the packet belonging to VLAN 500 enters port 23, defined as one of the Uplink Ports, and therefore will be forwarded to port 24.

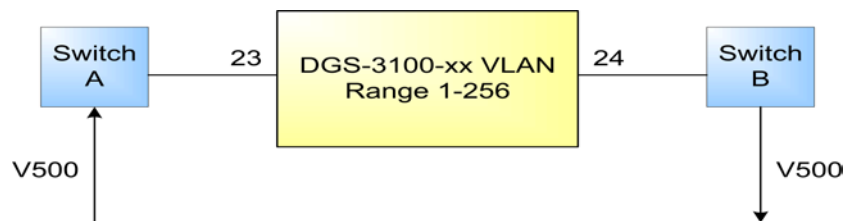

Figure 3–11. VLAN Trunking example between 2 switches

To define VLAN Trunking on the device:

1. Click **L2 Features > VLAN Trunking**. The *VLAN Trunking Page* opens:

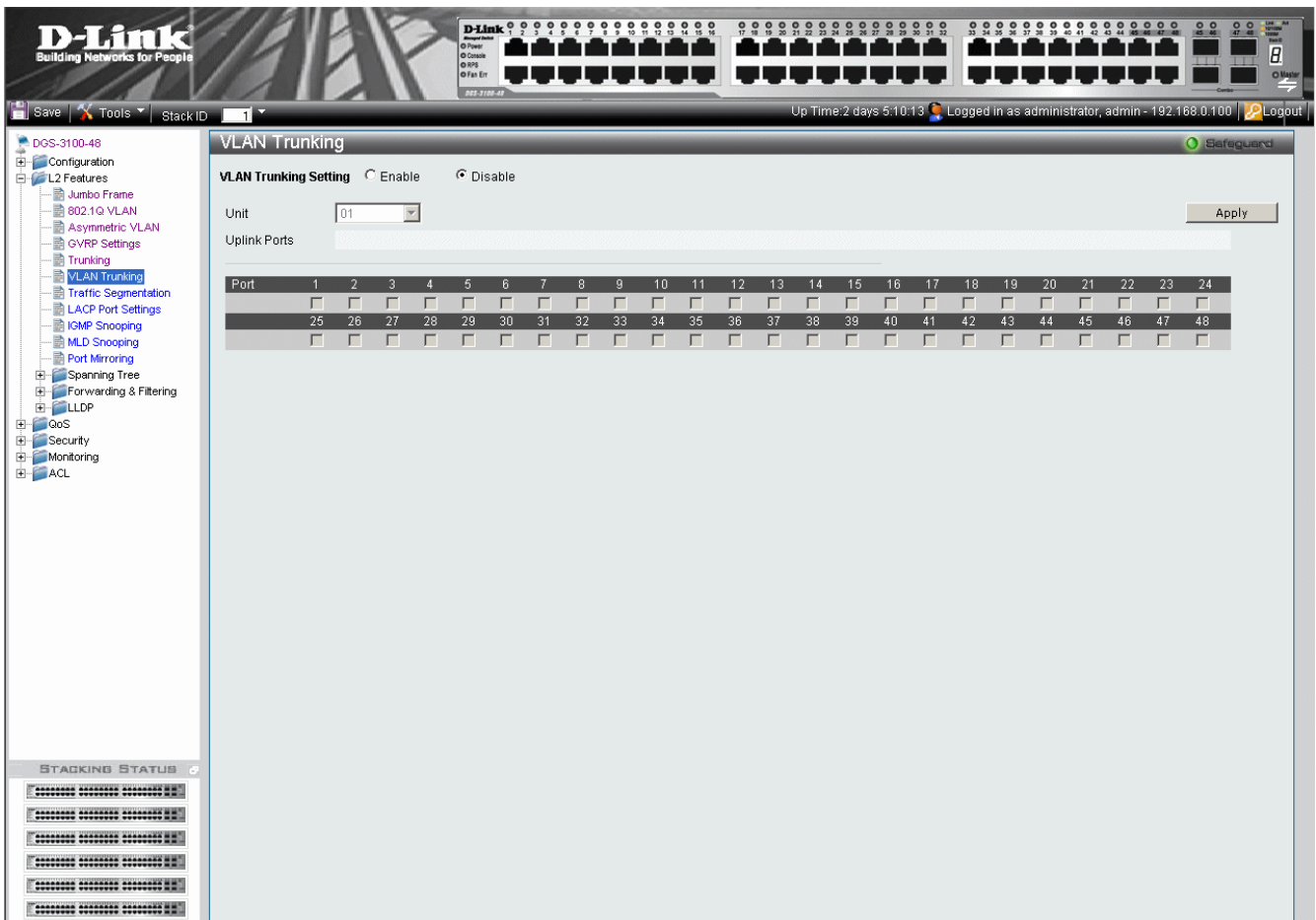

Figure 3–12. VLAN Trunking Page

The *VLAN Trunking Page* contains the following fields:

Field	Description
<b>VLAN Trunking Setting</b>	Defines whether VLAN Trunking Settings are enabled on the device. The possible field values are: <i>Enable</i> — Enables VLAN Trunking Settings on the device. <i>Disable</i> — Disables VLAN Trunking Settings on the device. This is the default value.
<b>Unit</b>	Defines the stacking member's Unit ID for which VLAN Trunking parameters are displayed
<b>Uplink Ports</b>	Displays the Uplink ports which are included in the VLAN Trunking.
<b>Ports</b>	Displays the ports which are included in VLAN Trunking.

2. Enable VLAN Trunking.
3. Select a stacking unit in the *Unit* field.
4. Check the ports to be added to the VLAN Trunking. The port numbers are displayed in the *Uplink Ports* field.
5. Click **Apply**. The VLAN Trunking settings are saved, and the device is updated

# Traffic Segmentation

The *Traffic Segmentation Page* enables administrators to force traffic from *source* ports to bypass the Forwarding Database (FDB), and forward all Unicast, Multicast and Broadcast traffic to the *forwarding* port,. Forwarding decisions by the forwarding port overwrite those of the protected source port. To define Traffic Segmentation:

1. Click **L2 Features > Traffic Segmentation**. The *Traffic Segmentation Page* opens:

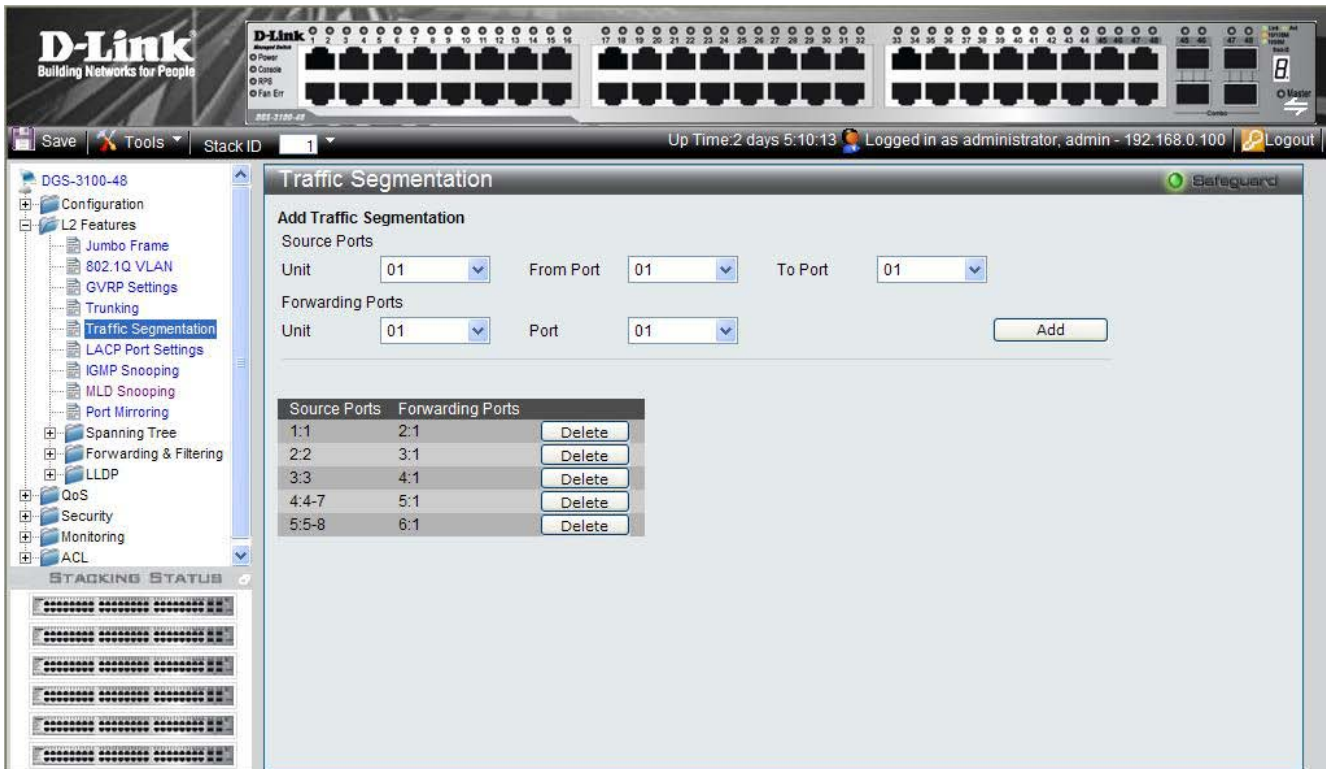

**Figure 3–13. Traffic Segmentation Page**

The *Traffic Segmentation Page* contains the following fields:

Field	Description
<b>Source Ports</b>	The port protected by the forwarding port, or uplink. <i>Unit</i> — The stacking member’s Unit ID and LAGs on which the source port is located. <i>From Port</i> or <i>From LAG</i> — The first source port/LAG number in a consecutive sequence of ports/LAGs. <i>To Port</i> — The last source port/LAG number in a consecutive sequence of ports/LAGs.
<b>Forwarding Ports</b>	The uplink that protects the specified source port. This port’s forwarding decisions overwrite the source port’s forwarding settings. <i>Unit</i> — The stacking member’s Unit ID and LAGs on which the forwarding port is located. <i>Port</i> or <i>LAG</i> — The forwarding port/LAG number.

2. Define the **Source** and **Forwarding Ports**.
3. Click **Add**. The new traffic forwarding definition appears in the Traffic Segmentation table, and the device is updated.

To delete a Traffic Segmentation entry:

1. Select the entry in the table.
2. Click **Delete**. The entry is deleted, and the device is updated.

## Configuring LACP

LAG ports can contain different media types if the ports are operating at the same speed. Aggregated links can be set up manually or automatically established by enabling LACP on the relevant links. Aggregate ports can be linked into link-aggregation port-groups. Each group is comprised of ports with the same speed. The *LACP Port Settings Page* contains fields for configuring LACP LAGs.

1. Click **L2 features > LACP Port Settings**. The *LACP Port Settings Page* opens:

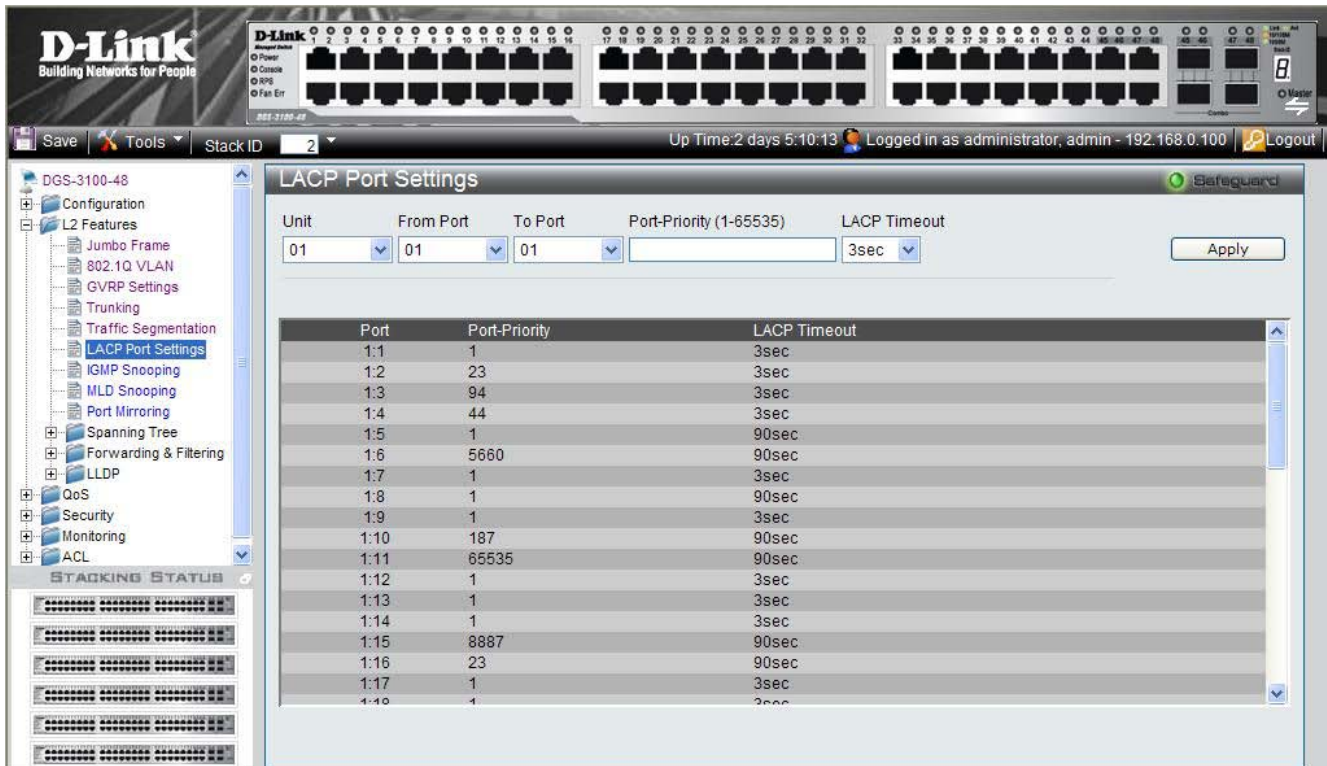

**Figure 3–14. LACP Port Settings Page**

The *LACP Port Settings Page* contains the following fields:

Field	Description
<b>Unit</b>	Defines the stacking member's Unit ID for which LACP parameters are displayed.
<b>From Port</b>	Defines the first port number that is displayed to which timeout and priority values are assigned.
<b>To Port</b>	Defines the last port number that is displayed to which timeout and priority values are assigned.
<b>Port-Priority (1-65535)</b>	Displays the LACP priority value for the port. The field range is 1-65535.
<b>Timeout</b>	Defines the administrative LACP timeout. The possible field values are: <i>Short (3 Sec)</i> — Defines the LACP timeout as 3 seconds. <i>Long (90 Sec)</i> — Defines the LACP timeout as 90 seconds. (This is the default value).

2. Select a stacking member in the *Unit* field.
3. Select the ports to and from which the LACP parameters are displayed in the *From/To Port* fields.
4. Define the *Port-Priority* and *LACP Timeout* fields.
5. Click **Apply**. The LACP parameters are defined, and the device is updated.



## Defining IGMP Snooping

When IGMP Snooping is enabled globally, all IGMP packets are forwarded to the CPU. The CPU analyzes the incoming packets and determines the following information:

- Which ports want to join which Multicast groups.
- Which ports have Multicast routers generating IGMP queries.
- Which routing protocols are forwarding packets and Multicast traffic.

Ports requesting to join a specific Multicast group issue an IGMP report, specifying that this Multicast group is accepting members. This results in the creation of the Multicast filtering database.

IGMP Snooping configuration page supports also IGMP Querier.

1. Click **L2 Features > IGMP Snooping**. The *IGMP Snooping Page* opens:

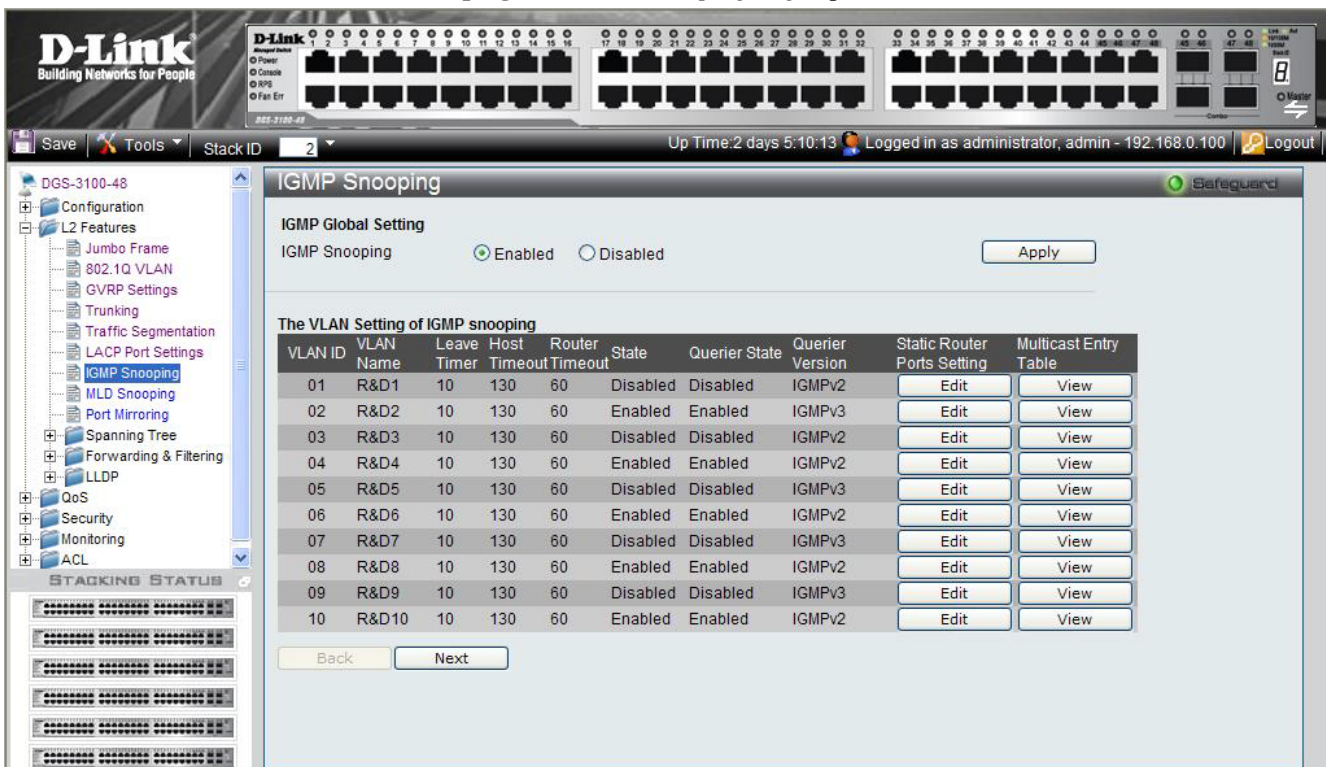

Figure 3–15. IGMP Snooping Page

The *IGMP Snooping Page* contains the following fields:

Field	Description
<b>IGMP Snooping</b>	Enables or disables IGMP Snooping. Bridge Multicast Filtering must first be enabled in order to enable IGMP Snooping. The possible field values are: <i>Enabled</i> — Enables IGMP Snooping on the device. <i>Disabled</i> — Disables IGMP Snooping on the device. (This is the default value).
<b>VLAN ID</b>	Specifies the VLAN ID.
<b>VLAN Name</b>	Displays the user-defined VLAN name.
<b>Leave Timer</b>	Defines the time a host waits to receive a Join message from another station after requesting to leave the IGMP group, prior to timing out. If a Leave Timeout occurs, the switch notifies the Multicast device to stop sending traffic. The Leave Timeout value is either user-defined, or an immediate leave value. The default timeout is 10 seconds. The field range is 0-16711450 seconds.

Field	Description
<b>Host Timeout</b>	Defines the time the host waits to receive a message before timing out. The default time is 260 seconds. The field range is 60-16711450 seconds.
<b>Router Timeout</b>	Defines the time the Multicast router waits to receive a message before it times out. The default value is 300 seconds. The field range is 1-16711450 seconds.
<b>State</b>	Indicates if IGMP snooping is enabled on the VLAN. The possible field values are: <i>Enable</i> — Enables IGMP Snooping on the VLAN. <i>Disable</i> — Disables IGMP Snooping on the VLAN. (This is the default value).
<b>Querier State</b>	Indicates if an IGMP Querier is enabled on the VLAN. The possible field values are: <i>Enabled</i> — An IGMP Querier is enabled on the VLAN. <i>Disabled</i> — An IGMP Querier is disabled on the VLAN. (This is the default value).
<b>Querier Version</b>	Indicates the IGMP Querier version on the VLAN. The possible field values are IGMPv2 and IGMPv3 (The default is IGMPv2).
<b>Static Router Port Setting (Edit button)</b>	Displays the IGMP Snooping and Static Router Ports Settings Page.
<b>Multicast Entry Table (View Button)</b>	Displays the Multicast Entry Table.

2. Click **Edit**. The *IGMP Snooping and Static Router Ports Settings* Page opens:

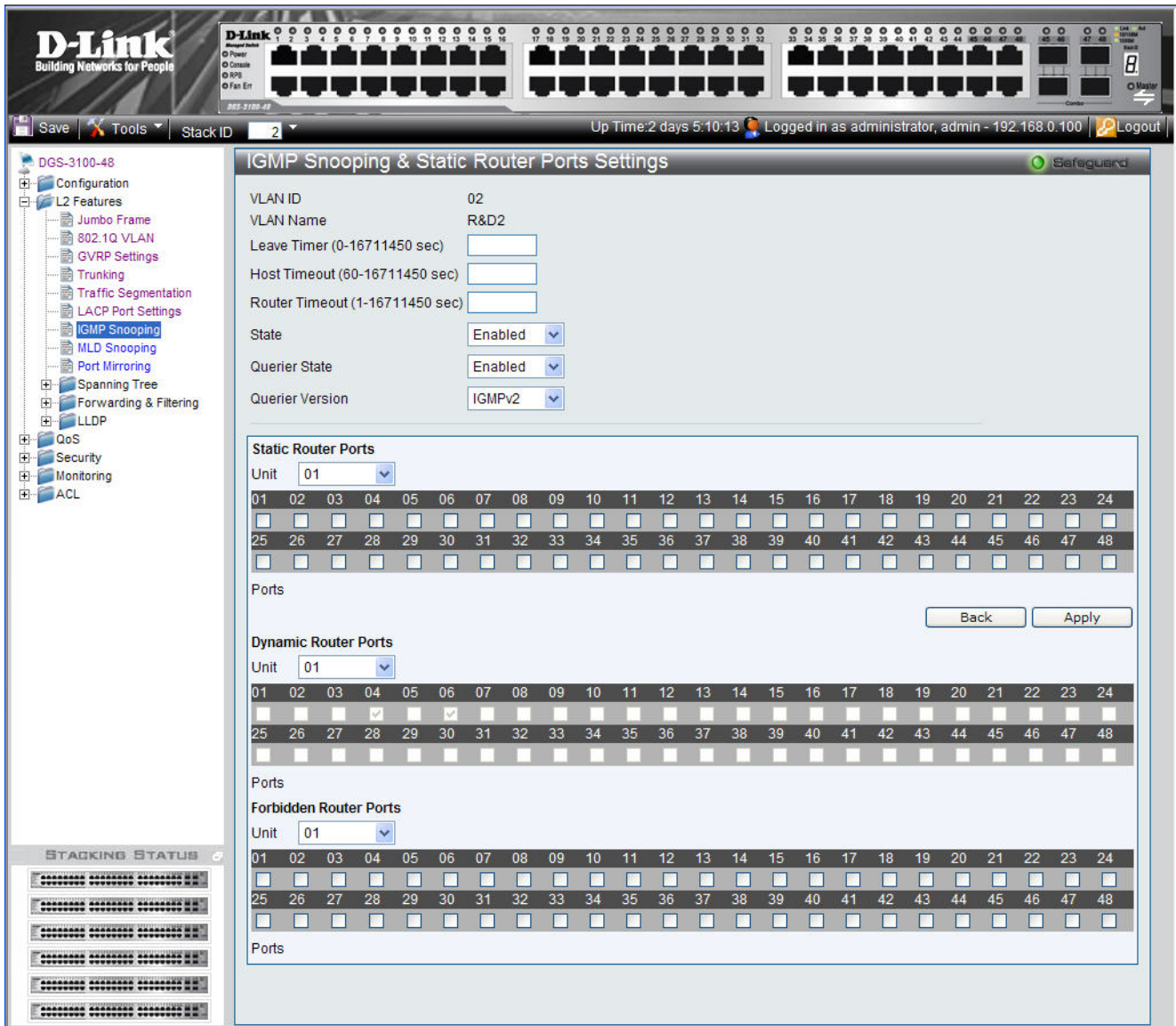

**Figure 3–16. IGMP Snooping and Static Router Ports Settings Page**

The *IGMP Snooping and Static Router Ports Settings* Page contains the following fields:

Field	Description
<b>VLAN ID</b>	Specifies the VLAN ID
<b>VLAN Name</b>	Displays the user-defined VLAN name.
<b>Leave Timer</b>	Defines the time a host waits to receive a Join message from another station after requesting to leave the IGMP group, prior to timing out. If a Leave Timeout occurs, the switch notifies the Multicast device to stop sending traffic. The Leave Timeout value is either user-defined, or an immediate leave value. The default timeout is 10 seconds. The field range is 0-16711450 seconds.
<b>Host Timeout</b>	Defines the time the host waits to receive a message before timing out. The default time is 260 seconds. The field range is 60-16711450 seconds.
<b>Router Timeout</b>	Defines the time the Multicast router waits to receive a message before it times out. The default value is 300 seconds. The field range is 1-16711450 seconds.
<b>State</b>	Indicates if IGMP snooping is enabled on the VLAN. The possible field values are:

Field	Description
	<i>Enable</i> — Enables IGMP Snooping on the VLAN. <i>Disable</i> — Disables IGMP Snooping on the VLAN
<b>Querier State</b>	Defines the IGMP Querier status on the VLAN. The possible field values are: <i>Enabled</i> — Enables an IGMP Querier on the VLAN. <i>Disabled</i> — Disables an IGMP Querier on the VLAN..
<b>Querier Version</b>	Defines the IGMP Querier version on the VLAN. The possible field values are IGMPv2 and IGMPv3.
<b>Unit</b>	Defines the unit number.
<b>Static Router Ports</b>	Defines the port numbers which can be added as static router ports.
<b>Ports</b>	Indicates the units and allocated ports as static router ports.
<b>Dynamic Router Ports</b>	Displays the port numbers which was learned as dynamic router ports.
<b>Forbidden Router Ports</b>	Defines the ports to be added as forbidden router ports.
<b>Ports</b>	Indicates the units and port numbers defined as forbidden router ports.

3. Define the *Leave Timer*, *Host Timeout*, *Router Timeout*, *State*, *Querier State*, *Querier Version*, *Static Dynamic* and *Forbidden Router Ports* fields.
4. Click . IGMP Snooping and Static Router Port Settings are defined, and the device is updated.

## Defining MLD Snooping

Multicast Listener Discovery (MLD) Snooping performs the same function for IPv6 multicast routers as IGMP Snooping does for IPv4 multicast routers.

The device supports two versions of MLD Snooping:

- MLDv1 Snooping detects MLDv1 control packets and sets up traffic bridging based on IPv6 destination multicast addresses. MLDv1 is equivalent to IGMPv2.
- MLDv2 Snooping uses control packets to set up traffic forwarding based on source IPv6 address and destination IPv6 multicast address. MLDv2 is equivalent to IGMPv3.

In a similar approach to IGMP snooping, MLD frames are snooped as they are forwarded by the switch from stations to an upstream multicast router. This facility allows a switch to determine the following:

- Where (on which ports) stations interested in joining a specific multicast group are located
- Where (on which ports) multicast routers sending multicast frames are located

This knowledge is used to exclude irrelevant ports (ports for which no stations have registered to receive a specific multicast group) from the forwarding set of an incoming multicast frame.

Two port types can be defined in the system:

- Host port - a port connected to an end-node device running an IGMP/MLD (multicast communication) application.
- Multicast Router (mrouter) port - a port connecting multicast router ports to the switch. This port receives all IGMP/MLD control packets (reports and queries) as well as all multicast data traffic associated with dynamic Multicast groups.

A port can be both a host port and mrouter port simultaneously.

1. Click **L2 Features > MLD Snooping**. The *MLD Snooping Page* opens:

The screenshot shows the D-Link web management interface for a DGS-3100-48 switch. The main configuration area is titled "MLD Snooping" and includes the following elements:

- MLD Global Setting:** A radio button for "Enabled" is selected, and "Disabled" is unselected. An "Apply" button is present.
- The VLAN Setting of MLD snooping:** A table with 10 rows, each representing a VLAN. The columns are: VLAN ID, VLAN Name, Done Timer, Host Timeout, Router Timeout, State, Static Router Ports Setting, and Multicast Entry Table. Each row has "Edit" and "View" buttons.

VLAN ID	VLAN Name	Done Timer	Host Timeout	Router Timeout	State	Static Router Ports Setting	Multicast Entry Table
01	R&D1	10	130	60	Disabled	Edit	View
02	R&D2	10	130	60	Enabled	Edit	View
03	R&D3	10	130	60	Disabled	Edit	View
04	R&D4	10	130	60	Enabled	Edit	View
05	R&D5	10	130	60	Disabled	Edit	View
06	R&D6	10	130	60	Enabled	Edit	View
07	R&D7	10	130	60	Disabled	Edit	View
08	R&D8	10	130	60	Enabled	Edit	View
09	R&D9	10	130	60	Disabled	Edit	View
10	R&D10	10	130	60	Enabled	Edit	View

Figure 3–17. MLD Snooping Page

The MLD Snooping Page contains the following fields:

Field	Description
<b>MLD Snooping</b>	Enables or disables MLD Snooping. The possible field values are: <i>Enabled</i> — Enables MLD Snooping on the device. <i>Disabled</i> — Disables MLD Snooping on the device. (This is the default value).
<b>VLAN ID</b>	Specifies the VLAN ID.
<b>VLAN Name</b>	Displays the user-defined VLAN name.
<b>Done Timer</b>	Specifies the time interval in seconds after which a port is removed from the Multicast membership group. Ports are removed from the Multicast membership when the port sends a Done Message, indicating the port requests to leave the Multicast group. The field range is 0-16711450 seconds. The default timeout is 10 seconds.
<b>Host Timeout</b>	Specifies the time interval in seconds after which a port is removed from a Multicast Group. Ports are removed if a Multicast group MLD report was not received from a Multicast port within the defined <i>Host Timeout</i> period. The possible field range is 60 - 16711450 seconds. The default timeout is 260 seconds.
<b>Router Timeout</b>	Specifies the time interval in seconds the Multicast router waits to receive a message before it times out. The possible field range is 60 - 16711450 seconds. The default timeout is 300 seconds.
<b>State</b>	Indicates if MLD snooping is enabled on the VLAN. The possible field values are: <i>Enabled</i> —MLD Snooping is enabled on the VLAN. <i>Disabled</i> —MLD Snooping is disabled on the VLAN. (This is the default value).
<b>Static Router Port Setting (Edit button)</b>	Displays the MLD Snooping & Static Router Ports Settings Page.
<b>Multicast Entry Table (View Button)</b>	Displays the Multicast Entry Table.

- Click . The *MLD Snooping & Static Router Ports Settings Page* opens:

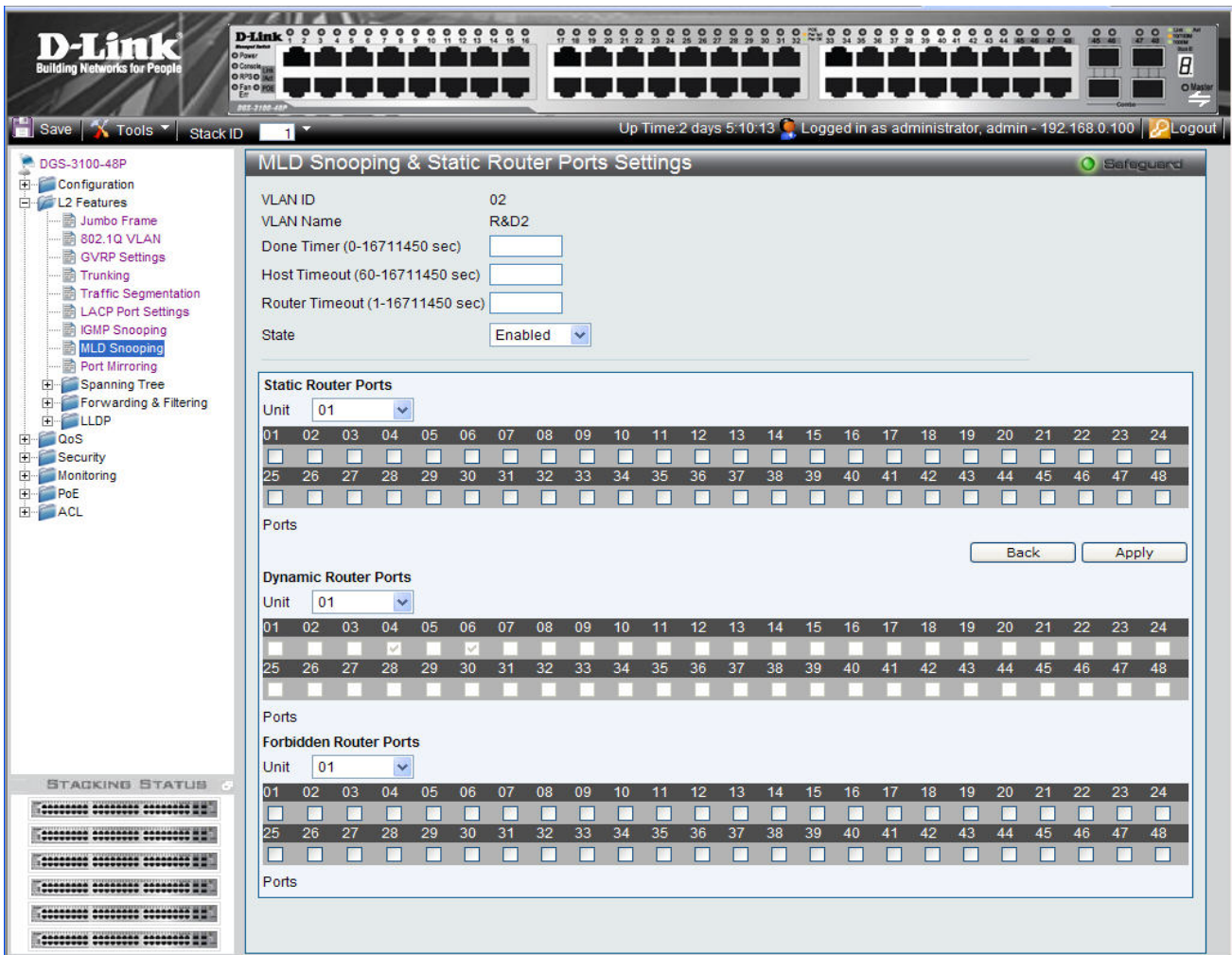

Figure 3–18. MLD Snooping & Static Router Ports Settings Page

The MLD Snooping & Static Router Ports Settings Page contains the following fields:

Field	Description
<b>VLAN ID</b>	Specifies the VLAN ID
<b>VLAN Name</b>	Displays the user-defined VLAN name.
<b>Done Timer (0-16711450 sec)</b>	Defines the time interval in seconds after which a port is removed from the Multicast membership group. Ports are removed from the Multicast membership when the port sends a Done Message, indicating the port requests to leave the Multicast group. The field range is 0 - 16711450 seconds. The default timeout is 10 seconds.
<b>Host Timeout (60-16711450 sec)</b>	Defines the time interval in seconds after which a port is removed from a Multicast Group. Ports are removed if a Multicast group MLD report was not received from a Multicast port within the defined <i>Host Timeout</i> period. The possible field range is 60 - 16711450 seconds. The default timeout is 260 seconds.
<b>Router Timeout (1-16711450 sec)</b>	Defines the time interval in seconds the Multicast router waits to receive a message before it times out. The possible field range is 1 - 16711450 seconds. The default timeout is 300 seconds.
<b>State</b>	Indicates if MLD snooping is enabled on the VLAN. The possible field values are:  <i>Enable</i> — Enables MLD Snooping on the VLAN. <i>Disable</i> — Disables MLD Snooping on the VLAN

Field	Description
<b>Unit</b>	Defines the unit number.
<b>Static Router Ports</b>	Defines the port numbers in the selected unit to be added as static router ports.
<b>Ports</b>	Displays the unit:port numbers defined as static router ports.
<b>Dynamic Router Ports</b>	Displays the port numbers in the selected unit learned as dynamic router ports.
<b>Ports</b>	Displays the unit:port numbers defined as dynamic router ports.
<b>Forbidden Router Ports</b>	Defines the port numbers in the selected unit to be added as forbidden router ports.
<b>Ports</b>	Displays the unit:port numbers defined as forbidden router ports.

3. Define the *Done Timer*, *Host Timeout*, *Router Timeout*, *State*, *Static*, *Dynamic*, and *Forbidden Router Ports* fields.
4. Click **Apply**. MLD Snooping and Static Router Port Settings are defined, and the device is updated.



## Configuring Port Mirroring

Switches inherently forward frames to relevant ports only. This creates difficulty when traffic needs to be monitored, either for information gathering (such as statistical analysis, security traces, etc.) or for troubleshooting higher-layer protocol operation. The device supports up to 8 source ports.

To enable the use of traffic analysis and monitoring devices, it is recommended enabling the user to specify that a desired ‘target’ port receives a copy of all traffic passing through a designated ‘source’ port.

In order to activate Port Mirroring, the target port must belong to the default VLAN.

1. Click **L2 Features > Port Mirroring**. The *Port Mirroring Page* opens:

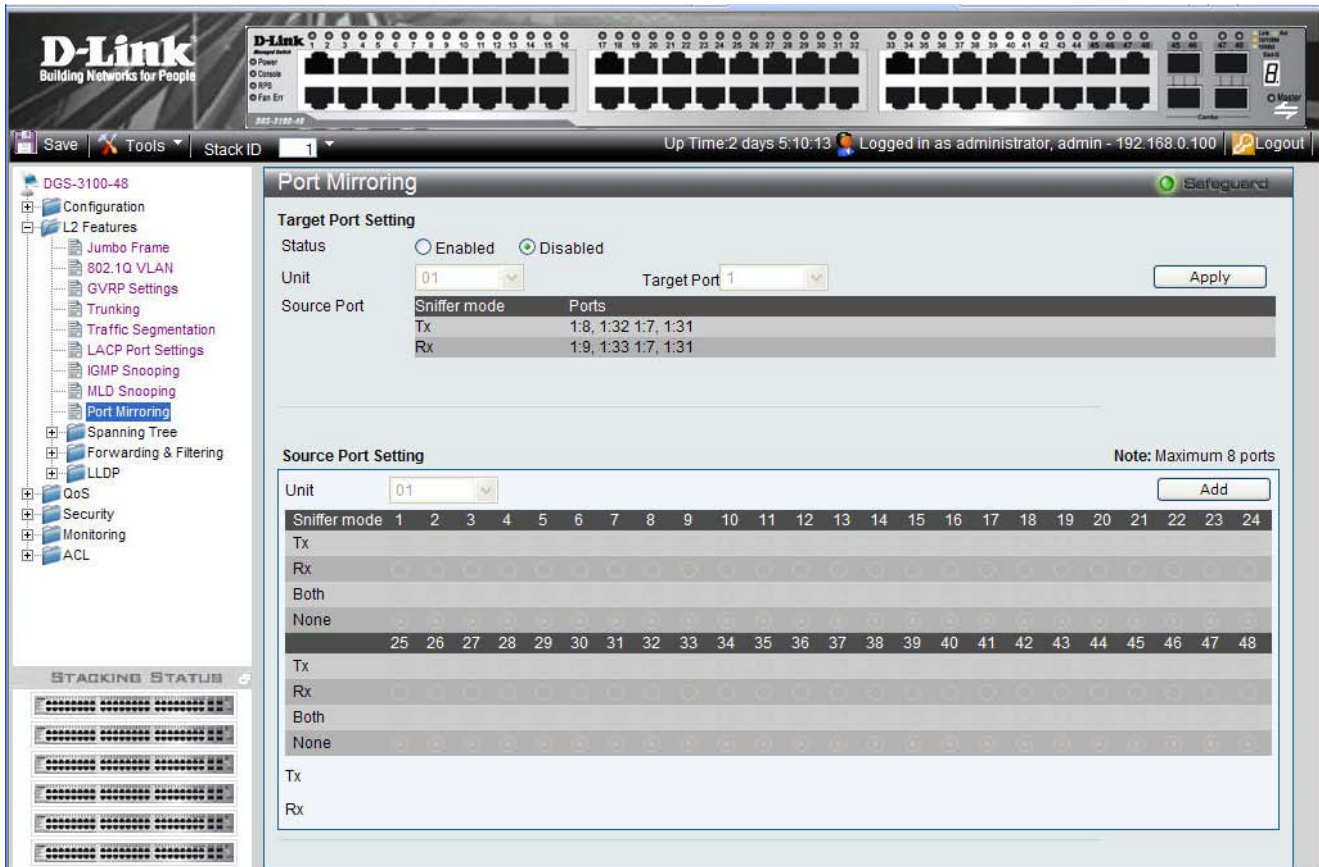

**Figure 3–19. Port Mirroring Page**

The *Port Mirroring Page* contains the following fields:

Field	Description
<b>Status</b>	Enables or disables target port setting. The default is Disabled.
<b>Unit</b>	Defines the unit number.
<b>Target Port</b>	Defines the target port.
<b>Source Port</b>	Displays the Sniffer Mode and the source port.

Source Port Setting

Field	Description
<b>Unit</b>	Selects the Unit to be displayed.
<b>Tx</b>	Indicates the transmit stream of data on the port.
<b>Rx</b>	Indicates the receive stream of data on the port.

Field	Description
Both	Defines the port mirroring on both receiving and transmitting ports.
None	Defines that port mirroring is not applied to the ports.

2. Define the *Status*, *Unit*, and *Target* fields.
3. Click  to activate the Port Mirroring function.
4. Define the *Unit*, *Tx*, and *Rx* fields under Source Port Setting.
5. Click  to capture the configured Source Ports in order to display them in the Source Port Setting table.

## Configuring Spanning Tree

*Spanning Tree Protocol (STP)* provides tree topography for any arrangement of bridges, as well as providing a single path between end stations on a network, thus eliminating loops.

Loops occur when alternate routes exist between hosts. Loops in an extended network can cause bridges to forward traffic indefinitely, resulting in increased traffic and reducing network efficiency.

The device supports the following STP versions:

Version	Description
<b>Classic STP</b>	Provides a single path between end stations, preventing loops from occurring.
<b>Rapid STP</b>	Detects and uses network topologies that provide faster convergence of the spanning tree, without creating forwarding loops.
<b>Multiple STP</b>	Provides various load balancing scenarios. For example, if port A is blocked in one STP instance, the same port can be placed in Forwarding State in another STP instance.

The *STP Bridge Global Settings Page* contains parameters for enabling STP on the device. This section contains the following topics:

- Defining Spanning Tree Global Parameters
- Defining STP Port Settings
- Defining Multiple Spanning Tree Configuration Identification
- Defining MSTP Port Information

## Defining Spanning Tree Global Parameters

While Classic STP prevents Layer 2 forwarding loops in a general network topology, convergence can take between 30-60 seconds. This time may delay detecting possible loops and propagating status topology changes. Rapid Spanning Tree Protocol (RSTP) detects and uses network topologies that allow a faster STP convergence without creating forwarding loops. When STP is enabled, Loopback Detection (LBD) is also enabled. Loopback Detection identifies any Loopback BPDUs that the Spanning Tree application receives on a port. In this case, the device sends a Loopback Detection trap for the port. When the condition is resolved, the device sends a Loopback Detection Resolved trap and the port learns the STP configuration again.

The *STP Bridge Global Settings Page* contains parameters for enabling STP on the device.

1. Click **L2 Features > Spanning Tree > STP Bridge Global Settings**. The *STP Bridge Global Settings Page* opens:

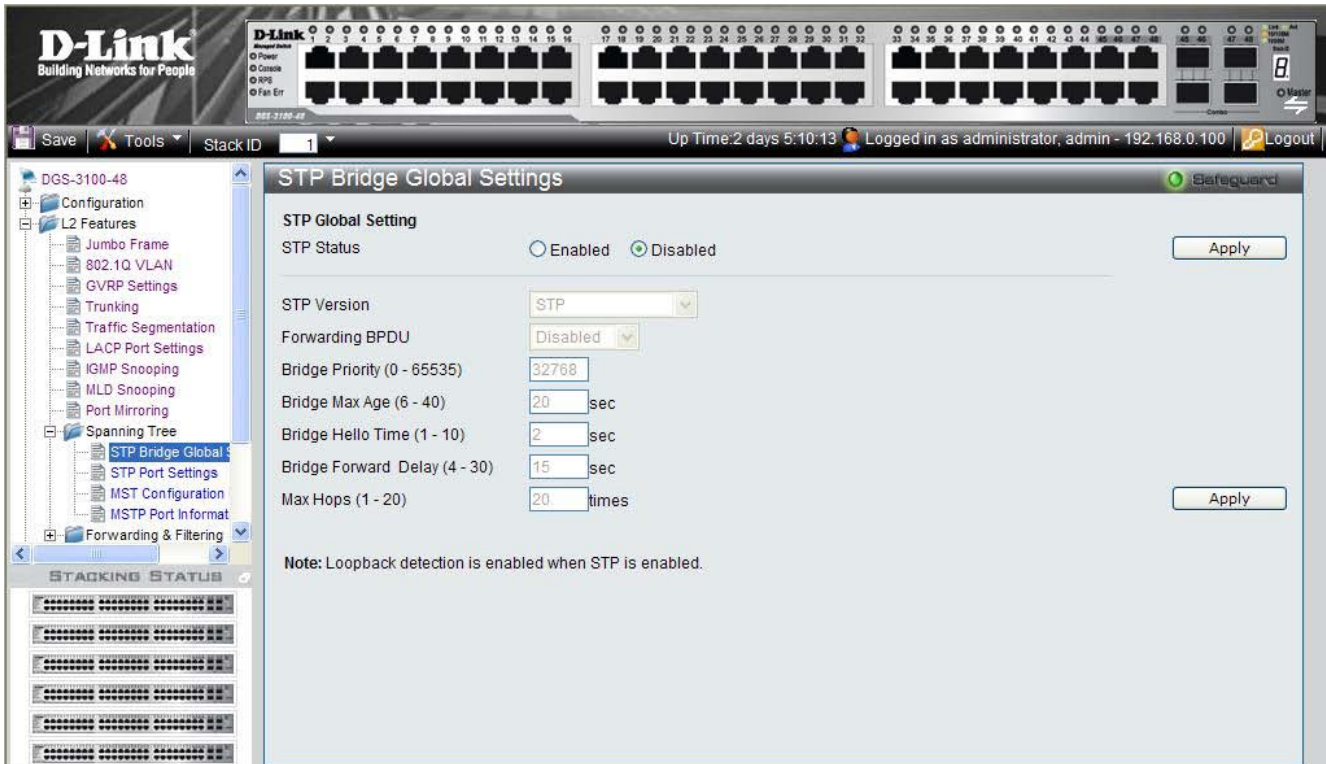

**Figure 3–20. STP Bridge Global Settings Page**

The *STP Bridge Global Settings Page* contains the following fields:

Field	Description
<b>STP Status</b>	Enable or disables STP globally on the switch. The default is Disabled.
<b>STP Version</b>	Defines the desired version of STP to be implemented on the switch. There are three choices: <i>STP</i> — Sets the Spanning Tree Protocol (STP) globally on the switch. <i>RSTP</i> — Sets the Rapid Spanning Tree Protocol (RSTP) globally on the switch. <i>MSTP</i> — Sets the Multiple Spanning Tree Protocol (MSTP) globally on the switch.
<b>Forwarding BPDU</b>	Bridges use Bridge Protocol Data Units (BPDU) to provide spanning tree information. STP BPDUs filtering is useful when a bridge interconnects two regions; each region needing a separate spanning tree. BPDU filtering functions only when STP is disabled either globally or on a single interface. The possible values are: <i>Enabled</i> – Allows the forwarding of STP BPDU packets from other network devices.. <i>Disabled</i> – BPDU forwarding is disabled on the device. (This is the default value)

Field	Description
<b>Bridge Priority (0 – 65535)</b>	Specifies the selected spanning tree instance device priority. The field range is 0-65535. The default value is 32768.
<b>Bridge Max Age (6- 40)</b>	Set to ensure old information is not circulated endlessly through redundant paths in the network, preventing the effective propagation of the new information. Set by the Root Bridge, this value aids in determining that the switch has spanning tree configuration values consistent with other devices on the bridged LAN. If the value ages out and a BPDU has still not been received from the Root Bridge, the switch will start sending its own BPDU to all other switches for permission to become the Root Bridge. If your switch has the lowest Bridge Identifier, it will become the Root Bridge. The user can choose between 6 and 40 seconds. The default value is 20.
<b>Bridge Hello Time (1 – 10)</b>	The interval between two transmissions of BPDU packets sent by the Root Bridge to indicate to all other switches that it is indeed the Root Bridge. The default value is 2.
<b>Bridge Forward Delay (4 – 30)</b>	Defines the time any port on the switch is in the listening state while moving from the blocking state to learning state and then to the forwarding state. The default value is 15.
<b>Max Hops (1 – 20)</b>	Specifies the total number of hops that occur before the BPDU is discarded. Once the BPDU is discarded, the port information is aged out. The possible field range is 1-20. The field default is 20 hops.
<b>LBD Recovery Time (30 – 86400)</b>	Defines the amount of time that passes after ports that were shut down through LBD are moved to active. The possible field range is 30 - 86400 seconds. The default is 60 seconds (2 minutes).

2. Select Enable/Disable in the *STP Status* field.
3. Define the *STP Version*, *Forwarding BPDU*, *Bridge Priority*, *Bridge Max Age*, *Bridge Hello Time*, *Bridge Forward Delay*, *Max Hops* fields and *LBD Recovery Time*.
4. Click . The Spanning Tree Global Parameters are defined, and the device is updated.



**NOTE:** The Global STP status default was 'Enable' in previous software versions and was changed to 'Disable'. Please note that if STP enabled is the required state, you should enable STP via the WEB GUI or the CLI.



**NOTE:** In case of STP loopback the port will be shutdown, the port will be activated after the loopback is removed

## Defining STP Port Settings

STP can be set up on a port per port basis. In addition to setting Spanning Tree parameters for use at the switch level, the switch enables configuring groups of ports, in which case each port-group has its own spanning tree and requires some of its own configuration settings. An STP group uses the switch level parameters entered above, with the addition of Port Priority and Port Cost.

An STP group spanning tree works in the same way as the switch level spanning tree, however the root bridge concept is replaced with a root port concept. A root port is a group port designated as the connection to the network for the group, based on port priority and port cost. Redundant links are blocked, just as redundant links are blocked at the switch level.

The switch level STP blocks redundant links between switches (and similar network devices). The port level STP blocks redundant links within an STP Group.

It is advisable to define an STP Group to correspond to a VLAN group of ports.

1. Click **L2 Features > Spanning Tree > STP Port Settings**. The *STP Port Settings Page* opens:

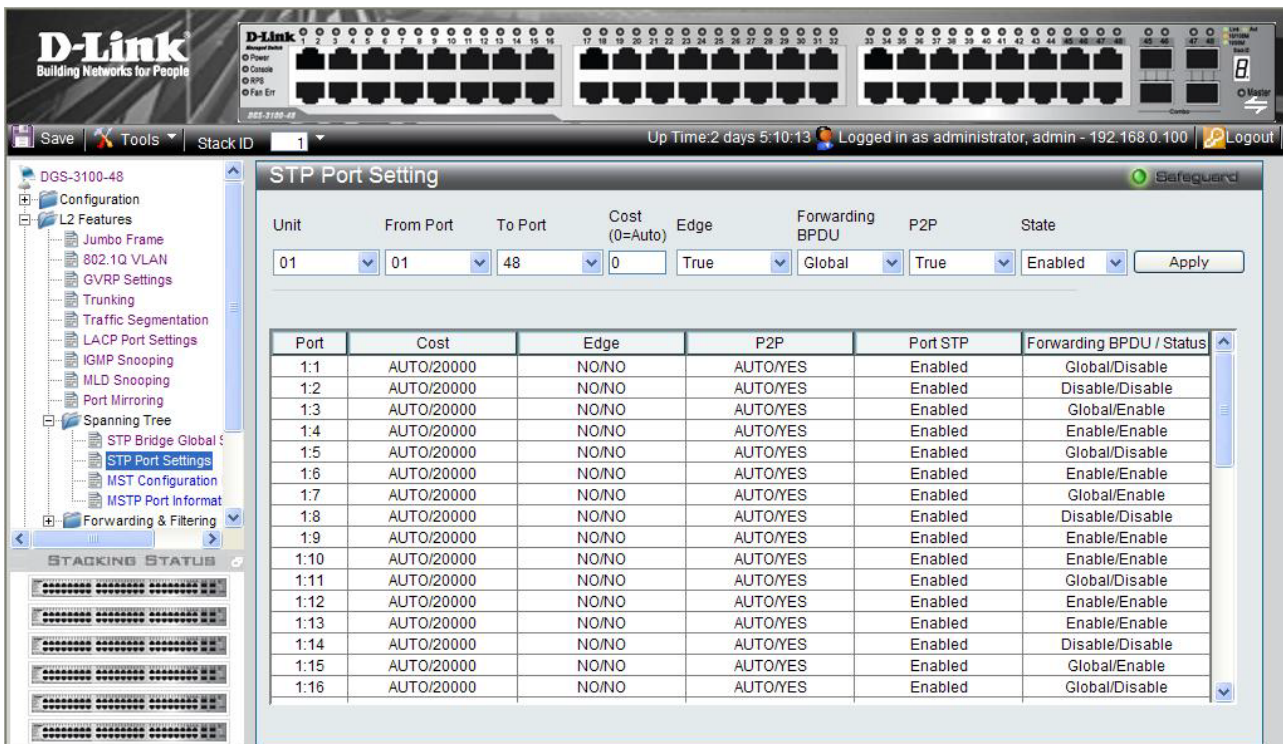

**Figure 3–21. STP Port Settings Page**

The *STP Port Settings Page* contains the following fields:

Field	Description
<b>Unit</b>	Indicates the stacking member for which the STP port settings are displayed.
<b>From Port</b>	Defines the first port in a consecutive sequence of ports.
<b>To Port</b>	Defines last port in a consecutive sequence of ports.
<b>Cost (0=Auto)</b>	<p>Defines a metric that indicates the relative cost of forwarding packets to the specified port list. Port cost can be set automatically or as a metric value. The default value is 0 (auto).</p> <p>0 (auto) — Setting 0 for the external cost automatically sets the speed for forwarding packets to the specified port(s) in the list (for optimal efficiency). Default port cost: 10Mbps port = 2000000, 100Mbps port = 200000. Gigabit port = 20000, Port-channel = 20000</p> <p>Value 1-200000000 — Define a value between 1 and 200000000 to determine the external cost. The lower the number, the greater the probability the port will be chosen to forward packets.</p>

Field	Description
<b>Edge</b>	<p>Indicates whether the selected port is an edge port. The possible field values are:</p> <p><i>True</i> — Defines the port as an edge port. Edge ports cannot create loops; however, they can lose edge port status if a topology change creates a potential for a loop. An edge port normally should not receive BPDU packets. If a BPDU packet is received, it automatically loses edge port status.</p> <p><i>False</i> — Indicates that the port does not have edge port status.</p>
<b>Forwarding BPDU</b>	<p>Bridges use Bridge Protocol Data Units (BPDU) to provide spanning tree information. STP BPDU filtering is useful when a bridge interconnects two regions; each region needing a separate spanning tree. BPDU filtering functions only when STP is disabled either globally or on a single interface. The possible field values are:</p> <p><i>Disabled</i> – BPDU filtering is enabled on the port.</p> <p><i>Enabled</i> – BPDU forwarding is enabled on the port (if STP is disabled).</p> <p><i>Global</i> – BPDU filtering functions according to the device-wide setting (see <i>STP Bridge Global Settings Page</i>).</p>
<b>P2P</b>	<p>Indicates whether the P2P of selected port is enabled. The possible field values are:</p> <p><i>True</i> — Indicates a point-to-point (P2P) link, P2P ports transition to a forwarding state rapidly thus benefiting from RSTP.</p> <p><i>False</i> — Indicates that the port cannot have P2P status.</p> <p><i>Auto</i> — Allows the port to have P2P status whenever possible and operate as if the P2P status were true. (A port that operates in full-duplex is assumed to be point-to-point, while a half-duplex port is considered as a shared port) If the port cannot maintain this status, (for example if the port is forced to half-duplex operation) the P2P status changes to operate as if the P2P value were False. The default setting is Auto.</p>
<b>State</b>	<p>Set to enable or disable STP for the selected group of ports. The default is Enabled. The port STP State overrides the STP Global State</p>

2. Define the *Unit, From Port, To Port, Cost, Edge, P2P, and State* fields.
3. Click . The STP Port Settings are defined, and the device is updated.

## Defining Multiple Spanning Tree Configuration Identification

Multiple Spanning Tree (MSTP) provides various load balancing scenarios by allowing multiple VLANs to be mapped to a single spanning tree instance, providing multiple pathways across the network. For example, while port A is blocked in one STP instance, the same port can be placed in the Forwarding state in another STP instance.

The *MST Configuration Identification Page* contains information for defining global MSTP settings, including region names, MSTP revision level. To define MSTP:

1. Click **L2 Features > Spanning Tree > MST Configuration Identification**. The *MST Configuration Identification Page* opens:

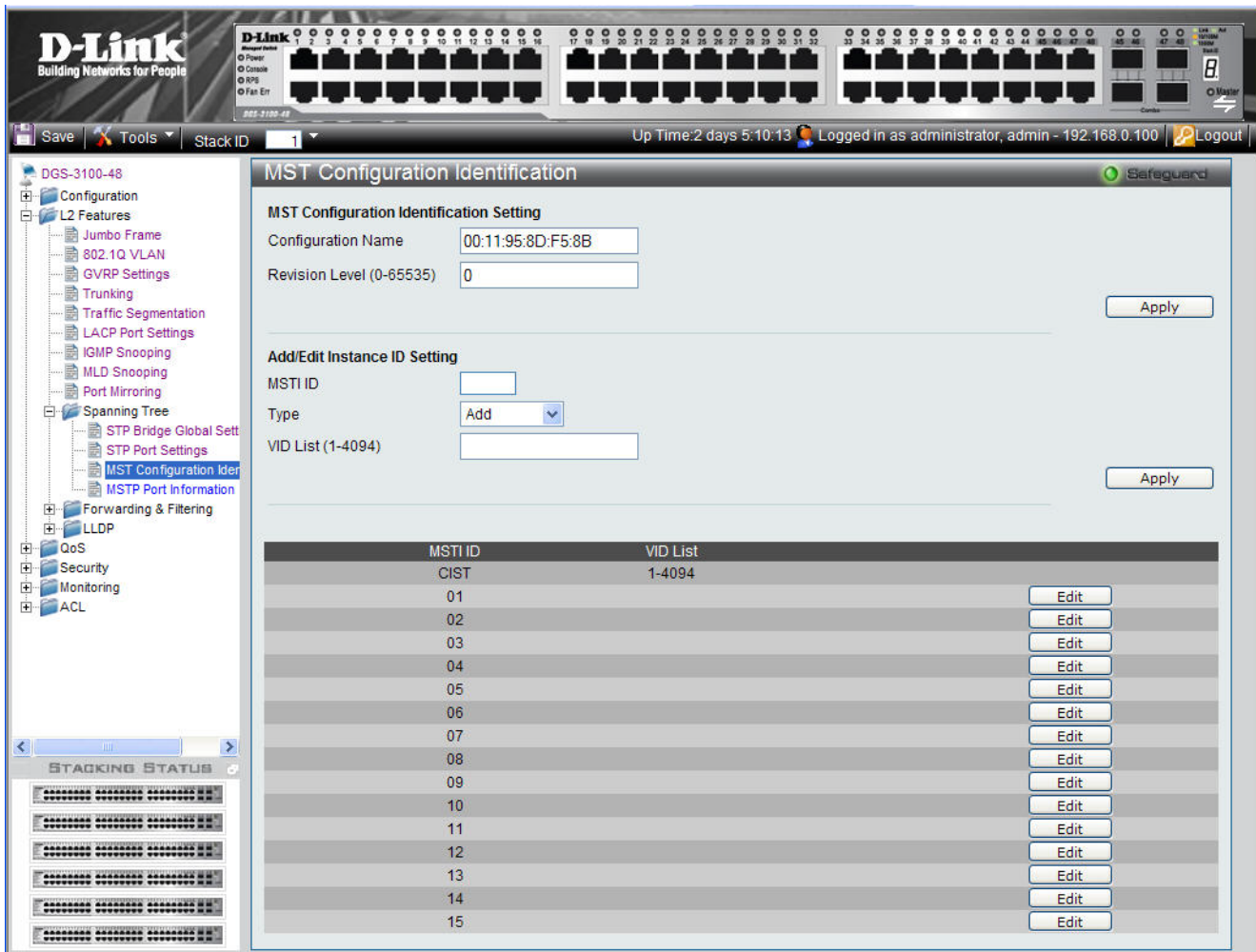

Figure 3–22. MST Configuration Identification Page

The *MST Configuration Identification Page* contains the following fields:

Field	Description
<b>Configuration Name</b>	A configured name set on the switch to uniquely identify the MSTI (multiple spanning tree instance). If a configuration name is not set, this field shows the MAC address of the device running MSTP.
<b>Revision Level (0-65535)</b>	This value, together with the configuration name, and identical vlans mapped for STP instance IDs identifies the MST region configured on the switch.
<b>MSTI ID</b>	Displays the MSTI ID associated with the VID List.
<b>Type</b>	Defines the type of edit. The possible values are: <i>Add</i> — Indicates that edit type is add.



Field	Description
	<i>Remove</i> — Indicates that edit type is remove.
<b>VID List (1-4094)</b>	Displays the VID List.

- Define the configuration name and revision level.
- Click **Apply**.
- Click **Edit** to an ID row to edit the ID value.
- Define the new value.
- Click **Apply**. The Multiple Spanning Tree Configuration Identification is defined, and the device is updated.

## Defining MSTP Port Information

Network Administrators can assign MSTP Interface settings in the *MSTI Config Information Page*. To define MSTP interface settings:

- Click **L2 Features > Spanning Tree > MSTP Port Information**. The *MSTI Config Information Page* opens:

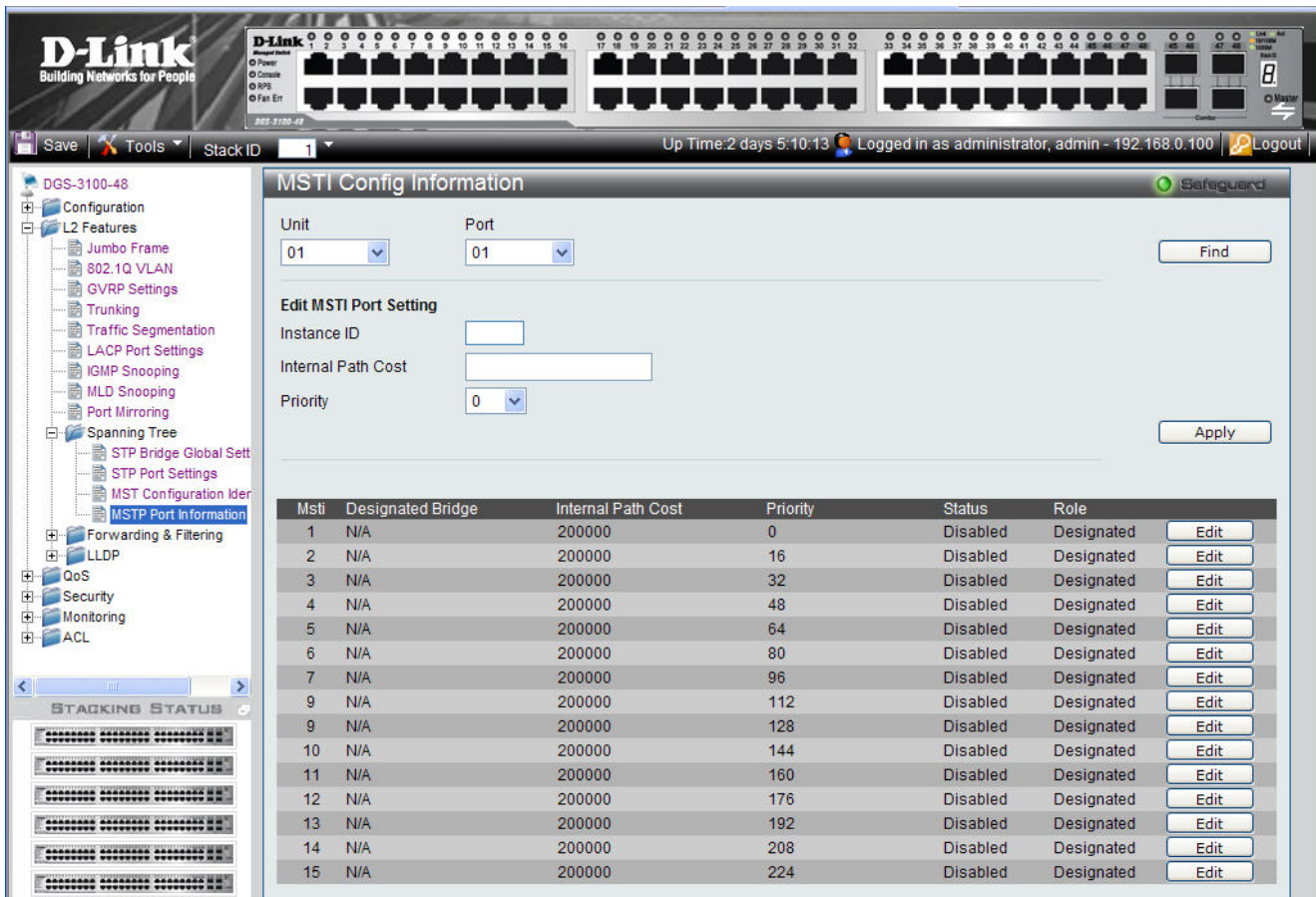

Figure 3–23. MSTI Config Information Page

The *MSTI Config Information Page* contains the following fields:

Field	Description
<b>Unit</b>	Defines the unit to find.
<b>Port</b>	Defines the Port to find.
<b>Instance ID</b>	Lists the MSTP instances configured on the device. Possible field range is 0-7.
<b>Internal Path Cost</b>	Indicates the port contribution to the Spanning Tree instance. The range should always be 1-

Field	Description
	200,000,000. The default value is automatically set cost, according to its speed. Default port cost: 10Mbps port = 2000000, 100Mbps port = 200000. Gigabit port = 20000, Port-channel = 20000.
<b>Priority</b>	Defines the interface priority for the specified instance. The default value is 128.
<b>Status</b>	Indicates whether the port is enabled for the specific instance. The possible field values are: <i>Forwarding</i> — Enables the port for the specific instance. <i>Listening</i> - Processes BPDUs received from the system module. <i>Learning</i> – Incorporates station location into its address database. <i>Blocking</i> - Discards frames received from the attached segment and frames switched from another port for forwarding. <i>Disabled</i> — Disables the port for the specific instance.
<b>Role</b>	Indicates the port role assigned by the STP algorithm to provide to STP paths. The possible field values are: <i>Enabled</i> — Enables the port for the specific instance. <i>Root</i> — Provides the lowest cost path to forward packets to the root device. <i>Designated</i> — Indicates the port or LAG through which the designated device is attached to the LAN. <i>Alternate</i> — Provides an alternate path to the root device from the root interface. <i>Backup</i> — Provides a backup path to the designated port path toward the Spanning Tree leaves. Backup ports occur only when two ports are connected in a loop by a point-to-point link or when a LAN has two or more connections connected to a shared segment. <i>Disabled</i> — Indicates the port is not participating in the Spanning Tree.

2. Define the values in the *Unit* and *Port* fields.
3. Click .
4. Define the *Internal Path Cost* and *Priority* fields.
5. Click .
6. Click  adjacent to an MSTI ID row to edit the values for Internal Path Cost and Priority.

# Defining Forwarding and Filtering

This section contains information for configuring both Unicast and Multicast filtering, and contains the following topics:

- Defining Unicast Forwarding
- Defining Multicast Forwarding
- Defining Multicast Filtering
- Defining DLF Filtering

## Defining Unicast Forwarding

The *Unicast Forwarding Page* contains parameters for configuring Unicast entries.

1. Click **L2 Features > Forward & Filtering > Unicast Forwarding**. The *Unicast Forwarding Page* opens:

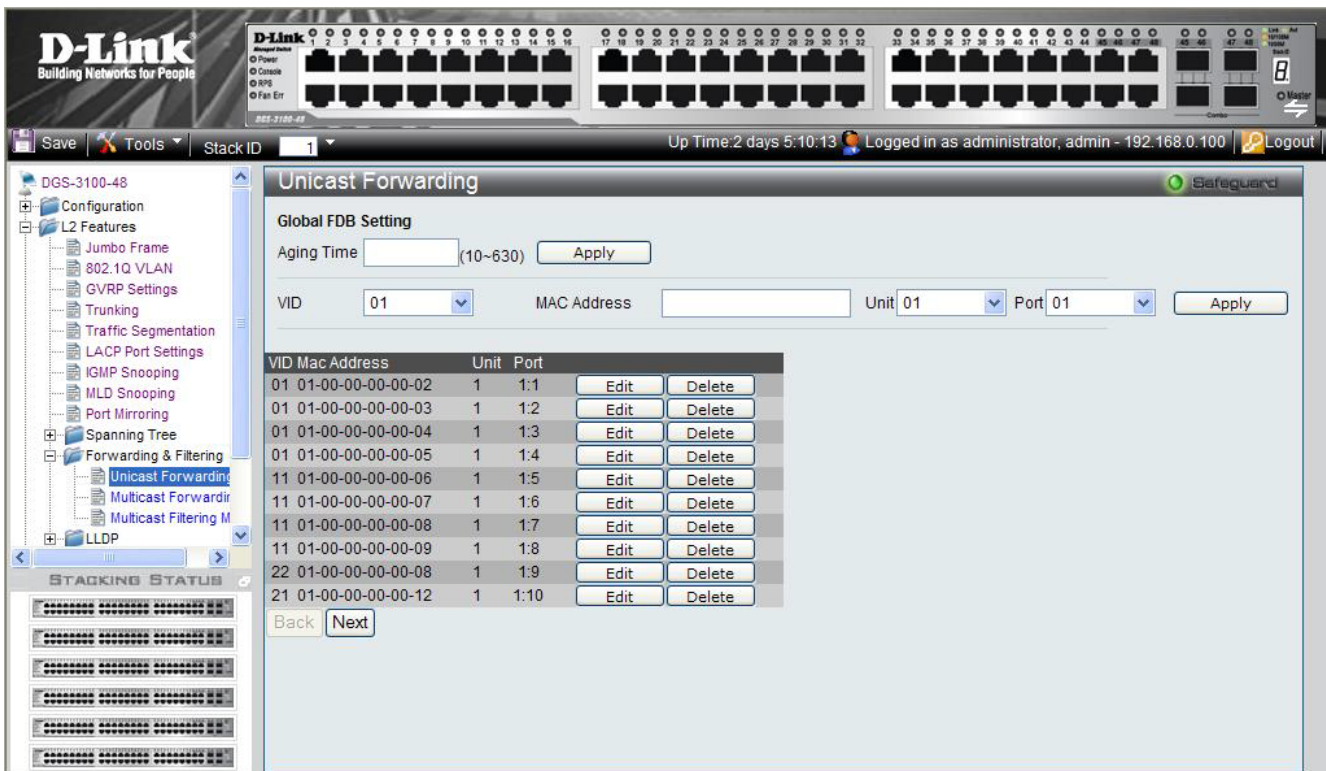

**Figure 3–24. Unicast Forwarding Page**

The *Unicast Forwarding Page* contains the following fields:

Field	Description
<b>Aging Time</b>	Defines the aging time of a Unicast packet. If the packet is not forwarded after this interval, it is discarded. Aging time is a global (FDB) database setting.
<b>VID</b>	Defines the VLAN ID.
<b>MAC Address</b>	Defines the Unicast MAC address to which packets are forwarded.
<b>Unit</b>	Defines the unit number.
<b>Port</b>	Defines the port number.

2. Define the VID, MAC Address, Unit, and Port fields.
3. Click **Apply**. The Unicast are defined, and the device is updated.

To edit a FDB table entry:

1. Select the entry.
2. Click **Edit**.
3. Define the values.
4. Click **Apply**. The entry is updated, and the device is updated.

To delete a FDB table entry:

1. Select the entry.
2. Click **Delete**. The entry is deleted, and the device is updated.

## Defining Multicast Forwarding

The *Multicast Forwarding Page* displays the ports and LAGs attached to the Multicast service group in the Ports and LAGs tables. Ports can be added either to existing groups or to new Multicast service groups. The *Multicast Forwarding Page* permits new Multicast service groups to be created. The *Multicast Forwarding Page* also assigns ports to a specific Multicast service address group.

1. Click **L2 Features > Forward & Filtering > Multicast Forwarding**. The *Multicast Forwarding Page* opens:

The screenshot shows the D-Link web interface for the Multicast Forwarding configuration. The top navigation bar includes 'Save', 'Tools', 'Stack ID', 'Up Time: 2 days 5:10:13', 'Logged in as administrator, admin - 192.168.0.100', and 'Logout'. The left sidebar shows the configuration tree with 'Multicast Forwarding' selected. The main content area displays a table of Multicast Forwarding entries:

VID	MAC Address	Type	Egress	Edit	Delete
01	01:00:00:00:00:02	Static	1:1, 1:3, 1:4, 1:5, 1:6, 1:7, 1:8, 1:9, 1:10, 1:25, 1:27, 1:28, 1:29, 1:30, 1:31, 1:32, 1:33, 1:34,	Edit	Delete
02	01:00:00:00:00:03	Static	1:11, 1:12, 1:13, 1:14, 1:15, 1:16, 1:25, 1:27, 1:28, 1:29, 1:30, 1:31, 1:32, 1:33, 1:34,	Edit	Delete
03	01:00:00:00:00:04	Static	1:1, 1:3, 1:4, 1:5, 1:6, 1:7, 1:8, 1:9, 1:10, 1:25, 1:27, 1:28, 1:29, 1:30, 1:31, 1:32, 1:33, 1:34,	Edit	Delete
04	01:00:00:00:00:05	Static	1:11, 1:12, 1:13, 1:14, 1:15, 1:16, 1:25, 1:27, 1:28, 1:29, 1:30, 1:31, 1:32, 1:33, 1:34,	Edit	Delete
05	01:00:00:00:00:06	Static	1:1, 1:3, 1:4, 1:5, 1:6, 1:7, 1:8, 1:9, 1:10, 1:25, 1:27, 1:28, 1:29, 1:30, 1:31, 1:32, 1:33, 1:34,	Edit	Delete
06	01:00:00:00:00:07	Static	1:11, 1:12, 1:13, 1:14, 1:15, 1:16, 1:25, 1:27, 1:28, 1:29, 1:30, 1:31, 1:32, 1:33, 1:34,	Edit	Delete
07	01:00:00:00:00:08	Static	1:1, 1:3, 1:4, 1:5, 1:6, 1:7, 1:8, 1:9, 1:10, 1:25, 1:27, 1:28, 1:29, 1:30, 1:31, 1:32, 1:33, 1:34,	Edit	Delete
08	01:00:00:00:00:09	Static	1:11, 1:12, 1:13, 1:14, 1:15, 1:16, 1:25, 1:27, 1:28, 1:29, 1:30, 1:31, 1:32, 1:33, 1:34,	Edit	Delete
09	01:00:00:00:00:10	Static	1:1, 1:3, 1:4, 1:5, 1:6, 1:7, 1:8, 1:9, 1:10, 1:25, 1:27, 1:28, 1:29, 1:30, 1:31, 1:32, 1:33, 1:34,	Edit	Delete
10	01:00:00:00:00:11	Static	1:11, 1:12, 1:13, 1:14, 1:15, 1:16, 1:25, 1:27, 1:28, 1:29, 1:30, 1:31, 1:32, 1:33, 1:34,	Edit	Delete

Below the table is a form for editing an entry:

VID: 01  
 Multicast MAC Address:   
 Unit: 01  
 Cancel Apply

The port selection grid shows ports 1-24 and 25-48, with 'None' and 'Egress' options for each.

Figure 3–25. Multicast Forwarding Page

The *Multicast Forwarding Page* contains the following fields:

Field	Description
VID	Defines the VLAN ID
Multicast MAC Address	Defines the Multicast MAC address to which packets are forwarded.
Unit	Defines the unit number.

Field	Description
Egress	Defines the Egress ports per multicast group.

2. Define the VID, Multicast MAC Address, Unit, and Egress fields.
3. Select either all, or individual ports:
  - Click **All** to select all ports as *None* or *Egress*;
  - Alternatively, click to select the ports individually. The default is 1-48 *None*.
4. Click **Apply**. The Multicast forwarding settings are applied to the port, and the device is updated.

To restore the default settings:

1. Click **Cancel**. The default settings are restored.
2. To edit a VID entry:
3. Select the entry.
4. Click **Edit**.
5. Define the fields.
6. Click **Apply**. The entry is deleted, and the device is updated.

To delete a VID entry:

1. Select the entry.
2. Click **Delete VID**.

## Defining Multicast Filtering

The *Multicast Filtering Mode Page* displays the port filtering mode for unregistered Multicast groups. Ports can filter or forward unregistered Multicast groups. The *Multicast Filtering Mode Page* permits specifying the Multicast filtering mode per port or globally for all ports.

1. Click **L2 Features > Forward & Filtering > Multicast Filtering Mode**. The *Multicast Filtering Mode Page* opens:

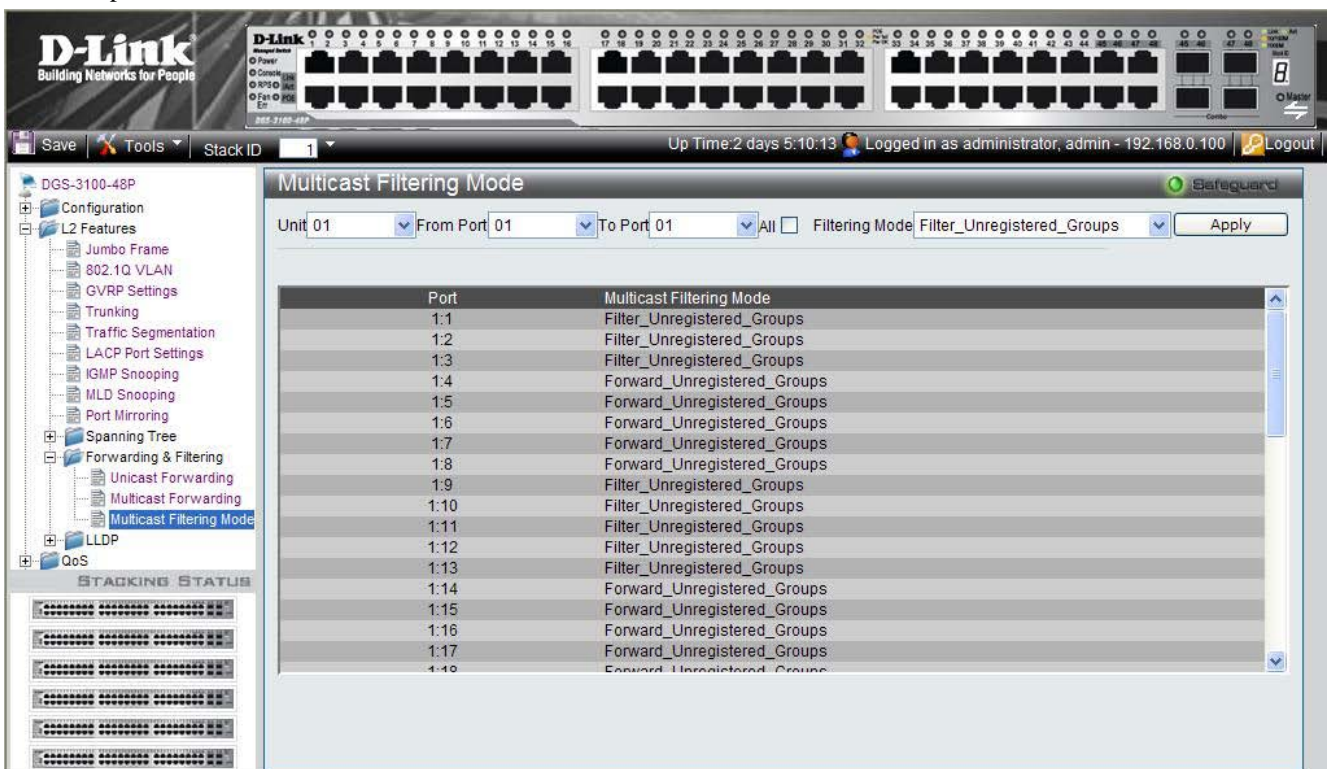

Figure 3–26. Multicast Filtering Mode Page

The Multicast Filtering Mode Page contains the following fields:

Field	Description
Unit	Defines the stacking unit number to specify a port range, or LAG to specify a LAG range.
From Port or From LAG	Defines the first port or LAG in a consecutive sequence of ports or LAGs.
To Port or To LAG	Defines the last port or LAG in a consecutive sequence of ports or LAGs.
All	Specifies that the filtering mode applies to all ports or LAGs.
Filtering Mode	Defines the multicast filtering mode for unregistered Multicast groups. The possible field values are:  <i>Filter Unregistered Groups</i> — Filters unregistered Multicast groups. <i>Forward Unregistered Groups</i> — Forwards unregistered Multicast groups. This is the default mode.

- Define the *Unit* and *Filtering Mode* fields.
- Select either *All* or specify a port (LAG) range in the *From Port (From LAG)* and *To Port (To LAG)* fields.
- Click **Apply**. The Multicast filtering settings are applied to the ports (LAGs), and the device is updated.

## Defining DLF Filtering

The *Destination Lookup Failure* (DLF) filtering mode allows the user to define egress filtering for unknown unicast packets. Once an egress port is set to filter/forward DLF packets, DLF traffic on all the VLANs will be configured to filter/forward DLF packets.

The *DLF Filtering Mode Page* allows users to specify DLF filtering per port or globally and define the required filtering mode. By default, the DLF filtering mode is defined as forwarding which causes packet flooding as opposed to packet filtering which minimizes traffic within the network.

- Click **L2 Features > Forward & Filtering > DLF Filtering Mode**. The *DLF Filtering Mode Page* opens:

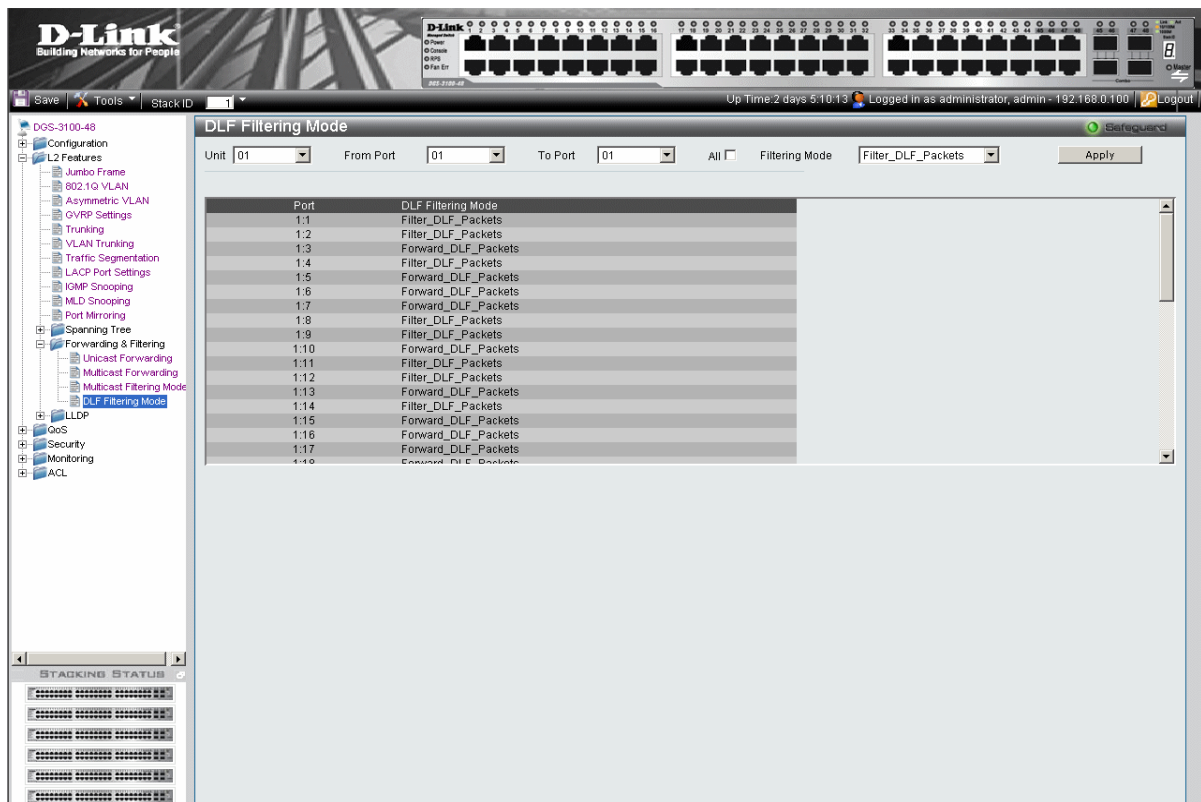

Figure 3–27. DLF Filtering Mode Page

The *DLF Filtering Mode Page* contains the following fields:

Field	Description
<b>Unit</b>	Defines the stacking unit number to specify a port range, or LAG to specify a LAG range.
<b>From Port or From LAG</b>	Defines the first port or LAG in a consecutive sequence of ports or LAGs.
<b>To Port or To LAG</b>	Defines the last port or LAG in a consecutive sequence of ports or LAGs.
<b>All</b>	Specifies that the filtering mode applies to all ports or LAGs.
<b>Filtering Mode</b>	Defines the DLF filtering mode for unregistered Multicast groups. The possible field values are: <i>Filter DLF Packets</i> — Prevents DLF Packets flooding.. <i>Forward DLF Packets</i> — Floods DLF packets within the network. This is the default mode.

2. Define the Unit and Filtering Mode fields.
3. Select either All or specify a port (LAG) range in the From Port (From LAG) and To Port (To LAG) fields.
4. Click . The DLF filtering settings are applied to the ports (LAGs), and the device is updated.

## Configuring LLDP

The *Link Layer Discovery Protocol* (LLDP) allows troubleshooting and enhancing network management by discovering and maintaining network topologies over multi-vendor environments. LLDP discovers network neighbors by standardizing methods for network devices to advertise themselves to other systems, and to store discovered information. Device discovery information includes:

Device Identification

Device Capabilities

Device Configuration

The advertising device transmits multiple advertisement message sets in a single LAN packet. The multiple advertisement sets are sent in the packet Type Length Value (TLV) field. LLDP devices must support chassis and port ID advertisement, as well as system name, system ID, system, description, and system capability advertisements.

This section contains information for configuring LLDP parameters, and includes the following topics:

- Defining LLDP Global Settings
- Defining LLDP Port Settings
- Defining LLDP Basic TLV Settings
- Defining LLDP Dot3 TLV Settings
- Viewing LLDP Local Port Information
- Viewing LLDP Remote Port Information

## Defining LLDP Global Settings

The *LLDP Global Setting Page* displays LLDP system information and contains parameters for configuring LLDP global settings.

1. Click **L2 Features > LLDP > LLDP Global Setting**. The *LLDP Global Setting Page* opens:

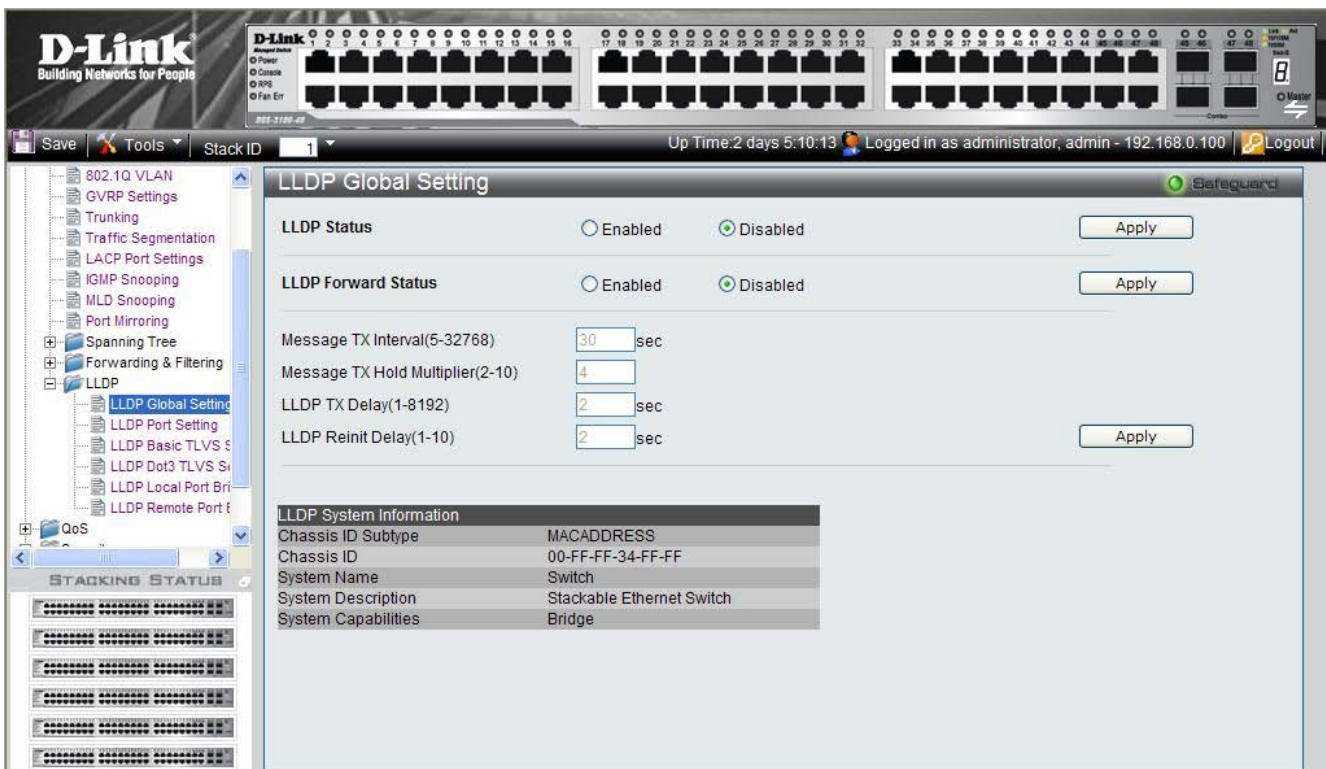

**Figure 3–28. LLDP Global Setting Page**

The LLDP Global Setting Page contains the following fields:



Field	Description
<b>LLDP Status</b>	Specifies the LLDP status on the device. The possible field values are: <i>Enabled</i> — Enables LLDP on the device. <i>Disabled</i> — Disables LLDP on the device. This is the default.
<b>LLDP Forward Status</b>	Specifies the LLDP packet forwarding status when LLDP is disabled on the device. The possible field values are: <i>Enabled</i> — Enables LLDP packet forwarding on the device. <i>Disabled</i> — Disables LLDP packet forwarding on the device.
<b>Message TX Interval</b>	Defines the LLDP message update transmission interval in seconds. The possible field values are 5 – 32768 seconds. The default is 30 seconds.
<b>Message TX Hold Multiplier</b>	Configures the Time-To-Live (TTL) of an LLDP packet, which is the time interval that a receiving device holds an LLDP packet before discarding it. The TTL is defined as the <i>Message TX Hold Multiplier</i> times the <i>Message TX Interval</i> . The possible field values are 2 – 10. The default is 4.
<b>LLDP TX Delay</b>	Defines the time delay in seconds between successive LLDP frame transmissions initiated by value or status changes. The possible field values are 1 – 8192 seconds. The default is 2 seconds.
<b>LLDP Reinit Delay</b>	Defines the time interval in seconds before reinitializing an LLDP transmission after LLDP is disabled. The possible field values are 1 – 10 seconds. The default is 2 seconds.

- To configure LLDP Global parameters, select *Enabled* in the *LLDP Status* field and click **Apply**. LLDP is enabled, and the device is updated.
- To configure the LLDP packet forwarding status when LLDP is disabled, define the *LLDP Forward Status* field and click **Apply**. The LLDP packet forwarding status is defined, and the device is updated.
- To configure LLDP Global parameters when LLDP is enabled, define the *Message TX Interval*, *Message TX Hold Multiplier*, *LLDP TX Delay* and *LLDP Reinit Delay* fields and click **Apply**. The LLDP packet forwarding status is defined, and the device is updated.

## Defining LLDP Port Settings

The *LLDP Port Setting Page* displays LLDP port information and contains parameters for configuring LLDP port settings.

- Click **L2 Features > LLDP > LLDP Port Setting**. The *LLDP Port Setting Page* opens:

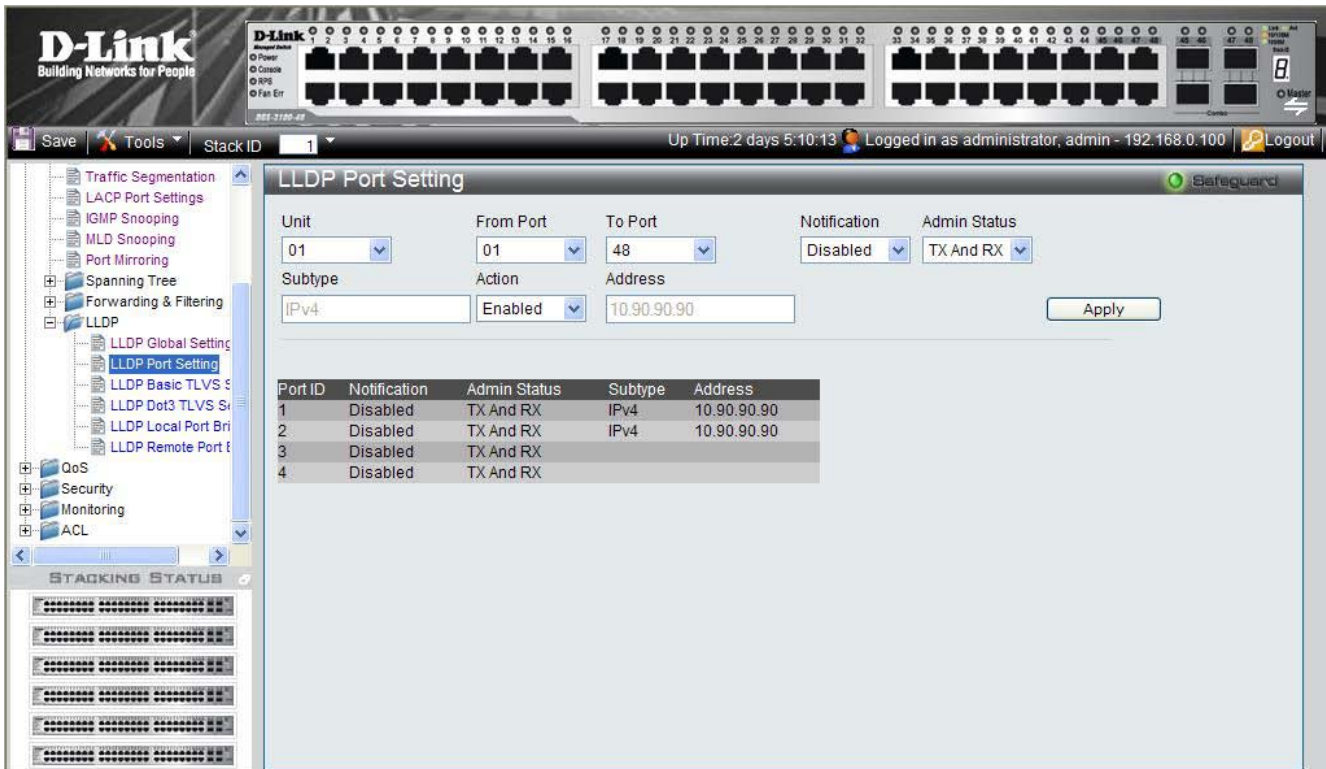

**Figure 3–29. LLDP Port Setting Page**

The LLDP Port Setting Page contains the following fields:

Field	Description
<b>Unit</b>	Indicates the stacking member for which the LLDP port settings are defined.
<b>From Port</b>	Defines the first port in a consecutive sequence of ports.
<b>To Port</b>	Defines last port in a consecutive sequence of ports.
<b>Notification</b>	Specifies whether notification is sent when an LLDP topology change occurs on the port. The possible field values are: <i>Enabled</i> — Enables LLDP notification on the port. <i>Disabled</i> — Disables LLDP notification on the port. This is the default.
<b>Admin Status</b>	Specifies the LLDP transmission mode on the port. The possible field values are: <i>TX</i> — Enables transmitting LLDP packets only. <i>RX</i> — Enables receiving LLDP packets only. <i>TX and RX</i> — Enables transmitting and receiving LLDP packets. This is the default. <i>Disabled</i> — Disables LLDP on the port.
<b>Subtype</b>	Defines the address subtype. For example, Always IPv4.
<b>Action</b>	Specifies whether the management address is advertised from the port. The possible field values are: <i>Enabled</i> — Enables advertisement from the port. This is the default. <i>Disabled</i> — Disables advertisement from the port.
<b>Address</b>	Defines the management address advertised from the interface. It is always the Switch's management address.

2. Define the *Unit*, *From Port*, *To Port*, *Notification*, *Admin Status*, *Subtype*, *Action* and *Address* fields.
3. Click **Apply**. The LLDP port settings are defined, and the device is updated.

## Defining LLDP Basic TLV Settings

The *LLDP Basic TLVS Setting Page* displays LLDP basic TLV port information and contains parameters for configuring LLDP basic TLV port settings.

1. Click **L2 Features > LLDP > LLDP Basic TLVS Setting**. The *LLDP Basic TLVS Setting Page* opens:

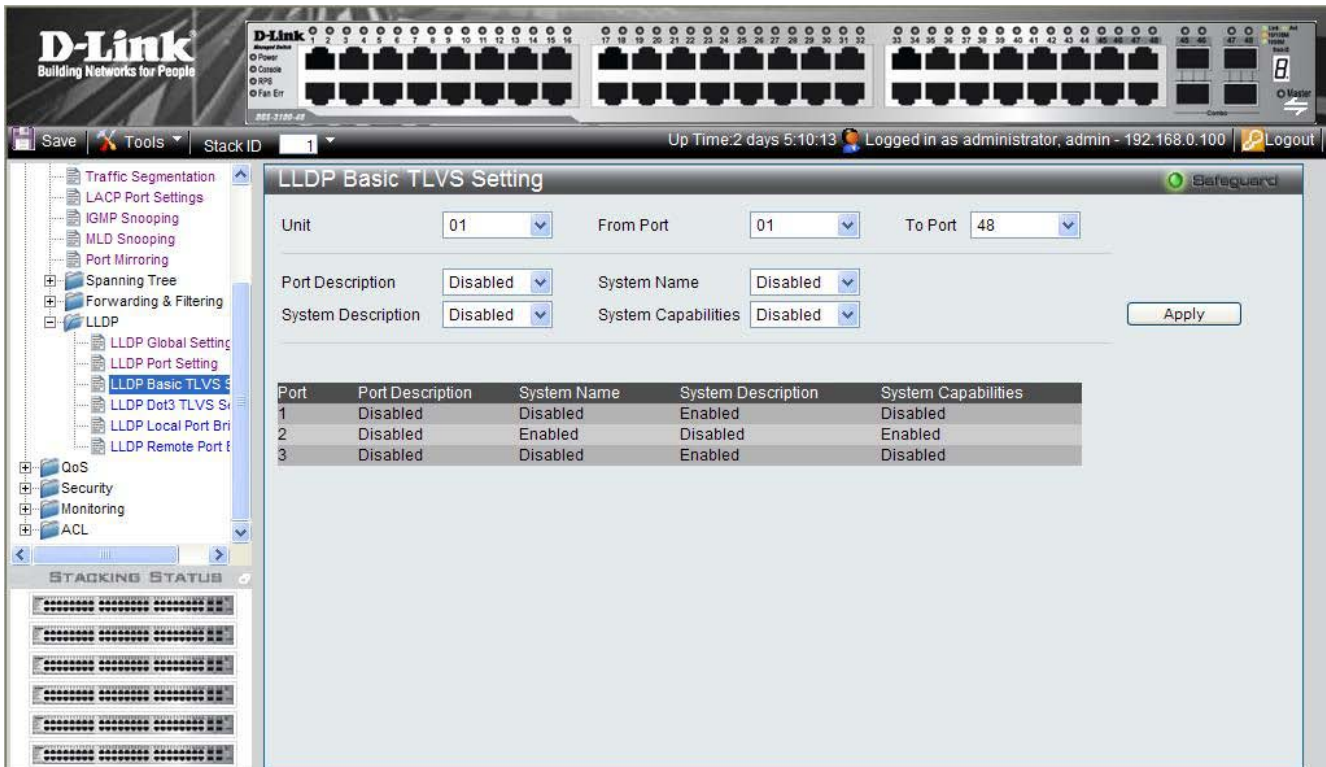

**Figure 3–30. LLDP Basic TLVS Setting Page**

The LLDP Basic TLVS Setting Page contains the following fields:

Field	Description
<b>Unit</b>	Indicates the stacking member for which the LLDP basic TLV port settings are defined.
<b>From Port</b>	Defines the first port in a consecutive sequence of ports.
<b>To Port</b>	Defines last port in a consecutive sequence of ports.
<b>Port Description</b>	Specifies whether the Port Description TLV is enabled on the port. The possible field values are: <i>Enabled</i> — Enables the Port Description TLV on the port. <i>Disabled</i> — Disables the Port Description TLV on the port.
<b>System Name</b>	Specifies whether the System Name TLV is enabled on the port. The possible field values are: <i>Enabled</i> — Enables the System Name TLV on the port. <i>Disabled</i> — Disables the System Name TLV on the port.
<b>System Description</b>	Specifies whether the System Description TLV is enabled on the port. The possible field values are: <i>Enabled</i> — Enables the System Description TLV on the port. <i>Disabled</i> — Disables the System Description TLV on the port.
<b>System Capabilities</b>	Specifies whether the System Capabilities TLV is enabled on the port. The possible field values are:

Field	Description
	<i>Enabled</i> — Enables the System Capabilities TLV on the port. <i>Disabled</i> — Disables the System Capabilities TLV on the port.

- Define the *Unit*, *From Port*, *To Port*, *Port Description*, *System Name*, *System Description* and *System Capabilities* fields.
- Click **Apply**. The LLDP basic TLV settings are defined, and the device is updated.

## Defining LLDP Dot3 TLV Settings

The *LLDP Dot3 TLVS Setting Page* displays LLDP Dot3 TLV port information and contains parameters for configuring LLDP Dot3 TLV port settings.

- Click **L2 Features > LLDP > LLDP Dot3 TLVS Setting**. The *LLDP Dot3 TLVS Setting Page* opens:

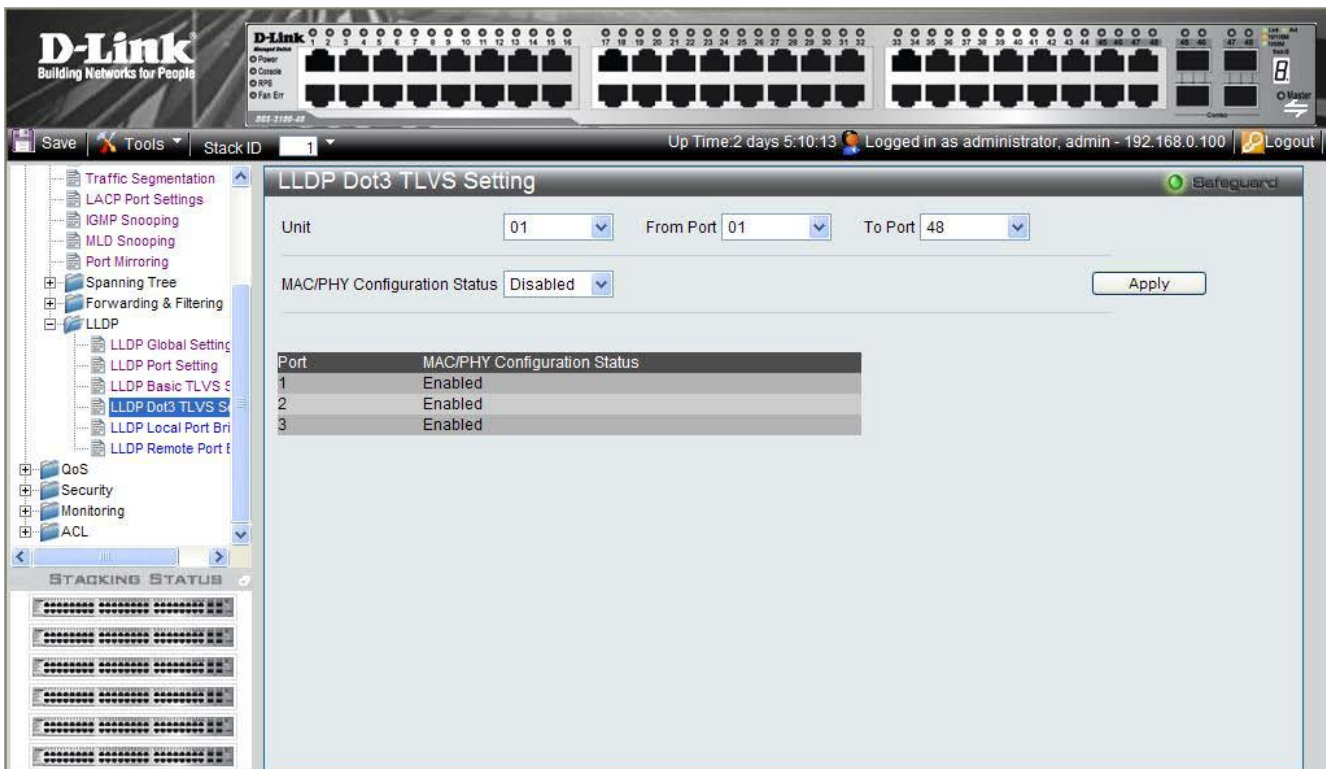

**Figure 3–31. LLDP Dot3 TLVS Setting Page**

The LLDP Dot3 TLVS Setting Page contains the following fields:

Field	Description
<b>Unit</b>	Indicates the stacking member for which the LLDP dot3 TLV port settings are defined.
<b>From Port</b>	Defines the first port in a consecutive sequence of ports.
<b>To Port</b>	Defines last port in a consecutive sequence of ports.
<b>MAC/PHY Configuration Status</b>	Specifies whether the MAC/PHY Configuration Status is enabled on the port. The possible field values are: <i>Enabled</i> — Enables the MAC/PHY Configuration Status on the port. <i>Disabled</i> — Disables the MAC/PHY Configuration Status on the port.

- Define the *Unit*, *From Port*, *To Port* and *MAC/PHY Configuration Status* fields.
- Click **Apply**. The LLDP Dot3 TLV settings are defined, and the device is updated.

## Viewing LLDP Local Port Information

The LLDP Local Port Brief Page displays LLDP local port information.

1. Click **L2 Features > LLDP > LLDP Local Port Brief**. The *LLDP Local Port Brief Page* opens:

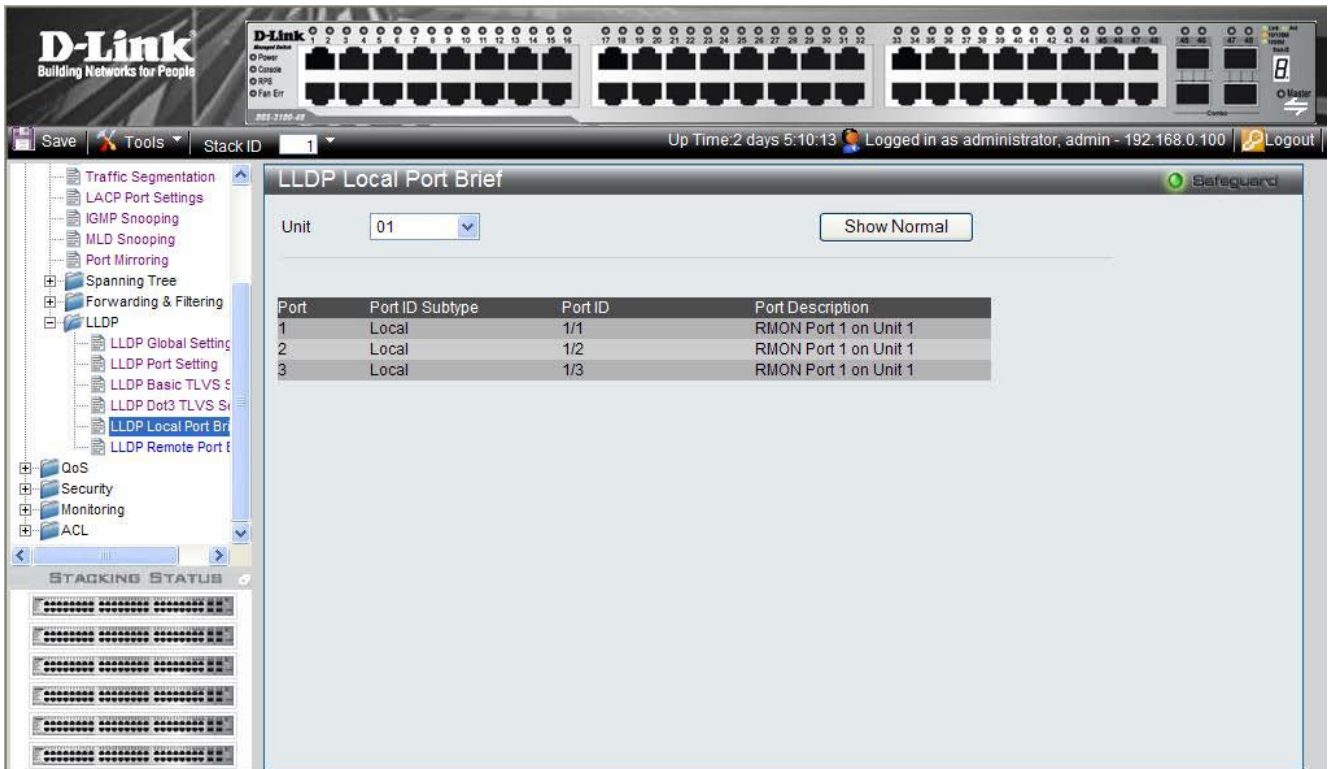

**Figure 3–32. LLDP Local Port Brief Page**

The LLDP Local Port Brief Page contains the following fields:

Field	Description
<b>Unit</b>	Indicates the stacking member for which the LLDP local port information is displayed.
<b>Port</b>	Indicates the port number.
<b>Port ID Subtype</b>	Displays the port ID subtype.
<b>Port ID</b>	Displays the port ID (Unit number/Port number).
<b>Port Description</b>	Displays the port description.

- Click **Show Normal**. The *LLDP Local Port Normal Page* is displayed.

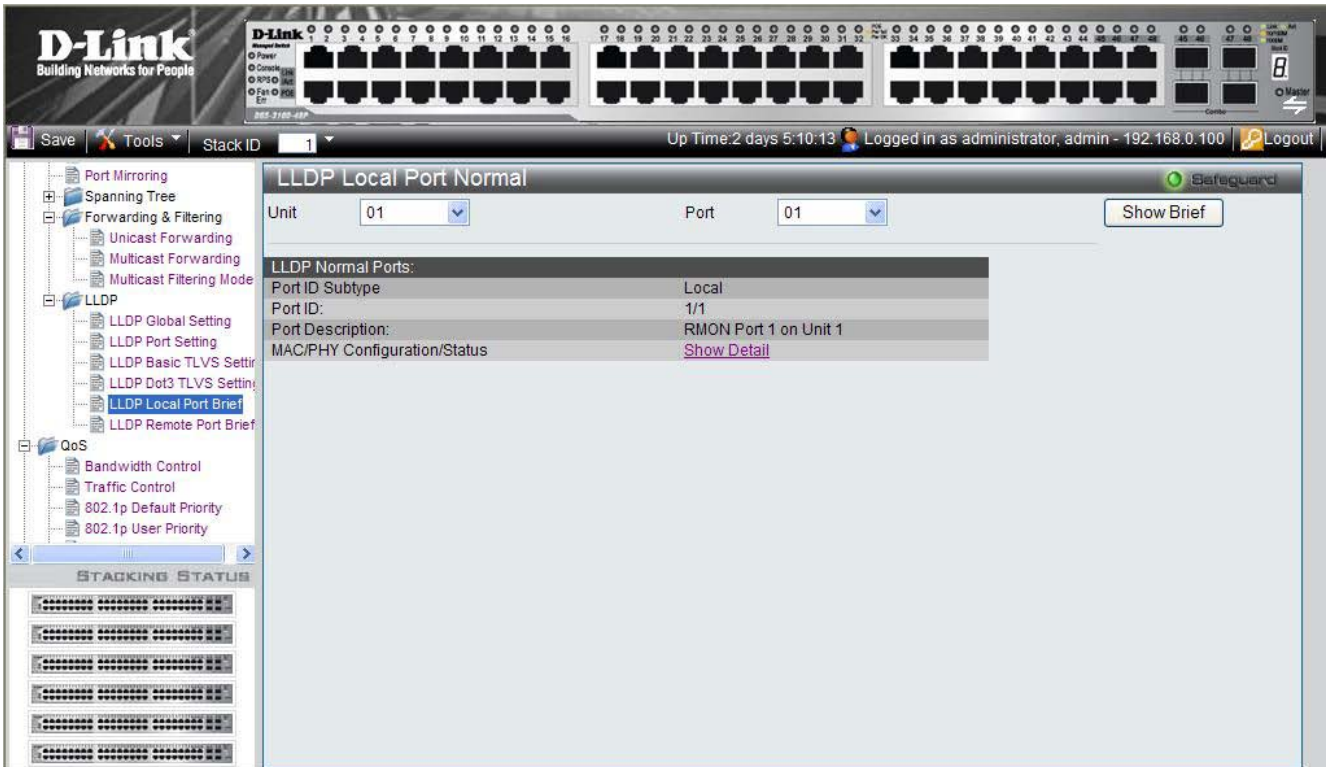

Figure 3–33. LLDP Local Port Normal Page

- To view the detailed MAC/PHY Configuration Status for the port, click Show Detail. The *LLDP Local Misc Detail Information Page* is displayed.

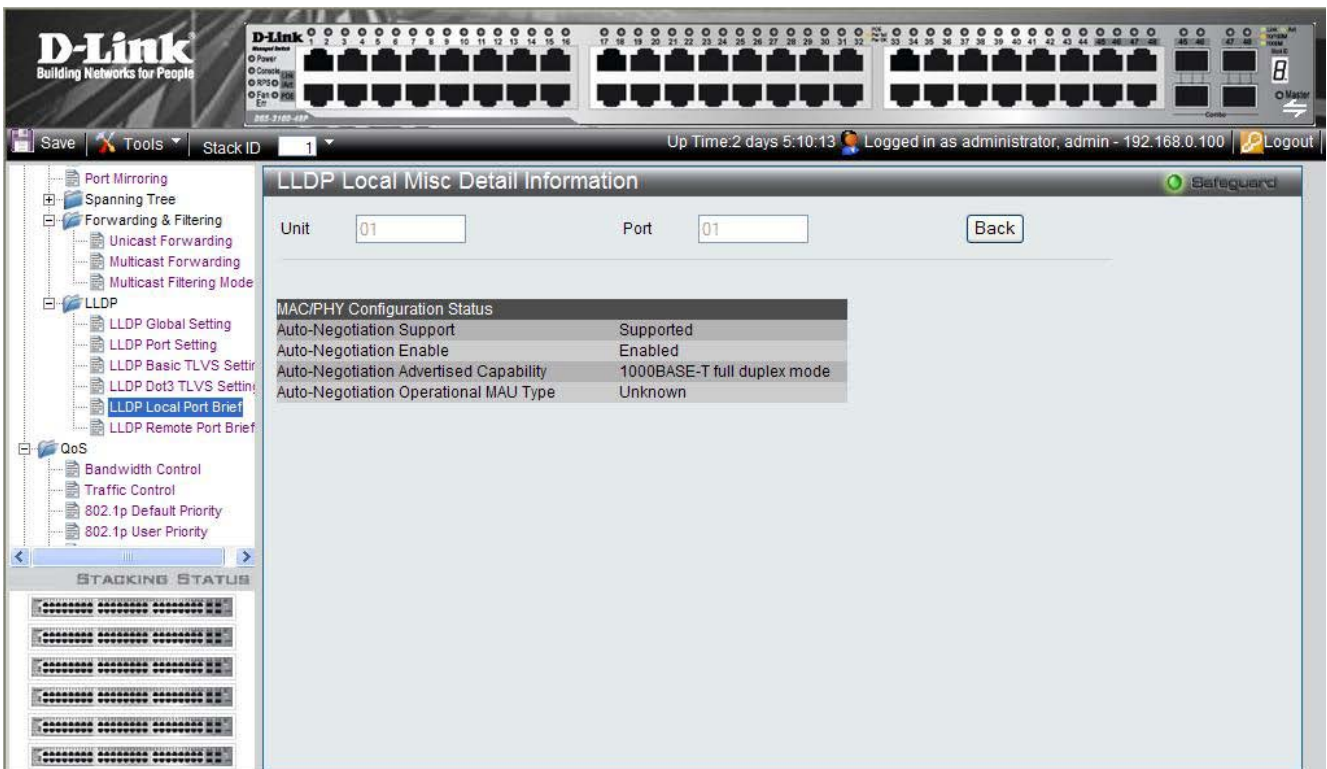

Figure 3–34. LLDP Local Misc Detail Information Page

The LLDP Local Misc Detail Information Page contains the following fields:

Field	Description
<b>Unit</b>	Indicates the stacking member for which the LLDP local detail information is displayed.
<b>Port</b>	Indicates the port number.
<b>Auto-Negotiation Support</b>	Indicates the port speed auto-negotiation support status.
<b>Auto-Negotiation Enable</b>	Indicates the port speed auto-negotiation active status.
<b>Auto-Negotiation Advertised Capability</b>	Displays the port speed auto-negotiation advertised capability. For example, 1000BASE-T full duplex mode.
<b>Auto-Negotiation Operational MAU Type</b>	Displays the Medium Attachment Unit (MAU) type. The MAU performs physical layer functions, including digital data conversion from the Ethernet interfaces' collision detection and bit injection into the network. For example, 100BASE-TX full duplex mode.

## Viewing LLDP Remote Port Information

The LLDP Remote Port Brief Page displays LLDP remote (neighbor) port information.

1. Click **L2 Features > LLDP > LLDP Remote Port Brief**. The *LLDP Remote Port Brief Page* opens:

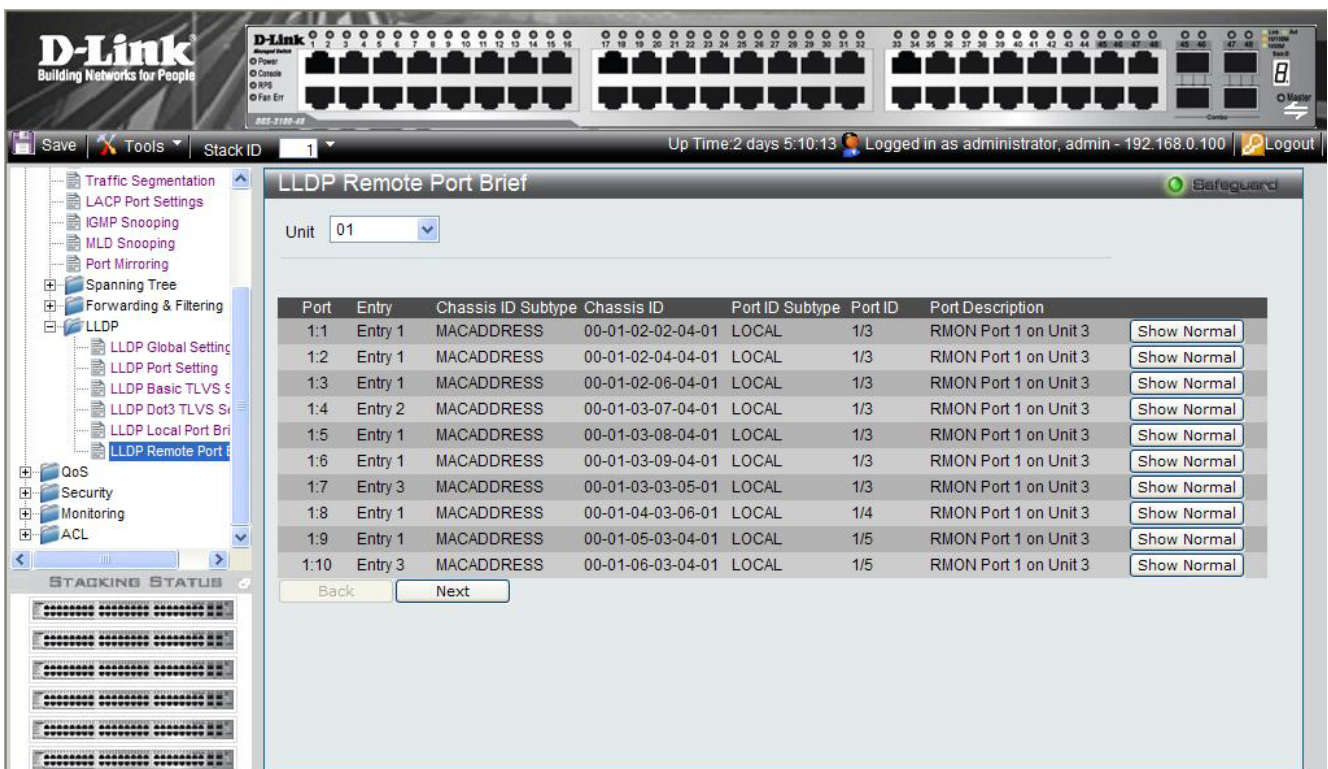

**Figure 3–35. LLDP Remote Port Brief Page**

The LLDP Remote Port Brief Page contains the following fields:

Field	Description
<b>Unit</b>	Indicates the stacking member for which the LLDP remote port information is displayed.
<b>Port</b>	Indicates the port number.
<b>Entry</b>	Indicates the the device's Media Service Access Point (MSAP) entry number.
<b>Chassis ID Subtype</b>	Displays the chassis ID subtype. For example, MAC address.

Field	Description
<b>Chassis ID</b>	Displays the chassis identification of the device transmitting the LLDP frame.
<b>Port ID Subtype</b>	Displays the port ID subtype. For example, IPv4 address.
<b>Port ID</b>	Displays the port ID (Unit number/Port number) of the port transmitting the LLDP frame.
<b>Port Description</b>	Displays the port description.

2. Click **Show Normal**. The *LLDP Remote Port Normal Page* is displayed.

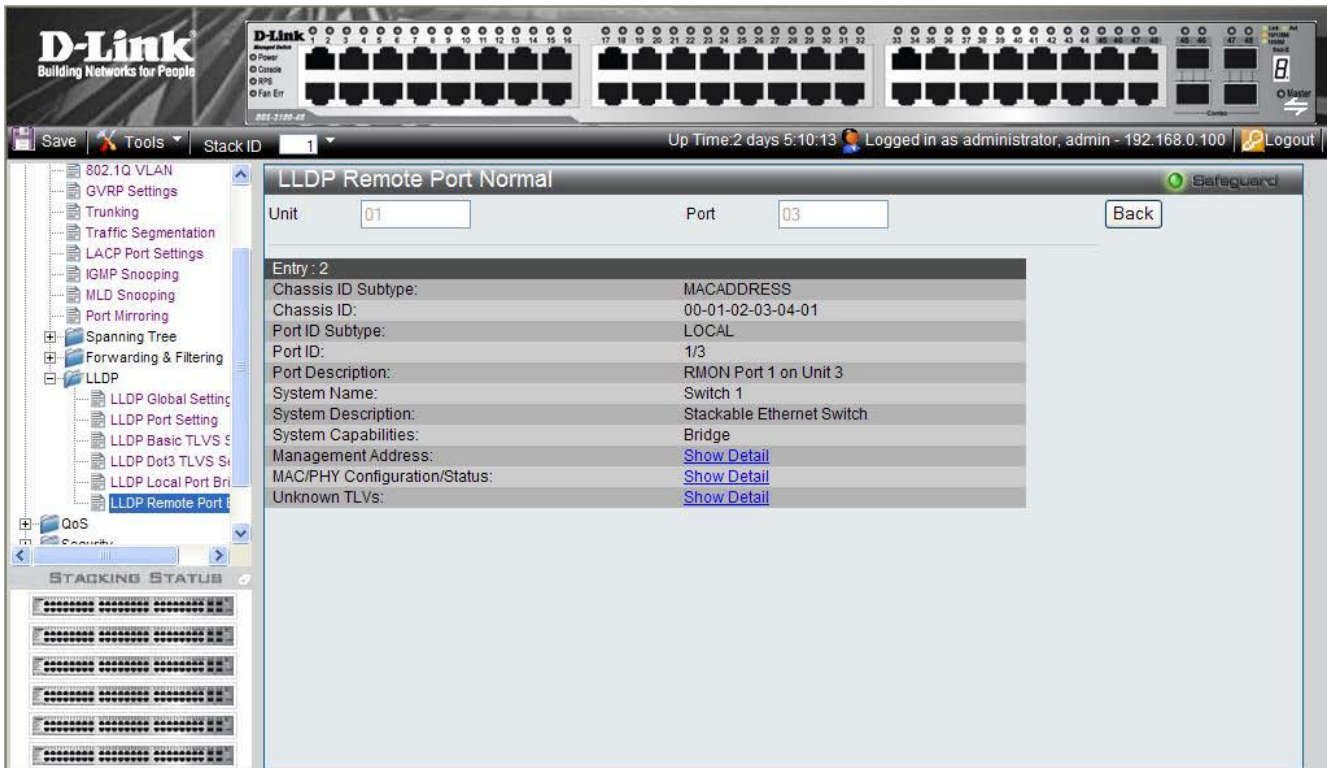

**Figure 3–36. LLDP Remote Port Normal Page**

3. To view the detailed Management Address information for the entry, click [Show Detail](#). The *LLDP Management Address Detail Information Page* is displayed.



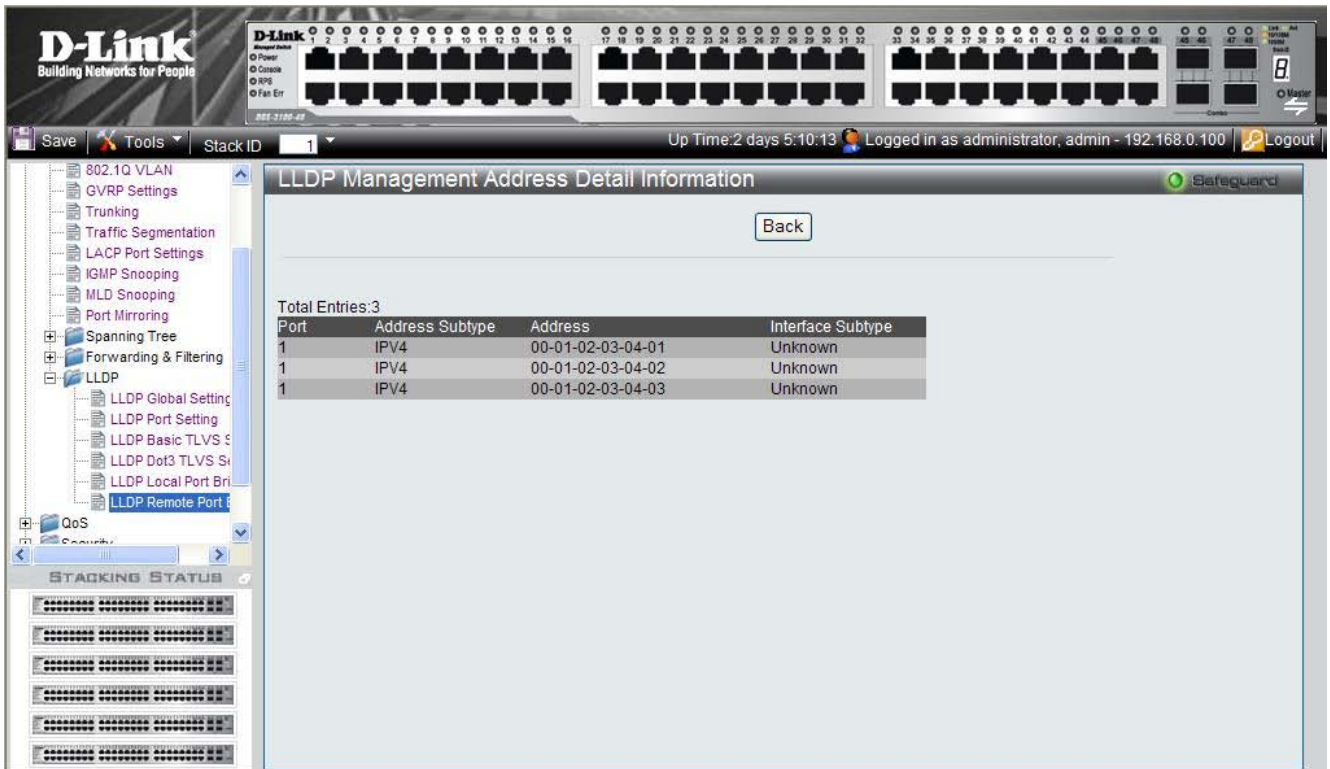

**Figure 3–37. LLDP Management Address Detail Information Page**

The LLDP Management Address Detail Information Page contains the following fields:

Field	Description
<b>Port</b>	Indicates the port number.
<b>Address Subtype</b>	Displays the managed address subtype. For example, MAC or IPv4.
<b>Address</b>	Displays the managed address.
<b>Interface Subtype</b>	Displays the port subtype.

4. Click  to return to the *LLDP Remote Port Normal Page*.
5. To view the detailed MAC/PHY Configuration/Status information for the entry, click Show Detail. The *LLDP Remote Misc Detail Information Page* is displayed.

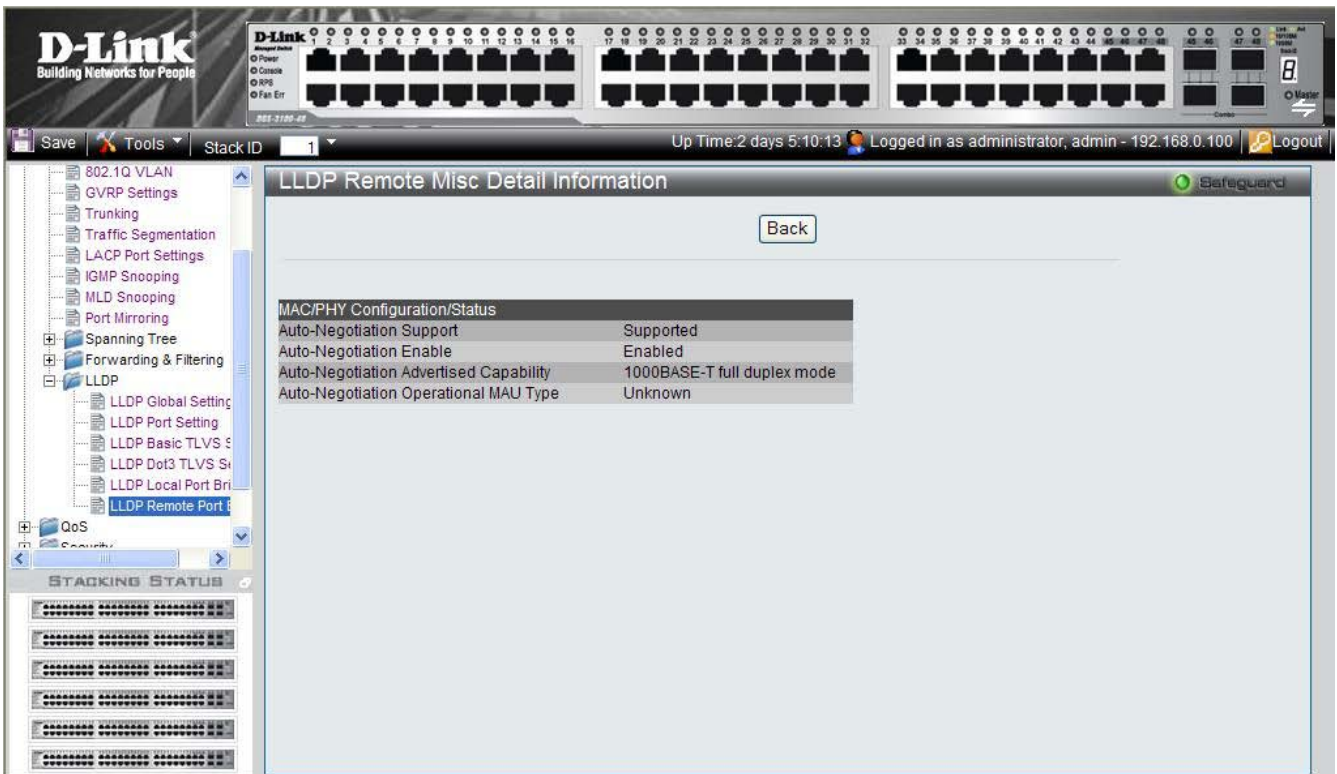

Figure 3–38. LLDP Remote Misc Detail Information Page

6. Click [Back](#) to return the *LLDP Remote Port Normal Page*.
7. To view the detailed information for unknown TLVs for the entry, click [Show Detail](#). The *LLDP Remote Unknown TLVs Detailed Information Page* is displayed.

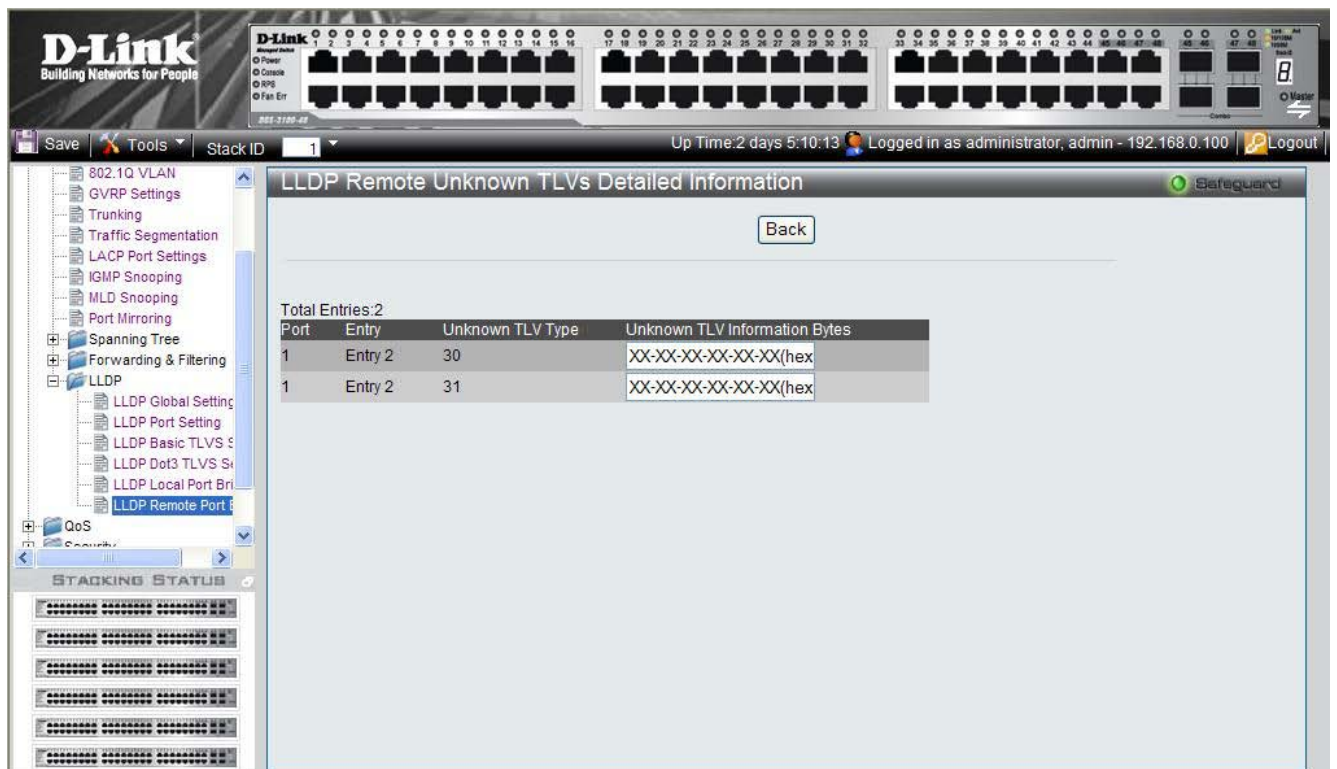

Figure 3–39. LLDP Remote Unknown TLVs Detailed Information Page

The LLDP Remote Unknown TLVs Detailed Information Page contains the following fields:

Field	Description
<b>Port</b>	Indicates the port number.
<b>Entry</b>	Indicates the entry number.
<b>Unknown TLV Type</b>	Indicates the unknown TLV type field
<b>Unknown TLV Information Bytes</b>	Displays the unknown TLV information bytes in hexadecimal format.

---

## CONFIGURING QUALITY OF SERVICE

### Configuring 1p

Priority tagging is an IEEE 802.1p defined standard function designed to provide a means of managing traffic on networks where many different types of data are transmitted simultaneously. It is intended to alleviate problems associated with the delivery of time-critical data over congested networks. The quality of applications dependent on such data, such as video conferencing, can be severely and adversely affected by even very small delays in transmission.

IEEE 802.1p standard-compliant network devices recognize the priority level of data packets and can assign priority labels or tags to packets, as well as strip priority tags from packets. The priority tag determines the packet's degree of expeditiousness and the queue to which it is assigned.

Priority tags are assigned values from 0 to 7, with 0 being assigned to the lowest priority data, and 7 to the highest. Generally, tag 7 is used for data associated with video or audio applications, sensitive to even slight delays, or for data from specified end users whose data transmissions warrant special consideration.

The switch enables increased definition for handling priority tagged data packets on the network. Using queues to manage priority tagged data enables user-specification for the data's relative priority to suit the needs of the network. Circumstances can arise where it is advantageous to group two or more different tagged packets into the same queue. Generally, however, it is recommended that the highest priority queue, Queue 1, be reserved for the data packets with a priority value of 7.

- 1) Classes not Queues should be used when explaining traffic handling techniques.
- 2) The ratio is Class0:Class1:Class2:Class3 = 1:2:4:8

A Weighted Round Robin system is employed on the switch to determine the rate which the queues are emptied of packets. The ratio used for clearing the queues is 4:1. This means that the highest priority queue, Queue 1, clears four packets for every packet which cleared from Queue 0.

It is important that the priority queue settings on the switch are for all ports, and all devices connected to the switch are affected. The priority queuing system is especially beneficial for networks that employ priority tag assignment capable switches.

QoS is an implementation of the IEEE 802.1p standard that allows network administrators a method of reserving bandwidth for important functions that require a large bandwidth or have a high priority, such as VoIP (voice-over Internet Protocol), Web browsing applications, file server applications or video conferencing. Not only a larger bandwidth can be created, but also a less critical traffic can be limited, so excessive bandwidth can be saved. The Switch has separate hardware queues on every physical port to which packets from various applications can be mapped to, and in turn prioritized. View the following map to see how the DGS-3100 series implements 802.1P priority queuing.

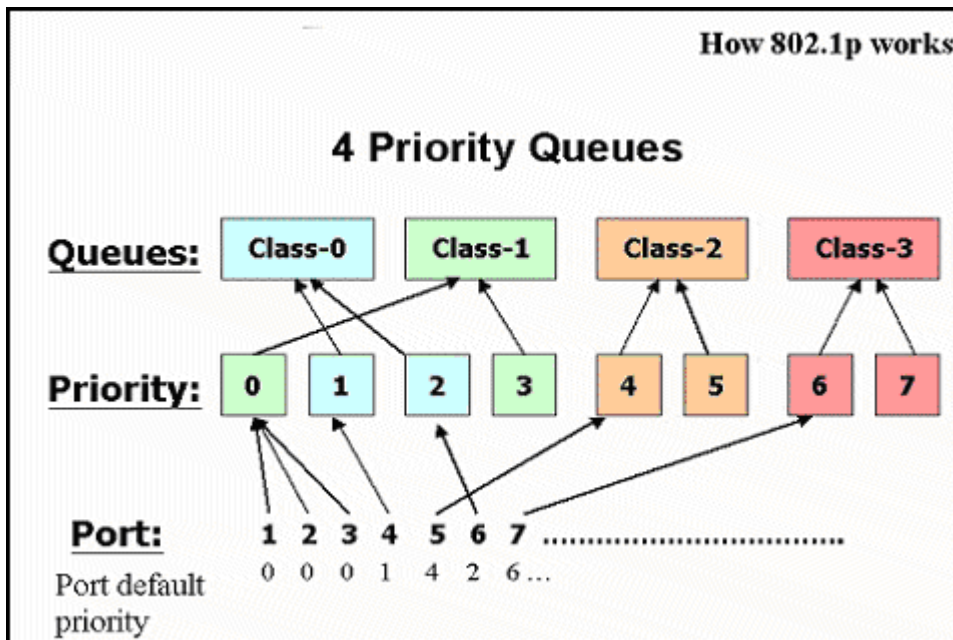

**Figure 4-1. Mapping QoS on the Switch**

The picture above shows the default priority setting for the Switch. Class-3 has the highest priority of the four priority queues on the Switch. In order to implement QoS, the user is required to instruct the Switch to examine the header of a packet to see if it has the proper identifying tag tagged. Then the user may forward these tagged packets to designated queues on the Switch where they will be emptied, based on priority.

For example, let us say a user wishes to have a video conference between two remotely set computers. The administrator can add priority tags to the video packets being sent out, utilizing the Access Profile commands. Then, on the receiving end, the administrator instructs the Switch to examine packets for this tag, acquires the tagged packets and maps them to a class queue on the Switch. Then in turn, the administrator will set a priority for this queue so that it will be emptied before any other packet is forwarded. This process results in the end user receiving all packets sent as quickly as possible, thus prioritizing the queue and allowing for an uninterrupted stream of packets, which optimizes the use of bandwidth available for the video conference.

## Understanding QoS

The Switch has four priority queues. These priority queues are labeled as 3 (the highest queue) to 0 (the lowest queue). The eight (0-7) priority tags, specified in IEEE 802.1p are mapped to the Switch's priority tags as follows:

- Priorities 1 and 2 are assigned to the Switch's Q0 queue.
- Priorities 0 and 3 are assigned to the Switch's Q1 queue.
- Priorities 4 and 5 are assigned to the Switch's Q2 queue.
- Priorities 6 and 7 are assigned to the Switch's Q3 queue.

For strict priority-based scheduling, any packets residing in the higher priority queues are transmitted first. Multiple strict priority queues empty based on their priority tags. Only when these queues are empty, are packets of lower priority transmitted.

For weighted round-robin queuing, the number of packets sent from each priority queue depends upon the assigned weight.

For weighted round-robin queuing, if each CoS queue has the same weight value, then each CoS queue has an equal opportunity to send packets just like round-robin queuing.

For weighted round-robin queuing, if the weight for a CoS is set to 0, then it will stop processing the packets from this CoS. The other CoS queues that have been given a nonzero value, and depending upon the weight, will follow a common weighted round-robin scheme.

Strict Priority should be configured at higher class than WRR.

If the user configures WRR, at least two queues should be configured as WRR.

Remember that the DGS-3100 series has four priority queues (and eight Classes of Service) for each port on the Switch.

This section contains the following topics:

- Defining Bandwidth Settings
- Configuring Storm Control
- Mapping Ports to Packet Priorities
- Mapping Priority to Classes (Queues)
- Configuring QoS Scheduling Mechanism
- Defining Multi-Layer CoS Settings

## Defining Bandwidth Settings

The *Bandwidth Control Page* allows network managers to define the bandwidth settings for a specified interface.

1. Click **QoS > Bandwidth Control**. The *Bandwidth Control Page* opens:

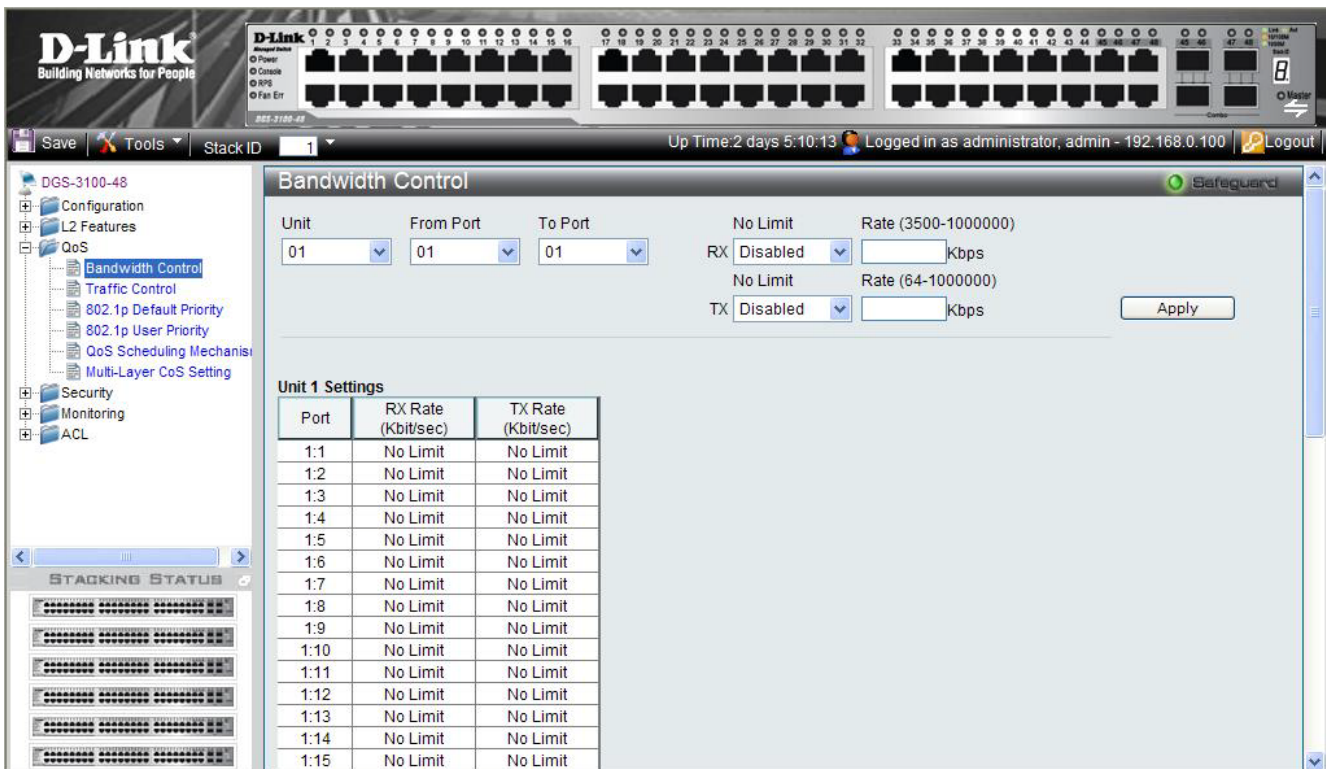

**Figure 4-2. Bandwidth Control Page**

The *Bandwidth Control Page* contains the following fields:

Field	Description
<b>Unit</b>	Defines the stacking member for which the bandwidth parameters are displayed
<b>From Port</b>	Defines from which port number bandwidth settings are displayed.
<b>To Port</b>	Defines to which port number bandwidth settings are displayed.
<b>RX No Limit</b>	Defines if ingress bandwidth limitation is assigned to the port. The field value options are: <i>Enabled</i> — Ensures no bandwidth limitations on the port. (This is the default value). <i>Disabled</i> — Enables ingress bandwidth limitations on the port. When disabled, user can enter a limit value in the RX Rate field.
<b>RX Rate (3500-1000000) kbps</b>	Specifies the maximum ingress rate on the port. The possible field range is 3500 – 1000000 Kbps
<b>TX No Limit</b>	Specifies whether egress bandwidth limitation applies to the port. The possible field values are: <i>Enabled</i> — Specifies no egress bandwidth limitations on the port. (This is the default value). <i>Disabled</i> — Enables egress bandwidth limitations on the port. When disabled, the user can enter a limit value in the <i>TX Rate</i> field.
<b>TX Rate (64-1000000) Kbps</b>	Specifies the maximum egress rate on the port. The possible field range is 64 – 1000000 Kbps.

2. Define the *Unit*, *From Port*, *To Port*, *No Limit* and *Ingress Rate* fields.
3. Click . The bandwidth settings are defined, and the device is updated.



## Configuring Storm Control

Storm control limits the amount of Multicast, Broadcast and Unknown Unicast frames accepted and forwarded by the device. When Layer 2 frames are forwarded, Broadcast, Multicast and Unknown Unicast frames are flooded to all ports on the relevant VLAN. This occupies bandwidth, and loads all nodes on all ports.

A Broadcast Storm is a result of an excessive amount of broadcast messages simultaneously transmitted across a network by a single port. Forwarded message responses are heaped onto the network, straining network resources or causing the network to time out.

1. Click **Qos > Traffic Control**. The *Traffic Control Settings Page* opens:

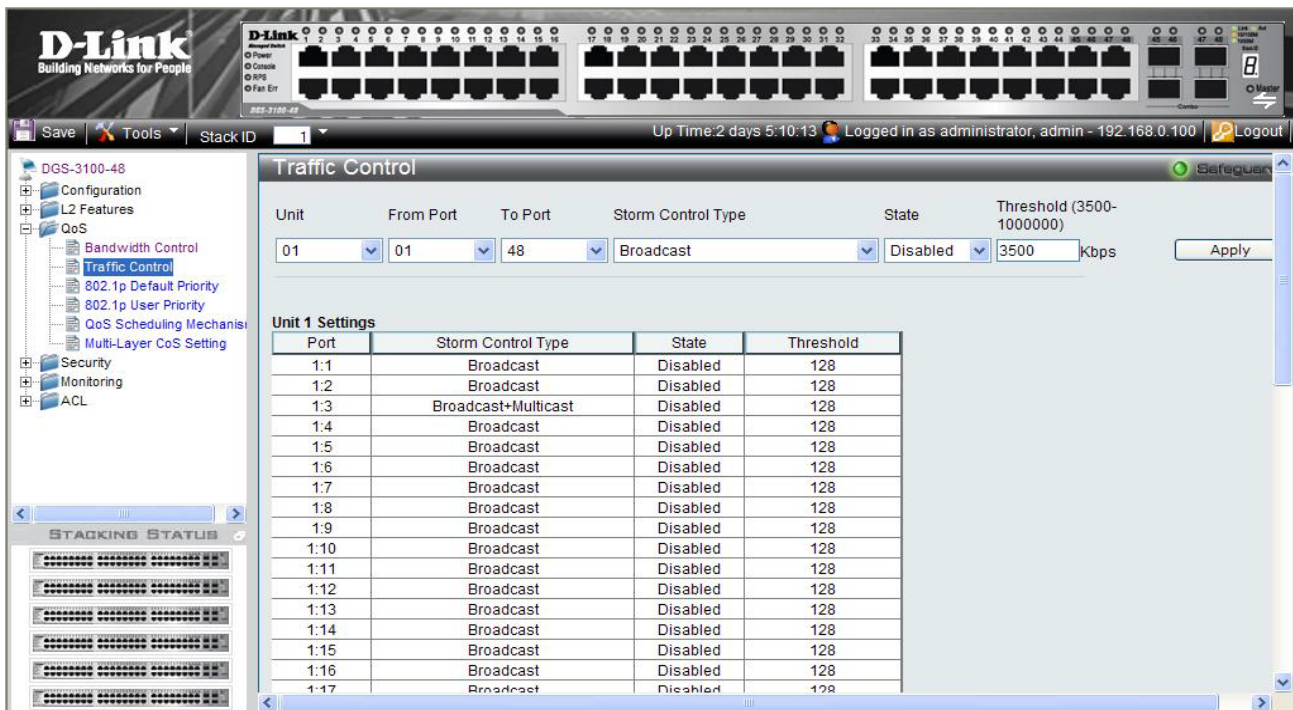

**Figure 4-3. Traffic Control Settings Page**

The *Traffic Control Settings Page* contains the following fields:

Field	Description
<b>Unit</b>	Defines the stacking member for which the storm control parameters are displayed.
<b>From Port</b>	Defines from which port storm control is configured.
<b>To Port</b>	Defines to which port storm control is configured.
<b>Storm Control Type</b>	Specifies the Broadcast mode currently enabled on the device. The possible field values are: <i>Broadcast Storm</i> <i>Broadcast and Multicast Storm</i> <i>Broadcast, Multicast and Unknown Unicast Storm</i>
<b>State</b>	Indicates which storm control is enabled on the port. The possible field values are: <i>Enable</i> — Enables storm control on the selected port. <i>Disable</i> — Disables storm control on the selected port. (This is the default value)
<b>Threshold (3500-1000000)</b>	Indicates the maximum rate (kilobits per second) at which 'storm' packets are forwarded. The range is 3500 -1,000,000. The default value is 3,500.

2. Define the *Unit*, *From Port*, *To Port*, *Storm Control Type*, *State*, and *Threshold* fields.
3. Click **Apply**. The storm control settings are configured, and the device is updated.

## Mapping Ports to Packet Priorities

The *802.1P Default Priority Page* provides traffic classification, by assigning priority values per port. The priority value is assigned when packet arrives to a port with an empty priority tag.

1. Click **Qos > 802.1p Default Priority**. The *802.1P Default Priority Page* opens:

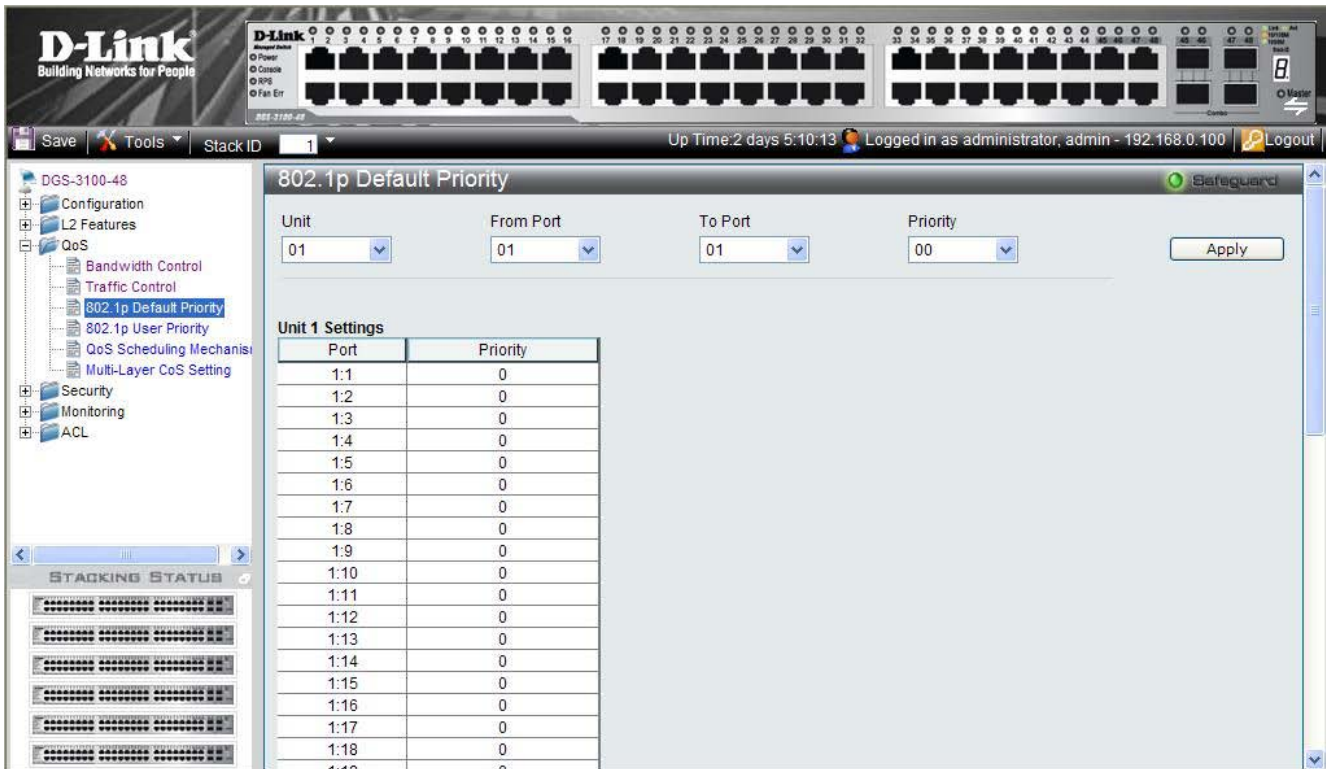

**Figure 4-4. 802.1P Default Priority Page**

The *802.1P Default Priority Page* contains the following fields:

Field	Description
<b>Unit</b>	Defines the stacking member for which the port packet priorities are displayed.
<b>From Port</b>	Defines the starting port for which the port packet priorities are defined.
<b>To Port</b>	Defines the ending port to which the port packet priorities are defined.
<b>Priority</b>	Defines the priority assigned to the port. The field range is 00-07, where 00 is the lowest priority and 07 is the highest priority.

2. Define the *Unit*, *From Port*, *To Port*, *Priority* fields.
3. Click . Ports are mapped to packet priorities, and the device is updated.

## Mapping Priority to Classes (Queues)

The *802.1P User Priority Page* allows network managers to assign priority tags to classes (queues). If a network manager defines a priority of 01 to Class 3, all packets arriving with an assigned value of 01 are sent to class (queue) 3.

The default mapping is:

- Priority 0, 3 is assigned to Q0. This is the lowest priority queue.
- Priority 1, 2 is assigned to Q1.
- Priority 4, 5 is assigned to Q2.
- Priority 6, 7 is assigned to Q3. This is the highest priority queue.

To map priority to queues:

1. Click **QoS > 802.1p User Priority**. The *802.1P User Priority Page* opens:

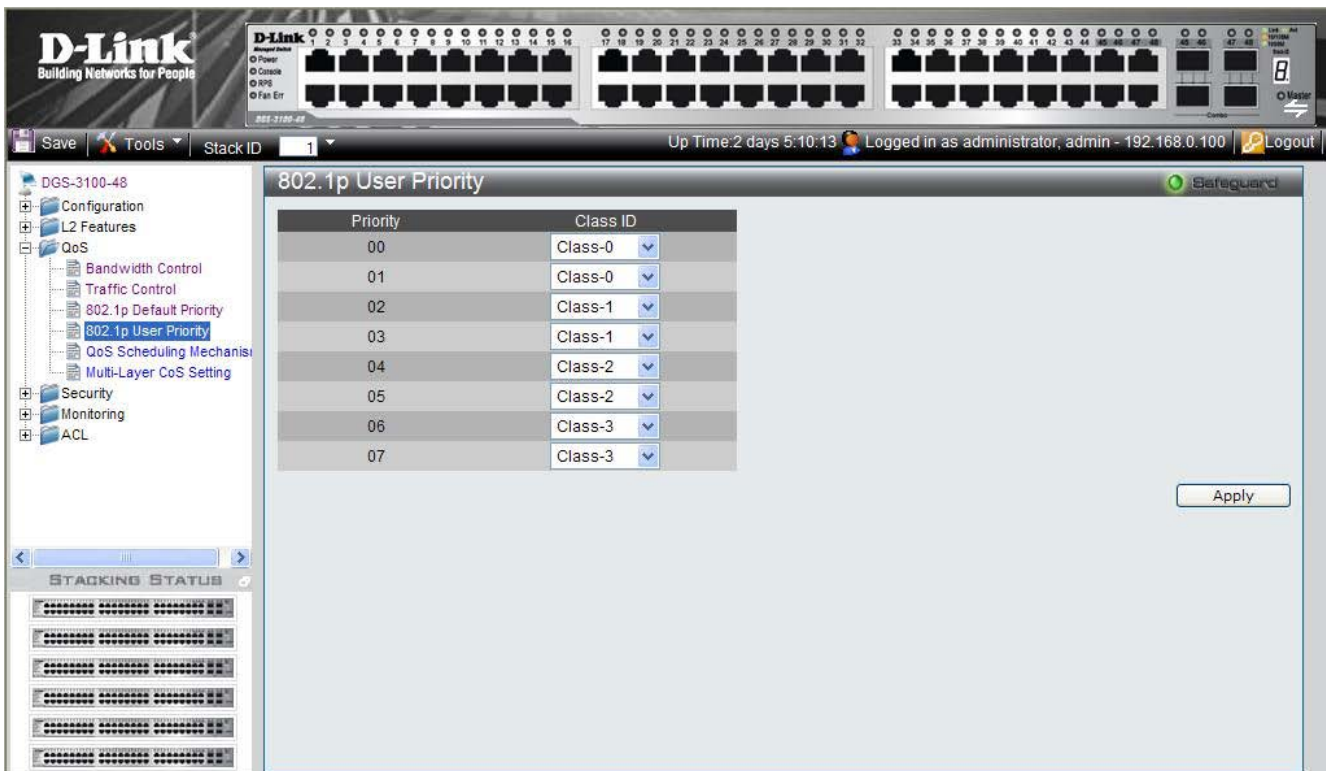

**Figure 4-5. 802.1P User Priority Page**

The *802.1P User Priority Page* contains the following fields:

Field	Description
<b>Priority</b>	Indicates the packet priority that is assigned to the queue.
<b>Class ID</b>	Defines the class (queue) that is assigned to the priority. Class 0 is the lowest priority queue, whereas Class 3 is the highest.

2. Define the queuing priority for 00 – 07 in the *Class ID* fields.
3. Click **Apply**. The User priority tags are assigned to classes, and the device is updated.

## Configuring QoS Scheduling Mechanism

The *QoS Scheduling Mechanism Page* contains fields for defining the QoS scheduling forwarding scheme. To define the QoS scheduling mechanism:

1. Click **QoS > QoS Scheduling Mechanism**. The *QoS Scheduling Mechanism Page* opens:

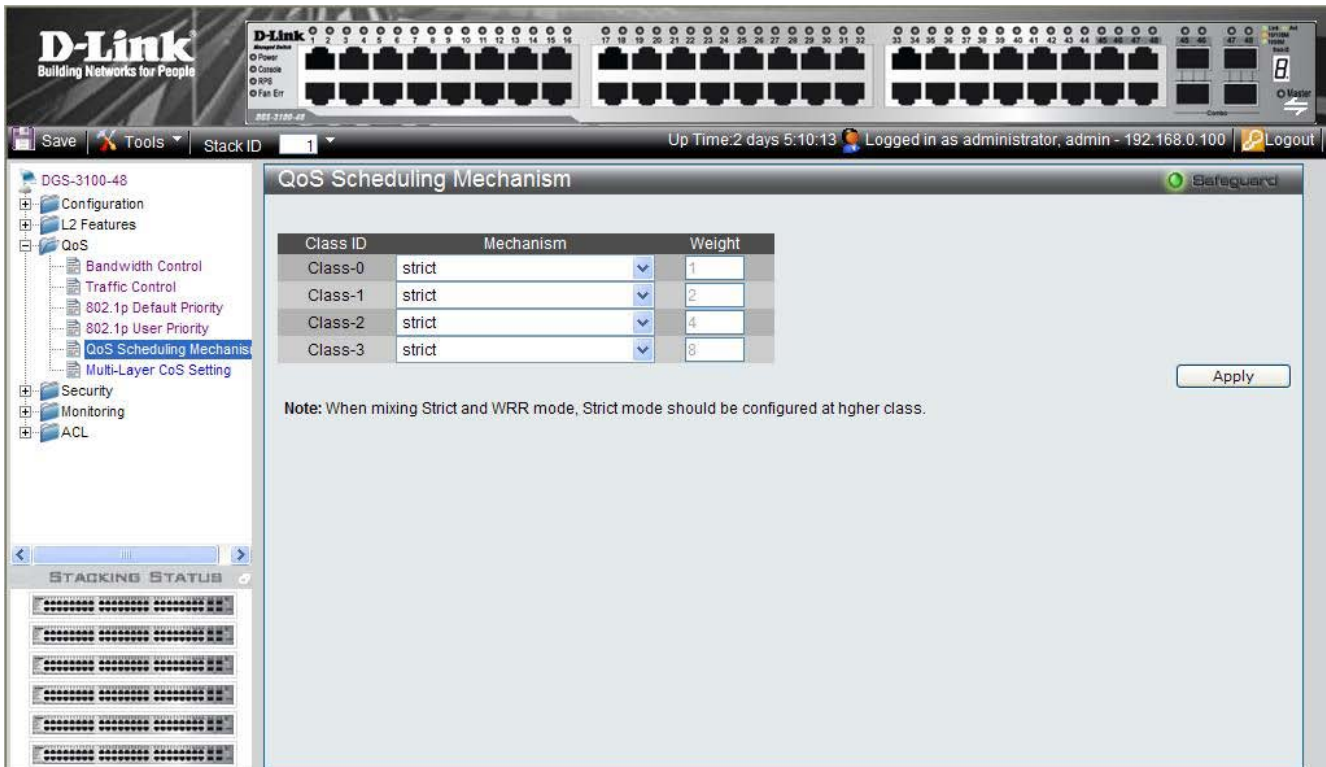

**Figure 4-6. QoS Scheduling Mechanism Page**

The *QoS Scheduling Mechanism Page* contains the following fields:

Field	Description
<b>Class ID</b>	Indicates the Class/queue for which the scheduling method is defined.
<b>Mechanism</b>	Defines the QoS class/queue scheduling method. The possible field values are: <i>Strict</i> — Specifies whether traffic scheduling is based strictly on the queue priority. Traffic with the highest Class of Service is the first traffic. That is, the highest class of service will finish before other queues empty. <i>Round Robin</i> — Assigns WRR weights to queues. This field is enabled only for queues in WRR queue mode. If a queue is set to 0 weight, the queue is not operational and is effectively closed. Each queue has a weight range, queues 0-3 have the range 0-15. When mixing Strict and WRR mode, Strict mode should be configured at higher class.(Class 3 and Class 2)
<b>Weight</b>	Assigns the specific WRR value to the Queue. The weight value range is 0-15.

2. Select the Class IDs in the *Mechanism* field.
3. Click **Apply**. The QoS Scheduling Mechanism is configured, and the device is updated.

## Defining Multi-Layer CoS Settings

For network administrators wanting to configure Multi Layer CoS settings, implementation in the switch is done via the Access Control List. Hence, the *Multi-Layer CoS Setting Page* has two hyperlinks; one to the Access Profile List, which enables the utilization of existing ACL rules to perform traffic classification, and the other to the ACL Configuration Wizard, which enables network administrators to create new ACL traffic classification rules. To define CoS/QoS settings:

1. Click **QoS > Multi-Layer CoS Settings**. The *Multi-Layer CoS Setting Page* opens:

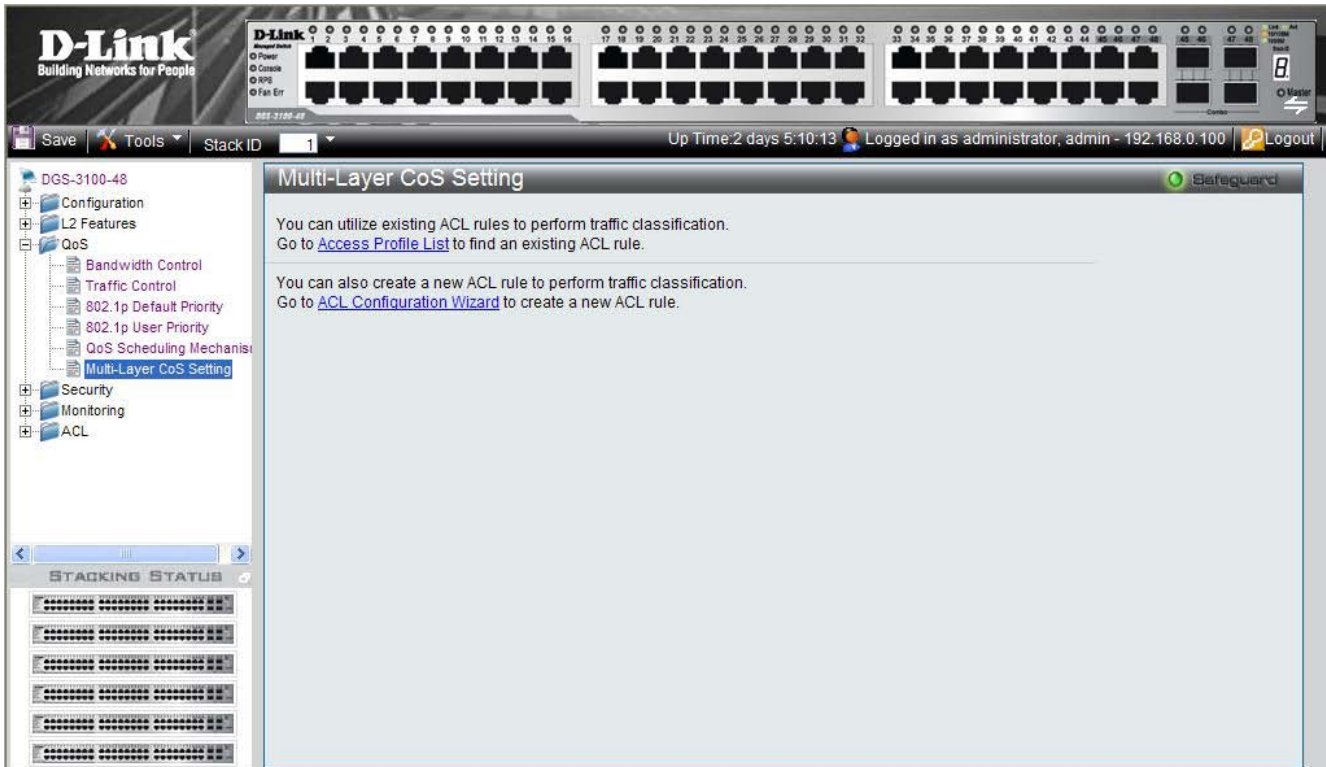

**Figure 4-7. Multi-Layer CoS Setting Page**

The *Multi-Layer CoS Setting Page* contains the following links:

- Access Profile List
  - ACL Configuration Wizard
2. Click the desired link. The relevant page opens (see *Defining Access Profile Lists*).

---

## SECURITY FEATURES

This section contains information for enabling and configuring device security including user accounts.

- Configuring Safeguard Engine
- Configuring Trust Host
- Configuring Port Security
- Configuring Guest VLANs
- Configuring Port Authentication 802.1X
- Defining EAP Forwarding Settings
- Configuring Secure Socket Layer Security
- Configuring Secure Shell Security
- Defining Application Authentication Settings

## Configuring Safeguard Engine

The *Safeguard Engine Page* allows network administrators to set network alarms to protect the CPU from attacks, based on *rising* and *falling threshold* levels of Broadcasts and CPU Utilization. The Safeguard mechanism immediately implements Broadcast Storm Control with a low threshold in order to hold the attack and release the CPU resources. To enable the safeguard engine:

1. Click **Security > Safeguard Engine**. The *Safeguard Engine Page* opens:

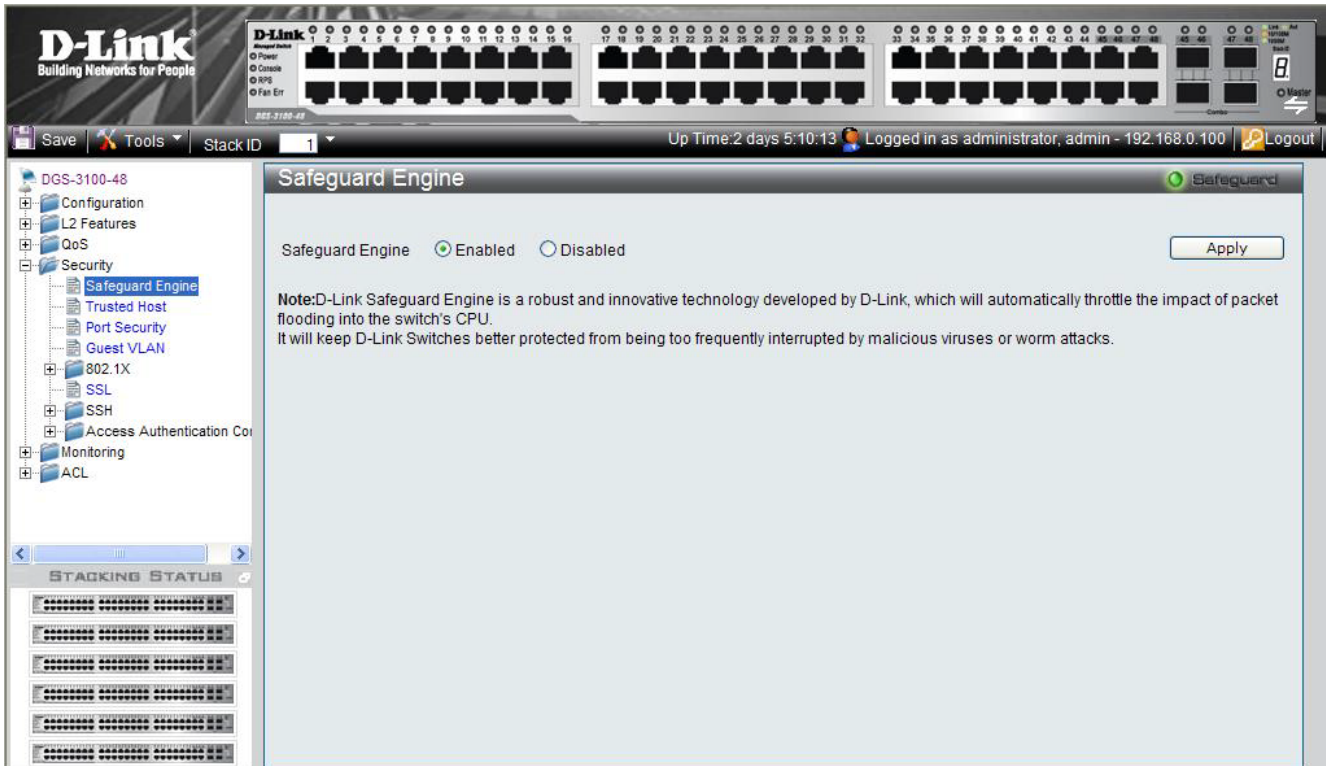

**Figure 5-1. Safeguard Engine Page**

The *Safeguard Engine Page* contains the following field:

Field	Description
<b>Safeguard Engine</b>	Indicates if the safeguard engine is enabled on the device. The possible field values are: <i>Enabled</i> — Enables the safeguard engine on the device. This is the default value. <i>Disabled</i> — Disables the safeguard engine on the device.
<b>Rising Threshold (20%-100%)</b>	Indicates the rising CPU Utilization thresholds enabling Safeguard. The possible field range is between 20%-100%. The default value is 70%.
<b>Falling Threshold (20%-100%)</b>	Indicates the falling CPU Utilization thresholds disabling Safeguard. The possible field range is between 20%-100%. The default value is 20%.

2. Set the safeguard engine status in the *Safeguard Engine* field.
3. Define the Rising Threshold and Falling Threshold fields.
4. Click **Apply**. The Safeguard Engine is enabled, and the device is updated.

## Configuring Trust Host

The *Trusted Host Page* permits network managers to manage the device from remote stations. Network managers can configure up to ten remote stations. Ensure that the remote stations are configured with the IP address from which the device is currently being configured to prevent disconnection. To enable Trust Host:

1. Click **Security > Trusted Host**. The *Trusted Host Page* opens:

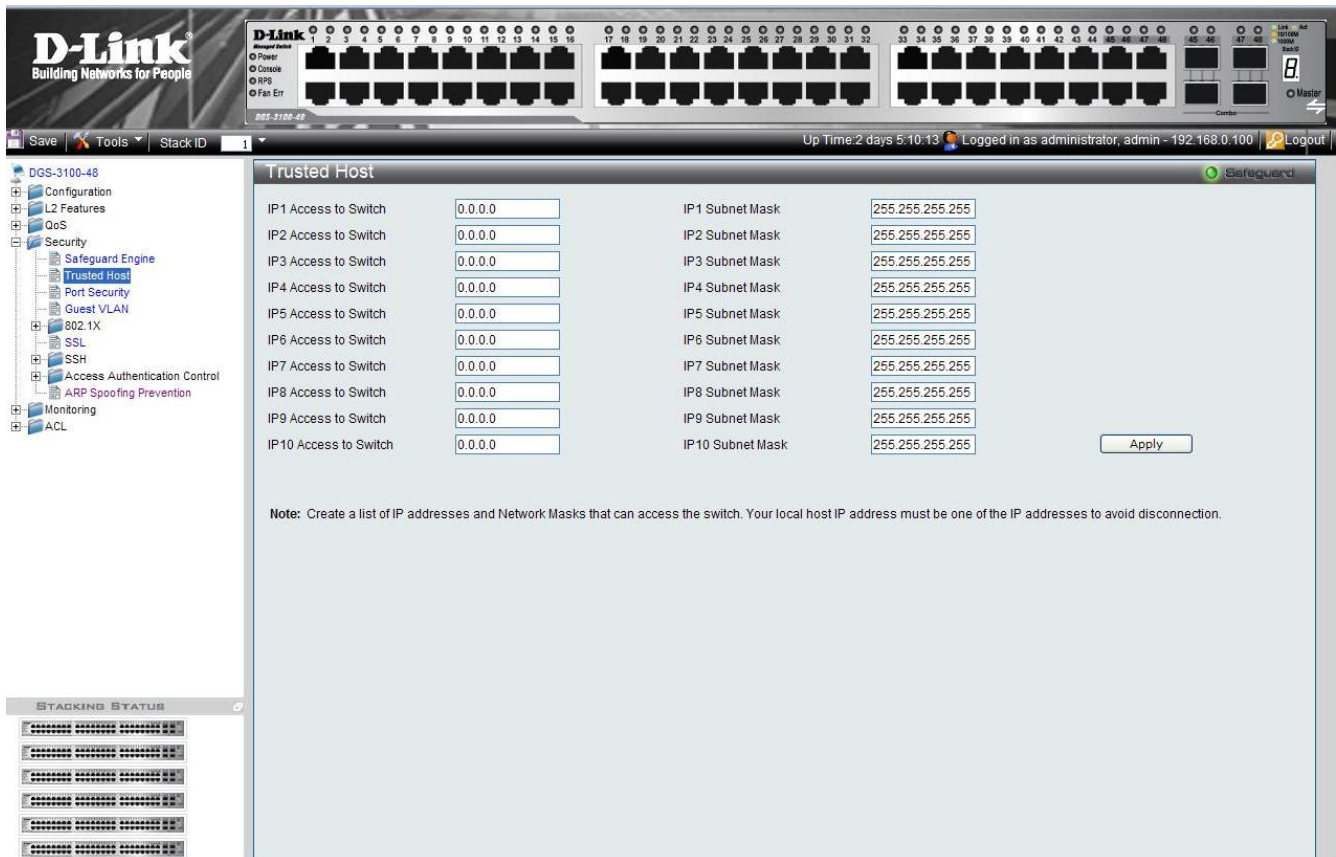

**Figure 5-2. Trusted Host Page**

The *Trusted Host Page* contains the following fields:

Field	Description
<b>IP Access to Switch (1-10)</b>	Defines the management station IP address from which the device can be managed.
<b>IP Subnet Mask to Switch (1-10)</b>	Defines the second management station IP Subnet Mask address from which the device can be managed

2. Define the IP1-10 Address fields and Subnet Mask to define the remote management stations.
3. Click **Apply**. The management stations are defined, and the device is updated.



## Configuring Port Security

Network security can be increased by limiting access on a specific port only to users with specific MAC addresses. The MAC addresses can be dynamically learned or statically configured. Locked port security monitors both received and learned packets that are received on specific ports. Access to the locked port is limited to users with specific MAC addresses. These addresses are either manually defined on the port, or learned on that port up to the point when it is locked. When a packet is received on a locked port, and the packet source MAC address is not tied to that port (either it was learned on a different port, or it is unknown to the system), the protection mechanism is invoked, and can provide various options. Unauthorized packets arriving at a locked port are either:

- Discarded with no trap
- Discarded with a trap

Locked port security also enables storing a list of MAC addresses in the configuration file. The MAC address list can be restored after the device has been reset. To define port security:

1. Click **Security > Port Security**. The *Port Security Page* opens:

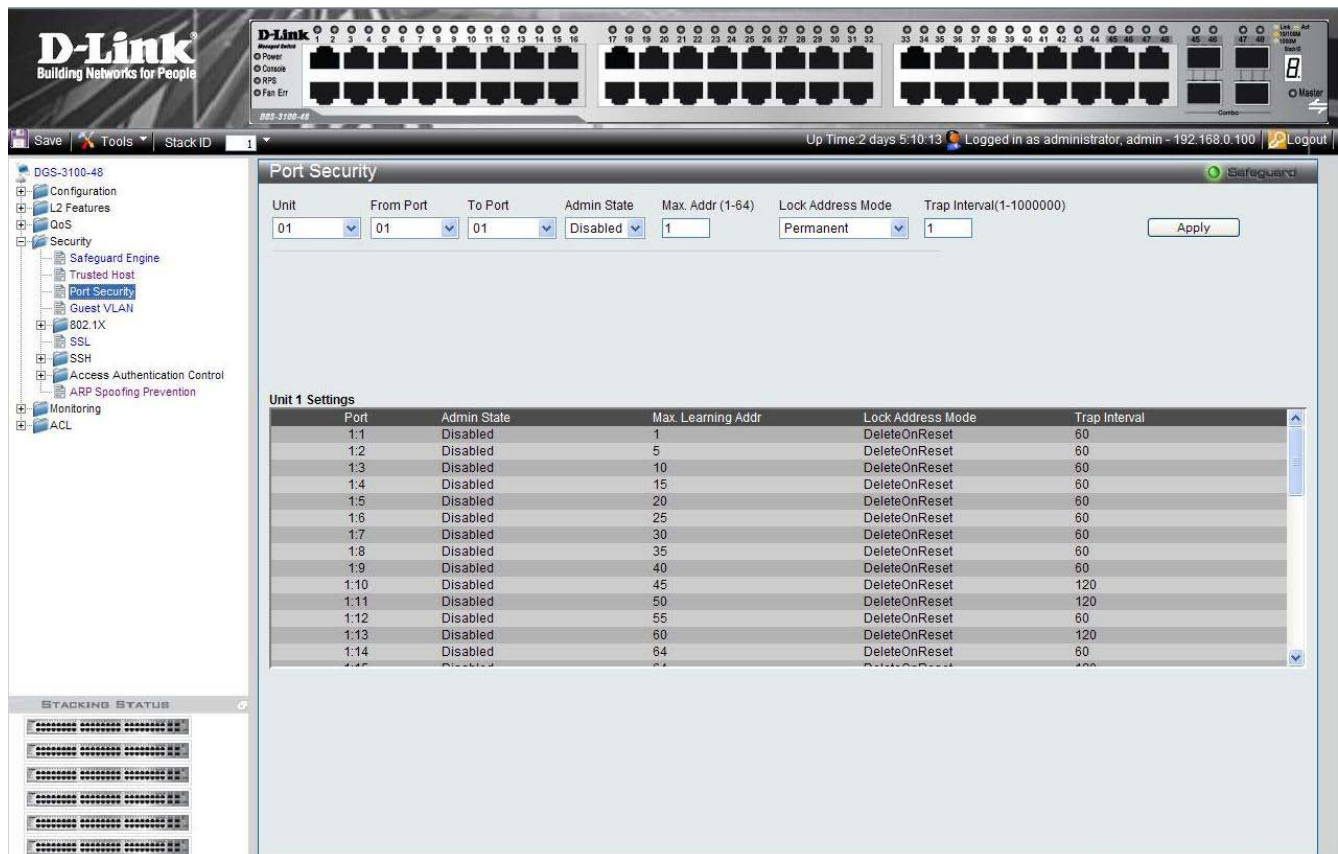

Figure 5-3. Port Security Page

The *Port Security Page* contains the following fields:

Field	Description
<b>Unit</b>	Displays the stacking member's ID for which the port security parameters are displayed.
<b>From Port</b>	Indicates the port number from which the port security parameters are displayed.
<b>To Port</b>	Indicates the port number to which the port security parameters are displayed.
<b>Admin State</b>	Indicates if port security on the device. The possible field values are: <i>Enable</i> — Indicates that port security is enabled on the device. <i>Disable</i> — Indicates that port security is disabled on the device. This is the default value.
<b>Max Address(1-64)</b>	Defines the number of MAC addresses. The field value is 1-64. The default value is 1.

Field	Description
<b>Lock Address Mode</b>	<p>The <i>Lock Address Mode</i> allows network administrators to limit the number of MAC addresses learned on a port, or to stop learning MAC address completely. Ports can be assigned a MAC address which is not aged out nor is the MAC address relearned, therefore <i>Locking</i> the port to the MAC address. After the port is locked, the all the dynamic MAC addresses associated with the port are deleted. The possible field values are:</p> <p><i>Permanent</i> – Learns up to the maximum number of dynamic addresses allowed on the port. The learned addresses are not aged out or relearned on other port for as long as the port is locked.</p> <p><i>Delete on Reset</i> – Deletes the current dynamic MAC addresses associated with the port. Learn up to the maximum addresses allowed on the port (this number is also configurable). Aging is disabled; the addresses are deleted on reset.</p> <p><i>Delete on Timeout</i> – Deletes the current dynamic MAC addresses associated with the port. The port learns up to the maximum addresses allowed on the port. Re-learned MAC addresses and address aging out are also enabled. The MAC addresses are deleted when the device is reset and on when the address is aged out.</p>
<b>Trap Interval (1-1000000)</b>	Indicates the amount of time (seconds) between Port Security traps sent to the interface. The possible field range is 1- 1000000 seconds. The field default is 10 seconds.
<b>Port</b>	Displays the specific port number.
<b>Max Learning Addr</b>	Indicates the maximum number of MAC addresses which learned on these ports.

- Define the Unit, From Port, To Port, Max Address (1-64), Admin State, Lock Address Mode and Trap Interval (1-1000000) fields.
- Click **Apply**. Port security is enabled, and the device is updated.

## Configuring Guest VLANs

Guest VLANs provide limited network access to authorized ports. If a port is denied network access via port-based authorization, but the Guest VLAN is enabled, the port receives limited network access. For example, a network administrator can use Guest VLANs to deny network access via port-based authentication, but grant internet access to unauthorized users. To define Guest VLANs:

1. Click **Security > Guest Vlan**. The *Guest VLAN Page* opens:

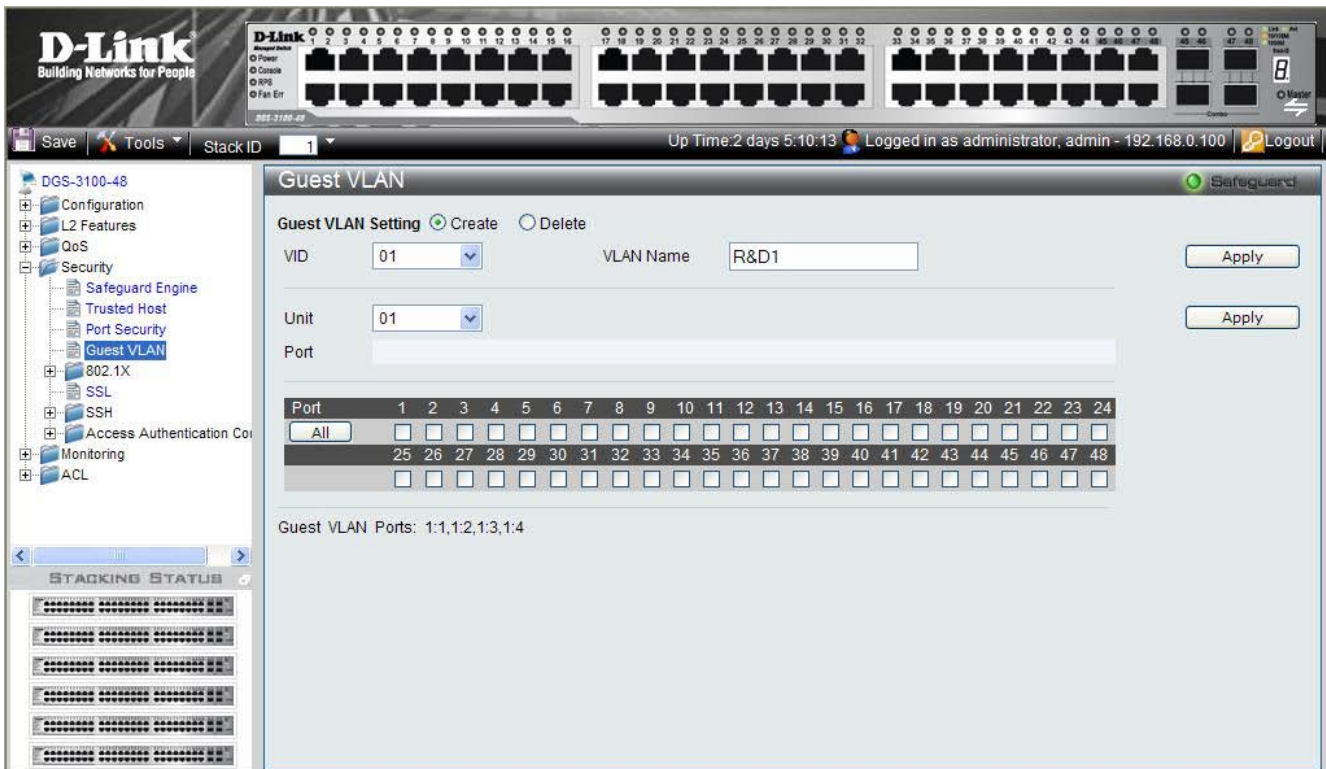

**Figure 5-4. Guest VLAN Page**

The *Guest VLAN Page* contains the following fields:

Field	Description
<b>VID</b>	Defines the VLAN ID on which the Guest VLAN is created.
<b>VLAN Name</b>	Defines the user-defined VLAN name assigned to the guest VLAN.
<b>Unit</b>	Defines the stacking member for which the Guest VLAN parameters are displayed.
<b>Port</b>	Defines the ports included in the Guest VLAN.

2. Define the VLAN ID in the *VID* field.
3. Define the VLAN name in the *VLAN Name* field
4. Select the stacking member which the Guest VLAN parameters are displayed in the *Unit* field.
5. Select the ports to be included in the Guest VLAN in the *Port* checkbox field. The selected ports appear in the *Port* field.
6. Click . The Guest VLAN is added, and the system is updated.

## Configuring Port Authentication 802.1X

Port-based authentication authenticates users on a per-port/per mac basis via an external server. Only authenticated and approved system users can transmit and receive data. Ports are authenticated via the RADIUS server using the *Extensible Authentication Protocol* (EAP). The 802.1x Access Control protocol consists of the following vital components which stabilize Access Control Security:

Component	Description
<b>Authenticators</b>	<p>The Authenticator is an intermediary between the Authentication Server and the Client. The authenticator:</p> <ul style="list-style-type: none"> <li>Requests certification information via the Client (EAPOL packets). The EAPOL packets are the only information allowed to pass between supplicants and the authentication server until the authenticator is granted system access.</li> <li>Verifies the information gathered from the Client with the Authentication Server, and relays the information to the Client.</li> </ul>
<b>Supplicants/Clients</b>	Specifies the host connected to the authenticated port requesting to access the system services.
<b>Authentication Server</b>	Specifies the server that performs the authentication on behalf of the authenticator, and indicates whether the supplicant is authorized to access system services. The Authentication Server is a remote device connected to the Client network and Authenticator. The Authentication Server must have RADIUS Server application enabled and configured. Clients connected to a port on the Switch must be authenticated by the Authentication Server before accessing any system services. The Authentication Server certifies the client's identity attempting to access the network by exchanging secure information between the RADIUS server and the Client.

Port-based authentication creates two access states:

State	Description
<b>Controlled Access</b>	Permits communication between the supplicant and the system, if the supplicant is authorized.
<b>Uncontrolled Access</b>	Permits uncontrolled communication regardless of the port state.

To enable the 802.1X:

1. Click **Security > 802.1X Setting**. The *802.1X Setting Page* opens:

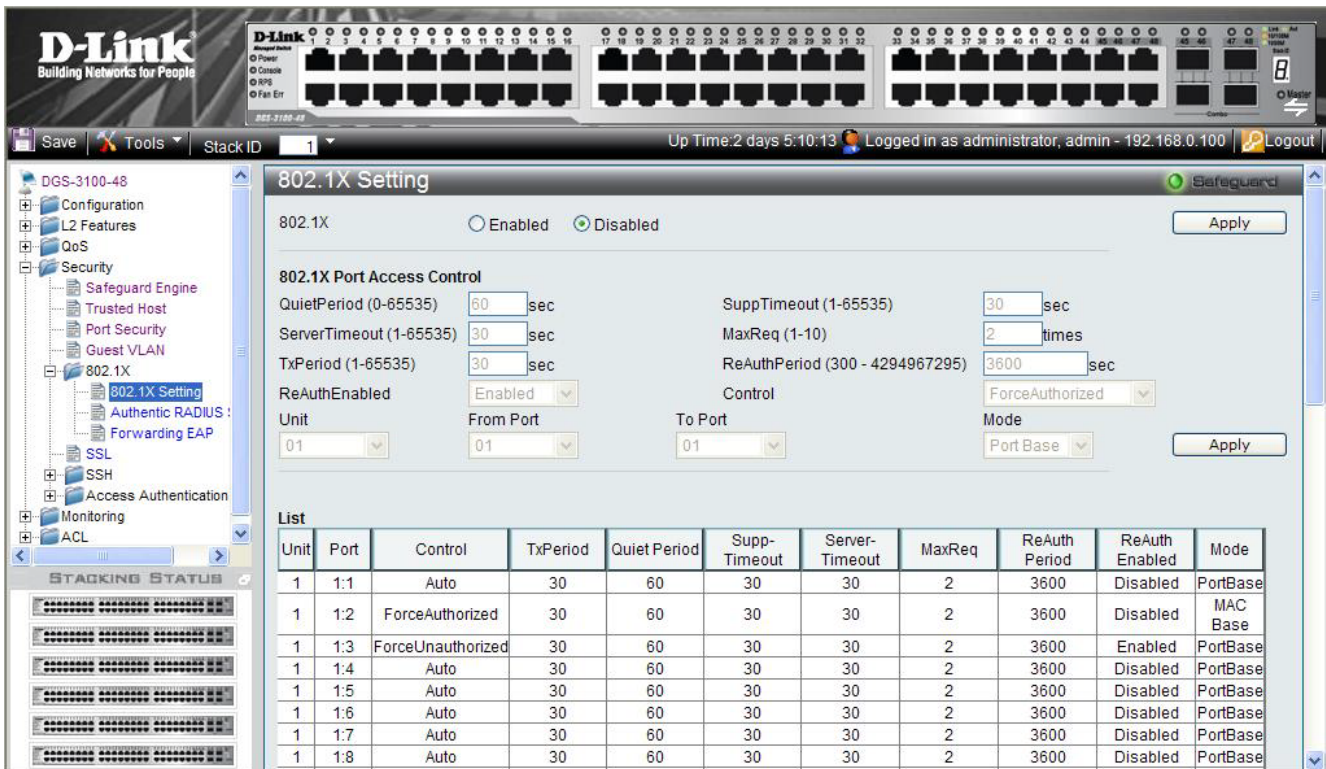

**Figure 5-5. 802.1X Setting Page**

The *802.1X Setting Page* contains the following fields:

Field	Description
<b>802.1X</b>	Indicates if 802.1X is enabled on the device. The possible field values are: <i>Enabled</i> — Enables 802.1X on the device. <i>Disabled</i> — Disables 802.1X on the device. This is the default value.
<b>QuietPeriod (0-65535) sec</b>	Indicates the number of seconds that the device remains in the quiet state following a failed authentication exchange. The possible field range is 0-65535. The field default is 60 seconds.
<b>SuppTimeout (1-65535) sec</b>	Indicates the amount of time that lapses before EAP requests are resent to the supplicant. The field value is in seconds. The field default is 30 seconds.
<b>ServerTimeout (1-65535) sec</b>	Defines the amount of time that lapses before the device re-sends a request to the authentication server. The field value is specified in seconds. The field default is 30 seconds.
<b>MaxReq (1-10) times</b>	Displays the total amount of EAP requests sent. If a response is not received after the defined period, the authentication process is restarted. The field default is 2 retries.
<b>TxPeriod (1-65535) sec</b>	Defines the amount of time (in seconds) that lapses before EAP requests are resent. The field default is 30 seconds.
<b>ReAuthPeriod (300 - 4294967295) sec</b>	Displays the time span (in seconds) in which the selected port is re-authenticated. The field default is 3600 seconds.
<b>ReAuthEnabled</b>	Indicates if ports/MAC address can be re-authenticated after the port/MAC address authentication has timed out. The possible field values are: <i>Enabled</i> — Enables re-authenticating the port or MAC addresses after the port or MAC address authentication has timed out. This is the default

Field	Description
	value. <i>Disabled</i> — Disables re-authenticating the port or MAC addresses after the port or MAC address authentication has timed out.
<b>Control</b>	Indicates the host status. If there is an asterisk (*), the port is either not linked or is down. The possible field values are: <i>ForceUnauthorized</i> — Indicates that either the port control is Force Unauthorized and the port link is down, or the port control is Auto but a client has not been authenticated via the port. <i>ForceAuthorized</i> — Indicates that the port control is Forced Authorized, and clients have full port access. <i>Auto</i> — Indicates that the port control is Auto. The user has to authenticate and get full access..
<b>Unit</b>	Indicate the stacking member for which the 802.1X parameters are defined.
<b>From Port</b>	Indicates the first port for which the 802.1X parameters are defined.
<b>To Port</b>	Indicates the last port for which the 802.1X parameters are defined.
<b>Mode</b>	Indicates the 802.1X mode enabled on the device. The possible field values are: <i>Port Base</i> — Enables 802.1X on ports. This is the default value. <i>MAC Base</i> — Enables 802.1xon MAC addresses.

2. Enable or disable the 802.1X status in the *802.1X* field.
3. Define the *Mode* field.
4. In the *802.1X Port Access Control* section, define the fields.
5. Set the *ReAuthEnabled* field and the *Control* fields.
6. Set the values in the *Unit*, *From Port*, and *To Port* fields.
7. Click . The 802.1x Access Control is configured, and the device is updated.

#### MAC Authentication (MAC-Based MAC Access Control)

MAC Authentication is configured in DGS-3100 series via '802.1x Setting' WEB page.

This functionality enables the user to allow specific MAC address to enter the switch while rejecting the unauthorized MAC addresses. The database of the authorized MAC addresses resides in a Radius Server.



**NOTE:** MAC-based authentication doesn't require 802.1X client enabled.

To enable MAC Authentication:

1. Click **Security > 802.1X Setting**. The *802.1X Setting Page* opens:

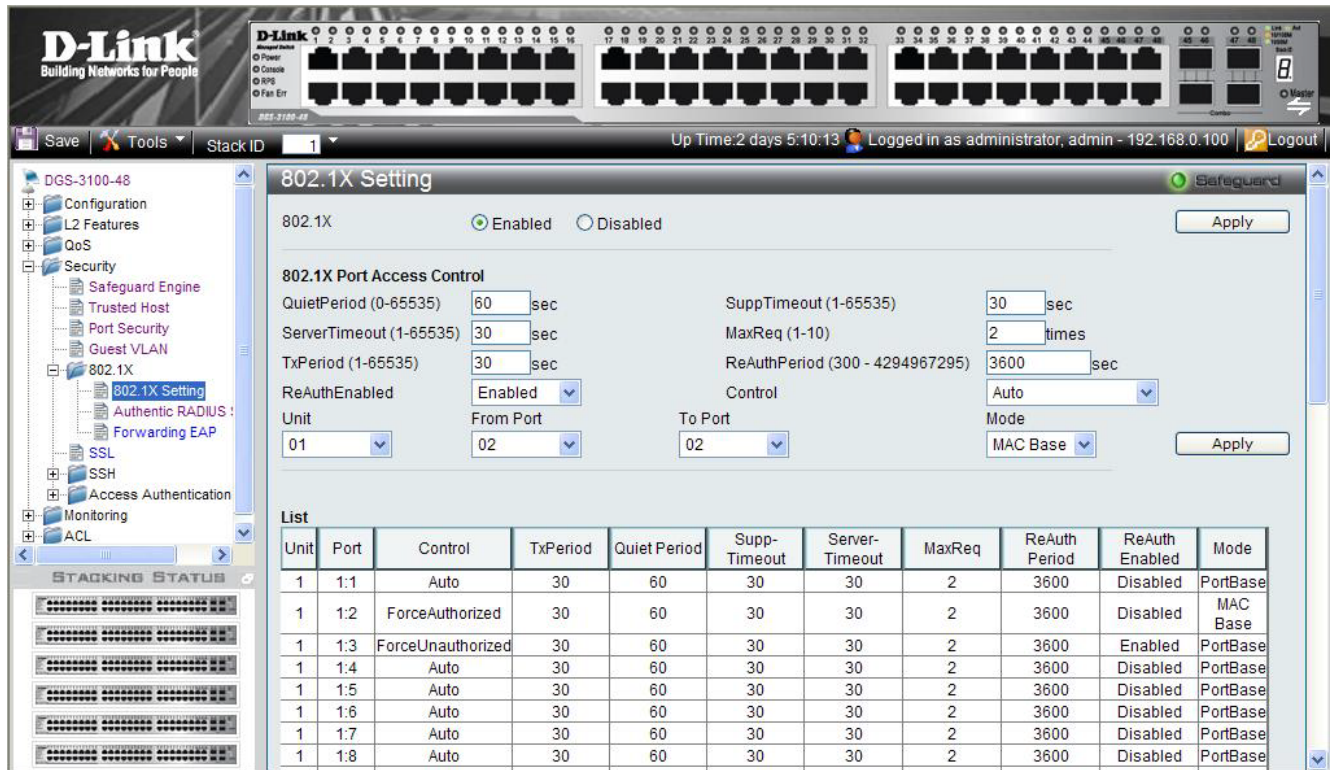

The *802.1X Setting Page* contains the following fields:

Field	Description
<b>802.1X</b>	Indicates if 802.1X is enabled on the device. The possible field values are: <i>Enabled</i> — Enables 802.1X (and MAC Authentication) on the device. <i>Disabled</i> —Disables 802.1X on the device. This is the default value.
<b>QuietPeriod (0-65535) sec</b>	Indicates the number of seconds that the device remains in the quiet state following a failed authentication exchange. The possible field range is 0-65535. The field default is 60 seconds.
<b>SuppTimeout (1-65535) sec</b>	Indicates the amount of time that lapses before EAP requests are resent to the supplicant. The field value is in seconds. The field default is 30 seconds.
<b>ServerTimeout (1-65535) sec</b>	Defines the amount of time that lapses before the device re-sends a request to the authentication server. The field value is specified in seconds. The field default is 30 seconds.
<b>MaxReq (1-10) times</b>	Displays the total amount of EAP requests sent. If a response is not received after the defined period, the authentication process is restarted. The field default is 2 retries.
<b>TxPeriod (1-65535) sec</b>	Defines the amount of time (in seconds) that lapses before EAP requests are resent. The field default is 30 seconds.
<b>ReAuthPeriod (300 - 4294967295) sec</b>	Displays the time span (in seconds) in which the selected port is re-authenticated. The field default is 3600 seconds.
<b>ReAuthEnabled</b>	Indicates if ports/MAC address can be re-authenticated after the port/MAC address authentication has timed out. The possible field values are: <i>Enabled</i> — Enables re-authenticating the port or MAC addresses after the port or MAC address authentication has timed out. This is the default value.

Field	Description
	<i>Disabled</i> — Disables re-authenticating the port or MAC addresses after the port or MAC address authentication has timed out.
<b>Control</b>	Indicates the host status. If there is an asterisk (*), the port is either not linked or is down. The possible field values are: <i>ForceUnauthorized</i> — Indicates that either the port control is Force Unauthorized and the port link is down, or the port control is Auto but a client has not been authenticated via the port. <i>ForceAuthorized</i> — Indicates that the port control is Forced Authorized, and clients have full port access. <i>Auto</i> — Indicates that the port control is Auto and at least single client or single MAC has been authenticated via the port.
<b>Unit</b>	Indicate the stacking member for which the 802.1X parameters are defined.
<b>From Port</b>	Indicates the first port for which the 802.1X parameters are defined.
<b>To Port</b>	Indicates the last port for which the 802.1X parameters are defined.
<b>Mode</b>	Indicates the 802.1X mode enabled on the device. The possible field values are: <i>Port Base</i> — Enables 802.1X on ports. This is the default value. <i>MAC Base</i> — Enables 802.1X on MAC addresses.

2. Enable or disable the 802.1X status in the *802.1X* field.
3. Define the *Mode* field (MAC Base for MAC Authentication)
4. In the *802.1X Port Access Control* section, define the *time* fields.
5. Set the *ReAuthEnabled* field and the *Control* fields.
6. Set the values in the *Unit*, *From Port*, and *To Port* fields.
7. Click . The MAC Authentication is configured, and the device is updated.

In order to activate MAC Based Authentication, the user should first enable 802.1X globally on the switch.

Then the user should define the port(s) that needs to be configured for MAC Authentication.

In the Mode control the user needs to select the 'MAC Base' option.

In addition to that the user needs to switch the 'port Control' to Auto and enable reauthentication

In order to complete the configuration the port must be member in the guest VLAN.



## Configuring MAC Authentication (by using Guest VLAN, 802.1X and Radius pages)

This is the sequence of operations required to configure MAC Authentication in DGS-3100 series.

1. In order to configure a guest VLAN, the user is required to create a VLAN first, in the following example the user creates VLAN 100 via click **L2 Features > 802.1Q VLAN**. The *802.1Q VLAN page* opens:

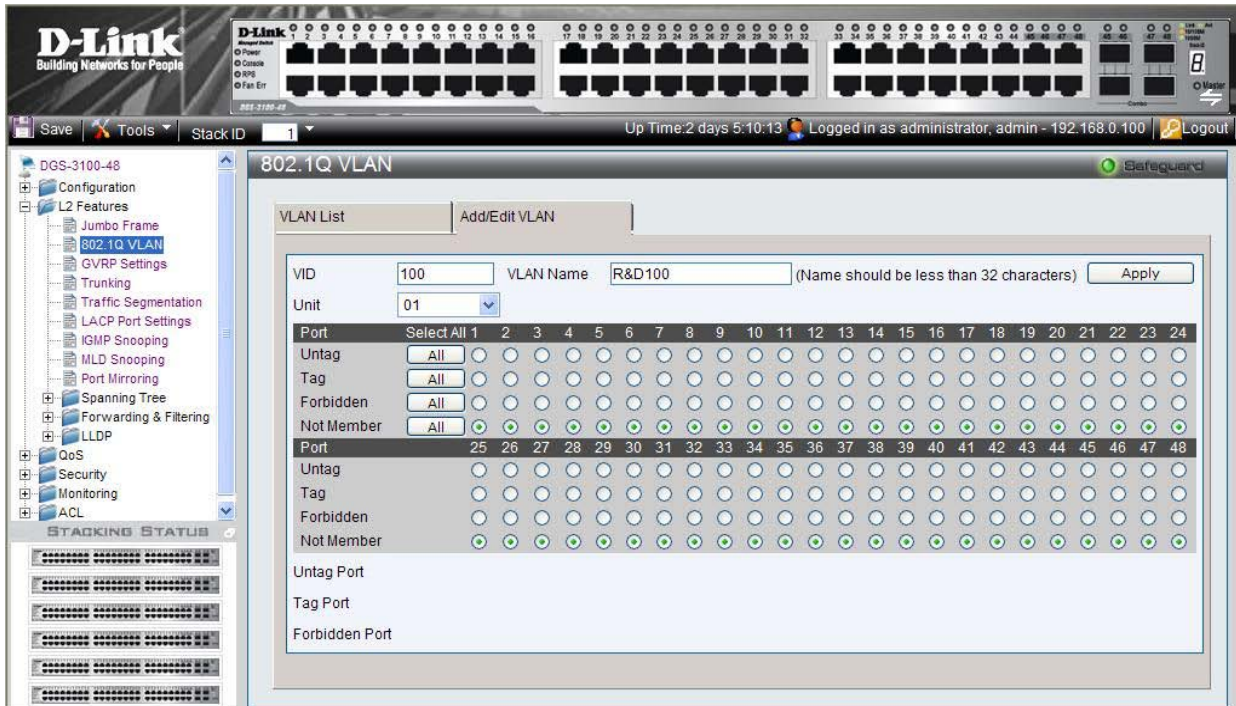

2. Assign ports to the Guest VLAN via click **Security > Guest VLAN** and according to the following example:

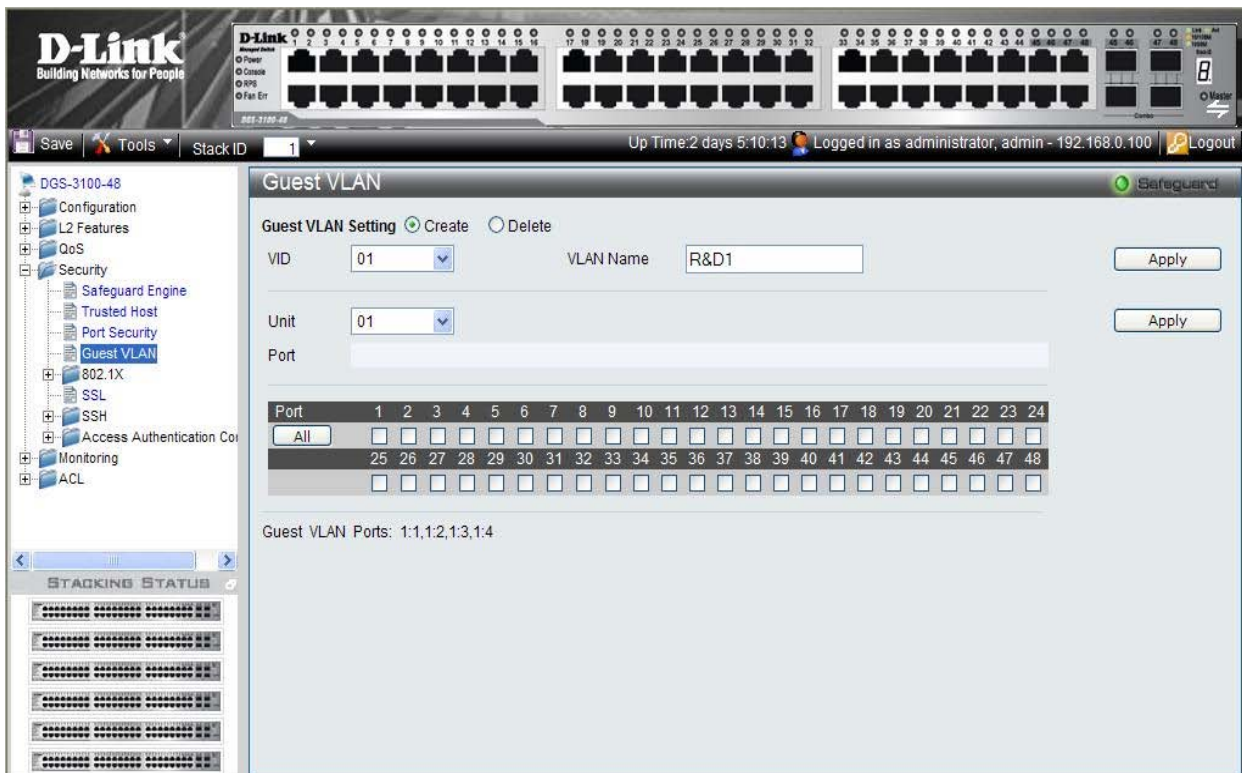

- After the ports were assigned to the Guest VLAN, the user needs to configure a Radius Server that will hold the MAC Authentication database. This should be done via click **Security > 802.1X > Authentic RADIUS Server** page according to the example below.

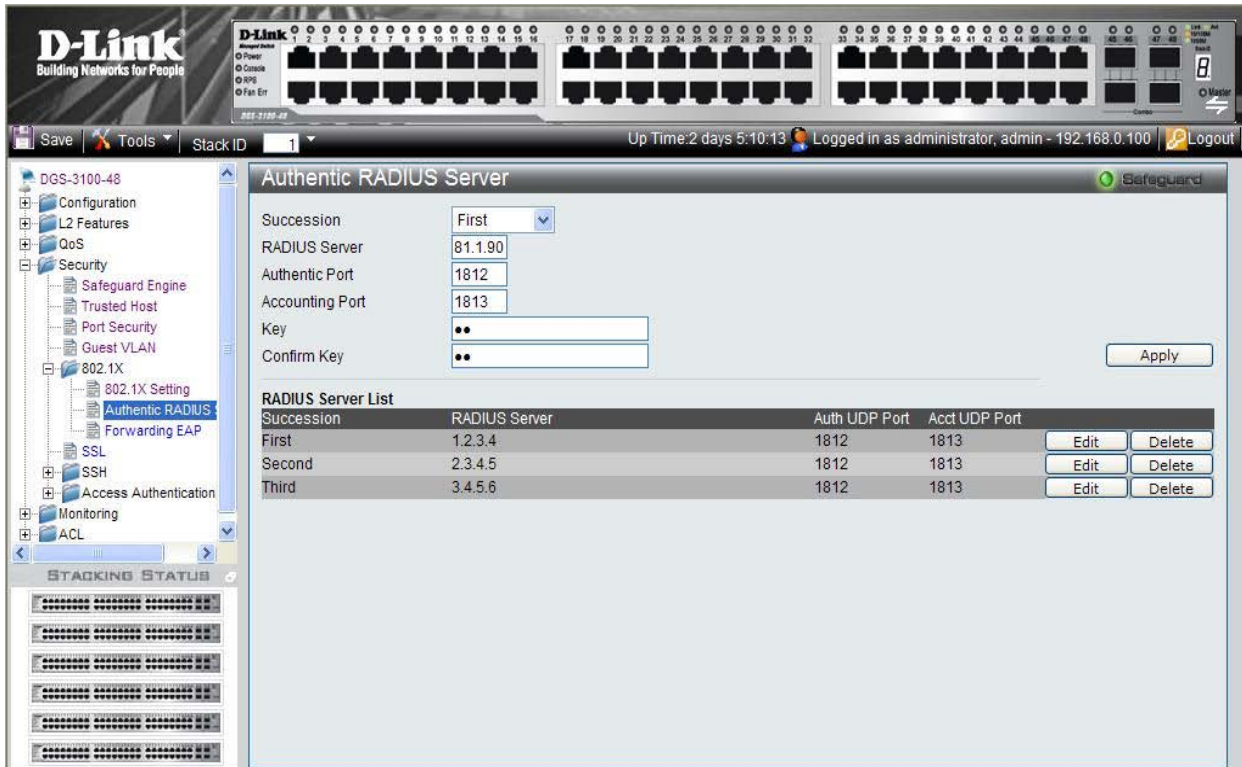

- Click **Security > 802.1X > 802.1X Setting** page: first, 802.1x should be enabled globally and in the port level, 802.1x Control should be configured as 'ForceAuthorized'.

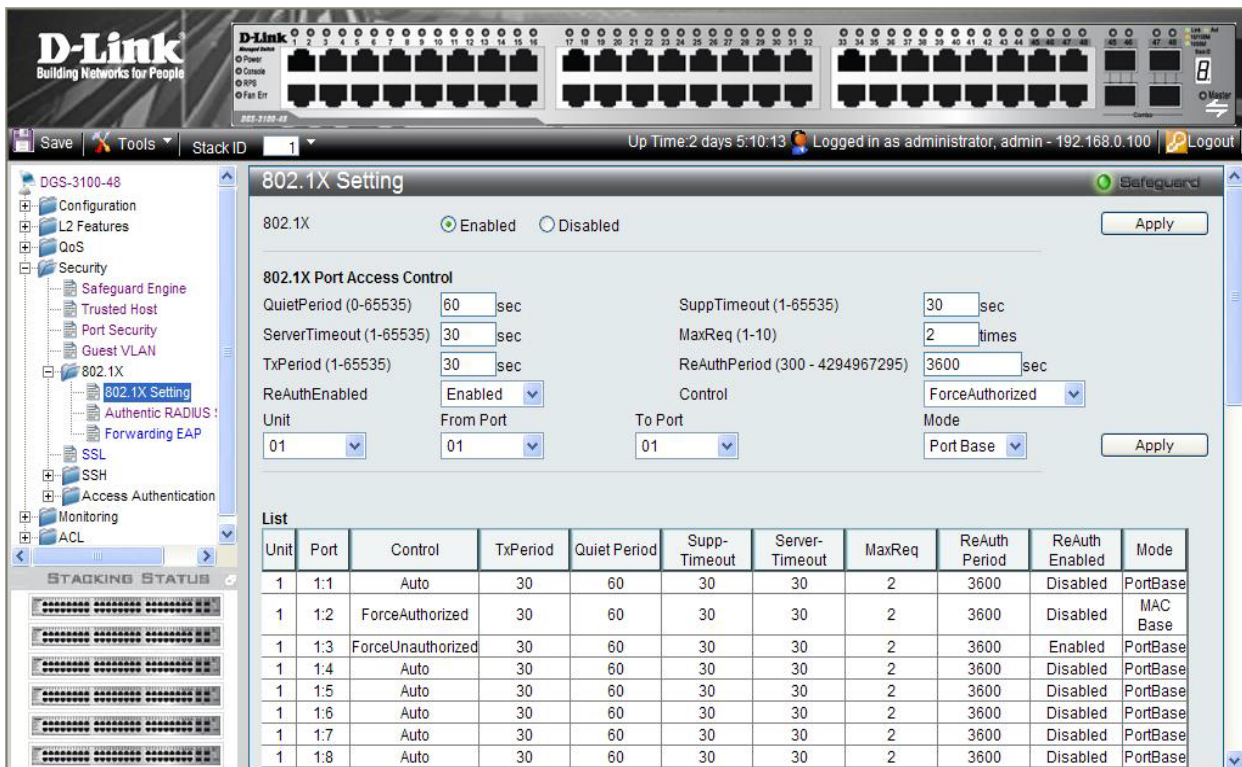

- The second step on **Security > 802.1X > 802.1X Setting** page will be configuration of the required ports as ‘MAC Based’ authentication (opposite to ‘Port Based’ authentication)

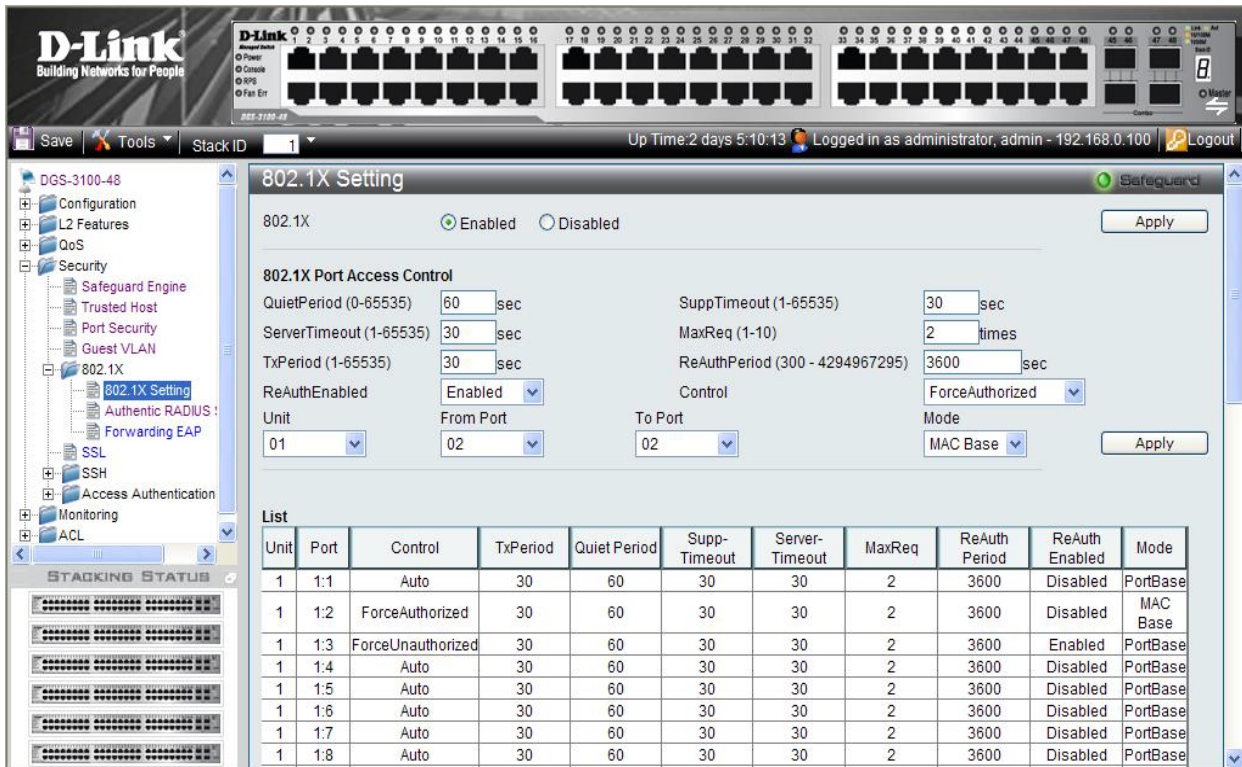

- The last step on **Security > 802.1X > 802.1X Setting** page should be setting the port control to ‘Auto’, this will complete the setting of MAC Authentication for the required ports.

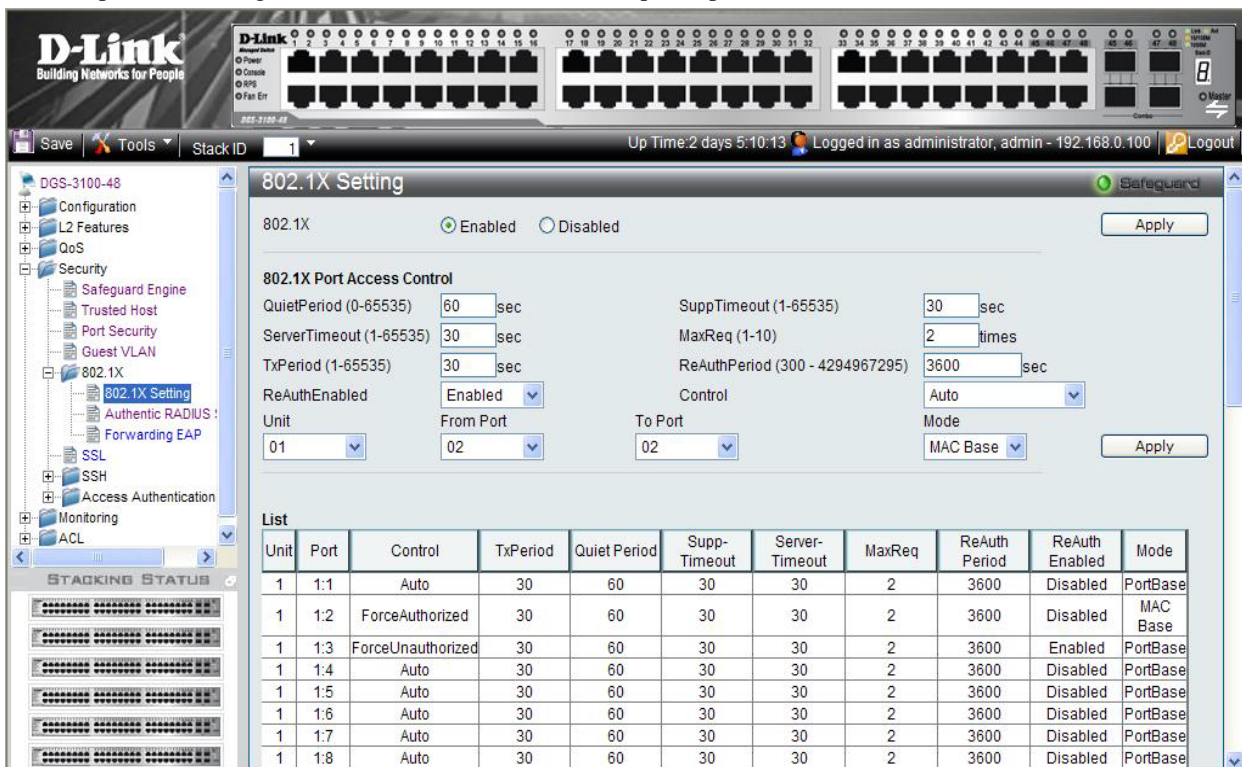

## Defining RADIUS Settings

Remote Authorization Dial-In User Service (RADIUS) servers provide additional security for networks. RADIUS servers provide a centralized authentication method for management access.

The default parameters are user-defined, and are applied to newly defined RADIUS servers. If new default parameters are not defined, the system default values are applied to newly defined RADIUS servers.

1. Click **Security > 802.1X > Authentic RADIUS Server**. The *Authentic RADIUS Server Page* opens:

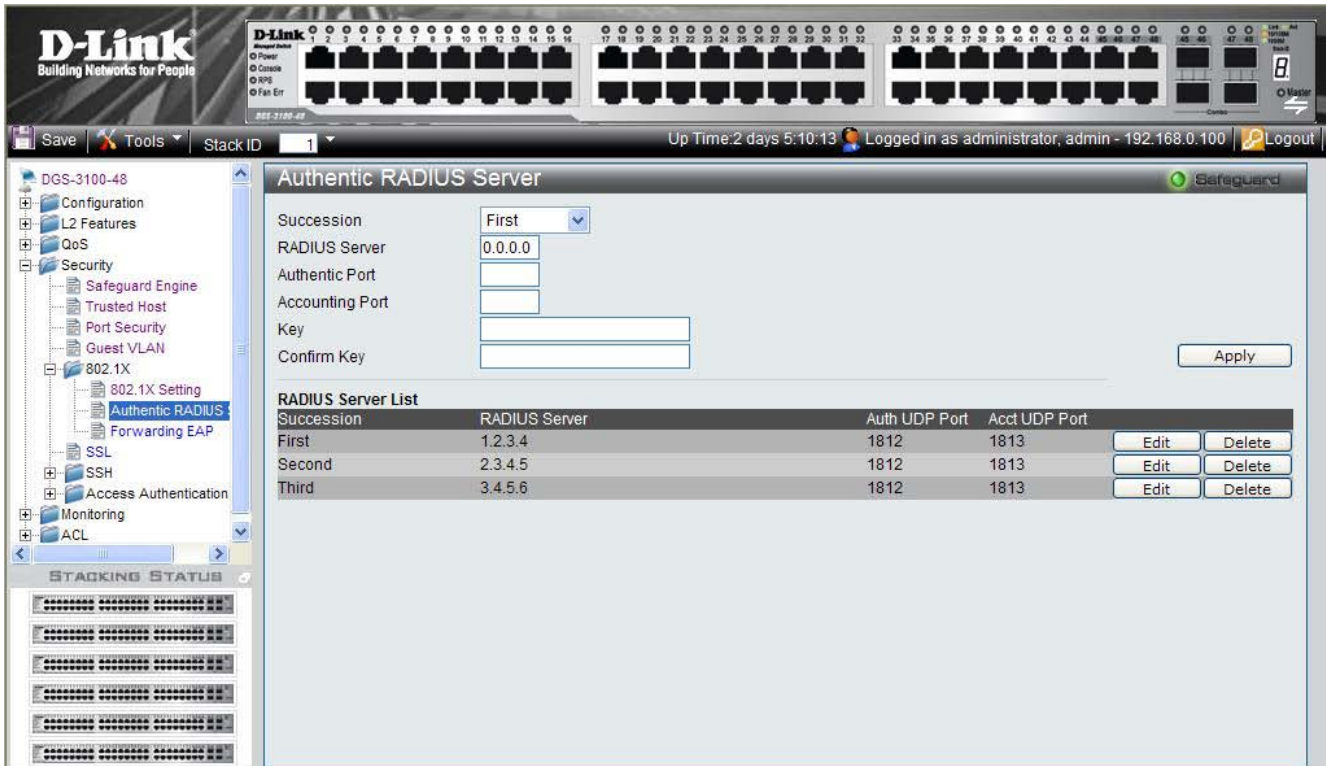

**Figure 5-6. Authentic RADIUS Server Page**

The *Authentic RADIUS Server Page* contains the following fields:

Field	Description
<b>Succession</b>	Defines the desired RADIUS server to configure. Network managers use up to 3 RADIUS servers for port authentication. The possible field values are: <i>First</i> — Indicates the RADIUS parameters are defined for the first RADIUS server. <i>Second</i> — Indicates the RADIUS parameters are defined for the second RADIUS server. <i>Third</i> — Indicates the RADIUS parameters are defined for the third RADIUS server.
<b>RADIUS Server</b>	Defines the RADIUS server IP addresses. The field format is X.X.X.X.
<b>Authentic Port</b>	Identifies the authentication port. The authentication port is used to verify the RADIUS server authentication. The authenticated port default is 1812.
<b>Accounting Port</b>	Defines the port used to send <i>Start</i> and <i>Stop</i> authentication messages. Information received through the RADIUS Accounting Port is recorded in the <i>RADIUS Authentication Page</i> . The default port is 1813.
<b>Key</b>	Defines the authentication and encryption key for communications between the device and the server. This key must match the encryption used on the server.
<b>Confirm Key</b>	Confirms the RADIUS key defined in the <b>Key</b> field.

2. Define the RADIUS server to configure in the *Succession* field.
3. Define the RADIUS server IP address in the *RADIUS Server* field.

4. Define the authentication port in the *Authentic Port* field.
  5. Define the accounting port in the *Accounting Port* field.
  6. Define the authentication and encryption key in the *Key* field.
  7. Reenter the RADIUS Key in the *Confirm Key* field.
  8. Click .
- To edit the Radius Server list, click  adjacent to the required listed server. The upper fields display the current values, which then can be edited.
  - To delete a radius server from the list, click  adjacent to the relative list entry. The radius servers are defined, and the device is updated.
  -

## Defining EAP Forwarding Settings

Ports use the *Extensible Authentication Protocol (EAP)* forwarding mechanism when 802.1x authentication is disabled. The *Forwarding EAP Page* allows the user to enable or disable forwarding EAP packets to an authentication server.

1. Click **Security > 802.1X > Forwarding EAP**. The *Forwarding EAP Page* opens:

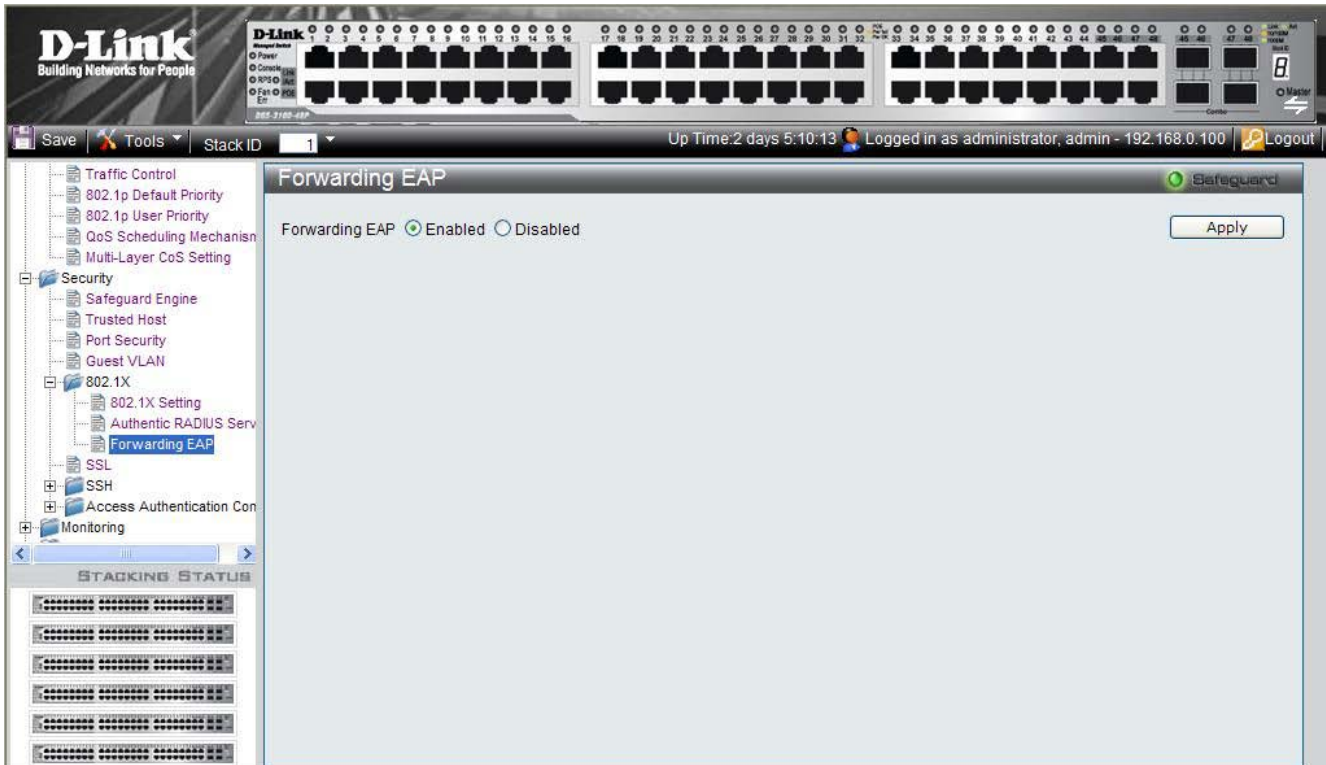

**Figure 5-7. Forwarding EAP Page**

The Forwarding EAP Page contains the following field:

Field	Description
<b>Forwarding EAP</b>	Specifies whether forwarding of EAP packets is enabled on the device. The possible field values are: <i>Enabled</i> — Enables forwarding of EAP packets. <i>Disabled</i> — Disables forwarding of EAP packets. This is the default.

2. Define the EAP packet forwarding status in the *Forwarding EAP* field.
3. Click **Apply**. The EAP packet forwarding status is defined, and the device is updated

## Configuring Secure Socket Layer Security

*Secure Socket Layer (SSL)* is a security feature that provides a secure communication path between a host and client through the use of authentication, digital signatures, and encryption. These security functions are implemented using a *Ciphersuite*, which is a security string that determines the exact cryptographic parameters, specific encryption algorithms and key sizes used for authentication sessions, and that consists of:

- **Key Exchange** —Ciphersuite strings specify the public key algorithm used. This switch utilizes the *Rivest Shamir Adleman (RSA)* public key algorithm. This is the first authentication process between client and host as they “exchange keys” in looking for a match and therefore authentication to be accepted to negotiate encryptions on the following level.
- **Encryption:** The second part of the ciphersuite that includes the encryption used for encrypting the messages sent between client and host. The Switch supports two types of cryptology algorithms:
  - *Stream Ciphers* – There are two types of stream ciphers on the Switch, *RC4 with 40-bit keys* and *RC4 with 128-bit keys*. These keys are used to encrypt messages and need to be consistent between client and host for optimal use.
  - *CBC Block Ciphers – Cipher Block Chaining (CBC)* links encrypted text blocks. The Switch supports the *3DES EDE* encryption code defined by the *Data Encryption Standard (DES)* to create the encrypted text.
- **Hash Algorithm** — This part of the ciphersuite allows the user to choose a message digest function which will determine a Message Authentication Code. This *Message Authentication Code* will be encrypted with a sent message to provide integrity and prevent against replay attacks. The Switch supports two hash algorithms, *Message Digest 5 (MD5)* and *Secure Hash Algorithm (SHA)*.

The *SSL Configuration Settings Page* permits network managers to enable SSL with all supported ciphersuites on the Switch. Ciphersuites are security strings that determines the exact cryptographic parameters, specific encryption algorithms and key sizes to be used for an authentication session. The Switch possesses three possible ciphersuites for the SSL function, which are enabled by default.



**NOTE:** Once SSL is enabled, the Web and Telnet are disabled.

To manage the device via an Embedded Web System while SSL is enabled, the web browser must support SSL encryption. URL headers must begin with *https://*, for example <https://10.90.90.90>.

The system supports up-to five SSH sessions.

To enable SSL on the device:

1. Click **Security > SSL**. The *SSL Configuration Settings Page* opens:

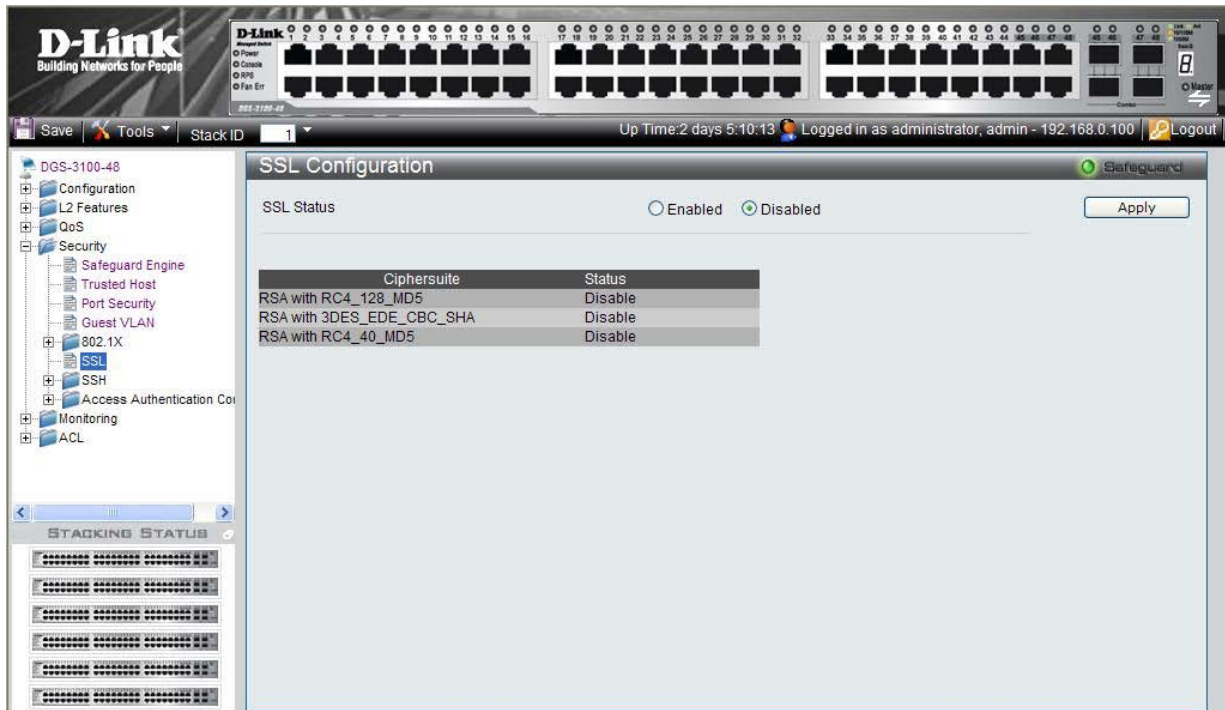

**Figure 5-8. SSL Configuration Settings Page**

The *SSL Configuration Settings Page* contains the following fields:

Field	Description
<b>SSL Status</b>	Indicates if SSL is enable on the device. The possible field values are: <i>Enabled</i> — Indicates SSL is enabled on the device. <i>Disabled</i> — Indicates SSL is disabled on the device. (This is the default value.)
<b>Ciphersuite</b>	Indicates the Ciphersuite. The possible field values are: <i>RSA with RC4 128 MD5</i> —Combines the RSA key exchange, stream cipher RC4 encryption with 128-bit keys and the MD5 Hash Algorithm. <i>RSA with 3DES EDE CBC SHA</i> — This ciphersuite combines the RSA key exchange, CBC Block Cipher 3DES_EDE encryption and the SHA Hash Algorithm. <i>RSA EXPORT with RC4 40 MD5</i> — This ciphersuite combines the RSA Export key exchange and stream cipher RC4 encryption with 40-bit keys.
<b>Status</b>	Indicates if the selected Ciphersuite is enable or disabled for SSL. The possible field values are: <i>Enable</i> — Enables the Ciphersuite for SSL. <i>Disable</i> — Disables the Ciphersuite for SSL.

2. Enable or disable the SSL status in the *SSL Status* field.
3. Click . The SSL status is defined, and the device is updated.



## Configuring Secure Shell Security

*Secure Shell* permits network users to securely login to the network from a remote location over an insecure network. SSH a secure login to remote host computers, a safe method of executing commands on a remote end node, and will provide secure encrypted and authenticated communication between two non-trusted hosts. SSH, with its array of unmatched security features is an essential tool in today’s networking environment. It is a powerful guardian against numerous existing security hazards that now threaten network communications.

Ensure the following steps are completed before configuring SSH:

- Create a user account with admin-level access using the **User Accounts** window in the **Administration folder**. This is identical to creating any other admin-level User Account on the Switch, including specifying a password. This password is used to logon to the Switch, once a secure communication path has been established using the SSH protocol.
- Configure the User Account to use a specified authorization method to identify users that are allowed to establish SSH connections with the Switch using the **Current Accounts** window (**Security > Secure Shell (SSH) > SSH User Authentication**). There is a special SSH method that may be used to authorize the user: *Public Key*. The default value is *None*.



**NOTE:** DGS-3100-xx only supports SSH protocol version 2.

To define SSH on the device:

1. Click **Security > SSH > SSH Configuration**. The *SSH Configuration Page* opens:

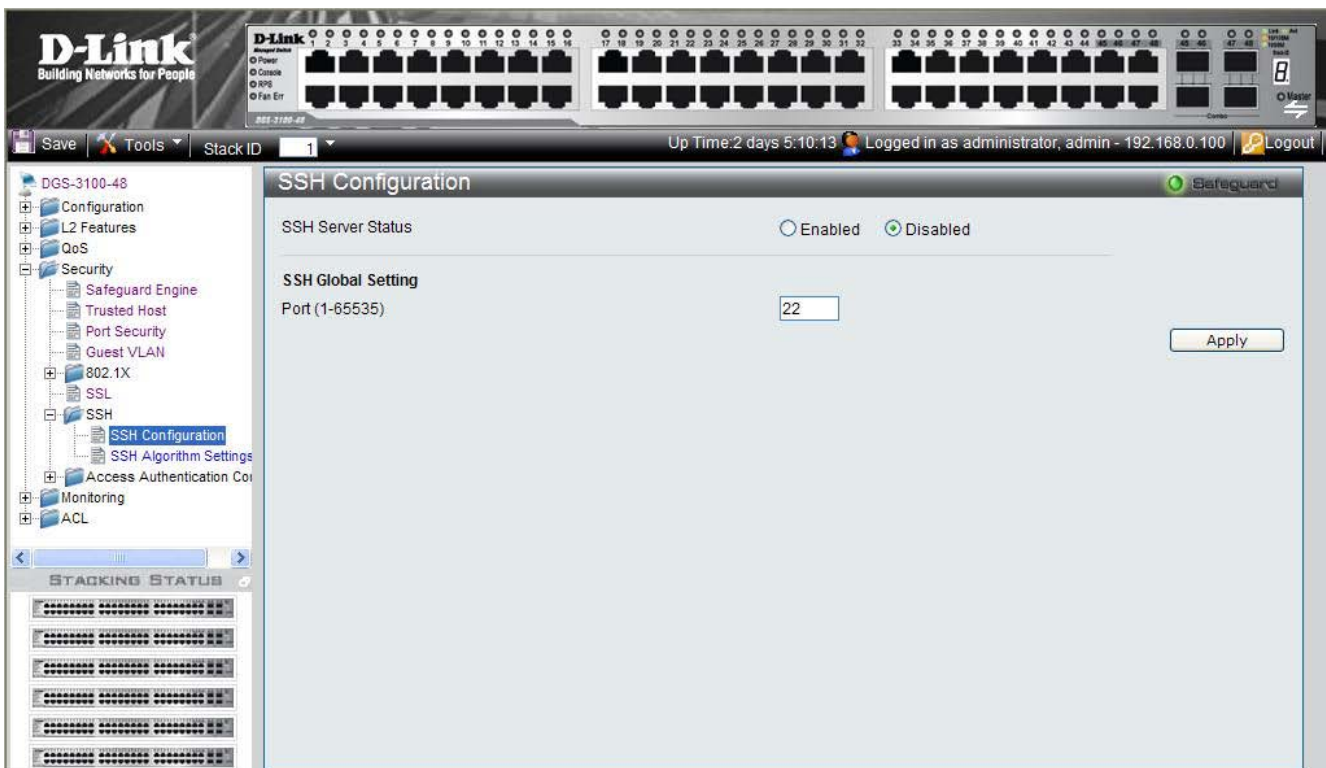

**Figure 5-9. SSH Configuration Page**

The *SSH Configuration Page* contains the following fields:

Field	Description
<b>SSH Server Status</b>	Indicates if SSH is enabled on the device. The possible field values are: <i>Enable</i> — Enables SSH on the device.

Field	Description
	<i>Disable</i> — Disables SSH on the device. This is the default value.
<b>Port (1-65535)</b>	Displays the port number used to authenticate the SSH session. The possible field range is 1-65535. The field default is 22.

2. Enable or disable the SSH server status in the *SSH Server Status* field.
3. Define the SSH global setting port number in the *Port (1-65535)* field.
4. Click . The SSH configuration is defined, and the device is updated.

## Defining SSH Algorithm Settings

This *SSH Algorithm Settings Page* allows network administrators to enable a public key for SSH authentication encryption. The following authentication keys are enabled for SSH:

- **Public Key Algorithm** — Encrypts a cryptographic key pair composed of a public key and a private key. The private key is kept secret, while the public key can be distributed. The encryption keys are mathematically similar, but a private key cannot be derived from the public key. Messages encrypted with a public key can be decrypted with the matching private key. The following Public Key Algorithms are supported:
  - *HMAC-RSA* — Supports the *Hash for Message Authentication Code (HMAC)* mechanism utilizing the RSA encryption algorithm.
  - *HMAC-DSA* — Supports the *Hash for Message Authentication Code (HMAC) Digital Signature Algorithm (DSA)* encryption algorithm.
- **Data Integrity Algorithm** — Validates message authentication information transmitted between two parties which share the same key. The following Data Integrity Algorithms are supported:
  - *HMAC-SHA* — Supports the *Hash for Message Authentication Code (HMAC) Secure Hash Algorithm (SHA)* mechanism.
  - *HMAC MD5* — Supports the *Hash for Message Authentication Code (HMAC) MD5 Message Digest (MD5)* mechanism.
- **Encryption Algorithm** — Generates authentication keys used to authenticate communications between different applications. The following Encryption Algorithms are supported
  - *3DES-CBC* — Supports a block size of 8 bytes (64 bits); its key size is 192 bits long. The first 8 bytes cannot be identical to the second 8 bytes, and the second 8 bytes cannot be identical to the third 8 bytes.
  - *AES128* — Provides a block cipher that encrypts and decrypts digital information. The AES128 algorithm is capable of using cryptographic 128 keys.
  - *AES192* — Provides a block cipher that encrypts and decrypts digital information. The AES192 algorithm is capable of using cryptographic 192 keys.
  - *AES256* — Provides a block cipher that encrypts and decrypts digital information. The AES256 algorithm is capable of using cryptographic 256 keys.
  - *RC4* — Supports a cipher with an up to 2048 bits key size.

All algorithms are enabled by default. To enable SSH Algorithms:

1. Click **Security > SSH > SSH Algorithm Settings**. The *SSH Algorithm Settings Page* opens:

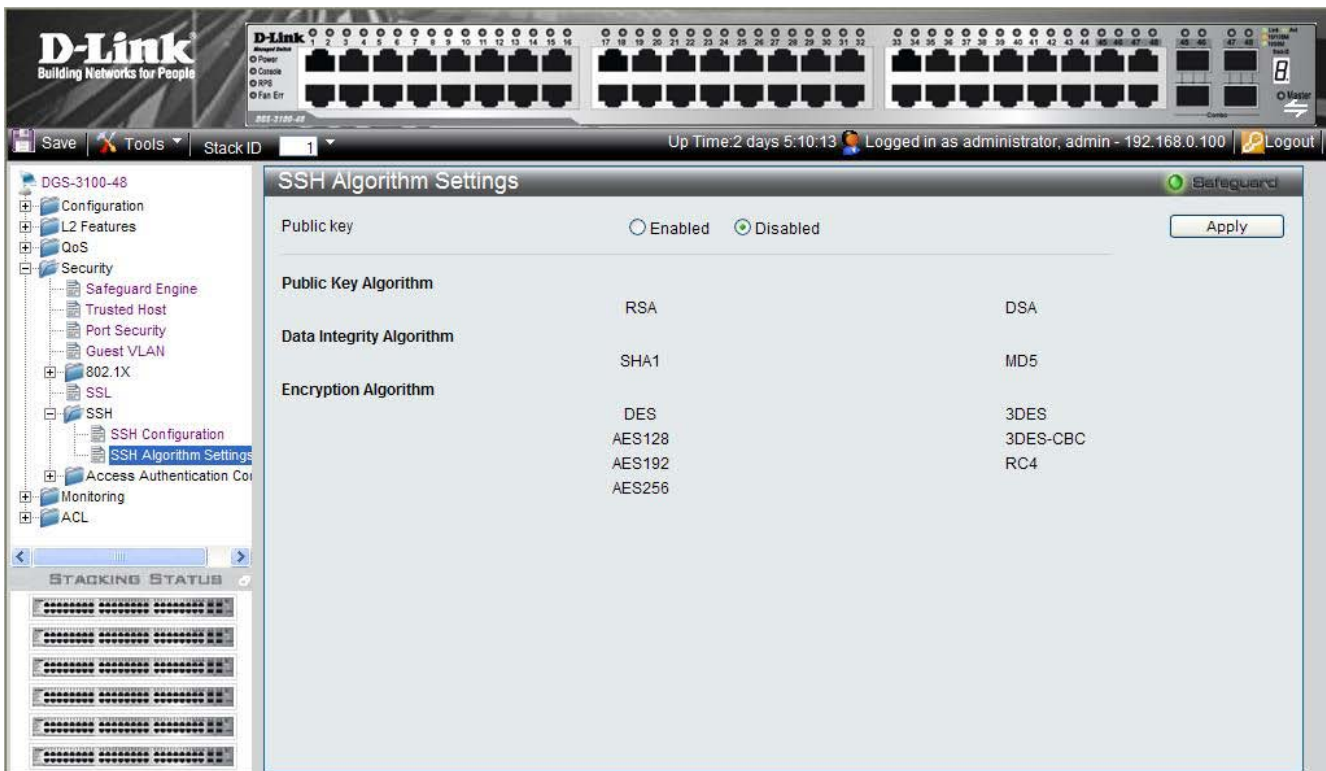

**Figure 5-10. SSH Algorithm Settings Page**

The *SSH Algorithm Settings Page* contains the following fields:

Field	Description
<b>Public key</b>	Indicates Publickey SSH User Authentication enabled on the device. The possible field values are: <i>Enabled</i> — Enables Publickey SSH User Authentication on the device. <i>Disable</i> — Disables Publickey SSH User Authentication on the device. Disable is the default value.
<b>Public Key Algorithm</b>	Displays the currently enabled Public Key Algorithms.
<b>Data Integrity Algorithm</b>	Displays the currently enabled Data Integrity Algorithms.
<b>Encryption Algorithm</b>	Displays the currently enabled Encryption Algorithms.

2. Enable or disable the public key status in the *Public key* field.
3. Click **Apply**. The Publickey SSH User Authentication setting is defined, and the device is updated.

## Defining Application Authentication Settings

Application Authentication permits network administrators to assign authentication methods for user authentication. For example, console users can be authenticated by Authentication List 1, while Telnet users are authenticated by Authentication List 2.

1. Click **Security > Access Authentication Control > Application Authentication Settings**. The *Application Authentication Settings Page* opens:

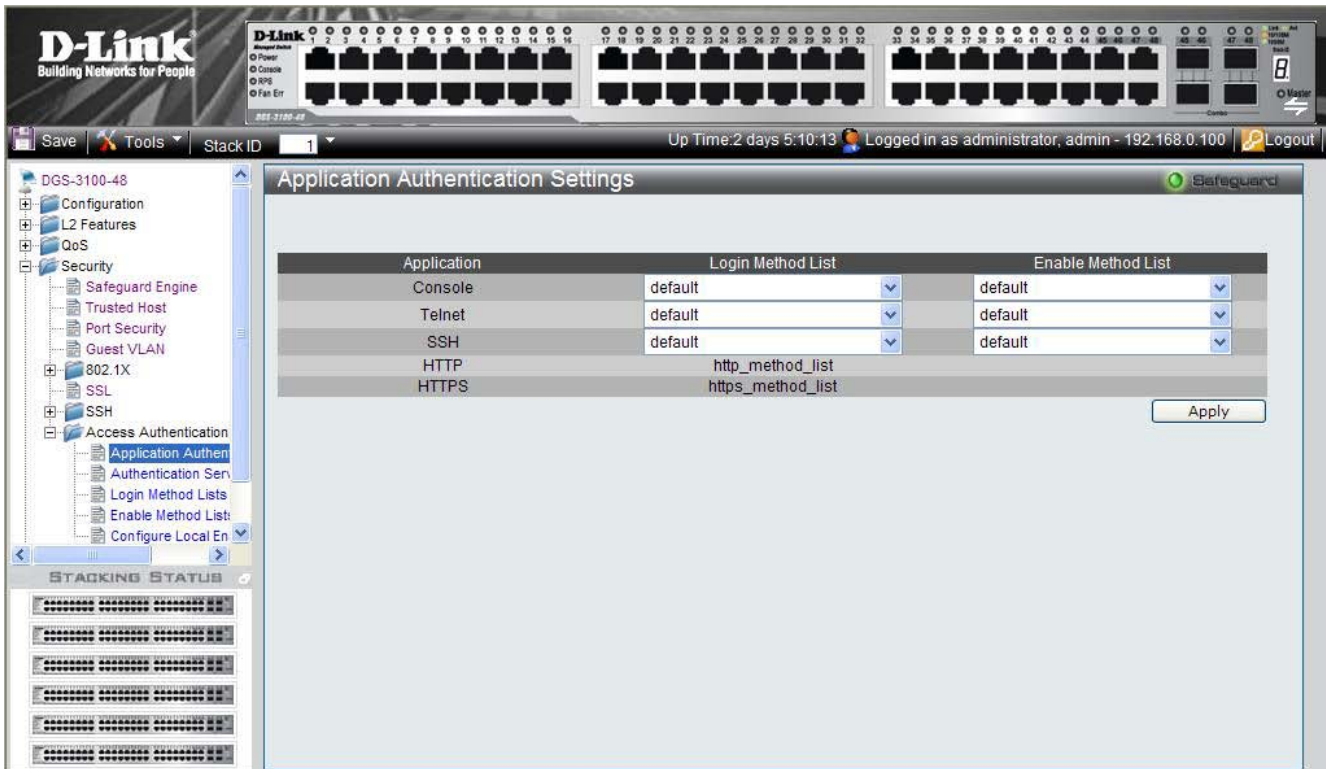

**Figure 5-11. Application Authentication Settings Page**

The *Application Authentication Settings Page* contains the following fields:

Field	Description
<b>Application</b>	Indicates the authentication application for which the Login Method or Enable Method lists are defined. The possible field values are:  <i>Console</i> — Indicates that Authentication profiles are used to authenticate console users. <i>Telnet</i> — Indicates that Authentication profiles are used to authenticate Telnet users. <i>Secure Telnet (SSH)</i> — Indicates that Authentication profiles are used to authenticate Secure Shell (SSH) users. SSH provides clients secure and encrypted remote connections to a device.
<b>Login Method List</b>	Defines the method used by the application to authenticate normal login. http_method_list and https_method_list are fixed method names for http and https respectively.
<b>Enable Method List</b>	Defines the method used by the application to enable a normal login.

2. Select the login method for the Console, Telnet, and Secure Telnet (SSH) from the list under *Login Method List*.
3. Select the enable method for the Console, Telnet, and Secure Telnet (SSH) from the list under *Enable Method List*.
4. Click . The Application Authentication settings are defined, and the device is updated.

## Configuring Authentication Server Hosts

The Authentication Server is a remote device connected to the same network as the Client and Authenticator. Users are authenticated using either RADIUS or TACACS+, and must be authenticated by the server before attaining network access. To define the Authentication Server information:

1. Click **Security > Access Authentication Control > Authentication Server Host**. The *Authentication Server Host Page* opens:

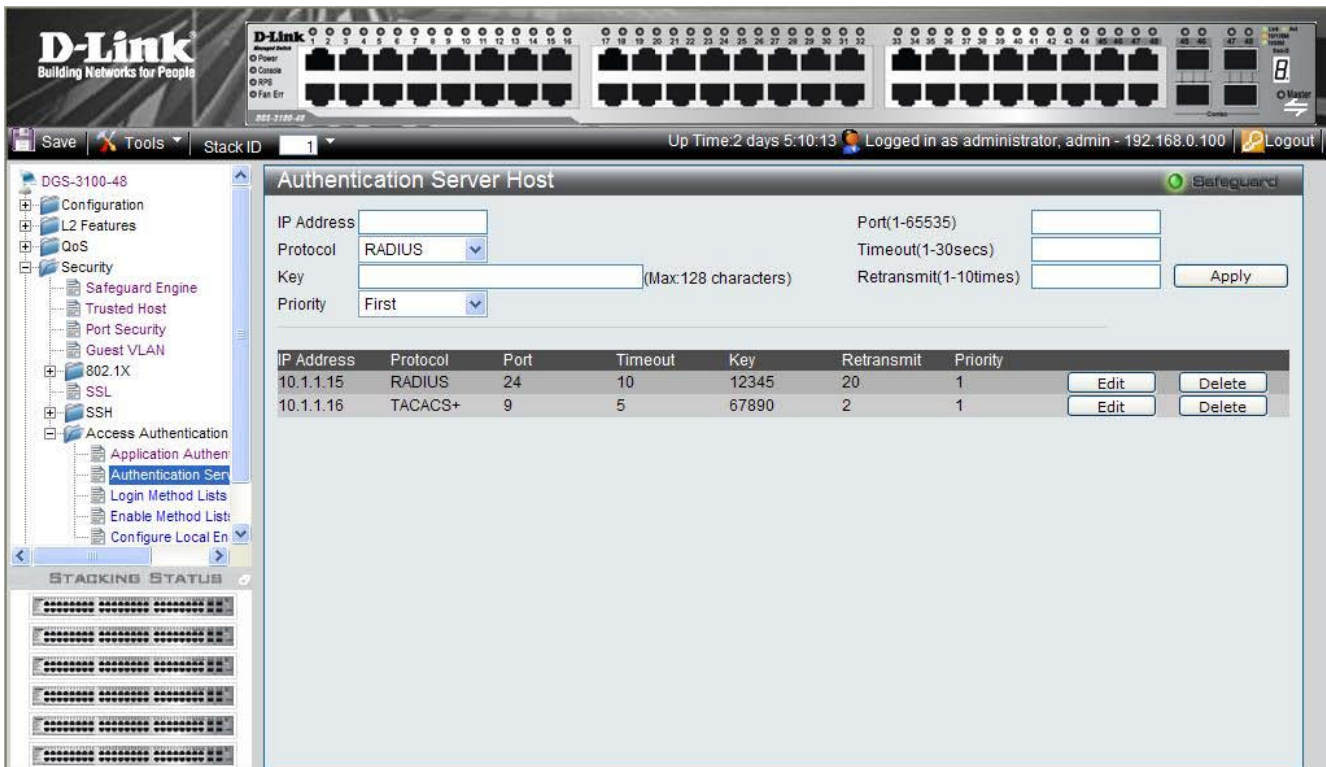

**Figure 5-12. Authentication Server Host Page**

The *Authentication Server Host Page* contains the following fields:

Field	Description
<b>IP Address</b>	Defines the IP address of the RADIUS or TACACS+ server authenticating network users.
<b>Protocol</b>	Indicates the authentication protocol used to authenticate network users. The possible field values are: <i>RADIUS</i> — Indicates that network users are authenticated via a RADIUS server. <i>TACACS+</i> — Indicates that network users are authenticated via a TACACS+ server.
<b>Key</b>	Defines the key used to authenticate network users. The key may contain up to 128 characters
<b>Priority</b>	Defines the priority assigned to the server. The field range is First -Third, where Third is the lowest priority and First is the highest priority.
<b>Port (1-65535)</b>	The port number for authentication requests. The host is not used for authentication if set to 0. If unspecified, the Radius port number defaults to 1812, TACACS+ port number defaults to 49.
<b>Timeout (1-30secs)</b>	Indicates the amount of time that passes, in which no authentication activity occurs, after which the authentication session times out.
<b>Retransmit (1-10 times)</b>	Indicates the number of times the port attempts to re- authenticate a timed out session.

2. Define the *IP Address*, *Protocol*, *Key*, *Port*, *Timeout*, and *Retransmit* fields.

3. Click **Apply**. The Authentication Host properties are defined, and the device is updated.
  - To edit an authentication, click **Edit** adjacent to the relevant IP Address on the list. The upper fields display the current values, which then can be edited.
  - To delete an authentication, click **Delete** adjacent to the relevant IP Address on the list. The Authentication Server settings are defined, and the device is updated.

## Defining Login Methods

Network users must first login to the device on the *Login Method Lists* Page. Access as non-administrative users is granted. To configure the device as a Network Administrator, the user must also log on to the device on the *Enable Method Lists* Page.

User authentication occurs in the order the methods are selected. If the first authentication method is not available, the next selected method is used. For example, if the selected authentication method is RADIUS, Local, and the RADIUS server is not available, the user is authenticated locally. To define the user only login method:

1. Click **Security > Access Authentication Control > Login Method Lists**. The *Login Method Lists* Page opens:

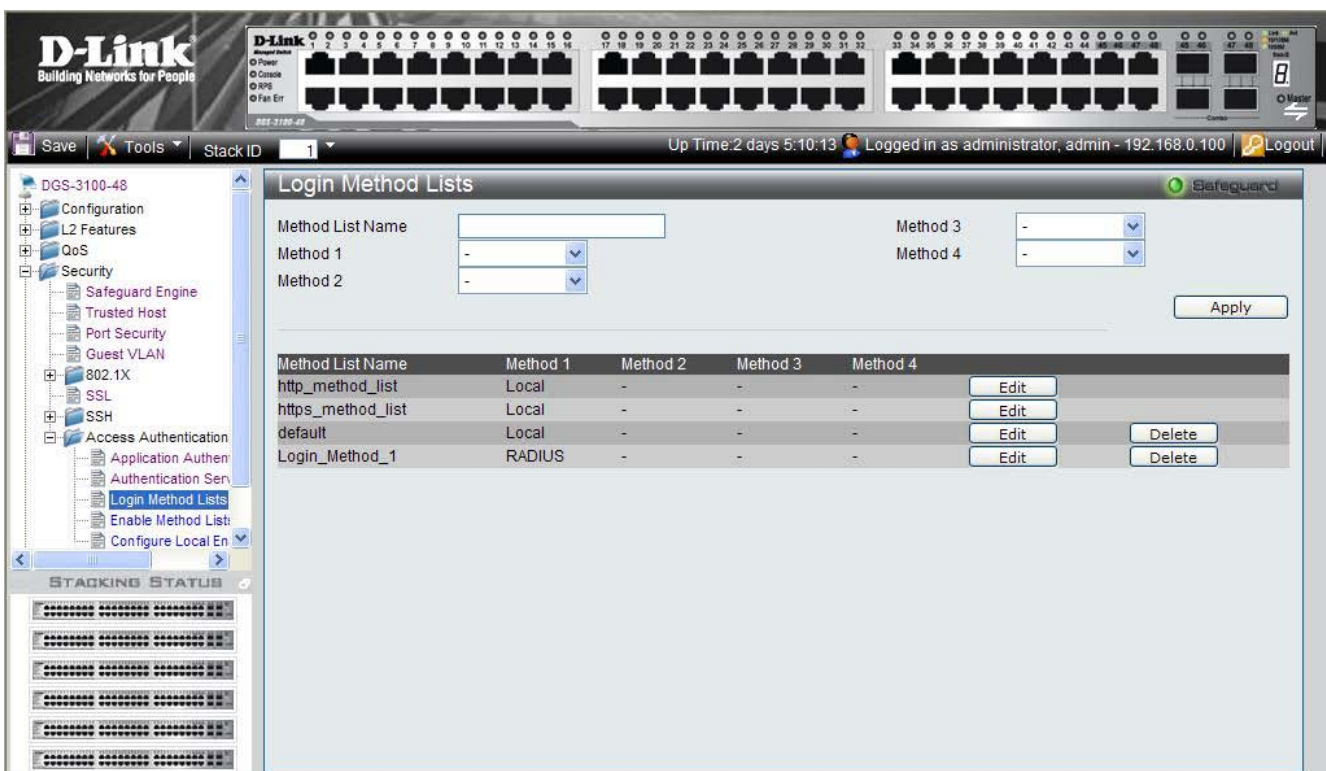

**Figure 5-13. Login Method Lists Page**

The *Login Method Lists* Page contains the following fields:

Field	Description
<b>Method List Name</b>	Displays the method list name. The field is user-defined besides the http_method_list and https_method_list which cannot be deleted or renamed.
<b>Method 1</b>	Indicates the first method used to authenticate the network user. The possible field values are: <i>RADIUS</i> — User authentication occurs at the RADIUS server. <i>TACACS+</i> — The user authentication occurs at the TACACS+ server. <i>None</i> — No user authentication occurs. <i>Local</i> — User authentication occurs at the device level. The device checks the user name and password for authentication.
<b>Method 2</b>	Indicates the second method used to authenticate the network user. The possible field values

Field	Description
	<p>are:</p> <p><i>RADIUS</i> — User authentication occurs at the RADIUS server.</p> <p><i>TACACS+</i> — The user authentication occurs at the TACACS+ server.</p> <p><i>None</i> — No user authentication occurs.</p> <p><i>Local</i> — User authentication occurs at the device level. The device checks the user name and password for authentication.</p>
<b>Method 3</b>	<p>Indicates the third method used to authenticate the network user. The possible field values are:</p> <p><i>RADIUS</i> — User authentication occurs at the RADIUS server.</p> <p><i>TACACS+</i> — The user authentication occurs at the TACACS+ server.</p> <p><i>None</i> — No user authentication occurs.</p> <p><i>Local</i> — User authentication occurs at the device level. The device checks the user name and password for authentication.</p>
<b>Method 4</b>	<p>Indicates the fourth method used to authenticate the network user. The possible field values are:</p> <p><i>RADIUS</i> — User authentication occurs at the RADIUS server.</p> <p><i>TACACS+</i> — The user authentication occurs at the TACACS+ server.</p> <p><i>None</i> — No user authentication occurs.</p> <p><i>Local</i> — User authentication occurs at the device level. The device checks the user name and password for authentication.</p>

2. Define the Method List Name in the *Method List Name* field.
3. Select the methods used to authenticate network users in the *Method 1*, *Method 2*, *Method 3* and, *Method 4* fields.
4. Click . The Login methods are defined, and the device is updated.
  - To edit the Method List, click  adjacent to a Method List Name on the list. The upper fields display the current values, which then can be edited.
  - To delete a Method List Name, click . The Login Method Lists are defined, and the device is updated.

## Defining Enable Methods

Network users must first login to the device on the *Enable Method Lists* Page. Access as non-administrative users is granted. The *Enable Method Lists* Page allows network managers to assign user privileges using authentication methods on the device. Once a user is assigned a normal user level privileges the network user is authenticated and granted network access and configuration privileges. A maximum of four Enable Method Lists can be defined on the device. The Enable Method List cannot be deleted but can be configured.

User authentication occurs in the order the methods are selected. If the first authentication method is not available, the next selected method is used. For example, if the selected authentication method is RADIUS, Local, and the RADIUS server is not available; the user is authenticated locally. To define authentication methods:

1. Click **Security > Access Authentication Control > Enable Method Lists**. The *Enable Method Lists* Page opens:

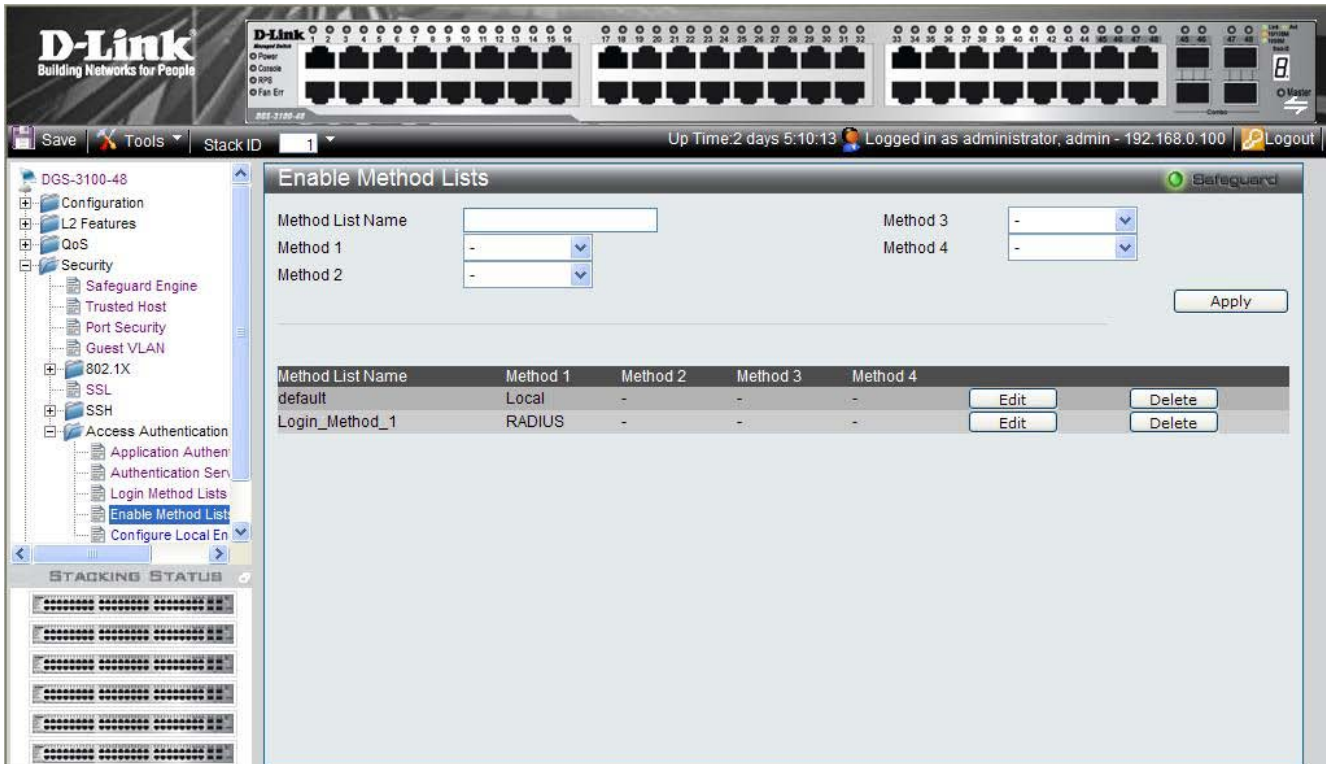

**Figure 5-14. Enable Method Lists Page**

The Enable Method Lists Page contains the following fields:

Field	Description
<b>Method List Name</b>	Defines the method list name. The field is user-defined besides the http_method_list and https_method_list which cannot be deleted or renamed.
<b>Method 1</b>	Indicates the first method used to authenticate the network user. The possible field values are: <i>RADIUS</i> — User authentication occurs at the RADIUS server. <i>TACACS+</i> — The user authentication occurs at the TACACS+ server. <i>None</i> — No user authentication occurs. <i>Local</i> — User authentication occurs at the device level. The device checks the user name and password for authentication.



Field	Description
<b>Method 2</b>	<p>Indicates the second method used to authenticate the network user. The possible field values are:</p> <p><i>RADIUS</i> — User authentication occurs at the RADIUS server.</p> <p><i>TACACS+</i> — The user authentication occurs at the TACACS+ server.</p> <p><i>None</i> — No user authentication occurs.</p> <p><i>Local</i> — User authentication occurs at the device level. The device checks the user name and password for authentication.</p>
<b>Method 3</b>	<p>Indicates the third method used to authenticate the network user. The possible field values are:</p> <p><i>RADIUS</i> — User authentication occurs at the RADIUS server.</p> <p><i>TACACS+</i> — The user authentication occurs at the TACACS+ server.</p> <p><i>None</i> — No user authentication occurs.</p> <p><i>Local</i> — User authentication occurs at the device level. The device checks the user name and password for authentication.</p>
<b>Method 4</b>	<p>Indicates the fourth method used to authenticate the network user. The possible field values are:</p> <p><i>RADIUS</i> — User authentication occurs at the RADIUS server.</p> <p><i>TACACS+</i> — The user authentication occurs at the TACACS+ server.</p> <p><i>None</i> — No user authentication occurs.</p> <p><i>Local</i> — User authentication occurs at the device level. The device checks the user name and password for authentication.</p>

2. Define the Method List Name in the *Method List Name* field.
3. Select the methods used to authenticate network users in the *Method 1*, *Method 2*, *Method 3* and, *Method 4* fields.
4. Click . The Enable method and passwords are defined, and the device is updated.
  - To edit the Enable Method List, click  adjacent to an Enable Method List Name on the list. The upper fields display the current values, which then can be edited.
  - To delete an Enable Method List Name, click . The Enable Method Lists are defined, and the device is updated.

## Configuring Local Enable Password

The *Configure Local Enable Password Page* allows network administrators to configure the local enabled password. To define the network Local Enable password:

1. Click **Security > Access Authentication Control > Configure Local Enable Password**. The Configure Local Enable Password Page opens:

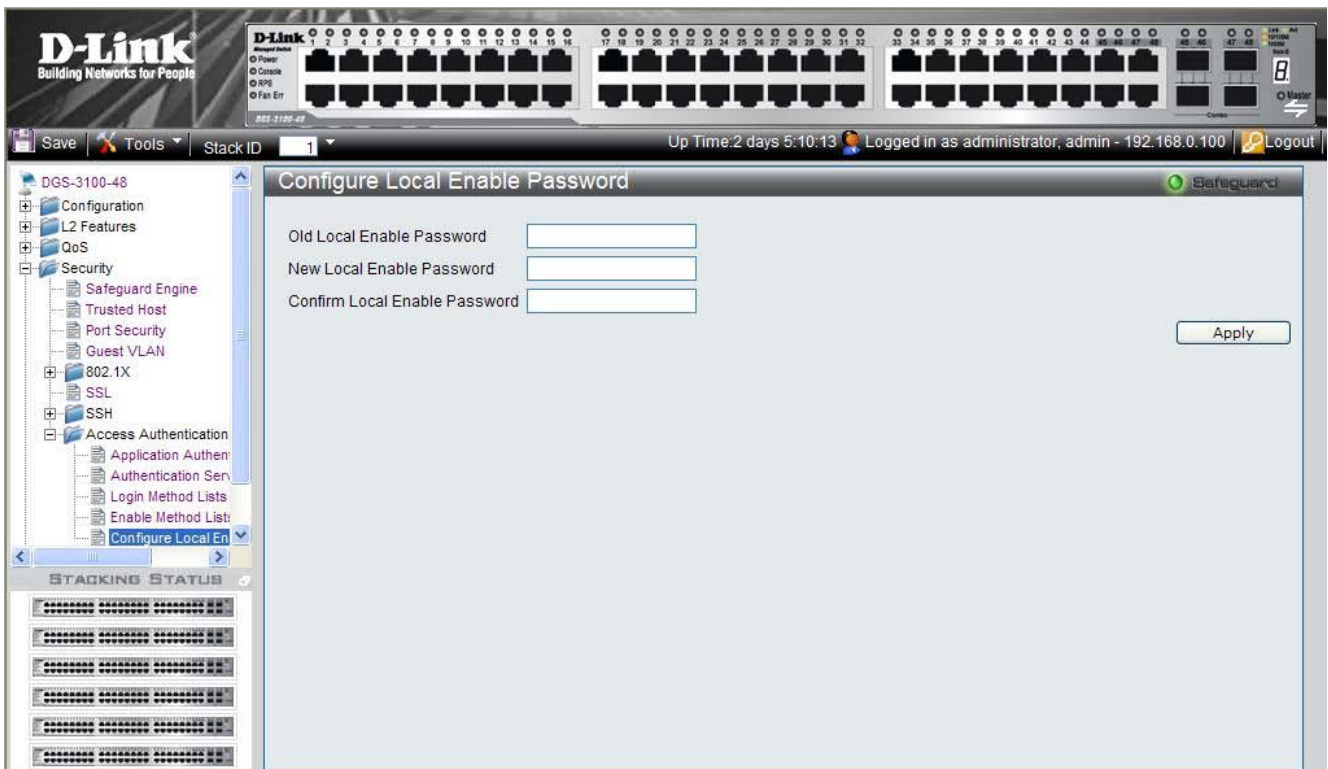

**Figure 5-15. Configure Local Enable Password Page**

The *Configure Local Enable Password Page* contains the following fields:

Field	Description
<b>Old Local Enable Password</b>	Provide the current network Enable password.
<b>New Local Enable Password</b>	Defines the new network Enable password. The field range is 1-15 characters.
<b>Confirm Local Enable Password</b>	Confirms the new network Enable password.

2. Enter the old local enable password in the *Old Local Enable Password* field.
3. Define the new local enable password in the *New Local Enable Password* field.
4. Re-enter the new password in the *Confirm Local Enable Password* field.
5. The new local enable password is configured, and the device is updated.

## Defining Arp Spoofing Prevention Settings

Dynamic ARP inspection is a security feature that validates ARP packets in a network. It intercepts, logs, and discards ARP packets with invalid IP-to-MAC address bindings. This capability protects the network from certain man-in-the-middle attacks

1. Click **Security > Arp Spoofing Prevention**. The Arp Spoofing Preventio opens:

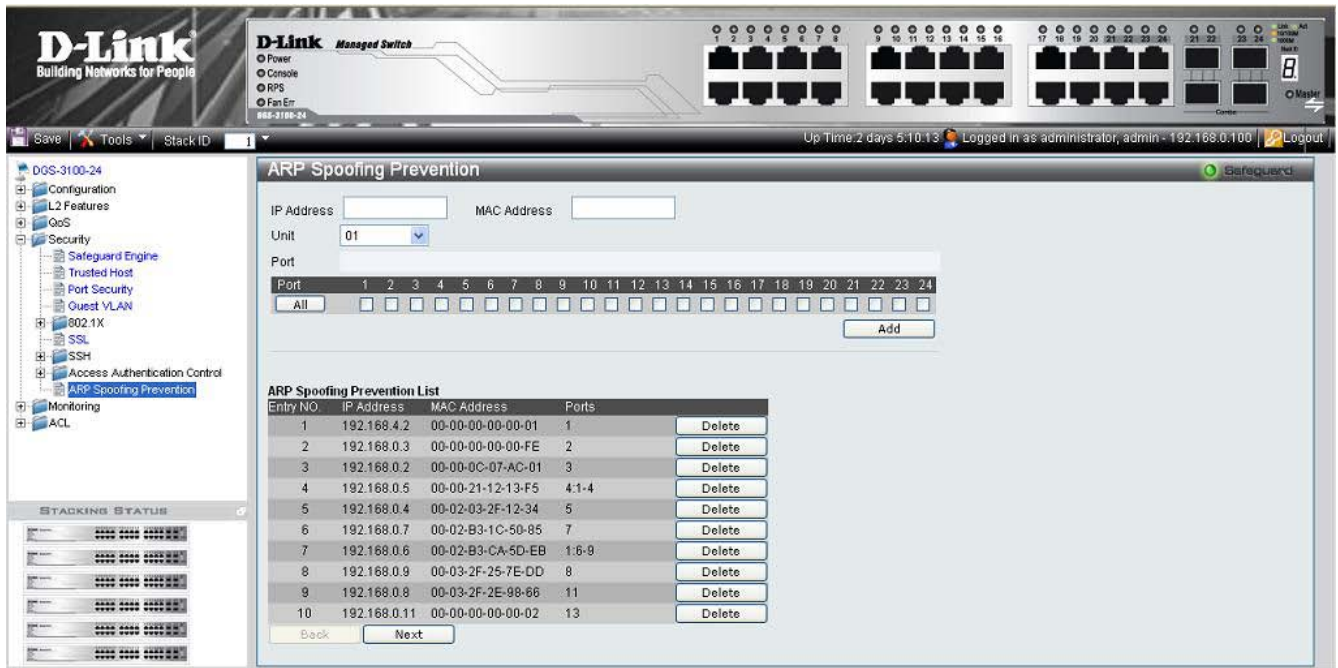

**Figure 5-16. Arp Spoofing Prevention Page**

The *Configure Local Enable Password Page* contains the following fields:

Field	Description
IP Address	Defines the IP address
MAC address	Defines the MAC address.
Unit	Defines the stacking member’s Unit ID.
Port	Defines the ports.
Port Select All	Select all ports.

2. Enter the IP address in the *IP Address* field.
3. Enter the MAC address in the *MAC Address* field.
4. Define the ports which could be applied ARP Spoofing Prevention rules on them.
5. Click **Add**.

The new ARP Spoofing Prevention definition appears in the ARP Spoofing Prevention List, and the device is updated.

---

## MONITORING THE DEVICE

This section contains information for view device and packet statistics as well as, viewing IGMP information and MAC address information. This section includes the following topics:

- Viewing Stacking Information
- Viewing CPU Utilization
- Viewing Port Utilization
- Viewing Packet Size Information
- Viewing Received Packet Statistics
- Viewing RADIUS Authenticated Session Statistics
- Viewing ARP Table
- Viewing MLD Router Ports
- Viewing Router Ports
- Viewing Session Table
- Viewing IGMP Group Information
- Viewing MLD Group Information
- Defining Dynamic and Static MAC Addresses
- Viewing System Log

## Viewing Stacking Information

The *Stacking Information Page* provides specific information for stacked devices. To show the Stacking Information Page:

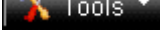
1. Click , and from the menu select *Show Stack Status*.
2. Alternatively, click **Monitoring > Stacking Information** in the Tree View. The *Stacking Information Page* opens:

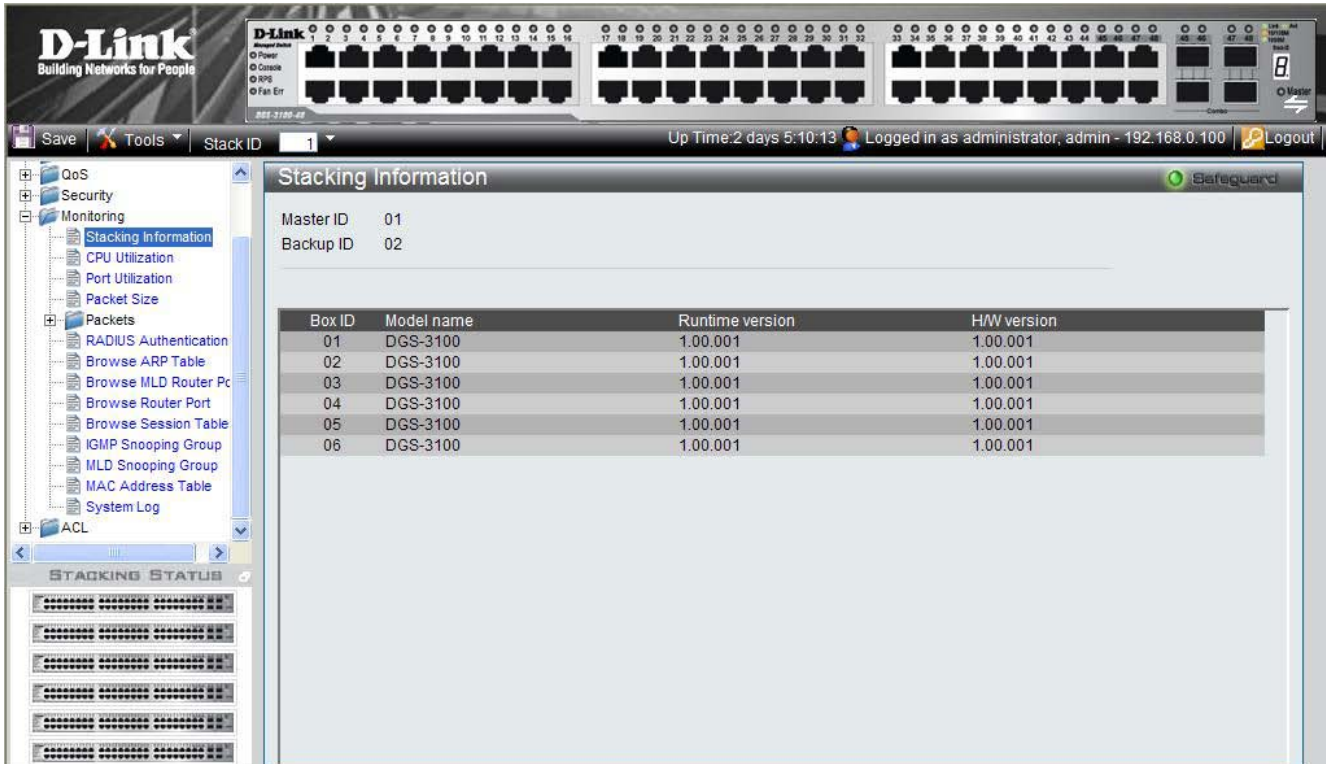

**Figure 6-1. Stacking Information Page**

The *Stacking Information Page* contains the following fields:

Field	Description
<b>Master ID</b>	Displays the Stacking Master Unit ID number. (unit ID 1 or 2).
<b>Backup ID</b>	Displays the Backup Master Unit ID number. (unit ID 1 or 2).
<b>Box ID</b>	Displays the Unit ID numbers assigned to the stacking members.
<b>Runtime version</b>	Indicates the software version running on the device.
<b>H/W version</b>	Displays the stacking member’s hardware version.

## Viewing CPU Utilization

The *CPU Utilization Page* contains information about the system's CPU utilization.

1. Click **Monitoring > CPU Utilization**. The *CPU Utilization Page* opens:



**Figure 6-2. CPU Utilization Page**

The *CPU Utilization Page* contains the following fields:

Field	Description
<b>Utilization</b>	Displays current CPU utilization by percentage.
<b>Time Interval</b>	Defines the 1-60 second time intervals in which the usage samples are taken as follows: 1,2,3,4,5,10,20,30,40,50,60.
<b>Record Number</b>	Defines the record number.
<b>Show/Hide</b>	Displays the CPU utilization information. The possible fields are: <i>Utilization checked</i> — Utilization information is enabled. This is the default value. <i>Utilization unchecked</i> — Utilization information is disabled.

2. Define the Time Interval and Record Number fields.
3. Define the *Show/Hide* field.
4. Click **Apply**. A sample record of CPU utilization is stored, and the device is updated.

## Viewing Port Utilization

The *Port Utilization Page* contains port utilization information for specific ports. To view port statistics:

1. Click **Monitoring > Port Utilization**. The *Port Utilization Page* opens:

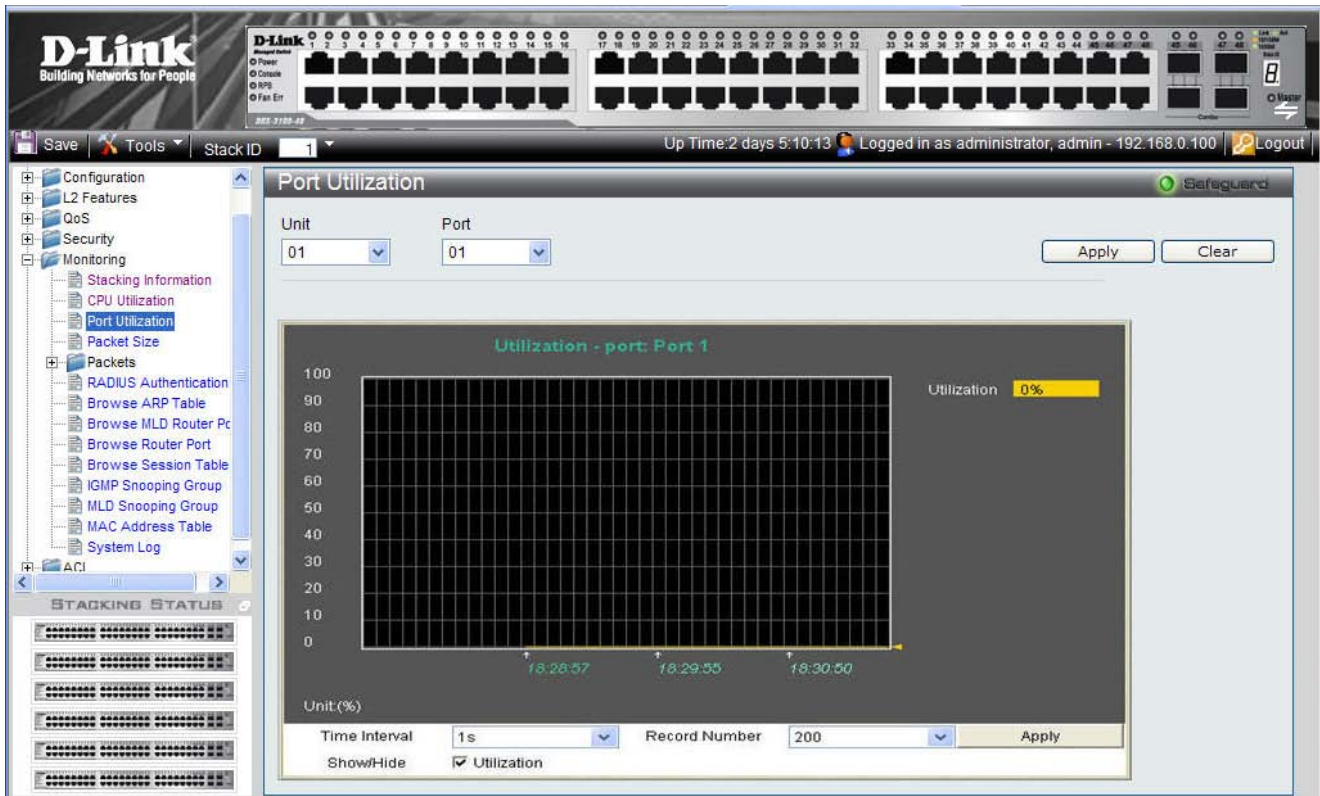

**Figure 6-3. Port Utilization Page**

The *Port Utilization Page* contains the following fields:

Field	Description
<b>Unit</b>	Defines the unit number.
<b>Port</b>	Defines the port number.
<b>Utilization</b>	Displays current CPU utilization by percentage.
<b>Time Interval</b>	Defines the 1-60 second time intervals in which the usage samples are taken as follows: 1,2,3,4,5,10,20,30,40,50,60.
<b>Record Number</b>	Defines the record number.
<b>Show/Hide</b>	Displays the CPU utilization information. The possible fields are: <i>Utilization checked</i> — Utilization information is enabled .This is the default value. <i>Utilization unchecked</i> — Utilization information is disabled.

2. Define the Unit, Port, Time Interval, and Record Number fields.
3. Define the *Show/Hide* field.
4. Click **Apply**. A sample record of CPU port utilization is stored, and the device is updated.

## Viewing Packet Size Information

The *Packet Size Page* displays packets received by the switch, arranged in seven groups and classed by size, to be viewed as either a line graph or a table.

1. Click **Monitoring > Packet Size**. The *Packet Size Page* opens:

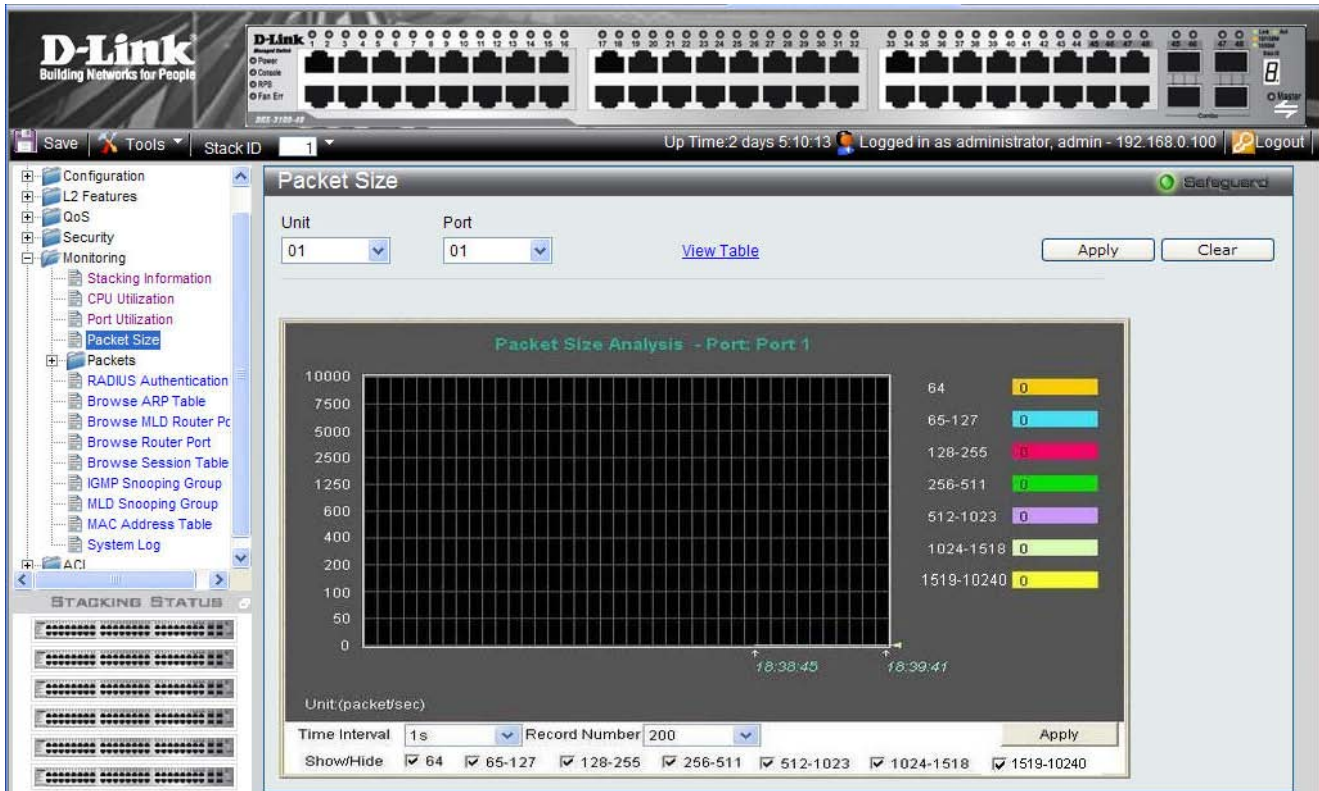

**Figure 6-4. Packet Size Page**

The *Packet Size Page* contains the following fields:

Field	Description
<b>Unit</b>	Defines the unit number.
<b>Port</b>	Defines the port number.
<b>Packet Size Analysis – Selected Port Number</b>	Displays current packet size for ports.
<b>Time Interval</b>	Displays the time intervals at which the packet samples are taken. The possible field values are: 1s - 5s, 10s, 15s, 20s, 30s, 40s, 50s, and 60s.
<b>Record Number</b>	Displays the packet size record number.
<b>Show/Hide</b>	Displays or hides packets size. The following packet length ranges can be displayed: 64, 65-127, 128-255, 256-511, 512-1023 and, 1024-1518 and 1519-10240.

2. Click **Apply**. A sample record of packet size analysis is stored, and the device is updated.
3. Define the *Show/Hide* field.
4. To view the graph as a table, click [View Table](#).



## Viewing Received Packet Statistics

The *Received(RX)* Page contains information about packets transmitted through device ports. To view received packet statistics:

1. Click **Monitoring > Packets > Received(RX)**. The *Received(RX)* Page opens:

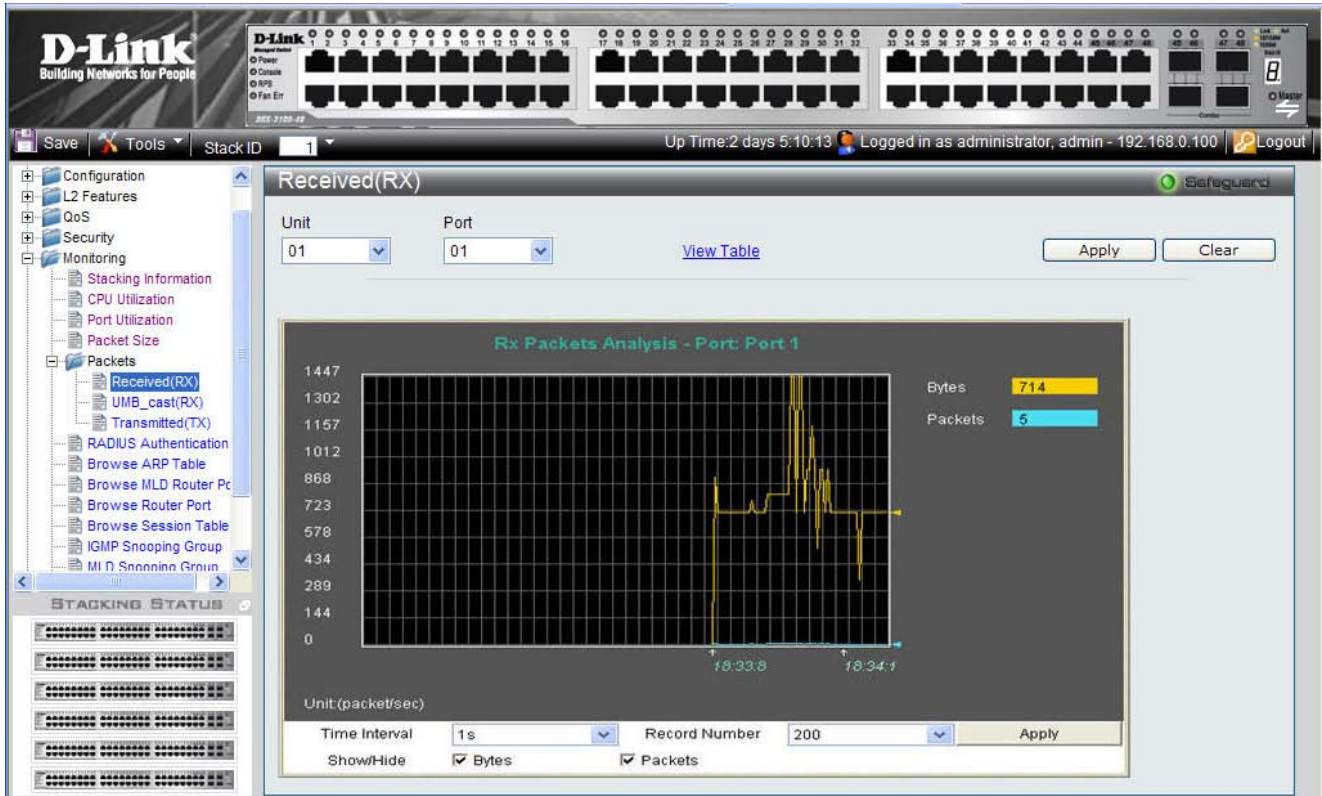

Figure 6-5. Received(RX) Page

The *Received(RX)* Page contains the following fields:

Field	Description
Unit	Displays the stacking member for which the transmitted packet statistics are displayed.
Port	Indicates the port for which the received packets parameters are displayed.
Bytes	Indicates the total number of bytes that were received on the port.
Packets	Indicates the total number of packets that were received on the port.
Time Interval	Indicates the time interval for which the received packets are displayed. The possible field values are: 1s - 5s, 10s, 15s, 20s, 30s, 40s, 50s, and 60s.
Record Number	Indicates the transmitted record number.
Show/Hide	Displays the bytes/packets received information. The possible fields are: <i>Bytes checked</i> — Checked displays the total amount of received bytes. <i>Packets checked</i> — Checked displays the total amount of received packets.

2. Define the *Unit* and *Port* fields.
3. Click **Apply** to load the defined parameters.
4. Define the *Time Interval* and *Record Number* fields.
5. Click **Apply**. The selected RX packet analysis is displayed.

- Define the *Show/Hide* field.
- To view the graph as a table, click [View Table](#).

## Viewing UMB\_cast Packet Statistics

The *UMB\_cast(RX)* Page displays the number of UMB cast (Unicast, Multicast and Broadcast) packets received on the device.

- Click **Monitoring > Packets > UMB\_cast(RX)**. The *UMB\_cast(RX)* Page opens:

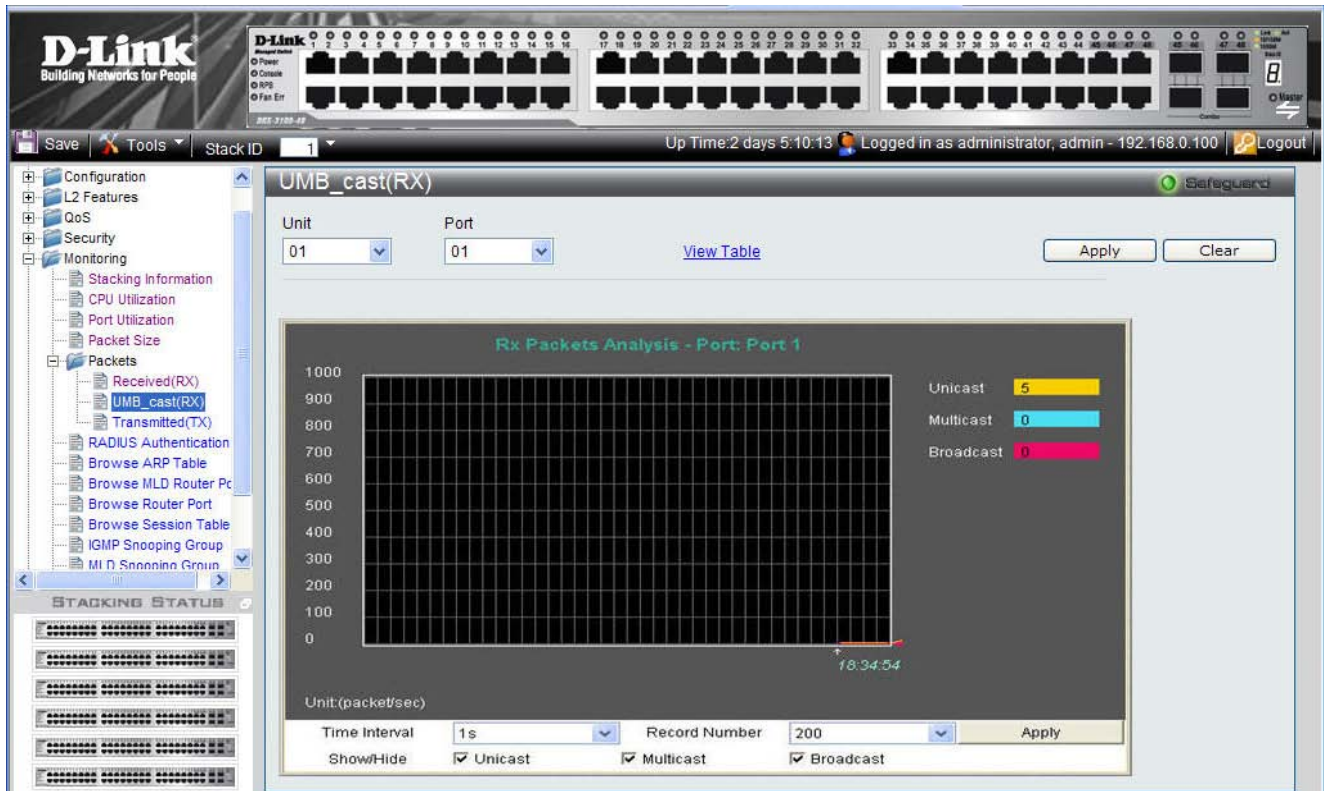

Figure 6-6. UMB\_cast(RX) Page

The *UMB\_cast(RX)* Page contains the following fields:

Field	Description
<b>Unit</b>	Indicates the stacking member for which the UMB_cast packets are displayed.
<b>Port</b>	Indicates the port for which the UMB_cast packets parameters are displayed.
<b>Unicast</b>	Indicates the number of Unicast packets received and transmitted through the device.
<b>Multicast</b>	Indicates the number of Multicast packets received and transmitted through the device.
<b>Broadcast</b>	Indicates the number of Broadcast packets received and transmitted through the device.
<b>Time Interval</b>	Indicates the time interval for which the UMB_cast packets are displayed. The possible field values are: 1s - 5s, 10s, 15s, 20s, 30s, 40s, 50s, and 60s.
<b>Record Number</b>	Indicates the transmitted record number.
<b>Show/Hide</b>	Displays the packets received information. The possible field values are: <i>Unicast checked</i> — Displays the total amount of transmitted Unicast packets. <i>Multicast checked</i> — Displays the total amount of transmitted Multicast packets. <i>Broadcast checked</i> — Displays the total amount of transmitted Broadcast packets.

- Define the *Unit* and *Port* fields.

3. Click **Apply** to load the defined parameters.

To clear the *Unit* and *Port* fields:

1. Click **Clear**. The fields are cleared.
2. Define the Time Interval and Record Number fields.
3. Click **Apply**. The selected UMB\_Cast (RX) packet analysis is displayed
4. To view the graph as a table, click [View Table](#).

## Viewing Transmitted Packet Statistics

The *Transmitted(TX)* Page contains information about packets transmitted through device ports. To view transmitted packet statistics:

1. Click **Monitoring > Packets > Transmitted(TX)**. The *Transmitted(TX)* Page opens:

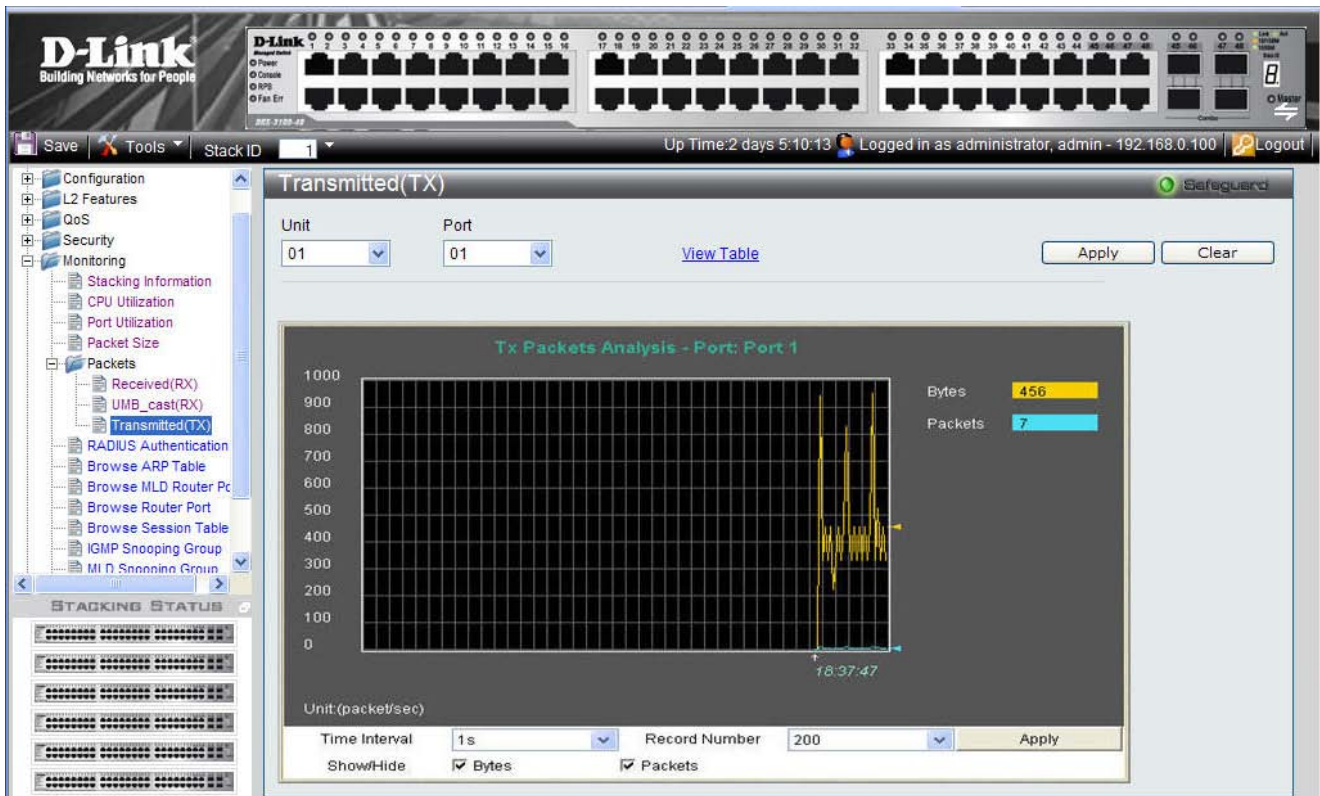

**Figure 6-7. Transmitted(TX) Page**

The *Transmitted(TX)* Page contains the following fields:

Field	Description
<b>Unit</b>	Indicates the stacking member ID for which the transmitted packets parameters are displayed.
<b>Port</b>	Indicates the port for which the transmitted packets parameters are displayed.
<b>Bytes</b>	Indicates the total number of bytes that were transmitted through the port.
<b>Packets</b>	Indicates the total number of packets that were transmitted through the port.
<b>Time Interval</b>	Indicates the time interval for which the transmitted packets are displayed. The possible field values are: 1s - 5s, 10s, 15s, 20s, 30s, 40s, 50s, and 60s.
<b>Record Number</b>	Indicates the transmitted record number.
<b>Show/Hide</b>	Displays the bytes/packets received information. The possible field values are: <i>Bytes checked</i> — Displays the total amount of transmitted bytes.

Field	Description
	<i>Packets checked</i> — Displays the total amount of transmitted packets.

2. Define the Unit and Port fields.
3. Click  to load the defined parameters.

To clear the *Unit* and *Port* fields:

1. Click . The fields are cleared.
2. Define the Time Interval and Record Number fields.
3. Click . The transmitted packet graph is updated.
4. To view the graph as a table, click [View Table](#).

## Viewing RADIUS Authenticated Session Statistics

The *RADIUS Authentication Page* provides RADIUS authentication sessions, including how many sessions were initiated, which ports initiated the authentication sessions, and whether or not the sessions were granted.

1. Click **Monitoring > Port Access Control > RADIUS Authentication**. The *RADIUS Authentication Page* opens:

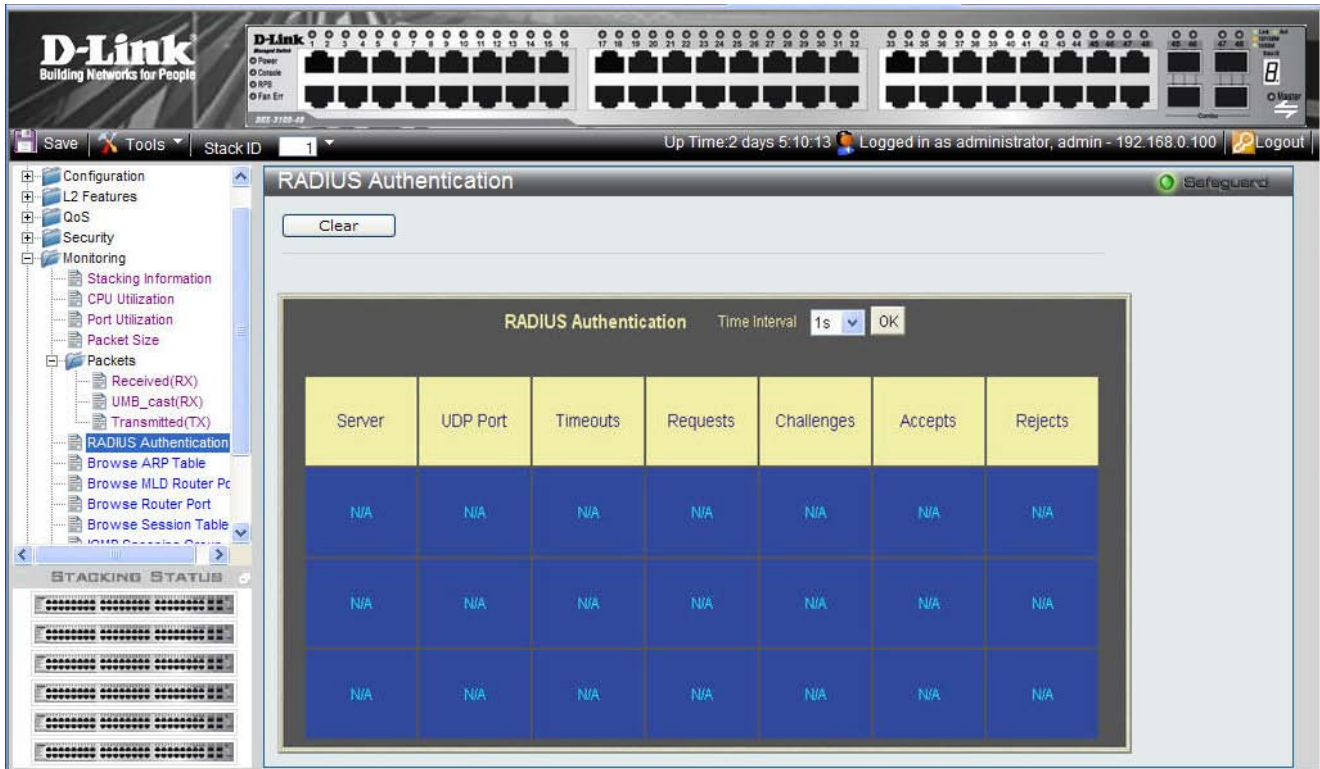

**Figure 6-8. RADIUS Authentication Page**

The *RADIUS Authentication Page* contains the following fields:

Field	Description
<b>Time Interval</b>	Indicates the how often the RADIUS authentication session information is updated. The various time intervals are: 15/30/60/no refresh.
<b>Server</b>	Displays the RADIUS server IP address.
<b>UDP Port</b>	Displays the UDP port through which the RADIUS session was initiated.
<b>Timeouts</b>	Indicates the number of session timeouts that occurred during the authentication session.
<b>Requests</b>	Indicates the amount of times the port requested an authentication session.
<b>Challenges</b>	Indicates the amount of times the port was challenged during an authentication session.
<b>Accepts</b>	Indicates the amount of authentication sessions initiated by the port which were accepted.
<b>Rejects</b>	Indicates the amount of authentication sessions initiated by the port which were rejected.

## Viewing ARP Table

The *Browse ARP Table Page* provides information regarding ARP VLANs, including which IP address was mapped to what MAC address. To view the ARP table:

1. Click **Monitoring > Browse ARP Table**. The *Browse ARP Table Page* opens:

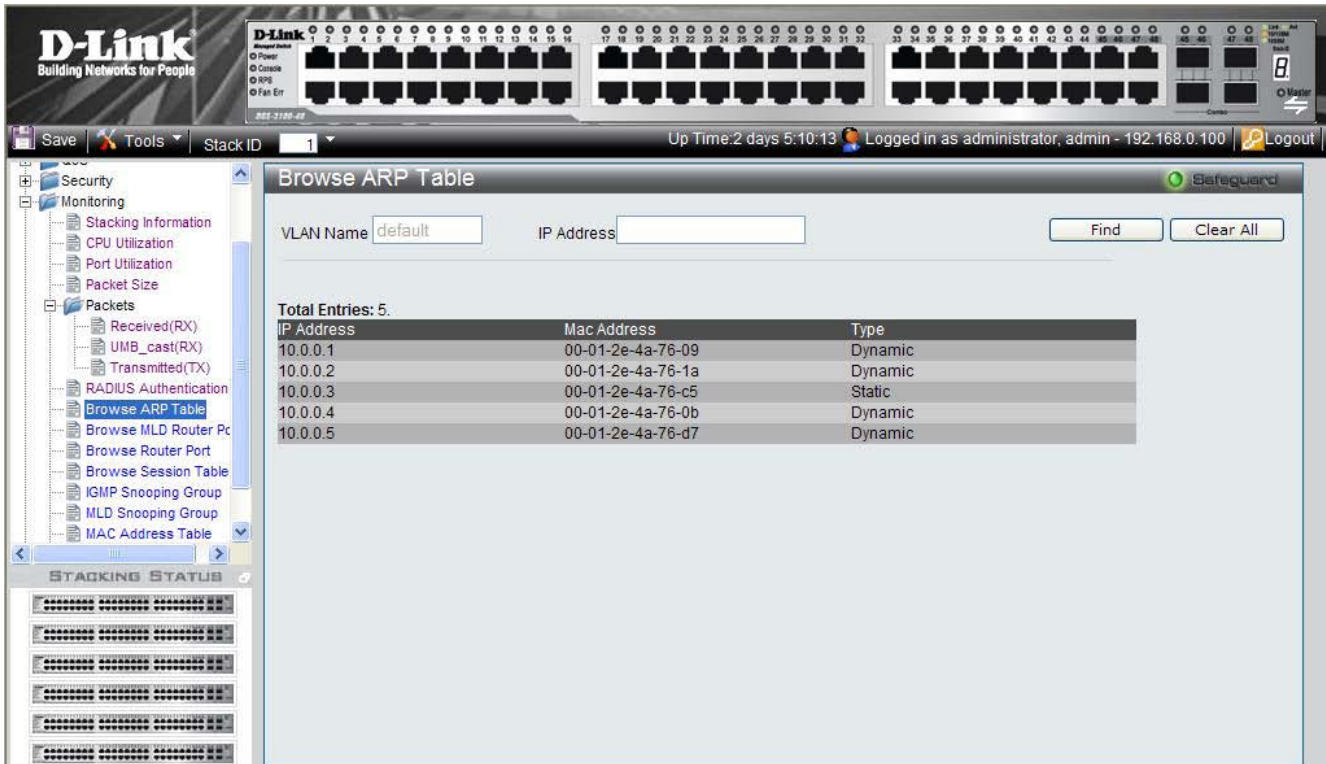

**Figure 6-9. Browse ARP Table Page**

The *Browse ARP Table Page* contains the following fields:

Field	Description
<b>VLAN Name</b>	Defines the VLAN for which the ARP mappings are defined.
<b>IP Address</b>	Defines the station IP address, which is associated with the MAC address.
<b>Total Entries</b>	Displays current ARP table entries, detailing the user defined interface name, IP address, MAC address and type (dynamic or static) of each entry.
<b>MAC Address</b>	Displays the MAC address associated with the IP address..
<b>Type</b>	Indicates how the MAC was assigned. The possible values are: <ul style="list-style-type: none"> <li>– Dynamic — Indicates that the MAC address is dynamically created.</li> <li>– Static — Indicates the MAC address is a static IP address.</li> </ul>

2. Click **Find**. The table updates and displays the values required.
3. Click **Clear** to clear the Browse ARP Table Page.

## Viewing MLD Router Ports

The *Browse MLD Router Port Page* displays which ports are connected to MLD routers. A port can be connected to an MLD router either as a static port or as a dynamic port or forbidden port.

1. Click **Monitoring > Browse MLD Router Port**. The *Browse MLD Router Port Page* opens:

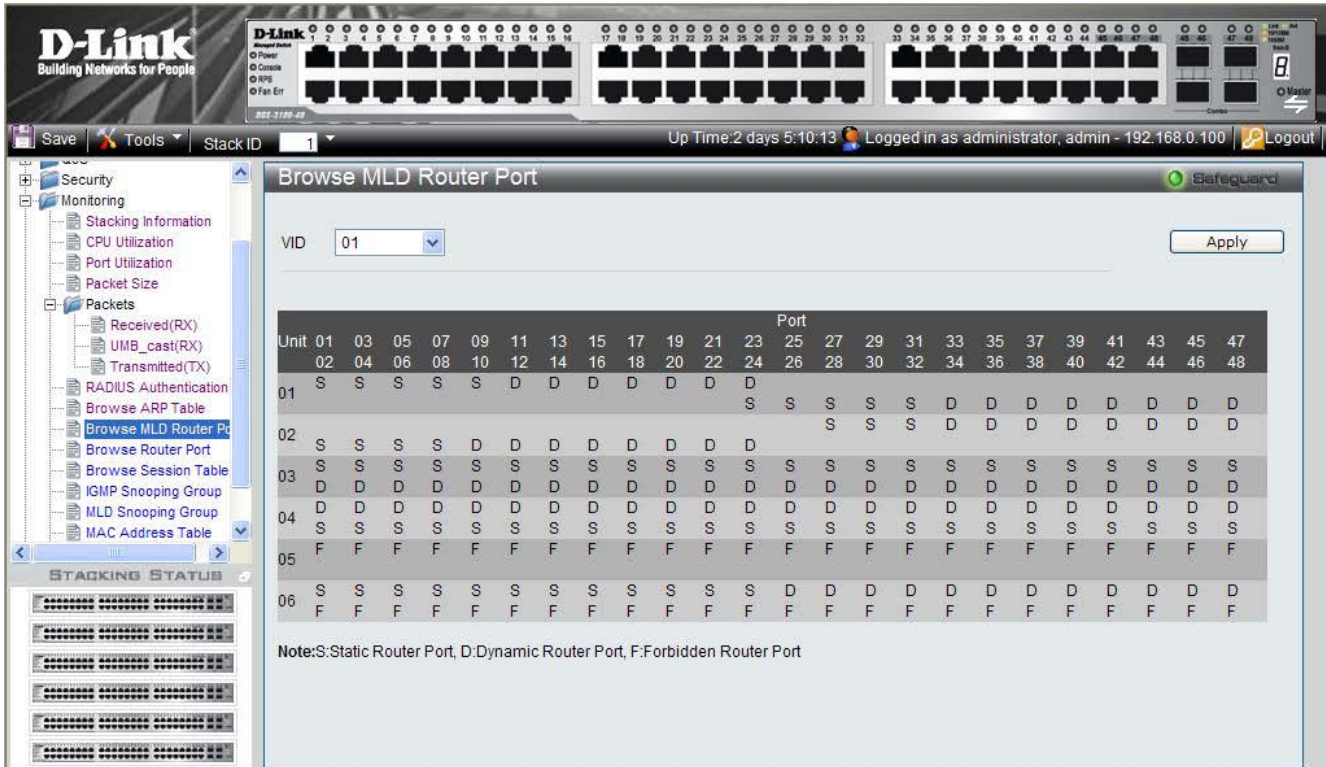

**Figure 6-10. Browse MLD Router Port Page**

The Browse MLD Router Port Page contains the following fields:

Field	Description
<b>VID</b>	Indicates the VLAN identification.
<b>Unit</b>	Indicates the stacking member for which the router ports information is displaying.
<b>Port</b>	Indicates the port for which the router port settings are displayed. Ports have the following settings: <i>S</i> — Indicates a statically configured port. <i>D</i> — Indicates a dynamically learned port. <i>F</i> — Indicates a forbidden port.

2. Define the *VID* field.
3. Click **Apply**. The selected ports appear on the selected VLAN.

## Viewing Router Ports

The *Browse Router Port Page* displays which ports are connected to routers. Ports can be connected to routers either as a static port or as a dynamic port.

1. Click **Monitoring > Browse Router Port**. The *Browse Router Port Page* opens:

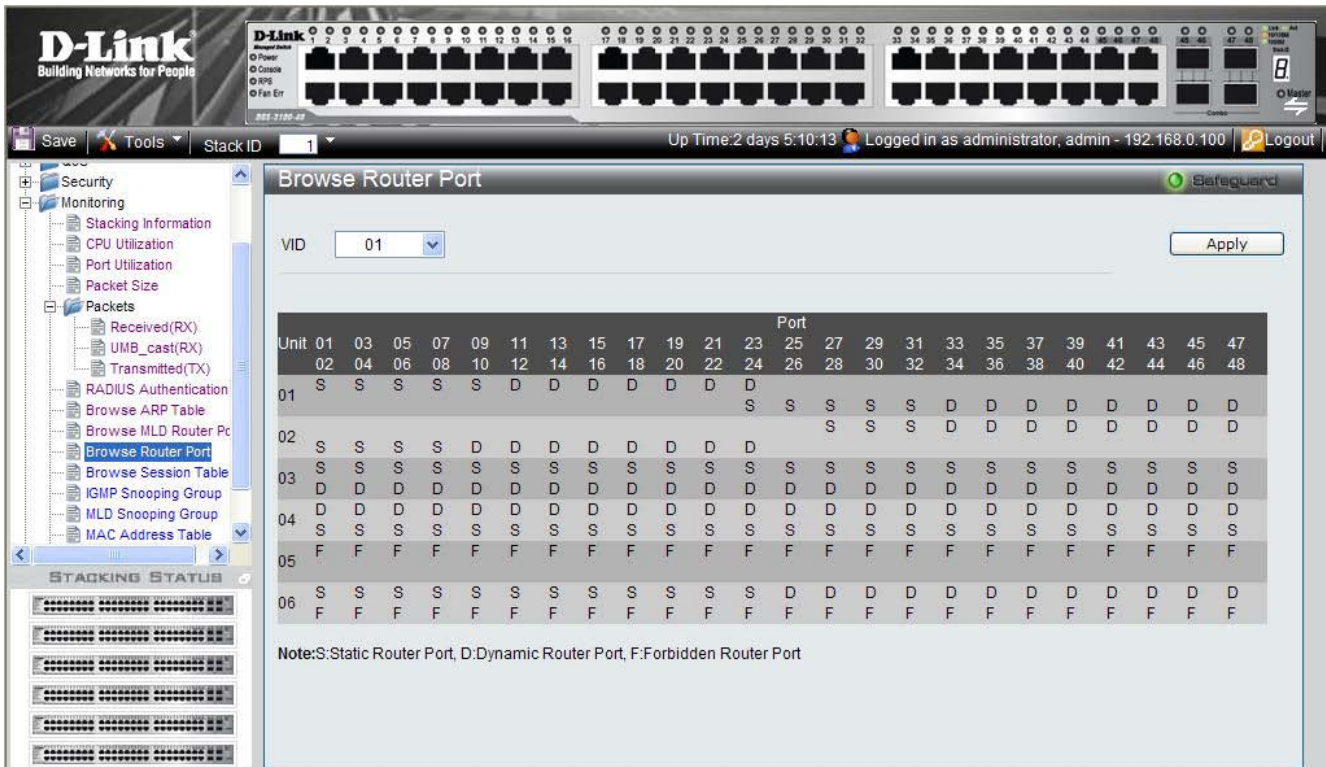

**Figure 6-11. Browse Router Port Page**

The *Browse Router Port Page* contains the following fields:

Field	Description
<b>VID</b>	Indicates the VLAN identification.
<b>Unit</b>	Indicates the stacking member for which the router ports information is displaying.
<b>Port</b>	Indicates the port for which the router port settings are displayed. Ports have the following settings: <i>S</i> — Indicates a static port. <i>D</i> — Indicates a dynamic port. <i>F</i> — Indicates a forbidden port.

2. Define the *VID* field.
3. Click . The selected ports appear on the selected VLAN.



## Viewing Session Table

The *Browse Session Table Page* displays information regarding device sessions which were initiated by system Users. To view session table information:

1. Click **Monitoring > Browse Session Table**. The *Browse Session Table Page* opens:

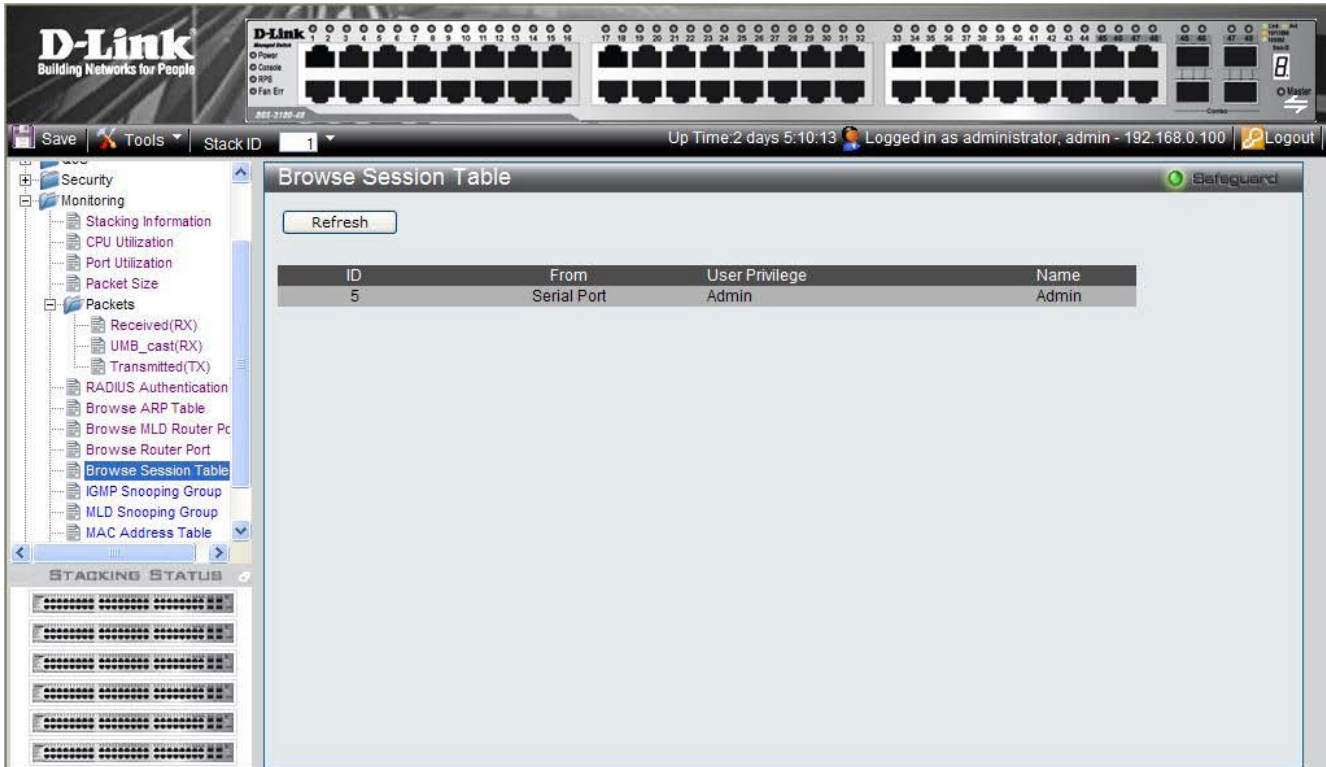

**Figure 6-12. Browse Session Table Page**

The *Browse Session Table Page* contains the following fields:

Field	Description
<b>ID</b>	Displays the browse session table entry.
<b>From</b>	Indicates the type of interface from which the system session was initiated.
<b>User Privilege</b>	Indicates the user privileged assigned to the user who imitated the system session.
<b>Name</b>	Displays the name of the user that initiated the system session.

## Viewing IGMP Group Information

The *IGMP Snooping Group Page* contains vital IGMP group information, including the Multicast Group IP address and the corresponding MAC address through which the IGMP packets passed.

1. Click **Monitoring >IGMP Snooping Group**. The *IGMP Snooping Group Page* opens:

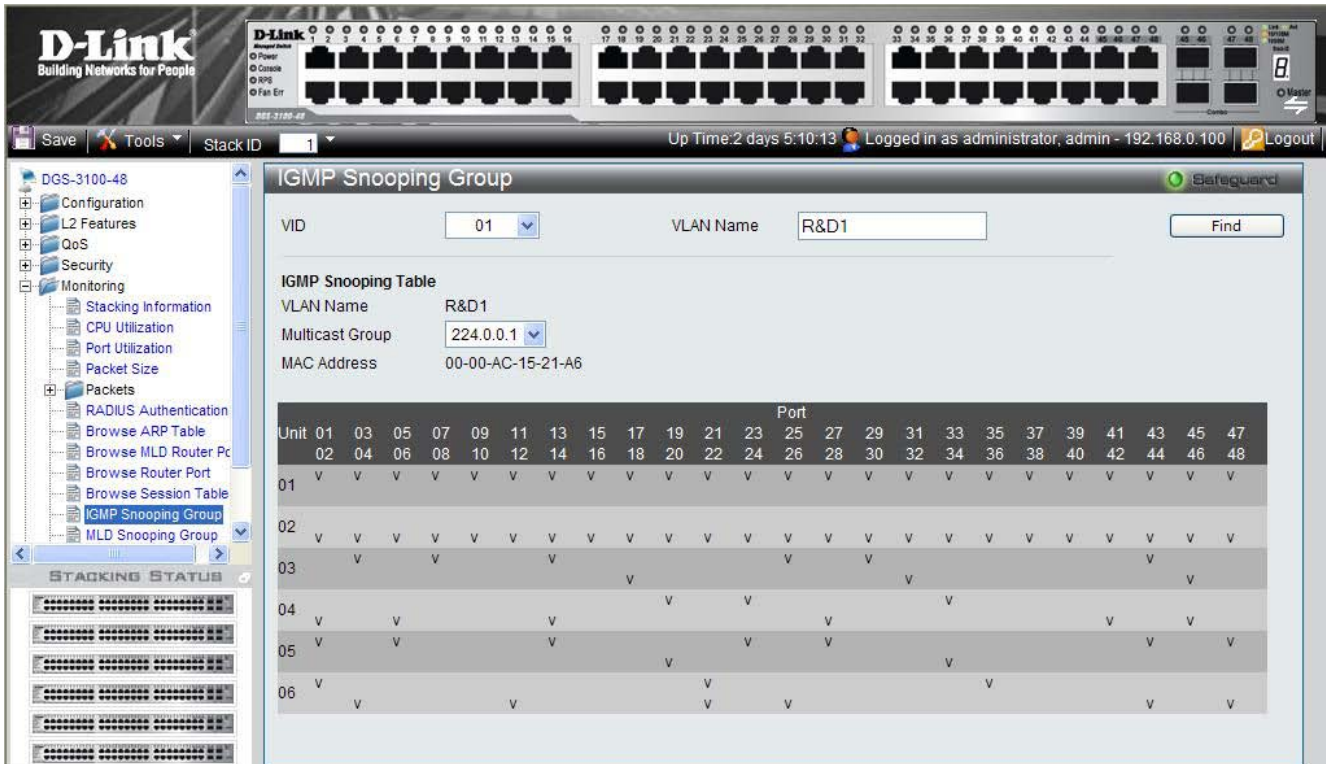

**Figure 6-13. IGMP Snooping Group Page**

The *IGMP Snooping Group Page* contains the following fields:

Field	Description
<b>VID</b>	Defines the VLAN ID for the IGMP Snooping Group.
<b>VLAN Name</b>	Defines the VLAN name.
<b>VLAN Name</b>	Displays the currently selected user-defined VLAN name.
<b>Multicast Group</b>	Displays the IP address assigned to the Multicast group.
<b>MAC Address</b>	Displays the MAC address assigned to the Multicast group.
<b>Port</b>	Displays the ports where the IGMP packets were snooped.

2. Define the VD and Vlan fields.
3. Click **Find**. The IGMP Snooping Group Page displays relevant information.

## Viewing MLD Group Information

The *MLD Snooping Group Page* contains vital MLD group information, including the Multicast Group IP address and the corresponding MAC address through which the MLD packets passed.

1. Click **Monitoring > MLD Snooping Group**. The *MLD Snooping Group Page* opens:

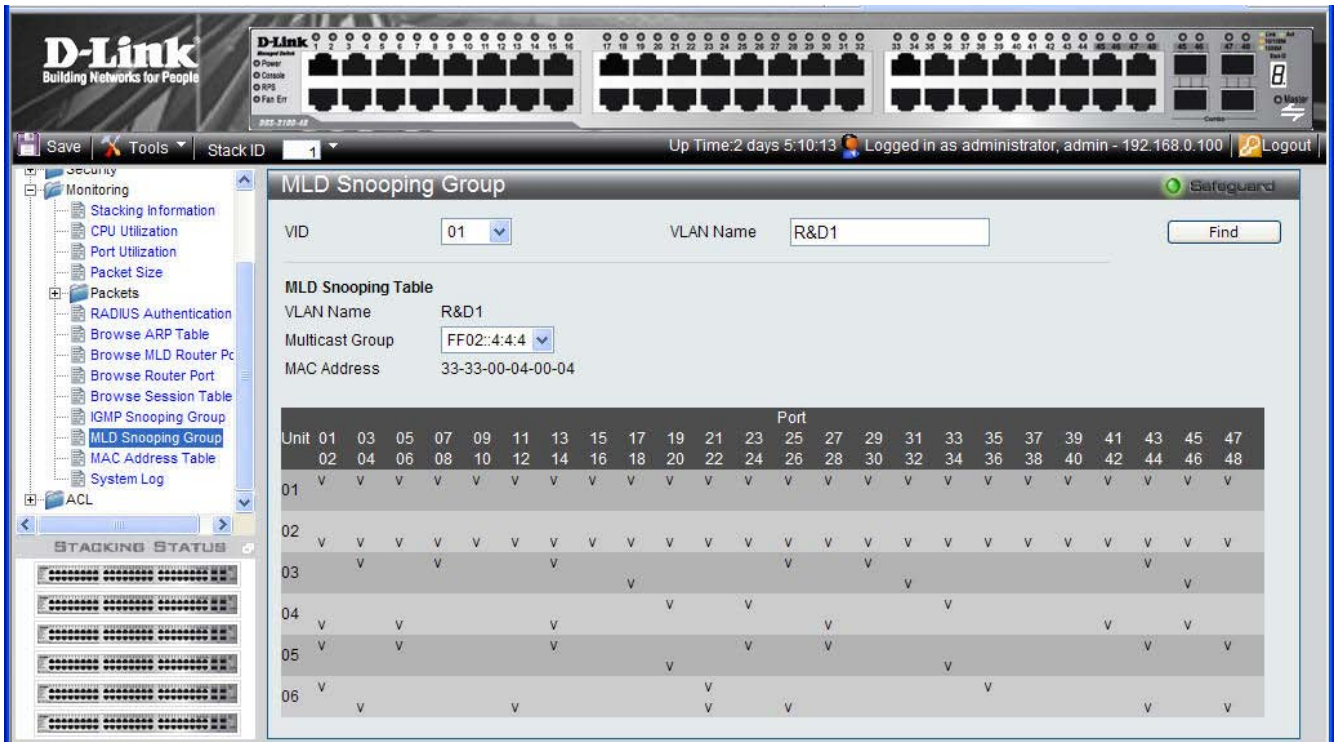

**Figure 6-14. MLD Snooping Group Page**

The MLD Snooping Group Page contains the following fields:

Field	Description
<b>VID</b>	Defines the VLAN ID for the MLD Snooping Group.
<b>VLAN Name</b>	Defines the VLAN name.
<b>VLAN Name</b>	Displays the currently selected user-defined VLAN name.
<b>Multicast Group</b>	Displays the IP address assigned to the Multicast group.
<b>MAC Address</b>	Displays the MAC address assigned to the Multicast group.
<b>Port</b>	Displays the ports where the MLD packets were snooped.

2. Define the *VID* and *VLAN Name* fields.
3. Click . The *MLD Snooping Group Page* displays relevant information

## Defining Dynamic and Static MAC Addresses

Packets addressed to destinations stored in either the Static or Dynamic databases are immediately forwarded to the port. The *MAC Address Table Page* can be sorted by interface, VLAN, or MAC Address, whereas MAC addresses are dynamically learned as packets from sources that arrive at the device. Static addresses are configured manually.

An address becomes associated with a port by learning the port from the frame's source address, however if a frame addressed to a destination MAC address is not associated with a port, that frame is flooded to all relevant VLAN ports. To prevent the Bridging table from overflowing, a dynamic MAC address, from which no traffic arrives for a set period, is erased.

To prevent static MAC addresses from being deleted when the device is reset, ensure that the port attached to the MAC address is locked.

1. Click **Monitoring > MAC Address Table**. The *MAC Address Table Page* opens:

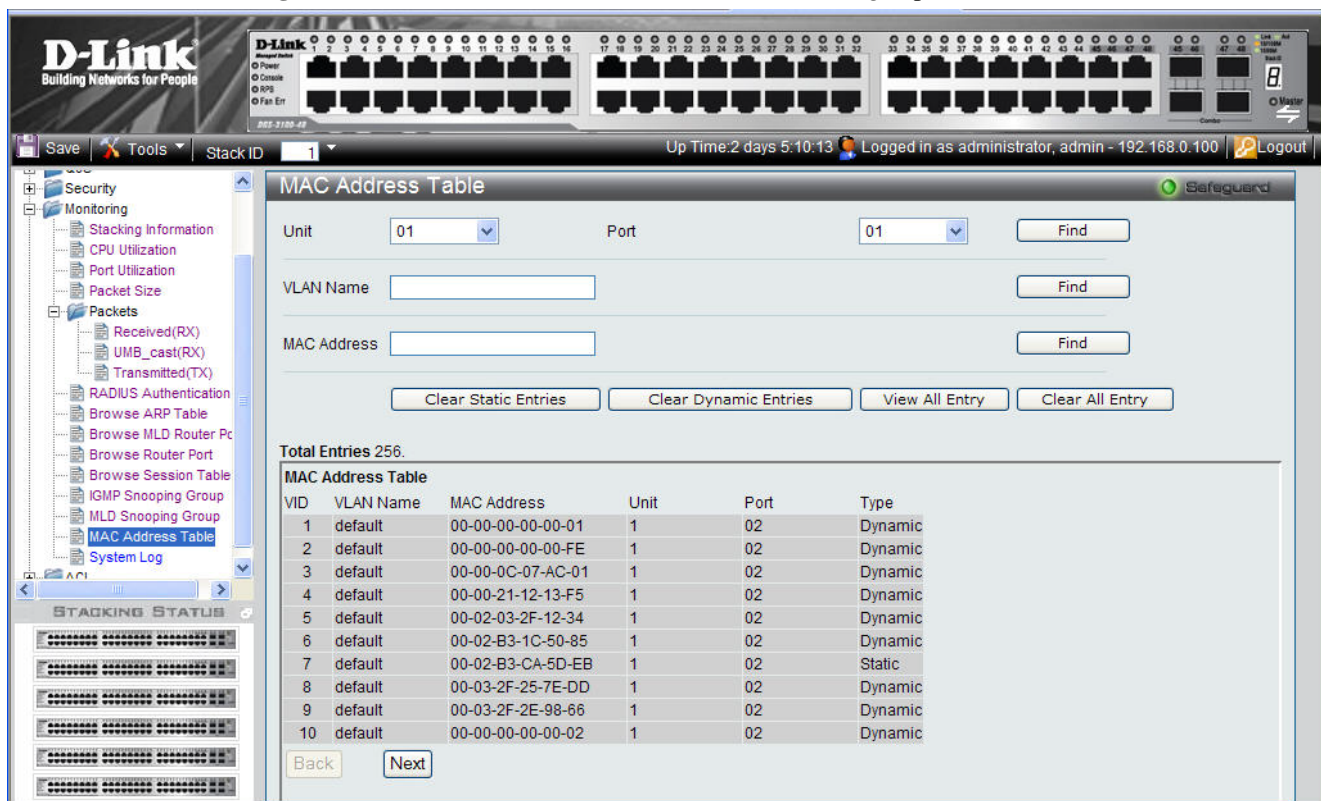

**Figure 6-15. MAC Address Table Page**

The *MAC Address Table Page* contains the following fields:

Field	Description
<b>Unit</b>	Displays the Stacking member Unit 1 for which the MAC address parameters are displayed.
<b>Port</b>	Defines the port for which the MAC address parameters are displayed.
<b>VLAN Name</b>	Defines the VLAN for which the MAC address parameters are displayed.
<b>MAC Address</b>	Displays the MAC address assigned to the port or VLAN.
<b>VID</b>	Displays the VLAN ID to which the MAC address is assigned.
<b>Type</b>	Indicates how the MAC was assigned. The possible values are: <ul style="list-style-type: none"> <li>– Dynamic — Indicates that the MAC address is dynamically created.</li> <li>– Static — Indicates the MAC address is a static IP address.</li> </ul>

2. Select the Stacking member in the Unit field.
3. Define the *Port*, *VLAN Name*, and *MAC Address* fields.

4. Click **Find**.
  - To view all entries, click **View All Entry**.
  - To clear static entries, click **Clear Static Entries**.
  - To clear dynamic entries, click **Clear Dynamic Entries**.
  - To clear all entries, click **Clear All Entry**. The MAC Address Table updates and displays total entries.
  - To scroll down the table, click **Next**.
  - To scroll up the table, click **Back**.

## Viewing System Log

The *System Log Page* provides information about system logs, including information when the device was booted, how the ports are operating, when users logged in, when sessions timed out, as well as other system information. To view the *System Log Page*:

1. Click **Monitoring > System Log**. The *System Log Page* opens:

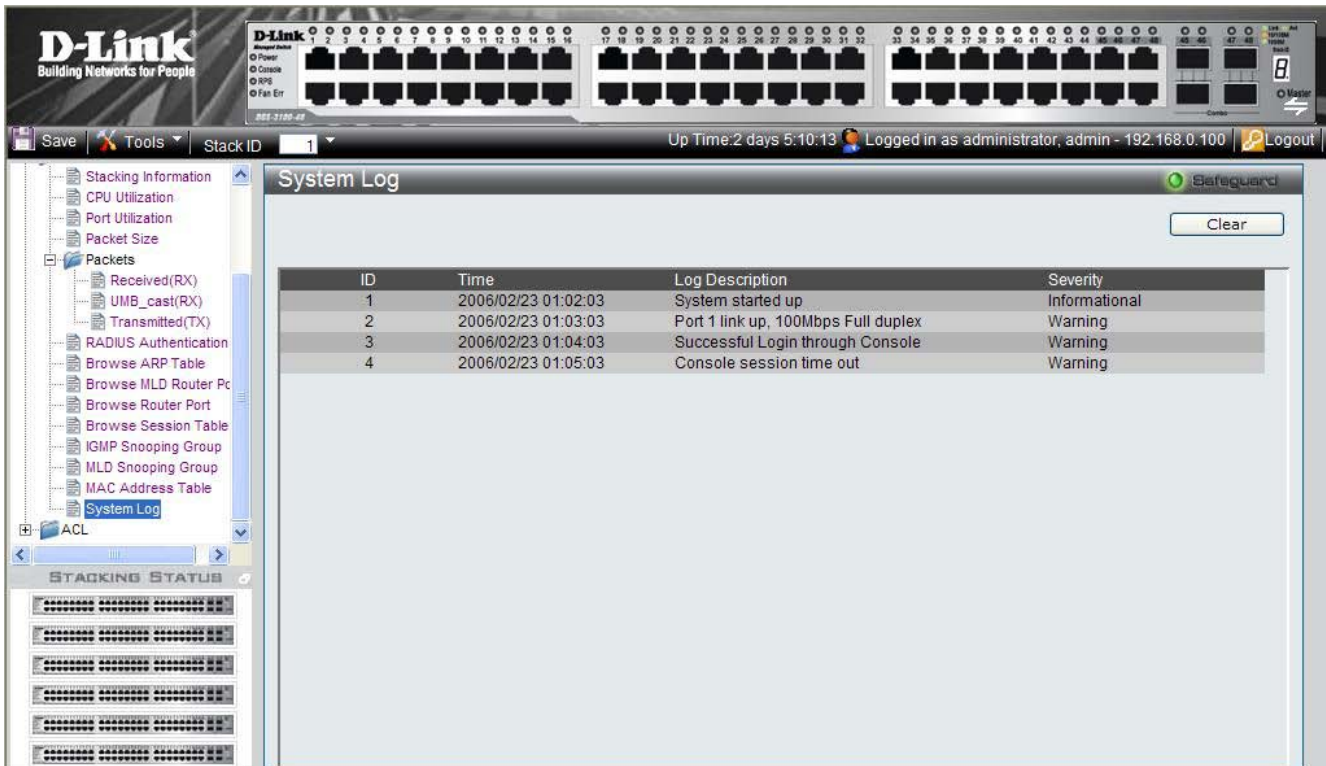

**Figure 6-16. System Log Page**

The *System Log Page* contains the following fields:

Field	Description
<b>ID</b>	Displays the system log table entry.
<b>Time</b>	Displays the time in days, hours, and minutes the log was entered in the Switch History Log Table.
<b>Log Description</b>	Displays a description event recorded in the <i>System Log Page</i> .
<b>Severity</b>	The following are the available log severity levels: <ul style="list-style-type: none"> <li>– Warning — The lowest level of a device warning. The device is functioning, but an operational problem has occurred.</li> <li>– Informational — Provides device information.</li> </ul>

To clear the log:

2. Click . The System Log Page is cleared.

---

## MANAGING POWER OVER ETHERNET DEVICES

*Power over Ethernet* (PoE) provides power to devices over existing LAN cabling, without updating or modifying the network infrastructure. Power over Ethernet removes the necessity of placing network devices next to power sources. Power over Ethernet can be used with:

- IP Phones
- Wireless Access Points
- IP Gateways
- Audio and video remote monitoring

Powered Devices are devices which receive power from the DGS-3100 series device power supplies, for example IP phones. Powered Devices are connected to the DGS-3100 series device via Ethernet ports.

PoE is enabled only on the DGS-3100-24P and DGS-3100-48P devices.

This section includes the following topics:

- Defining PoE System Information
- Displaying and Editing PoE System Information

## Defining PoE System Information

The *PoE Port Setting Page* contains system PoE information for enabling PoE on the device, monitoring the current power usage, and enabling PoE traps. To enable PoE on the device:

1. Click **PoE > PoE Port Setting**. The *PoE Port Setting Page* opens:

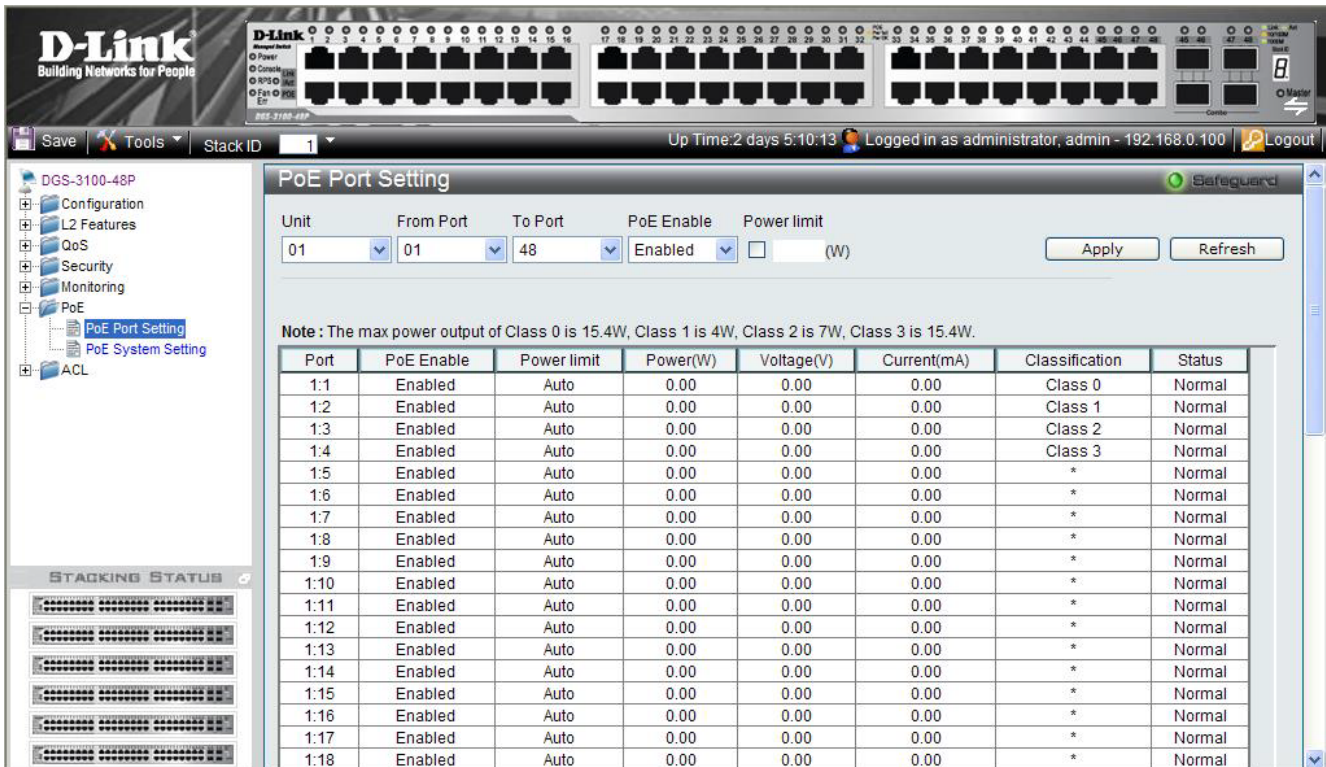

Figure 7-1. PoE Port Setting Page

The *PoE Port Setting Page* contains the following fields:

Fields	Description
<b>Unit</b>	Indicates the stacking member for which the PoE settings are displayed
<b>From Port</b>	Indicates from which port the PoE settings are applied.
<b>To Port</b>	Indicates to which port the PoE settings are applied.
<b>PoE Enable</b>	Indicates if PoE is enabled on the interface. The possible field values are: <i>Enabled</i> — Enables PoE on the interface. <i>Disabled</i> — Disables PoE on the interface. This is the default value.
<b>Power Limit</b>	Indicates the maximum amount of power available to the interface. The field value is displayed in Watts. If the <i>Power Limit</i> checkbox is left unchecked, the amount of power assigned is determined according to the class which is read from the powered device. If checked, the user can enter the Power Limit value thus overriding the value defined by the Powered device Class.
<b>Power (W)</b>	Indicates the amount of power assigned to the powered device connected to the selected interface.
<b>Voltage (W)</b>	Indicates the amount of voltage assigned to the powered device connected to the selected interface.
<b>Current (mA)</b>	Indicates the amount of power assigned to the provided powered device.
<b>Classification</b>	Indicates Power consumption classification of the powered device. The possible field values are: <i>Class 0</i> — Indicates the power consumption is 15.4W, which is the maximum output class.



Fields	Description
	<p><i>Class 1</i>— Indicates the power consumption is 4W.</p> <p><i>Class 2</i> — Indicates the power consumption is 7W.</p> <p><i>Class 3</i> — Indicates the power consumption is 15.4W.</p>
<b>Status</b>	<p>Indicates the inline power source status. The possible field values are:</p> <p><i>Normal</i> — Indicates that the power supply unit is functioning.</p> <p><i>Off</i> — Indicates that the power supply unit is not functioning.</p> <p><i>Faulty</i> — Indicates that the power supply unit is functioning, but an error has occurred. For example, a power overload or a short circuit.</p>

2. Define the *Unit*, *From Port*, *To Port*, *PoE Enable* and *Power Limit* fields.
3. Click **Apply**. The system PoE parameters are defined, and the device is updated.

## Displaying and Editing PoE System Information

The *PoE System Setting Page* displays system PoE information on the device, monitoring the current power usage, and enabling PoE traps. To display system PoE information on the device:

1. Click **PoE > PoE System Setting**. The *PoE System Setting Page* opens:

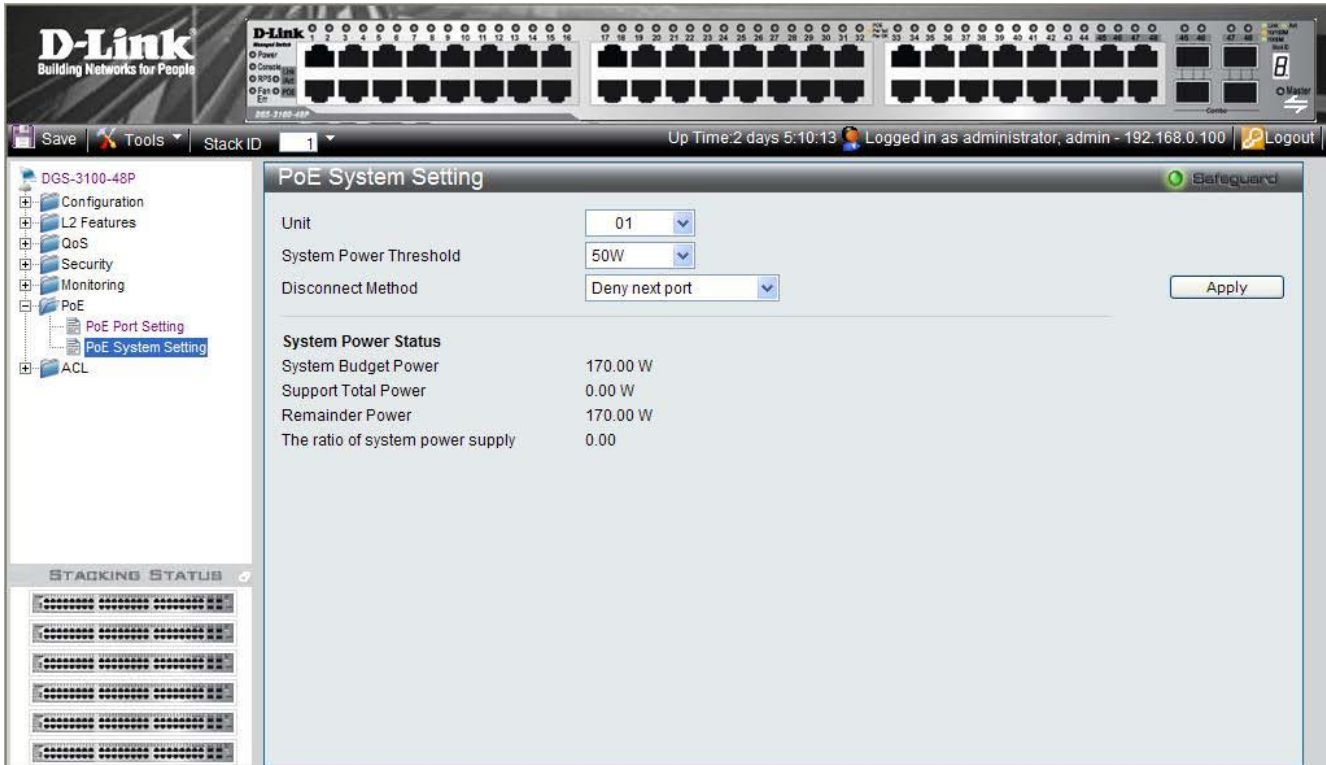

**Figure 7-2. PoE System Setting Page**

The *PoE System Setting Page* contains the following fields:

Fields	Description
<b>Unit</b>	Defines the unit.
<b>System Power Threshold</b>	Indicates the power in Watts consumed before an alarm is generated. The possible field values are: <i>50W</i> — Indicates 50 watts. <i>100W</i> — Indicates 100 watts. <i>170W</i> — Indicates 170 watts.
<b>Disconnect Method</b>	Indicates the method by which the powered device is disconnected from the interface. The possible values are: <i>Deny next port</i> — Indicates device disconnects by next port denial. <i>Deny Low priority port</i> — Indicates device disconnects by next low priority port.
<b>System Power Status</b>	Indicates the current system power status. The possible values are: <i>System Budget Power</i> — Indicates the power that can be supplied by the system. <i>Support Total Power</i> — Indicates the actual power which is consumed by the devices. <i>Remainder Power</i> — Indicates the remaining power that can be consumed by the devices (budget-total). <i>The ratio of system power supply</i> — total power/budget power.

---

## DEFINING ACCESS PROFILE LISTS

*Access Control Lists (ACL)* allow network managers to define classification actions and rules for specific ingress ports. Packets entering an ingress port with an active ACL are either admitted, denied or subject to Quality of Service action.

For example, a network administrator defines an ACL rule that states port number 20 can receive TCP packets, however, if a UDP packet is received, the packet is dropped.

Access Profiles and Access Rules that are made of the filters determine traffic classifications.

This section contains the following topics:

- Defining Time Ranges
- ACL Configuration Wizard
- Defining Access Profile Lists
- Defining Access Rules Lists
- Finding ACL Rules
- Defining Time Ranges

## ACL Configuration Wizard

The *ACL Configuration Wizard* Page provides information for configuring Access Control Lists. The ACL Configuration Wizard Page assists in configuring ACLs intuitively and quickly, and creates ACL profiles and rules automatically. To define ACLs:

1. Click **ACL > ACL Configuration Wizard**. The *ACL Configuration Wizard Page* opens:

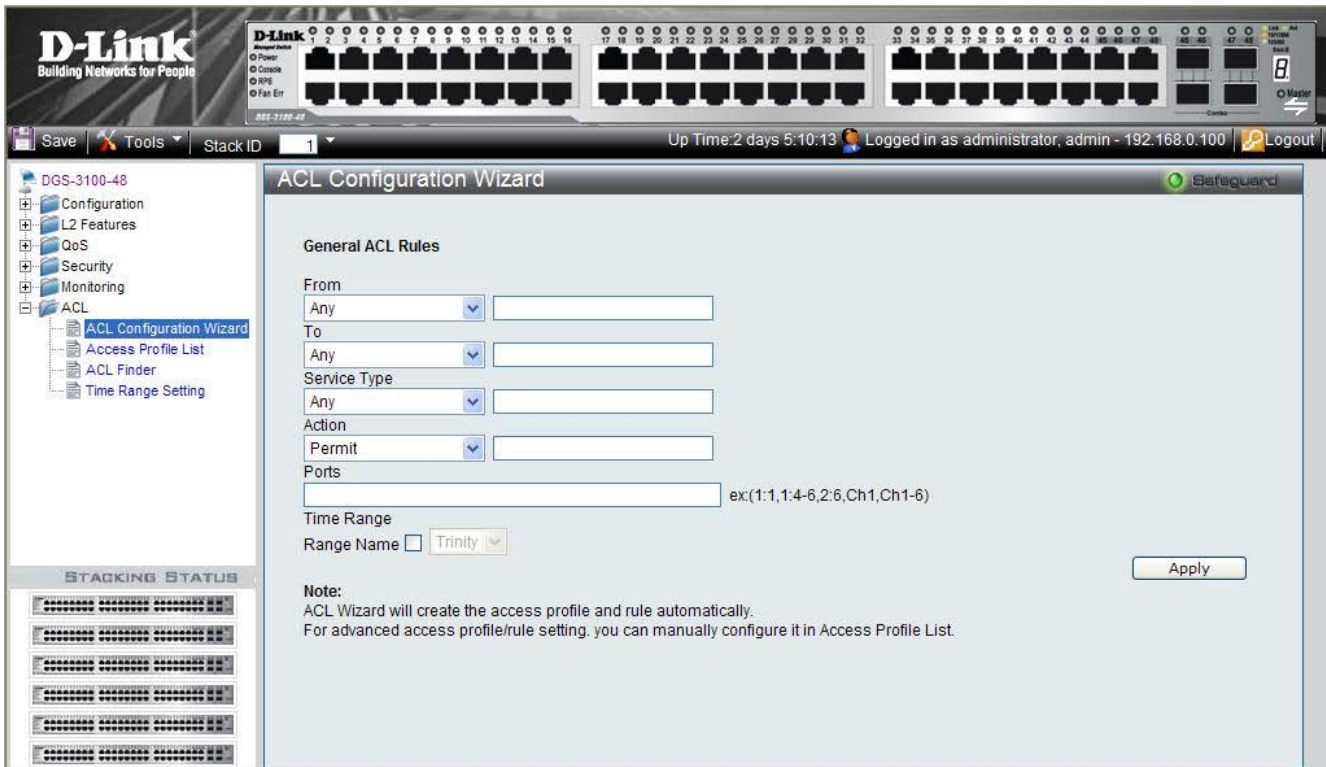

**Figure 8-1. ACL Configuration Wizard Page**

The *ACL Configuration Wizard* Page contains the following fields:

Fields	Description
<b>From</b>	Defines the origin of accessible packets. The possible values are: <i>Any</i> — Indicates ACL action will be on packets from any source. <i>MAC Address</i> — Indicates ACL action will be on packets from this MAC address. <i>IPv4 Addresses</i> — Indicates ACL action will be on packets from this IPv4 source address.
<b>To</b>	Defines the destination of accessible packets. The possible values are: <i>Any</i> — Indicates ACL action will take place for packets with any destination. <i>MAC Address</i> — Indicates ACL action will take place for packets to this MAC address only. <i>IPv4 Addresses</i> — Indicates ACL action will take place on packets to this IPv4 address.
<b>Service Type</b>	Defines the type of service. The possible values are: <i>Any</i> — Indicates ACL action will take place for packets of all service types. <i>Ethertype</i> — Specifies Ethertype packet filtering. <i>ICMP All</i> — Specifies an ICMP packets filtering <i>IGMP</i> — Specifies an IGMP packets filtering <i>TCP ALL</i> — Specifies an TCP packets filtering <i>TCP Source Port</i> — Matches the packet to the TCP Source Port <i>TCP Destination Port</i> — Matches the packet to the TCP Destination Port

Fields	Description
	<i>UDPAll</i> — Specifies a UDP Packets filtering. <i>UDP Source Port</i> — Matches the packet to the UDP Source Port <i>UDP Destination Port</i> — Matches the packet to the UDP Destination Port
<b>Action</b>	Defines the ACL forwarding action matching the rule criteria. The possible values are: <i>Permit</i> — Forwards packets if all other ACL criteria are met. <i>Deny</i> — Drops packets if all other ACL criteria is met. <i>Rate Limiting</i> — Rate limiting is activated if all other ACL criteria is met. <i>Change Ip Priority</i> — VPT (CoS) value is changed if all other ACL criteria is met. <i>Replace DSCP</i> — Reassigns a new DSCP value to the packet if all other ACL criteria are met.
<b>Ports</b>	Defines ports to be configured. An example of possible values is: 1:1, 1:4-6, and 2:6.
<b>Time Range</b>	Specifies whether the configured ACL is time-based.
<b>Range Name</b>	Selects the user-defined time range name to apply to the configured ACL.

2. Define the *From*, *To*, *Service Type*, *Action*, and *Ports* fields.  
 To configure a time-based ACL, check the *Time Range* box and select the *Range Name* from the list.
3. Click . The ACLs are configured, and the device is updated.

For advanced ACL setting please see the section below.

## Defining Access Profile Lists

This section contains the following topics:

- Adding ACL Profiles
- Defining Level 2 ACL
- Defining Level 3 ACL

### Adding ACL Profiles

The *ACL Profile List Page* provides information for configuring ACL Profiles manually. ACL profiles are attached to interfaces, and define how packets are forwarded if they match the ACL criteria.

1. Click **ACL > Access Profile List**. The *ACL Profile List Page* opens:

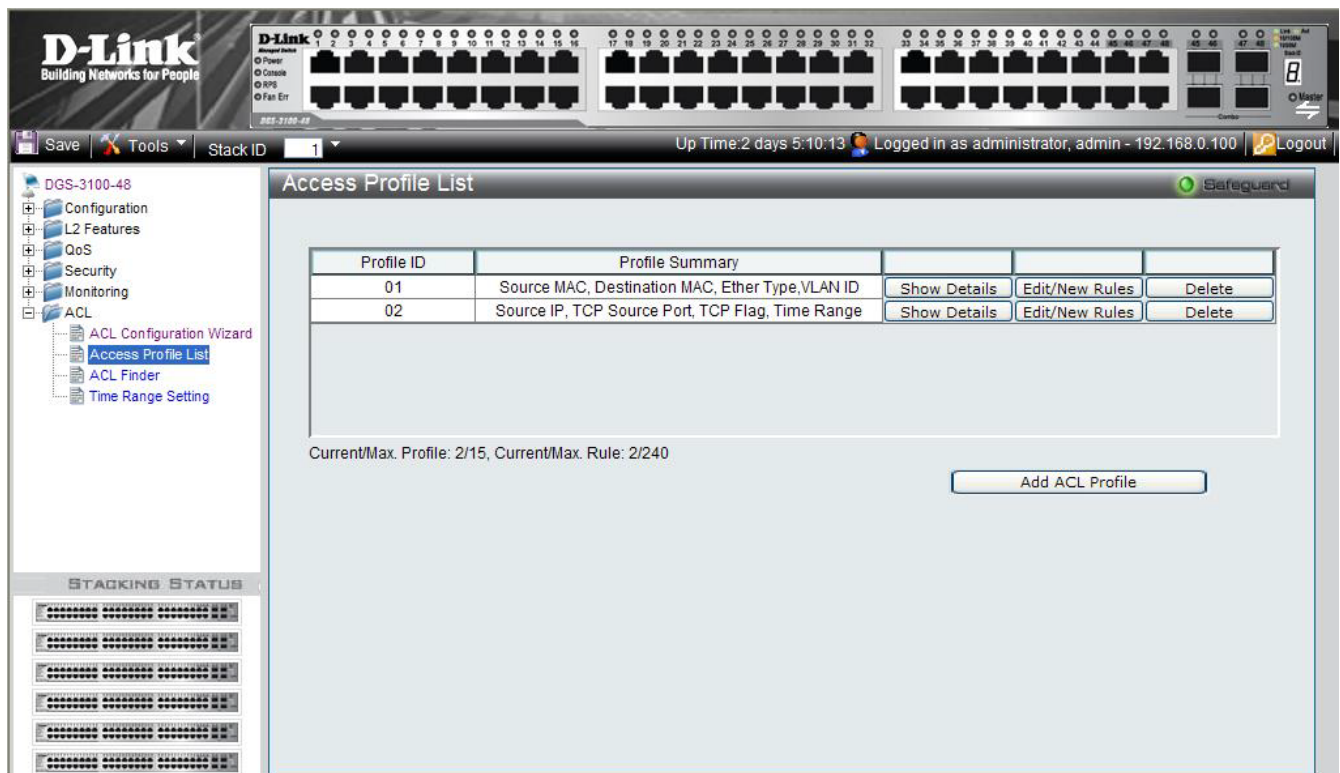

**Figure 8-2. ACL Profile List Page**

The *ACL Profile List Page* contains the following fields:

Field	Description
<b>Profile ID</b>	Displays the profile Identification number.
<b>Profile Summary</b>	Displays the access rule.

- To display an ACL's profile details, click **Show Details**. The ACL profile details are displayed below the ACL table.
  - To define or show an access rule, click **Edit/New Rules**. The *Add Access Rule Page* opens. (See 'Defining Access Rules Lists' section, below.)
  - To delete an ACL profile, click **Delete**. The ACL profile is deleted.
2. To add an ACL profile Click **Add ACL Profile**. The *Add ACL Profile Page* opens:

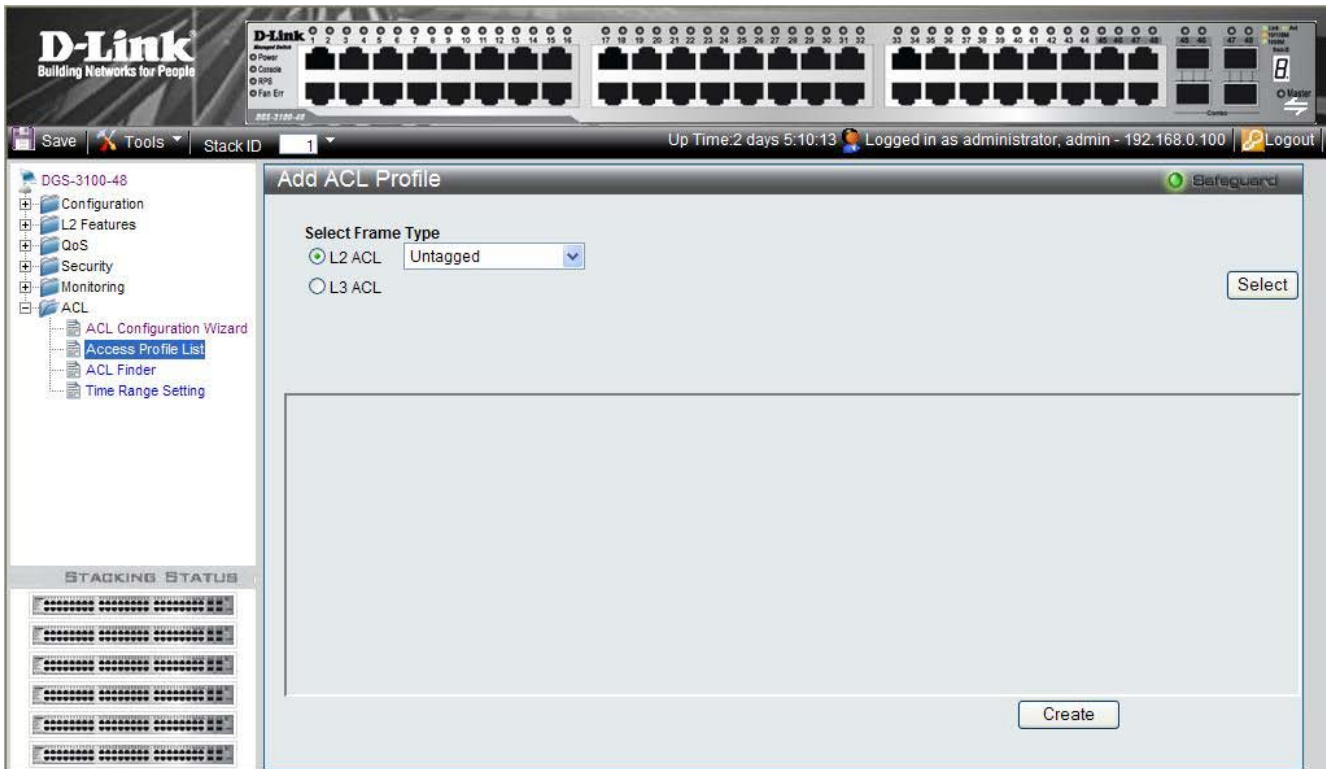

Figure 8-3. Add ACL Profile Page

The *Add ACL Profile Page* contains the following fields:

Field	Description
<b>L2 ACL</b>	Defines the ACL profile Layer 2 protocols. The possible values are: <i>Tagged</i> — Defines the profile Layer 2 to match 802.1Q fields in the Layer 2 header. <i>Untagged</i> — Defines the profile Layer 2 to check the Layer 2 header without the 802.1Q fields .
<b>L3 ACL</b>	Defines the ACL profile Layer 3 protocols. The possible fields are: <i>ICMP</i> — Specifies ICMP as the Layer 4 protocol the the access profile checks. <i>IGMP</i> — Specifies IGMP as the Layer 4 protocol the the access profile checks <i>TCP</i> — Specifies TCP as the Layer 4 protocol the the access profile checks. <i>UDP</i> — Specifies UDP as the Layer 4 protocol the the access profile checks.

- Define the *L2 ACL* or *L3 ACL* fields.
- Click **Select** The *Add ACL Profile Page* updates accordingly, enabling selection of the packet field to create filtering masks.

## Defining Level 2 ACL

If *L2 ACL Tagged* is selected, the page updates as follows:

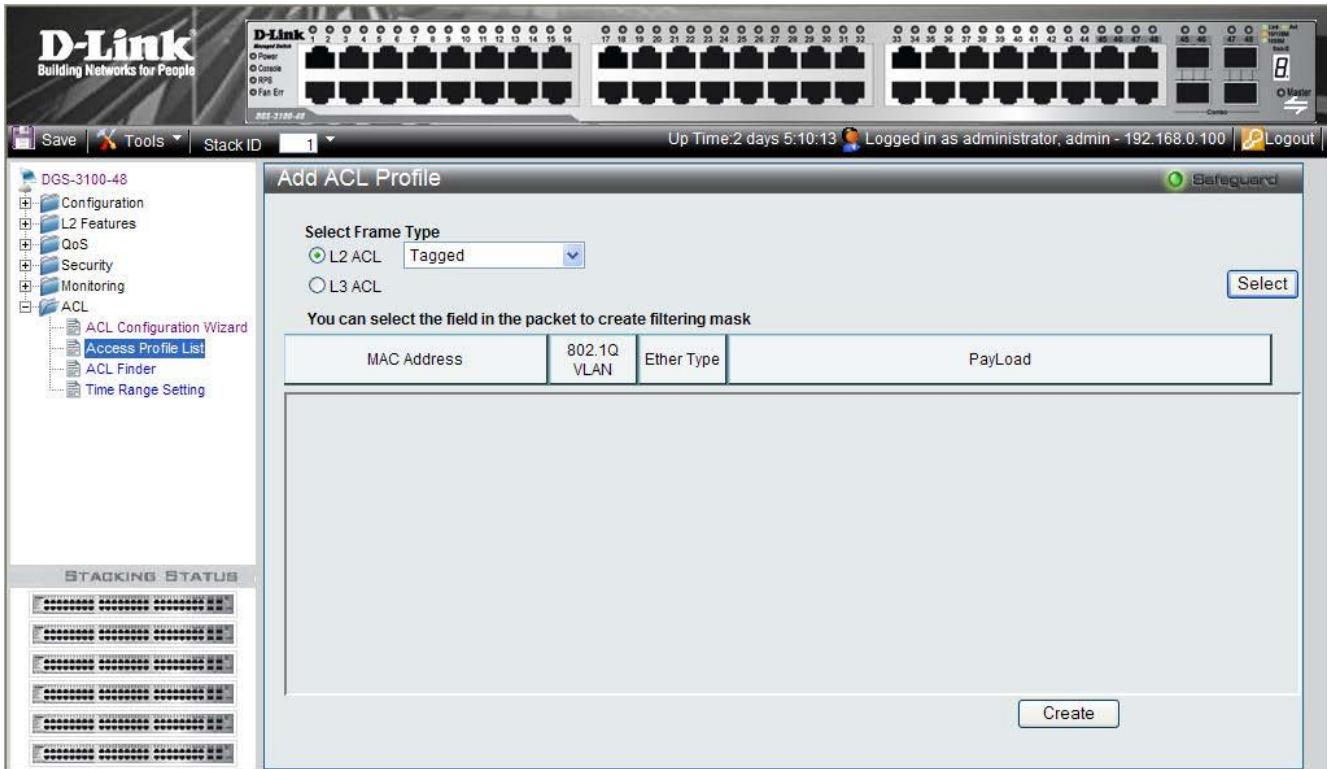

Figure 8-4. ACL Profile L2 ACL Tagged Page

To define L2 MAC Address ACL profile:

1. Click the *MAC Address* button. The *ACL Profile L2 ACL Tagged MAC Address Page* updates to show the following:

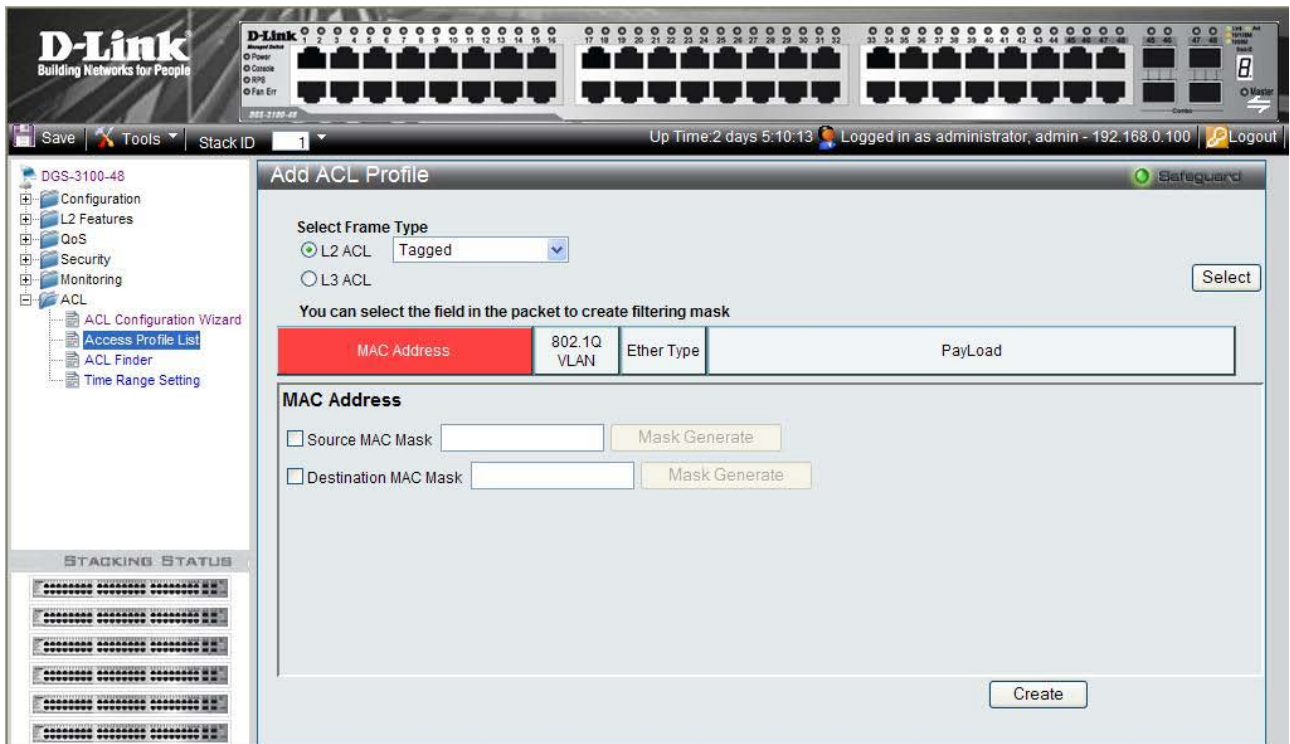

Figure 8-5. ACL Profile L2 ACL Tagged MAC Address Page



The *ACL Profile L2 ACL Tagged MAC Address Page* contains the following fields:

Field	Description
Source MAC Mask	Defines the range of source addresses relative to the ACL rules (0=ignore, 1=check). For example, to set 00:00:00:00:10:XX, use mask FF:FF:FF:FF:FF:00.
Destination MAC Mask	Defines the range of destination addresses relative to the ACL rules (0=ignore, 1=check). For example, to set 00:00:00:00:10:XX, use mask FF:FF:FF:FF:FF:00.

2. Select *Source MAC Mask* and/or *Destination MAC Mask*. The *Mask Generate* button is active.
3. Enter a MAC mask in the box adjacent to the *Mask Generate* button.  
Alternatively, click **Mask Generate**. The *Generate Mask by range* fields appear.  
Enter a MAC address range into the *Generate Mask by range* fields, and click **Calculate**. The mask is generated.
4. Click **Create**. The ACL profile is added, and the device is updated.

**To define L2 802.1Q VLAN ACL profile:**

1. Click the **802.1Q VLAN** button. The *ACL Profile L2 ACL Tagged VLAN Page* updates to show the following:

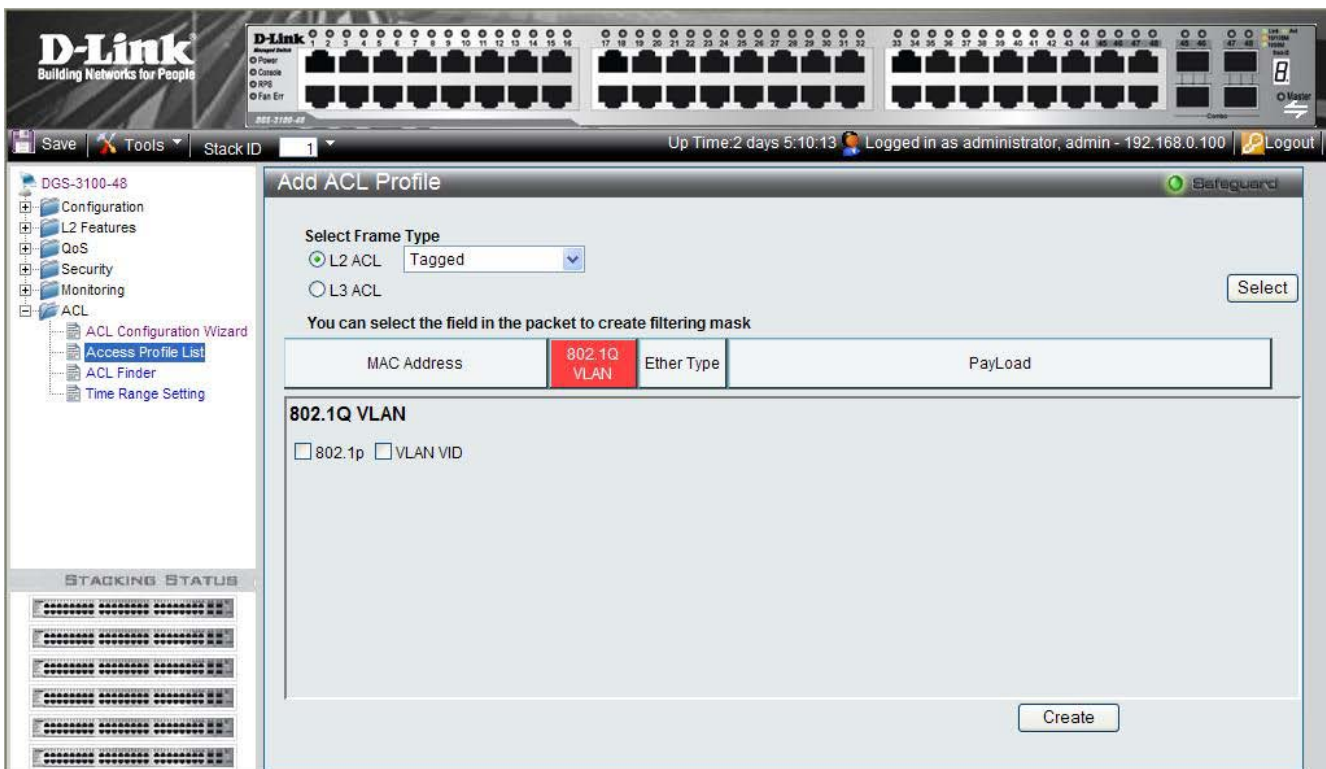

**Figure 8-6. ACL Profile L2 ACL Tagged VLAN Page**

The *ACL Profile L2 ACL Tagged VLAN Page* contains the following fields:

Field	Description
802.1p	Sets the 802.1p field as an essential field to match.
VLAN VID	Sets the VLAN VID field as an essential field to match.

2. Define the *802.1p* and *VLAN VID* fields.
3. Click **Create**. The ACL profile is added, and the device is updated.

**To define L2 Ether Type ACL profile**

This option defines whether or not the Ether Type field is checked for a match.

1. Click the **Ether Type** button. The *ACL Profile L2 ACL Tagged Ether Type Page* updates to show the following:

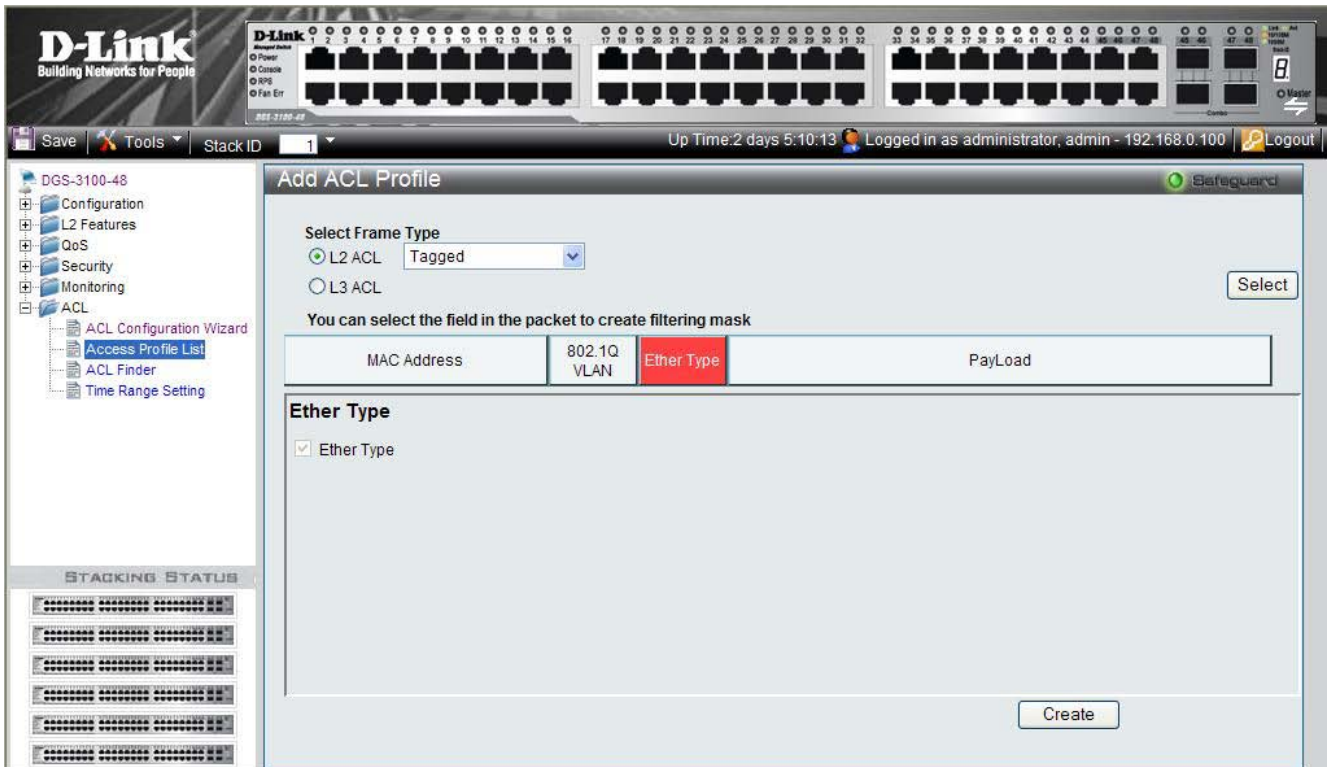

**Figure 8-7. ACL Profile L2 ACL Tagged Ether Type Page**

- Click . The ACL profile is added, and the device is updated.



**NOTE:** A combination of one or several filtering masks can be selected simultaneously. The page updates with the relevant field(s).

If *L2 ACL Untagged* is selected, the page updates as follows (without the 802.1Q VLAN field):

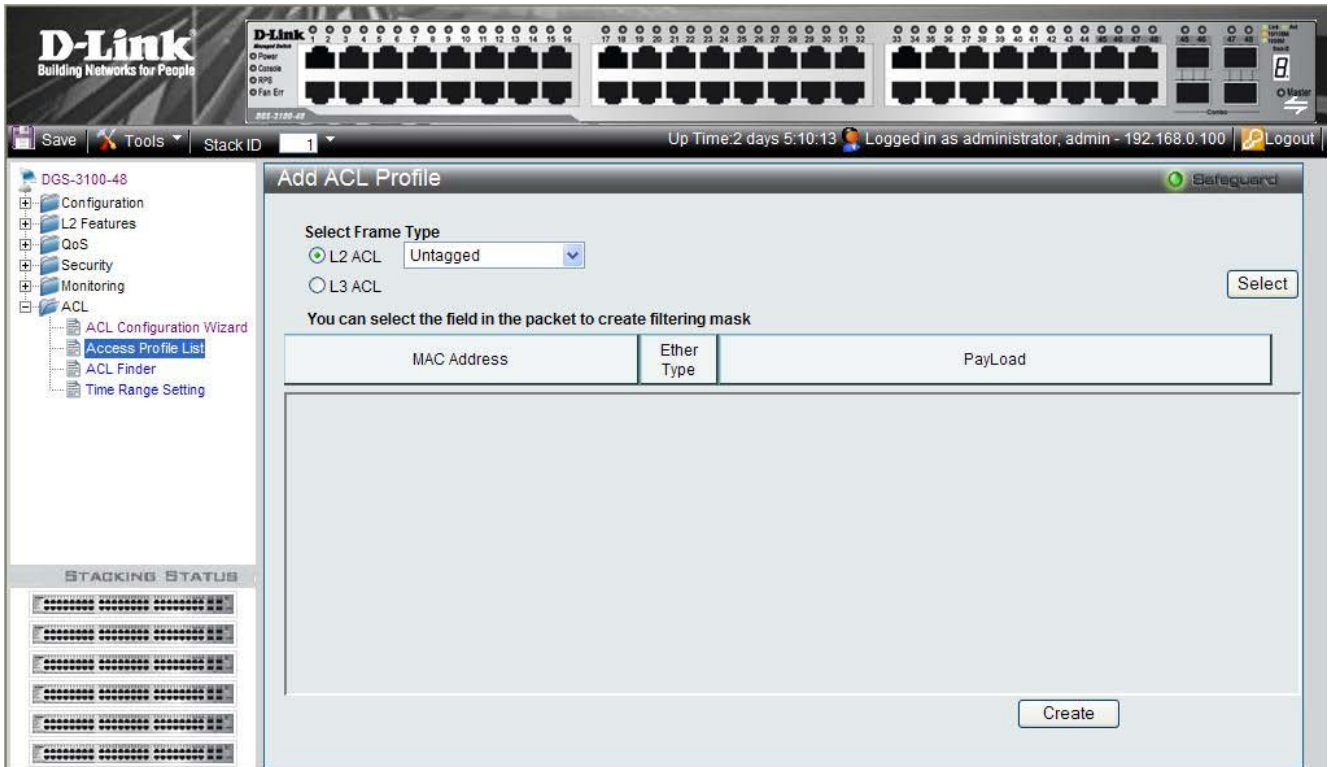

Figure 8-8. ACL Profile L2 ACL Untagged Page

### Defining Level 3 ACL

If *L3 ACL ICMP* is selected, the page updates as follows:

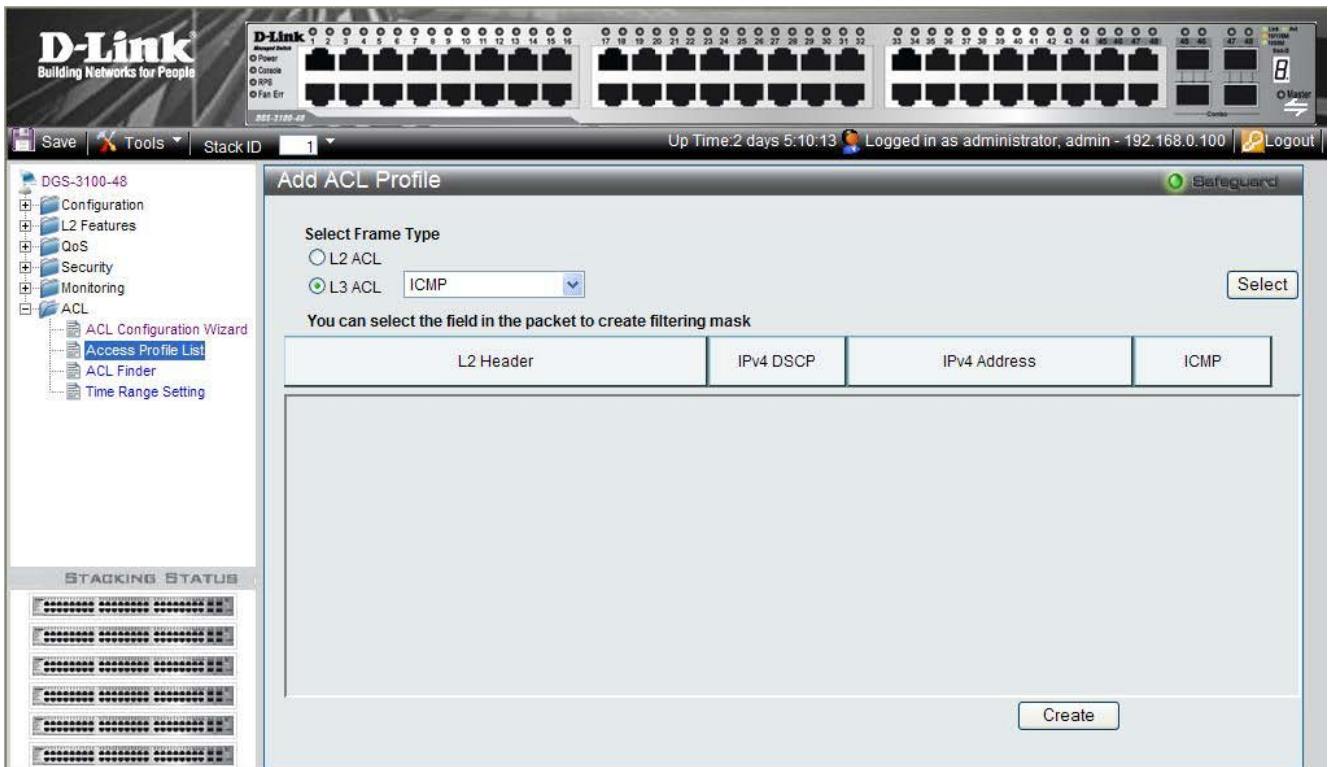

Figure 8-9. Add ACL Profile L3 Page

To define L3 IPv4 DSCP ACL profile:

This option defines whether or not the DSCP field is checked for a match.

1. Click the IPv4 DSCP button. The *ACL Profile L3 ACL ICMP IPv4 DSCP Page* updates to show the following:

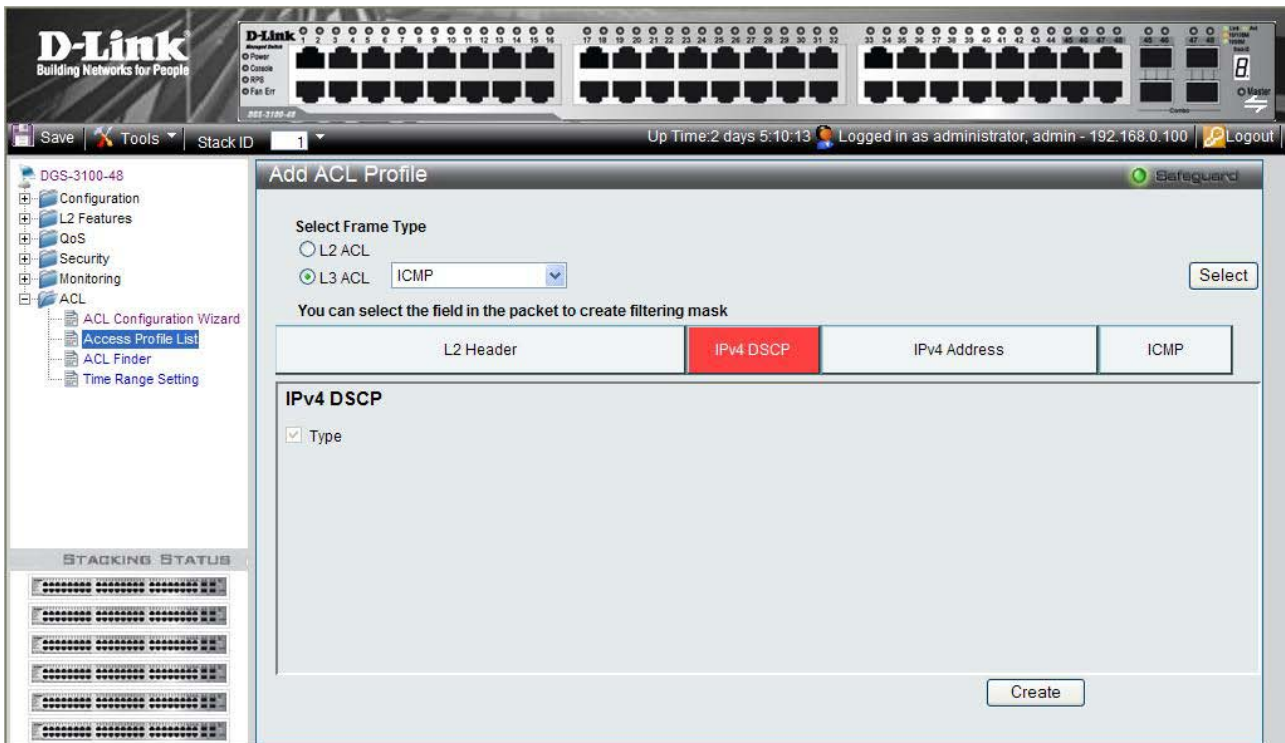

Figure 8-10. ACL Profile L3 ACL ICMP IPv4 DSCP Page

2. Click **Create**. The ACL profile is added, and the device is updated.

**To define L3 IPv4 Address ACL profile:**

1. Click the *IPv4 Address* button. The *ACL Profile L3 ACL ICMP IPv4 Address Page* updates to show the following:

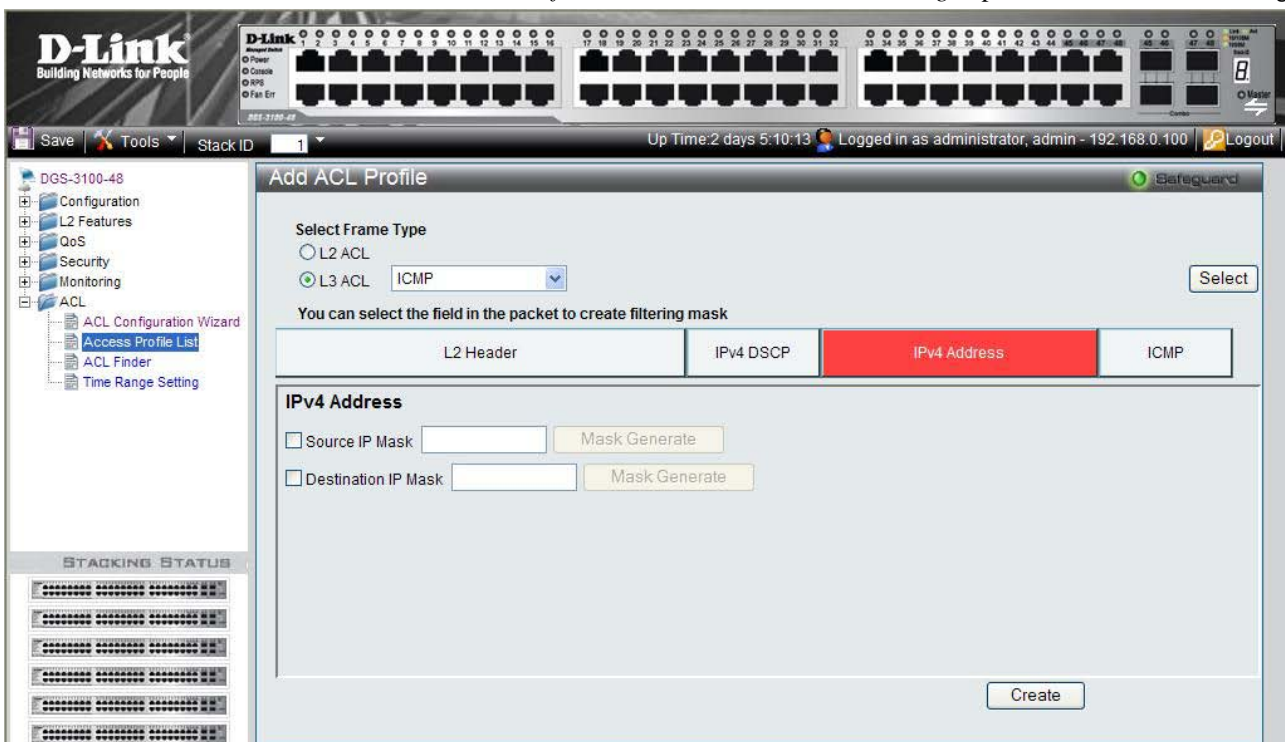

Figure 8-11. ACL Profile L3 ACL ICMP IPv4 Address Page

The *ACL Profile L3 ACL ICMP IPv4 Address Page* contains the following fields:

Field	Description
<b>Source IP Mask</b>	Defines the range of source IP addresses, relevant to the ACL rules. (0=ignore, 1=check). For example, to set 176.212.XX.XX, use mask 255.255.0.0
<b>Destination IP Mask</b>	Defines the range of destination IP addresses, relevant to the ACL rules. (0=ignore, 1=check). For example, to set 176.212.XX.XX, use mask 255.255.0.0

2. Select *Source IP Mask* and/or *Destination IP Mask*. The *Mask Generate* button is active.
3. Enter an IP mask in the box adjacent to the *Mask Generate* button.  
Alternatively, click **Mask Generate**. The *Generate Mask by range* fields appear.  
Enter an IP address range into the *Generate Mask by range* fields, and click **Calculate**. The mask is generated.
4. Click **Create**. The ACL profile is added, and the device is updated.

**To define L3 ICMP ACL profile:**

1. Click the ICMP button. The *ACL Profile L3 ACL ICMP Page* updates to show the following:

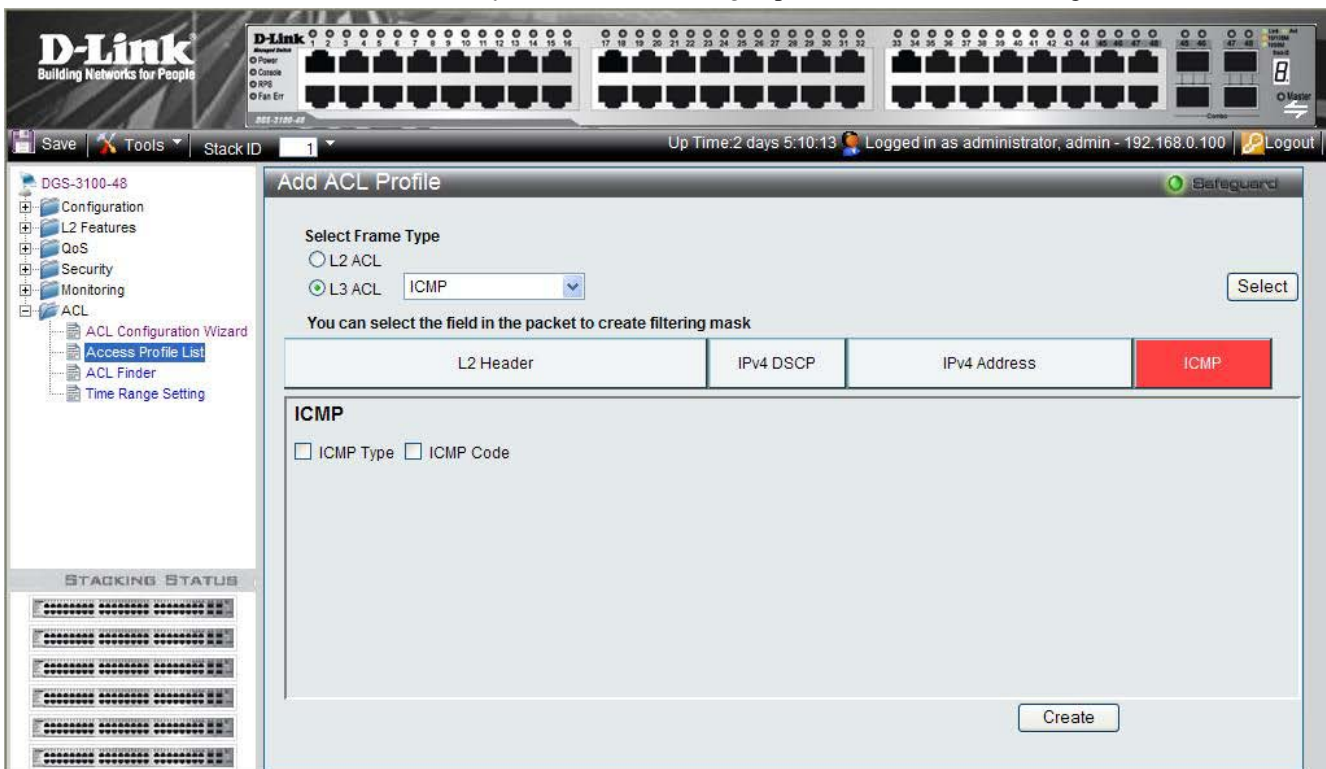

**Figure 8-12. ACL Profile L3 ACL ICMP Page**

The *ACL Profile L3 ACL ICMP Page* contains the following fields:

Field	Description
<b>ICMP Type</b>	Sets the ICMP Type field as an essential field to match.
<b>ICMP Code</b>	Sets the ICMP code field as an essential field to match.

2. Select the *ICMP Type* and/or *ICMP Code* fields.
3. Click **Create**. The ACL profile is added, and the device is updated.

**To define L3 IGMP ACL profile:**

This option defines whether or not the IGMP field is checked for a match.

If *L3 ACL IGMP* is selected, the page updates as follows:

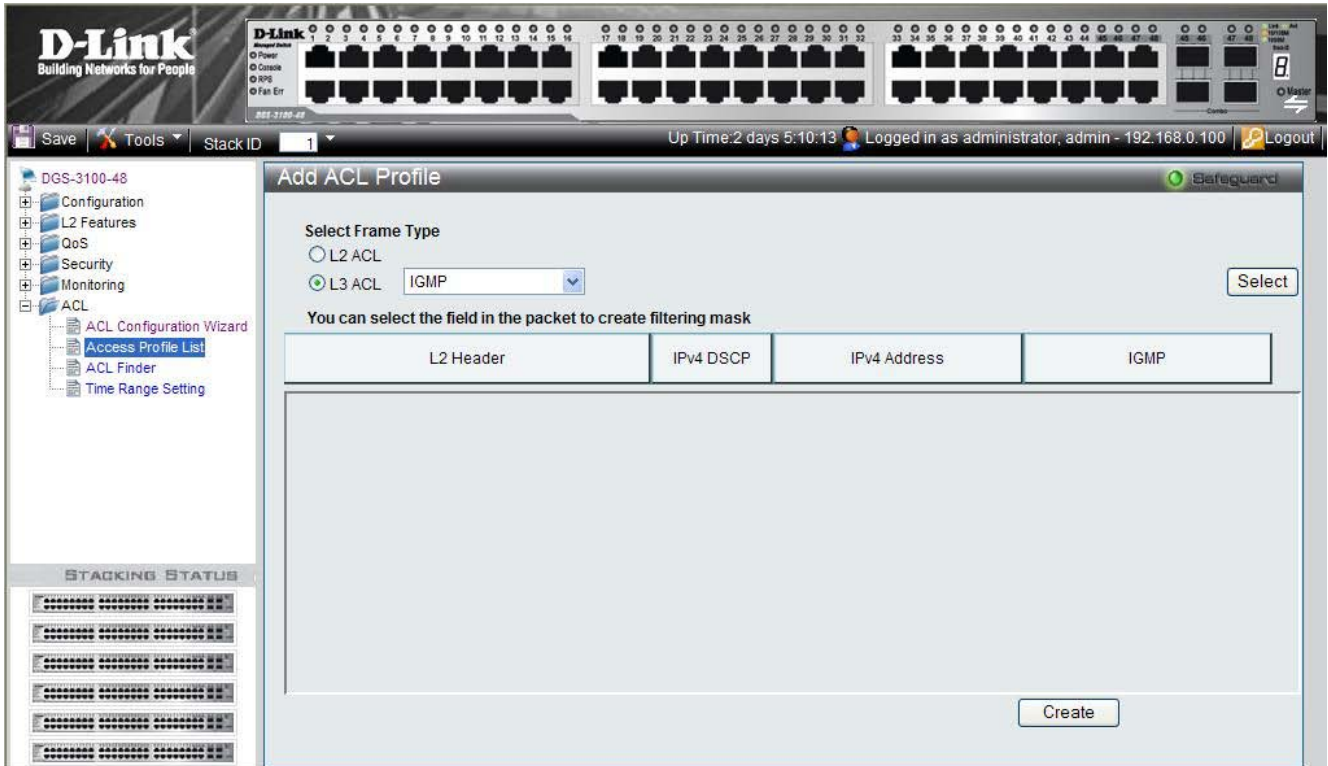

**Figure 8-13. ACL Profile L3 IGMP Page**

1. Click the IGMP button. The *ACL Profile L3 IGMP Selected Page* updates to show the following:

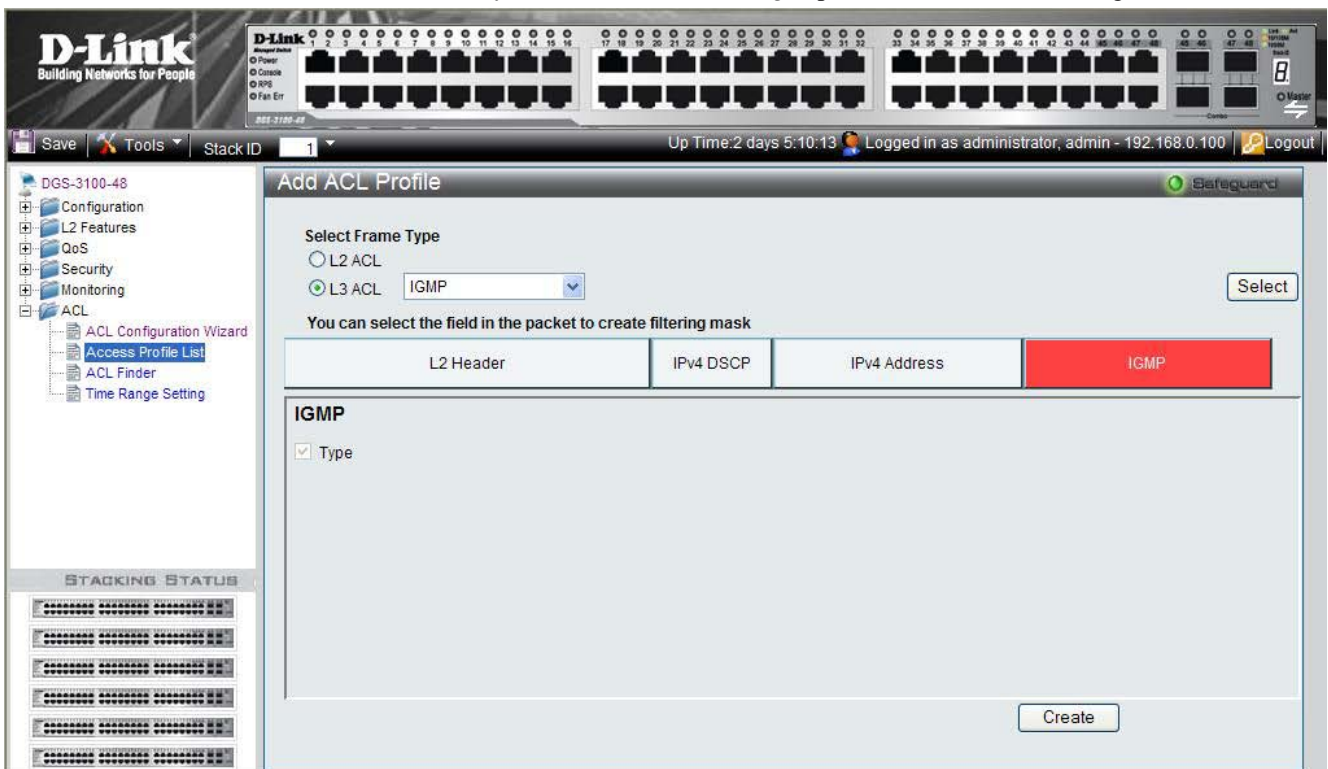

**Figure 8-14. ACL Profile L3 IGMP Selected Page**

2. Click **Create**. The ACL profile is added, and the device is updated.

If L3 ACL TCP is selected, the page updates as follows:

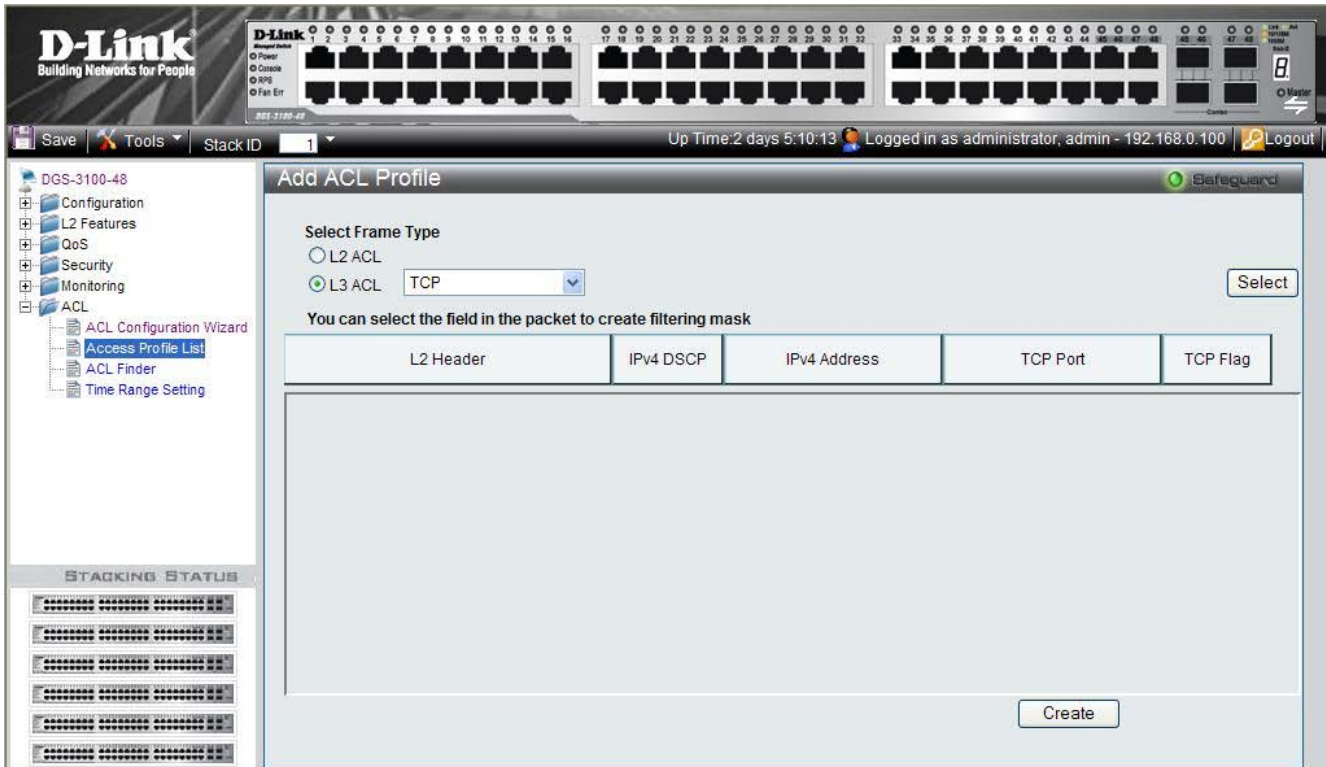

Figure 8-15. ACL Profile L3 TCP Page

To define L3 TCP Port ACL profile:

1. Click the TCP Port button. The *ACL Profile L3 TCP Port Page* updates to show the following:

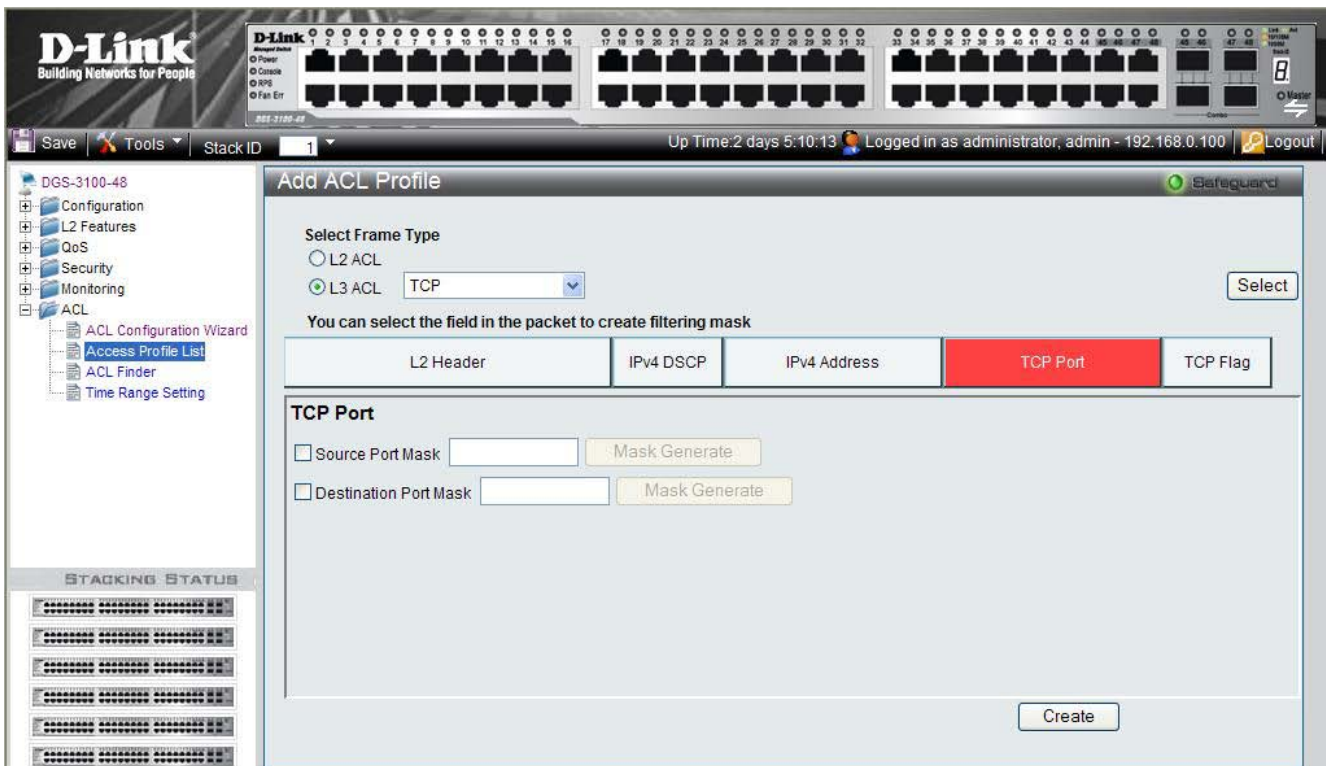

Figure 8-16. ACL Profile L3 TCP Port Page

The *ACL Profile L3 TCP Port Page* contains the following fields:

Field	Description
<b>Source Port Mask</b>	Defines the range of source Ports relevant to the ACL rules. (0=ignore, 1=check). For example, to set 0 – 15, set mask of FFF0.
<b>Destination Port Mask</b>	Defines the range of destination IP addresses, relevant to the ACL rules. (0=ignore, 1=check). For example, to set 0 – 15, set mask of FFF0.

2. Select *Source Port Mask* and/or *Destination Port Mask*. The *Mask Generate* button is active.
3. Enter a port ID in the box adjacent to the *Mask Generate* button.  
Alternatively, click **Mask Generate**. The *Generate Mask by range* fields appear.  
Enter a port ID range into the *Generate Mask by range* fields, and click **Calculate**. The mask is generated.
4. Click **Create**. The ACL profile is added, and the device is updated.

#### To define L3 TCP Flag ACL Profile:

This option defines whether or not the TCP Flag field is checked for a match.

1. Click the *TCP Flag* button. The *ACL Profile L3 TCP Flag Page* updates to show the following:

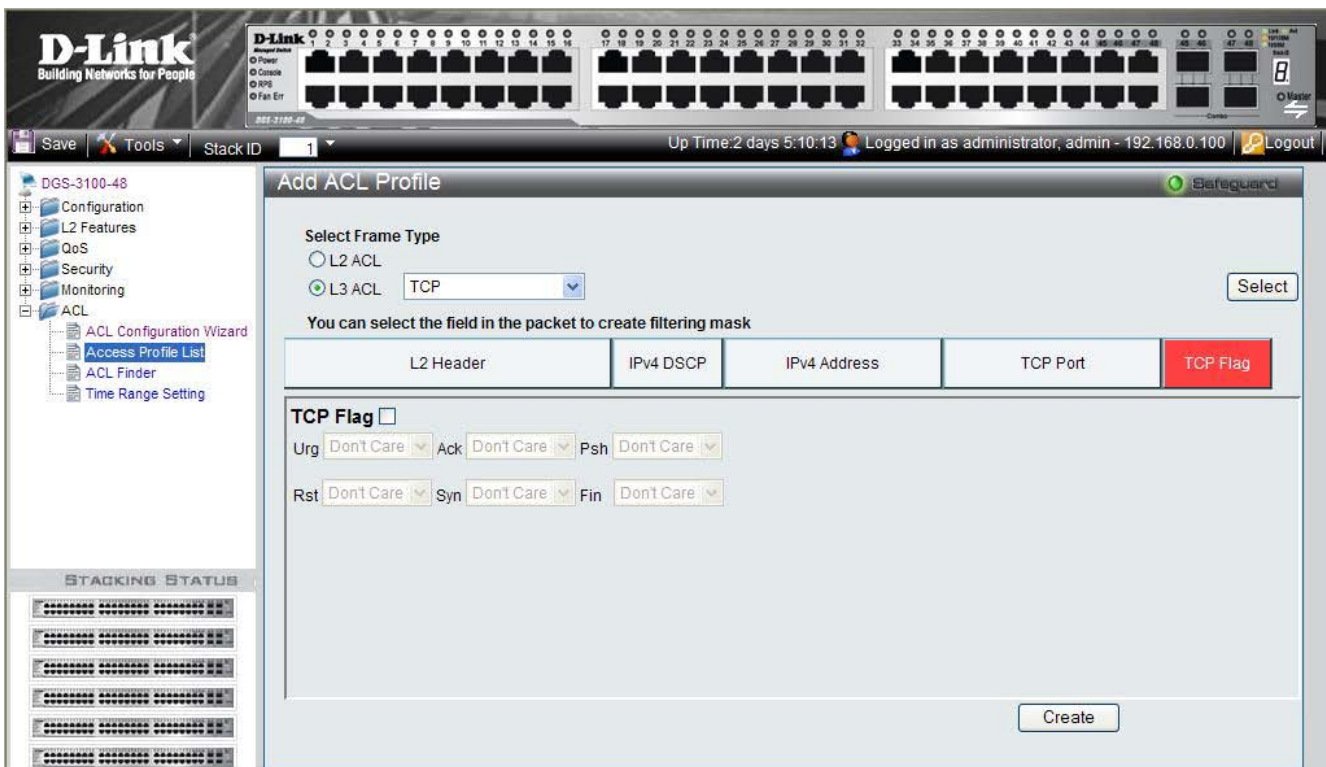

**Figure 8-17. ACL Profile L3 TCP Flag Page**

2. Click **Create**. The ACL profile is added, and the device is updated.



If L3 ACL UDP is selected, the page updates as follows:

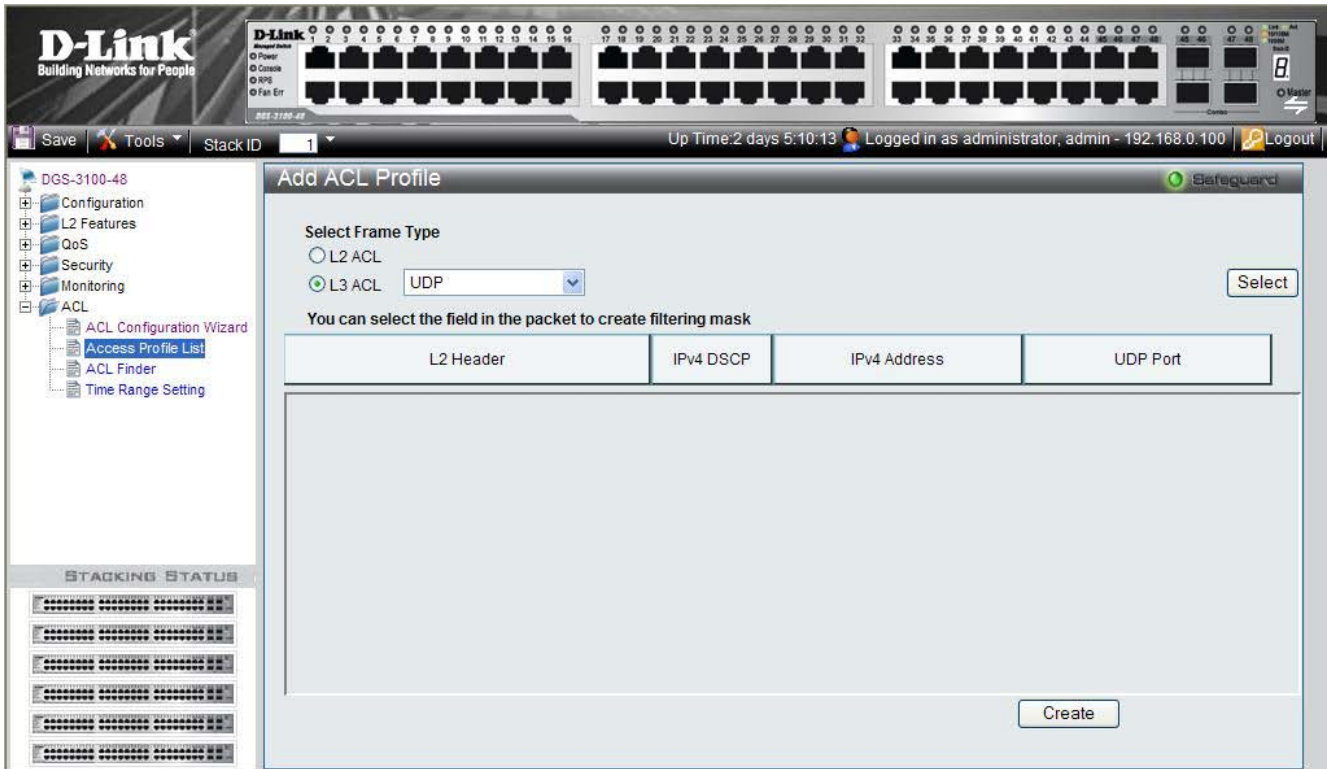

Figure 8-18. ACL Profile L3 UDP Page

1. Click the UDP Port button. The *ACL Profile L3 UDP Port Page* updates to show the following:

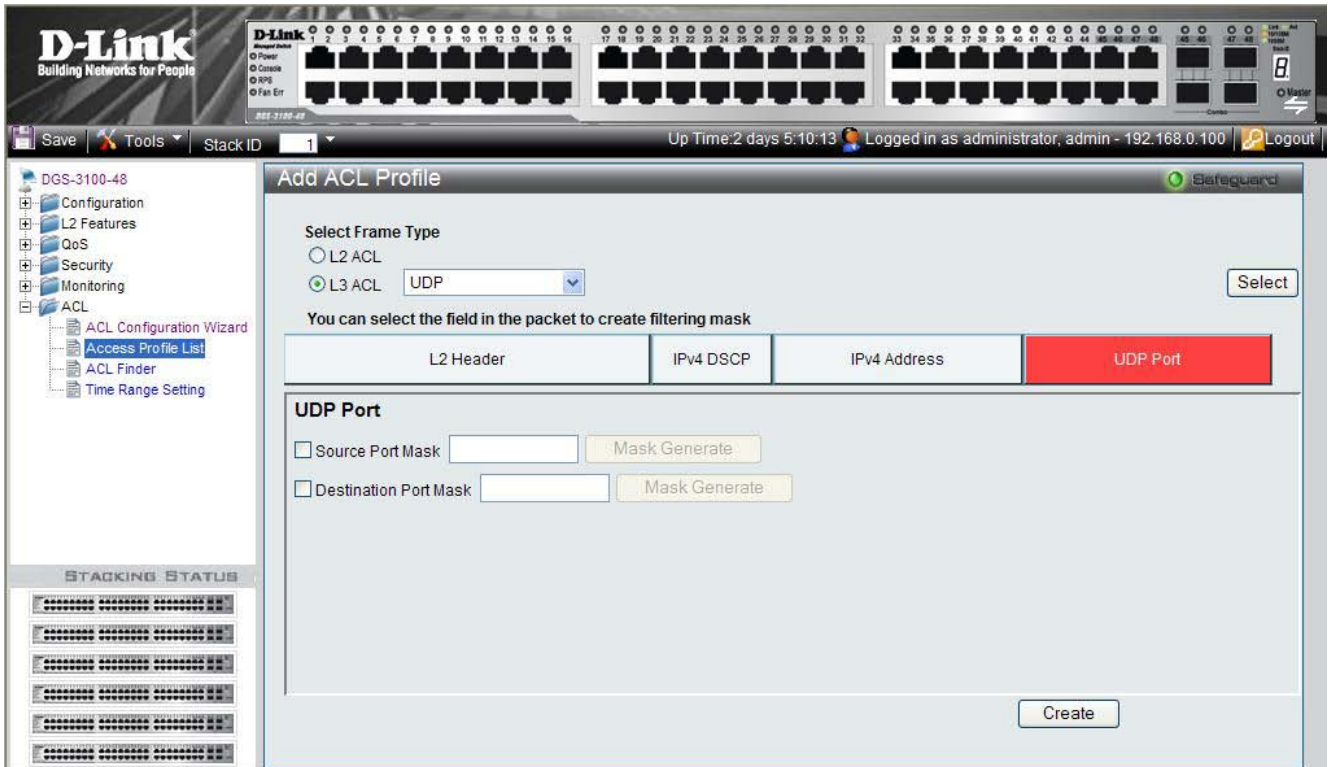

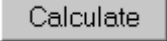



Figure 8-19. ACL Profile L3 UDP Port Page

The *ACL Profile L3 UDP Port Page* contains the following fields:

Field	Description
-------	-------------

Field	Description
Source Port Mask	Defines the range of source Ports relevant to the ACL rules. (0=ignore, 1=check). For example, to set 0 – 15, set mask of F.
Destination Port Mask	Defines the range of destination IP addresses, relevant to the ACL rules. (0=ignore, 1=check). For example, to set 0 – 15, set mask of F.

2. Select *Source Port Mask* and/or *Destination Port Mask*. The *Mask Generate* button is active.
3. Enter a port ID in the box adjacent to the *Mask Generate* button.  
Alternatively, click . The *Generate Mask by range* fields appear.  
Enter a port ID range into the *Generate Mask by range* fields, and click . The mask is generated.
4. Click . The ACL profile is added, and the device is updated.



**NOTE:** A combination of one or several filtering masks can be selected simultaneously. The page updates with the relevant field(s).

## Defining Access Rules Lists

The following conditions can be defined as Access Rules:

Filter	Description
Source Port IP Address and Wildcard Mask	Filters the packets by the Source port IP address and wildcard mask.
Destination Port IP Address and Wildcard Mask	Filters the packets by the Source port IP address and wildcard mask.
Protocol	Filters the packets by the Layer 4 protocol.
DSCP	Filters the packets by the DiffServ Code Point (DSCP) value.
IP Precedence	Filters the packets by the IP Precedence.
Action	Indicates the action assigned to the packet matching the ACL conditions. Packets are forwarded, dropped or going through QoS action.

- Click **ACL > Access Profile List**: The Access Profile List Page opens.

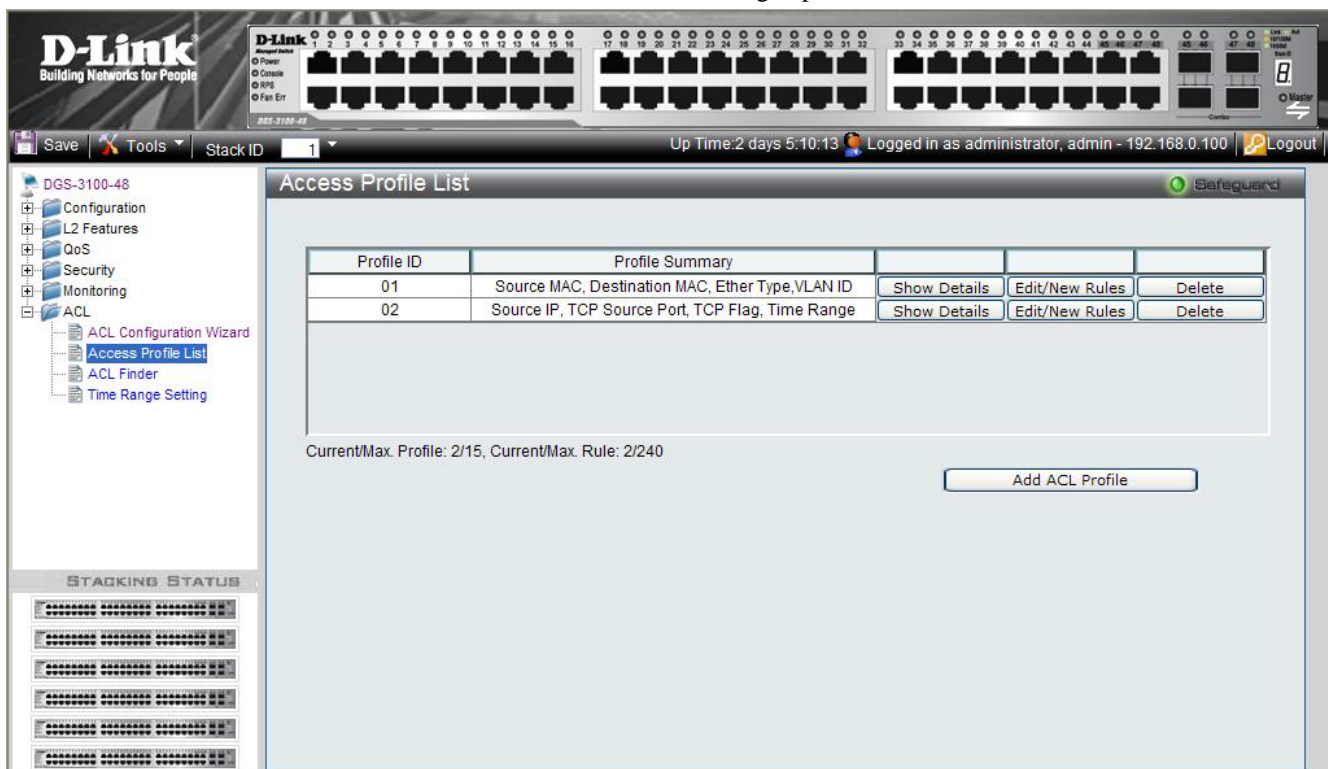

**Figure 8-20. Access Profile List Page**

The *Access Profile List Page* contains the following fields:

Field	Description
Profile ID	Displays the Access Profile of users with access to view the rule list.
Profile Summary	Displays the Access Rule.

To change ACL rules:

1. Click **Edit/New Rules**. The *Add Access Rule Page* opens:

The screenshot shows the 'Add Access Rule' page in the D-Link web interface. The page is titled 'Add Access Rule' and features a 'Safeguard' indicator. The main form area contains the following fields and options:

- Profile ID:** 02
- Source IP:** 172.168.0.1~172.168.0.255
- TCP Source Port:** 80
- TCP Flag Mask:** (empty)
- Rule Detail:** (Keep an input field as blank to treat the corresponding option as "don't care")
  - Access ID:** (input field)
  - Type:** IP
  - Source IP Address:** (input field) ex:(192.168.1.10/24)
  - TCP Flag:**
    - Urg   Ack   Psh
    - Rst   Syn   Fin
  - Source Port:** (input field) ex:(0-65535)
  - Ports:** (input field) ex:(1:1,2:1,Ch1,Ch1-6)
  - Action:** Permit
  - Time Range:** Range Name  Trinity

Buttons at the bottom right include 'Previous page' and 'Apply'.

**Figure 8-21. Add Access Rule Page (IP based ACL)**

The *Add Access Rule Page* contains the following fields:

Field	Description
<b>Profile ID</b>	Displays the Profile ID to which the rule is being added to.
<b>Source ID</b>	Displays the source IP address
<b>TCP Source Port</b>	Displays The TCP Source Port
<b>TCP Flag Mask</b>	Indicates if TCP flag mask is active.
<b>Access ID</b>	Defines the Access ID
<b>Type</b>	Displays the profile type (IP based).
<b>Source IP Address</b>	Displays the source IP address.
<b>TCP Flag</b>	Defines the indicated TCP flag that can be triggered.
<b>Source Port</b>	Displays the TCP source port.
<b>Ports</b>	Defines the ports or LAGs on which the access profile will work.
<b>Action</b>	Defines the action to be taken The possible values are: <i>Permit</i> — Forwards packets if all other ACL criteria are met. <i>Deny</i> — Drops packets if all other ACL criteria is met. <i>Rate Limiting</i> — Rate limiting is activated if all other ACL criteria are met. <i>Change IP priority</i> — VPT (CoS) value is changed if all other ACL criteria is met. <i>Replace DSCP</i> — Reassigns a new DSCP value to the packet if all other ACL criteria are met.
<b>Time Range</b>	Specifies whether the access rule is time-based.

Field	Description
Range Name	Selects the user-defined time range name to apply to the access rule.

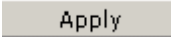
2. Define the *Rule Detail* fields.
3. Click . The rule is changed, and the device is updated.



**NOTE:** Each Access Profile must create rules with unique Access IDs, Access IDs cannot overlap in two different Access Profiles.

## Finding ACL Rules

The *ACL Finder Page* identifies any rule which has been assigned to a specific port. To find ACL rules:

1. Click **ACL > ACL Finder**: The *ACL Finder Page* opens:

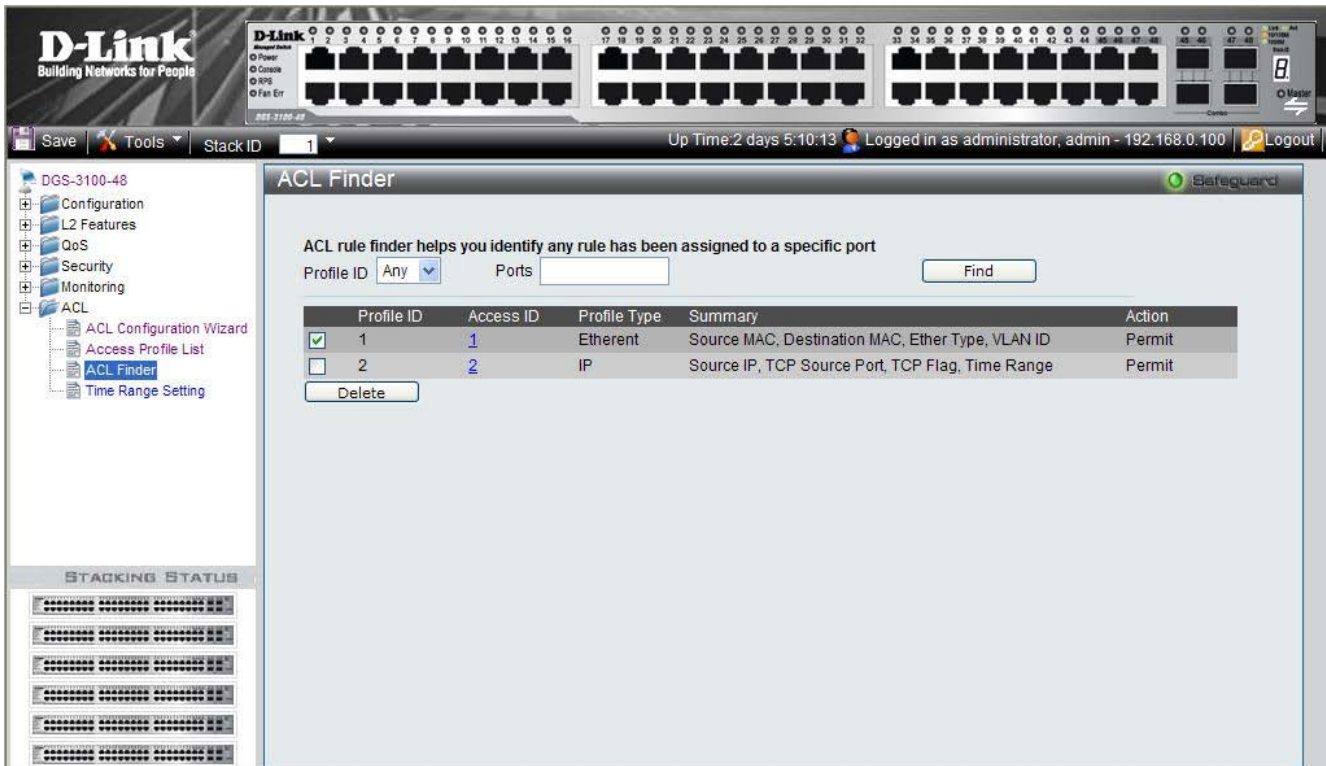

**Figure 8-22. ACL Finder Page**

The ACL Finder Page contains the following fields:

Field	Description
<b>Profile ID (list box)</b>	Defines the Profile ID for the search
<b>Ports</b>	Indicates the ports or LAGs for which rules are sought
<b>Profile ID</b>	Indicates the Profile ID
<b>Access ID</b>	Indicates the ACL rule ID number.
<b>Profile Type</b>	Indicates if the profile is IP or Ethernet
<b>Summary</b>	Displays the access rule.
<b>Action</b>	Displays the action chosen for the profile.

2. Define the *Profile ID* and *Ports* fields.
3. Click . The ACL rule is displayed.

To delete an ACL Profile entry:

1. Select the entry.
2. Click . The entry is deleted.
3. Click . The entry is deleted.

To view or define the rule details:

1. Click the Access ID (linked number). The *Rule Detail Page* opens:

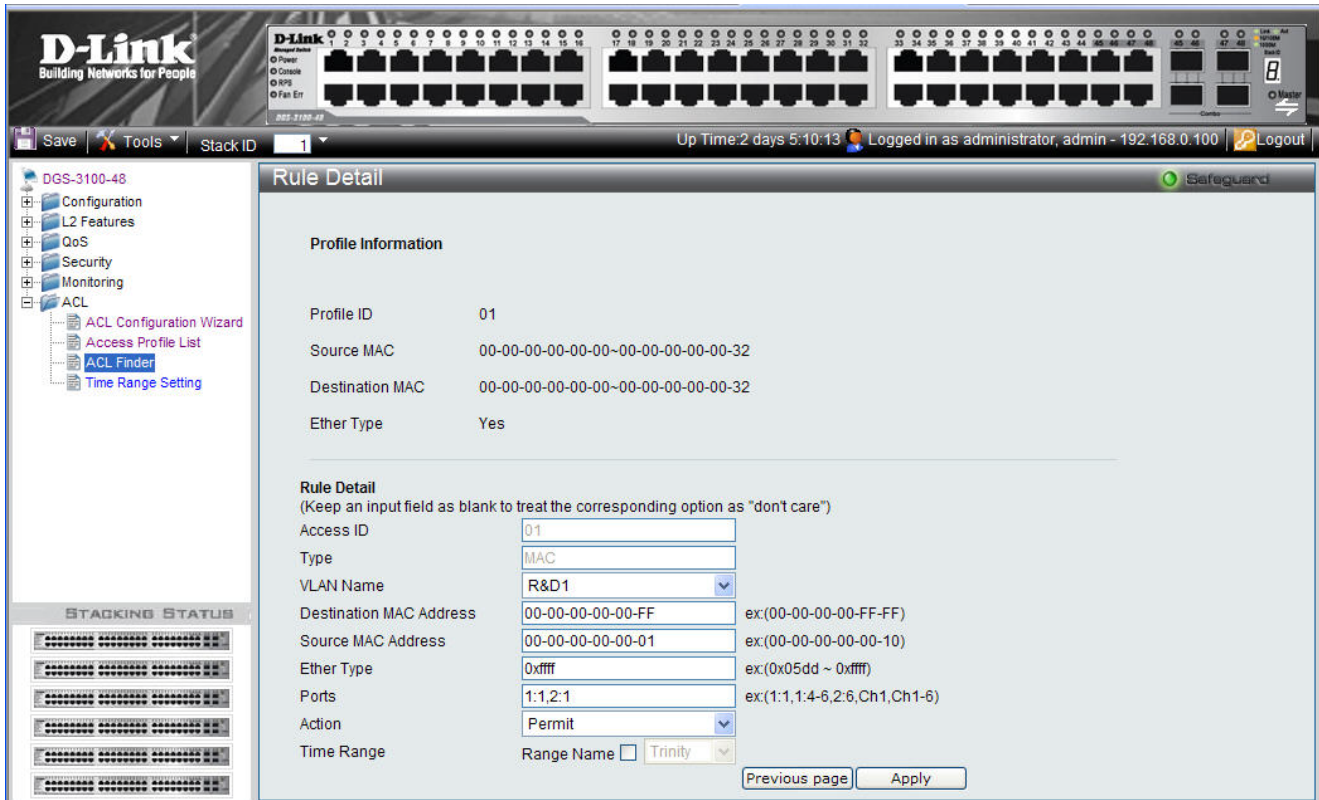
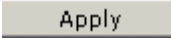

Figure 8-23. Rule Detail Page

The Rule Detail Page contains the following fields:

Field	Description
<b>Profile ID</b>	Displays the profile ID range.
<b>Source MAC</b>	Displays the Source MAC range.
<b>Destination MAC</b>	Displays the destination MAC range.
<b>Ether Type</b>	Displays if Ether Type is included.
<b>Access ID</b>	Defines the Access ID
<b>Type</b>	Displays the profile type (can be MAC based or IP based).
<b>VLAN Name</b>	Defines the user-defined VLAN name.
<b>Destination MAC Address</b>	Matches the destination MAC address to which packets will be subject to action.
<b>Source MAC Address</b>	Matches the source MAC address to which packets will be subject to action.
<b>Ether Type</b>	Defines the code type used.
<b>Ports</b>	Indicates the ports or LAGs for which rules are sought.
<b>Action</b>	Defines the action for the profile. The possible fields are: <i>Permit</i> — Forwards packets if all other ACL criteria are met. <i>Deny</i> — Drops packets if all other ACL criteria is met. <i>Rate Limiting</i> — Rate limiting is activated if all other ACL criteria are met. <i>Change IP priority</i> — VPT (CoS) value is changed if all other ACL criteria is met. <i>Replace DSCP</i> — Reassigns a new DSCP value to the packet if all other ACL criteria are met.
<b>Time Range</b>	Specifies whether the access rule is time-based.
<b>Range Name</b>	Selects the user-defined time range name to apply to the access rule.

2. Define the *Rule Detail* fields.
3. Click . The rule is defined, and the device is update



## Defining Time Ranges

Time-based ACLs allow users to define Access Control Lists based on time periods. The *Time Range Setting Page* defines a time range, which can be applied to an ACL rule. To define a time range:

1. Click **ACL > Time Range Setting**. The *Time Range Setting Page* opens:

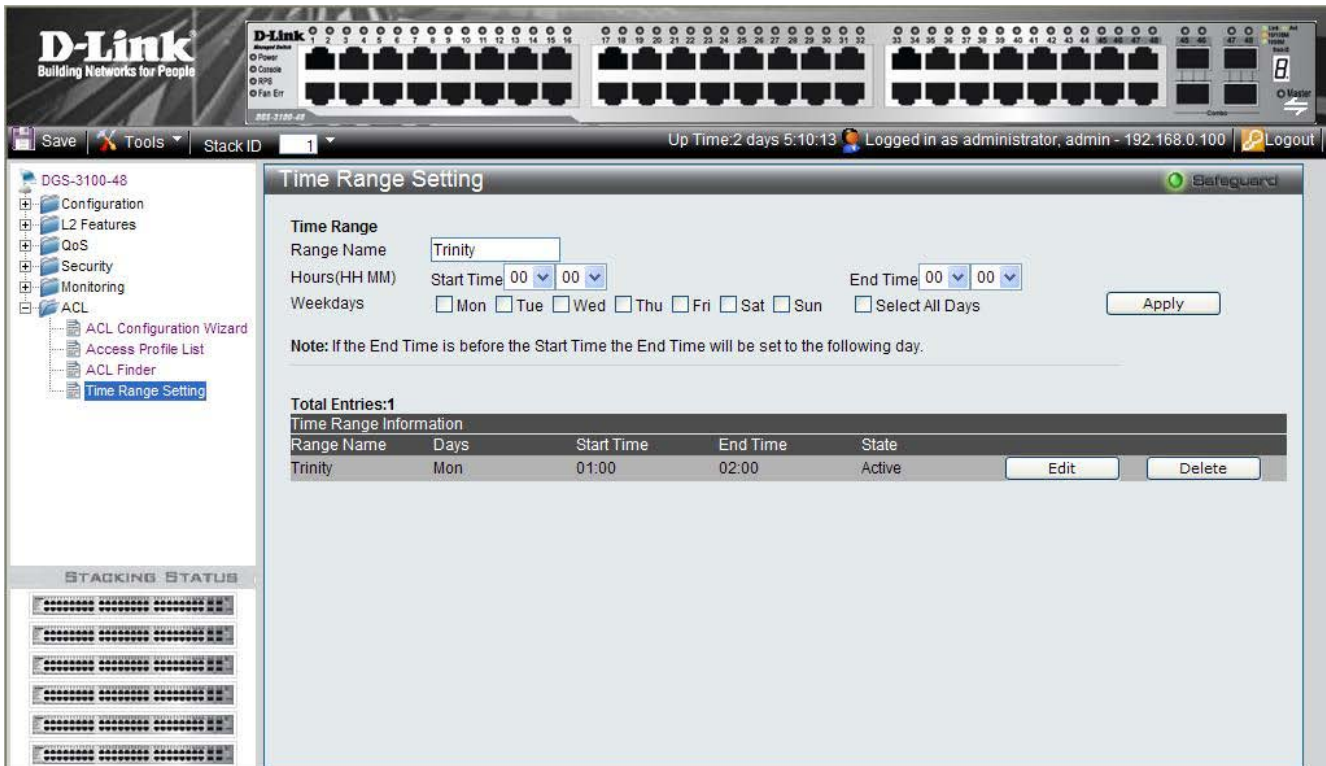

**Figure 8-24. Time Range Setting Page**

The Time Range Setting Page contains the following fields:

Field	Description
<b>Range Name</b>	Defines the Time Range Name. Up to 32 time ranges can be defined.
<b>Start Time (HH:MM)</b>	Specifies the time at which the time-based ACL is enabled. The field format is HH:MM. The possible field values are: <i>HH</i> : 00 – 23 (hours, in military format) <i>MM</i> : 00 – 59 (minutes)
<b>End Time (HH:MM)</b>	Specifies the time at which the time-based ACL is disabled. The field format is HH:MM. The possible field values are: <i>HH</i> : 00 – 23 (hours, in military format) <i>MM</i> : 00 – 59 (minutes)
<b>Weekdays</b>	Specifies the weekdays for which the time range applies.
<b>Select All Days</b>	Specifies that the time range is applied daily.

2. Define the *Range Name*, *Start Time* and *End Time* fields.
3. To define the applicable days, check the specific *Weekdays* or check *Select All Days*.
4. Click **Apply**. The Time Range is defined.

To delete a Time Range entry:

1. Select the entry.

2. Click **Delete**. A confirmation window is displayed.
3. Click **OK**. The entry is deleted.

To view or modify Time Range settings:

4. Click **Edit**. The *Time Range Edit Page* opens:

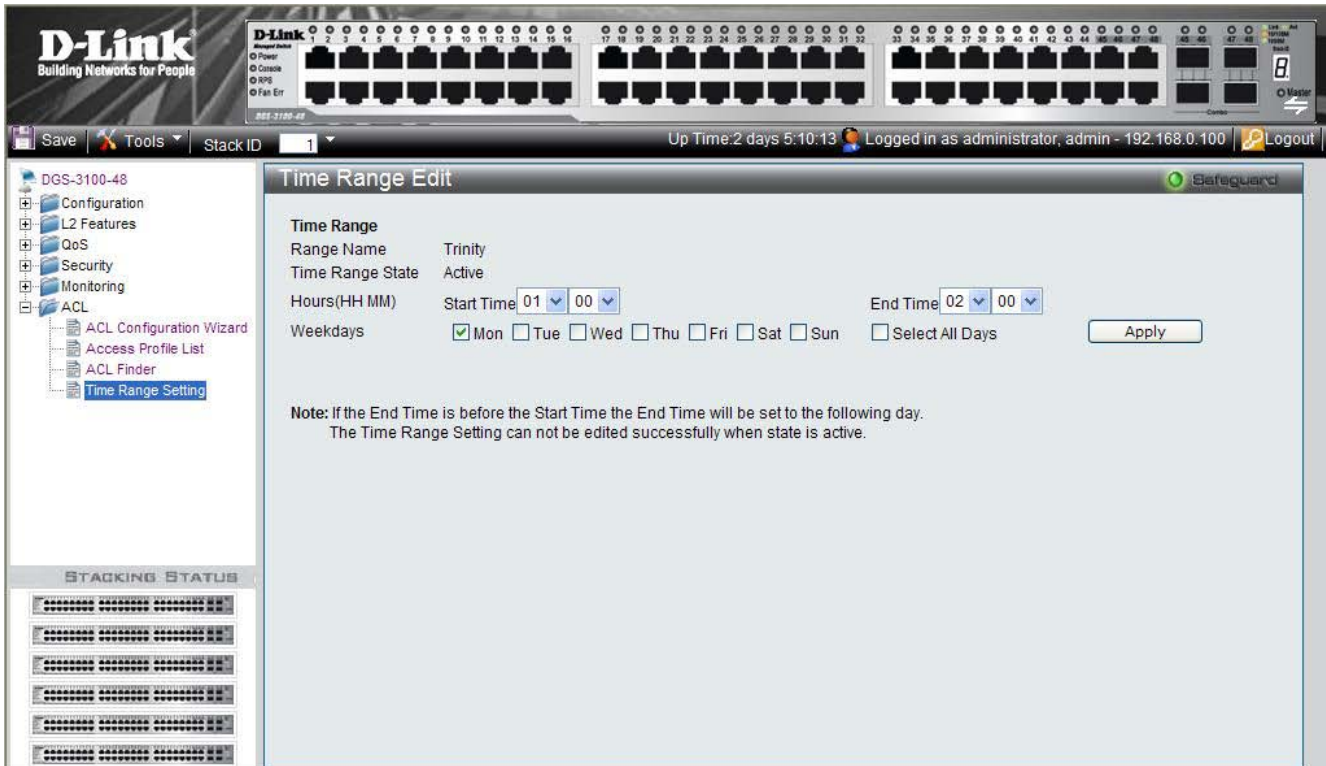

**Figure 8-25. Time Range Edit Page**

5. Define the *Time Range Edit* fields.
6. Click **Apply**. The time range is modified, and the device is updated

## Notes about 'IP' and 'MAC' Based ACLs in the DGS-3100 Series

ACLs can be configured in DGS-3100 series via the WEB GUI in two ways: through the 'ACL Configuration Wizard' screen (by automatic creation of profile and rule) and through the 'ACL Profile List' page by manual creation of profiles and rules.

By using the 'ACL Configuration Wizard' page the user can create simple ACLs in a simple way, after setting a rule via this page, the system will create an 'Access Profile' and also an 'Access Rule' and will bind it to a port/LAG or a group of ports/LAG. Each operation via the Wizard can create either MAC based ACL or IP based ACL, the user can't combine both types of ACLs in the same operation.



**NOTE:** Access Profile can be a MAC Access Profile or an IP Access Profile, when using the ACL Configuration Wizard, 'IP' or 'MAC' should be selected in the 'From' and 'To' dropdowns. When using the 'Access Profile List' page, after clicking: 'Add Access Profile', the user can choose whether to create 'L2 ACL' (MAC) or 'L3 ACL' (IP).

- The user can set IP based ACL and MAC Based ACL on the same port(s) in the following way:
  - Go to 'Add Access Profile' page.
  - Add L2 Access Profile with the desired fields.

- Add L3 Access Profile with the desired fields.
  - Go to 'Access Rule List' page, create rules for both profiles and apply it on the same port(s) /LAG(s).
- Now you have on the port(s) /LAG(s) IP Based ACL and MAC Based ACL.



**NOTE:** Adding rules to specific profile will have a unique Access ID in the range 1-240.  
When the user is adding a rule to different profiles he can't use the same Access ID for different rules.

## Notes about ACLs capacity in the DGS-3100 Series

- The user can create up to 15 Access Profiles.
- The user can configure up to 240 Access IDs, each Access ID is unique i.e. the same Access ID can't be created from two different Access Profiles.
- The maximum capacity of DGS-3100 series is 240 rules.
- The rules count will be done according to the following guidelines:
- The user should accumulate the rules of every unique set of rules (a unique set of rules is the same set of rules which is bound to one or more than one ports) /LAG(s)..
- The outcome of the above is that Access ID will be counted as a rule 'n' times where 'n' is the number of different settings of rules on different ports /LAG(s)..
  
- Examples for capacity calculations:
- Example #1:
  - Assume that Access IDs 1, 2, 3, 4 are bound to ports: 1-30, this is a unique set of rules and the count of rules in this case is 4.
  - Assume that Access IDs 5, 6 are bound to ports: 31-40, this is another unique set of rules and the count of additional rules will be 2.
  - Totally in the system we will use 6 rules out of the available 240!
  
- Example #2:
  - Assume that Access IDs 1, 2, 3, 4 are bound to ports: 1-10, this is a unique set of rules and the count of rules in this case is 4.
  - Assume that Access IDs 4, 5, 6 are bound to ports: 11-20, this is another unique set of rules and the count of additional rules will be 3.
  - In addition, Access IDs 5, 6 are bound to ports: 21-30, this is another unique set of rules and the count of additional rules will be 2.
  - Totally in the system there are: **4 + 3 + 2 = 9 rules!**



**NOTE:** ACL with action of Rate Limit can be applied only on one port/LAG at a time.

This type of ACL is treated by the system as a unique ACL on each port it is bound to, so all the rules on a port/LAG which has an ACL with Rate Limit action will be counted and consumed hardware resources.

From this reason, ACLs with Rate Limit action should be used very carefully, since the system maximum rule capacity can be reached if the user (for example) applies this rule on 240 ports. (which is less than the capacity of a full 6 unit stack of 48 ports switches.)

---

## **CONNECTORS AND CABLES**

This section describes the devices physical interfaces and provides information about cable connections. Stations are connected to the device ports through the physical interface ports on the front panel, whereas devices are connected to create stacking by connecting the HDMI interface ports located on back panel.

. The following pin connectors are described:

- Pin Connections for the 10/100/1000 Ethernet Interface
- Pin Connections for the HDMI Connector

## Pin Connections for the 10/100/1000 Ethernet Interface

The switching port can connect to stations wired with standard RJ-45 Ether straight or crossed cables. The following figure illustrates the pin allocation.

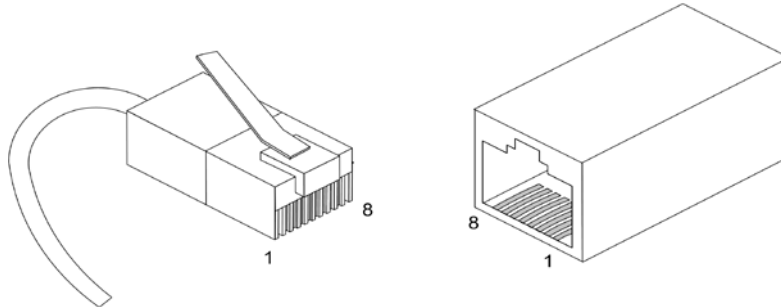

**Figure A-1. RJ-45 Pin Allocation**

### RJ-45 Ports Pinout

The following table describes the pin allocation of the RJ-45 and the console ports:

PIN	SIGNAL NAME
1	TxRx 1+
2	TxRx 1-
3	TxRx 2+
4	TxRx 2-
5	TxRx 3+
6	TxRx 3-
7	TxRx 4+
8	TxRx 4-

**Table 2: RJ-45 Pin Assignments**

## Pin Connections for the HDMI Connector

The stacking ports are used for connecting units using a standard HDMI cable.

The following figure illustrates the HDMI connector pin allocation:



Figure A-2. HDMI Pin Allocation

### HDMI Ports Pinout

The following table describes the pin allocation of the HDMI connector:

PIN	SIGNAL NAME	PIN	SIGNAL NAME
1	TMDS Data 2+	11	TMDS Clock Shield
2	TMDS Data 2 Shield	12	TMDS Clock-
3	TMDS Data 2	13	CEC
4	TMDS Data 1+	14	No Connect
5	TMDS Data 1 Shield	15	DDC Clock
6	TMDS Data 1-	16	DDC Data
7	TMDS Data 0+	17	Ground
8	TMDS Data 0 Shield	18	+5V Power
9	TMDS Data 0-	19	Hot Plug Detect
10	TMDS Clock+	20	SHELL

Table 3: HDMI Pin Assignments

## SYSLOG ERRORS

The Syslog Error Message Table displays a list of Syslog error messages appearing on the Switch according to level of severity and category, while providing a description for each error. There are seven levels of severity which are based on a hierarchy of severities. “Emergency” is the highest and “Debug” is the lowest. The user can only configure “All”, “Informational” and “Warning”. When a user configures a specific level, it applies to the configured level and all the levels above. For example, if a user defines an “Information” error message, it will apply to all messages from the “Informational” severity level up to the “Critical” level.

The seven severity levels are:

- 1. Critical
- 2. Warning
- 3. Error
- 4. Alert
- 5. Notice
- 6. Informational
- 7. Debug
- All – Represents Debug and above.

The following table displays the Syslog Error Messages:

**Table 4: Syslog Error Message Table**

ID	SEVERITY	CATEGORY	MESSAGE	DESCRIPTION
SYSLG6.4.0	Critical		%(1)s	
SYSLG8.16.10	Critical		No memory 1	
SYSLG8.16.11	Critical		No memory 2	
SYSLG8.16.16	Critical	web	No free connection at the moment - wait one minute and retry.	Currently there is no free connection available. Wait one minute and retry.
SYSLG8.16.17	Critical	System	No free memory	No free memory available.
SYSLG8.16.18	Critical	System	No free UDP port	The system must be restarted.
SYSLG8.16.29	Critical	System	Cannot create private memory pool	Cannot create a private memory pool.
SYSLG8.16.31	Critical	AAA	Session amount exceeded	Session amount exceeded.
SYSLG8.16.6	Critical	Up/Download	Illegal file type	Illegal file type.
SYSLG8.16.9	Critical	Up/Download	Duplication of file name	A file name is duplicated.
SYSLG8.47.35	Critical	IP	Select master IP failed on ifIndex %(1)j@	Selected master IP failed on the specified ifIndex.
SYSLG8.47.37	Critical	IP	Primary IP address could not be obtained@	Primary IP address could not be obtained.
SYSLG8.47.8	Critical		Table is empty@	The table is empty.
SYSLG8.49.22	Critical		sshTlp_packet_read_packet: Padding error - need %(1)d block %(2)d mod %(3)d	



ID	SEVERITY	CATEGORY	MESSAGE	DESCRIPTION
SYSLG8.49.24	Critical	SSH	sshTlp_kex_setup: Insufficient memory to perform key exchange.	Insufficient memory available to perform a key exchange.
SYSLG8.63.10	Critical	Stack	UNIT ID %(1)d,Msg:%(2)s	
SYSLG8.63.2	Critical	Stack	UNIT ID %(1)d,Trap:%(2)s	
SYSLG8.74.46	Critical	System	Cannot allocate memory for %(1)s	
SYSLG8.74.48	Critical	System	Create area %(1)s - cannot be inserted to list	The created specified area cannot be inserted into the list.
SYSLG8.16.16	Critical	web	No free connection at the moment - wait one minute and retry.	Currently there is no free connection available. Wait one minute and retry.
SYSLG8.16.17	Critical	System	No free memory	No free memory available.
SYSLG8.16.18	Critical	System	No free UDP port	The system must be restarted.
SYSLG8.16.29	Critical	System	Cannot create private memory pool	Cannot create a private memory pool.
SYSLG8.16.31	Critical	AAA	Session amount exceeded	Session amount exceeded.
SYSLG8.16.6	Critical	Up/Download	Illegal file type	Illegal file type.
SYSLG8.16.9	Critical	Up/Download	Duplication of file name	A file name is duplicated.
SYSLG8.47.35	Critical	IP	Select master IP failed on ifIndex %(1)j@	Selected master IP failed on the specified ifIndex.
SYSLG8.47.37	Critical	IP	Primary IP address could not be obtained@	Primary IP address could not be obtained.
SYSLG8.47.8	Critical		Table is empty@	The table is empty.
SYSLG8.49.22	Critical		sshTlp_packet_read_packet: Padding error - need %(1)d block %(2)d mod %(3)d	
SYSLG8.49.24	Critical	SSH	sshTlp_kex_setup: Insufficient memory to perform key exchange.	Insufficient memory available to perform a key exchange.
SYSLG8.63.10	Critical	Stack	UNIT ID %(1)d,Msg:%(2)s	
SYSLG8.63.2	Critical	Stack	UNIT ID %(1)d,Trap:%(2)s	
SYSLG8.74.46	Critical	System	Cannot allocate memory for %(1)s	
SYSLG8.74.48	Critical	System	Create area %(1)s - cannot be inserted to list	The created specified area cannot be inserted into the list.
SYSLG1.0.50	Error	IP	Invalid TFTP server IP Address, or Invalid / missing Instruction filename : %(1)s. Auto	Invalid TFTP server IP Address, or Invalid / missing instruction in the specified file name. The

ID	SEVERITY	CATEGORY	MESSAGE	DESCRIPTION
			Update aborted.	Auto Update process is aborted.
SYSLG1.0.51	Error	Up/Download	Failed to download the instruction File %(1)s. Auto Update aborted.	Failed to download the specified instruction File. The Auto Update process is aborted.
SYSLG1.0.52	Error	Up/Download	Failed to download File %(1)s. Auto Update aborted.	Failed to download specified file. The Auto Update process is aborted.
SYSLG1.0.53	Error	Up/Download	Failed to download File %(1)s. Auto Update aborted.@ reason : %(2)s	Failed to download specified file. The Auto Update process is aborted because of the specified reason.
SYSLG1.0.54	Error	AAA	Copy failed. Please verify that the configuration line in the instruction matches the name of the configuration file and that file exists on the server.	Copy failed. Please verify that the configuration line in the instruction matches the name of the configuration file and that file exists on the server.
SYSLG1.0.60	Error	Up/Download	Invalid auto update instruction file. Auto update aborted	The auto update instruction file is invalid. The Auto update process is aborted.
SYSLG1.0.61	Error	AAA	Can't restore factory defaults during auto update operation	The system could not restore the factory defaults during the auto update operation.
SYSLG1.5.21	Error	Stack	Lost connection with unit %(1)d reason 0x%(2)x. Unit will be rebooted .	Connection with the specified unit has been lost due to the specified reason. The unit will be rebooted.
SYSLG1.5.22	Error	Stack	Unit %(1)d was shutdown.	The specified unit was shutdown.
SYSLG4.10.1	Error		Transmission failed	Transmission has failed.
SYSLG4.11.0	Error	System	Reset to asic num %(1)d failed	The specified ASIC reset has failed.
SYSLG4.14.16	Error	System	Failed to get TAPI software version	Failed to get the TAPI software version.
SYSLG4.14.17	Error	System	Failed to get CORE software version	Failed to get the CORE software version.
SYSLG4.15.5	Error		%(1)s: Wrong mdix operative status	The mdix operative status is wrong.
SYSLG4.15.7	Error	Interface	ifIndex %(1)d - operation mode %(2)s	
SYSLG5.1.0	Error		%(1)s: Status %(2)s, value %(3)d	
SYSLG5.1.29	Error	VLAN	Failed to add entry for vlan %(1)d, mac %(2)s	Failed to add an entry for the specified VLAN and specified MAC address.
SYSLG5.1.30	Error	VLAN	Failed to delete entry for	Failed to delete an entry for

ID	SEVERITY	CATEGORY	MESSAGE	DESCRIPTION
			vlan %(1)d, mac %(2)s	the specified VLAN and specified MAC address.
SYSLG5.4.0	Error	Interface	SW3P_callback_rx_frame : Unknown frame encapsulation	Unknown frame encapsulation.
SYSLG6.0.0	Error	Up/Download	Boot image download aborted	The Boot image download process is aborted.
SYSLG6.0.10	Error	Up/Download	Flash programming failed	Flash programming has failed.
SYSLG6.0.11	Error	Security	Block programming failed	The Block programming process failed.
SYSLG6.0.4	Error	Up/Download	Boot image code file is too long	Boot image code file is too long.
SYSLG6.0.6	Error		Illegal format	Illegal format encountered.
SYSLG6.0.7	Error	Up/Download	The received file is not valid - download again!	The file received is invalid. The file needs to be downloaded again.
SYSLG6.0.8	Error	Up/Download	Boot1 programming failed, it is not valid any more	The Boot1 programming process failed, because it is not valid any more.
SYSLG6.0.9	Error	Up/Download	Boot2 programming failed, it is not valid any more	The Boot2 programming process failed, because it is not valid any more.
SYSLG7.0.121	Error	System	Memory overflow	There has been a memory overflow.
SYSLG7.0.130	Error	FDB	No free mac address	There is no free MAC address.
SYSLG7.0.78	Error	SNMP	Port %(1)j doesn't accept administrative parameter %(2)s@	The specified administrative parameter is not accepted.
SYSLG7.0.79	Error	Interface	Port %(1)j doesn't support %(2)s parameter@	The specified parameter is not supported.
SYSLG7.0.97	Error	VLAN	Memory overflow while creating the aggregateVlan Table@	Memory overflowed while creating the aggregate VLAN table.
SYSLG8.100.30	Error		Unable to synchronize a backup - dmanager problem: error - %(1)s, function - %(2)s	The Master is unable to synchronize the backup with the file. The data may be lost.
SYSLG8.100.32	Error	Up/Download	Wrong file version is received by backup unit.	Wrong file version is received by backup unit.
SYSLG8.100.33	Error	Up/Download	Wrong file size of backup unit.	The backup is not synchronized with a file.
SYSLG8.100.35	Error	Stack	The file update message from old master was received on backup unit. The file is ignored	The file update message from old master was received on backup unit. The file is ignored
SYSLG8.107.0	Error	FDB	Bad IGMP version@	The IGMP version is invalid.

ID	SEVERITY	CATEGORY	MESSAGE	DESCRIPTION
SYSLG8.107.1	Error	VLAN	Bad vlan tag@	The VLAN tag is invalid.
SYSLG8.107.2	Error		Inconsistent vlan count@	Inconsistent VLAN count.
SYSLG8.108.1	Error	IP	IPL4GENG_init: UDP port reservation failed	The UDP port reservation has failed.
SYSLG8.110.12	Error	SNMP	received %(1)s interval is less than min value	The specified received interval is less than minimum value.
SYSLG8.110.13	Error	SNMP	calculated %(1)s interval is less than min value	The calculated specified interval is less than the minimum value.
SYSLG8.2.2	Error	System	Buffer allocation failed.	Buffer allocation failed.
SYSLG8.20.11	Error	IP	ARP Table Overflow	The ARP Table is full.
SYSLG8.20.13	Error	System	Init config failed	The initialization process failed.
SYSLG8.22.1	Error	IP	IP forwarding result is undefined	The IP forwarding result is undefined.
SYSLG8.26.1	Error	System	Errors occurred during initialization	Errors occurred during the initialization process.
SYSLG8.26.9	Error		%(1)s: Errors occurred during initialization	The specified errors occurred during the initialization process.
SYSLG8.31.12	Error	AAA	Authentication failed for %(1)s, source - %(2)s	
SYSLG8.31.29	Error	AAA	Radius returned attribute error	The RADIUS has found an erroneous attribute
SYSLG8.31.30	Error	SNMP	Unknown variable	Unknown code or status is encountered.
SYSLG8.31.31	Error	AAA	User name received empty string	The user name is an empty string
SYSLG8.45.15	Error	Up/Download	Creating/updating entry in copy history table failed	Failed to creating/update an entry in the Copy History table.
SYSLG8.45.21	Error	Up/Download	Could not add message to copy messages table	Could not add a message to the Copy Messages table.
SYSLG8.45.5	Error	System	COPYG_init: Errors occurred during init	Errors occurred during initialization.
SYSLG8.47.33	Error	IP	Primary IP Address %(1)s was deleted@	The specified primary IP address was deleted.
SYSLG8.49.1	Error	SSH	SSH error: %(1)s	
SYSLG8.49.16	Error	SSH	sshHostKeySave: DER formatted private key string too long (%(1)d bytes).@The key could not be saved to flash.	The DER formatted private key string too long. The key could not be saved to flash.
SYSLG8.49.21	Error	SSH	sshAuthpTreatMessage: Unable to allocate connection	Unable to allocate a connection.

ID	SEVERITY	CATEGORY	MESSAGE	DESCRIPTION
SYSLG8.49.3	Error	SSH	Unable to allocate memory pool for SSH	Unable to allocate a memory pool for SSH.
SYSLG8.49.30	Error	SSH	sshp_text_handler: Unable to allocate memory for incoming text from the ssh connection. Data may have been lost.	Unable to allocate memory for incoming text from the SSH connection. Data may have been lost.
SYSLG8.49.4	Error	System	balloc: could not allocate %(1)d bytes (%(2)d)	Could not allocate the specified bytes.
SYSLG8.49.5	Error	Port Security	bfree: Cannot free memory: block is corrupt	Cannot free memory: The memory block is corrupt.
SYSLG8.49.6	Error	Port Security	bfree: Freeing more memory than was used	More memory was used,
SYSLG8.5.143	Error	SNMP	Unknown field %(1)s	The specified field is unknown.
SYSLG8.5.158	Error	System	Cannot update Hash	Cannot update the Hash.
SYSLG8.5.160	Error	System	Cannot clean Hash	Cannot clean the Hash values.
SYSLG8.5.161	Error	System	Cannot insert entry to Hash	Cannot insert an entry into Hash.
SYSLG8.5.162	Error	System	Cannot delete entry from Hash	Cannot delete an entry from Hash.
SYSLG8.5.180	Error	System	GCLIP_mib2cli_analyze_command: Cannot insert entry to Hash	Cannot insert an entry to Hash.
SYSLG8.5.181	Error	SNMP	Length is limited by 160 characters	The field length is limited by 160 characters.
SYSLG8.56.3	Error	Interface	Failed to set default priority@	Failed to set default priority.
SYSLG8.58.4	Error	Security	Failed to update queue@	Failed to update queue.
SYSLG8.6.6	Error	VLAN	Too Many Vlan.	Too many VLANs are defined.
SYSLG8.61.0	Error		%(1)s: Errors occurred during initialization	Errors occurred during initialization.
SYSLG8.63.11	Error	Stack	UNIT ID %(1)d,Msg:%(2)s	
SYSLG8.63.3	Error	Stack	UNIT ID %(1)d,Trap:%(2)s	
SYSLG8.73.1	Error	System	Errors occurred during initialization	Errors occurred during the initialization process.
SYSLG8.74.57	Error	SSH	Packet RX on interface %(1)s from %(2)s type %(3)s - %(4)s	Key IDs do not match; keys are expired or some other key configuration problems.
SYSLG8.74.58	Error	SSH	Packet RX on virtual interface %(1)s area %(2)s type %(3)s - %(4)s	Key IDs do not match; keys are expired or some other key configuration problems.
SYSLG8.75.1	Error	IP	SVNZIP encountered data	SVNZIP encountered the

ID	SEVERITY	CATEGORY	MESSAGE	DESCRIPTION
			error %(1)d in the file %(2)s	specified data error in the specified file.
SYSLG8.75.11	Error	Web	PGPRCS: Failed to open the page %(1)s - in <PGPRCSP_createPageB uffer>.	Failed to open the specified page.
SYSLG8.75.12	Error	Web	You must give the "html/" path as parameter@	The "html/" path must be given as a parameter.
SYSLG8.75.13	Error		We support up to %(1)d different paths.@	Up to the specified number of paths are supported.
SYSLG8.75.14	Error	Up/Download	Could not open the txt file you supplied@	The supplied text file could not be opened.
SYSLG8.75.15	Error	Web	EmbWeb init: error initializing The WebServer@	Error occurred initializing the WebServer.
SYSLG8.75.16	Error	Web	WEBSRVG_task: Failure fetching from pipe@	Failure fetching data from a pipe.
SYSLG8.75.17	Error	Web	WEBUTILG_snprintf: result too big	The WEBUTILG_snprintf result is too large.
SYSLG8.75.2	Error	IP	SVNZIP out of memory extracting file %(1)s	SVNZIP process encountered memory problems while extracting the specified file.
SYSLG8.75.21	Error		%(1)s	
SYSLG8.75.3	Error	IP	SVNZIP found CRC Error extracting file %(1)s	SVNZIP found a CRC error while extracting the specified file.
SYSLG8.75.33	Error	Web	PGPRCS: Found no end tag, between two tags.	No end tag, encountered between two tags.
SYSLG8.75.4	Error	IP	Can't get hostname	A hostname cannot be received.
SYSLG8.75.43	Error	Web	PGPRCS: Trying to set tag %(1)s which does not exist in the page	Trying to set the specified tag which does not exist in the page.
SYSLG8.75.5	Error	Web	GOAHEADG: Received illegal buffer length in HTTP Post request	Received an illegal buffer length error in an HTTP Post request.
SYSLG8.75.59	Error		WARNING - The "if- modified-since" date can not be taken from the system so it will be set to 1/1/1970	WARNING - The "if- modified-since" date can not be taken from the system so it will be set to 1/1/1970
SYSLG8.75.6	Error		Bad %(1)s pointer	The specified pointer is invalid.
SYSLG8.75.60	Error	Web	The HTTP Buffer sent is to big.@ The buffer size can be up to %(1)d bytes@	The HTTP Buffer sent is to big The buffer size can be up to the specified number of bytes.
SYSLG8.75.61	Error		WB_KERN: in	

ID	SEVERITY	CATEGORY	MESSAGE	DESCRIPTION
			WEBSRVG_sendSslGoA head got post header chunk without Content Length Attribute.@	
SYSLG8.75.62	Error	IP	SVNZIP found an error %(1)u extracting file %(2)s	SVNZIP found an error while extracting the specified file.
SYSLG8.75.63	Error	IP	SVNZIP file %(1)s not found	The specified SVNZIP file not found.
SYSLG8.75.65	Error	IP	EmbWeb init: error initializing The UPNP BIN File@	Error occurred initializing the UPNP BIN file.
SYSLG8.75.67	Error	Web	PGPRCS: Field posted value exceeded allowed size.@	Posted field value exceeded the allowed size.
SYSLG8.75.68	Error	Web	GOAHEADG: Received illegal length (%(1)d) for field (%(2)s) in HTTP request.@	In the HTTP request the specified field length is illegal.
SYSLG8.75.69	Error	Web	GOAHEADG: Received illegal URL in HTTP request.@	Received an illegal URL in an HTTP request.
SYSLG8.75.7	Error	IP	GOAHEADG: Couldn't open a socket on port %(1)d - Will open the socket on port %(2)d@	Could not open a socket on the specified port. The socket will be opened on the second specified port.
SYSLG8.75.70	Error	Web	GOAHEADG: Received HTTP header request exceeded allowed size.@	Received an HTTP header request to exceeded allowed size.
SYSLG8.75.71	Error	Web	GOAHEADG: Couldn't find web service struct entry.@	Could not find a web service struct entry.
SYSLG8.75.72	Error	Web	GOAHEADG: Couldn't create web service struct entry.@	Could not create a web service struct entry.
SYSLG8.75.74	Error	Web	GOAHEADG: missing HTTP file transfer mandatory Data.@	Missing mandatory HTTP file transfer data.
SYSLG8.75.75	Error	Web	GOAHEADG: Failed to Reserve Port %(1)d on System Initialization.@	Failed to reserve the specified port while the system is initialized.
SYSLG8.75.8	Error	IP	GOAHEADG: Couldn't open a socket on ports %(1)d - %(2)d	Could not open a socket on the specified ports.
SYSLG8.75.80	Error	Web	Listener port %(1)u configured for WEB service %(2)s is not available@	The specified Listener port configured for the specified WEB service is not available.
SYSLG8.77.25	Error	System	Cannot add new session - DB overflow!	Cannot add new session because of the DB overflow.

ID	SEVERITY	CATEGORY	MESSAGE	DESCRIPTION
SYSLG8.78.8	Error	System	Cannot allocate memory for user	The system cannot allocate memory for user.
SYSLG8.78.9	Error	System	Cannot create timer for user	The system cannot create a timer for user.
SYSLG8.83.5	Error	Up/Download	Backup %(1)d failed during runtime configuration @	The specified backup failed during runtime configuration.
SYSLG8.85.0	Error	Security	Unknown source received	An unknown source is received.
SYSLG8.85.1	Error	Web	Translation from url to name had failed	Translation from URL to name had failed.
SYSLG8.86.1	Error	SNMP	The enterprise given for trap is too long.	The given enterprise for trap is too long.
SYSLG8.86.2	Error	SSH	Not enough space for key of variable %(1)lu of trap %(2)lu.	There is not enough space for the key of the specified variable of the specified trap.
SYSLG8.86.26	Error		Memory not freed - SNMP Package: %(1)s Routine: %(2)d Location: %(3)d Size: %(4)d Unfreed block: %(5)s	
SYSLG8.86.29	Error		SNMP Package: %(1)s Routine: %(2)d Location: %(3)d Error: %(4)s	
SYSLG8.86.3	Error	SNMP	Not enough space for instance id of variable %(1)lu of trap %(2)lu.	There is not enough space for the instance ID of the specified variable of the specified trap.
SYSLG8.86.7	Error		SNMPCOMMG_StoreInitialCommunityEntry : no free community entry available	No free community entry is available.
SYSLG8.89.6	Error	SNMP	Unexpected entry fields were found in CDB, variable %(1)s	Unexpected entry fields were found in the specified CDB, and specified variable.
SYSLG8.89.7	Error	System	MIB variable %(1)lu not supported	The specified MIB variable is not supported.
SYSLG8.90.0	Error	AAA	Keymanager: Failed to send to backup	Failed to send to backup.
SYSLG8.90.1	Error	SSH	Keymanager: Size of the data exceeded	Size of the data exceeded.
SYSLG8.94.15	Error	System	Init: %(1)s	
SYSLG8.96.10	Error	Interface	Autogeneration of self-signed certificate was failed	Autogeneration of self-signed certificate has failed.
SYSLG8.97.17	Error	System	Buffer for notifying applicaton %(1)s could	The buffer for notifying the specified application could



ID	SEVERITY	CATEGORY	MESSAGE	DESCRIPTION
			not be allocated.	not be allocated.
SYSLG8.97.18	Error	System	Memory for notifying applicaton %(1)s could not be allocated.	Memory for notifying the specified application could not be allocated.
SYSLG1.0.55	Informational	Up/Download	File %(1)s has been Auto Updated	The specified file has been Auto Updated.
SYSLG1.0.56	Informational	Up/Download	Auto Update Completed; rebooting the switch	Auto Update is completed. The switch is being; rebooted.
SYSLG1.0.59	Informational	Up/Download	Active image successfully changed to image %(1)d	Active image is successfully changed to the specified image.
SYSLG1.2.4	Informational		entity configuration change trap.	
SYSLG1.3.0	Informational	Interface	Pse Port %(1)s delivering power to the PD.@	The specified PSE port is delivering power to the PD.
SYSLG1.3.1	Informational	System	PSE power usage %(1)d in unit %(2)d is above the threshold.@	The PSE power used by the specified unit is above the threshold.
SYSLG1.3.2	Informational	System	PSE power usage %(1)d in unit %(2)d is below the threshold.@	The PSE power used by the specified unit is below the threshold.
SYSLG1.5.23	Informational	Interface	Unit %(1)d was shutdown - JUMBO frames not supported.	The specified unit is shutdown because Jumbo frames are not supported.
SYSLG1.5.24	Informational	Stack	Master switchover: unit %(1)d is now master.	The specified unit is now the Master unit.
SYSLG1.5.25	Informational	Stack	Backup master unit %(1)d was removed from the stack.	The specified backup master is removed from the stack.
SYSLG1.5.26	Informational	Stack	Unit %(1)d was removed from the stack.	The specified unit is removed from the stack.
SYSLG1.5.28	Informational	IP	Ipc connection with unit %(1)d failed.	The IPC connection with the specified unit has failed.
SYSLG1.5.29	Informational		Configuration changed: %(1)s	
SYSLG1.5.30	Informational	Stack	Stack cable %(1)s : link %(2)s on unit-%(3)d	The specified stacking cable is connected to the specified unit.
SYSLG1.6.11	Informational		PS# %(1)d status changed - %(2)s.	The system uses two power supply sources: #1 and #2. The system can operate with one or both power supply units. The power supply has changed.
SYSLG1.6.8	Informational	System	FAN# %(1)d status changed - %(2)s.	The specified fan status has changed.
SYSLG4.10.13	Informational		Add dynamic MAC %(1)m - Vlan %(2)d failed, %(3)d mac failed to	

ID	SEVERITY	CATEGORY	MESSAGE	DESCRIPTION
			be inserted from the last trap	
SYSLG4.15.16	Informational		%(1)s %(2)s port %(3)s	
SYSLG4.15.18	Informational	Interface	Media changed from %(1)s to %(2)s on port %(3)s.	There has been a media change on the specified port.
SYSLG4.18.2	Informational	Security	Shaper cannot be applied on port %(1)s since it's working in half duplex. It will be applied when the port changes to full duplex.@	Shaper cannot be applied on the specified port because it is working in half duplex. It will be applied when the port changes to full duplex.
SYSLG4.6.9	Informational		%(1)s of port %(3)j differ from %(1)s of %(4)j	
SYSLG5.3.11	Informational		Activating service %(1)d	
SYSLG6.0.2	Informational	Up/Download	Boot image download started	The system supports the boot image update. A new file can be downloaded from a TFTP server. The message appears when this procedure starts.
SYSLG6.0.3	Informational	Up/Download	Boot image download completed	The Boot image download is completed successfully. The system supports the boot image update. A new file can be downloaded from a TFTP server. The message appears when this procedure is completed successfully.
SYSLG6.1.1	Informational		Port %(1)lu Up	
SYSLG6.2.1	Informational	Power	Power Supply #%(1)d is up	The system uses two power supply sources: #1 and #2. The system can operate with one or both power supply units. The specified power supply is up.
SYSLG7.0.0	Informational		%(1)s %(2)s	
SYSLG7.0.1	Informational		%(1)s %(2)s	
SYSLG7.13.0	Informational	1x	Port %(1)j is Authorized	The specified port is authorized.
SYSLG7.13.26	Informational	1x	MAC %(1)m is authorized on port %(2)j	The specified MAC is authorized on the specified port.
SYSLG7.15.0	Informational	Security	Port %(1)s suspended by Loopback Detection.@	The specified port is suspended by Loopback

ID	SEVERITY	CATEGORY	MESSAGE	DESCRIPTION
				Detection.
SYSLG7.2.0	Informational	Interface	Port %(1)j added to %(2)j	A physical port is added to a logical link that is called a trunk, LAG, or channel depending on the device.
SYSLG7.2.46	Informational	1x	Port %(1)j can not be added to %(2)j: Unauthorized	
SYSLG7.5.64	Informational	IP	Dynamic port %(2)j was added to VLAN %(1)j by GVRP	A dynamically configured port was added to a VLAN during a GVRP protocol operation.
SYSLG7.5.65	Informational	VLAN	Dynamic port %(2)j was removed from VLAN %(1)j by GVRP	A dynamically configured port was removed from a VLAN during a GVRP protocol operation.
SYSLG7.5.66	Informational	VLAN	Dynamic VLAN %(1)j was added by GVRP	A dynamically configured VLAN was added during a GVRP protocol operation.
SYSLG7.5.67	Informational	VLAN	Dynamic VLAN %(1)j was removed by GVRP	A dynamically configured VLAN was removed during a GVRP protocol operation.
SYSLG7.5.68	Informational		VLAN %(1)j changed from Dynamic to Static	A dynamically configured VLAN was deleted from the list of dynamic VLANs and was then added to the statically configured VLANs during a GVRP protocol operation.
SYSLG7.5.69	Informational		VLAN %(1)j changed from Static to Dynamic	A statically configured VLAN was deleted from the list of static VLANs and was then added to the dynamically configured VLANs during a GVRP protocol operation.
SYSLG7.8.11	Informational		%(1)s	
SYSLG7.8.12	Informational		%(1)s	
SYSLG7.8.13	Informational	SSH	Failed to allocated memory for key	The system did not provide sufficient memory for the key.
SYSLG8.10.37	Informational	bootup	The device has been configured via BOOTP	The device has been configured via BOOTP.
SYSLG8.10.38	Informational	DHCP	The device has been configured on interface %(1)j , IP %(2)y, mask %(3)y, DHCP server %(4)y	The device has been configured on the specified interface, with the specified IP address and mask on the specified DHCP server.
SYSLG8.101.6	Informational	IP	ARP packet dropped from port %(1)j with VLAN tag	ARP Inspection Log. The ARP packet is dropped

ID	SEVERITY	CATEGORY	MESSAGE	DESCRIPTION
			%(2)d and reason: %(3)s@SRC MAC %(4)m SRC IP %(5)y DST MAC %(6)m DST IP %(7)y	according to the specified reason
SYSLG8.15.0	Information al		Ping completion status: %(1)s	
SYSLG8.15.1	Information al		Ping completion status:%(1)s.Sent:%(2)u.R eceived:%(3)u.Times:Min %(4)u,Max %(5)u,Avg %(6)u	
SYSLG8.17.0	Information al		%(1)s-%(2)s-%(3)s %(4)s:%(5)s:%(6)s %% TELNETD-I- CONNECTION, telnet connection from %(7)s at %(8)s-%(9)s-%(10)s %(11)s:%(12)s:%(13)s	
SYSLG8.26.2	Information al		Warm Startup	Warm Startup: the system re-initialization with no changes in configuration.
SYSLG8.26.3	Information al	Up/Download	Cold Startup	Cold Startup: the system re- initialization with possible changes in configuration.
SYSLG8.26.4	Information al	Up/Download	All NVRAM sections are erased	The system supports a few NVRAM sections. Each user can access its NVRAM section only. All data from all user sections can be deleted from NVRAM; then NVRAM is set to default values.
SYSLG8.26.5	Information al		NVRAM section %(1)s is erased	The system supports a few NVRAM users. Each user can access its NVRAM section only. A given user section can be erased from NVRAM.
SYSLG8.26.7	Information al	System	Initialization task is completed	The system informs that tasks are created and ready to be run by GO functions.
SYSLG8.31.0	Information al	AAA	New request to create user	The application must authenticate a new user.
SYSLG8.31.1	Information al	AAA	User created successfully	A new user is created in the current table of authenticated users.
SYSLG8.31.11	Information al	AAA	Authentication succeeded	Authentication with the current method succeeded.
SYSLG8.31.3	Information al	AAA	Request for authentication	The user authentication process is started.
SYSLG8.31.40	Information al	AAA	New %(1)s connection for user %(2)s, source	A new connection for the specified user between the

ID	SEVERITY	CATEGORY	MESSAGE	DESCRIPTION
			% (5)s % (3)y destination % (5)s % (4)y ACCEPTED	specified source and destination addresses is accepted.
SYSLG8.31.43	Informational	AAA	% (1)s connection for user % (2)s, source % (5)s % (3)y destination % (5)s % (4)y TERMINATED	A connection for the specified user between the specified source and destination addresses is terminated.
SYSLG8.31.46	Informational	AAA	AAA FILE overflow. Compression is performed. Within a compression not valid records are deleted.	The AAA file is full. Compression is performed during which invalid records are deleted.
SYSLG8.31.5	Informational	AAA	Method being retried	Authentication with the current method failed, and authentication is repeated once more by using the same method.
SYSLG8.31.6	Informational		Method succeeded	Authentication with the current method succeeded – an access is granted.
SYSLG8.31.63	Informational	AAA	User CLI session for user % (2)s over % (1)s , source % (3)y destination % (5)s % (4)y TERMINATED. The Telnet/SSH session may still be connected.	The CLI session for the specified user between the specified source and destination addresses is terminated. The Telnet/SSH session may still be connected.
SYSLG8.31.64	Informational	AAA	User CLI session for user % (2)s over % (1)s , source % (3)y destination % (5)s % (4)y ACCEPTED	The CLI session for the specified user between the specified source and destination addresses is accepted.
SYSLG8.31.7	Informational	AAA	Method failed	
SYSLG8.31.8	Informational	AAA	Method error	
SYSLG8.45.18	Informational	Up/Download	Files Copy - source URL % (1)s destination URL % (2)s	The files are copied from the specified source address to the specified destination address.
SYSLG8.48.31	Informational	STP	Attention: port % (1)j from which the bpd was received is configured as Fast Port	A received BPD message indicates that the specified port is configured as the Fast port..
SYSLG8.49.11	Informational		sshpClientId: illegal connection id % (1)d	
SYSLG8.49.14	Informational	Security	Closed SSH connection to % (1)y	
SYSLG8.49.2	Informational	SSH	SSH log: % (1)s	The string parameter describes the reason this message was called.

ID	SEVERITY	CATEGORY	MESSAGE	DESCRIPTION
SYSLG8.49.9	Informational	AAA	sshpClientFind: illegal index %(1)d	
SYSLG8.5.168	Informational	console	MIB variable %(1)s not found in temporary DB	The specified MIB variable was not found in the Mib2cli temporary DB.
SYSLG8.5.169	Informational	SNMP	Unknown field name %(1)s	The SNMPServG_name_2_Id function failed because MIB variable name is unknown.
SYSLG8.5.170	Informational	console	Command Handler for command ID %(1)s is missing	The command handler for the specified command ID is missing.
SYSLG8.5.171	Informational	console	Command <%(1)s> processed in %(2)d.%(3)d secs	It took the specified number of seconds to process the specified command.
SYSLG8.50.18	Informational	Interface	Port changed status from notPresent to notPresent@	An indication of not present port when this port is already not present is wrong.
SYSLG8.63.14	Informational	Stack	UNIT ID %(1)d,Msg:%(2)s	(Valid for stackable projects only) See the relevant trap message as in the case when the specified stack member operating in the standalone mode issues it.
SYSLG8.63.6	Informational	Stack	UNIT ID %(1)d,Trap:%(2)s	(Valid for stackable projects only) See the relevant trap message as in the case when the specified stack member operating in the standalone mode issues it.
SYSLG8.74.51	Informational	Interface	Interface %(1)s state %(2)s	
SYSLG8.74.52	Informational	Interface	Virtual interface %(1)s area %(2)s state %(3)s	
SYSLG8.79.5	Informational	Web	File Delete - file URL %(1)s	The file at the specified URL has been deleted.
SYSLG8.83.2	Informational	Stack	Synchronization with unit %(1)d is failed @	Synchronization with the specified unit has failed.
SYSLG8.83.3	Informational	Stack	Synchronization with unit %(1)d is finished successfully @	Synchronization with the specified unit has succeeded.
SYSLG8.83.4	Informational	Stack	Wrong source unit id %(1)d, message discarded @	The specified source unit ID is incorrect, the message is discarded.
SYSLG8.84.0	Informational	IP	NTP Packet received from UDP	The NTP packet is received from the UDP.
SYSLG8.84.5	Informational		Illegal data size	The data size is too large.

ID	SEVERITY	CATEGORY	MESSAGE	DESCRIPTION
SYSLG8.84.9	Informational		NTP received - Mode % (1)d, src_ip % (2)s, dst_ip % (3)s, Interface % (4)d@	
SYSLG8.86.30	Informational	SNMP	SNMP Package: % (1)s Routine: % (2)d Location: % (3)d Error: % (4)s	
SYSLG8.86.31	Informational		Syslog testing logging of UINT_64 parameters: % (1)u % (2)i % (3)d % (4)x % (5)X	
SYSLG8.86.8	Informational	Up/Download	Number of % (2)s configuration items loaded: % (1)lu	The specified number of configuration commands has been loaded.
SYSLG8.92.1	Informational	Up/Download	XMODEM session has been aborted@	The XModem session is aborted.
SYSLG8.92.2	Informational	Up/Download	XMODEM session has been completed@	The XModem session is ended.
SYSLG8.95.10	Informational	Up/Download	Configuration Download has been started	The configuration file download process has started.
SYSLG8.95.3	Informational	Up/Download	Configuration Upload has been completed	The configuration file upload process has been successfully completed.
SYSLG8.95.4	Informational	Up/Download	Configuration Download has been completed	The configuration file download process has been successfully completed.
SYSLG8.95.9	Informational	Up/Download	Configuration Upload has been started	The configuration file upload process has started.
SYSLG8.96.8	Informational		Starting autogeneration of self-signed certificate - % (1)u bits	
SYSLG8.96.9	Informational	AAA	Autogeneration of self-signed certificate was successfully completed	The Autogeneration for a self-signed certificate was successfully completed
SYSLG1.0.55	Informational	Up/Download	File % (1)s has been Auto Updated	The specified file has been Auto Updated.
SYSLG1.0.56	Informational	Up/Download	Auto Update Completed; rebooting the switch	Auto Update is completed. The switch is being; rebooted.
SYSLG1.0.59	Informational	Up/Download	Active image successfully changed to image % (1)d	Active image is successfully changed to the specified image.
SYSLG1.2.4	Informational		entity configuration change trap.	
SYSLG1.3.0	Informational	Interface	Pse Port % (1)s delivering power to the PD.@	The specified PSE port is delivering power to the PD.
SYSLG1.3.1	Informational	System	PSE power usage % (1)d in unit % (2)d is above the threshold.@	The PSE power used by the specified unit is above the threshold.

ID	SEVERITY	CATEGORY	MESSAGE	DESCRIPTION
SYSLG1.3.2	Informational	System	PSE power usage %(1)d in unit %(2)d is below the threshold.@	The PSE power used by the specified unit is below the threshold.
SYSLG1.5.23	Informational	Interface	Unit %(1)d was shutdown - JUMBO frames not supported.	The specified unit is shutdown because Jumbo frames are not supported.
SYSLG1.5.24	Informational	Stack	Master switchover: unit %(1)d is now master.	The specified unit is now the Master unit.
SYSLG1.5.25	Informational	Stack	Backup master unit %(1)d was removed from the stack.	The specified backup master is removed from the stack.
SYSLG1.5.26	Informational	Stack	Unit %(1)d was removed from the stack.	The specified unit is removed from the stack.
SYSLG1.5.28	Informational	IP	Ipc connection with unit %(1)d failed.	The IPC connection with the specified unit has failed.
SYSLG1.5.29	Informational		Configuration changed: %(1)s	
SYSLG1.5.30	Informational	Stack	Stack cable %(1)s : link %(2)s on unit-%(3)d	The specified stacking cable is connected to the specified unit.
SYSLG1.6.11	Informational		PS# %(1)d status changed - %(2)s.	The system uses two power supply sources: #1 and #2. The system can operate with one or both power supply units. The power supply has changed.
SYSLG1.6.8	Informational	System	FAN# %(1)d status changed - %(2)s.	The specified fan status has changed.
SYSLG4.10.13	Informational		Add dynamic MAC %(1)m - Vlan %(2)d failed, %(3)d mac failed to be inserted from the last trap	
SYSLG4.15.16	Informational		%(1)s %(2)s port %(3)s	
SYSLG4.15.18	Informational	Interface	Media changed from %(1)s to %(2)s on port %(3)s.	There has been a media change on the specified port.
SYSLG4.18.2	Informational	Security	Shaper cannot be applied on port %(1)s since it's working in half duplex. It will be applied when the port changes to full duplex.@	Shaper cannot be applied on the specified port because it is working in half duplex. It will be applied when the port changes to full duplex.
SYSLG4.6.9	Informational		%(1)s of port %(3)j differ from %(1)s of %(4)j	
SYSLG5.3.11	Informational		Activating service %(1)d...	
SYSLG6.0.2	Informational	Up/Download	Boot image download started	The system supports the boot image update. A new



ID	SEVERITY	CATEGORY	MESSAGE	DESCRIPTION
				file can be downloaded from a TFTP server. The message appears when this procedure starts.
SYSLG6.0.3	Informational	Up/Download	Boot image download completed	The Boot image download is completed successfully. The system supports the boot image update. A new file can be downloaded from a TFTP server. The message appears when this procedure is completed successfully.
SYSLG6.1.1	Informational		Port %(1)lu Up	
SYSLG6.2.1	Informational	Power	Power Supply #%(1)d is up	The system uses two power supply sources: #1 and #2. The system can operate with one or both power supply units. The specified power supply is up.
SYSLG7.0.0	Informational		%(1)s %(2)s	
SYSLG7.0.1	Informational		%(1)s %(2)s	
SYSLG7.13.0	Informational	1x	Port %(1)j is Authorized	The specified port is authorized.
SYSLG7.13.26	Informational	1x	MAC %(1)m is authorized on port %(2)j	The specified MAC is authorized on the specified port.
SYSLG7.15.0	Informational	Security	Port %(1)s suspended by Loopback Detection.@	The specified port is suspended by Loopback Detection.
SYSLG7.2.0	Informational	Interface	Port %(1)j added to %(2)j	A physical port is added to a logical link that is called a trunk, LAG, or channel depending on the device.
SYSLG7.2.46	Informational	1x	Port %(1)j can not be added to %(2)j: Unauthorized	
SYSLG7.5.64	Informational	IP	Dynamic port %(2)j was added to VLAN %(1)j by GVRP	A dynamically configured port was added to a VLAN during a GVRP protocol operation.
SYSLG7.5.65	Informational	VLAN	Dynamic port %(2)j was removed from VLAN %(1)j by GVRP	A dynamically configured port was removed from a VLAN during a GVRP protocol operation.
SYSLG7.5.66	Informational	VLAN	Dynamic VLAN %(1)j was added by GVRP	A dynamically configured VLAN was added during a GVRP protocol operation.
SYSLG7.5.67	Informational	VLAN	Dynamic VLAN %(1)j	A dynamically configured

ID	SEVERITY	CATEGORY	MESSAGE	DESCRIPTION
	al		was removed by GVRP	VLAN was removed during a GVRP protocol operation.
SYSLG7.5.68	Informational		VLAN %(1)j changed from Dynamic to Static	A dynamically configured VLAN was deleted from the list of dynamic VLANs and was then added to the statically configured VLANs during a GVRP protocol operation.
SYSLG7.5.69	Informational		VLAN %(1)j changed from Static to Dynamic	A statically configured VLAN was deleted from the list of static VLANs and was then added to the dynamically configured VLANs during a GVRP protocol operation.
SYSLG7.8.11	Informational		%(1)s	
SYSLG7.8.12	Informational		%(1)s	
SYSLG7.8.13	Informational	SSH	Failed to allocated memory for key	The system did not provide sufficient memory for the key.
SYSLG8.10.37	Informational	bootup	The device has been configured via BOOTP	The device has been configured via BOOTP.
SYSLG8.10.38	Informational	DHCP	The device has been configured on interface %(1)j , IP %(2)y, mask %(3)y, DHCP server %(4)y	The device has been configured on the specified interface, with the specified IP address and mask on the specified DHCP server.
SYSLG8.101.6	Informational	IP	ARP packet dropped from port %(1)j with VLAN tag %(2)d and reason: %(3)s@SRC MAC %(4)m SRC IP %(5)y DST MAC %(6)m DST IP %(7)y	ARP Inspection Log. The ARP packet is dropped according to the specified reason
SYSLG8.15.0	Informational		Ping completion status: %(1)s	
SYSLG8.15.1	Informational		Ping completion status: %(1)s.Sent: %(2)u. Received: %(3)u. Times: Min %(4)u, Max %(5)u, Avg %(6)u	
SYSLG8.17.0	Informational		%(1)s-%(2)s-%(3)s %(4)s: %(5)s: %(6)s %% TELNETD-I-CONNECTION, telnet connection from %(7)s at %(8)s-%(9)s-%(10)s %(11)s: %(12)s: %(13)s	
SYSLG8.26.2	Informational		Warm Startup	Warm Startup: the system re-initialization with no

ID	SEVERITY	CATEGORY	MESSAGE	DESCRIPTION
				changes in configuration.
SYSLG8.26.3	Informational	Up/Download	Cold Startup	Cold Startup: the system re-initialization with possible changes in configuration.
SYSLG8.26.4	Informational	Up/Download	All NVRAM sections are erased	The system supports a few NVRAM sections. Each user can access its NVRAM section only. All data from all user sections can be deleted from NVRAM; then NVRAM is set to default values.
SYSLG8.26.5	Informational		NVRAM section %(1)s is erased	The system supports a few NVRAM users. Each user can access its NVRAM section only. A given user section can be erased from NVRAM.
SYSLG8.26.7	Informational	System	Initialization task is completed	The system informs that tasks are created and ready to be run by GO functions.
SYSLG8.31.0	Informational	AAA	New request to create user	The application must authenticate a new user.
SYSLG8.31.1	Informational	AAA	User created successfully	A new user is created in the current table of authenticated users.
SYSLG8.31.11	Informational	AAA	Authentication succeeded	Authentication with the current method succeeded.
SYSLG8.31.3	Informational	AAA	Request for authentication	The user authentication process is started.
SYSLG8.31.40	Informational	AAA	New %(1)s connection for user %(2)s, source %(5)s%(3)y destination %(5)s%(4)y ACCEPTED	A new connection for the specified user between the specified source and destination addresses is accepted.
SYSLG8.31.43	Informational	AAA	%(1)s connection for user %(2)s, source %(5)s%(3)y destination %(5)s%(4)y TERMINATED	A connection for the specified user between the specified source and destination addresses is terminated.
SYSLG8.31.46	Informational	AAA	AAA FILE overflow. Compression is performed. Within a compression not valid records are deleted.	The AAA file is full. Compression is performed during which invalid records are deleted.
SYSLG8.31.5	Informational	AAA	Method being retried	Authentication with the current method failed, and authentication is repeated once more by using the same method.
SYSLG8.31.6	Informational		Method succeeded	Authentication with the current method succeeded –

ID	SEVERITY	CATEGORY	MESSAGE	DESCRIPTION
				an access is granted.
SYSLG8.31.63	Informational	AAA	User CLI session for user % (2)s over % (1)s , source % (3)y destination % (5)s % (4)y TERMINATED. The Telnet/SSH session may still be connected.	The CLI session for the specified user between the specified source and destination addresses is terminated. The Telnet/SSH session may still be connected.
SYSLG8.31.64	Informational	AAA	User CLI session for user % (2)s over % (1)s , source % (3)y destination % (5)s % (4)y ACCEPTED	The CLI session for the specified user between the specified source and destination addresses is accepted.
SYSLG8.31.7	Informational	AAA	Method failed	
SYSLG8.31.8	Informational	AAA	Method error	
SYSLG8.45.18	Informational	Up/Download	Files Copy - source URL % (1)s destination URL % (2)s	The files are copied from the specified source address to the specified destination address.
SYSLG8.48.31	Informational	STP	Attention: port % (1)j from which the bpdud was received is configured as Fast Port	A received BPDU message indicates that the specified port is configured as the Fast port..
SYSLG8.49.11	Informational		sshpClientId: illegal connection id % (1)d	
SYSLG8.49.14	Informational	Security	Closed SSH connection to % (1)y	
SYSLG8.49.2	Informational	SSH	SSH log: % (1)s	The string parameter describes the reason this message was called.
SYSLG8.49.9	Informational	AAA	sshpClientFind: illegal index % (1)d	
SYSLG8.5.168	Informational	console	MIB variable % (1)s not found in temporary DB	The specified MIB variable was not found in the Mib2cli temporary DB.
SYSLG8.5.169	Informational	SNMP	Unknown field name % (1)s	The SNMPServG_name_2_Id function failed because MIB variable name is unknown.
SYSLG8.5.170	Informational	console	Command Handler for command ID % (1)s is missing	The command handler for the specified command ID is missing.
SYSLG8.5.171	Informational	console	Command <% (1)s> processed in % (2)d.% (3)d secs	It took the specified number of seconds to process the specified command.
SYSLG8.50.18	Informational	Interface	Port changed status from notPresent to notPresent@	An indication of not present port when this port is already not present is

ID	SEVERITY	CATEGORY	MESSAGE	DESCRIPTION
				wrong.
SYSLG8.63.14	Informational	Stack	UNIT ID %(1)d,Msg:%(2)s	(Valid for stackable projects only) See the relevant trap message as in the case when the specified stack member operating in the standalone mode issues it.
SYSLG8.63.6	Informational	Stack	UNIT ID %(1)d,Trap:%(2)s	(Valid for stackable projects only) See the relevant trap message as in the case when the specified stack member operating in the standalone mode issues it.
SYSLG8.74.51	Informational	Interface	Interface %(1)s state %(2)s	
SYSLG8.74.52	Informational	Interface	Virtual interface %(1)s area %(2)s state %(3)s	
SYSLG8.79.5	Informational	Web	File Delete - file URL %(1)s	The file at the specified URL has been deleted.
SYSLG8.83.2	Informational	stack	Synchronization with unit %(1)d is failed @	Synchronization with the specified unit has failed.
SYSLG8.83.3	Informational	Stack	Synchronization with unit %(1)d is finished successfully @	Synchronization with the specified unit has succeeded.
SYSLG8.83.4	Informational	Stack	Wrong source unit id %(1)d, message discarded @	The specified source unit ID is incorrect, the message is discarded.
SYSLG8.84.0	Informational	IP	NTP Packet received from UDP	The NTP packet is received from the UDP.
SYSLG8.84.5	Informational		Illegal data size	The data size is too large.
SYSLG8.84.9	Informational		NTP received - Mode %(1)d, src_ip %(2)s, dst_ip %(3)s, Interface %(4)d@	
SYSLG8.86.30	Informational	SNMP	SNMP Package: %(1)s Routine: %(2)d Location: %(3)d Error: %(4)s	
SYSLG8.86.31	Informational		Syslog testing logging of UINT_64 parameters: %(1)u %(2)i %(3)d %(4)x %(5)X	
SYSLG8.86.8	Informational	Up/Download	Number of %(2)s configuration items loaded: %(1)lu	The specified number of configuration commands has been loaded.
SYSLG8.92.1	Informational	Up/Download	XMODEM session has been aborted@	The XModem session is aborted.
SYSLG8.92.2	Informational	Up/Download	XMODEM session has been completed@	The XModem session is ended.
SYSLG7.14.0	Notice		LLDP status: %(1)s.	

ID	SEVERITY	CATEGORY	MESSAGE	DESCRIPTION
SYSLG8.1.0	Notice		Bad msg received from %(1)y on intf %(2)y	
SYSLG8.1.1	Notice		Ignoring msg from %(1)y on intf %(2)y	
SYSLG8.105.1	Notice	IP	IP FDB Table Overflow : %(1)s@	The IP FDB Table is full..
SYSLG8.16.2	Notice	Web	Session is closed after timeout is expired	Session is closed after timeout period is reached.
SYSLG8.26.6	Notice		NVRAM section %(1)s not found and cannot be erased	The specified NVRAM section not found and cannot be erased.
SYSLG8.45.7	Notice	Up/Download	The copy operation was completed successfully	The copy operation completed successfully.
SYSLG8.63.13	Notice	Stack	UNIT ID %(1)d,Msg:%(2)s	
SYSLG8.63.5	Notice	Stack	UNIT ID %(1)d,Trap:%(2)s	
SYSLG8.89.1	Notice	SNMP	Start conversion of old format CDB	The conversion of old format CDB has started.
SYSLG8.89.2	Notice	SNMP	End conversion of old format CDB	The conversion of old format CDB has finished.
SYSLG8.9.10	Notice	Interface	Type %(1)u not supported	The specified type is not supported.
SYSLG8.9.12	Notice		Illegal chksum, igmp_size = %(1)lu	
SYSLG7.14.0	Notice		LLDP status: %(1)s.	
SYSLG8.1.0	Notice		Bad msg received from %(1)y on intf %(2)y	
SYSLG8.1.1	Notice		Ignoring msg from %(1)y on intf %(2)y	
SYSLG8.105.1	Notice	IP	IP FDB Table Overflow : %(1)s@	The IP FDB Table is full..
SYSLG8.16.2	Notice	Web	Session is closed after timeout is expired	Session is closed after timeout period is reached.
SYSLG8.26.6	Notice		NVRAM section %(1)s not found and cannot be erased	The specified NVRAM section not found and cannot be erased.
SYSLG8.45.7	Notice	Up/Download	The copy operation was completed successfully	The copy operation completed successfully.
SYSLG8.63.13	Notice	Stack	UNIT ID %(1)d,Msg:%(2)s	
SYSLG8.63.5	Notice	Stack	UNIT ID %(1)d,Trap:%(2)s	
SYSLG8.89.1	Notice	SNMP	Start conversion of old format CDB	The conversion of old format CDB has started.
SYSLG8.89.2	Notice	SNMP	End conversion of old format CDB	The conversion of old format CDB has finished.

ID	SEVERITY	CATEGORY	MESSAGE	DESCRIPTION
SYSLG8.9.10	Notice	Interface	Type %(1)u not supported	The specified type is not supported.
SYSLG8.9.12	Notice		Illegal chksum, igmp_size = %(1)lu	
SYSLG1.0.32	Warning	Interface	You may need to set interface %(1)s to force full duplex and appropriate speed to match partner link configuration.	The specified interface may need to be set to force full duplex and appropriate speed to match partner link configuration.
SYSLG1.6.10	Warning	Power	PS# %(1)d status changed - %(2)s.	The specified port status has changed.
SYSLG4.5.3	Warning	Port Security	A packet with source MAC %(1)m tried to access through port %(2)j which is locked@	A security violation warning is issued to a user who activated a port as locked. When data from a new MAC address arrives to such port, a trap is sent.
SYSLG4.5.34	Warning	1x	A packet with source MAC %(1)m tried to access through port %(2)j which is authorize and multiple-host disable@	A packet with a specified MAC address attempted to gain access through a port which requires authorization and which is disabled for multiple hosts.
SYSLG5.3.10	Warning	Interface	Sum of the committed BW on interface %(1)d is more than port speed, all the services applied to it will scaled down.	The sum of the committed BW on the specified interface d is more than port speed, all the services applied to it will scaled down.
SYSLG5.3.12	Warning	Security	Service %(1)d is partially active, up to interface %(2)d.	The specified Service is partially active, up to a specified interface.
SYSLG5.3.13	Warning	Security	Service %(1)d can't be active because of erroneous %(2)s.	The specified Service cannot be active because of the specified errors.
SYSLG5.3.14	Warning		BW (in kbits) %(1)d, has %(2)s to trunk %(3)d	
SYSLG5.3.17	Warning	Security	Activating non-guarantee service %(1)d with ignored egress interfaces.	Activating non-guarantee specified services with ignored egress interfaces.
SYSLG5.3.18	Warning	Security	Drop profile in host parameter %(1)d is bigger than the ASIC maximum number %(2)d	Drop profile in specified host parameter is bigger than the ASIC maximum specified number.
SYSLG5.3.5	Warning	Interface	IfIndex %(1)d is now auto negotiation enable.	The specified IfIndex is now auto negotiation enabled.
SYSLG5.3.6	Warning	Interface	IfIndex %(1)d is configured with auto negotiation enable.	The specified IfIndex is configured with auto negotiation enabled.

ID	SEVERITY	CATEGORY	MESSAGE	DESCRIPTION
SYSLG5.3.7	Warning	Interface	Committing BW on egress interface %(1)d more than %(2)d percentages of interface speed.	Committing BW on the specified egress interface d more than the specified percentages of interface speed.
SYSLG5.3.8	Warning	Interface	Interface %(1)d changes to half duplex mode, some committed services can't be fulfilled.	The specified interface changes to half duplex mode and some committed services cannot be fulfilled.
SYSLG5.3.9	Warning	Interface	Interface %(1)d changes to higher speed rate. Current speed (in Kbit)%(2)d.	The specified interface speed is modified to a higher speed.
SYSLG6.1.0	Warning		Port %(1)lu Down	
SYSLG6.2.0	Warning	Power	Power Supply #(1)d is down	The specified power supply is down. The system uses two power supply sources: #1 and #2. The system can operate with one or both power supply units.
SYSLG7.0.161	Warning		%(1)s %(2)s	
SYSLG7.0.2	Warning		%(1)s %(2)s	
SYSLG7.0.3	Warning		%(1)s %(2)s	
SYSLG7.0.4	Warning		%(1)s %(2)s	
SYSLG7.0.5	Warning		%(1)s %(2)s	
SYSLG7.0.6	Warning		%(1)s %(2)s	
SYSLG7.0.7	Warning		%(1)s %(2)s	
SYSLG7.0.8	Warning		%(1)s %(2)s	
SYSLG7.0.9	Warning		%(1)s %(2)s	
SYSLG7.10.8	Warning	Security	failed to allocate rules in Asic for ifIndex %(1)d @	Failed to allocate ASIC rules in a specified change.
SYSLG7.10.9	Warning	Security	failed to add %(1)d rules to the Asic on ifIndex %(2)d @	Failed to add the specified rules to the ASIC on the specified ifIndex .
SYSLG7.13.1	Warning	1x	Port %(1)j is unAuthorized	The specified port is un authorized.
SYSLG7.13.27	Warning	FDB	MAC %(1)m was rejected on port %(2)j	The specified MAC address was rejected on the specified port.
SYSLG7.14.107	Warning	SNMP	LLDP %(1)s Warning: - Deleting Mngmnt address entry from CDB was failed: resource unavailable.@	The management address entry deletion from CDB failed. Resource are unavailable.
SYSLG7.2.1	Warning	Interface	Port %(1)j removed from %(2)j	The specified port is removed.
SYSLG7.2.2	Warning	Interface	Port %(1)j removed from %(2)j: port is	The specified port is removed and is indicated as



ID	SEVERITY	CATEGORY	MESSAGE	DESCRIPTION
			down/notPresent	being down or not present.
SYSLG8.0.4	Warning	IP	Network IP address %(1)s is unavailable	The IP address was most likely allocated statically.
SYSLG8.1.31	Warning	STP	Active change failed - unreachable route not added because of Routing table overflow	The message appears when topology changes took place but the system failed to add an entry to the table because no memory is available.
SYSLG8.10.14	Warning	bootup	BOOTP client received illegal IP mask in BOOTP msg	The BOOTP client received an illegal IP mask in the BOOTP message.
SYSLG8.10.15	Warning	DHCP	DHCP client received illegal IP mask in DHCP msg	The DHCP client received an illegal IP mask in DHCP message.
SYSLG8.10.16	Warning	bootup	BOOTP client received illegal IP address in BOOTP msg	The BOOTP client received an illegal IP address in the BOOTP message.
SYSLG8.10.17	Warning	DHCP	DHCP client received illegal IP address in DHCP msg	The DHCP client received an illegal IP address in the DHCP message.
SYSLG8.10.20	Warning	bootup	BOOTP msg indicates that IP interface and default router are not on the same subnet	Error in the BOOTP server configuration where the IP interface and default router are not on the same subnet.
SYSLG8.10.21	Warning	bootup	BOOTP msg indicates that IP interface and TFTP server are not on the same subnet	Error in the BOOTP server configuration where the IP interface and TFTP server are not on the same subnet.
SYSLG8.10.22	Warning	DHCP	DHCP msg on interface %(1)j indicates that IP interface %(2)y and default router %(2)y, mask %(3)y, are not on the same subnet	Error in the DHCP server configuration where the specified IP interface and specified default router with the specified mask are not on the same subnet.
SYSLG8.10.23	Warning	DHCP	DHCP msg on interface %(1)j indicates that default router %(2)y, mask %(3)y, sent by DHCP server %(4)y is either a subnet name or a broadcast	Error in the DHCP server configuration where the specified IP interface and specified default router with the specified mask are broadcast.
SYSLG8.10.24	Warning	DHCP	DHCP msg indicates that IP interface and TFTP server are not on the same subnet	Error in the DHCP server configuration where the IP interface and TFTP server are not on the same subnet.
SYSLG8.10.25	Warning	bootup	BOOTP msg indicates that file name was configured without configuring IP address of TFTP server	A BOOTP message must include a TFTP server IP address.
SYSLG8.10.26	Warning	IP	IP address of TFTP server is not configured	The TFTP server IP address must be configured.

ID	SEVERITY	CATEGORY	MESSAGE	DESCRIPTION
SYSLG8.10.27	Warning	IP	BOOTP client received file with too long name in BOOTP msg	A file name is composed of a limited number of characters as defined in the system.
SYSLG8.10.28	Warning	DHCP	DHCP client received file with too long name in DHCP msg	A file name is composed of a limited number of characters as defined in the system.
SYSLG8.10.29	Warning	AAA	Illegal auth protocol type %(1)u	Illegal authentication protocol type has been received in the DHCP Message Log.
SYSLG8.10.30	Warning	AAA	Illegal privacy required value %(1)u	Illegal required privacy is received in the DHCP Message Log.
SYSLG8.10.31	Warning	bootup	Authentication key change via BOOTP/DHCP client not allowed	The Authentication key change via BOOTP/DHCP client is not allowed.
SYSLG8.10.32	Warning	bootup	Privacy key change via BOOTP/DHCP client not allowed	A Privacy key change via BOOTP/DHCP client not allowed.
SYSLG8.10.33	Warning	SSH	Privacy key change required	A Privacy key change is required.
SYSLG8.10.34	Warning	AAA	Privacy Key change length %(1)u does not fit privacy protocol	The modified Privacy Key length does not fit the privacy protocol.
SYSLG8.10.35	Warning	AAA	Authentication password required	An authentication key is received, but not configured.
SYSLG8.10.36	Warning	SSH	Privacy password required	A Privacy password change is required.
SYSLG8.10.39	Warning	DHCP	The device has rejected an invalid IP configuration on interface %(1)j , IP %(2)y, mask %(3)y, DHCP server %(4)y	The device has rejected an invalid IP configuration on the specified interface with the specified mask and DHCP server.
SYSLG8.10.40	Warning	DHCP	The device has rejected a duplicated subnet configuration on interface %(1)j, IP %(2)y, mask %(3)y, DHCP server %(4)y	The device has rejected a duplicated subnet configuration on the specified interface with the specified mask and DHCP server.
SYSLG8.10.41	Warning	DHCP	Malformed DHCP packet √ Message type option was found in DHCP packet	A abnormal DHCP packet message type option was found in the DHCP packet.
SYSLG8.10.8	Warning	IP	BOOTP client received illegal magic cookie %(1)x%(2)x%(3)x%(4)x( %(5)x%(6)x%(7)x%(8)x - must be %(1)x%(2)x%(3)x%(4)x(	The 4-byte value of the received cookie must match the 4-byte value of the legal cookie.

ID	SEVERITY	CATEGORY	MESSAGE	DESCRIPTION
			%(5)x%(6)x%(7)x%(8)x	
SYSLG8.10.9	Warning	IP	DHCP client received illegal magic cookie %(1)x%(2)x%(3)x%(4)x( %(5)x%(6)x%(7)x%(8)x - must be %(1)x%(2)x%(3)x%(4)x( %(5)x%(6)x%(7)x%(8)x	The 4-byte value of the received cookie must match the 4-byte value of the legal cookie.
SYSLG8.100.11	Warning	IP	DHCP snooping received illegal magic cookie %(1)x%(2)x%(3)x%(4)x( %(5)x%(6)x%(7)x%(8)x - must be %(1)x%(2)x%(3)x%(4)x( %(5)x%(6)x%(7)x%(8)x	The 4-byte value of the received cookie must match the 4-byte value of the legal cookie.
SYSLG8.109.1	Warning		%(1)s@	
SYSLG8.16.25	Warning	FDB	Unexpected PDU code	Packet is corrupted and will be discarded.
SYSLG8.31.2	Warning	AAA	Cannot create a user	A user cannot be authenticated because of AAA low resources.
SYSLG8.31.36	Warning	AAA	Received unsupported authentication REPLY msg status=%(1)u (server msg: %(2)s)	Received a message indicating that authentication method is unsupported.
SYSLG8.31.37	Warning	AAA	Unsupported arguments for adding received in authorization RESPONSE msg: %(1)s	Received a message indicating the additional authentication argument is not supported.
SYSLG8.31.38	Warning	AAA	Unsupported arguments for replacement received in authorization RESPONSE msg: %(1)s	Received a message indicating the replacement authentication argument is not supported.
SYSLG8.31.39	Warning	AAA	Received unsupported authentication RESPONSE msg status = %(1)u	Received a message indicating authentication is not supported.
SYSLG8.31.41	Warning	AAA	New %(1)s connection for user %(2)s, source %(5)s%(3)y destination %(5)s%(4)y REJECTED	
SYSLG8.31.42	Warning	AAA	User %(1)s LOCKED after unsuccessful login from %(2)s, source %(5)s%(3)y destination %(5)s%(4)y	The specified user ID is locked after an unsuccessful login from the specified source to the specified destination.
SYSLG8.31.44	Warning	AAA	AAA FILE data corruption occurs. Valid data ONLY saved	AAA data corruption has occurred. All valid data has been saved.
SYSLG8.40.13	Warning	Security	%(1)s Packet dropped by Policy rule no.%(2)s .	The packet is dropped in accordance with the specified security criteria.

ID	SEVERITY	CATEGORY	MESSAGE	DESCRIPTION
SYSLG8.40.14	Warning	Security	%(1)s Packet forward by Policy rule no.%(2)s .	The specified packet is forward by the specified Policy rule.
SYSLG8.43.10	Warning	IP	TFTP connection cannot be started without IP address	Configuration error. The TFTP connection cannot be started without an IP address.
SYSLG8.43.7	Warning	Up/Download	Empty file downloaded, configuration unchanged	Configuration file is empty.
SYSLG8.44.0	Warning	FDB	IGMP Filter table is overflowed	The IGMP Filter table is full.
SYSLG8.44.1	Warning	FDB	Failed to insert entry to IGMP Filter table	Entries cannot be added to the table that a user has access to because the platform reached its limit.
SYSLG8.45.8	Warning	Up/Download	The copy operation has failed	The copy operation has failed.
SYSLG8.45.9	Warning	Up/Download	The configuration file has failed to download	The configuration file has failed to download.
SYSLG8.46.10	Warning	Security	Management ACL drop packet received on interface %(1)s%(2)j from %(3)y to %(4)y protocol %(5)d service %(6)s	A Management ACL drop packet is received on the specified interface.
SYSLG8.48.35	Warning	STP	%(1)j: STP status Blocking	STP status is in Blocking mode.
SYSLG8.48.36	Warning	STP	%(1)j: STP status Forwarding	STP status is in Forwarding mode.
SYSLG8.48.37	Warning	STP	%(1)j of instance %(2)d: STP status Blocking	For the specified instance the STP status is in Blocking mode.
SYSLG8.48.38	Warning	STP	%(1)j of instance %(2)d: STP status Forwarding	For the specified instance the STP status is in Forwarding mode.
SYSLG8.48.41	Warning	STP	%(1)j: STP Loopback Detection.	
SYSLG8.48.42	Warning	STP	%(1)j: STP Loopback Detection resolved.	
SYSLG8.49.10	Warning	AAA	sshpConId: connection %(1)d outside client range	Excessive number of clients serviced by the system.
SYSLG8.49.12	Warning	AAA	sshpClientId: connection id %(1)d is in the range reserved for channels	Excessive number of channels in the system.
SYSLG8.49.13	Warning	AAA	sshpClientId: connection %(1)d is outside the range reserved for clients	Excessive number of clients serviced by the system.
SYSLG8.49.51	Warning	SSH	The SSH daemon can not use the configured TCP port (the port is already	The SSH daemon cannot use the configured TCP port (the port is already being

ID	SEVERITY	CATEGORY	MESSAGE	DESCRIPTION
			being used).	used).
SYSLG8.49.52	Warning	AAA	Insufficient memory to generate an %(1)s key. Please close all SSH or SSL sessions and try again.	Insufficient memory to generate an authentication key. Close all SSH or SSL sessions and try again.
SYSLG8.49.7	Warning	SSH	SSH has been enabled but an encryption key was not found.@For key generation use the 'crypto key generate' commands. The service will start automatically when a host key is generated.	SSH has been enabled but an encryption key was not found. For key generation use the 'crypto key generate' commands. The service starts automatically when a host key is generated.
SYSLG8.5.190	Warning		%(1)s: %(2)s - no such expression variable	
SYSLG8.50.22	Warning	FDB	Failed to create multicast group entry of VLAN %(1)d MAC %(2)s@	The system resource to support this number of multicast entries is limited.
SYSLG8.51.0	Warning	FDB	IGMP group table overflow@	The IGMP group table is full.
SYSLG8.51.1	Warning	FDB	IGMP router table overflow@	The IGMP router table is full.
SYSLG8.51.10	Warning	FDB	IGMP Snooping: in version 3 received version 1 query msg	Version 3 IGMP Snooping received a Version 1 query message.
SYSLG8.51.11	Warning	FDB	IGMP Snooping: in version 3 received version 2 query msg	Version 3 IGMP Snooping received a Version 2 query message.
SYSLG8.51.39	Warning	FDB	BIGMPP_indication warning: Unknown value of frame type received for igmp snooping ( %(1)d igmp control frames dropped from the last warning)@	Unknown frame type value received for IGMP snooping. The specified IGMP control frames are dropped from the last warning.
SYSLG8.51.5	Warning	FDB	IGMP Snooping: in version 1 received leave v2 msg	Version 1 IGMP Snooping received a Version 2 leave message.
SYSLG8.51.6	Warning	FDB	IGMP Snooping: in version 1 received version 2 query msg	Version 1 IGMP Snooping received a Version 2 query message.
SYSLG8.51.7	Warning	FDB	IGMP Snooping: in version 1 received version 3 query msg	Version 1 IGMP Snooping received a Version 3 query message.
SYSLG8.51.8	Warning	FDB	IGMP Snooping: in version 2 received version 3 query msg	Version 2 IGMP Snooping received a Version 3 query message.
SYSLG8.51.9	Warning	FDB	IGMP Snooping: in version 2 received version 1 query msg	Version 2 IGMP Snooping received a Version 1 query message.

ID	SEVERITY	CATEGORY	MESSAGE	DESCRIPTION
SYSLG8.52.10	Warning	Port Security	Port Lock action on Mac Table has ended@	Port Lock action on the MAC Table has ended.
SYSLG8.52.2	Warning	FDB	Bridge forwarding table overflow@	The bridge forwarding table is full.
SYSLG8.52.6	Warning	FDB	BRMNP_nttb_hash_set_entry: Hash Insert Failed for VLAN: %(1)j Mac: %(2)s Port: %(3)j, Error: %(4)s	The MAC database is full. No entry can be inserted - the CPU memory limitations.
SYSLG8.52.9	Warning	Port Security	Port Lock action on Mac Table has started@	Port Lock action on the MAC Table has started.
SYSLG8.57.1	Warning	FDB	Bridge forwarding table overflow@	The bridge forwarding table is full.
SYSLG8.63.12	Warning	Stack	UNIT ID %(1)d,Msg:%(2)s	
SYSLG8.63.4	Warning	Stack	UNIT ID %(1)d,Trap:%(2)s	
SYSLG8.68.42	Warning	IP	Host and domain name size exceeds %(1)d bytes	Host and domain name size exceeds the specified number of bytes.
SYSLG8.74.55	Warning	Interface	Packet RX on interface %(1)s from %(2)s type %(3)s - %(4)s	Packets corrupted and (or) network problems.
SYSLG8.74.56	Warning	SSH	Packet RX on virtual interface %(1)s area %(2)s type %(3)s - %(4)s	Key IDs do not match; keys are expired or some other key configuration problems.
SYSLG8.74.60	Warning	SSH	Packet RX on virtual interface %(1)s area %(2)s type %(3)s - %(4)s	Key IDs do not match; keys are expired or some other key configuration problems.
SYSLG8.74.65	Warning	AAA	Packet TX from interface %(1)s - md5 auth key not found	Md5 keys are not found or are invalid.
SYSLG8.74.67	Warning	AAA	Packet TX from interface %(1)s - last authentication key has expired	Md5 keys are not found or are invalid.
SYSLG8.74.68	Warning	AAA	Packet RX on interface %(1)s from %(2)s - last authentication key has expired	Key IDs do not match; keys are expired or some other key configuration problems.
SYSLG8.75.0	Warning	Web	HTTPS server has been enabled but a certificate was not found.@For certificate generation use the - @ 'crypto certificate [1-2] generate' command.@The service will start automatically when a certificate is generated.	HTTPS server has been enabled but a certificate was not found. For a certificate generation use the - 'crypto certificate [1-2] generate' command. The service will start automatically when a certificate is generated.
SYSLG8.75.66	Warning		%(2)s service has been enabled but an encryption	The specified service has been enabled but an

ID	SEVERITY	CATEGORY	MESSAGE	DESCRIPTION
			key (certificate %(1)d) was not found. @For key generation use the 'crypto key generate' commands. The service will start automatically when a host key is generated.	encryption key was not found. For key generation use the 'crypto key generate' commands. The service starts automatically when a host key is generated.
SYSLG8.77.26	Warning	AAA	Invalid attribute %(1)d ignored - %(2)s	The specified attribute is ignored.
SYSLG8.78.14	Warning	AAA	Msg of %(1)u length received from server %(3)s is bigger than maximum - %(2)u. Information is truncated.	The message length is bigger than the specified maximum. Extra characters will be truncated.
SYSLG8.78.15	Warning	AAA	Parsing of the %(1)s msg received from TACACS server %(2)s failed	Parsing of the specified message received from the specified TACACS server has failed.
SYSLG8.78.18	Warning	IP	Unexpected TCP msg was received from server %(1)s	Unexpected TCP message was received from the specified server.
SYSLG8.78.2	Warning	AAA	No TACACS+ server is configured, cannot start authentication	No TACACS+ server is configured, so authentication cannot be performed.
SYSLG8.78.23	Warning	AAA	Connection to server %(1)s is aborted. Single Connection mode may not be supported by this server.	A connection attempt to a specified server is terminated. Single connection mode is not supported by the current server.
SYSLG8.78.6	Warning	AAA	No TACACS+ server is configured, cannot start authorization	No TACACS+ server is configured, so authorization cannot be started.
SYSLG8.78.7	Warning	AAA	Cannot create new user, too many users	Cannot create new user due to too many users already configured.
SYSLG8.79.4	Warning	Up/Download	FLMNGG_update_file_state: The entry of file %(1)s was not updated to the flash	The entry to the specified file was not updated to the flash.
SYSLG8.80.2	Warning	SNMP	PIMGLG_snmp_bindmib variable: For variable id %(1)lu the snmp operation %(2)s not supported.	For the specified variable ID the SNMP operation is not supported.
SYSLG8.81.12	Warning		Func=%(1)s:Line=%(2)d: %(3)s	
SYSLG8.81.14	Warning		Func=%(1)s:Line=%(2)d: Unknown return value %(3)d	
SYSLG8.81.18	Warning		Func=%(2)s:Line=%(1)d:	

ID	SEVERITY	CATEGORY	MESSAGE	DESCRIPTION
			Can't allocate buffer	
SYSLG8.81.19	Warning		Func=%(2)s:Line=%(1)d: No outgoing interface	
SYSLG8.81.20	Warning		%(1)s state mashine:State: %(2)s,Event: t: %(3)s:GroupIp=%(4)s,Src Ip=%(5)s received	
SYSLG8.81.21	Warning		%(1)s state mashine:Incompatible State: %(2)s,Event: %(3)s for GroupIp=%(4)s,SrcIp=%(5)s received	
SYSLG8.81.6	Warning	System	Module %(1)s: Call function %(2)s without init	In the specified module the specified call function is without initialization.
SYSLG8.81.7	Warning		%(1)s: Bad state in state machine %(2)s	The specified state is not correct is the specified state machine.
SYSLG8.81.8	Warning		%(1)s: Hash table %(2)s is full	The specified hash table is full.
SYSLG8.86.0	Warning	Up/Download	Configuration update of unit %(1)lu failed. Reason: %(2)s.	The specified unit configuration update failed.
SYSLG8.86.4	Warning	SNMP	Access attempted by unauthorized NMS	Access attempted by an unauthorized NMS.
SYSLG8.86.9	Warning	Up/Download	Error encountered while downloading config: %(1)s	An error occurred while downloading the specified configuration.
SYSLG8.89.8	Warning	SNMP	Overflow in CDB	There is an overflow in CDB.
SYSLG8.89.9	Warning	SNMP	Overflow in startup CDB. offset = %(1)lu, file end = %(2)lu	
SYSLG8.9.11	Warning	FDB	Timer allocation failed	The v1 Host Timer cannot be activated, and a router will stay in the v1 state.
SYSLG8.9.14	Warning	FDB	Querier->NonQuerier transition on Interface: %(1)j	An interface stopped to be a Querier.
SYSLG8.9.7	Warning	FDB	IGMP Cache table is overflowed	No entry can be inserted - the platform reached its limit.
SYSLG8.9.8	Warning	FDB	Received IGMP wrong version (V1) query	Received a wrong IGMP version (v1) query.
SYSLG8.9.9	Warning	FDB	Received IGMP wrong version (V2) query	Received a wrong IGMP version (v2) query
SYSLG8.95.0	Warning	Up/Download	Configuration upload has been aborted	Configuration file upload has been aborted.



ID	SEVERITY	CATEGORY	MESSAGE	DESCRIPTION
SYSLG8.95.1	Warning	Up/Download	Configuration download has been aborted	Configuration file download has been aborted.
SYSLG8.95.6	Warning		%(1)s	
SYSLG8.96.7	Warning		Unknown certificate subject field	
SYSLG8.98.6	Warning	System	Bad OS status	Bad OS status.
SYSLG8.98.7	Warning	FDB	Reached Maximum number of IGMP memberships	The IGMP database is full. No entry can be inserted.
SYSLG1.0.32	Warning	Interface	You may need to set interface %(1)s to force full duplex and appropriate speed to match partner link configuration.	The specified interface may need to be set to force full duplex and appropriate speed to match partner link configuration.
SYSLG1.6.10	Warning	Power	PS# %(1)d status changed - %(2)s.	The specified port status has changed.
SYSLG4.5.3	Warning	Port Security	A packet with source MAC %(1)m tried to access through port %(2)j which is locked@	A security violation warning is issued to a user who activated a port as locked. When data from a new MAC address arrives to such port, a trap is sent.
SYSLG4.5.34	Warning	1x	A packet with source MAC %(1)m tried to access through port %(2)j which is authorize and multiple-host disable@	A packet with a specified MAC address attempted to gain access through a port which requires authorization and which is disabled for multiple hosts.
SYSLG5.3.10	Warning	Interface	Sum of the committed BW on interface %(1)d is more than port speed, all the services applied to it will scaled down.	The sum of the committed BW on the specified interface d is more than port speed, all the services applied to it will scaled down.
SYSLG5.3.12	Warning	Security	Service %(1)d is partially active, up to interface %(2)d.	The specified Service is partially active, up to a specified interface.
SYSLG5.3.13	Warning	Security	Service %(1)d can't be active because of erroneous %(2)s.	The specified Service cannot be active because of the specified errors.
SYSLG5.3.14	Warning		BW (in kbits) %(1)d, has %(2)s to trunk %(3)d	
SYSLG5.3.17	Warning	Security	Activating non-guarantee service %(1)d with ignored egress interfaces.	Activating non-guarantee specified services with ignored egress interfaces.
SYSLG5.3.18	Warning	Security	Drop profile in host parameter %(1)d is bigger than the ASIC maximum number %(2)d	Drop profile in specified host parameter is bigger than the ASIC maximum specified number.
SYSLG5.3.5	Warning	Interface	IfIndex %(1)d is now auto	The specified IfIndex is

ID	SEVERITY	CATEGORY	MESSAGE	DESCRIPTION
			negotiation enable.	now auto negotiation enabled.
SYSLG5.3.6	Warning	Interface	IfIndex %(1)d is configured with auto negotiation enable.	The specified IfIndex is configured with auto negotiation enabled.
SYSLG5.3.7	Warning	Interface	Committing BW on egress interface %(1)d more than %(2)d percentages of interface speed.	Committing BW on the specified egress interface d more than the specified percentages of interface speed.
SYSLG5.3.8	Warning	Interface	Interface %(1)d changes to half duplex mode, some committed services can't be fulfilled.	The specified interface changes to half duplex mode and some committed services cannot be fulfilled.
SYSLG5.3.9	Warning	Interface	Interface %(1)d changes to higher speed rate. Current speed (in Kbit)%(2)d.	The specified interface speed is modified to a higher speed.
SYSLG6.1.0	Warning		Port %(1)lu Down	
SYSLG6.2.0	Warning	Power	Power Supply #%(1)d is down	The specified power supply is down. The system uses two power supply sources: #1 and #2. The system can operate with one or both power supply units.
SYSLG7.0.161	Warning		%(1)s %(2)s	
SYSLG7.0.2	Warning		%(1)s %(2)s	
SYSLG7.0.3	Warning		%(1)s %(2)s	
SYSLG7.0.4	Warning		%(1)s %(2)s	
SYSLG7.0.5	Warning		%(1)s %(2)s	
SYSLG7.0.6	Warning		%(1)s %(2)s	
SYSLG7.0.7	Warning		%(1)s %(2)s	
SYSLG7.0.8	Warning		%(1)s %(2)s	
SYSLG7.0.9	Warning		%(1)s %(2)s	
SYSLG7.10.8	Warning	Security	failed to allocate rules in Asic for ifIndex %(1)d @	Failed to allocate ASIC rules in a specified change.
SYSLG7.10.9	Warning	Security	failed to add %(1)d rules to the Asic on ifIndex %(2)d @	Failed to add the specified rules to the ASIC on the specified ifIndex .
SYSLG7.13.1	Warning	1x	Port %(1)j is unAuthorized	The specified port is un authorized.
SYSLG7.13.27	Warning	FDB	MAC %(1)m was rejected on port %(2)j	The specified MAC address was rejected on the specified port.
SYSLG7.14.107	Warning	SNMP	LLDP %(1)s Warning: - Deleting Mngmnt address entry from CDB was failed: resource	The management address entry deletion from CDB failed. Resource are unavailable.

ID	SEVERITY	CATEGORY	MESSAGE	DESCRIPTION
			unavailable.@	
SYSLG7.2.1	Warning	Interface	Port %(1)j removed from %(2)j	The specified port is removed.
SYSLG7.2.2	Warning	Interface	Port %(1)j removed from %(2)j: port is down/notPresent	The specified port is removed and is indicated as being down or not present.
SYSLG8.0.4	Warning	IP	Network IP address %(1)s is unavailable	The IP address was most likely allocated statically.
SYSLG8.1.31	Warning	STP	Active change failed - unreachable route not added because of Routing table overflow	The message appears when topology changes took place but the system failed to add an entry to the table because no memory is available.
SYSLG8.10.14	Warning	bootup	BOOTP client received illegal IP mask in BOOTP msg	The BOOTP client received an illegal IP mask in the BOOTP message.
SYSLG8.10.15	Warning	DHCP	DHCP client received illegal IP mask in DHCP msg	The DHCP client received an illegal IP mask in DHCP message.
SYSLG8.10.16	Warning	bootup	BOOTP client received illegal IP address in BOOTP msg	The BOOTP client received an illegal IP address in the BOOTP message.
SYSLG8.10.17	Warning	DHCP	DHCP client received illegal IP address in DHCP msg	The DHCP client received an illegal IP address in the DHCP message.
SYSLG8.10.20	Warning	bootup	BOOTP msg indicates that IP interface and default router are not on the same subnet	Error in the BOOTP server configuration where the IP interface and default router are not on the same subnet.
SYSLG8.10.21	Warning	bootup	BOOTP msg indicates that IP interface and TFTP server are not on the same subnet	Error in the BOOTP server configuration where the IP interface and TFTP server are not on the same subnet.
SYSLG8.10.22	Warning	DHCP	DHCP msg on interface %(1)j indicates that IP interface %(2)y and default router %(2)y, mask %(3)y, are not on the same subnet	Error in the DHCP server configuration where the specified IP interface and specified default router with the specified mask are not on the same subnet.
SYSLG8.10.23	Warning	DHCP	DHCP msg on interface %(1)j indicates that default router %(2)y, mask %(3)y, sent by DHCP server %(4)y is either a subnet name or a broadcast	Error in the DHCP server configuration where the specified IP interface and specified default router with the specified mask are broadcast.
SYSLG8.10.24	Warning	DHCP	DHCP msg indicates that IP interface and TFTP server are not on the same subnet	Error in the DHCP server configuration where the IP interface and TFTP server are not on the same subnet.
SYSLG8.10.25	Warning	bootup	BOOTP msg indicates that	A BOOTP message must

ID	SEVERITY	CATEGORY	MESSAGE	DESCRIPTION
			file name was configured without configuring IP address of TFTP server	include a TFTP server IP address.
SYSLG8.10.26	Warning	IP	IP address of TFTP server is not configured	The TFTP server IP address must be configured.
SYSLG8.10.27	Warning	IP	BOOTP client received file with too long name in BOOTP msg	A file name is composed of a limited number of characters as defined in the system.
SYSLG8.10.28	Warning	DHCP	DHCP client received file with too long name in DHCP msg	A file name is composed of a limited number of characters as defined in the system.
SYSLG8.10.29	Warning	AAA	Illegal auth protocol type %(1)u	Illegal authentication protocol type has been received in the DHCP Message Log.
SYSLG8.10.30	Warning	AAA	Illegal privacy required value %(1)u	Illegal required privacy is received in the DHCP Message Log.
SYSLG8.10.31	Warning	bootup	Authentication key change via BOOTP/DHCP client not allowed	The Authentication key change via BOOTP/DHCP client is not allowed.
SYSLG8.10.32	Warning	bootup	Privacy key change via BOOTP/DHCP client not allowed	A Privacy key change via BOOTP/DHCP client not allowed.
SYSLG8.10.33	Warning	SSH	Privacy key change required	A Privacy key change is required.
SYSLG8.10.34	Warning	AAA	Privacy Key change length %(1)u does not fit privacy protocol	The modified Privacy Key length does not fit the privacy protocol.
SYSLG8.10.35	Warning	AAA	Authentication password required	An authentication key is received, but not configured.
SYSLG8.10.36	Warning	SSH	Privacy password required	A Privacy password change is required.
SYSLG8.10.39	Warning	DHCP	The device has rejected an invalid IP configuration on interface %(1)j , IP %(2)y, mask %(3)y, DHCP server %(4)y	The device has rejected an invalid IP configuration on the specified interface with the specified mask and DHCP server.
SYSLG8.10.40	Warning	DHCP	The device has rejected a duplicated subnet configuration on interface %(1)j, IP %(2)y, mask %(3)y, DHCP server %(4)y	The device has rejected a duplicated subnet configuration on the specified interface with the specified mask and DHCP server.
SYSLG8.10.41	Warning	DHCP	Malformed DHCP packet √ Message type option was found in DHCP packet	A abnormal DHCP packet message type option was found in the DHCP packet.

ID	SEVERITY	CATEGORY	MESSAGE	DESCRIPTION
SYSLG8.10.8	Warning	IP	BOOTP client received illegal magic cookie % (1)x% (2)x% (3)x% (4)x% (5)x% (6)x% (7)x% (8)x - must be % (1)x% (2)x% (3)x% (4)x% (5)x% (6)x% (7)x% (8)x	The 4-byte value of the received cookie must match the 4-byte value of the legal cookie.
SYSLG8.10.9	Warning	IP	DHCP client received illegal magic cookie % (1)x% (2)x% (3)x% (4)x% (5)x% (6)x% (7)x% (8)x - must be % (1)x% (2)x% (3)x% (4)x% (5)x% (6)x% (7)x% (8)x	The 4-byte value of the received cookie must match the 4-byte value of the legal cookie.
SYSLG8.100.11	Warning	IP	DHCP snooping received illegal magic cookie % (1)x% (2)x% (3)x% (4)x% (5)x% (6)x% (7)x% (8)x - must be % (1)x% (2)x% (3)x% (4)x% (5)x% (6)x% (7)x% (8)x	The 4-byte value of the received cookie must match the 4-byte value of the legal cookie.
SYSLG8.109.1	Warning		% (1)s@	
SYSLG8.16.25	Warning	FDB	Unexpected PDU code	Packet is corrupted and will be discarded.
SYSLG8.31.2	Warning	AAA	Cannot create a user	A user cannot be authenticated because of AAA low resources.
SYSLG8.31.36	Warning	AAA	Received unsupported authentication REPLY msg status=% (1)u (server msg: % (2)s)	Received a message indicating that authentication method is unsupported.
SYSLG8.31.37	Warning	AAA	Unsupported arguments for adding received in authorization RESPONSE msg: % (1)s	Received a message indicating the additional authentication argument is not supported.
SYSLG8.31.38	Warning	AAA	Unsupported arguments for replacement received in authorization RESPONSE msg: % (1)s	Received a message indicating the replacement authentication argument is not supported.
SYSLG8.31.39	Warning	AAA	Received unsupported authentication RESPONSE msg status = % (1)u	Received a message indicating authentication is not supported.
SYSLG8.31.41	Warning	AAA	New % (1)s connection for user % (2)s, source % (5)s% (3)y destination % (5)s% (4)y REJECTED	
SYSLG8.31.42	Warning	AAA	User % (1)s LOCKED after unsuccessful login from % (2)s, source % (5)s% (3)y destination % (5)s% (4)y	The specified user ID is locked after an unsuccessful login from the specified source to the specified destination.

ID	SEVERITY	CATEGORY	MESSAGE	DESCRIPTION
SYSLG8.31.44	Warning	AAA	AAA FILE data corruption occurs. Valid data ONLY saved	AAA data corruption has occurred. All valid data has been saved.
SYSLG8.40.13	Warning	Security	%(1)s Packet dropped by Policy rule no.%(2)s .	The packet is dropped in accordance with the specified security criteria.
SYSLG8.40.14	Warning	Security	%(1)s Packet forward by Policy rule no.%(2)s .	The specified packet is forward by the specified Policy rule.
SYSLG8.43.10	Warning	IP	TFTP connection cannot be started without IP address	Configuration error. The TFTP connection cannot be started without an IP address.
SYSLG8.43.7	Warning	Up/Download	Empty file downloaded, configuration unchanged	Configuration file is empty.
SYSLG8.44.0	Warning	FDB	IGMP Filter table is overflowed	The IGMP Filter table is full.
SYSLG8.44.1	Warning	FDB	Failed to insert entry to IGMP Filter table	Entries cannot be added to the table that a user has access to because the platform reached its limit.
SYSLG8.45.8	Warning	Up/Download	The copy operation has failed	The copy operation has failed.
SYSLG8.45.9	Warning	Up/Download	The configuration file has failed to download	The configuration file has failed to download.
SYSLG8.46.10	Warning	Security	Management ACL drop packet received on interface %(1)s%(2)j from %(3)y to %(4)y protocol %(5)d service %(6)s	A Management ACL drop packet is received on the specified interface.
SYSLG8.48.35	Warning	STP	%(1)j: STP status Blocking	STP status is in Blocking mode.
SYSLG8.48.36	Warning	STP	%(1)j: STP status Forwarding	STP status is in Forwarding mode.
SYSLG8.48.37	Warning	STP	%(1)j of instance %(2)d: STP status Blocking	For the specified instance the STP status is in Blocking mode.
SYSLG8.48.38	Warning	STP	%(1)j of instance %(2)d: STP status Forwarding	For the specified instance the STP status is in Forwarding mode.
SYSLG8.48.41	Warning	STP	%(1)j: STP Loopback Detection.	
SYSLG8.48.42	Warning	STP	%(1)j: STP Loopback Detection resolved.	
SYSLG8.49.10	Warning	AAA	sshpConId: connection %(1)d outside client range	Excessive number of clients serviced by the system.
SYSLG8.49.12	Warning	AAA	sshpClientId: connection id %(1)d is in the range reserved for channels	Excessive number of channels in the system.

ID	SEVERITY	CATEGORY	MESSAGE	DESCRIPTION
SYSLG8.49.13	Warning	AAA	sshpClientId: connection % (1)d is outside the range reserved for clients	Excessive number of clients serviced by the system.
SYSLG8.49.51	Warning	SSH	The SSH daemon can not use the configured TCP port (the port is already being used).	The SSH daemon cannot use the configured TCP port (the port is already being used).
SYSLG8.49.52	Warning	AAA	Insufficient memory to generate an % (1)s key. Please close all SSH or SSL sessions and try again.	Insufficient memory to generate an authentication key. Close all SSH or SSL sessions and try again.
SYSLG8.49.7	Warning	SSH	SSH has been enabled but an encryption key was not found. @For key generation use the 'crypto key generate' commands. The service will start automatically when a host key is generated.	SSH has been enabled but an encryption key was not found. For key generation use the 'crypto key generate' commands. The service starts automatically when a host key is generated.
SYSLG8.5.190	Warning		% (1)s: % (2)s - no such expression variable	
SYSLG8.50.22	Warning	FDB	Failed to create multicast group entry of VLAN % (1)d MAC % (2)s@	The system resource to support this number of multicast entries is limited.
SYSLG8.51.0	Warning	FDB	IGMP group table overflow@	The IGMP group table is full.
SYSLG8.51.1	Warning	FDB	IGMP router table overflow@	The IGMP router table is full.
SYSLG8.51.10	Warning	FDB	IGMP Snooping: in version 3 received version 1 query msg	Version 3 IGMP Snooping received a Version 1 query message.
SYSLG8.51.11	Warning	FDB	IGMP Snooping: in version 3 received version 2 query msg	Version 3 IGMP Snooping received a Version 2 query message.
SYSLG8.51.39	Warning	FDB	BIGMPP_indication warning: Unknown value of frame type received for igmp snooping (% (1)d igmp control frames dropped from the last warning)@	Unknown frame type value received for IGMP snooping. The specified IGMP control frames are dropped from the last warning.
SYSLG8.51.5	Warning	FDB	IGMP Snooping: in version 1 received leave v2 msg	Version 1 IGMP Snooping received a Version 2 leave message.
SYSLG8.51.6	Warning	FDB	IGMP Snooping: in version 1 received version 2 query msg	Version 1 IGMP Snooping received a Version 2 query message.
SYSLG8.51.7	Warning	FDB	IGMP Snooping: in version 1 received version 3 query msg	Version 1 IGMP Snooping received a Version 3 query message.

ID	SEVERITY	CATEGORY	MESSAGE	DESCRIPTION
SYSLG8.51.8	Warning	FDB	IGMP Snooping: in version 2 received version 3 query msg	Version 2 IGMP Snooping received a Version 3 query message.
SYSLG8.51.9	Warning	FDB	IGMP Snooping: in version 2 received version 1 query msg	Version 2 IGMP Snooping received a Version 1 query message.
SYSLG8.52.10	Warning	Port Security	Port Lock action on Mac Table has ended@	Port Lock action on the MAC Table has ended.
SYSLG8.52.2	Warning	FDB	Bridge forwarding table overflow@	The bridge forwarding table is full.
SYSLG8.52.6	Warning	FDB	BRMNP_nttb_hash_set_entry: Hash Insert Failed for VLAN: %(1)j Mac: %(2)s Port: %(3)j, Error: %(4)s	The MAC database is full. No entry can be inserted - the CPU memory limitations.
SYSLG8.52.9	Warning	Port Security	Port Lock action on Mac Table has started@	Port Lock action on the MAC Table has started.
SYSLG8.57.1	Warning	FDB	Bridge forwarding table overflow@	The bridge forwarding table is full.
SYSLG8.63.12	Warning	Stack	UNIT ID %(1)d,Msg:%(2)s	
SYSLG8.63.4	Warning	Stack	UNIT ID %(1)d,Trap:%(2)s	
SYSLG8.68.42	Warning	IP	Host and domain name size exceeds %(1)d bytes	Host and domain name size exceeds the specified number of bytes.
SYSLG8.74.55	Warning	Interface	Packet RX on interface %(1)s from %(2)s type %(3)s - %(4)s	Packets corrupted and (or) network problems.
SYSLG8.74.56	Warning	SSH	Packet RX on virtual interface %(1)s area %(2)s type %(3)s - %(4)s	Key IDs do not match; keys are expired or some other key configuration problems.
SYSLG8.74.60	Warning	SSH	Packet RX on virtual interface %(1)s area %(2)s type %(3)s - %(4)s	Key IDs do not match; keys are expired or some other key configuration problems.
SYSLG8.74.65	Warning	AAA	Packet TX from interface %(1)s - md5 auth key not found	Md5 keys are not found or are invalid.
SYSLG8.74.67	Warning	AAA	Packet TX from interface %(1)s - last authentication key has expired	Md5 keys are not found or are invalid.
SYSLG8.74.68	Warning	AAA	Packet RX on interface %(1)s from %(2)s - last authentication key has expired	Key IDs do not match; keys are expired or some other key configuration problems.
SYSLG8.75.0	Warning	Web	HTTPS server has been enabled but a certificate was not found.@For certificate generation use the - @ 'crypto	HTTPS server has been enabled but a certificate was not found. For a certificate generation use the - 'crypto certificate [1-2]



ID	SEVERITY	CATEGORY	MESSAGE	DESCRIPTION
			certificate [1-2] generate' command.@The service will start automatically when a certificate is generated.	generate' command. The service will start automatically when a certificate is generated.
SYSLG8.75.66	Warning		%(2)s service has been enabled but an encryption key (certificate %(1)d) was not found.@For key generation use the 'crypto key generate' commands. The service will start automatically when a host key is generated.	The specified service has been enabled but an encryption key was not found. For key generation use the 'crypto key generate' commands. The service starts automatically when a host key is generated.
SYSLG8.77.26	Warning	AAA	Invalid attribute %(1)d ignored - %(2)s	The specified attribute is ignored.
SYSLG8.78.14	Warning	AAA	Msg of %(1)u length received from server %(3)s is bigger than maximum - %(2)u. Information is truncated.	The message length is bigger than the specified maximum. Extra characters will be truncated.
SYSLG8.78.15	Warning	AAA	Parsing of the %(1)s msg received from TACACS server %(2)s failed	Parsing of the specified message received from the specified TACACS server has failed.
SYSLG8.78.18	Warning	IP	Unexpected TCP msg was received from server %(1)s	Unexpected TCP message was received from the specified server.
SYSLG8.78.2	Warning	AAA	No TACACS+ server is configured, cannot start authentication	No TACACS+ server is configured, so authentication cannot be performed.
SYSLG8.78.23	Warning	AAA	Connection to server %(1)s is aborted. Single Connection mode may not be supported by this server.	A connection attempt to a specified server is terminated. Single connection mode is not supported by the current server.
SYSLG8.78.6	Warning	AAA	No TACACS+ server is configured, cannot start authorization	No TACACS+ server is configured, so authorization cannot be started.
SYSLG8.78.7	Warning	AAA	Cannot create new user, too many users	Cannot create new user due to too many users already configured.
SYSLG8.79.4	Warning	Up/Download	FLMNGG_update_file_state: The entry of file %(1)s was not updated to the flash	The entry to the specified file was not updated to the flash.
SYSLG8.80.2	Warning	SNMP	PIMGLG_snmp_bindmib variable: For variable id %(1)lu the snmp operation %(2)s not supported.	For the specified variable ID the SNMP operation is not supported.

ID	SEVERITY	CATEGORY	MESSAGE	DESCRIPTION
SYSLG8.81.12	Warning		Func=%(1)s:Line=%(2)d: %(3)s	
SYSLG8.81.14	Warning		Func=%(1)s:Line=%(2)d: Unknown return value %(3)d	
SYSLG8.81.18	Warning		Func=%(2)s:Line=%(1)d: Can't allocate buffer	
SYSLG8.81.19	Warning		Func=%(2)s:Line=%(1)d: No outgoing interface	
SYSLG8.81.20	Warning		%(1)s state mashine:State:%(2)s,Even t:%(3)s:GroupIp=%(4)s,Sr cIp=%(5)s received	
SYSLG8.81.21	Warning		%(1)s state mashine:Incompatible State:%(2)s,Event:%(3)s for GroupIp=%(4)s,SrcIp=%( 5)s received	
SYSLG8.81.6	Warning	System	Module %(1)s: Call function %(2)s without init	In the specified module the specified call function is without initialization.
SYSLG8.81.7	Warning		%(1)s: Bad state in state machine %(2)s	The specified state is not correct is the specified state machine.
SYSLG8.81.8	Warning		%(1)s: Hash table %(2)s is full	The specified hash table is full.
SYSLG8.86.0	Warning	Up/Download	Configuration update of unit %(1)lu failed. Reason: %(2)s.	The specified unit configuration update failed.
SYSLG8.86.4	Warning	SNMP	Access attempted by unauthorized NMS	Access attempted by an unauthorized NMS.
SYSLG8.86.9	Warning	Up/Download	Error encountered while downloading config: %(1)s	An error occurred while downloading the specified configuration.
SYSLG8.89.8	Warning	SNMP	Overflow in CDB	There is an overflow in CDB.
SYSLG8.89.9	Warning	SNMP	Overflow in startup CDB. offset = %(1)lu, file end = %(2)lu	
SYSLG8.9.11	Warning	FDB	Timer allocation failed	The v1 Host Timer cannot be activated, and a router will stay in the v1 state.
SYSLG8.9.14	Warning	FDB	Querier->NonQueirier transition on Interface: %(1)j	An interface stopped to be a Querier.
SYSLG8.9.7	Warning	FDB	IGMP Cache table is overflowed	No entry can be inserted - the platform reached its limit.

<b>ID</b>	<b>SEVERITY</b>	<b>CATEGORY</b>	<b>MESSAGE</b>	<b>DESCRIPTION</b>
SYSLG8.9.8	Warning	FDB	Received IGMP wrong version (V1) query	Received a wrong IGMP version (v1) query.
SYSLG8.9.9	Warning	FDB	Received IGMP wrong version (V2) query	Received a wrong IGMP version (v2) query
SYSLG8.95.0	Warning	Up/Download	Configuration upload has been aborted	Configuration file upload has been aborted.
SYSLG8.95.1	Warning	Up/Download	Configuration download has been aborted	Configuration file download has been aborted.
SYSLG8.95.6	Warning		%(1)s	
SYSLG8.96.7	Warning		Unknown certificate subject field	
SYSLG8.98.6	Warning	System	Bad OS status	Bad OS status.
SYSLG8.98.7	Warning	FDB	Reached Maximum number of IGMP memberships	The IGMP database is full. No entry can be inserted.



## Warranty and Support (USA Only)

Subject to the terms and conditions set forth herein, D-Link Systems, Inc. ("D-Link") provides this lifetime product warranty for hardware:

- Only for products purchased, delivered and used within the fifty states of the United States, the District of Columbia, U.S. Possessions or Protectorates, U.S. Military Installations, or addresses with an APO or FPO, and;
- Only with proof of purchase.

**Product Warranty:** D-Link warrants that the hardware portion of the D-Link product, including internal and external power supplies and fans ("Hardware"), will be free from material defects in workmanship and materials under normal use from the date of original retail purchase of the product ("Warranty Period"), except as otherwise stated herein.

The customer's sole and exclusive remedy and the entire liability of D-Link and its suppliers under this Warranty will be, at D-Link's option, to repair or replace the defective Hardware during the Warranty Period at no charge to the owner or to refund the actual purchase price paid. Any repair or replacement will be rendered by D-Link at an Authorized D-Link Service Office. The replacement hardware need not be new or have an identical make, model or part. D-Link may, at its option, replace the defective Hardware or any part thereof with any reconditioned product that D-Link reasonably determines is substantially equivalent (or superior) in all material respects to the defective Hardware. Repaired or replacement hardware will be warranted for the remainder of the original Warranty Period or ninety (90) days, whichever is longer, and is subject to the same limitations and exclusions. If a material defect is incapable of correction, or if D-Link determines that it is not practical to repair or replace the defective Hardware, the actual price paid by the original purchaser for the defective Hardware will be refunded by D-Link upon return to D-Link of the defective Hardware. All Hardware or part thereof that is replaced by D-Link, or for which the purchase price is refunded, shall become the property of D-Link upon replacement or refund.

**Software Warranty:** D-Link warrants that the software portion of the product ("Software") will substantially conform to D-Link's then current functional specifications for the Software, as set forth in the applicable documentation, from the date of original retail purchase of the Software for a period of ninety (90) days ("Software Warranty Period"), provided that the Software is properly installed on approved hardware and operated as contemplated in its documentation. D-Link further warrants that, during the Software Warranty Period, the magnetic media on which D-Link delivers the Software will be free of physical defects. The customer's sole and exclusive remedy and the entire liability of D-Link and its suppliers under this Limited Warranty will be, at D-Link's option, to replace the non-conforming Software (or defective media) with software that substantially conforms to D-Link's functional specifications for the Software or to refund the portion of the actual purchase price paid that is attributable to the Software. Except as otherwise agreed by D-Link in writing, the replacement Software is provided only to the original licensee, and is subject to the terms and conditions of the license granted by D-Link for the Software. Replacement Software will be warranted for the remainder of the original Warranty Period and is subject to the same limitations and exclusions. If a material non-conformance is incapable of correction, or if D-Link determines in its sole discretion that it is not practical to replace the non-conforming Software, the price paid by the original licensee for the non-conforming Software will be refunded by D-Link; provided that the non-conforming Software (and all copies thereof) is first returned to D-Link. The license granted respecting any Software for which a refund is given automatically terminates.

**Non-Applicability of Warranty:** The Warranty provided hereunder for D-Link's products will not be applied to and does not cover any products obtained through a special or unique pricing agreement, if such agreement provides for warranty terms different from those normally provided with the product or set forth herein, nor to any refurbished product and any product purchased through the inventory clearance or liquidation sale or other sales in which D-Link, the sellers, or the liquidators expressly disclaim their warranty obligation pertaining to the product and in that case, the product is being sold "As-Is" without any warranty whatsoever including, without limitation, the Warranty as described herein, notwithstanding anything stated herein to the contrary.

**Submitting A Claim:** The customer shall return the product to the original purchase point based on its return policy. In case the return policy period has expired and the product is within warranty, the customer shall submit a claim to D-Link as outlined below:

- The customer must submit with the product as part of the claim a written description of the Hardware defect or Software nonconformance in sufficient detail to allow D-Link to confirm the same, along with proof of purchase of the product (such as a copy of the dated purchase invoice for the product).
- The customer must obtain a Case ID Number from D-Link Technical Support by going to <https://support.dlink.com>, who will attempt to assist the customer in resolving any suspected defects with the product. If the product is considered defective, the customer must obtain a Return Material Authorization ("RMA") number by completing the RMA form and entering the assigned Case ID Number at <https://rma.dlink.com/>.
- After an RMA number is issued, the defective product must be packaged securely in the original or other suitable shipping package to ensure that it will not be damaged in transit, and the RMA number must be prominently marked on the outside of the package. Include any manuals or accessories in the shipping package.
- The customer is responsible for all in-bound shipping charges to D-Link. No Cash on Delivery ("COD") is allowed. Products sent COD will either be rejected by D-Link or become the property of D-Link. Products shall be fully insured by the customer and shipped to **D-Link Systems, Inc., 17595 Mt. Herrmann, Fountain Valley, CA 92708**. D-Link will not be held responsible for any packages that are lost in transit to D-Link. The repaired or replaced packages will be shipped to the customer via UPS Ground or any common carrier selected by D-Link. Return shipping charges shall be prepaid by D-Link if you use an address in the United States, otherwise we will ship the product to you freight collect. Expedited shipping is available upon request and provided shipping charges are prepaid by the customer.

D-Link may reject or return any product that is not packaged and shipped in strict compliance with the foregoing requirements, or for which an RMA number is not visible from the outside of the package. The product owner agrees to pay D-Link's reasonable handling and return shipping charges for any product that is not packaged and shipped in accordance with the foregoing requirements, or that is determined by D-Link not to be defective or non-conforming.

**What Is Not Covered:** The Warranty provided herein by D-Link does not cover: Products that, in D-Link's judgment, have been subjected to abuse, accident, alteration, modification, tampering, negligence, misuse, faulty installation, lack of reasonable care, repair or service in any way that is not contemplated in the documentation for the product, or if the model or serial number has been altered, tampered with, defaced or removed; Initial installation, installation and removal of the product for repair, and shipping costs; Operational adjustments covered in the operating manual for the product, and normal maintenance; Damage that occurs in shipment, due to act of God, failures due to power surge, and cosmetic damage; Any hardware, software, firmware or other products or services provided by anyone other than D-Link; and Products that have been purchased from inventory clearance or liquidation sales or other sales in which D-Link, the sellers, or the liquidators expressly disclaim their warranty obligation pertaining to the product. While necessary maintenance or repairs on your Product can be performed by any company, we recommend that you use only an Authorized D-Link Service Office. Improper or incorrectly performed maintenance or repair voids this Warranty.

**Disclaimer of Other Warranties:** EXCEPT AS SPECIFICALLY SET FORTH ABOVE OR AS REQUIRED BY LAW, THE PRODUCT IS PROVIDED "AS-IS" WITHOUT ANY WARRANTY OF ANY KIND WHATSOEVER INCLUDING, WITHOUT LIMITATION, ANY WARRANTY OF MERCHANTABILITY, FITNESS FOR A PARTICULAR PURPOSE AND NON-INFRINGEMENT. IF ANY IMPLIED WARRANTY CANNOT BE DISCLAIMED IN ANY TERRITORY WHERE A PRODUCT IS SOLD, THE DURATION OF SUCH IMPLIED WARRANTY SHALL BE LIMITED TO NINETY (90) DAYS. EXCEPT AS EXPRESSLY COVERED UNDER THE WARRANTY PROVIDED HEREIN, THE ENTIRE RISK AS TO THE QUALITY, SELECTION AND PERFORMANCE OF THE PRODUCT IS WITH THE PURCHASER OF THE PRODUCT.

**Limitation of Liability:** TO THE MAXIMUM EXTENT PERMITTED BY LAW, D-LINK IS NOT LIABLE UNDER ANY CONTRACT, NEGLIGENCE, STRICT LIABILITY OR OTHER LEGAL OR EQUITABLE THEORY FOR ANY LOSS OF USE OF THE PRODUCT, INCONVENIENCE OR DAMAGES OF ANY CHARACTER, WHETHER DIRECT, SPECIAL, INCIDENTAL OR CONSEQUENTIAL (INCLUDING, BUT NOT LIMITED TO, DAMAGES FOR LOSS OF GOODWILL, LOSS OF REVENUE OR PROFIT, WORK STOPPAGE, COMPUTER FAILURE OR MALFUNCTION, FAILURE OF OTHER EQUIPMENT OR COMPUTER PROGRAMS TO WHICH D-LINK'S PRODUCT IS CONNECTED WITH, LOSS OF INFORMATION OR DATA CONTAINED IN, STORED ON, OR INTEGRATED WITH ANY PRODUCT RETURNED TO D-LINK FOR WARRANTY SERVICE) RESULTING FROM THE USE OF THE PRODUCT, RELATING TO WARRANTY SERVICE, OR ARISING OUT OF ANY BREACH OF THIS WARRANTY, EVEN IF D-LINK HAS BEEN ADVISED OF THE POSSIBILITY OF SUCH DAMAGES. THE SOLE REMEDY FOR A BREACH OF THE FOREGOING WARRANTY IS REPAIR, REPLACEMENT OR REFUND OF THE DEFECTIVE OR NON-CONFORMING PRODUCT. THE MAXIMUM LIABILITY OF D-LINK UNDER THIS WARRANTY IS LIMITED TO THE PURCHASE PRICE OF THE PRODUCT COVERED BY THE WARRANTY. THE FOREGOING EXPRESS WRITTEN WARRANTIES AND REMEDIES ARE EXCLUSIVE AND ARE IN LIEU OF ANY OTHER WARRANTIES OR REMEDIES, EXPRESS, IMPLIED OR STATUTORY.

**Lifetime Warranty:** IF LOCAL LAW MANDATES THE USE OF A DEFINITION OF "LIFETIME WARRANTY" DIFFERENT FROM THAT PROVIDED HEREIN, THEN THE LOCAL LAW DEFINITION WILL SUPERSEDE AND TAKE PRECEDENCE, TO THE EXTENT NECESSARY TO COMPLY.

**Governing Law.** This Warranty shall be governed by the laws of the State of California. Some states do not allow exclusion or limitation of incidental or consequential damages, or limitations on how long an implied warranty lasts, so the foregoing limitations and exclusions may not apply. This Warranty provides specific legal rights and you may also have other rights which vary from state to state.

**Trademarks:** D-Link is a registered trademark of D-Link Systems, Inc. Other trademarks or registered trademarks are the property of their respective owners.

**Copyright Statement:** No part of this publication or documentation accompanying this product may be reproduced in any form or by any means or used to make any derivative such as translation, transformation, or adaptation without permission from D-Link Corporation/D-Link Systems, Inc., as stipulated by the United States Copyright Act of 1976 and any amendments thereto. Contents are subject to change without prior notice. Copyright 2009 by D-Link Corporation/D-Link Systems, Inc. All rights reserved.

**CE Mark Warning:** This is a Class A product. In a residential environment, this product may cause radio interference, in which case the user may be required to take adequate measures.

**FCC Statement:** This equipment has been tested and found to comply with the limits for a Class A digital device, pursuant to part 15 of the FCC Rules. These limits are designed to provide reasonable protection against harmful interference in a commercial installation. This equipment generates, uses, and can radiate radio frequency energy and, if not installed and used in accordance with the instructions, may cause harmful interference to radio communication. However, there is no guarantee that interference will not occur in a particular installation. Operation of this equipment in a residential environment is likely to cause harmful interference to radio or television reception. If this equipment does cause harmful interference to radio or television reception, which can be determined by turning the equipment off and on, the user is encouraged to try to correct the interference by one or more of the following measures:

- Reorient or relocate the receiving antenna.
- Increase the separation between the equipment and receiver.
- Connect the equipment into an outlet on a circuit different from that to which the receiver is connected.
- Consult the dealer or an experienced radio/TV technician for help.

**For detailed warranty information applicable to products purchased outside the United States, please contact the corresponding local D-Link office.**

## ***Product Registration***

***Register your D-Link product online at <http://support.dlink.com/register/>***

***Product registration is entirely voluntary and failure to complete or return this form will not diminish your warranty rights.***

# Tech Support

## Technical Support

You can find software updates and user documentation on the D-Link website.

D-Link provides free technical support for customers within the United States and within Canada for the duration of the service period, and warranty confirmation service, during the warranty period on this product. U.S. and Canadian customers can contact D-Link technical support through our website, or by phone.

### *Tech Support for customers within the United States:*

#### ***D-Link Technical Support over the Telephone:***

USA - 877-DLINK-55 (877-354-6555)

#### ***D-Link Technical Support over the Internet:***

<http://support.dlink.com>

### **Tech Support for customers within Canada:**

#### ***D-Link Technical Support over the Telephone:***

877-354-6560

#### ***D-Link Technical Support over the Internet:***

<http://support.dlink.com>



## Technical Support

### United Kingdom (Mon-Fri)

Home Wireless/Broadband 0871 873 3000 (9.00am–06.00pm, Sat 10.00am-02.00pm)  
 Managed, Smart, & Wireless Switches, or Firewalls 0871 873 0909 (09.00am – 05.30pm)  
 (BT 10ppm, other carriers may vary.)

### Ireland (Mon-Fri)

All Products 1890 886 899 (09.00am-06.00pm, Sat 10.00am-02.00pm)  
 € 0.05ppm peak, €0.045ppm off peak Times

### Internet

<http://www.dlink.co.uk>

<ftp://ftp.dlink.co.uk>

## Technische Unterstützung

Deutschland:	Web:	<a href="http://www.dlink.de">http://www.dlink.de</a>
	E-Mail:	support@dlink.de
	Telefon:	+49(0)1805 2787 0,14 € pro Minute
	Zeiten:	Mo. –Fr. 09:00 – 17:30 Uhr
Österreich:	Web:	<a href="http://www.dlink.at">http://www.dlink.at</a>
	E-Mail:	support@dlink.at
	Telefon:	+43(0)820 480084 0,116 € pro Minute
	Zeiten:	Mo. –Fr. 09:00 – 17:30 Uhr
Schweiz:	Web:	<a href="http://www.dlink.ch">http://www.dlink.ch</a>
	E-Mail:	support@dlink.ch
	Telefon:	+41(0)848 331100 0,08 CHF pro Minute
	Zeiten:	Mo. –Fr. 09:00 – 17:30 Uhr

\* Gebühren aus Mobilnetzen und von anderen Providern können abweichen.

\* Gebühren aus Mobilnetzen und von anderen Providern können abweichen.



## Assistance technique

Assistance technique D-Link par téléphone : 0820 0803 03

0.12 € la minute : Du lundi au vendredi de 9h à 19h

Assistance technique D-Link sur internet :

<http://www.dlink.fr>

## Asistencia Técnica

Asistencia Técnica Telefónica de D-Link: +34 902 30 45 45

0,067 €/min

De Lunes a Viernes de 9:00 a 19:00

<http://www.dlink.es>

## Supporto tecnico

Supporto Tecnico dal lunedì al venerdì dalle ore 9.00 alle ore 19.00 con orario continuato

Telefono: 199400057

<http://www.dlink.it/support>

## Technical Support

Tech Support for customers within the Netherlands:

0900 501 2007 / [www.dlink.nl](http://www.dlink.nl) / €0.15ppm anytime.

Tech Support for customers within Belgium:

070 66 06 40 / [www.dlink.be](http://www.dlink.be) / €0.175ppm peak, €0.0875ppm off peak

Tech Support for customers within Luxemburg:

+32 70 66 06 40 / [www.dlink.be](http://www.dlink.be)

## Pomoc techniczna

Telefoniczna pomoc techniczna firmy D-Link: 0 801 022 021

Pomoc techniczna firmy D-Link świadczona przez Internet:

## Technická podpora

Web: <http://www.dlink.cz/support/>

E-mail: [support@dlink.cz](mailto:support@dlink.cz)

Telefon: 225 281 553

Telefonická podpora je v provozu: PO- PÁ od 09.00 do 17.00

Pevna linka 1,78 CZK/min - mobil 5.40 CZK/min

## Technikai Támogatás

Tel. : 06 1 461-3001

Fax : 06 1 461-3004

Land Line 14,99 HUG/min - Mobile 49.99,HUF/min

email : [support@dlink.hu](mailto:support@dlink.hu)

URL : <http://www.dlink.hu>

## Teknisk Support

D-Link Teknisk telefon Support: 820 00 755

(Hverdager 08:00-20:00)

D-Link Teknisk Support over Internett: <http://www.dlink.no>

## Teknisk Support

***D-Link teknisk support over telefonen: Tlf. 7026 9040***

Åbningstider: kl. 08:00 – 20:00

D-Link teknisk support på Internettet: <http://www.dlink.dk>

## **Teknistä tukea asiakkaille Suomessa:**

Arkisin klo. 9 - 21  
numerosta : **06001 5557**  
Internetin kautta : <http://www.dlink.fi>

## **Teknisk Support**

D-Link Teknisk Support via telefon: 0900-100 77 00  
Vardagar 08.00-20.00  
D-Link Teknisk Support via Internet: <http://www.dlink.se>

## **Assistência Técnica**

Assistência Técnica da D-Link na Internet:  
<http://www.dlink.pt>  
e-mail: [soporte@dlink.es](mailto:soporte@dlink.es)

## **Τεχνική Υποστήριξη**

D-Link Hellas Support Center  
Κεφαλληνίας 64, 11251 Αθήνα,  
Τηλ: 210 86 11 114 (Δευτέρα- Παρασκευή 09:00-17:00)  
Φαξ: 210 8611114  
<http://www.dlink.gr/support>

## **Tehnička podrška**

Hvala vam na odabiru D-Link proizvoda. Za dodatne informacije, podršku i upute za korištenje uređaja, molimo vas da posjetite D-Link internetsku stranicu na [www.dlink.eu](http://www.dlink.eu)  
[www.dlink.biz/hr](http://www.dlink.biz/hr)

## **Tehnična podpora**

Zahvaljujemo se vam, ker ste izbrali D-Link proizvod. Za vse nadaljnje informacije, podpora ter navodila za uporabo prosimo obiščite D-Link - ovo spletno stran [www.dlink.eu](http://www.dlink.eu)  
[www.dlink.biz/sl](http://www.dlink.biz/sl)

## **Suport tehnica**

Vă mulțumim pentru alegerea produselor D-Link. Pentru mai multe informații, suport și manuale ale produselor vă rugăm să vizitați site-ul D-Link [www.dlink.eu](http://www.dlink.eu)  
[www.dlink.ro](http://www.dlink.ro)

## Technical Support

You can find software updates and user documentation on the D-Link website.

### Tech Support for customers in

#### Australia:

Tel: 1300-766-868

24/7 Technical Support

Web: <http://www.dlink.com.au>

E-mail: [support@dlink.com.au](mailto:support@dlink.com.au)

#### India:

Tel: 1800-233-0000 (MTNL & BSNL Toll Free)

+91-832-2885700 (GSM, CDMA & Others)

Web: [www.dlink.co.in](http://www.dlink.co.in)

E-Mail: [helpdesk@dlink.co.in](mailto:helpdesk@dlink.co.in)

### Indonesia, Malaysia, Singapore and Thailand:

Tel: +62-21-5731610 (Indonesia)

Tel: 1800-882-880 (Malaysia)

Tel: +65 6501 4200 (Singapore)

Tel: +66-2-719-8978/9 (Thailand)

24/7, for English Support only

Web: <http://www.dlink.com.sg/support/>

E-mail: [support@dlink.com.sg](mailto:support@dlink.com.sg)

#### Korea:

Tel: +82-2-2028-1815

Monday to Friday 9:00am to 6:00pm

Web: <http://www.d-link.co.kr>

E-mail: [arthur@d-link.co.kr](mailto:arthur@d-link.co.kr)

#### New Zealand:

Tel: 0800-900-900

24/7 Technical Support

Web: <http://www.dlink.co.nz>

E-mail: [support@dlink.co.nz](mailto:support@dlink.co.nz)



## Technical Support

You can find software updates and user documentation on the D-Link website.

### *Tech Support for customers in*

#### **Egypt:**

Tel: +202-2919035, +202-2919047  
 Sunday to Thursday 9:00am to 5:00pm  
 Web: <http://support.dlink-me.com>  
 E-mail: [support.eg@dlink-me.com](mailto:support.eg@dlink-me.com)

#### **Iran:**

Tel: +98-21-88880918,19  
 Saturday to Thursday 9:00am to 5:00pm  
 Web: <http://support.dlink-me.com>  
 E-mail: [support.ir@dlink-me.com](mailto:support.ir@dlink-me.com)  
[support@dlink.ir](mailto:support@dlink.ir)

#### **Israel:**

Magshimim 20, Petach Tikva 49348  
 Main Tel: 972-3-9215173  
 Customer Support Tel: 972-3-9212886  
 Web: [www.dlink.co.il](http://www.dlink.co.il)

#### **Pakistan:**

Tel: +92-21-4548158  
 +92-21-4548310  
 Monday to Friday 10:00am to 6:00pm  
 Web: <http://support.dlink-me.com>  
 E-mail: [zkashif@dlink-me.com](mailto:zkashif@dlink-me.com)

#### **South Africa and Sub Sahara Region:**

Tel: +27-12-665-2165  
 08600 DLINK (for South Africa only)  
 Monday to Friday 8:30am to 9:00pm South Africa Time  
 Web: <http://www.d-link.co.za>  
 E-mail: [support@d-link.co.za](mailto:support@d-link.co.za)

#### **Turkey:**

Tel: +90-212-2895659  
 Monday to Friday 9:00am to 6:00pm  
 Web: <http://www.dlink.com.tr>  
 E-mail: [turkiye@dlink-me.com](mailto:turkiye@dlink-me.com)

#### **U.A.E and North Africa:**

Tel: +971-4-4278127 (U.A.E)  
 Sunday to Thursday 9.00AM to 6.00PM GMT+4  
 Web: <http://www.dlink-me.com>  
 E-mail: [support.me@dlink-me.com](mailto:support.me@dlink-me.com)

#### **Saudi ARABIA (KSA):**

Tel: +966 01 217 0008  
 Fax: +966 01 217 0009  
 Saturday to Wednesday 9.30AM to 6.30PM  
 Thursdays 9.30AM to 2.00 PM  
 E-mail: [Support.sa@dlink-me.com](mailto:Support.sa@dlink-me.com)

**D-Link®**  
 Building Networks for People

## Техническая поддержка

Обновления программного обеспечения и документация доступны на Интернет-сайте D-Link.

D-Link предоставляет бесплатную поддержку для клиентов в течение гарантийного срока.

Клиенты могут обратиться в группу технической поддержки D-Link по телефону или через Интернет.

### **Техническая поддержка D-Link:**

+7(495) 744-00-99

### **Техническая поддержка через Интернет**

<http://www.dlink.ru>

e-mail: [support@dlink.ru](mailto:support@dlink.ru)



## SOPORTE TÉCNICO

Usted puede encontrar actualizaciones de softwares o firmwares y documentación para usuarios a través de nuestro sitio [www.dlinkla.com](http://www.dlinkla.com)

### SOPORTE TÉCNICO PARA USUARIOS EN LATINO AMERICA

Soporte técnico a través de los siguientes teléfonos de D-Link

PAIS	NUMERO	HORARIO
Argentina	0800 - 12235465	Lunes a Viernes 08:00am a 21:00pm
Chile	800 - 835465 ó (02) 5941520	Lunes a Viernes 08:00am a 21:00pm
Colombia	01800 - 9525465	Lunes a Viernes 06:00am a 19:00pm
Costa Rica	0800 - 0521478	Lunes a Viernes 05:00am a 18:00pm
Ecuador	1800 - 035465	Lunes a Viernes 06:00am a 19:00pm
El Salvador	800 - 6335	Lunes a Viernes 05:00am a 18:00pm
Guatemala	1800 - 8350255	Lunes a Viernes 05:00am a 18:00pm
México	01800 - 1233201	Lunes a Viernes 06:00am a 19:00pm
Panamá	011 008000525465	Lunes a Viernes 05:00am a 18:00pm
Perú	0800 - 00968	Lunes a Viernes 06:00am a 19:00pm
Venezuela	0800 - 1005767	Lunes a Viernes 06:30am a 19:30pm

### Soporte Técnico de D-Link a través de Internet

[www.dlinkla.com](http://www.dlinkla.com)

e-mail: [soporte@dlinkla.com](mailto:soporte@dlinkla.com) & [consultas@dlinkla.com](mailto:consultas@dlinkla.com)





## Suporte Técnico

Você pode encontrar atualizações de software e documentação de usuário no site da D-Link Brasil.

A D-Link fornece suporte técnico gratuito para clientes no Brasil durante o período de vigência da garantia deste produto.

### **Suporte Técnico para clientes no Brasil:**

Website para suporte: [www.dlink.com.br/suporte](http://www.dlink.com.br/suporte)  
e-mail: [suporte@dlink.com.br](mailto:suporte@dlink.com.br)

### **Telefones para contato:**

Clientes de São Paulo: 2755 6950  
Clientes das demais regiões: 0800 70 24 104  
Segunda à Sexta-feira, das 9:00h às 21:00h  
Sábado, das 9:00h às 15:00h



## D-Link 友訊科技 台灣分公司 技術支援資訊

如果您還有任何本使用手冊無法協助您解決的產品相關問題，台灣地區用戶可以透過我們的網站、電子郵件或電話等方式與D-Link台灣地區技術支援工程師聯絡。

### D-Link 免付費技術諮詢專線

0800-002-615

服務時間：週一至週五，早上9:00到晚上9:00

(不含周六、日及國定假日)

網 站：<http://www.dlink.com.tw>

電子郵件：[dssqa\\_service@dlink.com.tw](mailto:dssqa_service@dlink.com.tw)

如果您是台灣地區以外的用戶，請參考D-Link網站全球各地分公司的聯絡資訊以取得相關支援服務。

產品保固期限、台灣區維修據點查詢，請參考以下網頁說明：

<http://www.dlink.com.tw>

產品維修：

使用者可直接送至全省聯強直營維修站或請洽您的原購買經銷商。

**D-Link**<sup>®</sup>  
Building Networks for People

## Dukungan Teknis

Update perangkat lunak dan dokumentasi pengguna dapat diperoleh pada situs web D-Link.

### Dukungan Teknis untuk pelanggan:

#### Dukungan Teknis D-Link melalui telepon:

Tel: +62-21-5731610

#### Dukungan Teknis D-Link melalui Internet:

Email : [support@dlink.co.id](mailto:support@dlink.co.id)

Website : <http://support.dlink.co.id>



## Technical Support

この度は弊社製品をお買い上げいただき、誠にありがとうございます。  
させていただきます。

下記弊社 Web サイトからユーザ登録及び新製品登録を  
行っていただくと、ダウンロードサービスにて  
サポート情報、ファームウェア、ユーザマニュアルを  
ダウンロードすることができます。

**ディーリンクジャパン Web サイト**

URL:<http://www.dlink-jp.com>

**D-Link®**  
Building Networks for People

## 技术支持

---

办公地址：北京市东城区北三环东路 36 号 环球贸易中心 B 座  
26F 02-05 室 邮编: 100013

技术支持中心电话：8008296688/ (028)66052968

技术支持中心传真：(028)85176948

各地维修中心地址请登陆官方网站查询

网址：<http://www.dlink.com.cn>

办公时间：周一到周五，早09:00到晚18:00

