



XAPP794 (v1.3) December 20, 2013

1080p60 Camera Image Processing Reference Design

Authors: Mario Bergeron (Avnet, Inc.), Steve Elzinga, Gabor Szedo, Greg Jewett, and Tom Hill (Xilinx, Inc.)

Summary

The Xilinx Zynq®-7000 All Programmable (AP) SoC Video and Imaging Kit (ZVIK) builds on the Zynq-7000 AP SoC ZC702 evaluation kit (ZC702) [Ref 43] by including additional hardware, software, and IP components for the development of custom video applications. The included video reference designs, WUXGA color image sensor, and video I/O FPGA mezzanine card (FMC) with HDMI™ input and output allow for immediate development of video system software, firmware, and hardware designs.

This application note describes how to set up and run the 1080p60 camera image processing reference design (camera design) using the ZVIK. Instructions are also included on how to build the hardware and software components as well as how to create the SD card boot image.

The intended audience for this document includes video applications embedded system developers, hardware developers, and system architects. To learn more about the Zynq-7000 AP SoC, the ZVIK, or for further development using the embedded design kit, consult the [References](#) section. The [Appendix](#) provides a list of acronyms used in this application note.

Introduction

This application note describes the 1080p60 camera image processing reference design that showcases various features of the ZVIK, provides a working camera image processing example design, and introduces several Xilinx video IP cores.

Video input is generated by the VITA-2000 image sensor from ON Semiconductor, which is configured for 1080p60 resolution. The raw Bayer sub-sampled image is converted to an RGB image by an image processing pipeline implemented using LogiCORE™ IP video cores that remove defective pixels, de-mosaic, and color-correct the image. A video frame buffer is implemented in the processing system (PS) DDR3 memory, making images accessible to the ARM® processor cores via the AXI Video Direct Memory Access (VDMA). The video frame buffer is not required for the operation of the image processing pipeline, but is included in the design to enable the capture of input video images for analysis. [Figure 1](#) shows a block diagram of the design.

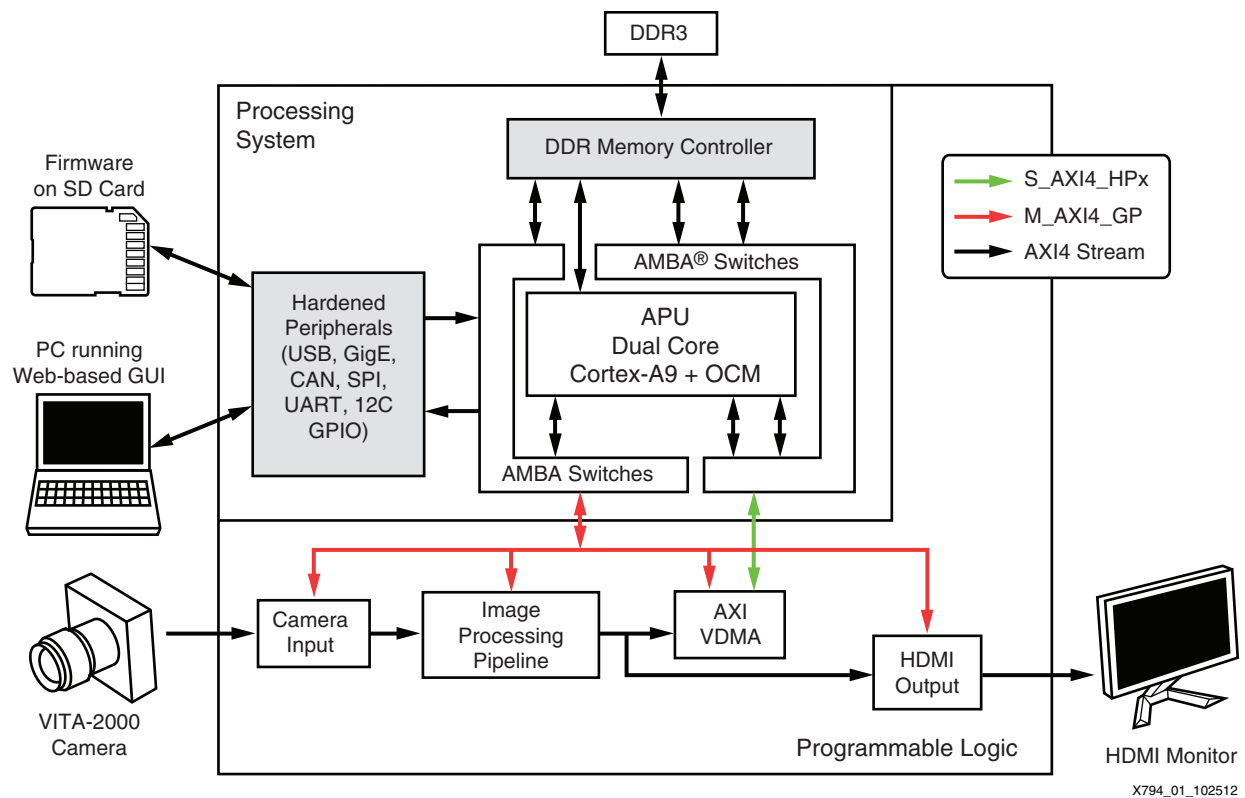

Figure 1: 1080p60 Camera Design Block Diagram

A web-based graphical user interface (GUI) allows configuring each of the Xilinx video IP cores in the image processing pipeline, displaying information about the incoming image such as histograms of the data, and enables processor-based operations on the data such as automatic white balance and automatic exposure.

The hardware evaluation cores contained in the design time out after approximately four hours, resulting in a blank screen. At this point, the board must be power-cycled to reload the design.

Host PC System Requirements

The host PC requirements to operate the camera design and its applications are:

- 32-bit/64-bit host PC with Ethernet port running Windows XP or Windows 7 Professional 32-bit/64-bit, or Ubuntu 10 or later 32-bit/64-bit Linux distribution.
- UART connected terminal (for example, Tera Term 4.69 or HyperTerminal).
- Zip/Unzip software (for example, 7-Zip).
- Web browser such as Internet Explorer (to operate the web-based GUI).
- USB-UART driver from Silicon Labs [Ref 39] (might already be installed). For information about installing the USB-UART driver, see *Zynq-7000 All Programmable SoC: ZC702 Evaluation Kit and Video and Imaging Kit Getting Started Guide* [Ref 1].

To build the hardware and software components, the Vivado® 2013.2 design tools are also required.

Target Hardware Requirements

The target hardware requirements for running the camera design and its applications are:

- Zynq-7000 All Programmable SoC Video and Imaging Kit, including:
 - Xilinx XC7Z020 CLG484-1 SoC-based ZC702 evaluation board.
 - Avnet FMC-IMAGEON FMC module.
 - VITA-2000 camera module (including optics, tripod, and cable).
 - HDMI cable.
 - SD-MMC flash card.
 - 12V power supply.
- HDMI monitor supporting 1080p60 resolution. A DVI monitor can also be used, but an HDMI female to DVI-D male connector adapter must be obtained (not provided with the kit). The connector adapter is available at most electronic retailers or through online sources.
- SD-MMC flash card writer.

For more information on the Zynq-7000 AP SoC Video and Imaging Kit, see:

www.xilinx.com/zvik

For more information on the Zynq-7000 AP SoC ZC702 evaluation board (including hardware user manual, schematics, and BOM), see:

www.xilinx.com/zc702

For more information on the Avnet FMC-IMAGEON FMC Module with ON Semiconductor image sensor, see:

www.em.avnet.com/fmc-imageon-v2000c

Running the Demonstration

This section describes how to run the 1080p60 camera image processing reference design on the ZVIK.

Reference Design File

The reference design files for this application note can be downloaded from:

<https://secure.xilinx.com/webreg/clickthrough.do?cid=199792>

Table 1 shows the reference design matrix.

Table 1: Reference Design Matrix

Parameter	Description
General	
Developer name	Xilinx
Target devices	Zynq-7000 AP SoC
Source code provided	Yes
Source code format	VHDL (some sources encrypted)
IP used	Video IP Cores
Simulation	
Functional simulation performed	N/A
Timing simulation performed	N/A
Test bench used for functional and timing simulations	N/A
Test bench format	N/A
Simulator software/version used	N/A
SPICE/IBIS simulations	N/A
Implementation	
Synthesis software tools/version used	Vivado 2013.2 design tools
Implementation software tools/version used	Vivado 2013.2 design tools
Static timing analysis performed	Yes (pass timing in PAR/TRACE)
Hardware Verification	
Hardware verified	Yes
Hardware platform used for verification	Zynq-7000 Video and Imaging Kit

Installing Design Files

Download the `xapp794.zip` files to the C: drive of the host PC:

```
C:\zc702-zvik-camera
```

Note: The Windows operating system has a 260 character limitation on the maximum length for a path. Make sure that the installation path is short to prevent path length related errors. If another location is chosen, there should be no spaces in the folder names.

Preparing the SD Card

Pre-built binaries for the camera design are provided in this directory:

```
..\zc702-zvik-camera\binaries\sd_content
```

Create a backup copy of the files on the SD card provided with the kit to enable them to be restored if desired. These files are also available on the ZVIK product page. Copy the contents of the `sd_content` directory to the root directory of the SD card.

By default, the design configures the ZVIK for IP address 192.168.1.10. This requires configuring the host computer to a compatible IP address, such as 192.168.1.20. If this is not possible, the IP address of the ZVIK in the configuration script should be changed:

```
..\zc702-zvik-camera\binaries\sd_content\config_my_ip.sh
```

On a Windows host, use a text editor that does not alter the end of line characters, such as Notepad.

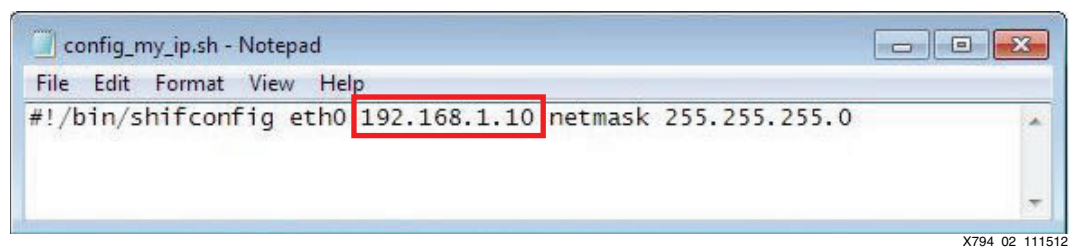

Figure 2: Modifying the ZVIK IP Address

With a subnet mask of 255.255.255.0, the first three number groups of the IP address must be identical in both the host computer IP address and the ZVIK IP address. For example, if the ZVIK is configured with the IP address 192.168.1.10 (and subnet mask 255.255.255.0), the host must be configured with an IP address containing identical numbers in the first three positions and a differing number in the fourth group, such as 192.168.1.20.

Configuring the Host IP Address

Configure the IP address of the host computer to one that is compatible with the ZVIK IP address discussed in [Preparing the SD Card](#). Record the host PC's original network settings so they can be restored after running the demonstration. Configure the computer's IP address to 192.168.1.20 (or similar). The subnet mask can be 255.255.255.0. The screen captures and icon names shown in this section might be slightly different depending on the computer's operating system version.

For Windows 7:

1. Click the **Start** button and select **Control Panel**.
2. Select **Network and Sharing Center**.
3. Select **Change Adapter Settings** from the options on the left panel.
4. Right-click the adapter corresponding to the wired Ethernet port identified as a local area connection and select **Properties**.
5. Accept the User Account Control dialog box by selecting **Yes**.
6. Click the **Internet Protocol Version 4 (TCP/IPv4)** entry and select **Properties**.
7. On the General tab, select **Use the following IP address** radio button.
8. In the IP address: field, enter **192.168.1.20** or a value that is compatible with the ZVIK IP address configured in the previous section.

- Click the **Subnet mask:** field and ensure that it is populated with 255.255.255.0. The dialog box should appear similar to [Figure 3](#).

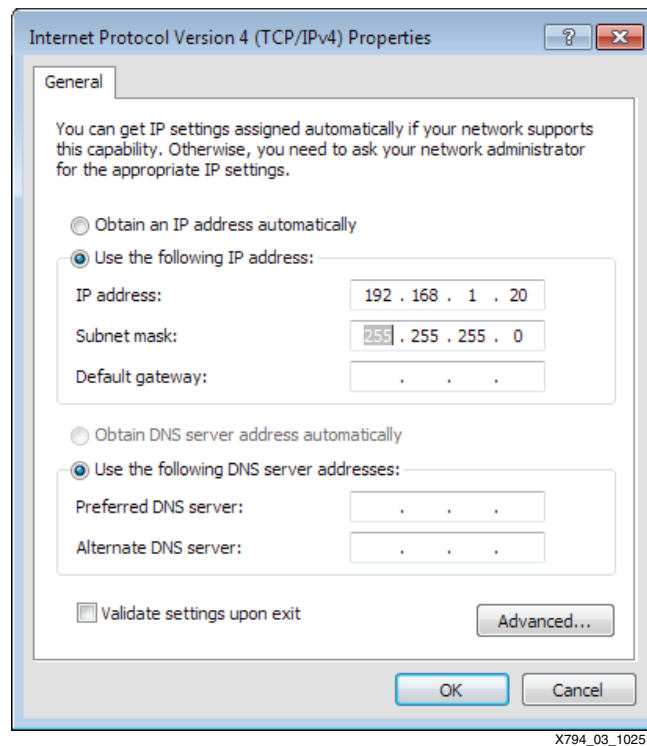

Figure 3: Host Computer IP Address Configuration Dialog Box

- Select **OK** to close the Internet Protocol Version 4 (TCP/IPv4) dialog box. Select **OK** to close the Local Area Connection Properties dialog box.

Assembling the Camera

If the camera assembly has been completed, go to [Setting Up the Hardware](#).

The ZVIK package contains these components, which must be assembled:

- IR cut filter
- Lens (2/3", 8 mm)
- VITA-2000-C image sensor module (with C-mount lens holder)
- Tripod
- LCEDI cable
- FMC-IMAGEON FMC module

To assemble the camera:

1. Remove both protective caps from the lens (2) (Figure 4).

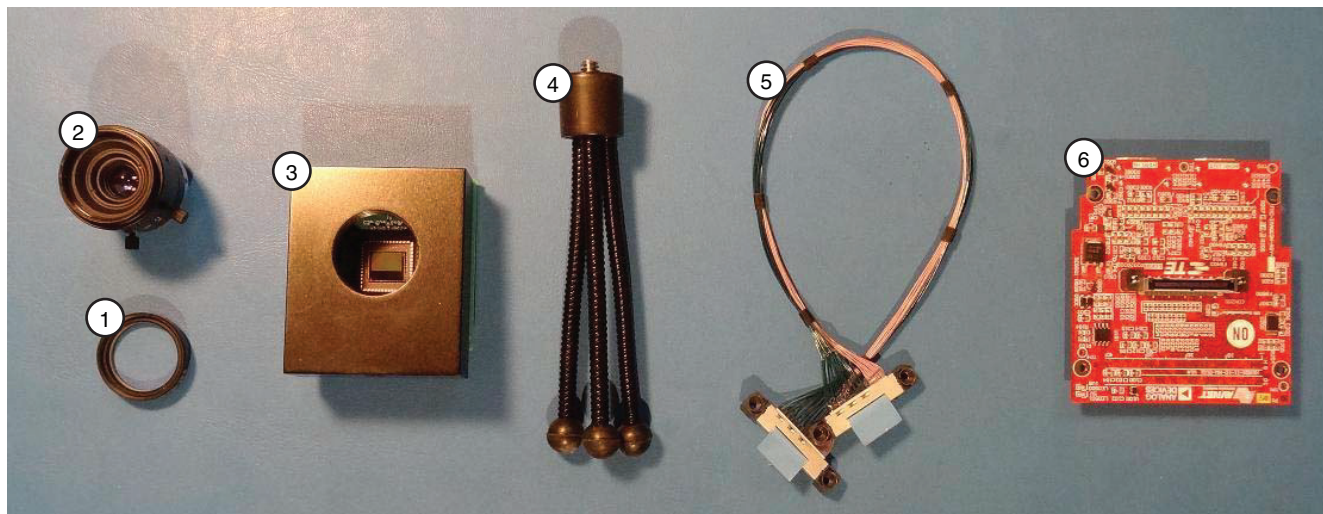

X794_04_102612

Figure 4: VITA-2000 Camera Assembly Step 1

2. Attach the IR cut filter (1) to the lens (2) (Figure 5). The filter screws onto the front of the lens.

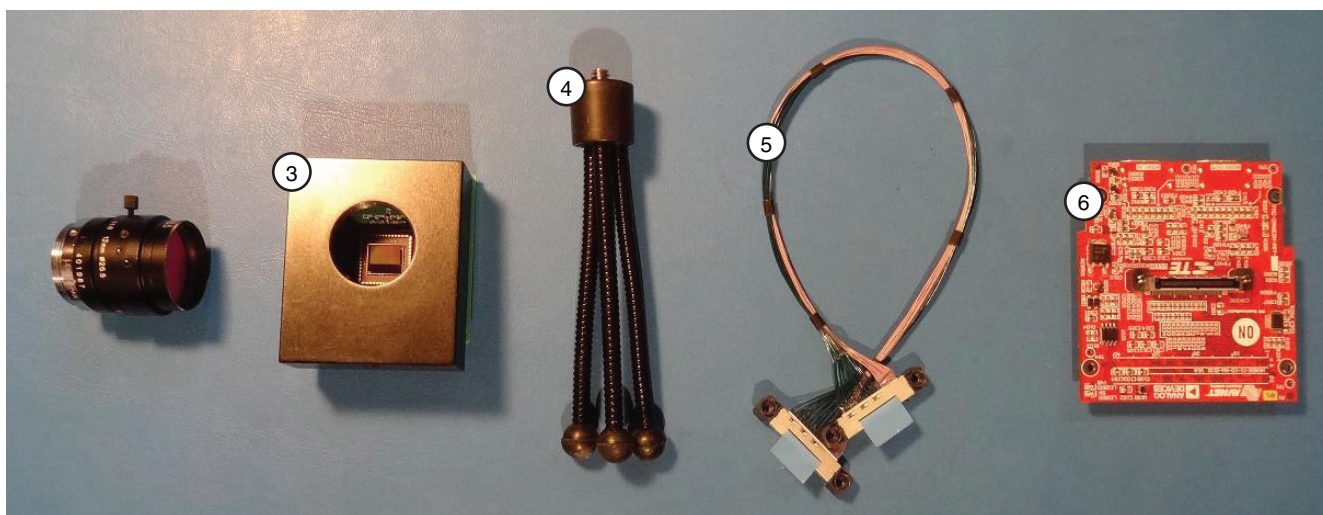

X794_05_102612

Figure 5: VITA-2000 Camera Assembly Step 2

3. Screw the IR cut filter and lens assembly onto the VITA-2000 image sensor module (3) (Figure 6). The image sensor module has a lens holder with an opening for standard C-mount lenses.

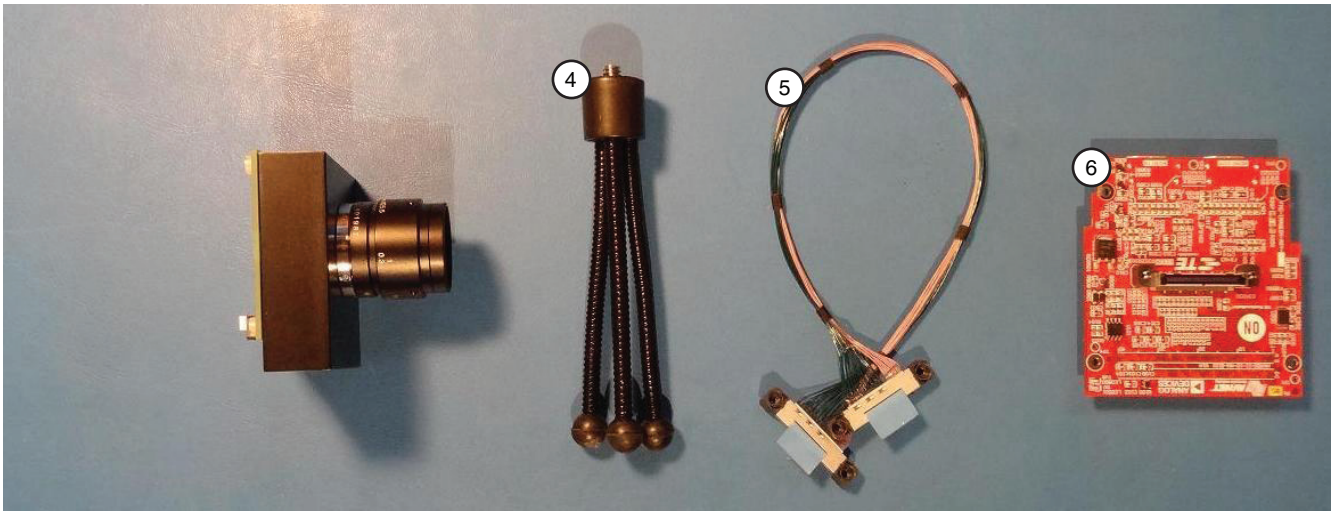

X794_06_102612

Figure 6: VITA-2000 Camera Assembly Step 3

4. Attach the tripod (4) to the bottom of the VITA-2000 image sensor module (Figure 7). The image sensor module lens holder has a hole that accepts standard tripods having a 1/4 inch screw with 20 threads per inch.

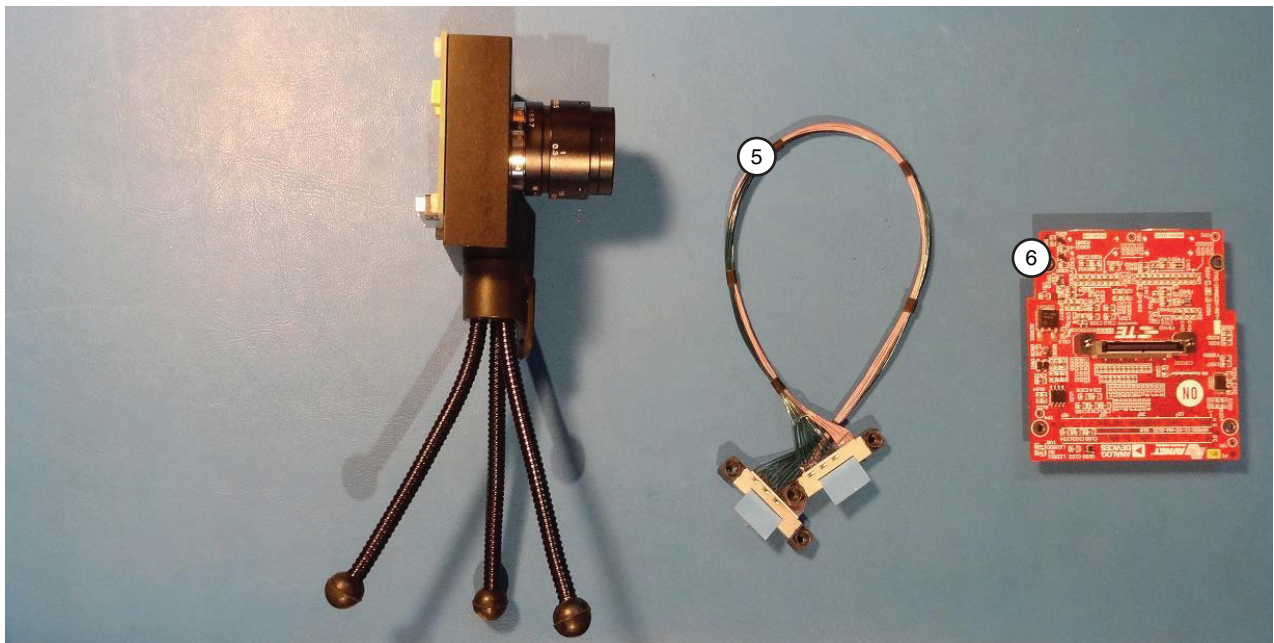

X794_07_102612

Figure 7: VITA-2000 Camera Assembly Step 4

5. Attach the LCEDI cable (5) to the back of the VITA-2000 image sensor module (Figure 8). Both ends of the LCEDI are identical. Either end can be connected to the image sensor module.

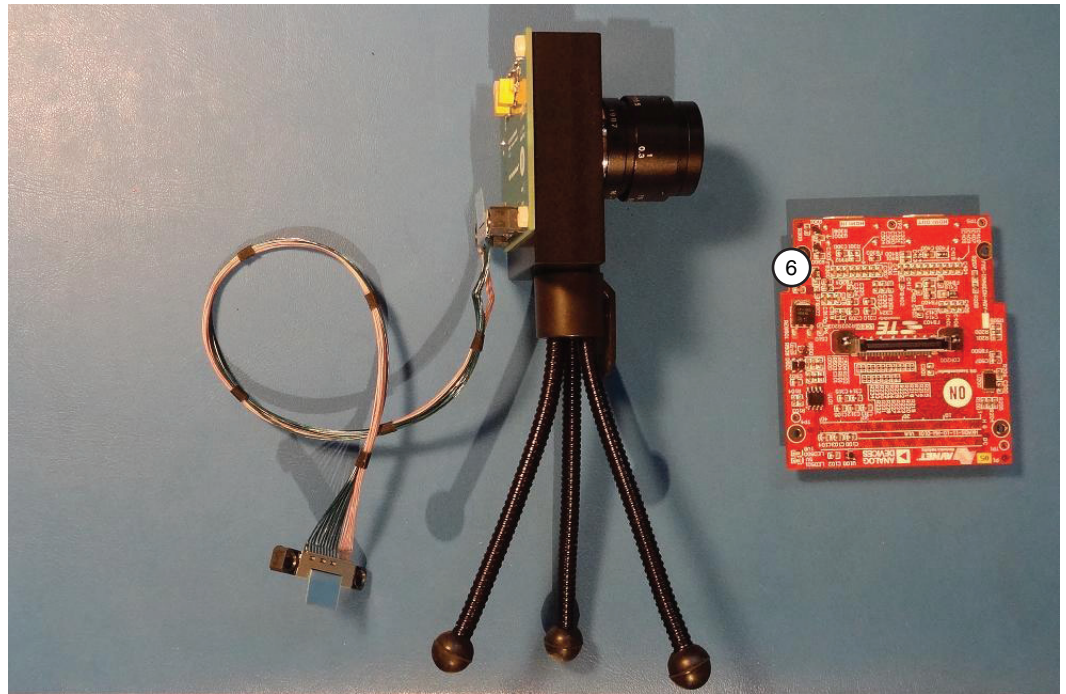

X794_08_102612

Figure 8: VITA-2000 Camera Assembly Step 5

6. Attach the other end of the LCEDI cable to the FMC-IMAGEON FMC module (6) (Figure 9).

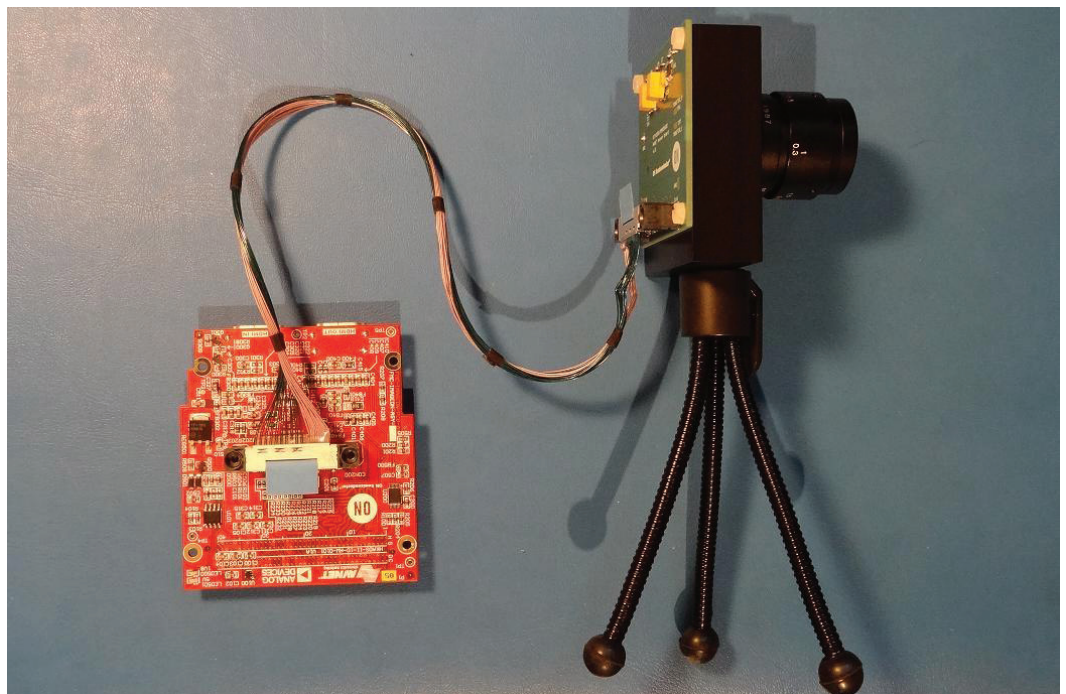

X794_09_102612

Figure 9: VITA-2000 Camera Assembly Step 6

The VITA-2000 color camera assembly is complete.

7. The FMC-IMAGEON FMC Module connects to the FMC2 connector of the ZC702 board FMC carrier. The flexibility of the LCEDI cable allows the camera to be positioned in virtually any direction (Figure 10).

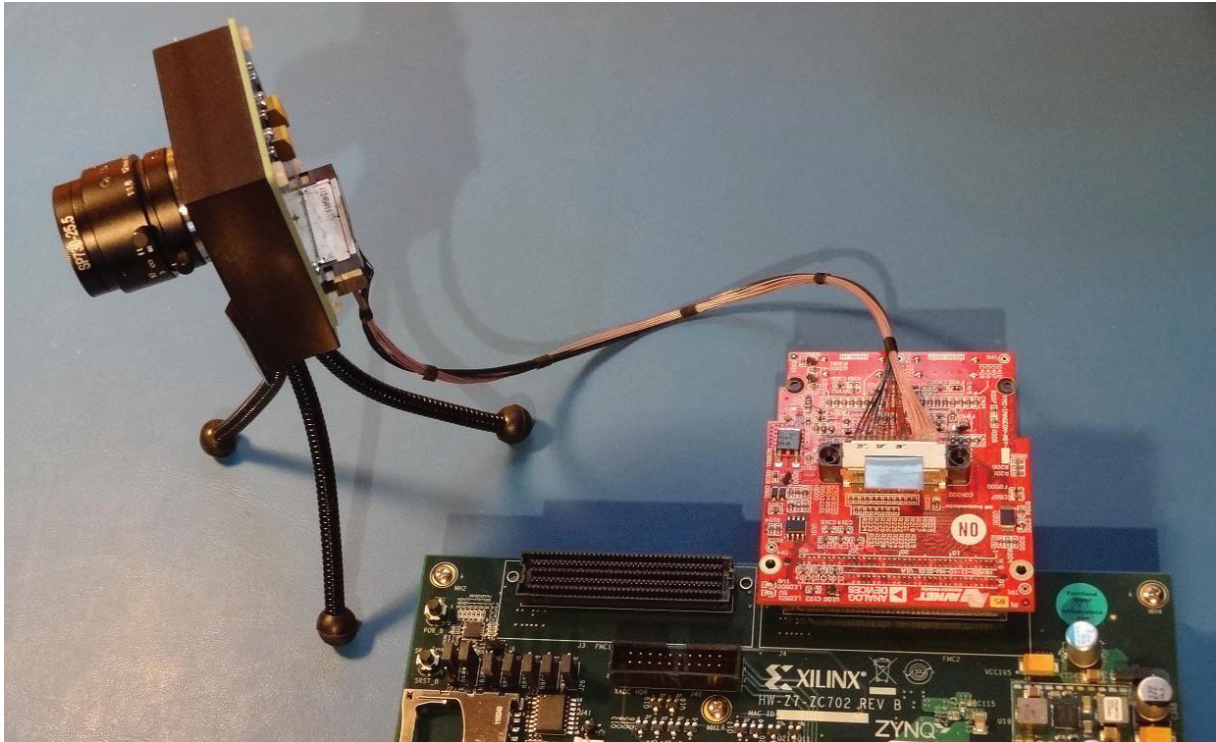

X794_10_102612

Figure 10: VITA-2000 Camera Assembly Step 7

8. The ZVIK package also contains two standoffs and four screws that secure the FMC-IMAGEON FMC module to the ZC702 board. The package also contains four longer screws, standoffs, and rubber feet to support the free end of the board. Assemble the hardware, as shown in [Figure 11](#).

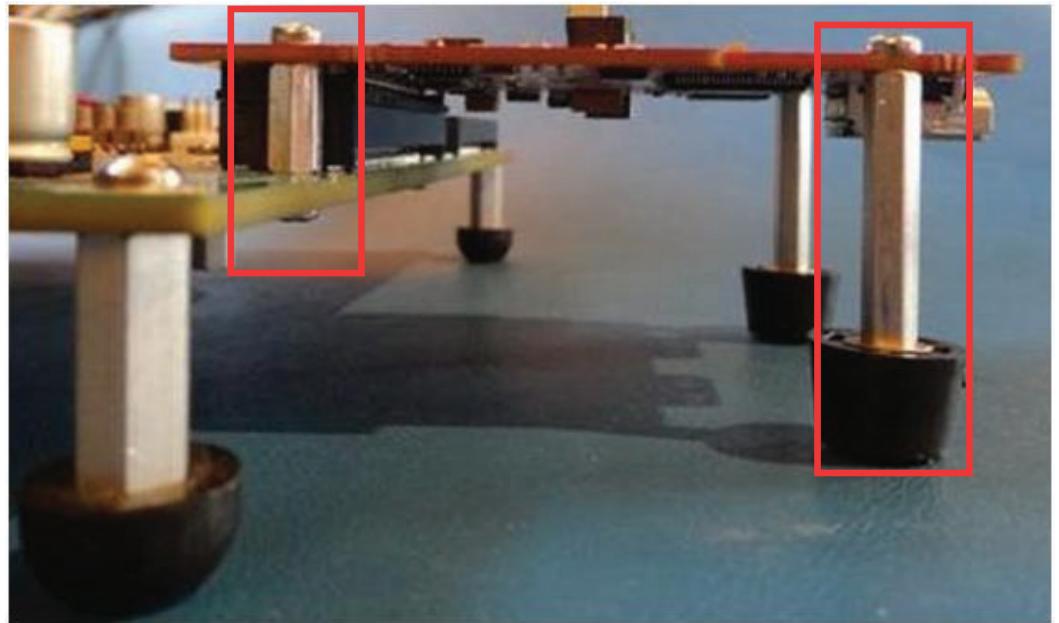

X794_11_102612

Figure 11: VITA-2000 Camera Assembly Step 8

Setting Up the Hardware

[Figure 12](#) illustrates how to connect the ZVIK for the 1080p60 camera design.

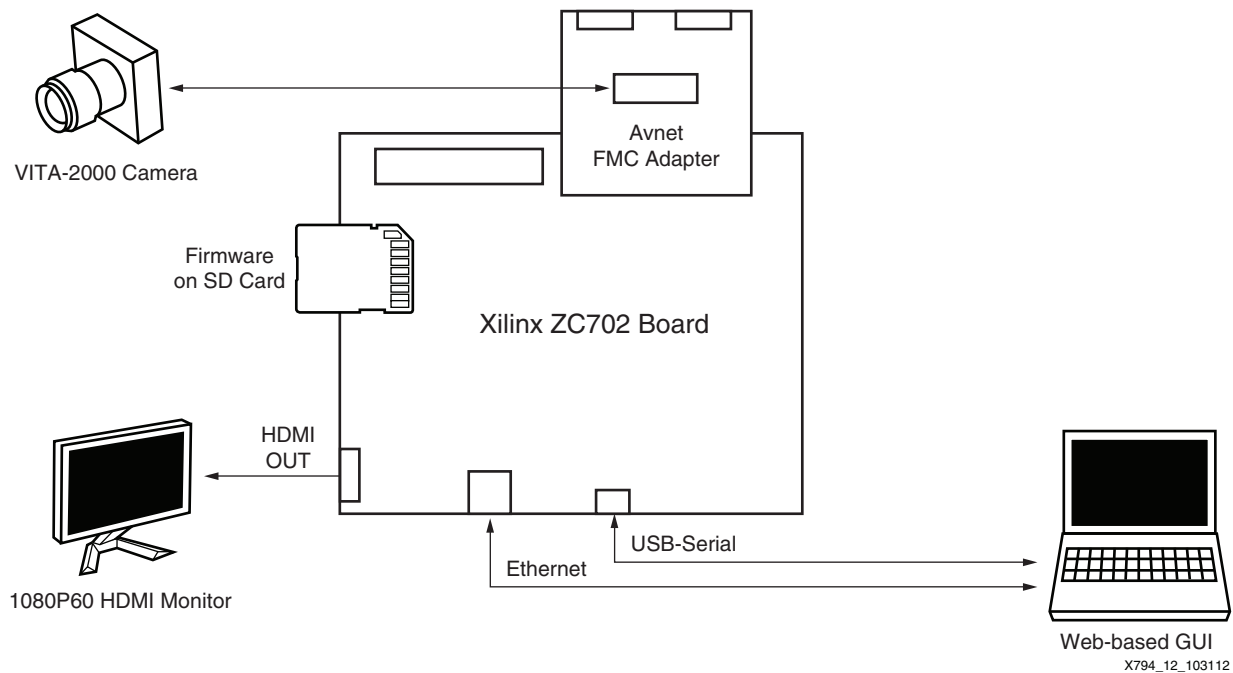

X794_12_103112

Figure 12: 1080p60 Camera Design Hardware Setup

To view this serial output, open a terminal window using the UART connection program (Terra Term or Hyperterminal) with these settings:

- 115200 baud
- 8 data bits
- No parity
- 1 stop bit
- No flow control

To determine which host computer COM port is mapped to the ZC702 Silicon Labs driver, follow these steps (for Windows):

Note: If not already installed, refer to the *Zynq-7000 All Programmable SoC: ZC702 Evaluation Kit and Video and Imaging Kit Getting Started Guide* (UG926) [Ref 1].

1. Right-click **My Computer** and select **Properties**.
2. Select the **Hardware** tab.
3. Click **Device Manager**.
4. Expand the Ports (COM & LPT) section.
5. Make note of the COM port for the Silicon Labs CP210x USB to UART Bridge item. This is the COM port that must be selected in the serial terminal program (Figure 14).

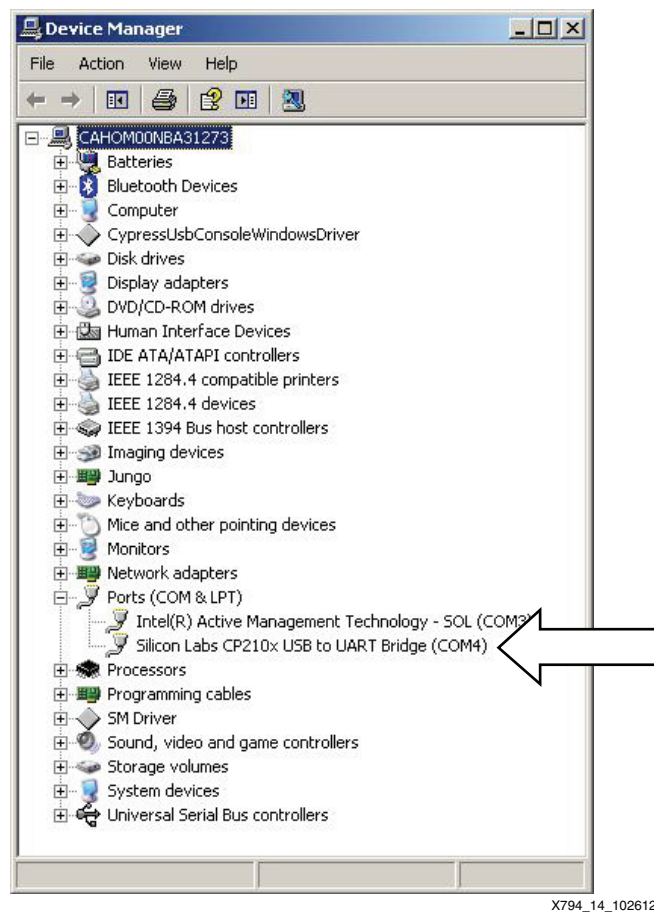

Figure 14: Determining COM Port in Windows

In the example illustrated in Figure 14, the COM port is COM4. This can be different for each computer.

To restart the boot process, press the POR_B button (SW1) located close to the SD card connector or power cycle the ZC702 board.

This boot sequence should be observed:

1. The ZC702 board is powered on.
2. The DONE LED is off.
3. The first stage bootloader takes approximately 20 seconds.
4. Camera design hardware is loaded into programmable logic.
5. The DONE LED turns on.
6. U-Boot takes approximately 30 seconds.
7. Linux Kernel boot takes approximately 15 seconds.
8. Camera design software is executed (this takes approximately 5 seconds).

The total boot sequence should take approximately 70 seconds (just over one minute).

U-Boot generates this output on the serial console:

```
U-Boot 2011.03 (Jul 12 2012 - 09:03:13)

DRAM: 256 MiB
MMC: SDHCI: 0
Using default environment

In: serial
Out: serial
Err: serial
Net: zynq_gem
Hit any key to stop autoboot: 0
Copying Linux from SD to RAM...

Device: SDHCI
Manufacturer ID: 3
OEM: 5344
Name: SU08G
Tran Speed: 25000000
Rd Block Len: 512
SD version 2.0
High Capacity: Yes
Capacity: 7.4 GiB
Bus Width: 4-bit
reading uImage

2725416 bytes read
reading devicetree.dtb

4366 bytes read
reading uramdisk.image.gz
.
.
.
Starting rcS...
++ Mounting filesystem
++ Setting up mdev
++ Mounting SD card to /mnt
++ Configuring IP Address
GEM: lp->tx_bd ffdfb000 lp->tx_bd_dma 2e145000 lp->tx_skb ef070280
GEM: lp->rx_bd ffdfc000 lp->rx_bd_dma 2e144000 lp->rx_skb ef070380
GEM: MAC 0x00350a00, 0x00002201, 00:0a:35:00:01:22
GEM: phydev ef28ea00, phydev->phy_id 0x1410e40, phydev->addr 0x7
```

```

eth0, phy_addr 0x7, phy_id 0x01410e40
eth0, attach [Marvell 88E1116R] phy driver
++ Starting telnet daemon
++ Starting http daemon
++ Starting ftp daemon
++ Starting dropbear (ssh) daemon
rcS Complete

```

Finally, the camera demonstration software generates this output on the serial console:

```

-----
--      Xilinx Zynq-7000 EPP Video and Imaging Kit      --
--      1080P60 Real-Time Camera Demonstration        --
-----

FMC-IPMI Initialization ...
Configure ZC702 IIC Mux for Port 6 (FMC2) ...
FMC Module Validation
Board Information:
    Manufacturer      = Avnet
    Product Name      = FMC-IMAGEON
    Serial Number     = 6122
    Part Number       = AES-FMCIMAGEON-G
SUCCESS : Detected FMC-IMAGEON module!
FMC-IMAGEON Initialization ...
FMC-IMAGEON Video Clock Initialization ...
Initialize Video Output for 1080P60 ...
    Video Resolution = 1080P
Video Generator Configuration ...
Configure ZC702 IIC Mux for Port 1 (HDMI) ...
ZC702 HDMI Output Initialization ...
FMC-IMAGEON VITA Receiver Initialization ...
FMC-IMAGEON VITA Initialization ...
FMC-IMAGEON VITA Configuration for 1080P60 timing ...
VITA Status =
    Image Width  = 1920
    Image Height = 1080
    Frame Rate   = 60 frames/sec
Video Detector Initialization ...
Video Detector Configuration ...
    Video Resolution = 1080P
    VTC Generator Configuration
        Horizontal Timing:
            HFrontPorchStart 0
            HSyncStart 88
            HBackPorchStart 132
            HActiveStart = 280
            HTotal = 2199
        Vertical Timing:
            V0FrontPorchStart 0
            V0SyncStart 4
            V0BackPorchStart 9
            V0ActiveStart 45
            V0Total 1124
Image Processing Pipeline (iPIPE) Initialization ...
Initializing iPipe cores ...
Chroma Resampler done
Enhance done
RGB2YCrCb done
Gamma done
CCM done
Stats done

```

```

TPG 0 done
TPG 1 done
CFA done
Initializing iPipe cores ... done!
Configure ZC702 IIC Mux for Port 1 (HDMI) ...
ZC702 HDMI Output Initialization ...
web avnet console : IN(/tmp/zvik_camera_linux_pipe_req) OUT(/tmp/zvik_camera_linux_pipe_rsp)
access(PIPE_IN_NAME, F_OK) ...done
access(PIPE_OUT_NAME, F_OK) ...done
open(PIPE_IN_NAME, O_RDONLY | O_NONBLOCK ) ...done
[web_session_handler] ... started

```

```

-----
--      Xilinx Zynq-7000 EPP Video and Imaging Kit      --
--      1080P60 Real-Time Camera Demonstration        --
-----

General Commands:
    help      Print the Top-Level menu Help Screen
    quit      Exit console (if applicable)
    verbose   Toggle verbosity on/off
    delay     Wait for specified delay
    mem       Memory accesses

I2C Commands
    iic0      IIC accesses on FMC-IPMI I2C chain
    iic1      IIC accesses on FMC-IMAGEON I2C chain

VITA Commands
    vita      VITA commands (init, status, ...)
    vspi      SPI accesses to VITA sensor
    vreg      Memory accesses to VITA receiver
    again     Analog gain (0-10)
    dgain     Digital gain (0-4095) where 128 corresponds to 1.00
    exposure  Exposure time (1-99) in percentage of frame period (16.66 msec)

iPIPE Commands
    dpc       Defect Pixel Correction configuration
    cfa       Color Filter Array Interpolation configuration
    stats|s   Image Statistics
    awb       Auto White Balance (on|off)
    agc       Auto Gain Control (on|off)
    aec       Auto Exposure Control (on|off)
    geq       Gamma Equalization (on|off)
    noise     Noise Reduction Threshold (0-255)
    enhance   Edge Enhancement Threshold (0-32768)
    halo      Halo Suppression Threshold (0-32768)
    ccm       Color Correction Matrix configuration
    gamma     Gamma Correction configuration

Video Source Selection
    video     Video Source Initialization and Selection (vita, ipipe)

Video Frame Buffer Commands
    vdma      Control frame buffer (start/stop/fill)
    rec       Save frame buffer image to BMP file
    play      Fill frame buffer image from BMP file

-----

zvik_camera>

```

Adjusting the Lens

The content captured by the image sensor and processed by the image processing pipeline should be visible on the monitor. If the image is blurry, adjust the lens focus, which ranges from 1 cm to 150 cm. If the image is too dark or too light, adjust the aperture (Figure 15). If the image is black, the aperture should be adjusted to allow more light to enter the image sensor.



Figure 15: Adjusting the Focus and Aperture

To adjust the focus, aperture, or both:

1. Unlock the set screws by loosening them on both the aperture and focus ring.
2. Twist until the desired result is achieved.
3. Lock the setting by tightening the set screw.

This kit includes an 8 mm lens that is appropriate for a broad range of video applications. If this lens is incorrect for a specific application, determine the required field of view (FOV) using these measurements:

- Distance to object (L)
- Size of object (H x V)

The FOV measurements are shown in [Figure 16](#).

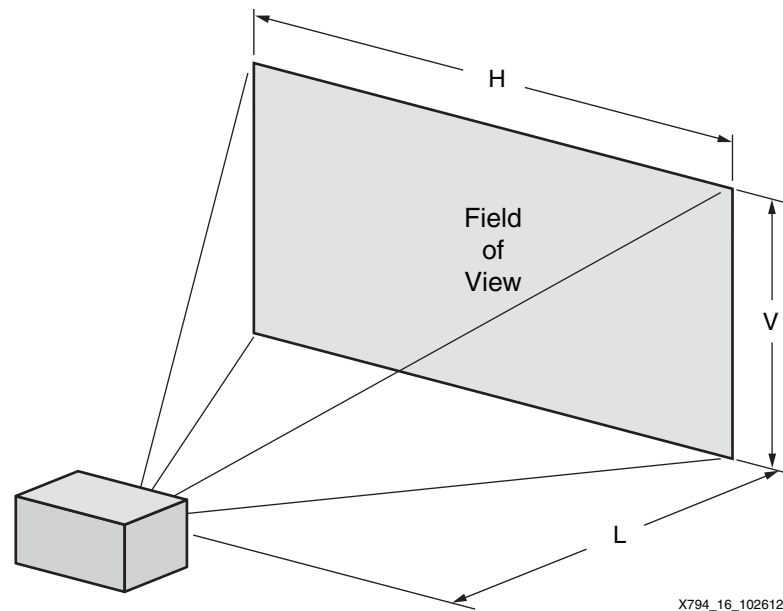

Figure 16: Determining the Required Field of View (FOV)

A lens calculator (such as www.1stvision.com/lens/lens_calculator) can determine the FOV and, consequently, the ideal lens choice for a specific application.

Using the Text-based Console

The Linux camera demonstration application accepts commands from a text-based console. Type the **help** command to list the supported commands. The Linux application also has a web-based GUI that significantly improves the ease-of-use and is described in [Using the Web-based GUI](#).

```
zvik_camera>help
help
```

```
-----
--      Xilinx Zynq-7000 EPP Video and Imaging Kit      --
--      1080P60 Real-Time Camera Demonstration         --
-----
General Commands:
  help      Print the Top-Level menu Help Screen
  quit      Exit console (if applicable)
  verbose   Toggle verbosity on/off
  delay     Wait for specified delay
  mem       Memory accesses

I2C Commands
  iic0      IIC accesses on FMC-IPMI I2C chain
  iic1      IIC accesses on FMC-IMAGEON I2C chain

VITA Commands
  vita      VITA commands (init, status, ...)
  vspi      SPI accesses to VITA sensor
  vreg      Memory accesses to VITA receiver
  again     Analog gain (0-10)
  dgain     Digital gain (0-4095) where 128 corresponds to 1.00
  exposure  Exposure time (1-99) in percentage of frame period (16.66 msec)

iPIPE Commands
  dpc       Defect Pixel Correction configuration
```

```

cfa      Color Filter Array Interpolation configuration
stats|s  Image Statistics
  awb    Auto White Balance (on|off)
  agc    Auto Gain Control (on|off)
  aec    Auto Exposure Control (on|off)
  geq    Gamma Equalization (on|off)
noise    Noise Reduction Threshold (0-255)
enhance  Edge Enhancement Threshold (0-32768)
halo     Halo Suppression Threshold (0-32768)
ccm      Color Correction Matrix configuration
gamma    Gamma Correction configuration
Video Source Selection
  video  Video Source Initialization and Selection (vita, ipipe)
Video Frame Buffer Commands
  vdma   Control frame buffer (start/stop/fill)
  rec    Save frame buffer image to BMP file
  play   Fill frame buffer image from BMP file

```

zvik_camera>

Type the **{command} help** command to obtain detailed help for a specific command. For example, to save an image from the video frame buffer to the SD card (/mnt), type these commands:

```

zvik_camera>rec help
rec help

```

Syntax :

```

rec {filename} => Write frame buffer image to BMP file

```

```

zvik_camera>rec /mnt/mypicture.bmp
rec /mnt/mypicture.bmp

```

```

height = 1080, width = 1920, n = 6220800

```

```

zvik_camera>

```

Using the Web-based GUI

To access the web-based GUI, open a web browser such as Internet Explorer and enter the ZVIK IP address <http://192.168.1.10> (or the address assigned in [Preparing the SD Card](#)). The web page shown in [Figure 17](#) appears.

Xilinx Zynq-7000 AP SoC Video and Imaging Kit - 1080P60 Real-Time Camera Demo

The screenshot displays the web-based GUI for the 1080P60 Real-Time Camera Demo. The interface is organized into several functional panels:

- General Settings:** Includes a 'Reset all settings' button.
- Image Sensor Settings:** Contains 'Processor Control' (Auto Gain, Auto Exposure, Target, Intensity), 'Image Sensor Auto Gain/Exposure' (Target, Intensity, Exposure, Analog Gain, Digital Gain), and 'Image Capture' (Click to Take Snapshot, color calibration chart).
- Automatic Demonstration Mode:** Features 'Click to Start', 'Click to Stop', 'Interval (msec): 5000', and 'Description: off'.
- Defective Pixel Correction:** Includes sliders for Pixel Age (0), Spatial Var (6000), and Temporal Var (2).
- Color Filter Array Interpolation:** Shows 'Bayer Phase' set to 'Red Green - 0'.
- Image Enhancement:** Includes sliders for Noise Reduce (0), Edge Enhance (0), and Halo Suppress (0).
- Color Correction Matrix:** Contains 'Processor Control' (Auto White Balance), 'White Balance' (Bypass), and sliders for Brightness (100), Contrast (0), and Saturation (100).
- Gamma Correction:** Includes 'Processor Control' (Gamma Equalization), 'Strength' (50), and 'Gamma Table' (Linear).
- Image Statistics:** Features 'Update', 'Click to Start', 'Click to Stop', 'Interval (msec): 2000', 'Scale' (9), 'Under-Exp' (0.5), and 'Over-Exp' (3.0). It also displays four histograms for intensity, red, green, and blue channels.

X794_17_111913

Figure 17: 1080p60 Camera Design Web-based GUI

If the host computer cannot establish a connection, it might be necessary to disable virus scanning, the firewall, or both. This is not typically required. To test whether the computer can communicate over the Ethernet connection, open a Command Prompt window (this is done in Windows 7 by selecting **Start Button > All Programs > Accessories > Command Prompt**) and type `ping 192.168.1.10` or `ping` followed by the IP address assigned to the ZVIK in the previous section. If this is not successful, review the IP configurations set in [Preparing the SD Card](#) and [Configuring the Host IP Address](#).

Adjusting the Image Sensor Gain and Exposure

The image sensor gain and exposure can be adjusted using the controls shown in [Figure 18](#).

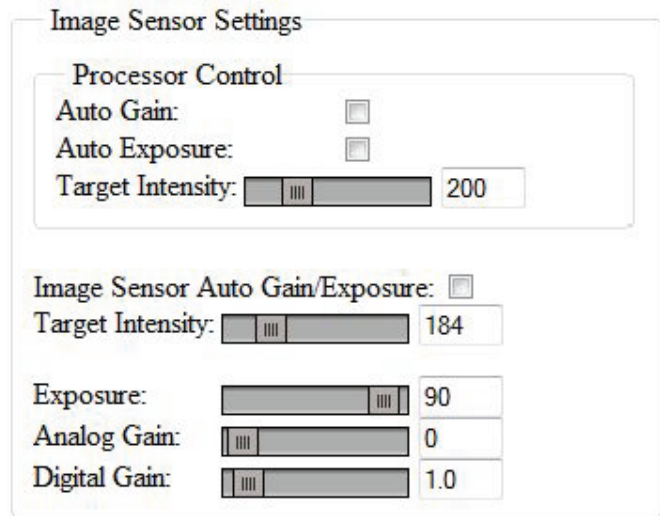

X794_18_102612

Figure 18: Image Sensor Gain and Exposure Controls

The check boxes shown in [Figure 18](#) allow the gain and exposure to be adjusted automatically by either of these two methods:

- **Processor Control:** One of the Zynq-7000 SoC processors collects information about the image from the Image Statistics IP core and uses this information to adjust the image sensor exposure and gain settings. The Target Intensity slider can be used to select the desired target intensity.
- **Image Sensor Auto Gain/Exposure:** Uses the image sensor internal auto gain/exposure control (AEC) to control the gain and exposure. The Target Intensity slider can be used to select the desired target intensity.

Note: When the processor control boxes are checked, they disable both the manual gain and exposure settings and the image sensor AEC.

Sliders allow the gain and exposure to be adjusted manually when the auto gain and exposure check boxes are not selected.

The analog gain provides a course manual adjustment of the image sensor gain, as shown in [Table 2](#).

Table 2: Analog Gain Slider Settings

Setting	Description
0	Analog gain = 0.00
1	Analog gain = 1.14
2	Analog gain = 1.33
3	Analog gain = 1.60
4	Analog gain = 2.00
5	Analog gain = 2.29
6	Analog gain = 2.67
7	Analog gain = 3.20
8	Analog gain = 4.00
9	Analog gain = 5.33
10	Analog gain = 8.00

The digital gain slider provides a fine manual adjustment of the image sensor gain, as shown in [Table 3](#).

Table 3: Digital Gain Slider Settings

Setting	Description
0.00–31.99	Digital gain = 0.00–31.99

The exposure slider provides a manual adjustment of the image sensor exposure time, as shown in [Table 4](#).

Table 4: Exposure Slider Settings

Setting	Description
1 – 99	Exposure in percentage of frame time (16.6 ms): 1% = 0.16 ms 99% = 16.5 ms

Capturing a 1080P Image

The Image Capture section of the web-based GUI allows capturing an image from the video frame buffer, as shown in [Figure 19](#).

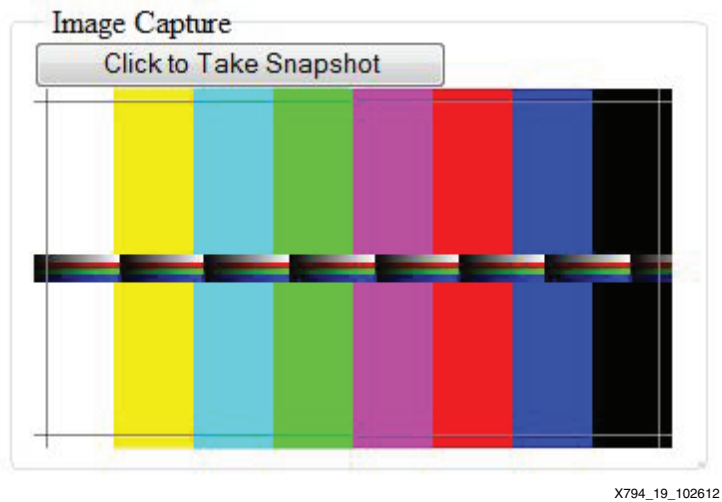

Figure 19: Image Capture Controls

After clicking **Click to Take Snapshot**, a scaled-down version of the image is displayed in the GUI. A full-size version of the image (24-bit RGB 1920 x 1080 bitmap (BMP)) can be saved to the host hard drive by right-clicking the image and selecting **Save Picture As**. This allows analysis of the image with a separate image viewing program.

Configuring the Defective Pixel Correction

The Xilinx Defective Pixel Correction IP core can be configured with three sliders, as shown in [Figure 20](#).

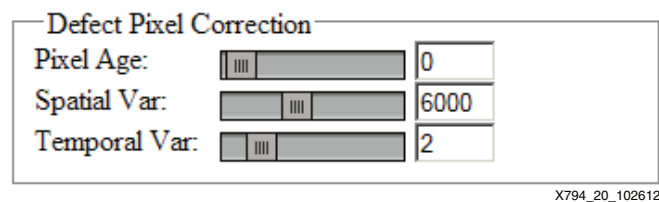

Figure 20: Defective Pixel Correction IP Core Controls

To observe the operation of the Defective Pixel Correction core, move the Pixel Age slider to 100. A few small white dots appear on the monitor. To better see the dots, point the image sensor at a uniform dark background. These are defective pixels in the image sensor. As the Pixel Age Slider is moved back to 0, the defective pixels are effectively removed from the image by the Defective Pixel IP core processing.

Configuring the Color Filter Array Interpolation

The Xilinx Color Filter Array Interpolation IP core Bayer Phase setting (Figure 21) can be changed, but only one setting produces a valid result with the VITA 2000 image sensor.

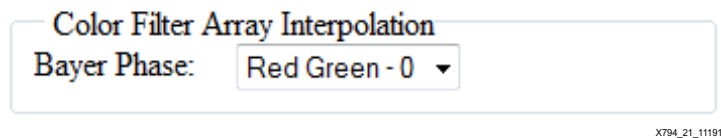

Figure 21: Color Filter Array IP Core Control

Image Enhancement

The Xilinx Image Enhancement IP core reduces image noise and enhances the edges of objects in each picture. Two-dimensional filters are used to suppress noise while preserving and enhancing edges in the picture.

- Low-pass filters are used to implement the noise reduction.
- High-pass filters are used to implement the edge enhancement.
- The halo suppression reduces the ringing or overshoot effect of high-pass filters.

The Image Enhancement IP core can be controlled with the three slides shown in Figure 22.

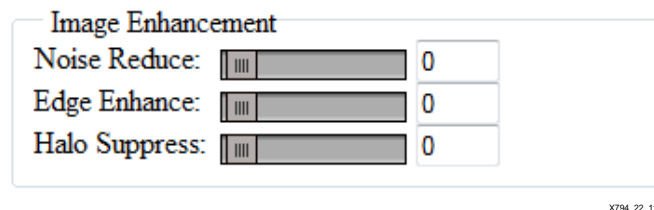

Figure 22: Image Enhancement IP Core Control

The Noise Reduce slider contains the amount of noise reduction applied by the low-pass filters. Allowable values are from 0 to 255, as shown in Table 5.

Table 5: Spatial Noise Reduction Strength Settings

Setting	Description
0	Spatial noise reduction OFF.
1-255	Spatial noise reduction ON. Number identifies strength of spatial noise reduction filter.

The Edge Enhance slider contains the amount of edge enhancement applied by the high-pass filters. The allowed values are from 0 to 32768, which is the integer representation of the range 0 to 1 using 16 bits with 15 fractional bits. Multiplication by 2^{15} yields the integer representation. See Table 6.

Table 6: Edge Enhancement Settings

Setting	Description
0	Edge enhancement OFF.
1-32768	Edge enhancement ON. Number identifies strength of edge enhancement

The Halo Suppress slider contains the amount of halo suppression. The allowed values are from 0 to 32768, which is the integer representation of the range 0 to 1 using 16 bits with 15 fractional bits. Multiplication by 2^{15} yields the integer representation. See [Table 7](#).

Table 7: Halo Suppression Settings

Setting	Description
0	Halo Suppression OFF.
1-32768	Halo Suppression ON. Number identifies strength of halo suppression.

Configuring the Color Correction Matrix

The Xilinx Color Correction Matrix IP core provides color correction of the image to correct for different illumination sources. The Color Correction IP core settings can be adjusted using the GUI controls shown in [Figure 23](#).

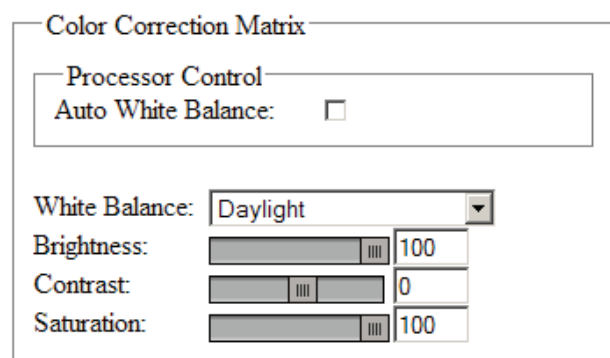

X794_23_110513

Figure 23: Color Correction Matrix IP Core Controls

The white balance list box applies pre-determined color corrections for four illumination conditions, as shown in [Table 8](#).

Table 8: White Balance Settings

Setting	Description
Bypass	Color correction OFF (all coefficients are 1.0)
Daylight	Color correction ON for daylight lighting conditions
Cool White Fluorescent	Color correction ON for cool white fluorescent (4500°K) lighting
U30 (Hot Fluorescent)	Color correction ON for hot fluorescent (3000°K) lighting
Incandescent	Color correction ON for incandescent lighting

Alternatively, the white balance setting can be automatically controlled by one of the Zynq-7000 SoC processors. Based on the information received from the Image Statistics IP core, the processor can select a weighted sum of one or more of the white balance configurations, based on the calculated probability of each of the possible light sources.

The Brightness and Contrast sliders can be used to change the intensity of the image, making it darker or brighter.

The Saturation slider can be used to change the intensity of the colors. A Saturation of 0 produces a grayscale image.

The color correction coefficients for the four illumination sources were generated by placing an X-Rite ColorChecker 24 Patch Classic target [\[Ref 40\]](#) in an X-Rite Macbeth Judge II light booth [\[Ref 41\]](#). Bitmap images were collected using the GUI for the four different illumination settings

(Daylight, Cool White Fluorescent, U30, and Incandescent sources) with the color correction matrix set to **Bypass** (no color corrections applied). Average values for the 24 patches at each illumination setting were calculated by a MATLAB® software script. A second script is used to model the Xilinx color correction matrix operations and determine a set of coefficients that result in output from the color correction matrix that best matches the known target values for the 24 patches. The MATLAB software scripts used to develop the coefficients for the Color Correction Matrix IP core are included in the 1080p60 camera image processing design files (`xapp794.zip`) that can be downloaded from the Application Notes link on the [ZVIK 2013.2 documentation page](#). Additional information on development of the color correction coefficients can be found in an article titled *Image Sensor Color Calibration Using the Zynq-7000 SoC* in the *Xcell Journal* [Ref 2].

Figure 24 illustrates the effects of white balance on the 24-patch ColorChecker chart for the four different illumination sources:

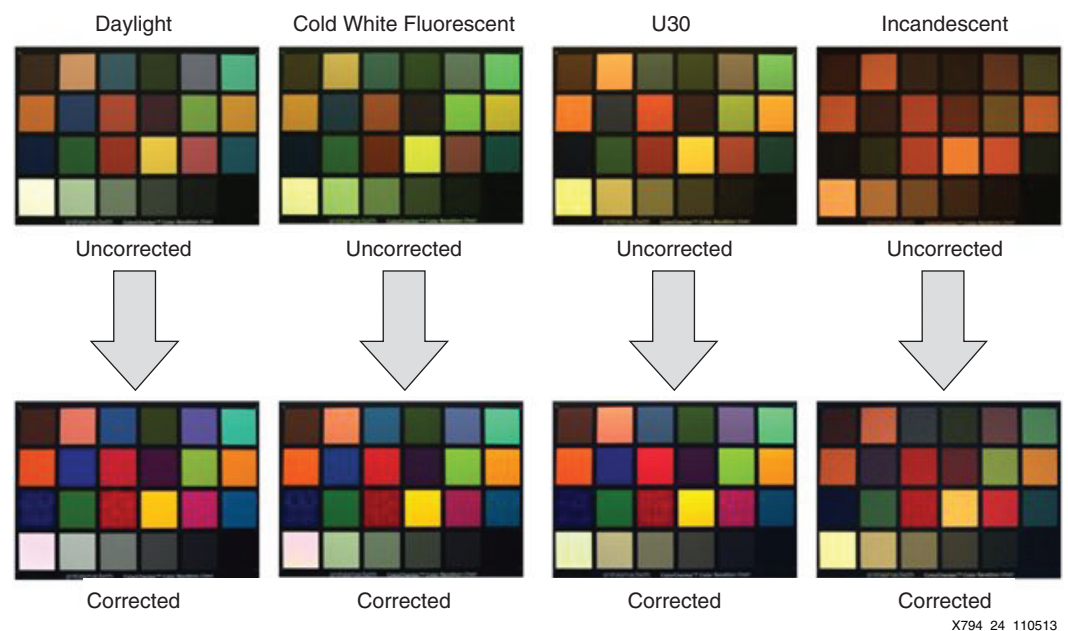

Figure 24: White Balance Color Checker Results

The top four images show the output of the image sensor and image processing pipeline with no color correction applied for four different illumination sources. There are marked differences in color for all four cases. The bottom images show the output with the various color corrections applied for each different illumination source and illustrate how the white balance setting corrects the colors. These images were taken in the X-Rite Macbeth Judge II light booth using the ZVIK camera design.

Xilinx provides support for the 1080p60 camera image processing reference design, IP cores such as the Color Correction Matrix, and Xilinx FPGA and SoC products. Xilinx cannot provide assistance to customers developing color correction coefficients for the ON Semiconductor or any other image sensor. Development of custom color correction coefficients is the responsibility of the customer. The MATLAB software scripts are provided as examples to assist customers in developing their own color corrections for different image sensors. Consult the Additional Resources tab of the [ZVIK product page](#) for additional information.

Configuring the Gamma Correction

The gamma correction IP core is implemented as a look-up table that is applied to all three color channels. The gamma correction IP core can be adjusted using the GUI controls shown in [Figure 25](#).

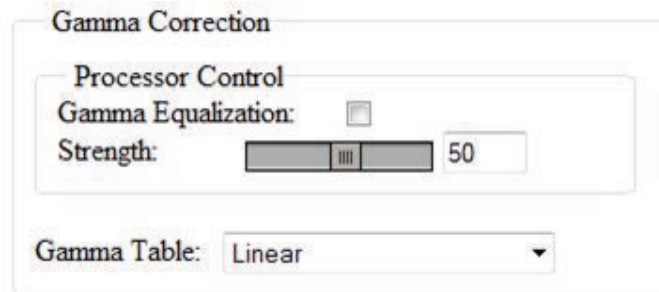

X794_25_110513

Figure 25: Gamma Correction IP Core Controls

The Gamma Table list box allows the manual gamma correction settings shown in [Table 9](#).

Table 9: Gamma Table Setting

Setting	Description
Linear	Gamma Correction OFF (linear look-up table)
Compression Table 1/2.2	Gamma Correction ON (gamma = 1/2.2)
Compression Table 1/1.6	Gamma Correction ON (gamma = 1/1.6)
Expansion Table 1.6	Gamma Correction ON (gamma = 1/1.6)
Expansion Table 2.2	Gamma Correction ON (gamma = 1/2.2)

Alternatively, the gamma correction setting can be automatically controlled by one of the Zynq-7000 SoC processors. Based on the information received from the image statistics IP core, the processor can calculate a look-up table that makes the most efficient use of the 0–255 values based on the image intensity histogram. The strength slider can be used to adjust the gamma correction strength applied by the processor.

Understanding the Image Statistics

The Xilinx Image Statistics IP core provides hardware-based image analysis to support auto-focus, auto-exposure, and auto-white balance applications. The third column in the web-based GUI provides feedback from the image statistics IP core in the form of histograms, as shown in [Figure 26](#).

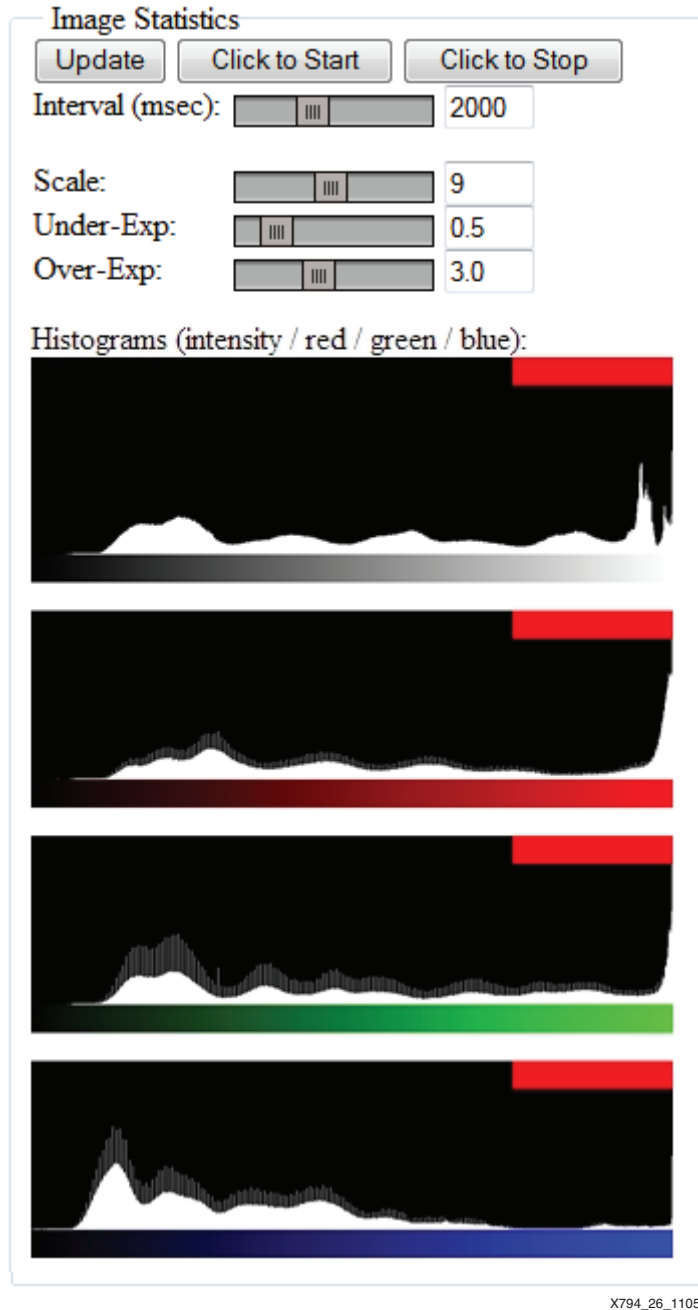

Figure 26: Histograms from the Xilinx Image Statistics IP Core

Four histograms are displayed. The content of each histogram is described by the color bar at the bottom of each histogram. The intensity histogram has a gray color bar, the red channel histogram has a red color bar, the green histogram has a green bar, and the blue histogram has a blue bar.

The intensity histogram (Figure 27) provides information about the overall image exposure.



X794_27_110513

Figure 27: Intensity Histogram

In addition to the histogram distribution of the data, the bar at the top of the histogram provides visual feedback on the exposure:

- A red bar on the top left indicates that the image is under-exposed according to the formula:
 $(\text{number of pixels in the } 0\text{--}64 \text{ range}) * (\text{under-exposure threshold}) > (\text{number of pixels in the } 64\text{--}192 \text{ range})$
- A red bar on the top right indicates that the image is over-exposed according to the this formula:
 $(\text{number of pixels in the } 192\text{--}255 \text{ range}) * (\text{over-exposure threshold}) > (\text{number of pixels in the } 64\text{--}192 \text{ range})$
- A green bar on the top indicates that the image has good exposure (neither under-exposed or over-exposed)

The under- and over-exposure thresholds can be adjusted by moving the Under-Exp and Over-Exp sliders at the top of the third column, as shown in Figure 28.

Image Statistics		
Update	Click to Start	Click to Stop
Interval (msec):	<input type="text" value="2000"/>	2000
Scale:	<input type="text" value="10"/>	10
Under-Exp:	<input type="text" value="0.5"/>	0.5
Over-Exp:	<input type="text" value="0.5"/>	0.5

X794_28_110513

Figure 28: Image Statistics Exposure Controls

The red histogram (Figure 29) shows the distribution of red pixel values.



Figure 29: **Red Histogram**

- A red bar on the top right indicates that the red color channel is over-saturated according to the formula:
(number of pixels in the 242–255 range) > 0
 - A green bar on the top indicates that the red color channel is not over-saturated.
- The green histogram (Figure 30) shows the distribution of green pixel values.

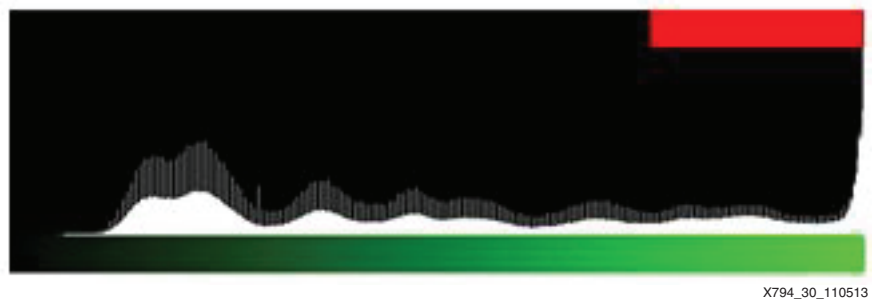

Figure 30: **Green Histogram**

- A red bar on the top right indicates that the green color channel is over-saturated according to the formula:
(number of pixels in the 242–255 range) > 0
 - A green bar on the top indicates that the green color channel is not over-saturated.
- The blue histogram (Figure 31) shows the distribution of blue pixel values.



Figure 31: **Blue Histogram**

- A red bar on the top right indicates that the blue color channel is over-saturated according to the formula:
(number of pixels in the 242–255 range) > 0

- A green bar on the top indicates that the blue color channel is not over-saturated.

The contents of the histograms are static by default, unless configured otherwise. There are two options for updating the histograms (see [Figure 28](#)):

1. To update the contents of the histograms a single time, click **Update**.
2. To periodically update the histograms, click **Click to Start**. To stop periodically updating the histograms, click **Click to Stop**. The frequency of the update can be adjusted by moving the **Interval (msec)** slider.

Hardware Platform

The block diagram for the 1080p60 camera reference design is shown in [Figure 32](#).

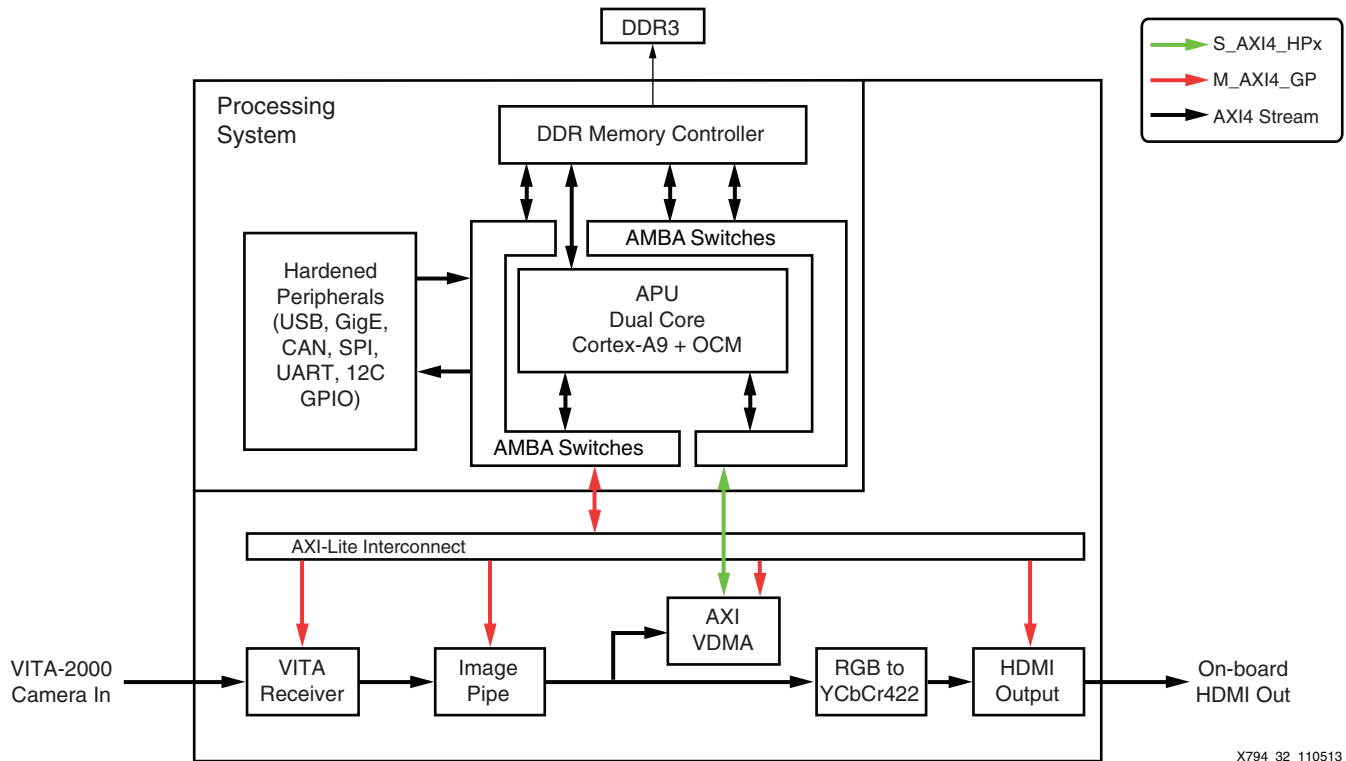

Figure 32: 1080p Camera Hardware Block Diagram

The details of the image processing pipeline are shown in [Figure 33](#).

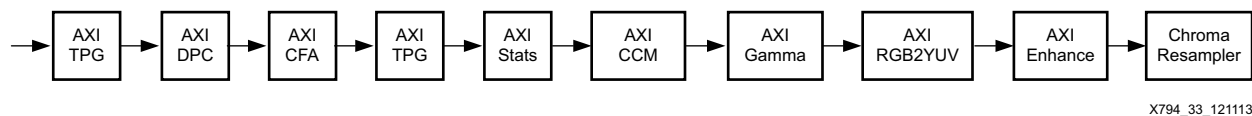

Figure 33: 1080p Camera Image Processing Pipeline

This design is implemented in a Zynq-7000 AP SoC device (XC7Z020CLG484-1) using Vivado 2013.2 design tools. The PL hardware utilization for the implemented design is shown in [Table 10](#).

Table 10: Hardware Utilization

FPGA Components	Total Available	Used	% Used
I/Os	200	58	29
LUTs	53,200	30,614	57
Registers	106,400	38,316	36
DSP48s	220	92	42
Block RAM			
RAMB36E1/FIFO36E1s	140	36	26
RAMB18E1/FIFO18E1s	280	16	6

Notes:

1. Device resource utilization results are dependent on the implementation tool versions. Exact results can vary. These numbers should be used as a guideline.

There are many advantages to implementing this system in a Zynq-7000 AP SoC:

- Processing-intensive pixel operations are efficiently implemented in the PL.
- Complex decision-making algorithms like automatic white balance and automatic exposure are efficiently implemented in the PS.
- Processor operations can easily be modified or added to the PS.
- The hardware system can easily be expanded or customized by adding/removing instances of Xilinx IP cores from the Xilinx IP catalog or third-party sources.
- The hardware system can be further customized by adding custom logic that either interfaces to the PS or is totally independent.
- A choice of Zynq-7000 AP SoC sizes allows room to shrink or expand the hardware PL to meet system requirements.

System Features

Processing System

- Two ARM Cortex™-A9 processors, each with a 32 KB instruction cache and a 32 KB data cache, and a NEON coprocessor
- ARM processors at 800 MHz
- 512 KB of level-2 cache
- 256 KB of on-chip RAM
- 128 KB of on-chip ROM
- AMBA® AXI interconnect
- Multi-protocol, 32-bit DDR DRAM controller
- DDR3 DRAM at 533 MHz
- Standard peripheral interfaces including flash, USB, Ethernet, UART, I2C, and more
- High bandwidth interconnect to and from the PL
- Power domain independent of the PL

Programmable Logic

- One 64-bit AXI interconnect at 148.5 MHz
- One 32-bit AXI interconnect at 50 MHz
- VITA receiver (serial LVDS) interface
- Image processing pipeline
- Video frame buffer (AXI-VDMA)
- HDMI output interface

Device Address Map

The pccores that are instantiated on the M_AXI_GP0 port are shown in [Table 11](#).

Table 11: AXI GP0 Address Map

Instance	Peripheral	Base Address	High Address
v_spc_1	Defective Pixel Correction (7.0)	0x43C00000	0x43C0FFFF
v_cfa_1	Color Filter Array Interpolation (7.0)	0x43C10000	0x43C1FFFF
v_tpg_1	Test Pattern Generator (5.0)	0x43C20000	0x43C2FFFF
v_tpg_2	Test Pattern Generator (5.0)	0x43C30000	0x43C3FFFF
v_stats_1	Image Statistics (6.0)	0x43C40000	0x43C4FFFF
v_ccm_1	Color Correction Matrix (6.0)	0x43C50000	0x43C5FFFF
v_gamma_1	Gamma Correction (7.0)	0x43C60000	0x43C6FFFF
v_rgb2ycrcb_1	RGB to YCrCb Color-Space Converter (7.0)	0x43C70000	0x43C7FFFF
v_enhance_1	Image Enhancement (8.0)	0x43C80000	0x43C8FFFF
v_cresample_1	Chroma Resampler (4.0)	0x43C90000	0x43C9FFFF
v_tc_1	Video Timing Controller (6.0)	0x43CA0000	0x43CAFFFF
iic_main	AXI IIC (2.0)	0x41600000	0x4160FFFF
fmc_imageon_iic	AXI IIC (2.0)	0x41610000	0x4161FFFF
fmc_imageon_vita_receiver_1	FMC-IMAGEON Vita Receiver (1.0)	0x43CB0000	0x43CBFFFF
axi_vdma_1	AXI Video Direct Memory Access (6.0)	0x43000000	0x4300FFFF

System Configuration

Clocking

The PL design has two clock domains: AXI4-Lite (register interface) and the video clock. The video clock drives the AXI4 (memory-mapped), AXI4-Stream peripherals, and the video input and output interfaces. These domains run at 50 MHz and 148.5 MHz, respectively.

The clock generator module receives the 148.5 MHz input clock from the external clock synthesizer on the Avnet FMC-IMAGEON card, generates a 37.125 MHz reference clock for the VITA image sensor, and propagates the 148.5 MHz signal as the video clock.

The PS generates the AXI4-Lite 50 MHz clock and the 200 MHz reference clock used to deserialize the video data from the VITA receiver.

The clock signals are shown in [Table 12](#).

Table 12: System Clocks

Clock Signal	Source	Frequency (MHz)	Use
clk_50MHz	PS – FCLK0	50	AXI4-Lite interconnect clock.
clk_200MHz	PS – FCLK1	200	200 MHz reference clock for deserializer in VITA receiver.
fmc_imageon_video_clk1	External video clock coming from clock synthesizer on FMC module	148.5	Input clock to clock generator.
vid_out_clk	Clock generator – MMCM ⁽¹⁾	148.5	Clock for video input, video output, video processing pipeline, and AXI4 interconnect.
vita_clk_ref	Clock generator – MMCM	37.125	Reference clock for VITA image sensor.

Notes:

1. Mixed-mode clock manager.

AXI Interconnect

The PL design has one interconnect for the AXI4 master and one interconnect for the AXI4-Lite register interface.

The AXI4 interconnect is connected to a master, the AXI VDMA. It is also connected to a slave, the HP0 port of the Zynq-7000 AP SoC PS. This interconnect operates at 148.5 MHz, and the data width is 64 bits. The read/write acceptance and issuance are set to 16. The acceptance and issuance helps improve system performance. The PS HP port can accept a maximum burst length of 16.

This read/write acceptance and issuance setting imposes a limitation on getting minimum acceptable bandwidth for every master in a multi-master system. The optimum setting of issuance and acceptance reduces throttle on the bus and compensates for long latencies.

The AXI4-Lite register interface is clocked at 50 MHz. The Zynq-7000 AP SoC PS GP0 port acts as the master on this interconnect and connected slaves have register maps. AXI CFA and AXI VTC are examples of slaves connected to this interconnect. The operations of the video pipeline are controlled by registers inside every IP core. Depending upon the data flow required in the video pipeline, the processor writes these registers through the AXI4-Lite interconnect. The AXI4-Lite interconnect accepts write or read transfers from the processor, performs address decoding, selects a particular slave, and establishes a communication channel between the processor and the slave device.

For detailed information about the complete feature set and a functional description of the AXI interconnect IP, refer to *LogiCORE IP AXI Interconnect* [[Ref 5](#)].

Video System Configuration

AXI VDMA

AXI VDMA has an AXI4-Stream interface and an AXI4 interface. The AXI VDMA has two channels: MM2S and S2MM. The MM2S channel is not implemented in this design.

The S2MM channel receives data from the master device connected through the streaming interface. The C_S_AXIS_S2MM_TDATA_WIDTH parameter decides the width of the streaming interface. Data received on the streaming interface is then written into the system memory through the memory-mapped interface. The C_M_AXI_S2MM_DATA_WIDTH parameter decides the data width of the memory-mapped interface and C_S2MM_MAX_BURST_LENGTH governs the burst length of the write transaction.

In this design, the stream interface data width is set to 32 bits and the memory-mapped interface width is 64 bits. The AXI VDMA is used in simple register direct mode, which removes the area cost of the scatter gather feature. Initialization, status, and management registers in the AXI VDMA core are accessed through an AXI4-Lite slave interface. To get the best possible throughput for AXI VDMA instances, the maximum burst length is set to 16. The store and forward feature of the AXI VDMA are enabled on both channels to improve system performance and reduce the risk of system throttling.

For additional information about the AXI VDMA LogiCORE solution and the detailed product guide, refer to the AXI VDMA product page:

www.xilinx.com/products/intellectual-property/axi_video_dma

Video Processing Pipeline Details

Test Pattern Generator

The Xilinx Test Pattern Generator IP Core generates test patterns for Video System bring-up, evaluation, and debug. The core provides a wide variety of tests patterns for debugging and assessing video system color, quality, edge and motion performance, and quality issues. The core can be inserted in an AXI4-Stream video interface that allows user-selectable pass-through of system video signals or insertion of test patterns.

There are two AXI TPG cores in the image processing pipeline, as shown in [Figure 34](#).

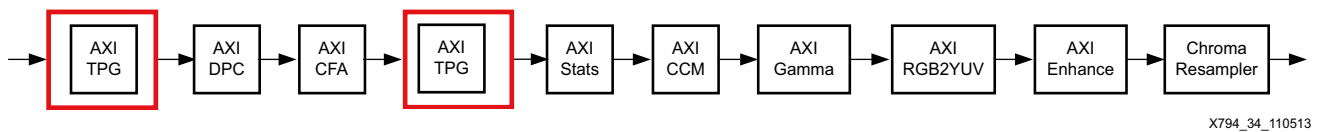

Figure 34: AXI TPG Core Pipeline Position

The first AXI TPG core can be used to insert defect pixels in the video processing pipeline to test the performance of the AXI DPC core. The second AXI TPG core can be used to insert a RGB test pattern into the video processing pipeline. In the final design, the two AXI TPG cores are disabled and pass the video data without modification to the next core in the pipeline. For additional information about the Test Pattern Generator LogiCORE solution and the detailed product guide, see the Test Pattern Generator product page:

www.xilinx.com/products/intellectual-property/tpg

Defective Pixel Correction

The AXI Defective Pixel Correction (DPC) core is the first processing element in the image processing pipeline, as shown in [Figure 35](#).

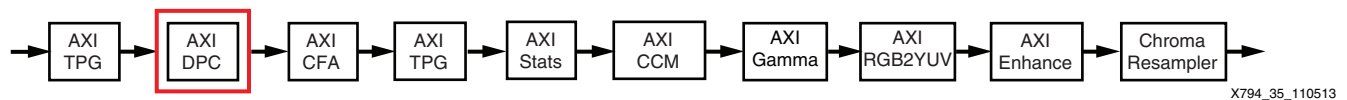

Figure 35: AXI DPC Core Pipeline Position

This core is responsible for correcting defective pixels, as illustrated in [Figure 36](#).

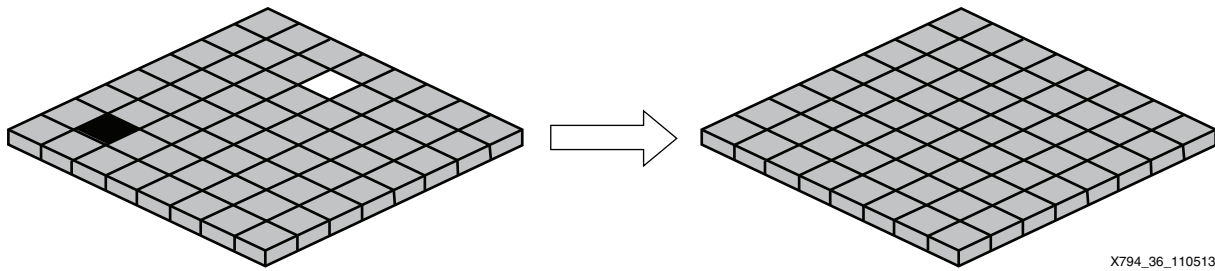

Figure 36: Defective Pixel Correction

For additional information about the Defective Pixel Correction LogiCORE solution and the detailed product guide, see the Defective Pixel Correction product page:

www.xilinx.com/products/intellectual-property/EF-DI-DEF-PIX-CORR

Color Filter Array Interpolation

The AXI Color Filter Array (CFA) core is the second processing element in the image processing pipeline, as shown in [Figure 37](#).

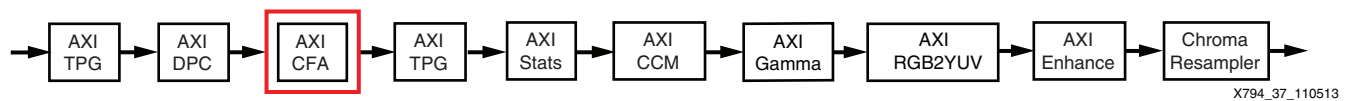

Figure 37: AXI CFA Core Pipeline Position

The most widespread and cost effective implementation of color image sensors involves placing color filters on top of each pixel in a Bayer pattern arrangement, as shown in [Figure 38](#).

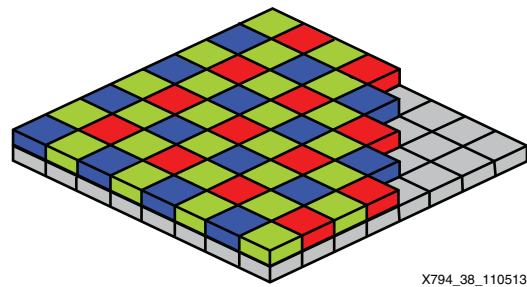

Figure 38: Bayer Pattern Color Filter

With this arrangement of color filters, each pixel captures only one of the three primary colors. The CFA core restores the missing two colors based on neighboring pixels.

For additional information about the Color Filter Array Interpolation LogiCORE solution and the detailed product guide, see the Color Filter Array Interpolation product page:

www.xilinx.com/products/intellectual-property/EF-DI-CFA

Image Statistics Engine

The AXI STATS core is used to gather various image statistics from the image processing pipeline (Figure 39) such as:

- Intensity histograms
- Color histograms

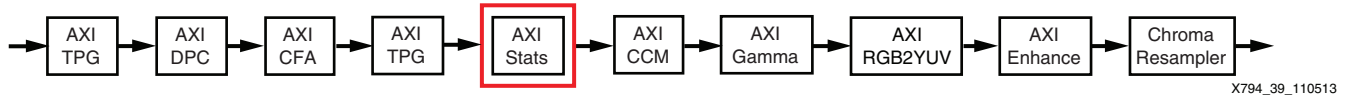

Figure 39: AXI Stats Core Pipeline Position

For additional information about the Image Statistics Engine LogiCORE solution and the detailed product guide, refer to the Image Statistics Engine product page:

www.xilinx.com/products/intellectual-property/EF-DI-IMG-STATS

Color Space Conversion

The color space conversion cores are used in the image processing pipeline to convert to/from the RGB color space and the YCrCb color space, as shown in Figure 40.

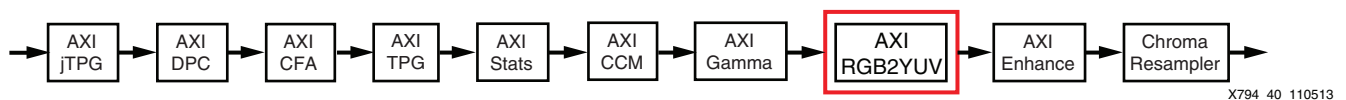

Figure 40: Color Space Conversion Cores Pipeline Position

For additional information about the Color Space Conversion LogiCORE solutions and the detailed product guides, see the Color Space Conversion product pages:

www.xilinx.com/products/intellectual-property/RGB_to_YCrCb

www.xilinx.com/products/intellectual-property/YCrCb_to_RGB

Image Edge Enhancement

The Image Enhancement LogiCORE™ IP is a programmable hardware block that can be used to reduce image noise and enhance the edges of objects in each picture. It is positioned in the image processing pipeline, as shown in Figure 41.

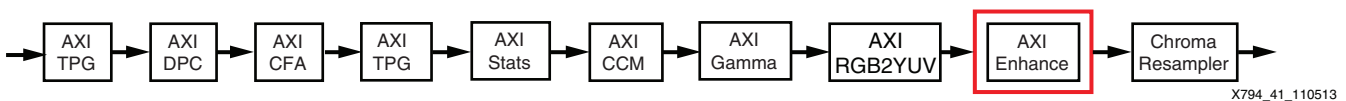

Figure 41: Image Enhancement

For additional information about the Image Enhancement LogiCORE solution and the detailed product guide, see the Image Enhancement product page:

www.xilinx.com/products/intellectual-property/EF-DI-IMG-ENHANCE

Color Correction Matrix

The AXI Color Correction Matrix (CCM) core is used to implement various color corrections in the image processing pipeline (Figure 42):

- White balance
- Brightness
- Contrast
- Saturation

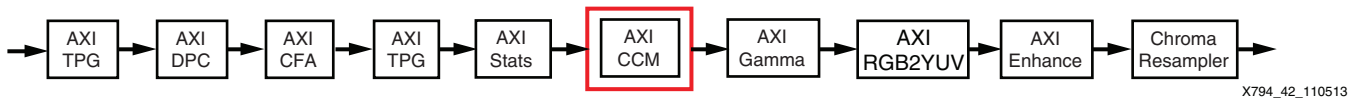

Figure 42: AXI CCM Core Pipeline Position

For additional information about the Color Correction Matrix LogiCORE solution and the detailed product guide, see the Image Edge Enhancement product page:

www.xilinx.com/products/intellectual-property/EF-DI-CCM

Gamma Correction

The AXI GAMMA core implements look-up tables that are used to implement gamma correction in the image processing pipeline, as shown in Figure 43.

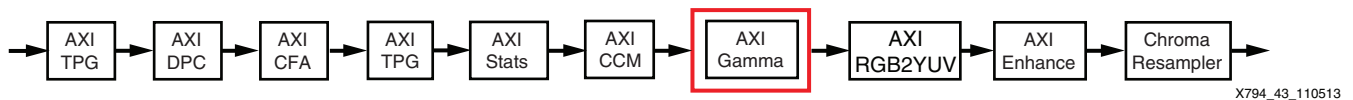

Figure 43: AXI Gamma Core Pipeline Position

For additional information about the Gamma Correction LogiCORE solution and the detailed product guide, see the Gamma Correction product page:

www.xilinx.com/products/intellectual-property/EF-DI-GAMMA

Software Platform

An application to demonstrate the capabilities of the Zynq-7000 AP SoC PS and PL combination for mainstream video embedded systems is implemented on top of Linux kernel 3.x. Developers can tailor Linux to their particular applications by porting their applications and customizing open source software packages. The pre-verified Linux platform enables rapid software platform modification to adapt to hardware changes.

Zynq-7000 AP SoC-based 1080p60 Camera Application

A unified and multi-threaded Linux software application is implemented to demonstrate the capabilities of the Zynq-7000 AP SoC PS and PL combination for mainstream video embedded systems. The main application initializes the video processing pipeline, and allows design configuration via the USB-serial connection or via the network with a web-based GUI.

The block diagram in [Figure 44](#) illustrates the general architecture of the Linux application.

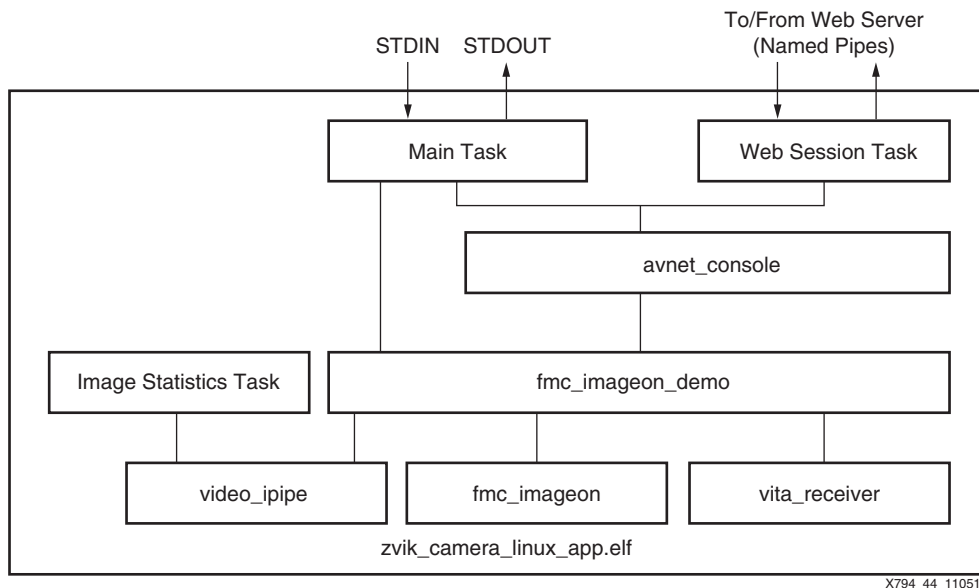

Figure 44: 1080p60 Camera Linux Application General Architecture

The application has three tasks:

1. Main Task (`main.c`)
2. Image Statistics Task (`vipp_stats_handler`)
3. Web Session Task

Each of these tasks are described in subsequent sections.

The block diagram in Figure 45 shows the source files that make up the 1080p60 camera application.

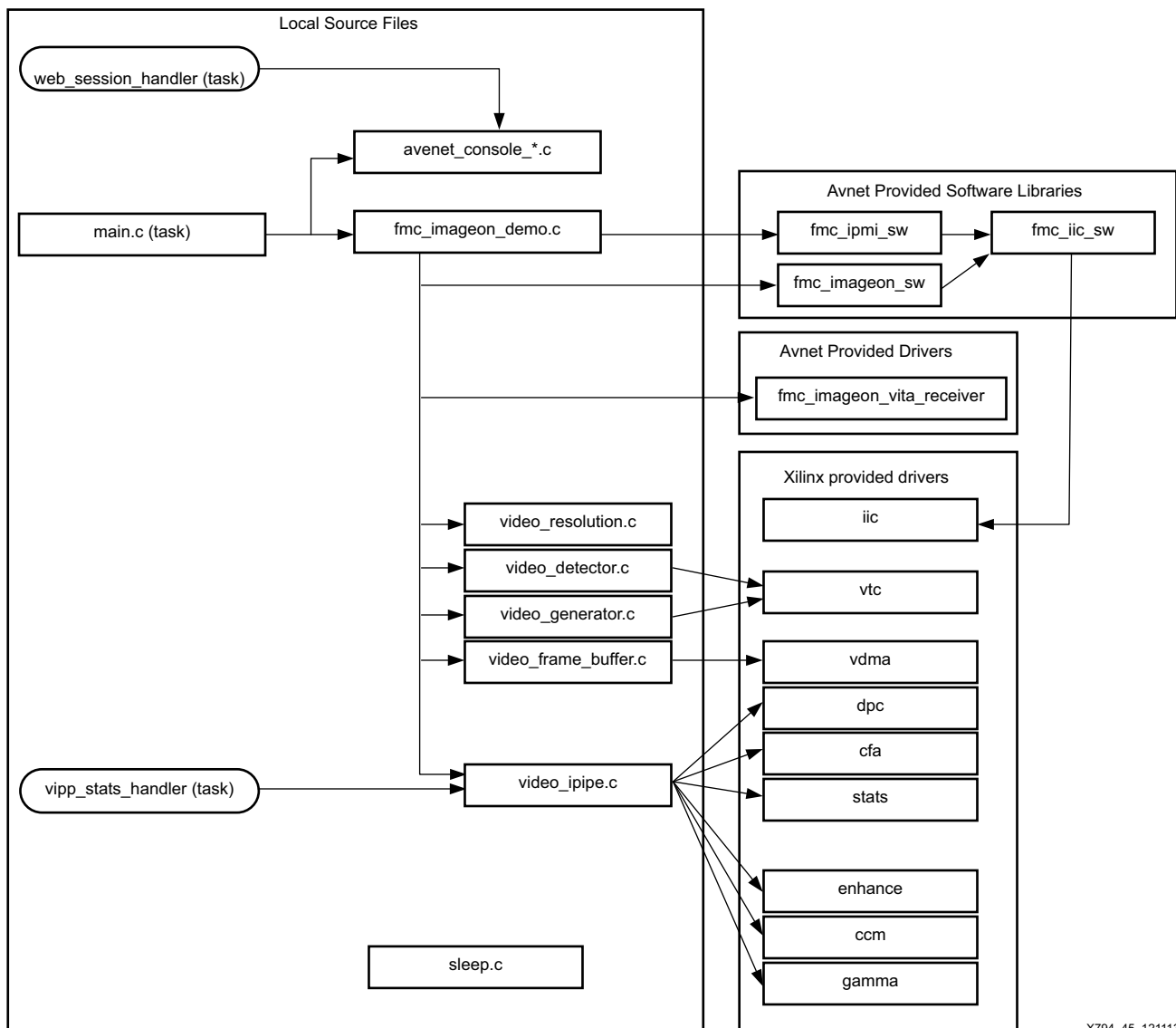

X794_45_121113

Figure 45: 1080p60 Camera Linux Application Source Files

The `fmc_imageon_demo.c` file contains most of the top-level initialization code for the camera design.

The `avnet_console_*.c` files, which implement a text-based command interface, are optional and can be removed from the application. This command interface is used by the main task to provide user control via the STDIN and STDOUT pipes. The command interface is also used by the web session task, via named pipes, to provide control from a web page serviced by a web server.

Main Task

The main task is the main() function, which initializes the reference design. This function also:

- Initializes the VITA image sensor
- Initializes the image processing pipeline
- Initializes the video frame buffer
- Launches the other tasks (image statistics task, web session task)

When the reference design has been initialized, it provides a text-based command interface via the STDIN and STDOUT pipes.

The main.c source code is:

```
// -----  
// Main entry point.  
//  
int main()  
{  
    // Specify Base Addresses of all PCOREs  
    init_base_addresses( &fmc_imageon_demo, 0 );  
  
    // Initialize FMC-IMAGEON Demo  
    fmc_imageon_demo_init( &fmc_imageon_demo );  
  
    // Initialize Web Console  
    print_avnet_console_web_app_header();  
    start_avnet_console_web_application();  
  
    // Initialize Serial Console  
    print_avnet_console_serial_app_header();  
    start_avnet_console_serial_application();  
  
    while (1)  
    {  
        // Process user input from Serial Console  
        if ( transfer_avnet_console_serial_data() )  
        {  
            // user requested to quit  
            break;  
        }  
    }  
  
    // Shutdown the FMC-IMAGEON Demo  
    fmc_imageon_demo_quit( &fmc_imageon_demo );  
  
    return 0;  
}
```

Image Statistics Task

The image statistics task (vipp_stats_handler) is launched when the video image processing pipeline is initialized.

This task periodically reads the image statistics from the image sensor, and performs these application examples:

- auto gain
- auto exposure
- auto white balance
- global contrast (gamma equalization)

Figure 46 illustrates how the image statistics handler interacts with the image processing pipeline.

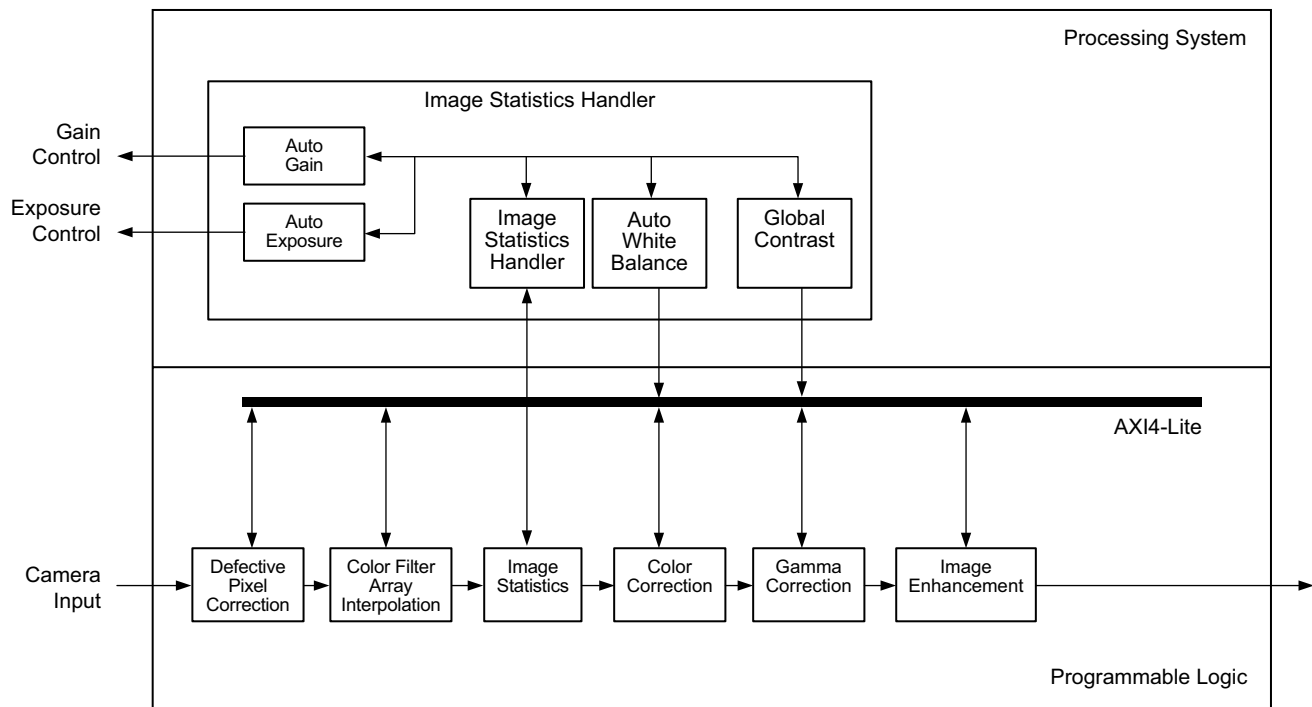

X794_46_121113

Figure 46: Image Statistics Handler

The image processing pipeline consists of these IP cores:

- Defective pixel correction
- Color filter array interpolation
- Image statistics
- Color correction
- Gamma correction
- Image enhancement

The image statistics IP core provides an important link with the Linux applications. It gathers statistics about the camera input, including intensity and chroma histograms, which are used to automatically adjust the image processing pipeline to improve image quality.

The image statistics task provides some interesting application examples that are all based on the image statistics IP core:

- Auto white balance: Attempts to determine the lighting conditions and applies a weighted sum of one or more of the pre-determined white balance corrections based on the calculated probability of each of the possible light sources using the color correction matrix IP core.
- Auto-gain: Based on the intensity of the image, reconfigures the image sensor gain setting.
- Auto-exposure: Based on the intensity of the image, reconfigures the image sensor exposure setting.
- Global contrast: Automatically determines a gamma correction look-up table.

Web Session Task

The web-based GUI is implemented with several applications. Figure 47 illustrates how these applications interact with each other.

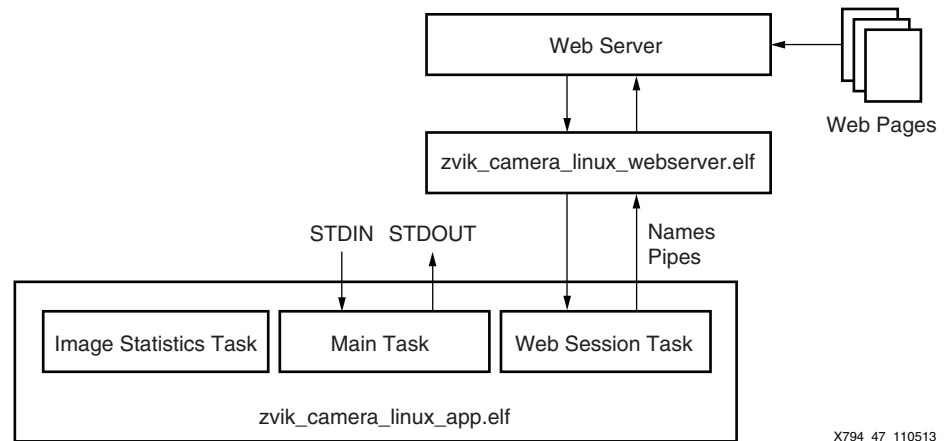

Figure 47: Web-Based GUI Block Diagram

The web server, a standard service provided by the open source BusyBox package in embedded Linux, is the engine that generates the reference design web-based GUI.

The web page (`index.html`) that makes up the web-based GUI uses these technologies:

- JavaScript
- CGI

When a CGI request is generated by the Web server, the `zvik_camera_linux_webserver.elf` application is invoked. When this occurs, the application translates the CGI request, which is in HTTP format, to text-based commands and sends the command to the `zvik_camera_linux_app.elf` application via a named pipe. The inverse of this process occurs for the response of each request or command.

Rebuilding the Hardware Platform

Licensing the Video and Image Processing Pack IP Cores

The image processing pipeline (iPipe) reference design uses several of the Xilinx Video and Image Processing Pack IP cores that must be licensed prior to use. Follow these steps to request an evaluation license:

1. Go to: www.xilinx.com/products/intellectual-property/EF-DI-VID-IMG-IP-PACK
2. Click the **Evaluate** link located on the upper-left of the web page, as shown in Figure 48, and follow the online instructions, as shown in Figure 49.

Video and Image Processing Pack

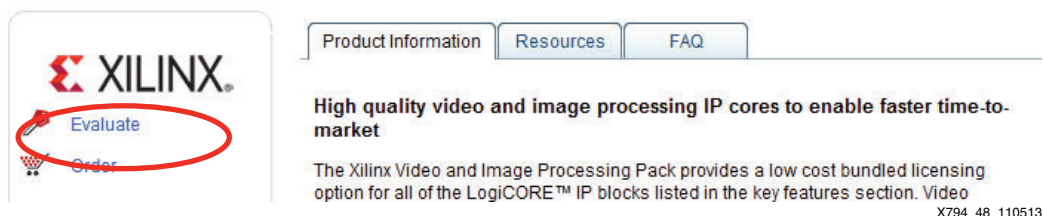

Figure 48: Xilinx Video and Image Processing Pack Evaluation License Example

In Vivado 2013.2, the Video and Image Processing Pack does not include licenses for these cores:

- Test Pattern Generator
- RGB to YCrCb Color-Space Conversion

These cores must be requested in addition to the Video and Image Processing Pack.

3. Select the **Add Evaluation and No Charge IP Cores** page to request licenses for the Video and Image Processing Pack, as well as the Test Pattern Generator, and RGB to YCrCb cores, as shown in [Figure 49](#). Any other evaluation licenses or no charge cores can be requested.

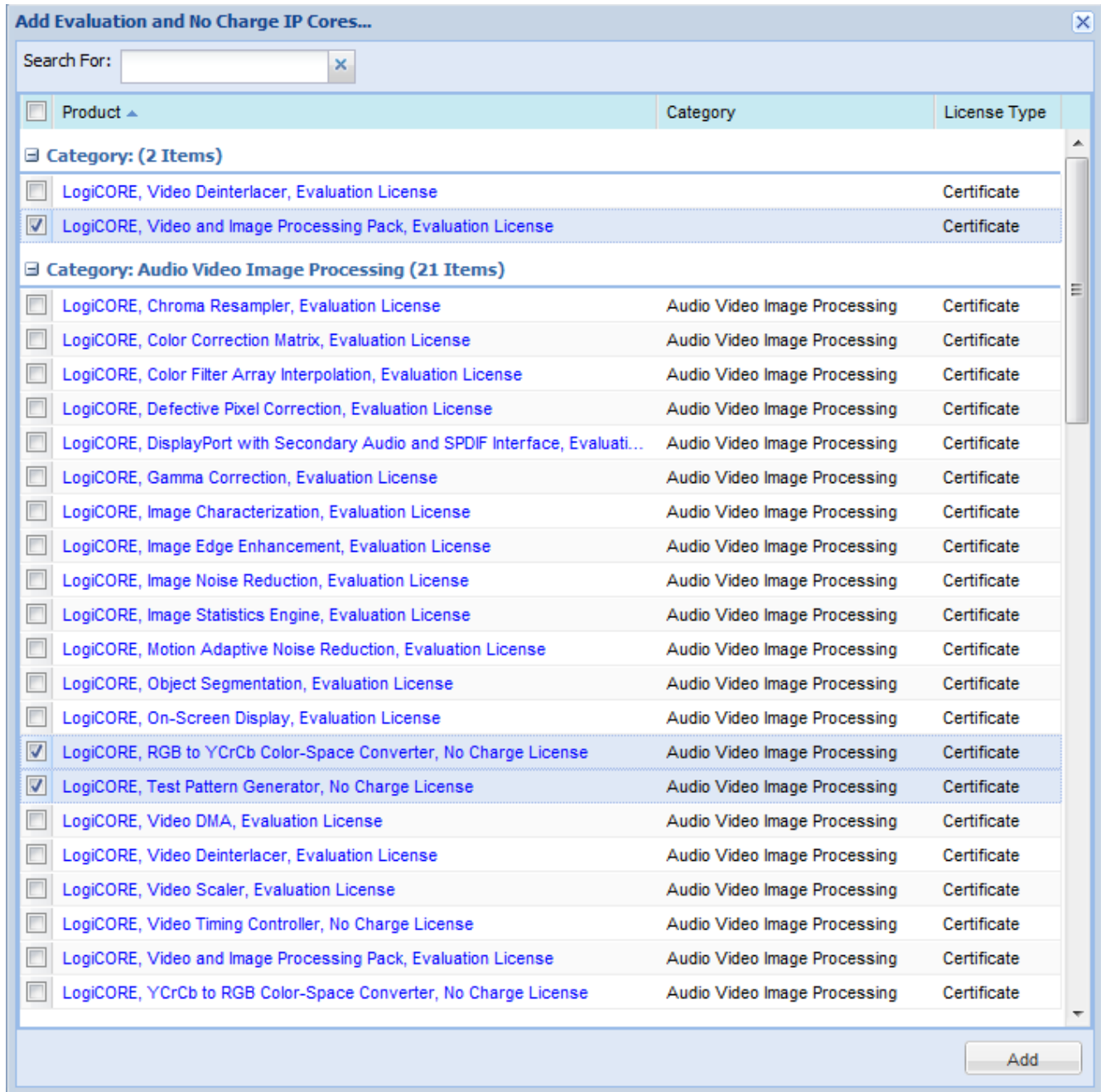

X794_49_121113

Figure 49: Add Core and No Charge Licenses

4. The generated license file is sent by email. Follow the enclosed instructions to add the evaluation license features for the Video and Image Processing Pack.

Build the Hardware Design Bitstream

1. Launch Vivado 2013.2:
 - On a Windows host, select **Start > All Programs > Xilinx Design Tools > Vivado 2013.2 > Vivado 2013.2**
 - On a Linux host, enter **vivado** at a command prompt.
2. From the Vivado welcome screen in the Tcl console, run these commands (see [Figure 50](#)):

```
cd C:/zc702-zvik-camera/hardware/vivado
source ./scripts/build_camera_design.tcl
```

The script will create a Vivado project called 'zvik_camera_2013.2' including an IP integrator block diagram. Then automatically build the bitstream.

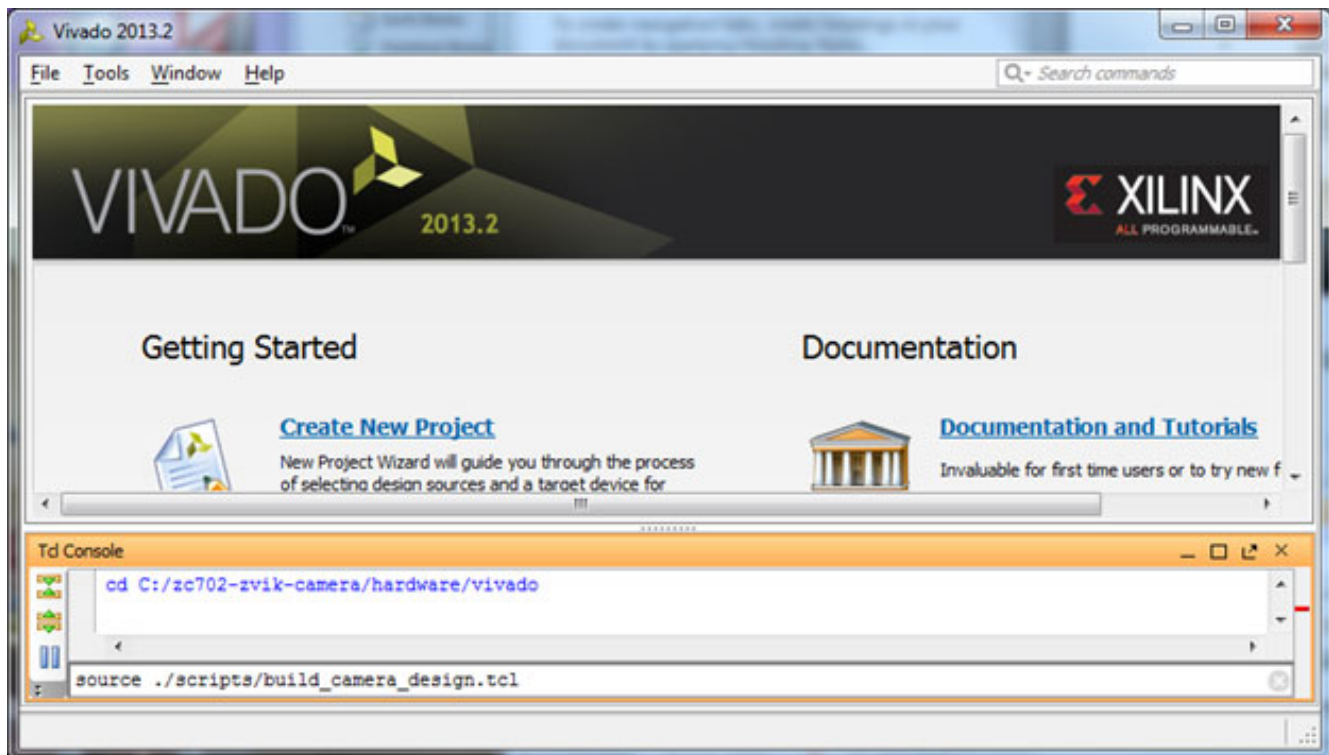

X794_50_121113

Figure 50: Vivado 2013 Tcl Console

3. Once the bitstream is created, select **Open Implemented Design** and click **OK** (see [Figure 51](#)).

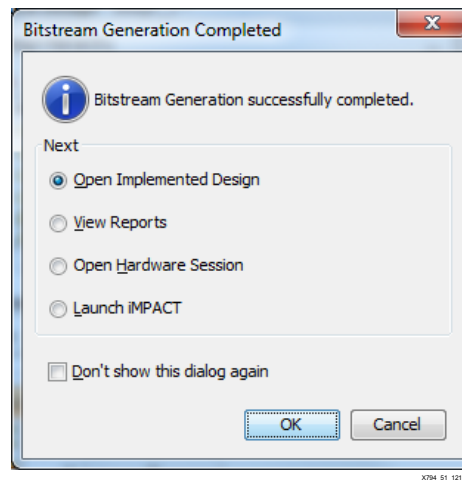

Figure 51: Bitstream Generation Completed

Exporting the Base Hardware Platform to SDK

Because the base hardware platform is used with the software development kit (SDK), information about the hardware platform must be provided to the SDK to allow development of software platforms and applications.

1. In the Vivado menu, select **File > Export > Export Hardware for SDK**.
2. Select **Launch SDK** and click **OK** (see [Figure 52](#))

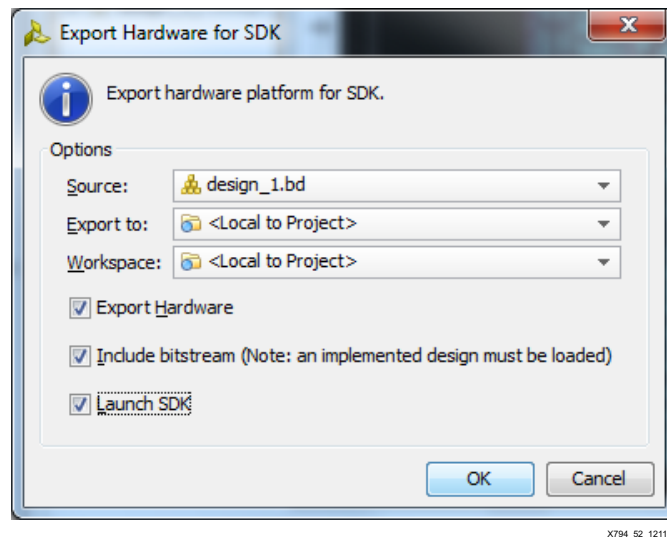

Figure 52: Export Hardware for SDK

- If you have not saved the IP Integrator block diagram, save it before exporting the hardware for SDK (Figure 53). Click **Save**.

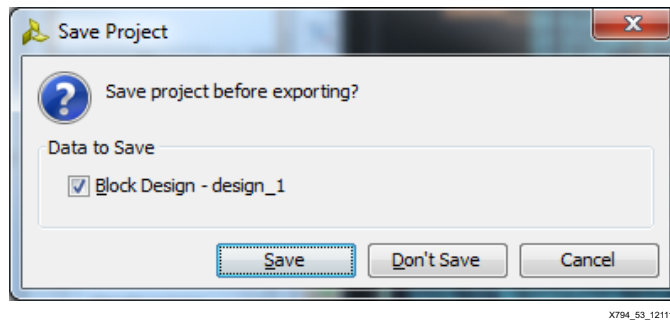

Figure 53: Save Project Before Exporting

Rebuilding the Software Applications

Extracting the Application Archives

In the `zvik_camera\sw` directory, extract the archives shown in Table 13:

Table 13: Application Archives

Archive Name	Description
<code>zvik_camera_linux_app</code>	This is the main application for the 1080p60 camera design.
<code>zvik_camera_linux_webserver</code>	This is the CGI application that services requests from the web-based GUI.

Importing and Building the Linux Applications

The Xilinx SDK included with Vivado 2013.2 or later tools can be used to build Linux applications.

To import the Linux applications into the SDK workspace:

- In the SDK tool, select **File > Import**.
- In the import wizard, expand the General folder and select **Existing Projects into Workspace**. Click **Next**.
- To specify the project sources root directory in the Select Root directory, click **Browse** and select **C:\zc702-zvik-camera\software\workspace**.
- After the root directory is specified, the import wizard shows a list of projects available to import, as shown in Figure 54. Make these selections:
 - Ensure that the `zvik_camera_linux_app` project is selected.
 - Select the **Copy projects into workspace** checkbox to make a local copy of the projects in the workspace when the import is done.

Note: The projects in the import wizard might appear in a different order than that shown in [Figure 54](#).

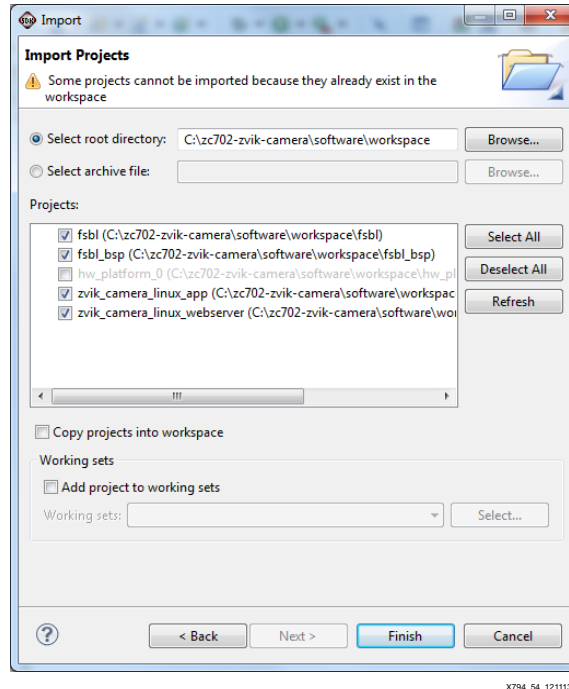

Figure 54: Importing Linux Applications

5. Click **Finish**. The SDK tool imports the selected projects. The software application is compiled during the import process.

Debugging the Linux Application

Before starting a remote debug session with the ZVIK, make sure the Linux application is NOT running on the ZVIK:

1. Open the serial console (115200 baud)
2. Type the quit command in the zvik_camera linux application:

```
zvika_camera>quit
quit
```

```
zvika_camera>
zynq>
```

3. At the Linux prompt, type the ifconfig command to confirm the ZVIK IP address:

```
zynq> ifconfig
eth0      Link encap:Ethernet  HWaddr 7E:CA:CF:54:6D:4E
          inet addr:192.168.1.10  Bcast:192.168.0.255  Mask:255.255.255.0
          UP BROADCAST RUNNING MULTICAST  MTU:1500  Metric:1
          RX packets:93 errors:0 dropped:0 overruns:0 frame:0
          TX packets:0 errors:0 dropped:0 overruns:0 carrier:0
          collisions:0 txqueuelen:1000
          RX bytes:17184 (16.7 KiB)  TX bytes:0 (0.0 B)
          Interrupt:54 Base address:0xb000
```

```
zynq>
```

- Optionally, to permanently prevent the application from auto-starting on boot, edit the `init.sh` script on the SD card and comment out the statement shown using the “#” character:

```
zynq> vi /mnt/launch_my_app.sh
# /mnt/zvik_camera_linux_app.elf
```

A remote connection can be established between the SDK tool and the ZVIK using Secure Shell (SSH) by following these steps:

- In the SDK tool, select **Window > Open Perspective > Other ...**.
- Select **Remote System Explorer**, then click **OK**.
- In the Remote Systems tab, click the new connection icon as shown in [Figure 55](#).

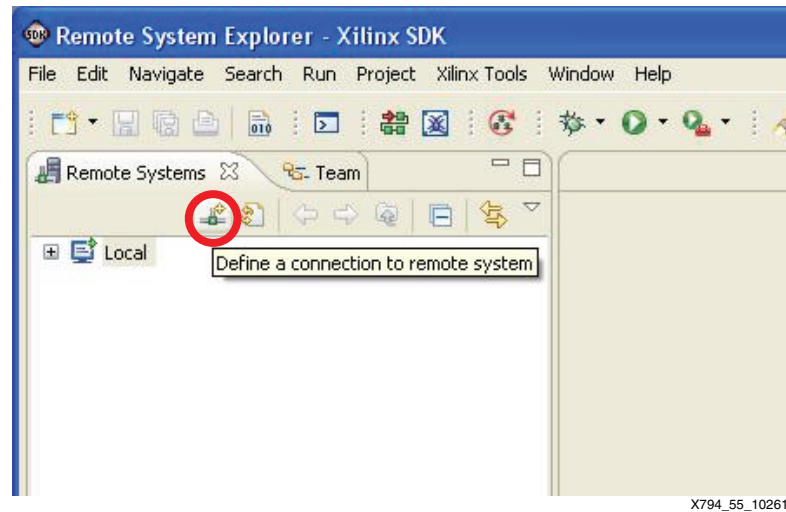

X794_55_102612

Figure 55: Define a Connection to a Remote System

- Select **SSH Only**, then click **Next**.
- In the Host name field, type the IP address of the ZVIK (i.e., **192.168.1.10**) then click **Finish**.
- In the Remote Systems tab, open the 192.168.1.10 section, then open the Sftp Files section.
- Double-click the Root section.
- In the Enter Password dialog box, enter **root** for both user ID and password.
- Select **Save User ID** and **Save password**, then click **OK**.
- If a dialog box appears with a warning about the authenticity of the 192.168.1.10 host, click **Yes**.
- If a dialog box appears with a warning that `known_hosts` does not exist, click **Yes**.
- Navigate to the `/mnt` directory. The contents of the SD card should be visible.

To open a terminal to enter Linux commands on the ZVIK:

- In the Remote Systems tab, Select **Ssh Terminals**.
- Right-click and select **Launch Terminal**.

The `zvik_camera_linux_app` application can be debugged remotely with the SDK tool by following these steps:

- Switch to the C/C++ perspective by selecting **Window > Open Perspective > Other**, then select **C/C++ (Default)**.
- Select the `zvik_camera_linux_app` application.

3. Right-click and select **Debug As**.
4. Select **Debug Configurations....**
5. In the Debug Configurations dialog box, select **Remote ARM Linux Application**, then click the new launch configuration button, as shown in [Figure 56](#).

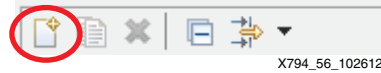
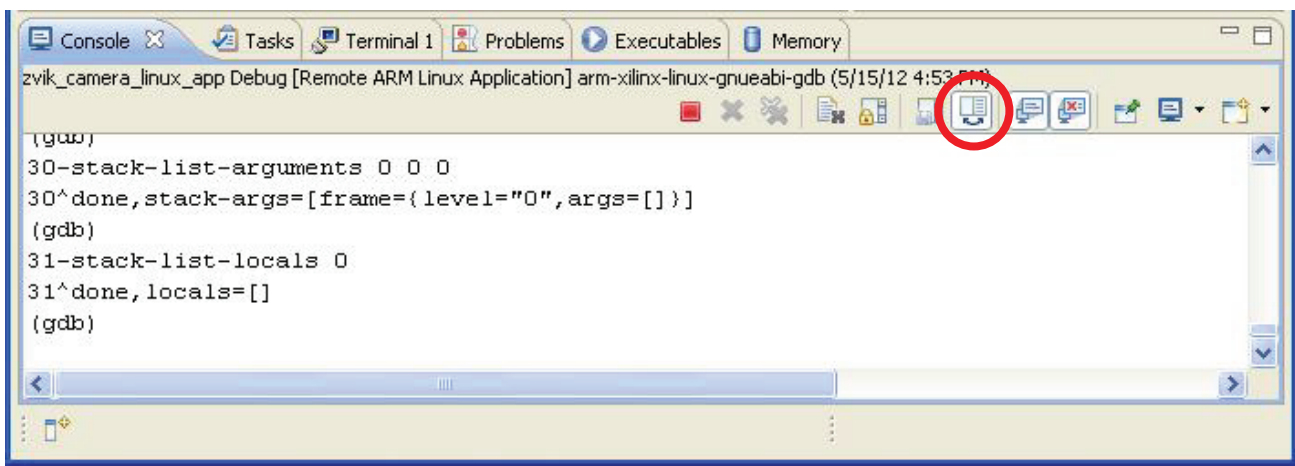

Figure 56: **New Launch Configuration Button**

6. In the Connection list, select the ZVIK IP address (i.e., **192.168.1.10**).
7. In the Remote Absolute File Path for C/C++ Application field, specify the path **/tmp/zvik_camera_linux_app.elf**
8. Click **Apply**.
9. Click **Debug**. The application is downloaded to the specified remote path and the Debug perspective opens.
10. Click **Yes** when asked to open the debug perspective.
11. In the Console tab, click the verbose console mode button as shown in [Figure 57](#) to disable the verbose console mode.



X794_57_102612

Figure 57: **Verbose Console Mode**

12. Click the display selected console button, and select the `zvik_camera_linux_app.elf` entry, as shown in [Figure 58](#).

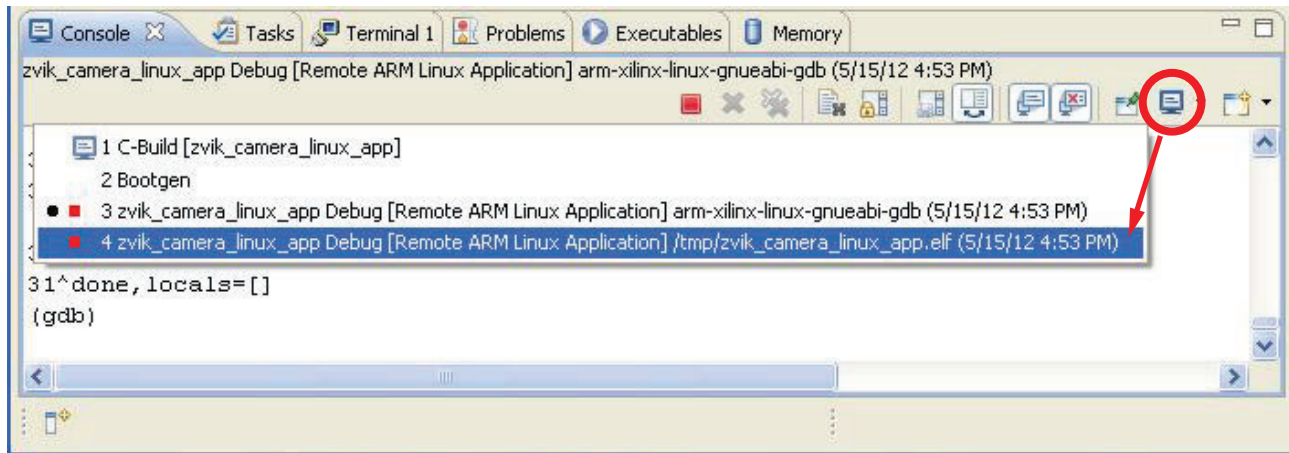

X794_58_102612

Figure 58: Display Selected Console

13. Click the **Resume** button (or press F8). The console output shown in [Figure 59](#) is displayed.

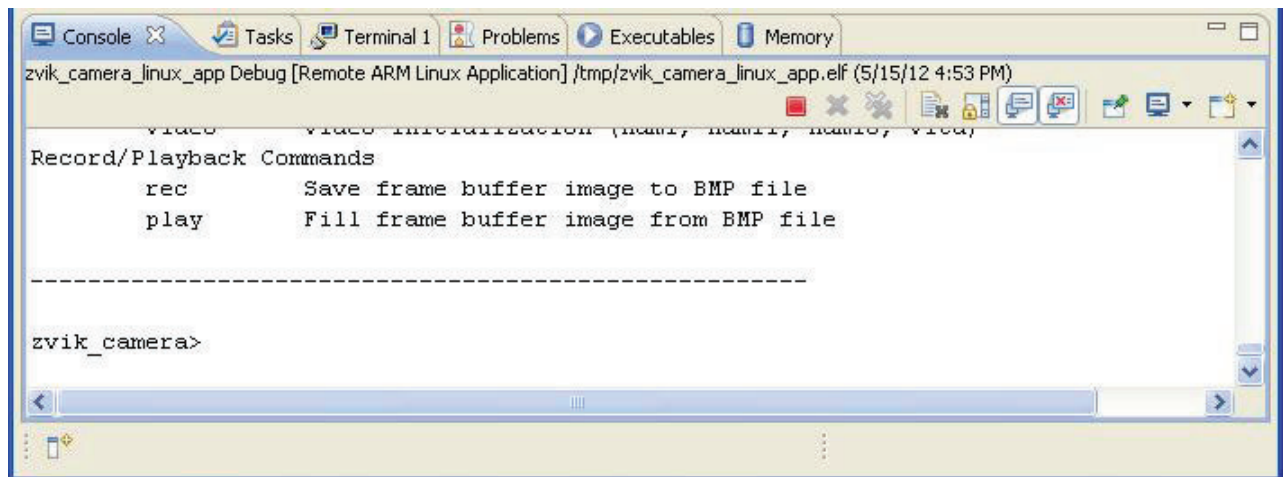

X794_59_102612

Figure 59: Example Console Output

14. Add this breakpoint:
- Source file: `avnet_console.c`
 - Function: `avnet_console_record_command`
15. Select **Window > Open Perspective > C/C++** to view the C/C++ perspective.
16. Expand the `zvik_camera_linux_app` application, then double-click the `avnet_console.c` source file.

17. Search for the `avnet_console_record_command` function, then double-click the left margin to enable a breakpoint. Select the command **Search > C/C++ Search** and enter the function name. The search results appear in a new tab in a window below the source window (see [Figure 60](#)).



Figure 60: Breakpoint Search Results

18. Switch back to the Debug perspective.
19. On the console, type `rec /mnt/image1.bmp`, then press enter. The debugger stops on the specified breakpoint.
20. Click the **Resume** button (or press F8). The contents of the video frame buffer are saved to a BMP file.
21. Switch to the Remote System Explorer perspective.
22. Select the `mnt` directory, then right-click and select **Refresh**. The newly created `image1.bmp` is now visible.
23. Select the `image1.bmp` file, then right-click and select **Open With > Default Editor**. The image file is now visible in the editor window.
24. Switch back to the Debug perspective.
25. Open a web browser and enter the address `http://192.168.1.10`.
26. When loaded, the web page invokes the `rec /mnt/www/webshot.bmp` command. The debugger is stopped on the specified breakpoint again.
27. Disable the breakpoint.
28. Click **Resume** (or press F8).

The ZVIK camera linux application has successfully been remotely debugged.

Preparing the SD Card Boot Image

To configure and boot the ZC702 board with a customized hardware design and Linux platform, the ISE tools and provided script files should be used to prepare the image files described in [Table 14](#).

Table 14: ZC702 Evaluation Board Image Files

Image Name	Description
BOOT.BIN	The <code>zynq_fsbl.elf</code> , <code>u-boot.elf</code> , and <code>system.bit</code> files combined and renamed <code>BOOT.BIN</code> to satisfy licensing requirements.
<code>init.sh</code>	Tells the system what application to launch.
<code>config_my_ip.sh</code>	Specifies the default IP address.
<code>devicetree.dtb</code>	Device tree blob for booting a RAM disk.
<code>ramdisk8M.image.gz</code>	BusyBox-based Linux root file system.
<code>zImage</code>	Linux kernel Image.
<code>www</code>	Web-based GUI files.
<code>www/cgi-bin/zvik_camera_linux_webserver.elf</code>	CGI application for web-based GUI.
<code>zvik_camera_linux_app.elf</code>	Main Linux application for camera design.

The `BOOT.BIN` file consists of the Zynq FSBL binary image (`zynq_fsbl.elf`), ARM Linux u-boot binary image (`u-boot.elf`), and the FPGA hardware design bitstream file (`system.bit`).

To update the SD card with custom Linux applications, copy the custom ELF files to the SD card in the location indicated in [Table 14](#). Use the mouse to copy this file from the C/C++ Perspective of the SDK user interface, then replace the file of the same name in the `C:\zvik_camera\binaries\sd_content` folder.

To update the SD card with a custom hardware design bitstream, copy the `system.bit` file from `zvik_camera\hw\SDK\SDK_Export\hw` to the `zvik_camera\binaries\boot_image` directory, regenerate the `BOOT.BIN` file as described in [Regenerating the BOOT.BIN File](#), then copy the custom `BOOT.BIN` file to the SD card.

Regenerating the BOOT.BIN File

The `BOOT.BIN` file can be regenerated using the SDK tool by following these steps:

1. In the SDK tool window, select **Xilinx Tools > Create Boot Image** (see [Figure 61](#)).

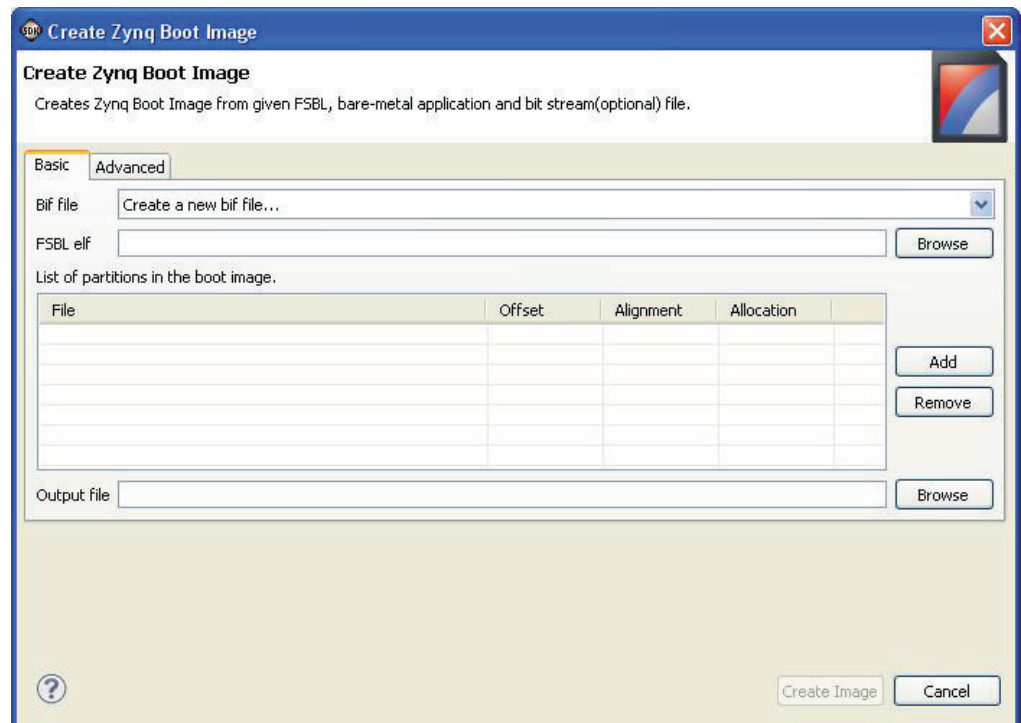

X794_61_111512

Figure 61: Create Zynq Boot Image Dialog

2. Click the **Browse** button under the Basic tab adjacent to the FSBL elf entry.
3. Select the `C:\zc702-zvik-camera\binaries\boot_image\fsbl.elf` file and click **Open**.
4. Click the **Add** button.
5. Select the `C:\zc702-zvik-camera\binaries\boot_image\system.bit` file and click **Open**.
6. Click the **Add** button again.
7. Select the `C:\zc702-zvik-camera\binaries\boot_image\u-boot.elf` file and click **Open**.
8. Click the **Browse** button adjacent to the Output Folder entry.
9. Select the `C:\zc702-zvik-camera\binaries\boot_image` file directory and click **OK**.
10. Click the **Create Image** button.
11. If the “Output file already exists” dialog appears, click **OK**.
12. Rename the generated file `u-boot.bin` to **BOOT.BIN**.
13. Copy the updated `BOOT.BIN` file to the SD card.

Linux Kernel Image and Linux Root File System

It is beyond the scope of this application note to provide instructions for regenerating the Linux kernel image and the Linux root file system.

It is assumed that the Linux root file system is created as described here:

wiki.xilinx.com/zynq-rootfs

or use the pre-built RAM disk image available here:

xilinx.wdfiles.com/local--files/zynq-release-14-2/14.2-release.tar.gz

Appendix

Table 15 lists the acronyms used in this application note.

Table 15: Acronyms

Acronym	Definition
DPC	Defective Pixel Correction
EDK	Embedded Development Kit
FMC	FPGA Mezzanine Card
FSBL	First Stage Boot Loader
PS	Processing System
PL	Programmable Logic (FPGA logic cell array)
SDK	Software Development Kit
TPG	(Video) Test Pattern Generator
VTC	Video Timing Controller
VDMA	Video Direct Memory Access
ZVIK	Zynq-7000 All Programmable SoC Video and Imaging Kit

References

1. To search the Answer Database of silicon, software, and IP questions and answers, or to create a technical support WebCase, see:

www.xilinx.com/support

For a comprehensive listing of Video and Imaging application notes, white papers, reference designs and related IP cores, see the Video and Imaging Resources page at:

www.xilinx.com/esp/video/refdes_listing.htm#ref_des

These documents provide supplemental material useful with this application note.

Zynq-7000 All Programmable SoC Documents and Links

1. Zynq-7000 All Programmable SoC ZC702 Evaluation Kit documentation page:
www.xilinx.com/support/documentation/zc702
2. Xcell Journal, Issue 81, Fourth Quarter 2012
www.xilinx.com/publications/archives/xcell/Xcell81.pdf#Oct12NL
3. [UG585](#), *Zynq-7000 All Programmable SoC Technical Reference Manual*
4. [DS406](#), *LogiCORE IP Processor System Reset Module Product Specification*
5. [DS768](#), *LogiCORE IP AXI Interconnect*
6. Xilinx Open Source ARM Git Repository:
git.xilinx.com/
7. [UG973](#), *Vivado Design Suite User Guide: Release Notes, Installation, and Licensing Guide*
8. Xilinx ARM GNU Tools:
wiki.xilinx.com/zynq-tools
9. Using Git:
wiki.xilinx.com/using-git
10. [UG821](#), *Zynq-7000 All Programmable SoC Software Developers Guide*
11. Xilinx Zynq-7000 All Programmable SoC website:
www.xilinx.com/products/silicon-devices/soc/zynq-7000
12. Zynq-7000 All Programmable SoC Product Table:
www.xilinx.com/publications/prod_mktg/zynq7000/Zynq-7000-combined-product-table.pdf
13. [DS190](#), *Zynq-7000 All Programmable SoC Overview*
14. git: The fast version control system home page:
git-scm.com/
15. Zynq Linux: Downloading the Kernel Tree:
xilinx.wikidot.com/zynq-linux#toc7
16. Zynq Linux: Configuring and Building the Linux Kernel:
xilinx.wikidot.com/zynq-linux#toc8
17. Xilinx Open Source Linux:
wiki.xilinx.com/open-source-linux
18. Xilinx Device Tree Generator:
xilinx.wikidot.com/device-tree-generator
19. Device Tree general information:
devicetree.org/Main_Page
20. AMBA AXI4-Stream Protocol Specification:
infocenter.arm.com/help/index.jsp?topic=/com.arm.doc.ih0051a/index
21. PCI-SIG Documentation:
www.pcisig.com/specifications
22. Xilinx PlanAhead Design and Analysis Tool website:
www.xilinx.com/tools/planahead
23. [UG873](#), *Zynq-7000 All Programmable SoC Concepts, Tools, and Techniques*
24. [UG888](#), *Vivado Design Suite Tutorial Design Flows Overview*

Video Documents

25. [PG001](#), *LogiCORE IP Color Correction Matrix Product Guide*
26. [PG002](#), *LogiCORE IP Color Filter Array Interpolation Product Guide*
27. [PG003](#), *LogiCORE IP Image Edge Enhancement Product Guide*
28. [PG004](#), *LogiCORE IP Gamma Correction Product Guide*
29. [PG005](#), *LogiCORE IP Defective Pixel Correction Product Guide*
30. [PG008](#), *LogiCORE IP Image Statistics Product Guide*
31. [PG011](#), *LogiCORE IP Image Noise Reduction Product Guide*
32. [PG012](#), *LogiCORE IP Chroma Resampler Product Guide*
33. [PG013](#), *LogiCORE IP RGB To YCrCb Color-Space Converter Product Guide*
34. [PG014](#), *LogiCORE IP YCrCb To RGB Color-Space Converter Product Guide*
35. [PG016](#), *LogiCORE IP Video Timing Controller Product Guide*
36. [PG020](#), *LogiCORE IP AXI Video Direct Memory Access Product Guide*
37. [UG761](#), *AXI Reference Guide*
38. [UG934](#), *AXI4-Stream Video IP and System Design Guide*

Additional Useful Documents

Documents associated with other software, tools, and IP used by the design are available at these vendor or public websites:

39. Silicon Labs CP210x USB to UART Bridge VCP Drivers:
www.silabs.com/products/mcu/Pages/USBtoUARTBridgeVCPDrivers.aspx
40. X-Rite ColorChecker Classic
xritephoto.com/ph_product_overview.aspx?ID=1192
41. X-Rite Judge II
www.xrite.com/product_overview.aspx?ID=1131

Additional Useful Sites for Boards and Kits

More information on Zynq-7000 family boards, FMC extension cards, and other kits based on the Zynq-7000 All Programmable architecture is available here:

42. Xilinx Zynq-7000 All Programmable SoC Boards and Kits:
www.xilinx.com/products/boards_kits/zynq-7000
43. Zynq-7000 All Programmable SoC ZC702 Evaluation Kit:
www.xilinx.com/ZC702
44. Xilinx Zynq Embedded Processors Base TRD wiki page:
wiki.xilinx.com/zc702-base-trd
45. Xilinx Zynq-7000 All Programmable SoC Video and Imaging Kit:
www.xilinx.com/products/boards-and-kits/DK-Z7-VIDEO-G
46. ON Semiconductor Image Sensor with HDMI Input/Output FMC bundle:
www.em.avnet.com/fmc-imageon-v2000c

Revision History

The following table shows the revision history for this document.

Date	Version	Description of Revisions
11/22/2012	1.0	Initial Xilinx release.
11/29/2012	1.1	Removed references to targeted reference design (TRD). Updated Figure 52, page 46 and Figure 53, page 47 . Updated the path for the hardware description files and Zynq device initialization C source code in Exporting the Base Hardware Platform to SDK, page 46 . Added path for <code>system.bit</code> file in Preparing the SD Card Boot Image, page 53 .
01/02/2013	1.2	Added Reference Design File . Updated Figure 26 , Figure 27 , Figure 29 , Figure 30 , and Figure 31 .
12/20/2013	1.3	Updated for Vivado 2013.2 design tools. Noise Reduction and Edge Enhancement cores replaced by Image Enhancement core. Updated U-boot output in Observing the Linux Console on the Serial Port . Updated Figure 21 , Figure 33 , Figure 34 , Figure 35 , Figure 37 , Figure 39 , Figure 40 , Figure 41 , Figure 42 , Figure 42 , Figure 43 , and Figure 46 . Updated Table 11 , Table 12 , and Table 14 . Removed Reset section in System Configuration . Updated Programmable Logic , Clocking , AXI Interconnect , AXI VDMA , Debugging the Linux Application , and Linux Kernel Image and Linux Root File System .

Notice of Disclaimer

The information disclosed to you hereunder (the "Materials") is provided solely for the selection and use of Xilinx products. To the maximum extent permitted by applicable law: (1) Materials are made available "AS IS" and with all faults, Xilinx hereby DISCLAIMS ALL WARRANTIES AND CONDITIONS, EXPRESS, IMPLIED, OR STATUTORY, INCLUDING BUT NOT LIMITED TO WARRANTIES OF MERCHANTABILITY, NON-INFRINGEMENT, OR FITNESS FOR ANY PARTICULAR PURPOSE; and (2) Xilinx shall not be liable (whether in contract or tort, including negligence, or under any other theory of liability) for any loss or damage of any kind or nature related to, arising under, or in connection with, the Materials (including your use of the Materials), including for any direct, indirect, special, incidental, or consequential loss or damage (including loss of data, profits, goodwill, or any type of loss or damage suffered as a result of any action brought by a third party) even if such damage or loss was reasonably foreseeable or Xilinx had been advised of the possibility of the same. Xilinx assumes no obligation to correct any errors contained in the Materials or to notify you of updates to the Materials or to product specifications. You may not reproduce, modify, distribute, or publicly display the Materials without prior written consent. Certain products are subject to the terms and conditions of the Limited Warranties which can be viewed at www.xilinx.com/warranty; IP cores may be subject to warranty and support terms contained in a license issued to you by Xilinx. Xilinx products are not designed or intended to be fail-safe or for use in any application requiring fail-safe performance; you assume sole risk and liability for use of Xilinx products in Critical Applications: www.xilinx.com/warranty.htm#critapps.

Automotive Applications Disclaimer

XILINX PRODUCTS ARE NOT DESIGNED OR INTENDED TO BE FAIL-SAFE, OR FOR USE IN ANY APPLICATION REQUIRING FAIL-SAFE PERFORMANCE, SUCH AS APPLICATIONS RELATED TO: (I) THE DEPLOYMENT OF AIRBAGS, (II) CONTROL OF A VEHICLE, UNLESS THERE IS A FAIL-SAFE OR REDUNDANCY FEATURE (WHICH DOES NOT INCLUDE USE OF SOFTWARE IN THE XILINX DEVICE TO IMPLEMENT THE REDUNDANCY) AND A WARNING SIGNAL UPON FAILURE TO THE OPERATOR, OR (III) USES THAT COULD LEAD TO DEATH OR PERSONAL INJURY. CUSTOMER ASSUMES THE SOLE RISK AND LIABILITY OF ANY USE OF XILINX PRODUCTS IN SUCH APPLICATIONS.