



WARNING

THIS MANUAL CONTAINS IMPORTANT SAFETY,
PERFORMANCE AND SERVICE INFORMATION.

Read it before you take the first ride on your new bicycle, and keep it for reference.

OWNER'S MANUAL

NOVARA[®]
Now is a great time to ride

VERSION
2010 A

CONGRATULATIONS ON YOUR PURCHASE OF A NOVARA® BICYCLE

ABOUT US:

Novara is a registered trademark of Recreational Equipment, Inc (REI).
Novara bicycles are manufactured and distributed exclusively by REI.

THE REI GUARANTEE:

Our 100% satisfaction guarantee ensures that every item you purchase at REI meets your high standards—or you can return it for a replacement or refund.

This policy covers most of what is referenced as a “warranty” in many bicycle-related materials. Please contact us for additional information.

USEFUL LIFE

Nothing lasts forever, including your bike. When the useful life of your bike or its components is over, continued use is hazardous. Every Novara bicycle frame and the components attached to the frame have a finite, limited useful life.

ALL NOVARA FRAMES AND COMPONENTS SHOULD BE PERIODICALLY CHECKED BY AN REI OR OTHER PROFESSIONAL BICYCLE MECHANIC for signs of wear, damage, stress and/or other potential points of failure. The frequency of these checks is affected by frequency of use, environmental considerations, bicycle type, riding style, riding conditions and other factors. Please contact us for additional information.

CONTACT US

PHONE:

Our Contact Center is open Monday through Sunday,
4am to 11pm Pacific Time.

From the U.S. and Canada: **1-800-426-4840**

International: 1-253-891-2500 (English language only)

Fax: 1-253-891-2523

WEB:

REI.com
novarabike.com

MAIL:

REI
Sumner, WA
98390

RETAIL STORES:

To learn which REI retail location will best serve your needs, please visit [REI.com/stores](https://www.rei.com/stores) or call the Contact Center.

USE OF THIS MANUAL

Novara Bicycle Owner’s Manual

This manual contains important information affecting your safety and the proper use of bicycles. It is an important document for every bicycle owner. It is organized into two parts:

PART I

This is a generic guide to the proper function and use of bicycles. This information is licensed to us and is used by many bike companies. Many aspects of bicycles and their operation are common or “generic” and this section covers many of them.

PART II

This portion of the manual contains information specific to Novara bicycles and topics we feel you need to be informed about.

A manual cannot teach you how to ride, and a manual the size of an encyclopedia could not cover every combination of bicycle, rider and conditions. The Novara manuals and supplements focus mainly on the bicycle and do not teach you to ride. REI and other companies offer great varieties of online, printed and person-to-person learning opportunities. Please take the time to appropriately inform yourself if you have a curiosity, question or concern.

This manual is not intended as a comprehensive use, service, repair or maintenance manual. It contains no thorough assembly instructions. Nor is this manual a detailed service guide for any part of your bike. Please contact your local REI store or a reputable bicycle dealer for all service, repairs or maintenance. REI or your other service provider should also be able to refer you to online materials, classes or books on bicycle use and maintenance.

Other Manuals and Instructions

Many of the components on your bike were not made by Novara or REI. When available from the manufacturer, Novara packages these manuals and/or instructions with our bikes for delivery to you. We strongly recommend that you read and follow all the manufacturer's specific instructions included with your bike.

Service Locations

REI would like to be your primary contact for service and adjustment of your bicycle, instruction in its use and any other questions. Please contact your local REI store. In those locations where there is no REI store, please contact your local bicycle shop. If you choose another service location, all Novara-brand service parts will come from REI. Please contact us with questions.

PART I

CONTENTS

USE OF THIS MANUAL	1
--------------------------	---

PART I

GENERAL WARNING.....	4
----------------------	---

A SPECIAL NOTE FOR PARENTS.....	4
---------------------------------	---

SECTION 1. FIRST STEPS.....	5–8
-----------------------------	-----

1.A Bike Fit.....	5
1.B Safety First.....	5
1.C Mechanical Safety Check.....	6
1.D First Ride	8

SECTION 2. SAFETY	8–14
-------------------------	------

2.A The Basics.....	9
2.B Riding Safety	10
2.C Off-Road Safety.....	11
2.D Wet-Weather Riding.....	11
2.E Night Riding	12
2.F Extreme, Stunt or Competition Riding	13
2.G Changing Components or Adding Accessories.....	14

SECTION 3. FIT	15–19
----------------------	-------

3.A Stand-Over Height	15
3.B Saddle Position	16
3.C Handlebar Height and Angle.....	18
3.D Control Position Adjustments	19
3.E Brake Reach	19

SECTION 4. TECH	20–37
-----------------------	-------

4.A Wheels.....	20
4.B Seatpost Quick-Release Clamp	26
4.C Brakes.....	27
4.D Shifting Gears.....	31
4.E Pedals.....	33
4.F Bicycle Suspension.....	34
4.G Tires and Tubes	35

SECTION 5. SERVICE.....	38–40
-------------------------	-------

5.A Service Intervals	39
5.B If Your Bicycle Sustains an Impact.....	40

PART II

SECTION A. IMPORTANT SAFETY INFO	42–48
---	-------

A.1 Bicycling-Inherent Risk	42
A.2 Warning Label	43
A.3 Riding in Traffic, Commuting	43
A.4 Riding at Night, Dusk, Dawn.....	44
A.5 Refinishing.....	45
A.6 Physical Modifications.....	45
A.7 Bicycles Have Sharp Surfaces	46
A.8 Installing Accessories	46
A.9 Bicycle Racks.....	46
A.10 Tire Size	47
A.11 Toe-Clip Overlap	47
A.12 Aftermarket Brake Systems.....	48
A.13 Aftermarket Power Systems	48

SECTION B. INTENDED USE	50–53
----------------------------------	-------

This section also includes weight limit information.

B.1 Children's Sidewalk.....	51
B.2 Sport and Performance Road	51
B.3 General-Purpose Riding.....	52
B.4 Cross-Country Riding.....	52
B.5 Advanced Cross-Country.....	53
B.6 All-Mountain	53

SECTION C. OFF-ROAD RIDING	54–55
-------------------------------------	-------

C.1 Inspection and Maintenance Routines	54
C.2 Suspension	54
C.3 Jumping	55
C.4 Downhill and Lift-Serviced Riding.....	55
C.5 Fixed-Gear Riding and Conversion	55

SECTION D. MATERIALS AND INSPECTION.....	56–64
---	-------

D.1 Understanding Metal as a Material	56
D.2 Understanding Carbon Fiber.....	60
D.3 Understanding Components.....	62
D.4 Riding Through Water	63
D.5 Bicycle Lifespan	64

SECTION E. MAINTENANCE	64–67
---------------------------------	-------

E.1 Warranty Tune.....	64
E.2 Cleaning.....	65
E.3 Preventing Corrosion	65
E.4 Lubrication.....	65
E.5 Tightening Torques.....	66
E.6 Bicycle Repair/Work Stands	66
E.7 Serial Number.....	67

SECTION F. BICYCLE TRAINERS	67
--------------------------------------	----

SECTION G. PRE-RIDE CHECKLIST.....	68
---------------------------------------	----

PART I

GENERAL WARNING

Like any sport, bicycling involves risk of injury and damage. By choosing to ride a bicycle, you assume the responsibility for that risk, so you need to know — and to practice — the rules of safe and responsible riding and of proper use and maintenance. Proper use and maintenance of your bicycle reduces risk of injury.

This manual contains many “Warnings” and “Cautions” concerning the consequences of failure to maintain or inspect your bicycle and of failure to follow safe cycling practices.

The combination of the safety alert symbol  and the word **WARNING** indicates a potentially hazardous situation that, if not avoided, could result in serious injury or death.

The combination of the safety alert symbol  and the word **CAUTION** indicates a potentially hazardous situation that, if not avoided, may result in minor or moderate injury, or is an alert against unsafe practices.

The word **CAUTION** used without the safety alert symbol indicates a situation that, if not avoided, could result in serious damage to the bicycle.

Because it is impossible to anticipate every situation or condition that can occur while riding, this manual makes no representation about the safe use of the bicycle under all conditions. There are risks associated with the use of any bicycle that cannot be predicted or avoided and that are the sole responsibility of the rider.

A SPECIAL NOTE FOR PARENTS

As a parent or guardian, you are responsible for the activities and safety of your minor child, and that includes making sure that the bicycle is properly fitted to the child; that it is in good repair and safe operating condition; that you and your child have learned and understand the safe operation of the bicycle; and that you and your child have learned, understand and obey not only the applicable local motor vehicle, bicycle and traffic laws, but also the common sense rules of safe and responsible bicycling. As a parent, you should read this manual and its warnings and review the bicycle’s functions and operating procedures with your child, before letting your child ride the bicycle.

WARNING

MAKE SURE THAT YOUR CHILD ALWAYS WEARS AN APPROVED BICYCLE HELMET WHEN RIDING; BUT ALSO MAKE SURE THAT YOUR CHILD UNDERSTANDS THAT A BICYCLE HELMET IS FOR BICYCLING ONLY, AND MUST BE REMOVED WHEN NOT RIDING.

Failure to follow this warning could result in serious injury or death.

SECTION 1. FIRST STEPS

NOTE: We strongly urge you to read this Manual in its entirety before your first ride. At the very least, read and make sure that you understand each point in this section, and refer to the cited sections on any issue that you don’t completely understand. Please note that not all bicycles have all of the features described in this manual. Ask your local REI store to point out the features of your bicycle.

1.A - BIKE FIT

1. Is your bike the right size? To check, see Section 3.A. If your bicycle is too large or too small for you, you may lose control and fall. If your new bike is not the right size, ask your local REI store to adjust or exchange it before you ride it.
2. Is the saddle at the right height? To check, see Section 3.B. If you adjust your saddle height, follow the Minimum Insertion instructions in Section 3.B.
3. Are saddle and seatpost securely clamped? A correctly tightened saddle will allow no saddle movement in any direction. See Section 3.B.
4. Are the stem and handlebars at the right height for you? If not, see Section 3.C.
5. Can you comfortably operate the brakes? If not, you may be able to adjust their angle and reach. See Section 3.D and 3.E.
6. Do you fully understand how to operate your new bicycle? If not, before your first ride, have your local REI store explain any functions or features that you do not understand.

1.B - SAFETY FIRST

1. Always wear an approved helmet when riding your bike, and follow the helmet manufacturer’s instructions for fit, use and care.
2. Do you have all the other required and recommended safety equipment? See Section 2. It’s your responsibility to familiarize yourself with the laws of the areas where you ride, and to comply with all applicable laws.
3. Do you know how to correctly operate your wheel quick-releases? Check Section 4.A to make sure. Riding with an improperly adjusted wheel quick release can cause the wheel to wobble or disengage from the bicycle and cause serious injury or death.
4. If your bike has toe-clips and straps or clipless (“step-in”) pedals, make sure you know how they work (see Section 4.E). These pedals require special techniques and skills. Follow the pedal manufacturer’s instructions for use, adjustment and care.
5. Do you have “toe overlap”? On smaller framed bicycles your toe or toe-clip may be able to contact the front wheel when a pedal is all the way forward and the wheel is turned. Read Section 4.E and Part II Section A.11 if you have toe-clip overlap.
6. Does your bike have suspension? If so, check Section 4.F. Suspension can change the way a bicycle performs. Follow the suspension manufacturer’s instructions for use, adjustment and care.

PART I

1.C - MECHANICAL SAFETY CHECK

Routinely check the condition of your bicycle before every ride.

Nuts, Bolts, Screws and Other Fasteners

Because manufacturers use a wide variety of fastener sizes and shapes made in a variety of materials, often differing by model and component, the correct tightening force or torque cannot be generalized.

To make sure that the many fasteners on your bicycle are correctly tightened. See page PART II, Section E.

Always refer to the torque specifications in the instructions provided by the manufacturer of a component in question.

Correctly tightening a fastener requires a calibrated torque wrench. A professional bicycle mechanic with a torque wrench should torque the fasteners on your bicycle. If you choose to work on your own bicycle, you must use a torque wrench and the correct tightening torque specifications from the bicycle or component manufacturer or from your local REI store. If you need to make an adjustment at home or in the field, we urge you to exercise care and to have the fasteners you worked on checked by your local REI store as soon as possible.

WARNING

CORRECT TIGHTENING FORCE ON FASTENERS —NUTS, BOLTS, SCREWS—ON YOUR BICYCLE IS IMPORTANT.

TOO LITTLE FORCE, AND THE FASTENER MAY NOT HOLD SECURELY. TOO MUCH FORCE, AND THE FASTENER CAN STRIP THREADS, STRETCH, DEFORM OR BREAK. EITHER WAY, INCORRECT TIGHTENING FORCE CAN RESULT IN COMPONENT FAILURE, WHICH CAN CAUSE YOU TO LOSE CONTROL AND FALL WITH RISK OF SERIOUS INJURY OR DEATH.

Make sure nothing is loose. Lift the front wheel off the ground by two or three inches, then let it bounce on the ground. Anything sound, feel or look loose? Do a visual and tactile inspection of the whole bike. Any loose parts or accessories? If so, secure them. If you're not sure, ask someone with experience to check.

Tires and Wheels

Make sure tires are correctly inflated (see Section 4.G.1). Check by putting one hand on the saddle, one on the intersection of the handlebars and stem, then bouncing your weight on the bike while looking at tire deflection. Compare what you see with how it looks when you know the tires are correctly inflated; and adjust if necessary.

Tires in good shape? Spin each wheel slowly and look for cuts in the tread and sidewall. Replace damaged tires before riding the bike.

Wheels true? Spin each wheel and check for brake clearance and side-to-side wobble. If a wheel wobbles side-to-side even slightly, or rubs against or hits the brake pads, take the bike to a qualified bike shop to have the wheel trued.

CAUTION

On many bicycles, the wheels must be true for the brakes to work properly. Wheel truing is a skill that requires special tools and experience. Do not attempt to true a wheel unless you have the knowledge, experience and tools needed to do the job correctly. Improper wheel truing could result in injury.

Wheel rims clean and undamaged? Make sure the rims are clean and undamaged at the tire bead and, if you have rim brakes, along the braking surface.

WARNING

BICYCLE WHEEL RIMS ARE SUBJECT TO WEAR.

ASK YOUR LOCAL REI STORE ABOUT WHEEL RIM WEAR. SOME WHEEL RIMS HAVE A RIM WEAR INDICATOR THAT BECOMES VISIBLE OR INVISIBLE AS THE RIM'S BRAKING SURFACE WEARS. EITHER INDICATOR WILL SHOW YOU THAT THE RIM HAS REACHED ITS MAXIMUM USABLE LIFE. RIDING A WHEEL THAT IS AT THE END OF ITS USABLE LIFE CAN RESULT IN WHEEL FAILURE, WHICH CAN CAUSE YOU TO LOSE CONTROL AND FALL WITH RISK OF SERIOUS INJURY OR DEATH.

Brakes

Check the brakes for proper operation (see Section 4.C). Squeeze the brake levers. Are the brake quick-releases closed? Are all control cables seated and securely engaged? Do the brake pads contact the wheel rim squarely and make full contact with the rim? Do the brake pads touch the wheel rim within an inch of brake lever movement? Can you apply full braking force at the levers without having them touch the handlebar? If not, your brakes need adjustment. Do not ride the bike until the brakes are properly adjusted by a professional bicycle mechanic.

Wheel Retention System

Make sure the front and rear wheels are correctly secured. See Section 4.A.

Seatpost

If your seatpost has a quick-release for easy height adjustment, check that it is properly adjusted and in the locked position. See Section 4.B.

Handlebar and Saddle Alignment

Make sure the saddle and handlebar stem are parallel to the bike's center line and clamped tight enough so that you can't twist them out of alignment. See Section 3.B and 3.C.

Handlebar Ends

Make sure the handlebar grips are secure and in good condition. Also be sure the handlebar ends and extensions are plugged. If the handlebars have bar end extensions, make sure they are clamped tight enough so you can't twist them.

WARNING

LOOSE OR DAMAGED HANDLEBAR GRIPS OR EXTENSIONS CAN CAUSE YOU TO LOSE CONTROL AND FALL. UNPLUGGED HANDLEBARS OR EXTENSIONS CAN CUT YOU AND CAUSE SERIOUS INJURY IN AN OTHERWISE MINOR ACCIDENT.

VERY IMPORTANT SAFETY NOTE:

Please also read and become thoroughly familiar with the important information on the lifespan of your bicycle and its components in PART II, Section D. Materials and Inspection.

PART I

1.D - FIRST RIDE

When you buckle on your helmet and go for your first familiarization ride on your new bicycle, be sure to pick a controlled environment, away from cars, other cyclists, obstacles or other hazards. Ride to become familiar with the controls, features and performance of your new bike.

Familiarize yourself with the braking action of the bike (see Section 4.C). Test the brakes at slow speed, putting your weight toward the rear and gently applying the brakes, rear brake first. Sudden or excessive application of the front brake could pitch you over the handlebars. Applying brakes too hard can lock up a wheel, which could cause you to lose control and fall. Skidding is an example of what can happen when a wheel locks up.

If your bicycle has toe-clips or clipless pedals, practice getting in and out of the pedals. See Section 1.B.4 above and Section 4.E.

If your bike has suspension, familiarize yourself with how the suspension responds to brake application and rider weight shifts. See Section 1.B.6 above and Section 4.F.

Practice shifting the gears (see Section 4.D). Remember never to move the shifter while pedaling backward, nor pedal backwards immediately after having moved the shifter. This could jam the chain and cause serious damage to the bicycle.

Check out the handling and response of the bike; and check the comfort.

If you have any questions, or if you feel anything about the bike is not as it should be, consult your local REI store before you ride.

SECTION 2. SAFETY



WARNING

MANY STATES REQUIRE SPECIFIC SAFETY DEVICES. IT IS YOUR RESPONSIBILITY TO FAMILIARIZE YOURSELF WITH THE LAWS OF THE STATE WHERE YOU RIDE AND TO COMPLY WITH ALL APPLICABLE LAWS, INCLUDING PROPERLY EQUIPPING YOURSELF AND YOUR BIKE AS THE LAW REQUIRES. FAILURE TO FOLLOW THE LAWS COULD RESULT IN SERIOUS INJURY OR DEATH.

Observe all local bicycle laws and regulations.

Observe regulations about bicycle lighting, licensing of bicycles, riding on sidewalks, laws regulating bike path and trail use, helmet laws, child carrier laws, special bicycle traffic laws.

It's your responsibility to know and obey the laws.

2.A - THE BASICS

1. Always wear a cycling helmet that meets the latest certification standards and is appropriate for the type of riding you do. Always follow the helmet manufacturer's instructions for fit, use and care of your helmet. Most serious bicycle injuries involve head injuries that can be avoided if the rider wears an appropriate helmet.

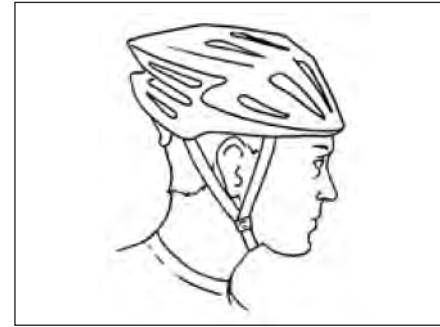

Figure 1. Bicycle Helmet

Your helmet should be:

- U.S. Consumer Product Safety Commission (CPSC) certified (look for the label on the helmet)
- Properly sized for you
- Properly fitted to you
- Properly attached to your head!
- Undamaged

ASK YOUR LOCAL REI STORE FOR HELP



WARNING

FAILURE TO WEAR A HELMET WHEN RIDING UNNECESSARILY EXPOSES YOU TO THE RISK OF SERIOUS INJURY OR DEATH.

2. Always do the Mechanical Safety Check (Section 1.C) before you get on a bike.
3. Be thoroughly familiar with the controls of your bicycle: brakes (Section 4.C.); pedals (Section 4.E.); shifting (Section 4.D.)
4. Be careful to keep body parts and other objects away from the sharp teeth of chainrings, the moving chain, the turning pedals and cranks, and the spinning wheels of your bicycle.
5. Always wear:
 - Shoes that will stay on your feet and will grip the pedals. Never ride barefoot or in sandals.
 - Bright, visible clothing that is not so loose that it can become tangled in the bicycle or snagged by objects at the side of the road or trail.
 - Protective eye wear, to protect against airborne dirt, dust and bugs—tinted when the sun is bright, clear when it's not.
6. Don't jump with your bike. Jumping a bike, particularly a BMX or mountain bike, can be fun; but it can put huge and unpredictable stress on the bicycle and its components. Riders who insist on jumping their bikes risk serious damage to their bicycles as well as to themselves. Before you attempt to jump, do stunt riding or race with your bike, read and understand Section 2.F.
7. Ride at a speed appropriate for conditions. Increased speed means higher risk.

PART I

2.B - RIDING SAFETY

Obey all rules of the road and all local traffic laws.

1. You are sharing the road or path with others—motorists, pedestrians and other cyclists. Respect their rights.
2. Ride defensively. Always assume that others do not see you.
3. Look ahead, and be ready to avoid:
 - Vehicles slowing or turning, entering the road or your lane ahead of you, or coming up behind you.
 - Parked car doors opening.
 - Pedestrians stepping out.
 - Children or pets playing near the road.
 - Pot holes, sewer grating, railroad tracks, expansion joints, road or sidewalk construction, debris and other obstructions that could cause you to swerve into traffic, catch your wheel or otherwise cause you to lose control and have an accident.
 - The many other hazards and distractions which can occur on a bicycle ride.
4. Ride in designated bike lanes, on designated bike paths or as close to the edge of the road as possible, in the direction of traffic flow or as directed by local governing laws.
5. Stop at stop signs and traffic lights; slow down and look both ways at street intersections. Remember that a bicycle always loses in a collision with a motor vehicle, so be prepared to yield even if you have the right of way.
6. Use approved hand signals for turning and stopping.
7. Never ride with headphones. They mask traffic sounds and emergency vehicle sirens, distract you from concentrating on what's going on around you, and their wires can tangle in the moving parts of the bicycle, causing you to lose control.
8. Never carry a passenger, unless it is a small child wearing an approved helmet and secured in a correctly mounted child carrier or a child-carrying trailer.
9. Never carry anything that obstructs your vision or your complete control of the bicycle, or which could become entangled in the moving parts of the bicycle.

10. Never hitch a ride by holding on to another vehicle.
11. Don't do stunts, wheelies or jumps. If you intend to do stunts, wheelies, jumps or go racing with your bike despite our advice not to, read Section 2.F now. Think carefully about your skills before deciding to take the large risks that go with this kind of riding.
12. Don't weave through traffic or make any moves that may surprise people with whom you are sharing the road.
13. Observe and yield the right of way.
14. Never ride your bicycle while under the influence of alcohol or drugs.
15. If possible, avoid riding in bad weather, when visibility is obscured, at dawn, dusk or in the dark, or when extremely tired. Each of these conditions increases the risk of accident.

2.C - OFF-ROAD SAFETY

We recommend that children not ride on rough terrain unless they are accompanied by an adult.

1. The variable conditions and hazards of off-road riding require close attention and specific skills. Start slowly on easier terrain and build up your skills. If your bike has suspension, the increased speed you may develop also increases your risk of losing control and falling. Get to know how to handle your bike safely before trying increased speed or more difficult terrain.
2. Wear safety gear appropriate to the kind of riding you plan to do.
3. Don't ride alone in remote areas. Even when riding with others, make sure that someone knows where you're going and when you expect to be back.
4. Always take along some kind of identification, so that people know who you are in case of an accident; and take along a couple of dollars in cash for a candy bar, a cool drink or an emergency phone call.
5. Yield right of way to pedestrians and animals. Ride in a way that does not frighten or endanger them, and give them enough room so that their unexpected moves don't endanger you.
6. Be prepared. If something goes wrong while you're riding off-road, help may not be close.
7. Before you attempt to jump, do stunt riding or race with your bike, read and understand Section 2.F.

Off-Road Respect

Obey the local laws regulating where and how you can ride off-road, and respect private property. You may be sharing the trail with others—hikers, equestrians, other cyclists. Respect their rights. Stay on the designated trail. Don't contribute to erosion by riding in mud or with unnecessary sliding. Don't disturb the ecosystem by cutting your own trail or shortcut through vegetation or streams. It is your responsibility to minimize your impact on the environment. Leave things as you found them, and always take out everything you brought in.

2.D - WET-WEATHER RIDING

Under wet conditions, the stopping power of your brakes (as well as the brakes of other vehicles sharing the road) is dramatically reduced and your tires don't grip nearly as well. This makes it harder to control speed and easier to lose control.

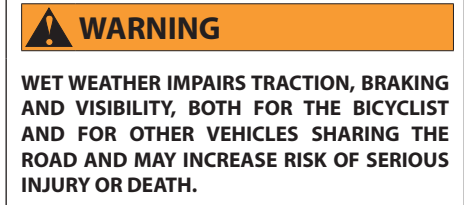

The risk of an accident is dramatically increased in wet conditions. To make sure that you can slow down and stop safely in wet conditions, ride more slowly and apply your brakes earlier and more gradually than you would under normal, dry conditions. See also Section 4.C.

PART I

2.E - NIGHT RIDING

Riding a bicycle at night is many times more dangerous than riding during the day. A bicyclist is very difficult for motorists and pedestrians to see. Therefore, children should never ride at dawn, at dusk or at night. Adults who chose to accept the greatly increased risk of riding at dawn, at dusk or at night need to take extra care both riding and choosing specialized equipment that helps reduce that risk. Consult your local REI store about night riding safety equipment.

 **WARNING**

REFLECTORS ARE NOT A SUBSTITUTE FOR LIGHTS. RIDING AT DAWN, AT DUSK, AT NIGHT OR AT OTHER TIMES OF POOR VISIBILITY WITHOUT AN ADEQUATE BICYCLE LIGHTING SYSTEM AND WITHOUT REFLECTORS IS DANGEROUS AND MAY RESULT IN SERIOUS INJURY OR DEATH.

Bicycle reflectors are designed to pick up and reflect street lights and car lights in a way that may help you to be seen and recognized as a moving bicyclist.

 **CAUTION**

Check reflectors and their mounting brackets regularly to make sure that they are clean, straight, unbroken and securely mounted. Have your local REI store replace damaged reflectors and straighten or tighten any that are bent or loose.

 **WARNING**

REMOVING THE REFLECTORS MAY REDUCE YOUR VISIBILITY TO OTHERS USING THE ROADWAY. BEING STRUCK BY OTHER VEHICLES MAY RESULT IN SERIOUS INJURY OR DEATH.

If you choose to ride under conditions of poor visibility, check and be sure you comply with all local laws about night riding, and take the following strongly recommended additional precautions:

- Purchase and install battery- or generator-powered head and tail lights which meet all regulatory requirements and provide adequate visibility.
- Wear light colored, reflective clothing and accessories, such as a reflective vest, reflective arm and leg bands, reflective stripes on your helmet, flashing lights attached to your body and/or your bicycle ... any reflective device or light source that moves will help you get the attention of approaching motorists, pedestrians and other traffic.
- Make sure your clothing or anything you may be carrying on the bicycle does not obstruct a reflector or light.
- Make sure that your bicycle is equipped with correctly positioned and securely mounted reflectors.

WHILE RIDING AT DAWN, AT DUSK OR AT NIGHT:

- Ride slowly.
- Avoid dark areas, areas of heavy or fast-moving traffic.
- Avoid road hazards.
- If possible, ride on familiar routes.

IF RIDING IN TRAFFIC :

- Be predictable. Ride so that drivers can see you and predict your movements.
- Be alert. Ride defensively and expect the unexpected.
- If you plan to ride in traffic often, ask your local REI store about traffic safety classes or a good book on bicycle traffic safety.

2.F - EXTREME, STUNT OR COMPETITION RIDING

Whether you call it Aggro, Hucking, Freeride, North Shore, Downhill, Jumping, Stunt Riding, Racing or something else: If you engage in this sort of extreme, aggressive riding you **will** get hurt, and you voluntarily assume a greatly increased risk of injury or death.

Not all bicycles are designed for these types of riding, and those that are may not be suitable for all types of aggressive riding. Check with your local REI store or the bicycle's manufacturer about the suitability of your bicycle before engaging in extreme riding.

When riding fast downhill, you can reach speeds achieved by motorcycles, and therefore face similar hazards and risks. Have your bicycle and equipment carefully inspected by a qualified mechanic and be sure it is in perfect condition. Consult with expert riders and race officials on conditions and equipment advisable at the site where you plan to ride. Wear appropriate safety gear, including an approved full-face helmet, full-finger gloves, and body armor. Ultimately, it is your responsibility to have proper equipment and to be familiar with course conditions.

 **WARNING**

ALTHOUGH MANY CATALOGS, ADVERTISEMENTS AND ARTICLES ABOUT BICYCLING DEPICT RIDERS ENGAGED IN EXTREME RIDING, THIS ACTIVITY IS EXTREMELY DANGEROUS AND INCREASES YOUR RISK OF INJURY OR DEATH.

Remember that the action depicted is being performed by professionals with many years of training and experience. Know your limits and always wear a helmet and other appropriate safety gear. Even with state-of-the-art protective safety gear, you could be seriously injured or killed when jumping, stunt riding, riding downhill at speed or in competition.

PART I

We recommend against this type of riding because of the increased risks; but if you choose to take the risk, at least:

- Take lessons from a competent instructor first
- Start with easy learning exercises and slowly develop your skills before trying more difficult or dangerous riding
- Use only designated areas for stunts, jumping, racing or fast downhill riding
- Wear a full-face helmet, safety pads and other safety gear
- Understand and recognize that the stresses imposed on your bike by this kind of activity may break or damage parts of the bicycle
- Take your bicycle to your local REI store if anything breaks or bends. Do not ride your bicycle when any part is damaged.

If you ride downhill at speed, do stunt riding or ride in competition, know the limits of your skill and experience. Ultimately, avoiding injury is your responsibility.

2.G - CHANGING COMPONENTS OR ADDING ACCESSORIES

There are many components and accessories available to enhance the comfort, performance and appearance of your bicycle. However, if you change components or add accessories, you do so at your own risk. The bicycle's manufacturer may not have tested that component or accessory for compatibility, reliability or safety on your bicycle.

Before installing any component or accessory, including a different size tire, make sure that it is compatible with your bicycle by checking with your local REI store. Be sure to read, understand and follow the instructions that accompany the products you purchase for your bicycle. See also PART II, Section D. Materials and Inspection.

WARNING

FAILURE TO CONFIRM COMPATIBILITY, PROPERLY INSTALL, OPERATE AND MAINTAIN ANY COMPONENT OR ACCESSORY CAN RESULT IN DIMINISHED PERFORMANCE OR COMPROMISED CONTROL OF YOUR BICYCLE. THIS CAN LEAD TO LOSS OF CONTROL OR CRASHES RESULTING IN SERIOUS INJURY OR DEATH.

SECTION 3. FIT

NOTE: Correct fit is an essential element of bicycling safety, performance and comfort. Making the adjustments to your bicycle that result in correct fit for your body and riding conditions requires experience, skill and special tools. Always have your local REI store make the adjustments on your bicycle; or, if you have the experience, skill and tools, have your local REI store check your work before riding. If your new bike doesn't fit, ask your local REI store to adjust or exchange it before you ride it.

CAUTION

A properly fitting bicycle is essential to a good cycling experience. A poorly fitting bicycle will, at best, make your experience less enjoyable and at worst, be difficult to operate and control safely.

3.A - STAND-OVER HEIGHT

Stand-over height is a primary element of a proper bike fit (see fig. 2). It is the distance from the ground to the top of the bicycle's frame at that point where your crotch is when straddling the bike. To check for correct stand-over height, straddle the bike while wearing the kind of shoes in which you'll be riding, and bounce vigorously on your heels. If your crotch touches the frame, the bike is too big for you. Don't even ride the bike around the block. A bike which you ride only on paved surfaces and never take off-road should give you a minimum stand-over height clearance of 2 inches (5cm). A bike that you'll ride on unpaved surfaces should give you a minimum of 3 inches (7.5cm) of stand-over height clearance. And a bike that you'll use off road should give you 4 inches (10 cm) or more of clearance.

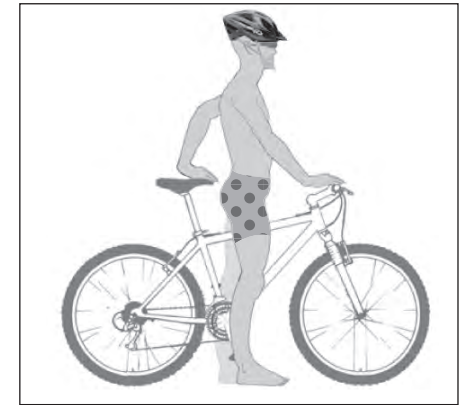

Figure 2. Stand-Over Height

WARNING

IF YOU PLAN TO USE YOUR BIKE FOR JUMPING OR STUNT RIDING, READ SECTION 2.F AGAIN.

Standover height does not apply to bicycles with step-through frames. Instead, the limiting dimension is determined by saddle height range. You must be able to adjust your saddle position as described in 3.B. Saddle Position without exceeding the limits set by the height of the top of the seat tube and the "Minimum Insertion" or "Maximum Extension" mark on the seatpost.

PART I

3.B - SADDLE POSITION

Correct saddle adjustment is an important factor in getting the most performance and comfort from your bicycle. If the saddle position is not comfortable for you, see your local REI store.

The saddle can be adjusted in three directions:

1. Up-and-Down Adjustment

To check for correct saddle height (fig. 3):

- Sit on the saddle;
- Place one heel on a pedal;
- Rotate the crank until the pedal with your heel on it is in the down position and the crank arm is parallel to the seat tube.

If your leg is not completely straight, your saddle height needs to be adjusted. If your hips must rock for the heel to reach the pedal, the saddle is too high. If your leg is bent at the knee with your heel on the pedal, the saddle is too low.



Figure 3. Saddle Position

Ask your local REI store to set the saddle for your optimal riding position and to show you how to make this adjustment. If you choose to make your own saddle height adjustment:

- loosen the seatpost clamp
- raise or lower the seatpost in the seat tube
- make sure the saddle is straight fore and aft
- re-tighten the seatpost clamp to the recommended torque (See manufacturer's instructions).

Once the saddle is at the correct height, make sure that the seatpost does not project from the frame beyond its "Minimum Insertion" or "Maximum Extension" mark (fig. 4).

WARNING

IF YOUR SEATPOST IS NOT INSERTED IN THE SEAT TUBE AS DESCRIBED IN B.1 ABOVE, THE SEATPOST MAY BREAK, WHICH COULD CAUSE YOU TO LOSE CONTROL AND FALL WITH RISK OF SERIOUS INJURY OR DEATH.

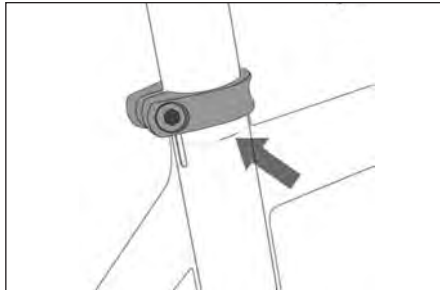

Figure 4. Minimum Insertion Mark

2. Front-and-Back Adjustment

The saddle can be adjusted forward or back to help you get the optimal position on the bike. Ask your local REI store to set the saddle for your optimal riding position and to show you how to make this adjustment.

If you choose to make your own front and back adjustment, make sure that the clamp mechanism is clamping on the straight part of the saddle rails and is not touching the curved part of the rails, and that you are using the recommended torque on the clamping fastener(s) (See manufacturer's instructions).

3. Saddle-Angle Adjustment

Most people prefer a horizontal saddle; but some riders like the saddle nose angled up or down just a little. Your local REI store can adjust saddle angle or teach you how to do it.

If you choose to make your own saddle angle adjustment and you have a single-bolt saddle clamp on your seatpost, it is critical that you loosen the clamp bolt sufficiently to allow any serrations on the mechanism to disengage before changing the saddle's angle, and then that the serrations fully re-engage before you tighten the clamp bolt to the recommended torque (See manufacturer's instructions).

NOTE: If your bicycle is equipped with a suspension seatpost, periodically ask your local REI store to check it.

Small changes in saddle position can have a substantial effect on performance and comfort. To find your best saddle position, make only one adjustment at a time.

A correctly tightened saddle adjusting mechanism will not allow saddle movement in any direction. Periodically check to make sure that the saddle adjusting mechanism is properly tightened.

WARNING

AFTER ANY SADDLE ADJUSTMENT, BE SURE THAT THE SADDLE ADJUSTING MECHANISM IS PROPERLY TIGHTENED BEFORE RIDING. A LOOSE SADDLE CLAMP OR SEATPOST BINDER CAN CAUSE DAMAGE TO THE SEATPOST, OR CAN CAUSE YOU TO LOSE CONTROL AND FALL WITH RISK OF SERIOUS INJURY OR DEATH.

PART I

If, in spite of carefully adjusting the saddle height, tilt and fore-and-aft position, your saddle is still uncomfortable, you may need a different saddle design. Saddles, like people, come in many different shapes, sizes and resilience. Your local REI store can help you select a saddle which, when correctly adjusted for your body and riding style, will be comfortable.

If your saddle causes you pain, numbness or other discomfort, listen to your body and stop riding until you see your local REI store about saddle adjustment or a different saddle.

CAUTION

Some people have claimed that extended riding with a saddle that is incorrectly adjusted or that does not support your pelvic area correctly can cause short-term or long-term injury to nerves and blood vessels, or even impotence with risk of injury.

3.C - HANDLEBAR HEIGHT AND ANGLE

Your bike is equipped either with a “threadless” stem, which clamps on to the outside of the steerer tube (fig. 5), or with a “quill” stem, which clamps inside the steerer tube by way of an expanding binder bolt (fig. 6). If you aren’t absolutely sure which type of stem your bike has, ask your local REI store.

If your bike has a “threadless” stem, your local REI store may be able to change handlebar height by moving height-adjustment spacers from below the stem to above the stem, or vice versa. Otherwise, you’ll have to get a stem of different length or rise. Consult your local REI store. Do not attempt to do this yourself, as it requires special knowledge.

If your bike has a “quill” stem, you can ask your local REI store to adjust the handlebar height a bit by adjusting stem height.

A quill stem has an etched or stamped mark on its shaft which designates the stem’s “Minimum Insertion” or “Maximum Extension”. This mark must not be visible above the headset.

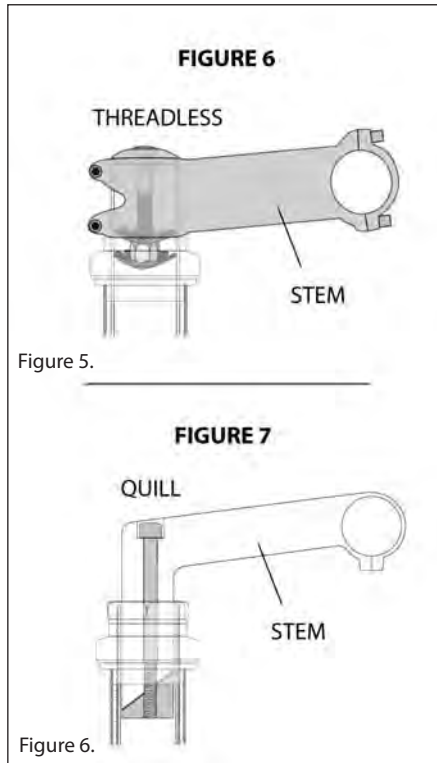

Figure 5.

Figure 6.

Some bicycles are equipped with an adjustable angle stem. If your bicycle has an adjustable angle stem, ask your local REI store to show you how to adjust it. Do not attempt to make the adjustment yourself, as changing stem angle may also require adjustments to the bicycle’s controls.

WARNING

AN INCORRECTLY TIGHTENED STEM BINDER BOLT, HANDLEBAR BINDER BOLT OR BAR-END EXTENSION CLAMPING BOLT MAY COMPROMISE STEERING ACTION, WHICH COULD CAUSE YOU TO LOSE CONTROL AND FALL WITH RISK OF SERIOUS INJURY OR DEATH.

Place the front wheel of the bicycle between your legs and attempt to twist the handlebar/stem assembly. If you can twist the stem in relation to the front wheel, turn the handlebars in relation to the stem, or turn the bar-end extensions in relation to the handlebar, the bolts are insufficiently tightened.

Your local REI store can also change the angle of the handlebar or bar-end extensions.

3.D - CONTROL POSITION ADJUSTMENTS

The angle of the brake and shift control levers and their position on the handlebars can be changed. Ask your local REI store to make the adjustments for you.

If you choose to make your own control lever angle adjustment, be sure to re-tighten the clamp fasteners to the recommended torque. (See manufacturer’s instructions).

3.E - BRAKE REACH

Many bikes have brake levers that can be adjusted for reach. If you have small hands or find it difficult to squeeze the brake levers, your local REI store can either adjust the reach or fit shorter reach brake levers.

WARNING

THE SHORTER THE BRAKE LEVER REACH, THE MORE CRITICAL IT IS TO HAVE CORRECTLY ADJUSTED BRAKES, SO THAT FULL BRAKING POWER CAN BE APPLIED WITHIN AVAILABLE BRAKE LEVER TRAVEL.

BRAKE LEVER TRAVEL INSUFFICIENT TO APPLY FULL BRAKING POWER CAN RESULT IN LOSS OF CONTROL, WHICH MAY RESULT IN SERIOUS INJURY OR DEATH.

PART I

SECTION 4. TECH

It's important to your safety, performance and enjoyment to understand how things work on your bicycle.

We urge you to ask your local REI store how to do the things described in this section before you attempt them yourself, and that you have your local REI store check your work before you ride the bike.

If you have even the slightest doubt as to whether you understand something in this section of the Manual, talk to your local REI store.

4.A - WHEELS

Bicycle wheels are designed to be removable for easier transportation and for repair of a tire puncture. In most cases, the wheel axles are inserted into slots, called "dropouts" in the fork and frame, but some suspension mountain bikes use what is called a "through axle" wheel mounting system.

If you have a mountain bike equipped with through axle front or rear wheels, make sure that your local REI store has given you the manufacturer's instructions, and follow those when installing or removing a through axle wheel. If you don't know what a through axle is, ask your local REI store.

Wheels are secured in one of three ways:

- A hollow axle with a shaft ("skewer") running through it which has an adjustable tension nut on one end and an over-center cam on the other (cam action system, fig. 7a and fig. 7b)

- A hollow axle with a shaft ("skewer") running through it which has a nut on one end and a fitting for a hex key, lock lever or other tightening device on the other (through-bolt wheel, fig. 8)
- Hex nuts or hex key bolts which are threaded onto or into the hub axle (bolt-on wheel, fig. 9)

It is essential that you:

- Ask your local REI store to help you make sure you know how to install and remove your wheels safely.
- Understand and apply the correct technique for clamping your wheel in place.
- Each time, before you ride the bike, check that the wheel is securely clamped.

The clamping action of a correctly secured wheel must emboss the surfaces of the dropouts.

WARNING

RIDING WITH AN IMPROPERLY SECURED WHEEL CAN CAUSE THE WHEEL TO WOBBLE OR FALL OFF THE BICYCLE, WHICH CAN CAUSE SERIOUS INJURY OR DEATH.

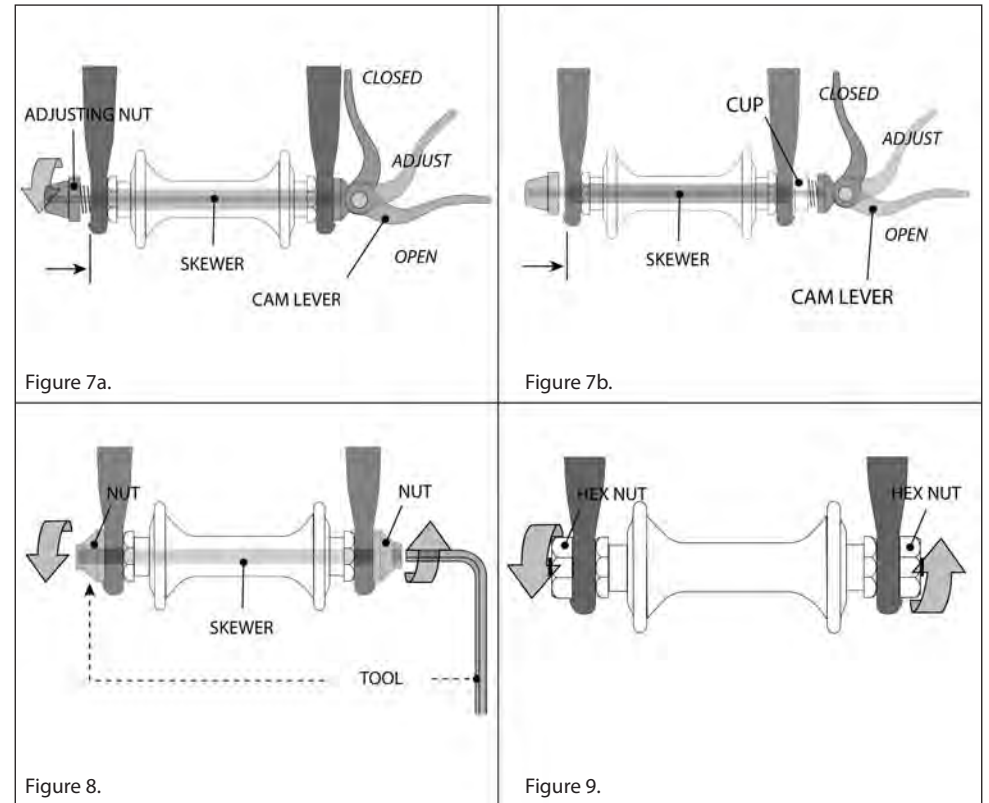

Your bicycle may be equipped with a different securing method for the front wheel than for the rear wheel. Discuss the wheel securing method for your bicycle with your local REI store.

It is very important that you understand the type of wheel securing method on your bicycle, that you know how to secure the wheels correctly, and that you know how to apply the correct clamping force that safely secures the wheel.

Ask your local REI store to instruct you in correct wheel removal and installation, and ask for the manufacturer's instructions.

PART I

1. Front Wheel Secondary Retention Devices

Most bicycles have front forks that utilize a secondary wheel retention device to reduce the risk of the wheel disengaging from the fork if the wheel is incorrectly secured. Secondary retention devices are not a substitute for correctly securing your front wheel.

Secondary retention devices fall into two basic categories:

- a. The clip-on type is a part the manufacturer adds to the front wheel hub or front fork.
- b. The integral type is molded, cast or machined into the outer faces of the front fork dropouts.

Ask your local REI store to explain the particular secondary retention device on your bike.

 **CAUTION**

Do not remove or disable the secondary retention device.

As its name implies, it serves as a back-up for a critical adjustment. If the wheel is not secured correctly, the secondary retention device can reduce the risk of the wheel disengaging from the fork.

2. Wheels With Quick-Release Systems

The wheel hub is clamped in place by the force of the quick-release against one dropout and pulling the tension-adjusting nut, by way of the skewer, against the other dropout. The amount of clamping force is controlled by the tension-adjusting nut. Turning the tension-adjusting nut clockwise while keeping the cam lever from rotating increases clamping force; turning it counterclockwise while keeping the cam lever from rotating reduces clamping force. Less than half a turn of the tension-adjusting nut can make the difference between safe clamping force and unsafe clamping force.

3. Removing and Installing Wheels

The removal and re-installation of most hub brakes and internal gear hubs requires special knowledge. Incorrect removal or assembly can result in brake or gear failure, which can cause you to lose control and fall with risk of serious injury or death.

 **CAUTION**

If your bike is equipped with a hub brake such as a rear coaster brake, front or rear drum, band or roller brake; or if it has an internal gear rear hub, do not attempt to remove the wheel unless you are confident that you can re-install it properly. Incorrect installation can affect the braking, shifting and handling characteristics of the bicycle.

 **CAUTION**

If your bike has a disc brake, exercise care in touching the rotor or caliper. Disc rotors have sharp edges, and both rotor and caliper can get very hot during use and create a risk of injury.

A. Removing a Disc Brake or Rim Brake Front Wheel

- (1) If your bike has rim brakes, disengage the brake's quick-release mechanism to increase the clearance between the tire and the brake pads (See Section 4.C figs. 10–13).

- (2) If your bike has quick-release retention, move the lever from the locked or CLOSED position to the OPEN position (fig. 7a and fig. 7b).

- (3) If your front fork has an integral secondary retention device, and a quick-release system (fig. 7a) loosen the tension-adjusting nut enough to allow removing the wheel from the dropouts. If your front wheel uses a cam-and-cup system, (fig. 7b) squeeze the cup and cam lever together while removing the wheel. No rotation of any part is necessary with the cam-and-cup system.

You may need to tap the top of the wheel with the palm of your hand to release the wheel from the front fork.

B. Installing a Disc Brake or Rim Brake Front Wheel

 **CAUTION**

If your bike is equipped with a front disc brake, be careful not to damage the disc, caliper or brake pads when re-inserting the disc into the caliper. Never activate a disc brake's control lever unless the disc is correctly inserted in the caliper. Improper disc brake adjustment could result in injury. See also Section 4.C.

- (1) If your bike has quick-release front wheel retention, move the lever so that it curves away from the wheel (fig. 7b). This is the OPEN position. If your bike has through-bolt or bolt-on front wheel retention, go to the next step.

PART I

- (2) With the steering fork facing forward, insert the wheel between the fork blades so that the axle seats firmly at the top of the fork dropouts. If your bike has a clip-on type secondary retention device, engage it.
- (3) If you have a quick-release: holding the cam lever in the ADJUST position with your right hand, tighten the tension adjusting nut with your left hand until it is finger tight against the fork dropout (fig. 7a).
- (4) While pushing the wheel firmly to the top of the slots in the fork dropouts, and at the same time centering the wheel rim in the fork:
 - (a) With a quick-release system, move the cam lever upwards and swing it into the CLOSED position (fig. 7a and fig. 7b). The lever should now be parallel to the fork blade and curved toward the wheel. To apply enough clamping force, you should have to wrap your fingers around the fork blade for leverage, and the lever should leave a clear imprint in the palm of your hand.
 - (b) With a through-bolt or bolt-on system, tighten the fasteners to the torque specifications in the hub manufacturer's instructions.

NOTE: If, on a quick-release system, the lever cannot be pushed all the way to a position parallel to the fork blade, return the lever to the OPEN position. Then turn the tension adjusting nut counterclockwise one-quarter turn and try tightening the lever again.

- (5) If you disengaged the brake quick-release mechanism in Section 4.A.3.A.1 above, re-engage it to restore correct brake pad-to-rim clearance.
- (6) Spin the wheel to make sure that it is centered in the frame and clears the brake pads; then squeeze the brake lever and make sure that the brakes are operating correctly.

C. Removing a Disc Brake or Rim Brake Rear Wheel

- (1) If you have a multi-speed bike with a derailleur gear system: shift the rear derailleur to high gear (the smallest, outermost rear sprocket).

If you have an internal gear rear hub, consult your local REI store or the hub manufacturer's instructions before attempting to remove the rear wheel.

If you have a single-speed bike with rim or disc brake, go to step (4) below.
- (2) If your bike has rim brakes, disengage the brake's quick-release mechanism to increase the clearance between the wheel rim and the brake pads (see Section 4.C, figs. 10–13).

- (3) On a derailleur gear system, pull the derailleur body back with your right hand.
- (4) With a quick-release mechanism, move the quick-release lever to the OPEN position (fig. 7b). With a through-bolt or bolt-on mechanism, loosen the fastener(s) with an appropriate wrench, lock lever or integral lever; then push the wheel forward far enough to be able to remove the chain from the rear sprocket.
- (5) Lift the rear wheel off the ground a few inches and remove it from the rear dropouts.

D. Installing a Disc Brake or Rim Brake Rear Wheel

CAUTION

If your bike is equipped with a rear disc brake, be careful not to damage the disc, caliper or brake pads when re-inserting the disc into the caliper. Never activate a disc brake's control lever unless the disc is correctly inserted in the caliper to avoid risk of injury.

- (1) With a quick-release system, move the cam lever to the OPEN position (see fig. 7a and fig. 7b). The lever should be on the side of the wheel opposite the derailleur and freewheel sprockets.
- (2) On a derailleur bike, make sure that the rear derailleur is still in its outermost, high gear, position; then pull the derailleur body back with your right hand. Put the chain on top of the smallest freewheel sprocket.
- (3) On single-speed, remove the chain from the front sprocket, so that you have plenty of slack in the chain. Put the chain on the rear wheel sprocket.
- (4) Then, insert the wheel into the frame dropouts and pull it all the way in to the dropouts.

- (5) On a single-speed or an internal gear hub, replace the chain on the chainring; pull the wheel back in the dropouts so that it is straight in the frame and the chain has about 1/4 inch of up-and-down play.
- (6) With a quick-release system, move the cam lever upwards and swing it into the CLOSED position (fig. 7a and fig. 7b). The lever should now be parallel to the seat stay or chain stay and curved toward the wheel. To apply enough clamping force, you should have to wrap your fingers around the seat stay or chainstay for leverage, and the lever should leave a clear imprint in the palm of your hand.
- (7) With a through-bolt or bolt-on system, tighten the fasteners to the torque specifications in Appendix D or the hub manufacturer's instructions.

NOTE: If, on a quick-release system, the lever cannot be pushed all the way to a position parallel to the seat stay or chain stay, return the lever to the OPEN position. Then turn the tension adjusting nut counterclockwise one-quarter turn and try tightening the lever again.

WARNING

SECURELY CLAMPING THE WHEEL WITH A QUICK-RELEASE RETENTION DEVICE TAKES CONSIDERABLE FORCE. RIDING WITH AN IMPROPERLY SECURED WHEEL CAN ALLOW THE WHEEL TO WOBBLE OR FALL OFF THE BICYCLE, WHICH CAN CAUSE SERIOUS INJURY OR DEATH.

See also WARNING in PART I, Section 4.A: Wheels.

PART I

- (8) If you disengaged the brake quick-release mechanism in Section 4.A.3.C.2 above, re-engage it to restore correct brake pad-to-rim clearance.
- (9) Spin the wheel to make sure that it is centered in the frame and clears the brake pads; then squeeze the brake lever and make sure that the brakes are operating correctly.

4.B. - SEATPOST QUICK-RELEASE CLAMP

Some bikes are equipped with a quick-release seatpost binder. The seatpost quick-release binder works exactly like the one on a wheel (Section 4.A.2).

WARNING

RIDING WITH AN IMPROPERLY TIGHTENED SEATPOST CAN ALLOW THE SADDLE TO TURN OR MOVE AND CAUSE YOU TO LOSE CONTROL AND FALL WITH RISK OF SERIOUS INJURY OR DEATH. THEREFORE:

- 1. ASK YOUR LOCAL REI STORE TO HELP YOU MAKE SURE YOU KNOW HOW TO CORRECTLY CLAMP YOUR SEATPOST.**
- 2. UNDERSTAND AND APPLY THE CORRECT TECHNIQUE FOR CLAMPING YOUR SEATPOST.**
- 3. BEFORE YOU RIDE THE BIKE, FIRST CHECK THAT THE SEATPOST IS SECURELY CLAMPED.**

Adjusting the Seatpost Quick-Release Mechanism

The action of the quick-release squeezes the seat collar around the seatpost to hold the seatpost securely in place. The amount of clamping force is controlled by the tension-adjusting nut. Turning the tension-adjusting nut clockwise while keeping the cam lever from rotating increases clamping force; turning it counterclockwise while keeping the cam lever from rotating reduces clamping force. Less than half a turn of the tension adjusting nut can make the difference between safe and unsafe clamping force.

If you can fully close the cam lever without wrapping your fingers around the seatpost or a frame tube for leverage, and the lever does not leave a clear imprint in the palm of your hand, the tension is insufficient. Open the lever; turn the tension adjusting nut clockwise a quarter turn; then try again.

4.C - BRAKES

There are three general types of bicycle brakes: rim brakes, which operate by squeezing the wheel rim between two brake pads; disc brakes, which operate by squeezing a hub-mounted disc between two brake pads; and internal hub brakes. All three can be operated by way of a handlebar-mounted lever. On some models of bicycle, the internal hub brake is operated by pedaling backwards. This is called a Coaster Brake and is described below in Section 4.C.3.

WARNING

BRAKES ARE A CRITICAL SYSTEM FOR THE SAFE OPERATION OF YOUR BICYCLE. RIDING WITH IMPROPERLY ADJUSTED OR WORN BRAKES CAN RESULT IN LOSS OF CONTROL OR CRASHES THAT CAN CAUSE IN SERIOUS INJURY OR DEATH.

1. Brake Controls and Features

It's very important to your safety that you learn and remember which brake lever controls which brake on your bike.

Make sure that your hands can reach and squeeze the brake levers comfortably. If your hands are too small to operate the levers comfortably, consult your local REI store before riding the bike. The lever reach may be adjustable; or you may need a different brake lever design.

Most rim brakes have some form of quick-release mechanism to allow the brake pads to clear the tire when a wheel is removed or reinstalled. When the brake quick release is in the open position, the brakes are inoperative. Ask your local REI store to make sure that you understand the way the brake quick release works on your bike (see figs. 10–13) and check each time to make sure both brakes work correctly before you get on the bike.

2. How Brakes Work

The braking action of a bicycle is a function of the friction between the brake surfaces—usually the brake pads and the wheel rim. To make sure that you have maximum friction available, keep your rims, disc rotors, and brake pads clean and free of lubricants, waxes or polishes.

PART I

Brakes are designed to control your speed, not just to stop the bike. Maximum braking force for each wheel occurs at the point just before the wheel “locks up” (stops rotating) and starts to skid. Once the tire skids, you actually lose most of your stopping force and all directional control. You need to practice slowing and stopping smoothly without locking up a wheel. The technique is called progressive brake modulation. Instead of jerking the brake lever to the position where you think you’ll generate appropriate braking force, squeeze the lever, progressively increasing the braking force. If you feel the wheel begin to lock up, release pressure just a little to keep the wheel rotating just short of lockup.

It’s important to develop a feel for the amount of brake lever pressure required for each wheel at different speeds and on different surfaces. To better understand this, experiment a little by walking your bike and applying different amounts of pressure to each brake lever until the wheel locks.

When you apply one or both brakes, the bike begins to slow, but your body wants to continue at the speed at which it was going. This causes a transfer of weight to the front wheel (or, under heavy braking, around the front wheel hub, which could send you flying over the handlebars).

A wheel with more weight on it will accept greater brake pressure before lockup; a wheel with less weight will lock up with less brake pressure. So, as you apply brakes and your weight is transferred forward, you need to shift your body toward the rear of the bike, to transfer weight back on to the rear wheel; and at the same time, you need to both decrease rear braking and increase front braking force. This is even more important on descents, because descents shift weight forward.

Two keys to effective speed control and safe stopping are controlling wheel lockup and weight transfer. This weight transfer is even more pronounced if your bike has a front suspension fork. Front suspension “dips” under braking, increasing the weight transfer (see also Section 4.F). Practice braking and weight transfer techniques where there is no traffic or other hazards and distractions.

Everything changes when you ride on loose surfaces or in wet weather. Tire adhesion is reduced, so the wheels have less cornering and braking traction and can lock up with less brake force. Moisture or dirt on the brake pads reduces their ability to grip. The way to maintain control on loose or wet surfaces is to go more slowly.

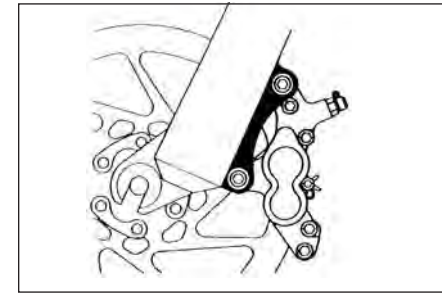

Figure 10.

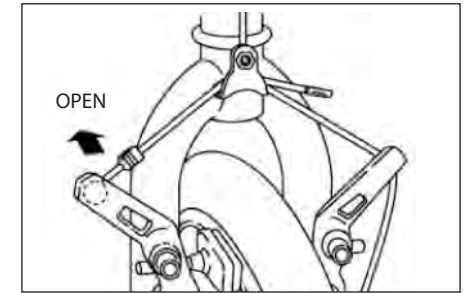

Figure 12.

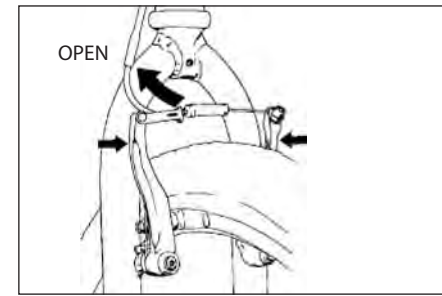

Figure 11.

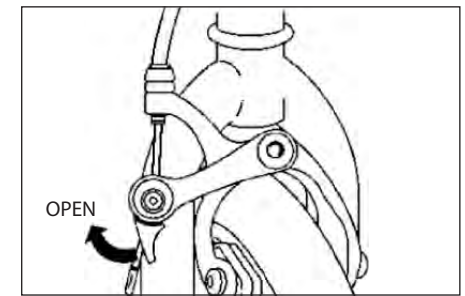

Figure 13.

PART I

3. Coaster Brakes

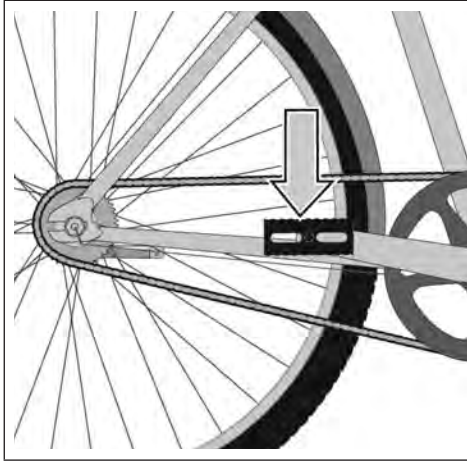

Figure 14.

a) How the coaster brake works

The coaster brake is a sealed mechanism which is a part of the bicycle's rear wheel hub. The brake is activated by reversing the rotation of the pedal cranks (indicated by arrow in fig. 14 above). Start with the pedal cranks in a nearly horizontal position, with the front pedal in about the 4 o'clock position, and apply downward foot pressure on the pedal that is to the rear. About 1/8 turn rotation will activate the brake. The more downward pressure you apply, the more braking force, up to the point where the rear wheel stops rotating and begins to skid.

Before riding, make sure that the brake is working properly. If it is not working properly, have the bicycle checked by your local REI store before you ride it. If your bike has only a coaster brake, ride conservatively. A single rear brake does not have the stopping power of front-and-rear brake systems.

b) Adjusting your coaster brake

Coaster brake service and adjustment requires special tools and special knowledge. Do not attempt to disassemble or service your coaster brake. Take the bicycle to your local REI store for coaster brake service.

4.D - SHIFTING GEARS

Your multi-speed bicycle will have a derailleur drivetrain (see 1. below), an internal gear hub drivetrain (see 2. below) or, in some special cases, a combination of the two.

1. How a derailleur drivetrain works

If your bicycle has a derailleur drivetrain, the gear-changing mechanism will have:

- a rear cassette or freewheel
- a rear derailleur
- usually a front derailleur
- one or two shifters
- one, two or three front sprockets called chainrings
- a drive chain

a) Shifting gears

There are several different types and styles of shifting controls: levers, twist grips, triggers, combination shift/brake controls, push-buttons, and so on. Ask your local REI store to explain the type of shifting controls that are on your bike, and to show you how they work.

The vocabulary of shifting can be pretty confusing. A downshift is a shift to a "lower" or "slower" gear, one which is easier to pedal. An upshift is a shift to a "higher" or "faster", harder-to-pedal gear. What's confusing is that what's happening at the front derailleur is the opposite of what's happening at the rear derailleur. Please read the instructions on Shifting the Rear Derailleur and Shifting the Front Derailleur, below.

For example, you can select a gear which will make pedaling easier on a hill (make a downshift) in one of two ways: shift the chain down the gear "steps" to a smaller gear at the front, or up the gear "steps" to a larger gear at the rear. So, at the rear gear cluster, what is called a downshift looks like an upshift. The way to keep things straight is to remember that shifting the chain in towards the centerline of the bike is for accelerating and climbing and is called a downshift. Moving the chain out or away from the centerline of the bike is for speed and is called an upshift.

Whether upshifting or downshifting, the bicycle derailleur system design requires that the drive chain be moving forward and be under at least some tension. A derailleur will shift only if you are pedaling forward.

CAUTION

Never move the shifter while pedaling backward, nor pedal backwards immediately after having moved the shifter, as this may increase the risk of injury. This could jam the chain and cause serious damage to the bicycle.

b) Shifting the rear derailleur

The rear derailleur is controlled by the right shifter.

The function of the rear derailleur is to move the drive chain from one gear sprocket to another. The smaller sprockets on the gear cluster produce higher gear ratios. Pedaling in the higher gears requires greater pedaling effort, but takes you a greater distance with each revolution of the pedal cranks. The larger sprockets produce lower gear ratios. Using them requires less pedaling effort, but takes you a shorter distance with each pedal crank revolution. Moving the chain from a smaller sprocket of the gear cluster to a larger sprocket results in a downshift. Moving the chain from a larger sprocket to a smaller sprocket results in an upshift. In order for the derailleur to move the chain from one sprocket to another, the rider must be pedaling forward.

c) Shifting the front derailleur

The front derailleur, which is controlled by the left shifter, shifts the chain between the larger and smaller chainrings. Shifting the chain onto a smaller chainring makes pedaling easier (a downshift). Shifting to a larger chainring makes pedaling harder (an upshift).

PART I

d) Which gear should I be in?

The combination of largest rear and smallest front gears (fig. 15) is for the steepest hills. The smallest rear and largest front combination is for the greatest speed. It is not necessary to shift gears in sequence. Instead, find the “starting gear” that is right for your level of ability—a gear that is hard enough for quick acceleration but easy enough to let you start from a stop without wobbling—and experiment with upshifting and downshifting to get a feel for the different gear combinations. At first, practice shifting where there are no obstacles, hazards or other traffic, until you’ve built up your confidence. Learn to anticipate the need to shift, and shift to a lower gear before the hill gets too steep. If you have difficulties with shifting, the problem could be mechanical adjustment. See your local REI store for help.

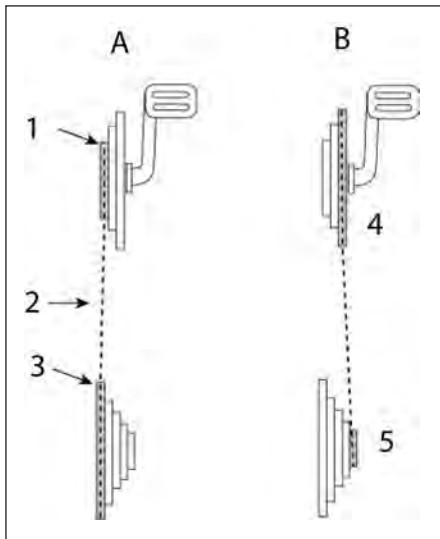

Figure 15.
A. Hills
1. Smallest front
2. Chain
3. Largest rear
B. Greatest Speed
4. Largest front
5. Smallest rear

e) What if it won't shift gears?

If moving the shift control one click repeatedly fails to result in a smooth shift to the next gear, chances are that the mechanism is out of adjustment. Take the bike to your local REI store to have it adjusted.

2. How an internal gear hub drivetrain works

If your bicycle has an internal gear hub drivetrain, the gear changing mechanism will consist of:

- a 3-, 5-, 7-, 8-, 12-speed or possibly an infinitely variable internal gear hub
- one, or sometimes two shifters
- one or two control cables
- one front sprocket called a chainring
- a drive chain

a) Shifting internal gear hub gears

Shifting with an internal gear hub drivetrain is simply a matter of moving the shifter to the indicated position for the desired gear. After you have moved the shifter to the gear position of your choice, ease the pressure on the pedals for an instant to allow the hub to complete the shift.

b) Which gear should I be in?

The numerically lowest gear (1) is for the steepest hills. The numerically largest gear is for the greatest speed.

Shifting from an easier, “slower” gear (like 1) to a harder, “faster” gear (like 2 or 3) is called an upshift. Shifting from a harder, “faster” gear to an easier, “slower” gear is called a downshift. It is not necessary to shift gears in sequence. Instead, find the “starting gear” for the conditions—a gear that is hard enough for quick acceleration but easy enough to let you start from a stop without wobbling—and experiment with upshifting and downshifting to get a feel for the different gears. At first, practice shifting where there are no obstacles, hazards or other traffic, until you’ve built up your confidence. Learn to anticipate the need to shift, and shift to a lower gear before the hill gets too steep. If you have difficulties with shifting, the problem could be a mechanical adjustment. See your local REI store for help.

c) What if it won't shift gears?

If moving the shift control one click repeatedly fails to result in a smooth shift to the next gear, chances are that the mechanism is out of adjustment. Take the bike to your local REI store to have it adjusted.

4.E - PEDALS

1. Some bicycles come equipped with pedals that have sharp and potentially dangerous surfaces. These surfaces are designed to add safety by increasing grip between the rider’s shoe and the pedal. If your bicycle has this type of high-performance pedal, you must take extra care to avoid serious injury from the pedals’ sharp surfaces. Based on your riding style or skill level, you may prefer a less aggressive pedal design, or choose to ride with shin pads. Your local REI store can show you a number of options and make suitable recommendations.
2. Toe-clips and straps are a means to keep feet correctly positioned and engaged with the pedals. The toe-clip positions the ball of the foot over the pedal spindle, which gives maximum pedaling power. The toe strap, when tightened, keeps the foot engaged throughout the rotation cycle of the pedal. While toe-clips and straps give some benefit with any kind of shoe, they work most effectively with cycling shoes designed for use with toe-clips. Your local REI store can explain how toe-clips and straps work. Shoes with deep treaded soles or welts which might allow the foot to be trapped should not be used with toe-clips and straps.

Until it becomes a reflex action, the technique requires concentration which can distract your

attention and cause you to lose control and fall, increasing the risk of serious injury or death.

Practice the use of toe-clips and straps where there are no obstacles, hazards or traffic. Keep the straps loose, and don’t tighten them until your technique and confidence in getting in and out of the pedals warrants it. Never ride in traffic with your toe straps tight.

3. Clipless pedals (sometimes called “step-in” pedals) are another means to keep feet securely in the correct position for maximum pedaling efficiency. They have a plate, called a “cleat” on the sole of the shoe, which clicks into a mating spring-loaded fixture on the pedal.

CAUTION

Getting into and out of pedals with toe-clips and straps requires skill which can only be acquired with practice.

PART I

They only engage or disengage with a very specific motion that must be practiced until it becomes instinctive. Clipless pedals require shoes and cleats that are compatible with the make and model pedal being used.

Many clipless pedals are designed to allow the rider to adjust the amount of force needed to engage or disengage the foot. Follow the pedal manufacturer's instructions, or ask your local REI store to show you how to make this adjustment. Use the easiest setting until engaging and disengaging becomes a reflex action, but always make sure that there is sufficient tension to prevent unintended release of your foot from the pedal.

CAUTION

Clipless pedals are intended for use with shoes specifically made to fit them and are designed to firmly keep the foot engaged with the pedal.

Do not use shoes which do not engage the pedals correctly, as you will increase the risk of injury.

Practice is required to learn to engage and disengage the foot safely. Until engaging and disengaging the foot becomes a reflex action, the technique requires concentration which can distract your attention and cause you to lose control and fall. Practice engaging and disengaging clipless pedals in a place where there are no obstacles, hazards or traffic; and be sure to follow the pedal manufacturer's setup and service instructions. If you do not have the manufacturer's instructions, see your local REI store or contact the manufacturer.

4.F - BICYCLE SUSPENSION

Many bicycles are equipped with suspension systems. There are many different types of suspension systems—too many to deal with individually in this manual. If your bicycle has a suspension system of any kind, be sure to read and follow the suspension manufacturer's setup and service instructions. If you do not have the manufacturer's instructions, see your local REI store or contact the manufacturer.

WARNING

FAILURE TO MAINTAIN, CHECK AND PROPERLY ADJUST THE SUSPENSION SYSTEM MAY RESULT IN SUSPENSION MALFUNCTION, WHICH MAY CAUSE YOU TO LOSE CONTROL AND FALL WITH RISK OF SERIOUS INJURY OR DEATH.

If your bike has suspension, the increased speed you may develop also increases your risk of injury. For example, when braking, the front of a suspended bike dips. You could lose control and fall if you do not have experience with this system. Learn to handle your suspension system safely. See also Section 4.C.

Never change suspension adjustment unless you are thoroughly familiar with the suspension system manufacturer's instructions and recommendations, and always check for changes in the handling and braking characteristics of the bicycle after a suspension adjustment by taking a careful test ride in a hazard-free area.

WARNING

CHANGING SUSPENSION ADJUSTMENT CAN CHANGE THE HANDLING AND BRAKING CHARACTERISTICS OF YOUR BICYCLE WITH RISK OF SERIOUS INJURY OR DEATH.

Suspension can increase control and comfort by allowing the wheels to better follow the terrain. This enhanced capability may allow you to ride faster; but you must not confuse the enhanced capabilities of the bicycle with your own capabilities as a rider. Increasing your skill will take time and practice. Proceed carefully until you have learned to handle the full capabilities of your bike.

CAUTION

Not all bicycles can be safely retrofitted with some types of suspension systems. Before retrofitting a bicycle with any suspension, check with the bicycle's manufacturer to make sure that what you want to do is compatible with the bicycle's design. Failing to do so can result in catastrophic frame failure with risk of injury.

4.G - TIRES AND TUBES

1. Tires

Bicycle tires are available in many designs and specifications, ranging from general-purpose designs to tires designed to perform best under very specific weather or terrain conditions. If, once you've gained experience with your new bike, you feel that a different tire might better suit your riding needs, your local REI store can help you select the most appropriate design.

The size, pressure rating, and on some high-performance tires the specific recommended use, are marked on the sidewall of the tire (see fig. 16). The part of this information that is most important to you is tire pressure.

Exceeding the recommended maximum pressure may blow the tire off the rim, which could cause damage to the bike and injury to the rider and bystanders.

CAUTION

Never inflate a tire beyond the maximum pressure marked on the tire's sidewall.

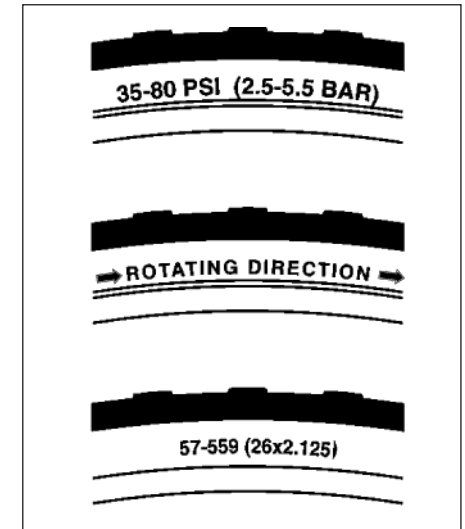

Figure 16.

The best and safest way to inflate a bicycle tire to the correct pressure is with a bicycle pump that has a built-in pressure gauge.

Gas station air hoses and other air compressors are not made for bicycle tires. They move a large volume of air very rapidly, and will raise the pressure in your tire very rapidly, which could cause the tube to explode and increase the risk of injury.

CAUTION

There is a safety risk in using gas station air hoses or other air compressors.

Tire pressure is given either as maximum pressure or as a pressure range. How a tire performs under different terrain or weather conditions depends largely on tire pressure. Inflating the tire to near its maximum recommended pressure gives the lowest rolling resistance; but also produces the harshest ride. High pressures work best on smooth, dry pavement.

PART I

Very low pressures, at the bottom of the recommended pressure range, give the best performance on smooth, slick terrain such as hard-packed clay, and on deep, loose surfaces such as deep, dry sand.

Tire pressure that is too low for your weight and the riding conditions can cause a puncture of the tube by allowing the tire to deform sufficiently to pinch the inner tube between the rim and the riding surface.

Pencil-type automotive tire gauges can be inaccurate and should not be relied upon for consistent, accurate pressure readings. Instead, use a high-quality dial gauge to avoid risk of injury.

Ask your local REI store to recommend the best tire pressure for the kind of riding you will most often do, and have the local REI store inflate your tires to that pressure. Then, check inflation as described in Section 1.C so you'll know how correctly inflated tires should look and feel when you don't have access to a gauge. It is important to check your tire pressures before every ride.

Some special high-performance tires have unidirectional treads: their tread pattern is designed to work better in one direction than in the other. The sidewall marking of a unidirectional tire will have an arrow showing the correct rotation direction. If your bike has unidirectional tires, be sure that they are mounted to rotate in the correct direction.

2. Tube Valves

There are primarily two kinds of bicycle tube valves: The Schrader valve and the Presta valve. The bicycle pump you use must have the fitting appropriate to the valve stems on your bicycle.

The Schrader valve (fig. 17) is like the valve on a car tire. To inflate a Schrader valve tube, remove the valve cap and clamp the pump fitting onto the end of the valve stem. To let air out of a Schrader valve, depress the pin in the end of the valve stem with the end of a key or other appropriate object.

The Presta valve (fig. 17) has a narrower diameter and is only found on bicycle tubes. To inflate a Presta valve tube using a Presta-headed bicycle pump, remove the valve cap; unscrew (counterclockwise) the valve stem lock nut; and push down on the valve stem to free it up. Then push the pump head on to the valve head, and inflate. To inflate a Presta valve with a Schrader pump fitting, you'll need a Presta adapter (available at your local REI store) which screws onto the valve stem once you've freed up the valve. The adapter fits into the Schrader pump fitting. Close the valve after inflation. To let air out of a Presta valve, open up the valve stem lock nut and depress the valve stem.

We highly recommend that you be familiar with tire and tube repair and that you carry the items necessary for common roadside repairs. This may include a spare inner tube, patch kit, flat-fixing sealant, wrenches, a pump, tire levers and other items. Consult with your local REI store as to what you should be prepared for.

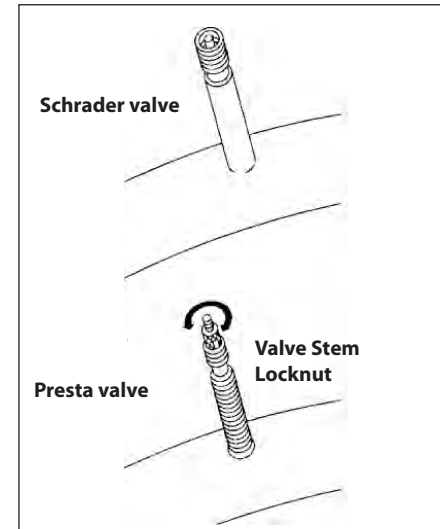

Figure 17.

PART I

SECTION 5. SERVICE

Technological advances have made bicycles and bicycle components more complex, and the pace of innovation is increasing.

It is impossible for this manual to provide all the information required to properly repair and/or maintain your bicycle.

In order to help minimize the chances of an accident and possible injury, it is critical that you have any repair or maintenance which is not specifically described in this manual performed by your local REI store. Equally important is that your individual maintenance requirements will be determined by everything from your riding style to geographic location.

Consult your local REI store for help in determining your maintenance requirements.

Many bicycle service and repair tasks require special knowledge and tools. Do not begin any adjustments or service on your bicycle until you have learned from your local REI store how to properly complete them. Improper adjustment or service may result in damage to the bicycle or reduced functionality or performance.

If you want to learn to do major service and repair work on your bike, you have three options:

1. REI will provide at the time of sale copies of the manufacturer's installation and service instructions for the components on your bike. If you would like more information, you may also contact the component manufacturer.
2. Join a cycling club or group, utilize online resources and/or look for a good book on the topic of repair.
3. Research the availability of bicycle repair courses in your area.

We recommend that you ask someone with experience to check the quality of your work the first time you work on something and before you ride the bike. Since that will require the time of a mechanic, there may be a modest charge for this service.

We also recommend that you ask your local REI store for guidance on what spare parts would be appropriate for you to have once you have learned how to replace such parts when they require replacement.

5.A - SERVICE INTERVALS

Some service and maintenance can and should be performed by the owner, and require no special tools or knowledge beyond what is presented in this manual.

The following are examples of the type of service you should perform yourself. All other service, maintenance and repair should be performed at your local REI store, or in a properly equipped facility by a qualified bicycle mechanic using the correct tools and procedures specified by the manufacturer.

1. **BREAK-IN PERIOD:** Your bike will last longer and work better if you break it in. Control cables and wheel spokes may stretch or "seat" when a new bike is first used and may require readjustment by your local REI store or another qualified bike mechanic. Your Mechanical Safety Check (Section 1.C) will help you identify some things that need readjustment. But even if everything seems fine to you, it's best to take your bike back to the local REI store or another qualified bike mechanic for a checkup. REI stores typically suggest you bring the bike in for a 30-day checkup. Another way to judge when it's time for the first checkup is to bring the bike in after three to five hours of hard off-road use, or about 10 to 15 hours of on-road or more casual off-road use. But if you think something is wrong with the bike, take it to your local REI store or another qualified bike mechanic before riding it again.
2. **BEFORE EVERY RIDE:** Mechanical Safety Check (Section 1.C)
3. **AFTER EVERY LONG OR HARD RIDE:** Clean the bike and lightly oil the chain. Wipe off excess oil. Lubrication is a function of climate. Talk to your local REI store or another qualified bike mechanic about the best lubricants and the recommended lubrication frequency for your area.

4. AFTER EVERY LONG OR HARD RIDE OR AFTER EVERY 10 TO 20 HOURS OF RIDING:

- Squeeze the front brake and rock the bike forward and back. Everything feel solid? If you feel a clunk with each forward or backward movement of the bike, you probably have a loose headset. Have your local REI store or another qualified bike mechanic check it.
- Lift the front wheel off the ground and swing it from side to side. Feel smooth? If you feel any binding or roughness in the steering, you may have a tight headset. Have your local REI store or another qualified bike mechanic check it.
- Grab one pedal and rock it toward and away from the center line of the bike; then do the same with the other pedal. Anything feel loose? If so, have your local REI store or another qualified bike mechanic check it.
- Take a look at the brake pads. Starting to look worn or not hitting the wheel rim squarely? Time to have them adjusted or replaced.
- Carefully check the control cables and cable housings. Any rust? Kinks? Fraying? If so, have them replaced.
- Squeeze each adjoining pair of spokes on either side of each wheel between your thumb and index finger. Do they all feel about the same? If any feel loose, have the wheel checked for tension and trueness.
- Check to make sure that all parts and accessories are still secure, and tighten any that are not.
- Check the frame, particularly in the areas around all tube joints; the handlebars; the stem; and the seatpost for any deep scratches, cracks or discoloration. These are signs of stress-caused fatigue and indicate that a part is at the end of its useful life and needs to be replaced. See also PART II, Section D: Materials and Inspection.

PART I

5. **AS REQUIRED:** If either brake lever fails the Mechanical Safety Check (Section 1.C), don't ride the bike. Have your local REI store or another qualified bike mechanic check the brakes. If the chain won't shift smoothly and quietly from gear to gear, the derailleur is out of adjustment. See your local REI store or another qualified bike mechanic.
6. **EVERY 25 (HARD OFF-ROAD) TO 50 (ON-ROAD) HOURS OF RIDING:** Take your bike to your local REI store or another qualified bike mechanic for a complete checkup.
7. Scratches, cracks, fraying and discoloration are signs of stress-caused fatigue and indicate that a part is at the end of its useful life and needs to be replaced. While the materials and workmanship of your bicycle or of individual components may be covered by a warranty for a specified period of time by the manufacturer, this is no guarantee that the product will last forever.

Please be sure to read PART II, Section D.3: Understanding Components and PART II, Section D.5: Bicycle Lifespan.

WARNING

LIKE ANY MECHANICAL DEVICE, A BICYCLE AND ITS COMPONENTS ARE SUBJECT TO WEAR AND STRESS. DIFFERENT MATERIALS AND MECHANISMS WEAR OR FATIGUE FROM STRESS AT DIFFERENT RATES AND HAVE DIFFERENT LIFE CYCLES.

IF A COMPONENT'S LIFE CYCLE IS EXCEEDED, THE COMPONENT CAN SUDDENLY AND CATASTROPHICALLY FAIL, WITH RISK OF SERIOUS INJURY OR DEATH.

5.B - IF YOUR BICYCLE SUSTAINS AN IMPACT

Check your bike for damage and take it to your local REI store for a thorough check.

Carbon composite components, including frames, wheels, handlebars, stems, cranksets, brakes, etc. that have sustained an impact must not be ridden until they have been disassembled and thoroughly inspected by a qualified mechanic.

See also PART II, Section D.5: Bicycle Lifespan.

WARNING

A CRASH OR OTHER IMPACT CAN PUT EXTRAORDINARY STRESS ON BICYCLE COMPONENTS, CAUSING THEM TO FATIGUE PREMATURELY. COMPONENTS SUFFERING FROM STRESS FATIGUE CAN FAIL SUDDENLY AND CATASTROPHICALLY, CAUSING LOSS OF CONTROL, SERIOUS INJURY OR DEATH.

PART II

SECTION A. IMPORTANT SAFETY INFORMATION

A Wide Range of Bicycling Injuries Are Possible

Many hazards are described, and we have attempted to explain how to avoid or minimize the dangers. Because any fall can result in serious injury, paralysis or death, we do not repeat the warning of these potential consequences every time we call attention to a hazard. Some low-speed falls may result in serious injuries, and some wild, high-speed falls may result in none. The reality is that the exact nature of the consequences of a fall or accident are not predictable.

Bicycles Cannot Protect You

Bicycles are lightweight, human-powered vehicles. Unlike a car, much like a motorcycle, there is no restraint system for your body, no protective structure around your body. Crash worthiness cannot be a design criterion. A rider sits on a bicycle and can be easily thrown off for many reasons, including overly hard use of the front brakes (See PART I, Section 4.C: Brakes) or striking an obstacle.

A.1 - BICYCLING-INHERENT RISK

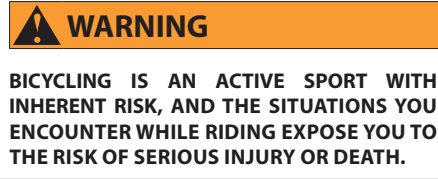

The risk cannot be taken away or eliminated. You can minimize risk by doing the following:

- Bicycle training and practice
- Progressive step-by-step learning of new cycling skills
- The good judgment to ride in control
- Bicycle experience; riding with experienced riders
- Use of a proper bicycle helmet and appropriate protective gear
- Reading and thinking about this entire owner's manual; all owner's manual supplements and instructions that came with your bicycle are essential to your safety and part of the learning process
- Riding within your own unique capabilities and considering the conditions where you are riding

A.2 - WARNING LABEL

We urge you to locate the warning label on your bike. It contains important information that you and anyone else who rides your bike should read and follow.

Do not remove it. If yours is damaged or missing, contact REI for a no-charge replacement.

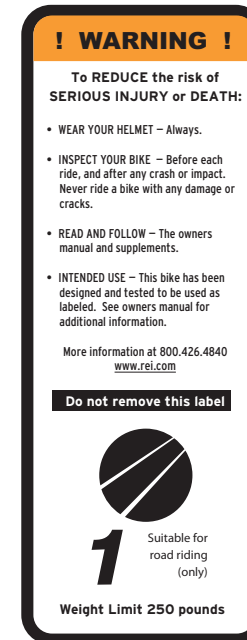

Your Warning label may look different depending on bike styles.

A.3 - RIDING IN TRAFFIC, COMMUTING



As noted elsewhere in this manual, you must learn and obey local traffic laws. Riding in traffic is hazardous. We cannot teach you about all of these hazards.

Here are just several important topics you must consider: Traffic laws, accidents, intersections, commuting and utility cycling, where to ride on roadway, changing lanes in traffic, riding at night, improving your odds with safety, lighting, and weather equipment.

Many bike clubs conduct training programs and workshops that focus on these and other safe-cycling topics. Contact REI or your local bicycle retailer. Seek the advice of an experienced bicycle commuter in your community.

PART II

A.4 - RIDING AT NIGHT, DUSK, DAWN

WARNING

RIDING AT NIGHT/DUSK OR AT DAWN IS VERY HAZARDOUS AND CAN RESULT IN SERIOUS INJURY OR DEATH.

Avoid riding at night. If you choose to ride at night:

- Install front and rear lights.
- Install a blinker or strobe light.
- Check your local, state or federal laws as lights may be required for riding at dusk, night, or dawn.
- Wear reflective clothing.
- Stay alert; others may not see you.
- Make sure your bicycle is equipped with all required reflectors, lights, strobes or blinkers.

Required Reflectors

The location and type of each reflector on your bike is required by the U.S. Consumer Product Safety Commission (CPSC). Your Novara bike must be delivered with: 1. A front-mounted, forward-facing reflector 2. A rear-mounted, rear-facing reflector, 3. A spoke-mounted reflector on each wheel, 4. Front- and rear-facing reflectors on the left and right pedals. **DO NOT REMOVE, BLOCK OR COVER REFLECTORS.**

Much Higher Risks at Night

The risk of an accident, particularly being struck by a motor vehicle, is much higher at night. If you choose to accept this higher risk, improve your odds with a proper lighting system, strobe light, light-colored reflective clothing and careful riding. Seek the advice of an experienced bicycle commuter in your community.

Mountain Biking at Night

Mountain biking at night is risky. Take the challenges outlined in Part II Section C and add another level of difficulty and risk. Seeing the terrain is much more difficult at night. Mountain biking at night is only for skilled mountain bikers, on familiar terrain, with excellent lighting systems, riding with other skilled mountain bikers, and riding cautiously.

Adding Lighting REFLECTORS ARE NOT A SUBSTITUTE FOR PROPER LIGHTS. IT IS YOUR RESPONSIBILITY TO EQUIP YOUR BICYCLE WITH ALL NATIONAL, STATE AND LOCALLY MANDATED LIGHTS. Riding at dawn, at dusk, at night or at other times of poor visibility without a bicycle lighting system that meets local and state laws and without reflectors is dangerous and may result in serious injury or death.

A.5 - REFINISHING

WARNING

REPAINTING AND/OR REFINISHING YOUR BIKE IS A MAJOR MODIFICATION THAT CAN CAUSE AND/OR CONCEAL DAMAGE LEADING TO FAILURE AND ACCIDENTS WITH RISK OF SERIOUS INJURY OR DEATH.

We understand that you may have an interest in repainting or refinishing your bike. Please do not, as the potential risks are great. Each type of material, method of construction and surface coating type requires specialty knowledge and tools to safely complete a quality refinish. Even if a detailed and professional inspection is performed before, during and after, you still run the risk of concealing potential problems. No change in appearance is worth these risks.

Small chips or minor scratches may be touched up with automotive paint.

A.6 - PHYSICAL MODIFICATION

WARNING

DO NOT PHYSICALLY MODIFY YOUR BIKE FRAME OR COMPONENTS IN ANY WAY. MODIFICATIONS CAN CAUSE DAMAGE LEADING TO FAILURE AND ACCIDENTS WITH RISK OF SERIOUS INJURY OR DEATH.

- Don't sandblast, shot blast or glass bead.
- Don't use any coarse sandpaper.
- Don't grind, wire brush, file, scrape or machine buff.
- Don't weld, braze or let anyone touch your bike with a torch.
- Don't drill any holes.
- Don't acid dip or etch.
- Don't anodize or chrome plate.

Any of these procedures can seriously harm the structural integrity and/or longevity of your frame fork or components.

PART II

A.7 - BICYCLES HAVE SHARP SURFACES

CAUTION

Bicycles have exposed sharp surfaces and can cause injury.

Exercise caution with chainrings and pointed, aggressive platform pedals, as they have sharp and potentially dangerous surfaces. Use caution when working on your bike. If you slip or fall you could be injured.

A.8 - INSTALLING ACCESSORIES

There are countless accessories that have been designed to fit on a bike or be used during your rides. Many of them can add greatly to your enjoyment of the sport.

CAUTION

Incompatible accessories or poorly or improperly mounted accessories can affect the performance of your bicycle and may be unsafe, causing risk of injury.

Please use your best judgment when selecting, installing and using accessories for your bicycle. It is nearly impossible to predict all of the ways in which your accessory selections could affect your riding and operation of your bike, potentially creating additional safety hazards. Your local REI store and many other retailers can offer guidance as to the options that will be best to achieve your desired results. Always be sure to practice riding with any new additions to your bike on hazard- and traffic-free roads.

Pay particular attention when requesting, installing and/or using any items that involve, affect or change the primary functional systems of your bike. Primary systems include the brake, steering, seating, wheel and/or drive systems. We also ask that you use the same judgment that you would use for operating any vehicle when you decide to install and use any electronic, navigational or communication devices on your bike. Many municipalities have legal requirements that may apply to your use of these items as well.

If you cannot have all accessories mounted by your local REI store or other professional bicycle mechanic, please be sure to follow the instructions and seek assistance when appropriate. Always be sure that any accessory installed to your bike does not block or interfere with its required reflectors or lighting system.

A.9 - BICYCLE RACKS

Automobile bicycle racks are available from many manufacturers and many rack designs exist. They are convenient devices for transporting your bike. However, any bicycle rack has potential to damage your bicycle. Damage can occur immediately, after repeated mounting and dismounting, or while the bike is being transported. We can't cover all the possible ways in which a rack might cause damage to your bike.

CAUTION

Read and follow the rack manufacturer's instructions before mounting your bike to avoid risk of injury.

All frames and forks can be damaged by the clamps and support systems of a bike rack. Both carbon and aluminum can suffer serious abrasion damage by any uncontrolled movement during transport. All damage to your bike can be serious, which is why you must take extra care when selecting and using bike racks.

When mounting your bike on an external rack, remove all bags, panniers, water bottles, etc. to minimize wind resistance and reduce the chances for loss and damage.

Contact your local REI store or your local bicycle retailer for help choosing and using a bike rack.

A.10 - TIRE SIZE

WARNING

MOUNTING THE WRONG SIZE TIRES CAN RESULT IN THEM HITTING THE FORK OR FRAME WHEN RIDING. A MOVING TIRE CAN BE STOPPED WHEN IT TOUCHES THE FORK OR FRAME. IF THIS HAPPENS, YOU CAN LOSE CONTROL OF YOUR BIKE AND BE THROWN OFF, RESULTING IN SERIOUS INJURY OR DEATH.

Take care that the tires you select are compatible with your bike's fork or frame design. Also, be sure to follow the manufacturer's recommendations for your suspension systems.

When you are considering tires for your bike take into account:

The actual measured size of a tire may be different than its sidewall marking. Each time you mount a new tire, take the time to inspect the actual clearance between the rotating tire and all parts of the frame. The CPSC requires at least 1/16" (1.6 mm) tire clearance from any part of the bike. Allowing for lateral rim flex and a wheel or rim that is out-of-true will likely mean choosing a rear tire that provides even more clearance than the CPSC recommends.

Ask your local REI store or bicycle retailer for the right tires for your bike and its particular components.

A.11 - TOE-CLIP OVERLAP

WARNING

TOE-CLIP OVERLAP COULD CAUSE YOU TO LOSE CONTROL OF YOUR BIKE, LEADING TO SERIOUS INJURY OR DEATH.

What is It?

"Toe-clip overlap" or "toe overlap" describes the toe of your shoe or toe-clip contacting the front tire (or front fender) as in fig 18. This may occur when the pedal with your shoe (with or without a toe-clip) is all the way forward and the front wheel is turned sharply to a position where the toe or toe-clip can contact the tire (or fender). If you ride with clipless pedals, attach your riding shoes to the pedals and check for front tire clearance.

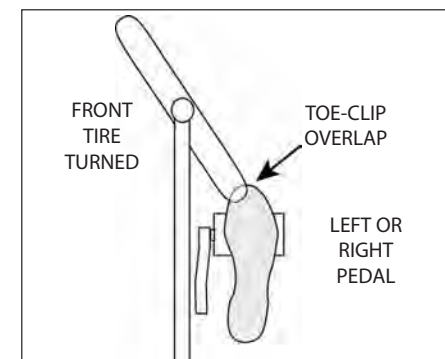

"Toe-clip overlap" is more common on small frame size bicycles. It can be simple to reduce contact with the front tire: have the inside pedal up before beginning a turn. As you turn to the left, the inside (left) pedal should be positioned at twelve o'clock. As you turn to the right, the inside (right) pedal should be positioned at twelve o'clock. Having the inside pedal up will prevent any toe-clip-to-tire contact and maximize cornering ground clearance.

Whether or not you have overlap, or how much overlap you have, can be changed. Be aware that toe clearance can be increased or decreased by changes in crank arm length, size of pedals or toe-clips used, size of tires used, addition of fenders, and the size and/or design of shoes worn.

PART II

A.12 - AFTERMARKET BRAKE SYSTEMS

WARNING

DO NOT MODIFY YOUR FRAME, FORK OR COMPONENTS IN ANY WAY TO MOUNT BRAKE SYSTEMS. THESE MODIFICATIONS CAN CAUSE DAMAGE LEADING TO SERIOUS INJURY OR DEATH.

Choose only brakes that mount to the frame, swingarm, or fork using only the existing disc brake, V-brake or cantilever mounts. Do not modify the existing mounts or clamp, weld, or in any other way add new or different mounts. Any modification may weaken or damage the frame. For maintenance instructions and other warnings, read the literature provided by the brake manufacturer.

When choosing replacements, please ask your local REI store or your local bicycle retailer.

A.13 - AFTERMARKET POWER SYSTEMS

WARNING

DO NOT INSTALL A POWER SYSTEM (GAS OR ELECTRIC) ONTO YOUR BIKE.

YOUR NOVARA BIKE WAS NOT DESIGNED OR INTENDED FOR USE WITH ANY TYPE OF AFTERMARKET POWER SYSTEM AND ITS INSTALLATION MAY ALTER THE PERFORMANCE CHARACTERISTICS AND/OR SHORTEN THE LIFESPAN OF THE FRAME, FORK AND COMPONENTS. THIS CAN RESULT IN REDUCED CONTROL AND ACCIDENTS THAT CAN LEAD TO SERIOUS INJURY OR DEATH.

There are many types of power systems from many different manufacturers. We simply can't predict what can go wrong by installing one.

We can say that installing an aftermarket power system represents a MAJOR modification of your bike. It will change the way your bike handles and fundamentally alter its operation.

When combined with your bike, the power system can become dangerous to operate. For example, the brakes may not be adequate for higher speeds, nor may the tires be rated for the additional weight.

PART II

SECTION B. INTENDED USE

WARNING

IT IS IMPORTANT THAT YOU UNDERSTAND YOUR BICYCLE AND ITS INTENDED USE. USING A BICYCLE IN A MANNER FOR WHICH IT WAS NOT INTENDED CAN LEAD TO ACCIDENTS RESULTING IN SERIOUS INJURY OR DEATH.

No one type of bicycle is suited for all purposes. Your local REI store can help you pick the right Novara bicycle for you and help you understand its limitations.

Prior to a purchase, modification of a current bicycle or a major change in use, do your research. Spend time at your local REI store or your local bicycle retailer and find someone with expertise in the area that interests you. Look online, engage local clubs or user groups, read books and magazines, and make a list of all of the questions that you don't have answers to. Seemingly small differences in bikes, components and accessories can greatly change the intended use, lifespan and/or performance of a bicycle for a certain purpose.

There are many types of bicycles and many variations within each type. There are bicycles that mix features and others that cross categories. For example, there are road racing bicycles with triple cranks that have the low gearing of a touring bike and the quick handling of a racing bike but are not well suited for carrying heavy loads on a tour. For that purpose, you want a touring bike. There are urban and comfort bicycles that can be fitted with off-road tires although they are not intended for off-road use. For that purpose you want a mountain bike.

On the following pages, we outline the intended use categories that REI and Novara use for the development of our bicycles. Please remember that these usage conditions are generalized and evolving, as are bicycles and the way they are used.

Please contact your local REI store if you have any questions about a Novara bike and your intended use.

B.1 - CHILDREN'S SIDEWALK

! WARNING !

To REDUCE the risk of SERIOUS INJURY or DEATH:

- WEAR YOUR HELMET – Always.
- INSPECT YOUR BIKE – Before each ride, and after any crash or impact. Never ride a bike with any damage or cracks.
- READ AND FOLLOW – The owners manual and supplements.
- INTENDED USE – This bike has been designed and tested to be used as labeled. See owners manual for additional information.

More information at 800.426.4840
www.rei.com

Do not remove this label



Adult supervision required
No traffic
Weight Limit 80 pounds

CONDITION 0

Bikes designed for riding by children over the age of three under appropriate parental supervision in a manner consistent with the child's bicycling skills. Bicycles intended for this use are "sidewalk bicycles."

MAXIMUM WEIGHT LIMIT

RIDER lbs. / kg	LUGGAGE* lbs. / kg	TOTAL lbs. / kg
80 / 36	0 / 0	80 / 36

B.2 - SPORT AND PERFORMANCE ROAD

! WARNING !

To REDUCE the risk of SERIOUS INJURY or DEATH:

- WEAR YOUR HELMET – Always.
- INSPECT YOUR BIKE – Before each ride, and after any crash or impact. Never ride a bike with any damage or cracks.
- READ AND FOLLOW – The owners manual and supplements.
- INTENDED USE – This bike has been designed and tested to be used as labeled. See owners manual for additional information.

More information at 800.426.4840
www.rei.com

Do not remove this label



1 Suitable for road riding (only)

Weight Limit 250 pounds

CONDITION 1

Bikes designed for riding on a paved surface where the tires do not lose ground contact.

MAXIMUM WEIGHT LIMIT

RIDER lbs. / kg	LUGGAGE* lbs. / kg	TOTAL lbs. / kg
250 / 113	10 / 4.5	260 / 118

*Seat bag / handlebar bag only

PART II

B.3 - GENERAL-PURPOSE RIDING

B.4 - CROSS-COUNTRY RIDING

B.5 - ADVANCED CROSS-COUNTRY

B.6 - ALL-MOUNTAIN

! WARNING !

To REDUCE the risk of SERIOUS INJURY or DEATH:

- WEAR YOUR HELMET – Always.
- INSPECT YOUR BIKE – Before each ride, and after any crash or impact. Never ride a bike with any damage or cracks.
- READ AND FOLLOW – The owners manual and supplements.
- INTENDED USE – This bike has been designed and tested to be used as labeled. See owners manual for additional information.

More information at 800.426.4840
www.rei.com

Do not remove this label



1+ Suitable for road riding and smooth trails

Weight Limit 250 pounds

! WARNING !

To REDUCE the risk of SERIOUS INJURY or DEATH:

- WEAR YOUR HELMET – Always.
- INSPECT YOUR BIKE – Before each ride, and after any crash or impact. Never ride a bike with any damage or cracks.
- READ AND FOLLOW – The owners manual and supplements.
- INTENDED USE – This bike has been designed and tested to be used as labeled. See owners manual for additional information.

More information at 800.426.4840
www.rei.com

Do not remove this label



2 For off-road riding with obstacles less than 12" (30cm)

Weight Limit 250 pounds

! WARNING !

To REDUCE the risk of SERIOUS INJURY or DEATH:

- WEAR YOUR HELMET – Always.
- INSPECT YOUR BIKE – Before each ride, and after any crash or impact. Never ride a bike with any damage or cracks.
- READ AND FOLLOW – The owners manual and supplements.
- INTENDED USE – This bike has been designed and tested to be used as labeled. See owners manual for additional information.

More information at 800.426.4840
www.rei.com

Do not remove this label



3 For rough off-road riding and jumps less than 24" (61cm)

Weight Limit 250 pounds

! WARNING !

To REDUCE the risk of SERIOUS INJURY or DEATH:

- WEAR YOUR HELMET – Always.
- INSPECT YOUR BIKE – Before each ride, and after any crash or impact. Never ride a bike with any damage or cracks.
- READ AND FOLLOW – The owners manual and supplements.
- INTENDED USE – This bike has been designed and tested to be used as labeled. See owners manual for additional information.

More information at 800.426.4840
www.rei.com

Do not remove this label



4 For extreme off-road riding

Weight Limit 250 pounds

CONDITION 1+

Bikes designed for riding Condition 1, plus smooth gravel roads and improved trails with moderate grades where the tires do not lose ground contact.

CONDITION 2

Bikes designed for riding Condition 1.5, plus intermediate off-road trails, small obstacles, and smooth technical areas, including areas where momentary loss of tire contact with the ground may occur. NO jumping.

CONDITION 3

Bikes designed for riding Condition 2, plus rough trails, obstacles, and technical areas, including areas where momentary loss of tire contact with the ground may occur. NO jumping.

Novara does not produce bicycles in this category.

CONDITION 4

Bikes designed for riding Conditions 1, 2 and 3, plus rough technical areas, moderately sized obstacles, and small jumps.

Novara does not produce bicycles in this category.

MAXIMUM WEIGHT LIMIT

RIDER lbs. / kg	LUGGAGE lbs. / kg	TOTAL lbs. / kg
250 / 113	30 / 14	280 / 127
Touring/Trekking		
250 / 113	55 / 25	305 / 138

MAXIMUM WEIGHT LIMIT

RIDER lbs. / kg	LUGGAGE lbs. / kg	TOTAL lbs. / kg
250 / 125	55 / 25	305 / 138
Full Suspension		
250 / 125	5 / 2.3	255 / 116

SECTION C. OFF-ROAD RIDING

Off-road riding usually involves many variables such as constantly changing traction, obstacles, changes in line of sight, up hill, down hill, soft surfaces, dry surfaces and wet surfaces. Off-road riding requires managing a complex and constantly changing rider-to-bicycle feedback loop of traction, weight distribution, application of power, application of brakes and steering driven by the conditions one encounters. The complexity and ever-changing nature of off-road riding requires focus, concentration, strength, fitness and learning to read the trail. The art of managing all of this while surrounded by nature makes it a challenging and wonderful sport.

CAUTION

Mountain bike riding is very different from riding a bike on the road. For starters, it is almost certain you will fall off and be injured.

Join a club and find experienced people to teach you. Practice and learn to stay in control. Carefully, progressively learn to expand your limits, but always ride within them.

C.1 - INSPECTION AND MAINTENANCE ROUTINES

CAUTION

Mountain bike riding is very hard on bikes. Mountain bikes need frequent cleaning, maintenance and inspection to reduce the risk of injury.

Clean your bike after every ride and conduct a pre-ride inspection (see Pre-Ride Checklist) before you head back out riding. Read the section on inspection in this manual and remember off-road use can be hard on a bicycle, and maintenance and repair is likely needed more often than for on-road use. Failure to keep up with maintenance and inspection increases the risk that you won't have a good time out on your bike.

C.2 - SUSPENSION

Suspension can increase the handling capabilities and comfort of your bicycle. An enhanced capability may allow you to ride faster, particularly on rough or bumpy surfaces. As common sense tells you, increased speed brings increased risk.

Do not confuse the built-in capabilities of a suspension bike with your own capabilities, which must be learned. Increasing your skill will take time and practice. Stay in control, and carefully, gradually learn the feel and handling of your suspension bike.

When you apply the front brakes on a suspension bike, the front of the bike will fall or dip as weight shifts forward. This is normal. (The front of your car dips when you apply the brakes.) You must learn to anticipate this weight shift and compensate by shifting your body weight back.

C.3 - JUMPING

WARNING

JUMPING IS VERY RISKY. YOU COULD FALL, LEADING TO SERIOUS INJURY OR DEATH.

Novara does not produce bicycles that are designed for this type of use.

C.4 - DOWNHILL AND LIFT-SERVICED RIDING

WARNING

DOWNHILL OFF-ROAD RIDING, WHETHER LIFT-SERVED, PEDALED OR SHUTTLED, INVOLVES A VOLUNTARY ASSUMPTION OF A VERY LARGE SET OF RISKS. IT REQUIRES A GREAT DEAL OF SKILL AND SPECIALTY EQUIPMENT FOR SAFE PARTICIPATION. THE RISKS ARE LARGE AND CRASHES CAN LEAD TO SERIOUS INJURY OR DEATH.

Novara does not produce bicycles that are designed for this type of use.

C.5 - FIXED-GEAR RIDING AND CONVERSION

Some Novara bicycles can be converted into a "fixed-gear" type of bicycle. A fixed-gear or "fixie" is a bicycle where the rear wheel and hub are connected directly to the crankset and cannot coast or freewheel. As a result, the pedals cannot move independently of the rear wheel.

As one of the simplest forms of a bicycle drivetrain, fixed gear riding can be rewarding for those who use it. However, it is an advanced form of riding and should only be considered by those who are highly experienced and technically proficient.

CAUTION

CAUTION: PLEASE TAKE THE TIME TO PRACTICE AND GET FAMILIAR WITH YOUR FIXED GEAR.

Some items of important consideration are:

- **Pedal strike: When cornering, you can not stop pedaling. You must manage the risk of contacting the ground with your pedals.**
- **Derailment: If the chain is not properly tensioned and aligned, it could come loose and fall off. This will greatly reduce your control and possibly become entangled in the rear wheel, risking lock-up.**
- **Pinching: Catching something in the drivetrain will result in one or both of the following events: damage to the item or rear-wheel lockup.**
- **Pedal Contact: If you lose control or contact with the pedals while in motion, it can be very difficult to regain control until the bike is completely stopped. For this reason, clipless pedals are not recommended for fixed-gear riding.**

Conversion:

If your bicycle was not sold as a model intended to be used with a fixed-gear drivetrain, please consult your local REI store or local bicycle dealer about its suitability. Chain tension and chainline are critical elements to a safe conversion and for this and other reasons, not all bicycles are good candidates for fixed-wheel use.

WARNING

DO NOT REMOVE OR DISABLE THE PRIMARY BRAKING SYSTEMS ON ANY BICYCLE FOR USE AS A FIXED-GEAR BICYCLE. RIDING A BICYCLE WITHOUT THE BRAKING SYSTEMS IT WAS DESIGNED AND SOLD WITH GREATLY INCREASES THE POTENTIAL FOR LOSS OF CONTROL LEADING TO ACCIDENTS WHICH MAY RESULT IN SERIOUS INJURY OR DEATH.

SECTION D. MATERIALS AND INSPECTION

In this section, we outline some material science basics and explain how they relate to your bicycle, some of the trade-offs made in designing your bicycle, and what you can expect from your bicycle. We will also provide important basic guidelines on how to maintain and inspect it.

WARNING

FREQUENT INSPECTION OF YOUR BIKE IS IMPORTANT FOR YOUR SAFETY. USE THE PRE-RIDE CHECKLIST BEFORE AND AFTER EVERY RIDE.

RIDING A BICYCLE WITH EXISTING DAMAGE CAN LEAD TO ACCIDENTS THAT MAY RESULT IN SERIOUS INJURY OR DEATH.

A detailed inspection of your bicycle is important. How often this is needed depends upon you, the bicycle, your riding style, environmental conditions, frequency of use and many other factors.

You, the rider/owner, have control and knowledge of how often you use your bike, how hard you use it and where you use it. Because we, as the designer and manufacturer, cannot track your use, you are responsible for inspection and maintenance.

If you are not interested in the “hands-on” aspects of your bicycle and do not wish to perform inspection or maintenance on your own bike, then you must make your local REI store or local bicycle retailer a partner in maintaining and inspecting your bicycle. Work with your bicycle shop to determine a maintenance and inspection schedule appropriate for your riding.

For your safety, understanding and communication with your local REI store, we urge you to read this section. The materials used to make your bike determine how to inspect it properly.

D.1 - UNDERSTANDING METAL AS A MATERIAL

a) Properties of Materials

Please understand that there is no single truth that can be stated that accurately characterizes the nature of the different materials used in constructing bicycles. How a chosen material is applied is much more important than the material alone. One must look at the way the bike is designed, tested, and manufactured together with an understanding of the material.

Metals vary widely in their resistance to corrosion. Steel must be protected or rust will attack it. Aluminum and titanium quickly develop an oxide film that protects the metal from further corrosion. Both are therefore quite resistant to corrosion. Aluminum is not perfectly corrosion resistant and particular care must be used where it contacts other metals or galvanic corrosion can occur.

Metals, as a class of materials, are comparatively ductile. Ductile means bending, buckling and stretching before breaking. Generally speaking, of the common bicycle frame-building materials, steel is the most ductile, followed by titanium and then aluminum.

When all metal bikes are crashed you will usually see some evidence of this ductility in bent, buckled or folded metal.

It is now common for the main frame to be made of metal and the fork of carbon fiber. See D.2 Understanding Carbon Fiber below. The relative ductility of metals and the lack of ductility of carbon fiber means that in a crash scenario you can expect some bending or buckling in the metal but none in the carbon. Below a certain load the carbon fork may stay intact even though the frame is damaged. Above a certain load the carbon fork will be completely broken.

b) Metal Fatigue 101

Common sense tells us that nothing that is used lasts forever. The more you use something, the harder you use it, and the worse the conditions you use it in, the shorter its life.

Fatigue is the term used to describe accumulated damage to a part caused by repeated loading. To cause fatigue damage, the load the part receives must be great enough. A crude, often-used example is bending a paper clip back and forth (repeated loading) until it breaks. This simple definition will help you understand that fatigue has nothing to do with time or age. A bicycle in a garage does not fatigue. Fatigue happens only through use.

So what kind of “damage” are we talking about? On a microscopic level, a crack forms in a highly stressed area. As the load is repeatedly applied, the crack grows. At some point the crack becomes visible to the naked eye. Eventually it becomes so large that the part is too weak to carry the same load that, without the crack, it could carry. At that point, there can be a complete and immediate failure of the part.

One can design a part that is so strong that fatigue life is nearly infinite. This requires a lot of material and a lot of weight. Any structure that must be light and strong will have a finite fatigue life. Aircraft, race cars and motorcycles all have parts with finite fatigue lives. If you wanted a bicycle with an infinite fatigue life, it would weigh far more than any bicycle sold today. So we all make a trade-off: the wonderful, lightweight performance we want requires that we inspect the structure.

In most cases a fatigue crack is not a defect. It is a sign that the part has been worn out, a sign the part has reached the end of its useful life. When your car tires wear down to the point that the tread bars are contacting the road, those tires are not defective. Those tires are worn out and the tread bar says “time for replacement.” When a metal part shows a fatigue crack, it is worn out. The crack says “time for replacement.”

WARNING

DO NOT RIDE A FRAME OR FORK WITH ANY CRACK, EVEN A SMALL ONE. RIDING A CRACKED FRAME OR FORK COULD LEAD TO YOUR FRAME/FORK BREAKING, WHICH MAY RESULT IN SERIOUS INJURY OR DEATH.

• **CORROSION IS DAMAGE.** Many parts of a bicycle are susceptible to corrosive damage. Please understand that human sweat is highly corrosive.

SIMPLE RULE 1: Keep your bike clean, store it carefully, lubricate the moving parts, and remove anything corrosive as soon as you can.

• **STAINS AND DISCOLORATION CAN OCCUR NEAR A CRACK.** Such staining can also be an early warning that a part is fatigued or damaged.

SIMPLE RULE 2: Inspect and investigate any staining to see if it is associated with a crack or other damage.

• **SIGNIFICANT SCRATCHES, GOUGES, DENTS OR SCORING CREATE STARTING POINTS FOR CRACKS.** Think about the cut into the material surface as a focal point for stress (in fact engineers call such areas “stress risers”—areas where stress is concentrated). Perhaps you have seen glass cut. You’ll recall how the glass was scored and then broke right along the scored line.

SIMPLE RULE 3: Avoid scratches, gouges or scoring your bike. When the inevitable occurs, pay frequent attention to this area and consider replacement of the part.

• **CRACKS AND OTHER DAMAGE MAY MAKE CREAKING NOISES AS YOU RIDE.** Think about any unusual noise as an opportunity to investigate its cause. Remember that a well-maintained and structurally sound bicycle should be very quiet and free of creaks and squeaks.

SIMPLE RULE 4: Investigate and find the source of any noise. It may not be a crack, but whatever is causing the noise should be fixed before riding.

c) Fatigue Is Not a Perfectly Predictable Science

Fatigue is not a perfectly predictable science, but we can give you some general factors to help you determine how often you need to inspect (or have your retailer inspect) your bicycle. The more you fit the “shorten product life” profile, the more frequently you need to inspect. The more you fit the “lengthen product life” profile, the less frequently you need to inspect.

Factors that shorten product life:

- Hard, harsh riding style
- “Hits,” crashes, jumps or other “shots” to bike
- High mileage
- Higher body weight
- Stronger, fitter, and/or more aggressive riders
- Corrosive environment (wet, salt air, winter road salt, accumulated sweat)
- Presence of abrasives (mud, dirt, sand and soil) in riding environment

Factors that lengthen product life:

- Smooth, fluid riding style
- No “hits,” crashes, jumps or other “shots” to bike
- Low mileage
- Lower body weight
- Less aggressive rider
- Non-corrosive environment (dry, salt-free air)
- Clean riding environment

d) Quick Frame and Fork Inspection

1. Clean the bike and remove the wheels.
2. Inspect the whole frame carefully for cracks.
 - Pay particular attention to the underside of the top and down tubes where they connect to the head tube.
 - Inspect joined areas in detail. This is where two items are connected or welded.
 - Be sure to look at the inside of the rear triangle and the dropouts.
3. Inspect the fork carefully for cracks. Pay particular attention around the dropouts, brake mounting areas and crown.
4. Finally, check all mounted components for obvious loosening.

e) Other Suspension Forks

If you have a fork made by a third party, please read and follow the inspection instructions contained in the manual that cover that fork. If you do not have the third party’s manual, please contact your local REI store or your local bicycle retailer for information on getting a copy.

PART II

D.2 - UNDERSTANDING CARBON FIBER

All riders with high-performance bicycles and components should understand a fundamental reality of carbon fiber. Composite materials constructed of carbon fiber are strong and light, but when crashed or overloaded, carbon fibers do not fail progressively through bending or distortion, instead they fail catastrophically and break.

a) What Is Carbon Fiber?

The term “carbon fiber” refers to parts that are made up of different component materials. Carbon fiber composites typically include a strong, light fiber in a matrix of plastic epoxy, molded to form a shape. The epoxy matrix bonds the carbon fibers together, transfers load to other fibers, and provides a smooth outer surface. The carbon fibers are the “skeleton” that carries the load.

b) Why Are Carbon Fibers Used?

Unlike metals, which have uniform properties in all directions, carbon fibers can be placed in specific orientations to optimize the structure for particular loads. The choice of where to place the carbon fibers gives engineers a powerful tool to create strong, light bicycles. Engineers can also orient fibers to suit other goals such as comfort and vibration damping.

Carbon fiber materials have a very high strength-to-weight ratio. Used properly, carbon fiber is an amazingly lightweight structural material relative to metals. Carbon fiber is also corrosion resistant, much more so than most metals.

c) What Are the Limits of Carbon Fiber?

Well-designed carbon fiber frames, forks and components have long fatigue lives. However, REI still urges you to regularly inspect your carbon fiber frame, fork or components.

d) Protect Carbon Fiber From Extreme Temperatures

Protect your carbon fiber bike and parts from extremely high temperatures when storing or transporting it.

Do not store your bike in places where the temperature will exceed 66.5°C (150°F) for extended periods of time.

For example, do not leave your bike lying flat in a black pickup truck bed in the desert sun or under the glass of a hatchback car.

e) Composite Frame, Fork and Component Inspection

Cracks:

Inspect for cracks and broken or splintered areas. Any crack is serious. Do not ride any bicycle or component that has a crack of any size.

Delamination:

Delamination is serious damage. Carbon fiber is made from layers of fabric. Delamination means that the layers of fabric are no longer bonded together. Do not ride any bicycle or component that has any delamination. These are some delamination clues:

- A cloudy or white area. This kind of area looks different from the ordinary undamaged areas. Undamaged areas will look glassy, shiny or “deep,” as if one was looking into a clear liquid. Delaminated areas will look opaque and cloudy.
- Bulging or deformed shape. If delamination occurs, the surface shape may change. The surface may have a bump, bulge, or soft spot, or not be smooth and fair.
- A difference in sound when tapping the surface. If you gently tap the surface of an undamaged composite you will hear a consistent sound, usually a hard, sharp sound. If you then tap a delaminated area, you will hear a different sound, usually a duller, less-sharp sound.

Unusual Noises:

Either a crack or delamination can cause creaking noises while riding. Think about such a noise as a serious warning signal. A well-maintained bicycle will be very quiet and free of creaks and squeaks. Investigate and find the source of any noise. It may not be a crack or delamination, but whatever is causing the noise must be fixed before riding.

 **WARNING**

CREAKS OR UNUSUAL NOISES COMING FROM YOUR BIKE NEED TO BE INVESTIGATED. UNUSUAL NOISES OFTEN OCCUR PRIOR TO A COMPONENT FAILURE, WHICH CAN LEAD TO A COMPLETE FAILURE RESULTING IN INJURY OR DEATH.

 **WARNING**

DO NOT RIDE A FRAME OR FORK WITH ANY DELAMINATION OR CRACK. IF YOU RIDE A DELAMINATED OR CRACKED FRAME/FORK/COMPONENT IT MAY COMPLETELY BREAK APART WITH RISK OF ACCIDENT, SERIOUS INJURY OR DEATH.

PART II

D.3 - UNDERSTANDING COMPONENTS

It is often necessary to remove and disassemble components in order to properly and carefully inspect them. Most customers will use this component list as a checklist. The intention here is to tell you which parts, and which areas of those parts, most need inspection. Insist that your mechanic also do such inspections.

WARNING

FAILURE TO DISASSEMBLE OR REASSEMBLE BICYCLE COMPONENTS PROPERLY COULD RESULT IN AN ACCIDENT, WITH RISK OF SERIOUS INJURY OR DEATH.

If disassembly is required, remember that there can be special tools and techniques required. Unless you are an experienced bicycle mechanic, we urge you to have this work done at your local REI store.

As always, if you see anything that you are unsure of, do not ride the bike; take it in for service.

Do not ride any component with a crack, even a small one. We recommend that you clearly mark or destroy any compromised component you replace so that it cannot be used again.

a) Aftermarket “Superlight” Components

Think carefully about your rider profile as outlined above. Discuss your needs and your profile very honestly with your retailer. Take these choices seriously and understand that you are responsible for the changes.

b) Original Equipment Components

Novara tests the fatigue life of many of the components that are original equipment on your bike. This means that the designs of many original equipment components have met our test criteria and have reasonable fatigue life. It does not mean that the original equipment components will last forever; they will not.

c) Stem

Clean and inspect carefully for cracks. Pay particular attention to the underside of the stem. If the stem is of welded construction, examine the edges of each weld. See also the closely related handlebar section below.

d) Handlebar

Remove from stem. With road bars, you will need to remove the handlebar tape. Remove any handlebar-mounted components. Clean and inspect carefully for cracks. Pay particular attention to the area where the handlebar emerges from the stem. This is the area where virtually all handlebars will eventually break. Periodic replacement of all handlebars is strongly recommended. How often they need to be replaced depends upon the many factors outlined above.

Be sure that you do not scratch or score the surface of the handlebar with either the stem or the brake or the shifter levers. As noted above, any such damage will reduce the life of the handlebar and could lead to breakage.

If you find that there is a sharp edge or burr on the inside of the stem, right where the handlebar emerges, it must be smoothed out with fine sandpaper (220 grit or finer) before the new handlebar is installed. Such a sharp edge or burr could cause a scratching or scoring of the handlebar. As noted above, any such damage will reduce the life of the handlebar and could lead to breakage.

e) Seatpost

Remove from seat tube and remove from saddle. Disassemble the head/saddle clamp assembly. Clean and inspect all parts carefully for cracks.

Pay particular attention to the bolt (or bolts) that clamp the saddle in place. If the bolt looks stretched, bent or in any way damaged, replace it. Note that these bolts have been known to be broken due to fatigue when not properly tightened. They must be properly tightened with a torque wrench to specification.

The threads of the seatpost bolts must be greased before reassembly.

Be sure the clamp assembly is clamped only to the straight parallel part of the saddle rails.

f) Seatpost Lubrication

Clean and apply the following to a seatpost before inserting it into the frame:

FRAME MATERIAL		SEAT POST LUBRICATION
SEAT TUBE	SEAT POST	
METAL	METAL	GREASE
METAL	CARBON FIBER	CARBON GEL
CARBON FIBER	METAL	CARBON GEL
CARBON FIBER	CARBON FIBER	CARBON GEL

GREASE: A high-quality bicycle bearing grease

CARBON GEL: A gel-like lubricant formulated for use with carbon fiber components.

g) Saddle

While the saddle is off the seatpost, clean and inspect the rails carefully for cracks. Check the saddle rails to the saddle body; make sure that the rails are firmly attached.

h) Pedals

Remove both from the crankset. Clean and inspect carefully for cracks. Pay particular attention to the pedal axle. See clipless pedal manufacturer's instructions for information on cleat wear and replacement.

e) Crankset

Remove both sides from the bottom bracket. Clean and inspect all parts carefully for cracks. Examine both inside and outside surfaces. Pay particular attention to edges, shapes and changes of shape that are a part of your particular crankset design. Also check the area around the pedal mounting holes.

f) Wheels

Clean the wheels. Inspect the hub for cracks where the spokes are attached. Inspect the rim where the spokes meet it.

g) Brake Track of Wheel Rim

The brake track is the surface of the rim where the brake pads make contact, and this surface will wear with use. We urge you to inspect for this. Rims wear out more quickly on a bike used in wet conditions.

Many rims have brake track wear indicators; please look for this feature. If the wear indicator shows that the rim is worn out, there is a danger that the rim could be broken due to tire pressure and/or riding loads.

WARNING

DO NOT RIDE ON A RIM THAT HAS BEEN WORN OUT. IF THE RIM BREAKS WHILE YOU ARE RIDING YOU COULD HAVE AN ACCIDENT, WITH RISK OF SERIOUS INJURY OR DEATH.

D.4 - RIDING THROUGH WATER

CAUTION

“Sealed” components (such as suspension forks, headsets, bottom brackets and hubs) are effective at keeping mud and grit out of your bearings.

However, any bike that is submerged or exposed to large amounts of water will require a complete bearing overhaul to prevent extensive—and expensive—damage.

DO NOT ride in the ocean. Any bicycle substantially exposed or submerged in salt water will likely need a complete overhaul or replacement to avoid risk of injury.

PART II

D.5 - BICYCLE LIFESPAN

Nothing Lasts Forever, Including Your Bike

When the useful life of your bike or its components is over, continued use is hazardous.

Every Novara frame, fork and components attached to them have a limited useful life. The length of that life will vary with the construction and materials used in the frame and components, the maintenance and care the frame and components receive over their life, and the type and amount of use to which the frame and components are subjected. Use in competitive events, trick riding, ramp riding, jumping, aggressive riding, riding on severe terrain, riding in severe climates, riding with heavy loads, commercial activities and other types of non-standard use can dramatically shorten the life of the frame and components. Any one or a combination of these conditions may result in an unpredictable breakage.

ALL FRAMES AND COMPONENTS SHOULD BE PERIODICALLY CHECKED BY A PROFESSIONAL MECHANIC for indicators of stress and/or potential breakage, including cracks, deformation, delamination, creaking sounds, corrosion, paint peeling, dents, and any other indicators of potential problems, inappropriate use or abuse. These are important safety checks and very important to help prevent accidents, bodily injury to the rider and shortened product life.

SECTION E. MAINTENANCE

 **WARNING**

INSPECTION AND MAINTENANCE ARE CRITICAL TO YOUR SAFETY AND THE LONGEVITY OF YOUR BICYCLE.

A POORLY MAINTAINED BIKE IS MORE LIKELY TO BREAK OR MALFUNCTION, LEADING TO AN ACCIDENT WHERE YOU CAN BE SERIOUSLY INJURED OR KILLED.

E.1 - WARRANTY TUNE

REI tries to minimize the “break-in” effect of a new bicycle by precisely adjusting it with this initial period in mind. However, the bicycle will need mechanical attention during the first ten (10) to fifteen (15) hours of use to return it to an optimum performance level.

In essence, a “Warranty Tune” brings a recently purchased bicycle back to the state it was in when it left the store for the first time. This “Warranty Tune” is a free service that REI provides to our customers, ensuring a positive ongoing experience.

As a general rule of thumb, two months of moderate riding in good conditions, 2–3 times weekly, will be sufficient to break in a bicycle. If you experience any problems sooner, you should bring the bicycle in for service immediately.

E.2 - CLEANING

Use only water and dishwashing liquid.

On suspension forks and shocks, cover adjustment knobs and air filter (if equipped) with a clean plastic bag secured temporarily with a rubber band or masking tape.

Before wiping away dirt, use an ordinary water hose to gently spray off heavy soils and dirt.

 **CAUTION**

DO NOT power wash or use water under high pressure to clean your bike. Power washing can force contaminants into parts where they can promote corrosion and result in accelerated wear creating a risk of injury.

DO NOT use compressed air to dry.

DO NOT use abrasive or harsh chemical cleaners/solvents.

E.3 - PREVENTING CORROSION

After cleaning and drying it is a good idea to lightly coat the water-bottle bosses with a water displacing lubricant to minimize corrosion. This is particularly important on bicycles used in coastal salt air environments and those drenched in sweat on an indoor trainer.

E.4 - LUBRICATION

After cleaning your bike you should lubricate the external moving parts. Consult with your local REI store or your local retailer to choose among the many types of lubes best suited to your bicycle, climate and riding conditions. After the chain, the pivot points on your derailleurs are the most common areas to lube. Apply a small drop of oil to each pivot point and wipe off the excess.

Periodically, depending upon how aggressively, how often, and where you ride and the design of the components on your bike, other lubrication may be part of your ongoing maintenance. If you are not an experienced bicycle mechanic, take your bike to your local REI store or local bicycle retailer.

Other Lubrication Checklist

	• Derailleur Cables
	• Brake Cables
	• Brake Pivots
	• Headset Bearings
	• Bottom Bracket Bearings
	• Hub Bearings
	• Freehub
	• Seatpost to Seat Tube

PART II

E.5 - TIGHTENING TORQUES

Correct tightening torque for the fasteners (bolts, screws, nuts) on your bicycle is important for the durability and performance of your bicycle. We urge you to buy and use a torque wrench for all of your repair work.

Find Tightening Torque Information

The wide range of bicycle models and components used means that a listing of tightening torque would be out of date by the time it was published. Many fasteners should be installed with a thread-locking adhesive such as Loctite®.

To determine correct tightening torque and any adhesive application for a fastener we ask you to check:

- Markings on the component.
- Torque specs in the component manufacturer's instructions.
- Torque specs listed on the websites of component manufacturers.

E.6 - BICYCLE REPAIR / WORK STANDS

The clamping jaws of a bike stand can generate a crushing force strong enough to seriously damage your frame. See figure 19.

Place your bike in a stand by extending the seatpost and positioning the stand clamp on the extended seatpost. Don't extend beyond the MINIMUM INSERT line marked on the seatpost.

Since your carbon fiber seatpost can also be damaged by clamping force, adjust the stand clamp for the minimum clamping force needed to secure the bike.

Also, before clamping, clean the post and protect the seatpost finish with a rag.

CAUTION

Never place your bike in a bike stand by clamping it onto the bike frame. Improper clamping could cause damage leading to a risk of injury.

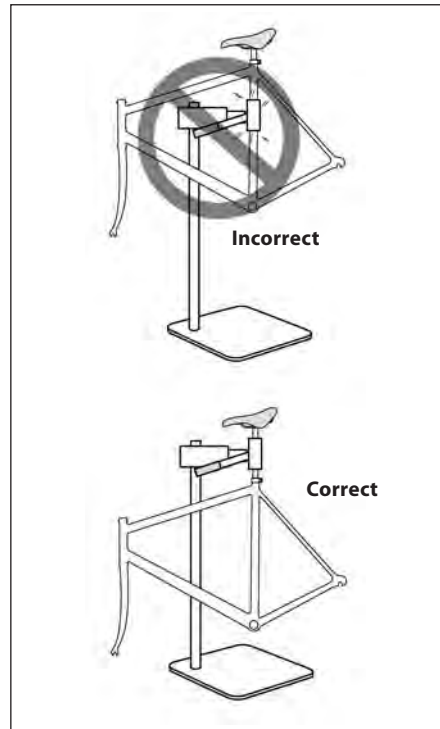

Figure 19.

E.7 - SERIAL NUMBER

The serial number for your bike is located on a barcoded label that is attached permanently to the underside of the bottom bracket. See fig. 20.

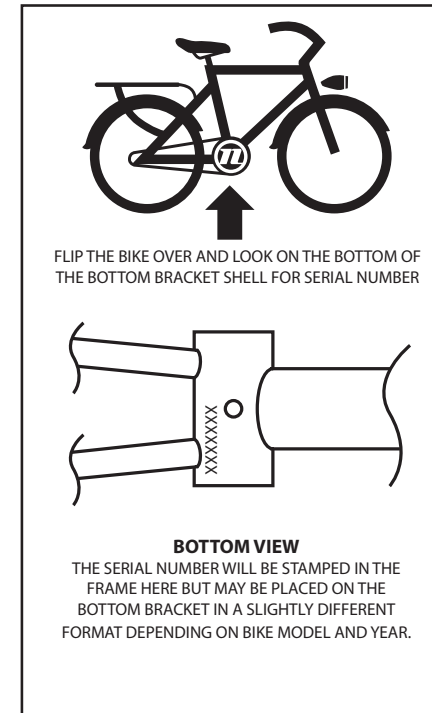

Figure 20. Underside of Bottom Bracket

Where Else Can I Find the Serial Number?

The serial number should also appear on your original purchase documents.

SECTION F

BICYCLE TRAINERS

Potential Damage

CAUTION

Improperly mounting a bike in a trainer, or using one that is not compatible with your particular bike frame, can cause damage with risk of injury.

Ask your local REI store for help selecting the right trainer and using it correctly.

If you ride a trainer that requires removal of the front wheel and clamps the fork dropouts, be sure your fork quick-release is tight! Relative movement will wear parts and weaken and damage your bike.

If you ride a trainer that holds the bike up by clamping the rear quick-release between two cones, take off the lightweight quick-release that came with your bike. Substitute a heavy, classic, all-steel quick-release and clamp it tight! Relative movement will wear parts and weaken and damage your bike. Note that many modern quick-releases will not fit the clamping cones in this kind of trainer because their shapes are incompatible.

Be particularly cautious with a carbon frame or fork. Carbon is relatively soft and not abrasion resistant. If there is any relative movement, carbon will wear quickly.

If you ride a trainer a lot, consider using an old bike: corrosion from sweat will take its toll. Weight is irrelevant. Save wear on your expensive components.

Risk to Children

CAUTION

KEEP CHILDREN AWAY FROM BICYCLES MOUNTED ON STATIONARY TRAINERS, EVEN WHEN THE BICYCLE IS NOT IN USE.

Spinning wheels attract children's attention and present a serious risk to young fingers.

Children have also been known to rotate cranks by hand on bicycles left unattended on stationary trainers, putting themselves at risk of serious injury.

PART II

SECTION G. PRE-RIDE CHECKLIST

WARNING

FOLLOW THIS CHECKLIST BEFORE EVERY RIDE. IF YOU HAVE ANY REASON TO SUSPECT THAT YOUR BICYCLE IS NOT FUNCTIONING PROPERLY, DO NOT RIDE IT.

HAVE IT INSPECTED BY AN REI STORE OR YOUR PREFERRED LOCAL RETAILER. TO LOCATE YOUR NEAREST REI STORE CALL 1-800-426-4840. FAILURE TO FOLLOW THIS CHECKLIST AND HAVE ANY POTENTIAL PROBLEM INSPECTED COULD LEAD TO AN ACCIDENT, WITH RISK OF SERIOUS INJURY OR DEATH.

Are you wearing a helmet and other appropriate equipment and clothing, such as protective glasses and gloves? Do not wear loose clothing that could become entangled in the bicycle (See PART I, Section 2.A: The Basics).

Are your seatpost and stem securely fastened? Twist the handlebars firmly from side to side while holding the front wheel between your knees. The stem must not move in the steering tube. Similarly, the seatpost must be secure in the seat tube (See PART I, Section 3: Fit).

Are you visible to motorists? If you are riding at dusk, dawn or night, you must make yourself visible to motorists. Use front and rear lights and a strobe or blinker. Reflectors alone do not provide adequate visibility. Wear reflective clothing (see PART I, Section 2.E: Night Riding and PART II, Section A: Important Safety Information).

Is it raining or wet? If so, be more cautious. Your braking distances will increase, and your tires' grip on the road will decrease. Remember that motorists' visibility decreases with bad weather (see PART I, Section 2.D: Wet-Weather Riding and PART II, Section A: Important Safety Information).

Are your tires properly inflated? Tires must be inflated to the recommended pressure (see PART I, Section 4.G: Tires and Tubes).

Are your wheels true? Lift each end of the bike and spin each wheel. Does the space between the rim and the brake pads, or the tire and the frame, remain nearly the same size as the wheel turns? Are your spokes tight? (See PART I, Section 1.C: Mechanical Safety Check.)

Are your wheels' quick-releases properly fastened? Be sure to read the section on proper operation of quick-release skewers (see PART I, Section 4.A: Wheels).

Are your front and rear brakes functioning properly? With any rim brake, the brake pads must make firm contact with the rim without the brake levers hitting the handlebar grip. With V-brakes, the quick-release "noodle" must be properly installed. With cantilever brakes, the straddle cable must be properly attached. With caliper brakes, if there is a quick release function, it must be closed.

With hydraulic disc brakes, check that the lever feels firm and does not move too close to the handlebar grip, and there is no evidence of leaking brake fluid. With cable-actuated disc brakes, check that the lever feels firm and does not move too close to the handlebar grip. With any disc brakes, the brake pads must make firm contact with the rotor without the brake levers hitting the handlebar grip (see PART I, Section 4.C: Brakes).

How do your clipless pedals work today? Clip in and out of your pedals before you begin. Experienced cyclists do. The connection between cleat and pedal is affected by dozens of factors, including dirt, mud, lubrication, spring tension and wear. By clipping in and out you will check the function and have a fresh memory of how they feel (see PART I, Section 4.E: Pedals).

How recently were your frame, fork and components inspected? Never ride a frame, fork or components with any crack or damage (see PART II, Section D: Materials and Inspection).

RULES OF THE TRAIL

MOUNTAIN BIKERS, PLEASE DO YOUR PART TO MAINTAIN TRAIL ACCESS BY OBSERVING THE FOLLOWING RULES OF THE TRAIL:

- **RIDE ON OPEN TRAILS ONLY.** Respect trail and road closures (ask if uncertain), avoid trespassing on private land, and obtain permits or other authorization as may be required. Federal and state wilderness areas are closed to cycling.
- **LEAVE NO TRACE.** Be sensitive to the dirt beneath you; practice low-impact cycling. Wet and muddy trails are more vulnerable to damage. When the trailbed is soft, consider other riding options. Stay on existing trails and do not create new ones. Be sure to pack out at least as much as you pack in.
- **CONTROL YOUR BICYCLE!** Inattention for even a second can cause problems. Obey all bicycle speed regulations and recommendations.
- **ALWAYS YIELD THE TRAIL.** Let your fellow trail users know you're coming. A friendly greeting or bell is considerate and works well. Show your respect when passing others by slowing to a walk or even stopping. Anticipate that other trail users may be around corners or in blind spots.
- **NEVER SCARE ANIMALS.** All animals are startled by an unannounced approach, sudden movement or loud noise. Give animals extra room and time to adjust to you. When passing horses, use special care and follow the directions of the horseback rider (ask if uncertain). Running cattle and disturbing wildlife are serious offenses. Leave gates as you found them, or as marked.
- **PLAN AHEAD.** Know your equipment, your ability and the area in which you are riding, and prepare accordingly. Be self-sufficient at all times, keep your equipment in good repair, and carry necessary supplies for changes in weather or other conditions. Always wear a helmet and safety gear.

The above information is a synopsis of the "Rules of the Trail" information provided by the International Mountain Bicycling Association (IMBA), a group that is dedicated to promoting environmentally sound and socially responsible off-road bicycling. For the complete text or more information on IMBA, please visit imba.com or call (303) 545-9011.

RIDE SAFE AND SMART

- Always wear a helmet when riding.
- Use lights, front and rear, when cycling at night and in low-visibility weather conditions—reflectors aren't enough.
- Have a clear-sounding horn or bell to warn others of your approach.
- Do not carry passengers or packages that interfere with your vision or control.
- Always give pedestrians the right of way.
- Reduce speed at all intersections, look both ways, then proceed with caution.
- Watch for cars pulling out into traffic and car doors opening.
- Know and obey all local and state traffic rules and regulations.

PRE-RIDE CHECKLIST



FOLLOW THIS CHECKLIST BEFORE EVERY RIDE. IF YOU HAVE ANY REASON TO SUSPECT THAT YOUR BICYCLE IS NOT FUNCTIONING PROPERLY, DO NOT RIDE IT. Have it inspected by an Authorized Novara Retailer. To locate your nearest Authorized Novara Retailer call 1-800-426-4840. Failure to follow this checklist and to have any potential problem inspected could lead to an accident, with risk of serious injury, paralysis or death.

USE THIS CHECKLIST TO KEEP YOUR BIKE IN PEAK CONDITION

- Tires Proper inflation
Good condition; no signs of cuts or wear
- Wheels Quick-release levers secured
Wheels true and centered in frame/fork
- Brakes Pads secure and aligned properly
Brakes centered
Brake levers symmetrical and secure
Cables and housings free of kinks/frays
Lever has at least 1" before bottoming against handlebar
- Handlebar Aligned and properly secured
- Stem Aligned and properly secured
- Headset No play, turns freely
- Saddle/seatpost Aligned and properly secured
- Drivetrain..... Check for over-/under-shifts
Chain clean and lubed
- Pedals Properly secured
- Crank arms Properly secured
- Bottom bracket. No side-to-side play, spins freely
- Accessories..... Racks, bottle cages, fenders, etc. secured
- Helmet No cracks or breaks

Questions about any of these parts or adjustments? Our knowledgeable bike staff is happy to answer your questions.

REI MASTER TECHNICIANS ENSURE YOU GET EXPERT SERVICE

From basic maintenance to complete overhaul—even wheel-building—any job or question about your bike can be handled by REI Master Technicians.

REI Master Techs know bikes inside and out. An intensive certification program at the renowned Barnett Bicycle Institute in Colorado ensures it.

Every REI bike-shop staff member is trained and certified by the REI Master Tech in each store, so you can count on getting consistent, knowledgeable service every time.

OUR 100% SATISFACTION GUARANTEE

Our 100% satisfaction guarantee ensures that every item you purchase at REI meets your high standards—or you can return it for a replacement or refund.



DISTRIBUTED BY RECREATIONAL EQUIPMENT, INC.
SUMNER, WA 98390