

TRAXXAS

1/8 SCALE NHRA
FUNNY CAR
RACE REPLICAS

MODEL 6907



OWNERS MANUAL

INTRODUCTION

- 3 BEFORE YOU PROCEED
- 4 SAFETY PRECAUTIONS
- 5 TOOLS, SUPPLIES, AND REQUIRED EQUIPMENT
- 6 ANATOMY OF THE MODEL
- 7 QUICK START: GETTING UP TO SPEED
- 7 RAISING AND ADJUSTING THE BODY
- 8 TRAXXAS TQi RADIO SYSTEM
- 14 ADJUSTING THE ELECTRONIC SPEED CONTROL
- 15 DRIVING YOUR MODEL
- 17 TUNING ADJUSTMENTS
- 21 MAINTAINING YOUR MODEL
- 22 TQi ADVANCED TUNING GUIDE

Thank you for purchasing the Traxxas NHRA Funny Car. In addition to capturing the look of a full-size Funny Car with its incredibly scale appearance, your model accurately simulates genuine Funny Car performance as well. The included Traxxas ET-3S Brushless Power System delivers powerful throttle response, and the unique, 4-channel TQi radio system is customized for drag-racing use with its innovative Burnout, Staging, and Race Modes, and electronic Launch Control. Only Traxxas offers such detail, performance, and fun in a realistic, race replica. Get ready for a new kind of R/C experience!

This manual contains the instructions you will need to operate and maintain your model so that you can enjoy it for years to come. We know you're excited about getting your new model on the road, but it's very important that you take the time to read through the Owner's Manual. This manual contains all the necessary set-up and operating procedures that will allow you to unlock the performance potential that Traxxas engineers designed into your model. **Also be sure to read and follow ALL precautions and warnings in this manual, on all documents enclosed with your model, and on all labels or tags attached to your model or model's accessories. They are there to educate you on how to operate your model safely and also get maximum life and performance from your model.** Even if you are an experienced R/C enthusiast, it's important to read and follow the procedures in this manual and all accompanying documents. We work hard every day to ensure you receive the highest level of customer satisfaction possible. We truly want you to enjoy your new model!

Thank you again for going with Traxxas.

Traxxas Support

Traxxas support is with you every step of the way. Refer to the next page to find out how to contact us and what your support options are.

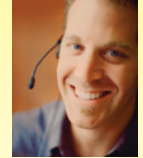

Quick Start

This manual is designed with a Quick Start path that outlines the necessary procedures to get your model up and running in the shortest time possible. If you are an experienced R/C enthusiast you will find it helpful and fast. Be sure and read through the rest of the manual to learn about important safety, maintenance, and adjustment procedures. Turn to page 7 to begin.



BEFORE YOU PROCEED

Carefully read and follow all instructions in this and any accompanying materials to prevent serious damage to your model. Failure to follow these instructions will be considered abuse and/or neglect.

Before running your model, look over this entire manual and examine the model carefully. If for some reason you decide it is not what you wanted, then do not continue any further. Return the model to your hobby dealer. **Note that your hobby dealer absolutely cannot accept an item for return or exchange after it has been run or is otherwise no longer in as-new condition.**

 **Note:** The Power System is **NOT WATERPROOF**. Do not expose the power system to any type of water, condensation, or moisture. Water damage voids warranty coverage.

Warnings, Helpful Hints, & Cross-References

Throughout this manual, you'll notice warnings and helpful hints identified by the icons below. Be sure to read them!

 An important warning about personal safety or avoiding damage to your model and related components.

 Special advice from Traxxas to make things easier and more fun.

 Refers you to a page with a related topic.

Support

If you have any questions about your model or its operation, call the Traxxas Technical Support line toll-free at: **1-888-TRAXXAS (1-888-872-9927)***

Technical support is available Monday through Friday from 8:30am to 9:00pm central time. Technical assistance is also available at Traxxas.com. You may also e-mail customer support with your question at support@Traxxas.com. Join thousands of registered members in our online community at Traxxas.com.

Traxxas offers a full-service, on-site repair facility to handle any of your Traxxas service needs. Maintenance and replacement parts may be purchased directly from Traxxas by phone or online at BuyTraxxas.com. You can save time, along with shipping and handling costs, by purchasing replacement parts from your local dealer.

Do not hesitate to contact us with any of your product support needs. We want you to be thoroughly satisfied with your new model!

REGISTERING YOUR MODEL

In order to serve you better as our customer, please register your product within 10 days of your purchase online at Traxxas.com/register or mail the enclosed registration card.

Traxxas.com/register

Traxxas
6250 Traxxas Way
McKinney, TX 75070
Phone: 972-265-8000
Toll-free 1-888-TRAXXAS

Internet
Traxxas.com
E-mail: support@Traxxas.com

Entire contents ©2013 Traxxas. Traxxas, Ready-To-Race, Ready-To-Win and ProGraphix are trademarks or registered trademarks of Traxxas. Other brand names and marks are the property of their respective holders and are used only for purposes of identification. No part of this manual may be reproduced or distributed in print or electronic media without the express written permission of Traxxas. Specifications are subject to change without notice.



Official
Licensed
Product

Ford Oval and nameplates are registered trademarks owned and licensed by Ford Motor Company.

TM and © National Hot Rod Association 2012. All rights reserved. The trademark NHRA and other trademarks used are the exclusive property of the National Hot Rod Association and used only with its permission. NHRA and the NHRA names and logos are service marks, trademarks, and/or registered trademarks of the National Hot Rod Association.

® and © Copyright 2012 The Maxx Trust. All Rights Reserved. Courtney Force and all logos and likenesses are trademarks exclusively licensed to John Force Racing, Inc. Used with permission. www.johnforce.com

*US residents only

SAFETY PRECAUTIONS



All instructions and precautions outlined in this manual should be strictly followed to ensure safe operation of your model.



This model is not intended for use by children under 14 years of age without the supervision of a responsible and knowledgeable adult.



When Operated with NiMH Batteries

No previous experience with radio controlled models is required. Models require a minimum of setup, maintenance, or support equipment.

(Battery not included)



When Operated with LiPo Batteries

Expert Drivers Only! This product is capable of extreme speed and acceleration! Experience with LiPo batteries and the additional charging, storage, and operation requirements of LiPo batteries is required. Ages 14 and under should not use LiPo batteries without adult supervision.

(Battery not included)



All of us at Traxxas want you to safely enjoy your new model. Operate your model sensibly and with care, and it will be exciting, safe, and fun for you and those around you. Failure to operate your model in a safe and responsible manner may result in property damage and serious injury. The precautions outlined in this manual should be strictly followed to help ensure safe operation. You alone must see that the instructions are followed and the precautions are adhered to.

IMPORTANT POINTS TO REMEMBER

- Your model is not intended for use on public roads or congested areas where its operation can conflict with or disrupt pedestrian or vehicular traffic.
- Never, under any circumstances, operate the model in crowds of people. Your model is very fast and could cause injury if allowed to collide with anyone.
- Because your model is controlled by radio, it is subject to radio interference from many sources that are beyond your control. Since radio interference can cause momentary losses of radio control, always allow a safety margin in all directions around the model in order to prevent collisions.
- The motor, battery, and speed control can become hot during use. Be careful to avoid getting burned.
- Don't operate your model at night, or anytime your line of sight to the model may be obstructed or impaired in any way.
- **Most importantly, use good common sense at all times.**

BATTERIES AND BATTERY CHARGING

The speed control uses rechargeable batteries that must be handled with care for safety and long battery life. Make sure to read and follow all instructions and precautions that were provided with your battery packs and your charger. It is your responsibility to charge and care for your battery packs properly. In addition to your battery and charger instructions, here are some more tips to keep in mind.

- Never leave batteries to charge unattended.
- Remove the batteries from the model while charging.
- Allow the battery packs to cool off between runs (before charging).
- Always unplug the battery from the electronic speed control when the model is not in use and when it is being stored or transported.
- Do not use battery packs that have been damaged in any way.
- Do not use battery packs that have damaged wiring, exposed wiring, or a damaged connector.
- Children should have responsible adult supervision when charging and handling batteries.

LiPo Batteries

WARNING: Lithium Polymer (LiPo) batteries require special care and handling procedures for long life and safe operation. LiPo batteries are intended only for advanced users that are educated on the risks associated with LiPo battery use. **Traxxas does not recommend that anyone under the age of 14 use or handle LiPo battery packs without the supervision of a knowledgeable and responsible adult.**

LiPo batteries have a minimum safe discharge voltage threshold that should not be exceeded. The ESC is equipped with built-in Low-Voltage Detection that alerts the driver when LiPo batteries have reached their minimum voltage (discharge) threshold. **It is the driver's responsibility to stop immediately to prevent the battery pack from being discharged below its safe minimum threshold.**

Low-Voltage Detection on the speed control is just one part of a comprehensive plan for safe LiPo battery use. **It is critical for you, the user, to follow all other instructions supplied by the battery manufacturer and the charger manufacturer for proper charging, use, and storage of LiPo batteries. Make sure you understand how to use your LiPo batteries.** Be aware that Traxxas shall not be liable for any special, indirect, incidental, or consequential damages arising out of the installation and/or use of LiPo batteries in Traxxas products.

If you have questions about LiPo battery usage, please consult with your local hobby dealer or contact the battery and/or charger manufacturer.



Important! Always Use Low-Voltage Detection With LiPo Batteries

From the factory, the model's speed control has been set up for LiPo batteries, with Low-Voltage Detection enabled. This system is designed to prevent accidental over-discharging of LiPo batteries. If you choose to run NiMH batteries in your model, the Low-Voltage Detection may be switched off to ensure maximum run time with NiMH batteries. **Caution: Low-Voltage Detection MUST be enabled if you use LiPo batteries in your model. Before using LiPo batteries in your model, make certain you read, understand, and follow all warnings and precautions included in this manual.**

TOOLS, SUPPLIES, AND REQUIRED EQUIPMENT

Your model comes with a set of specialty metric tools. You'll need to purchase other items, available from your hobby dealer, to operate and maintain your model.

SUPPLIED TOOLS AND EQUIPMENT:



2.5mm "L" wrench



2.0mm "T" wrench



1.5mm "L" wrench



Turnbuckle wrench

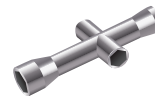

4-way wrench

REQUIRED EQUIPMENT: (SOLD SEPARATELY)



4 AA alkaline batteries



Rechargeable battery pack with Traxxas High-Current Connector

See page 11 for a list of compatible Traxxas Power Cell batteries



Battery charger
EZ-Peak Plus shown (Part#2933)

ALSO AVAILABLE:

Take Your Racing to the Next Level With Traxxas DTS-1 (patents pending)

Traxxas puts the *race* in drag race with authentic timing and scoring. The Traxxas DTS-1 staging and timing system uses laser precision to determine the winner with microsecond accuracy and lets you race at distances up to 330 feet (a quarter-mile, in 1/4 scale). Stage your cars with pinpoint accuracy and watch the lights—the DTS-1 system's LED starting tree lets you select Sportsman or Pro light sequence to start your race. The DTS-1 is completely portable and sets up in minutes to turn any smooth straightaway into your personal dragstrip!



Tune Like the Pros With Traxxas Link.

The TQi radio system is Docking Base ready so that you can use your iPhone® or iPod touch® and Traxxas Link (available on the App Store) to capture all the nuances of Pro competition. Traxxas Link also works with the DTS-1 to fill in your time slip with reaction time, elapsed time, and miles per hour. Keep a run history on each of your models. Share time slips and set up races with your friends—Traxxas Link runs the race and fills in the brackets for you. Any two cars can compete fairly, regardless of their top speeds! Race like the pros, using staging strategy to throw off your opponent. Only Traxxas makes drag racing so easy, accurate, fast, and fun—with all the info you need to go even faster next time! See page 27 for more info.

DTS-1, Docking Base, and Traxxas Link App all available separately.



For more information on batteries, see *Use the Right Batteries* on page 12.



Recommended Equipment

These items are not required for the operation of your model, but are a good idea to include in any R/C toolbox:

- Safety glasses
- Traxxas Ultra Premium Tire Glue, Part #6468 (CA glue)
- Hobby knife
- Side cutters and/or needle nose pliers
- Phillips screwdriver
- Soldering iron

ANATOMY OF THE MODEL

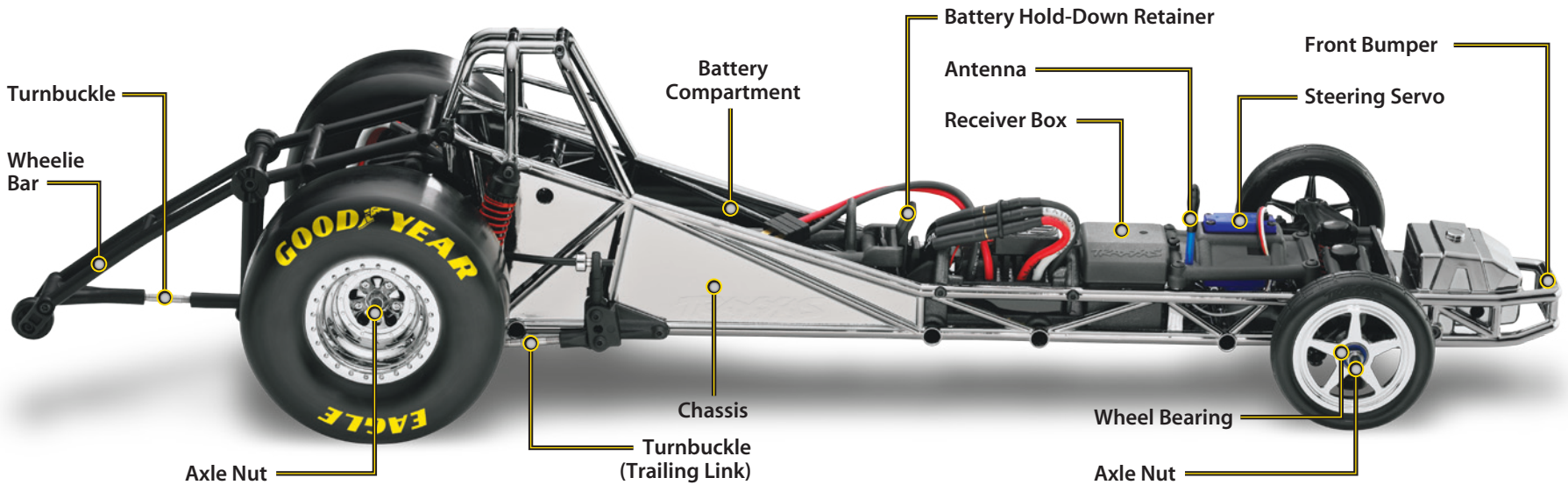
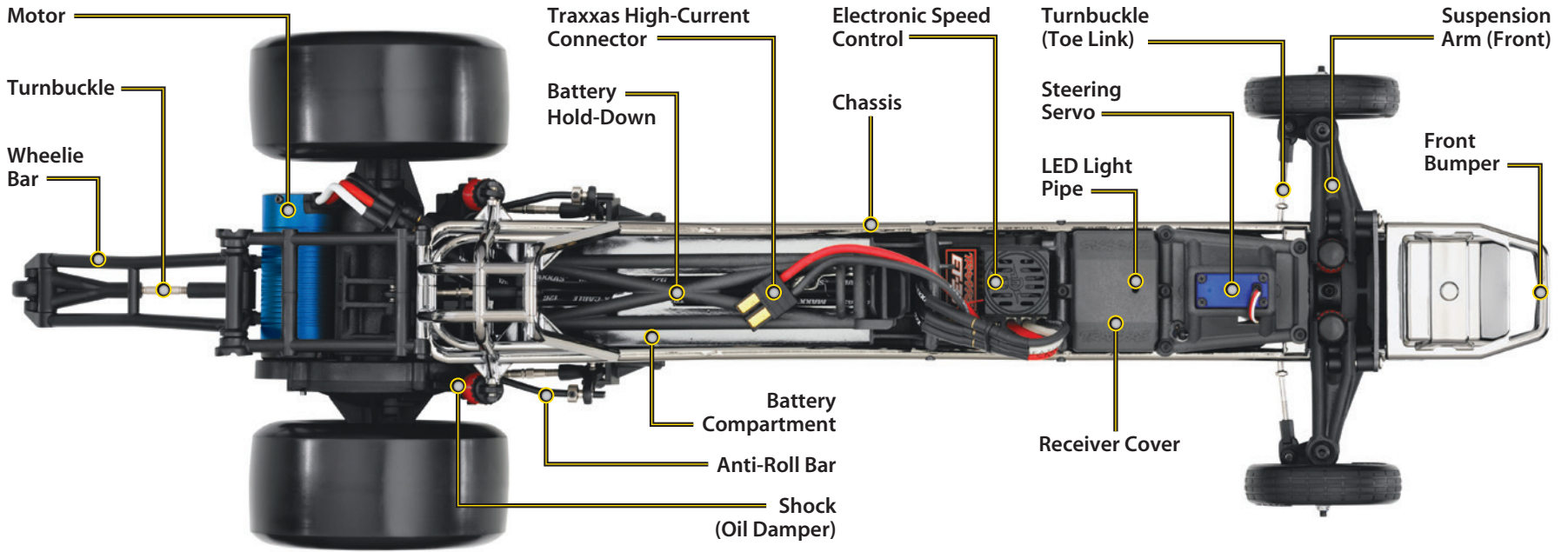

QUICK START: GETTING UP TO SPEED

 The following guide is an overview of the procedures for getting your model running. Look for the Quick Start logo on the bottom corners of Quick Start pages.

1. Read the safety precautions on page 4

For your own safety, understand where carelessness and misuse could lead to personal injury.

2. Charge the battery pack

Fully charge a battery pack (not included). Charge your battery now so it will be ready when you finish the other setup procedures.

3. Install batteries in the transmitter • See page 11

The transmitter requires 4 AA alkaline or rechargeable batteries.

4. Install battery pack in the model • See page 11

Your model requires a fully charged battery pack (not included).

5. Turn on the radio system • See page 12

Make a habit of turning the transmitter on first and off last.

6. Check servo operation • See page 12

Make sure the steering servo is working correctly.

7. Range test the radio system • See page 13

Follow this procedure to make sure your radio system works properly at a distance and that there is no interference from outside sources.

8. Drive your model • See pages 15-16

Driving tips and adjustments for your model.

9. Maintain your model • See page 21

Follow these critical steps to maintain the performance of your model and keep it in excellent running condition.



The Quick Start Guide is not intended to replace the full operating instructions available in this manual. Please read this entire manual for complete instructions on the proper use and maintenance of your model.

RAISING AND ADJUSTING THE BODY

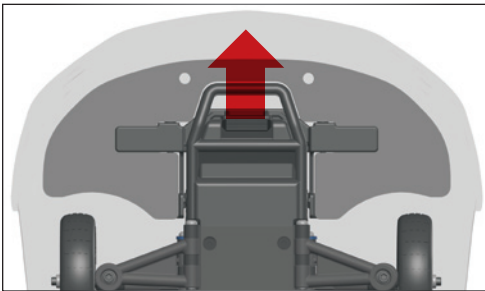

Your model has a realistic tilt-up body and does not require body clips. To raise the body for chassis access, reach beneath the front bumper and pull the latch toward the front of the car and gently lift the body. The rear body pivot has detents and will hold the body in place. The tightness of the pivots may be adjusted by tightening the pivot screw using a 2.5mm hex driver.

Note: Over-tightening the pivot screws will result in premature wear of the body mount detents.

Front body height can be adjusted by raising the mount in its holder. To access

the body mount, first remove the 4x10 countersunk screws that secure the body mount to the body. Then, you may remove the 3mm screws that secure the mount, move the mount to the position you wish to use, and reinstall the screws. Refer to the exploded views in your Service and Support Guide for more information.

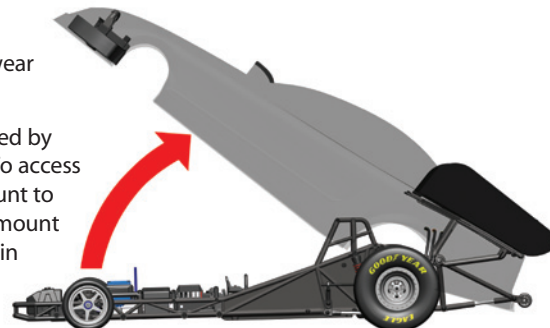

Look for the Quick Start logo at the bottom of Quick Start pages.





Applying Decals

The main decals for your model have been applied at the factory. Additional decals are printed on self-adhesive clear mylar and are die-cut for easy removal. Use a hobby knife to lift the corner of a decal and lift it from the backing.

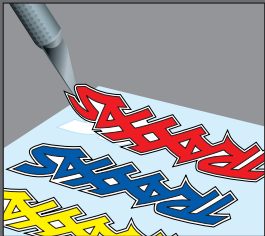

To apply the decals, place one end down, hold the other end up, and gradually smooth the decal down with your finger as you go. This will prevent air bubbles. Placing both ends of the decal down and then trying to smooth it out will result in air pockets. Look at the photos on the box for typical decal placement.

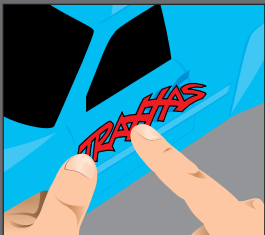

INTRODUCTION

Your model includes the latest Traxxas TQi 2.4GHz transmitter with Traxxas Link™ Model Memory. The transmitter's easy-to-use design provides instant driving fun for new R/C enthusiasts, and also offers a full complement of pro-level tuning features for advanced users – or anyone interested in experimenting with the performance of their model. The steering and throttle channels feature adjustable Exponential, End Points, and Sub-Trims. Steering and braking Dual Rate are also available. Many of the next-level features are controlled by the Multi-Function knob, which can be programmed to control a variety of functions. The detailed instructions (page 22) and Menu Tree (page 25) included in this manual will help you understand and operate the advanced functions of the new TQi radio system. For additional information and how-to videos, visit Traxxas.com.

RADIO AND POWER SYSTEM TERMINOLOGY

Please take a moment to familiarize yourself with these radio and power system terms. They will be used throughout this manual. A detailed explanation of the advanced terminology and features of your new radio system begins on page 22.

2.4GHz Spread Spectrum – This model is equipped with the latest R/C technology. Unlike AM and FM systems that require frequency crystals and are prone to frequency conflicts, the TQi system automatically selects and locks onto an open frequency, and offers superior resistance to interference and “glitching.”

Balance Charger – A LiPo battery contains individual cells. A balance charger monitors the voltage of each cell and charges the cells equally. This assures maximum performance and battery life by preventing individual cells within the pack from over-charging. Traxxas recommends the EZ-Peak Plus balance charger for Traxxas Power Cell LiPo batteries.

BEC (Battery Eliminator Circuit) - The BEC can either be in the receiver or in the ESC. This circuit allows the receiver and servos to be powered by the main battery pack in an electric model. This eliminates the need to carry a separate pack of 4 AA batteries to power the radio equipment.

Brushless Motor - A D/C brushless motor replaces the brushed motor's traditional commutator and brush arrangement with intelligent electronics that energize the electromagnetic windings in sequence to provide rotation. Opposite of a brushed motor, the brushless motor has its windings (coils) on the perimeter of the motor can and the magnets are mounted to the spinning rotor shaft.

Charging bag – A fire-retardant sleeve used to contain batteries during charging. The charging bag is designed to mitigate the effects of a fire or explosion due to the use of an incorrect charger, charger setting, or a damaged battery. ALWAYS charge LiPo batteries in a charging bag or other fire-containment vessel designed for battery charging.

Cogging - Cogging is a condition sometimes associated with brushless motors. Typically, it is a slight stutter noticed when accelerating from a stop. It happens for a very short period as the signals from the electronic speed control and the motor synchronize with each other.

Current - Current is a measure of power flow through the electronics, usually measured in amps. If you think of a wire as a garden hose, current is a measure of how much water is flowing through the hose.

Docking Base – Accessory base for the TQi transmitter that permits the installation of an Apple iPod touch® or iPhone.® *See page 27 for more information.*

ESC (Electronic Speed Control) - An electronic speed control is the electronic motor control inside the model. Electronic speed controls use power more efficiently than mechanical speed controls so that the battery runs longer. An electronic speed control also has circuitry that prevents loss of steering and throttle control as the battery loses its charge.

4-channel radio system - The TQi radio system, consisting of the receiver, the transmitter, and the servo. The system uses four channels: one to operate the throttle, one to operate the steering, one to select the driving mode (Burnout, Stage, Race), and one to operate the electronic Launch Control (on/off).

Frequency band - The radio frequency used by the transmitter to send signals to your model. This model operates on the 2.4GHz direct-sequence spread spectrum.

kV Rating - Brushless motors are often rated by their kV number. The kV rating equals no-load motor RPM with 1 volt applied. The kV increases as the number of wire turns in the motor decreases. As the kV increases, the current draw through the electronics also increases.

LiPo – Abbreviation for Lithium polymer batteries. This type of battery chemistry provides the maximum possible performance for your model. However, LiPo batteries are not for novice users and require specific charging and handling to provide reliable and

safe operation. Follow all the precautions in this manual as well as any precautions and warnings included with your batteries before charging LiPo batteries and installing them in your model.

mAh – Abbreviation for milliamp hour. A measure of the capacity of the battery pack. The higher the number, the longer the battery will last between recharges.

Neutral position - The standing position that the servos seek when the transmitter controls are at the neutral setting.

NiMH - Abbreviation for nickel-metal hydride, the most common radio-control battery type. NiMH packs have lower current handling ability and less capacity than LiPo packs, but are generally lower in cost and provide reliable performance.

Receiver - The radio unit inside your model that receives signals from the transmitter and relays them to the servos.

Resistance - In an electrical sense, resistance is a measure of how an object resists or obstructs the flow of current through it. When flow is constricted, energy is converted to heat and is lost.

Rotor - The rotor is the main shaft of the brushless motor. In a brushless motor, the magnets are mounted to the rotor, and the electromagnetic windings are built into the motor housing.

Sensor – Device in the model that gathers data for telemetry such as temperature, voltage, or RPM.

Sensored - Sensored refers to a type of brushless motor that uses an internal sensor in the motor to communicate rotor position information back to the electronic speed control.

Sensorless - Sensorless refers to a brushless motor that uses advanced instructions from an electronic speed control to provide smooth operation. Additional motor sensors and wiring are not required.

Servo - Small motor unit in your model that operates the steering mechanism.

Telemetry – Describes the capability for the model to provide real-time information such as speed, temperature, RPMs, and voltage back to the transmitter for display.

Transmitter - The hand-held radio unit that sends throttle and steering instructions to your model.

Traxxas Link – iPhone/iPod touch application that provides access to telemetry data and adjustments in the TQi radio system. Sold separately on the App Store (Apple.com). *See page 27 for more information.*

Trim - The fine-tuning adjustment of the neutral position of the servos, made by adjusting the throttle and steering trim knobs on the face of the transmitter. **Note:** The Multi-Function knob must be programmed to serve as a throttle trim adjustment.

Thermal Shutdown Protection - Temperature sensing electronics used in the electronic speed control detect overloading and overheating of the transistor circuitry. If excessive temperature is detected, the unit automatically shuts down to prevent damage to the electronics.

Voltage - Voltage is a measure of the electrical potential difference between two points, such as between the positive battery terminal and ground. Using the analogy of the garden hose, while current is the quantity of water flow in the hose, voltage corresponds to the pressure that is forcing the water through the hose.

IMPORTANT RADIO SYSTEM PRECAUTIONS

- For maximum range, always point the front of the transmitter toward the model.
- Do not kink the receiver's antenna wire. Kinks in the antenna wire will reduce range.
- DO NOT CUT any part of the receiver's antenna wire. Cutting the antenna will reduce range.
- Extend the antenna wire in the model as far as possible for maximum range. It is not necessary to extend the antenna wire out of the body, but wrapping or coiling the antenna wire should be avoided.
- Do not allow the antenna wire to extend outside the body without the protection of an antenna tube, or the antenna wire may get cut or damaged, reducing range. It is recommended to keep the wire inside the body (in the antenna tube) to prevent the chance of damage.



To prevent loss of radio range do not kink or cut the black wire, do not bend or cut the metal tip, and do not bend or cut the white wire at the end of the metal tip.

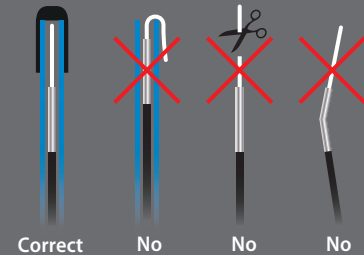



ET 2400 Motor Specifications

Type:
1415 Sensorless brushless

RPM/volt (kV): 2400

Magnet type:
Ultra High-Temperature Sintered Neodymium

Connection type:
3.5mm bullet

Wire size: 12 Gauge

Max RPM: 75,000

Diameter: 36mm (1.42")

Length: 70mm (2.76")

Weight: 299g (10.55oz)

ESC/Motor Wiring Diagram

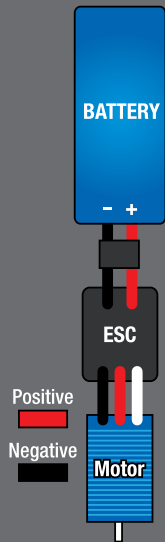

Your model is equipped with the newest TQi 2.4GHz transmitter with Traxxas Link™ Model Memory. The transmitter has four channels for controlling the throttle modes, electronic Launch Control, and steering. The receiver inside the model has five output channels. Your model is equipped with one servo and an electronic speed control.

TRANSMITTER AND RECEIVER

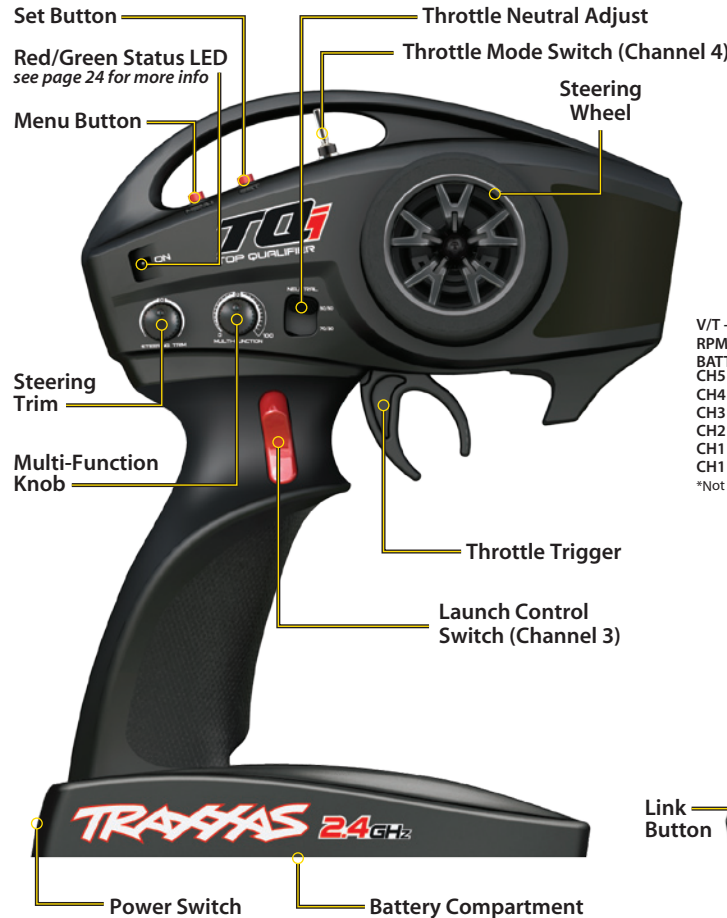

MODEL WIRING DIAGRAM

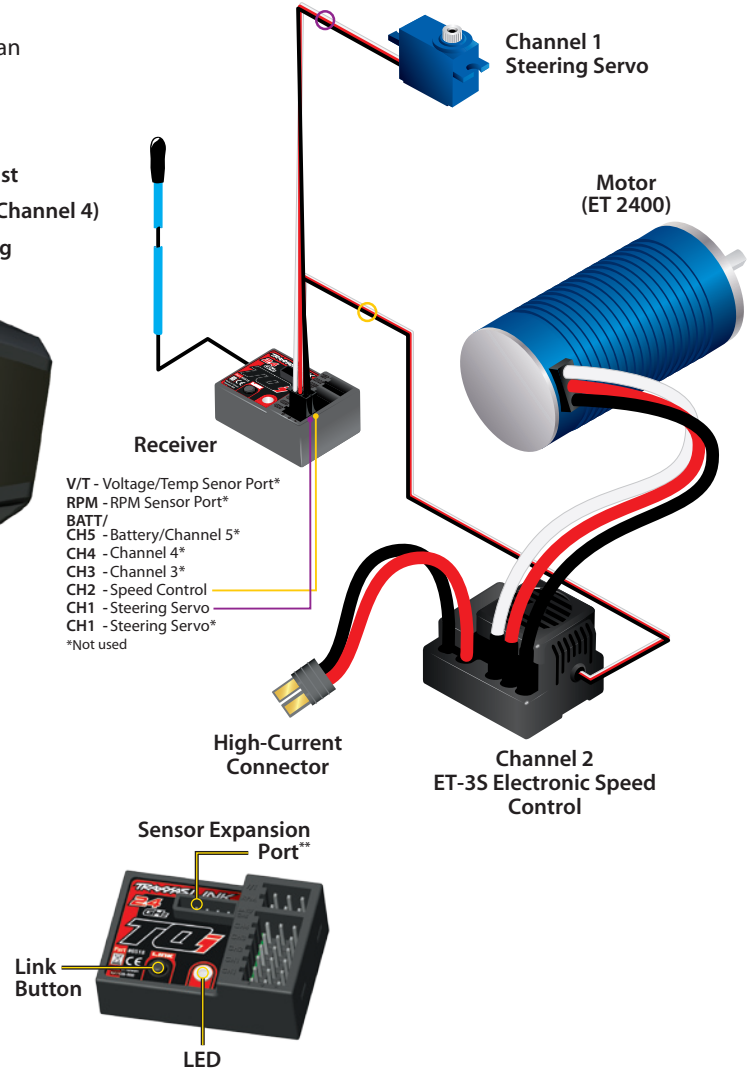

** Accessory sensor port for use with TQi Docking Base (see Traxxas.com and included materials for more information)

INSTALLING TRANSMITTER BATTERIES

Your TQi transmitter uses 4 AA batteries. The battery compartment is located in the base of the transmitter.

1. Remove the battery compartment door by sliding the door open.
2. Install the batteries in the correct orientation as indicated in the battery compartment.
3. Reinstall the battery door and snap it closed.
4. Turn on the transmitter and check the status indicator for a solid green light.

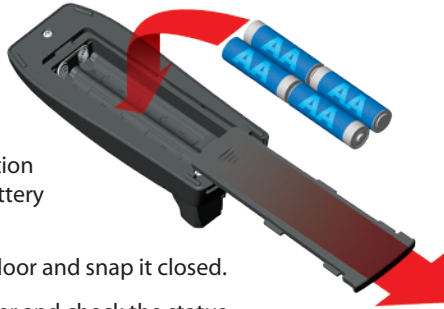

If the status LED flashes red, the transmitter batteries may be weak, discharged, or possibly installed incorrectly. Replace with new or freshly charged batteries. The power indicator light does not indicate the charge level of the battery pack installed in the model. Refer to the Troubleshooting section on page 24 for more information on the transmitter Status LED codes.



INSTALLING THE BATTERY PACK

Your model features a 2-position battery hold-down to accommodate a variety of LiPo and NiMH batteries. From the factory, the compartment is set up for 6-cell NiMH packs and the Traxxas Power Cell LiPo batteries indicated in the Power Cell Battery Compatibility Chart. A "tall" battery strap clip is included to accommodate 7- and 8-cell NiMH hump packs as well as other Traxxas Power Cell LiPo batteries. See the following chart for the complete listing of Traxxas Power Cell batteries that may be used in the model.

Note: Your model requires a battery pack with a Traxxas High-Current connector. Do not attempt to modify or remove the High-Current Connector to allow fitment of a battery with a different connector. Modifying or removing the High-Current Connector will void the model's 90-day Electronics Warranty.



Power Cell Battery Compatibility Chart

Battery	Item #	Standard Clip	"Tall" Clip	Gearing	Speed
7-Cell Series 5 NiMH Hump	2961		•	14/68	40+mph
8-Cell Series 5 NiMH Hump	2963		•	14/68	40+mph
2S 3300mAh LiPo	2840	•		14/68	40+mph
2S 3300mAh LiPo	2840	•		16/68	45+mph
2S 3300mAh LiPo	2840	•		18/68	50+mph
2S 4000mAh LiPo	2841	•		14/68	40+mph
2S 4000mAh LiPo	2841	•		16/68	45+mph
2S 4000mAh LiPo	2841	•		18/68	50+mph
2S 4000mAh LiPo	2841	•		20/68	50+mph
2S 5800mAh LiPo	2843	•		14/68	40+mph
3S 3300mAh LiPo	2846	•		14/68	55+mph
3S 4000mAh LiPo	2849	•		14/68	60+mph
2S 10000mAh LiPo	2854		•	14/68	40+mph
3S 6400mAh LiPo	2857		•	16/68	60+mph
3S 6400mAh LiPo	2857		•	18/68	65+mph
3S 6400mAh LiPo	2857		•	20/68	70+mph

Installing the Battery Pack

1. Insert the battery into the tray with the High-Current Connector positioned towards the front of the car.
2. Insert the hold-down into the lower set of holes in the support.
3. Align the hold-down over the retainer and press down until it snaps into place.
4. When you are ready to drive, connect the battery's High-Current Connector to the speed control.

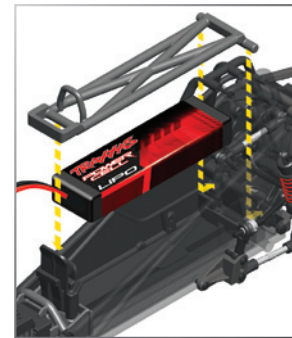

Note: The speed control does not have an on/off switch. Make certain your transmitter is switched on and you are ready to operate the model before plugging the battery into the speed control.

Removing the Battery Packs

1. Unplug the High-Current Connector.
2. Flex the retainer away from the battery.
3. Lift the battery hold-down up and remove the battery.



If the power indicator doesn't light green, check the polarity of the batteries. Check rechargeable batteries for a full charge. If you see any other flashing signal from the LED, refer to the chart on page 24 to identify the code.



The following Traxxas High-Current Connector packages are available from your hobby dealer. When using adapters, be careful not to exceed the current rating of the Molex connector.

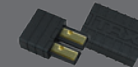

Part #3060
Single Male/Female



Part #3080
2-Pack Female



Part #3061
Male Charge Adapter



Part #3070
2-Pack Male



Part #3062
Female Charge Adapter





Remember, always turn the TQi transmitter on first and off last to avoid damage to your model.



Use the Right Batteries

Your transmitter uses AA batteries. Use new alkaline batteries, or rechargeable batteries such as NiMH (Nickel Metal Hydride) batteries in your transmitter. Make sure rechargeable batteries are fully charged according to the manufacturer's instructions.

If you use rechargeable batteries in your transmitter, be aware that when they begin to lose their charge, they lose power more quickly than regular alkaline batteries.

Caution: Discontinue running your model at the first sign of weak batteries (flashing red light) to avoid losing control.



When rechargeable batteries begin to lose their charge, they will fade much faster than alkaline dry cells. Stop immediately at the first sign of weak batteries. Never turn the transmitter off when the battery pack is plugged in. The model could run out of control.



RADIO SYSTEM RULES

- **Always turn your TQi transmitter on first and off last.** This procedure will help to prevent your model from receiving stray signals from another transmitter, or other source, and running out of control. Your model has electronic failsafes to prevent this type of malfunction, but the first, best defense against a runaway model is to always turn the transmitter on first and off last.
- In order for the transmitter and receiver to bind to one another, the receiver in the model must be turned on within 20 seconds of turning on the transmitter. The transmitter LED will flash fast red, indicating a failure to link. If you miss it, simply turn off the transmitter and start over.
- Always turn on the transmitter before plugging in the battery.
- Always use new or freshly charged batteries for the radio system. Weak batteries will limit the radio signal between the receiver and the transmitter. Loss of the radio signal can cause you to lose control of your model.

RADIO SYSTEM BASIC ADJUSTMENTS



Throttle Neutral Adjustment

The throttle neutral adjustment is located on the transmitter face and controls the forward/reverse travel of the throttle trigger. Change the adjustment by pressing the button and sliding it to the desired position. There are two settings available:

50/50: Allows equal travel for both acceleration and reverse.

70/30: Allows more throttle travel (70%) and less reverse travel (30%).

Note: We strongly recommend to leave this control in its factory location until you become familiar with all the adjustments and capabilities of your model. To change the throttle neutral adjust position, turn the transmitter off before adjusting the neutral position. **You will need to reprogram your electronic speed control to recognize the 70/30 setting.** Turn to ESC Setup Programming on page 14 for instructions.

Torque Control Setting (Multi-Function Knob)

The Multi-Function knob can be programmed to control a variety of functions. From the factory, the Multi-Function knob controls the Torque Control setting. Torque Control allows you to set the amount of torque limiting the speed control will provide. The ideal setting will match the car's torque to the available traction, so



you can launch as quickly as possible without breaking traction and spinning the tires. Slippery conditions require less torque; high-traction conditions allow you to increase the torque setting.

Adjusting the Torque Control is simple. To increase torque, turn the Multi-Function knob clockwise. Turning the knob to its stop will result in zero torque limiting (maximum power). To reduce torque, turn the Multi-Function knob counterclockwise. For racing, you will typically adjust the Torque Control setting until you can launch at full throttle without spinning the tires. See "Driving your Model" on page 15 for more information. **Note: Extremely limited torque settings will greatly inhibit vehicle performance and will make the model behave as though its battery is low.**



Steering Trim

The electronic steering trim located on the face of the transmitter adjusts the neutral (center) point of the steering channel.

USING THE RADIO SYSTEM

The TQi Radio System has been pre-adjusted at the factory. The adjustment should be checked before running the model, in case of movement during shipping. Here's how:

1. Turn the transmitter switch on. The status LED on the transmitter should be solid green (not flashing).
2. **Elevate the model on a block or a stand so that all the tires are off the ground.** Make sure your hands are clear of the moving parts of the model.
3. Plug the battery pack in the model into the speed control. The model is now ON.
4. Turn the steering wheel on the transmitter back and forth and check for rapid operation of the steering servo. Also, check that the steering mechanism is not loose or binding. If the steering operates slowly, check for weak batteries.
5. When looking down at the model, the front wheels should be pointing straight ahead. If the wheels are turned slightly to the left or right, slowly adjust the steering trim control on the transmitter until they are pointing straight ahead.
6. Gently operate the throttle trigger to ensure that you have forward and reverse operation, and that the motor stops when the throttle trigger is at neutral. **WARNING: Do not apply full throttle in forward or reverse while the model is elevated.**
7. Once adjustments are made, unplug the model first, and then turn off the transmitter.

RADIO SYSTEM CONTROLS



Range-Testing the Radio System

Before each running session with your model, you should range-test your radio system to ensure that it operates properly.

1. Turn on the radio system and check its operation as described in the previous section.
2. Have a friend watch the model. Make sure hands and clothing are clear of the wheels and other moving parts on the model.
3. Walk away from the model with the transmitter until you reach the farthest distance you plan to operate the model.
4. Operate the controls on the transmitter once again to be sure that the model responds correctly.
5. Do not attempt to operate the model if there is any problem with the radio system or any external interference with your radio signal at your location.



Higher Speeds Require Greater Distance

The faster you drive your model, the more quickly it will near the limit of radio range. At 60mph, a model can cover 88 feet every second! It's a thrill, but use caution to keep your model in range. If you want to see your model achieve its maximum speed, it is best to position yourself in the middle of the model's running area, not the far end, so you drive

the model towards and past your position. In addition to maximizing the radio's range, this technique will keep your model closer to you, making it easier to see and control.

Your model's radio system is designed to operate reliably up to the approximate distance that it is no longer easy or comfortable to see and control the model. Most drivers will struggle to see and drive their model at distances farther than a football field (300+ feet). At greater distances, you could lose sight of your model and you may also exceed the radio system's operating range, which will cause the failsafe system to activate. For best visibility and control of your model, keep your model within 200 feet, regardless of the maximum range available. **No matter how fast or far you drive your model, always leave adequate space between you, the model, and others. Never drive directly toward yourself or others.**

TQi Binding Instructions

For proper operation, the transmitter and receiver must be electronically 'bound.' **This has been done for you at the factory.** Should you ever need to re-bind the system or bind to an additional transmitter or receiver, follow these instructions. **Note:** The receiver must be powered on for binding and the transmitter and receiver must be within 5 feet of each other.

1. Press and hold the transmitter's SET button as you switch the transmitter on. The transmitter's LED will flash red slowly.
2. Press and hold the receiver's LINK button as you switch on the speed control by plugging a battery into it.
3. When the transmitter and receiver's LEDs turn solid green, the system is bound and ready for use. Confirm that the steering and throttle operate properly before driving your model.

Setting up the Antenna

The receiver antenna has been set up and installed from the factory. The antenna is secured by a 3x4mm set screw. To remove the antenna tube, simply remove the set screw with the included 1.5mm wrench.

When reinstalling the antenna, slide the wire into the bottom of the tube until the white tip of the antenna is at the top of the tube under the black cap. Next, insert the tube into the mount, making sure the antenna wire is in the slot in the antenna mount. Install the set screw next to the antenna tube. Use a 1.5mm wrench to tighten the screw. Do not over-tighten. Do not bend or kink the antenna wire or shorten the antenna tube.

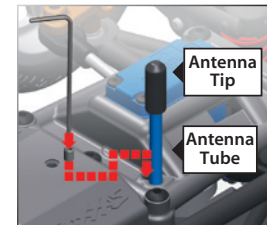

Using Reverse: While driving, push the throttle trigger forward to apply brakes. Once stopped, return the throttle trigger to neutral. Push the throttle trigger forward again to engage proportional reverse.



Automatic Failsafe

The TQi transmitter and receiver are equipped with an automatic failsafe system that does not require user programming. In the event of signal loss or interference, the throttle will return to neutral and the steering will hold its last commanded position. If failsafe activates while you are operating your model, determine the reason for signal loss and resolve the problem before operating your model again.

In order to re-acquire the signal after the failsafe has activated, you will need to walk a longer distance closer to the model than the distance the model travelled out of range. Simply keep walking towards the model until you re-acquire the signal.





ET-3S Specifications

Cells:
8-cell NiCad/NiMH, 3S LiPo

Resistance:
0.0003 Ohms per phase

Brake :
Proportional with adjustable curve

Reversible:
Yes - with lockout

Low-Voltage Detection:
Programmable

Case Size:
1.75"x1.44"x0.85"

Weight with Wires:
121g

Connector Type:
3.5mm bullet



The Traxxas ET-3s speed control is powered by Castle. Additional features and instructions are available in the *Driver's Ed Guide* at CastleCreations.com.

The ET-3S speed control should not need reprogramming with normal use. However, if you install a different radio system in your model, or change the transmitter's throttle-neutral setting from 50/50 to 70/30, you will need to reprogram the speed control. Follow these instructions to reprogram the speed control:

1. Elevate the model so the rear wheels are off the ground and install the battery of your choice in the battery compartment.
2. Switch on your transmitter.
3. Hold full throttle while you switch the model on by plugging a charged battery pack into the ET-3S controller. After a few seconds, you will hear multiple tones and the RED LED will light.
4. Hold full brake. After a few seconds, you will hear multiple tones and the YELLOW LED will light.
5. Release the trigger to the neutral position. After a few seconds, you will hear multiple tones and ALL THE LEDs will light.
6. Wait a few more seconds for the speed control to "arm," indicated by a double tone. You are now ready to drive.

Low-Voltage Detection

Important! Always Use Low-Voltage Detection with LiPo Batteries. From the factory, the model's speed control has been set up for LiPo batteries, with Low-Voltage Detection enabled. This system is designed to prevent accidental over-discharging of LiPo batteries. **CAUTION: Low-Voltage Detection MUST be enabled if you use LiPo batteries in your model.**

If you choose to run NiMH batteries in your model, Low-Voltage Detection may be switched off to ensure maximum run time. Follow these steps to access the Low-Voltage Detection programming mode:

1. Turn your transmitter on and hold full throttle.
2. While holding full throttle, plug a fully charged battery into the speed control. **Note:** You may need assistance to complete this step.
3. Continue to hold full throttle. After a few seconds, you will hear four consecutive beeps, signaling full-throttle calibration.
4. Continue to hold full throttle. Once you hear a second set of four beeps, release the throttle to neutral. You are now in programming mode.

Note: Low-Voltage Detection is the seventh programming mode. In order to skip Programming Modes 1–6, make sure you push the throttle trigger to REVERSE, then release to neutral, as indicated in the steps below. **Failure to do so may cause unintended reprogramming of your speed control, resulting in poor performance of your vehicle.**

5. Push the throttle trigger to the reverse position and hold until the speed control beeps quickly, then release. The speed control will beep once, pause, and then beep twice to signify that you are in Programming Mode 1, Option 2.
6. Continue to *push reverse/release* to neutral until you hear seven beeps, a pause, and then one beep, signaling you are in Programming Mode 7, Option 1.
7. Pull the trigger to full throttle and hold until the speed control beeps quickly, then release. This will disable Low-Voltage Detection. You should hear eight beeps, a pause, then one beep, signaling you have moved to the next programming mode.
8. At this point, you can power off the speed control; then, power it back on to return to normal operation, or you can continue to *push reverse/release* to neutral six more times, making sure that you hear the fast confirmation beeps for each action. After the sixth time, the speed control will emit a tone, indicating the end of the programming cycle and the return to normal operation.



To enable Low-Voltage Detection for use with LiPo batteries, follow steps 1–5 above. For steps 6 and 7, continue to *push reverse/release to neutral* until you hear seven beeps, a pause, and then two beeps. Pull the trigger to full throttle and hold until the speed control beeps quickly, then release. This will enable Low-Voltage Detection. Complete step 8 to return to normal operation.

If you have questions or require technical assistance while performing this procedure, please contact Traxxas Technical Support at 1-888-TRAXXAS (1-888-872-9927). Outside of the US, call +1-972-265-8000.

Your model does much more than simulate the look of a full-size Funny Car; it also simulates its performance. In drag racing, a Funny Car competitor will first warm up the tires by performing a **Burnout**. The driver will spin the rear tires, heating them until they smoke, to warm and soften the rubber for maximum grip. Once the car is **Staged** (properly positioned on the starting line), the driver will engage a **Launch Control** system that allows the engine to be revved up and held to the RPM the driver wants for the start of the race. When the race begins, the driver disengages the Launch Control to instantly launch the car down the track, and uses the throttle pedal to modulate power and stay on the edge of traction. Your model features Burnout, Staging, and Race modes, plus an electronic Launch Control, that allow you to race in exactly the same way.

Burnout, Staging, and Race Modes

The three-position switch on top of the TQi transmitter controls the three power modes: Burnout, Staging, and Race.



Burnout Mode: Out of the box, the switch should be in the rearmost position, which is Burnout Mode. In this mode, there is no torque limiting. Use this mode to perform a burnout to warm the tires before a run (see *“Warming the Tires for Maximum Traction”*). Burnout Mode can also be used for general driving and for racing. Burnout Mode can be used with the Launch Control system (see *“Using Launch Control”*)



Staging Mode (*patents pending*): Move the switch to the middle position to access Staging Mode. This mode provides very fine low-speed control so you may easily stage the car when racing with the DTS-1 staging system and starting tree, or when simply using a starting line drawn on the pavement. When in staging mode, pulling the trigger approximately half way will cause the speed control to move the car in very small increments by rotating the motor's output shaft just 1/8 of a turn at a time. The car will “click” toward the starting line. As you pull the trigger closer to the grip, the car will “click” toward the line faster, until it achieves a steady crawl. You can move the car one “click” at a time by tapping the throttle trigger. The Staging Mode also works in reverse, in case you pull the car too far forward while staging. Staging Mode will operate with or without Launch Control engaged. **Note:** Do not drive the model in Staging Mode for extended periods or overheating may result.



Race Mode: Move the switch to the forward position to access Race Mode. This mode enables the transmitter's Multi-Function Knob to control the motor's torque. If the Multi-function Knob is turned fully clockwise, torque will not be limited and the model will put the maximum torque to the ground. As the Multi-Function Knob is turned counterclockwise, the torque-limiting effect is increased and the model will put less torque to the ground. Race Mode can be used in conjunction with Launch Control.



Using Launch Control (*patents pending*)

In full-size drag cars, a launch control system allows the driver to rev the engine to the RPM best for launching the car, and hold the RPM without moving the car until the lights go green. The model's electronic launch control system allows a similar technique.

Set the Launch Control switch so the top half of the switch is depressed. Launch Control is now engaged, and you can operate the throttle trigger without causing the model to move. Hold the trigger to full throttle with the model in Race Mode. When you're ready to launch the car, depress the lower half of the Launch Control switch. The transmitter will automatically apply full throttle with the torque limit you've selected using the Multi-Function Knob. Proportional throttle control is not affected. If you experience wheel spin, you can reduce throttle input by adjusting the trigger position. **Note:** Launch Control must be engaged while in Stage Mode for it to function properly when used in Burnout or Race Mode. Engaging Launch Control after switching to Burnout or Race mode will not affect throttle or braking.

Warming the Tires for Maximum Traction

Just like a full-size Funny Car, the model's traction can be enhanced by doing a “burnout” to warm the tires. To do a burnout, hold the wheelie bar as you apply the throttle so the tires spin on the pavement. Do not press the tires to the pavement, simply restrain the car from moving forward. A burnout should last 5 seconds or less. It is normal to smell warm rubber when performing a burnout, but the tires will not smoke. Run the car after the burnout to check available traction, and repeat the burnout if necessary to achieve the desired level of traction. Avoid consecutive burnouts without running or resting the vehicle between burnouts, or you may overheat the speed control.









Do Not Operate your model in Wet Conditions

Your new Traxxas model features a waterproof steering servo, but the electronic speed control, motor, receiver box, receiver, and the model itself are not waterproof or water-resistant. Do not operate the model in wet conditions, including wet pavement. Do not run the model through puddles. Operating this model on wet surfaces will reduce control and may damage the electronics, resulting in loss of control.

Racing Sequence Recap

To get the best possible drag-racing performance from your model, follow these steps:

- | | |
|---|--|
| 1. Select Burnout Mode and perform a burnout to warm the tires. |  |
| 2. Select Staging Mode. |  |
| 3. Engage Launch Control by depressing the upper half of the switch. Then stage the car. |  |
| 4. Select Race Mode. |  |
| 5. Hold the throttle trigger to full throttle. |  |
| 6. On the "Go!" signal, disengage Launch Control to launch the car. Use the trigger to adjust throttle input during your run. |  |

DRIVING PRECAUTIONS

Here are some important precautions to keep in mind.

- Allow the model to cool for a few minutes between runs. This is particularly important when using high capacity battery packs that allow extended periods of running. Monitoring temperatures will extend the lives of the batteries and motor.
- Do not continue to operate the model with low batteries or you could lose control of it. Indications of low battery power include slow operation, sluggish servos (slow to return to center), or ESC shutdown due to low voltage. Stop immediately at the first sign of weak batteries. When the batteries in the transmitter become weak, the power light will begin to flash red. Stop immediately and install new batteries.
- Because the model is controlled by radio, it is subject to radio interference from

many sources beyond your control. Since radio interference can cause momentary losses of control, allow a safety margin of space in all directions around the model in order to prevent collisions.

- Do not drive the model at night, on public streets, or in large crowds of people.
- If the model becomes stuck against an object, do not continue to run the motor. Remove the obstruction before continuing. Do not push or pull objects with the model.
- Use good, common sense whenever you are driving your model. Intentionally driving in an abusive and rough manner will only result in poor performance and broken parts. Take care of your model so that you can enjoy it for a long time to come.
- High performance vehicles produce small vibrations that may loosen hardware over time. Frequently check wheel nuts and other screws on your vehicle to ensure that all hardware remains properly tightened.

About Run Time

A large factor affecting run time is the type and condition of your batteries. The milliamp hour (mAh) rating of the batteries determines how large their "fuel tank" is. A 5000mAh battery pack will theoretically run twice as long as a 2500mAh pack. Because of the wide variation in the types of batteries that are available and the methods with which they can be charged, it's impossible to give exact run times for the model.

Another major factor that affects run time is how the model is driven. Run times may decrease when the model is driven repetitively from a stop to top-speed and with repetitive hard acceleration.

Tips for Increasing Run Time

- Use batteries with the highest mAh rating you can purchase.
- Read and follow all maintenance and care instructions provided by the manufacturer of your batteries and charger.
- Keep the electronic speed control cool. Make certain airflow to the speed control is unimpeded.
- Use the correct Low-Voltage Detection setting for your battery (*see page 14*). Low-Voltage Detection can be off for maximum NiMH battery runtime. Never use LiPo batteries while Low-Voltage Detection is turned off.
- Lower your gear ratio. Installing a smaller pinion or larger spur gear will lower your gear ratio, causing less power draw from the motor and battery, and reducing overall operating temperatures.
- Maintain your model. Do not allow dirt or damaged parts to cause binding in the drivetrain. Keep the motor clean.

mAh Ratings and Power Output

The mAh rating of the battery can affect your top speed performance. The higher capacity battery packs experience less voltage drop under heavy load than low mAh rated packs. The higher voltage potential allows increased speed until the battery begins to become discharged.

TUNING ADJUSTMENTS

Once you become familiar with driving your model, you might need to make adjustments for better driving performance.

Adjusting the Toe-in

Geometry and alignment specs play an important roll in your model's handling. Take the time to set them correctly. Set the steering trim on your transmitter to neutral. Now, adjust your servo and tie rods so that both wheels are pointing straight ahead and are parallel to each other (0-degrees toe-in). This will ensure the same amount of steering in both directions.

For increased stability, add one- to two-degrees of toe-in to each front wheel. Use the turnbuckles to adjust the alignment.

Ride Height

Ride height can be adjusted by turning the spring pre-load adjusters on the shock bodies. Turn the adjusters to the left to raise the ride height. Turn them to the right to lower the ride height. When adjusting spring pre-load be sure to change the adjustment equally on the left and right sides so the suspension remains balanced. Optimum ride height is 15mm clearance between the front of the chassis and the ground and 18mm between the rear of the chassis and the ground. Always set the ride height so the chassis has a slight forward rake, with the rear ride height slightly higher than the front ride height.

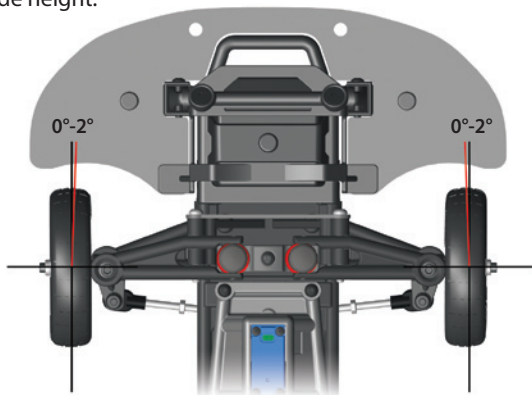

Factory Toe-In Settings

Front: 0-degrees

Rear: 0-degrees, non-adjustable

Adjusting the Anti-Roll Bar

Your model is equipped with an anti-roll bar to adjust its "roll-stiffness," the tendency for the chassis to lean in turns.

As shown in the illustration, moving the link toward the front of the car will decrease the stiffness of the anti-roll bar, allow greater chassis lean and more cornering traction. Moving the link toward the rear of the car will increase the stiffness of the anti-roll bar and reduce cornering traction. To adjust the link, loosen the setscrew in the upper link's pivot using the 1.5mm hex driver included with your model. Slide the link to the desired position, then tighten the set screw. To maintain balanced handling, always adjust the left and right sides of the anti-roll bar equally.

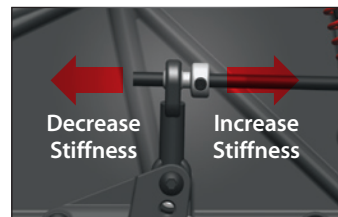

Caution: Since the car is a drag-racing model and is engineered primarily to run in a straight line, it will not corner as effectively as a general-purpose car. Reduce corner speed to prevent rolling the car over while turning.

Adjusting the Rear Suspension Linkages

The model's rear suspension has been designed for maximum drag racing performance. On high-traction surfaces, you may wish to experiment with reducing the tendency for the rear end to "squat" and transfer weight to the rear axle. The rear

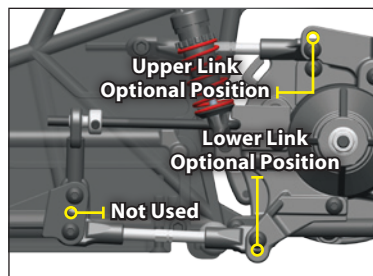

suspension's side links each have an additional adjustment hole on the transmission that will decrease squatting under acceleration. To further reduce squatting, the upper link may be moved to its optional position on the transmission as well. **Note:** The side links' chassis mounts have an open upper position, but using this position requires the sway bar to be removed. Removing the swaybar is not recommended.



Important: The shocks are assembled at the factory with a center-to-center distance (between the rod end balls) of 48mm. Any time the shocks are removed and disassembled, this distance should be checked to ensure proper operation of the suspension.

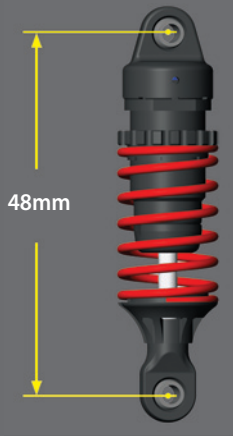

Adjusting the Wheelie Bar

The model's wheelie bar can be set very precisely to ensure proper weight transfer for maximum traction. To raise or lower the height of the wheelie bar, use the supplied 4mm wrench to turn the turnbuckle. If you are holding the rear of the car toward you, turning the turnbuckle counterclockwise will lower the wheelie bar (resulting in lower wheelies), and turning it clockwise will raise the wheelie bar (to allow higher wheelies). Experiment to see which setting gives the best weight transfer and performance.

SHOCKS

The 4 oil-filled shocks (dampers) effectively control the suspension movement by preventing the wheels and tires from continuing to "bounce" after rebounding from a bump. Changing the oil in the shocks can vary the suspension damping effect. Changing the oil to a higher viscosity oil will increase damping. Lowering the viscosity of the oil will cause the suspension damping to be reduced. Damping should be increased (with higher viscosity oil) if the model is bottoming out easily. Damping should be decreased (with thinner viscosity oil) if the model is hopping over small bumps and feels unstable. The viscosity of shock oil is affected by extremes in operating temperature; an oil of certain viscosity will become less viscous at higher temperatures and more viscous at lower temperatures. Operating in regions with cold temperatures may require lower viscosity oil. Your model's shocks are filled with 60 weight oil in the front and 40 weight oil in the rear. Only use 100% silicone oil in the shock.

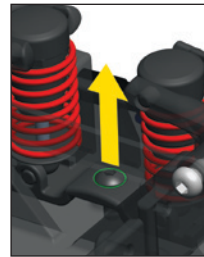

Removing the Front Shocks

To gain access to the front shocks, follow these steps. Refer to the exploded views in the included Service and Support Guide for reference:

1. Gently flex the suspension arms to free the shocks' caps from the arms.
2. Using the 2.0mm hex driver included with your model, remove the screw that secures the lower shock mount.
3. Lift the shocks out of the chassis.
4. Gently flex the lower shock mount to release the shocks.

Removing the Rear Shocks

To gain access to the rear shocks, follow these steps. Refer to the exploded views in the included Service and Support Guide for reference:

1. Using the 7mm wrench included with your model, remove the axle nuts from the rear wheels, and then remove the wheels.
2. Using the 2.0mm hex driver included with your model, remove the upper and lower screws that secure the shocks.

Replacing Shock Oil

The shocks have to be removed from the vehicle and disassembled to change the oil.

1. Remove the lower spring retainer and shock spring.
2. Remove the upper shock cap. If you cannot unscrew the cap with your fingers, pass the 2mm 'L' wrench through the cap's eyelet so you can apply more leverage. Turn the cap counterclockwise to loosen it.
3. Empty the used shock oil from the shock body.
4. Fill the shock with new silicone shock oil up to the top of the shock body.
5. Slowly move the piston up and down (always keeping it submerged in oil) to release the air bubbles. Let the shock sit for a few minutes to allow any remaining air bubbles to surface.
6. Slowly thread the upper cap with the installed shock bladder onto the shock body. The excess oil will bleed out of the small hole in the shock cap.
7. Tighten the shock cap until snug.

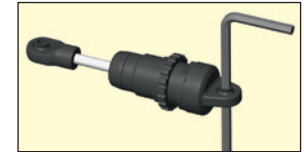

Springs

The front and rear springs on the model have identical spring rates, but different lengths. Ensure the triple orange springs (three orange marks on the spring) are on the rear, and the double orange springs (two orange marks) are on the front. The springs' preload can be adjusted by turning the spring pre-load adjuster. Adjusting the preload changes the ride height. Adjust the preload so that the ride height at the front of the model is 14-15mm and the ride height at the rear of the model is 16-18mm. Rougher surfaces may require increased ride height.

GEARING AND DIFFERENTIAL

Changing the gearing allows you to fine tune the speed of the model and control the temperatures of the battery packs and motor. Use a lower gear ratio (numerically larger) to reduce current draw and temperatures. Use a higher gear (numerically lower) to increase top speed. Use the following formula to calculate the overall ratio for combinations not listed on the gear chart:

$$\frac{\text{\# Spur Gear Teeth}}{\text{\# Pinion Gear Teeth}} = \text{Final Gear Ratio}$$

When using “higher” gear ratios (numerically lower), it is important to monitor the temperatures of the battery and motor. If the battery is extremely hot (150°F), and/or the motor is too hot to touch (200°F), your model is probably over-gearred and drawing too much current. This temperature test assumes that the model is close to factory stock weight and operates freely with no excessive friction, dragging, or binding, and the battery is fully charged and in good condition. **Note:** Check and adjust gear mesh if a spur and/or pinion gear is changed.

This model is equipped with a Traxxas ET 2400 motor. The gear combination that comes stock on each model provides good overall acceleration and top speed.

Repetitive starting and stopping will result in motor overheating. The speed control’s thermal overload protection system will shut down power in the event of severe overheating. The model will operate normally once the speed control reaches safe operating temperature. To prevent motor overheating, only use recommended gearing.

Changing the Pinion Gear

Follow these steps to alter the gearing of your model. The required tools are included with your model. Refer to the exploded views in the included Service and Support Guide for reference:

1. Remove the right rear wheel using the 7mm socket on the 4-way wrench.
2. Remove the screw holding the pinion cover with a 2.0mm “L” wrench.
3. Loosen the setscrew that secures the pinion with a 1.5mm “L” wrench. It does not have to be removed completely.

4. Remove the existing pinion gear from the motor shaft.
5. Using the 2.5mm “L” wrench, loosen the two screws that secure the motor. You do not need to remove the screws completely.
6. Slide the new pinion onto the motor shaft. If installing a larger pinion, you will need to slide the motor back in its mount for spur gear clearance.
7. Align the pinion’s set screw with the flat side of the motor’s shaft, and align the pinion with the spur gear. Tighten the set screw.
8. Adjust the gear mesh so there is just a “tick” of free play between the pinion and spur gear.
9. Tighten the motor mounting screws and re-install the pinion cover.

Adjusting Gear Mesh

Incorrect gear mesh is the most common cause of stripped spur gears. Gear mesh should be checked and adjusted anytime a gear is replaced. To set the gear mesh, cut a narrow strip of notebook paper and run it into the gear mesh. Loosen the motor screws and slide

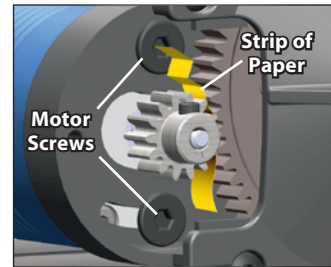

the motor and pinion gear into the spur gear. Retighten the motor screws and then remove the strip of paper. You should be able to run a fresh strip of paper through the gears without binding them.

Tuning the Differential

The action of the model’s rear gear differential can be tuned for different driving conditions and performance requirements. From the factory, the differential is sealed to maintain consistent long-term performance. Changing the oil in the differential with either lower or higher viscosity oil will vary the performance characteristics of the differential. Changing to a higher viscosity oil in the differential will reduce the tendency for motor power to be transferred to the wheel with the least traction. Higher viscosity (thicker) oil causes the differential to act like a limited-slip differential, distributing more equal power to the left and right wheels. Your model will generally benefit from higher viscosity oil when being driven on low traction surfaces. From the factory, the differential is filled with SAE 500K viscosity silicone oil. The differential must be removed from the

Gearing Compatibility Chart:
The chart below shows recommended gear combination ranges for your model.

		Spur Gear		
		62	65	68
Pinion Gear	13	-	-	-
	14	-	-	4.86
	15	-	-	4.53
	16	-	-	4.25
	17	-	3.82	4.00
	18	-	3.61	3.78
	19	-	3.52	3.58
	20	3.10	3.25	3.40
	21	2.95	3.10	3.24
	22	2.82	2.95	3.09
	23	2.70	2.83	2.96

- Stock out-of-box setup, recommended for most running
- Usable gearing range
- Fits, but not recommended

vehicle and disassembled to change/replace oil. Follow the steps below to access and refill the differential. Refer to the exploded views in the included Service and Support Guide for reference. The required tools are included with your model:

1. Remove the right wheel and left wheel using the 7mm socket on the 4-way wrench.
2. Remove the wheel hex and hex pin from both sides.
3. Remove the four screws on the right side spur gear cover using the 2mm "T" wrench.
4. Pull the differential assembly out (this includes the internal differential housing and two driveshafts).
5. Remove the four screws from the left-hand side of the internal differential housing using the 2mm "T" wrench.
6. Once all four screws are removed, pull the two differential housing halves apart. Be sure to keep the gasket seal for the two halves.
7. Clean out existing differential fluid.
8. Fill the right side of the differential housing with the new fluid.
9. Install the gasket, making sure it is free of any dirt or debris.
10. Install the left side of the housing and make sure all gears are meshed and driveshafts are rotating properly.
11. Install four screws through the left side and tighten using the 2mm "T" wrench.
12. Re-install the differential housing and two driveshafts, ensuring the internal and external bearings are seated properly.
13. Re-install the right side cover, drive hex pins, drive hexes, and wheels.

CENTERING YOUR SERVO

If you have removed the servo horn from your model's steering servo, or the servo has been removed for service or cleaning, the servo must be re-centered prior to installation of the servo horn or installation of the servo in the model.

1. Remove the servo horn from the steering servo.
2. Connect the steering servo to Channel 1 on the receiver. Connect the electronic speed control (ESC) to Channel 2. The white wire on the servo lead is positioned towards the receiver's LED.
3. Turn the transmitter power switch on. Make certain the transmitter's batteries are not depleted.
4. Turn the transmitter's steering trim knob to the center "0" position.
5. Disconnect the black and white motor wires to prevent the motor from turning during the next steps. Connect a fresh battery pack to the speed control. The servo's output shaft will automatically jump to its center position.
6. Install the servo horn onto the servo output shaft. The servo horn should face toward the center of the chassis and be perpendicular to the servo body.
7. Check servo operation by turning the steering wheel back and forth to ensure that the mechanism has been centered properly and you have equal throw in both directions. Use the transmitter's steering trim knob to fine-tune the position of the servo horn so the model tracks straight when the steering wheel is at neutral.

If you have questions or need technical assistance, call Traxxas at

1-888-TRAXXAS

(1-888-872-9927) (U.S. residents only)

MAINTAINING YOUR MODEL

Your model requires timely maintenance in order to stay in top running condition.

Frequently inspect the vehicle for obvious damage or wear. Look for:

1. Cracked, bent, or damaged parts
2. Check the wheels and steering for binding.
3. Check the operation of the shock absorbers.
4. Check the wiring for any frayed wires or loose connections.
5. Check the mounting of the receiver and servo(s) and speed control.
6. Check the tightness of the wheel nuts with a wrench.
7. Check the operation of the radio system, especially the condition of the batteries.
8. Check for any loose screws in the chassis structure or suspension.
9. Check the operation of the steering servo and ensure that it is not binding.
10. Inspect the gears for wear, broken teeth, or debris lodged between the teeth.
11. Check the tires to make sure they are firmly bonded to the wheels.
12. Check tires for excessive wear. Replace the tires if the inner belting is exposed.
13. Check the antenna wire for any kinks or damage that could shorten the radio range.

Other periodic maintenance:

- **Chassis:** Keep the chassis clean of accumulated dirt and grime. Periodically inspect the chassis for damage.
- **Suspension:** Periodically inspect the model for signs of damage, such as bent or dirty suspension pins, bent turnbuckles, loose screws, and any signs of stress or bending. Replace components as needed.
- **Steering:** Over time, you may notice increased looseness in the steering system. The tie rod ends (Part #6938) and servo saver (Part #6944) may wear out from use. Replace these components as needed to restore factory tolerances.

- **Shocks:** Keep the oil level in the shocks full. Use only 100% pure silicone shock oil to prolong the life of the seals. If you are experiencing leakage around the top of the shock, inspect the bladder in the top cap for signs of damage or distortion from overtightening. If the bottom of the shock is leaking, then it is time for a rebuild. The Traxxas rebuild kit for two shocks is Part #7062.
- **Driveline:** Inspect the driveline for signs of wear and any unusual noise or binding. Inspect driveshafts for cracks or twisting. All joints must rotate smoothly. Inspect the spur gear for wear and check the tightness of the set screw in the pinion gear. Tighten, clean, or replace components as needed.

Storage

When you are through running the model for the day, blow it off with compressed air or use a soft-bristled paint brush to dust off the vehicle.

Always disconnect and remove the battery from the model whenever the model is stored. If the model will be stored for a long time, then also remove the batteries from the transmitter.



Always wear eye protection when using compressed air or spray cleaners and lubricants.



High performance vehicles generate small vibrations while driving. These vibrations may loosen hardware over time and require attention. Always check your wheel nuts and other hardware and tighten or replace when necessary.



Always use the proper length motor bolts. The standard motor mounting bolts are 3x8mm. Using motor bolts that are too long can interfere with the motor's rotation and damage the motor's internals!





Starting Over:

Restoring Factory Defaults

When programming your TQi transmitter, you may feel the need to start over with a clean slate. Follow these simple steps to restore the factory settings:

1. Turn the transmitter off.
2. Hold both MENU and SET.
3. Turn the transmitter on.
4. Release MENU and SET. The transmitter LED will blink red.
5. Press MENU five times. The LED will blink red 6 times repeatedly.
6. Press SET to clear settings. The LED will turn solid green and the transmitter is restored to default.

Your Traxxas transmitter has a programmable Multi-Function knob that can be set to control various advanced transmitter functions (set to Torque Control by default, see page 14). Accessing the programming menu is done by using the menu and set buttons on the transmitter and observing signals from the LED. An explanation of the menu structure follows on page 25. Experiment with the settings and features to see if they can improve your driving experience.

Steering Sensitivity (Exponential)

The Multi-Function knob on the TQi transmitter can be programmed to control Steering Sensitivity (also known as exponential). The standard setting for Steering Sensitivity is “normal (zero exponential),” with the dial full left in its range of travel. This setting provides linear servo response: the steering servo’s movement will correspond exactly with the input from the transmitter’s steering wheel. Turning the knob clockwise from center will result in “negative exponential” and decrease steering sensitivity by making the servo less responsive near neutral, with increasing sensitivity as the servo nears the limits of its travel range. The farther you turn the knob, the more pronounced the change in steering servo movement will be. The term “exponential” comes from this effect; the servo’s travel changes exponentially relative to the input from the steering wheel. The exponential effect is indicated as a percentage—the greater the percentage, the greater the effect. The illustrations below show how this works.

Normal Steering Sensitivity (0% exponential)

In this illustration, the steering servo’s travel (and with it, the steering motion of the model’s front wheels) corresponds precisely with the steering wheel. The ranges are exaggerated for illustrative purposes.

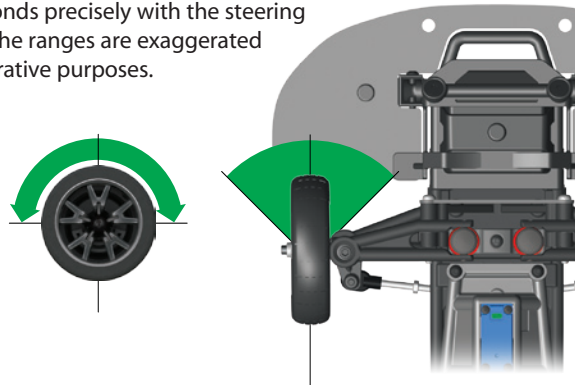

Decreased Steering Sensitivity (Negative Exponential)

By turning the Multi-Function knob clockwise, the steering sensitivity of the model will be decreased. Note that a relatively large amount of steering wheel travel results in a smaller amount of servo travel. The farther you turn the knob, the more pronounced the effect becomes. Decreased steering sensitivity may be helpful when driving on low-traction surfaces and when driving at high speed. The ranges are exaggerated for illustrative purposes.

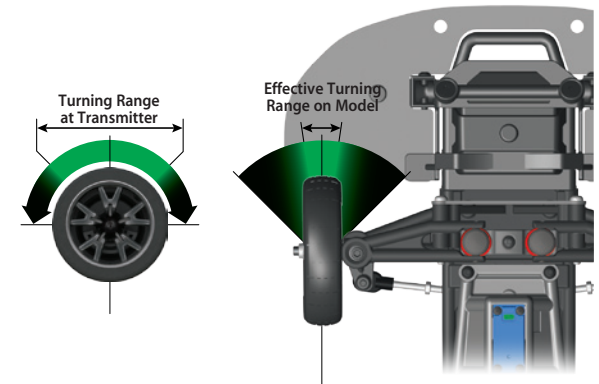

Experiment! Try varying degrees of exponential. By default, the model is set to 70% exponential. There’s no wrong way to adjust exponential. Any setting that makes you more comfortable with your car’s handling is the “right setting.”

Throttle Sensitivity (Throttle Exponential)

The Multi-Function knob can be set to control Throttle Sensitivity. Throttle Sensitivity works the same way as Steering Sensitivity as described above, but applies the effect to the throttle channel. Only forward throttle is affected; brake/reverse travel remains linear regardless of the Throttle Sensitivity setting.

Steering Percentage (Dual Rate)

The Multi-Function knob can be set to control the amount (percentage) of servo travel applied to steering. Turning the Multi-Function knob fully clockwise will deliver maximum steering throw; turning the knob counterclockwise reduces steering throw (**Note:** turning the dial counterclockwise to its stop will eliminate all servo travel). Be aware that the steering End Point settings define the servo’s maximum steering throw. If you set Steering Percentage

to 100% (by turning the Multi-Function knob fully clockwise), the servo will travel all the way to its selected end point, but not past it. Reducing steering throw can also be useful in making a model easier to control on high-traction surfaces, and limiting steering output for oval racing where large amounts of steering travel are not required.

Braking Percentage

The Multi-Function knob may also be set to control the amount of brake travel applied by the servo in a nitro-powered model. Electric models do not have a servo-operated brake, but the Braking Percentage function still operates the same way in electric models. Turning the Multi-Function knob fully clockwise will deliver maximum brake throw; turning the knob counterclockwise reduces brake throw (**Note:** Turning the dial counterclockwise to its stop will eliminate all brake action).

Throttle Trim

Setting the Multi-Function knob to serve as throttle trim will allow you to adjust the throttle's neutral position to prevent unwanted brake drag or throttle application when the transmitter trigger is at neutral. **Note:** Your transmitter is equipped with a Throttle Trim Seek mode to prevent accidental runaways. See the sidebar for more information.

Steering and Throttle End Points

The TQi transmitter allows you to choose the limit of the servo's travel range (or its "end point") independently for left and right travel (on the steering channel) and throttle/brake travel (on the throttle channel). This allows you to fine-tune the servo settings to prevent binding caused by the servo moving steering or throttle linkages (in the case of a nitro model) farther than their mechanical limits. The end point adjustment settings you select will represent what you wish to be the servo's maximum travel; the Steering Percentage or Braking Percentage functions will not override the End Point settings.

Steering and Throttle Sub-Trim

The Sub-Trim function is used to precisely set the neutral point of the steering or throttle servo in the event that simply setting the trim knob to "zero" does not completely center the servo. When selected, Sub-Trim allows finer adjustment to the servo output shaft's position for precise setting of the neutral point. Always set

the Steering Trim knob to zero before making final adjustment (if required) using Sub-Trim. If Throttle Trim has been previously adjusted, the Throttle Trim will need to be reprogrammed to "zero" before making final adjustment using Sub-Trim.

Setting Lock

Once you've adjusted all of these settings the way you like them, you may want to disable the Multi-Function knob so none of your settings can be changed. This is especially handy if you operate multiple vehicles with a single transmitter via Traxxas Link™ Model Memory.

Multiple Settings and the Multi-Function Knob

It is important to note that settings made with the Multi-Function knob are "overlaid" on top of each other. For example, if you assign the Multi-Function to adjust Steering Percentage and set it for 50%, then reassign the knob to control Steering Sensitivity, the transmitter will "remember" the Steering Percentage setting. Adjustments you make to Steering Sensitivity will be applied to the 50% steering throw setting you selected previously. Likewise, setting the Multi-Function knob to "disabled" will prevent the knob from making further adjustments, but the last setting of the Multi-Function knob will still apply.

TRAXXAS LINK MODEL MEMORY

Traxxas Link Model Memory is an exclusive, patent-pending feature of the TQi transmitter. Each time the transmitter is bound to a new receiver, it saves that receiver in its memory along with all the settings assigned to that receiver. When the transmitter and any bound receiver are switched on, the transmitter automatically recalls the settings for that receiver. There is no need to manually select your vehicle from a list of model memory entries.

Model Lock

The Traxxas Link Model Memory feature can store up to thirty models (receivers) in its memory. If you bind a thirty-first receiver, Traxxas Link Model Memory will delete the "oldest" receiver from its memory (in other words, the model you used the longest time ago will be deleted). Activating Model Lock will lock the receiver in memory so it cannot be deleted.

You may also bind multiple TQi transmitters to the same model making it possible to pick up any transmitter and any previously bound model in your collection and simply turn them on and drive.



Throttle Trim Seek Mode

When the Multi-Function knob is set to throttle trim, the transmitter remembers the throttle trim setting. If the throttle trim knob is moved from the original setting while the transmitter is off, or while the transmitter was used to control another model, the transmitter ignores the actual position of the trim knob. This prevents the model from accidentally running away. The LED on the face of the transmitter will rapidly blink green and the throttle trim knob (Multi-Function knob) will not adjust the trim until it is moved back to its original position saved in memory. To restore throttle trim control, simply turn the Multi-Function knob either direction until the LED stops blinking.



Failsafe

Your Traxxas radio system is equipped with a built-in failsafe function that returns the throttle to its last saved neutral position in the event of a signal loss. The LED on the transmitter and the receiver will rapidly flash red.

In order to re-acquire the signal after the failsafe has activated, you will need to walk a longer distance closer to the model than the distance the model travelled out of range. Simply keep walking towards the model until you re-acquire the signal.

With Traxxas Link Model Memory, there is no need remember which transmitter goes with which model and there is never a need to have to select any model from a list of model memory entries. The transmitter and receiver do it all for you automatically.

To activate Model Lock:

1. Switch on the transmitter and receiver you wish to lock.
2. Press and hold MENU. Release when the status LED blinks green.
3. Press MENU three times. The status LED will blink green four times repeatedly.
4. Press SET. The status LED will blink green in single-flash intervals.
5. Press SET once. The status LED will blink red once repeatedly.
6. Press MENU once, the LED will blink red twice repeatedly.
7. Press SET, the LED will blink rapidly green. The memory is now locked. Press and hold MENU to return to driving mode.

Note: To unlock a memory, press SET twice at step 5. The LED will blink rapidly green to indicate the model is unlocked. To unlock all models, press MENU twice at step 6 and then press SET.

To delete a model:

At some point, you may wish to delete a model you no-longer drive from the memory.

1. Switch on the transmitter and receiver you wish to delete.
2. Press and hold MENU. Release when the status LED blinks green.
3. Press MENU three times. The status LED will blink green four times repeatedly.
4. Press SET once. The status LED will blink green once repeatedly.
5. Press MENU once. The status LED will blink green twice repeatedly.
6. Press SET. The memory is now selected to be deleted. Press SET to delete the model. Press and hold MENU to return to driving mode.

TRANSMITTER LED CODES

LED Color / Pattern	Name	Notes
Solid green	Normal Driving Mode	See page 12 for information on how to use your transmitter controls.
Slow red (0.5 sec on / 0.5 sec off)	Binding	See page 13 for more information on binding.
Flashing fast green (0.1 sec on / 0.15 sec off)	Throttle Trim Seek Mode	Turn the Multi-Function knob right or left until the LED stops flashing. See page 23 for more information.
Flashing medium red (0.25 sec on / 0.25 sec off)	Low Battery Alarm	Put new batteries in the transmitter. See page 11 for more information.
Flashing fast red (0.125 sec on / 0.125 sec off)	Link Failure / Error	Transmitter and receiver are no longer bound. Turn the system off and then back on to resume normal operation. Find source of the link failure (i.e., out of range, low batteries, damaged antenna).
Programming Patterns		
Counts out number (green or red) then pauses	Current menu position	See Menu Tree for more information.
Fast green 8 times	Menu setting accepted (on SET)	
Fast red 8 times	Menu SET invalid	User error such as trying to delete a locked model.

RECEIVER LED CODES

LED Color / Pattern	Name	Notes
Solid green	Normal Driving Mode	See page 12 for information on how to use your transmitter controls.
Slow red (0.5 sec on / 0.5 sec off)	Binding	See page 13 for more information on binding.
Flashing fast red (0.125 sec on / 0.125 sec off)	Failsafe / Low-Voltage Detect	Consistent low voltage in the receiver triggers Failsafe so there is enough power to center the throttle servo before it completely loses power.

MENU TREE

The menu tree below shows how to navigate through the TQi transmitter's various settings and functions. Press and hold MENU to enter the menu tree, and use the following commands to navigate through the menu and select options.

MENU: When you enter a menu, you always start at the top. Press MENU to move down the menu tree. When you reach the bottom of the tree, pressing MENU again will return you to the top.

SET: Press SET to move across the menu tree and select options. When an option is committed to the transmitter's memory, the status LED will rapidly blink green.

BACK: Press both MENU and SET to go back one level in the menu tree.

EXIT: Press and hold MENU to exit programming. Your selected options will be saved.

ECHO: Press and hold SET to activate the "echo" function. Echo will "play back" your current position on the Menu Tree, should you lose your place. For example: If your current position is Steering Channel End Points, holding SET will cause the LED to blink green twice, green once, and then red three times. Echo will not alter your adjustments or change your position in the programming sequence.

Below is an example of how to access a function in the menu tree. In the example, the user is setting the Multi-Function knob to be a steering Dual Rate control.

- To set the Multi-Function knob to control STEERING DUAL RATE (%):
1. Switch the transmitter on.
 2. Press and hold MENU until the green LED lights. It will blink in single intervals.
 3. Press SET. The red LED will blink in single intervals to indicate Steering Dual Rate has been selected.
 4. Press MENU twice. The red LED will blink three times repeatedly to indicate Steering Percentage has been selected.
 5. Press SET to select. The green LED will blink 8 times fast to indicate successful selection.
 6. Press and hold MENU to return to driving mode.

Restoring Factory Defaults:

Transmitter OFF	Hold both MENU and SET	Transmitter ON	Release MENU and SET. Red LED blinks	Press MENU 5 times. Red LED blinks 6 times	Press SET to clear settings. LED will turn solid green. Transmitter is restored to default
-----------------	------------------------	----------------	--------------------------------------	--	--

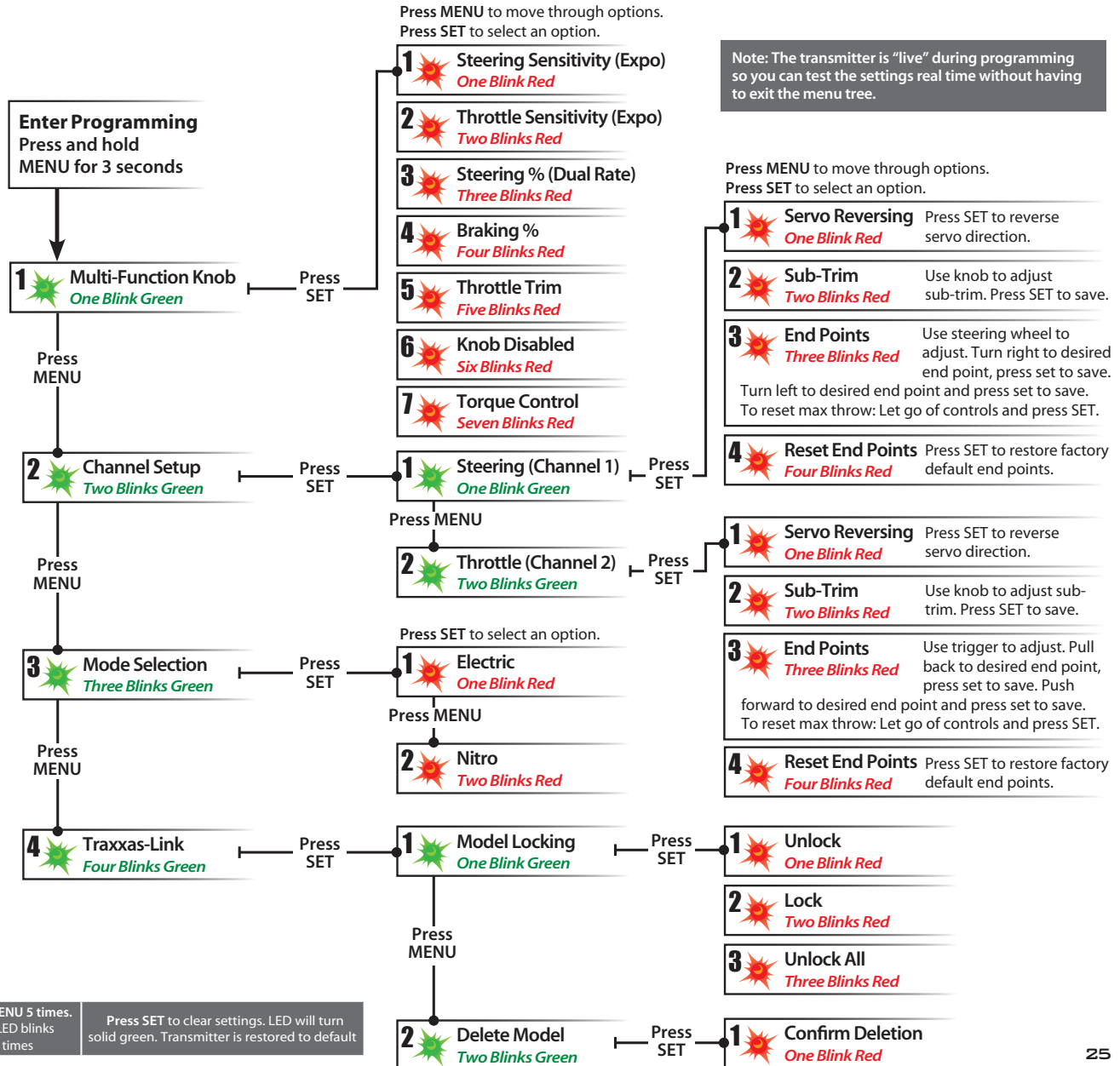

Note: The transmitter is "live" during programming so you can test the settings real time without having to exit the menu tree.

Set Multi-Function knob for STEERING SENSITIVITY (Expo)	Press/hold MENU green LED blinks	Press SET red LED blinks	Press SET to confirm green LED blinks (x8)	Press/hold MENU returns to driving mode						
Set Multi-Function knob for THROTTLE SENSITIVITY (Expo)	Press/hold MENU green LED blinks	Press SET red LED blinks	Press MENU to confirm red LED blinks (x2)	Press SET to select green LED blinks (x8)	Press/hold MENU returns to driving mode					
Set Multi-Function knob for STEERING DUAL RATE (%)	Press/hold MENU green LED blinks	Press SET red LED blinks	Press MENU twice red LED blinks (x3)	Press SET to select green LED blinks (x8)	Press/hold MENU returns to driving mode					
Set Multi-Function knob for BRAKING PERCENTAGE (%)	Press/hold MENU green LED blinks	Press SET red LED blinks	Press MENU 3 times red LED blinks (x4)	Press SET to select green LED blinks (x8)	Press/hold MENU returns to driving mode					
Set Multi-Function knob for THROTTLE TRIM	Press/hold MENU green LED blinks	Press SET red LED blinks	Press MENU 4 times red LED blinks (x5)	Press SET to select green LED blinks (x8)	Press/hold MENU returns to driving mode	Adjust the Multi-Function knob until the LED turns solid green.				
To LOCK the Multi-Function knob	Press/hold MENU green LED blinks	Press SET red LED blinks	Press MENU 5 times red LED blinks (x6)	Press SET to lock green LED blinks (x8)	Press/hold MENU returns to driving mode					
To REVERSE the direction of STEERING servo	Press/hold MENU green LED blinks	Press MENU green LED blinks (x2)	Press SET green LED blinks	Press SET red LED blinks	Press SET to reverse servo direction	Press/hold MENU returns to driving mode				
To set the SUB-TRIM of the STEERING servo	Press/hold MENU green LED blinks	Press MENU green LED blinks (x2)	Press SET green LED blinks	Press SET red LED blinks	Press MENU red LED blinks (x2)	Use Multi-Function knob to set neutral	Press SET to save position	Press/hold MENU returns to driving mode		
To set the END POINTS of the STEERING servo	Press/hold MENU green LED blinks	Press MENU green LED blinks (x2)	Press SET green LED blinks	Press SET red LED blinks	Press MENU twice red LED blinks (x3)	Turn steering wheel to desired max left and right travel	Press SET to save each position	Turn steering wheel to test settings	IF END POINTS ARE OK: Press/hold MENU returns to driving mode	IF END POINTS NEED TO BE CHANGED: Press SET and repeat steps 6-8
To reset the END POINTS of STEERING servo to defaults	Press/hold MENU green LED blinks	Press MENU green LED blinks (x2)	Press SET green LED blinks	Press SET red LED blinks	Press MENU 3 times red LED blinks (x4)	Press SET to reset end points	Press/hold MENU returns to driving mode			
To REVERSE the direction of THROTTLE servo	Press/hold MENU green LED blinks	Press MENU green LED blinks (x2)	Press SET green LED blinks	Press MENU green LED blinks (x2)	Press SET red LED blinks	Press SET to reverse servo direction	Press/hold MENU returns to driving mode			
To set the SUB-TRIM of the THROTTLE servo	Press/hold MENU green LED blinks	Press MENU green LED blinks (x2)	Press SET green LED blinks	Press MENU green LED blinks (x2)	Press SET red LED blinks	Press MENU red LED blinks (x2)	Use Multi-Function knob to set neutral	Press SET to save position	Press/hold MENU returns to driving mode	
To set the END POINTS of the THROTTLE servo	Press/hold MENU green LED blinks	Press MENU green LED blinks (x2)	Press SET green LED blinks	Press MENU green LED blinks (x2)	Press SET red LED blinks	Press MENU twice red LED blinks (x3)	Use throttle trigger to set desired max throttle or brake	Press SET to save Use trigger to test	IF END POINTS ARE OK: Press/hold MENU returns to driving mode	IF END POINTS NEED TO BE CHANGED: Press SET and repeat steps 7-9
To reset the END POINTS of THROTTLE servo to defaults	Press/hold MENU green LED blinks	Press MENU green LED blinks (x2)	Press SET green LED blinks	Press MENU green LED blinks (x2)	Press SET red LED blinks	Press MENU 3 times red LED blinks (x4)	Press SET green LED blinks (x8)	Press/hold MENU returns to driving mode		

MENU TREE FORMULAS

To select functions and make adjustments to the TQi transmitter without referencing the menu tree, turn your transmitter on, find the function in the left column you wish to adjust, and simply follow the corresponding steps.



Always turn your transmitter on first.

PROGRAMMING YOUR TQi TRANSMITTER WITH YOUR APPLE IPHONE OR IPOD TOUCH

The Traxxas Docking Base (Part #6510 - sold separately) for the TQi transmitter installs in minutes to transform your iPhone® or iPod touch® into a powerful tuning tool that allows you to replace the transmitter's button/LED programming system with an intuitive, high-definition, full-color graphical user interface.



Traxxas Link

The powerful Traxxas Link app (available in the Apple App Store) gives you complete control over the operation and tuning of your Traxxas model with stunning visuals and absolute precision. Install Traxxas Link telemetry sensors on the model, and Traxxas Link displays real-time data such as speed, RPM, temperature, and battery voltage.

Intuitive iPhone and iPod touch interface

Traxxas Link makes it easy to learn, understand, and access powerful tuning options. Control Drive Effects settings such as steering and throttle sensitivity, steering percentage, braking strength, and throttle trim by simply touching and dragging the sliders on the screen.



Tap and slide to adjust Steering Sensitivity, Throttle Trim, Braking Percent, and more!

Real-Time Telemetry

When you equip your model with sensors, the Traxxas Link dashboard comes to life showing you speed, battery voltage, RPM, and temperature. Set threshold warnings and log maximums, minimums, or averages. Use the recording function to document your dashboard view, with sound, so that you can keep your eyes on your driving and not miss a single apex.



The customizable Traxxas Link dashboard delivers real-time RPM, speed, temperature, and voltage data.

Manage up to 30 Models with Traxxas Link

The TQi radio system automatically keeps track of what vehicles it has bound to and what settings were used for each--up to 30 models total! Traxxas Link provides a visual interface to name the models, customize their settings, attach profiles, and lock them into memory. Simply choose a model and any previously bound transmitter, power them up, and start having fun.



The TQi Docking Base is sold separately (Part #6510). The Traxxas Link application is available from the Apple App store for iPhone and iPod touch mobile devices. iPhone and iPod touch are not included with the TQi Docking Base.

For more information about the TQi Docking Base and the Traxxas Link application, visit Traxxas.com

Download Now!



TRAXXAS
LINK

Available on the
App Store

Made for
iPod iPhone

Made for
· iPod touch (4th generation)
· iPod touch (3rd generation)
· iPod touch (2nd generation)

· iPhone 4S
· iPhone 4
· iPhone 3GS
· iPhone 3G

"Made for iPod" and "Made for iPhone" mean that an electronic accessory has been designed to connect specifically to iPod and iPhone, respectively, and has been certified by the developer to meet Apple performance standards. Apple is not responsible for the operation of this device or its compliance with safety and regulatory standards. Please note that the use of this accessory with iPod and iPhone may affect wireless performance.



TRAXXAS

Official Radio Controlled Performance Products of 

6250 TRAXXAS WAY, MCKINNEY, TEXAS 75070 • 1-888-TRAXXAS