



# 2019 NISSANCONNECT<sup>®</sup>

OWNER'S MANUAL

For your safety, read carefully and keep in this vehicle.

## NISSAN CONSUMER AFFAIRS DEPARTMENT

For assistance or inquiries about the NISSAN warranty, service or general questions, contact the NISSAN Consumer Affairs Department at:

### **For U.S. customers**

Nissan North America, Inc.  
Consumer Affairs Department  
P.O. Box 685003  
Franklin, TN 37068-5003  
1-800-NISSAN-1  
(1-800-647-7261)

### **For Canadian customers**

Nissan Canada Inc.  
5290 Orbitor Drive  
Mississauga, Ontario L4W 4Z5  
1-800-387-0122

## NISSAN NAVIGATION SYSTEM HELPDESK CONTACT INFORMATION

For assistance or inquiries about the NissanConnect® with Navigation system, or to order updated map data, contact the NISSAN NAVIGATION SYSTEM HELPDESK at:

- E-MAIL: [nissan-navi-info@here.com](mailto:nissan-navi-info@here.com)
- WEBSITE: [www.NissanNavigation.com](http://www.NissanNavigation.com)
- PHONE: 1-888-661-9995

## NISSANCONNECT® SERVICES AND APPS HELPDESK CONTACT INFORMATION

For assistance or inquiries about the NissanConnect® Services or Apps, contact Nissan Owner Services helpdesk at:

- E-MAIL: [nissanownerservices@nissan-usa.com](mailto:nissanownerservices@nissan-usa.com)
- WEBSITE: <https://www.nissanusa.com/connect/support>
- PHONE: 1-855-426-6628

## FOREWORD

Thank you for purchasing a NISSAN vehicle.

This user's manual is for NissanConnect® with Navigation, Apps and Services offered in your NISSAN vehicle.

Operation instructions for the following systems are included in this manual.

- Audio
- Hands-Free Phone
- NissanConnect® Apps
- NissanConnect® Services
- Navigation
- Voice Recognition
- Information and settings viewable on NissanConnect®

Please read this manual carefully to ensure safe operation of NissanConnect® with Navigation, Apps and Services.

- Because of possible specification changes and optional equipment, some sections of this manual may not apply to your vehicle.
- All information, specifications and illustrations in this manual are those in effect at the time of printing. NISSAN

reserves the right to change specifications or design at any time without notice.

- Do not remove this manual from the vehicle when selling this vehicle. The next user of this system may need the manual.



# Table of Contents

## 1 Introduction

How to use this manual....	1-2
Safety information.....	1-3
Trademarks.....	1-4
Regulatory information....	1-5
Legal disclaimer.....	1-6
Licenses.....	1-8

## 2 Getting Started

Control buttons and touch screen display (center display).....	2-2
Starting system.....	2-12
Touch panel operation.....	2-13
System status screen....	2-15
Shortcut menu.....	2-15
Map menu (models with navigation system).....	2-16

Display View Bar (models with navigation system).....	2-16
How to input letters and numbers.....	2-18
System settings.....	2-20
Functions disabled while driving.....	2-29
Additional system information.....	2-30

## 3 Audio system

Audio operation precautions.....	3-2
Names and functions of audio control buttons.....	3-14
Audio operations.....	3-17
Audio settings.....	3-39
Disc/USB memory device care and cleaning.....	3-42

Gracenote® End User License Agreement.....	3-42
Mobile Entertainment System (MES) (if so equipped).....	3-43

## 4 Bluetooth® Hands-Free Phone

Bluetooth® Hands-Free Phone System.....	4-2
Bluetooth® information.....	4-12

## 5 Information

Information menu.....	5-2
SiriusXM Traffic™ information (if so equipped).....	5-4
SiriusXM® Travel Link (if so equipped).....	5-8

NissanConnect® Services (if so equipped).....	5-14
NissanConnect® Apps.....	5-25

## 6 Navigation (if so equipped)

Safety information.....	6-3
Map data authentication .....	6-3
Map operation .....	6-4
Setting destination.....	6-15
Route guidance.....	6-30
Storing a location/route.....	6-45
Navigation settings.....	6-54
General information.....	6-57

## 7 Voice Recognition

Voice Recognition System .....	7-2
-----------------------------------	-----

## 8 Troubleshooting guide

Customer assistance.....	8-2
System unit.....	8-3
Audio system .....	8-4
Bluetooth® Hands-Free Phone System .....	8-14
Navigation (if so equipped).....	8-18
Voice recognition .....	8-26

# 1 Introduction

How to use this manual .....	1-2	Regulatory information .....	1-5
For safe operation .....	1-2	Laser product .....	1-5
Reference symbols .....	1-2	Bluetooth® devices .....	1-5
Screen illustrations .....	1-2	Legal disclaimer .....	1-6
Safety information .....	1-3	Licenses .....	1-8
Trademarks .....	1-4	Telematic Control Unit Gen2K (if so equipped) .....	1-8



# 1. Introduction

## HOW TO USE THIS MANUAL

This manual uses special words, symbols, icons and illustrations organized by function.

Please refer to the following items and familiarize yourself with them.

### FOR SAFE OPERATION



#### WARNING

This is used to indicate the presence of a hazard that could cause death or serious personal injury. To avoid or reduce this risk, the procedures must be followed precisely.



#### CAUTION

This is used to indicate the presence of a hazard that could cause minor or moderate personal injury or damage to your vehicle. To avoid or reduce this risk, the procedures must be followed carefully.



#### NOTE:

This indicates items that help you understand and maximize the performance of your vehicle. Ignoring them may lead to a malfunction or poor performance.

### REFERENCE SYMBOLS



#### INFO:

This indicates information that is necessary for efficient use of your vehicle or accessories.



Reference page:

This indicates the title and page that you should refer to.

< >:

This indicates a control button or a switch.

[ ]:

This indicates a key/item displayed on the screen.



Voice Command:

This indicates an operation by voice command.

### SCREEN ILLUSTRATIONS

- The illustrations in this manual are representatives of various models and may not be identical with the design and specifications of your vehicle.
- Icons and menu items displayed on the screen may be abbreviated or omitted from the screen illustrations when appropriate. The omitted icons and menu items are described as dotted lines as illustrated.

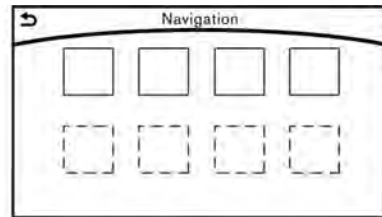
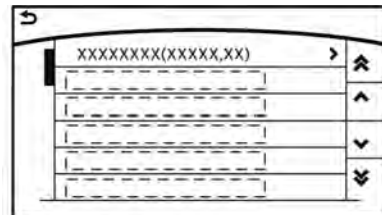



## SAFETY INFORMATION

This system is primarily designed to help you support pleasant driving as outlined in this manual. However, you, the driver, must use the system safely and properly. Information and the availability of services may not always be up to date. The system is not a substitute for safe, proper and legal driving.

Before using the system, please read the following safety information. Always use the system as specified in this manual.



### WARNING

- **To operate the system, first park the vehicle in a safe location and set the parking brake. Operating the system while driving can distract the driver and may result in a serious accident.**
- **Exercise extreme caution at all times so full attention may be given to vehicle operation. If the system does not respond immediately, please be patient and keep your eyes on the road. Inattentive driving may lead to a crash resulting in serious injuries or death.**

- **Do not disassemble or modify this system. Doing so may result in an accident, fire or electrical shock.**
- **If you notice any foreign objects in the system hardware, spill liquid on the system or notice smoke or a smell coming from it, stop using the system immediately and contact a NISSAN dealer. Ignoring such conditions may lead to an accident, fire or electrical shock.**



### CAUTION

- **Some jurisdictions may have laws limiting the use of video screens while driving. Use this system only where it is legal to do so.**
- **Extreme temperatures [below  $-4^{\circ}\text{F}$  ( $-20^{\circ}\text{C}$ ) and above  $158^{\circ}\text{F}$  ( $70^{\circ}\text{C}$ )] could affect the performance of the system.**
- **The display screen may break if it is hit with a hard or sharp object. If the glass screen breaks, do not touch it. Doing so could result in an injury.**



### NOTE:

**Do not keep the system running with the engine stopped. Doing so may discharge the vehicle battery. When you use the system, always keep the engine running.**

# 1. Introduction

## TRADEMARKS



HD Radio Technology manufactured under license from iBiquity Digital Corporation. U.S. and Foreign Patents. For patents see <http://patents.dts.com/>. HD Radio and the HD, HD Radio, and "ARC" logos are registered trademarks or trademarks of iBiquity Digital Corporation in the United States and/or other countries.



SiriusXM® services require a subscription after trial period and are sold separately or as a package. Our satellite service is available only to those at least 18 and older in the 48 contiguous United States and DC. For more information visit [www.siriusxm.com](http://www.siriusxm.com).



Required SiriusXM® Satellite Radio and

SiriusXM Traffic™ monthly subscriptions are sold separately. SiriusXM Traffic™ are only available in select markets. For more information, see [www.siriusxm.com/siriusxmtraffic](http://www.siriusxm.com/siriusxmtraffic).



Required SiriusXM® Satellite Radio and SiriusXM® Travel Link monthly subscriptions are sold separately. SiriusXM® Travel Link is only available in select markets. For more information, see [www.siriusxm.com/travellink](http://www.siriusxm.com/travellink).



"Made for iPod®" and "Made for iPhone®" mean that an electronic accessory has been designed to connect specifically to iPod® or iPhone®, respectively, and has been certified by the developer to meet Apple performance standards. Apple is not responsible for the operation of this device or its compliance with safety and regulatory standards. Please note that the use of this accessory with iPod® or iPhone® may affect wireless performance. Apple, the Apple logo, iPhone®, iPod®, iPod classic®, iPod nano®, and iPod touch® are

trademarks of Apple Inc., registered in the U.S. and other countries. Lightning™ is a trademark of Apple Inc. App Store™ is a service mark of Apple Inc.



Music and video recognition technology and related data are provided by Gracenote®. Gracenote is the industry standard in music recognition technology and related content delivery. For more information visit [www.gracenote.com](http://www.gracenote.com).

CD, DVD, Blu-ray Disc, and music and video-related data from Gracenote, Inc., copyright © 2000 to present Gracenote. Gracenote Software, copyright © 2000 to present Gracenote. One or more patents owned by Gracenote apply to this product and service. See the Gracenote website for a non-exhaustive list of applicable Gracenote patents. Gracenote, CDDB, MusicID, MediaVOCS, the Gracenote logo and

logotype, and the “Powered by Gracenote” logo are either registered trademarks or trademarks of Gracenote in the United States and/or other countries.



The Bluetooth® word mark and logos are registered trademarks owned by Bluetooth SIG, Inc. and any use of such marks by DENSO CORPORATION is under license. Other trademarks and trade names are those of their respective owners.

## Google

© 2012 Google Inc. All rights reserved. Google Calendar™ calendaring application is a trademark of Google Inc.

## REGULATORY INFORMATION

### LASER PRODUCT

This NissanConnect® with Navigation (if so equipped), Apps and Services (if so equipped) is certified as a Class 1 laser product.

The system complies with DHHS Rules 21 CFR Chapter 1, Subchapter J.



### WARNING

- **Do not disassemble or modify this system. There are no user serviceable parts in the system.**
- **If maintenance, adjustments and operations other than those specified in this manual are attempted, injury due to laser radiation and exposure could occur.**

## BLUETOOTH® DEVICES

### FCC Regulatory information

**FCC ID: HYQDNNS086**

### NOTE

This device complies with part 15 of the FCC Rules. Operation is subject to the following two conditions: (1) This device may not cause harmful interference, and (2) this device must accept any interference received, including interference that may cause undesired operation.

### FCC WARNING

Changes or modifications not expressly approved by the party responsible for compliance could void the user's authority to operate the equipment.

**CAUTION:** Radio Frequency Radiation Exposure

This equipment complies with FCC radiation exposure limits set forth for uncontrolled environment and meets the FCC radio frequency (RF) Exposure Guidelines.

This equipment has very low levels of RF energy that it deemed to comply without maximum permissive exposure evaluation (MPE). But it is desirable that it should be installed and operated with at least 20 cm and more between the radiator and person's body.

# 1. Introduction

**Co-location:** This transmitter must not be co-located or operated in conjunction with any other antenna or transmitter.

## IC Regulatory information

The antenna cannot be removed (and changed) by user.

### NOTE

This device complies with Industry Canada license-exempt RSS standard(s). Operation is subject to the following two conditions: (1) This device may not cause interference, and (2) this device must accept any interference, including interference that may cause undesired operation of the device.

**CAUTION:** Radio Frequency Radiation Exposure

This equipment complies with IC radiation exposure limits set forth for uncontrolled environment and meets RSS-102 of the IC radio frequency (RF) Exposure rules. This equipment has very low levels of RF energy that it deemed to comply without maximum permissive exposure evaluation (MPE). But it is desirable that it should be installed and operated with at least 20cm and more between the radiator and person's body.

**Co-location:** This transmitter must not be co-located or operated in conjunction

with any other antenna or transmitter.

This Class B digital apparatus meets all requirements of the Canadian Interference-Causing Equipment Regulations.

### For Canadian customers:

L'antenne ne peut être enlevée (et modifiée) par l'utilisateur.

### NOTE

Le présent appareil est conforme aux CNR d'Industrie Canada applicables aux appareils radio exempts de licence. L'exploitation est autorisée aux deux conditions suivantes: (1) l'appareil ne doit pas produire de brouillage, et (2) l'utilisateur de l'appareil doit accepter tout brouillage radioélectrique subi, même si le brouillage est susceptible d'en compromettre le fonctionnement.

## LEGAL DISCLAIMER



### WARNING

Driving is serious business and requires your full attention. Only use features and connected devices when safe and legal to do so. Some features, including automatic crash notification and SOS, are dependent upon the telematics device being in operative condition, its ability to connect to a wireless network, compatible wireless network availability, navigation map data and GPS satellite signal reception, the absence of which can limit or prevent the ability to reach the NissanConnect® Services Data Center and NissanConnect® Services Response Center or receive support. GPS mapping may not be detailed in all areas or reflect current road status. Never program GPS while driving. Only use Remote Engine Start (if so equipped) and Remote Horn (if so equipped) features in accordance with any laws, rules or ordinances in effect in your vehicle's location.

Feature availability is dependent on vehicle model, trim level, packaging and op-

tions. Compatible connected device may be required and feature availability may be dependent on device's capability. Refer to connected device's owner's manual for details. Late availability for some features.

Some services and features are provided by independent companies not within NISSAN's control. Should service provider terminate or restrict service or features, service or features may be suspended or terminated without notice or with no liability to NISSAN or its partners or agents. Services and features may require compatible cellular network provided by independent companies not within NISSAN or its partners' or agents' control. Cellular network signal strength may vary and may not be available in all areas or at all times. Services and features may not function if cellular network is unavailable, restricted, or terminated. NISSAN and its partners or agents are not responsible for associated costs or other third party changes that may be required for continued operation due to cellular network unavailability, restriction, or termination (including equipment replacements/upgrades, if available, or roaming charges on alternative networks). Technology is evolving, and changes by independent companies are not within NISSAN's or its partners' or agents' control.

Enrollment, owner consent, personal identification number (PIN), and subscription agreement may be required to receive full suite of features and services. Trial periods (if applicable) begin on the date of vehicle purchase or lease of a new NISSAN. Trial periods may be subject to change at any time and may be subject to early termination without notice. Required subscriptions may be sold separately for each available feature or service after trial period ends, and may continue until you call service provider to cancel. Installation costs, one-time activation fee, other fees and taxes may apply. Fees and programming subject to change. Feature may be subject to age restrictions in some areas. Subscriptions governed by service provider's subscription agreement, terms and conditions and privacy statements available at service provider's website. Text rates or data usage may apply.

The NISSAN names, logos and slogans are trademarks owned by or licensed to Nissan Motor Co. Ltd. or its North American subsidiaries. Other trademarks and trade names are those of their respective owners.

For important safety information, system limitations, and additional operating and feature information, see dealer, owner's manual, or [www.nissanusa.com/](http://www.nissanusa.com/)

connect/important-information.

# 1. Introduction

## LICENSES

### TELEMATIC CONTROL UNIT GEN2K (if so equipped)

#### A. INTRODUCTION

This product Telematic Control Unit Gen2K incorporates the following software:

- (1) the software developed by, or developed for, Ficosa International, S.A. ("Ficosa"),
- (2) the software owned by third party and licensed to Ficosa,
- (3) the software licensed under the GNU GENERAL PUBLIC LICENSE, Version 2 ("GPL"),
- (4) the software licensed under the GNU LIBRARY GENERAL PUBLIC LICENSE, Version 2.0 or the GNU LESSER GENERAL PUBLIC LICENSE, Version 2.1 (collectively "LGPL"), the Mozilla Public license v2 ("MPL"), the GPL-2.0 license with-OpenSSL-exception ("GPOpenSSL") and GNU GENERAL PUBLIC LICENSE, Version 3 with GCC exception (together with the GPL software, jointly "Copyleft Software"), and/or
- (5) open sourced software licensed under terms and conditions other than Copyleft

Software.

For the software classified as (3) or (4) above, a copy of the license text is included with the source code in the URL indicated below, and please also refer to the terms and conditions of Copyleft Software licenses at the websites listed below:

GPL: <http://www.gnu.org/licenses/old-licenses/gpl-2.0.html> and <https://www.gnu.org/licenses/gpl-3.0.en.html>

LGPL: <http://www.gnu.org/licenses/old-licenses/lgpl-2.1.html> and <http://www.gnu.org/licenses/old-licenses/lgpl-2.0.html>

MPL: <https://www.mozilla.org/en-US/MPL/2.0/>

GPL-2.0-with-OpenSSL-exception: <https://gitlab.com/cryptsetup/cryptsetup/blob/master/COPYING>

GPLv3 GCC Exception: <https://www.gnu.org/licenses/gcc-exception-3.1.en.html>

The software classified as (3) and (4) above are copyrighted by multiple people. Please refer to the websites below regarding the copyright notices of those people. <https://www.ficosa.com/software/>

[opensource/](https://www.ficosa.com/software/opensource/)

The software licensed under the licenses indicated in (3) and (4) above ("Copyleft Software") is distributed in the hope that it will be useful, but WITHOUT ANY WARRANTY, without even the implied warranty of MERCHANTABILITY or FITNESS FOR A PARTICULAR PURPOSE.

For at least three (3) years from delivery of a device embedding the above product, Ficosa will give to any third party who contacts us at the Contact Information provided below, for a charge no more than our cost of physically performing source code distribution, a complete machine-readable copy of the source code corresponding to the Copyleft Software indicated above. When requesting this source code, please specify Product: Telematic Control Unit Gen2K and version Cx9.

Furthermore, source code and licenses corresponding to the Copyleft Software listed above is freely available to you and any member of the public at the website listed below:

<https://www.ficosa.com/software/opensource/>

## [Contact Information]

For enquiries about open source software at FICOSA, please contact Ficoso's Compliance Officer by email: FOSS@ficoso.com

Please note that we are unable to answer any queries regarding source code details, etc.

In addition, it is necessary for end users to provide their own internet connection.

The end user is responsible for any connection or line charges incurred through browsing websites or downloading.

## B. LICENSING ANC COPYRIGHT NOTICE INFORMATION

The software classified as (5) above contains various open sourced software ("OSS") listed in the below website. Please see the website indicted next for the terms and conditions of the licenses (OSS Licenses) and other information regarding the OSS contained this Product:  
<https://www.ficoso.com/software/opensource/>

# 1. Introduction

---

**MEMO**



# 2 Getting Started

Control buttons and touch screen display (center display) .....	2-2	Scrolling list or message .....	2-14
Liquid crystal display .....	2-2	Selecting item .....	2-14
Center multi-function control panel (Type A) (if so equipped) .....	2-3	Adjusting settings .....	2-14
Center multi-function control panel (Type B) (if so equipped) .....	2-6	System status screen .....	2-15
Center multi-function control panel (Type C) (if so equipped) .....	2-7	Shortcut menu .....	2-15
Multi-function controller .....	2-8	Edit shortcut menu .....	2-15
Steering wheel switches (Type A) (if so equipped) .....	2-9	Map menu (models with navigation system) .....	2-16
Steering wheel switches (Type B) (if so equipped) .....	2-10	Display View Bar (models with navigation system) .....	2-16
Audio accessories .....	2-11	Customizing the Display View Bar .....	2-18
Starting system .....	2-12	How to input letters and numbers .....	2-18
Start-up warning .....	2-12	Alphanumeric character (letters and numbers) input screen .....	2-18
Touch panel operation .....	2-13	System settings .....	2-20
How to use touch screen .....	2-13	Settings menu .....	2-20
Operating menu screen .....	2-13	Pairing Bluetooth® device .....	2-28
		Functions disabled while driving .....	2-29
		Additional system information .....	2-30
		Additional help .....	2-31

## 2. Getting Started

### CONTROL BUTTONS AND TOUCH SCREEN DISPLAY (center display)

Designs and button layout may vary depending on models and specifications.

#### LIQUID CRYSTAL DISPLAY

The display is a liquid crystal display and should be handled with care.



#### WARNING

- **Never disassemble the display. Some parts utilize extremely high voltage. Touching them may result in serious personal injury.**
- **ALWAYS give your full attention to driving.**
- **Avoid using vehicle features that could distract you. If distracted, you could lose control of your vehicle and cause an accident.**



#### CAUTION

**The glass screen on the liquid crystal display may break if it is hit with a hard or sharp object. If the glass screen breaks, do not touch it. Doing so could result in an injury.**

#### Characteristics of liquid crystal display

- If the temperature inside the vehicle is especially low, the display will stay relatively dim or the movement of the images may be slow. These conditions are normal. The display will function normally when the interior of the vehicle has warmed up.
- Some pixels in the display are darker or brighter than others. This condition is an inherent characteristic of liquid crystal display, and it is not a malfunction.
- A remnant of the previous display image may remain on the screen. This screen burn is inherent in this type of display, and it is not a malfunction.

#### Maintenance of display

To clean the display screen, use a dry, soft cloth. If additional cleaning is necessary, use a small amount of neutral detergent with a soft cloth. Never spray the screen with water or detergent. Dampen the cloth first, then wipe the screen.



#### CAUTION

- **To clean the display, stop the vehicle in a safe location.**
- **Clean the display with the ignition switch in the OFF position. If the display is cleaned while the ignition switch is in the ON position, unintentional operation may occur.**
- **When cleaning the display, never use a rough cloth, alcohol, benzine, thinner or any kind of solvent or paper towel with a chemical cleaning agent. Doing so will cause scratches or deterioration of the panel.**
- **Do not splash any liquid such as water or car fragrance on the display. Contact with liquid will cause the system to malfunction.**

### CENTER MULTI-FUNCTION CONTROL PANEL (Type A) (if so equipped)

#### Models with Intelligent Around View Monitor:

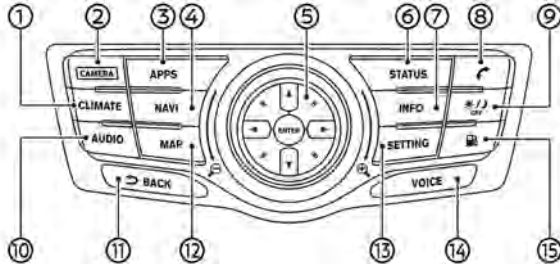

① **<CLIMATE>:**

Push to display the screen for air conditioner operations.

For additional information, refer to the vehicle Owner's Manual.

② **<CAMERA>:**

Push to operate the Intelligent Around View Monitor.

For additional information, refer to the vehicle Owner's Manual.

Push and hold **<CAMERA>** to switch the display brightness to the daytime mode or the nighttime mode, and to adjust the display brightness level using the multi-function controller while the indicator is displayed.

③ **<APPS>:**

Push to display the available Apps.

"NissanConnect® Apps"  
(page 5-25)

④ **<NAVI>:**

Push to display the navigation menu screen.

"Setting destination" (page 6-15)  
 "Route menu screen" (page 6-35)

⑤ Multi-function controller:

Use to select an item on the screen, select the highlighted item, or scroll the map on the screen, etc.

"Multi-function controller"  
(page 2-8)

⑥ **<STATUS>:**

Push to display the current setting of the vehicle information, air conditioner, audio and navigation route information.

"System status screen"  
(page 2-15)

⑦ **<INFO>:**

Push to display the information menu.

"Information menu" (page 5-2)

⑧ **<☎>:**

Push to operate the hands-free phone system.

"4. Bluetooth® Hands-Free Phone"

⑨ **<\*||>:**

Push to switch the display brightness to the daytime mode or the nighttime mode, and to adjust the display brightness level using the multi-function controller while the indicator is displayed. Push and hold to turn the display on/off.

⑩ **<AUDIO>:**

Push to operate the audio system.

"Audio main operations"  
(page 3-17)

## 2. Getting Started

### ⑪ < ↩ BACK>:

Push to return to the previous screen. In a settings screen, this button is also used to apply the setting.

### ⑫ <MAP>:

Push to display the current location map screen.

 "Displaying current vehicle location" (page 6-6)

Push again to display the Display View Bar.

 "Display View Bar (models with navigation system)" (page 2-16)

### ⑬ <SETTING>:

Push to access the system settings.

 "Settings menu" (page 2-20)

### ⑭ <VOICE>:

Push to repeat the voice guidance for a guide point.

### ⑮ < >:

Push to display the fuel economy information.

 "Information menu" (page 5-2)

### Models without Intelligent Around View Monitor:

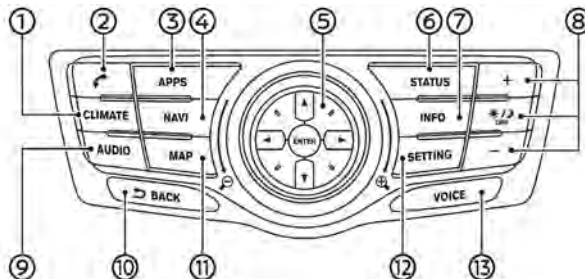

### ① <CLIMATE>:

Push to display the screen for air conditioner operations.

For additional information, refer to the vehicle Owner's Manual.

### ② < >:

Push to operate the hands-free phone system.

 "4. Bluetooth® Hands-Free Phone"

### ③ <APPS>:

Push to display the available Apps.

 "NissanConnect® Apps" (page 5-25)

### ④ <NAVI>:

Push to display the navigation menu

screen.

 "Setting destination" (page 6-15)

 "Route menu screen" (page 6-35)

### ⑤ Multi-function controller:

Use to select an item on the screen, select the highlighted item, or scroll the map on the screen, etc.

 "Multi-function controller" (page 2-8)

### ⑥ <STATUS>:

Push to display the current setting of the vehicle information, air conditioner, audio and navigation route information.

 "System status screen" (page 2-15)

⑦ **<INFO>**:

Push to display the information menu.

 "Information menu" (page 5-2)

⑧ **<\*F>, <+>/<->**:

Push **<\*F>** to switch the display brightness to the daytime mode or the nighttime mode, and to adjust the display brightness level using the multi-function controller while the indicator is displayed. Push and hold **<\*F>** to turn the display on/off.

The display brightness can also be adjusted using **<+>/<->**.

⑨ **<AUDIO>**:

Push to operate the audio system.

 "Audio main operations"  
(page 3-17)

⑩ **<↵ BACK>**:

Push to return to the previous screen. In a settings screen, this button is also used to apply the setting.

⑪ **<MAP>**:

Push to display the current location map screen.

 "Displaying current vehicle location" (page 6-6)

Push again to display the Display View Bar.

 "Display View Bar (models with navigation system)" (page 2-16)

⑫ **<SETTING>**:

Push to access the system settings.

 "Settings menu" (page 2-20)

⑬ **<VOICE>**:

Push to repeat the voice guidance for a guide point.

## 2. Getting Started

### CENTER MULTI-FUNCTION CONTROL PANEL (Type B) (if so equipped)

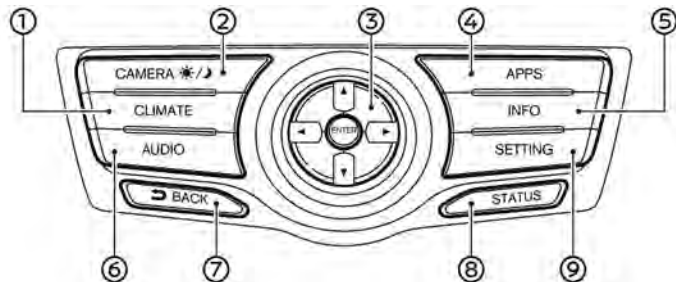

#### ① <CLIMATE>:

Push to display the screen for air conditioner operations.

For additional information, refer to the vehicle Owner's Manual.

#### ② <CAMERA\* / > (models with Intelligent Around View Monitor):

Push <CAMERA\* / > to operate the Intelligent Around View Monitor. For additional information, refer to the vehicle Owner's Manual.

Push and hold <CAMERA\* / > to switch the display brightness to the daytime mode or the nighttime mode, and to adjust the display brightness level using the multi-function controller while the indicator is displayed.

<\* / > OFF> (models without Intelligent Around View Monitor):

Push <\* / > OFF> to switch the display brightness to the daytime mode or the nighttime mode, and to adjust the display brightness level using the multi-function controller while the indicator is displayed.

Push and hold <\* / > OFF> to turn the display on/off.

#### ③ Multi-function controller:

Use to select an item on the screen, select the highlighted item, etc.

☞ "Multi-function controller" (page 2-8)

#### ④ <APPS>:

Push to display the available Apps.

☞ "NissanConnect® Apps" (page 5-25)

#### ⑤ <INFO>:

Push to display the information menu.

☞ "Information menu" (page 5-2)

#### ⑥ <AUDIO>:

Push to operate the audio system.

☞ "Audio main operations" (page 3-17)

#### ⑦ < > BACK>:

Push to return to the previous screen. In a settings screen, this button is also used to apply the setting.

#### ⑧ <STATUS>:

Push to display the current setting of the vehicle information, air conditioner and audio system.

☞ "System status screen" (page 2-15)

#### ⑨ <SETTING>:

Push to access the system settings.

☞ "Settings menu" (page 2-20)

### CENTER MULTI-FUNCTION CONTROL PANEL (Type C) (if so equipped)

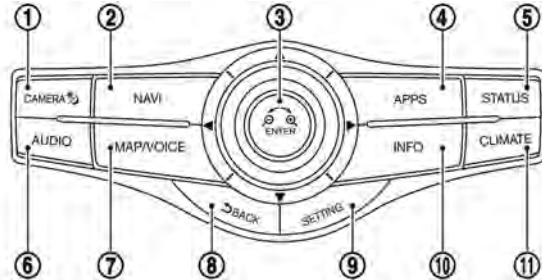

- ① **<CAMERA </b>>** (models with Intelligent Around View Monitor):

Push **<CAMERA </b>>** to operate the Intelligent Around View Monitor. For additional information, refer to the vehicle Owner's Manual.

Push and hold **<CAMERA </b>>** to switch the display brightness to the daytime mode or the nighttime mode, and to adjust the display brightness level using the multi-function controller while the indicator is displayed.

**< OFF>** (models without Intelligent Around View Monitor):

Push **< OFF>** to switch the display brightness to the daytime mode or the nighttime mode, and to adjust

the display brightness level using the multi-function controller while the indicator is displayed.

Push and hold **< OFF>** to turn the display on/off.

- ② **<NAVI>\***:  
Push to display the navigation menu screen.  
 "Setting destination" (page 6-15)  
 "Route menu screen" (page 6-35)
- ③ Multi-function controller:  
Use to select an item on the screen, select the highlighted item, or scroll the map on the screen, etc.  
 "Multi-function controller" (page 2-8)

- ④ **<APPS>**:  
Push to display the available Apps.  
 "NissanConnect® Apps" (page 5-25)
- ⑤ **<STATUS>**:  
Push to display the current setting of the vehicle information, air conditioner, audio and navigation route information.  
 "System status screen" (page 2-15)
- ⑥ **<AUDIO>**:  
Push to operate the audio system.  
 "Audio main operations" (page 3-17)
- ⑦ **<MAP/VOICE>\***:  
Push to display the current location map screen. Push and hold to repeat the voice guidance for a guide point.  
 "Displaying current vehicle location" (page 6-6)  
Push again to display the Display View Bar.  
 "Display View Bar (models with navigation system)" (page 2-16)
- ⑧ **< BACK>**:  
Push to return to the previous screen. In a settings screen, this button is also used to apply the setting.

## 2. Getting Started

### ⑨ <SETTING>:

Push to access the system settings.

☞ "Settings menu" (page 2-20)

### ⑩ <INFO>:

Push to display the information menu.

☞ "Information menu" (page 5-2)

### ⑪ <CLIMATE>:

Push to display the screen for air conditioner operations.

For additional information, refer to the vehicle Owner's Manual.

\*:For some countries, the navigation system may not include map data of the area and navigation related function may not be available.

## MULTI-FUNCTION CONTROLLER

### With directional buttons

#### Models with navigation system:

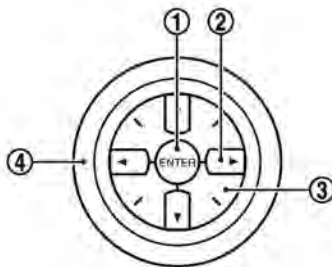

#### ① <ENTER>:

Push to select the highlighted item on the screen.

If this button is pushed while a map is displayed, the shortcut menu or the map menu screen is displayed.

☞ "Shortcut menu" (page 2-15)

☞ "Map menu (models with navigation system)" (page 2-16)

#### ② Main directional buttons:

Push to move across the map, highlight an item on the screen or adjust a setting (volume, brightness, etc.).

#### ③ Additional directional buttons:

Push to move across the map or select an item on the character input screen.

#### ④ Center dial:

Turn to highlight an item on the screen or adjust a setting.

The center dial can also be used to adjust the map scale.

#### Models without navigation system:

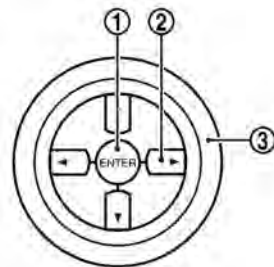

#### ① <ENTER>:

Push to select the highlighted item on the screen.

If this button is pushed while the climate screen or status screen is displayed, the shortcut menu screen is displayed.



## 2. Getting Started

 "Shortcut menu" (page 2-15)

### ② Main directional buttons:

Push to highlight an item on the screen or adjust a setting (volume, brightness, etc.).

### ③ Center dial:

Turn to highlight an item on the screen or adjust a setting.

### Without directional buttons

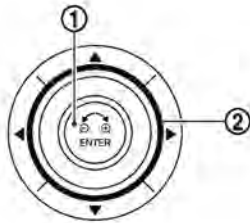

### ① <ENTER>:

Push to select the highlighted item on the screen.

If this button is pushed while a map is displayed, the shortcut menu or the map menu screen is displayed.

 "Shortcut menu" (page 2-15)

 "Map menu (models with naviga-

tion system)" (page 2-16)

### ② Center dial/slide switch:

Turn to highlight an item on the screen, to adjust a setting, or to adjust the map scale.

Slide (push upward/downward/leftward/rightward) to highlight an item on the screen or to adjust a setting (volume, brightness, etc.). The map can be scrolled by sliding this switch.

### NOTE:

**For some countries, the navigation system may not include map data of the area and navigation related function may not be available.**

### STEERING WHEEL SWITCHES (Type A) (if so equipped)

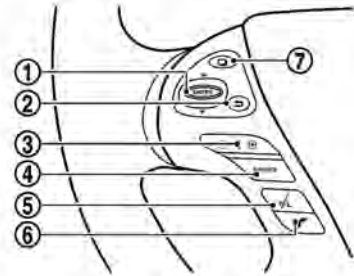

### ① <ENTER>:

Tilt to highlight an item on the screen or adjust a setting. Push to select the highlighted item.

Audio operations are possible by tilting the switch.

 "Steering wheel mounted audio control buttons (Type A)" (page 3-16)

### Models with navigation system:

If this button is pushed while a map is displayed, the shortcut menu or the map menu screen is displayed.

 "Shortcut menu" (page 2-15)

 "Map menu (models with navigation system)" (page 2-16)

## 2. Getting Started

### Models without navigation system:

If this button is pushed while the climate screen or status screen is displayed, the shortcut menu screen is displayed.

 "Shortcut menu" (page 2-15)

② < >:

Push this switch to go back to the previous screen.

③ <-|+>:

Push to adjust the volume.

④ <SOURCE>:

Push to switch the audio mode (source).

 "Steering wheel mounted audio control buttons (Type A)" (page 3-16)

⑤ <  >:

Push to start a voice recognition session. During a voice recognition session, pushing this button cancels the voice guidance and you can speak a voice command immediately.

Push and hold this button to end a voice recognition session.

 "7. Voice Recognition"

⑥ <  >:

Push to operate the hands-free

phone system.

 "4. Bluetooth® Hands-Free Phone"

⑦ <  >:

This button is used for the vehicle information display operation.

For additional information, refer to the vehicle Owner's Manual.

 **NOTE:**

**You are unable to operate the touch screen display using the switches on the steering wheel whenever the vehicle information display shows the setting display.**

### STEERING WHEEL SWITCHES (Type B) (if so equipped)

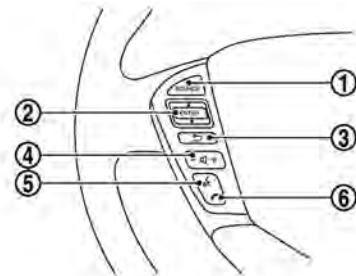

① <SOURCE>:

Push to switch the audio mode (source).

 "Steering wheel mounted audio control buttons (Type B)" (page 3-16)

② <ENTER>\*:

Tilt to highlight an item on the screen or adjust a setting. Push to select the highlighted item.

Audio operations are possible by tilting the switch.

 "Steering wheel mounted audio control buttons (Type B)" (page 3-16)

If this button is pushed while a map is

## 2. Getting Started

displayed, the shortcut menu or the map menu screen is displayed.

"Shortcut menu" (page 2-15)

"Map menu (models with navigation system)" (page 2-16)

③ :

Push this switch to go back to the previous screen.

④ :

Push to adjust the volume.

⑤ :

Push to start a voice recognition session. During a voice recognition session, pushing this button cancels the voice guidance and you can speak a voice command immediately.

Push and hold this button to end a voice recognition session.

"7. Voice Recognition"

⑥ :

Push to operate the hands-free phone system.

"4. Bluetooth® Hands-Free Phone"

\*:For some countries, the navigation system may not include map data of the area and navigation related function may not be available.

### AUDIO ACCESSORIES

The vehicle is equipped with the USB connection ports and the auxiliary input jacks (if so equipped). When connected, the in-vehicle audio system can play audio contents from the compatible device.



#### INFO:

- Even when iPod® and/or iPhone® are connected to both of the two USB/iPod® connection ports, the system recognizes only one of the connected iPod® or iPhone® at a time.
- Only one of the two connected USB memory devices can be operated by the Voice Recognition System.  
 "Voice recognition settings" (page 7-14)
- The USB connector can be used for charging the connected USB device (maximum output up to 5volt, 5W, 1.0A). The USB device will be charged continuously while the ignition switch is in the ACC or ON position. Some USB devices can not be charged according to their specifications.
- The rear media interface for the Mobile Entertainment System (if so equipped) which includes the ports for USB and HDMI is located at the rear of the

center console box.

"Rear media interface" (page 3-58)

#### Type A (if so equipped):

The USB connection ports and the auxiliary input jacks are located in the center console box.

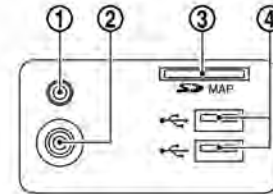

① Auxiliary audio input jack:

Connect an audio player that accepts a 1/8 in (3.5 mm) TRS connector (such as an MP3 player etc.) to play music.

② Auxiliary video input jack:

Connect a video player to play a video.

③ SD card slot (if so equipped):

The card slot is for the map SD card for the navigation system.

"SD card slot" (page 6-64)

## 2. Getting Started

### ④ USB/iPod® connection ports:

Connect to play media from an iPod®, iPhone® or a USB memory device. Refer to the device manufacturer's owner information regarding the proper use and care of the device.

### ⓘ NOTE:

**Depending on the size and shape of USB memory device, the console lid may not fully close. Do not force the console lid closed as this may damage the USB memory device.**

### Type B (if so equipped):

The USB connection ports are located on the lower instrument panel.

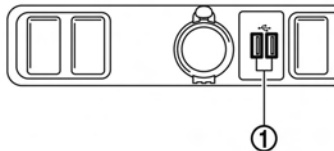

Example

### ① USB/iPod® connection ports:

Connect to play media from an iPod®, iPhone® or a USB memory device. Refer to the device manufacturer's owner information regarding the proper use and care of the device.

## STARTING SYSTEM

The system starts when the ignition switch is placed in the ACC or ON position.

### START-UP WARNING

When the ignition switch is placed in the ACC or ON position, the start-up screen is displayed.

Touch [OK] after reading and agreeing with the message. If you do not agree to the message, some of the functions will be disabled.

### ⓘ NOTE:

**Do not keep the NissanConnect® system turned on with the engine stopped. Doing so may discharge the vehicle battery. When you use NissanConnect®, always keep the engine running.**

### TOUCH PANEL OPERATION

This system is mainly operated with the touch screen display.

#### HOW TO USE TOUCH SCREEN

Basic operations can be done by touching, swiping and dragging on the screen.

- **Touch**

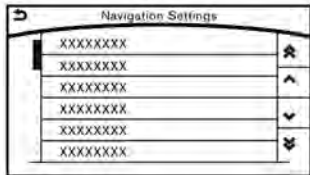
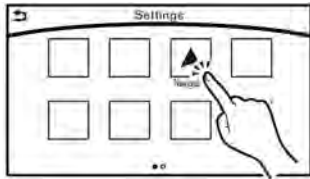

Select and execute the selected key on the screen.

- **Swipe**

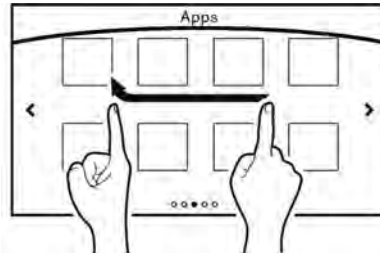

Menu screen pages will skip to the next page.

- **Drag**

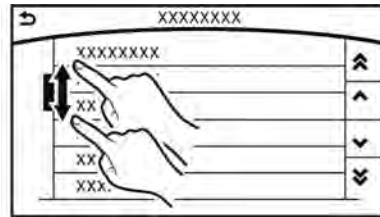

Drag the scroll bar up or down to scroll the menu screen.

#### Models with navigation system:

More various operations are possible for a map screen.

 "Map operation" (page 6-4)

#### OPERATING MENU SCREEN

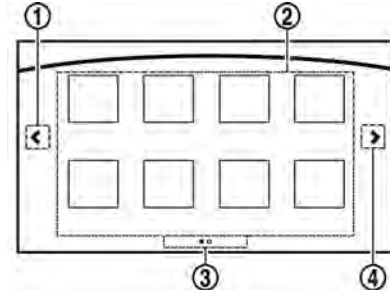

- ① Touch [ < ] to scroll to the previous page.
- ② Touch the preferred icon to execute a function and display the next screen.
- ③ Indicates the position of the currently displayed page out of the total number of available pages.
- ④ Touch [ > ] to scroll to the next page.

A swipe gesture can also be used to move quickly between pages.

## 2. Getting Started

### SCROLLING LIST OR MESSAGE

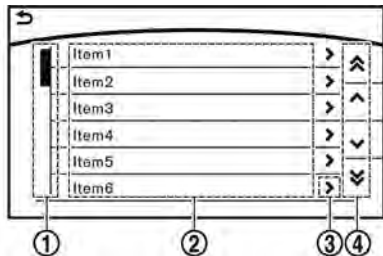

- ① Drag the scroll bar up or down to scroll the message or list up or down.
- ② Touch the preferred item.
- ③ If a listed item name is not completely displayed (due to length), touch [➤] to display the hidden part of the name.
- ④ Touch [^] or [v] to scroll the message or list one item at a time.  
Touch [⏶] or [⏷] to skip to the next page.

### SELECTING ITEM

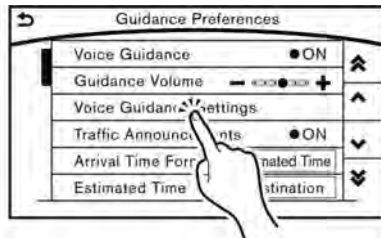

When an item is touched, it is executed and the next screen is displayed.  
Touch [⏪] to return to the previous screen.

### ADJUSTING SETTINGS

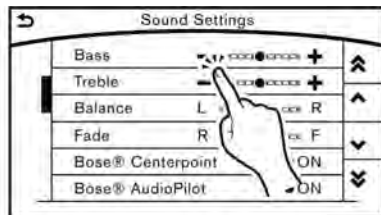

The level of volume, brightness, etc. can be adjusted.

Touch the adjustment keys, such as [ + ]/[ - ], [ L ]/[ R ], etc., to adjust each item. Each time a key is touched, the indicator moves

along the bar.

### SYSTEM STATUS SCREEN

By pushing **<STATUS>**, the current status of the system can be displayed.



#### INFO:

There are different status screens displayed depending on various factors, such as the currently active mode, whether a destination (models with navigation system) has been set or not, etc.

Touching [**<**]/[**>**] can switch air conditioner status screen, navigation route information screen (models with navigation system) and information screen.

#### Models with navigation system:

When no route is set, a compass and the current location is displayed instead of the route information.

### SHORTCUT MENU

#### Models with navigation system:

To display the shortcut menu, push **<ENTER>** or touch [  ] while the current location map screen is displayed.

The items on the shortcut menu can be customized to your preference.

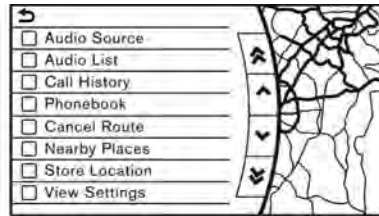

#### Available items:

- [Audio Source]
- [Audio List]
- [Call History]
- [Phonebook]
- [Cancel Route]
- [Nearby Places]
- [Store Location]
- [View Settings]

- [Select Add/Edit]

#### Models without navigation system:

To display the shortcut menu, push **<ENTER>** or touch [  ] while the climate or status screen is displayed.

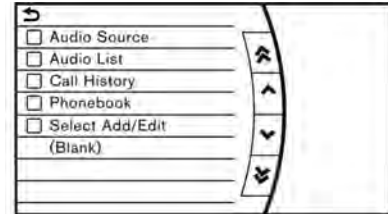

#### Available items:

- [Audio Source]
- [Audio List]
- [Call History]
- [Phonebook]
- [Select Add/Edit]

### EDIT SHORTCUT MENU

The following procedure can be used to edit or sort the shortcut menu.

1. Select [Select Add/Edit] to register a new item to the menu, or to change an existing menu item.

## 2. Getting Started

### 2. Select the preferred setting.

- [Change Order]

Change the order in which shortcut menu items are shown. Touch and hold [☰] displayed next to the item you wish to relocate. Drag the icon to the position in the list where you wish to insert it.

- [Edit Shortcut Items]

Select items to be displayed in the shortcut menu.

### MAP MENU (models with navigation system)

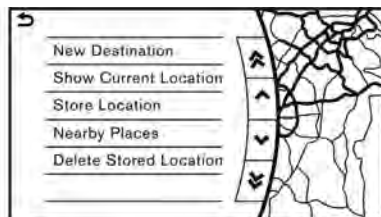

While scrolling the map screen, push **<ENTER>** or touch [☰] to display the Map Menu.

- [New Destination]
- [Show Current Location]
- [Store Location]
- [Nearby Places]
- [Delete Stored Location]



#### INFO:

[Delete Stored Location] is available only when the cross pointer is aligned over the stored location.

### DISPLAY VIEW BAR (models with navigation system)

Various information screens can be shown by selecting from the Display View Bar.

Available views may vary depending on models and specifications.

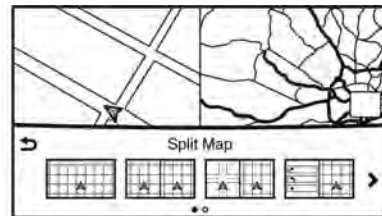

When the screen displays the current location map, push **<MAP>/<MAP/VOICE>** to show the Display View Bar.

Select an icon in the Display View Bar. The current view will change and the Display View Bar will be closed.

The following display views are available.





## 2. Getting Started

### Viewing Fuel Economy:

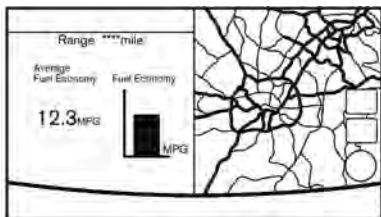

This displays the fuel economy information.

### Viewing Eco Drive Report:

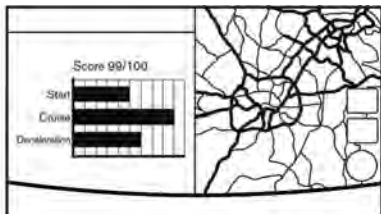

Your driving score will be displayed in real time, with 100 points designated as the score for ideal eco-driving.

To improve your score:

- When starting off, depress the accelerator gently.

- When cruising, accelerate and decelerate as little as possible.
- When decelerating, release the accelerator early.

### CUSTOMIZING THE DISPLAY VIEW BAR

The menu icons on the Display View Bar can be set to your preference.

1. Push **<SETTING>** and touch [Navigation] to display the navigation setting screen.
2. Touch [Map & Display View] and touch [Change Order].
3. Change the order of the icons to be displayed on the Display View Bar. Touch and hold the [≡] displayed next to the item you wish to relocate. Drag the icon to the position in the list where you wish to insert the item.

### HOW TO INPUT LETTERS AND NUMBERS

The keyboard screen differs depending on the model and specification.

### ALPHANUMERIC CHARACTER (letters and numbers) INPUT SCREEN

Alphanumeric characters can be entered using the keyboard. The designs and the displayed items may vary depending on the type of screen.

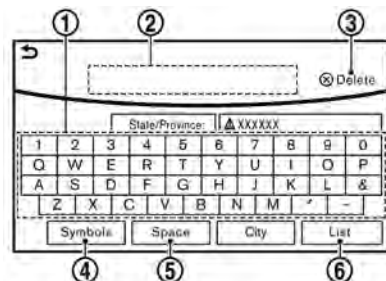

- ① Touch a character on the displayed keyboard. The selected character is entered.
- ② Entered characters are displayed here.

- ③ Touch [Delete] to delete the last character entered.  
Touch and hold [Delete] to delete all the characters entered.
- ④ The symbol keys are displayed by touching [Symbols]. The alphabet keys are displayed by touching [A-Z].
- ⑤ Touch [Space] to enter a space.
- ⑥ Touch [OK] or [List] to finalize your input.



### INFO:

- Touch [CAPS] to toggle uppercase and lowercase characters on the keyboard screen.
- Touch [◀ ] or [▶ ] to move the character input position.

## 2. Getting Started











### SYSTEM SETTINGS

#### SETTINGS MENU



The system settings can be changed to your preference.

Available setting items may vary depending on models and specifications.

Push **<SETTING>** to display the Settings menu and touch a setting item you wish to adjust.

Menu item	Result
[Bluetooth]	Sets the Bluetooth® streaming audio and phone.  "Bluetooth® settings" (page 2-28)
[Phone/Mail]	Displays the phone/mail setting screen.  "Phone and text message settings" (page 4-9)
[Vehicle]	Displays the vehicle settings screen.  "Vehicle settings" (page 2-22)
[Navigation]	Displays the navigation settings screen.  "Navigation settings" (page 6-54)
[Audio]	Displays the audio settings screen.  "Audio settings" (page 3-39)
[Screen]	Displays the touch screen display setting screen.  "Screen settings" (page 2-23)
[Volume Adjustment]	Displays the volume adjustment setting screen.  "Volume settings" (page 2-24)
[Clock]	Displays the clock setting screen.  "Clock settings" (page 2-27)
[NissanConnect Services]	Displays the NissanConnect® Services setting screen.  "NissanConnect® Services settings" (page 5-24)
[Voice Recognition]	Displays the voice recognition function setting screen.  "Voice recognition settings" (page 7-14)

## 2. Getting Started

Menu item		Result
[Camera/Sonar]		Displays the camera/parking sensor (sonar) system setting screen. For additional information, refer to the vehicle Owner's Manual.
[Driver Assistance]		Displays the Driver Assistance setting screen. For additional information, refer to the vehicle Owner's Manual.
[Other]	[Language]	Displays the language setting screen.  "Language settings" (page 2-25)
	[Language & Units]	Displays the language and units setting screen.  "Language & Units settings" (page 2-26)
	[Keyboard Type]	Sets the keyboard type to [ABC] or [QWERTY] .
	[Low on Fuel Alert]	Sets the fuel low notification to on/off.
	[Software Information]	Displays the software information.

## 2. Getting Started

### Vehicle settings (if so equipped)

This menu changes the vehicle settings.

Available setting items may vary depending on models and specifications.

1. Push **<SETTING>**.
2. Touch [Vehicle].

Setting item	Result
[Lamp ON When Door Unlocks]	When this item is set to on, the interior lights illuminate when any door is unlocked.
[Light Sensitivity]	Sets the auto light sensitivity.
[Light Off Delay]	Sets the auto light delay timer.
[Speed Sensing Wiper Interval]	Sets the wiper interval to be adjusted automatically according to the vehicle speed.
[Selective Door Unlock]	Sets the selective door unlock.
[Intelligent Key Lock/Unlock]	When this item is turned on, door lock/unlock function by pushing the door handle request switch will be activated.
[Lift Steering Wheel on Exit]	Sets the lift steering wheel on exit.
[Slide Driver's Seat Back on Exit]	Sets the driver's seat back on exit.
[Reset Settings]	Returns all vehicle setting values to default.

### Screen settings

This menu turns the display on/off and adjusts the image quality of the screen.

Available setting items may vary depending on models and specifications.

1. Push **<SETTING>**.
2. Touch [Screen].

Setting item		Action
[Display Settings]	[Brightness]	Adjusts the brightness.
	[Contrast]	Adjusts the contrast.
	[Black Level]	Adjusts the black level.
[Display OFF]		Turns the screen on/off. Push and hold <b>&lt;CAMERA&gt;/&lt;OFF&gt;/&lt;CAMERA* / &gt;/&lt;* / &gt; OFF</b> for more than 2 seconds to turn the screen on.
[Day/Night]		Adjusts the screen brightness. Toggles the screen color between the day screen and the night screen.
[Change Map Color]		Toggles the screen color between the daytime mode and the night time mode.
[Reset Settings]		This restores the screen settings to default.

## 2. Getting Started

### Volume settings

This menu turns on/off and adjusts the volume for various functions and system beeps.

Available setting items may vary depending on models and specifications.

1. Push **<SETTING>**.
2. Touch [Volume Adjustment].

Setting item	Action
[Audio Volume]	Adjusts the volume of the audio system.
[Voice Guidance]	Toggles the voice guidance on/off.
[Guidance Volume]	Adjusts the volume level of the guidance volume.
[Ringtone Volume]	Adjusts the volume level of the ringtone.
[Incoming Call Vol.]	Adjusts the incoming call volume.
[Outgoing Call Vol.]	Adjusts the outgoing call volume.
[RDS Volume]	Adjusts the volume level of the RDS announcement.
[NissanConnect Svcs. Vol]	Adjust the volume level of the NissanConnect® Services information channel.
[Sonar Volume]	Adjusts the volume level of the sonar warning volume.
[Button Beep sound]	Toggles the button beep sound and alarm for a prohibited operation between on and off.



### Language settings (if so equipped)

This changes the language used in the system.

Available setting items may vary depending on models and specifications.

1. Push **<SETTING>**.
2. Touch [Other].
3. Touch [Language].

Setting item	Action
[System Language]	Select the language of the display, voice announcements, and voice recognition functions.



#### INFO:

- Do not change the ignition switch position while changing the language.
- The Voice Recognition System can be used only if the language is supported by the Voice Recognition System.
- Depending on the language selected, available voice commands for the Voice Recognition System may differ.

## 2. Getting Started

### Language & Units settings (if so equipped)

This changes the language and measurement unit used in the system.

Available setting items may vary depending on models and specifications.

1. Push <SETTING>.
2. Touch [Other].
3. Touch [Language & Units].

Setting item	Action
[System Language]	Select the language of the display, voice announcements, and voice recognition functions.
[Fuel Economy Unit Settings]	Select the preferred fuel economy unit.
[Tire Pressure Units]	Select the preferred tire pressure unit.
[Temperature Units]	Select the preferred temperature unit.



#### INFO:

- Do not change the ignition switch position while changing the language.
- The Voice Recognition System can be used only if the language selected in this setting is supported by the system.
- Depending on the language selected, available voice commands for the Voice Recognition System may differ.

### Clock settings

This changes the clock settings.

Available setting items may vary depending on models and specifications.

1. Push **<SETTING>**.

2. Touch [Clock].

Setting item	Action
[On-Screen Clock]	Sets the clock display on/off. When this item is on, the clock display appears.
[Daylight Savings Time]	Select the setting for the daylight savings time from ON and OFF.
[Clock Format (24h)]	Select the clock format between 12-hour and 24-hour times. When the indicator light illuminates, the clock is set to the 24-hour format.
[Time Zone]	Select an appropriate time zone from the list. When selecting [AUTO], the system selects the time zone automatically.
[Offset Adjustment]	Adjusts the offset value (hour and minutes).
[>]	[Time Adjustment]
	[Calendar Adjustment]

## 2. Getting Started

### PAIRING BLUETOOTH® DEVICE

Your vehicle is equipped with a Bluetooth® Hands-Free Phone System and Bluetooth® streaming audio. If you are an owner of a compatible Bluetooth® enabled cellular phone or Bluetooth® streaming audio module, you can set up the wireless connection between your cellular phone and the in-vehicle phone module, or Bluetooth® streaming audio device and the in-vehicle audio module. With Bluetooth® wireless technology, you can make or receive a telephone call with your cellular phone in your pocket and listen to music on your Bluetooth® streaming audio device via the in-vehicle system.

#### Pairing cellular phone/audio device

1. Push **<SETTING>**.
2. Touch [Bluetooth] and touch [Connect Device].
3. Touch [Add New (X/5 Free)] to register a device.
4. When a PIN code appears on the screen, operate the compatible Bluetooth® cellular phone to enter the PIN code.

The pairing procedure for cellular

phones varies depending on the model of cellular phone. Refer to the owner's manual for the cellular phone for details.

If the registered device has both audio and phone functions, the system displays a message asking if you would like to register the device for another function.

The procedure for connecting a cellular phone/audio device varies depending on the Bluetooth® device. Refer to the owner's manual for the Bluetooth® device for details.



#### NOTE:

**Some cellular phones or other devices may cause interference or a buzzing noise to be emitted from the audio system speakers. Storing the device in a different location may reduce or eliminate the noise.**



#### INFO:

It is recommended that you visit a NISSAN dealer for compatibility, or call NISSAN Consumer Affairs Department for instructions on pairing NISSAN recommended cellular phones or audio devices.

### Bluetooth® settings

The Bluetooth® settings can be set in detail according to the user's preference.

1. Push **<SETTING>**.
2. Touch [Bluetooth].
3. Touch the preferred item.
  - [Bluetooth]  
Turn the Bluetooth® connection to the vehicle on/off.
  - [Connect Device]  
Touch this item to connect to the Bluetooth® device. You can also delete a registered device and display information for the registered device.
  - [Select Phone]  
Registered Bluetooth® Hands-Free Phones are shown on the list. Select a device from the list to disconnect or connect a Bluetooth® device.
  - [Select Audio Device]  
Registered Bluetooth® streaming audio players are shown on the list. Select a device from the list to disconnect or connect a Bluetooth® device.
  - [Vehicle Bluetooth Device Info.]  
The registered device name and the

PIN code can be changed.

### **FUNCTIONS DISABLED WHILE DRIVING**

To help ensure safe driving, some functions cannot be operated or have limited operation while the vehicle is in motion.

The on-screen text and keys for these restricted functions will be "grayed-out" or muted and cannot be selected while driving. In some cases, a screen message will appear indicating a restricted function.

Restricted functions while driving include:

- Character (letter and number) input screen.
- Scrolling and viewing of certain list screens.
- Displaying detail information and touching item on the information screen.
- Adding/editing home location, address book entries and current route. (models with navigation system)
- Making a call by dialing number and using handset phonebook.
- Setting phone, NissanConnect® Services (if so equipped) and Bluetooth® functions.

These functions will become available again when the vehicle is not in motion.

Some of the destination setting functions (models with navigation system) that become unavailable while driving can be operated by Voice Recognition System. Available voice commands may differ depending on the language setting.

## 2. Getting Started

### ADDITIONAL SYSTEM INFORMATION

NissanConnect® with Navigation (if so equipped), Apps and Services (if so equipped) uses an operating system like those found on many computers, tablets and cellular phones. Like these devices, processing speed may vary, and system response delays or resets may occur intermittently. This does not indicate a malfunction, and further information on system operation can be found below.

#### System Start-Up

Due to the large number of features and capabilities that the system needs to load on start-up, it may take up to a minute for all functions (such as Apps) to be available.

#### System Response Delay

The system uses an operating system like those found on many computers, tablets and cellular phones. Like these devices, sometimes programs do not respond immediately and this may temporarily delay system use.

In most situations, simply waiting a few moments longer should be sufficient for the pending operations to complete.

If the system temporarily does not respond to commands, the system can be

easily reset. Simply push and hold **<VOL/ON-OFF>** on the audio system for at least 5 seconds. The system will turn off and restart.

After restarting, all functions should be available.

#### System Reset

As noted above, intermittent system resets may occur during normal operation. You may also wish to reset the system if you find that a particular feature is not loading or responding. Often, a quick system reset will resolve any issue you may be experiencing. After restarting, all functions will be available as described above.

#### System Updates

Like many digital devices, the system is designed to allow for software updates as enhancements are developed and additional features added. If you have questions about system performance, it is recommended that you contact a NISSAN dealer to ensure that your vehicle has had the latest available software installed.

#### Operating Tips

The system provides several methods of operation to suit your preferences. The following are suggested operating tips.

- Operating the control panel, steering wheel controls or other controls too quickly can cause a lag between the control and the display. Operate the controls carefully and allow the system to respond to your request.
- NISSAN recommends using Voice Recognition whenever possible to select options while driving. Some touch screen functionality is intentionally unavailable during driving. Please view the available voice commands by pushing **< V >** and then selecting a category on the display.
- Models with navigation system:  
When looking for a street address or Points of Interest (POI), remember that you can use Connected Search and Destination Assistance features within NissanConnect® Services to expand your search methods and results. The Voice Recognition System recognizes a defined set of commands. These commands can be viewed in the display by pushing **< V >** and then selecting a category from the displayed list. The commands can also be found in the Voice Recognition section under the command list.

 "Command list" (page 7-7)

- In some situations, the system may not be able to recognize your command even if you say the exact command. This can be due to noise conditions or an accent.
- In some unique cases, the system may expect a word to be spoken as it is spelled as opposed to the way it is normally pronounced.

### ADDITIONAL HELP

For additional technical information, it is recommended that you contact a NISSAN dealer for troubleshooting help.

## 2. Getting Started

---

**MEMO**



# 3 Audio system

Audio operation precautions .....	3-2	USB memory device player .....	3-29
Radio .....	3-2	iPod® player .....	3-32
Compact Disc (CD) player .....	3-4	Bluetooth® streaming audio .....	3-35
Digital Versatile Disc (DVD) player (if so equipped) .....	3-5	Auxiliary (AUX) devices (if so equipped) .....	3-37
USB (Universal Serial Bus) connection port .....	3-8	Audio settings .....	3-39
Compressed audio files (MP3/WMA/AAC) .....	3-9	Disc/USB memory device care and cleaning .....	3-42
Bluetooth® streaming audio .....	3-13	Discs .....	3-42
Names and functions of audio control buttons .....	3-14	USB memory device .....	3-42
Audio main buttons (Type A) (if so equipped) .....	3-14	Gracenote® End User License Agreement .....	3-42
Audio main buttons (Type B) (if so equipped) .....	3-15	Mobile Entertainment System (MES) (if so equipped) .....	3-43
Steering wheel mounted audio control buttons (Type A) (if so equipped) .....	3-16	Precautions .....	3-44
Steering wheel mounted audio control buttons (Type B) (if so equipped) .....	3-16	Technical Information .....	3-44
Audio operations .....	3-17	Remote controller and headphones .....	3-53
Audio main operations .....	3-17	Rear media interface .....	3-58
Radio .....	3-19	Activating rear displays .....	3-58
Compact Disc (CD) player .....	3-24	Operations on rear displays .....	3-59
Digital Versatile Disc (DVD) player (if so equipped) .....	3-26	Setting and information .....	3-60
		Controlling the rear system on the front display .....	3-61
		Operating tips .....	3-62
		Care and maintenance .....	3-64

### 3. Audio system

#### AUDIO OPERATION PRECAUTIONS

##### WARNING

- The driver must not attempt to operate the audio system while the vehicle is in motion, so that full attention may be given to the vehicle operation.
- Park the vehicle in a safe location and apply the parking brake before operating the audio system and playing movies (if so equipped).

##### CAUTION

- Operate the audio system only when the vehicle engine is running. Operating the audio system for extended periods of time with the engine turned off can discharge the vehicle battery.
- Do not allow these systems to get wet. Excessive moisture, such as spilled liquids, may cause the system to malfunction.

#### RADIO

Place the ignition switch in the ACC or ON position before turning on the radio. If you listen to the radio with the engine not running, the ignition switch should be placed in the ACC position.

Radio reception is affected by station signal strength, distance from radio transmitter, buildings, bridges, mountains and other external influences. Intermittent changes in reception quality normally are caused by these external influences.

**Using a cellular phone in or near the vehicle may influence radio reception quality.**

#### Radio reception

Your radio system is equipped with state-of-the-art electronic circuits to enhance radio reception. These circuits are designed to extend reception range, and to enhance the quality of that reception.

However there are some general characteristics of both FM and AM radio signals that can affect radio reception quality in a moving vehicle, even when the finest equipment is used. These characteristics are completely normal in a given reception area, and do not indicate any malfunction in your radio system.

Reception conditions will constantly

change because of vehicle movement. Buildings, terrain, signal distance and interference from other vehicles can work against ideal reception. Described below are some of the factors that can affect your radio reception.

Some cellular phones or other devices may cause interference or a buzzing noise to come from the audio system speakers. Storing the device in a different location may reduce or eliminate the noise.

#### FM radio reception

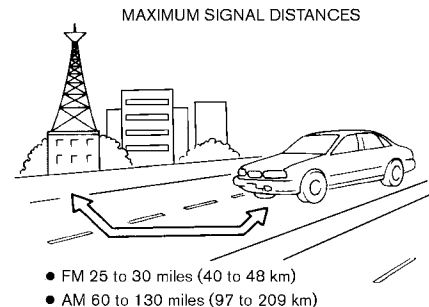

Range: the FM range is normally limited to 25 to 30 miles (40 to 48 km), with monaural (single station) FM having

slightly more range than stereo FM. External influences may sometimes interfere with FM station reception even if the FM station is within 25 miles (40 km). The strength of the FM signal is directly related to the distance between the transmitter and receiver. FM signals follow a line-of-sight path, exhibiting many of the same characteristics as light. For example they will reflect off objects.

**Fade and drift:** As your vehicle moves away from a station transmitter, the signals will tend to fade and/or drift.

**Static and flutter:** During signal interference from buildings, large hills or due to antenna position, usually in conjunction with increased distance from the station transmitter, static or flutter can be heard. This can be reduced by lowering the treble setting to reduce the treble response.

**Multipath reception:** Because of the reflective characteristics of FM signals, direct and reflected signals reach the receiver at the same time. The signals may cancel each other out, resulting in momentary flutter or loss of sound.

### AM radio reception

AM signals, because of their low frequency, can bend around objects and skip along the ground. In addition, the signals

can bounce off the ionosphere and be bent back to earth. Because of these characteristics, AM signals are also subject to interference as they travel from transmitter to receiver.

**Fading:** Occurs while the vehicle is passing through freeway underpasses or in areas with many tall buildings. It can also occur for several seconds during ionospheric turbulence even in areas where no obstacles exist.

**Static:** Caused by thunderstorms, electrical power lines, electric signs and even traffic lights.

### HD Radio™ Technology reception (if so equipped)

HD Radio™ Technology reception needs to be activated to receive HD Radio broadcasts.

 "Audio settings" (page 3-39)

This enables you to receive radio broadcasts digitally (where available), providing a better quality sound with clear reception. When this feature is not activated or HD Radio broadcasts are not available, you will receive analog radio (AM/FM) broadcasts.

### Satellite radio reception

When the satellite radio is used for the first time or the battery has been replaced, the satellite radio may not work properly. This is not a malfunction. Wait more than 10 minutes with the satellite radio ON and the vehicle outside of any metal or large building for the satellite radio to receive all of the necessary data.

SiriusXM® services require a subscription after trial period and are sold separately or as a package. The satellite service is available only in the 48 contiguous USA and DC. SiriusXM® satellite service is also available in Canada; see [www.siriusxm.ca](http://www.siriusxm.ca).

The satellite radio performance may be affected if cargo carried on the roof blocks the satellite radio signal.

If possible, do not put cargo near the satellite antenna.

A buildup of ice on the satellite radio antenna can affect satellite radio performance. Remove the ice to restore satellite radio reception.

### 3. Audio system

#### COMPACT DISC (CD) PLAYER

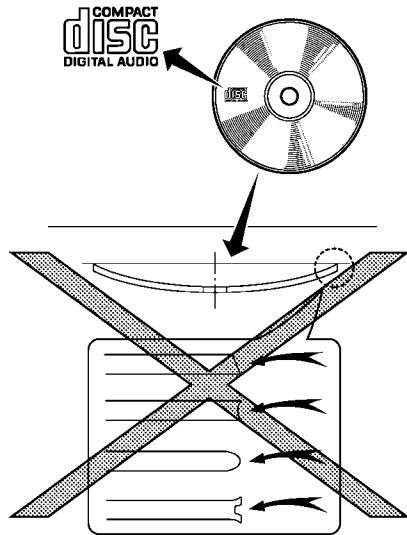

- Do not force a compact disc into the CD insert slot. This could damage the CD and/or CD player.
- Trying to load a CD with the CD door closed could damage the CD and/or CD player.



- During cold or rainy weather, the player may malfunction due to the humidity. If this occurs, remove the CD and dehumidify or ventilate the player completely.
- The player may skip while driving on rough roads.
- The CD player sometimes cannot function when the passenger compartment temperature is extremely high. Decrease the temperature before use.
- Only use high quality 4.7 in (12 cm) round discs that have the "COMPACT disc DIGITAL AUDIO" logo on the disc or packaging.
- Do not expose the CD to direct sunlight.
- CDs that are of poor quality, are dirty, scratched, or covered with fingerprints, or that have pin holes may not work properly.
- The following CDs may not work properly:
  - Copy control compact discs (CCCD)
  - Recordable compact discs (CD-R)
  - Rewritable compact discs (CD-RW)

- Do not use the following CDs as they may cause the CD player to malfunction.
  - 3.1 in (8 cm) discs
  - CDs that are not round
  - CDs with a paper label
  - CDs that are warped, scratched, or have abnormal edges
- This audio system can only play pre-recorded CDs. It has no capabilities to record or burn CDs.
- If a CD cannot be played, error messages similar to the following may be displayed.
  - Disc read error:  
Indicates a CLV/Focus, TOC or Access error. Check and re-insert the CD. Make sure that it is inserted correctly.
  - Eject disc, please:  
Indicates a mechanism error. If the CD can be ejected, eject and re-insert the CD. If the CD cannot be ejected, it is recommended that you contact a NISSAN dealer.
  - Unplayable error:  
Indicates that no readable files are found on the inserted CD. Check the data on your CD.

### 3. Audio system

#### DIGITAL VERSATILE DISC (DVD) PLAYER (if so equipped)

##### Copyright and trademark

- The technology protected by the U.S. patent and other intellectual property rights owned by Macrovision Corporation and other right holders is adopted for this system.
- This copyright protected technology cannot be used without a permit from Macrovision Corporation. It is limited to be personal use, etc., as long as the permit from Macrovision Corporation is not issued.
- Modifying or disassembling is prohibited.
- Dolby digital is manufactured under license from Dolby Laboratories, Inc.
- Dolby and the double D mark  are trademarks of Dolby Laboratories, Inc.
- DTS is a registered trademark of DTS, Inc. and DTS 2.0  is a trademark of DTS, Inc.
- DTS and DTS Digital Surround  are registered trademarks of DTS, Inc.

##### Parental level (parental control)

DVDs with the parental control settings can be played with this system. Please use your own judgement to set the parental control with the system.

##### Disc selection

You can play the following disc formats with the DVD drive:

- DVD-Video
- DVD-VR
- Video-CD
- DTS-CD

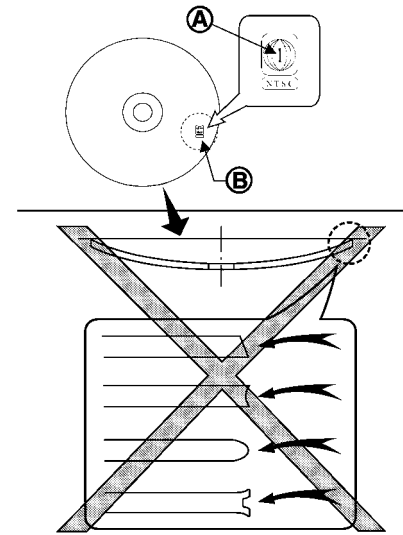

Use DVDs with the region code "ALL" or the code applicable to your DVD player. (The region code **A** is displayed as a small symbol printed on the DVD **B**.) This vehicle-installed DVD player can only play DVDs with an applicable region code.

**Do not use the following DVDs as they may cause the DVD player to malfunction.**

### 3. Audio system

tion:

- 3.1 in (8 cm) discs
- DVDs with incompatible region code
- DVDs that are not round
- DVDs with a paper label
- DVDs that are warped, scratched, or have unequal edges

The following DVDs may not work properly:

- Recordable digital video discs (DVD-R)
- Rewritable digital video discs (DVD-RW)

Specification chart for DVD

**Playable media:**

The following media can be played on the system.

- DVD+RW
- DVD+R
- DVD+R DL
- DVD-RW (corresponds to CPRM)
- DVD-R (corresponds to CPRM)
- DVD-R DL (corresponds to CPRM)
- DVD-ROM

- Dual DISC (not guaranteed)

**Video codec:**

The following video codecs are supported by the system.

Video file format	
DVD Video	
DVD-VR with CPRM	
VIDEO CD	Ver. 1.0
	Ver. 1.1
	Ver. 2.0
DTS CD	

### 3. Audio system

#### Audio codec:

The following combinations of audio codecs support video formats.

Sound format	DVD-Video	DVD-VR	Video-CD	DTS-CD
LPCM	Supported	Supported	Not supported	Not supported
Dolby Digital	Supported	Supported	Not supported	Not supported
Dolby Digital EX	Supported with limited output *1	Not supported	Not supported	Not supported
Dts	Supported	Not supported	Not supported	Supported
dts-ES	Supported with limited output *2	Not supported	Not supported	Not supported
dts 96/24	Supported with limited output *3	Not supported	Not supported	Not supported
MPEG1 Layer3	Supported	Supported	Supported	Not supported
MPEG2 Layer3	Supported with limited output *4	Supported with limited output	Not supported *5	Not supported

\*1 A back surround channel is assigned to the LS and RS channels and output.

\*2 A surround centre channel is assigned to the LS and RS channels and output.

\*3 Output in 48kHz / 24bit.

\*4 A back surround channel of DVD-Video and DVD-VR/MPEG2 is assigned to the LS and RS channels and output.

\*5 MPEG2 Layer3 of VIDEO CD indicates SVCD. SVCD may play but its performance is not guaranteed. The 2ch output is utilized for the audio output of SVCD.

### 3. Audio system

#### USB (Universal Serial Bus) CONNECTION PORT



##### WARNING

**Do not connect, disconnect or operate the USB memory device while driving.**

**Doing so can be a distraction. If distracted you could lose control of your vehicle and cause an accident or serious injury.**



##### CAUTION

- **Do not force the USB memory device into the USB connection port. Inserting the USB memory device tilted or upside down into the port may damage the port. Make sure that the USB memory device is connected correctly into the USB connection port.**
- **Do not grab the USB connection port cover (if so equipped) when pulling the USB memory device out of the port. This could damage the port and the cover.**
- **Do not leave the USB cable in a place where it can be pulled unintentionally. Pulling the cable may**

#### damage the port.

The vehicle is not equipped with a USB memory device. USB memory devices should be purchased separately as necessary.

This system cannot be used to format USB memory devices. To format a USB memory device, use a personal computer.

In some areas, the USB memory device for the front seats plays only sound without images for regulatory reasons, even when the vehicle is parked.

This system supports various USB memory devices, USB hard drives and iPod® players. Some USB memory devices may not be supported by this system.

- Partitioned USB memory devices may not play correctly.
- Some characters used in other languages (Chinese, Japanese, etc.) may not appear properly in the display. Using English language characters with a USB memory device is recommended.

#### General notes for USB use

Refer to your device manufacturer's own information regarding the proper use and care of the device.

#### Notes for iPod® use

"Made for iPod®" and "Made for iPhone®" mean that an electronic accessory has been designed to connect specifically to iPod® or iPhone®, respectively, and has been certified by the developer to meet Apple performance standards. Apple is not responsible for the operation of this device or its compliance with safety and regulatory standards. Please note that the use of this accessory with iPod® or iPhone® may affect wireless performance.

Apple, the Apple logo, iPhone®, iPod®, iPod classic®, iPod nano® and iPod touch® are trademarks of Apple Inc., registered in the U.S. and other countries. Lightning™ is a trademark of Apple Inc. App Store<sup>SM</sup> is a service mark of Apple Inc.

- Improperly plugging in an iPod® may cause a check-mark to be displayed on/off (flickering). Always make sure that the iPod® is connected properly.
- An iPod nano® (1st generation) may remain in fast-forward or rewind mode if it is connected during a seek operation. In this case, please manually reset the iPod®.
- An iPod nano® (2nd generation) will continue to fast-forward or rewind if it is disconnected during a seek operation.



tion.

- An incorrect song title may appear when the Play Mode is changed while using an iPod nano® (2nd generation).
- Audiobooks may not play in the same order as they appear on an iPod®.
- Large video files cause slow responses in an iPod®. The in-vehicle touch screen display may momentarily black out, but will soon recover.
- If an iPod® automatically selects large video files while in the shuffle mode, the in-vehicle touch screen display may momentarily black out, but will soon recover.

### COMPRESSED AUDIO FILES (MP3/WMA/AAC)

#### Explanation of terms

- **MP3** — MP3 is short for Moving Pictures Experts Group Audio Layer 3. MP3 is the most well known compressed digital audio file format. This format allows for near "CD quality sound, but at a fraction of the size of normal audio files. MP3 conversion of an audio track can reduce the file size by approximately a 10:1 ratio (sampling: 44.1 kHz, bit rate: 128 kbps) with virtually no perceptible loss in quality. The compression reduces certain parts of the sound that seem inaudible to most people.
- **WMA** — Windows Media Audio (WMA) is a compressed audio format created by Microsoft as an alternative to MP3. The WMA codec offers greater file compression than the MP3 codec, enabling storage of more digital audio tracks in the same amount of space when compared to MP3s at the same level of quality.  
This product is protected by certain intellectual property rights of Microsoft Corporation and third parties. Use or distribution of such technology

outside of this product is prohibited without a license from Microsoft or an authorized Microsoft subsidiary and third parties.

- **AAC** — Advanced Audio Coding (AAC) is a compressed audio format. AAC offers greater file compression than MP3 and enables music file creation and storage at the same quality as MP3.
- **Bit rate** — Bit rate denotes the number of bits per second used by a digital music file. The size and quality of a compressed digital audio file is determined by the bit rate used when encoding the file.
- **Sampling frequency** — Sampling frequency is the rate at which the samples of a signal are converted from analog to digital (A/D conversion) per second.
- **Multisession** — Multisession is one of the methods for writing data to media. Writing data once to the media is called a single session, and writing more than once is called a multisession.
- **ID3/WMA Tag** — The ID3/WMA tag is the part of the encoded MP3 or WMA file that contains information about the digital music file such as song title,

### 3. Audio system

artist, album title, encoding bit rate, and track time duration, etc. ID3 tag information is displayed on the Album/Artist/Track title line on the display.

\* Windows® and Windows Media® are registered trademarks or trademarks of Microsoft Corporation in the United States of America and/or other countries.

#### Playback order

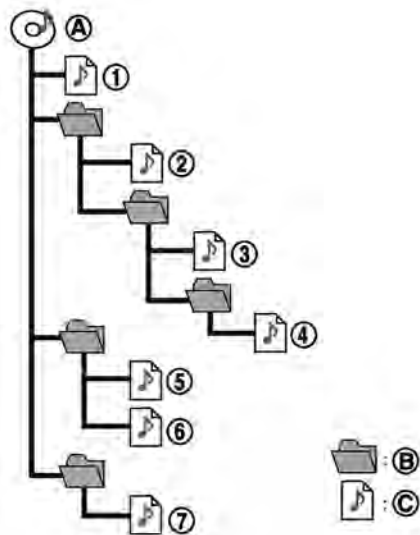

- (A) Root folder
- (B) Folder
- (C) Audio file

- The folder names of folders not containing compressed audio files are not shown on the display.
- If there is a file in the top level of a disc/USB, the root folder is displayed.
- The playback order is the order in which the files were written by the writing software, so the files might not play in the desired order.
- The music playback order of compressed audio files is as illustrated.

#### Specification chart for CD

Supported media			CD, CD-R, CD-RW
Supported file systems			CD, CD-R, CD-RW
Supported versions*1	MP3	Version	MPEG1 Audio Layer3, MPEG2 Audio Layer3, MPEG2.5 Audio Layer3
		Sampling frequency	MPEG2.5 Audio Layer3: 8kHz, 11.025kHz, 12kHz MPEG2 Audio Layer3: 16kHz, 22.05kHz, 24kHz MPEG1 Audio Layer3: 32kHz, 44.1kHz, 48kHz
		Bit rate	8 kbps - 320 kbps, VBR
	WMA*2	Version	WMA7, WMA8, WMA9.1, WMA9.2
		Bit rate / Sampling frequency	Bit rate: Ver7, Ver8: 32-192kbps Ver9, Ver9.1, Ver9.2: 32-192kbps, VBR Sampling frequency: Ver7, Ver8: 8k/11.025k/16k/22k/32k/44.1k Ver9, Ver9.1, Ver9.2: 8k/11.025k/16k/22k/32k/44.1k/48 kHz
	AAC*3	Bit rate / Sampling frequency	Bit rate: 8-320 kbps, VBR Sampling frequency: 11.025-48kHz
Tag information (Song title, Artist name and Album name)			ID3 tag VER1.0, VER1.1, VER2.2, VER2.3, VER2.4 (MP3 only)
			WMA Tag (WMA only)
			AAC Tag (AAC only)
Folder levels			CD, CD-R, CD-RW: Folder levels: 8, Folders: 255 (including root folder), Files: 510 (Max. 255 files for one folder)
Displayable character codes*4			01: SHIFT-JIS, ASCII, ISO-8859-1, UTF-8, UTF-16 BOM, UTF-16 Big Endian, UTF-16 Little Endian, 02: UNICODE, 03: UTF-16

\*1 Files created with a combination of 48 kHz sampling frequency and 64 kbps bit rate cannot be played.

\*2 Protected WMA files (DRM) cannot be played.

\*3 Made by iTunes®.

\*4 Available codes depend on what kind of media, versions, and information are going to be displayed.

### 3. Audio system

#### Specification chart for USB

Supported media	USB2.0
Supported file systems	FAT32
Folder levels	Folder levels: 8, Folders: 512 (including the root folder), Files: 5000

Format		Sampling rate	Supported/Not supported
MPEG1	Layer-1	-	Not supported
	Layer-2	-	Not supported
	Layer-3	44.1, 48, 32 kHz	Supported (32-320 kbps)
MPEG2	Layer-1	-	Not supported
	Layer-2	-	Not supported
	Layer-3	22.05, 24, 16 kHz	Supported (16-160 kbps)
MPEG2.5	Layer-1	-	Not supported
	Layer-2	-	Not supported
	Layer-3	11.025, 12, 8 kHz	Supported (16-160 kbps)
WMA*1		32, 44.1, 48 kHz	Supported VER.7/8 (48-192 bps) VER.9/9.1/9.2 (48-320 bps)
AAC (MPEG4)*2 (Extension "m4a" only)		8, 11.025, 12, 16, 22.05, 24, 32, 44.1, 48 kHz	Supported (16-320 kbps)

\*1 Professional (voice, lossless, multichannel) is not supported.

\*2 AAC (MPEG-2) is not supported.

### Windows Media Player

This product is protected by certain intellectual property rights of Microsoft. Use or distribution of such technology outside of this product is prohibited without a license from Microsoft.

### BLUETOOTH® STREAMING AUDIO

- Some Bluetooth® streaming audio devices may not be recognized by the in-vehicle audio system.
- It is necessary to set up the wireless connection between a compatible Bluetooth® streaming audio device and the in-vehicle Bluetooth® module before using the Bluetooth® streaming audio.
- The Bluetooth® streaming audio may be stopped under the following conditions:
  - When receiving a hands-free call
  - When checking the connection to the hands-free phone
  - When connecting the hands-free phone or audio device
  - When downloading a phonebook memory from a connected cellular phone
- Do not place a Bluetooth® streaming audio device in an area surrounded by metal or far away from the in-vehicle Bluetooth® module to prevent tone quality degradation and wireless connection disruption.
- While an audio device is connected through Bluetooth® wireless connection, the battery of the device may discharge quicker than usual.
- This system supports the Bluetooth® Advanced Audio Distribution Profile (A2DP) and Audio/Video Remote Control Profile (AVRCP).
- Wireless LAN (Wi-Fi) and the Bluetooth® functions share the same frequency band (2.4 GHz). Using the Bluetooth® and the wireless LAN functions at the same time may slow down or disconnect the communication and cause undesired noise. It is recommended that you turn off the wireless LAN(Wi-Fi) when using the Bluetooth® functions.

### 3. Audio system

#### NAMES AND FUNCTIONS OF AUDIO CONTROL BUTTONS

AUDIO MAIN BUTTONS (Type A) (if so equipped)

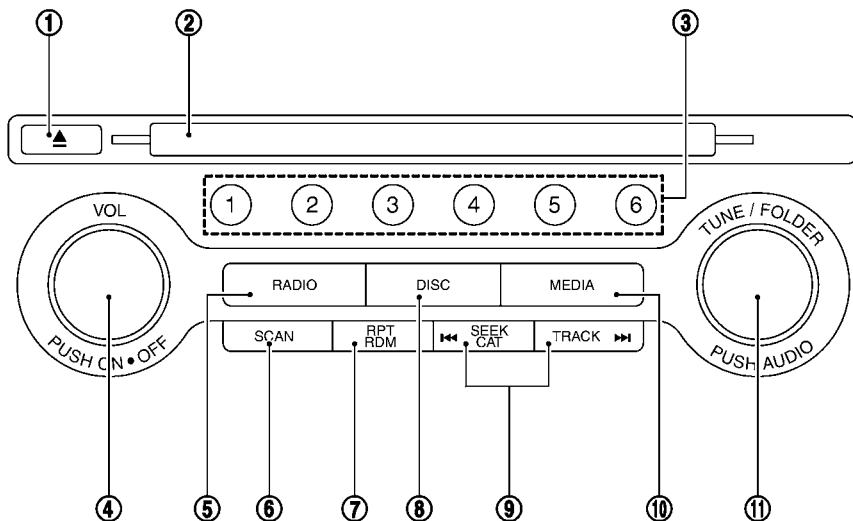

- ① **< ▲ >**:  
Push to eject a disc.
- ② Disc slot:  
Insert a disc with the label side facing up.
- ③ Radio memory buttons:  
Using the buttons, up to 6 preferred stations can be registered in the preset list for each band.
- ④ **<VOL/ON-OFF>**:  
Push to turn the audio system on/off. Turn to adjust the volume.
- ⑤ **<RADIO>**:  
Push to switch to the radio mode. The radio band will shift in the order of AM, FM and SXM® (SiriusXM®) each time the button is pushed.
- ⑥ **<SCAN>**:  
Push to scan when scannable source is playing. Touch again to stop scanning.
- ⑦ **<RPT-RDM>**:  
Push to change the play mode.
- ⑧ **<DISC>**:  
Plays the CD or DVD (if so equipped).

⑨ **<SEEK-CAT>/<TRACK>**:

Functions to seek radio stations, select SXM® channel categories or to skip and fast-forward/rewind through tracks.

⑩ **<MEDIA>**:

Each time the button is pushed, an available audio source will be selected.

⑪ **<TUNE/FOLDER AUDIO>**:

Bass, treble, balance and fade can be adjusted by pushing this button and turning the knob to select the item to adjust.

Also, functions to manually tune the radio stations/channels and to select MP3/WMA/AAC folders.

**INFO:**

The audio system settings can be linked and memorized for each of the Intelligent Keys (if so equipped). For additional information, refer to the vehicle Owner's Manual.

AUDIO MAIN BUTTONS (Type B) (if so equipped)

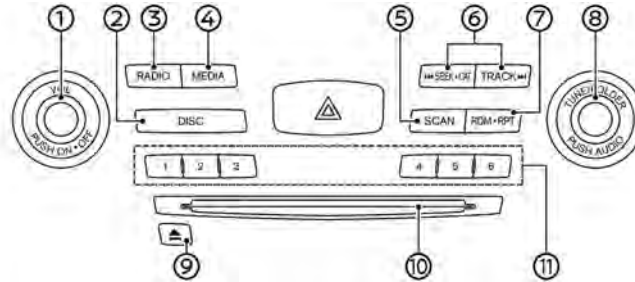

① **<VOL/ON-OFF>**:

Push to turn the audio system on/off. Turn to adjust the volume.

② **<DISC>**:

Plays the CD or DVD.

③ **<RADIO>**:

Push to switch to the radio mode. The radio band will shift in the order of AM, FM and SXM® (SiriusXM®) each time the button is pushed.

④ **<MEDIA>**:

Each time the button is pushed, an available audio source will be selected.

⑤ **<SCAN>**:

Push to scan when scannable source is playing. Touch again to stop scanning.

⑥ **<SEEK-CAT>/<TRACK>**:

Functions to seek radio stations, select SXM® channel categories or to skip and fast-forward/rewind through tracks.

⑦ **<RDM-RPT>**:

Push to change the play mode.

⑧ **<TUNE/FOLDER AUDIO>**:

Bass, treble, balance and fade can be adjusted by pushing this button and turning the knob to select the item to adjust.

### 3. Audio system

Also, functions to manually tune the radio stations/channels and to select MP3/WMA/AAC folders.

- ⑨ < ▲ >:  
Push to eject a disc.
- ⑩ Disc slot:  
Insert a disc with the label side facing up.
- ⑪ Radio memory buttons:  
Using the buttons, up to 6 preferred stations can be registered in the preset list for each band.



#### INFO:

The audio system settings can be linked and memorized for each of the Intelligent Keys (if so equipped). For additional information, refer to the vehicle Owner's Manual.

#### STEERING WHEEL MOUNTED AUDIO CONTROL BUTTONS (Type A) (if so equipped)

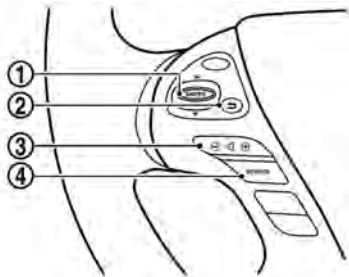

- ① <ENTER>:  
While the display is showing a map (if so equipped), status or audio screen, tilt this switch upward or downward to select a station/channel, track or folder. For most audio sources, tilting the switch up/down for more than 1.5 seconds provides a different function than tilting up/down for less than 1.5 seconds.
- ② < ⏪ > :  
Push to go back to the previous screen or cancel the selection if it is not completed.

- ③ < -||+ > :  
Push to adjust the volume.
- ④ <SOURCE>:  
With the ignition switch in the ACC or ON position, push this button to turn the audio system on. Push to change the audio source.



#### NOTE:

**You are unable to operate the touch screen display using the switches on the steering wheel whenever the vehicle information display shows the setting display.**

#### STEERING WHEEL MOUNTED AUDIO CONTROL BUTTONS (Type B) (if so equipped)

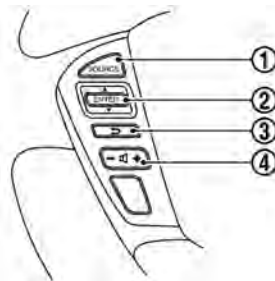



### ① <SOURCE>:

With the ignition switch in the ACC or ON position, push this button to turn the audio system on. Push to change the audio source.

### ② <ENTER>:

While the display is showing a map, status or audio screen, tilt this switch upward or downward to select a station/channel, track or folder. For most audio sources, tilting the switch up/down for more than 1.5 seconds provides a different function than tilting up/down for less than 1.5 seconds.

### ③ <↶>:

Push to go back to the previous screen or cancel the selection if it is not completed.

### ④ <←|→>:

Push to adjust the volume.

## AUDIO OPERATIONS

### AUDIO MAIN OPERATIONS

#### Turning audio system on/off

The ignition switch must be in the ACC or ON position to turn on the audio system. Push <VOL/ON-OFF> on the audio system to turn on the last audio source which was playing immediately before the system was turned off. To turn off the audio system, push <VOL/ON-OFF> again.

#### Displaying audio screen

Push <AUDIO> on the control panel to display the current audio screen.

### Selecting audio source

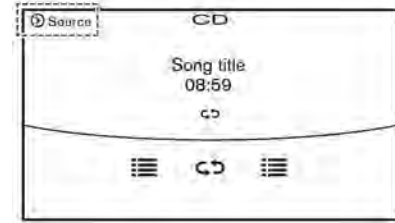

1. Turn on the audio source menu screen by touching [Source] on the upper left corner of the audio screen.
2. Select an item from the audio source menu screen.



#### INFO:

- Pushing <RADIO>, <DISC>, <MEDIA> or <SOURCE> can also change the audio source.
  - ↳ "Names and functions of audio control buttons" (page 3-14)
- If the audio system has been turned off while one of the audio sources was playing, turning the audio system back on will play the audio source that was playing when the system was turned

### 3. Audio system

off.

- The audio source can also be changed with the source bar on top of the audio screen.

#### Audio source bar

The audio source can be changed with the source bar on top of the audio screen. The source bar display can be turned on/off.

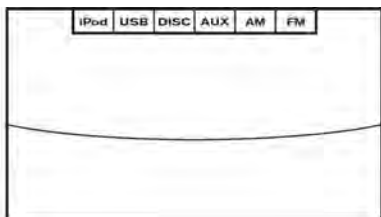

Example

#### Turning source bar on/off:

You can select whether the source bar on top of the audio screens is displayed or not.

1. Touch [Source] on the upper left corner of the audio screen.
2. Touch [Show Source Bar] to turn the indicator on/off.

#### Editing source bar:

The audio sources to be displayed on the source bar can be changed.

1. Touch [Source] on the upper left corner of the audio screen.
2. Touch [Edit Source Bar].
3. Touch one of the keys on the source bar and then touch one of the audio sources from the source list to register the audio source in the source bar.

#### RADIO

#### How to view radio operation screen

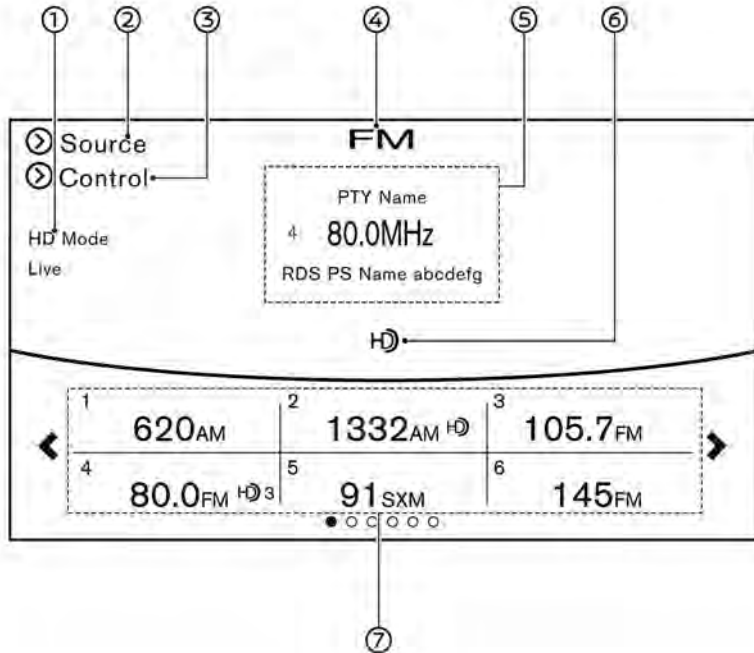

The radio screen can be viewed and operated on the touch screen display.

Designs and items displayed on the screen may vary depending on models and specifications.

- 1** Radio mode indicator:  
The current radio mode is displayed.
- 2** [Source]:  
Touch to switch to the source select screen.  
☞ "Selecting audio source" (page 3-17)
- 3** [Control]:  
Touch to display the control screen.  
☞ "Radio controls" (page 3-22)
- 4** Radio band indicator:  
Current radio band (AM, FM or SXM®) is displayed.
- 5** Reception information display:  
Reception information available at the time such as frequency, station/channel name, etc. are displayed.  
On the SXM® screen, touch this area to display the category list.
- 6** HD Radio reception status indicator (for AM and FM) (if so equipped):  
The icon is displayed when HD Radio

### 3. Audio system

digital signal is received. The icon flashes when the radio is acquiring the digital signal but the sound output is not yet in the HD Radio mode.

#### ⑦ Preset list:

36 stations/channels (FM/AM/SXM®) can be registered in the preset list.

 "Radio operation" (page 3-20)



#### INFO:

HD Radio (if so equipped) reception needs to be activated to receive HD Radio broadcasts. This enables you to receive radio broadcasts digitally (where available), providing a better quality sound with clear reception. When this feature is not activated or HD Radio broadcasts are not available, you will receive analog radio (AM/FM) broadcasts.

#### Radio operation

Available functions and items displayed on the screen may vary depending on models and specifications.

#### Radio activation and band selection:

Push **<RADIO>** or select the preferred radio band (AM, FM or SXM®) from the audio source list to turn on the radio. Each time **<RADIO>** is pushed, the radio band

will change.

 "Selecting audio source" (page 3-17)



#### INFO:

When the stereo broadcast signal is weak, the radio will automatically change from stereo to monaural reception.

#### Seeking stations/channels:

##### AM and FM radio

Push **<SEEK-CAT>/<TRACK>** to tune from low to high or high to low frequencies and to stop at the next broadcasting station.

Tilting and holding **<ENTER>** on the steering wheel will also seek up/down to the next station.

##### SiriusXM® Satellite Radio

Push **<SEEK-CAT>/<TRACK>** to tune to the first channel of the next or previous category.

Tilting and holding **<ENTER>** on the steering wheel will also fast tune the channels.

#### Manual tuning:

To tune to the preferred station manually, turn **<TUNE/FOLDER AUDIO>** until the preferred station is selected.

#### Scan tuning:

To scan tune the stations/channels, touch [Control] on the display and touch [Scan]. The stations/channels will be tuned from low to high frequencies and stop at each broadcasting station/channel for 5 seconds. Touching [Scan] again during this 5 seconds period will stop scan tuning and the radio will remain tuned to that station/channel.

Pushing **<SCAN>** can also scan tune the stations/channels.

#### Presetting:

Up to 36 stations/channels can be registered for AM, FM and SXM® in the preset list.

1. Select a radio band (AM, FM or SXM®).
2. Tune to the station/channel you wish to store in the preset list.
3. Touch and hold one of the preset numbers in the preset list or push and hold the desired radio memory buttons.
4. The information such as frequency (AM/FM), channel number (SXM®), etc. will be displayed on the preset list.



### INFO:

- To change the preset stations/channels, touch and hold one of the preset numbers. You can select whether to change the station/channel or to delete the preset setting.
- Tilt **<ENTER>** on the steering wheel to scroll up/down the preset stations/channels.

### Alert Notification (SXM® only):

Favorite artists and songs can be registered to receive an alert notice when a song of the registered conditions is on the radio. To tune to the respective channel, touch [Listen to be consistent]. The alert can be ignored by touching [Cancel].

 "Radio controls" (page 3-22)



### INFO:

Satellite Radio:

- The satellite mode requires an active SiriusXM® Satellite Radio subscription. The satellite service is available only to those at least 18 and older in the 48 contiguous United States and DC.
- It may take some time to receive the activation signal after the initiation of the SiriusXM® Satellite Radio subscription. After receiving the activation

signal, an available channel list will automatically be updated in the radio. Change the ignition switch position from LOCK to ACC to update the SiriusXM® channel list.

### 3. Audio system

#### Radio controls

Touch [Control] on the AM, FM or SXM® screen to display the control screen.



The following items are available.

Available setting items may vary depending on the models and specifications.

#### FM/AM:

[Station List]	Touch to display the available station list. While listening to FM radio, Auto Update is not performed.
[Scan]	Touch to scan tune the stations.  "Radio operation" (page 3-20)
[HD Radio Mode]	When this item is turned on, the analog and digital reception switches automatically. When this item is turned off, the reception is fixed in the analog mode.
[HD Radio Info]	Touch to display the HD Radio information such as name of song, artist and album. This item is available when [RDS-Info] is not active.
[Tag] (HD Radio broadcasts only)	Touch to register the tag information for iTunes® Tagging. If an iPod® is plugged in after the registration, the tag information can be stored in an iPod® and be used to purchase the songs via iTunes®.
[RDS-Info] (FM only)	Touch to display the RDS information. This item is available when [HD Radio Info] is not active.

#### SXM®:

[Categories]	Touch to display the category list.
[Direct Tune]	Touch to display the keypad to enter the frequency and directly tune to the channel.  "Radio operation" (page 3-20)
[Scan]	Touch to scan tune the channels.  "Radio operation" (page 3-20)
[Instant Replay]	Up to 30 minutes of the broadcast of the channel that has been tuned in to can be replayed. Touch to select from [▶], [⏮], [▶▶], [◀◀], [▶▶] and [◀◀].

### 3. Audio system

[Tag]		Touch to register the tag information for iTunes® Tagging. If an iPod® is plugged in after the registration, the tag information can be stored in an iPod® and be used to purchase the songs via iTunes®.
[Other]	[Favorite Artists]	Touch to set a favorite artists alert notification. Up to 8 artists can be registered. While a song of your favorite artist is playing, touch the list and touch [Add]/[Update]. To receive the alert notification, select [Notify Alert ON].
	[Favorite Songs]	Touch to set a favorite songs alert notification. Up to 8 songs can be registered. While your favorite song is playing, touch the list and touch [Add]/[Update]. To receive the alert notification, select [Notify Alert ON].
	[Customize Channel List]	Touch to customize the channel list. Only the selected channels will be tuned in to when you seek or scan the channels. You can select each item or select [All Select]/[Deselect All].
	[Artist Alert History]	Touch to display the artist list for an alert notice.
	[Song Alert History]	Touch to display the song list for an alert notice.
	[Favorite Alert Settings]	Touch to turn on/off the alert notice for the registered favorite artists and songs.
	[Channel Locking Settings]	Touch to select or unselect the channel that you wish to lock out. A passcode is required to change the settings. The default passcode is 1234.

### 3. Audio system

#### COMPACT DISC (CD) PLAYER

#### How to view CD operation screen

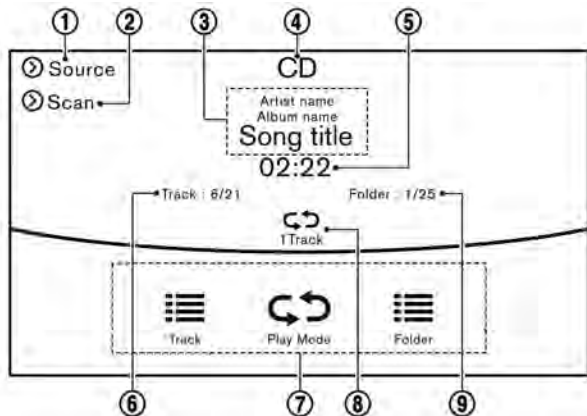

① [Source]:

Touch to switch to the source list screen.

"Selecting audio source"  
(page 3-17)

② [Scan]:

Touch to play the first 10 seconds of the tracks. Touch again to stop scanning.

③ Track information:

Track information such as the song title, artist name, and album name is displayed.

④ Audio source indicator:

Indicates that CD is currently selected.

⑤ Play time:

The play time of the track is displayed.

⑥ Track number:

This indicates the current track number and the total number of tracks.

⑦ CD menu:

CD menu items are displayed. Touch an icon to display the list or to change the setting.

- [Track]
- [Play Mode]
- [Folder] (for MP3, WMA, AAC)

⑧ Play Mode indicator:

This indicates the current play mode. Touch to change the play mode.

#### For CDs without compressed audio files:

Mode	Screen display
[Disc Repeat]	Disc
[1 Track Repeat]	1 Track
[Disc Random]	Disc



#### For CDs with compressed audio files:

Mode	Screen display
[Disc Repeat]	↻ Disc
[1 Folder Repeat]	↻ 1 Folder
[1 Track Repeat]	↻ 1 Track
[Disc Random]	⌂ Disc
[1 Folder Random]	⌂ 1 Folder

- ⑨ Folder number (for MP3, WMA, AAC):  
This indicates the folder number when a CD with compressed audio files is loaded.

#### CD player operation

##### Loading:

Insert the CD into the slot with the label side facing up. The CD will be guided automatically into the slot and starts playing.

After loading the CD, the CD screen will appear on the display.

##### Activation and playing:

The CD mode can be selected from the source list or by pushing **<DISC>** with a CD loaded to play the CD.

☞ "Names and functions of audio control buttons" (page 3-14)

☞ "Selecting audio source" (page 3-17)

If the system has been turned off while the CD was playing, pushing **<VOL/ON-OFF>** will start the audio system set to the CD screen.

##### Selecting track/folder:

Touch [Track] or [Folder] in the CD menu and select a preferred track or folder from the list.

Push **<SEEK-CAT>/<TRACK>** or tilt **<ENTER>** on the steering wheel up/down briefly to move to the next or previous track.

For CDs with compressed audio files, turn **<TUNE/FOLDER AUDIO>** or tilt and hold **<ENTER>** on the steering wheel to move to the next or previous folder.

☞ "Names and functions of audio control buttons" (page 3-14)

##### Fast-forwarding or rewind:

Push and hold **<SEEK-CAT>/<TRACK>** to fast-forward or rewind the track. Release **<SEEK-CAT>/<TRACK>** to play the track at normal speed.

##### Scanning:

Touch [Scan] on the display or push **<SCAN>** to scan the tracks in the CD. While scanning, the CD will play the first 10 seconds of each track and move on to the next track. Touching [Scan] or pushing **<SCAN>** again within the 10 seconds will stop scanning.

##### Changing play mode:

Touch [Play Mode], [**↻**] or [**⌂**] to select the play mode. Pushing **<RPT-RDM>/<RDM-RPT>** can also change the play mode.

##### Ejecting CD:

Push **<▲>** to eject the CD. If the CD is ejected and left unremoved, it will be reloaded into the slot to protect the CD.

### 3. Audio system

#### DIGITAL VERSATILE DISC (DVD) PLAYER (if so equipped)

##### Precautions

- Use DVDs with the region code "ALL" or the code applicable to the DVD player. (The region code is displayed as a small symbol printed on the top of the DVD). This vehicle-installed DVD player can only play DVDs with the applicable region code.
- Images cannot be displayed when the ignition switch is in the ON position.
- Some VIDEO-CD functions may not be supported with this system.
- Available menus and functions may vary depending on the type of disc.

#### How to view DVD operation screen

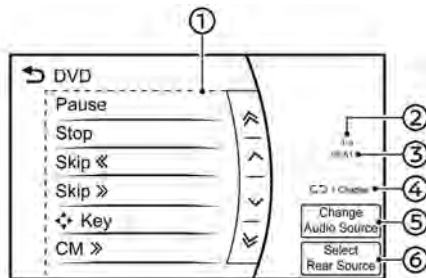

##### ① DVD operation menu:

DVD menu items are displayed. Touch a key to operate the DVD.

- [Play]/[Pause]
- [Stop]
- [Skip <<]
- [Skip >>]
- [◀▶ Key]
- [CM >>]
- [CM <<]
- [Top Menu]
- [Title List]
- [Title Menu]
- [10 Key Search]

- [Select No.]

- [Previous Title]

- [Next Title]

- [Default Position]

- [Display Settings]

- [Play Mode]

##### ② Title/chapter number:

This indicates the DVD title/chapter number currently selected.



##### ③ Play time:

The play time of the track is displayed.

##### ④ Play mode indicator:

This indicates the current play mode.

Mode	Screen display
[OFF]	↻ OFF
[1 Disc Repeat]	↻ Disc
[1 Chapter Repeat]	↻ 1 Chapter
[Disc Random]	↻ Disc

- ⑤ [Change Audio Source]  
Touch to display the source select screen.  
 "Selecting audio source"  
(page 3-17)
- ⑥ [Select Rear Source] (if so equipped):  
Touch to display the Mobile Entertainment System screen.  
 "Controlling the rear system on the front display" (page 3-61)



#### INFO:

- The DVD menu list will appear when the screen is touched while a movie is playing.
- The availability of the DVD menu items depend on the type of DVD.

#### DVD player operation

##### Loading:

Insert the DVD into the slot with the label side facing up. The DVD will be guided automatically into the slot and start playback.

When a DVD is loaded, the DVD operation screen is displayed on the display.

##### Activation and playing:

Inserting the DVD into the slot will activate the DVD mode. The DVD mode can also be selected from the source list or by pushing **<DISC>** with a DVD loaded.

 "Names and functions of audio control buttons" (page 3-14)

 "Selecting audio source" (page 3-17)

Touch [Play] in the DVD menu to start playing. Touch [Pause] to pause and touch [Stop] to stop playing the DVD.

##### Skipping:

Touch [Skip <<] or [Skip >>] in the DVD menu to skip to the next or previous track/chapter.

##### Displaying keys:

Touch [ Key] in the DVD menu to display operation keys such as [Enter] or

[Return], etc. on the display.

##### Skipping commercial messages:

Touch [CM <<] or [CM >>] in the DVD menu to skip commercials.

##### Displaying top menu:

Touch [Top Menu] in the DVD menu to display the top menu specific to each disc. For additional information, refer to the disc instructions.

##### Displaying title list:

Touch [Title List] in the DVD menu to display the title list.

##### Displaying title menu:

Touch [Title Menu] in the DVD menu to display the title menu specific to each disc. For additional information, refer to the disc instructions.

##### Selecting track/chapter/menu number:

Touch [10 Key Search] or [Select No.] in the DVD menu to display the keyboard screen. Enter the track/chapter or menu number you wish to play.

##### Viewing next/previous title:

Touch [Next Title] or [Previous Title] in the DVD menu to shift to the next title or

### 3. Audio system

return to the previous title.

#### Viewing from default list:

Touch [Default Position] in the DVD menu to view from the default list.

#### Adjusting the display:

Touch [Display Settings] in the DVD menu to adjust the display settings of the display.

[Brightness]	Adjusts the display brightness.
[Contrast]	Adjusts the display contrast.
[Black Level]	Adjusts the display black level.
[Tint]	Adjusts the tint level.
[Color]	Adjusts the color.
[Reset Settings]	Resets all the display settings to default.

#### Changing play mode:

Touch [Play Mode] in the DVD menu to select the play mode.

#### Available modes:

- DVD Video

- OFF
- 1 Chapter Repeat
- DVD VR
  - 1 Disc Repeat
  - 1 Chapter Repeat
- Video CD 1.1
  - 1 Disc
  - 1 Track Repeat
  - 1 Disc Random
- DTS-CD
  - 1 Disc Repeat
  - 1 Track Repeat
  - 1 Disc Random

#### USB MEMORY DEVICE PLAYER

#### Connecting USB memory device



#### WARNING

**Do not connect, disconnect or operate the USB memory device while driving. Doing so can be a distraction. If distracted, you could lose control of your vehicle and cause an accident or serious injury.**



#### CAUTION

- **Do not force the USB memory device into the USB connection port. Inserting the USB memory device tilted or upside down into the port may damage the port. Make sure that the USB memory device is connected correctly to the USB connection port.**
- **Do not grab the USB connection port cover (if so equipped) when pulling the USB memory device out of the port. This could damage the port and the cover.**
- **Do not leave the USB cable in a place where it can be pulled unintentionally. Pulling the cable may**

#### damage the port.

Refer to your device manufacturer's owner information regarding the proper use and care of the device.

When compatible storage devices are plugged into the jack, compatible audio files on the storage devices can be played through the vehicle's audio system.

USB connection port location:

 "Audio accessories" (page 2-11)

### 3. Audio system

#### How to view USB operation screen

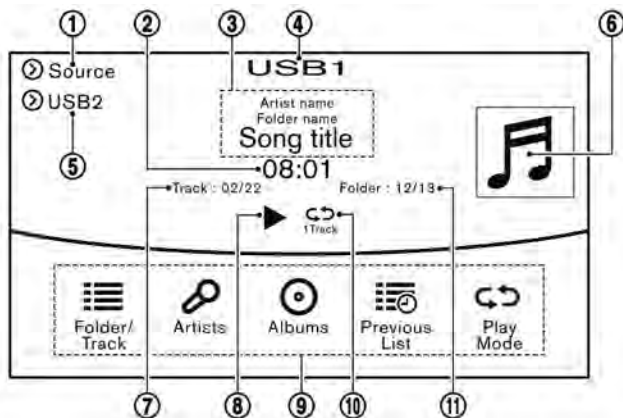

① [Source]:

Touch to switch to the source list screen.

"Selecting audio source"  
(page 3-17)

② Play time:

The play time of the track is displayed.

③ Track information:

Track information such as the song title, artist name and folder name is displayed.

④ Audio source indicator:

Indicates which of the two USB memory devices is selected.

⑤ [USB1]/[USB2]:

Touch to switch to the other connected USB memory device.

⑥ Album artwork:

An image of the CD cover is displayed when available.

⑦ Track number:

This indicates the track number and the total number of tracks.

⑧ [▶]/[⏸]:

Touch to play or pause the track.

⑨ USB menu:

USB menu items are displayed. Touch an icon to display the list or to change the setting.

- [Folder/Track]
- [Artists]
- [Albums]
- [Previous List]
- [Play Mode]
- [Scan]

⑩ Play mode indicator:

This indicates the current play mode. Touch to change the play mode.

Mode	Screen display
[All Track Repeat]	↻ All
[1 Folder Repeat]	↻ 1 Folder
[1 Track Repeat]	↻ 1 Track
[All Random]	⌘ All
[1 Folder Random]	⌘ 1 Folder

① Folder number:

This indicates the folder, artist or album number and the total number of folders/lists.

#### USB memory device player operation

##### Activation and playing:

USB memory device mode can also be activated from the audio source list and the audio source bar by the touch panel operation or by pushing **<MEDIA>**.

☞ "Names and functions of audio control buttons" (page 3-14)

☞ "Selecting audio source" (page 3-17)

To play the USB memory device, touch [▶], and to pause the USB memory, touch [⏸] on the USB operation screen.

##### Selecting play list:

Select a play list by touching an icon on the USB menu.

- [Folder/Track]
- [Artist]
- [Album]
- [Previous List]

##### Skipping tracks/folders:

Push **<SEEK·CAT>/<TRACK>** or tilt **<ENTER>** on the steering wheel up/down briefly. To skip to the next or previous track.

To skip to the next or previous folder, turn **<TUNE/FOLDER AUDIO>** or tilt and hold **<ENTER>** on the steering wheel.

##### Fast-forwarding or rewinding:

Push and hold **<SEEK·CAT>/<TRACK>** to fast-forward or rewind the track. Release **<SEEK·CAT>/<TRACK>** to play the track at normal speed.

##### Scanning:

Touch [Scan] on the display or push **<SCAN>** to scan the tracks in the USB memory device. While scanning, the USB memory device will play the first 10 seconds of each track and move on to

the next track. Touching [Scan] or pushing **<SCAN>** again within the 10 seconds will stop scanning.

##### Changing play mode:

Touch [Play Mode], [↻] or [⌘] to select the play mode. Pushing **<RPT·RDM>/<RDM·RPT>** can also change the play mode.

### 3. Audio system

#### iPod® PLAYER

#### Connecting iPod®



#### WARNING

**Do not connect, disconnect or operate the iPod® while driving. Doing so can be a distraction. If distracted, you could lose control of your vehicle and cause an accident or serious injury.**



#### CAUTION

- **Do not force the iPod® device into the USB connection port. Inserting the iPod® cable tilted or upside down into the port may damage the port. Make sure that the iPod® cable is connected correctly to the USB connection port.**
- **Do not grab the USB connection port cover (if so equipped) when pulling the iPod® cable out of the port. This could damage the port and the cover.**
- **Do not leave the iPod® cable in a place where it can be pulled unintentionally. Pulling the cable may damage the port.**

Refer to your device manufacturer's owner information regarding the proper use and care of the device.

The battery of the iPod® will be charged while the device is connected to the vehicle if the iPod® supports USB connection charging.

Depending on the model and firmware version of the iPod®, the display on the iPod® shows a NISSAN or Accessory Attached screen when the connection is completed. When the iPod® is connected to the vehicle, the iPod® music library can only be operated using the vehicle audio controls.

USB connection port location:

 "Audio accessories" (page 2-11)

#### Compatibility:

Made for

- iPod touch® (5th generation)
- iPod touch® (4th generation)
- iPod touch® (3rd generation)
- iPod touch® (2nd generation)
- iPod touch® (1st generation)
- iPod with video
- iPod classic®

- iPod nano® (7th generation)
- iPod nano® (6th generation)
- iPod nano® (5th generation)
- iPod nano® (4th generation)
- iPod nano® (3rd generation)
- iPod nano® (2nd generation)
- iPod nano® (1st generation)
- iPhone® 5s
- iPhone® 5
- iPhone® 4S
- iPhone® 4
- iPhone® 3GS
- iPhone® 3G
- iPhone®



#### INFO:

- The iPod touch® may not respond quickly with the system in some cases.
- Make sure that the iPod® firmware is updated.
- The Lightning™ connector works with iPhone® 5, iPhone® 5s, iPod touch® (5th generation) and iPod nano® (7th generation).



- The 30-pin connector works with iPhone® 4S, iPhone® 4, iPhone® 3GS, iPhone® 3G, iPhone®, iPod touch® (1st through 4th generation), iPod classic® and iPod nano® (1st through 6th generation).
- USB works with iPhone® 5, iPhone® 4S, iPhone® 4, iPhone® 3GS, iPhone® 3G, iPhone®, iPod touch® (1st through 5th generation), iPod classic® and iPod nano® (1st through 7th generation).

#### How to view iPod® operation screen

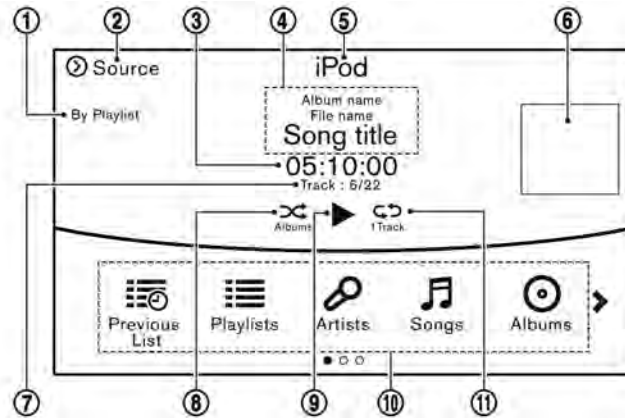

- |  |  |
|--|--|
| ① Search condition indicator:<br>This indicates the current search condition.                      | ④ Track information:<br>Track information such as the song title, artist name and album name is displayed. |
| ② [Source]:<br>Touch to switch to the source list screen.<br>] Selecting audio source" (page 3-17) | ⑤ Audio source indicator:<br>This indicates that the iPod® is currently selected.                          |
| ③ Play time:<br>The play time of the track is displayed.   | ⑥ Album artwork:<br>An image of the CD cover is displayed when available.                                  |

### 3. Audio system

- ⑦ Track number:  
This indicates the current track number and the total number of tracks.

- ⑧ Shuffle mode indicator:  
Touch to change the shuffle mode.

Mode	Screen display
[Shuffle Albums]	⌘ Albums
[All Songs]	⌘ Songs
[Shuffle Off]	⌘ Off

- ⑨ [▶]/[⏸]:  
Touch to play or pause the track.
- ⑩ iPod® menu:
- [Previous List]
  - [Playlists]
  - [Artists]
  - [Songs]
  - [Albums]
  - [Genres]
  - [Composers]
  - [Podcasts]
  - [Audiobooks]
  - [Shuffle]
  - [Repeat]

- ⑪ Repeat mode indicator:  
Touch to change the repeat mode.

Mode	Screen display
[All Track Repeat]	↻ All
[1 Track Repeat]	↻ 1 Track
[Repeat Off]	↻ Off

#### iPod® player operation

##### Activation and playing:

Inserting the iPod® cable into the connection port will activate the iPod® mode.

iPod® can also be selected from the audio sources list and the source bar by touch panel operation or by pushing **<MEDIA>**.

 "Names and functions of audio control buttons" (page 3-14)

 "Selecting audio source" (page 3-17)

To play and pause the iPod®, touch [▶]/[⏸] in the iPod® menu.

##### Selecting search method:

A list of search methods is displayed in the iPod® menu. Touch and select an item to play the iPod® in your preferred settings.

##### Fast-forwarding or rewinding:

Push and hold **<SEEK-CAT>/<TRACK>** to fast-forward or rewind the song. Release **<SEEK-CAT>/<TRACK>** to play the song at normal speed.

##### Changing play mode:

Touch [Shuffle], [Repeat], [⌘] or [↻] to select the play mode. Pushing **<RPT-RDM>/<RDM-RPT>** can also change the play mode.

##### Skipping songs:

Push **<SEEK-CAT>/<TRACK>** or tilt **<ENTER>** on the steering wheel to skip to the next or previous song.

Even when iPod® and/or iPhone® are inserted into both of the two USB connection ports, the system recognizes only one of the connected iPod® and/or iPhone® at a time.

#### BLUETOOTH® STREAMING AUDIO

Your vehicle is equipped with Bluetooth® streaming audio.

If you have a compatible Bluetooth® device with streaming audio (A2DP profile), you can set up a wireless connection between your Bluetooth® device and the in-vehicle audio system. This connection allows you to listen to the audio from the Bluetooth® device using your vehicle speakers. It may also allow basic control of the device for playing and skipping audio files using the AVRCP Bluetooth® profile. Not all Bluetooth® devices have the same level of controls for AVRCP. Please consult the manual for your Bluetooth® device for more details.

Wireless LAN (Wi-Fi) and the Bluetooth® functions share the same frequency band (2.4 GHz). Using the Bluetooth® and the wireless LAN functions at the same time may slow down or disconnect the communication and cause undesired noise. It is recommended that you turn off the wireless LAN (Wi-Fi) when using the Bluetooth® functions.

#### Connecting Bluetooth® streaming audio device

Bluetooth® streaming audio device must be connected to the vehicle before opera-

tion.

 "Pairing Bluetooth® device" (page 2-28)

#### How to view Bluetooth® streaming audio operation screen

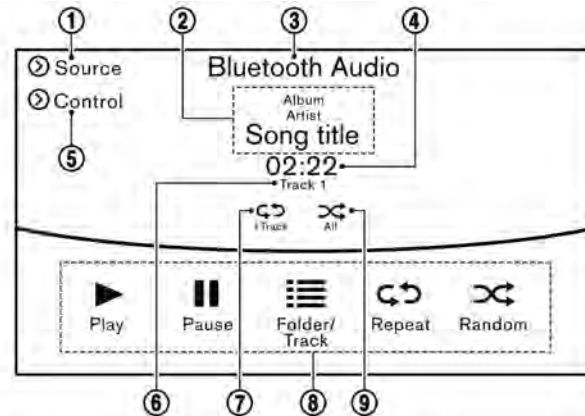

- ① [Source]: Touch to switch to the source list screen.  
 "Selecting audio source" (page 3-17)
- ② Audio source indicator: This indicates that Bluetooth® streaming audio is currently selected among other sources.
- ③ Track information: Track information such as the song title, artist name and folder name is displayed.
- ④ Play time: The play time of the track is displayed.

### 3. Audio system

⑤ [Control]:

Touch to display the control screen.  
☞ "Bluetooth® streaming audio controls" (page 3-37)

⑥ Track number:

This indicates the track number.

⑦ Repeat mode indicator:

Touch to change the repeat mode.

Mode	Screen display
[All Track Repeat]	↻All
[1 Folder Repeat]	↻1 Folder
[1 Track Repeat]	↻1 Track
[Repeat Off]	↻Off

⑧ Bluetooth® streaming audio menu:

- [Play]
- [Pause]
- [Folder/Track]
- [Repeat]
- [Random]

⑨ Random mode indicator:

Touch to change the random mode.

Mode	Screen display
[All Random]	⌂All
[1 Folder Random]	⌂1 Folder
[Random Off]	⌂OFF



**INFO:**

Depending on the audio device that is connected to the vehicle, track information may not be displayed.

#### Bluetooth® streaming audio operation

The ability to pause, change tracks, fast-forward, rewind, randomize and repeat music may be different between devices. Some or all of these functions may not be supported on each device.

- Depending on the Bluetooth® streaming audio device that is connected, it may not be possible to perform audio operations.
- Depending on the Bluetooth® streaming audio device that is connected, a time lag may occur before music is played back.

#### Activation and playing:

Bluetooth® streaming audio device can be selected from the audio sources list by touching [Source] or by pushing **<MEDIA>**.

☞ "Names and functions of audio control buttons" (page 3-14)

☞ "Selecting audio source" (page 3-17)

To play the Bluetooth® streaming audio device, touch [Play] and to pause the Bluetooth® streaming audio device, touch [Pause] in the Bluetooth® streaming audio menu.

#### Selecting folder/track:

Touch [Folder/Track] to select a folder/track.

#### Changing play mode:

Touch [Repeat], [Random], [↻] or [⌂] to select the play mode. Pushing **<RPT·RDM>/<RDM·RPT>** can also change the play mode.

#### Fast-forwarding or rewinding:

Push and hold **<SEEK·CAT>/<TRACK>** to fast-forward or rewind the song. Release **<SEEK·CAT>/<TRACK>** to play the song at normal speed.

#### Skipping songs/folders:

Push **<SEEK-CAT>/<TRACK>** or tilt **<ENTER>** on the steering wheel to skip to the next or previous song.

To skip to the next or previous folder, turn **<TUNE/FOLDER AUDIO>**.

#### Bluetooth® streaming audio controls

Touch [Control] on the Bluetooth® streaming audio operation screen to display the control screen.

[Select Audio Device]	Touch to select a different Bluetooth® streaming audio device from a list of registered Bluetooth® devices.  "Bluetooth® settings" (page 2-28)
[Connect Device]	Touch to connect a new Bluetooth® device.

#### AUXILIARY (AUX) DEVICES (if so equipped)

##### Connecting auxiliary devices

The auxiliary audio input jack accepts any standard analog audio input such as from a portable cassette player, CD player or MP3 player.

A video player can be connected to the auxiliary video input jack to play movies.

Auxiliary audio input jack location:

 "Audio accessories" (page 2-11)



#### INFO:

Insert a 1/8 in (3.5 mm) stereo mini plug in the audio input jack. If a cable with a mono plug is used, the audio output may not function normally.

#### How to view AUX operation screen



Touch [Display Settings] to adjust the display settings. Touch [Change Audio Source] to display the source select screen.

 "Selecting audio source" (page 3-17)

Designs and items displayed on the screen may vary depending on models and specifications.

#### AUX operation

##### Activation and playing:

Turn on an AUX device.

Connecting an AUX device into the jack will activate the AUX mode.

AUX can be selected from the other audio sources by touching [Source] or by pushing **<MEDIA>**.

 "Names and functions of audio con-

### 3. Audio system

---

Control buttons" (page 3-14)

 "Selecting audio source" (page 3-17)

## AUDIO SETTINGS

Audio settings can be adjusted or audio related functions can be turned on/off using the following procedure.

Some of the setting items may not be displayed when the audio system is turned off.

Available setting items may vary depending on the models and specifications.

1. Push **<SETTING>**.
2. Touch [Audio].

The following setting items are available:

- [Sound Settings]

Setting Items	Action
[Bass]	Adjust the speaker tone quality and sound balance by touching [+)/[-], [L]/[R] or [R]/[F].
[Treble]	
[Balance]	
[Fade]	
[Bose® Centerpoint]	When this item is turned on, surround sound playback is generated from a traditional stereo recording. Turn on this item to activate Bose® Centerpoint and to change its effect level with the [Surround Vol].
[Surround Vol]	Touch [+)/[-] to adjust [Surround Vol] level if Bose® Centerpoint is turned on.
[Speed Sensitive Vol]	This automatically adjusts the volume depending on the vehicle speed. Touch [+)/[-] to change the sensitivity level.
[Driver's Audio Stage]	When this item is turned on, a better sound quality will be provided to the driver's position. The driver can enjoy a more crisp and clear sound that is specialized for the driver's seat position. The prominence of the effect of this feature depends on the type of music that is played. For some music, it may be difficult to recognize the effect of this feature.

- [Display Album Cover Art]

Turn this item on to display image files from the media device. If the media device does not contain images, no image will be

### 3. Audio system

displayed.

- [Radio Settings]

Setting Items	Action
[HD Radio Mode (AM)]	When this item is turned on, the analog and digital reception switches automatically.
[HD Radio Mode (FM)]	When this item is turned off, the reception is fixed in the analog mode.

- [DVD Settings]

Setting Items	Action
[Angle]	Images and movies can be viewed in different angles if the DVD contains this data. Switch the angle number by touching [+]/[-].
[CM Skip]	Select commercial skip length from 15, 30, and 60 seconds.
[DRC]	Select the DRC (Dynamic Range Compression) setting from OFF, 1 and 2. DRC allows tuning of the dynamic range of sound recorded in the Dolby Digital format.
[Angle Mark]	Turn the angle mark display on/off. When this item is turned on, [Multi Angle] will be displayed on the DVD screen.
[Menu Skip]	DVD menus are automatically configured and the contents will be played directly when this item is turned on. Note that some discs may not be played directly even if this item is turned on.
[DOWN MIX]	When this item is turned on, a multi-channel recording will be converted to a traditional two channel (stereo) recording.
[DVD Language]	Enter the language code of the preferred language.
[Language]	Changeable items will vary depending on the type of DVD. For DVD-V: Audible language can be changed by touching [+]/[-]. For Video CD: Select the sound setting from Main audio, Sub audio and Main/Sub audio. For DVD VR: Select the sound setting from Main audio 1, Sub audio 1, Main/Sub audio 1, Main audio 2, Sub audio 2, and Main/Sub audio 2.
[Subtitle]	The subtitle language can be changed by touching [+]/[-].



[DVD Screen Settings]	Touch to adjust the DVD aspect ratio.
[PG/PL Mode]	Touch to switch the PG/PL mode setting.

**INFO:**

The Available setting items differ depending on the DVD.

- [AUX settings]

<b>Setting Items</b>	<b>Action</b>
[AUX Image Display]	The image display size setting can be selected from [Normal], [Wide] and [Cinema].
[Volume Setting]	The volume setting can be selected from [Low], [Medium] and [High].

### 3. Audio system

#### DISC/USB MEMORY DEVICE CARE AND CLEANING

##### DISCS

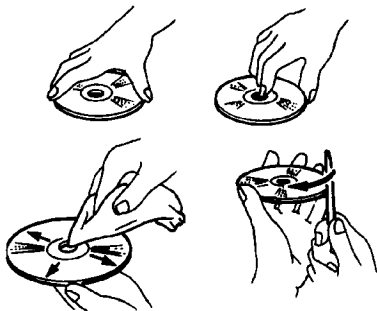

- Handle a disc by its edges. Never touch the surface of the disc. Do not bend the disc.
- Always place discs in their storage cases when they are not being used.
- To clean a disc, wipe the surface from the center to the outer edge using a clean, soft cloth. Do not wipe the disc using a circular motion.  
Do not use a conventional record cleaner or alcohol intended for indus-

trial use.

- The inner and outer edges of a new disc may be rough. Remove the rough edges by rubbing the inner and outer edges with the side of a pen or pencil as illustrated.

##### USB MEMORY DEVICE

- Never touch the terminal portion of the USB memory device.
- Do not place heavy objects on the USB memory device.
- Do not store the USB memory device in very humid locations.
- Do not expose the USB memory device to direct sunlight.
- Do not spill any liquids on the USB memory device.

Refer to the owner's manual for the USB memory device for details.

#### GRACENOTE® END USER LI- CENSE AGREEMENT

This application or device contains software from Gracenote, Inc. of Emeryville, California ("Gracenote"). The software from Gracenote (the "Gracenote Software") enables this application to perform disc and/or file identification and obtain music-related information, including name, artist, track, and title information ("Gracenote Data") from online servers or embedded databases (collectively, "Gracenote Servers") and to perform other functions. You may use Gracenote Data only by means of the intended End-User functions of this application or device.

You agree that you will use Gracenote Data, the Gracenote Software, and Gracenote Servers for your own personal non-commercial use only. You agree not to assign, copy, transfer, or transmit the Gracenote Software or any Gracenote Data to any third part. YOU AGREE NOT TO USE OR EXPLOIT GRACENOTE DATA, THE GRACE SOFTWARE, OR GRACENOTE SERVERS, EXCEPT WHEN EXPRESSLY PERMITTED HEREIN.

You agree that your non-exclusive license to use the Gracenote Data, the Gracenote Software, and Gracenote Servers will ter-

minate if you violate these restrictions. If your license terminates, you agree to cease any and all use of the Gracenote Data, the Gracenote Software, and Gracenote Servers. Gracenote reserves all rights in Gracenote Data, the Gracenote Software, and the Gracenote Servers, including all ownership rights. Under no circumstances will Gracenote become liable for any payment to you for any information that you provide. You agree that Gracenote, Inc. may enforce its rights under this Agreement against you directly in its own name.

The Gracenote service uses a unique identifier to track queries for statistical purposes. The purpose of a randomly assigned numeric identifier is to allow the Gracenote service to count queries without knowing anything about who you are. For more information, see the web page for the Gracenote Privacy Policy for the Gracenote service.

The Gracenote Software and each item of Gracenote Data is licensed to you "AS IS". Gracenote makes no representations or warranties, express or implied, regarding the accuracy of any Gracenote Data from the Gracenote Servers. Gracenote reserves the right to delete data from the Gracenote Servers or to change data categories for any cause that Gracenote

seems sufficient. No warranty is made that the Gracenote Software or Gracenote Servers are error-free or that functioning of Gracenote Software or Gracenote Servers will be uninterrupted. Gracenote is not obligated to provide you with new enhanced or additional data types or categories that Gracenote may provide in the future and is free to discontinue its services at any time.

GRACENOTE DISCLAIMS ALL WARRANTIES EXPRESS OR IMPLIED, INCLUDING, BUT NOT LIMITED TO, IMPLIED WARRANTIES OF MERCHANTABILITY, FITNESS FOR A PARTICULAR PURPOSE, TITLE, AND NON-INFRINGEMENT. GRACENOTE DOES NOT WARRANT THE RESULTS THAT WILL BE OBTAINED BY YOUR USE OF THE GRACENOTE SOFTWARE OR ANY GRACENOTE SERVER. IN NO CASE WILL GRACENOTE BE LIABLE FOR ANY CONSEQUENTIAL OR INCIDENTAL DAMAGES OR FOR ANY LOST PROFITS OR LOST REVENUES.

© Gracenote, Inc. 2009

#### **MOBILE ENTERTAINMENT SYSTEM (MES) (if so equipped)**

If your vehicle is equipped with the Mobile Entertainment System (MES), you can enjoy playing audio and movie files on the rear displays with images and sound.

##### **Playable source:**

- DVD (if so equipped)
- AUX device (if so equipped)
- USB memory device (connected to the rear USB connection port)
- HDMI device

The front and left/right rear displays can show different sources individually.

CD/DVD (if so equipped) slot location:

 "Names and functions of audio control buttons" (page 3-14)

Auxiliary input jack location (if so equipped):

 "Audio accessories" (page 2-11)

Rear media interface (USB and HDMI connection ports) location:

 "Rear media interface" (page 3-58)

### 3. Audio system



#### WARNING

The driver must not attempt to operate the Mobile Entertainment System while driving so full attention may be given to vehicle operation.



#### CAUTION

- Do not attempt to use the system in extremely high or low temperature conditions [below -4°F (-20°C) or above 158°F (70°C)].
- To avoid draining the vehicle battery, do not operate the system for more than 15 minutes without starting the engine.

The front display is designed to not show images during driving, as the driver's attention must be given to vehicle operation for safety. Sounds are still audible. To show images on the front display, stop the vehicle in a safe location, move the shift lever to the "P" (Park) position and apply the parking brake.

#### PRECAUTIONS

Start the engine when using the Mobile Entertainment System.



#### WARNING

The driver must not attempt to operate the Mobile Entertainment System or wear the headphones while the vehicle is in motion so that full attention may be given to vehicle operation.

Park the vehicle in a safe location and apply the parking brake to view the images on the front center display with the Mobile Entertainment System.



#### CAUTION

- Only operate the Mobile Entertainment System while the engine is running. Operating the Mobile Entertainment System for extended periods of time with the engine turned off can discharge the vehicle battery.
- Do not allow the system to get wet. Excessive moisture, such as spilled liquids, may cause the system to

malfunction.

- While playing VIDEO-CD media, this DVD player does not guarantee complete functionality of all VIDEO-CD formats.

#### TECHNICAL INFORMATION

##### USB media support

##### Supported USB media:

USB 1.1	Low Speed (1.5 Mbps), Full Speed (12 Mbps)
USB 2.0	Low Speed (1.5 Mbps), Full Speed (12 Mbps), High Speed (480 Mbps)

##### Mass Storage Support:

The Mobile Entertainment System recognizes the connected USB media as a mass storage device.

##### Supported file systems and partition:

The first partition of the following file systems are supported.

- NTFS
- FAT32

- FAT16
- HFS+

**Supported folder structure:**

Folders	1,000 folders maximum
Files	10,000 files maximum
Pass length	3072 characters maximum
Full name length	232 characters maximum
Folder levels	11 levels maximum (when root is regarded as level 0)

**Supported format and decode:**

Video codec:

Codec	Profile	Maximum Resolution/Frame Rate	Notes
DivX	DivX 3.11/4/5/6	SD (720 x 576)/30	Only single-instance playback is supported for DivX 3.11.
Flash	-	1080 p/30	-
H.263	-	1080 p/30	-
H.264	BP/MP/HP	1080 p/30	Extended file is not supported.
MPEG-1	-	1080 p/30	-
MPEG-2	MP@ML	1080 p/30	-
MPEG-4	SP/ASP	1080 p/30	-
Real Video	RV8/9/10	1080 p/30	-
XviD	-	SD (720 x 576)/30	-

### 3. Audio system

Codec	Profile	Maximum Resolution/Frame Rate	Notes
WMV7/8	-	D1/30	HD version is not provided. Only single instance playback is supported for WMV7/8.
WMV9/VC-1	SP/MP/AP	1080 p/30	Complex Profile is not supported.

Audio codec:

Codec	Supported Bitrates	Sampling Frequency	Channels	Codec Features Supported
AAC (MPEG4 AAC-LC)	8 kbps - 320 kbps	8, 11.025, 16, 22.05, 24, 32, 44.1, 48 KHz	Mono/Stereo/ 5.1 -> Stereo Downmixing	<ul style="list-style-type: none"> <li>- Complies with ISO/IEC 13818-7</li> <li>- ADTS/ADIF Output</li> <li>- Modes: Mono, Stereo, Dual Mono, Joint Stereo (Intensity Stereo (IS) and Mid-side Stereo (MS))</li> <li>- All tools of 13818-7 LC + PNS are supported.</li> <li>- CRC check is supported.</li> <li>- Header formats: AAC, ADIF, ADTS</li> </ul>
AAC+ (ENHANCED AAC+)	Up to 264 kbps	Up to 48 KHz	Mono/Stereo	<ul style="list-style-type: none"> <li>- Modes: Mono, Stereo, Dual Mono</li> <li>- Header formats: ADIF, ADTS</li> </ul>
Linear PCM	-	Up to 48 KHz	Stereo	Max 16bit only
RealAudio (3, 6, 9, 10)	6 to 96 kbps	8, 11.025, 22.05, 44.1 KHz	Mono/Stereo	Downmixing is not supported.
Dolby Digital	64 to 640 kbps	48 KHz	Mono/Stereo/ 5.1 -> Stereo Downmixing	Modes: Mono, Stereo, 5.1 -> Stereo Downmixing

### 3. Audio system

Codec	Supported Bitrates	Sampling Frequency	Channels	Codec Features Supported
MP3	32 to 320 kbps (MPEG-1 Layer 1,2,3) 8 to 160 kbps (MPEG-2 Layer 1,2,3)	8/11.025/12 KHz (MPEG-2.5) 16/22.05 /24 KHz (MPEG-2) 32/44.1/48 KHz (MPEG-1)	Mono/Stereo	- Complies with ISO 11172-3 and ISO 13818-3 - Modes: Mono, Stereo, Dual Mono, Joint Stereo (Intensity Stereo (IS) and Mid-side Stereo (MS)) - CRC check is supported.
OGG Vorbis	Up to 128 kbps	8 to 48 KHz	Mono/Stereo	-
WMA v9 (std) WMA v10 (std)	Up to 384 kbps	Up to 48 KHz	Mono/Stereo	- Decodes WMA streams generated using encoder v2, v7, v8, v9, v10 content. - Supports all L1, L2, and L3 profiles.

Depending on the combination of video codec, audio codec, and format, some files cannot be played with the Mobile Entertainment System.

#### Combinations of video/audio codecs and playable file extensions:

Video	Audio Codec	Extension
H.263	AAC	".3gp", ".3g2"
H.264	AAC	".avi", ".3gp", ".3g2", ".mp4", ".m4v", ".divx", ".mov"
	AAC+	".avi", ".3gp", ".3g2", ".mp4", ".m4v", ".divx", ".mov"
	Linear PCM	".avi", ".divx"
	Dolby Digital	".avi", ".mp4", ".m4v", ".divx", ".mov", ".m2ts", ".mts"
	MP3	".avi", ".flv", ".mp4", ".m4v", ".divx", ".mov"
	WMA	".avi", ".divx"

### 3. Audio system

Video	Audio Codec	Extension
Divx	AAC	".avi", ".divx"
	Linear PCM	".avi", ".divx"
	Dolby Digital	".avi", ".divx"
	MP3	".avi", ".divx"
	WMA	".avi", ".divx"
XviD	AAC	".avi", ".mp4", ".m4v", ".divx", ".mov"
	AAC+	".avi", ".mp4", ".m4v", ".divx", ".mov"
	Linear PCM	".avi", ".divx"
	Dolby Digital	".avi", ".mp4", ".m4v", ".divx", ".mov"
	MP3	".avi", ".mp4", ".m4v", ".divx", ".mov"
	WMA	".avi", ".divx"
MPEG-1	AAC	".avi", ".mp4", ".m4v", ".divx", ".mov"
	AAC+	".avi", ".mp4", ".m4v", ".divx", ".mov"
	Linear PCM	".avi", ".divx"
	Dolby Digital	".avi", ".mp4", ".m4v", ".mpg", ".divx", ".mov"
	MP3	".avi", ".mp4", ".m4v", ".mpg", ".mpeg", ".divx", ".mov"
	WMA	".avi", ".divx"
MPEG-2	AAC	".avi", ".mp4", ".m4v", ".divx"
	AAC+	".avi", ".mp4", ".m4v", ".divx"
	Linear PCM	".avi", ".divx"
	Dolby Digital	".avi", ".mp4", ".m4v", ".mpg", ".divx"
	MP3	".avi", ".mp4", ".m4v", ".mpg", ".divx"
	WMA	".avi", ".divx"



### 3. Audio system

Video	Audio Codec	Extension
MPEG-4	AAC	".avi", ".3gp", ".mp4", ".m4v", ".divx", ".mov"
	AAC+	".avi", ".3gp", ".mp4", ".m4v", ".divx", ".mov"
	Linear PCM	".avi", ".divx"
	Dolby Digital	".avi", ".mp4", ".m4v", ".divx", ".mov"
	MP3	".avi", ".mp4", ".m4v", ".divx", ".mov"
	WMA	".avi", ".divx"
WMV7/8	AAC	".avi", ".divx"
	Linear PCM	".avi", ".divx"
	Dolby Digital	".avi", ".divx"
	MP3	".avi", ".divx"
	WMA	".avi", ".wmv", ".divx"
WMV9/VC-1	Linear PCM	".avi", ".divx"
	Dolby Digital	".avi", ".divx"
	MP3	".avi", ".divx"
	WMA	".avi", ".wmv", ".divx"
Flash	MP3	".flv"
Real Video	Real Audio	".rmvb", ".rm"
Without Picture (Audio only)	AAC	".m4a", ".aac"
	AAC+	".m4a", ".aac"
	Linear PCM	".wav", ".aiff"
	Dolby Digital	".m4a", ".ac3"
	MP3	".mp3", ".m4a"
	Ogg Vorbis	".ogg"
	WMA	".wma"

## 3. Audio system

### Apple support

When an iPhone®, iPad®, or iPod® is connected, the Mobile Entertainment System will play music with the iPod® technology and initiate quick charging (up to 2.1 A). The following Apple products are supported:

- iPhone® 5s (iOS 7.0.4)
- iPhone® 5c (iOS 7.1)
- iPhone® 5 (iOS 6.1.4)
- iPhone® 4S (iOS 5.1.1)
- iPhone® 4 (iOS 7.1)
- iPhone® 3GS (iOS 6.1.6)
- iPhone® 3G (iOS 4.2.1)
- iPad® (4th generation) (iOS 7.0.4)
- iPad® (3rd generation) (iOS 6.0)
- iPad® (2nd generation) (iOS 6.0)
- iPad® (1st generation) (iOS 5.1.1)
- iPad Air® (iOS 7.0.4)
- iPad mini™ (2nd generation) (iOS 7.0.4)
- iPad mini™ (1st generation) (iOS 7.0.4)
- iPod touch® (5th generation) (iOS 6.1.3)
- iPod touch® (4th generation) (iOS 6.1.3)

- iPod touch® (3rd generation) (iOS 5.1.1)
- iPod touch® (2nd generation) (iOS 4.2.1)
- iPod touch® (1st generation) (iOS 3.1.3)
- iPod nano® (7th generation) (Firmware version 1.0.2)
- iPod nano® (6th generation) (Firmware version 1.2)
- iPod nano® (5th generation) (Firmware version 1.0.2)
- iPod nano® (4th generation) (Firmware version 1.0.3)
- iPod nano® (3rd generation) (Firmware version 1.1.2)
- iPod nano® (2nd generation) (Firmware version 1.1.3)
- iPod nano® (1st generation) (Firmware version 1.3.1)
- iPod classic® (160 GB) (End 2009) (Firmware version 2.0.4)
- iPod classic® (120 GB) (Firmware version 2.0.1)
- iPod classic® (Firmware version 1.1.2)



"Made for iPod®", "Made for iPhone®", and

"Made for iPad®" mean that an electronic accessory has been designed to connect specifically to iPod®, iPhone®, or iPad®, respectively, and has been certified by the developer to meet Apple performance standards. Apple is not responsible for the operation of this device or its compliance with safety and regulatory standards. Please note that the use of this accessory with iPod®, iPhone®, or iPad® may affect wireless performance.

iPad®, iPhone®, iPod®, iPod classic®, iPod nano®, iPod touch®, and Retina are trademarks of Apple Inc., registered in the U.S. and other countries. iPad Air® and iPad mini™ are trademarks of Apple Inc.

### Licenses

#### Dolby:

Manufactured under license from Dolby Laboratories. Dolby and the double-D symbol are trademarks of Dolby Laboratories.

## 3. Audio system

### DivX:

This DivX Certified® device has passed rigorous testing to ensure it plays DivX® video. To play purchased DivX movies, first register your device at [vod.divx.com](http://vod.divx.com). Find your registration code in the DivX VOD section of your device setup menu.

DivX®, DivX Certified® and associated logos are trademarks of DivX, LLC and are used under license. Covered by one or more of the following U.S. patents: 7,295,673; 7,460,668; 7,515,710; 8,656,183; 8,731,369; RE45,052.



### RMVB:

Portions of this software are included under license from RealNetworks, Inc. Copyright 1995-2011, RealNetworks, Inc. All rights reserved.

### HDMI:

The terms HDMI and HDMI High-Definition Multimedia Interface, and the HDMI Logo are trademarks or registered trademarks of HDMI Licensing LLC in the United States and other countries.

### MPEG4-AVC (H.264):

THIS PRODUCT IS LICENSED UNDER THE AVC PATENT PORTFOLIO LICENSE FOR THE PERSONAL AND NON-COMMERCIAL USE OF A CONSUMER TO (i) ENCODE VIDEO IN COMPLIANCE WITH THE AVC STANDARD ("AVC VIDEO") AND/OR (ii) DECODE AVC VIDEO THAT WAS ENCODED BY A CONSUMER ENGAGED IN A PERSONAL AND NON-COMMERCIAL ACTIVITY AND/OR WAS OBTAINED FROM A VIDEO PROVIDER LICENSED TO PROVIDE AVC VIDEO. NO LICENSE IS GRANTED OR SHALL BE IMPLIED FOR ANY OTHER USE. ADDITIONAL INFORMATION MAY BE OBTAINED FROM MPEG LA, L.L.C. SEE [HTTP://WWW.MPEGLA.COM](http://www.mpegla.com)

### VC-1:

THIS PRODUCT IS LICENSED UNDER THE VC-1 PATENT PORTFOLIO LICENSE FOR THE PERSONAL AND NON-COMMERCIAL USE OF A CONSUMER TO (i) ENCODE VIDEO IN COMPLIANCE WITH THE VC-1 STANDARD ("VC-1 VIDEO") AND/OR (ii) DECODE VC-1 VIDEO THAT WAS ENCODED BY A CONSUMER ENGAGED IN A PERSONAL AND NON-COMMERCIAL ACTIVITY AND/OR WAS OBTAINED FROM A VIDEO PROVIDER LICENSED TO PROVIDE VC-1 VIDEO. NO LICENSE IS GRANTED OR SHALL BE

IMPLIED FOR ANY OTHER USE. ADDITIONAL INFORMATION MAY BE OBTAINED FROM MPEG LA, L.L.C. SEE [HTTP://WWW.MPEGLA.COM](http://www.mpegla.com)

### MPEG-4 VISUAL:

USE OF THIS PRODUCT IN ANY MANNER THAT COMPLIES WITH THE MPEG-4 VISUAL STANDARD IS PROHIBITED, EXCEPT FOR USE BY A CONSUMER ENGAGING IN PERSONAL AND NON-COMMERCIAL ACTIVITIES.

### MP3:

MPEG Layer-3 audio coding technology licensed from Fraunhofer IIS and Thomson.

### WMA/WMV:

This product includes technology owned by Microsoft Corporation and under a license from Microsoft Licensing, GP. Use or distribution of such technology outside of this product is prohibited without a license from Microsoft Corporation and/or Microsoft Licensing, GP as applicable.

### Sorenson Spark Video decoder:

This product contains an officially licensed Sorenson Spark optimized video decoder licensed from Sorenson Media, Inc.

### 3. Audio system

---

#### Nature surround sound:



Nature surround sound is a general term for the family of the latest acoustic signal processing technology produced by DIMAGIC Co., Ltd.

#### REMOTE CONTROLLER AND HEADPHONES

##### Remote controller

A remote controller is provided with the Mobile Entertainment System.

The remote controller is for the rear display operation and cannot be used to control portable devices.

The following buttons/switches are on the remote controller.

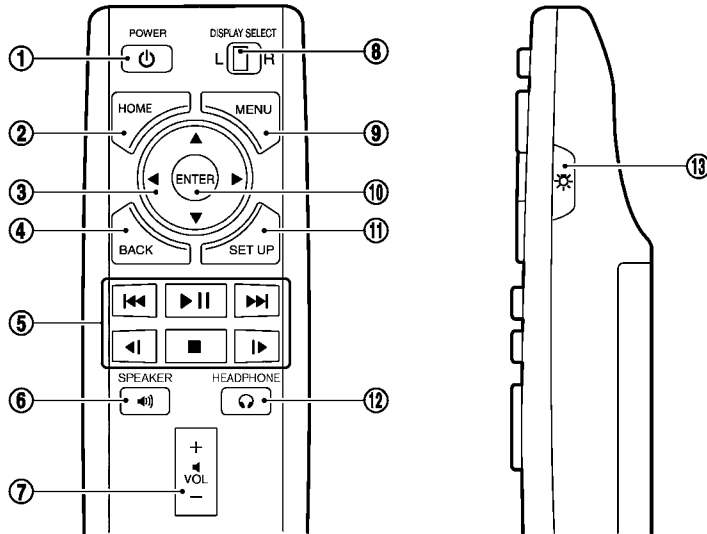

① < ⏻ >:

The rear displays can be activated or deactivated individually.

② < HOME >:

Push to display the HOME screen. Select the media from the DVD (if so equipped), AUX (if so equipped), USB and HDMI interface device.

③ < ▲ >, < ▼ >, < ◀ >, < ▶ > (Select buttons):

Push the select buttons to select the items displayed on the rear screens.

④ < BACK >:



Push to go back to the previous screen.

⑤ Keypad:

Push the keys below for operations.

### 3. Audio system

- < ▶|| > Push to play or pause the movie.
- < ■ > Push to stop playing the movie.
- < ▶▶ > Push to select the next chapter. Push and hold to fast-forward the movie.
- < ◀◀ > Push once to return to the beginning of the current chapter. Push again to select the previous chapter. Push and hold to rewind the current movie.
- < |▶ > Push to fast-forward skipping a number of seconds (for DVD-VIDEO).
- < ◀| > Push to rewind skipping a number of seconds (for DVD-VIDEO).
- ⑥ <SPEAKER>:  
Push to turn on all of the in-vehicle speakers.
- ⑦ Volume control button < + >/< - >:  
Push to adjust the speaker volume.
- ⑧ <DISPLAY SELECT>:  
Slide the switch to the side corresponding to the screen you wish to operate (L or R).

- ⑨ <MENU>:  
Push to display the operation screen for the source that is being played.  
 "Menus" (page 3-59)
- ⑩ <ENTER>:  
Push to execute the selected item.
- ⑪ <SET UP>:  
Push to display the rear seat display settings.  
 "Setting and information" (page 3-60)
- ⑫ <HEADPHONE>:  
Push to turn on the sound from the headphones and turn off the speakers.
- ⑬ <ⓧ>:  
Push to turn on the backlighting of the remote controller buttons.

#### Battery replacement:



#### CAUTION

- An improperly disposed battery can harm the environment. Always confirm local regulations for battery disposal.
- When changing the batteries, do not let dust or oil get on the components.



#### NOTE:

Change the batteries of the remote controller when it does not function properly.

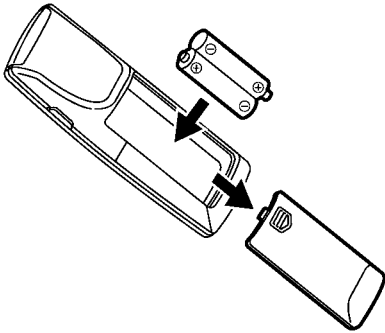

To replace the battery:

1. Open the lid as illustrated above.
2. Replace both batteries with new ones.
  - Recommended battery: Size AA x 2
  - Be careful not to touch the battery terminal.
  - Make sure that the  $\oplus$  and  $\ominus$  ends on the batteries match the markings inside the compartment.
3. Close the lid securely.
  - If you will not be using the remote controller for long periods of time, remove the batteries.

- Replacement of the batteries is needed when the remote controller only functions at extremely close distances to the Mobile Entertainment System or when it does not function at all.

#### Headphones

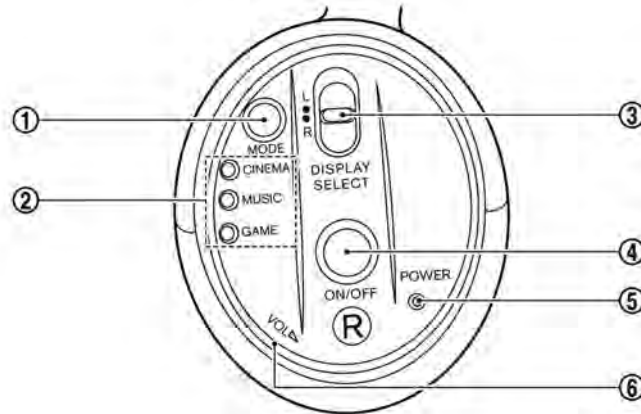

Two wireless headphones are provided with the Mobile Entertainment System. The headphones can only be used in the rear seats.

#### ① <MODE>:

Push to select a surround audio mode optimal for the media. Three types of virtual surround modes supported by Nature surround sound technology are available. When the surround

### 3. Audio system

audio modes are turned off, a regular 2.0 ch stereo mode is applied.

CINEMA:

Optimum mode for movies. Provides powerful surround audio as if you are in a theater.

MUSIC:

Provides natural and clear sounds with stability optimal for listening to music.

GAME:

Provides realistic sounds for playing games with bass enhanced sounds.

#### ② Mode indicators:

The selected surround audio mode will illuminate.

#### ③ <DISPLAY SELECT>:

Slide this switch to select which of the audio sources to listen to when the rear displays are playing different sources.

L: The headphone will play audio from the source playing on the left display.

R: The headphone will play audio from the source playing on the right display.

#### ④ <ON/OFF>:

Push to turn the headphones on or off.

#### ⑤ Power ON/OFF indicator:

Illuminates when the headphones are turned on.

#### ⑥ <VOL> :

Turn to adjust the volume.

#### Operating tips:

- The headphones will automatically turn off after several minutes if there is no audio output during that period. The headphones will also turn off after approximately 4 hours of continuous use. To prevent the battery from being discharged, keep the power turned off when not in use.
- If the sound from the headphones is not clear, it may be due to interference from an infrared communication device or a cellular phone. If this happens, turn down the headphone volume or stop using the headphones. It is also possible that the headphones may be too far or offset from the transmitter which is in the rear display screen. Use the headphones in front of the rear display.

- The sound may also be interrupted temporarily when there is something between the headphones and the transmitter causing interference. Move the source of interference, such as opaque materials, hands, hair, etc.

#### Battery replacement:



- **An improperly disposed battery can harm the environment. Always confirm local regulations for battery disposal.**
- **When changing the batteries, do not let dust or oil get on the components.**



**Change the batteries of the headphones when they stop functioning while playing or when noise is produced.**



### 3. Audio system

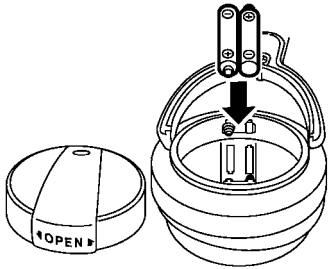
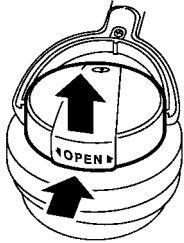

To replace the battery:

1. Open the lid as illustrated above.

For headphones, use a flat object, such as a coin, if necessary, to open the lid located on the back of the left headphone speaker.

2. Replace both batteries with new ones.
  - Recommended battery: Size AAA x 2
  - Be careful not to touch the battery terminal.
  - Make sure that the  $\oplus$  and  $\ominus$  ends on the batteries match the markings inside the compartment.
3. Close the lid securely.

Audio jacks for wired headphones

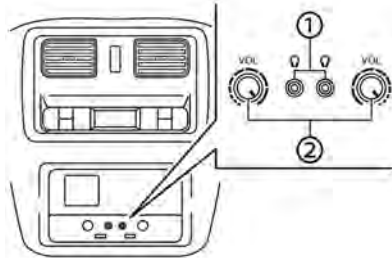

Type A (if so equipped)

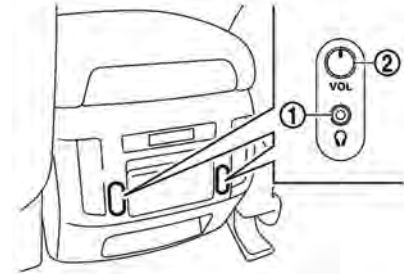

Type B (if so equipped)

Commercially available headphones can also be used by connecting them to the headphone jacks ① located at the rear of the center console box.

To adjust the volume of the wired headphone, push <VOL> ② on the corresponding side (left/right) to pull out the knob which can be rotated to turn up or down the volume.

Push <VOL> ② back in when it is not in use.

### 3. Audio system

#### REAR MEDIA INTERFACE

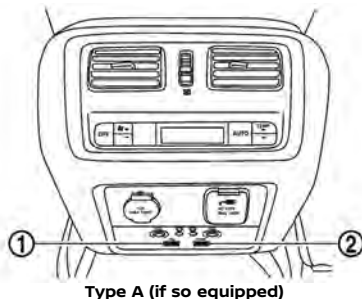

Type A (if so equipped)

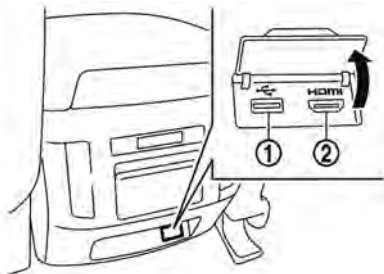

Type B (if so equipped)

Ports for the USB ① and HDMI ② interface are located at the rear of the center console box.

Compatible devices connected to the ports can be played on the rear displays. Turn off the power of the portable device

3-58

before connecting to the port.



#### NOTE:

Do not apply strong pressure to any portable device (such as a USB memory device) or cable that is connected to the USB connection port or the HDMI port. It could damage the device and the ports.

#### ACTIVATING REAR DISPLAYS

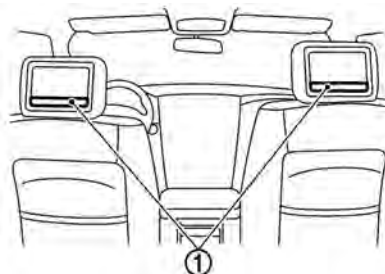

#### CAUTION

- The glass on the display screens may break if hit with a hard or sharp object. If the glass breaks, do not touch the liquid crystalline material. In case of contact with skin, wash immediately with soap and water.

- Applying pressure to the display screens may damage it.

📖 “Care and maintenance”  
(page 3-64)

The rear displays are located on the back of the front head restraints.

Use the remote controller to operate the rear display screens.

📖 “Remote controller” (page 3-53)

Select the left or right rear display using **<DISPLAY SELECT>** on the remote controller and push **<⏻>** to activate the corresponding rear display. When the display is turned on, a green indicator on the lower corner of the display will illuminate.

The lower part of the rear displays ① functions as a signal receiver/transmitter for the remote controller and wireless headphones, and should not be blocked or covered.

Turning the rear displays on/off can also be done on the front display.

📖 “Controlling the rear system on the front display” (page 3-61)

#### ! NOTE:

- The rear displays may turn off automatically when the temperature is high to protect the display screens from being damaged.
- The movement of the images displayed on the rear displays could slow down when the temperature is below 32°F (0°C) but this is not a malfunction. The movement will return to normal when the temperature rises between 32°F (0°C) and 122°F (50°C).
- The following conditions may occur but these are characteristics of the crystal display and are not malfunctions:
  - Black spots, bright spots and afterimages appear on this display.
  - The screen appears faint or dimmed depending on the angle viewed.

#### OPERATIONS ON REAR DISPLAYS

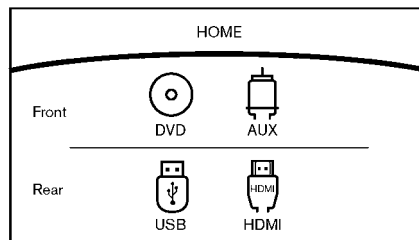

#### Example

Use the remote controller and take the following steps to operate the rear displays from the rear seats:

1. Turn on the rear displays using < ⏻ > on the remote controller.
2. Push < HOME > and select a source from the DVD (if so equipped), AUX (if so equipped), USB or HDMI interface devices.

When USB is selected for the first time after the USB memory device is connected, select a file you wish to play from the File Browser screen.

#### Menus

Push < MENU > on the remote controller to display the operation screen for the source that is playing. Select and adjust the preferred items using the Select buttons and < ENTER > on the remote controller. The available menu items differ depending on the selected source.

#### Available menu items:

- [Speaker Output]  
When this item is turned on, the audio of the source playing on the corresponding rear display will be output to the vehicle speakers.
- [Top Menu] (DVD only)  
Select to display the top menu screen.
- [Title Menu] (DVD only)  
Menus specific to each disc will be shown. For details, see the instructions attached to the disc.
- [Title Search] (DVD only)  
A scene that belongs to a specified title will be displayed each time [+ ] side or [- ] side is selected.
- [10 key Search] (DVD only)  
Select [10 key Search] to display the number entry screen. Enter the number you want to search for and select

### 3. Audio system

[OK] with the remote controller. The selected title/chapter will be played.

- [Audio] (DVD, USB (DivX) only)  
Select a preferred settings for the audio output.
- [Subtitle] (DVD, USB (DivX) only)  
Choose the preferred subtitle language setting.
- [Angle] (DVD only)  
If the DVD contains data of different angles, the angle of the image can be changed.
- [File Browser] (USB only)  
The data contained in the USB can be browsed. The tracks are automatically categorized by playlists, songs, artists, composers, genres, etc.
- [Play Mode] (USB only)  
Select a preferred play mode from [Normal]/[Repeat]/[Shuffle].
- [Aspect Ratio]  
Aspect can be selected from Normal, Wide, Cinema and Full.
- [Select No.] (Video-CD only)  
Select a section number you wish to play.

#### SETTING AND INFORMATION

Various settings for the Mobile Entertainment System such as aspect ratio, language, etc., can be changed on the rear displays.

Push **<SET UP>** on the remote controller and select the preferred item to change the rear display settings and to view the system information.

##### Available items

- [System Settings]
- [Display Settings]
- [Information]

#### System settings

To change the settings of the Mobile Entertainment System, push **<SET UP>** on the remote controller and select [System Settings].

Select the preferred item and adjust the setting using the remote controller.

##### Available items:

- [Aspect Ratio]  
Select the image size from normal, wide, cinema and full.
- [Language]  
The language displayed on the screen can be changed. Select [Manual] and

then select a preferred language from the list. To apply the same language that is applied to the front display, select [Auto].

The language of the rear menu screens can be set independently from the front display. The rear display language settings will be applied to both the rear left and rear right displays.

- [Operation Guide]  
When this item is turned on, an explanation for the menu highlighted on the screen will appear at the bottom of the screen.
- [DivX® VOD]  
DivX® VOD license information can be viewed.

#### Display settings

To change the rear display settings, push **<SET UP>** on the remote controller and select [Display Settings].

Select the preferred item and adjust the setting using the remote controller.

##### Available items:

- [Display Adjustment]

### 3. Audio system

- [Picture Mode]  
Select image quality from normal, dynamic, cinema and game.
- [Auto Bright]  
Select from normal, bright, off and dark. The brightness of the screen is adjusted automatically according to the brightness inside the vehicle compartment. The sensor is located on the right side corner of the rear displays.
- [Brightness]/[Tint]/[Contrast]/[Color]/[Black Level]  
Adjust the levels using < ◀ ▶ > or < ▶ ▶ > on the remote controller.
- [Default]  
Select this item to reset the screen settings to the default value.
- [Automatic Detail Enhancement]  
The enhancement of the contrast for details can be adjusted automatically with this function. Select the level of the function from high, medium and low.
- [Super Resolution]  
Blurred images with a low resolution can be converted and adjusted into more crisp, clearer images. Select the level of the function from high, medium or low.

- [Automatic Contrast Adjustment]  
Objects in dark images that are difficult to view can be adjusted and enhanced automatically for clearer viewing. Select the level of the function from high, medium or low.
- [Noise Reduction]  
With the noise reduction function, block noise that accompanies images can be reduced. Select the level of the function from high, medium or low.

#### Software information

To display the software information of the Mobile Entertainment System, push **<SET UP>** on the remote controller and select [Information].

#### CONTROLLING THE REAR SYSTEM ON THE FRONT DISPLAY

To control the rear displays and the rear speakers on the front display, push **<AUDIO>** on the control panel when the audio screen is displayed, and then touch [Rear Display].

 "Selecting audio source" (page 3-17)

The Mobile Entertainment System screen will appear on the front display, allowing the system to be controlled from the front seats.

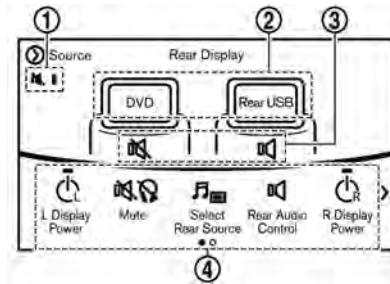

- ① Status display icons:  
Status of the speakers and the remote controller is shown in icons. Touch the icons to change the setting.
- ② Source selection indicator:  
Displays the currently selected source on the corresponding rear display.  
Touch the left/right rear display icon to display the operation screen. The currently selected source on the corresponding rear display can be operated from the screen.
- ③ Speaker status indicator:  
Indicates which of the audio sources is selected to be heard from the speaker. Touch to show the Rear Audio Control screen and change

### 3. Audio system

the speaker setting.

#### ④ Settings menu:

Various settings can be changed. Touch a preferred menu to change the setting.

#### Available Settings menu items:

- [L Display Power]/[R Display Power]: Touch to turn on or off the rear display on the left/right side.
- [Mute]: Touch to mute or unmute all the speakers and the headphones.
- [Select Rear Source]: Touch to display the Select Rear Source screen. Select [Left Screen] or [Right Screen] and then select a source to be played on the screen.
- [Rear Audio Control]: Touch to display the Rear Audio Control screen. Select a sound setting from the following items:
  - [No rear sound – front only]
  - [Play sound for left display]
  - [Play sound for right display]
  - [Headphone Only]

- [Source Control]: Touch to display the operation screen for the currently selected source. Touch [Left Screen] or [Right Screen] to select which of the rear displays you wish to operate.
- [Remote Controller Lock]: Touch to lock or unlock the remote controller operation. When the ignition switch is placed in the OFF or LOCK position, the remote controller will be unlocked.
- [Rr Speaker Mute]: Touch to mute or unmute the rear speakers.
- [Auto Display Power ON]: Touch to turn on or off the setting for automatic power on setting. When this item is turned on, both the left and right rear displays will turn on automatically when the DVD (if so equipped) is inserted into the front unit and the movie will start to play.

#### OPERATING TIPS

- The rear USB and the rear HDMI cannot be played on the front screen.
- Devices connected to the USB connection port for the front display cannot be played on the rear displays.
- When connecting a device to the USB connection port for the first time, the system structures the file list and this could slow down the operation speed. This is not a malfunction.
- The operation speed of the system could slow down when the left and right displays play different files from the same device connected to the USB connection port. This is not a malfunction.
- Images from DVDs (if so equipped) or devices connected to the USB connection port may not be displayed in adequate ratio depending on the resolution. To correct the ratio, adjust the aspect using the remote controller.  
 "System settings" (page 3-60)
- If a computer with an HDMI output terminal is connected to the HDMI input terminal, the computer may not automatically shift to the output mode. To view images on the rear

displays, operate the computer and change the mode to the output mode according to the computer owner's manual.

- Depending on the USB memory device, the image may not start playing upon activation or connection of the device to the USB connection port. In that case, remove and reinsert the USB memory device into the port.

#### Multiple source display

It is possible to play different sources on each display.

Refer to the following table of example combinations.

#### Playback combinations by media:

Rear Display (L)	Rear Display (R)	Availability of playback on the left and right displays
DVD*1	DVD*1	Simultaneous playback
DVD*1	USB	Individual playback
DVD*1	HDMI	Individual playback
HDMI	HDMI	Simultaneous playback
HDMI	USB	Individual playback
USB	USB	Individual playback*2

- \*1 DVDs cannot be played depending on models and specifications.
- \*2 When playing a USB memory device simultaneously on the left and right displays, playback may be limited by the image quality (resolution) of the data. Refer to the following examples of combinations. However, when the system is under a heavy load, there are some combinations that cannot be played.

#### Combinations according to USB memory device image quality:

Rear Display (L)	Rear Display (R)	Availability of individual playback on the left and right displays
FULL HD (Maximum 1920 x 1080p)	FULL HD (Maximum 1920 x 1080p)	Not available (Simultaneous playback)
FULL HD (Maximum 1920 x 1080p)	SD (Maximum 720 x 480p)	Available
HD (Maximum 1280 x 720p)	HD (Maximum 1280 x 720p)	Not available (Simultaneous playback)
HD (Maximum 1280 x 720p)	QHD (Maximum 960 x 540p)	Available
HD (Maximum 1280 x 720p)	SD (Maximum 720 x 480p)	Available

### 3. Audio system

QHD (Maximum 960 x 540p)	QHD (Maximum 960 x 540p)	Available
QHD (Maximum 960 x 540p)	SD (Maximum 720 x 480p)	Available
SD (Maximum 720 x 480p)	SD (Maximum 720 x 480p)	Available
FULL HD (Maximum 1920 x 1080p)	HD (Maximum 1280 x 720p)	Not available (Files selected from the rear cannot be played. Enjoy the combinations that can be played.)
FULL HD (Maximum 1920 x 1080p)	QHD (Maximum 960 x 540p)	Not available (Files selected from the rear cannot be played. Enjoy the combinations that can be played.)



#### NOTE:

- Different movie files cannot be played on the left and right displays at the same time if either or both of the movie files contain images with high resolution.
- When DVD (if so equipped) or AUX device (if so equipped) is selected to be played on the rear displays, different movie files cannot be played on the left and right displays at the same time.

#### CARE AND MAINTENANCE



#### CAUTION

- Do not apply excessive force to the monitor screens.
- Avoid touching or scratching the screens as it may become dirty or damaged.
- Do not attempt to operate the system in extreme temperature conditions [below -4°F (-20°C) and above 158°F (70°C)].
- Do not attempt to operate the system in extreme humidity (less than 10% or more than 75%).

- For cleaning, turn the rear displays off and use a soft dry cloth. Never use a rough cloth, alcohol, benzine, thinner or any kind of solvent or paper towel with a chemical cleaning agent. They will scratch or cause discoloration to the displays. If dirt does not come off with a dry cloth, slightly dampen the cloth with neutral detergent.



## 4 Bluetooth® Hands-Free Phone

Bluetooth® Hands-Free Phone System .....	4-2	Phone .....	4-4
Control buttons and microphone .....	4-3	Hands-free text messaging assistant .....	4-5
Connecting Bluetooth® Hands-Free Phone .....	4-3	Phone and text message settings .....	4-9
		Bluetooth® information .....	4-12



## 4. Bluetooth® Hands-Free Phone

### BLUETOOTH® HANDS-FREE PHONE SYSTEM



#### WARNING

- Only use a phone after stopping your vehicle in a safe location. If you have to use a phone while driving, exercise extreme caution at all times so full attention may be given to vehicle operation.
- If you find yourself unable to devote full attention to vehicle operation while talking on the phone, pull off the road in a safe location and stop your vehicle before doing so.



#### CAUTION

To avoid draining the vehicle battery, only use a phone after starting the engine.

Your vehicle is equipped with a Bluetooth® Hands-Free Phone System. If you are an owner of a compatible Bluetooth® enabled cellular phone, you can set up the wireless connection between your cellular

phone and the in-vehicle phone module. With Bluetooth® wireless technology, you can make or receive a telephone call with your cellular phone in your pocket.

Once a cellular phone is connected to the in-vehicle phone module, the procedure for connecting the phone does not need to be performed again. Your phone is automatically selected by the in-vehicle phone module when the ignition switch is placed in the ON position with the selected cellular phone turned on and carried in the vehicle.

You can register up to five different Bluetooth® cellular phones to the in-vehicle phone module. However, you can talk on only one cellular phone at a time.

The Voice Recognition System supports phone commands, so dialing a phone number using your voice is possible.

 "7. Voice Recognition"

- Wireless LAN (Wi-Fi) and the Bluetooth® functions share the same frequency band (2.4GHz). Using the Bluetooth® and wireless LAN functions at the same time may slow down or disrupt communications and could cause undesired noise. It is recommended that you turn wireless LAN (Wi-Fi) off when using the Bluetooth® functions.

- Set up the wireless connection between a compatible cellular phone and the in-vehicle phone module before using the Bluetooth® Hands-Free Phone System.
- Some Bluetooth® enabled cellular phones may not be recognized by the in-vehicle phone module. It is recommended you contact a NISSAN dealer for phone compatibility.
- You will not be able to use a hands-free phone under the following conditions:
  - Your vehicle is outside the service area for your cellular phone network.
  - Your vehicle is in an area where it is difficult to receive radio waves, such as in a tunnel, in an underground parking garage, behind a tall building or in a mountainous area.
  - Your cellular phone is locked in order to prevent dialing.
- When the radio wave condition is not ideal or ambient sound is too loud, it may be difficult to hear the other person's voice during a call.
- This Bluetooth® system supports Wideband speech, which enhances

## 4. Bluetooth® Hands-Free Phone

the sound quality of phone calls placed over Bluetooth®. To take advantage of this feature, the cellular device should be used on a carrier supporting Adaptive MultiRate Wideband (AMR-WB) or HD voice technology. The performance of AMR-WB may vary by carrier and calling area. Consult your cellular phone carrier if you experience issues with call quality or connection.



- Immediately after the ignition switch is placed in the ON position, it may be impossible to receive a call for a short period of time.
- Do not place the cellular phone in an area surrounded by metal or far away from the in-vehicle phone module to prevent tone quality degradation and wireless connection disruption.
- While a cellular phone is connected through the Bluetooth® wireless connection, the battery of the cellular phone may discharge quicker than usual.
- If the Bluetooth® Hands-Free Phone System seems to be malfunctioning, it is recommended that you visit a NISSAN dealer for troubleshooting help.

- Some cellular phones or other devices may cause interference or a buzzing noise to be emitted from the audio system speakers. Storing the device in a different location may reduce or eliminate the noise.
- Refer to the owner's manual for the cellular phone for information regarding the telephone pairing procedure specific to your phone, battery charging, and cellular phone antenna, etc.
- The antenna display on the touch screen display may not match the antenna display of some cellular phones.
- The battery display on the touch screen display may not match the battery display of some cellular phones.
- Keep the interior of the vehicle as quiet as possible to hear the caller's voice clearly as well as to minimize echoes.
- If reception between callers is unclear, adjusting the incoming or outgoing call volume may improve the clarity.

### CONTROL BUTTONS AND MICROPHONE

#### Control buttons:

The hands-free phone system can be operated mainly with <  > on the steering wheel.

For models with <  > on the control panel, the same operation as <  > on the steering wheel can be conducted using this button on the control panel.

 "Control buttons and touch screen display (center display)" (page 2-2)

This chapter mainly explains the operation method using the steering wheel switch.

#### Microphone:

The microphone is located near the map light.

### CONNECTING BLUETOOTH® HANDS-FREE PHONE

The cellular phone must be connected to the Bluetooth® Hands-Free Phone System before commencing operation. Up to 5 cellular phones can be connected to the system.

 "Pairing Bluetooth® device" (page 2-28)

## 4. Bluetooth® Hands-Free Phone

### PHONE

#### Phone selection

Select one of the connected devices for operation.

1. Push < ⏪ > on the steering wheel and then touch [Select Phone]. A list of the connected cellular phones is displayed.
2. Select one of the connected cellular phones from the list.
3. When selection of the device is successful, a message on the display indicates that the cellular phone was selected.

#### Making a call

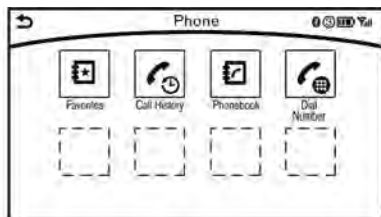

1. Push < ⏪ > on the steering wheel.
2. Select one of the following methods to make a call.

#### Available methods

- [Favorites]  
Select a telephone number from a list of personally selected numbers.
- [Call History]  
Select a telephone number from recent incoming or outgoing calls.
- [Phonebook]  
Select a telephone number from the phonebook.

The telephone number must be transferred to the phonebook from the cellular phone prior to using this method.

☞ "Phone and text message settings" (page 4-9)

- [Dial Number]  
Input the phone number manually using the keypad displayed on the screen. Touch the key to call the number.  
☞ "How to input letters and numbers" (page 2-18)
3. The number will be dialed and the screen will change to the call in progress screen.

#### Receiving a call

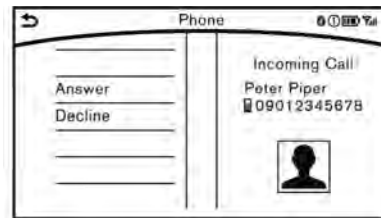

When you receive a phone call, a notification message is displayed on the touch screen display with a ring tone.

#### Taking a call:

To answer a call, take one of the following actions.

- Touch [Answer].
- Push < ⏪ > on the steering wheel.

#### Rejecting a call:

To reject a call, touch [Decline].

## 4. Bluetooth® Hands-Free Phone

### Receiving a call while on the line with another person:

When another phone call is received while on the line with another person, a message box informing you of the incoming call will appear on the display.

#### Available items

Available Items	Action
[Answer]	Take the second call and put the first call on hold.
[Decline]	Reject the second call and keep the first call on line.

### During a call

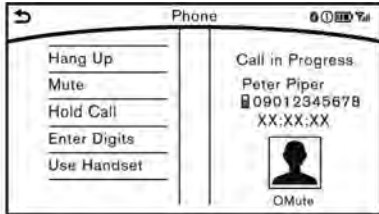

There are various options available during a call. Select one of the following options displayed on the screen if necessary.

#### Available items

Available Items	Action
[Switch Call]*	Answer another incoming call. The person you are talking to will be placed on hold. Push once more to speak to the person on hold again.
[Hang Up]	This disconnects the person you are currently connected to and will connect you to the person who is on hold.
[Mute]/[Cancel Mute]	When muted, your voice will not be heard by the person on the other end of the line.
[Hold Call]**	Place the call on hold.
[Enter Digits]	Using the touch tone, send digits to the connected party for using services such as voice-mail.
[Use Handset]/[Use Hands free]	Transfer the call to the cellular phone.
[End All Calls]*	Hang up all calls including the ones that were on hold.

\* Available when multiple lines are connected.

\*\* Available when a single line is connected.

- To adjust the volume of the person's voice to be louder or quieter, push <-|+> on the steering wheel or turn <VOL/ON-OFF> on the audio system, while talking on the phone.
- Touch [Mute] if you do not want your voice to be heard by the person on the other end of the line.

### HANDS-FREE TEXT MESSAGING ASSISTANT



#### WARNING

**Use the text messaging feature after parking your vehicle in a safe location. If you have to use the feature while driving, exercise extreme caution at all times so full attention may be given to vehicle operation.**

**Laws in some jurisdictions may restrict the use of some of the applications and features, such as social networking and texting.**

## 4. Bluetooth® Hands-Free Phone



### CAUTION

This feature is disabled if the connected device does not support the Message Access Profile (MAP). For additional information, refer to the owner's manual for your phone.

Laws in some jurisdictions may restrict the use of "Text-to-Speech". Check local regulations before using this feature.

The text messaging assistant system allows the sending and receiving of the text messages through the vehicle interface.

Depending on the device that is connected to the vehicle, some of the items/functions may not be displayed or used.

### Receiving a message

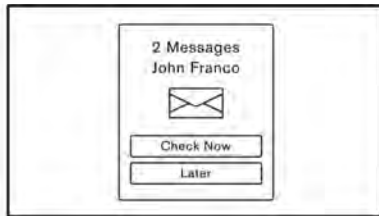

When the cellular phone connected to the vehicle receives a text message, a notification is displayed on the display accompanied by a tone.

To check the message, touch [Check Now]. Touch [Later] to save the message to be checked later.

Before using the text messaging assistant feature, confirm the settings of the iPhone®.

1. Connect your iPhone® to the Bluetooth® Hands-Free Phone System.
2. Disconnect iPhone® from the Bluetooth® settings menu.  
     "Bluetooth® settings" (page 2-28)
3. Turn "Show Notification" ON from the Bluetooth® setting menu on your iPhone®.

4. Place the ignition switch in the OFF position, and then place the ignition switch in the ACC or ON position after waiting approximately 3 minutes.

### Displaying received message list

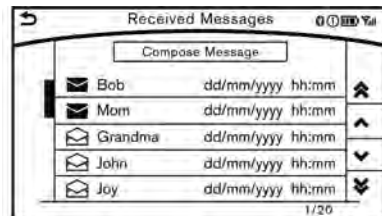

1. Push <  > on the steering wheel.
2. Touch [Text Messages].
3. Touch an item on the list to read or to reply to the message.



### INFO:

Up to 20 messages can be stored on the message list.

## 4. Bluetooth® Hands-Free Phone

### Received message screen

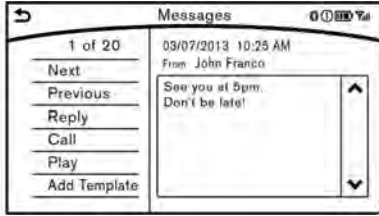

Touching [Check Now] on the new message notification screen or selecting a message from the message list will show details of the received message on the display.

#### Available actions:

- [Next]  
Touch to read the next message.
- [Previous]  
Touch to read the previous message.
- [Reply]  
Depending on the connected cellular phone, a reply template can be selected.  
[Send] "Sending a text message"  
(page 4-7)
- [Call]  
If the sender of the message is regis-

tered in the Phonebook, touch this menu to make a call to the sender.

- [Play]/[Stop]  
Touch [Play] to have the hands-free phone system read out the received message. Touch [Stop] to stop reading.
- [Add Template]  
The received text message can be added to the template (text list).



#### INFO:

- The next or previous message will be read if <ENTER> on the steering wheel is tilted up or down while the received text message is read out.
- If the sender's name and address are registered in the Phonebook, the name of the sender is displayed as sender information on the screen.

### Sending a text message

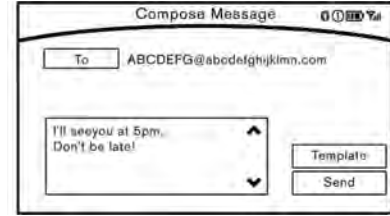

1. Push < > on the steering wheel.
2. Touch [Text Message].
3. Touch [Compose Message].

The following items are available.

## 4. Bluetooth® Hands-Free Phone

Available items		Action
[To]	[Keypad]	Type in the address of the recipient using the keypad. Touch [OK] to confirm the address.
	[Phonebook]	Select a recipient from the phonebook and touch [OK] to confirm.
[Template]	Select from list	Select an item from the message list. The selected text will be added to the message to be sent.
	[Edit Text Message Replies]	Select an item in the message list to be edited. Use the keypad to edit the text and touch [OK] to complete editing.
[Send]		Touch to send the message.



## 4. Bluetooth® Hands-Free Phone

### PHONE AND TEXT MESSAGE SETTINGS

#### Phone settings

The Bluetooth® Hands-Free Phone System can be set in detail according to the user's preference.

1. Push **<SETTING>**.
2. Touch [Phone/Mail].
3. Touch [Phone Settings].

The following phone setting items are available.

#### Incoming Call Settings:

Setting item	Action
[Ringtone]	Select a type of ringtone.

#### Phonebook/Favorites Settings:

Setting item	Action		
[Configure Phonebook Settings]	[Automatic Transfer Settings]	[Phonebook Auto download]	Turn automatic download of the phonebook from the cellular phone on/off.
		[Call History Download]	Turn automatic download of the cellular phone call history on/off.
	[Manual Phonebook Transfer]	[Transfer and Overwrite] (Depending on cellular phone)	Manually transfer information from the phonebook on the cellular phone.
		[Transfer and Add] (Depending on cellular phone)	
[Delete Phonebook]		To delete a single item, select the item you wish to delete from the list. Touch [Delete All] to delete all items. To delete multiple items, touch [Multiple Selection].	

## 4. Bluetooth® Hands-Free Phone

[Favorites Settings]	[Delete Favorites]		To delete a single item, select the item you wish to delete from the list. Touch [Delete All] to delete all items. To delete multiple items, touch [Multiple Selection].
	[Add to Favorites]	[From Phonebook]	Select items from the phonebook of the in-vehicle system to add to the favorites.
		[From Outgoing Calls]	Select items from the outgoing calls list to the in-vehicle system to add to the favorites.
		[From Incoming Calls]	Select items from the incoming calls list of the in-vehicle system to add to the favorites.
		[From Missed Calls]	Select items from the missed calls list of the in-vehicle system to add to the favorites.
[Delete Call History]	[Delete Outgoing Call History]		To delete a single item, select the item you wish to delete from the list. Touch [Delete All] to delete all items. To delete multiple items, touch [Multiple Selection].
	[Delete Incoming Call History]		
	[Delete Missed Call History]		
	[Delete ALL Call History]		

## 4. Bluetooth® Hands-Free Phone

### Mail settings

Various settings can be changed from the Mail Settings screen.

1. Push **<SETTING>**.
2. Touch [Phone/Mail].
3. Touch [Mail Settings].

The following mail setting items are available.

Settings item	Settings item
[Message Download Settings]	The transfer function can be turned on/off. When the transfer function is on, the phonebook on the cellular phone will be automatically downloaded to the hands-free messaging system when connected.
[Attempts for Sending]	The number of reattempts after failing to send a text message can be selected between 0 and 3.
[New Message Alert]	The type of tone used for the notification sound can be selected.
[Edit Text Message Replies]	The template (text to select from when composing an outgoing message) can be edited.

### Phonebook

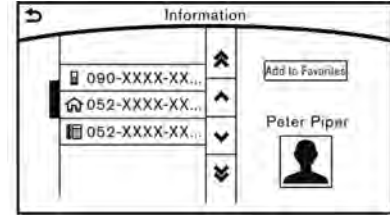

Information in the phonebook on cellular phones can be downloaded.

☞ "Phone settings" (page 4-9)

1. Push **< >** on the steering wheel.
2. Touch [Phonebook] and select from the list.

This can be viewed on the display and used to make calls or send text messages.

## 4. Bluetooth® Hands-Free Phone

### Favorites

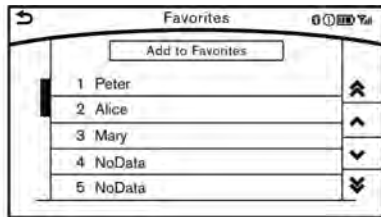

Up to 40 phone numbers can be transferred to the favorites list from a cellular phone.

1. Push < **↩** > on the steering wheel.
2. Touch [Favorites] and select from the list.

It can be viewed on the display and used to make calls or send text messages.

### Voice Tag:

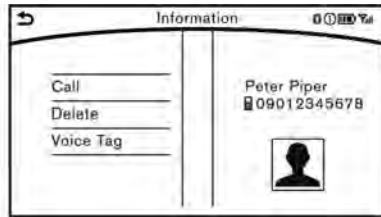

A custom voice tag can be recorded for phone numbers on the favorites list and used to dial the number by speaking it.

1. Push < **↩** > on the steering wheel.
2. Touch [Favorites].
3. Select an item from the list.
4. Touch [Voice Tag].

The following items are available.

Available items	Action
[Register]	Touch to record a voice tag for the phone number.
[Re-registration]	Touch to record the voice tag.
[Play]	Touch to play the recorded voice tag.
[Delete]	Touch to delete the voice tag.

### BLUETOOTH® INFORMATION

Information about the connected Bluetooth® device can be viewed.

1. Push < **SETTING** >.
2. Touch [Bluetooth].
3. Touch [Vehicle Bluetooth Device Info.].

The following items are available.

Available items	Action
[Device Name]	The name of the connected Bluetooth® device is displayed. Touch [Device Name] to display the keyboard input screen for editing.
[Enter PIN Code]	The passkey of the connected Bluetooth® device is displayed. Touch [Enter PIN Code] to display the keyboard input screen.
Device Address	The device address of the connected Bluetooth® device is displayed.

# 5 Information

Information menu .....	5-2	NissanConnect® Services features .....	5-14
SiriusXM Traffic™ information (if so equipped) .....	5-4	Connecting to Interactive Voice Menu .....	5-19
Viewing traffic information .....	5-4	Setting route to a searched destination .....	5-20
Viewing available traffic information .....	5-4	Viewing information feeds .....	5-20
Display urgent traffic information .....	5-6	Emergency support .....	5-22
Traffic Information Settings .....	5-6	NissanConnect® Services settings .....	5-24
Traffic information on map .....	5-7	NissanConnect® Apps .....	5-25
SiriusXM® Travel Link (if so equipped) .....	5-8	NissanConnect® Apps overview .....	5-25
Viewing SiriusXM® Travel Link .....	5-8	Using applications .....	5-25
NissanConnect® Services (if so equipped) .....	5-14	NissanConnect® Vehicle Apps .....	5-25
Subscription to NissanConnect® Services .....	5-14		
Legal disclaimer .....	5-14		

## 5. Information



### INFORMATION MENU

The information screen sets or displays various information that is helpful for using the vehicle.

Push **<INFO>** to display the information menu.

The displayed items vary depending on models and specifications.

Menu item	Result
[Fuel Economy]	Displays the Fuel Economy. The current and average fuel economy and the distance to empty can be confirmed.
[History]	The Fuel Economy history screen can be scrolled. Displays Fuel Economy history screen. Touch [ <b>&lt;</b> ]/[ <b>&gt;</b> ] to display an older history or the newest history.
[Reset]	Resets the average Fuel Economy. The average for the Reset-to-Reset period is stored as a fuel economy history.
[Tire Pressures]	The tire pressure information is displayed for reference.
[Select Units]	Changes the measurement units.
[Maintenance]	The maintenance intervals can be displayed for the engine oil, oil filter, tire and other reminders. The following settings are available for each maintenance item. [Distance]: Set the interval (mileage) of the maintenance schedule. [Reset Distance]: Reset the driving distance to the new maintenance schedule. [Show Alerts]: Display the reminder automatically when the set distance is reached.
[Engine Oil]	
[Oil Filter]	
[Tire]	
[Other Reminders]	
[Eco Drive Report]	Displays the Eco Drive Report for "Start"/"Cruise"/"Deceleration".
[History]	The Eco Drive Report History screen can be scrolled. Displays the Eco Drive Report History screen. Touch [ <b>&lt;</b> ]/[ <b>&gt;</b> ] to display an older history or the newest history.

Menu item		Result
	[Reset]	Resets the Eco Drive Report screen. The average for the Reset-to-Reset period is stored as an Eco Drive Report history.
[Traffic Information]		Traffic information can be viewed.  "Viewing traffic information" (page 5-4)
[Map Information]		Displays the map version, software version and Navi ID.
[NissanConnect Services]		Displays the NissanConnect® Services menu.  "NissanConnect® Services" (page 5-14)
[SXM Info]		Display the SiriusXM® Travel Link information menu.  "Viewing SiriusXM® Travel Link" (page 5-8)



### INFO:

- A SiriusXM® Travel Link or SiriusXM Traffic™ subscription is necessary to receive SiriusXM® information services.
- Use of NissanConnect® Services features is dependent upon a valid subscription and the telematics device being in operative condition, as well as cellular phone connectivity, navigation map data and GPS satellite signal reception being available.

## 5. Information

### SiriusXM TRAFFIC™ INFORMATION (if so equipped)

#### VIEWING TRAFFIC INFORMATION

SiriusXM Traffic™ information is a subscription service offered by SiriusXM® Satellite Radio.

This service provides real-time information regarding traffic flow, accidents, road construction and other incidents, where available.

SiriusXM Traffic™ combines information from commercial and public traffic data providers including government departments of transportation, police, emergency services, road sensors, cameras and aircraft reports. The traffic information is broadcast to the vehicle by the SiriusXM® satellites. Traffic information available for the route you selected is shown on the navigation screen so traffic conditions between your vehicle and the destination are known. Three types of real-time traffic information for major roadways are shown on the navigation system:

- Unscheduled traffic data for example, accidents and disabled vehicles.

- Scheduled traffic data, for example road construction and road closures.
- Traffic flow information (rate of speed data).



#### WARNING

**SiriusXM Traffic™ information is not a substitute for attentive driving. Traffic conditions change constantly and emergency situations can arise without warning. Relying only on SiriusXM Traffic™ information may lead to a collision and could result in serious personal injury.**



#### NOTE:

**Flow information is provided only for roads equipped with traffic sensors and is not available in all markets covered by the service. Flow data may not be available on portions of a road that is under construction.**

SiriusXM Traffic™ information is available in for a limited number of markets. To subscribe or to check if this service is available in your area: call 1-866-635-2349 or see [www.siriusxm.com/siriusxmtraffic](http://www.siriusxm.com/siriusxmtraffic)



#### INFO:

If you do not have a contract for SiriusXM Traffic™ information service, a message appears, and it will not be possible to check the information on the traffic information system.

#### VIEWING AVAILABLE TRAFFIC INFORMATION

SiriusXM Traffic™ information is a subscription service offered by SiriusXM® Satellite Radio.

This service provides real-time information regarding traffic flow, accidents, road construction and other incidents, where available.

SiriusXM Traffic™ combines information from commercial and public traffic data providers including government departments of transportation, police, emergency services, road sensors, cameras and aircraft reports. The traffic information is broadcast to the vehicle by the SiriusXM® Satellite Radio. Available traffic information on the route the driver selected is shown on the navigation screen so traffic conditions between you and the destination are known. Three types of real-time traffic information for major roadways are shown on the navigation system:



- \* Unscheduled traffic data for example, accidents and disabled vehicles.
- \* Scheduled traffic data, for example road construction and road closures.
- \* Traffic flow information (rate of speed data).



### WARNING

SiriusXM Traffic™ information is not a substitute for attentive driving. Traffic conditions change constantly and emergency situations can arise without warning. Relying only on SiriusXM Traffic™ information may lead to a collision and could result in serious personal injury.



### NOTE:

Flow information is provided only for roads equipped with traffic sensors and is not available in all markets covered by the service. Flow data may not be available on portions of a road that is under construction.

 "SiriusXM® Travel Link" (page 5-8)

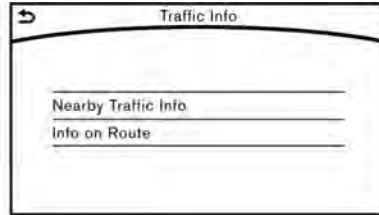

1. Push <INFO>.
2. Touch [Traffic Information].
3. Touch the preferred information.

Available item	Action
[Nearby Traffic Info]	The list of available traffic information around the current vehicle location is displayed.
[Info on Route]	This is only available when a route is set. The list of traffic information found on the recommended route from the current vehicle location to the destination is displayed. The detailed information about displayed events can also be checked.

### Viewing traffic information list

The list of traffic information found on the recommended route from the current vehicle location to the destination is displayed. The detailed information about displayed events can also be checked.

1. Push <INFO>.
2. Touch [Traffic Information].
3. Touch [Nearby Traffic Info] or [Info on Route].
4. Touch the preferred information from Traffic info screen.

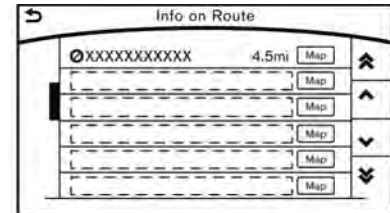

5. Touch the event to check the detailed information. Touch [Map] to display traffic information location.

## 5. Information

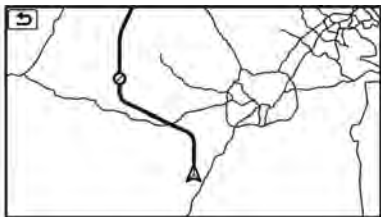

6. The map screen centered around the selected event is displayed. On the display, the detailed information about the event is displayed.

The message can be scrolled.

7. Touch [  ] to return to the previous screen.

### DISPLAY URGENT TRAFFIC INFORMATION

When an urgent event is found around the current vehicle location, a message pops up automatically with a voice announcement.

The message includes the icon, event type, event information and the direct distance from the current location to the event.



#### INFO:

- Urgent traffic information is displayed regardless of whether the traffic information system is on or off.
- When there are multiple urgent events, the event with the shortest direct distance from the current location is displayed.
- If the urgent event is on the recommended route, and if a detour is found, the detour route notification screen is displayed when the vehicle approaches the detour point.

### TRAFFIC INFORMATION SETTINGS

This displays or changes the settings for the traffic information related functions.

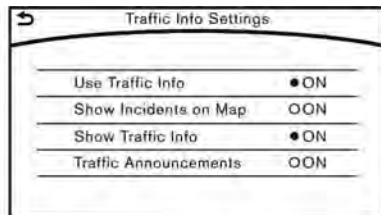

1. Push <SETTING>.
2. Touch [Navigation].

3. Touch [Traffic Info Settings].
4. Touch the preferred setting. The indicator for the selected setting illuminates.

#### Available setting items:

- [Use Traffic Info]  
Enables all traffic information related functions.
- [Show Incidents on Map]  
Displays the traffic incidents (e.g., accident) on the map screen.
- [Show Traffic Info]  
Displays the traffic flow with an arrow on the map screen.
- [Traffic Announcements]  
Announces the traffic information event on the route.



#### INFO:

- Even when [Show Traffic Info] and [Show Incidents on Map] are set to off, the list display of [Info on Route] and [Nearby Traffic Info] will not be affected.
- Even when [Traffic Announcements] is set to off, the route guidance will not be affected. Also, the announcement of emergency information and weather-

er information will not be turned off.



### Voice command

1. Push <  > located on the steering wheel.
2. After the tone sounds, speak a command.

To turn the traffic information system on or off:

“Traffic Information”





### TRAFFIC INFORMATION ON MAP

With a subscription to SiriusXM Traffic™ service, traffic information is displayed on both 2D map and Birdview™ map screens.

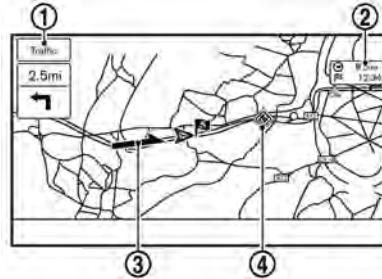
 “Notes on SiriusXM Traffic™ information” (page 5-13)

### Screen information



- ① **Traffic indicator**  
Displays the reception condition of traffic information transmitted from the provider.  
When the traffic information transmitted from the provider is not detected, the traffic indicator will not be displayed.
- ② **Estimated travel time to destination**  
calculated with consideration of traffic information on route.
- ③ **Road conditions**  
Free Flow: Green arrow  
Moderate traffic: Yellow arrow  
Heavy traffic: Red arrow  
Section affected by serious traffic event: Purple arrow
- ④ **Traffic information icon**  
If a route is not already set, all of the traffic information icons on the map screen are displayed in color. When a route is already set, the icons on the route are displayed in color, and the icons outside the route are displayed in gray.  
  -  : Accident
  -  : Closed road
  -  : Information
  -  : Road work
  -  : Slippery road

## 5. Information

 : Weather

 : Incident

### Traffic information display and scale levels

2D map and Birdview™ Map	
5 miles	10 km
2 miles	4 km
1 mile	2 km
1/2 mile	1 km
1/4 mile	400 m
1/8 mile	200 m
1/16 mile	100 m
1/32 mile	50 m
1/64 mile	25 m

### SiriusXM® TRAVEL LINK (if so equipped)

SiriusXM® Travel Link information is a subscription service offered by SiriusXM® Satellite Radio. It is necessary to subscribe to use the SiriusXM® Travel Link information.

This service provides real-time information regarding current weather, fuel prices, sports scores, stock tickers and movie times where available. The SiriusXM® Travel Link is broadcast to the vehicle by SiriusXM® Satellite Radio.

The service enables you to view the following information on the navigation system:

\*Current information around the destination

\*Detailed information and forecasts of an area of interest

\*Countrywide and local maps with the current weather, temperature, warnings and road condition information

\*List of warning/watches events detected around the current location

\*Pop-up messages on the navigation screen with voice announcements when warnings and watches are detected around the current location



### WARNING

**SiriusXM® Travel Link information is not a substitute for attentive driving. Weather conditions change constantly and emergency situations can arise without warning. Relying only on SiriusXM® Travel Link information could result in serious personal injury.**

### VIEWING SiriusXM® TRAVEL LINK

SiriusXM® Travel Link information is available in limited markets. To subscribe to or check if this service is available in the area, call 1-866-635-2349 or access <http://www.siriusxm.com/travellink>.



### INFO:

- If a contract is not completed for the SiriusXM® Travel Link information service, a message appears and it will not be possible to check the information on the traffic information system.
- The weather information is available only for areas that provide weather

information to SiriusXM® Travel Link.

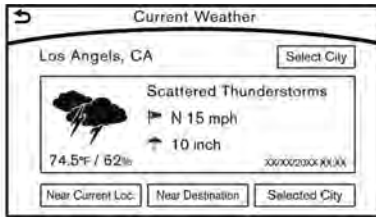

Example

#### Automotive Weather information

Step 1	Step 2	Menu item	Action
Push <INFO>.	[SXM Info]	[Automotive Weather]	Display current weather condition information. Touch [Near Destination] to display the current weather condition for the area near the destination, touch [Near Current Loc.] to display the current weather conditions near the vehicles current location. Touch [Selected City] to change the city.
		[5-DAY Forecast]	Display the current five-day weather forecast. Touch [Near Destination] to display the five-day weather forecast for area near the destination, touch [Near Current Loc.] to display the five-day weather forecast for the area near the vehicle's current location. Touch [Selected City] to change the city.

## 5. Information

Step 1	Step 2	Menu item	Action
		[Graphical Map]	Display a graphical map of the weather information. Touch [+] / [-] to change the map scale to 320 miles (640 km) (U.S), 32 miles (64 km) (Middle scale) or 5 miles (10 km) (Detail scale). Touch [Radar] to display the weather radar map. Touch [Chart] to display weather surface features and pressure, when the map scale is U.S. (320 miles (640 km)). Touch [Storm] to display Storm information, when the map scale is U.S. (320 miles (640 km)) or Middle scale (32 miles (64 km)). Touch [Winds] to display wind information, when map scale is Detail scale (5 miles (10 km)).

### Fuel Prices information

Step 1	Step 2	Menu item	Action
Push <INFO>.	[SXM Info]	[Fuel Prices]	Display fuel prices. Select gas station from the fuel prices list to display detail information or a call a selected gas station from the list. Touch [Select Fuel] to select fuel type information, touch [Prices] to display the fuel price list. Touch [Near Current Loc.] / [Near Destination] / [Select Fuel] to sort by distance or sort by prices from the list. Set a destination by selecting a gas station from the list.

## 5. Information

### Sports Score information

Step 1	Step 2	Menu item		Action
Push <INFO>.	[SXM Info]	[Sports Scores]	Select from list.	Display current event state (scheduled game, during the game, match results).
			SXM® channels to display information	Select to listen to the radio.
		[Select League]	[Add League]	Add favorite sports genre for the list. Up to 10 items can be registered in the list.
		[Delete League]	[Multi Select]	Delete multiple selected sports scores.
			[Delete All]	Delete all sports scores.
			Select from list.	Delete a selected sports score.
			Select from list.	Display the details of a score.
	[See Another Day]	Display the event state of another day.		

## 5. Information

### Stock Tickers information

Step 1	Step 2	Menu item	Action	
Push <INFO>.	[SXM Info]	[Stock Tickers]	Display stock names, stock prices, fluctuation contents, variable stock prices, and the receiving date/time.	
		[Add Stock]	Add displaying stock.	
		[Delete Stock]	[Delete All]	Delete all stocks.
			[Multi Select]	Delete multiple selected stock.
			Select from list.	Delete a selected stock.

### Movie Times information

Step 1	Step 2	Menu item	Action		
Push <INFO>.	[SXM Info]	[Movie Listings]	[Select City]	Select from list.	Select a city.
		[Theater]	[Movies]		Display detailed movie information.
			Select from list.	[GO]	Set a destination selected from the list of theaters.
			[Near Destination]		Display the theater near the vehicle's destination.
			[Near Current Loc.]		Display the theater near the vehicle's current location.
			[Selected City]		Change the city.
		[Movie]	Select from list.		Display information for the movie theater selected from the list.
			[Details]		Display movie title, rating and run time.



### Notes on SiriusXM Traffic™ information

- The SiriusXM Traffic™ information service is not provided for some cities. In addition, the cities for which the traffic information service is provided may be changed.
- In some cases, infrastructure problems may prevent the complete display of the traffic information. This is not a malfunction.
- Due to infrastructure problems, or due to the time when the traffic information service broadcast is received, the displayed information may differ from the actual traffic conditions.
- Depending on the traffic information, a detour route may be slower than the original route.
- SiriusXM Traffic™ is a service of SiriusXM® Radio. SiriusXM Traffic™ is only available in select markets and is subject to data availability. Reception of the SiriusXM® signal may vary depending on location. It requires a monthly premium subscription. The service provider is solely responsible for the quality and accuracy of the information provided. All fees and programming are subject to change.

For more details on the SiriusXM Traffic™ service, terms and conditions, please visit [www.siriusxm.com](http://www.siriusxm.com).

You can also contact SiriusXM® at 1-866-635-2349.

- SiriusXM Traffic™ is available in over 130 metropolitan markets. For the most current list of markets covered, please refer to [www.siriusxm.com/siriusxmtraffic](http://www.siriusxm.com/siriusxmtraffic), or call SiriusXM® Listener Care at 1-866-635-2349.
- Due to road maintenance, infrastructure problems (e.g. malfunction of road sensors, outage of central computer of infrastructure) or natural disasters, there are times when some or all traffic information may not be available.
- Incident information is based on human collection. Not all incidents that have happened are collected and provided.
- Due to infrastructure problems, or transmission delay, there are times when the information may differ from the actual condition. Always observe safe driving practices and follow all traffic regulations.

- Due to the coverage and quality of traffic information and road conditions, it is not always possible for the system to provide the shortest time route even when traffic information is considered.
- Traffic information that is displayed may differ from information from other media (e.g., radio), as other media may use different information sources.

## 5. Information

### **NISSANCONNECT® SERVICES (if so equipped)**

#### **SUBSCRIPTION TO NISSANCONNECT® SERVICES**

It is necessary to subscribe to NissanConnect® Services in order to use NissanConnect® Services. To activate NissanConnect® Services, you can enroll via the NissanConnect® Services app, NissanConnect® portal website, or by contacting a NISSAN dealer.

NissanConnect® Services are offered by SiriusXM® or other third party vendors in accordance with the terms and conditions and the privacy policies outlined in a Subscription Agreement.

#### **LEGAL DISCLAIMER**



#### **WARNING**

**Driving is serious business and requires your full attention. Only use features and connected devices when safe and legal to do so. Some features, including automatic crash notification and SOS, are dependent upon the telematics device being in operative condition, its ability to connect to a wireless network, compatible wireless**

**network availability, navigation map data and GPS satellite signal receptions, the absence of which can limit or prevent the ability to reach the NissanConnect® Services Data Center and NissanConnect® Services Response Center or receive support. GPS mapping may not be detailed in all areas or reflect current road status. Never program GPS while driving. Only use Remote Engine Start (if so equipped) and Remote Horn (if so equipped) features in accordance with any laws, rules or ordinances in effect in your vehicle's location.**

**Avoid operating NissanConnect® Services in such a way that you are distracted while driving. Except for services provided under Demonstration Mode, a NissanConnect® Services Subscription Agreement is required to use this service.**

Beginning on the date of purchase of your vehicle, a trial period for the services is included for a limited period of time.

Services are dependent upon subscription enrollment and the telematics device being in operative condition, cellular connection availability, navigation map data, and GPS satellite signal reception, which

can limit the ability to reach NissanConnect® Services or to receive support. The service requires a compatible 4G LTE/3G cellular network. Should the cellular provider terminate or restrict network service, services will not be available. Under this circumstance, your service may be suspended or terminated without notice and without liability to NISSAN, NISSAN's third party service providers, the underlying wireless carrier or any third party beneficiary. In the event that a change of telecommunications systems or services becomes necessary, you are solely responsible for replacing, as well as the cost of replacing, any equipment in the vehicle that is necessitated. Terms and conditions of NissanConnect® Services Subscription Agreement apply.

#### **NISSANCONNECT® SERVICES FEATURES**

NissanConnect® Services provides various types of information and services by connecting your vehicle to the NissanConnect® Services Data Center and NissanConnect® Services Response Center using the TCU (Telematics Control Unit) installed in your vehicle.



### WARNING

- Radio waves could adversely affect electric medical equipment. Individuals who use a pacemaker should contact the device manufacturer regarding any possible effects before using the system.
- The TCU (Telematics Control Unit) antenna is installed inside the upper central part of the instrument panel. An occupant should not get any closer to the antenna than specified by the pacemaker manufacturer. The radio waves from the TCU (Telematics Control Unit) antenna may adversely affect the operation of the pacemaker while using the NissanConnect® Services.
- Please note that the Automatic Collision Notification (ACN) service and Emergency Calling (E-Call) function cannot be used in the following conditions:
  - The vehicle moves outside the NissanConnect® Services area and connection with the TCU (Telematics Control Unit) is affected.

– The vehicle is in a location with poor signal reception such as a tunnel, underground parking, behind a building or in a mountainous area.

- It may not be possible to make an emergency call depending on the severity of a collision and/or emergency.
- Emergency functions and services will not be available without a paid subscription to NissanConnect® Services.
- The Automatic Collision Notification (ACN) service may not function properly depending on the severity of a collision and/or emergency.



### INFO:

- NissanConnect® Services features are dependent upon subscription enrollment and the telematics device being in operative condition, cellular connectivity, navigation map data and GPS satellite signal reception. Terms and conditions of the NissanConnect® Services Subscription Agreement apply.

- Enrollment is required in order to receive NissanConnect® Services. The services that can be received vary depending on the plan in which you are enrolled.
- Trial period includes beginning on the date of purchase, however you must still be enrolled and activated to use services.
- After the trial period, you must enroll in a paid subscription for NissanConnect® Services to continue using the features. The services that can be received vary depending on the plan to which you subscribe.
- Laws in some jurisdictions may restrict the use of "Text-to-Speech." Check local regulations before using this feature.

NissanConnect® Services may be updated. The latest detailed information is available on the following websites or from the support line.

#### **NissanConnect® Services website:**

For U.S.

[www.nissanusa.com/connect](http://www.nissanusa.com/connect)

For Canada

[www.nissan.ca/nissanconnect](http://www.nissan.ca/nissanconnect)

## 5. Information

(English)

[www.nissan.ca/nissanconnect/fr](http://www.nissan.ca/nissanconnect/fr)  
(French)

**NissanConnect® Services support line:**

1-855-426-6628

- **Roadside Assistance Service:**

Roadside Assistance allows you to receive assistance from the Roadside Response Specialist for a non-emergency incident that requires a towing or third-party response service. The service is accessed by touching  on the map screen. Roadside Assistance may also be used in conjunction with the Emergency Assistance service, if warranted.

 "Connecting to Interactive Voice Menu" (page 5-19)

- **Emergency Calling (E-Call):**

The Emergency Calling (E-Call) feature provides emergency assistance by connecting to a Response Specialist. In the event of an emergency, by pushing the in-vehicle **<SOS>** to use this feature. The Response Specialist provides various assistance depending on the situation.

 "Emergency support" (page 5-22)

- **Automatic Collision Notification (ACN):**

The TCU (Telematics Control Unit) generates a signal automatically to the NissanConnect® Services Response Center in the case of an accident severe enough to trigger one of the vehicle's air bags. Upon the signal, a Response Specialist receives the vehicle location along with customer information and notifies the proper authorities in accordance with established policies and procedures.

- **Remote Engine Start/Stop (if so equipped):**

If the vehicle is equipped with both TCU (Telematics Control Unit) and Remote Engine Start, customers can remotely start the engine via the NissanConnect® Services website or app.

- **Remote Door Lock/Unlock (if so equipped):**

The Remote Door Lock/Unlock feature allows the customer to access the vehicle remotely from the NissanConnect® Services website or app to send the lock or unlock commands to the vehicle.

- **Remote Horn & Lights (if so equipped):**

Customers can activate the vehicle's headlights and horn via the NissanConnect® Services website or app.

- **Curfew Alert:**

Customers can set the time interval for acceptable and unacceptable operation of the vehicle via NissanConnect® portal website and NissanConnect® Services app. If the time restrictions are violated, the customer will be automatically notified (e-mail, text message, or phone call).

- **Alarm Notification:**

The Alarm Notification feature will notify you via the chosen notification method on the NissanConnect® portal website when your vehicle alarm system is activated.

- **Boundary Alert:**

The Boundary Alert helps you keep track of your NISSAN vehicle, even after you have handed the keys to another person. Set "stay within" or "keep out of" drive zones on the NissanConnect® portal website, and you will receive a notification if your vehicle is driven outside those boundaries.

- **Maintenance Alert/Reminder:**

The center sends maintenance and other relevant info. to registered e-mail address (PC/Mobile) based on the vehicle information (e.g. driving mileage, etc.) sent at the center access timing. Details of vehicle information are separately examined.

- **Journey Planner:**

Customers can create a multiple way-point route via Journey Planner on the NissanConnect® Services website and send the details directly to their vehicle.

- **Destination Download:**

Customers can search for different locations via the NissanConnect® Services website and send them directly to their vehicle.

- **Connected Search:**

Customers can access Internet search engines directly from the vehicle to find exact destinations to navigate to.

- **Stolen Vehicle Locator:**

In the event that the customer's vehicle is stolen, after filing a police report the customer can contact NissanConnect® Services via phone and report the vehicle stolen. At that point, NissanConnect® Services emergency

support staff will work with authorities to attempt to recover the vehicle.

- **Valet Alert:**

Customers will be notified if their vehicle is driven outside the radius that they activate via the NissanConnect® Services website or app.

### Notice to Bluetooth® Hands-Free Phone users

The Bluetooth® Hands-Free Phone System will be disabled and not be able to take phone calls while the vehicle is connected to the NissanConnect® Services Response Specialists or the emergency support staff at the NissanConnect® Service Response Center. This is to avoid various services by NissanConnect® Services Response Specialists (such as Destination Assistance) and NissanConnect® Services emergency support staff being interrupted by incoming calls. Incoming phone calls received while the vehicle is connected to the Service Center will not be listed in the call history of the Bluetooth® Hands-Free Phone System. However those incoming calls may be listed in the call history of your mobile phone, depending on its capabilities. After disconnecting communication with the NissanConnect® Services Response Spe-

cialist or NissanConnect® Services emergency support staff, check the incoming call history on your mobile phone when it is safe to do so.

### Service application

A separately purchased NissanConnect® Services subscription is required. For more details, refer to the NissanConnect® Services website or contact the NissanConnect® Services support line.

#### **NissanConnect® Services website:**

For U.S.

[www.nissanusa.com/connect](http://www.nissanusa.com/connect)

For Canada

<http://www.nissan.ca/en/connect>  
(English)

[www.nissan.ca/nissanconnect/fr](http://www.nissan.ca/nissanconnect/fr)  
(French)

#### **NissanConnect® Services support line:**

1-855-426-6628

## 5. Information



### INFO:

If the vehicle is owned by another person and is resold, the subscription for this service must be canceled and all data stored on the device must be deleted.

### Operating tips



### WARNING

- **Use NissanConnect® Services after stopping your vehicle in a safe location. If you have to use NissanConnect® Services while driving, exercise extreme caution at all times so full attention may be given to vehicle operation.**
- **If you are unable to devote full attention to vehicle operation while talking with the NissanConnect® Services, pull off the road to a safe location and stop your vehicle.**
- Do not use NissanConnect® Services with the engine stopped. Doing so may discharge the vehicle battery.
- NissanConnect® Services cannot be used under the following conditions:

- NissanConnect® Services subscription has expired.
- The vehicle is outside the area where the cellular network service is receivable.
- The vehicle is in a location with poor signal reception such as tunnels, underground parking garages, behind buildings or in mountainous areas.
- The line is busy.
- The TCU (Telematics Control Unit) or other systems of your vehicle are not working properly.
- The NissanConnect® Services network system is disabled.
- Information Feeds download cannot be used when the vehicle is connected to the NissanConnect® Services Data Center and NissanConnect® Services Response Center.
- Communication with the NissanConnect® Services Data Center is related to the data communication mode and may cause occasional difficulty in receiving signals, and the signal receivable area may be limited compared to regular mobile phones.

- You may hear clicks or experience interruptions while speaking with the NissanConnect® Services Response Specialists. This is due to a shift in the connection zone and is not a malfunction.
- Depending on the line used, the sound volume may decrease. Adjust the volume as necessary.
- Received sounds may be distorted or ambient noise may sound like voices of a crowd. This is due to the use of the digital line and is not a malfunction.
- You may hear your own voice from the speaker when talking with the NissanConnect® Services Response Specialists due to a network disturbance. When this occurs, reconnect the line after a few minutes or at a different location.
- This vehicle incorporates a communication device that is called a TCU (Telematics Control Unit). The communication connection between this unit and the NissanConnect® Services Data Center allows for various services. When the system connects to the NissanConnect® Services Data Center, an antenna icon will appear in the upper right corner of the screen. Use the service in a location where the

symbol representing good signal reception appears on the screen.

: When the signal reception is good

: When the signal reception is bad

- NissanConnect® Services uses the TCU (Telematics Control Unit). Even if the signal strength bar of the in-vehicle data communication module indicates good reception, connection to the NissanConnect® Services Data Center may be disabled. This does not indicate a malfunction. Operate the system again after a few minutes.

### CONNECTING TO INTERACTIVE VOICE MENU

Various services to support your driving are available by using Interactive Voice Menu. For more details, refer to the NissanConnect® Services website or contact the NissanConnect® Services support line.

#### NissanConnect® Services website:

For U.S.

[www.nissanusa.com/connect](http://www.nissanusa.com/connect)

For Canada

[www.nissan.ca/nissanconnect](http://www.nissan.ca/nissanconnect)  
(English)

[www.nissan.ca/nissanconnect/fr](http://www.nissan.ca/nissanconnect/fr)

(French)

#### NissanConnect® Services support line:

1-855-426-6628

1. Push **<INFO>**.
2. Touch [NissanConnect Services].
3. Touch [Connect to Voice Menu].
4. The system connects to the NissanConnect® Services Response Center and menu options will be announced. Speak your preferred option.
  - Destination Assistance  
Set a destination using an Interactive Voice Response (IVR) system.
  - Roadside Assistance  
Connect to the Roadside Response Specialist.
  - Valet Alert  
Turns on the Valet Alert function and monitors the vehicle movement within a certain range.
  - Account Management  
Connects to the NissanConnect® Services Response Specialist.

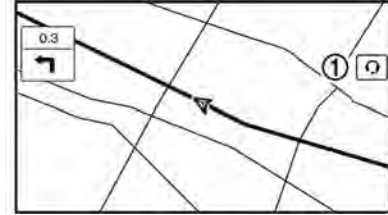

#### INFO:

- You can also connect to a NissanConnect® Services Interactive Voice Menu by touching the IVR soft button ① on the map.
- After selecting [Connect to Voice Menu], it may take some time until the system initiates connection, depending on the technical environment and whether the TCU (Telematics Control Unit) is being used by other services.
- If your Bluetooth® Hands-Free phone receives an incoming call while you are speaking with an operator, a pop-up message asking whether you would like to take the call is displayed.
- To avoid disconnecting the line, do not turn off the engine.

## 5. Information

### SETTING ROUTE TO A SEARCHED DESTINATION

Use Connected Search to find destinations via the Internet and set a route to them directly from your navigation system.

1. Push **<INFO>**.
2. Touch [NissanConnect Services].
3. Touch [Connected Search]. A keyboard is displayed.
4. Enter the keyword and touch [Search]. The system will connect to the Internet and the search results will be displayed.
5. Touch a preferred destination from the list and touch [Start] to start the route guidance.

### VIEWING INFORMATION FEEDS

Contents of the various NissanConnect® Services information can be downloaded.

### Downloading information feeds

1. Push **<INFO>**.
2. Touch [NissanConnect Services].
3. Touch [Sync All Feeds]. A folder list is displayed.
4. Touch a preferred folder. A list of information feeds is displayed.
5. Touch a preferred information feed. The content can be viewed on the touch screen display if the vehicle is parked. While driving, the system will read out the information.



#### INFO:

- Touch [Menu] during communication with the NissanConnect® Services Data Center to cancel the connection.
- A message is displayed when the communication is disconnected while downloading information due to a poor communication status. Select [Yes] to restart the download.
- Laws in some jurisdictions may restrict the use of "Text-to-Speech". Check local regulations before using this feature.
- Some terminology such as personal names, place names, special terms,

symbols, etc. may not be announced correctly. This is not a malfunction.

- The system will pause announcements when interrupted by the voice guidance given by the navigation system. When the voice guidance finishes, the system will restart the announcement.
- The volume can be adjusted when the system announces the information.  
 "Volume settings" (page 2-24)
- The selected content is read out while the vehicle is being driven, or if parked, you can read the content on the display.
- Content settings can be made using the NissanConnect® Services website. For more details, refer to the NissanConnect® Services website or contact the NissanConnect® Services support line.  
**NissanConnect® Services website:**  
For U.S.  
[www.nissanusa.com/connect](http://www.nissanusa.com/connect)  
For Canada  
[www.nissan.ca/nissanconnect](http://www.nissan.ca/nissanconnect) (English)  
[www.nissan.ca/nissanconnect/fr](http://www.nissan.ca/nissanconnect/fr) (French)



### NissanConnect® Services support line:

1-855-426-6628

### Screen information:

When information feeds are downloaded from the NissanConnect® Services Data Center, the contents of the information are displayed while the vehicle is stopped.

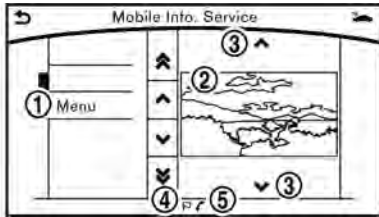

#### ① Menu:

Stop the announcement of the content (Text-to-Speech) and display the operation menu.

#### ② Contents:

The contents of the NissanConnect® Services feeds are displayed.

#### ③ [ ^ ]/[ v ]:

Turns to the next or previous page if the information has a number of content pages.

#### ④ [Map Icon]:

If the information contains map information, the icon will be displayed. It can be set as the destination.

#### ⑤ [Phone Icon]:

If the information contains phone number information, the icon is displayed. It is possible to make a phone call to the facility.

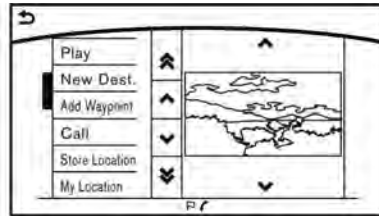

After parking the vehicle in a safe location and touching [Menu], the operation menu is displayed on the screen.



#### INFO:

The availability of the operation menu items differs depending on the contents of the selected information feeds.

### Updating All Information Feeds

It is possible to synchronize with the list updated NissanConnect® portal website, such as "Destination Send to Car" or "Journey Planner", etc.

For more details, refer to the NissanConnect® Services website or contact the NissanConnect® Services support line.

#### NissanConnect® Services website:

For U.S.

[www.nissanusa.com/connect](http://www.nissanusa.com/connect)

For Canada

[www.nissan.ca/nissanconnect](http://www.nissan.ca/nissanconnect) (English)

[www.nissan.ca/nissanconnect/fr](http://www.nissan.ca/nissanconnect/fr) (French)

#### NissanConnect® Services support line:

1-855-426-6628

1. Push <INFO>.

2. Touch [NissanConnect Services].

3. Touch [Sync All Feeds].

4. The latest information is sent from the NissanConnect® Services Response Center and an updated list is displayed.

## 5. Information

### Viewing information feeds history

The information feeds that were previously referred to are displayed.

1. Push **<INFO>**.
2. Touch [NissanConnect Services].
3. Touch [History].

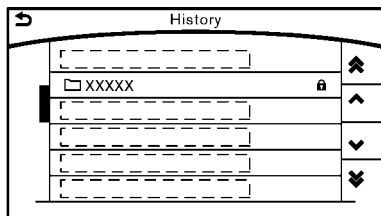

4. Touch the preferred item.
5. A history list is displayed. Touch the preferred information feed.

### EMERGENCY SUPPORT

NissanConnect® Services provides various services to support an emergency response for the registered vehicle and its occupants.

For example, in the event of an illness or serious injury, you can seek support by pushing **<SOS>** (the SOS call switch located near the map light) and connecting to the NissanConnect® Services Response

Center. The NissanConnect® Services Response Center can pinpoint the location of the vehicle via GPS (Global Positioning System), and send the information to law enforcement, ambulance services or other agencies as needed.

#### NissanConnect® Services website:

For U.S.

[www.nissanusa.com/connect](http://www.nissanusa.com/connect)

For Canada

[www.nissan.ca/nissanconnect](http://www.nissan.ca/nissanconnect)  
(English)

[www.nissan.ca/nissanconnect/fr](http://www.nissan.ca/nissanconnect/fr)  
(French)

#### NissanConnect® Services support line:

1-855-426-6628



#### WARNING

- Please note that the Automatic Collision Notification service and Emergency Calling (E-Call) function cannot be used in the following conditions:
  - Emergency functions and services will not be available without a paid subscription to NissanConnect® Services.

– The NissanConnect® Services network system is disabled.

– The vehicle moves outside the service area where the TCU (Telematics Control Unit) is connected to the system.

– The vehicle is outside the area where the cellular network service is receivable.

– The vehicle is in a location with poor signal reception such as tunnels, underground parking garages, behind buildings or in mountainous areas.

– The line is busy.

– The TCU (Telematics Control Unit) or other systems of your vehicle are not working properly.

– It may not be possible to make an emergency call depending on the severity of a collision and/or emergency.

- Park the vehicle in a safe location and set the parking brake before operating **<SOS>**.
- Only use this service in case of an emergency. There may be a penalty for inappropriate use of the

service.

- Radio waves could adversely affect electric medical equipment. Individuals who use a pacemaker should contact the device manufacturer regarding any possible effects before using the system.
- The TCU (Telematics Control Unit) antenna is installed inside the upper central part of the instrument panel. An occupant should not get any closer to the antenna than specified by the pacemaker manufacturer. The radio waves from the TCU antenna may adversely affect the operation of the pacemaker while using the NissanConnect® Services.

### Making an emergency call



1. Push **<SOS>**. An emergency call is sent to the emergency call center. At the same time, the vehicle information (location of the vehicle, vehicle speed and the direction of travel) is also transferred.
2. When the line is connected to the NissanConnect® Services Response Center, speak to the emergency support staff.

If you want to cancel the emergency call, push and hold **<SOS>** for a few seconds.



#### INFO:

- After **<SOS>** is pushed, it may take some time until the system initiates a connection, depending on the technical environment and whether the TCU (Telematics Control Unit) is being used by other services.
- Emergency support is available when **<SOS>** indicator lamp is turned on. Emergency support cannot be used when **<SOS>** indicator lamp is turned off.
- When the emergency support is disabled after **<SOS>** was pushed, display shows an error message.
- To avoid disconnecting the line, do not turn off the engine.

## 5. Information

### NISSANCONNECT® SERVICES SETTINGS

You can delete NissanConnect® Services history, return to the default settings, and display user information from the setting screen.

Step 1	Step 2	Menu		Action
Push <SETTING>	[Nissan-Connect-Services]	[Information Settings]	[Send Vehicle Information]	When this item is turned on, the vehicle information (the data regarding your driving information such as vehicle location, driving history, fuel economy, etc.) can be sent to the NissanConnect® Services center.
			[Delete Vehicle Information]	Delete all Vehicle Information.
		[Delete Search History]	[Delete Voice Menu History]	Delete all Voice Menu history.
			[Delete Connected Search History]	Delete all Connected Search history.
			[Delete NissanConnect Services History]	Delete NissanConnect® Services histories.
		[Reset All NissanConnect Services Settings]	All NissanConnect® Services settings are returned to default.	
		[Unit ID Information]	Display the Unit ID, TCU (Telematics Control Unit) ID, SIM ID and VIN Information necessary for user registration.	
		[Vehicle Data Transmission Setting]	When [OK] is touched, data transmission to the NissanConnect® Services Data Center is enabled. Touch [Decline] to disable the NissanConnect® Services functions.	

### NISSANCONNECT® APPS

#### NISSANCONNECT® APPS OVERVIEW

Laws in some jurisdictions may restrict the use of some applications and features. Check local regulations for any requirements.

#### CAUTION

- While driving, some operations are limited in order to prevent distracting the driver. While driving, avoid keeping a close watch on the display.
- Some application services may be subject to change or termination without prior notice.

#### USING APPLICATIONS

#### NOTE:

To use APP functions, the clock should be set appropriately for checking the SSL expiration date.

 "Clock settings" (page 2-27)

#### Main operation

Push **<APPS>** to display the menu screen. Touch the icon for the desired application. The selected application will be launched.

#### INFO:

The applications shown on the menu screen and the display order can be customized.

Some applications can be set to launch automatically when the ignition switch is placed in the ON position.

 "App Garage screen" (page 5-25)

#### NISSANCONNECT® VEHICLE APPS

NissanConnect® Vehicle Apps are unique applications developed by NISSAN that are installed on the in-vehicle hardware.

#### App Garage screen

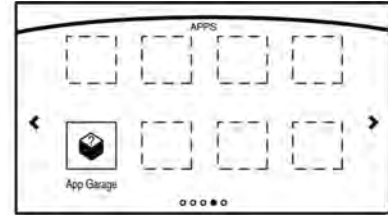

Push **<APPS>** and touch [App Garage].

#### Available settings:

- [App Garage Settings]  
Touch to view Apps information, manage Apps, customize shortcuts on the menu screen and set notifications.
- Available application list  
Displays the installed Vehicle Apps. When a listed application is selected, the application will start.

## 5. Information

### App Garage Settings screen:

You can use various application settings.

1. Push **<APPS>** and touch [App Garage].
2. Touch [App Garage Settings].

Available items may vary depending on models and specifications.

Menu Item		Action
[All Apps]		Shows all applications. Select an application from the list to modify additional application-specific settings.
[Running Apps]	Applications list	Displays all running applications. To display application information or stop an application, select the desired application from the list.
	[Stop All]	Stops all running applications.
[Menu Icon Location Setting]	Applications list	Shows or hides the application icon on the apps screen.
	[Delete All]	Deletes all application icons on the apps screen.
[Auto Start Setting]		Enable this setting to automatically launch the application when the ignition switch is placed in the ON position.
[System Information]		Displays system information.
[Install Apps via USB]		Installs an application via USB from the NISSAN Owner's Portal Website .
[Network Notification]		This function is not applied.
[Installation Notification]		If [Installation Notification] is on, a pop-up message is displayed when a new application is installed.
[Factory Data Reset]		Discards stored application data.



### NOTE:

- Depending on the type of application, some applications may not be displayed in [Running Apps] field even if they are running.
- After resetting the data by using [Factory Data Reset], the system will respond slowly because of the high work load of the system. Place the ignition switch in the OFF position and wait 5 minutes. Then place the ignition switch in the ON position again.
- Vehicle Apps may not work for 30 seconds after placing the ignition switch in the ON position.
- The [Auto Start Setting] function may not be available for some applications.

## 5. Information

### The major Apps available

The major Apps available for use in NissanConnect® Apps are as follows.

Note that the applications are subject to updates and changes.

Available items vary depending on the vehicle model and specifications.

APPS	Descriptions
[Quick Guide]	You can see how to connect a Bluetooth® device, make a call and set the clock.
[Driving Performance]	Vehicle performance such as Fuel Flow, Accel, etc., can be checked intuitively.
[Maintenance Note]	You can check maintenance items inside the vehicle at your convenience.
[Compass]	In addition to the current traveling direction of the vehicle, the direction of the destination is also shown. Accurate information cannot be provided if GPS position information cannot be obtained.
[Clock]	The clock shows the current time in various kinds of skins.



#### WARNING

- Use the information from the Driving Performance strictly as a reference to make your driving more comfortable. The readings are not meant to prevent accidents caused by reckless driving or poor driving conditions (due to weather, road conditions, etc.). Always obey all traffic regulations and posted speed limits.

- Operating the Driving Performance while driving can lead to a crash resulting in serious injuries or death. Always park the vehicle in a safe place before operating the display screen.
- Look at the display screen only briefly while driving. Keep your eyes on the road. Inattentive driving may lead to a crash resulting in serious injuries or death.



Example of how NissanConnect®  
Vehicle Apps is used

**Example: Driving Performance applica-  
tion (if so equipped):**

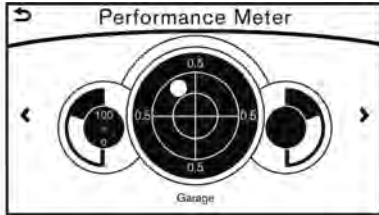

This allows you to see the vehicle status  
and the results of driving operation.

1. Push **<APPS>** and touch [Driving Performance]. The Driving Performance meter is displayed.
2. Touch [**<**] or [**>**] to change the layout of the Driving Performance meter.

Touch the meter illustration on the Performance Meter screen to select another meter to display.

## 5. Information

---

**MEMO**

# 6 Navigation (if so equipped)

Safety information .....	6-3	Searching by connecting to Data Center .....	6-27
Map data authentication .....	6-3	Setting by NissanConnect® Services .....	6-27
Map operation .....	6-4	Setting point on map .....	6-28
Map types .....	6-4	Procedures after setting route .....	6-29
Displaying current vehicle location .....	6-6	Route guidance .....	6-30
Moving map .....	6-7	About route guidance .....	6-30
Changing scale of map .....	6-8	Route guidance screens .....	6-33
Change map .....	6-9	Canceling Route .....	6-35
Setting split screen .....	6-9	Route menu screen .....	6-35
Map view settings .....	6-11	Editing route .....	6-36
Displaying information on map .....	6-14	Recalculating route .....	6-38
Traffic information on map .....	6-14	Searching for detour route using traffic information .....	6-39
Setting destination .....	6-15	Displaying Turn List .....	6-40
Changing region .....	6-15	Route guidance settings .....	6-40
Destination screen .....	6-17	Storing a location/route .....	6-45
Finding address .....	6-20	Storing location .....	6-45
Finding points of interest .....	6-20	Storing route .....	6-46
Setting home as destination .....	6-22	Storing avoid area .....	6-46
Finding nearby place .....	6-23	Editing stored information .....	6-47
Searching from Stored Locations .....	6-23	Deleting stored item .....	6-51
Searching from history .....	6-24	Transferring information to/from address book .....	6-53
Using Journey Planner .....	6-24	Navigation settings .....	6-54
Setting intersection .....	6-25	General information .....	6-57
Setting freeway entrance/exit .....	6-25	Current vehicle location .....	6-57
Setting city center .....	6-26	Route calculation .....	6-61
Setting by phone number .....	6-26		
Setting from stored routes .....	6-26		

Route guidance .....	6-62
Map data .....	6-64

### SAFETY INFORMATION

The navigation system is primarily designed to guide you and help you to reach your destination. However, you, the driver, must use the system safely and properly. Information concerning road conditions, traffic signs and the availability of services may not always be up to date. The system is not a substitute for safe, proper, and legal driving.



#### WARNING

**Do not rely on route guidance alone. Always be sure that all driving maneuvers are legal and safe in order to avoid accidents.**

### MAP DATA AUTHENTICATION

Map data authentication may be required when using the navigation system for the first time or after updating the map data.

1. The system starts when the ignition switch is placed in the ACC or ON position for the first time. The map data authentication screen is displayed.
2. Enter the 16 alphanumeric characters in four parts containing four characters each. Each of the four parts is displayed separately.

## 6. Navigation (if so equipped)

### MAP OPERATION

#### MAP TYPES

Two types of map views are available: 2D map and Birdview™ (3D) map.

#### 2D map



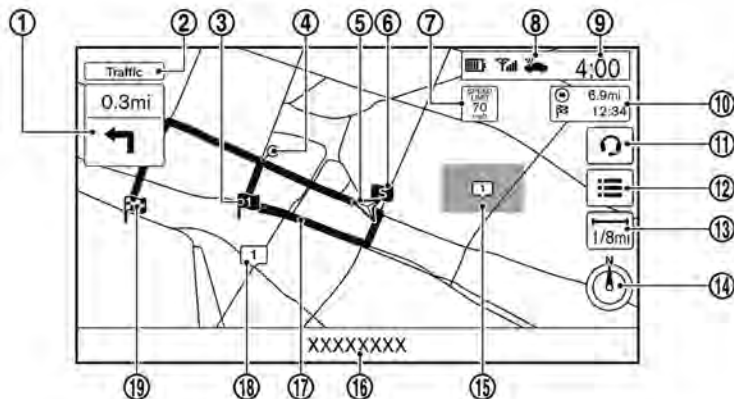



The 2D map displays the map in a two-dimensional environment similar to a road map.



#### Screen information:

- ①  Arrow:  
Indicates the turning direction of the next guide point. Distance to the

guide point is also indicated above the arrow. This indicator will appear when a destination or waypoint is set and route guidance is started.

- ② Traffic indicator:  
Displays the reception condition of traffic information transmitted from the traffic information provider.  
When the traffic information transmitted from the provider is not detected, the traffic indicator will not be displayed.
- ③  Waypoint:  
Displays the set locations between the starting point and the destination. A maximum of five waypoints can be set.
- ④  Guide point:  
Indicates a guide point on the route.
- ⑤  Vehicle icon:  
Indicates the current vehicle location and the direction of travel.
- ⑥  Starting point:  
Displays the vehicle location, with which the route is set, as the starting point.
- ⑦  Speed limit icon:  
Displays the speed limit of the current driving road.
- ⑧  NissanConnect® Services antenna icon:

## 6. Navigation (if so equipped)

When the system connects to the NissanConnect® Services Data Center, an antenna icon will appear on the screen.

 "NissanConnect® Services features" (page 5-14)

### ⑨ Clock:

Displays current time.

 "Clock settings" (page 2-27)

### ⑩ Remaining time and distance to the destination:

Indicates the approximate remaining time and distance to the destination or waypoint. This indicator will appear when a destination or waypoint is set and route guidance is started.

### ⑪ IVR soft button:

Touch the icon to connect to the NissanConnect® Services Interactive Voice Menu.

 "Connecting to Interactive Voice Menu" (page 5-19)

### ⑫ Map menu icon:

Touch the icon to display the shortcut menu or map menu.

 "Shortcut menu" (page 2-15)

 "Map menu (models with navigation system)" (page 2-16)

### ⑬ Scale indicator:

Indicates the scale of the map.

Touch the icon to display the scale bar. The map scale can be adjusted using the scale bar.

 "Changing scale of map" (page 6-8)

### ⑭ Direction indicator:

Indicates the directional setting of the map. Touch the icon to change the setting.

 : North always pointing up.

 : Direction of the vehicle always pointing up.

Touch the icon to change the setting from among North Up, Heading Up and Birdview™ (3D) map.

### ⑮ Avoid area (green or blue):

Displays the areas to avoid that are stored in the Address Book. During the route search, the route guidance is performed by searching for a route that avoids those areas.

### ⑯ Street name:

Displays the name of the street that the vehicle is currently driving on.

### ⑰ Suggested route:

Appears in bold blue during route guidance.

### ⑱ Stored location (yellow):

Displays the locations that are stored in the Address Book. The icons can be changed according to your preferences.

### ⑲ Destination:

Indicates the destination location of the route guidance.

Upon reaching the destination, the address will be displayed on the map screen.

## Birdview™ (3D) map

Birdview™ displays the map from an elevated perspective. In Birdview™, it is easy to recognize an image of the route because it provides a panoramic view over a long distance.

## 6. Navigation (if so equipped)

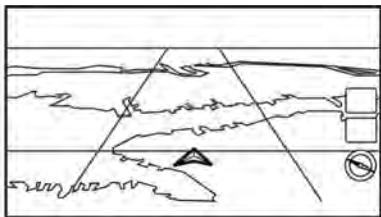

### INFO:

Note the following items about the Birdview™ display.

- "Birdview™" is a registered trademark of Clarion Co., Ltd.
- The map in Birdview™ always appears with the current forward direction facing up.

### Building graphics

In an area where the building graphics are stored in the map data, the building graphics are displayed when the map is zoomed in. On the 2D map display, these are called "Building footprint graphics", and on the Birdview™ display, these are called "3D building graphics".

The way of looking at the map is the same for the 2D and Birdview™ maps.

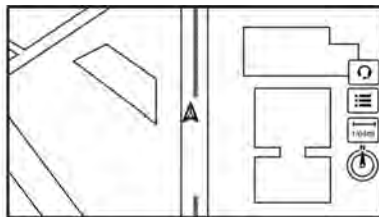

Building footprint graphics (2D map)

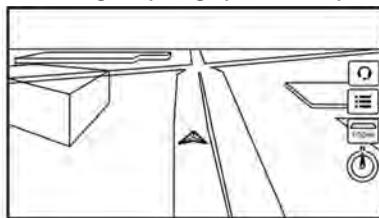

3D building graphics (Birdview™ map)



### INFO:

In an area where the building graphics are not stored in the map data, the normal map is displayed even when the map is zoomed in.

## DISPLAYING CURRENT VEHICLE LOCATION

### Operating with control panel

The basic map screen displays the current location (the position where the vehicle mark is located). Push **<MAP>/<MAP/VOICE>** to display the current location on the map when another screen is displayed.

### Operating with touch panel operation

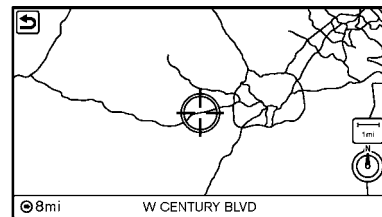

After moving the map, touch [  ] on the map screen to display the current location map screen.



### MOVING MAP

The operations for moving across the map are different between the 2D and Birdview™ maps.

Map scrolling operations are limited and not fully available while driving. When detailed map screen is displayed while driving, the map cannot be scrolled.

#### 2D map

The following touch panel operations are available to move map.

- **Touch**  
Touch the screen. The cross pointer is displayed at the center of the map. Touching the screen again will scroll the map toward the touched location.
- **Long touch**  
Touch the direction to move to. The map continues to scroll while the screen is touched.  
While driving, one-touch continuous scrolling is disabled.
- **Drag**  
Drags the map while the screen is touched.
- **Swipe**  
Swipe to scroll the map.

#### Multi-function controller operation:

##### With directional buttons:





Push and hold the main directional buttons and the additional directional buttons to scroll the map in the corresponding direction. The cross pointer is displayed at the center of the map.

##### Without directional buttons:

Slide (push upward/downward/leftward/rightward) the slide switch to scroll the map in the corresponding direction. The cross pointer is displayed at the center of the map.

#### Birdview™ (3D) map

The following touch panel operations are available to move map.

- **Touch**  
Touch the screen. The cross pointer is displayed at the center of the map. Touching the screen again will scroll the map toward the touched location. Touch  or  to change the direction of the map.
- **Long touch**  
Touch and hold a point on the map or touch and hold  or  in the direction to move the map to. The map continues to move while the

screen is touched.

While driving, one-touch continuous scrolling is disabled.

- **Drag**  
Drags the map while the screen is touched.
- **Swipe**  
Swipe the touch panel to scroll the map screen quickly.

#### Multi-function controller operation:

##### With directional buttons:

Push and hold the left and right main directional buttons to rotate the map counterclockwise or clockwise.

Push and hold the rest of the main directional buttons or additional directional buttons to scroll the map in the corresponding direction. The cross pointer is displayed at the center of the map.

##### Without directional buttons:

Slide the slide switch in the direction of left or right to rotate the map counterclockwise or clockwise.

Slide the slide switch in the direction of except for left or right to move continuously across the map in one direction.

## 6. Navigation (if so equipped)

### CHANGING SCALE OF MAP

There are several methods for changing the map scale.

#### Touch panel operation

##### Touching scale bar:

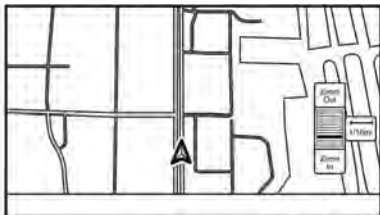

1. Touch [  ].  
The scale bar is displayed.
2. Touch [Zoom In] or [Zoom Out] to change the scale.

##### Pinch-in:



To view a wider area, pinch-in the map screen.

##### Pinch-out:



To view the map in detail, pinch-out the map screen.



##### INFO:

While driving, Pinch-in/Pinch-out are disabled.

#### Multi-function controller operation

Turn the center dial clockwise or counterclockwise to change the map scale.

Clockwise: Zoom in

Counterclockwise: Zoom out

##### Free Zoom:

When [Small Step Zoom With Dial] is turned on, the map scale may be adjusted in regular steps or in free zoom (finer scale adjustment in smaller steps) when the center dial is rotated or [Zoom In]/[Zoom Out] is touched and held.

 "Navigation settings" (page 6-54)

#### Map scale

Any required map scale (map coverage) between 320 miles (640 km) and 1/64 mile (25 m) can be selected.

## 6. Navigation (if so equipped)

US Units	Metric Units
320 miles	640 km
80 miles	160 km
32 miles	64 km
8 miles	16 km
5 miles	10 km
2 miles	4 km
1 mile	2 km
1/2 mile	1 km
1/4 mile	500 m
1/8 mile	200 m
1/16 mile	100 m
1/32 mile	50 m
1/64 mile	25 m



### INFO:

The traffic information icons are not displayed on the map screen when the map scale is set to 8 miles (16 km) or higher.

"Traffic information on map"  
(page 6-14)

### CHANGE MAP

The map view type can be changed by touching [ ] / [ ] on the map screen.

The screen will change to North Up, Heading Up and Birdview™ (3D) map each time [ ] / [ ] is touched.



North Up



Heading Up

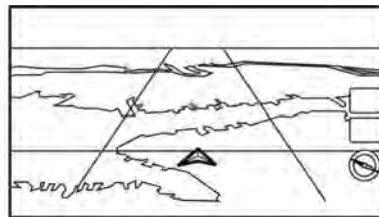

Birdview™

You can also set the map view by pushing **<SETTING>** and touch [Navigation].

"Map view settings" (page 6-11)

### SETTING SPLIT SCREEN

It is possible to view the two types of map view or the map view, and other information at the same time. The right screen displays the map screen, and the left screen displays a turn list or an information screen.

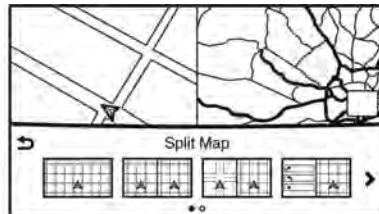

## 6. Navigation (if so equipped)

---

1. Push **<MAP>/<MAP/VOICE>** while the current location map screen is displayed, the Display View Bar is displayed.
2. Select the screen you would like to set.  
 "Display View Bar (models with navigation system)" (page 2-16)

### MAP VIEW SETTINGS

The setup for the map view is performed from the Settings menu.

1. Push **<SETTING>**.
2. Touch [Navigation].

The following settings are available.

Available items may vary depending on models and specifications.

Menu item		Action
[Map & Display View]	[Change Order]	Sort the icon on the Display View Bar.
	[Full Map]	Display full map screen.
	[Split Map]	Select one of the settings to be applied to the display.  "Display View Bar (models with navigation system)" (page 2-16)
	[Intersection]	
	[Turn List]	
	[Where am I?]	
	[Turn by Turn]	
	[Fuel Economy]	
	[Eco Drive Report]	

## 6. Navigation (if so equipped)

Menu item		Action	
[Map Preferences]	[Map View]	[North Up]	Select one of the map views to be applied to the map screen.
		[Heading Up]	
		[Birdview (3D)]	
		[Long Range Heading Up]	The position of the vehicle icon can be changed to view a wider area in the traveling direction. The vehicle icon is located slightly lower than the center of the screen. Long Range Map View is available only when the map view is "Heading Up".
		[Map Color]	Select a preferred map color.
	[Map Text Size]	[Large]	Sets the font size.
		[Medium]	
		[Small]	
		[Birdview Angle]	Adjusts the Birdview™ angle.
		[Auto North Up]	Sets the top of the map to remain oriented to the north.
		[Show FWY Exit]	Sets the display of the freeway exit information icon on/off.
		[Automatic Display in Fwy Mode]	The turn list can be set to on or off to be displayed automatically while driving on a freeway.
	[Names Displayed on Map]	[Place Names]	Allows place names to be displayed on the map screen.
	[POI Names]	Allows facilities names to be displayed on the map screen.	
	[Road Names]	Allows road names to be displayed on the map screen.	
[Left Split Map Settings]	[Left Side Map Orientation]	The map view for the left side of split screen can be selected from [North Up] or [Heading Up].	

## 6. Navigation (if so equipped)

Menu item			Action
		[Long-Range Driving Direction]	Allows the map view for the left side of the split screen to change the position of the vehicle icon so that a wider area in the traveling direction can be viewed. The vehicle icon is located slightly lower than the center of the screen.

## 6. Navigation (if so equipped)

### DISPLAYING INFORMATION ON MAP





Some information on the map can be displayed or hidden.

#### Displaying facility icons

The facility icons can be displayed or hidden by type.

1. Push **<SETTING>**.
2. Touch [Navigation].
3. Touch [POI Icons Displayed on Map].
4. Touch the preferred icon. The indicator of the selected icon illuminates.

#### Available setting icon

-  Restaurant
-  Gas Station
-  Hotel
-  ATM
-  Rest Area



#### INFO:

- The map icons are not displayed on the map screen when the map scale is set to 1/4 mile (500 m) or higher in the 2D and Birdview™ map.

- If brand icons are registered in the map data, the brand they will be displayed on the map instead of the general map icons listed.

### Displaying map scrolling information

Information about the location, on which the center of the cross pointer is placed by scrolling on the map, can be set to be displayed.

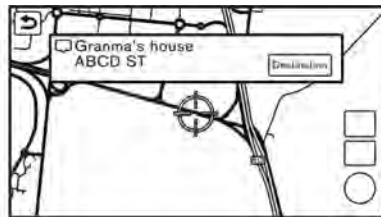

1. Push **<SETTING>**.
  2. Touch [Navigation] and touch [Other Settings].
  3. Touch [Map Scrolling Information].
  4. Touch the preferred information item.
- The following information items are available.

The items displayed on the screen may vary depending on models and speci-

fications.

- [Stored Location Icon Info]
- [Destination/Waypoint Icon Info]
- [Latitude/Longitude Info]

### Road color

The road types are differentiated by color.

Freeway: Red or light red (zoomed in)

Main road: Brown or dark yellow

Narrow street: Gray

Road with incomplete map data: Dark green

### TRAFFIC INFORMATION ON MAP

With a subscription to the SiriusXM Traffic™, traffic information is displayed.

 "Traffic information on map"  
(page 5-7)

Free Flow: Green arrow

Moderate traffic: Yellow arrow

Heavy traffic: Red

Section affected by serious traffic event: Purple

The following traffic information icons may be displayed

 : Accident

 : Closed road



## 6. Navigation (if so equipped)

 : Information

 : Road work

 : Slippery road

 : Weather

 : Incident

### SETTING DESTINATION

#### CHANGING REGION

When setting a destination, the location can be narrowed down by specifying the region or city.

#### Specifying state/province

The state to be searched will be changed when searching for a destination by entering an address: [Street Address], [Points of Interest] or [Intersection], etc.

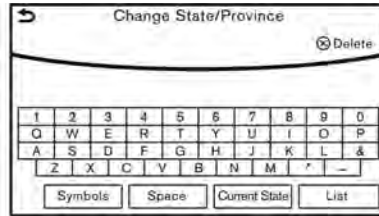

1. Push **<NAVI>**.
2. Touch [Destination Menu].
3. Touch the key of the desired search method to be set.
4. Touch [State/Province:].
5. Enter the name of the state and then touch [List]. A list screen is displayed.

6. Touch the preferred region from the list. After setting, the display automatically returns to the Destination screen.

#### INFO:

- It is not possible to search for a route from the continental United States to Hawaii.
- When the system is restarted, it sets the state to that automatically detected by the GPS.
- When display State/Province input screen, touch [Country] to change the country.

#### Specifying city

When searching for a destination, the search can be narrowed down by specifying the city.

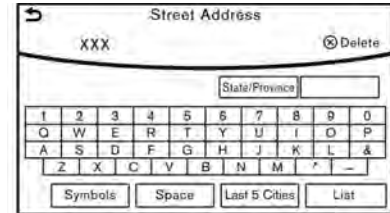

## 6. Navigation (if so equipped)

---

1. Touch [City]. A character input screen is displayed.
2. Enter the name of the city and then touch [List]. A list screen is displayed.



### INFO:

- The same screen will be displayed when a location is searched from a street.
  - Touch [Last 5 Cities] to display the last five cities set as destinations.
  - Touch [All Cities] to display the all cities in the current state/province.
3. Touch the city of the destination from the list.



### INFO:









The number of matches are displayed to the left of the entry results. In some cases, the number of matches displayed on the screen and in the list may differ. If this occurs, enter more characters to further reduce the number of matches.

## 6. Navigation (if so equipped)











### DESTINATION SCREEN

There are several methods that can be used to set a destination. Understand the advantages of each method and select the best method for finding and setting a preferred destination.





The items displayed on the screen may vary depending on models and specifications.

Step	Setting item		Action
Push <NAVI>.	[Street Address]		Searches for a destination by address.  "Finding address" (page 6-20)
	[Points of Interest]		Searches for a destination from various categories of businesses or locations.  "Finding points of interest" (page 6-20)
	[Home]		Searches for a route from the current location to the previously stored home destination.  "Setting home as destination" (page 6-22)
	[Destination Menu]	[Street Address]	Searches for a destination by address.  "Finding address" (page 6-20)
		[Points of Interest]	Searches for a destination from various categories of businesses or locations.  "Finding points of interest" (page 6-20)
		[Home]	Searches for a route from the current location to the previously stored home destination.  "Setting home as destination" (page 6-22)
		[Nearby Places]	Searches for points of interest near the current vehicle location, such as restaurants and charging stations, etc.  "Finding nearby place" (page 6-23)
	[Stored Locations]	Searches for a destination from the list of the stored locations.  "Searching from Stored Locations" (page 6-23)	

## 6. Navigation (if so equipped)



Step	Setting item		Action
		[Previous Destinations]	Sets the previous starting point as the destination. Searches for the destination from the previous destinations.  "Searching from history" (page 6-24)
		[Journey Planner]	Sets a route plan downloaded from the NISSAN Owner's Portal Website.  "Using Journey Planner" (page 6-24)
		[Intersection]	Searches for a destination from an intersection.  "Setting intersection" (page 6-25)
		[Freeway Entrance/Exit]	Searches for a destination from a freeway entrance/exit.  "Setting freeway entrance/exit" (page 6-25)
		[City Center]	Sets the center of a city as the destination.  "Setting city center" (page 6-26)
		[Phone Numbers]	Searches for a point of interest by a telephone number.  "Setting by phone number" (page 6-26)
		[Stored Routes]	Selects a stored route.  "Setting from stored routes" (page 6-26)
		[Connected Search]	Input a keyword of a point of interest and connect and search the NissanConnect® Services Data Center.  "Searching by connecting to Data Center" (page 6-27)
Scroll map and touch [ ≡ ].	[New Destination]		Set a location scrolled to on the map as the destination.  "Setting point on map" (page 6-28)
Push <INFO>.	[NissanConnect Services]	[Connect to Voice Menu]	Connects to the NissanConnect® Services Interactive Voice Menu. You can also connect to the NissanConnect® Services Interactive Voice Menu using the IVR (Interactive Voice Response) soft button.  "Searching by using IVR soft button on map" (page 6-27)  "Connecting to Interactive Voice Menu" (page 5-19)
		[Sync All Feeds]	Updates information list by connecting to the NissanConnect® Services Data Center.

## 6. Navigation (if so equipped)

Step	Setting item	Action
	[Connected Search]	Input a keyword of a point of interest and connect and search the NissanConnect® Services Data Center.  "Searching by connecting to Data Center" (page 6-27)
	[Send to Car]	Search for a location using Google maps, and download the information to set the destination via the NissanConnect® Services Data Center.  "Using Google send-to-car" (page 6-28)
	[Destination Send to Car]	Search for destinations from a point of interest (POI) database accessed within the NissanConnect® portal website.  "Using Destination Send to Car" (page 6-28)
	[Journey Planner]	Sets a route plan downloaded from the NISSAN Owner's Portal Website.  "Using Journey Planner" (page 6-24)
	[History]	The information feeds that were previously referred to are displayed.



### INFO:

- If the route is already set, the selected location becomes a waypoint.
- After setting a destination, the location of the destination can be adjusted and the location can be stored in the Address Book, etc.  
 "Procedures after setting route" (page 6-29)
- The destination can be deleted.  
 "Canceling Route" (page 6-35)

## 6. Navigation (if so equipped)

### FINDING ADDRESS

Searches for a destination by address.

1. Push **<NAVI>**.
2. Touch [Street Address]. A number input screen is displayed.

Street Address

1234

State/Province

1	2	3
4	5	6
7	8	9
	0	

Intersection

A-Z City City Center OK

3. Input the street address.
  - When [City] is selected, a city can be specified by typing the city name.
  - When [City Center] is touched while a city is selected, the center of the city becomes the target of the search.
  - Touch [Intersection] to enter the intersection.
  - If the house number is not available, touch [No House #].
4. When information about house number, street, city, and state are entered, the destination is proposed on the display. Touch [OK].



#### INFO:

- Touch [State/Province:] or [City] to narrow down the specified region and city.  
☞ "Changing region" (page 6-15)
5. Enter the name of the street. After finishing the entry, touch [List]. A list of streets is displayed.
  6. Touch the street of the destination from the list.



#### INFO:

- Touch [↶] to return to the previous screen.
7. Touch [Start] to start route guidance.



#### INFO:

- The [Street Address] can also be set by pushing **<NAVI>** and then touching [Destination Menu].
- After setting a destination, the location of the destination can be adjusted and the location can be stored in the Address Book, etc.  
☞ "Procedures after setting route" (page 6-29)



#### Voice command

1. Push **<🗨>** located on the steering wheel.
2. After the tone sounds, speak a command.

To searches for a destination by address: "Navigation", "Street Address"

### FINDING POINTS OF INTEREST

This allows you to find a facility by name or by category. Specify the region and city of the destination to find it more quickly.



#### NOTE:

**Locations and business hours of facilities are subject to change, which may not be reflected in the map data. Double-check this information before you go to an emergency facility to ensure that you can receive the proper support. Otherwise, you may not receive emergency help when you arrive at the destination.**

**A confirmation message also appears on the navigation screen. Follow the displayed instructions and check the items required.**

## 6. Navigation (if so equipped)

### Searching by a landmark name

1. Push **<NAVI>**.
2. Touch [Points of Interest].
3. Touch [Spell Name]. A character input screen is displayed.

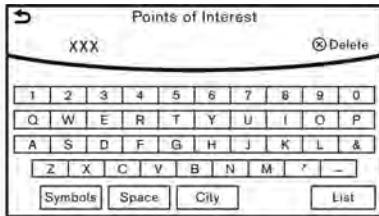

#### INFO:

- Touch [City] and touch [Last 5 Cities] to display the last five cities recently set as destinations.
4. Enter the name of the destination facility. After finishing the entry, touch [List]. A list screen is displayed.
  5. Touch the preferred destination facility from the list.

#### **Narrow down conditions:**

- [Sort]:
- [By Distance]:  
Shows a list of facilities that are

near the current vehicle location.

- [By Name]:  
Shows a list of facilities sorted alphabetically by name order.
- [By Category]:  
Display the list that summarizes the entered names into categories. Select the category to narrow down the search. Touch [Show Related] to display the related facility on the narrowed down category list.

- [City/Area]:
- [Within a City]:  
Input the city to narrow down the target city.
- [Near Destination]:  
When the destination is set, this indicates a list of facilities around the destination.
- [Show Along Route]:  
The system displays the facilities located along the route.

#### INFO:

- Touch [ⓘ] in the list screen to display the detailed information about the POI that is selected. Touch [Call] to make a call to the facility.
6. Whole route map is displayed. Touch [Start] to start route guidance.

#### INFO:

- The [Points of Interest] can also be set by pushing **<NAVI>** and then touching [Destination Menu].
- If [Space] is touched and a keyword is inputted, a search will be possible after entering two or more words.
- After setting a destination, the location of the destination can be adjusted and the location can be stored in the Stored Locations, etc.  
 "Procedures after setting route" (page 6-29)

## 6. Navigation (if so equipped)

Searching from the landmark category

1. Push **<NAVI>**.
2. Touch [Points of Interest]. The main category menu is displayed.
3. Touch the main category. The subcategory list is displayed.
4. Touch the subcategory. A list screen is displayed.

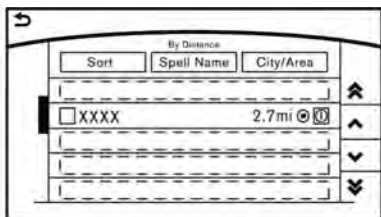

### Narrow down conditions:

- [Sort]:
  - [By Distance]: Shows a list of facilities that are near the current vehicle location.
  - [By Name]: Shows a list of facilities sorted alphabetically by name order.

- [Spell Name]: Enter the facilities name to narrow down the search.
  - [City/Area]:
    - [Within a City]: Input the city to narrow down the target city.
    - [Near Destination]: When the destination is set, this indicates a list of facilities around the destination.
    - [Show Along Route]: The system displays the facilities located along the route.
5. Touch the preferred destination facility from the list.  
Touch [Start] to start route guidance.



### INFO:

- After setting a destination, the location of the destination can be adjusted.  
 "Procedures after setting route" (page 6-29)
- If the nearest POI cannot be searched, a message asking whether to search from an extended area will be displayed. When [Yes] is selected, the system starts to search for POI in a

wider area.

### SETTING HOME AS DESTINATION

The home location can be set as the destination if the home location is stored in advance. This function is especially useful when searching for a route to return to the home location.

1. Push **<NAVI>**.
2. Touch [Home].
3. The home location is displayed, and the system sets the home location as the destination.



### INFO:

If the home location is not stored yet, the system will automatically display a screen for storing it.

 "Storing home location" (page 6-45)

4. Touch [Start] to start route guidance.



### INFO:

The [Home] can also be set by pushing **<NAVI>** and then touching [Destination Menu].



## 6. Navigation (if so equipped)



### Voice command

1. Push **<NAV>** located on the steering wheel.
2. After the tone sounds, speak a command.

To set the home location as the destination:

"Home"

### FINDING NEARBY PLACE

A facility located near the current vehicle location or another location that you move to by scrolling the map can be set as the destination. This allows you to set the destination to a facility located near the current vehicle location or another location that you move to by scrolling the map.

1. Push **<NAVI>**.
2. Touch [Destination Menu].
3. Touch [Nearby Places]. The category list is displayed.
4. Select [RESTAURANT] for example.
5. Select preferred category from the sub category list.
6. Touch the preferred destination from the list. The position of the selected location is displayed in the preview.



### INFO:

- If the suggested route is already set, by touching [Show Along Route], the system displays only the facilities located along the route.
- A maximum of 100 facilities can be displayed on the list screen.

7. Touch [Start] to start route guidance.



### INFO:

You can also set the destination by touching [**≡**] when scrolling the map and selecting [Nearby Places] from the shortcut menu.

### SEARCHING FROM STORED LOCATIONS

Storing frequently used destinations in the Address Book makes it easy to set a destination. Locations should be stored in the Address Book before using this function.

"Storing location" (page 6-45)

1. Push **<NAVI>**.
2. Touch [Destination Menu].
3. Touch [Stored Locations].

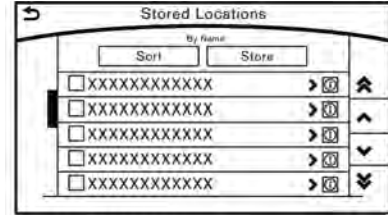

4. Touch the preferred location from the list.



### INFO:

- Selecting [Sort] displays a list of various sort functions.
  - [By Number]:  
The Address Book entries are displayed in ascending numerical order.
  - [By Name]:  
The Address Book entries are displayed in alphabetic order.
  - [By Icon]:  
By selecting a particular icon, a list that contains only the Address Book entries associated with that icon is displayed.

## 6. Navigation (if so equipped)

— [By Group]:

By selecting a particular group (family, friends, leisure, etc.), the selected group is displayed at the top of the list.

- When [Store] is touched, a new location can be stored.

5. Touch [Start] to start route guidance.



### Voice command

1. Push < > located on the steering wheel.
2. After the tone sounds, speak a command.

To set the destination from the Stored Locations:

“Stored Locations”

### SEARCHING FROM HISTORY

A previous destination can be set as the destination.

Up to 100 previous destinations will be automatically stored. If the number of previous destinations exceeds 100, the oldest one will be replaced by the newest one.

1. Push <NAVI>.

2. Touch [Destination Menu].
3. Touch [Previous Destinations]. A list screen is displayed.
4. Touch the previous start point or the previous destination from the list.
5. Touch [Start] to start route guidance.



### Voice command

1. Push < > located on the steering wheel.
2. After the tone sounds, speak a command.

To display the previous destinations list:  
“Previous Destinations”

### USING JOURNEY PLANNER

It is possible to set the route according to the route plan created in advance by the NISSAN Owner’s Portal Website.



### INFO:

Use of NissanConnect® Services features is dependent upon a valid subscription and the telematics device being in operative condition, as well as cellular connectivity, navigation map data and GPS satellite signal reception being available.

1. Push <NAVI>.
2. Touch [Destination Menu].
3. Touch [Journey Planner]. The system will connect to the NissanConnect® Services Data Center and display the Journey Planner list screen.

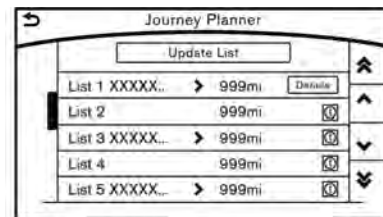

4. Select the preferred route plan from the list.



### INFO:

- Touch [Update List] to update the list information.
  - Touch [Details] to preview the route.
  - Touch to display facility information.
5. The selected route plan is displayed. Touch [Start] after confirming the location of the displayed destination.

## 6. Navigation (if so equipped)



### INFO:

- The Journey Planner can also be set by pushing **<INFO>** and then touching [NissanConnect Services].
- Journey Planner is a NissanConnect® Services feature. Subscription is required to use the NissanConnect® Services.
- Journey Planner cannot be used if [Decline] is touched on the Start-up Screen.
- Refer to the NISSAN Owner's Portal Website for how to set the destination using Journey Planner.

### SETTING INTERSECTION

It is possible to set an intersection of any two streets as the destination and have the system calculate a route.

1. Push **<NAVI>**.
2. Touch [Destination Menu] and touch [Intersection].
3. The first street input screen is displayed.



### INFO:

Touch [State/Province:], [Country] or [City] to narrow down the specified country and city.

4. Enter the name of the first street. After finishing the entry, touch [List]. A list screen is displayed.



### INFO:

If the country or city is changed after selecting the first street, the first street that was selected will be canceled.

5. Touch a street as the first street from the list.
6. The second street input screen is displayed.
7. Enter the name of the second street. After finishing the entry, touch [List]. A list screen is displayed.



### INFO:

Touch [Map] on the list to preview the location of the selected junction.

8. Touch a street as the second street from the list.
9. Whole route map is displayed. Touch [Start] to start route guidance.

### SETTING FREEWAY ENTRANCE/EXIT

It is possible to set the destination to an entrance or exit of a freeway.

1. Push **<NAVI>**.
2. Touch [Destination Menu].
3. Touch [Freeway Entrance/Exit]. A character input screen is displayed.
4. Enter the name of the freeway. After finishing entry, touch [List].
5. Touch the preferred freeway.

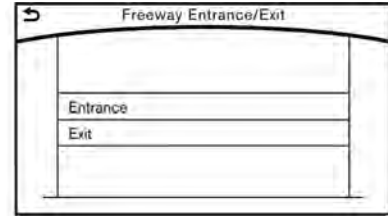

6. Touch [Entrance] /[Exit]. A list screen is displayed.
7. Touch the preferred destination from the list. The selected location is displayed in the preview.

## 6. Navigation (if so equipped)



### INFO:

Touch [Sort] and touch [By Distance] to sort the list by the nearest distance. Touch [By Road No.] to sort by the road no.

8. Touch [Start] to start route guidance.

### SETTING CITY CENTER

It is possible to set the center of a specified city as a destination.

1. Push <NAVI>.
2. Touch [Destination Menu].
3. Touch [City Center]. A character input screen is displayed.
4. Enter the name of the city and touch [List]. A list screen is displayed.



### INFO:

Touch [Last 5 Cities] to display the last five cities recently set as destinations.

5. Touch the preferred destination from the list.



### INFO:

6. The selected destination is displayed. Touch [Map] to preview on the display. Touch [Start] after confirming the location of the displayed destination.

### SETTING BY PHONE NUMBER

If the phone number of a facility is known, it is possible to search for a facility by entering the phone number.



### INFO:

- If the area code of the specified telephone number does not exist in the map data, the system cannot search for the location.
  - Only the locations included in the database in the map data can be searched for by phone number. Residential phone numbers cannot be used to search for a location.
1. Push <NAVI>.
  2. Touch [Destination Menu].
  3. Touch [Phone Numbers]. The telephone number input screen is displayed.
  4. Enter the telephone number including the area code. After finishing entry, touch [OK].



### INFO:

- A list screen is displayed if there are two or more search results. Touch the preferred destination from the list.
5. The selected destination is displayed. Touch [Start] after confirming the location of the displayed destination.

### SETTING FROM STORED ROUTES

It is possible to select a preferred route from the stored routes.

1. Push <NAVI>.
2. Touch [Destination Menu].
3. Touch [Stored Routes]. A list screen is displayed.
4. Touch the preferred route from the list.

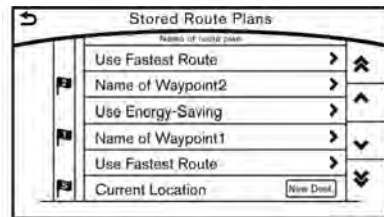

5. The stored route is displayed, touch [New Dest.].

## 6. Navigation (if so equipped)

6. The entire route is shown on the map. Touch [Start] to start route guidance.



### INFO:

- The stored route only includes locations (destination and waypoints) and route calculation conditions, not the route itself. Therefore, when the destination is set using a stored route, a different route may be suggested if the current vehicle location is different from the one when the route was stored.

### SEARCHING BY CONNECTING TO DATA CENTER

It is possible to find a point of interest by inputting a keyword and connecting to the NissanConnect® Services Data Center. The searched location can be set as a destination.



### INFO:

Use of NissanConnect® Services features is dependent upon a valid subscription and the telematics device being in operative condition, as well as cellular connectivity, navigation map data and GPS satellite signal reception being available.

1. Push **<NAVI>**.
2. Touch [Destination Menu].
3. Touch [Connected Search].
4. Enter the keyword and touch [Search]. The system will connect to the NissanConnect® Services Data Center and the search results will be displayed.
5. Touch the preferred destination from the list.



### INFO:

- Touch [info] to display the facility information.
  - Touch [Details] to display the information feeds screen.  
☞ "Screen information" (page 5-21)
6. The entire destination is shown. Touch [Start] to start route guidance.



### INFO:

The Connected Search can also be set by pushing **<INFO>** and then touching [NissanConnect Services].

### SETTING BY NISSANCONNECT® SERVICES

It is possible to set the destination using the NissanConnect® Services features.

☞ "NissanConnect® Services" (page 5-14)



### INFO:

Use of NissanConnect® Services features is dependent upon a valid subscription and the telematics device being in operative condition, as well as cellular connectivity, navigation map data and GPS satellite signal reception being available.

Searching by using IVR soft button on map

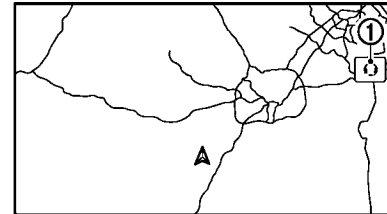

It is possible to set a destination by touching the IVR (Interactive Voice Response) soft button ① on the map. You can choose from the options provided by

## 6. Navigation (if so equipped)

the voice guidance and speak your choice, or ask the NissanConnect® Services Response Specialists directly to search for your destination.

☞ "Connecting to Interactive Voice Menu" (page 5-19)

### Using Google send-to-car

It is possible to search for a location using Google maps, and to download the information to set the destination via the NissanConnect® Services Data Center.

1. Push <INFO>.
2. Touch [NissanConnect Services].
3. Touch [Send to Car].

The system connects to the NissanConnect® Services Data Center and the destination list is downloaded.

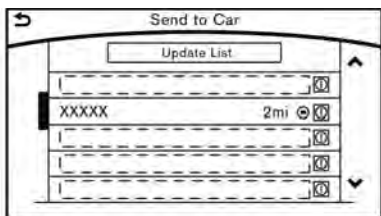

4. Select the preferred destinations from the list. The position of the selected location is displayed in the preview.

#### INFO:

Select [Update List] to update the list information.

5. Touch [Start] to start route guidance.

#### INFO:

Refer to the NISSAN Owner's Portal Website for the destination setting using Google send-to-car.

### Using Destination Send to Car

Destination Send to Car enables you to search for destinations from a point of interest (POI) database accessed within the NissanConnect® portal website.

1. Push <INFO>.
2. Touch [NissanConnect Services].
3. Touch [Destination Send to Car].
4. Select preferred folder.
5. Select preferred channel. The list of destinations which you set at the NissanConnect® portal website is displayed.
6. Select preferred destination from the list.

#### INFO:

Select [Update List] to update the list of point of interest.

### SETTING POINT ON MAP

It is possible to set a location scrolled to on the map as the destination and have the system calculate a route.

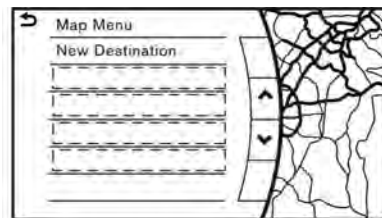

1. Scroll the map, place the cross pointer over the preferred location, and touch [ ].

#### INFO:

- The point on the blinking road where the center of the cross pointer is located can be set as a destination.
2. Touch [New Destination].
  3. The entire route is shown. Touch [Start] to start route guidance.

### PROCEDURES AFTER SETTING ROUTE

The system sets the destination to the selected location and starts calculating a route. After performing a route search, route guidance can be started. Also, it is possible to confirm or change a route.

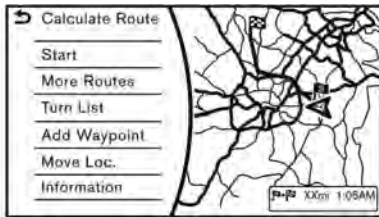

Example

#### Available items after setting route

- [Start]: Starts route guidance to the selected destination.  
If no operations have been performed on the system for several seconds, [Start] is automatically selected, and the system starts route guidance. When the vehicle is being driven, [Start] is automatically selected and the system will start the route guidance function.

- [More Routes]: Route conditions for route calculation can be changed.  
The routes may not always be different.
  - [Fastest Route] : Prioritizes the shortest time.
  - [Energy-Saving] : Energy-Saving route.
  - [Shortest Distance] : Prioritizes the shortest distance.
- [Turn List]: Display the turn list.
- [Add Waypoint]: Allows you to edit the route by adding a destination or waypoint.
  - If a waypoint is added, three alternative routes cannot be selected.
  - If a destination is added, the prior destination becomes a waypoint.
  - It is possible to edit or add a destination or waypoints to the route that is already set.  
 "Editing route" (page 6-36)
- [Move Loc.]: The location of the destination or waypoint can be adjusted by moving

the cross pointer across the map.  
 "Moving location of destination" (page 6-29)

- [Information]: Allows you to store the destination. If there is information about the destination (street address and phone number) stored in the map data, it can also be displayed.

#### Moving location of destination

The location of the destination can be adjusted by moving the cross pointer across the map.

1. After setting destination, touch [Move Loc.].
2. Touch map screen. A map screen with the destination located on the map center is displayed.
3. Adjust the location by moving the cross pointer across the map and touch [OK]. The location of the destination is modified.

#### INFO:

- The screen for adjusting the location also changes when the map screen displayed on the right side of the screen is touched.

## 6. Navigation (if so equipped)

- The map scale can be changed.  
 "Changing scale of map"  
(page 6-8)

### ROUTE GUIDANCE

#### ABOUT ROUTE GUIDANCE

After setting the route, select [Start] to start route guidance.

Throughout route guidance, the system navigates you through the guide points using visual and voice guidance.



#### CAUTION

- **The navigation system's visual and voice guidance is for reference purposes only. The contents of the guidance may be inappropriate depending on the situation.**
- **Follow all traffic regulations when driving along the suggested route (e.g., one-way traffic).**  
 "Route guidance" (page 6-62)



## 6. Navigation (if so equipped)

### Voice guidance during route guidance

#### Basics of voice guidance:

Voice guidance announces which direction to turn when approaching an intersection for which a turn is necessary.

#### Example of voice guidance:

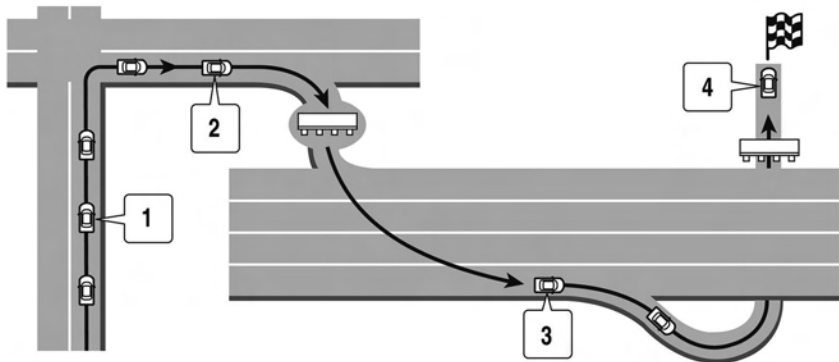

- ① "In about one quarter mile (400 meters), right (left) turn."  
"Right (left) turn ahead."

- ② "In about one quarter mile (400 meters) freeway entrance on your right onto (road number and direction)."  
"Freeway entrance on your right onto (road number and direction)."

- ③ "In about one mile (two kilometers), exit on your right."  
"Exit on your right."  
④ "You have arrived at your destination. Ending route guidance."



#### INFO:

- Distances may vary, depending on the vehicle speed.
- Directions will differ, depending on the road type.
- There may be some cases in which voice guidance and actual road conditions do not correspond. This may occur because of discrepancies between the actual road and the information on the map data, or may also be due to the vehicle's speed.
- In case voice guidance does not correspond to the actual road conditions, follow the information obtained from traffic signs or notices on the road.
- Route guidance provided by the navigation system does not take carpool lane driving into consideration, especially when carpool lanes are separated from other road lanes.

## 6. Navigation (if so equipped)

- The system will only announce street names when the system language is set to English. Street names are not announced when the system is set to French or Spanish.
- When approaching a guide point (intersection or corner), destination, etc. during route guidance, voice guidance announces the remaining distance and/or turning direction.

### Repeating voice guidance:

This function is available throughout route guidance, from the time after the route calculation is completed until the vehicle arrives at the destination.

Push **<VOICE>** or push and hold **<MAP/VOICE>**. Voice guidance will be repeated.



### INFO:

- If **<VOICE>** is pushed or **<MAP/VOICE>** is pushed and held when the vehicle is deviating from the suggested route and when the automatic reroute function is off, voice guidance will announce, "Proceed to the highlighted route."
- If **<VOICE>** is pushed or **<MAP/VOICE>** is pushed and held when the vehicle is going in the wrong direction, the

system will announce a route to allow you to resume the route set with voice guidance.

### Notification when approaching destination:

When approaching the destination, voice guidance will announce, "You have arrived at your destination. Ending route guidance." To reach your final destination, refer to the map screen.

### Notes on voice guidance:

- Voice guidance in this system should be regarded as a supplementary function. When driving the vehicle, check the route on the map and follow the actual roads and traffic regulations.
- Voice guidance is activated only for intersections with certain conditions. There may be cases where the vehicle has to turn, but voice guidance is not provided.
- Voice guidance contents may vary, depending on the direction of the turn and the type of intersection.
- The voice guidance timing will vary depending on the situation.

- When the vehicle has deviated from the suggested route, voice guidance is not available. The system will not announce this. Refer to the map and recalculate the route.

 "Recalculating route" (page 6-38)

- Voice guidance may not accurately correspond with road numbers and directions at freeway junctions.
- Voice guidance may not accurately correspond to street names at freeway exits.
- The displayed street names may sometimes differ from the actual names, or "UNKNOWN STREET NAME" may be displayed.
- Voice guidance is not available when the [Voice Guidance] is turned off.  
 "Volume settings" (page 2-24)
- Voice guidance will start when the vehicle enters the suggested route. Refer to the map for directions to the starting point of the route.
- When approaching a waypoint, voice guidance will announce, "You have arrived at waypoint 1 (2, 3, 4,...)." Voice guidance will switch to the next section of the route. When voice guidance is not available, refer to the map for directions.

## 6. Navigation (if so equipped)

- In some cases, voice guidance ends before arrival at the destination. Refer to the destination icon on the map to reach the destination.
- If the system recognizes on which side the destination (waypoint) is located, voice guidance will announce "on the right/left" after announcing the arrival at the destination.
- Voice guidance may be partially operational or inoperative due to the angle of roads at an intersection.
- Because freeway lane information is available only for approximately 7,000 major freeways in North America, it is not possible to display information for all junctions and exits.
- Freeway exit information may differ from the information on the actual exit signs.
- Because it is not possible to consider data concerning roads that are seasonally available or unavailable, a route may be displayed that does not match the actual traffic restrictions. Be sure to follow the actual traffic restrictions while driving.
- Canada and Alaska contain many roads with incomplete map data. As a result, when searching for a route, the

route may include roads with incomplete data. In regions where road data is not complete, voice guidance may stop for long periods of time. Be sure to follow the actual traffic restrictions while driving.

### ROUTE GUIDANCE SCREENS

Various guidance screens are displayed during route guidance.

### Guidance screen settings

The guidance screen can be displayed at all times even when the vehicle is located away from the guide point. Various types of screens can be set.

 "Display View Bar (models with navigation system)" (page 2-16)

### Route guidance on map screen

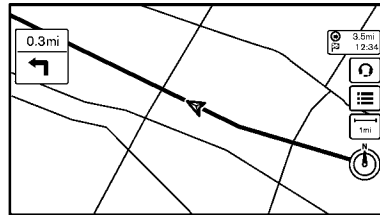

When route guidance starts, the small turn arrow on map is displayed in the upper left corner of the map screen. This arrow indicates the turning direction at the next guide point (corner or intersection). The distance is also displayed. At the top of the screen, the distance to the next guide point and the name of the next street to turn on to are displayed. Also, there may be cases where next street names are announced.

## 6. Navigation (if so equipped)

### Enlarged intersection view

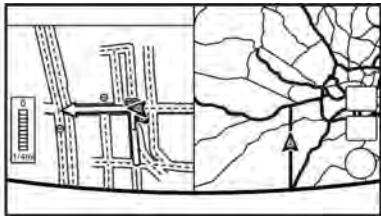

When approaching a guide point, the system automatically changes to the split screen and shows an enlarged view of the intersection on the left screen. To switch to the previous screen while the enlarged intersection view is displayed, push **<MAP>/<MAP/VOICE>**.

Depending on the setting, the system can constantly display the split screen as the display view screen.

### Junction guidance

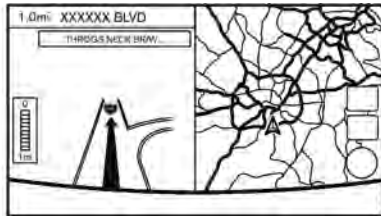

While driving on a freeway, when the vehicle is approximately 1 mile (approximately 2 km) from a junction, the system automatically switches to the split screen and displays an enlarged view of the junction on the left screen. After passing the junction, the system automatically returns to the full screen mode. To switch to the previous screen while the enlarged junction view is displayed, push **<MAP>/<MAP/VOICE>**.

### Turn list

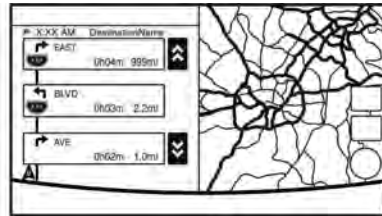

When [Turn List] in the view settings menu is turned on, a turn list can be displayed on the left side of the screen. The left screen automatically switches to an enlarged view of the intersection when approaching a guide point. To switch to the previous screen push **<MAP>/<MAP/VOICE>**.

## 6. Navigation (if so equipped)

### Showing freeway exit information

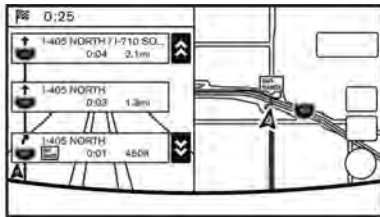

When [Show FWY Exit] is set to ON and the route includes a freeway or toll road, all exits along the route which have exit information will be shown in the turn list. The exit information is shown as icons.

### Selecting a waypoint from the exit information list

When exit information is displayed on the turn list, a waypoint to a facility located near the freeway exit can be set as a waypoint. The facility categories that are not shown with an icon cannot be selected.

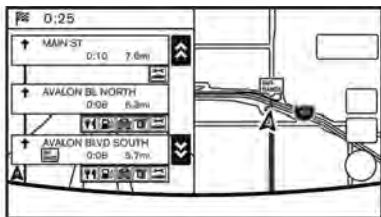

1. Touch the exit where the exit information icon is displayed. The category list screen is displayed.
2. Touch the landmark category. The list screen for showing facilities located near the freeway exit is displayed.

#### INFO:

- The facility categories that are not shown with an icon cannot be selected.
3. Touch the preferred facility for the waypoint.
  4. The waypoint is set, and the route search is performed.  
 "Procedures after setting route" (page 6-29)

### CANCELING ROUTE

It is possible to delete a destination and all waypoints that have already been set.

1. Push <NAVI>.
2. Touch [Cancel Route].
3. A confirmation message is displayed.  
The destination and the waypoints are deleted.

#### INFO:

- The [Cancel Route] can also be set by pushing <NAVI> and then touching [Route Menu].
- The deleted destination and waypoints cannot be reactivated.

### ROUTE MENU SCREEN



#### WARNING

**Always stop the vehicle in a safe location before modifying the route conditions. Modifying the route conditions while driving may cause an accident.**

During route guidance, the route conditions can be modified and the route information can be confirmed. Set route

## 6. Navigation (if so equipped)

conditions according to your personal preference.

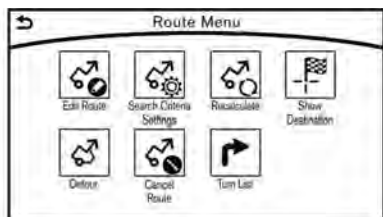

1. Push **<NAVI>**.
2. Touch [Route Menu].
3. The following items are available.

### Available settings

- [Edit Route]:  
Edit or add a destination or waypoint to the route that is already set.  
☞ "Editing route" (page 6-36)
- [Search Criteria Settings]:  
Change the route calculation conditions anywhere along the route.  
☞ "Route Settings" (page 6-43)
- [Recalculate]  
Manually search for the route again after changing the search conditions and have the system calculate a route.  
☞ "Recalculating route" (page 6-38)

- [Show Destination]:  
The destination is displayed on the map screen.
- [Detour]:  
A detour of a specified distance can be calculated.  
☞ "Specified distance based detour" (page 6-39)
- [Cancel Route]:  
The destination and the waypoints on the route are deleted.
- [Turn List]:  
Display the turn list.  
☞ "Displaying Turn List" (page 6-40)



### INFO:

The [Cancel Route], [Turn List] and [Edit Route] can be set only by pushing **<NAVI>**.

## EDITING ROUTE

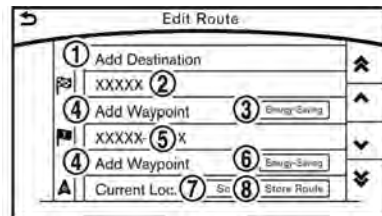

1. Push **<NAVI>**.
2. Touch [Edit Route].
3. Set the preferred conditions.

### Available settings

- ① [Add Destination]:  
Touch to add a destination.  
☞ "Setting destination or waypoint" (page 6-37)
- ② Current destination:  
Changes or deletes the destination.  
☞ "Editing/deleting destination or waypoint" (page 6-37)
- ③ Condition for calculating a route to the destination:  
Changes the conditions for calculating a route to the destination.  
☞ "Changing route calculation conditions" (page 6-38)

## 6. Navigation (if so equipped)

- ④ [Add Waypoint]:  
☞ "Setting destination or waypoint" (page 6-37)
- ⑤ Current waypoint:  
Changes or deletes the waypoint.  
☞ "Editing/deleting destination or waypoint" (page 6-37)
- ⑥ Condition for calculating a route to a waypoint:  
Changes the conditions for calculating a route to a waypoint.  
☞ "Changing route calculation conditions" (page 6-38)
- ⑦ [Sort]:  
Sorts the waypoint and the destination.
- ⑧ [Store Route]:  
Stores route include a destination, waypoints, and route condition. A maximum of five routes can be stored. Stored routes can be easily retrieved and set as the suggested route.



### INFO:

The [Edit Route] can also be set by pushing **<NAVI>** and then touching [Route Menu].

### Setting destination or waypoint

A destination or waypoint can be added to a route that has already been set. A total of six destinations or waypoints can be set.

1. Push **<NAVI>**.
2. Touch [Edit Route].

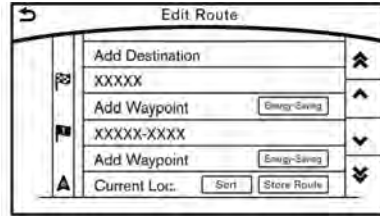

3. Touch [Add Destination] or [Add Waypoint].



### INFO:

If [Add Destination] is selected, the current destination changes to a waypoint.

4. Set a destination or waypoint. The method of searching for a destination or waypoint is the same as the one for a destination.  
☞ "Destination screen" (page 6-17)
5. The system will recalculate the routes.



### INFO:

The prior route is automatically deleted.

### Editing/deleting destination or waypoint

A destination or waypoint that has already been set can be modified or deleted. If a location is modified or deleted when a suggested route is already set, the prior suggested route will be recalculated accordingly.

1. Touch a destination or waypoint that is already set.

## 6. Navigation (if so equipped)

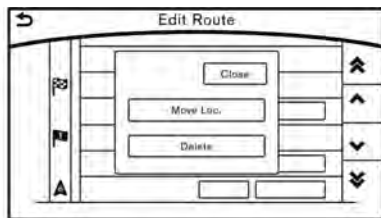

2. Touch the item you would like to set.

### Available settings

- [Move Loc.]:  
The location of the destination or waypoint can be adjusted by moving the cross pointer across the map.
- [Delete]:  
A destination or waypoint that has already been set can be deleted.



### INFO:

If the destination is deleted, the final waypoint of the route becomes the destination.

### Changing route calculation conditions

Each section of the route between waypoints can have different route calculation conditions. After setting these conditions, the entire route can be recalculated.

1. Touch the preferred section of the route to the destination or waypoint.

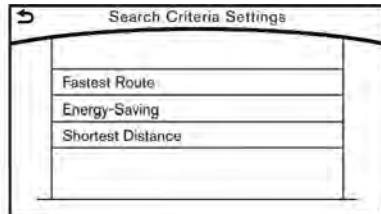

2. Touch the preferred condition.
3. The conditions are changed and the display returns to the Edit Route screen.



### INFO:

- The recalculated route may not be the shortest route because the system prioritizes roads that are easy to drive on for safety reasons.

### Changing order of destination and waypoints

The order of a destination and waypoints that are already set can be changed.

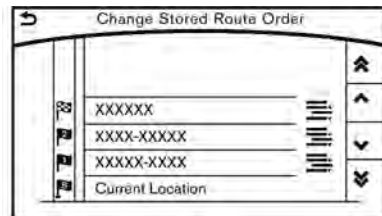

1. Touch [Sort]. A list of the destination and waypoints is displayed.
2. When [≡] is touched, a chime will sound. Still touching the icon, slide it to the place where you would like to move it.
3. Touch [↩] to apply the change.

### RECALCULATING ROUTE

A route can be manually searched again after changing the search conditions.

1. Push <NAVI>.
2. Touch [Route Menu].
3. Touch [Recalculate]. A message is displayed and the route is recalculated.



## 6. Navigation (if so equipped)



### INFO:

- When a waypoint has been set on the route, the system will search for only one route, even if route recalculation is performed.
- When the vehicle deviates from the suggested route, the route from the current location to the destination is automatically searched again by the Auto Reroute function.  
 "Route Settings" (page 6-43)

### SEARCHING FOR DETOUR ROUTE USING TRAFFIC INFORMATION

There are two methods for setting a detour route: A detour route setting taking traffic information into consideration and a detour route setting specifying the distance.

#### Traffic information based detour

When a serious traffic event occurs on the route, or if the system finds a faster route, a detour alert will display automatically. If the automatic alert is not noticed, a detour can also be searched for manually.

1. Push **<NAVI>**.
2. Touch [Route Menu].

3. Touch [Detour].
4. Touch [Traffic Detour].

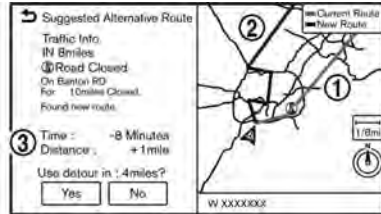

5. When the detour search is successful, detailed information about the detour route and the comparison screen of the two routes are displayed.
  - ① Original route (blue)
  - ② Detour route (purple)
  - ③ The change of distance and estimated travel time to destination when the detour route is taken.
6. To accept the suggested detour route, touch [Yes].



### INFO:

- If no route is set, or [Use Traffic Info] is turned off, this function cannot be operated.

- If a detour route is not selected and no further action is performed, the detour route will be automatically canceled.
- The detour suggestion can be retrieved even after the message disappears by manually selecting [Traffic Detour]. The system will then search for the detour again and will suggest a detour if one is available at that time.
- Without a subscription to SiriusXM Traffic™, it will not be possible to receive traffic detour information or apply settings for functions related to traffic information. A message appears when a related menu item is selected.

#### Specified distance based detour

To detour from the suggested route, a route detouring for a specified distance can be calculated.

1. Push **<NAVI>**.
2. Touch [Route Menu].
3. Touch [Detour].
4. Touch a detour distance select from 1/2 mile, 1 mile, 3 miles or 5 miles. After calculating the detour, the system displays the detour route on the map.

## 6. Navigation (if so equipped)



### INFO:

- When the vehicle has deviated from the suggested route, [Detour] cannot be selected.
- If the system cannot calculate a detour with the specified conditions the previous suggested route is displayed.
- If the vehicle is traveling very fast, the detour route may start from a location that the vehicle has already passed.

### Automatic detour guidance

When [Auto Reroute] and [Use Traffic Info] are turned on in the detailed route settings, a message will be displayed automatically when the system finds a detour.

"Route Settings" (page 6-43)

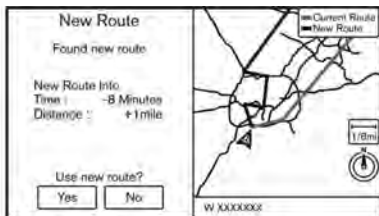

To accept the suggested detour route, touch [Yes].



### INFO:

- If no operation is performed for one minute after the message is displayed, the message disappears. The detour will not be accepted, and the current suggested route will remain unchanged.
- When [Traffic Announcement] is turned on in the guidance settings, the system will announce voice guidance at the same time that the message appears on the screen.  
 "Guidance settings" (page 6-41)

### DISPLAYING TURN LIST

Details of the suggested route can be viewed in the turn list.

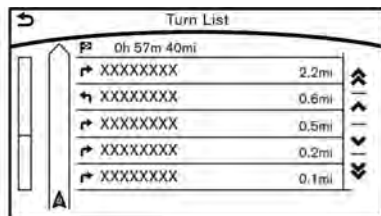

1. Push **<NAVI>**.
2. Touch [Turn List].



### INFO:

The [Turn List] can also be set by pushing **<NAVI>** and then touching [Route Menu].

### ROUTE GUIDANCE SETTINGS

The route search conditions and route guidance can be set.

## 6. Navigation (if so equipped)

### Guidance settings

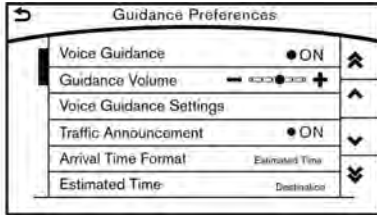

Various guidance information can be set to be played during route guidance and the route and/or voice guidance can be activated or deactivated.



1. Push <SETTING>.
2. Touch [Navigation].

Setting item		Action
[Guidance Preferences]	[Voice Guidance]	Activates or deactivates voice guidance.
	[Guidance Volume]	Adjusts the volume level of voice guidance.
	[Voice Guidance Settings]	Sets advanced settings for the voice guidance announced or chime at guide points.
	[Turn Point]	Turns on the sound that chimes when a maneuver should be performed.
	[Simple Guide]	The system announces voice guidance twice: "Simple Guidance 1" and "Simple Guidance 2".
	[Normal Guide]	The system announces voice guidance three times : "Simple Guidance 1", "Simple Guidance 2" and "Turn Point".
	[Full Guide]	The system announces voice guidance at all times.

## 6. Navigation (if so equipped)

Setting item		Action	
	[Traffic Announcement]	Activate/deactivate the traffic announcement. When this item is activated, the system provides an announcement of a traffic information event on the route. The indicator illuminates if traffic announcement is activated.	
	[Arrival Time Format]	[Estimated Time of Arrival]	Displays the estimated arrival time.
		[Trip Time Remaining]	Displays the time required to travel to the destination.
	[Estimated Time]	[Destination]	Switches the display of the estimated travel time to the destination or waypoint that is displayed on the map screen. Display  of the travel time to the destination.
		[Waypoints]	Display  of the travel time to the waypoint.
	[Set Average Speeds]	[Auto]	If set to ON, the system automatically calculates the time required to travel to the destination.
		[Freeway]	Adjust the average vehicle speed on a freeway.
		[Main Road]	Adjust the average vehicle speed on a main road.
		[Town Road]	Adjust the average vehicle speed on a town road.
		[Residential]	Adjust the average vehicle speed in a residential area.
	[Reset Settings]	Sets the average vehicle speeds to the default values.	
	[Auto Reroute]	If the vehicle deviates from the suggested route, the system automatically recalculates a route that guides the vehicle to the suggested route.	

## 6. Navigation (if so equipped)



### INFO:

The guidance volume can also be adjusted by turning **<VOL/ON-OFF>** or pushing **<-|+>** on the steering wheel while voice guidance is being announced.

### Route Settings

It is possible to set the conditions of the route search.

1. Push **<SETTING>**.
2. Touch [Navigation].

Setting Item		Action		
[Route Search Criteria]	[Search Criteria]	[Fastest Route]	Prioritizes using freeway.	
		[Energy-Saving]	Prioritizes the route with the lowest fuel consumption.	
		[Shortest Distance]	Prioritizes the shortest route.	
	[Route Preferences]	[Minimize Toll Roads]	Minimizes the use of toll roads.	
		[Use Time Restricted Roads]	[Use Restricted Roads (Recommended)]	Uses any roads subject to time restrictions.
			[Ignore Restrictions]	Does not use any roads subject to restrictions.
			[Avoid Restricted Roads]	Uses roads subject to restrictions sparingly.
		[Use Real Time Traffic Info]	Uses the latest traffic information received via the SiriusXM Traffic™ broadcast.	
		[Use Avoid Area Settings]	Enables the avoid area setting. "Storing avoid area" (page 6-46)	

## 6. Navigation (if so equipped)

Setting Item		Action
	[Use Ferries]	Includes the use of ferries.
	[Use Learned Routes]	Uses the roads that are most frequently traveled with the help of self-learning technology.
	[Use HOV Lanes]	Uses the HOV lanes.
	[Auto Reroute]	If the vehicle deviates from the suggested route, the system automatically recalculates a route that leads the vehicle to the suggested route.



### INFO:

- Only one of these route condition can be utilized at a time.
- The recalculated route may not be the shortest route because the system prioritizes roads that are easy to drive on for safety reasons.
- If route conditions are set from [Search Criteria], all sections in the route are subject to the same route conditions even though different route conditions have been set for different sections in [Edit Route].
- If [Use Time Restricted Roads] is deactivated, the system calculates a route without any consideration of the regulations concerning the time or day of the week. Therefore, the suggested route may include a road subject to traffic regulations concerning the time

or day of the week. When driving along the route, always follow all traffic regulations regardless of whether [Use Time Restricted Roads] is set to be considered or not.

- If the system cannot calculate any alternative routes, the previous route is displayed.
- If the vehicle greatly deviates from the suggested route, the system calculates a new route.
- Traffic jam information displayed on the map screen is not statistical traffic information.
- Even when [Use Real Time Traffic Info] is turned on, if traffic information has not been provided for the area, a detour may not always be indicated in a location where a traffic jam occurs.

- The system may not lead to a detour if traffic closure or a traffic jam occurs far from the present location.
- The system calculates to reduce the time required for the entire route from the start to the destination. If there are no appropriate routes, the system may lead to a route where a traffic jam occurs instead of leading to a detour.

### STORING A LOCATION/ROUTE

#### STORING LOCATION

Often visited locations can be stored in the Stored Locations. The stored addresses can be easily retrieved to set them as a destination or waypoint. The Stored Locations can store up to 200 locations.

#### Storing home location



1. Push **<NAVI>**.
2. Touch [Home].
3. If the home location is not registered, the system asks to store it.
4. Set the Home location using the same procedure as setting a destination.  
☞ "Destination screen" (page 6-17)
5. A message is displayed and the home location is stored.

#### Other Settings

1. Push **<SETTING>**.
2. Touch [Navigation] and touch [Edit/Delete Stored Locations].
3. Touch [Stored Locations] and touch [Home Location (None)].
4. Touch the appropriate method to set a location. The search methods are the same as for setting a destination.  
☞ "Destination screen" (page 6-17)
5. Adjust the location of the stored item and edit the contents of the stored item as necessary. After finishing the setting, touch [↵].

#### Storing location by searching

It is possible to store a location by searching in various ways.

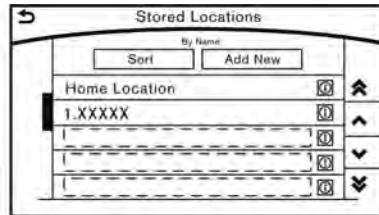

1. Push **<SETTING>**.

2. Touch [Navigation].
3. Touch [Edit/Delete Stored Locations].
4. Touch [Stored Locations].
5. Touch [Add New].
6. Touch the appropriate method to set a location. The search methods are the same as for setting a destination.  
☞ "Destination screen" (page 6-17)
7. A message is displayed, and the address of the location is stored in the Stored Locations.
8. Adjust the location of the stored item and edit the contents of the stored item as necessary.  
☞ "Editing stored home and location" (page 6-48)
9. After finishing the setting, touch [↵].



#### INFO:

- When the location is stored in the Stored Locations, [Stored Locations] can be used to search for the location.
- When 200 store locations are already stored, a new store location cannot be stored until a currently stored store location is deleted.

## 6. Navigation (if so equipped)

### Storing location by moving map

1. Move to the preferred location on the map and touch [ ≡ ].

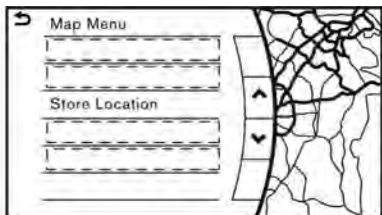

2. Touch [Store Location]. Confirm the contents of the message then touch [Yes].
3. The icon representing the stored location is displayed on the map.



#### INFO:

The address is stored in the first available position number in the Store Location list.

### STORING ROUTE

A maximum of five calculated routes can be stored. Stored routes can be easily retrieved and set as the suggested route. If any waypoints are not set on the route, the route cannot be stored.

1. Push <NAVI> and touch [Edit Route].
2. Touch [Store Route]. A confirmation message is displayed. Select [Yes] to store the current route.

### Other settings

A route can also be stored using the following procedure.

1. Push <SETTING>.
2. Touch [Navigation] and touch [Edit/Delete Stored Locations].
3. Touch [Stored Route Plans].
4. Touch [Store Current Route]. A confirmation message is displayed.
5. Confirm the contents of the message then touch [Yes]. The current route is stored.



#### INFO:

- A stored route includes only locations (destination and waypoints) and route calculation conditions, not the route itself.
- The route is stored in the first available position number in the store current route list.
- When five routes are already stored in the address book, a new route cannot be stored until a route is deleted.

"Deleting stored item" (page 6-51)

### STORING AVOID AREA

An Avoid Area can be stored. The Avoid Area is an area that can be excluded from a route, such as a road that is always congested. Once Avoid Areas are stored, the system avoids those areas when calculating a route. Up to 10 Avoid Areas can be stored.

1. Push <SETTING>.
2. Touch [Navigation] and touch [Edit/Delete Stored Locations].
3. Touch [Avoid Areas].

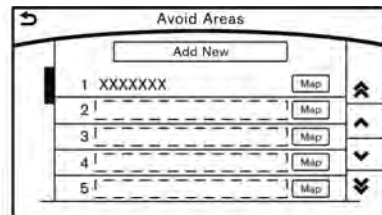

4. Touch [Add New].  
Touch the appropriate method to search for a location.  
 "Destination screen" (page 6-17)
5. Adjust the location edit the contents of the Avoid area as necessary.  
 "Editing avoid area" (page 6-50)



6. After finishing the setting, touch [ ➔ ].



### INFO:

- A maximum of 10 Avoid Areas can be stored. When 10 Avoid Areas are already stored, a new Avoid Area cannot be stored until a currently stored Avoid Area is deleted.  
☞ "Deleting stored item" (page 6-51)

### EDITING STORED INFORMATION

Items stored in the system can be modified. These settings can be edited to make the navigation system more useful.

## 6. Navigation (if so equipped)

### Editing stored home and location

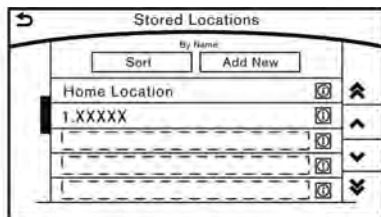

Step 1	Step 2	Step 3	Step 4	Action
1. Push <SETTING>. 2. Touch [Navigation]. 3. Touch [Edit/Delete Stored Locations]. 4. Touch [Stored Locations].	[Sort]			Sort the stored locations.
	[Add New]			Add a new location.  "Storing location by searching" (page 6-45)
	[Home Location]	[Edit]	[Move Location]	Adjust the location of the stored location.
			[Phone No.]	Stores the telephone number of the home location.
			[Icon]	Changes the icon of the home to the preferred one.
			[Show Icon on Map]	Displays the home icon on the map.
			[Alarm Sounds]	Sets the tone of the alarm that sounds when the vehicle approaches the home.
			[Alarm Direction]	Sets the alarm to sound when approaching from a specific direction.
	[Alarm Distance]	Sets the alarm to sound when reaching a specific distance to the home.		
	[Delete]		Delete the stored home location.	

## 6. Navigation (if so equipped)

Step 1	Step 2	Step 3	Step 4	Action
	Touch the preferred stored address from the list.	[Edit]	[Move Location]	Adjust the location of the stored location.
			[Name]	Changes the name of a stored location.
			[Phone No.]	Stores the telephone number of a stored location.
			[Icon]	Changes the icon of a stored location to the preferred one.
			[Show Icon on Map]	Displays the icon on the map of a stored location.
			[Group]	Groups the stored locations.
			[Alarm Sounds]	Sets the tone of the alarm that sounds when the vehicle approaches a stored location.
			[Alarm Direction]	Sets the alarm to sound when approaching from a specific location.
		[Alarm Distance]	Sets the alarm to sound when reaching a specific distance to a stored location.	
		[Delete]		Delete the stored location.



### INFO:

- By changing the icons, the usage of the [By Icon] option of the sort function can be optimized more effectively.
- By grouping the stored addresses, the [By Group] option of the sort function can be used more effectively in the [Sort] mode.
- Once the direction and the distance to sound an alarm are set, the system will sound the alarm when the vehicle enters the triggering zone.
- Touch [ ⓘ ] to display the location information.

## 6. Navigation (if so equipped)

### Editing avoid area

Step 1	Step 2	Step 3	Action
1. Push <SETTING>. 2. Touch [Navigation]. 3. Touch [Edit/Delete Stored Locations]. 4. Touch [Avoid Areas].	[Edit]	[Move Location]	Display the Avoid Area, and adjusts the location of the Avoid Area.
		[Rename]	Changes the name of an Avoid Area.
		[Resize Area]	Adjusts the range of the Avoid Area.
		[Minimize Toll Roads]	Sets the route to include or not include freeways.
5. Touch the preferred Avoid Area from the list.	[Delete]		Delete an Avoid Area.



#### INFO:

- Touch [Add New] on the list screen to add a new avoid area.
- Touch [Map] on the list screen to display the avoid area location.
- The Avoid Area is displayed in green if it includes a freeway or in blue if it does not include a freeway.
- If the current vehicle location is set to an Avoid Area, the system will not provide route guidance.

### Editing stored route

1. Push **<SETTING>**.
2. Touch [Navigation] and touch [Edit/Delete Stored Locations].
3. Touch [Stored Route Plans].
4. Touch the preferred stored route from the list.

### Available setting items

- [Rename]:  
Changes the stored route name.
- [Delete]:  
Delete the stored route.



### INFO:

- Deleted items cannot be restored. Before deleting an item, always make sure that the item is no longer needed.



### INFO:

Touch [Store Current Route] to store the current route.

### DELETING STORED ITEM

The locations and routes in the Address Book can be deleted. Two deletion methods are available: deleting an individual item and deleting all stored items.

## 6. Navigation (if so equipped)

### Deleting stored item individually

1. Push <SETTING>.
2. Touch [Navigation] and touch [Edit/Delete Stored Locations].

Step 1	Step 2	Step3	Action
[Delete Stored Items]	[Delete Stored Location]	[Sort]	Sort stored locations in [By Number]/[By Name]/[By Icon]/[By Group].
		[Delete All]	Delete all stored locations.
		[Multi Select]	Delete the selected stored locations. Touch [Select All] to select all stored locations. Touch [Clear All] to reset the selected stored location.
		Stored location list	Touch the preferred item from the list, delete the selected stored location individually.
	[Delete Stored Route Plans]	[Delete All]	Delete all stored routes.
		Touch the preferred item from the list.	Delete the selected stored routes.
	[Delete Avoid Areas]	[Delete All]	Delete all Avoid Areas.
		Touch the preferred item from the list.	Delete the selected Avoid Area.
	[Reset Learned Routes]		Delete the learned routes.

## 6. Navigation (if so equipped)



### INFO:

- Touch [ⓘ] to display the location information.
- Touch [Map] to display the stored location map.

### Deleting individual item on map

1. Align the cross pointer over the preferred stored location for deletion by moving on the map, and then touch [☰].

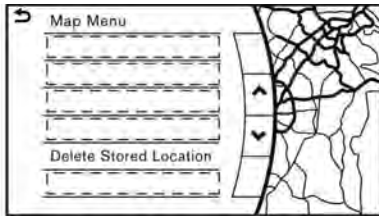

2. Touch [Delete Stored Location]. A confirmation message is displayed.
3. Touch [Yes]. The stored location is deleted from the Stored Locations.
4. Touch [↩] to return to the current location.

### TRANSFERRING INFORMATION TO/FROM ADDRESS BOOK

The information of the stored home and addresses can be exported and imported using a USB memory device.



### INFO:

A USB memory device can be used to transfer data but it is not possible to edit the data using a personal computer, etc. Two USB connection ports are located in the center console box or on the lower instrument panel.

☞ "Audio accessories" (page 2-11)

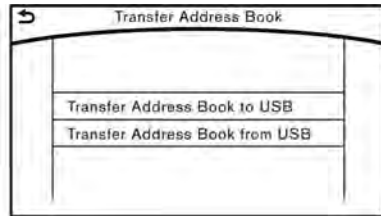

1. Insert a USB memory device and push <SETTING> and touch [Navigation].
2. Touch [Edit/Delete Stored Locations] and touch [Transfer Address Book].
3. Touch [Transfer Address Book to USB] or [Transfer Address Book from USB].

4. Touch [All], [Home Location] or [Stored Locations].



### NOTE:

**Do not remove the USB memory until the system completely imports or exports the data.**



### INFO:

- If the USB memory already has the data for a stored address, a confirmation message is displayed. Once overwritten, the original data cannot be recovered.

## 6. Navigation (if so equipped)

### NAVIGATION SETTINGS

The navigation system can be customized according to the user's preference.

1. Push <SETTING>.
2. Touch [Navigation].
3. Touch the item you would like to set.

#### [Map & Display View]

Setting Map & Display View.

 "Map view settings" (page 6-11)

#### [Map Preferences]

Setting map view, orientation, font size or map color etc.

 "Map view settings" (page 6-11)

#### [POI Icons Displayed on Map]

The facility icons can be displayed or hidden by type.

 "Displaying facility icons" (page 6-14)

#### [Guidance Preferences]

Various guidance information can be set to be played during route guidance and the route and/or voice guidance can be activated or deactivated.

 "Guidance settings" (page 6-41)

#### [Route Search Criteria]

It is possible to set the condition of the route search.

 "Route Settings" (page 6-43)

#### [Traffic Info Settings]

Displays or changes the settings for the traffic information.

 "Traffic Information Settings" (page 5-6)

#### [Safety Guide Settings]



## 6. Navigation (if so equipped)

Setting item	Action
[Speed Limit Info]	Display speed limit information.

### [Edit/Delete Stored Locations]

Stored Locations, Route Plans and Avoid Area. You can also edit stored Items.

 "Editing stored information" (page 6-47)

### [Delete Previous Destinations]

Setting item	Action
[Multiple Selection]	Previous destination list
	[Select All]
	[Delete]
[Delete All]	Delete all previous destination.
[Previous Start Point]	Delete previous start point.
Touch the preferred previous destination from the list.	Delete previous destination.



### INFO:

Touch [  ] to display the location information.

## 6. Navigation (if so equipped)

### [Other Settings]

Setting item	Action	
[Small Step Zoom With Dial]	Sets the free zoom function on or off. It is possible to adjust the scale in smaller steps than with normal scale adjustment.	
[Map Scrolling Information]	Information about the location, on which the center of the cross pointer is placed by scrolling on the map, can be set to be displayed.  "Displaying map scrolling information" (page 6-14)	
[Customize Nearby Places]	Item List	Customize the five nearby categories to show the categories that you frequently use.
	[Restore Default Settings]	Reset the five nearby categories that you have set.
[Tracking Dots Displayed on Map]	[Show Tracking Dots on Map]	Displays a stored tracked route on the map.
	[Dist. Between Tracking Dots]	Select tracking dot interval.
	[Delete Track to Current Location]	Deletes the stored tracked route.
[Adjust Current Location]	If the vehicle icon indicating the current vehicle location is not in the correct position, the location of the vehicle icon on the map screen can be adjusted.	

### [Reset Settings]

This resets various settings (display, volume level, etc.) to the default settings.

### GENERAL INFORMATION

#### CURRENT VEHICLE LOCATION

##### Display of current vehicle location

This navigation system combines the data obtained from the vehicle (by gyro sensor) and from GPS (Global Positioning System) satellites to calculate the current location of the vehicle. This position is then displayed throughout route guidance to a destination.

##### What is GPS (Global Positioning System)?

GPS is a position detecting system that uses satellites deployed by the U.S. government. This navigation system receives radio signals from three or more different satellites that orbit 13,049 miles (21,000 km) above the earth in space, and detect the position of the vehicle by utilizing the principle of triangulation.

##### Positioning adjustment:

When the system judges that the vehicle position is not accurate based on vehicle speed and gyro sensor data calculations, the system will automatically adjust the position of the vehicle icon using GPS signals.

##### Receiving signals from GPS satellites:

The reception of GPS signals can be weak, depending on the environment. Vehicles in the following areas/environments may not receive GPS signals.

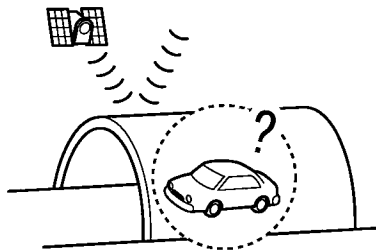

- Inside tunnels or parking garages

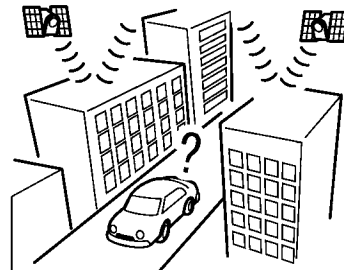

- In areas with numerous tall buildings

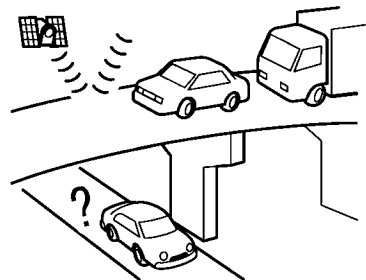

- Under multi-layered highways

## 6. Navigation (if so equipped)

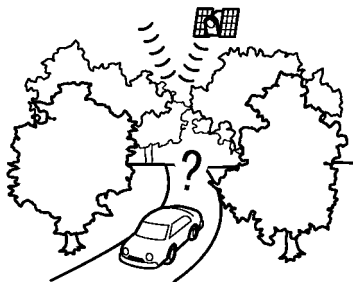

- Areas with numerous tall trees

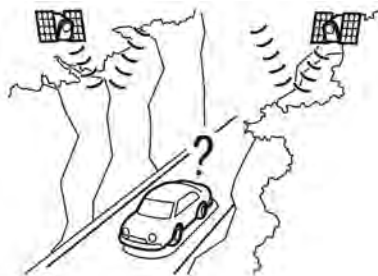

- In a canyon

### INFO:

The GPS antenna is located on the instrument panel inside the vehicle. Do not place any objects, especially cellular phones or transceivers, on the instrument panel. Because the strength of the GPS signal is approximately one billionth of that of TV waves, phones and transceivers will affect or may totally disrupt the signal.

### Incorrect display of vehicle position

The following cases may affect the display accuracy of the vehicle's position or traveling direction. The accuracy will return to normal if the driving conditions return to normal.

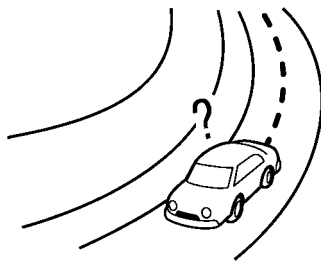

- When there is a similar road nearby.

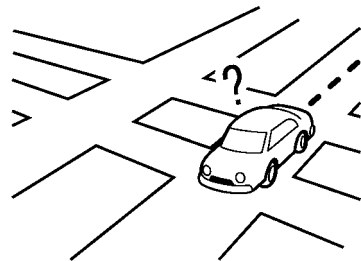

- When the vehicle is traveling in an area with a grid pattern road system.

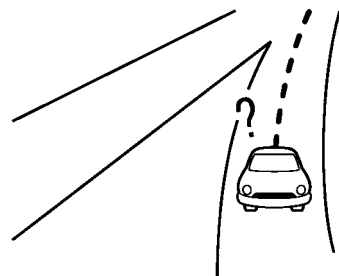

- When the vehicle is passing through a large Y-shaped intersection/junction.

## 6. Navigation (if so equipped)

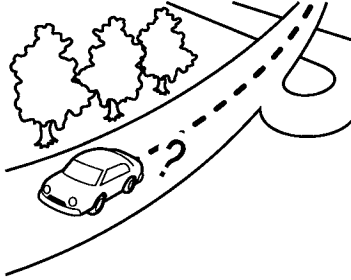

- When the vehicle is traveling on a continuous, slowly curving road.

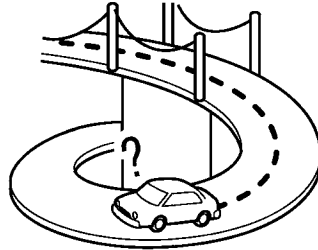

- When the vehicle is on a loop bridge.

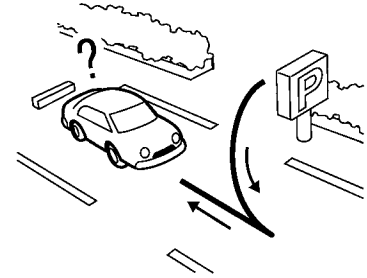

- When repeatedly turning left or right, or driving in zigzags.

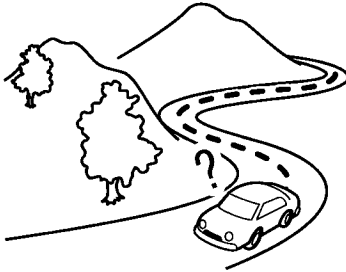

- When the vehicle is traveling on a road with repeating S-shaped curves.



- When the vehicle is on a snow-covered or unpaved road.

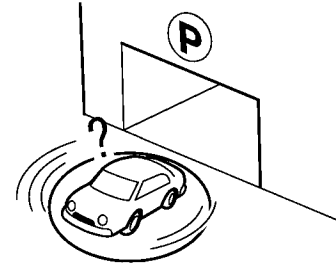

- When the vehicle is rotated on a parking lot turntable while the ignition switch is off.

## 6. Navigation (if so equipped)

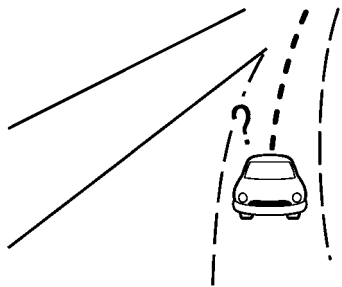

- When driving on a road not displayed on the map screen or a road that has been changed due to additional construction or other reasons.

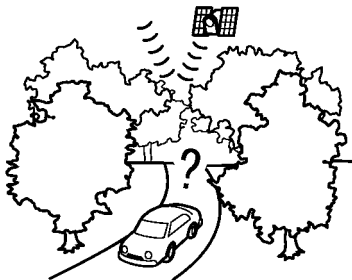

- When the GPS positioning accuracy is low.

### INFO:

- The vehicle icon may be misaligned when starting the vehicle just after starting the engine.
- The vehicle icon may also be misaligned if different sized tires or tire chains are installed.
- The system has a function that automatically corrects the vehicle icon position when it is misaligned from the actual position.
- Vehicle position correction by GPS may not function when the vehicle is stopped.
- If the vehicle icon position does not return to normal even after driving for a while, correct the vehicle icon position manually.

### Detailed Map Coverage Areas (MCA) for navigation system

This system is designed to help guiding to the destination, and it also performs other functions as outlined in this manual. However, the system must be used safely and properly. Information concerning road conditions, traffic signs and the availability of services may not always be up-to-date. The system is not a substitute

for safe, proper and legal driving.

Map data covers select metropolitan areas in the United States and Canada.

Map data includes two types of areas: "Detailed coverage areas" providing all detailed road data and other areas showing "Main roads only".

### INFO:

Detailed map data is not available in many areas and is generally limited to select major metropolitan areas.

### When gray road is displayed on map

- When you are driving on a road displayed in gray after the vehicle has deviated from the suggested route during route guidance, automatic re-routing may not start immediately.
- The navigation system does not provide route guidance for roads displayed in dark green. Therefore, if the destination is set on a road displayed in dark green, the enlarged map display will return to the ordinary map screen at some point on a suggested route that is near the destination. Also, voice guidance will stop at some point on a suggested route that is near the

destination.

- Places information and street names near roads displayed in gray may not be contained in the map data.

### ROUTE CALCULATION

- There may be cases where carpool lanes are included on a suggested route when the automatic rerouting function is activated, even if the [Use Time Restricted Roads] is set to [Use Restriction Info].  
 "Route Settings" (page 6-43)
- The navigation system does not provide route guidance for roads displayed in dark green.
- If the destination is set on a dark green road, the enlarged map display will switch to the ordinary map screen at some point and suggest a route that is near the destination. The distance and direction to the endpoint of the suggested route will be displayed in the lower right corner of the screen. Also, at this time, voice guidance will announce, "The route to the destination includes roads through incomplete map areas. Voice guidance will not be provided in these areas."  
When approaching the endpoint of the suggested route, voice guidance will

announce, "Entering the road with incomplete map data. Use the direction arrow and distance information to proceed to your destination."

To reach the destination, refer to the map screen. Always follow actual roads and regulations and drive safely.

- The suggested route may not be the shortest, nor are other circumstances such as traffic jams considered.
- Because of the inevitable difference in road conditions and circumstances between the time you use this system and the time the information was produced for the map data, there may be discrepancies in roads and regulations. In such cases, actual road conditions and regulations take precedence over map data information.
- During route calculation, the map will not scroll, however the vehicle icon will move according to the actual vehicle's movement.
- During route calculation, buttons such as **<MAP>/<MAP/VOICE>** and **<NAVI>** will be disabled.
- In some cases, after the calculation is complete, the calculated route may not be immediately displayed.

- Waypoints that have been passed will be disregarded by rerouting calculation.
- If you scroll the map while the suggested route is being drawn, it may take more time to finish drawing.
- Route calculation may not be completed in the following cases.
  - If there is no main road within a range of 1.5 miles (2.5 km) from the vehicle, a message saying so will appear on the screen. Try recalculating when the vehicle is closer to a main road.
  - If there is no main road within a range of 1.5 miles (2.5 km) from the destination or waypoint, a message saying so will appear on the screen. Try setting the location closer to a main road.
  - If the vehicle is too close to the destination or if there are no roads to the destination, a message saying so will appear on the screen.
  - If it is impossible to reach the destination or waypoints because of traffic regulations, etc.
  - If the only route to reach the destination or waypoints is extremely

## 6. Navigation (if so equipped)

complicated.

- The following may occur when the route is displayed.
  - If you calculate a route on a main road, the starting point of the route may not exactly match the current vehicle location.
  - The endpoint of the route may not exactly match the destination.
  - If you calculate a route on a main road, the system may display a route from another main road. This may be because the position of the vehicle icon is not accurate. In this case, park the vehicle in a safe location and reset the vehicle icon, or continue driving to see if the position of the vehicle icon is automatically adjusted before recalculating the route.
  - There are cases in which the system shows an indirect route to reach the destination or waypoints, if you set them from stored or facility information. In order to correct this, you must be careful about the traffic direction, especially when lanes with different travel directions are shown separately, such as interchanges and service areas.

- This system makes no distinction between limited traffic control and total control (blockage). It may show an indirect route even if the road is usable.
- Even if the freeway preference is set to OFF, a route that uses the freeway may be suggested.
- Even if the ferry preference is set to OFF, a route that uses a ferry line may be suggested.

### ROUTE GUIDANCE



#### INFO:

The system will only announce street names when the system language is set to English. Street names are not announced when the system is set to French/Spanish.

### Notification of intersection on ordinary road

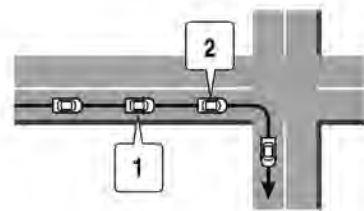

1. "In about one quarter mile (400 meters), right (left) turn."
2. "Right (left) turn ahead."



### Notification of consecutive intersections on ordinary roads

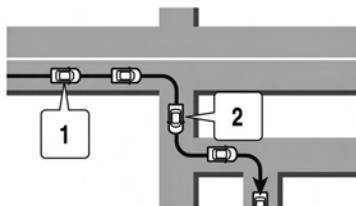

When the road has three or more consecutive intersections ahead, voice guidance will announce the following.

1. "In about one quarter mile (400 meters), right (left) turn, then in about one quarter mile (400 meters) left (right) turn."
2. "Left (right) turn ahead, then in about one quarter mile (400 meters) right (left) turn."

### Notification of freeway entrance

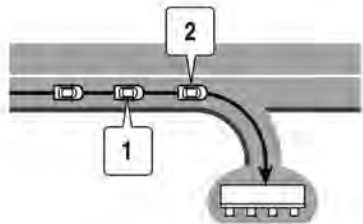

1. "In about one quarter mile (400 meters) freeway entrance on your right onto (road number and direction)."
2. "Freeway entrance on your right onto (road number and direction)."

## 6. Navigation (if so equipped)

### Notification of freeway junction

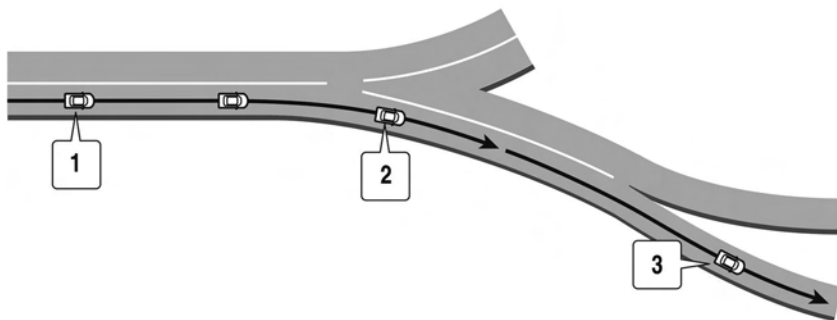

1. "In about one mile (two kilometers), keep to the right (left) onto (road number and direction), then in about one quarter mile (400 meters) keep to the right (left)."
2. "Keep to the right (left) onto (road number and direction), then in about one quarter mile (400 meters) keep to the right (left) onto (road number and direction)."
3. "Keep to the right (left) onto (road number and direction)."

### Notification of freeway exit

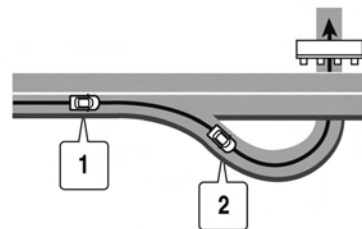

1. "In about one mile (two kilometers), exit on your right."
2. "Take the second exit on your right."

### MAP DATA

#### SD card slot

The SD card slot is located on the driver's side of the lower instrument panel or inside the center console box.



#### NOTE:

- **Never insert foreign objects such as coins into the SD card slot. Doing so may result in a malfunction of the device.**

## 6. Navigation (if so equipped)

- **Do not apply overload to the SD card when inserting it to the slot. Doing so may result in a malfunction of the device.**
- **The SD card may be hot when it is removed from the device. This does not indicate a malfunction.**

### How to handle the Map SD card

When handling the map SD card, please be careful and adhere to the following instructions:

- An SD card is inserted in the slot or provided with your vehicle. This is an SDHC card that is exclusively used for this device. This card includes the map data. The SDHC card is necessary to operate the device. Do not remove this card except when the map data requires updating.
- Never analyze, modify, delete or format the map data. Doing so may cause improper operation of the device.
- The SDHC card that is exclusively used for this device will not work properly if it is inserted in another device.
- The map data cannot be used even if it is copied to another SDHC card.

- Do not remove the SDHC card containing map data that is inserted in the slot. When this SDHC card containing map data is removed the navigation system will not operate. If the SDHC card containing map data is accidentally removed, after reinserting the SDHC card containing map data into the slot, place the ignition switch in the OFF position and then place it back in the ON position again.
- If you have to take out the SDHC card, push the inserted SDHC card in and release it to eject the SDHC card from the slot.

### How to order map data updates

To order updated map data, contact the NISSAN NAVIGATION SYSTEM HELPDESK. See the contact information on the inside front cover of this manual.

### About map icons

The marks of companies displayed by this product to indicate business locations are the marks of their respective owners. The use of such marks in this product does not imply any sponsorship, approval, or endorsement by such companies of this product.

### About map data

1. This map data has been prepared by CLARION CO., LTD. (CLARION), under license from HERE. It has added, processed and digitized data based on the digital road map data of HERE. Due to the production timing of the map data, some new roads may not be included in this map data or some of the names or roads may be different from those at the time you use this map data.
2. Traffic control and regulation data used in this map data may be different from those at the time you use this map data due to the data production timing. When driving your vehicle, follow the actual traffic control signs and notices on the roads.
3. Reproducing or copying this map software is strictly prohibited by law.

Published by Clarion Co., Ltd. Manufactured by ZENRIN CO., LTD.

© 2018 HERE. All Rights Reserved.

© ZENRIN CO., LTD. 2018. All rights reserved.

## 6. Navigation (if so equipped)



### WARNING

- This navigation system should not be used as a substitute for your own judgement. Any route suggestions made by this navigation system may never override any local traffic regulations, your own judgement, and/or knowledge of safe driving practices. Disregard route suggestions by the navigation system if such suggestions would: cause you to perform an hazardous or illegal maneuver, place you in an hazardous situation, or route you into an area you consider unsafe.
- The advice provided by the navigation system is to be regarded only as a suggestion(s). There may be situations where the navigation system displays the vehicle's location incorrectly, fails to suggest the shortest course, and/or fails to direct you to your desired destination. In such situations, rely on your own driving judgement, taking into account the current driving conditions.
- Do not use the navigation system to route you to emergency ser-

vices. The database does not contain a complete listing of the locations of emergency service providers such as police, fire stations, hospitals and clinics. Please use your judgement and your ability to ask for directions in these situations.

- As the driver you solely are responsible for your driving safety.
  - In order to avoid traffic accidents, do not operate the system while driving.
  - In order to avoid traffic accidents, operate the system only when the vehicle is stopped at a safe place and the parking brake is set.
  - In order to avoid traffic accidents or traffic offence, remember that the actual road conditions and traffic regulations take precedence over the information contained on the navigation system.
  - Accordingly, the Software may contain inaccurate or incomplete information due the passage of time, changing circumstances, and the nature of the sources used. Please ob-

serve the actual traffic circumstances and regulations at all times while driving.

- In a situation when the actual road conditions and traffic regulations differ from the information contained on the navigation system, abide by traffic rules.
- The navigation system does not provide, or account for in any way, information regarding traffic and road laws; speed restrictions; road conditions including road slope, grade, and/or surface conditions; obstruction information including bridge and tunnel height and width, and/or other prevailing driving and/or road conditions. Always rely on your own driving judgment, taking into account the current driving conditions.
- Minimize the amount of time spent viewing the screen while driving.

The marks of companies displayed by this product to indicate business locations are the marks of their respective owners. The use of such marks in this

product does not imply any sponsorship, approval, or endorsement by such companies of this product.

### End-user terms

The data ("Data") is provided for your personal, internal use only and not for resale. It is protected by copyright, and is subject to the following terms and conditions which are agreed to by you, on the one hand, and CLARION CO., LTD. ("CLARION") and its licensors (including their licensors and suppliers) on the other hand.

© 2018 HERE. All rights reserved.

This data includes information taken with permission from Canadian authorities, including © Her Majesty, © Queen's Printer for Ontario, © Canada Post, GeoBase®, © Department of Natural Resources Canada. All rights reserved.

HERE holds a non-exclusive license from the United States Postal Service® to publish and sell ZIP+4® information.

© United States Postal Service® 2018. Prices are not established, controlled or approved by the United States Postal Service®. The following trademarks and registrations are owned by the USPS: United States Postal Service, USPS, and ZIP+4.

### Terms and conditions:

**Personal Use Only.** You agree to use this Data together with Nissan Automotive Products for the solely personal, non-commercial purposes for which you were licensed, and not for service bureau, time-sharing or other similar purposes. Accordingly, but subject to the restrictions set forth in the following paragraphs, you agree not to otherwise reproduce, copy, modify, decompile, disassemble or reverse engineer any portion of this Data, and may not transfer or distribute it in any form, for any purpose, except to the extent permitted by mandatory laws. Multi-disc sets may only be transferred or sold as a complete set as provided by CLARION and not as a subset thereof.

**Restrictions.** Except where you have been specifically licensed to do so by CLARION, and without limiting the preceding paragraph, you may not (a) use this Data with any products, systems, or applications installed or otherwise connected to or in communication with vehicles, capable of vehicle navigation, positioning, dispatch, real time route guidance, fleet management or similar applications; or (b) with or in communication with any positioning devices or any mobile or wireless-connected electronic or computer devices,

including without limitation cellular phones, palmtop and handheld computers, pagers, and personal digital assistants or PDAs.

**Warning.** The Data may contain inaccurate or incomplete information due to the passage of time, changing circumstances, sources used and the nature of collecting comprehensive geographic data, any of which may lead to incorrect results.

**No Warranty.** This Data is provided to you "as is," and you agree to use it at your own risk. CLARION and its licensors (and their licensors and suppliers) make no guarantees, representations or warranties of any kind, express or implied, arising by law or otherwise, including but not limited to, content, quality, accuracy, completeness, effectiveness, reliability, fitness for a particular purpose, usefulness, use or results to be obtained from this Data, or that the Data or server will be uninterrupted or error-free.

**Disclaimer of Warranty:** CLARION AND ITS LICENSORS (INCLUDING THEIR LICENSORS AND SUPPLIERS) DISCLAIM ANY WARRANTIES, EXPRESS OR IMPLIED, OF QUALITY, PERFORMANCE, MERCHANTABILITY, FITNESS FOR A PARTICULAR PURPOSE OR NON-INFRINGEMENT. Some States, Territories and Countries do not allow certain

## 6. Navigation (if so equipped)

warranty exclusions, so to that extent the above exclusion may not apply to you.

**Disclaimer of Liability:** CLARION AND ITS LICENSORS (INCLUDING THEIR LICENSORS AND SUPPLIERS) SHALL NOT BE LIABLE TO YOU: IN RESPECT OF ANY CLAIM, DEMAND OR ACTION, IRRESPECTIVE OF THE NATURE OF THE CAUSE OF THE CLAIM, DEMAND OR ACTION ALLEGING ANY LOSS, INJURY OR DAMAGES, DIRECT OR INDIRECT, WHICH MAY RESULT FROM THE USE OR POSSESSION OF THE INFORMATION; OR FOR ANY LOSS OF PROFIT, REVENUE, CONTRACTS OR SAVINGS, OR ANY OTHER DIRECT, INDIRECT, INCIDENTAL, SPECIAL OR CONSEQUENTIAL DAMAGES ARISING OUT OF YOUR USE OF OR INABILITY TO USE THIS INFORMATION, ANY DEFECT IN THE INFORMATION, OR THE BREACH OF THESE TERMS OR CONDITIONS, WHETHER IN AN ACTION IN CONTRACT OR TORT OR BASED ON A WARRANTY, EVEN IF CLARION OR ITS LICENSORS HAVE BEEN ADVISED OF THE POSSIBILITY OF SUCH DAMAGES. Some States, Territories and Countries do not allow certain liability exclusions or damages limitations, so to that extent the above may not apply to you.

**Export Control.** CLARION shall not export from anywhere any part of the Data or any direct product thereof except in compliance with, and with all licenses and

approvals required under, applicable export laws, rules and regulations, including but not limited to the laws, rules and regulations administered by the Office of Foreign Assets Control of the U.S. Department of Commerce and the Bureau of Industry and Security of the U.S. Department of Commerce. To the extent that any such export laws, rules or regulations prohibit HERE from complying with any of its obligations hereunder to deliver or distribute Data, such failure shall be excused and shall not constitute a breach of this Agreement.

**Entire Agreement.** These terms and conditions constitute the entire agreement between CLARION (and its licensors, including their licensors and suppliers) and you pertaining to the subject matter hereof, and supersedes in their entirety any and all written or oral agreements previously existing between us with respect to such subject matter.

**Governing Law.** The above terms and conditions shall be governed by the laws of the Netherlands, without giving effect to (i) its conflict of laws provisions, or (ii) the United Nations Convention for Contracts for the International Sale of Goods, which is explicitly excluded. You agree to submit to the jurisdiction of the Netherlands for any and all disputes, claims and

actions arising from or in connection with the Data provided to you hereunder.

**Government End Users.** If the Data is being acquired by or on behalf of the United States government or any other entity seeking or applying rights similar to those customarily claimed by the United States government, the Data is a "commercial item" as that term is defined at 48 C.F.R. ("FAR") 2.101, is licensed in accordance with the End-User Terms under which this Data was provided, and each copy of the Data delivered or otherwise furnished shall be marked and embedded as appropriate with the following "Notice of Use," and shall be treated in accordance with such Notice:

### NOTICE OF USE

CONTRACTOR (MANUFACTURER/ SUPPLIER) NAME: HERE

CONTRACTOR (MANUFACTURER/SUPPLIER) ADDRESS:

c/o Nokia 425 West Randolph Street,  
Chicago, Illinois 60606

This Data is a commercial item as defined in FAR 2.101 and is subject to the End-User Terms under which this Data was provided.

© 2018 HERE - All rights reserved.

If the Contracting Officer, federal govern-

## 6. Navigation (if so equipped)

---

ment agency, or any federal official refuses to use the legend provided herein, the Contracting Officer, federal government agency, or any federal official must notify HERE prior to seeking additional or alternative rights in the Data

## 6. Navigation (if so equipped)

---

MEMO



# 7 Voice Recognition

Voice Recognition System .....	7-2
Using Voice Recognition System .....	7-2
Before starting .....	7-2

Giving voice commands .....	7-2
Voice recognition settings .....	7-14





## 7. Voice Recognition

### VOICE RECOGNITION SYSTEM

#### USING VOICE RECOGNITION SYSTEM

##### Initialization

The Voice Recognition System will activate in a few seconds after the ignition switch is placed in the ACC or ON position. Once activation is complete, you can start using the system by pushing <  > on the steering wheel and speaking voice commands. If <  > on the steering wheel is pushed before the activation completes, the display will show a message to wait until the system is ready.

##### BEFORE STARTING

To get the best recognition performance from the Voice Recognition System, observe the following items.

- The interior of the vehicle should be as quiet as possible. Close the windows to eliminate surrounding noises (traffic noise and vibration sounds, etc.), which may prevent the system from correctly recognizing the voice commands.
- Wait until the tone sounds before speaking a command.

- Speak in a natural conversational voice without pausing between words.
- The Voice Recognition System can only be operated in the languages that are supported by the Voice Recognition System.
- Available voice commands may vary depending on the language setting.
- For models with voice recognition control capability of navigation function:
  - The navigation system related commands can only be used within the area where the map data is included in the navigation system.

#### GIVING VOICE COMMANDS

1. Push <  > located on the steering wheel.

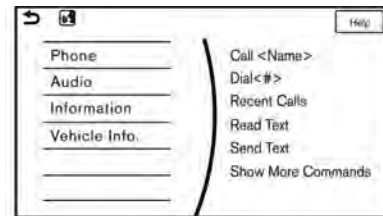

Example

2. A list of commands appears on the screen, and the system provides a voice menu prompt.

When this screen is displayed, almost all of the commands can be recognized. Available commands for each category can be shown on the right side of the screen. Use the multi-function controller to highlight a category listed on the left side of the screen and display the available commands by category.



### INFO:

Selecting a category by touching the screen or pushing **<ENTER>** will execute the command. After executing the category command, only the commands related to the selected category can be recognized.

"Command list" (page 7-7)

3. After the tone sounds and the icon on the screen changes from to , speak a command. You can also select a command by touching the screen directly.



### INFO:

The Voice Recognition System will pause operation when the multi-function controller is moved. To resume operation, push **<VOLUME>** on the steering wheel.

4. Continue to follow the voice menu prompts and speak after the tone sounds until the preferred operation is completed.



### INFO:

To cancel the voice command, push and hold **<VOLUME>**.

You can interrupt the voice prompt at any time by pushing **<VOLUME>**.

### Operating tips

- Speak a command after the tone.
- If the command is not accepted, the system prompts you to speak the command again. Repeat the command in a clear voice.
- Push **<BACK>** on the steering wheel once to return to the previous screen.
- Voice commands spoken from the passenger seat cannot be recognized.
- When **<VOLUME>** on the steering wheel is pushed while the air conditioner is set to the Auto mode, the system controls the air conditioner fan speed in order to improve Voice Recognition performance. When the air conditioner is set to the manual mode, the fan speed does not change. The accuracy of Voice Recognition may be affected depending on the fan speed and the air direction.
- To skip the voice guidance function and give the command immediately,

push **<VOLUME>** on the steering wheel to interrupt the system. Remember to speak after the tone.

- To cancel the command, push and hold **<VOLUME>** on the steering wheel.
- To adjust the volume of the system feedback, push **<VOLUME+>** on the steering wheel or use **<VOL/ON-OFF>** on the audio system while the system is making an announcement.
- Models with navigation system:  
For searching with Street Address, Point of Interest and City Center, the searching area is automatically set to the state where your vehicle is located. Change the search area to another state if necessary.  
 "Changing region" (page 6-15)

### Voice Prompt Interrupt:

By pushing **<VOLUME>** on the steering wheel, the voice prompt can be interrupted allowing you to speak a voice command without listening to the voice prompt till the end. Remember to wait for the tone before speaking.

## 7. Voice Recognition

### How to display voice command screen

1. Push  $\langle \text{voice icon} \rangle$  to display the first screen of the voice command list.
2. Speak a command or select an item from the voice command list. The second screen is displayed.
3. Speak a command. The list screen is displayed.
4. Speak the preferred number from the list to perform operation.



#### INFO:

The voice commands can be spoken one at a time following prompts step by step or spoken successively in one step.

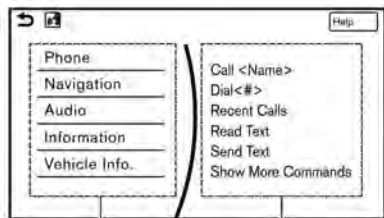

First screen (Example)

- ① Shows available command list. It is also possible to select a command from this list by touching the screen or using the multi-function controller.
- ② Shows available command list. Displayed commands are only available to execute through Voice Recognition. You can say commands from the left screen and the right screen continuously.

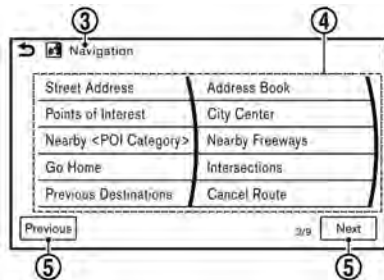

Second screen

- ③ Previously selected command: A command previously spoken or selected is displayed.
- ④ Command list: You can say a command from the list, touch the screen directly or select, using the steering wheel switch or the multi-function controller. You can say

preferred word for  $\langle \text{ } \rangle$  enclosed part of the command.

- ⑤ [Previous]/[Next]:

Say as a command or touch to go to the previous/next screen. It cannot be selected using the steering wheel switch or multi-function controller.

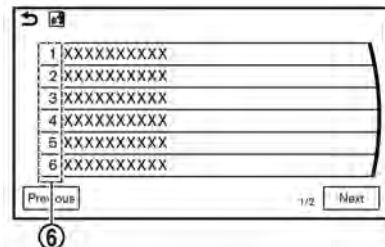

List screen

- ⑥ Command numbers:

Speak 1 to 6 numbers to select. It is also possible to select a command from this list by touching the screen or using the multi-function controller.

### How to speak numbers

Voice Recognition System requires the user to speak numbers in a certain way when giving voice commands.

#### General rule:

Only single digits 0 (zero) to 9 can be used. (For example, if speaking 500, “five zero zero” can be used, but “five hundred” cannot.)

#### Examples:

1-800-662-6200

“One eight zero zero six six two six two zero zero”

For the best recognition, speak “zero” for the number “0” and “oh” for the letter “o”.

### Voice command examples

As examples, some additional basic operations that can be performed by voice commands are described here.

#### Example 1– Placing a call from hands-free phonebook:

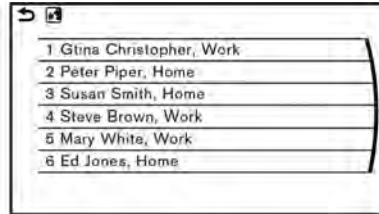

1. Push <math>\leftarrow</math> <math>\rightarrow</math> located on the steering wheel.
2. Wait for the indicator to change to . Speak “Phone”.



#### INFO:

- You can also speak “Phone” “Call <Name>” continuously. After “Dial” is spoken, no name listed in Phonebook can be recognized. Only telephone numbers can be recognized.
3. Speak “Call <Name>”.

When an option is set in the contact list of a cellular phone, the option can be commanded directly. For example, “Call John Smith Work” or “Call John Smith Other”, etc.



#### INFO:

- Names in Phonebook can be recognized by speaking the person’s first and last name, or just their first name. When a name is spoken in the order of last name and then first name, or when only the last name is spoken, the name cannot be recognized.
  - Even if words describing family relations, such as “Dad” or “Mom”, are registered in a cellular phone, the system can only recognize names. If you want the system to recognize words like “Dad” or “Mom”, register “Dad/Mom” in Favorites from [Phonebook/Favorites Settings] or register “Dad/Mom” as a name in a cellular phone.
4. The system announces, “Please say or select an item number from the displayed list.” To select the displayed matching item, speak a number from 1 to 6.

## 7. Voice Recognition



### INFO:

- If the selected number has more than one phone number registered to it, the phone number list screen is displayed.

### Example 2- Playing radio:

1. Push < > located on the steering wheel.
2. Wait for the indicator to change to and speak "Audio".
3. Speak "Play FM" to turn on the FM radio.



### INFO:

- You can also speak "FM <station number>" to turn the radio on and tune in a preferred radio station.
- Using "FM <frequency> HD <channel number>" allows you to specify the HD sub-channel directly.

### Example 3 - Setting destination by Nearby Places (models with navigation system):

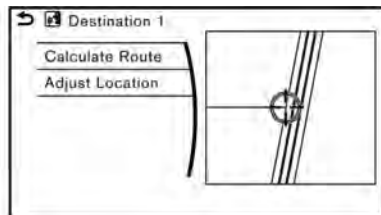

1. Push < > located on the steering wheel.
2. Wait for the indicator to change to and speak "Navigation".
3. Speak "Nearby".

If a route is already set, choose "Near Current Location", "Along Route" or "Near Destination".

4. Speak a category number (between 1 to 6) from the displayed candidates.
5. Speak the list of places of interest in the category.
6. Speak "Calculate Route" to start calculating a route to the destination.

### Command list

To use the voice recognition function, you can speak commands in the order of 1st command, 2nd command and 3rd command. You can also operate the system by speaking the 2nd or 3rd command directly.

Variable numbers or words such as names can be applied in < > when speaking a command.

Some navigation commands are only for English.

Available commands may vary depending on models, specifications and conditions.

#### General command

Command	Action
Show More Commands	Display other commands of the same category.
Go Back	Corrects the last recognition result to return to the previous screen.
Exit	Cancels Voice Recognition.
Help	Announces how to use voice guidance.
Next	Skip to the next page.
Previous	Skip to the previous page.

#### General phone command

The following commands can be used during the Voice Recognition session.

Command	Action
Change Number	Change a spoken phone number.
Dial	The system makes a call to the spoken phone number.

#### Phone command

## 7. Voice Recognition

1st Command	2nd Command	3rd Command	4th Command	Action	
Phone	Call <Name>	<1 - 6>		Makes a call to a contact that is stored in the mobile phone. Select from the list of displayed contacts on the screen.	
	Dial <#>	Dial		Makes a call to a spoken phone number.	
		Change Number		Change a spoken phone number.	
	Recent Calls	<1 - 6>		Makes a call to the recent incoming, outgoing or missed call number.	
	Read Text	<1 - 6>	Play		You can listen to recent text messages received. Reads out a text message. Select from the list of current received message.
			Reply		Reply to a received message.
			Call		Call to the sender of the message.
	Send Text	<phonebook name>		You can select a text message from a list and send it a contact name. You can select the type from <Work>, <Mobile>, <Home> or <Other>.	
		<phonebook name> <type>			
	Phonebook	<phonebook name>		Makes a call to a contact that is stored in the mobile phone. You can select the type from <Work>, <Mobile>, <Home> or <Other>. Select [Reply] to reply by a message. Select [Call] to call the sender.	
		<phonebook name> <type>			
	Favorites	<favorite name> <1 - 6>		Access frequently called contacts by storing into the favorite list.	
		<favorite name> <Type>			
Redial				Makes a call to the last outgoing phone number.	
Add Phone				Use this command to connect a compatible Bluetooth® device to system. Follow the on-screen instructions to complete the pairing process from your handset.	
Call <Name> Home	<1 - 6>			"Call" followed by a contact name stored in your phonebook from the cellular phone and the location name "Home".	





**NOTE:**

The system can read out SMS text messages in voice. However, it cannot always read the text correctly.

**Audio command**

1st Command	2nd Command	Action
Audio	USB Play Artist	Turns on the USB, selecting the artist.
	USB Play Album	Turns on the USB, selecting the album.
	USB Play Song	Turns on the USB, selecting the track. You can speak the commands successively.
	iPod Play Artist	Turns on the iPod®, selecting the artist.
	iPod Playlist	Turns on the iPod®, playing the playlist which you said.
	Play <Source Name>	Play the audio source which you said.
	CD	Turns on the CD, selecting the track number.
	USB All Artists	Display the USB all artists list.
	USB All Albums	Display the USB all albums list.
	USB All Folders	Display the USB all folders list.
	iPod All Artists	Display the iPod® all artists list.
	iPod All Albums	Display the iPod® all albums list.
	iPod All Songs	Display the iPod® all songs list.

**Notes on operating audio by Voice Recognition:**

- An audio device connected via Bluetooth® cannot be operated with the Voice Recognition System. Source change is only available for Bluetooth® streaming audio.

## 7. Voice Recognition

- Song title and Artist name information will be overwritten when another iPod®/iPhone® is connected after song titles and artists names in the previously connected iPod®/iPhone® have been installed.
- If two USB memory devices are connected at the same time, voice operation will only be available for use with one registered and selected device. When selecting [YES] in the pop-up screen that displays after a new USB audio device is connected, the USB audio device is registered in the Voice Recognition System and is selected automatically. One iPod® and one USB memory device can be registered in the system. If a USB audio device is newly registered, old data is overwritten. It may take a few moments to register an audio device. If you want to enable voice operation for music stored on a previously registered audio device, select the device you want to use in advance.

 "Voice recognition settings" (page 7-14)

Even when a device has been previously registered, simply connecting the device will not result in it being selected automatically.

- The Voice Recognition System may not function when the song information is too long (artist names, album titles, song titles, and playlists, etc.)

### General navigation command (if so equipped)

The following commands can be used during the Navigation voice recognition session.

Command	Action
Within a City	Search a destination from the specified city.
Change State	Change the state to search.
Calculate Route	Calculate a route.
Adjust Location	Fine-tune the destination.

### Navigation command (if so equipped)

## 7. Voice Recognition

1st Command	2nd Command	3rd Command	Action	
Navigation	Nearby <POI Category>	<1 - 6>	Say "Nearby" followed by a POI category name such as Gas station, Restaurant or Parking. You can say any category name that appears when using manual controls. The system will always search for nearby matches regardless of the current state location.	
	Go Home		Sets a route to your home location.	
	Previous Destinations	<1 - 6>	Sets a route to a previously entered destination.	
	Address Book	<Stored location name> <1 - 6>	Sets a route to a location stored in the Stored Locations.	
	Cancel Route		Delete a destination and way point.	
	Recalculate Route	Freeway Preferred		Sets the route search condition to find a route with a maximum use of freeways.
		Energy-Saving		Sets the route search condition to find the route that is the most energy saving.
		Shortest Distance		Sets the route search condition to find the route that is the shortest in distance.
	Zoom In <1-13>		Increases the magnification of the map by the number of steps specified.	
	Zoom Out <1-13>		Decreases the magnification of the map by the number of steps specified.	
	Zoom Streets		Change to the street map.	
	North Up		Sets the 2D full map to North Up.	
	Heading Up		Sets the 2D full map to Heading Up.	
	2D Map		Change the current map to a 2D Heading Up map.	
3D Map		Change the current map to a 3D map.		

## 7. Voice Recognition

1st Command	2nd Command	3rd Command	Action
	Repeat Instruction		Speaks the current navigation guidance.
	Voice Guidance OFF / Voice Guidance ON		Turns the navigation guidance on/off.
	Show POI Icons		Display the icon of <POI Category> in map.
	Remove POI Icons		Remove the icon of <POI Category> in map.



### NOTE:

- **When searching for an address, the state cannot be specified by voice commands. Speak an address within the state or change the state setting prior to starting the Voice Recognition session.**



### INFO:

- When the current car position is in Puerto Rico and Guam, the system does not recognize the general navigation commands.
- Searching by Points of Interest is limited to the area of the current state or the state set in Change State. The Points of Interest command is a function that recognizes the POI names registered in the navigation system.
- When the "Points of Interest" command is spoken in Voice Recognition, some POI cannot be used for "Points of Interest" search with voice command operations.  
For "Nearby" search, all registered categories can be recognized by the Voice Recognition System.  
It may be possible to change some of the categories.

### Information command

## 7. Voice Recognition

1st Command	2nd Command	Action
Information	Voice Menu	Connect to the NissanConnect® Services Response Specialists.
	Fuel Prices	Display the fuel prices.
	Weather Forecast	Display the weather forecast.
	Current Weather	Display the nearby weather (current weather).
	Sports Scores	Display the sports scores.
	Traffic Information	Turns the traffic information system on or off.
	Route Information	Display the route information.

- The Fuel Prices, Weather Forecast, Current Weather, Sports Scores and Traffic Information will not operate without a subscription to SiriusXM® Radio.

### Vehicle information command (if so equipped)

1st Command	2nd Command	Action
Vehicle Info.	Temperature <60-90 (°F) >/<18-32 (°C)>	Change the set temperature.
	Climate Control ON/OFF	Turns on/off the Climate Control system.
	Tire Pressures	Displays tire pressures information on the display.
	Fuel Economy	Displays fuel economy information.
	Maintenance	Displays maintenance information on the display.

## 7. Voice Recognition

---

### VOICE RECOGNITION SETTINGS

Voice recognition functions can be set.

1. Push **<SETTING>**.
2. Touch [Voice Recognition].
3. Touch the item you want to set.

#### **Available settings**

- [Minimize Voice Feedback]:  
Set [Minimize Voice Feedback] function ON (short feedback) or OFF (long feedback).
- [Audio Device Setting]:  
Select an audio device to be operated via the Voice Recognition System from the list of devices registered to the in-vehicle audio system. The device with an indicator light illuminated can be operated with the Voice Recognition System.

# 8 Troubleshooting guide

Customer assistance .....	8-2	Bluetooth® Hands-Free Phone System .....	8-14
System unit .....	8-3	Navigation (if so equipped) .....	8-18
Liquid crystal display .....	8-3	Basic operations .....	8-18
Audio system .....	8-4	Vehicle icon .....	8-19
AM radio .....	8-4	Route calculation and visual guidance .....	8-21
HD Radio technology (if so equipped) .....	8-5	Voice guidance .....	8-23
Compact Disc (CD) player .....	8-7	Traffic information (if so equipped) .....	8-24
iPod® player .....	8-9	NissanConnect® Services (if so equipped) .....	8-25
USB memory .....	8-11	Voice recognition .....	8-26
Bluetooth® streaming audio .....	8-12		

## 8. Troubleshooting guide

---

### **CUSTOMER ASSISTANCE**

For assistance or to order updated map data (if so equipped), contact the NISSAN NAVIGATION SYSTEM HELPDESK. For other assistance or inquiries, contact NISSAN Consumer Affairs Department. See the contact information on the inside front cover of this manual.



## SYSTEM UNIT

## LIQUID CRYSTAL DISPLAY

Symptom	Possible cause	Possible solution
The screen is too dark.	The cabin temperature is too low.	Wait until the cabin temperature becomes moderate.
	Screen brightness is set to the maximum darkness.	Adjust the brightness setting of the screen. ☞ "Screen settings" (page 2-23)
The screen is too bright.	Screen brightness is set to the maximum brightness.	Adjust the brightness setting of the screen. ☞ "Screen settings" (page 2-23)
A small black spot or a small bright spot appears on the screen.	This is a phenomenon typical to liquid crystal display.	This is not a malfunction.
A dot or stripe pattern appears on the screen.	Electromagnetic waves that are generated from neon billboards, high voltage electric power cables, ham radios or other radio devices equipped to other vehicles may adversely affect the screen.	This is not a malfunction.
Image lag appears on the screen.	This is a phenomenon typical to liquid crystal display.	This is not a malfunction.
Image motion displayed on the screen is slow.	The cabin temperature is below 32°F (0°C).	Wait until the in-cabin temperature rises to above 32°F (0°C).
When looking at the screen from an angle, the screen lightens or darkens.	This is a phenomenon typical to liquid crystal display.	Adjust the brightness setting of the screen. ☞ "Screen settings" (page 2-23)
The screen turns blue or an error message is displayed on the display.	The SD card is not inserted into the slot correctly (models with navigation system).	If the SD card containing map data is accidentally removed, place the ignition switch in the OFF position and reinsert the SD card containing map data into the slot.
	A system malfunction has occurred.	Contact a NISSAN dealer for inspection.

## 8. Troubleshooting guide

### AUDIO SYSTEM

#### AM RADIO

Symptom	Possible cause	Possible solution
AM reception deteriorates at night.	AM stations are required to lower their power at night.	This is not a malfunction.

## 8. Troubleshooting guide

### HD RADIO TECHNOLOGY (if so equipped)

#### Sound

Symptom	Possible cause	Possible solution
Delay in digital audio on HD Radio broadcasts.	The radio acquires an analog station first and blends to digital signal.	This is not a malfunction.
Audio skip, stutter or echo.	The radio station has not properly aligned the digital and analog audio.	Verify correct operation on another station. Report any station with poor performance.
Volume changing up/down.	The radio station has not properly aligned digital and analog audio level.	Verify correct operation on another station and check <a href="http://www.hdradio.com">www.hdradio.com</a> for stations in the area. Report any station with poor performance.
Sound fading in and out.	The transition between analog and digital is taking place (blending).	Verify transition performance on several stations in the area. Report any stations with poor alignment.
Excessive blending (Transition between analog and digital).	The vehicle is located near the edge of the digital coverage area.	Refer to <a href="http://hdradio.com">hdradio.com</a> to verify radio stations in your coverage area.
Digital audio not better than analog audio.	Audio processing on the digital audio at a station can potentially decrease the digital audio sound quality.	Verify correct operation on another station. Report any station with poor performance.

## 8. Troubleshooting guide

### Functional

Symptom	Possible cause	Possible solution
Keep losing my local stations.	The digital coverage is slightly less than the analog signal coverage.	Verify correct operation on another station. This is expected behavior.
	Shadowing (urban / terrain) can cause reduced digital coverage.	Verify correct operation on another station.
Some data fields are blank.	Text information is sent at the broadcaster's discretion.	Verify correct operation on another station. Report station issues.
Text information is truncated / appears to be more available.	The display is limited to a fixed number of characters and more data is being sent than can be shown.	This is intended behavior.
AM reception deteriorates at night.	AM stations are required to lower their power at night.	This is not a malfunction.

## 8. Troubleshooting guide

### COMPACT DISC (CD) PLAYER

Symptom	Possible cause	Possible solution
Music cannot be played back.	The disc is inserted upside down.	Insert a CD with the label side facing up.
	Moisture has accumulated inside the unit.	Wait until the moisture evaporates (approximately 1 hour).
	The cabin temperature is too high.	Wait until the cabin temperature becomes moderate.
	The disc is scratched or dirty.	Wipe off any dirt from the disc. Scratched discs cannot be recovered. Replace the disc.
	Depending on the condition in which they are stored, discs may become unreadable due to deterioration (for example, keeping the discs in the passenger compartment, etc.).	Replace the disc with a deterioration-free disc. Do not use a deteriorated disc. The label surface of a disc may crack or chip, and the layer of the label surface may eventually peel off.
Compressed audio files cannot be played back.	If both music CD files (CD-DA data) and compressed audio files (MP3 data, etc.) are mixed on one disc, the compressed audio files cannot be played back.	Prepare a disc that contains compressed audio files only.
	The files are not named using characters that are compliant with the specifications.	Use the character codes and the number of characters that are compliant with the specifications for the folder names and file names. In addition, always use ".MP3", ".WMA", ".mp3" or ".wma" file extensions.
It takes a long time before the music starts playing.	The disc contains a large amount of data.	Some time may be required to check the files. It is recommended that unnecessary folders or any files other than compressed audio files should not be recorded on a disc.
The sound quality is poor.	The disc is dirty.	Wipe off any dirt from the disc.

## 8. Troubleshooting guide

Symptom	Possible cause	Possible solution
No sounds are played although the CD play time is displayed.	The system is playing the first track of a mix mode disc. (Mix mode is a format in which data except music is recorded on the first track and music data is recorded on one other than the first track in a session.)	Play music data in other tracks.
Music cuts off or skips.	The combination of writing software and hardware might not match; or the writing speed, writing depth, writing width, etc. might not match the specifications.	Create a disc using different writing speed settings, etc.
The system skips the selected track and moves to the next track.	A non-MP3/WMA file has been given an extension of ".MP3", ".WMA", ".mp3" or ".wma".	Prepare MP3/WMA files.
	Some of the file cannot be played due to copyright protection.	Prepare playable files.
The tracks do not play back in the desired order.	The folder locations on the disc are changed by the writing software while the files are written on the disc.	Check the settings of the writing software and create a new disc.

## 8. Troubleshooting guide

### iPod® PLAYER

Symptom	Possible cause	Possible solution
The system does not recognize an iPod®.	The connector cable is not correctly connected or the iPod® does not correctly operate.	Connect the connector cable again. If the system does not recognize the iPod® after performing the procedure above, reset the iPod®.
	The iPod® that is connected is not compatible with the system.	Check the iPod® model and firmware versions available for the system.
	The USB extension cable is not correctly connected.	Do not use a USB extension cable.
	The cable is rapidly connected to or disconnected from the USB connection port.	Slowly connect or disconnect the USB cable.
An iPod® cannot be operated.	The iPod® is connected to the in-vehicle audio system while headsets, etc. are connected to the iPod®.	Remove all equipment from the iPod® after disconnecting the iPod® from the system, and then connect it to the system again.
	The iPod® is not operating normally.	Disconnect and re-connect the iPod® to the in-vehicle audio system.
	The system plays back an album/track that includes particular album art.	Disconnect the iPod® from the in-vehicle audio system and then reset the iPod®. Disable the album art and then reconnect the iPod® to the system.
An iPod® does not respond.	There are too many tracks in a category.	Decrease the number of tracks in a category (less than 3,000 tracks).
	The shuffle function is turned on.	Turn off the shuffle function if many tracks are stored on the iPod®.
Music cannot be played back.	The connector is not connected to the iPod®.	Firmly connect the connector until it clicks.
Music stops playing.	The sound cuts off due to vibration resulting from the iPod® being in an unstable location.	Place the iPod® in a stable location where it does not roll over.

## 8. Troubleshooting guide

Symptom	Possible cause	Possible solution
The sound is distorted.	The EQ (equalizer) function of the iPod® is turned on.	Turn off the EQ (equalizer) function.
The iPod® battery requires more time than usual to charge.	Charging the iPod® battery may take longer while the iPod® is playing.	If the iPod® requires charging, it is recommended to stop playback.
An iPod® cannot be charged while connected to the system.	The cable connected to the iPod® may be deteriorated (cable disconnection, etc.).	Check the cable.
The connected iPod® cannot be operated with the in-vehicle system.	—	The operation of an iPod® must be performed using the in-vehicle audio system after the iPod® is connected to the system.
The sound skips.	Surrounding circumstances (noise, etc.) may cause the audio to skip.	This does not indicate a malfunction.
	A USB extension cable is used.	Do not use a USB extension cable.



### USB MEMORY

Symptom	Possible cause	Possible solution
The system does not recognize a USB memory device.	A USB extension cable is used.	Do not use a USB extension cable.
	A USB hub is used.	Do not use a USB hub.
	Connection or disconnection operation of the USB memory device was too abrupt.	Connect or disconnect the USB memory device slowly.

## 8. Troubleshooting guide

### BLUETOOTH® STREAMING AUDIO

Symptom	Possible cause	Possible solution
Registration cannot be performed.	The Bluetooth® streaming audio device is not compatible with the in-vehicle audio system.	Check the owner's manual for the Bluetooth® streaming audio device.
	The PIN code is incorrect.	Check the PIN code for the Bluetooth® streaming audio device that is to be registered.
		Check that the PIN code for the Bluetooth® streaming audio device is consistent with that for the in-vehicle audio system.
	Another Bluetooth® device is used in the vehicle.	Turn off the other Bluetooth® device and wait until registration is completed.
Music cannot be played.	The Bluetooth® streaming audio device is not compatible with the in-vehicle audio system.	Check the owner's manual for the Bluetooth® streaming audio device.
	The system is not set to the Bluetooth® streaming audio mode.	Push <b>&lt;MEDIA&gt;</b> to select the Bluetooth® streaming audio mode.
	The sound may cut off when a Bluetooth® streaming audio device is operated.	Turn on the Bluetooth® adapter when it is used for a Bluetooth® streaming audio device.
Music stops playing.	The Bluetooth® streaming audio device is not compatible with the in-vehicle audio system.	It is recommended that you consult a NISSAN dealer for a recommended Bluetooth® streaming audio device.
	A cellular phone is connected.	This is not a malfunction.
	The sound may cut off when a Bluetooth® streaming audio device is operated.	Push <b>&lt;MEDIA&gt;</b> to select the Bluetooth® streaming audio mode, and then operate the device on the vehicle's display screen.
Audio operation cannot be performed.	A Bluetooth® streaming audio device that does not support audio operations is in use.	This is not a malfunction. Refer to the owner's manual for the Bluetooth® streaming audio device.

## 8. Troubleshooting guide

Symptom	Possible cause	Possible solution
	An error occurs when connecting to a Bluetooth® streaming audio profile.	Turn the power source of the Bluetooth® streaming audio player off and on, and then resume connection with the system.

## 8. Troubleshooting guide

### BLUETOOTH® HANDS-FREE PHONE SYSTEM

Symptom	Possible cause	Possible solution
A cellular phone cannot be registered.	The cellular phone is not compatible with the in-vehicle hands-free phone system.	Use a cellular phone compatible with the system. It is recommended that you consult a NISSAN dealer for model compatibility.
	Registration of the cellular phone has been performed incorrectly.	Check the registration procedure, and then register the cellular phone again.
A cellular phone cannot be connected or becomes disconnected after registration is complete.	The Bluetooth® setting of the in-vehicle hands-free phone system is turned off.	Turn on the Bluetooth® setting of the system.
	The Bluetooth® setting of the cellular phone is turned off.	Turn on the Bluetooth® setting of the cellular phone.
	The remaining battery level of the cellular phone is low.	Charge the battery of the cellular phone.
	The wireless Bluetooth® connection may be disrupted depending on the location of the cellular phone.	Do not place the cellular phone in an area surrounded by metal or far away from the in-vehicle hands-free phone system. Do not place the cellular phone close to the seats or your body.
	Registration of the cellular phone is not complete.	Perform registration of the cellular phone.
Having trouble reconnecting to hands-free phone after previously successfully registered.	The cellular phone software is not running properly or software is not up to date.	First, reboot your cellular phone and make sure to shut it down on a regular basis to refresh the software condition. If that does not resolve the symptom, check for any cellular phone software updates and update your cellular phone software.

## 8. Troubleshooting guide

Symptom	Possible cause	Possible solution
A call to a particular number fails.	If the system tries to make a call several times to the same phone number (for example: the party does not respond to the call, the party is out of the network service area, or the call is abandoned before the party responds), the system may reject a request to make a call to the phone number.	Turn the cellular phone off and then on again to reset the connection.
The system does not recognize the connection of a cellular phone and cannot receive or make a call.	The cellular phone is not compatible with the in-vehicle hands-free phone system.	Use a cellular phone compatible with the system. It is recommended that you consult a NISSAN dealer for model compatibility.
	The cellular phone is not connected.	Check the registration procedure, and then register the cellular phone again.
	The phone operation is limited by the functions (such as dial lock, etc.) of the registered cellular phone.	Remove any settings that are limiting use of the cellular phone, and then perform registration again.
Registered voice tag is cut short.	Speaking of the voice tag did not fit within the 5 second recording period after the beep.	Speak the voice tag within 5 seconds after the beep.
The other party cannot hear your voice. The other party can hear your voice, but it cracks or cuts out.	The cellular phone is not connected.	Check the registration procedure, and then register the cellular phone again.
	The fan speed of the air conditioner is too fast.	Decrease the fan speed of the air conditioner.
	The ambient noise level is excessive. (For example: heavy rain, construction sites, inside a tunnel, oncoming vehicles, etc.)	Close the windows to shut out ambient noise.
	The noise generated by driving the vehicle is too loud.	Reduce the vehicle speed, and then speak a command.
	The incoming or outgoing voice level is too loud.	Adjust the incoming or outgoing voice level properly.

## 8. Troubleshooting guide

Symptom	Possible cause	Possible solution
The voice is cut out or noise is heard during a call.	The wireless Bluetooth® connection may be disrupted depending on the location of the cellular phone.	Do not place the cellular phone in an area surrounded by metal or far away from the in-vehicle hands-free phone system. Do not place a cellular phone close to the seats or your body.
When a cellular phone is operated to make a call, the hands-free function is no longer available.	Some models of a cellular phone do not switch to the hands-free mode when they are operated to make a call.	This is not a malfunction. Make a call again using the handsfree function.
The other party's voice cannot be heard. There is no ringtone.	The volume level is set to the minimum.	Adjust the volume level.
	A cellular phone is not connected.	Check the registration procedure, and then register the cellular phone again.
Each volume level (ringtone, incoming voice or outgoing voice) is different.	Each volume level is not adjusted properly.	Adjust each volume level properly.
The antenna display is different between the vehicle screen and the screen on a cellular phone. Making or receiving a call is unavailable even though the antenna display indicates that it is possible to do so.	The antenna display varies depending on the model of cellular phone.	This does not indicate a malfunction. The antenna display and remaining battery level shown on the vehicle screen may be different from those shown on the cellular phone screen. Use them as a reference.
A voice cannot be heard clearly when using a cellular phone behind tall buildings.	Some structures such as tall buildings, etc. may cause irregular reflection of radio waves or completely shut out radio waves that are used for cellular phones.	This is not a malfunction.
Noise is heard when using a cellular phone under/near areas of elevated railroads, high voltage electric power cables, traffic signals, or neon billboards, etc.	Electromagnetic waves that are generated or distorted may adversely affect the cellular phone.	This is not a malfunction.
Noise is heard in the sound from the audio system while using a cellular phone.	Radio waves that are generated from a cellular phone may adversely affect the sound from the audio system.	This is not a malfunction.

## 8. Troubleshooting guide

Symptom	Possible cause	Possible solution
The sound skips.	The cellular phone may have turned on the wireless LAN (Wi-Fi).	Turn off the wireless LAN (Wi-Fi).
Phonebook cannot be downloaded.	An error occurred during the phone pairing process.	Re-register the Bluetooth® pairing information after deleting the pairing information from both the cellular phone and the in-vehicle system.

## 8. Troubleshooting guide

### NAVIGATION (if so equipped)





#### BASIC OPERATIONS

Symptom	Possible cause	Possible solution
No image is displayed.	The brightness is at the lowest setting.	Adjust the brightness of the display. ☞ "Screen settings" (page 2-23)
	The display is turned off.	Push and hold <b>&lt;CAMERA&gt;/&lt;OFF&gt;/&lt;CAM-&lt;CAMERA*/&gt;/&lt;*/&gt; OFF&gt;</b> to turn on the display.
No voice guidance is available. or The volume is too high or too low.	The volume is not set correctly, or it is turned off.	Adjust the volume of voice guidance.
	Voice guidance is not provided for certain streets (roads displayed in gray).	This is not a malfunction.
No map is displayed on the screen.	A screen other than a map screen is displayed.	Push <b>&lt;MAP&gt;/&lt;MAP/VOICE&gt;</b> .
The screen is too dim. The movement is slow.	The temperature in the interior of the vehicle is low.	Wait until the interior of the vehicle has warmed up.
Some pixels in the display are darker or brighter than others.	This condition is an inherent characteristic of liquid crystal display.	This is not a malfunction.
Some menu items cannot be selected.	Some menu items become unavailable while the vehicle is driven.	Park the vehicle in a safe location, and then operate the navigation system.
Navigation system related functions cannot be operated.	The SD card is not inserted into the slot.	Insert the appropriate SD card.



## 8. Troubleshooting guide

### VEHICLE ICON

Symptom	Possible cause	Possible solution
Names of roads and locations differ between Plan View and Birdview™.	This is because the quantity of the displayed information is reduced so that the screen does not become too cluttered. There is also a chance that names of the roads or locations may be displayed multiple times, and the names appearing on the screen may be different because of a processing procedure.	This is not a malfunction.
The vehicle icon is not displayed in the correct position.	The vehicle was transported after the ignition switch was pushed off, for example, by a ferry or car transporter.	Drive the vehicle for a period of time on a road where GPS signals can be received.
	The position and direction of the vehicle icon may be incorrect depending on the driving environments and the levels of positioning accuracy of the navigation system.	This is not a malfunction. Drive the vehicle for a period of time to automatically correct the position and direction of the vehicle icon.  "Current vehicle location" (page 6-57)
When the vehicle is traveling on a new road, the vehicle icon is located on another road nearby.	Because the new road is not stored in the map data, the system automatically places the vehicle icon on the nearest road available.	Updated road information will be included in the next version of the map data.
The screen does not switch to the night screen even after turning on the headlights.	The daytime screen was set the last time the headlights were turned on.	Set the screen to the night screen mode using  >/<CAMERA-  />/<  /> OFF when turning on the headlights.  "Screen settings" (page 2-23)
The map does not scroll even when the vehicle is moving.	The current location map screen is not displayed.	Push <MAP>/<MAP/VOICE>.
The vehicle icon is not displayed.	The current location map screen is not displayed.	Push <MAP>/<MAP/VOICE>.

## 8. Troubleshooting guide

Symptom	Possible cause	Possible solution
The location of the vehicle icon is misaligned from the actual position.	When using tire chains or replacing the tires, speed calculations based on the speed sensor may be incorrect.	Drive the vehicle for a period of time (at approximately 19 MPH (30 km/h) for about 30 minutes) to automatically correct the vehicle icon position. If this does not correct the vehicle icon position, it is recommended that you visit a NISSAN dealer.
	The map data has a mistake or is incomplete (the vehicle icon position is always misaligned in the same area).	Updated road information will be included in the next version of the map data.

## 8. Troubleshooting guide

### ROUTE CALCULATION AND VISUAL GUIDANCE

Symptom	Possible cause	Possible solution
Waypoints are not included in the auto reroute calculation.	Waypoints that have been already passed are not included in the auto reroute calculation.	To go to that waypoint again, edit the route.
Route information is not displayed.	Route calculation has not yet been performed.	Set the destination and perform route calculation.
	The vehicle is not on the suggested route.	Drive on the suggested route.
	Route guidance is set to OFF.	Turn on route guidance.
	Route information is not provided for certain types of roads (roads displayed in dark green).	This is not a malfunction.
The auto reroute calculation (or detour calculation) suggests the same route as the one previously suggested.	Route calculations took priority conditions into consideration, but the same route was calculated.	This is not a malfunction.
A waypoint cannot be added.	Five waypoints are already set on the route, including ones that the vehicle has already passed.	A maximum of 5 waypoints can be set on the route. To go to 6 or more waypoints, perform route calculations multiple times as necessary.
The suggested route is not displayed.	Roads near the destination cannot be calculated.	Reset the destination to a main or ordinary road, and recalculate the route.
	The starting point and destination are too close.	Set a more distant destination.
	The starting point and destination are too far away.	Divide the trip by selecting one or two intermediate destinations, and perform route calculations multiple times.
	There are time restricted roads (by the day of the week, by time) near the current vehicle location or destination.	Set [Use Time Restricted Roads] to OFF.  "Route Settings" (page 6-43)
A part of the route is not displayed.	The suggested route includes narrow streets (roads displayed in gray).	This is not a malfunction.

## 8. Troubleshooting guide

Symptom	Possible cause	Possible solution
The part of the route that the vehicle has already passed is deleted.	A route is managed by sections between waypoints. If the vehicle passed the first waypoint, the section between the starting point and the waypoint is deleted (it may not be deleted depending on the area).	This is not a malfunction.
An indirect route is suggested.	If there are restrictions (such as one-way streets) on roads close to the starting point or destination, the system may suggest an indirect route.	Adjust the location of the starting point or destination.
	The system may suggest an indirect route because route calculation does not take into consideration some areas such as narrow streets (gray roads).	Reset the destination to a main or ordinary road, and recalculate the route.
The landmark information does not correspond to the actual information.	This may be caused by insufficient or incorrect map data.	Updated information will be included in the next version of the map data.
The suggested route does not exactly connect to the starting point, waypoints or destination.	There is no data for route calculation closer to these locations.	Set the starting point, waypoints and destination on a main road, and perform route calculation.



## 8. Troubleshooting guide

### VOICE GUIDANCE

Symptom	Possible cause	Possible solution
Voice guidance is not available.	Voice guidance is only available at certain intersections marked with  . In some cases, voice guidance is not available even when the vehicle makes a turn.	This is not a malfunction.
	The vehicle has deviated from the suggested route.	Go back to the suggested route or request route calculation again.
	Voice guidance is set to OFF.	Turn on voice guidance.
	Route guidance is set to OFF.	Turn on route guidance.
The guidance content does not correspond to the actual road conditions.	The content of voice guidance may vary, depending on the types of intersections at which turns are made.	Follow all traffic rules and regulations.

## 8. Troubleshooting guide

### TRAFFIC INFORMATION (if so equipped)

Symptom	Possible cause	Possible solution
Traffic information is not displayed.	Traffic information is not set to ON.	Set the traffic information to ON.
	The vehicle is in an area where traffic information is not available.	Scroll to an area where traffic information is available.
	The subscription to SiriusXM Traffic™ is incomplete, or the subscription to SiriusXM Traffic™ has expired.	Check the subscription status of SiriusXM Traffic™.
	The map scale is set at a level where the display of icons is impossible.	Check that the map scale is set at a level in which the display of icons is possible.  "Traffic information on map" (page 5-7)
With the automatic detour route search ON, no detour route is set to avoid congested areas.	There is no faster route compared to the current route, based on the road network and traffic information.	The automatic detour search is not intended for avoiding traffic jams. It searches for the fastest route taking into consideration conditions as traffic jams. Follow the current route. Also see "NOTES ON TRAFFIC INFORMATION" for further information.  "Notes on SiriusXM Traffic™ information" (page 5-13)
The route does not avoid a road section with traffic information stating that it is closed due to road construction.	The navigation system is designed not to avoid this event because the actual period of closure may differ from the declared roadwork period.	Observe the actual road conditions and follow the instructions on the road for a detour when necessary. If the road is closed, use the detour function and set the detour distance to avoid the road section that is closed.

## 8. Troubleshooting guide

### NISSANCONNECT® SERVICES (if so equipped)

Symptom	Possible cause	Possible solution
The system cannot connect to the NissanConnect® Services Data Center.	A subscription for the NissanConnect® Services has not been established.	Sign up for a subscription to the NissanConnect® Services. For details about subscriptions, contact the NissanConnect® Services support line at 1-855-426-6628.
	The communication line is busy.	Try again after a short period of time.
	The vehicle is in a location where it is difficult to receive radio waves.	When the vehicle moves to an area where radio waves can be transmitted sufficiently, communication will be restored. When the icon on the display shows that the vehicle is inside the communication area, the system can be used.
	TCU (Telematics Control Unit) is not turned on.	If the icon does not show that the vehicle is inside the communication area despite the fact that the vehicle is in that location, contact the NissanConnect® Services support line at 1-855-426-6628.
	Radio wave reception is not sufficient for TCU operation.	When the vehicle moves to an area where radio waves can be transmitted sufficiently, communication will be restored. When the icon on the display shows that the vehicle is inside the communication area, the system can be used.
Some of the items that are displayed on the menu screen cannot be selected.	The vehicle is being driven and some menu items are disabled.	The vehicle is being driven. Stop the vehicle in a safe location and apply the parking brake before operating the functions.
Some parts of the screen are not displayed.	The vehicle is being driven and some menu items are disabled.	Operate the system after stopping the vehicle in a safe location and applying the parking brake.
The system does not announce information.	The volume level is set to the minimum.	Adjust the volume level by operating <VOL/ON-OFF> located on the audio system or <- +> on the steering wheel while the system is announcing information.

## 8. Troubleshooting guide

### VOICE RECOGNITION

Symptom	Possible cause	Possible solution
The system does not operate or fails to interpret the command correctly.	The interior of the vehicle is too noisy.	Close the windows or make sure the other occupants are quiet.
	The fan speed of the air conditioner is too fast.	Decrease the fan speed of the air conditioner.
	The noise generated by driving the vehicle is too loud.	Reduce the vehicle speed, and then speak the command.
	The voice command is spoken in a low voice.	Speak the command in a louder voice.
	The command is spoken too fast.	Speak the command after confirming the following: Voice guidance is announced, a tone sounds, and an icon on the screen changes from white to orange.
	The command is spoken too slowly.	Speak in a natural voice without pausing between words.
The system prompts to repeat a command.	Pronunciation is unclear.	Speak clearly.
	The command is spoken too late after the tone.	Speak the command within 5 seconds after confirming the following: Voice guidance is announced, a tone sounds, and an icon on the screen changes from white to orange.
	An improper command is spoken.	Speak the command or a number that is displayed in white on the screen. Speak a command that is shown in the command list.
The system does not correctly recognize a number spoken.	Many numbers are spoken at once.	Place a pause between the appropriate digits for correct recognition by the system. When speaking a telephone number, place a pause between area codes and dial codes, etc.



## 8. Troubleshooting guide

Symptom	Possible cause	Possible solution
Voice recognition does not operate, and a tone sounds twice after < 𐄂 > is pushed.	< 𐄂 > is pushed before the system is ready to accept voice commands.	After turning on NissanConnect®, wait for the Voice Recognition System to be ready before giving voice commands.
The USB memory device cannot be operated with Voice Recognition.	Depending on the device, an iPhone® or iPod® may be recognized as a USB memory device.	This is not a malfunction.
	More than one audio device is connected to the USB connection port.	Only one audio device can be operated with the Voice Recognition System even when multiple numbers of devices are connected. Select an audio source to operate with the Voice Recognition System.
The USB/iPod® operation screen is grayed out.	The audio device is not connected.	Connect an audio device to the system.
	An audio source to be operated with the Voice Recognition System has not been selected.	Select an audio source to be operated with the Voice Recognition System.
An error message is displayed when trying to select a track and operate the USB/iPod®.	The track information is being processed for registration by the system.	Song information will be loaded into the system when a new audio device is registered for the first time or when the song information in the pre-registered device has been changed. Wait for the loading to complete (this may take from a few minutes up to an hour).
	The number of songs stored on the connected audio device exceeds its capacity.	Decrease the number of songs stored on the audio device.
	No song is stored on the audio device.	Store songs on the connected audio device. Storing songs with information such as artist name, album name, song name, and playlist, etc. will make Voice Recognition song search available.

## 8. Troubleshooting guide

Symptom	Possible cause	Possible solution
The Navigation item is not displayed in the voice operation menu screen.	Voice Recognition command preparation for the system is not completed immediately after the system is started.	Display any screen other than the Voice Recognition screen, and then push < ㄹ >.
The system does not correctly recognize a Point of Interest (POI) name spoken.	There are some rare cases where a POI is unavailable by Voice Recognition but the location can be found on the map.	This is not a malfunction. Consider using an alternative search method, like street address.
	Partial or alias name is spoken.	For best results, speak the full name.
	Some POI category names can only be searched when nearby.	This is not a malfunction.

**A**

- Additional system information..... 2-30
- Adjusting settings..... 2-14
- App Garage screen..... 5-25
- Audio accessories..... 2-11
- Audio jacks for wired headphones... 3-57
- Audio main buttons..... 3-14, 3-15
- Audio main operations..... 3-17
- Audio operation precautions..... 3-2
- Audio settings..... 3-39
- Audio source..... 3-17
- Audio system..... 3-1
- Audio system Steering wheel  
audio controls..... 3-16
- Auxiliary (AUX) devices..... 3-37

**B**

- Bluetooth® devices..... 1-5
- Bluetooth® Hands-Free Phone..... 4-1
- Bluetooth® information..... 4-12
- Bluetooth® settings..... 2-28
- Bluetooth® streaming audio... 3-13, 3-35
- Building graphics..... 6-6

**C**

- Canceling Route..... 6-35

- Changing map view..... 6-9
- Changing order of destination  
and waypoints..... 6-38
- Changing region..... 6-15
- Changing scale of map..... 6-8
- Clock settings..... 2-27
- Command list..... 7-7
- Compact Disc (CD) player..... 3-4, 3-24
- Compressed audio  
files (MP3/WMA/AAC)..... 3-9
- Connecting Bluetooth® device..... 2-28
- Connecting Bluetooth®  
Hands-Free Phone..... 4-3
- Connecting Bluetooth® streaming  
audio device..... 2-28
- Connecting cellular phone..... 2-28
- Connecting to Interactive  
Voice Menu..... 5-19
- Control buttons and touch  
screen display..... 2-2
- Control panel..... 2-3, 2-6, 2-7
- Controlling the rear system on the  
front display..... 3-61
- Current vehicle location..... 6-57
- Customer assistance..... 8-2

**D**

- Deleting stored item..... 6-51

- Destination screen..... 6-17
- Disc/USB memory device care  
and cleaning..... 3-42
- Display settings..... 2-23
- Display urgent traffic information..... 5-6
- Display View Bar..... 2-16
- Displaying current vehicle location.... 6-6
- Displaying information on map..... 6-14
- DVD player..... 3-5, 3-26

**E**

- Editing route..... 6-36
- Editing stored information..... 6-47
- Emergency support..... 5-22

**F**

- Favorites..... 4-12
- Finding address..... 6-20
- Finding nearby place..... 6-23
- Finding points of interest..... 6-20
- Functions disabled while driving..... 2-29

**G**

- Giving voice commands..... 7-2
- Guidance screen settings..... 6-33

## 9. Index

- H**
- Hands-Free phone..... 4-4
  - Hands-Free Text message..... 4-5
  - Headphones..... 3-55
  - How to display voice command screen..... 7-4
  - How to handle the Map SD card..... 6-65
- I**
- Information feeds..... 5-20
  - Information menu..... 5-2
  - iPod® player..... 3-32
- L**
- Language & Units settings..... 2-26
  - Language settings..... 2-25
  - Laser product..... 1-5
  - Legal disclaimer..... 1-6
  - Liquid crystal display..... 2-2
- M**
- Mail settings..... 4-11
  - Maintenance of display..... 2-2
  - Making a call..... 4-4
  - Map data..... 6-64
  - Map data authentication..... 6-3
  - Map menu..... 2-16
  - Map operation..... 6-4
  - Map types..... 6-4
  - Map view settings..... 6-11
  - Mobile Entertainment System (MES)..... 3-43
  - Mobile Entertainment System setting and information..... 3-60
  - Moving map..... 6-7
  - Multi-function controller..... 2-8
  - Multiple source display..... 3-63
- N**
- Navigation..... 6-1
  - Navigation settings..... 6-54
  - NissanConnect® Apps..... 5-25
  - NissanConnect® Services..... 5-14
  - NissanConnect® Services features..... 5-14, 5-17
  - NissanConnect® Services settings..... 5-24
  - NissanConnect® Vehicle Apps..... 5-25
  - Notes on SiriusXM Traffic™ information..... 5-13
- P**
- Pairing Bluetooth® device..... 2-28
  - Phone..... 4-4
  - Phone selection..... 4-4
  - Phone settings..... 4-9
  - Phonebook..... 4-11
  - Procedures after setting route..... 6-29
- R**
- Radio..... 3-2, 3-19
  - Rear displays..... 3-58, 3-63
  - Rear media interface..... 3-58
  - Recalculating route..... 6-38
  - Receiving a call..... 4-4
  - Receiving a message..... 4-6
  - Regulatory information..... 1-5
  - Remote controller..... 3-53
  - Route calculation..... 6-61
  - Route guidance..... 6-30, 6-62
  - Route guidance settings..... 6-40
  - Route menu screen..... 6-35
- S**
- Safety information..... 1-3, 6-3
  - Screen settings..... 2-23
  - Scrolling list or message..... 2-14
  - Searching for detour route using traffic information..... 6-39
  - Searching from history..... 6-24

- Searching from Stored Locations..... 6-23
  - Selecting audio source..... 3-17
  - Selecting item..... 2-14
  - Sending a text message..... 4-7
  - Setting by
    - NissanConnect® Services..... 6-27
    - Setting by phone number..... 6-26
    - Setting city center..... 6-26
    - Setting destination..... 6-15
    - Setting freeway entrance/exit..... 6-25
    - Setting from stored routes..... 6-26
    - Setting home as destination..... 6-22
    - Setting intersection..... 6-25
    - Setting point on map..... 6-28
  - Settings menu..... 2-20
  - Shortcut menu..... 2-15
  - SiriusXM Traffic™ information..... 5-4
  - SiriusXM® Travel Link..... 5-8
  - Split screen..... 6-9
  - Starting system..... 2-12
  - Start-up warning..... 2-12
  - Steering wheel mounted audio control buttons..... 3-16
  - Steering wheel switch..... 2-9
  - Storing avoid area..... 6-46
  - Storing home location..... 6-45
  - Storing location..... 6-45
  - Storing location/route..... 6-45
  - Storing route..... 6-46
  - Subscription to NissanConnect® Services..... 5-14
  - System settings..... 2-20
  - System status screen..... 2-15
- T**
- Text message..... 4-5
  - Text message settings..... 4-11
  - Touch panel..... 2-13
  - Trademarks..... 1-4
  - Traffic information on map..... 5-7
  - Traffic information settings..... 5-6
  - Transferring information to/from address book..... 6-53
- U**
- Updating All Information Feeds..... 5-21
  - USB (Universal Serial Bus)..... 3-8, 3-29
  - USB connection port and auxiliary input jacks..... 2-11
  - Using Destination Send to Car..... 6-28
  - Using Google send-to-car..... 6-28
  - Using Journey Planner..... 6-24

**V**

- Vehicle Apps..... 5-25, 5-29
- Vehicle settings..... 2-22
- Viewing available traffic information..... 5-4
- Viewing information feeds history..... 5-22
- Viewing SiriusXM® Travel Link..... 5-8
- Viewing traffic information..... 5-4
- Voice Prompt Interrupt..... 7-3
- Voice recognition settings..... 7-14
- Voice Recognition System..... 7-2
- Volume settings..... 2-24

---

**MEMO**

---

**MEMO**

---

**MEMO**



---

**MEMO**

---

**MEMO**



# PATHFINDER ARMADA

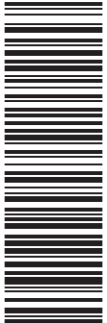

Printing : February 2019  
Publication No.: N19E SG5NJU1  
Printed in the U.S.A.

SG5NJ-N