

**MPA-10 / MPA-20 / MPA-200 /
MPA-1200 / MPA-10000**
Single Channel Electronic Pipette

MPB-200-8 / MPB-1200-8
Multi Channel Electronic Pipette



INSTRUCTION MANUAL



1WMPD4002874G

WARNING DEFINITIONS

The warnings described in this manual have the following meanings:

 DANGER	An imminently hazardous situation which, if not avoided, will result in death or serious injury.
 WARNING	A potentially hazardous situation which, if not avoided, could result in death or serious injury.
 CAUTION	A potentially hazardous situation which, if not avoided, may result in minor or moderate injury or damage to the instrument.
NOTE	Information or cautions to use the device correctly.

© 2015 A&D Company Ltd. All rights reserved.

No part of this publication may be reproduced, transmitted, transcribed, or translated into any language in any form by any means without the written permission of A&D Company Ltd.

The contents of this manual and the specifications of the instrument covered by this manual are subject to change for improvement without notice.

CONTENTS

CONTENTS	1
1. FOR SAFE USE	3
1-1 Precaution on the pipette use	3
1-2 Precautions on handling the battery	3
2. INTRODUCTION	4
3. FEATURE	4
4. COMPLIANCE	5
5. MPA / MPB FUNCTION	7
6. PACKING CONTENTS AND NAME OF ITEMS	8
7. PREPARATION BEFORE USE	10
7-1 Installing the battery.....	10
7-2 Recharging the battery	11
7-3 Exchange Selectable power plug	12
7-4 Before operating the pipette	13
7-5 Parts names and materials	14
7-6 Precautions before dispensing	15
8. NAME AND FUNCTIONS OF DISPLAY AND KEYS	16
8-1 Display and functions.....	16
8-2 Key switches and functions	17
9. FUNCTION AND HOW TO USE	18
9-1 Standard mode (AUTO).....	18
9-2 Multiple dispensing mode (MD)	19
9-3 Mixing mode (MIX)	22
9-4 System setting mode (SYS)	24
9-5 Program setting mode	26
9-6 Reverse operation (Dispensing liquid that tends to remain in the tip)	26
9-7 Blowout function	28
9-8 Total discharge function.....	29
9-9 “Pre-dispensing function” for multiple dispensing	29
9-10 Advanced dispensing jobs.....	29
10. PIPETTING FOR ACCURATE DISPENSING	30
11. CALIBRATING THE PIPETTE USING AN ELECTRONIC BALANCE	31
11-1 Volume calibration function (μL calibration function).....	31
11-2 Resetting the volume calibration.....	32
11-3 Dispensing in a unit of weight (in mg unit).....	33
11-4 Weight calibration function (mg calibration function)	34
12. ADJUSTING TIP EJECTOR HEIGHT	36
13. STORAGE AND MAINTENANCE	36

13-1	Replacing the lower part	36
13-2	Cleaning the tip holder.....	37
13-3	After maintenance performance check	38
13-4	Autoclave	39
14.	TROUBLE SHOOTING	39
15.	WHEN REQUESTNG REPAIRE.....	41
16.	SPECIFICATIONS	42
17.	LIST OF ITEMS SOLD SEPARATELY (DISPOSABLE ITEMS)	44
17-1	Stands and hanger.....	44
17-2	Tips, tip boxes and the filter	45
17-3	Disposable items (User replaceable).....	47
17-4	Inspection equipment.....	48

1. FOR SAFE USE

1-1 Precaution on the pipette use

DANGER

- This instrument is not an explosion proof instrument. Do not use the pipette in an environment where there is a risk of explosion, or use it for explosive chemicals that may cause explosion.
- When using potentially harmful solutions, such as infectious bacteria or viruses, radioactive substances that have a risk of exposure, or poisons, exercise extreme caution and follow all safety measures.

CAUTION

- Please refer to “7-5 Parts names and materials” and “17-2 Tips, tip boxes and the filter” for compatibility when organic solvents or corrosive solutions are to be dispensed.
- Do not attempt to disassemble or repair the pipette by yourself. Refer to “14. TROUBLE SHOOTING” when it appears that the pipette has a mechanical error.

1-2 Precautions on handling the battery

The MPA / MPB series use the high-density lithium-ion battery.

To prevent injuries or accidents due to a leaking battery, heat generation, fire or burst, and to ensure safe use, be sure to keep the manual on hand.

DANGER

- Do not dispose of the battery in fire, do not heat it, do not disassemble or modify it.
- Do not splash water on the battery, or do not keep the battery in a location at high temperature or high humidity.
- Do not allow battery contacts to contact metal. When keeping or carrying the battery, be sure not to allow the battery to contact metal.

WARNING

- Recharge the batteries with pipette installed. The pipette can be used even when the battery is being recharged.
- When recharging is unsuccessful even after charging for the specified time (Five hours up to fully recharged), stop recharging a battery.
- Use only the supplied with the pipette. Do not use other batteries.

CAUTION

- Do not use a leaking battery.
- Because the battery body may become hot when using the pipette continuously for a long time, take care not to get burned when handling it.
- Should you get battery fluid from a leaking battery in your eye, immediately flush with copious amounts of water and seek immediate medical attention.
Should the liquid contact the clothes or skin, rinse immediately with copious amounts of water.

2. INTRODUCTION

Thank you very much for purchasing the single channel electric pipette MPA series and multichannel electric pipette MPB series. be sure to thoroughly read this manual in order to use the product safely and correctly.

3. FEATURE

The MPA / MPB series is a high precision and performance electronic pipette that achieves operability without putting a burden on the hand.

This pipette is developed for the purpose to prevent RSI (Repetitive Strain Injury) which may occur when repeatedly using a manual pipette, and does not require any special skill so anyone can easily and accurately dispense the specified volume.

- Pipette is operated by merely pressing a key, the degree*1 of fatigue is 1/100 or less of when using pipette manually. (*1 Calculated by operating force and movement)
- It has an ergonomic design, fitting the hand for easy adjustments and operation.
- Using a lithium-ion battery enables usage for long periods of time.*2
(*2 Refer to “16. SPECIFICATIONS”)
- Impact-absorbing pads adopted to fully protect against falling. (Patent pending)

4. COMPLIANCE

Compliance with FCC Rules

Please note that this device generates, uses and can radiate radio frequency energy. This device has been tested and has been found to comply with the limits of a Class A computing device pursuant to Subpart J of Part 15 of FCC rules. These rules are designed to provide reasonable protection against interference when this device is operated in a commercial environment. If this unit is operated in a residential area, it may cause some interference and under these circumstances the user would be required to take, at his own expense, whatever measures are necessary to eliminate the interference. (FCC = Federal Communications Commission in the U.S.A.)

Compliance With EMC Directives of CE mark

CE This device features radio interference suppression , safety regulation and restriction of Hazardous Substances in compliance with the following Council Directives

Council directive 2004/108/EC	EN61326	EMC directive
Council directive 2006/95/EC	EN61010-1	Low voltage directive
Council directive 2011/65/EU	EN50581	Restriction of the use of certain Hazardous Substances

The CE mark is an official mandatory European marking.

Please note that any electronic product must comply with local laws and regulations when sold or used anywhere outside Europe.



A & D Instruments Ltd. hereby declare that the following Weighing product conforms to the requirements of the council directives on ...

**Electromagnetic Compatibility (EMC) 2004/108/EC,
Low Voltage Equipment (LVD) 2006/95/EC amended by 93/68/EEC and
Restriction of the use of certain Hazardous Substances (RoHS) 2011/65/EU**

provided that they bear the CE mark of conformity.

Model/Series....MPA Series

Standards applicable:

EN61326-1:2013

Electrical equipment for measurement, control and laboratory use -EMC requirements Part 1: General requirements

EN-61010-1:2010

Safety requirements for electrical equipment for measurement, control, and laboratory use. General requirements

EN-61010-2-101:2002

Safety requirements for electrical equipment for measurement, control and laboratory use. Particular requirements for in vitro diagnostic (IVD) medical equipment

EN-50581:2012

Technical documentation for the assessment of electrical and electronic products with respect to the restriction of hazardous substances

CE Mark first applied 30th May 2014

Signed for A&D Instruments in Oxford England 18th June 2014

P. Argus
Managing Director

5. MPA / MPB FUNCTION

- The pipette has three modes where advantages of electromotion are utilized. (Refer to “9. FUNCTION AND HOW TO USE”)
 - Standard mode (AUTO)
This is for basic pipette operation. In this mode, the pipette aspirates once and then dispenses once.
 - Multiple dispensing mode (MD)
This is for dispensing liquid on a microplate, etc. In this mode, the pipette aspirates once and dispenses several times.
 - Mixing mode (MIX)
This is a useful operation when uniformly mixing liquids of different types. In this mode, the pipette repeats a cycle of aspirating and dispensing.
- User setting allows storage within the pipette of up to nine programs containing operating mode and dispensed volume. By reading them out when necessary, operation for setting again can be omitted. Settings from the prior use are stored in memory even with the power turned off.
- The pipette is equipped with the reverse operation suitable for dispensing a liquid that has a tendency to remain in the tip. (Refer to “9-6 Reverse operation (Dispensing liquid that tends to remain in the tip)”)
- The pipette also has “Dispensing correction function” (Patent applied for) with multiple dispensing to cancel errors due to backlash. It enables the dispensing of liquids precisely without difference due to operators. (Refer to “9-9 “Pre-dispensing function “ for multiple dispensing”)
- Various kinds of tips can be used. (The height of the tip ejector can be adjusted) (Refer to “12. ADJUSTING HEIGHT OF THE TIP EJECTOR”)
- Calibration (adjustment) of dispensed volumes is easy. (User CAL function). Even differences in dispensed amounts due to tip differences can be corrected. (Refer to “11-1 Volume calibration function (μL calibration function)” (Patent applied for)
- Dispensing by weight is also available. Refer to “11-3 Dispensing in a unit of weight (in mg unit)” (Patent applied for)

6. PACKING CONTENTS AND NAME OF ITEMS

Confirm that the following contents are all included.

- Electronic pipette MPA-10 / 20 / 200 / 1200 /10000
MPB-200-8 / 1200-8
(Any one among them)
- Accessories
 - (1) Battery (1 pc)
 - (2) The AC adapter (Combined use for charging) (Switching with AC100V to 240V)
Selectable power plug (A / BF / C / S type)
* AC adapter has the A type AC adapter plug attached.
Use AC adapter plug for AC adapter to match local outlet.

Note

Please confirm that the AC adapter type is correct for your local voltage and receptacle type.

- (3) Power cable (USB cable: Mini B plug - A plug)
- (4) Instruction manual (This document)
- (5) Quick operation guide
- (6) Performance certification (Pipette Accuracy Test Result)
- (7) Pipette tip
 - MPA-10/20/200/1200
For 10/20 μ L (1 pc), for 200 μ L (1 pc), for 1200 μ L (1 pc)
 - MPA-10000
For 10mL (1 pc), Filter(1 pc)

(The filter comes fitted in the pipette.)
 - Tips are not included with the MPB.
- (8) Name sticker (The pipette has a location in the battery compartment for affixing the name sticker.

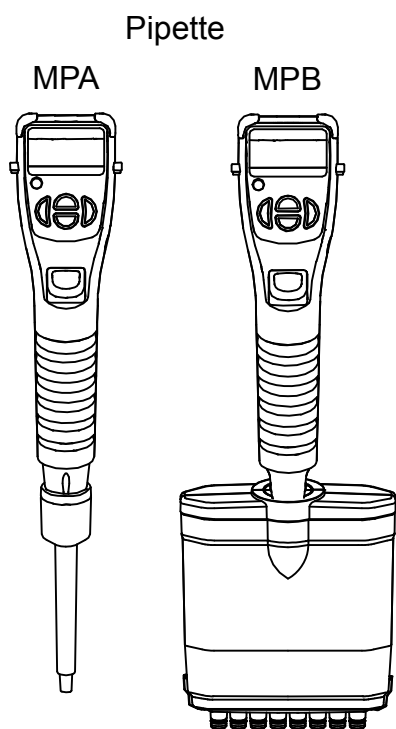

(1) Battery



(2) AC adapter *

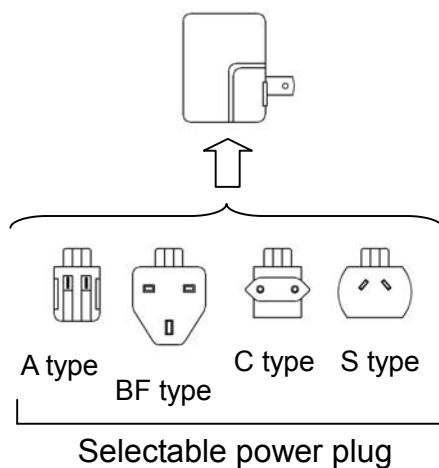

(3) Power cable



(7) Pipette tip (1pc of each) *

(4) Instruction manual

(5) Quick operation guide

(6) Performance certification

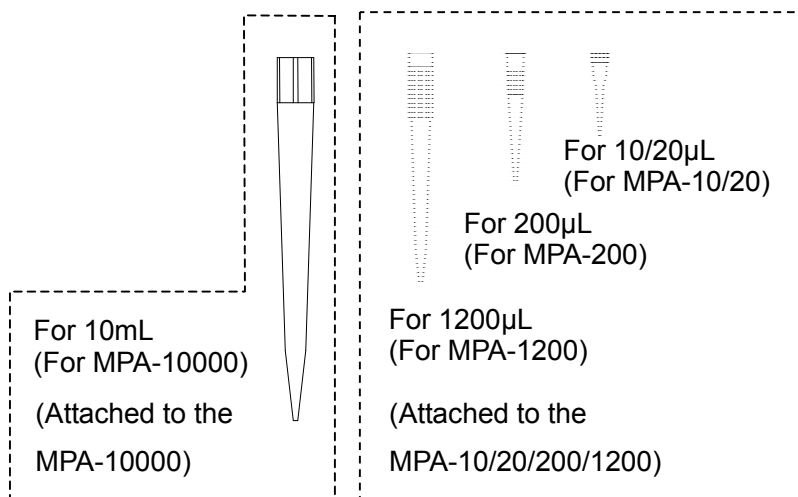
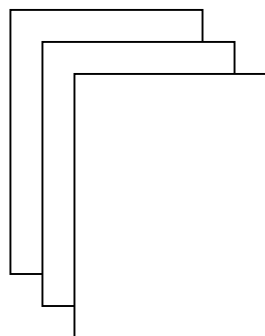

(8) Name sticker



* Tips are not included with the MPB.

Should the pipette arrive damaged or an accessory be missing, contact the nearest A&D dealer.

Note

The accessories included with this product may be changed without notice.

7. PREPARATION BEFORE USE

7-1 Installing the battery

1. Remove the battery cover (2) by sliding it upward while pressing and holding the battery cover release button (1).
2. Connect the terminal of the battery's cable, as shown in the figure below, to the connector for the battery in the bottom of the battery compartment. When connecting the terminal, be sure it is connected in the proper direction.
3. Install the battery so that the battery cable is in the cable guide.
4. Attach the battery cover on the pipette by sliding it downward from the upside.

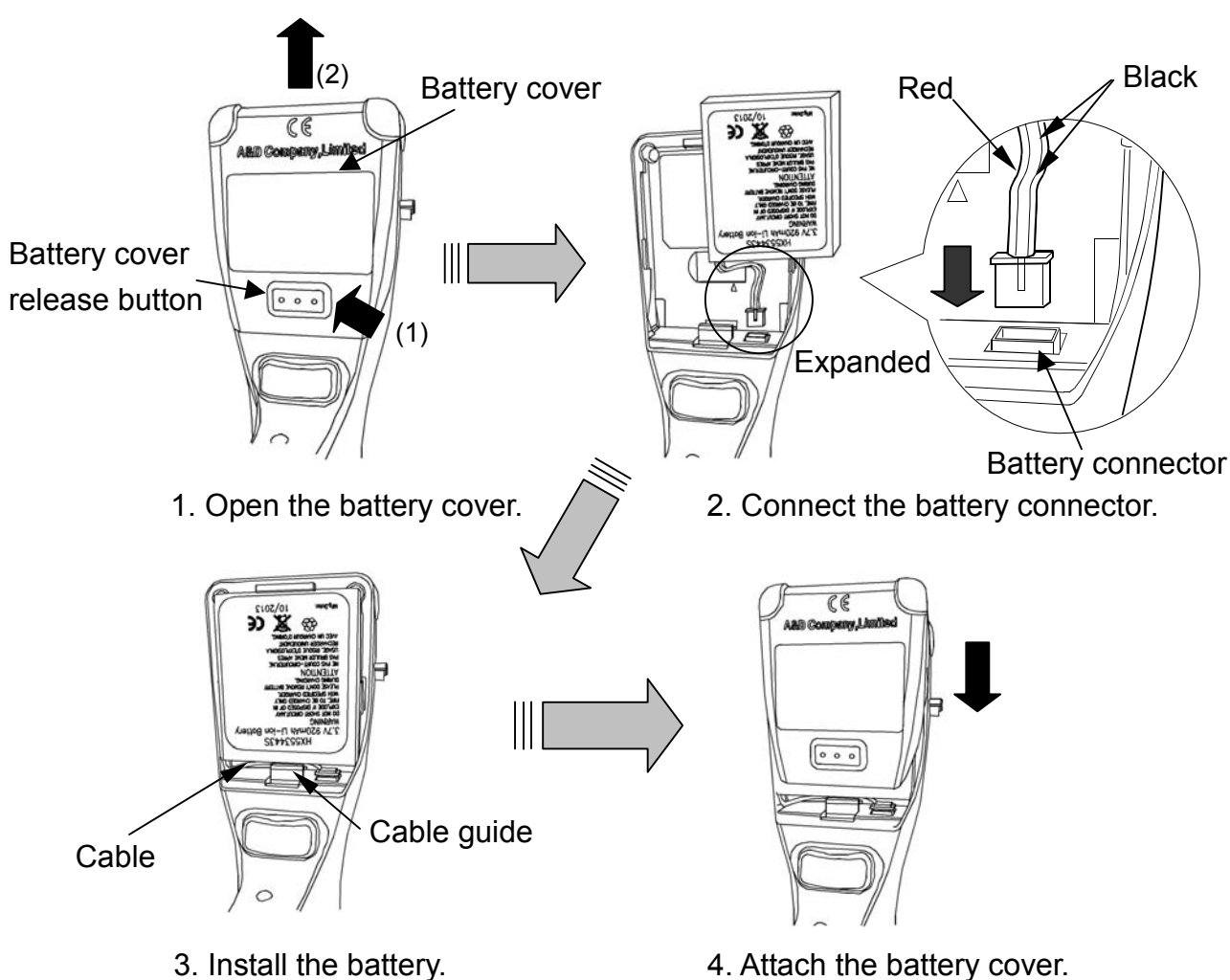

Note

When connecting the battery to the pipette, all illuminations on the display illuminate and the pipette built-in piston automatically goes to the initial default position. If a key is pressed, the pipette goes into the operating mode.

7-2 Recharging the battery

When purchasing the instrument, the battery does not have a full charge. For initial use, first charge the battery fully. Recharge the battery with the battery installed in the pipette. Pipette use is available during recharging.

Recharging

1. Remove the power connector cover from the pipette.
2. Connect the power cable connected to the AC adapter to the power connector on the pipette.
3. Connect the AC adapter plug to the outlet. The battery mark  will be displayed on LCD of the pipette, and it will blink during recharging. If connecting the power cable to the outlet before setting the battery in the pipette, please note that the recharging will not start. When the recharging is complete, the battery mark changes from blinking to a steady illumination, then the recharging completes automatically. (About five hours)

NOTE:

After recharging the battery completely, remove the power cable from the pipette. Firmly attach the power connector cover by pushing it onto the pipette.

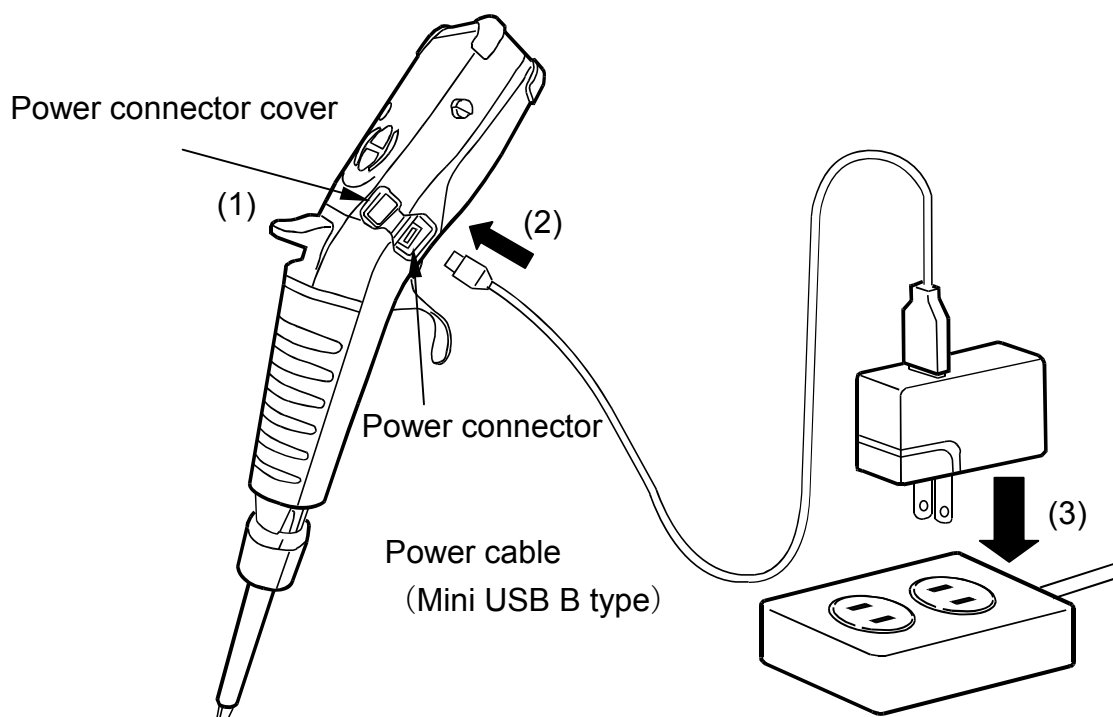

—How to use the charging stand (sold separately)—

Pipettes can be charged by hooking onto one of the following devices mentioned in “17-1 Stands and hanger”: charging stand for single MPA, charging stand for four MPAs, charging hanger.

Consult the instruction manual for each device for more details.

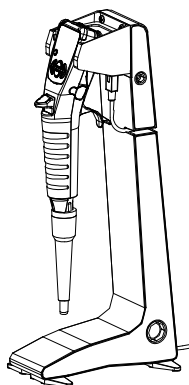

Charging stand for single MPA

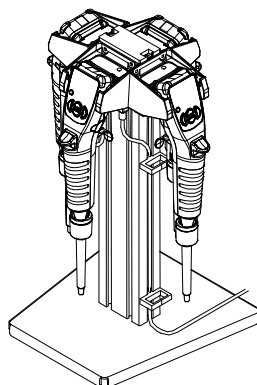

Charging stand for four MPAs

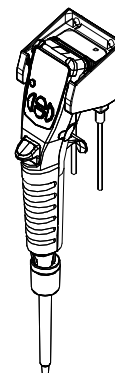

Charging hanger

7-3 Exchange Selectable power plug

The A-Type power supply plug is originally attached to the AC adapter, Please change the power supply plug to the one that suits your location.

Exchange method

1. As shown, remove the power supply plug from the AC adapter.
2. As shown, put on the power supply plug that you want to use.

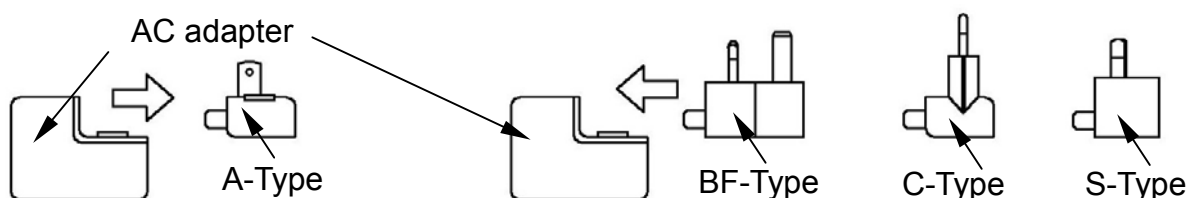



1. Remove the power supply plug.

2. Put on an appropriate power supply plug.

7-4 Before operating the pipette

Holding the pipette

- Hold the pipette so that the finger hook is between a forefinger and middle finger.
- To aspirate or dispense a liquid, operate the  Operation key or the  Up key below the display. Operate the  Operation key using the forefinger, as shown in the figure below.
- Operate the eject button by using the thumb to remove the tip.

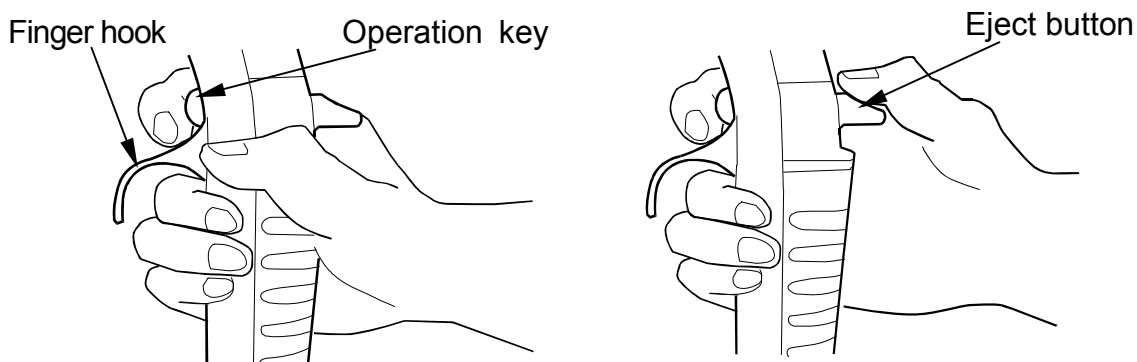

Operating mode and standby mode

- The pipette goes into standby mode to reduce the battery wasting to minimize battery use if the pipette is idle for 10 minutes.
- When off, the pipette can be returned to the operation mode by pressing any key, and information such as setting volume will be displayed on the display (Refer to example of the display), enabling dispensing. At this time, the pipette automatically positions the built-in piston to the initial default position.
- While in the operating mode, holding down the  Operation key for approx. five seconds will turn the pipette off.

Operation

Turning the power off manually

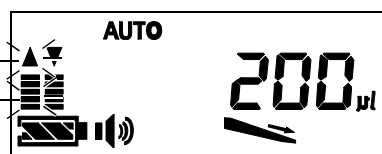

(The display is example.)

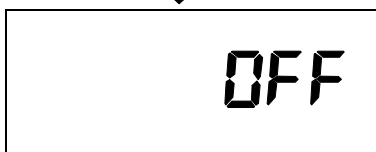

Press and hold the  Operation key on the pipette for at least five seconds until OFF is displayed on the display. Buzzer sounds (Three times), and the pipette turns the power off (OFF).

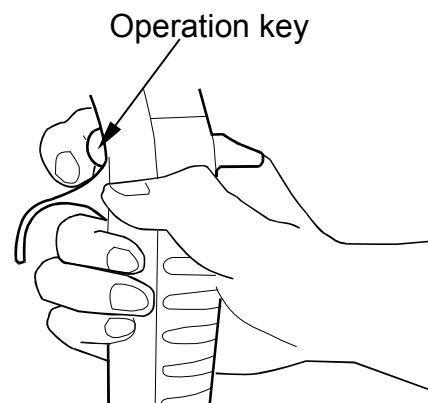

7-5 Parts names and materials

The following shows the each name of electronic pipette

When confirming LCD, refer to “8-1 Display and functions” for details.

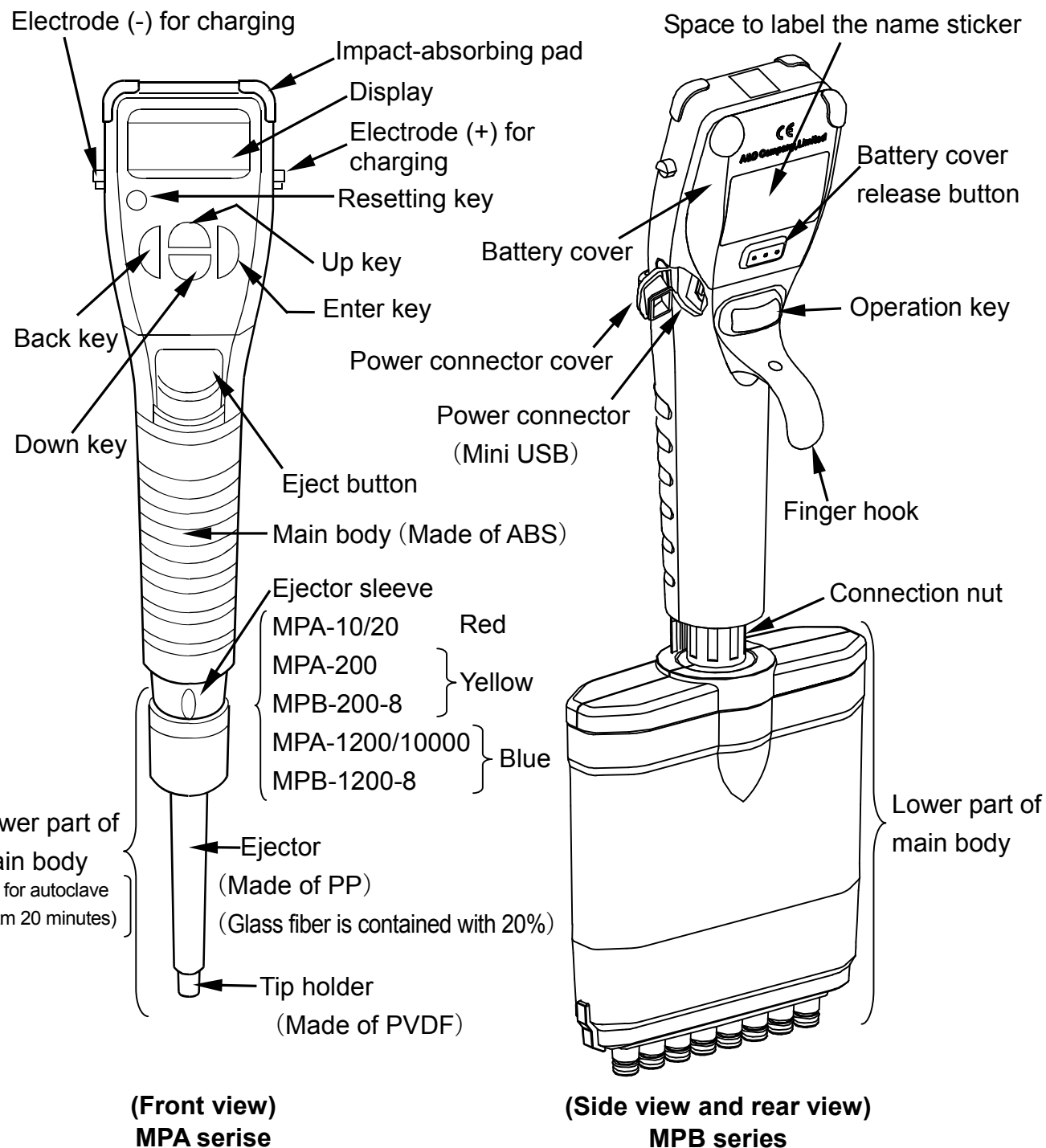

7-6 Precautions before dispensing

- 1) Before dispensing any material ensure the power is on. If power is switched on when tip is submerged in a liquid the piston will return and the tip holder will become wet.
- 2) Precautions for using the MPA-10000
 - To prevent liquid from touching the tip holder be sure to attach the MPA-10000 filter to the tip holder.

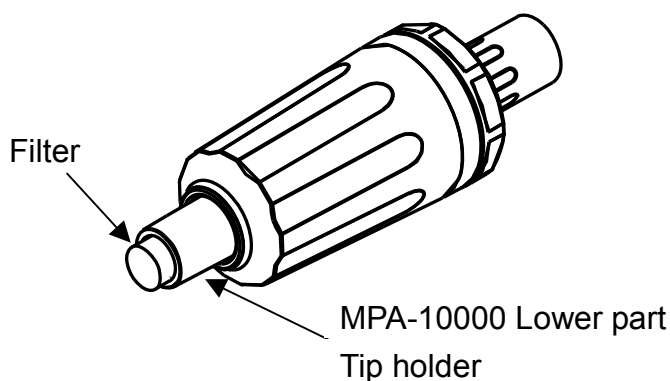

- When removing the tip be sure not to twist as the assembling screw in the lower part may become loose.
- 3) If the tip cannot be removed via the eject button consult "12 ADJUSTING TIP EJECTOR HEIGHT "
 - 4) Changing the number of MPB channels

The MPB can be used with 1 to 8 channels depending on the number of cylinder units installed.
Please refer to 13. Storage and maintenance for how to remove the cylinder unit.

Example with 4 channels

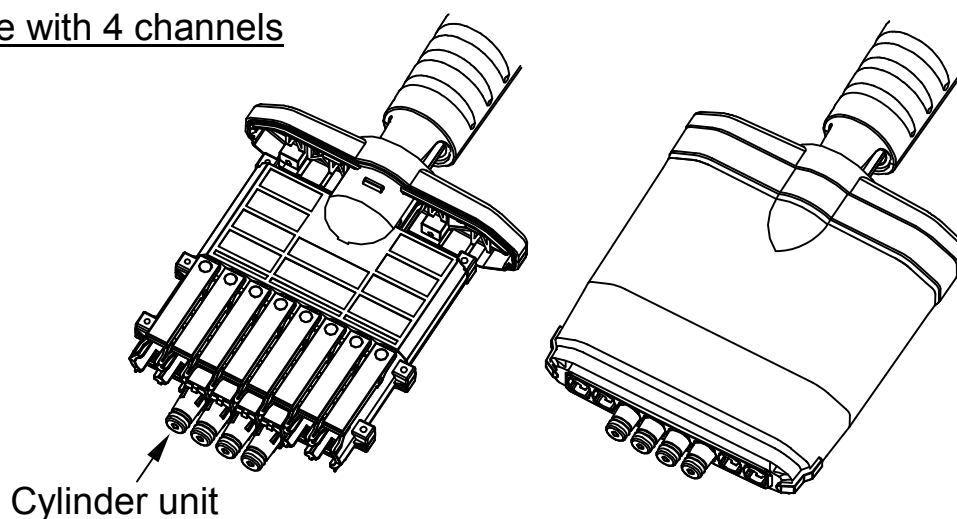





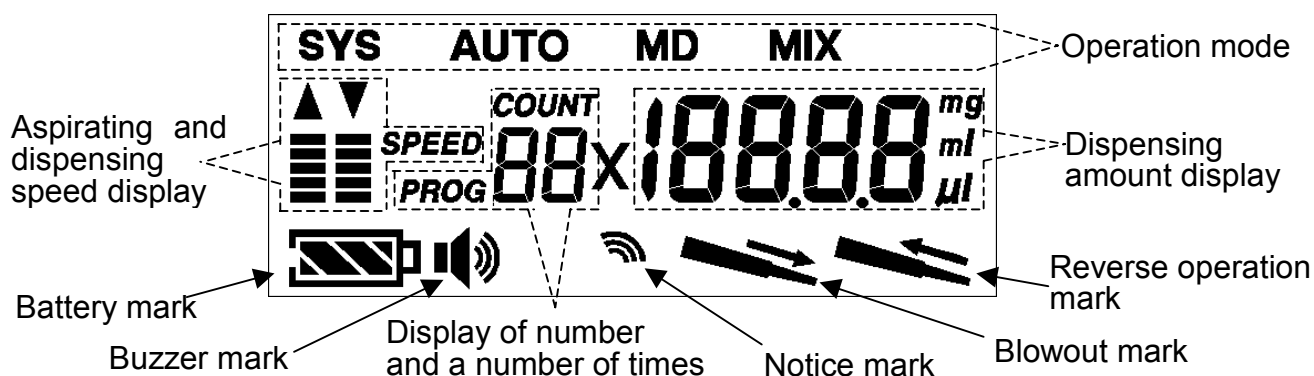

8. NAME AND FUNCTIONS OF DISPLAY AND KEYS







8-1 Display and functions





	Symbols	Descriptions	
Operation mode display	SYS	System setting mode	Used to set up functions before pipetting, such as aspirating/dispensing speed, reverse operation, etc. (Refer to "9-4 System setting mode (SYS)".)
	Shows the operation mode when operating the pipette.		
	AUTO	Standard mode	(Refer to "9-1 Standard mode (AUTO)".)
	MD	Multiple dispensing mode	(Refer to "9-2 Multiple dispensing mode (MD)".)
	MIX	Mixing mode	(Refer to "9-3 Mixing mode (MIX)".)
Dispensing amount display	188.88 ^{mg} / _{ml} / _{ul}	Shows the setting value of the dispensing amount. Displays in μ L, mL, or mg	
Blowout mark		Shows whether the blowout is enabled or disabled. (Refer to "9-7 Blowout function".)	
Reverse operation mark		Shows reverse operation. (Refer to "9-6 Reverse operation (Dispensing liquid that tends to remain in the tip)".)	
Display of number and a number of time	COUNT PROG 88X	COUNT : Shows the number of times the same operation is to be carried out. PROG : Shows the stored number of user setting. (Refer to "9-5 Program setting mode".)	

	Symbols	Descriptions
Aspirating and dispensing speed display		Shows the speed level when aspirating or dispensing the liquid. ▲ blinks when aspirating, ▼ blinks when dispensing (Refer to "9-4 System setting mode (SYS)".)
Notice mark		When illuminated: Shows that volume calibration has been carried out. When flashing: Shows that weight mode for dispensing (mg) has been selected. (Refer to "11-3 Dispensing in a unit of weight (in mg unit)".)
Buzzer mark		Shows the buzzer is to sound or not. (Refer to "9-4 System setting mode (SYS)".)
Battery mark		Shows the battery status.  Charging amount: Full  Charging amount: Low (Recharge the battery using AC adapter.)  During charging

8-2 Key switches and functions

Keys	Symbols	Functions and descriptions
Setting keys	Enter key 	Confirms the setting content.
	Back key 	Changes the mode or cancels it.
	Up key 	Increases the volume and setting value. Changes items (Mode).
	Down key 	Decreases the volume and setting value. Changes items (Mode).
Resetting key		Stops dispensing a liquid and returns the built-in piston to the initial default position. By pressing the Resetting key, all illuminations illuminate. After that, the pipette returns to the operating mode if any key is pressed.
Operation key		Starts aspirating and dispensing. Discharges all the liquid left in the tip when held down in the middle of multiple dispensing. Puts the pipette in standby mode when held down further.

Useful use method: The  Operation key (key switch on rear side on the pipette) has the same function as the  Up key. This allows you to quickly perform settings such as changing the volume without shifting the pipette in the hand.

9. FUNCTION AND HOW TO USE

The MPA / MPB series have three modes, the standard mode (AUTO), multiple dispensing mode (MD) and the mixing mode (MIX).

9-1 Standard mode (AUTO)

1) Operating the standard mode

This is a basic operation for pipetting. Aspirating one time and dispensing one time.
This operation is the same as for a manual pipette.

2) Selecting the standard mode

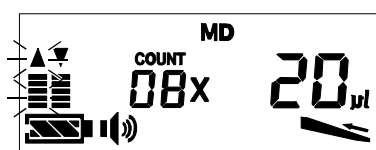

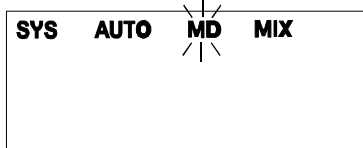

(The display is example.)

[1] Press the  Back key.

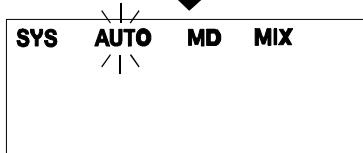

[2] Press the  Up or Down key to select "AUTO".



[3] Press the  Enter key to select standard mode (AUTO).



[4] Press the  Up or Down key to change to volume that you would like to dispense.

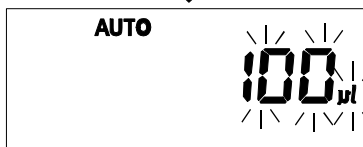

[5] Press the  Enter key to confirm dispensing amount.

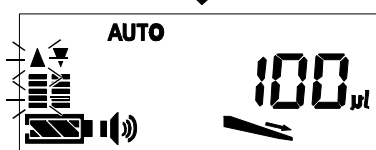

If you would like to change the dispensing amount, Press the  Enter key before aspirating.

When setting, operate from step 4 as described above.

3) Operating the standard mode

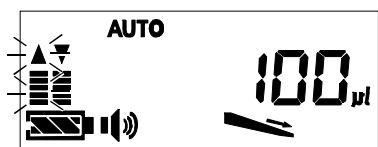

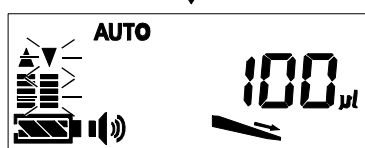
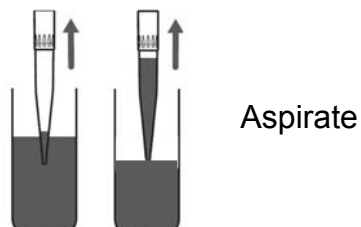

- [1] Put the tip end into the liquid to be dispensed and press the  Operation key on the pipette to aspirate the liquid.

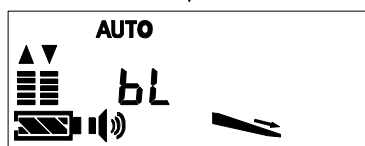
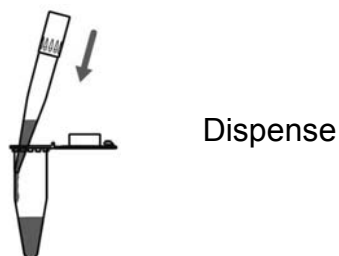

- [2] Put the tip end into the receiving vessel and press the  Operation key on the pipette to dispense the liquid.



- [3] Press the  Operation key on the pipette to dispense the liquid remaining in the tip.
(When the blowout function is ON ().)

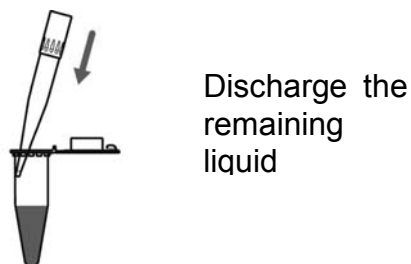

9-2 Multiple dispensing mode (MD)

1) Operation of the multiple dispensing mode

This is a suitable function to dispense the same liquid continuously, such as when dispensing a liquid on a microplate, etc. The operation consists of aspirating one time and dispensing several times.

When carrying out pre-rinse for multiple dispensing or stopping multiple dispensings, use the total discharge function. (Refer to “9-8. Total discharge function”)
 Minimum dispensing amount and maximum dispensing count for multiple dispensing mode is as follow.

MODEL	Minimum dispensing amount	Maximum dispensing count
MPA-10	0.3 μ L	33 times
MPA-20	0.3 μ L	66 times
MPA-200	3 μ L	66 times
MPA-1200	15 μ L	80 times
MPA-10000	0.1mL	99 times
MPB-200-8	3 μ L	66 times
MPB-1200-8	15 μ L	80 times

2) Selecting the multiple dispensing mode

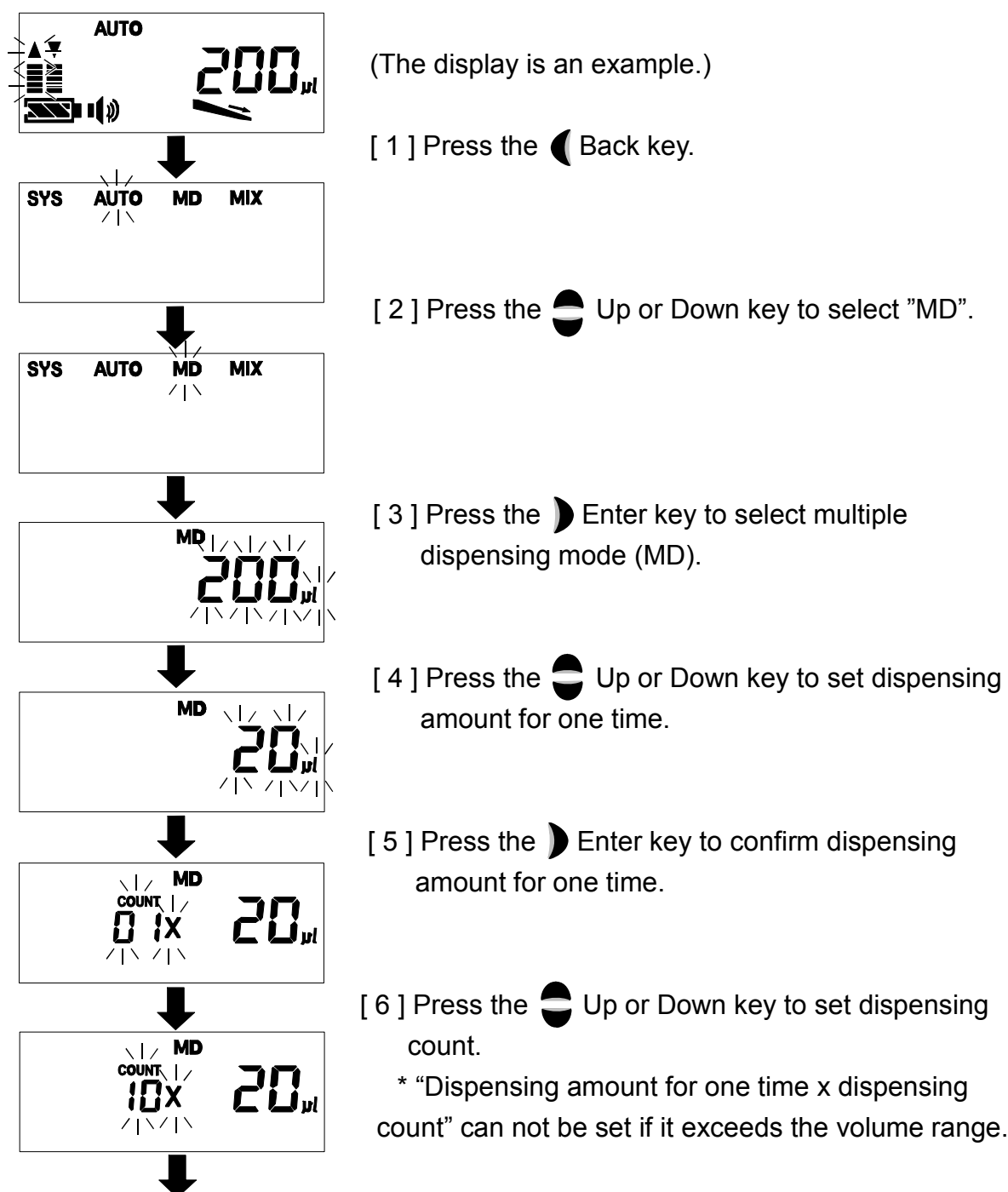

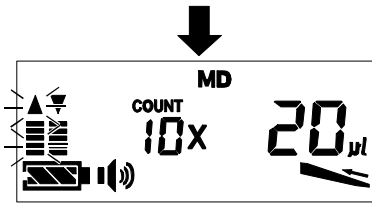

[7] Press the  Enter key to confirm the dispensing count.

If you would like to change dispensing amount or dispensing count, press the  Enter key before starting aspiration.

When setting, operate from step 4 described above.

3) Operating the multiple dispensing mode

The following example is when dispensing 20µL x 10 times.

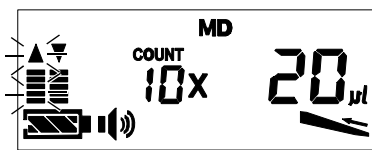

[1] Put the tip end into the liquid to be dispensed and press the  Operation key on the pipette to aspirate the liquid.
(The example shows 20µL x 10 times = approx. 200µL)

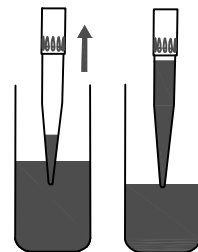
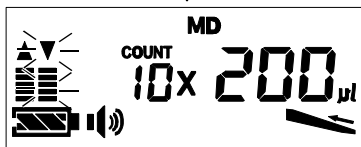

Aspirate

[2] Put the tip end into a receiving vessel and press the  Operation key on the pipette to dispense the amount for one time.

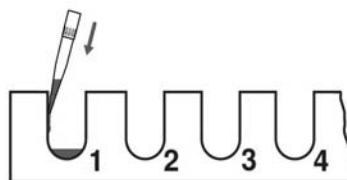
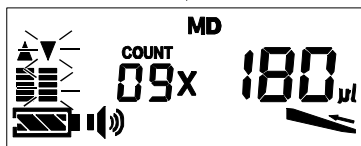

Dispense

[3] In a similar manner, put the tip end into the next vessel and press the  Operation key to dispense the liquid.

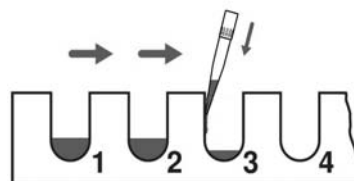
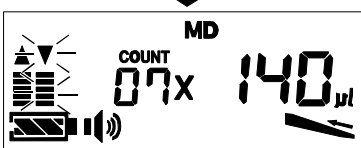

Dispense

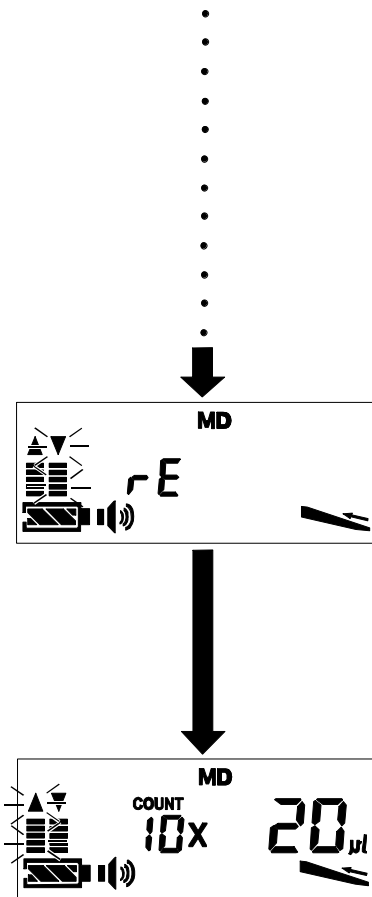

[4] Repeat the operation described above with the dispensing count set.
 When the set count of dispensing operations is completed a buzzer will sound twice.
 (In the example, the buzzer sounds twice after 10 dispensing operations have been completed)

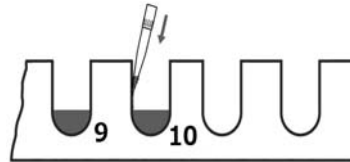

[5] Press the  Operation key on the pipette to discharge the remaining liquid.
 (In the multiple dispensing mode, reverse operation occurs automatically.)



Discharge the remaining liquid

9-3 Mixing mode (MIX)

1) Operation of the mixing mode

This is a useful operation when uniformly mixing different types of liquids. In this method, aspirating and dispensing are repeated. This type of repetitive operation often results in fatigue, but with this pipette it is automatically carried out with the touch of one switch.

2) Selecting the mixing mode

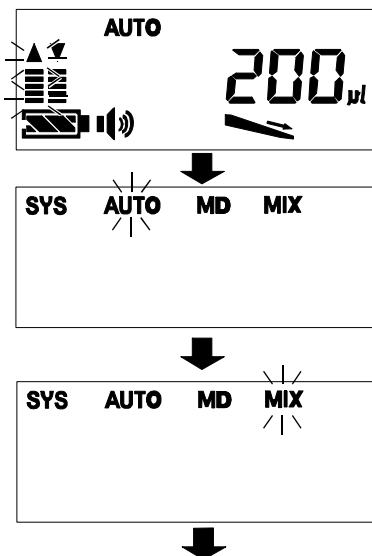



(The display is example.)

[1] Press the  Back key.

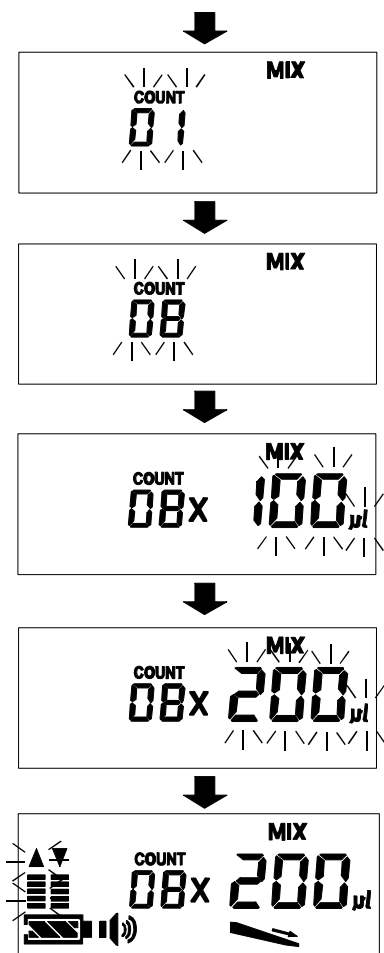
[2] Press the  Up or Down key to select "MIX".





[3] Press the  Enter key to select mixing mode (MIX).

[4] Press the  Up or Down key to set mixing count (One set with aspirating and dispensing).
* Ten times maximum

[5] Press the  Enter key to confirm mixing count.

[6] Press the  Up or Down key to set mixing volume (Volume for aspirating when mixing).

[7] Press the  Enter key to confirm mixing volume.

If you would like to change the mixing count or amount, press the  Enter key before aspirating.

When setting, operate from step 4 described above.

3) Operating the mixing mode

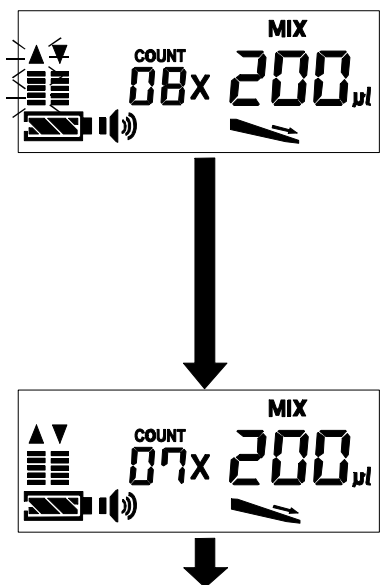

[1] Insert the tip end in the liquid to be mixed.

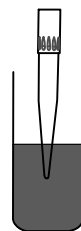

[2] Press the  Operation key on the pipette to aspirate the set mixing volume.



Aspirating of mixed

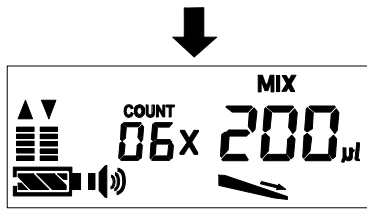

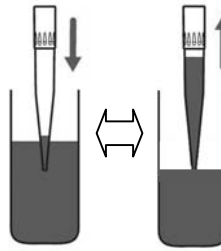

[3] The pipette executes the set count of aspirating-dispensing cycles while leaving approximately 1/3 of the set mixing volume in the tip.

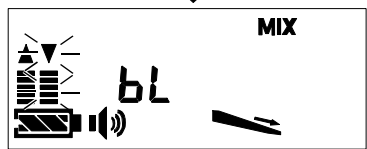
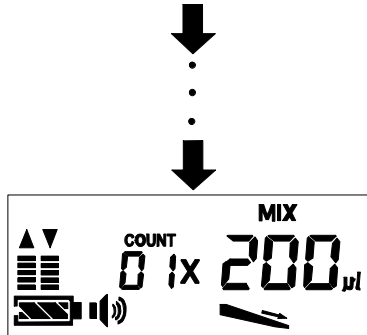

Dispensing to absorption
Repeat with mixing count set.



[4] Press the  Operation key on the pipette to dispense the liquid remaining in the tip.
(When the blowout function is ON () .)

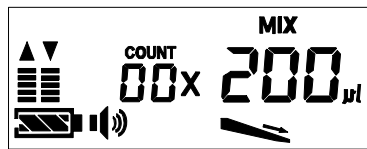

[5] One mixing operation is completed once the aspirated liquid is completely discharged.
When the operation is completed a buzzer sounds twice.

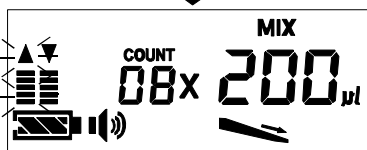

9-4 System setting mode (SYS)

The SYS mode is used to perform or read out pipetting operation settings that suit the purpose or the liquid to be handled.

2) Operating the system setting mode

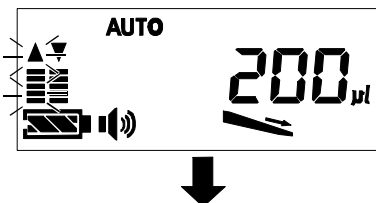

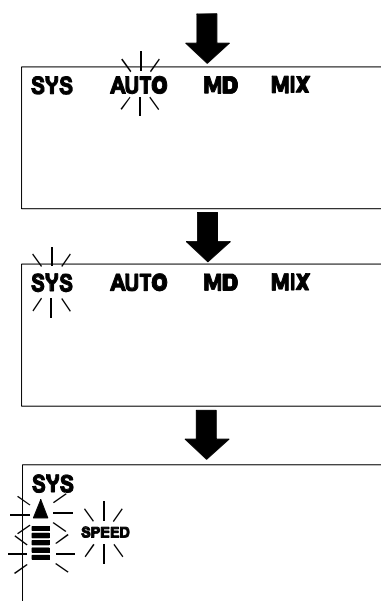

(The display is example.)

[1] Press the  Back key.















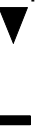

[2] Press the  Up or Down key to select “SYS”.

[3] Press the  Enter key to enter the system setting mode.

[4] By pressing the  Up or Down key, change the setting of each item, and press the  Enter key to confirm it.

2) Item of the system setting mode

Display of the each item and setting contents

Functions	Displays	Setting contents
Aspirating speed	 SPEED	High speed  Low speed 
Dispensing speed	 SPEED	High speed  Low speed 
Buzzer		On
		Off
Blowout		On
		Off
Reverse operation *3		Off
		On
Program memory	PROG  	Nine programs between 01 and 09 are available for the “   “. (Read out your preferred program from the programs previously set.)

*3 The reverse operation is only selectable when blowout setting is off. It cannot be selected when the pipette is in MIX mode, either.

9-5 Program setting mode

The nine programs can be saved in the program memory built into the pipette (PROG 01 to 09). By saving a frequently used mode or volume for operation beforehand, these setting can easily be read out from the next use. Select and set the mode or volume to be saved before saving the program setting.

Saving the program setting

Set the pipette to your preferred settings.

Example: When saving the AUTO mode, dispensing volume 200 μ L, buzzer ON and blowout ON

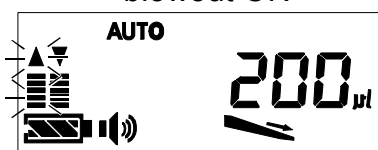

(The display is example.)

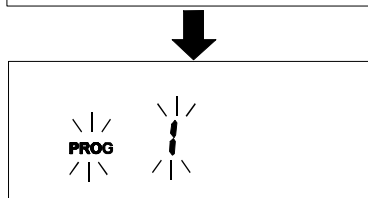

[1] Press and hold the  Down key to enter program setting saving mode.

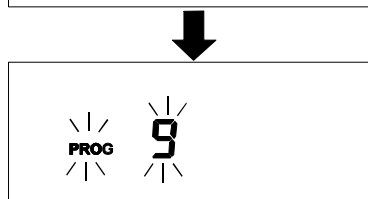

[2] Press the  Up or Down key to select program number to be save from 1 to 9.

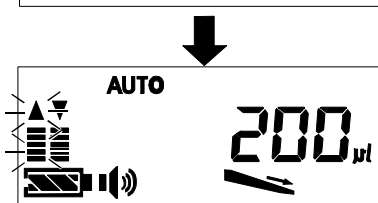

[3] Press the  Enter key to save the setting. Once these have been saved a buzzer will sound once.

Reading out the program setting

The set program can be read out at system setting mode (SYS).
(Refer to “9-4 system setting mode (SYS)” for details)

9-6 Reverse operation (Dispensing liquid that tends to remain in the tip)

When you would like to accurately dispense a viscous liquid that has a tendency to remain in the tip, we recommend using the reverse operation. By aspirating a large amount of the liquid beforehand, the reverse operation enables the correction of the amount of liquid remaining in the tip. Additionally, if the aspirating/dispensing speed is slowed air-mixing can be prevented.

To enable reverse operation, set the setting of  at system setting mode (SYS).
(Refer to “9-4 System setting mode (SYS)”.)

1) Setting the reverse mode

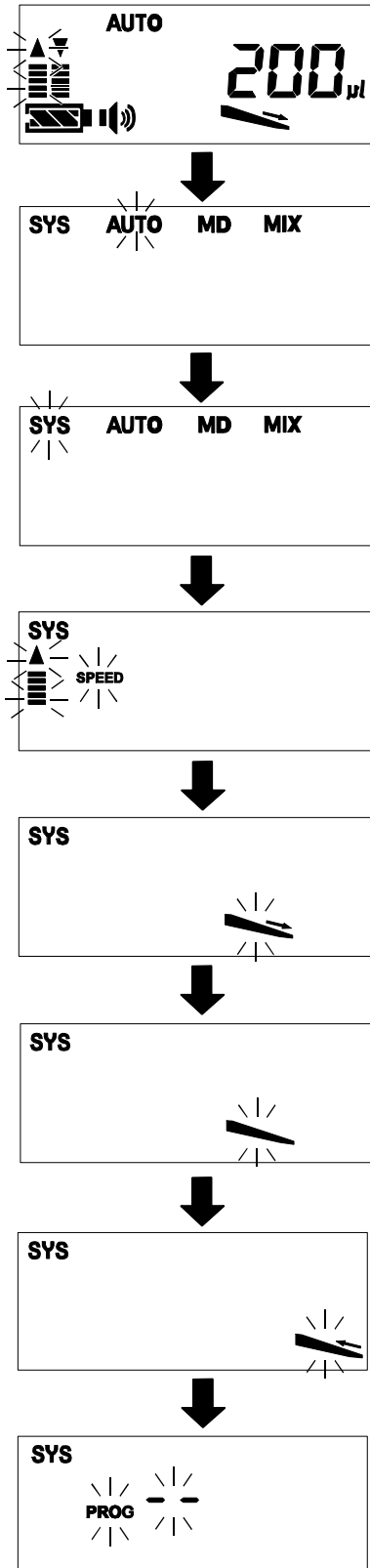





(The display is example.)



[1] Press the  Back key.



[2] Press the  Up or Down Key to select "SYS".

[3] Press the  Enter key to enter the system setting mode.

[4] Press the  Enter key several times until  is displayed.

[5] Turn the blowout operation mode OFF  using the  Up/Down key, then confirm this selection by pressing the  Enter key.

[6] Turn the reverse operation mode ON  using the  Up/Down key, then confirm this selection by pressing the  Enter key.

[7] End the system setting mode by pressing the  Enter key while **PROG**   is being displayed.

2) Operating the reverse mode

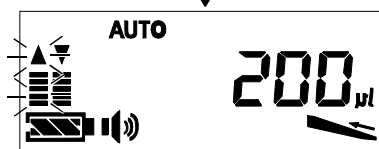
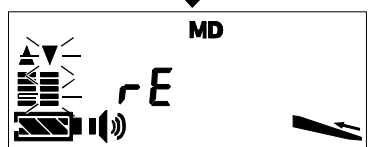
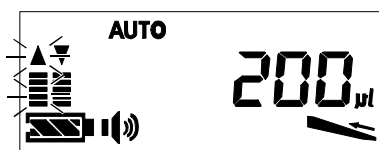

[1] Press the  Operation key on the pipette to aspirate the liquid.

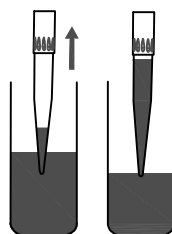

Aspirate

[2] Press the  Operation key on the pipette to dispense the liquid.



Dispense

[3] Press the  Operation key on the pipette to discharge the remaining liquid.



Discharge the remaining liquid

9-7 Blowout function

This is the function to forcibly dispensing the liquid remaining in the end of the tip by temporarily lowering the piston built in the pipette below the start position for aspiration after dispensing the liquid remaining in the tip.

By pressing the  Operation key when “bL” is shown on the display, carry out blowout.

* After carrying out blowout, the built-in piston remains in the blowout position while the  Operation key is being held down, and it returns to initial position when the finger was released from the Operation key. By releasing the Operation key after removing the tip end from the vessel, aspiration of the dispensed liquid in the tip again can be prevented.

9-8 Total discharge function

Pressing and holding the  Operation key expels all of the liquid remaining in the tip. This function is useful when, for example, you want to terminate the operation halfway through multiple dispensing.

Continuing to hold the  Operation key down after this turns the pipette power off.

9-9 “Pre-dispensing function” for multiple dispensing

The electronic pipette aspirates and dispenses a liquid by moving the internal piston up and down using motor. Since movement of motor and piston reverses when the operation switches from aspirating to dispensing, an error in dispensing volume due to backlash will occur. To correct this error, the MPA / MPB series is equipped with the “pre-dispensing function for multiple dispensing, which automatically discharges a small amount of sample before delivery. This ensures the piston is always set in the descending direction when dispensing starts, keeping the margin of error to a minimum.

9-10 Advanced dispensing jobs

When advanced dispensing jobs need to be done, the following modes on the MPA / MPB series are available.

- 1) Dispensing and mixing mode (AUTO+MIX)
By combining Standard mode (AUTO) and Mixing mode (MIX), the device can proceed to mix after performing the standard operation.
The dispensing amount, number of mixes, and mixing volume can be set separately.
- 2) Sequential aspirating mode (SA)
A number of differing liquids can be aspirated at individually set volumes and dispensed together.
- 3) Sequential dispensing mode (Sd)
Aspirated liquid can be dispensed sequentially at individually set volumes.

For detailed operating procedures please refer to the supplementary manual for advanced functions on our website (<http://www.aandd.jp/>)

Please refer to MPA series (Supplementary manual for advanced functions) on the A&D website for more information.

10. PIPETTING FOR ACCURATE DISPENSING

- When performing aspiration, if the tip is immersed too deeply into the sample liquid, an amount larger than the selected dispensing volume may be delivered, as excess liquid attaches the outside of the tip. Ideally, for aspiration, the tip should be dipped into the liquid to a depth of 2 to 3 mm.

The pipette is designed to correctly perform aspiration when it is in the vertical position.

Therefore, hold the pipette as vertically as possible when aspirating.

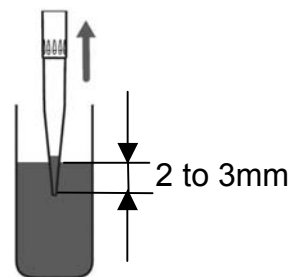

- Be sure to increase the number of pre-rinses when aspirating volatile liquids. Volatile substances in the tip can lead to lowering in the amount dispensed.
 - When replacing the tip, pre-rinse the tip with the necessary dispensing volume setting. The reverse operation is recommended for a sample liquid that tends to linger in the tip.
- ※ For accurately dispensing various kinds of liquids, please refer to “Pipette Operation Guide – for accurate dispensing with pipettes” on the A&D website.
(http://www.aandd.jp/products/test_measuring/pipette/mpa.html)

11. CALIBRATING THE PIPETTE USING AN ELECTRONIC BALANCE

The MPA / MPB series provide user with a dispensing volume calibration function. Using this function, it is easy to correct (calibrate) errors due to differences in tips used, etc. When you need to always control the dispensed volumes in a precise manner, perform volume calibration as necessary when you change the dispensing volume setting. For verification of dispensed volumes necessary for calibration, A&D's pipette accuracy tester - AD-4212A-PT, AD-4212B-PT, FX-300i-PT, or combined use of BM series and BM-014 (Sold separately) - are useful.

11-1 Volume calibration function (μ L calibration function)

This is a function to correct the dispensing volume of the MPA / MPB series. Using an A&D pipette accuracy tester or other appropriate device, measure the volume actually dispensed as opposed to the selected dispensing volume setting, and then enter the actual dispensed volume to the pipette to correct its dispensing volume. To calibrate the dispensing volume, complete the following procedure:

Calibrating the dispensing volume

1. Set the dispensing amount of the MPA / MPB series to the volume to which you would like to calibrate it. (The example is 100 μ L)
2. Using an electronic balance, measure and record an actual dispensed volume as opposed to the selected dispensing amount setting. (The example is 95 μ L)
3. Enter an actual dispensed volume to the pipette by the following procedure.

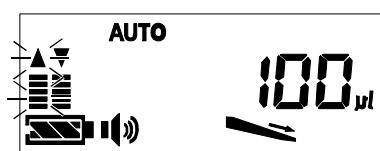

Selected dispensing volume setting for calibration (μ L)
(Example is 100 μ L.)

[1] Press the  Back key.

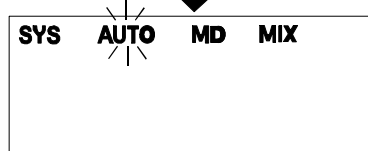

(μ L calibration mode)

[2] Press and hold the  Back key for approx. three seconds while "AUTO" is selected.

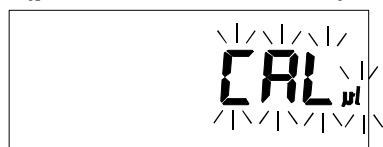

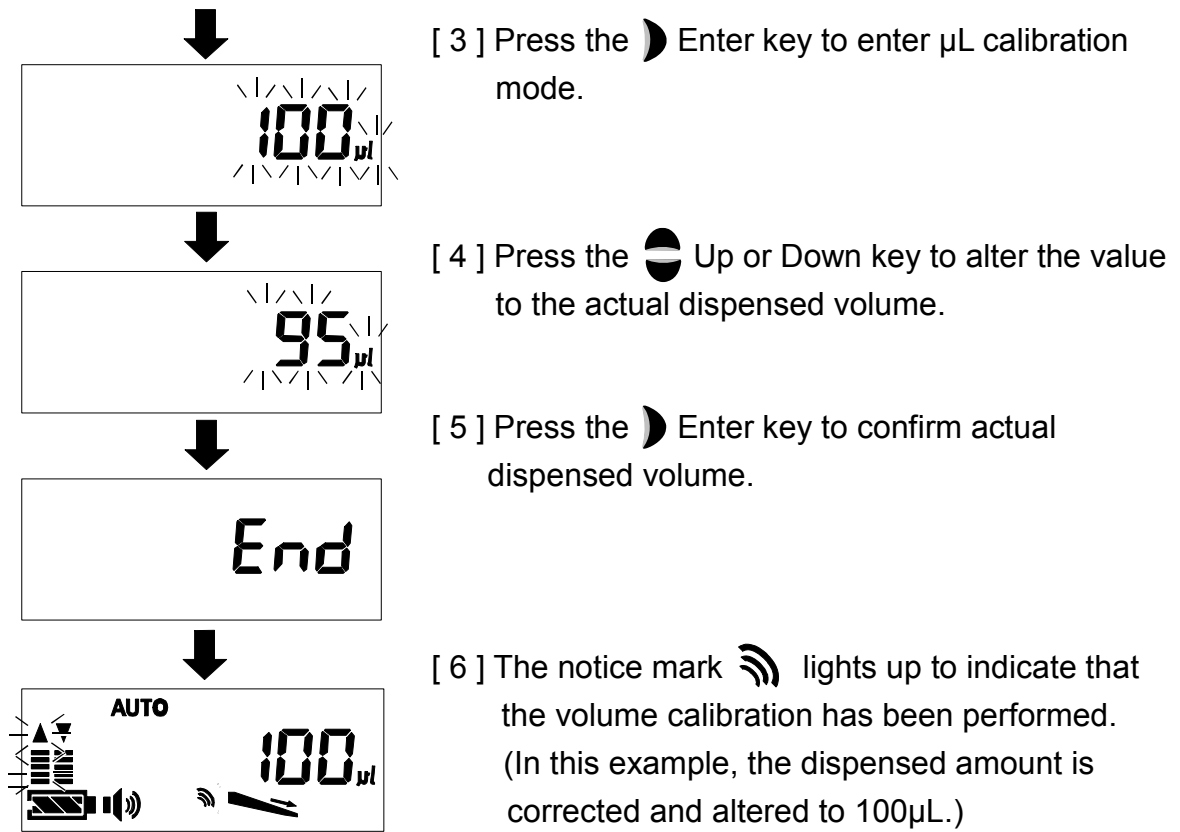

* After calibrating, a volume range that can be selected may be limited depending on available movement range of the piston.

11-2 Resetting the volume calibration

Go through the following procedure to restore the factory default settings for volume calibration:

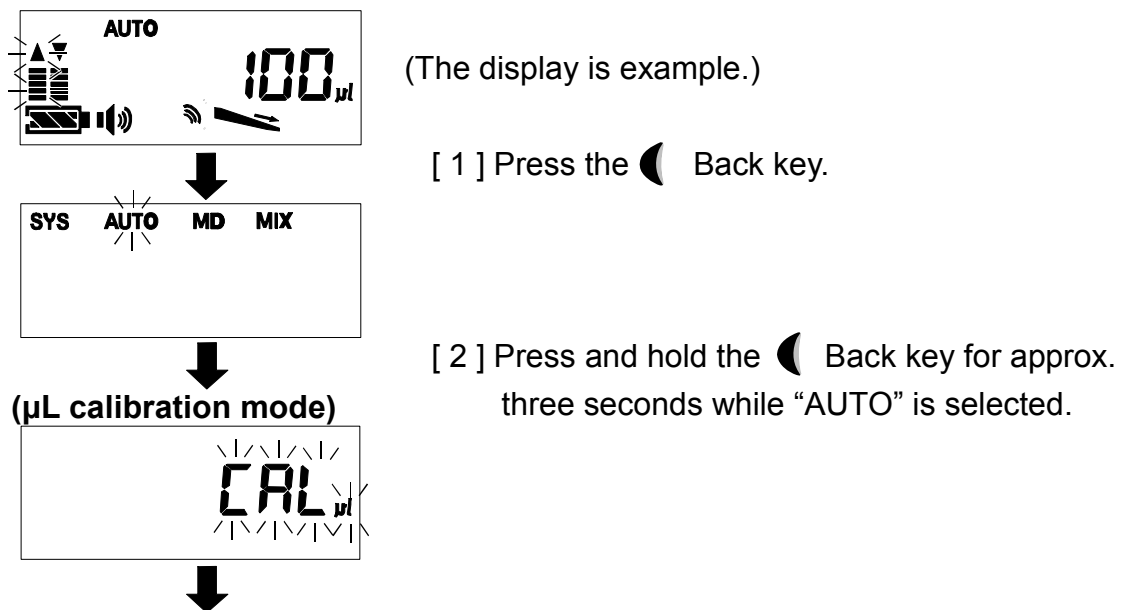

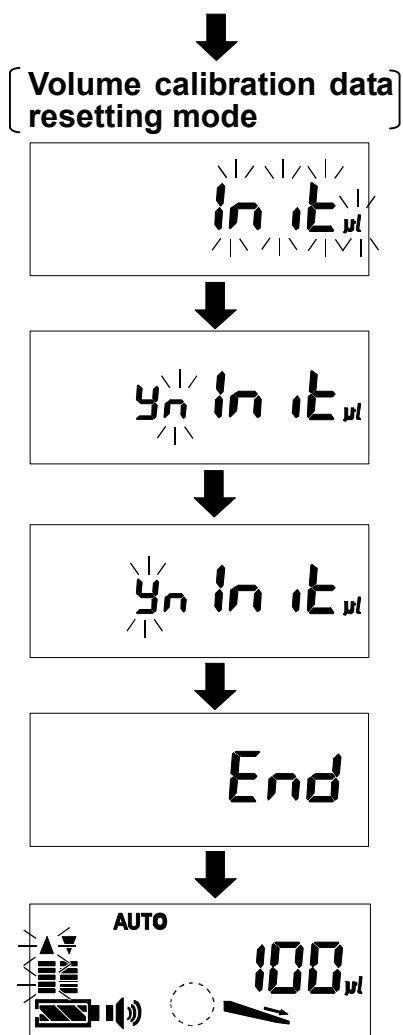

[3] Press the Up or Down key to select volume calibration data resetting mode.

[4] Press the Enter key to enter volume calibration data resetting mode.

[5] Press the Up or Down key to select **y** .
(**y** means YES and **n** means NO.)

[6] Press the Enter key to reset volume calibration data.

[7] The Notice mark is turned off to indicate that volume calibration data have reverted back to the factory default.

11-3 Dispensing in a unit of weight (in mg unit)

Dispensing of a liquid can be performed by weight (mg) instead of volume. (mg unit function)
This function is useful when you handle a liquid that needs to be managed by weight, such as a diluted solution of a solid or powder. Although the density of a liquid can vary depending on the sample type and concentration, by weighing the dispensed amount with an electronic balance and inputting the result into the pipette, it becomes possible to easily dispense the liquid in a unit of weight (mg).

Selecting the mg unit

The unit (volume: μL / weight: mg) for pipetting can be toggled by the following method.
When the mg unit is selected, the Notice mark blinks and the μL unit is turned off.

* When the unit of weight (mg unit) is selected, perform weight calibration by the dispensing amount to be used. (The weight calibration data reverts back to the factory default once the unit is switched to μL .)

Method for selecting the mg unit

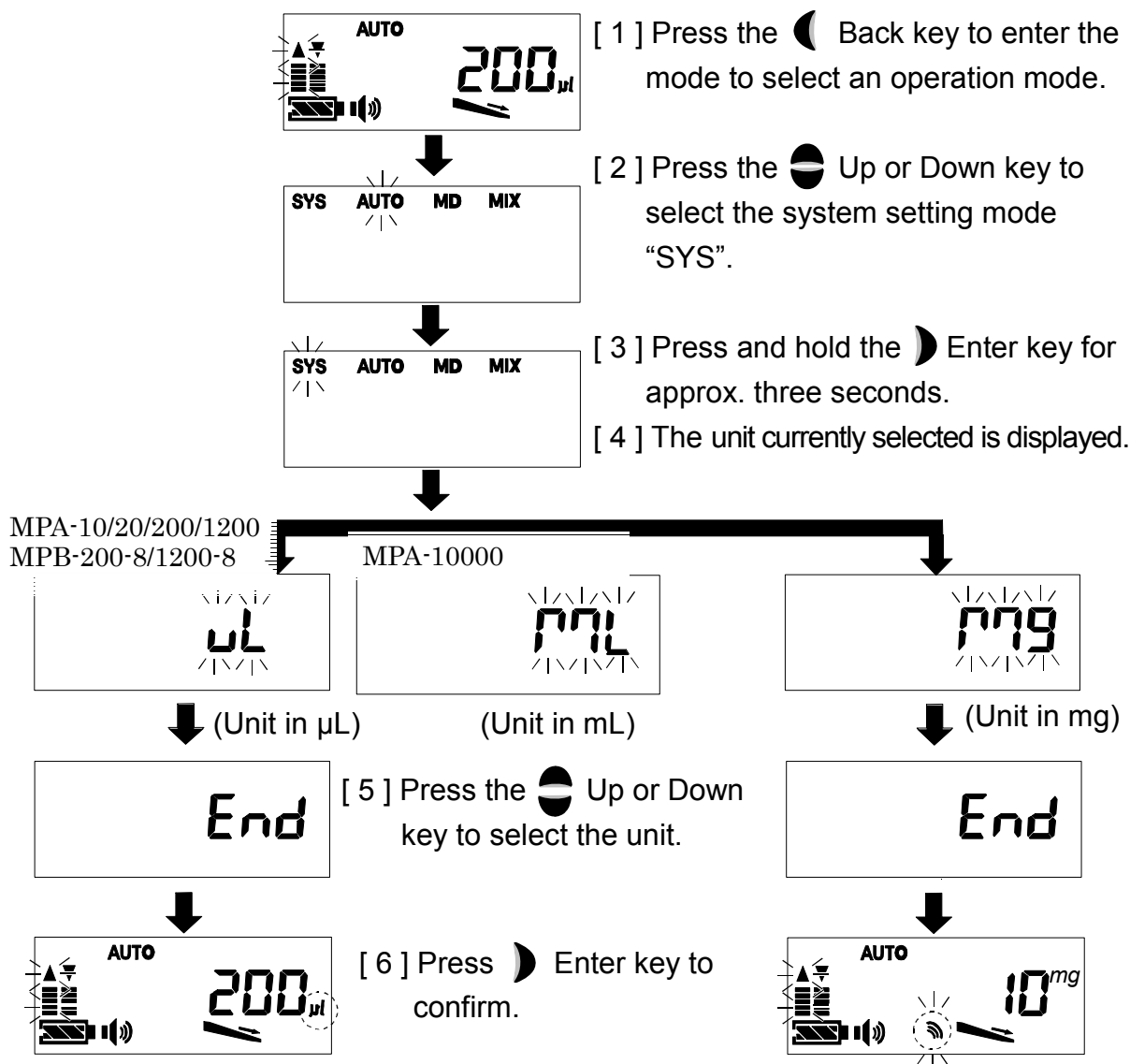

With the μL unit selected, the Notice mark is turned off while the μL unit mark lights up.

With the mg unit selected, the Notice mark blinks and the mg unit mark displays

* The calibration data reverts back to the factory default once the weight unit is switched.

11-4 Weight calibration function (mg calibration function)

The density of a liquid varies depending on the type and concentration of the material. Make sure to perform mg calibration when you dispense a different sample or use the mg unit for the first time. Further, when you need to always control dispensed amounts in a precise manner, perform mg calibration when you change the dispensing amount setting as well.

Method for mg calibration

1. Select the mg unit beforehand. (Refer to “11-3 Dispensing in a unit of weight (in mg unit)”)
2. Set the dispensing amount of the MPA / MPB series to the weight to which you would like to calibrate it. (The example is 100mg)
3. Using an electronic balance, measure and record an actually dispensed weight as opposed to the selected dispensing amount setting. (The example is 95mg)
4. Enter an actual dispensed weight to the pipette by the following procedure.

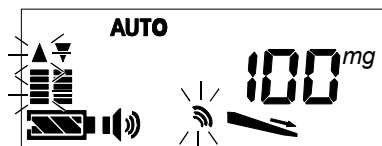

[1] Press the  Back key to enter the mode to select an operation mode.

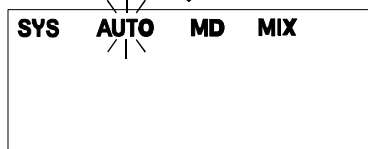

[2] Press and hold the  Back key for approx. three seconds while “AUTO” is selected.

(mg calibration mode)



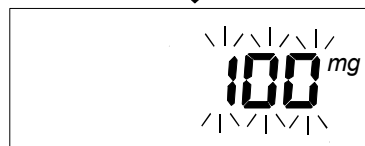

[3] Press the  Enter key to enter mg calibration mode.

In mg calibration mode, the Notice mark  illuminates while μ L mark is turned off

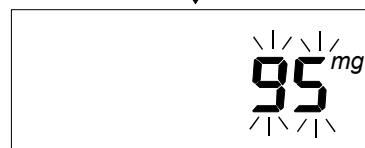

[4] Press the  Up or Down key to alter the value to the actual dispensed weight. (The example is 95mg)



[5] Press the  Enter key to confirm the actual dispensed weight.

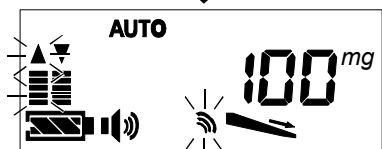
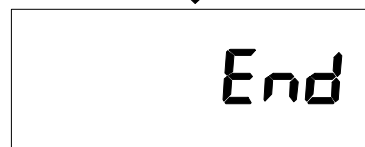

(In this example, the dispensed amount is corrected and altered to 100mg.)

12. ADJUSTING TIP EJECTOR HEIGHT

A height of the tip ejector can be adjusted so that it can match the conditions of how the Tip used was connected. Use a small minus screwdriver. By tuning the adjustment screw in a counter-clockwise direction, the tip ejector's position is lowered so that the tip can be removed. For the MPB, remove the lower part to adjust the screw.

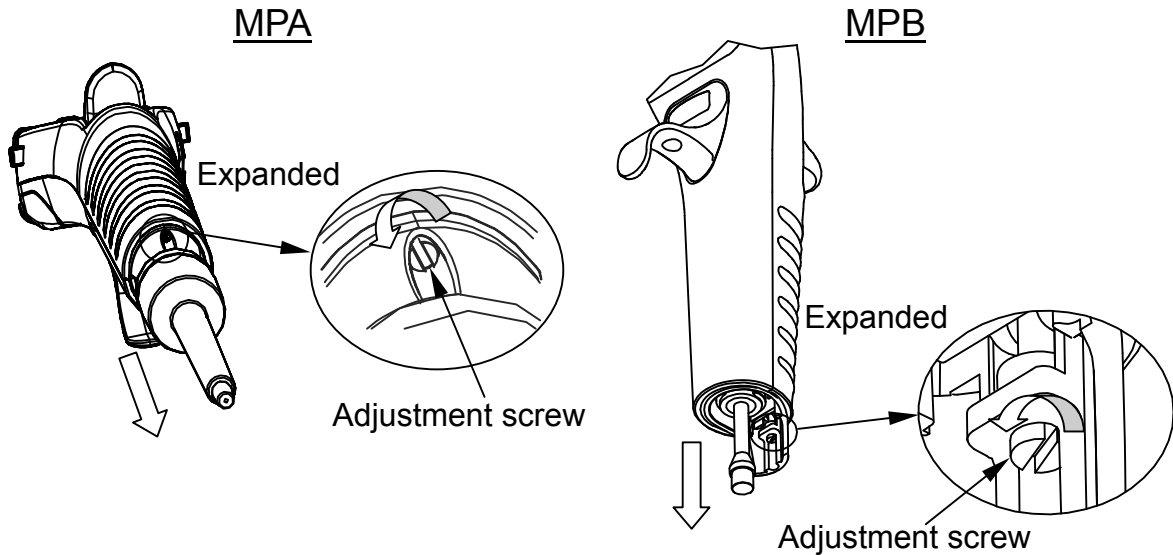

13. STORAGE AND MAINTENANCE

13-1 Replacing the lower part

If the lower part is contaminated or damaged it can be replaced.

- Removing/reattaching the lower part -

- Hold the base of the pipette tightly and twist the connection nut to the left to loosen.
 - Once the connection nut is removed the lower part can be removed by pulling.
- The piston and piston rod are connected by magnet.
- The lower part can be autoclaved. Refer to "13-4 Autoclave"

*Only as for the MPA series

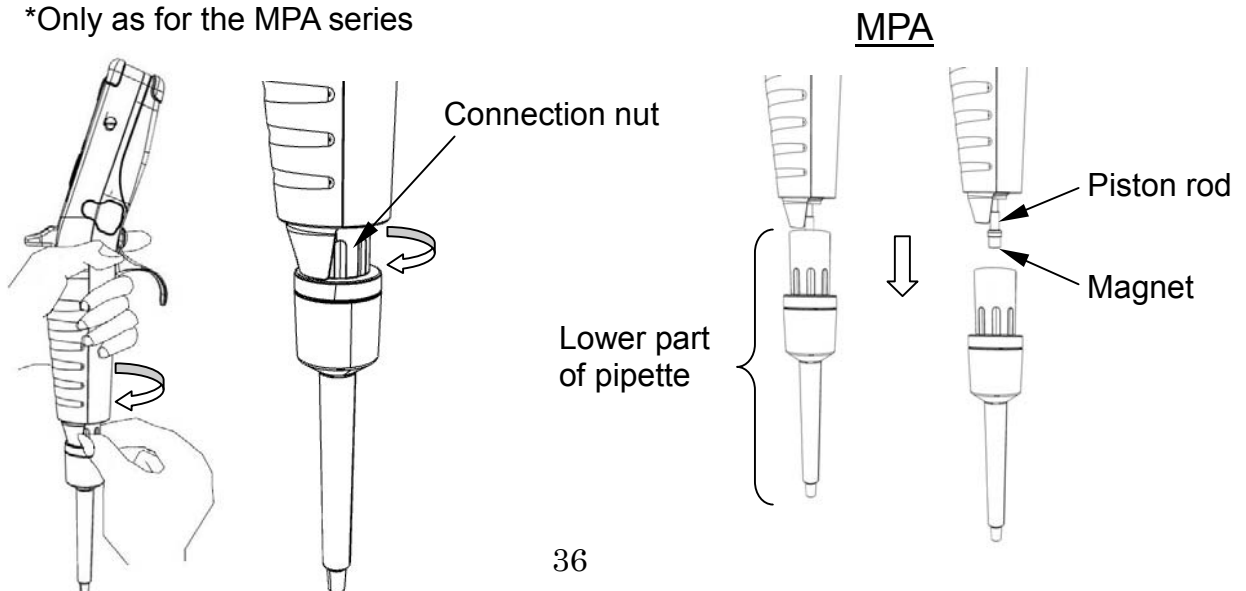

- Reverse the removal procedure to reattach the lower part.
- Use caution near objects affected by strong magnetic fields as the magnet is powerful.

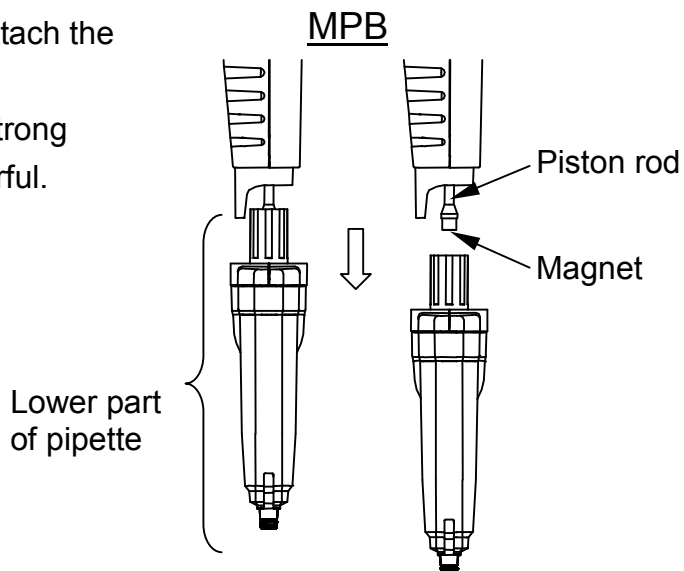

13-2 Cleaning the tip holder

The outer part of the tip holder can be cleaned by simple removal of the ejector. The tip holder should be cleaned with 60% isopropyl alcohol, 70% ethanol, or a neutral detergent.

MPA

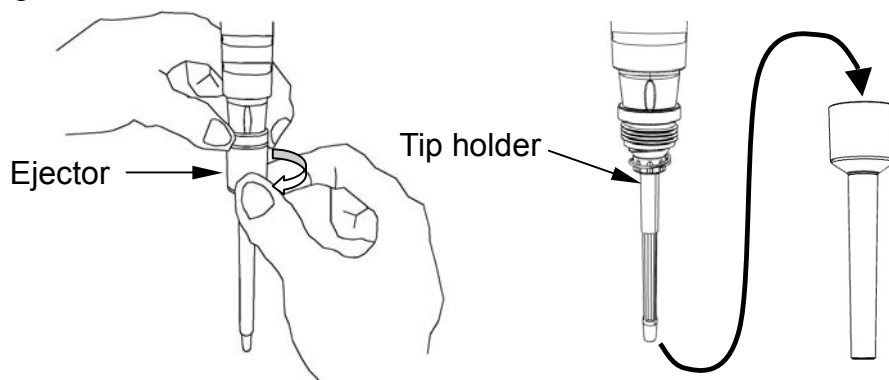

Please refrain from loosening or further disassembling the tip holder as this leads to debris becoming attached to the inner parts degrading performance of the device.

MPB

Push both sides of the ejector inward and pull the ejector down to remove.

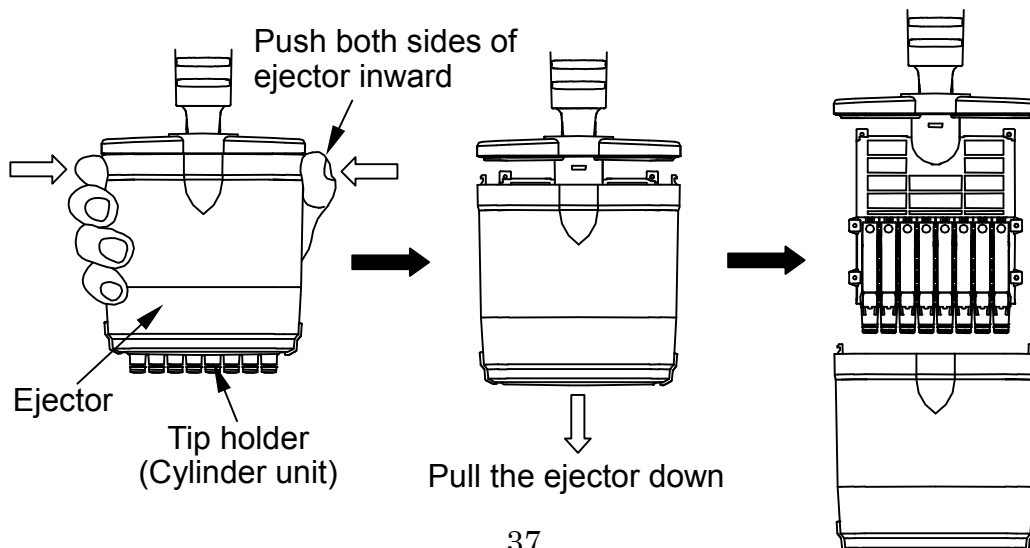

You can remove cylinder units from each channel of the MPB for cleaning or replacement.

- Remove the ejector, push both cylinder detachment switches to release the lock then pull out the cylinder unit.

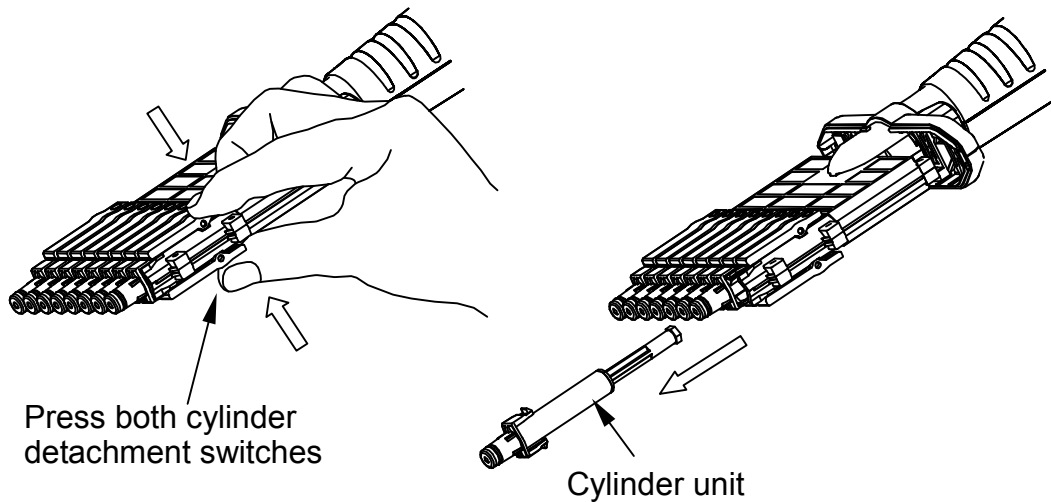

- To install a cylinder unit, extend the piston of the cylinder unit and insert until the cylinder detachment switch locks.

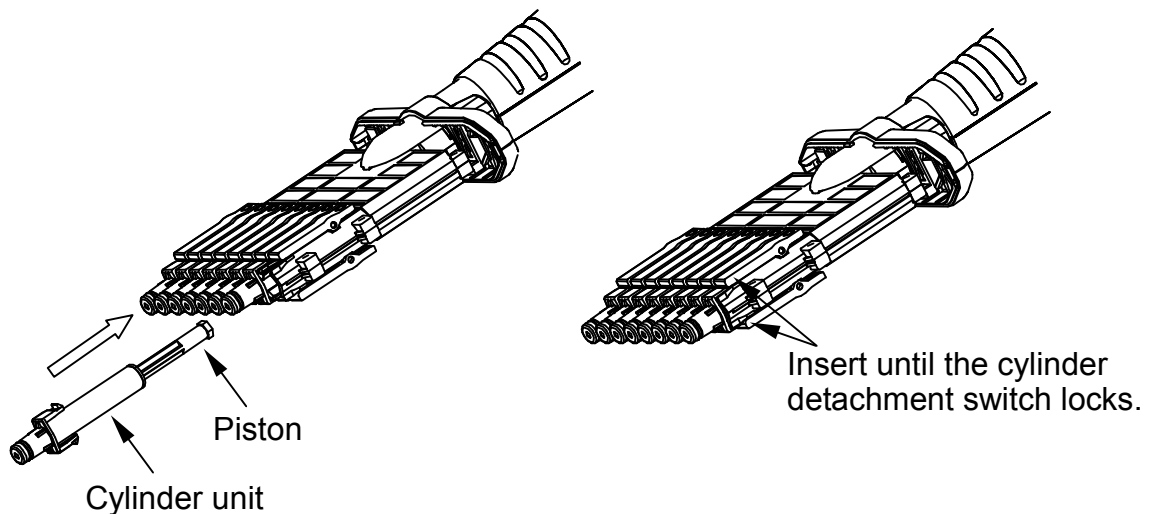

13-3 After maintenance performance check

After replacing the lower part or cleaning the tip holder it is recommended that checks to ensure volume and proper functioning be conducted through use of Leak Tester (AD-1690) and Pipette Accuracy Tester (BM series with BM-014, AD-4212A-PT, AD-4212B-PT, FX-300i-PT, etc., sold separately).

Refer to “17-4 Inspection equipment”

13-4 Autoclave

After removal, the pipette lower part can be sterilized in an autoclave.

*Only as for the MPA series

Autoclave settings for lower part: Run at 121°C at 2 ATMs for 20 minutes

- Be sure to allow the lower part to completely dry before reassembling the pipette.
- Please refrain from using sterilization processes other than autoclave as they can damage the pipette.

14. TROUBLE SHOOTING

Due to repeatedly aspirating and dispensing various liquids the micropipette easily succumbs to damage and contamination. In the event of device failure consult the following table. Request repair if that still doesn't solve the problem. (Refer to "15. WHEN REQUESTING REPAIR")

Problem	Reason	How to fix
Device won't turn on	Battery not charged	Charge the battery
	Battery connector not properly attached	Remove and reattach the battery connector
	Contamination of electrodes	Clean electrodes
	Battery degradation	Replace the battery
Device will not aspirate	Battery charge insufficient	Charge the battery
	Tip holder head jammed	Clean or replace the lower part
	Piston doesn't move	*When cleaning ensure no foreign objects enter the piston section
Leakage from the tip	Use of contaminated tip	Use a new tip
	Tip is loose	Attach the tip properly
	Piston seal is defective	Replace the lower part
	Abrasion, denting, or damage to the tip holder	Replace the lower part
	Use of volatile liquids	Refer to "10 PIPETTING FOR ACCURATE DISPENSING"
Liquid remains in the tip	Liquid has high viscosity	Refer to "9-6 Reverse operation"

Problem	Reason	How to fix
Amount dispensed is too much	Liquid on outer part of tip	Refer to "10 PIPETTING FOR ACCURATE DISPENSING"
Amount dispensed is too little	Solvent evaporates and increases pressure inside the tip.	Refer to "10 PIPETTING FOR ACCURATE DISPENSING"
Device produces an abnormal noise	Piston becomes stuck When the pipette hasn't been used for a while inner piston parts can become stuck due to grease.	After moderate usage device should return to normal functionality.
Tip won't eject	Tip length is incorrect	Refer to "12 ADJUSTING TIP EJECTOR HEIGHT"
Tip holder discoloration	Dispensing acids for long times.	If device functionality is affected replace the lower part.
01 Err	Connection nut (Refer to "7-5 Parts names and materials") is loose	Reattach the connection nut. Press the reset key and reset the device.
02 Err 98 Err	Stepping motor failure	Press the reset key and return the motor position to the origin

15. WHEN REQUESTING REPAIR

The pipette requires repair if an error occurs and can not be corrected by following the troubleshooting methods provided in this manual. In this case, please contact your local A&D representative.

When requesting repairs, it is essential that you confirm the pipette is free of contamination by a harmful material. Please photocopy the “Attestation of contamination removal” that can be found on the last page of this manual, fill in the required items, and attach it to the pipette you are going to send.

16. SPECIFICATIONS

		MPA-10			MPA-20			MPA-200			MPA-1200			MPA-10000		
Volume range		0.3 to 10.0µL			0.3 to 20.0µL			3.0 to 200.0µL			15 to 1200µL			0.1 to 10.0mL		
Performance	Volume	1.0 µL	5.0 µL	10.0 µL	2.0 µL	10.0 µL	20.0 µL	10 µL	100 µL	200 µL	100 µL	600 µL	1200 µL	1.0 mL	5.0 mL	10.0 mL
	Accuracy (±)	4.0 %	2.0 %	1.0 %	4.0 %	2.0 %	1.0 %	2.5 %	1.2 %	0.6 %	2.5 %	1.0 %	0.5 %	2.5 %	1.0 %	0.5 %
	Repeatability (CV)	2.5 %	0.8 %	0.4 %	2.5 %	0.8 %	0.4 %	1.0 %	0.3 %	0.15 %	0.6 %	0.3 %	0.15 %	0.6 %	0.15 %	0.15 %
Maximum dispensing count by minimum dispensing amount		0.3 µL x 33 times			0.3 µL x 66 times			3 µL x 66 times			15 µL x 80 times			0.1 mL x 99 times		
Operation mode		AUTO (Standard mode) , MD(Multiple dispensing mode) MIX (Mixing mode) , SYS (System setting mode)														
Program memory		9 programs														
Aspirating and dispensing speed		5 speed (set to 3 at time of shipment)														
Maximum number of dispensing (When recharging fully)		Approx. 1,800 times * 1														
Charging time		Approx. 5 hours at 100% charging														
Pipette driving method		stepping motor														
Energy saving setting		Automatically power turning off after ten minutes														
AC adapter * 2		- Input: AC100-240V 50/60Hz Power plug: Selectable - Output: DC5V / 1A														
Autoclave treatment		Possible for the lower part of the pipette (121°C, 2 ATMs, 20 minutes)														
Use environment temperature		15 to 30°C														
Use environment humidity		85% RH or less														
Battery		Lithium-ion battery 3.7V / 920mAh MD														
Total length (device)		Approx. 280mm														
Weight (Battery is included.)		Approx. 150g			Approx. 160g			Approx. 170g			Approx. 190g					

*1 When in standard mode with maximum aspirating and dispensing speeds, and on a full charge

*2 For recharging. The pipette can be used even when recharging.

		MPB-200-8			MPB-1200-8		
Volume range		3.0 to 200.0 μ L			15 to 1200 μ L		
Performance	Volume	10 μ L	100 μ L	200 μ L	100 μ L	600 μ L	1200 μ L
	Accuracy (\pm)	5.0%	2.4%	1.2%	5.0%	2.0%	1.0%
	Repeatability (CV)	2.0%	0.6%	0.3%	1.2%	0.6%	0.3%
Maximum dispensing count by minimum dispensing amount		3 μ L x 66 times			15 μ L x 80 times		
Operation mode		AUTO (Standard mode) , MD(Multiple dispensing mode) MIX (Mixing mode) , SYS (System setting mode)					
Program memory		9 programs					
Aspirating and dispensing speed		5 speed (set to 3 at time of shipment)					
Maximum number of dispensing (When recharging fully)		Approx. 800 times * 1					
Charging time		Approx. 5 hours at 100% charging					
Pipette driving method		stepping motor					
Energy saving setting		Automatically power turning off after ten minutes					
AC adapter * 2		- Input: AC100-240V 50/60Hz Power plug: Selectable - Output: DC5V / 1A					
Autoclave treatment		Impossible					
Use environment temperature		15 to 30°C					
Use environment humidity		85% RH or less					
Battery		Lithium-ion battery 3.7V / 920mAh MD					
Total length (device)		Approx. 290mm					
Weight (Battery is included.)		Approx. 290g			Approx. 280g		

*1 When in standard mode with maximum aspirating and dispensing speeds, and on a full charge

*2 For recharging. The pipette can be used even when recharging.

17. LIST OF ITEMS SOLD SEPARATELY (DISPOSABLE ITEMS)

17-1 Stands and hanger

○AX-ST-CH-A1 Charging stands for single MPA

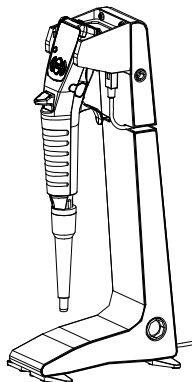

○AX-ST-CH-M4 Charging stand for four MPAs

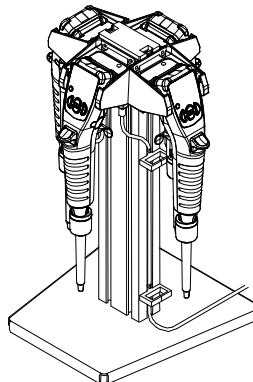

○AX-ST-CHG Charging hanger

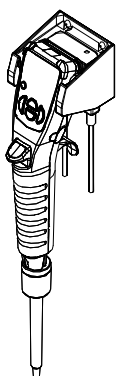

○AX-HA-STD Hanger

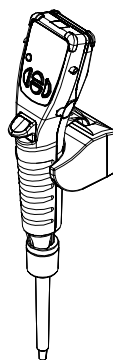

○AX-ST-ACR Acrylic stand

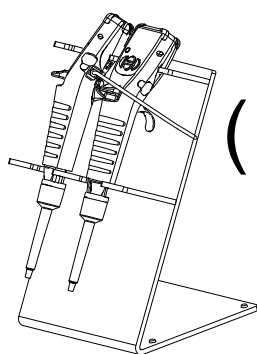

(MPA : For 2
MPB : For 1)

○AX-ST-SUS Stainless steel stand

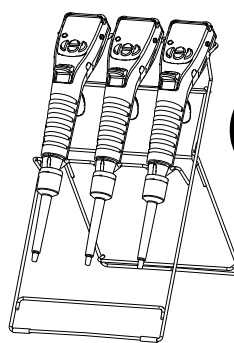

(MPA : For 3
MPB : For 2)

○AX-PAD-MPA Pipette Elbow Cushion

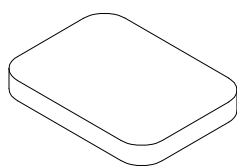

○AX-HOLDER-SET Sample Cup Holder

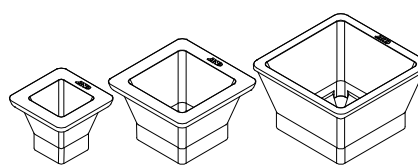

17-2 Tips, tip boxes and the filter

Number	Name	Applicable pipette						
		MPA -10	MPA -20	MPA -200	MPA -1200	MPA -10000	MPB -200-8	MPB -1200-8
AX-BOX-200A	Tip box with locking parts *3 10/20/200 μ L	○	○	○			○	
AX-BOX-1200A	Tip box with locking parts *3 1200 μ L				○			○
AX-BOX-200B	Tip box (Simple type) *3 10/20/200 μ L	○	○	○			○	
AX-BOX-1200B	Tip box (Simple type) *3 1200 μ L				○			○
AX-CART-10/20	Tip cartridge A&D 10/20 μ L Standard tip *4 96tips \times 10 set	○	○					
AX-CART-200	Tip cartridge A&D 200 μ L Standard tip *4 96tips \times 10 set			○			○	
AX-CART-1200	Tip cartridge A&D 1200 μ L Standard tip *4 96tips \times 10 set				○			
AX-CART-1200-8	Tip cartridge A&D 1200 μ L Standard tip *4 96tips \times 10 set							○
AX-BULK-10ML	Bulk Tip A&D 10mL Standard tip *4 250tips					○		
AX-FILTER-10ML	Filter for the MPA-10000 (for the main device), 100 pcs					○		

*3: The tip is not included with the tip box.

*4: Material: Tip, cartridge...PP

Example)

○AX-BOX-200A. X-BOX-1200A Tip box with locking parts

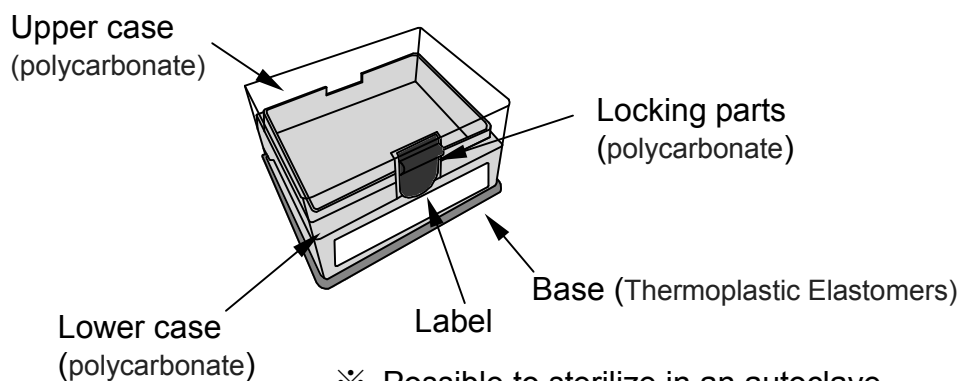

※ Possible to sterilize in an autoclave
(Remove the base for autoclave)

○AX-BOX-200B. AX-BOX-1200B Tip box

Upper Case (polycarbonate)

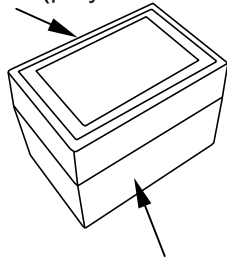

Lower case (polycarbonate)

※ Possible to sterilize in an autoclave

○AX-CART-10/20. AX-CART-200. AX-CART-1200. AX-CART-1200-8 Tip cartridge

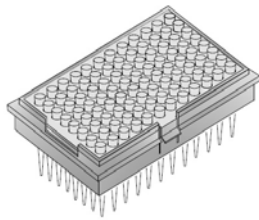

Consultation)

The tip is marked with lines to act as guidelines for the aspiration amount.

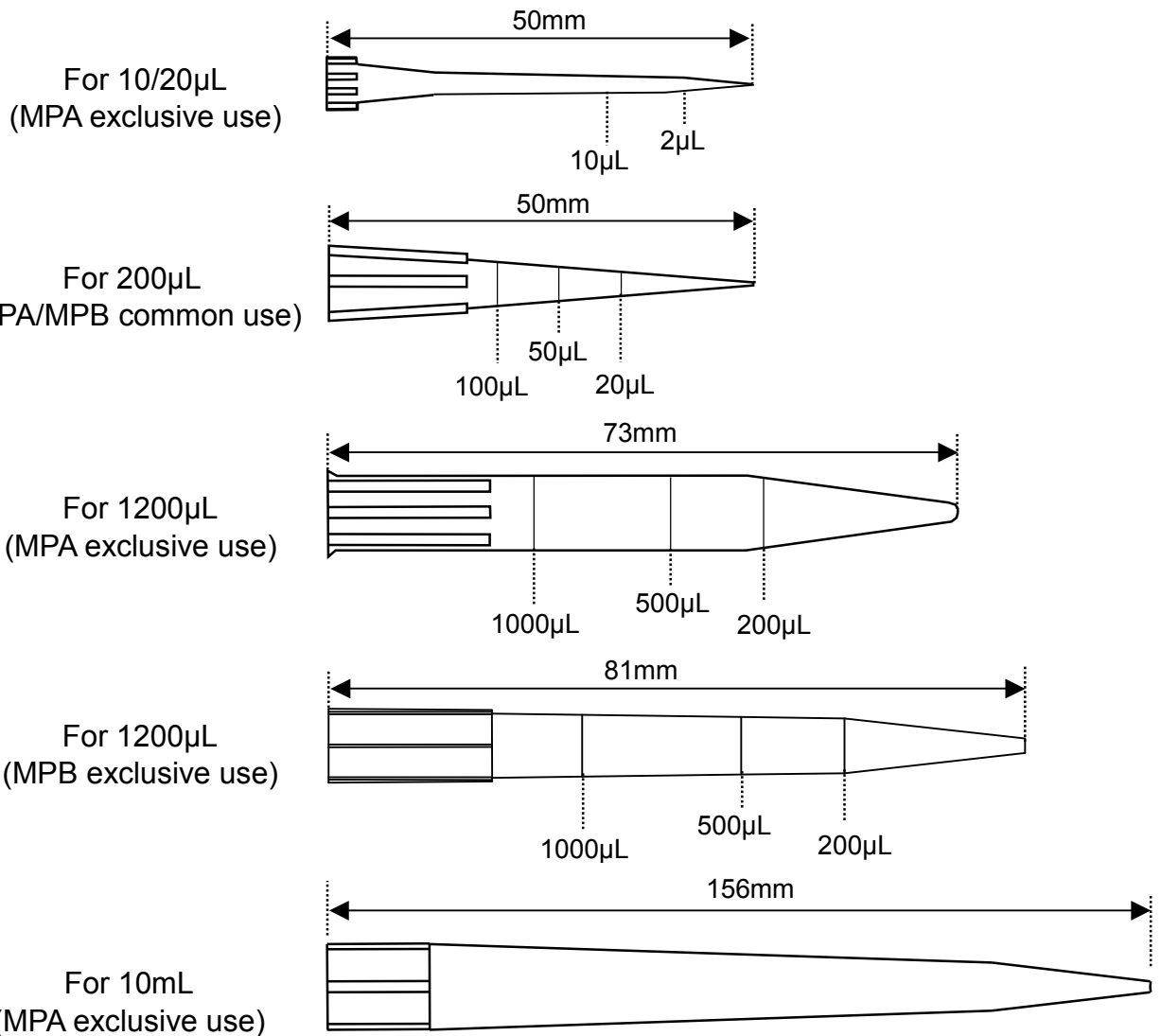

17-3 Disposable items (User replaceable)

Number	Name	Applicable pipette						
		MPA -10	MPA -20	MPA -200	MPA -1200	MPA -10000	MPB -200-8	MPB -1200-8
AX-LOW-10	Lower part (10 μ L)	○						
AX-LOW-20	Lower part (20 μ L)		○					
AX-LOW-200	Lower part (200 μ L)			○				
AX-LOW-1200	Lower part (1200 μ L)				○			
AX-LOW-10000	Lower part (10mL)					○		
AX-LOW-200-8	Lower part (200 μ L)						○	
AX-LOW-1200-8	Lower part (1200 μ L)							○
AX-CYL-200	Cylinder unit (200 μ L)						○	
AX-CYL-1200	Cylinder unit (1200 μ L)							○
AX-BAT-MPA	Battery	○	○	○	○	○	○	○
AX-TB265	AC adapter (Provided as standard)	○	○	○	○	○	○	○



Lower part for MPA



Battery for MPA / MPB

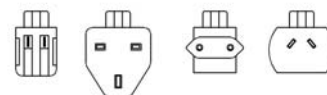
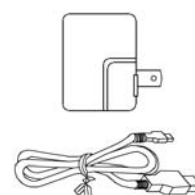

AC adapter for MPA / MPB

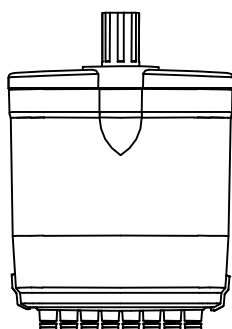

Lower part for MPB



Cylinder unit for MPB

17-4 Inspection equipment

- Leak tester AD-1690

Leakage within the pipette can be easily checked.

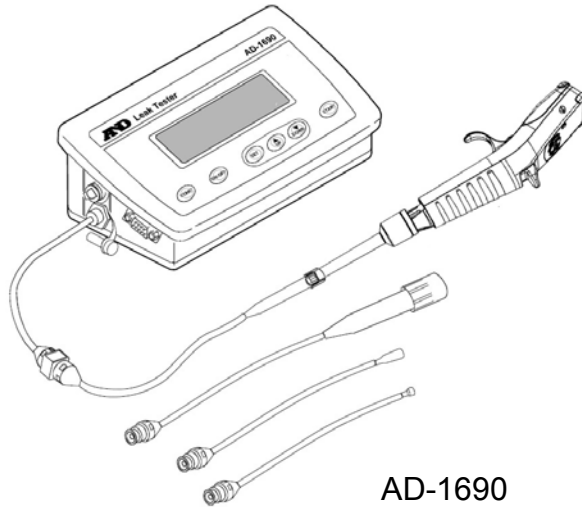

AD-1690

- Pipette accuracy tester

{	BM-20/22(BM-014 attached)	MPA-10/20
	AD-4212B-PT	MPA-10/20/200/1200
		MPB-200-8/1200-8
	BM-252(BM-014 attached)	MPA-20/200/1200/10000
		MPB-200-8/1200-8
	AD-4212A-PT	MPA-200/1200
		MPB-200-8/1200-8
	FX-300i-PT	MPA-1200/10000
		MPB-200-8/1200-8

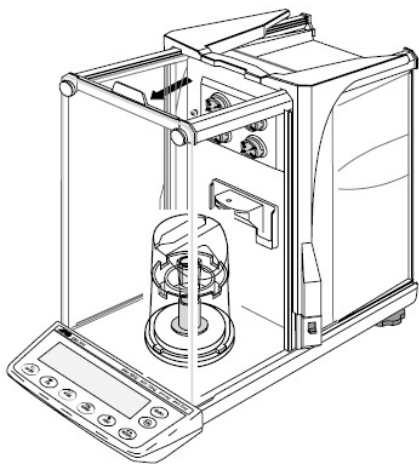

BM-20/22 (BM-014 attached)
BM-252 (BM-014 attached)

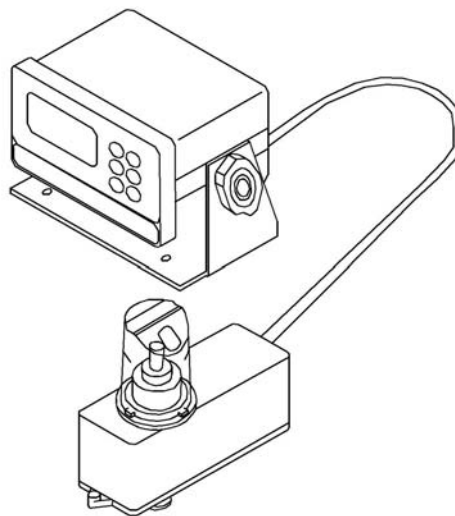

AD-4212A-PT
AD-4212B-PT

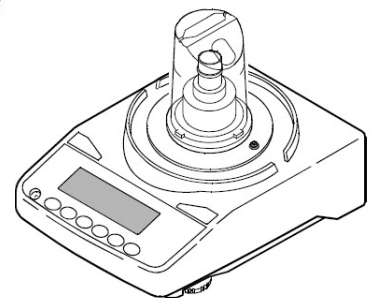

FX-300i-PT

○ Pipette Professional AD-1695

Pre-registered pipettes can be connected to Leak Tester (AD-1690) and Pipette Accuracy Tester (balance) and accuracy and reproducibility data from pipettes can be evaluated, recorded and output to assist in daily and periodic checks.

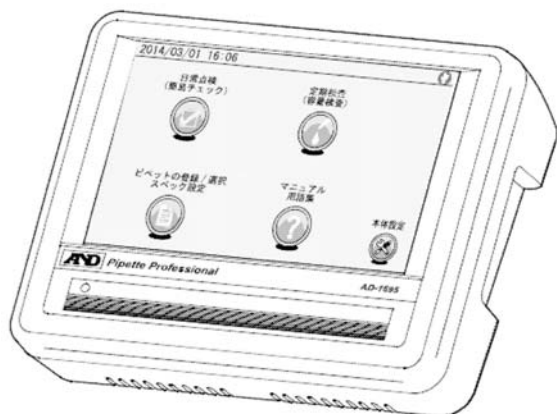

AD-1695

Attestation of contamination removal

Please fill in the following items when you send a pipette for repair.

Model name: _____

Serial number S/N: _____

I attest to the fact that this pipette is free of contamination by any substances that could pose a health threat to humans, such as Infectious bacteria or viruses, radioactive substances with associated risks of exposure, toxic substances, etc.

Signature: _____

Date: _____

Company name

(Facility name): _____

Section name: _____

Address: _____



A&D Company, Limited

3-23-14 Higashi-Ikebukuro, Toshima-ku, Tokyo 170-0013, JAPAN
Telephone: [81] (3) 5391-6132 Fax: [81] (3) 5391-6148

A&D ENGINEERING, INC.

1756 Automation Parkway, San Jose, California 95131, U.S.A.
Telephone: [1] (408) 263-5333 Fax: [1] (408)263-0119

A&D INSTRUMENTS LIMITED

Unit 24/26 Blacklands Way, Abingdon Business Park, Abingdon, Oxfordshire OX14 1DY United Kingdom
Telephone: [44] (1235) 550420 Fax: [44] (1235) 550485

A&D AUSTRALASIA PTY LTD

32 Dew Street, Thebarton, South Australia 5031, AUSTRALIA
Telephone: [61] (8) 8301-8100 Fax: [61] (8) 8352-7409

A&D KOREA Limited

한국에이.엔.디(주)
서울특별시 영등포구 국제금융로6길33 (여의도동) 맨하탄빌딩 817 우편 번호 07331
(817, Manhattan Bldg., 33. Gukjegeumyung-ro 6-gil, Yeongdeungpo-gu, Seoul, 07331 Korea)
전화: [82] (2) 780-4101 팩스: [82] (2) 782-4280

ООО A&D RUS

ООО "ЭЙ энд ДИ РУС"
121357, Российская Федерация, г.Москва, ул. Вереysкая, дом 17
(Business-Center "Vereyskaya Plaza-2" 121357, Russian Federation, Moscow, Vereyskaya Street 17)
тел.: [7] (495) 937-33-44 факс: [7] (495) 937-55-66

A&D INSTRUMENTS INDIA PRIVATE LIMITED

509, उद्योग विहार , फेस -5, गुडगांव - 122016, हरियाणा , भारत
(509, Udyog Vihar, Phase-V, Gurgaon - 122 016, Haryana, India)
फोन : 91-124-4715555 फैक्स : 91-124-4715599

ऐ&डी इन्स्ट्रुमेन्ट्स इण्डिया प्रा० लिमिटेड