A stylized world map in shades of blue, centered on the Atlantic Ocean. The map is overlaid with a grid of latitude and longitude lines. The background is a solid blue color. The title text is superimposed on the map.

# Capacitive GPS Rearview Mirror Recorder User Manual

## User manual

Thank you for choosing our company capacitive GPS Rearview Mirror Recorder

1. Our company reserves the right of final interpretation of this manual
2. This manual have been carefully checked, but does not exclude the possibility of a small mistakes. If found, please contact our customer service center
3. Please read carefully the "manual" with the operation instructions, and only use my factory supplied accessories. If not in accordance with the correct procedure to use the product, or connect incompatible parts, will cause the warranty expire automatically, the extent that Harm you and the safety of others. This company does not undertake any responsibility.
4. Due to the development of traffic construction, may navigation electronic map data and actual traffic indication is not completely identical, please be sure to follow the road status, local signs and other traffic rules traffic.
5. This product only route reference, drivers should pay attention to road conditions, weather conditions and other factors influencing driving safety. software updates and upgrades information will be published on the company's website, the customer can decide whether to renew or upgrade.

In this manual, the picture is for reference only, refer to the actual product.



## Contents

<b>1. General description</b> .....	4
<b>2. Beginning Use</b> .....	6
2.1 Charge the battery.....	6
2.2 Use the storage card.....	6
2.3 Hot plug of storage card.....	7
2.4 Memory space.....	7
2.5 Power on/off.....	7
2.6 Connect to wireless networks.....	8
2.7 Bluetooth headset.....	8
<b>3. Home Screen</b> .....	9
3.1 Status and notifications.....	9
3.2 Shortcuts to Add widgets.....	11
3.3 Finger gestures.....	11
3.4 Coping files to and from the storage card.....	12
3.5 Searching the device and the web.....	13
<b>4. Personalizing</b> .....	14
4.1 Change the Notification ringtone.....	14
4.2 Change your wallpaper.....	14
4.3 Personalize your Home screen with widgets.....	14
4.4 Rearrange or remove widgets and icons on your Home screen.....	15
<b>5. Web browsing</b> .....	16
<b>6 Manage Applications</b> .....	16
<b>7. Typical applications introduction</b> .....	17
7.1 GPS Info.....	17
7.2 FM Transmitter.....	17
7.3 Car DVR Introduction.....	18
7.4 Music Player.....	21
7.5 Video Player.....	23
7.6 Gallery.....	24
7.7 File Manager.....	26
7.8 Instant Messaging tools.....	27
7.9 Emails.....	27
<b>8. Settings</b> .....	28
8.1 Wireless & networks.....	28
8.2 Sound.....	28
8.3 Display.....	29
8.4 Storage.....	30
8.5 Apps.....	30
8.6 Accounts& Sync.....	31
8.7 Location service.....	31
8.8 Security settings.....	31
8.9 Language & Keyboard setting.....	32
8.10 Backup &reset.....	32

8.11Date & Time setting.....	32
8.12Accessibility.....	33
8.13Developer options.....	34
8.14About Device.....	34
<b>9. Troubleshooting</b> .....	35
9.1 Force shutdown.....	35
9.2 Restore default settings.....	35
9.3 System updating.....	35
9.4 Reset.....	35
<b>10. FAQ</b> .....	35



# 1. General description

## 1.1 INTRODUCTION

Thank you for choosing our company a capacitive GPS rearview mirror recorder. This product uses the latest Android4.0.4 system, set the navigator, drive recorder and anti-glare rearview mirror in one, Easy installation, convenient and simple; navigation while video recording, add a fun for your driving experience . This product supports 3D navigation, HD driving record, anti-glare rearview, secret communication Bluetooth headset, FM emission, Music, movies, e-book reading, picture browsing, calendar, calculator, function and application of casual games. And reversing, so that you can enjoy a better driving experience.

## 1.2 Product packaging

- 1 host
  - 2 Bluetooth headset
  - 3 power line
  - 4 MINI USB connection line
  - 5 manual
- The above listed articles refer to the actual product.

## 1.3 Product Appearance

The structure of the product is shown as follows:

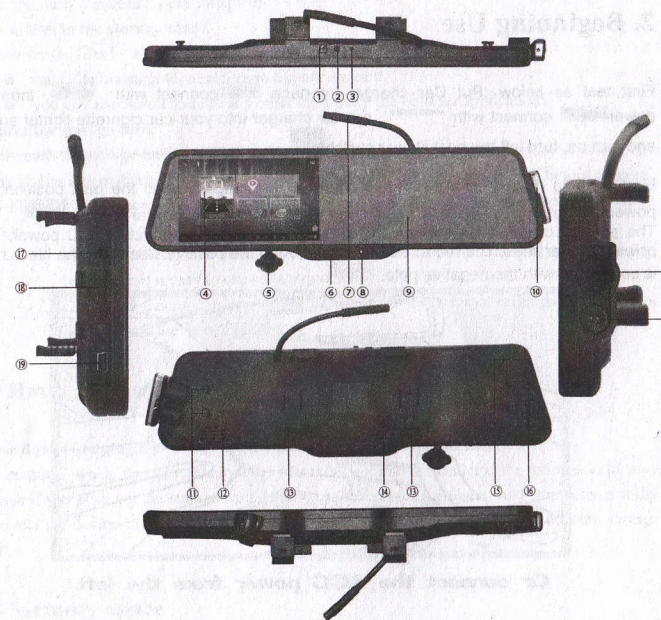

1、12V DC out	2、 power switch	3、 power input lamp
4、 5 inch display	5、 recorder, camera	6、 key switch / lock screen
7、 Power line connector	8 、 recorder file locking button	9、 anti-glare rearview mirror
10、 Bluetooth headset	11、 radar hook	12、 speaker
13 、 tensioning clamp	14、 GPS speaker	15、 Reset
16、 radar hook	17、 earphone jack	18、 recorder slot
19、 GPS USB	20、 magnetic absorption	21 、 Bluetooth headset Charging port



## 2. Beginning Use

First test as below :Put Car charger interface connect with , then put power connect with , put car charger into your car cigarette lighter socket and turn on, turn left the host Power switch.

Firstly, clamp device on the rearview mirror of the car, adjust to the best position; the power line through the visor wiring, hidden line to the bridge. Put car charger. The product can also be through the left A column wiring connected ACC power, cut power adapter lines, The red thread is connected to the positive electrode, the black head is connected with the negative pole.

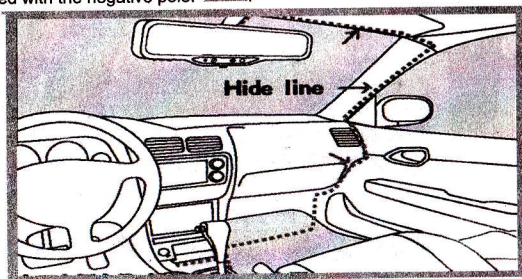

Or connect the ACC power from the left

**Statement:** The software updates sporadically since we continuously devote to product quality improvements. When operation for the product(s) your purchased differs from that described in this manual, please follow your product(s).

### 2.1 Charge the battery

It comes with a built-in polymer rechargeable battery and is designed to use only manufacture-specified original batteries and accessories. When the battery is low, please charge it timely.

#### Charge by Charger

Plug one terminal of the charger into the power adapter socket, and the other to the power jack of the device to charge it.

### 2.2 Use the storage card

Insert the storage card

The storage card slot is on the panel side, just insert the TF Flash card with its gold contacts facing down and push it in until it clicks into place.

#### Browse files in the storage card

To browse the files in the storage card, do one of the following:

- run "File Manager" to view files in the storage card
- you can also install and run any other third party file browser applications

#### Remove the storage card

Simply push the storage card in to eject it from its slot.

To avoid data loss or damage, please stop using files/ programs in the storage card before remove the T-Flash card, and then tap **Settings> Storage> Unmount shared storage** to remove it safely.

[Note]:

1. Make sure the location and direction of the storage card is correct when inserting, otherwise it is easy to cause damage/destroy to the storage card.
2. To avoid incompatibility or unrecognized of the storage card, major brands of storage card are recommended.

### 2.3 Hot plug of storage card

**Please do not hot plug the storage card when using or browsing its files.**

For example, when you are running the Music/Video Player/ Gallery, the storage card may damage if you push out the storage card directly and the running program will stop automatically to protect the device. As for details of inserting/removing storage card, see **2.2 Use the storage card**.

### 2.4 Memory space

The device contains 2 memory spaces: local storage & extended storage card. Local storage appears as "Local" and extended storage card as "EXTSD" in the device. The capacity of built-in flash varies from 8GB and 16GB because of different model of the PE11 series. The built-in flash capacity of your device depends on the model you purchased. PE11 series support extended storage card of capacity maximum 32GB.

### 2.5 Power on/off

**Power on:** press down the Power Button and hold for a while to turn on the device when the battery is full enough

**Power off:** press down the Power Button to prompt a check box, select **OK** to turn off the device

**Screen Lock:** press down the Power Button to shutdown the screen to save battery life. Press down the Power Button again to activate the locked Home Screen. After unlocking, the device will resume the screen before locking the screen.



## 2.6 Connect to wireless networks

To connect to a wireless network, you should follow:

1. tap **Settings** on the Home screen;
2. tap **Wi-Fi**;
3. select **ON**;
4. the network names and security settings of detected Wi-Fi networks are displayed in the Wi-Fi networks section;
5. tap a Wi-Fi network to connect. If you selected an open network, you will be automatically connected to the network. If you selected a network that is secured with WEP, enter the key and then tap **Connect**.

Depending on the network type and its security settings, you may also need to enter more information or choose a security certificate.

6. after successful connection, the Wi-Fi connected icon will appear on the status bar.

## 2.7 Bluetooth headset



Bluetooth headset with Bluetooth mobile phone connection, particularly convenient for incoming and outgoing calls. Before using this function, please turn Bluetooth on. Long press the Bluetooth headset 6-8 seconds, the indicating lamp on the headset in the red and blue flashing alternately, searching through mobile phone Bluetooth, name: GPS518. password 0000 pairs can be completed using the. After use, placed in the right headphone adsorption and charge.

## 3. Home Screen

The Home screen is your starting point to access all the features on your device. It displays application icons, widgets, shortcuts, and other features. You can customize the Home screen with different wallpaper & widgets and display items you want. See the *Personalizing* chapter. When you sign in, the Home screen opens.



### Sleep mode

Sleep mode suspends your device to a low power state while the display is off in order to save battery power. You will still be able to receive messages and calls while the device is in Sleep mode.

[Note]: If the device is in sleep mode more than 30 minutes, the device will automatically turn off to save electricity.

### Switch to sleep mode

Simply press down the Power Button; and the device will automatically shutdown the display screen when there is no operation on the screen for a period of time.

### Wake up from sleep mode

To wake up your device manually, press the Power Button. You will then see that the device has locked the screen.

### Unlocking the screen

Press the bar on the lock screen and then slide your finger upwards to unlock the screen.

### Browse Home Screen

















You can go to the extended Home screen by sliding your finger horizontally across the screen to go to the left or right side of the Home screen. Tap the icon  to view all applications on your device.

## 3.1 Status and notifications

### Status and Notification Icons may appear

The status bar presents media volume, networks condition, battery condition, time and so on. When an application is running, corresponding notification icon will appear in the notification area. Icons you may often see are listed as follows:



Status icons and its meanings		Notification icons its meanings	
	Tap to go to the Home screen		New Gmail/Google Mail message
	Back		New Email message
	Recently viewed		Music player is ongoing
	Menu icon		SD card is mounted
	Notification		USB Connected
	Connected to a Wi-Fi network and display the signal strength		Airplane mode
	Battery is charging		FM is on
	Search satellite is going on		Video recording is running in the background

### Open notification panel

When new notification icon displays in the status bar, press and hold the status bar, then slide your finger downward to open the Notifications panel as follows:



If you have several notifications, you can scroll down the screen to view more notifications.

[Tip]: You can also open the Notifications panel on the Home screen by pressing Menu icon on the panel and then tapping **Notifications**.

In the popping notification panel, there are shortcut buttons for turning on/off Wi-Fi, airplane mode, auto-rotate screen and for adjusting screen brightness.

**Close the Notifications panel**

Simply press the Back button on the device panel.

### 3.2 Shortcuts to Add widgets

To add widgets to Home screen, you can

1. tap  on the home screen to enter into all apps interface as follows



2. tap **WIDGETS**

3. select one item.

Slide your finger horizontally on the home screen to check widgets that can be added to the home screen. Widgets selectable are as follows:

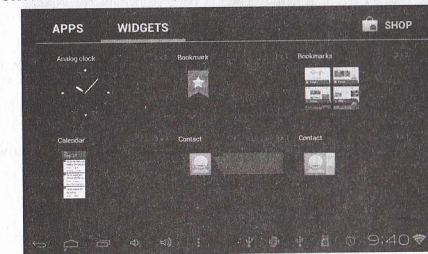

### 3.3 Finger gestures

**Tap:** When you want to type using the keyboard, select items onscreen such as application and settings icons, or press onscreen buttons, simply tap them with your finger.

**Press and hold:** To open the available option for an item (e.g. contact or link in a web page), simply press and hold the item.

**Swipe or slide:** To swipe or slide means to drag your finger vertically or horizontally across the



screen.

**Drag:** Press and hold your finger with some pressure before you start to drag. While dragging, do not release your finger until you have reached the target position.

**Rotate:** For most screens, you can automatically change the screen orientation from portrait to landscape by turning the device sideways. When entering text, you can turn the device sideways to bring up a bigger keyboard. Refer to Settings chapter for more details.

### 3.4 Coping files to and from the storage card

You can copy music, photos/pictures and others to your device to personalize your device.

1. Use the USB cable that came with your device to connect it to a USB port on your computer.
2. when the icon  appears in the notification area, open the notification panel and tap **USB Connected** to popup the following screen:





3. tap **Turn on USB storage**, when the notification icon  turns yellow, the computer will recognize your device as a removable disk;
4. find the removable disk and open it. Do one of the followings:
  - Copy the files from the computer to the storage card's root folder.
  - Copy the files from the storage card to a folder in your computer or computer desktop.
5. after copying the files, unmount the removable disk (that is, your device) as required by your computer's operating system to safely remove your device.
6. disconnect your device from the computer.

If your want your device remain connecting to the computer and enable reading its storage card, you can open the Notifications panel and tap **Turn off USB storage**.

[Note]: you can also realize communication between the device and the computer by tapping **Settings> Developer options>USB Debugging**.

### 3.5 Searching the device and the web

You can search for information on your device and on the Web by using the Quick Search Box.

1. press  on the home screen to enter into all apps interface;
2. tap **Search** and then enter the search item in the Quick Search Box  
As you type, matching items on your device and suggestions from Google web search are shown as a list. The suggested items that appear will depend on the options that you have selected in the search settings.
3. Do one of the following:
  - If what you're searching for is in the list of suggestions, tap it in the list. The item opens in the appropriate application.
  - If what you're searching for is not in the list, tap  to open the search option menu.

Tap **Web** and then tap  to search the Web. The web browser opens, displaying results of a Google search on the Web



## 4. Personalizing

### 4.1 Change the Notification ringtone

Choose from the available selections of notification ringtones on your device. You can also download or copy notification ringtones or songs to your device' storage card and choose one to use as your notification ringtone. To find out how you can copy files to your storage card, see "Copying files to and from the storage card".

1. In the Home screen, tap Settings > Sound > Default notification.
2. Tap the notification ringtone you want to use. The notification ringtone briefly plays when selected.
3. Tap OK.

### 4.2 Change your wallpaper

Personalizing your Home screen wallpaper with your favorite photo is a quick and easy way to change the feel of your device and give it a fresh look. Browse the collection of wallpapers included in your device or choose from photos that you have taken with the camera.

To change your Home screen or lock screen wallpaper, you can:

1. tap **Settings>Display**
2. and then tap **Wallpaper**.

**【Note】** : you can also tap the menu icon on the home screen and then select **Wallpaper**.

3. choose source of wallpaper  
you can do one of the following:

- Tap **Super-HD Player** to select a photo/picture that you have taken using the camera or copied to your storage card. Tap **Crop** to crop the photo/picture and set the cropped picture as wallpaper.
- Tap **Wallpapers** gallery to choose from preset wallpapers and then tap **Set wallpaper**.
- Tap **Live Wallpapers** gallery to choose from preset wallpapers and then tap **Set wallpaper**.

### 4.3 Personalize your Home screen with widgets

Widgets put at-a-glance important information and media content up front on your Home screen. Some widgets are already added to your Home screen for your convenience. You can add more from the available selections of widgets, or download more widgets.

#### ① adding a widget to your Home screen

For details on how to add a widget to your Home screen, please refer to section 3.2 *Shortcuts to Add widgets*.

[Note]: To remove a widget, press and hold the widget until the icon  appears, drag the widget onto it and release your finger.

#### ② Adding folders on your Home screen

Use folders to group related applications and other shortcuts to keep your Home screen tidy and organized.

Press and hold the application shortcut and stack it onto another shortcut to create a folder for the applications you want to file together, and then release your finger to finish creating a folder. You can drag any other application shortcut into the new folder.

#### To rename a folder:

1. Tap the folder to open it.
2. Tap **Unnamed Folder** to prompt the keyboard.
3. Enter a new folder name and then tap **OK**.

### 4.4 Rearrange or remove widgets and icons on your Home screen

Rearrange the widgets and icons on your Home screen to give room for adding more items to the Home screen. You can also remove widgets and icons that you don't frequently use.

#### ① Moving a widget or icon

1. Press and hold the widget or icon you want to move.  
You'll see a yellow box around the widget or icon. Don't release your finger.
2. Drag the widget or icon to a new location on the screen.  
Pause at the left or right edge of the screen to drag the widget or icon onto another Home screen panel.
3. When the widget or icon is where you want it, release your finger.  
If you've released your finger but a message shows that there's no space to place the widget or icon, drag it right or left again to another Home screen panel.

#### ② Removing a widget or icon

1. Press and hold the widget or icon you want to remove. You'll see a yellow box around the widget or icon. Don't release your finger.
2. Drag the widget onto the cross icon  on the screen.
3. When the widget or icon also turns red, release your finger.



## 5. Web browsing

User can connect to the network via the browser.

Tap the browser icon  on the Home screen to open it as follows:



## 6 Manage Applications

You can personalize and enrich your PE11 by installing a wide variety of free and paid apps ranging from productivity apps, entertainment, to games. When you find a program you want, you can easily download and install it on your PE11 with just a few steps as follows:

### How to install Android third-party programs



1. download the programs you want from web sites and store them into your storage card or local memory. You can also copy programs downloaded on your computer into your storage card or local memory;
2. run the application File manager
3. find the third-party program you want, and then use functions of File manager to install it to your device.

### How to uninstall Android third-party programs

To dismount the program, you can also use functions of File manager and you can also by tapping **Settings > Apps > Downloaded** to uninstall a third-party application.

## 7. Typical applications introduction

### 7.1 GPS Info

Tap  in the Home screen and tap the GPS Info icon  to enter the following interface:

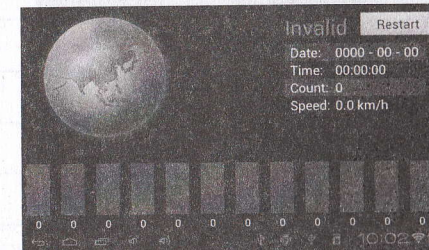

[Note]: you can enter the above screen by tapping Navi> GPS Info.

To reset the GPS satellite receiver, you can tap  and a dialog box will popup as follows:

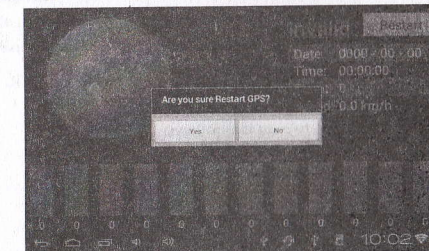

Tap "Yes" to finish reset and tap "No" to exit.

### 7.2 FM Transmitter

FM Transmitter lets you listen to FM radio station on your PE11.

[Note]: To use the FM function, you need to insert power supply as an FM transmitter.

To listen to an FM station, you should, tap the icon  in the Home screen to go to the FM Transmitter interface as follows





Definition of icons is listed as follows:

	FM radio frequency
	Tap to fine tune the radio frequency by -0.1 MHz.
	Tap to fine tune the radio frequency by +0.1 MHz.
	Drag to tune in to a frequency on the FM band.
	Turn off or on FM radio.
	Tap to exit

### 7.3 Car DVR Introduction

[Note]: please insert TF card properly into the device before running the car DVR.

Operation

Tap the DVR icon on the home screen to open it as follows:



In the DVR function interface, you can view current date & time, and car speed. tap the icon



to start recording.

To protect the current video file, you can tap the icon to save it under the directory **Save File** in case of overwriting of the video file when the memory capacity is in lack. To stop

recording, simply tap the icon in the recording interface.

#### 2. Playback

To check and view the video recorded, tap the icon to enter the VideoRecord interface as follows:



[Note]: during recording, video files under the directory **Temp File** will be overwritten if the memory capacity is in lack. So please backup important videos under the **Save File**.

To delete unnecessary videos, just press and hold on the video unwanted until a dialog box prompt and then click as required to confirm deleting.

#### Play back temp file

Tap **Temp File** in the above the interface to check and view all video files under the directory, select one video and tap on it to play back and the playback interface is as follows:



When playback, tap to stop/resume playing the video, tap to select playing the

previous/next video under this directory, or drag the icon leftward/rightward to view the

video clip you want. Tap the icon to check the longitude and latitude when this video









recorded. Tap  to save this video under the **Save File** directory.

#### Play back save file

Tap **Save File** in the above the interface to check and view all video files under the directory, select one video and tap on it to play back and the playback interface is as follows:



When playback, tap  to stop/resume playing the video, tap  to select playing the previous/next video under this directory, or drag the icon  leftward/rightward to view the video clip you want. Tap the icon  to check the longitude and latitude when this video recorded. Tap  to delete this video.

To set the parameters of car DVR function, tap the icon  to enter the setting options interface as follows:

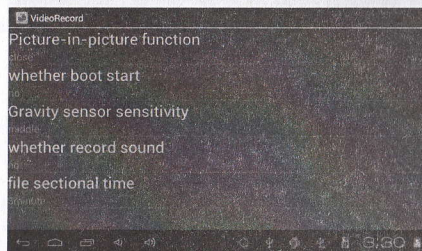

Picture- in-Picture function: tap to prompt the dialog box, select open, the car DVR window will appear on other interface when recording, double tap on the window to enter the recording interface.

Whether boot start: select YES, and then the car DVR will automatically run background after booting the device.

Gravity sensor sensitivity: there are high/middle/low for options to protect current video being overwritten when crush occurs

Whether record sound: if select YES, then the sound will be recorded when recording the video; if select NO, it will record only the image.

File selection time: tap to select the time interval for saving the file.

#### Video play & track check on computer

Read the TF card containing video recordings on computer, you can see file folders as follows:

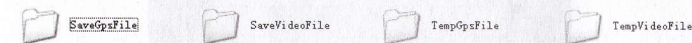

These folders respectively cover files on protected GPS information, protected videos, temporary GPS information (unprotected file, which can be overwritten when the storage space is insufficient) and temporary videos. Open the folder containing videos to play video within. Open the GPS information folder, read the files in kml format via the application google earth, and then you can check the travel track on computer.

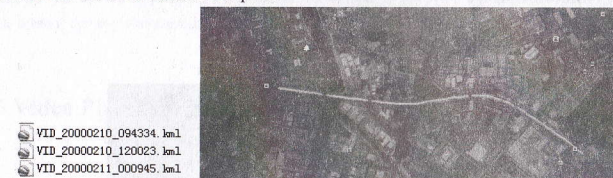

## 7.4 Music Player

Enjoy listening to songs and music on your PE11 using the Music application. You need to copy music files to your storage card first to use the Music application to play music. To find out how to copy files, see *"Copying files to and from the storage card"*. Audio formats supported include/wav/ac3/aac/ogg /ra/amr/m4a/wma and so on.

Tap the icon  on the Home screen to enter the following screen:

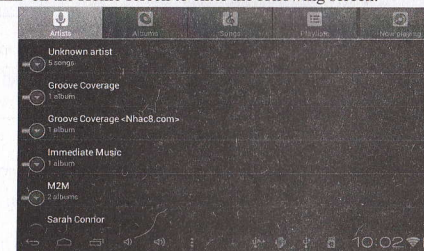

Your music is organized into different categories such as Artists, Songs and Albums. Tap one of the category tabs to view a category.



Press and hold one item in the above interface until the operation menu as follows:

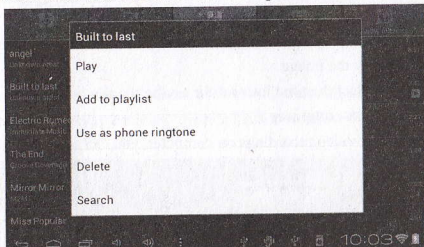

Tap **Play** to play the selected item.

Tap **Add to playlist** to add the selected song into Current playlist or into a new playlist created as you like.

Tap **Use as phone ringtone** to set the song as phone ringtone.

Tap **Delete** to delete the song from the list.

Tap **Search** to search the song on the internet or in the device.

Select a song in the playlist and tap on it to start playing as follows:



	Tap to go to the previous song.
	Tap to play, pause, or resume playing the song
	Tap to go to the next song
	Tap to go to the now playing list
	Tap to switch the following repeat modes: repeat all songs; repeat current songs; do not repeat
	Tap to shuffle the current playlist.

When the music is on, tap menu icon to prompt the operation bar as follows:

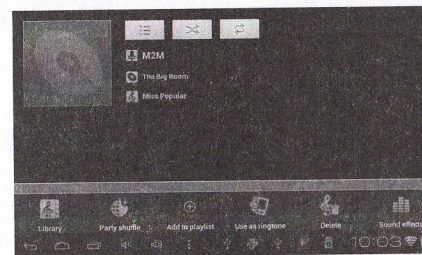

Here you can turn on/off party shuffle, or use the song as ringtone, or add the song to the playlist, or set the sound effect of the song or go to the Library directly. And you can also delete the song by tapping corresponding buttons in the operation bar.

When screen turns off, you can control the music playback right from the Lock screen when you “wake up” the device by pressing POWER button. If you do not see the playback controls on the Lock screen, tap anywhere on the screen to display the playback controls.

## 7.5 Video Player

Tap the launcher icon on the Home screen and tap the Super-HD player icon to go to the following interface:



Photos and videos are classified automatically for easy view.

Double tap on a video file to start playing it.

On the video playing screen, tap on the screen to popup the control bar as follows:



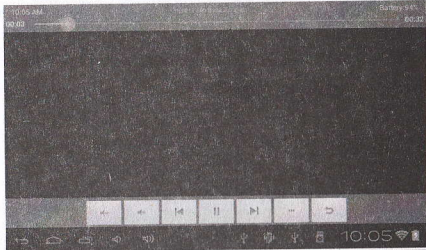

	volume down
	volume up
	Tap to play the previous video file in the video list
	Tap to play/pause the Now playing video file
	Tap to play the next video file in the video list
	Tap to unfold the control bar for personalizing the play mode, such as video track, zoom mode and so on
	Tap this icon to go back to the video file list interface
	Drag the slider to adjust playing progress

## 7.6 Gallery

You use Gallery to view pictures and play videos that you've taken with Camera, downloaded, or copied onto your SD card. You can perform basic editing tasks on pictures and set them as your wallpaper or contact picture. You can also share your pictures and videos with friends.

On the Home screen tap the Super-HD player icon to run the gallery application.

### Browse & edit pictures/photos

Tap an album to open it and view its contents;

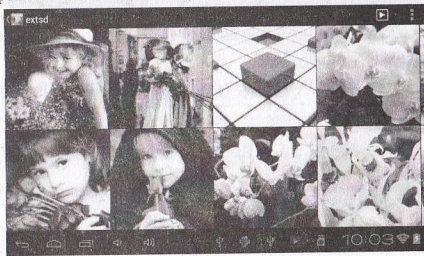

Tap on upper right corner of the screen to browse all photos/pictures in slideshow mode.

Select a picture to view it in full screen mode; drag left or right to view the next or previous picture in the album; move your fingers inward/outward to zoom out/zoom in the selected photo/picture. Tap to share it with friends via email, tap to delete/cancel deleting it, tap

to pop up the following control bars:

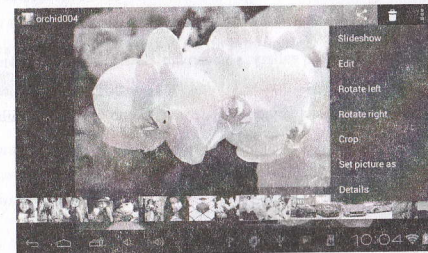

Tap **Slideshow** to slide show all pictures in the album;

Tap **Edit** to edit it. When the picture is zoomed in, drag the picture to view parts that are not in view. When the picture is zoomed to fit the window, drag left or right to view the next or previous picture in the album.

Tap **Rotate left** or **Rotate right** to rotate the picture/photo 90° anticlockwise or clockwise;

Tap **Crop** and then the following cropping rectangle will appear on top of the picture/photo:

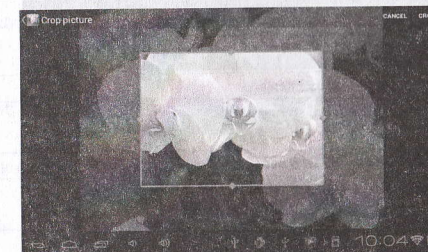

Drag from the inside of the cropping tool to move it; drag an edge of the cropping tool to resize it to any proportion; drag a corner of the cropping tool to resize it with a fixed proportions.

Tap **Crop** to save a copy of the picture as you cropped it. The original uncropped version remains on your SD card.

Tap **Set picture as** to set the current picture/photo as wallpaper/ contact icon;

Tap **Details** to more details about the current picture/photo;



### Browse & play music/video



Use Gallery to play videos/music or that in your SD card. And you can also share them with others.

Open a Gallery album containing videos /music and tap one to play it.

During playing, tap on the screen to popup the playback controls.

To quit the playing screen, press the power button, and tap Back icon in the status bar. **Share a video/music**

When browsing the video/music in the gallery, you can tap  to share the video/ music with







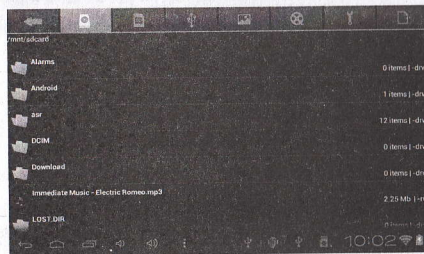

your friends; tap  to delete the selected video/music; tap  to get more details about the video/music.

## 7.7 File Manager

### ① Introduction to File Manager

On the Home screen, tap the file manager icon  to open it as follows:



	Tap to back to the previous interface
	Tap to display files in local storage card
	Tap to display files in T Flash card
	Tap to display files in other external storage device
	Tap to display all pictures/photos
	Tap to display all video files
	Tap to open the tool box for process info and application backup
	Tap to open/shutdown multiple choice of items

### ② File Management

In the above screen, you can search a wanted file quickly and you can also manage your files in the local disk and your storage card. In addition, you can create/rename file folder(s) and uninstall a third party application.

**Paste:** press  to select an item/multiple items in the list and tap **Copy/Move**, and then go to the file folder where you want to copy/move the item(s) in, then press and hold the folder until the **Folder operation** menu popup, select **Paste into Folder**.

**Delete:** press  to select an item/multiple items and tap **Delete** to delete the item(s) directly.

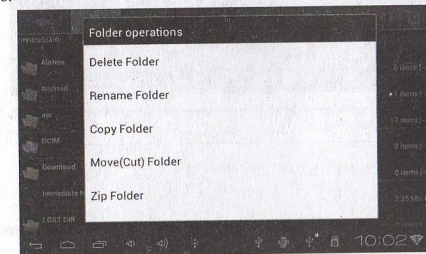

#### Folder operation

Press and hold any folder in the local disk or your storage card until the **Folder operation** menu pop up as follows:



You can select an option to execute corresponding operations.

**Search:** when you do not know the definite location of an item or there are many items in the list,

to find it quickly, you can tap the Menu icon  and then tap  to open the keyboard to search it.

## 7.8 Instant Messaging tools

You can download and install chat tools on your device such as Fring, MSN Messenger and so on.

## 7.9 Emails

Tap the launcher icon  on the Home screen to display all icons, tap the Email/Gmail icon to run it. You can:

6. set mail accounts
7. create new mails
8. receive and send mails
9. download or open the attached files



## 8. Settings

Control and customize your device settings on the Settings screen.

To open the Settings screen, simply tap the Settings icon  on the Home screen.



You can scroll on the screen upwards/downwards to check the rest setting items.

### 8.1 Wireless & networks

Configure your device's wireless connections, e.g., Wi-Fi, enable the Airplane mode, or set the options for mobile networks, Virtual Private Networks, and more.

#### Wi-Fi

To turn on/off Wi-Fi, simply slide your finger rightward/leftward on the control bar.

### 8.2 Sound

Set the device and notification ring tones, volume adjust, vibrate and silent mode operation.

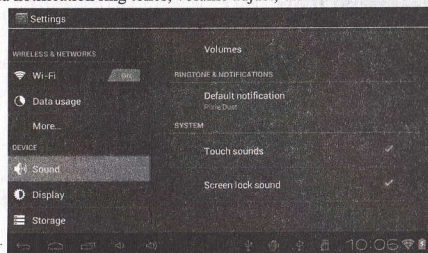

#### Volume

To adjust the volume for media, games, and alarms:

1. tap Settings > Sound > Volume;

2. drag the control bar leftwards/rightwards to turn down/up the volume for media and notification;
3. tap **OK**.

#### Notification ringtone

To set a notification ringtone:

4. tap Settings > Sound > Default notification
5. tap a ringtone to listen to it
6. enable a ringtone as notification ringtone by tapping **OK**.

#### Touch sound

Check to enable sounds when touching the screen.

#### Screen lock sounds

Check to enable playing sound when making screen selection.

## 8.3 Display

Set the screen brightness, wallpaper, font size and screen timeout.

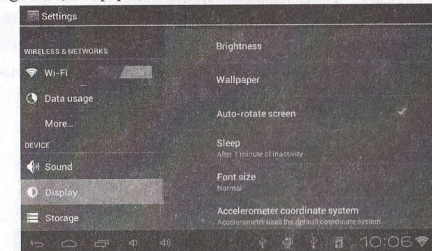

#### Brightness

Use the slider to set a brightness level you want at all times when using the PE11. For the best battery performance, use the dimmest comfortable brightness.

#### Wallpaper

Tap to select source of wallpaper and set wallpaper for the device.

#### Sleep

Opens a dialog where you can set how long to wait after you tap the screen or press a button before the screen darkens. For the best battery performance, use the shortest convenient timeout.

#### Font size

Opens a dialog where you can set font size.

#### Accelerometer coordinate system

Open a dialog where you can set the coordinate system for the device.

#### Screen adaption

Check to enable screen adaption.



## 8.4 Storage

Check the usage condition of the storage space on the internal I& external storage card. You can erase all data on the SD card and unmount the external SD card for safety removal. Unmount the SD card: tap settings > storage > unmount shared storage > OK.

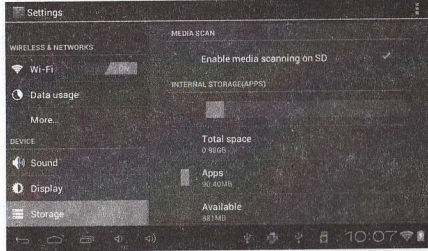

Tap  and then select **USB computer connection** to set the connection type, there are 3 modes provided: Media device, Camera and Mass storage. When the storage card remains in your device, you can tap **Mount Storage** to mount and read data in the storage card.

## 8.5 Apps

Manage applications and installation of new programs.



**Apps**  
Opens a list of all the applications and other software installed on your PE11, along with their sizes. By default, only downloaded applications are shown, and they are sorted in alphabetical order. Press  and tap **Sort by size** to display applications in order by size. Tap an application to open its Application Info screen.

To manage and/or remove uploaded applications, tap Settings > Apps > Downloaded.

### Running services

To check and control running service, tap Settings > Apps > Running.

## 8.6 Accounts & Sync

Log in or out from your social network accounts, Google Account, and Exchange ActiveSync account. You can also manage synchronization and other settings for your accounts.

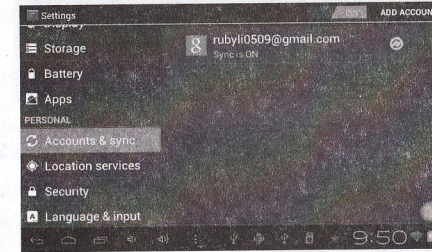

Tap **Add account** in the above screen to add new accounts by following onscreen instructions.

Tap the icon  to prompt the following screen to manage your accounts:

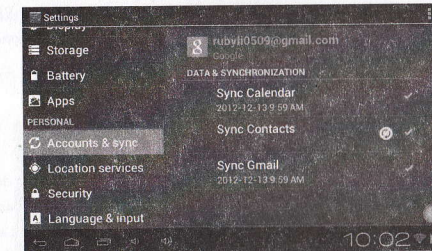

Check  to turn on/off data synchronization, press the menu icon  and then tap

**Remove account** to remove the selected account from your device.

## 8.7 Location service

Enable applications using data from sources such as Wi-Fi and mobile networks to orientate your location and improve Google search results via check the options.

## 8.8 Security settings

Set the screen lock mode and owner information, encrypt your device, manage password and



administrate your device.

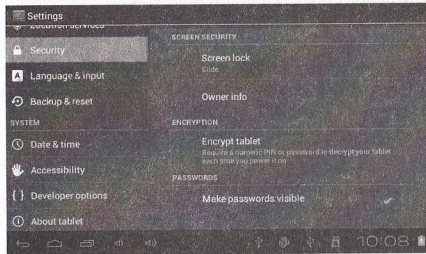

To set screen lock mode, tap **Settings > Security > Screen lock** to personalize the screen lock mode for you device.

#### Unknown source

Check to permit installation of applications that you obtain from web sites, email, or other locations other than Android Market.

### 8.9 Language & Keyboard setting

Use the Language & Keyboard settings to select the language for the text on your PE11 and for configuring the onscreen keyboard, including words that you've added to its dictionary.

### 8.10 Backup & reset

You can enable or disable the automatic backup feature of the device and reset the device.

**[Note]:** after factory data reset, you personalizing settings and the installed third-party applications will be removed from your device. Before restoring default settings, it is suggested to backup data/applications you want and remove your storage card safely in case of data loss or damage during restoring factory default settings.

### 8.11 Date & Time setting

Set the date and time, time zone, and date or time format. To turn off auto time synchronization and be able to manually change time zone settings.

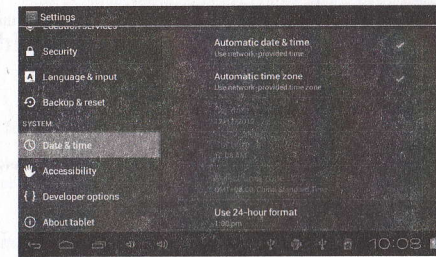

**Automatic:** Uncheck to set the date, time, and time zone on PE11 manually, rather than obtaining the current time from the mobile network.

**Set date:** If Automatic is unchecked, opens a dialog where you can manually set PE11's date.

**Select time zone :** If Automatic is unchecked, opens a dialog where you can set PE11's time zone.

**Set time:** If Automatic is unchecked, opens a dialog where you can set PE11's time.

**Use 24-hour format:** Check to display the time using 24-hour time format, for example, 13:00 rather than 1:00 pm.

**Select date format:** Opens a dialog where you can select the format for displaying dates

### 8.12 Accessibility

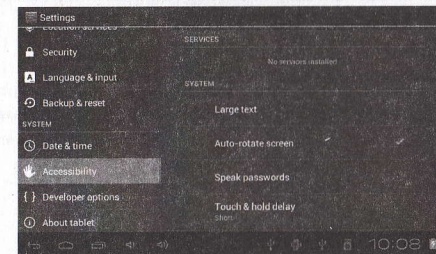

**TalkBack:** check to provide spoken feedback to help blind users

**Identify Gesture:** tap to enable identify gesture app

**Large text:** check to enlarge text

**Auto-rotate screen:** Check to automatically switch the orientation of the screen as you turn the device sideways or even upside down.

**Speak password:** check to enable speak password

**Text-to-speech output:** tap on it to open a screen on which you can listen to an example of speech synthesis, enable/disable your settings, to check default engine, to set speech rate and language and so on.

**Touch&hold delay:** tap to select the time delayed for hold & touch.



Enhance web accessibility: tap to enable/disable installing scripts from Google that make their web contain more accessibility.

### 8.13 Developer options

You can set the USB debugging mode, select screen stay awake and so on. And you can also manage user interface and apps.



**USB debugging:** Check to permit debugging tools on a computer to communicate with your PE11 via a USB connection.

**Stay awake:** Check to prevent the screen from dimming and locking when the PE11 is connected to a charger or to a USB device that provides power. Don't use this setting with a static image on the PE11 for long periods of time, or the screen may be marked with that image.

**Allow mock locations:** Check to permit a development tool on a computer to control where the PE11 believes it is located, rather than using the PE11's own internal tools for this purpose.

### 8.14 About Device

View the device status such as the network type, battery power level, and network name. You can also check the battery use of individual applications or view the legal information and software version of your PE11.

## 9. Troubleshooting

### 9.1 Force shutdown

Press the Power Button for about 5 seconds and the device will be forced shutdown

### 9.2 Restore default settings

To restore the factory default settings, you can tap Settings > Backup& reset> Factory data reset.

**Warning:** data of your Google account, your personalized settings, installed appellations will be removed from your device once you execute factory default settings, so please make a careful decision whether to restore default settings. Before restoring default settings, it is suggested to backup data/applications you want.

### 9.3 System updating

After system update/upgrade, it may occur that the uploaded third-party can not run or its data loss/damage. This is normal phenomena rather than system fault. You just need to upload and installed the third-party applications again in the device. It is recommended to backup data of the third-party applications before system update/upgrade.

### 9.4 Reset

When the system halts accidentally or does not response, please press the Reset key to force the system stop or press and hold the power button for 8 seconds to turn off the device forcibly.

**[Note]:** it is normal for the device feels hot during charging, please use at ease.



## 10 FAQ

If your system does not work, please do the following. If still not out of the question, please contact with our company customer service center.

Fault	Reason	Solution
Startup failure	Low battery	Supply external power and charge the battery.
	System down	Reset the GPS navigator.
Sudden power cut	Low battery	Supply external power and charge the battery.
No/ vague display	Low backlight	Turn up the backlight.
	Backlight off	Tap the screen with the touch pen.
Incorrect tapping response	Touch screen not calibrated	Recalibrate the screen.
No sounds	Low volume	Turn up the volume.
	Poor contact of earphone	Connect the earphone.
Communication with PC	Poor USB connection	Connect the USB cable.
GPS signals reception failure	Weak GPS satellite signal	About 3 minutes are needed for low intensity of local GPS satellite signal.
Loss of map data	Accidental deletion	Contact your agent or distributor. Input a new password after recovering the GPS data.

- [tip]: 1. long press power button for 8 seconds, the device will force the shutdown.
2. original factory set and clear all data, please press the menu button → settings → privacy → restore factory settings. Selection of resetting the device will delete the Google account, system and application data and settings, download the application, please use this carefully.
  3. After the upgrade of the system, third party program installed will be unable to use or data loss. this is a normal, not a system failure, you need to download and install third party applications again. Backup before update.

Note: When charging the fuselage will be hot, which belongs to the normal situation, Please Don't worry