



Sigma Series

User Manual

Contents

Introduction	5
Warranty	5
Technical support	5
List of consumables	5
Product Warranty Period	5
Conditions to exercise the warranty	5
How to exercise the warranty?	5
Warranty exclusions	5
Limitations and liability exemptions	5
Conformity	9
Specifications	10
Safety and compliance	12
General information	12
Hazards	12
Proper area to install the printer	14
Moving the machine	15
Installation	16
What is in the box?	16
Unboxing	17
Diagram	17
Set up	21
Remove protections	21
Install printing surface	21
Using the printer	22
Online	22
Ethernet	22
WiFi	22
Offline	22
SD Card	22
Turn on the printer	22

Getting started	23
Welcome setup	23
Language	23
Network connectivity	23
Register	25
Setup assistant	28
Load filament	28
Printer calibration	31
Printing surface calibration	31
Z Offset calibration	32
Installing shims	35
XY Offset calibration	38
X Axis calibration	38
Y Axis calibration	39
Operation	41
Control panel	41
Preparing a print	42
BCN3D Cura	42
Installing BCN3D Cura	42
Add printer	42
Add an offline virtual printer	42
Add a printer that is linked to your account	43
Printing modes	43
Regular	44
Single	44
Dual	46
Mirror	48
Duplication	50
How to print the file	51
Online printing	51
From the BCN3D Cloud dashboard	52
From BCN3D Cura via cloud	53
Offline printing	54
Via SD card	54
Detach print from build plate	55
Use a spatula	55
Use water	56
Reusage of the magigoo adhesives	56
Clean the glass surface	56
Rating	57

Menu structure	58
Home screen	58
Print	58
Select file from SD card	58
While printing	59
Utilities	61
Filament	61
Calibration	64
Maintenance	66
Printer setup	67
Temperatures	71
Information	72
Maintenance	73
General maintenance	73
Hotend	74
Extruder	75
Printing surface	76
Motion system	77
Firmware upgrade	77
Troubleshootin	78
Error message	78
Glossary	80
Filaments	82
BCN3D Technical Assistance Services	83
Terms and Conditions	84
Open Source	86

Introduction

Warranty

BARCELONA THREE DIMENSIONAL PRINTERS, S.L. provides this Warranty to the consumers of the BCN3D brand products included in the sales package ("Product").

This Warranty will be valid only in the country in which the sale of the Products has been made. BARCELONA THREE DIMENSIONAL PRINTERS, S.L. hereby guarantee that, within the warranty period, BARCELONA THREE DIMENSIONAL PRINTERS, S.L. or an authorized service company will correct, within a reasonable period of time, the defects of materials or manufacturing detected in the Products, according to the clauses set out below.

All the products purchased at BCN3D Technologies are covered by the **Law 23/2003** of July 10 of Warranties on the Sale of Consumer Goods (consolidated in Royal Legislative Decree 1/2007). Also covered by the **Directive 99/44 /CE** of the European Parliament and of the Council of 25 May 1999 on certain aspects of the sale and warranties of consumer goods, as amended by the Directive **2011/83/UE** of the European Parliament European Parliament and the Council of 25 October 2011 on the rights of consumers.

The products acquired to integrate them in a productive or commercial process, will have a warranty period of not less than six months as provided in the **articles 1484 to 1491 of the Civil Code** for hidden defects or defects.

Product Warranty Period

As previously stated, all products purchased directly from BCN3D Technologies will have a 24-month warranty for all those purchases made within the European Union, and 12 months for the rest of the countries. The warranty will come into force from the date on which the product was purchased for the first time by the end customer (invoice date). If you do not have the purchase invoice, the manufacturing date of the product registered by BCN3D Technologies will be considered as the beginning of the warranty period.

Technical Support

For any questions or problems with BCN3D Products, please contact us at:

Carrer de Miquel Servet, 18
08850 Gavà, Barcelona (Espanya)
Email: support@bcn3d.com
Tel: +34 935 95 43 43

BARCELONA THREE DIMENSIONAL
PRINTERS, S.L.
VAT: ESB67235069
Manufactured in Spain

List of Consumable components

This document lists the Consumable components that, due to their natural deterioration, are excluded from the Warranty: **Hotends, Teflon tubes, Glass printing surface, Filament spools, Printing adhesive (Magigoo), Printed parts, Calibration gauge, Shims.**

Warranty

Conditions to exercise the warranty

The BCN3D warranty is granted under the following conditions:

- 1 Acquire the product through BCN3D Technologies or one of its authorized resellers (See <https://www.bcn3d.com/en/reseller/> to see the addresses of authorized BCN3D Distributors).
- 2 Be within the established deadlines, which are:
 - **2 years** from the invoice date for purchases within the EU.
 - **1 year** from the invoice date for purchases outside the EU.
- 3 The product must be packed in its original packaging. Otherwise, BCN3D Technologies reserves the right to accept or reject the return, or if it is estimated, a depreciation of the product.
- 4 The product has been sold as new, not as reconditioned or used.
- 5 The serial number of the product to be returned will have to correspond to the one in the BCN3D Technologies records.
- 6 Unless specifically requested by BCN3D Technologies, nothing else should be sent apart from the Product. All accessories and removable storage devices such as SD memory cards must be removed from the product. BCN3D Technologies is not responsible for the loss, damage or destruction of accessories or removable storage devices, unless caused intentionally or negligently by BCN3D Technologies.
- 7 Customers are allowed to use third-party materials, accessories, etc, since that does not cancel the warranty. As long as the use of these elements does not cause damage to the Product, the part (s) affected by this damage will be excluded from the warranty.

8 If a part of the Product is repaired or replaced during the warranty period, the remaining warranty period for the entire product will apply to this part. However, repairing and / or replacing a part will not extend the warranty period.

BCN3D Technologies official Distributors are responsible for the warranty on behalf of BCN3D Technologies. Therefore, any warranty notification must be made directly to the BCN3D Technologies official Distributor where the product was originally purchased.

Any warranty claim must first be acknowledged and accepted, either by BCN3D Technologies or by a Distributor of BCN3D Technologies. The Distributor is obliged to rectify any damage for free according to this guarantee. In the event that the defect can not be repaired, the Distributor, within the warranty period, will replace the Product for an identical product, or if the product is no longer manufactured, for a similar product of the same value or offer an adequate refund.

Depending on the country, the warranty may not automatically include the costs incurred for the shipping of the defective Products for repair or replacement.

How to exercise the warranty?

In order to exercise the warranty, you will have to contact us to support@bcn3d.com.

- 1 You will receive a document by email to be completed (RMA), so that we can authorize the reparation.
- 2 Once the RMA is completed, you must send it to support@bcn3d.com duly completed.
- 3 The technical support department will assess the situation and within 48 hours will tell you whether or not we accept your return request. If accepted, it will assign you an RMA number with a validity of 30 days.

Warranty

4 The product must be sealed in its **original packaging**. In the case of not returning the order in its original and sealed packaging, BCN3D Technologies reserves the right to accept or reject the return or establish a depreciation of the product.

5 Once the product has been packed, we will send a transporter that will pick up the goods to be returned perfectly packed, being able to desist from the collection in case of improper packing. It is important that you place the **RMA number visible on the package**.

6 Once the goods are received in our facilities, our technical service will inspect them and determine whether the product is covered by warranty or not.

7 If the user does not accept the reparation, BCN3D Technologies will return the product by the agreed method of RMA. If the user does not collect the product, or if it can not be sent to the address provided by the user, BCN3D Technologies will contact the user by the means that he considers convenient and previously provided. If the user does not collect the product during the 90 days following the moment of sending the information, BCN3D Technologies reserves the right to invoice the cost of storage, disposal of the product according to the applicable laws and regulations, and any law for non-payment.

Warranty exclusions

This Warranty does not cover:

1 Defects caused by inappropriate transportation (without original packaging) or handling of the Product (including without limitation, defects caused by sharp elements, cutting, bending, compression or fall).

2 The wear and tear caused by the use of the Product, including, but not limited to, the wear of moving parts, control panels or elements that interact with the

operation of the Product.

3 The damages caused by the non-compliance of the maintenance plan exposed in the User's Manual of the Product.

4 The malfunctions or damages caused by modifications, alterations or repairs carried out by any individual or company not authorized by BARCELONA THREE DIMENSIONAL PRINTERS, S.L., being excluded from this assumption the replacements of consumables.

5 Damages caused by unusual failures in the electrical network.

6 Damage caused by abuse, misuse, accident or negligence when using the Product.

7 Effects derived from the Product's exposure to floods, fire, humidity, spillage of food or chemical compounds, corrosion, oxidation, extreme atmospheric conditions or any other agent external to the Product.

8 Damages derived from the use of Software other than that recommended by BCN3D Technologies.

9 Damages caused by not using materials recommended by BCN3D Technologies.

10 The components considered as Consumables, listed in the attached document.

11 Any product in which the serial number is not visible.

Warranty

Limitations and liability exemptions

This Warranty is the sole and exclusive Warranty of BARCELONA THREE DIMENSIONAL PRINTERS, S.L. and the sole and exclusive responsibility of BARCELONA THREE DIMENSIONAL PRINTERS, S.L. for the defects present in its Products. Therefore, this Warranty replaces any other guarantee issued by BARCELONA THREE DIMENSIONAL PRINTERS, S.L., whether oral or written on any method.

However, this Warranty does not limit either the consumer's rights, specified in current legislation, or the rights against the seller, also set out in the legislation.

BARCELONA THREE DIMENSIONAL PRINTERS, S.L. is not responsible in any case for the loss of business, loss of contracts, loss of profits, loss of savings, increase of costs or expenses for the use of its Products. In the same way, BARCELONA THREE DIMENSIONAL PRINTERS, S.L. rejects the responsibility of any indirect, accidental or collateral damage caused by the use of its Products.

Conformity

The BARCELONA THREE DIMENSIONAL PRINTERS, S.L. hereby declares that the BCN3D Sigma:



Complies with the essential requirements and any other applicable or required provisions of the Directives:

2006/42/CEE Machinery Directive

2014/35/UE Low Voltage Directive

2014/30/UE Electromagnetic Compatibility Directive (EMC)

2011/65/UE Restrictions on the use of hazardous substances in electrical and electronic equipment (RoHS)

2009/125/CE Ecodesign requirements for energy related products

2012/19/UE Waste electrical and electronic equipment

2014/53/UE The harmonisation of Member States' legislation on the marketing of radio equipment.

Conformity with the requirements of these directives is justified by the following harmonised standards:

2006/42/CEE UNE-EN ISO 12100:2012; UNE-EN ISO13732-1 :2008; EN ISO 7010:2012

2014/35/UE UNE-EN 60204-1; UNE-EN 60947-3:2009

2014/30/UE UNE-EN 55022:2011; UNE-EN 55024:2011; UNE-EN 61000-4-3-2:2007

Changes / modifications not approved by the responsible party could void the user's authority to operate the equipment.



This equipment has been tested and found to comply with the limits for a Class A digital device, pursuant to part 15 of the FCC Rules. These limits are designed to provide reasonable protection against harmful interference when the equipment is operated in a commercial environment. This equipment generates, uses and can radiate radio frequency energy and, if not installed and used in accordance with the instruction manual, may cause harmful interference to radio communications. Operation of this equipment in a residential area is likely to cause harmful interference in which case the user will be required to correct the interference at his own expense.



REI-RAEE: 6989

BARCELONA THREE DIMENSIONAL PRINTERS, S.L.

Carrer de Miquel Servet, 18, 08850 Gavà, Barcelona

Tel: +34 935 95 43 43

www.bcn3d.com

Specifications

PRINTER PROPERTIES	
3D Printing Technology	Fused Filament Fabrication (FFF)
Architecture	Independent Dual EXtruder (IDEX)
Printing volume	420mm x 300mm x 200mm
Number of extruders	2
Warranty	2 years for EU countries 1 year for non-EU countries
Extruder system	Extruder Bondtech™ high-tech dual drive gears Hotends optimized and manufactured by e3D™
Printing modes	Single mode, Dual mode, Support mode, Duplication mode, Mirror mode
Electronics	Single Board Computer: Toradex ARM Compute Module Motion Board: BCN3D Electronics with Independent Stepper Drivers
Firmware	BCN3D Embedded Linux distribution BCN3D Sigma D25 - Marlin
Heated bed	Silicone thermal pad
Screen	5" full color capacitive touchscreen
Supported languages	Spanish, English, German, French, Italian, Japanese, Portuguese, Chinese
Supported files	*.gcode
Operating sound	49 dB
Nozzle diameter	Brass nozzle: 0,4mm (default) 0,8mm
Certifications	CE / FCC
Connectivity	Offline printing: SD card Online printing: WiFi or Ethernet (through BCN3D Cloud)

Specifications

MATERIALS	
Filament diameter	2,85 ± 0,05 mm
Compatible materials	Standard materials: PLA, PET-G, TPU, PVA
Open filament systems	Yes
PHYSICAL PROPERTIES	
Overall dimensions	690mm (W) x 530mm (D) x 550mm (H) (720mm with bowden)
Weight	30Kg
Shipping box dimensions	780mm (W) x 570mm (D) x 725mm (H)
Shipping weight	43Kg
Shipping method	Box
PRINTING PROPERTIES	
Recommended profiles	Layer height: 0,2mm 0,3mm 0,4mm (depending on nozzle diameter)
Layer height	0,05mm - 0,5mm (custom profiles)
Positioning resolution (X / Y / Z)	1,25µm / 1,25µm / 1µm
Operating temperature	15 °C - 30 °C
Extruder maximum temperature	300 °C
Heated bed maximum temperature	80 °C
ELECTRIC PROPERTIES	
Input	AC 84-240V, AC 3,6-1,3A, 50-60Hz
Maximum power consumption	650W
SOFTWARE	
File preparation software	BCN3D Cura
Operating Systems	Windows, Mac, Linux
Supported files	STL, 3MF, OBJ, AMF
Wireless connectivity	BCN3D Cloud
Supported browsers	Google Chrome, Mozilla Firefox, Microsoft Edge, Safari, Opera

Safety and compliance

General information

To avoid potential residual risks the user should read and understand the following safety measures (you are strongly advised to read this before using the machine).

To highlight the areas where extra care should be taken, safety alert stickers have been affixed to the relevant parts of the machine to warn the user of potential hazards.

Any modifications made to the machine without the manufacturer's approval will invalidate the product's Declaration of Conformity (CE) and warranty.

Consequently, the BARCELONA THREE DIMENSIONAL PRINTERS, S.L. ARE EXEMPT FROM ANY LIABILITY IF THE USER DOES NOT FOLLOW THE INSTRUCTIONS FOR USE.

Hazards

The following stickers have been affixed to the printer to warn users about the hazardous areas of the machine, and actions which are not recommended as they will stop the machine from working properly.

Supervise the printer while it is printing to make sure it is working properly.

This device is not a toy. It should not be used by minors under 16 without the supervision of an adult.

The spatula can be a dangerous tool that may cause injuries. Use it only to remove plastic residue after calibration assistant or a printing job.

Handle the glass printing surface with care. Make sure it is not dropped or hit with anything as this could seriously

Safety and compliance

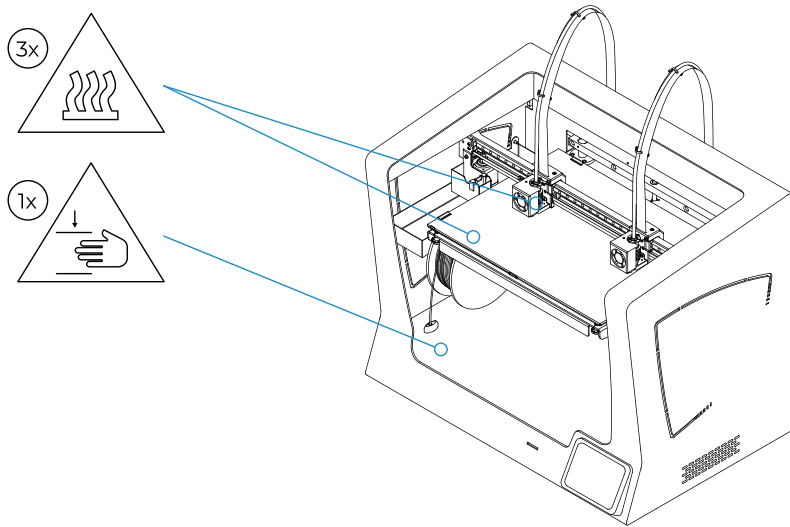

The printer is powered by mains voltage, which is hazardous when touched.

This has been marked with a high-voltage symbol on the bottom cover.

As with any other appliance, do not touch the terminals of the mains, the switch, or the power supply. There is a risk of electrocution.

Connect the machine to an electrical outlet according to the current legislation.

Do not connect or disconnect any device and/or electrical connector when the machine is connected to the power supply.

In the event of an emergency, stop the machine immediately by pressing the switch, and disconnect the power supply.



Do not touch the hot parts (heated bed and hot-ends) when the machine is switched on, and wait 15 minutes after it has been switched off before touching them.

Take care about the indications of temperature shown on the screen.

There is a potential risk of burns: the hotend can reach temperatures up to 300 °C, while the silicone heater mat can reach temperatures of 200 °C. Do not touch either of these parts with your bare hands.



WARNING OF
HAND INJURY

Do not put any object or part of the body between the mobile parts of the printer, when it is moving or can start moving.

Specifically the force of the build plate is enough to cause damage.



The printing materials are not innocuous and emit toxic fumes.

Always print in open or well-ventilated spaces and use a protective mask.

Do not breathe closer than 25 cm from the tool head when printing.

Proper area to install the printer

In order to ensure easy access to the printer during normal operations and maintenance, install the machine in a place with enough space between walls and other equipment.

The distance measured from the back of the printer to the wall has to be at least 200mm to allow easy access from the side of the printer. This space is important to guarantee easy access to extruders, FRS and external spools.

Do not cover the printer while working in order to ensure a good ventilation. Do leave at least 100mm of free space on each side of the printer for proper ventilation and at least 200mm at the front of the printer to prevent possible damages.

Install the printer on a table or workbench that supports at least 50kg (recommended 100kg) and that has at least a 20% more surface than the footprint of the printer in each direction (recommended 1000mm x 800mm).

Use the machine at temperatures of 15 °C ~ 30 °C and relative humidity below 50%.

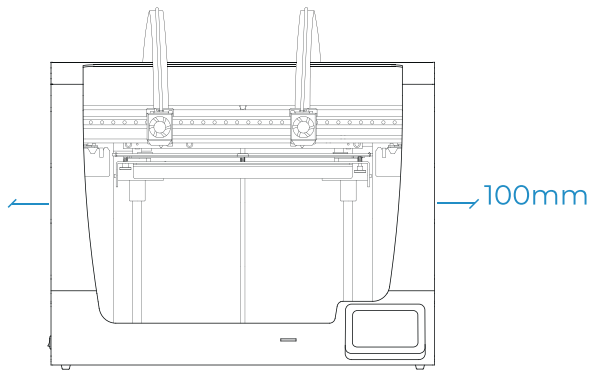

Moving the machine

To ensure safe movement of the machine, follow the steps described below:

- Switch off the printer
- Disconnect the power supply cable from the rear of the machine. Also disconnect the ethernet cable and USB Wifi dongle if it is connected.
- Ensure the glass printing surface is well fixed with the clamps.
- The printer is heavy, two people are necessary to perform this step. Make sure that the table where the printer is being installed, is close enough.
- Lean the printer backwards holding it from both the side handle and the front-bottom.

Installation

What is in the box?

Printer box:

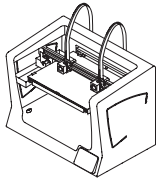

BCN3D Sigma
with 0.4mm hotends

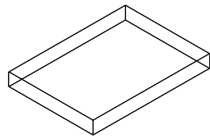

Glass printing surface

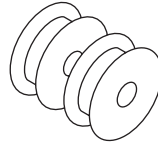

2 PLA spools

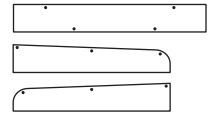

3 plastic covers +
10 Thumbscrews

Upper box:

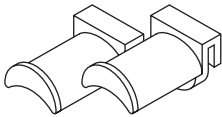

2 Spool holders

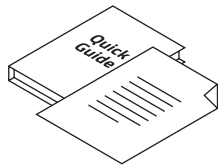

Quick start guide and warranty

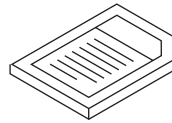

SD card

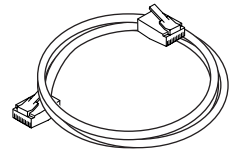

Ethernet cable

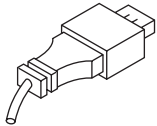

USB cable



Spatula

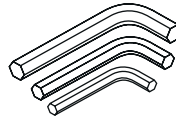

3 Allen key

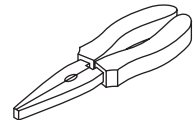

Pliers

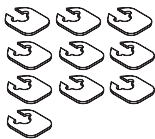

10 Shims

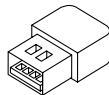

USB dongle

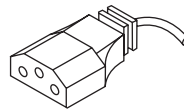

Power supply cable

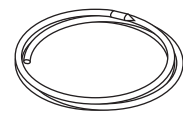

Nylon cleaning filament

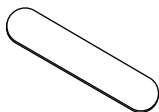

Calibration gauge

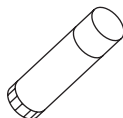

Magigoo glue stick

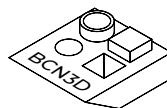

Sample part

Unboxing

Unboxing

Unboxing

Watch our [video](#) to see how to correctly unbox.

The printer is heavy and therefore this step needs to be performed by two people. Make sure that the table where the printer is being installed, is close enough.

 Retain packaging for warranty service.

 Proper area to take out the printer with your hands.

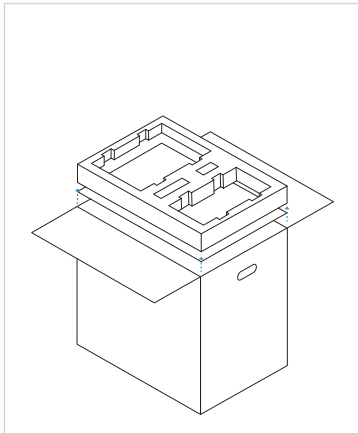

1. Open the box from the top.

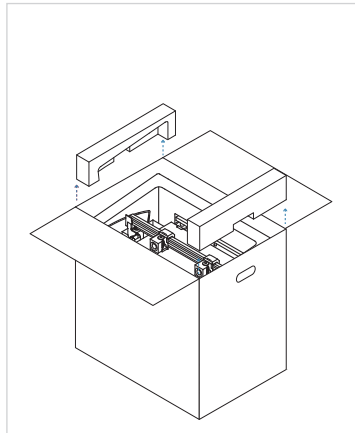

2. Remove the components from the foam and place them on a table. Then remove the foam and the cardboard.

3. Remove the lateral foam protections.

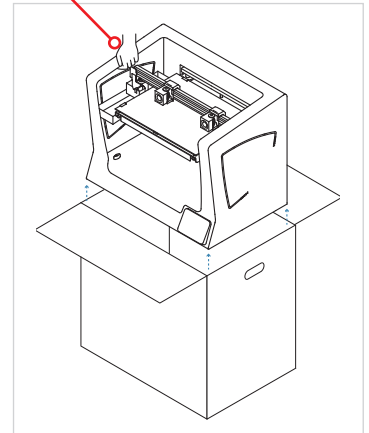

4. Lift the printer with care holding it from the side flanges and place it on the table.

5. Open the plastic bag containing the printer.

Diagram

1. Hotend
2. Bowden tube
3. Purge tank
4. SD Card reader
5. Touchscreen
6. Spool holder
7. Filament spool
8. Glass printing surface
9. Extruder
10. Power plug
11. USB port
12. Ethernet port
13. External spool holder
14. External filament spool
15. Filament Runout sensor (FRS)
16. Power switch

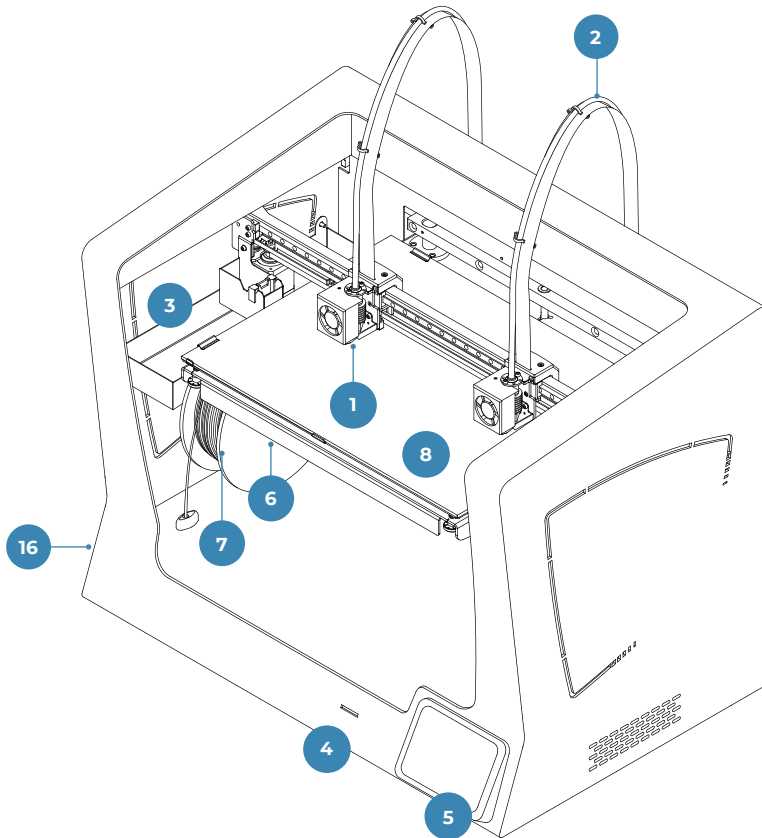

Diagram

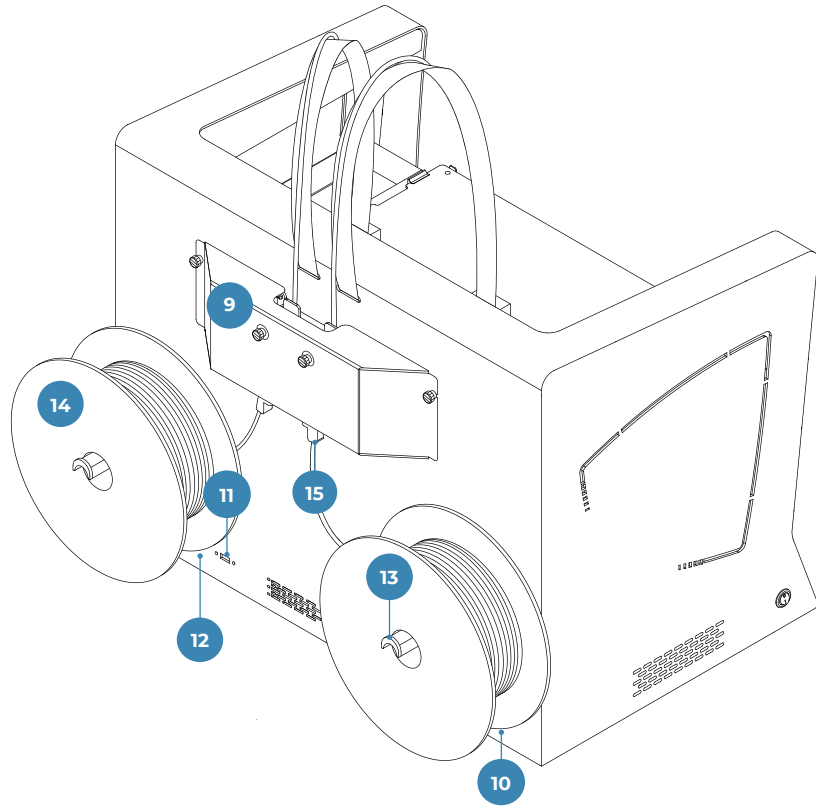

Diagram

- 20. Leveling thumbscrews
- 21. Clamps
- 22. Glass printing surface
- 23. Platform
- 24. Build plate

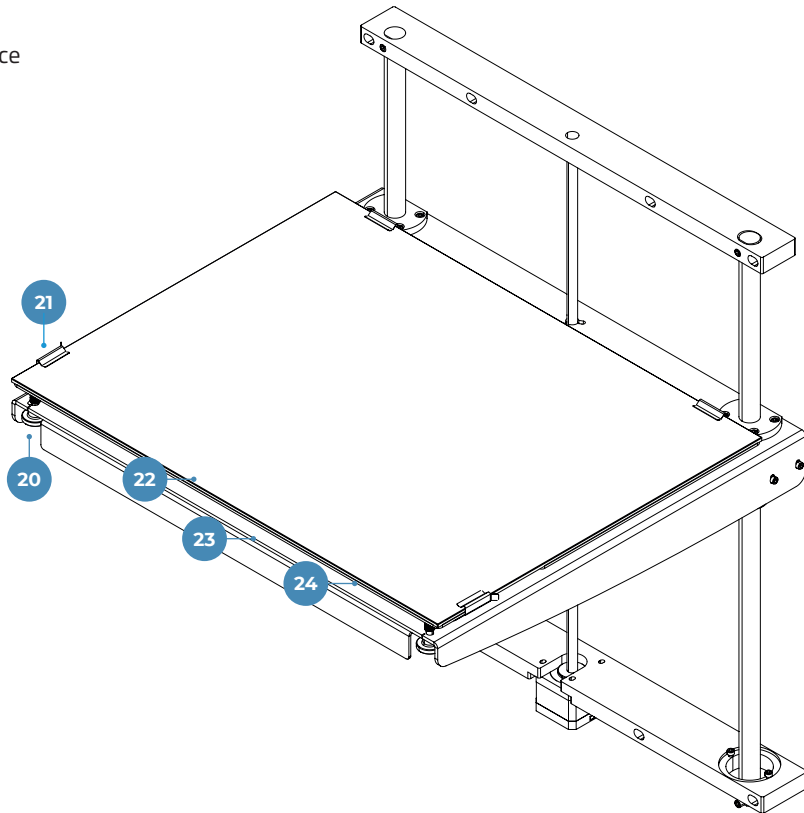

- 25. Hotend
- 26. Hotend fan
- 27. Layer fan
- 28. Coupling clip
- 29. Coupling collect

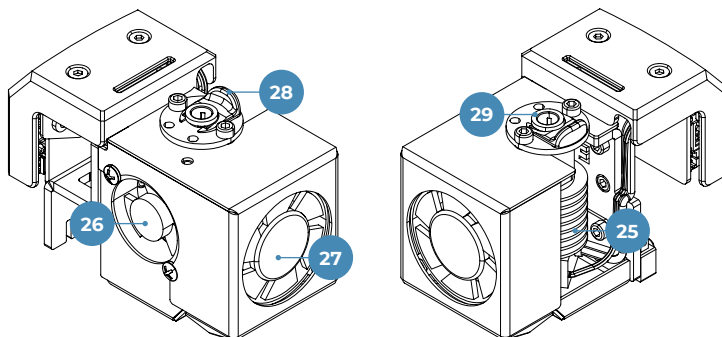

Set up

In order to ensure the safe packaging and transport of the printer, some of the components are sent in separate packages. Before starting to print with the BCN3D Sigma Series printer, those parts need to be installed in order to complete the setup process.

For any query while setting up the printer, please refer to section [BCN3D Technical Assistance Services](#).

Follow the steps below to prepare the printer:

Remove protections

Foam protections are set during the packing process in order to protect some parts that may move during transportation. It is very important that the foam protections are removed before printing. Follow the instructions:

- **Remove all the protection foams inside the printer.** There are three on the carriage and one under the printing surface.

Install plastic covers

- Take the plastic covers and thumbscrews from the packaging.
- Peel off the protective films.
- Use the thumbscrews to install the plastic covers.

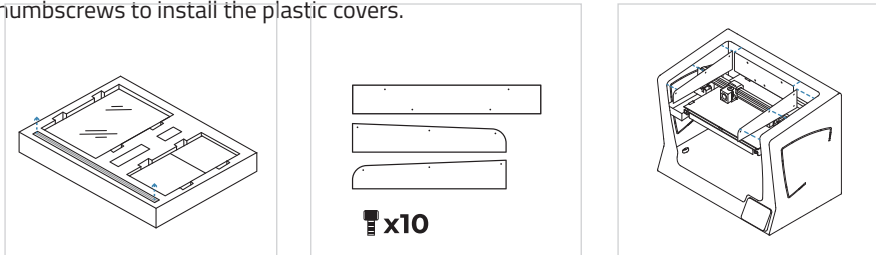

Install printing surface

The BCN3D Sigma printing surface is the area where the hotends deposit the material layer by layer to construct the model. It is very important that the printing surface is correctly installed before printing. Follow the instructions:

Watch our [video](#) to see how to correctly position the printing surface.

- Pivot the left and right spring clips away from the aluminium platform.
- Take the glass printing surface from the upper protective foam.
- Place the glass printing surface on top of the aluminium platform.
- Insert the glass with light force into the back spring clips.
- Fix it with the left and right spring clips.



The glass printing surface glass must be handled with care. In case of breakage, it may cause injuries.

Set up

Using the printer

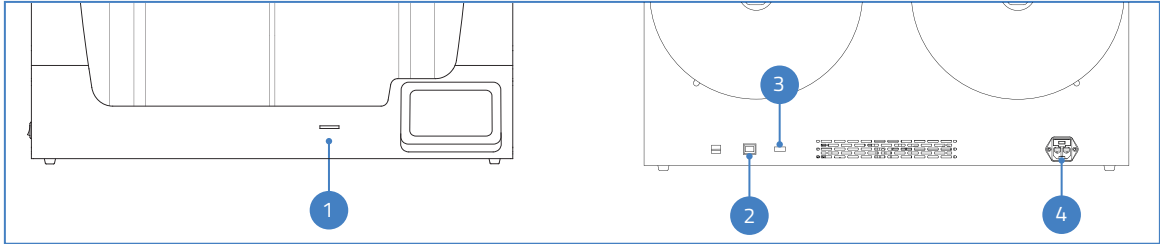

1. SD Card
2. Ethernet cable
3. WiFi module
4. Power cable

The BCN3D Sigma Series can be used online or offline. However connecting the printer to the network is needed in order to register it and to use the BCN3D Cloud functionality.

 Ethernet connection is more stable than Wifi, so having both options, we recommend connecting the printer using an Ethernet connection.

Online

Ethernet

- Take the ethernet cable out from accessories box.
- Connect the ethernet cable to the ethernet port at the back of the printer.
- Connect the other end of the cable to a network source.

WiFi

- Find the USB WiFi Dongle in the accessories box.
- Plug the USB WiFi Dongle into the USB port at the back of the printer.

Offline

SD Card

- Find the SD Card in the accessories box.
- Insert the SD Card into the SD Card slot at the front of the printer.

Turn on the printer

- Take the power supply cable out from the accessories box that was on top of the printer.
- Connect the power supply cable to the power socket at the back of the printer.
- Plug the other end of the cable into a wall outlet.
- Turn the printer on. The power switch is found on the left side of the printer.

Getting started

Once the printer is correctly installed on a table or workbench, it is time to proceed with the preparation protocols. These protocols include registering the printer, inserting the materials and performing the calibration.

Watch our [video](#) to see how to run the Setup Assistant

Welcome setup

The first step is to turn on the printer. The power switch is found on the left side of the printer (see the diagram).

The first time the printer starts, a welcome setup wizard helps the user to configure some settings, such as the language, the connectivity and the registration.



Language

BCN3D Sigma series printers are prepared to show information in several languages. In this screen choose your preferred language on the list and tap *Continue*.



Network connectivity

The BCN3D Sigma series printers come with the ability to connect to a network in order to monitorize, control and visualize the data generated by the usage.

There are three available options, whether the printer is connected via ethernet (option A), via WiFi (option B) or if no network is available (option C). For each option, follow the steps indicated on the screen.

Welcome setup

A. Ethernet connection

In order to use this option, the ethernet cable must be connected as indicated in Ethernet cable connection. Connect the other end of the cable to a network source. If the cable is well connected and the LAN (Local Area Network) uses DHCP, then the next screen shows up, indicating that the printer has been connected successfully.

If the network does not use DHCP, the connection cannot be set up automatically. To configure the network connection manually, follow the instructions described in the Printer setup section.

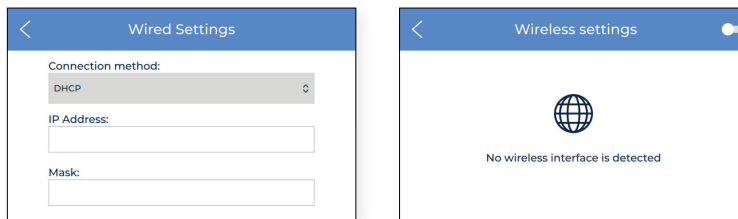

B. WiFi connection

When the wireless option is preferred, the USB WiFi Dongle must be connected, as indicated in the section WiFi connection. At this point, a screen similar to the one below appears:

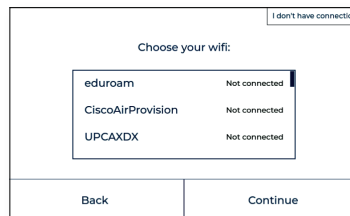

A list of detected wireless networks appears. Select the preferred wireless network from that list. In case a password is needed, please type the password and tap Connect.

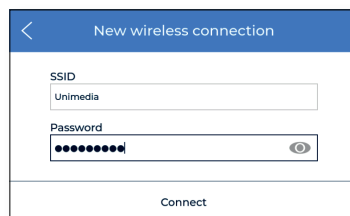

Welcome setup

When the printer has been successfully connected, a screen will appear:

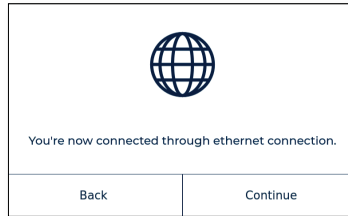

C. No network connection

If none of the two options above are available, or you don't want to use all the features available in the BCN3D

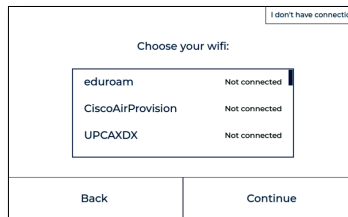

You can connect and register the printer later via the display menu Utilities > Printer Setup > Register printer, following the steps indicated in the Register section. This step is very important for warranty and support purposes.

Register

It is very important that the printer is registered. This is a mandatory step for warranty and support purposes and it is needed to be able to use the BCN3D Cloud functionalities. To perform this operation the printer must have a working internet connection.

Once the printer is connected to the network, the registration process starts. Scan QR code or visit the link that appears on the screen.

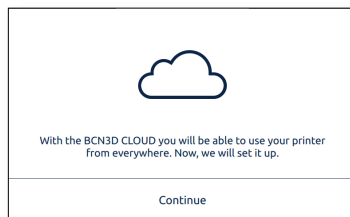

If you do not have an account in BCN3D Cloud see option A, otherwise see option B.

Welcome setup

A. New User

If you do not have an already active BCN3D Cloud account, fill your user information in the form that appears on the browser.

¡Welcome to the BCN3D experience and thanks to trust in our products! Register your 3D printer to stay updated and enjoy the best user experience.

[Already registered? Sign In](#)

User information

Email *

Username *

Fullname *

Password * Confirm Password *

Printer serial number *
040-201020-4572

Personal information

When did you start using this printer? *

This printer will be used for *

Application*

Industry*

Country*

I have read the [Privacy policy](#), [Terms and Conditions](#)

After submitting the form an email will be sent in order to verify the sign up process. Once verified, both the account in BCN3D Cloud and your printer will be registered.

Welcome setup

B. Existing user

If you already have an account on BCN3D Cloud, please press the “Sign in” link in the form. Then insert your credentials (email and password), and follow up with the form as shown in the image below.

¡Welcome to the BCN3D experience and thanks to trust in our products! Register your 3D printer to stay updated and enjoy the best user experience.

[Sign In with another user](#)

Printer serial number *
040-201020-4572

Personal information

When did you start using this printer? *
-- Choose an option --

This printer will be used for *
-- Choose an option --

Application*
-- Choose an option --

Industry *
-- Choose an option --

Country *
-- Choose an option --

[Register your printer](#)

After submitting the form your printer will be registered. Continuing on the printer’s screen, the following screen will appear:

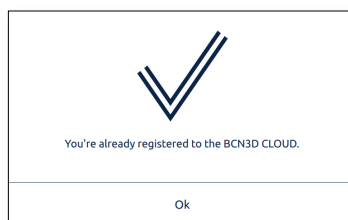

After the registration, the Setup assistant will appear on the touchscreen. This process shows the required steps before printing. Some of these steps are loading filament material and printer calibration.

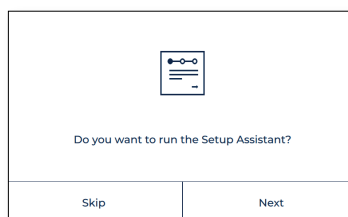

Setup Assistant

Load filament

Next step is to load filament into the left and right extruder. Before pressing Next, be sure the spools are in the correct position and ready to feed the system. Follow the instructions below

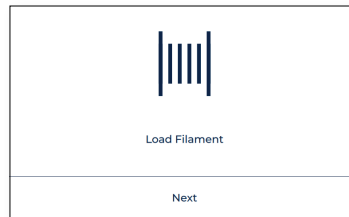

 Watch our [video](#) to see how to load the filament.

Spool installation

Take the spools from the bottom tray and the 3D printed spool holders from the accessories box. Sigma Series printers have the possibility to install the spools inside the printer or in the back. Follow the instructions below depending on each option:

Internal spool feeding

Recommended when the spools fit inside the printer. The maximum recommended spool diameter is 200mm.

- Place the spool holders inside the printer.
- Open the filament box and remove the protective plastic.

 Keep the zip bag that is inside the cardboard box and put the silica gel bag inside. When the filament spool is not in use, place it inside the zip bag to prevent the moisture from degrading the material.

- Place the spool onto the spool holder.

External spool feeding

Recommended in case the spools exceed the 200mm diameter, or when the filament runs out and a new spool is needed.

- Place the external spool holders on the back of the printer.

 Keep the zip bag that is inside the cardboard box and put the silica gel bag inside. When the filament spool is not in use, place it inside the zip bag to prevent the moisture from degrading the material.

- Open the filament box and remove the protective plastic.
- Place the spool onto the external spool holder.

Setup Assistant

Feeding filament to the system

Once the spools are in place, press Next and follow the instructions on the screen:

- Choose the Left extruder and PLA material. After that, the printer will start heating up and adjusting the temperatures of the selected hotend.

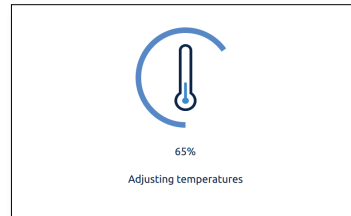
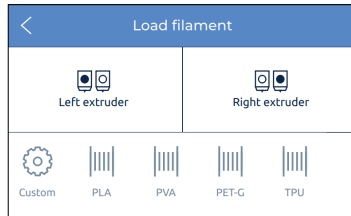

- Remove the PLA spool from the spool holder.
- Unclip the start end of the filament from the spool.

i Do not let the loose end free, to prevent knots in the filament.

- Take the loose end and cut the filament at 45° and straighten the filament a bit to ease the insertion.

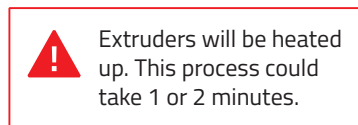
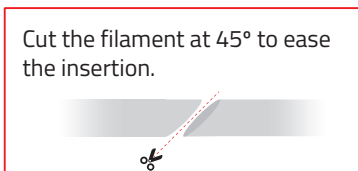

- Take the tip of the filament out of the placing hole and cut the first centimeters of the filament to ensure it is straight.
- Place the spool onto the spool holder and insert the loose end of the filament into the feeding hole to prevent undesired unroll. Be sure that the filament unrolls in the correct direction (see image below).

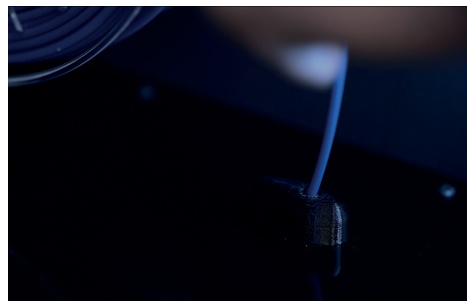

Setup Assistant

- Push the filament gently through the tubes until it arrives at the extruder. Notice that the filament may get a bit stuck in the Filament Run-out Sensor (FRS). The filament should be pushed through the FRS until it doesn't move forward because it arrives at the extruder.

HINT: Taking a look at the back of the printer may also help to know if the filament is in the correct position.



- Follow the instructions on the screen to finish the operation. The Next button on the screen should be enabled. In case the button is still grayed out, that means that the filament hasn't passed through the FRS. If that is the case, push the filament further until the button is enabled and you feel it stops at the extruder.

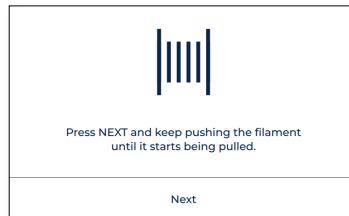

- In case the filament hasn't reached the nozzle, but it is in the upper bowden tube, tap and hold the "Load" button on the screen in order to move more filament towards the end of the tube, until there is fused filament coming out of the nozzle. Then, press "Accept"

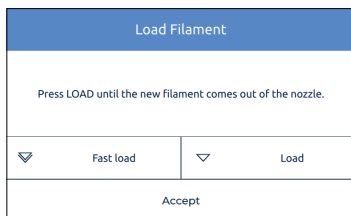

- Repeat the process for the second extruder.

Setup Assistant

Printer calibration

Before start printing, printer calibration must be performed to ensure a reliable first layer and adhesion of the print to the build surface, and to ensure a proper alignment of both printheads.

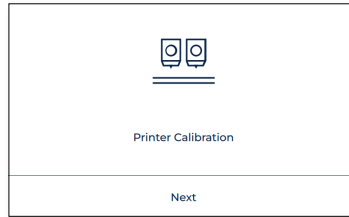

NOTE: Remove the foams under the calibration screws, if you did not do it during printer setup.

Printing surface calibration

Printing surface calibration is a guided process performed by the printer to create a reliable first layer. During this process, the printer will measure the surface level and it will guide you to adjust the calibration screws of the build plate.

 Watch our [video](#) to see how to calibrate the printer.

Tap on the *Next* button to start the process and follow the instructions on the screen:

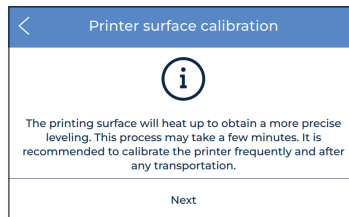

- Once the calibration sensors placed on the printheads probed all the four points on the surface, it may be that the build plate is not completely flat. In this case, the following screen appears indicating which screw needs to be turned, the direction of the turn and the amount of portions that need to be turned, as indicated in the image below:

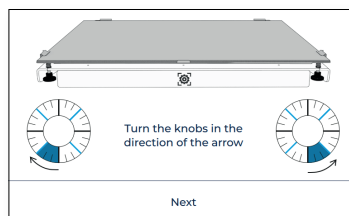

Setup Assistant

- In case some adjustments were made, the procedure suggests to perform the same probing again, in order to fine tune the levelness of the printing surface. Tap the *Redo* button to repeat the operation.

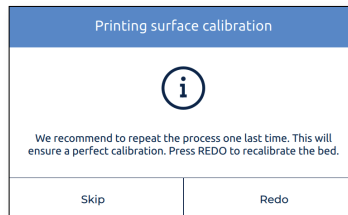

- Normally a maximum of two operations is needed. However it is suggested to perform as many operations as needed until the *Success* screen appears, indicating that the calibration is correct.



Z Offset calibration

Z offset is the vertical distance between the nozzles and build surface. It is necessary to configure it before printing but also when you change hotends.

Tap on the *Next* button to start the process and follow the instructions on the screen:

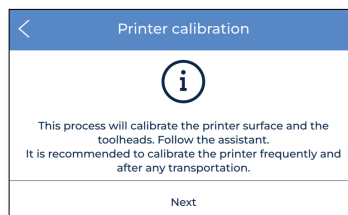

Setup Assistant

- The process starts calibrating the Z offset of the left extruder.

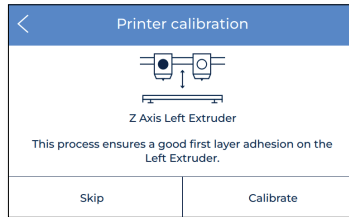

- The hotend heats up. After that, it is mandatory to clean the nozzle with a piece of paper or metal brush, so that no rests of filament is on the tip of the nozzle. This is important because during calibration, a gauge has to be placed between the nozzle and the glass.



- When indicated on the screen, apply a thin and uniform layer of printing adhesive (Magigoo glue stick included in the Upper Box) on the entire printing surface glass to ensure a better calibration.

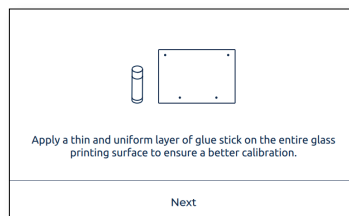

- Place the Calibration Gauge (included in the accessory box inside the Upper Box) between the nozzle and the printing surface glass, hold the other end and move it back and forth, without pressing the platform. Use the arrows on the screen to raise (^) or lower (v) the platform until you feel some resistance while sliding the gauge. The gauge should not flex. Tap on the Accept button when it is done.

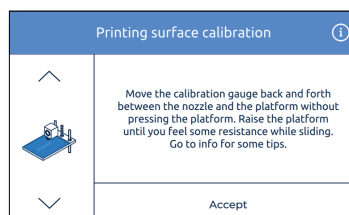

Setup Assistant

HINT: Press the up-right button with the *info* icon to get more information about how the gauge should fit beneath the nozzle.

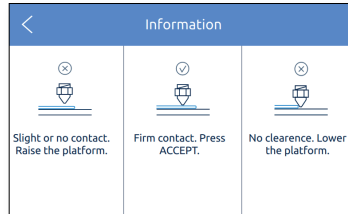

- At this time, the printer starts printing a short test print to validate the process. In this print, five lines will be printed at different heights, in order to choose the best one.

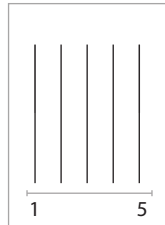

- Select the best line
 - If the nozzle is too close to the glass, the line will be transparent or non-uniform.
 - The line must be adhered to the printing glass and with no gaps..
 - If the nozzle is too far to the glass, the line won't be properly adhered to the printing glass and there will be gaps in it.

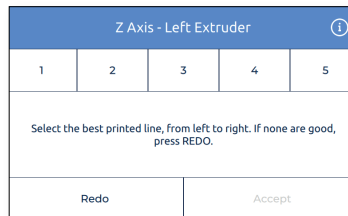

HINT: Press the up-right button with the *info* icon to get more information on how to choose the best printed line.

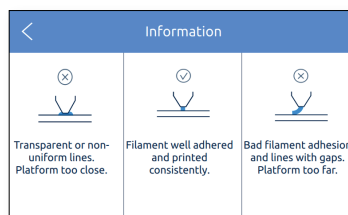

Setup Assistant

- If none are good, press REDO to repeat the test print.
 - If the lines were printed good but too close or too far from the surface, select the best printed line.
 - If the printed lines show signs of under-extrusion, press REDO to repeat the last test print.

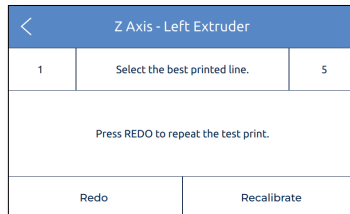

- Repeat the processes for the right extruder.

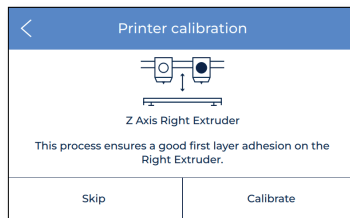

Installing shims

The BCN3D Sigma Series features four printing modes: Single, Dual, Mirror and Duplication. During Mirror and Duplication both toolheads work simultaneously.

To do it successfully it is key important to make sure both nozzle tips are exactly at the same height. However, due to manufacturing and assembly tolerances the offset between tips can be up to 0.5mm.

The BCN3D Sigma Series automatically corrects the offsets when printing in Duplication/Mirror modes by printing a raft in the toolhead that is higher. However, this correction may distort the first layer since it's not printed directly on the glass surface.

During the Printer Calibration process or before printing a job with Duplication or Mirror mode, the BCN3D Sigma may suggest you to install shims to correct the Z offset between nozzle tips. To correct this offset, there are different options:

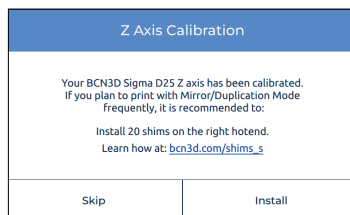

Setup Assistant

 Follow the instructions below or in our Knowledge Base.

- *Skip installing shims:* Although this option will correct the offset, the printed part from one extruder may experiment different adhesion.
- *Install shims to mechanically correct the Z offset:* Printing a raft takes time and wastes material. For those users planning to use the Mirror or Duplication modes frequently, it is highly recommended to install the shims when it is suggested during the Printer Calibration process.
 - Select Install.
 - Wait until the printer cools down to avoid any dangerous manipulation.

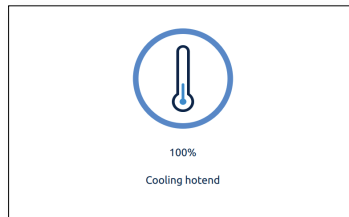

- Turn off the printer with the power switch at the left side of the printer. Take note of the amount of shims that have to be installed.

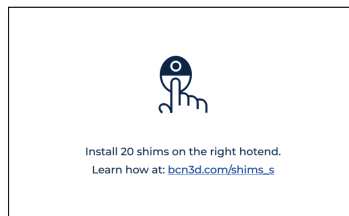

- Loose the 2 bolts at the specified hotend.

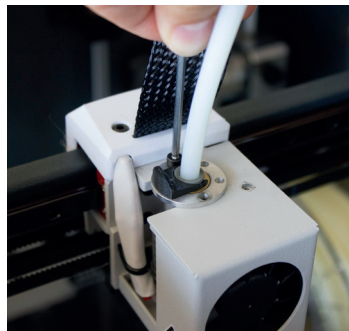
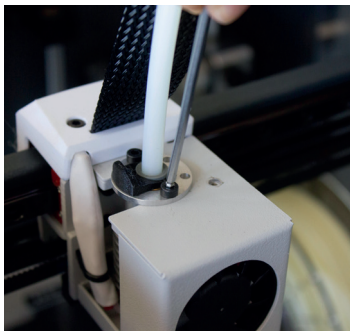

Setup Assistant



- Install as many shims as indicated on the screen.

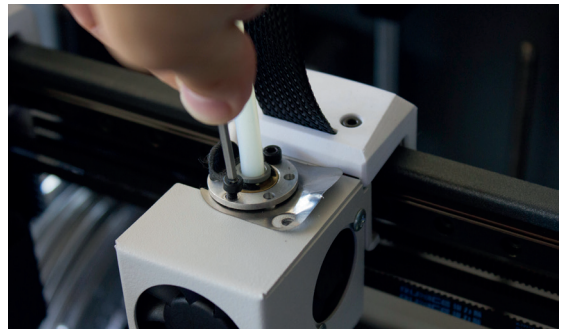
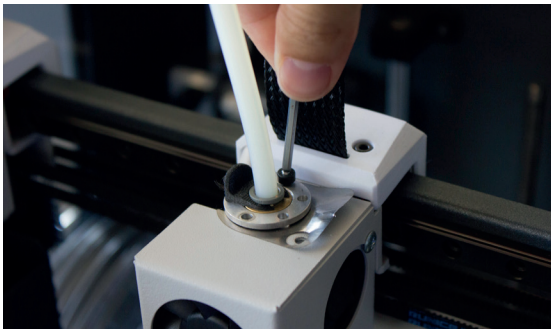

- Screw the bolts again.



- Turn on the machine and follow the instructions on the screen.

Have you installed the shims?	
 No	 Yes

Setup Assistant

XY Offset calibration

After calibrating the Z offset, it is time to calibrate the offset between both print heads. This procedure is very important while printing the same model with both extruders, either for dual color printing or for printing with support material.

The procedure is splitted in two parts, to calibrate the X offset and the Y offset, although the process is very similar in both axes.

X Axis calibration

X offset is the horizontal distance between the nozzles along the X direction. It is necessary to configure it before

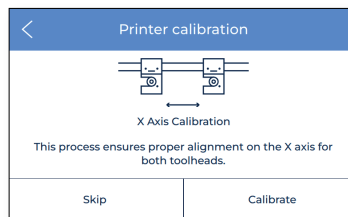

Tap *Calibrate* and follow the steps on the screen:

- Ensure that a thin and uniform layer was applied on the entire printing surface glass.

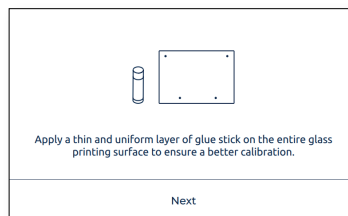

- The printer now prints 10 lines from left to right along the Y direction with both extruders, as in the image below:

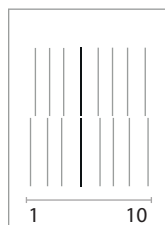

Setup Assistant

- Find the best aligned couple of lines and select the number which corresponds to these lines on the screen. If none are good, press *Redo* to repeat the test print.

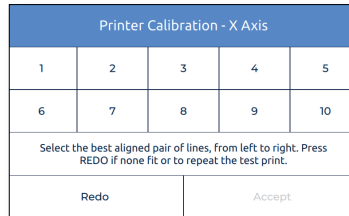

- If there is no perfect alignment and a *Redo* operation was selected, another screen appears. In this case select whether the lines on the left (1) or on the right (10) have better alignment.

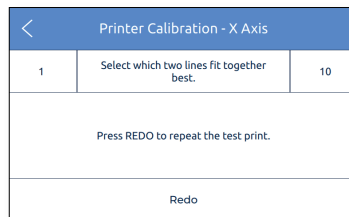

Y Axis calibration

Y offset is the horizontal distance between the nozzles along the Y direction. It is necessary to configure it before printing but also when changing a hotend.

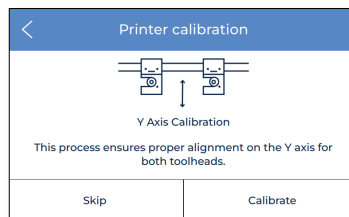

Tap *Calibrate* and follow the steps on the screen:

- Ensure that a thin and uniform layer was applied on the entire printing surface glass.

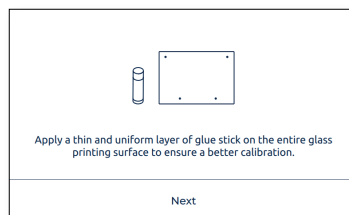

Setup Assistant

- The printer now prints 10 lines from front to back along the X direction with both extruders, as in the image below:



- Find the best aligned couple of lines and select the number which corresponds to these lines on the screen. If none are good, press *Redo* to repeat the test print.

Y Axis Calibration				
1	2	3	4	5
6	7	8	9	10
Select the best aligned pair of lines, from top to bottom. Press REDO if none fit or to repeat the test print.				
Redo		Accept		

- If there is no perfect alignment and a *Redo* operation was selected, another screen appears. In this case select whether the lines on the back (1) or on the front (10) have better alignment.

Y Axis Calibration		
1	Select the best printed line.	10
Press REDO to repeat the test print.		
Redo		



Operation

Once the Setup Assistant wizard finishes, it is time to start operating the printer. Considering that the printer is connected to the network, registered, loaded with material in both extruders and correctly calibrated in the X, Y and Z directions, this chapter focuses on the preparation of the model to be printed, printing the file and collecting the print once it finishes.

Control panel

The printer can be controlled at all times through the touchscreen and the main operations can be accessed from the main menu.

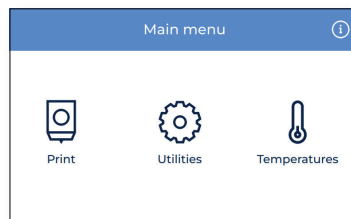

To know more how to navigate through all the menu options, please check the Menu structure in this user manual.

Preparing a print

BCN3D Cura

BCN3D Cura is a free and easy-to-use 3D printing software that prepares your digital model for 3D printing. Such a complex process has been carefully optimized and tested for BCN3D products. As a result, the user enjoys a flawless 3D printing experience while increasing the reliability of the process.

BCN3D Cura includes validated printing profiles to increase the printing success rate. Just select the installed hotends and materials on the printer to get the right set of parameters. And, of course, those experts users still can tweak more than 200 parameters.

Installing BCN3D Cura

Visit [Knowledge base](#) to download the suitable version of BCN3D Cura for your Operative System and the BCN3D Cura manual. Once downloaded, follow the installation wizard.

Add printer

After the installation, when opening BCN3D Cura for the first time, you will be asked to select your BCN3D Sigma Series printer.

Add an offline virtual printer

- Select the Sigma D25 profile.

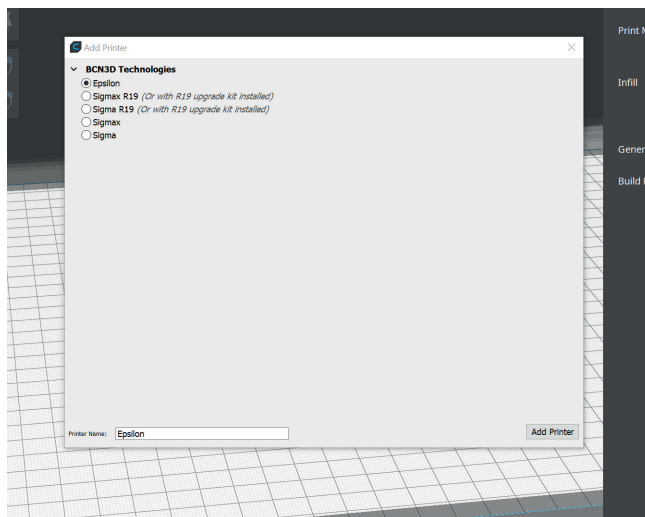

Preparing a print

Add a printer that is linked to your account

- To add a printer into BCN3D Cura and take profit of all BCN3D Cloud functionalities, the printer must be registered and have an internet connection, as indicated in the sections Network connectivity and Register.
- Sign-in in your BCN3D account.

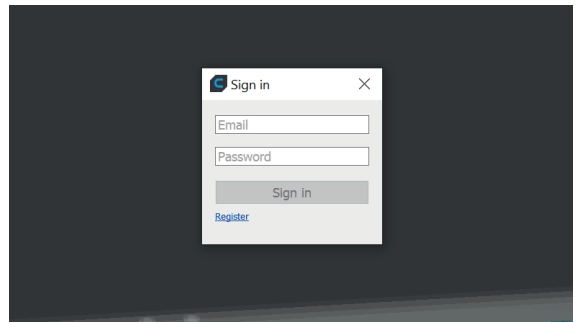
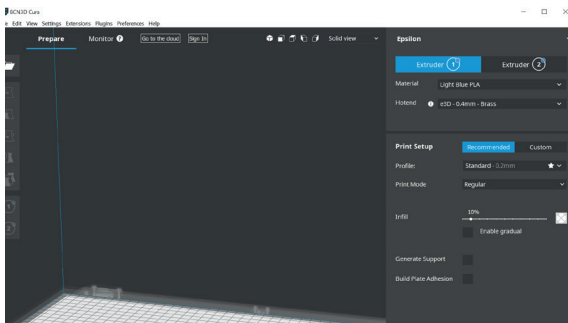

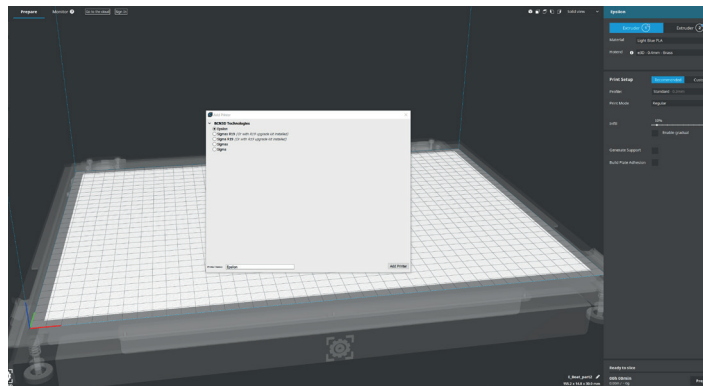

- Select the printer you want to print with.



Printing modes

BCN3D Cura takes advantage of all the benefits of the IDEX system: simply merge multi-material models, generate support structures, cut down printing times by combining hotends with different nozzle sizes or even double production capacity thanks to duplication and mirror mode.

-  Visit [Learn](#) to know more about success stories, learn about our latest updates, whitepapers and more.
-  In order to perform the first dual print, visit [Sample parts](#) section to download the BCN3D Benchmark file or the gcode. Notice this gcode is a dual print configured for PLA and 0.4 hotends

Preparing a print

Regular

In Regular mode, single or dual prints can be performed.

For single prints, It only uses one toolhead. It is ideal to print large models, taking advantage of the massive print surface or just to print with one single material.

For dual prints, It uses both toolheads. It is ideal to print multicolor, multi-material parts or to cut down printing times by combining hotends with different nozzle sizes.

Single

- Select *Regular* in the Print mode list option.

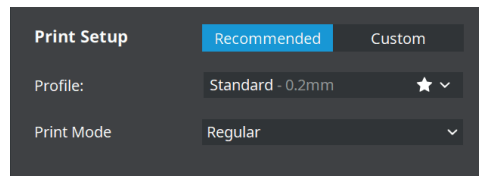

- Click *Open File*.

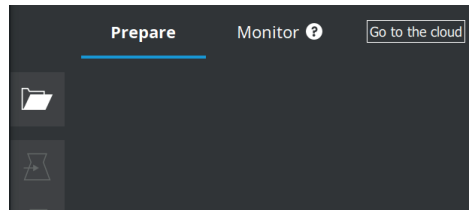

- Select the STL file to be printed.
- Select the model, it will be highlighted with a blue outline. Use the adjustment tools to move, scale or rotate as needed.

 Visit [Knowledge base](#) to download BCN3D Cura manuals to get more information about adjustment tools.

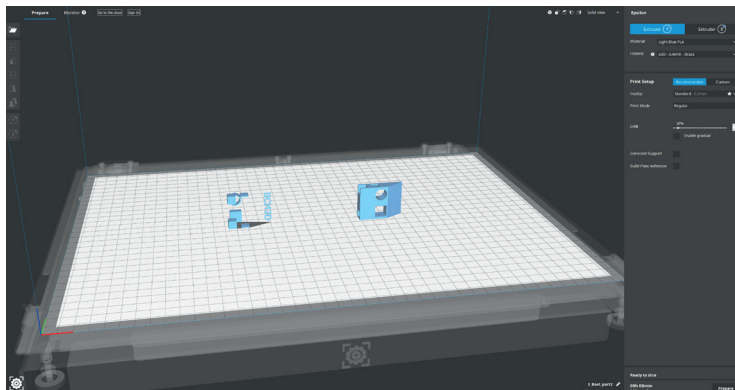

Preparing a print

- Click one part of the model and assign the extruder to print with.

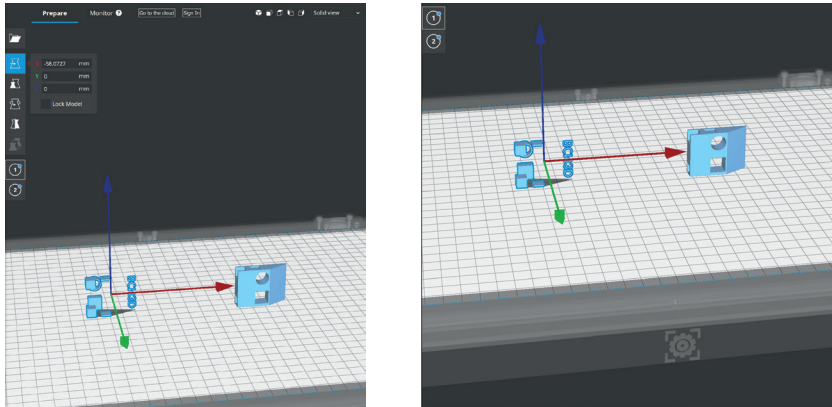

- Then select the material loaded in the selected Extruder.

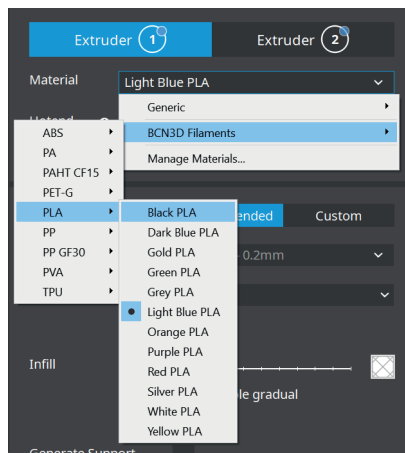

- Select Profile.

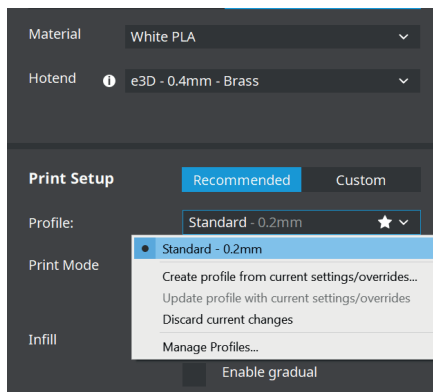

Preparing a print

- Click *Prepare* to generate the printing file.



Dual

- Select *Regular* in the Print mode list option.

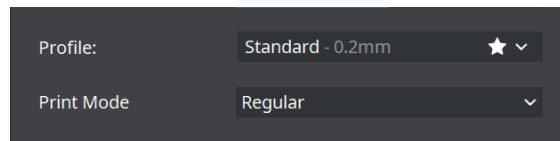

- Click *Open File*.

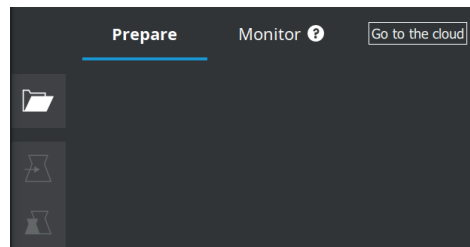

- Select the STL file to be printed. A Benchmark model can be found in the Sample parts folder.
- Click one part of the model and assign the extruder to print with.

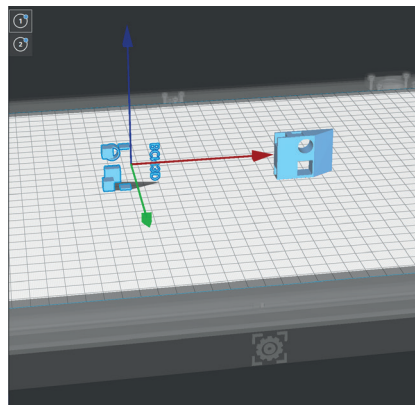
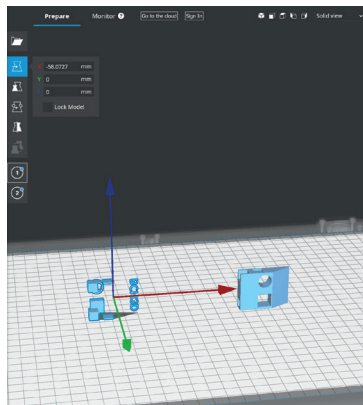

Preparing a print

- Then select the material loaded in the Extruder 1.

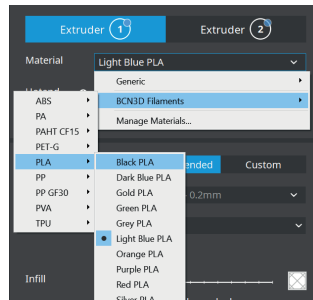

- Repeat the process with the other part, assign the Extruder 2 and select the material loaded.

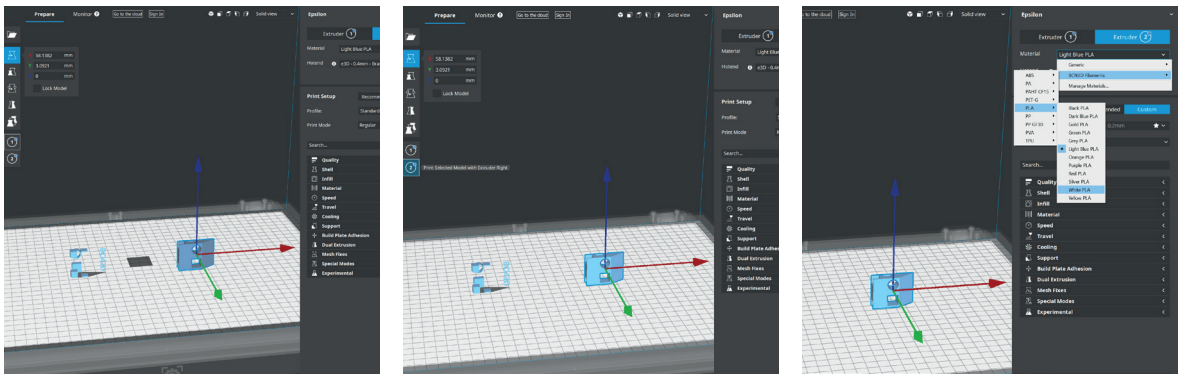

- Select the models by Shift+Left Click. Selected models will be highlighted with a blue outline. Right click on any of the selected models, and select Merge Models

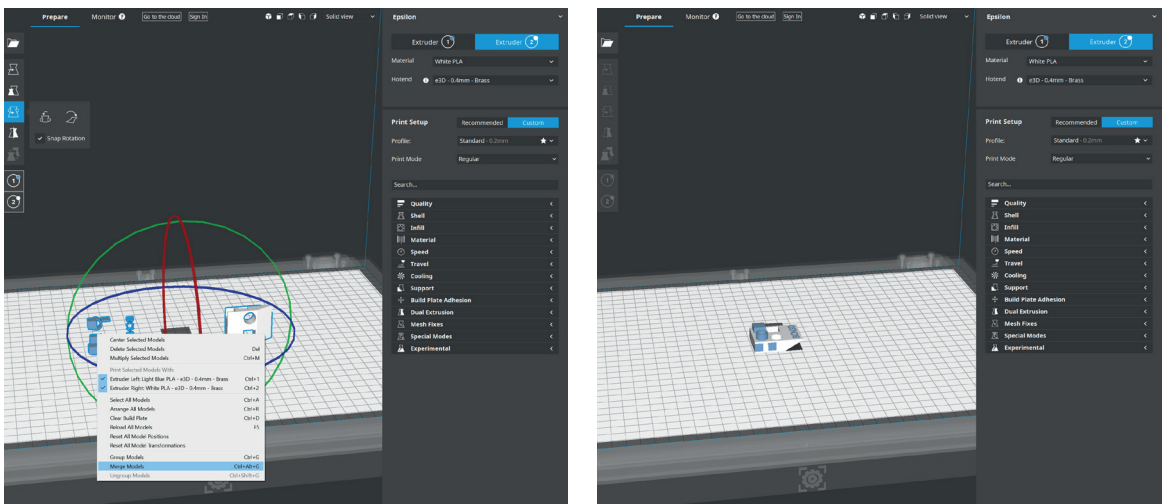

Preparing a print

- Select *Profile*.

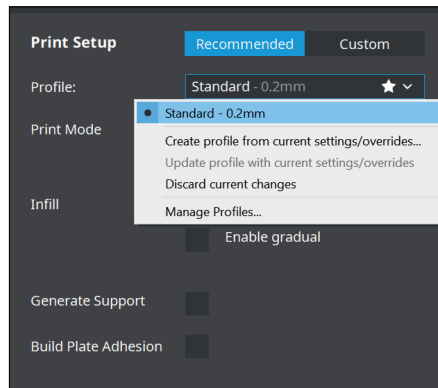

- Click *Prepare* to generate the printing file.



Mirror

Print the model and its symmetrical part (along the X axis) at the same time. Using this printing mode, the printing capacity is doubled, but the available printing surface is reduced to less than half the original size.

- Select *Mirror* in the Print mode list option.

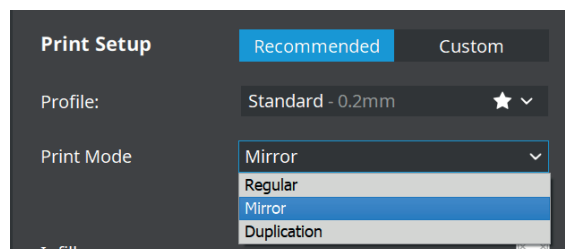

- Click *Open File*.

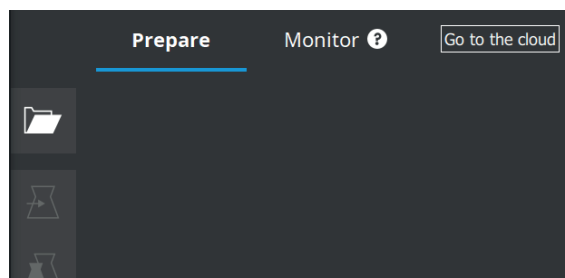

Preparing a print

- Select the STL file to be printed. It can be found in the [Sample parts](#) folder.

(Information) Note how the available printing volume is reduced and the loaded models automatically move to the left. These models can still be modified. A preview of the duplicated or mirrored parts is available at the right.

- Then select the material loaded in the Extruder 1.

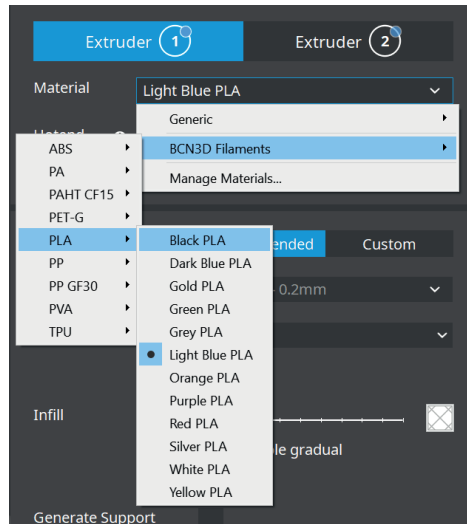

- Select the printing profile for the Left Extruder. Make sure the material loaded at Right Extruder is the same as in the Left Extruder.

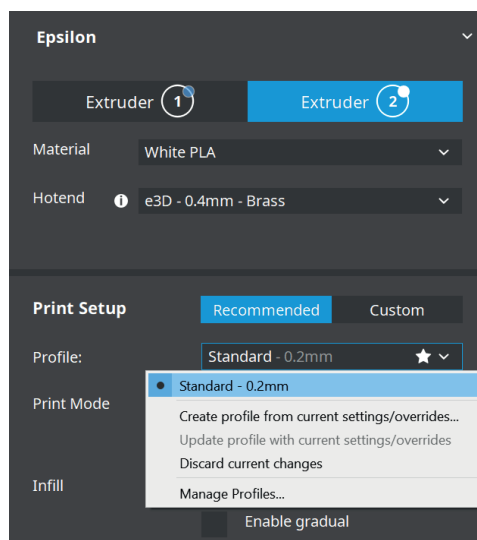

Preparing a print

- Click *Prepare* to generate the printing file.

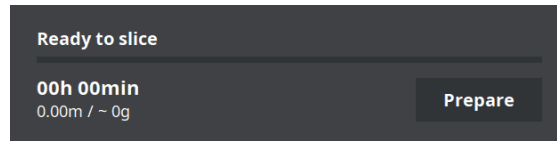

Duplication

Print the same model with both toolheads simultaneously and double the printing capacity. This mode is ideal for short runs of production. Bear in mind the available printing surface will be reduced by half.

- Select *Duplication* in the Print mode list option.

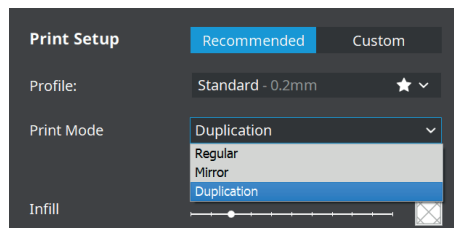

- Click *Open File*.

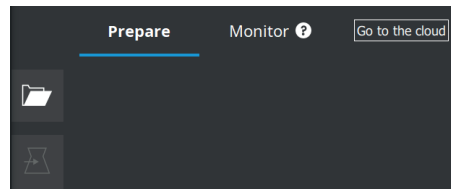

- Select the STL file to be printed. It can be found in the [Sample parts](#) folder.

i Note how the available printing volume is reduced and the loaded models automatically move to the left. These models can still be modified. A preview of the duplicated or mirrored parts is available at the right.

How to print the file

- Then select the material loaded in the Extruder 1.

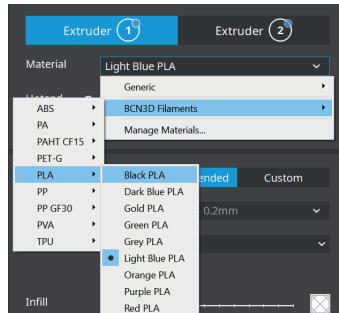

- Select the printing profile for the Left Extruder. Make sure the material loaded at Right Extruder is the same as in the Left Extruder.

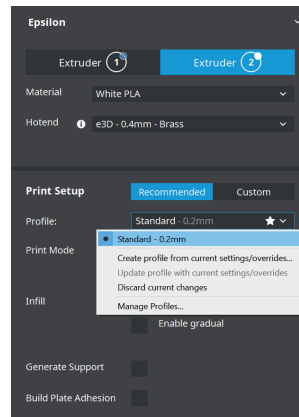

- Click *Prepare* to generate the printing file.



The BCN3D Sigma Series printer allows printing the files via two different routes: *online printing*, either from the BCN3D Cloud dashboard or from BCN3D Cura via cloud, and *offline printing*, via SD-card.

Online printing

To print via the Cloud the printer must be registered and have an internet connection, as indicated in the sections Network connectivity and Register.

There are two options for online printing: using the BCN3D Cloud dashboard or directly from BCN3D Cura. Choose the preferred option and follow the instructions:

How to print the file

From the BCN3D Cloud dashboard

- Slice the project in BCN3D Cura as shown in Preparing a print and a Save file button will appear on the right bottom panel. Click Save file and store the printing file (.GCode) somewhere in the computer.
- Select either Go to the Cloud button from BCN3D Cura dashboard or open a browser window and go to <https://cloud.bcn3d.com>.

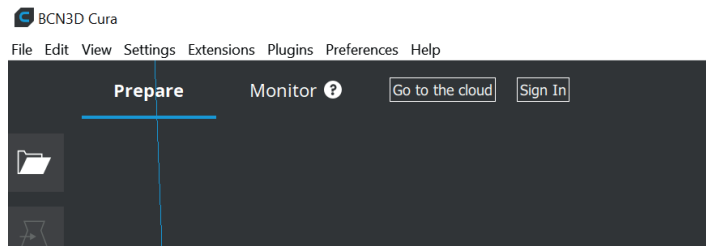

- Then sign in with the BCN3D Cloud account.
- Find the preferred printer on the list.

i In order to use this functionality, the printer must be in the Ready state.

- Click on *Upload* a file and select the printing file previously stored.
- Wait for the process to upload the file and wait until the printer downloads it correctly. The printer will start automatically as soon as the printing file is downloaded.

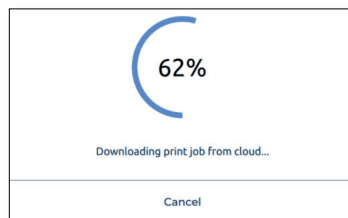

i To know more about the features available on BCN3D Cloud, read [the manual](#).

(HINT) Do not forget to apply a thin and uniform layer of printing adhesive (Magigoo included in the Upper Box) on the entire glass to ensure that your print adheres reliably to the printing surface.

How to print the file

From BCN3D Cura via cloud

- With BCN3D Cura opened, select the Sign in button on the header. This will open a pop-up window asking for the BCN3D Cloud account credentials.

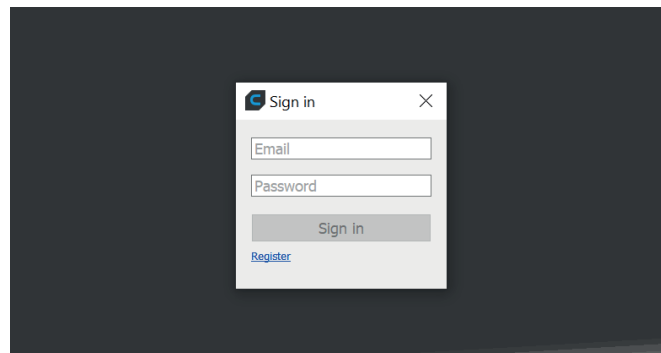
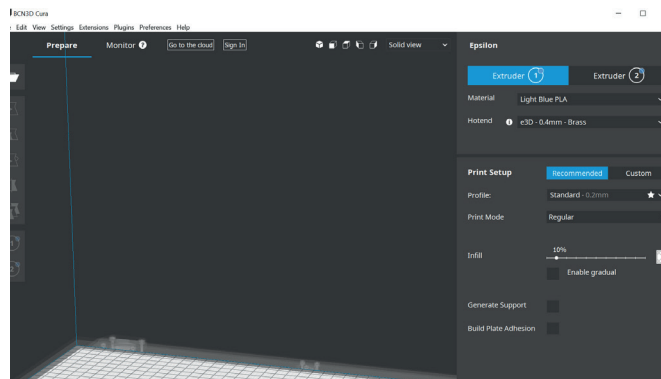

i Be sure that there is an online virtual printer setup. If not, follow the instructions in the section Add printer in BCN3D Cura.

- Slice the project in BCN3D Cura as shown in Preparing a print and a Send to Printer button will appear on the right bottom panel. Click Send to Printer and the printing file will be sent automatically to the selected printer.

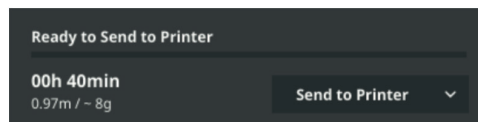

(HINT) Do not forget to apply a thin and uniform layer of printing adhesive (Magigoo included in the Upper Box) on the entire glass to ensure that your print adheres reliably to the printing surface.

How to print the file

Offline printing

Whenever a network connected printer is not available or the preferred option is to run a print job directly from the printer, the offline printing is available. In this case, BCN3D Sigma printers include a SD card reader aside from the touchscreen.

Via SD card

- Insert the SD card (or micro-SD card) in the computer.
- Slice the project in BCN3D Cura as shown in Preparing a print and a Save to Removable Drive button will appear on the right bottom panel. Click Save to Removable Drive and the printing file will be automatically stored in the SD card.

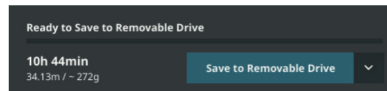

- Safely remove the SD card from the computer and insert it into the SD Card slot at the front of the printer.

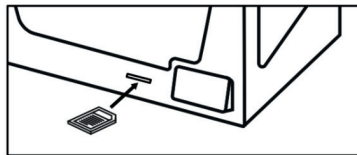

- Select *Print* in the main menu of the touchscreen.

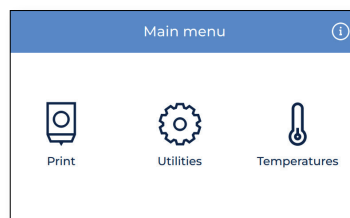

- Scroll the list and choose the file to print. The printer will ask to confirm if the choice is correct and automatically start printing when approving.

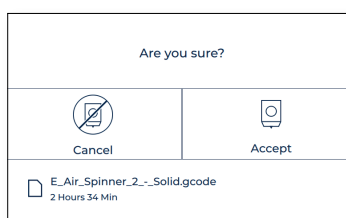
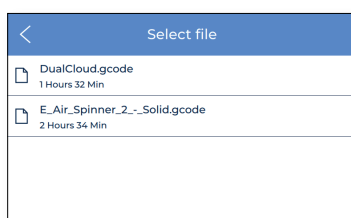

Detach print from build plate

Once the print job is finished, it will be indicated on the touchscreen.

There are several methods to detach the print. The process varies slightly on with what material you have used to print. It is very important in order to prevent chipping from the glass and extend its useful lifespan.

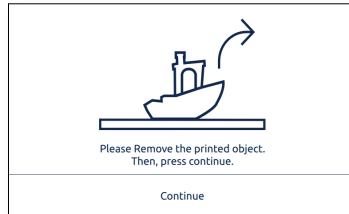

Use a spatula

- Once the print job has finished, allow the build plate and the print to cool down 15 minutes. After this time, the material will contract as it cools, allowing you to easily remove the print.
- If your printed part is still adhered to the glass surface, remove the glass out from the printer as shown in the Set up section and place it on a clean and flat surface.
Removing the part inside of the printer can result in disruption of the calibration.
- Place the spatula (included in the Upper box) under the part, parallel to the build surface, avoiding too steep angles, and apply a small amount of force to remove the print.
Always remove the parts with a movement that is made from your body. Remember to be cautious of where you are having your second hand while removing the print to avoid hurting yourself.
- A tip is to tilt the glass so you have the underside visible to see what parts of the print are already detached.
- This process is recommended for materials like: PLA, PVA, PP, PA, PAHTCF, PPGF, PET-G.
- When the print has been removed, place the glass surface back in the printer and press the *Continue* button.

Detach print from build plate

Use water

- If you are having difficulties removing some of these parts with only a spatula, try out using water as described below.
- As described before, wait at least 15 minutes after the print job has finished.
- Remove the glass out from the printer as shown in the Set up section and place it on a clean and flat surface.
- Almost all the different adhesives are water soluble. Because of this reason one of the most effective ways to remove some materials from the build plate is to dissolve the glue with some water.

 Don't apply water inside of the printer! This can damage the printer and electronics inside of it.

- If you have a small part, spray water on the glass where the model is located. You will start hearing it detach from the glass. Make sure that the water gets in under the part so the glue dissolves everywhere properly.
- Wait a few moments and remove the part, it should be easy to remove the part. If it is still adhered, apply more water.
- If you have a big part it is recommended to put the whole glass bed into a container of water and leave there to let the adhesive dissolve.
- Depending on the size of the print the time it should soak in water differs. 5-10 min is usually enough.
- This process is recommended for ABS and TPU.
Be aware that PA and PAHTCF absorbs water so make sure to dry the part afterwards.
- When the print has been removed, place the glass surface back in the printer and press the Continue button.

Reusage of the magigoo adhesives

Depending on the size and material the amount of times you can reuse the same adhesive differs. Although it is possible to print several times and reuse the applied layer of the same magigoo, we recommend (see Maintenance for more information) cleaning the glass printing surface with warm water and soap before each print to ensure a good first layer adhesion.

The more time you are reusing it the higher the risk is that the model could warp or not stick properly. Dust, grease or removing a print may also reduce the adhesion quality of a layer of glue.

Reusing the adhesive for ABS, PA and PPGF is not recommended.

Clean the glass surface

Before starting a new print, check the glass surface. If there are print leftovers or magigoo adhesive stuck to the glass, clean the surface following these steps:

- Remove the glass out from the printer opening the build plate clamps and slide the glass forward.
- The magigoo adhesives are easily washed away with regular water. Using regular soap will make it even easier. All the magigoo adhesives are non-toxic making it safe to flush down in the drain.
- Use a towel or paper to wipe the glass dry before putting it back into the printer.
- To place the glass on the build plate see install printing surface.





Rating

Rating is a very useful feature that the BCN3D Sigma Series printers include. Every print job can be rated from 1 to 5, indicating how bad or well the print comes out of the printer, respectively. This information is sent to the BCN3D Cloud where some statistics are shown. It also helps BCN3D improve current and future products.

In order to use this functionality, once the print is detached from the build plate, the touchscreen shows the following screen:



Select the number of "stars" depending on the quality of your printed part. Use the following chart as a guideline on how to rate your printed parts:

- | | |
|---|--|
|  | Print not finished or it is rubbish. I have to print it again. |
|  | Print finished but it is useless. It has lots of defects. I have to print it again. |
|  | Print finished and it is somehow useful as a first iteration. It has some defects, but I don't have to print it again. |
|  | Print finished very nicely. It still has some small defects. I don't have to print it again. |
|  | Print is almost perfect. It may have very small artifacts but only noticeable looking very closely. |

Menu structure

This chapter provides an overview of the Sigma Series User Interface. In order to set up your printer or perform any operation, please follow the procedures in the corresponding sections: Preparation and Operation.

Home screen

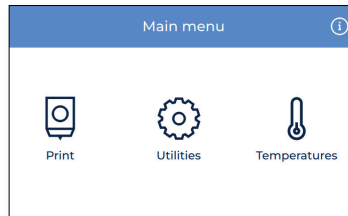

In the main menu, there is an item for each of the main actions the user can perform:

1. **Print:** start a printjob stored on the SD card.
2. **Utilities:** access to main operations related to material, calibration, maintenance and setup.
3. **Temperatures:** check temperatures of hotends and build platform and perform preheat.
4. **Information:** check unit specific information such as software version, serial number, ... or printjobs statistics.

Print

Select the **Print** menu icon to initiate a print stored on the SD card. Be sure that your SD card is correctly inserted in order to see all the files.

If you prefer using the BCN3D Cloud dashboard to start a print, please take a look at the BCN3D Cloud user guide: From the BCN3D Cloud dashboard.

Select file from SD card

Files in the list show in alphabetical order. Scroll with your finger and tap the desired print job in order to start printing.

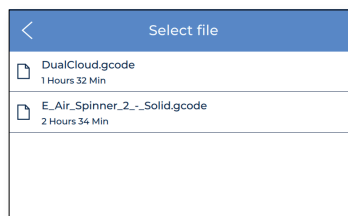

Print

When selecting the element on the list, a confirmation message appears to ensure that the file was not selected by mistake.

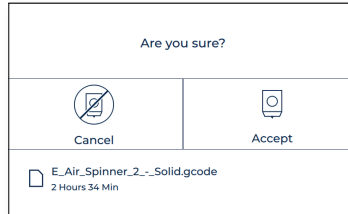

It's possible that a message shows up on the screen indicating that the combination of materials and/or hotends currently inserted on the printer do not match the combination selected on the print job.

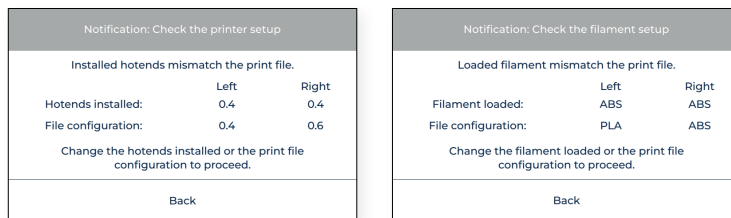

In this case, please proceed with the needed operation: change hotend or unload and load material.

While printing

Once the print job starts, the temperatures adjust to the ones indicated on the slicer program. During the entire printing process, this is the menu shown on the screen:

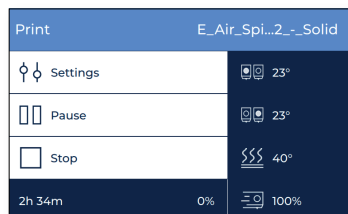

Print

In this menu, users can perform several actions:

1. **Settings:** access to several parameters that can be tweaked during a print: adjust build plate and hotend temperatures, cooler fan speed, flow rate, print speed or light intensity.

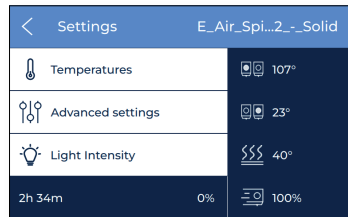

2. **Pause:** pause the current print. Printheads automatically move to their home position. At this point, several operations are available to perform, such as purge, change filament or adjust light intensity.

After finishing operating the printer, tap on **resume** to continue printing or **stop** to end the print job.

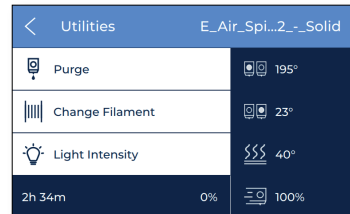
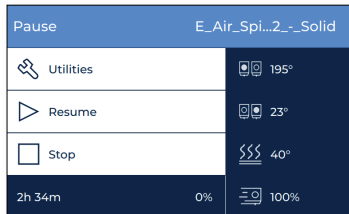

3. **Stop:** finalize the current print. The printer stops printing and the printheads automatically move to their home position.

Before stopping, a confirmation message appears on the screen to ensure that tapping on the stop button was not a user mistake.

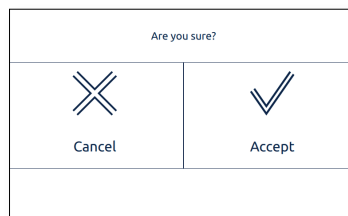

Utilities

Select the **Utilities** menu icon to scroll over all setup, maintenance and calibration options.

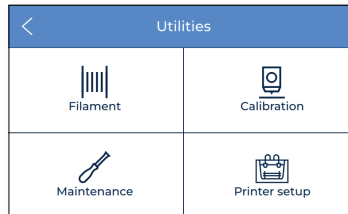

Filament

In this menu, all the possible operations related to the printing material are shown.

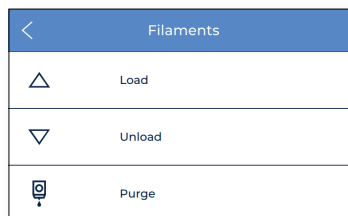

1. **Load:** this process guides the users through the operation of feeding a material filament to the hotend. This is also included in the *Setup assistant*. Be sure to have the filament spool ready and follow the instructions on the screen:
 - Select the extruder the material will be loaded to, and select the type of material. This is very important for the temperatures to be adjusted accordingly.

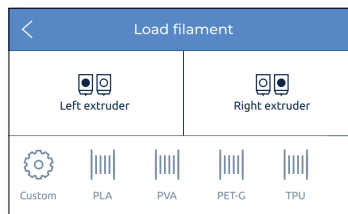

- Push the filament gently through the tubes until it arrives at the extruder. Notice that the filament may get a bit stuck in the Filament Run-out Sensor (FRS). The filament should be pushed through the FRS until it doesn't move forward because it arrives at the extruder.

Utilities

HINT: Taking a look at the back of the printer may also help to know if the filament is in the correct position.

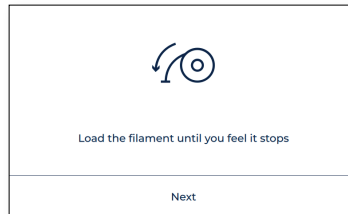

- Follow the instructions on the screen to finish the operation. At the end, the filament should be coming out of the nozzle.



- In case the filament hasn't reached the nozzle, but it's in the upper bowden tube, tap and hold the "Load" button on the screen in order to move more filament towards the end of the tube, until there is fused filament coming out of the nozzle. Then, press "Accept"

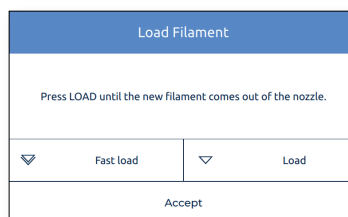

Utilities

2. **Unload:** this process guides the users through the operation of removing a material filament from the hotend. It's normally executed before inserting a new material.

- Select the extruder the material will be removed from.

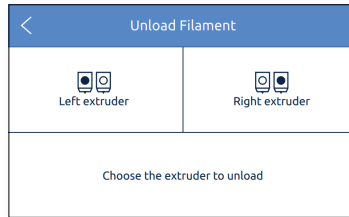

- As soon as the nozzle reaches the correct temperature, press *Next* and the material will automatically purge a little bit before moving backwards. Be sure to roll the spool back and pull the filament out of the tubes.

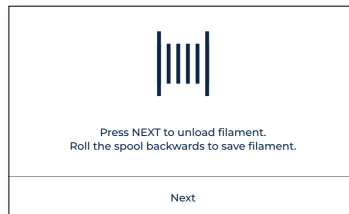

3. **Purge:** this procedure is used to move filament towards the nozzle in order to ensure that there is filament on the tip before starting a print.

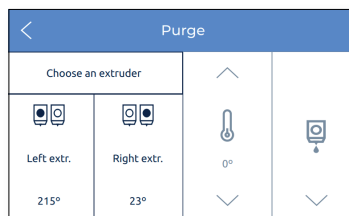

Utilities

Calibration

Several options are available with regards to the calibration of the printer.

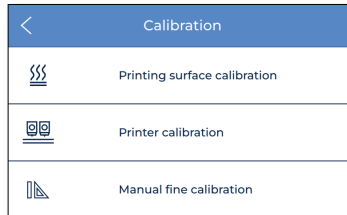

1. **Printing surface calibration:** this process ensures that the printing surface is correctly flat before printing. This operation is very easy to perform and at the same time very important to achieve good results. This is also included in the *Setup assistant*.

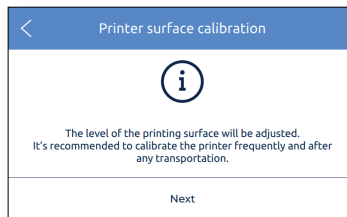

2. **Printer calibration:** it performs all the needed calibrations related to the offsets between the two extruders and the nozzles in relation to the build plate. This operation may take some time but at the same time is very important to achieve good results. This is also included in the *Setup assistant*.

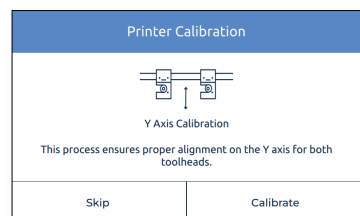
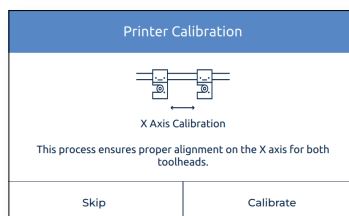
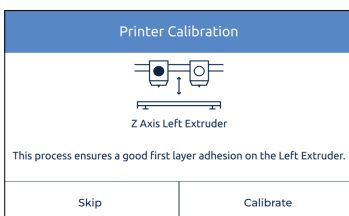

Utilities

Once the Z axis offset of the two extruders is performed, the printer indicates how many shims need to be installed in order to keep both nozzles at the same height. This allows it to print in “mirror” and “duplication” modes more consistently. More information about how to install shims can be found in the Installing shims chapter in this document. To know more about how to print in “mirror” or “duplication” mode, go to the Printing modes section in this document.

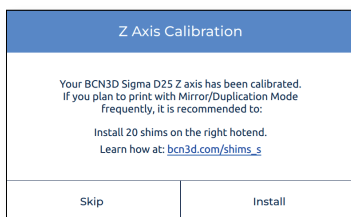

- 3. **Manual fine calibration:** this is considered a fine-tuning operation and is only recommended for advanced users. It allows the modification of X, Y offsets between the two nozzles and the Z offsets of the nozzles with respect to the printing platform.

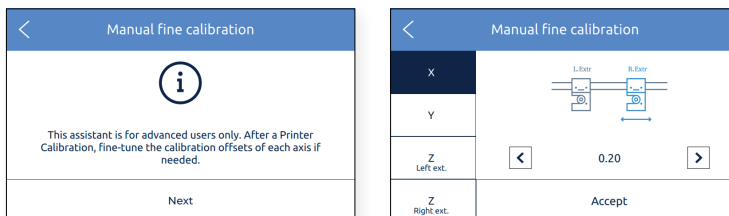

Utilities

Maintenance

This menu contains several operations to use when the user is performing maintenance tasks. For more information about maintenance processes and recommended frequency, refer to the Maintenance section in this document.

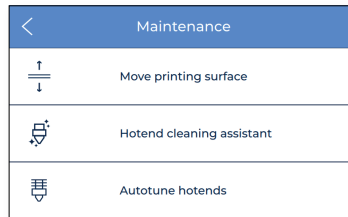

1. **Move printing surface:** it is used when it is needed to lower or raise the printing platform. This is a very simple operation and it is very useful to separate the printing platform from the print heads.

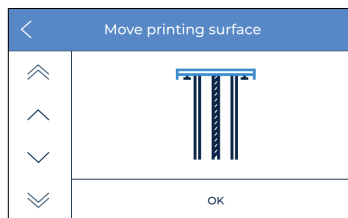

2. **Hotend cleaning assistant:** this procedure is meant to remove the rests of dust and previously used material from inside the hotend. It is recommended that this operation is performed regularly or when the nozzle is clogged. Follow the instructions on the screen or take a look at section Cleaning hotend to know more about how to perform this operation.

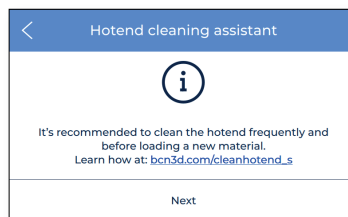

Utilities

- 3. **Autotune hotends:** this operation adjusts the hotend parameters controlling its temperature. It is essential to perform this task when changing a hotend. The process is very simple and automatic. Just follow the instructions on the screen.

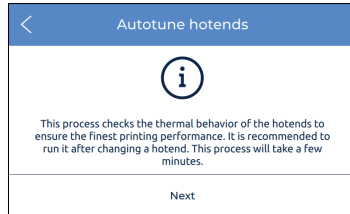

Printer setup

This menu contains most operations that allow the user to control the configuration of the printer.

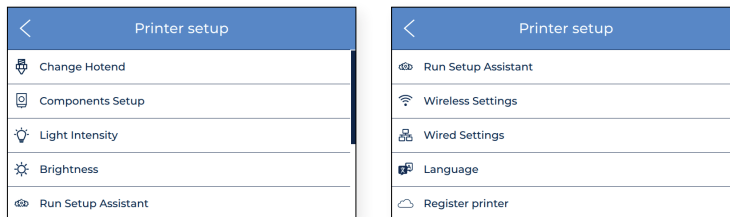

- 1. **Change hotend:** it starts the operation to change the hotend. Follow the instructions on the screen. For more information, see Change hotend maintenance. It's recommended to perform a Printer calibration after changing the hotend.

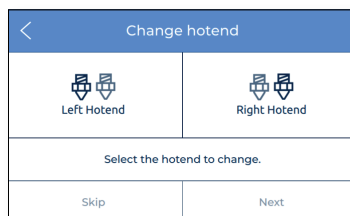

Utilities

- Components setup:** this setup screen shows the current hotend configuration in both left and right extruders and whether the filament runout sensor and the door sensor are activated or not.

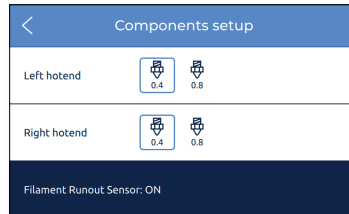

- Light intensity:** it adjusts the brightness of the LEDs on the printer.

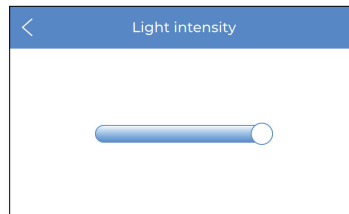

- Brightness:** shows a sliding bar to adjust the brightness of the touchscreen.

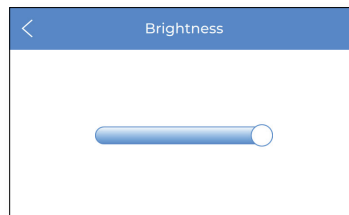

- Run setup assistant:** this menu entry activates the wizard of the setup assistant as it is indicated in the *Setup Assistant* section on this manual.



Utilities

6. **Wireless settings:** if the dongle wifi is connected and wireless interface is turned on, this menu shows the list of wireless networks the user can connect the printer to.

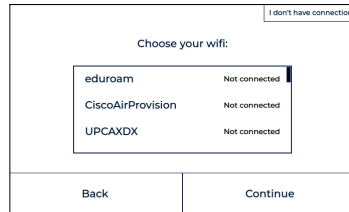

At the top right of the screen, the wireless interface can be turned off. In this case or when the wifi dongle is not connected, this menu shows the following screen.

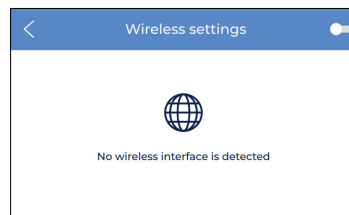

7. **Wired settings:** this menu shows the configuration settings of the network when the printer is connected using an ethernet cable.

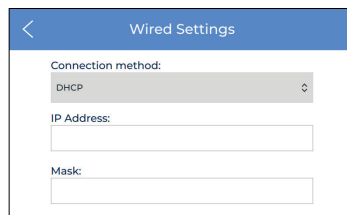

Utilities

8. **Language:** it shows the list of available languages. Select the desired language and the printer will automatically change the menus and information to that language.





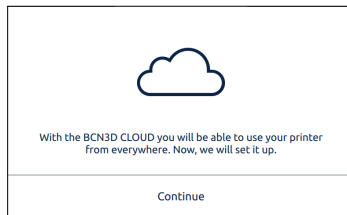

9. **Register printer:** in case the printer was unregistered from the BCN3D Cloud dashboard, this process runs the wizard to register the printer again and link it to the user's account. Follow the instructions as in the Register section of this document.

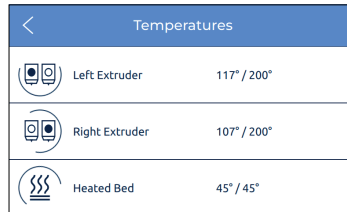

Temperatures

Select the **Temperatures** menu icon to check hotends and heated bed's temperatures.



Temperatures		
	Left Extruder	117° / 200°
	Right Extruder	107° / 200°
	Heated Bed	45° / 45°

The temperatures are shown in the following format:

current temperature / target temperature
(example: 117° / 200°)

Preheating these elements is done by tapping on the corresponding button. The temperatures of the preheat is determined by the printer itself depending on the materials that are loaded into the extruders.

These elements can be turned off by tapping again on the button. After this action, the target temperature is automatically set to 0°C and the temperature will go progressively down.

 HINT: Be careful when operating these elements while they are still hot.

Information

Select the **Information** icon on the top right part of the screen in order to verify information about the current unit or to know how to get support in case it is needed..

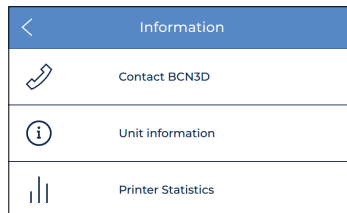

1. **Contact BCN3D:** get address, phone number and email address to contact the manufacturer.



2. **Unit information:** it shows information about the version of the different packages of software that are installed in the printer, and the serial number of the current unit. This data is mandatory to have it ready in case contact to support is needed.
Current configuration of the print heads, formed by material and hotend's nozzle size, is also available on this screen.

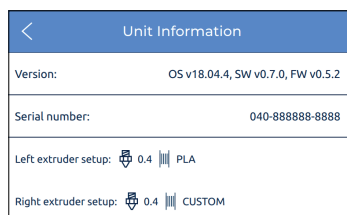

3. **Printer statistics:** it shows some statistics related to the current unit. The date shown here contains total printing hours, number of prints completed, moved distance of the tools and volumen printed. For more statistics, refer to the BCN3D Cloud dashboard.

Maintenance

Maintenance is a very important work to keep in mind every day in order to keep the printer in good condition and always performing at its maximum capabilities.

The following information shows which activities have to be carried out to give the BCN3D Sigma D25 the proper maintenance and their frequency. Maintenance activities do not take much time and are not complicated. However, for those that need more attention, more detailed guidelines are provided to guide you through the process.

General maintenance

In general, there are some recommendations when performing general maintenance, but there are some indications that you must always consider in order to extend product life.

A very important advice is to keep your printer always free of dust and operating in a dry and cool place. We suggest that the printer operates in an environment at temperatures between 15 and 30 °C and relative humidity below 50%. Regarding the filaments, in general we also advise that the spools that are not currently in use are always stored in an airtight container, with relative humidity below 50% (although this may vary for certain materials).

Activity	Frequency	Tools
Clean the printer	Daily	Cloth
Remove filament leftovers spread inside the printer	Daily	Vacuum cleaner Compressed air
Remove filament inside the purge buckets by removing the buckets	Daily	-
Clean dust in hotend fans, cooling fans and build chamber fan	Monthly	Compressed air
Change HEPA and active carbon filter	Every 1500 printing hours (indicated by the printer)	HEPA/Carbon filter
Update printer OS and firmware	If the printer is connected, update when the update message shows up. If it's not connected, check monthly on the BCN3D website.	-

Maintenance

Hotend

Hotends are a very important part of your printer and the quality and reliability of it depends on them. We recommend taking care of them in order to extend their lifespan, that it's estimated to be more than 1000 printing hours. This time depends on the type of material that is used and the proper maintenance that is performed.

Activity	Frequency	Tools
Check if the nozzle is clogged by doing a purge or checking for under-extrusion in the previous prints	Every print	-
Check if the hotend and cooler fan are working properly	Every print	-
Clean the hotend	Weekly or when switching materials	Nylon filament
Perform XYZ offset hotend calibration	Every 300 printing hours, after transportation or after changing hotend	=
Check if the hotend cables are correctly connected to the hotend electronic board (behind the print head)	Every 300 printing hours or when changing hotend	-
Check if the screws that secure the hotend to the print head are not loose	Every 300 printing hours or when changing hotend	Allen key
Change hotend	More than 1000 printing hours	Allen key, Scissors or cutting pliers and Hotend

Maintenance

Extruder

The extruder motors are responsible for moving the filament towards the hotends. Having the right amount of material in the tip of the nozzle depends on them. They are usually very stressed components that are moving all the time, so that they need very careful maintenance.

Activity	Frequency	Tools
How to clean the Bondtech extruder	Weekly	Compressed air
Check bowden tubes and connections to the extruder	Every 300 printing hours	-
Check if the cables are correctly connected to the motor driver and the extruder motor	Every 300 printing hours	-
Tune the thumbscrew tensioner to adjust the pressure exerted by the drive gears onto the filament	Every 1000 printing hours	
Check toothed wheels	Every 1000 printing hours	-

Maintenance

Printing surface

Glass printing surface is a very delicate component of the printer, that can break or degrade if not treated properly. Proper calibration and therefore good printing quality depends on the flatness and cleanliness of this surface. This is a component that has to be maintained every time you start a printing process. The estimated lifespan of this component is 500 printing hours, but it highly depends on the material used, the calibration and the type of printing.

Activity	Frequency	Tools
Clean the glass printing surface with warm water and soap	Before each print	Spatula Cloth
Check correct strength of the clamps	Before each print	-
Perform printing surface calibration	Weekly or after transportation	-
Check the glass printing surface for scratches	Every 300 printing hours	-

Maintenance

Motion system

Motion system involves all the parts that move during printing. This includes X, Y and Z motors, linear guides, driver pulleys, belts, and so on. These parts are prepared and selected accordingly to last for a long time, however some parts could get loose and therefore affect the printing quality. We highly recommend performing easy maintenance tasks in order to keep the system as in its first day.

Activity	Frequency	Tools
Clean the axes linear guides and lead screws from material remains and dust	Weekly	Cloth Compressed air
Clean filament remains in motor shafts and belts	Weekly	Cloth Tweezers Compressed air
Check if the captive screws on the motor and rod pulleys are tightened and aligned with the flat surface of the motor shaft	Every 300 printing hours	Allen key
Lubricate X/Y linear guides and Z-axis screw and rods	Every 1000 printing hours	Cloth Lubrication kit
Check X/Y belts tension, and adjust if loose	Every 1000 printing hours	Allen key Screwdriver
Check connections of moving cables	Every 1000 printing hours	-

(Information) Visit BCN3D website to find different types of [BCN3D Spare Parts](#) and [BCN3D Consumables](#) for BCN3D printers.

Firmware upgrade

At BCN3D we want you to have a great printing experience, and to achieve this we are continually working to create new firmware upgrades for our printers.

To ensure that your printer is equipped with the latest features it is recommended to keep the firmware updated to the latest version.

Visit [Knowledge Base](#) to follow the instructions.

Troubleshooting

The [Knowledge Base Troubleshooting](#) includes a list of processes to try to fix the most common issues that might occur.

If you do not find a solution to your problem in this section, please contact the BCN3D Technologies support team through [Contact Support](#).

Error message

Error message is a list of errors that BCN3D Sigma D25 can show through the screen to isolate the specific cause or causes of the symptom. The symptom is a failure of some process to produce any results.

If you identify some of these error messages, make sure to check the [Knowledge Base Troubleshooting](#) first. If the problem persists, please visit [Contact Support](#) in order to solve it.

Error message	Description
Heating Failed on Left Hotend	A heater error on one of the Hotends or HotBed can occur when the printer is trying to heat up but the sensor does not report an increase in temperature or it is not fast enough. The display will show with which print core a problem has been detected.
Heating Failed on Right Hotend	
Heating Failed on HotBed	
Thermal runaway on Left Hotend	A heater error on one of the Hotends or HotBed can occur when the printer reaches the target temperature but afterwards it detects a decrease of the temperature. The display will show with which print core a problem has been detected.
Thermal runaway on Right Hotend	
Thermal runaway on HotBed	
Max Temperature triggered on Left Hotend	This error occurs when one of the Hotends or HotBed is reading a temperature that is too low. The display will show with which print core a problem has been detected.
Max Temperature triggered on Right Hotend	
Max Temperature triggered on HotBed	

Troubleshooting

Error message	Description
Min Temperature triggered on Left Hotend	This error occurs when one of the Hotends or HotBed is reading a temperature that is too high. The display will show with which print core a problem has been detected. This error is caused by a faulty connection to the temperature sensor. It could also mean that the Hotends or Heatbed are not connected properly. The error may also appear when Hotend are removed without following the Change Hotend procedure in the touchscreen menu.
Min Temperature triggered on Right Hotend	
Min Temperature triggered on HotBed	
Firmware flashing error	This error can appear when the printer failed to successfully upload the firmware from embedded electronics to the mainboard. This error is caused by a faulty connection or the printer has been turned off during the process. Automatically, the printer will retry the process.
Machine configuration error Printer configuration not found	The printer can not find the Printer configuration file needed to define the machine. This is a file related to the firmware update.
Emergency Stop	The printer will activate the emergency stop when it is not able to finish a command. Usually this problem is related to homing issues.
Unknown Error	The BCN3D Printer has encountered an unknown error. Unfortunately, we do not know the cause of this error. Please contact BCN3D Technologies Technical Assistance Services by raising a support request above.

Glossary

Adhesion: In the context of 3D printing, adhesion of printout to the printer's heatbed. Insufficient printout adhesion may cause partial or complete separation of the printout from the heatbed during printing. The glass heatbed and Magigoo adhesive solutions ensure a good adhesion of materials.

BCN3D Cloud account: The username and password you will use to sign in to BCN3D Cloud to allow you to directly send print jobs from anywhere, to monitor a group of printers even if they are placed in different locations, and to easily share your printer with other teammates.

BCN3D Cura: BCN3D Cura is a free and easy-to-use 3D printing software that prepares your model for 3D printing. It provides an intuitive user interface and an improved workflow, both for newcomers and expert users. It is based on the renowned Open Source slicer and is compatible with all BCN3D 3D printers.

Bridge: A part of the model printed in the air, suspended between two parts of the printout. The bridge is calculated in a special way when preparing the file for printing. If the bridge is too long, it may get deformed. In such cases, such printout elements should be supported with support structures.

Brim: One of the methods of improving the adhesion of printouts to the heatbed. It consists in enlarging the adhesion surface of the printout to the heatbed by generating additional external outlines of the model proper at the level of the first printout layer. The more outline lines are added, the larger the adhesion surface will be. The brim should be used in the case of problems with separating the printout from the heatbed.

Ethernet cable: The cable used to connect your printer to a local area network.

Extruder: The extruder draws the material from the spool, melts it, and pushes it through a nozzle onto the Build Surface.

Filament Run-out Sensor (FRS): A job-saving sensor that detects when the filament is finished and pauses the printing process until it is reloaded again.

Firmware: The software that runs on your BCN3D Printer.

Internal storage: The part of the BCN3D Sigma Series onboard storage that you can use to send files directly to the printer and access to print history.

Nozzle: The opening on the end of the Hotend from which heated material emerges to be spread onto the Printing surface.

Printing surface: The surface made of glass on which the extruder prints on.

Setup assistant: The set of tasks that runs when you turn on the BCN3D Printer for the first time. The setup assistant helps you load material, calibration and start a test print.

Glossary

Supports: Enabling supports option in BCN3D Cura, automatically generated support structures used to prop up any sections of a print that will not stand alone.

Teflon tube: The plastic tube that guides the material from the material spool to the extruder and from the extruder to the hotend.

Touchscreen: The touchscreen at the lower right corner of the printer. The touchscreen allows you to start prints, change settings and view status information.

Print job: A print job is a file that has been submitted to be printed. This file is the result of preparing your model through BCN3D Cura. The format of print jobs is .Gcode.

Print profile: The settings used to slice your 3D model and create a print file. BCN3D Cura software comes with preset profiles carefully optimized and tested for BCN3D products.

Safety Pause: Door sensor that will stop the printing process every time the enclosure door is opened.

SD Card: You can use a SD Card to transfer print files to and from the BCN3D Printers.

.Gcode: The format of print files that contain instructions for your BCN3D Printer.

.STL: A widely used file format for 3D models.

.OBJ: A file format used for 3D models.

Filaments

Visit [BCN3D website](#) to know more about filaments portfolio or [Knowledge base](#) to learn how to handle and print different types of materials.

BCN3D Technologies

Technical Assistance Services

If you do not find a solution to your problem in this manual, please contact the BCN3D Technologies support team through [Contact Support](#)

Technical Assistance

You can contact the technical assistance services by email, and we will answer you as quickly as possible. Please remember to include your phone number so we can contact you.

support@bcn3d.com

Email

If you have a question that is not related to technical assistance, please send us an email to the address below. A BCN3D Technologies expert will contact you as quickly as possible.

info@bcn3d.com

You can find all of this information in the Contact Section of our website:

<https://www.bcn3d.com/contact-us/>

Be sure to include the serial number of your printer whenever you send us a query to help us provide the best possible services.

Terms and conditions

Overall Vision

The terms “we”, “us” and “our” refer to BCN3D Technologies. The terms “you” and “your” refer to the person or entities that purchase any service or product. BCN3D Technologies offers all the information about products, tools, and services available, always conditioned to the acceptance of all the terms, conditions, policies and notices that are specified below. By purchasing one of our products, you will be accepting our terms and conditions, including the additional terms and conditions and the policies mentioned in this document.

Return policy

BCN3D accepts returns for refunds or exchanges, subject to the following:

1 Withdrawal right

You have 14 days from the date of reception of the product to execute the right of withdrawal. In order to request a return, the product must not have been opened, it should be closed and sealed inside its original box. If you have opened the product, it will not be eligible for a refund. This said, the transport costs (both shipping and return, in addition to possible customs fees if the merchandise comes from outside the European Union) will be responsible of the customer and deducted from the amount to be returned.

Requirements:

- Having acquired the product through **BCN3D Technologies**
- Be within the established deadline, **which is 14 calendar days from the reception** of the order.

2 Defective goods

If you detect any defect in the operation of the product, you have 7 working days from the reception of the product to communicate this defect and proceed to its return.

You should contact the sales department by email through sales@bcn3d.com or by phone +34 935 95 43 43, to notify this incident.

In this case, BCN3D Technologies will be responsible for all the transportation costs.

In cases of wear or tear of the product due to causes that are not exclusively of its use, BCN3D Technologies reserves the right to accept or reject the return of the product, in addition to establishing the conditions of such return or substitution of the product.

3 The product received has been damaged during transport

The client will have 24 hours to verify and communicate the integrity of all the components of the order and verify that all the pertinent goods are included within the total set of the demanded product. An order will be considered delivered when the delivery receipt is signed by the customer.

Upon receiving the goods, you must ensure the external package is in good conditions and shows no symptoms of having received a blow. If the package has any sign of having received a blow or any other damage, you must reject it, reflecting it on the delivery note of the carrier and notifying the logistics department by email (logistics@bcn3d.com) during the following 24h.

Terms and conditions

How to make a return?

In order to make a return first, you will have to contact us to sales@bcn3d.com, explaining the reason of your willingness to return or substitute one or more products.

- You will receive a document by email to be completed (RMA), so that we can authorize the return.
 - Once the RMA is completed, you must send it to sales@bcn3d.com duly completed.
 - The after-sales department will assess the situation and within 48 hours will tell you whether or not we accept your return request. If accepted, it will assign you an RMA number with a validity of 30 days.
 - The product must be sealed in its **original packaging**. In the case of not returning the order in its original and sealed packaging, BCN3D Technologies reserves the right to accept or reject the return or establish a depreciation of the product.
 - Once the product has been packed, we will send a transporter that will pick up the goods to be returned perfectly packed, being able to desist from the collection in case of improper packing. It is important that you place the **RMA number visible on the package**.
 - You will not have to pay anything to the courier, except if the withdrawal right is applied (first case), where the cost of the carriage will be deducted from the amount to be returned; or in case the damages produced in the products are not caused by the transport or are not a manufacture defect. In all these scenarios the customer will be responsible for the shipping costs.
- Once the goods are received in our facilities, our technical service will inspect them and determine whether the return is accepted or not.
 - The refunds will be carry out between the 1st and 10th of the month according the return acceptance. For example, if the return becomes effective on April 15, the money will be paid between May 1 and May 10.
 - In case of not accepting the return for damages produced outside BCN3D Technologies responsibility, you will be given the option to repair the product or return it as it is. Both the repair and shipping will be borne by the customer.

Open source

Open source is a development model that promotes universal access by granting software licenses free of charge, and also universal distribution, including subsequent improvements.

We believe that adopting an open source philosophy offers many advantages:

- **More control:** We can see everything that is happening with the source code, designs etc., and modify them to suit our needs.
- **It helps us learn:** We can see and read the software designs that other people have made, which helps us to become better programmers and engineers.
- **Safety:** Since the designs are open designs, a lot more people can modify and/or correct any errors that the original programmer may have made.
- **Making improvements quickly:** The open source community provides a lot of information about how to improve the product. This helps us to fix errors and update programmes much more quickly.

Using open source licenses for the products we develop is a way of expressing our willingness to share, to collaborate with other people in a transparent way (so that others can see what we are doing and join in), to embrace failure as a means of improving, and to expect, even encourage, everyone else to do the same.

BCN3D Technologies and its products would not be where they are today without the RepRap project and its open source community. The RepRap project started out as an initiative whose objective was to develop a 3D printer which could print most of its own components and be a low-cost printer. As an open source project, all of the designs produced by the project have been released under a free software General Public License (GPL).

This project does not only include hardware, but has been conceived as a complete ecosystem of tools for printing, from the CAD/CAM software to the code read by the machine to print physical objects.

BCN3D Sigma D25 printer use many open source tools and technologies, such as Marlin software and the Cura pre-processed software. The first controls all the printer's components, while the second converts the 3D file into G-code, a language the machine is able to understand.

Marlin firmware is published under a GPL license. This means that we must keep Marlin open, and must provide our source code to end users. For this reason we have our repository on the Github platform, where we post all the changes we make.

Cura software is published under an AGPLv3 license. This is the same as the GPLv3 general license but a paragraph has been added to Section 13 which makes it obligatory to provide source code to those who use software through a network. We therefore have repositories for each operating system so that users can access the source code.

Open Source is not only used for code, but also covers hardware. In our case all the mechanical and electronic parts are published under a GPLv3 license.

BCN3D Technologies is firmly committed to open source initiatives, and we believe that with the help of the community we will be able to make better products.

