

# DrayTek

## Vigor2865 Series

### 35b Security Firewall



QUICK START GUIDE (RF MODEL)

V1.1



# Vigor 2865

## VDSL 35b Security Firewall

### Quick Start Guide

#### (Wireless models)

Version: 1.2

Firmware Version: V4.0.5.1

Region: United Kingdom & Ireland

For updates and support, visit [www.draytek.co.uk](http://www.draytek.co.uk)

Date: April 28, 2020

**Note:** Product specification is subject to continuous evolution which may not always be reflected in current documentation. For the formal specification and details of the supported features of your product, please refer only to the web site at [www.draytek.co.uk](http://www.draytek.co.uk)

## Safety Instructions and Approval

### Safety Instructions

- Read the installation guide thoroughly before you set up the router.
- The router is a complicated electronic unit that may be repaired only by authorized and qualified personnel. Do not try to open or repair the router yourself.
- Do not place the router in a damp or humid place, e.g. a bathroom.
- Do not stack the routers.
- The router should be used in a sheltered area, within a temperature range of +5 to +40 Celsius.
- Do not expose the router to direct sunlight or other heat sources. The housing and electronic components may be damaged by direct sunlight or heat sources.
- Do not deploy the cable for LAN connection outdoor to prevent electronic shock hazards.
- Keep the package out of reach of children.
- When you want to dispose of the router, please follow local regulations on conservation of the environment.

### Warranty

We warrant to the original end user (purchaser) that the router will be free from any defects in workmanship or materials for a period of two (2) years from the date of purchase from a DrayTek authorized dealer in the UK/Ireland. Please keep your purchase receipt in a safe place as it serves as proof of date of purchase. During the warranty period, and upon proof of purchase, should the product have indications of failure due to faulty workmanship and/or materials, we will, at our discretion, repair or replace the defective products or components, without charge for either parts or labour, to whatever extent we deem necessary to restore the product to proper operating condition. Any replacement will consist of a new or re-manufactured functionally equivalent product of equal value, and will be offered solely at our discretion. This warranty will not apply if the product is modified, misused, tampered with, damaged by external factors, used with unapproved accessories or subjected to abnormal working conditions. Warranty applies to hardware only, not software or firmware. Defects which do not significantly affect the usability of the product will not be covered by the warranty. We reserve the right to revise the manual and online documentation and to make changes from time to time in the contents hereof without obligation to notify any person of such revision or changes.



## Declaration of Conformity

Hereby, DrayTek Corporation declares that the radio equipment type Vigor2865 is in compliance with Directive 2014/53/EU.

The full text of the EU Declaration of Conformity is available at the following internet address:

<http://www.draytek.com.tw/ftp/Vigor2865/Document/CE/>

Manufacturer: DrayTek Corp.

Address: No. 26, Fu Shing Road, HuKou Township, HsinChu Industrial Park, Hsin-Chu County, Taiwan 303

Product: Vigor2865 Series

Importer: SEG, 11 Capital Business Park, Borehamwood, Herts, WD6 1GW

Frequency Information for Europe area:

2.4G WLAN	2412MHz - 2472 MHz, max. TX power: 19.98dBm *1
5G WLAN	5160MHz - 5340 MHz, max. TX power: 22 dBm *2 5480MHz - 5720 MHz, max. TX power: 27 dBm
LTE	B1[1920-1980 MHz (TX); 2110-2170 MHz (RX)]; B3[1710-1785 MHz (TX); 1805-1880 MHz (RX)]; B7[2500-2570 MHz (TX); 2620-2690 MHz (RX)]; B8[880-915 MHz (TX); 925-960 MHz (RX)]; B20[832-862 MHz (TX); 791-821 MHz (RX)]; *3
3G	B1[1920-1980 MHz (TX); 2110-2170 MHz (RX)]; B3[1710-1785 MHz (TX); 1805-1880 MHz (RX)]; B5[824-849 MHz (TX); 869-894 MHz (RX)]; B8[880-915 MHz (TX); 925-960 MHz (RX)] *3
	Requirements in AT/BE/BG/CZ/DZ/DK/EE/FR/DE/IS/IE/IT/EL/ES/CY/LV/LI/LT/LU/HU/MT/NL/NO/PL/PT/RO/SI/SK/TR/FI/SE/CH/UK/HR. 5150MHz~5350MHz is for indoor use only.

(\*1: for 2.4G WLAN model; \*2: for 5G WLAN model; \*3: for LTE model)

This product is designed for LTE, DSL and 2.4GHz /5GHz WLAN network use in the UK & Ireland.

\*The external power supply used for each product will be model dependent.

	1	2	3	4	5	6	7	8	9
A Manufacturer	CWT	CWT	CWT	CWT	CWT	APD	APD	APD	APD
B Address	No. 222, Sec. 2, Nankan Rd., Lujhu Township, Taoyuan County 338, Taiwan	No. 222, Sec. 2, Nankan Rd., Lujhu Township, Taoyuan County 338, Taiwan	No. 222, Sec. 2, Nankan Rd., Lujhu Township, Taoyuan County 338, Taiwan	No. 222, Sec. 2, Nankan Rd., Lujhu Township, Taoyuan County 338, Taiwan	No. 222, Sec. 2, Nankan Rd., Lujhu Township, Taoyuan County 338, Taiwan	No.5, Lane 83, Lung-Sou St., Taoyuan City 330, Taiwan	No.5, Lane 83, Lung-Sou St., Taoyuan City 330, Taiwan	No.5, Lane 83, Lung-Sou St., Taoyuan City 330, Taiwan	No.5, Lane 83, Lung-Sou St., Taoyuan City 330, Taiwan
C Model identifier	2ABBO12F UK 2ABBO12F EU	2ABBO18F UK 2ABBO18F EU	2ABLO24F UK 2ABLO24F EU	2ABLO30F UK 2ABLO30F EU	2ABNO36F UK 2ABNO36F EU	WA-12M12FG WA-12M12FK	WB-18D12FG WB-18D12FK	WA-24Q12FG WA-24Q12FK	WA-36A12FG WA-36A12FK
D Input voltage	100-240V	100-240V	100-240V	100-240V	100-240V	100-240V	100-240V	100-240V	100-240V
E Input AC frequency	50/60Hz	50/60Hz	50/60Hz	50/60Hz	50/60Hz	50/60Hz	50/60Hz	50/60Hz	50/60Hz
F Output voltage DC	12.0V	12.0V	12.0V	12.0V	12.0V	12.0V	12.0V	12.0V	12.0V
G Output current	1.0A	1.5A	2.0A	2.5A	3.0A	1.0A	1.5A	2.0A	3.0A
H Output power	12.0W	18.0W	24.0W	30.0W	36.0W	12.0W	18.0W	24.0W	36.0W
I Average active efficiency	84.9%	86.2%	87.6%	87.8%	89.8%	83.7%	85.4%	86.6%	88.2%
J Efficiency at low load 10%	73.6%	78.0%	81.3%	83.3%	83.7%	74.5%	80.5%	86.4%	85.4%
K No-load power consumption	0.07W	0.07W	0.07W	0.07W	0.07W	0.07W	0.10W	0.07W	0.10W

External power supply (Power Adapter) information. For more updates, please visit [www.draytek.co.uk](http://www.draytek.co.uk).



### **Join the UK mailing list**

Users in the UK & Ireland can sign up to our mailing list which goes out approximately 4 times per year with products news, updates, hints & tips and offers.

For details, please visit [www.draytek.co.uk/list](http://www.draytek.co.uk/list)

### **Firmware & Tools Updates**

Due to the continuous evolution of DrayTek technology and emerging risks, router firmware updates may be issued. Please consult the DrayTek web site for more information on newest firmware, tools and documents: [www.draytek.co.uk](http://www.draytek.co.uk) (For UK/Ireland)

### **Regional and Network Compatibility**

For all models, please check that you have been supplied with a device intended for your geographic region and networks. Hardware and software varies by region, as well as local support and warranty services. To be sure of compatibility and local support, ensure that you are buying the correct product through authorized channels. The outside of the product's box will state the region compatibility (e.g. "Applied Region: UK"). If you are unsure, check with DrayTek or your supplier. The use of unofficial components (e.g. PSUs) or adapting interfaces or the use of unauthorized software/firmware may cause malfunction, product damage or personal danger and invalidates your warranty and access to support services.

## ***Table of Contents***

<b>1. Package Contents .....</b>	<b>1</b>
<b>2. Panel Explanation.....</b>	<b>2</b>
2.1 Vigor2865ac / Vigor2865Lac / Vigor2865ax.....	2
2.2 Vigor2865Vac .....	6
<b>3. Hardware Installation .....</b>	<b>8</b>
3.1 Network Connection .....	8
3.2 LTE Antenna & SIM Card Installation (LTE models only).....	9
3.3 Wall-Mounted Installation .....	11
3.4 Rack Mount Kit Installation.....	12
<b>4. Setup &amp; Configuration.....</b>	<b>13</b>
4.1 Accessing the Router Web Interface .....	13
4.2 WAN1 - ADSL and VDSL2 Connection Setup.....	16
4.2.1 PPPoE connection with VDSL and 35b .....	16
4.2.2 DHCP / Static IP connection with VDSL and 35b .....	19
4.2.3 PPPoA connection with ADSL / ADSL2+.....	22
4.3 WAN2 – Ethernet Connection Setup.....	23
4.3.1 PPPoE.....	24
4.3.2 Static or Dynamic IP.....	25
4.4 LTE Modem Setup (LTE models only) .....	26
<b>5. Getting Further Help.....</b>	<b>30</b>
5.1 Additional Feature Setup.....	30
5.2 Keep up to date with our mailing list .....	30
5.3 Firmware Updates .....	31
5.4 Security & Router Best Practice.....	31

# 1. Package Contents



**Vigor router**



**Quick Start Guide**  
(This document)



**RJ-11 to RJ-11 Cable (Annex A)**  
(Connects to your DSL line)



**RJ-45 Cable (Ethernet)**  
(Connects to your PC or Switch)

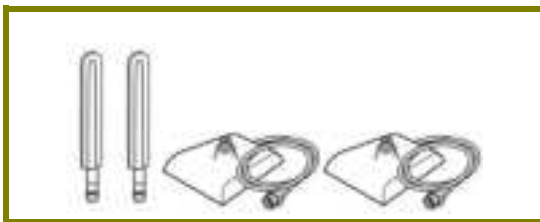

**Antenna + Magnetic Base (L models)**

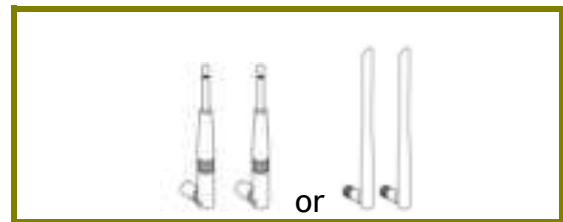

**Antenna (ac/ax models)**

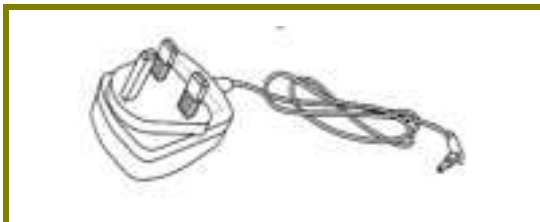

**UK-type Power Adapter**

The maximum power consumption is **28 Watts**.

## 2. Panel Explanation

### 2.1 Vigor2865ac / Vigor2865Lac / Vigor2865ax

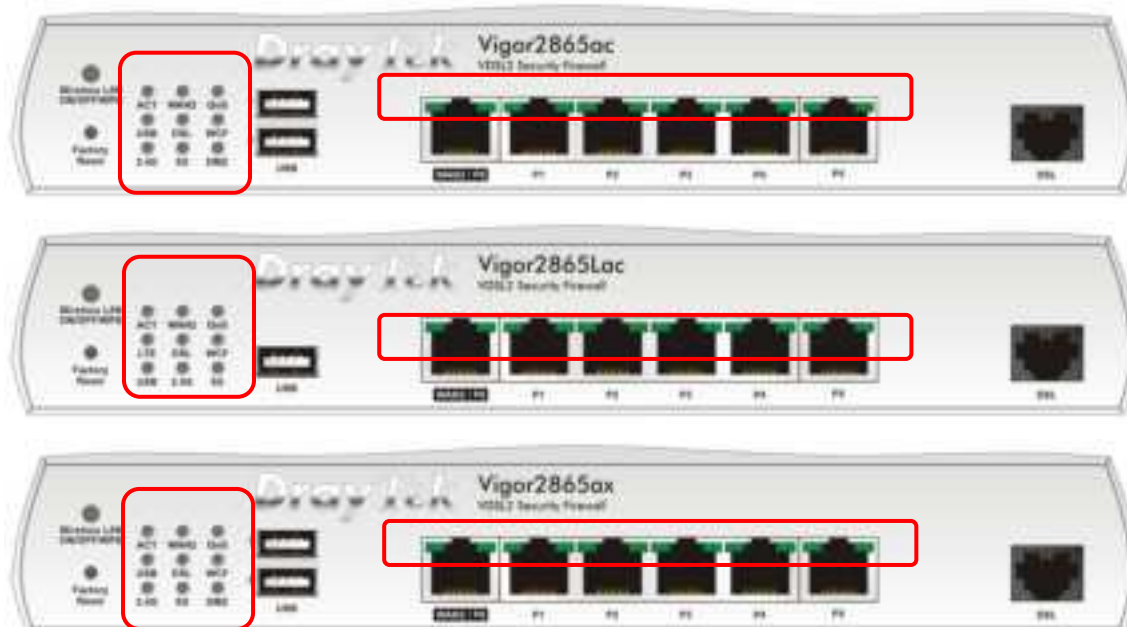

LED	Status	Explanation
ACT	Off	The router is powered off
	Blinking	The router is ready and operating normally
WAN2	On	Internet connection is ready for use
	Off	Internet connection is offline
	Blinking	Data is being transmitted over WAN2
QoS	On	Quality of Service is active
	Off	Quality of Service is inactive
USB	On	USB device is connected and ready for use
	Off	No USB device is connected
	Blinking	Data is being transmitted over USB
LTE (LTE models only)	On	LTE internet is connected and ready for use
	Off	LTE modem is not detected, or has serious problem (e.g., no SIM card, SIM pin error, SIM deactivated, etc.)
	Blinking	Slowly: LTE modem is connecting Quickly: Data is being transmitted over LTE
DSL	On	DSL connection synchronised
	Blinking	Slowly: DSL connection not currently synchronising or not detected Quickly: DSL connection is synchronising
WCF	On	Web Content Filter is active (It is enabled from <b>[Firewall] &gt; [General Setup]</b> )
	Off	Web Content Filter is inactive

2.4G / 5G (Wireless LAN)	On	2.4G: 2.4GHz Access Point is active 5G: 5GHz Access Point is active
	Off	Wireless Access point is inactive
	Blinking	2.4GHz/5GHz LED will blink slowly when transmitting over that interface ACT & WLAN LEDs blink rapidly when WPS is ready for WPS clients to connect. After 2 minutes, the router will disable WPS pairing mode
DMZ	On	DMZ Port is enabled
	Off	DMZ Port is not enabled
	Blinking	Data is being transmitted through DMZ Port



***LED on Connector***

WAN2 / P6	Left LED	On	Ethernet WAN (RJ45) is connected
		Off	Ethernet WAN is disconnected
		Blinking	Data is transmitting (sending/receiving)
	Right LED	On	The port is connected with 1000Mbps
		Off	The port is connected with 10/100Mbps
		Blinking	Data is transmitting (sending/receiving)
LAN P1~P5	Left LED	On	Ethernet LAN (RJ45) is connected
		Off	Ethernet LAN is disconnected
		Blinking	Data is transmitting (sending/receiving)
	Right LED	On	The port is connected with 1000Mbps
		Off	The port is connected with 10/100Mbps
		Blinking	Data is transmitting (sending/receiving)

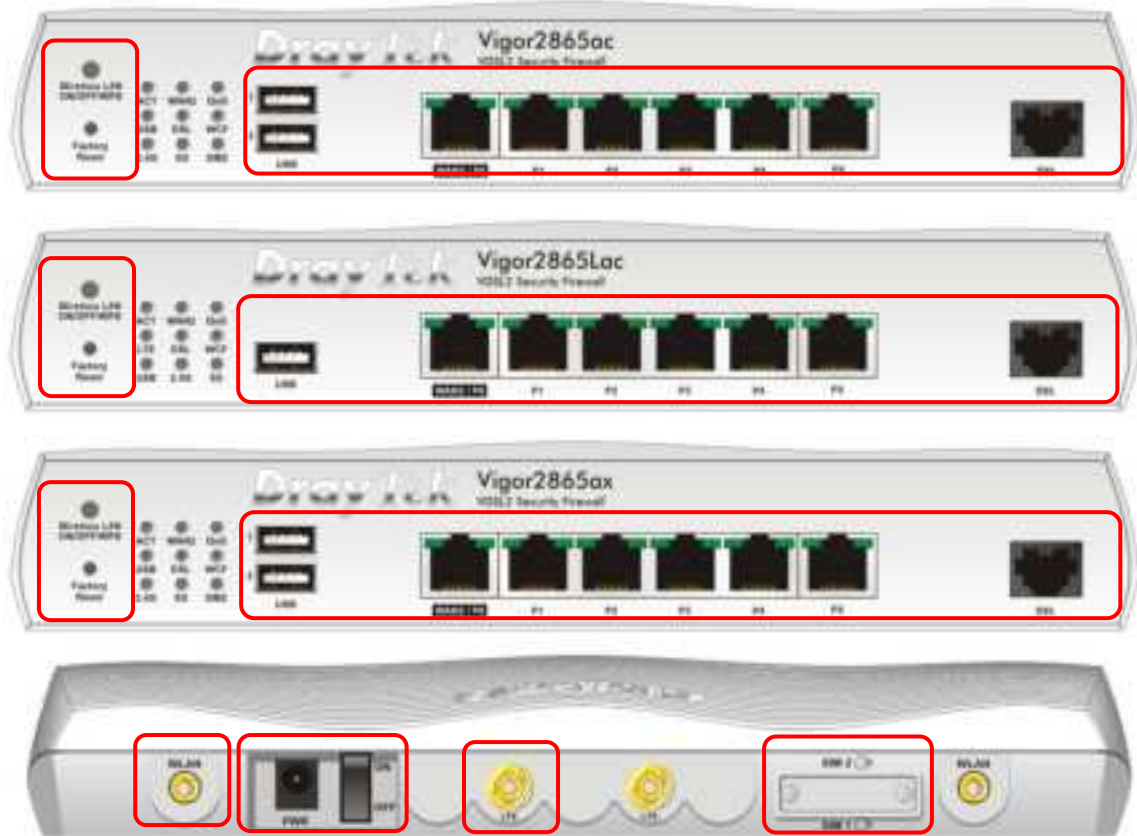
The port “WAN2 / P6” is switchable. It can be used for LAN connection or WAN connection according to the settings configured in WUI.



Interface	Description
Wireless LAN ON/OFF/WPS	<p>Wireless band will be switched on/off in a cycle:</p> <ul style="list-style-type: none"> <li>● 2.4G (On) and 5G (On) - Default state.</li> <li>● 2.4G (Off) and 5G (On) - press and release the button once.</li> <li>● 2.4G (On) and 5G (Off) - press and release the button twice.</li> <li>● 2.4G (Off) and 5G (Off) - press and release the button three times.</li> </ul> <p>When WPS is enabled in the router's web interface, press this button for more than 2seconds to enable WPS pairing mode.</p>
Factory Reset	<p>Restore the default settings. Usage: Turn on the router (ACT LED is blinking). Press gently and hold for more than 5 seconds. When the ACT LED blinks rapidly, release the button and the router will restart with its factory default configuration.</p>
USB1-2 / USB	<p>Connector for a USB 3G/4G modem, storage, printer or USB Thermometer</p>
WAN2 / P6	<p>RJ-45 Gigabit Ethernet connector for WAN modem / router</p>

LAN P1-P5	RJ-45 Gigabit Ethernet connectors for local network devices
DSL	RJ-11 connector for ADSL or VDSL line
	RP-SMA Connector for installing WLAN antennas
PWR	Connector for the power adapter
ON/OFF	Power Switch. Turns the unit on or off
	SMA Antenna Connector for installing LTE antennas (LTE models only)
Dual SIM Slot 	SIM1 & SIM2 (LTE models only): Standard size SIM card slot - Mini or Micro SIMs will require a SIM card adapter (not included) to fit.  See <b>Section 3.2</b> for more information on fitting a SIM card.

## 2.2 Vigor2865Vac



LED	Status	Explanation
ACT	Off	The router is powered off
	Blinking	The router is ready and operating normally
WAN2	On	Internet connection is ready for use
	Off	Internet connection is offline
	Blinking	Data is being transmitted over WAN2
QoS	On	Quality of Service is active
	Off	Quality of Service is inactive
USB	On	USB device is connected and ready for use
	Off	No USB device is connected
	Blinking	Data is being transmitted over USB
DSL	On	DSL connection synchronised
	Blinking	Slowly: DSL connection not currently synchronising or not detected Quickly: DSL connection is synchronising
Phone1/2	On	The phone connected to this port is off-hook
	Off	The phone connected to this port is on-hook
	Blinking	A phone call is incoming
2.4G/5G (Wireless LAN)	On	2.4G: 2.4GHz Access Point is active 5G: 5GHz Access Point is active
	Off	Wireless Access point is inactive
	Blinking	2.4GHz/5GHz LED will blink slowly when transmitting over that interface ACT & WLAN LEDs blink rapidly when WPS is ready for WPS clients to connect. After 2 minutes, the router will disable WPS pairing mode

### LED on Connector

WAN2 / P6	Left LED	On	Ethernet WAN (RJ45) is connected
		Off	Ethernet WAN is disconnected
		Blinking	Data is transmitting (sending/receiving)
	Right LED	On	The port is connected with 1000Mbps
		Off	The port is connected with 10/100Mbps
LAN P1~P5	Left LED	On	Ethernet LAN (RJ45) is connected
		Off	Ethernet LAN is disconnected
		Blinking	Data is transmitting (sending/receiving)
	Right LED	On	The port is connected with 1000Mbps
		Off	The port is connected with 10/100Mbps

The port “WAN2 / P6” is switchable. It can be used for LAN connection or WAN connection according to the settings configured in WUI.



Interface	Description
Wireless LAN ON/OFF/WPS	<p>Wireless band will be switched on/off in a cycle:</p> <ul style="list-style-type: none"> <li>● 2.4G (On) and 5G (On) - Default state.</li> <li>● 2.4G (Off) and 5G (On) - press and release the button once.</li> <li>● 2.4G (On) and 5G (Off) - press and release the button twice.</li> <li>● 2.4G (Off) and 5G (Off) - press and release the button three times.</li> </ul> <p>When WPS is enabled in the router’s web interface, press this button for more than 2seconds to enable WPS pairing mode.</p>
Factory Reset	Restore the default settings. Usage: Turn on the router (ACT LED is blinking). Press gently and hold for more than 5 seconds. When the ACT LED blinks rapidly, release the button and the router will restart with its factory default configuration.
USB1~2	Connector for a USB 3G/4G modem, storage, printer or USB Thermometer
WAN2 / P6	RJ-45 Gigabit Ethernet connector for WAN modem / router
LAN P1-P5	RJ-45 Gigabit Ethernet connectors for local network devices
Phone 1/2	RJ-11 connectors for VoIP usage with analogue telephones
DSL	RJ-11 connector for ADSL or VDSL line
	RP-SMA Connector for installing WLAN antennas
PWR	Connector for the power adapter
ON/OFF	Power Switch. Turns the unit on or off

### 3. Hardware Installation

This section will guide you through installing the router's port connections and fitting the router securely, either to a wall using the supplied mounting hardware, or into a 19" rack with the optional RM1 rack mounting kit.

Before starting to configure the router, you must first connect up the cables.

#### 3.1 Network Connection

1. **ADSL/VDSL Connections:** Connect the **VDSL/ADSL** interface to the **Modem** or **DSL** port of the external splitter/microfilter (not supplied) with the RJ-11 line cable. In some cases, your RJ-11 DSL socket will be built-into your phone line socket on the wall and you won't have a separate microfilter/splitter.

**WAN2 Connections:** Connect the cable Modem/DSL Modem/Media Converter to the WAN port of router with Ethernet cable (RJ-45).

2. **LAN Connections:** Connect a LAN port of the router to your computer or switch.
3. **Wireless Antennas:** Screw the supplied wireless antennas on to the antenna connectors on the back of the router.
4. **Power Supply:** Connect the power adapter to the Vigor 2865's PWR socket on the rear and plug the power adapter into a suitable mains socket. Turn the Vigor 2865 on using its power switch.
5. The router will start up. After completing the system test, the **ACT** LED will light up and start blinking once per second to indicate that it is ready for use. (For more detailed information of LED status, please refer to section 3. Panel Explanation)

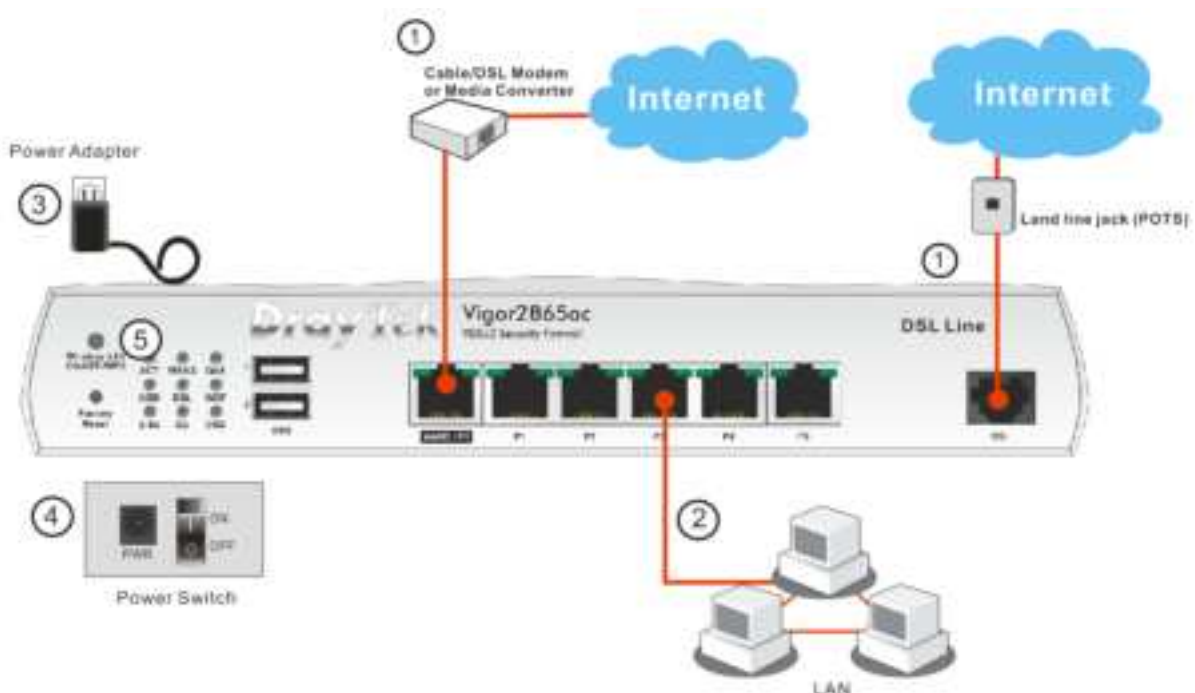

### 3.2 LTE Antenna & SIM Card Installation (LTE models only)

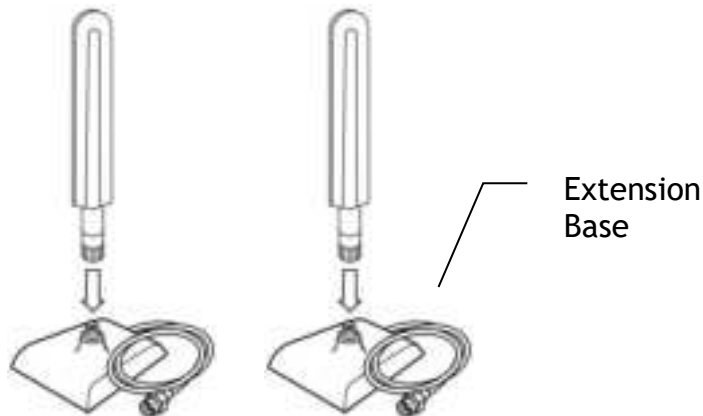

The supplied LTE antenna should be fitted to the magnetic antenna base before connecting the antenna to the router.

There are two LTE antenna connectors on the unit; if only a single antenna can be installed, use the LTE antenna connector adjacent to the power switch (highlighted below).



Before installing the SIM card, turn the router off. It should not be fitted while the router is powered on.

When installing a SIM card into the router, un-screw and remove the SIM card slot cover. When inserted, the SIM card contacts should be facing downwards with the notch on the left side pointing towards back of the router.

The SIM card slot is designed for Standard size SIM cards only, fitting a Mini or Micro SIM without a Standard size SIM card adapter could result in damage to the SIM card slot.

Push the SIM card into either slot until it 'clicks' into place, with the SIM card's contacts facing downwards like so:



Vigor2865 LTE routers have two types of antenna connector; the LTE modem (black antennas) use the inner SMA antenna connectors. The Wireless LAN (white antennas) use the outer RP-SMA antenna connectors.

These must be installed onto the correct antenna connectors for normal LTE signal and normal Wireless LAN functionality.

The supplied antennas should be installed to the connectors as shown:

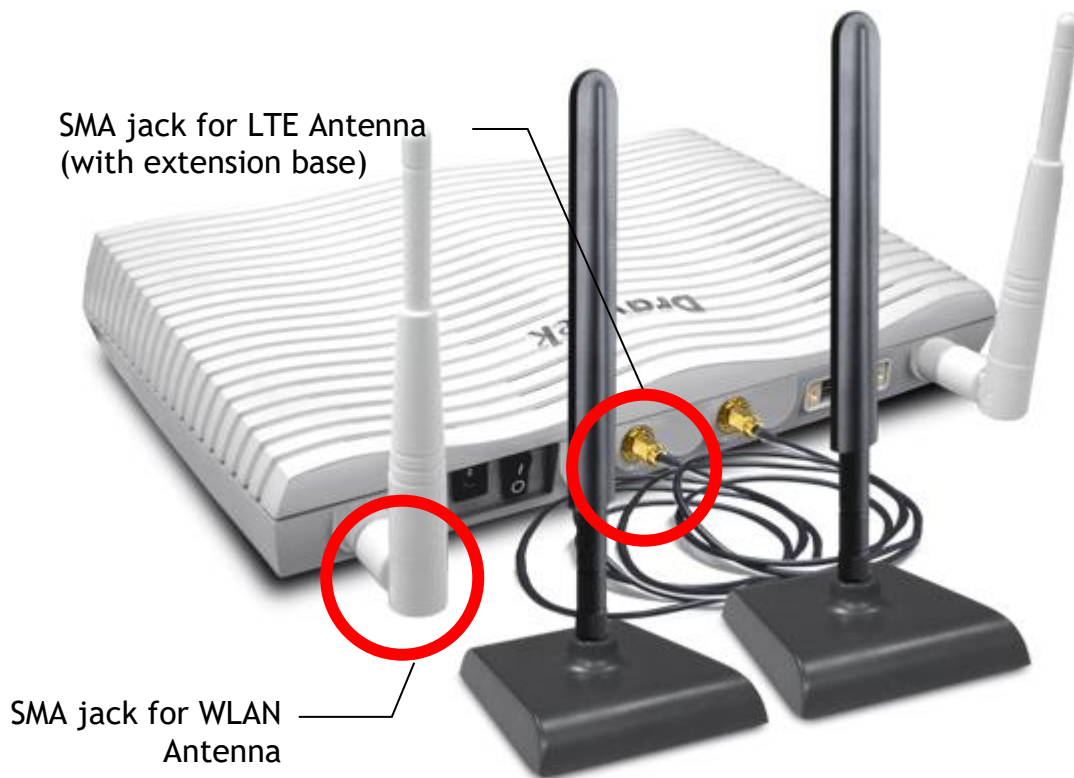

### 3.3 Wall-Mounted Installation

DrayTek Vigor 2865 series routers have keyhole type mounting slots on the underside to hang the router on, using screws attached to a wall or other surface.

1. A template is provided in the Vigor router packaging box to enable you to space the screws correctly on the wall
2. Place the template on the wall in the desired position and drill holes through the cardboard template at the marked points
3. Fit screws into the wall using the appropriate type of wall plug for the wall material

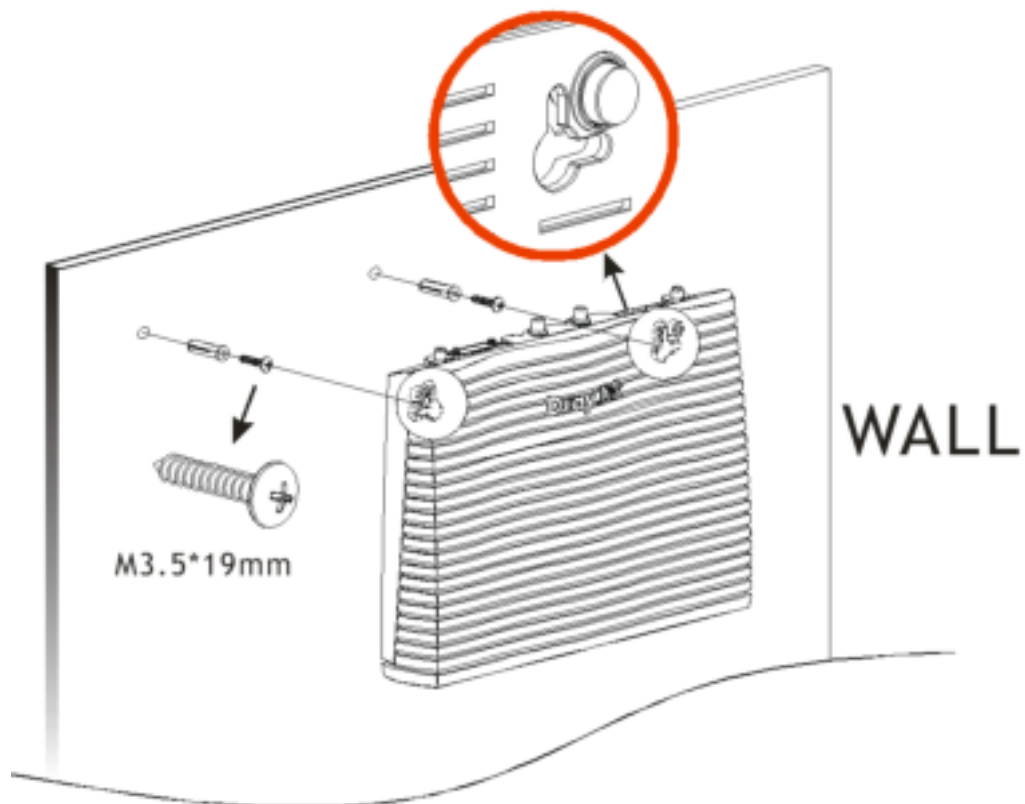

**Note**

The recommended drill diameter is 6.5mm (1/4").

4. With the screws installed, the router can be slotted into place

### 3.4 Rack Mount Kit Installation

The DrayTek Vigor2865 series router can be fitted securely in a standard 19" 1U rack mount space using the **RM1 Rack Mount Plate** (available separately). When fitted, the router is held firmly and cannot be removed, pushed back or fall off the bracket accidentally.



The router must be fitted into the bracket before you fix the bracket into your rack.

To fit it correctly, locate the groove around the edge of the front panel of the router. The front of the RM1 bracket slides into this groove, therefore preventing the router from moving once fitted.

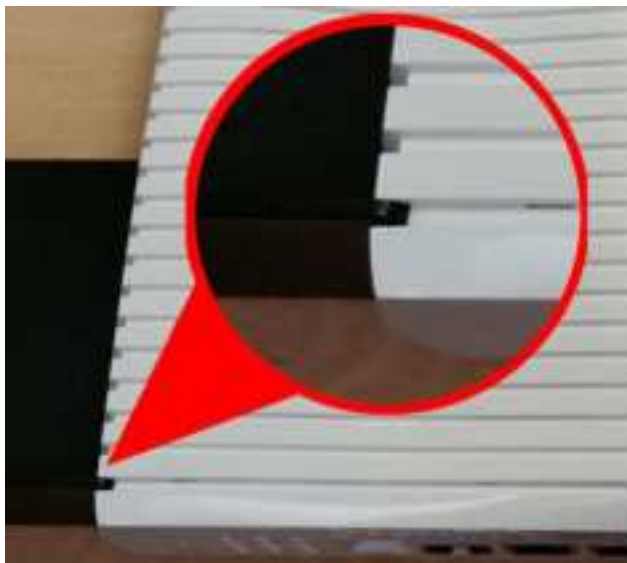

Once the router has been dropped into the groove, you can fit the bracket into the rack using the screws supplied.

## 4. Setup & Configuration

This section provides examples of how to initially access the router and configure internet access for the most common types of Internet connection in the UK.

If the instructions in this quick start guide do not allow you to get online with your ISP or type of Internet connection, there are additional guides available from the Product Knowledgebase on [www.draytek.co.uk](http://www.draytek.co.uk).



### Note

To access the router, your PC will need to either get its IP address using DHCP or have an IP address in the 192.168.1.x range.

For details on how to change this, please refer to the “Trouble Shooting” section in the User Guide.

### 4.1 Accessing the Router Web Interface

Open a web browser on your PC and type <https://192.168.1.1>.

The <https://> prefix ensures that your connection is encrypted using SSL so that your session data cannot be intercepted. Without that prefix, your data passes in clear text.

You may get a warning from your browser (IE, Chrome, Edge, Safari etc.) about your server (the router) having an invalid certificate. Your browser will demand further confirmation or exception before allowing access. The warnings will look something like these examples.

An example of how to access the router via HTTPS with Mozilla Firefox:

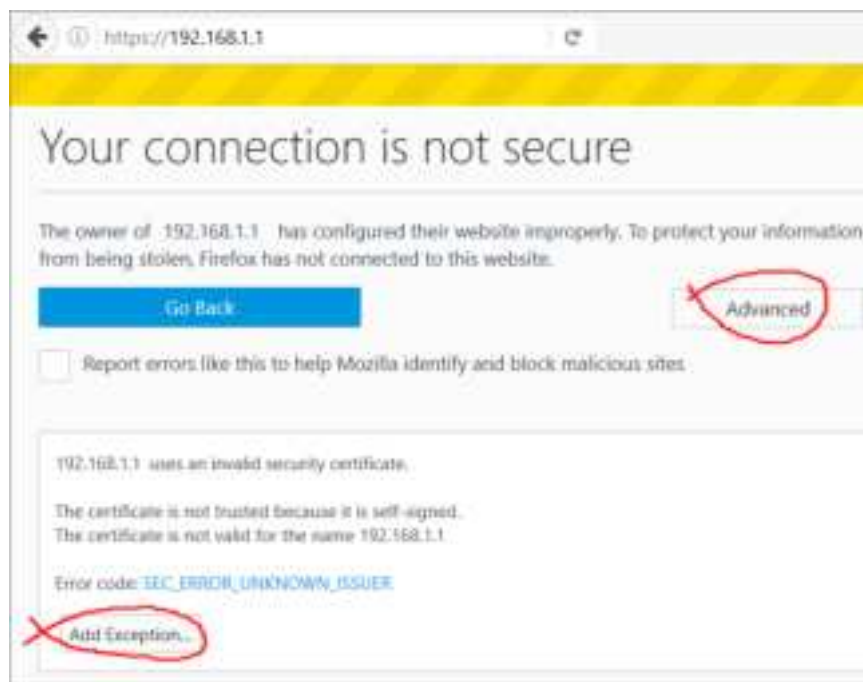

An example from Microsoft Edge, click “Continue to this webpage” to proceed:

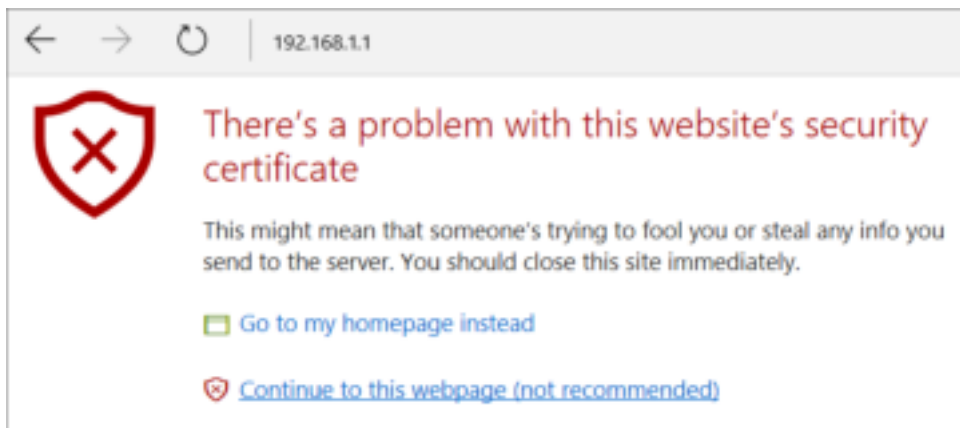

Most other browsers will present equivalent warnings. In each case, following the prompts/links will allow you to access the router's web interface. It is still encrypted with SSL/TLS.



---

**Note**

This warning appears because the router's default certificate is 'self-signed' rather than issued to you by a certificate authority who has verified your identity.

A self-signed certificate means that you cannot verify the identity of the server, but as it's your own local router, that shouldn't be an issue - your connection is still encrypted.

---

The router login prompt will then request a username and password to allow access.



The factory default login details are:

**Username:** admin  
**Password:** admin



**Note**

If you cannot access the web interface, please go to the “Trouble Shooting” section in the User Guide to determine the cause of and solve your problem.

Upon successful login, the router will display the **Dashboard**, which shows a summary of the router model, WAN status, front panel port status and other information:

**System Information**

Model Name	Vigor2865ac	System Up Time	0:20:59
Router Name	DrayTek	Current Time	Sat Jan 01 2000 00:20:38
Firmware Version	4.0.0.1 STD	Build Date/Time	Dec 22 2019 11:08:56
DGL Version	860F07_A/B/C HW: A	LAN MAC Address	00-1D-AA-AA-CF-C0

**LAN & LAN Information**

IP Address	DHCP	IP Address	DHCP
LAN1 192.168.1.1/24	v	LAN2 192.168.17.1/24	v
LAN3 192.168.3.1/24	v	LAN4 192.168.4.1/24	v
LAN5 192.168.5.1/24	v	LAN6 192.168.6.1/24	v
LAN7 192.168.7.1/24	v	LAN8 192.168.8.1/24	v
DMZ PORT 192.168.254.1/24	v	IP Routed Subnet 192.168.0.1/24	v

**LAN Internet Access**

Line / Mode	IP Address	MAC Address	Up Time
WAN1 VDSL2 / ---	Disconnected	00-1D-AA-AA-CF-C1	00:00:00
WAN2 Ethernet / Static IP	172.16.3.135	00-1D-AA-AA-CF-C2	0:20:06
WAN3 Wireless 2.4G / ---	Disconnected	00-1D-AA-AA-CF-C3	00:00:00
WAN4 Wireless 5G / ---	Disconnected	00-1D-AA-AA-CF-C0	00:00:00
WAN5 USB / ---	Disconnected	00-1D-AA-AA-CF-C3	00:00:00
WAN6 USB / ---	Disconnected	00-1D-AA-AA-CF-C0	00:00:00

**Interface**

DGL	Connected : Down Stream : 0Kbps / Up Stream : 0Kbps
WAN	Connected : 1, WAN1 WAN2 WAN3 WAN4 WAN5 WAN6
LAN	Connected : 0, Port1 Port2 Port3 Port4 Port5
WLAN	Connected : 0
WLAN3G	Connected : 0
USB	Connected : 0, USB 1, USB 2



**Note**

We recommend configuring a secure password when first logging in to the router’s administration interface.

The router’s administration password can be changed from [System Maintenance] > [Administrator Password]

## 4.2 WAN1 - ADSL and VDSL2 Connection Setup

The WAN1 interface of the Vigor 2865 router can connect to either an ADSL / ADSL2+ connection or a VDSL2 / 35b Supervectoring connection.

If your Internet connection uses VDSL2 or 35b and your ISP has supplied you with a Username and Password to connect to the Internet, go to section 4.2.1 PPPoE connection with VDSL and 35b

If your Internet connection uses VDSL2 and your ISP does not supply or require a Username and Password to connect to the Internet, go to section 4.2.2 DHCP / Static IP connection with VDSL and 35b

If your Internet connection uses ADSL or ADSL2+ and your ISP has supplied you with a Username and Password to connect to the Internet, go to section 4.2.3 PPPoA connection with ADSL / ADSL2+

### 4.2.1 PPPoE connection with VDSL and 35b

1. Go to [WAN] > [General Setup] and click on the WAN1 link:

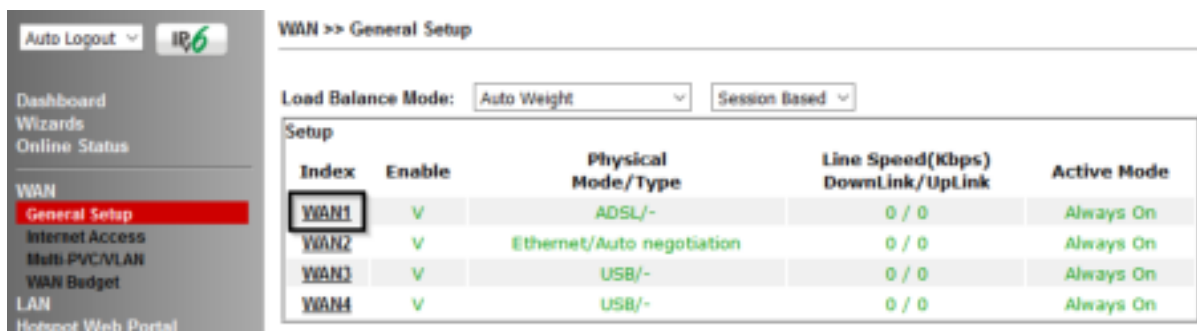

WAN >> General Setup

Load Balance Mode:

Index	Enable	Physical Mode/Type	Line Speed(Kbps) DownLink/UpLink	Active Mode
<b>WAN1</b>	<input checked="" type="checkbox"/>	ADSL/-	0 / 0	Always On
WAN2	<input checked="" type="checkbox"/>	Ethernet/Auto negotiation	0 / 0	Always On
WAN3	<input checked="" type="checkbox"/>	USB/-	0 / 0	Always On
WAN4	<input checked="" type="checkbox"/>	USB/-	0 / 0	Always On

2. On the settings page, Enable the Service - VLAN Tag insertion:

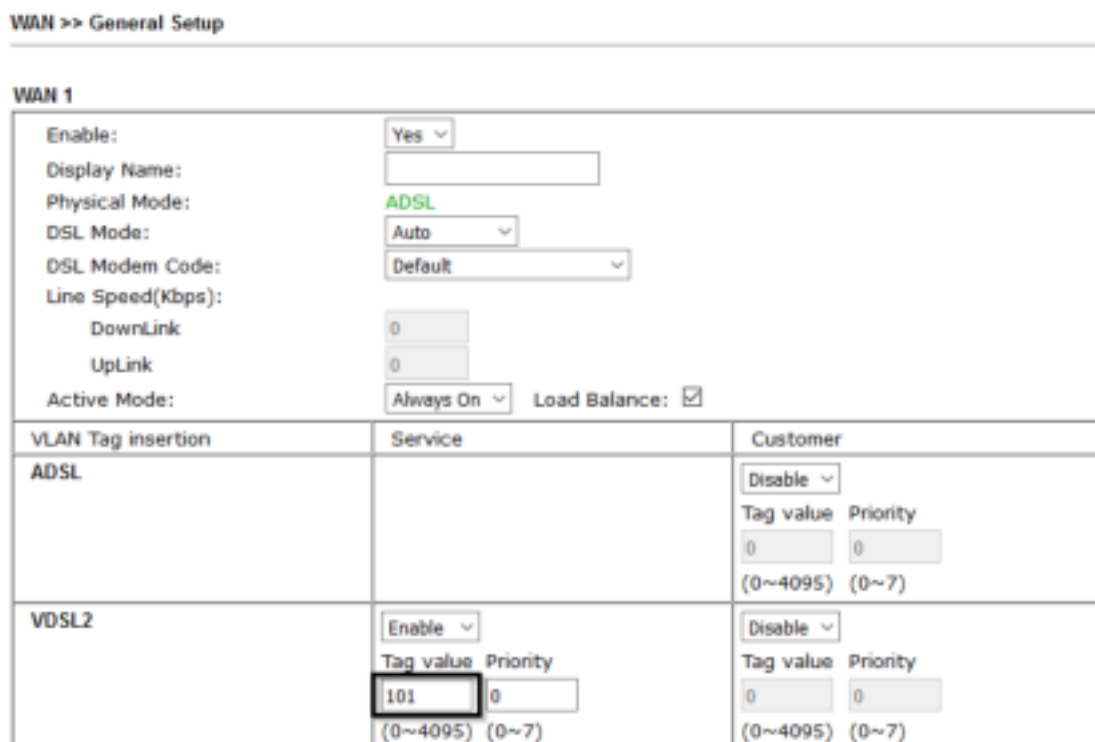

WAN >> General Setup

WAN 1

Enable:

Display Name:

Physical Mode: **ADSL**

DSL Mode:

DSL Modem Code:

Line Speed(Kbps):  
DownLink:   
UpLink:

Active Mode:  Load Balance:

VLAN Tag insertion	Service	Customer
<b>ADSL</b>		<input type="text" value="Disable"/> Tag value: <input type="text" value="0"/> Priority: <input type="text" value="0"/> (0~4095) (0~7)
<b>VDSL2</b>	<input type="text" value="Enable"/> Tag value: <input type="text" value="101"/> Priority: <input type="text" value="0"/> (0~4095) (0~7)	<input type="text" value="Disable"/> Tag value: <input type="text" value="0"/> Priority: <input type="text" value="0"/> (0~4095) (0~7)

Set the **Service - Tag** value to **101** if you're in the **UK**.

Set the **Service - Tag** value to **10** if you're in **Ireland**.



**Note** These VLAN tag values are required to connect to ISPs that operate on the Openreach or OpenEir VDSL2 networks, if your ISP operates on a different VDSL2 network, this tag value may differ. Please check with your ISP or the DrayTek UK Knowledgebase for ISP specific guides.

The DSL mode can be set to "VDSL2 only" but this is not required. Click **OK** on that page to apply the changes.

### 3. Go to **[WAN] > [Internet Access]**

Set the **WAN1 Access Mode** to **PPPoE / PPPoA**, then click the **Details Page** button to proceed:

Index	Display Name	Physical Mode	Access Mode	Details Page	IPv6
WAN1		ADSL / VDSL2	PPPoE / PPPoA	Details Page	IPv6
WAN2		Ethernet	None	Details Page	IPv6
WAN3		USB	None	Details Page	IPv6
WAN4		USB	None	Details Page	IPv6

### 4. On the PPPoE / PPPoA settings tab:

**WAN 1**

**PPPoE / PPPoA** | MPoA / Static or Dynamic IP | IPv6

Enable  Disable

**Modem Settings (for ADSL only)**

Multi-PVC channel: Channel 1

VPI: 0

VCI: 38

Encapsulating Type: VC MUX

Protocol: PPPoA

Modulation: Multimode

**ISP Access Setup**

Service Name<sup>1</sup>: [ ]

Username: A123456@HG00.btclick.c

Password: [ ]

Fallback account

Fallback Username: [ ]

Fallback Password: [ ]

Select the **Enable** radio button at the top of the page to ensure that the PPPoE interface is enabled.

Input the username into the **Username** field and password in the **Password** field, as required.

The Service Name does not need to be specified.

If your ISP has provided a static IP address, that can be specified by setting the **Fixed IP** setting to **Yes** and entering the IP in the **Fixed IP Address** field.

Click **OK** on this page to apply the changes and the router will then prompt to restart.

Click **OK** to restart the router.

- Once the router has restarted, the **[Online Status] > [Physical Connection]** page will display the VDSL information and PPP connection status.

If the WAN1 section shows an IP address, it has connected to the internet successfully:

Online Status						
Physical Connection						System Uptime: 0:8:44
IPv4			IPv6			
LAN Status		Primary DNS: 194.72.0.98		Secondary DNS: 213.120.234.26		
IP Address		TX Packets		RX Packets		
192.168.1.1		0		0		
WAN 1 Status						>> Drop PPPoA
Enable	Line	Name	Mode	Up Time		
Yes	VDSL2		PPPoE	0:07:41		
IP	GW IP	TX Packets	TX Rate(Bps)	RX Packets	RX Rate(Bps)	
217.34.6.35	217.42.145.215	224580	805	339568	963	
WAN 2 Status						
Enable	Line	Name	Mode	Up Time		
Yes	Ethernet		---	00:00:00		
IP	GW IP	TX Packets	TX Rate(Bps)	RX Packets	RX Rate(Bps)	
---	---	0	0	0	0	
WAN 3 Status						
Enable	Line	Name	Mode	Up Time	Signal	
Yes	USB		---	00:00:00	-	
IP	GW IP	TX Packets	TX Rate(Bps)	RX Packets	RX Rate(Bps)	
---	---	0	0	0	0	
VDSL2 Information (VDSL2 Firmware Version: 05-04-08-00-00-06 )						
Profile	State	UP Speed	Down Speed	SNR Upstream	SNR Downstream	
17A	SHOWTIME	20000 (Kbps)	80000 (Kbps)	15 (0.1dB)	6 (0.1dB)	



**Note**

If the WAN 1 IP address displayed begins with 172.16.x.x, it's possible that the ISP has not accepted the supplied Username and Password for the Internet connection.

Check that the ISP Access Setup - Username and Password match the details supplied by your ISP.

## 4.2.2 DHCP / Static IP connection with VDSL and 35b

1. Go to [WAN] > [General Setup] and click on the WAN1 link:

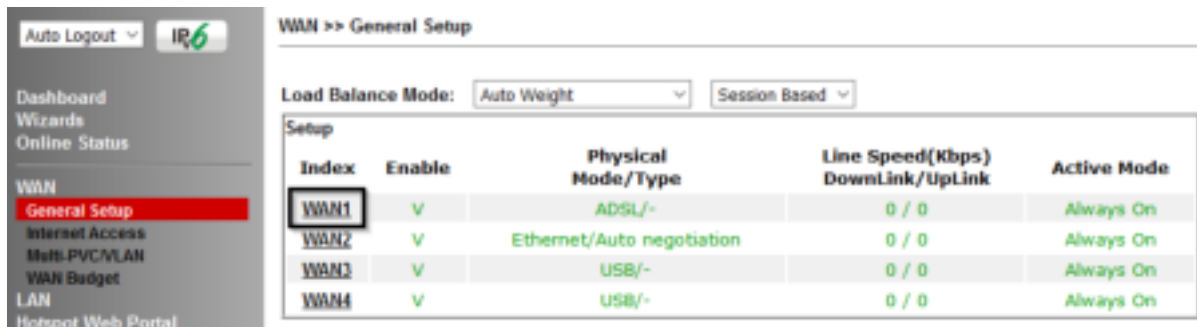

Auto Logout | IR6

Dashboard  
Wizards  
Online Status

WAN  
General Setup  
Internet Access  
Multi-PVC/VLAN  
WAN Budget  
LAN  
Hotspot Web Portal

WAN >> General Setup

Load Balance Mode: Auto Weight | Session Based

Index	Enable	Physical Mode/Type	Line Speed(Kbps) DownLink/UpLink	Active Mode
WAN1	<input checked="" type="checkbox"/>	ADSL/-	0 / 0	Always On
WAN2	<input checked="" type="checkbox"/>	Ethernet/Auto negotiation	0 / 0	Always On
WAN3	<input checked="" type="checkbox"/>	USB/-	0 / 0	Always On
WAN4	<input checked="" type="checkbox"/>	USB/-	0 / 0	Always On

2. On the settings page, Enable the Service - VLAN Tag insertion.  
Set the Tag value setting to 101 if you're in the UK.  
Set the Tag value setting to 10 if you're in Ireland.  
The DSL mode can be set to "VDSL2 only" but this is not required.  
Click OK on that page to apply the changes.

WAN >> General Setup

WAN 1

Enable:	Yes	
Display Name:	<input type="text"/>	
Physical Mode:	ADSL	
DSL Mode:	Auto	
DSL Modem Code:	Default	
Line Speed(Kbps):		
DownLink	<input type="text" value="0"/>	
UpLink	<input type="text" value="0"/>	
Active Mode:	Always On	Load Balance: <input checked="" type="checkbox"/>
VLAN Tag insertion	Service	Customer
ADSL		Disable Tag value: <input type="text" value="0"/> Priority: <input type="text" value="0"/> (0~4095) (0~7)
VDSL2	Enable Tag value: <input checked="" type="text" value="101"/> Priority: <input type="text" value="0"/> (0~4095) (0~7)	Disable Tag value: <input type="text" value="0"/> Priority: <input type="text" value="0"/> (0~4095) (0~7)



### Note

These VLAN tag values are required to connect to ISPs that operate on the Openreach or OpenEir VDSL2 networks, if your ISP operates on a different VDSL2 network, this tag value may differ. Please check with your ISP or the DrayTek UK Knowledgebase for ISP specific guides.

- Go to [WAN] > [Internet Access]  
Set the WAN1 Access Mode to MPoA / Static or Dynamic IP, then click the Details Page button to proceed:

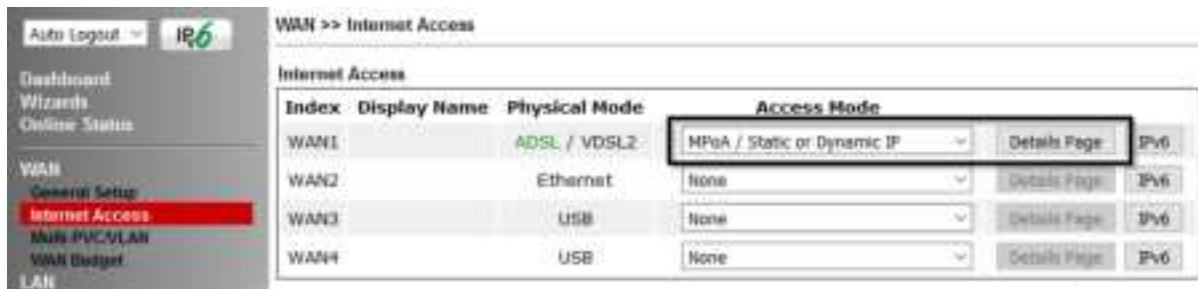

- In the MPoA / Static or Dynamic IP settings:  
Select the **Enable** option and select **Obtain an IP address automatically** which will obtain an IP from the ISP using DHCP.  
If your ISP has provided a static IP range, with a Network address and a Subnet Mask, specify that with the **Specify an IP address** option.

WAN >> Internet Access

WAN 1

Enable
  Disable

**Modem Settings (for ADSL only)**  
 Multi-PVC channel: Channel 2  
 Encapsulation: 1483 Bridged IP LLC  
 VPI: 0  
 VCI: 101  
 Modulation: Multimode

**WAN Connection Detection**  
 Mode: ARP Detect

MTU: 1492 (Max: 1500)  
 Path MTU Discovery: Detect

RIP Protocol  
 Enable RIP

**Bridge Mode**  
 Enable Bridge Mode  
 Bridge Subnet: LAN 1

**WAN IP Network Settings**

Obtain an IP address automatically  
 Specify an IP address

Router Name: Vigor  
 Domain Name:   
 DHCP Client Identifier  
 Username:   
 Password:   
 IP Address:   
 Subnet Mask:   
 Gateway IP Address:   
 Default MAC Address  
 Specify a MAC Address  
 MAC Address: 00 - 1D - AA : FE - FA - 79

**DNS Server IP Address**  
 Primary IP Address: 8.8.8.8  
 Secondary IP Address: 8.8.4.4

Click **OK** on this page to apply the changes and the router will then prompt to restart. Click **OK** to restart the router.

- Once the router has restarted, the [Online Status] > [Physical Connection] page will display the VDSL information and PPP connection status.  
If the WAN1 section shows an IP address, it has connected to the internet successfully:

Auto Logout IP6

Dashboard  
Quick Start Wizard  
Online Status  
**Physical Connection**  
Virtual WAN

---

WAN  
LAN  
NAT  
Firewall  
User Management  
Objects Setting  
C.SM  
Bandwidth Management  
Applications  
VPN and Remote Access  
Certificate Management  
Wireless LAN  
SSL VPN  
USB Application  
System Maintenance  
Diagnostics  
External Devices

---

Support Area  
Product Registration

Online Status

---

Physical Connection System Uptime: 0:8:44

IPv4		IPv6	
LAN Status		Primary DNS: 194.72.0.98	
Secondary DNS: 213.120.234.26			
IP Address	TX Packets	RX Packets	
192.168.1.1	0	0	

WAN 1 Status >> Drop PPPoA

Enable	Line	Name	Mode	Up Time		
Yes	VDSL2		PPPoE	0:07:41		
IP	GW IP	TX Packets	TX Rate(Bps)	RX Packets	RX Rate(Bps)	
217.34.6.35	217.42.145.215	224580	805	339568	963	

WAN 2 Status

Enable	Line	Name	Mode	Up Time		
Yes	Ethernet		---	00:00:00		
IP	GW IP	TX Packets	TX Rate(Bps)	RX Packets	RX Rate(Bps)	
---	---	0	0	0	0	

WAN 3 Status

Enable	Line	Name	Mode	Up Time	Signal
Yes	USB		---	00:00:00	-
IP	GW IP	TX Packets	TX Rate(Bps)	RX Packets	RX Rate(Bps)
---	---	0	0	0	0

VDSL2 Information (VDSL2 Firmware Version: 05-04-08-00-00-06 )

Profile	State	UP Speed	Down Speed	SNR Upstream	SNR Downstream
17A	SHOWTIME	20000 (Kbps)	80000 (Kbps)	15 (0.1dB)	6 (0.1dB)

### 4.2.3 PPPoA connection with ADSL / ADSL2+

1. Go to [WAN] > [Internet Access]

Firstly set the WAN1 Access Mode to PPPoE / PPPoA, then click the Details Page button to proceed:

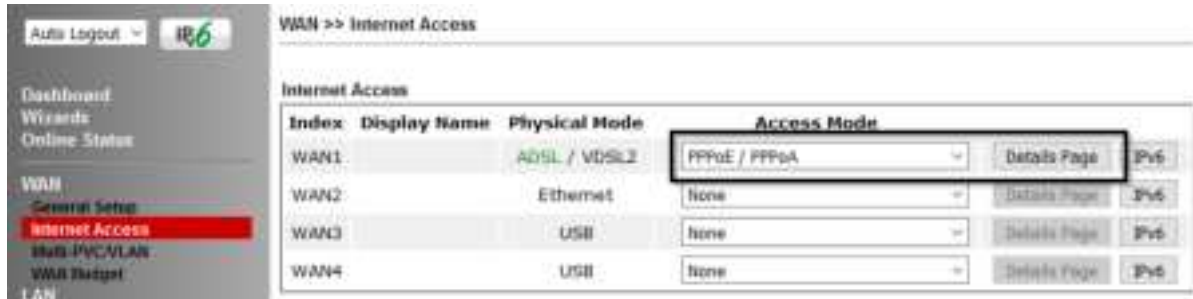

2. On the PPPoE / PPPoA settings tab:

The details for the VPI and VCI settings for ADSL should be correct for UK usage, with 0 and 38 being the defaults. In most cases, it will not be necessary to change these.

The Modulation setting can be left on its default of Multimode which will auto-detect the correct ADSL type to use.

Select the Enable radio button at the top of the page to ensure that the PPPoE interface is enabled.

Input the username into the Username field and password in the Password field, as required.

The Service Name does not need to be specified.

If your ISP has provided a static IP address, that can be specified by setting the Fixed IP setting to Yes and entering the IP in the Fixed IP Address field.

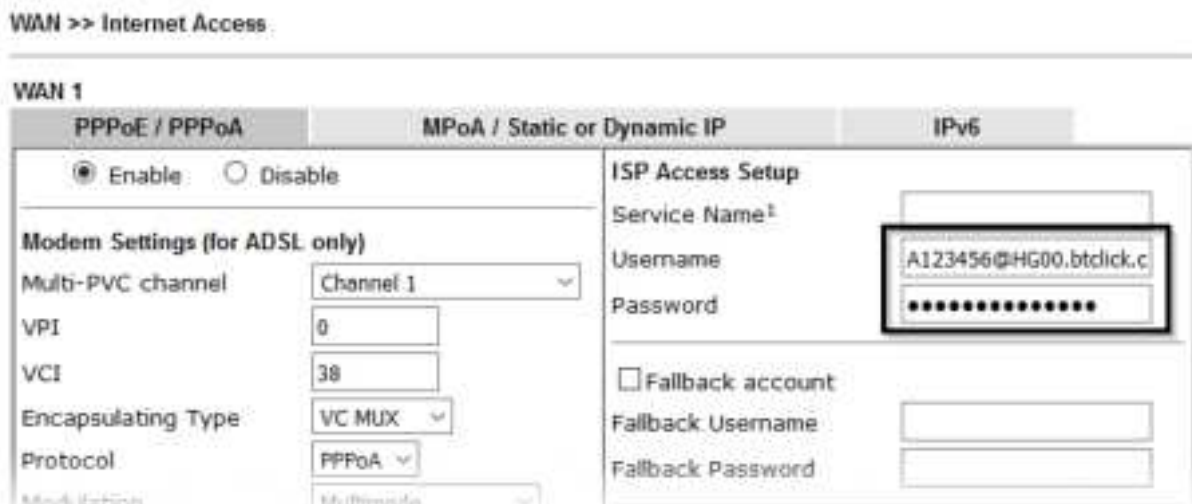

Click OK on this page to apply the changes and the router will then prompt to restart. Click to restart the router.

- Once the router has restarted, the [Online Status] > [Physical Connection] page will display the ADSL information and PPP connection status, if the WAN1 section shows an IP address, it has connected to the internet successfully:

The screenshot shows the 'Online Status' page of a router. The 'Physical Connection' section is active, displaying details for WAN1, WAN2, and WAN3. WAN1 is connected to the internet with an IP address of 192.168.1.1. WAN2 and WAN3 are not connected. The VDSL2 information section shows the profile as 17A and the state as SHOWTIME.

LAN Status		IPv4		IPv6		System Uptime: 0:8:44	
IP Address	TX Packets	Primary DNS: 194.72.0.98	RX Packets	Secondary DNS: 213.120.234.26			
192.168.1.1	0		0				
<b>WAN 1 Status</b> >> <a href="#">Disp PPPoE</a>							
Enable	Line	Name	Mode	Up Time			
Yes	VDSL2		PPPoE	0:07:41			
IP	GW IP	TX Packets	TX Rate(Bps)	RX Packets	RX Rate(Bps)		
217.34.6.35	217.42.145.215	224580	805	339568	963		
<b>WAN 2 Status</b>							
Enable	Line	Name	Mode	Up Time			
Yes	Ethernet		---	00:00:00			
IP	GW IP	TX Packets	TX Rate(Bps)	RX Packets	RX Rate(Bps)		
---	---	0	0	0	0		
<b>WAN 3 Status</b>							
Enable	Line	Name	Mode	Up Time	Signal		
Yes	USB		---	00:00:00	-		
IP	GW IP	TX Packets	TX Rate(Bps)	RX Packets	RX Rate(Bps)		
---	---	0	0	0	0		
<b>VDSL2 Information</b> (VDSL2 Firmware Version: 05-04-08-00-00-06 )							
Profile	State	UP Speed	Down Speed	SNR Upstream	SNR Downstream		
17A	SHOWTIME	20000 (Kbps)	80000 (Kbps)	15 (0.1dB)	6 (0.1dB)		



**Note**

If the WAN 1 IP address displayed begins with 172.16.x.x, it's possible that the ISP has not accepted the supplied Username and Password for the Internet connection.

Check that the ISP Access Setup - Username and Password match the details supplied by your ISP.

### 4.3 WAN2 – Ethernet Connection Setup

The WAN2 interface of the Vigor 2865 router can connect to a modem such as the Vigor 130 VDSL2 to Ethernet modem, an ISP supplied router or another network with an Internet connection.

If you are using a modem and your ISP has supplied you with a Username and Password to connect to the Internet, go to section 4.3.1 PPPoE

If the router is connected to a modem and the ISP does not supply or require a Username and Password to connect to the Internet, or you are connecting the WAN2 connection to another router or network go to section 4.3.2 Static or Dynamic IP

### 4.3.1 PPPoE

This connection method will typically be used with a modem such as the Vigor 130 VDSL2 modem, which passes through the PPPoE connection from the ISP to the router.

1. Go to **[WAN] > [Internet Access]**

Firstly set the **WAN2 Access Mode** to **PPPoE**, then click the **Details Page** button to proceed:



2. In the PPPoE settings tab:

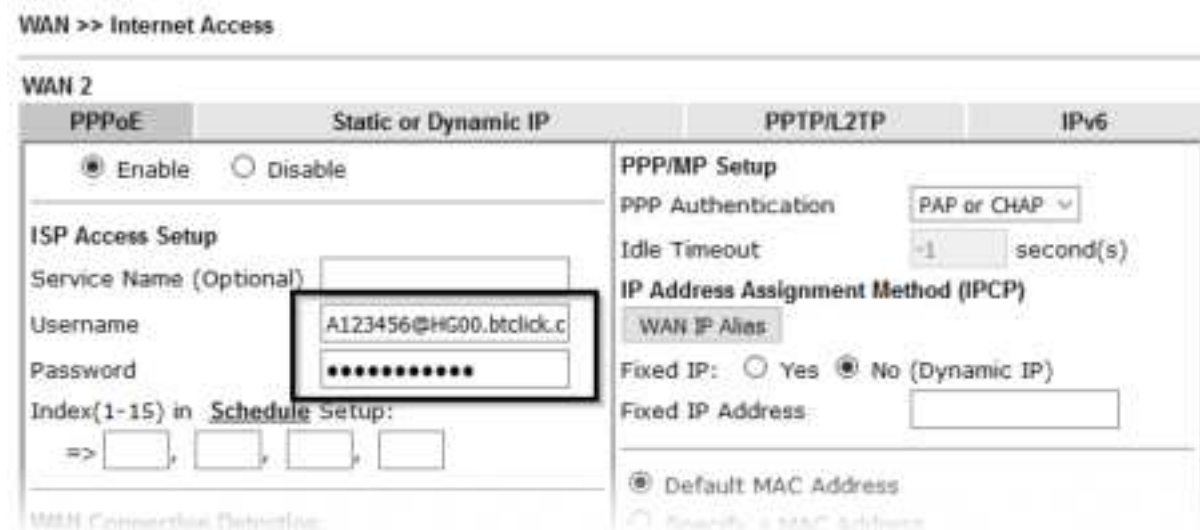

Select the **Enable** radio button at the top of the page to ensure that the PPPoE interface is enabled.

Input the username into the **Username** field and password in the **Password** field, as required. The Service Name does not need to be specified.

If your ISP has provided a static IP address, that can be specified by setting the **Fixed IP** setting to **Yes** and entering the IP in the **Fixed IP Address** field.

Click **OK** on that page to save the settings and the router will then prompt to restart, allow it to restart to properly apply the changes.

Once the router has restarted, log back into the web interface and select **[Online Status] > [Physical connection]**, if it has connected, the relevant **WAN Interface** status text will be in green along with an IP address which indicates that the connection is active and ready for use.

## 4.3.2 Static or Dynamic IP

1. Go to [WAN] > [Internet Access]

Set the WAN2 Access Mode to **Static or Dynamic IP**, then click the **Details Page** button to proceed:



2. In the Static or Dynamic IP settings:

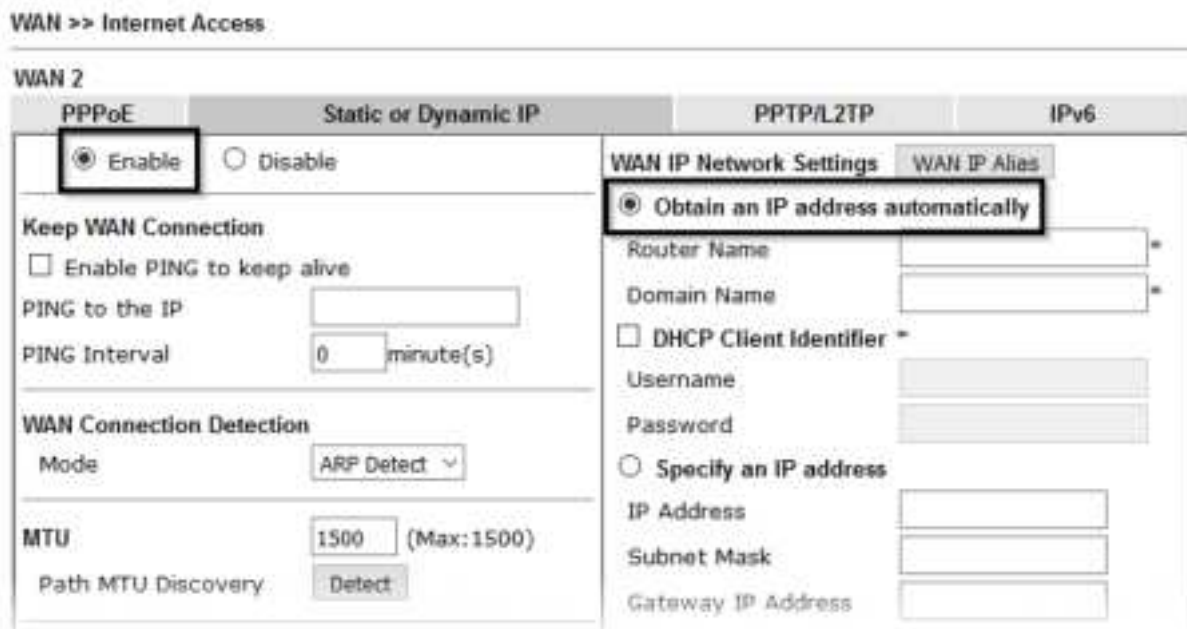

Select the **Enable** option and select **Obtain an IP address automatically** which will obtain an IP from the ISP with DHCP.

If your ISP has provided a static IP range, with a Network address and a Subnet Mask, specify that with the **Specify an IP address** option.

Click **OK** on this page to apply the changes and the router will then prompt to restart. Click to restart the router.

Once the router has restarted, log back into the web interface and select **[Online Status] > [Physical connection]**, if it has connected, the relevant **WAN Interface** status text will be in green along with an IP address which indicates that the connection is active and ready for use.

## 4.4 LTE Modem Setup (LTE models only)

The LTE modem integrated into DrayTek LTE routers (“L” suffix) can connect directly to a mobile broadband network and operate as either a main internet connection or a backup internet connection. The modem is integrated into the router instead of using a separate USB modem and requires a SIM card to connect to the mobile broadband network required.

The settings for the mobile broadband network will vary by provider, some will require the **APN (Access Point Name)** while others may require that and a username and password. If those details are not set, the mobile network may reject the connection attempts of the Vigor LTE router, which will result in the router showing no signal / no IP address.

To configure the LTE WAN interface on the router, it is first necessary to fit the SIM card in the router, refer to section 3.2 for details of SIM card and antenna installation.

After the SIM card has been installed, power on the router, access the router’s web interface and go to **[WAN] > [General Setup]** to confirm the LTE WAN options, by clicking the **LTE** link:

WAN >> General Setup

Load Balance Mode: Auto Weight

Index	Enable	Physical Mode/Type	Line Speed(Kbps) DownLink/UpLink	Active Mode
WAN1	<input type="checkbox"/>	ADSL/-	0 / 0	Always On
WAN2	<input type="checkbox"/>	Ethernet/Auto negotiation	0 / 0	Always On
<b>LTE</b>	<input type="checkbox"/>	USB/-	0 / 0	Always On
WAN4	<input type="checkbox"/>	USB/-	0 / 0	Always On

OK

In the LTE General Setup options, ensure that the connection is **Enabled** and set the **Active Mode** as required.

If the internet connection should always be available, set it to **Always On**:

WAN >> General Setup

LTE

Enable: Yes

Display Name:

Physical Mode: USB

Line Speed(Kbps):

DownLink:

UpLink:

Active Mode: Always On Load Balance:

If the connection will be used as a backup internet connection, set the **Active Mode** to **Failover**:

- Select "Any of the selected WAN" if the LTE connection will come online if only one WAN interface selected goes offline. For instance, in the example below, if either WAN1 or WAN2 are offline, the LTE WAN interface will become active:

Active Mode:  Load Balance:

Active When:

Any of the selected WAN disconnect

All of the selected WAN disconnect

WAN 1  WAN 2  WAN 3  WAN 4

- Select "All of the selected WAN" if the LTE connection will come online only when all of the WAN interfaces selected are offline:

Active Mode:  Load Balance:

Active When:

Any of the selected WAN disconnect

All of the selected WAN disconnect

WAN 1  WAN 2  WAN 3  WAN 4

Click **OK** to save those changes.

Go to **[WAN] > [Internet Access]**. Set the **Access Mode** to **3G/4G LTE Modem (DHCP Mode)** and click the **Details Page** button:



On the Details for the LTE WAN interface:

**LTE**

**3G/4G LTE Modem(DHCP mode)** **IPv6**

Enable  Disable

SIM PIN code:

Network Mode:  (Default: 4G/3G/2G)

APN Name:

LTE software version:

LTE hardware version:

**Keep WAN Connection**

Enable PING to keep alive (Timeout: 10 secs.)

PING to the IP:

Authentication:

Username:  (Optional)

Password:  (Optional)

**Preferred LTE Band**

**Network Scan**

Enable Bridge Mode (Use LAN Port P1)

Bridge Specific MAC Address

Set the **3G/4G LTE Modem (DHCP mode)** setting to **Enable** and configure these settings as required for your SIM card / ISP:

**SIM PIN code** - If your SIM card has a PIN code, enter it, otherwise leave this **blank**

**Network Mode** - **4G/3G/2G** auto-selects the ideal network type. Set this to a specific mode to force that connection type, i.e. 4G Only.

**APN Name** - Enter the APN required for your SIM card. This may vary by plan / SIM type, check with your provider if you're not sure.

**Username and Password** - Enter these if required by the ISP.

**Authentication** - Select **PAP** or **CHAP**. Select **PAP Only** if your ISP requires it

Click **OK** to save and apply those settings.

Go to the **[Dashboard]** to check the network connection state under the **LTE Status** section:

**Dashboard**

The screenshot shows the DrayTek Vigor2865L router dashboard. At the top, there are status indicators for ACT, WAN2, GoS, LTE, DSL, WCF, USB, VPN, DMZ, and a Factory Reset button. Below this is a row of network ports: WAN1, P1, P2, P3, P4, P5, and DSL. The main content area is divided into three sections:

- System Information:**

Model Name	Vigor2865L	System Up Time	0:03:52
Router Name	DrayTek	Current Time	Wed Nov 20 2019 09:33:11
Firmware Version	4.0.5_RC1_STD	Build Date/Time	Oct 18 2019 11:23:09
DSL Version	BB0F07_A/B/C HW: A	LAN MAC Address	00-1D-AA-1F-AC-B8
- IPv4 LAN Information:**

	IP Address	DHCP		IP Address	DHCP
LAN1	192.168.1.1/24	v	LAN2	192.168.2.1/24	v
LAN3	192.168.3.1/24	v	LAN4	192.168.4.1/24	v
LAN5	192.168.5.1/24	v	LAN6	192.168.6.1/24	v
LAN7	192.168.7.1/24	v	LAN8	192.168.8.1/24	v
DMZ PORT	192.168.254.1/24	v	IP Routed Subnet	192.168.0.1/24	v
- IPv4 Internet Access:**

Line / Mode	IP Address	MAC Address	Up Time
- LTE Status:**

Status	Operational
Bridge mode	Disabled
Access Tech	LTE
Band	E-UTRA Op Band 20
Operator	3
Signal	RSRP: -91 dBm (Good) RSSI: -69 dBm (Excellent)
New SMS	

The **[Online Status] > [Physical Connection]** page will show connection details for the LTE WAN interface. If the details show in red text, the LTE internet connection is down. When the LTE details text shows in green, the router will be able to use that WAN interface for internet access.

If the LTE WAN is configured to operate as a backup, the router will keep this internet connection offline until the requirements are met (other WAN interfaces down) for it to come online.

Auto Logout 

Dashboard  
Wizards  
**Online Status**

WAN  
General Setup  
Internet Access  
Multi-PVC/VLAN  
WAN Budget

LAN  
Load-Balance/Route Policy  
NAT  
Hardware Acceleration  
Firewall  
User Management  
Objects Setting  
CSM  
Bandwidth Management  
Applications  
VPN and Remote Access  
Certificate Management  
Central VPN Management  
Central AP Management  
LTE  
Wireless LAN  
SSL VPN  
USB Application  
System Maintenance  
Diagnostics  
External Devices

Online Status

Physical Connection  System Uptime: 6day 0:40

IPv4			IPv6			
<b>LAN Status</b>			Primary DNS: 109.249.185.224		Secondary DNS: 109.249.190.32	
IP Address	TX Packets	RX Packets				
192.168.1.1	27778	17184				
<b>WAN 1 Status</b> >> <a href="#">Dial PPPoA</a>						
Enable	Line	Name	Mode	Up Time		
Yes	ADSL		PPPoA	00:00:00		
IP	GW IP	TX Packets	TX Rate(Bps)	RX Packets	RX Rate(Bps)	
---	---	0	0	0	0	
<b>WAN 2 Status</b>						
Enable	Line	Name	Mode	Up Time		
Yes	Ethernet		---	00:00:00		
IP	GW IP	TX Packets	TX Rate(Bps)	RX Packets	RX Rate(Bps)	
---	---	0	0	0	0	
<b>LTE Status</b> >> <a href="#">Release</a>						
Enable	Line	Name	Mode	Up Time		
Yes	USB		DHCP Client	0:01:30		
IP	GW IP	TX Packets	TX Rate(Bps)	RX Packets	RX Rate(Bps)	
100.98.21.12	100.98.21.13	15455	47204	26241	31698	
<b>USB Modem</b>	<b>Status</b>	<b>Base Station ID</b>	<b>Signal Strength(RSSI)</b>	<b>Signal Quality(CINR)</b>	<b>NetWork Mode</b>	
Device Exists	Operational	00:A0:C6:00:01:55	-64 dBm	36 dB (99%) 	4G/3G/2G	

Additional details on the LTE modem status can be found under [LTE] > [Status]:

Auto Logout 

Dashboard  
Wizards  
Online Status

Search menu

WAN  
LAN  
Hotspot Web Portal  
Routing  
NAT  
Firewall  
User Management  
Objects Setting  
CSM  
Bandwidth Management  
Applications  
VPN and Remote Access  
Certificate Management  
LTE  
General Settings  
SMS Inbox  
Send SMS  
Router Commands  
**Status**  
USB Application  
System Maintenance  
Diagnostics

LTE >> Status [Refresh](#)

LTE Modem	
Status:	Operational
IMEI:	86668
IMSI:	23420
ICCID:	89442
Access Tech:	LTE
Band:	E-UTRA Op Band 20
Operator:	3
Mobile Country Code:	234
Mobile Network Code:	20
Location Area Code:	65534
Cell ID:	111
RSRP Signal:	-86 dBm (Excellent)
RSSI Signal:	-59 dBm (Excellent)
Active Channel:	6175
Max Channel TX Rate:	--- Mbps
Max Channel RX Rate:	--- Mbps
LTE SMS	
SMS Centre Number:	---
SMS Service Status:	Not ready
SMS Loading:	Not ready
New SMS:	---

## 5. Getting Further Help

If the router does not appear to be operating correctly or you cannot get online to the Internet, please visit our web site ([www.draytek.co.uk](http://www.draytek.co.uk)) for further troubleshooting advice or to contact our support technicians. Always have your serial number to hand.

Users in the UK/Ireland using qualifying products should visit for support options including email support, telephone support, our help knowledgebase and access to the UK user support forums.

If you are **outside** of the UK/Ireland, please contact your own local supplier, email to [support@draytek.com](mailto:support@draytek.com) or visit [www.draytek.com/support](http://www.draytek.com/support)

For warranty service, in the first instance, please contact the support services, as listed above, for help in diagnosing or eliminating the problem or issue. The support department can arrange repair or service if then deemed necessary.

The standard Vigor 2865 series warranty is 'Return to base' (RTB) unless you have VigorCare which provides enhanced services (see [www.draytek.co.uk/vigorcure](http://www.draytek.co.uk/vigorcure)).

You should keep your proof of purchase (original invoice) safely in case warranty or other service is ever required.

### 5.1 Additional Feature Setup

This is a quick setup guide to get you online with your new router.

Your Vigor 2865 series router is capable of very much more and has a plethora of other features.

These are covered in the main user manual, which is available on the Downloads page:

<https://www.draytek.co.uk/support/downloads>

The online knowledgebase has additional information on how to configure the router's Internet connectivity and more advanced features:

<https://www.draytek.co.uk/support/product-knowledgebase>

### 5.2 Keep up to date with our mailing list

Now that you have your DrayTek product, you should keep up to date with product updates (firmware), security advisories and other product news, advice or special offers. Users in the UK/Ireland can subscribe to our mailing list. For details and to subscribe, please visit

In other countries or regions, please contact your local distributor/supplier for local options.

## 5.3 Firmware Updates

It is strongly recommended that you keep your router firmware up to date with the latest version in order to have all of the latest security and feature improvements.

Always obtain firmware from official sources, i.e. (for UK/Ireland users).

There are two firmware file types:

.all - upgrade retaining all previous settings

.rst - upgrade and reset to factory default

It is recommended to take a configuration backup prior to upgrading the firmware.

## 5.4 Security & Router Best Practice

Your router is the gateway to an entire business network and data. Even the best security equipment requires correct usage in order to ensure that its features are effective.

There are many simple practices that every router user should adopt to help reduce the risk to their network or business as well as some very common and simple mistakes that people habitually make - simple mistakes which could then be exploited by others.

We've produced our free guide "**Router Best Practice**" which contains essential information for anyone installing, configuring or using a broadband router or wireless LAN.

Available to download: <https://www.draytek.co.uk/best>