

**Network Master Series
MU909014A/A1/B/B1/C/C6/
MU909015A6/B/B1/C/C6
μOTDR Module
Operation Manual**

16th Edition

- This document explains the operation of the MT9090A main frame, MU909014A/A1/B/B1/C/C6, MU909015A6/B/B1/C/C6 μOTDR modules.
- For safety and warning information, please read this manual before attempting to use the equipment.
- Keep this manual with the equipment.

ANRITSU CORPORATION

Safety Symbols

To prevent the risk of personal injury or loss related to equipment malfunction, Anritsu Corporation uses the following safety symbols to indicate safety-related information. Ensure that you clearly understand the meanings of the symbols BEFORE using the equipment. Some or all of the following symbols may be used on all Anritsu equipment. In addition, there may be other labels attached to products that are not shown in the diagrams in this manual.

Symbols used in manual



DANGER

This indicates a very dangerous procedure that could result in serious injury or death if not performed properly.



WARNING

This indicates a hazardous procedure that could result in serious injury or death if not performed properly.



CAUTION

This indicates a hazardous procedure or danger that could result in light-to-severe injury, or loss related to equipment malfunction, if proper precautions are not taken.

Safety Symbols Used on Equipment and in Manual

The following safety symbols are used inside or on the equipment near operation locations to provide information about safety items and operation precautions. Ensure that you clearly understand the meanings of the symbols and take the necessary precautions BEFORE using the equipment.



This indicates a prohibited operation. The prohibited operation is indicated symbolically in or near the barred circle.



This indicates an obligatory safety precaution. The obligatory operation is indicated symbolically in or near the circle.



This indicates a warning or caution. The contents are indicated symbolically in or near the triangle.



This indicates a note. The contents are described in the box.



These indicate that the marked part should be recycled.

Network Master Series

MU909014A/A1/B/B1/C/C6, MU909015A6/B/B1/C/C6

μOTDR Module

Operation Manual

15 January 2012 (First Edition)

10 May 2016 (16th Edition)

Copyright © 2012-2016, ANRITSU CORPORATION.

All rights reserved. No part of this manual may be reproduced without the prior written permission of the publisher.

The contents of this manual may be changed without prior notice.

Printed in Japan

For Safety

WARNING



- ALWAYS refer to the operation manual when working near locations at which the alert mark shown on the left is attached. If the advice in the operation manual is not followed, there is a risk of personal injury or reduced equipment performance. The alert mark shown on the left may also be used with other marks and descriptions to indicate other dangers.

- Overvoltage Category

This equipment complies with overvoltage category II defined in IEC 61010. DO NOT connect this equipment to the power supply of overvoltage category III or IV.

- Laser radiation warning

- NEVER look directly into the cable connector on the equipment nor into the end of a cable connected to the equipment. There is a risk of injury if laser radiation enters the eye.

- The Laser Safety label is attached to the equipment for safety use as indicated in "Laser Safety" later in this section.

Repair



- Only qualified service personnel with a knowledge of electrical fire and shock hazards should service this equipment. This equipment cannot be repaired by the operator. DO NOT attempt to remove the equipment covers or unit covers or to disassemble internal components. There are high-voltage parts in this equipment presenting a risk of severe injury or fatal electric shock to untrained personnel. In addition, there is a risk of damage to precision components.

Calibration



- The performance-guarantee seal verifies the integrity of the equipment. To ensure the continued integrity of the equipment, only Anritsu service personnel, or service personnel of an Anritsu sales representative, should break this seal to repair or calibrate the equipment. Be careful not to break the seal by opening the equipment or unit covers. If the performance-guarantee seal is broken by you or a third party, the performance of the equipment cannot be guaranteed.

For Safety

WARNING

Replacing Battery



- When replacing the battery, use the specified battery and insert it with the correct polarity. If the wrong battery is used, or if the battery is inserted with reversed polarity, there is a risk of explosion causing severe injury or death.

Battery Fluid

- DO NOT short the battery terminals and never attempt to disassemble the battery or dispose of it in a fire. If the battery is damaged by any of these actions, the battery fluid may leak. This fluid is poisonous. DO NOT touch the battery fluid, ingest it, or get in your eyes. If it is accidentally ingested, spit it out immediately, rinse your mouth with water and seek medical help. If it enters your eyes accidentally, do not rub your eyes, rinse them with clean running water and seek medical help. If the liquid gets on your skin or clothes, wash it off carefully and thoroughly.

Battery Disposal

- DO NOT expose batteries to heat or fire. Do not expose batteries to fire. This is dangerous and can result in explosions or fire. Heating batteries may cause them to leak or explode.

LCD

- This equipment uses a Liquid Crystal Display (LCD). DO NOT subject the equipment to excessive force or drop it. If the LCD is subjected to strong mechanical shock, it may break and liquid may leak. This liquid is very caustic and poisonous. DO NOT touch it, ingest it, or get in your eyes. If it is ingested accidentally, spit it out immediately, rinse your mouth with water and seek medical help. If it enters your eyes accidentally, do not rub your eyes, rinse them with clean running water and seek medical help. If the liquid gets on your skin or clothes, wash it off carefully and thoroughly .

High temperature

- Turn off the unit and allow alkaline batteries to cool before touching or removing. The temperature of batteries may rise by approximately +20°C if used continuously for an extended period of time.
-

For Safety

Laser Safety

Class 1, 1M and 3R indicate the danger degree of the laser radiation specified below according to IEC 60825-1:2007.

Class 1: Lasers that are safe under reasonably foreseeable conditions of operation, including the use of optical instruments for intrabeam viewing.

Class 1M: Lasers emitting in the wavelength range from 302.5 to 4000 nm that are safe under reasonably foreseeable conditions of operation, but may be hazardous if the user employs optics within the beam. Two conditions apply:

- a) for diverging beams, if the user views the laser output with certain optical instruments (for example, eye loupes, magnifiers and microscopes) within a distance of 100 mm; or
- b) for collimated beams, if the user views the laser output with certain optical instruments (for example, telescopes and binoculars).

Class 3R: Lasers that emit in the wavelength range from 302.5 to 10^6 nm where direct intrabeam viewing is potentially hazardous but the risk is lower than for Class 3B lasers.



CAUTION

Use of controls or adjustments or performance of procedures other than those specified herein may result in hazardous radiation exposure.

The use of optical instruments with this product will increase eye hazard.

For Safety

WARNING

Laser Safety

Before using this instrument, always ensure that the warning light is lit when the optical output switch is turned on. If this warning light does not turn on, the equipment may be faulty and for safety reasons should be returned to an Anritsu service center or representative for repair.

The laser in this equipment is classified as Class 1, 1M, or 3R according to the IEC 60825-1: 2007 standard.

Never use optical instruments to directly view Class 1M laser products. Doing so may result in serious damage to the eyes.

Table 1 Laser Safety Classifications Based on IEC 60825-1:2007

Model Name	Class	Max. Optical Output Power (W)*	Pulse Width(s)/ Repetition Rate	Emitted Wavelength (nm)	Beam Divergence (deg)	Incorporated Laser Specification (refer to Table 2)	Laser Aperture
MU909014A-053/063	1	0.15	20×10 ⁻⁶ /0.009	1625	11.5	d)	Figure 1, [1]
MU909014A1-053/063	1	0.15	20×10 ⁻⁶ /0.009	1625	11.5	d)	Figure 2, [1]
	3R	0.003	CW	650	11.5	f)	Figure 2, [2]
MU909014A-054/064	1	0.15	20×10 ⁻⁶ /0.009	1650	11.5	e)	Figure 1, [1]
MU909014A1-054/064	1	0.15	20×10 ⁻⁶ /0.009	1650	11.5	e)	Figure 2, [1]
	3R	0.003	CW	650	11.5	f)	Figure 2, [2]
MU909015A6-053/063	1	0.15	20×10 ⁻⁶ /0.009	1625	11.5	d)	Figure 1, [1]
MU909015A6-054/064	1	0.15	20×10 ⁻⁶ /0.009	1650	11.5	e)	Figure 1, [1]
MU909014B MU909015B-056/066	1M	0.15	20×10 ⁻⁶ /0.015	1310	11.5	a)	Figure 1, [1]
	1	0.15	20×10 ⁻⁶ /0.009	1550	11.5	c)	Figure 1, [1]

For Safety

Table 1 Laser Safety Classifications Based on IEC 60825-1:2007 (Continued)

Model Name	Class	Max. Optical Output Power (W)*	Pulse Width(s)/ Repetition Rate	Emitted Wavelength (nm)	Beam Divergence (deg)	Incorporated Laser Specification (refer to Table 2)	Laser Aperture
MU909014B1 MU909015B1 -056/066	1M	0.15	20×10^{-6} / 0.015	1310	11.5	a)	Figure 2, [1]
	1	0.15	20×10^{-6} / 0.009	1550	11.5	c)	Figure 2, [1]
	3R	0.003	CW	650	11.5	f)	Figure 2, [2]
MU909014C/C6 MU909015C/C6 -057/067	1M	0.15	20×10^{-6} / 0.015	1310	11.5	a)	Figure 3, [1]
	1	0.15	20×10^{-6} / 0.009	1550	11.5	c)	Figure 3, [1]
	1	0.15	20×10^{-6} / 0.009	1625	11.5	d)	Figure 3, [2]
MU909014C/C6 MU909015C/C6 -058/068	1M	0.15	20×10^{-6} / 0.015	1310	11.5	a)	Figure 3, [1]
	1	0.15	20×10^{-6} / 0.009	1550	11.5	c)	Figure 3, [1]
	1	0.15	20×10^{-6} / 0.009	1650	11.5	e)	Figure 3, [2]
MU909015C -059/069	1M	0.15	20×10^{-6} / 0.015	1310	11.5	a)	Figure 1, [1]
	1	0.15	20×10^{-6} / 0.009	1490	11.5	b)	Figure 1, [1]
	1	0.15	20×10^{-6} / 0.009	1550	11.5	c)	Figure 1, [1]
MU909015C6 -059/069	1M	0.15	20×10^{-6} / 0.015	1310	11.5	a)	Figure 3, [1]
	1	0.15	20×10^{-6} / 0.009	1490	11.5	b)	Figure 3, [1]
	1	0.15	20×10^{-6} / 0.009	1550	11.5	c)	Figure 3, [1]

*: Indicates the possible optical output power when each and every reasonably foreseeable single-fault condition is included.

For Safety

Table 2 Incorporated Laser Specifications





Incorporated Laser	Max. Optical Output Power (W) ^{*1}	Pulse Width (s)/Repetition Rate	Emitted Wavelength (nm)	Beam Divergence (deg) ^{*2}
a)	0.3	$20 \times 10^{-6} / 0.015$	1310	11.5
b)	0.3	$20 \times 10^{-6} / 0.009$	1490	11.5
c)	0.3	$20 \times 10^{-6} / 0.009$	1550	11.5
d)	0.3	$20 \times 10^{-6} / 0.009$	1625	11.5
e)	0.3	$20 \times 10^{-6} / 0.009$	1650	11.5
f)	0.003	CW	650	11.5

*1: Maximum output power is the estimated value when something breaks down.

*2: This product incorporates a laser diode module with optical fiber output.

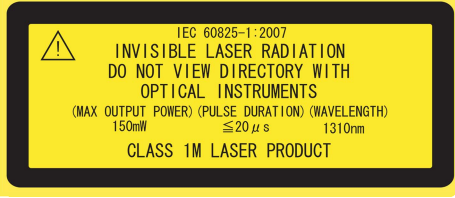
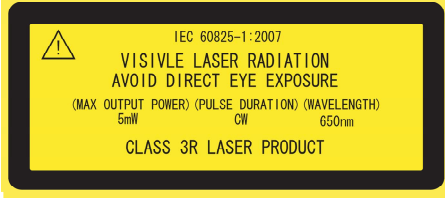
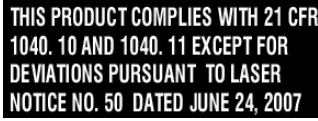
For Safety

Table 3 Labels on Product

	Type	Label	Affixed to:	Model Name
1	Explanation		Figure 4, A	MU909014A MU909015A6
2	Explanation		Figure 4, B	MU909014B/C/C6 MU909015B/C/C6
3	Explanation		Figure 4, C	MU909014A1/ MU909014B1/ MU909015B1
4	Certification		Figure 4, D	All models
5	Identification		Figure 4, E	All models
6	Warning		Figure 4, F	MU909014A1/ MU909014B1/ MU909015B1
7	Aperture		Figure 4, G	MU909014A1/ MU909014B1/ MU909015B1

For Safety

Laser Radiation Markings

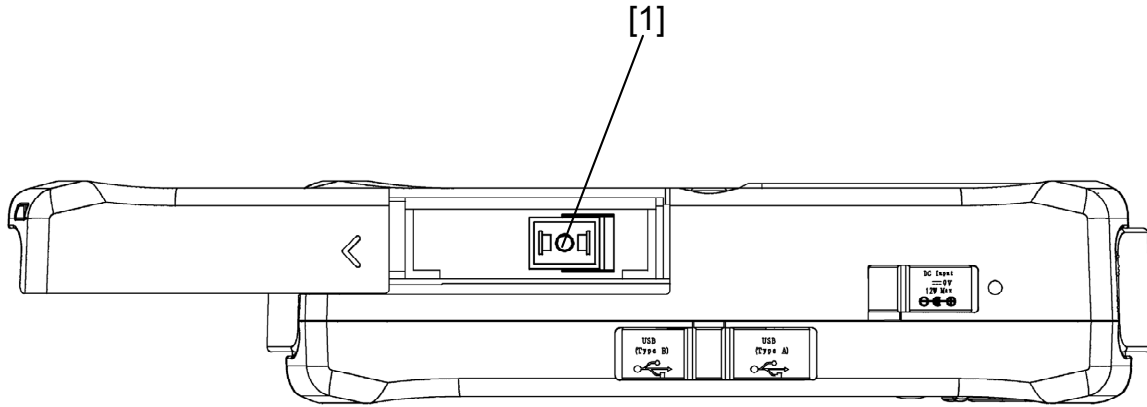

Figure 1 Locations of Laser Beam Apertures (MU909014A/B MU909015A6/B and MU909015C-059/069)

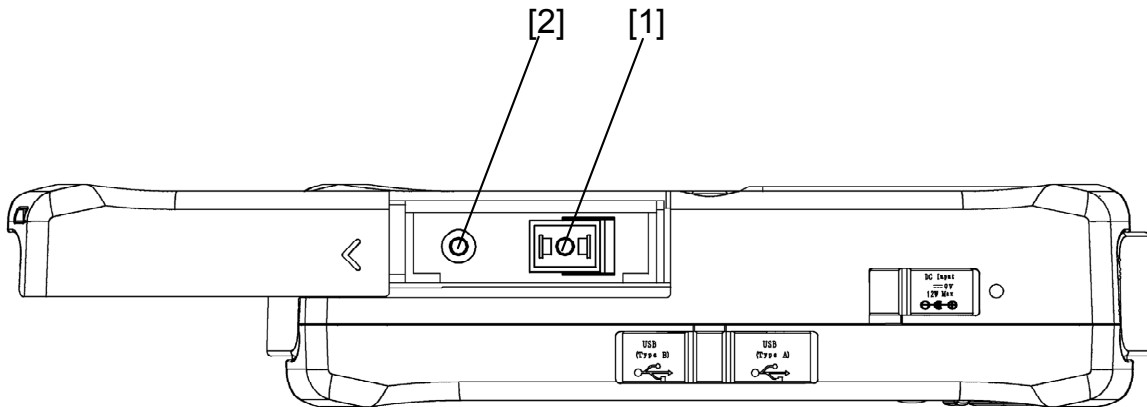

Figure 2 Locations of Laser Beam Apertures (MU909014A1/B1 and MU909015B1)

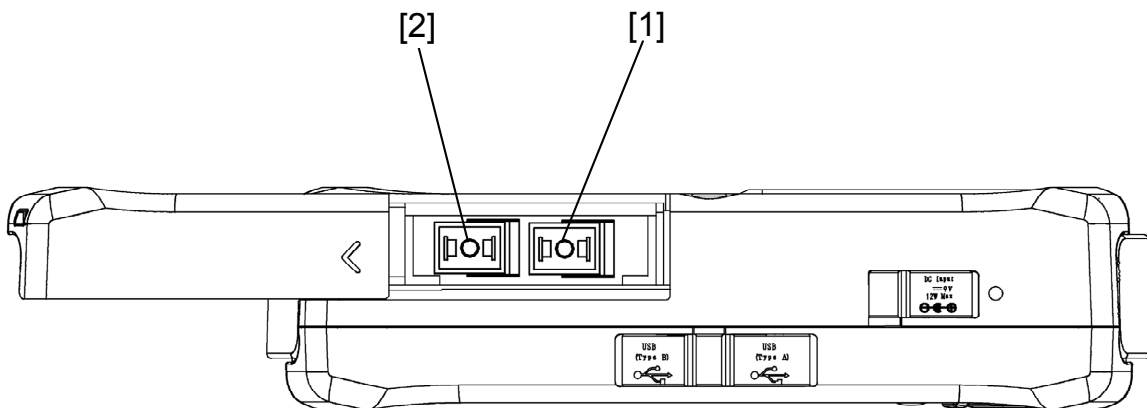

Figure 3 Locations of Laser Beam Apertures (MU909014C/C6 and MU909015C/C6)

For Safety

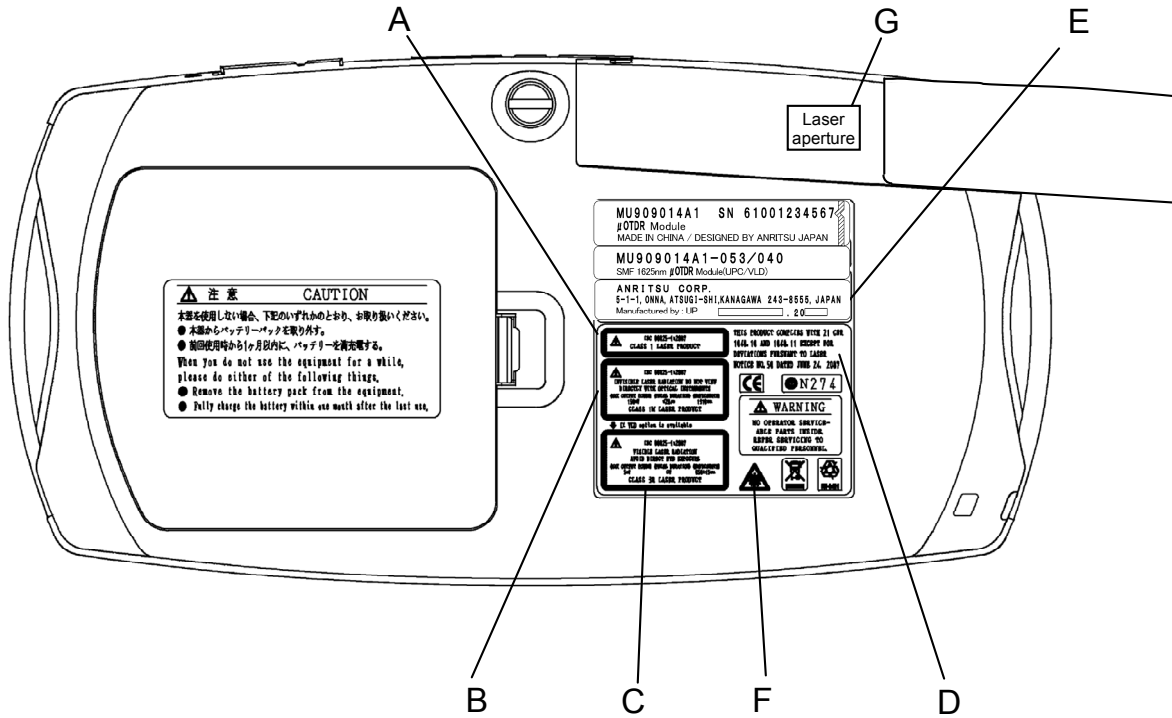
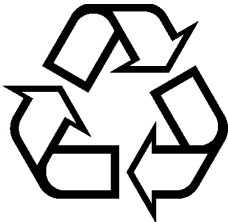

Figure 4 Locations of Affixed Labels

For Safety

FOR U.S. CUSTOMERS

Please Recycle.



Ni-MH

The product that you have purchased contains a rechargeable battery. The battery is recyclable. At the end of its useful life, under various state and local laws, it may be illegal to dispose of this battery into the municipal waste stream. Check with your local solid waste officials for details in your area for recycling options or proper disposal.

Before disposing of this product, discharge the battery and mail it to your Anritsu Service or Sales office.

1. Attach the battery pack to the product.
2. Disconnect the AC adapter, if used.
3. Turn the power switch to on.
4. Leave the product on until the power indicator goes off; the battery is now discharged.
5. Remove the battery.
6. Insulate the battery terminals with adhesive tape.
7. Mail it to your Anritsu Service or Sales office, or to the following address.

ANRITSU COMPANY
490 Jarvis Drive, Morgan Hill, CA 95037-2809, USA

For Safety

FOR EU & EFTA CUSTOMERS

Please Recycle.



Ni-MH



Read the following when using products to which the mark shown on the above is attached.

The product that you have purchased contains a rechargeable battery. The battery is recyclable. At the end of its useful life, under various state and local laws, it may be illegal to dispose of this battery into the municipal waste. Check with your local solid-waste disposal officials for details of recycling options or proper disposal in your area.

Before disposing of this product, discharge the battery and mail it to your Anritsu Service or Sales office.

1. Disconnect the AC adapter, if used.
2. Turn the power switch to on.
3. Leave the product on until the power indicator goes off; the battery is now discharged.
4. Remove the battery.
5. Insulate the battery terminals with adhesive tape.
6. Please recycle in accordance with your national or regional legislation.

Nach Gebrauch der Ver Kaufsstelle Zurückgeben.

Après usage à rapporter au point de vente.

For Safety

CAUTION

External Storage Media

This equipment uses a USB memory as external storage media for storing data and programs. If this media is mishandled or becomes faulty, important data may be lost.

Anritsu can take no responsibility for lost data, and users are recommended to always back up important data at regular intervals.

To reduce the possibility of data loss, particular attention should be given to the following points.

Pay careful attention to the following points.

- Never remove the USB memory from the instrument while it is being accessed.
- The USB memory may be damaged by static electric charges.
- Anritsu has thoroughly tested all external storage media shipped with this instrument. Users should note that external storage media not shipped with this instrument may not have been tested by Anritsu, thus Anritsu cannot guarantee the performance or suitability of such media.

Internal Memory

This instrument uses internal flash memory for storing data and programs. If this media is mishandled or becomes faulty, important data may be lost.

Anritsu can take no responsibility for lost data, and users are recommended to always back up important data at regular intervals.

To reduce the possibility of data loss, particular attention should be given to the following points.

Pay careful attention to the following points.

- Use this instrument within the recommended operating temperature range. In addition, do not use it in locations where the temperature changes quickly.
- Take care not to hit or shake the instrument while the power is on.

Use in a residential environment

This instrument is designed for an industrial environment.

In a residential environment this instrument may cause radio interference in which case the user may be required to take adequate measures.

Use in Corrosive Atmospheres

Exposure to corrosive gases such as hydrogen sulfide, sulfurous acid, and hydrogen chloride will cause faults and failures.

Note that some organic solvents release corrosive gases.

Equipment Certificate

Anritsu Corporation certifies that this equipment was tested before shipment using calibrated measuring instruments with direct traceability to public testing organizations recognized by national research laboratories, including the National Institute of Advanced Industrial Science and Technology, and the National Institute of Information and Communications Technology, and was found to meet the published specifications.

Anritsu Warranty

Anritsu Corporation will repair this equipment free-of-charge if a malfunction occurs within one year after shipment due to a manufacturing fault. However, software fixes will be made in accordance with the separate Software End-User License Agreement. Moreover, Anritsu Corporation will deem this warranty void when:

- The fault is outside the scope of the warranty conditions separately described in the operation manual.
- The fault is due to mishandling, misuse, or unauthorized modification or repair of the equipment by the customer.
- The fault is due to severe usage clearly exceeding normal usage.
- The fault is due to improper or insufficient maintenance by the customer.
- The fault is due to natural disaster, including fire, wind, flooding, earthquake, lightning strike, or volcanic ash, etc.
- The fault is due to damage caused by acts of destruction, including civil disturbance, riot, or war, etc.
- The fault is due to explosion, accident, or breakdown of any other machinery, facility, or plant, etc.
- The fault is due to use of non-specified peripheral or applied equipment or parts, or consumables, etc.
- The fault is due to use of a non-specified power supply or in a non-specified installation location.
- The fault is due to use in unusual environments^(Note).
- The fault is due to activities or ingress of living organisms, such as insects, spiders, fungus, pollen, or seeds.

In addition, this warranty is valid only for the original equipment purchaser. It is not transferable if the equipment is resold.

Anritsu Corporation shall assume no liability for injury or financial loss of the customer due to the use of or a failure to be able to use this equipment.

Note:

For the purpose of this Warranty, "unusual environments" means use:

- In places of direct sunlight
- In dusty places
- In liquids, such as water, oil, or organic solvents, and medical fluids, or places where these liquids may adhere
- In salty air or in places where chemically active gases (sulfur dioxide, hydrogen sulfide, chlorine, ammonia, nitrogen dioxide, or hydrogen chloride etc.) are present
- In places where high-intensity static electric charges or electromagnetic fields are present
- In places where abnormal power voltages (high or low) or instantaneous power failures occur
- In places where condensation occurs
- In the presence of lubricating oil mists
- In places at an altitude of more than 2,000 m
- In the presence of frequent vibration or mechanical shock, such as in cars, ships, or airplanes

Anritsu Corporation Contact

In the event of this equipment malfunctions, contact an Anritsu Service and Sales office. Contact information can be found on the last page of the printed version of this manual, and is available in a separate file on the CD version.

Notes On Export Management

This product and its manuals may require an Export License/Approval by the Government of the product's country of origin for re-export from your country.

Before re-exporting the product or manuals, please contact us to confirm whether they are export-controlled items or not.

When you dispose of export-controlled items, the products/manuals need to be broken/shredded so as not to be unlawfully used for military purpose.

Crossed-out Wheeled Bin Symbol

Equipment marked with the Crossed-out Wheeled Bin Symbol complies with council directive 2012/19/EC (the “WEEE Directive”) in European Union.



For Products placed on the EU market after August 13, 2005, please contact your local Anritsu representative at the end of the product's useful life to arrange disposal in accordance with your initial contract and the local law.

Software End-User License Agreement (EULA)

Please read this Software End-User License Agreement (hereafter this EULA) carefully before using (includes executing, copying, registering, etc.) this software (includes programs, databases, scenarios, etc., used to operate, set, etc., Anritsu electronic equipment). By reading this EULA and using this software, you are agreeing to be bound by the terms of its contents and Anritsu Corporation (hereafter Anritsu) hereby grants you the right to use this Software with the Anritsu-specified equipment (hereafter Equipment) for the purposes set out in this EULA.

1. Grant of License and Limitations

1. Regardless of whether this Software was purchased from or provided free-of-charge by Anritsu, you agree not to rent, lease, lend, or otherwise distribute this Software to third parties and further agree not to disassemble, recompile, reverse engineer, modify, or create derivative works of this Software.
2. You may make one copy of this Software for backup purposes only.
3. You are not permitted to reverse engineer this software.
4. This EULA allows you to install one copy of this Software on one piece of Equipment.

2. Disclaimers

To the extent not prohibited by law, in no event shall Anritsu be liable for personal injury, or any incidental, special, indirect or consequential damages whatsoever, including, without limitation, damages for loss of profits, loss of data, business interruption or any other commercial damages or losses, arising out of or related to your use or inability to use this Software.

3. Limitation of Liability

- a. If a fault (bug) is discovered in this Software, preventing operation as described in the operation manual or specifications whether or not the customer uses this software as described in the manual, Anritsu shall at its own discretion, fix the bug, or exchange the software, or suggest a workaround, free-of-charge. However, notwithstanding the above, the following items shall be excluded from repair and warranty.
 - i) If this Software is deemed to be used for purposes not described in the operation manual or specifications.
 - ii) If this Software is used in conjunction with other non-Anritsu-approved software.
 - iii) Recovery of lost or damaged data.
 - iv) If this Software or the Equipment has been modified, repaired, or otherwise altered without Anritsu's prior approval.
 - v) For any other reasons out of Anritsu's direct control and responsibility, such as but not limited to, natural disasters, software virus infections, etc.
- b. Expenses incurred for transport, hotel, daily allowance, etc., for on-site repairs by Anritsu engineers necessitated by the above faults shall be borne by you.
- c. The warranty period for faults listed in article 3a above covered by this EULA shall be either 6 months from the date of purchase of this Software or 30 days after the date of repair, whichever is longer.

4. Export Restrictions

You may not use or otherwise export or re-export directly or indirectly this Software except as authorized by Japanese and United States law. In particular, this software may not be exported or re-exported (a) into any Japanese or US embargoed countries or (b) to anyone on the Japanese or US Treasury Department's list of Specially Designated Nationals or the US Department of Commerce Denied Persons List or Entity List. By using this Software, you warrant that you are not located in any such country or on any such list. You also agree that you will not use this Software for any purposes prohibited by Japanese and US law, including, without limitation, the development, design and manufacture or production of missiles or nuclear, chemical or biological weapons of mass destruction.

5. Termination

Anritsu shall deem this EULA terminated if you violate any conditions described herein. This EULA shall also be terminated if the conditions herein cannot be continued for any good reason, such as violation of copyrights, patents, or other laws and ordinances.

6. Reparations

If Anritsu suffers any loss, financial or otherwise, due to your violation of the terms of this EULA, Anritsu shall have the right to seek proportional damages from you.

7. Responsibility after Termination

Upon termination of this EULA in accordance with item 5, you shall cease all use of this Software immediately and shall as directed by Anritsu either destroy or return this Software and any backup copies, full or partial, to Anritsu.

8. Dispute Resolution

If matters of dispute or items not covered by this EULA arise, they shall be resolved by negotiations in good faith between you and Anritsu.

9. Court of Jurisdiction

This EULA shall be interpreted in accordance with Japanese law and any disputes that cannot be resolved by negotiation described in Article 8 shall be settled by the Japanese courts.

Cautions against computer virus infection

- Copying files and data
Only files that have been provided directly from Anritsu or generated using Anritsu equipment should be copied to the instrument.
All other required files should be transferred by means of USB or CompactFlash media after undergoing a thorough virus check.
- Adding software
Do not download or install software that has not been specifically recommended or licensed by Anritsu.
- Network connections
Ensure that the network has sufficient anti-virus security protection in place.

Protection Against Computer Virus Infections

Prior to the software installation

Before installing this software or any other software recommended or approved by Anritsu, run a virus scan on your computer, including removable media (e.g. USB memory stick and CF memory card) you want to connect to your computer.

When using this software and connecting with the measuring instrument

- Copying files and data

On your computer, do not save any copies other than the following:

- Files and data provided by Anritsu
- Files created by this software
- Files specified in this document

Before copying these files and/or data, run a virus scan, including removable media (e.g. USB memory stick and CF memory card).

- Connecting to network

Connect your computer to the network that provides adequate protection against computer viruses.

Cautions on Proper Operation of Software

This software may not operate normally if any of the following operations are performed on your computer:

- Simultaneously running any software other than that recommended or approved by Anritsu
- Closing the lid (Laptop computer)
- Turning on the screen saver function
- Turning on the battery-power saving function (Laptop computer)

For how to turn off the functions, refer to the operation manual that came with your computer.

CE Conformity Marking

Anritsu affixes the CE conformity marking on the following product(s) in accordance with the Council Directive 93/68/EEC to indicate that they conform to the EMC and LVD directive of the European Union (EU).

CE marking



1. Product Model

Model: Network Master Series MU909014C/C6/
MU909015A6/C/C6
μOTDR Module

2. Applied Directive

EMC: Directive 2004/108/EC
LVD: Directive 2006/95/EC

3. Applied Standards

- EMC: Emission: EN 61326-1: 2013 (Class A)
Immunity: EN 61326-1: 2013 (Table 2)

	Performance Criteria*
IEC 61000-4-2 (ESD)	B
IEC 61000-4-3 (EMF)	A
IEC 61000-4-4 (Burst)	B
IEC 61000-4-5 (Surge)	B
IEC 61000-4-6 (CRF)	A
IEC 61000-4-8 (RPFMF)	A
IEC 61000-4-11 (V dip/short)	B, C

*: Performance Criteria

A: The equipment shall continue to operate as intended during and after the test. No degradation of performance or loss of function is allowed below a performance level specified by the manufacturer, when the equipment is used as intended. The performance level may be replaced by a permissible loss of performance. If the minimum performance level or the permissible performance loss is not specified by the manufacturer, either of these may be derived from the product the description and documentation and what

the user may reasonably expect from the equipment if used as intended.

- B: The equipment shall continue to operate as intended after the test. No degradation of performance or loss of function is allowed below a performance level specified by the manufacturer, when the equipment is used as intended. The performance level may be replaced by a permissible loss of performance. During the test, degradation of performance is however allowed. No change of actual operating state or stored data is allowed. If the minimum performance level or the permissible performance loss is not specified by the manufacturer, either of these may be derived from the product description and documentation and what the user may reasonably expect from the equipment if used as intended.
- C: Temporary loss of function is allowed, provided the function is self-recoverable or can be restored by the operation of the controls.

Harmonic current emissions:

EN 61000-3-2: 2006 +A1:2009 A2:2009

(Class A equipment)

: No limits apply for this equipment with an active input power under 75 W.

- LVD: EN 61010-1: 2010 (Pollution Degree 2)

4. Authorized representative

Name: Murray Coleman
Head of Customer Service EMEA
ANRITSU EMEA Ltd.

Address, city: 200 Capability Green, Luton
Bedfordshire, LU1 3LU

Country: United Kingdom

C-Tick Conformity Marking

Anritsu affixes the C-Tick mark on the following product(s) in accordance with the regulation to indicate that they conform to the EMC framework of Australia/New Zealand.

C-Tick mark



1. Product Model

Model: Network Master Series MU909014C/C6/
MU909015A6/C/C6
μOTDR Module

2. Applied Standards

EMC: Emission: EN 61326-1: 2013 (Class A equipment)

About This Manual

This document explains the methods for operating, calibrating, and maintaining the MT9090A Network Master main frame and following μ OTDR modules.

- MU909014A/A1
- MU909014B/B1
- MU909014C/C6
- MU909015A6
- MU909015B/B1
- MU909015C/C6

In particular, make sure you read Chapter 1 “Overview” so you have a clear understanding of the basic functions and operations. The other chapters provide more details; use them in conjunction with the glossary at the back of the manual to quickly find what you need.

Refer to the figure in Section 4.1 “Measurement Procedure” for a quick summary of the operation flow.

Table of Contents

For Safety	iii
-------------------------	------------

About This Manual.....	I
-------------------------------	----------

Chapter 1 Outline..... 1-1

1.1 Overview of μ OTDR.....	1-2
1.2 Application	1-11
1.3 Terminology	1-12

Chapter 2 Preparation 2-1

2.1 Product Configuration	2-2
2.2 Name of Each Part	2-6
2.3 Basic Notes on Use	2-12
2.4 Supplying Power.....	2-13
2.5 Using Ni-MH Battery Pack.....	2-14
2.6 Connecting Fiber to Measurement Port.....	2-18
2.7 Cleaning optical connector and adapter	2-19
2.8 Cautions on Handling Optical Fiber Cables.....	2-23
2.9 Changing Optical Connector.....	2-25
2.10 Connecting Peripheral Devices	2-27
2.11 Changing Test Module.....	2-30

Chapter 3 General Operation and System Setups

..... 3-1

3.1 Powering Up and Down	3-2
3.2 Titles of Screen Parts	3-4
3.3 Changing General Settings.....	3-6
3.4 Managing Files – Mass Storage	3-18
3.5 Capturing Screen Images	3-27
3.6 Using Softkey Board	3-28
3.7 Using Help Function	3-30
3.8 Confirming Version Information	3-31
3.9 Setting Screen Displayed after Power-Up	3-33

Chapter 4 Locating Fiber Faults 4-1

4.1 Measurement Procedure 4-2
4.2 Setting Parameters and Preferences 4-3
4.3 Starting Measurement 4-19
4.4 Viewing Trace 4-22
4.5 Analyzing Trace 4-33
4.6 Setting header to trace 4-42
4.7 Saving trace manually 4-44
4.8 Loading Trace Data (Mass Storage-Load) 4-47
4.9 Restoring Defaults (All Defaults)..... 4-49
4.10 Calculation Method 4-50
4.11 Using VFL (Visual Fault Locator)..... 4-58
4.12 Measuring with Fiber Visualizer 4-59
4.13 Creating a Summary 4-72

1/11

2/12

3

4

Chapter 5 Locating Drop Cable Faults 5-1

5.1 Models That Support the DCFL Function 5-2
5.2 Measurement Procedure 5-3
5.3 Measuring a Drop Cable 5-4
5.4 Viewing Trace 5-11
5.5 Saving Trace Data 5-11
5.6 Loading Trace Data 5-11

5

6

7

Chapter 6 Measuring Optical Power of PON System

..... 6-1

6.1 Using PON Power Meter 6-2

8

Chapter 7 Checking Fiber Connection End..... 7-1

7.1 Confirming Fiber Connection End
(Optical Fiber Identification)..... 7-2
7.2 Using Light Source 7-3
7.3 Measuring Optical Power..... 7-5

9

10

Chapter 8 Measuring Loss of Optical Parts 8-1

8.1 Measuring Optical Loss 8-2
8.2 Measuring Procedures of Optical Loss..... 8-7

Appendix

Index

Chapter 9 Inspecting Fiber Surface 9-1

9.1 Component Parts of Fiberscope 9-2
9.2 Connecting VIP 9-5
9.3 Using VIP 9-7
9.4 Analyzing VIP Images..... 9-13
9.5 Creating a Report 9-15
9.6 Working with VIP Image Files..... 9-20

Chapter 10 Remote GUI and Folder Sharing. 10-1

10.1 Configuring the Network Settings for μ OTDR..... 10-2
10.2 Setting the Remote GUI Password..... 10-18
10.3 File Sharing Setting 10-19
10.4 Using the Remote GUI..... 10-23

Chapter 11 Performance Test and Calibration

..... 11-1

11.1 Performance Test 11-2
11.2 Calibration..... 11-32
11.3 Performance Test Result Sheet..... 11-33

Chapter 12 Maintenance 12-1

12.1 Daily Maintenance 12-2
12.2 Updating Firmware 12-3
12.3 Notes On Storage 12-8
12.4 Transporting and Disposal..... 12-9

Appendix A Specifications A-1

Appendix B Default Value..... B-1

Appendix C Software License C-1

Index Index-1

Chapter 1 Outline

This chapter describes the functional overview, application, and terminology of the MT9090A Network Master.

1.1	Overview of μ OTDR.....	1-2
1.1.1	OTDR Function.....	1-4
1.1.2	Connection Verification Function.....	1-6
1.1.3	Live Communications Detection Function	1-6
1.1.4	Visual Fault Locator (VFL) Option	1-6
1.1.5	PON Power Meter Function	1-7
1.1.6	Light Source Function.....	1-7
1.1.7	Optical Power Meter Function	1-8
1.1.8	Optical Loss Measurement Function.....	1-8
1.1.9	DCFL Function	1-9
1.1.10	Fiber Surface Inspection Function.....	1-10
1.2	Application	1-11
1.3	Terminology	1-12
1.3.1	Explanation of Terms.....	1-12
1.3.2	Abbreviations	1-14

1.1 Overview of μ OTDR

The main frame of the MT9090A Network Master series is a multi-platform instrument that supports various measurement functions according to installed modules.

This manual describes how to operate the MT9090A main frame (the main frame hereafter) and fiber maintenance tester (the modules hereafter).

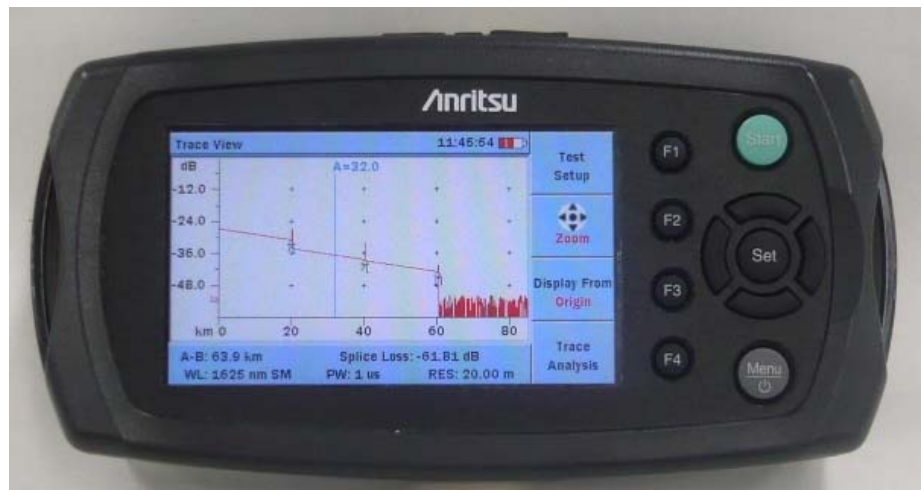

Figure 1.1-1 Front Panel Layout

The MT9090A Network Master series fits easily in one hand and has an OTDR function for measuring loss and detecting fault points in optical fiber systems. Some models have the functions of the PON power meter, light source, visual fault locator (VFL) optical source, power meter and optical loss test addition to OTDR function.

By connecting the accessory fiberscope, the end surface of the fiber can be displayed on the module. This function allows the inspection of the end surface of the fiber for scratches, damage, and dirt.

Measured traces and screenshots can be captured on a PC via USB connection.

The MT9090A Network Master series include the following models which consist of different specifications and functions.

Table 1.1-1 Model Name and Difference in Specifications

Spec. Model	Trace (nm)					Dynamic range (dB)	Function other than OTDR					
	1310	1490	1550	1625	1650		VFL	PON Power Meter	Light source	Power meter	Loss test	Fiber surface Inspection
MU909014A				*1	*1	30						✓
MU909014A1				*1	*1	30	✓					✓
MU909014B	✓		✓			30				✓		✓
MU909014B1	✓		✓			30	✓			✓		✓
MU909014C	✓		✓	*1	*1	30				✓		✓
MU909014C6	✓		✓	*1	*1	30		✓	✓	✓	✓	✓
MU909015A6				*1	*1	35		✓	✓	✓		✓
MU909015B	✓		✓			35				✓		✓
MU909015B1	✓		✓			35	✓			✓		✓
MU909015C	✓	*1	✓	*1	*1	35				✓		✓
MU909015C6	✓	*1	✓	*1	*1	35		✓	✓	✓	✓	✓

*1: Select either one of wavelengths according to the module option.

This document describes all functions above. Refer to the corresponding section of the function in your model.

You can see demonstration movies on the following homepages.

<http://www.anritsu.tv/en-us/mt9090aconnectorcare>

(MT9090A Connector Care)

<http://www.anritsu.tv/en-us/mt9090afrompowerontotracesaving>

(MT9090A From Power on to Trace Saving)

<http://www.anritsu.tv/en-us/mt9090amanualanalysisofcapturedtrace>

(MT9090A Manual Analysis of Captured Trace)

<http://www.anritsu.tv/en-us/mt9090aotdrmeasurementapplicationedition>

(MT9090A OTDR Measurement Application Edition)

<http://www.anritsu.tv/en-us/mt9090anonotdrmeasurementfunctions>

(MT9090A Non OTDR Measurement Functions)

<http://www.anritsu.tv/en-us/fibervisualizer>

(OTDR - Fiber Visualizer)

1.1.1 OTDR Function

An OTDR (Optical Time Domain Reflectometer) measures the loss and reflection of an optical fiber.

The OTDR launches optical pulses into the optical fiber and also receives optical pulses that are returned by internal reflection in the optical fiber. The loss of the optical fiber is calculated by the OTDR from the measured received optical pulses. The elapsed time from when optical pulses are launched into the fiber until they return is used to calculate the distance to and loss of displayed faults in the fiber.

The loss and distance data is stored in memory and displayed as traces on the screen. For accurate measurement, an optical pulse launched into the fiber must reach the far end of the optical fiber and the backscattered light returned by the end surface must be returned to the OTDR before the next optical pulse is launched into the fiber. Consequently, a distance range corresponding to the length of the optical fiber being measured is specified by **Range** on the Test Setup screen. If **Range** and **Pulse width** are set to Auto, the OTDR determines the optimum values for these settings.

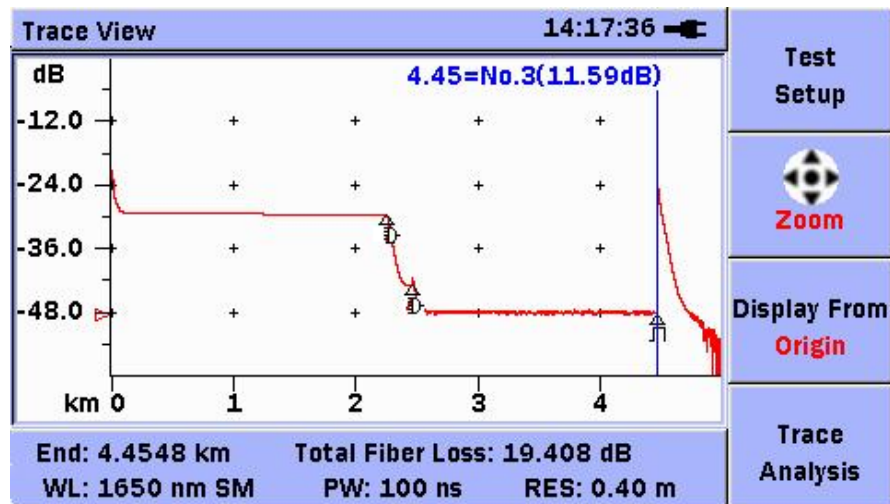

Figure 1.1.1-1 Example of OTDR Measurement Results

The OTDR has functions of detecting and analyzing points in the fiber where loss and reflected light occur using the measured results. These detected points are called 'events', which are displayed on the Trace Analysis screen.

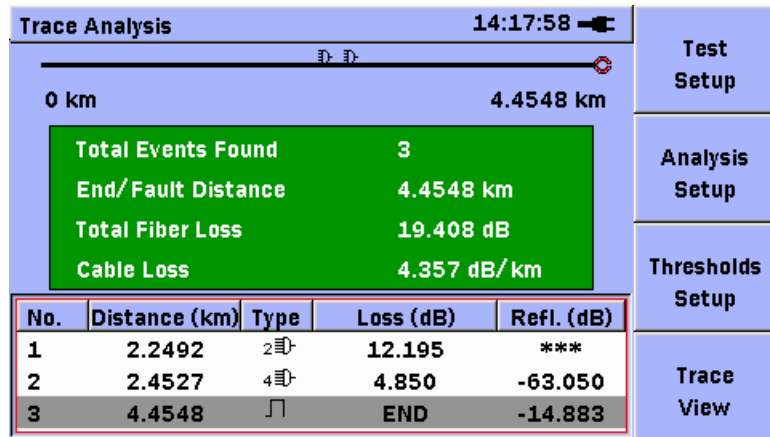

Figure 1.1.1-2 Example of Event Display

The MT9090A Network Master series has the Fiber Visualizer function to see the fiber status visually when measured by the OTDR. With the error points and connection conditions displayed graphically, the fiber statuses can be easily checked.

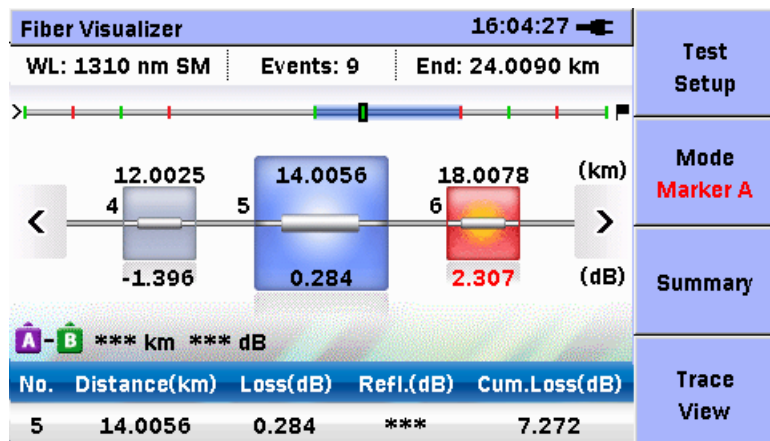

Figure 1.1.1-3 Example of Fiber Visualizer

1.1.2 Connection Verification Function

The connection verification function is used to verify that the optical fiber is connected correctly to the module before starting OTDR measurements.

The verification result is displayed as **GOOD**, **FAIR**, or **POOR**.

Refer to Section 4.3 “Starting Measurement” for more details.

1.1.3 Live Communications Detection Function

The live communications detection function detects the presence of optical signals used for live communications in the fiber before starting OTDR measurements.

A warning message is displayed if light with a wavelength of 1550 nm is detected.

Refer to Section 4.2.2 “Setting Measurement Method (Setup-Preferences)” for more details.

1.1.4 Visual Fault Locator (VFL) Option

It is a visible (red) light source. Since the light is visible, it is useful for locating faults in the dead zone by visually checking for diffuse escaping light.

Refer to Section 4.10 “Using VFL (Visual Fault Locator)” for more details.



Figure 1.1.4-1 Visual Fault Locator (VFL)

1.1.5 PON Power Meter Function

The PON power meter function enables the simultaneous measurement of the optical power of two wavelengths used for the downstream signal of the Passive Optical Network (PON).

The optical power with wavelength of 1490 nm used for video communications and the optical power with wavelength of 1550 nm used for data communications are displayed.

Refer to Chapter 6 “Measuring Optical Power of PON System” for more details.



Figure 1.1.5-1 PON Power Meter Screen

1.1.6 Light Source Function

The light source function outputs continuous optical signals or modulated optical signals.

The fiber core contrast and loss can be measured with the combination of the light source function and optical power meter.

Refer to Section 7.2 “Using Light Source” for more details.

1.1.7 Optical Power Meter Function

The optical power meter function is used to detect the presence of an optical signal in the fiber cable and to confirm that the level of live communication signals meets the specified value.

Refer to Section 7.3 “Measuring Optical Power” for more details.

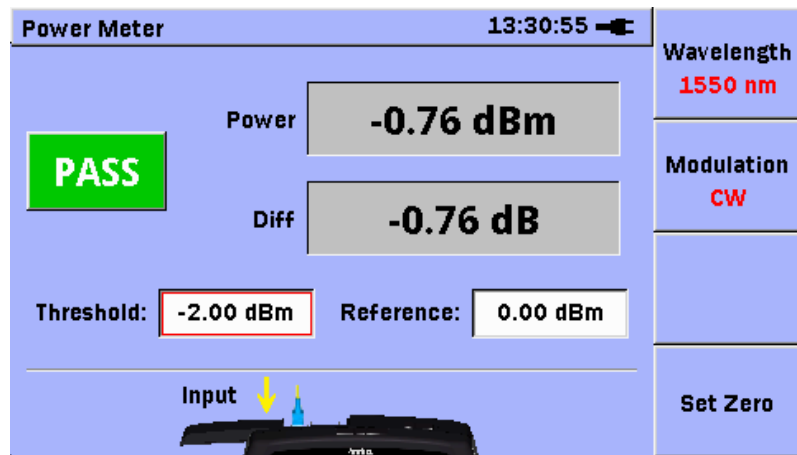

Figure 1.1.7-1 Optical Power Meter Screen

1.1.8 Optical Loss Measurement Function

The optical loss measurement function measures the optical loss of fibers and optical parts using the light source function and power meter function.

Refer to Chapter 8 “Measuring Loss of Optical Parts” for more details.

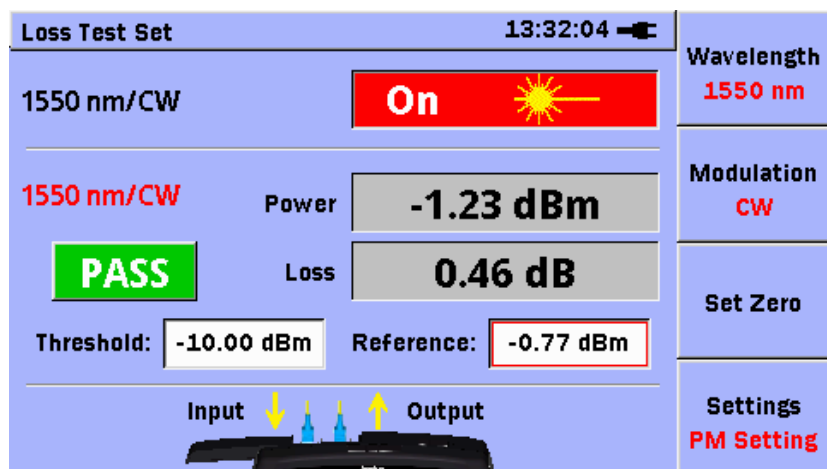

Figure 1.1.8-1 Loss Test Screen

1.1.9 DCFL Function

The DCFL function is a useful function to investigate faults occurring in a drop cable. It consists of the Power Meter function and OTDR function, so you are not required to switch measuring instruments or applications.

Refer to Chapter 5 “Investigating Fiber Abnormalities (Faults)” for more details.

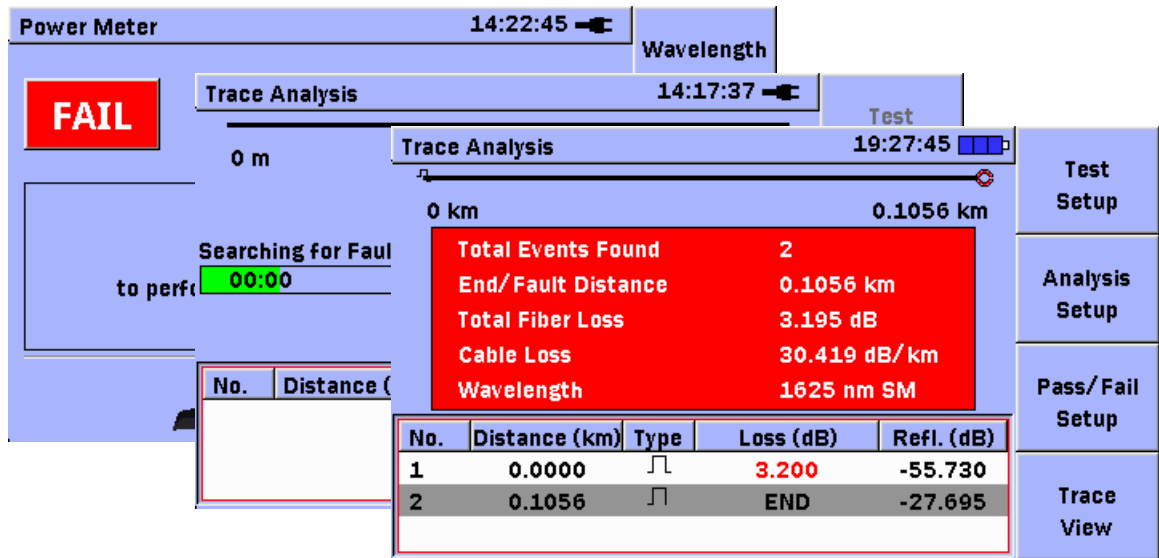

Figure 1.1.9-1 DCFL Function Screens

1.1.10 Fiber Surface Inspection Function

By connecting the accessory fiberscope to MT9090A, you can view magnified images of the surfaces of the optical I/O connector and the end surface of the connected optical fiber on the LCD of the MT9090A.

Check for scratches or dirt on the end surfaces of the optical I/O connector and the optical fiber, using the fiberscope.

Refer to Chapter 9 “Inspecting Fiber Surface” for more details.

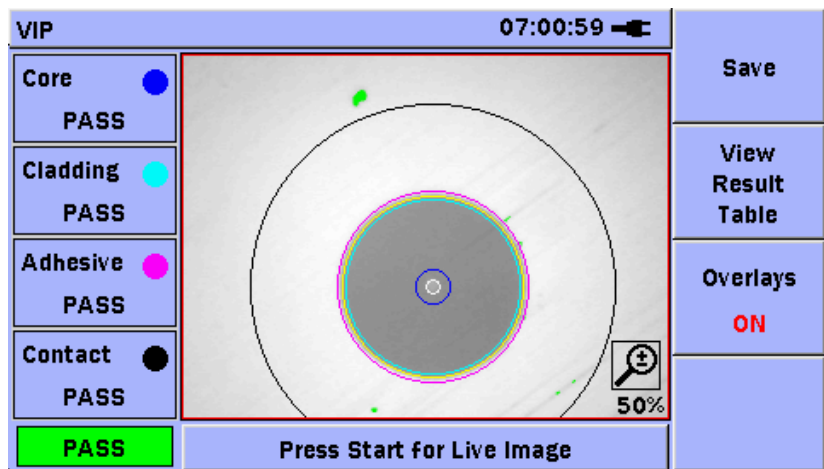

Figure 1.1.10-1 Fiber End Surface Display

1.2 Application

Finding Faults in Optical Fibers

The OTDR, PON power meter, power meter, and fiberscope functions of the MT9090A Network Master are used in a subscriber's home to troubleshoot faults in optical cables between the subscriber's home and carrier's office.

With the communication method called PON (Passive Optical Network), the optical signals at wavelength of 1310/1490/1550 nm are used for communications between the subscriber's home and carrier's office.

The μ OTDR modules find faults using optical signals at wavelengths of 1310 nm and 1550 nm. When optical signals at wavelengths of 1490 nm and 1550 nm are used for one optical fiber like the PON, it is difficult to measure the power at each wavelength using the optical power meter. The PON power meter function can identify which wavelength has the failure by measuring the optical power at each wavelength.

Since wavelengths of 1625 nm and 1650 nm are different from the wavelengths used for live optical communications, they have no impact on the live network. (Optical filter is required for ONU or OLT to block 1625/1650 nm light.)

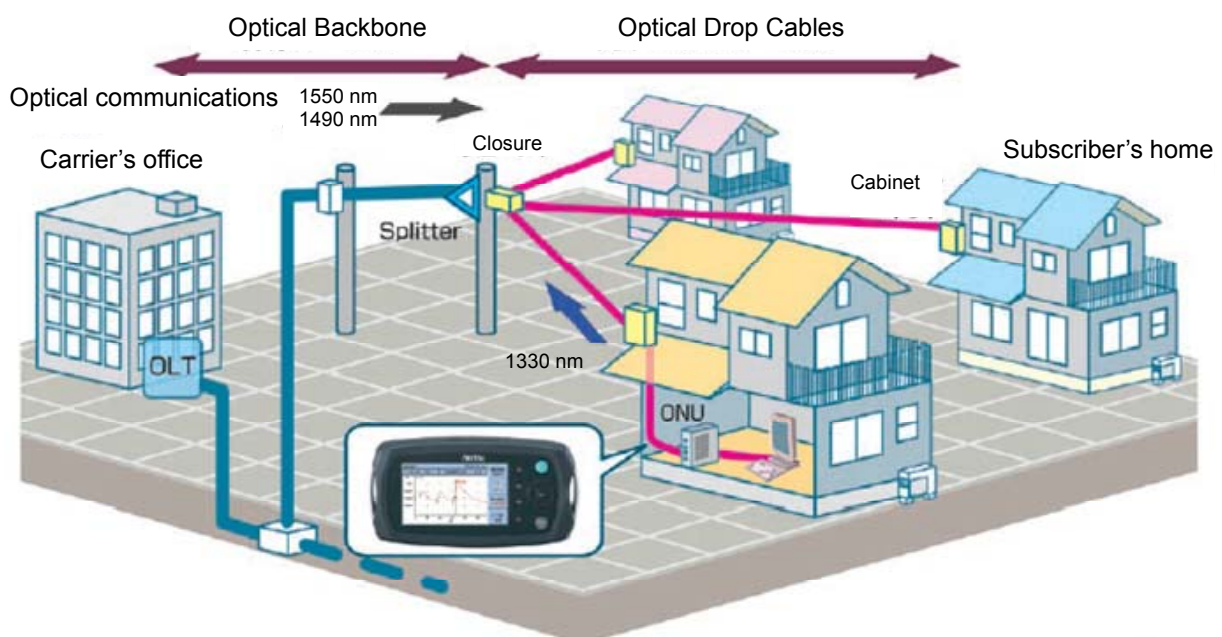

Figure 1.2-1 Finding Faults in Fiber from Each Subscriber's Home (Passive Optical Network Measurement)

1.3 Terminology

1.3.1 Explanation of Terms

This section describes the terms used in this manual.

BSC (Backscatter Coefficient)

The BSC is the proportion of reflected light to light propagating in the fiber during optical transmissions.

The BSC varies according to the fiber structure and materials.

BSL (Backscatter Level)

BSL is the level of the light reflected back to the module.

The BSL is proportional to the BSC and pulse width and inversely proportional to the Index of Refraction.

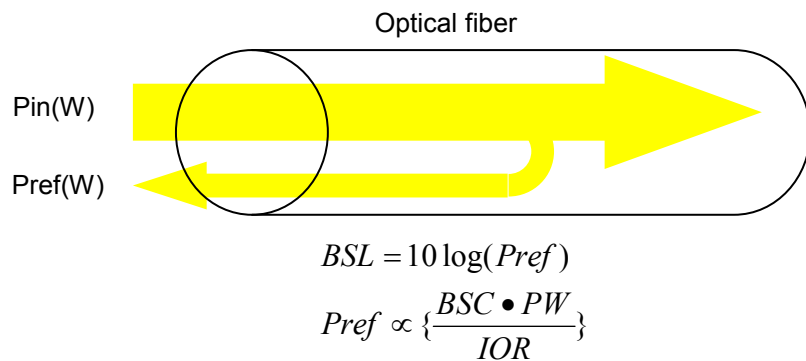

Figure 1.3.1-1 Definition of BSL

Dead Zone

The dead zone is a region of the optical fiber where BSL cannot be observed correctly due to traces caused by reflections.

The following diagram shows the dead zone as defined in Appendix A: Specifications.

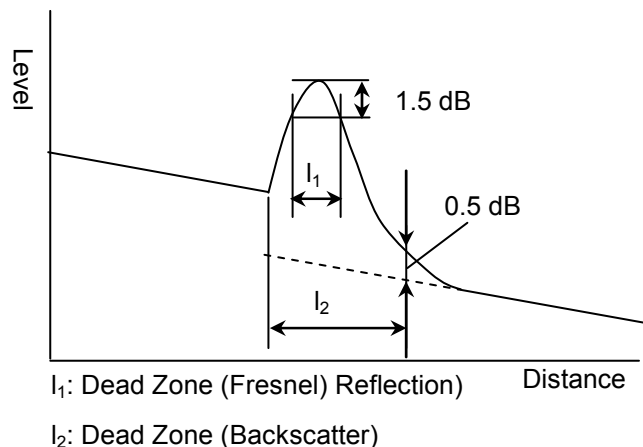

Figure 1.3.1-2 Dead Zone

Dynamic Range

The dynamic range is the ratio of the maximum and minimum measurable levels.

For an OTDR, it is the ratio of the level at the connection point of the measuring instrument and the noise level.

Refer to Section 11.1.4 “Dynamic range” for the dynamic range measurement method.

IOR (Index of Refraction)

This is the IOR of the optical fiber. The OTDR calculates distance using the time taken for the optical pulse launched into the fiber to return and the IOR.

Pulse Width

This is the width of the optical pulse launched into the fiber. A large pulse width increases the power of the optical signal returned by the fiber and faults in the fiber, so the dynamic range becomes wider.

Conversely, the dead zone and resolution also become larger. Using a shorter pulse width reduces the dead zone and resolution.

Refer to Section 11.1.3 “Pulse Width” for more details about setting the pulse width measurement method.

1.3.2 Abbreviations

The following table lists the abbreviations used in this manual.

Table 1.3.2-1 List of Abbreviations

Abbreviations	Full Term
AC	Alternating Current
AVG	Averaging
BSC	Back Scattering Coefficient
CW	Continuous Wave
DC	Direct Current
DCFL	Drop Cable Fault Locator
IOR	Index of Refraction
LS	Light Source
LSA	Least Squares Approximation
min	Minute
MM	Multi Mode fiber
MOD	Modulation
N/A	Not Applicable
ORL	Optical Return Loss
OTDR	Optical Time Domain Reflectometer
PM	Power Meter
PON	Passive Optical Network
Pt	Point
PW	Pulse Width
RES	Resolution
sec	second
SM	Single Mode fiber
S/N	Signal to Noise Ratio
TRT	Total Run Time
UPC	Ultra Physical Contact
USB	Universal Serial Bus
VIP	Video Inspection Probe
WL	Wavelength

Chapter 2 Preparation

This chapter describes the parts of the MU909014x/15x and the preparations before use.

2.1	Product Configuration	2-2
2.1.1	Standard configuration	2-2
2.1.2	Options	2-4
2.2	Name of Each Part	2-6
2.2.1	Front Panel	2-6
2.2.2	Top Connector Panel.....	2-8
2.2.3	Back Panel	2-10
2.2.4	Bottom Panel	2-11
2.3	Basic Notes on Use	2-12
2.4	Supplying Power	2-13
2.5	Using Ni-MH Battery Pack	2-14
2.5.1	Installing Ni-MH Battery Pack.....	2-14
2.5.2	Battery Replacement – Battery pack to AA batteries	2-16
2.6	Connecting Fiber to Measurement Port.....	2-18
2.7	Cleaning optical connector and adapter	2-19
2.8	Cautions on Handling Optical Fiber Cables.....	2-23
2.9	Changing Optical Connector.....	2-25
2.10	Connecting Peripheral Devices	2-27
2.10.1	Type A USB Port	2-28
2.10.2	Type B USB Port	2-29
2.11	Changing Test Module.....	2-30

2.1 Product Configuration

2.1.1 Standard configuration

The parts included in the standard configuration are listed below.
Contact your Anritsu Service and Sales Office or agent if any parts are missing or damaged.

Table 2.1.1-1 Standard Configuration

Item	Model/Ordering Number	Name	Q'ty	Remarks
Main frame	MT9090A	Main frame	1	
Module*1	MU909014A	μOTDR Module	1	Wavelength: 1625 nm or 1650 nm*2
	MU909014A1	μOTDR Module	1	VFL (Visual Fault Locator) Wavelength: 1625 nm or 1650 nm*2
	MU909014B	μOTDR Module	1	Wavelength: 1310 /1550 nm Dynamic range: 30 dB
	MU909014B1	μOTDR Module	1	VFL (Visual Fault Locator) Wavelength: 1310 /1550 nm Dynamic range: 30 dB
	MU909014C	μOTDR Module	1	3 wavelengths*2, Dynamic range: 30 dB, Power meter
	MU909014C6	μOTDR Module	1	3 wavelengths*2, Dynamic range: 30 dB, Light source, Power meter, PON power meter, Loss Test
	MU909015A6	μOTDR Module	1	1 wavelength*2, Dynamic range: 35 dB, Light source, PON power meter, Power meter
	MU909015B	μOTDR Module	1	Wavelength: 1310/1550 nm Dynamic range: 35 dB
	MU909015B1	μOTDR Module	1	VFL (Visual Fault Locator) Wavelength: 1310/1550 nm Dynamic range: 35 dB
	MU909015C	μOTDR Module	1	3 wavelengths*2, Dynamic range: 35 dB, Power meter
	MU909015C6	μOTDR Module	1	3 wavelengths*2, Dynamic range: 35 dB, Light source, Power meter, PON power meter, Loss Test

*1: Select either one

*2: Specify the number of required wavelengths when purchasing modules.

Table 2.1.1-1 Standard Configuration (Cont'd)

Item	Model/Ordering Number	Name	Q'ty	Remarks
Accessory	–	Optical Connector	1	Select one option.
	W3585AE	MU909014A/A1/B/B1/C/C6, MU909015A6/B/B1/C/C6 μOTDR Module Quick Guide	1	English (Printed version)
	Z1579A	MU909014A/A1/B/B1/C/C6, MU909015A6/B/B1/C/C6 μOTDR Module Operation Manual (CD-R)	1	English, Quick Guide

2.1.2 Options

The following options are available for use with the main frame. Select the required options as necessary. Refer to Appendix A “Specifications” for details on the specifications.

Table 2.1.2-1 Module Options

Model	Name
MU909014A-053	SMF 1625nm μ OTDR Module (UPC)
MU909014A1-053	SMF 1625nm μ OTDR Module (UPC/VLD)
MU909014A-054	SMF 1650nm μ OTDR Module (UPC)
MU909014A1-054	SMF 1650nm μ OTDR Module (UPC/VLD)
MU909014A-063	SMF 1625nm μ OTDR Module (APC)
MU909014A1-063	SMF 1625nm μ OTDR Module (APC/VLD)
MU909014A-064	SMF 1650nm μ OTDR Module (APC)
MU909014A1-064	SMF 1650nm μ OTDR Module (APC/VLD)
MU909014B-056	SMF 1310/1550nm μ OTDR Module (UPC)
MU909014B1-056	SMF 1310/1550nm μ OTDR Module (UPC/VLD)
MU909014B-066	SMF 1310/1550nm μ OTDR Module (APC)
MU909014B1-066	SMF 1310/1550nm μ OTDR Module (APC/VLD)
MU909014C-057	SMF 1310/1550/1625nm μ OTDR Module (UPC)
MU909014C6-057	SMF 1310/1550/1625nm μ OTDR Module (UPC/OPM/LS)
MU909014C-067	SMF 1310/1550/1625nm μ OTDR Module (APC)
MU909014C6-067	SMF 1310/1550/1625nm μ OTDR Module (APC/OPM/LS)
MU909014C-058	SMF 1310/1550/1650nm μ OTDR Module (UPC)
MU909014C6-058	SMF 1310/1550/1650nm μ OTDR Module (UPC/OPM/LS)
MU909014C-068	SMF 1310/1550/1650nm μ OTDR Module (APC)
MU909014C6-068	SMF 1310/1550/1650nm μ OTDR Module (APC/OPM/LS)
MU909015A6-053	SMF 1625nm μ OTDR Module (UPC/OPM/LS)
MU909015A6-063	SMF 1625nm μ OTDR Module (APC/OPM/LS)
MU909015A6-054	SMF 1650nm μ OTDR Module (UPC/OPM/LS)
MU909015A6-064	SMF 1650nm μ OTDR Module (APC/OPM/LS)
MU909015B-056	SMF 1310/1550nm μ OTDR Module (UPC)
MU909015B1-056	SMF 1310/1550nm μ OTDR Module (UPC/VLD)
MU909015B-066	SMF 1310/1550nm μ OTDR Module (APC)
MU909015B1-066	SMF 1310/1550nm μ OTDR Module (APC/VLD)
MU909015C-057	SMF 1310/1550/1625nm μ OTDR Module (UPC)
MU909015C6-057	SMF 1310/1550/1625nm μ OTDR Module (UPC/OPM/LS)
MU909015C-067	SMF 1310/1550/1625nm μ OTDR Module (APC)
MU909015C6-067	SMF 1310/1550/1625nm μ OTDR Module (APC/OPM/LS)
MU909015C-058	SMF 1310/1550/1650nm μ OTDR Module (UPC)
MU909015C6-058	SMF 1310/1550/1650nm μ OTDR Module (UPC/OPM/LS)
MU909015C-068	SMF 1310/1550/1650nm μ OTDR Module (APC)
MU909015C6-068	SMF 1310/1550/1650nm μ OTDR Module (APC/OPM/LS)
MU909015C-059	SMF 1310/1490/1550nm μ OTDR Module (UPC)
MU909015C6-059	SMF 1310/1490/1550nm μ OTDR Module (UPC/OPM/LS)
MU909015C-069	SMF 1310/1490/1550nm μ OTDR Module (APC)
MU909015C6-069	SMF 1310/1490/1550nm μ OTDR Module (APC/OPM/LS)

Table 2.1.2-2 Connector Option

Model	Model
-037	FC Connector
-039	DIN 47256 Connector
-040	SC Connector
-025	FC-APC Connector key width 2.0mm
-026	SC-APC Connector

2.2 Name of Each Part

2.2.1 Front Panel

The front panel contains the controls, which operate unit, and the LCD display.

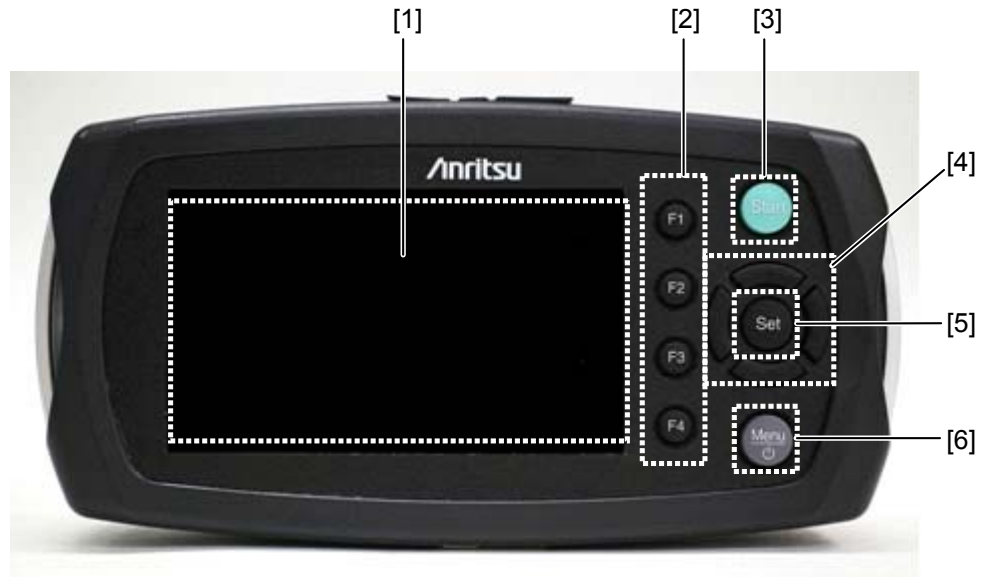

Figure 2.2.1-1 Front Panel

[1] LCD display

[2] **F1** to **F4** (Function key):

Each function key is designated depending on the current operating mode of the unit. You can find the function of each key to its immediately left in the display.

[3] **Start** (**Start** key):

Press **Start** to start measurement.

Press **Start** during measurement to stops measurement.

[4] **Up**, **Down**, **Left**, and **Right** keys):

Left key:

- Waveform display screen—
Decrease the width of the trace or move the marker left.
- General Setups—
Move the highlight left.



key:

- Waveform display screen—
Increase the width of the trace or move the marker right.
- General Setups—
Move highlight right.



key:

- Waveform display screen—
Increase the height of the trace or move the marker to the left event (Limited when Loss Mode is **Event**).
- General Setups—
Move up the highlight.



key:

- Waveform display screen—
Decrease the height of the trace or move the marker to the right event (Limited when Loss Mode is **Event**).
- General Setups—
Move down the highlight.

[5]  (Set key):

Confirm the values entered and each selection.

[6]  (**Menu/Power** key):

- Press **Menu/Power** key to power up the unit.
- Press **Menu/Power** key to display the pop-up menu for the current screen if the unit is powered on.

2.2.2 Top Connector Panel

The top connector panel of the unit contains the measurement port, USB ports, DC Input port, and battery status LED.

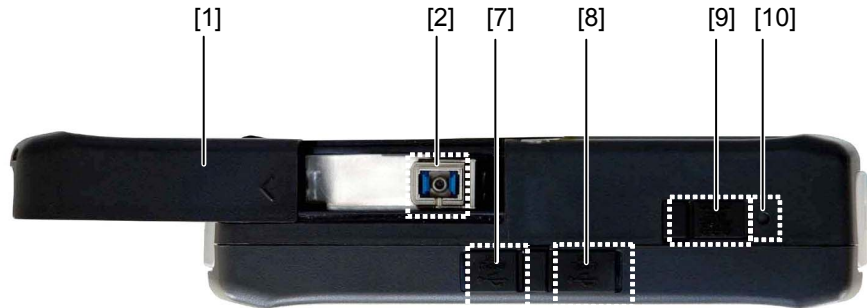

Figure 2.2.2-1 Top Connector Panel (MU909014A/B, MU909015A6/B and MU909015C-059/069)

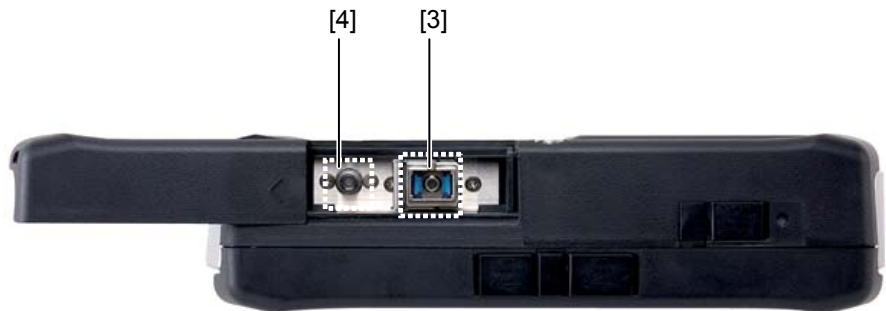

Figure 2.2.2-2 Top Connector Panel (MU909014A1/B1, MU909015B1)

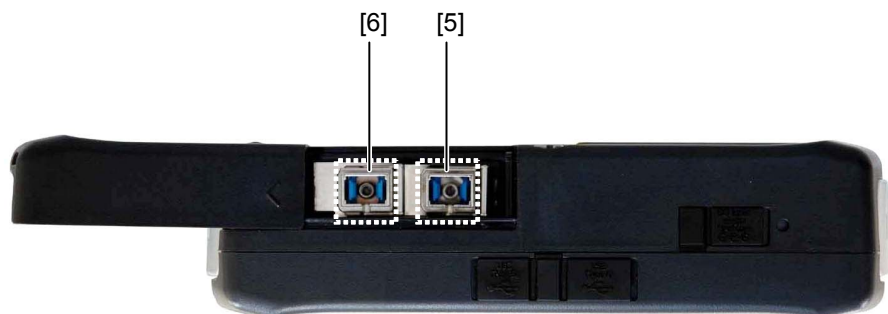

Figure 2.2.2-3 Top Connector Panel (MU909014C/C6, MU909015C/C6 and MU909015C6-059/069)

[1] Slide Cover

[2] Measurement Port

1625 or 1650 nm OTDR (MU909014A, MU909015A6)

1310/1550 nm OTDR (MU909014B, MU909015B)

1310/1490/1550 nm OTDR (MU909015C-059/069)

- [3] Measurement Port
 - 1625 or 1650 nm OTDR (MU909014A1)
 - 1310/1550 nm OTDR (MU909014B1, MU909015B1)
- [4] Visual Fault Locator Port
- [5] Measurement Port
 - 1310/1550 nm OTDR (MU909014C/C6, MU909015C/C6)
 - 1310/1490/1550 nm OTDR (MU909015C6-059/069)
- [6] Measurement Port
 - 1625 or 1650 nm OTDR (MU909014C/C6, MU909015C/C6)
 - Optical power meter (MU909015C6-059/069)
- [7] USB (Type B) Port
- [8] USB (Type A) Port
- [9] DC Input port
- [10] Battery Status LED

2.2.3 Back Panel

The back panel contains the battery compartment and a fastener that secures the test module to the Network Master main unit.

There are also various compliance and warning labels as well as the model and serial number label (item 3 in Figure 2.2.3-1).



Figure 2.2.3-1 Back Panel

- [1] Battery Compartment
- [2] Fastener
- [3] Model and serial number label
- [4] Compliance and warning labels

2.2.4 Bottom Panel

The bottom panel of the main frame is provided with the model and serial number label.



Figure 2.2.4-1 Bottom Panel

[1] Model and serial number label

2.3 Basic Notes on Use

CAUTION

Keep the measurement port cover closed except when a cable is connected. This cover prevents dust and other contaminants from collecting on the measurement port.

Condensation may occur on the inside surface of the unit when it is carried into a room (high temperature) from an outdoor location (low temperature), etc. If this occurs, allow the unit to dry out thoroughly before turning on the power. Water droplets and dust in the MT9090A, etc., can cause a short circuit, resulting in a fire, electric shock, or accident.

Use the unit within the operating temperature range (–10°C to +50°C) and storage temperature range (–30°C to +70°C). If the unit is placed in a car or other enclosed space for a long time, the ambient temperature may exceed the specified range, resulting in a unit malfunction.

Do not use any AC charger/adaptor or Ni-MH battery pack other than the one supplied. Otherwise, the unit may be damaged due to nonconformity with specifications.

Never look directly into the cable connector on the equipment nor into the end of a cable connected to the equipment. If laser radiation enters the eye, there is a risk of injury.

In addition, the unit outputs high-power optical pulses. Remove the communication device from the optical fiber before measurement to prevent damage to the photo receiving circuit of the communication device connected to the optical fiber to be measured, Anritsu will take no responsibility for damage to the communication or any other device.

Anritsu recommends that the unit be inspected once a year at Anritsu Customer Services (a fee will be charged).

 **CAUTION (Continued)**

For other notes on use, read the safety-related information in this manual thoroughly before use.

2.4 Supplying Power

Connecting AC charger/adaptor

Use the AC charger/adaptor provided as a standard accessory of the main frame.

Using other AC adapters may result in damage to the unit and/or battery pack.



Figure 2.4-1 AC Adapter

1. Open the DC Input connector cover (Figure 2.2.2-1) and plug the AC charger/adaptor jack to the DC Input connector.
2. Plug the AC charger/adaptor's transformer into an AC outlet.

2.5 Using Ni-MH Battery Pack

2.5.1 Installing Ni-MH Battery Pack

Follow the procedure below to install a Ni-MH battery pack.

 **CAUTION**

Always power down the Network Master before removing the Ni-MH battery pack. The battery pack and/or the unit may be damaged when you remove the battery pack with the Network Master powered on.

Remove the Ni-MH battery pack to avoid damage to the battery pack and/or the unit when storing the Network Master for a long period of time (several months). Otherwise, be sure to recharge the unit periodically (every one or two months).

1. Power down the unit if operating. Disconnect the AC charger/adaptor if connected.
2. Hold down the latch and lift the battery compartment cover (Figure 2.2.3-1) to open.
3. Remove batteries if installed.
4. Plug the battery pack connector into the battery pack plug of the module. The battery pack connector has an alignment tab to prevent reverse polarity connection. Align the connector tab with the plug slot to make the correct connection.

 **CAUTION**

Correctly plug the three-pin battery pack connector into the battery plug. Wrong connection may damage the battery pack and main frame.

5. Slide the Ni-MH battery pack into the battery compartment, making sure the followings:
 - The battery release ribbon (red) is tucked underneath, leaving a certain amount exposed to use when removing the battery pack.
 - The THIS SIDE UP label is facing up.

6. Reattach the battery compartment cover.



2

Preparation

Figure 2.5.1-1 Battery Compartment

- [1] Ni-MH battery pack plug
- [2] Module release latch
- [3] Ni-MH battery pack
- [4] Battery release ribbon (Red)

2.5.2 Battery Replacement – Battery pack to AA batteries

MT9090A can also be powered by AA Ni-MH or alkaline batteries.

Follow the procedure below to replace the battery pack with AA batteries:

 **CAUTION**

Always power down the unit before removing old AA batteries. Settings and data files may be lost if the batteries are removed with powered on.

If storing the unit for a long period of time (1 to 2 months), remove replaceable batteries from the unit. When periods without use in the Network Master, they may corrode or leak and damage the main frame.

Follow the instructions in the manual when using AA batteries.

When changing the batteries, always use new batteries of the same type of manufacturer and change all four batteries at a time. Wrong battery can cause the battery to overheat or damage the Network Master.

Take care not to get burned when replacing alkaline batteries with new ones. Temperature of alkaline batteries may increase by approximately 20°C after 2 hours of continuous measurement.

1. Power down the unit if operating. Disconnect the AC charger/adaptor if connected.
2. Hold the latch and lift the battery compartment cover (Figure 2.2.3-1) to open.
3. Pull the battery release ribbon to lift the Ni-MH battery pack, and unplug it from its receptacle located next to the module release latch.
4. Insert 4 new AA batteries into the compartment in correct directions, referring to the polarity symbols marked next to the battery contacts.
5. Reattach the battery compartment cover.

Note:

The Network Master does not recharge AA Ni-MH batteries.
Recharge them using a dedicated charger for Ni-MH batteries.

2.6 Connecting Fiber to Measurement Port

The measurement port is used to connect fiber for Fault Locate test applications.

CAUTION

Never force the connector ferrule or insert it at an angle into the adapter. Optical fibers are susceptible to loss from microbends or other stress. Position the patch cord to minimize mechanical strain.

Use a single mode fiber for the optical connector. If a multi-mode fiber is used by mistake, you cannot obtain accurate measurement values.

Connect the optical fiber cable to the port displayed on the screen. If the optical fiber cable is connected to a wrong port, you cannot obtain accurate measurement values.

1. Slide and open the cover (Figure 2.2.2-1) on the Measurement Port.
2. Clean the surfaces of the connector and fiber before connecting the fiber. Refer to Section 2.7 “Cleaning optical connector and adapter” for details.
3. Connect the fiber under test directly to the measurement port.



Figure 2.6-1 Connecting Fiber to Measurement Port

2.7 Cleaning optical connector and adapter

Cleaning the end surface of the ferrule inside the MT9090A

Use the adapter cleaner, an applicable part for the MT9090A, to clean the ferrule inside the optical I/O connector of the MT9090A. Clean the ferrule periodically. The following shows how to clean an optical adapter, using an FC adapter as an example. Clean other types of optical adapters in the same manner. When the instrument is a model with a fixed SC connector, clean with the optical connector mounted in the module.

2

Preparation

 **WARNING**

Be sure to check that there is no light being emitted before cleaning and checking the ferrule end surface.

 **CAUTION**

Performance will be unsatisfactory if the MT9090A is used with dust or dirt accumulated on the ferrule end surfaces. The ferrule end surfaces of the connected fibers and the MT9090A may burn if high-output lights are used with accumulated dust or dirt. Thoroughly clean the ferrule end surfaces of the connected fibers and the MT9090A before measurement.

1. Lift the adapter lever until the latch is released, and then gently pull out the adapter towards you.

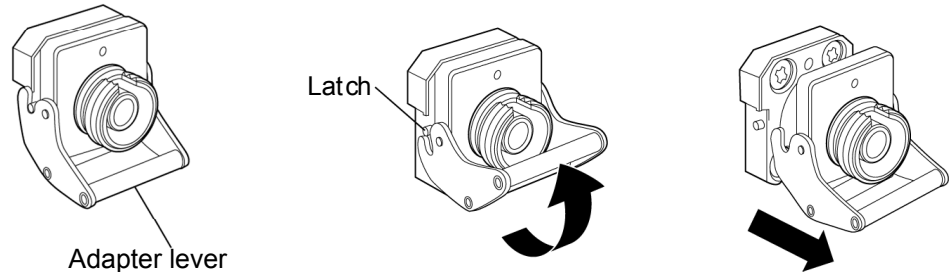

Figure 2.7-1 Cleaning of end surface of ferrule inside MT9090A - 1

2. Apply an alcohol-moistened adapter cleaner to the end surface and sides of the ferrule to clean it.

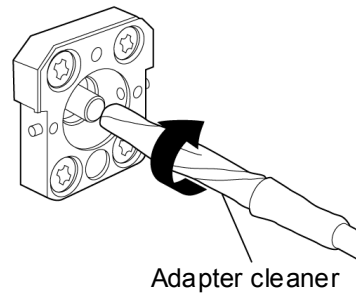

Figure 2.7-2 Cleaning of end surface of ferrule inside MT9090A - 2

3. Apply the tip of a new, dry adapter cleaner (not moistened with alcohol) to the end surface of the ferrule and wipe in one direction a few times.

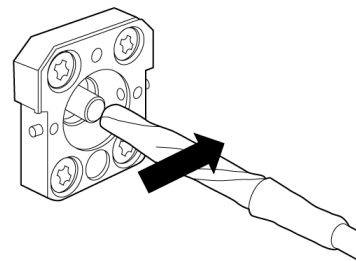

Figure 2.7-3 Cleaning of end surface of ferrule inside MT9090A - 3

4. Clean inside the adapter using an adapter cleaner.
(Refer to the optical adapter cleaning procedure in the next page.)
5. Attach the adapter in the reverse order or removal with care not to damage the end surface of the ferrule.

Cleaning the optical adapter

Use the adapter cleaner for the MT9090A to clean the optical adapter used for optical fiber cable connection. The following shows how to clean an optical adapter, using an FC adapter as an example. Clean other types of optical adapters in the same manner.

The following method should also be used for cleaning the adapter, which is removed before cleaning the end surface of the ferrule inside the MT9090A.

Insert an adapter cleaner into the split sleeve of the optical adapter, and rotate it in one direction while moving it back and forth.

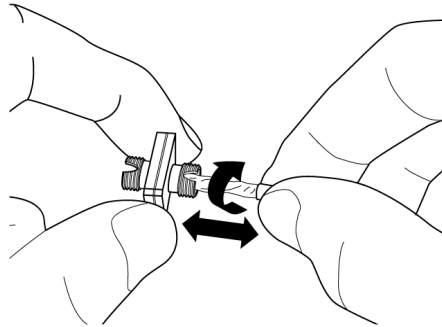

Figure 2.7-4 Cleaning of end surface of ferrule inside MT9090A - 4

Note:

Confirm the ferrule diameter, and use a 1.25-mm or 2.5-mm diameter dedicated adapter cleaner.

Cleaning the ferrule end surface of optical fiber cable

Use the ferrule cleaner, an applicable part for the MT9090A, to clean the ferrule end surface of an optical fiber cable. The following shows how to clean the ferrule end surface, using an FC connector as an example. Clean other types of optical connectors in the same manner.

1. Push the ferrule cleaner lever to show the cleaning face.

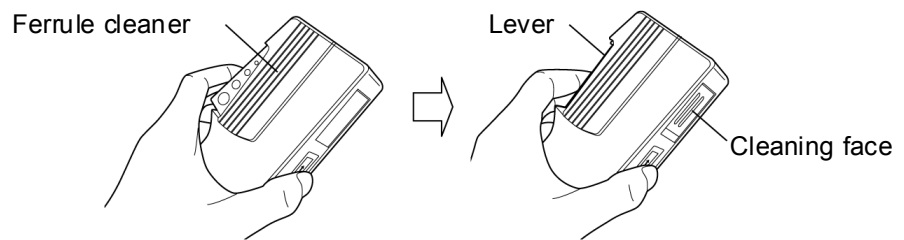

Figure 2.7-5 Cleaning of ferrule end surface of optical fiber - 1

2. While holding the lever in a depressed position, press the ferrule end surface of the optical connector against the cleaning face, and slide it in one direction.

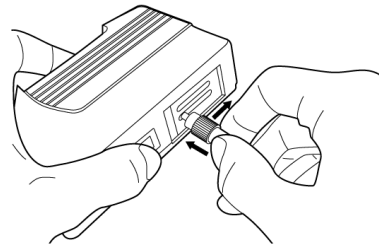

Figure 2.7-6 Cleaning of ferrule end surface of optical fiber - 2

Notes on cleaning

- Do not use a used adapter cleaner for cleaning, only use a new one.
- Do not use a cotton swab when finishing cleaning to prevent cotton fiber adhesion to the ferrule end surface.
- Fit caps on unused adapters.

2.8 Cautions on Handling Optical Fiber Cables

Optical fiber cables may degrade in performance or be damaged if handled improperly.

Note the following points when handling them.

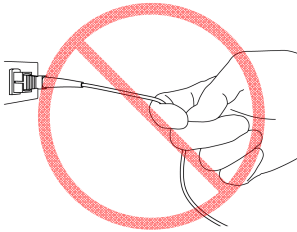

CAUTION

Do not pull the cable when removing the connector.

Doing so may either break the optical fiber inside the cable or strip the cable sheath from the optical connector.

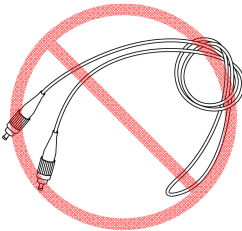

CAUTION

Do not excessively bend, fold, or pinch an optical fiber cable.

Doing so may break the optical fiber inside the cable. Keep the bend radius of an optical fiber cable at 30 mm or more. If the radius is less, optical fiber cable loss will increase.

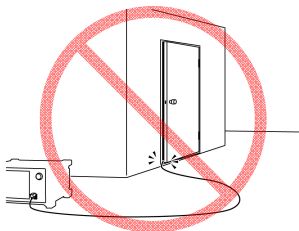
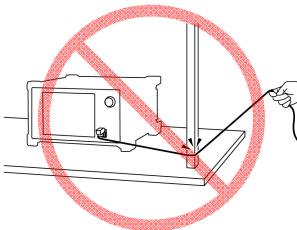

CAUTION

Do not excessively pull on or twist an optical fiber cable. Also, do not hang anything by using a cable.

Doing so may break the optical fiber inside the cable.



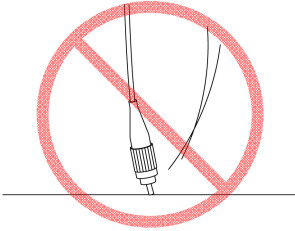

⚠ CAUTION

Be careful not to hit the end of an optical connector against anything hard such as the floor or a desk by dropping the optical fiber cable.

Doing so may damage the connector end and increase connection loss.

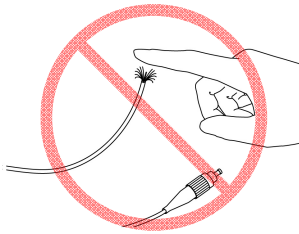

⚠ WARNING

Do not touch the end of a broken optical fiber cable.

The broken optical fiber may pierce the skin, causing injury.

⚠ CAUTION

Do not disassemble optical connectors.

Doing so may break the part or degrade the performance.

2.9 Changing Optical Connector

Lift the lever until the latch is released, and then pull out the optical connector. If the module is using a fixed SC connector, the optical connector cannot be changed.

⚠ WARNING

Never look directly into the cable connector on the equipment nor into the end of a cable connected to the equipment. If laser radiation enters the eye, there is a risk of injury.

⚠ CAUTION

When changing the optical connector, take care not to scratch the connector mating surfaces.

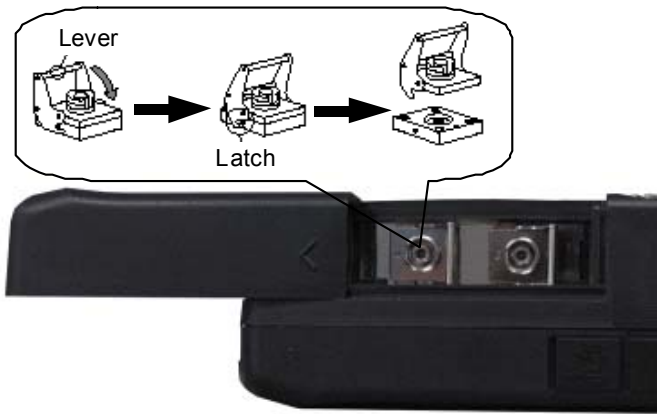

Figure 2.9-1 Changing Optical Connector

The connector types are shown below for reference.

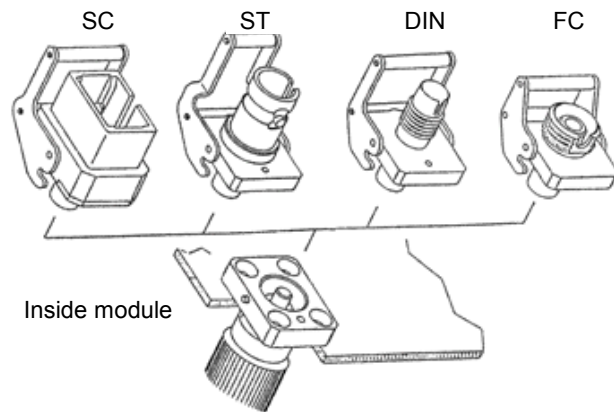

Figure 2.9-2 Types of Optical Connector

2.10 Connecting Peripheral Devices

The unit has two USB ports to which a USB device or personal computer (PC) can be connected. When a PC is connected via a USB cable, files saved in the Network Master can be transferred directly to the PC. Any PC running Windows 2000, Windows XP SP3 or Windows 7 (32 bit) can be connected via a USB cable to the Network Master.

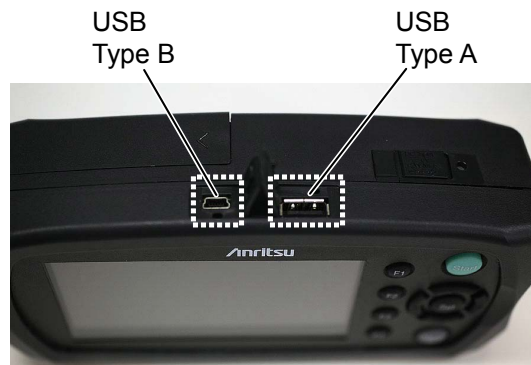

Figure 2.10-1 USB Port

2.10.1 Type A USB Port

The Type A USB port is provided for connecting a USB memory stick, USB Ethernet converter, USB Wi-Fi dongle or USB Bluetooth dongle.

Use USB devices conforming to USB 1.1. Not all commercially available USB devices are compatible with this port.

Contact Anritsu for information on USB devices that can be used.



Figure 2.10.1-1 Connecting USB memory

CAUTION

Never remove the USB memory stick when reading, saving, copying or deleting folders or files. Failure to do so may damage files or USB memory stick itself.

The following message dialog is displayed when USB memory is connected to the instrument.



Figure 2.10.1-2 USB Memory Detection Dialog Message

2.10.2 Type B USB Port

By using a USB cable to connect the Type B USB port of the unit to a personal computer, you can access the internal memory of the unit directly from the PC. Any PC running Windows 2000, Windows XP SP3 or Windows 7 (32 bit) can be connected via a USB cable to the Network Master.

The Network Master cannot be operated when connected to a PC. Follow the procedure below to connect the Network Master and PC.

CAUTION

Always use the Safely Remove Hardware function of the PC before disconnecting the USB cable that connects the PC and instrument. Failure to do so may damage the internal memory.

1. Close these screens before making a connection.
The PC cannot be connected while the instrument File Utility or Settings screen is displayed.
2. Remove a USB Ethernet converter or Video Inspection Probe, if connected.
3. Connect one end of the USB cable to the Type B USB Port on the top of the instrument.
4. Connect the other end of the cable to a USB port on the PC.



Figure 2.10.2-1 USB Cable Connection

2.11 Changing Test Module

Follow the procedure below to remove the current test module from the Network Master main frame and install a new test module.

1. Power down the unit if operating.
2. Disconnect the AC charger/adaptor if connected.
3. Open the battery compartment and remove the battery pack or AA batteries if installed.
4. Loosen the mounting screws on the back of the main frame.
5. Pull forward on the Network Master main frame to separate it from the test module, holding down the module release latch (Figure 2.5.1-1).

Note:

Avoid damage to the cables when removing the main frame from the module since the Network Master main frame and test module fit together snugly.

6. Install the new test module, aligning two tabs on the back side of the Network Master main frame (the opposite end of the 100 pin connector) to two slots on the new test module.
7. Applying firm but gentle pressure, seat the Network Master mainframe onto the test module.
DO NOT force two sections together.
8. Tighten the mounting screws with a tightening torque of 0.5 Nm or less.
9. Reinstall the battery pack or AA batteries if removed in step 2. Reattach the battery compartment cover.

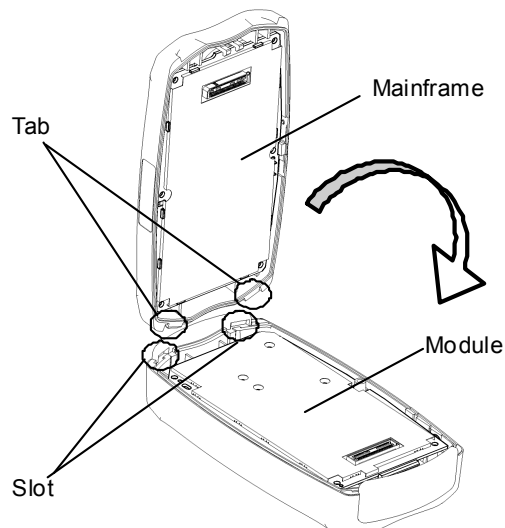

Figure 2.11-1 Alignment Tabs and Slots

Chapter 3 General Operation and System Setups

This chapter describes basic operations and system settings, such as power-on and file-related operations.

3.1	Powering Up and Down	3-2
3.1.1	Powering Up the Unit.....	3-2
3.1.2	Powering Down the Unit.....	3-3
3.2	Titles of Screen Parts	3-4
3.3	Changing General Settings.....	3-6
3.3.1	General.....	3-6
3.3.2	Preferences	3-10
3.3.3	Auto Save	3-15
3.4	Managing Files – Mass Storage	3-18
3.4.1	Creating New Folder.....	3-20
3.4.2	Deleting File or Folder	3-21
3.4.3	Copying File or Folder	3-22
3.4.4	Renaming File or Folder.....	3-24
3.4.5	Copying or Deleting Multiple Files or Folders	3-25
3.5	Capturing Screen Images	3-27
3.6	Using Softkey Board	3-28
3.7	Using Help Function	3-30
3.8	Confirming Version Information	3-31
3.9	Setting Screen Displayed after Power-Up	3-33

3.1 Powering Up and Down

3.1.1 Powering Up the Unit

1. Supply power to the main frame. Refer to Section 2.4 “Connecting Power” and 2.5 “Using Battery Pack” for more details.
2. Press .
The unit performs a self-test when the Anritsu splash screen is displayed, followed by the Network Master splash screen.
3. When the self-test passes, the Top Menu is displayed.
The message **Initialization Failed** is displayed if the power-up self-test fails.

Note:





If the Network Master splash screen does not appear after powering up, the unit may have failed in initialization or self-test. Run the unit through a power cycle (power down/power up). If the same problem occurs again after the unit has been run through a power cycle, it is likely the module has not been installed correctly to the main frame. Refer to Section 2.11 “Changing Modules”, and retry to install the module correctly. If the problem persists, contact the Anritsu Technical Support Center or your local Anritsu representative.

To switch the screen displayed at step 3, refer to Section 3.9 “Setting Screen Displayed after Power-Up”.

 **CAUTION**

Do not use any AC charger/adaptor other than one supplied with the Network Master. Failure to do so may result in damage to the unit and/or the Ni-MH battery pack.

3.1.2 Powering Down the Unit

1. Press  (**Menu/Power**) key, and a pop-up menu appears.
2. Use  and  to select the **Power Down** selection in the menu. Then, press  key.
3. The Power Down verification screen is displayed.
Highlight **Yes** and then press  key.
4. Power to the main frame is cut.

Note:

You can perform a forced power down at any time by holding down  key for 10 seconds.

3.2 Titles of Screen Parts

The titles of screen parts are shown below.

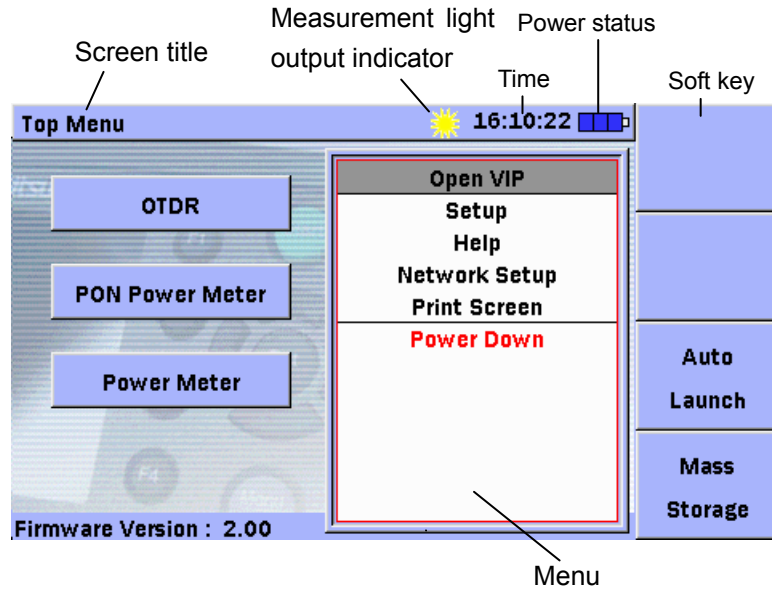



Figure 3.2-1 Names of Screen Items

Screen Title

Displays the title of the current screen.

Measurement light output

 is displayed while light for performing measurement is being output.

Time

Displays the current time in a 24 hour format (hh:mm:ss).

Power status



 Indicates that the unit is connected to an external power supply.

 Indicates that the unit is operating on battery power. The amount of charge remaining in the battery is indicated in red.

Soft keys

This area presents the on-screen details for **F1** through **F4** keys.

Menu

Press  key to display the pop-up menu for the current screen, if one is available. Press  key to hide the pop-up menu while it is displayed.

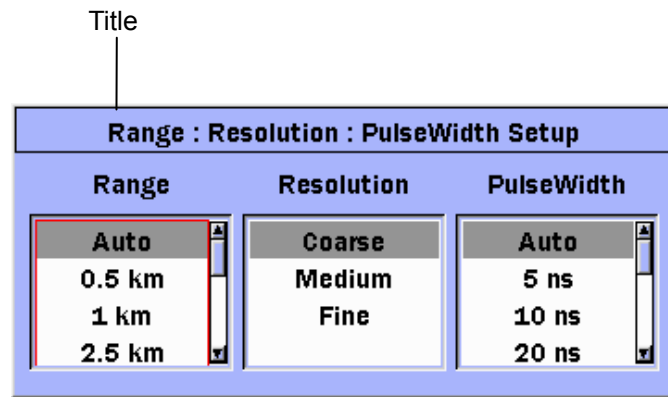

Figure 3.2-2 Pop-up Window Titles





Title

The titles of pop-up windows are displayed.

3.3 Changing General Settings

3.3.1 General

The General setups consist of basic settings for the unit: Date & Time, Language, and Auto Power Off.

1. Press  key on the Top Menu screen to display the General Functions pop-up menu.
2. Use  and  to select **Setup**, and then press  key to display the Setup screen.
3. Press  (General) key to display the Setup-General screen.

The Setup-General screen consists of two tabs: **Basic** tab and **Advanced** tab.

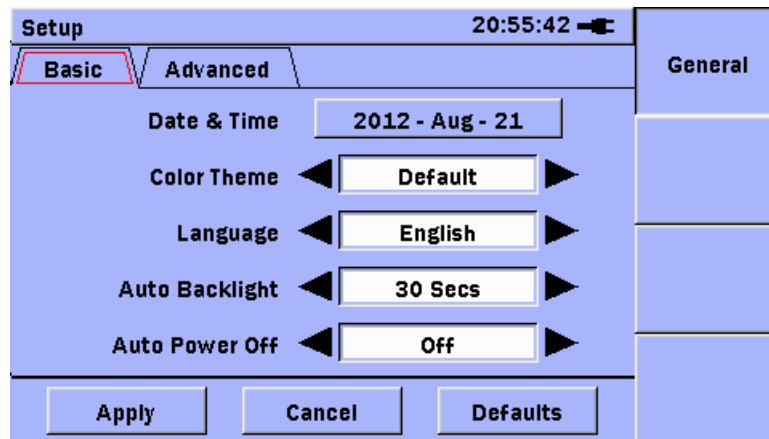























Figure 3.3.1-1 Setup-General Screen [Basic]

4. Use , , , and  to select the **Basic** tab.
5. Use  and  to select the **Date & Time** field.
 - (1) Press  key, and the **Set Date And Time** screen appears.
 - (2) Use  and  to move the highlight to the desired selection.
 - (3) Use  and  to scroll to the desired setting.
 - (4) Repeat steps (2) and (3) until the desired date and time are displayed on the screen.
 - (5) Press  (**OK**) to accept the new Date & Time setting. To cancel, press  (**Cancel**).
6. Use  and  to scroll to the desired setting. Refer to Table 3.3.1-1 “Setting Items”.
7. Use  and  to move the highlight to the desired selection.

8. Repeat steps 6 and 7 until the desired changes are made.
9. Use , , , and  to select the **Advanced** tab.

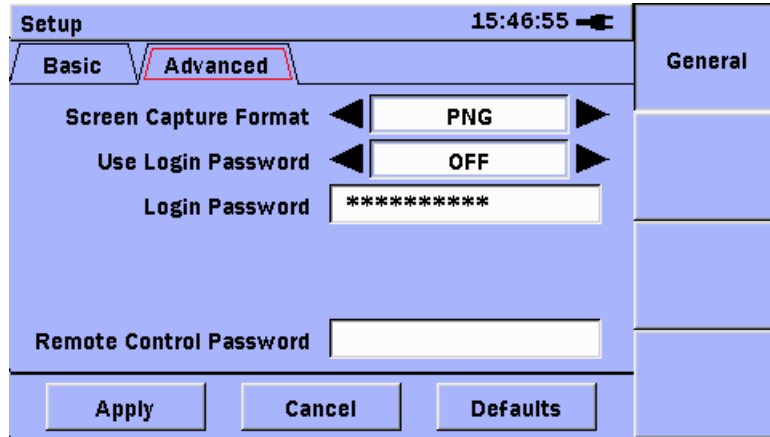























Figure 3.3.1-2 Setup-General Screen [Advanced]

10. Use , and  to select **Screen Capture Format**. Refer to Table 3.3.1-1 “Setting Items”.
Use , and  to change the setting contents.
11. Use , and  to select **Use Login Password**. Refer to Table 3.3.1-1 “Setting Items”.
Use , and  to change the setting contents.
12. If you want to use the Login Password, use , and  to select **Login Password**. Refer to Table 3.3.1-1 “Setting Items”.
13. Press  to enter the password.

Note:

Use the AC charger/adaptor when entering the password.
Please keep the password carefully. If you forget the password, you cannot login the unit.
The default of the login password is the serial number of the module.

14. Use , and  to select **Remote Control Password**. Refer to Table 3.3.1-1 “Setting Items”.
15. Press  to enter the password.
16. When you have finished making the desired General setting, use , , , and  to select **Apply**, and press . To cancel, select **Cancel**, and then press .

To restore the factory default settings, select **Defaults**, and then press . Refer to Appendix B “Default Value” for more details.

17. The changes are reflected.











Table 3.3.1-1 Setting Items

Item	Function	Available Options
Color Theme	Changes screen display colors. We recommend Outdoor White when using out of doors under blue sky.	Default, Outdoor White , Night, Orange Crush, Lush Green
Language	Switches the language of the on-screen characters.	English, Japanese, Chinese(T), Chinese(S) *1, French, German, Spanish(SP), Spanish(LA), Italian, Korean, Polish, Portuguese, Finnish, Danish, Swedish, Russian, Dutch
Auto Backlight off	The Auto Backlight Off setting turns off the LCD screen backlight when a set period of time passes without any key presses. When the time period elapses and the backlight goes out, pressing any key on the unit will restore the backlight. When the modules are operating with batteries and this setting is Off, the backlight goes low in 1 minute without any key presses.	Off, 30 Secs, 5 Mins, 10 Mins, 15 Mins, 20 Mins, 25 Mins, 30 Mins, 35 Mins, 40 Mins, 45 Mins, 50 Mins, 55 Mins, 60 Mins,
Auto Power Off	The Auto Power Off function shuts down the unit when the unit is inactive for a set period of time.	Off, 10 Mins, 30 Mins, 60 Mins, 90 Mins, 120 Mins
Screen Capture Format	Changes saved data format when Print Screen is selected from Menu.	BMP, JPEG, PNG
Use Login Password	While the Use Login Password is On, a password prompt is displayed when the power is turned On. The unit cannot be operated until the user logs in with the correct password.	Off, On
Login Password	Change a password for login.	Up to 12 characters The default is the last 4 digits of the serial number of the module.
Remote Control Password	Change a password for Remote Control.	Up to 12 characters

*1: Some symbols in “Chinese(S)” differ from those in other languages.
For example, “\$” is displayed as “\”.

3.3.2 Preferences

The Preferences setups can be selected only during OTDR function, Fiber Visualizer function or DCFL function.

1. Press the  key to display the General Functions pop-up menu.
2. Press  and  to select **Setup**, and then press  key to display the Setup screen.
3. Press  (**Preferences**) to display Setup-Preferences screen. The Setup screen consists of the tabs **1**, **2** and **3**.
4. Use , , , and  to select the tab **1**.
5. Use  and  to scroll to the desired setting. Refer to Table 3.3.2-1.

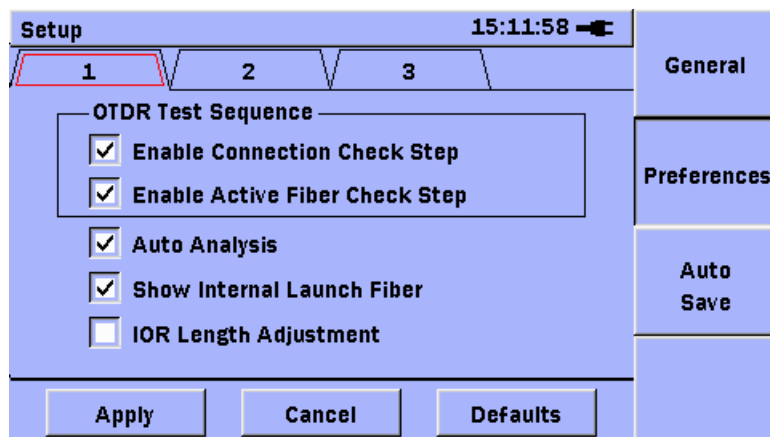



Figure 3.3.2-1 Setup-Preferences Screen
(In case of OTDR function)

Note:

Enable Active Fiber Check Setup is not displayed for DCFL function.

Auto Analysis cannot be disabled for Fiber Visualizer function and DCFL function.

6. Press  to select the checkbox.
7. Repeat steps 5 and 6 until the desired changes are made.

8. Use , , , and  to select the tab 2.

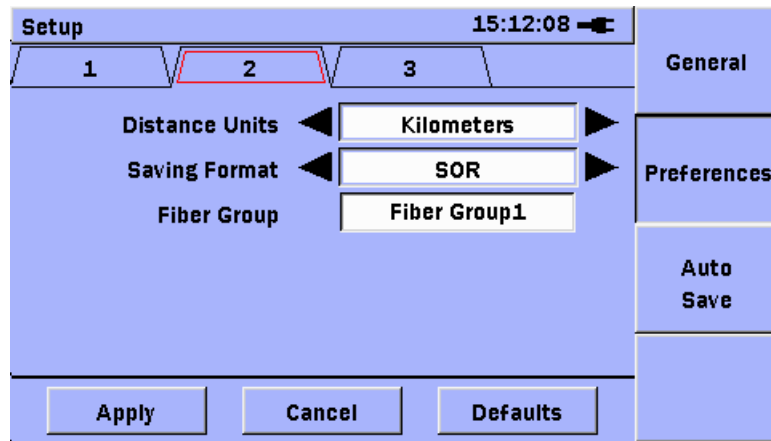

Figure 3.3.2-2 Setup-Preferences Screen 2
(In case of OTDR or DCFL function)

Note:

Event icon movement and End event for ORL are displayed for Fiber Visualizer function.

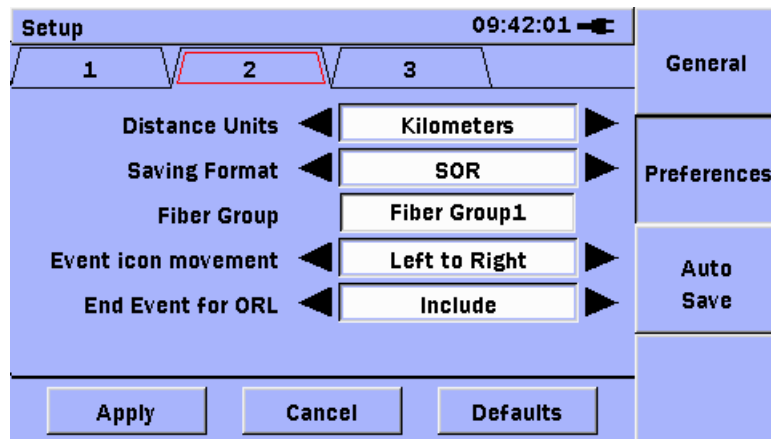













Figure 3.3.2-3 Setup-Preferences Screen 2
(In case of Fiber Visualizer function)

9. Use  and  to scroll to the desired setting. Refer to Table 3.3.2-1.
- Use  and  to change the setting.
10. If you want to change the Fiber Group, use  and  to scroll Fiber Group, and then press  key. The Fiber Group screen is displayed.

11. Use  and  to select the type, and then use  and  to select the desired fiber group. You can change **Fiber Group 2** and **3** only.

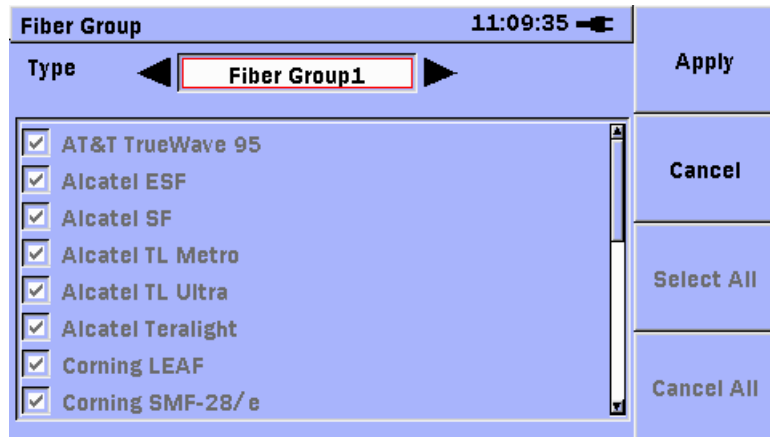











Figure 3.3.2-4 Fiber Group Screen

12. Use  and  to select the fiber type that you want to display in the IOR : BSC Setup dialog box. Then, press  to check.
13. When the type is changed, press  (**Apply**).
To cancel, press  (**Cancel**).
14. Repeat steps 10 and 13 until the desired changes are made.
15. Use , , , and  to select the tab **3**.

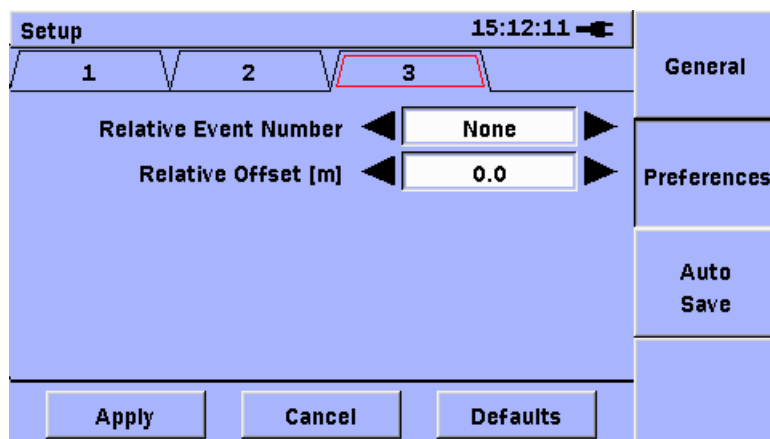











Figure 3.3.2-5 Settings Screen

16. Use  and  to scroll to the desired setting. Refer to Table 3.3.2-1.
Use  and  to change the setting.
17. When completed, use , , , and  to select **Apply**, and then press  key.

To cancel, select **Cancel**, and then press .

To restore the factory default settings, select **Defaults**, and then press . Refer to Appendix B “Default Value” for more details.

18. The changes are reflected.

Table 3.3.2-1 Setting Items (Preferences)

Item	Function	Settings
Enable Connection Check Step	Selects whether or not to check connected fiber status at measurement start.	Off, On
Enable Active Fiber Check Step	Selects whether or not to check for active (live) communications signal in connected fiber at measurement start.	Off, On
Auto Analysis	Selects whether or not to execute automatic trace analysis at measurement end. Note: Auto Analysis is always enabled for Fiber Visualizer function.	Off, On
Show Internal Launch Fiber	Selects whether or not to include trace display for main-frame built-in dummy fiber at Trace View screen.	Off, On
IOR Length Adjustment	Selects whether or not to display distance range for current cursor when setting IOR at Test Setup screen (Figure 3.3.2-6 and Figure 3.3.2-7).	Off, On
Distance Units	Selects units for distance range displayed at Test Setup and Trace View screens.	Kilometers, Meters, Kilofeet, Feet, Mile
Saving Format	Selects format of file for saving measured trace. The size of files saved in the XML and SOR&XML formats is relatively larger than files saved in the SOR format and such files take a longer time to complete save processing. If you select ZIP , multiple waveform files with different wavelengths are saved to a single file.	SOR, XML, SOR&XML, ZIP
Fiber Group	Selects a Fiber Type displayed at IOR:BSC Setup dialog box. Note: The Fiber Group1 cannot be changed. All Fiber types are displayed if you select.	Fiber Group1 Group2 Group3
Event icon movement*	Selects the icon movement direction by pressing the arrow keys on Fiber Visualizer window.	Left to Right, Right to Left
End event for ORL*	Selects whether to include end event in calculation of the total optical return loss.	INCLUDE, OMIT
Relative measurement	Selects starting point of events. Select an event number as a starting point (zero position). The event positions located before the selected event are shown in minus values. Note: Select Offset when setting Relative distance (km).	None, 0 to 5, Offset
Relative distance (km)	Sets the distance to the starting point (zero position) in m unit. To activate the Relative distance, select the “Offset” in Relative measurement.	0.0 to 10000.0

*: Available only for Fiber Visualizer function.

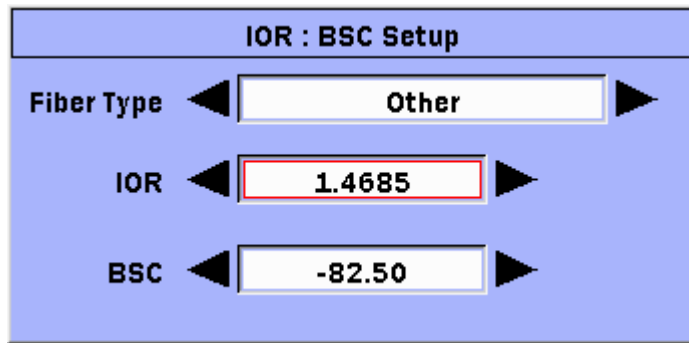

Figure 3.3.2-6 IOR:BSC Setup Screen
(IOR Length Adjustment: Off)

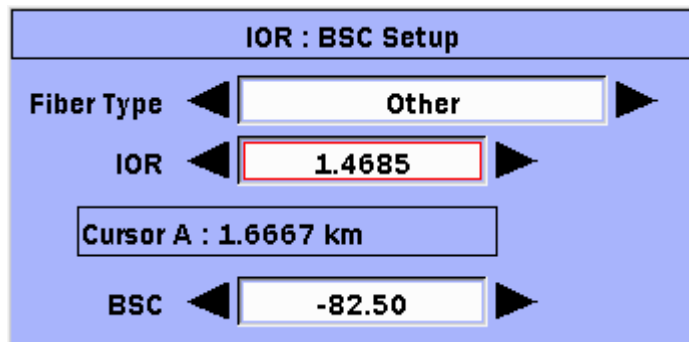









Figure 3.3.2-7 IOR:BSC Setup Screen
(IOR Length Adjustment: On)

3.3.3 Auto Save

1. Press  key on OTDR function to display the General Functions pop-up menu.
2. Press  and  to select **Setup**, and then press  key to display the Setup screen.
3. Press  (**Auto Save**) to display the Setup-Auto Save screen.
4. Use  and  to scroll to the desired setting. Refer to Table 3.3.3-1.

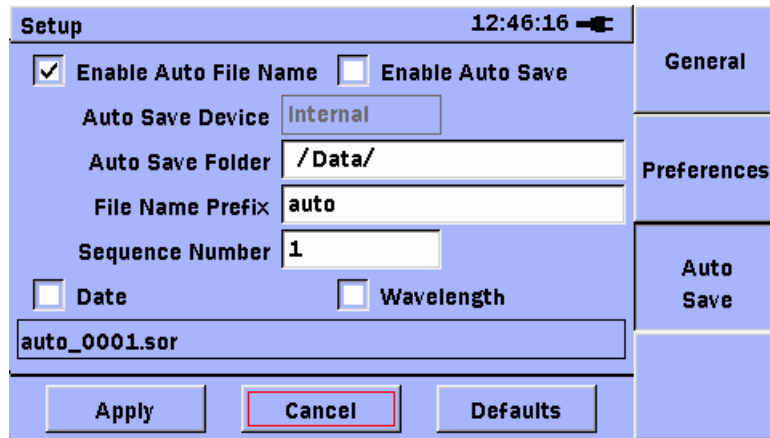

Figure 3.3.3-1 Setup- Auto Save Screen

5. Press to select the checkbox.
6. To change the saving destination of the measurement results, select **Auto Save Folder** using and press to display folder selection screen.
7. Select the folder to save the measurement results and press (Setting).
8. To add a specific word string to the file name to save the measurement results, select **File Name Prefix** by using and press to display the Character Input screen.
9. When editing is finished, press (Apply).
10. To change the sequence number for file names, select **Sequence Number** using , and press to display the Character Input screen.
11. When editing is finished, press (Apply).
12. When completed, use , , , and to select **Apply**, and then press key.
To cancel, select **Cancel**, and then press .
- To restore the factory default settings, select **Defaults**, and then press . Refer to Appendix B “Default Value” for more details.
13. The changes are reflected.

Table 3.3.3-1 Setting Items (Auto Save)

Item	Function	Settings
Enable Auto File Name	Appends Sequence Number to name set at Filename Prefix and creates file. Both Date and Wavelength information can be added.	Off, On
Enable Auto Save	Auto-saves trace file at measurement end. Cannot save at measurement end at real-time measurement.	Off, On
Auto Save Device	Displays a device to save files when Enable Auto Save is selected.	Internal memory or USB memory. Can only save to USB memory when USB memory stick is inserted.
Auto Save Folder	Set the saving destination of the measurement results.	Folder Name
File Name Prefix	Specifies save file name when Enable Auto File Name is selected.	Alphabet, Number, Symbol 21 alphanumeric characters max.
Sequence Number	Appends specified number to file names. Auto-increments the sequence number by one on save completion.	0 to 9999
Date	Appends date and time information to file names.	Off, On
Wavelength	Appends measurement wavelength data to file names. Note: When ZIP is selected as a format for saving waveforms, this item is fixed to Off .	Off, On

The file naming rules are as follows.

When the SOR save format is selected, the file extension is **.sor**.

When the XML save format is selected, the file extension is **.xml**.

When the SOR&XML save format is selected, the file extension is **.sor (.xml)**.

When the ZIP save format is selected, the file extension is **.zip**.

Filename Prefix_Date_Wavelength_Sequence Number.sor

Example:

Filename Prefix	auto
Date	Oct/27/2011
Wavelength	1310 nm
Sequence Number	1

auto_27102011_1310nm_001.sor

3.4 Managing Files – Mass Storage

Files can be saved to either built-in memory or USB memory stick. When copying either image files of screens saved to built-in memory or trace data files to USB memory, use the file management operations. The Mass Storage selection provides access to the following file operations:

- Creating a new folder
- Deleting files/folders
- Copying files/folders
- Renaming files/folders

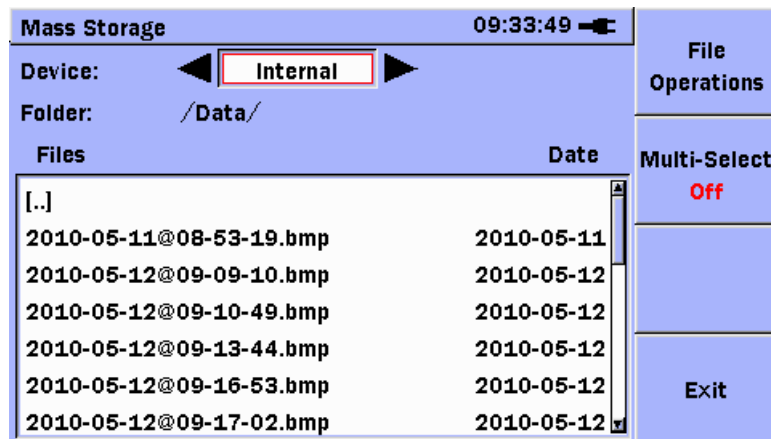

Figure 3.4-1 Mass Storage Screen



1. Press **F4** (**Mass Storage**) on the top menu to display the Mass Storage screen. Pressing **Menu** at any of the following screens displays the menu. Highlight **Mass Storage** using **Left** and **Right**, and then press **Set** to display the Mass Storage screen. The Mass Storage screen cannot be displayed during measurement or while verifying the connection.
 - Connection Check screen
 - Test Setup screen
 - Trace Analysis screen
 - Trace View screen

2. Pressing **F4 (Exit)** when the file operation is complete closes the Mass Storage screen.

Notes:







- If there are files or folders using characters that cannot be set at the character input screen, the file or folder name cannot be displayed correctly. Read the name after changing it using a PC, etc. Refer to Section 3.6 “Using Softkey Board” for characters that can be displayed correctly by the main frame.
- The Logs, Properties, and Screen Captures folders stored in the built-in memory are system folders used by the main frame. Do not change system folders.

3.4.1 Creating New Folder

1. Access the Mass Storage File Operations screen.
2. Use  and  to select the mass storage device; **Internal** or **USB**.





Note:

If there is no USB device connected to the unit, **USB** cannot be selected.

3. Verify that **Multi-Select** is set to Off.
When Off is set, **Multi-Select/Off** is displayed at . If **Multi-Select/On** is displayed, press  to switch to Off.
4. Use  and  to select the directory or folder where the new folder is to be located, and then press . Folders are displayed enclosed in brackets [].
Repeat this operation to move to a folder two levels higher or lower than the current folder. To move to the higher level folder, select [..] and press .

Note:

Selecting a folder containing 500 or more files will require a few seconds to display the folder contents on the Mass Storage screen.



5. Press  (**File Operations**).
6. Use  and  to select **New Folder**, and then press .
7. A folder named **newFolder** is added to the current directory.

Note:

If there is already a file or folder with the same name, a number is appended after newFolder to create the file or folder without overwriting the existing one.







For example, when newFolder already exists, newFolder1 is created, and if newFolder1 already exists, newFolder2 is created.

3.4.2 Deleting File or Folder

1. Access the Mass Storage File Operations screen.
2. Use  and  to select the mass storage device to delete; **Internal** or **USB**.







Note:

If there is no USB memory stick attached to the unit, **USB** cannot be selected.

3. Verify that Multi-Select is set to Off.
When Off is set, **Multi-Select/Off** is displayed at . If **Multi-Select/On** is displayed, press  to switch to **Multi-Select/Off**.
4. Use  and  to select the directory or folder to delete, and then press . Folders are displayed enclosed in brackets []. Repeat this operation to move to a folder two levels higher or lower than the current folder. To move to the higher level folder, select [.] and press .

Note:

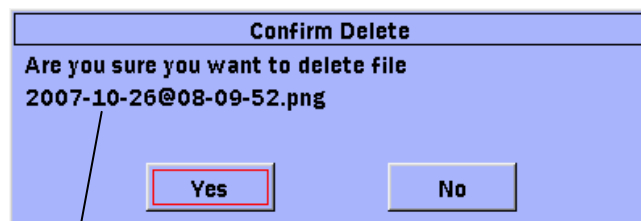

Selecting a folder containing 500 or more files will require a few seconds to display the folder contents on the Mass Storage screen.

5. Use  and  to select the directory or folder to delete. The selected folder is displayed enclosed in brackets [].
6. Press  (**File Operations**).
7. Use  and  to select **Delete**, and then press . The following message appears.





The file/folder displayed here will be deleted.

Figure 3.4.2-1 Confirm Delete screen





8. If the displayed folder name (file name) is correct, select **Yes** using  and  and press . To cancel, select **No**.
9. The selected folder or file is deleted.

3.4.3 Copying File or Folder

1. Access the Mass Storage File Operations screen.
2. Use  and  to select the mass storage device to copy; **Internal** or **USB**.

Note:









If there is no USB device connected to the unit, **USB** cannot be selected.

3. Verify that **Multi-Select** is set to Off.
When Off is set, **Multi-Select/Off** is displayed at . If **Multi-Select/On** is displayed, press  to switch to Off.
4. Use  and  to select the directory or folder to copy, and then press . The selected folder is displayed enclosed in brackets [].

Repeat this operation to move to a folder two levels higher or lower than the current folder. To move to the higher level folder, select [..] and press .



Note:





Selecting a folder containing 500 or more files will require a few seconds to display the folder contents on the Mass Storage screen.

5. Use  and  to select the directory or folder to copy. The selected folder is displayed enclosed in brackets [].
6. Press  (**File Operations**).
7. Use  and  to select **Copy**, and then press . The Destination window is displayed over the Mass Storage File Operations screen.
8. Use  and  to select the mass storage device to copy; **Internal** or **USB**.





Note:

If there is no USB device connected to the unit, **USB** cannot be selected.





9. Use  and  to select the directory or folder to copy, and then press **F1 (Paste)**. Press **F2 (Cancel)** to not perform copying.
10. If you select a folder or file that already exists in the copy destination, an overwrite confirmation message appears. If it is not displayed, proceed to step 12.
11. To overwrite a single file:

Use  and  to select **Yes**, and then press .
To cancel, select **No**, and then press .

To overwrite multiple files (a file at a time):

Use  and  to select **Yes**, and then press  to overwrite.
To cancel, select **No**.
If a overwrite process is completed or canceled, a message confirming you to overwrite the next file appears. The message appears until all the selected files are processed.
To cancel, select **Cancel**, and then press .

To overwrite multiple files (all files at a time):

Use  and  to select **All**, and then press  to automatically overwrite all the files.
To cancel, select **Cancel**, and then press .

12. Confirm that the file or folder has been pasted to the desired location.

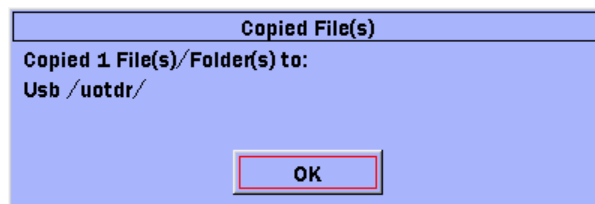





Figure 3.4.3-1 File(s) Copied Dialog





13. Press  to close the dialog and return to the Mass Storage screen.

3.4.4 Renaming File or Folder

1. Access the Mass Storage File Operations screen.
2. Use  and  to select the directory or folder to rename; **Internal** or **USB**.

Note:













If there is no USB memory stick connected to the unit, **USB** cannot be selected.

3. Verify that **Multi-Select** is set to Off.
When Off is set, **Multi-Select/Off** is displayed at . If **Multi-Select/On** is displayed, press  to switch to Off.
4. Select the location of the folder or file for the name change using  and , and press . The selected folder is displayed enclosed in brackets [].

Repeat this operation to move to a folder two levels higher or lower than the current folder. To move to the higher level folder, select [.] and press .

Note:

Selecting a folder containing 500 or more files will require a few seconds to display the folder contents on the Mass Storage screen.

5. Use  and  to select the directory or folder to rename. The selected folder is displayed enclosed in brackets [].
6. Press  (**File Operations**).
7. Use  and  to select **Rename**, and then press  to display the SoftkeyBoard screen.
 - (1) Use , , , and  to highlight the desired letter in the character matrix.
 - (2) Press  key to add the highlighted letter to the name field.
 - (3) Repeat steps (1) and (2) to complete the file/folder name. Up to 23 characters can be used.
 - (4) When the file/folder name is completed, press  (**OK**). To cancel, press  (**Cancel**).

Refer to Section 3.6 “Using Softkey Board” for details about character input.

8. The selected folder or file is changed to the input name.
 If a file with the same name exists, the following message appears.
 If you select **Yes**, the file will be overwritten.
 If you select **No**, the file name change will not be overwritten.

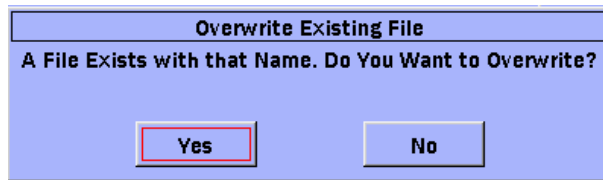

Figure 3.4.4-1 Overwrite Existing File Dialog

Following message appears if same name folder exists. In this case, the folder name will not be changed.

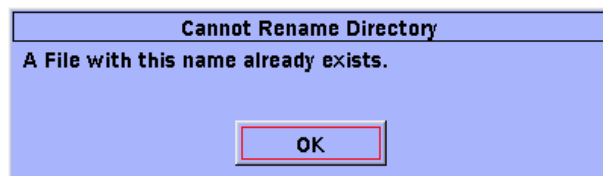

Figure 3.4.4-2 Cannot Rename Directory Dialog

3.4.5 Copying or Deleting Multiple Files or Folders

Follow the following below to copy or delete multiple files or folders in one step.

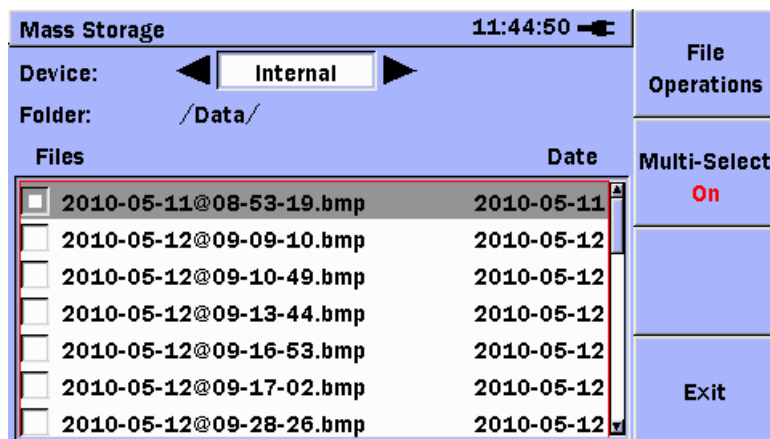





Figure 3.4.5-1 Mass Storage Screen (Multi-Select/On)

1. Access the Mass Storage File Operations screen.
2. Use  and  to select the mass storage device to copy or delete; **Internal** or **USB**.





Note:





If there is no USB device connected to the unit, **USB** cannot be selected.





3. Press  (**Multi-Select/Off**), and the current setting value (red) on the softkey is switched to "On" and an empty checkbox is displayed in front of each filename in the current directory or folder.





Note:

When **Multi-Select** is set to On, you cannot access any folders higher or lower than the current folder.

4. Use  and  to select the first file or folder to copy/delete, and then press  key. A check mark appears in the checkbox for the highlighted file. Pressing  again clears the checkbox. The selected folder or file is the copy/delete target. The selected folder is displayed enclosed in brackets [].

To select all of the files in the current folder or all of the folders in the current directory; press  (**File Operations**), use  and  to select **Select All**, and then press  key.





To clear all of the files in the current folder or all of the folders in the current directory; press  (**File Operations**), use  and  to select **Unselect All**, and then press  key.

5. Press  (**File Operations**).
6. Use  and  to select **Delete** or **Copy**, and then press .
7. Refer to Section 3.4.2 "Deleting File or Folder" or Section 3.4.3 "Copying File or Folder" for operations from hereon.

3.5 Capturing Screen Images

Use the Print Screen function to save images on test result screens and most setup screens in bmp, jpeg, or png format. Bmp files are saved to the Internal Data directory. However, menus and message dialogs cannot be saved.

Refer to 3.3.1 “General” for how to select the Screen Capture Format (BMP, JPEG, PNG).

1. Display the screen to save.
2. Press  to display the General Functions pop-up menu.
3. Use  and  to select **Print Screen**, and then press . The file is saved with the following name to the Data folder of the built-in memory.

yyyy-mm-dd@HH-MM-SS.bmp

yyyy: Gregorian year when screen saved

mm: Month when screen saved

dd: Day when screen saved

HH: Hour (24-h clock) when screen saved

MM: Minute when screen saved

SS: Second when screen saved

Note:

Files saved by the main frame cannot be displayed by it. Copy the saved file to a PC, etc., to display it.

4. The Print Screen Complete dialog box appears in about 2 to 3 seconds.

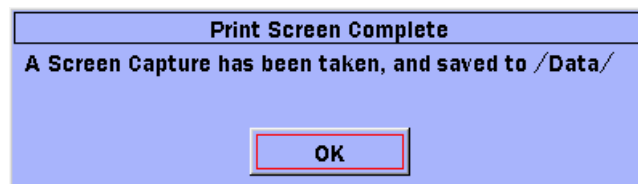



Figure 3.5-1 Print Screen Complete Dialog

5. Press  to close the dialog and return to the Mass Storage screen.

3.6 Using Softkey Board

This section describes how to input alphanumeric characters at the SoftkeyBoard screen. The SoftkeyBoard screen of the Network Master, contains only alphanumeric characters that you can input.

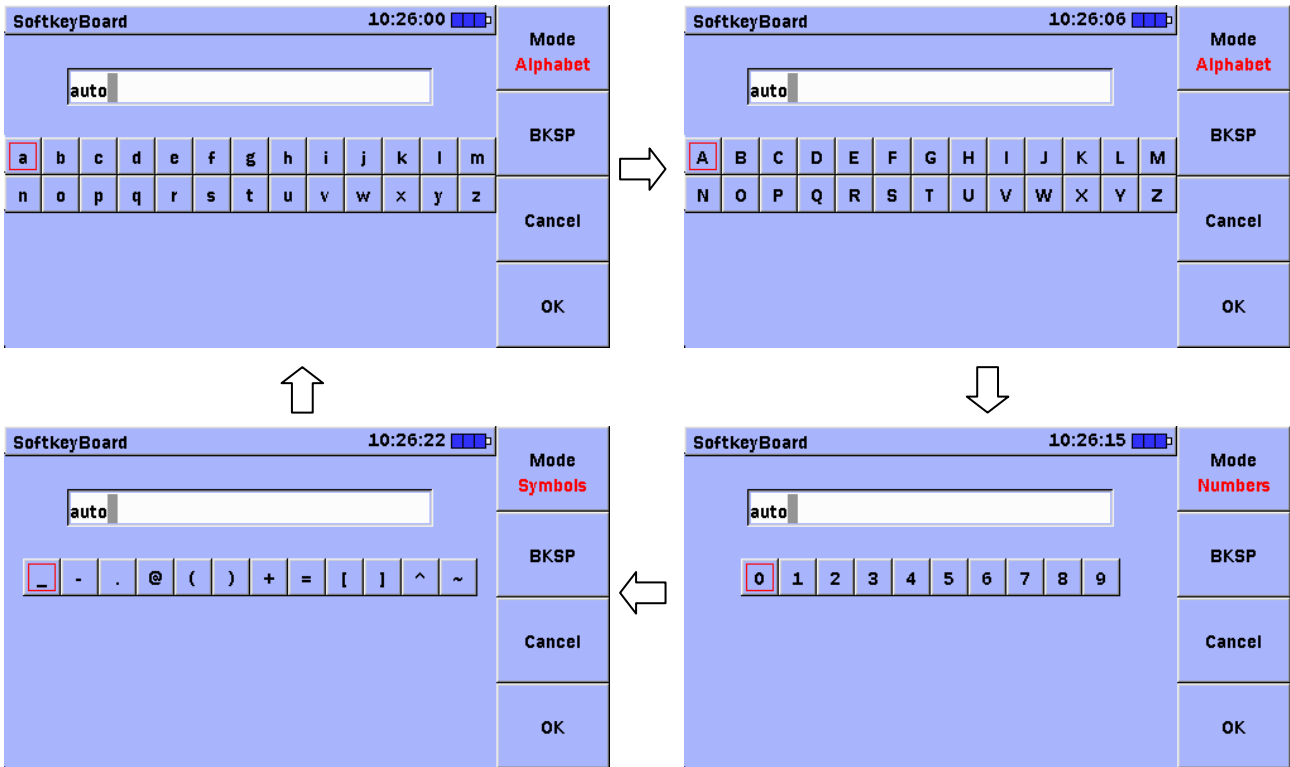





Figure 3.6-1 Input Character Transitions

You can input characters with the following buttons.

- **Rename** of **F1 (File Operations)** in Mass Storage
- **Files** in Mass Storage (**Save**)
- **Filename Prefix** or **Sequence Number** of **F3 (Auto save)** in Setup screen
- **Filename** of **F1 (Save)** in VIP screen
- **Filename** of Export PNG image screen

1. Execute one of the following operations.
 - Select **Rename** from **F1 (File Operations)** in Mass Storage, and press **Set**.
 - Select **Filename Prefix** from **F3 (Auto Save)** in Setup screen, and press **Set**.
 - Select **Sequence Number** from **F3 (Auto Save)** in Setup screen, and press **Set**.
 - Select **Filename** from **F1 (Save)** in VIP screen, and press **Set**.
 - Press **Menu** in the VIP screen, select **Save As PNG Image**, and press **Set**. Then, select **Filename** and press **Set**.
 - Press **Menu** in the VIP screen, select **Create PDF Report**, and press **Set**. Then, press **F1 (Create Report)**, select **Filename**, and press **Set**.
2. Each press of **F1** switches the input character type. Select one from Alphabet, Numbers, and Symbols as shown in Figure 3.6-1. Press **F1** to select the type of character input. The current character type is displayed in **F1**.
3. Use **Up**, **Down**, **Left**, and **Right** to select the desired letter in the character matrix.
4. Press **Set** key to add the highlighted letter to the name field. Press **F2 (BKSP)** to clear the entry in the name field.
5. Repeat steps 1 to 3 over to input the required characters.
6. When the name is completed, press **F4 (OK)**. Press **F3 (Cancel)** to cancel the input.

3.7 Using Help Function

1. Press  key to display the General Functions pop-up menu.
2. Use  and  to select **Help**, and then press  key to display the help dialog box.

Note:

The **Help** menu is not displayed at the Mass Storage screen and Fiber Visualizer screen.

3. Press any of , , , , and  to exit the help dialog box.

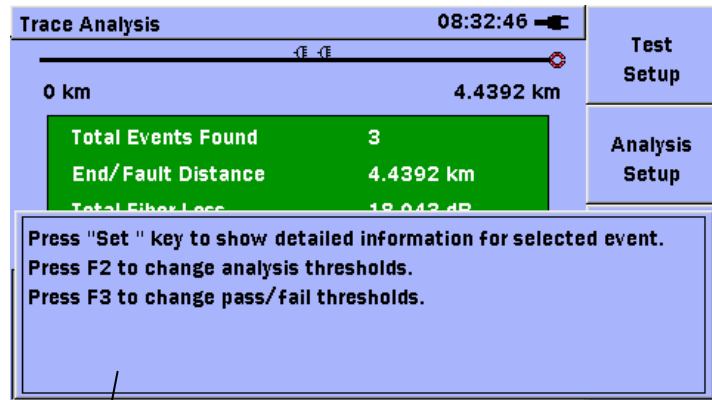

Help message

Figure 3.7-1 Example of Help Message

3.8 Confirming Version Information

The **About** function provides access to the Version/Serial Number Information window which lists the framework and test application software version levels, as well as the serial numbers for the main frame and module. The appearance of the Version screen depends on the installed modules and options.

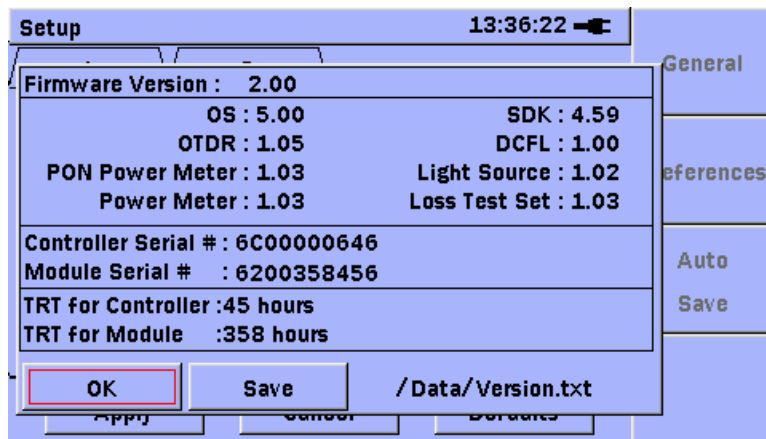













Figure 3.8-1 Version Screen

1. Press  key to display the General Functions pop-up menu.
2. Press  and  to select **Setup**, and then press  key to display the Setup screen.
3. Press  key to display the General Functions pop-up menu.
4. Use  and  to select **About**, and then press  to display the Version/Serial Number information.

5. Select **OK** using  and , and then press  to close the Version screen. Select **Save** and press  to save the version information as a text file with the name Versions.txt in the Data folder of the internal memory.

```
Firmware Version 2.00

OS : 5.00
SDK : 4.59

OTDR :1.05
DCFL :1.00
PON Power Meter :1.03
Light Source :1.02
Power Meter :1.03
Loss Test Set :1.03

Controller Serial # 6C00000646
Module Serial # 6200358456

TRT for Controller 45 hours
TRT for Module 358 hours
```

Figure 3.8-2 Example of Saved Version Information

Note:

The saved file cannot be displayed on this instrument. Use a PC to display the file.

3.9 Setting Screen Displayed after Power-Up

The screen to be displayed after power-up can be selected among the following; and the next screen can be changed.

- Top Menu
- OTDR
- Fiber Visualizer
- DCFL
- PON Power Meter*
- Light Source*
- Power Meter*
- Optical loss measurement*

*: For the correspondence of functions to models that can be set, refer to Table 1.1-1.

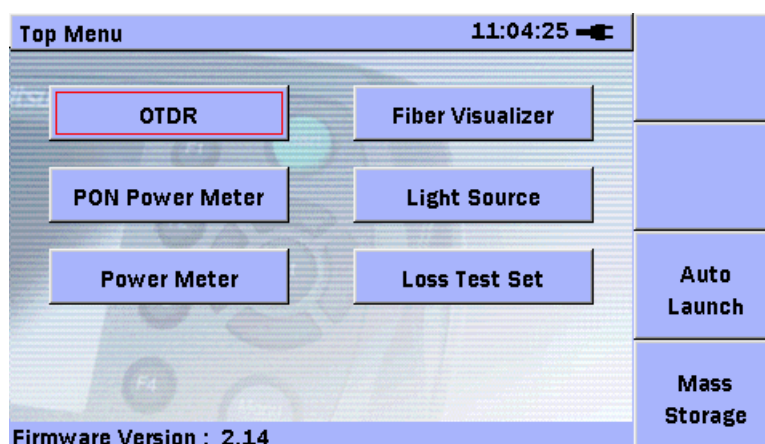

Figure 3.9-1 Top Menu (MU909014C6/15C6)

1. Press to display the General Functions pop-up menu.
2. Use and to highlight **Top Menu**, and then press .
3. A confirmation dialog appears. Use and to select **Yes**, and then press to display the Top Menu screen.
4. Press (**Auto Launch**).

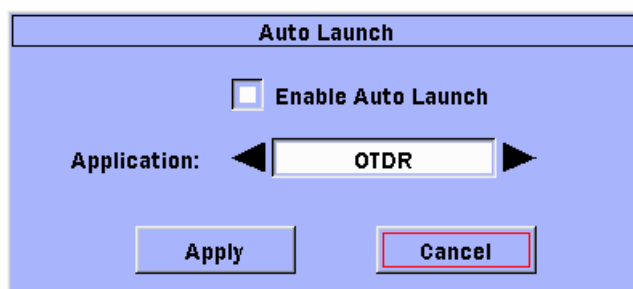















Figure 3.9-2 Auto Launch Pop-up Menu

5. When setting to Top Menu, use  and  to select **Enable Auto Launch** and press  to clear the checkbox.
6. When setting to Test Setup, use  and  to select **Enable Auto Launch**, and then press  to select the checkbox.
7. Use  and  to select **Application**.
8. When completed, use , , , and  to select **Apply**, and then press  key. To cancel, select **Cancel**, and then press .

Chapter 4 Locating Fiber Faults

This chapter explains the methods of fiber loss measurement and fault point detection using OTDR function or Fiber Visualizer function. Refer to Chapter 2 for the fiber connection method and precautions on handling.

When using Fiber Visualizer function, refer to Section 4.12 “Measuring with Fiber Visualizer”.

4.1	Measurement Procedure	4-2
4.2	Setting Parameters and Preferences	4-3
4.2.1	Setting Measurement Conditions (Test Setup)	4-4
4.2.2	Setting Measurement Method (Setup-Preferences)	4-13
4.2.3	Setting Auto Save Mode (Setup-Auto Save)..	4-16
4.3	Starting Measurement	4-19
4.3.1	Checking Connection	4-19
4.3.2	Operation Depending on Connection Check Result	4-21
4.4	Viewing Trace	4-22
4.4.1	Trace View	4-22
4.4.2	Using Cursor	4-27
4.4.3	Zooming in and out Trace Display	4-30
4.4.4	Swap Traces	4-32
4.5	Analyzing Trace	4-33
4.5.1	Trace analysis	4-33
4.5.2	Setting event detection conditions (Analysis Setup)	4-38
4.5.3	Setting OK/NG thresholds (Thresholds Setup)	4-40
4.6	Setting header to trace	4-42
4.7	Saving trace manually	4-44
4.8	Loading Trace Data (Mass Storage-Load)	4-47
4.9	Restoring Defaults (All Defaults)	4-49
4.10	Calculation Method	4-50
4.10.1	Loss measurements	4-50
4.10.2	Event Evaluation	4-55
4.11	Using VFL (Visual Fault Locator)	4-58
4.12	Measuring with Fiber Visualizer	4-59
4.13	Creating a Summary	4-72

4.1 Measurement Procedure

The following flowchart shows the procedure for measuring the loss and distance range of an optical fiber system by using OTDR function.

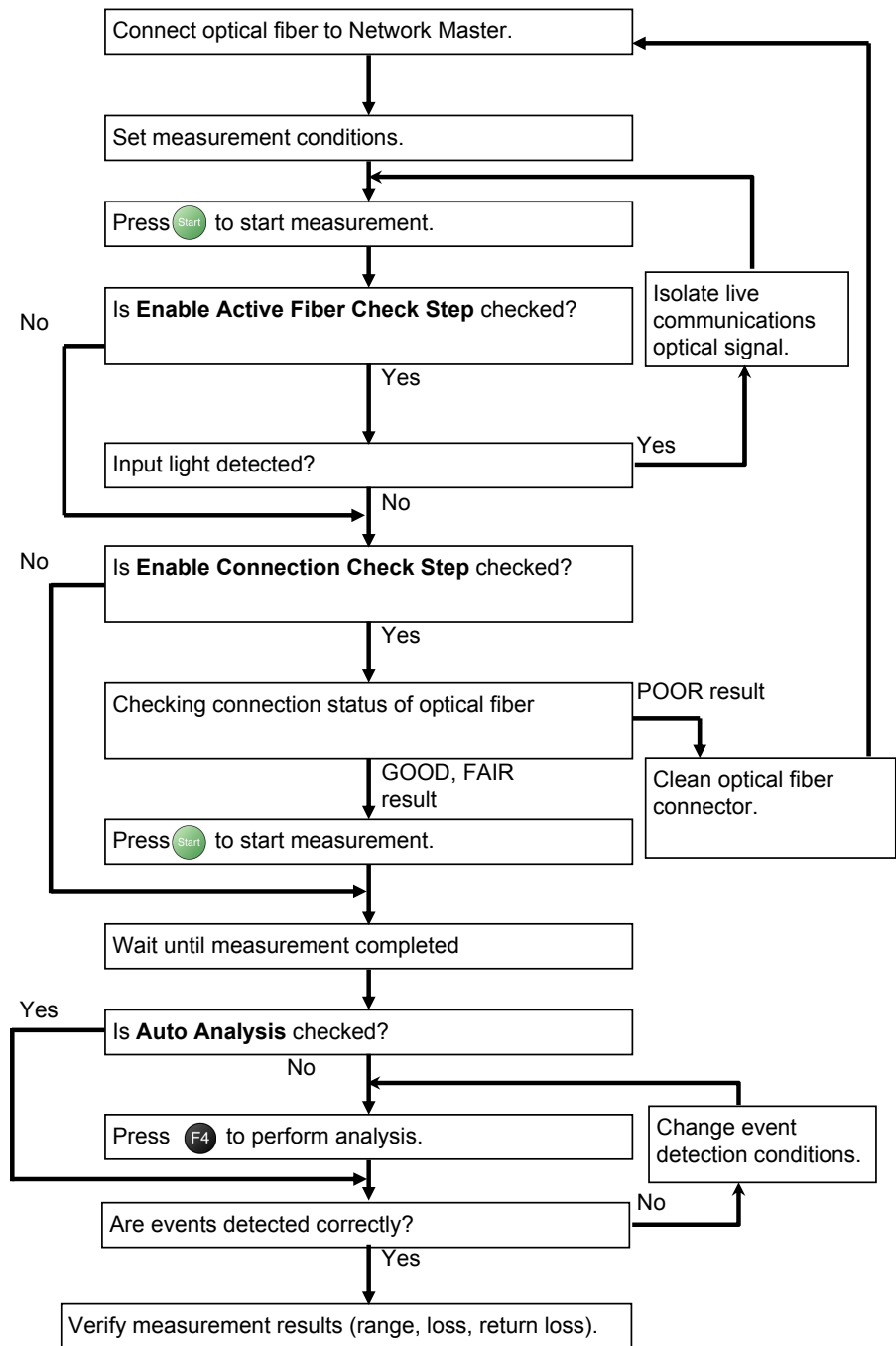

Figure 4.1-1 Optical Fiber System Measurement Procedure

4.2 Setting Parameters and Preferences

Set the following items before measurement.

- **Measurement Conditions**
 - Wavelength
 - Optical fiber characteristics (IOR, BSC)
 - Measurement conditions (measurement distance, resolution, pulse width, averaging time)
 - Loss measurement method
- **Measurement Methods**
 - Whether or not to execute pre-measurement connection check.
 - Whether or not to execute pre-measurement live communications signal check.
 - Whether or not to execute post-measurement trace analysis.
- **Measurement Results**
 - Whether or not to display instrument internal fiber waveform.
 - Whether or not to display cursor position when setting fiber characteristics (IOR, BSC).
 - Whether or not to set distance range units.
- **Methods for Saving Measured Results**
 - Whether or not to automatically save a file after measurement.
 - Whether or not to automatically create a file name (character string, date, wavelength, start number).

4.2.1 Setting Measurement Conditions (Test Setup)

The following items are set in the Test Setup screen.

Table 4.2.1-1 Optical Fiber Test Setup Items

Item	Function	Parameters	Default
Full Auto	Distance Range, Resolution, Pulse width, and Averaging count are set automatically. Setting this function to ON sets Apply to All Wavelength to ON.	Off, On	On
Apply to All Wavelength	The following items are set to the same values for all wavelengths. Range, Resolution, Pulsewidth, Averaging	Off, On	On
Range* ^{1, *2, *3, *4}	Sets maximum distance range.	[mi]: Auto, 0. 3, 0. 6, 1. 6, 3. 1, 6. 2, 15. 5, 31. 1, 46. 6, 77. 7, 155. 3 [ft]: Auto, 1640, 3281, 8202, 16404, 32808, 82021, 164042, 246063, 410105, 820210 [kf]: Auto, 1.64, 3.281, 8.202, 16.404, 32.808, 82.021, 164.042, 246.063, 410.105, 820.210 [m]: Auto, 500, 1000, 2500, 5000, 10000, 25000, 50000, 75000, 125000, 250000 [km]: Auto, 0.5, 1, 2.5, 5, 10, 25, 50, 75, 125, 250	Auto* ⁵
Resolution* ²	Set the display resolution.	Coarse, Medium, Fine* ¹	Medium
Pulsewidth* ^{1, *2}	Set the pulse width. “us” indicates microseconds (μs).	Auto, 5 ns, 10 ns, 20 ns, 50 ns, 100 ns, 200 ns, 500 ns, 1 us, 2 us, 5 us, 10 us, 20 us* ¹	Auto* ⁵
Averaging* ²	The averaging time is set when Test Mode is Average.	Auto, 1, 5, 10, 15, 30, 45, 60, 90, 120, 180	Auto

*1: Refer to Table 4.2.1-2 for the combination of the distance range value and settable pulse width.

*2: Available only when the **Full Auto** check box is not selected (Off).

*3: Refer to Table 4.2.1-3 “Wavelength and Fiber Type Combination” for the combination of the OTDR wavelength and settable Fiber Type.

*4: Auto or 0.5 to 10 km are available for DCFL.

*5: 1 km / 10ns for DCLF

Table 4.2.1-1 Optical Fiber Test Setup Items (Cont'd)

Item	Function	Parameters	Default
Macro Bend Analysis	Enable the macrobend detection. This function can be used when the Test Mode is set to Dual WL.	Off, On	Off
PON	<p>Set the numbers of “splitters” and “branches in each splitter”, respectively.</p> <p>When each of Range, Pulsewidth and Averaging is set to Auto, it is set to the value appropriate for locating faults in the PON from the subscriber’s home, according to the numbers of “splitters” and “branches in each splitter”.</p> <ul style="list-style-type: none"> The number of splitters If Detection is selected, the number of splitters is detected automatically. The number of branches in each splitter If 1x?? is selected, the number of branches is detected automatically. 	<p>The number of splitters: 1, 2, 3, Detection, None</p> <p>The number of branches in each splitter: 1x2, 1x4, 1x8, 1x16, 1x32, 1x64, 1x128, 1x??</p>	None
Fiber Type*3	Set the fiber cable type to be connected.	Refer to Table 4.2.1-3 “Wavelength and Fiber Type Combination”.	Other
IOR	The connected fiber IOR is set.	1.3000 to 1.7000 0.0001 steps	1.4677*6 1.4680*7 1.4682*8 1.4685*9
BSC	<p>When using a special optical fiber, set the backscatter coefficient.</p> <p>This is not changed at normal fault detection.</p>	-90.0 to -40.0 0.01 steps	-78.50*6 -81.10*7 -81.50*8 -82.50*9
Loss Mode	Set the loss measurement methods displayed at the Trace View screen.	2-Pt Loss, Splice Loss, dB/km Loss, dB/km LSA(A), dB/km LSA(B), ORL*10, Event	Event*11 2-Pt Loss*12
Test Mode*15	Set whether to use real time or averaging time.	Average, Real Time, Dual WL	Average
Wavelength *13, *14 *15	Set the measurement wavelength.	1310 nm, 1550 nm, 1625 nm, 1650 nm	1310 nm

*6: Wavelength 1310 nm

*7: Wavelength 1490 nm

*8: Wavelength 1550 nm

*9: Wavelength 1625 nm, 1650 nm

- *10: If the density of the resolution is ultra-high, it takes some times to measure the return loss.
- *11: When the Test Mode is **Average**.
- *12: When the Test Mode is **Real Time**.
- *13: Displayed on only two-wavelength or three-wavelength model.
- *14: Depends on the model, refer to Table 1.1-1
- *15: For DCFL, the setting can not be changed from the default.

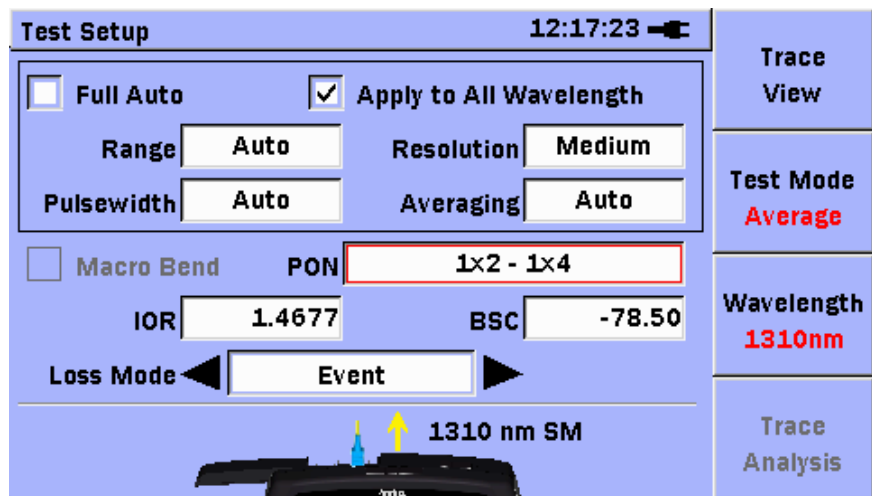

Figure 4.2.1-1 Test Setup Screen

Set the measurement conditions as follows.

1. Press **F1 (Test Setup)** in any of the following screens.
 - Connection Check Step screen (when connection check stopped)
 - Trace Analysis screen
 - Trace View screen (when measurement stopped)

2. Set the measurement mode.

Press **F2 (Test Mode)** to select **Average, Real Time, or Dual WL**.

Note:

Set the wavelength to 1310 or 1550 nm when selecting **Dual WL**.

3. Press **F3 (Wavelength)** to select wavelength.

In addition, an up arrow indicating optical connector, wavelength, optical fiber type to be used, and laser output is displayed at the bottom of the screen.

Note:

When **Dual WL** is selected, you can select the only 1310/1550 nm wavelength.

4. Use , , , and to select item.

- Select the **Full Auto** check box when the following items are set to **Auto**.

Press  to select the item(s).

- Range
- Resolution
- Pulsetwidth
- Averaging
- Apply to All Wavelength

Note:

When the **Full Auto** check box is selected, the display of five items in the box changes as follows:

Range, Pulsetwidth: Auto

Averaging: **Auto** when the Test Mode is Average or Dual WL
Real Time when the Test Mode is Real Time

Resolution: When the Test Mode is Average or Dual WL,
 • **Medium** if **PON** is set to **None**.
 • **Coarse** if **PON** is set to other than **None**.
Coarse when the Test Mode is Real Time.





Apply to All Wavelength: On

- When each of the following items is set to **Auto**, set the splitter so that it is set to the value appropriate for locating faults in the PON from the subscriber's home.

- Range
- Pulsetwidth
- Averaging

Note:

Optimum auto-setting is applied only to items that are Auto.

- Use , , , and  to select **PON**, press . A pop-up window to set PON appears.

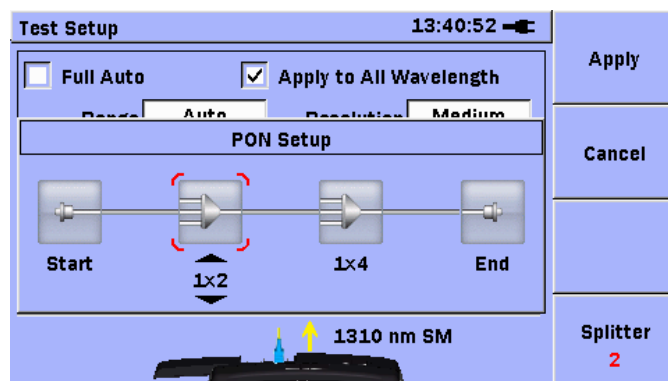

Figure 4.2.1-2 PON Setup pop-up window

- (2) Press **F4 (Splitter)** to set the number of splitters.
 - (3) Use **←** and **→** to select a splitter, and use **▲** and **▼** to set the number of branches.
 - (4) Press **Set**.
7. When the **Full Auto** check box is not selected, make the following settings:
- (1) Use **▲**, **▼**, **←**, and **→** to select **Range**, **Pulsewidth**, or **Resolution**.
 - (2) Press **Set**. A pop-up window appears.

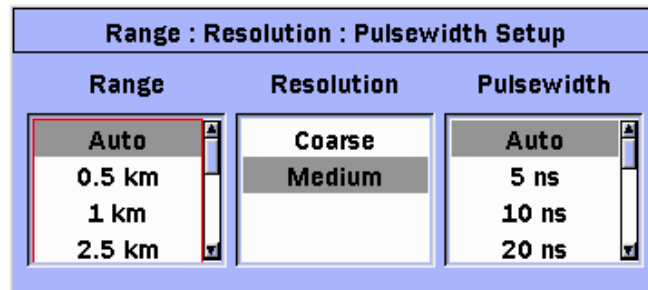

Figure 4.2.1-3 Range: Resolution: Pulsewidth Setup pop-up window

- (3) Use **←** and **→** to move the highlight to the desired selection.
- (4) Use **▲** and **▼** to move the highlight to the desired selection.
- (5) Repeat steps (3) through (4).
- (6) When the settings is complete, press **Set**.
- (7) When the Test Mode is **Average**, use **▲**, **▼**, **←**, and **→** to select **Averaging**.
- (8) Press **Set**, and a pop-up window appears

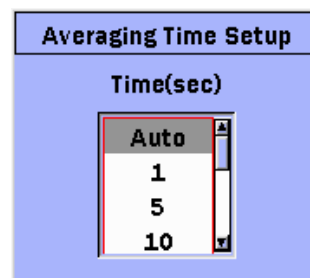



















Figure 4.2.1-4 Averaging Time Setup pop-up window

- (9) Use  and  to change the desired setting.
When Resolution is Fine, only Auto or values more than 30 can be selected.
- (10) When the settings is complete, press .
- (11) Use , , , and  to select **Apply to All Wavelength**.
- (12) To reflect the setting to all the wavelengths, press  to select the item.
- (13) Use , , , and  to select **Macro Bend Analysis**.
- (14) To detect the macrobend, press .
8. Use , , , and  to select **IOR** or **BSC**, and then press .





The IOR or BSC Setup pop-up window is displayed.

When the wavelength is 1310 nm, 1550 nm, or 1625 nm, Fiber Type can be selected. When Fiber is changed, the IOR and BSC values of the selected optical fiber cable are displayed.

When IOR Length Adjustment at the Setup-Preferences screen is selected, the position of the cursor selected at the Trace View screen is displayed.

When IOR is changed, the cursor position changes.

If the length of the fiber is known, align the cursor with the end of the fiber and set the IOR so that the cursor position matches the fiber length.

- (1) Use  and  to highlight the item.
- (2) Use  and  to change the setting.
- (3) Repeat steps (1) and (2).
- (4) When the setting is complete, press .

Note:

When IOR and BSC are changed, the loss at the Trace View and Trace Analysis screens is recalculated.

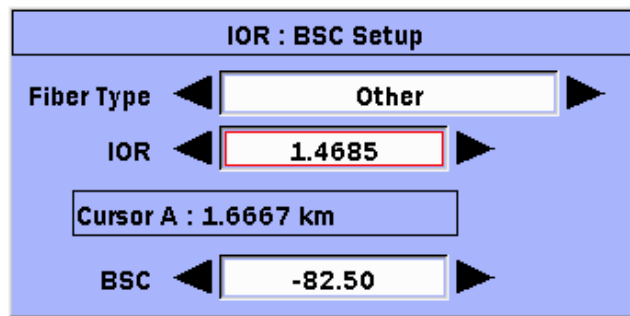

Figure 4.2.1-5 IOR BSC Setup Pop-up Window (with cursor)

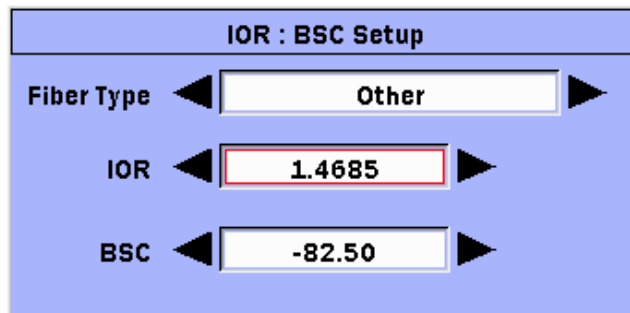

Figure 4.2.1-6 IOR: BSC Setup IOR BSC Setup Pop-up Window (without cursor)





9. Use  and  to select **Loss Mode**.
10. Use  and  to select the desired loss mode.

Table 4.2.1-2 Range, Resolution, and Pulse Width Combinations

		Range									
		0.3	0.6	1.6	3.1	6.2	15.5	31.1	46.6	77.7	155.3
Mile		0.3	0.6	1.6	3.1	6.2	15.5	31.1	46.6	77.7	155.3
ft		1640	3281	8202	16404	32808	82021	164042	246063	410105	820210
km		0.5	1	2.5	5	10	25	50	75	125	250
Pulsewidth	5 ns	✓	✓	✓	✓	✓	✓	✓	✓	✓	✓
	10 ns	✓	✓	✓	✓	✓	✓	✓	✓	✓	✓
	20 ns	✓	✓	✓	✓	✓	✓	✓	✓	✓	✓
	50 ns	✓	✓	✓	✓	✓	✓	✓	✓	✓	✓
	100 ns	✓	✓	✓	✓	✓	✓	✓	✓	✓	✓
	200 ns				✓	✓	✓	✓	✓	✓	✓
	500 ns					✓	✓	✓	✓	✓	✓
	1 us						✓	✓	✓	✓	✓
	2 us							✓	✓	✓	✓
	5 us								✓	✓	✓
	10 us								✓	✓	✓
	20 us									✓	✓

✓: Available

Table 4.2.1-3 Wavelength and Fiber Type Combination

Fiber	Wavelength				
	1310	1490	1550	1625	1650
AT&T TrueWave 95	✓		✓		
Alcatel ESF	✓		✓		
Alcatel SF	✓		✓		
Alcatel TL Metro	✓		✓		
Alcatel TL Ultra			✓		
Alcatel Teralight			✓		
Corning LEAF	✓		✓	✓	
Corning SMF-28/e	✓		✓	✓	
Corning SUB SMF-1s			✓		
G.652	✓		✓		✓
G.653			✓		
G.655			✓		
IOR=1.48	✓		✓	✓	
Lucent AllWave	✓		✓		
Lucent TW 97	✓		✓		
Lucent TW RS 98	✓		✓	✓	
Pirelli			✓		
SIECOR/Corning SMF-28e	✓		✓		
Sumitomo PureGuide			✓		
Sumitomo SM OF SE-3	✓		✓		
Others	✓	✓	✓	✓	✓

✓: Available





4.2.2 Setting Measurement Method (Setup-Preferences)





The following items are set at the Setup–Preferences screen.

Table 4.2.2-1 Setup-Preferences Items

Item	Function	Default
Enable Connection Check Step	Performs a connection check before the measurement start.	On
Enable Active Fiber Check Step	Performs a “live fiber” check on the currently connected fiber under test to check whether the fiber is carrying traffic before measurement.	On
Auto Analysis	Automatically performs OTDR trace analysis at the completion of data collection for the current fiber under test. If a trace is not detected, trace analysis cannot be performed. Note: Auto Analysis is always enabled for Fiber Visualizer function.	On
Show Internal Launch Fiber	Displays the instrument internal fiber trace in the Trace View screen.	On
IOR Length Adjustment	Displays the cursor position in the IOR and BSC pop-up windows of the Test Setup screen.	Off
Distance Units	Sets the distance units displayed at Trace Analysis in the Trace View screen. Select from Miles, Feet, Kilofeet, Meters, and Kilometers.	Kilometers
Save Format	Selects a format for saving measured trace as a file. The size of files saved in the XML and SOR&XML formats is relatively larger than files saved in the SOR format and such files take a longer time to complete save processing. If you select ZIP , multiple waveform files with different wavelengths are saved to a single file.	SOR
Fiber Group	Selects Fiber Type is displayed on IOR:BSC Setup screen. Selected Fiber Type can be saved in Fiber Group2 or Fiber Group3. The Fiber Type of Fiber Group1 cannot change.	Fiber Group1
Event icon movement*	Selects the icon movement direction by pressing the arrow keys on Fiber Visualizer screen.	Left to Right
End event for ORL*	Selects whether to include end event for calculation of the total optical return loss.	INCLUDE

*: Available only for Fiber Visualizer function.

1. Press  to display the General Functions pop-up menu.
2. Press  and  to select **Setup**, and then press  to display the Setup screen.

3. Press **F2** (**Preferences**) to display Setup-Preferences screen. There are the tabs 1 and 2 in the Set-up screen.
4. Use , , , and  to select the tab 1.

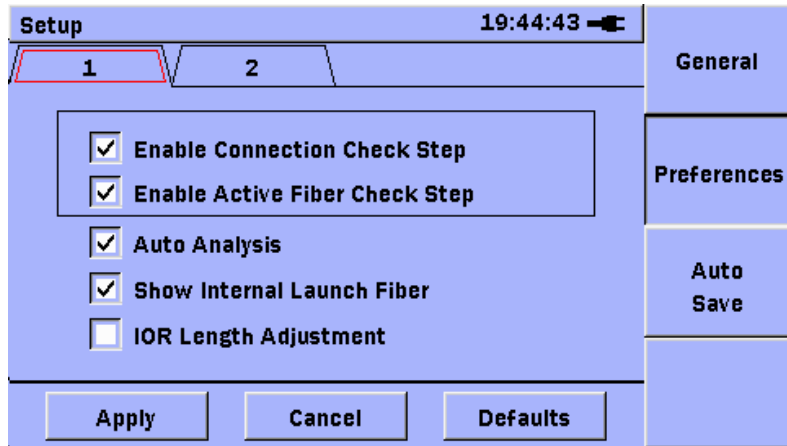









Figure 4.2.2-1 Setup-Preferences Screen 1

5. Use  and  to select the item. Press  to select or clear the item.
6. When the changes completed, use , , , and  to select the tab 2, and press .

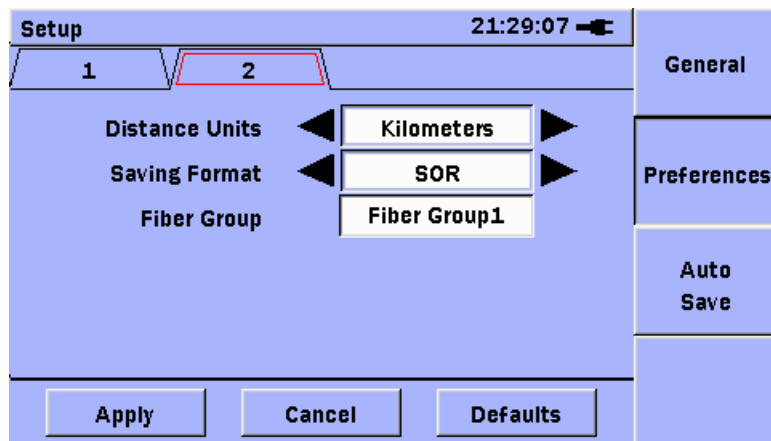

Figure 4.2.2-2 Setup-Preferences Screen 2

Note:

Event icon movement and End event for ORL are displayed for Fiber Visualizer function.

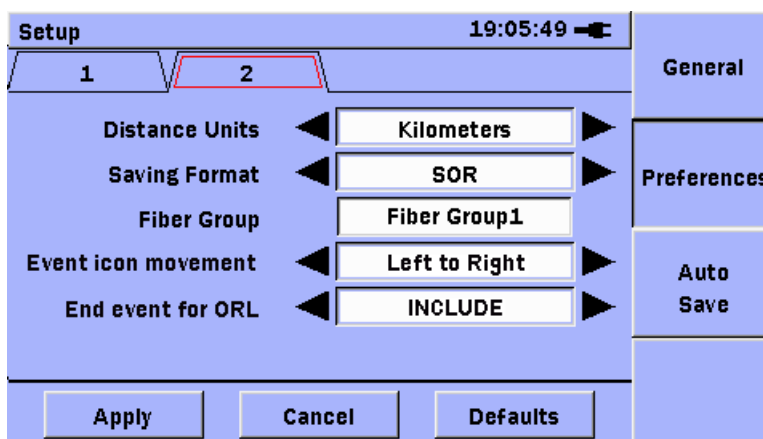







































Figure 4.2.2-3 Setup-Preferences Screen 2

7. Use  and  to select **Distance Units**.
 8. Use  and  to select the unit of distance listed in Table 4.2.2-1.
 9. Use  and  to select **Saving Format**.
 10. Use  and  to select the format.
 11. Use  and  to select Fiber Group, and then press  to displays the Fiber Group screen.
 12. Use  and  to select the Type.
 13. Use  and  to select the Fiber Group.
 14. Use  and  to select the desired Fiber Type, and then press  to select (clear) the check box.
Press  to select all Fiber Type.
Press  not to select all Fiber Type.
 15. Press  to apply the changes.
Press  to close the Fiber Group screen.
 16. Use  and  to select **Event icon movement**.
 17. Use  and  to select the icon movement direction.
 18. Use  and  to select **End event for ORL**.
 19. Use  and  to select whether to include end event in calculation.
 20. When completed, use , , , and  to select **Apply**, and then press . To cancel, select **Cancel**, and then press .
- To restore default settings shown in Table 4.2.2-1, select **Defaults**, and then press .

4.2.3 Setting Auto Save Mode (Setup-Auto Save)





The following items are set in the Setup–Auto Save screen.

Table 4.2.3-1 Setup-Auto Save Screen Items

Item	Function	Default
Enable Auto File Name	Automatically generates the names of files to save.	Off
Enable Auto Save	Automatically saves files upon completion of each measurement .	Off
Auto Save Device	Displays the device to which files will be saved.	*
Filename Prefix	Sets a character string to be appended to automatically generated file names.	auto
Date	Appends date to automatically generated file names.	Off
Wavelength	Appends wavelength to automatically generated file names. Note: When ZIP is selected as a format for saving waveforms, this item is fixed to Off .	Off
Sequence Number	Sets a start number of automatically generated file names.	1

*: **Internal** is displayed when the USB memory is not connected, and **USB** is displayed when the USB memory is connected.

Change the auto-save settings using the following procedure.

1. Press  to display the General Functions pop-up menu.
2. Press  and  to select **Setup**, and then press  to display the Setup screen.
3. Press  (**Auto Save**) to display the Setup-Auto Save screen.

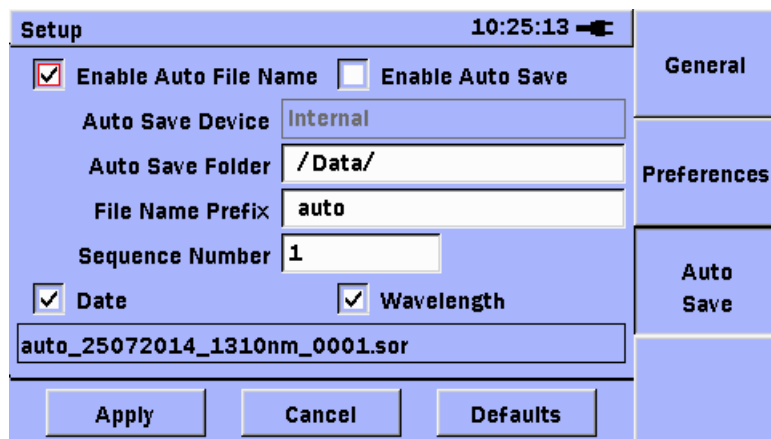









































Figure 4.2.3-1 Setup-Auto Save screen

4. Use  and  to select **Enable Auto File Name**.
5. Press  to select the check box, and the file name will be automatically generated. If the check box is cleared, the file name

cannot be automatically generated.

If not selected, the file name can be input when saving a file.

6. Use  and  to select **Enable Auto Save**.
7. Auto Save is enabled when  is pressed to select the check box. If the check box is cleared, Auto Save is disabled.
8. Use  and  to select **Auto Save Folder**.
 - (1) Press  to display the Select Folder screen.
 - (2) Use , , , and  to select a folder to save the measurement results.
 - (3) Press  (**Select**) to set the selected folder and to close the folder selection screen.
 - (4) The selected folder path is displayed as **Auto Save Folder** on the setting screen.
9. Use  and  to select File Name **Prefix**.
 - (1) Press  (**Title**) to display the entry screen for the character strings.
 - (2) Use , , , and  to select the desired letter in the character matrix.
 - (3) Press  to add the selected letter to the name field.
 - (4) Repeat steps (2) and (3). Up to 21 characters can be used.
 - (5) When the name is completed, press  (**OK**). To cancel, press  (**Cancel**).

Refer to Section 3.6 “Using Softkey Board” for details about character input.
10. Use , , , and  to select **Date**.
11. Press  to select the check box and append the date to the automatically generated file name. If the check box is cleared, the date cannot be appended to automatically generated file names.
12. Use , , , and  to select **Wavelength**.
13. Press  to select the check box and append the wavelength to the automatically generated file name. If the check box is cleared, the wavelength cannot be appended to automatically generated file names.
14. Use  and  to select **Sequence Number**.
 - (1) Press  to display the numeric keypad.
 - (2) Use ,  to set the starting sequence number for automatically-created file name as a number within 4 digits.
 - (3) Press  to input the number.

15. The name of the file that is automatically saved first is displayed in the frame.

In Figure 4.2.3-1, it is auto_25072014_1310nm_0001.sor.

16. When completed, use , , , and  to select **Apply**, and then press . To cancel, select **Cancel**, and then press .

To restore the defaults as shown in Table 4.2.3-1, select **Defaults**, and then press .

4.3 Starting Measurement

Press  at the next screen to start measurement.

- Connection Check screen
- Test Setup screen
- Trace Analysis screen
- Trace View screen

Select the **Enable Active Fiber Check Step** check box to check the existence of a live communications optical signal.

If a live communications optical signal is detected, a message is displayed and measurement is stopped.

Select the **Enable Connection Check Step** check box in the Measurement Function Settings screen to display the Connection Check screen.



4

Locating Fiber Faults

4.3.1 Checking Connection



Figure 4.3.1-1 Connection Check Step screen

- [1] Connection status indicator
Displays the status of the optical fiber cable connector as GOOD (green background), FAIR (yellow background), or POOR (red background).
- [2] Detailed connection status display field
Displays the details of the current connector status.
- [3]  (Test Setup)
Displays the Test Setup screen.
- [4]  (Stop)
Aborts connection check.
To resume connection check, press .

- [5] **F3 (Continue)**
Starts measurement after connection check result is displayed.
- [6] Connection figure
Displays the wavelength port for measurement.



4.3.2 Operation Depending on Connection Check Result

Perform the following operation depending on the result of the connection check.



Note:

If the Dual WL is selected at Test Mode, Connection Check is measured with 1550 nm

- **GOOD:**

If the good status lasts for three seconds or more, the test will automatically advance and the Trace View screen is displayed. Press  or  (**Continue**) to immediately display the Trace View screen.



- **FAIR:**

Press  or  (**Continue**) to display the Trace View screen.

- **POOR:**

Consider the following possible causes:

POOR connector connection status

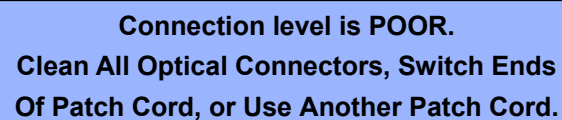

There is a possibility that the connector connection status is bad. Press  (**Stop**) to stop the connection check and clean the connector. After completing cleaning, press  again and run the connection check.



**Connection level is POOR.
Clean All Optical Connectors, Switch Ends
Of Patch Cord, or Use Another Patch Cord.**

Figure 4.3.2-1 POOR connection status

Short optical fiber cable connection

There is a possibility that the connection check function does not work. In this case, press  or  (**Continue**) to start the measurement.

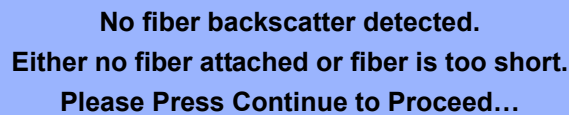

**No fiber backscatter detected.
Either no fiber attached or fiber is too short.
Please Press Continue to Proceed...**

Figure 4.3.2-2 Short optical fiber cable connection

Note:

This function checks the connection status of the optical fiber cable with no connectors for at least 50 m. Disable this function when connecting several short optical fiber cables, such as patch cords.



4.4 Viewing Trace

4.4.1 Trace View

When the measurement starts, the Trace View screen appears.

To stop measurement, press .

The Trace View screen can also be accessed by doing any of the following:

- Pressing  (Trace View) in the Test Setup screen.
- Pressing  (Trace View) in the Test Analysis screen.

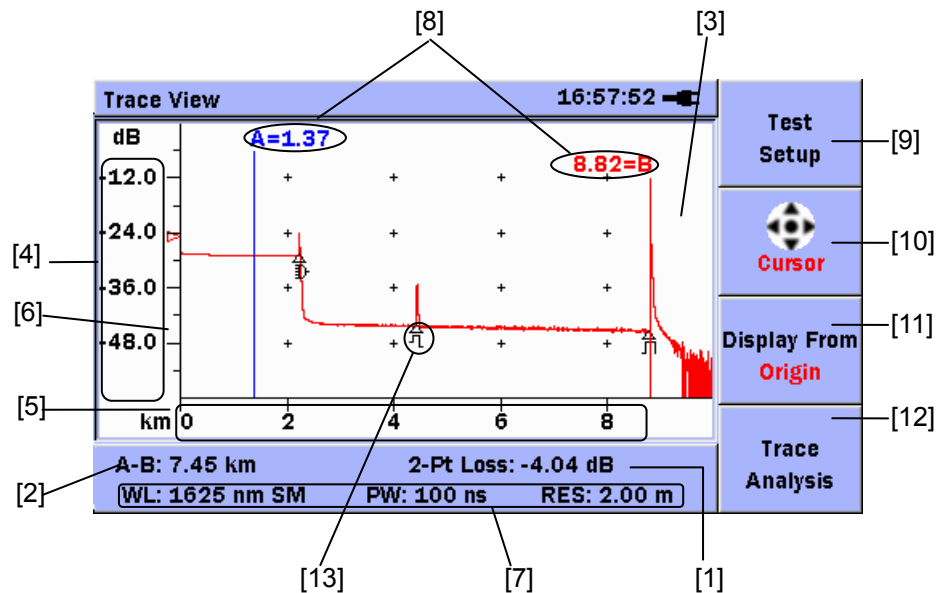

Figure 4.4.1-1 Trace View Screen (When Loss Mode is not Event)

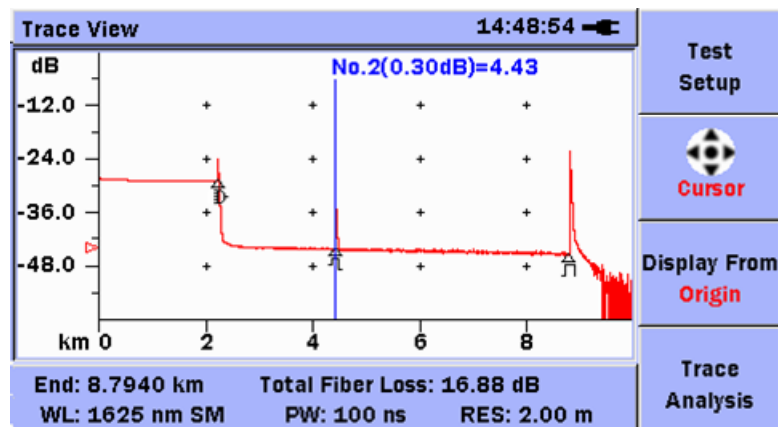

Figure 4.4.1-2 Trace View Screen (When Loss Mode is Event)

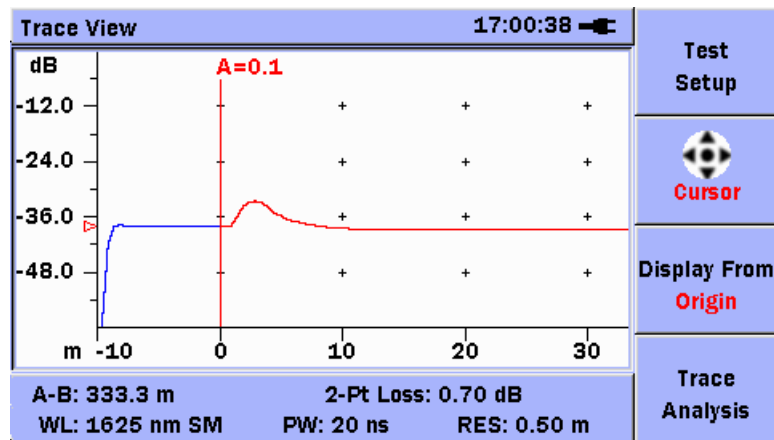

Figure 4.4.1-3 Trace View Screen (with internal fiber displayed)

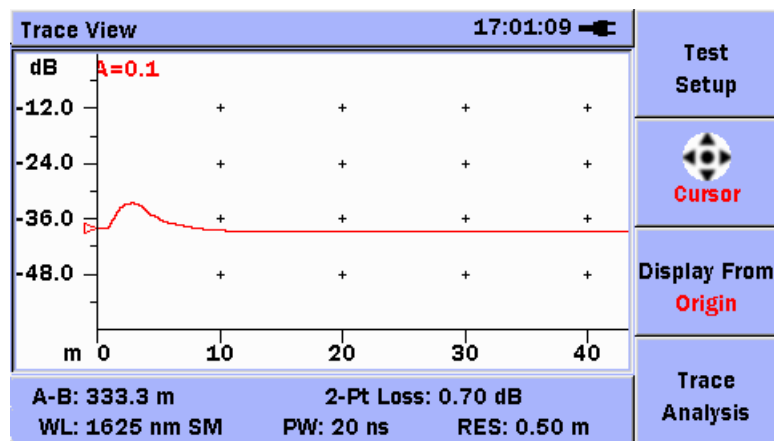









Figure 4.4.1-4 Trace View screen (without internal fiber displayed)



- [1] Loss mode, measured loss value
The loss measurement method and measured loss are displayed in the following units.
[2-pt Loss], [Splice Loss], [ORL], [Event]: dB
[dB/km Loss], [dB/km Loss LSA]: dB/km
There is no display during averaging measurement.
- [2] Cursor A-B Distance/Fiber Far End Display Field
When the Loss Mode is not Event, the distance between cursor A and cursor B is displayed in the distance units (km, m, ft, kf, mi) set in the Measurement Function Settings screen.
When the Loss Mode is Event, the far end of the optical fiber cable is displayed in the distance units set in the Measurement Functions Setting screen.
- [3] Trace graph
Displays measured waveform.





- [4] Graph y-axis
Displays trace level scale (dB).
- [5] Graph x-axis
Displays distance scale.
Displays distance units (km, m, ft, kf, mi) set in the Measurement Function Settings screen.
- [6] Level indicator
Displays level of trace selected by cursor at ▷ symbol on y-axis.
Refer to item [8] for the cursor selection method.
- [7] Measurement conditions
Displays following values:
WL: Wavelength
PW: Pulse width
SM: Single-mode fiber
RES: Resolution
- [8] Cursor A, Cursor B/Event Cursor
When the Loss Mode is not Event, Cursor A and Cursor B are displayed as vertical lines on the waveform trace; when Loss Mode is Event, the Event cursor is displayed as a vertical line on the waveform trace. The cursor position **distance from origin at 0 m or 0 ft** is displayed on the cursor. The loss value and cursor position are displayed above the event cursor. The distance units are the units set in the Test Setup screen (km, m, ft, kf, mi). The operation of cursor is described below.

Before operating cursors, verify that **Cursor** is displayed at . If **Zoom** is displayed, press  to switch to the **Cursor** mode.









For the case of Cursor A and Cursor B

- The selected cursor is switched each time  is pressed.
The selected cursor is displayed in red and cleared cursors are displayed in blue.
- Press  and  to move the selected cursor left and right. Hold down  and  to move the cursor faster.

The movement of the cursor and trace in the trace display field when  and  are pressed differs according to the display origin setting. Refer to item [11] for the origin settings.

- Press  and  to move the selected cursor to the event position. Press  to move the cursor from the current position to the event closest to the start of the trace (left side). Press  to move the cursor to the event closest to the end of the trace (right side).

For the case of Event cursor

- The cursor is always blue and indicates the event position.
- Press  and  or  and  to move the cursor the adjacent event.
- Press  or  to move the cursor from the current position to the event closest to the start of the trace (left side).
- Press  or  to move the nearest event cursor in the end point direction (right).

Refer to section 4.4.2 “Using Cursor” for the cursor operation procedure.

[9]  (Test Setup)



Press  (Test Setup) to display the Test Setup screen.

Refer to section 4.2.1 “Setting Measurement Conditions (Test Setup)” for details.

[10]  (Cursor),  (Zoom)

Cursor and Zoom are switched each time  is pressed.

[11]  (Display From/Origin),  (Display From/A),
 (Display From/B),  (Display From/Event)

The trace display origin is switched each time  is pressed. The contents of  are the current setting.







Refer to the following for the display origin setting and operation.



- Origin: The start point (left end) of the horizontal axis of the trace display field becomes the start point of the measured trace.

When the internal fiber display is enabled, the start point of the horizontal axis of the trace display field becomes the start point of the internal fiber.

When the internal fiber display is disabled, the start point of the horizontal axis of the trace display field becomes the optical connector of the Network Master.

Select the whole fiber or the part of the trace around the start to verify, etc.

- A: The center of the horizontal trace field is fixed at the position of cursor A.
When cursor A is selected in this condition and  and  are pressed, the entire measured trace can be shifted left or right.
Select the trace around cursor A to be verified.
- B: The center of the horizontal trace field is fixed at the position of cursor B.
When cursor B is selected in this condition and  and  are pressed, the entire measured trace can be shifted left or right.
Select this when you want to confirm the trace near cursor B.
- Event: The center of the horizontal trace field is fixed at the position of event cursor. Press  and  in this condition to move the event cursor to the left and right of the event. Select this when you want to confirm the trace near the event.

[12]  (**Trace Analysis**)/ (**Mode**)

At Average measurement, or when measurement is stopped:
Press  (**Trace Analysis**), and the Trace Analysis screen is displayed.

Refer to section 4.5 “Analyzing Trace” for the Trace Analysis screen.

At Real Time measurement:

Fast and High S/N are switched each time  (**Mode**) is pressed.

The measurement speed is faster when Fast is set.

The noise is suppressed when High S/N is set.

[13] Event Marker









When an event is detected in the Trace Analysis screen, the corresponding event is displayed.

Refer to Table 4.5.1-1 “Event Type List” for details of events.

4.4.2 Using Cursor

Cursor mode

In the Cursor mode, cursors displayed on the trace display field can be moved. This is used to measure distance between cursors and for loss analysis. Combined use with the Zoom mode supports even finer analysis. Move the cursors as described in the following procedure.

1. Press **F3** to switch the trace origin.
2. If **Zoom** is displayed at **F2**, press **F2** to switch to the Cursor mode.
3. For cursor A and cursor B, press **Set** to select the cursor to move. The selected cursor is displayed in red. The Event cursor is always displayed in blue.
4. For cursor A and cursor B, press  and  to move the selected cursor left and right. Hold down  and  to move the cursor faster. For the Event cursor, press  and  to move the cursor left and right to the nearest event position.
5. Press  and  while cursor A or B is selected to move the cursor to the event position. For the Event cursor, the cursor moves to the adjacent event.

The displayed cursor differs according to the Loss Mode setting.

Table 4.4.2-1 Trace View screen

Loss Mode Cursor	2-pt Loss	Splice Loss	dB/km Loss	dB/km Loss LSA	ORL	Event
Cursor A	✓	✓	✓	✓	✓	
Cursor B	✓	✓	✓	✓	✓	
LSA1		✓		✓		
LSA2		✓		✓		
LSA3		✓		✓		
LSA4		✓		✓		
Event						✓

✓: Displayed cursor

The operation of the LSA1, LSA2, LSA3, and LSA4 cursors differs according to the Loss Mode.

When Loss Mode is Splice Loss:

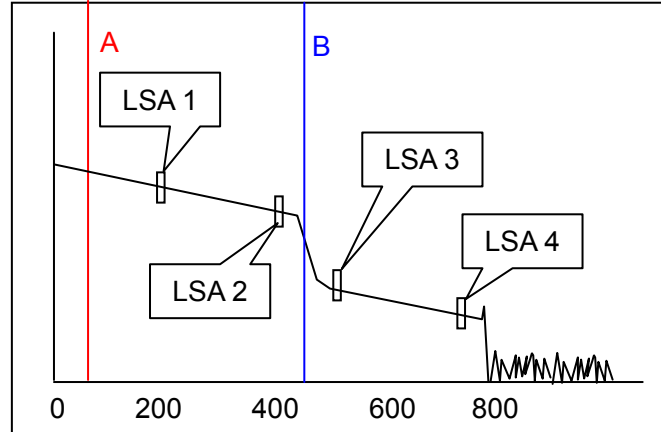



Figure 4.4.2-1 Splice Loss Cursor Display

Press  to select the cursor in the sequence of A, B, LSA 1, LSA 2, LSA 3, and LSA 4.

Cursors LSA 1 and LSA 2 are displayed in the left of Cursor B.

Cursor LSA 1 is displayed in the left of Cursor LSA 2.

Cursors LSA 3 and LSA 4 are displayed in the right of Cursor B.

Cursor LSA 3 is displayed in the left of Cursor LSA 4.

When Cursor B moves, Cursors LSA 1 to 4 move as well.

When Loss Mode is dB/km Loss LSA:

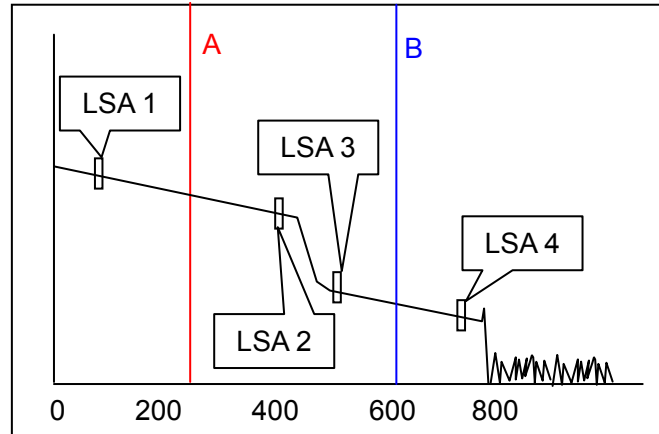



Figure 4.4.2-2 dB/km Loss LSA Cursor Display

Press  to select the cursor in the sequence of A, B, LSA 1, LSA 2, LSA 3, and LSA 4.

Cursors LSA 1 and LSA 2 are displayed in the left and right of Cursor A, respectively.

Cursor LSA 1 is displayed in the left of Cursor LSA 2.

Cursors LSA 3 and LSA 4 are displayed in the left and right of Cursor B, respectively.

Cursor LSA 3 is displayed in the left of Cursor LSA 4.

When Cursor A moves, Cursors LSA 1 and LSA 2 move as well.

When Cursor B moves, Cursors LSA 3 and LSA 4 move as well.

4.4.3 Zooming in and out Trace Display

Zoom mode

The Zoom mode enlarges and reduces (zooms in and out) the size of the trace in the trace display field. It is useful for verifying event details.

The appearance of the zoomed trace differs according to the display origin setting.

- A, B: The trace is zoomed in and out centered on the trace level and cursor position of the display origin selected by **F3**.
- Origin: The trace is zoomed in and out centered on the waveform start point and trace level 0 dB.
- Event: The trace is zoomed in and out centered on the trace level and event cursor position.

Zoom in and out the trace as described below.

When display origin is cursor A or B:





1. If **Cursor** is displayed at **F2**, press **F2** to switch to the Zoom mode.
2. Press **F3** to switch the cursor used as the center of zooming in and out. When zooming in or out vertically, centering is performed on the trace level of the cursor for the display origin selected by **F3**. When zooming in or out horizontally, centering is performed centered on the position of the cursor for the display origin selected by **F3**.
3. Press **Set** to select the same cursor as the cursor for the display origin selected by **F3**. The selected cursor is displayed in red.
4. Press  to zoom out the trace horizontally, centering on the cursor for the display origin selected by **F3**.

Press  to zoom in the trace horizontally, centering on the cursor for the display origin selected by **F3**.

Press  to zoom in trace vertically, centering on the trace level of the cursor for the display origin selected by **F3**.

Press  to zoom out the trace vertically, centering on the trace level of the cursor for the display origin selected by **F3**.

When the Loss Mode is Splice Loss or dB/km Loss LSA, the trace can be zoomed in and out, centering on the cursors LSA1 thru LSA4.









1. Press  to set the LSA cursor. The selected cursor is displayed in red.
2. Press , , , and  to zoom in and out.

The following table shows the combination of LSA cursors that can be set to the center, Loss Mode, and display origin.





Table 4.4.3-1 LSA Cursor Combination Supporting Zoom-in/out around Center

		Display Origin	
		A	B
Loss Mode	Splice Loss LSA	–	LSA1, LSA2, LSA3, LSA4
	dB/km Loss LSA	LSA1, LSA2	LSA3, LSA4

When display origin is Origin:

1. If **Cursor** is displayed at , press  to switch to the Zoom mode.
2. Press  to switch to  (**Display From/Origin**).
3. Press  to zoom out the trace horizontally, centering on the trace origin.
Press  to zoom in the trace horizontally, centering on the trace origin.
Press  to zoom in the trace vertically, centering on the trace level 0 dB.
Press  to zoom out the trace vertically, centering on the trace level 0 dB.

When display origin is Event:

1. If **Cursor** is displayed at , press  to switch to the Zoom mode.
2. Press  to switch to  (**Display From/Origin**).
3. Press  to zoom out the trace horizontally, centering on the event cursor.

Press  to zoom in the trace horizontally, centering on the event cursor.





Press  to zoom in the trace vertically, centering on the waveform level of the event cursor.

Press  to zoom out the trace vertically, centering on the waveform level of the event cursor.

4.4.4 Swap Traces

When the measurement starts with Dual WL, two waveforms are displayed in the Trace View screen. The current waveform can be switched between 1310 and 1550 nm waveforms.

To swap trace:

1. Press  to display the General Functions pop-up menu.
2. Select **Swap Traces** with  and , and then press  to switch current waveform.
3. The current waveform is displayed in red.

4.5 Analyzing Trace

Analysis of the measured trace detects points where loss and reflection occur as well as the far end of the fiber as events.

4.5.1 Trace analysis

When **Auto Analysis** is selected in the Setup–Preference screen, the trace is captured by Average measurement and displayed in the Trace Analysis screen.

Operate using any of the following:

- Pressing **F4** (**Trace Analysis**) in the Test Setup screen.
- Pressing **F4** (**Trace Analysis**) in the Trace View screen.

Note:

The Trace Analysis screen is not displayed even if **F4** (**Trace Analysis**) is pressed during measurement or when there is no trace.

The trace analysis results are displayed in the Trace Analysis screen.

Note:

The trace analysis results might not have fully covered all events on the fiber. It should be recommended to take a look at the OTDR trace at the end.

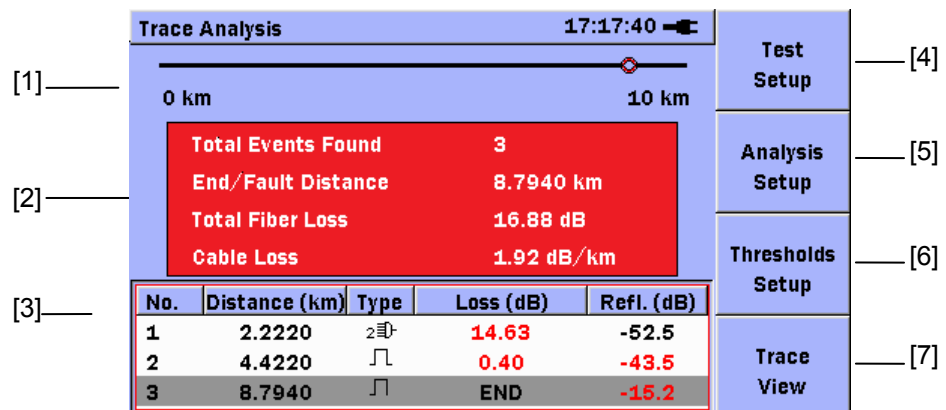

Figure 4.5.1-1 Trace Analysis Screen

[1] Optical fiber schematic

When fault detection is completed, all events are displayed in the event table. Additionally, if the selected event is other than the fiber far end, its position is indicated on the fiber schematic by the Δ symbol.

The far end or a break in the optical fiber cable is indicated by the

☉ symbol. This is displayed when the far end or out-of-range is detected.

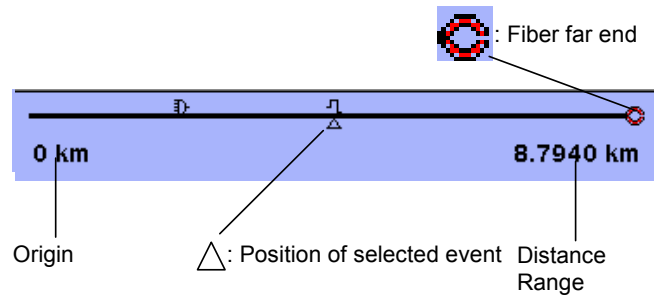





Figure 4.5.1-2 Fiber Schematic

[2] Results display field
Displays the following analysis results:

- Total Events Found
- End/Fault Distance
- Total Fiber Loss
- Cable Loss: This is the total loss of the fiber divided by the distance to the fiber far end or fault point.
- Wavelength

If the far end of the optical fiber is not detected, *** is displayed at Total Fiber Loss and Cable Loss.

[3] Event table
When trace analysis is completed, the event data for the optical fiber cable are displayed. “Splice points exceeding the set threshold value” and “the far end and breaks in the fiber” are displayed in tabulated format. Select the event using  and , and then press  to display the Event Description dialog box.

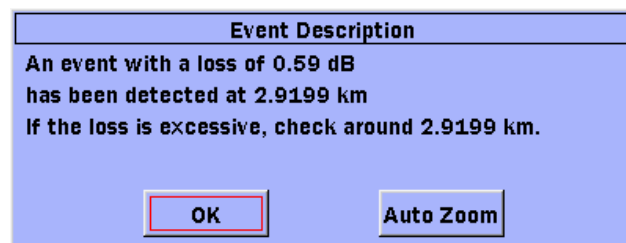







Figure 4.5.1-3 Event Description







Use  and  to select **OK**. Press  to close the **Event Description** dialog box.

Use  and  to select **Auto Zoom**. Press  to display the Trace View with Auto Zoom for the selected Event.

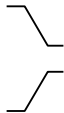
The following information is displayed in the event table.

- No: Displays the number of the fault event counted from left end of the fiber schematic
- Distance: Displays the distance from the main frame optical connector to the event
- Type: Displays the type of the event. The event types are backscatter, non-backscatter, group, far end, out-of-range, and Splitter. Any of the following icons may be displayed, depending on the event.

Table 4.5.1-1 Event Type List

Icon	Type	Description
	Reflective	Reflection from a splice point, such as a Fresnel reflection caused by a mechanical splice or connector.
	Non-Reflective	Non-reflective events include such low loss events as fusion splices and Macro Bends. If the loss is a negative value, the “rising to the right” icon is displayed.
	Grouped	Events spaced too close to each other for Analysis to distinguish them as separate events are reported as Grouped events.
	Far End	Any event with a loss equal to or greater than the Fiber End threshold is reported as the Far End event.
	Questionable End	A Questionable End event is reported, instead of a Far End event, when an Out of Range or Out of Distance condition is encountered. <ul style="list-style-type: none"> • Out of dynamic range If there is noise in the trace before the detected far end/break, the dynamic range is setting is incorrect. Out of Range is displayed at Loss in the event table. • Out of distance range If the end of trace is reached before the detected far end/break, the distance range is incorrect. Out of Dist. is displayed at Loss in the event table.
	Splitter	Loss due to presence of optical fiber cable splitter
	Macro Bend	Reports as an event “Macro Bend” when the detected event exceeds the specified threshold for the Macro Bend. The loss calculated for the event is marked with an M.

- **Loss:** The Loss calculated for the event is displayed. When the event is at the far end or a break in the fiber cable, **END** is displayed.
- **Refl.:** A reflectance value is displayed for all reflective events. ******* is displayed for non-reflective events. In addition to the reflectance value, two other indicators may be present: S or >.
 - S:
Measurement cannot be performed correctly when the level of the reflective event is saturated.
 - >:
The level of the reflection point cannot be measured accurately because a large value is set for the dead zone display resolution.

Note:

If the measured value cannot be determined because the event is too close, ******* is displayed. The event auto-detect function is a secondary function for simple measurement, so measured values are not assured. Sometimes, it will detect events incorrectly so perform final OK/NG evaluation of results by observing the trace.

[4] **F1 (Test Setup)**

Press **F1 (Test Setup)** to display the Test Setup screen.

[5] **F2 (Analysis Setup)**

Press **F2 (Analysis Setup)** to display the Analysis Setup screen.

[6] **F3 (Thresholds Setup)**

Press **F3 (Thresholds Setup)** to display the Thresholds Setup screen.

[7] **F4 (Trace View)**

Press **F4 (Trace View)** to display the Trace View screen.

At this time, cursor A is positioned at 0 and cursor B is positioned at the event selected in the event table. When Loss Mode is Event, an event cursor is positioned at the position of the selected event.

Note:

When changing from the Trace View screen to the Trace Analysis screen without changing the event selected in the event table and then redisplaying the Trace Views screen again, the positions of cursor A and cursor B and the graph display range do not change.

4.5.2 Setting event detection conditions (Analysis Setup)

The event detection conditions are set.

Table 4.5.2-1 Analysis Setup Screen Items

Item	Function	Setting Range	Default
End of Fiber	Sets loss evaluated as end of fiber.	1 to 99	3
Event Loss	Sets absolute loss evaluated as backscatter and non-backscatter events.	0.01 to 9.99	0.05
Reflectance	Sets return loss evaluated as reflectance.	-20.0 to -70.0	-60.0
Macro Bend*	Sets loss when evaluating as macro bends. Macro Bend is used when the Macro Bend Analysis is selected in the Test Setup screen.	0.3 to 2.0	0.3
1x2*	Sets the loss to be evaluated as a 1x2 branch splitter.	0.1 to "Setting value of 1x4" -0.1	3.0
1x4*	Sets the loss to be evaluated as a 1x4 branch splitter.	Between the setting values of 1x2 +0.1 and 1x8 -0.1	6.0
1x8*	Sets the loss to be evaluated as a 1x8 branch splitter.	Between the setting values of 1x4 +0.1 and 1x16 -0.1	9.0
1x16*	Sets the loss to be evaluated as a 1x16 branch splitter.	Between the setting values of 1x8 +0.1 and 1x32 -0.1	12.0
1x32*	Sets the loss to be evaluated as a 1x32 branch splitter.	Between the setting values of 1x16 +0.1 and 1x64 -0.1	15.0
1x64*	Sets the loss to be evaluated as a 1x64 branch splitter.	Between the setting values of 1x32 +0.1 and 1x128 -0.1	18.0
1x128*	Sets the loss to be evaluated as a 1x128 branch splitter.	"Setting value of 1x64" +0.1 to 30.0	21.0

*: This is not displayed by the DCFL function.

1. Press **F2** (**Analysis Setup**) in the Trace Analysis screen to display the Analysis Setup (1/2) screen.

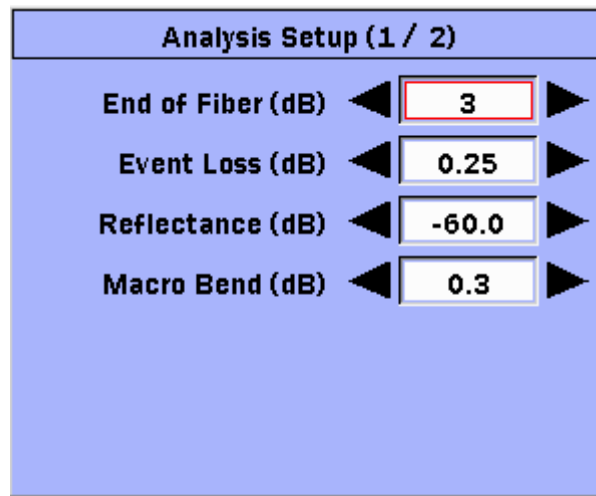

Figure 4.5.2-1 Analysis Setup Pop-up Screen (1/2)

2. Press and to select **End of Fiber**, and press and to set the loss evaluated as an end of fiber.
3. Press and to select **Event Loss**, and press and to set the loss evaluated as an event.
4. Press and to select **Reflectance**, and press and to set the return loss evaluated as reflectance.
5. Press and to select **Macro Bend**, and press and to set the loss evaluated as macro bend.
6. Press **F4** (**Page (1/2)**) in the Trace Analysis screen to display the Analysis Setup (2/2) screen.

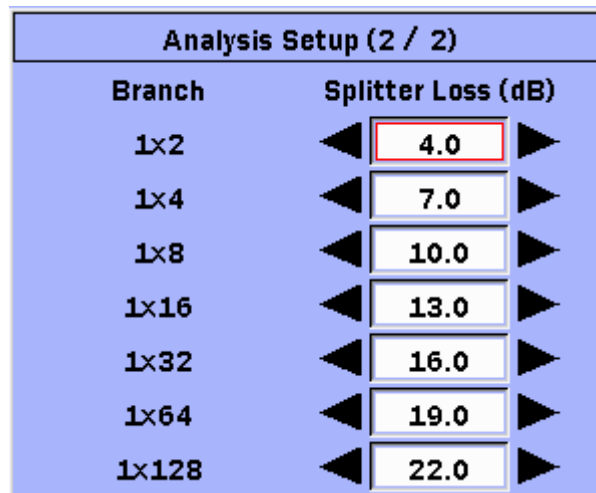





Figure 4.5.2-2 Analysis Setup Pop-up Screen (2/2)

7. Press  and  to select the number of branches, and press  and  to set the loss evaluated as a splitter event.
8. When the change is complete, press **F1 (Apply)**. Trace analysis is executed and the results are updated.
 Press **F2 (Cancel)** to cancel the setting.
 Press **F3 (Defaults)** to return to the factory presets shown in Table 4.5.2-1.

4.5.3 Setting OK/NG thresholds (Thresholds Setup)

Set the OK/NG thresholds for evaluating loss and return loss.

Table 4.5.3-1 Thresholds Setup Screen Items

Item	Function	Setting Range	Default
Non-Reflective	Sets event loss evaluated as OK/NG. Non-backscatter event loss greater than this setting is displayed in red.	0.05 to 30.00	0.20
Reflective	Sets event return loss evaluated as OK/NG. Backscatter loss greater than this setting is displayed in red.	0.05 to 30.00	0.50
Splitter Loss*2	Sets the value to make a pass-fail judgment of the event splitter. The splitter event loss is displayed in red, if it is greater than the analysis threshold plus the pass-fail threshold.	0.1 to 20.0	3.0
Reflectance	Sets event return loss evaluated as OK/NG. Event return loss greater than this setting is displayed in red.	10.0 to 50.0	20.0
Total Fiber Loss	Sets loss evaluated as total fiber loss. Total Fiber Loss is displayed in red when the total loss of the fiber is greater than this setting.	0.1 to 60.0	10.0
ORL*1 *2	Sets the total ORL (optical return loss) to evaluate the ORL of the entire fiber. If the total ORL is smaller than this value, the ORL is displayed in red.	0.0 to 60.0	27.0

*1: This is not displayed by the OTDR functions.

*2: This is not displayed by the DCFL functions.

1. Press **F3** (**Thresholds Setup**) in the Trace Analysis screen to display the Thresholds Setup screen.

Pass/Fail Setup	
Event Loss	
Non-Reflective (dB)	0.20
Reflective (dB)	0.20
Splitter Loss (dB)	3.0
Reflectance (dB)	-20.0
Total Fiber Loss (dB)	10.0
ORL (dB)	27.0

Figure 4.5.3-1 Thresholds Setup Pop-up Screen

2. Press and to select **Non-Reflective**, and press and to set the threshold for non-reflective event losses.
3. Press and to select **Reflective**, and press and to set the threshold for reflective event losses.
4. Press and to select **Splitter Loss**, and press and to set the threshold for splitter losses.
5. Press and to select **Reflectance**, and press and to set the threshold for event return loss evaluation value.
6. Press and to select **Total Fiber Loss**, and press and to set the threshold for total fiber loss.
7. Press and to select **ORL**, and press and to set the threshold for total ORL of events.
8. When the change is complete, press **F1** (**Apply**). When executing trace analysis and updating the trace analysis results press **F2** (**Cancel**) to cancel the setting.
To restore the factory defaults as shown in Table 4.5.3-1, press **F3** (**Defaults**).

4.6 Setting header to trace

The header can be included in the trace file when saving measurement results.

Note:

- If trace data has been loaded, the header saved in the trace data appears on the header screen.
- Sequence Number will be set to 0 if the loaded trace file had been saved by the firmware version 2.22 or older.

Table 4.6-1 Header Screen Items

Item	Function	Setting Range	Default
Cable ID	Sets the measured ID of cable.	Up to 30 characters	Blank
Fiber ID	Sets the measured ID of fiber.	Up to 30 characters	Blank
Sequence Number	Sets Sequence Number setup in the Auto Save screen.	0 to 9999	Sequence Number setup in the Auto Save screen
Location A	Sets the location name at measurement start.	Up to 30 characters	Blank
Location B	Sets the location name at measurement end.	Up to 30 characters	Blank
Direction	Sets a direction to be measured.	Up to 30 characters	A->B
Operator	Sets the measured person's name	Up to 30 characters	Blank

1. Press **F2 (Header)** in the Save Trace As screen to display the Header screen.

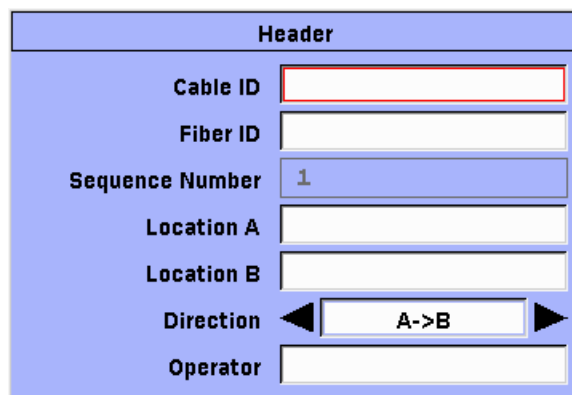















Figure 4.6-1 Header Pop-up Screen

2. Press **Up Arrow** and **Down Arrow** to select **Cable ID**, and then press **Set** to display the SoftKeyboard (Character Input) screen.

3. Press , , , and  to select the character for input, and press .
4. When the name is completed, press  (**OK**). To cancel, press  (**Cancel**).
Refer to section 3.6 “Using Softkey Board” for details about character input.
5. Set Fiber ID, Location A, Location B, and Operator in the same manner.
6. Press , and  to select **Direction**, and press  and  to set A->B or B->A.
7. When the change is complete, press  (**Apply**).
To cancel, press  (**Cancel**) to cancel the setting.
To restore the factory defaults as shown in Table 4.6-1, press  (**Defaults**).

4.7 Saving trace manually

Measurement results can be saved as a trace file either to internal memory or to external USB memory. Use this function when wanting to keep the actual results.

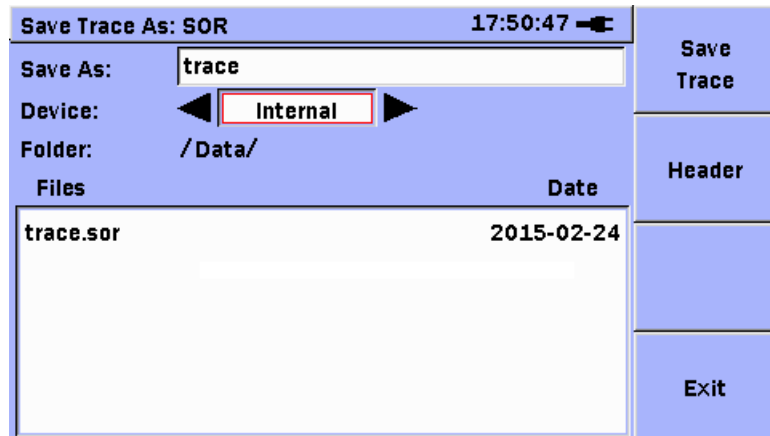





Figure 4.7-1 Save Trace As Screen

To manually save files:



1. In any of the following screen, press .
 - Test Setup screen
 - Trace View screen
 - Trace Analysis screen
2. Use  and  to select **Save**, and then press  to display the Save Trace As screen.





Note:

Save is not displayed either during measurement or when no trace is displayed.

The extension of saving file is displayed on the top of the screen. Saving format can be changed in the Setup-Preferences screen.

3. Select **Save As** and press  to display the SoftKeyboard (Character Input) screen.

If a file name is not determined, press  and  to select **Save As**.

- (1) Press , , , and  to select the character for input.
- (2) Press  to add the highlighted letter to the name field.

- (3) Repeat steps (1) and (2). Up to 19 characters can be used. The file extension is automatically appended.
- (4) When the name is completed, press **F4** (**OK**). To cancel, press **F3** (**Cancel**).

Refer to section 3.6 “Using Softkey Board” for details about character input.

4. Press **▲** and **▼** to select **Device**.
5. Press **←** and **→** to select the device where the trace file will be saved. Either **Internal** or **USB** can be selected.

Note:

If there is no USB device connected to the unit, **USB** cannot be selected.

6. Press **▲** and **▼** to select the folder for saving the trace file, and press **Set**. The selected folder is displayed enclosed in brackets [].

Repeat this operation to move to a folder two levels higher or lower than the current folder. To move to the higher level folder, select [..] and press **Set**.

Notes:

- When saving the trace file to built-in memory, you can select only the Data folder or its subordinate folder as a save location.
 - Selecting a folder containing 500 or more files will require a few seconds to display the folder contents on the Mass Storage screen.
7. Press **F2** (**Header**) to display the Header screen.
Enter the header to save in Trace data.

Figure 4.7-2 Header screen

8. When the change is complete, press **F1 (Apply)**.
To cancel, press **F2 (Cancel)** to cancel the setting.
To restore the factory defaults as shown in Table 4.6-1, press **F3 (Defaults)**.
9. Press **F1 (Save Trace)** to save the trace folder.
To stop the file save, press **F2 (Exit)**.

If a file with the same name exists, the message below will be displayed.

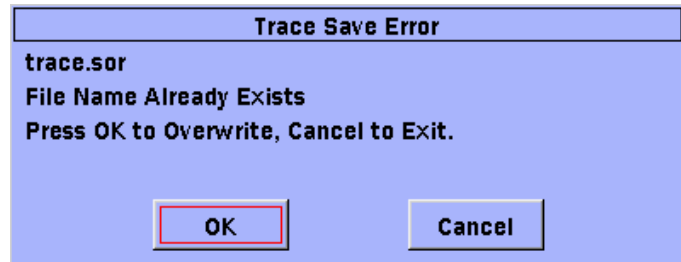

Figure 4.7-3 Trace Save Error message

If you select **OK**, the file is overwritten.

If you select **Cancel**, the trace is not saved.

Note:

- If there are files or folders using characters that cannot be set at the character input screen, the file or folder name cannot be displayed correctly. Read the name after changing it using a PC, etc. Refer to section 3.6 “Using Softkey Board” for the characters that can be displayed correctly by the main frame.
- The Logs, Properties, and ScreenCaptures folders in the built-in memory are system folders. Do not change system folders.

4.8 Loading Trace Data (Mass Storage-Load)

Saved trace files can be loaded from built-in memory or USB memory. This is useful when you want to verify the trace of a previously measured fiber cable.

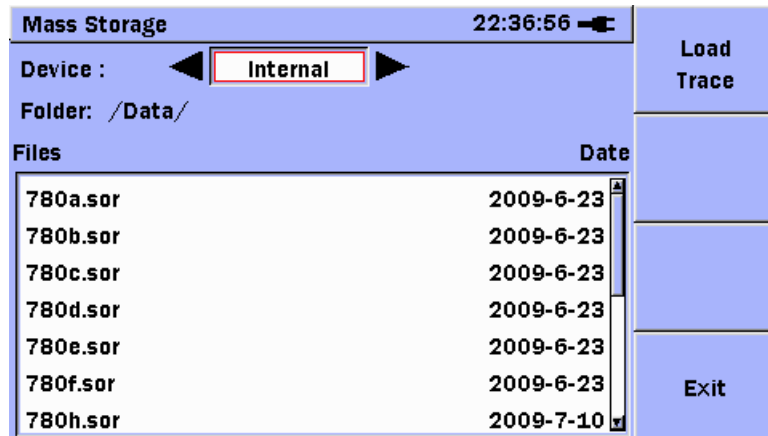







Figure 4.8-1 Mass Storage (Load) Screen

Load the trace file using the following procedure.

- In any of the following screen, press .
 - Test Setup screen
 - Connection Check Step screen
 - Trace View screen
 - Trace Analysis screen
- Use  and  to select **Load**, and then press  to display the Mass Storage (Load) screen.



Note:

Load is not displayed during measurement or the connection check.

- Press  and  to select the memory where the trace file was saved. Either **Internal** or **USB** can be selected.

Note:





If there is no USB device connected to the unit, **USB** cannot be selected.

4. Press  and  to select the folder where the trace file was saved, and then press . The selected folder is displayed enclosed in brackets [].

Repeat this operation to move to a folder two levels higher or lower than the current folder. To move to the higher level folder, select [..] and press .

Note:

Selecting a folder containing 500 or more files will require a few seconds to display the folder contents on the Mass Storage screen.

5. Press  and  to select the trace file to load, and press  (Load Trace). The trace is displayed on the Trace View screen and the trace file data is also applied to the Test Setup screen. To stop loading the trace, press  (Exit).

Note:

The following parameters in Trace View indicate the value of the loaded trace, not that of the current module.

- WL
- PW
- RES

The following items in Test Setup are replaced by the setting of the loaded trace.

- BSC
- IOR

Loss Mode is displayed as Event, if Load Trace is executed when the **Full Auto** check box is selected (On).

Only files saved by the following Anritsu models can be loaded:

- MU909014A
- MU909014A1
- MU909014B
- MU909014B1
- MU909014C
- MU909014C6
- MU909015A6
- MU909015B
- MU909015B1
- MU909015C
- MU909015C6

4.9 Restoring Defaults (All Defaults)

All general settings other than Date & Time, Color Theme, Language, Login Password, and Remote Control Password can be restored to the factory defaults.

Measured waveforms are deleted by restoring the factory defaults.

Files saved to built-in memory are not deleted.

Table 4.9-1 Items initialized by All Defaults

Initialized Item	Settings
Test Setup	Refer to Table 4.2.1-1
Setup-General (Excluding Date & Time, Color Theme, Language, Screen Capture Format, Use Login Password, Login Password, and Remote Control Password)	Auto Backlight: 5 Mins Auto Power Off: 10 Mins
Setup-Preference	Refer to Table 4.2.2-1
Setup-Auto Save	Refer to Table 4.2.3-1
Trace View	F2: Zoom F3: Display From Origin F4: Fast*
Trace Analysis-Analysis Setup	Refer to Table 4.5.2-1
Trace Analysis-Threshold Setup	Refer to Table 4.5.3-1
Header	Refer to Table 4.6-1

*: Displayed during measurement only when Test Mode is Real Time.

- Press **F1** (**Test Setup**) at any of the following screens.
 - Connection Check Step screen (when connection check is stopped)
 - Trace Analysis screen
 - Trace View screen (when measurement is stopped)
- Press **Menu** to display the General Functions pop-up menu.
- Use **▲** and **▼** to select **All Defaults**, and then press **Set**. A confirmation dialog appears when restoring the factory defaults.
- Use **◀** and **▶** to select **Yes**, and press **Set** to restore the factory defaults.

4.10 Calculation Method

4.10.1 Loss measurements

The loss displayed in the Trace View screen is calculated as follows.

2-pt Loss

The 2-Point Loss Measurement uses a data point at Cursor A and a data point at Cursor B to calculate the change in dB between the two points. Normally the Cursor A (Y-Axis) data is greater than the Cursor B (Y-Axis) data and a positive loss measurement is displayed.

$$Loss = L_A - L_B$$

Loss: Loss [dB]

L_A: Level of Cursor A

L_B: Level of Cursor B

When connecting a fiber with a different BSC, sometimes the loss value may become negative.

2pt-Loss is used to measure the loss between two points on the optical fiber.

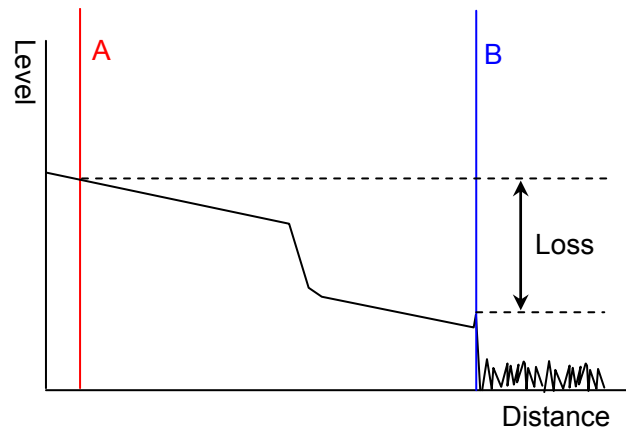

Figure 4.10.1-1 2-pt Loss Measurement Method

Splice Loss

Use Splice Loss mode to measure the optical power loss caused by connectors, splices, and couplers on a fiber optic cable.

The trace measured at a fiber splice looks like the solid line in the following diagram. The loss due to the pulse width and sample count occurring across distance ΔL is observed.

In fact, loss only occurs at the splice as shown by the dotted lines.

Consequently, this loss cannot be measured using the 2-pt Loss mode.

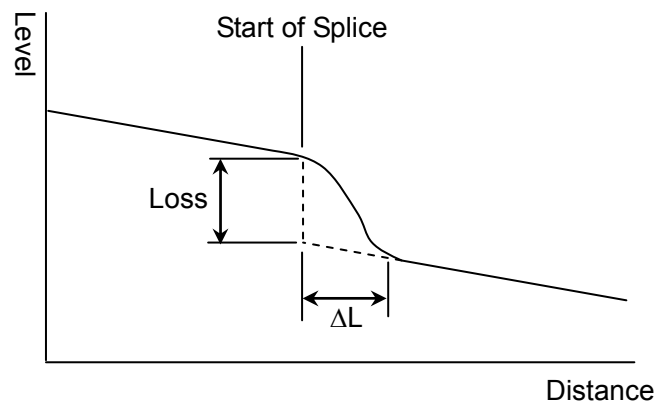

Figure 4.10.1-2 Fiber Splice Measurement

Using the Splice Loss mode, two linear approximations are generated from the LSA cursors using the least squares method. The level difference between the linear approximations at cursor B is the measured splice loss.

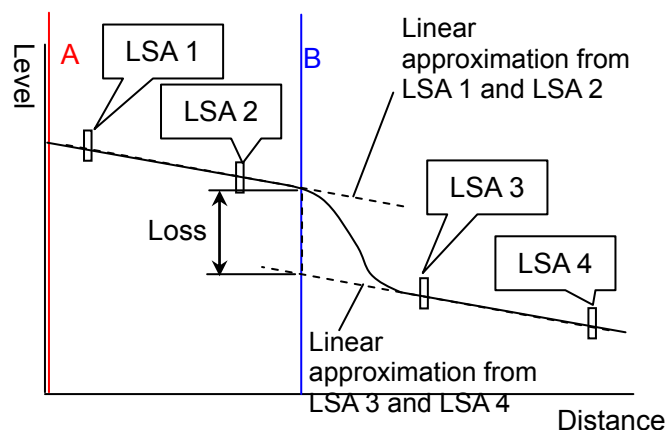

Figure 4.10.1-3 Splice Loss Measurement Method

dB/km Loss

dB/km Loss is found by dividing the 2pt Loss by the distance between the markers.

$$Loss = \frac{L_A - L_B}{D_B - D_A}$$

Loss: Loss (dB/km)

D_A: Distance of Cursor A (km)

D_B: Distance of Cursor B (km)

L_A: Level of Cursor A

L_B: Level of Cursor B

dB/km Loss LSA

dB/km Loss LSA is found as the loss per kilometer using the same linear approximation as used for Splice Loss measurement.

$$Loss = \frac{L_A - L_B}{D_B - D_A}$$

Loss: Loss (dB/km)

D_A: Distance of Cursor A (km)

D_B: Distance of Cursor B (km)

L_A: Cursor A linear approximation level

L_B: Cursor B linear approximation level

The cursor A level is obtained by linear approximation from the trace between LSA 1 and LSA 2.

The cursor B level is obtained by linear approximation from the trace between LSA 3 and LSA 4.

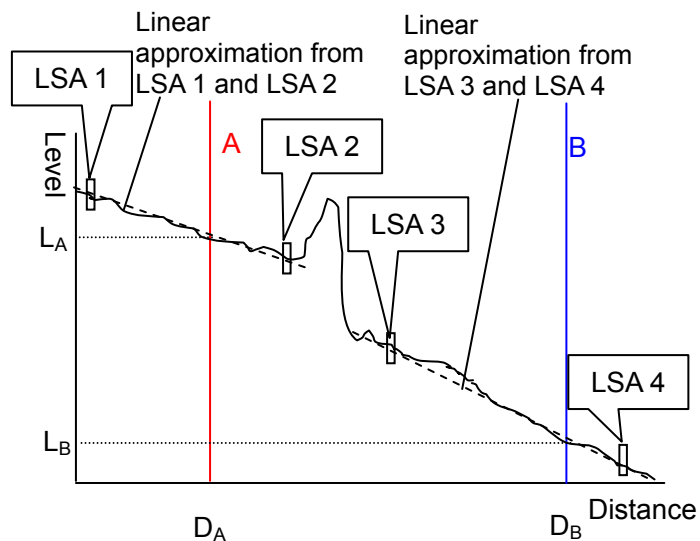

Figure 4.10.1-4 dB/km Loss LSA Measurement Method

ORL (Optical Return Loss)

ORL (Optical Return Loss) is the ratio of the level of the returned optical signal to the level at the position of cursor A. The level of the returned optical signal is the optical power returned from the trace between cursor A and cursor B.

ORL is displayed in dB units and the numerical value of ORL becomes larger as the returned level becomes smaller.

$$ORL = -10 \log_{10} \left(\frac{ER}{Ein} \right) = -10 \{ \log_{10}(BSL) - \log_{10}(PW) + \log_{10} \left(\int_a^b R(t) dt \right) \}$$

$$ER = \int_a^b P(t) dt = BSL \times P_a \times \int_a^b R(t) dt$$

$$Ein = P_a \times PW$$

$$R(t) = \frac{P(t)}{BSL \times P_a}$$

$$BSL = \frac{BSC \times \alpha_R \times c \times PW}{2 \times IOR}$$

ORL: return loss (dB)

ER: Energy (J) of light returned between cursor A and cursor B

Ein: Energy (J) of light inserted at position of cursor A

BSL: backscatter coefficient level

PW: Pulse width of inserted light

P(t): Power (W) measured by OTDR after elapsed time (t) after pulse insertion

a: Time when OTDR receives light returned from cursor A

b: Time when OTDR receives light returned from cursor

Pa: Peak power of light pulse passing position of cursor A

R(t): Power (W) measured by OTDR normalized by backscatter level (W) at position of cursor A

BSC: backscatter coefficient

α_R : Rayleigh scattering loss

c: Speed of light 3×10^8 (m/s)

IOR: index of refraction

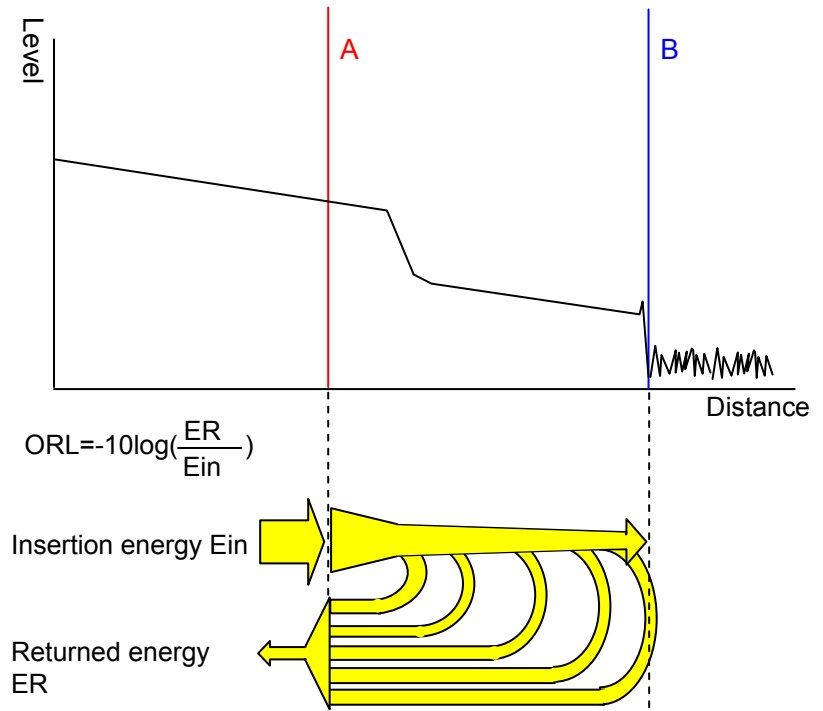

Figure 4.10.1-5 ORL Measurement Method

4.10.2 Event Evaluation

The causes of events displayed in the Trace Analysis screen are evaluated as follows.

Reflective

These are events caused by Fresnel reflection due to the presence of optical connectors, mechanical splices, etc.

Any of the following points are evaluated as reflective events:

- Points where measured reflectance exceeds Reflectance set in the Analysis Setup screen
- Points where loss measurement result exceeds Event Loss setting in the Analysis Setup screen

The event table Reflectance is measured as follows.

The trace peak level L_1 is detected.

The Rayleigh scattering level L_2 immediately before the peak level is measured.

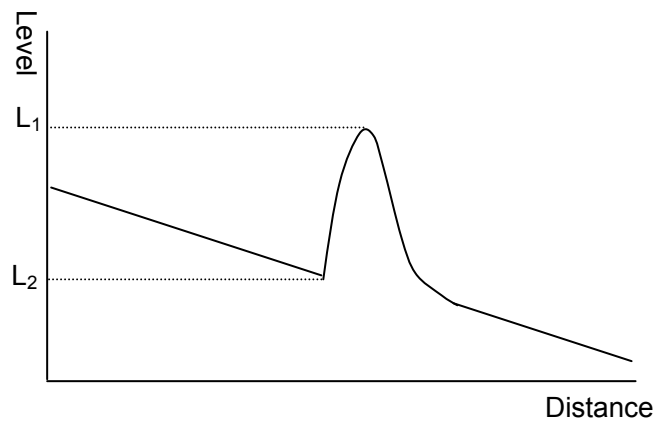

Figure 4.10.2-1 ORL Measurement Method

The ORL value is found from the following equation:

$$ORL = -10\{\log_{10}(BSL) + \log_{10}(10^{\frac{L_B - L_A}{5}} - 1)\}$$

$$BSL = \frac{BSC \times \alpha_R \times c \times PW}{2 \times IOR}$$

ORL: return loss (dB)

α_R : Rayleigh scattering loss

c: Speed of light 3×10^8 (m/s)

BSC: backscatter coefficient

IOR: index of refraction

PW: Pulse Width

L₁: Peak level

L₂: Preceding Rayleigh scattering level

Non-Reflective

These are events where there is loss that is not due to Fresnel reflection, such as at fusion splices or where the fiber is bent.

The point where the measured loss exceeds the Event Loss set in the Analysis Setup screen is evaluated as a non-reflective event.

At non-reflective events, ORL is displayed as **N/A**.

Grouped

Multiple points where the measured losses are larger than the Event Loss set in the Analysis Setup screen and where separate losses cannot be measured individually because the interval between events is too short are evaluated as grouped events.

The measured loss is displayed as the total of the losses of the multiple points.

Sometimes, reducing the pulse width makes it possible to separate the events.

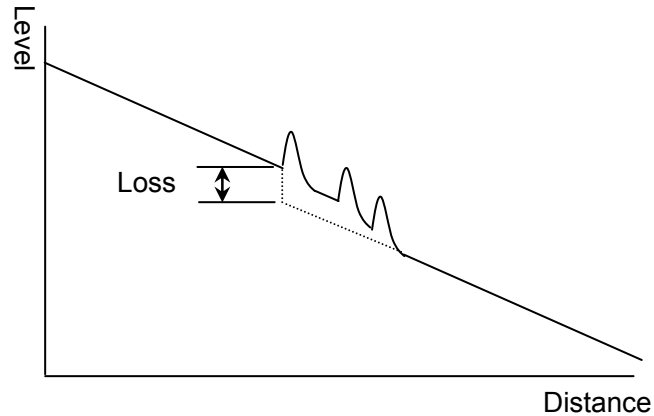

Figure 4.10.2-2 Group Event Loss

Far End

This event is either the far end of the fiber or a break in the fiber.

The point at the noise level boundary is evaluated as the far end event.

Questionable End

In these events, either the fiber length or the loss is out of the screen range.

Events where no far end is displayed on the trace or where the noise level at the right end of the trace falls below the noise level are evaluated as Questionable End events.

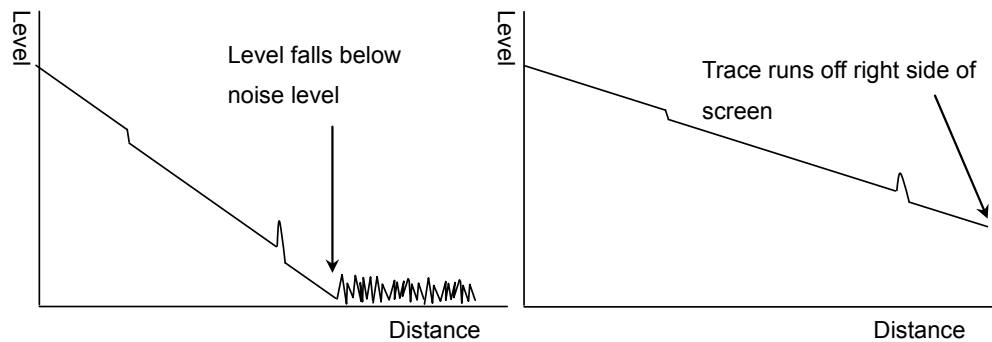

Figure 4.10.2-3 Questionable End Events

Splitter

The splitter event is where the fiber is divided using a splitter, etc.





A point where the loss measurement result exceeds the Splitter setting in the Analysis Setup screen but that is not the noise level boundary is evaluated as a Splitter event.

4.11 Using VFL (Visual Fault Locator)

The Visual Fault Locator (VFL) is a visible (red) light source. Since the light from the VFL is visible, it is useful for locating fault points in the dead zone by visually checking the diffusing light.

The VFL is an option – not all units are equipped with the VFL.

To use the Visual Fault Locator:

1. On the OTDR or Fiber Visualizer function screen, press .
2. In the menu shown in Figure 4.11-1, select **VFL** with  and , and then press .

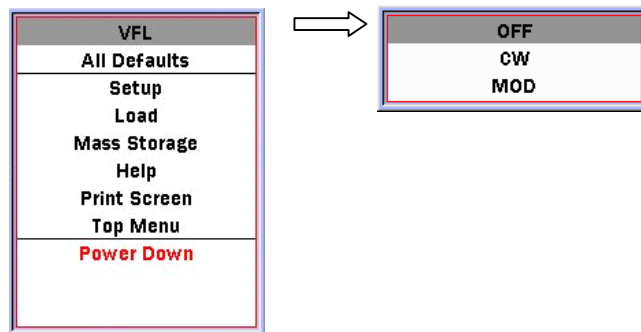





Figure 4.11-1 VFL Control Menu

3. In the VFL screen, select the desired item with  and , and then press .
 - OFF: Switches visible light source (VFL) off
 - CW: Switches VFL on
 - MOD: Flashes VFL
4. When **CW** or **MOD** is selected, the flashing red VFL Laser On icon appears at the top of the screen when the VFL's visible laser diode is operating.

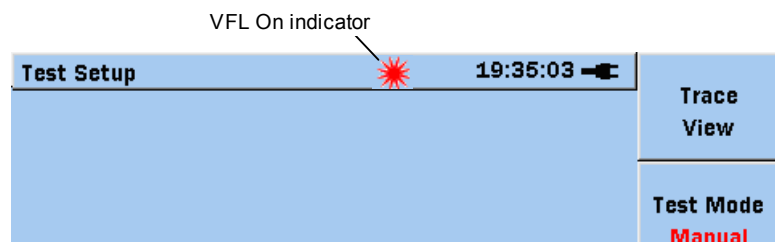

Figure 4.11-2 VFL Laser On indicator

4.12 Measuring with Fiber Visualizer

With Fiber Visualizer, the connection conditions and fault points of the optical fiber can be easily checked by graphic icons.

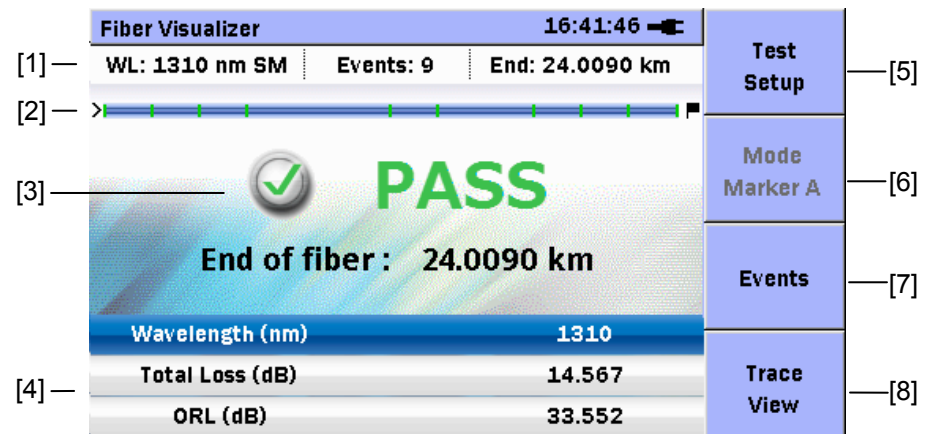

Figure 4.12-1 Fiber Visualizer Screen (Summary)

- [1] Wavelength, event number, far end display area
The wavelength, event number, and far end position that were used for the measurement are displayed.
- [2] Fiber Schematic
Shows event positions or event icon positions on display. The events that exceeded the PASS/FAIL thresholds are displayed in red.
- [3] PASS/FAIL Result
If all the PASS/FAIL thresholds are cleared, "PASS" is displayed. Even if only one item fails to clear the threshold, "FAIL" is displayed.
- [4] Total Results
The values of the total loss and total optical return loss are displayed per wavelength.
- [5] **F1 (Test Setup)**
Displays the Test Setup screen.
- [6] **F2 (Mode)**
Switches the Event screen mode among Marker A, Marker B and Event Edit.
- [7] **F3 (Event)**
Displays the Event screen.
- [8] **F4 (Trace View)**
Displays the Trace View screen..

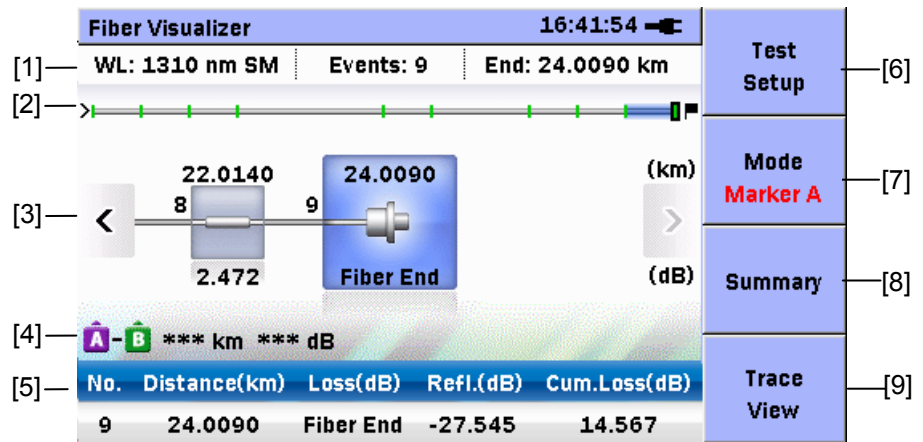
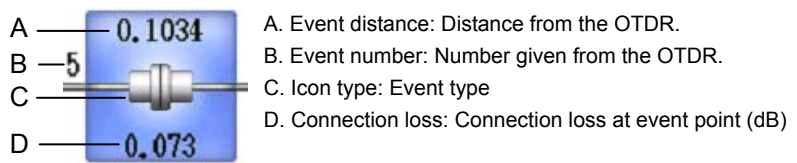

Figure 4.12-2 Fiber Visualizer Screen (Event)

- [1] Wavelength, event number, far end display area
The wavelength, event number, and far end position that are used for the measurement are displayed.
- [2] Fiber schematic
Shows event positions or event icon positions on display. The events that exceed the PASS/FAIL thresholds are displayed in red.
- [3] Event icon display area
Analyzing the waveform automatically, fiber connection points, fusion points, and splitters are displayed in icons. The events that exceed the PASS/FAIL thresholds are displayed in red.

Event icon details:



- [4] Distance between events and loss
Displays the distance and loss between A-B events.
- [5] Total Results
The values of the total loss and total optical return loss are displayed per wavelength.
- [6] **F1 (Test Setup)**
Displays the Test Setup screen.
- [7] **F2 (Mode)**
Switches the mode among Marker A, Marker B and Event Edit.
- [8] **F3 (Summary)**
Displays the Summary screen.

- [9] **F4 (Trace View)**
Displays the Trace View screen.

Perform the following steps to operate Fiber Visualizer.

1. Press **Menu** to display the menu.
2. Use **▲** and **▼** to select **Top Menu**, and press **Set** to display the top menu screen.
3. Use **◀** and **▶** to select **Fiber Visualizer**. The Fiber Visualizer screen is displayed.

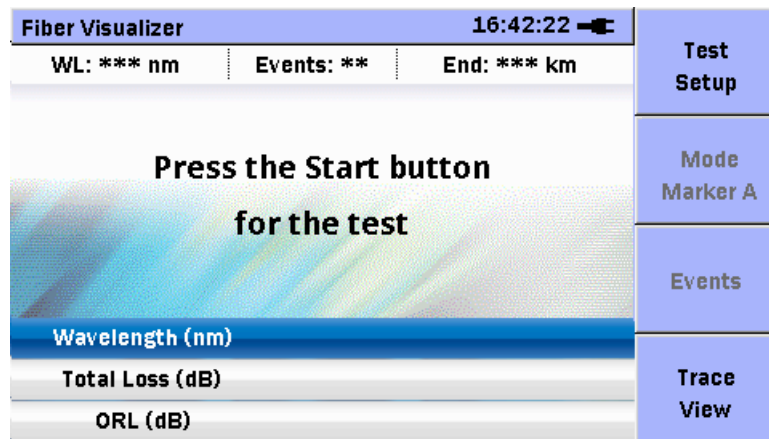



Figure 4.12-3 Fiber Visualizer Screen

4. Press **Start** to start the measurement.
If the setting is still in factory default, the measurement is executed entirely by automatic setting.
To set the measurement conditions manually, refer to Section 4.2 “Setting Parameters and Preferences”.
5. If the connection check is enabled, the connection check screen is displayed.
For details, refer to Section 4.3 “Starting Measurement”.

- When the measurement starts, the progress bar shows the current status.

Press  to stop the measurement.

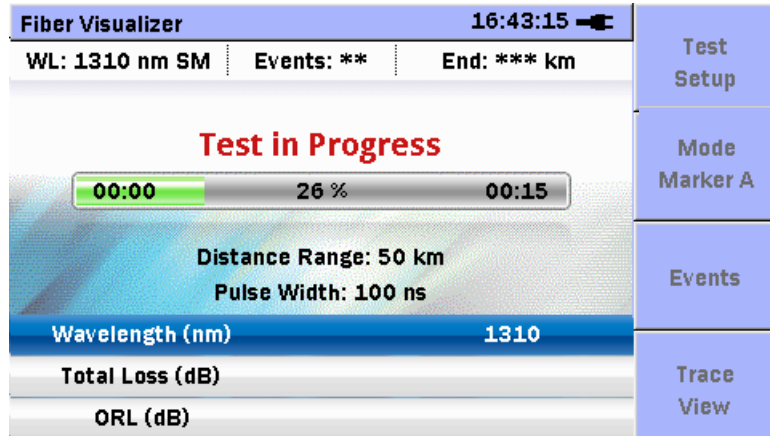

Figure 4.12-4 Measurement Screen

When the **Full Auto** check box is selected (On), events are detected more accurately by measuring with pulse width switched automatically. At the bottom of the screen, the event detection progress is indicated by icons.



Figure 4.12-5 Measurement Screen
(When the Full Auto Check Box Is Selected)

Note:

Waveform analysis cannot be retried by loading the waveform file that is measured with the **Full Auto** check box selected.

- When the measurement completes, the summary is displayed.

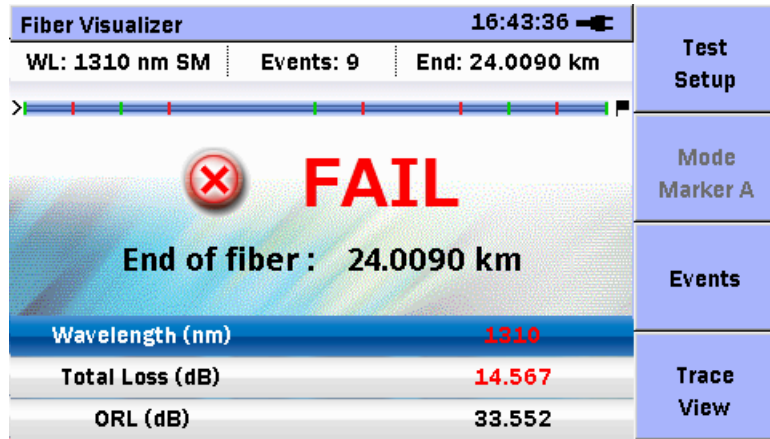

Figure 4.12-6 Fiber Visualizer Screen (Summary)

- If the result is “PASS”: Go to Step 14 and output the measurement results on the report.
If the result is “FAIL”: Press **F3** (Event).
- The Event screen is displayed.

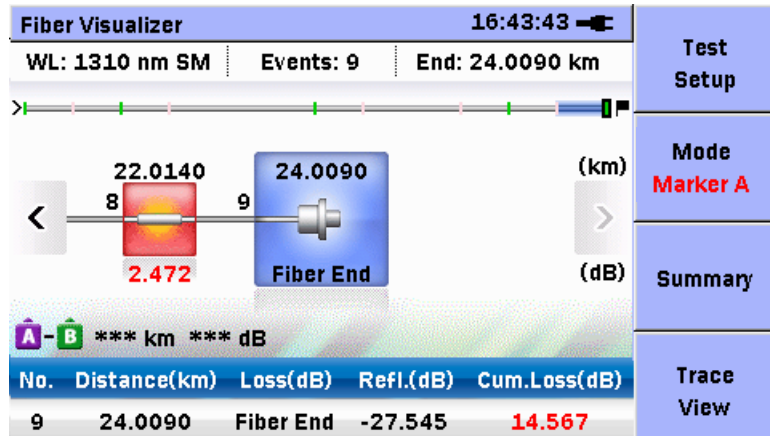

Figure 4.12-7 Fiber Visualizer Screen (Event)

There are 3 event icon types as below. The icon color changes according to the pass-fail threshold.

Blue icon: The icon is selected (positioned at the center of the screen) and its value is lower than the threshold.

Grey icon: The icon is not selected and its value is lower than the threshold.

Red icon: The value of the icon is higher than the threshold. Selected or not, it is always in red.

Table 4.12-1 Event Type List

Icon	Type	Description
	Reflective	Reflection from a splice point, such as a Fresnel reflection caused by a mechanical splice or connector.
	Non-Reflective	Non-reflective events include such low loss events as fusion splices and Macro Bends. If the loss is a negative value, the “rising to the right” icon is displayed.
	Grouped	Events spaced too close to each other for Analysis to distinguish them as separate events are reported as Grouped events.
	Far End	Any event with a loss equal to or greater than the Fiber End threshold is reported as the Far End event.
	Questionable End	A Questionable End event is reported, instead of a Far End event, when an Out of Range or Out of Distance condition is encountered. <ul style="list-style-type: none"> • Out of dynamic range If there is noise in the trace before the detected far end/break, the dynamic range is setting is incorrect. Out of Range is displayed at Loss in the event table. • Out of distance range If the end of trace is reached before the detected far end/break, the distance range is incorrect. Out of Dist. is displayed at Loss in the event table.
	Splitter	Loss due to presence of optical fiber cable splitter
	Macro Bend	Reports as an event “Macro Bend” when the detected event exceeds the specified threshold for the Macro Bend.

- Use and to select the red event icon so that the event details are displayed at the bottom of the screen. The events that exceed the PASS/FAIL thresholds are displayed in red.

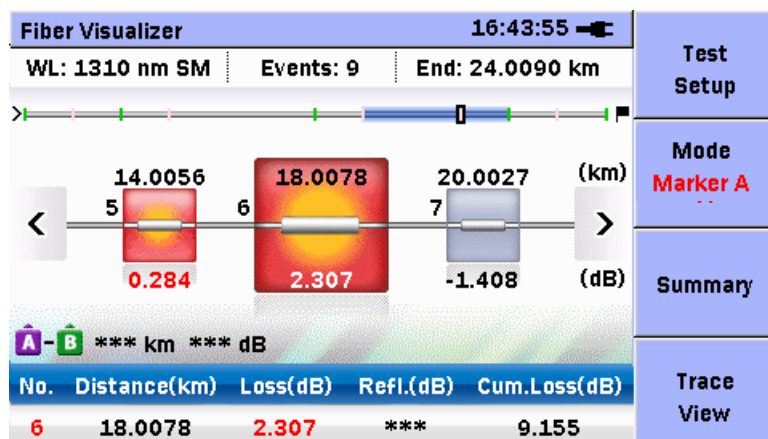













Figure 4.12-8 Fiber Visualizer Screen (Event)

11. To measure the loss and distance between the events, use  and  to select the event for setting the marker and press . Marker A and Marker B are switched by pressing .
12. Change the event type according to the following procedure:
 - (1) Press  to switch to **Event Edit**.
 - (2) Use  and  to select an event you want to edit.
 - (3) Press  to view the list of events that can be edited.
 - (4) Use  and  to select an event type.
 - (5) Press  to apply the change.
13. Press  to display the selected event waveform.

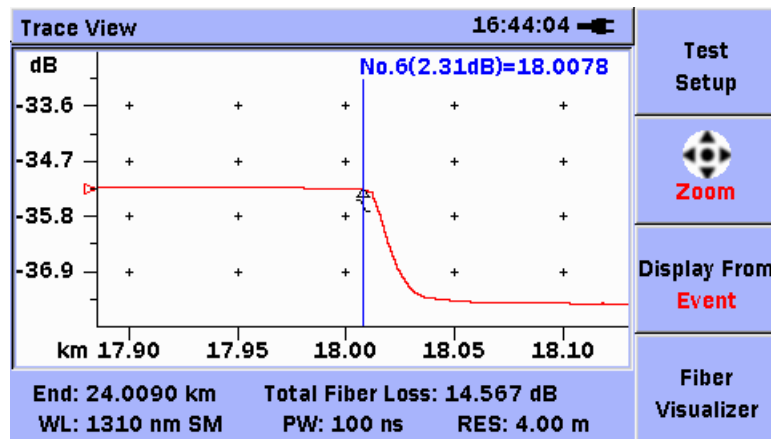





Figure 4.12-9 Fiber Visualizer Screen

14. To operate the Trace View screen, refer to Section 4.4 “Viewing Trace”.
15. When all the events are PASS, output the measurement data in the report.
16. Press  to display the menu.
17. Use  and  to select **Create PDF**, and press . If there are no measurement results, **Create PDF** is not found in the menu.

18. The Create Report screen is displayed. When it is used for the first time, the **Contents** tab is displayed.



Figure4.12-10 Create Report Screen (Contents Tab)







19. Use  and  to select the **Contents** tab.
20. Use  and  to select the items to output in the report and press . The checked items will be output.



Figure 4.12-11 Create Report Screen (Contents Tab)

21. When finish the setting, use  and  to select the **Comments** tab. If **Include Report Header** is checked, the contents setup on the **Comments** tab will be output.

22. Use  and  to select the item to edit and press .

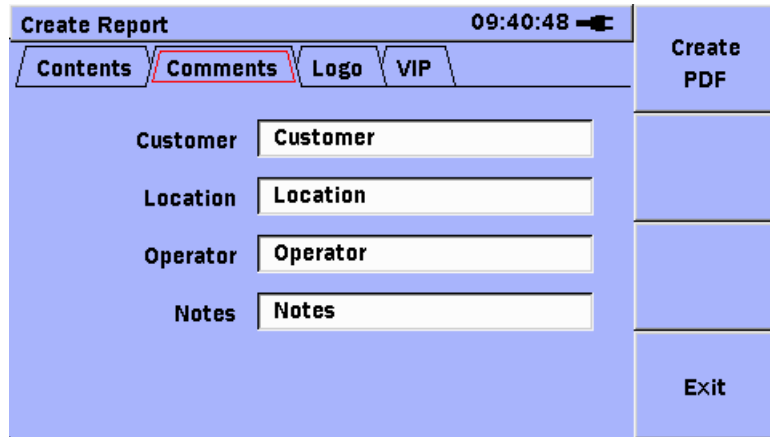



Figure 4.12-12 Create Report Screen (Comments Tab)

23. The entry screen for the character strings appears. For inputting characters, refer to Section 3.6 “Using Softkey Board”.
24. When finish the setting, use  and  to select the **Log** tab.

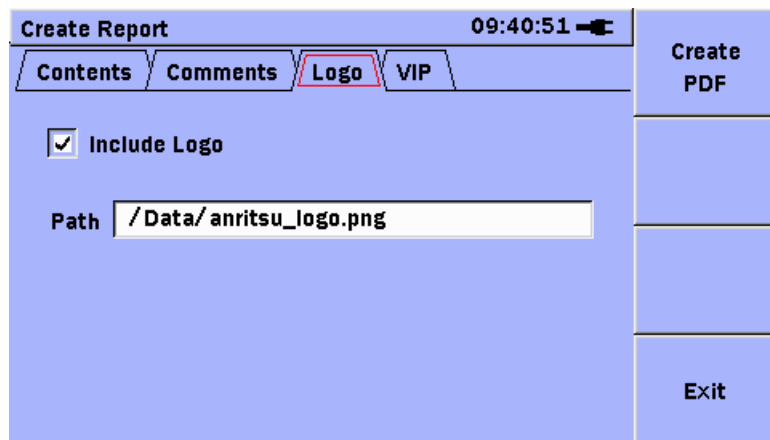







Figure 4.12-13 Create Report Screen (Logo Tab)

25. To output the logo on the report, use  and  to select **Include Logo**, and press  to select.
26. Use  and  to select **Path** and press .

27. The Select Logo File screen will be displayed.

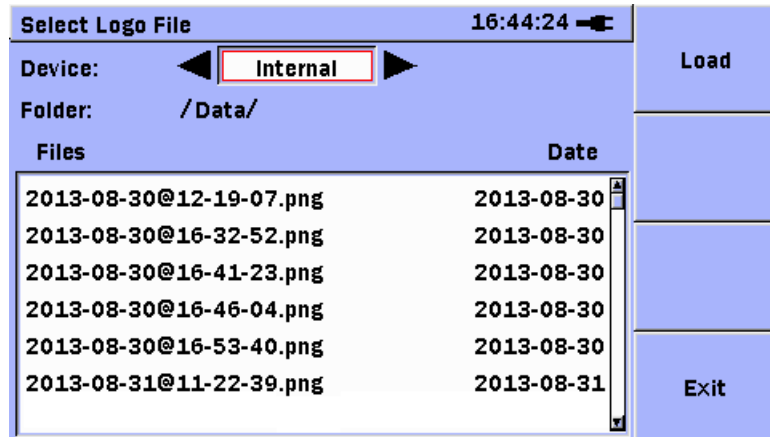

Figure 4.12-14 Select Log File Screen

- 28. Use and to select the logo file to output and press (Load).
- 29. The path of the selected logo is displayed.
- 30. To include an image(s) captured by the VIP in a report, use and to select the VIP tab.

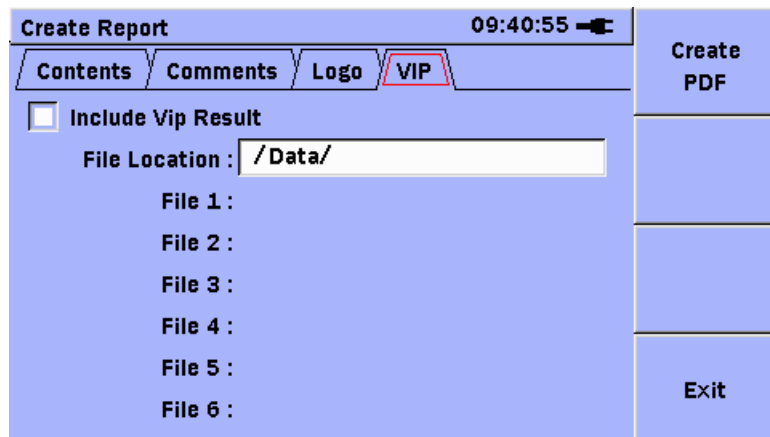

Figure 4.12-15 Create Report Screen (VIP Tab)

- 31. To output an image(s) captured by the VIP to a report, use and to move the focus to the **Include VIP Result** check box, and then press to select it.
- 32. Use and to move the focus to the **File Location** box, and then press .
- 33. The Select VIP Image screen is displayed.

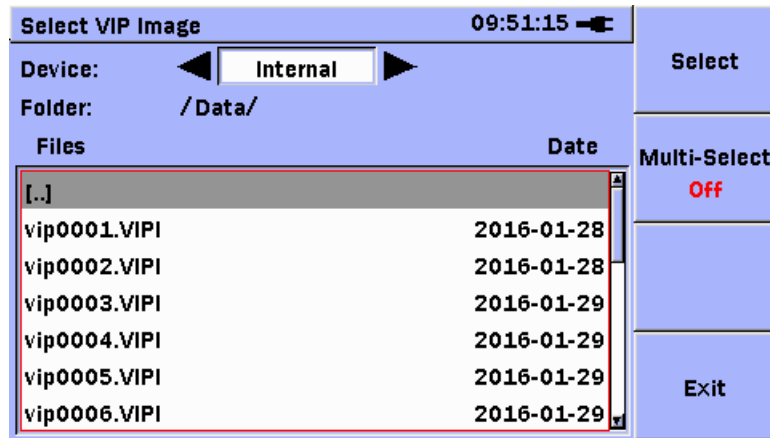

Figure 4.12-16 Select VIP Image Screen

- Use and to move the focus to the VIPI file you want to output, and then press **F1** (**Select**) to select it.
Up to 6 VIPI files can be selected.

Note:

To select multiple files, press **F2** (**Multi-Select**) to set to **On**, and then select each file you want to output.

- The selected file name(s) is/are displayed in the Create Report screen.

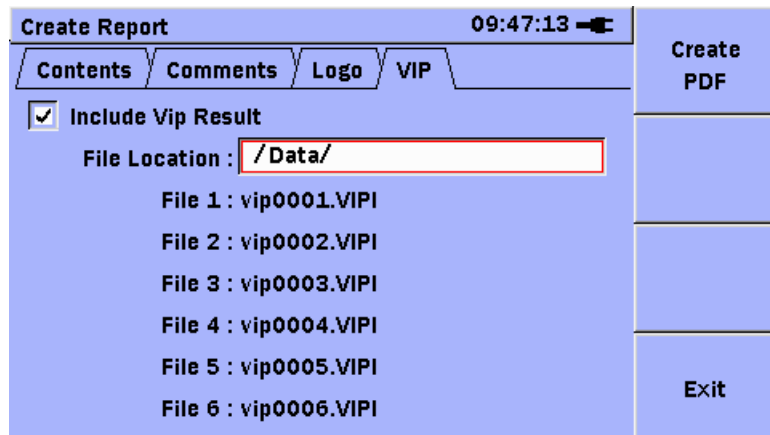

Figure 4.12-17 Select VIP Image Screen

- When all the setting completes, press **F1** (**Create PDF**).
- The Mass Storage screen is displayed.

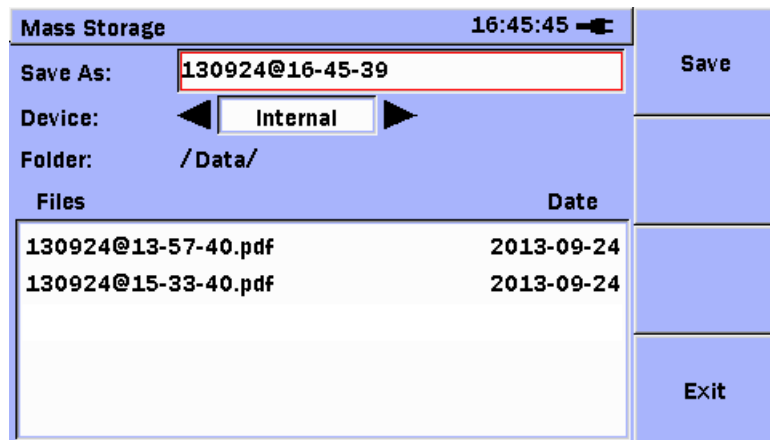
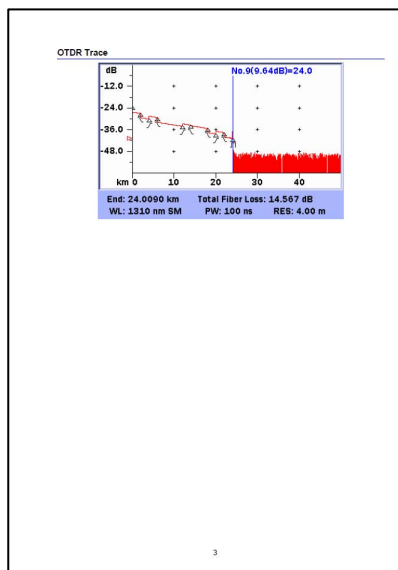
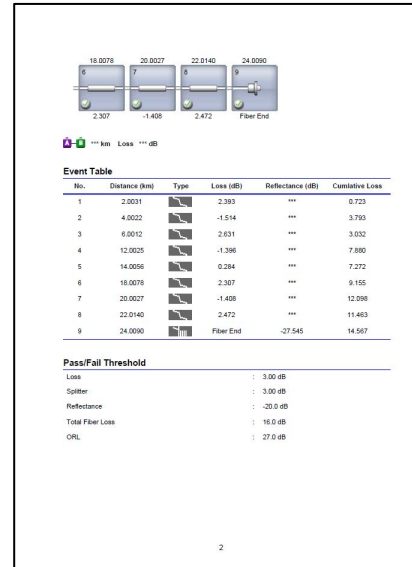
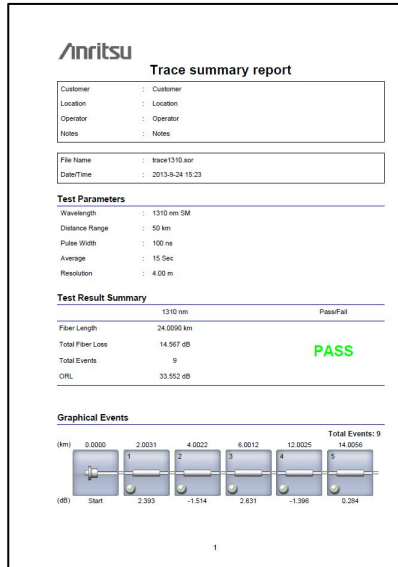

Figure 4.12-18 Mass Storage Screen

38. Set the file name and destination file and press **F1** (Save).

39. The PDF file with the set name is created.



VIP Test Summary

File Name	vip_27042016_0001.vpi	vip_27042016_0002.vpi	vip_27042016_0003.vpi
Probe Model	G0203A	G0203A	G0203A
Tip Type	FBET-U25M	FBET-U25M	FBET-U25M
Test Profile	SM UPC +45 (IEC #1300-3-35 end.0)	SM UPC +45 (IEC #1300-3-35 end.0)	SM UPC +45 (IEC #1300-3-35 end.0)
Capture Time	2016-04-27 10:22:46	2016-04-27 10:23:36	2016-04-27 10:24:57
Result	PASS	FAIL	FAIL
Core	PASS	PASS	PASS
Cladding	PASS	PASS	PASS
Adhesive	PASS	PASS	PASS
Contact	PASS	FAIL	FAIL
Image			
File Name	vip_27042016_0004.vpi	vip_27042016_0005.vpi	vip_27042016_0006.vpi
Probe Model	G0203A	G0203A	G0206A
Tip Type	FBET-U25M	FBET-U25M	2.5PC-M
Test Profile	SM UPC +45 (IEC #1300-3-35 end.0)	SM UPC +45 (IEC #1300-3-35 end.0)	SM UPC +45 (IEC #1300-3-35 end.0)
Capture Time	2016-04-27 10:25:37	2016-04-27 10:27:18	2016-04-27 10:29:28
Result	FAIL	PASS	PASS
Core	PASS	PASS	PASS
Cladding	FAIL	PASS	PASS
Adhesive	PASS	PASS	PASS
Contact	FAIL	PASS	PASS
Image			

4

Locating Fiber Faults

4.13 Creating a Summary

The summary can be output in text format from the saved trace files (.sor).

Note:

















The value of the Non-Reflective event which has the largest loss is output to Max Splice.

“---“ is output when no Non-Reflective event exists.

[Header]							
Txt File Release 2.23							
Base MU909015B-056							
S/N 6C01234567890							
Date 16/2/2015/							
Time 06:04							
Filename /Usb/fiber_info_otdr.txt							
Nb File 6							
[Results]							
Fib #	Dir.	Laser	Tot loss	Distance	Evt	Max Splice	Tot ORL
1	A->B	1550	9.479	40.0715	2	1.836	31.423
2	A->B	1550	9.437	40.0715	2	1.835	31.507
3	A->B	1550	9.456	40.0715	2	1.819	31.525
4	B->A	1550	7.191	40.0695	2	-0.332	30.875
5	B->A	1550	7.318	40.0695	2	-0.343	30.946
6	B->A	1550	7.251	40.0695	2	-0.369	31.000

Figure 4.13-1 Summary

Creating a summary:

1. Press  on Top Menu screen to display the General Functions pop-up menu.
2. Select Create Summary with  and , and then press  to display the Select Trace Files screen.
3. Select a desired trace file to create summary with  and . To select multiple files, press  (**Multi-Select**) to set Multi-Select to On. Then select trace files with  and . Press  to determine the selection.
4. To select all trace files in the folder, press  (**Multi-Select**) to set Multi-Select to On. Then press  (**Select**), select **Select All** with  and , and press . Select **UnSelect All** to cancel the selection of all the files.
5. Press  (**Create Summary**), the Save Summary screen appears. If there is no trace data,  (**Create Summary**) is dimmed.

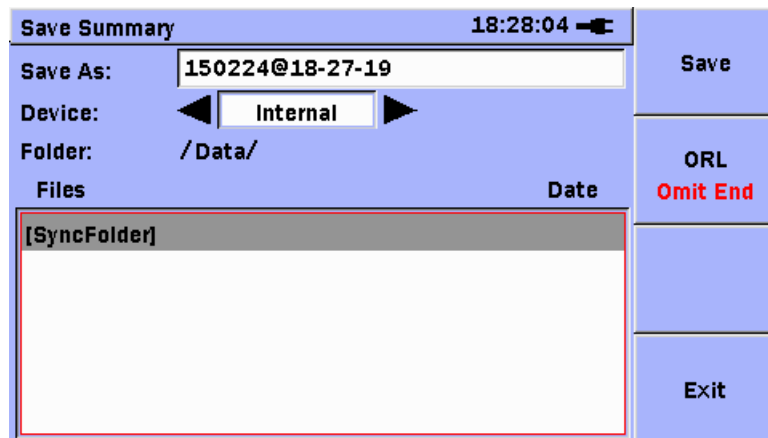

Figure 4.13-2 Save PDF Report Screen

6. To exclude the Far End from calculating the Total ORL (Tot ORL column) output to the summary, press **F2** (**ORL**) to set to **Omit End**.
To include the Far End in the calculation, set to **Include End**.
7. Select a desired file with **Left Arrow** and **Right Arrow**, and press **Set** to enter the file name. The default file name is "DATE TIME". Refer to section 3.6 "Using Softkey Board" for details of character input.
8. Select a destination folder.
9. Press **F1** (**Save**) to save the summary in text file.
Press **F4** (**Exit**) to exit without saving.

Chapter 5 *Locating Drop Cable Faults*

This chapter describes how to measure loss and locate faults in drop cables by using the DCFL (drop cable fault locator).

Refer to Chapter 2 for the fiber connection method and precautions on handling.

5.1	Models That Support the DCFL Function	5-2
5.2	Measurement Procedure	5-3
5.3	Measuring a Drop Cable.....	5-4
5.3.1	Starting the DCFL function	5-4
5.3.2	Checking the output power.....	5-4
5.3.3	Performing OTDR measurement.....	5-8
5.4	Viewing Trace	5-11
5.5	Saving Trace Data	5-11
5.6	Loading Trace Data	5-11

5.1 Models That Support the DCFL Function

Only the following models support the DCFL function.

Table 5.1-1 Models That Support the DCFL Function

Model	Remarks
MU909014C6-057/-067	Three-wavelength, Light Source, PON power meter, Optical Loss Test model
MU909014C6-058/-068	Three-wavelength, Light Source, PON power meter, Optical Loss Test model
MU909015C6-057/-067	Three-wavelength, Light Source, PON power meter, Optical Loss Test model
MU909015C6-058/-068	Three-wavelength, Light Source, PON power meter, Optical Loss Test model
MU909015A6-053/-063	One-wavelength, Light Source, PON power meter, Optical Loss Test model
MU909015A6-054/-064	One-wavelength, Light Source, PON power meter, Optical Loss Test model

Notes:

- The 1310/1490/1550 nm model with option -059/-069 cannot use the DCFL function.
- Models other than the above models do not display **DCFL** in the top menu screen.

5.2 Measurement Procedure

The following figure shows the flow of the procedure for measuring loss and locating faults in a drop cable by using the DCFL function. On the top menu, start the DCFL function, and perform measurement according to the following procedure.

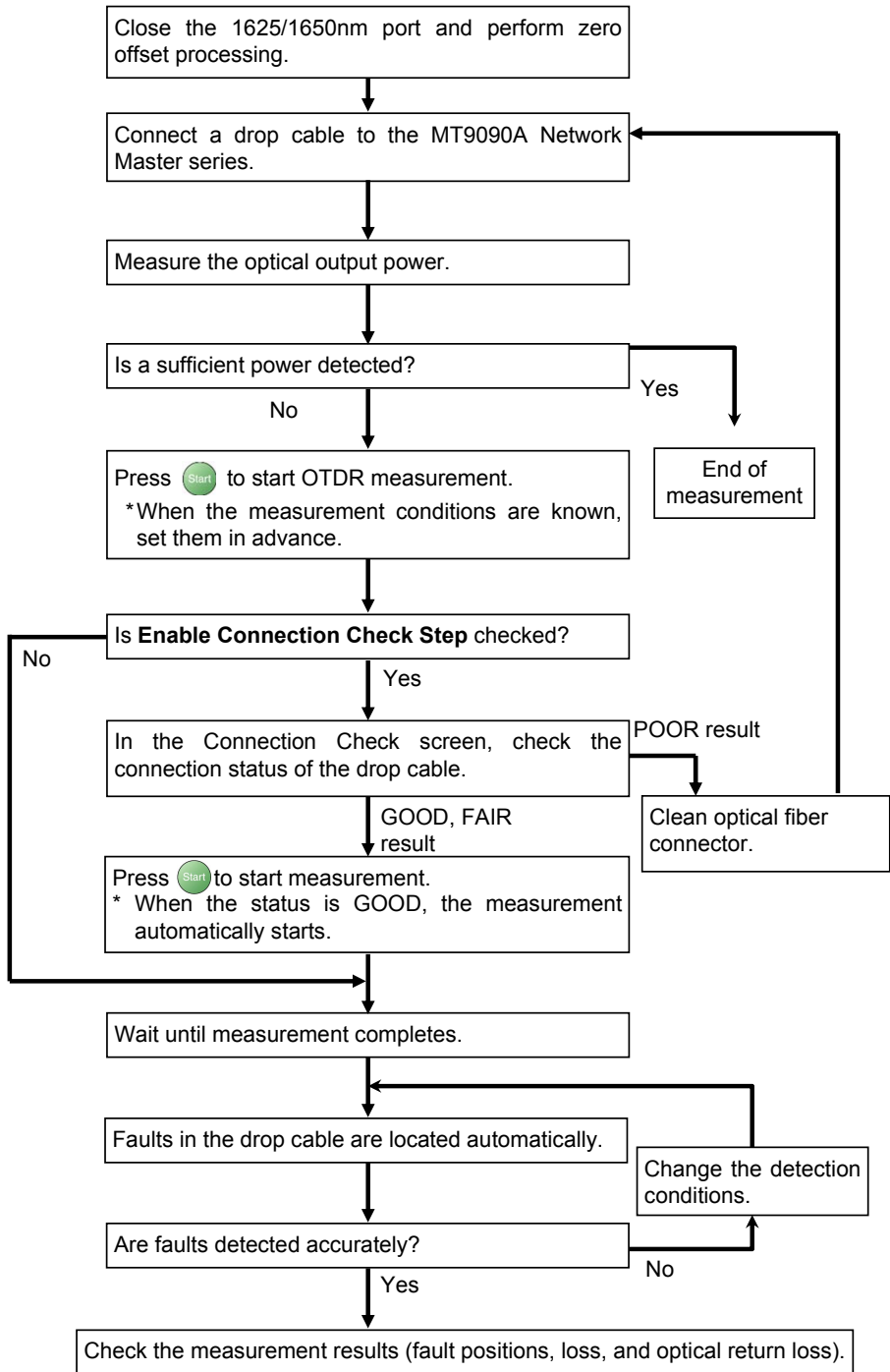

Figure 5.2-1 Drop Cable Measurement Procedure

5.3 Measuring a Drop Cable

The DCFL function easily locates faults in a drop cable that is used when leading an optical fiber from a telephone pole into the subscriber’s home. This section describes how to locate faults occurring in a drop cable.

5.3.1 Starting the DCFL function

Select DCFL in the top menu screen to start.

5.3.2 Checking the output power

When the DCFL function starts, the Power Meter screen appears. Check that a sufficient optical power is output from the drop cable.

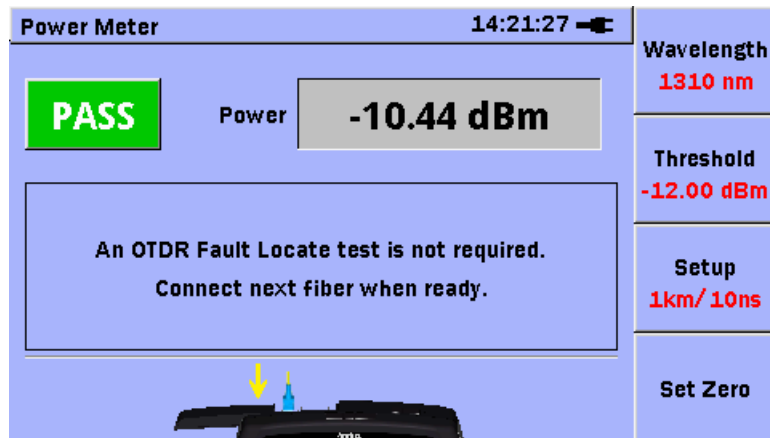

Figure 5.3.2-1 Power Meter Screen (DCFL)

You can set the following items in the Power Meter screen (DCFL).

Table 5.3.2-1 Setting Items of Power Meter Screen (DCFL)

Item	Function	Setting Range	Default
Wavelength	Sets the wavelength band of optical signal to be measured (nm).	1310, 1490, 1550, 1625, 1650	1310
Threshold	Sets the threshold for a pass/fail evaluation of the input power (dBm).	-50.00 to 26.00	Off (-26.00)
Setup	Sets the OTDR measurement conditions.	Refer to 4.2 “Setting Parameters and Preferences”.	Refer to 4.2.
Set Zero	Performs zero offset processing.	None	None

Power meter measured value

The measured optical power value is displayed by the absolute value (dBm) or difference value (dB). When the measured value is higher than the Max. measurement level, **Over Range** is displayed. On the other hand, when the measured value is lower than the Min. measurement level, **Under Range** is displayed.

Pass/Fail evaluation











The optical power measured value is compared with the threshold (dBm) for evaluation.

OK: The optical power is equal to the threshold or more.

NG: The optical power is less than the threshold.

Zero level calibration

Before measurement start, calibrate the internal zero level of the unit.



1. Press  to display the menu.
2. Select **Top Menu** with  and  , and then press  to display the top menu screen.
3. Select **DCFL** with  and .
4. Press .
5. Remove the optical fiber from the unit.
6. Close the slide cover.
7. Press  (**Set Zero**). The set zero confirmation screen is displayed.
8. Select **Start** with  and  , and then press .

Zeroing... is displayed during set zero execution.

9. The set zero is finished when the following appear.
dBm: [Under Range]
dB: [-----]

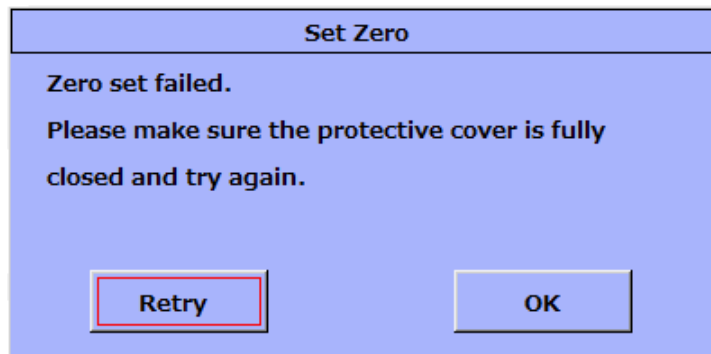
Only  is available during zero level calibration. If the zero level calibration fails, the message below will be displayed.



When the set zero is re-executed, confirm the slide cover is firmly closed, and then select **Retry**. Press  to start the set zero. Select **OK**, and press  to return to the PON Power Meter screen. If the set zero fails repeatedly, contact Anritsu or our sales dealer.

Power meter measurement condition setup

1. Start the DCFL function.
2. Press  (**Wavelength**) to select the wavelength.

Threshold setup

When executing a pass/fail evaluation of the measured optical power value, set the threshold.

1. Start the DCFL function.
2. Press **F2** (**Threshold value**).

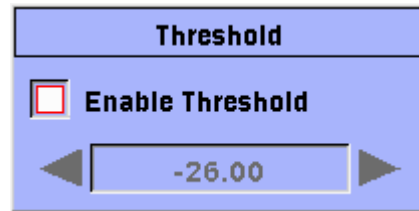



3. Select **Enable Threshold** with and .
4. Select the check box with .
5. Select threshold field with and .
6. Set the threshold level with and .
7. Press to finish the threshold setup.
8. **PASS** or **FAIL** is displayed on the power meter screen.

Press to display the top menu to terminate the power meter.

When a sufficient output power is not detected, press to start OTDR measurement.

5.3.3 Performing OTDR measurement

When a sufficient output power is not detected, press  in the Power Meter screen to start OTDR measurement. OTDR measurement can check a drop cable for faults and cable loss that cannot be detected by the power meter.

Press  in the Power Meter screen to display the Trace Analysis screen.

Note:

When **Enable Connection Check Step** is checked in the Setup-Preferences Screen 1, the Connection Check Step screen appears. For more information about the Connection Check Step screen, refer to 4.3.1, “Checking Connection”.

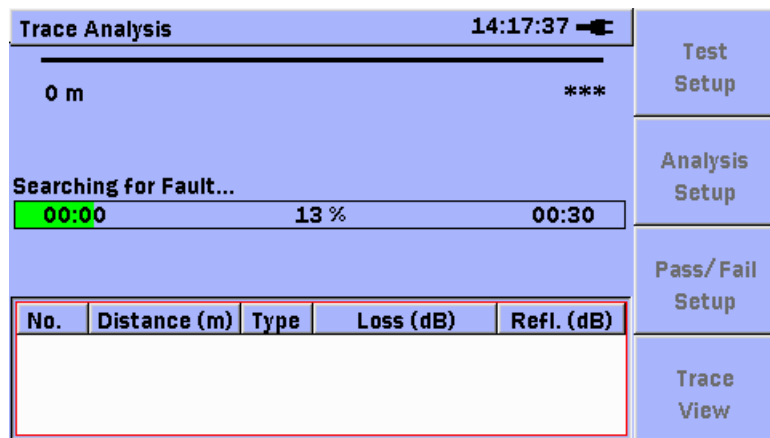

Figure 5.3.3-1 Trace Analysis Screen (DCFL)

You can set the following items in the Trace Analysis screen (DCFL).

Table 5.3.3-1 Setting Items of Trace Analysis Screen (DCFL)

Item	Function	Setting Range	Default
Test Setup	Sets the OTDR measurement conditions.	Refer to 4.2 “Setting Parameters and Preferences”	Refer to 4.2.
Analysis Setup	Sets the threshold (dB) for fault detection.	Refer to 4.5.2 “Setting event detection conditions (Analysis Setup)”	Refer to 4.5.2.
Pass / Fail Setup	Sets the threshold (dB) for pass/fail evaluation of calculation results.	Refer to 4.5.3 “Setting OK/NG thresholds (Thresholds Setup)”	Refer to 4.5.3.
Trace View	Displays the measured trace.	None	None

Setting the measurement conditions

1. Start the DCFL function.
2. Display the Test Setup screen by doing any of the following:
 - Pressing **F3** (**Test Setup**) in the Power Meter screen
 - Pressing **F1** (**Test Setup**) in the Trace Analysis screen
 - Pressing **F4** (**More**) in the Trace View screen and select **Test Setup**.
3. Set the measurement conditions.

Refer to 4.2, “Setting Parameters and Preferences” for more details.



4. Press **F4** (**Exit**).

Starting OTDR measurement

1. Start the DCFL function.
2. Press **Start** in the Power Meter screen or Connection Check screen to display the Trace Analysis screen.
3. When the measurement completes, analysis results are displayed. Refer to 4.5, “Analyzing Trace” for more details.

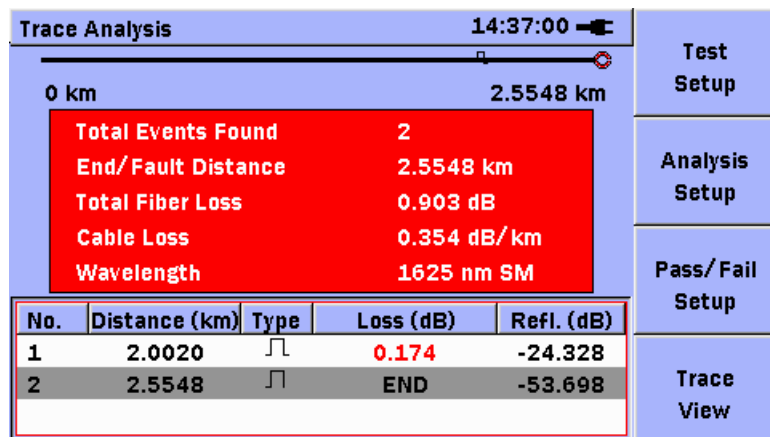

Setting the threshold values for analysis

1. When the measurement completes, display the Trace Analysis screen by doing any of the following:
 - Pressing **F2** (**Analysis Setup**) in the Trace Analysis screen.
 - Pressing  and selecting **Analysis Setup**
2. Set the threshold values for detecting faults.
Refer to 4.5.2, “Setting event detection conditions (Analysis Setup)” for more details.
3. When the change is complete, press **F1** (**Apply**). Trace analysis is executed and the results are updated.

Setting the threshold values for pass/fail evaluation

1. When the measurement completes, display the Pass/Fail Setup screen by doing any of the following:
 - Pressing **F3** (**Pass/Fail Setup**) in the Trace Analysis screen
 - Pressing  and selecting **Pass/Fail Setup**
2. Set the threshold values for pass/fail evaluation items.
Refer to 4.5.3, “Setting OK/NG thresholds (Thresholds Setup)” for more details.
3. When the change is complete, press **F1** (**Apply**). Trace analysis is executed and the results are updated.

Starting real-time measurement

1. When the measurement completes, press **F4** (**Trace View**) in the Trace Analysis screen to display the Trace View screen.
2. Press **F1** (**Real Time**) to start real-time measurement.
3. Press **F4** (**Mode**) during real-time measurement to switch the measurement mode between Fast and High S/N. When the measurement mode is set to High S/N, the noise gets suppressed but the measurement time becomes longer.
4. Press  to stop the measurement.

To terminate OTDR measurement, press  to display the top menu.

To return to the Power Meter screen, press .

5.4 Viewing Trace

If faults in a drop cable cannot be located accurately, the DCFL function checks the measured trace.

Refer to 4.4, “Viewing Trace” for more details.

5.5 Saving Trace Data

The DCFL function can save measurement results to a file. The power meter data at the time  is pressed in the Power Meter screen is saved.

Note:

The MT9090A Network Master series cannot display saved power meter data.

For how to save trace data, refer to 4.6, “Saving trace manually”.

5.6 Loading Trace Data

The DCFL function can load saved trace files (.sor).

Note:

The MT9090A Network Master series cannot display saved power meter data.

For how to load trace data, refer to 4.7, “Loading Trace Data (Mass Storage-Load)”.

Chapter 6 Measuring Optical Power of PON System

This chapter describes how to use the PON power meter function for the Network Master.

6.1 Using PON Power Meter 6-2

6.1 Using PON Power Meter

The PON power meter separates the wavelength of the downstream signal of the PON, and measures two powers simultaneously.

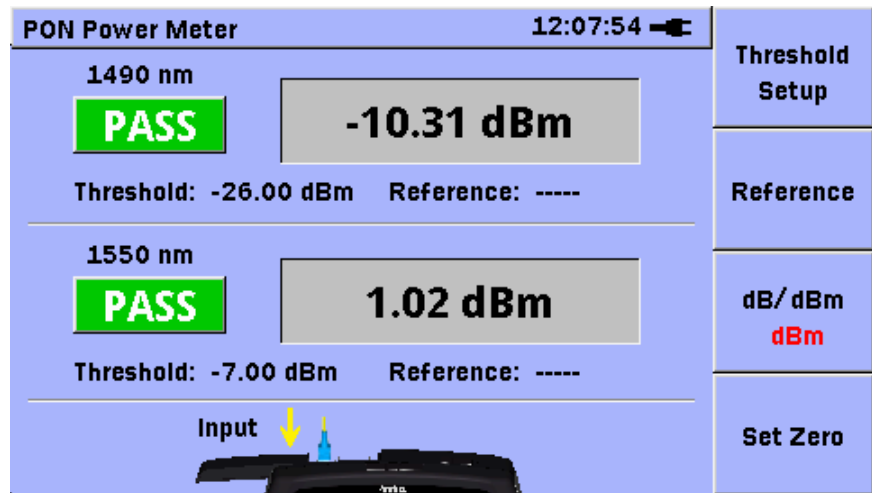







Figure 6.1-1 PON Power Meter Screen

Table 6.1-1 PON Power Meter Screen Setting Items

Item	Function	Setting Range	Default
Threshold:	Threshold value for a pass/fail evaluation of the measured value (dBm)	1490 nm: -50.00 to 13.00	-26.00
		1550 nm: -50.00 to 26.00	-7.00
Enable Threshold	Evaluation result display setting	Off, On	Off
Reference	Reference level of difference value display (dBm)	-99.9 to 99.9	-----
dB/dBm	Absolute value (dBm)/relative value (dB) display switching	dB, dBm	dBm

The measured optical power value of each wavelength is displayed as the absolute value (dBm) or difference value (dB). When the measured value is higher than the upper limit of the measurement level range, **Over Range** is displayed, and when it is lower than the lower limit, **Under Range** is displayed.

When the measured optical power value is higher than the set threshold, **OK** is displayed, and when it is lower, **NG** is displayed.



1. Press  to display the menu.
2. Select **Top Menu** with  and , and then press  to display the top menu screen.
3. Select **PON Power Meter** with  and . The PON Power Meter screen is displayed.

To terminate the PON power meter, press  to display the top menu screen.

Zero level calibration

Before measurement start, calibrate the internal zero level of the unit.

1. Remove the optical fiber from the unit.
2. Close the slide cover.
3. Press  (**Set Zero**). The set zero confirmation screen is displayed.



4. Select **Start** with  and , and then press .

Zeroing... is displayed during set zero execution.

5. The set zero is finished when the following appear.
 dBm: [Under Range]
 dB: [----]

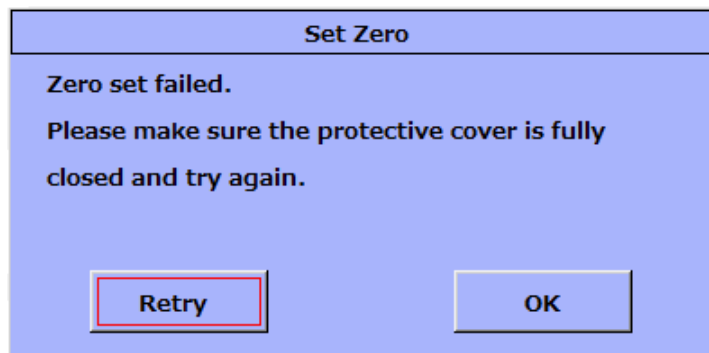
Only  is available during zero level calibration. If the zero level calibration fails, the message below will be displayed.



When the set zero is re-executed, confirm the slide cover is firmly closed, and then select **Retry**. Press  to start the set zero. Select **OK**, and press  to return to the PON Power Meter screen. If the set zero fails repeatedly, contact Anritsu or our sales dealer.

Threshold setup

When executing a pass/fail evaluation of the measured optical power value, set the threshold.

1. Press **F1** (**Threshold value**).

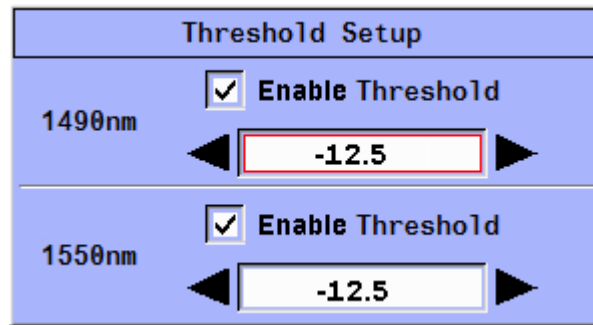

2. Select **Enable Threshold** for 1490 nm with and .
3. Select the check box with .
4. Select **1490 nm** threshold field with and .
5. Set the threshold level with and .
6. Repeat Step 2 to 5 again for 1550 nm.
7. Press **F1** (**Setup**) to finish the threshold setup.
To cancel the setup, press **F2** (**Cancel**).
Press **F3** (**Defaults**) to restore the defaults in Table 6.1-1.
8. **PASS** or **FAIL** is displayed on the PON power meter screen.

Level difference

When displaying difference, set the reference value as 0 dB.

1. Press **F2** (**Reference Value**) to set the currently displayed optical power as the Reference value.

The set reference value is displayed on the screen.

However, the reference value is displayed in the following cases:

- When the measured optical power value is **Over Range** or **Under Range**
- When **F2** (**Reference Value**) has been pressed and the measured optical power value is **Over Range** or **Under Range**:

2. Press **F3** (**dB/dBm**) to select the dB.

The difference from the Reference value is displayed in the PON power meter screen. However, it is not displayed when the measured optical power value is **Over Range** or **Under Range**.

Chapter 7 Checking Fiber Connection End

This chapter describes how to confirm the destination of the fiber connection and how to use the optical source function and power meter.

7.1	Confirming Fiber Connection End (Optical Fiber Identification).....	7-2
7.2	Using Light Source	7-3
7.3	Measuring Optical Power.....	7-5

7.1 Confirming Fiber Connection End (Optical Fiber Identification)

Optical fiber cables are composed of many optical fibers.

Identifying which connector is connected to each end of a cable is called “Optical Fiber Identification”.

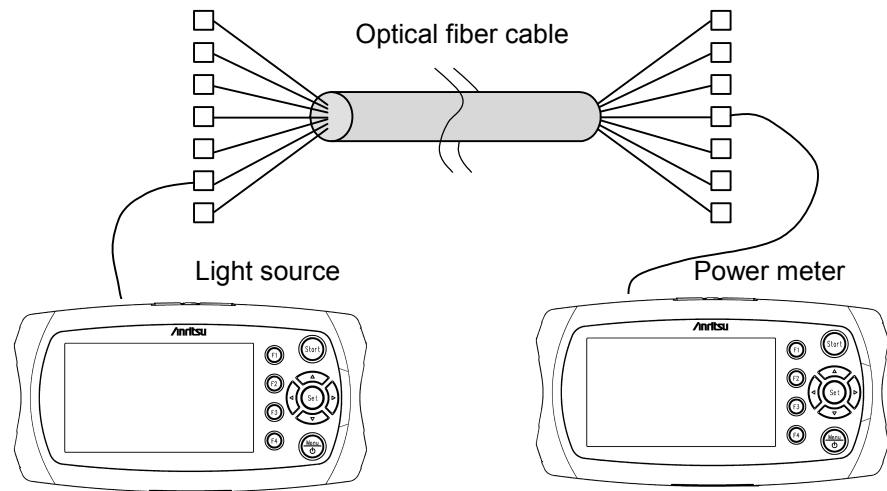

Figure 7.1-1 Connection Diagram for Optical Fiber Identification

The light source is connected to an optical fiber cable connector and the power meter is connected to a connector at the other end of the cable to detect the optical output from the light source.

Since there is also light used by the optical communications in the fiber, it is not possible to discriminate light received from the light source using optical fiber identification just by measuring the optical power with a power meter.





To identify the light using optical fiber identification, the optical signal from the light source must be modulated at any of 270 Hz, 1 kHz or 2 kHz. Optical fiber identification detects the light by measuring the power of the modulated light using the power meter.

7.2 Using Light Source





The light source outputs the optical signals of wavelength used in the OTDR continuously or modulated.

It can be used for identification and loss measurement for the optical fiber with the use of the optical power meter.

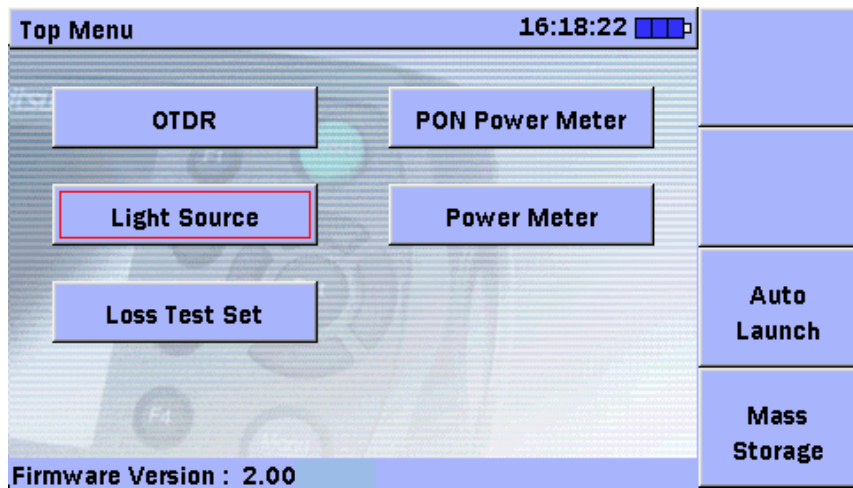
To use the Light Source:

1. Press  to display the General Functions pop-up menu.
2. Select **Top Menu** with  and , and then press  to display the top menu screen.



3. Select the Light Source with , , , and , and then press  to display the Light Source screen.



4. Press **F1 (Wavelength)** to select the wavelength. An arrow is displayed on the image of the connector that outputs the optical signal.
5. Press **F2 (Modulation)** to select the modulation frequency. When **CW** is selected, the signal to be output is not modulated.
6. Press **Start** to change the display to **On** and output the optical signal. Also the measurement optical signal output icon is displayed.



7. Press **Start** again to stop the optical signal output. The display changes to **Off**.

Table 7.2-1 Setting Items on Light Source Screen

Item Name	Function	Setting Range	Default
Wavelength	Wavelength band of optical signal to be output (nm)	Refer to Table 7.2-2.	Refer to Table 7.2-2.
Modulation	Modulation frequency	CW, 270, 1k, 2k	CW

Note:

When turning off the power once, the modulation is set to **CW**.

Table 7.2-2 Wavelength Setting Item

Model Name/Option	Setting Range	Default
MU909014C/C6-057/067	1310, 1550, 1625	1310
MU909014C/C6-058/068	1310, 1550, 1650	1310
MU909015A6-053/063	1625	1625
MU909015A6-054/064	1650	1650
MU909015C/C6-057/067	1310, 1550, 1625	1310
MU909015C/C6-058/068	1310, 1550, 1650	1310
MU909015C/C6-059/069	1310, 1490, 1550	1310

7.3 Measuring Optical Power

The power meter can measure the optical power of the wavelength from 1310 nm to 1650 nm. Also, it can measure the modulated optical power.

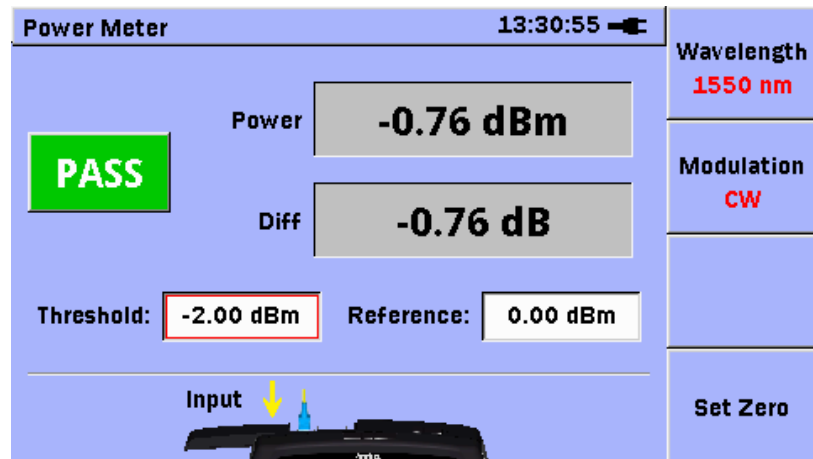

Figure 7.3-1 Power Meter Screen

Table 7.3-1 Setting Items of Power Meter Screen

Item Name	Function	Setting Range	Default
Wavelength*1	Wavelength band of optical signal to be measured (nm)	1310, 1490, 1550, 1625, 1650	1310
Modulation*2	Optical modulation frequency	CW, 270 Hz, 1 kHz, 2 kHz	CW
Threshold value	Threshold for a pass/fail evaluation of the power or loss (dBm)	-50.00 to 26.00	0.00*3
Reference value	Reference value of loss (dBm)	-50.00 to 26.00	0.00

*1: The MU909014C and MU909015C cannot select 1625 and 1650.

*2: The MU909014C and MU909015C cannot change the modulation.

*3: The default value is -26.00 in DCFL application.

Power meter measured value

The measured optical power value is displayed by the absolute value (dBm) or difference value (dB). When the measured value is higher than the Max. measurement level, **Over Range** is displayed. On the other hand, when the measured value is lower than the Min. measurement level, **Under Range** is displayed.

Level difference

The level difference for the reference value is displayed.

When the measured value is higher than the reference level, a positive value is displayed.

When the measured value is lower than the reference level, a negative value is displayed.











Pass/Fail evaluation

The optical power measured value is compared with the threshold (dBm) for evaluation.

OK: The optical power is equal to the threshold or more.





NG: The optical power is less than the threshold.

Power meter measurement condition setup

1. Press  to display the menu.
2. Select Top Menu with  and , and then press  to display the **top menu** screen.
3. Select **Power Meter** with  and .
4. Press .
5. Press  (**Wavelength**) to select the wavelength.
6. When using the MU909014C6/MU909015A6/C6, press  (**Modulation**) to set the modulation frequency.
Press  to display the top menu to terminate the power meter.

Zero level calibration

Before measurement start, calibrate the internal zero level of the unit.

1. Remove the optical fiber from the unit.
2. Close the slide cover.
3. Press  (**Set Zero**).
The Set Zero confirmation screen is displayed.
4. Select Start with  and , and then press . **Zeroing...** is displayed while executing the set zero.
5. The zero level calibration is finished when the following appears.
dBm: **Under Range**
dB: -----
Only  is available while executing the Set Zero.

If the zero level calibration fails, the message below will be displayed.

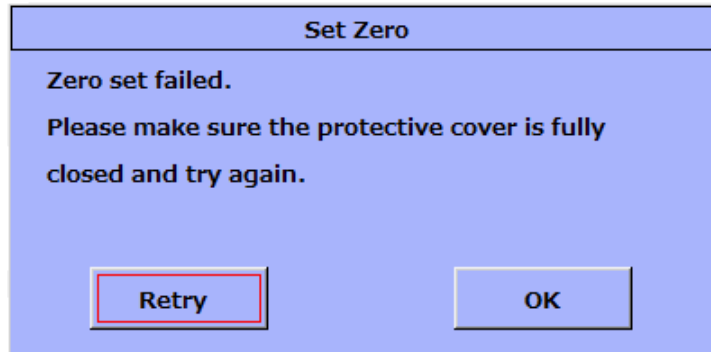

When the set zero is re-executed, confirm the slide cover is firmly closed, and then select **Retry**.

Press **Set** to execute the set zero.

Select **OK**, and press **Set** to return to the PON Power Meter screen.





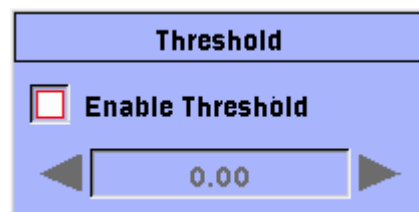

If the set zero fails repeatedly, contact Anritsu or our sales dealer.

Threshold setup

When executing a pass/fail evaluation of the measured optical power value, set the threshold.



1. Select **Threshold** with  and , and press **Set**.









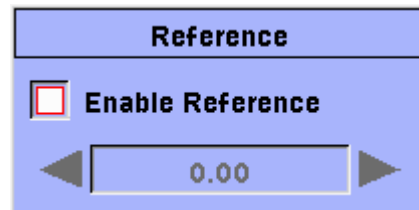

2. Select **Enable Threshold** with  and .
3. Select the check box with **Set**.
4. Select the threshold field with  and .
5. Set the threshold level with  and .
6. Press **Set** to finish the threshold setup.
7. **PASS** or **FAIL** is displayed on the power meter screen.

Difference Setup

When displaying difference, set the reference value as 0 dB.



1. Select **Reference Value** with  and , and press .



2. Select **Enable Reference Value** with  and .
3. Select the check box with .
4. Select the reference field with  and .
5. Set the reference value with  and .

Press  (**Paste**) to set the currently displayed optical power as the Reference value.

 is unavailable when **Over Range** or **Under Range** is displayed.

6. Press  (**Setup**) to finish the reference value setup.
To cancel the setup, press  (**Cancel**).
Press  (**Defaults**) to restore the defaults in Table 7.3-1.
7. The value that is obtained by subtracting the reference value from the measured value is displayed as the difference.

Chapter 8 Measuring Loss of Optical Parts

This chapter describes how to measure the loss of the optical parts using the optical loss measurement function.

8.1	Measuring Optical Loss	8-2
8.2	Measuring Procedures of Optical Loss.....	8-7

8.1 Measuring Optical Loss

The optical loss test can measure the loss of the fiber and optical parts using the light source function and power meter function.

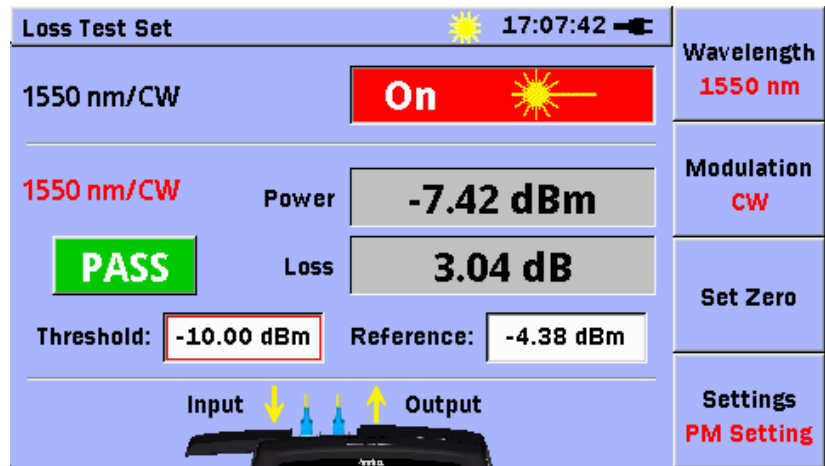

Figure 8.1-1 Loss Test Set Screen

Table 8.1-1 Setting Items of Loss Test Set Screen (Power Meter)

Item Name	Function	Setting Range	Default
Wavelength	Wavelength band of optical signal to be measured (nm)	1310, 1490, 1550, 1625, 1650	1310
Modulation	Optical modulation frequency (Hz)	CW, 270, 1k, 2k	CW
Threshold value	Threshold for a pass/fail evaluation of the measured value (dBm)	-50.0 to 26.0	-10.0
Enable Threshold value	Evaluation result display setting	On, Off	On
Reference value	Reference level of optical loss measurement (dBm)	-50.0 to 26.0	0.00
Enable Reference value	Evaluation result display setting	On, Off	On







Table 8.1-2 Setting Items of Optical Loss Measurement Screen (Light Source)

Item Name	Function	Setting Range	Default
Wavelength*	Wavelength band of optical signal to be measured (nm)	1310, 1490, 1550	1310
Modulation	Optical modulation frequency (Hz)	CW, 270, 1k, 2k	CW

*: Depends on the model, refer to Table 1.1-1

Note:

When turning off the power once, the modulation is set to **CW**.

1. Press  to display the menu.
2. Select Top Menu with  and , and then press  to display the top menu screen.
3. Select **Optical Loss Measurement** with  and . The optical loss measurement screen is displayed.
Press  to display the top menu to terminate the optical loss measurement.

Setting Light Source

1. Press **F4 (Next)** to display Setting Light Source.
2. Press **F1 (Wavelength)** to select the wavelength of the light source.
3. Press **F2 (Modulation)** to set the modulation frequency of the light source.
4. Press **Start** to change the display to **On** and output the optical signal.
5. Press **Start** again to stop the optical signal output. The display changes to **Off**.

To set power meter

1. Press **F4 (Next)** to display **PM Setting**.

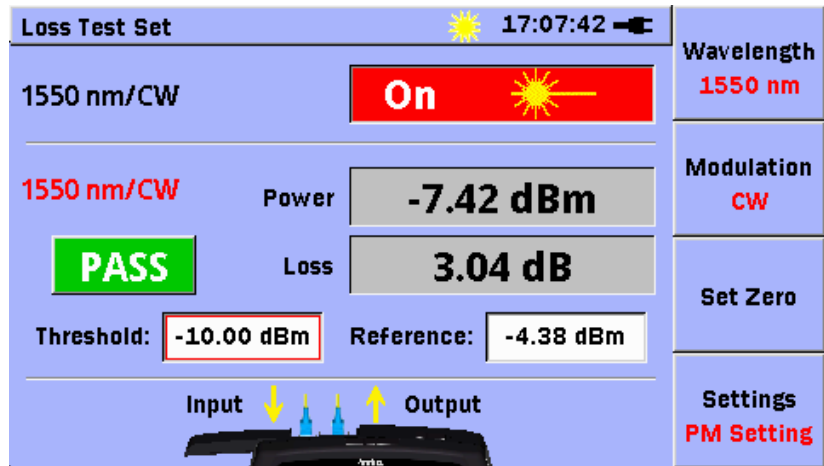

2. Press **F1 (Wavelength)** to select the wavelength of the power meter.
3. Press **F2 (Modulation)** to set the modulation frequency of the optical source.
4. Set the zero calibration, threshold value, and reference value of the power meter. For the setting method, refer to the following pages.

Zero level calibration

Before measurement start, calibrate the internal zero level of the unit.

1. Remove the optical fiber from the unit.
2. Close the slide cover.
3. Press **F3 (Set Zero)**. The zero calibration confirmation screen is displayed.
4. Select Start with **◀** and **▶**, and then press **Set**.

Zeroing... is displayed while executing the set zero.

5. The zero level calibration is finished when the following appears.
 dBm: **Under Range**
 dB: -----
 Only **Menu** is available while executing the offset.

If the zero level calibration fails, the message below will be displayed.

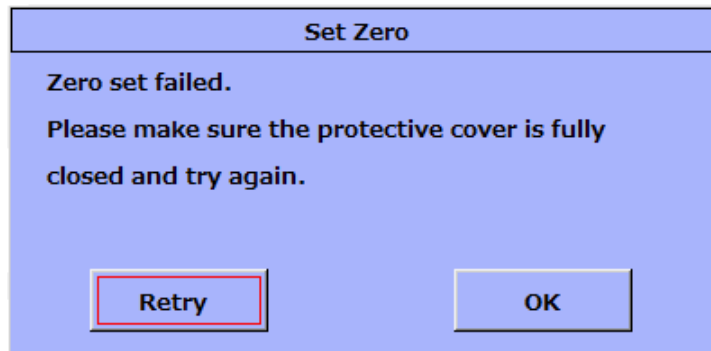

When the set zero is re-executed, confirm the slide cover is firmly closed, and then select **Retry**. Pressing **Set** executes the set zero.







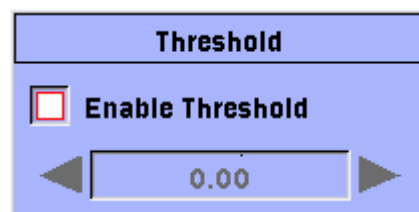

Select **OK**, and press **Set** to return to the PON Power Meter screen. If the set zero fails repeatedly, contact Anritsu or our sales dealer.

Threshold setup

When executing a pass/fail evaluation of the measured optical power value, set the threshold.



1. Select Threshold with **◀** and **▶**, and press **Set**.









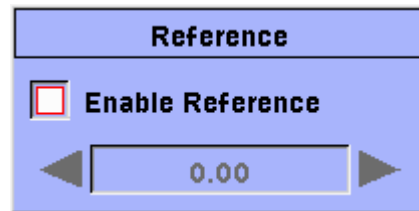

2. Select **Enable Threshold** with  and .
3. Select the check box with .
4. Select to the threshold field with  and .
5. Set the threshold level with  and .
6. Press  (**Setup**) to finish the threshold setup.
7. **PASS** or **FAIL** is displayed in the Power Meter screen.

Level difference setup

For the difference display, set the reference level of 0 dB



1. Select the reference value with  and . Press .



2. Select **Enable Reference Value** with  and .
3. Select the check box with .
4. Select the reference field with  and .
5. Set the reference value with  and .

Press  (**Paste**) to set the currently displayed optical power as the Reference value.

 is unavailable when **Over Range** or **Under Range** is displayed.

6. Press  (**Setup**) to finish the reference setup.
To cancel the setup, press  (**Cancel**).
Press  (**Defaults**) to restore the defaults in Table 8.1-1.
7. The value that is obtained by subtracting the reference value from the measured value is displayed as the difference.

8.2 Measuring Procedures of Optical Loss

1. Connect a single-mode fiber to each of two optical connectors on the unit.
2. Use an optical adapter to connect two single-mode fibers.

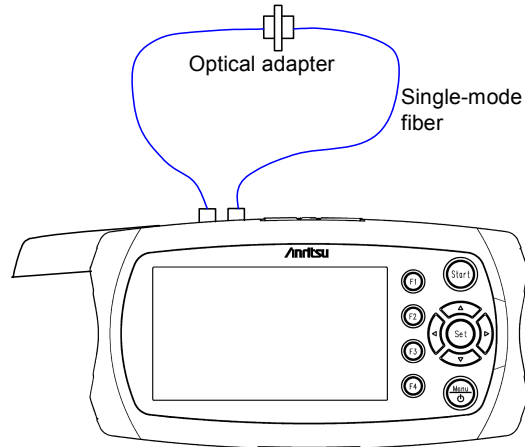

3. Press **F4 (Setting)** to display **Setting Optical Source**.
4. Press **F1 (Wavelength)** to select the wavelength of the optical source.
5. Press **F2 (Modulation)** to set the modulation frequency of the optical source.
6. Press **Start** to output the light.
7. Press **F4 (Setting)** to display **PM Setting**.
8. Press **F1 (Wavelength)** to select the wavelength of the power meter.
9. Press **F2 (Modulation)** to set the modulation frequency of the power meter to the same frequency of the optical source. Check that neither **Over Range** nor **Under Range** is displayed at the power display.
10. Select **Reference Value** with **←** and **→**, and press **Set**.
11. Select **Enable Loss Measurement** with **▲** and **▼**.
12. Select the check box with **Set**. If the check box is not selected, ******* is displayed at the loss display.
13. Select the loss input field with **▲** and **▼**.
14. Press **F4 (Paste)**. However, **F4** is unavailable when **Over Range** or **Under Range** is displayed. Use **←** and **→** to input the **Reference Value**.
15. Press **F1 (Setting)**.
16. Remove the optical fiber connected at Step 2, and connect to the DUT.

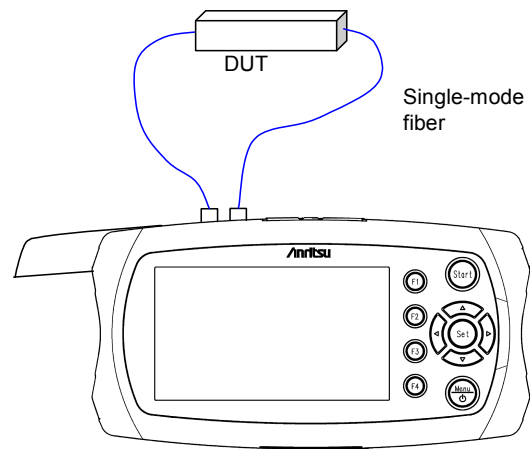

17. The loss of DUT is displayed.

Chapter 9 *Inspecting Fiber Surface*

The Video Inspection Probe (VIP) option is used to inspect fiber optic terminations.

This chapter describes how to use the VIP.

9.1	Component Parts of Fiberscope	9-2
9.2	Connecting VIP	9-5
9.3	Using VIP	9-7
9.4	Analyzing VIP Images.....	9-13
9.5	Creating a Report	9-15
9.6	Working with VIP Image Files.....	9-20

9.1 Component Parts of Fiberscope

μOTDR can use following VIP.

OPTION- 545 VIP	Magnification 200/400
G0293A	Magnification 400
G0306A	Magnification 400
G0306B	Magnification 400

This section explains the component parts of the OPTION- 545 VIP. For other VIPs, refer to the corresponding operation manuals.

The VIP option consists of the following component parts.

Table 9.1-1 Composition of Fiberscope

Product Name	Quantity
	OPTION- 545 VIP
Video Inspection Probe (VIP)	1
USB converter	1
Probe tip	5
Soft case	1



OPTION- 545 VIP

Figure 9.1-1 Fiber Scope (VIP)

Note:

The software CD contains the VIP Analysis software that runs on PC only. See the application software help for details on how to use.

[1] Video Inspection Probe (VIP)

This small lightweight probe contains a long-life coaxial LED light source and CCD video camera.

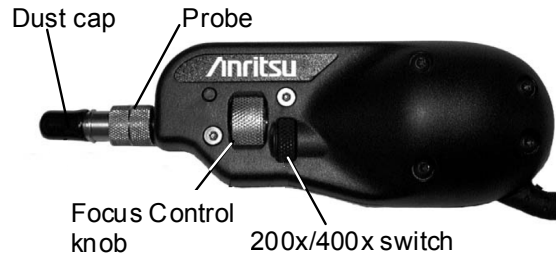

Figure 9.1-2 Video Inspection Probe (VIP)

[2] USB converter

[3] Probe Tips

The VIP includes five interchangeable probe tips: three standard tips (FC, ST, and SC) and two universal tips (\varnothing 1.25 mm and \varnothing 2.5 mm).

Standard Tips

These tips allow inspection of the fiber surface on the opposite side of the bulkhead (i.e. inside hardware devices or on the back side of patch panels).



Figure 9.1-3 Standard Tips

Universal Tips

Two universal tips are primarily used for inspecting patch cords.

The \varnothing 1.25 mm tip is compatible with \varnothing 1.25 mm ferrules (as used in LC and MU type connector) while the \varnothing 2.5 mm tip is compatible with \varnothing 2.5 mm ferrules (as used in FC, ST, and SC style connectors).



Universal 1.25 mm
adapter



Universal 2.5 mm
adapter

Figure 9.1-4 Universal Tips

9.2 Connecting VIP

This section explains about the OPTION-545 VIP.

For other VIPs, refer to the corresponding operation manuals.

Attaching a Probe Tip

Use the following procedure to attach a probe tip to the VIP.

1. Remove the dust cap.

Refer to Figure 8.1-2 for the location of the dust cap. If a probe tip is already attached, loosen the front retaining nut until it slides freely on the Barrel assembly.

Note:

Do not touch the lens surface or separate the probe from the fiberscope main body. If the probe is removed by mistake, align the notch of the probe with the pin of the probe mounting screw of the fiberscope body and secure it by tightening the probe nut (at fiberscope side).

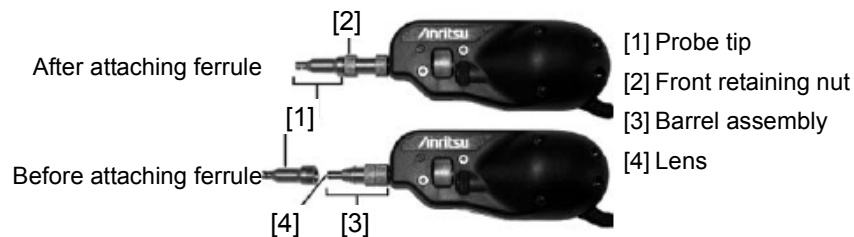

Figure 9.2-1 Probe Tips

2. Select the desired probe tip.

Make sure that the key (small set screw on the inside of the threaded end of the probe tip) aligns with the key channel on the barrel assembly and slide the probe tip into place. Refer to Figure 8.2-2 for details.

Note:

Do not adjust the set screw. The \varnothing 1.25 mm and \varnothing 2.5 mm Universal probe tips do not have keys.



Figure 9.2-2 Attaching a Probe Tip

3. Secure the probe tip in place with the front retaining nut.

Connecting the VIP to the USB Converter

For OPTION- 545 VIP, use the following procedure to connect the Video Inspection Probe to the USB converter.

1. Align the VIP connector (curly cord side) to the receptacle on the USB converter. When properly aligned, the connector slides into the receptacle.
2. Use the retaining nut on the connector to secure it to the USB converter.



Figure 9.2-3 VIP Connected to USB Converter

Connecting the VIP to the Unit

Use the following procedure to connect the VIP to the Network Master.

1. Open the cover of the Type A USB port on the main frame. (Refer to Fig. 2.2.2-1 for the location of the port.)
2. Insert the USB connector into the USB Type A port.





Note:

When the fiberscope is connected during measurement, the VIP screen is displayed.

9.3 Using VIP

Starting the VIP:

Operate the fiberscope using the following procedure. A captured image will look similar to the live image. If it is read from a file, a filename will be loaded and displayed on the screen title.

You can pan and zoom in and out the captured image using , , , and .

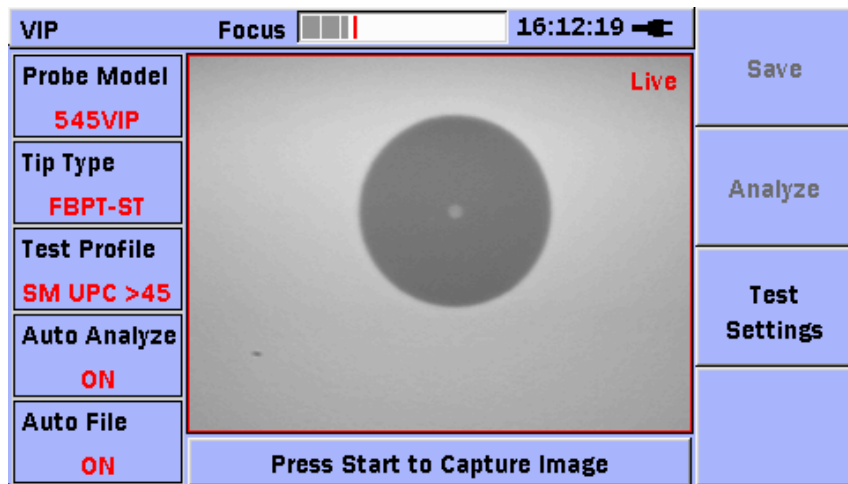

















Figure 9.3-1 VIP Screen

1. Press  to display the General Functions pop-up menu.
2. Select Open VIP with , and , and then press  to display the VIP screen.
3. Connect the Probe to μ OTDR, and then use the 200x/400x switch to set the desired magnification rate (as shown in Figure 8.1-2).
4. Use the Focus Control knob (as shown in Figure 8.1-2) to adjust the focus of the image, if the image is not in clear focus. When the image comes into clear focus, the grey focus indicator (at the top of the screen) overlaps the red best focus position bar.
5. If you want to change the Test Settings, press  (**Test Settings**). It is needed to analyze correctly.
6. Select the desired item with , and , and then press .
7. When all the desired items are selected, press  to capture image.
8. Press  to pan, and  appears in the lower right corner of the screen.
9. Press , , , and  to move the image.

















10. Press  to toggle the mode to Zoom, and  appears in the lower right corner of screen.
11. Press  to zoom in the image. The range is 50 to 200%.
Press  to zoom out the image.
12. If you want to view the captured image in full screen mode, press  to display the General Functions pop-up menu.
13. Select View Full Screen with  and , and then press  to switch to full screen mode.
14. The captured image is displayed full screen.
You can pan and zoom in and out using , , , and .



Figure 9.3-2 Full Screen

15. Press  (**Back**) to exit full screen.

Setting the Probe Model:

1. Press **F3** (**Test Settings**) in the VIP screen, and the Test Settings menu appears.
2. Select **Probe Model** with  and , and then press  to display the Select Probe Model dialog box.

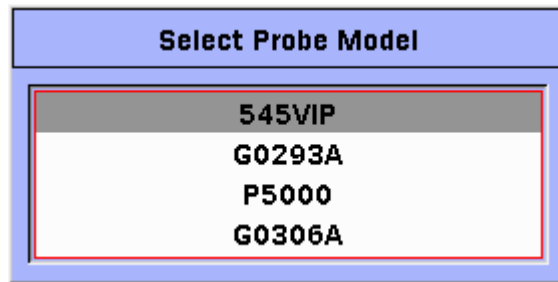





Figure 9.3-3 Select Probe Model screen

3. Select a probe with  and , and then press  to set the Probe Model.

Note:

Only the probes in the list can be used.

Setting the Tip Type:

1. Press **F3** (**Test Settings**) in the VIP screen, and the Test Settings menu appears.
2. Select Tip Type with  and , and then press  to display the Select Tip Type dialog box.

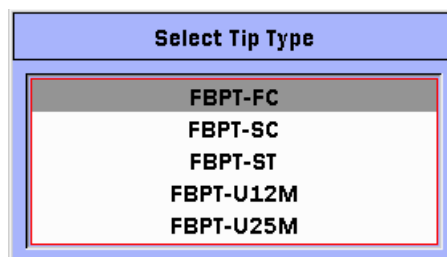





Figure 9.3-4 Select Tip Type (for 545VIP) screen

3. Select a tip with  and , and then press  to set the Tip Type.

Note:

Only the tips in the list can be used.

Setting the Test Profile (The kind of fiber to use):

1. Press **F3** (**Test Settings**) in the VIP screen, and the Test Settings menu appears.
2. Select Test Profile with  and , and then press  to display the Select Test Profile dialog box.

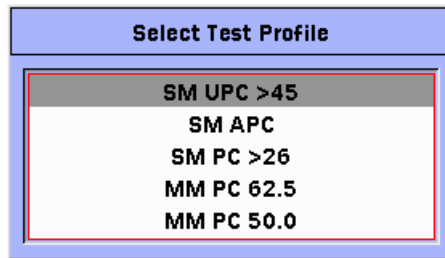







Figure 9.3-5 Select Test Profile screen

3. Select a profile with  and , and then press  to set the Test Profile.

Setting the Auto Setup:

1. Press **F3** (**Test Settings**) in the VIP screen, and the Test Settings menu appears.
2. Select Auto Setup with  and , and then press  to display the Setup tab.

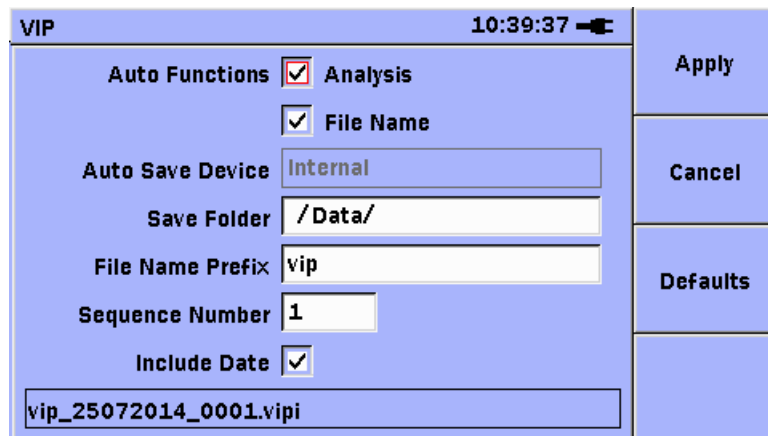

























Figure 9.3-6 Setup Tab

3. Select Analysis with  and , and then press  to select the check box. If you select the check box, Auto Analysis is performed after capturing an image.

4. Select File Name with  and , and then press  to select the check box. If you select the checkbox, Auto File Name is performed after capturing an image.
Go to step 14, if you do not select the File Name check box.
5. Use  and  to select **Save Folder**.
 - (1) Press  to display the Select Folder screen.
 - (2) Use , , , and  to select a folder to save the measurement results.
 - (3) Press  (**Select**) to set the selected folder and to close the folder selection screen.
 - (4) The selected folder path is displayed as **Auto Save Folder** on the setting screen.
6. Select File Name Prefix with  and , and then press  to enter characters. The Softkey Board screen appears. (Refer to Section 3.6 “Using Softkey Board”.)
7. Select the Sequence Number with  and , and then press  to enter numbers.
8. Use Softkey Board to establish a start number for the auto-increment section of the Auto-Filename. The setting range of the Sequence Number is from 0 to 9999, in increments of 1.
9. Select the Include Date with  and , and then press  to select the check box. If you select the checkbox, the date when you save the file is included in a file name.



The file naming rules are as follows.

The file extension is .vipi.





File Name Prefix_Date_Sequence Number.vipi

Example: vip_06082012_001.vipi

Filename Prefix	vip
Date	Aug 6, 2012
Sequence Number	1

10. When setting is completed, press  (**Apply**) to apply the settings. Press  (**Back**) to close the Setup tab and cancel the settings. If you want to restore the default settings, press  (**Defaults**).

Exiting the VIP Mode

1. Press  to display the General Functions pop-up menu.
2. Select **Close VIP** with  and , and then press  to close the VIP screen.

9.4 Analyzing VIP Images

Images captured by the VIP can be analyzed on the μ OTDR.

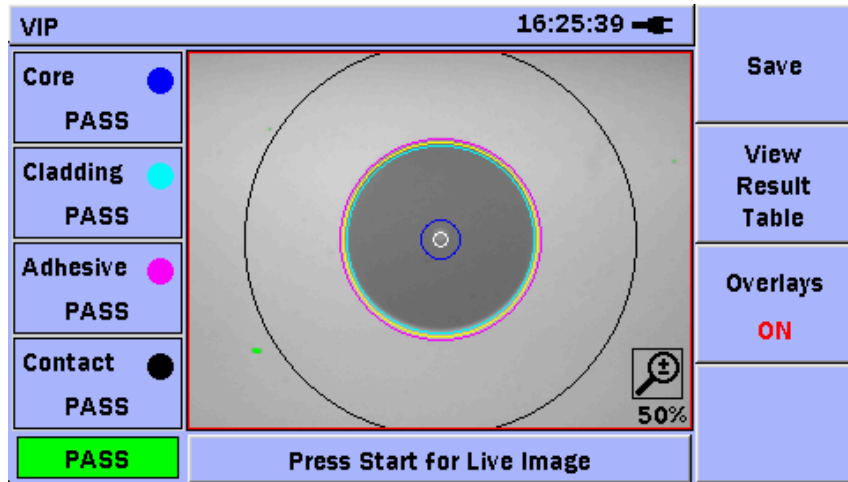

Figure 9.4-1 Analyzing a VIP Image

Analyzing a VIP image:

1. Capture the image or load a VIP image.
2. If you want to change the Test Settings, press **F3** (**Test Settings**) and change the settings.
3. Press **F2** (**Analyze**) to start analysis of the VIP image. The progress bar is displayed during analysis.
4. Circle of analysis range on the VIP image and PASS/FAIL indicator are displayed if analysis is normally completed.
5. Press **F2** (**View Result Table**) after analyzing, the analysis details table is displayed.

Zone Name				Diameter (μ)		Result	
1	Core	25		PASS			
2	Cladding	120		PASS			
3	Adhesive	130		PASS			
4	Contact	250		PASS			

	Defects	Count	Area (μ^2)	Scratches	Count
1	PASS	0	0.00	PASS	0
2	PASS	0	0.00	PASS	0
3	PASS	0	0.00	PASS	0
4	PASS	0	0.00	PASS	0

Figure 9.4-2 Analysis Details Table

If there are defects, whose size is not acceptable, found on the fiber, they are displayed in red which indicates they are Fail. The table shows the zone and area of each defect.

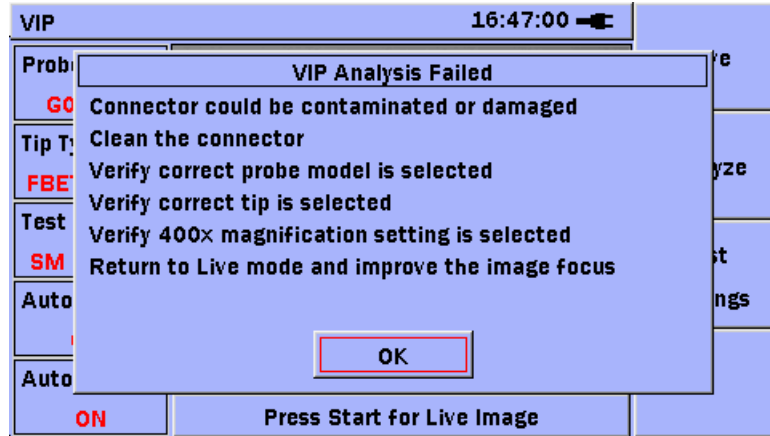

Figure 9.4-3 VIP Analysis Failed Pop-up

9.5 Creating a Report

Analysis results can be output as a PDF file to the μ OTDR.

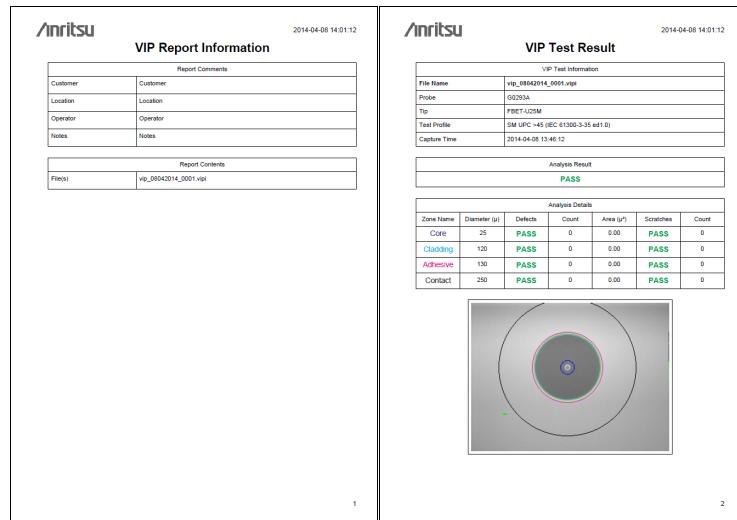









Figure 9.5-1 PDF Report

Notes:

- VIP image displayed at 100% scale in the VIP screen is output as a PDF file.
- Image saved as a VIPI file is output as a PDF file.

Creating a report:

1. Capture the image or load a VIP image.
2. Press  to display the General Functions pop-up menu.
3. Select Create Report with  and , and then press  to display the VIP screen.
4. If you want to change the Report Settings, use , , , and  to select the desired tab, and then change the settings.

5. Press **F1** (**Create PDF**), the Save PDF Report screen appears.
If there is no VIP image, **F1** (**Create PDF**) is dimmed.

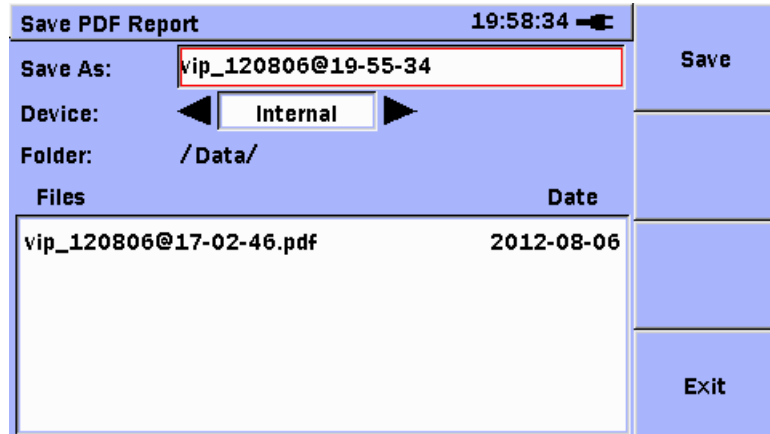

Figure 9.5-2 Save PDF Report Screen

Setting the VIP – General settings –:

1. Capture the image or load a VIP image.
2. Press **Menu** to display the General Functions pop-up menu.
3. Select Create Report with **Left Arrow** and **Right Arrow**, and then press **Set** to display the VIP screen.
4. Select the General tab with **Left Arrow**, **Right Arrow**, **Up Arrow**, and **Down Arrow** to change the General settings.

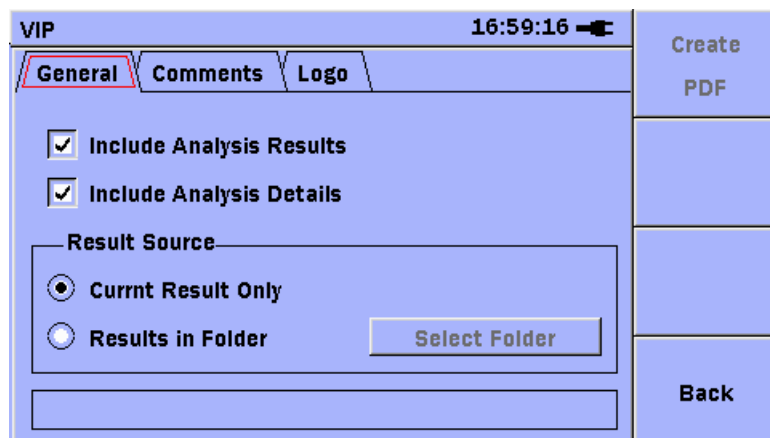







Figure 9.5-3 General Tab

5. Select Include Analysis Results with **Left Arrow** and **Right Arrow**, and then press **Set** to select the check box. If you select the check box, Analysis results are included in a report.

6. Select Include Analysis Details with  and , and then press  to select the check box. If you select the check box, the analysis details table is included in a report.
7. Select Result Source with  and , and then press  to select the radio button.

Current Result Only –



Includes only the results of the current analysis in a report.

Note:

If there is no captured or loaded image available, this button is disabled, and reports can only be made from previously saved test results.

Results in Folder –

Includes all the VIP results in the selected folder. When this button is selected, a default folder name will appear on the screen, and the Select Folder softkey will be enabled.

Select the Select Folder with  and  and press , and then the Select Folder with VIP Results screen that allows you to select a different file folder is displayed.











Select Folder with VIP Results		18:25:02	
Device:	 Internal 		Select
Folder:	/Data/		
Files		Date	
vip_06082012_000.vipi		2012-08-06	
vip_06082012_001.vipi		2012-08-06	
vip_06082012_002.vipi		2012-08-06	
vip_06082012_999.vipi		2012-08-06	
			Exit

Figure 9.5-4 Analysis Details Table

Setting the VIP – Comments settings –:

Headers hold valuable information about the VIP Report files. You don't need to fill the header each time a new VIP image is analyzed.

Information entered in the VIP Create PDF screen is retained until the header requires editing.

1. Press  to display the General Functions pop-up menu.
2. Select Create Report with  and , and then press  to display the VIP screen.
3. Select the Comments tab with , , , and  to edit the header.

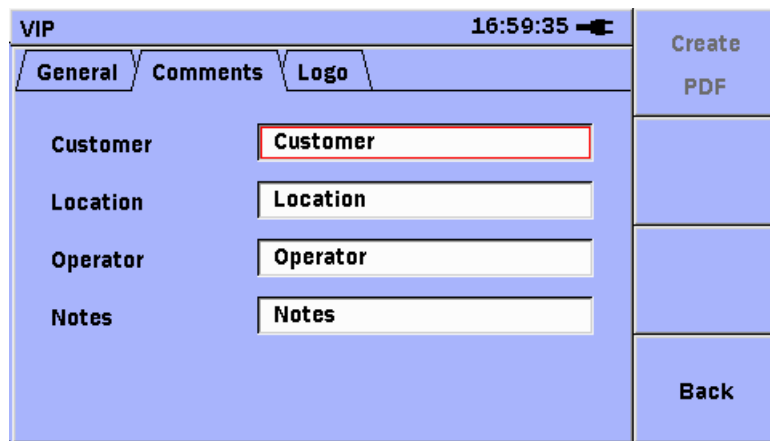





Figure 9.5-5 Comments Tab

4. Select the desired field with  and , and then press  to edit the field. Header consists of the following fields.

Refer to Section 3.6. "Using Softkey Board" for how to edit.

- Customer: This field allows you to enter a customer name.
- Location: This field allows you to enter a location, such as an address or city.
- Operator: This field allows you to enter an operator name.
- Notes: This field allows you to enter any notes that may be desired concerning the specific job.

Setting the VIP – Logo settings –:

The logo can be included in a report.

Note:

Only PNG format files can be used.

















1. Press  to display the General Functions pop-up menu.
2. Select Create Report with  and , and then press  to display the VIP screen.
3. Select the Logo tab with , , , and  to change the Logo.



Figure 9.5-6 Logo tab screen

4. Select the Include Logo with  and , and then press  to select the check box. If you select the check box, the logo is included in a report.
5. Select the Path with  and , and then press  to display the Load PDF Logo screen.
6. When you select a desired logo file, press  (**Load**) to load the logo file.
Or
Press  (**Exit**) to not load the logo file.

9.6 Working with VIP Image Files

Images captured by the VIP can be saved as PNG or vipi files. You can view the saved images on the μ OTDR or analyze them using the VIP Analysis software on a PC.

Note:

The mass storage feature cannot be used from the PC when any of the following screens is displayed:

- Export PNG Image
- Save PDF Report
- Save VIP Image
- Load VIP Image
- Import PNG Image

Saving a VIP image as a vipi file:

Save a VIP image using the following procedure.

1. Display the desired image in the VIP screen.
2. Auto File Name is ON: Press **F1 (Save)**, and the VIP image is automatically saved as a vipi file.

Or –

Auto File Name is OFF: Press **F1 (Save)**, and the Save VIP Image screen appears. Continue from step 3.

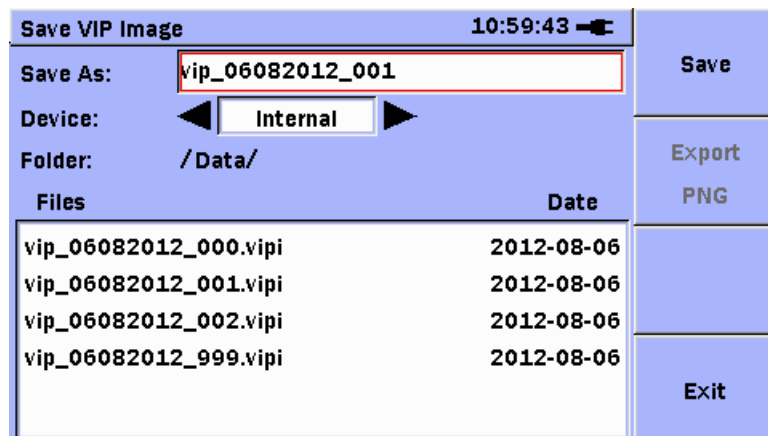

Figure 9.6-1 Save VIP Image Screen

Note:

The VIP image cannot be saved when there is no captured image or loaded image.

3. Select the Save As to enter file name, and then press **Set**.
The file name is entered automatically as “vip_DATE@TIME”.
4. Edit a file name, referring to Section 3.6. “Using Softkey Board”.
5. Select the desired directory or folder to save the file.
6. Press **F1 (Save)** to save the VIP image as a vipi file.
Press **F4 (Exit)** not to save.

Saving a VIP image as PNG file:

Save a VIP image using the following procedure.

1. Display the desired image in the VIP screen.
2. Press **Menu** to display the General Functions pop-up menu.
3. Select Export To PNG with **Left Arrow** and **Right Arrow**, and then press **Set** to display the Export PNG Image screen.

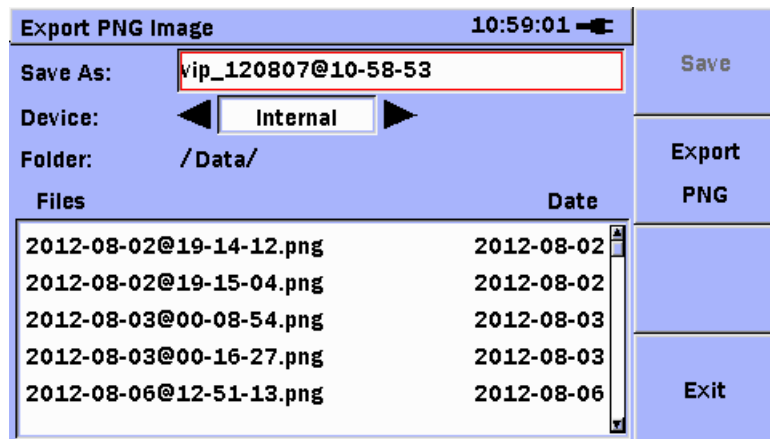

Figure 9.6-2 Export PNG Image Screen

Note:









The VIP image cannot be saved when there is no captured image or loaded image.

4. Select the Save As to enter file name, and then press **Set**.
The file name is entered automatically as “vip_DATE@TIME”.
5. Edit a file name using the softkey board.
6. Select the desired directory or folder to save the file.
7. Press **F2 (Export PNG)** to save the VIP image as a PNG file.
Press **F4 (Exit)** not to save.



Loading a VIP Image from a vipi file

Display saved VIP images using the following procedure.

1. Press  to display the General Functions pop-up menu.
2. Select Open VIP with  and , and then press  to display the VIP screen.
3. Press  to display the General Functions pop-up menu.
4. Select Load VIP Image with  and , and then press  to display the Load VIP Image screen.

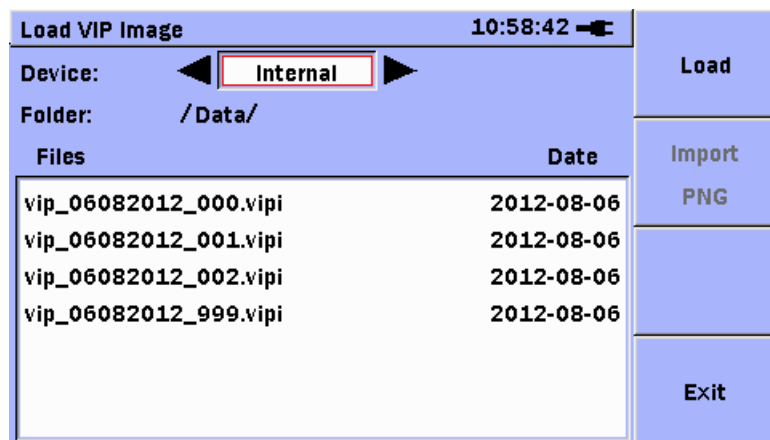













Figure 9.6-3 Load VIP Image Screen

5. Select the desired directory or folder from which a file is loaded, and then press .
6. Press  (**Load**) to read the VIP image from the vipi file.
Press  (**Exit**) not to read.

Loading a VIP Image from PNG file

Display saved VIP images using the following procedure.

1. Press  to display the General Functions pop-up menu.
2. Select Open VIP with  and , and then press  to display the VIP screen.
3. Press  to display the General Functions pop-up menu.
4. Select Import From PNG with  and , and then press  to display the Import PNG Image screen.

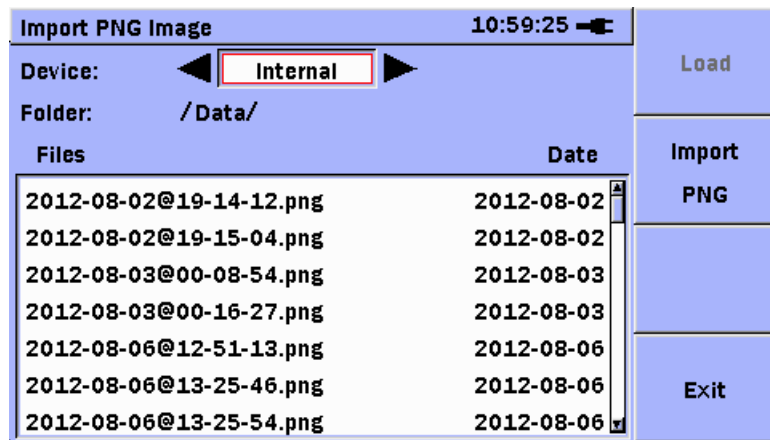





Figure 9.6-4 Import PNG Image Screen

5. Select the desired directory or folder from which a file is loaded, and then press .
6. Press  (**Import PNG**) to read the VIP image from the PNG file. Press  (**Exit**) not to read.

Chapter 10 Remote GUI and Folder Sharing

This chapter describes the remote GUI and folder sharing features. These features use an USB Ethernet converter, USB Wi-Fi dongle, or USB Bluetooth dongle.

Refer to the release note for the latest information on USB network devices that can be used with μ OTDR.

Note:

- USB hubs cannot be used.
- The latest release note is available on the Anritsu Download site (<https://www1.anritsu.co.jp/Download/MService/Login.asp>).

The remote GUI feature provides the following capabilities:

- You can connect to μ OTDR from a browser that supports Adobe Flash Player.
There is no need to install any application on the PC.
- Password authentication is available when connecting to μ OTDR.
- The browser screen is updated in real time.
- The μ OTDR screen is displayed on the browser, allowing operation in the same way as on the main system.
- Files can be downloaded from μ OTDR.
- Files can be uploaded from the PC.

The Shared folder includes the following features:

- There is no need to install any application on the PC.
- Folders can be shared between the PC and μ OTDR.
- Password authentication is available when connecting to a shared folder.
- Folders can be copied, moved, deleted, and created.

10.1	Configuring the Network Settings for μ OTDR.....	10-2
10.1.1	Configuring Ethernet settings	10-4
10.1.2	Configuring Wi-Fi settings	10-8
10.1.3	Configuring Bluetooth settings	10-15
10.2	Setting the Remote GUI Password.....	10-18
10.3	File Sharing Setting	10-19
10.4	Using the Remote GUI.....	10-23

10.1 Configuring the Network Settings for μ OTDR

μ OTDR connects to the network via a USB Wi-Fi dongle or USB Bluetooth dongle.

The following table shows the list of USB network devices that can be used. Refer to the release note for the latest information.

Note:

They may not be used due to compatibility problems.

If this is the case, use USB network devices whose compatibility has been confirmed.

Also, multiple USB devices cannot be connected using a USB hub.

Table 10.1-1 List of Compatible USB Network Devices

USB Ethernet Converter	
Planex	UE-100TX-G3
USB Wi-Fi dongle	
BUFFALO	WLI-UC-GNM
I•O DATA	WN-G300U
Logitec	LAN-W150N/U2
	LAN-W300N/U2
Sitecom	WL-329
	WL-345
	WLA-4000
USB Bluetooth dongle	
BUFFALO	BSHSBD04BK
	BSHSBD05BK
	BSHSBD08BK
IOGEAR	GBU421
Logitec	LBT-UAN01C1
Planex	BT-Micro3H2X
	BT-MicroEDR1X
Sanwa Supply	MM-BTUD27
Targus	ACB20EU
Technika	NBA111

When you connect a USB network device, the Network Setup screen is displayed on the Top Menu screen.

You can also access the Network Setup screen by pressing  on the Top Menu screen.

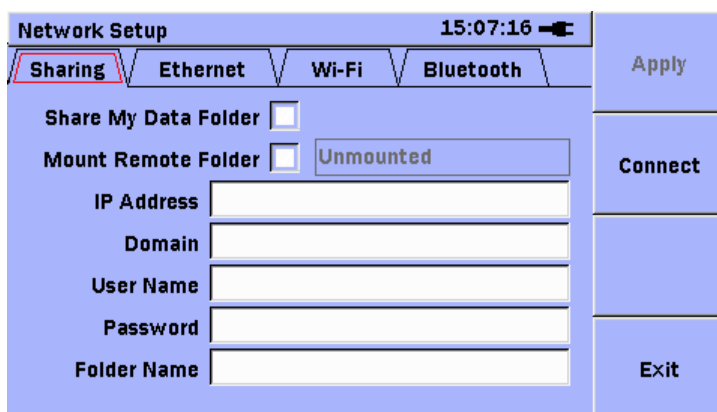

Figure 10.1-1 Network Setup Screen

Reconfigure the μ OTDR network settings according to the operating environment.

10.1.1 Configuring Ethernet settings

When using a USB Ethernet converter, set the following items on the **Ethernet** tab of the Network Setup screen.





Table 10.1.1-1 Setting Items (Ethernet Connection)

Item	Function	Parameters	Default
DHCP	If this check box is ON, IP Address, Subnet Mask and Default Gateway are assigned automatically.	Off, On	On
IP Address*	Set IP Address.	0.0.0.0 to 255.255.255.255	192.168.200.1
Subnet Mask*	Set Subnet Mask.	0.0.0.0 to 255.255.255.255	255.255.0.0
Default Gateway*	Set the Default Gateway.	0.0.0.0 to 255.255.255.255	0.0.0.0

*: Set only when DHCP is set to “Off”.

Setting the address (Automatic Assignment)

If the network supports **DHCP**, an IP address will be assigned automatically by the network. To use **DHCP**, follow the steps below:

1. Connect the USB Ethernet converter to the USB type A port of the controller on the Top Menu screen.
If USB Ethernet converter is already connected, continue to step 2.
When not connected, continue to step 4.
2. Press  to display the General Functions pop-up menu on the Top Menu screen.
3. Press  and  to select **Network Setup**, and then press  to access the Network Setup screen.
4. The **Ethernet** tab of the Network Setup screen is displayed.

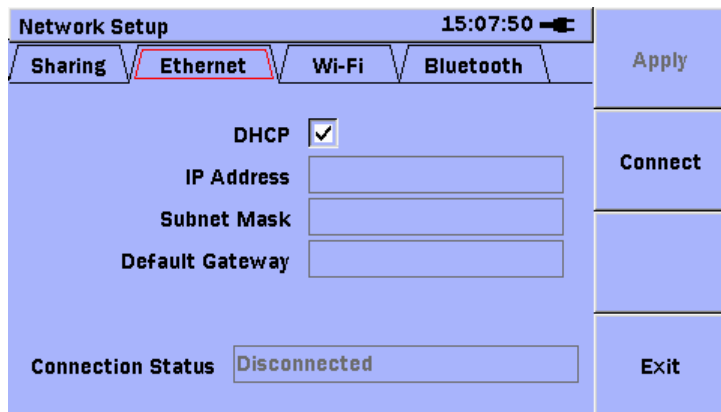





Figure 10.1.1-1 Ethernet Tab

5. Press  and  to select **DHCP**, and then press  to select the check box.

6. To use DHCP, press **F1 (Apply)**. To cancel, press **F4 (Close)**.
7. Connect the RJ-45 connector of the Ethernet drop cable to Ethernet end of the USB-Ethernet converter.
8. Press **F2 (Connect)** to connect the network.
If connection is completed, the address is displayed.
If not, IP Address, Subnet Mask and Default Gateway are left blank.

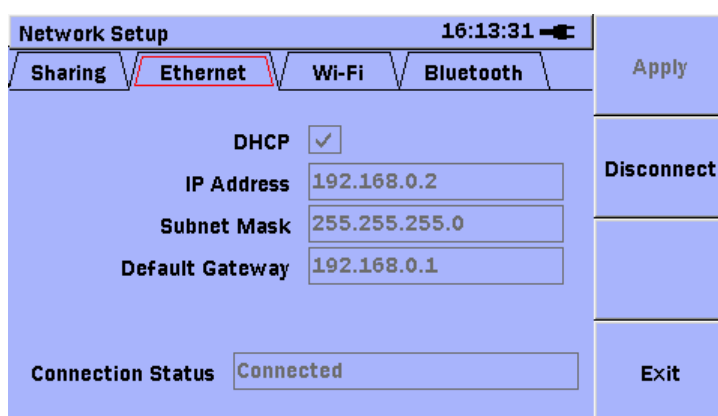

Figure 10.1.1-2 Screen for Successful DHCP Connection

Note:

If the DHCP request was not successful, please check your network. When you do not solve, please set an address manually.





9. If you want to disconnect the network, press **F2 (Disconnect)** to disconnect the network.
10. Dismount the USB Ethernet converter.

Note:

Disconnect the network before dismount the USB Ethernet converter.

Setting the address (Manual Assignment)

If the network does not support **DHCP**, or manual assignment of an IP address is desired, follow the steps below:

1. Connect the USB Ethernet converter to the USB type A port of the controller on the Top Menu screen.
If USB Ethernet converter is already connected, continue to step 2.
When not connected, continue to step 4.
2. Press  to display the General Functions pop-up menu on the Top Menu screen.
3. Press  and  to select the Network Setup screen, and then press .
4. The **Ethernet** tab of the Network Setup screen is displayed.

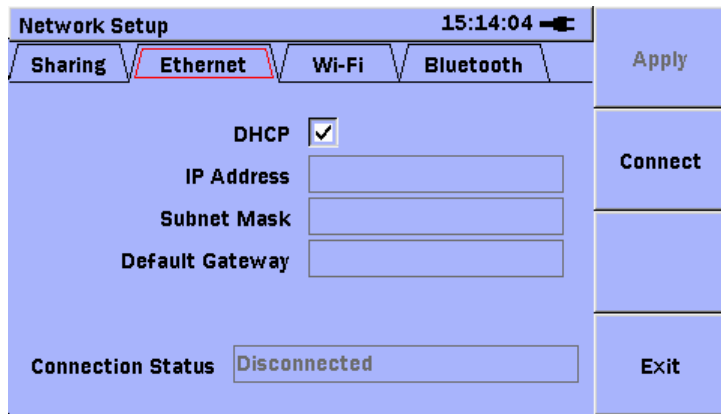















Figure 10.1.1-3 Ethernet tab Screen

5. Press  and  to select **DHCP**, and then press  to clear the check box.
6. Press  and  to select an item, and then press  to edit the address.
7. The address screen appears.
8. Press , , , and  to specify each address.

Note:

Leave the **Default Gateway** box blank if a default gateway is not used.

9. To enable the new address, press  (**Set**).
To cancel, press  (**Cancel**).
10. Repeat step 6 to 9.
11. After you set all the addresses, press  (**Set**).
To cancel, press  (**Exit**) and close the Network Setup screen.

12. Connect the LAN cable to the USB Ethernet converter.
13. Press **F2** (**Connect**) to connect to the network.
Once a connection is established, “Connected” is displayed in the **Connection Status** box.

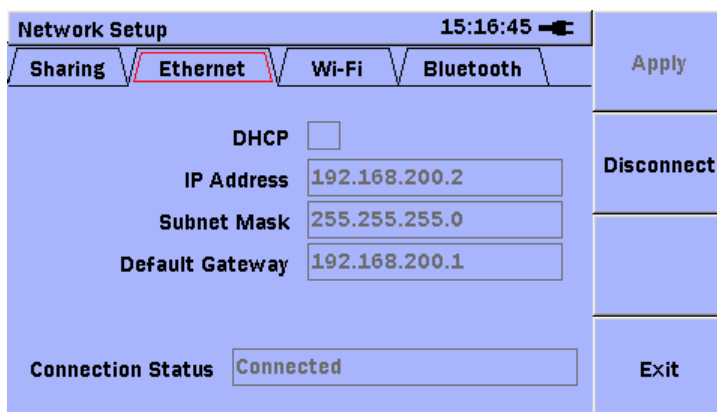

Figure 10.1.1-4 Screen for Successful Connection

14. If you want to disconnect the network, press **F2** (**Disconnect**) to disconnect the network.
15. Remove the USB Ethernet converter.

Note:

Disconnect from the network before removing the USB Ethernet converter.

10.1.2 Configuring Wi-Fi settings

When using a USB Wi-Fi dongle, set the following items on the **Wi-Fi** tab of the Network Setup screen.

Note:



Contact your network administrator for the access point to be connected.

Table 10.1.2-1 Setting Items (Wi-Fi Connection)

Item	Function	Parameters	Default
Target Device (SSID)	Sets the target access point.	Up to 32 characters	Blank
Security	Sets the encryption method.	None, WEP, WPA, WPA2	None
Password	Set the password.	Up to 26 characters	Blank
DHCP	When this check box is selected, the IP address, subnet mask, and default gateway will be assigned automatically.	Off, On	On
IP address*	Set IP Address.	0.0.0.0 to 255.255.255.255	0.0.0.0
Subnet mask*	Set Subnet Mask.	0.0.0.0 to 255.255.255.255	0.0.0.0
Default Gateway*	Set the Default Gateway.	0.0.0.0 to 255.255.255.255	0.0.0.0

*: Set only when DHCP is set to “Off”.

Automatically searching the target access point and connecting to it

1. Connect the USB Wi-Fi dongle to the USB-A port on the top connector panel.
If already connected, proceed to Step 2.If it is not yet connected, proceed to Step 4.
2. On the Top Menu screen, press  to access the menu.
3. Press  and  to select **Network Setup** to display the Network Setup screen is displayed.

- The **Wi-Fi** tab of the Network Setup screen is displayed. The target network that is found first is displayed.

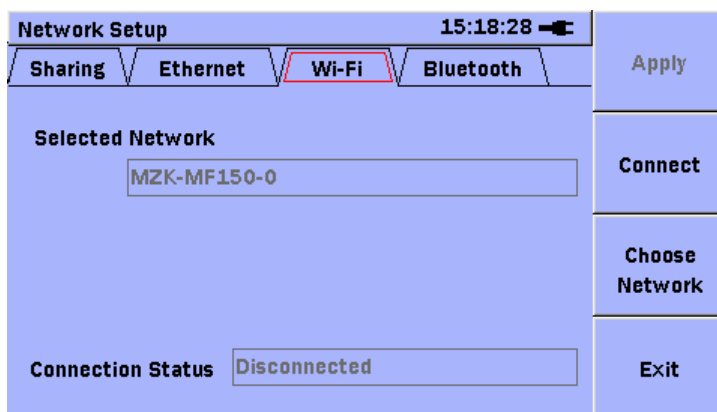





Figure 10.1.2-1 Wi-Fi Tab

- To change the target network connection, press **F3** (**Choose Network**).
- Select the desired access point using  and , and press . If the desired target network is not listed, press **F2** (**Refresh**).

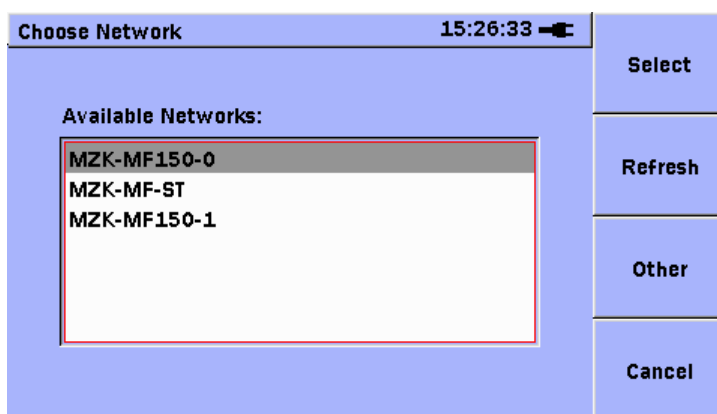





Figure 10.1.2-2 Choose Network Screen

7. Select the setting to be altered using  and , and press .

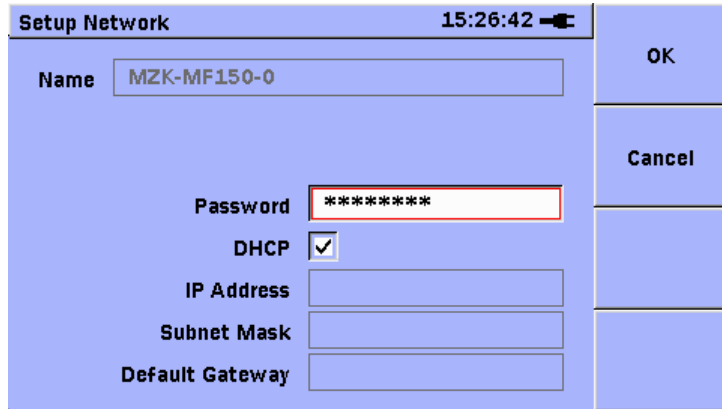

















Figure 10.1.2-3 Network Setup Screen

8. Select the **Password** box using  and , and press  to display the Softkey Board screen. Enter the password for the access point.
Refer to section 3.6 “Using Softkey Board” for details on entering characters.
9. When using DHCP, press  and  to select **DHCP**, and then press  to select the check box.
If you prefer not to use DHCP, press  and  to select **DHCP**, and then press  to clear the check box. You can now enter the IP address, subnet mask, and default gateway. Press  and  to select each item, and then press  to access the address input screen.
10. After you complete all the settings, press  (**Set**).
To cancel the settings, press  (**Cancel**).
11. Check that the desired target access point has been selected, and press  (**Select**).

12. Check that the selected access point is displayed in the **Selected Network** box on the **Wi-Fi** tab, and press **F2** (**Connect**). The IP address is displayed when successfully connected.

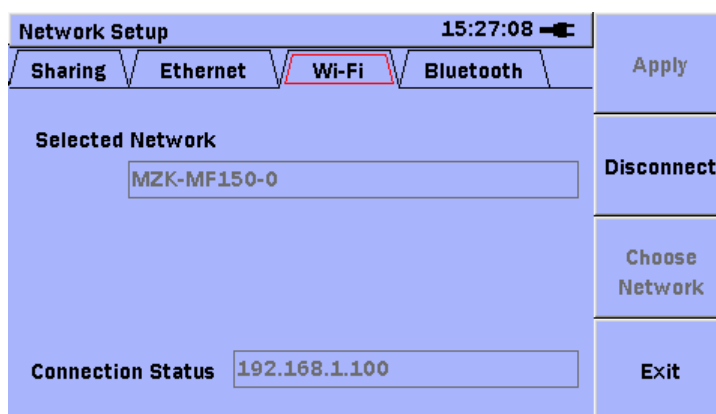

Figure 10.1.2-4 Screen For Successful Connection

Notes:

- Normally, you cannot connect to an access point with an invalid password. If the last access point to which you connected is valid, you are automatically connected to it.
 - The history of connections to the access points is cleared when powering off the module or removing the USB Wi-Fi dongle from the module.
13. To disconnect from the network, press **F2** (**Disconnect**) on the **Wi-Fi** tab.
 14. Remove the USB Wi-Fi dongle.



Note:

Disconnect from the network before removing the USB Wi-Fi dongle.

Setting and connecting the target network manually

Note:

Write down the SSID of the access point to which you want to connect.

1. Connect the USB Wi-Fi dongle to the USB-A port on the top connector panel.
If already connected, proceed to Step 2. If it is not yet connected, proceed to Step 4.
2. On the Top Menu screen, press  to access the menu.
3. Press  and  to select Network Setup to display the Network Setup screen is displayed.
4. The Network Setup Wi-Fi tab is displayed.
The target network that is found first is displayed.

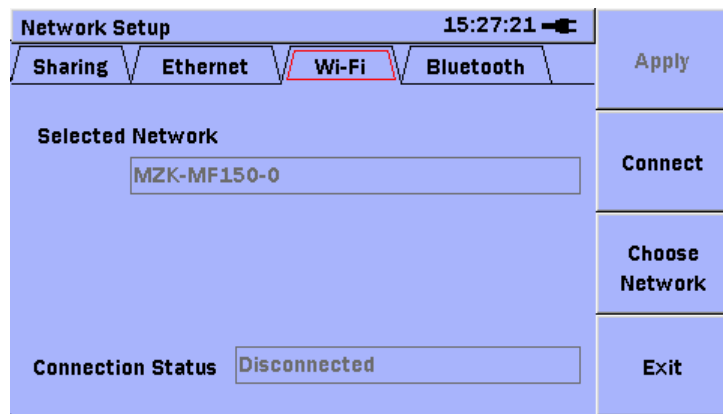



Figure 10.1.2-5 Wi-Fi Tab

5. Press  (**Choose Network**) to change the target network connection.
6. Press  (**Other**).

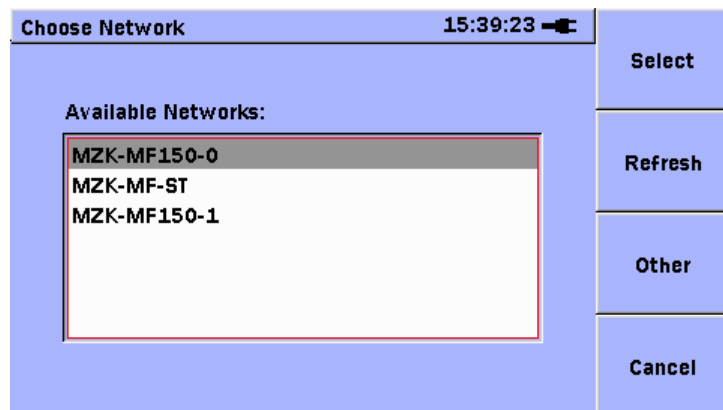





Figure 10.1.2-6 Target Device (SSID) Screen

7. Select the target network using  and , and press  to display the Softkey Board screen. Enter the SSID of the access point to which you want to connect.
Refer to section 3.6 “Using Softkey Board” for details on entering characters.

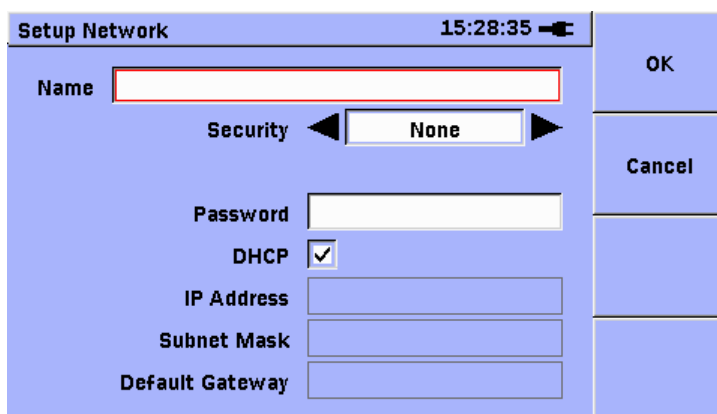























Figure 10.1.2-7 Network Setup Screen

8. Press  and  to select the type of security, and then press  and  to set up the security.
9. Press  and  to select the **Password** box, and then press  to display the Softkey Board screen. Leave blank if a password is not used. Refer to section 3.6 “Using Softkey Board” for details on entering characters.
10. When using DHCP, press  and  to select DHCP, and then press  to select the check box.
If you prefer not to use DHCP, press  and  to select DHCP, and then press  to clear the check box.
The IP address, subnet mask, and default gateway can now be entered.   Select the items using  and , and press  to display the address input window.
11. Once all of the settings are complete, press  (**Set**).
To cancel the settings, press  (**Cancel**).

Note:

An error message is displayed if the **Name** box is blank or if a name which exists on the list of detected access points is entered.

12. Check that the desired target access point has been selected, and press  (**Select**).

13. Check that the access point selected is displayed in the **Selected Network** box on the **Wi-Fi** tab, and press **F2** (**Connect**). The IP address is displayed when successfully connected.

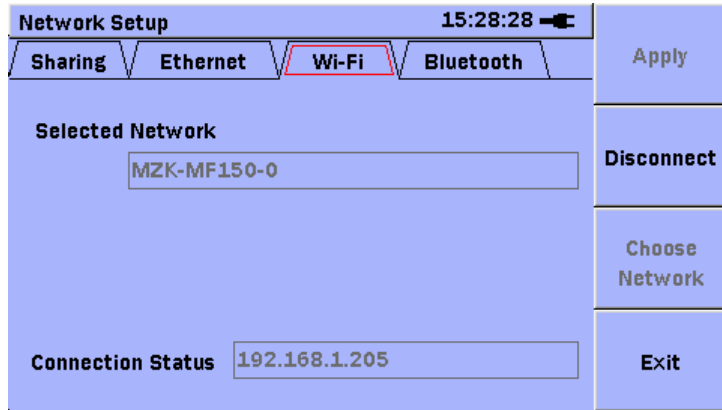

Figure 10.1.2-8 Screen For Successful Connection

Notes:

- Normally, you cannot connect to an access point with an invalid password. If the last access point to which you connected is valid, you are automatically connected to it.
 - The history of connections to the access points is cleared when powering off the module or removing the USB Wi-Fi dongle from the module.
14. To disconnect from the network, press **F2** (**Disconnect**) on the **Wi-Fi** tab.
 15. Remove the USB Wi-Fi dongle.

Note:

Disconnect from the network before removing the USB Wi-Fi dongle.

10.1.3 Configuring Bluetooth settings

When using a USB Bluetooth dongle, set the following items on the **Bluetooth** tab of the Network Setup screen.



Notes:

- For details of the target network Bluetooth settings, refer to the operation manual or website for the device to be used.
- FTP profile is required when sharing folders via Bluetooth. The Windows standard driver does not support USB Bluetooth dongles, so use the utility software and driver that come with your USB Bluetooth dongle.

Table 10.1.3-1 Setting Items (Bluetooth Connection)

Item	Function	Parameters	Default
Device name	Specify the unit's Bluetooth interface name.	Up to 16 characters	uOTDR-xxxxxxxxxx x: Serial Number of Module
PIN code	Sets the PIN code used for pairing.	Up to 16 characters	123456

Establishing a connection

1. Connect a USB Bluetooth dongle in the USB port (A Type) on the top connector panel. If already connected, proceed to Step 2. If it is not yet connected, proceed to Step 4.
2. On the Top Menu screen, press  to access the menu.
3. Press  and  to select **Network Setup**. The Network Setup screen is displayed.
4. The **Bluetooth** tab of the Network Setup screen is displayed.

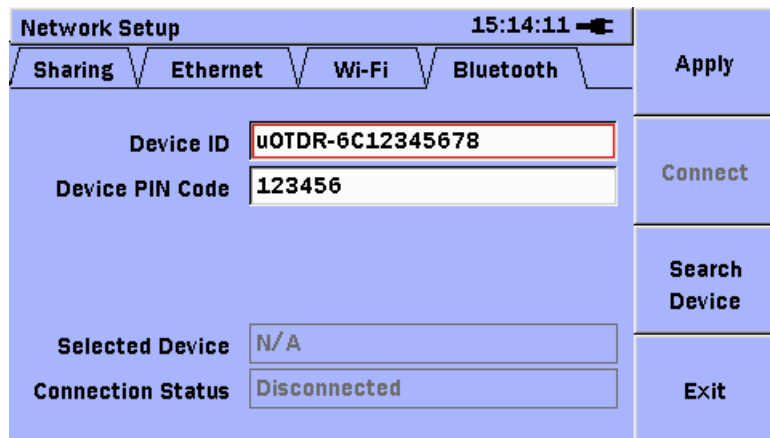















Figure 10.1.3-1 Bluetooth Tab

5. Press  and  to select the **Device Name** box, and then press  to display the Softkey Board screen.
6. Enter the device name. Refer to section 3.6 “Using Softkey Board” for details on entering characters.
7. Press  and  to select the **PIN Code** box, and then press  to display the Softkey Board screen.
8. Enter the PIN code. Refer to section 3.6 “Using Softkey Board” for details on entering characters.
9. Press  (**Apply**) to confirm the device name and PIN code.
10. Press  (**Search Device**) to search for the device to be connected to. If the list is empty, the device search starts automatically.
11. To search manually, press  (**Refresh**). Available Bluetooth devices detected in the vicinity are displayed on the list.
12. Select the desired device using  and , and press  (**Select**).
To cancel, press  (**Cancel**).

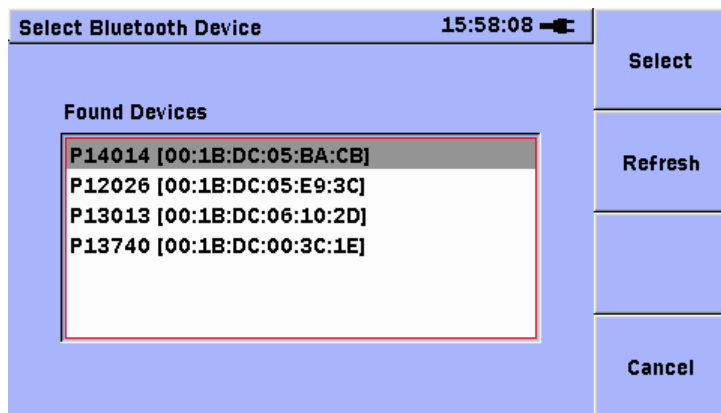



Figure 10.1.3-2 FTP Target Device Search Screen

13. Press  (**Set**) to enable the new settings.
14. Press  (**Connect**) to connect to the selected device.
15. If the connected device displays a message requesting you to enter a PIN code, enter the PIN code set in Step 8.

- Once pairing is completed, the device is automatically connected. Once a connection is established, “Connected” is displayed in the **Connection Status** box.

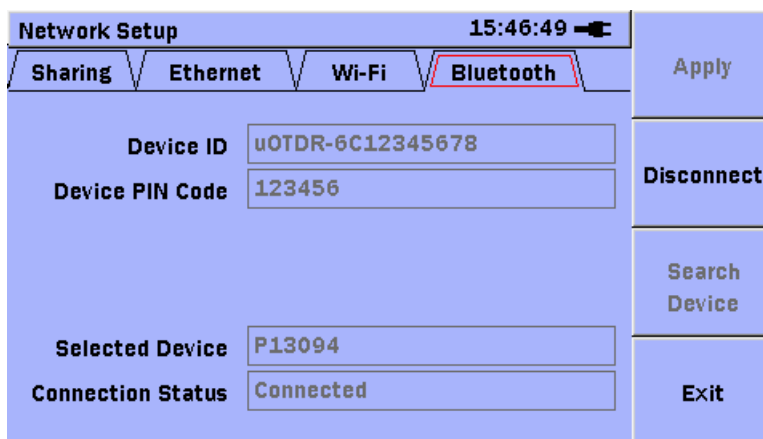

Figure 10.1.3-3 Screen for Successful Connection

- When successfully connected, Remote is displayed as media in the Mass Storage Screen or other screens, and the shared folders on the connected device can be accessed from the module. In My Bluetooth Places on the PC, the internal media of the module is displayed.

Notes:











- For how to configure shared folders on the PC, refer to the instruction manual for your utility software.
 - Read-only files cannot be overwritten from the module when connected via Bluetooth.
 - Read-only files cannot be deleted from the module when connected via Bluetooth.
- To disconnect from the network, press **F2** (**Disconnect**) on the **Bluetooth** tab.
 - Remove the USB Bluetooth dongle.

Note:

Disconnect from the network before removing the USB Bluetooth dongle.

10.2 Setting the Remote GUI Password

This section describes how to set the remote GUI password.

1. On the Top Menu screen, press  to access the menu.
2. Press   to select **Setup**, and then press  to display the Setup screen.
3. Press     to select the Advanced tab.
4. Press  and  to select the Remote GUI Password box, and then press  to display the Remote GUI Password Setup screen.
5. Set the password. Refer to section 3.6 “Using Softkey Board” for details on entering characters.

10.3 File Sharing Setting

To share files and folders, set the following items on the **Sharing** tab of the Network Setup screen.

Note:

When sharing files and folders, connect to the network via Ethernet or Wi-Fi .

The shared folders on the PC are displayed as “Remote” in the Device box on the Mass Storage screen. For details of the PC settings, refer to the Microsoft website.

Table 10.3-1 Setting Items

Item	Function	Parameters	Default
Share Internal Memory	When this check box is selected, the internal memory of the μ OTDR is shared.	Off, On	Off
Share PC Folder	When this check box is selected, the computer's shared folder is shared.	Off, On	Off
IP Address	Set the IP Address of PC.	0.0.0.0 to 255.255.255.255	Blank
Domain	Set the domain name of PC.	Up to 30 characters	Blank
Host name	Set the computer host name.	Up to 20 characters	Blank
Password	Set the password of PC.	Up to 20 characters	Blank
Folder Name	Set the folder name of PC.	Up to 30 characters	Blank









Setting up a shared folder: Steps on a computer (Windows XP)

1. Create a folder directly in the C drive, and configure the folder as a shared folder.
2. Right-click the folder and click **Sharing and Security**.
3. On the **Sharing** tab, select **Share this folder**.
4. Check that the folder icon is changed as shown in Figure 10.3-1.



Figure 10.3-1 Shared Folder

Setting up a shared folder: Steps on the μ OTDR

1. On the Top Menu screen, press  to access the menu.
2. Press  and  to select Network Setup, and then press  to access the Network Setup screen.
3. Use , , , and  to select the **Sharing** tab.

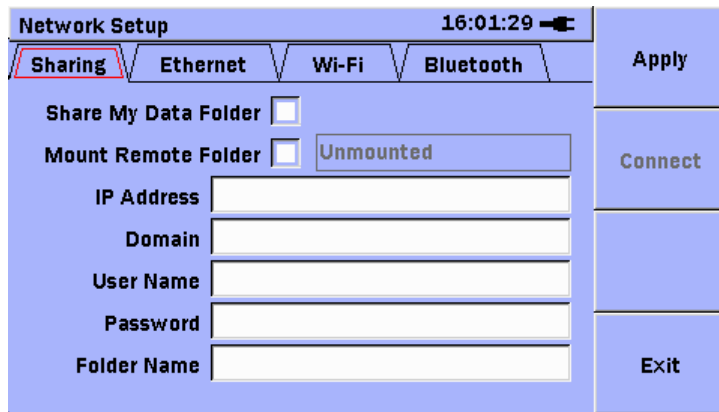















































Figure 10.3-2 Sharing Tab

4. Press  and  to move to the Share Internal Memory check box, and then press  to select the check box.
If you don't want to share the μ OTDR internal memory, clear the check box.
5. Press  and  to move to the Share PC Folder check box, and then press  to select the check box.
If you don't want to share the shared folder on the PC, clear the check box.
6. Press  and  to select the IP Address box, and then press  to display the address input screen.
7. Press , , , and  to enter the computer's IP address.
8. To set the address, press  (Set). To cancel, press  (Cancel).
9. Press  and  to select the Domain Name box, and then press  to display the Softkey Board screen.
10. Press , , , and  to enter the computer's domain name.
11. For details on entering the domain name, refer to section 3.6 "Using Softkey Board".
12. Press  and  to select the Host Name box, and then press  to display the Softkey Board screen.
13. Press , , , and  to enter the computer's user name.
14. For details on entering the host name, refer to section 3.6 "Using Softkey Board".

15. Press  and  to select the Password box, and then press  to display the Softkey Board screen.
16. Press , , , and  to enter the computer's login password.
17. For details on entering the password, refer to section 3.6 "Using Softkey Board".
18. Press  and  to select the Folder Name box, and then press  to display the Softkey Board screen.
19. Press , , , and  to enter the folder name. The folder name is specified as the folder name created by the PC settings.
20. For details on entering the folder name, refer to section 3.6 "Using Softkey Board".
21. When the setting has been completed, press  (**Apply**) to confirm the sharing settings.
To cancel setup, press  (**Close**).

Once you have completed settings for sharing between the unit and a computer, refer to section 10.1.1 or 10.1.2 to establish a network connection. Once the connection is established and folders are successfully shared, "Mounted" is displayed in the Mount Remote Folder box on the **Sharing** tab.

Shared folders can be accessed from the Network Setup screen when "Mounted" is displayed.

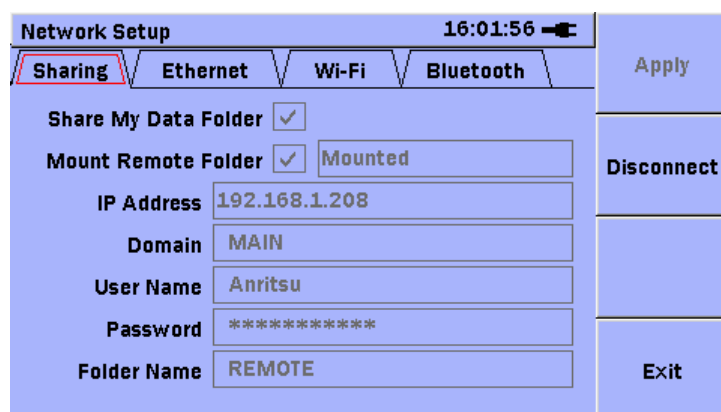

Figure 10.3-3 Sharing Tab (Folder Shared)

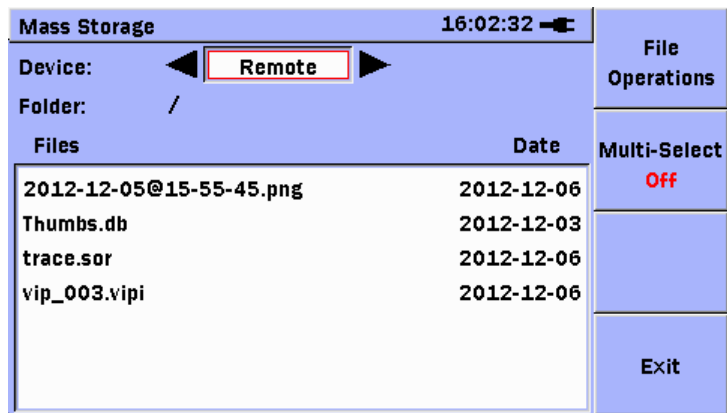

Figure 10.3-4 Mass Storage Screen (Folder Shared)

10.4 Using the Remote GUI

The following equipment and software is required when using the remote GUI.

Table 10.4-1 Required Equipment

Equipment	Performance
PC	OS: Windows XP Pro SP3 or later CPU: Pentium4 3.0 GHz or more Memory: 1 GB or more Free hard disk space: 5 GB or more Ethernet: 10/100 BASE-T or wireless LAN Display: 1280 × 1024 or more
Software	Microsoft Internet Explorer Ver 8.0 or later Adobe Flash Player 10.1 or later
USB Ethernet Converter*	USB1.1/2.0 support, 10/100 BASE-T
USB Wi-Fi dongle*	USB1.1/2.0 support, IEEE802.11 compatible

*: Either one.

Notes:

- The Web browser to be used must support Adobe Flash™ technology.
- Refer to the release note for details of USB devices that can be used.
- USB hubs cannot be used.

After the network connection is established, use the remote GUI according to the following procedure.

1. Start the web browser on the PC.
2. In the address bar, enter `http://xxx.xxx.xxx.xxx` (`xxx.xxx.xxx.xxx` is the IP address assigned in 10.1.1 or 10.1.2).
3. The Network Master screen appears when successfully connected.

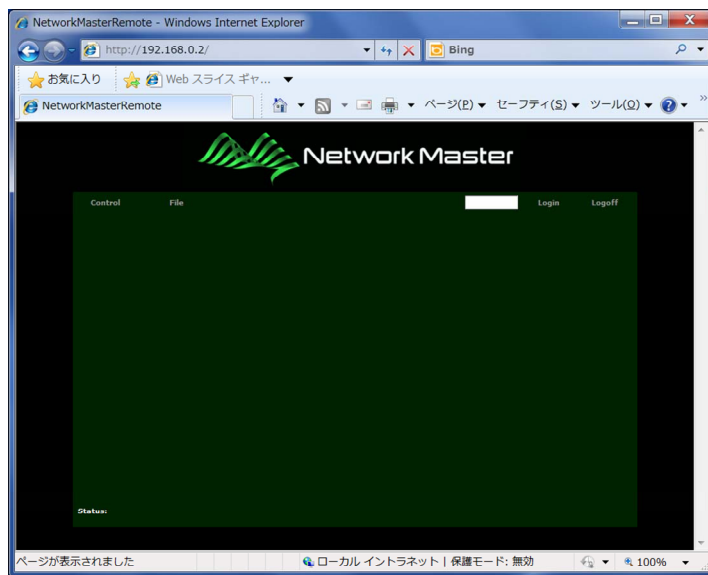

Figure 10.4-1 Remote GUI (before Login)

4. Enter the remote GUI password that was specified in 10.2, and then click the Login label. The μ OTDR screen appears upon successful login.

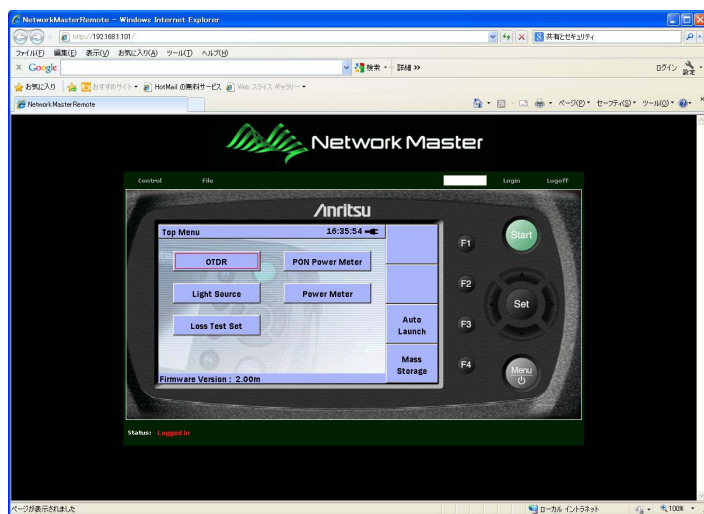

Figure 10.4-2 Remote GUI (After Login)

Remote GUI Functions

1. **Control** –

The remotely connected μ OTDR can be controlled via the screen displayed on the web browser. The Control screen is displayed after logging in.

2. **File** –

The internal media of the remotely connected μ OTDR are displayed. The following functions are available on the File screen.

- File Upload (from PC to μ OTDR) - Waveform files can be sent from the PC to μ OTDR.
- File Download (from μ OTDR to PC) - Measurement data can be acquired from μ OTDR.

Use the Control functions according to the following procedure.

1. Click the **Control** label at the upper left of μ OTDR.
2. A red circle appears when the mouse cursor is located over any of the graphic front-panel keys (F1, F2, F3, F4, Start, Set, Menu, Up, Down, Left, and Right) as shown in Figure 10.4-3.



Figure 10.4-3 Remote GUI (When F1 Key Selected)

3. Clicking when the red circle is displayed carries out the operation of the actual key on the device remotely connected.

Use the File functions according to the following procedure.

1. Click the **File** label at the upper left of μ OTDR.
2. The file menu is displayed.

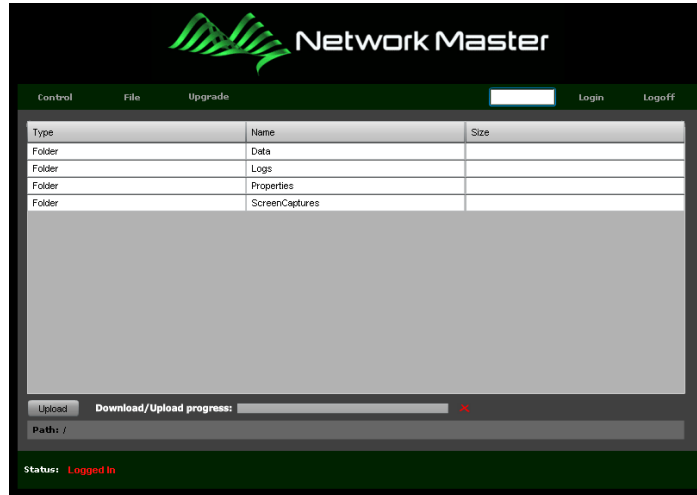

Figure 10.4-4 Remote GUI (File Menu)

3. To change a folder, click the name whose **Type** column shows "Folder". The file menu displays the selected folder as shown in Figure 10.4-5.

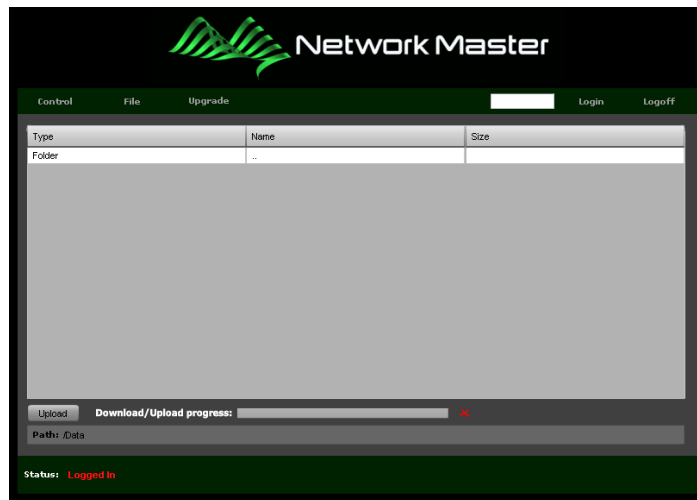
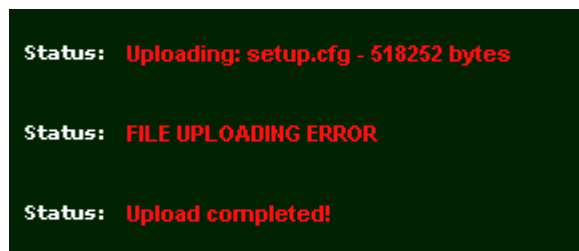

Figure 10.4-5 Remote GUI (Folder)

4. To download a file, click on the filename. The Save File screen appears when clicked.
5. To upload a file, click at the lower left of the file menu. The Select File screen appears when clicked.

Notes:

- When uploaded, the file is saved in the folder currently displayed. A warning message will be displayed in the Status bar if no folder is being displayed.
- Files cannot be uploaded or downloaded unless there is at least 1 MB of free space on the internal memory.
- To abort downloading or uploading, click the **Close** button (✕).
- The Status bar also displays error messages as well as progress status and completion message as shown below.

**Figure 10.4-6 Status Messages**

Exit the remote GUI according to the following procedure.

1. Click the **Logoff** label at the upper right of μ OTDR.
2. Close the Web browser.

Note:

The remote connection may be broken if the web browser is closed before logging off. Always log off before exiting the remote GUI.

Chapter 11 Performance Test and Calibration

This chapter describes how to check the performance of the unit and calibrate measurement values. Contact Anritsu or our sales dealer when the performance test proves that the specifications are not satisfied. Provide the following information when requesting repairs.

- Device name and serial number.
- Description of the Failure conditions
- The name and contact information of the supervisor who understands the failure conditions clearly and should receive a notification at the completion of repairs.

11.1	Performance Test	11-2
11.1.1	Required instruments for performance test....	11-7
11.1.2	Wavelength.....	11-10
11.1.3	Pulse Width	11-12
11.1.4	Dynamic range	11-14
11.1.5	Distance Measurement Accuracy.....	11-17
11.1.6	Linearity	11-19
11.1.7	Dead Zone	11-23
11.1.8	Optical output power and wavelength of Visual Fault Locator (VFL).....	11-26
11.1.9	Optical output power and wavelength of Light Source	11-28
11.1.10	Measurement accuracy of optical power meter and PON power meter.....	11-30
11.2	Calibration.....	11-32
11.2.1	Backscatter coefficient level calibration.....	11-32
11.2.2	Measurement accuracy of optical power meter	11-32
11.3	Performance Test Result Sheet.....	11-33

11.1 Performance Test

The following eight items are tested to check the performance of this instrument.

(Items 7 and 8 apply only to the units that are equipped with the optional VFL and OPM.)

1. Optical wavelength
2. Pulse width
3. Dynamic range (One-way back-scattered light dynamic range test)
4. Distance measurement accuracy
5. Linearity
6. Dead zone
7. Optical output power and wavelength of light source
8. Measurement accuracy of the power meter and PON power meter

Clean the optical connector before testing. The steps in this section are described based on conditions where the power is On and the MT9090A Series is activated.

Rated values for Each Test Item

Unless otherwise specified, the following rated values are guaranteed at a temperature of $25^{\circ}\text{C} \pm 5^{\circ}\text{C}$.

Table 11.1-1 MU909014A/A1/B/B1, MU909015B/B1 OTDR Specifications

Item	Rated values	Remarks
Wavelength	1310 ±25 nm* ¹ 1550 ±25 nm* ¹ 1625 ±15 nm* ² 1650 ±15 nm* ³	
Pulse Width (ns)* ⁴	5, 10, 20, 50, 100 ns, 200, 500 ns, 1, 2, 5, 10, 20 μs	
Dynamic Range (S/N=1)* ⁵	MU909014B/B1 (1310/1550 nm) 23.5/22 dB* ⁶ , 31.5/30 dB* ⁷	
	MU909015B/B1 (1310/1550 nm) 27/25 dB* ⁶ 36/35 dB* ⁷	
	MU909014A/A1 (1625 nm) 23.5 dB* ⁶ , 31.5 dB* ⁷	
	MU909014A/A1 (1650 nm) 23 dB* ⁶ 31.5 dB* ⁷	

*1: MU909014B/MU909014B1, MU909015B/MU909015B1

*2: MU909014A/MU909014A1-053, MU909014A/MU909014A1-063

*3: MU909014A/MU909014A1-054, MU909014A/MU909014A1-064

*4: Typical

*5: S/N = 1 Dynamic range value applies +2.6 dB to the noise peak values.

At 25°C, 180 s of averaging, except during battery charging

*6: Pulse width 500 ns

*7: Pulse width 20 μs

Table 11.1-2 MU909014C/C6, MU909015A6/C/C6 OTDR Specifications

Item	Specifications				
Wavelength	Model		Specifications		
	MU909014C/C6-057/067 MU909015C/C6-057/067		1310±25 nm 1550±25 nm 1625±15 nm		
	MU909014C/C6-058/068 MU909015C/C6-058/068		1310±25 nm 1550±25 nm 1650±15 nm		
	MU909015C/C6-059/069		1310±25 nm 1490±25 nm 1550±25 nm		
	MU909015A6-053/063		1625±5 nm		
	MU909015A6-054/064		1650±15 nm		
Pulse Width*1	5, 10, 20, 50, 100, 200, 500 ns, 1, 2, 5, 10, 20 μs				
Dynamic Range (dB)(S/N=1)*1,*2	MU909014C/C6				
	Wavelength \ Pulse width	1310 nm	1550 nm	1625 nm*3	1650 nm*4
	500 ns	24.5	23	24	23
	20 μs	32.5	31	32.5	32.5
	MU909015A6				
	Wavelength \ Pulse width	1625 nm*5	1650 nm*6		
	500 ns	25	24		
	20 μs	35	35		
	MU909015C/C6-057/067/058/068				
	Wavelength \ Pulse width	1310 nm	1550 nm	1625 nm*3	1650 nm*4
	500 ns	27	26	25	24
	20 μs	38	37	35	35
MU909015C/C6-059/069					
Wavelength \ Pulse width	1310 nm	1490 nm	1550 nm		
500 ns	25	24	24		
20 μs	36	35	35		
Distance Measurement Accuracy	±1 m ±(3 m×distance range×10 ⁻⁶) ±marker resolution However, excludes uncertainty due to IOR				

Table 11.1-2 MU909014C/C6, MU909015A6/C/C6 OTDR Specifications (Cont'd)

Item	Specifications
Loss Measurement Accuracy (Linearity)	± 0.05 dB/dB or ± 0.1 dB (Whichever greater)
Dead zone (Backscatter light) *1,*7,*8	Wavelength 1310 nm: ≤ 4.0 m Wavelength 1490/1550/1625/1650 nm: ≤ 4.5 m
Dead zone (Fresnel reflection) *1,*7,*9	≤ 0.8 m

*1: Typical

*2: S/N=1 Dynamic range value applies +2.6 dB to the noise peak values.
At 25°C, 180 s of averaging, 125 km of distance range, except during battery charging

*3: Option 057/067

*4: Option 058/068

*5: Option 053/063

*6: Option 054/064

*7: IOR=1.500000

*8: 25°C, pulse width 5 ns, return loss 45 dB, deviation ± 0.5 dB, except during charging battery

*9: 25°C, pulse width 5 ns, return loss 45 dB, width lower than the peak of reflected waveform by 1.5 dB, except during charging battery

**Table 11.1-3 MU909014C6, MU909015A6/C6
Light Source Specifications**

Item	Specifications	
Wavelength* ¹	Model	Rated values
	MU909014C6-057/067	1310±25 nm
	MU909015C6-057/067	1550±25 nm 1625±25 nm
	MU909014C6-058/068	1310±25 nm
	MU909015C6-058/068	1550±25 nm 1650±25 nm
	MU909015C6-059/069	1310±25 nm 1490±25 nm 1550±25 nm
	MU909015A6-053/063	1625±25 nm
MU909015A6-054/064	1650±25 nm	
Optical output power	-5±1.5 dBm* ^{1,*2}	

*1: CW, 25°C

*2: Fiber length 2 m, after the warm-up time passes.

Table 11.1-4 MU909014A1/B1, MU909015B1 VFL Specifications

Item	Rated values	Remarks
Center wavelength	650 ±15 nm*	
Optical output power	0 ±3 dBm*	

*: 25°C, CW

**Table 11.1-5 MU909014A/A1/B/B1/C/C6, MU909015A6/B/B1/C/C6
Optical Power Meter Specifications**

Item	Rated values	Remarks
Level accuracy	±0.5 dB*	

*: Wavelength 1310/1490/1550 nm, -20 dBm (CW), 25±5°C, when using the master connector fiber and after executing the zero offset

**Table 11.1-6 MU909014C6, MU909015A6/C6
PON Power Meter Specifications**

Item	Rated values	Remarks
Level accuracy	± 0.5 dB*	

*: Wavelength 1490/1550 nm, -20 dBm (CW), $25 \pm 5^\circ\text{C}$, when using the master connector fiber and after executing the zero offset

11.1.1 Required instruments for performance test

The following table shows the instruments and their performance required for the performance tests.

Table 11.1.1-1 Required Instruments for Performance Test

Item	Performance	Name of Recommended Device
Optical Spectrum Analyzer	Wavelength: 600 to 1650 nm Level: -65 to $+20$ dBm Wavelength accuracy: ± 0.3 nm Supported Single mode / Multi mode Fiber	MS9740A (Anritsu)
Variable Optical Attenuator	Wavelength: 1200 to 1650 nm Insertion loss: 3 dB or less Attenuation: 0 to 30 dB Resolution: 0.001 dB or less	8163B+81570A (Agilent Technologies)
Optical-to-Electrical Converter	Wavelength: 1100 to 1650 nm Rising/Falling: 500 ps or lower Compatible fiber: Single mode or 62.5 μm Multi mode	P6703B (Tektronix)
Oscilloscope	Bandwidth: DC to 1 GHz	TDS5104B (Tektronix)
SM Optical Fiber	Fiber length: 2 km, one 20 km or longer, one 40 to 50 km, one 500 to 800 m, one 2 to 3 m, two	

Table 11.1.1-1 Required Instruments for Performance Test (Cont'd)

Item	Performance	Name of Recommended Device
Optical Coupler (1:1)	Structure: 1 × 2 Coupling ratio: 50%:50% Excess loss: 1 dB or less	
Optical Coupler (10:1)	Type: 1 × 2 Splitting ratio: 10%:90% Excess loss: 1 dB max.	
Optical Power Meter	Wavelength: 1000 to 1650 nm Level: -50 to +10 dBm Accuracy: ±0.2 dB	AQ2212+AQ2200-211 (Yokogawa Meters & Instruments Corporation)
Optical Power Meter (Wavelength: 650 nm)	Wavelength: 650 nm Level: -65 to +10 dBm Level accuracy: ±0.3 dB	OPM37LAN (Sanwa Electric Instrument Co., Ltd.)
Light Source	Wavelength: 1310±5 nm Level: +10 dBm or more Level accuracy: ±0.1 dB Compatible fiber: Single mode	AQ2212+AQ2200-111 (Yokogawa Meters & Instruments Corporation)
	Wavelength: 1490±5 nm Level: +10 dBm or more Level accuracy: ±0.1 dB	
	Wavelength: 1550±5 nm Level: +10 dBm or more Level accuracy: ±0.1 dB	

Table 11.1.1-2 Test Items/Measuring Instruments

Test Items Measurement instrument and cable	Optical Pulse Test						VFL		Light Source		Power Meter	PON Power Meter
	Wavelength	Pulse Width	Dynamic range	Distance Measurement Accuracy	Linearity	Dead Zone	Output Power	Wavelength	Optical Output	Wavelength	Level Accuracy	Level Accuracy
Optical Spectrum Analyzer	✓	-	-	-	-	-	-	✓	-	✓	-	-
Variable Optical Attenuator	✓	✓	✓	-	-	✓	-	-	-	-	✓	✓
Optical-to-Electrical Converter	-	✓	-	-	-	-	-	-	-	-	-	-
Oscilloscope	-	✓	-	-	-	-	-	-	-	-	-	-
SM Optical Fiber Optical Fiber 2 km	-	-	-	✓	-	-	-	-	-	-	-	-
SM Optical Fiber Optical Fiber 20 km	-	-	✓	-	-	-	-	-	-	-	-	-
SM Optical Fiber Optical Fiber 40 to 50 km	-	-	✓	-	✓	-	-	-	-	-	-	-
Optical Coupler (1:1)	-	-	✓	-	-	-	-	-	-	-	-	-
Optical Coupler (10:1)	-	-	-	-	-	✓	-	-	-	-	-	-
Light Source (1310 nm)	-	-	-	-	-	-	-	-	-	-	✓	-
Light Source (1490 nm)	-	-	-	-	-	-	-	-	-	-	✓	✓
Light Source (1550 nm)	-	-	✓	-	-	-	-	-	-	-	-	-
Optical Power Meter	-	-	✓	-	-	-	-	-	✓	-	✓	✓
Optical Power Meter (650 nm)	-	-	-	-	-	-	✓	-	-	-	-	-
Light Source	-	-	-	-	-	-	-	-	-	-	✓	-
SM Optical Fiber 500 to 800 m	-	-	-	-	-	✓	-	-	-	-	-	-

11.1.2 Wavelength

Check that the center wavelength satisfies the specifications.

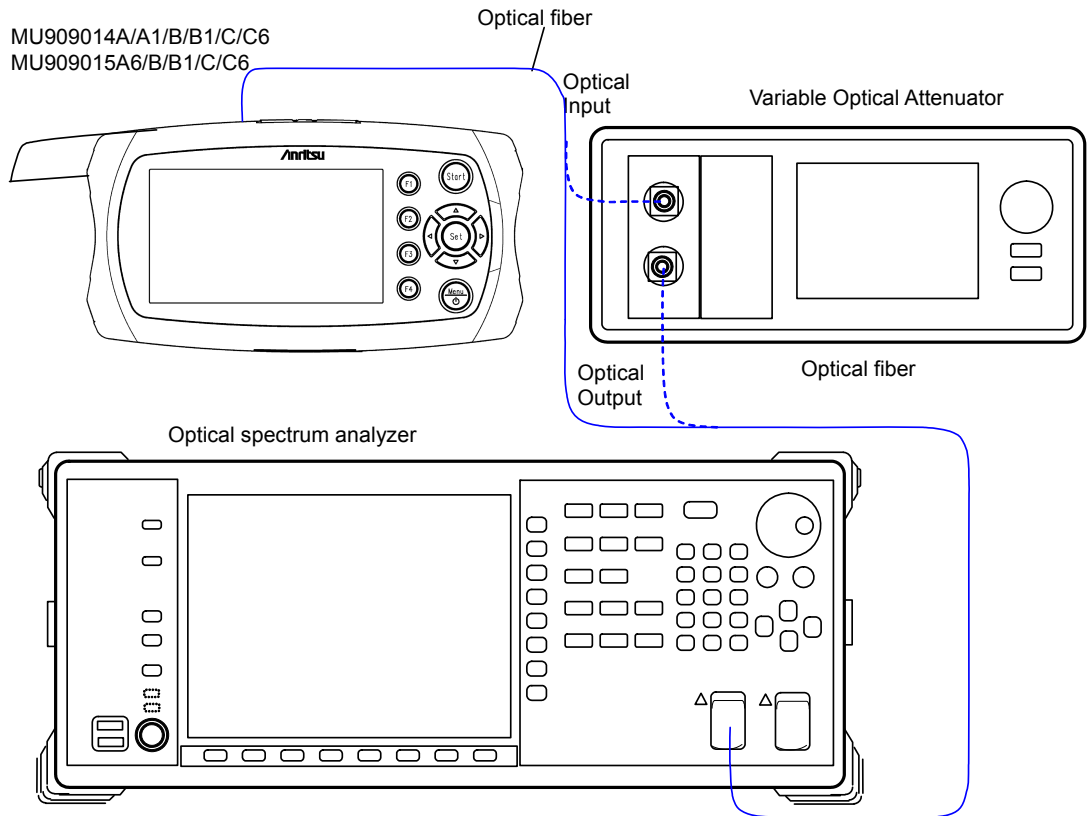



Figure 11.1.2-1 Wavelength Test - Connection Diagram

Test Procedure:

1. Connect the main frame and measuring instruments as shown in Figure 11.1.2-1.
2. Set the optical spectrum analyzer as follows:
Span: 50 nm
Res: 0.05 nm
VBW: 1 kHz
Sampling Point: 2001
Analysis: RMS K=1, S.Level: 20 dB
3. Set the wavelength of the main frame at Center of the spectrum analyzer.
4. Press **F1** (**Test Setup**) in any of the following screens.
 - Trace Analysis screen
 - Trace View screen
5. Press **F2** to select **Real Time**.
6. Set Pulse width to 1 μ s.

7. Press . Confirm that the measured light is displayed at the top of the screen.
8. Measure the optical pulse spectrum of the main frame with the spectrum analyzer.
9. If the waveform level measured by the spectrum analyzer is saturated, adjust the attenuation of the variable optical attenuator.
10. Record the center wavelength measured by the spectrum analyzer.
11. When using the MU909014B/B1 and MU909015B/B1, change the wavelength in the **Test Setup** screen and repeat steps 3 to 10 over.

11.1.3 Pulse Width

Check that the pulse width satisfies the specifications.

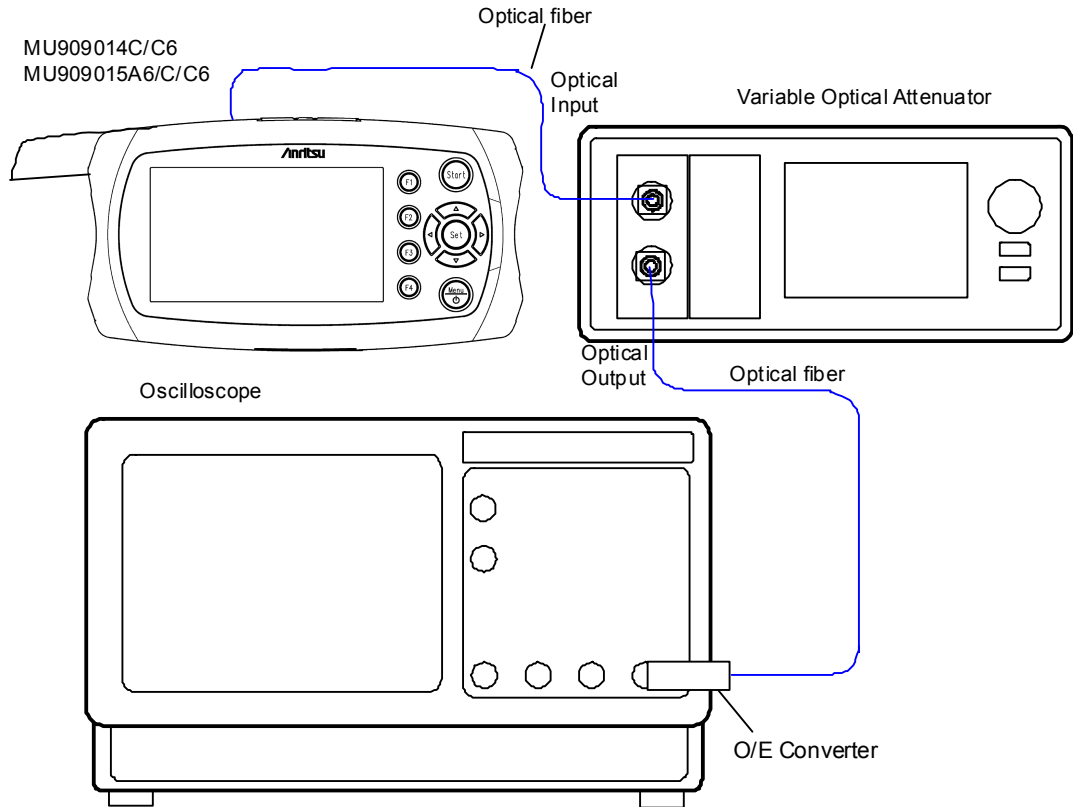

Figure 11.1.3-1 Pulse Width Test - Connection Diagram

Test Procedure:

1. Connect the main frame and measuring instruments as shown in Figure 11.1.3-1.
2. Press **F1** (**Test Setup**) at any of the following screens.
 - Trace Analysis screen
 - Trace View screen
3. Clear **Full Auto**.
4. Press **F2** to select **Real Time**.
5. Set Pulse width to **5 ns**.
6. Press **Start**. Confirm that the measured light is displayed at the top of the screen.
7. Adjust the oscilloscope trigger level, amplitude and time base scale to display the waveform in the oscilloscope. Adjust the optical variable attenuator to prevent the waveform monitor from becoming saturated.

8. Monitor the waveform with the oscilloscope and measure the pulse width at half the amplitude of the peak level as shown in Figure 10.1.3-2 and record the results.
9. Change **Pulse Width** as described in Step 5 and repeat steps 6 to 8 over.

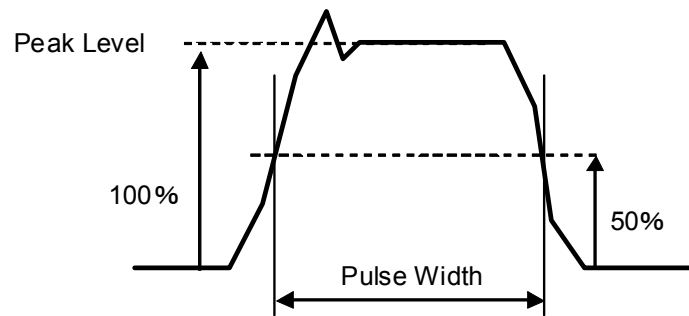

Figure 11.1.3-2 Example - Peak Level at Half Amplitude measurement

10. When using the MU909014B/B1 and MU909015B/B1, change the wavelength in the **Test Setup** screen and repeat steps 5 to 9 over.

11.1.4 Dynamic range

Check that the dynamic range (One-way back-scattered light dynamic range) satisfies the specification.

The measurement method depends on the model.

<MU909014A/A1, MU909015A6 Test Procedure>

At MU909014A/A1, MU909015A6 dynamic range measurement, background light is input using the light source.

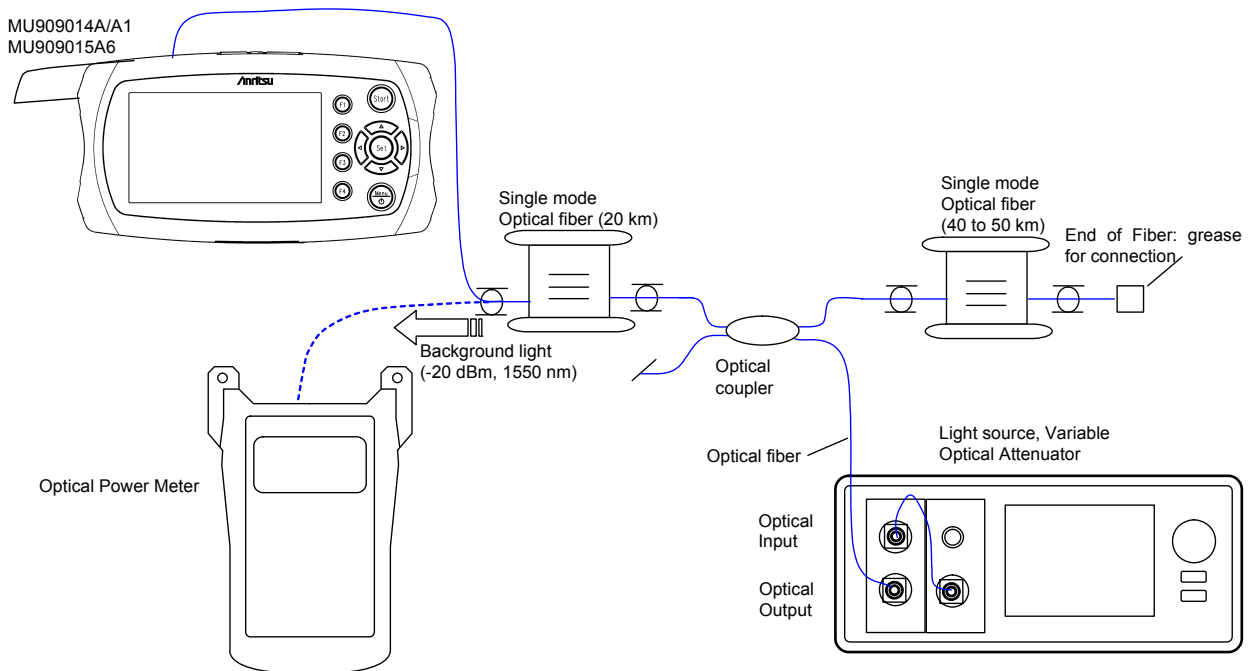

Figure 11.1.4-1 Dynamic Range Test – Connection Diagram (MU909014A/A1, MU909015A6)

Test Procedure:

1. Connect the light source, variable optical attenuator, optical coupler, single-mode fiber, and optical power meter as shown in Figure 11.1.4-1.
2. Set the power meter wavelength to 1550 nm.
3. Set the light source optical output to on.
4. Adjust the attenuation of the variable optical attenuator so the power meter displays -20 ± 0.1 dBm.
5. Disconnect the fiber connected to the power meter and connect to the main frame.
6. Press **F1** (**Test Setup**) in any of the following screens.
 - Trace Analysis screen
 - Trace View screen
7. Clear **Full Auto**.

8. Press **F2** to select **Average**.
9. Press **F3** to set the wavelength to **1625 nm** or **1650 nm**.
10. Set Pulse width to **500 ns**.
11. Set Resolution to **Coarse**.
12. Set Averaging to **180 s**.
13. Set Loss Mode to **2-pt Loss**.
14. Press **Start**. Confirm that the measured light is displayed at the top of the screen.
15. When measurement is completed, move cursor A to the position of the optical output connector (see Figure 11.1.4-2).
16. Move cursor B to the peak noise position and record the 2-pt Loss.
17. Add 2.6 dB to the value recorded at step 15. Record the measured result.
18. Set **Pulse Width** as described in step 10 to 20 μ s. Repeat steps 14 to 17 over.

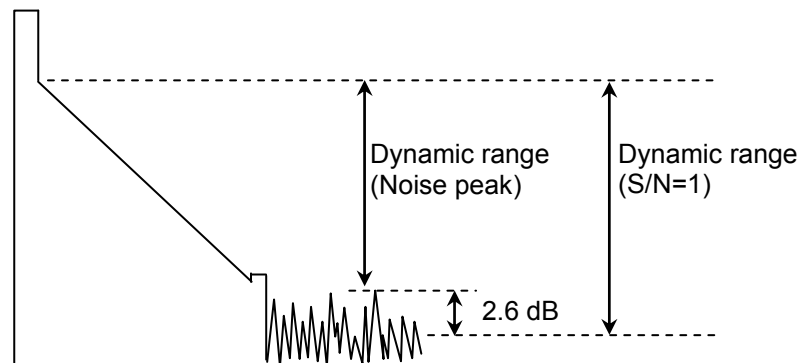
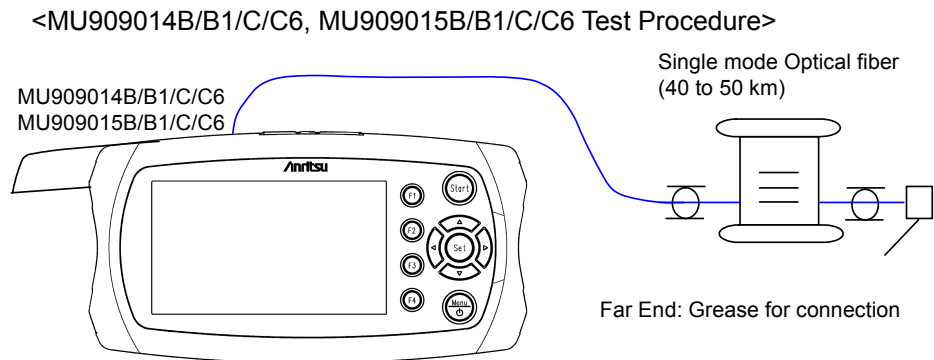

Figure 11.1.4-2 Dynamic Range Test - Connection Diagram



**Figure 11.1.4-3 Dynamic Range Measurement Setup
(MU909014B/B1/C/C6, MU909015B/B1/C/C6)**

Test Procedure:

1. Connect the devices as shown in Figure 11.1.4-3.
2. Press **F1** (**Test Setup**) in any of the following screens.
 - Trace Analysis screen
 - Trace View screen
3. Clear **Full Auto**.
4. Press **F2** to select **Average**.
5. Press **F3** to set Wavelength to **1310 nm**.
6. Set Pulse width to **500 ns**.
7. Set Resolution to **Coarse**.
8. Set Averaging to **180 s**.
9. Set Loss Mode to **2-pt Loss**.
10. Press **Start**. Confirm that the measured light is displayed at the top of the screen.
11. When measurement is completed, move cursor A to the position of the optical output connector (see Figure 11.1.4-2).
12. Move cursor B to the peak noise position and record the 2-pt Loss.
13. Add 2.6 dB to the value recorded at step 12. Record the measured result.
14. Set Pulse Width as described in step 6 to 20 μ s. Repeat steps 10 to 13 over.
15. Change the wavelength in the **Test Setup** screen and repeat steps 10 to 14 over.

11.1.5 Distance Measurement Accuracy

Measure the optical fiber whose length and refraction index are known, then perform a horizontal axis (i.e., measurement distance) accuracy test. This is not required for other ranges when this test is performed at a certain distance range.

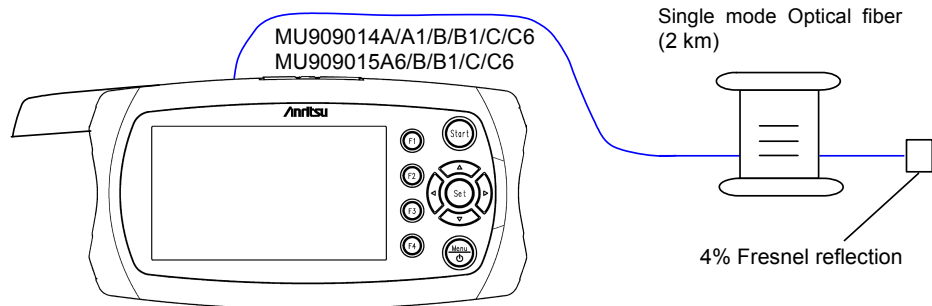

Figure 11.1.5-1 Distance Measurement Accuracy Test - Connection Diagram

Test Procedure:

1. Connect the modules as shown in Figure 11.1.5-1.
2. Press **F1** (**Test Setup**) in any of the following screens.
 - Trace Analysis screen
 - Trace View screen
3. Clear **Full Auto**.
4. Press **F2** to select **Average**.
5. Set Range to **5 km**.
6. Set Pulse width to **10 ns**.
7. Set Averaging to **180 s**.
8. Set Loss Mode to **2-pt Loss**.
9. Set the optical fiber's index of refraction to IOR.
10. Press **Start**. Confirm that the measured light is displayed at the top of the screen.
11. When the measurement is complete, press **F2** to select **Cursor**.
12. Press **Set** to select Cursor A. Move the cursor A to the 0 km position.
13. Press **Set** to select Cursor B.
14. Move the cursor to the location of Fresnel reflection. (See Figure 11.1.5-2.)
15. Press **F3** to select **B**.
16. Press **F2** to select **Zoom**.
17. Press **Right Arrow** and set the horizontal-axis scale to 0.005 km/div.

18. Press **F2** to select **Cursor**.
19. Align cursor B precisely with the rise point of the Fresnel reflection. Record the measured result.
20. For the MU909014C/C6/MU909015A6/C/C6, change the wavelength in the **Test Setup** screen and repeat over from step 5 to 19.

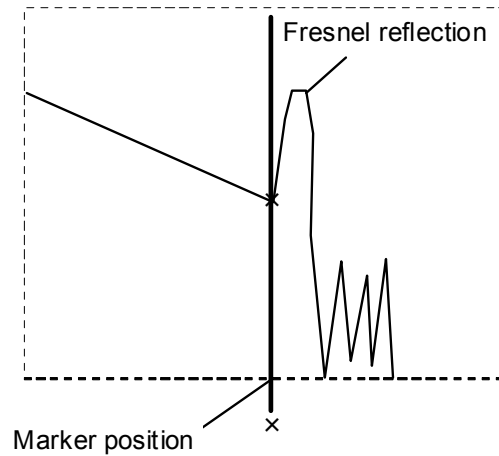

Figure 11.1.5-2 Waveform Measurement Position

11.1.6 Linearity

Confirm the accuracy (level measurement) of the vertical axis.

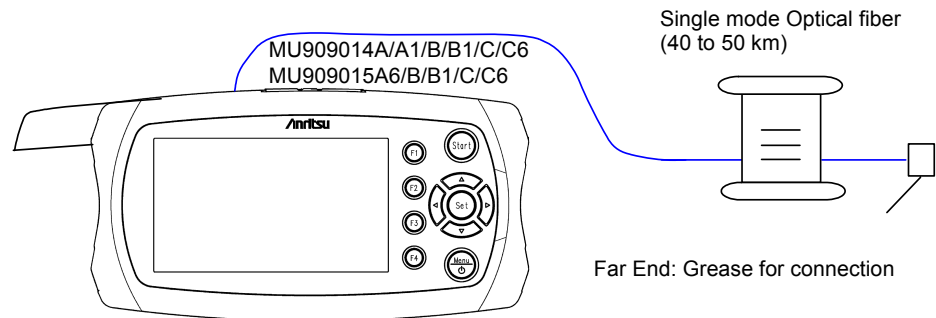

Figure 11.1.6-1 Linearity Measurement Connection Diagram

<Test procedure for one fiber setup>

1. Connect the modules as shown in Figure 11.1.6-1.
2. Press **F1** (**Test Setup**) in any of the following screens.
 - Trace Analysis screen
 - Trace View screen
3. Clear **Full Auto**.
4. When using the MU909014 B/B1/C/C6 or MU909015 B/B1/C/C6, press **F3** to select 1310 nm.
5. Press **F2** to select **Average**.
6. Set Pulse Width to **100 ns**.
7. Set Averaging to **180 s**.
8. Set Loss Mode to **dB/km LSA**.
9. Press **Start**. Confirm that the measured light is displayed at the top of the screen.
10. When the measurement is complete, move the cursor A to the 0 km position.

For the wavelength 1625/1650 nm:

11. Move cursor B to the 4 km position and record the measured value.
12. Move cursor A to the 2 km position.
13. Move cursor B to the 6 km position and record the measured value.
14. Move cursor A and cursor B in 2-km increments until cursor B reaches the 30 km position and record the measured value (Figure 11.1.6-2).
15. Calculate the average of the values recorded from steps 11 to 14.
16. Calculate the difference between the value calculated in step 15 and the values recorded in steps 11 to 14 and multiply this value by 4.

For the wavelength 1310/1550 nm:

11. Move cursor B to the 3 km position and record the measured value.
12. Move cursor A to the 1.5 km position.
13. Move cursor B to the 4.5 km position and record the measured value.
14. Move cursor A and cursor B in 1.5-km increments until cursor B reaches the 30 km position and record the measured value (Figure 11.1.6-2).
15. Calculate the average of the values recorded from steps 11 to 14.
16. Calculate the difference between the value calculated in step 15 and the values recorded in steps 11 to 14 and multiply this value by 3.

<Test Procedure for multi-fiber setup >

For the wavelength 1625/1650 nm:

1. Perform the same operations as described for <Test procedure for one fiber setup> up to step 11.
2. Move cursor B to the 4 km position and record the measured value.
3. With cursor B inside the connection point range, move cursor A and cursor B in 2-km increments and measure the measured value.
4. Calculate the average of the values recorded from steps 2 to 3.
5. Calculate the difference between the value calculated in step 15 and the values recorded in steps 2 to 3 and multiply this value by 4.
6. Move cursor A to a position that is a multiple of 2 km further than the connection point.
7. Move cursor B to a position 4 km from cursor A and record the dB/km LSA.
8. With cursor B inside the next connection point range, move cursor A and cursor B in 2-km increments and measure the measured value.
9. Calculate the average of the values recorded from steps 7 to 8.
10. Calculate the difference between the value calculated in step 9 and the values recorded in steps 7 to 8 and multiply this value by 4.
11. Move cursor B to a position 4 km from cursor A and record the measured value.
12. Repeat steps 6 to 10 until cursor B reaches the 30 km position.

<Test Procedure for multi-fiber setup>

For the wavelength 1310/1550 nm

1. Perform the same operations as described for <Test procedure for one fiber setup> up to step 11.
2. Move cursor B to the 3 km position and record the measured value.
3. With cursor B inside the connection point range, move cursor A and cursor B in 1.5-km increments and measure the measured value.
4. Calculate the average of the values recorded from steps 2 to 3.
5. Calculate the difference between the value calculated in step 4 and the values recorded in steps 2 to 3 and multiply this value by 3.
6. Move cursor A to a position that is a multiple of 1.5 km further than the connection point.
7. Move cursor B to a position 3 km from cursor A and record the measured value.
8. With cursor B inside the next connection point range, move cursor A and cursor B in 1.5-km increments and measure the measured value.
9. Calculate the average of the values recorded from steps 7 to 8.
10. Calculate the difference between the value calculated in step 9 and the values recorded in steps 7 to 8 and multiply this value by 3.
11. Move cursor B to a position 3 km from cursor A and record the measured value.
12. Repeat steps 6 to 10 until cursor B reaches the 30 km position.

Example: When connecting fiber (16 km x 2) for the wavelength 1625 nm or 1650 nm

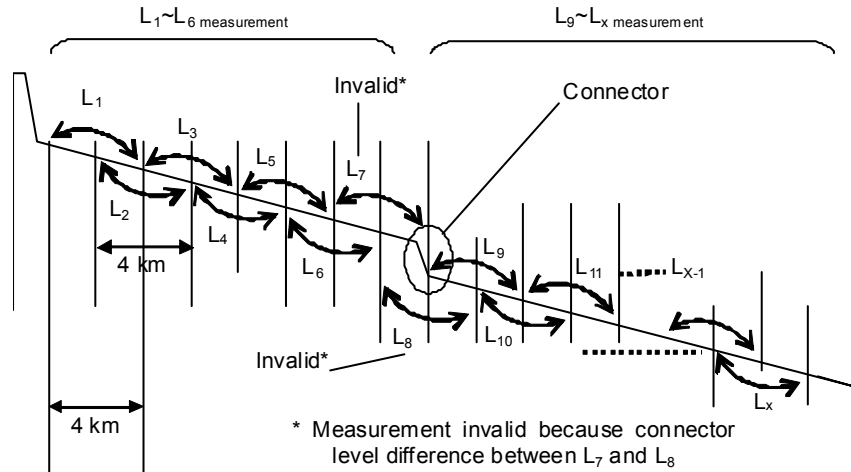

Figure 11.1.6-2 Loss Measurement Positions

L₁ to L₆ Measurement

$$\text{Mean value } L_{\text{ave}_1} = (L_1 + L_2 + L_3 + L_4 + L_5 + L_6) / 6$$

$$L_{\text{diff}_1} = (L_1 - L_{\text{ave}_1}) \times 4$$

$$L_{\text{diff}_2} = (L_2 - L_{\text{ave}_1}) \times 4$$

.....

$$L_{\text{diff}_6} = (L_6 - L_{\text{ave}_1}) \times 4$$

L₉~L_x Measurement

$$\text{Mean value } L_{\text{ave}_2} = (L_9 + L_{10} + L_{11} + \dots + L_x) / (x - 9 + 1)$$

$$L_{\text{diff}_9} = (L_9 - L_{\text{ave}_2}) \times 4$$

$$L_{\text{diff}_{10}} = (L_{10} - L_{\text{ave}_2}) \times 4$$

.....

$$L_{\text{diff}_x} = (L_x - L_{\text{ave}_2}) \times 4$$

Confirm that $L_{\text{diff}_n} \{L_{\text{diff}_1}, L_{\text{diff}_2}, \dots, L_{\text{diff}_6}, L_{\text{diff}_9}, \dots, L_{\text{diff}_x}\}$ is within ± 0.1 .

11.1.7 Dead Zone

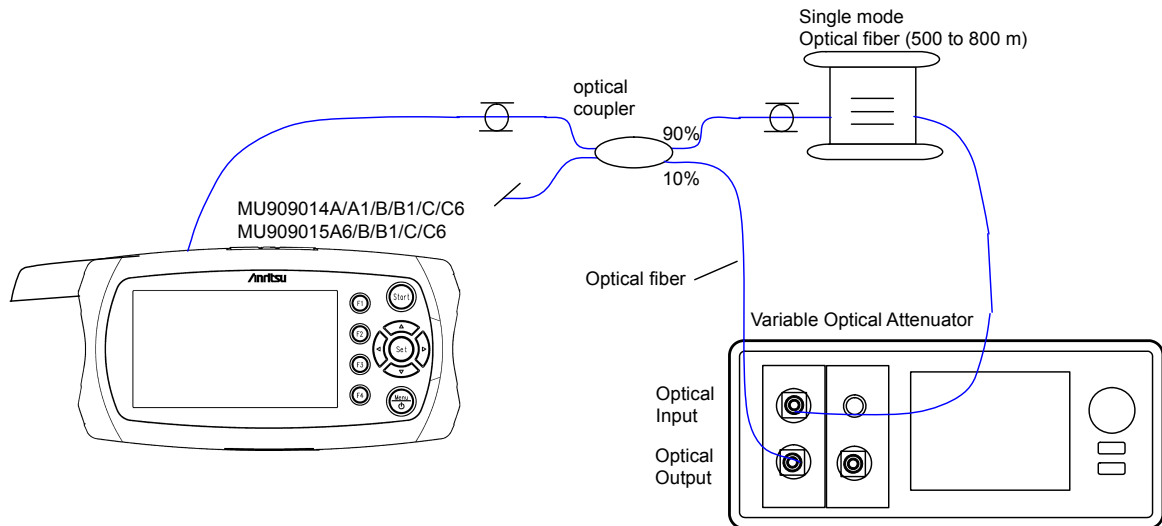

Figure 11.1.7-1 Dead Zone Measurement Setup

1. Connect the devices as shown in Figure 11.1.7-1.
2. Press **F1** (**Test Setup**) in any of the following screens.
 - Trace Analysis screen
 - Trace View screen
3. Clear **Full Auto**.
4. Press **F2** to select **Average**.
5. When using other than the MU909014A/A1 and MU909015A6, press **F3** (**Wavelength**) to select **1310 nm**.
6. Set Range to **25 km**.
7. Set Resolution to **Medium**.
8. Set Pulse width to **500 ns**.
9. Set Averaging to **10 s**.
10. Press **Start**. Confirm that the measured light is displayed at the top of the screen.
11. After measurement is completed, press **F4** (**Trace Analysis**).
12. Confirm the Fresnel reflection return loss at the 300 to 400 m point in the event table.
13. Adjust the attenuation of the variable optical attenuator so the return loss becomes 45 ± 0.2 dB.

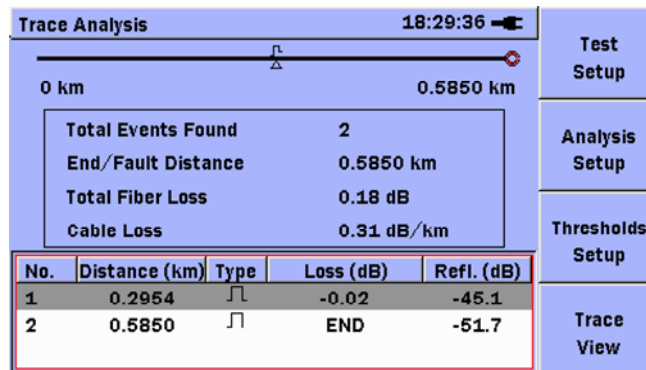

Figure 11.1.7-2 Return Loss Setup Example

14. Repeat steps 10 to 13 until the return loss in the event table becomes 45 ± 0.2 dB.
15. Press **F1** (**Test Setup**).
16. Set Range to **1 km**.
17. Set Resolution to **Medium**.
18. Set Pulse width to **5 ns**.
19. Set Averaging to **10 s**.
20. Set Loss Mode to **2-pt Loss**.
21. Press **Start**. Confirm that the measured light is displayed at the top of the screen.
22. When the measurement is complete, press **F2** to select **Cursor**.
23. Press **Set** to select Cursor A.
24. Move cursor A to the position before the Fresnel reflection where the level is 1.5 dB lower than Fresnel reflection peak.
25. Press **Set** to select Cursor B.
26. Move cursor B to the position after the Fresnel reflection where the level is 1.5 dB lower than the Fresnel reflection peak.

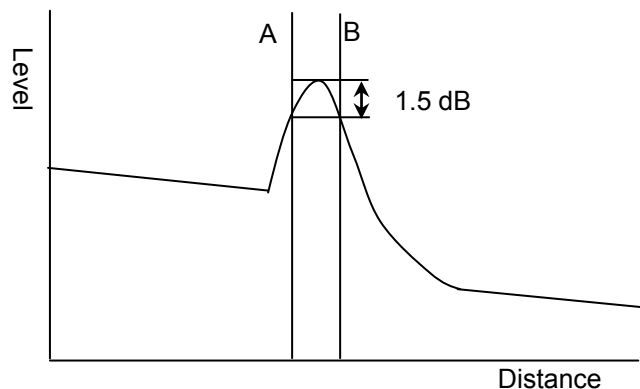



Figure 11.1.7-3 Cursor Position to Measure Fresnel Dead Zone

27. Record the difference in the position of cursor A and cursor B (Fresnel dead zone).
28. Move cursor B to a position 0.5 dB higher than the BSC level of the Fresnel reflection.
29. Press  to select Cursor A.
30. Move cursor A to the rising position of the Fresnel reflection.

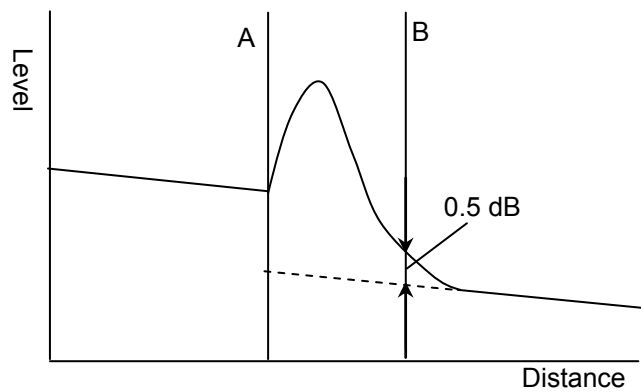

Figure 11.1.7-4 Cursor Position to Measure Backscatter coefficient Dead Zone

31. Record the difference in the position of cursor A and cursor B (backscatter coefficient dead zone)
32. For the MU909014B/B1 and MU909015B/B1, change the wavelength in the **Test Setup** screen and repeat over from step 5 to 31.

11.1.8 Optical output power and wavelength of Visual Fault Locator (VFL)

Check that the output power level and wavelength of the optional Visual Fault Locator (the VFL is a Visible Laser Diode) satisfy their respective specifications.

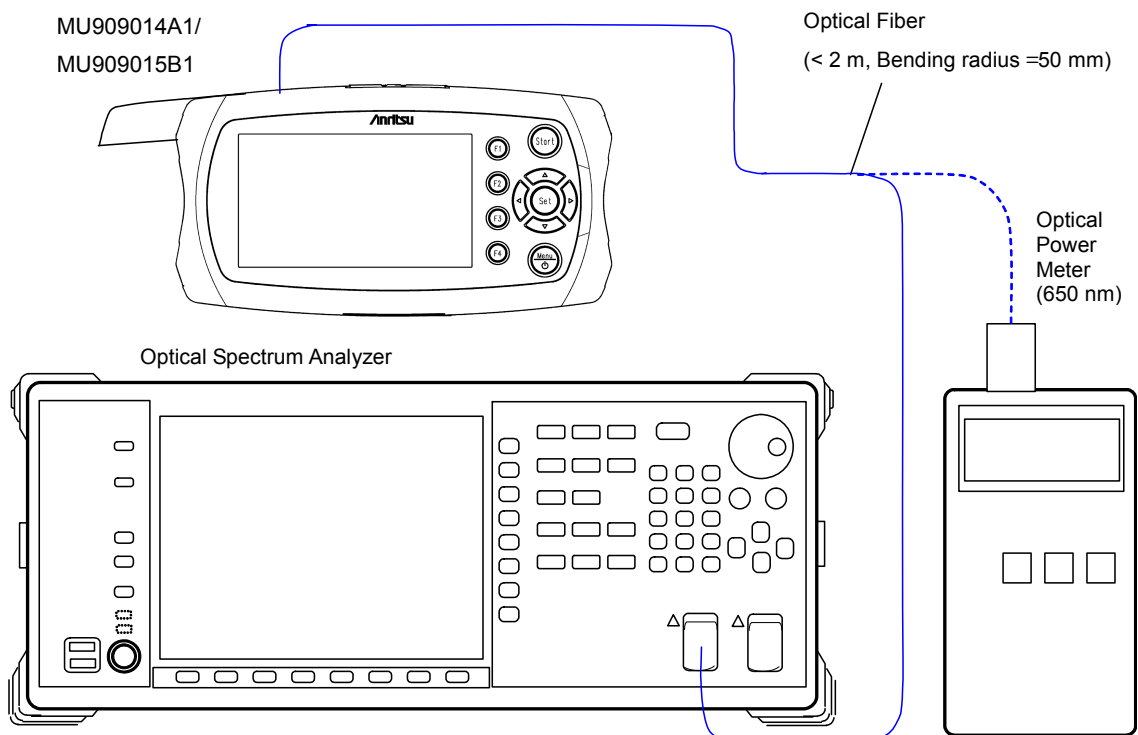





Figure 11.1.8-1 Optical Power Level and Wavelength of VFL Test - Connection Diagram

Test Procedure:

1. Connect the devices as shown in Figure 11.1.8-1.
2. Set the optical spectrum analyzer as follows:
Center: 650 nm
Span: 50 nm
Res: 0.05 nm
VBW: 1 kHz
Sampling Point: 2001
Analysis: Threshold, Cut.Level: 3 dB
3. Press .
4. Highlight **VFL**, and then press .
5. Highlight **CW**, and then press .
6. Measure the center wavelength of the spectrum analyzer and record the result.
7. Set the optical power meter wavelength to 650 nm.

8. Connect the VFL output of the main frame to the optical power meter as shown in Figure 11.1.8-1.
9. Measure the output level with the optical power meter and record the result.

Note:

Set VFL to **CW** and test the wavelength and optical output performance.

Do not set VFL to **MOD** when testing performance.

11.1.9 Optical output power and wavelength of Light Source

Confirm that the wavelength and optical output level of the light source satisfy their respective specifications.

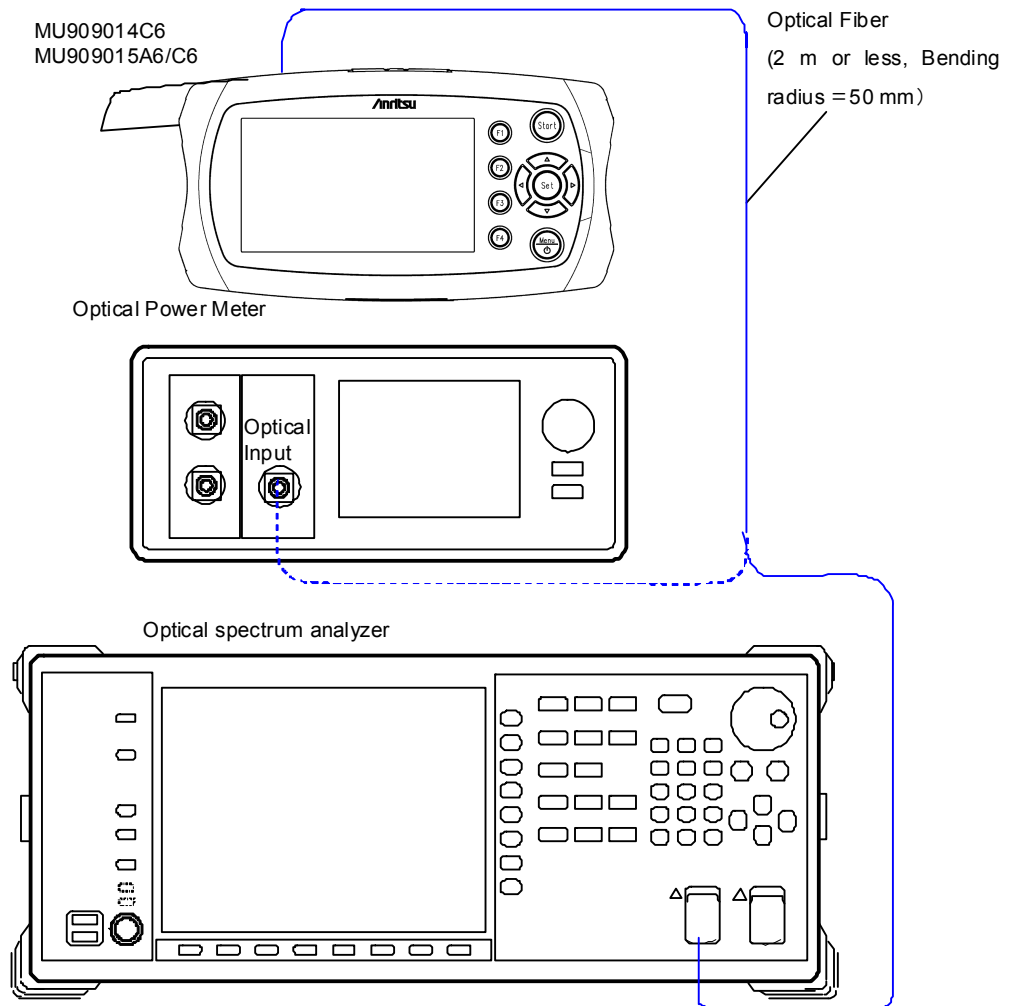

Figure 11.1.9-1 Light Source Test Connection Diagram

Test Procedure:







The test procedure is described below, taking the 1310-nm wavelength of MU909014C6 and MU909015C6 as an example. For the test for other wavelengths, change the waveform setting for the optical spectrum analyzer and optical power meter.

1. Connect the devices as shown in Figure 11.1.9-1.
2. Set the optical spectrum analyzer as follows:
 - Center: 1310 nm
 - Span: 50 nm
 - Res: 0.05 nm

VBW: 1 kHz

Sampling Point: 2001

Analysis: Threshold, Cut.Level: 3 dB

3. Press .
4. Highlight the top menu, and then press .
5. Highlight **Light Source**, and then press .
6. Press  (**Wavelength**) to set Wavelength to **1310 nm**.
7. Press  (**Modulation**) to set to **CW**.
8. Press  to change the display to **On**.
9. Measure the center wavelength of the optical spectrum analyzer and record the result.
10. Connect the light source output of the unit to the optical power meter as shown in Figure 11.1.9-1.
11. Measure the optical output level with the optical power meter and record the result.

11.1.10 Measurement accuracy of optical power meter and PON power meter

Confirm that the measurement accuracy of the power meter satisfy the specifications. Be sure to execute the zero offset of the optical power meter before measurement. .

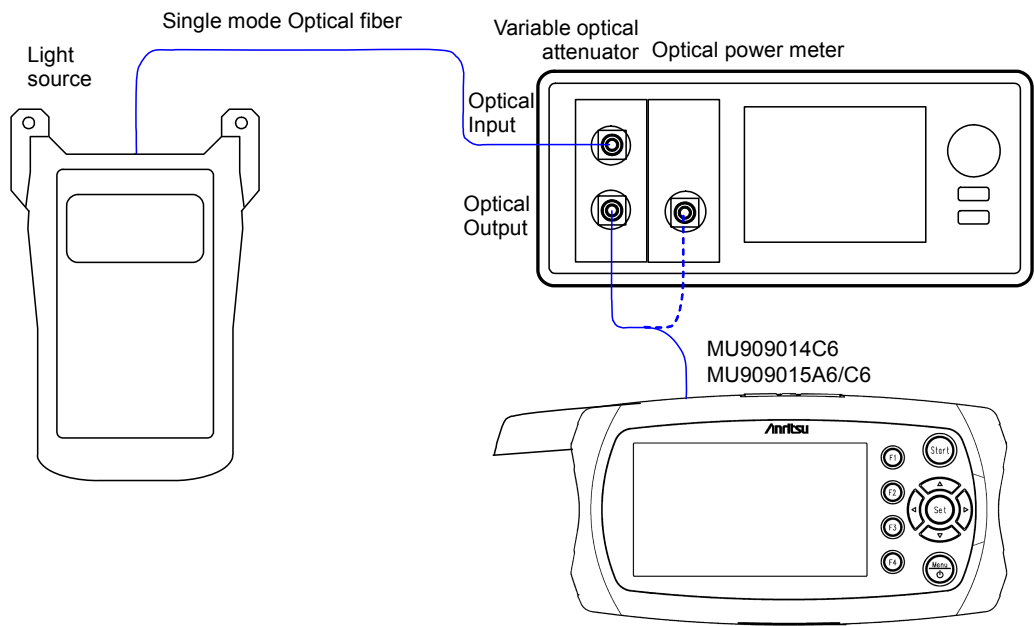











Figure 11.1.10-1 Optical Power Meter Measurement Accuracy Test - Connection Diagram

Test Procedure:

The test procedure is described below, taking the 1550-nm wavelength of MU909014C6 and MU909015C6 as an example. For the test for other wavelengths, change the waveform setting for the light source and optical power meter.

1. Connect the light source and variable optical attenuator using optical fiber as shown in Figure 11.1.10-1.
2. Use an optical fiber to connect the output of the variable optical attenuator to the optical power meter.
3. Set the wavelength of the light source to 1550 nm and output the signal.
4. Set the wavelength of the optical power meter to 1550 nm.
5. Adjust the attenuation of the variable optical attenuator so that the optical power meter displays -20 ± 0.005 dBm. Record the level display of the optical power meter.

6. Disconnect the fiber connected to the power meter and connect to the main frame.
7. Press .
8. Highlight **Top Menu**, and then press .
9. Highlight **Power Meter**, and then press .
10. Press  (**Wavelength**) to select **1550 nm**.
11. Press  (**Modulation**) to set to **CW**.
12. Record the display of the unit.
13. Calculate the difference between the display levels recorded at steps 5 and 11.
14. For models with the PON power meter, press .
15. Select **Top Menu**, and then press .
16. Select **PON Power Meter**, and then press .
17. Press  (**Mode**) to change the display to **dBm**.
18. Record the power display for 1550 nm.

11.2 Calibration

The parameters that can be calibrated are the Backscatter coefficient (BSC) level and the measurement accuracy of OPM (Optical Power Meter).

11.2.1 Backscatter coefficient level calibration

Table 11.2.1-1 Requirements for backscatter coefficient level calibration

Item	Rated values	Quantity
SM Optical Fiber	5 km or longer	2
Optical Connector	With known return loss	1

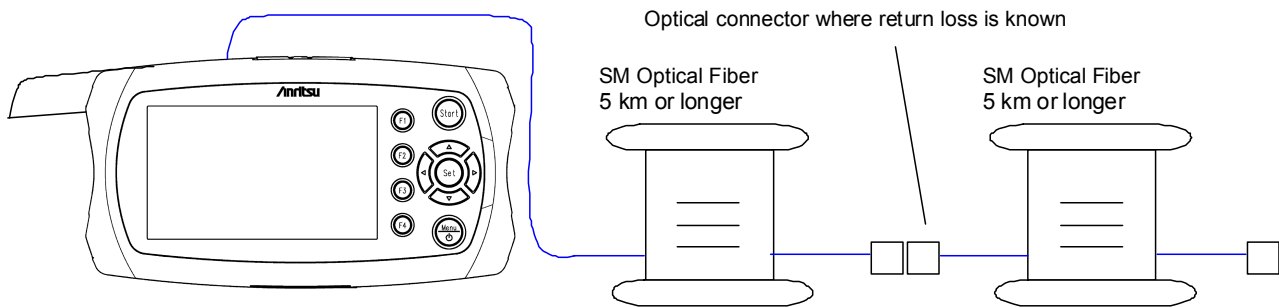

Figure 11.2.1-1 Backscatter Coefficient Level Calibration – Connection Diagram

Calibration Procedure:

1. Prepare an optical connector with a known return loss of R_0 dB and connect it with an optical fiber to the main frame as shown in Figure 11.2.1-1.
2. Press **Start** to start the measurement.
3. After measurement is completed, press **F4 (Trace Analysis)** in the Trace View Screen
4. Confirm that the connector event is displayed in the screen and record the return loss. This value is assumed to be R_1 dB.
5. Find the difference between this value and R_0 dB as $\Delta R = (R_1 - R_0)$.
6. Press **F1 (Test Setup)**.
7. Set the sum of the currently set BSC value and ΔR .
8. Repeat steps 2 to 7 over; calibration is completed when the displayed return losses become the same as the value of R_0 .

11.2.2 Measurement accuracy of optical power meter

To maintain the performance of this power meter, we recommend that calibration be performed once or twice a year.

Please contact Anritsu for calibration of the OPM measurement accuracy.

11.3 Performance Test Result Sheet

Document Number: _____

Test site: _____

Date: _____

Test supervisor: _____

Equipment Name: _____

Serial No.: _____

Software version: _____

Option: _____

Ambient temperature _____ °C

Relative humidity _____ %

Equipment used: Model _____ Serial number _____

Model _____ Serial number _____

Model _____ Serial number _____

Model _____ Serial number _____

Remarks _____

Table 11.3-1 Wavelength

Wavelength Settings	Minimum Value	Measured Value	Maximum Value	Measurement Accuracy	Pass/Fail
1310 nm	1285 nm	nm	1335 nm		Pass/Fail
1490 nm	1465 nm	nm	1515 nm		Pass/Fail
1550 nm	1525 nm	nm	1575 nm		Pass/Fail
1625 nm	1610 nm	nm	1640 nm		Pass/Fail
1650 nm	1635 nm	nm	1665 nm		Pass/Fail

Table 11.3-2 Pulse Width (Wavelength 1310 nm)

Pulsewidth Settings	Minimum Value	Measured Value	Maximum Value*	Measurement Accuracy	Pass/Fail
5 ns		ns			
10 ns	7 ns	ns	13 ns		Pass/Fail
20 ns	14 ns	ns	26 ns		Pass/Fail
50 ns	35 ns	ns	65 ns		Pass/Fail
100 ns	85 ns	ns	115 ns		Pass/Fail
200 ns	170 ns	ns	230 ns		Pass/Fail
500 ns	465 ns	ns	535 ns		Pass/Fail
1 μs	0.93 μs	μs	1.07 μs		Pass/Fail
2 μs	1.86 μs	μs	2.14 μs		Pass/Fail
5 μs	4.65 μs	μs	5.35 μs		Pass/Fail
10 μs	9.3 μs	μs	10.7 μs		Pass/Fail
20 μs	18.6 μs	μs	21.4 μs		Pass/Fail

Table 11.3-3 Pulse Width (Wavelength 1490 nm)

Pulsewidth Settings	Minimum Value	Measured Value	Maximum Value*	Measurement Accuracy	Pass/Fail
5 ns		ns			
10 ns	7 ns	ns	13 ns		Pass/Fail
20 ns	14 ns	ns	26 ns		Pass/Fail
50 ns	35 ns	ns	65 ns		Pass/Fail
100 ns	85 ns	ns	115 ns		Pass/Fail
200 ns	170 ns	ns	230 ns		Pass/Fail
500 ns	465 ns	ns	535 ns		Pass/Fail
1 μ s	0.93 μ s	μ s	1.07 μ s		Pass/Fail
2 μ s	1.86 μ s	μ s	2.14 μ s		Pass/Fail
5 μ s	4.65 μ s	μ s	5.35 μ s		Pass/Fail
10 μ s	9.3 μ s	μ s	10.7 μ s		Pass/Fail
20 μ s	18.6 μ s	μ s	21.4 μ s		Pass/Fail

Table 11.3-4 Pulse Width (Wavelength 1550 nm)

Pulsewidth Settings	Minimum Value	Measured Value	Maximum Value*	Measurement Accuracy	Pass/Fail
5 ns		ns			
10 ns	7 ns	ns	13 ns		Pass/Fail
20 ns	14 ns	ns	26 ns		Pass/Fail
50 ns	35 ns	ns	65 ns		Pass/Fail
100 ns	85 ns	ns	115 ns		Pass/Fail
200 ns	170 ns	ns	230 ns		Pass/Fail
500 ns	465 ns	ns	535 ns		Pass/Fail
1 μ s	0.93 μ s	μ s	1.07 μ s		Pass/Fail
2 μ s	1.86 μ s	μ s	2.14 μ s		Pass/Fail
5 μ s	4.65 μ s	μ s	5.35 μ s		Pass/Fail
10 μ s	9.3 μ s	μ s	10.7 μ s		Pass/Fail
20 μ s	18.6 μ s	μ s	21.4 μ s		Pass/Fail

Table 11.3-5 Pulse Width (Wavelength 1625 nm)

Pulsewidth Settings	Minimum Value	Measured Value	Maximum Value*	Measurement Accuracy	Pass/Fail
5 ns		ns			
10 ns	7 ns	ns	13 ns		Pass/Fail
20 ns	14 ns	ns	26 ns		Pass/Fail
50 ns	35 ns	ns	65 ns		Pass/Fail
100 ns	85 ns	ns	115 ns		Pass/Fail
200 ns	170 ns	ns	230 ns		Pass/Fail
500 ns	465 ns	ns	535 ns		Pass/Fail
1 μ s	0.93 μ s	μ s	1.07 μ s		Pass/Fail
2 μ s	1.86 μ s	μ s	2.14 μ s		Pass/Fail
5 μ s	4.65 μ s	μ s	5.35 μ s		Pass/Fail
10 μ s	9.3 μ s	μ s	10.7 μ s		Pass/Fail
20 μ s	18.6 μ s	μ s	21.4 μ s		Pass/Fail

Table 11.3-6 Pulse Width (Wavelength 1650 nm)

Pulsewidth Settings	Minimum Value	Measured Value	Maximum Value*	Measurement Accuracy	Pass/Fail
5 ns		ns			
10 ns	7 ns	ns	13 ns		Pass/Fail
20 ns	14 ns	ns	26 ns		Pass/Fail
50 ns	35 ns	ns	65 ns		Pass/Fail
100 ns	85 ns	ns	115 ns		Pass/Fail
200 ns	170 ns	ns	230 ns		Pass/Fail
500 ns	465 ns	ns	535 ns		Pass/Fail
1 μs	0.93 μs	μs	1.07 μs		Pass/Fail
2 μs	1.86 μs	μs	2.14 μs		Pass/Fail
5 μs	4.65 μs	μs	5.35 μs		Pass/Fail
10 μs	9.3 μs	μs	10.7 μs		Pass/Fail
20 μs	18.6 μs	μs	21.4 μs		Pass/Fail

Table 11.3-7 Dynamic Range MU909014B/B1 (Wavelength 1310 nm)

Pulsewidth Settings	Minimum Value	Measured Value	Measurement Accuracy	Pass/Fail
500 ns	23.5 dB	dB		Pass/Fail
20 μ s	31.5 dB	dB		Pass/Fail

Table 11.3-8 Dynamic Range MU909014B/B1 (Wavelength 1550 nm)

Pulsewidth Settings	Minimum Value	Measured Value	Measurement Accuracy	Pass/Fail
500 ns	22 dB	dB		Pass/Fail
20 μ s	30 dB	dB		Pass/Fail

Table 11.3-9 Dynamic Range MU909015B/B1 (Wavelength 1310 nm)

Pulsewidth Settings	Minimum Value	Measured Value	Measurement Accuracy	Pass/Fail
500 ns	27 dB	dB		Pass/Fail
20 μ s	36 dB	dB		Pass/Fail

Table 11.3-10 Dynamic Range MU909015B/B1 (Wavelength 1550 nm)

Pulsewidth Settings	Minimum Value	Measured Value	Measurement Accuracy	Pass/Fail
500 ns	25 dB	dB		Pass/Fail
20 μ s	35 dB	dB		Pass/Fail

Table 11.3-11 Dynamic Range MU909014A/A1 (Wavelength 1625 nm)

Pulsewidth Settings	Minimum Value	Measured Value	Measurement Accuracy	Pass/Fail
500 ns	23.5 dB	dB		Pass/Fail
20 μ s	31.5 dB	dB		Pass/Fail

Table 11.3-12 Dynamic Range MU909014A/A1 (Wavelength 1650 nm)

Pulsewidth Settings	Minimum Value	Measured Value	Measurement Accuracy	Pass/Fail
500 ns	23 dB	dB		Pass/Fail
20 μ s	31.5 dB	dB		Pass/Fail

Table 11.3-13 Dynamic Range (MU909014C/C6-057/067/058/068)

Wavelength	Pulsewidth Settings	Minimum Value	Measured Value	Measurement Accuracy	Pass/Fail
1310 nm	500 ns	23.5 dB	dB		Pass/Fail
	20 μ s	31.5 dB	dB		Pass/Fail
1550 nm	500 ns	22 dB	dB		Pass/Fail
	20 μ s	30 dB	dB		Pass/Fail
1625 nm	500 ns	23 dB	dB		Pass/Fail
	20 μ s	31.5 dB	dB		Pass/Fail
1650 nm	500 ns	22 dB	dB		Pass/Fail
	20 μ s	31.5 dB	dB		Pass/Fail

Table 11.3-14 Dynamic Range (MU909015A6/C/C6-057/067/058/068)

Wavelength	Pulsewidth Settings	Minimum Value	Measured Value	Measurement Accuracy	Pass/Fail
1310 nm	500 ns	26 dB	dB		Pass/Fail
	20 μ s	37 dB	dB		Pass/Fail
1550 nm	500 ns	25 dB	dB		Pass/Fail
	20 μ s	36 dB	dB		Pass/Fail
1625 nm	500 ns	24 dB	dB		Pass/Fail
	20 μ s	34 dB	dB		Pass/Fail
1650 nm	500 ns	24 dB	dB		Pass/Fail
	20 μ s	34 dB	dB		Pass/Fail

Table 11.3-15 Dynamic Range (MU909015/C/C6-059/069)

Wavelength	Pulsewidth Settings	Minimum Value	Measured Value	Measurement Accuracy	Pass/Fail
1310 nm	500 ns	25 dB	dB		Pass/Fail
	20 μ s	36 dB	dB		Pass/Fail
1490 nm	500 ns	24 dB	dB		Pass/Fail
	20 μ s	35 dB	dB		Pass/Fail
1550 nm	500 ns	24 dB	dB		Pass/Fail
	20 μ s	35 dB	dB		Pass/Fail

Table 11.3-16 Distance Measurement Accuracy

Length of Optical Fiber (km)	Measured Value (km)	Minimum Value (m)	Difference (m)	Maximum Value (m)	Pass/Fail
		-1.35		1.35	Pass/Fail

Specifications: $\pm 1 \text{ m} \pm (3 \text{ m} \times \text{measured distance (m)} \times 10^{-5}) \pm \text{marker resolution}$

When Range is 5 km and the horizontal scale is 0.005 km/div, the measurement range is 5000 m and the marker resolution is 0.2 m.

Table 11.3-17 Linearity (Wavelength 1625 nm, 1650 nm)

Location of Cursor A (km)	Location of Cursor B (km)	Loss (dB/km)	Minimum Value (dB)	Difference from Mean Loss x 4 (dB)	Maximum Value (dB)	Pass/Fail
0	4		-0.1		0.1	Pass/Fail
2	6		-0.1		0.1	Pass/Fail
4	8		-0.1		0.1	Pass/Fail
6	10		-0.1		0.1	Pass/Fail
8	12		-0.1		0.1	Pass/Fail
10	14		-0.1		0.1	Pass/Fail
12	16		-0.1		0.1	Pass/Fail
14	18		-0.1		0.1	Pass/Fail
16	20		-0.1		0.1	Pass/Fail
18	22		-0.1		0.1	Pass/Fail
20	24		-0.1		0.1	Pass/Fail
22	26		-0.1		0.1	Pass/Fail
24	28		-0.1		0.1	Pass/Fail
26	30		-0.1		0.1	Pass/Fail

Mean 1 (dB/km)

Mean 2 (dB/km)

Table 11.3-18 Linearity (Wavelength 1310 nm)

Location of Cursor A (km)	Location of Cursor B (km)	Loss (dB/km)	Minimum Value (dB)	Difference from Mean Loss x 3 (dB)	Maximum Value (dB)	Pass/Fail
0	3		-0.1		0.1	Pass/Fail
1.5	4.5		-0.1		0.1	Pass/Fail
3	6		-0.1		0.1	Pass/Fail
4.5	7.5		-0.1		0.1	Pass/Fail
6	9		-0.1		0.1	Pass/Fail
7.5	10.5		-0.1		0.1	Pass/Fail
9	12		-0.1		0.1	Pass/Fail
10.5	13.5		-0.1		0.1	Pass/Fail
12	15		-0.1		0.1	Pass/Fail
13.5	16.5		-0.1		0.1	Pass/Fail
15	18		-0.1		0.1	Pass/Fail
16.5	19.5		-0.1		0.1	Pass/Fail
18	21		-0.1		0.1	Pass/Fail
19.5	22.5		-0.1		0.1	Pass/Fail
21	24		-0.1		0.1	Pass/Fail
22.5	25.5		-0.1		0.1	Pass/Fail
24	27		-0.1		0.1	Pass/Fail
25.5	28.5		-0.1		0.1	Pass/Fail
27	30		-0.1		0.1	Pass/Fail

Mean 1 (dB/km), Mean 2 (dB/km)

Table 11.3-19 Fresnel Dead Zone

Wavelength (nm)	Measured Value	Maximum Value	Measurement Accuracy	Pass/Fail
1310	m	0.8 m		Pass/Fail
1490	m	0.8 m		Pass/Fail
1550	m	0.8 m		Pass/Fail
1625	m	0.8 m		Pass/Fail
1650	m	0.8 m		Pass/Fail

Table 11.3-20 MU909014A/A1/B/B1, MU909015B/B1
Backscatter Dead Zone

Wavelength (nm)	Measured Value	Maximum Value	Measurement Accuracy	Pass/Fail
1310	m	5.0 m		Pass/Fail
1550	m	5.0 m		Pass/Fail
1625	m	5.0 m		Pass/Fail
1650	m	5.0 m		Pass/Fail

Table 11.3-21 MU909014C/C6, MU909015A6/C/C6
Backscatter Dead Zone

Wavelength (nm)	Measured Value	Maximum Value	Measurement Accuracy	Pass/Fail
1310	m	4.0 m		Pass/Fail
1490	m	4.5 m		Pass/Fail
1550	m	4.5 m		Pass/Fail
1625	m	4.5 m		Pass/Fail
1650	m	4.5 m		Pass/Fail

Table 11.3-22 Light Source

Item	Wavelength (nm)	Minimum Value	Measured Value	Maximum Value	Measurement Accuracy	Pass/Fail
Wavelength	1310 nm	1285 nm	nm	1335 nm		Pass/Fail
	1490 nm	1465 nm	nm	1515 nm		Pass/Fail
	1550 nm	1525 nm	nm	1575 nm		Pass/Fail
	1625 nm	1600 nm	nm	1650 nm		Pass/Fail
	1650 nm	1625 nm	nm	1675 nm		Pass/Fail
Level	1310 nm	-6.5 dBm	dBm	-3.5 dBm		Pass/Fail
	1550 nm	-6.5 dBm	dBm	-3.5 dBm		Pass/Fail
	1625 nm	-6.5 dBm	dBm	-3.5 dBm		Pass/Fail
	1650 nm	-6.5 dBm	dBm	-3.5 dBm		Pass/Fail

Table 11.3-23 VFL

Item	Minimum Value	Measured Value	Maximum Value	Measurement Accuracy	Pass/Fail
Wavelength	635 nm	nm	665 nm		Pass/Fail
Level	-2.5 dBm	dBm	2.5 dBm		Pass/Fail

Table 11.3-24 Power Meter

Item	Wavelength (nm)	Minimum Value	Measured Value	Maximum Value	Measurement Accuracy	Pass/Fail
Measurement Accuracy	1310 nm	-0.5 dB	dB	0.5 dB		Pass/Fail
	1490 nm	-0.5 dB	dB	0.5 dB		Pass/Fail
	1550 nm	-0.5 dB	dB	0.5 dB		Pass/Fail

Wavelength	OPM reading	μ OTDR	Level Difference
1310 nm	dBm	dBm	dB
1490 nm	dBm	dBm	dB
1550 nm	dBm	dBm	dB

Table 11.3-25 PON Power Meter

Item	Wavelength (nm)	Minimum Value	Measured Value	Maximum Value	Measurement Accuracy	Pass/Fail
Measurement Accuracy	1490 nm	-0.5 dB	dB	0.5 dB		Pass/Fail
	1550 nm	-0.5 dB	dB	0.5 dB		Pass/Fail

Wavelength	OPM reading	μ OTDR	Level Difference
1490 nm	dBm	dBm	dB
1550 nm	dBm	dBm	dB

Chapter 12 Maintenance

This chapter describes the daily maintenance of the Network Master as well as firmware upgrades, storage, and transport.

12.1	Daily Maintenance	12-2
12.2	Updating Firmware	12-3
	12.2.1 Summary	12-3
	12.2.2 Preparing for Firmware Upgrade	12-3
	12.2.3 Updating Firmware	12-4
12.3	Notes On Storage	12-8
12.4	Transporting and Disposal.....	12-9

12.1 Daily Maintenance

Be sure to turn off the power before performing daily maintenance.

Panel surface dirt

When the external surfaces become dirty, or when using the Network Master in dusty locations, etc., or before long-term storage, clean off any soiling using a soft cloth slightly moistened with neutral detergent.

Screen surface dirt

NEVER clean with organic solvents, such as benzene, thinners, toluene, etc. Use a soft dry cloth or a cloth slightly moistened with ethanol to clean off any grease marks, fingerprints, etc.

Loose screws

Use a coin or flat-blade screwdriver to tighten screws.

12.2 Updating Firmware

12.2.1 Summary

The main frame has a firmware upgrade function to add new functions and resolve any software bugs. The firmware is updated by loading the released update using installer file.

The latest firmware update can be downloaded from the home page at <http://downloads.anritsu.com/downloads/>

For details, contact Anritsu Service or nearest representative.

12.2.2 Preparing for Firmware Upgrade

Copy the installer to USB memory using the following procedure.

1. Download the install file (.bbm extension) from the home page download site.
2. Copy the downloaded install file to the root folder of the USB memory.

Example:

Copy to D:\, when the USB memory is drive D:.

12.2.3 Updating Firmware

 **CAUTION**

ALWAYS use the AC adapter when updating the firmware.

Update the firmware using the following procedure.

1. If operating, power down the unit.
2. Connect the USB memory that contains the copied install file to the main frame.
3. Connect the AC adapter to the main frame.
4. Hold down **F1** while powering up the unit (press ).
5. Firmware Update screen is displayed.

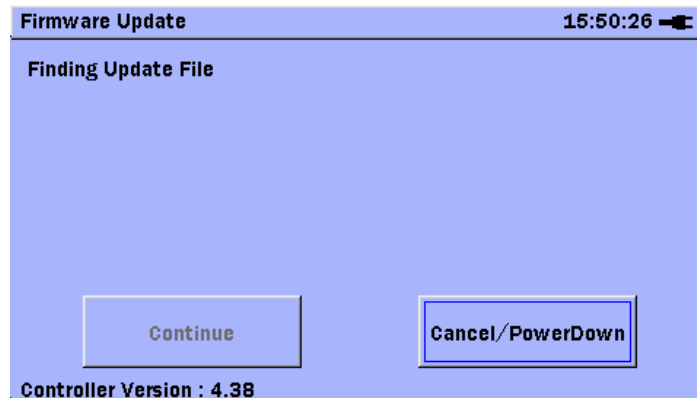

Figure 12.2.3-1 Initial Firmware Update Screen

6. When the USB memory contains several install files, the file selection screen is displayed. Press  and  to select the required install file and press .

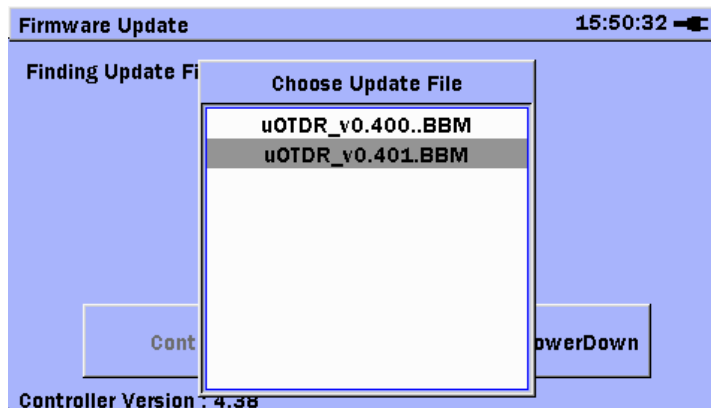











Figure 12.2.3-2 Install File Selection Screen

7. The install file is loaded to the main frame by pressing Continue as described below.

Use     to select **Continue**, and then press  to start updating the firmware.

To cancel the update, use     to select **Cancel/PowerDown**, and then press .

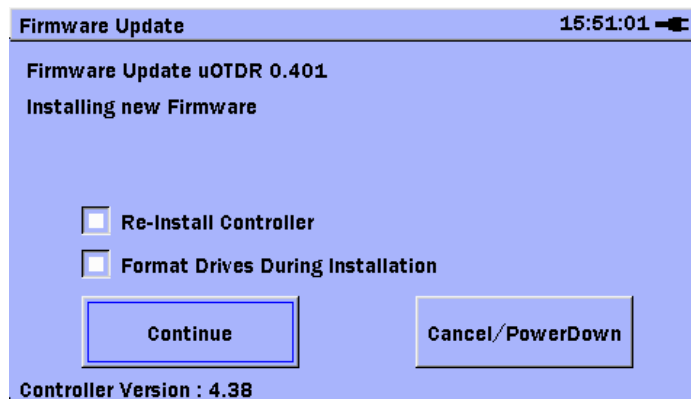







Figure 12.2.3-3 Starting Firmware Update

Select the firmware update options under the following circumstances:

- When the software does not start
- When data files cannot be read
- When Re-install Controller checked:
Update the MT9099A main frame software before updating the firmware.
Press  and  to select **Re-install Controller**, and then press  to update the firmware and bootloader contents.
- When Format Drives During Installation checked:
Press  and  to select **Format Drives During Installation**, and then press  to format the internal memory before updating the firmware.

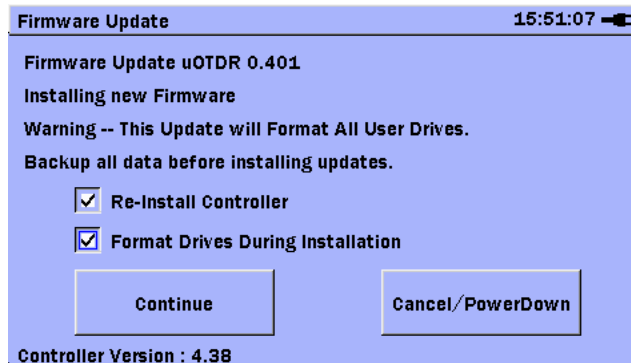

Figure 12.2.3-4 Firmware Update Options

Note:

When updating firmware after selecting Format Drives During Installation, all memory in the main frame, excluding USB memory, is formatted. Before updating the firmware, we strongly recommend making a backup of the contents of the internal memory first.

 **CAUTION**

If power to the main frame is cut while updating the bootloader, the main frame may be left unable to boot. **NEVER** cut the power while updating the bootloader.

8. A progress bar is displayed while the firmware is updating. It shows the progress of the firmware update.

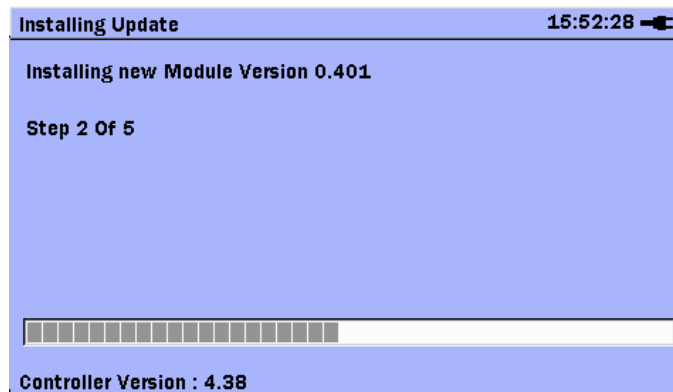



Figure 12.2.3-5 Firmware Update Progress Bar

9. **Finish** is displayed when the firmware update is completed. Press  to finish the update and switch off the power to the main frame.

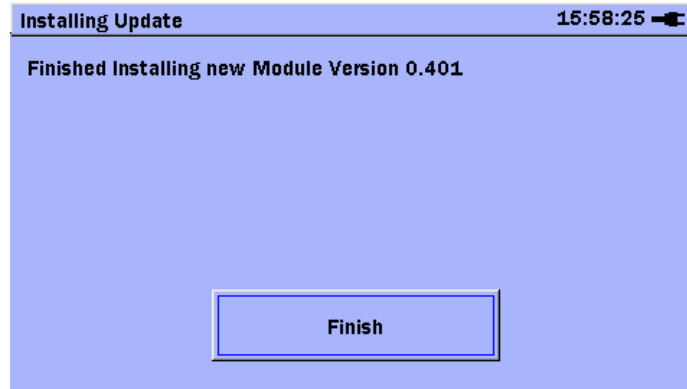

Figure 12.2.3-6 Firmware Update Completed

12.3 Notes On Storage

Remove any dust or dirt adhering to the equipment before storage.

Remove batteries from the Network Master.

Pack accessories, such as adapters and CD-ROM, etc., into the accessories box and store it with the main frame.

Avoid storing in these places:

- In direct sunlight
- Dusty places
- Damp places where condensation may occur on the equipment's surface
- Places with active/corrosive gases
- Places where the equipment may be oxidized
- Places where there is a risk of vibration or mechanical shock
- Places where there is a risk of packing boxes falling over
- Places where the temperature and humidity are as follows:
Temperature: -30°C or lower, or 70°C or higher
Humidity: 95% or higher

Recommended storage conditions

It is recommended that the equipment be stored in a place that meets the ambient conditions suggested above, plus the following conditions, if it is not to be used for a long period of time:

- Temperature: 5°C to 45°C
- Humidity: 40% to 80%
- Little temperature and humidity fluctuations within 1 day

12.4 Transporting and Disposal

This section describes the precautions to observe when transporting and disposing of the main frame at the end of its useful life.

Repackaging

Use the original shipping materials, or an approved optional transit case, when repacking the unit for transport. Repack according to the following procedure when the original shipping materials (or a transit case) are not available.

1. Procure a corrugated cardboard, wooden, or aluminum box large enough to pack in cushioning material around the unit.
2. Wrap the main frame in some material such as plastic sheeting that will prevent entry of dust and water.
3. Place the unit into the box.
4. Pack soft materials around the main frame so that it cannot slide around inside the packing box.
5. Secure the outside of the box with packaging cord, adhesive tape, bands, or other such implements.

Transporting

In addition to preventing vibration as much as possible, transport under conditions meeting the storage conditions outlined above.

Disposal

When the main frame has reached the end of its useful life, dispose of it in accordance with local environmental regulations.

Before disposal, dismantle or physically destroy any non-volatile memory media in the Network Master to ensure that data in memory cannot be recovered by third parties.

Appendix A Specifications

A.1 MT9090A Main Frame

Table A.1-1 Product Configuration

Model	Name	
MT9090A	– Main Frame –	
	Main Frame	
B0601B	– Standard Accessories –	
	Standard soft case	1
G0202A*	Ni-MH battery pack	1
G0203A	AC Charger/Adapter	1
Z1023A	Strap	1
B0663A	Protector	1

*: It can be charged by MT9090A main frame. There is no external charger.

Table A.1-2 Application Parts

Model	Name
B0600B	Hard case
B0602A	Deluxe soft case
HR-3UTG-4BP	Ni-MH battery packs (4)
NC-M58*	Battery charger
J1402A	Car plug cord

*: Special dedicated nickel metal-hydride battery pack (HR-3UTG-4BP)

The NiMH battery pack (G0202A) cannot be recharged.

Table A.1-3 Specifications

Item	Specifications	Remarks
Display	4.3-inch color TFT LCD (480×272 pixels, with LED backlight, transmissive)	
Interface	USB1.1, Type A×1 (Memory), Type B×1 (USB mass storage)	
Dimensions	180 (W)×96 (H)×18 (D) mm	

Table A.2-1 Ni-MH battery pack

Item	Specifications	Remarks
Battery type	Ni-MH Battery pack	
Voltage, Capacity	DC 4.8 V, 2700 mAh	

Table A.1-2 AC Adapter

Item	Specifications	Remarks
AC rated input	AC 100 to 240 V, 50/60 Hz*	
DC rated input	DC 9 V	

*: Operating voltage: within the range of +10% to -10% from the rated voltage

A.2 μ OTDR Module

A.2.1 Configuration

Table A.2.1-1 Product Configuration

Model	Name	Remarks
	– Main Frame –	
MU909014A	μ OTDR Module	Specify wavelength as option.
MU909014A1	μ OTDR Module	Specify visible light source and wavelength as option.
MU909014B	μ OTDR Module	Two wavelengths, Dynamic range 30 dB model
MU909014B1	μ OTDR Module	Two wavelengths, Dynamic range 30 dB model
MU909014C	μ OTDR Module	Three wavelengths, Dynamic range 30 dB, Power meter
MU909014C6	μ OTDR Module	Three wavelengths, Dynamic range 30 dB, light source, PON power meter, Loss Test
MU909015A6	μ OTDR Module	One wavelength, Dynamic range 35 dB, Power meter, PON power meter
MU909015B	μ OTDR Module	Two wavelengths, Dynamic range 35 dB model
MU909015B1	μ OTDR Module	Two wavelengths, Dynamic range 35 dB model
MU909015C	μ OTDR Module	Three wavelengths, Dynamic range 35 dB, Power meter
	μ OTDR Module	
MU909015C6	μ OTDR Module	Three wavelengths, Dynamic range 35 dB, light source, PON power meter, Loss Test
	– Standard Accessories –	
	Optical Connector	Specify type as option.
W3585AE	Quick Guide	Printed version
Z1579A	μ OTDR Module Operation Manual (CD-R)	Operation manual, Quick guide
	– Options –	
-053	1625 nm, UPC	For MU909014A/A1, MU909015A6
-054	1650 nm, UPC	For MU909014A/A1, MU909015A6
-063	1625 nm, APC	For MU909014A/A1
-064	1650 nm, APC	For MU909014A/A1
-056	1310/1550 nm, UPC	For MU909014B/B1, MU909015B/B1
-066	1310/1550 nm, APC	For MU909014B/B1, MU909015B/B1
-057	1310/1550/1625 nm, UPC	For MU909014C/C6, MU909015C/C6
-067	1310/1550/1625 nm, APC	For MU909014C/C6, MU909015C/C6
-058	1310/1550/1650 nm, UPC	For MU909014C/C6, MU909015C/C6
-068	1310/1550/1650 nm, APC	For MU909014C/C6, MU909015C/C6
-059	1310/1490/1550 nm, UPC	For MU909015C/C6
-069	1310/1490/1550 nm, APC	For MU909015C/C6

Table A.2.1-1 Product Configuration (Cont'd)

Model	Name	Remarks
-025	– Connection Options – FC-APC Connector	
-026	SC-APC Connector	
-037	FC Connector	
-039	DIN47256 Connector	
-040	SC Connector	

Table A.2.1-2 Applicable Parts

Model	Name
FS-PT-USB-CASE	Hard case for VIP option
OPTION- 545 VIP	Video Inspection Probe (x200/x400)
G0293A	Video Inspection Probe Lite (x400)
G0306A	Video Inspection Probe Lite (x400)
G0306B	Video Inspection Probe Lite (x400)
B0663A	Protector
J0617B	Replaceable optical connector (FC-PC)
J0618E	Replaceable optical connector (DIN)
J0619B	Replaceable optical connector (SC)
J0635x*	FC/PC patch cord (SM fiber)
J0739A	Replaceable optical connector (FC-APC)
J1480A	USB-Ethernet converter
Z0284	Adapter Cleaner
Z0914A	Ferrule cleaner
Z0915A	Replacement reel for Ferrule cleaner
Z0916A	Ferrule side face cleaner, stick type
Z1580A	Protector & softcase
W3586AE	μOTDR Module Operation Manual (Printed)

*: Use the following codes to specify the length (x) of the patch cord.
A: 1 meter; B: 2 meters; C: 3 meters

A.2.2 Common Specifications

Table A.2.2-1 Specifications

Item	Specifications
Measurement Condition Setup IOR BSC	1.3000 to 1.7000 (0.0001 step) −90.0 to −40.0 (0.1 step)
Trace View Number of Sampling Points Sampling Resolution* ¹ Marker Resolution* ¹	Refer to Table A.2.2-2. Refer to Table A.2.2-2. 0.02 to 400 m
Auto measurement (fault evaluation) Measurement Items Event Analysis Threshold value Pass/Fail Evaluation Threshold Value Number of Detected Events: Connection Check	Displays events evaluated as faults in the order close to the near end. Displays the distance of fault candidate, total loss or connection loss, event type, and return loss on the fault evaluation screen. * The auto measurement is a secondary function for simple measurement, and it does not assure the measurement values. The detection might be incorrect, so make a final pass/fail evaluation of the measurement results only after observing the waveform data. Distance of each event, connection loss, return loss, and event type (table display) Splice loss: 0.01 to 9.99 dB (0.01 dB/ step) Return loss: 20.0 to 70.0 dB (0.1 dB/ step) Splitter: 1 to 40 dB (1 dB/ step) Splice loss: 0.10 to 30.00 dB (0.01 dB/ step) Return loss: 10.0 to 50.0 dB (0.1 dB/ step) Total loss: 0.1 to 60.0 dB (0.1 dB/ step) Up to 99 Checks the connection status of the optical connection
Manual Measurement Measurement Items Real-time Sweep* ²	Loss and distance between two points Sweep time: 1 sec or less

*1: IOR = 1.500000

*2: When the resolution is standard, the design is assured.

Table A.2.2-1 Specifications (Cont'd)

Item	Specifications
Other functions	<ul style="list-style-type: none"> ● Loss measurement mode: 2pt-Loss, Splice Loss, dB/km LSA, dB/km, ORL, Event ● Date & Time display/setting ● Color Theme: Default, Lush Green, Night, Orange Crush, Outdoor White ● Language: English, Japanese, Chinese (Simplified), Chinese (Traditional), French, German, Spanish (Spain), Spanish (Latin America), Italian, Polish, Portuguese, Finnish, Korean, Danish, Swedish, Russian ● Auto Backlight OFF: 30 sec, OFF, 5 to 60 min (5 min step) ● Auto Power OFF: OFF, 30 to 120 min (30 min step) ● Dummy fiber display switch function ● Distance unit setting: Mile, Feet, Kilofeet, Meters, Kilometers ● Trace file:SR-4731 format ● Load Trace (Only trace files saved on same unit can be loaded) ● Save Trace (Manual save) ● Auto Save ● Mass Storage function ● Screen Capture: BMP, JPEG, PNG format ● Battery display ● Connector Video Inspection Probe (VIP option) Save function: PNG format Load function: PNG format ● Macrobend function (by using 1310 nm and 1550 nm) ● WiFi/Bluetooth connection ● Remote GUI function ● Fiber type list customize function ● Fiber Visualizer function ● DCFL function
Power Supply	<ul style="list-style-type: none"> ● Dedicated battery pack or 4 AA Ni-MH batteries ● AA Alkaline batteries ● DC: Rating 9 V ● AC: Rating 100 to 240 V, frequency: 50/60 Hz, (with dedicated AC adapter)^{*3}
Power consumption	12 VA or less (including during charging battery)
Dedicated battery pack	Ni-MH (nickel-metal hydride) battery
Battery operating time	Operating time:8 hours ^{*4, *5}
Battery charging time	4 h ^{*4,*6}
Dimensions (excluding protrusions)	190(W) × 96(H) × 30(D) mm
Mass	≤ 700 g ^{*7}

- *3: Operating voltage: within the range of +10% to -10% from the rated voltage
- *4: Typical
- *5: Telcordia GR-196-CORE Issue 2, September 2010, automatic back light off: 30 sec, automatic power off: Disabled, 25°C, design assurance
- *6: Temperature range: +10° to +30°C
With power off, temperature range for $\geq 90\%$ charge
- *7: Total of MT9090A main frame, fiber maintenance tester, and dedicated battery pack

Table A.2.2-2 Sampling Resolution and Number of Sampling Points (MU909014A/A1/B/B1, MU909015B/B1)

Distance Range (km)	Standard		High Resolution		Super-high Resolution	
	Number of points	Resolution	Number of points	Resolution	Number of points	Resolution
0.5	5001	10 cm	10001	5 cm	---	---
1	5001	20 cm	20001	5 cm	---	---
2.5	5001	50 cm	25001	10 cm	---	---
5	5001	1 m	25001	20 cm	---	---
10	5001	2 m	20001	50 cm	---	---
25	5001	5 m	25001	1 m	---	---
50	5001	10 m	25001	2 m	---	---
75	3751	20 m	15001	5 m	---	---
125	6251	20 m	25001	5 m	125001	1 m
250	6251	40 m	25001	10 m	250001	1 m

Table A.2.2-3 Sampling Resolution and Number of Sampling Points (MU909014C/C6, MU909015A6/C/C6)

Distance Range (km)	Standard		High Resolution		Super-high Resolution	
	Number of points	Resolution	Number of points	Resolution	Number of points	Resolution
0.5	5001	10 cm	10001	5 cm	25001	2 cm
1	5001	20 cm	20001	5 cm	50001	2 cm
2.5	5001	50 cm	12501	20 cm	25001	10 cm
5	5001	1 m	12501	40 cm	50001	10 cm
10	5001	2 m	20001	50 cm	100001	10 cm
25	5001	5 m	12501	2 m	25001	1 m
50	5001	10 m	12501	4 m	50001	1 m
75	7501	10 m	15001	5 m	75001	1 m
125	6251	20 m	12501	10 m	125001	1 m
250	6251	40 m	12501	20 m	250001	1 m

Table A.2.2-4 Environment Conditions

Item		Specifications
Operating Temperature, Humidity	MU909014A/A1/B/B1, MU909015B/B1	-5°C to +40°C, ≤ 80%* (Battery charging, +10° to +30°C, power off)
	MU909014C/C6, MU909015A6/C/C6	-10°C to +50°C, ≤ 95%* (Battery charging, +10°C to +30°C, power off)
Storage Temperature, Humidity	MU909014A/A1/B/B1, MU909015B/B1	-20°C to +60°C, ≤ 80%*
	MU909014C/C6, MU909015A6/C/C6	-30°C to +70°C, ≤ 95%*
Vibration		MIL-T-28800E Class3
Shock		MIL-T-28800E
Drop		MIL-T-28800E Style C (20.3 cm corner, surface; total 14 drops, power off)
Bump		IEC60068-2-29, JIS C60068-2-29
Shock-on-desk		MIL-T-28800E (45° or 100 mm corner, edge total 4 drops, power on)
Dust proof, water proof		JIC C0920 IPX1
EMC		EN61326-1: 2013 (Class A, Table 2) RN61000-3-2: 2006 +A1:2009 A2:2009 (Class A)

*: No condensation

A.2.3 MU909014A/A1B/B1, MU909015B/B1

Table A.2.3-1 Specifications

Item	Specifications		Remarks
Wavelength*1	Model Name/Option	Specifications	Pulse width: 1 μ s
	MU909014A/A1-053	1625 \pm 15 nm	
	MU909014A/A1-063		
	MU909014A/A1-054		
	MU909014A/A1-064	1650 \pm 15 nm	
	MU909014B/B1-056	1310 \pm 25 nm, 1550 \pm 25 nm	
	MU909014B/B1-066		
	MU909015B/B1-056		
MU909015B/B1-066			
Fiber under test	10/125 μ m single mode fiber (ITU-T G.652)		
Pulse width	Auto, 5, 10, 20, 50, 100, 200, 500 ns, 1, 2, 5, 10, 20 μ s		
Dynamic range*1,*2	Model Name/Option	Specifications	
	MU909014A/A1-053	24.5 dB (Pulse width 500 ns)*3	
	MU909014A/A1-063	32.5 dB (Pulse width 20 μ s)*3	
	MU909014A/A1-054	24 dB (Pulse width 500 ns)*3	
	MU909014A/A1-064	32.5 dB (Pulse width 20 μ s)*3	
	MU909014B/B1-056	24.5 dB (Pulse width 500 ns)*3,*4 23 dB (Pulse width 500 ns)*3,*5	
	MU909014B/B1-066	32.5 dB (Pulse width 20 μ s)*3,*4 31 dB (Pulse width 20 μ s)*3,*5	
	MU909015B/B1-056	28 dB (Pulse width 500 ns)*3,*4 26 dB (Pulse width 500 ns)*3,*5	
MU909015B/B1-066	37 dB (Pulse width 20 μ s)*3,*4 36 dB (Pulse width 20 μ s)*3,*5		
Dead zone*1,*6	Backscattered light: \leq 5.0 m*3,*7 Fresnel reflection: \leq 1.0 m*3,*8		
Distance Range*6	Auto, 0.5, 1, 2.5, 5, 10, 25, 50, 75, 125, 250 km/ Auto, 1640, 3281, 8202, 16404, 32808, 82021, 164042, 246063, 410105, 820210 feet		
Distance Measurement Accuracy	\pm 1 m \pm (3 m \times distance range \times 10 ⁻⁵) \pm marker resolution However, excludes uncertainty due to IOR		
Loss Measurement Accuracy (Linearity)	\pm 0.05 dB/dB or \pm 0.1 dB, whichever greater		

Table A.2.3-1 Specifications (Cont'd)

Item	Specifications	Remarks																															
Optical output peak power	150 mW max. (+21.76 dBm max.)																																
Return Loss Measurement Accuracy	±2 dB	Distance Range: 25 km Pulse width: 2 μs																															
Laser safety	<table border="1" data-bbox="491 685 1150 1021"> <thead> <tr> <th data-bbox="491 685 692 788" rowspan="2">Model</th> <th colspan="3" data-bbox="692 685 1150 734">IEC 60825-1:2007</th> </tr> <tr> <th data-bbox="692 734 842 788">Class 1</th> <th data-bbox="842 734 992 788">Class 1M</th> <th data-bbox="992 734 1150 788">Class 3R</th> </tr> </thead> <tbody> <tr> <td data-bbox="491 788 692 824">MU909014A</td> <td data-bbox="692 788 842 824">✓</td> <td data-bbox="842 788 992 824"></td> <td data-bbox="992 788 1150 824"></td> </tr> <tr> <td data-bbox="491 824 692 860">MU909014A1</td> <td data-bbox="692 824 842 860">✓</td> <td data-bbox="842 824 992 860"></td> <td data-bbox="992 824 1150 860">✓</td> </tr> <tr> <td data-bbox="491 860 692 896">MU909014B</td> <td data-bbox="692 860 842 896">✓</td> <td data-bbox="842 860 992 896">✓</td> <td data-bbox="992 860 1150 896"></td> </tr> <tr> <td data-bbox="491 896 692 931">MU909014B1</td> <td data-bbox="692 896 842 931">✓</td> <td data-bbox="842 896 992 931">✓</td> <td data-bbox="992 896 1150 931">✓</td> </tr> <tr> <td data-bbox="491 931 692 967">MU909015B</td> <td data-bbox="692 931 842 967">✓</td> <td data-bbox="842 931 992 967">✓</td> <td data-bbox="992 931 1150 967"></td> </tr> <tr> <td data-bbox="491 967 692 1003">MU909015B1</td> <td data-bbox="692 967 842 1003">✓</td> <td data-bbox="842 967 992 1003">✓</td> <td data-bbox="992 967 1150 1003">✓</td> </tr> </tbody> </table> <p data-bbox="485 1025 1150 1120">21 CFR 1040.10 Except for deviations pursuant to Laser Notice No.50 dated June 24 2007.</p>	Model	IEC 60825-1:2007			Class 1	Class 1M	Class 3R	MU909014A	✓			MU909014A1	✓		✓	MU909014B	✓	✓		MU909014B1	✓	✓	✓	MU909015B	✓	✓		MU909015B1	✓	✓	✓	
			Model	IEC 60825-1:2007																													
		Class 1		Class 1M	Class 3R																												
		MU909014A	✓																														
		MU909014A1	✓		✓																												
		MU909014B	✓	✓																													
		MU909014B1	✓	✓	✓																												
		MU909015B	✓	✓																													
MU909015B1	✓	✓	✓																														

*1: 25°C

Except while charging battery

*2: S/N=1, Averaging time 180 s

*3: Typical

*4: Wavelength 1310 nm

*5: Wavelength: 1550 nm; 25°C

*6: IOR=1.500000

*7: Reflectance; 45 dB; Pulse Width: 5 ns; Deviation: ±0.5 dB

*8: Reflectance 45 dB, Pulse width 5 ns (width at 1.5 dB below reflection peak level)

A.2.4 MU909014C/C6, MU909015C/C6

Table A.2.4-1 Specifications

Item	Specifications															
Wavelength*1,*2	<table border="1"> <thead> <tr> <th>Model Name/Option</th> <th>Specifications</th> </tr> </thead> <tbody> <tr> <td>MU909014C/C6-057/067/058/068</td> <td>1310±25 nm,</td> </tr> <tr> <td>MU909015C/C6-057/067/058/068/059/069</td> <td>1550±25 nm, 1310±20 nm*3 1550±20 nm*3</td> </tr> <tr> <td>MU909015C/C6-059/069</td> <td>1490±25 nm, 1490±20 nm*3</td> </tr> <tr> <td>MU909014C/C6-057/067</td> <td rowspan="2">1625±15 nm</td> </tr> <tr> <td>MU909015C/C6-057/067</td> </tr> <tr> <td>MU909014C/C6-058/068</td> <td rowspan="2">1650±15 nm</td> </tr> <tr> <td>MU909015C/C6-058/068</td> </tr> </tbody> </table>	Model Name/Option	Specifications	MU909014C/C6-057/067/058/068	1310±25 nm,	MU909015C/C6-057/067/058/068/059/069	1550±25 nm, 1310±20 nm*3 1550±20 nm*3	MU909015C/C6-059/069	1490±25 nm, 1490±20 nm*3	MU909014C/C6-057/067	1625±15 nm	MU909015C/C6-057/067	MU909014C/C6-058/068	1650±15 nm	MU909015C/C6-058/068	
	Model Name/Option	Specifications														
	MU909014C/C6-057/067/058/068	1310±25 nm,														
	MU909015C/C6-057/067/058/068/059/069	1550±25 nm, 1310±20 nm*3 1550±20 nm*3														
	MU909015C/C6-059/069	1490±25 nm, 1490±20 nm*3														
	MU909014C/C6-057/067	1625±15 nm														
	MU909015C/C6-057/067															
	MU909014C/C6-058/068	1650±15 nm														
MU909015C/C6-058/068																
Fiber under test	10/125 μ m single mode fiber (ITU-T G.652)															
Pulse width	Auto, 5, 10, 20, 50, 100, 200, 500 ns, 1, 2, 5, 10, 20 μ s															
Dynamic range*1,*3,*4	The guaranteed values are values in the table from which 1 dB is subtracted.															
	MU909014C/C6-057/067/058/068															
	<table border="1"> <thead> <tr> <th>Trace Pulse width</th> <th>1310 nm</th> <th>1550 nm</th> <th>1625 nm*5,*7</th> <th>1650 nm*6,*7</th> </tr> </thead> <tbody> <tr> <td>500 ns</td> <td>24.5</td> <td>23</td> <td>24</td> <td>23</td> </tr> <tr> <td>20 μs</td> <td>32.5</td> <td>31</td> <td>32.5</td> <td>32.5</td> </tr> </tbody> </table>	Trace Pulse width	1310 nm	1550 nm	1625 nm*5,*7	1650 nm*6,*7	500 ns	24.5	23	24	23	20 μ s	32.5	31	32.5	32.5
	Trace Pulse width	1310 nm	1550 nm	1625 nm*5,*7	1650 nm*6,*7											
	500 ns	24.5	23	24	23											
	20 μ s	32.5	31	32.5	32.5											
MU909015C/C6-057/067/058/068																
<table border="1"> <thead> <tr> <th>Trace Pulse width</th> <th>1310 nm</th> <th>1550 nm</th> <th>1625 nm*5,*8</th> <th>1650 nm*6,*8</th> </tr> </thead> <tbody> <tr> <td>500 ns</td> <td>27</td> <td>26</td> <td>25</td> <td>24</td> </tr> <tr> <td>20 μs</td> <td>38</td> <td>37</td> <td>35</td> <td>35</td> </tr> </tbody> </table>	Trace Pulse width	1310 nm	1550 nm	1625 nm*5,*8	1650 nm*6,*8	500 ns	27	26	25	24	20 μ s	38	37	35	35	
Trace Pulse width	1310 nm	1550 nm	1625 nm*5,*8	1650 nm*6,*8												
500 ns	27	26	25	24												
20 μ s	38	37	35	35												
MU909015C/C6-059/069																
<table border="1"> <thead> <tr> <th>Trace Pulse width</th> <th>1310 nm</th> <th>1490 nm</th> <th>1550 nm</th> </tr> </thead> <tbody> <tr> <td>500 ns</td> <td>25</td> <td>24</td> <td>24</td> </tr> <tr> <td>20 μs</td> <td>36</td> <td>35</td> <td>35</td> </tr> </tbody> </table>	Trace Pulse width	1310 nm	1490 nm	1550 nm	500 ns	25	24	24	20 μ s	36	35	35				
Trace Pulse width	1310 nm	1490 nm	1550 nm													
500 ns	25	24	24													
20 μ s	36	35	35													

*1: 25°C, except while charging battery

*2: Pulse width:1 μ s

*3: Typical

*4: S/N=1, Averaging time: 180 seconds, distance range: 125 km

*5: Option 057/067

- *6: Option 058/068
- *7: Specified with background light: 1310/1550 nm, -20 dBm(CW)
- *8: Specified without background light.

Table A.2.4-1 Specifications (Cont'd)

Item	Specifications
Dead zone (BSL)*1, *3,*9,*10	Wavelength 1310 nm: ≤ 4.0 m Wavelength 1490/1550/1625/1650 nm: ≤ 4.5 m
Dead zone (Fresnel reflection)*1, *3,*9,*11	≤ 0.8 m
Distance range*9	Auto setup, 0.5, 1, 2.5, 5, 10, 25, 50, 75, 125, 250 km Auto setup 1640, 3281, 8202, 16404, 32808, 82021, 164042, 246063, 410105, 820210 feet
Distance Measurement Accuracy	±1 m ±(3 m×distance range×10 ⁻⁵) ±cursor resolution However, excludes uncertainty due to IOR
Loss Measurement Accuracy (Linearity)	±0.05 dB/dB or ±0.1 dB (Whichever greater)
Optical output peak power*12	150 mW or less (+21.76 dBm or less)
Return Loss Measurement Accuracy*12,*13	14.8±2 dB
Auto measurement (Fault Locate test) Active fiber check*14	Detects active signal (-40 dBm or more) in fiber under test
Laser safety	IEC 60825-1:2007 Class 1, Class 1M 21CFR1040.10 and 1040.11 except for deviations pursuant to Laser Notice No.50 (dated June 24, 2007)

- *9: IOR=1.500000
- *10: 25°C, Pulse width 5 ns, return loss 45 dB, Deviation±0.5 dB
- *11: 25°C, Pulse width 5 ns, return loss 45 dB, Width at 1.5 dB below reflection peak level
- *12: Design assurance
- *13: Distance range: 25 km, Pulse width: 2µs, when the 20 km fiber opened end is measured, BSC: -78.5 (1310 nm), -80.1 (1490 nm), -81.5 (1550 nm), -82.5 (1625/1650 nm)
- *14: Wavelength: only for 1310/1550 nm port

A.2.5 MU909015A6

Table A.2.5-1 Specifications

Item	Specifications		
Wavelength*1,*2	Model Name/Option		Specifications
	MU909015A6-053/063		1625±15 nm
	MU909015A6-054/064		1650±15 nm
Fiber under test	10/125 μ m single mode fiber (ITU-T G.652)		
Pulse width	Auto, 5, 10, 20, 50, 100, 200, 500 ns, 1, 2, 5, 10, 20 μ s		
Dynamic range*1,*3,*4,*7	The guaranteed values are values in the table from which 1 dB is subtracted.		
	Trace Pulse width	1625 nm*5	1650 nm*6
	500 ns	25	24
	20 μ s	35	35
Dead zone (BSL)*1,*3,*8,*9	≤ 4.5 m		
Dead zone (Fresnel reflection)*1,*3,*8,*10	≤ 0.8 m		
Distance range*8	Auto setup, 0.5, 1, 2.5, 5, 10, 25, 50, 75, 125, 250 km Auto setup, 1640, 3281, 8202, 16404, 32808, 82021, 164042, 246063, 410105, 820210 feet		

*1: 25°C, except while charging battery

*2: Pulse width:1 μ s

*3: Typical

*4: S/N=1, Averaging time: 180 seconds, distance range: 125 km

*5: Option 053/063

*6: Option 054/064

*7: Specified without background light.

*8: IOR = 1.500000

*9: 25°C, Pulse width 5 ns, return loss 45 dB, Deviation±0.5 dB

*10: 25°C, Pulse width 5 ns, return loss 45 dB, Width at 1.5 dB below reflection peak level

Table A.2.5-1 Specifications (Cont'd)

Item	Specifications
Distance Measurement Accuracy	±1 m ±(3 m×distance range×10 ⁻⁵) ±cursor resolution However, excludes uncertainty due to IOR
Loss Measurement Accuracy (Linearity)	±0.05 dB/dB or ±0.1 dB (Whichever greater)
Optical output peak power *11	150 mW or less (+21.76 dBm or less)
Return Loss Measurement Accuracy*11,*12	14.8±2 dB
Laser safety	IEC 60825-1:2007 Class1 21CFR1040.10 and 1040.11 except for deviations pursuant to Laser Notice No.50 (dated June 24, 2007)

*11: Design assurance

*12: Distance range: 25 km, Pulse width: 2µs, when the 20 km fiber opened end is measured, BSC: -82.5

A.2.6 Other Functions

Table A.2.6-1 VFL (MU909014A1/B1, MU909015B1)

Item	Specifications	Remarks
Supported fiber	SM Fiber (ITU-T G.652)	
Optical Connector	Universal ϕ 2.5 mm	
Center wavelength	650 \pm 15 nm*	
Output Level	0 \pm 3 dBm*	0.5 to 2 mW
Output Function	OFF, CW, MOD	

*: CW, 25°C

Table A.2.6-2 Light Source (MU909014C6, MU909015A6/C6)

Item	Specifications																
Supported Fiber	10/125 μ m Single Mode Fiber (ITU-T G.652)																
Optical Port	Shared with OTDR port of each wavelength																
Optical Connector	Shared with OTDR port																
Wavelength*1	<table border="1"> <thead> <tr> <th>Model Name/Option</th> <th>Specifications</th> </tr> </thead> <tbody> <tr> <td>MU909014C6-057/067/058/068</td> <td>1310\pm25 nm,</td> </tr> <tr> <td>MU909015C6-057/067/058/068/059/069</td> <td>1550\pm25 nm</td> </tr> <tr> <td>MU909015C/C6-059/069</td> <td>1490\pm25 nm</td> </tr> <tr> <td>MU909014C6-057/067</td> <td rowspan="3">1625\pm25 nm</td> </tr> <tr> <td>MU909015A6-053/063</td> </tr> <tr> <td>MU909015C6-057/067</td> </tr> <tr> <td>MU909014C6-058/068</td> <td rowspan="3">1650\pm25 nm</td> </tr> <tr> <td>MU909015A6-054/064</td> </tr> <tr> <td>MU909015C6-058/068</td> </tr> </tbody> </table>	Model Name/Option	Specifications	MU909014C6-057/067/058/068	1310 \pm 25 nm,	MU909015C6-057/067/058/068/059/069	1550 \pm 25 nm	MU909015C/C6-059/069	1490 \pm 25 nm	MU909014C6-057/067	1625 \pm 25 nm	MU909015A6-053/063	MU909015C6-057/067	MU909014C6-058/068	1650 \pm 25 nm	MU909015A6-054/064	MU909015C6-058/068
	Model Name/Option	Specifications															
	MU909014C6-057/067/058/068	1310 \pm 25 nm,															
	MU909015C6-057/067/058/068/059/069	1550 \pm 25 nm															
	MU909015C/C6-059/069	1490 \pm 25 nm															
	MU909014C6-057/067	1625 \pm 25 nm															
	MU909015A6-053/063																
	MU909015C6-057/067																
	MU909014C6-058/068	1650 \pm 25 nm															
	MU909015A6-054/064																
MU909015C6-058/068																	
Optical Output Level	-5 \pm 1.5 dBm*1,*2																
Instant Stability	\leq 0.2 dB*3																
Light Emission Mode	CW, 270 Hz, 1 kHz, 2 kHz																
Warm-up time	10 minutes (after optical output is turned ON)																

*1: CW, 25°C

*2: Fiber length 2 m, after the warm-up time passes

*3: CW, \pm 1°C at one point within -10 to +50°C, difference between the maximum value and minimum value for one minute, single mode fiber 2 m, when the optical power meter with return loss of 40 dB or more is used, and after the warm-up time passes

Table A.2.6-3 Optical Power Meter (MU909014B/14B1/15B/15B1)

Item	Specifications	Remarks
Compatible fiber	SM Fiber (ITU-T G.652)	
Optical Connector	Shared with Measurement Port	
Waveform Settings	1310/1490/1550/1625/1650 nm	
Optical power Measurement Range	-50 to -5 dBm	10 nW to 0.3 mW
Measurement Accuracy	±0.5 dB*	Measured with a master fiber (FC)
Absolute Max. Input	+10 dBm	10 mW

*: 1310/1490/1550 nm, CW, -20 dBm, 25°C ±3°C

Table A.2.6-4 Optical Power Meter (MU909014C/C6, MU909015A6/C/C6)

Item	Specifications	
Supported Fiber	SM Fiber (ITU-T G.652)	
Measurement Port	Model	Rated Value
	MU909014C-057/067/058/068	Shared with OTDR port (wavelength 1310/1550 nm)
	MU909015C-057/067/058/068	
	MU909015C-059/069	Shared with OTDR port (wavelength 1310/1490/1550 nm)
	MU909015A6-053/063/054/064	Shared with OTDR port
	MU909014C6-057/067/058/068	Shared with OTDR port (Wavelength 1625/1650 nm)
	MU909015C6-057/067/058/068	
	MU909015C6-059/069	Dedicated port
Optical Connector	Shared with OTDR port, Dedicated port(059/069)	
Wavelength Settings	Model	Rated Value
	MU909014C	1310/1490/1550 nm
	MU909015C	
	MU909014C6	1310/1490/1550/1625/1650 nm
	MU909015A6	
	MU909015C6	
Measurement Mode	Model	Rated Value
	MU909014C	CW
	MU909015C	
	MU909014C6	CW, 270 Hz, 1 kHz, 2 kHz
	MU909015A6	
	MU909015C6	

Table A.2.6-4 Optical Power Meter (MU909014C/C6, MU909015A6/C/C6) (Cont'd)

Item	Specifications	
Optical Power Measurement Range	Model	Rated Value
	MU909014C	-50 to -5 dBm (CW)* ¹
	MU909015C	
	MU909014C6	-50 to 26 dBm (CW)* ¹ -40 to 13 dBm (270 Hz, 1 kHz, 2 kHz)* ¹
	MU909015A6	
	MU909015C6	
Measurement Accuracy	± 0.5 dB* ² , * ³	

*1: 1550 nm

*2: 1310/1490/1550 nm

*3: CW, -20 dBm, 25°C, on master connector fiber (FC) use, after zero offset execution

Table A.2.6-5 PON Optical Power Meter (MU909014C6, MU909015A6/C6)

Item	Specifications	
Supported Fiber	SM Fiber (ITU-T G.652)	
Measurement Port	Model	Rated Value
	MU909014C6-057/067/058/068	Shared with OTDR port (wavelength 1625/1650 nm)
	MU909015C6-057/067/058/068	
	MU909015A6-053/063/054/064	Shared with OTDR port
MU909015C6-059/069	Dedicated port	
Optical Connector	Shared with OTDR port, Dedicated port(059/069)	
Wavelength	1490/1550 nm	
Optical Power Measurement Range* ¹	1490 nm: -50 to 13 dBm 1550 nm: -50 to 26 dBm	
Measurement Accuracy	± 0.5 dB* ²	
Isolation* ³	1490 nm: > 35 dB 1550 nm: > 50 dB	

*1: CW

*2: 1490/1550 nm, CW, -20 dBm, 25°C, on master connector fiber (FC) use, after zero offset execution

*3: Design assurance

Table A.2.6-6 Optical Loss Measurement (MU909014C6, MU909015C6)

Item	Specifications
Supported Fiber	SM Fiber (ITU-T G.652)
Measurement Port	Light source: Model for 057/067/058/068: Shared with OTDR port (wavelength 1310/1550 nm) Model for 059/069: Shared with OTDR port (wavelength 1310/1490/1550 nm) Optical power meter: Model for 057/067/058/068: Shared with OTDR port (wavelength 1625 or 1650 nm) Model for 059/069: Dedicated port
Optical Connector	Shared with OTDR port(057/067/058/068), Dedicated port(059/069)
Light Source	
Wavelength	Model for 057/067/058/068: 1310±25 nm, 1550±25 nm Model for 059/069: 1310±25 nm, 1550±25 nm, 1490±25nm
Optical Output Level	-5±1.5 dBm*1,*2
Instant Stability	≤ 0.2 dB*3
Light Emission Mode	CW, 270 Hz, 1 kHz, 2 kHz
Warm-up Time	10 minutes (after optical output is turned ON)
Optical Power Meter	
Wavelength Settings	1310/1490/1550/1625/1650 nm
Measurement mode	CW, 270 Hz, 1 kHz, 2 kHz
Optical power Measurement Range	-50 to 26 dBm (CW) -40 to 13 dBm (270 Hz, 1 kHz, 2 kHz)*4
Measurement Accuracy	±0.5 dB*5

*1: CW, 25°C

*2: Fiber length 2 m, after the warm-up time passes

*3: Wavelength 1310/1550 nm, CW, ±1°C at one point within -10 to +50°C, difference between the maximum value and minimum value for one minute, single mode fiber 2 m, when the optical power meter with return loss of 40 dB or more is used

*4: 1550 nm

*5: 1310/1490/1550 nm, CW, -20 dBm, 25°C, on master connector fiber (FC) use, after zero offset execution

Appendix B Default Value

Table B-1 Setup-General

Item	Default
Auto Backlight	5 minutes
Auto Power Off	10 minutes
Screen Capture Format	PNG
Use Login Password	OFF
Login Password	Serial number of module
Remote Control Password	Blank

Table B-2 Setup-Preferences

Item	Default
Enable Connection Check Step	On
Enable Active Fiber Check Step	On
Auto Analysis	On
Show Internal Launch Fiber	On
IOR Length Adjustment	Off
Distance Unit	Kilometers
Saving Format	SOR
Fiber Group	Fiber Group1
Event icon movement	Left to Right
End event for ORL	OMIT

Table B-3 Setup-Auto Save

Item	Default
Enable Auto File Name	Off
Enable Auto Save	Off
Auto Save Folder	/Data/
File Name Prefix	auto
Sequence Number	1
Date	Off
Wavelength	Off

Table B-4 Test Setup

Item	Default
Full Auto	On
PON (ONU to OLT)	Off
Range	Auto
Resolution	Medium
Pulse width	Auto
Averaging	Auto
Apply to All Wavelength* ¹	On
Macro Bend Analysis	Off
IOR	1.4677* ² 1.4682* ³ 1.4685* ⁴
BSC	-78.5* ² -81.5* ³ -82.5* ⁴
Loss mode	Event
F2 Test Mode	Average
F3 Wavelength* ³	1310 nm* ³

*1: Not displayed in MU909015A6

*2: Wavelength: 1310 nm

*3: Wavelength: 1310 nm

*4: Wavelength: 1310/1550 nm

Table B-5 Trace View

Item	Default
F2	Zoom
F3 Display Form	Origin
F4 Mode*	Fast

*: Displayed on OTDR only

Table B-6 Analysis-Setup

Item	Default
End of Fiber	3 dB
Event Loss	0.25 dB
Reflectance	-60.0 dB
Macro Bend	0.3 dB
Branch	1x8
Splitter Loss	10.0 dB

Table B-7 Thresholds-Setup

Item	Default
Total Fiber Loss	10.0 dB
Event Loss	0.20 dB
Reflectance	-20.0 dB
Splitter Loss	3.0 dB
ORL	27.0 dB

Table B-8 PON Power Meter

Item	Default
F3 dB/dBm	dBm

Table B-9 PON Power Meter Pass/Fail Evaluation Threshold

Item	Default
Enable Threshold	1490 nm: Off 1550 nm: Off
Threshold	1490 nm: -26.00 1550 nm: -7.00

Table B-10 Power Meter

Item	Default
F1 Wavelength	1310 nm
F2 Modulation*	CW

*: Displayed on in MU909015A6

Table B-11 Power Meter-Reference

Item	Default
Enable reference value	Off
Reference value	0.00 dBm*1 -5.00 dBm*2

*1: MU909014C6, MU909015A6, MU909015C6

*2: MU909014C, MU909015C

Table B-12 Power Meter Pass/Fail Evaluation Threshold

Item	Default
Enable Threshold	Off
Threshold	0.00 dBm* ¹ -5.00 dBm* ²

*1: MU909014C6, MU909015A6, MU909015C6

*2: MU909014C, MU909015C

Table B-13 Light Source

Item	Default
F1 Wavelength*	1310 nm
F2 Modulation	CW

*: Not switched in MU909015A6

Table B-14 Optical Loss Measurement • Light Source

Item	Default
F1 Wavelength	1310 nm
F2 Modulation	CW
Optical output	Off

Table B-15 Optical Loss Measurement • Power Meter

Item	Default
F1 Wavelength	1310 nm
F2 Modulation	CW
Enable reference value	Off
Reference	0.00 dBm
Enable Threshold	On
Threshold	-10.00 dBm

Appendix C Software License

This instrument comes with the package software as described in Table C-1. Note, however, that the package software is not covered by the Anritsu Software License Agreement.

Go to the following website for details of each license *1 to 5.

<https://www1.anritsu.co.jp/Download/MService/Login.asp>

Table C-1 Software License

Package	License	Remarks
linux-2.6.35.14	GPL ^(*1)	
busybox	GPL ^(*1)	
e2fsprogs	GPL ^(*1)	
sys5utils	GPL ^(*1)	
util-linux	GPL ^(*1)	
inetutils 1.5	GPL ^(*1)	
freetype 2.1.7	FTL ^(*2) ,GPL ^(*1)	
mtd-utils	GPL ^(*1)	
U-Boot 1.1.4	GPL ^(*1)	
Microwindows	MPL ^(*3)	Microwindows was downloaded from CVS on 2 Aug 2006.
flnx 0.18	LGPL+exceptions ^(*4)	
dosfstools 2.11	GPL ^(*1)	
portman 5 beta	Other ^(*5)	

References are to page numbers.

Symbol and Numbers

2

2-Point Loss 4-50

A

Abbreviations..... 1-14

About..... 3-31

About This Manual I

All Defaults..... 4-49

Application.....1-11

Apply to All Wavelength 4-4

Auto Analysis..... 4-13

Auto Backlight off 3-9

Auto Launch 3-33

Auto Power Off 3-9

Auto Save Device..... 4-16

Averaging..... 4-4

Averaging Time Setup..... 4-8

B

BSC 1-12, 4-5

BSL..... 1-12

C

Cable ID 4-42

Cable Loss..... 4-34

Calibration.....11-32

Color Theme 3-9

Connection Check..... 4-19

Connection Verification Function..... 1-6

Copy..... 3-22

cursor 4-25

Cursor 4-27

CW..... 4-58

D

Daily Maintenance 12-2

Date 4-16

dB/km Loss 4-52

dB/km Loss LSA 4-52

Dead Zone 1-12

Default B-1

Default Gateway..... 10-4

Delete 3-21

DHCP 10-4

Direction..... 4-42

Display From 4-25

Disposal..... 12-9

Distance Range..... 1-13, 4-4, 10-19

Distance Units 4-13

dynamic range 11-14

E

Enable Active Fiber Check Step 4-13

Enable Auto File Name 4-16

Enable Auto Save 4-16

Enable Connection Check Step 4-13

End/Fault Distance 4-34

Event Loss..... 4-38

Event Marker..... 4-26

Event table..... 4-34

F

FAIR 4-21

Far End 4-36, 4-56, 4-64

Fast..... 4-26

Fiber ID 4-42

fiber maintenance tester 1-2

Fiber Visualizer 4-59

Fiberscope 1-10

File Sharing Setting..... 10-19

Filename Prefix 4-16

Firmware..... 12-3

Firmware Update screen 12-4

Full Auto 4-4, 10-19

G

GOOD 4-21

Grouped..... 4-36, 4-56, 4-64

H

Header 4-45

Help 3-30

High S/N..... 4-26

Index

I

install file 12-3
IOR 1-13, 4-5
IOR Length Adjustment..... 4-13
IOR:BSC Setup..... 4-10
IP Address..... 10-4

L

Language 3-9
Live Communications Detection 1-6
Live communications optical signal detection 1-7
Load..... 4-47
Load Trace 4-48
Location A 4-42
Location B..... 4-42
Loss Mode 4-5

M

Macro Bend..... 4-38
Mass Storage 3-18
Measurement light output..... 3-4
Measurement Procedure..... 4-2, 5-3
Menu 3-4
MOD..... 4-58
Mode..... 4-26

N

Network Settings for μ OTDR 10-2
New Folder..... 3-20
Non-Reflective 4-36, 4-40, 4-56, 4-64

O

OFF 4-58
Optical fiber schematic 4-33
optical loss 8-2
Optical power meter..... 11-30
Origin 4-25, 4-30
ORL..... 4-40, 4-53
OTDR 1-4

P

PC 10-23
Performance Test..... 11-2
Performance Test Result Sheet 11-33

PON..... 4-5
PON (ONU to OLT) 10-19
PON Setup 4-7
POOR 4-21
Power Down..... 3-3
Power meter measured value 5-5, 7-5
Power status 3-4
Print Screen 3-27
Probe Tips 9-3
pulse width..... 11-12
Pulse Width..... 1-13
Pulsewidth 4-4

Q

Questionable End 4-36, 4-57, 4-64

R

Range:Resolution:Pulse Width setup 4-8
Reflectance..... 4-38, 4-40
Reflective..... 4-36, 4-40, 4-55, 4-64
Rename 3-24
Repack..... 12-9
Resolution 4-4, 10-19

S

Save As 4-44
Save Trace..... 4-46
Screen Capture Format..... 3-9
Screen Title 3-4
Sequence Number..... 4-42
Sequence Number..... 4-16
Setting the Remote GUI Password 10-18
Setup-Auto Save 4-16
Setup-General..... 3-6, 3-15
Setup-Preferences..... 3-10, 4-13
Show Internal Launch Fiber 4-13
Soft keys..... 3-4
Software License C-1
Splice Loss 4-51
Splitter 4-36, 4-57, 4-64
Splitter Loss..... 4-40
Storage 12-8
Subnet Mask 10-4

T

- Test Mode 4-5
- Test Setup 4-4
- Thresholds Setup screen 4-41, 4-42
- time 3-4
- To Power Down the unit 3-3
- To Power Up the unit 3-2
- Top Menu 3-33
- Total Events Found 4-34
- Total Fiber Loss 4-34, 4-40
- Trace Analysis 4-33
- Trace View 4-22, 4-32
- Transportation 12-9
- Type 4-36

U

- universal tips 9-3
- USB converter 9-3
- USB Ethernet Converter 10-23
- Using the Remote GUI 10-23

V

- VFL 4-58
- Video Inspection Probe (VIP) 9-3
- VIP tab 4-68
- Visual Fault Locator 11-26, 11-28
- Visual Fault Locator (VFL) 4-58

W

- wavelength 11-10
- Wavelength 4-5, 4-6, 4-16

Z

- Zooming 4-30

