

# CO-200

Offline lock user guide

Instructions for CO-Series offline locks

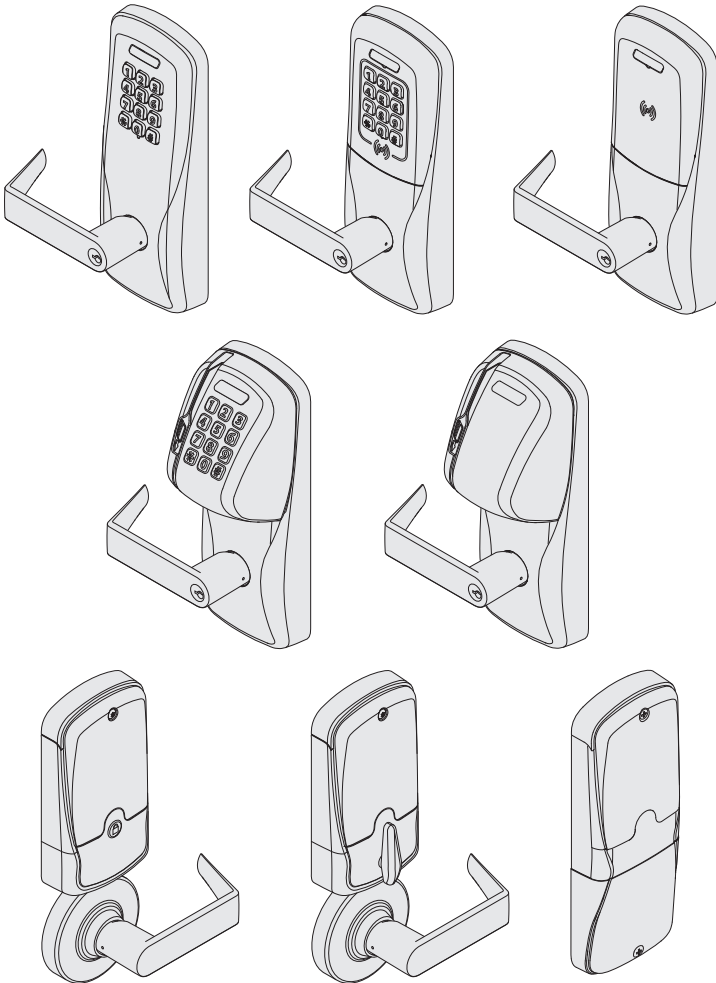

# Contents

Overview .....	3
Lock functions .....	4
Getting started .....	4
Schlage Utility Software (SUS) .....	4
Construction access mode .....	5
Create the master construction credential - locks with card readers .....	5
Locks with card readers – Add construction access mode user credentials .....	5
Cancel construction access mode .....	5
Locks with keypads .....	6
Credential types and functions .....	6
Credential forms .....	6
Manual programming instructions .....	7
PROGRAMMING credentials .....	7
NORMAL USE credentials .....	8
TOGGLE credentials .....	9
FREEZE credentials .....	10
PASS THROUGH credentials .....	11
OTHER programming .....	12
Error codes .....	13
Test lock operation .....	14
Mechanical test .....	14
Test in factory default mode .....	14
Test in normal operation mode .....	14
Normal lock operation .....	14
Reset to factory defaults .....	15
Level 1 factory default reset .....	15
Level 2 factory default reset .....	15
Batteries .....	16
Low battery indications .....	17
Battery failure modes .....	17
LED reference .....	18
Schlage button .....	18
Optional Inside Push Button (IPB) .....	18
Optional Inside Push Button (IPB) .....	18
Troubleshooting .....	19
FCC Statements .....	20

This product is compliant of UL294 and ULC-S319 standard. This product's compliance would be invalidated through the use of any add-on, expansion, memory or other module that has not yet been evaluated for compatibility for use with this UL Listed product, in accordance with the requirements of the Standards UL 294 and ULC-S319. This product has been evaluated for ULC-S319 Class I.

UL294 Access Control Levels tested to: Destructive Attack - Level 1; Line Security - Level 1; Endurance - Level 4; Standby Power - Level 1.

## Overview

The Schlage CO-200 is an off-line electronic lock in the CO-Series product line.

- This product is listed for UL 294 and ULC-S319.
- The lock is configured to operate as Classroom/Storeroom function. Optional Office or Privacy functions are available.
- The lock is powered by four (4) AA batteries. See *Batteries* on page 16 for more information.
- Outside lever is normally locked.
- Inside lever always allows egress.
- The lock maintains an audit trail of events in the normal operating mode.
- The lock is configured using the Schlage Utility Software (SUS). See *Schlage Utility Software (SUS)* on page 4 for more information.

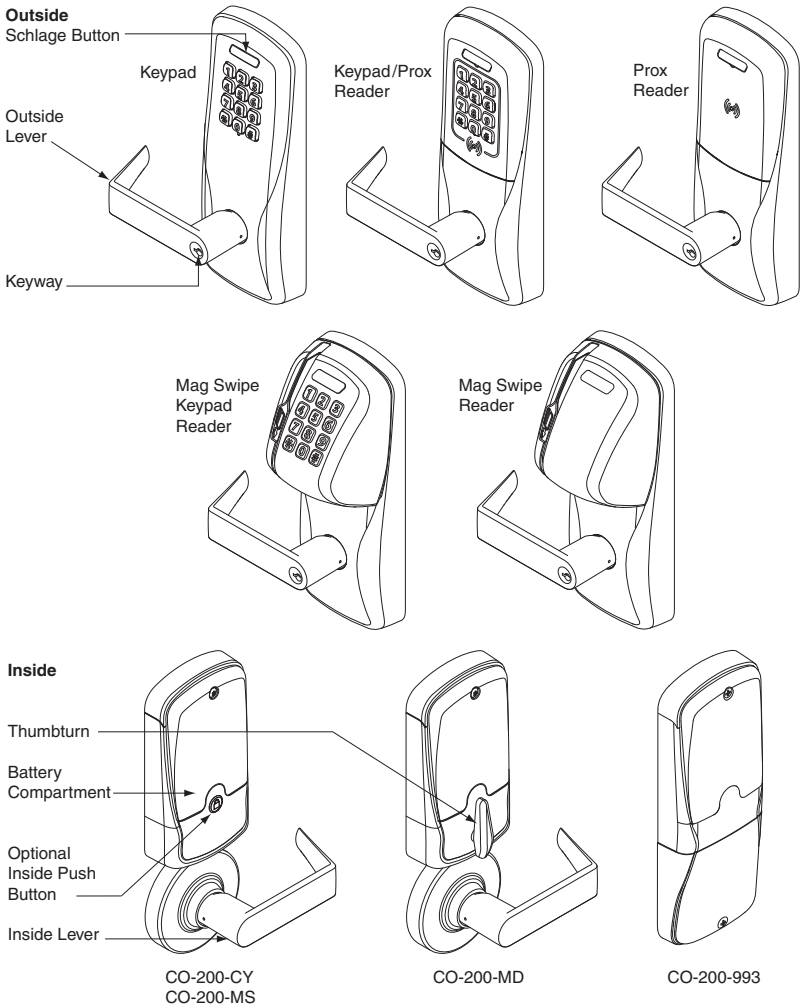

## Lock functions

The CO-200 is available in one of three functions:

**Privacy (40):** Lockset is normally secure. Pressing the Inside Push Button or extending the deadbolt will disable normal electronic access from the outside. Opening the door, retracting the deadbolt or pressing the Inside Push Button a second time deactivates the privacy status.

**Office (50):** Lockset is normally secure. Inside Push Button may be used to select passage or secured status.

**Classroom/Storeroom (70):** Lockset is normally secure. Valid toggle credentials may be used to change to a passage or secure status.

## Getting started

Follow these steps when setting up a new lock.

1. Install the lock. See the installation guide that came with the lock or visit [www.allegion.com/us](http://www.allegion.com/us) (see Support>Schlage Electronics>Electronic Locks Technical Library) for more information.
2. Make sure the batteries are installed properly. See *Batteries* on page 16 for more information.
3. Before programming, the lock may be used in construction access mode. See *Construction access mode* on page 5 for more information. The lock should remain in construction access mode until you are ready to set up the rest of the system.
4. Test the lock for proper mechanical and electronic operation. See *Test lock operation* on page 14 for more information.
5. When ready to set up for normal use, remove factory default security settings, then program the user credentials. See *Manual programming instructions* on page 7 for more information.
6. Consult the Schlage Utility Software (SUS) user guide for information about configuring the lock.
7. Familiarize yourself with the information in this guide.

**Save this user guide for future reference.**

## Schlage Utility Software (SUS)

**The Schlage Utility Software is used for programming and setup only.**

The Schlage Utility Software (SUS) is used to configure locks. The SUS configures lock functions that cannot be configured with manual programming, and is used to transfer data files between the access control software and locks.

For more information about the SUS, see the SUS user guide.

## Construction access mode

Construction access mode is used to allow access before the lock has been programmed, and for testing purposes.

- Enabled by default.
- The lock will remain in construction access mode until the mode is cancelled as described below.
- No audits are captured while lock is in construction access mode.

### Create the master construction credential - locks with card readers

1. Press and hold the Schlage button while presenting a credential.
2. This credential becomes the master construction credential, and is used to program construction access.
3. The Schlage button will blink green on the left and right as confirmation.

After you have created the master construction credential, you can then use that card to add construction access mode user credentials.

① **The master construction credential will not grant access. It is used only to add additional credentials.**

### TIP

Use the same master construction credential for all the locks in the facility.

If you present the first card to a new lock to create the master construction credential and the card is not accepted, the lock has either been programmed or already has a master construction credential.

If the master construction credential cannot be located, or to put the lock back into construction access mode, reset the lock to factory settings. See *Reset to factory defaults* on page 15 for more information.

### Locks with card readers – Add construction access mode user credentials

Construction access mode credential type	Steps to add construction access mode user credentials				
	1	2	3	4	5
<b>Normal use construction credential</b> Unlocks the lock for relock delay period	Present master construction credential to reader →	Green LEDs blink →	Present user credential within 20 seconds →	Green LEDs blink and credential is added →	Repeat steps 3 and 4 for additional credentials.
<b>Toggle construction credential</b> Changes the state of lock from locked to unlocked or vice versa	Present master construction credential to reader →	Green LEDs blink →	Press and hold Schlage button while presenting user credential within 20 seconds →	Green LEDs blink, 2 beeps will sound and credential is added →	Credentials added with the master construction credential will have 24/7 access.

### Cancel construction access mode

Construction access mode may be cancelled by one of the following methods:

- load a door file using the SUS
- reset the lock to factory settings (see *Reset to factory defaults* on page 15 for more information).

**When construction mode is cancelled, the master construction credential and all other credentials added using the master construction credential will no longer function.**

## Locks with keypads

In the factory default reset state, offline locks with keypads, with or without additional credentials, have a default PIN of 13579 and “#”, which can be used for installation, testing and construction access. To test, enter 13579 and “#”. The Schlage button will blink and the lock will unlock. The default PIN is automatically deleted when a new programming credential is created, construction credentials are created, or the lock is programmed with the Schlage Utility Software (SUS).

## Credential types and functions

**Programming credential:** A card or 5 digit code used only for lock programming.

**Card or PIN credentials:** A card that is presented, or a 3-6 digit code entered on the keypad.

**Card ID number:** When adding any new card credential, a 3-6 digit code is entered prior to presenting the card. This code becomes the Card ID Number. This number can be used to delete a card credential without physically having the card. *Keep a log of all Card ID Numbers for future reference.*

*Note: A unique credential must be used for each credential type described below (for example, a single credential may not be used for both normal use and toggle functions).*

Credential type	Function
Programming PIN or card	Used <u>only to program</u> the lock. Does not unlock the lock.
Normal use credential	Unlocks the lock <i>momentarily</i> after a credential is presented or entered.
Toggle credential	Changes the state of the lock from locked (secured) to unlocked (unsecured), or vice versa, unless in a Freeze state.
Freeze credential	Freezes the lock in the current state. The lock remains frozen until any Freeze credential is presented again. (A pass-through credential will override a lock in frozen state as described below).
Pass-through credential	Unlocks a lock <i>momentarily</i> , regardless of state. A valid Pass-through credential can unlock a door set to any secured lockout mode (e.g., Freeze, Privacy, Time Zones, Door Auto-Locks and Holidays). The door will relock after the specified relock time.

## Credential forms

Normal, toggle, freeze and pass-through credential types are used in one of three forms:

**PIN** credential – a 3-6 digit code entered on the keypad.

**CARD** credential – a card presented to the lock.

**CARD + Card ID Number** credential – a card (with a unique Card ID number) presented to the lock. (See a description of Card ID number above for more information.)

Steps for designating each form are in the *Manual programming instructions* on the following pages.

# Manual programming instructions

## Important notes:

- ① Wait for the Schlage button LEDs to stop flashing before continuing to the next step.
- ① Programming mode will time out if no entry is made in 20-25 seconds. Time out is indicated by three left and nine right red blinks of the Schlage button.
- ① An incorrect entry is indicated by a solid red left and blinking green right LED on the Schlage button. Refer to *Error codes* on page 13 to interpret error code patterns.
- ① A unique credential must be used for each credential type (for example, a single credential may not be used for both normal use and toggle functions).

## PROGRAMMING credentials

To complete this action:	Perform the following steps:			
	Wait for  to stop flashing between each step!			
	1	2	3	4
Create new Programming Code (PIN)	Enter ⑨ ⑦ ⑤ ③ ① * (This is the default programming PIN)	Enter ⑦ *	Enter new 5 digit Programming code and * Wait for right green light.	Reenter the new 5 digit Programming code and * Wait for confirmation: 2 right green blinks.
Create new Programming Card	Enter ⑨ ⑦ ⑤ ③ ① *	Enter ⑦ *	Present new programming card.	Wait for confirmation: 2 right green blinks.

Note: Programming codes such as 1-1-1-1-1 or 1-2-3-4-5 can be easily selected by non-authorized users and should not be used.

① Note: Before creating any credential in the following steps, determine which credential form is desired (see *Credential forms* on page 6).

## NORMAL USE credentials

Note: Until a new Normal Use PIN is created, the default PIN is **1 3 5 7 9 #**

To complete this action:	Perform the following steps:					
	Wait for  to stop flashing between each step!					
	1	2	3	4	5	6
Create a Normal Use PIN	Enter Programming PIN and * OR Present Programming card	Enter 3 *	Enter new 3-6 digit PIN and * *	For another PIN, go back to step 3	Press * again to finish	Wait for confirmation: 2 right green blinks.
Create a Normal Use CARD	Enter Programming PIN and * OR Present Programming card	Enter 3 *	Enter new 3-6 digit Card ID Number and *	Wait for right green light. Present new CARD to lock.	For another CARD, go back to step 3 OR press * again	Wait for confirmation: 2 right green blinks.
Create a Normal Use CARD + Card ID Number	Enter Programming PIN and * OR Present Programming card	Enter 3 3 *	Enter 3 1 1 *	Enter new 3-6 digit Card ID Number and *  Wait for right green light.	Present new CARD to lock.	For another CARD+Card ID credential, go back to step 4 OR press * again to finish  Wait for confirmation: 2 right green blinks.



































- ① Note: Before creating any credential in the following steps, determine which credential form is desired (see *Credential forms* on page 6).

## TOGGLE credentials

To complete this action:	Perform the following steps: Wait for  to stop flashing between each step!					
	1	2	3	4	5	6
Create a Toggle PIN	Enter Programming PIN and * OR Present Programming card	Enter 3 3 *	Enter 1 9 1 *	Enter new 3-6 digit PIN and * Wait for right green light.	For another PIN, go back to step 4 OR press * again to finish	Wait for confirmation: 2 right green blinks.
Create a Toggle CARD	Enter Programming PIN and * OR Present Programming card	Enter 3 3 *	Enter 1 9 1 *	Enter new 3-6 digit Card ID Number and * Wait for right green light.	Present new CARD to lock.	For another CARD, go back to step 4 OR press * again to finish Wait for confirmation: 2 right green blinks.
Create a Toggle CARD + Card ID Number	Enter Programming PIN and * OR Present Programming card	Enter 3 3 *	Enter 3 9 1 *	Enter new 3-6 digit Card ID Number and * Wait for right green light.	Present new CARD to lock.	For another CARD+Card ID credential, go back to step 4 OR press * again to finish Wait for confirmation: 2 right green blinks.

- ① Note: Before creating any credential in the following steps, determine which credential form is desired (see *Credential forms* on page 6).

## FREEZE credentials

To complete this action:	Perform the following steps:					
	Wait for  to stop flashing between each step!					
	1	2	3	4	5	6
Create a Freeze PIN	Enter Programming PIN and  OR Present Programming card	Enter   	Enter    	Enter new 3-6 digit PIN and   Wait for right green light.	For another PIN, go back to step 4 OR press  again to finish	Wait for confirmation: 2 right green blinks.
Create a Freeze CARD	Enter Programming PIN and  OR Present Programming card	Enter   	Enter    	Enter new 3-6 digit Card ID Number and  Wait for right green light.	Present new CARD to lock.	For another CARD, go back to step 4 OR press  again to finish Wait for confirmation: 2 right green blinks.
Create a Freeze CARD + Card ID Number	Enter Programming PIN and  OR Present Programming card	Enter   	Enter    	Enter new 3-6 digit Card ID Number and  Wait for right green light.	Present new CARD to lock.	For another CARD+Card ID credential, go back to step 4 OR press  again to finish Wait for confirmation: 2 right green blinks.



























- ① Note: Before creating any credential in the following steps, determine which credential form is desired (see *Credential forms* on page 6).













## PASS THROUGH credentials

To complete this action:	Perform the following steps:					
	Wait for  to stop flashing between each step!					
	1	2	3	4	5	6
Create a Pass Through PIN	Enter Programming PIN and * OR Present Programming card	Enter 3 3 *	Enter 1 1 9 *	Enter new 3-6 digit PIN and * * Wait for right green light.	For another PIN, go back to step 4 OR press * again to finish	Wait for confirmation: 2 right green blinks.
Create a Pass Through CARD	Enter Programming PIN and * OR Present Programming card	Enter 3 3 *	Enter 1 1 9 *	Enter new 3-6 digit Card ID Number and * Wait for right green light.	Present new CARD to lock.	For another CARD, go back to step 4 OR press * again to finish Wait for confirmation: 2 right green blinks.
Create a Pass Through CARD + Card ID Number	Enter Programming PIN and * OR Present Programming card	Enter 3 3 *	Enter 3 1 9 *	Enter new 3-6 digit Card ID Number and * Wait for right green light.	Present new CARD to lock.	For another CARD+Card ID credential, go back to step 4 OR press * again to finish Wait for confirmation: 2 right green blinks.

- ① Note: Before creating any credential in the following steps, determine which credential form is desired (see *Credential forms* on page 6).

## OTHER programming

To complete this action:	Perform the following steps:				
	Wait for  to stop flashing between each step!				
	1	2	3	4	5
Delete a credential	Enter Programming PIN and  OR Present Programming card	Enter <b>5</b> 	Enter the PIN or Card ID Number to be deleted and 	To delete another Card credential, go back to step 3 OR press  again to finish	Wait for confirmation: 2 right green blinks.
Change PIN length	Enter Programming PIN and  OR Present Programming card	Enter <b>9 9</b> 	Enter <b>4</b> 	Enter <b>3</b> , <b>4</b> , <b>5</b> , OR <b>6</b> for desired PIN length	Press  again to finish Wait for confirmation: 2 right green blinks.
Change relock delay period	Enter Programming PIN and  OR Present Programming card	Enter <b>9 9</b> 	Enter <b>1</b> 	Each button press adds to the total delay time Example: <b>1</b> + <b>9</b> adds a 10 second delay	Press  again to finish Wait for confirmation: 2 right green blinks.
Disable/ Enable Beeper	Enter Programming PIN and  OR Present Programming card	Enter <b>9 9</b> 	Enter <b>3</b> 	Enter <b>0</b>  to disable beeper OR <b>7</b>  to enable beeper	Press  again to finish Wait for confirmation: 2 right green blinks.
Disable/ Enable occupancy indicator feature	Enter Programming PIN and  OR Present Programming card	Enter <b>9 9</b> 	Enter <b>5</b> 	Enter <b>0</b>  to disable occupancy indicator blinks OR <b>7</b>  to enable occupancy indicator fast blinks OR <b>8</b>  to enable occupancy indicator slow blinks	Press  again to finish Wait for confirmation: 2 right green blinks

To complete this action:	Perform the following steps:				
	Wait for  to stop flashing between each step!				
	1	2	3	4	5
Disable/ Enable offline lockdown configuration	Enter Programming PIN and 	Enter   	Enter  	Enter   to disable the offline lockdown configurations OR   to configure the offline lockdown functionality for use	Press  again to finish Wait for confirmation: 2 right green blinks.

## Error codes

❶ All error codes are indicated on the Schlage button by a **solid red left LED**, and a **blinking green right LED**. The number of green blinks indicates the error code.

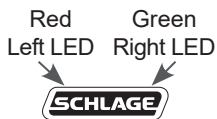

Number of green blinks	Error code description
1	Computer programming error (not complete).
2	Too long programming/user code entered. Programming code must be five (5) digits. User code length cannot exceed six (6) digits.
3	Memory full, too many codes. Delete some codes.
4	Programming code cannot be deleted, only changed.
5	Programming code entries do not match. Programming code not changed.
6	Invalid command. Invalid function code entered.
7	Code not found.
8	Code too short. Programming code length must be five (5) digits. User code minimum length is three (3) digits.
9	Not a unique code.
10	Manual programming not allowed.

Error code functions have not been verified by Underwriters Laboratories Inc.

## Test lock operation

If you encounter problems while performing any of the following tests, review the installation guide and correct any problems.

### Mechanical test

1. Rotate the inside lever or depress the push bar to open the door. Operation should be smooth, and the latch should retract.
2. Insert the key into the keyway and rotate the key and the outside lever to open the door. Operation should be smooth, and the latch should retract. The Schlage button will light solid green until the key is released and the latch is extended.

### Test in factory default mode

1. For locks with a keypad, press any number key. The lock will beep and the Schlage button will blink red.
2. The Schlage button will blink red twice when a credential is presented and the lock is in factory default mode, and has no access programming.
3. For locks with keypads, enter the default PIN (13579 and "#") to verify access. The Schlage button will blink green, a beep will sound, and the door will unlock for the preset relock delay period. After the relock delay period, the lock will relock and the Schlage button will blink red. If the lever retracts and holds the latch through the relock delay period, then the Schlage button will light green until the lever is released.

### Test in normal operation mode

1. Present a valid credential. The Schlage button will blink green, a beep will sound and the door will unlock for the preset lock delay period. The lock will re-lock after the lock delay period and the Schlage button will then blink red. If the lever retracts and holds the latch through the relock delay period, then the Schlage button will light green until the lever is released.
2. If an invalid credential is presented, the Schlage button will blink red, a beep will sound and the door will not unlock.

## Normal lock operation

After credentials have been programmed, present credentials to operate the lock as follows:

Credential type	Action
PIN or Card	Present or enter credential to reader → Green blink and access granted
Card+Card ID Number	Present credential to reader → Press Card ID Number <sup>1</sup> → Within 5 seconds, Press (#) <sup>2</sup> → Green blink and access granted

<sup>1</sup> If the Card ID is entered incorrectly, press "\*" to start over.

<sup>2</sup> The default PIN/Card ID length is six (6) digits. The "#" key must be used as an ENTER key for PINs/Card IDs with fewer than six digits. PIN length can be configured using the SUS, so users do not have to press "#" key.

## Reset to factory defaults

**All information in the lock will be deleted and reset to factory defaults!**

**The door must be locked (not toggled open or in the middle of normal access) before resetting to factory defaults.**

### Level 1 factory default reset

- ① **Level 1 factory default reset will delete configurations and settings in the main controller in the lock.**
- ① **Main controller configurations that will reset to factory default include: programming and user codes.**
- ① **Level 1 factory default reset will not reset configurations and settings in the reader.**
  1. Press and hold the Schlage button. Wait for the lock to beep twice and two green blinks of the Schlage button, indicating confirmation.
  2. After confirmation signals, release the Schlage button.
  3. Rotate the mechanical key within 10 seconds and hold. The Schlage button will light green. Continue holding the key until confirmation signals are observed (the Schlage button light will turn off one second and a one second beep will sound). After confirmation signals, release the mechanical key.
  4. The Schlage button will light green for one second and a one-second beep will sound to confirm reset to factory defaults.
- ① **If the mechanical key is not rotated within 10 seconds, two beeps and two red blinks indicate timeout.**

### Level 2 factory default reset

- ① **Level 2 factory default reset will delete all configurations and settings in the lock and the reader.**
- ① **Reader configurations that will reset to factory default include: keypad format, magstripe reader track, beeper on/off, and contactless card.**
- ① **Days in Use counter and lock type configurations will not reset.**

To complete Level 2 factory default reset, repeat steps 2 through 4 **within 10 seconds of the confirmation signals of level 1 factory default reset.**

If more than 10 seconds pass after the confirmation signals of level 1 reset, then level 1 reset must be repeated prior to performing level 2 reset.

## Batteries

Battery voltage can be checked with the SUS. Changing batteries does not affect any programmed data.

To install or replace alkaline batteries:

1. Remove the battery cover.
2. Remove the battery bracket. **Do not allow the battery pack to hang from the wires.**
3. Install the new batteries (install only new AA Alkaline batteries). Make sure the batteries are installed in the correct orientation.
4. Reinstall the battery pack and battery bracket.
5. Reinstall the battery cover, making sure the plug is to the right of the battery pack (CY, MS, and MD locks). **Be careful not to pinch the battery wires when installing the battery cover.**

① For coin cell battery installation or replacement, refer to instructions at [www.allegion.com/us](http://www.allegion.com/us).

**CAUTION! Danger of explosion if batteries are incorrectly replaced! Replace only with the same or equivalent type. Dispose of used batteries according to the manufacturer's instructions.**

This product has been evaluated for ULC-S319 compliance with AA and coin cell batteries listed below. For installations requiring ULC-S319, these battery models should be used.

AA batteries: Duracell PC1500, MN1500; Energizer E91, EN91, AX91, XR91; RayoVac 815, 815-HE

Coin cell batteries: Energizer CR2025, CR2032; Maxell CR2025, CR2032, Panasonic CR2025, CR2032; RayoVac KECR2025, KECR2032.

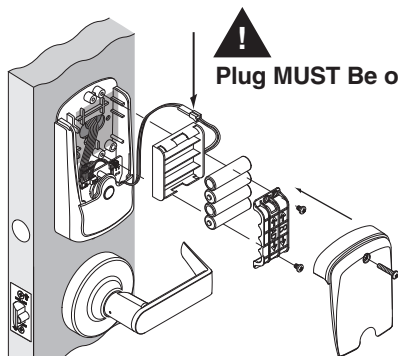

CY, MS, & MD

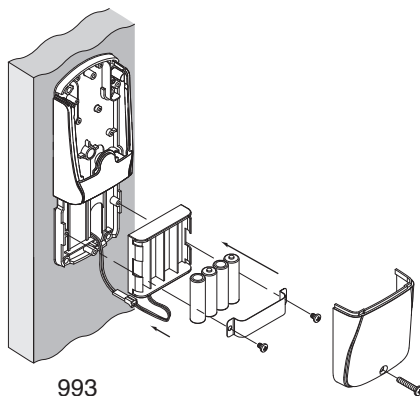

993



## Low battery indications

Condition	Indicator	Solution
Batteries low	After credential is presented – 9 red blinks of Schlage button (Left = AA batteries Right = Coin Cell battery) then normal indicator	Replace batteries immediately to avoid battery failure. Lock is intended to operate for 500 cycles in low battery condition.
Battery Failure (configured by SUS)	No LED or beeps and valid credentials do not grant access	Replace batteries immediately. Mechanical override key must be used to unlock the lock.

## Battery failure modes

- ① **The battery failure mode is set using the SUS. See the SUS user guide for more information.**

Mode	Description
Fail As-Is (default)	Lock remains in current state until batteries are replaced.
Fail Unlocked	Lock unlocks and remains unlocked until batteries are replaced.
Fail Locked	Lock locks and remains locked until batteries are replaced.

## LED reference

Most LED indicators are configured with the SUS. See SUS user guide for more information.

### Schlage button

Condition	Lights
Access denied	2 red blinks
Access denied, user outside time zone	4 red blinks
Factory default reset	One-second solid green with one-second beep
Waiting for PIN	5 left red with right green blinks, then solid right green
Low battery indicator, AA batteries	9 left red blinks
Low battery indicator, coin cell battery	9 right red blinks
Momentary unsecured access	1 green blink, then one red blink on relock
USB active with no physical connection	Left green blinking
An incompatible reader is on the lock	2 red blinks and 2 beeps with each card or key press, or 5 red blinks and 5 beeps on power-up
Occupancy indicator fast blinks are enabled	1 red blink every 1.5 seconds*
Occupancy indicator slow blinks are enabled	Sequential 1 red blink on both left and right every 1.5 seconds*

\* The red blinks will turn amber if the lock's battery is low.

### Optional Inside Push Button (IPB)

Action	Lights
Office Mode –Allows lock to toggle between locked (normal) and unlocked state	
Press IPB to lock	1 red blink
Press IPB to unlock <sup>1</sup>	1 green blink
Privacy Mode – Allows the lock to toggle between normal access and a state in which normal credentials are ignored	
With door closed, press IPB to engage privacy <sup>2</sup>	4 green blinks
With door closed, press IPB to release privacy <sup>3</sup>	4 red blinks
With offline lockdown configuration enabled, press IPB for 4 seconds to activate lockdown <sup>4</sup>	2 amber and 2 red blinks
With offline lockdown configuration enabled, press IPB for 4 seconds to deactivate lockdown	2 amber and 2 green blinks

1 Unlocking the lock with the IPB will cause the lock to remain unlocked until the IPB is depressed again.

2 On locks configured with a mortise-deadbolt, throwing the deadbolt will also engage privacy.

3 If DPS is used, then opening door will also release privacy. If a mortise-deadbolt is used, then retracting the deadbolt will also release privacy.

4 Opening of door or deadbolt retraction will not deactivate the offline lockdown mode when it is active.

### Optional Inside Push Button (IPB)

Condition	Lights
Occupancy indicator blinks fast mode/slow mode	1 red blink every 3 seconds*
Offline lockdown active	1 red blink every 10 seconds

\* The red blinks will turn amber for the occupancy indicator blinks when the lock's battery is low.

## Troubleshooting

Problem	Possible cause	Solution
<p>The lock beeper does not sound and the keypad does not light when the Schlage button is pressed.</p>	<p>The beeper may be turned off.</p> <p>The battery or wired power may be improperly connected.</p> <p>The batteries may be inserted with incorrect polarity.</p> <p>The reader may not be properly seated into the front escutcheon.</p> <p>The reader connector may have bent pins.</p> <p>The through-door cable may not be properly plugged in.</p>	<p>Use manual programming or the SUS to enable the beeper (see <i>Disable/Enable Beeper</i> on page 12 or the SUS user guide for more information)</p> <p>Check that the battery or wired power is connected correctly.</p> <p>Check that the batteries are inserted in the correct polarity.</p> <p>Check that the reader is fully seated into the front escutcheon.</p> <p>Check that there are no bent pins in the reader connector.</p> <p>Check that the through-door cable is plugged in correctly. The red wire should be on the left and not pinched in the door.</p> <p><i>Refer to the installation instructions that came with the CO-200 lock, or this user guide for details on the above mentioned procedures.</i></p>
<p>The connection with the SUS is not successful.</p>	<p>The triangles on the outside lock assembly (cylindrical and mortise locks only) may not be properly aligned.</p>	<p>Check the outside lock assembly (cylindrical and mortise locks only). The triangles on the back of the lock assembly must be properly aligned.</p> <p><i>Refer to the installation instructions that came with the CO-200 lock for details.</i></p>
<p>The Schlage button is always on solid green.</p>	<p>The triangles on the outside lock assembly may not be properly aligned (cylindrical and mortise locks only).</p>	<p>Check the outside lock assembly (cylindrical and mortise locks only). The triangles on the back of the lock assembly must be properly aligned.</p> <p><i>Refer to the installation instructions that came with the CO-200 lock</i></p>
<p>The reader is not working.</p> <p>The Smart card is not reading.</p> <p>The magnetic swipe card is not reading correctly (no beeps or blinks).</p>	<p>The through door cable may be pinched.</p> <p>The Smart card default of the card reader may not be correct for the Smart card.</p> <p>The “Mag Track in Use” default for all magnetic card credential readers is “Track2”. The magnetic swipe card data may be on Track1 or Track3.</p>	<p>Check that the through door cable is not pinched.</p> <p>Change the Smart card format using the SUS. Select CO-200 “Lock Properties”, “Reader” tab, and “Smart cards in use”.</p> <p>Use the SUS to change “Mag Track in Use”. Select CO-200 “Lock Properties”, “Reader” tab, and “MAG Card Track selection”.</p> <p><i>Refer to the installation instructions that came with the CO-200 lock, or the SUS user guide for details on the above mentioned procedures.</i></p>

Problem	Possible cause	Solution
The LEDs and beeper indicate an incompatible reader (2 red blinks and 2 beeps with each card or key press, or 5 red blinks and 5 beeps on power-up).	The reader is not the original reader matched with the lock at the factory.	The lock must be installed with the original reader that came with the lock.

## FCC Statements

### Allegion Agency Statements

#### Compliance Statement (Part 15.19)

This device complies with Part 15 of the FCC Rules.

Operation is subject to the following two conditions:

1. This device may not cause harmful interference, and
2. This device must accept any interference received, including interference that may cause undesired operation.

#### Warning (Part 15.21)

Changes or modifications not expressly approved by the party responsible for compliance could void the user's authority to operate the equipment.

#### FCC Interference Statement (Part 15.105 (b))

This equipment has been tested and found to comply with the limits for a Class B digital device, pursuant to Part 15 of the FCC Rules. These limits are designed to provide reasonable protection against harmful interference in a residential installation. This equipment generates uses and can radiate radio frequency energy and, if not installed and used in accordance with the instructions, may cause harmful interference to radio communications. However, there is no guarantee that interference will not occur in a particular installation. If this equipment does cause harmful interference to radio or television reception, which can be determined by turning the equipment off and on, the user is encouraged to try to correct the interference by one of the following measures:

- Reorient or relocate the receiving antenna.
- Increase the separation between the equipment and receiver.
- Connect the equipment into an outlet on a circuit different from that to which the receiver is connected.
- Consult the dealer or an experienced radio/TV technician for help.

#### RF Exposure Statement

To comply with FCC/IC RF exposure requirements for mobile transmitting devices, this transmitter should only be used or installed at locations where there is at least 20 cm separation distance between the antenna and all persons.

#### Section 7.1.5 of RSS-GEN

Operation is subject to the following two conditions:

1. This device may not cause interference, and
2. This device must accept any interference, including interference that may cause undesired operation of the device.

**Customer Service**

1-877-671-7011 [www.allegion.com/us](http://www.allegion.com/us)



© Allegion 2020  
P516-271 Rev. 03/20-m