

AuroRa® Installation Guide

Read all instructions before installing the AuroRa system.

The AuroRa installation guide is designed to help you plan and complete the installation of your AuroRa Lighting Control System.

Refer to the information included in this guide to learn about the following:

- AuroRa lighting control package contents
- How to install AuroRa dimmers
- How to operate your system
- How to expand the system's capability

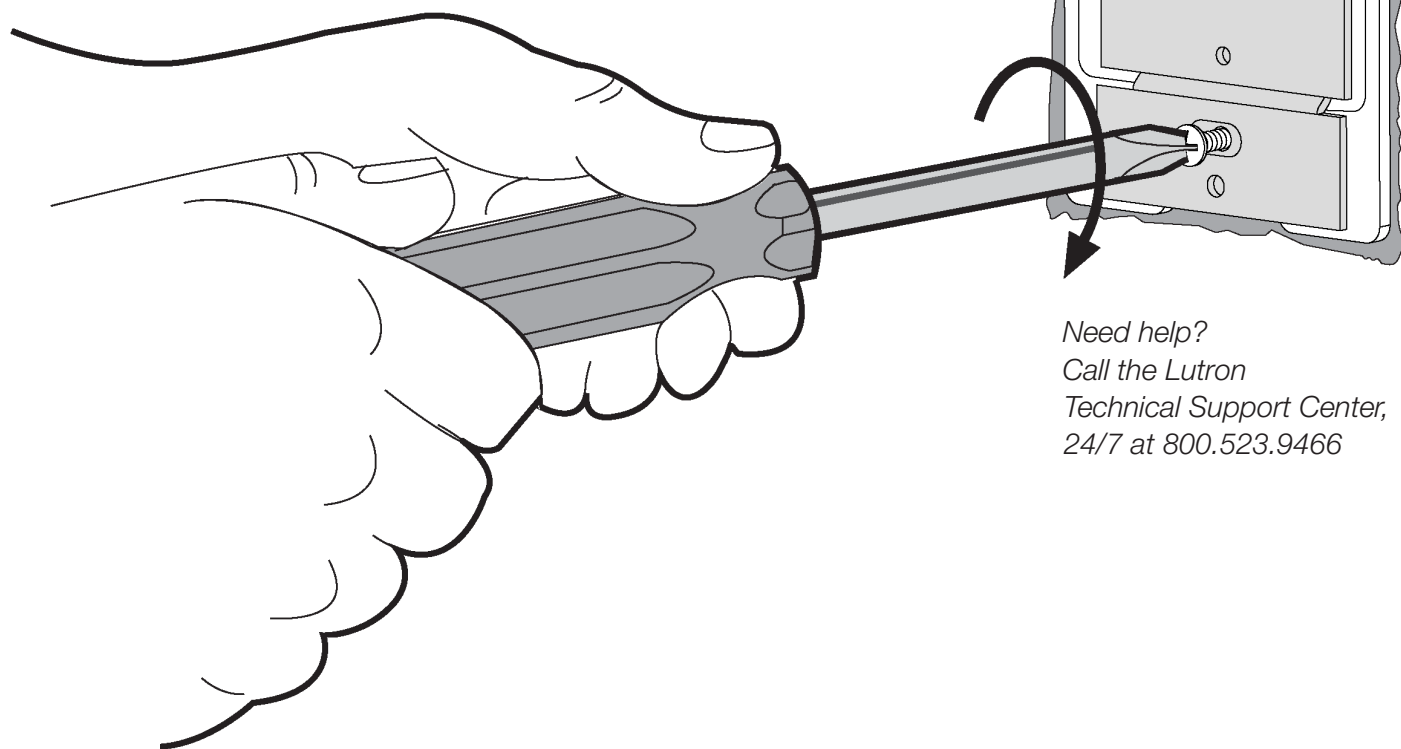

*Need help?
Call the Lutron
Technical Support Center,
24/7 at 800.523.9466*

Please leave installation guide with resident homeowner.



This symbol is intended to alert the user to the presence of important installation and operating instructions.

Consumer Information:



DANGER: This lighting control system must not be used to control equipment other than lighting. It must not be used to control equipment which could create hazardous situations, such as entrapment, if operated accidentally. Examples of equipment which must not be controlled by this system include (but are not limited to) motorized gates, garage doors, industrial doors, microwave ovens, heating pads, etc. It is the installer's responsibility to ensure that only lighting is connected to this system.

FCC Information

NOTE: This equipment has been tested and found to comply with the limits for a Class B digital device, pursuant to part 15 of FCC rules. Operation is subject to the following:

1. This device may not cause harmful interference, and
2. This device must accept any interference received, including interference that may cause undesired operation. The user is encouraged to try to correct the interference by one or more of the following measures:
 - Re-orient or relocate the receiving antenna.
 - Increase the separation between the equipment and receiver.
 - Connect the equipment into an outlet on a circuit different from that to which the receiver is connected.
 - Consult the dealer or an experienced radio/TV technician for help.



CAUTION: Changes or modifications not expressly approved by Lutron Electronics Co. may void the user's authority to operate this equipment.

table of contents

Installing your system is simple. We recommend you read through all the instructions before starting.

Choose from the topics below to help guide you through the process.

Before You Begin (AuroRa® package contents)	2
Selecting Dimmer Locations	3
Installing a Dimmer	4
Installing the Designer Insert	4
Replacing Switches With Dimmers	5
Setting Up the Master Control	12
Setting Up the Central Antenna	13
Installing the Wireless Controller	14
How to Operate the System	15
Adding to the System	
• bridging two systems	16
• activating additional wireless controllers	17
Frequently Asked Questions	18
General Information	19
Troubleshooting	21

If you have any questions, the Lutron Technical Support Hotline is ready to help 24 hours, 7 days a week. Call us at 800.523.9466 for immediate assistance. Or, find information on the internet at www.lutron.com/aurora.

AuroRa® | before you begin

AuroRa package contents

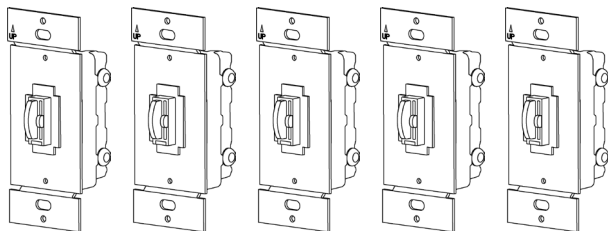

Dimmers
(5)

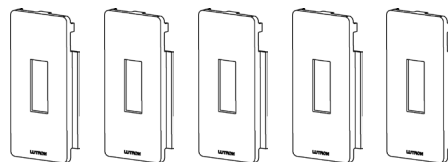

Designer inserts
(5)*



Wireless controller
rubber footpads
(4)

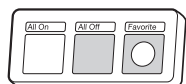

Wireless
controller
(1)

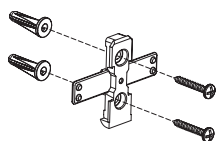

Wireless controller
wall mount
bracket kit
(1)*

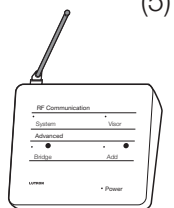

Central antenna
and dc adapter
(1)

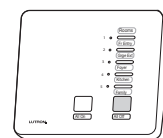

Master control
and dc adapter
(1)



Label sheets
(2)

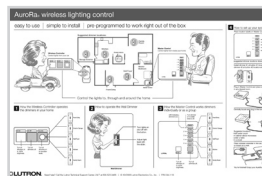

"At a glance"
instruction sheet
(1)



Installation
guide
(1)



Wire connector
and screw kit
(5)

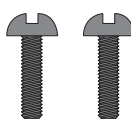

Small
screwdriver
(1)

* not included:
AR-ENTRY

Tools you may need

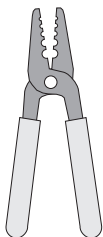

Wire
stripper



Slotted
screwdriver



Phillips
screwdriver



Wire
cutter



Electrical tape



Flashlight

selecting dimmer locations

1

Decide which lights you want to control with dimmers

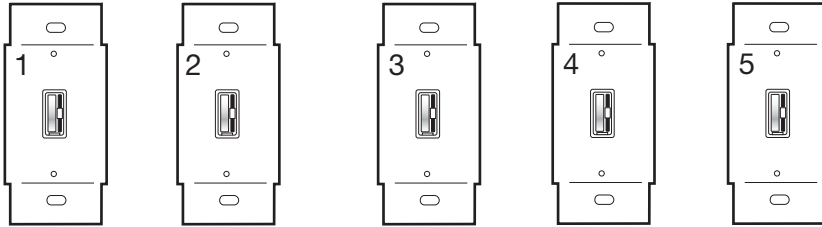

Choose your dimmer locations:

Dimmer 1: _____

Dimmer 2: _____

Dimmer 3: _____

Dimmer 4: _____

Dimmer 5: _____

NOTICE:

- Use dimmers with 120 V incandescent light fixtures only.
- Total wattage of all light bulbs controlled by each dimmer must be between 50 and 600 W.

✓ Helpful Hint:

Dimmer 1 should control your most used light. Dimmer 2 should control your second most used light.

Suggested Locations:

- Dimmer 1: Front Entry
- Dimmer 2: Garage Exterior
- Dimmer 3: Hall/Foyer
- Dimmer 4: Kitchen
- Dimmer 5: Family Room

2

Personalize your system

Label your master control with your light locations

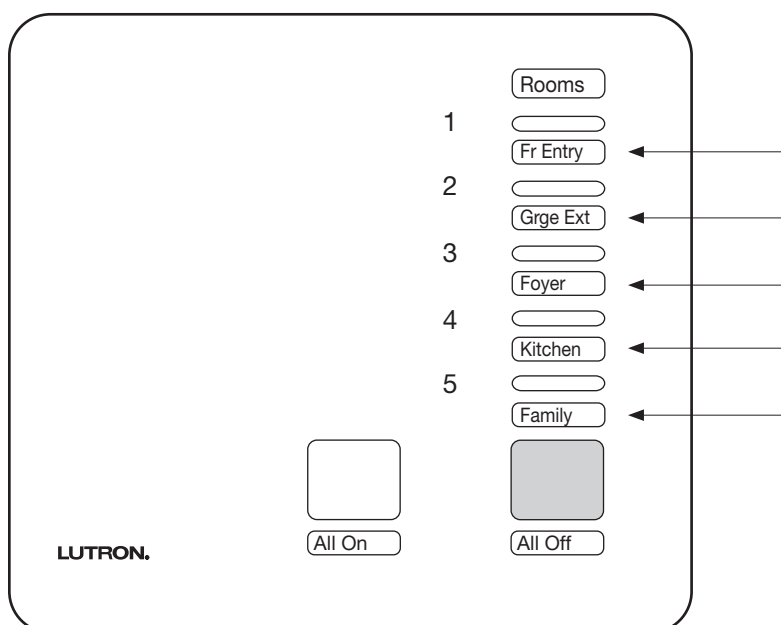

Master Control

Label device to match your location (suggested locations shown)

✓ Helpful Hint:

Use the labels included in the package.

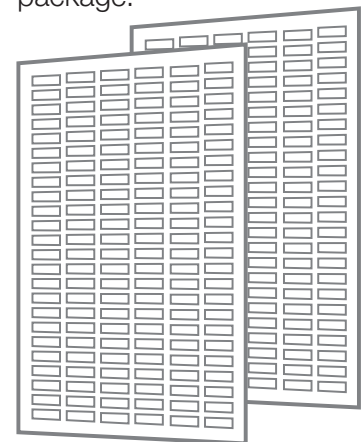

installing a dimmer

Installing an AuroRa® dimmer is as simple as replacing a light switch

Your first step is to identify how many switches control the lights you have decided to add to your system.

- This is important so that you use the correct installation instructions.
- Lutron has created specific instructions for lights controlled by one, two, or three switches to help simplify your installation.

After you have installed the first dimmer, repeat the process until all of the AuroRa dimmers have been installed.

Installing the designer insert

(use with designer opening wallplates)
Designer-style Wallplate Inserts allow Lutron Traditional-style dimmers and switches to be used with designer-style wallplates.

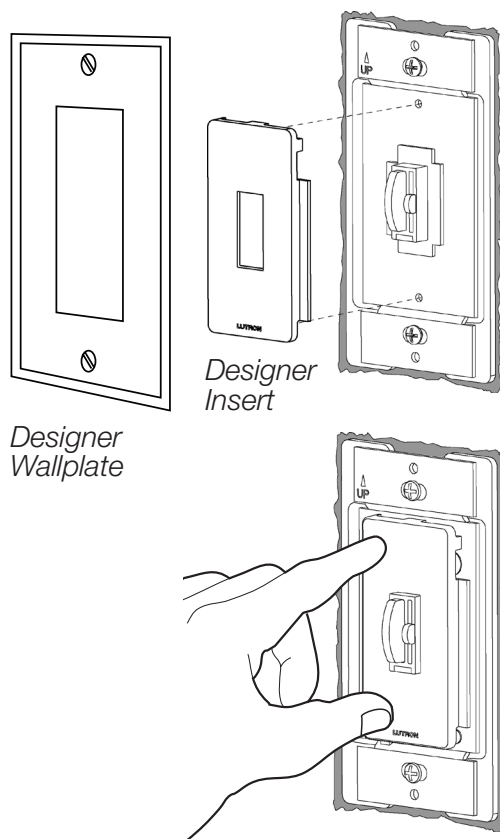

A. Slide the insert over the dimmer, making sure to line up the pins on the back of the insert with the screw holes on the dimmer as shown.

B. Press the insert firmly in place.

C. Re-install the wallplate.

CAUTION

If this is your first time wiring a dimmer, we recommend that you read over all information found on page 19 before proceeding. If you have any questions, give our 24/7 Technical Support Center a call at 800.523.9466.

- Use dimmers with 120 V incandescent lighting fixtures only. Do not use with low-voltage transformers.
- The total wattage of all light bulbs controlled by each dimmer must be between 50 and 600 W.
- When combining dimmers in the same wallbox, the dimmer's load capacity must be reduced (See "Derating Chart" on page 19).

replacing switches with dimmers

Write down how many switches control the lights you selected as 1-5 on your master control.

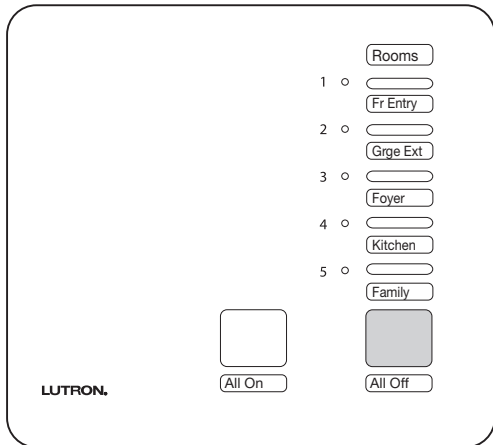

Your Locations:

Number of Switches:

1: _____

2: _____

3: _____

4: _____

5: _____

Master Control

1

For lights controlled by one switch, use instructions on pages 6 and 7

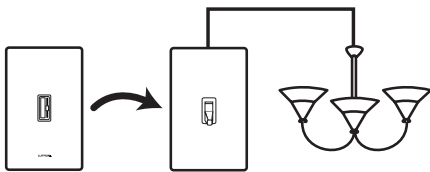

✓ Helpful Hint:
This circuit is called a single-pole circuit.

- Typical location:
- Porch light
 - Bedroom light

2

For lights controlled by two switches, use instructions on pages 8 and 9

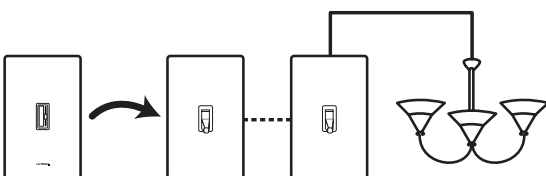

✓ Helpful Hint:
This circuit is called a three-way circuit.

- Typical location:
- Hallway light
 - Kitchen light

3

For lights controlled by three or more switches, use instructions on pages 10 and 11

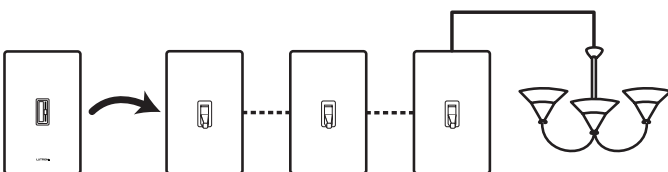

✓ Helpful Hint:
This circuit is called a four-way circuit.

- Typical location:
- Stairwell light

lights controlled by one switch

1

Turn power off at corresponding circuit breaker or remove fuse

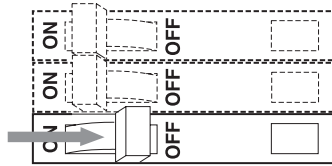

! WARNING:

Power must be turned off for your safety.

2

Remove wallplate

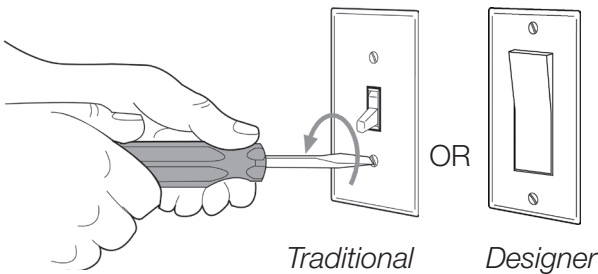

✓ Helpful Hint:

Save your wallplate and screws.

3

Unscrew existing switch and pull it forward out of the wall

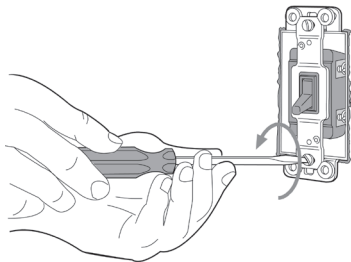

✓ Helpful Hint:

Once switch is pulled out, you should see one of the following:

- A.** Two insulated wires each attached to a screw. One ground wire (green or bare) attached to a screw. To uninstall switch, refer to instructions 4A.
- B.** Two insulated wires inserted into back of existing switch. One ground wire attached to a screw. To uninstall switch, refer to instructions 4B.

4A

Uninstall switch
(wires attached to screws only)

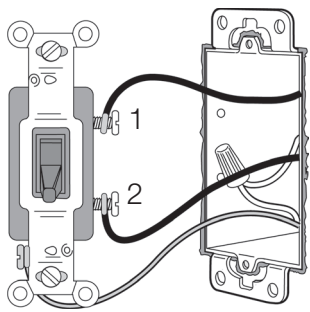

3 (ground wire)

Turn screw to loosen and disconnect wires (1, 2, 3) from the switch.

4B

Uninstall switch (wires attached to back of existing switch)

Insert screwdriver (included in package) into the holes found on the back of existing switch and pull out wires (1, 2). Loosen screw and disconnect ground wire (3).

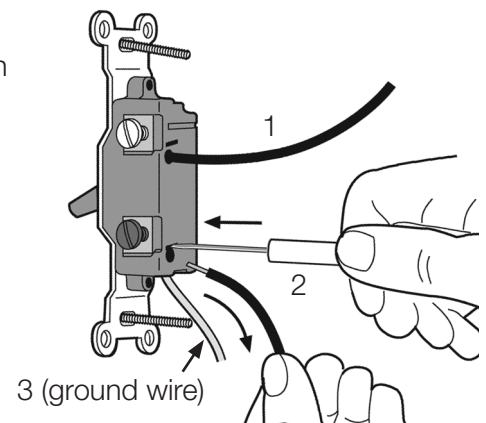

3 (ground wire)

5

Install dimmer

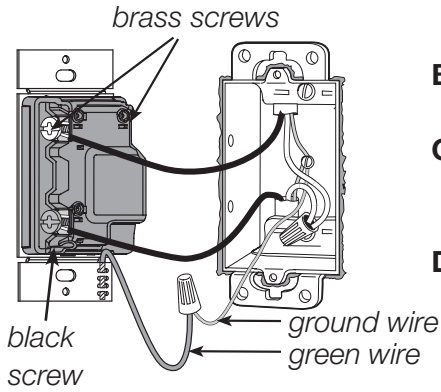

- A.** Connect the green or bare wire (ground wire) to the green wire on the dimmer with a wire connector.
- B.** Connect one wire to the black screw on the dimmer.
- C.** Connect the other wire to either one of the two gold colored screws (brass) on the dimmer.
- D.** Tighten the brass screw that is not being used.



Wire Connector

6

Mount dimmer

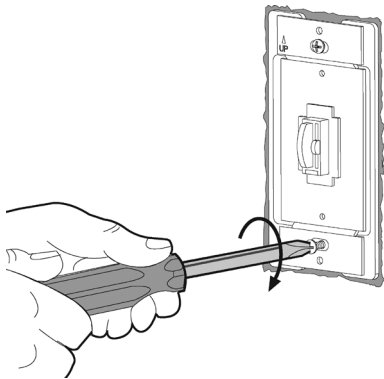

7

Replace wallplate

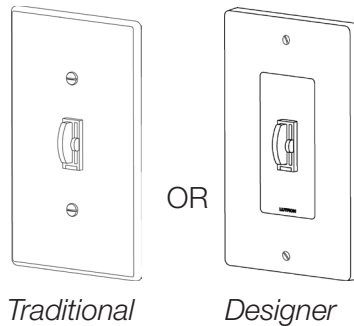

✓ Helpful Hint:
See page 4 – installing designer insert.

8

Turn power on at circuit breaker or replace fuse

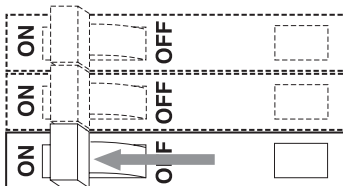

lights controlled by two switches

1

Turn power off at circuit breaker or remove fuse

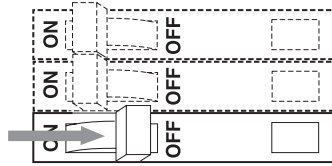

WARNING:

Power must be turned off for your safety.

2

Remove wallplate

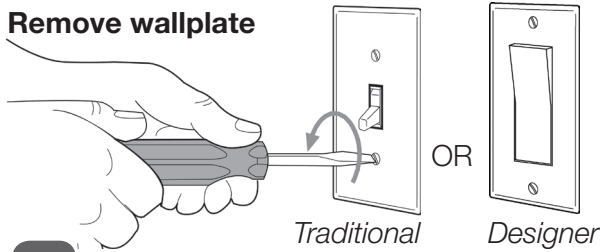

Helpful Hint:

Save your wallplate and screws.

3

Unscrew existing switch and pull it forward out of the wall (do not disconnect wires yet)

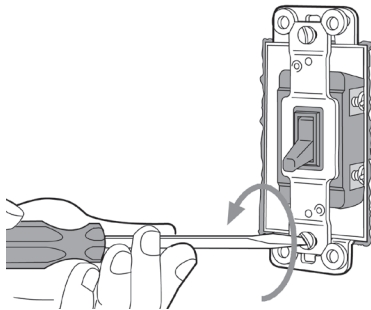

NOTICE:

Only replace one of the two switches controlling the light with a dimmer.

Helpful Hint:

Once switch is pulled out, you should see one of the following:

- A.** Three insulated wires each attached to a screw. One ground wire (green or bare) attached to a screw. To uninstall switch, refer to instructions 4A.
- B.** Three insulated wires inserted into back of existing switch. One ground wire attached to a screw. To uninstall switch, refer to instructions 4B.

4A

Uninstall switch

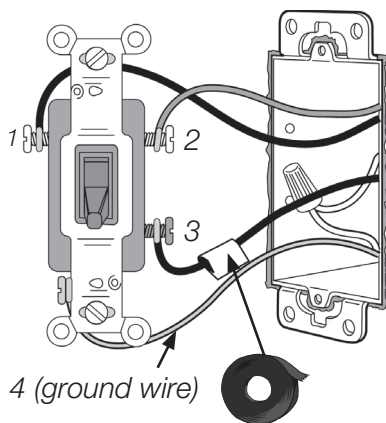

- A.** Tag the wire attached to the different colored screw. This screw is usually labeled COMMON.
- B.** Disconnect the wires from the switch.

4B

Uninstall switch

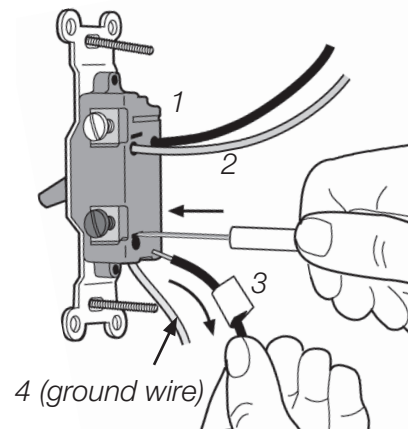

To pull out wires 1, 2, and 3, refer to page 6 step 4B for instructions.

5

Install dimmer

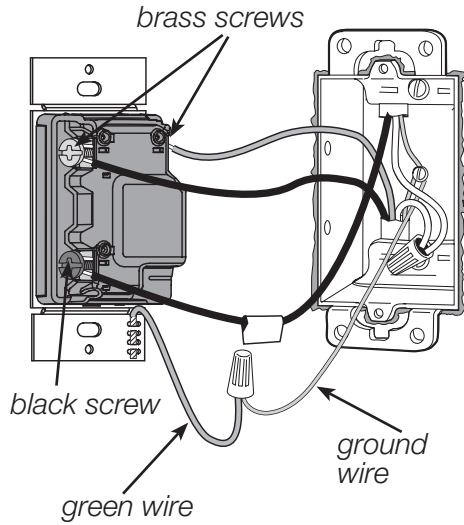

A. Connect the green or bare wire (ground wire) to the green wire on the dimmer with a



Wire Connector

B. Connect the tagged wire to the black colored screw on the dimmer.

C. Connect one of the remaining wires to either of the gold colored screws (brass) on the dimmer.

D. Connect the remaining wire to the remaining gold colored screw (brass) on the dimmer.

6

Mount dimmer

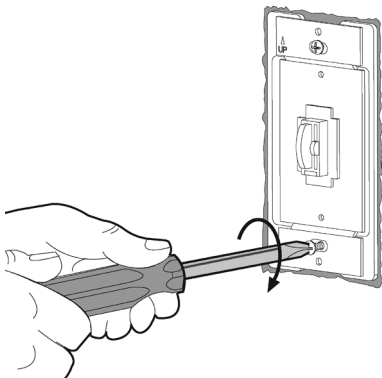

7

Replace wallplate

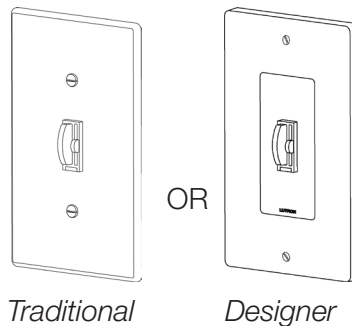

✓ Helpful Hint:

See page 4 – installing designer insert.

8

Turn power on at circuit breaker or replace fuse

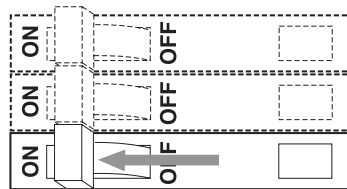

lights controlled by three or more switches

1

Turn power off at circuit breaker or remove fuse

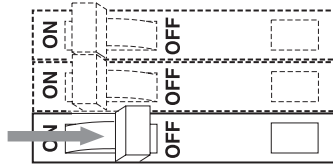

WARNING:

Power must be turned off for your safety.

2

Remove wallplate



Helpful Hint:

Save your wallplate and screws.

3

Unscrew existing switch and pull it forward out of the wall (do not disconnect wires yet)

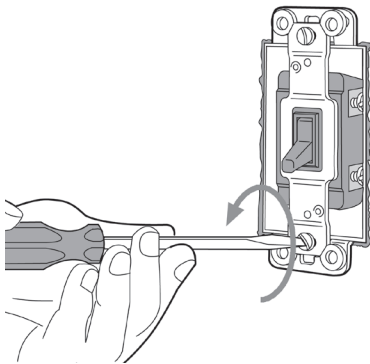

NOTICE:

Only replace one of the switches controlling the light with a dimmer.

Helpful Hint:

Once switch is pulled out, you should see one of the following:

- A.** Three insulated wires each attached to a screw. One ground wire (green or bare) attached to a screw. To uninstall switch, refer to instructions 4A.
- B.** Three insulated wires inserted into back of existing switch. One ground wire attached to a screw. To uninstall switch, refer to instructions 4B.

Locate a switch with three insulated wires attached to it
correct

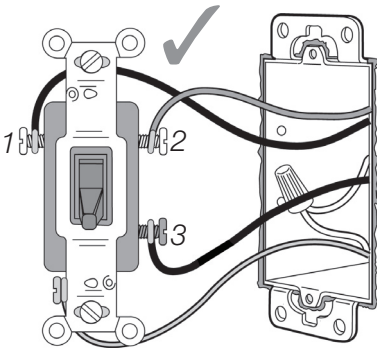

incorrect

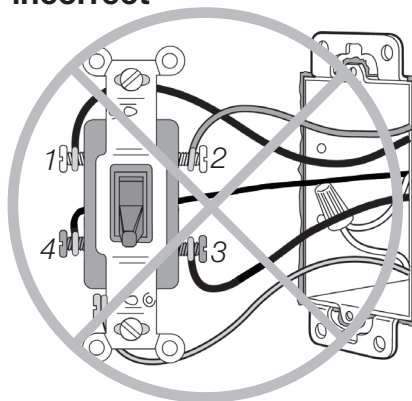

NOTE:

Do not disconnect the switch if it has four wires attached to it, remount it and remove one of the other two switches. The AuroRa® dimmer cannot be used in a switch location that has four wires.

4A

Uninstall switch

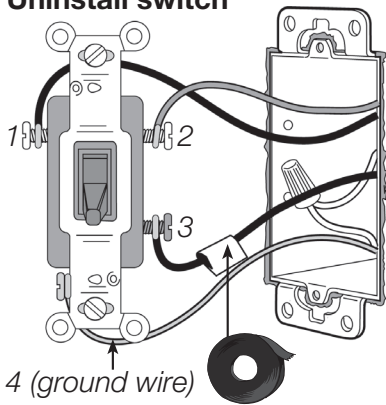

- A.** Tag the wire attached to the different colored screw. This screw is usually labeled COMMON.
- B.** Disconnect the wires from the switch.

4B

Uninstall switch

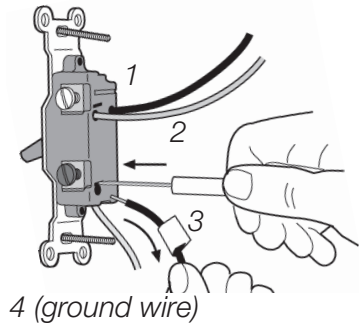

- 4 (ground wire)
- Refer to page 6 step 4B for instructions. (pull out wires 1, 2, 3)

5

Install dimmer

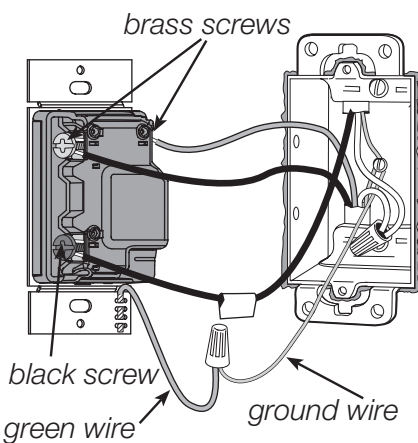

- A.** Connect the green or bare wire (ground wire) to the green wire on the dimmer with a wire connector.
- B.** Connect the tagged wire to the black colored screw on the dimmer.
- C.** Connect one of the remaining wires to either of the gold colored screws (brass) on the dimmer.
- D.** Connect the remaining wire to the remaining gold colored screw (brass) on the dimmer.



Wire Connector

6

Mount dimmer

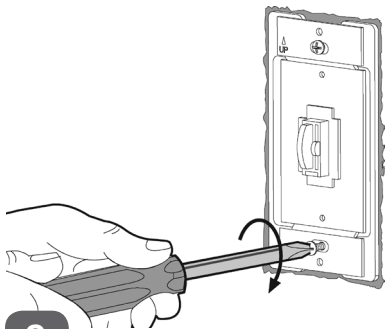

7

Replace wallplate

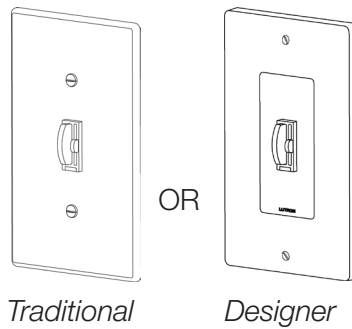

- ✓ **Helpful Hint:** See page 4 – installing designer insert.

8

Turn power on at circuit breaker or replace fuse

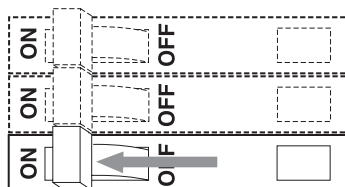

setting up the master control

1

Select a location and plug in to a standard wall outlet

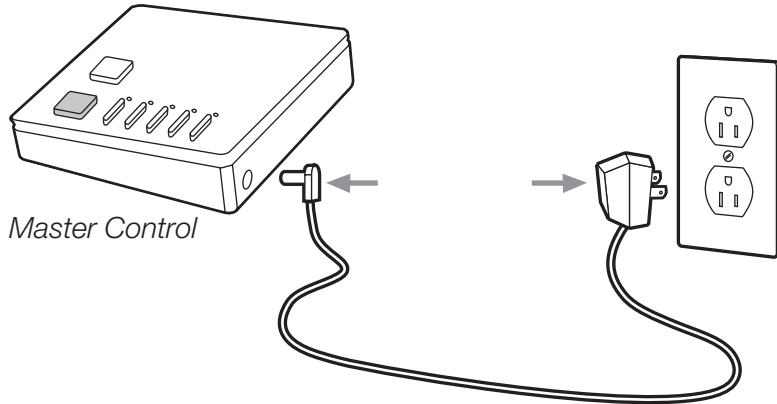

✓ **Helpful Hint:**

Place the master control where you will want to control lights throughout your home.

Suggested locations:

- Bedside table
- Kitchen counter

2

Remove the temporary label

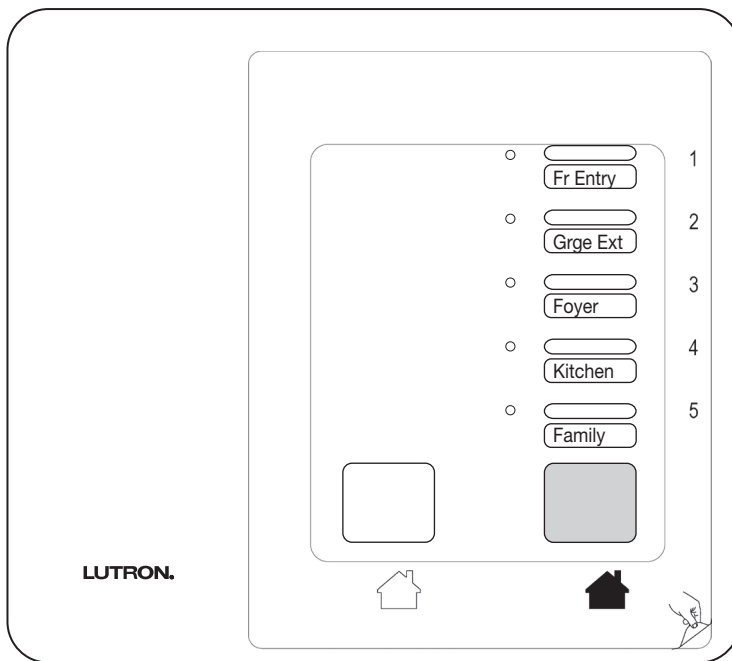

- A.** Peel off label at lower right corner.

Master Control

setting up the central antenna

1

Find the approximate center of your system

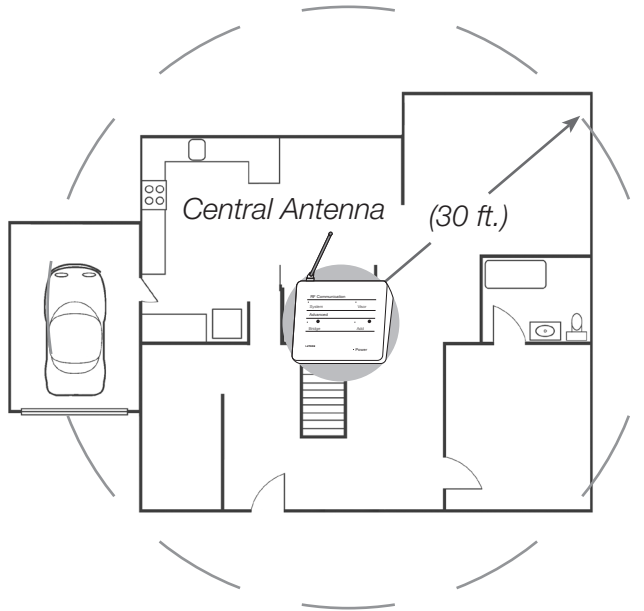

✓ Helpful Hint:

The central antenna works best within 30 ft. of your master control and dimmers.

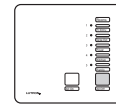

Master Control

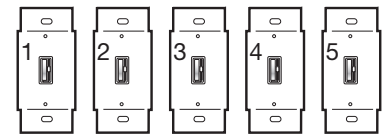

Dimmers

2

Plug in the central antenna

The central antenna plugs in to a standard wall outlet and should be placed centrally in the home to ensure the best Radio Frequency coverage.

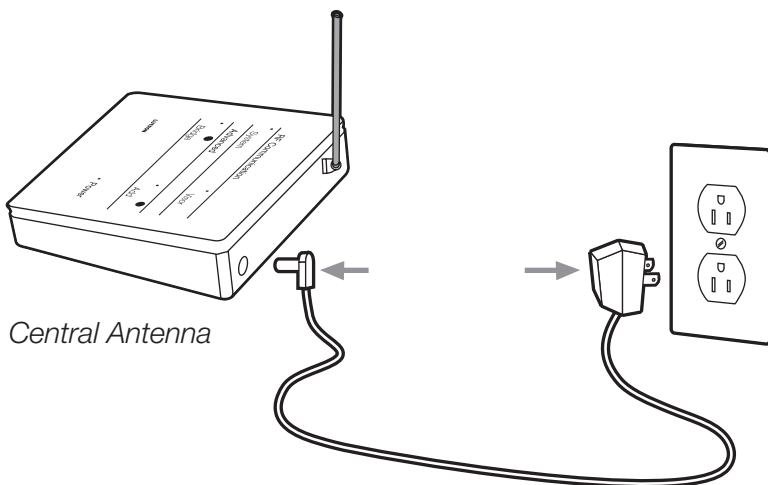

✓ Helpful Hint:

Don't place your central antenna inside a metal container. The metal container will block radio signals and keep the central antenna from working properly.

The central antenna does not need to be placed in the open. We recommend placing it in a discrete location that is out of sight.

Suggested locations:

- Under a sofa
- Under a table
- In a closet
- In a cabinet above microwave

installing the wireless controller

The wireless controller may be mounted in a variety of ways:

- On a vehicle's visor using the supplied visor clip
- Placed on a table using the rubber footpads
- Mounted on a wall using the wall mount

1

Visor mount

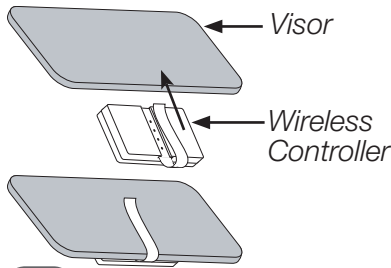

A. Mount wireless controller onto vehicle's visor. Visor clip may need to be manually opened depending on visor thickness.

2

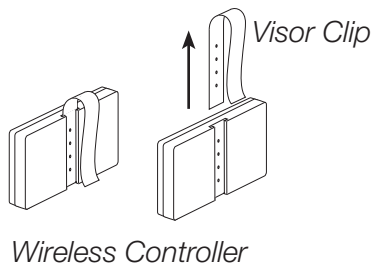

A. Preparation for tabletop use or wall mounting

Remove visor clip from wireless controller by sliding visor clip out of the channel on the back of the unit.

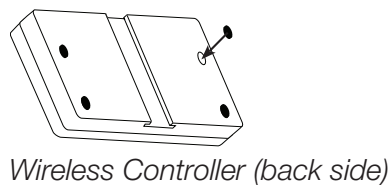

B. Peel and stick footpads

For tabletop use, attach footpads to wireless controller. Peel the footpads from the paper backing and place in the four circular indentations on the back of the wireless controller.

3

Wall mount

A. Attach wall bracket to wall using the supplied screws and wall anchors. When mounting the Wireless Controller horizontally, make sure that the end stop is at the bottom. **NOTE:** Drill pilot holes for the wall anchors using a 3/16" drill bit.

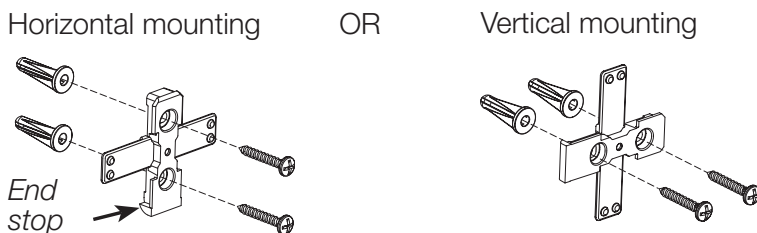

B. Slide wireless controller onto wall bracket. The clip on the wall bracket slides into the channel on the back of the wireless controller.

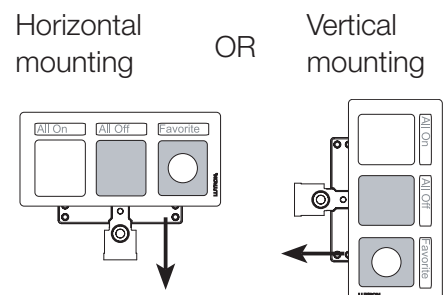

how to operate the system

1

Monitor and control lights throughout the home from one place

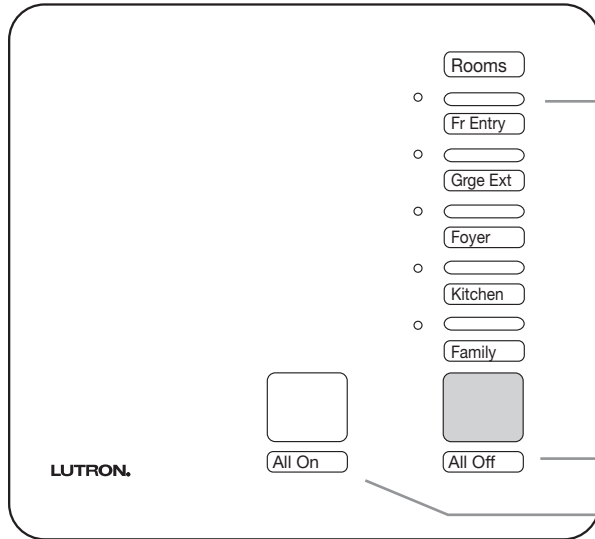

Master Control

Turn dimmer on (to slider level) or off. LED indicates dimmer is on.

Double-tap turns light on to 100%.

Turn all dimmers off.

Turn all dimmers on to 100% brightness.

2

Control lights conveniently from the car

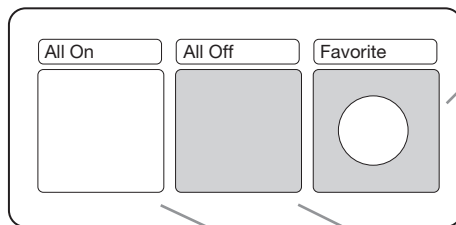

Wireless Controller

Turn all dimmers on to the slider levels.

Turn all dimmers off.

Turn all dimmers on to 100% brightness.

3

Dim to transform the look of any room

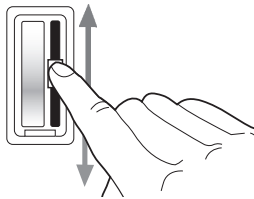

Slide to adjust light level.

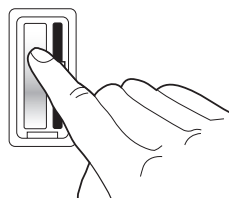

Tap to turn lights on and off.

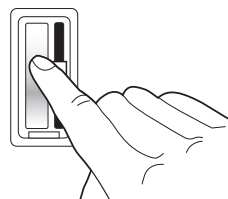

Double-tap button turns lights on to 100%.

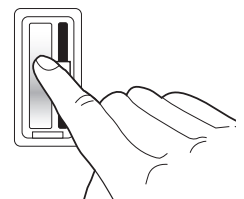

Hold button for 1-2 seconds to start 10 second fade to off.

adding to the system

An AuroRa® system can be expanded to control ten *AuroRa* dimmers by bridging two *AuroRa* systems together.

Bridging Two AuroRa Systems Together

- Purchase and install two separate *AuroRa* systems.
- To bridge two systems, press and hold the “Bridge” button on the central antenna of either system for 3 seconds. The “Bridge” LED should flash slowly.
- Press and hold the “Bridge” button on the second central antenna for 3 seconds. The “Bridge” LED should flash slowly. The LEDs on both central antennas will begin to flash quickly as the bridging process starts. The loads in both systems will start flashing.
- When the process is finished, the “Bridge” LEDs on both central antennas will stop flashing and stay on. The loads in both systems will stop flashing.

The systems are now bridged.

Unbridging the system

For information about returning your system to its original default settings, visit www.lutron.com/aurora.

The central antennas should be at least 3 ft. apart and within 60 ft. of each other when bridging two systems.



Central Antenna

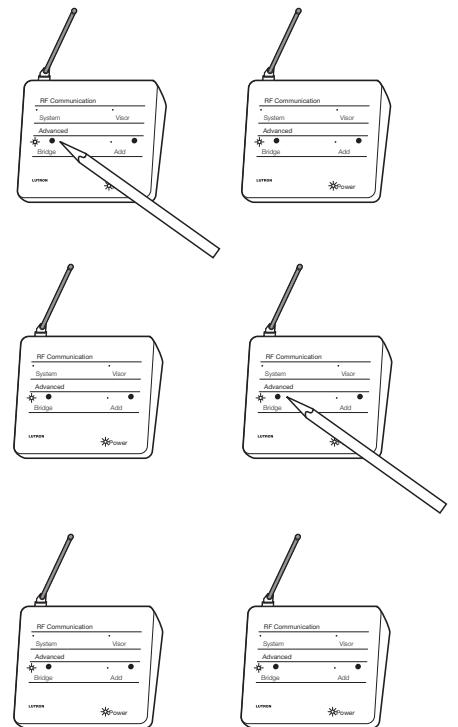

Bridged system functionality

“All On” Button

All dimmers in both systems will turn on to full brightness.

“All Off” Button

All dimmers in both systems will turn off.

“Favorite” Button

All dimmers in both systems will turn on to their local slider levels.

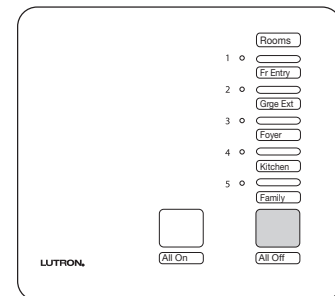

Master Control

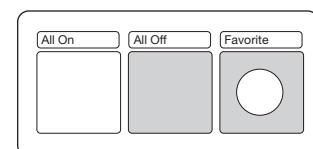

Wireless Controller

adding to the system

Activating additional wireless controllers (nine maximum)

Before additional wireless controllers can be used to control lights in the AuroRa® system, they must be activated. Follow the steps below to activate a wireless controller.

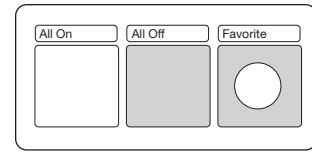

Wireless Controller

1

Enter advanced “Add” mode

Press and hold the “Add” button on the central antenna until the LED light begins to flash (approximately 3 seconds). Dimmers that are in the system will flash the lights connected to each. The master control will flash the LEDs corresponding to dimmers present in the system.

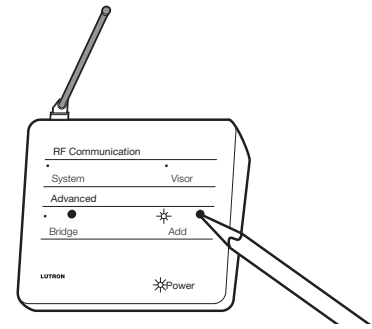

2

Activate wireless controller

Press and hold any button on the wireless controller until the “Visor” LED light on the central antenna starts flashing (approximately three seconds), indicating the wireless controller has been activated in the system. The “Add” LED and the “Visor” LED will remain flashing until the wireless controller button is released.

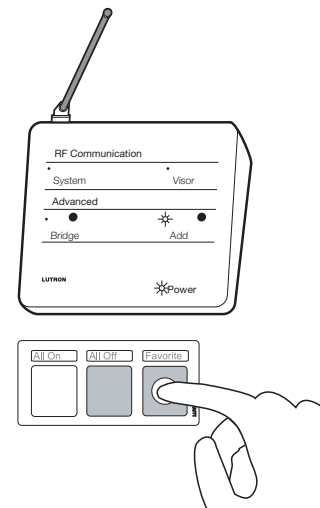

3

Exit advanced “Add” mode

Press and hold the “Add” button until the “Add” LED light stops flashing and remains off (approximately 3 seconds). The dimmers will stop flashing their lights.

The wireless controller has now been activated.

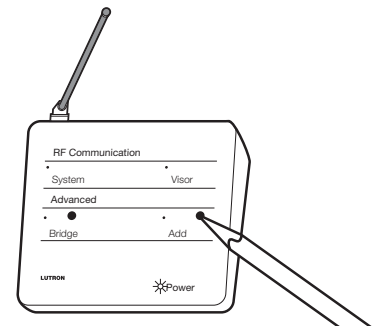

frequently asked questions

How far away can I use my wireless controller?

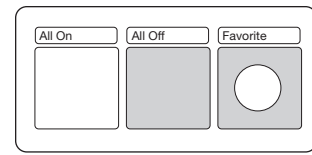
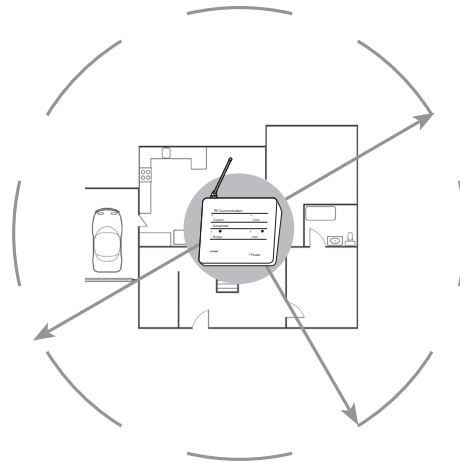

*Wireless Controller**

*100 ft. typical range in any direction from the central antenna

What is the range of the central antenna?

The central antenna has a radio frequency range of at least 30 ft. in any direction.

Will other equipment in my home or neighboring homes interfere with my AuroRa® system?

AuroRa operates at a frequency different from most remote controls, cellular/portable phones, and other wireless devices. The communication protocol ensures that any device operating at the same frequency will not affect your system.

What happens to the *AuroRa* system during a power outage?

AuroRa has non-volatile memory that maintains all system addressing and master control programming during a power outage. After the power outage, the memory restores all system lighting to its previous state before the power failure.

Can I replace or move a dimmer after the initial installation?

Yes. One or all of the dimmers can be relocated to different locations in the home, if the user prefers to control different lights. All system addressing, as well as master control and wireless controller programming remains unchanged.

Can I add to my *AuroRa* system?

You can increase the capability of your *AuroRa* system by adding another complete package or by adding up to nine additional wireless controllers (See “Bridging *AuroRa* Systems” on page 16 and “Activating additional Wireless Controllers” on page 17).

Can I use two *AuroRa* dimmers to control a light or a group of lights?

No. *AuroRa* dimmers work with standard 3 or 4-way switches. Only one *AuroRa* dimmer can be used to control a light or group of lights.

general information

1. **CAUTION:** To avoid overheating and possible damage to other equipment, do not use dimmers to control receptacles, fluorescent lighting fixtures, motor-operated or transformer-supplied appliances.
2. **CAUTION:** Use dimmers with 120 V~ incandescent lighting fixtures only. Do not use with low-voltage transformers.
3. Install in accordance with all national and local electrical codes.
4. When there is no ground wire or way to connect the wallbox, to ground within the wallbox the NEC® 2002, Article 404-9 allows a dimmer without a grounding connection to be installed as a replacement, (as long as a plastic, noncombustible wallplate is used). For this type of installation, cap or remove the green ground wire on the dimmer, and use an appropriate wallplate (such as Lutron's Fassada® series wallplates).
5. Do not paint dimmers or wallplates.
6. Cleaning Instructions: Clean with a soft, damp cloth only. Do not use any chemical cleaners.
7. The total wattage of all light bulbs controlled by each dimmer must be between 50 and 600 W.
8. Dimmers work with most incandescent light bulbs. Dimmers may not work with dioded light bulbs (Sylvania Designer 16™ or Philips PAR-16™).
9. Operate system in temperatures between 0° C (32° F) and 40° C (104° F).
10. Dimmer may feel warm to the touch during normal operation.
11. Recommended wallbox depth is 2 1/2" minimum.

12. Single-pole circuit

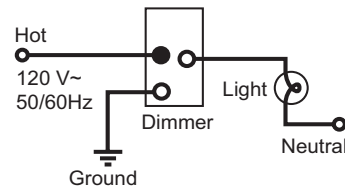

Three-way circuit

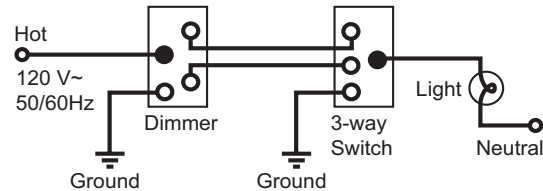

Four-way circuit

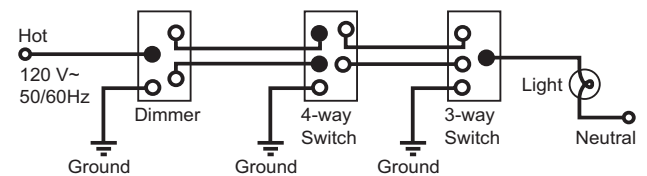

13. When combining dimmers in the same wallbox, the dimmer's load capacity must be reduced.

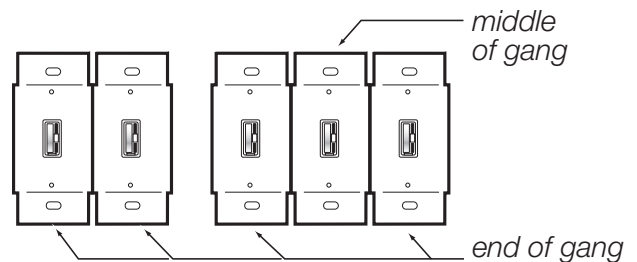

- CAUTION:** Follow the load capacities in table below for multi-ganged dimmers.

Derating Chart

Model	Not Ganged	End of Gang	Middle of Gang
AR-6D	600 W	500 W	400 W

general information

14. Wire Preparation: Trim or strip wallbox wires to the length indicated by the strip gauge on the back of the dimmer.

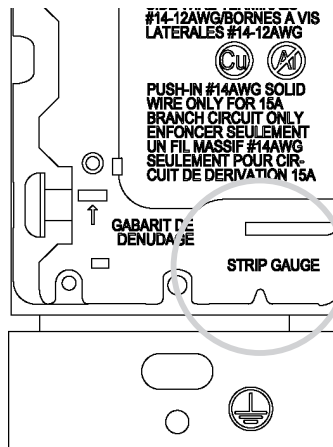

Back view of dimmer

Push-in: To reinstall, simply insert wire by hand. Use #14 AWG solid copper wire only. Insert wires fully. For aluminum wire, consult an electrician. DO NOT use stranded or twisted wire.

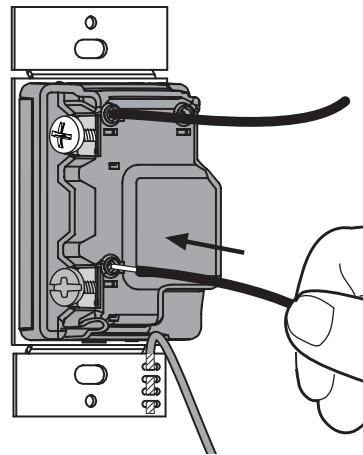

Screw terminals: Tighten securely. Screw terminals are for use with solid copper wire only. For aluminum wire, consult an electrician. DO NOT use stranded or twisted wire.

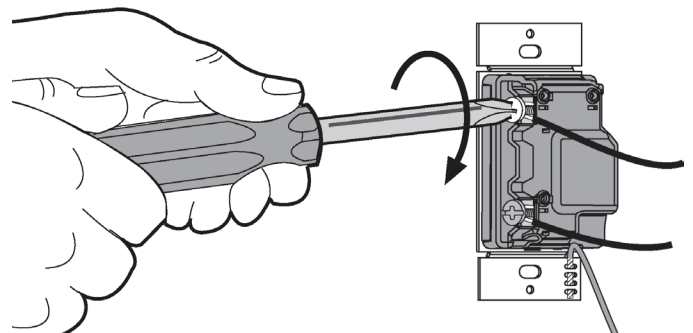

15. Replacing light bulbs:

Pull service switch out to open position to replace light bulbs (this cuts all power to the dimmer). Push service switch in after new bulb is installed to restore power.

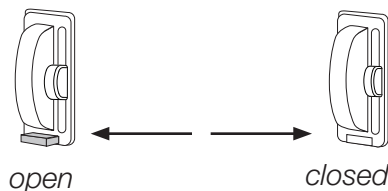

troubleshooting

Symptom	Possible Cause	Remedy
Dimmers do not respond to the wireless controller.	Central antenna is not powered.	Ensure that plug on the rear of the central antenna is inserted fully and that the unit is plugged in to a live wall receptacle.
	The wireless controller may be out of communication range of the central antenna.	Move the wireless controller closer to the central antenna and try again. Typically 100 ft.
	Batteries in the wireless controller are weak or dead. (factory installed batteries are designed to last ten (10) years during typical usage)	Replace batteries in the wireless controller with new ones (CR2032).
Master control or central antenna appears not to be working at all.	No power available to unit.	Ensure that the plug on the rear of the unit is inserted fully and that the unit is plugged in to a live wall receptacle. Check that the receptacle is not controlled by a switch. Check that breaker is on and not tripped.
	Faulty dc adapter.	Swap dc adapters with master control or central antenna and check unit for power.
A dimmer appears not to be working at all.	Burned out or missing light bulb.	Replace light bulb.
	Service switch is in the OFF position (pulled out).	Turn service switch on by pushing the switch in. See note 15 on page 20.
	No power available to unit.	Check that breaker is on and not tripped.

troubleshooting

Symptom	Possible Cause	Remedy
Dimmer keeps turning on and off.	Unit has been wired incorrectly.	Refer to wiring instructions.
	Wattage is under recommended minimum load.	See number 7 on page 19.
	2 or more <i>AuroRa</i> ® dimmers on one circuit.	Remove and replace additional <i>AuroRa</i> dimmer with standard single pole or 3-way switch.
Dimmer performs normally when operated manually, but fails to respond to master control button pushes.	The dimmer may be out of communication range of the central antenna.	Move the central antenna closer to the dimmer.
	The master control may be out of communication range of the central antenna.	Move central antenna closer to master control.

notes

notes

AuroRa® Installation Guide

Patent Statement

These products may be covered under one or more of the following U.S. patents: 5,248,919; 5,637,930; 5,838,226; 5,848,054; 5,905,442; 5,982,103; 6,687,487; 6,803,728; 7,091,672; D428,855 and corresponding foreign patents. U.S. and foreign patents pending. Lutron, AuroRa, and the sunburst logo are registered trademarks of Lutron Electronics Co., Inc.

Lutron | AuroRa® Installation Guide

Worldwide Technical and Sales Assistance

If you have questions concerning the installation or operation of this product, call the Lutron Technical Support Center.

Please provide the exact model number when calling.

Model number can be found on the product packaging. Example:

AR-ENTRY-xx

AR-ENT-1-xx

AR-ENT-S-xx

AR-ENT-F-xx

USA, Canada, and the Caribbean 800.523.9466

Other countries call: +1.610.282.3800

Fax: +1.610.282.3090

Visit us on the web at www.lutron.com/aurora



Lutron Electronics Co., Inc.

7200 Suter Road

Coopersburg, PA 18036