

1973 Airstream Owners Manual



An Airstream travel trailer offers you the ultimate in travel luxury and mobility. This owner's manual is your key to carefree travel fun. It contains information necessary to avoid problems. Consult it when you have a question about your new Airstream. It has been designed to aid you in knowing your trailer better. Should you trade or sell your Airstream, please leave the manual with the trailer. Go Airstream and make this your year for carefree vacations.

Contents

Wally Byam Caravans/Clubs	2
Warranty and Service	4
Service Centers	6
Wally Byam Stores	9
Tow Car Equipment	10
Chassis	11
Tires	13
Hitching Up	14
Towing Tips	16
Overnight Stop	19
Extended Stay	20
Winter Airstreaming	24
Storage and Winterizing	24
Exterior	28
Floor Plans	30
Interior	34
L.P.G. System	40
Refrigerator	41
Micro Wave Oven	43
Range/Oven	44
Furnace	46
Water Heater	48
Water System	49
Drain/Waste/Vent Systems	51
Thermasan	54
Electrical System	55
Battery	57
Battery Charger	58
Electrical Trouble Shooting	64
Specifications	65
Lubrication and Maintenance	66
Pre Travel Check List	68
Index	70

Wally Byam Caravans/Clubs

When you bought your Airstream, you bought a whole new way of life. Airstream owners enjoy endless opportunities for friendship, fun and adventure. You may join every **Airstream Wally Byam Caravan and Airstream Company Rally**. We arrange for such rallies each year: one in the North West, South West, North East and South East. You also become eligible to join the **Wally Byam Caravan Club International**, the largest single make trailer club in the world. The **WBCCI** is made up of 22,959 family memberships and 131 local chapters or units throughout the United States, Canada and Mexico. They meet at monthly rallies, or where weather conditions prevent year round rallies, Caravanners come together for pot luck dinners to plan events for the good seasons.

Since the first Wally Byam Caravan in 1951, 89 Airstream Caravans have gone to most parts of the world. Caravans to Canada and Mexico are now so popular that there are eight each year. Many a lifelong friendship was started on these trips. Old-timers and new owners share experiences and find a new kind of fellowship, and there is no better way to learn to use your Airstream. Caravanners enjoy many advantages: the security of traveling in a group, planned entertainment and exceptional sightseeing opportunities. The prestige and good will established over many years by our Caravans adds further benefit to Caravanner membership.



The “**Caravanner**” and the “**Blue Beret**” are the official Caravan Club publications. The bi-monthly “**Caravanner**” is for general distribution to owners and prospective buyers, while the monthly “**Blue Beret**” is for WBCCI members only.

Several months before a Caravan rolls, the “**Caravanner**” and the “**Blue Beret**” publish a description and a registration coupon. Everyone who registers receives a detailed bulletin with complete information on the caravan. When going abroad, all official matters such as insurance, tourist cards and border crossing formalities are handled for you by the Caravan staff.

On every Airstream Caravan, the route is carefully planned, and a day by day itinerary, including mail stops, is given to all Caravan-

ners in advance. Our staff also makes all the arrangements for parking, entertainment, tours, etc. well ahead of the starting date. Airstream Caravan Programs always take caravanners of all ages into account. Airstream provides the Caravan Staff: a leader, a recreation director, a service representative and an advance representative. This staff is backed by committees composed of interested Caravan members who assist in the day-to-day operations.

Wally Byam, pioneer trailer traveler, and founder of the Airstream Company, was born on July Fourth and the first **International Rally** was in the form of a huge birthday party for him at Bull Shoals, Arkansas. It was patterned after the International Rallies in Europe which Wally and his wife Stella had attended for many years. Everyone enjoyed this first big rally so much that the club



decided to make it an annual event. Since then, International Rallies have grown and grown. Some 4,000 Airstream Travel Trailer-families recently gathered at Louisville, Kentucky for the 1972 International Rally.

Only Wally Byam Caravanners and WBCCI members are entitled to have an official **Trailer Number** and be listed in the **Annual Directory**. The Annual Directory contains a schedule of all major rallies and Airstream Wally Byam Caravans for the year, and announces the activities of the Ham Radio, C.B. Radio, Square Dance and the many other WBCCI special interest clubs.

Along with the fun, Airstream owners recognize the need for better legislation, more and better overnight parking facilities, more sanitary stations and other travel conveniences.

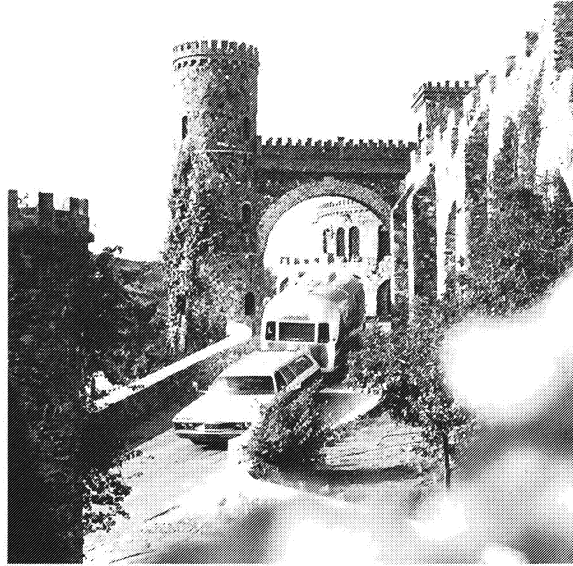

They are alert to adverse bills governing travel trailers and have achieved much through the actions of the strong **WBCCI National Legislative Committee**.

The Way of Life Department, of the Airstream Company dedicates its full time staff to improving the owners' fun and makes use of all the information and experience gained by owners over the years to help develop even better Airstreams.

Become part of the Airstream Way of Life. Join our WBCCI activities and we believe you will enrich your life. Owners join through a local unit of WBCCI. All operate autonomously, elect their own officers and fix their own dues. Annual International dues are paid with the unit dues at the time of application. These are at present: International dues,

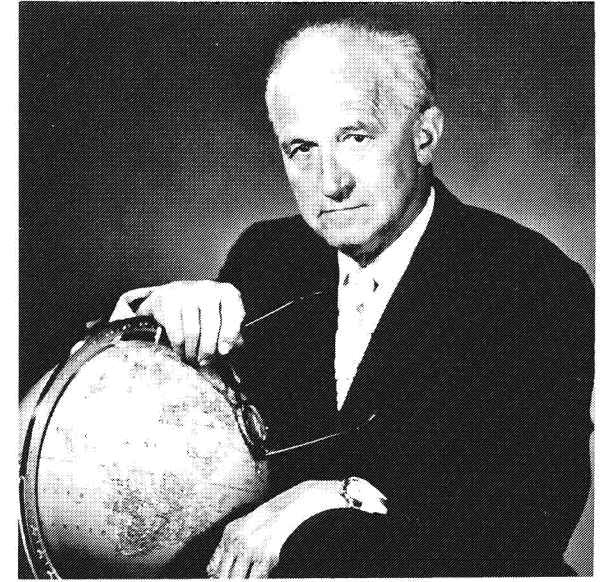

\$5.00 per trailer and unit dues from \$1 to \$5. If you are interested, please write to the following address and we will forward your letter to the unit nearest you:

WBCCI Headquarters Office
15939 Piuma Avenue
Cerritos, California 90701

Warranty and Service

Airstream offers the most complete and explicit warranty in the industry. Your valuable warranty covers every item in your trailer (except tires and battery) against failures resulting from defects in either material or workmanship for two years from date of purchase as the original owner.

Adjustments to appliances, gas pressure or other normal service and maintenance requirements are not a part of the warranty. The warranty is designed to cover defects in material and workmanship.

Your tires and battery are warranted by their respective manufacturers and will be handled by their service centers according to the terms of their written policy.

Please read the facsimile warranty carefully. As soon as the factory has received your signed check-out and acceptance sheet, a formal warranty is issued to you, together with an owner's identification card. As soon as you receive your warranty, please attach it over the facsimile for safekeeping. **In order to qualify for service without charge under the Airstream Warranty Program, your owner's identification card or warranty must be presented to the service representative.**

The Airstream Certified Performance Check-out, or C.P.C., is an exclusive Airstream program. Before leaving the factory, each and

every vital part of an Airstream is tested for performance. Each test is signed and certified by an inspector. After the Airstream arrives on your dealer's lot, all of these vital parts and systems are again tested. When you take delivery of your new Airstream, a factory trained trailer expert personally gives you a complete check-out on the trailer.

C.P.C. does not stop here. After you have traveled with your Airstream for 1000 miles (or 60 days, whichever comes first) you can make an appointment with any one of the 175 Airstream dealers or service centers for still another check-out of your trailer. At that time, a specified list of performance checks on your trailer equipment will be conducted and any deficiencies you have experienced since taking delivery will be corrected. Give the C.P.C. card overleaf to the dealer when you take your Airstream for the 1000 mile check.

Please contact your dealer if you need service. Major service under your Airstream Warranty is available through our nationwide network of factory trained specialists at Airstream Certified Dealer Service Centers listed on pages 6, 7 and 8 of this manual. **All centers operate on an appointment basis for the utmost efficiency.** When you require service from the Airstream factory or a certified service center, please contact the service manager for an appointment, and kindly



inform him if you are unable to keep the appointment date or wish to change it.

Airstream factory service may be arranged by contacting the service manager:

Airstream, Jackson Center, Ohio 45334
(513) 596-6129

Airstream, 15939 Piuma Avenue
Cerritos, California 90701
(213) 860-4411

Airstream Service Manuals are available through the Factory Service Departments for \$15.00 each (see order form to the right).

1000 Mile Check Authorization Card

This card entitles you, under the exclusive Airstream Certified performance checkout program, to a 1000 mile (or 60 day . . . whichever comes sooner) Performance Check of your Airstream travel trailer.

In the event you are traveling or moving, this service may be performed by any franchised Airstream dealer in the United States or Canada but, of course it is recommended that the check-up be performed by your selling dealer because of his logical interest in you as his customer.

We would suggest that you make an appointment with your dealer in advance of your arrival or inspection date.



Authorization for Interim Airstream Warranty

Airstream Serial Number _____ Delivery Date _____

Purchased by: Name _____

Address _____

Purchased from: Name _____

Address _____

This card is valid for 60 days from date of delivery.

1973 Airstream Service Manual Order Form

If you would like more information on the maintenance and specifications of your new Airstream fill in order form completely and mail to:

Airstream Inc.
Jackson Center, Ohio 45334
or
Airstream Inc.
15939 Piuma Avenue
Cerritos, California 90701

Please send me the 1973 Airstream Service Manual, price \$15.00* per copy, to the following address:

Name _____

Address _____

City _____ State _____ Zip Code _____

Enclosed \$15.00* check or money order Please send C.O.D.
payable to Airstream Inc.

*Ohio Purchasers — Add 4% Sales Tax
California Purchasers — Add 5% Sales Tax

Please place your Registered Warranty over this Facsimile within the line, the folded edge on top. There is a glue strip on the back for this purpose.



AIRSTREAM WARRANTY

For the lifetime of the Registered Warranty Holder, or so long as he continues as the original owner of the Airstream Travel Trailer, Airstream warrants the metal shell, frame, axle and axle assembly to and including spindle (excluding shock absorbers) to be free from defects in material and workmanship; all other component parts, including shock absorbers (excluding tires and batteries) are likewise warranted for a period of two years from the date of purchase. Any warranty defects will be corrected without cost upon return of the trailer, or defective part, to any Airstream factory or authorized Airstream service center.

This warranty is in lieu of all other warranties of merchantability or fitness expressed or implied, there being no warranties which extend beyond the description on the face hereof and expressly excludes conditions resulting from normal wear, accident, abuse, exposure or overload.

AIRSTREAM

Ohio factory: 177 West Church Street, Jackson Center, Ohio 45334
California factory: 15939 Piuma Avenue, Cerritos, California 90701



AIRSTREAM WARRANTY

Service Centers

ALABAMA

Alabama Auto Carriage Company
2359 West Fairview
P.O. Box 1695
Montgomery, Alabama 36108

The New Camper City, Inc.
7320 First Avenue, North
Birmingham, Alabama 35206

ARKANSAS

Fred & Jack Trailer Sales
10318 New Benton Highway (I-30W)
Little Rock, Arkansas 72209

ARIZONA

Robert Crist & Company
2025 East Main Street
Mesa, Arizona 85201

Robert Crist & Company
8833 N. Black Canyon Hwy.
Phoenix, Arizona 85021

CALIFORNIA

Bob Belknap Trailer Sales, Inc.
420 South Harbor Boulevard
Santa Ana, California 92704

Caswell Trailer Sales
950 West Foothill Boulevard
Claremont, California 91711

Coastline Trailer Sales
303 North Ventura Avenue
Ventura, California 93001

Haller Trailer Sales
15711 S. Lakewood Blvd.
Paramount, California 90723

Holiday Trailer Sales
770 East Baseline
San Bernardino, California 92410

Nelson's Trailer Sales
28001 Mission Blvd.
Hayward, California 94544

Ralph's Trailer Sales & Supply
1025 East Main
El Cajon, California 92021

Valley Trailer Sales, Inc.
1650 El Camino Avenue
Sacramento, California 95815

Western Motors Rec. Center
1900 Lakeville – Hwy. 116
Petaluma, California 94952

COLORADO

Chisman Trailer Sales
2501 East Boulder Street
Colorado Springs, Colorado 80909

A. A. Airstream Co.
4350 S. Federal Blvd.
Englewood, Colorado 80110

CONNECTICUT

Camperama, Inc.
Mill Plain, Rte. 6
Between Exit 1 & 3, I-84
Danbury, Connecticut 06810

DELAWARE

Richard Rice Trailer Company, Inc.
2343 South Dupont Hwy.
Dover, Delaware 19901

FLORIDA

Bell's Trailer Park & Sales
R.R. No. 4, Box 382
Highway 90, West
Tallahassee, Florida 32310

Campdown U.S.A., Inc.
16500 S. Dixie Highway
Miami, Florida 33157

Carpenter's Campers, Inc.
8450 Pensacola Blvd.
Pensacola, Florida 32501

Cribb's Campers
5408 San Juan Avenue
Jacksonville, Florida 32210

Eldorado Mobile Home Sales
6915 - 14th St. West
Bradenton, Florida 33507

Indian River Trailer Sales
5855 U. S. Highway No. 1
Cocoa, Florida 32922

Indian River Trailer Sales, Inc.
5001 Sand Lake Road
Route 528
Orlando, Florida 32809

C. J. Stoll, Inc.
5985 - 34th Street, North
U. S. 19
St. Petersburg, Florida 33714

GEORGIA

Airstream By Davis, Inc.
9726 Tara Boulevard
US 41-19
Jonesboro, Georgia 30236

Biltmore Gardens Mobile Homes
4707 Ogeechee Road
US Highway 17 South
Savannah, Georgia 31405

Bud K's Kamper Korral
4740 Pio Nono
4646 Houston Avenue
Macon, Georgia 31206

ILLINOIS

Robert Crist & Company
9100 South Stony Island Avenue
Chicago, Illinois 60617

Crystal Valley, Inc. 4220 Northwest H
4220 Northwest Highway
US 14 at Route 31
Crystal Lake, Illinois 60014

Mann's Trailer Sales
1600 North Main
Normal, Illinois 61761

Rocket Trailer Sales
Route 30 and Sixth Avenue
Rock Falls, Illinois 61071

INDIANA

Berning Trailers Sales
5220 New Haven Avenue
Fort Wayne, Indiana 46803

Bert's Trailer Sales, Inc.
R. R. No. 3, Box 17 (East U.S. 20)
Michigan City, Indiana 46360

Brown County Travel Trailers
R. R. 4
Nashville, Indiana 47448

Draper's Auto & Trailer Sales, Inc.
912 State Road, 67 East
Anderson, Indiana 46013

Elkhart Travel Center, Inc.
3008 S. Nappanee Street
Elkhart, Indiana 46514

Four Seasons Trailer Sales Corp.
8225 W. Washington Street
Indianapolis, Indiana 46231

IOWA

Bill Brown Trailer Sales
3700 - 3708 East 14th Street
Des Moines, Iowa 50313

Ace Fogdall, Inc.
5324 University Avenue
Cedar Falls, Iowa 50613

Imperial Sport-A-Rama, Inc.
1727 Ankeny Road
Ankeny, Iowa 50021

Bob La Veine Trailer Sales
890 West Mt. Pleasant Road
West Burlington, Iowa 52655

KANSAS

Boulevard Trailer, Inc.
5617 West Kellogg
Wichita, Kansas 67209

KENTUCKY

Crouch Campers & Trailers
4450 Clarks River Drive
Hwys. 60-62-68 SE
Paducah, Kentucky 42001

Murphy Sales Company, Inc.
Winchester Road (U. S. 60W)
Mt. Sterling, Kentucky 40353

Murphy Sales Company, Inc.
Benson Road
Shelbyville, Kentucky 40065

LOUISIANA

Camper Village
15838 Florida Blvd.
Baton Rouge, Louisiana 70815

Travel Center, Inc.
3625 Industrial Drive
Bossier City, Louisiana 71010

MARYLAND

B & J Trailer Sales
113 South Philadelphia Blvd.
Aberdeen, Maryland 21001

MASSACHUSETTS

Mosher Travel Trailer Centers, Inc.
Blue Jay 4 Corners
Sutton, Massachusetts 01527
Mail to – P. O. Box 228
Milbury, Massachusetts 01527

Donahue's Trailer Sales
88 Mountain Road, Box 126
Burlington, Massachusetts 01803

MICHIGAN

Bob Frank Trailer Sales, Inc.
1416 West Columbia
Battle Creek, Michigan 49015

Kolbe Trailer Sales
4401 East Eight Mile Road
Warren (Detroit) Michigan 48091

Mid-State Trailer Sales, Inc.
5103 Eastman Road
1/2 Mile South of I-75 on U.S. 10
Midland, Michigan 48640

Northwoods Trailer Sales
G-6369 North Dort Highway
Mt. Morris, Michigan 48458

Osborne Camping Center
6939 South Cedar
Lansing, Michigan 48910

Warner Trailer Sales, Inc.
3098 West Huron Street
Pontiac, Michigan 48054

Woodland Travel Center, Inc.
5190 Plainfield Road
Grand Rapids, Michigan 49505

MINNESOTA

Benson's Trailer Sales
3140 Miller Trunk Highway
Duluth, Minnesota 55811

Hart Trailer Sales, Inc.
Highway 71
Long Prairie, Minnesota 56347

Minnesota Trailer Sales, Inc.
11350 Highway 65, N. E.
Minneapolis, Minnesota 55434

Pioneer Trailer Sales
Highway 218, South
Box 12, R.R. No. 2
Austin, Minnesota 55912

MISSOURI

Bill Thomas Camper Sales, Inc.
5217 N. Lindbergh Blvd.
Bridgeton (St. Louis), Missouri 63042

I-44 Recreational Vehicles, Inc.
P. O. Box 93
S. Side Halltown Exit on I-44
14 Mi. W. of Springfield, Mo.
Halltown, Missouri 65664

Kansas City Trailer Sales, Inc.
14817 South 71 Highway
Grandview, Missouri 64030

MONTANA

Northland Travel Center
5124 Laurel Road
Billings, Montana 59101

Modern Equipment Company, Inc.
4025 - 10th Avenue, South
Great Falls, Montana 59401

NEBRASKA

Autosport RV Center
6101 "L" Street
Omaha, Nebraska 68117

NEVADA

"95" Trailer Sales
4339 Tonopah Highway
Las Vegas, Nevada 89106

Webb's Travel Trailers
295 Kietzke Lane
Reno, Nevada 89502

NEW HAMPSHIRE

Currier Travel Trailer Sales, Inc.
R.F.D.
Havehill, New Hampshire 03765

NEW JERSEY

South Jersey Travel Trailer Center, Inc.
Route 47
Franklinville, New Jersey 08322

NEW MEXICO

Gunn's Recreational Vehicles, Inc.
12020 Central Avenue, S.E.
Albuquerque, New Mexico 87123

NEW YORK

Atlantic Trailer Sales
1226 Fairport Road
Fairport, New York 14450

Callahan's Trailer Sales
R. D. No. 1, Route 15
Lindley, New York 14858

Carson Rotary Service
321 Bridge Street
Vestal, New York 13850

Eddy's Trailer Sales, Inc.
4005 Jericho Turnpike
East Northport, New York 11731

Maroone Family Travel Center, Inc.
2550 Walden Avenue
Exit 52, East N. Y. Thruway
Buffalo, New York 14225

Niblack Trailer Sales
691 McLean Avenue
Corner N. Y. Thruway
Yonkers, New York 10704

O'Malley Enterprises, Inc.
P. O. Box 116
Traffic Circle, Rt. 9 & 7
Latham, New York 12110

NORTH CAROLINA

College Park
4208 New Bern Avenue
Raleigh, North Carolina 27604

College Park
North Church Street Ext.
U.S. 301 & 301A, North
Rocky Mount, North Carolina 27801

Faires, Inc.
3217 North Tryon Street
Box 5205, Routes 29 & 49
Charlotte, North Carolina 28206

Out Of Doors Mart, Inc.
Drawer 799
Kernersville, North Carolina 27284

OHIO

Avalon Travel Center, Inc.
11761 Portage Road
Canal Fulton, Ohio 44614

Buckeye Airstream Service & Sales, Inc.
Baltimore Road – Box 13
North of East I-70 on 310 at Route 40
Etna, Ohio 43018

Coachman Camping Center
410 East Sandusky Street
Findlay, Ohio 45840

Marine Mart Trailer Sales
3 mi. S. of I-71 on U.S. 62 & 63
Harrisburg, Ohio 43126

Murphy Travel Trailers of Ohio, Inc.
11526 Chester Road
I-75 at Howard Johnson
Cincinnati, Ohio 45246

P J Airstream Sales, Inc.
5247 Alexis Road
Sylvania, Ohio 43560

Richland Travel Trailers
2607 Emma Lane
I-71 & Route 30
Mansfield, Ohio 44903

*Frank B. Ricketts Mobile Homes -
Travel Trailers*
P. O. Box 583
Clark Street and Maple Road
Cambridge, Ohio 43725

OKLAHOMA

Brassfield Mobilhomes
7207 N. W. 39th Expressway
Bethany, Oklahoma 73008

OREGON

Casade Trailer Sales
1876 Highway 99 North
Eugene, Oregon 97402

Spencer Mobile Homes
9341 S. E. 82nd Avenue
Portland, Oregon 97266

PENNSYLVANIA

Lyle W. Bennett Co. Inc.
Travel Trailer Division
3725 West 12th St.
Erie, Pennsylvania 16505

Farnsworth Camping Center
Route 54
Elysburg, Pennsylvania 17824

Walter H. Glasgow
1650 Lincoln Way, East
Chambersburg, Pennsylvania 17201

Trav-L-Homes
Lewis Road
Royersford, Pennsylvania 19468

Turner Airstream Sales
412 Lincoln Highway, West
Jeannette, Pennsylvania 15644

Universal Motor Sales
1024 North Main Street
Butler, Pennsylvania 16001

Village Green Trailer Sales Company
M. R. 26 (Route 452)
Media, Pennsylvania 19063

F. W. Wise Gas Company, Inc.
209 Bridge Street
Clearfield, Pennsylvania 16830

RHODE ISLAND

Arlington Trailer Sales
966 Quaker Lane, Rte. 2
Warwick, Rhode Island 02818

SOUTH CAROLINA

Dixie Lee Trailer Sales
Highway U. S. 1 & 78
P. O. Box 306
Clearwater, South Carolina 29822

Skyway Mobile Homes
Box 262 - U.S. 25 at 276
4 Mi. N. of Greenville
Travelers Rest, South Carolina 29690

Superior Travel Trailers
7660 Garners Ferry Road
Columbia, South Carolina 29209
P. O. Box 9163

SOUTH DAKOTA

Burt's Trailer Sales
714 North Euclid Avenue
Pierre, South Dakota 57501

Capital City Trailer Sales
801 North Euclid Avenue
P. O. Box 116
Pierre, South Dakota 57501

Milt's Camper Sales
26th Street and Sycamore Drive
Sioux Falls, South Dakota 57103

TENNESSEE

Cullum & Maxey Sales & Servicenter
160 McGavock Pike
Donelson (Nashville), Tennessee 37214

Bobby Jones Trailer Sales
4222 James Road (in Raleigh)
Memphis, Tennessee 38128

Tri City Travel Trailer Sales
Route 1, East Stone Drive
Bristol-Kingsport Highway 11W
Kingsport, Tennessee 37660

TEXAS

Abbott Trailer Sales
408 Avenue Q
Lubbock, Texas 79401

Baker Travel Trailers
4200 East Belknap
Fort Worth, Texas 76117

D & M Trailer Sales
1720 South Nelson
Amarillo, Texas 79103

Otis Thomas Sales, Inc.
2606 Jacksboro Highway
Wichita Falls, Texas 76302

Finn's Trailer Sales
118 Arnold Blvd.
Abilene, Texas 79605

Land Yacht Trailer Sales, Inc.
4616 Titanic Avenue
El Paso, Texas 79904

South Texas Trailers & Supplies
Highway 77, South
P. O. Box 1051
Sinton, Texas 78387

Sportsman Travel Trailer, Inc.
7935 Gulf Freeway, Exit 12
Houston, Texas 77017

Stabmann Sales Company
3336 Austin Highway
San Antonio, Texas 78233

Texas Travel Trailers
1715 N. Stemmons Freeway
Lewisville, Texas 75067

Lloyd's Trailer Sales, Inc.
350 Twin City Highway
Port Neches, Texas 77651

UTAH

Intermountain Trailer Sales
3776 Wall Avenue
P. O. Box 1503
Ogden, Utah 84401

VIRGINIA

American Trailer Sales Co., Inc.
7904 Richmond Highway
Alexandria, Virginia 22306

Bay Camping, Inc.
3757 Bonney Road
Virginia Beach, Virginia 23452

McGeorge Travel Center
6200 W. Broad Street
Richmond, Virginia 23230

Travel Trailers of Va., Inc.
P. O. Box 807
2211 South Main Street
Harrisonburg, Virginia 22801

WASHINGTON

Central Trailer Exchange, Inc.
14433 Pacific Highway, South
Seattle, Washington 98168

Don's Trailer Sales
E. 7217 Sprague Avenue
Spokane, Washington 99206

Tveten Motor Company
45th and Pacific Avenues
Tacoma, Washington 98408

WEST VIRGINIA

Don's Travel Trailers
459 Winfield Road
U.S. 60 at 17
St. Albans, West Virginia 25177

WISCONSIN

Apache R. V. Center
2300 W. Beltline Hwy.
Middleton, Wisconsin 53562

J & M Homes
1360 Velp Avenue
Green Bay, Wisconsin 54303

Mauston Home Sales, Inc.
101 Prospect
Mauston, Wisconsin 53948

Northside Trailer Sales, Inc.
N 56 - W 13180 Silver Spring Rd.
1 Mile W. of Highway 100
Menomonee Falls, Wisconsin 53051

Sweet Trailer Sales
U.S. 51 and U.S. 2
Hurley, Wisconsin 54534

WYOMING

Burman Airstream Company
158 North 3rd Street
Laramie, Wyoming 82070

CANADA

Can-Am Trailers, Ltd.
P. O. Box 370
Highway 4, ½ mile N. 401, Exit 19
Lambeth, Ontario, Canada

Claynor Trailer Sales
4172 - 207th Street, R.R. #2
Langley, B.C., Canada

Totem Trailers, Ltd.
85 Plains Road, West
Burlington, Ontario, Canada

Totem Trailers Ltd.
1701 Dundas Highway East
Mississauga, Ontario, Canada

Travel Trailers Western, Ltd.
5804 - 104 Street
Edmonton 70, Alberta, Canada

Twin City Trailer Sales, Ltd.
P. O. Box 395
Dartmouth Highway
Bedford, Halifax Co., Nova Scotia



Jackson Center, Ohio



Cerritos, California

Wally Byam Stores

To make trailering more enjoyable, there are Wally Byam Stores established at the majority of Airstream dealers. All Airstream dealers have the opportunity of purchasing for you the necessary equipment which would enable you to enjoy your new Airstream trailer to the utmost. The Wally Byam Stores authorized dealerships stretch from coast to coast, and these dealers stock hundreds of items which are tested and approved by travel experts. Be sure and get a Wally Byam Stores Catalog from your dealer or write to:

Wally Byam Stores
Ohio Building
Ohio Avenue
Sidney, Ohio 45365

The following is a list of equipment we recommend:

1. First aid kit
2. Flashlight
3. Fire extinguisher (B:C-type)
4. Emergency road flares
5. Tool box of small hand tools such as: screwdrivers, pliers, crescent wrench, etc.
6. Crosstype lug wrench for trailer wheels
7. Pop rivets and gun
8. Battery booster cables
9. Tire gauge (up to 100 lbs. P.S.I.)
10. Hitch ball lube
11. Small bi-directional spirit level
12. Heavy-duty turn signal flasher
13. Hydraulic jack for trailer axle
14. Four stabilizing jacks
15. Wheel chocks to fit against tires and prevent the trailer from moving while parked
16. Spare tire for single axle trailers
17. Two 50 ft. lengths of 5/8" high pressure water hose spare rubber washers and a "y" connection which enables two trailers to be hooked up to one faucet
18. Two plastic pails for carrying fresh water
19. Quick disconnect garden hose coupling
20. One 6 ft. and one 10 ft. sewer hose and coupler
21. Tote tank drain water and auxiliary waste holding tank and drain hose.
22. Drain cap with hose fitting
23. Holding tank cleaner and deodorizer
24. 75 ft. electric cord with a 30 amp. capacity
25. Cord adapter, 3-15 amp.
26. Spare 20 and 50 amp. cartridge fuses and light bulbs.
27. Can of Spra-Kleen
28. Short handled shovel (G.I. type, Army surplus)
29. Cleaning equipment: broom, sponges, mop, etc.
30. Bathtub stopper

Tow Car Equipment

If you plan to buy a new car to tow your Airstream, we suggest that you include in your purchase the trailer towing options offered by most automobile manufacturers. These include such things as an oversized generator and radiator, heavy duty springs and shock absorbers, automatic transmission cooler, oversized fan, heavy duty flusher unit and others, depending on the make of the vehicle.

Transmissions may be manual or automatic, but an automatic transmission will prolong your car's engine life and does a better job of controlling engine loads than the average driver using a manual shift.

Having adequate power is very important when considering the purchase of a new car or the trailer towing capability of your present one. Emission controls that are required by the Federal Government have reduced overall engine power. To determine generally what the tow capability of your car is, divide the total weight of your trailer by the cubic inch displacement of your automobile engine. This ratio should be between 10 and 20 pounds of trailer weight per cubic inch of engine displacement with 15 pounds per cubic inch considered optimal. For example, with a 31' Airstream weighing 6500 pounds totally loaded for travel and a car with 400 cubic inch displacement engine, divide 6500 by 400 giving a value of 16.25 pounds of trailer

weight per cubic inch engine displacement. This is very close to the optimal value and the automobile should have adequate power for towing the trailer. Remember that engine power is only one indication of the car's towing capabilities; the axle ratio and cooling capabilities certainly must be considered. We suggest you review the owner's manual of your present car and discuss your automobile towing capabilities with your Airstream dealer and your automobile dealer.

The majority of new trailerists carry more food and other supplies than really needed. Remember that every item you take along is one more thing to stow and adds weight to the total load you must pull. Consolidate items in shelves, lockers, and in the refrigerator. It is better to have one full and one empty locker than two half empty ones. Special care must be taken not to overload the front and rear ends of the trailer.

See tire section for correct tire sizes and pressures for your trailer and load on page 13.

Chassis

The Dura-Torque axle is designed to last the life of your trailer without service, except for lubrication of the wheel bearings. Under no circumstances should welding be done on or near the axle.

The Kelsey Hayes Brakes are operated by 12 volt current from your car and **must be hooked up so that you have an integral system with your car brakes.** To prevent problems and insure satisfactory braking action, install a Kelsey Hayes Controller (or equivalent) and selective resistor in line with the controller in your car.

A Kelsey Hayes Controller (or equivalent) installed in your car will synchronize the trailer brakes with your car brakes. It is designed to apply the trailer brakes just before your car brakes. To adjust, turn the handle counterclockwise to apply trailer brakes earlier and clockwise to apply trailer brakes later. The controller will hold this setting.

A selective resistor to match the weight of your trailer to the controller should be installed on the fire wall of your engine compartment. It should be correctly adjusted during installation. However if you wish to change the action of your brakes proceed as follows:

Check the initial trailer brake application with

the controller fully applied (clockwise). If the resistor setting is correct, the controller full "on" position should provide firm braking action just short of skidding on dry pavement. Follow the chart below and change the setting to achieve greater or less braking, as required. The adjustment setting of the controller and the selective resistor should be checked by your dealer during regular maintenance inspection.

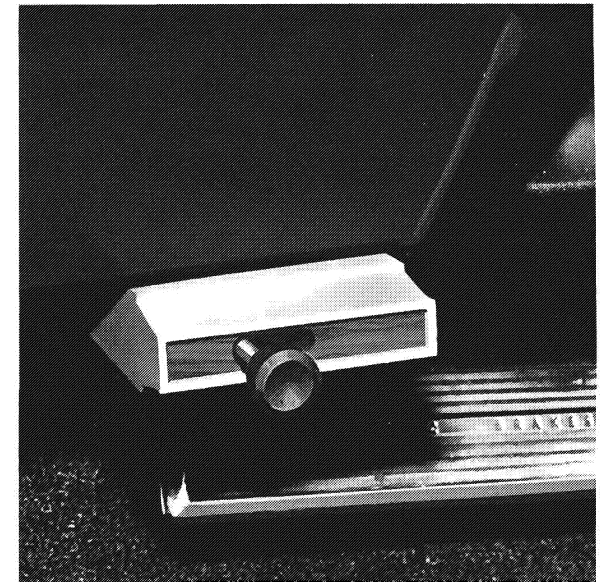

Trailer Brake Controller

Selective Resistor

All settings shown are for 12 volt tow car with 12 volt brakes, and trailers with 2 axle - 4 brake arrangement except where noted.

Model	Trailer Wt. (lbs.)	Setting
21 Ft. S (1 axle - 2 brake)	3500 - 4000	
21 Ft. S 23 Ft. S	3500 - 4000 4000 - 4500	
23 Ft.	4500 - 5200	
25 Ft. 27 Ft.	5200 - 5500 5500 - 6000	
29 Ft. 31 Ft. 31 Ft.	6000 - 6500 6500 - 7000 7000 - 7500	

In the event of an accidental separation of the tow car and trailer, the **break-away switch** is a device which will set and lock the trailer brakes for a sufficient length of time to stop the trailer. The switch is activated when the small pin in the front of the unit is pulled out by the wire attached to it and to the car. **This pin should be pulled out, lubricated with light household oil and replaced every 90 days.**

When the trailer is connected to the tow car, the **break-away switch loop should be attached to the permanent frame of your hitch.** When disconnecting trailer from tow car, remove wire loop from the frame, **do not remove pin from switch, because this will apply the trailer brakes.**

Airstream recommends that your brake system be checked and adjusted by a Certified Service Center. However, in emergencies, to adjust brakes:

1. Remove the small rubber plug at the base of the backing plate on the brake drum.
2. Jack the wheel up so that you can spin it by hand. Tighten the brakes (using a brake adjusting tool or a screwdriver that has been bent to a 90° angle) until the wheel is locked, then back off until you have a free spinning wheel, which will be approximately 8 notches.
3. Repeat this operation with all trailer wheels.

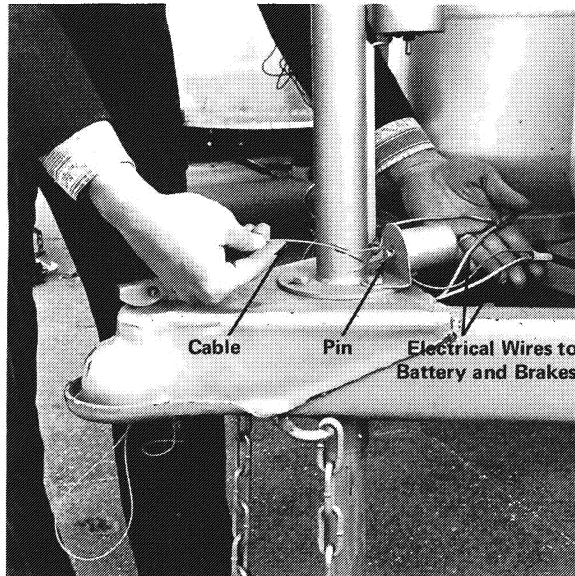

Break Away Switch

Brake Adjustment

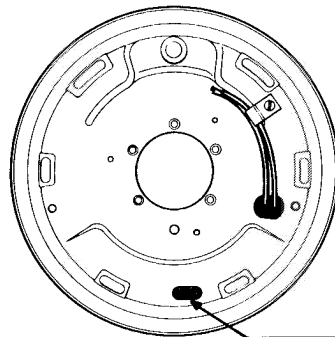

Adjusting hole.

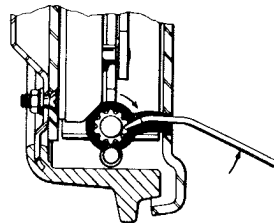

To tighten, turn clockwise.

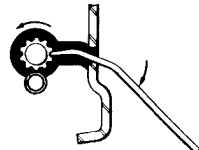

To loosen, turn counterclockwise.

Tires



Tire Changing

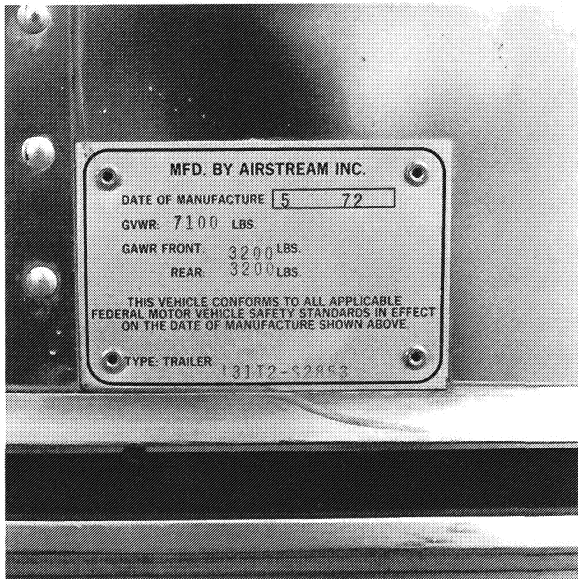

Gross Vehicle Weight Rating

Your Airstream is equipped at the factory with name brand trailer tires. Airstream dealers cannot make adjustments to tires. This must be done by a dealer who handles that particular brand. If you ever have tire problems, check the local telephone directory for the nearest dealer.

To get the maximum performance from your tires check the air pressure often, but only when the tires are cool and never bleed out air immediately after driving. Recommended tire pressures vary with load conditions. For specific pressures refer to the table below.

It is also important to periodically check on the tightness of the lug nuts. They should be tightened to a torque of 110 ft.-lbs. on the standard steel wheel and 60 ft.-lbs. on the optional aluminum/magnesium wheel. If you do not have your own torque wrench, this should be done as tightly as possible with a cross type lug wrench and then verified at a service station.

Park out of the sun in warm climate whenever possible. In desert regions use tire covers to prevent ultra-violet deterioration.

To change a tire with a jack, a 3" aluminum pad is provided on all trailers just to the rear of the wheels and beneath the frame to indicate the proper jack placement position. On tandem axle models a flat tire may be changed without the aid of a jack. Drive the unit up a ramp 8" wide, 6" high and about 3

feet long at the base (see photo).

Be sure to rebalance the hub, drum, wheel and tire assembly each time a tire is changed or rotated.

In an emergency remove the flat tire and the independent suspension of the Dura-Torque Axle allows a four wheel unit to be safely towed on three wheels for a short distance (100 miles maximum) and only at a low speed (30 MPH). Be especially cautious in crossing holes or dips in the road. It is good practice to set your rear view mirrors so that you can observe your tires at all times.

Per Federal Regulations, your trailer is placarded on the front roadside area with a gross vehicle weight rating and a gross axle weight rating. The gross vehicle weight rating is the maximum the trailer can weigh when it is being towed. The gross axle weight rating is the maximum load that can be on each axle when the trailer is being towed. Because of the number of models and options available please check with your dealer or the factory for the amount of available capacity for personal cargo in your Airstream.

Tire Pressure

7.00-15	6-ply	40 p.s.i.
7.00-15XC steel radial	6-ply	52 p.s.i.
7.00-15	8-ply	60 p.s.i.

Hitching Up

Hitching your Airstream trailer is something that will become almost second nature with practice. However, there are a few tips, learned from experience, which will help you.

The electric jack is strongly recommended for anyone who, for any reason, should not physically exert himself. Available as a factory option or through the Wally Byam Stores, the electric jack makes hitching and unhitching a much easier operation.

Steps for Hitching Up

1. Jack up the trailer hitch until there is clearance for the hitch ball to slide under, remove safety pin and raise the locking lever.
2. Back the car straight back to the hitch. This can best be accomplished through the use of pre-arranged hand signals with the help of another person, but if you are hitching up by yourself we recommend the use of a hook-up view mirror.
3. Lower the trailer hitch onto the hitch ball; then close the locking lever and insert safety pin. Note the height of the hitch ball.
4. Now raise the trailer and car to the full height of the hitch jack and then attach the leveling bars. Lower the car and trailer and note the height of the hitch ball. The object is to adjust the tension on the load leveling bars so that the car and trailer are held up about 1" higher at the hitch ball than before the bars were attached. This will result in the best balance for towing and steering control as the weight equalizing hitch transmits the hitch weight of the trailer via the load leveling bars

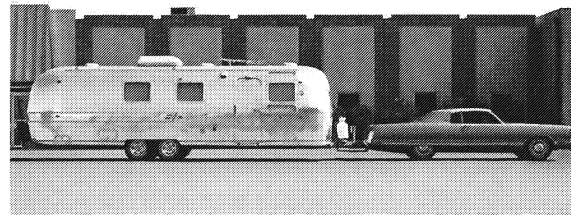

Hitch Installation Proper – Hitch ball slightly higher.

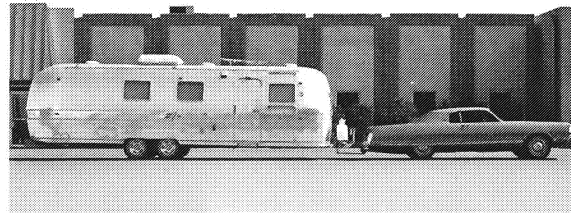

Hitch Low – Load on front wheels too light. Need more tension on load equalizing bars.

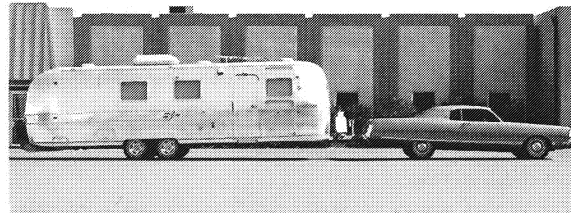

Hitch High – Load on front wheels too heavy. Too much tension on load equalizing bars.

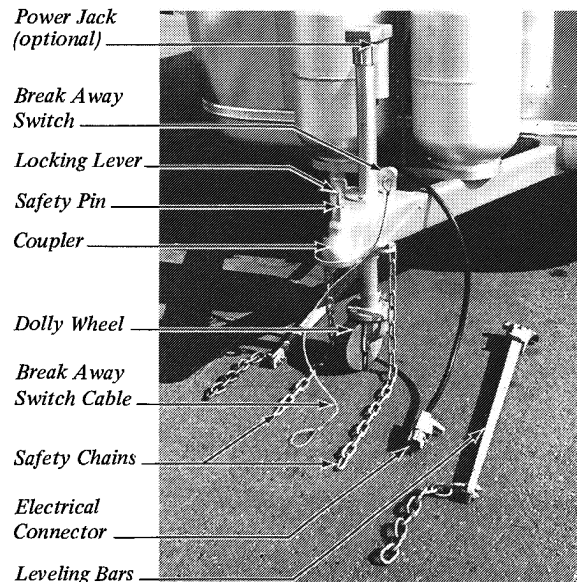

Power Jack (optional)

Break Away Switch

Locking Lever

Safety Pin

Coupler

Dolly Wheel

Break Away Switch Cable

Safety Chains

Electrical Connector

Leveling Bars

Hitching Up Equipment

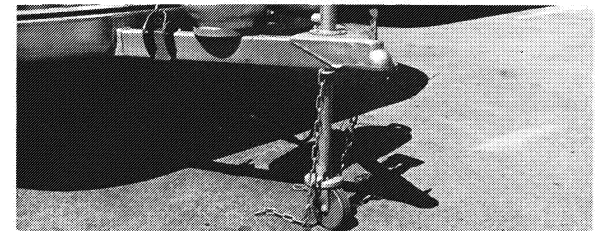

Hitching Up Step 1.



Step 2.

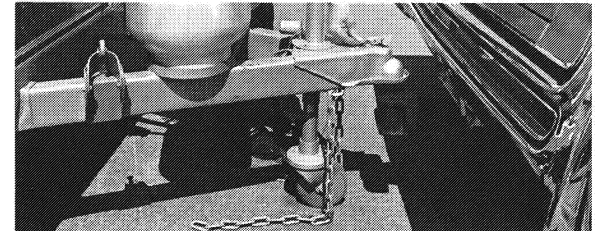

Step 3.

onto all four wheels of the car. A little practice with your rig will teach you how far to pull up the bar, and you may wish to mark the chain links that match your rig. Always choose level ground for checking correct hook-up. For further information see hitch manufacturers' literature.

Note: If your car is equipped with adjustable load leveling air shocks, you must load the car first with typical luggage and passengers and bring it back to level. Then attach the trailer and adjust the load leveling bars. Otherwise the air shocks on your car will overload the rear wheels.

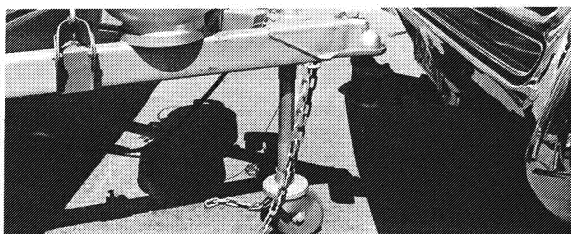

Step 4.a.



4.b.

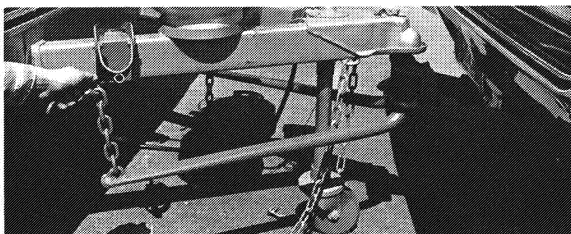

4.c.

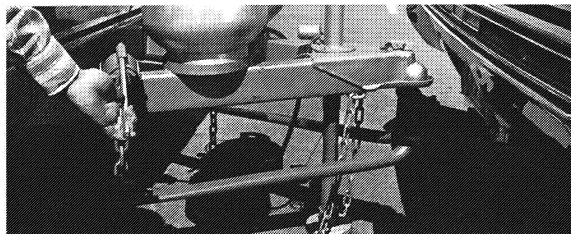

4.d.

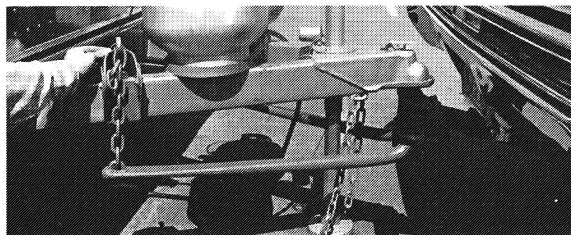

4.e.

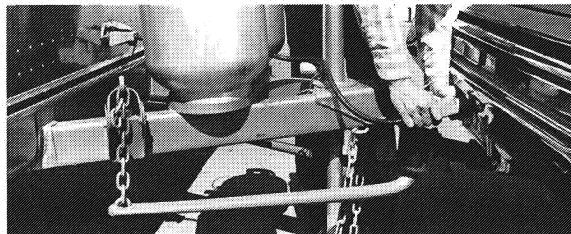

Step 5.

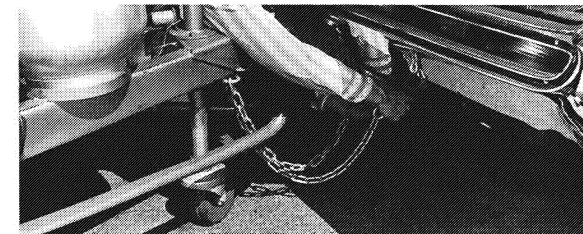

Step 6.a.

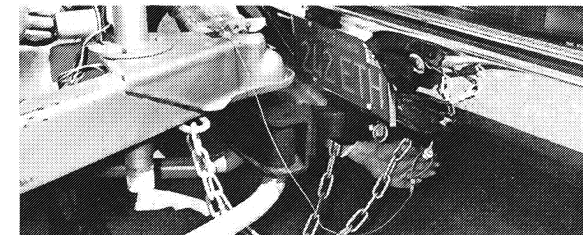

6.b.

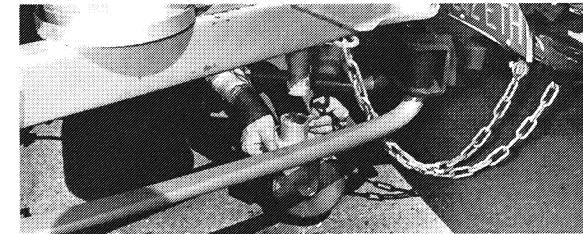

Step 7.

The hitch ball on your car should be installed at a height of 19-1/2" to the top of the hitch ball, measured when the car is unloaded.

A low hitch ball increases tailwagging tendencies by lowering the nose of the trailer thus changing the center of support for the trailer and reducing the weight on the front wheels of the car.

5. Plug in the **electrical connector cord** and check running, directional, and brake lights. The electrical connector cord should be completely removed and stored when not in use.

6. Attach the **break-away switch cable** and the **safety chains** to the welded portion of the hitch or the car's frame, but never to the

removable ball mount. Cross the safety chains under the hitch.

7. Retract the hitch jack completely for maximum ground clearance. Remove the **dolly wheel** and **jack pad**, and stow them in the car's trunk, along with leveling jack and other gear used when stopped. Never tow your trailer with the jack down or the dolly wheel on. Check that the fold-away step is up and that the main door is completely closed and locked for towing. If it is not locked the constant vibration of travel may cause it to open with possible damage.

8. Move the rig ahead about 50 feet and test the trailer brakes, then check the ground for forgotten objects. Regularly check the condi-

tion of your tires, air pressure, and the tightness of the lug-nuts. For specific tire pressures refer to page 13.

Towing Tips

A few hours of towing practice in a large empty supermarket parking lot will make pulling your Airstream over the road much easier. Line out two corners for both left and right turns. You may also use these corners to practice backing and parking. **Observe that the tracks made by the trailer wheels are distinctly different from those made by your car.** Studying this will make it easier for you to correct mistakes. Truck or trailer type fender or door grip rear view mirrors are a must for maximum visibility and in most States they are required by law.

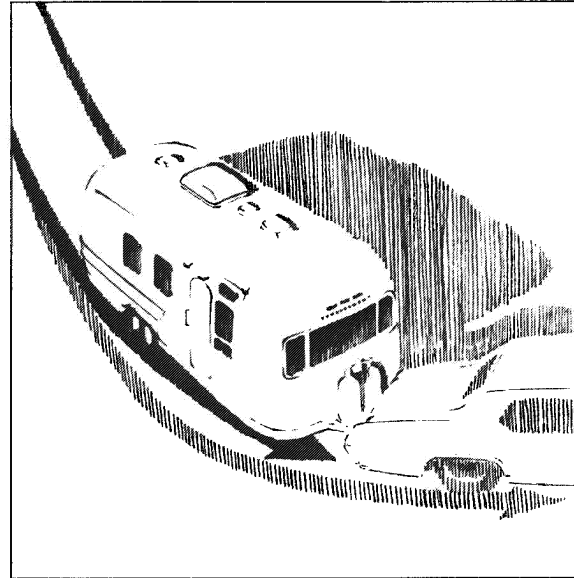

Tracking

You are now ready to tow. After checking the traffic, signal that you are about to pull away and start slowly. Look often in your mirrors, and observe the action of the trailer, then carefully move into the proper lane of traffic. Remember that the trailer wheels will not follow the path of the car's wheels, therefore, **wider turns are necessary when turning to the left or to the right.**

On freeways or expressways try to pick the lane you want, and stay in it. Always maintain plenty of space between you and the car ahead, at least the length of the car plus trailer, for every ten miles per hour. Remember that in order to pass another vehicle, you will need longer to accelerate. You must also allow for the length of the trailer when returning to the right hand lane. On a two lane road, cars will be lining up behind you because you travel at a lower speed. It is both courteous and sensible to signal, pull onto the

shoulder, and let them pass. Your Airstream is designed to be towed easily at any legal speed, so if you are not careful you may be inclined to forget it is there. Your car brakes will automatically apply the trailer brakes first if properly adjusted. This will make you stop as if you were driving the car alone and keep your car and trailer in a straight line.

When trailering, you might encounter a temporary cooling system overload during severe conditions — such as hot days when pulling on a long grade, when slowing down after higher-speed driving, or driving long idle periods in traffic jams. If the hot indicator light comes on and you have your air conditioning turned on, turn it off. If the light doesn't go off in about a minute, pull over in a safe place and put on your emergency brake. Don't turn off the engine. Increase the

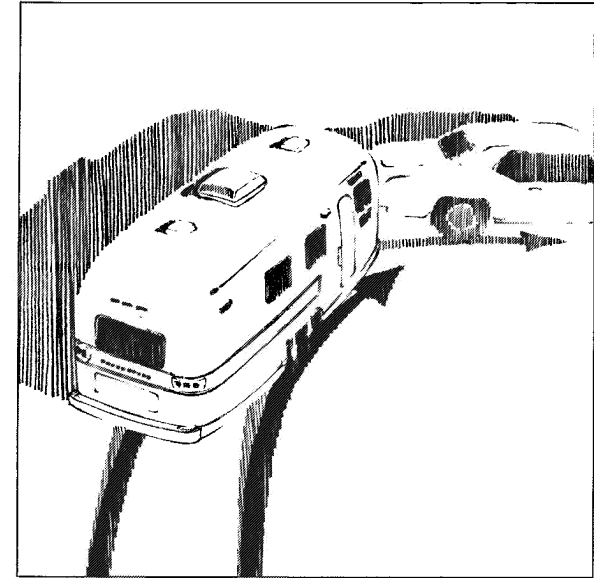

engine idle speed. Lift the engine hood and check for fluid leaks at the radiator hoses, radiator or radiator overflow outlet. Check to see that all drive belts are intact and the fan is turning. Light should go off within one minute. When the light is out, proceed on the highway a little slower. Ten minutes later resume normal driving. Caution: Never open a radiator cap when the car is hot! Check the car coolant level when the car is cool.

When going downhill in dry weather, down shift so that engine compression will slow the whole rig down. Take dips and depressions in the road slowly and do not resume normal driving speeds until you are sure that the trailer wheels are clear of the dip.

On slippery pavement do not use engine drag to help slow down as this may cause the rear

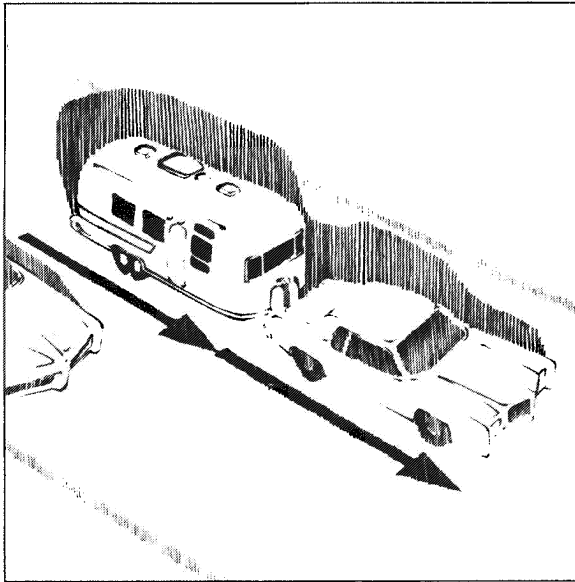

Passing

wheels of the car to skid. On icy pavement drive slowly and if you feel the car is skidding, gently apply the trailer brakes only. This will bring the car and trailer back into a straight line. Chains do not help trailer wheels.

When driving in mud and sand let the momentum carry the rig through. Apply power gently and use as little as possible. Stay in the tracks of the vehicle ahead and keep the car in the highest possible gear. If you do get stuck it is best to tow out both car and trailer together without unhitching.

If you have to tow long distances over bad roads, the stones and gravel thrown back by your tires will dent and scratch the aluminum finish of your Airstream. To prevent this, use masking tape to secure heavy sheets of card-

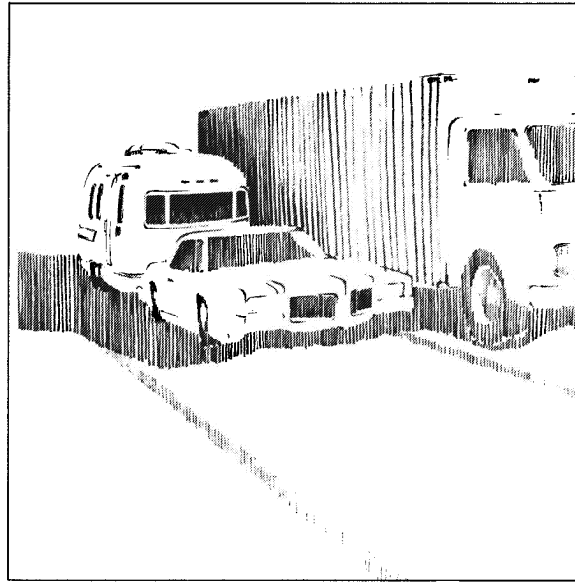

board to the lower front end of the trailer.

Despite the best hitch, you will notice that whenever a large bus or truck overtakes your rig the displaced air first pushes the trailer rear to the right and then affects the front. **Do not apply the brakes.** Steer very slightly, momentarily, toward the bus or truck. This will compensate for the sway induced by the passing vehicle.

When stopping on a hill or slope, leaving your car in gear is not enough for stand-still-safety. **Chock the trailer wheels** to be doubly sure. Never use the break-away switch as a parking brake because it will burn out the magnets and drain the trailer battery.

Backing Up

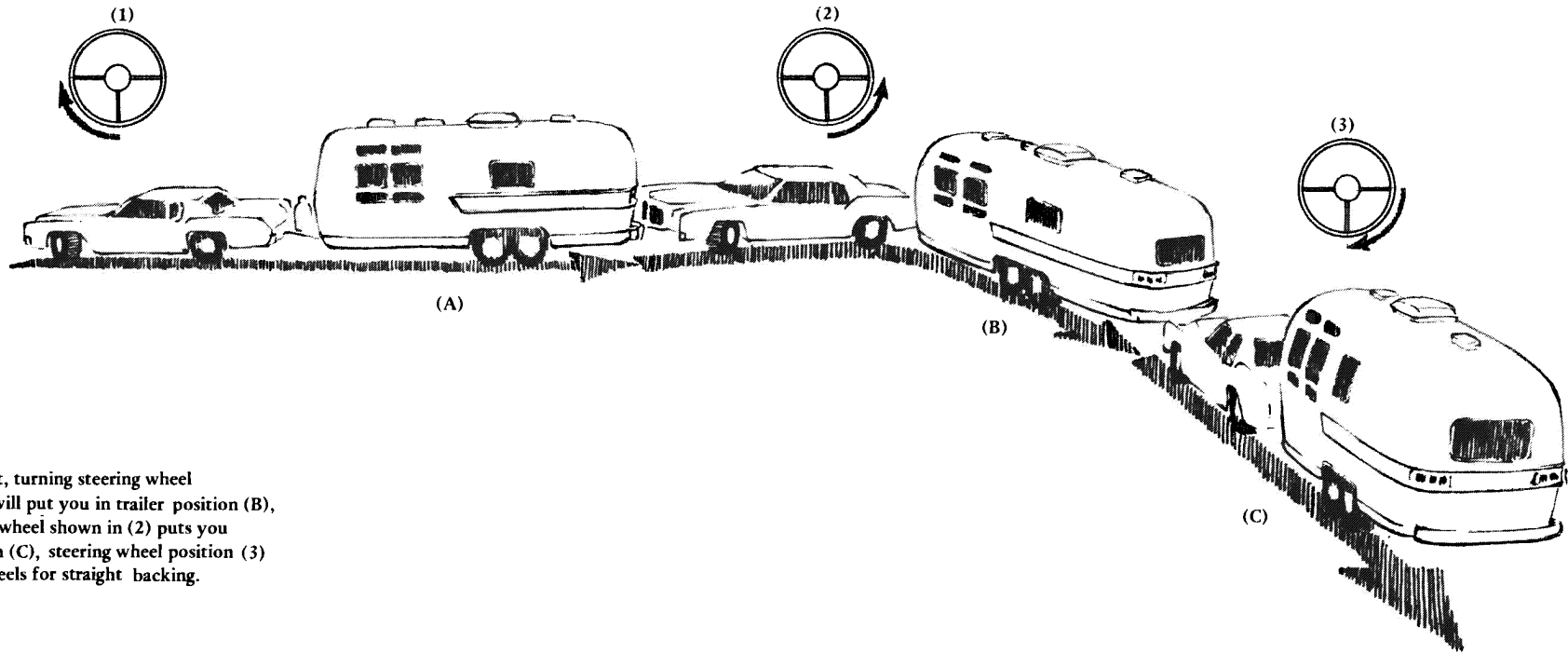

Position (A) start, turning steering wheel as shown in (1) will put you in trailer position (B), turning steering wheel shown in (2) puts you in trailer position (C), steering wheel position (3) returns front wheels for straight backing.

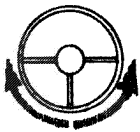

Indicates steering direction

In backing up, the important thing to remember is to **do everything slowly** and to correct immediately if you see the trailer turning the wrong way. Concentrate on the rear of the trailer. With your car and trailer in a straight line, back up slowly and turn the bottom of the steering wheel in the direction you want the trailer to go. Watch out the window or in the mirror until the rear of the trailer is pointing in the desired direction. Then turn the steering wheel in the opposite direction.

Your car will be following the trailer in an arc. Straighten the car and trailer by turning the steering wheel more sharply, then when they are in line, straighten the steering wheel. **Always try to back to your left because the visibility is much better.** (See illustration.) When you don't make it on the first try it is usually much easier to pull forward to your original position and start over.

Overnight Stop

Airstream owners have parked virtually every place imaginable from filling stations to farm lands. In time you will develop a knack for spotting wonderful little roadside locations by turning off the main highway and exploring. See the end of this section for applicable state laws.

There are many modern trailer parks including State, County and Federal parks with good facilities, where you may obtain hook-ups of electrical, water and sewer connections. Directories are published which describe in detail these parks and tell what is available in the way of services and hookups.

On overnight or weekend trips, chances are you will not use up the capacity of the sewage holding tank, deplete the water supply or run down the battery which supplies the 12 volt current.

On a longer trip, when you have stayed where sewer connections and utility hook-ups were not available, it will be necessary for you to stop from time to time to dispose of the waste in the holding tank and replenish the water supply. Many gas stations (chain and individually owned) have installed **sanitary dumping stations** for just this purpose. Booklets are available which list these dumping stations.

When stopping for the night your Airstream is built to be safely parked in any spot that is relatively level and where the ground is firm.



Your facilities are with you, you are self-contained. Unless the car is needed for transportation, it is not necessary to unhitch. Try to pick as level a parking spot as possible. **Stabilizing jacks or blocks** probably won't be required for an overnight stay; however if you put the jack pad on the hitch jack and run the hitch jack down to take the weight off the car's springs this will provide some stability. If you must park on a slope, **park facing downhill**; it is easier to level the Airstream this way.

All you need to do to enjoy the self-contained luxury of your Airstream is to:

1. Light the water heater, refrigerator and furnace pilots if required. See pages 40-48 for complete details on LPG system and gas operated appliances.
2. Turn on the gas supply at the range and light the pilot.

Before moving on, check your campsite, both for cleanliness and also to be sure you haven't left anything behind, turn off the gas supply petcock to the range and make sure everything is properly stowed. Use your Pre-Travel Check List on page 67 and you are ready for more travel adventure.

Extended Stay

Making a long trip in your Airstream is not very different from making a weekend excursion. Since everything you need is right at hand you are at home wherever you go. When packing for an extended trip take everything you need, but only what you need.

When you plan to stay in the same place for several days, weeks, or months, you will want your trailer to be as level and steady as possible. Check the attitude of your Airstream with a small spirit level set on the inside work counter or the trailer hitch "A-Frame." If a correction is necessary then you must level from side to side first. This can be done most easily up a small ramp consisting of 2" x 6" boards about four feet long and tapered at both ends. (See photo) We do not recommend placing tires in a hole for leveling.

Level from front to rear by disconnecting the hitch from the car, putting the jack pad under the hitch jack and adjusting the jack up or down until you are level. Block or chock the wheels to keep the trailer from rolling. Use stabilizing jacks at all four corners, as shown, to eliminate the natural spring action of the axles. If you have B.A.L. stabilizing jacks (optional) use the wrench, located in the hose carrier, to lower the two units on the low side. Bring trailer to a level position side to side. Lower opposite stabilizing units to a firm position.

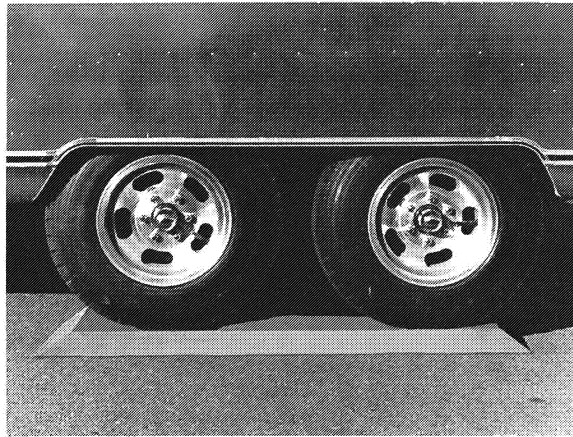

Trailer Leveling

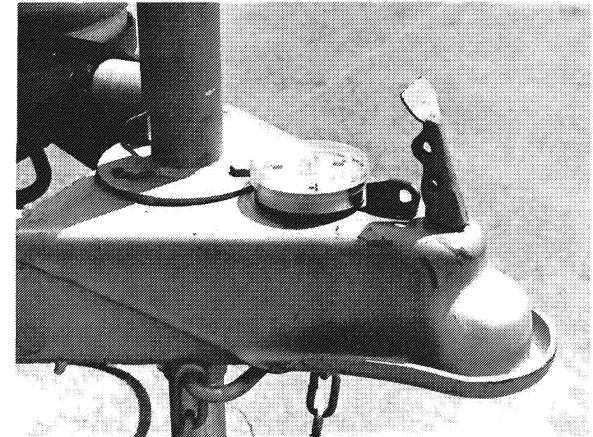

Spirit Level

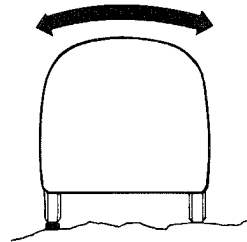

1. Level from Side to Side

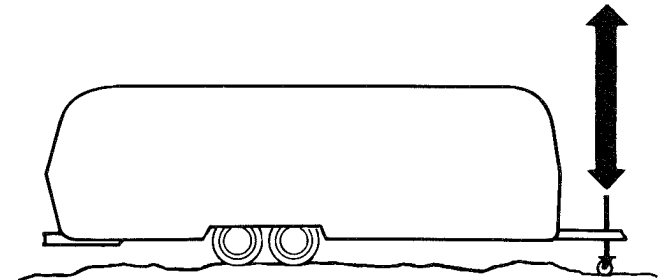

2. Level from Front to Rear

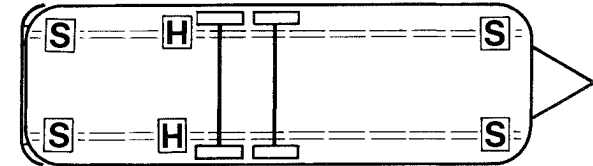
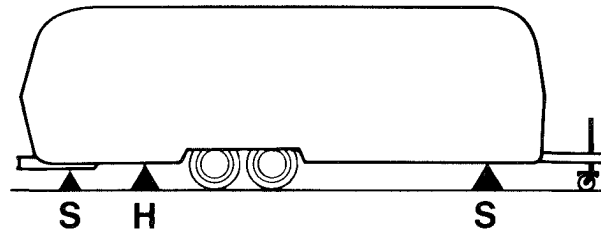

H - Hydraulic Jack Positions
S - Stabilizing Jack Positions

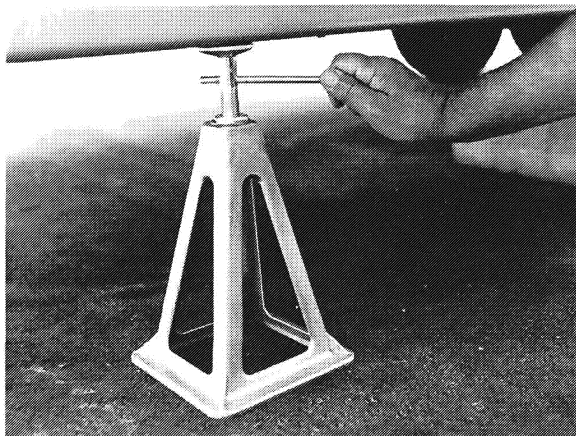

Stabilizing Jack

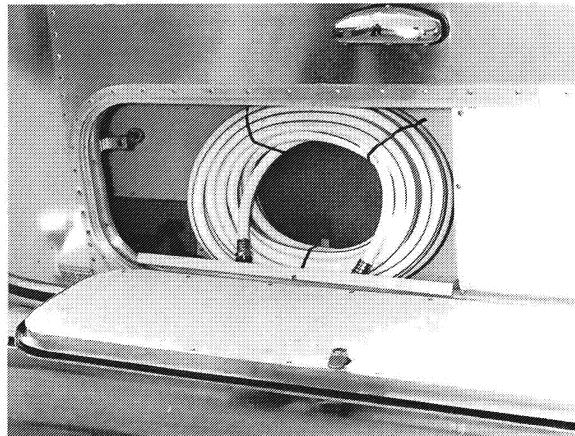

Water Hose Storage

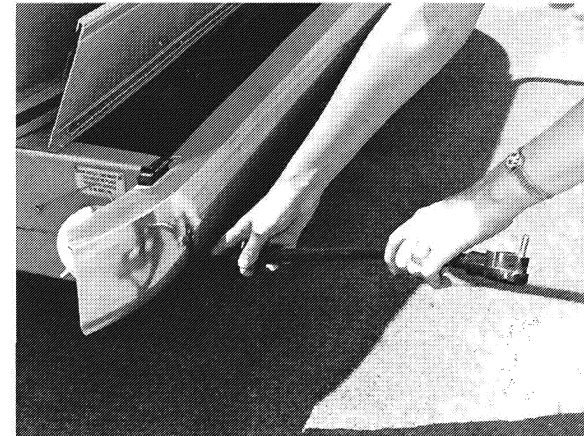

120 Volt Electrical Cable

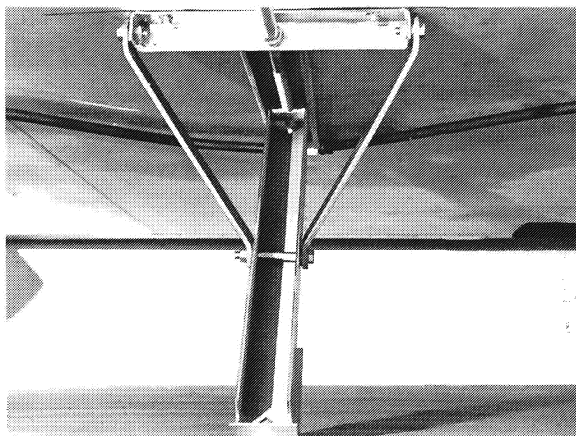

B.A.L. Stabilizing Jack



City Water Hook-Up

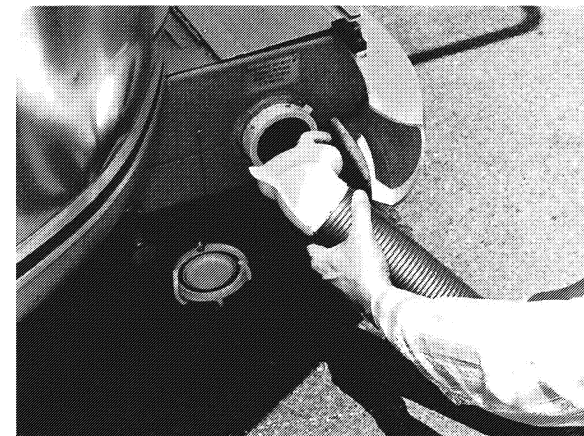

Waste Drain Hose Hook-Up

Note: Whenever the trailer must be lifted with a jack, as when changing a tire or leveling on very rough terrain, **always place the jack under the main frame rail.** A 3" aluminum pad is provided to indicate the proper position for the jack. Never use stabilizing jacks to lift the trailer.

Hook up to water by attaching a 5/8" high pressure water hose to the city water service.

Plug the **electrical cable**, which is stored in the bumper storage compartment into the **city power service.** Be sure you have the wire grounded and have the proper polarity. See page 54 for technical details.

Hook your **waste drain hose** into the sewer disposal facility and attach to the drain outlet in your trailer. For details on this procedure refer to page 51.

Turn on gas supply; light the range and oven pilots, light the water heater, refrigerator and furnace pilots.

State Laws

Trailer traveling through our United States requires a knowledge of many state regulations. Here is a brief summary of three of these regulations.

MSL: Maximum Speed Limit of vehicles towing a trailer.

OS: Permissibility of making Overnight Stops on highways or roadside rest areas.

DOG: Permissibility of keeping a dog overnight in State or County parks.

NOTE: State laws may change after the printing of this manual. Watch carefully for posted signs.

ALABAMA

MSL: 70 mph days, 60 mph nights on open highway.

OS: Permitted unless otherwise posted.

DOG: Not allowed.

ALASKA

MSL: 60 mph.

OS: Permitted off highway.

DOG: Permitted in state parks at night.

ARIZONA

MSL: As posted

OS: Permitted at roadside rest areas unless otherwise posted.

DOG: Permitted if leashed in state and county parks

ARKANSAS

MSL: 75 mph days, 65 mph nights.

OS: Permitted off highway where posted.

DOG: Permitted if leashed in state and county parks

CALIFORNIA

MSL: 55 mph.

OS: Not permitted.

DOG: Allowed if leashed.

COLORADO

MSL: 60 mph open highway, 40 mph open mountain hwy.

OS: Not permitted.

DOG: Permitted if leashed in state and county parks.

CONNECTICUT

MSL: As posted.

OS: Permitted where posted.

DOG: Permitted if leashed in state and county parks, one pet per campsite. Not permitted on beaches at any time.

DELAWARE

MSL: 60 mph days, 45 mph nights.

OS: Permitted unless posted.

DOG: Allowed if leashed

DISTRICT OF COLUMBIA

MSL: As posted.

OS: Permitted

FLORIDA

MSL: 60 mph days, 55 mph nights.

OS: Not permitted

DOG: Daytime only on leash.

GEORGIA

MSL: 60 mph.

OS: Not permitted.

DOG: Dogs must be kept on leash at all times.

HAWAII

MSL: Set by local ordinance.

OS: Permitted off highway.

IDAHO

MSL: 70 mph days, 60 mph nights.

OS: Permitted.

DOG: Permitted in state and county parks if leashed.

ILLINOIS

MSL: 55 mph.

OS: Permitted.

DOG: Permitted in state parks if leashed.

INDIANA

MSL: 65 mph, 70 mph on interstate highways.

OS: Not permitted.

DOG: Permitted in state parks if leashed.

IOWA

MSL: 65 mph days, 55 mph nights.

OS: Permitted unless posted.

DOG: Permitted on 6 foot leash.

KANSAS

MSL: 70 mph days, 60 mph nights.
OS: Permitted in rest areas.
DOG: Permitted if leashed, except on beaches.

KENTUCKY

MSL: 70 mph nights, 60 mph nights.
OS: Permitted off highway.
DOG: Permitted in state and county parks if leashed.

LOUISIANA

MSL: 60 mph.
OS: Permitted where posted.
DOG: Permitted in state parks if leashed.

MAINE

MSL: 70 mph days, 60 mph nights.
OS: Permitted.
DOG: Permitted if leashed.

MARYLAND

MSL: 45 mph.
OS: Allowed.
DOG: Permitted in state forests, but not state parks.

MASSACHUSETTS

MSL: 50 mph days, 40 mph nights.
OS: Determined by local
DOG: regulations.
Permitted on leash.

MICHIGAN

MSL: 50 mph.
OS: Not permitted.
DOG: Permitted if leashed.

MINNESOTA

MSL: 65 mph.
OS: Permitted where posted.
DOG: Permitted on 6 foot leash.

MISSISSIPPI

MSL: 65 mph.
OS: Permitted.
DOG: No information available.

MISSOURI

MSL: 70 mph days, 65 mph nights.
OS: Not permitted.
DOG: Only on leash of 10 ft. or less.

MONTANA

MSL: 50 mph.
OS: Permitted as posted.
DOG: Permitted if leashed.

NEBRASKA

MSL: 75 mph days, 65 mph nights.
OS: Not permitted.
DOG: Permitted in state parks if leashed. Check at county parks.

NEVADA

MSL: "Reasonable and proper," or as posted.
OS: Permitted.
DOG: Permitted if leashed; household pets only.

NEW HAMPSHIRE

MSL: 45 mph.
OS: Permitted.
DOG: Permitted in state parks if leashed.

NEW JERSEY

MSL: 60 mph days, 50 mph nights.
OS: Permitted.
DOG: Permitted in state and county parks on 7 foot leash and attended at all times.

NEW MEXICO

MSL: 60 mph.
OS: Permitted off highway.
DOG: Permitted if leashed.

NEW YORK

MSL: 65 mph days, 55 mph nights.
OS: Emergency parking only.
DOG: Permitted if leashed and proof of rabies inoculation; not permitted in Long Island and Palisades state parks.

NORTH CAROLINA

MSL: 55 mph.
OS: Permitted.
Permitted in state parks on
DOG: 6 foot leash.

NORTH DAKOTA

MSL: 50 mph.
OS: Permitted.
DOG: Permitted on leash.

OHIO

MSL: 70 mph days, 60 mph nights.
OS: Permitted.
DOG: Not permitted.

OKLAHOMA

MSL: 60 mph days, 55 mph nights.
OS: Permitted where posted.
DOG: Permitted if leashed.

OREGON

MSL: 70 mph days, 55 mph nights.
OS: Permitted where posted.
DOG: Permitted if leashed.

PENNSYLVANIA

MSL: As posted.
OS: Permitted.
DOG: Not allowed.

RHODE ISLAND

MSL: 60 mph days, 50 mph nights.
OS: Permitted off highway.
DOG: Permitted on 6 foot leash.

SOUTH CAROLINA

MSL: As posted.
OS: Not permitted.
DOG: Must be on leash.

SOUTH DAKOTA

MSL: 75 mph days, 70 mph nights.
OS: Permitted off highway.
DOG: Check at parks.

TENNESSEE

MSL: 65 mph.
OS: Not permitted.
DOG: Permitted in state parks if leashed.

TEXAS

MSL: 60 mph.
OS: Permitted.
DOG: Permitted if leashed.

UTAH

MSL: As posted.
OS: Permitted off highway.
DOG: Permitted if leashed.

VERMONT

MSL: As posted, day, 65 mph night.
OS: Permitted off highway in emergency.
DOG: Must be on 7 foot leash and have proof of rabies inoculation.

VIRGINIA

MSL: 65 mph days, 55 mph nights.
OS: Permitted off highway.
DOG: Permitted if leashed.

WASHINGTON

MSL: 50 mph. Nights use posted truck speeds.
OS: Permitted.
DOG: Permitted if leashed.

WEST VIRGINIA

MSL: 70 mph days, 55 mph nights.
OS: Not permitted.
DOG: Permitted if leashed.

WISCONSIN

MSL: 70 mph days, 65 mph nights.
OS: Not permitted.
DOG: Permitted at state parks if leashed.

WYOMING

MSL: As posted.
OS: Not permitted.
DOG: Permitted in state parks if leashed.

Winter Airstreaming

Traveling in an Airstream during the cold winter months can be one of the most exhilarating experiences in all trailering. When we speak of cold, we are talking about temperatures of zero to -10 degrees. Airstreams properly outfitted with thermopane windows have been cold-soaked at -20 degrees with no adverse effects and with no real discomfort. Thermopane side windows which are offered as an option, do not require storm windows and improve the efficiency of the heating system.

Additionally a battery charger, that operates off the trailer's gas system, is available as an option. We recommend this option when you are planning extensive winter usage.

There are of course certain precautions which must be taken as you would in your own home in low temperatures.

1. There should be heat in the trailer at all times.
2. You must have a plentiful supply of propane gas.
3. If your stay is longer than overnight (and you do not have the battery charger option), then you should endeavor to have 110 V electricity available. The battery (fully charged) will not last more than about 18 hours in zero weather. Of course you can always run your car to recharge the battery and normally the battery will attain sufficient power to run another 9



hours by running your engine for approximately 45 minutes to one hour at fast idle. For more detailed information on the battery see page 57.

4. Minimize use of electricity if 110 volt power source is not available.
5. Your Airstream has forced air heating in the holding tank and trunk area. There is also heating around the water tank.

Storage and Winterizing

When storing your trailer for short or long periods use the same precautions as you would in your own home in regard to perishables, ventilation and rain protection. In addition, for prolonged storage periods, flush out all the drain lines and the holding tank. Also, drain the entire water system including the water heater and the water storage tank. Instructions for draining the water system are explained in the following paragraphs on winterizing.

Twice a year or after a long storage period, we suggest you take your unit in for a check-up and cleaning of the gas operated appliances.

The main consideration in winterizing is to guard against freezing damage to the hot and cold water systems, the waste drain system (including the traps), the waste-holding tank, the water heater and the battery. To completely winterize your Airstream, follow this procedure:

1. Level the trailer from side to side and front to rear. Open all the faucets.
2. Turn the water pump switch to the OFF position.
3. Open all drain valves. On International rear bath models, two are located in the rear trunk (roadside), and three are under the galley sink. On International center bath models, one is located under the bed on the roadside and three are under the

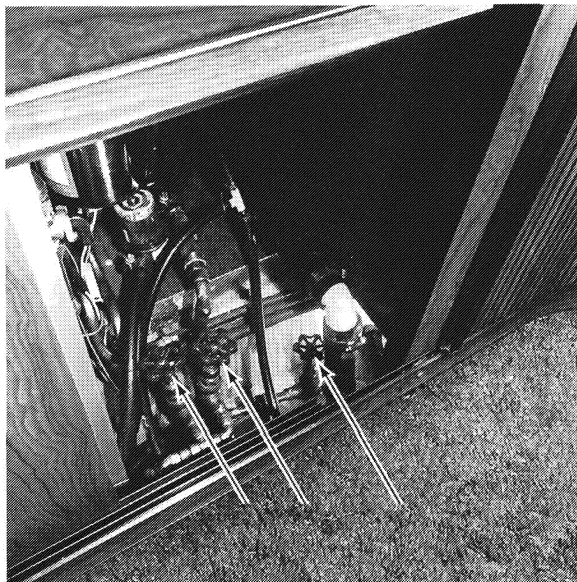

Water Drain Valves Galley (Int'l.)

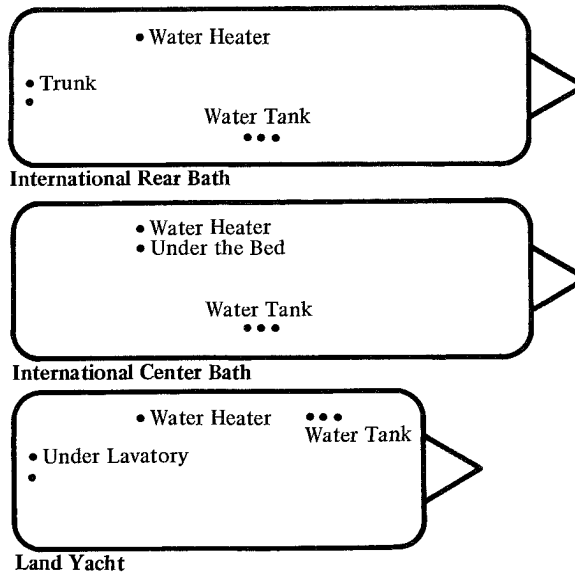

• Drain Valve Locations

galley sink. On Land Yacht models, two are in the cabinet below the bathroom lavatory and three are under the galley sink. On all models one is located on the water heater accessible through the exterior access panel.

4. While the water is draining from the system, open and flush the toilet flushing valve. Depress hand spray thumb button and hold the spray head below rim of the toilet and drain the hand spray line. There is danger of damage from freezing if water remains in these lines and valves. Drain all water from telephone showerhead flexible hose.
5. Lower the front of the trailer as far as the jack will allow until water ceases to drain, then crank the jack up as high as it will go and let any remaining water drain out the rear drain valves.
6. After the water has stopped running from the drain lines, apply air pressure, if available, to the drain lines with all drain valves and faucets still open. This will force any remaining water from the water heater and remove any water which may be trapped in low areas.
7. Pour a cup of antifreeze (Glycol) into the lavatory, sink, and tub drains to prevent freezing of water in traps.
8. Be sure to open the waste-holding tank drain valve and drain and flush the tank thoroughly. (This is very important as the sewage in the tank, if frozen, could seriously damage the tank.)
9. Remove the lower portion of the water purifier, if your trailer is so equipped, and drain the purifier.
10. Disconnect the inlet and outlet connections of the water pump and turn the

pump by hand until all the water is expelled.

11. It is very important for optimum life of your battery to check it periodically and to keep it fully charged. This is especially true in winter months when the temperature may drop below freezing. Please refer to the battery section for more information on battery maintenance.
12. Remove any items (food, cosmetics, etc.) from trailer interior that might be damaged by freezing — or might damage the trailer if containers break.

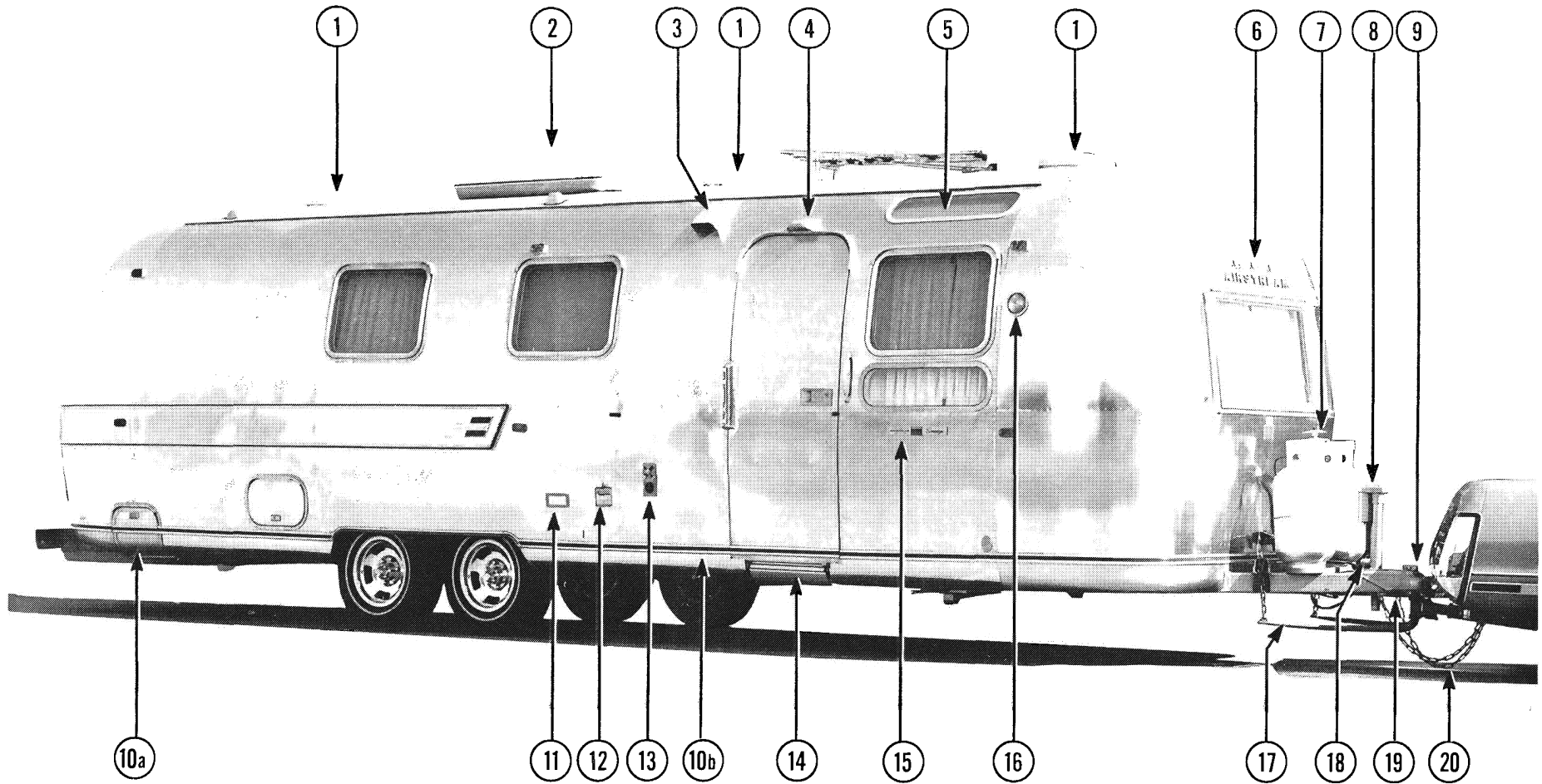

Exterior Identification

No.	Description	Page No.	No.	Description	Page No.
1.	Roof Vent	38	10a.	Battery compartment (rear bath)	57
2.	Air conditioner (optional)	36	10b.	Battery compartment (ctr. bath)	57
3.	Range exhaust vent	44	11.	120 volt outlet	55
4.	Main door light	67	12.	Water inlet (tank)	49
5.	Vista view window (optional)	29	13.	Furnace vent	46
6.	Cluster lights	26	14.	Main door step	28
7.	L.P.G. tanks and regulator	40	15.	Serial number plate	—
8.	Electric jack (optional)	14	16.	Exterior light	67
9.	Coupler	14	17.	Load equalizing bars	14

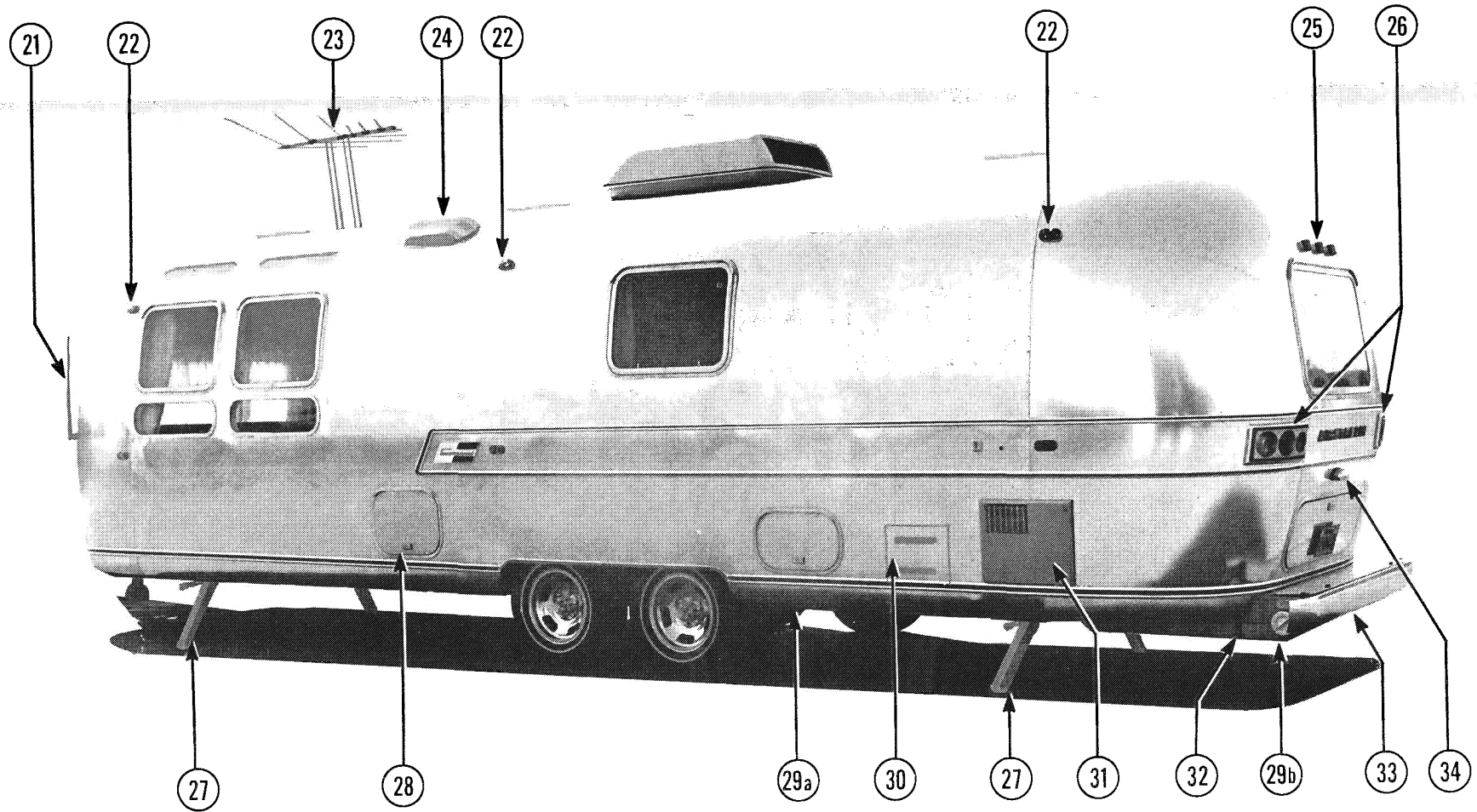

No.	Description	Page No.	No.	Description	Page No.
18.	Break away switch and cable	15	27.	B.A.L. stabilizing jacks (optional)	20
19.	Electrical connector (towing)	62	28.	Refrigerator access door	41
20.	Safety chains	14	29a.	Waste outlet (center bath)	51
21.	Radio antenna (optional)	29	29b.	Waste outlet (rear bath)	51
22.	Clearance light	67	30.	Battery charger (optional)	58
23.	T.V. antenna (optional)	29	31.	Water heater access panel	48
24.	Refrigerator vent	41	32.	Water inlet (city)	49
25.	Cluster lights	67	33.	Electrical inlet (city)	55
26.	Stop, tail, turn and backup lights.	67	34.	License plate light	67

Exterior

The Airstream exterior has been covered by an acrylic lacquer finish providing years of environmental protection. Washing the exterior of your Airstream is similar to washing an automobile. Both have high quality finishes and certain precautions must be taken to protect them. Oil, grease, dust, and dirt may be removed by washing with any mild nonabrasive soap or detergent. Automatic dishwasher detergents and acid etch cleaners are too strong and should never be used. **Always clean your Airstream in the shade or on a cloudy day when the aluminum skin is cool.** Cleaning should be followed by a thorough clean water rinse. Spots and streaks may be prevented by drying the unit with a chamois or a soft cloth.

After cleaning and drying, a good grade of nonabrasive automotive paste or liquid wax will increase the life of the finish, especially in coastal areas where the finish is exposed to salt air or in polluted industrial areas. It will also protect the shell from minor scratches and make subsequent cleaning easier. Wax should normally be applied every three to six months.

It is important to remove sap, seeds, gum, resin, asphalt, etc., as soon as possible after they appear by washing and rewaxing. Sunlight and time will bake-harden these materials making them almost impossible to remove without heavy buffing. If asphalt remains on the trailer after washing, use a small amount of kerosene on a rag and wipe

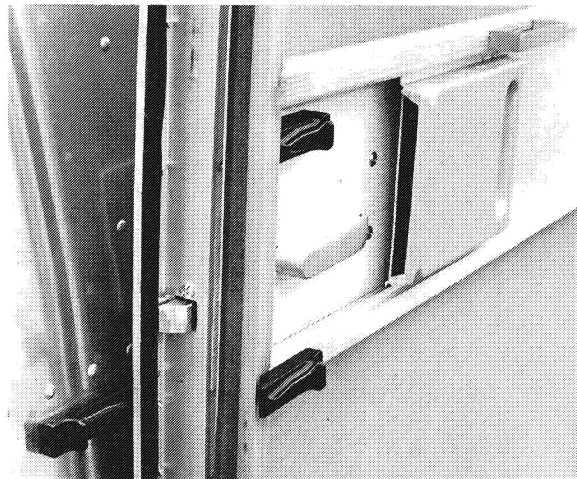

Main & Screen Door Catches

the spots individually, being careful not to scratch the aluminum.

For small areas of damage to the acrylic protective coating, or where oxidation is beginning to occur, remove all traces of the acrylic coating with a good grade of lacquer solvent and then thoroughly clean the aluminum with an aluminum cleaner. Then respray the area with clear acrylic lacquer. **All items needed for these minor repairs to the exterior shell are available at Wally Byam Stores.** For extensive refinishing we recommend that you contact an Airstream Service Center or the factory for instructions or to arrange for factory service. To keep your trailer looking new, paint the "A Frame," L.P.G. tanks, and rear frame periodically, by brushing on aluminum lacquer or, if possible, by spraying.

Each time you connect the 7-way electrical connector check for dirt and corrosion. Keep the contacts clean with "Spra-Kleen".

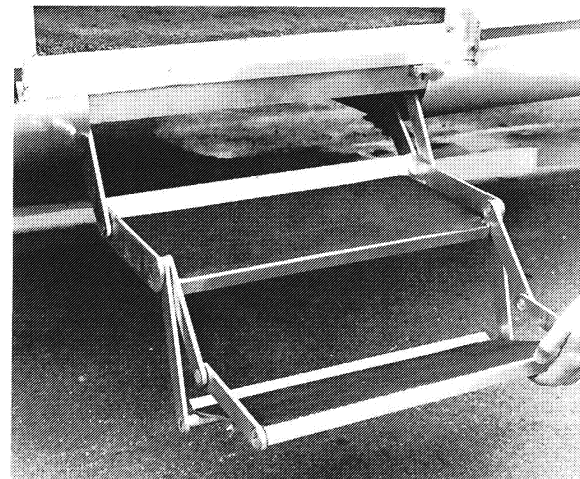

Fold Away Step

It is important that the main door be completely closed and locked during towing. If it is not locked the constant vibration of travel may cause it to open with possible damage.

For your security the lock has been designed as a dead bolt. For this reason never try to shut the door when it is locked. The door is properly closed when the handle is firm. If the door is difficult to open, push in to release the latch. When the door swings open it will automatically latch against the side of the trailer.

The screen door latches to the main door or operates independently using the same type latch that holds the main door open.

To operate the Fold-Away Step just press down the latch on the right hand side and the step will automatically drop into position. To stow the step simply lift the front edge and then push it up under the trailer to its stowed position.



Window Operation

The **Extension Step** (optional) is permanently attached to the main step and when needed it is simply flipped out. **Never travel with step lowered.**

Your Airstream has a new **High Strength Safety Glass Front Window** that is stronger than car windshields. Inside this window is a **second window of tough acrylic plastic**. The combination represents a great improvement in safety and convenience as it eliminates the need for a rock guard and also acts as a thermo pane for better temperature control.

The **windows** in your trailer are of tempered safety plate glass. To open: release the two lever locks at the bottom, lift up on the two side operator handles until the window is in the desired position, and place the operators into one of the three positioning slots on the side of the frames. To lock the windows, reverse this procedure.

These windows are cleaned in the same manner that ordinary windows are. Clean the seals with a damp cloth or mild detergent every three to six months taking care not to use strong solvents as they will damage the seals. A coat of natural silicone lubricant applied after the seal has dried will keep it flexible. Spread the lubricant evenly with a brush or finger, working it into the surface. This is a good practice for all rubber seals in your Airstream. For replacement of a damaged window contact an Airstream Service Center or the factory.

The thermo pane concept on the front window will be offered as an option on the side windows. The **thermo pane side windows** (optional) will also include metalized mylar tint. With the thermo pane, storm windows will not be required for winter operation, and will improve the efficiency of the air conditioning system. This also eliminates the need to remove the screens in order to install storm windows.

Screens are made of plastic for hard wear and easy maintenance. Clean with a damp cloth. **Note:** They will melt at the point of contact if touched by a cigarette.

Vistaview Windows (optional) are available for interior lighting while maintaining privacy and are equipped with integral shades.

Factory recommended awnings give shade during trips and rallies. They are easy to operate and can be installed by your dealer.

The aluminum construction of your trailer

creates a radio-shield and you will need outside antennas for perfect reception.

A police-type telescoping whip **Radio Antenna** (optional) is available for 12 V AM-FM transistor radios and should be professionally installed next to the front window roadside of your trailer on a swivel mount.

T.V. Antenna (optional): The controls are in the ceiling directly below the antenna. To raise the antenna, turn hand crank clockwise until it stops. Then turn on TV set and select channel. While watching picture, push handle up toward ceiling and rotate antenna. If you hit a stop in rotation before the picture is clear, reverse rotation. You may have to readjust when changing channels. To close, reverse the direction of cranking. Check outside that the antenna is folded and pointed straight forward.

Motorized TV Antenna: The controls are located on the curbside wall just above the arm rest. To raise the antenna, depress the up button and hold it in place until the red light goes off. The antenna is now ready for rotating to the desired position. Press the top of the rotating button and rotate the antenna until you get the best possible TV picture. If you go too far, press the lower portion of the rotating button and the antenna will move in the opposite direction. To stow the antenna, press the bottom of the rotating button and allow the antenna to rotate until the red light goes off. The antenna is now ready for lowering so press the "lower" button and hold it until the red light goes off again. You are now ready for travel.

Floor Plans

No.	Description	Page No.
1.	Electrical inlet-city	55
2.	Waste outlet	51
3.	Water inlet-city	49
4.	120 volt distribution panel	56
5.	Water heater	48
6.	Bed light	38
7.	Furnace	46
8.	Water inlet-tank	49
9.	Water pump	49
10.	Table	37
11.	Front lounge	34
12.	Toilet	52
13.	Univolt	56
14.	Battery	57
15.	Range exhaust hood	44
16.	Range and oven	44
17.	Sink	36
18.	Refrigerator	41
19.	Air conditioner (optional)	36
20.	Central control panel	34
21.	L.P.G. tanks and regulator	40
22.	Hitch	14

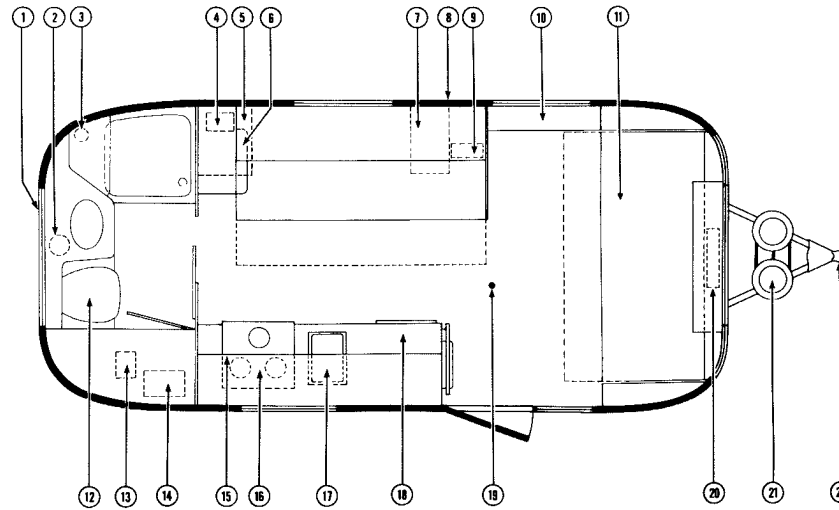

21 Ft. Double

23 Ft. Twin and Double

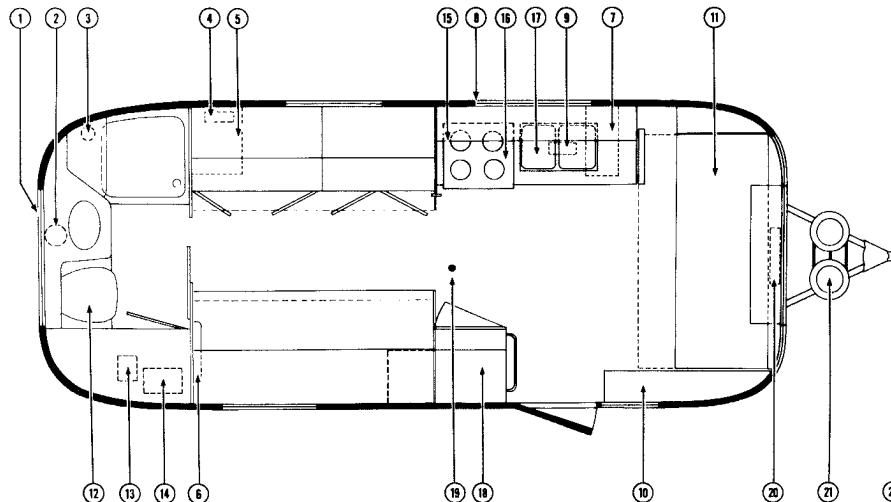

Floor Plans

No.	Description	Page No.
1.	Electrical inlet-city	55
2.	Waste outlet	51
3.	Water inlet-city	49
4.	Toilet	52
5.	Water heater	48
6.	120 volt distribution panel	56
7.	Range exhaust hood	44
8.	Range and oven	44
9.	Water inlet-tank	49
10.	Furnace	46
11.	Sink	36
12.	Water pump	44
13.	Front lounge	34
14.	Univolt	56
15.	Battery	57
16.	Bed light	38
17.	Air conditioner (optional)	36
18.	Refrigerator	41
19.	Table	37
20.	Central control panel	34
21.	L.P.G. tanks and regulator	40
22.	Hitch	14

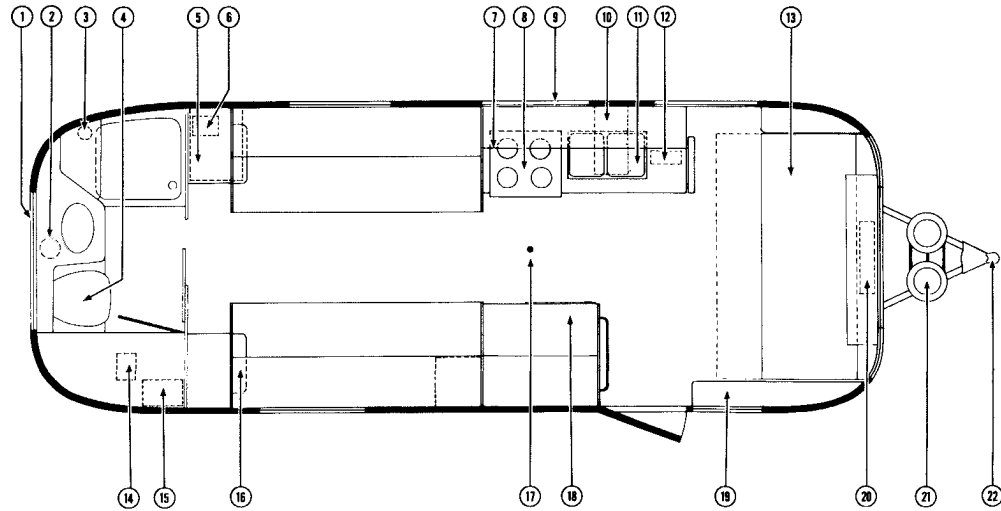

25 Ft. Twin and Double

27 Ft. Twin and Double

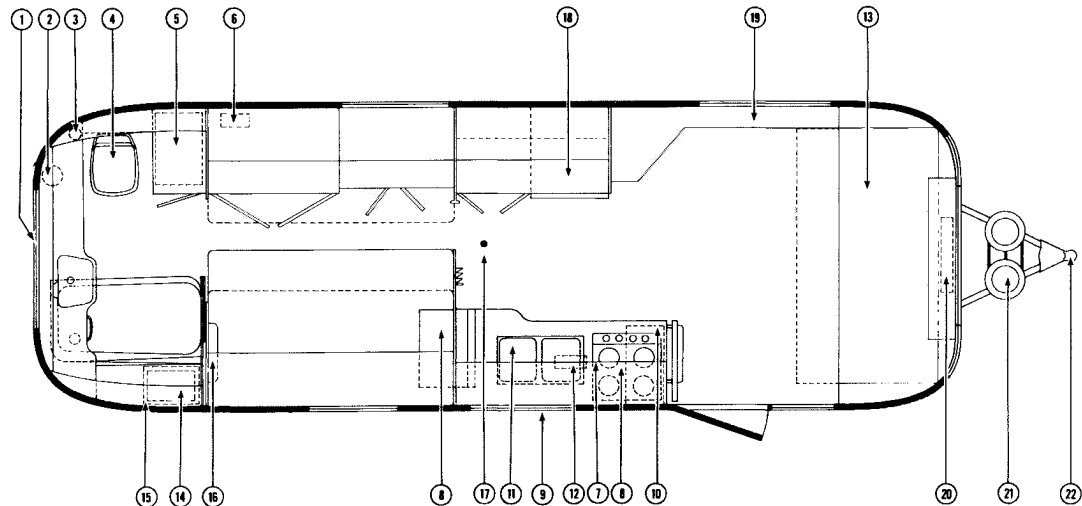

Floor Plans

No.	Description	Page No.
1.	Electrical inlet-city	55
2.	Waste outlet	51
3.	Water inlet-city	49
4.	Toilet	52
5.	Water heater	48
6.	120 volt distribution panel	56
7.	Refrigerator	41
8.	Table	37
9.	Front lounge	34
10.	Battery	57
11.	Univolt	56
12.	Bed light	38
13.	Oven	44
14.	Air conditioner (optional)	36
15.	Sink	36
16.	Water inlet-tank	49
17.	Water pump	49
18.	Range exhaust hood	44
19.	Range	44
20.	Furnace	46
21.	Central control panel	34
22.	L.P.G. tanks and regulator	40
23.	Hitch	14

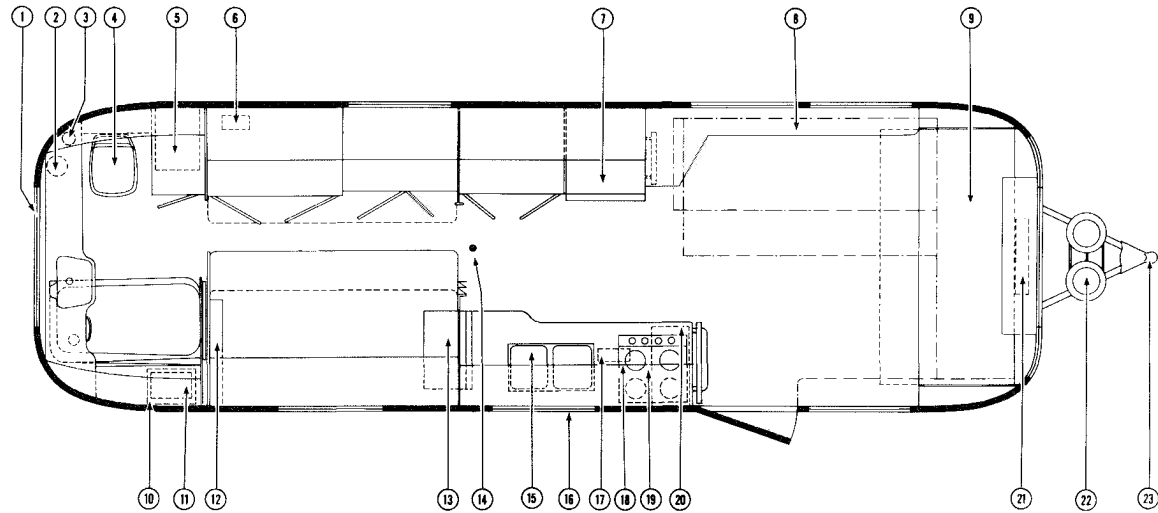

29-Ft. Twin and Double — Rear Bath

31 Ft. Twin and Double — Rear Bath

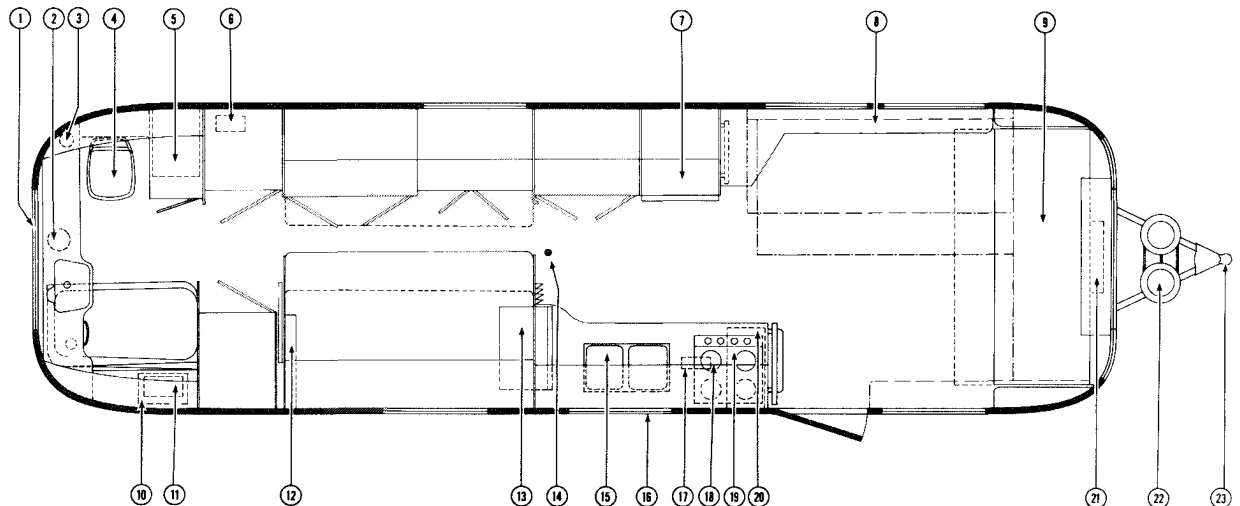

Floor Plans

No.	Description	Page No.
1.	Electrical inlet-city	55
2.	Water inlet-city	49
3.	120 volt distribution panel	56
4.	Water heater	48
5.	Waste outlet	51
6.	Toilet	52
7.	Refrigerator	41
8.	Table	37
9.	Front lounge	34
10.	Air conditioner (optional)	36
11.	Sink	36
12.	Water inlet-tank	49
13.	Furnace	46
14.	Range exhaust hood	44
15.	Range and oven	44
16.	Water pump	49
17.	Univolt	56
18.	Battery	57
19.	Central control panel	34
20.	L.P.G. tanks and regulator	40
21.	Hitch	14

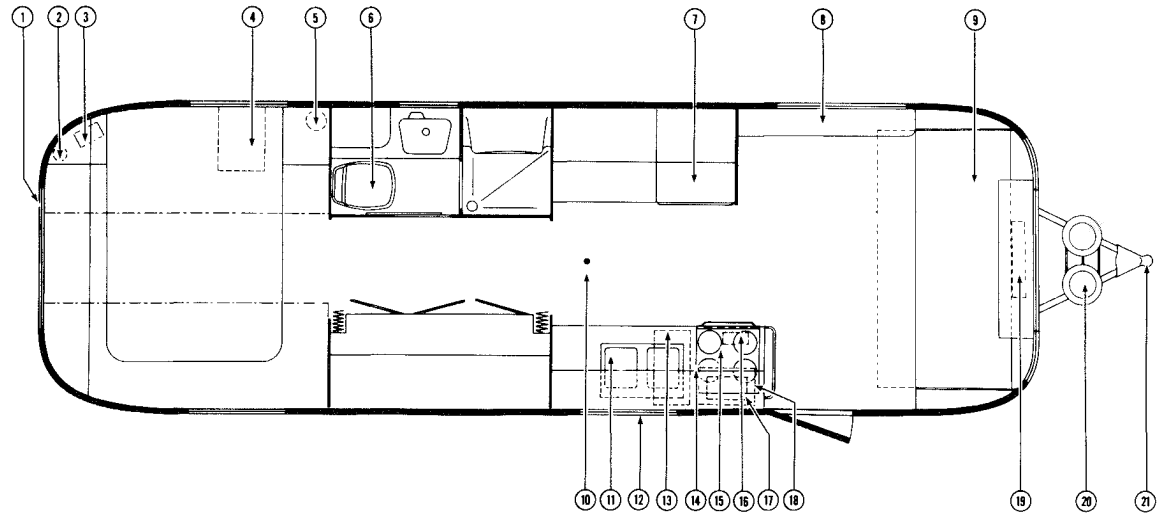

29 Ft. Twin and Double — Center Bath

31 Ft. Twin and Double — Center Bath

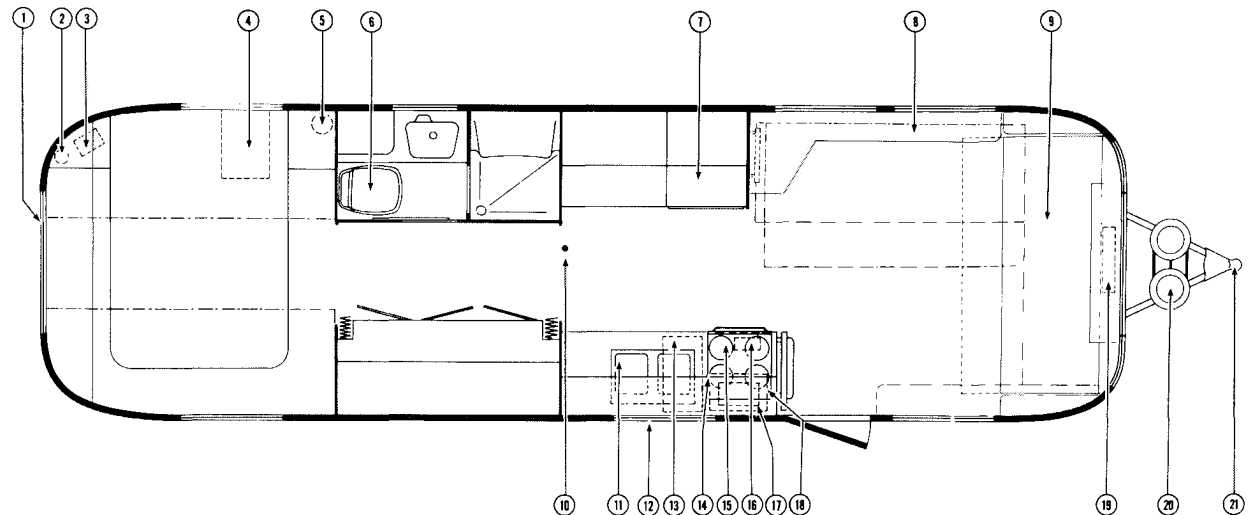



Lounge Into Bed 1.



2.

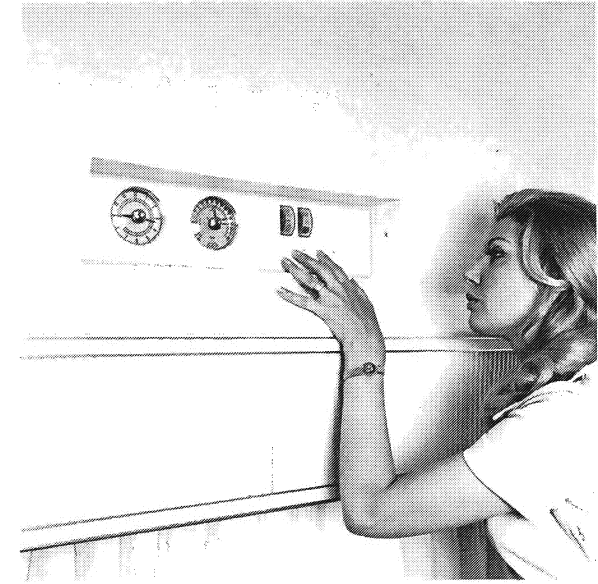

Central Control Panel

Interior

The Airstream interior has been designed for comfort, convenience, durability and appearance. An understanding of the operational procedures and maintenance techniques of the interior appointments will add to your pleasure as well as the long life of your trailer.

To convert the Lounge into a bed, pull the back cushion down toward you onto the seat. Grasp the front rail of the seat in the center, lift it slightly and pull it out until it stops. Lay the back cushion down to finish the bed. To return, reverse this process.

Make beds in the usual way, using fitted sheets $\frac{3}{4}$ bed size. The space behind the rear cushion is ideal for storing bedding for both front travel lounges and side pull-out beds. An

easy method of storing bedding is to remove and store pillows and then fold back the ends of the bedding neatly to expose about 2" of the mattress; then, starting from the edge nearest to you, roll up the bedding as tightly as possible towards the back wall. Raise the rear cushion to its normal position.

To make fixed twin beds, lift mattress slightly, pull it away from the wall and then tuck bedding in along wall. Note: Please do not launder mattress ticking; it has to be dry cleaned to prevent shrinkage.

The **Central Control Panel**, located above the front roof locker of your unit, contains the necessary instrumentation to monitor your Airstream's systems.

The **Panel Light** switch lights up the panel and makes an excellent night light.

The **Clock** is operated by a 'C' cell battery which will last from nine months to a year. Reset the time with the knob on the bezel and change the battery from the rear of the panel.

The **Battery Condition Tester** has a switch which operates a meter indicating: Good condition, fair and low. (This meter does not indicate true battery condition while you are hooked-up to 120 volt city power.) When it shows low condition, you should take every reasonable step to conserve power by using as few lights as possible and switching off appliances.

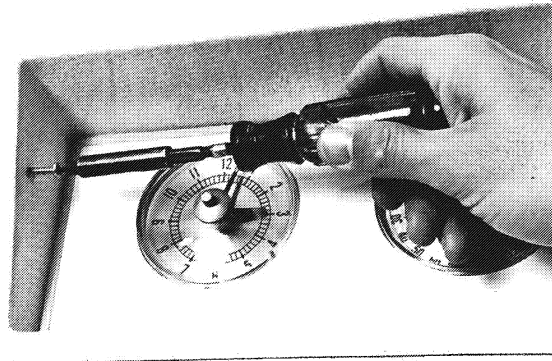

Central Control Panel Removal

The **Ammeter** indicates whether the trailer battery is being charged. If discharge is indicated, reduce your power usage. The Univolt System charges the battery only to the extent of any surplus over and above the electrical demands you make. The battery will not be able to recharge until the power usage is reduced. Therefore, before leaving on a trip, conserve power usage the night before to insure a fully charged battery.

The **Water Pump Switch**, when on, also lights up the indicator light. On trailers without a Central Control Panel, this switch is in the galley area. For a complete discussion of the pump, please refer to page 49.

The **Water Level Indicator Lights** show the



Stereo Tape and AM/FM Radio

amount of water in the water tank. Press the button and the light will show: "1/2" when the tank is at least half full, "1/4" when the tank is at least 1/4 but less than half, and "0-0" when it is less than one quarter full. If no lights show, the tank is nearly empty. In rare cases, when the tank has been filled with very pure water, as from a mountain stream, the indicator lights may not work at all.

The **Holding Tank Level** indicates "1/2" when it reaches half full, and "3/4" when it reaches the three quarters full mark.

The **Power-On Light** will glow automatically when you are hooked up to city power. This light and the polarity warning light are your checks on a proper 120 volt connection.

The **Thermometer** indicates the outside temperature, and the minimum and maximum temperatures reached since the last setting. The lowest temperature reached the night before and the highest temperature reached during the day may be determined by resetting the pointers the night before. To reset the pointers turn the center adjusting knob on the bezel clockwise and counterclockwise until the pointers are against the temperature hand. **Do not apply excessive pressure against the temperature hand.**

Access to the rear of the Central Control Panel is necessary for replacement of: the clock battery, panel light bulbs and the water pump fuse. To get behind, remove the attaching screws, grasp the center, pull down, and swing the panel out and forward.

A new **Motorola AM-FM multiplex radio (stereo)**, and **8 track cartridge tape deck** are available. It has controls with an additional "fadar" which allows the front speakers to be turned on by themselves, or the rear speakers by themselves, or any combination of front or rear speakers.

The **8-Track Stereo Tape Cartridge Player** is designed for installation in vehicles and incorporates solid state circuitry and automatic program change. To operate:

1. Turn tape player on by inserting tape cartridge into tape slot (label side up and open end first) until it is firmly seated.
2. Adjust left and right **VOLUME** controls for desired sound level between speakers. Adjust the **TONE** control for desired bass or treble response.

3. To change programs, push and release the program selector button. Each time this button is pushed and released, the next program will play. If button is not pushed, programs will play in succession, automatically and continuously.
4. To turn tape player off, pull cartridge out approximately one inch from its seated position. Never allow cartridge to remain seated when tape player is not in use. Store tapes in a cool area (in their containers) with the open (tape) end down. Protect tapes from direct sunlight and dust.



Air Conditioner Ducts and Filter

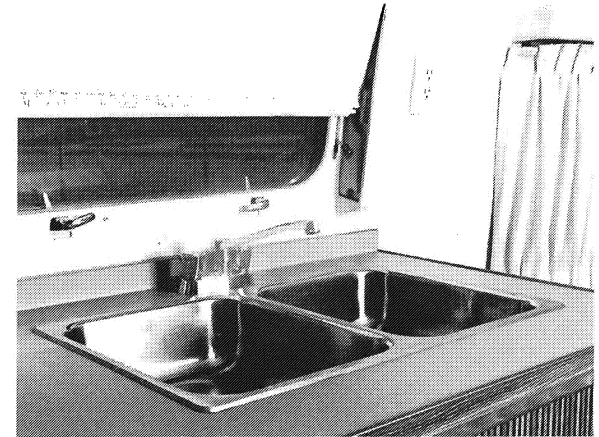

Stainless Steel Sink

In time, oxide from recording tape will accumulate on the tape head and capstan shaft which can cause tape hiss and erratic operation. The more often the tape player is used, the more often it should be cleaned.

Clean the head with a cotton swab moistened with isopropyl alcohol. Do Not Use carbon tetrachloride.

To clean the capstan shaft, first turn on the motor by depressing the motor switch (next to the capstan shaft) with the eraser end of a pencil. Use a cotton swab moistened with alcohol on the shaft.

Fuses for the radio, tape deck and main radio line are located behind the central control panel.

The **Bay Breeze Airconditioner** (optional) requires expert installation. Please let your Airstream dealer or one of our factories install it. Airconditioner high and low speed setting. To operate: (1) Close door, windows and

ventilators. (2) Set thermostat to desired temperature (75° is normal). Do not make frequent changes. (3) Set the fan switch (left under thermostat) to "HI" position. (4) Set main switch (right under thermostat) to "cool." When the inside temperature is 90° or less and expected to continue, set speed to "LO." To shut down: Set main switch to "OFF."

Shut off to clean or replace the filter. Remove, brush off loose lint, run water through filter or move it briskly in soapy detergent water. Rinse thoroughly, dry completely and replace. The unit has a low voltage starter kit to help start under marginal conditions. Do not run under 103 volts.

Stainless steel sinks cannot be harmed by boiling water. However, salt, mustard, mayonnaise and ketchup will cause pitting. Stubborn stains will yield to paste made of water and slightly abrasive cleaner. Be sure to work in

the direction of the polish-lines on the steel, to keep the original finish. Fingerprints are sometimes a problem. They can be minimized by applying a cleaner that leaves a film of thin wax: simply wipe it on and remove the excess with a dry cloth. After this, fingerprints can be wiped off with a soft dry cloth, or one moistened with a little wax cleaner. The surface should always be washed before wax is applied. Regular cleaning will prevent build-up of scale and film. Ordinary soaps or detergents are best for routine cleaning of the stainless steel sinks. Rinse thoroughly with warm water and wipe dry with a cloth to avoid streaks and spots.

For further information on galley equipment refer to page 41 for the refrigerator and page 44 for the range and oven.

To open the table, lift the table into a horizontal position, depress latch and pull the folding leg down until it locks in position. To



Table Opening 1.



2.

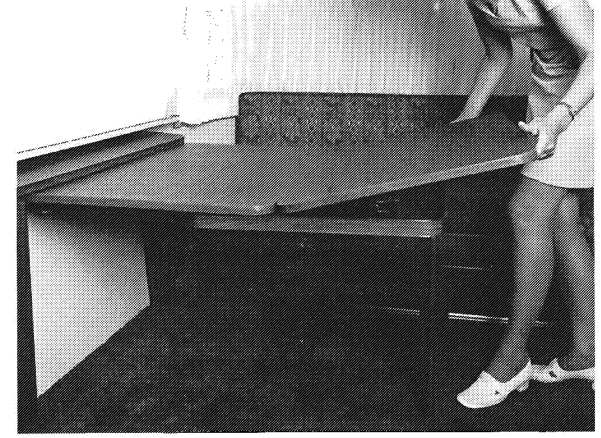

3.

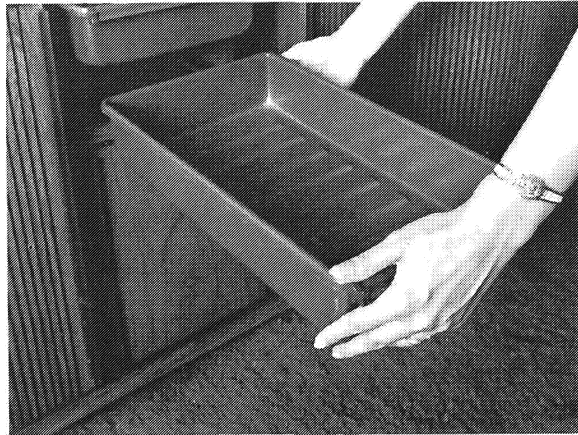

Storage Drawers

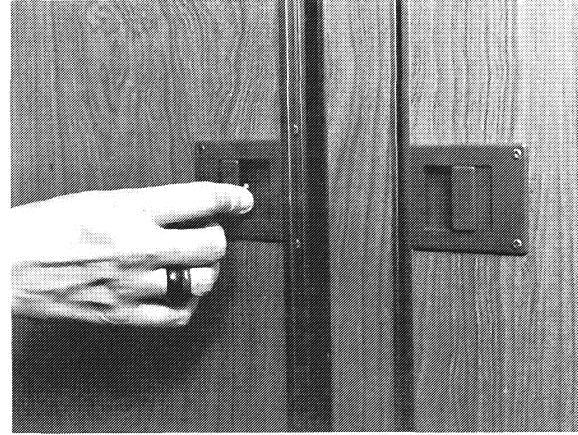

Wardrobe Catches

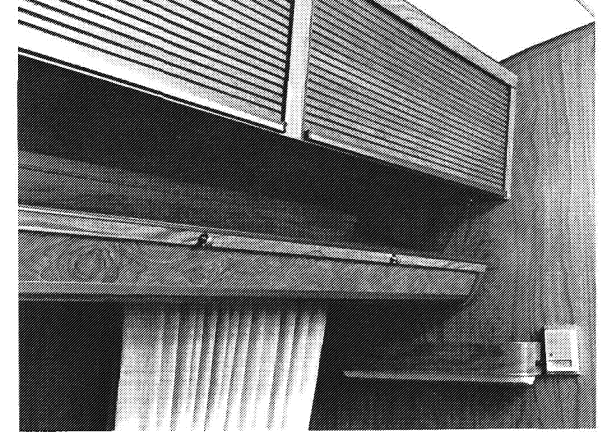

Drop Down Locker

extend the table pull out on the latch underneath the table right next to the leg and lift the table and leg slightly off the floor. Now pull the extension frame and leg out as far as they will go. Release the catch on the extension table leaf and rotate it over onto the extended frame. By raising the leg the entire table can be slid forward and aft for your seating comfort.

To stow simply reverse the procedure and unlock the leg and drop the table to the wall.

All the drawers and shelves are removable allowing you storage flexibility and ease of packing and unpacking.

Wardrobe catches are self-locking and they may be opened by sliding the touch plate away from the door opening.

A drop-down locker attached to the roof lockers is available for additional storage space for bedding, etc. in the bedroom.

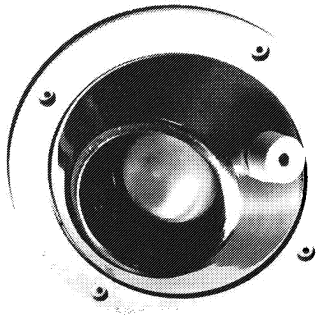
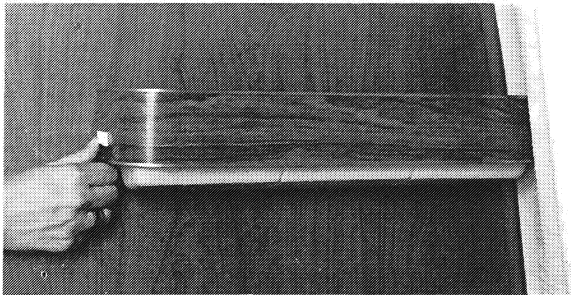

Area Lights

Bed-lights are operated by a switch on the side. To replace bulbs snap the lens out by squeezing gently the long side of the lens until it drops out of the fixture. **Area lights** have switches on the rim.

When attaching wall hung improvements, like hooks for clothing, bookshelves and extra towel racks, secure with half-inch No. 8 sheet metal screws ~~(#1111)~~ with flat binder heads, make holes in the aluminum inner walls with a small hand drill (No. 32 drill bit).

Ceiling light fixtures are incorporated with the ceiling fresh air vents. To operate the lights turn the forward control knob clock-

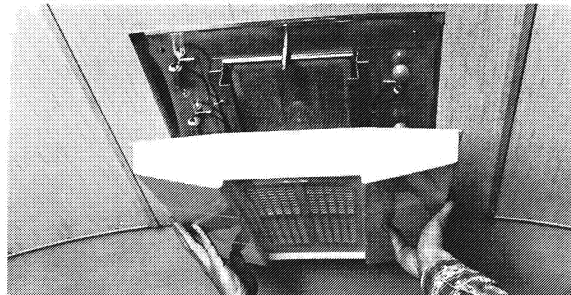

Below Bed Storage (Fixed Twin)

wise; first position 2 lights, second position 4 lights, third position 6 lights, fourth position to replace the bulbs and remove the lens.

The **fresh air vents** are operated by the aft control handle. Turning clockwise will raise the vent and at the maximum extension vents with fans will automatically turn on. For maximum air without fan, open until fan starts and back up just enough to turn fan off. Turning counterclockwise will close the vent. Airstream vents are designed to allow air circulation while still keeping out rain and can be used in any weather. Screens should be removed for periodic cleaning.

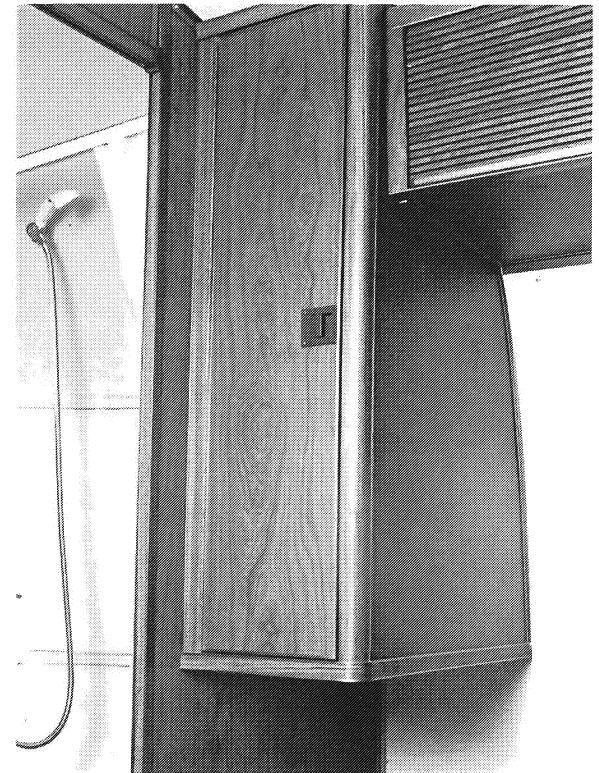

Hanging Wardrobe

The **below bed storage** is available on fixed twin models for additional storage of bedding and linen or fishing and hunting gear.

The **hanging wardrobe** (optional), located over the foot of the bed, increases storage for short items like shirts, blouses, skirts and short coats.

The lavatory bowl, counter top, tub or shower pan in your Airstream bathroom are made of a special ABS long-wearing, light weight, high strength plastic material. When cleaning, use soap or detergent only — never use scouring powder.



International Rear Bath

The toilet exhaust fan in International rear bath models is in the bathroom wardrobe wall left of the toilet and is operated by a switch under the vanity light. In International center bath models the fan is located behind the toilet and is operated by a switch located on the wall behind the toilet. In Land Yacht models the fan is located on the bathroom wardrobe panel. Complete toilet instructions are on pages 51-53.

The telephone shower head is designed to give maximum flexibility in usage and provide for water saving techniques when using your trailer on self-containment.

When using the shower head, it should be held in the hand and moved about the body. Normally the best water conservation procedure is to wet the entire body and then turn the water off with the push button at the



International Center Bath

shower head. Apply soap, lather thoroughly, then rinse the soap off.

On International models, the shower can be turned on and off without disturbing the hot-cold adjustment. The telephone shower head is also used to fill the tub for taking a bath.

The medicine chest is behind the mirror in the International rear bathroom. The 120 volt and 12 volt outlets are located below the medicine compartment on the roadside of the unit.

The medicine chest in the International center bath is to the left of the lavatory with the 120 volt and 12 volt outlets located on the right hand side of the medicine chest.

The lights in the International rear bathroom

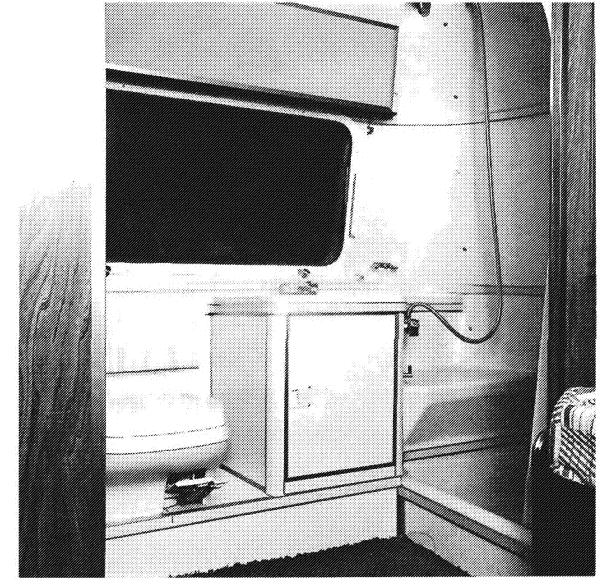

Land Yacht Bath

are operated by a switch under the roadside light. By lifting slightly and pulling out, the lights can be adjusted to any angle for makeup. To change bulbs squeeze lens and pop it out.

The light in the International center bath is operated by a switch at the top center of the base. To change bulbs, squeeze the lens at each end and pop it out.

The light in the Land Yacht bathroom is operated by a switch on the lens. To change bulbs unscrew the switch knob and remove retainer nut.

L.P.G. System

Your Airstream is equipped with two tanks for LPG (Liquid Petroleum Gas). LPG burns with a clean blue flame and produces more heat than natural gas. There are two basic types of LPG in common usage: **Butane and Propane**. Butane is widely used where temperatures are normally above freezing the year round and Propane is used where subfreezing temperatures are common, since Butane freezes at 32°F as compared to -40°F for Propane. All of the orifices in your Airstream LPG appliances are of the universal type which will burn either fuel.

How long a full tank of gas will last is dependent on usage. In cold weather when you are using the furnace, large amounts of hot water, and are doing extensive cooking, you will naturally use more than you will in warm weather when you may do limited cooking. On the average, with normal cooking and other appliance use, you can probably count on three weeks service from each 28-lb. tank.

International models are equipped with an **Automatic Gas Regulator**. Both tanks are connected to this regulator and are turned on. Gas is drawn from only one tank at a time and when the tank being used is depleted the regulator automatically switches to the full tank. An indicator on the regulator points toward the tank being used to give you a visual reminder when one tank is empty. The empty tank can be removed for refilling without disturbing the tank being used.

Simply close the tank valve, disconnect it, have it filled and reconnect.

To remove the gas tanks, disconnect the tubing nut with a wrench and loosen the bar handle which holds the tanks in place. The tubing nut has a left hand thread so be sure to always turn it clockwise to loosen and counterclockwise to tighten. When replacing a tank, connect and tighten the tubing nut before clamping it in place.

If you have allowed both tanks to run out, air may have gotten into the lines. In this event, the air must be forced out through the lines by gas pressure before you will be able to light the pilots. Hold a match to the pilot of the appliance closest to the tanks until it lights and stays lit. Then move to the next closest, etc. For complete appliance operating instructions, refer to pages 41-48.

Note: In some states it is illegal to leave the gas tanks turned on while towing a trailer.



L.P.G. Tanks

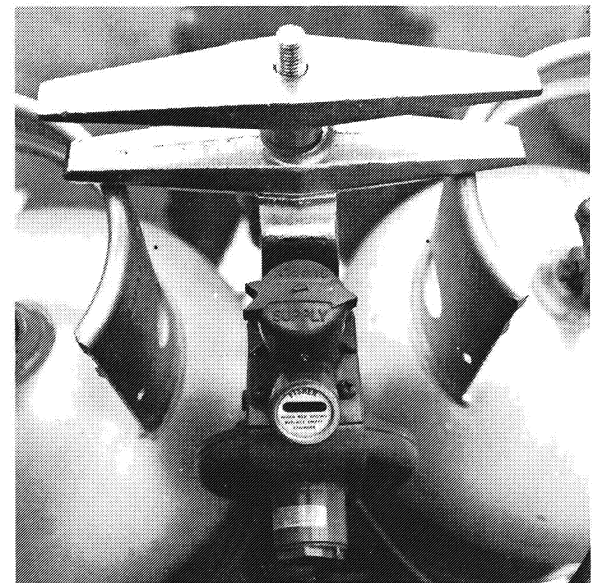

Automatic Gas Regulator

Refrigerator

Your Airstream is equipped with an A.G.A. approved Dometic gas-electric refrigerator. These are the finest refrigerators available for trailer use and will give you many years of faithful service.

For best operation of this refrigerator it is important to level your trailer. When parking try to avoid having a strong wind blowing directly against the vent outlet for most efficient operation.

For gas operation, the valve must always be fully opened whenever the refrigerator is in use. A partially opened valve effects no savings and may interfere with the operation of the unit.

Before the refrigerator is started on gas, open the outside access panel in the trailer behind the refrigerator and check that the electric switch lever (A) is in the OFF position.

Outside access doors are opened by unlocking and turning the handle 1/4 turn counterclockwise.

To light, open the refrigerator door. The controls are located inside the food compartment near the bottom of the unit.

1. Turn the gas valve handle (B) to the open position, and turn the gas thermostat knob (C) to setting No. 4.
2. Pull knob (D) of the automatic pilot and keep it out for 15 seconds. Then turn the flint knob (E) counterclockwise with a

rapid movement. This will create a spark which lights the burner.

3. After the burner is lit, which can be seen through reflector window (F), keep the knob (D) pulled outward for an additional 15 seconds.
4. Release the knob (D) and check that the burner is operating.

If the burner is not operating, repeat the lighting procedure.

As soon as the required cold temperature inside the cabinet is reached, the thermostat cuts the burner main flame to the by-pass flame sufficient to keep the safety valve open during gas operation. During electric operation the thermostat cycles the flow of the electrical current to maintain the set temperature.

Your Dometic incorporates a unique, fully automatic defrosting device for the general food storage compartment, which eliminates the necessity for manual defrosting at frequent intervals normally associated with most conventional refrigerators in the medium size range. Furthermore, the time interval of each defrosting cycle, and the frequency, have been so arranged that during defrosting there is no noticeable effect upon the temperature of the foods stored in the refrigerator, and the frozen food storage conditions can be maintained at all times in the frozen storage compartment.

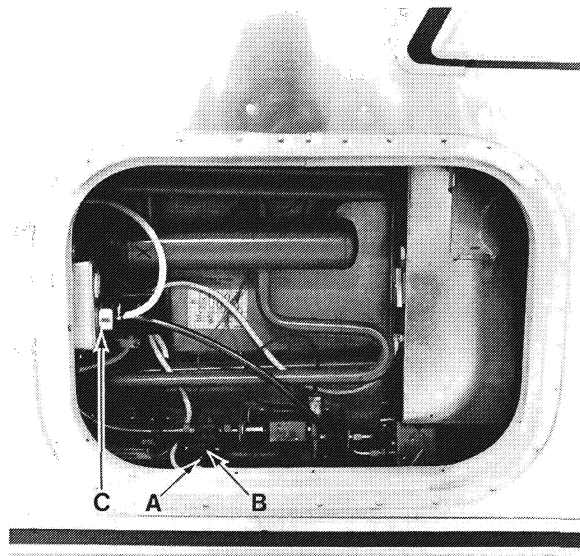

Outside Access Door

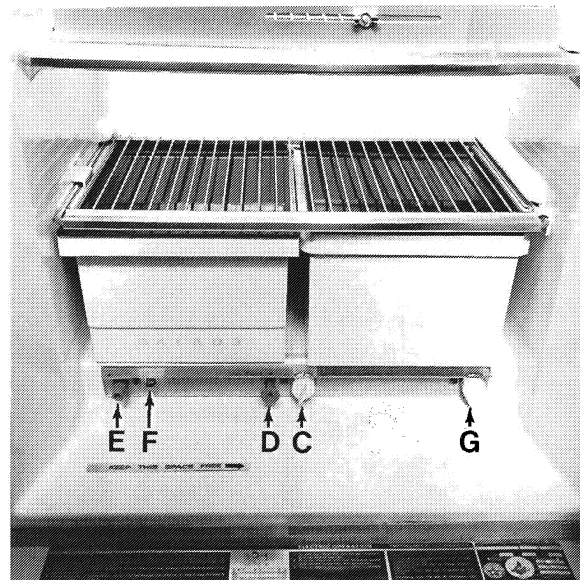

Controls Inside Refrigerator

When cleaning, remove all food and clean the interior and all other plastic parts with warm water, and mild detergents. Never use abrasive or caustic cleaning powders, polishes, cleaning paste, gasoline, turpentine or other solvent type cleaners. Use a damp cloth for cleaning and finish with a soft dry cloth.

When the refrigerator is to be out of operation for some time, always leave the door slightly open or place a pie tin of barbecue charcoal on the shelf.

Incorporated in the burner bracket is an automatic flame failure device which allows gas to pass only when the burner is lighted, keeping the thermocouple hot. Should the flame be blown out, the thermocouple will cool and the device will cut off the flow of gas to the burner.

For electric operation, follow these instructions:

1. To start the refrigerator, turn the gas valve (B) to the shut-off position.
2. Check to be sure the electrical cord is plugged into 110-volt outlet (C) located in the refrigerator exterior access panel. Turn the switch lever (A), located in the same area, to the ON position.
3. Turn the electric thermostat knob (G) to setting No. 4.

For best operation even during extended stays in parks your unit should be periodically run on gas.

The refrigerator has automatic thermostatic control of the temperature in the food storage space. The gas thermostat (C) controls the

temperature during gas operation, while the electric thermostat (G) controls the temperature during electric operation. **Be sure to make the temperature setting on the correct thermostat.**

The following are some trouble shooting tips for emergency use only. They relate to gas operation and should normally be done by the dealer.

Problem: Flame goes out. The thermostat is out of adjustment. To adjust it, turn the dial to "zero". If the flame does not go down to the "low" by-pass setting, follow this procedure:

1. Unscrew the large cap screw at the rear of the thermostat and remove the valve. Clean the seat and valve, and replace.
2. If procedure (1) does not correct the problem, adjust the set screw out (in counterclockwise direction) until the flame goes down to the "low" position.

If the flame keeps going out when the dial is turned to (O), remove and clean the by-pass screw which is located as shown in the diagram above.

Problem: Burner does not light. Remove and clean the burner barrel, and/or check the gas supply.

On gas refrigerators, the flue will require cleaning at least every six months. To do this, it will be necessary to gain access to the back of the cabinet. When cleaning the flue proceed as follows:

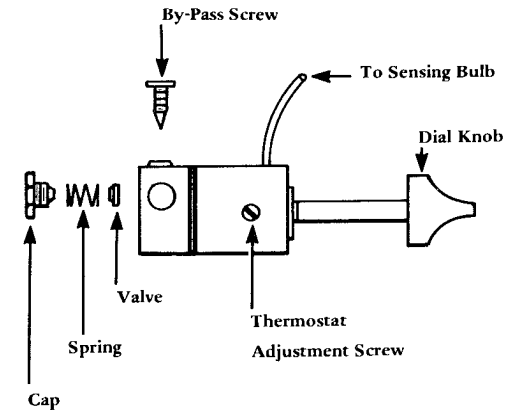

Thermostat

Unscrew the burner housing, then lift out the baffle on its support wire from the top of the boiler tube.

From the top, clean the flue with a suitable flue brush. Also clean the baffle, before putting back in place.

An obstruction in the flue will reduce or stop flue draft. Flue obstructions will cause odors outside refrigerator, slow freezing and higher cabinet temperatures.

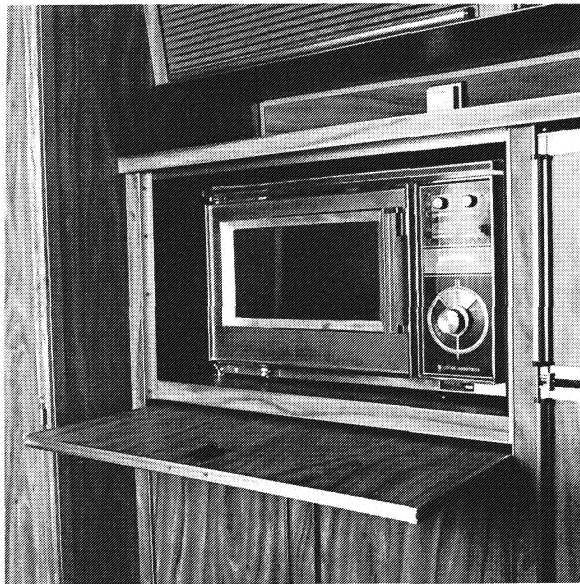

Micro Wave Oven

Micro Wave Oven

The portable Litton Industries, Atherton Division Micro Wave Oven is available as an option. Airstream dealers cannot service or make adjustments to the oven. This must be done by an authorized Litton Industries dealer. If you ever have problems with the oven check the local telephone directory for the nearest dealer.

The operation of your electronic oven is as simple as 1, 2, 3:

1. Press the **ON/OFF** button. This starts the cooling fan and cavity lights. Only 5 seconds are needed for warm-up.
2. Depress thumb latch on handle, open door and place food item inside. Set timer for desired setting. NOTE: The first half of the timer covers 4 minutes in short second

increments. To set timer on a short time, e.g., 15 seconds, first turn to 1 minute then back to 15 seconds.

3. Press the **START** button to begin the cooking process. NOTE: When you open the door, cooking will stop automatically until you close the door and re-press the **START** button. Your timer will maintain the proper time setting.

We recommend that you try one of the following to acquaint you with this exciting new idea in cooking:

1. Easy bacon! Place 3 strips of bacon over paper toweling on a paper plate. Cover with several paper towels (to prevent spatter). Cook for 2½ minutes.
2. A quick apple! Wash and core apple. Fill center with a mixture of ½ tablespoon butter and 1 tablespoon brown sugar. Place in a large custard cup or desert dish. Cover with wax paper and cook for 2 to 2½ minutes.
3. Pouch of frozen vegetables! Place frozen pouch in oven. Cook (thaw) for 2 minutes. Puncture a small hole in the top of the bag (for steam to escape). Continue to cook for 2 minutes longer.

Please read your cooking guide carefully. It will help you learn about your new Litton Electronic Oven quickly.

IMPORTANT

Safety and Maintenance Instructions.

Your new Litton Micro Wave Oven has been carefully designed and thoroughly tested to meet exacting safety standards. However, it is

important for you as a user to observe certain precautions and care in utilizing your Litton oven for maximum performance and safety. The door on your oven has been carefully designed to contain the micro wave energy; therefore, it is important that you observe the following:

1. Do not operate the oven with any object closed between the door and the oven face.
2. Do not operate the oven if there has been any damage to the oven face or door including loose or broken hinges or latch, or if the door does not close firmly against the oven front.
3. Do not attempt to defeat the interlock switches. They are there for your protection. You will note that upon operating the door latch while the oven is in the cook cycle, the oven cook light will go out. If the light does not go out, the front interlock switch is not operating properly. In such case, do not operate the oven until the interlock switch has been repaired.
4. Remember that it requires considerable electrical power to operate the micro wave oven (15 amps). Operation of other 120 volt appliances should be kept at a minimum when operating the oven.

The door enclosing the micro wave oven can also be used as additional counter space.

Your new oven requires very little maintenance except for cleanliness. Do not allow grease, soil or splatter to build up on the door seal to the oven cavity. Litton maintains trained service technicians in all principal metropolitan areas. It is suggested that these authorized service agencies be utilized for proper repair and adjustment of your oven.

Range/Oven

Your Airstream is equipped with a Magic Chef gas range and oven. The following are some hints on how to keep them operating at their best.

The range is equipped with coaxial orifices for use with LPG. The flame will be approximately $\frac{1}{2}$ inch long. **Do not attempt to adjust gas to burner.** The orifices have no adjustment.

Air shutters on top burners are to be adjusted so that each cone of the flame is separate and distinct and appears as illustrated in the figure to the right. Air shutters set too far open will cause the flame to lift away from the burner head and it will be difficult to light. If the air shutters are closed too much, the flame will look hazy and the distinct cones will be missing.

Problem: Flame lifts off ports—Too much air.

Problem: Soot formations — Not enough air.

Problem: Flame flashes back into air mixture chamber — Too much air in proportion to gas. Slightly decrease air.

Problem: Orange flame; caused by small filings in new burners or dust in air—Clean burners.

Problem: Burner fails to light — Usually too much air.

Note: To adjust air-gas mixture, rotate the sleeve behind the burner control knob. Decrease air by closing the opening, and increase air by opening it.



International Range



Land Yacht Range and Oven

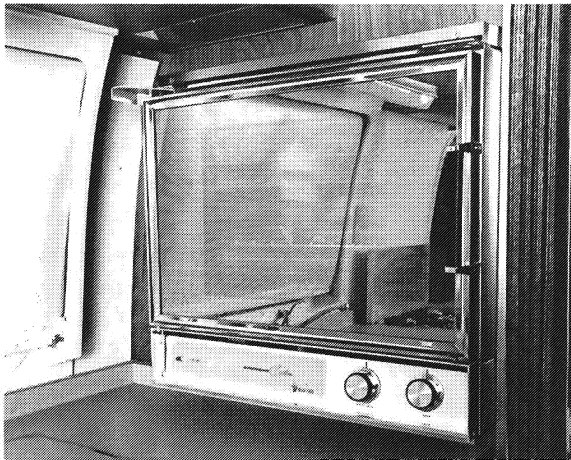

International Oven

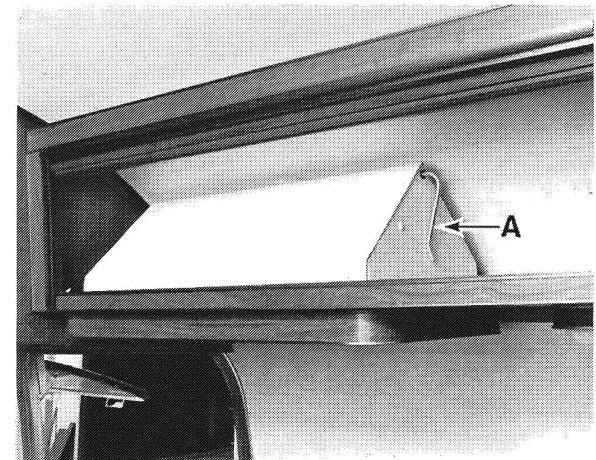

Range Exhaust Hood

Adjust the top pilot so that the tip of the flame is just over the edge of the inner cone. The burners should light within 4 seconds. If lighting is difficult, refer back to the previous step.

Never allow the top cover to be closed while the range is in operation, as this will extinguish the flame and permit gas to escape into the trailer.

The **range exhaust hood** provides venting of cooking heat and smoke from the trailer. To operate, pull lever (A), on right hand side of hood, toward you. This will open the shutter and turn on the switch for the power fan. Clean the filter regularly with warm water and detergent. To remove the filter, remove the two screws that secure it to the housing and let it drop out. Keep the vent housing clean from grease and dirt by frequent washing.

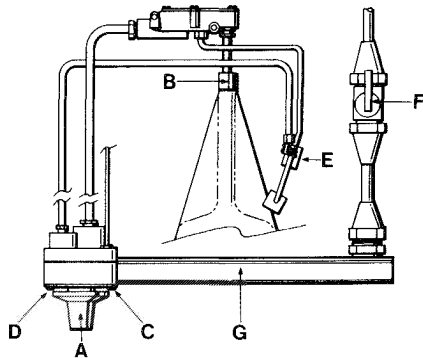

Combination Range and Oven Controls

Note:

The range gas line shut-off valve (F) located under the top of the range at the right end of manifold pipe (G) must be turned off when towing the trailer, when changing the gas tanks, or if the gas supply is turned off for any reason. Be sure oven pilot light has been relighted as soon as range shut-off valve is turned on.

The thermostat on your oven does not have a by-pass setting. It will cycle off and on at all temperature settings except broil. No by-pass adjustment is necessary.

Oven Section:

The Thermostat Control Knob (A) is combined with the constant pilot shut-off. For normal use: turn only between "OFF" and "BROIL." When traveling, turn to "PILOT OFF." Relight only when you want to use the oven, by turning from "PILOT OFF" to "OFF" and lighting with a match.

The air shutter (B) on the main burner is to be adjusted so that each cone of flame is separate and distinct, as illustrated.

Constant Pilot Adjustment:

1. Remove Control Knob and Bezel (A).
2. Using a screwdriver, turn slotted red-colored Constant Pilot Selector (C) to LP position. When the slot is in the vertical position, the Selector Cartridge is in the "OFF" position.

Heater Pilot Adjustment:

1. Replace Control Knob and turn to the 300 degree setting on the Control Knob Dial. This opens the thermostatic valve in the thermostat and allows gas to flow through the Heater Pilot Tube to the Heater Pilot.
2. Remove the Control Knob.
3. Using a screwdriver, turn the slotted green-colored Heater Pilot Adjusting Cartridge (D) in either direction until the pilot flame just envelopes the Temperature Responsive Element (E).
4. Replace Bezel and Control Knob.
5. Make any air shutter adjustments for oven burner flames.

Important: Your oven is equipped with a safety ignition that requires a minimum of 30 seconds to operate after turning the oven control knob on. The oven pilot may be slow in lighting due to air in the gas lines.

Cleaning instructions:

1. The main top has been hinged from the back so that it can be raised for cleaning around the top burners.
2. When cleaning the top burner heads, care should be taken that all ports are opened up with a toothpick afterwards.
3. Spill-over or spotting in the oven or broiler are more easily cleaned when removed promptly after they occur. Never wash porcelain when warm. Never use cleaning powder containing grit or acid. When oven bottom is replaced after cleaning and servicing, be sure that it is locked in place. The front return flange on the oven bottom must hook under the side support angles to prevent warping.

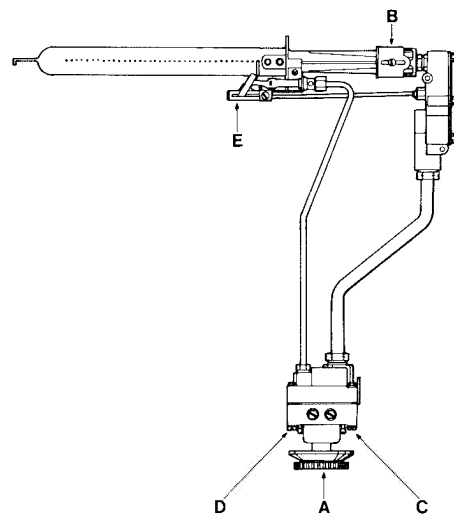

Wall Oven Controls



Separation of Flame into Distinct Cones

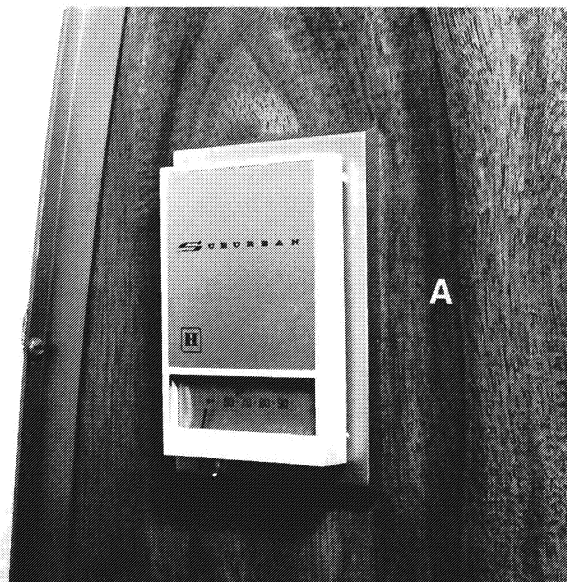

Furnace Thermostat

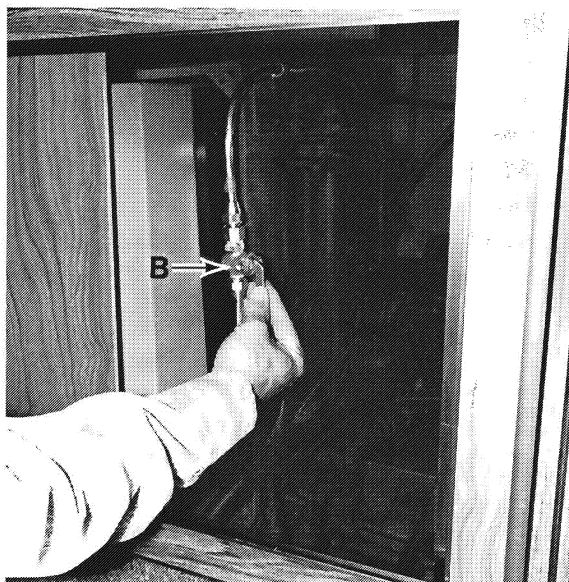

Manual Gas Valve



Furnace Controls (21 Ft.)

Furnace

The Airstream furnace is an American Gas Association approved Suburban unit designed specifically for travel trailers. It has a sealed combustion system with a dual blower for maximum air circulation. One blower circulates room air while the other draws in air for combustion. The adjustable louvered heat registers control warm air flow while cold air returns through the galley cabinet toe kick opening.

The heat duct system also circulates warm air around the holding tank, water tank, and one-stop-service center, a vital feature when operating in below freezing weather.

The Suburban furnace is thermostatically controlled. When the thermostat calls for

heat, the blower starts and only after it has reached nearly full speed will the burner light. After the temperature set on the thermostat is reached the blower will continue to run for a short time removing most of the remaining heat from the furnace as well as forcing the combustion gases from the heat exchanger. To turn the furnace off for an extended period of time turn the thermostat (A) to its "OFF" setting and turn the manual gas valve (B) to its "OFF" position (perpendicular to the gas line). Operating instructions are printed inside the furnace door.

Trouble-free operation of the Suburban furnace will depend on your adherence to recommended operating procedures and precautions. Corrections of possible malfunctions

presented here will be helpful in an emergency situation, but **servicing should be done by a dealer.** One note of caution regarding flue gases: they are vented from the furnace to the outside of the trailer through a vent in the outside wall. **Do not in any way obstruct this vent by placing clothing or other flammable material on the vent assembly.** Check it often to make certain it does not become clogged.

The furnace may be lighted with the electromagnetic lighter or a match.

1. Set the thermostat (A) to the "OFF" position.
2. Unlatch the furnace door, and open it.
3. Turn on the manual gas valve (B).
4. Remove the lighter hole cover (C).

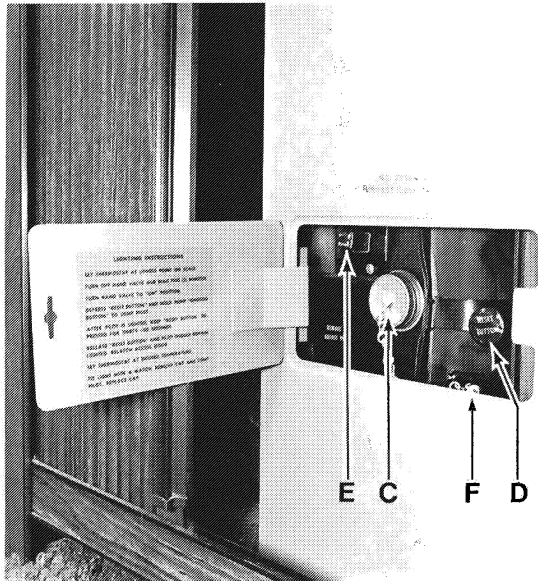

Furnace Controls (23-31 Ft.)

5. Depress the reset button (D) and hold it in.
6. Light the pilot by pressing quickly on the ignition button (E), or with a match.
7. After the pilot is lit, keep the reset button depressed for thirty seconds.
8. Release the reset button and the pilot should remain lit.

If the pilot goes out, repeat the above steps keeping the reset button depressed for a longer period of time. The pilot may not light immediately due to the presence of air in the gas line. It may be necessary to hold the reset button in for a minute or more before the pilot ignites. Replace the lighter hole cover (C) as soon as the pilot is lit and close the front access door and set the thermostat (A). If the furnace has just gone out, turn the

manual gas valve (B) off and wait 5 minutes before attempting to relight the pilot.

Differences in pressure between the room air and the outside air may cause a strong draft to come through the furnace once the lighter hole cover is removed. Opening a window or the door on the same wall as the furnace while lighting the pilot will prevent this from happening. Differences in inside and outside temperature will have no effect on furnace operation once the lighter hole cover (C) has been replaced.

Adjustment of Main Burner (Primary Air):

Set the furnace into operation by advancing the thermostat and allow to run until it reaches near-maximum operating temperature. Observe the main burners through the lighter hole cover (C). The flame should be without a trace of yellow and be “sitting” on the burner. As the furnace was tested at the factory before shipment, it may be found that the primary air is already in proper adjustment. However, adjustments may vary from one location to another due to differences in elevation and in characteristics of the fuel gases.

If the flame burns yellow or “lifts” off the burner, it needs adjustment. Take out the screws retaining the rectangular cover plate (F) and lift the plate off. Inside the opening is a threaded rod with the visible end slotted to receive a screwdriver. By turning the rod you will adjust the position of the main burner air shutter. This air shutter should be adjusted to the point where a slight trace of yellow remains in the tip of the flame. Replace the

cover and check that the yellow tips have now disappeared. **Caution: the lighter opening cover and the primary air adjustment cover plate must be in place for proper operation of the furnace.**

The most common cause of furnace failure is pilot outage, the inability of the pilot to stay lit unless the reset button is depressed. The trouble is usually in the thermocouple, which is located inside the cover plate near the pilot light. Check to see that the end of the thermocouple lead is screwed firmly into the safety pilot valve and that the joint is clean.

The furnace can be used to circulate air during hot weather by shutting off the gas valve (B) and turning the thermostat (A) up higher than the temperature in the trailer. **Return the thermostat to the “OFF” setting whenever the furnace is not in use.**

When the humidity is high inside your trailer and you wish to remove moisture, open a roof vent and turn on a vent fan or open a window slightly for cross ventilation.

Water Heater

The Bowen Gas Water Heater is equipped with a Robertshaw 100% shut-off safety valve which shuts off the gas supply if the pilot flame is extinguished or the water temperature becomes excessively hot. It is lighted and serviced from the outside through an access panel at the roadside, rear, of the trailer.

Procedure for lighting or relighting:

1. Be sure the water heater is filled with water. Open the hot water faucet at the sink and when the water flows, the heater is full.
2. Turn the gas cock knob (A) to the "OFF" position and the temperature indicator dial (B) to the lowest temperature position.
3. Wait sufficient length of time to allow gas, which may have accumulated in the burner compartment, to escape (approximately five minutes).
4. Turn gas cock knob (A) to "PILOT."
5. Depress and hold the red reset knob (E) and push the lighter (D) in and turn until the pilot flame ignites. This may take several turns of the knob. Or you may light it with a match.
6. Keep the reset knob depressed for one-half minute after the pilot flame ignites.
7. Turn the gas cock knob to "ON."
8. Set the temperature indicator dial to the desired water temperature.
9. To shut down the water heater, turn the gas cock knob to the "OFF" position.

Pilot Flame Adjustment.

If the pilot flame does not have a small orange

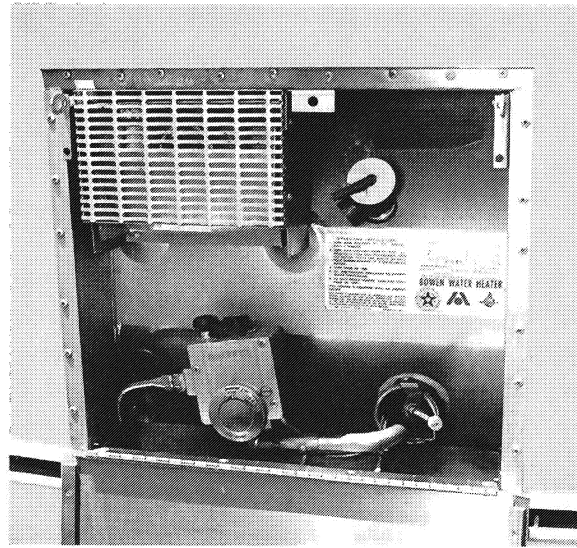

Water Heater Access Panel

tip, the pilot is not getting enough gas. The flame should be about 1/4 inch in vertical height when the water in the tank is cold and the burner is off, 1/4 to 3/8 inch in horizontal length when the tank is warm.

A large orange flame indicates excessive gas supply, which will result in short pilot life and early replacement. The pilot has been properly adjusted at the factory and should operate with a blue, orange tipped flame enveloping the pilot thermocouple. Removal of the pilot adjustment cap (C) in the lower right corner of the control will reveal the pilot adjustment screw. Turning this screw clockwise reduces the flow of gas to the pilot (blue flame) and counter-clockwise, the gas supply will increase (orange flame). Always replace the Pilot Adjustment Cap to prevent gas leakage.

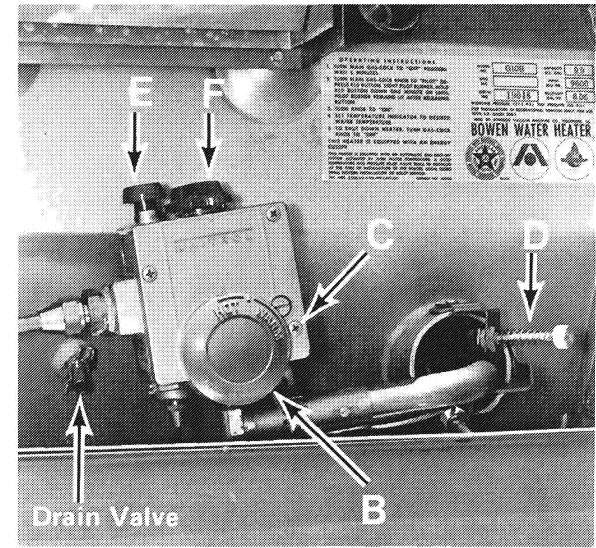

Water Heater Controls and Drain Valve

Air Shutter Adjustment.

All fuels depend upon air (oxygen) to give them proper burning characteristics. A yellow, smoking flame indicates a lack of air and a noisy hard blue flame indicates too much air. The air shutter slides back and forth along the burner tube and is held in place by a small shutter adjustment screw (D). Loosen the screw for adjustment. A good method of adjusting the air shutter is to slide the shutter to the right until yellow tipping occurs on the main burner flame (not the pilot) and then slowly slide the shutter to the left until all signs of yellow tipping are gone. When proper adjustment has been obtained, tighten the screw holding the air shutter. The outside access door must be kept firmly locked for proper operation.

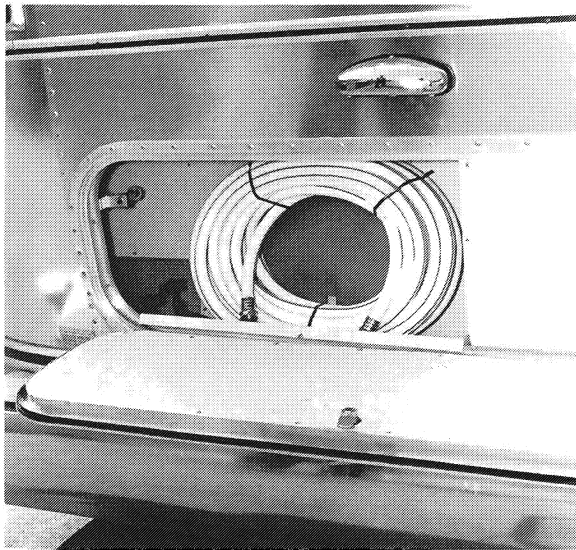

Water Hose Storage

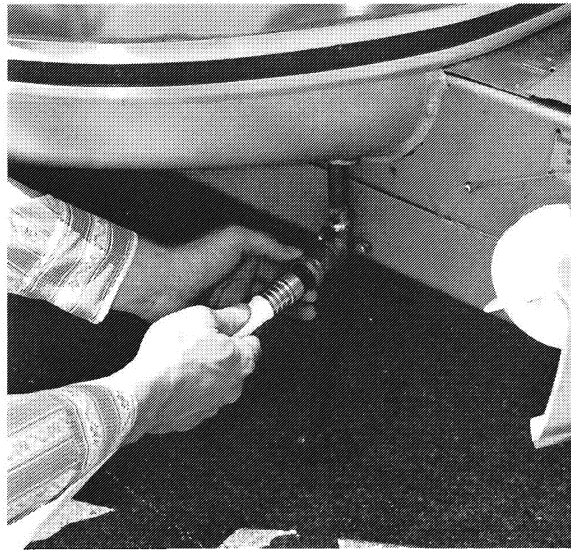

City Water Supply Connection

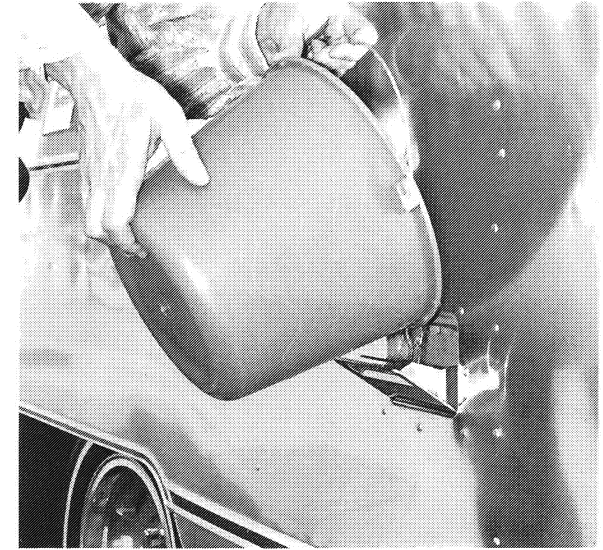

Water Tank Fill Spout

Water System

The Airstream Water System provides full service both when the trailer is self-contained, or when city water is available. Water heater capacity is 10 U. S. gallons in 27-ft. through 31-ft. units and 6 gallons in 21 ft. through 25 ft. units. The water tank stores 45 gallons of clean fresh water for all your needs.

When self contained, the Water Pump should be turned on. The switch is located on the Central Control Panel above the front roof locker of your Airstream or in the galley area. The Water Pump will run whenever a faucet is opened, and will shut off when the faucet is closed. It will deliver 3 gallons per minute under constant pressure.

Note: The Water Pump must be turned off when hooked up to city water supply and

when you leave your Airstream unattended.

For city water supply, connect a 5/8" high pressure hose to the water inlet fitting (see photograph) located under the rear roadside corner of the trailer, just forward of the bumper. Turn the hose on and slowly open an inside faucet until the water flows free of air. The system will now be ready for use. If you are staying for some time where city water is available, drain the water storage tank. The drain valve is accessible through a hole in the floor below the galley sink. Be sure to refill the tank with fresh water before departing. The system has check valves in the water lines to protect the water tank while you are connected to the city water supply.

The water tank is located under the floor just forward of the axle. To fill the water storage tank, open the filler spout (see photo) on the exterior wall adjacent to the galley, and fill with a hose or a bucket, until the water supply pipe is overflowing. Close and lock the spout and the water system is ready to use.

To clean the tank, pour some bicarbonate of soda into the filler spout with several gallons of water and allow to stand for a minimum of four hours. Then flush the tank out by opening the drain valve and running fresh water through it.

The water pump and filter are under the Galley Sink. The filter screen should be cleaned periodically to prevent accumulation of dirt and sand. To remove the screen,

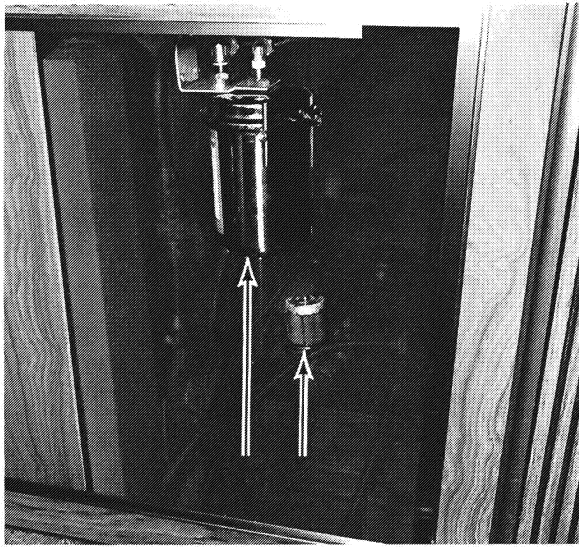

Water Pump Filter and Water Purifier

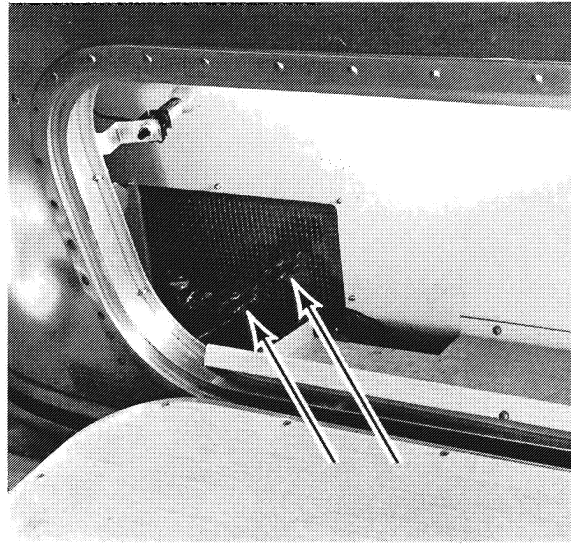

Water Drain Valve (Int'l. Rear Bath)

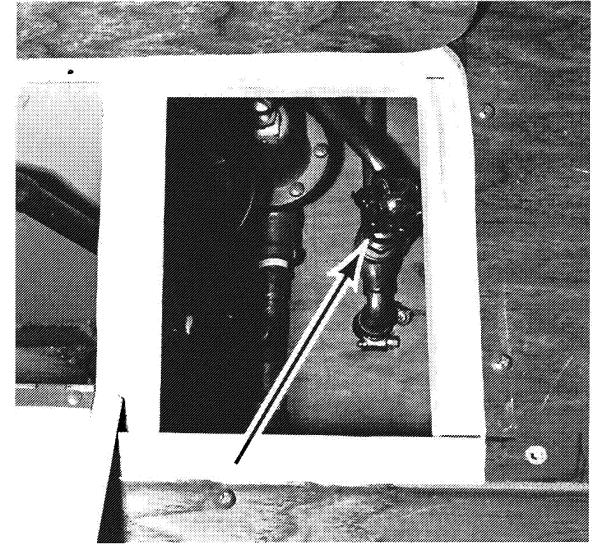

Water Drain Valve (Int'l. Center Bath)

disconnect the rubber hoses from both ends, separate the screen housing, remove the screen, clean and replace.

The **Everpure EN-1 Water Purifier** (standard on International models) is located under the galley sink. It will remove all dirt and colloidal matter, and eliminate most chlorine, phenol and similar odors and tastes while delivering sparkling taste-free water for drinking and cooking. The filter is connected to the cold water line only. The purifier is not guaranteed to remove the tastes and odors of iron and sulphur. To remove these tastes, chlorinate the water supply. Super chlorination will precipitate dissolved iron, and the purifier will then remove the formed chlorine salts. To purify any questionable water add 1 tsp. of chlorine (ordinary household bleach) per 10 gallons of water to the water tank. 4½ tsp. for a 45 gallon tank. We recommend the use of tablets available at Wally Byam Stores.

The quality of the water never varies even at the end of the filter pack life, however as the minute pores slowly fill up with impurities, this will gradually reduce the rate of flow until it is necessary to change the filter. Instructions are in each box, and we advise buying two at a time, always keeping one in reserve.

The **Water Pressure Regulator** is on the roadside of the rear trunk in International rear bath models, below the bed in International center bath models and in the aft roadside wardrobe of Land Yachts. It protects the plumbing inside your trailer, regardless of the variation in city water pressures. The pressure at the faucet is kept constant.

The water system has built in drain valves to protect it from winter freezing. For complete details see *Storage and Winterizing*, page 25.

Drain/Waste/ Vent Systems

Your Airstream has a drain and waste system similar to the one in your home. The system includes a waste holding tank made from molded plastic, free from corrosion problems, with a trouble free dump valve. This tank enables you to use the toilet for several days away from disposal facilities. The waste water from the sink, shower, bath and lavatory bypasses the holding tank, yet drains through the same outlet as the waste; therefore you need to make only one connection when hooking up in a trailer park with sewer facilities.

When the toilet will no longer drain, the tank is full and must be emptied. Watch this closely, because when the tank is full, sewage cannot be emptied from the toilet bowl. In models with a central control panel, watch the tank level indicator. To empty the tank, attach the sewer hose by pressing the bayonet fitting onto the dump valve outlet and rotate clockwise until it feels solid and secure. Attach the outlet end of the hose to the sewage outlet, making sure that the hose is placed so that it will drain completely. The dump valve has two wire loops that lock the handle in the closed position. To unlock push outward on the wire loops and they will snap loose, permitting you to open the valve. Pull up the dump valve handle as far as it will go and wait until the tank is drained. Close the dump valve and refill the tank with 5 to 10

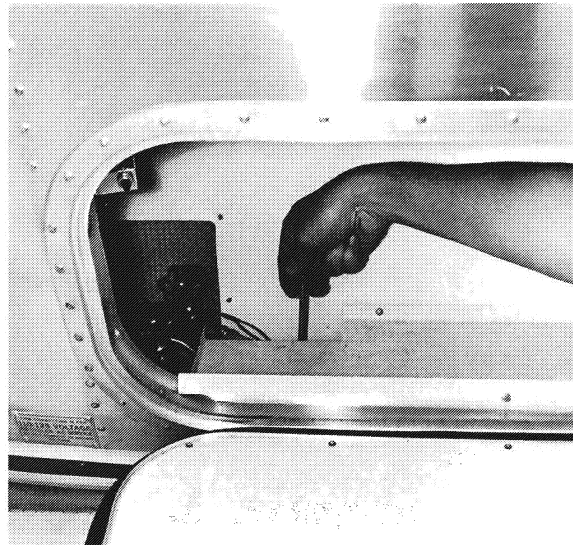

International Rear Bath Dump Valve

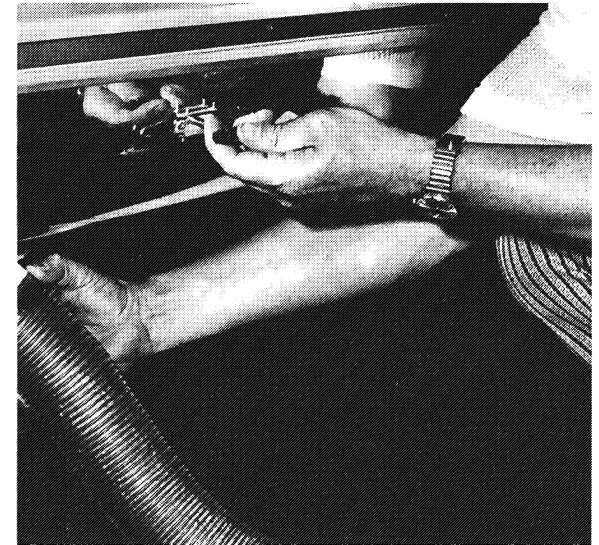

International Center Bath Dump Valve



International Rear Bath Sewage Outlet

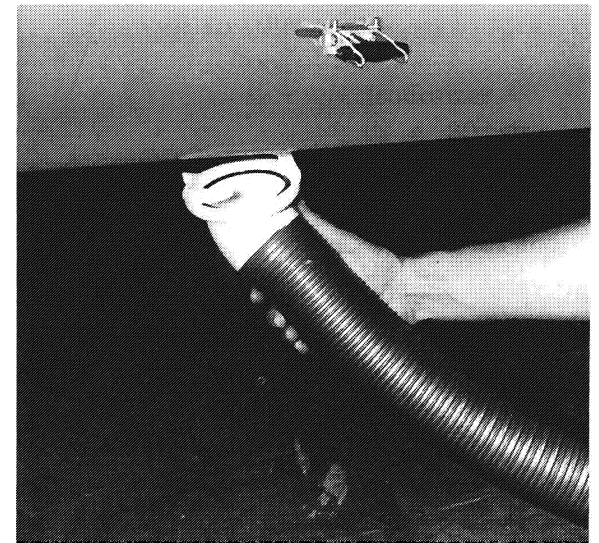

International Center Bath Sewage Outlet

gallons of clean water and repeat the operation until all paper and waste material is flushed out. The capacity of the holding tank on International models, rear and center bath, is 17 gallons and on Land Yacht models 13 gallons.

On International rear bath models, a convenient fitting for flushing the holding tank (see photo) is on the roadside of the rear trunk compartment. Replace the plug after using the fitting. The sewer hose is stored in the rear bumper compartment. Rinse out the sewer line before storing.

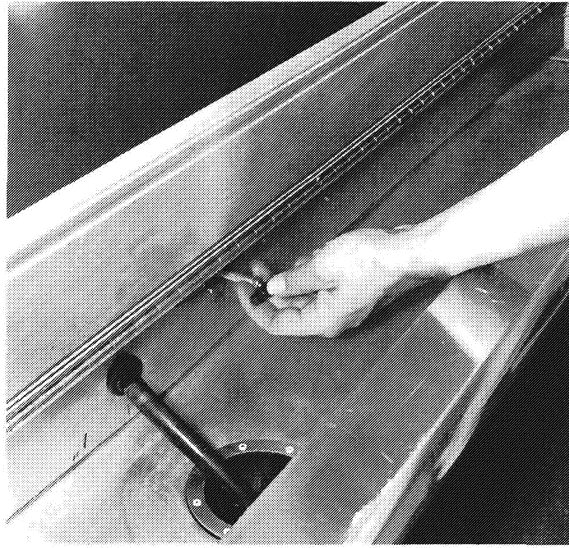

Land Yacht Dump Valve

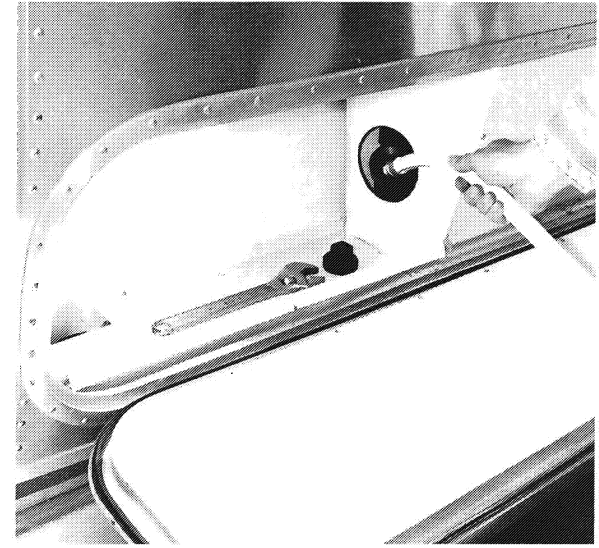

International Rear Bath Flushing Fitting

The Aqua Magic toilet employs a new principle: a sliding self cleaning positive seal blade. Odors cannot escape from the holding tank into the trailer. The unit uses less than 2 quarts of water for automatic flush. A special feature is the second pedal attached to the main foot pedal which, when pressed by itself, allows fresh water through either the fill rim or hand spray without opening the slide valve.

When conserving water, use the hand spray in the following way:

1. Hold the hand spray in ready position over bowl.
2. Depress thumb button and step on the foot pedal, which sprays water and dumps the contents at the same time.
3. Spray bowl clean.
4. Release foot pedal, shutting off water flow.
5. If you wish to refill bowl with water for next use, depress small foot pedal till water reaches desired level.

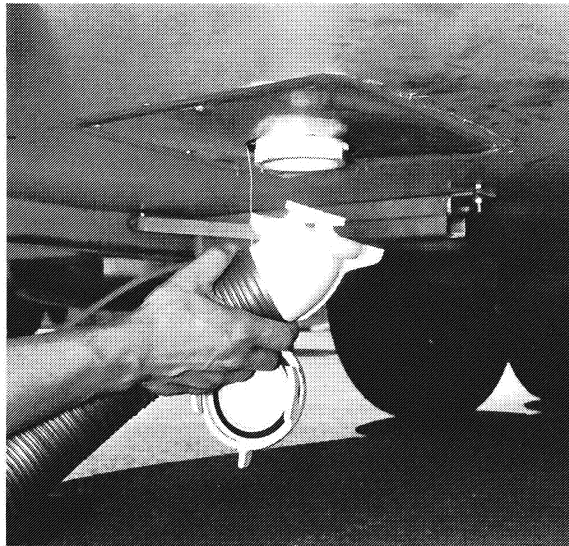

Land Yacht Sewage Outlet



Toilet Hand Spray

When using automatic flush:

1. Step on main foot pedal, and this will automatically open the slide valve and drop the waste into holding tank.
2. Hold pedal down until water begins to swirl. This fills rim storage and rinses the

bowl.

3. Release the foot pedal. This will close the valve blade and stop fresh water from flowing. The bowl will refill automatically.

If you are certain to empty your holding tank



Toilet Pedal Operation

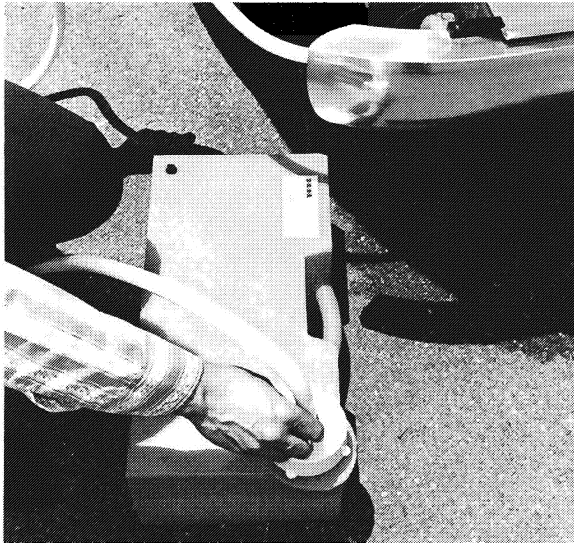

Auxiliary Waste Bucket

every few days, you can use the toilet on automatic flush. It uses very little water and the tank will provide for the requirements of two adults from 2 to 4 days.

Whenever water is scarce, the hand spray flush

makes it possible to stay a week or longer in areas where you cannot empty the holding tank. In flushing for urine only, first, wet the bowl with fresh water, and again after use. Starting with a dry bowl takes more water for the final rinse. To flush for urine and solid matter: spray just enough water in the dry bowl to provide for floating the paper and solids. After use, rinse down the sides with the hand spray and empty the bowl. Hold the slide valve open and spray and rinse the lower surfaces. Even if it appears clean, quickly spray it one more time, then release the pedal and it is ready for the next use.

When connected to a sewer outlet keep the holding tank dump valve closed and empty the tank every few days or whenever it becomes almost full. Only by sending a large volume of liquid through the holding tank at a time will toilet paper and other solids completely wash away. This practice will avoid the accumulation of solids in the holding tank which could lead to an unpleasant cleaning job. Should solids accumulate and close the dump valve, fill the tank about half full with water then tow the trailer for a few miles. The turbulence and surging of the water will usually dissolve the solids into suspension so the tank can be drained.

There are certain items that should never be put into the toilet or tank. Facial and other similar tissues: because they have wet strength and do not dissolve easily. Toilet paper, especially white, dissolves well after a period of traveling.

Detergents and bleaches should not be used as

deodorizers because they may damage your tank.

Use a trailer sewage tank deodorizer instead. Antifreeze, Ammonias, Alcohols and Acetones may cause damage to the tank, valve parts, tank fittings, and drain hose. For protection against freezing, use recommended fluids (See Winterizing, page 24).

Dishwater and Washwater, as they contain detergents which attack the system, should not be dumped into the tank. Some state and federal parks prohibit draining sinks and bathwater into the ground, though this is done in the wilderness. We suggest you use a pail under the drain outlet and discard the water in a public bathroom.

Additionally, some states will not allow the dumping of dish water and wash water into open buckets. In these states (Oregon and Ohio) the auxiliary waste tank, available through the Wally Byam Stores, should be used.

Be sure to keep your dump valve closed while using this tank. Attach the ½" x 5' hose from the auxiliary waste tank to the special fitting on the drain (this fitting available at Wally Byam Stores).

Note: Water conservation must be practiced as this tank will fill rapidly. When tank is filled it may be emptied into any authorized dump facility.

Thermasan

The **Thermasan** option is a model BLT-200 with an **OFF-ON switch** that also acts as dimmer control for three signal lights: The **green ready light** indicates that the system is on. The **red reaction light** shows when the pump is moving wastes through the connecting lines to the hot exhaust. The **white empty bulb** will light when the holding tank is empty.

You may test your **Thermasan** to see if it is moving wastes anytime you desire by pushing the small black button located beneath the three operation lights. Press the button and hold it in at least 30 seconds to see if the red and green lights are slowly flashing, indicating that the pump is operating properly. If the lights do not flash check your electrical disconnect coupling at the trailer hitch.

Each time you hitch or unhitch remember to insert or remove the **Thermasan** connections. The fluid coupling is disconnected by pushing the slip ring towards the trailer and removing the trailer portion.

Operation:

Switch your **Thermasan** control to the "ON" position; the **green light** will glow indicating that the system is ready.

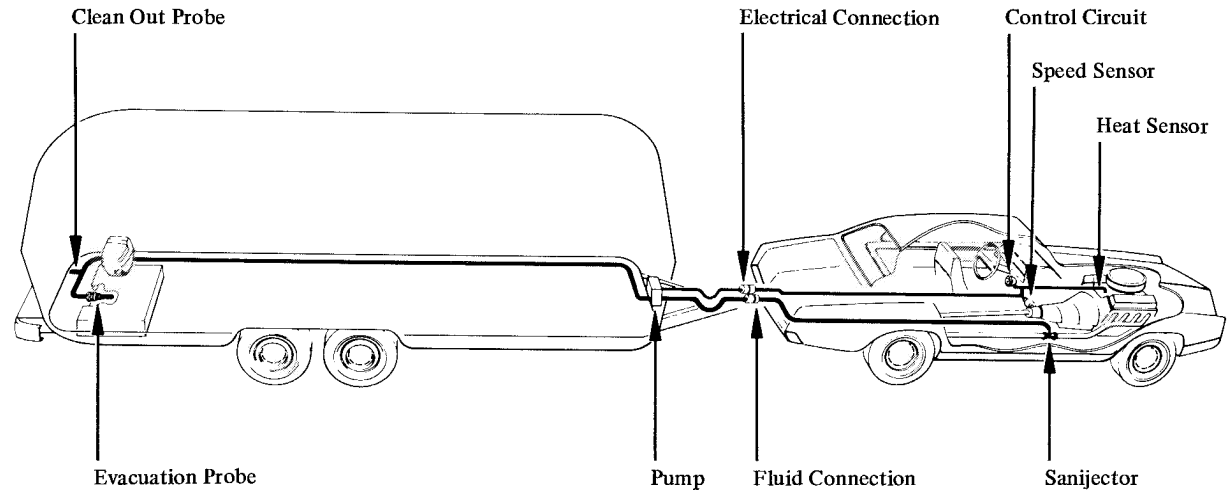

As the speed of your vehicle reaches thirty plus miles per hour and the engine exhaust reaches proper temperature for waste destruction, the **pump** is actuated to withdraw the wastes from the holding tank and transfer it through the connection system into the exhaust. The red reaction light signals that wastes are moving through the lines and being destroyed in a harmless emission that complies with Federal Register, Volume 33, No. 108, Par. 2 and National Sanitation Foundation Standard No. 24 at the rate of 3 gallons per hour.

When on a vacation or trip, operate the unit some each traveling day. Occasional draining of your holding tank by conventional sewer hookup is recommended to remove any foreign particles or other insoluble matter.

Frozen waste lines or a frozen holding tank will not allow the system to destroy waste.

You may overcome this by using a recreational vehicle holding tank anti-freeze (Glycol base). **Do not use Kerosene.**

Chemical Treatment:

With a **Thermasan** installed on your Air-stream, use more water for flushing. With more water mixed with wastes, there is less possibility of exhaust odors. Strong exhaust odors do not mean that the **Thermasan** is operating improperly but indicates that chemical treatment is required. Recommended treatment is:

1. Pour one bottle of **Thermasan** chemical (available at Wally Byam Stores) into an empty or full holding tank through the toilet bowl.
2. Add one-half of a bottle after every four days of toilet operation.

Electrical System

The exclusive **Airstream Univolt System** enables you to use the lights and appliances whether operating on self-contained battery power or hooked up to 120 volt city power. This combination unit is designed for protection from damage up to and including a dead short. The 12 volt light bulbs give off the same light as regular household bulbs, so that when operating on self-contained battery power, everything works normally except the 120 volt convenience outlets and electrical operation of the refrigerator.

Convenience Outlets for 120 volts and 12 volts are located throughout the interior of the trailer, see diagrams page 61.

Exterior outlets for 120 V are located on the curbside exterior wall, aft of the main door.

When operating with city power, make very certain that the service is 120 volt and not 220 volt. Open the bumper storage compartment lid, uncoil only the needed amount of cord, pull it through the access door on the bottom of the storage compartment, and plug it into the city power source.

The univolt system has a new transformer designed to maintain constant output voltages regardless of the variances that occur in city power systems. The transformer design eliminates the need for complex electronic sensing systems to charge the battery, minimizing the possibility of failures and greatly increasing its overall reliability.

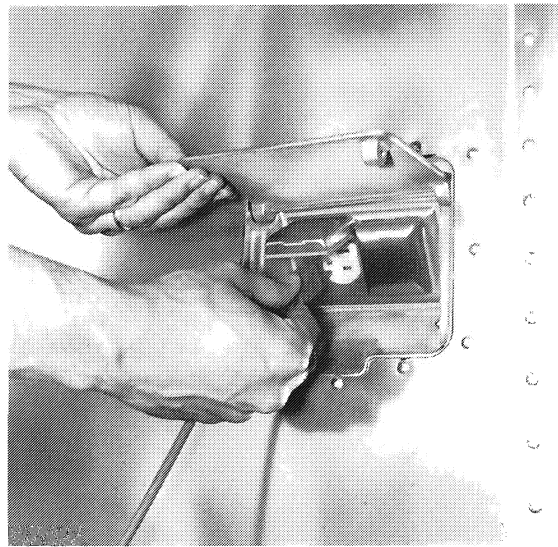

120 Volt Exterior Outlet

When the three pronged plug can be used, there will be no problem with proper polarity or grounding. In some older parks and other locations where three pronged outlets are not available, take certain precautions to insure proper grounding and polarity:

1. Attach the three pronged plug to a two prong adapter. The third conductor line of this adapter has a short wire lead which is the ground line.
2. If possible, clamp the ground line to the junction box or to a water pipe, and then insert the two prong plug into the receptacle.
3. Check the polarity light located above the water heater access panel on International models and to the roadside of the license plate on Land Yacht models. If it is on, pull out the plug, turn it over and reinsert. The light will now be out.

When no water pipe is available, experienced

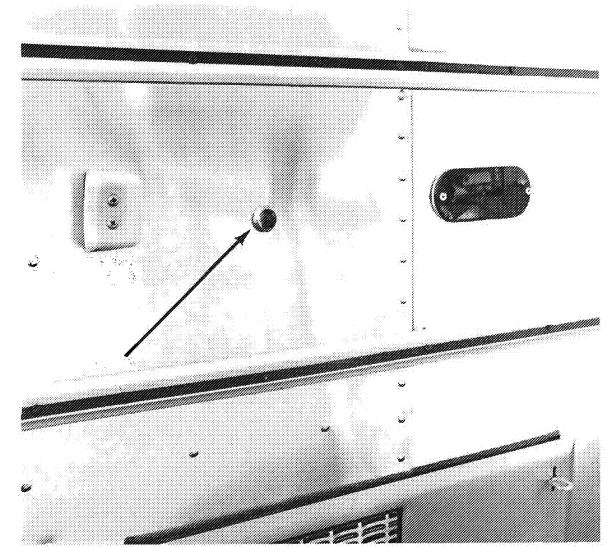

International Polarity Warning Light

travelling people will drive a metal rod two feet into the ground and attach the ground lug to it thus providing the unit with proper grounding.

The polarity warning light indicates improper polarity and it should be off when the power supply cable is used with a two pronged adapter. It may occasionally glow when the three wire system is in use, but your trailer is properly grounded, and in this case you may ignore the light.

To operate self-contained, simply disconnect the power supply cable from the city power receptacle. Store the supply cable in the hose storage compartment.

When your Airstream is hooked up to 120 volt A.C. the **Univolt System automatically charges the trailer battery** and, if it is hooked up, your automobile battery as well. The

speed and degree of charge depends on how much power is used for lights and appliances, as only the surplus goes to charging the battery. (Please refer to the specifications section for more information on power consumption.) If you are making an extended stay or storing your Airstream, then you should (if it is available) **keep your trailer hooked up to 120 volt current.**

Whenever possible, use the automatic built-in charger of the Univolt System for charging. The charging circuit automatically controls the current, reducing it as the battery increases in charge. At service stations, make certain they give your battery a slow charge because quick charges will drastically shorten the life of the battery as will allowing repeated complete discharges.

The Univolt is located at the rear curb side interior next to the bathtub in **International rear bath models**, and is accessible through the rear wardrobe or through the bedroom partition under the bed, depending upon the particular model.

In International center bath models the Univolt is located under the galley and is accessible through a door attached to the magazine rack.

In Land Yacht models the Univolt is located in the bathroom wardrobe, accessible through the bedroom wardrobe or through the bedroom partition under the bed.

On International rear bath models the 120 volt circuit breaker panel is in the rear

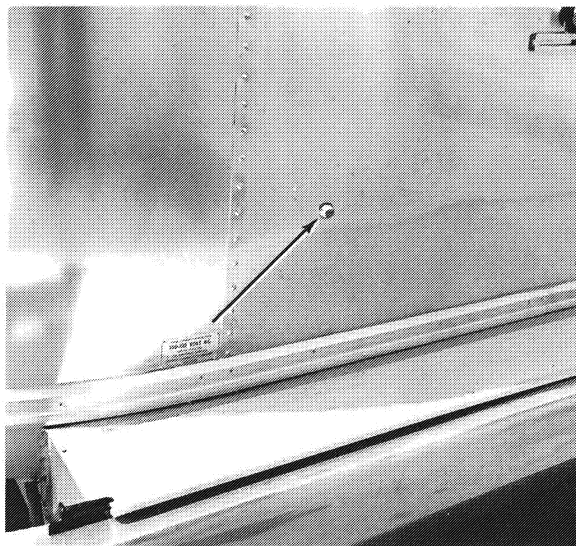

Land Yacht Polarity Warning Light



Univolt

roadside wardrobe. **On International center bath models** it is located under the bathroom lavatory top. **On Land Yacht models** it is located in the curbside bathroom wardrobe. In the event of failure of a 120 volt circuit, check your circuit breaker first. While you are connected to the 120 volt receptacle, the wiring is protected by circuit breakers in the breaker panel. If a breaker continues to trip after you have reset it several times, your circuit may be overloaded with appliances or there may be a short in the circuit. If lessening the load does not solve the problem consult an Airstream Service Center or the factory.

The Univolt System and the Central Control Panel are provided with a series of fuses (see illustrations page 63) for the safety of you

and your unit. Trouble with the electrical system is extremely unlikely, but if it should occur we recommend that you contact your nearest Certified Service Center for repairs. We have included a trouble shooting chart to be used in emergencies only.

Details of electric motor amperage, light bulb size, and fuse and circuit breaker locations are shown on the chart in the specifications section on page 65.

When being towed, the 12 volt battery in your Airstream is receiving a constant charge from the car's generator or alternator through the **Seven Way Connector**. The charge rate is controlled by your automobile's voltage regulator. It is important to keep the seven way connector clean: one method is to use "Spra-Kleen."

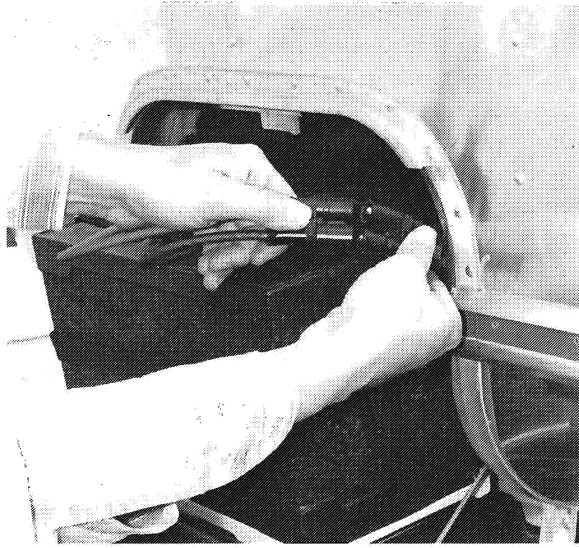

Battery Cable Quick Disconnects

Battery

A normal battery will discharge by itself in 30 to 45 days, therefore, it is necessary to periodically check the battery and charge it as is necessary. We suggest checking the battery at least every two weeks in freezing weather. A fully charged battery will not freeze under any normal circumstances, therefore, it is imperative that you keep your battery charged during the winter. A safe level of charge is a specific gravity reading of 1.225. A fully charged battery has a specific gravity of 1.250 to 1.280. Always use a hydrometer which has a temperature correction scale.

Maintain a clean battery top and check terminals and cables for tightness and cleanliness. A dirty battery will dissipate its charge through surface contamination. Clean battery top with a damp cloth and dry thoroughly.

The terminals should be tight and free of corrosion. To clean terminals, neutralize with a solution of baking soda, rinse in clear water, and dry. Prior to reinstalling, coat terminals and battery posts with a light film of non-metallic grease. Petroleum jelly will do as an alternate, but will require more frequent application. **Important: reconnect the battery cables to the correct battery posts.** For example, if negative ground the black cable should be connected to the negative (-) post and the red cable to the (+) post. The polarity may be determined by inspecting the battery post which is grounded on the tow vehicle, since it must always match the trailer. For example, if negative pole of the tow vehicle is grounded, the polarity of the trailer battery is negative ground.

Add water to cells as necessary. Check the electrolyte level at least once a month. When you are traveling steadily and for an extended period of time, or you are in climates above 90°F check the electrolyte level every two weeks.

Caution: The gases generated within a storage battery cell may be ignited by an open flame or spark in the vicinity of the battery. **Do not use a match to provide light for checking the level of water.**

During the winter the battery should be removed from the Airstream and stored in a cool, dry place, kept full of water, cleaned and charged monthly. A battery which is allowed to completely lose its charge will never regain its original power, or a full charge.

On International rear bath and Land Yacht models the battery is located in a rear curbside compartment. On International center bath models it is located in a front curbside compartment. The battery slides out onto the opened door for service and removal. For removal it is not necessary to remove cables from battery terminals, just pull quick disconnects apart (see photo).

For battery service or replacement, go to any service station or dealer who sells and services this battery. The battery is rated for 100 amp. hrs. at 80°F and has a 24 month prorated warranty.

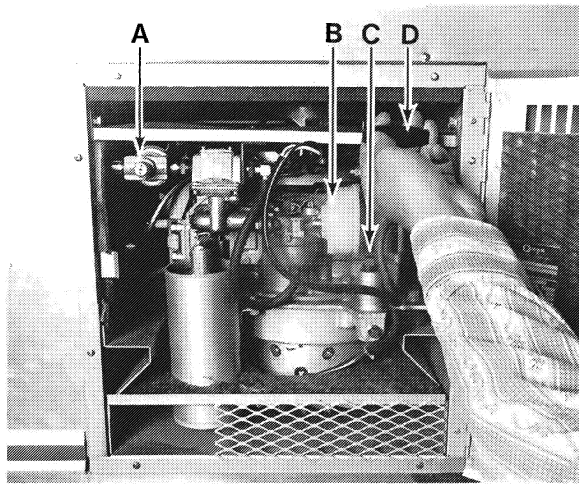

Battery Charger Controls

Battery Charger

General Information:

To identify your particular model, refer to the model and specification letter given on the nameplate. Electrical characteristics of the unit are also given on the nameplate.

How to interpret MODEL and SPEC letter:

0.3	TL	-	212R	/	1	B
1	2		3		4	5

1. Indicates watt rating (0.3 = 300 watts).
2. Factory code for series identification.
3. Indicates voltage code: 212 indicates 12 to 15 volts DC, R indicates remote electric starting.
4. Factory code for optional equipment. Number 1 indicates basic unit.
5. Specification letter which advances when factory makes production modifications.

If necessary to contact a dealer or the factory regarding the unit, always mention the complete model, specification letter and serial number as shown on the Onan nameplate. Refer to the engine nameplate if requesting information from its manufacturer.

The Onan TL Battery Charger is a complete unit made up of a DC generator driven by a single-cylinder, 4-cycle Tecumseh engine. Gaseous-fueled (LPG), the unit can be electric started by the remote control or manually by the use of the recoil starter. The generator is mounted directly on the engine and is positioned in the lower portion of the battery charger compartment. Remote control for the unit, located in the living room roof locker, contains the adjustable timer, start button and charge indicator lamp.

Specifications:

Engine	Tecumseh 1 cylinder
Fuel	Propane gas
Normal Fuel Consumption (at rated load)	0.9 lb/hr
Generator (combination starter & DC generator)**	
Rated Voltage (2000 rpm)	15
Amperes (2000 rpm)	20
Ground	Negative only
Remote Control	
Timer Operation Settings (hours)	0 to 3
Remote Start	Yes

**Rated output to 8000 feet altitude.

Operation:

Before initial operation of the TL battery charger, check all the fuel connections, wire connections, battery, oil level, etc. Check the air inlet and outlets for obstructions which could cause overheating.

Be sure the crankcase has been filled with oil. Oil level is 1/8 inch below top of fill opening when the unit is level. Pour oil slowly to prevent trapping air. See Maintenance and Service Section for all types and complete lubricating oil recommendations.

If the engine doesn't start initially after using the following instructions, remove the spark plug, clean, dry thoroughly and re-install. Smoky exhaust, due to oil in the cylinder, might appear on initial start and is normal.

Electric Starting

1. Turn the adjustable timer on the remote control to the desired duration of operation.
2. Push the START BUTTON on the remote control to crank the engine.

If the timer is set to zero, the unit won't start regardless how long cranking is continued.

Note: For easier starting in cooler temperatures, the choke can be manually closed while the engine cranks — helps draw fuel through the fuel regulator. The choke is located on engine carburetor.

Manual Starting

1. Turn the adjustable timer on the remote control to the desired duration of operation.

2. Push in the fuel solenoid button (A).
3. Pull the start rope (D) with a fast, steady pull to crank the engine.
4. As soon as the engine is running, release the fuel solenoid button. Generator current now holds the fuel solenoid open.

Battery Charging

The charge rate of the TL battery charger is factory set for battery charging. A small lamp marked "GENERATING" lights once the unit is running and charging properly. Operation time ranges to 3 hours and is set by the adjustable timer on the remote control.

Light loads, appliances or fixtures, can be operated from the battery while the unit is running. If the load should ever exceed generator capacity, the generator field will collapse and prevents any damage. As an indication, the small "GENERATING" lamp on the remote control will fail to light when the generator field collapses. Remove some load for proper operation.

As a general guide, a 100 ampere-hour battery requires approximately 3 hours charging if the battery is in a low charge condition. For a more exact determination, use a hydrometer. See Battery section, page 57.

Stopping

Stopping occurs automatically when the adjustable timer on the remote control returns to zero. If you wish to shut down the unit before automatic shutdown, manually turn the pointer on the timer back to zero.

High Temperatures

1. See that nothing obstructs air flow to and from the unit.
2. Keep cooling fins clean.

Low Temperatures

1. Use correct SAE oil for temperature conditions. Change oil only when engine is warm.
2. Keep batteries in a well charged condition.
3. Partially restrict cool air flow if necessary, but use care to avoid overheating.

Extremely Dusty or Dirty Conditions

1. Keep unit clean. Keep cooling system clean.
2. Service air cleaner as frequently as required.
3. Change crankcase oil more often than shown in Maintenance and Service.
4. Keep governor linkage clean.

Out-of-Service Protection

Protect an engine to be out-of-service for more than 30 days as follows:

1. Run unit until thoroughly warm.
2. Turn off fuel supply.
3. Drain oil from oil base while still warm. Refill and attach a warning tag stating oil viscosity used.
4. Service air cleaner and cover with plastic.
5. Wipe entire unit. Coat rustable parts with a light film of grease or oil.
6. Cover air inlet and outlet openings.
7. Disconnect battery and follow standard storage procedures.

Service and Maintenance:

Regularly scheduled maintenance is the key

to lower operating costs and longer service life for the unit. However, actual operating conditions under which a unit is run should be the determining factor in establishing a maintenance schedule. When operating in very dusty or dirty conditions, some of the service periods may have to be reduced. The schedules are divided into two categories: **Owner Maintenance Schedule** — performed by the owner, and **Critical Maintenance Schedule** — performed by qualified service personnel.

For any abnormalities in operation, unusual noises from engine or generator, loss of power, overheating, etc., contact your dealer or factory.

Crankcase Oil

Check the oil level every 4 hours of operating or before each time the unit is used. Change oil every 25 hours but more often if operated in extremely dusty or dirty conditions. For the first fill of oil on a new unit, change oil after two hours operation.

The oil capacity of the engine is 21 ounces. Fill to the oil level which is 1/8 inch below the top of the oil fill opening (C). Pour slowly to prevent trapping air.

When adding oil between changes, always use the same brand that is in the crankcase. Various brands of oil may not be compatible when mixed. Ambient temperatures must be the guide for selection of the proper weight oil. Following are recommendations:

Above 32 F — use SAE 30

Below 32 F — use SAE 10W

Critical Maintenance Schedule

Maintenance Items	Operational Hours	
	200	500
Inspect Magneto Breaker Points	x	
Clean Commutator	x1	
Check Brushes	x2	
Clean Generator	x	
Grind Valves		x

x1 Perform more often in extremely dusty conditions.

x2 Replace brushes when worn to 7/16 inch or less.

Owner Maintenance Schedule

Maintenance Items	Daily	Operational Hours			
		4	25	50	100
Inspect Unit	x				
Check Fuel	x				
Check Oil Level		x			
Clean Air Cleaner			x1		
Change Crankcase Oil			x1		
Clean Governor Linkage				x1	
Check Spark Plug					x
Clean Crankcase Breather					x

x1 Perform more often in extremely dusty conditions.

Use a good quality, heavy duty oil with the API (American Petroleum Institute) designation SE or SE/CC. Don't use an oil with the designation CD unless it is also designated SE and the oil manufacturer certifies it will perform satisfactorily in gasoline engines.

Note: If oils with these designations are not yet available, use an oil with the API designation MS, MS/DG or MS/DM which has passed all the Automotive Manufacturer's Sequence Tests and the MIL-L-2104B Tests.

Air Cleaner

The polyurethane type air cleaner (B) must normally be cleaned every 25 hours, more often if the engine runs rich and emits black,

smoky exhaust due to clogged air cleaner element. To service the air cleaner, remove the air cleaner cover. Then remove the polyurethane element and wash in a detergent and water solution as you would a sponge. Squeeze out the cleaning solution and re-oil the element by applying generous amounts of oil to the sides and open ends. Squeeze to distribute the oil and remove excess oil. Reinstall the element and air cleaner cover.

Crankcase Breather

To remove the crankcase breather assembly (located behind cylinder intake pipe), take out the fastening screws and lift off the breather assembly. The breather has the filtering element held in the cover by a small barb. Depress the element with a blade between the element and cover. Once the element is loosened from the barb, the element can be removed from the cover.

Clean the element with a suitable solvent or household detergent. Blow out the solvent or cleanser used with low pressure air. When re-installing the breather assembly, the drain hole or rectangular opening is at the bottom. Note: The filtering element doesn't have to be lubricated before re-installing because it's lubricated by crankcase vapors during operation.

Ignition

Every 100 hours, remove, inspect, clean and regap the spark plug to .020". If the plug looks discolored or has fouled, replace it. Because the plug used is a special length plug for installation, use the same plug type as the original or equivalent.

Electrical Outlet Locations

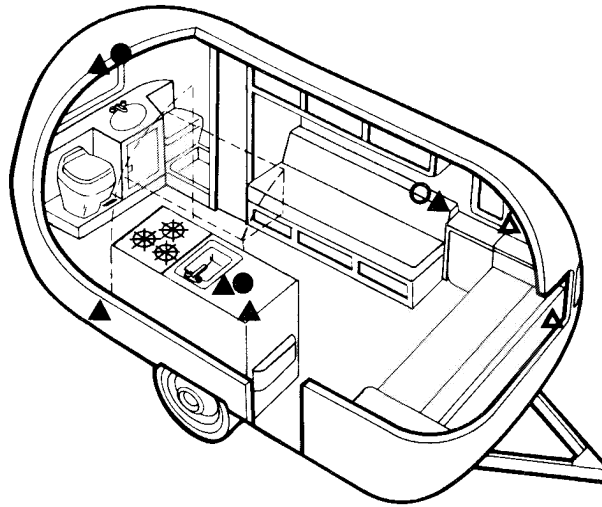

21 ft.

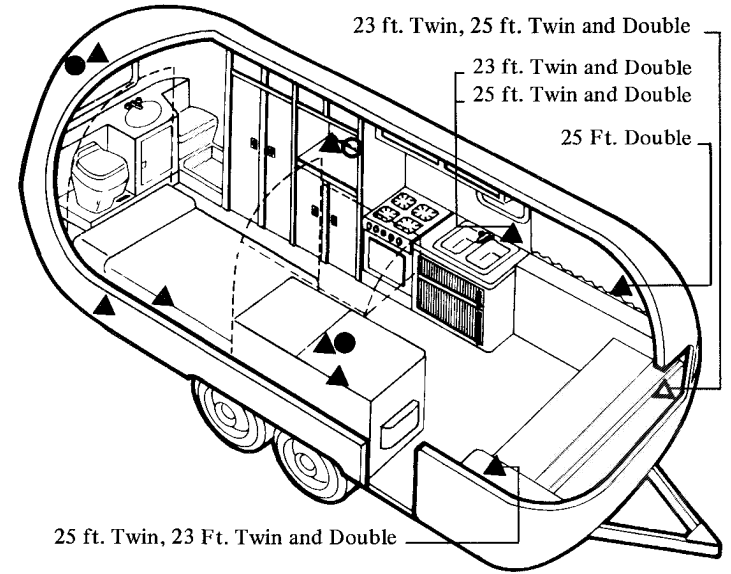

25 ft. Twin, 23 Ft. Twin and Double

23 ft. Twin, 25 ft. Twin and Double
 23 ft. Twin and Double
 25 ft. Twin and Double
 25 Ft. Double

23 ft.-25 ft.

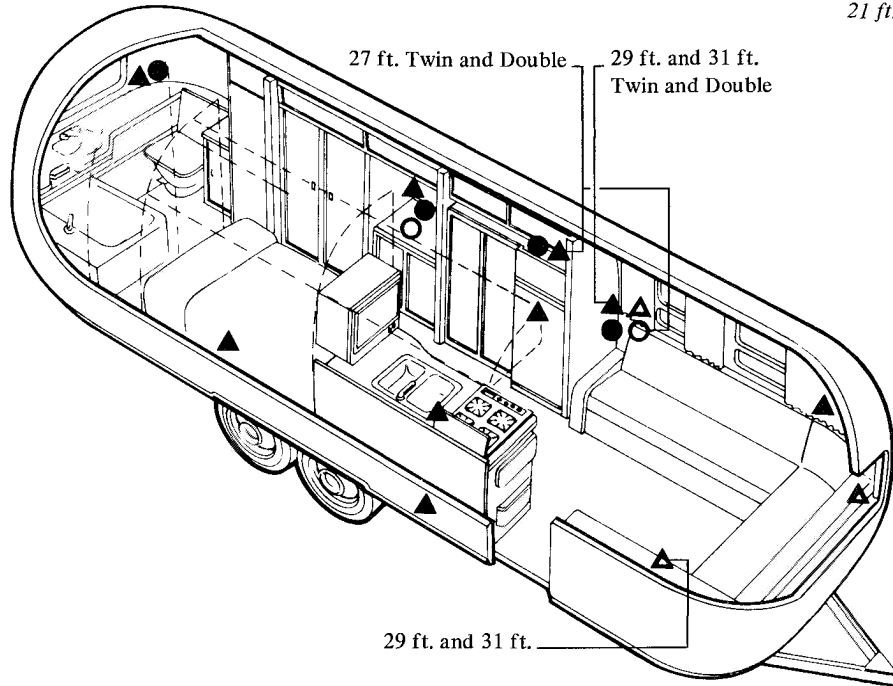

27 ft. Twin and Double
 29 ft. and 31 ft.
 Twin and Double

29 ft. and 31 ft.

27 ft.-29 ft.-31 ft. Rear Bath

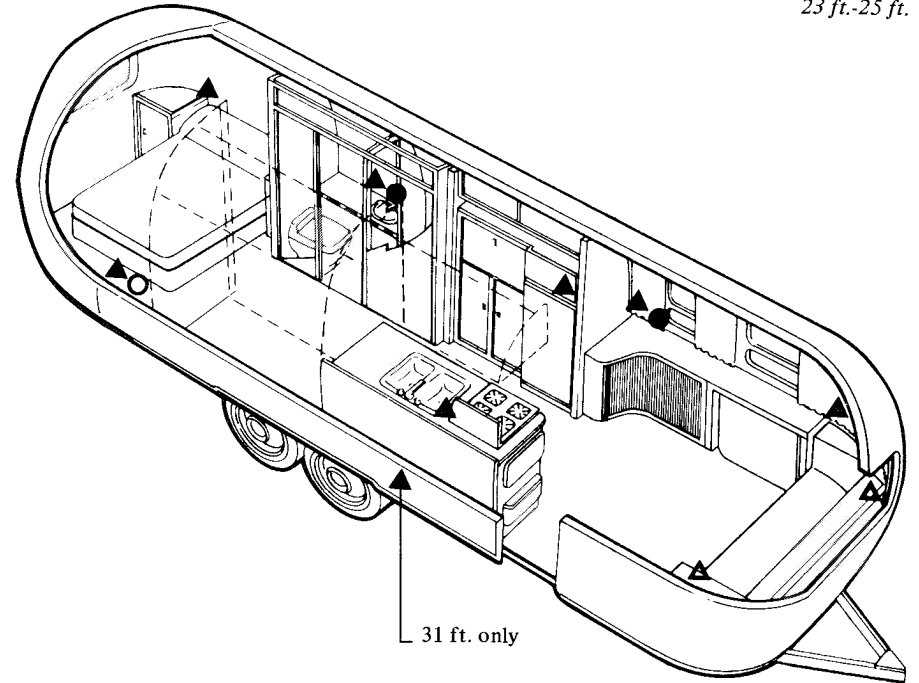

31 ft. only

29 ft.-31 ft. Center Bath

- ▲ 120V Standard
- 12V Standard
- △ 120V Optional
- 12V Optional

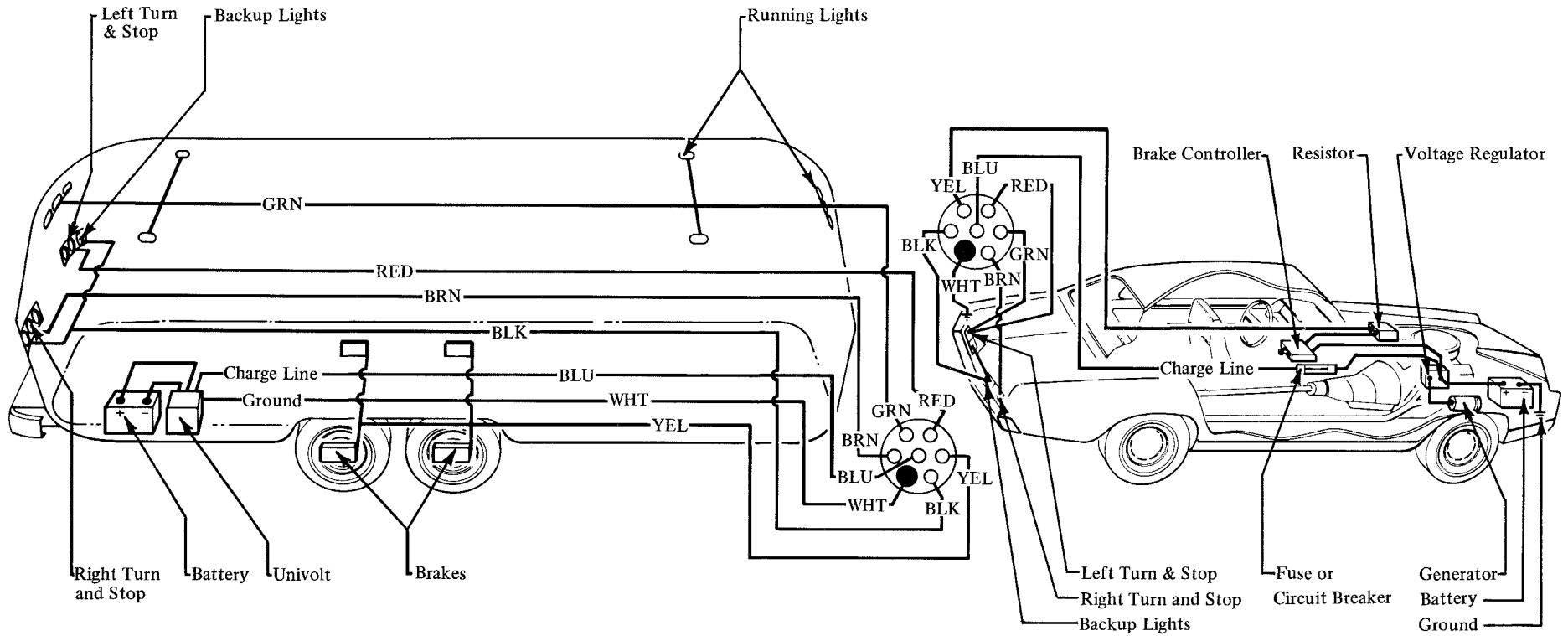

Car-Trailer Electrical Connector

Polarity of trailer battery must match polarity of car battery. e.g. If negative pole of car battery is grounded, negative pole of trailer battery must be grounded.

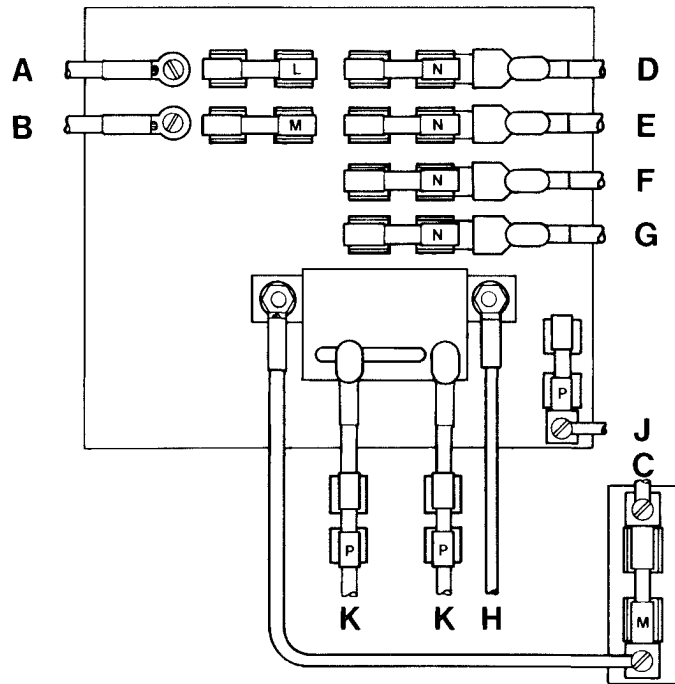

Low Voltage Distribution Panel

- A — Car Battery (pos) & Circuit #5
- B — Trailer Battery + (pos)
- C — Trailer Battery - (neg)
- D — Circuit #1
- E — Circuit #2
- F — Circuit #3
- G — Circuit #4
- H — Negative Load
- J — Power-On-Light
- K — Ammeter
- L — AGU 40 - amp - Fuse
- M — AGU 50 - amp - Fuse
- N — SFE 20 - amp - Fuse
- P — SFE 4 - amp - Fuse

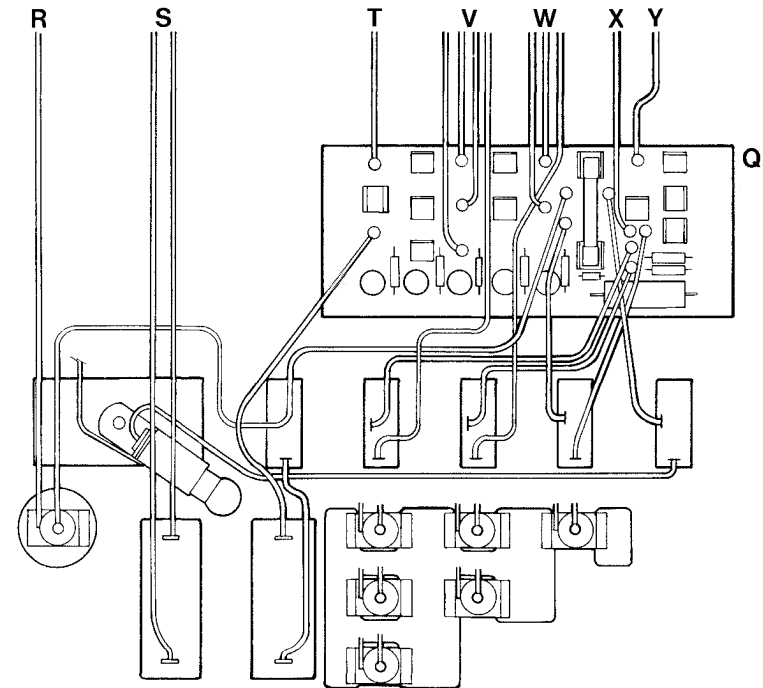

Central Control Panel

- Q — Printed Circuit Board
- R — Power-On
- S — Ammeter Shunt
- T — 12 V - (neg)
- V — Water Tank Probe
- W — Holding Tank Probe
- X — Water Pump
- Y — 12 V + (pos)

Electrical Trouble Shooting

Symptom	Possible Cause	Remedy
No 12-volt power (Lights, appliances do not work)	<ol style="list-style-type: none"> 1. Input line and/or battery not connected 2. Trailer battery on wrong polarity 	<ol style="list-style-type: none"> 1. Make necessary connections 2. See items 3, 4, 5, and 6
Blown fuse	<ol style="list-style-type: none"> 3. Overloaded circuit (over 50 amps) 4. Electrical short 5. Shorted battery 6. Battery terminals not properly corrected to UNIVOLT + and - terminals 	<ol style="list-style-type: none"> 3. Turn off switches to reduce load. Replace blown fuse in Univolt or next to Univolt. 4. Find blown fuse in Univolt and identify circuit. From wiring diagrams check the circuit for defective wiring, lamps or motors. 5. Replace battery and fuse 6. Make proper connections; replace fuse
Dim lights or sluggish fan motor	<ol style="list-style-type: none"> 7. 25- or 50-cycle power (some foreign countries) 8. Discharged battery (when operating without 120-volt line) 	<ol style="list-style-type: none"> 7. Use 60-cycle power 8. Charge battery
UNIVOLT will not charge battery	<ol style="list-style-type: none"> 9. Input line not connected 10. Battery not connected (or polarity reversed) 11. Bad battery 12. Too many lights and appliances in use 13. Fuse blown 	<ol style="list-style-type: none"> 9. Connect input line 10. Connect battery to UNIVOLT 11. Replace battery 12. Reduce electrical load 13. Replace fuse
Specific gravity of battery is too high (over 1.275)	<ol style="list-style-type: none"> 14. Battery is low on water 	<ol style="list-style-type: none"> 14. Add distilled water to battery

Specifications

Light and Appliance Amperages

Item	Lamp Number	Amperage
Control Panel Light	53X	.1
Water Pump	—	9.9 max.
Ceiling Fan	—	4.8
Bathroom Exhaust Fan	—	2.0
Range Exhaust Fan	—	2.0
Furnace Fan		
Int'l 27-31 Ft.	—	5.0
L. Y. 23-25 Ft.	—	3.4
L.Y. 21 Ft.	—	2.9
Toilet Exhaust Fan	—	2.0
Reading Lights:		
Living Room	1383	1.6 each bulb
Bedroom	1141	1.6 each bulb
Main Door Light	1141	1.6
Ceiling Light (6 Bulbs):		
Living Room, Galley,	1141F	1.6 each bulb
Bedroom, Bathroom	1141F	1.6 each bulb
Galley and Vanity Lights under Roof Locker	1141	1.6 each bulb
Trunk Lights:		
Service Center, Trunk	67	.6 each bulb
Clearance & Cluster Lights	1895	
Stop & Turn Signal	1034	
License Plate Light	89	
Backup Lights	1073	
Battery		100 amp hrs. at 80° F.

Fuses and Circuit Breakers

Circuit	Location	Rating
Air Conditioner and General Circuit	120 volt panel	10 amp C.B. (man. resetting)
Charge Line from Car	Univolt	AGU 40 amp fuse
Low Voltage Circuits	Univolt	SFE 20 amp fuse
Trailer Battery Fuse (+)	Univolt	AGU 50 amp fuse
Trailer Battery Fuse (-)	Nxt. to Univolt	AGU 50 amp fuse
Power On Circuit	Univolt	SFE 4 amp fuse
Ammeter	Nxt. to Univolt	SFE 4 amp fuse
Stereo/Radio Fader	Cen. Ctrl. Pnl.	IAG 5 amp fuse
Central Control Panel	Main Cen. Ctrl. Pnl.	AGC 15 amp fuse
Stereo Tape	Cen. Ctrl. Pnl.	SFE 9 amp fuse
Radio	Cen. Ctrl. Pnl.	IAG 5 amp fuse

Capacities

Appliance	Capacity
Waste Holding Tank (Int'l Rear & Center Bath)	17 gal.
Waste Holding Tank (L.Y.)	13 gal.
Water Tank (Int'l & L.Y.)	45 gal.
Water Heater 27 ft. thru 31 ft. (Int'l)	10 gal.
Water Heater 21 ft. thru 25 ft. (L.Y.)	6 gal.

Lubrication and Maintenance

Your Airstream is without a doubt the finest engineered travel trailer ever to be mass-produced. Every design feature and component has been chosen with the thought in mind of giving you thousands of miles of trouble-free operation. By adhering to the following

minimum maintenance schedule and the additional exterior and interior maintenance suggestions you will enjoy all of the pleasure you dream of from your trailer . . . and more.

Item	Every 1,000 miles or 30 days	Every 5,000 miles or 90 days	Every 10,000 miles or 6 months	Procedure
All Exterior Door Locks	X			Lubricate by shooting in dry graphite.
Battery	X			Check water level — fill with distilled water only.
Battery Charger				See page 58.
Brakes			X	Inspect and adjust.
Break Away Switch		X		Pull pin and lubricate with light household oil.
Entrance Door Hinge	X			Lubricate with light household oil.
Hitch Ball Latch	X			Lubricate with engine motor oil.
Hitch Jack	X			Lubricate with light household oil (put oil can spout up under handle and allow oil to run down post).
LPG Hold Down Knob	X			Lubricate with light household oil.
Range Exhaust Hood	X			Clean fan blades and wash filter.
Refrigerator Flue Cleaning				See page 42.
Retracting Step		X		Lubricate moving parts.
Roof Vent Elevator Screws	X			Lubricate with light household oil.
Strike Pocket on Main Door	X			Coat with paraffin.
Tires	X			Check for foreign objects. Air pressure — page 13.
Water Pump		X		Check belt for wear and proper tension.
Wheel Bearings			X	Clean, repack, and adjust.
Wheel Lug Nuts		X*		Check for tightness.
Window Seals/Door Seals		X		Clean with mild detergent and coat with “Slipicone.”
7-Way Plugs and Receptacle		X		Clean contacts and coat with “SPRA-KLEEN.”

*Note: On new trailers check lug nuts every 200 miles for the first 1,000 miles.

Note: If and when new materials and production techniques are developed which can improve the quality of its product, Airstream reserves the right to make such changes.

Maintenance Record

Date	Mileage	Address	Dealer	Service Performed	Remarks

Pre-Travel Check List

Interior	Exterior	Home
<ol style="list-style-type: none">1. Turn off water pump switch.2. Check battery water level.3. Close windows and vents.4. Turn off Gas to Range & Oven.5. Lock all interior cabinet doors.6. Lock refrigerator door (Seal containers first.)7. Hold down or stack securely all loose, hard and sharp objects.8. Fasten sliding & foldette doors.9. Drain toilet bowl.10. Turn off interior lights.11. Secure and lock the Main door.12. Pull up step.	<ol style="list-style-type: none">1. Disconnect and stow:<ol style="list-style-type: none">a) electrical hook-up cordb) sewer-hose hook-up hose. (flush out)c) water hook-up hose.2. Turn off gas line shut-off valve to appliances.3. Remove and stow leveling jacks and wheel chocks.4. Check hitch: it must be properly attached.5. Check safety chains and breakaway switch cable.6. Fully retract jack. Remove and stow dolly wheel.7. Check clearance and stop lights.8. Check lug nuts.9. Check tires, for correct pressure see page 13.10. Check that TV antenna is pointed forward and dipoles closed.11. Adjust car mirrors.12. Pull forward some 50 ft., test brakes, and check site for forgotten objects and cleanliness.	<ol style="list-style-type: none">1. Leave key with your neighbor.2. Store valuables and important papers in a safe place.3. Discontinue newspaper, milk and other deliveries.4. Ask the Post Office to hold your mail for you.5. Arrange with the Telephone Company for discontinued or 'Vacation Service'.6. Arrange care for your pets.7. Have your lawn, garden and house plants cared for.8. Lock all windows and doors securely. Keep shades open for a lived-in look.9. Cover all food to keep out mice and insects.10. Eliminate all fire hazards. Place matches in a tin box or glass jar.11. Store oil, gasoline and other inflammables properly.12. Destroy all newspapers, magazines and oily rags.13. Notify police.
		Personal
		<ol style="list-style-type: none">14. Automobile insurance to cover you and your family fully.15. Avoid cash. Use travelers checks and credit cards.16. Confirm reservations.17. Have sunglasses for everyone.18. Pack cameras and films.19. Make a check list of clothing for everyone, and toilet articles.

Index

Air Conditioner	36	Equipment List	9	Overheating	16	Tire Pressures	13
Aluminum Shell	28	Extended Stay	20	Overnight Stop	19	Toilet	52
Ammeter	35	Extension Step	28	Panel Switches	34	Towing Tips	16
Amperage Chart	65	Exterior	28	Pilot Adjustment:		Trailer Storage	24
Automatic Gas Regulator	40	Exterior Check List	68	Furnace	47	Trouble Shooting:	
Axle	11	Factory Service	4	Oven	45	Electrical	64
Backing	18	Fan Switch	36, 38	Range	44	Furnace	47
Ball (Hitch)	14	Filter (Air Conditioner)	36	Refrigerator	42	Range and Oven	44
Battery	57	Filter (Water)	50	Water Heater	48	Refrigerator	42
Battery Condition Tester	34	Flat Tires	13	Personal Check List	68	Water Systems	49
Battery Charger	58	Foldaway Step	28	Power On	35	TV Antenna	29
Brake Controller	11	Gas (LPG) System	40	Polarity Light	55	Univolt	56
Brakes	11	Gas Tank	40	Range	44	Utility Connection	21
Bulbs (Replacement)	65	Grounding	55, 57	Refrigerator	41	Vista View Windows	29
Capacities	65	Hitch	14	Refrigerator Defrosting	41	Vents	38
Car Connector	15, 62	Hitch Ball Height	14	Registration	4	Warranty	5
Cargo Capacity	13	Hitching Up	14	Regulator (LPG)	40	Water Drainage Procedure ...	24, 49
Ceiling Fans	38	Holding Tank	51	Repair Centers	6	Water Drain Valves	25, 49
Ceiling Vents	38	Home Check List	68	Removing Moisture	47	Water Filter	50
Central Control Panel	34	Interior Check List	68	Running Gear	10	Water Heater	48
Chassis	11	Interior Maintenance	34	Self-Contained (Drainage)	51	Water Inlet	49
Check Lists	68	Jacking Trailer	21	Self-Contained (Electrical)	56	Water Level Indicator	35
Circuit Breakers	56	Lubrication Chart	66	Service Centers	6	Water Pump	49
City Power	55	Laws	22	Sewer Connection	51	Water Pump Switch	35, 49
Clock	34	Leveling	20	Shower Head	39	Water Purifier (Filter)	50
Defrosting	41	Leveling Bars	14	Sink Maintenance	36	Water Pressure Regulator	50
Drainage System	51	Light Bulb Replacement	65	Specifications	65	Water System	49
Dump Valve	51	Lights	38	Stabilizing Jack Positions	20	Weight: HP Radio	10
Electrical Components	55	L.P.G. System	40	Switches: Lights	38	Windows	29
Electrical Connector	15	Loading	10	Tank (Sewage)	51	Winterizing	24
Electrical Inlet	55	Lighting	38	Tank (Water)	49		
Electrical Panels	34, 63	Micro Wave Oven	43	Telephone Shower Head	39		
Electrical System	55	Motoring Check List	69	Thermasan	54		
Electric Jack (Hitch)	14	Oven	44	Tires	13		
		Oven Cleaning	45				

