

Nikon

DIGITAL CAMERA

COOLPIX B700

Reference Manual



Quick Topic Search

-
- Read this manual thoroughly before using the camera.
 - To ensure proper use of the camera, be sure to read "For Your Safety" (page vi).
 - After reading this manual, keep it in a readily accessible place for future reference.

En

Quick Topic Search

You can return to this page by tapping or clicking  in the lower right of any page.

Main Topics

Introduction	iii
Table of Contents	ix
Parts of the Camera	1
Getting Started.....	13
Basic Shooting and Playback Operations	20
Connecting to a Smart Device (SnapBridge).....	28
Shooting Features.....	37
Playback Features.....	84
Movies	94
Connecting the Camera to a TV, Printer, or Computer	105
Using the Menu.....	115
Technical Notes.....	177

Common Topics



For Your Safety



Connecting to a
Smart Device



Tips for Setting
Exposure



Manual Focus



Functions of the
Controls



Functions That
Cannot Be Used
Simultaneously



Troubleshooting



Index



Introduction

Read This First

Thank you for purchasing the Nikon COOLPIX B700 digital camera.

Symbols and Conventions Used in This Manual

- Tap or click  in the lower right of each page to display “Quick Topic Search” (ii).
- Symbols

Symbol	Description
	This icon marks cautions and information that should be read before using the camera.
	This icon marks notes and information that should be read before using the camera.
	This icon marks other pages containing relevant information.

- SD, SDHC, and SDXC memory cards are referred to as “memory cards” in this manual.
- Smartphones and tablets are referred to as “smart devices.”
- The setting at the time of purchase is referred to as the “default setting.”
- The names of menu items displayed on the camera screen, and the names of buttons or messages displayed on a computer screen appear in bold.
- In this manual, images are sometimes omitted from screen display samples so that screen indicators can be more clearly shown.



Information and Precautions

Life-Long Learning

As part of Nikon's "Life-Long Learning" commitment to ongoing product support and education, continually updated information is available online at the following websites:

- For users in the U.S.A.: <http://www.nikonusa.com/>
- For users in Europe: <http://www.europe-nikon.com/support/>
- For users in Asia, Oceania, the Middle East, and Africa: <http://www.nikon-asia.com/>

Visit these websites to keep up-to-date with the latest product information, tips, answers to frequently asked questions (FAQs), and general advice on digital imaging and photography. Additional information may be available from the Nikon representative in your area. Visit the website below for contact information.

<http://imaging.nikon.com/>

Use Only Nikon Brand Electronic Accessories

Nikon COOLPIX cameras are designed to the highest standards and include complex electronic circuitry. Only Nikon brand electronic accessories (including battery chargers, batteries, AC adapters, and USB cables) certified by Nikon specifically for use with this Nikon digital camera are engineered and proven to operate within the operational and safety requirements of this electronic circuitry.

THE USE OF NON-NIKON ELECTRONIC ACCESSORIES COULD DAMAGE THE CAMERA AND MAY VOID YOUR NIKON WARRANTY.

The use of third-party rechargeable Li-ion batteries not bearing the Nikon holographic seal could interfere with normal operation of the camera or result in the batteries overheating, igniting, rupturing, or leaking.

Holographic seal: Identifies this device as an authentic Nikon product.



For more information about Nikon brand accessories, contact a local authorized Nikon dealer.

Before Taking Important Pictures

Before taking pictures on important occasions (such as at weddings or before taking the camera on a trip), take a test shot to ensure that the camera is functioning normally. Nikon will not be held liable for damages or lost profits that may result from product malfunction.



About the Manuals

- No part of the manuals included with this product may be reproduced, transmitted, transcribed, stored in a retrieval system, or translated into any language in any form, by any means, without Nikon's prior written permission.
- Illustrations and screen content shown in this manual may differ from the actual product.
- Nikon reserves the right to change the specifications of the hardware and software described in these manuals at any time and without prior notice.
- Nikon will not be held liable for any damages resulting from the use of this product.
- While every effort was made to ensure that the information in these manuals is accurate and complete, we would appreciate it were you to bring any errors or omissions to the attention of the Nikon representative in your area (address provided separately).

Comply with Copyright Notices

Under copyright law, photographs or recordings of copyrighted works made with the camera can not be used without the permission of the copyright holder. Exceptions apply to personal use, but note that even personal use may be restricted in the case of photographs or recordings of exhibits or live performances.

Disposing of Data Storage Devices

Please note that deleting images or formatting data storage devices such as memory cards does not completely erase the original image data. Deleted files can sometimes be recovered from discarded storage devices using commercially available software, potentially resulting in the malicious use of personal image data. Ensuring the privacy of such data is the user's responsibility.

Before discarding a data storage device or transferring ownership to another person, make sure to reset all of the camera's settings in **Reset all** in the setup menu (📖116). After resetting, erase all data in the device using commercial deletion software, or format the device in **Format memory** or **Format card** in the setup menu (📖116), then completely refill it with images containing no private information (for example, images of empty sky). Care should be taken to avoid injury or damage to property when physically destroying memory cards.



For Your Safety

To prevent damage to property or injury to yourself or to others, read "For Your Safety" in its entirety before using this product.

Keep these safety instructions where all those who use this product will read them.



DANGER

Failure to observe the precautions marked with this icon carries a high risk of death or severe injury.



WARNING

Failure to observe the precautions marked with this icon could result in death or severe injury.



CAUTION

Failure to observe the precautions marked with this icon could result in injury or property damage.



WARNING

- Do not use while walking or operating a motor vehicle. Failure to observe this precaution could result in accidents or other injury.
- Do not disassemble or modify this product. Do not touch internal parts that become exposed as the result of a fall or other accident. Failure to observe these precautions could result in electric shock or other injury.
- Should you notice any abnormalities such as the product producing smoke, heat, or unusual odors, immediately disconnect the battery or power source. Continued operation could result in fire, burns or other injury.
- Keep dry. Do not handle with wet hands. Do not handle the plug with wet hands. Failure to observe these precautions could result in fire or electric shock.
- Do not let your skin remain in prolonged contact with this product while it is on or plugged in. Failure to observe this precaution could result in low-temperature burns.
- Do not use this product in the presence of flammable dust or gas such as propane, gasoline or aerosols. Failure to observe this precaution could result in explosion or fire.
- Do not aim the flash at the operator of a motor vehicle. Failure to observe this precaution could result in accidents.



- Keep this product out of reach of children. Failure to observe this precaution could result in injury or product malfunction. In addition, note that small parts constitute a choking hazard. Should a child swallow any part of this product, seek immediate medical attention.
- Do not entangle, wrap or twist the straps around your neck. Failure to observe this precaution could result in accidents.
- Do not use batteries, chargers, AC adapters, or USB cables not specifically designated for use with this product. When using batteries, chargers, AC adapters, and USB cables designated for use with this product, do not:
 - Damage, modify, forcibly tug or bend the cords or cables, place them under heavy objects, or expose them to heat or flame.
 - Use travel converters or adapters designed to convert from one voltage to another or with DC-to-AC inverters.Failure to observe these precautions could result in fire or electric shock.
- Do not handle the plug when charging the product or using the AC adapter during thunderstorms. Failure to observe this precaution could result in electric shock.
- Do not handle with bare hands in locations exposed to extremely high or low temperatures. Failure to observe this precaution could result in burns or frostbite.
- Do not leave the lens pointed at the sun or other strong light sources. Light focused by the lens could cause fire or damage the product's internal parts. When shooting backlit subjects, keep the sun well out of the frame.



CAUTION

- Turn this product off when its use is prohibited. Disable wireless features when the use of wireless equipment is prohibited. The radio-frequency emissions produced by this product could interfere with equipment onboard aircraft or in hospitals or other medical facilities.
- Remove the battery and disconnect the AC adapter if this product will not be used for an extended period. Failure to observe this precaution could result in fire or product malfunction.
- Do not touch moving parts of the lens or other moving parts. Failure to observe this precaution could result in injury.
- Do not fire the flash in contact with or in close proximity to the skin or objects. Failure to observe this precaution could result in burns or fire.
- Do not leave the product where it will be exposed to extremely high temperatures, for an extended period such as in an enclosed automobile or in direct sunlight. Failure to observe this precaution could result in fire or product malfunction.





DANGER for Batteries

- Do not mishandle batteries. Failure to observe the following precautions could result in the batteries leaking, overheating, rupturing, or catching fire:
 - Use only rechargeable batteries approved for use in this product.
 - Do not expose batteries to flame or excessive heat.
 - Do not disassemble.
 - Do not short-circuit the terminals by touching them to necklaces, hairpins, or other metal objects.
 - Do not expose batteries or the products in which they are inserted to powerful physical shocks.
- Do not attempt to recharge EN-EL23 rechargeable batteries using chargers/cameras not specifically designated for this purpose. Failure to observe this precaution could result in the batteries leaking, overheating, rupturing, or catching fire.
- If battery liquid comes into contact with the eyes, rinse with plenty of clean water and seek immediate medical attention. Delaying action could result in eye injuries.



WARNING for Batteries

- Keep batteries out of reach of children. Should a child swallow a battery, seek immediate medical attention.
- Do not immerse this product in water or expose to rain. Failure to observe this precaution could result in fire or product malfunction. Immediately dry the product with a towel or similar object should it become wet.
- Discontinue use immediately should you notice any changes in the batteries, such as discoloration or deformation. Cease charging if they do not charge in the specified period of time. Failure to observe this precaution could result in the batteries leaking, overheating, rupturing, or catching fire.
- Prior to disposal, insulate battery terminals with tape. Overheating, rupture, or fire may result should metal objects come into contact with the terminals. Recycle or dispose of batteries in accord with local regulations.
- If battery liquid comes into contact with a person's skin or clothing, immediately rinse the affected area with plenty of clean water. Failure to observe this precaution could result in skin irritation.



Table of Contents

Quick Topic Search	ii
Main Topics.....	ii
Common Topics	ii
Introduction	iii
Read This First	iii
Symbols and Conventions Used in This Manual	iii
Information and Precautions.....	iv
For Your Safety	vi
Parts of the Camera	1
The Camera Body.....	2
Principle Functions of the Controls.....	4
The Monitor/Viewfinder	7
Switching the Information Displayed on the Screen (DISP Button).....	7
For Shooting.....	8
For Playback.....	11
Getting Started.....	13
How to Attach the Camera Strap and Lens Cap	14
Inserting the Battery and Memory Card.....	15
Removing the Battery or Memory Card.....	15
Charging the Battery	16
Opening the Monitor	17
Camera Setup.....	18
Basic Shooting and Playback Operations	20
Shooting Images.....	21
Using the Flash	23
Recording Movies	23
Switching Between the Monitor and Viewfinder.....	24
Playing Back Images.....	25
Deleting Images	26
The Image Selection Screen for Deletion	27



Connecting to a Smart Device (SnapBridge)	28
Installing the SnapBridge App	29
Connecting the Camera and a Smart Device	30
Disabling or Enabling the Wireless Connection	33
Image Upload and Remote Photography	34
Image Upload	34
Remote Photography	35
If a Dialog Related to Wi-Fi Connections Is Displayed in iOS	35
If Images Cannot Be Uploaded Successfully	36
<hr/>	
Shooting Features	37
Selecting a Shooting Mode	38
📷 (Auto) Mode	39
Scene Mode (Shooting Suited to the Shooting Conditions)	40
Tips and Notes About Scene Mode	41
Using Skin Softening	48
Shooting with Easy Panorama	49
Playback with Easy Panorama	51
Creative Mode (Applying Effects When Shooting)	52
P, S, A, and M Modes (Setting the Exposure for Shooting)	54
Tips for Setting Exposure	55
The Control Range of the Shutter Speed (P, S, A, and M Modes)	57
U (User Settings) Mode	58
Saving Settings in U Mode (Save User Settings)	59
Setting Shooting Functions with the Multi Selector	60
Flash Mode	61
Self-timer	64
Smile Timer (Shooting Smiling Faces Automatically)	65
Focus Mode	66
Using Manual Focus	68
Exposure Compensation (Adjusting Brightness)	70
Using the Fn1 (Function 1)/ Fn2 (Function 2) Buttons	71
Using the Zoom	72
Focusing	74
The Shutter-release Button	74
Using Target Finding AF	74
Using Face Detection	75
Subjects Not Suitable for Autofocus	76
Focus Lock	77
Default Settings (Flash, Self-timer, and Focus Mode)	78
Functions That Cannot Be Used Simultaneously When Shooting	80



Playback Features.....	84
Playback Zoom.....	85
Thumbnail Playback/Calendar Display.....	86
Viewing and Deleting Images Captured Continuously (Sequence).....	87
Viewing Images in a Sequence.....	87
Deleting Images in a Sequence	88
Editing Images (Still Images)	88
Before Editing Images	88
Quick Retouch: Enhancing Contrast and Saturation	89
D-Lighting: Enhancing Brightness and Contrast.....	89
Skin Softening: Softening Skin Tones	90
Filter Effects: Applying Digital Filter Effects.....	91
Small Picture: Reducing the Size of an Image	92
Crop: Creating a Cropped Copy.....	93
Movies	94
Basic Operations of Movie Recording and Movie Playback.....	95
Capturing Still Images While Recording Movies	98
Shooting Time-lapse Movies	99
Recording Superlapse Movies.....	101
Operations During Movie Playback	102
Editing Movies	103
Extracting Only the Desired Portion of a Movie.....	103
Saving a Frame from a Movie as a Still Image	104
Connecting the Camera to a TV, Printer, or Computer	105
Utilizing Images.....	106
Viewing Images on a TV	107
Printing Images Without a Computer	108
Connecting the Camera to a Printer	108
Printing Images One at a Time	109
Printing Multiple Images	110
Transferring Images to a Computer (ViewNX-i).....	112
Installing ViewNX-i.....	112
Transferring Images to a Computer	112



Using the Menu	115
Menu Operations	116
The Image Selection Screen	118
Menu Lists	119
The Shooting Menu.....	119
The Movie Menu.....	120
The Playback Menu	120
The Network Menu	121
The Setup Menu	122
The Shooting Menu (The Common Shooting Options)	123
Image Quality	123
Image Size.....	125
The Shooting Menu (P, S, A, or M Mode)	126
Picture Control (COOLPIX Picture Control)	126
Custom Picture Control (COOLPIX Custom Picture Control).....	130
White Balance (Adjusting Hue).....	131
Metering	134
Continuous Shooting	135
ISO Sensitivity	139
Exposure Bracketing.....	140
AF Area Mode	141
Autofocus Mode.....	144
Flash Exp. Comp.....	144
Noise Reduction Filter	145
Active D-Lighting	145
Multiple Exposure	146
Zoom Memory.....	148
Startup Zoom Position.....	149
M Exposure Preview	149
The Movie Menu	150
Movie Options.....	150
Autofocus Mode.....	153
Electronic VR.....	154
Wind Noise Reduction	154
Zoom Microphone.....	155
Frame Rate.....	155



The Playback Menu	156
Mark for Upload.....	156
Slide Show.....	157
Protect.....	158
Rotate Image.....	158
Sequence Display Options.....	159
Choose Key Picture.....	159
The Network Menu	160
Operating the Text Input Keyboard.....	161
The Setup Menu	162
Time Zone and Date.....	162
Slot Empty Release Lock.....	164
Monitor Settings.....	165
EVF Auto Toggle (Automatically Switching the Display to the Viewfinder).....	166
Date Stamp.....	166
Vibration Reduction.....	167
AF Assist.....	168
Digital Zoom.....	168
Assign Side Zoom Control.....	169
Sound Settings.....	169
Auto Off.....	170
Format Card.....	170
Language.....	170
Charge by Computer.....	171
Image Comment.....	172
Copyright Information.....	173
Location Data.....	174
Toggle Av/Tv Selection.....	174
Reset File Numbering.....	175
Peaking.....	176
Reset All.....	176
Firmware Version.....	176



Technical Notes	177
Notices	178
Notes About Wireless Communication Functions	180
Caring for the Product	183
The Camera.....	183
The Battery	184
The Charging AC Adapter.....	185
Memory Cards.....	186
Cleaning and Storage	187
Cleaning	187
Storage.....	187
Error Messages	188
Troubleshooting	191
File Names	199
Optional Accessories	200
Specifications	201
Memory Cards That Can Be Used.....	205
Index	207



Parts of the Camera

The Camera Body	2
Principle Functions of the Controls	4
The Monitor/Viewfinder.....	7



The Camera Body

Flash raised

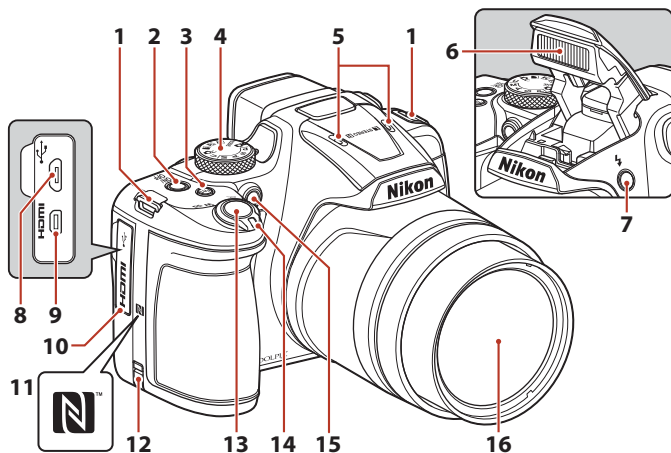

1	Eyelet for camera strap.....	14	11	N-Mark (NFC antenna)	30
2	Power switch/power-on lamp (charge lamp)	16, 18, 23	12	Power connector cover (for optional AC adapter).....	200
3	F n1 (function 1) button.....	71	13	Shutter-release button	22, 74
4	Mode dial.....	21, 38		Zoom control.....	72
5	Microphone (stereo)	95, 155		W : Wide-angle	72
6	Flash.....	23, 61	14	T : Telephoto	72
7	⚡ (flash pop-up) button	61		⏏ : Thumbnail playback	86
8	Micro-USB connector.....	16, 106		Q : Playback zoom	85
9	HDMI micro connector (Type D).....	106		Self-timer lamp.....	64
10	Connector cover	16, 106	15	Red-eye reduction lamp	63
				AF-assist illuminator.....	168
			16	Lens	



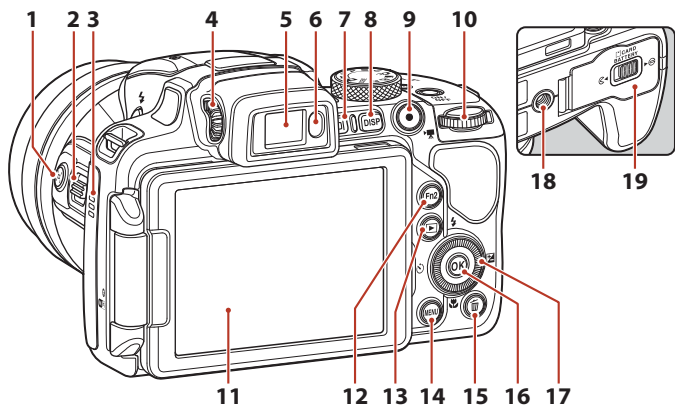





<p>1 (snap-back zoom) button 73</p> <p>Side zoom control 72</p> <p>2 W : Wide-angle 72</p> <p>T : Telephoto 72</p> <p>3 Speaker 102, 169</p> <p>4 Diopter adjustment control 24</p> <p>5 Electronic viewfinder 24</p> <p>6 Eye sensor 24</p> <p>7 (monitor) button 24</p> <p>8 DISP (display) button 7</p> <p>9 (movie-record) button 23, 95</p> <p>10 Command dial 54</p>	<p>11 Monitor 7, 17</p> <p>12 Fn2 (function 2) button 71</p> <p>13 (playback) button 25</p> <p>14 MENU (menu) button 116, 119</p> <p>15 (delete) button 26</p> <p>16 (apply selection) button 116</p> <p>17 Rotary multi selector (multi selector)* 60, 116</p> <p>18 Tripod socket</p> <p>19 Battery-chamber/memory card slot cover 15</p>
--	---





* Also referred to as the “multi selector” in this manual.

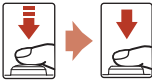











Principle Functions of the Controls

Control	Main Function	
 Mode dial	For shooting	Select a shooting mode (📖38).
 Zoom control	For shooting	Move toward T (📞) (telephoto) to zoom in closer to the subject, and move toward W (📐) (wide-angle) to zoom out and view a larger area.
	For playback	<ul style="list-style-type: none"> • Move toward T (📞) to zoom in on the image, and move toward W (📐) to display images as thumbnails or the calendar. • Adjust the volume for movie playback.
 📐 (Snap-back) zoom button	For shooting	Widen the angle of view temporarily.
 Side zoom control	For shooting	Use the function assigned in Assign side zoom control . <ul style="list-style-type: none"> • Zoom (default setting): Move toward T (telephoto) to zoom in closer to the subject, and move toward W (wide-angle) to zoom out and view a larger area. • Manual focus: When the focus mode is set to MF (manual focus), adjust the focus.
 Shutter-release button	For shooting	When the button is pressed halfway: Set focus and exposure. When the button is pressed all the way: Release the shutter.
	For playback	Return to shooting mode.



Control	Main Function	
  (movie-record) button	For shooting	Start and stop movie recording.
	For playback	Return to shooting mode.
 Multi selector	For shooting	<ul style="list-style-type: none"> While the shooting screen is displayed: Display the following setting screens by pressing: <ul style="list-style-type: none"> Up (▲): ⚡ (flash mode) Left (◀): ⌚ (self-timer/smile timer) Down (▼): 🌿 (focus mode) Right (▶): ☒ (exposure compensation) When the shooting mode is A or M: Rotate the multi selector to set the f-number.
	For playback	<ul style="list-style-type: none"> While the playback screen is displayed: Change the displayed image using up (▲), left (◀), down (▼), right (▶), or by rotating the multi selector. While a zoomed image is displayed: Move the display area.
	For setting	<ul style="list-style-type: none"> Select an item using ▲▼◀▶ or by rotating the multi selector, and then apply the selection by pressing the OK button.
 OK (apply selection) button	For playback	<ul style="list-style-type: none"> Display individual images of a sequence in full-frame playback mode (📖26). Scroll an image shot with Easy panorama. Play back movies. Switch from thumbnail playback or zoomed image display to full-frame playback.
	For setting	Apply the item that you selected by using the multi selector.
 Command dial	For shooting	<ul style="list-style-type: none"> When the shooting mode is P (📖54): Set the flexible program. When the shooting mode is S or M (📖54): Set the shutter speed.
	For playback	Change the magnification rate of a zoomed image.



Control	Main Function	
 MENU (menu) button	For shooting/ playback	Display or close the menu (📖116).
 Fn1 (function 1) button	For shooting	When the shooting mode is P , S , A , M , or U : Display or close the setting menus such as Continuous or Vibration reduction .
 Fn2 (function 2) button		
  (monitor) button	For shooting/ playback	Switch between the monitor and viewfinder (📖24).
 DISP (display) button	For shooting/ playback	Switch the information displayed on the screen.
  (playback) button	For shooting	Play back images (📖25).
	For playback	<ul style="list-style-type: none"> When the camera is turned off, press and hold down this button to turn the camera on in playback mode (📖25). Return to shooting mode.
  (delete) button	For shooting	Delete the last image that was saved (📖26).
	For playback	Delete images (📖26).



The Monitor/Viewfinder

The information that is displayed on the shooting or playback screen changes depending on the camera's settings and state of use.

Switching the Information Displayed on the Screen (DISP Button)

To switch the information displayed on the screen during shooting or playback, press the **DISP** (display) button.

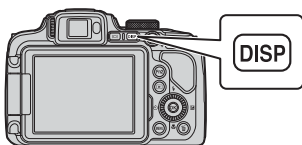

For Shooting

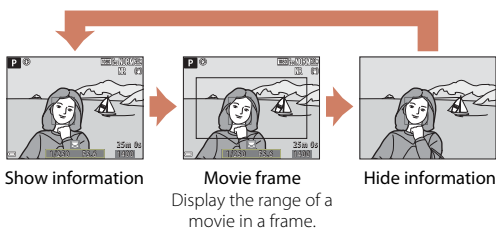

For Playback

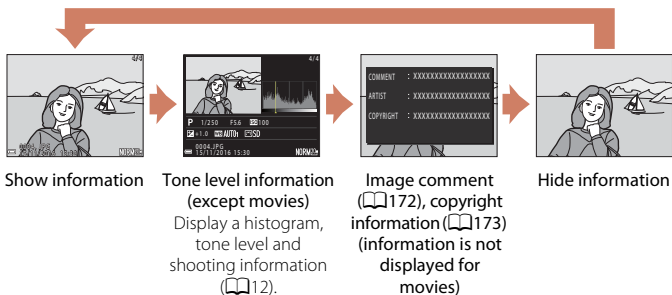

For Shooting

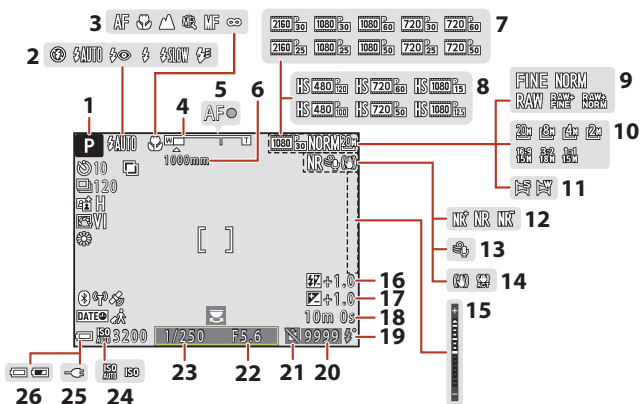

1	Shooting mode	38	15	Exposure indicator	56
2	Flash mode	61	16	Flash exposure compensation	144
3	Focus mode	66	17	Exposure compensation value	70
4	Zoom indicator	67, 72	18	Remaining movie recording time	95, 96
5	Focus indicator	22	19	Ready light	61
6	Zoom memory	148	20	Number of exposures remaining (still images)	21, 124
7	Movie options (normal speed movies)	150	21	Enable release icon (when no memory card is inserted)	164, 193
8	Movie options (HS movies)	151	22	F-number	54
9	Image quality	123	23	Shutter speed	54
10	Image size	125	24	ISO sensitivity	139
11	Easy panorama	49	25	Charging AC Adapter connection indicator	
12	Noise reduction filter	145	26	Battery level indicator	21
13	Wind noise reduction	154			
14	Vibration reduction icon	167			
	Electronic VR icon	154			



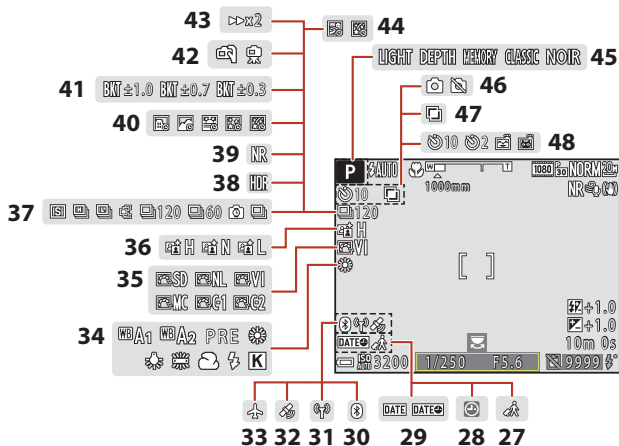

27	Travel destination icon	162	39	Noise reduction burst/single shot.....	42, 43
28	"Date not set" indicator.....	162, 192	40	Time-lapse movie	99
29	Date stamp	166	41	Exposure bracketing	140
30	Bluetooth communication indicator	161	42	Hand-held/tripod	41
31	Wi-Fi communication indicator	160	43	Playback speed.....	101
32	Location data.....	174	44	Multiple exp. Lighten	47
33	Airplane mode.....	160	45	Effect group (creative mode).....	52
34	White balance	131	46	Still image capture (during movie recording).....	98
35	COOLPIX Picture Control.....	126	47	Multiple exposure	146
36	Active D-Lighting.....	145		Self-timer indicator	64
37	Continuous shooting mode	45, 135	48	Smile timer.....	65
38	Backlighting (HDR)	44		Pet portrait auto release	45, 64



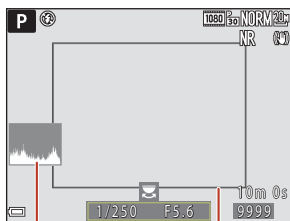
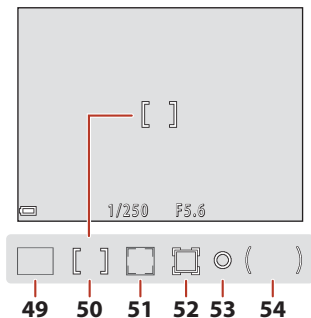

55

56

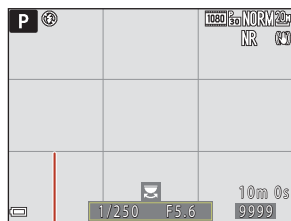

57

- | | | | |
|-----------|--|-----------|--|
| 49 | Focus area (target finding AF) 74, 142 | 53 | Spot metering area..... 134 |
| 50 | Focus area (center/manual) 40, 52, 77, 141 | 54 | Center-weighted area..... 134 |
| 51 | Focus area (face detection, pet detection) 45, 65, 75, 141 | 55 | View/hide histograms..... 165 |
| 52 | Focus area (subject tracking) 142, 143 | 56 | Framing border (Moon or Bird-watching scene mode, or snap-back zoom) 46, 73 |
| | | 57 | View/hide framing grid..... 165 |



For Playback

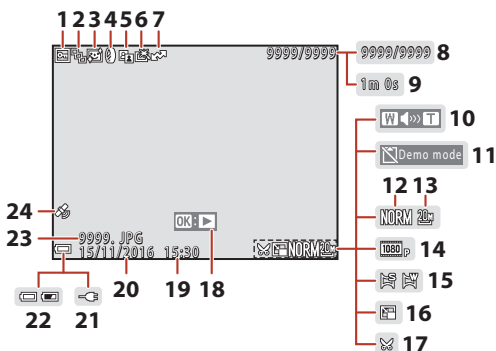

1	Protect icon.....	158	14	Movie options.....	150
2	Sequence display (when Individual pictures is selected).....	159	15	Easy panorama indicator.....	51
3	Skin softening icon.....	90	16	Small picture icon.....	92
4	Filter effects icon.....	91	17	Crop icon.....	93
5	D-Lighting icon.....	89		Easy panorama playback guide.....	51
6	Quick retouch icon.....	89	18	Sequence playback guide.....	87
7	Upload reservation icon.....	156		Movie playback guide.....	95
8	Current image number/ total number of images		19	Time of recording	
9	Movie length or elapsed playback time		20	Date of recording	
10	Volume indicator.....	102	21	Charging AC Adapter connection indicator	
11	Enable release icon (when no memory card is inserted).....	164	22	Battery level indicator.....	21
12	Image quality.....	123	23	File number and type.....	199
13	Image size.....	125	24	Recorded location data indicator...	174



Tone Level Information Display

You can check for loss of contrast detail in highlights and shadows from the histogram that is displayed, or the flashing display for each tone level. These provide guidelines when adjusting the image brightness with functions such as exposure compensation.

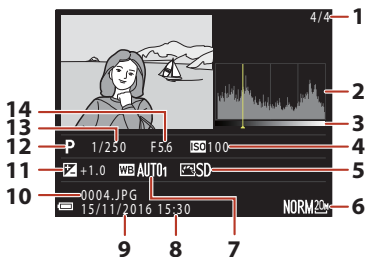

1	Current image number/ total number of images	8	Time of recording 18, 162
2	Histogram ¹	9	Date of recording 18, 162
3	Tone level ²	10	File number and type 199
4	ISO sensitivity 139	11	Exposure compensation value 70
5	COOLPIX Picture Control 126	12	Shooting mode 38
6	Image quality/Image size 123, 125	13	Shutter speed 54
7	White balance 131	14	F-number 54

¹ A histogram is a graph showing the distribution of tones in the image. The horizontal axis corresponds to pixel brightness, with dark tones to the left and bright tones to the right. The vertical axis shows the number of pixels.

² The tone level indicates the brightness level. When the tone level to check is selected using the multi selector ◀▶ or rotating it, the area of the image that corresponds to the selected tone level flashes.



Getting Started

How to Attach the Camera Strap and Lens Cap.....	14
Inserting the Battery and Memory Card.....	15
Charging the Battery.....	16
Opening the Monitor.....	17
Camera Setup.....	18



How to Attach the Camera Strap and Lens Cap

Attach the lens cap to the strap, and then attach the strap to the camera.

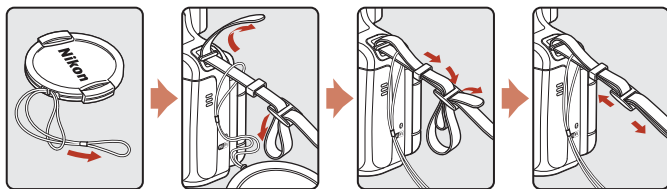

Attach the strap at two places.

Lens Cap

At times when you are not shooting images, attach the lens cap to the lens to protect it.



Inserting the Battery and Memory Card

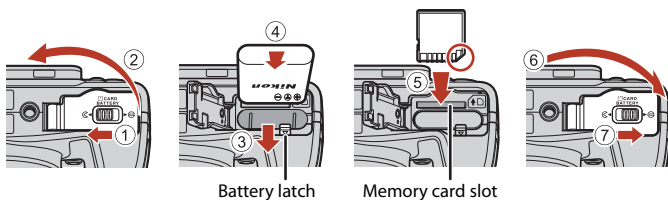

- With the battery's positive and negative terminals oriented correctly, move the orange battery latch (③), and fully insert the battery (④).
- Slide the memory card in until it clicks into place (⑤).
- Be careful not to insert the battery or memory card upside-down or backward, as this could cause a malfunction.

✓ Formatting a Memory Card

The first time you insert a memory card that has been used in another device into this camera, make sure to format it with this camera.

- **Note that formatting a memory card permanently deletes all images and other data on the memory card.** Be sure to make copies of any images you wish to keep before formatting the memory card.
- Insert the memory card into the camera, press the **MENU** button, and select **Format card** in the setup menu (📖116).

Removing the Battery or Memory Card

Turn the camera off and make sure that the power-on lamp and screen have turned off, and then open the battery-chamber/memory card slot cover.

- Move the battery latch to eject the battery.
- Gently push the memory card into the camera to partially eject the memory card.
- Be careful when handling the camera, battery, and memory card immediately after using the camera, as they may be hot.



Charging the Battery

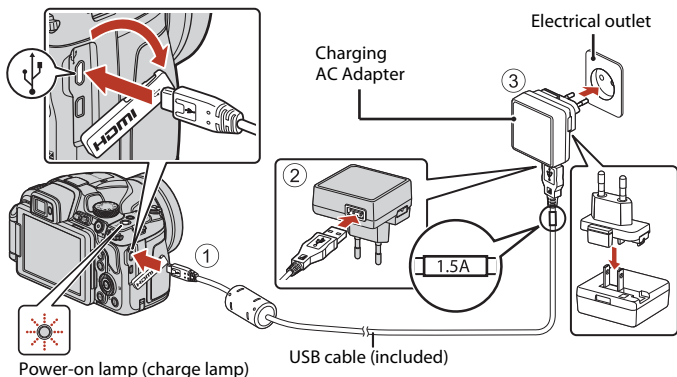

If a plug adapter* is included with your camera, securely connect it to the Charging AC Adapter. Once the two are connected, attempting to forcibly remove the plug adapter could damage the product.

* The shape of the plug adapter varies according to the country or region in which the camera was purchased.

This step can be omitted if the plug adapter comes permanently bonded to the Charging AC Adapter.

- Charging starts when the camera is connected to an electrical outlet while the battery is inserted, as shown in the illustration. The power-on lamp (charge lamp) slowly flashes while the battery is charging.
- When charging is complete, the power-on lamp turns off. Unplug the Charging AC Adapter from the electrical outlet, and disconnect the USB cable. Charging time is about 3 hours for a fully exhausted battery.
- The battery cannot be charged when the power-on lamp quickly flashes, possibly due to one of the reasons described below.
 - The ambient temperature is not suited to charging.
 - The USB cable or Charging AC Adapter is not properly connected.
 - The battery is damaged.



✓ Notes About the USB Cable

- Do not use a USB cable other than the UC-E21. Using a USB cable other than the UC-E21 could result in overheating, fire or electric shock.
- Check the shape and direction of the plugs and do not insert or remove the plugs at an angle.

✓ Notes About Charging the Battery

- The camera can be operated while the battery is charging, but the charging time increases. The power-on lamp (charge lamp) turns off while the camera is being operated.
 - Movies cannot be recorded while the battery is charging.
- Do not, under any circumstances, use another make or model of AC adapter other than the EH-73P/EH-73PCH Charging AC Adapter, and do not use a commercially available USB-AC adapter or a battery charger for a mobile phone. Failure to observe this precaution could result in overheating or in damage to the camera.

Opening the Monitor

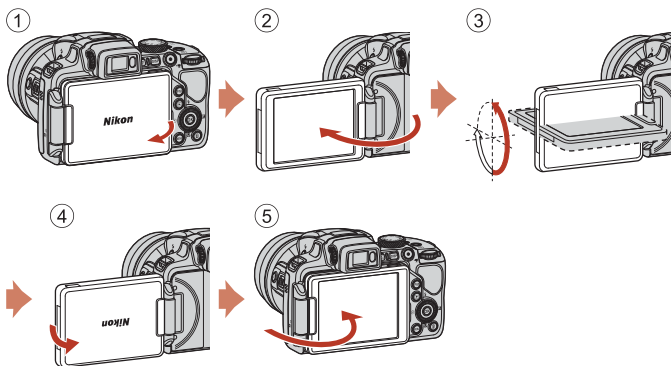

- You can adjust the direction and angle of the monitor. For normal shooting, fold the monitor against the back of the camera, facing out (⑤).
- When you are not using or carrying the camera, fold the monitor against the camera body with the screen facing in (①).

✓ Notes About the Monitor

When moving the monitor, do not apply excessive force and move slowly within the monitor's adjustable range so that the connection will not be damaged.



Camera Setup

1 Press the power switch to turn on the camera.

- Use the multi selector to select and adjust settings.

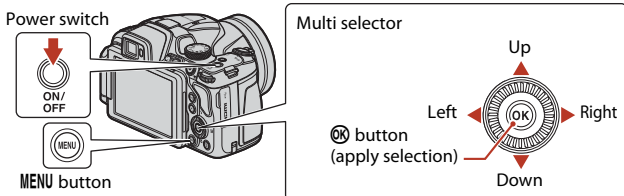

- A language selection dialog will be displayed. Press ▲▼ on the multi selector to highlight a language and press the OK button to select.
- The language can be changed at any time using the setup menu (📖116) → **Language**.

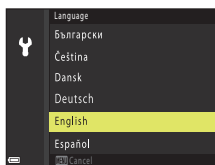

2 When the dialog at right is displayed, follow the instructions below and press the MENU button or OK button.

- If you will not establish a wireless connection with a smart device: Press the MENU button and proceed to step 3.
- If you will establish a wireless connection with a smart device: Press the OK button. See "Connecting to a Smart Device (SnapBridge)" (📖28) for information about the setup procedure.



3 When prompted to set the camera clock, press ▲▼ to highlight Yes and press the OK button.



4 Highlight your home time zone and press the **OK** button.

- Press ▲ to set daylight saving time. When it is on, the time is one hour earlier and ☀ is displayed at the top of the map. Press ▼ to turn daylight saving time off.

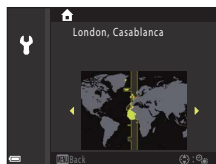

5 Press ▲▼ to select a date format and press the **OK** button.

6 Enter the current date and time and press the **OK** button.

- Press ◀▶ to highlight items and press ▲▼ to change.
- Press the **OK** button to set the clock.

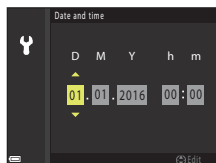

7 When prompted, select **Yes** and press the **OK** button.

- Setup is complete when the camera switches to the shooting screen.
- The time zone and date can be changed at any time using the setup menu (📖116)
➔ **Time zone and date.**



Basic Shooting and Playback Operations

Shooting Images.....	21
Playing Back Images.....	25
Deleting Images.....	26





Shooting Images

 (auto) mode is used here as an example.  (auto) mode enables you to perform general shooting in a variety of shooting conditions.

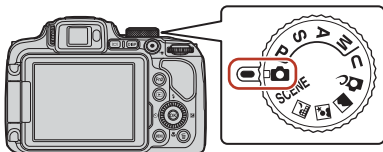
1 Rotate the mode dial to .



Number of exposures remaining

- Battery level indicator
 - : The battery level is high.
 - : The battery level is low.
- Press the **DISP** (display) button to switch the information displayed on the screen each time.

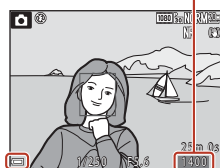

Battery level indicator

2 Hold the camera steady.

- Keep fingers and other objects away from the lens, flash, AF-assist illuminator, microphone, and speaker.

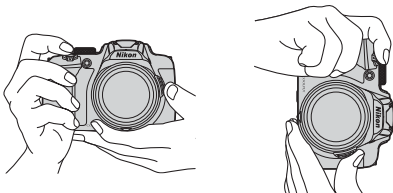

3 Frame the picture.

- Move the zoom control or the side zoom control to change the zoom lens position.
- If you lose sight of the subject while shooting with the lens in telephoto position, press the  (snap-back zoom) button to temporarily widen the visible area so that you can frame the subject more easily.

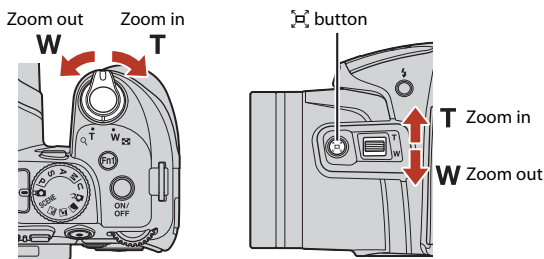

4 Press the shutter-release button halfway.

- To press the shutter-release button "halfway" means to press and hold the button at the point where you feel a slight resistance.
- When the subject is in focus, the focus area or focus indicator is displayed in green.
- When you are using digital zoom, the camera focuses in the center of the frame and the focus area is not displayed.
- If the focus area or focus indicator flashes, the camera is unable to focus. Modify the composition and try pressing the shutter-release button halfway again.

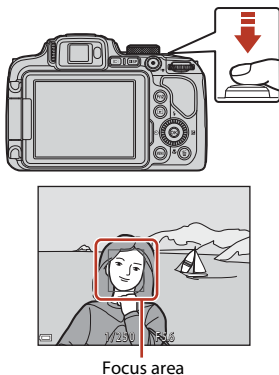

5 Without lifting your finger, press the shutter-release button all the way down.





✓ Notes About Saving Images or Movies

The indicator showing the number of exposures remaining or the indicator showing the remaining recording time flashes while images or movies are being saved. **Do not open the battery-chamber/memory card slot cover or remove the battery or memory card** while an indicator is flashing. Doing this could result in loss of data, or in damage to the camera or the memory card.

📎 The Auto Off Function

- When no operations are performed for about one minute, the screen turns off, the camera enters standby mode, and then the power-on lamp flashes. The camera turns off after remaining in standby mode for about three minutes.
- To turn the screen back on while the camera is in standby mode, perform an operation such as pressing the power switch or shutter-release button.

📎 When Using a Tripod

- We recommend using a tripod to stabilize the camera in the following situations:
 - When shooting in dim lighting with the flash mode set to  (off)
 - When the zoom is at a telephoto position
- When using a tripod to stabilize the camera during shooting, set **Vibration reduction to Off** in the setup menu ( 116) to prevent potential errors caused by this function.



Using the Flash

In situations where a flash is needed, such as in dark locations or when the subject is backlit, press the  (flash pop-up) button to raise the flash.

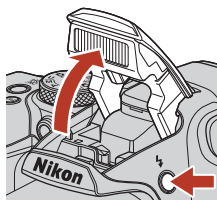
- When not using the flash, gently push to lower the flash until it clicks shut.



Recording Movies

Display the shooting screen and press the  (movie-record) button to start recording a movie. Press the  button again to end recording.

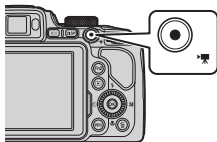

Switching Between the Monitor and Viewfinder

It is recommended that you use the viewfinder when bright conditions make it difficult to see the monitor, such as when outdoors in sunlight.

- When you bring your face close to the viewfinder, the eye sensor responds to it and the viewfinder turns on, and the monitor turns off (default setting).
- You can also press the  (monitor) button to switch the display between the monitor and viewfinder.

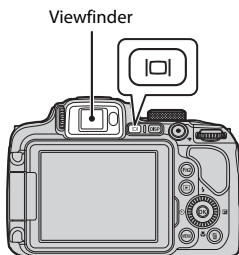

Diopter Adjustment of the Viewfinder

When the image in the viewfinder is difficult to see, adjust by rotating the diopter adjustment control while looking through the viewfinder.

- Take care not to scratch your eye with your fingertips or nails.

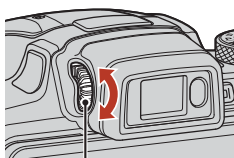

Diopter adjustment control

Notes About Checking and Adjusting Image Colors

Use the monitor on the back of the camera because the monitor has higher color reproducibility than the viewfinder.







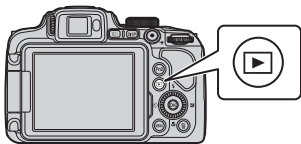

Playing Back Images

1 Press the (playback) button to enter playback mode.

- If you press and hold down the  button while the camera is turned off, the camera turns on in playback mode.



2 Use the multi selector to select an image to display.

- Press and hold down    to scroll through the images quickly.
- Images can also be selected by rotating the multi selector.
- Press the **DISP** (display) button to switch the information displayed on the screen each time.
- To play back a recorded movie, press the  button.
- To return to shooting mode, press the  button or shutter-release button.
- Move the zoom control toward **T** () in full-frame playback mode to zoom in on an image.

Display the previous image

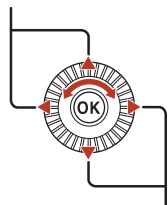

Display the next image

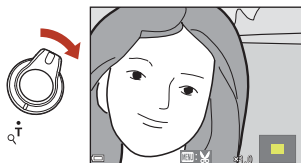

- In full-frame playback mode, move the zoom control toward **W** () to switch to thumbnail playback mode and display multiple images on the screen.

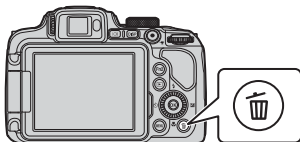

Deleting Images

- 1 Press the  (delete) button to delete the image currently displayed on the screen.



- 2 Use the multi selector   to select the desired deletion method and press the  button.

- To exit without deleting, press the **MENU** button.

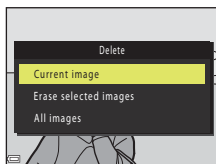

- 3 Select **Yes** and press the  button.

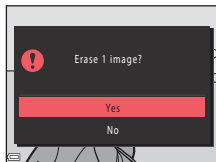

- Deleted images cannot be recovered.



Notes About Deleting Images Simultaneously Saved in RAW and JPEG

When using this camera to delete images captured using **RAW + Fine** or **RAW + Normal** in the **Image quality** (📖 119) setting, both of the simultaneously saved RAW and JPEG images are deleted. You cannot delete only one format.

Deleting Images Captured Continuously (Sequence)

- Images captured continuously are saved as a sequence, and only the first image of the sequence (the key picture) is displayed in playback mode (default setting).
- If you press the  button while a key picture is displayed for a sequence of images, all images in the sequence are deleted.
- To delete individual images in a sequence, press the  button to display them one at a time and press the  button.

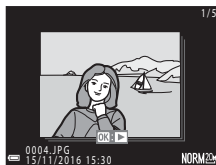

Deleting the Image Captured While in Shooting Mode

When using shooting mode, press the  button to delete the last image that was saved.



The Image Selection Screen for Deletion

1 Use the multi selector ◀▶ or rotate it to select the image that you want to delete.

- Move the zoom control (📖) toward **T** (🔍) to switch to full-frame playback, or **W** (📐) to switch to thumbnail playback.

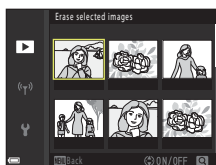

2 Use ▲▼ to select **ON** or **OFF**.

- When **ON** is selected, an icon is displayed under the selected image. Repeat steps 1 and 2 to select additional images.

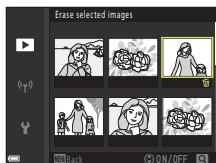

3 Press the **OK** button to apply the image selection.

- A confirmation dialog is displayed. Follow the on-screen instructions to operate.



Connecting to a Smart Device (SnapBridge)

Installing the SnapBridge App.....	29
Connecting the Camera and a Smart Device	30
Image Upload and Remote Photography	34



Installing the SnapBridge App

When you install the SnapBridge app and establish a wireless connection between a SnapBridge-supported camera and smart device, you can upload images captured with the camera to the smart device, or use the smart device to release the camera shutter (📖34).



- Procedures are described using the SnapBridge app Version 2.0. Use the latest version of the SnapBridge app. The operating procedures may vary depending on the camera's firmware, version of the SnapBridge app, or OS of the smart device.
- See the documentation provided with the smart device for information on how to use it.

1 Install the SnapBridge app on the smart device.

- Download the app from the Apple App Store® for iOS, and from Google Play™ for Android™. Search for "snapbridge" and then install it.



- Visit the applicable download site for more information about supported OS versions.
- The "SnapBridge 360/170 app" cannot be used with this camera.

2 Enable Bluetooth and Wi-Fi on the smart device.

- **Use the SnapBridge app to connect to the camera. You cannot connect from the Bluetooth settings screen on the smart device.**

Screens in the SnapBridge App

- ① You can view notices from Nikon and the SnapBridge app Help, as well as configure the app's settings.
- ② Primarily perform connection settings for smart devices and cameras.
- ③ You can view, delete, or share images downloaded from the camera.

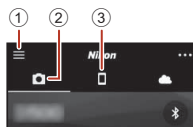

Connecting the Camera and a Smart Device

- Use a sufficiently charged battery so that the camera does not turn off during the procedure.
- Insert a memory card with sufficient free space into the camera.

1 Camera: Select **Network menu** (📖116) → **Connect to smart device**, and press the **OK** button.

- The dialog in step 2 is displayed when you turn on the camera for the first time. This step is unnecessary in such cases.

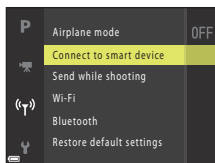

2 Camera: Press the **OK** button when the dialog on the right is displayed.

- A dialog prompting you whether to use the NFC function is displayed. If you will use the NFC function, touch the NFC antenna of the smart device to **N** (N-mark) on the camera. When **Start pairing?** is displayed on the smart device, tap **OK** and proceed to step 7. If you will not use the NFC function, press the **OK** button.

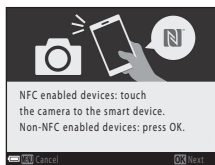
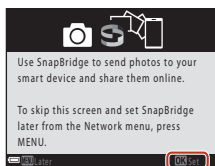

3 Camera: Confirm that the dialog on the right is displayed.

- Prepare the smart device and proceed to the next step.

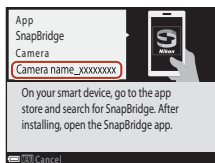

4 Smart device: Launch the SnapBridge app and tap **Pair with camera**.

- When the dialog to select a camera is displayed, tap the camera you want to connect to.
- If you did not connect to the camera by tapping **Skip** at the upper-right of the screen when launching the SnapBridge app for the first time, tap **Pair with camera** in the  tab and proceed to step 5.



5 Smart device: In the **Pair with camera** screen, tap the camera name.

- For iOS, if a dialog explaining the procedure is displayed when connecting, confirm the details and tap **Understood** (if it is not displayed, scroll down the screen). Tap the camera name again when the screen to select an accessory is displayed (it may take some time for the camera name to be displayed.).

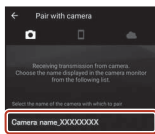

6 Camera/smart device: Confirm that the camera and smart device display the same number (six digits).

- For iOS, the number may not be displayed on the smart device depending on the OS version. Proceed to step 7 in such cases.

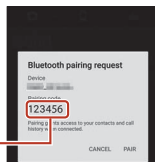

7 Camera/smart device: Press the button on the camera and **PAIR** in the SnapBridge app.

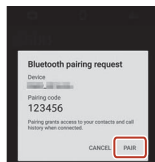



8 Camera/smart device: Finish the connection settings.

Camera: Press the **OK** button when the dialog on the right is displayed.

Smart device: Tap **OK** when the dialog indicating that pairing is complete is displayed.



9 Camera: Follow the on-screen instructions to complete the setup process.

- To record location data with photographs, select **Yes** when prompted and enable the location data features. Enable location data features on the smart device, and in the  tab of the SnapBridge app → **Auto link options** → enable **Synchronize location data**.
- You can synchronize the camera clock to the time reported by the smart device by selecting **Yes** when prompted. In the  tab of the SnapBridge app → **Auto link options** → enable **Synchronize clocks**.

Connecting the camera and smart device is complete.

Still images captured with the camera are automatically uploaded to the smart device.

To Learn More About the SnapBridge App

See the online help for details on how to use the SnapBridge app (after connecting, refer to the SnapBridge app menu → **Help**).

<http://nikonimglib.com/snbr/onlinehelp/en/index.html>



If the Connection Is Unsuccessful

- If the camera displays **Could not connect.** when connecting
 - Press the **OK** button and repeat the procedure from step 2 (📖30) in “Connecting the Camera and a Smart Device” to connect again.
 - Press the **MENU** button to cancel the connection.
- The issue may be solved by relaunching the app. Close the SnapBridge app completely and then tap the app icon again to launch it. When the app launches, repeat the procedure from step 1 (📖30) in “Connecting the Camera and a Smart Device.”
- If the camera cannot connect and an error occurs in iOS, the camera may be registered as a device in iOS. Launch the iOS settings app and deregister the device (camera name) in such cases.

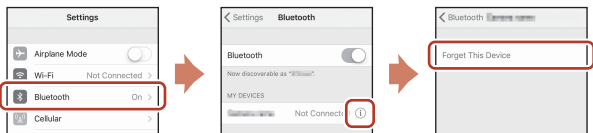

Disabling or Enabling the Wireless Connection

Use any of the following methods to disable or enable the connection.

- Switch the setting in **Network menu → Airplane mode** in the camera. You can set it to **On** to turn off all communication functions in places where wireless communication is prohibited.
- Switch the setting in **Network menu → Bluetooth → Connection** in the camera.
- Switch the setting in the  tab → **Auto link options → Auto link** in the SnapBridge app.
You can reduce battery consumption of the smart device by disabling this setting.



Image Upload and Remote Photography

Image Upload

There are three ways to upload images.

- RAW images cannot be uploaded.



Automatically upload images to the smart device every time they are captured ^{1,2}	Network menu in the camera → Send while shooting → set Still images to Yes . Movies cannot be uploaded automatically.
Select images in the camera and upload them to the smart device ^{1,2}	Playback menu in the camera → use Mark for upload to select images. Movies cannot be selected for upload.
Use the smart device to select images in the camera and download them to the smart device	 tab in the SnapBridge app → tap Download pictures . A dialog related to Wi-Fi connections is displayed. Tap OK ³ and select images.

¹ The size of images that are uploaded is 2 megapixels.

² When **Network menu** → **Bluetooth** → **Send while off** in the camera is set to **On**, images are uploaded to the smart device automatically even when the camera is turned off.

³ Depending on the iOS version, you must select the camera SSID when you tap **OK**. See "If a Dialog Related to Wi-Fi Connections Is Displayed in iOS" (📖35).

Notes About When in a Wi-Fi Connection

- If the smart device enters sleep mode or you switch from the SnapBridge app to another app, the Wi-Fi connection will be disconnected.
- Some functions of the SnapBridge app cannot be used during a Wi-Fi connection. To cancel a Wi-Fi connection, tap the  tab →  → **Yes**.

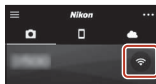

Remote Photography

You can tap the  tab in the SnapBridge app → **Remote photography** to release the camera shutter using a smart device.

- Follow the instructions in the SnapBridge app to switch to a Wi-Fi connection. In iOS, a dialog related to Wi-Fi connections may be displayed. In such a case, see “If a Dialog Related to Wi-Fi Connections Is Displayed in iOS” (📖35).
- You cannot perform remote photography if a memory card is not inserted in the camera.

If a Dialog Related to Wi-Fi Connections Is Displayed in iOS

The SnapBridge app normally connects the camera and smart device via Bluetooth. However, switch to a Wi-Fi connection when using **Download pictures** or remote photography. Depending on the iOS version, you must switch the connection manually. In such a case, use the following procedure to set the connection.

1 Write down the camera SSID (camera name at default) and password displayed in the smart device, and then tap **View options**.

- You can change the SSID or password by using **Network menu** → **Wi-Fi** → **Network settings** in the camera. To protect your privacy, we recommend that you change the password regularly. Disable the wireless connection when changing the password (📖33).





2 Select the SSID you wrote down in step 1 from the list of connections.

- When you connect for the first time, input the password you wrote down in step 1 while taking note of uppercase and lowercase characters. Inputting the password is unnecessary after the first time connecting.
- The Wi-Fi connection is complete when ✓ is displayed next to the camera SSID as shown in the screen on the right. Return to the SnapBridge app and operate the app.



If Images Cannot Be Uploaded Successfully

- If the connection is disconnected while uploading images through the **Send while shooting** or **Mark for upload** function in the camera, the connection and image upload may resume when you turn the camera off and then on again.
- You may be able to upload by canceling the connection and then establishing a connection again. Tap the  tab in the SnapBridge app →  → **Forget camera** → camera whose connection you want to cancel → **Yes*** to cancel the connection, and then follow the instructions in “Connecting the Camera and a Smart Device” (📖30) to establish a connection again.

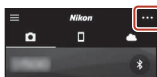

* For iOS, a dialog about device registration will be displayed. Launch the iOS settings app and deregister the device (camera name).

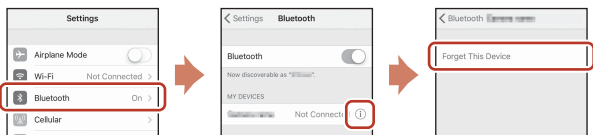

✓ Notes About Image Upload and Remote Photography

- When the camera is being operated, you may be unable to upload images or uploading may be canceled, or you may be unable to perform remote photography using the SnapBridge app.
- When the camera is set to the following, you cannot upload images or use remote photography. Change the settings or switch to playback mode.
 - **Multiple exp. Lighten** scene mode
 - When **Exposure bracketing** is set to **±0.3**, **±0.7**, or **±1.0**
 - When **Multiple exposure mode** is set to **On**



Shooting Features

Selecting a Shooting Mode	38
 (Auto) Mode.....	39
Scene Mode (Shooting Suited to the Shooting Conditions)	40
Creative Mode (Applying Effects When Shooting)	52
P , S , A , and M Modes (Setting the Exposure for Shooting)	54
U (User Settings) Mode.....	58
Setting Shooting Functions with the Multi Selector	60
Flash Mode.....	61
Self-timer	64
Smile Timer (Shooting Smiling Faces Automatically)	65
Focus Mode	66
Exposure Compensation (Adjusting Brightness).....	70
Using the Fn1 (Function 1)/ Fn2 (Function 2) Buttons.....	71
Using the Zoom	72
Focusing	74
Default Settings (Flash, Self-timer, and Focus Mode)	78
Functions That Cannot Be Used Simultaneously When Shooting	80



Selecting a Shooting Mode

You can rotate the mode dial to align the desired shooting mode with the indicator mark on the camera body.

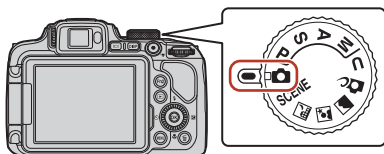

- **📷 (Auto) mode**
Select this mode to perform general shooting in a variety of shooting conditions.
- **SCENE, 🌃, 🌃, and 🌃 (Scene) modes**
Select any one of scene modes based on the shooting conditions, and you can take pictures with the appropriate settings for those conditions.
 - **SCENE:** Press the **MENU** button and select a scene mode. When using **Scene auto selector**, the camera recognizes the shooting conditions when you frame a picture, and you can take pictures in accordance with the conditions.
 - 🌃 (night landscape): Use this mode to shoot night landscapes.
 - 🌃 (night portrait): Use this mode to shoot evening and night portraits that include background scenery.
 - 🌃 (landscape): Use this mode to shoot landscapes.
- **📷 (Creative) mode**
Apply effects to images during shooting.
- **P, S, A, and M modes**
Select these modes for greater control over shutter speed and f-number.
- **U (User settings) mode**
The frequently used settings in **P, S, A,** and **M** modes can be saved. To shoot with the saved settings, rotate the mode dial to **U**.









(Auto) Mode

Select this mode to perform general shooting in a variety of shooting conditions.

- The camera detects the main subject and focuses on it (target finding AF). If a human face is detected, the camera automatically sets focus priority on it.
- See "Focusing" (74) for more information.



Functions Available in (Auto) Mode

- Flash mode (61)
- Self-timer (64)
- Smile timer (65)
- Focus mode (66)
- Exposure compensation (70)
- Shooting menu (123)



Scene Mode (Shooting Suited to the Shooting Conditions)

Select any one of scene modes based on the shooting conditions, and you can take pictures with the appropriate settings for those conditions.

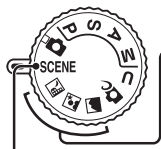

Night landscape (📖41)^{1, 2}, Night portrait (📖41),
 Landscape (📖42)^{1, 2}

Rotate the mode dial to , , or and take pictures.

SCENE

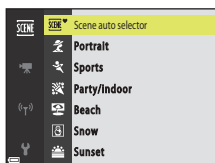
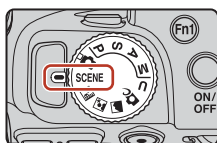

Press the **MENU** button to display the scene menu and select one of the following scene modes using the multi selector.

Scene auto selector (default setting) (📖42)	Backlighting (📖44) ¹
Portrait	Easy panorama (📖49) ¹
Sports (📖43) ¹	Pet portrait (📖45)
Party/indoor (📖43) ¹	Moon (📖46) ^{1, 2, 3}
Beach ¹	Bird-watching (📖46) ¹
Snow ¹	SOFT Soft ¹
Sunset ^{1, 2, 3}	Selective color (📖46) ¹
Dusk/dawn ^{1, 2, 3}	Multiple exp. Lighten (📖47) ³
Close-up (📖43)	Time-lapse movie (📖99) ³
Food (📖44)	Superlapse movie (📖101) ¹
Fireworks show (📖44) ³	

¹ The camera focuses on the area in the center of the frame. The position of the area cannot be moved.





² The camera focuses at infinity.

³ Use of a tripod is recommended. Set **Vibration reduction** (📖167) to **Off** in the setup menu when using a tripod to stabilize the camera during shooting.









Tips and Notes About Scene Mode

Night landscape

- Press the **MENU** button to select  **Hand-held** or  **Tripod** in **Night landscape**.
-  **Hand-held** (default setting):
 - Press the shutter-release button all the way to capture a series of images which are combined into a single image and saved.
 - Once the shutter-release button is pressed all the way, hold the camera still until a still image is displayed. After taking a picture, do not turn the camera off before the screen switches to the shooting screen.
 - The angle of view (i.e., the area visible in the frame) seen in the saved image is narrower than that seen on the shooting screen.
 - Continuous shooting may not be possible in certain shooting conditions.
-  **Tripod**:
 - One image is captured at a slow shutter speed when the shutter-release button is pressed all the way.
 - Vibration reduction is disabled regardless of the **Vibration reduction** setting (167) in the setup menu.

Night portrait

- Press the **MENU** button to select  **Hand-held** (default setting) or  **Tripod** in **Night portrait**.
- One image is captured at a slow shutter speed. Compared to using  **Tripod**, when  **Hand-held** is selected, the camera sets a slightly faster shutter speed in accordance with the shooting conditions to prevent camera shake.
- When  **Tripod** is selected, vibration reduction is disabled regardless of the **Vibration reduction** setting (167) in the setup menu.
- Raise the flash before shooting.
- If human faces are detected when the picture is taken, the camera softens the facial skin tones using the skin softening function (48).

















Landscape

- Press the **MENU** button to select **Noise reduction burst** or **Single shot** in **Landscape**.
- **Noise reduction burst:** This enables you to shoot a sharp landscape with a minimum of noise.
 - Press the shutter-release button all the way to capture a series of images which are combined into a single image and saved.
 - Once the shutter-release button is pressed all the way, hold the camera still until a still image is displayed. After taking a picture, do not turn the camera off before the screen switches to the shooting screen.
 - The angle of view (i.e., the area visible in the frame) seen in the saved image is narrower than that seen on the shooting screen.
 - Continuous shooting may not be possible in certain shooting conditions.
- **Single shot** (default setting): Saves images with emphasized outlines and contrast.
 - One image is captured when the shutter-release button is pressed all the way.

SCENE → Scene auto selector

- When you point the camera at the subject, the camera automatically recognizes the shooting conditions and adjusts the shooting settings accordingly.

	Portrait (for taking close-up portraits of one or two people)
	Portrait (for taking portraits of large numbers of people, or images in which the background takes up a large portion of the frame)
	Landscape
	Night portrait (for taking close-up portraits of one or two people)
	Night portrait (for taking portraits of large numbers of people, or images in which the background takes up a large portion of the frame)
	Night landscape <ul style="list-style-type: none">• The camera shoots images continuously and combines and saves them as a single image in the same way as when Hand-held in  (night landscape) (41) is selected.
	Close-up
	Backlighting (for taking pictures of subjects other than people)
	Backlighting (for taking portrait pictures)
	Other shooting conditions

- Under some shooting conditions, the camera may not select the desired settings. In this case, select another shooting mode (38).
- If human faces are detected when the picture is taken, the camera softens the facial skin tones using the skin softening function (48).



SCENE → Sports





- While the shutter-release button is held all the way down, images are captured continuously.
- The camera can capture about 5 images continuously at a rate of about 5 fps.
- The frame rate for continuous shooting may become slow depending on the current image quality setting, image size setting, the memory card used, or shooting conditions.
- Focus, exposure, and hue for the second and subsequent images are fixed at the values determined with the first image.

SCENE → Party/indoor

- To avoid the effects of camera shake, hold the camera steady. Set **Vibration reduction** (📖167) to **Off** in the setup menu when using a tripod to stabilize the camera during shooting.

SCENE → Close-up

On the screen displayed when  **Close-up** is selected, select **Noise reduction burst** or **Single shot**.

- **Noise reduction burst:** This enables you to shoot a sharp image with a minimum of noise.
 - Press the shutter-release button all the way to capture a series of images which are combined into a single image and saved.
 - Once the shutter-release button is pressed all the way, hold the camera still until a still image is displayed. After taking a picture, do not turn the camera off before the screen switches to the shooting screen.
 - If the subject moves or there is a significant camera shake during continuous shooting, the image may be distorted, overlapped, or blurred.
 - The angle of view (i.e., the area visible in the frame) seen in the saved image is narrower than that seen on the shooting screen.
 - Continuous shooting may not be possible in certain shooting conditions.
- **Single shot:** Saves images with emphasized outlines and contrast.
 - One image is captured when the shutter-release button is pressed all the way.
- The focus mode (📖66) setting is changed to  (macro close-up) and the camera automatically zooms to the closest position at which it can focus.
- You can move the focus area. Press the  button, use the multi selector  or rotate it to move the focus area, and press the  button to apply the setting.



SCENE → 🍴 Food

- The focus mode (📖66) setting is changed to 🍷 (macro close-up) and the camera automatically zooms to the closest position at which it can focus.
- You can adjust hue by using the command dial. The hue setting is saved in the camera's memory even after the camera is turned off.
- You can move the focus area. Press the Ⓚ button, use the multi selector ▲▼◀▶ or rotate it to move the focus area, and press the Ⓚ button to apply the setting.



SCENE → 🎆 Fireworks show

- The shutter speed is fixed at about four seconds.
- Exposure compensation cannot be used (📖70).

SCENE → 📷 Backlighting

- On the screen displayed when 📷 **Backlighting** is selected, select **On** or **Off** to enable or disable the high dynamic range (HDR) function based on the shooting conditions.
- **Off:** The flash fires to prevent the subject from being hidden in shadow. Shoot images with the flash raised.
 - Press the shutter-release button all the way to capture one image.
- **On:** Use when taking pictures with very bright and dark areas in the same frame.
 - When the shutter-release button is pressed all the way, the camera shoots images continuously and saves the following two images.
 - A non-HDR composite image
 - An HDR composite image in which the loss of details in highlights or shadows is minimized
 - If there is only enough memory to save one image, an image processed by D-Lighting (📖89) at the time of shooting, in which dark areas of the image are corrected, is the only image saved.
 - Once the shutter-release button is pressed all the way, hold the camera still until a still image is displayed. After taking a picture, do not turn the camera off before the screen switches to the shooting screen.
 - The angle of view (i.e., the area visible in the frame) seen in the saved image is narrower than that seen on the shooting screen.
 - Under some shooting conditions, dark shadows may appear around bright subjects or bright areas may appear around dark subjects.

👍 Notes About HDR

Use of a tripod is recommended. Set **Vibration reduction** (📖167) in the setup menu to **Off** when using a tripod to stabilize the camera.



SCENE → 🐾 Pet portrait

- When you point the camera at a dog or cat, the camera detects the pet's face and focuses on it. By default, the shutter is automatically released when a dog or cat face is detected (pet portrait auto release).
- On the screen displayed when 🐾 **Pet portrait** is selected, select **[S] Single** or **[C] Continuous**.
 - **[S] Single**: Whenever a dog or cat face is detected, the camera captures one image.
 - **[C] Continuous**: Whenever a dog or cat face is detected, the camera captures three images continuously.

✔ **Pet Portrait Auto Release**

- Press the multi selector ◀ (🔊) to change the **Pet portrait auto release** setting.
 - **[ON]**: The camera automatically releases the shutter when it detects a dog or cat face.
 - **OFF**: The camera does not release the shutter automatically, even if a dog or cat face is detected. Press the shutter-release button. The camera also detects human faces when **OFF** is selected.
- **Pet portrait auto release** is set to **OFF** after five bursts have been taken.
- Shooting is also possible by pressing the shutter-release button, regardless of the **Pet portrait auto release** setting.

✔ **Focus Area**

- When the camera detects a face, the face is displayed inside a yellow border. When the camera acquires focus on a face displayed inside a double border (focus area), the double border changes to green. If no faces are detected, the camera focuses on the area in the center of the frame.
- Under some shooting conditions, the pet face may not be detected and other subjects may be displayed inside a border.

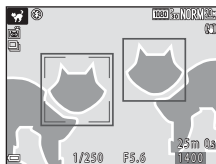

SCENE → 🌕 Moon

- At the wide-angle zoom position, the framing border is displayed to indicate the angle of view equivalent to that of a 1440 mm lens (in 35mm [135] format). When you frame the moon inside the framing border and press the **OK** button, the angle of view becomes equivalent to that of a 1440 mm lens.
- You can adjust hue by using the command dial. The hue setting is saved in the camera's memory even after the camera is turned off.
- Adjust the brightness with exposure compensation (📖70) according to shooting conditions such as the waxing and waning of the moon and shooting requirements.

SCENE → 🐦 Bird-watching

- On the screen displayed when **Bird-watching** is selected, select **[S] Single** or **[C] Continuous**.
- **[S] Single**: One image is shot each time the shutter-release button is pressed.
- **[C] Continuous**: While the shutter-release button is held all the way down, images are captured continuously.
The camera can capture about 5 images continuously at a rate of about 5 fps.
- At the wide-angle zoom position, the framing border is displayed to indicate the angle of view equivalent to that of a 800 mm lens (in 35mm [135] format). When you frame a bird inside the framing border and press the **OK** button, the angle of view becomes equivalent to that of a 800 mm lens.

SCENE → 🖌️ Selective color

- Keeps only a selected image color and makes other colors black-and-white.
- Rotate the command dial to select the desired color, and press the **OK** button to apply the color. To change the color selection, press the **OK** button again.



SCENE → Multiple exp. Lighten

- The camera automatically captures moving subjects at regular intervals, compares each image and composites only their bright areas, and then saves them as one image. Light trails such as the flow of car lights or motion of stars are captured.
- On the screen displayed when **Multiple exp. Lighten** is selected, select **Nightscape + light trails** or **Star trails**.

Option	Description
Nightscape + light trails	<p>Use to capture the flow of car lights against a night landscape background.</p> <ul style="list-style-type: none">• You can rotate the command dial to set the desired interval between the shots. The set interval becomes the shutter speed. When 50 shots are taken, the camera automatically stops shooting.• For every 10 shots taken, one composite image with trails overlapped from the start of shooting is automatically saved.
Star trails	<p>Use to capture the motion of stars.</p> <ul style="list-style-type: none">• Shots are taken at a shutter speed of 25 seconds every 30 seconds. When 300 shots are taken, the camera automatically stops shooting.• For every 30 shots taken, one composite image with trails overlapped from the start of shooting is automatically saved.



- The screen may turn off during the shooting interval. The power-on lamp flashes while the screen is off.
- To end shooting before it automatically ends, press the button.
- When you have obtained the desired trails, end shooting. If you continue shooting, details in the composited areas may be lost.
- When shooting faraway subjects such as airplanes or fireworks, setting the focus mode to (infinity) or **M** (manual focus) is recommended ([book 67](#)).
- Exposure compensation cannot be used ([book 70](#)).

Notes About Multiple Exp. Lighten

- Do not rotate the mode dial or insert a new memory card until shooting ends.
- Use batteries with a sufficient amount of charge remaining to prevent the camera from turning off during shooting.





Time Remaining

You can check the time remaining until shooting automatically ends on the screen.



Using Skin Softening

In  (night portrait), **Scene auto selector**, or **Portrait**, if human faces are detected, the camera processes the image to soften facial skin tones before saving the image (up to three faces).

Skin softening can also be applied to saved images in playback mode (90).



Notes About Skin Softening

- It may take more time than usual to save images after shooting.
- Under some shooting conditions, the desired skin softening results may not be achieved, and skin softening may be applied to areas of the image where there are no faces.



Shooting with Easy Panorama

Rotate the mode dial to **SCENE** → **MENU** button →  Easy panorama →  button

- 1 Select  **Normal (180°)** or  **Wide (360°)** as the shooting range and press the  button.

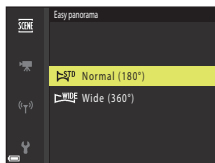





- 2 Frame the first edge of the panorama scene, and then press the shutter-release button halfway to focus.

- The zoom position is fixed at wide-angle.
- The camera focuses in the center of the frame.



- 3 Press the shutter-release button all the way, and then remove your finger from the shutter-release button.

-     are displayed to indicate the direction of camera movement.



- 4 Move the camera in one of the four directions until the guide indicator reaches the end.

- When the camera detects which direction it is moving in, shooting begins.
- Shooting ends when the camera captures the specified shooting range.
- Focus and exposure are locked until shooting ends.

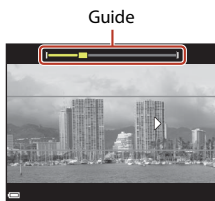

Example of Camera Movement

- Using your body as the axis of rotation, move the camera slowly in an arc, in the direction of the marking ($\triangle \nabla \langle \rangle$).
- Shooting stops if the guide does not reach the edge within about 15 seconds (when $\triangle \nabla \langle \rangle$ **Normal (180°)** is selected) or within about 30 seconds (when $\triangle \nabla \langle \rangle$ **Wide (360°)** is selected) after shooting starts.



✓ Notes About Easy Panorama Shooting

- The range of the image seen in the saved image is narrower than that seen on the screen at the time of shooting.
- If the camera is moved too quickly or shaken too much, or if the subject is too uniform (e.g. walls or darkness), an error may occur.
- If shooting is stopped before the camera reaches the half-way point in the panorama range, a panorama image is not saved.
- If more than half of the panorama range is captured but shooting ends before reaching the edge of the range, the range not captured is recorded and displayed in gray.

📎 Image Size of Easy Panorama

There are four different image sizes (in pixels), as described below.

When $\triangle \nabla \langle \rangle$ **Normal (180°)** is set

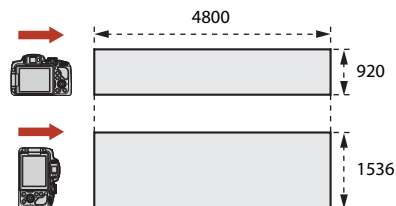

When $\triangle \nabla \langle \rangle$ **Wide (360°)** is set

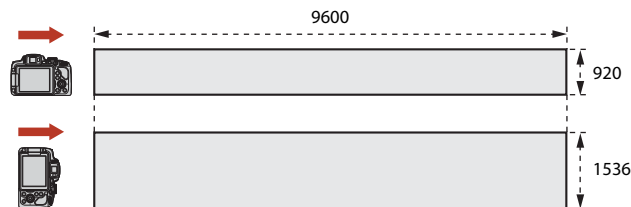

Playback with Easy Panorama

Switch to playback mode (📖25), display an image captured using easy panorama in full-frame playback mode, and then press the **OK** button to scroll the image in the direction that was used when shooting.

- Rotate the multi selector to fast-forward or rewind scroll playback.

Playback controls are displayed on the screen during playback.

Use the multi selector **◀▶** to select a control, and then press the **OK** button to perform the operations described below.



Function	Icon	Description
Rewind		Hold down the OK button to rewind scroll playback.*
Fast-forward		Hold down the OK button to fast-forward scroll playback.*
Pause		Pause playback. The operations listed below can be performed while paused.
		Hold down the OK button to rewind.*
		Hold down the OK button to scroll.*
		Resume automatic scrolling.
End		Return to full-frame playback mode.

* These operations can also be performed by rotating the multi selector.

Notes About Easy Panorama Images

- The images cannot be edited on this camera.
- This camera may not be able to scroll the playback of, or zoom in on, easy panorama images captured with another make or model of digital camera.

Notes About Printing Panorama Images

The entire image may not be able to be printed depending on the printer's settings. Additionally, printing may not be possible depending on the printer.



Creative Mode (Applying Effects When Shooting)

Apply effects to images during shooting.

- Five effect groups are available: **Light** (default setting), **Depth**, **Memories**, **Classic**, and **Noir**.



1 Press the **OK** button.

- The effect selection screen is displayed.

2 Use the multi selector ◀▶ to select an effect.

- The effect group can be changed by rotating the command dial.
- To exit without saving the selection, press ▲.

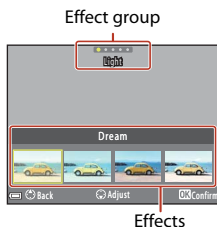

3 To adjust the effect, press ▼.

- If you do not want to adjust the effect, press the **OK** button to proceed to step 6.



- 4** Use ◀▶ to highlight the desired option and then press ▼.
- Select **Amount**, **Exposure compensation**, **Contrast**, **Hue**, **Saturation**, **Filter**, or **Peripheral illumination**. The options that can be selected vary depending on the group.

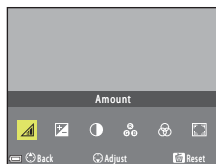

- 5** Use ◀▶ to adjust the effect level and press the Ⓚ button.

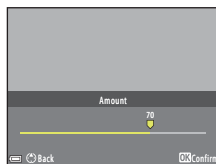

- 6** Press the shutter-release button or the ● (▶ movie-record) button to shoot.
- When the camera detects a human face, it focuses on that face (📖75).

Selecting an Effect Group and Effect

You can also select an effect group and effect by pressing the **MENU** button when the screen in step 1 is displayed.

Functions Available in Creative Mode

- Flash mode (📖61)
- Self-timer (📖64)
- Focus mode (📖66)
- Exposure compensation (📖70)
- Shooting menu (📖123)



P, S, A, and M Modes (Setting the Exposure for Shooting)

In **P**, **S**, **A**, and **M** modes, you can set exposure (combination of shutter speed and f-number) according to the shooting conditions. Also, you can achieve greater control when shooting images by setting the shooting menu options (📖119).

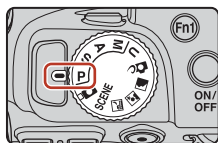

Shooting mode	Description
P Programmed auto	<p>You can let the camera adjust the shutter speed and f-number.</p> <ul style="list-style-type: none"> The combination of shutter speed and f-number can be changed by rotating the command dial (flexible program). While the flexible program is in effect, the X (flexible program mark) is displayed on the upper left of the screen. To cancel the flexible program, rotate the command dial in the opposite direction than when you set it until the X is no longer displayed, change the shooting mode, or turn off the camera.
S Shutter-priority auto	Rotate the command dial to set the shutter speed. The camera automatically determines the f-number.
A Aperture-priority auto	Rotate the multi selector to set the f-number. The camera automatically determines the shutter speed.
M Manual	Set both the shutter speed and f-number. Rotate the command dial to set the shutter speed. Rotate the multi selector to set the f-number.

- The allocations of the controls for setting the exposure can be changed using **Toggle Av/Tv selection** in the setup menu (📖116).

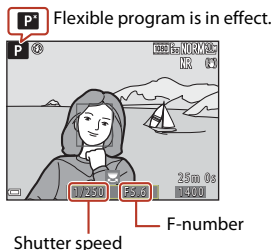
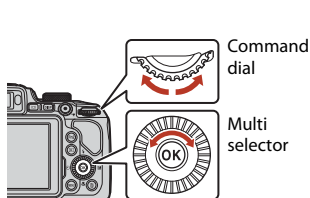

Tips for Setting Exposure

The sense of dynamism and amount of background defocus in subjects vary by changing the combinations of shutter speed and f-number even if the exposure is the same.

Effect of the Shutter Speed

The camera can make a fast-moving subject appear static at a fast shutter speed, or highlight the motion of a moving subject at a slow shutter speed.



Faster
1/1000 s



Slower
1/30 s

Effect of the F-number

The camera can bring the subject, foreground and background into focus, or blur the subject's background intentionally.



Small f-number
(larger aperture)
f/3.3



Large f-number
(smaller aperture)
f/7.6

Shutter Speed and F-number

- The control range of the shutter speed differs depending on the zoom position, f-number, or ISO sensitivity setting.
- The f-number of this camera also changes depending on the zoom position.
- When zooming is performed after the exposure is set, exposure combinations or the f-number may be changed.
- Large apertures (expressed by small f-numbers) let more light into the camera, and small apertures (large f-numbers) let less light. The smallest f-number represents the largest aperture, and the largest f-number represents the smallest aperture.



✓ Notes About Setting Exposure

When the subject is too dark or too bright, it may not be possible to obtain the appropriate exposure. In such cases, the shutter speed indicator or f-number indicator flashes when the shutter-release button is pressed halfway (except when the **M** mode is used). Change the shutter speed setting or f-number.

Exposure Indicator (When in **M** Mode)

The degree of deviation between the adjusted exposure value and the optimal exposure value measured by the camera is displayed in the exposure indicator on the screen. The degree of deviation in the exposure indicator is displayed in terms of EV (-2 to +2 EV in increments of 1/3 EV).

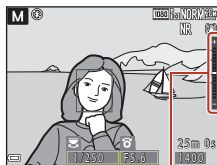

Exposure indicator

✓ Notes About ISO Sensitivity

When **ISO sensitivity** (📖119) is set to **Auto** (default setting) or **Fixed range auto**, the ISO sensitivity in **M** mode is fixed at ISO 100.

Functions Available in **P**, **S**, **A**, and **M** Modes

- Flash mode (📖60)
- Self-timer (📖60)
- Smile timer (📖60)
- Focus mode (📖66)
- Exposure compensation (📖60)
- Shooting menu (📖119)
- Functions that can be set using the **Fn1** (function 1)/**Fn2** (function 2) buttons (📖117)



📎 Focus Area

The focus area for autofocus varies depending on the setting of **AF area mode** (📖119) in the shooting menu. When set to **Target finding AF** (default setting), the camera detects the main subject and focuses on it. If a human face is detected, the camera automatically sets focus priority on it.



The Control Range of the Shutter Speed (**P**, **S**, **A**, and **M** Modes)

The control range of the shutter speed differs depending on the zoom position, f-number, or ISO sensitivity setting. Additionally, the control range changes in the following continuous shooting settings.

Setting		Control range
ISO sensitivity ( 139) ¹	Auto ² , Fixed range auto ²	1/4000 ³ –1 s (P , S , and A modes) 1/4000 ³ –15 s (M mode)
	ISO 100	1/4000 ³ –8 s (P , S , and A modes) 1/4000 ³ –15 s (M mode)
	ISO 200	1/4000 ³ –4 s (P , S , and A modes) 1/4000 ³ –8 s (M mode)
	ISO 400	1/4000 ³ –4 s
	ISO 800	1/4000 ³ –2 s
	ISO 1600	1/4000 ³ –1 s
	ISO 3200	1/4000 ³ –1/2 s
Continuous ( 135)	Continuous H, Continuous L	1/4000 ³ –1/30 s
	Pre-shooting cache, Continuous H: 120 fps	1/4000–1/125 s
	Continuous H: 60 fps	1/4000–1/60 s
	Intvl timer shooting	Same as when Single is set

¹ The ISO sensitivity setting is restricted depending on the continuous shooting setting (82).

² In **M** mode, the ISO sensitivity is fixed at ISO 100.

³ The maximum shutter speed when the f-number is set to the largest value (smallest aperture) at the maximum wide-angle zoom position. The closer the zoom position is to telephoto, or the smaller the f-number (larger aperture) is, the slower the maximum shutter speed becomes. For example, the maximum shutter speed is 1/2500 second when the f-number is set to the largest value (smallest aperture) at the maximum telephoto zoom position.



U (User Settings) Mode

Setting combinations that are frequently used for shooting with **P** (programmed auto), **S** (shutter-priority auto), **A** (aperture-priority auto), or **M** (manual) can be saved in **U**.

Rotate the mode dial to **U** to retrieve the settings saved in **Save user settings**.

- Frame the subject and shoot with these settings, or change the settings as required.

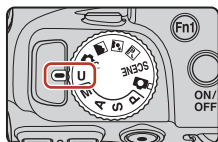

The following settings can be saved.

General Settings

- Shooting modes **P**, **S**, **A**, and **M** (154)
- Zoom position (172)
- Flash mode (161)
- Self-timer (164)
- Focus mode (166)
- Exposure compensation (170)
- Fn button (171)

Shooting menu

- Image quality (123)
- Image size (125)
- Picture Control (126)
- Custom Picture Control (130)
- White balance (131)
- Metering (134)
- Continuous (135)
- ISO sensitivity (139)
- Exposure bracketing (140)
- AF area mode (141)
- Autofocus mode (144)
- Flash exp. comp. (144)
- Noise reduction filter (145)
- Active D-Lighting (145)
- Multiple exposure (146)
- Zoom memory (148)
- Startup zoom position (149)
- M exposure preview (149)



Saving Settings in U Mode (Save User Settings)

The frequently used settings in **P**, **S**, **A**, and **M** modes can be saved. At the time of purchase, the default settings of **P** mode are saved.

1 Rotate the mode dial to **P**, **S**, **A**, **M**, or **U**.

- If you want to change the shooting mode, select **P**, **S**, **A**, or **M**.
- If you do not want to change the saved shooting mode, select **U**.

2 Change to a frequently used combination of shooting settings.

- See [58](#) for settings details.
- The flexible program (when set to **P**), shutter speed (when set to **S** or **M**), or f-number (when set to **A** or **M**) settings will also be saved.

3 Press the **MENU** (menu) button to display the shooting menu.



4 Use the multi selector **▲▼** to select **Save user settings**, and press the **OK** button.

- The previous saved settings are overwritten by the current settings as the **U** mode.

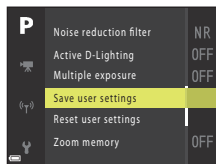

Resetting U (User Settings) Mode

If **Reset user settings** is selected in the shooting menu, the settings that are saved in the user settings are restored to their default values.

✓ **Notes About the Clock Battery**

If the internal clock battery is exhausted, the settings saved in **U** will be reset. Writing down any important setting is recommended.



Setting Shooting Functions with the Multi Selector

When the shooting screen is displayed, you can press the multi selector ▲ (⚡) ◀ (⌚) ▼ (🌸) ▶ (📷) to set the functions described below.

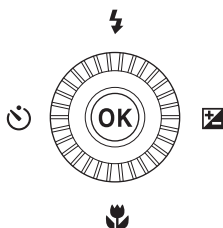

- ⚡ **Flash mode**

When the flash is raised, the flash mode can be set according to shooting conditions.

- ⌚ **Self-timer/Smile timer**

- Self-timer: The shutter is automatically released in 10 or 2 seconds.
- Smile timer: The shutter is automatically released when the camera detects a smiling face.

- 🌸 **Focus mode**

According to the distance to the subject, **AF** (autofocus), 🌸 (macro close-up), or ▲ (infinity) can be set. **MF** (manual focus) can be set when the shooting mode is **P, S, A, M, or U**, or when the scene mode is **Sports, Fireworks show, Bird-watching, Soft, Selective color, Multiple exp. Lighten, Time-lapse movie** (night sky or star trails), or **Superlapse movie**.

- 📷 **Exposure compensation**

You can adjust overall image brightness.

The functions that can be set vary depending on the shooting mode.



Flash Mode

When the flash is raised, the flash mode can be set according to shooting conditions.

1 Press the (flash pop-up) button to raise the flash.

- When the flash is lowered, flash operation is disabled and  is displayed.

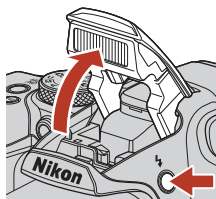

2 Press the multi selector (⚡).

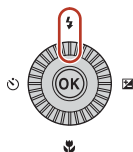

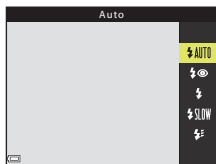

3 Select the desired flash mode (62) and press the button.

- If the setting is not applied by pressing the  button, the selection will be canceled.



The Ready Light

While the flash is charging,  flashes. The camera cannot shoot images.

If charging is complete,  is displayed steadily when you press the shutter-release button halfway.

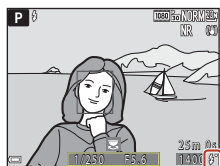

Ready light



Available Flash Modes

AUTO Auto

The flash fires when necessary, such as in dim lighting.

- The flash mode indicator is only displayed immediately after setting on the shooting screen.

Auto with red-eye reduction/Red-eye reduction

Reduce red-eye in portraits caused by the flash ( 63).

- When **Red-eye reduction** is selected, the flash fires whenever a picture is taken.

Fill flash/Standard flash

The flash fires whenever a picture is taken.

SLOW Slow sync

Suited to evening and night portraits that include background scenery. Fill flash fires to illuminate the main subject; slow shutter speeds are used to capture background at night or under dim lighting.

Rear-curtain sync

Fill flash fires just before the shutter closes, creating the effect of a stream of light behind moving subjects.

Notes About Shooting with the Flash









When using the flash at the wide-angle zoom position, the area around the image may be dark depending on the distance to the subject.



This may be improved if you move the zoom control slightly toward the telephoto position.



The Flash Mode Setting

The available flash modes differ depending on the shooting mode.

Flash mode	 ¹	SCENE. 		P ¹	S ¹	A ¹	M ¹
 AUTO Auto	✓	2	✓	–	–	–	–
 Auto with red-eye reduction	✓		✓	–	–	–	–
Red-eye reduction	–		–	✓	✓	✓	✓
 Fill flash	✓		✓	–	–	–	–
Standard flash	–		–	✓	✓	✓	✓
 SLOW Slow sync	✓		✓	✓	–	✓	–
 Rear-curtain sync	✓		✓	✓	✓	✓	✓

¹ When shooting with  (auto with red-eye reduction) in  (auto) mode, and when shooting mode **P**, **S**, **A**, or **M** is used, the applied setting is saved in the camera's memory even after the camera is turned off.

² Availability depends on the setting. See "Default Settings (Flash, Self-timer, and Focus Mode)" (78) for more information.

Auto with Red-eye Reduction/Red-eye Reduction

The red-eye reduction lamp glows before the main flash to reduce the red-eye effect. In addition, if the camera detects red-eye while saving an image, the affected area is processed to reduce red-eye before the image is saved.

Note the following when shooting:

- Because the red-eye reduction lamp glows, more time than usual is required until the shutter is released after you press the shutter-release button.
- More time than usual is required to save images.
- Red-eye reduction may not produce the desired results in some situations.
- In rare cases, red-eye reduction may be applied to areas of an image unnecessarily. In these cases, select another flash mode and take the picture again.



Self-timer

The camera is equipped with a self-timer that releases the shutter 10 seconds or 2 seconds after you press the shutter-release button. Set **Vibration reduction** (📖167) to **Off** in the setup menu when using a tripod to stabilize the camera during shooting.

1 Press the multi selector ◀ (📷).

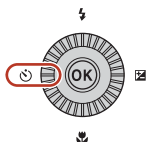

2 Select the desired self-timer mode, and press the (OK) button.

- 🕒10s (10 seconds): Use on important occasions, such as weddings.
- 🕒2s (2 seconds): Use to prevent camera shake.
- If the setting is not applied by pressing the (OK) button, the selection will be canceled.
- When the shooting mode is **Pet portrait** scene mode, 📷 (pet portrait auto release) is displayed (📖45). The self-timer cannot be used.

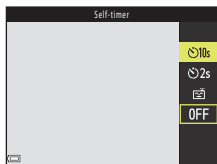

3 Frame the picture and press the shutter-release button halfway.

- Focus and exposure are set.

4 Press the shutter-release button all the way down.

- Countdown starts. The self-timer lamp flashes and then glows steadily about one second before the shutter is released.
- When the shutter is released, the self-timer is set to **OFF**.*
- To stop the countdown, press the shutter-release button again.



- * When the shooting mode is **Moon** scene mode, the self-timer is not automatically set to **OFF**. To end self-timer, select **OFF** in step 2.



Smile Timer (Shooting Smiling Faces Automatically)

When the camera detects a smiling face, you can take a picture automatically without pressing the shutter-release button.

- This function can be used when the shooting mode is **☰** (auto), **P**, **S**, **A**, **M**, or **U**, or when the scene mode is **Portrait** or **Night portrait**.

1 Press the multi selector ◀ (☺).

- Change any flash mode, exposure, or shooting menu settings before pressing ◀.

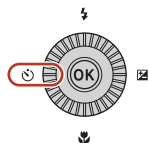

2 Select ☺ (smile timer), and press the OK button.

- If the setting is not applied by pressing the OK button, the selection will be canceled.

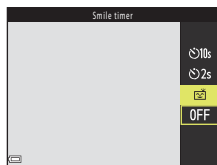

3 Frame the picture and wait for the subject to smile without pressing the shutter-release button.

- Point the camera at a human face.
- If the camera detects that the face framed by the double border is smiling, the shutter is automatically released.
- Whenever the camera detects a smiling face, it automatically releases the shutter.

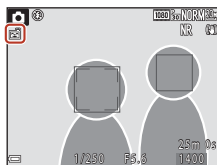

4 End automatic shooting.

- To end automatic shooting with smile timer, return to step 1 and select **OFF**.

✓ Notes About Smile Timer

Under some shooting conditions, the camera may be unable to detect faces or detect smiles (☞75). The shutter-release button can also be used for shooting.

✎ When the Self-timer Lamp Flashes

When using smile timer, the self-timer lamp flashes when the camera detects a face and flashes quickly immediately after the shutter is released.



Focus Mode

You can select the focus mode that is appropriate for the shooting distance.

- 1 Press the multi selector ▼ (🌿).

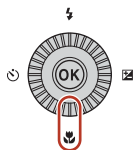

- 2 Select the desired focus mode (📖67) and press the OK button.

- If the setting is not applied by pressing the OK button, the selection will be canceled.

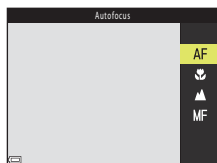

Available Focus Modes



Autofocus

Use when the distance from the subject to the lens is 50 cm (1 ft 8 in.) or more, or 2.0 m (6 ft 7 in.) or more at the maximum telephoto zoom position.

- The focus mode icon on the shooting screen is displayed only immediately after the setting is made.

Macro close-up

Set when taking close-up pictures.

When the zoom ratio is set to a position where  and the zoom indicator are displayed in green, the camera can focus on subjects as close as approximately 10 cm (4 in.) from the lens. When the zoom is at a position more wide-angled than where  is displayed, the camera can focus on subjects as close as approximately 1 cm (0.4 in.) from the lens.

Infinity

Use when shooting distant scenes through window glass or when shooting landscapes.

The camera automatically adjusts the focus near infinity.

- The camera may not be able to focus on nearby objects.

Infinity

Use when shooting the sky and the fireworks show.

Manual focus

The focus can be adjusted on any subject at a distance from approximately 1 cm (0.4 in.) to infinity (∞) from the lens (68). The closest distance at which the camera can focus varies depending on the zoom position.

Focus Mode Setting

- The setting may not be available with some shooting modes.
- For shooting modes **P**, **S**, **A**, and **M**, the setting is saved in the camera's memory even after the camera is turned off.



Using Manual Focus

Manual focus is available when the shooting mode is **P**, **S**, **A**, **M**, or **U**, or when the scene mode is **Sports**, **Fireworks show**, **Bird-watching**, **Soft**, **Selective color**, **Multiple exp.** **Lighten**, **Time-lapse movie** (night sky or star trails), or **Superlapse movie**.

- 1 Press the multi selector ▼ (👉), select MF (manual focus), and then press the OK button.

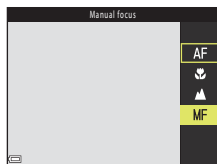
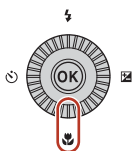

- 2 Use the multi selector to adjust the focus while checking the enlarged view.

- An enlarged view of the center area of the image is displayed. Press ◀ to switch the view between 2x and 4x.
- Rotate the multi selector clockwise to focus on near subjects, or counterclockwise to focus on far subjects. The focus can be adjusted in higher detail by rotating the multi selector slowly or rotating the command dial.
- When ▶ is pressed, the camera focuses on the subject in the center of the frame with autofocus. The manual focus can be operated after the camera focuses with autofocus.
- Focusing is assisted by highlighting areas that are in focus in white (peaking) (📖69). Press ▲▼ to adjust the peaking level.
- Press the shutter-release button halfway to confirm the composition of the picture. Press the shutter-release button all the way to take the picture.

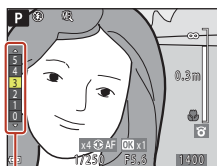

Peaking level

- 3 Press the OK button.

- The set focus is locked.
- Press the shutter-release button all the way to take the picture.
- To readjust the focus, press the OK button to display the screen in step 2.

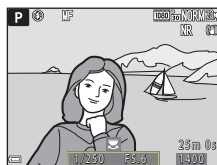

MF (Manual Focus)

- The digits displayed for the gauge on the right of the screen in step 2 serve as a guideline for the distance to a subject that is in focus when the gauge is near the center.
- The actual range at which the subject can be in focus varies depending on the f-number and zoom position. To see whether the subject is in focus, check the image after shooting.
- Set **Assign side zoom control** (122) in the setup menu to **Manual focus** to focus by using the side zoom control instead of the multi selector in step 2.

Peaking

- The range of the contrast level considered to be in focus can be changed by adjusting the peaking level. It is effective to set the level low for high contrast subjects, and high for low contrast subjects.
- Peaking highlights high contrast areas of the image in white. Under some shooting conditions, highlighting may not work properly or areas that are not in focus may be highlighted.
- You can disable the peaking display using **Peaking** (122) in the setup menu.



Exposure Compensation (Adjusting Brightness)

You can adjust overall image brightness.

- 1 Press the multi selector ► (Z).

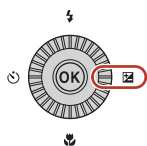

- 2 Select a compensation value and press the OK button.

- To brighten the image, set a positive (+) value.
- To darken the image, set a negative (-) value.
- The compensation value is applied, even without pressing the OK button.

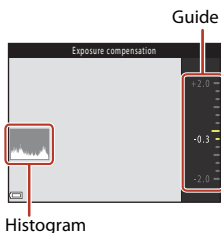

Exposure Compensation Value

- If the setting is applied in **P**, **S**, or **A** mode, it will remain saved in the camera's memory even after the camera is turned off.
- Exposure compensation cannot be used in the following shooting modes:
 - When scene mode (📖40) is set to **Fireworks show**, **Multiple exp. Lighten**, or **Night sky (150 minutes)** or **Star trails (150 minutes)** in time-lapse movie
 - **M** (manual) mode (📖54)
- When the exposure compensation is set while using a flash, the compensation is applied to both the background exposure and the flash output.

Using the Histogram

A histogram is a graph showing the distribution of tones in the image. Use as a guide when using exposure compensation and shooting without the flash.

- The horizontal axis corresponds to pixel brightness, with dark tones to the left and bright tones to the right. The vertical axis shows the number of pixels.
- Increasing exposure compensation value shifts tone distribution to the right, and decreasing it shifts tone distribution to the left.



Using the Fn1 (Function 1)/Fn2 (Function 2) Buttons

If you press the **Fn1** button or **Fn2** button in **P**, **S**, **A**, **M**, or **U** mode, you can quickly configure the pre-saved menu options. Menu options can be saved to the **Fn1** button and **Fn2** button.

- The menu options listed below can be saved.

Image quality (📖123)	Continuous (📖135)
Image size (📖125)	ISO sensitivity (📖139)
Picture Control (📖126)	AF area mode (📖141)
White balance (📖131)	Vibration reduction (📖167)
Metering (📖134)	

1 Press the **Fn1** (function 1) or **Fn2** (function 2) button when the shooting screen is displayed.

- The setting options of the menu that was set (default setting is **Continuous**) and **Fn Fn button** can be selected.

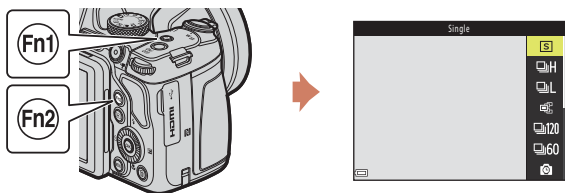

2 Use the multi selector to select a setting and press the **OK** button.

- If the setting is not applied by pressing the **OK** button, the selection will be canceled.
- To return to the shooting screen without changing the setting, press the **Fn1** button, **Fn2** button, or shutter-release button.
- To set a different menu option, select **Fn Fn button** and press the **OK** button. Select the desired menu option and press the **OK** button to set it.



Using the Zoom

When you move the zoom control, the zoom lens position changes.

- To zoom in: Move toward **T**
- To zoom out: Move toward **W**
- Rotating the zoom control all the way in either direction adjusts the zoom quickly (except during movie recording).

- The zoom can also be operated by moving the side zoom control toward **T** or **W**.

The function of the side zoom control can be set in the **Assign side zoom control** (📖169) in the setup menu.

- A zoom indicator is displayed on the shooting screen when the zoom control is moved.
- Digital zoom, which allows you to further magnify the subject up to approximately 4x (when **Movie options** (📖150) is set to $\frac{2160}{60p}$ **2160/30p** or $\frac{2160}{60p}$ **2160/25p**, up to approximately 2x) the maximum optical zoom ratio, can be activated by moving and holding the zoom control toward **T** when the camera is zoomed in to the maximum optical zoom position.

Zoom out Zoom in

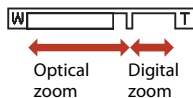
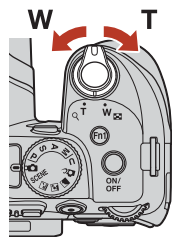

Digital Zoom



The zoom indicator changes to blue when the digital zoom is activated, and it changes to yellow when the zoom magnification is increased further.

- Zoom indicator is blue: Image quality is not noticeably reduced by using the Dynamic Fine Zoom.
- Zoom indicator is yellow: There may be cases in which image quality is noticeably reduced.
- The indicator remains blue across a wider area when the image size is smaller.
- The zoom indicator may not change to blue when using certain continuous shooting settings or other settings.



Using the Snap-back Zoom

If you lose sight of the subject while shooting with the lens in telephoto position, press the  (snap-back zoom) button to temporarily widen the visible area so that you can frame the subject more easily.

- While pressing the  button, frame the subject inside the framing border of the shooting screen. To widen the visible area further, move the zoom control toward **W** while pressing the  button.
- Release the  button to return to the original zoom position.
- Snap-back zoom is not available during movie recording.

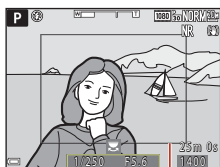
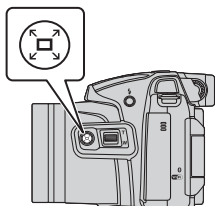

Framing border



Focusing

The Shutter-release Button

Press halfway



To press the shutter-release button “halfway” means to press and hold the button at the point where you feel a slight resistance.

- Focus and exposure (shutter speed and f-number) are set when you press the shutter-release button halfway. Focus and exposure remain locked while the button is pressed halfway.
- The focus area varies depending on the shooting mode.



Press all the way



To press the shutter-release button “all the way” means to press the button down completely.

- The shutter is released when the shutter-release button is pressed all the way.
- Do not use force when pressing the shutter-release button, as this may result in camera shake and blurred images. Press the button gently.

Using Target Finding AF

In  (auto) mode, or when **AF area mode** ( 141) in **P**, **S**, **A**, **M**, or **U** mode is set to **Target finding AF**, the camera focuses in the manner described below when you press the shutter-release button halfway.

- The camera detects the main subject and focuses on it. When the subject is in focus, the focus area is displayed in green. If a human face is detected, the camera automatically sets focus priority on it.

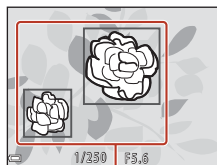

Focus areas

- If no main subject is detected, the camera automatically selects one or more of the nine focus areas containing the subject closest to the camera. When the subject is in focus, the focus areas that are in focus are displayed in green.

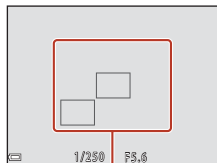

Focus areas





✓ Notes About Target Finding AF

- Depending on shooting conditions, the subject that the camera determines to be the main subject may vary.
- The main subject may not be detected when using certain **White balance** or **Picture Control** settings.
- The camera may not detect the main subject appropriately in the following situations:
 - When the subject is very dark or bright
 - When the main subject lacks clearly defined colors
 - When the shot is framed so that the main subject is on the edge of the screen
 - When the main subject is composed of a repeating pattern

Using Face Detection

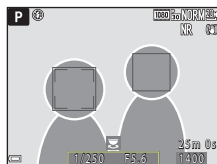

In the following settings, the camera uses face detection to automatically focus on human faces.

-  (night portrait), **Scene auto selector**, or **Portrait** scene mode (📖40)
- Creative mode (📖52)
-  (smile timer) (📖65)
- When **AF area mode** (📖141) is set to **Face priority**



If the camera detects more than one face, a double border is displayed around the face that the camera focuses on, and single borders are displayed around the other faces.

If the shutter-release button is pressed halfway when no faces are detected:

- When **Scene auto selector** is selected, the focus area changes depending on the shooting conditions that the camera recognizes.
- In  (night portrait) and **Portrait**, the camera focuses on the area in the center of the frame.
- In creative mode or when **AF area mode** is set to **Face priority**, the camera selects the focus area containing the subject closest to the camera.
- When  (smile timer) is selected, the camera focuses on the subject in the center of the frame.

✓ Notes About Face Detection

- The camera's ability to detect faces depends on a variety of factors, including the direction in which the faces are looking.
- The camera cannot detect faces in the following situations:
 - When faces are partially hidden by sunglasses or otherwise obstructed
 - When faces take up too much or too little of the frame



Viewing Images Captured Using Face Detection

During playback, the camera automatically rotates images according to the orientation of the faces that were detected at the time of shooting (except for images captured using **Continuous** (📖135) or **Exposure bracketing** (📖140)).

Subjects Not Suitable for Autofocus

The camera may not focus as expected in the following situations. In rare cases, the subject may not be in focus despite the fact that the focus area or the focus indicator is displayed in green:

- Subject is very dark
- Objects of sharply differing brightness are included in the shooting conditions (e.g. the sun behind the subject makes that subject appear very dark)
- No contrast between the subject and surroundings (e.g. a portrait subject wearing a white shirt is standing in front of a white wall)
- Several objects are at different distances from the camera (e.g. the subject is inside a cage)
- Subjects with repeating patterns (window blinds, buildings with multiple rows of similarly shaped windows, etc.)
- Subject is moving rapidly

In the situations noted above, try pressing the shutter-release button halfway to refocus several times, or focus on another subject positioned at the same distance from the camera as the actual desired subject, and use focus lock (📖77).

The camera can also focus using manual focus (📖67, 68).



Focus Lock

Use focus lock to capture creative compositions even when the focus area is set to the center of the frame.

- 1 Position the subject in the center of the frame and press the shutter-release button halfway.

- The camera focuses on the subject and the focus area is displayed in green.
- Exposure is also locked.

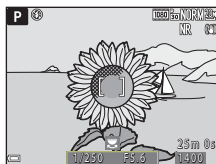

- 2 Without lifting your finger, recompose the picture.

- Make sure to maintain the same distance between the camera and the subject.



- 3 Press the shutter-release button all the way down to take the picture.



Moving the Focus Area to the Desired Position

In **P**, **S**, **A**, or **M** shooting mode, the focus area can be moved using the multi selector by setting **AF area mode** (📖141) in the shooting menu to one of the manual options.



Default Settings (Flash, Self-timer, and Focus Mode)

The default settings for each shooting mode are listed below.

	Flash mode (60)	Self-timer (60)	Focus mode (60)
(auto)	AUTO	OFF ¹	AF ²
(creative)	AUTO	OFF	AF ³
P, S, A, and M		OFF ¹	AF
U (user settings)		OFF ¹	AF
Scene modes			
(night landscape)	⁴	OFF	⁴
(night portrait)	⁵	OFF ¹	AF ⁴
(landscape)	⁴	OFF	⁴
(scene auto selector)	AUTO ⁴	OFF	AF ⁴
(portrait)		OFF ¹	AF ⁴
(sports)	⁴	OFF ⁴	AF ⁶
(party/indoor)	⁷	OFF	AF ⁴
(beach)	AUTO	OFF	AF ³
(snow)	AUTO	OFF	AF ³
(sunset)	⁴	OFF	⁴
(dusk/dawn)	⁴	OFF	⁴
(close-up)	AUTO ⁸	OFF	⁴
(food)	⁴	OFF	⁴
(fireworks show)	⁴	OFF ⁴	⁹
(backlighting)	¹⁰	OFF	AF ⁴
(easy panorama)	⁴	OFF ⁴	AF ⁴
(pet portrait)	⁴	¹¹	AF ³
(moon)	⁴	2s	⁴
(bird-watching)	⁴	OFF	AF ¹²
SOFT (soft)	AUTO	OFF	AF



	Flash mode (60)	Self-timer (60)	Focus mode (60)
(selective color)	AUTO	OFF	AF
(multiple exp. lighten)	⁴	OFF	AF/ ¹³
(time-lapse movie)	⁴	OFF	AF// ¹⁴
(superlapse movie)	⁴	OFF	AF

- ¹ Smile timer can also be selected.
- ² **MF** (manual focus) cannot be selected.
- ³ **AF** (autofocus) or (macro close-up) can be selected.
- ⁴ Cannot be changed.
- ⁵ Cannot be changed. When set to **Hand-held**, the flash mode setting is fixed at fill flash with slow sync and red-eye reduction. When set to **Tripod**, the flash mode setting is fixed at auto with slow sync and red-eye reduction.
- ⁶ **AF** (autofocus) or **MF** (manual focus) can be selected.
- ⁷ May switch to slow sync with red-eye reduction flash mode.
- ⁸ The flash is fixed at (off) when using **Noise reduction burst**.
- ⁹ (infinity) or **MF** (manual focus) can be selected.
- ¹⁰ When **HDR** is set to **Off**, the flash mode is fixed at (fill flash). When **HDR** is set to **On**, the flash mode is fixed at (off).
- ¹¹ Pet portrait auto release can be set to on or off. Self-timer cannot be used.
- ¹² Can be selected from **AF** (autofocus), (infinity) or **MF** (manual focus).
- ¹³ When using **Nightscape + light trails**, **AF** (autofocus), (infinity), or **MF** (manual focus) can be selected. When using **Star trails**, (infinity) or **MF** (manual focus) can be selected.
- ¹⁴ The focus is fixed at **AF** (autofocus) when using **Cityscape (10 minutes)**, or (infinity) when using **Landscape (25 minutes)** or **Sunset (50 minutes)**. (infinity) or **MF** (manual focus) can be selected when using **Night sky (150 minutes)** or **Star trails (150 minutes)**.















Functions That Cannot Be Used Simultaneously When Shooting

Some functions cannot be used with other menu settings.

Restricted function	Setting	Description
Flash mode	Focus mode (📖66)	When ▲ (infinity) or ∞ (infinity) is selected, the flash cannot be used.
	Image quality (📖123)	When saving RAW images, red-eye is not reduced even when ⚡👁 (auto with red-eye reduction/red-eye reduction) is set (including simultaneously saved JPEG images).
	Continuous (📖135)	The flash cannot be used (except for Intvl timer shooting).
	Exposure bracketing (📖140)	The flash cannot be used.
Self-timer/ Smile timer	Focus mode (📖66)	When a setting other than AF (autofocus) is selected, smile timer is set to OFF .
	AF area mode (📖141)	When Subject tracking is selected, the self-timer/smile timer cannot be used.
Focus mode	Smile timer (📖65)	When smile timer is selected, the focus mode is fixed at AF (autofocus).
	AF area mode (📖141)	When Subject tracking is selected, MF (manual focus) cannot be set.
Image quality	Continuous (📖135)	<ul style="list-style-type: none"> When Pre-shooting cache is selected, Image quality is fixed at Normal. When Continuous H: 120 fps or Continuous H: 60 fps is selected, RAW, RAW + Fine, or RAW + Normal cannot be used.
	Multiple exposure (📖146)	When Multiple exposure mode is set to On , RAW , RAW + Fine , or RAW + Normal cannot be used.



Restricted function	Setting	Description
Image size	Image quality ( 123)	<ul style="list-style-type: none"> When RAW is selected, Image size is fixed at  5184×3888. When RAW + Fine or RAW + Normal is selected, Image size of JPEG images can be set. However,  5184×2920,  5184×3456,  3888×3888 cannot be selected.
	Continuous ( 135)	<p>Image size is set as follows depending on the continuous shooting setting:</p> <ul style="list-style-type: none"> Pre-shooting cache:  (image size: 1280 × 960 pixels) Continuous H: 120 fps:  (image size: 640 × 480 pixels) Continuous H: 60 fps:  (image size: 1920 × 1080 pixels)
Picture Control	AF area mode ( 141)	When Subject tracking is selected, Monochrome cannot be set.
	Active D-Lighting ( 145)	When using Active D-Lighting , Contrast in manual adjustment cannot be adjusted.
White balance	Picture Control ( 126)	When Monochrome is selected, White balance is fixed at Auto (normal) .
Metering	Active D-Lighting ( 145)	When using Active D-Lighting , Metering is reset to Matrix .



Restricted function	Setting	Description
Continuous Exposure bracketing	Continuous (📖135)/ Exposure bracketing (📖140)/Multiple exposure (📖146)	Continuous , Exposure bracketing , and Multiple exposure can only be used one at a time.
	Self-timer (📖64)	<ul style="list-style-type: none"> When self-timer is used, a single image is shot even if Continuous H, Continuous L, or Pre-shooting cache has been set. If Intvl timer shooting is set, shooting finishes automatically after one image is shot. Exposure bracketing cannot be used.
	Smile timer (📖65)	<ul style="list-style-type: none"> When the camera detects smiling faces and the shutter is released, only one image is shot. If Intvl timer shooting is set, shooting finishes automatically after one image is shot. Exposure bracketing cannot be used.
	Image quality (📖123)	When RAW , RAW + Fine , or RAW + Normal is selected, Pre-shooting cache , Continuous H: 120 fps , or Continuous H: 60 fps cannot be used.
	Picture Control (📖126)	When Monochrome is selected, Exposure bracketing cannot be used.
ISO sensitivity	Continuous (📖135)	When Pre-shooting cache , Continuous H: 120 fps , or Continuous H: 60 fps is selected, ISO sensitivity is fixed at Auto .
AF area mode	Smile timer (📖65)	The camera captures images using face detection regardless of the applied AF area mode option.
	Focus mode (📖66)	<ul style="list-style-type: none"> When a setting other than Subject tracking is selected and ▲ (infinity) is selected as the focus mode for shooting, the camera focuses at infinity regardless of the applied AF area mode option. When MF (manual focus) is selected, the AF area mode cannot be set.
	Picture Control (📖126)	When Monochrome is selected, Subject tracking cannot be set.
	White balance (📖131)	When Target finding AF is selected and white balance is set to any setting other than Auto (normal) , the camera focuses on a face or selects one or more of the nine focus areas containing the subject closest to the camera.
Autofocus mode	Smile timer (📖65)	When smile timer is selected, the autofocus mode operates using the Single AF setting.
	Focus mode (📖66)	When ▲ (infinity) is selected in the focus mode, the autofocus mode operates using the Single AF setting.



Restricted function	Setting	Description
Multiple exposure	Image quality (📖123)	When RAW , RAW + Fine , or RAW + Normal is selected, Multiple exposure cannot be used.
	Continuous (📖135)/Exposure bracketing (📖140)	Continuous , Exposure bracketing , and Multiple exposure can only be used one at a time.
Monitor settings	AF area mode (📖141)	<ul style="list-style-type: none"> When Subject tracking is selected and after the subject has been registered (during subject tracking), the histogram is not displayed. The histogram is not displayed when Target finding AF is selected.
Date stamp	Image quality (📖123)	When RAW , RAW + Fine , or RAW + Normal is selected, date and time cannot be stamped on images.
	Continuous (📖135)	When Pre-shooting cache , Continuous H: 120 fps , or Continuous H: 60 fps is selected, date and time cannot be stamped on images.
Digital zoom	Smile timer (📖65)	When smile timer is selected, digital zoom cannot be used.
	Image quality (📖123)	When RAW , RAW + Fine , or RAW + Normal is selected, digital zoom cannot be used.
	AF area mode (📖141)	When Subject tracking is selected, digital zoom cannot be used.
	Zoom memory (📖148)	When Zoom memory is set to On , digital zoom cannot be used.
Shutter sound	Continuous (📖135)	When Pre-shooting cache , Continuous H: 120 fps , or Continuous H: 60 fps is selected, shutter sound is disabled.
	Exposure bracketing (📖140)	Shutter sound is disabled.

✓ Notes About Digital Zoom

- Depending on the shooting mode or the current settings, digital zoom may not be available (📖168).
- When digital zoom is in effect, selectable options for AF area mode or metering mode are restricted.



Playback Features

Playback Zoom.....	85
Thumbnail Playback/Calendar Display.....	86
Viewing and Deleting Images Captured Continuously (Sequence)	87
Editing Images (Still Images)	88



Playback Zoom

Moving the zoom control toward **T** (🔍 playback zoom) in full-frame playback mode (📖25) zooms in on the image.

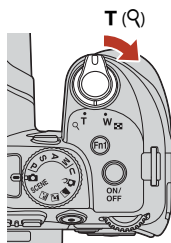

Full-frame Playback

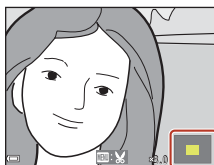

Image is zoomed in.

- You can change the magnification rate by moving the zoom control toward **W** (📐) or **T** (🔍). The zoom can also be adjusted by rotating the command dial.
- To view a different area of the image, press the multi selector **▲▼◀▶**.
- If you are viewing an image that was captured using face detection or pet detection, the camera zooms in on the face detected at the time of shooting (except images captured using **Continuous** or **Exposure bracketing**). To zoom in on an area of the image where there are no faces, adjust the magnification rate and then press **▲▼◀▶**.
- When a zoomed image is displayed, press the **OK** button to return to full-frame playback mode.

Cropping Images

When a zoomed image is displayed, you can press the **MENU** button to crop the image to include only the visible portion and save it as a separate file (📖93).



Thumbnail Playback/Calendar Display

Moving the zoom control toward **W** (📷 thumbnail playback) in full-frame playback mode (📖25) displays images as thumbnails.

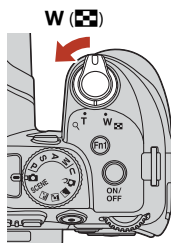

Full-frame Playback



Thumbnail Playback



Calendar Display

- You can change the number of thumbnails displayed by moving the zoom control toward **W** (📷) or **T** (🔍).
- While using thumbnail playback mode, use the multi selector ▲▼◀▶ or rotate it to select an image, and then press the **OK** button to display that image in full-frame playback mode.
- While using calendar display mode, use ▲▼◀▶ or rotate it to select a date, and then press the **OK** button to display the images captured on that day.

✓ Notes About Calendar Display

Images captured when the camera's date is not set are treated as images captured on January 1, 2016.



Viewing and Deleting Images Captured Continuously (Sequence)

Viewing Images in a Sequence

Images captured continuously are saved as a sequence.

The first image of a sequence is used as the key picture to represent the sequence when displayed in full-frame playback mode or thumbnail playback mode (default setting).

To display each image in the sequence individually, press the **OK** button.

After pressing the **OK** button, the operations listed below are available.

- To display the previous or next image, rotate the multi selector or press **◀▶**.
- To display images that are not included in the sequence, press **▲** to return to the key picture display.
- To display images in a sequence as thumbnails, or to play them back in a slide show, set **Sequence display options** (📖159) to **Individual pictures** in the playback menu.



✓ Sequence Display Options

Images captured continuously with cameras other than this camera cannot be displayed as a sequence.

🔗 Playback Menu Options Available When Using Sequence

- When images in a sequence are displayed in full-frame playback mode, press the **MENU** button to select functions in playback menu (📖120).
- If you press the **MENU** button when a key picture is displayed, the following settings can be applied to all images in the sequence:
 - Mark for upload, Protect



Deleting Images in a Sequence

When the  (delete) button is pressed for images in a sequence, the images that are deleted vary depending on how the sequences are displayed.

- When the key picture is displayed:
 - **Current image:** All images in the displayed sequence are deleted.
 - **Erase selected images:** When a key picture is selected on the erase selected images screen ()118), all images in that sequence are deleted.
 - **All images:** All images on the memory card are deleted.
- When images in a sequence are displayed in full-frame playback mode:
 - **Current image:** The image currently displayed is deleted.
 - **Erase selected images:** Images that are selected in the sequence are deleted.
 - **Entire sequence:** All images in the displayed sequence are deleted.

Editing Images (Still Images)

Before Editing Images



You can easily edit images on this camera. Edited copies are saved as separate files. Edited copies are saved with the same shooting date and time as the original.

Restrictions on Image Editing

- RAW images cannot be edited.
- A JPEG image can be edited up to 10 times. A still image created by editing a movie can be edited up to 9 times.
- You may not be able to edit images of a certain size or with certain editing functions.



Quick Retouch: Enhancing Contrast and Saturation



Press the  button (playback mode) → Select an image → MENU button → Quick retouch →  button

Use the multi selector ▲▼ to select the desired effect level and press the  button.

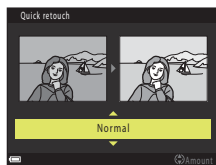
- The edited version is displayed on the right.
- To exit without saving the copy, press .



D-Lighting: Enhancing Brightness and Contrast



Press the  button (playback mode) → Select an image → MENU button → D-Lighting →  button

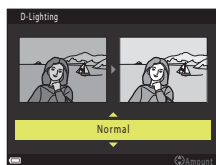

Use the multi selector ▲▼ to select the desired effect level and press the  button.

- The edited version is displayed on the right.
- To exit without saving the copy, press .





Skin Softening: Softening Skin Tones

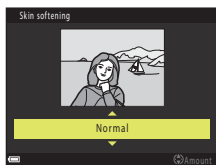

Press the  button (playback mode) → Select an image → **MENU** button → Skin softening →  button

- 1 Use the multi selector   to select the desired effect level and press the  button.

- To exit without saving the copy, press .



- 2 Preview the result and press the  button.

- The edited face is zoomed in.
- When more than one face has been edited, press   to switch the face that is displayed.
- To change the effect level, press the **MENU** button and return to step 1.
- An edited copy is created.

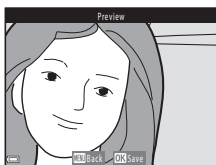



Notes About Skin Softening



- The skin tones can be enhanced for up to 12 faces, starting with the one closest to the center of the frame and moving outward.
- Depending on the direction in which faces are looking, or the brightness of faces, the camera may be unable to accurately detect faces, or the skin softening function may not perform as expected.
- If no faces are detected, a warning is displayed and the screen returns to the playback menu.



Filter Effects: Applying Digital Filter Effects

Press the  button (playback mode) → Select an image → MENU button → Filter effects →  button

Option	Description
Soft portrait	Blurs the background of human subjects. When no human subjects are detected, keeps the area in the center of the frame in focus and blurs the surrounding area.
Selective color	Keeps only a selected image color and makes other colors black-and-white.
Cross screen	Produces star-like rays of light that radiate outward from bright objects such as sunlight reflections and city lights. Suitable for night scenes.
Fisheye	Creates images that look like they were shot with a fisheye lens. Suitable for images shot in macro mode.
Miniature effect	Creates images that look like close-up photos of a diorama. Suitable for images shot while looking down from a high location, with the main subject near the center of the frame.
Painting	Creates images with the ambience of paintings.
Vignette	Lowers the peripheral light intensity from the center to the edges of an image.
Photo illustration	Emphasizes outlines and reduces the number of colors to create images with the ambience of illustrations.
Portrait (color + B&W)	Makes colors of the background of human subjects black-and-white. When no human subjects are detected, keeps colors of the area in the center of the frame and makes the surrounding area black-and-white.

1 Use the multi selector   to select the desired filter effect and press the  button.

- When effects other than **Selective color** are selected, proceed to step 3.

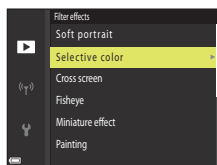

- 2 Use ▲▼ to select the color to keep and press the **OK** button.



- 3 Preview the result and press the **OK** button.

- An edited copy is created.
- To exit without saving the copy, press ◀.



Small Picture: Reducing the Size of an Image

Press the  button (playback mode) → Select an image → **MENU** button → Small picture → **OK** button

- 1 Use the multi selector ▲▼ to select the desired copy size and press the **OK** button.

- When the aspect ratio of the image is 16:9, the image size is fixed at 640 × 360. Press the **OK** button to proceed to step 2.

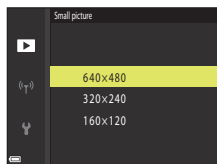

- 2 Select **Yes** and press the **OK** button.

- An edited copy is created (compression ratio of approximately 1:8).

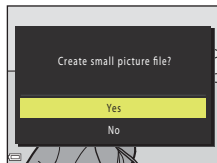

Notes About Small Picture

When the aspect ratio of the image is 3:2 or 1:1, the image cannot be edited.



Crop: Creating a Cropped Copy

1 Move the zoom control to enlarge the image (📖85).

2 Adjust the image so that only the portion that you want to keep is displayed, and then press the **MENU** (menu) button.

- Move the zoom control toward **T** (🔍) or **W** (📐) to adjust the magnification rate. Set a magnification rate at which **MENU** (📄) is displayed.
- Use the multi selector ▲▼◀▶ to scroll to the portion of the image that you want to display.



3 Check the image and press the **OK** button.

- To change the portion you want to keep, return to step 2 by pressing ◀.
- To exit without saving the cropped image, press the **MENU** button.

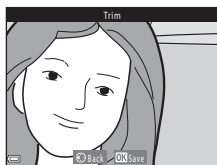

4 Select **Yes** and press the **OK** button.

- An edited copy is created.



Image Size

- The aspect ratio (horizontal to vertical) of the cropped copy is the same as the original.
- When the image size of the cropped copy is 320 × 240 or smaller, the image is displayed at a smaller size during playback.



Movies

Basic Operations of Movie Recording and Movie Playback.....	95
Capturing Still Images While Recording Movies.....	98
Shooting Time-lapse Movies.....	99
Recording Superlapse Movies.....	101
Operations During Movie Playback.....	102
Editing Movies.....	103



Basic Operations of Movie Recording and Movie Playback

1 Display the shooting screen.

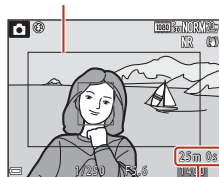

- Check the remaining amount of movie recording time.
- It is recommended that you display the movie frame that indicates the area that will be recorded in a movie (📖96).

Movie frame



Remaining movie recording time

2 Press the movie-record) button to start movie recording.

- The camera focuses on the subject in the center of the frame.
- Press the  button to pause recording, and press the  button again to resume recording (except when an HS movie option is selected in **Movie options**). Recording automatically ends if it remains paused for about five minutes.
- You can capture a still image by pressing the shutter-release button while recording a movie (📖98).

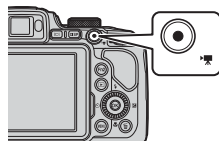

3 Press the movie-record) button again to end recording.

4 Select a movie in full-frame playback mode and press the button to play it back.

- An image with a movie options icon is a movie.

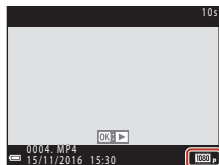

Movie options



Movie Frame

- Press the **DISP** button to display the movie frame (📖7). Check the range of a movie in the frame before movie recording.
- The area that is recorded in a movie varies depending on the settings of **Movie options**, **Electronic VR**, etc. in the movie menu.

Focusing

- The focus can be adjusted during movie recording in the following manner in accordance with the **Autofocus mode** (📖153) setting of the movie menu.
 - **AF-S Single AF** (default setting): The focus is locked when movie recording starts. To perform the autofocus function during movie recording, press the multi selector ◀.
 - **AF-F Full-time AF**: The focus is adjusted repeatedly even during movie recording.
- When the focus mode (📖66) is **MF** (manual focus), adjust the focus manually. The focus can be adjusted while recording movies by rotating the multi selector counterclockwise to focus on far subjects or clockwise to focus on near subjects.

Exposure

- When the multi selector ▶ is pressed during movie recording, the exposure is locked. To unlock, press ▶ again.

Maximum Movie Recording Time

Individual movie files cannot exceed 4 GB in size or 29 minutes in length, even when there is sufficient free space on the memory card for longer recording.

- The remaining recording time for a single movie is displayed on the shooting screen.
- Recording may end before either limit is reached if camera temperature becomes elevated.
- The actual remaining recording time may vary depending on the movie content, subject movement, or type of memory card.
- Memory cards with an SD Speed Class rating of 6 or faster are recommended for recording movies (when recording 4K UHD movies at an image size/frame rate of **2160/30p** or **2160/25p**, cards rated UHS Speed Class 3 or faster are recommended). When using a memory card with a lower Speed Class rating, movie recording may stop unexpectedly.



Camera Temperature

- The camera may become hot when recording movies for an extended period of time or when the camera is used in a hot area.
- If the inside of the camera becomes extremely hot when recording movies, the camera will automatically stop recording. The amount of time remaining until the camera stops recording (⌚10s) is displayed.
After the camera stops recording, it turns itself off.
Leave the camera off until the inside of the camera has cooled.

Notes About Movie Recording

Notes About Saving Images or Movies

The indicator showing the number of exposures remaining or the indicator showing the remaining recording time flashes while images or movies are being saved. **Do not open the battery-chamber/memory card slot cover or remove the battery or memory card** while an indicator is flashing. Doing this could result in loss of data, or in damage to the camera or the memory card.

Notes About Recorded Movies

- The zoom indicator is not displayed during movie recording.
- There may be some degradation in image quality when digital zoom is used. If you zoom in on the subject while recording a movie, the zoom motion temporarily stops at the position where optical zoom is changed to digital zoom.
- The sounds of zoom control operation, zoom, autofocus lens drive movement, vibration reduction, and aperture operation when brightness changes may be recorded.
- The following phenomena may be seen on the screen while recording movies. These phenomena are saved in the recorded movies.
 - Banding may occur in images under fluorescent, mercury-vapor, or sodium-vapor lighting.
 - Subjects that move quickly from one side of the frame to the other, such as a moving train or car, may appear skewed.
 - The entire movie image may be skewed when the camera is panned.
 - Lighting or other bright areas may leave residual images when the camera is moved.
- Depending on the distance to the subject or the amount of zoom applied, colored stripes may appear on subjects with repeating patterns (fabrics, lattice windows, etc.) during movie recording and playback. This occurs when the pattern in the subject and the layout of the image sensor interfere with each other; it is not a malfunction.

Notes About Autofocus for Movie Recording



Autofocus may not perform as expected (📖76). Should this occur, focus using manual focus (📖67, 68) or try the following:

1. Set **Autofocus mode** in the movie menu to **Single AF** (default setting) before starting movie recording.
2. Frame another subject (positioned at the same distance from the camera as the intended subject) in the center of the frame, press the  button to start recording, and modify the composition.





Capturing Still Images While Recording Movies

If the shutter-release button is pressed all the way while recording a movie, one frame is saved as a still image (JPEG image). Movie recording continues while the still image is being saved.

- A still image can be captured when  is displayed on the screen. When  is displayed, a still image cannot be captured.
- The size of the captured still image is determined by the movie image size (150).



✓ Notes About Capturing Still Images During Movie Recording

- Still images cannot be saved during movie recording in the following situations:
 - When movie recording is paused
 - When the remaining movie recording time is less than five seconds
 - When **Movie options** (150) is set to HS movie
- Up to 20 still images can be saved while recording a single movie when **Movie options** is set to  **2160/30p** or  **2160/25p**.
- It may take some time to save the images after shooting.
- The frames of a movie that were recorded when a still image was being captured may not play back smoothly.
- The sounds of operating the shutter-release button when saving a still image may be heard in the recorded movie.
- If the camera moves when the shutter-release button is pressed, the image may be blurred.







Shooting Time-lapse Movies

The camera can automatically capture still images at a specified interval to create time-lapse movies that are approximately 10 seconds long.

- When the **Frame rate** setting of the movie menu is set to **30 fps (30p/60p)**, 300 images are captured and saved with **1080 P 1080/30p**. When set to **25 fps (25p/50p)**, 250 images are captured and saved with **1080 P 1080/25p**.



Rotate the mode dial to **SCENE** → **MENU** button →  Time-lapse movie →  button

Type (required shooting time)	Interval time	
	30 fps (30p/60p)	25 fps (25p/50p)
 Cityscape (10 minutes) ¹ (default setting)	2 s	2.4 s
 Landscape (25 minutes) ¹	5 s	6 s
 Sunset (50 minutes) ¹	10 s	12 s
 Night sky (150 minutes) ²	30 s	36 s
 Star trails (150 minutes) ³	30 s	36 s

¹ The camera focuses on the area in the center of the frame.

² Suited for recording the movement of stars.

³ Star movement appears as lines of light due to image processing.

- Use the multi selector  to select a type, and press the  button.

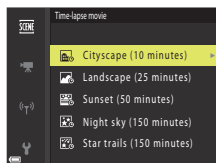

- Select whether or not to fix exposure (brightness), and press the  button (except Night sky and Star trails).

- When **AE-L on** is selected, the exposure used for the first image is used for all images. When the brightness changes drastically like at dusk, **AE-L off** is recommended.

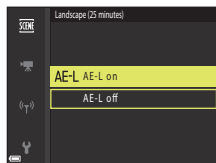

3 Stabilize the camera by using a tool such as a tripod.

4 Press the shutter-release button to capture the first image.

- Set exposure compensation (📖70) before releasing the shutter for the first image (when using **Night sky (150 minutes)** or **Star trails (150 minutes)**, exposure compensation cannot be used). Exposure compensation cannot be changed after the first image is captured. Focus and hue are fixed when the first image is captured.
- The shutter is automatically released for the second and subsequent images.
- The screen may turn off while the camera is not capturing images.
- Shooting ends automatically when 300 or 250 images are captured.
- Press the ⏹ button to end shooting before the required shooting time elapses and create a time-lapse movie.
- Sound and still images cannot be saved.

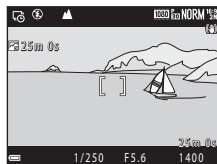

✓ **Notes About Time-lapse Movie**

- Do not exchange the memory card until shooting is complete.
- Use a sufficiently charged battery to prevent the camera from turning off unexpectedly.
- Time-lapse movies cannot be recorded by pressing the ● (📷) button.
- Do not rotate the mode dial to a different setting until shooting is complete.
- Vibration reduction is disabled regardless of the **Vibration reduction** setting (📖167) in the setup menu.



Recording Superlapse Movies

The camera records movies and saves them in fast motion ($\frac{1080}{25}$ P **1080/30p** or $\frac{1080}{25}$ P **1080/25p**). Use to record a movie while moving the camera. The camera compresses the time of changes in the subject and saves the movie.

Rotate the mode dial to **SCENE** → **MENU** button →  Superlapse movie →  button

1 Use the multi selector to select a playback speed, and press the button.

- At the default setting of **2x**, a movie recorded for two minutes is played back as a one-minute movie.
- If an individual movie file reaches 4 GB in size or the recording time exceeds 29 minutes, recording ends automatically.

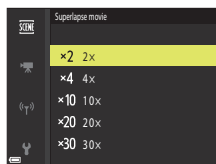



2 Press the (movie-record) button to start recording.

- You can check the recording time and playback time on the screen.
- It is recommended that you display the movie frame that indicates the area that will be recorded in a movie (96).
- Sound is not recorded.



Shooting Still Images

- A still image ($\frac{1920}{24}$ (1920 × 1080 pixels)) can be captured if you press the shutter-release button before pressing the  (movie-record) button.
- You can shoot still images while recording movies (98).



Operations During Movie Playback

To adjust the volume, move the zoom control while a movie is playing (📖2).

Rotate the multi selector or the command dial to fast-forward or rewind.

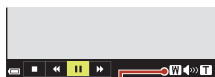

Volume indicator

Playback controls are displayed on the screen.

The operations described below can be performed by using the multi selector ◀▶ to select a control and then pressing the Ⓞ button.



When paused

Function	Icon	Description	
Rewind	◀◀	Hold down the Ⓞ button to rewind the movie.	
Fast-forward	▶▶	Hold down the Ⓞ button to fast-forward the movie.	
Pause	⏸	Pause playback. The operations listed below can be performed while paused.	
		◀⏮	Rewind the movie one frame. Hold down the Ⓞ button for continuous rewinding.*
		▶⏭	Advance the movie one frame. Hold down the Ⓞ button for continuous advancing.*
		▶	Resume playback.
		📄	Extract the desired portion of a movie and save it as a separate file.
End	■	Extract a single frame of a movie and save it as a still image.	
		Return to full-frame playback mode.	

* The movie can also be advanced or rewound by one frame by rotating the multi selector or command dial.



Editing Movies

When editing movies, use a sufficiently charged battery to prevent the camera from turning off during editing.

Extracting Only the Desired Portion of a Movie

The desired portion of a recorded movie can be saved as a separate file.

1 Play back a desired movie and pause at the start point of the portion that you want to extract (📖102).

2 Use the multi selector ◀▶ to select the 📺 control, and then press the ⓄK button.

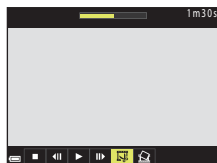

3 Use ▲▼ to select 📺 (choose start point).

- Use ◀▶ or rotate the command dial to move the start point.
- To cancel editing, select ↶ (back), and press the ⓄK button.

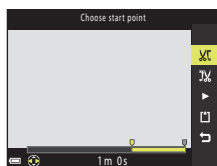

4 Use ▲▼ to select 📺 (choose end point).

- Use ◀▶ or rotate the command dial to move the end point.
- To preview the specified portion, use ▲▼ to select ▶ and then press the ⓄK button. Press the ⓄK button again to stop previewing.

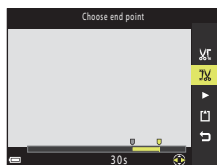

5 Use ▲▼ to select (save) and press the .

- Follow the instructions on the screen to save the movie.







Notes About Movie Extracting



- A movie that was created by editing cannot be edited again.
- The actual trimmed portion of a movie may differ slightly from the portion selected using the start and end points.
- Movies cannot be trimmed so that they are less than two seconds long.

Saving a Frame from a Movie as a Still Image

The desired frame of a recorded movie can be extracted and saved as a still image.

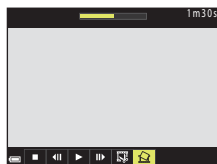
- Pause a movie and display the frame to be extracted (102).
- Use the multi selector  to select the  control and press the .



- Select **Yes** when a confirmation dialog is displayed, and press the  button to save the image.
- The still image is saved with **Normal** as the image quality. The image size is determined by the original movie image size (150).

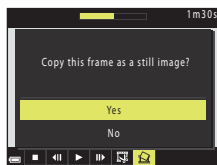

Restrictions on Extracting Still Images

Still images cannot be extracted from a movie recorded with an HS movie option.



Connecting the Camera to a TV, Printer, or Computer

Utilizing Images	106
Viewing Images on a TV	107
Printing Images Without a Computer	108
Transferring Images to a Computer (ViewNX-i)	112



Utilizing Images

In addition to using the SnapBridge app to enjoy the captured images, you can also utilize the images in various ways by connecting the camera to the devices described below.

Viewing Images on a TV



Images and movies captured with the camera can be viewed on a TV. Connection method: Connect a commercially available HDMI cable to the TV's HDMI input jack.

Printing Images Without a Computer



If you connect the camera to a PictBridge-compatible printer, you can print images without using a computer. Connection method: Connect the camera directly to the printer's USB port with the USB cable.

Transferring Images to a Computer (ViewNX-i)



You can transfer images and movies to a computer for viewing and editing. Connection method: Connect the camera to the computer's USB port with the USB cable.

- Before connecting to a computer, install ViewNX-i on the computer.

✓ Notes About Connecting Cables to the Camera

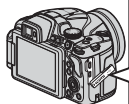

Open the connector cover.



Insert the plug.

Micro-USB connector

HDMI micro connector (Type D)

- Make sure to turn the camera off before connecting or disconnecting cables. Check the shape and direction of the plugs and do not insert or remove the plugs at an angle.
- Make sure that the camera battery is sufficiently charged. If the EH-67A AC Adapter (available separately) is used, this camera can be powered from an electrical outlet. Do not, under any circumstances, use an AC adapter other than the EH-67A. Failure to observe this precaution could result in overheating or damage to the camera.
- For information about the connection methods and subsequent operations, refer to the documentation included with the device in addition to this document.



Viewing Images on a TV

1 Turn off the camera and connect it to the TV.

- Check the shape and direction of the plugs and do not insert or remove the plugs at an angle.

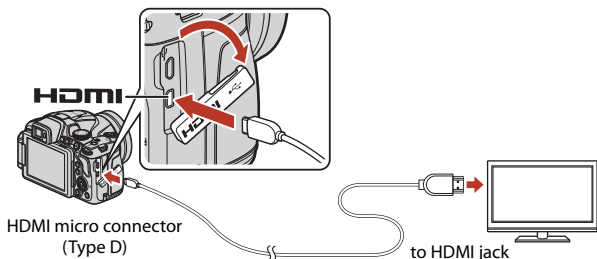

2 Set the TV's input to external input.

- See the documentation provided with your TV for details.

3 Press and hold down the (playback) button to turn on the camera.

- Images are displayed on the TV.
- The camera screen does not turn on.
- To play back movies that were saved using **2160/30p** or **2160/25p** in 4K UHD quality, use a TV and HDMI cable that support 4K.



Printing Images Without a Computer

Users of PictBridge-compatible printers can connect the camera directly to the printer and print images without using a computer.

Connecting the Camera to a Printer

- 1 Turn on the printer.
- 2 Turn off the camera and connect it to the printer using the USB cable.
 - Check the shape and direction of the plugs and do not insert or remove the plugs at an angle.

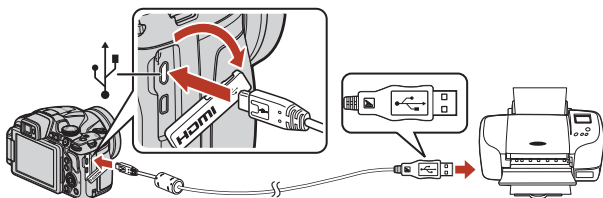

- 3 The camera is automatically turned on.
 - The **PictBridge** startup screen (①) is displayed on the camera screen, followed by the **Print selection** screen (②).

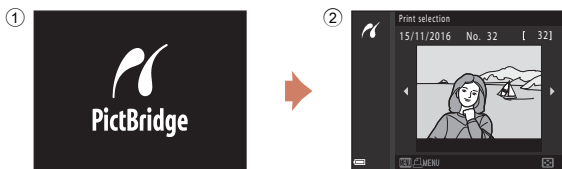

If the PictBridge Startup Screen Is Not Displayed

When **Auto** is selected for **Charge by computer** (171), it may be impossible to print images with direct connection of the camera to some printers.

If the PictBridge startup screen is not displayed after the camera is turned on, turn the camera off and disconnect the USB cable. Set **Charge by computer** to **Off** and reconnect the camera to the printer.



Printing Images One at a Time

1 Use the multi selector ◀▶ to select the desired image and press the **OK** button.

- Move the zoom control toward **W** (📐) to switch to thumbnail playback or **T** (📺) to switch to full-frame playback.

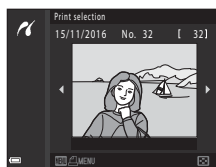

2 Use ▲▼ to select **Copies** and press the **OK** button.

- Use ▲▼ to set the desired number of copies (up to nine) and press the **OK** button.

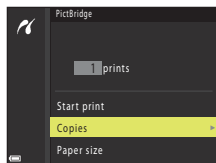

3 Select **Paper size** and press the **OK** button.

- Select the desired paper size and press the **OK** button.
- To print with the paper size setting configured on the printer, select **Default**.
- The paper size options available on the camera vary depending on the printer that you use.

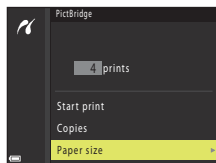

4 Select **Start print** and press the **OK** button.

- Printing starts.

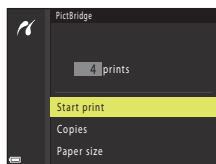

Printing Multiple Images

- 1 When the **Print selection** screen is displayed, press the **MENU** (menu) button.

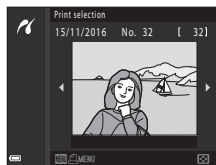

- 2 Use the multi selector ▲▼ to select **Paper size** and press the **OK** button.
 - Select the desired paper size and press the **OK** button.
 - To print with the paper size setting configured on the printer, select **Default**.
 - The paper size options available on the camera vary depending on the printer that you use.
 - To exit the print menu, press the **MENU** button.

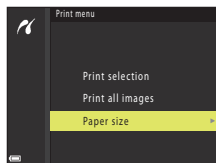

- 3 Select **Print selection** or **Print all images** and press the **OK** button.

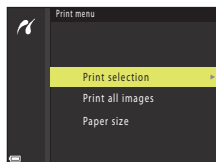

Print selection

Select images (up to 99) and the number of copies (up to 9) of each.

- Use the multi selector ◀▶ to select images, and use ▲▼ to specify the number of copies to be printed.
- Images selected for printing are indicated by 📄 and the number of copies to be printed. To cancel the print selection, set the number of copies to 0.
- Move the zoom control toward **T** (🔍) to switch to full-frame playback or **W** (🖼️) to switch to thumbnail playback.
- Press the **OK** button when setting is complete. When the screen for confirming the number of print copies is displayed, select **Start print** and press the **OK** button to start printing.

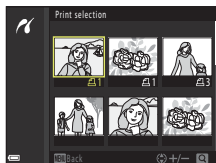

Print all images

One copy each of all images saved on the memory card is printed.

- When the screen for confirming the number of print copies is displayed, select **Start print** and press the **OK** button to start printing.



Transferring Images to a Computer (ViewNX-i)

Installing ViewNX-i

ViewNX-i is free software that enables you to transfer images and movies to your computer for viewing and editing.

To install ViewNX-i, download the latest version of the ViewNX-i installer from the following website and follow the on-screen instructions to complete installation.

ViewNX-i: <http://downloadcenter.nikonimglib.com>

For system requirements and other information, see the Nikon website for your region.

Transferring Images to a Computer

1 Prepare a memory card that contains images.

You can use any of the methods below to transfer images from the memory card to a computer.

- **SD memory card slot/card reader:** Insert the memory card into the card slot of your computer or the card reader (commercially available) that is connected to the computer.
- **Direct USB connection:** Turn the camera off and ensure that the memory card is inserted in the camera. Connect the camera to the computer using the USB cable. The camera automatically turns on.

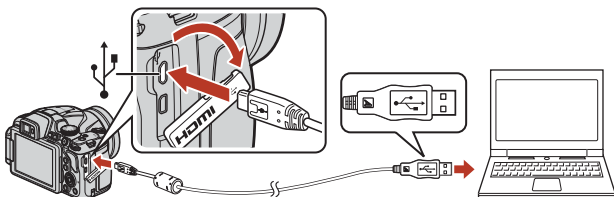

✓ Notes About Connecting the Camera to a Computer

Disconnect all other USB-powered devices from the computer. Connecting the camera and other USB-powered devices to the same computer simultaneously may cause a camera malfunction or excessive power supply from the computer, which could damage the camera or memory card.



If a message is displayed prompting you to choose a program, select Nikon Transfer 2.

- **When using Windows 7**

If the dialog shown on the right is displayed, follow the steps below to select Nikon Transfer 2.

- 1 Under **Import pictures and videos**, click **Change program**. A program selection dialog will be displayed; select Nikon Transfer 2 and click **OK**.
- 2 Double-click the Nikon Transfer 2 icon.

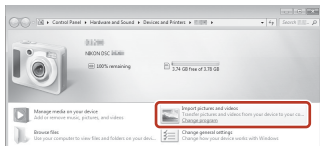

- **When using Windows 10 or Windows 8.1**

If the dialog shown on the right is displayed, click the dialog and then click **Import File/Nikon Transfer 2**.

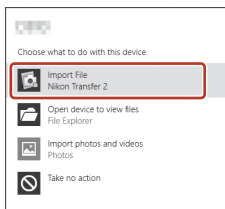

- **When using OS X or macOS**

If Nikon Transfer 2 does not automatically start, launch the **Image Capture** application that comes bundled with Mac while the camera and your computer are connected, and select Nikon Transfer 2 as the default application to open when the camera is connected to your computer.

If the memory card contains a large number of images, it may take a while for Nikon Transfer 2 to start. Wait until Nikon Transfer 2 starts.

Notes About Connecting the USB Cable

Operation is not guaranteed if the camera is connected to the computer via a USB hub.

Using ViewNX-i

Consult online help for more information.



2 After Nikon Transfer 2 starts, click **Start Transfer**.

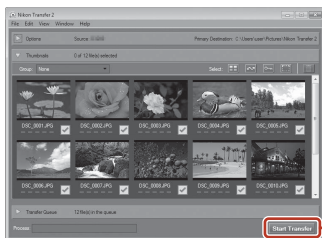

- Image transfer begins. When image transfer is complete, ViewNX-i starts and the transferred images are displayed.

3 Terminate the connection.

- If you are using a card reader or card slot, choose the appropriate option in the computer operating system to eject the removable disk corresponding to the memory card and then remove the memory card from the card reader or card slot.
- If the camera is connected to the computer, turn the camera off and disconnect the USB cable.

Capture NX-D

Use Nikon's Capture NX-D software to fine-tune photos or to change settings for RAW pictures and save them in other formats. Capture NX-D is available for download from: <http://nikonimglib.com/ncnxd/>







Using the Menu

Menu Operations.....	116
Menu Lists	119
The Shooting Menu (The Common Shooting Options)	123
The Shooting Menu (P , S , A , or M Mode).....	126
The Movie Menu	150
The Playback Menu.....	156
The Network Menu	160
The Setup Menu.....	162



Menu Operations

You can set the menus listed below by pressing the **MENU** (menu) button.

-  Shooting menu^{1,2}
-  Movie menu¹
-  Playback menu³
-  Network menu
-  Setup menu

¹ Press the **MENU** button when the shooting screen is displayed.

² Menu icons and available setting options vary depending on the shooting mode.

³ Press the **MENU** button when the playback screen is displayed.

1 Press the **MENU** (menu) button.

- The menu is displayed.

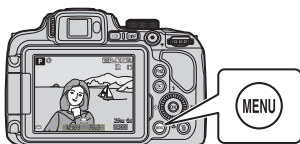

2 Press the multi selector ◀.

- The current menu icon is displayed in yellow.

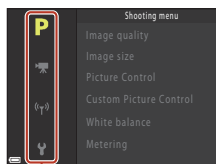

Menu icons

3 Select a menu icon and press the **OK** button.

- The menu options become selectable.

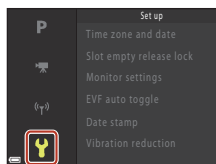

4 Select a menu option and press the **OK** button.

- Certain menu options cannot be set depending on the current shooting mode or the state of the camera.
- Items can also be selected by rotating the multi selector.

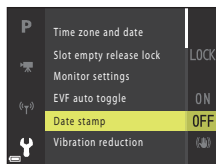

5 Select a setting and press the **OK** button.

- The setting you selected is applied.
- When you are finished using the menu, press the **MENU** button.
- When a menu is displayed, you can switch to shooting mode by pressing the shutter-release button or **Q** button.

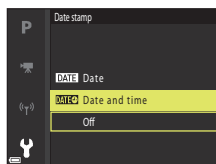

Using the **Fn1 (Function 1)/Fn2 (Function 2) Buttons**

If you press the **Fn1** button or **Fn2** button in **P**, **S**, **A**, **M**, or **U** mode, you can quickly configure the pre-saved menu options (default setting is **Continuous**). To set a different menu option, select **Fn** **Fn button** and select the desired menu option.

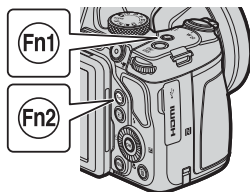

The Image Selection Screen

When an image selection screen such as the one shown on the right is displayed while operating the camera menu, follow the procedures described below to select the images.

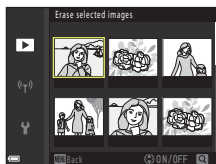

1 Use the multi selector ◀▶ or rotate it to select the desired image.

- Move the zoom control (📖) toward **T** (🔍) to switch to full-frame playback, or **W** (📐) to switch to thumbnail playback.
- Only one image can be selected for **Rotate image** and **Choose key picture**. Proceed to step 3.

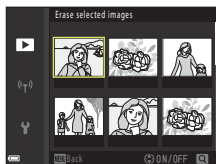

2 Use ▲▼ to select **ON** or **OFF**.

- When **ON** is selected, an icon is displayed under the selected image. Repeat steps 1 and 2 to select additional images.

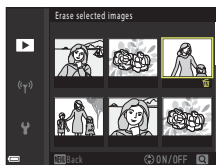

3 Press the **OK** button to apply the image selection.

- When a confirmation dialog is displayed, follow the on-screen instructions to operate.





Menu Lists

The Shooting Menu

Enter shooting mode → MENU button

Common Options

Option	Default setting	
Image quality*	Normal	123
Image size*	 5184×3888	125

* Also can be set by pressing the **Fn1** (function 1) button or **Fn2** (function 2) button ( 117).

For P, S, A, M, and U Modes

Option	Default setting	
Picture Control*	Standard	126
Custom Picture Control	–	130
White balance*	Auto (normal)	131
Metering*	Matrix	134
Continuous*	Single	135
ISO sensitivity*	Auto	139
Exposure bracketing	Off	140
AF area mode*	Target finding AF	141
Autofocus mode	Pre-focus	144
Flash exp. comp.	0.0	144
Noise reduction filter	Normal	145
Active D-Lighting	Off	145
Multiple exposure	<ul style="list-style-type: none">• Multiple exposure mode: Off• Auto gain: On	146
Save user settings	–	59
Reset user settings	–	59





Option	Default setting	
Zoom memory	Off	148
Startup zoom position	24 mm	149
M exposure preview	Off	149

* Also can be set by pressing the **Fn1** (function 1) button or **Fn2** (function 2) button ( 117).

The Movie Menu

Enter shooting mode → MENU button →  menu icon →  button

Option	Default setting	
Movie options	 1080/30p or  1080/25p	150
Autofocus mode	Single AF	153
Electronic VR	On	154
Wind noise reduction	Off	154
Zoom microphone	On	155
Frame rate	–	155

The Playback Menu

Press the  button (playback mode) → MENU button

Option	
Mark for upload ¹	156
Quick retouch ²	89
D-Lighting ²	89
Skin softening ²	90
Filter effects ²	91
Slide show	157



Option	
Protect ¹	158
Rotate image ¹	158
Small picture ²	92
Sequence display options	159
Choose key picture ¹	159

¹ Select an image on the image selection screen. See “The Image Selection Screen” (📖 118) for more information.

² Edited images are saved as separate files. Some images may not be edited.

The Network Menu

Press the MENU button →  menu icon →  button

Option	
Airplane mode	160
Connect to smart device	160
Send while shooting	160
Wi-Fi	160
Bluetooth	161
Restore default settings	161



The Setup Menu

Press the **MENU** button →  menu icon →  button

Option	
Time zone and date	162
Slot empty release lock	164
Monitor settings	165
EVF auto toggle	166
Date stamp	166
Vibration reduction*	167
AF assist	168
Digital zoom	168
Assign side zoom control	169
Sound settings	169
Auto off	170
Format card	170
Language	170
Charge by computer	171
Image comment	172
Copyright information	173
Location data	174
Toggle Av/Tv selection	174
Reset file numbering	175
Peaking	176
Reset all	176
Firmware version	176

* Also can be set by pressing the **Fn1** (function 1) button or **Fn2** (function 2) button ( 117).



The Shooting Menu (The Common Shooting Options)

Image Quality

Enter shooting mode* → MENU button → shooting mode menu icon → Image quality →  button

* The image quality can be set in any shooting mode. The setting is also applied to other shooting modes (except shooting mode **U** and **Easy panorama** scene mode).

Set the image quality (compression ratio) used when saving images.

Lower compression ratios result in higher quality images, but the number of images that can be saved is reduced.



Option		Description
FINE	Fine	Finer image quality than Normal . Compression ratio of about 1:4
NORM	Normal (default setting)	Normal image quality, suitable for most applications. Compression ratio of about 1:8
RAW	RAW	Raw data from the image sensor are saved without additional processing. You can use a computer to change settings that were set during shooting such as white balance and contrast. • Image size is fixed at  5184×3888 File format: RAW (NRW), Nikon's own format
RAW-F	RAW + Fine	Two images are recorded, one RAW image and one fine-quality JPEG image.
RAW-N	RAW + Normal	Two images are recorded, one RAW image and one normal-quality JPEG image.

Notes About Image Quality

- RAW images cannot be captured in the following shooting modes:
 - Scene modes
 - Night landscape mode
 - Night landscape portrait mode
 - Landscape mode
 - Creative modeIf you change the shooting mode to any of the above shooting modes when a RAW image quality has been selected, the image quality will change to **Fine** or **Normal**.
- This function may not be available to use in combination with other functions (80).



RAW Images of This Camera

- RAW images cannot be processed on this camera.
- ViewNX-i ( 112) needs to be installed on the computer to be able to view RAW images on the computer.
- RAW images cannot be edited or printed directly. You can adjust images or process RAW images if you transfer RAW images to a computer, and then use software such as Capture NX-D ( 114).

Saving of RAW and JPEG Images at the Same Time

- The RAW image and the JPEG image that are saved at the same time have the same file number but with their own extensions, “.NRW” and “.JPG” ( 199).
- When playing back on the camera, only the JPEG image is displayed.
- Note that when the JPEG image is deleted, the RAW image that was saved at the same time is also deleted.

Number of Images That Can Be Saved



- The approximate number of images that can be saved can be checked on the screen when shooting ( 21).
- Note that due to JPEG compression, the number of images that can be saved may vary greatly depending on the image content, even when using memory cards with the same capacity and the same image quality and image size settings. In addition, the number of images that can be saved may vary depending on the make of the memory card.
- If the number of exposures remaining is 10,000 or more, the number of exposures remaining display shows “9999.”









Image Size

Enter shooting mode* → MENU button → shooting mode menu icon → Image size →  button

* The image size can be set in any shooting mode. The setting is also applied to other shooting modes (except shooting mode **U**, **Easy panorama** scene mode, and **Superlapse movie**).

Set the image size (number of pixels) used when saving JPEG images.

The larger the image size, the larger the size at which it can be printed, but the number of images that can be saved is reduced.

Option*	Aspect ratio (horizontal to vertical)
 5184×3888 (default setting)	4:3
 3264×2448	4:3
 2272×1704	4:3
 1600×1200	4:3
 5184×2920	16:9
 5184×3456	3:2
 3888×3888	1:1

* The numerical values indicate the number of pixels that are captured.
Example:  **5184×3888** = approx. 20 megapixels, 5184 × 3888 pixels

Notes About Printing Images at 1:1 Aspect Ratio

Change the printer setting to “Border” when printing images at a 1:1 aspect ratio.

Some printers may not be able to print images at a 1:1 aspect ratio.

Notes About Image Size

This function may not be available to use in combination with other functions (80).









The Shooting Menu (P, S, A, or M Mode)

- See "U (User Settings) Mode" (📖58) for information about **Save user settings** and **Reset user settings**.

Picture Control (COOLPIX Picture Control)

Rotate the mode dial to **P, S, A, M,** or **U** → MENU button → **P, S, A, M,** or **U** menu icon → Picture Control →  button

Change the settings for image recording according to the shooting conditions or your preferences. Sharpness, contrast and saturation can be adjusted in detail.

Option	Description
 SD Standard (default setting)	Standard processing for balanced results. Recommended for most situations.
 NL Neutral	Minimal processing for natural results. Select for images that will later be processed or retouched.
 VI Vivid	Images are enhanced for a vivid, photoprint effect. Select for images that emphasize primary colors, such as blue, red, and green.
 MC Monochrome	Shoots monochrome photographs such as in black-and-white or sepia.
 C-1 Custom 1*	Changes to the setting of Custom 1 in COOLPIX Custom Picture Control.
 C-2 Custom 2*	Changes to the setting of Custom 2 in COOLPIX Custom Picture Control.

* Only displayed when the setting customized in **Custom Picture Control** (📖130) has been registered.

Notes About COOLPIX Picture Control

- The COOLPIX Picture Control function of this camera cannot be used with other makes of cameras, Picture Control function of software such as Capture NX-D, Picture Control Utility 2, etc.
- This function may not be available to use in combination with other functions (📖80).



Customizing Existing COOLPIX Picture Controls: Quick Adjust and Manual Adjust

COOLPIX Picture Control can be customized using “Quick adjust”, which allows for balanced adjustment of sharpness, contrast, saturation and other image editing components, or using “Manual adjust”, which allows for detailed adjustment of the components individually.

1 Use the multi selector ▲▼ to select the desired type of COOLPIX Picture Control and press the **OK** button.

- Items can also be selected by rotating the multi selector.

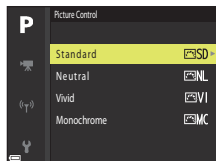

2 Use ▲▼ to highlight the desired option (📖128) and use ◀▶ to select a value.

- Press the **OK** button to set the value.
- To change the adjusted values to the default setting, select **Reset** and press the **OK** button.

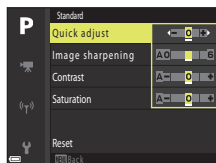

Types of Quick Adjust and Manual Adjust

Option	Description
Quick adjust ¹	<p>Adjusts the sharpness, contrast and saturation levels automatically. Setting to the – side reduces the effect of the selected COOLPIX Picture Control, and setting to the + side emphasizes its effect.</p> <ul style="list-style-type: none"> • Default setting: 0
Image sharpening	<p>Controls how much outlines are sharpened during shooting. The higher the number, the sharper the image, and the lower the number, the softer the image.</p> <p>Select A (auto) for automatic adjustment.</p> <ul style="list-style-type: none"> • Default setting: 3 for Standard or Monochrome, 2 for Neutral, and 4 for Vivid
Contrast	<p>Controls the contrast.</p> <p>Setting to the – side gives the image a softer appearance, and setting to the + side gives it a harder appearance. Select lower values to prevent highlights in portrait subjects from being “washed out” in direct sunlight, higher values to preserve detail in misty landscapes and other low contrast subjects.</p> <p>Select A (auto) for automatic adjustment.</p> <ul style="list-style-type: none"> • Default setting: 0
Saturation ²	<p>Controls the vividness of colors.</p> <p>Setting to the – side reduces the vividness, and setting to the + side increases the vividness.</p> <p>Select A (auto) for automatic adjustment.</p> <ul style="list-style-type: none"> • Default setting: 0
Filter effects ³	<p>Simulates the effect of color filters on monochrome photographs.</p> <ul style="list-style-type: none"> • OFF: Filter effects are not used. • Y (yellow), O (orange), R (red): Enhance contrast. Can be used to tone down the brightness of the sky in landscape photographs. The contrast is strengthened in the order Y → O → R. • G (green): Softens skin tones and the color of features such as lips. Suitable for portraits. • Default setting: OFF



Option	Description
Toning ³	<p>Controls the tint used in monochrome photographs from B&W (black-and-white), Sepia, and Cyanotype (blue-tinted monochrome).</p> <p>Pressing the multi selector ▼ when Sepia or Cyanotype is selected enables you to select a saturation level. Press ◀▶ to adjust the saturation.</p> <ul style="list-style-type: none"> • Default setting: B&W (black-and-white)

¹ Quick adjust is not available in **Neutral**, **Monochrome**, **Custom 1**, and **Custom 2**. The values set manually are disabled if quick adjust is used after manual setting.

² Not displayed for **Monochrome**.

³ Only displayed for **Monochrome**.

Notes About Image Sharpening

The effects of **Image sharpening** cannot be previewed on the screen during shooting. Check the results in playback mode.

Notes About Contrast, Saturation, and A (Auto)



Results for contrast and saturation vary with the exposure, and the position and size of the subject in the frame.



Custom Picture Control (COOLPIX Custom Picture Control)

Rotate the mode dial to **P**, **S**, **A**, **M**, or **U** → MENU button → **P**, **S**, **A**, **M**, or **U** menu icon → Custom Picture Control →  button

Customize the settings of COOLPIX Picture Control (127) and register them in **Custom 1** or **Custom 2** of **Picture Control**.

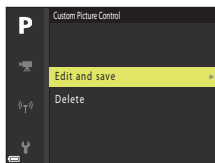

1 Use the multi selector   to select **Edit and save**, and press the  button.

- Select **Delete** to delete a registered COOLPIX Custom Picture Control.



2 Select the original COOLPIX Picture Control (126) to be edited, and press the  button.

3 Use   to highlight the desired option and use   to select a value (127).

- The options are the same as those for adjusting the COOLPIX Picture Control.
- Press the  button when you finish adjustment.
- To change the adjusted values to the default setting, select **Reset** and press the  button.

4 Select the registration destination and press the  button.



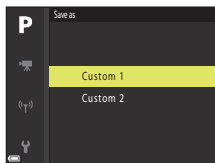





- **Custom 1** or **Custom 2** becomes selectable in **Picture Control** or **Custom Picture Control**.
- To change the adjusted values, select **Custom 1** or **Custom 2** in **Picture Control** or **Custom Picture Control**.



White Balance (Adjusting Hue)



Rotate the mode dial to **P, S, A, M**, or **U** → MENU button → **P, S, A, M**, or **U** menu icon → White balance →  button

Adjust white balance to suit the light source or weather conditions in order to make the colors in images match what you see with your eyes.

Option	Description
AUTO1 Auto (normal) (default setting)	White balance is automatically adjusted.
AUTO2 Auto (warm lighting)	When set to Auto (warm lighting) , the images are preserved with warm colors if they are shot under an incandescent light source. When using the flash, white balance is adjusted according to the flash lighting condition.
PRE Preset manual	Use when the desired result is not achieved with Auto (normal) , Auto (warm lighting) , Incandescent , etc. ( 133).
 Daylight*	Use under direct sunlight.
 Incandescent*	Use under incandescent lighting.
 Fluorescent	Use under most types of fluorescent lighting. Choose one of 1 (cool-white fluorescent), 2 (day white fluorescent), and 3 (daylight fluorescent).
 Cloudy*	Use under overcast skies.
 Flash*	Use with the flash.
 Choose color temp.	Use to directly specify color temperature ( 132).

* Fine adjustments in seven steps are available. Apply positive (+) to increase blue hue and negative (-) to increase red hue.

Notes About White Balance

- Lower the flash when white balance is set to any setting other than **Auto (normal)**, **Auto (warm lighting)**, or **Flash** (23).
- This function may not be available to use in combination with other functions (80).



Color Temperature

Color temperature is an objective measure of colors of light sources which are expressed in the unit of absolute temperature (K: Kelvin). Light sources with lower color temperatures appear more reddish, while light sources with higher color temperatures appear more bluish.

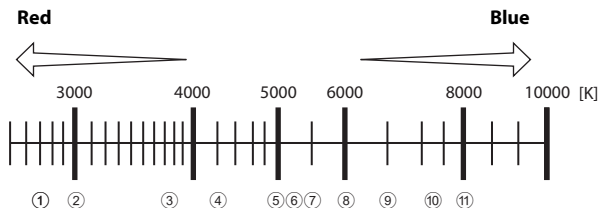

- | | |
|--|-----------------------------------|
| ① Sodium-vapor lamps: 2700K | ⑦ Flash: 5400K |
| ② Incandescent/
Warm-white fluorescent: 3000K | ⑧ Cloudy: 6000K |
| ③ White fluorescent: 3700K | ⑨ Daylight fluorescent: 6500K |
| ④ Cool-white fluorescent: 4200K | ⑩ High temp. mercury-vapor: 7200K |
| ⑤ Day white fluorescent: 5000K | ⑪ Shade: 8000K |
| ⑥ Direct sunlight: 5200K | |



Using Preset Manual

Follow the procedures described below to measure the white balance value under the lighting used during shooting.

1 Place a white or gray reference object under the lighting that will be used during shooting.

2 Use the multi selector ▲▼ to select **Preset manual**, and press the **OK** button.

- The lens extends to the zoom position for measurement.

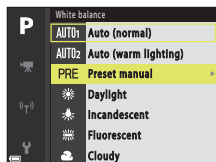

3 Select **Measure**.

- To apply the last measured value, select **Cancel**.



4 Frame the white or gray reference object in the measuring window, and press the **OK** button to measure the value.

- The shutter is released and measurement is complete (no image is saved).

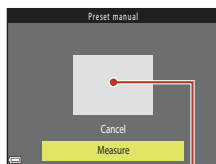

Measuring window

✓ Notes About Preset Manual

A white balance value for flash lighting cannot be measured with **Preset manual**. When shooting using the flash, set **White balance** to **Auto (normal)**, **Auto (warm lighting)**, or **Flash**.







Metering

Rotate the mode dial to **P, S, A, M,** or **U** → MENU button → **P, S, A, M,** or **U** menu icon → Metering →  button

The process of measuring the brightness of the subject to determine the exposure is known as "metering."

Use this option to set the method of how the camera meters exposure.

Option	Description
 Matrix (default setting)	The camera uses a wide area of the screen for metering. Recommended for typical shooting.
 Center-weighted	The camera meters the entire frame but assigns greatest weight to the subject in the center of the frame. The classic metering for portraits; it preserves background details while letting lighting conditions in the center of the frame determine exposure.*
 Spot	The camera meters the area shown by the circle in the center of the frame. This can be used when the subject is much lighter or darker than the background. Ensure that the subject is within the area shown by the circle when shooting.*

* To set focus and exposure for off-center subjects, change **AF area mode** to manual and set the focus area to the center of the frame, and then use focus lock (77).

Notes About Metering

- When digital zoom is in effect, **Center-weighted** or **Spot** is selected depending on the zoom ratio.
- This function may not be available to use in combination with other functions (80).













Display on the Shooting Screen

When **Center-weighted** or **Spot** is selected, the metering range guide (10) is displayed (except when digital zoom is used).



Continuous Shooting

Rotate the mode dial to **P, S, A, M**, or **U** → MENU button → **P, S, A, M**, or **U** menu icon → Continuous →  button

Option	Description
 Single (default setting)	One image is captured each time the shutter-release button is pressed.
 Continuous H	While the shutter-release button is held all the way down, images are captured continuously. <ul style="list-style-type: none"> The camera can capture up to about 5 images continuously at a rate of about 5 fps.
 Continuous L	While the shutter-release button is held all the way down, images are captured continuously. <ul style="list-style-type: none"> The camera can capture up to about 200 images continuously at a rate of about 2 fps.
 Pre-shooting cache	Pre-shooting cache shooting begins when the shutter-release button is pressed halfway. When the shutter-release button is pressed all the way down, the camera saves the current image as well as the images captured immediately before the button is pressed ( 136). Pre-shooting cache makes it easy to capture perfect moments. <ul style="list-style-type: none"> The camera can capture up to about 20 images continuously at a rate of about 15 fps (including a maximum of 5 images captured in the pre-shooting cache). The image quality is fixed at Normal and the image size is fixed at  (1280 × 960 pixels).
 Continuous H: 120 fps	Each time the shutter-release button is pressed all the way down, images are captured continuously at a high speed rate. <ul style="list-style-type: none"> The camera can capture up to about 60 images continuously at a rate of about 120 fps. Image size is fixed at  (640 × 480 pixels).
 Continuous H: 60 fps	Each time the shutter-release button is pressed all the way down, images are captured continuously at a high speed rate. <ul style="list-style-type: none"> The camera can capture up to about 60 images continuously at a rate of about 60 fps. Image size is fixed at  (1920 × 1080 pixels).
 Intvl timer shooting	The camera automatically captures still images continuously at the specified interval ( 137).



✓ Notes About Continuous Shooting

- Focus, exposure and white balance are fixed at the values determined with the first shot in each series.
- It may take some time to save the images after shooting.
- When ISO sensitivity increases, noise may appear in captured images.
- The frame rate may become slower depending on the image quality, image size, memory card type or shooting conditions (such as when saving RAW images).
- When using **Continuous H: 120 fps** or **Continuous H: 60 fps**, banding or variance in brightness or hue may occur in images that were captured under lighting that flashes quickly at high speeds, such as fluorescent, mercury-vapor, or sodium-vapor lighting.
- This function may not be available to use in combination with other functions (📖80).

📎 Pre-shooting Cache

When the shutter-release button is pressed halfway or all the way down, images are saved as described below.

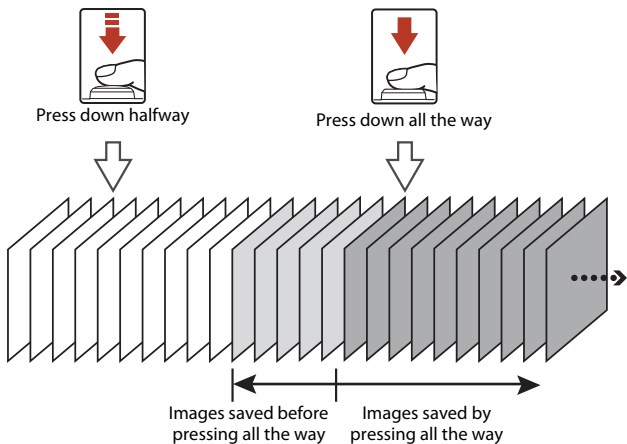



- The pre-shooting cache icon (📄) on the shooting screen changes to green while the shutter-release button is pressed halfway.





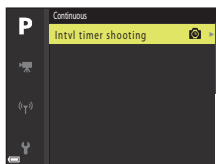

Interval Timer Shooting

Rotate the mode dial to **P**, **S**, **A**, **M**, or **U** → MENU button → **P**, **S**, **A**, **M**, or **U** menu icon → Continuous →  button

- 1 Use the multi selector   to select  **Intvl timer shooting**, and then press the  button.



- 2 Set the desired interval between each shot.
 - Use   to select an item, and use   to set the time.
 - Press the  button when setting is complete.

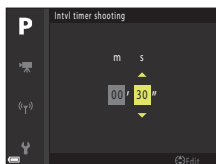

- 3 Press the **MENU** (menu) button to display the shooting screen.
- 4 Press the shutter-release button to shoot the first image.
 - The shutter is automatically released at the specified interval to shoot second and subsequent images.
 - The screen turns off and the power-on lamp flashes during the intervals between shots.
- 5 When the desired number of images have been captured, press the shutter-release button.
 - Shooting ends.
 - Shooting ends automatically when the memory card becomes full.



Notes About Interval Timer Shooting

- To prevent the camera from turning off unexpectedly during shooting, use a sufficiently charged battery.
- If the EH-67A AC Adapter (available separately;  200) is used, this camera can be powered from an electrical outlet. Do not, under any circumstances, use an AC adapter other than the EH-67A. Failure to observe this precaution could result in overheating or damage to the camera.
- Do not rotate the mode dial to a different setting while performing interval timer shooting.
- If the shutter speed is slow and saving an image takes time compared to the specified interval, some of the shots during Interval timer shooting may be canceled.



ISO Sensitivity

Rotate the mode dial to **P, S, A, M,** or **U** → MENU button → **P, S, A, M,** or **U** menu icon → ISO sensitivity →  button

A higher ISO sensitivity allows darker subjects to be captured. Additionally, even with subjects of similar brightness, pictures can be taken at faster shutter speeds, and blurring caused by camera shake and subject movement can be reduced.

- When a higher ISO sensitivity is set, images may contain noise.

Option	Description
ISO sensitivity	<ul style="list-style-type: none">• Auto (default setting): Sensitivity is automatically selected from the range of ISO 100 to 1600.• Fixed range auto: The range in which the camera automatically adjusts ISO sensitivity can be selected from ISO 400 ISO 100-400 or ISO 800 ISO 100-800.• 100 to 3200: ISO sensitivity is fixed at the specified value.
Minimum shutter speed	<p>Set the shutter speed at which ISO sensitivity starts to be automatically adjusted when the shooting mode is P or A. If the exposure is insufficient with the shutter speed that is set here, the ISO sensitivity is increased automatically to obtain the optimal exposure.</p> <ul style="list-style-type: none">• The setting is enabled when ISO sensitivity is set to Auto or Fixed range auto.• If the exposure is still insufficient even after ISO sensitivity is increased, the shutter speed slows down.• Default setting: None

Notes About ISO Sensitivity

- In **M** (manual) mode, when set to **Auto, ISO 100-400,** or **ISO 100-800,** the ISO sensitivity is fixed at ISO 100.
- This function may not be available to use in combination with other functions (80).

ISO Sensitivity Display on the Shooting Screen

- When **Auto** is selected, **ISO** is displayed when the ISO sensitivity increases.
- When **ISO 100-400** or **ISO 100-800** is selected, the maximum value for ISO sensitivity is displayed.





Exposure Bracketing

Rotate the mode dial to **P**, **S**, or **A** → MENU button → **P**, **S**, or **A** menu icon → Exposure bracketing →  button

The exposure (brightness) can be changed automatically during continuous shooting. This is effective for shooting when it is difficult to adjust the picture brightness.

Option	Description
Off (default setting)	Exposure bracketing is not performed.
± 0.3	When the shutter-release button is pressed all the way, 3 shots are taken in sequence and the camera varies exposure by 0, -0.3 , and $+0.3$ over the shots.
± 0.7	When the shutter-release button is pressed all the way, 3 shots are taken in sequence and the camera varies exposure by 0, -0.7 , and $+0.7$ over the shots.
± 1.0	When the shutter-release button is pressed all the way, 3 shots are taken in sequence and the camera varies exposure by 0, -1.0 , and $+1.0$ over the shots.

Notes About Exposure Bracketing





- **Exposure bracketing** is not available in **M** (manual) mode.
- When exposure compensation (70) and ± 0.3 , ± 0.7 , or ± 1.0 in **Exposure bracketing** are set simultaneously, the combined exposure compensation values are applied.
- This function may not be available to use in combination with other functions (80).



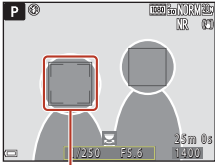

AF Area Mode

Rotate the mode dial to **P, S, A, M,** or **U** → MENU button → **P, S, A, M,** or **U** menu icon → AF area mode → **OK** button

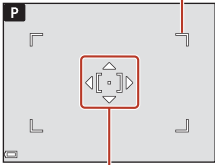
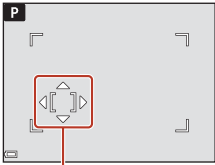
Set how the camera selects the focus area for autofocus.

Option	Description
<p> Face priority</p>	<p>When the camera detects a human face, it focuses on that face. See “Using Face Detection” (p.75) for more information.</p> <p>When framing a composition with no human subjects or detected faces, the camera automatically selects one or more of the nine focus areas containing the subject closest to the camera.</p>  <p style="text-align: center;">Focus area</p>
<p> Manual (spot)</p> <p> Manual (normal)</p> <p> Manual (wide)</p>	<p>Use the multi selector  or rotate it to move the focus area to where you want to focus.</p> <p>To use the multi selector to configure the flash mode or other settings, press the OK button. To return to moving the focus area, press the OK button again.</p> <p>Scope of movable focus area</p>  <p style="text-align: center;">Focus area (center)</p>  <p style="text-align: center;">Focus area (moved)</p>

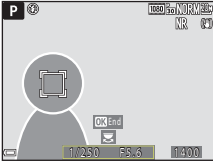

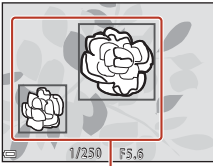
Option	Description
 Subject tracking	<p>Use this function to take pictures of moving subjects. Register the subject on which the camera focuses. The focus area automatically moves to track the subject. See "Using Subject Tracking" (📖143) for more information.</p> 
 Target finding AF (default setting)	<p>When the camera detects the main subject, it focuses on that subject. See "Using Target Finding AF" (📖74).</p>  <p style="text-align: center;">Focus areas</p>

✓ Notes About AF Area Mode

- When digital zoom is in effect, the camera focuses on the area in the center of the frame regardless of the **AF area mode** setting.
- This function may not be available to use in combination with other functions (📖80).



Using Subject Tracking

Rotate the mode dial to **P**, **S**, **A**, **M**, or **U** → MENU button → **P**, **S**, **A**, **M**, or **U** menu icon → AF area mode → **OK** button →  Subject tracking → **OK** button → MENU button

1 Register a subject.

- Align the subject that you want to track with the border in the center of the frame and press the **OK** button.
- When the subject is registered, a yellow border (focus area) is displayed around it and the camera begins tracking the subject.
- If the subject cannot be registered, the border is displayed in red. Change the composition and try registering the subject again.
- To cancel subject registration, press the **OK** button.
- If the camera can no longer track the registered subject, the focus area disappears. Register the subject again.

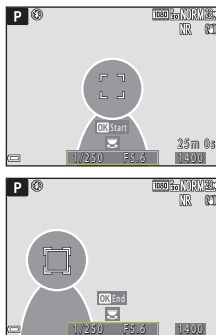

2 Press the shutter-release button all the way to take the picture.

- If the shutter-release button is pressed while the focus area is not displayed, the camera focuses on the subject in the center of the frame.



✓ Notes About Subject Tracking

- If you perform operations such as zooming while the camera is tracking the subject, the registration is canceled.
- Subject tracking may not be possible in certain shooting conditions.



Autofocus Mode

Rotate the mode dial to **P, S, A, M,** or **U** → MENU button → **P, S, A, M,** or **U** menu icon → Autofocus mode →  button

Set how the camera focuses when shooting still images.

Option	Description
AF-S Single AF	The camera focuses only when the shutter-release button is pressed halfway.
AF-F Full-time AF	The camera always focuses even if the shutter-release button is not pressed halfway. The sound of lens drive movement is heard while the camera focuses.
PRE-AF Pre-focus (default setting)	Even if the shutter-release button is not pressed halfway, the camera focuses when subject movement is detected or when the composition of the framed image is significantly changed.

Notes About Autofocus Mode

This function may not be available to use in combination with other functions (80).

Autofocus Mode for Movie Recording

Autofocus mode for movie recording can be set with **Autofocus mode** (153) in the movie menu.

Flash Exp. Comp.

Rotate the mode dial to **P, S, A, M,** or **U** → MENU button → **P, S, A, M,** or **U** menu icon → Flash exp. comp. →  button

Adjust the flash output.

Use this option when the flash is too bright or too dark.

Option	Description
+0.3 to +2.0	The flash output is increased from +0.3 to +2.0 EV, in increments of 1/3 EV, to make the main subject of the frame appear brighter.
0.0 (default setting)	The flash output is not adjusted.
-0.3 to -2.0	The flash output is reduced from -0.3 to -2.0 EV, in increments of 1/3 EV, to prevent unwanted highlights or reflections.



Noise Reduction Filter

Rotate the mode dial to **P, S, A, M,** or **U** → MENU button → **P, S, A, M,** or **U** menu icon → Noise reduction filter → **OK** button

Set the strength of the noise reduction function that is normally performed when saving images.

Option	Description
NR* High	Performs noise reduction at a level higher than the standard strength.
NR Normal (default setting)	Performs noise reduction at the standard strength.
NR Low	Performs noise reduction at a level lower than the standard strength.

Active D-Lighting

Rotate the mode dial to **P, S, A, M,** or **U** → MENU button → **P, S, A, M,** or **U** menu icon → Active D-Lighting → **OK** button

Details in highlights and shadows are preserved, and the natural contrast that is seen with the naked eye is well reproduced in the image captured. This is particularly effective for shooting conditions with high contrast, such as brightly lit outdoor scenery from a dark room or shaded subjects at a sunny seaside.

Option	Description
暗H High 暗N Normal 暗L Low	Set the effect level.
OFF Off (default setting)	Active D-Lighting is not applied.

✓ Notes About Active D-Lighting

- Additional time is required to save images after shooting.
- This function may not be available to use in combination with other functions (📖80).

📎 Active D-Lighting Versus D-Lighting

- The **Active D-Lighting** captures images while reducing loss of details in highlights, and adjusts the tone when saving images.
- The **D-Lighting** (📖89) option in the playback menu adjusts the tone of saved images.



Multiple Exposure

Rotate the mode dial to **P, S, A, M,** or **U** → MENU button → **P, S, A, M,** or **U** menu icon → Multiple exposure → **OK** button

The camera combines two to three images and saves them as a single image.

Option	Description
Multiple exposure mode	Shoots images in multiple exposure mode when set to On . <ul style="list-style-type: none">• Individual images are also saved.• Default setting: Off
Auto gain	Set whether or not to automatically adjust the brightness of the image when combining images. <ul style="list-style-type: none">• Default setting: On

✓ Notes About Multiple Exposure

- It may take some time to combine images.
- Multiple exposure is terminated if the auto off function (📖170) triggers the standby mode during shooting. When shooting with a long interval between shots, setting a longer time for the auto off function is recommended.
- This function may not be available to use in combination with other functions (📖80).
- When shooting at a slow shutter speed in multiple exposure mode, noise (bright spots) may appear in saved images.

Multiple Exposure Shooting

Rotate the mode dial to **P, S, A, M,** or **U** → MENU button → **P, S, A, M,** or **U** menu icon → Multiple exposure → **OK** button

- 1 Use the multi selector ▲▼ to select **Multiple exposure mode**, and then press the **OK** button.

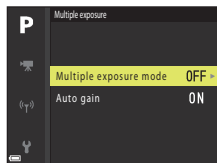

- 2 Select **On**, and then press the **OK** button.

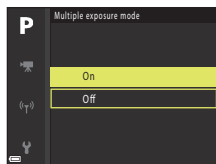

- 3 Press the **MENU** (menu) button to display the shooting screen.

- 4 Press the shutter-release button to shoot the first image.



- 5 Press the shutter-release button to shoot the second image.

- Frame the picture while looking at the first image displayed translucently.
- When shooting the second image, the combined image of the first and second images is saved, and displayed translucently.
- To end multiple exposure at the second image, set **Multiple exposure mode** to **Off** or change the mode dial to any mode other than **P**, **S**, **A**, **M**, or **U**.



- 6 Press the shutter-release button to shoot the third image.

- The combined image of the first to third images is saved and multiple exposure ends.
- It may take some time until the third image is shot.



Zoom Memory

Rotate the mode dial to **P, S, A, M,** or **U** → MENU button → **P, S, A, M,** or **U** menu icon → Zoom memory → **OK** button

Option	Description
On	<p>When the zoom control is moved, the zoom position (equivalent to focal length/angle of view in 35mm [135] format) is switched to the positions that have been selected by setting the check box to on in this menu option.</p> <ul style="list-style-type: none">Choose the focal length with the multi selector ▲▼, and then press the OK button to set the check box to on [✓] or off. The following settings are available: 24 mm, 28 mm, 35 mm, 50 mm, 85 mm, 105 mm, 135 mm, 200 mm, 300 mm, 400 mm, 500 mm, 600 mm, 800 mm, 1000 mm, 1200 mm, and 1440 mm.Default setting: On [✓] for all the check boxesTo finish setting, press the multi selector ►.The zoom position set in the Startup zoom position is automatically set to on [✓].The zoom memory function cannot be used with the side zoom control.
Off (default setting)	<p>The zoom position can be moved to any position, including the positions that can be set with On.</p>

Notes About Zoom Operation

- When more than one focal length has been set, move the zoom control to switch to the focal length closest to that before the operation. To switch to a different focal length, release the zoom control and then move it again.
- Set **Zoom memory** to **Off** when using the digital zoom.



Startup Zoom Position

Rotate the mode dial to **P, S, A, M,** or **U** → MENU button → **P, S, A, M,** or **U** menu icon → Startup zoom position →  button

Set the zoom position (equivalent to focal length/angle of view in 35mm [135] format) for when the camera is turned on.

The following settings are available: **24 mm** (default setting), **28 mm, 35 mm, 50 mm, 85 mm, 105 mm,** and **135 mm.**

M Exposure Preview

Rotate the mode dial to **P, S, A, M,** or **U** → MENU button → **P, S, A, M,** or **U** menu icon → M exposure preview →  button



Set whether or not to reflect the brightness to the shooting screen when the exposure is changed in **M** (manual) mode.



Option	Description
On	Reflects the brightness to the shooting screen.
Off (default setting)	Does not reflect the brightness to the shooting screen.



The Movie Menu











Movie Options

Enter shooting mode → MENU button →  menu icon → Movie options →  button

Select the desired movie option to record. Select normal speed movie options to record at normal speed, or HS movie options (151) to record in slow or fast motion. The movie options that can be selected vary depending on the **Frame rate** setting (155).

- Memory cards with an SD Speed Class rating of 6 or faster are recommended for recording movies (205).

Normal Speed Movie Options



Option (Image size/ Frame rate, File format)	Image size	Aspect ratio (horizontal to vertical)	Max. recording time
 2160/30p (4K UHD)  2160/25p (4K UHD)	3840 × 2160	16:9	Approx. 7 minutes
 1080/30p  1080/25p (default setting)	1920 × 1080	16:9	Approx. 26 minutes
 1080/60p  1080/50p	1920 × 1080	16:9	Approx. 13 minutes
 720/30p  720/25p	1280 × 720	16:9	Approx. 29 minutes
 720/60p  720/50p	1280 × 720	16:9	Approx. 28 minutes



HS Movie Options

Recorded movies are played back in fast or slow motion.

See "Playing Back in Slow Motion and Fast Motion" (📖152).

Option	Image size Aspect ratio (horizontal to vertical)	Description
 HS 480/4×	640 × 480 4:3	1/4-speed slow motion movies • Max. recording time: 7 minutes 15 seconds (playback time: 29 minutes)
 HS 720/2×	1280 × 720 16:9	1/2-speed slow motion movies • Max. recording time: 14 minutes 30 seconds (playback time: 29 minutes)
 HS 1080/ 0.5×	1920 × 1080 16:9	2× speed fast motion movies • Max. recording time: 29 minutes (playback time: 14 minutes 30 seconds)

✓ Notes About HS Movie

- Sound is not recorded.
- Zoom position, focus, exposure, and white balance are locked when movie recording starts.



Playing Back in Slow Motion and Fast Motion

When recording at normal speed:

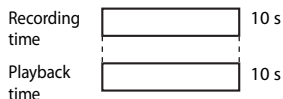

When recording at $\frac{480}{120}$ HS 480/4x, or $\frac{480}{100}$ HS 480/4x:

Movies are recorded at 4x normal speed.

They are played back in slow motion at 4x slower speed.

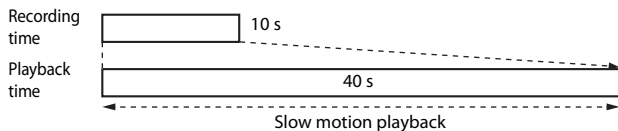



When recording at $\frac{1080}{15}$ HS 1080/0.5x, or $\frac{1080}{25}$ HS 1080/0.5x:

Movies are recorded at 1/2 normal speed.

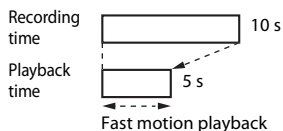
They are played back in fast motion at 2x faster speed.



Autofocus Mode

Enter shooting mode → MENU button →  menu icon → Autofocus mode →  button

Set how the camera focuses when recording movies.



Option	Description
AF-S Single AF (default setting)	Focus is locked when movie recording starts. Select this option when the distance between the camera and the subject will remain fairly consistent.
AF-F Full-time AF	The camera focuses continuously. Select this option when the distance between the camera and subject will change significantly during recording. The sound of the camera focusing may be heard in the recorded movie. Use of Single AF is recommended to prevent the sound of the camera focusing from interfering with recording.

Notes About Autofocus Mode

- In superlapse movie mode, the setting is fixed at **Single AF**.
- When an HS movie option is selected in **Movie options**, the setting is fixed at **Single AF**.
- This function may not be available to use in combination with other functions (80).



Electronic VR

Enter shooting mode → MENU button →  menu icon → Electronic VR →  button



Set whether or not to perform electronic VR when recording movies.

Option	Description
On (default setting)	Performs electronic VR. <ul style="list-style-type: none">• The angle of view (i.e., the area seen in the frame) becomes narrower.• When Vibration reduction (167) is set to Normal or Active in the setup menu, optical vibration reduction is performed simultaneously.
Off	Does not perform electronic VR.

Notes About Electronic VR

- In superlapse movie mode, the setting is fixed at **On**.
- When **2160/30p**, **2160/25p**, or an HS movie option is selected in **Movie options**, the setting is fixed at **Off**.



Wind Noise Reduction

Enter shooting mode → MENU button →  menu icon → Wind noise reduction →  button

Option	Description
On	Reduces the sound that is produced when wind passes over the microphone during movie recording. Other sounds may become difficult to hear during playback.
Off (default setting)	Wind noise reduction is disabled.





Zoom Microphone

Enter shooting mode → MENU button →  menu icon → Zoom microphone →  button

Option	Description
On (default setting)	In accordance with the angle of view, the camera records sounds over a wide area at the wide-angle zoom position, and records sounds in the limited area at the telephoto zoom position.
Off	Zoom microphone is disabled.

Frame Rate

Enter shooting mode → MENU button →  menu icon → Frame rate →  button

Select the frame rate used when recording movies. When the frame rate setting is switched, options that can be set in **Movie options** ( 150) change.



Option	Description
30 fps (30p/60p)	Suited for playback on a TV using the NTSC standard.
25 fps (25p/50p)	Suited for playback on a TV using the PAL standard.



The Playback Menu

See “Editing Images (Still Images)” (📖88) for information about image editing functions.

Mark for Upload

Press the  button (playback mode) → MENU button → Mark for upload →  button

Select still images in the camera and upload them to a smart device that has a wireless connection established with the SnapBridge app.

On the image selection screen (📖118), select or deselect images to upload.

- The size of images that are uploaded is restricted to 2 megapixels. To upload still images at their original size, use **Download pictures** in the SnapBridge app.
- RAW images and movies cannot be selected. To upload movies to a smart device, use **Download pictures** in the SnapBridge app.
- Note that when you select **Reset all** (📖176) in the setup menu or **Restore default settings** (📖161) in the network menu, the Mark for upload settings that you made are canceled.





Slide Show

Press the  button (playback mode) → MENU button → Slide show →  button



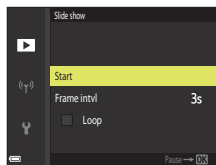

Play back images one by one in an automated “slide show.” When movie files are played back in the slide show, only the first frame of each movie is displayed.

1 Use the multi selector to select **Start** and press the button.

- The slide show begins.
- To change the interval between images, select **Frame intvl**, press the  button, and specify the desired interval time before selecting **Start**.
- To repeat the slide show automatically, select **Loop** and press the  button before selecting **Start**.
- The maximum playback time is up to about 30 minutes even if **Loop** is enabled.







2 End or restart the slide show.

- The screen shown on the right is displayed after the slide show ends or is paused. To exit the show, select  and then press the  button. To resume the slide show, select  and then press the  button.





Operations During Playback

- Use the multi selector   to display the previous/next image. Press and hold down   to rewind/fast-forward images quickly.
- Press the  button to pause or end the slide show.



Protect



Press the  button (playback mode) → MENU button → Protect →  button

The camera protects selected images from accidental deletion.

Select images to protect or cancel protection from the image selection screen (118).

Note that formatting the memory card permanently deletes all data including protected files (170).

Rotate Image

Press the  button (playback mode) → MENU button → Rotate image →  button

Specify the orientation in which saved images are displayed during playback. Still images can be rotated 90 degrees clockwise or 90 degrees counterclockwise. Images that were saved in the “tall” orientation can be rotated up to 180 degrees in either direction.

Select an image from the image selection screen (118). When the Rotate image screen is displayed, use the multi selector  or rotate it to rotate the image 90 degrees.

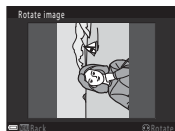

Rotate 90 degrees
counterclockwise





Rotate 90 degrees
clockwise

Press the  button to finalize display orientation, and save orientation information with the image.



Sequence Display Options



Press the  button (playback mode) → MENU button → Sequence display options →  button

Select the method used to display images in the sequence (87).

Option	Description
Individual pictures	Displays each image in a sequence individually.  is displayed on the playback screen.
Key picture only (default setting)	Displays only the key picture for images in a sequence.

Settings are applied to all sequences, and the setting is saved in the camera's memory even after the camera is turned off.

Choose Key Picture

Press the  button (playback mode) → display a sequence for which you want to change the key picture → MENU button → Choose key picture →  button

Specify a different image in the sequence as the key picture.

- When the key picture selection screen is displayed, select an image (118).



The Network Menu

Press the **MENU** button →  menu icon →  button

Configure the wireless network settings to connect the camera and a smart device.

- Some settings cannot be changed while a wireless connection is established. To change them, disconnect the wireless connection.

Option	Description
Airplane mode	Select On to turn off all wireless connections.
Connect to smart device	Select when using the SnapBridge app to connect the camera and a smart device ( 30).
Send while shooting	Set the conditions for automatically sending images to a smart device. <ul style="list-style-type: none">• The size of images that are uploaded is restricted to 2 megapixels. To upload still images at their original size, use Download pictures in the SnapBridge app.
Wi-Fi	Network settings SSID* : Change the SSID. Set a 1- to 32-character alphanumeric SSID. Auth./encrypt. : Select whether or not to encrypt the communications between the camera and the connected smart device. Communications are not encrypted when Open is selected. Password* : Set the password. Set an 8- to 36-character alphanumeric password. Channel : Select the channel used for wireless connections. Subnet mask : Use the default setting (255.255.255.0) under normal conditions. DHCP server IP address : Use the default setting (192.168.0.10) under normal conditions.
	Current settings Display the current settings.



Option	Description	
Bluetooth	Connection	Select Disable to turn off Bluetooth communication.
	Paired devices	Change the smart device to connect with, or delete the connected smart device. This camera can be paired with up to five smart devices, but can connect to only one device at a time.
	Send while off	Set whether or not to allow the camera to communicate with the smart device when the camera is off or in standby mode (📖23).
Restore default settings	Restore all network menu settings to their default values.	

* See “Operating the Text Input Keyboard” (📖161) for information on how to enter alphanumeric characters.

Operating the Text Input Keyboard

- Use the multi selector ▲▼◀▶ to select alphanumeric characters. Press the **OK** button to enter the selected character in the text field and move the cursor to the next space.
- To move the cursor in the text field, select ← or → on the keyboard, and press the **OK** button.
- To delete one character, press the **🗑️** button.
- To apply the setting, select ↵ on the keyboard and press the **OK** button.

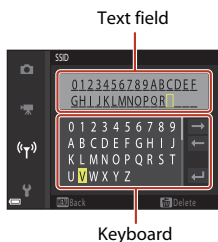

The Setup Menu

Time Zone and Date

Press the **MENU** button → **Y** menu icon → Time zone and date → **OK** button

Set the camera clock.

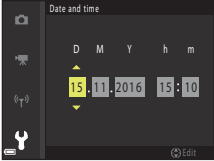
Option	Description
Sync with smart device	Select On to synchronize the date and time setting with a smart device. Enable the clock synchronization function of the SnapBridge app.
Date and time	Set the date and time if Sync with smart device is set to Off . <ul style="list-style-type: none">• Select a field: Press the multi selector ◀▶.• Edit the date and time: Press ▲▼. Date and time can also be changed by rotating the multi selector or command dial.• Apply the setting: Select the minute field setting and press the OK button or ▶. 
Date format	Select Year/Month/Day , Month/Day/Year , or Day/Month/Year .
Time zone	Set time zone and daylight saving time. <ul style="list-style-type: none">• When Travel destination (👤) is set after having set the home time zone (🏠), the time difference between the travel destination and the home time zone is automatically calculated, and the date and time are saved for the selected region.



Setting the Time Zone

- 1 Use the multi selector ▲▼ to select **Time zone** and press the OK button.

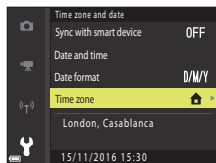

- 2 Select **Home time zone** or **Travel destination** and press the OK button.

- The date and time displayed on the screen changes depending on whether the home time zone or travel destination is selected.

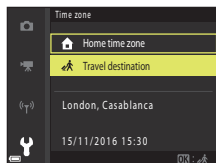

- 3 Press ▶.

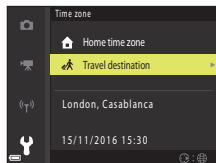

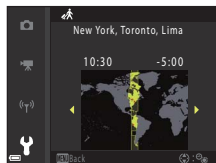

- 4 Use ◀▶ to select the time zone.

- Press ▲ to enable daylight saving time function, and ☀ is displayed. Press ▼ to disable the daylight saving time function.
- Press the OK button to apply the time zone.
- If the correct time is not displayed for the home or travel destination time zone setting, set the appropriate time in **Date and time**.



Slot Empty Release Lock

Press the MENU button →  menu icon → Slot empty release lock →  button











Set whether or not the shutter can be released when no memory card is inserted in the camera.

Option	Description
Release locked (default setting)	Unless a memory card is inserted in the camera, the shutter cannot be released.
Enable release	Even when no memory card is inserted in the camera, the shutter can be released. However, Demo mode is displayed on the image captured when no memory card is inserted and the image cannot be printed or saved on a memory card, although the image is displayed on the screen.



Monitor Settings

Press the MENU button →  menu icon → Monitor settings →  button

Option	Description
Image review	Set whether or not to display the captured image immediately after shooting. <ul style="list-style-type: none">• Default setting: On
Monitor options	Adjust the monitor brightness and hue. <ul style="list-style-type: none">• Use the multi selector   to adjust brightness,   to adjust hue and then press the  button.• Default setting: Brightness 3, Hue 0• Cannot be set when the viewfinder is used.
EVF options	Adjust the viewfinder brightness and hue. <ul style="list-style-type: none">• Use the multi selector   to adjust brightness,   to adjust hue and then press the  button.• Default setting: Brightness 2, Hue 0• Cannot be set when the monitor is used.
View/hide framing grid*	Set whether or not to display a boxed guide for framing on the shooting screen. <ul style="list-style-type: none">• Default setting: Off• The framing grid is not displayed during movie recording or when the enlarged center of the image is displayed in MF (manual focus).
View/hide histograms*	Set whether or not to display a graph that shows the brightness distribution in the image ( 10, 70) on the shooting screen. <ul style="list-style-type: none">• Default setting: Off• Can be displayed only in the following shooting modes:<ul style="list-style-type: none">- When in P, S, A, or M mode (if Manual (spot), Manual (normal), or Manual (wide) is selected in AF area mode)- When in scene modes (except Easy panorama)• The histogram is not displayed during movie recording or when MF (manual focus) is selected.

* To display or hide these indicators, press the **DISP** (display) button when **On** is selected (.





EVF Auto Toggle (Automatically Switching the Display to the Viewfinder)

Press the MENU button →  menu icon → EVF auto toggle →  button



Option	Description
On (default setting)	When you bring your face close to the viewfinder, the eye sensor responds to it and the display is automatically switched from the monitor to viewfinder.
Off	Even when you bring your face close to the viewfinder, the display is not switched to the viewfinder.

Date Stamp

Press the MENU button →  menu icon → Date stamp →  button

The shooting date and time can be stamped on images when shooting.



Option	Description
 Date	Date is stamped on images.
 Date and time	Date and time are stamped on images.
Off (default setting)	Date and time are not stamped on images.



✓ Notes About Date Stamp



- Stamped date and time form a permanent part of image data and cannot be deleted. The date and time cannot be stamped on images after they have been captured.
- The date and time cannot be stamped in the following situations:
 - When the scene mode is set to **Night landscape** (when set to **Hand-held**), **Night portrait** (when set to **Hand-held**), **Sports, Backlighting** (when **HDR** is set to **On**), **Easy panorama**, **Pet portrait** (when set to **Continuous**), **Bird-watching** (when set to **Continuous**), or **Multiple exp. Lighten**
 - When **Image quality** (📖 123) is set to **RAW**, **RAW + Fine**, or **RAW + Normal**
 - When **Pre-shooting cache**, **Continuous H: 120 fps**, or **Continuous H: 60 fps** is selected for **Continuous** (📖 135)
 - When recording movies
 - When saving still images during movie recording
 - When extracting still images from a movie during movie playback
- The stamped date and time may be difficult to read when using a small image size.

Vibration Reduction

Press the **MENU** button → **V** menu icon → **Vibration reduction** → **OK** button

Select the vibration reduction setting used when shooting.

Select **Off** when using a tripod to stabilize the camera during shooting.



Option	Description
 Normal (default setting)	Compensates camera shake that commonly occurs when shooting at telephoto zoom positions or slow shutter speeds. The camera automatically detects the panning direction and only compensates for vibration caused by camera shake. When the camera is panned horizontally, for example, vibration reduction only reduces vertical shake. If the camera is panned vertically, vibration reduction only compensates for horizontal shake.
 Active	Camera shake is automatically compensated during shooting if a comparatively large camera shake is likely to occur when shooting from a car or under poor foothold conditions.
Off	Compensation is not performed.

✓ Notes About Vibration Reduction

- After turning on the camera or after switching from playback mode to shooting mode, wait until the shooting screen is ready before taking pictures.
- Images on the screen may be displayed blurry immediately after shooting.
- Vibration reduction may be unable to completely eliminate the effects of camera shake in some situations.





AF Assist

Press the MENU button →  menu icon → AF assist →  button

Option	Description
Auto (default setting)	The AF-assist illuminator automatically lights up when you press the shutter-release button under dim lighting. The illuminator has a range of about 4.0 m (13 ft) at the maximum wide-angle position and about 4.0 m (13 ft) at the maximum telephoto position. <ul style="list-style-type: none">Note that for some scene modes or focus areas, the AF-assist illuminator may not light.
Off	The AF-assist illuminator does not light.

Digital Zoom

Press the MENU button →  menu icon → Digital zoom →  button

Option	Description
On (default setting)	Digital zoom is enabled.
Off	Digital zoom is disabled.

Notes About Digital Zoom

- Digital zoom cannot be used in the following scene modes.
 - Night portrait, Scene auto selector, Portrait, Backlighting** (when set to HDR), **Easy panorama, Pet portrait, Time-lapse movie, Superlapse movie**
- Digital zoom cannot be used in other shooting modes when using certain settings (83).



Assign Side Zoom Control

Press the **MENU** button → **Y** menu icon → Assign side zoom control → **OK** button

Choose the function to be performed during shooting when the side zoom control is moved.

Option	Description
Zoom (default setting)	When shooting, use the side zoom control (📷22) to adjust the zoom.
Manual focus	When the focus mode is set to MF (manual focus), use the side zoom control to focus (📷68). <ul style="list-style-type: none">• Move the side zoom control toward T to focus on distant subjects.• Move the side zoom control toward W to focus on near subjects.

Sound Settings

Press the **MENU** button → **Y** menu icon → Sound settings → **OK** button

Option	Description
Button sound	When On (default setting) is selected, the camera produces one beep when operations are performed, two beeps when focus is acquired on the subject, and three beeps when an error occurs. <ul style="list-style-type: none">• Sounds are disabled when using Pet portrait or Bird-watching scene mode.
Shutter sound	When On (default setting) is selected, the shutter sound is produced when the shutter is released. <ul style="list-style-type: none">• The shutter sound is not produced when using continuous shooting mode (except Continuous H and Continuous L), when recording movies, or when using Easy panorama, Pet portrait, or Bird-watching scene mode.



Auto Off

Press the MENU button → Y menu icon → Auto off → OK button

Set the amount of time that elapses before the camera enters standby mode (📖23). You can select **30 s**, **1 min** (default setting), **5 min**, or **30 min**.

Setting the Auto Off Function

The time that passes before the camera enters standby mode is fixed in the following situations:

- When a menu is displayed: 3 minutes (when auto off is set to **30 s** or **1 min**)
- When the AC adapter is connected: 30 minutes

Format Card

Press the MENU button → Y menu icon → Format card → OK button

Use this option to format a memory card.

Formatting the memory cards permanently deletes all data. Data that has been deleted cannot be recovered. Make sure to save important images to a computer before formatting.

To start formatting, select **Format** on the screen that is displayed and press the OK button.

- Do not turn the camera off or open the battery-chamber/memory card slot cover during formatting.
- You may not be able to select this setting while a wireless connection is established.



Language

Press the MENU button → Y menu icon → Language → OK button

Select a language for display of camera menus and messages.



Charge by Computer

Press the MENU button →  menu icon → Charge by computer →  button

Option	Description
AUTO Auto (default setting)	When the camera is connected to a computer that is running ( 106), the battery inserted into the camera is automatically charged using power supplied by the computer. <ul style="list-style-type: none">• The power-on lamp slowly flashes while the battery is charging. When charging is complete, the power-on lamp stops flashing and turns on.
Off	The battery inserted into the camera is not charged when the camera is connected to a computer.

Notes About Charging with a Computer

- When connected to a computer, the camera turns on and starts charging. If the camera is turned off, charging stops.
- About 5 hours and 30 minutes are required to charge a fully exhausted battery. Charging time increases when images are transferred while the battery is charging.
- The camera turns off automatically if there is no communication with the computer for 30 minutes after the battery has finished charging.

When the Power-on Lamp (Charge Lamp) Quickly Flashes

Charging cannot be performed, possibly due to one of the reasons described below.

- The ambient temperature is not suited to charging. Charge the battery indoors with an ambient temperature of 5°C to 35°C (41°F to 95°F).
- The USB cable is not connected correctly or the battery is faulty. Make sure that the USB cable is connected correctly or replace the battery if necessary.
- The computer is in sleep mode and is not supplying power. Wake up the computer.
- The battery cannot be charged because the computer cannot supply power to the camera due to the computer's settings or its specifications.

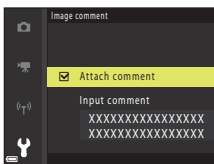

Image Comment

Press the MENU button → Y menu icon → Image comment → OK button

Attach a comment that was previously registered to images that will be captured. You can imprint the attached comment to images that will be sent to a smart device using the SnapBridge app. See SnapBridge app online help for more information. You can also check the attached comment using ViewNX-i metadata.

Option	Description
Attach comment	<p>A comment registered with Input comment is attached to images.</p> <ul style="list-style-type: none">• Select Attach comment, press the OK button, and set the check box to on (✓). The comment will be attached to the images captured afterwards.
Input comment	<p>You can register a comment of up to 36 alphanumeric characters.</p> <ul style="list-style-type: none">• Select Input comment, press ►, and the input screen is displayed. See “Operating the Text Input Keyboard” (📖161) for information about the input method.



Copyright Information

Press the **MENU** button → **Y** menu icon → Copyright information → **OK** button

Attach the copyright information that was previously registered to images that will be captured.

You can imprint the attached copyright information to images that will be sent to a smart device using the SnapBridge app. See SnapBridge app online help for more information.

You can also check the attached copyright information using ViewNX-i metadata.

Option	Description
Attach copyright info	<p>Copyright information registered with Artist and Copyright is attached to images.</p> <ul style="list-style-type: none">Select Attach copyright info, press the OK button, and set the check box to on (✓). The copyright information will be attached to the images captured afterwards.
Artist	<p>You can register an artist name of up to 36 alphanumeric characters.</p> <ul style="list-style-type: none">Select Artist, press ▶, and the input screen is displayed. See “Operating the Text Input Keyboard” (📖161) for information about the input method.
Copyright	<p>You can register a copyright owner name of up to 54 alphanumeric characters.</p> <ul style="list-style-type: none">Select Copyright, press ▶, and the input screen is displayed. See “Operating the Text Input Keyboard” (📖161) for information about the input method.

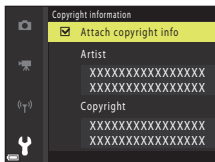

✓ Notes About Copyright Information

- To prevent illegal use of artist names and copyright owner names when lending or transferring ownership of the camera, make sure to disable the **Attach copyright info** setting. Also, make sure that the artist name and copyright owner name are blank.
- Nikon is not responsible for any kind of trouble or damage resulting from the use of **Copyright information**.

📝 Displaying Copyright Information

If you input both **Artist** and **Copyright**, only the copyright owner name is imprinted to images in the SnapBridge app.



Location Data

Press the **MENU** button → **Y** menu icon → Location data → **OK** button

Set whether or not to add shooting location information to the images that you take.

Option	Description
Download from device	Select Yes to add location information from a smart device to the images that you take. Enable the location information function of the SnapBridge app.
Position	Display the obtained location information. <ul style="list-style-type: none">The information is not updated while it is being displayed. To update it, perform Position again.

Toggle Av/Tv Selection

Press the **MENU** button → **Y** menu icon → Toggle Av/Tv selection → **OK** button

Change which controls to use for setting the exposure in **P**, **S**, **A**, **M**, or **U** mode.

Option	Description
Do not toggle selection (default setting)	Use the command dial to set the flexible program or shutter speed, and the multi selector to set the f-number.
Toggle selection	Use the multi selector to set the flexible program or shutter speed, and the command dial to set the f-number.



Reset File Numbering

Press the **MENU** button → **Y** menu icon → Reset file numbering → **OK** button

When **Yes** is selected, the sequential numbering of file numbers is reset (📖199). After resetting, a new folder is created and the file number for the next image captured starts with "0001."

✓ Notes About Reset File Numbering

Reset file numbering cannot be applied when the folder number reaches 999 and there are images in the folder. Insert a new memory card or format the memory card (📖170).

📎 Folders for Storing Files

Still images and movies shot or recorded with this camera are saved in folders of the memory card.

- Sequential numbers are added to folder names in ascending order, starting with "100" and ending with "999" (the folder names are not displayed on the camera).
- A new folder is created in the following situations:
 - When the number of files in a folder reaches 999
 - When a file in a folder is numbered "9999"
 - When **Reset file numbering** is performed
- A new folder is created each time a series of images are captured using interval timer shooting, and the images are saved in that folder with file numbers starting with "0001."



Peaking

Press the **MENU** button → **Y** menu icon → Peaking → **OK** button

Option	Description
On (default setting)	When operating MF (manual focus), focusing is assisted by highlighting areas that are in focus in white on the image displayed on the screen (📖68, 69).
Off	Peaking is disabled.

Reset All

Press the **MENU** button → **Y** menu icon → Reset all → **OK** button

When **Reset** is selected, the camera's settings are restored to their default values.

- The network menu settings are also restored to their default values.
- Some settings, such as **Time zone and date** or **Language**, are not reset. User settings that were saved in **U** of the mode dial are not reset. To reset these settings, use **Reset user settings** (📖59).
- You may not be able to select this setting while a wireless connection is established.

Resetting File Numbering

To reset file numbering to "0001", delete all images saved on the memory card before selecting **Reset all**. **Reset file numbering** can also be used to reset to "0001" (📖175).

Firmware Version

Press the **MENU** button → **Y** menu icon → Firmware version → **OK** button

View the current camera firmware version.

- You may not be able to select this setting while a wireless connection is established.



Technical Notes

Notices.....	178
Notes About Wireless Communication Functions	180
Caring for the Product	183
The Camera	183
The Battery	184
The Charging AC Adapter.....	185
Memory Cards.....	186
Cleaning and Storage	187
Cleaning	187
Storage	187
Error Messages	188
Troubleshooting.....	191
File Names.....	199
Optional Accessories.....	200
Specifications.....	201
Memory Cards That Can Be Used.....	205
Index	207



Notices

Notices for Customers in the U.S.A.

IMPORTANT SAFETY INSTRUCTIONS - SAVE THESE INSTRUCTIONS.

DANGER - TO REDUCE THE RISK OF FIRE OR ELECTRIC SHOCK, CAREFULLY FOLLOW THESE INSTRUCTIONS

For connection to a supply not in the U.S.A., use an attachment plug adapter of the proper configuration for the power outlet if needed.

The power supply unit is intended to be correctly orientated in a vertical or floor mount position.

Federal Communications Commission (FCC) Radio Frequency Interference Statement

This equipment has been tested and found to comply with the limits for a Class B digital device, pursuant to Part 15 of the FCC rules. These limits are designed to provide reasonable protection against harmful

interference in a residential installation. This equipment generates, uses, and can radiate radio frequency energy and, if not installed and used in accordance with the instructions, may cause harmful interference to radio communications. However, there is no guarantee that interference will not occur in a particular installation. If this equipment does cause harmful interference to radio or television reception, which can be determined by turning the equipment off and on, the user is encouraged to try to correct the interference by one or more of the following measures:

- Reorient or relocate the receiving antenna.
- Increase the separation between the equipment and receiver.
- Connect the equipment into an outlet on a circuit different from that to which the receiver is connected.
- Consult the dealer or an experienced radio/television technician for help.



CAUTIONS

Modifications

The FCC requires the user to be notified that any changes or modifications made to this device that are not expressly approved by Nikon Corporation may void the user's authority to operate the equipment.

Interface Cables

Use the interface cables sold or provided by Nikon for your equipment. Using other interface cables may exceed the limits of Class B Part 15 of the FCC rules.



Notice for Customers in the State of California

WARNING

Handling the cord on this product will expose you to lead, a chemical known to the State of California to cause birth defects or other reproductive harm.

Wash hands after handling.

Nikon Inc.,

1300 Walt Whitman Road, Melville, New York 11747-3064, U.S.A.

Tel: 631-547-4200

Notice for Customers in Canada

CAN ICES-3 B / NMB-3 B

Notices for Customers in Europe

CAUTIONS

RISK OF EXPLOSION IF BATTERY IS REPLACED BY AN INCORRECT TYPE.

DISPOSE OF USED BATTERIES ACCORDING TO THE INSTRUCTIONS.

This symbol indicates that electrical and electronic equipment is to be collected separately.

The following apply only to users in European countries:

- This product is designated for separate collection at an appropriate collection point. Do not dispose of as household waste.
- Separate collection and recycling helps conserve natural resources and prevent negative consequences for human health and the environment that might result from incorrect disposal.
- For more information, contact the retailer or the local authorities in charge of waste management.



This symbol on the battery indicates that the battery is to be collected separately.

The following apply only to users in European countries:

- All batteries, whether marked with this symbol or not, are designated for separate collection at an appropriate collection point. Do not dispose of as household waste.
- For more information, contact the retailer or the local authorities in charge of waste management.



Notes About Wireless Communication Functions

Restrictions on Wireless Devices

The wireless transceiver included in this product conforms to wireless regulations in the country of sale and is not for use in other countries (products purchased in the EU or EFTA can be used anywhere within the EU and EFTA). Nikon does not accept liability for use in other countries. Users who are unsure as to the original country of sale should consult with their local Nikon service center or Nikon-authorized service representative. This restriction applies to wireless operation only and not to any other use of the product.

Security

Although one of the benefits of this product is that it allows others to freely connect for the wireless exchange of data anywhere within its range, the following may occur if security is not enabled:

- Data theft: Malicious third-parties may intercept wireless transmissions to steal user IDs, passwords, and other personal information.
- Unauthorized access: Unauthorized users may gain access to the network and alter data or perform other malicious actions. Note that due to the design of wireless networks, specialized attacks may allow unauthorized access even when security is enabled. Nikon is not responsible for data or information leaks that may occur during data transfer.
- Do not access networks that you are not permitted to use, even if they are displayed on your smartphone or tablet. Doing so may be regarded as unauthorized access. Only access networks that you are permitted to use.

Personal Information Management and Disclaimer

- User information registered and configured on the product, including wireless LAN connection settings and other personal information, is susceptible to alteration and loss resulting from operational error, static electricity, accident, malfunction, repair or other handling. Always keep separate copies of important information. Nikon is not responsible for any direct or indirect damages or lost profits resulting from alteration or loss of content that is not attributable to Nikon.
- Before discarding this product or transferring it to another owner, perform **Reset all** in the setup menu (📖116) to delete all user information registered and configured with the product, including wireless LAN connection settings and other personal information.
- Nikon is not responsible for any damages resulting from unauthorized use of this product by third parties in the event that the product is stolen or lost.



Precautions when Exporting or Carrying This Product Abroad

This product is controlled by the United States Export Administration Regulations (EAR). The permission of the United States government is not required for export to countries other than the following, which as of this writing are subject to embargo or special controls: Cuba, Iran, North Korea, Sudan, and Syria (list subject to change).

Notice for Customers in the U.S.A. and Canada

Federal Communications Commission (FCC) and Industry of Canada (IC)

Declaration of Conformity

This device complies with Part 15 of FCC Rules and Industry Canada licence-exempt RSS standard(s). Operation is subject to the following two conditions: (1) this device may not cause interference, and (2) this device must accept any interference, including interference that may cause undesired operation of this device.

FCC/IC RF Exposure Statement

This transmitter must not be co-located or operated in conjunction with any other antenna or transmitter.

The available scientific evidence does not show that any health problems are associated with using low power wireless devices. There is no proof, however, that these low power wireless devices are absolutely safe. Low power wireless devices emit low levels of radio frequency energy (RF) in the microwave range while being used. Whereas high levels of RF can produce health effects (by heating tissue), exposure of low-level RF that does not produce heating effects causes no known adverse health effects. Many studies of low-level RF exposures have not found any biological effects. Some studies have suggested that some biological effects might occur, but such findings have not been confirmed by additional research.

COOLPIX B700, which is equipped with a TYPE1FJ (FCC ID:VPYLB1FJ / IC ID:772C-LB1FJ) Wireless LAN Module, has been tested and found to comply with FCC/IC radiation exposure limits set forth for an uncontrolled environment and meets the FCC radio frequency (RF) Exposure Guidelines in Supplement C to OET65 and RSS-102 of the IC radio frequency (RF) Exposure rules. Please refer to the SAR test report that was uploaded to FCC website.



Notice for Customers in Europe

Declaration of Conformity (Europe)

Hereby, Nikon Corporation declares that the radio equipment type COOLPIX B700 is in compliance with Directive 2014/53/EU.

The full text of the EU declaration of conformity is available at the following internet address: http://imaging.nikon.com/support/pdf/DoC_B700.pdf.

- Maximum output power: 7.4 dBm (EIRP)
- Operating frequency:
 - Wi-Fi: 2412–2462 MHz (1–11 channels)
 - Bluetooth: 2402–2480 MHz
 - Bluetooth Low Energy: 2402–2480 MHz
 - NFC: 13.56 MHz

Notice for Customers in Jamaica

This product contains a Type Approved Module by Jamaica: "SMA – TYPE1FJ"

Notice for Customers in Singapore

This device complies with radio-frequency regulations.

**Complies with
IMDA Standards
DA103423**



Caring for the Product

Observe the precautions described below in addition to the warnings in "For Your Safety" (📖vi-viii) when using or storing the device.

The Camera

Do Not Apply Strong Impact to the Camera

The product may malfunction if subjected to strong shock or vibration. In addition, do not touch or apply force to the lens.

Keep Dry

The device will be damaged if immersed in water or subjected to high humidity.

Avoid Sudden Changes in Temperature

Sudden changes in temperature, such as when entering or leaving a heated building on a cold day, can cause condensation to form inside the device. To prevent condensation, place the device in a carrying case or a plastic bag before exposing it to sudden changes in temperature.

Keep Away from Strong Magnetic Fields

Do not use or store this device in the vicinity of equipment that generates strong electromagnetic radiation or magnetic fields. Doing so could result in loss of data or camera malfunction.

Do Not Point the Lens at Strong Light Sources for Extended Periods

Avoid pointing the lens at the sun or other strong light sources for extended periods when using or storing the camera. Intense light may cause the image sensor to deteriorate or produce a white blur effect in photographs.

Turn the Product Off Before Removing or Disconnecting the Power Source or Memory Card

Do not remove the battery while the product is on, or while images are being saved or deleted. Forcibly cutting power in these circumstances could result in loss of data or in damage to the memory card or internal circuitry.



Notes About the Monitor

- Monitors (including electronic viewfinders) are constructed with extremely high precision; at least 99.99% of pixels are effective, with no more than 0.01% being missing or defective. Hence while these displays may contain pixels that are always lit (white, red, blue, or green) or always off (black), this is not a malfunction and has no effect on images recorded with the device.
- Images in the monitor may be difficult to see under bright lighting.
- Do not apply pressure to the monitor, as this could cause damage or malfunction. Should the monitor break, care should be taken to avoid injury caused by broken glass and to prevent the liquid crystal from the display touching the skin or entering the eyes or mouth.

The Battery

Precautions for Use

- Note that the battery may become hot after use.
- Do not use the battery at ambient temperatures below 0°C (32°F) or above 40°C (104°F) as this could cause damage or malfunction.
- If you notice any abnormalities such as excessive heat, smoke, or an unusual smell coming from the battery, immediately discontinue use and consult your retailer or Nikon-authorized service representative.
- After removing the battery from the camera or optional battery charger, put the battery in a plastic bag, etc. in order to insulate it.

Charging the Battery

Check the battery level before using the camera and replace or charge the battery if necessary.

- Charge the battery indoors with an ambient temperature of 5°C to 35°C (41°F to 95°F) before use.
- A high battery temperature may prevent the battery from charging properly or completely, and may reduce battery performance. Note that the battery may become hot after use; wait for the battery to cool before charging.
When charging the battery inserted into this camera using the Charging AC Adapter or a computer, the battery is not charged at battery temperatures below 0°C (32°F) or above 50°C (122°F).
- Do not continue charging once the battery is fully charged as this will result in reduced battery performance.
- The battery temperature may increase during charging. However, this is not a malfunction.

Carrying Spare Batteries

Whenever possible, carry fully charged spare batteries when taking pictures on important occasions.



Using the Battery When Cold

On cold days, the capacity of batteries tends to decrease. If an exhausted battery is used at a low temperature, the camera may not turn on. Keep spare batteries in a warm place and exchange as necessary. Once warmed, a cold battery may recover some of its charge.

Battery Terminals

Dirt on the battery terminals may prevent the camera from functioning. Should the battery terminals become dirty, wipe them off with a clean, dry cloth before use.

Charging an Exhausted Battery

Turning the camera on or off while an exhausted battery is inserted in the camera may result in reduced battery life. Charge the exhausted battery before use.

Storing the Battery

- Always remove the battery from the camera or optional battery charger when it is not being used. Minute amounts of current are drawn from the battery while it is in the camera, even when not in use. This may result in excessive battery drain and complete loss of function.
- Recharge the battery at least once every six months and completely exhaust it before returning it to storage.
- Put the battery in a plastic bag, etc. in order to insulate it and store it in a cool place. The battery should be stored in a dry location with an ambient temperature of 15°C to 25°C (59°F to 77°F). Do not store the battery in hot or extremely cold locations.

Battery Life

A marked drop in the time a fully charged battery retains its charge, when used at room temperature, indicates that the battery needs to be replaced. Purchase a new battery.

Recycling Used Batteries

Replace the battery when it no longer holds a charge. Used batteries are a valuable resource. Please recycle used batteries in accordance with local regulations.

The Charging AC Adapter

- The EH-73P/EH-73PCH Charging AC Adapter is for use only with compatible devices. Do not use with another make or model of device.
- Do not use any USB cable other than the UC-E21. Using a USB cable other than the UC-E21 could result in overheating, fire or electric shock.
- Do not, under any circumstances, use another make or model of AC adapter other than the EH-73P/EH-73PCH Charging AC Adapter, and do not use a commercially available USB-AC adapter or a battery charger for a mobile phone. Failure to observe this precaution could result in overheating or in damage to the camera.
- The EH-73P/EH-73PCH is compatible with AC 100–240 V, 50/60 Hz electrical outlets. When using in other countries, use a plug adapter (commercially available) as necessary. For more information about plug adapters, consult your travel agency.



Memory Cards

Precautions for Use

- Use only Secure Digital memory cards (📖205).
- Be sure to follow the precautions described in the documentation included with the memory card.
- Do not put labels or stickers on memory cards.

Formatting

- Do not format the memory card using a computer.
- The first time you insert a memory card that has been used in another device into this camera, be sure to format it with this camera. We recommend formatting new memory cards with this camera before using them with this camera.
- **Note that formatting a memory card permanently deletes all images and other data on the memory card.** Be sure to make copies of any images you wish to keep before formatting the memory card.
- If the message **Card is not formatted. Format card?** is displayed when the camera is turned on, the memory card must be formatted. If there is data that you do not want to delete, select **No**. Copy the necessary data to a computer, etc. If you want to format the memory card, select **Yes**. The confirmation dialog will be displayed. To start formatting, press the  button.
- Do not perform the following during formatting, while data is being written to or deleted from the memory card, or during data transfer to a computer. Failure to observe this precaution could result in the loss of data or in damage to the camera or memory card:
 - Open the battery-chamber/memory card slot cover to remove/insert the battery or memory card.
 - Turn off the camera.
 - Disconnect the AC adapter.



Cleaning and Storage

Cleaning

Do not use alcohol, thinner, or other volatile chemicals.

Lens/ viewfinder	Avoid touching glass parts with your fingers. Remove dust or lint with a blower (typically a small device with a rubber bulb attached to one end that is pumped to produce a stream of air out the other end). To remove fingerprints or other stains that cannot be removed with a blower, wipe the lens with a soft cloth, using a spiral motion that starts at the center of the lens and working toward the edges. If this fails, clean the lens using a cloth lightly dampened with commercial lens cleaner.
Monitor	Remove dust or lint with a blower. To remove fingerprints and other stains, clean the monitor with a soft, dry cloth, being careful not to apply pressure.
Body	Use a blower to remove dust, dirt, or sand, then wipe gently with a soft, dry cloth. After using the camera at the beach or other sandy or dusty environment, wipe off any sand, dust, or salt with a dry cloth lightly dampened with fresh water and dry thoroughly. Note that foreign matter inside the camera could cause damage not covered by the warranty.

Storage

Remove the battery if the camera will not be used for an extended period. To prevent mold or mildew, take the camera out of storage at least once a month.

Turn the camera on and release the shutter a few times before putting the camera away again. Do not store the camera in any of the following locations:



- Places that are poorly ventilated or subject to humidity of over 60%
- Exposed to temperatures above 50°C (122°F) or below -10°C (14°F)
- Next to equipment that produces strong electromagnetic fields, such as televisions or radios

For storing the battery, follow the precautions in “The Battery” (📖184) in “Caring for the Product” (📖183).









Error Messages



Refer to the table below if an error message is displayed.

Display	Cause/Solution	
Battery temperature is elevated. The camera will turn off.	The camera turns off automatically. Wait until the camera or battery temperature has cooled before resuming use.	-
The camera will turn off to prevent overheating.		
Memory card is write protected.	The write-protect switch is in the "lock" position. Slide the write-protect switch to the "write" position.	-
This card cannot be used.	An error occurred while accessing the memory card. <ul style="list-style-type: none"> • Use an approved memory card. • Check that the terminals are clean. • Confirm that the memory card is correctly inserted. 	15, 205
This card cannot be read.		
Card is not formatted. Format card?	The memory card has not been formatted for use in the camera. Formatting deletes all data saved on the memory card. If you need to keep copies of any images, make sure to select No and save the copies to a computer or other medium before formatting the memory card. Select Yes and press the  button to format the memory card.	15, 186
Out of memory.	Delete images or insert a new memory card.	15, 26
Image cannot be saved.	An error occurred while saving the image. Insert a new memory card or format the memory card.	15, 170
	The camera has run out of file numbers. Insert a new memory card or format the memory card.	15, 170
Image cannot be modified.	Check that the images can be edited.	88, 196
Cannot record movie.	A time-out error occurred while saving the movie on the memory card. Select a memory card with a faster write speed.	205
Cannot reset file numbering.	File numbering cannot be reset because the sequential number of a folder has reached the upper limit. Insert a new memory card or format the memory card.	15, 170



Display	Cause/Solution	
Memory contains no images.	Insert a memory card that contains images.	15
File contains no image data.	The file was not created or edited with this camera. The file cannot be viewed on this camera. View the file using a computer or the device used to create or edit this file.	–
All images are hidden.	<ul style="list-style-type: none"> There are no images available for a slide show, etc. There are no images that can be displayed on the image selection screen for deletion. 	–
This image cannot be deleted.	The image is protected. Disable protection.	158
Raise the flash.	<ul style="list-style-type: none"> When the scene mode is Scene auto selector, you can capture an image even if the flash is lowered but the flash will not fire. When the scene mode is Night portrait or Backlighting with HDR set to Off, you must raise the flash to capture an image. 	42 41, 44
Lens error. Try again after turning the camera off and on.	If the error persists, contact your retailer or Nikon-authorized service representative.	191
Communications error	An error occurred while communicating with the printer. Turn the camera off and reconnect the USB cable.	108
System error	An error occurred in the camera's internal circuitry. Turn the camera off, remove and reinsert the battery, and turn the camera on. If the error persists, contact your retailer or Nikon-authorized service representative.	191
Printer error: check printer status.	After solving the problem, select Resume and press the  button to resume printing.*	–
Printer error: check paper.	Load the specified size of paper, select Resume , and press the  button to resume printing.*	–
Printer error: paper jam.	Remove the jammed paper, select Resume , and press the  button to resume printing.*	–
Printer error: out of paper.	Load the specified size of paper, select Resume , and press the  button to resume printing.*	–
Printer error: check ink.	There is a problem with the printer's ink. Check the ink, select Resume , and press the  button to resume printing.*	–



Display	Cause/Solution	
Printer error: out of ink.	Replace the ink cartridge, select Resume , and press the  button to resume printing.*	–
Printer error: file corrupt.	There is a problem with the image file to be printed. Select Cancel and press the  button to cancel printing.	–

* See the documentation provided with your printer for further guidance and information.





Troubleshooting

If the camera fails to function as expected, check the list of common problems below before consulting your retailer or Nikon-authorized service representative.

Power, Display, Settings Issues

Problem	Cause/Solution	
The camera is on but does not respond.	<ul style="list-style-type: none"> • Wait for recording to end. • If the problem persists, turn the camera off. If the camera does not turn off, remove and reinsert the battery or batteries or, if you are using an AC adapter, disconnect and reconnect the AC adapter. Note that although any data currently being recorded will be lost, data that have already been recorded will not be affected by removing or disconnecting the power source. 	–
The camera cannot be turned on.	The battery is exhausted.	15, 16, 184
The camera turns off without warning.	<ul style="list-style-type: none"> • The camera automatically turns off to save power (auto off function). • The camera and battery may not work properly at low temperatures. • The inside of the camera has become hot. Leave the camera off until the inside of the camera has cooled, and then try turning it on again. 	23 184 –
The monitor or viewfinder is blank.	<ul style="list-style-type: none"> • The camera is off. • The battery is exhausted. • The camera automatically turns off to save power (auto off function). • You cannot turn on both the monitor and viewfinder at the same time. It may take a while to switch between the monitor and viewfinder. • The camera is connected to a TV or computer. • Interval timer shooting, Multiple exp. Lighten scene mode (when Star trails is set) shooting, or time-lapse movie shooting is in progress. 	18 21 23 – – –
The camera becomes hot.	The camera may become hot when used for an extended period of time such as to shoot movies, or when used in a hot environment; this is not a malfunction.	–







Problem	Cause/Solution	
The battery inserted in the camera cannot be charged.	<ul style="list-style-type: none"> • Confirm all connections. • When connected to a computer, the camera may not charge for any of the reasons described below. <ul style="list-style-type: none"> - Off is selected for Charge by computer in the setup menu. - Battery charging stops if the camera is turned off. - Battery charging is not possible if the camera's display language and date and time have not been set, or the date and time were reset after the camera's clock battery was exhausted. Use the Charging AC Adapter to charge the battery. - Battery charging may stop when the computer enters sleep mode. - Depending on the computer specifications, settings, and status, battery charging may not be possible. 	16 116, 171 – 18 – –
The monitor is hard to see.	<ul style="list-style-type: none"> • The surrounding area is too bright. <ul style="list-style-type: none"> - Move to a darker place. - Use the viewfinder. • Adjust the screen brightness. 	24 165
The viewfinder is hard to see.	<ul style="list-style-type: none"> • Adjust the diopter of the viewfinder. • Adjust the screen brightness. 	24 165
 flashes on the screen. Date and time of recording are not correct.	<ul style="list-style-type: none"> • If the camera clock has not been set,  flashes on the shooting screen, and images and movies saved before the clock is set are dated "00/00/0000 00:00" and "01/01/2016 00:00" respectively. Set the correct time and date for Time zone and date in the setup menu. • The camera clock is not as accurate as ordinary watches or clocks. Periodically compare the time of the camera clock with that of a more accurate timepiece and reset as required. 	9, 162
No information displayed on the screen.	Shooting and photo information may be hidden. Press the DISP button until information is displayed.	7
Date stamp not available.	Time zone and date has not been set in the setup menu.	116, 162
Date not stamped on images even when Date stamp is enabled.	<ul style="list-style-type: none"> • The current shooting mode does not support Date stamp. • A function that restricts the Date stamp function is enabled. • The date cannot be stamped on movies. 	38, 167 80 –



Problem	Cause/Solution	
Screen for setting time zone and date is displayed when the camera is turned on.	The clock battery is exhausted; all settings were restored to their default values. Configure the camera settings again. <ul style="list-style-type: none"> The internal clock battery is used to power the camera clock and to retain certain settings. Charging time of the clock battery takes about 10 hours when you insert the battery into the camera or connect the AC adapter (available separately) to the camera, and the clock battery operates for several days even after the camera battery is removed. 	-
The camera settings reset.		
Reset file numbering cannot be done.	Although a new folder is created on the memory card by resetting file numbering, etc., if the sequential number of a folder name (which is not displayed on the camera) reaches the upper limit ("9999"), reset is not possible. Change the memory card, or format the memory card.	15, 170, 175
The camera makes sound.	When Autofocus mode is set to Full-time AF or while in some shooting modes, the camera may produce an audible focusing sound.	38, 144, 153





Shooting Issues

Problem	Cause/Solution	
Cannot switch to shooting mode.	Disconnect the HDMI cable or USB cable.	106
Cannot take pictures or record movies.	<ul style="list-style-type: none"> When the camera is in playback mode, press the  button, shutter-release button or  button. When menus are displayed, press the MENU button. When the scene mode is Night portrait or Backlighting with HDR set to Off, raise the flash. The flash is charging while  is flashing. Movies cannot be recorded when the camera is connected to the Charging AC Adapter. The battery is exhausted. Insert a memory card with sufficient free space. 	2, 25 117 23, 41, 44 61 17 16, 184 15



Problem	Cause/Solution	
The camera cannot focus.	<ul style="list-style-type: none"> The subject is too close. Try shooting using the Scene auto selector or Close-up scene mode, or the macro close-up focus mode. Incorrect focus mode setting. Check or change the setting. The subject is hard to focus on. Set AF assist in the setup menu to Auto. <ul style="list-style-type: none"> Subject is not in focus area when the shutter-release button is pressed halfway. The focus mode is set to MF (manual focus). Turn the camera off and then on again. 	38, 42, 43, 60, 67 66 76 116, 168 22, 141 66, 68 –
Colored stripes appear on the screen when shooting.	Colored stripes may appear when shooting subjects with repeating patterns (such as window blinds); this is not a malfunction. The colored stripes will not appear in captured images or recorded movies. However, when using Continuous H: 120 fps or HS 480/4x , the colored stripes may be seen in the captured images and recorded movies.	–
Images are blurred.	<ul style="list-style-type: none"> Use the flash. Enable vibration reduction. <ul style="list-style-type: none"> Use a tripod to stabilize the camera (using the self-timer at the same time is more effective). 	23, 61 154, 167 64
Bright specks appear in images captured with flash.	Flash is reflecting off particles in air. Lower the flash.	23, 61
Flash does not fire.	<ul style="list-style-type: none"> A shooting mode where the flash cannot fire is selected. A function that restricts the flash is enabled. 	78 80
Digital zoom cannot be used.	<ul style="list-style-type: none"> Digital zoom is set to Off in the setup menu. Digital zoom cannot be used with certain shooting modes or when using certain settings in other functions. 	116, 168 83, 168
Image size not available.	<ul style="list-style-type: none"> A function that restricts the Image size option is enabled. When the scene mode is set to Easy panorama, the image size is fixed. 	80 49
No sound when the shutter is released.	Off is selected for Shutter sound in Sound settings in the setup menu. No sound is produced with some shooting modes and settings, even when On is selected.	80, 116, 169
AF-assist illuminator does not light.	Off is selected for the AF assist option in the setup menu. AF-assist illuminator may not light depending on the position of the focus area or the current scene mode, even when Auto is selected.	116, 168



Problem	Cause/Solution	
Images appear smeared.	The lens is dirty. Clean the lens.	187
Colors are unnatural.	White balance or hue is not adjusted properly.	44, 131
Randomly spaced bright pixels ("noise") appear in image.	The subject is dark and the shutter speed is too slow or ISO sensitivity is too high. Noise can be reduced by: <ul style="list-style-type: none"> Using the flash Specifying a lower ISO sensitivity setting 	23, 61 139
Bright spots appear in image.	When shooting at a slow shutter speed in multiple exposure mode, noise (bright spots) may appear in saved images.	–
Images are too dark (underexposed).	<ul style="list-style-type: none"> The flash window is blocked. The subject is beyond the range of the flash. Adjust exposure compensation. Increase ISO sensitivity. The subject is backlit. Use the flash or the Backlighting scene mode. 	21 202 70 139 23, 44
Images are too bright (overexposed).	Adjust exposure compensation.	70
Unexpected results when flash set to  (auto with red-eye reduction).	Use any shooting mode other than Night portrait , and change the flash mode to any setting other than  (auto with red-eye reduction/red-eye reduction) and try taking the picture again.	61, 78
Skin tones are not softened.	<ul style="list-style-type: none"> Under some shooting conditions, facial skin tones may not be softened. For images containing four or more faces, try using Skin softening in the playback menu. 	48 90, 116
Saving images takes time.	It may take more time to save images in the following situations: <ul style="list-style-type: none"> When the noise reduction function is in operation When the flash mode is set to  (auto with red-eye reduction/red-eye reduction) When capturing images in the following scene modes. <ul style="list-style-type: none"> Hand-held in Night landscape Noise reduction burst in Landscape or Close-up HDR is set to On in Backlighting Easy panorama Continuous in the shooting menu is set to Continuous H: 120 fps or Continuous H: 60 fps When using smile timer while shooting When using Active D-Lighting while shooting When using multiple exposure while shooting When Image quality is set to RAW, RAW + Fine, or RAW + Normal When capturing still images while recording a movie with Movie options set to 2160/30p or 2160/25p 	– 62 41 42, 43 44 49 116, 135 65 145 146 123 98







Problem	Cause/Solution	
A ring-shaped belt or rainbow-colored stripe appears on the screen or images.	When shooting with backlighting or when a very strong light source (such as sunlight) is in the frame, a ring-shaped belt or rainbow-colored stripe (ghosting) may occur. Change the position of the light source, or frame the picture so that the light source does not enter the frame, and try again.	–
Cannot select a setting/ Selected setting is disabled.	<ul style="list-style-type: none"> • Certain menu items are unavailable depending on the shooting mode. Menu items that cannot be selected are displayed in gray. • A function that restricts the selected function is enabled. 	–

Playback Issues

Problem	Cause/Solution	
File cannot be played back.	<ul style="list-style-type: none"> • This camera may not be able to play back images saved with another make or model of digital camera. • This camera cannot play back RAW images or movies saved with another make or model of digital camera. • This camera may not be able to play back data edited on a computer. • Files cannot be played back during interval timer shooting. 	– – – 135
Cannot zoom in on image.	<ul style="list-style-type: none"> • Playback zoom cannot be used with movies. • This camera may not be able to zoom in on images captured with another make or model of digital camera. • When zooming in on a small-sized image, the magnification rate shown on the screen may differ from the actual magnification rate of the image. 	–
Cannot edit image.	<ul style="list-style-type: none"> • Some images cannot be edited. Images that have already been edited may not be edited again. • There is not enough free space on the memory card. • This camera is unable to edit images captured with other cameras. • Editing functions used for images are not available for movies. 	51, 88, 124 – – –
Cannot rotate image.	This camera cannot rotate images captured with another make or model of digital camera.	–



External Device Issues

Problem	Cause/Solution	
<p>Cannot establish a wireless connection with a smart device.*</p>	<ul style="list-style-type: none"> • See "Connecting to a Smart Device (SnapBridge)" when establishing a wireless connection for the first time. 28 • Also see "If the Connection Is Unsuccessful." 33 • If a wireless connection is established, perform the following operations. <ul style="list-style-type: none"> - Turn the camera off and then on again. 36 - Restart the SnapBridge app. – - Cancel the connection and then establish a connection again. 36 • Check the Network menu settings in the camera. 160 <ul style="list-style-type: none"> - Set Airplane mode to Off. - Set Bluetooth → Connection to Enable. • If the camera is registered with two or more smart devices, select the smart device you want to connect in Network menu → Bluetooth → Paired devices in the camera. If two or more cameras are registered in the SnapBridge app, switch the connection on the app. 161 • Use a sufficiently charged battery. – • Insert a memory card with sufficient free space into the camera. 15 • Disconnect the HDMI cable or USB cable. 106 • Enable Bluetooth, Wi-Fi, and the location data functions on the smart device. – • In the  tab of the SnapBridge app → Auto link options → turn on Auto link. If it is off, Download pictures and Remote photography can be used, but images cannot be downloaded automatically. – 	
<p>Cannot upload images to a smart device that has a wireless connection established with the SnapBridge app.*</p>	<ul style="list-style-type: none"> • Perform the operations described below when uploading automatically. <ul style="list-style-type: none"> - Set Network menu → Send while shooting → Still images in the camera to Yes. 160 - In the  tab of the SnapBridge app → Auto link options → turn on Auto link. – - In the  tab of the SnapBridge app → Auto link options → turn on Auto download. – - If Network menu → Bluetooth → Send while off in the camera is set to Off, turn on the camera or change the setting to On. 161 • Insert a memory card into the camera. 15 • You may not be able to upload images or uploading may be canceled while the camera is being operated. – • Depending on the status of the camera, you may not be able to upload images or uploading may be canceled. 36 • Also see "If Images Cannot Be Uploaded Successfully." 36 	



Problem	Cause/Solution	
Cannot perform remote photography from a smart device that has a wireless connection established with the SnapBridge app.*	<ul style="list-style-type: none"> Remote photography cannot be performed when a memory card is not inserted into the camera. Insert a memory card. You may not be able to perform remote photography while the camera is being operated. Depending on the status of the camera, you may not be able to perform remote photography. 	35 – 36
Cannot download still images at the original size in the SnapBridge app.*	For Send while shooting and Mark for upload in the camera, the size of images that are downloaded is restricted to 2 megapixels. To download still images at their original size, use Download pictures in the SnapBridge app.	–
Images saved in the camera are not displayed on a connected smart device or computer.	If the number of images saved on a memory card in the camera exceeds 10,000, images captured thereafter may not be displayed in a connected device. <ul style="list-style-type: none"> Reduce the number of images saved on the memory card. Copy the necessary images to a computer, etc. 	–
Images are not displayed on TV.	<ul style="list-style-type: none"> A computer or printer is connected to the camera. The memory card contains no images. 	–
Nikon Transfer 2 does not start when the camera is connected to a computer.	<ul style="list-style-type: none"> The camera is off. The battery is exhausted. The USB cable is not correctly connected. The camera is not recognized by the computer. The computer is not set to start Nikon Transfer 2 automatically. For more information about Nikon Transfer 2, refer to help information contained in ViewNX-i. 	– 106, 171 106, 112 – –
The PictBridge screen is not displayed when the camera is connected to a printer.	With some PictBridge-compatible printers, the PictBridge startup screen may not be displayed and it may be impossible to print images when Auto is selected for Charge by computer in the setup menu. Set Charge by computer to Off and reconnect the camera to the printer.	116, 171
Images to be printed are not displayed.	The memory card contains no images.	–
Cannot select paper size with the camera.	The camera cannot be used to select the paper size in the following situations, even when printing from a PictBridge-compatible printer. Use the printer to select the paper size. <ul style="list-style-type: none"> The printer does not support the paper sizes specified by the camera. The printer automatically selects the paper size. 	–

* See "Connecting to a Smart Device (SnapBridge)" (28) and SnapBridge online help.



File Names

Images or movies are assigned file names as follows.

File name: DSCN0001.JPG

(1) (2) (3)

(1) Identifier	Not shown on the screen of the camera. <ul style="list-style-type: none">• DSCN: Original still images, movies, still images created by the movie editing function• SSCN: Small picture copies• RSCN: Cropped copies• FSCN: Images created by an image editing function other than crop and small picture, movies created by the movie editing function
(2) File number	Assigned in ascending order, starting with "0001" and ending with "9999." <ul style="list-style-type: none">• A new folder is created each time a series of images are captured using interval timer shooting, and the images are saved in that folder with file numbers starting with "0001."
(3) Extension	Indicates file format. <ul style="list-style-type: none">• .JPG: JPEG still images• .NRW: RAW still images• .MP4: Movies

Notes

When images are captured with the **Image quality** (📖123) setting set to **RAW + Fine** or **RAW + Normal**, the RAW and JPEG images that are saved at the same time are assigned the same identifier and file number. The pair of images is saved in the same folder, and is counted as one file.

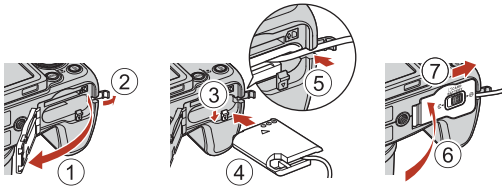

Optional Accessories

Battery Charger	MH-67P Battery Charger Charging time is about 3 hours and 20 minutes for a fully exhausted battery.
AC Adapter	EH-67A AC Adapter (connect as shown)  <p>Before closing the battery-chamber/memory card slot cover, fully insert the power connector cable into the slot in the battery chamber. If part of the cable protrudes from the slots, the cover or cable may be damaged when the cover is closed.</p>
Hand Strap	AH-CP1 Hand Strap

Availability may vary with country or region.

See our website or brochures for the latest information.



Specifications

Nikon COOLPIX B700 Digital Camera

Type	Compact digital camera
Number of effective pixels	20.3 million (Image processing may reduce the number of effective pixels.)
Image sensor	1/2.3-in. type CMOS; approx. 21.14 million total pixels
Lens	NIKKOR lens with 60x optical zoom
Focal length	4.3–258 mm (angle of view equivalent to that of 24–1440 mm lens in 35mm [135] format)
f/-number	f/3.3–6.5
Construction	16 elements in 11 groups (4 ED lens elements and 1 super ED lens element)
Digital zoom magnification	Up to 4x (angle of view equivalent to that of approx. 5760 mm lens in 35mm [135] format) Up to 2x when Movie options is set to 2160/30p or 2160/25p (angle of view equivalent to that of approx. 2880 mm lens in 35mm [135] format)
Vibration reduction	Lens shift (still images) Combination of lens shift and electronic VR (movies)
Autofocus (AF)	Contrast-detect AF
Focus range	<ul style="list-style-type: none">• [W]: Approx. 50 cm (1 ft 8 in.)–∞, [T]: Approx. 2.0 m (6 ft 7 in.)–∞• Macro close-up mode: Approx. 1 cm (0.4 in.)–∞ (wide-angle position) (All distances measured from center of front surface of lens)
Focus-area selection	Target finding AF, face priority, manual (spot), manual (normal), manual (wide), subject tracking
Viewfinder	Electronic viewfinder, 0.5 cm (0.2-in.) approx. 921k-dot equivalent LCD with the diopter adjustment function (–3 – +1 m ⁻¹)
Frame coverage (shooting mode)	Approx. 100% horizontal and vertical (compared to actual picture)
Frame coverage (playback mode)	Approx. 100% horizontal and vertical (compared to actual picture)
Monitor	7.5 cm (3-in.), approx. 921k-dot (RGBW), wide viewing angle TFT LCD with anti-reflection coating and 6-level brightness adjustment, vari-angle TFT LCD
Frame coverage (shooting mode)	Approx. 100% horizontal and vertical (compared to actual picture)
Frame coverage (playback mode)	Approx. 100% horizontal and vertical (compared to actual picture)



Storage	
Media	SD/SDHC/SDXC memory card
File system	DCF and Exif 2.3 compliant
File formats	Still images: JPEG, RAW (NRW) (Nikon's own format) Movies: MP4 (Video: H.264/MPEG-4 AVC, Audio: AAC stereo)
Image size (pixels)	<ul style="list-style-type: none"> • 20 M 5184×3888 • 8 M 3264×2448 • 4 M 2272×1704 • 2 M 1600×1200 • 16:9 15 M 5184×2920 • 3:2 18 M 5184×3456 • 1:1 15 M 3888×3888
ISO sensitivity (Standard output sensitivity)	<ul style="list-style-type: none"> • ISO 100–1600 • ISO 3200 (available when using P, S, A, or M mode)
Exposure	
Metering mode	Matrix, center-weighted, spot
Exposure control	Programmed auto exposure with flexible program, shutter-priority auto, aperture-priority auto, manual, exposure bracketing, exposure compensation (–2.0 – +2.0 EV in steps of 1/3 EV)
Shutter	
Speed	Mechanical and CMOS electronic shutter <ul style="list-style-type: none"> • 1/4000*–1 s • 1/4000*–15 s (when ISO sensitivity is 100 in M mode) • 25 s (Star trails in Multiple exp. Lighten scene mode) * When the f-number is set to f/7.6 (wide-angle position)
Aperture	
Range	Electromagnetic 6-blade iris diaphragm 8 steps of 1/3 EV (W) (A , M mode)
Self-timer	Can be selected from 10 s and 2 s
Flash	
Range (approx.) (ISO sensitivity: Auto)	[W]: Approx. 0.5–7.0 m (1 ft 8 in.–22 ft) [T]: Approx. 1.5–3.4 m (5 ft–11 ft)
Flash control	TTL auto flash with monitor preflashes
Flash exposure compensation	In steps of 1/3 EV in the range between –2 and +2 EV



Interface	
USB connector	Micro-USB connector (Do not use any USB cable other than the included UC-E21 USB Cable.), Hi-Speed USB <ul style="list-style-type: none"> • Supports Direct Print (PictBridge)
HDMI output connector	HDMI micro connector (Type D)
Wi-Fi (Wireless LAN)	
Standards	IEEE 802.11b/g (standard wireless LAN protocol)
Operating frequency	2412–2462 MHz (1–11 channels)
Authentication	Open system, WPA2-PSK
Bluetooth	
Communication protocols	Bluetooth Specification Version 4.1
Supported languages	Arabic, Bengali, Bulgarian, Chinese (Simplified and Traditional), Czech, Danish, Dutch, English, Finnish, French, German, Greek, Hindi, Hungarian, Indonesian, Italian, Japanese, Korean, Marathi, Norwegian, Persian, Polish, Portuguese (European and Brazilian), Romanian, Russian, Serbian, Spanish, Swedish, Tamil, Telugu, Thai, Turkish, Ukrainian, Vietnamese
Power sources	One EN-EL23 Rechargeable Li-ion Battery (included) EH-67A AC Adapter (available separately)
Charging time	Approx. 3 h (when using EH-73P/EH-73PCH Charging AC Adapter and when no charge remains)
Battery life¹	
Still images	Approx. 420 shots when using EN-EL23
Movie recording (actual battery life for recording) ²	Approx. 1 h 30 min when using EN-EL23
Tripod socket	1/4 (ISO 1222)
Dimensions (W × H × D)	Approx. 125.0 × 85.0 × 106.5 mm (5.0 × 3.4 × 4.2 in.) (excluding projections)
Weight	Approx. 570 g (1 lb 4.2 oz) (including battery and memory card)
Operating environment	
Temperature	0°C–40°C (32°F–104°F)
Humidity	85% or less (no condensation)

- All measurements are performed in conformity with Camera and Imaging Products Association (CIPA) standards or guidelines.



- 1 Battery life does not reflect the use of SnapBridge and may vary with the conditions of use, including temperature, the interval between shots, and the length of time that menus and images are displayed.
- 2 Individual movie files cannot exceed 4 GB in size or 29 minutes in length. Recording may end before this limit is reached if camera temperature becomes elevated.

EN-EL23 Rechargeable Li-ion Battery

Type	Rechargeable lithium-ion battery
Rated capacity	DC 3.8 V, 1850 mAh
Operating temperature	0°C–40°C (32°F–104°F)
Dimensions (W × H × D)	Approx. 34.9 × 47 × 10.5 mm (1.4 × 1.9 × 0.5 in.)
Weight	Approx. 34 g (1.2 oz)

EH-73P/EH-73PCH Charging AC Adapter

Rated input	AC 100–240 V, 50/60 Hz, MAX 0.14 A
Rated output	DC 5.0 V, 1.0 A
Operating temperature	0°C–40°C (32°F–104°F)
Dimensions (W × H × D)	Approx. 55 × 22 × 54 mm (2.2 × 0.9 × 2.2 in.) (excluding plug adapter) For Argentina: Approx. 55 × 63 × 59 mm (2.2 × 2.5 × 2.4 in.) For Brazil: Approx. 55 × 67 × 59 mm For India: Approx. 55 × 63.5 × 59 mm
Weight	Approx. 51 g (1.8 oz) (excluding plug adapter) For Argentina: Approx. 76 g (2.7 oz) For Brazil: Approx. 73 g For India: Approx. 76 g

The symbols on this product represent the following:

~ AC, == DC,  Class II equipment (The construction of the product is double-insulated.)

- Nikon will not be held liable for any errors this manual may contain.
- The appearance of this product and its specifications are subject to change without notice.



Memory Cards That Can Be Used

The camera supports SD, SDHC, and SDXC memory cards.

- The camera supports UHS-I.
- Memory cards with an SD Speed Class rating of 6 or faster are recommended for recording movies (when recording 4K UHD movies at an image size/frame rate of **2160/30p** or **2160/25p**, cards rated UHS Speed Class 3 or faster are recommended). When using a memory card with a lower Speed Class rating, movie recording may stop unexpectedly.
- If you use a card reader, make sure that it is compatible with your memory card.
- Contact the manufacturer for information on features, operation, and limitations on use.

Trademark Information

- Windows is either a registered trademark or trademark of Microsoft Corporation in the United States and/or other countries.
- The *Bluetooth*[®] word mark and logos are registered trademarks owned by Bluetooth SIG, Inc. and any use of such marks by Nikon Corporation is under license.
- Apple[®], App Store[®], the Apple logos, Mac, OS X, macOS, iPhone[®], iPad[®], iPod touch[®] and iBooks are trademarks or registered trademarks of Apple Inc., in the U.S. and other countries.
- Android and Google Play are trademarks or registered trademarks of Google Inc. The Android robot is reproduced or modified from work created and shared by Google and used according to terms described in the Creative Commons 3.0 Attribution License.
- iOS is a trademark or registered trademark of Cisco Systems, Inc., in the United States and/or other countries and is used under license.
- Adobe, the Adobe logo, and Reader are either trademarks or registered trademarks of Adobe Systems Incorporated in the United States and/or other countries.
- SDXC, SDHC, and SD Logos are trademarks of SD-3C, LLC.



- PictBridge is a trademark.
- HDMI, HDMI logo and High-Definition Multimedia Interface are trademarks or registered trademarks of HDMI Licensing, LLC.

HDMI



- Wi-Fi and the Wi-Fi logo are trademarks or registered trademarks of the Wi-Fi Alliance.
- The N-Mark is a trademark or registered trademark of NFC Forum, Inc. in the United States and in other countries.
- All other trade names mentioned in this manual or the other documentation provided with your Nikon product are the trademarks or registered trademarks of their respective holders.

"Made for iPod," "Made for iPhone," and "Made for iPad" mean that an electronic accessory has been designed to connect specifically to iPod, iPhone, or iPad, respectively, and has been certified by the developer to meet Apple performance standards. Apple is not responsible for the operation of this device or its compliance with safety and regulatory standards. Please note that the use of this accessory with iPod, iPhone, or iPad may affect wireless performance.

AVC Patent Portfolio License

This product is licensed under the AVC Patent Portfolio License for the personal and non-commercial use of a consumer to (i) encode video in compliance with the AVC standard ("AVC video") and/or (ii) decode AVC video that was encoded by a consumer engaged in a personal and non-commercial activity and/or was obtained from a video provider licensed to provide AVC video. No license is granted or shall be implied for any other use. Additional information may be obtained from MPEG LA, L.L.C. See <http://www.mpegla.com>.

FreeType License (FreeType2)

Portions of this software are copyright © 2012 The FreeType Project (<http://www.freetype.org>). All rights reserved.

MIT License (HarfBuzz)

Portions of this software are copyright © 2016 The HarfBuzz Project (<http://www.freedesktop.org/wiki/Software/HarfBuzz>). All rights reserved.



Index

Symbols

- Auto mode 38, 39
- Creative mode..... 38, 52
- SCENE** Scene mode..... 38, 40
- A** Aperture-priority auto mode
..... 38, 54
- S** Shutter-priority auto mode.... 38, 54
- Landscape mode 38, 40, 42
- P** Programmed auto mode 38, 54
- M** Manual mode 38, 54
- Night portrait mode..... 38, 40, 41
- Night landscape mode... 38, 40, 41
- U** User settings mode..... 38, 58
- Playback zoom 25, 85
- W** Wide-angle..... 72
- Thumbnail playback..... 25, 86
- T** Telephoto 72
- Snap-back zoom button 3, 4, 73
- Apply selection button..... 3, 5
- Playback button..... 3, 6, 25
- Delete button..... 3, 6, 26, 88
- (Movie-record) button
..... 3, 5, 23, 95
- DISP** Display button..... 3, 6, 7
- Fn1** Function 1 button..... 2, 6, 71
- Fn2** Function 2 button 3, 6, 71
- Flash pop-up button..... 2, 23, 61
- MENU** Menu button..... 3, 6, 116
- Monitor button 3, 6, 24
- Self-timer/Smile timer.... 60, 64, 65
- Focus mode..... 60, 66
- Flash mode 60, 61
- Exposure compensation 60, 70
- N-Mark..... 2, 30
- A**
- AC adapter..... 106, 200
- Active D-Lighting 119, 145
- AF area mode..... 71, 119, 141
- AF assist 122, 168
- AF-assist illuminator..... 2
- Airplane mode 121, 160
- Aperture-priority auto mode 38, 54
- App..... 29
- Assign side zoom control..... 122, 169
- Auto flash 62
- Auto mode 38, 39
- Auto off..... 23, 122, 170
- Auto with red-eye reduction 62, 63
- Autofocus... 67, 76, 119, 120, 144, 153
- Autofocus mode..... 119, 120, 144, 153
- B**
- Backlighting 40, 44
- Battery 15, 203
- Battery charger..... 200
- Battery level indicator..... 21
- Beach 40
- Bird-watching 40, 46
- Bluetooth..... 121, 161
- Brightness..... 122, 165
- Button sound 169
- C**
- Calendar display..... 86
- Capture NX-D..... 114
- Charge by computer..... 122, 171
- Charge lamp..... 2, 16
- Charging AC Adapter..... 16, 204
- Choose key picture..... 121, 159
- Close-up 40, 43
- Color temperature..... 132
- Command dial 3, 5, 54
- Computer..... 106, 112



Connect to smart device 121, 160
 Connector cover 2, 16, 106
 Continuous 71, 119, 135
 Contrast 128
 COOLPIX Custom Picture Control
 119, 130
 COOLPIX Picture Control ... 71, 119, 126
 Copyright information 122, 173
 Creative mode 38, 52
 Crop 85, 93
 Custom Picture Control 119, 130



D

Date and time 18, 122, 162
 Date format 19, 162
 Date stamp 122, 166
 Daylight saving time 19, 163
 Delete 26, 88
 Digital zoom 72, 122, 168
 Diopter adjustment control 3, 24
 Direct Print 106, 108
 D-Lighting 89, 120
 Dusk/dawn  40
 Dynamic Fine Zoom 72

E

Easy panorama  40, 49
 Editing movies 103
 Editing still images 88
 Electronic VR 120, 154
 EVF auto toggle 122, 166
 EVF options 165
 Exposure bracketing 119, 140
 Exposure compensation 60, 70
 Extension 199
 Extracting still images 104
 Eye sensor 3, 24
 Eyelet for camera strap 2, 14

E

Face detection 75
 Face priority 141
 Fast motion movies 151, 152
 File name 199
 Fill flash 62
 Filter effects 91, 120, 128
 Fireworks show  40, 44
 Firmware version 122, 176
 Flash 2, 61
 Flash exp. comp. 119, 144
 Flash mode 60, 61
 Fn button setting 71, 117
 F-number 54
 Focal length 120, 148, 201
 Focus 22, 74, 96, 141, 144, 153
 Focus area 10, 22, 45, 74, 141
 Focus indicator 8, 22
 Focus lock 77
 Focus mode 60, 66
 Food  40, 44
 Format 15, 122, 170
 Format card 15, 122, 170
 Format memory cards 15, 122, 170
 Frame rate 120, 155
 Full-frame playback 11, 25, 85, 86
 Full-time AF 119, 120, 144, 153
 Functions that cannot be used
 simultaneously 80





H

Hand strap 200
 HDMI micro connector 2, 107
 HDR 44
 High-speed continuous 135
 Histogram 12, 70, 122, 165
 HS movie 151, 152







I

Identifier 199



Image comment.....	122, 172	Movie recording time remaining	95, 96
Image quality	71, 119, 123	Multi selector	5, 60
Image review	165	Multiple exp. Lighten 	40, 47
Image selection screen.....	118	Multiple exposure	119, 146
Image sharpening.....	128	N	
Image size.....	71, 119, 125	Network menu	116, 160
Infinity.....	67	Night landscape mode	38, 40, 41
Interval timer shooting	135, 137	Night portrait mode	38, 40, 41
ISO sensitivity.....	71, 119, 139	Noise reduction filter.....	119, 145
L		Number of exposures remaining	21, 124
Landscape mode.....	38, 40, 42	O	
Language	122, 170	Optical zoom.....	72
Lens.....	2, 187, 201	Optional accessories.....	200
Lens cap.....	14	P	
Li-ion rechargeable battery	15, 204	Paper size.....	109, 110
Location data.....	122, 174	Party/indoor 	40, 43
M		Peaking	122, 176
M exposure preview.....	120, 149	Pet portrait 	40, 45
Macro close-up.....	67	PictBridge	106, 108
Manual focus.....	67, 68	Picture Control	71, 119, 126
Manual mode	38, 54	Playback	25, 95
Mark for upload	120, 156	Playback menu.....	120, 156
Memory capacity.....	21, 95	Playback mode.....	25
Memory card.....	15, 186, 205	Playback zoom	25, 85
Metering	71, 119, 134	Portrait 	40
Microphone (stereo).....	2	Power	18
Micro-USB connector ...	2, 16, 108, 112	Power connector cover	2
Minimum shutter speed	139	Power switch.....	2, 18
Mode dial	2, 4, 21, 38	Power-on lamp	2, 23
Monitor	3, 7, 17, 187	Pre-focus	119, 144
Monitor options	165	Preset manual.....	133
Monitor settings.....	122, 165	Pre-shooting cache	135, 136
Moon 	40, 46	Pressing halfway	4, 22, 74
Movie menu	120, 150	Print.....	108, 109, 110
Movie options	120, 150	Printer	106, 108
Movie playback.....	25, 95		
Movie recording.....	23, 95		



- Programmed auto mode..... 38, 54
 Protect..... 121, 158
- Q**
 Quick adjust..... 128
 Quick retouch..... 89, 120
- R**
 Ready light..... 61
 Rear-curtain sync..... 62
 Rechargeable battery..... 16
 Red-eye reduction..... 62, 63
 Red-eye reduction lamp..... 2, 63
 Reset all..... 122, 176
 Reset file numbering..... 122, 175
 Reset user settings..... 59
 Restore default settings..... 121, 161
 Rotary multi selector..... 5, 60
 Rotate image..... 121, 158
- S**
 Saturation..... 128
 Save user settings..... 59
 Scene auto selector ..... 38, 40, 42
 Scene mode..... 38, 40
 Selective color ..... 40, 46
 Self-timer..... 60, 64
 Self-timer lamp..... 2, 64, 65
 Send while shooting..... 121, 160
 Sequence..... 26, 87
 Sequence display options..... 121, 159
 Setup menu..... 122, 162
 Shooting..... 38, 95
 Shooting information..... 7
 Shooting menu..... 119, 123, 126
 Shooting mode..... 38
 Shutter sound..... 169
 Shutter speed..... 54, 57
 Shutter-priority auto mode..... 38, 54
 Shutter-release button..... 2, 4, 22, 74
- Side zoom control..... 3, 4, 22
 Single..... 119, 135
 Single AF..... 119, 120, 144, 153
 Skin softening..... 48, 90, 120
 Slide show..... 120, 157
 Slot empty release lock..... 122, 164
 Slow motion movies..... 151, 152
 Slow sync..... 62
 Small picture..... 92, 121
 Smile timer..... 60, 65
 SnapBridge app..... 29
 Snow ..... 40
 Soft **SOFT**..... 40
 Sound settings..... 122, 169
 Speaker..... 3
 Sports ..... 40, 43
 Standard flash..... 62
 Startup zoom position..... 120, 149
 Subject tracking..... 142, 143
 Sunset ..... 40
 Superlapse movie ..... 40, 101
 Sync with smart device..... 162
- T**
 Target finding AF..... 74, 142
 Telephoto..... 72
 Thumbnail playback..... 25, 86
 Time difference..... 162
 Time zone..... 19, 163
 Time zone and date..... 18, 122, 162
 Time-lapse movie ..... 40, 99
 Toggle Av/Tv selection..... 122, 174
 Tone level..... 12
 Tone level information..... 7, 12
 Toning..... 129
 TV..... 106, 107
- U**
 USB cable..... 16, 106, 108, 112
 User settings mode..... 38, 58



V

- Vibration reduction..... 71, 122, 167
- View/hide framing grid ... 10, 122, 165
- Viewfinder..... 3, 7, 24, 187
- ViewNX-i 106, 112
- Volume 102

W

- White balance 71, 119, 131
- Wide-angle..... 72
- Wi-Fi..... 121, 160
- Wind noise reduction 120, 154

Z

- Zoom 72
- Zoom control..... 2, 4, 72
- Zoom memory..... 120, 148
- Zoom microphone..... 120, 155



No reproduction in any form of this manual, in whole or in part (except for brief quotation in critical articles or reviews), may be made without written authorization from NIKON CORPORATION.

NIKON CORPORATION

© 2016 Nikon Corporation



CT7J06(11)
6MN65711-06