

HYUNDAI



Xcent OWNER'S MANUAL

Operation
Maintenance
Specifications

All information in this Owner's Manual is current at the time of publication. However, Hyundai Motor India Limited reserves the right to make changes at any time without prior notice and without obligation to incorporate such changes so that our policy of continual product improvement may be carried out.

This booklet applies to all variants of this vehicle and includes descriptions and explanations of optional as well as standard equipment.

As a result, you may find material in this booklet that does not apply to your specific vehicle. This booklet is not intended to be a substitute for the owner's manual given in compact disc to you.

The owner's manual given in the Compact Disc along with this booklet, contains all the features and relevant information about your vehicle in PDF format and should not be utilized for any other purpose. Avoid direct sunlight to CD & do not keep it in high temperature zone i.e more than 70 degree celcius.

CAUTION: MODIFICATIONS TO YOUR HYUNDAI

Your Hyundai vehicle should not be modified in any way. Such modifications may adversely affect the performance, safety or durability of your Hyundai vehicle and may, in addition, violate conditions of the limited warranties covering the vehicle. Certain modifications may also be in violation of regulations established by the Department of Transportation and other government agencies in your country.

TWO-WAY RADIO OR CELLULAR TELEPHONE INSTALLATION

Your Hyundai vehicle is equipped with electronic fuel injection and other electronic components. It is possible for an improperly installed/adjusted two-way radio or cellular telephone to adversely affect electronic systems. For this reason, we recommend that you carefully follow the radio manufacturer's instructions or consult your Hyundai dealer for precautionary measures or special instructions if you choose to install one of these devices.

SAFETY AND VEHICLE DAMAGE WARNING

This owner's manual includes information titled as WARNING, CAUTION and NOTICE.
These titles indicate the following:

WARNING

This indicates that a condition may result in harm, serious injury or death to you or other persons if the warning is not heeded. Follow the advice provided with the warning.

CAUTION

This indicates that a condition may result in damage to your vehicle or its equipment if the caution is not heeded. Follow the advice provided with the caution.

*** NOTICE**

This indicates that interesting or helpful information is being provided.

FOREWORD

Thank you for choosing Hyundai vehicle. We are pleased to welcome you to the growing number of discriminating people who drive Hyundais. The advanced engineering and high-quality construction of each Hyundai we build is something of which we're very proud.

Your owner's manual will introduce you to the features and operation of your new Hyundai vehicle. It is suggested that you read it carefully because the information it contains can contribute greatly to the satisfaction you receive from your new car.

Hyundai Motor India Ltd. also recommends that service and maintenance on your vehicle be performed by an authorized Hyundai dealer.

HYUNDAI MOTOR INDIA LIMITED

CAUTION

Severe engine and transaxle damage may result from the use of poor quality fuels and lubricants that do not meet Hyundai specifications. You must always use high quality fuels and lubricants that meet the specifications listed on Page 10-4 in the Vehicle Specifications chapter of the Owner's Manual.

Note : Because future owners will also need the information included in this manual, if you sell this Hyundai vehicle, please leave the manual in the vehicle for their use. Thank you.

Copyright 2017 Hyundai Motor India Ltd. All rights reserved. No part of this publication may be reproduced, stored in any retrieval system or transmitted in any form or by any means without the prior written permission of Hyundai Motor India Ltd.



Table of contents

Maintenance Record Sheet

1

Hyundai Warranty Policy

2

Introduction

3

Your vehicle at a glance

4

Safety system of your vehicle

5

Features of your vehicle

6

Driving your vehicle

7

What to do in an emergency

8

Maintenance

9

Specifications & Consumer information

10

Index

I







Maintenance Record Sheet

MAINTENANCE RECORD SHEET 1-2

Maintenance Record Sheet

(Repair category - Free Ser./Paid Ser./Running Repair/Acc. Repair)

Repair Date	RO No.	Kms.	Repair Category	Details of repair done	Name of Servicing Dealer	Ser. Adv. Sign.	Tech. Sign.

Maintenance Record Sheet

(Repair category - Free Ser./Paid Ser./Running Repair/Acc. Repair)

Repair Date	RO No.	Kms.	Repair Category	Details of repair done	Name of Servicing Dealer	Ser. Adv. Sign.	Tech. Sign.



Maintenance Record Sheet

(Repair category - Free Ser./Paid Ser./Running Repair/Acc. Repair)

Repair Date	RO No.	Kms.	Repair Category	Details of repair done	Name of Servicing Dealer	Ser. Adv. Sign.	Tech. Sign.



Hyundai Warranty Policy

HYUNDAI NEW VEHICLE WARRANTY 2-2
REPLACEMENT PARTS WARRANTY..... 2-3
EMISSION WARRANTY 2-5
HYUNDAI EXTENDED WARRANTY..... 2-7

HYUNDAI NEW VEHICLE WARRANTY

Hyundai Motor India Limited hereinafter called "HMIL", warrants that each new Hyundai vehicle sold shall be free from any defects in material and workmanship, under normal use and maintenance, subject to the following terms and conditions.

1. Warranty period

This warranty shall exist for a period of 24 months from the date of delivery to the first purchaser irrespective of the mileage. However, the warranty for *Xcent* taxi trim is 36 months/100,000 kilometers whereas other Xcent trims being used for commercial purpose such as Taxi/Touristoperation will have warranty period 24 months/40,000 kilometers from the date of delivery which soever is earlier. This warranty is transferable to subsequent owner for the remaining warranty period. This warranty is applicable only in India and not transferable to any other country.

2. What is covered

Except as provided in paragraph 3 hereof, our Authorized Dealers shall either

repair or replace, any Hyundai genuine part that is acknowledged by HMIL to be defective in material or workmanship within the warranty period stipulated above, at no cost to the owner of the Hyundai vehicle for parts or labour. Such defective parts which have been replaced will become the property of HMIL.

3. What is not covered

This warranty shall not apply to:

- o Normal maintenance services other than the three free services, including without limitation, cleaning and polishing, minor adjustments, engine tuning, oil/fluid changes, filters replenishment, fastener retightening, wheel balancing, wheel alignment and tyre rotation etc.
- o Replacement of parts as a result of normal wear and tear such as spark plugs, belts, brake pads and linings, clutch disc/facing, filters, wiper blades, bulbs, fuses, etc.
- o Damage or failure resulting from:
 - ❖ Negligence of proper maintenance as required in this Owner's Manual and Service Booklet.

- ❖ Misuse, abuse, accident, theft, flooding or fire.
- ❖ Use of improper or insufficient fuel, fluids or lubricants.
- ❖ Use of parts other than Hyundai Genuine Parts.
- ❖ Any device and/or accessories not supplied by HMIL.
- ❖ Modifications, alterations, tampering or improper repair.
- ❖ Parts used in applications of which they were not designed or not approved by HMIL.
- ❖ Slight irregularities not recognised as affecting quality or function of the vehicle or parts, such as slight noise or vibrations, or items considered characteristic of the vehicle.
- ❖ Airborne "fallout", Industrial fall out, acid rain, hail and wind storms, or other Acts of God.
- ❖ Paint scratches, dents or similar paint or body damage.
- ❖ Action of road elements (sand, gravel, dust or road debris) which results in stone chipping of paint or glass.

WARRANTY

- o Incidental or consequential damages, including without limitation, loss of time, inconvenience, loss of use of vehicle or commercial loss.

Audio Video Navigation system, Batteries, Audio Systems, Tyres and Tubes originally equipped on Hyundai vehicles are warranted directly by the respective manufacturers and not by HMIL.

This warranty is the entire warranty given by HMIL for Hyundai vehicles and no dealer or its or his agent or employee is authorized to extend or enlarge this warranty and no dealer or its or his agent or employee is authorized to make any oral warranty on HMIL's behalf.

HMIL reserves the right to make any change in design or make any improvement on the vehicle at any time without any obligation to make the same change on vehicles previously sold.

HMIL reserves the right for the final decision in all warranty matters.

Owner's Responsibilities

- o Proper use, maintenance and care of vehicle in accordance with the instructions contained in this Owner's Manual and Service Booklet. If the vehicle is subject to severe usage conditions, such as operation in extremely dusty, rough, more repeated short distance driving or heavy city traffic during hot weather, maintenance of vehicle should be done more frequently as mentioned in this Owner's Manual and Service Booklet.
- o Retention of maintenance service records. It may be necessary for the customer to show that the required maintenance has been performed, as specified in this Owner's Manual and Service Booklet.
- o Delivery of the vehicle during regular service business hours to any authorized Hyundai Dealer to obtain warranty service.
- o In order to maintain the validity of this Basic Warranty, the vehicle must be serviced by Hyundai Authorized workshop in accordance to the Owner's Manual and Service Booklet.

PARTS REPLACEMENT

Hyundai Motor India Limited hereinafter called "HMIL", warrants that each new Hyundai Genuine replacement part purchased from and installed by Hyundai Authorized Dealer shall be free from any defects in material or workmanship, under normal use and maintenance, subject to the following terms and conditions.

1. Warranty period

This warranty shall exist for a period of 6 months or until the vehicle has been driven for a distance of 10,000 Kilometers from the date of installation of replacement part by Hyundai Authorized Dealer, whichever occurs first.

2. What is covered

Except as provided in paragraph 3 hereof, our Authorized Dealer who had sold and installed the replacement part earlier shall either repair or replace the said Hyundai genuine part that is acknowledged by HMIL to be defective in material or workmanship within the warranty period stipulated above, at no cost to the

owner of the Hyundai vehicle for parts or labour.

3. What is not covered

This warranty shall not apply to:

- o Normal maintenance services of parts such as cleaning, adjustment or replacement (i.e. spark plugs that are oil fouled, lead fouled, or which fail due to the use of low grade fuel).
- o Parts that fail due to abuse, misuse, neglect, alteration or accident or which have been improperly lubricated or repaired.
- o Parts used in applications for which they were not designed or approved by HMIL.
- o Failure due to normal wear of parts.
- o Direct or indirect failures caused by misuse and improper maintenance of vehicle and installation of non-Hyundai parts on the vehicle.
- o Any vehicle on which the odometer reading has been altered so that mileage cannot be accurately determined.
- o Incidental or consequential damages, including without limitation, loss of time, inconvenience, loss of use of vehicle or commercial loss.

This warranty is the entire warranty given by HMIL for Hyundai replacement parts and no dealer or its or his agent or employee is authorized to extend or enlarge this warranty and no dealer or its or his agent or employee is authorized to make any oral warranty on HMIL's behalf.

HMIL reserves the right for the final decision in all warranty matters.

Owner's Responsibilities

- o Proper use, maintenance and care of the vehicle in accordance with the instructions contained in the Owner's Manual and Service Booklet.
- o Retention of maintenance service records. It may be necessary for the customer to show that the required maintenance has been performed, as specified in this Owner's Manual and Service Booklet.
- o Retention of the customer's copy of the original repair order and its invoice/bill against which the part was replaced.
- o Delivery of the vehicle during regular service business hours to the same Hyundai Authorized Dealer who had sold and installed the replacement

part.

- o In order to maintain the validity of this Parts replacement Warranty, the vehicle must be serviced by Hyundai Authorized workshop in accordance to the Owner's Manual and Service Booklet.

EMISSION WARRANTY

HMIL extends the Mass Emission standards (BSIV) for its vehicle in the following cities:

- (1) Delhi/NCR, (2) Mumbai, (3) Chennai, (4) Chennai, (5) Bangalore (6) Hyderabad including Secunderabad, (7) Ahmedabad, (8) Pune, (9) Surat, (10) Kanpur, (11) Agra. (For the vehicles Manufactured on or after 01/04/20. (12) Lucknow (13) Sholapur (For the vehicles Manufactured on or after 01/06/2010). (14) Puduchery, (15) Mathura, (16) vapi, (17) Jamnagar, (18) Ankleshwar, (19) Hissar, (20) Bharatpur, (21) Silvasa, (22) Dama &

Diu, (23) Aligarh, (24) Rae Bareilly, (25) Unnao, (26) Karnal, (27) Kurukshetra, (28) Yamunanagar, (29) Valsad, (30) Nizamabad, (31) Medak & (30) Mehboobnagar (For the vehicles

Manufactured on or after 01/10/2010).

The Mass Emission Standards (BS III) shall apply to all the states and union territories, except at above. As and when Govt. of India notifies additional/

new cities under Mass

Emission Standards (BS IV), Such cities would be automatically covered.

subject to other terms of the warranty policy and the conditions and obligations laid down hereunder, Hyundai Motor India Limited hereinafter called "HMIL", certifies that the components liable to affect the emission of the gaseous pollutants in the vehicle in normal use despite the use to which it may be subjected, comply with the provisions of Rule 115(2) of the Central Motor Vehicle Rules, 1989 hereinafter referred to as the "In-use emission standard",

and further warrants that if on examination by a dealer duly authorized by HMIL, the vehicle is discovered to be failing to meet the In-use emission standard as specified in the said rule, our Authorized Dealer shall take such corrective measures as may be necessary and shall at its sole discretion either repair or replace free of charge, such components of emission control system as are specified in paragraph 3 here of.

1. Warranty period

This warranty will be in addition to and run parallel to the New Vehicle Warranty and shall exist for a period of 36 months or until the vehicle has been driven for a distance of 80,000 kilometers from the date of delivery to the first purchaser, whichever occurs first. This warranty is transferable to subsequent owner for the remaining warranty period.

2. What is covered

Our Authorized Dealers shall either repair or replace, any Hyundai genuine part listed in paragraph 3 hereof, that is acknowledged by HMIL to

be defective in material or workmanship within the warranty period stipulated above, after examinations carried out to confirm that none of the original settings have been tampered with, at no cost to the owner of the Hyundai vehicle for parts or labour. Such defective parts which have been replaced will become the property of HMIL.

3. Emission Warranty Parts List

3.1 Engine Control Module System

- Engine Control Module
- Crankshaft Position Sensor, Camshaft Position Sensor, Throttle Position Sensor, MAP Sensor, O₂ Sensor, IAT & ECT Sensor

3.2 Fuel Metering System

- Fuel injectors
- Fuel Pumps

3.3 Air Induction System

- Air Cleaner Housing Assembly
- Throttle Body
- Intake Manifold
- Idle Speed Control Actuator

3.4 Ignition System

- H.T. Cable Set
- Ignition Coil
- Power Transistor
- Distributor and internal parts

3.5 Evaporative Emission Control System

- Vapour Storage Canister
- Fuel Tank
- Fuel Filler Tube and Fuel filler Cap
- Purge Control Solenoid Valve
- Canister Close Valve

3.6 PCV System

- PCV Valve.
- PCV Hoses
- Oil Filler Cap

3.7 Catalytic Converter System

- Exhaust Manifold
- Exhaust Pipe Assembly
- Catalytic Converter

3.8 Exhaust Gas Recirculation (EGR) System (Diesel Engines)

- EGR Control System

3.9 Miscellaneous items used in above Systems

- Vacuum hoses, clamps, fittings, tubing or mounting hard-

ware used with the above systems. Valves, Switches and Solenoids.

4. What is not covered

This Emission Warranty shall not apply to:

- o Normal maintenance services including without limitation, engine tuning, oil/fluid changes, filters replenishment, etc.
- o Replacement of parts as a result of normal wear and tear such as spark plugs, filters, etc.
- o The vehicle reported without valid 'Pollution Under Control' certificate for the period immediately preceding the test during which the failure is discovered.
- o The vehicle which has been run on adulterated fuel or lubricant or fuel/lubricants other than those specified by HMIL.
- o Damage or failure resulting from:
 - ❖ Negligence of proper maintenance as required in this Owner's Manual and Service Booklet.
 - ❖ Misuse, abuse, accident, theft, flooding or fire.
 - ❖ Use of improper or insufficient fuel, fluids or lubricants.
 - ❖ Any repair carried out other than by Hyundai Authorized Dealer/ Service Centre.
 - ❖ Use of parts other than Hyundai Genuine Parts.
 - ❖ Any device and/or accessories not supplied by HMIL.
 - ❖ Modifications, alterations, tampering or improper repair.
 - ❖ Parts used in applications for which they were not designed or not approved by HMIL.
 - ❖ Any penalties that may be charged by statutory authorities on account of failure to comply with the In-use emission standards.
 - ❖ The vehicle in which the odometer has been tampered with, changed or been disconnected.
- o Any consequential repairs or replacement of parts which may be found necessary to establish compliance to In-use emission

standards, in addition to the replacement of the components covered under Emission Warranty, will not be made free of cost unless such parts are also found to be in warrantable condition within the scope and limit of the New Vehicle Warranty.

- o Incidental or consequential damages, including without limitation, loss of time, inconvenience, loss of use of vehicle or commercial loss.

This warranty is the entire warranty given by HMIL for Hyundai vehicles and no dealer or its or his agent or employee is authorized to extend or enlarge this warranty and no dealer or its or his agent or employee is authorized to make any oral warranty on HMIL's behalf.

HMIL reserves the right to make any change in design or make any improvement on the vehicle at any time without any obligation to make the same change on vehicles previously sold.

HMIL reserves the right for the final decision in all warranty matters.

OWNER'S RESPONSIBILITIES

- o Proper use, maintenance and care of vehicle in accordance with the instructions contained in this Owner's Manual and Service Booklet. If the vehicle is subject to severe usage conditions, such as operation in extremely dusty, rough, more repeated short distance driving or heavy city traffic during hot weather, maintenance of vehicle should be done more frequently as mentioned in this Owner's Manual and Service Booklet.
- o In order to maintain the validity of this Emission Warranty, the vehicle must be serviced by Hyundai Authorized Dealer or Service Centre in accordance to the Owner's Manual and Service Booklet.
- o Retention of maintenance service records. It may be necessary for the customer to show that the required maintenance has been performed, as specified in this Owner's Manual and Service Booklet.
- o Immediate Delivery of the vehicle to any authorized Hyundai Dealer

upon discovery of failure to comply with the In-use emission standard in spite of proper use, maintenance and care of vehicle in accordance with the instructions contained in this Owner's Manual and Service Booklet.

- o Production of "Pollution Under Control" (PUC) certificate valid for the period immediately preceding the test during which the failure is discovered, the test having been carried out either for obtaining a new certificate, or pursuant upon being directed by an officer as referred to in sub-rule (2) of Rule 116 of the Central Motor Vehicles Rules.

HYUNDAI EXTENDED WARRANTY*

HMIL offers optional paid extended warranty on selected models, in addition to the basic new vehicle warranty. For more details on Hyundai Extended Warranty please call the nearest dealer or our toll free number 1-800-11-4645

**Conditions apply*

We are pleased to introduce you to our 24 X 7 Hyundai Road Side Assistance Programme

**Our Road Side Assistance number is : 1800 102 4645 (toll free),
(0124) 2564645 (call charges apply)**

Hyundai Roadside Assistance is a 24 X 7 emergency support provided in the event of any mechanical/ electrical breakdown and/or road traffic accident of a vehicle.

Covered events & benefits *

Break Down/Accident



Roadside repair or vehicle recovery in case of breakdown/road traffic accident.

Tire Related



Tire Puncture-Replacement of punctured tire with the spare tire.

Battery related



Dead Battery-Jump start.

Key Related



Locked keys, lost keys or broken vehicle keys.

Fuel related



Out of fuel, incorrect fuel or contaminated fuel.

***Terms and conditions apply.**

Terms & Conditions

- 1). The service is applicable for the basic warranty period of the vehicle.
- 2). The 24 X 7 Road side assistance is available up to a nearest Hyundai authorized dealer workshop.
- 3). The service is applicable for a condition in which the vehicle has been immobile.
- 4). Cost of parts replacement is not included, unless covered under Hyundai Warranty.
- 5). Cost of repairs made to your vehicle is not included, unless it is covered under Hyundai Warranty.



Introduction

HOW TO USE THIS MANUAL..... 3-2
FUEL REQUIREMENTS..... 3-3
• **Petrol engine..... 3-3**
• **Diesel engine..... 3-5**
VEHICLE BREAK-IN PROCESS..... 3-6



Introduction

HOW TO USE THIS MANUAL

We want to help you get the greatest possible driving pleasure from your vehicle. Your Owner's Manual can assist you in many ways. We strongly recommend that you read the entire manual. In order to minimize the chance of death or injury, you must read the WARNING and CAUTION sections in the manual.

Illustrations complement the words in this manual to best explain how to enjoy your vehicle. By reading your manual, you learn about features, important safety information, and driving tips under various road conditions.

The general layout of the manual is provided in the Table of Contents. Use the index when looking for a specific area or subject; it has an alphabetical listing of all information in your manual.

Chapters: This manual has ten chapters plus an index. Each section begins with a brief list of contents so you can tell at a glance if that section has the information you want.

You'll find various WARNING's, CAUTION's, and NOTICE's in this manual. These were prepared to enhance your personal safety. You should carefully read and follow ALL procedures and recommendations provided in these WARNING's, CAUTION's and NOTICE's.

WARNING

WARNING indicates a situation in which harm, serious bodily injury or death could result if the warning is ignored.

CAUTION

CAUTION indicates a situation in which damage to your vehicle could result if the caution is ignored.

*** NOTICE**

NOTICE indicates interesting or helpful information is being provided.

FUEL REQUIREMENTS

Petrol engine

Unleaded

Your new vehicle is designed to use only unleaded fuel having an Octane Rating of RON (Research Octane Number) 91 / AKI (Anti-Knock Index) 87 or higher. (Do not use methanol blended fuels)

Your new vehicle is designed to obtain maximum performance with UNLEADED FUEL, as well as minimize exhaust emissions and spark plug fouling.



CAUTION

NEVER USE LEADED FUEL. *The use of leaded fuel is detrimental to the catalytic converter and will damage the engine control system's oxygen sensor and affect emission control.*

Never add any fuel system cleaning agents to the fuel tank other than what has been specified. (We recommend that you contact an authorized HYUNDAI dealer for details)



WARNING

- Do not "top off" after the nozzle automatically shuts off when refueling.
- Always check that the fuel cap is installed securely to prevent fuel spillage in the event of an accident.

Petrol containing alcohol and methanol

Gasohol, a mixture of petrol and ethanol (also known as grain alcohol), and petrol or gasohol containing methanol (also known as wood alcohol) are being marketed along with or instead of leaded or unleaded petrol.

Do not use gasohol containing more than 10% ethanol, and do not use petrol or gasohol containing any methanol. Either of these fuels may cause drivability problems and damage the fuel system, engine control system and emission control system. Discontinue using gasohol of any kind if drivability problems occur. Vehicle damage or driveability problems may not be covered by the manufacturer's warranty if they result from the use of:

1. Gasohol containing more than 10% ethanol.
2. Petrol or gasohol containing methanol.
3. Leaded fuel or leaded gasohol. (Except for vehicle designed to use leaded petrol for some countries)



CAUTION

Never use gasohol which contains methanol. Discontinue use of any gasohol product which impairs drivability.

Introduction

Using fuels such as;

- Silicone (Si) contained fuel,
- MMT (Manganese, Mn) contained fuel,
- Ferrocene (Fe) contained fuel, and
- Other metallic additives contained fuels,

may cause vehicle and engine damage or cause plugging, misfiring, poor acceleration, engine stalling, catalyst melting, abnormal corrosion, life cycle reduction, etc.

Also, the Malfunction Indicator Lamp (MIL) may illuminate.

* NOTICE

Damage to the fuel system or performance problem caused by the use of these fuels may not be covered by your New Vehicle Limited Warranty.

Use of MTBE

HYUNDAI recommends avoiding fuels containing MTBE (Methyl Tertiary Butyl Ether) over 15.0% vol. (Oxygen Content 2.7% weight) in your vehicle.

Fuel containing MTBE over 15.0% vol. (Oxygen Content 2.7% weight) may reduce vehicle performance and produce vapor lock or hard starting.

CAUTION

Your New Vehicle Limited Warranty may not cover damage to the fuel system and any performance problems that are caused by the use of fuels containing methanol or fuels containing MTBE (Methyl Tertiary Butyl Ether) over 15.0% vol. (Oxygen Content 2.7% weight.)

Do not use methanol

HYUNDAI recommends avoiding fuels containing MTBE (Methyl Tertiary Butyl Ether) over 15.0% vol. (Oxygen Content 2.7% weight) in your vehicle.

Fuel containing MTBE over 15.0% vol. (Oxygen Content 2.7% weight) may reduce vehicle performance and produce vapor lock or hard starting.

CAUTION

Your New Vehicle Limited Warranty may not cover damage to the fuel system and performance problems that are caused by the use of methanol or fuels containing methanol.

Fuel Additives

HYUNDAI recommends that you use unleaded gasoline which has an Octane Rating of RON (Research Octane Number) 91 / AKI (Anti-Knock Index) 87 or higher.

For customers who do not use good quality gasolines including fuel additives regularly, and have problems starting or the engine does not run smoothly, one bottle of additives added to the fuel tank at every 10,000 km.

Additives are available from your authorized HYUNDAI dealer along with information on how to use them. Do not mix other additives.

Petrols for cleaner air

To help contribute to cleaner air, HYUNDAI recommends that you use petrols treated with detergent additives, which help prevent deposit formation in the engine. These petrols will help the engine run cleaner and enhance performance of the Emission Control System.

Operation in foreign countries

If you are going to drive your vehicle in another country, be sure to:

- Observe all regulations regarding registration and insurance.
- Determine that acceptable fuel is available.

Diesel engine

Diesel fuel

Diesel engine must be operated only on commercially available diesel fuel that complies with EN 590 or comparable standard. (EN stands for "European Norm"). Do not use marine diesel fuel, heating oils, or non-approved fuel additives, as this will increase wear and cause damage to the engine and fuel system. The use of non-approved fuels and / or fuel additives will result in a limitation of your warranty rights.

Diesel fuel of 52 to 54 cetane is used in your vehicle. If two types of diesel fuel are available, use summer or winter fuel properly according to the following temperature conditions.

- Above -5°C (23°F) ... Summer type diesel fuel.
- Below -5°C (23°F) ... Winter type diesel fuel.

Watch the fuel level in the tank very carefully: If the engine stops through fuel failure, the circuits must be completely purged to restart.

Introduction

CAUTION

- **Do not let any petrol or water enter the tank. This would make it necessary to drain it out and to bleed the lines to avoid jamming the injection pump and damaging the engine.**
- **In winter, in order to cut down incidents due to freezing, paraffin oil may be added to the fuel if the temperature drops to below -10°C (50°F). Never use more than 20% paraffin oil.**

Biodiesel

Commercially supplied biodiesel blends of no more than 5% biodiesel, commonly known as "B5 biodiesel" may be used in your vehicle if it meets EN 14214 or equivalent specifications. (EN stands for "European Norm"). The use of biofuels made from rapeseed methyl ester (RME), fatty acid methyl ester (FAME), vegetable oil methyl ester (VME) etc. or mixing diesel with biodiesel will cause increased wear or damage to the engine and fuel system. Repair or replacement of worn or damaged components due to the use of non approved fuels will not be covered by the manufactures warranty.

CAUTION

- **Never use any fuel, whether diesel or B5 biodiesel that fails to meet the latest petroleum industry specification.**
- **Never use any fuel additives or treatments that are not recommended or approved by the vehicle manufacturer.**

VEHICLE BREAK-IN PROCESS

No special break-in period is needed. By following a few simple precautions for the first 1,000 km (600 miles) you may add to the performance, economy and life of your vehicle.

- Do not race the engine.
- While driving, keep your engine speed (rpm, or revolutions per minute) between 2,000 rpm and 4,000 rpm.
- Do not maintain a single speed for long periods of time, either fast or slow. Varying engine speed is needed to properly break-in the engine.
- Avoid hard stops, except in emergencies, to allow the brakes to seat properly.
- Don't let the engine idle longer than 3 minutes at one time.

Your vehicle at a glance

INTERIOR OVERVIEW	4-2
INSTRUMENT PANEL OVERVIEW	4-3
ENGINE COMPARTMENT	4-4
• Petrol engine	4-4
• Diesel engine	4-5

INTERIOR OVERVIEW

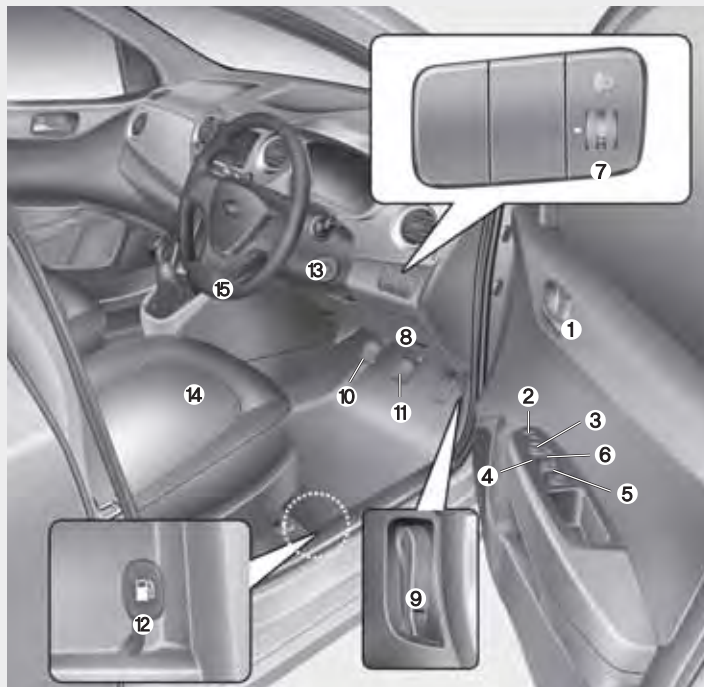

- 1. Door lock/unlock button6-16
 - 2. Outside rearview mirror folding*6-37
 - 3. Outside rearview mirror control*6-37
 - 4. Power window lock button*6-26
 - 5. Power window switches*6-23
 - 6. Central door lock switch*6-17
 - 7. Head lamp leveling device*6-57
 - 8. Fuse box9-60
 - 9. Hood release lever6-28
 - 10. Clutch pedal*7-13
 - 11. Brake pedal7-21
 - 12. Fuel filler lid opener6-30
 - 13. Key ignition switch/
Engine start/stop button7-4, 7-7
 - 14. Seats5-2
 - 15. Steering wheel6-33
- * : if equipped

OBA013003

INSTRUMENT PANEL OVERVIEW

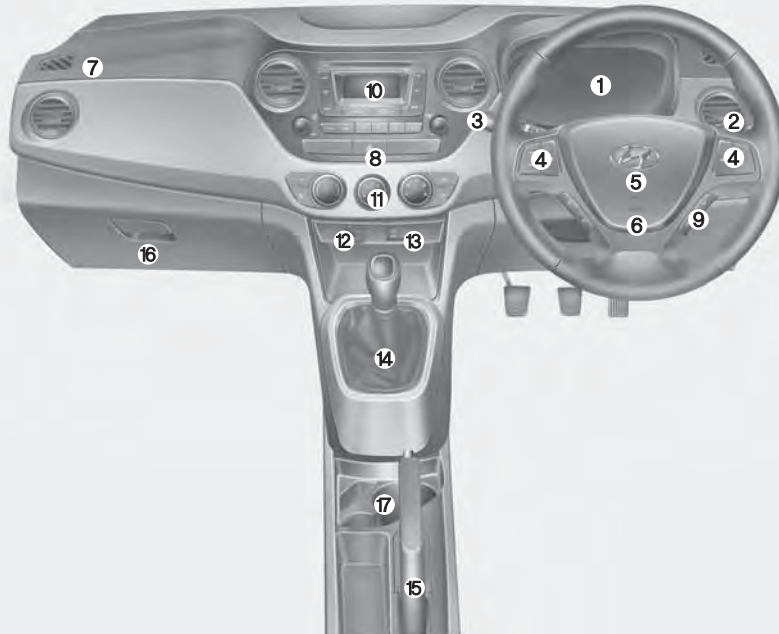

- 1. Instrument cluster6-39
 - 2. Light control / Turn signals.....6-54, 6-56
 - 3. Wiper/Washer.....6-58
 - 4. Audio remote control*6-86
 - 5. Horn6-34
 - 6. Driver's front air bag*5-28
 - 7. Passenger's front air bag*.....5-28
 - 8. Hazard warning flasher.....6-53
 - 9. Trip computer*6-42
 - 10. Audio system*6-92, 6-121
 - 11. Climate control system*6-63, 6-71
 - 12. Cigarette lighter*/
Power outlet*6-82, 6-84
 - 13. AUX, USB and iPod port*6-88
 - 14. Shift lever7-13, 7-16
 - 15. Parking brake lever7-22
 - 16. Glove box6-80
 - 17. Cup holder6-83
- * : if equipped

OBA013004

ENGINE COMPARTMENT

■ Petrol engine

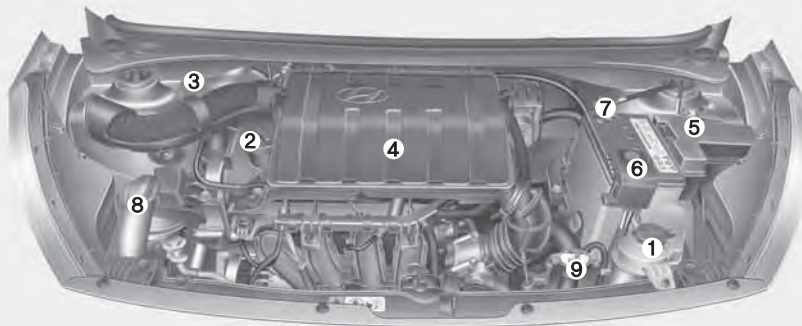

- 1. Engine coolant reservoir9-29
- 2. Engine oil filler cap9-25
- 3. Brake/clutch fluid reservoir9-31
- 4. Air cleaner.....9-37
- 5. Fuse box9-58
- 6. Positive battery terminal9-44
- 7. Negative battery terminal.....9-44
- 8. Windshield washer fluid reservoir9-34
- 9. Radiator cap9-30
- 10. Engine oil dipstick9-25

* The actual engine compartment in the vehicle may differ from the illustration.

OBA013006R

■ Diesel engine

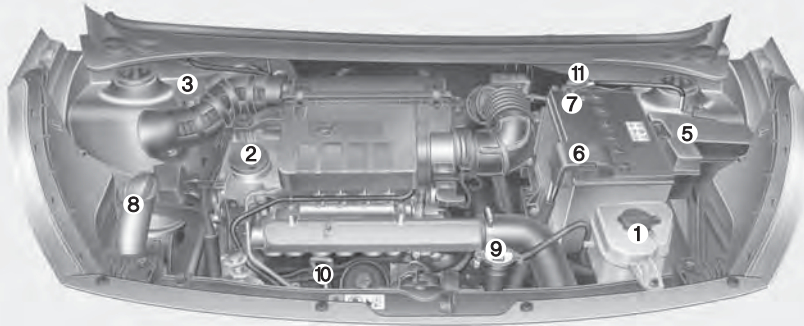

- 1. Engine coolant reservoir9-29
- 2. Engine oil filler cap9-26
- 3. Brake/clutch fluid reservoir9-31
- 4. Air cleaner.....9-37
- 5. Fuse box9-58
- 6. Positive battery terminal9-44
- 7. Negative battery terminal.....9-44
- 8. Windshield washer fluid reservoir9-34
- 9. Radiator cap9-30
- 10. Engine oil dipstick9-26
- 11. Fuel filter9-35

* The actual engine compartment in the vehicle may differ from the illustration.

OBA013007R

Safety features of your vehicle

SEATS	5-2
• Front seat adjustment	5-4
• Rear seat adjustment	5-7
SEAT BELTS	5-10
• Seat belt restraint system	5-10
• Pre-tensioner seat belt	5-14
• Additional seat belt safety precautions	5-17
• Care of seat belts	5-19
CHILD RESTRAINT SYSTEM (CRS)	5-20
• Selecting a Child Restraint System (CRS)	5-21
• Installing a Child Restraint System (CRS)	5-23
AIR BAG	
- SUPPLEMENTAL RESTRAINT SYSTEM	5-27
• Where are the air bags?	5-29
• How does the air bags system operate?	5-30
• What to expect after an air bag inflates	5-34
• Do not install a child restraint on the front passenger seat	5-35
• Why didn't my air bag go off in a collision?	5-35
• SRS care	5-40
• Additional safety precautions	5-41
• Air bag warning labels	5-41

SEATS

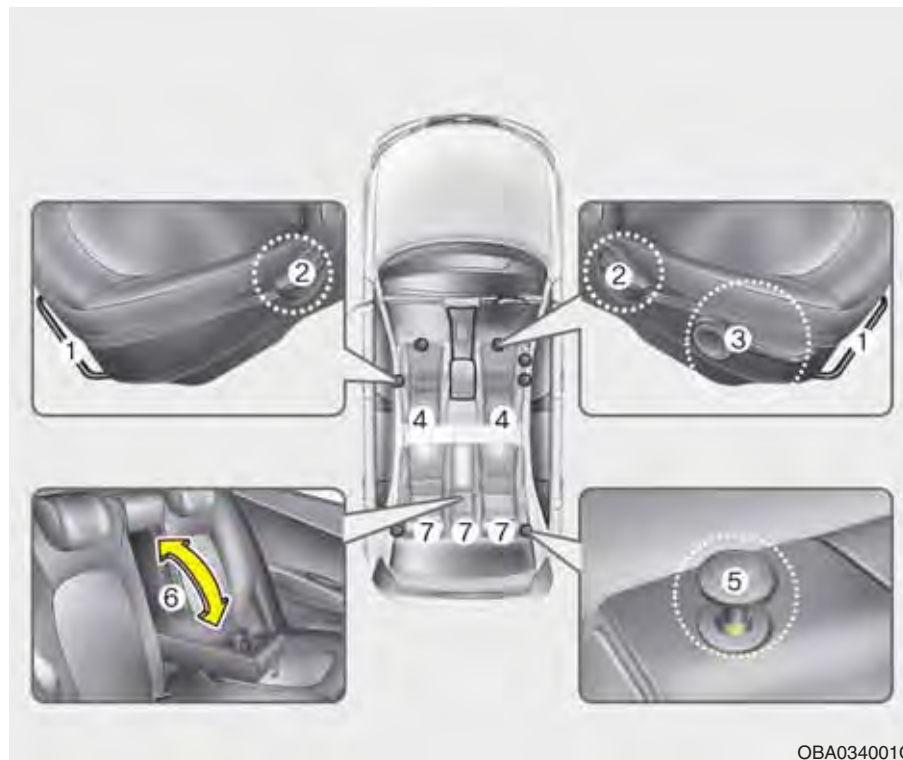

Front seats

- (1) Forward and rearward
- (2) Seatback angle
- (3) Seat cushion height (driver's seat)*
- (4) Headrest

Rear seats

- (5) Seat folding*
- (6) Armrest*
- (7) Headrest

* : if equipped

OBA034001Q

⚠ WARNING - Loose objects

Loose objects in the driver's foot area could interfere with the operation of the foot pedals, possibly causing an accident. Do not place anything under the front seats.

⚠ WARNING - Uprighting seat

When you return the seatback to its upright position, hold the seatback and return it slowly and be sure there are no other occupants around the seat. If the seatback is returned without being held and controlled, the back of the seat could spring forward resulting in accidental injury to a person struck by the seatback.

⚠ WARNING - Driver responsibility for front seat passenger

Riding in a vehicle with a front seatback reclined could lead to serious or fatal injury in an accident. If a front seat is reclined during an accident, the occupant's hips may slide under the lap portion of the seat belt applying great force to the unprotected abdomen. Serious or fatal internal injuries could result. The driver must advise the front passenger to keep the seatback in an upright position whenever the vehicle is in motion.

⚠ WARNING - Driver's seat

- Never attempt to adjust seat while the vehicle is moving. This could result in loss of control, and an accident causing death, serious injury, or property damage.
- Do not allow anything to interfere with the normal position of the seatback. Storing items against a seatback or in any other way interfering with proper locking of a seatback could result in serious or fatal injury in a sudden stop or collision.
- Always drive and ride with your seatback upright and the lap portion of the seat belt snug and low across the hips. This is the best position to protect you in case of an accident.
- In order to avoid unnecessary and perhaps severe air bag injuries, always sit as far back as possible from the steering wheel while maintaining comfortable control of the vehicle. It is recommended that drivers allow at least 25 cm (10 in.) between the center of the steering wheel and their chest.



Front seat adjustment

Forward and rearward

To move the seat forward or rearward:

1. Pull the seat slide adjustment lever up and hold it.
2. Slide the seat to the position you desire.
3. Release the lever and make sure the seat is locked in place.

Adjust the seat before driving, and make sure the seat is locked securely by trying to move forward and rearward without using the lever. If the seat moves, it is not locked properly.

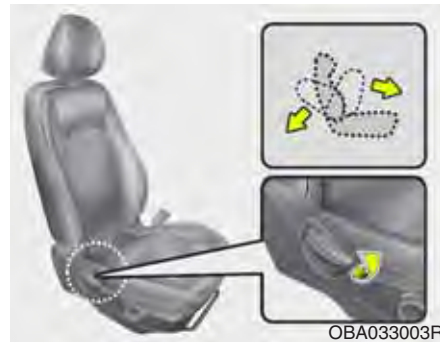

Seatback angle

To recline the seatback:

1. Lean forward slightly and lift up the seatback recline lever.
2. Carefully lean back on the seat and adjust the seatback of the seat to the position you desire.
3. Release the lever and make sure the seatback is locked in place. (The lever **MUST** return to its original position for the seatback to lock.)



Seat cushion height (for driver's seat) (if equipped)

To change the height of the seat cushion, move the lever upwards or downwards.

- To lower the seat cushion, push down the lever several times.
- To raise the seat cushion, pull up the lever several times.

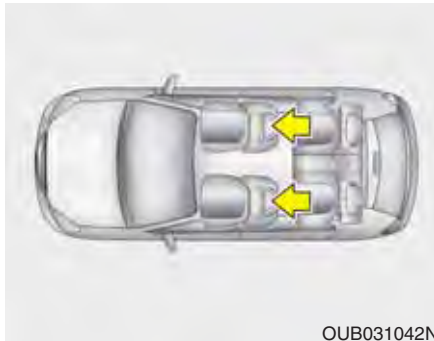

Headrest

The driver's and front passenger's seats are equipped with a headrest for the occupant's safety and comfort.

The headrest not only provides comfort for the driver and front passenger, but also helps protect the head and neck in the event of a collision.

⚠ WARNING

To reduce the risk of serious injury or death in an accident, take the following precautions when adjusting your headrests:

- Always properly adjust the headrests for all passengers **BEFORE** starting the vehicle.
- **NEVER** let anyone ride in a seat with the headrest removed.
- Adjust the headrests so the middle of the headrests is at the same height as the height of the top of the eyes (see diagram).

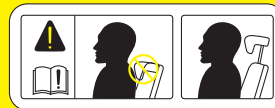

- **NEVER** adjust the headrest position of the driver's seat when the vehicle is in motion.
- Adjust the headrest as close to the passenger's head as possible. Do not use a seat cushion that holds the body away from the seatback.



Adjusting the height up and down (if equipped)

To raise the headrest, pull it up to the desired position (1). To lower the headrest, push and hold the release button (2) on the headrest support and lower the headrest to the desired position (3).

Safety features of your vehicle



Removal/Reinstall (if equipped)

To remove the headrest, raise it as far as it can go then press the release button (1) while pulling the headrest up (2).

To reinstall the headrest, put the headrest poles (3) into the holes while pressing the release button (1). Then adjust it to the appropriate height.

⚠ WARNING

Always make sure the headrest locks into position after reinstalling and adjusting it properly.



Seatback pocket (if equipped)

The seatback pocket is provided on the back of the driver's and/or front passenger's seatback.

⚠ WARNING - Seatback pocket

Do not put heavy or sharp objects in the seatback pocket. In an accident they could come loose from the pocket and injure vehicle occupants.



Passenger seat under tray (if equipped)

To open the tray, pull up the tray and then pull it out forward.

⚠ WARNING - Flammable materials

Do not store cigarette lighters, propane cylinders, or other flammable/explosive materials in the tray. These items may catch fire and/or explode if the vehicle is exposed to hot temperatures for extended periods.

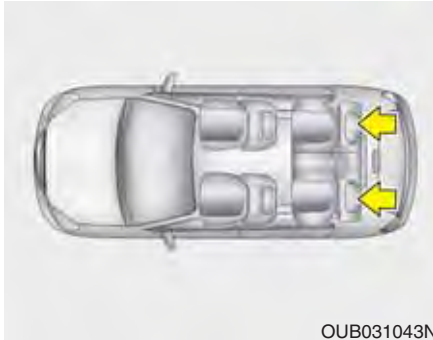

OUB031043N

Rear seat adjustment

Headrest

The rear seat(s) is equipped with headrests in the outboard seating positions (and/or center seating position) for the occupant's safety and comfort.

The headrest not only provides comfort for passengers, but also helps protect the head and neck in the event of a collision.

⚠ WARNING

To reduce the risk of serious injury or death in an accident, take the following precautions when adjusting your headrests:

- Always properly adjust the headrests for all passengers **BEFORE** starting the vehicle.
- **NEVER** let anyone ride in a seat with the headrest removed.
- Adjust the headrests so the middle of the headrests is at the same height as the height of the top of the eyes (see diagram).

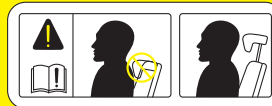

- **Adjust the headrest as close to the passenger's head as possible. Do not use a seat cushion that holds the body away from the seatback.**

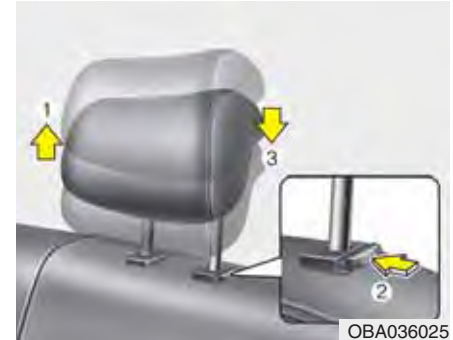

OBA036025

Adjusting the height up and down (if equipped)

To raise the headrest, pull it up to the desired position (1). To lower the headrest, push and hold the release button (2) on the headrest support and lower the headrest to the desired position (3).

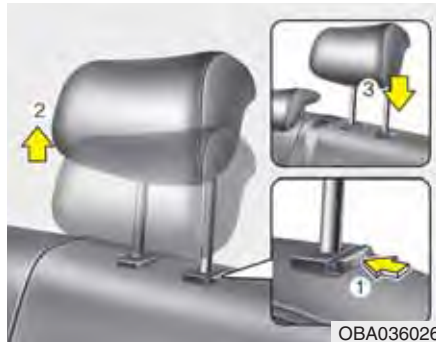

Removal/Reinstall (if equipped)

To remove the headrest, slightly fold the rear seatback, raise the headrest as far as it can go then press the release button (1) while pulling upward (2).

To reinstall the headrest, slightly fold the rear seatback, put the headrest poles (3) into the holes while pressing the release button (1). Then adjust it to the appropriate height.

⚠ WARNING

Always make sure the headrest locks into position after reinstalling and adjusting it properly.



Armrest (if equipped)

The armrest is located in the center of the rear seat. Pull the armrest down from the seatback to use it.

You will find cup holders on the center armrest.

Folding the rear seat

The rear seatbacks may be folded to facilitate carrying long items or to increase the luggage capacity of the vehicle.

⚠ WARNING

- Never allow passengers to sit on top of the folded down seatback while the vehicle is moving as this is not a proper seating position and no seat belts are available for use. This could result in serious injury or death in case of an accident or sudden stop.
- Objects carried on the folded down seatback should not extend higher than the top of the front seats. This could allow cargo to slide forward and cause injury or damage during sudden stops.

1. Set the front seatback to the upright position and if necessary, slide the front seat forward.
2. Lower the rear headrests to the lowest position (if equipped with adjustable headrests).

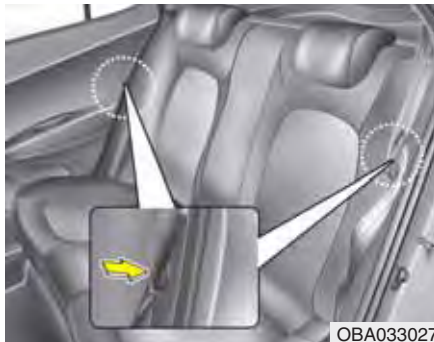

3. Insert the rear lap/shoulder belt plate into the holder on the side trim. It will prevent the lap/shoulder belt from interfering with the seatback when folding.



4. Pull up both sides of the seatback lever and fold the seatback toward the front of the vehicle.

To use the rear seat, lift and push up the seatback backward. Push the seatback firmly until it clicks into place. Make sure the seatback is locked in place.

When returning the rear seatbacks to the upright position, remember to return the rear shoulder belts to their proper position.

⚠ WARNING

When returning the rear seatback from a folded to an upright position, hold the seatback and return it slowly. Ensure that the seatback is completely locked into its upright position by pushing on the top of the seatback. In an accident or sudden stop, the unlocked seatback could allow cargo to move forward with great force and enter the passenger compartment, which could result in serious injury or death.

SEAT BELTS

Seat belt restraint system

WARNING - Cargo

Cargo should always be secured to prevent it from being thrown about the vehicle in a collision and causing injury to the vehicle occupants. Do not place objects in the rear seats, since they cannot be properly secured and may hit the front seat occupants in a collision.

WARNING - Cargo loading

Make sure the engine is off, the shift lever is in P (Park, for automatic transaxle vehicle) or 1st gear (for manual transaxle vehicle), and the parking brake is securely applied whenever loading or unloading cargo. Failure to take these steps may allow the vehicle to move if the shift lever is inadvertently moved to another position.

WARNING

- For maximum restraint system protection, the seat belts must always be used whenever the vehicle is moving.
- Seat belts are most effective when seatbacks are in the upright position.
- Children age 12 and under must always be properly restrained in the rear seat. Never allow children to ride in the front passenger seat. If a child over 12 must be seated in the front seat, he/she must be properly belted and the seat should be moved as far back as possible.
- Never wear the shoulder belt under your arm or behind your back. An improperly positioned shoulder belt can cause serious injuries in a crash. The shoulder belt should be positioned midway over your shoulder across your collarbone.
- Avoid wearing twisted seat belts. A twisted seat belt will not protect you properly in an accident. Be sure the belt webbing is straight and not twisted.

(Continued)

(Continued)

- Each belt assembly must only be used by one occupant; it is dangerous to put a belt around a child being carried on a occupant's lap.
- Be careful not to damage the belt webbing or hardware. If the belt webbing or hardware is damaged, replace it.

WARNING

Damaged seat belts and seat belt assemblies will not operate properly. Always replace:

- Frayed, contaminated, or damaged webbing.
- Damaged hardware.
- The entire seat belt assembly after it has been worn in an accident, even if damage to webbing or assembly is not apparent.

WARNING

No modifications or additions should be made by the user which will either prevent the seat belt adjusting devices from operating to remove slack.



Seat belt warning

As a reminder to the driver, the seat belt warning light on the instrument cluster will blink for approximately 6 seconds each time you place the ignition switch in the ON position regardless of belt fastening.

If the driver's seat belt is unfastened after the ignition switch is in the ON position, the seat belt warning light will blink again for approximately 6 seconds.

If the driver's seat belt is unfastened when the ignition switch is in the ON position or if it is unfastened after the ignition switch is in the ON position, the seat belt warning chime will sound for approximately 6 seconds. At this time, if the seat belt is fastened, the chime will stop at once. (if equipped)

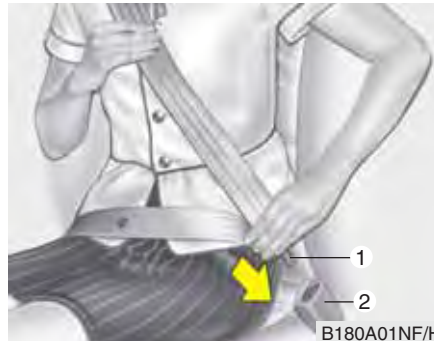

Lap/shoulder belt

To fasten your seat belt:

Pull it out of the retractor and insert the metal tab (1) into the buckle (2). There will be an audible "click" when the tab locks into the buckle.

The seat belt automatically adjusts to the proper length only after the lap belt portion is adjusted manually so that it fits snugly around your hips. If you lean forward in a slow, easy motion, the belt will extend and let you move around. If there is a sudden stop or impact, however, the belt will lock into position. It will also lock if you try to lean forward too quickly.

*** NOTICE**

If you are not able to smoothly pull enough of the seat belt out from the retractor, firmly pull the seat belt out and release it. After release, you will be able to pull the belt out smoothly.

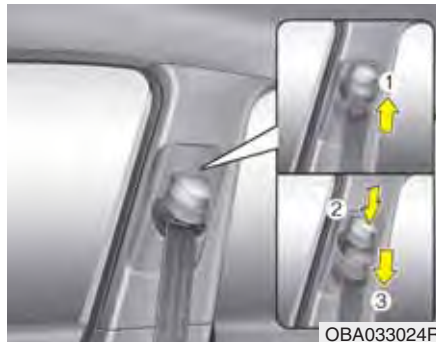

Height adjustment (if equipped)

You can adjust the height of the shoulder belt anchor to one of the 4 positions for maximum comfort and safety.

The shoulder portion should be adjusted so that it lies across your chest and mid-way over your shoulder nearest the door, not over your neck.

To adjust the height of the seat belt anchor, lower or raise the height adjuster into an appropriate position.

To raise the height adjuster, pull it up (1). To lower it, push it down (3) while pressing the height adjuster button (2).

Release the button to lock the anchor into position. Try sliding the height adjuster to make sure that it has locked into position.

⚠ WARNING

Always position the shoulder belt anchor into locked position at the appropriate height. Never position the shoulder belt across your neck or face. Improperly positioned seat belts can cause serious injuries in an accident.

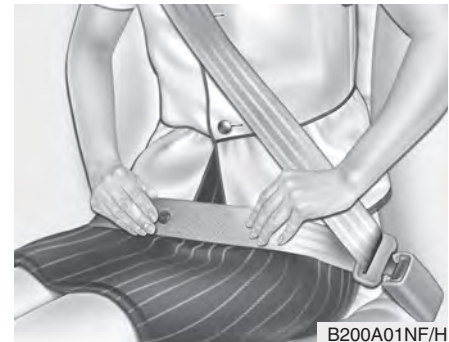

⚠ WARNING

Improperly positioned seat belts may increase the risk of serious injury in an accident. Take the following precautions when adjusting the seat belt:

- Position the lap portion of the seat belt as low as possible across your hips, not on your waist, so that it fits snugly.

This allows your strong pelvic bones to absorb the force of the crash, reducing the chance of internal injuries.

- Position one arm under the shoulder belt and the other over the belt, as shown in the illustration.

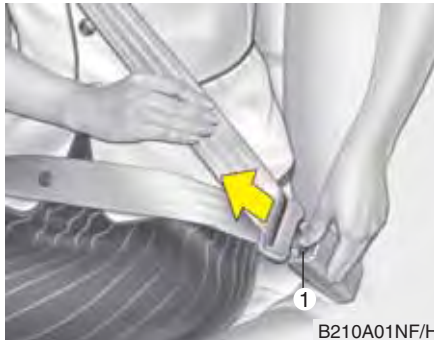

To release the seat belt:

The seat belt is released by pressing the release button (1) in the locking buckle. When it is released, the belt should automatically draw back into the retractor.

If this does not happen, check the belt to be sure it is not twisted, then try again.



Lap belt

To fasten your seat belt:

To fasten a 2-point static type belt, insert the metal tab (1) into the locking buckle (2). There will be an audible "click" when the tab locks into the buckle. Make sure the belt is properly locked and that the belt is not twisted.

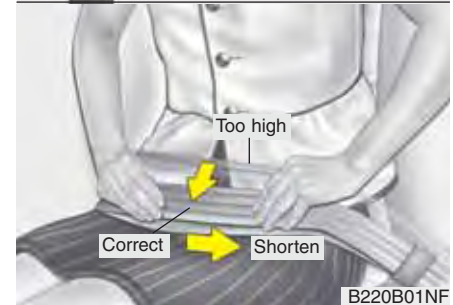

With a 2-point static type seat belt, the length must be adjusted manually so it fits snugly around your hip. Fasten the belt and pull on the loose end to tighten the belt. The belt should be placed as low as possible on your hips, not on your waist. If the belt is too high, it could increase the possibility of injury in an accident.

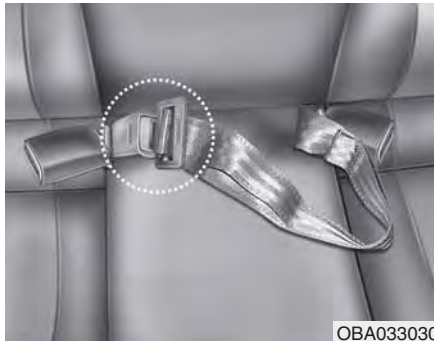

When using the rear center seat belt, the buckle with the “CENTER” mark must be used. (if equipped)



To release the seat belt:

Press the release button (1) on the buckle and remove the metal tab from the buckle.



Pre-tensioner seat belt (if equipped)

Your vehicle is equipped with driver's and front passenger's pre-tensioner seat belts. The purpose of the pre-tensioner is to make sure that the seat belts fit tightly against the occupant's body in certain frontal collisions. The pre-tensioner seat belts can be activated, where the frontal collision is severe enough, together with the air bags.

When the vehicle stops suddenly, or if the occupant tries to lean forward too quickly, the seat belt retractor will lock into position. In certain frontal collisions, the pre-tensioner will activate and pull the seat belt into tighter contact against the occupant's body.

If the system senses excessive seat belt tension on the driver or passenger's seat belt when the pre-tensioner activates, the load limiter inside the pre-tensioner will release some of the pressure on the affected seat belt. (if equipped)

⚠ WARNING

To obtain maximum benefit from a pre-tensioner seat belt:

1. The seatbelt must be worn correctly and adjusted to the proper position. Please read and follow all of the important information and precautions about your vehicle's occupant safety features – including seat belts and air bags – that are provided in this manual.
2. Be sure you and your passengers always wear seat belts properly.

⚠ WARNING

- Pre-tensioners are designed to operate only one time. After activation, pre-tensioner seat belts must be replaced. All seat belts, of any type, should always be replaced after they have been worn during a collision.
- The pre-tensioner seat belt assembly mechanisms become hot during activation. Do not touch the pre-tensioner seat belt assemblies for several minutes after they have been activated.
- Do not hit the pre-tensioner seat belt assemblies.
- Do not attempt to inspect or replace the pre-tensioner seat belts yourself. We recommend that the system be serviced by an authorized HYUNDAI dealer.
- Do not attempt to service or repair the pre-tensioner seat belt system in any manner.

(Continued)

(Continued)

- Improper handling of the pre-tensioner seat belt assemblies, and failure to heed the warnings not to strike, modify, inspect, replace, service or repair the pre-tensioner seat belt assemblies may lead to improper operation or inadvertent activation and serious injury.
- If the vehicle or pre-tensioner seat belt must be discarded, we recommend that you contact an authorized HYUNDAI dealer.

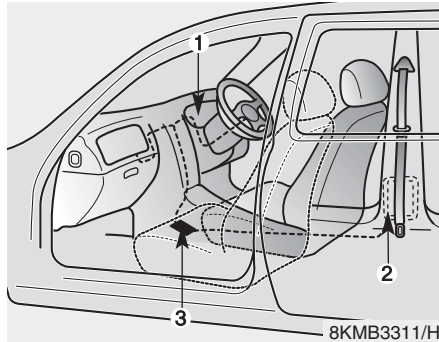

The seat belt pre-tensioner system consists mainly of the following components. Their locations are shown in the illustration:

1. SRS air bag warning light
2. Retractor pre-tensioner assembly
3. SRS control module

* NOTICE

The sensor that activates the SRS air bag is connected with the pre-tensioner seat belts. The SRS air bag warning light on the instrument panel will illuminate for approximately 6 seconds after the ignition switch is placed in the ON position, and then it should turn off. If the pre-tensioner is not working properly, the warning light will illuminate even if the SRS air bag is not malfunctioning. If the warning light does not illuminate, stays illuminated or illuminates when the vehicle is being driven, we recommend the pre-tensioner seat belts and/or SRS air bags be inspected by an authorized HYUNDAI dealer as soon as possible.

* NOTICE

- Both the driver's and front passenger's pre-tensioner seat belts will be activated in certain frontal collisions.
- When the pre-tensioner seat belts are activated, a loud noise may be heard and fine dust, which may appear to be smoke, may be visible in the passenger compartment. These are normal operating conditions and are not hazardous.
- Although it is non-toxic, the fine dust may cause skin irritation and should not be breathed for prolonged periods. Wash all exposed skin areas thoroughly after an accident in which the pre-tensioner seat belts were activated.

Additional seat belt safety precautions

Seat belt use during pregnancy

The seat belt should always be used during pregnancy. The best way to protect your unborn child is to protect yourself by always wearing the seat belt.

Pregnant women should always wear a lap-shoulder seat belt. Place the shoulder belt across your chest, away from your neck. Place the lap belt below your abdomen so that it fits **SNUGLY** across your hips and pelvic bone.

WARNING

To reduce the risk of serious injury or death to an unborn child during an accident, pregnant women should **NEVER** place the lap portion of the seat belt above or over the area of the abdomen where the unborn child is located.

Seat belt use and children

Infant and small children

Most countries have child restraint laws which require children to travel in approved child restraint devices, including booster seats. The age at which seat belts can be used instead of child restraints differs among countries, so you should be aware of the specific requirements in your country, and where you are travelling. Infant and child restraints must be properly placed and installed in a rear seat. For more information refer to the “Child Restraint Systems” in this chapter.

WARNING

ALWAYS properly restrain infants and small children in a child restraint appropriate for the child's height and weight.

To reduce the risk of serious injury or death to a child and other passengers, **NEVER** hold a child in your lap or arms when the vehicle is moving. The violent forces created during an accident will tear the child from your arms and throw the child against the interior of the vehicle.

Small children are best protected from injury in an accident when properly restrained in the rear seat by a child restraint system that meets the requirements of the Safety Standards of your country. Before buying any child restraint system, make sure that it has a label certifying that it meets Safety Standard of your country. The restraint must be appropriate for your child's height and weight. Check the label on the child restraint for this information. Refer to “Child Restraint Systems” in this chapter.

Larger children

Children under age 13 and who are too large for a booster seat must always occupy the rear seat and use the available lap/shoulder belts. A seat belt should lie across the upper thighs and be snug across the shoulder and chest to restrain the child safely. Check belt fit periodically. A child's squirming could put the belt out of position. Children are afforded the most safety in the event of an accident when they are restrained by a proper restraint system and/or seat belts in the rear seat.

If a larger child over age 13 must be seated in the front seat, the child must be securely restrained by the available lap/shoulder belt and the seat should be placed in the rearmost position.

If the shoulder belt portion slightly touches the child's neck or face, try placing the child closer to the center of the vehicle. If the shoulder belt still touches their face or neck they need to be returned to an appropriate booster seat.

WARNING

- Always make sure larger children's seat belts are worn and properly adjusted.
- NEVER allow the shoulder belt to contact the child's neck or face.
- Do not allow more than one child to use a single seat belt.

Transporting an injured person

A seat belt should be used when an injured person is being transported. Consult a physician for specific recommendations.

One person per belt

Two people (including children) should never attempt to use a single seat belt. This could increase the severity of injuries in case of an accident.

Do not lie down

Sitting in a reclined position when the vehicle is in motion can be dangerous. Even when buckled up, the protections of your restraint system (seat belts and/or air bags) is greatly reduced by reclining your seatback.

To reduce the chance of injuries in the event of an accident and to achieve the maximum effectiveness of the restraint system, all passengers should be sitting up and the front and rear seats should be in an upright position when the car is moving. A seat belt cannot provide proper protection if the person is lying down in the rear seat or if the front or rear seats are in a reclined position.

WARNING

- NEVER ride with a reclined seatback when the vehicle is moving.
- Riding with a reclined seatback increases your chance of serious or fatal injuries in the event of a collision or sudden stop.
- Drivers and passengers should always sit well back in their seats, properly belted, and with the seatbacks upright.

Care of seat belts

Seat belt systems should never be disassembled or modified. In addition, care should be taken to assure that seat belts and belt hardware are not damaged by seat hinges, doors or other abuse.

Periodic inspection

All seat belts should be inspected periodically for wear or damage of any kind. Any damaged parts should be replaced as soon as possible.

Keep belts clean and dry

Seat belts should be kept clean and dry. If belts become dirty, they can be cleaned by using a mild soap solution and warm water. Bleach, dye, strong detergents or abrasives should not be used because they may damage and weaken the fabric.

When to replace seat belts

The entire seat belt assembly or assemblies should be replaced if the vehicle has been involved in an accident. This should be done even if no damage is visible. We recommend that you consult an authorized HYUNDAI dealer.

CHILD RESTRAINT SYSTEM (CRS)

WARNING

Always properly restrain children in the rear seats of the vehicle.

Children of all ages are safer when restrained in the rear seat. A child riding in the front passenger seat can be forcefully struck by an inflating air bag resulting in **SERIOUS INJURY** or **DEATH**.

Children under age 13 must always ride in the rear seats and must always be properly restrained to minimize the risk of injury in an accident, sudden stop or sudden maneuver. According to accident statistics, children are safer when properly restrained in the rear seats than in the front seat. Even with air bags, children can be seriously injured or killed. Children too large for a child restraint must use the seat belts provided.

Most countries have child restraint laws which require children to travel in approved child restraint devices. The laws governing the age or height/weight restrictions at which seat belts can be used instead of child restraints differs among countries, so you should be aware of the specific requirements in your country, and where you are traveling.

Child restraint systems must be properly placed and installed in the rear seat. You must use a commercially available child restraint system that meets the requirements of the Safety Standards of your country.

Child restraint systems are generally designed to be secured in a vehicle seat by lap belt or the lap belt portion of a lap/shoulder belt in the rear seats of the vehicle.

Child Restraint System (CRS)

Infants and younger children must be restrained in an appropriate rear-facing or forward-facing CRS that has first been properly secured to the rear seat of the vehicle. Read and comply with the instructions for installation and use provided by the manufacturer of the child restraint.

WARNING

An improperly secured child restraint can increase the risk of **SERIOUS INJURY** or **DEATH** in an accident. Always take the following precautions when using a child restraint system:

- **NEVER** install a child or infant restraint in the front passenger's seat.
- Always properly secure the child restraint to a rear seat of the vehicle.
- Always follow the child restraint system manufacturer's instructions for installation and use.

(Continued)

(Continued)

- Always properly restrain your child in the child restraint.
- Do not use an infant carrier or a child safety seat that "hooks" over a seat-back, it may not provide adequate protection in an accident.
- After an accident, we recommend a HYUNDAI dealer check the child restraint system, seat belts, ISOFIX lower anchorages and top-tether anchorages.

Selecting a Child Restraint System (CRS)

When selecting a CRS for your child, always:

- Make sure the CRS has a label certifying that it meets applicable Safety Standards of your country.
- Select a child restraint system based on your child's height and weight. The required label or the instructions for use typically provide this information.
- Select a child restraint system that fits the vehicle seating position where it will be used.
- Read and comply with the warnings and instructions for installation and use provided with the child restraint system.

Child restraint system types

There are three main types of child restraint systems: rear-facing seats, forward-facing seats, and booster seats. They are classified according to the child's age, height and weight.

Rear-facing child seats

WARNING

NEVER install a child or infant restraint in the front passenger's seat. Placing a rear-facing child restraint in the front seat can result in **SERIOUS INJURY** or **DEATH** if the child restraint is struck by an inflating air bag.

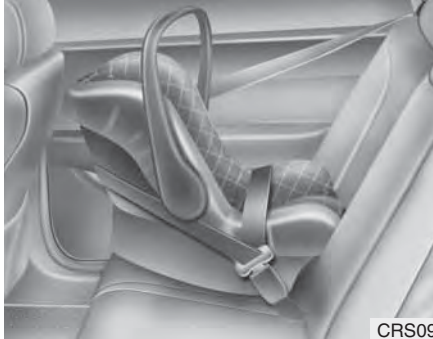

A rear-facing child seat provides restraint with the seating surface against the back of the child. The harness system holds the child in place, and in an accident, acts to keep the child positioned in the seat and reduce the stress to the fragile neck and spinal cord.

All children under age one must always ride in a rear-facing infant child restraint.

Convertible and 3-in-1 child seat typically have higher height and weight limits for the rear-facing position, allowing you to keep your child rear-facing for a longer period of time.

Continue to use a rear-facing child seat for as long as your child will fit within the height and weight limits allowed by the child seat manufacturer. It's the best way to keep them safe. Once your child has outgrown the rear-facing child restraint, your child is ready for a forward-facing child restraint with a harness.



Forward-facing child seats

A forward-facing child seat provides seats for the child's body with a harness. Keep children in a forward-facing child seat with a harness until they reach the top height or weight limit allowed by your child restraint's manufacturer.

Once your child outgrows the forward-facing child restraint, your child is ready for a booster seat.

Booster seats

A booster seat is a restraint designed to improve the fit of the vehicle's seat belt system. A booster seat positions the seat belt so that it fits properly over the lap of your child. Keep your child in a booster seat until they are big enough to sit in the seat without a booster and still have the seat belt fit properly.

For a seat belt to fit properly, the lap belt must lie snugly across the upper thighs, not the stomach. The shoulder belt should lie snug across the shoulder and chest and not across the neck or face. Children under age 13 must always ride in the rear seats and must always be properly restrained to minimize the risk of injury.

Installing a Child Restraint System (CRS)

WARNING

Before installing your child restraint system always:

- Read and follow the instructions provided by the manufacturer of the child restraint.
- Read and follow the instructions regarding child restraint systems in this manual.

Failure to follow all warnings and instructions could increase the risk of the SERIOUS INJURY or DEATH if an accident occurs.

After selecting a proper child seat for your child, check to make sure it fits properly in your vehicle. Follow the instructions provided by the manufacturer when installing the child seat. Note these general steps when installing the seat to your vehicle:

- **Properly secure the child restraint system to the vehicle.** All child seats must be secured to the vehicle with the lap belt or lap part of a lap/shoulder belt.
- **Make sure the child restraint system is firmly secured.** After installing a child seat to the vehicle, push and pull the seat forward and from side-to-side to verify that it is securely attached to the seat. A child seat secured with a seat belt should be installed as firmly as possible. However, some side-to-side movement can be expected.

WARNING

A child restraint system in a closed vehicle can become very hot. To prevent burns, check the seating surface and buckles before placing your child in the child restraint.

Securing a child restraint system with a lap belt or lap/shoulder belt

All child restraint system must be secured to a vehicle rear seat with the lap belt or the lap part of a lap/shoulder belt.

⚠ WARNING

ALWAYS place a rear-facing child restraint system in the rear seat of the vehicle.

Placing a rear-facing child restraint system in the front seat can result in serious injury or death if the child restraint system is struck by an inflating air bag.



Installing a child restraint system with a lap belt

To install a child restraint system on the center rear seats, do the following:

1. Place the child restraint system on the center rear seat and route the lap belt through the restraint, following the restraint manufacturer's instructions.
Be sure the seat belt webbing is not twisted.
2. Fasten the lap belt latch into the buckle. Listen for the distinct "click" sound.
3. Adjust the lap belt for a snug hold on the child restraint system by pulling the loose end of the belt.

4. Push and pull on the child restraint system to confirm that the seat belt is holding it firmly in place.

To remove the child restraint system, press the release button on the buckle and then pull the lap belt out of the restraint.

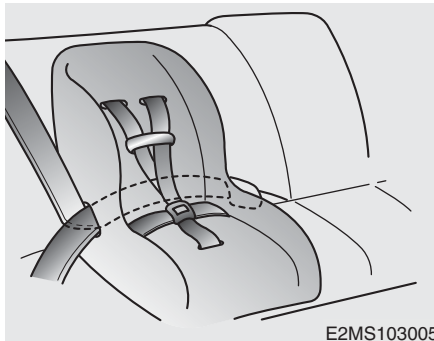

Installing a child restraint system with a lap/shoulder belt

To install a child restraint system on the rear seats, do the following:

1. Place the child restraint system on a rear seat and route the lap/shoulder belt around or through the restraint, following the restraint manufacturer's instructions.

Be sure the seat belt webbing is not twisted.

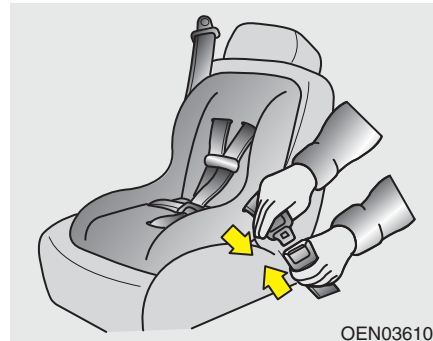

2. Fasten the lap/shoulder belt latch into the buckle. Listen for the distinct "click" sound.

*** NOTICE**

Position the release button so that it is easy to access in case of an emergency.

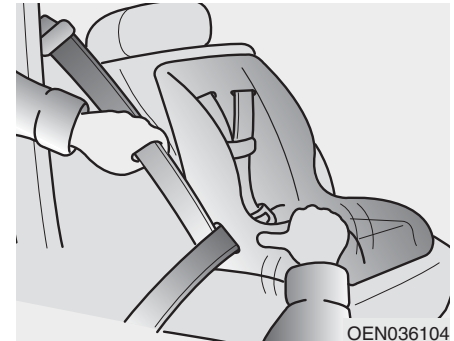

3. Remove as much slack from the belt as possible by pushing down on the child restraint system while feeding the shoulder belt back into the retractor.
4. Push and pull on the child restraint system to confirm that the seat belt is holding it firmly in place.

To remove the child restraint system, press the release button on the buckle and then pull the lap/shoulder belt out of the restraint and allow the seat belt to retract fully.

Safety system of your vehicle

Child seat restraint suitability for seat position using the seat belt

Use child safety seats that have been officially approved and are appropriate for your children. When using the child safety seats, refer to the following table.

Age group	Seating position			
	Co Driver	Rear Left	Rear Right	Rear center
0 : Up to 10 kg	-	U	U	-
0+ : Up to 13 kg	-	U	U	-
I : 9 kg to 18 kg	-	U	U	-
II : 15 kg to 25 kg	-	U	U	-
III : 22 kg to 36 kg	-	U	U	-

U : Universal Category

UF: Universal Front Facing

Note:- UF shall not be used for mass group 0 & 0+.

AIR BAG - SUPPLEMENTAL RESTRAINT SYSTEM

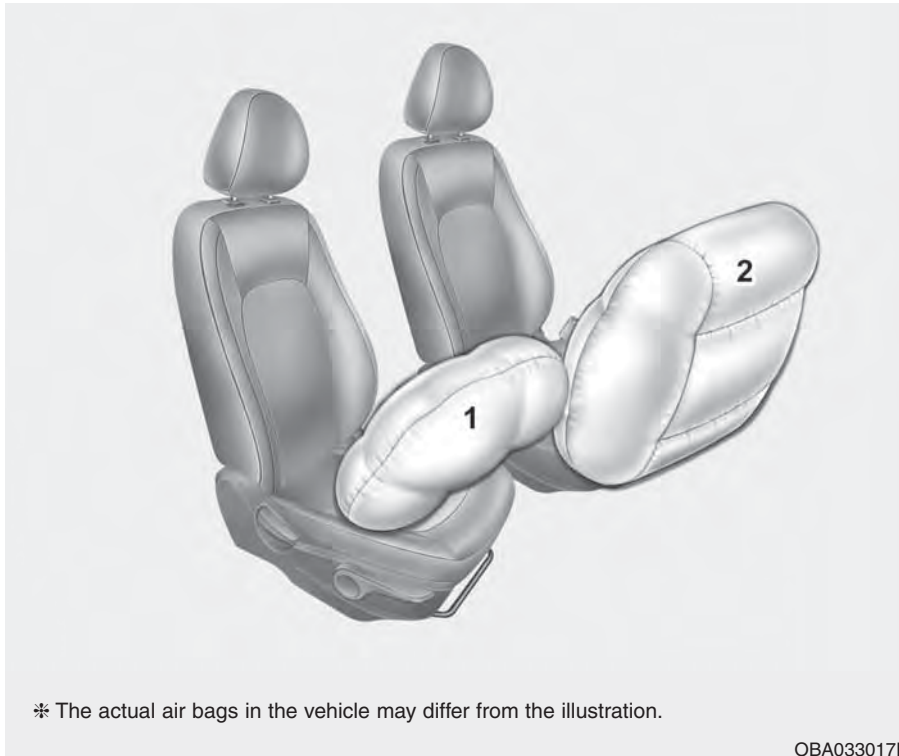

- (1) Driver's front air bag*
- (2) Passenger's front air bag *

* : if equipped

⚠ WARNING

- Even in vehicles with air bags, you and your passengers must always wear the safety belts provided in order to minimize the risk and severity of injury in the event of a collision or rollover.
- SRS and pretensioners contain explosive chemicals. If scraping a vehicle without removing SRS and pretensioners from a vehicle, it may cause fire. Before scraping a vehicle, we recommend that you contact an authorized HYUNDAI dealer.
- Keep the SRS parts and wirings away from water or any liquid. If the SRS components are inoperative due to exposure to water or liquids, it may cause fire or severe injury.

The front air bags are designed to supplement the three-point seat belts. For these air bags to provide protection, the seat belts must be worn at all times when driving.

You can be severely injured or killed in an accident if you are not wearing a seat belt. Air bags are designed to supplement seat belts, but do not replace them. Also, air bags are not designed to deploy in every collision. In some accidents, the seat belts are the only restraint protecting you.

WARNING - AIR BAG SAFETY PRECAUTIONS

ALWAYS use seat belts and child restraints - every trip, every time, everyone! Even with air bags, you can be seriously injured or killed in a collision if you are improperly belted or not wearing your seat belt when the air bag inflates.

NEVER place a child in any child restraint or booster seat in the front passenger seat. An inflating air bag could forcefully strike the infant or child causing serious or fatal injuries.

ABC - Always Buckle Children under age 13 in the back seat. It is the safest place for children of any age to ride. If a child age 13 or older must be seated in the front seat, he or she must be properly belted and the seat should be moved as far back as possible.

All occupants should sit upright with the seatback in an upright position, centered on the seat cushion with their seat belt on, legs comfortably extended and their feet on the floor until the vehicle is parked and the engine is turned off. If an occupant is out of position during an accident, the rapidly deploying air bag may forcefully contact the occupant causing serious or fatal injuries.

You and your passengers should never sit or lean unnecessarily close to the air bags or lean against the door or center console.

Move your seat as far back as possible from front air bags, while still maintaining control of the vehicle. It is recommended that drivers allow at least 25 cm (10 in.) between the center of the steering wheel and the chest.

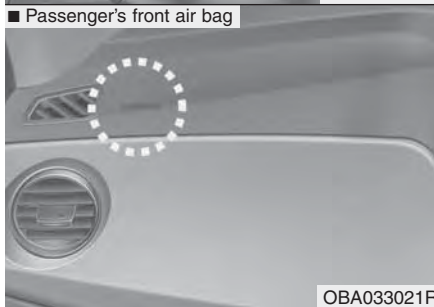

The SRS consists of air bags which are located in the center of the steering wheel and the passenger's side front panel pad above the glove box.

The air bags are labeled with the letters "AIR BAG" embossed on the pad covers.

The purpose of the SRS is to provide the vehicle's driver and front passengers with additional protection than that offered by the seat belt system alone in case of a frontal impact of sufficient severity.

⚠ WARNING

To reduce the risk of serious injury or death from an inflating front air bags, take the following precautions:

- Seat belts must be worn at all times to help keep occupants positioned properly.
- Adjust the front passenger's and driver's seats as far to the rear as possible while allowing you to maintain full control of the vehicle.
- Never lean against the door or center console.

(Continued)

(Continued)

- Do not allow the front passenger to place their feet or legs on the dashboard.
- Do not allow the passenger to ride in the front seat when the front passenger's air bag OFF indicator is illuminated.
- No objects (such as crash pad cover, cellular phone holder, cup holder, perfume or stickers) should be placed over or near the air bag modules on the steering wheel, instrument panel, windshield glass, and the front passenger's panel above the glove box. Such objects could cause harm if the vehicle is in a crash severe enough to cause the air bags to deploy.
- Do not attach any objects on front windshield and inside mirror.

Where are the air bags?

Driver's and passenger's front air bags (if equipped)

Your vehicle is equipped with a Supplemental Restraint System (SRS) and lap/shoulder belts at both the driver and passenger seating positions.

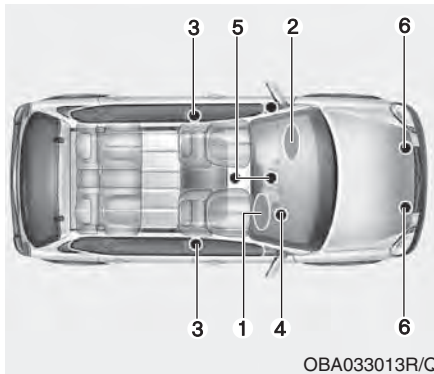

How does the air bags system operate?

The SRS consists of the following components:

1. Driver's front air bag module*
2. Passenger's front air bag module*
3. Pre-tensioner seatbelt system*
4. Air bag warning light*
5. SRS control module (SRSCM)*
6. Front impact sensors*

*: if equipped

The SRSCM continually monitors all SRS components while the ignition switch is ON to determine if a crash impact is severe enough to require air bag deployment or pre-tensioner seat belt deployment.



SRS warning light

The SRS (Supplement Restraint System) air bag warning light on the instrument panel displays the air bag symbol depicted in the illustration. The system checks the air bag electrical system for malfunctions. The light indicates that there is a potential problem with your air bag system.

The SRS air bag warning light on the instrument panel will illuminate for about 6 seconds after the ignition switch is turned to the ON position, after which the air bag warning light should go out.

WARNING

If your SRS malfunctions, the air bag may not inflate properly during an accident increasing the risk of serious injury or death.

If any of the following conditions occur, your SRS is malfunctioning:

- The light does not turn on for approximately six seconds when the ignition switch is placed in the ON position.
- The light stays on after illuminating for approximately six seconds.
- The light comes on while the vehicle is in motion.
- The light blinks when the engine is running.

We recommend that an authorized HYUNDAI dealer inspect the SRS as soon as possible if any of these conditions occur.

During a moderate to severe frontal collision, sensors will detect the vehicle's rapid deceleration. If the rate of deceleration is high enough, the control unit will inflate the front air bags.

The front air bags help protect the driver and front passenger by responding to frontal impacts in which seat belts alone cannot provide adequate restraint. When needed, the side air bags help provide protection in the event of a side impact or rollover by supporting the side upper body area.

- Air bags are activated (able to inflate if necessary) only when the ignition switch is in the ON position.
- Air bags inflate in the event of a severe frontal or side collision to help protect the occupants from serious physical injury.

- There is no single speed at which the air bags will inflate. Generally, air bags are designed to inflate based upon the severity of a collision and its direction. These two factors determine whether the sensors produce an electronic deployment/inflation signal.
- Air bag deployment depends on a number of factors including vehicle speed, angles of impact and the density and stiffness of the vehicles or objects which your vehicle impacts during a collision. The determining factors are not limited to those mentioned above.
- The front air bags will completely inflate and deflate in an instant. It is virtually impossible for you to see the air bags inflate during an accident. It is much more likely that you will simply see the deflated air bags hanging out of their storage compartments after the collision.

Safety system of your vehicle

- To help provide protection, the air bags must inflate rapidly. The speed of air bag inflation is a consequence of extremely short time in which to inflate the air bag between the occupant and the vehicle structures before the occupant impacts those structures. This speed of inflation reduces the risk of serious or life-threatening injuries and is thus a necessary part of air bag design. However, the rapid air bag inflation can also cause injuries which can include facial abrasions, bruises and broken bones because the inflation speed also causes the air bags to expand with a great deal of force.

- There are even circumstances under which contact with the air bag can cause fatal injuries, especially if the occupant is positioned excessively close to the air bag.

You can take steps to reduce the risk of being injured by an inflating air bag. The greatest risk is sitting too close to the air bag. An air bag needs about 25 cm (10 in.) of space to inflate. It is recommended that drivers allow at least 25 cm (10 in.) between the center of the steering wheel and the chest.



When the SRSCM detects a sufficiently severe impact to the front of the vehicle, it will automatically deploy the front air bags.

■ Driver's front air bag (2)

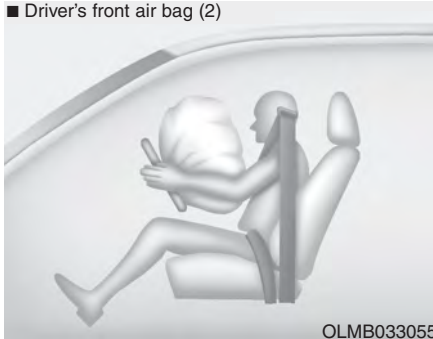

Upon deployment, tear seams molded directly into the pad covers will separate under pressure from the expansion of the air bags. Further opening of the covers allows full inflation of the air bags.

A fully inflated air bag, in combination with a properly worn seat belt, slows the driver's or the passenger's forward motion, reducing the risk of head and chest injury.

■ Driver's front air bag (3)

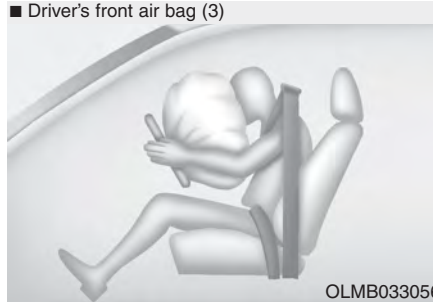

■ Passenger's front air bag



After complete inflation, the air bag immediately starts deflating, enabling the driver to maintain forward visibility and the ability to steer or operate other controls.

⚠ WARNING

To prevent objects from becoming dangerous projectiles when the passenger's air bag inflates:

- Do not install or place any objects (drink holder, CD holder, stickers, etc.) on the front passenger's panel above the glove box where the passenger's air bag is located.
- Do not install a container of liquid air freshener near the instrument cluster or on the instrument panel surface.

What to expect after an air bag inflates

After a front air bag inflates, it will deflate very quickly. Air bag inflation will not prevent the driver from seeing out of the windshield or being able to steer.

WARNING

After an air bag inflates, take the following precautions:

- Open your windows and doors as soon as possible after impact to reduce prolonged exposure to the smoke and powder released by the inflating air bag.
- Do not touch the air bag storage area's internal components immediately after an air bag has inflated. The parts that come into contact with an inflating air bag may be very hot.
- Always wash exposed skin areas thoroughly with lukewarm water and mild soap.
- We recommend that an authorized HYUNDAI dealer replace the air bag immediately after deployment. Air bags are designed to be used only once.

Noise and smoke from inflating air bag

When the air bags inflate, they make a loud noise and they leave smoke and powder in the air inside of the vehicle. This is normal and is a result of the ignition of the air bag inflator. After the air bag inflates, you may feel substantial discomfort in breathing because of the contact of your chest with both the seat belt and the air bag, as well as from breathing the smoke and powder. The powder may aggravate asthma for some people. If you experience breathing problems after an air bag deployment, seek medical attention immediately.

Though the smoke and powder are non-toxic, they may cause irritation to the skin, eyes, nose, throat, etc. If this is the case, wash and rinse with cold water immediately and seek medical attention if the symptoms persist.



OYDESA2042

Do not install a child restraint on the front passenger seat

Never install a child restraint in the front passenger's seat. An inflating air bag can forcefully strike a child or restraint resulting in serious or fatal injury.

⚠ WARNING

NEVER place a rear-facing or front-facing child restraint in the front passenger's seat of the vehicle. An inflating frontal air bag could forcefully strike a child resulting in serious injury or death. Always properly restrain children in an appropriate child restraint in the rear seat of the vehicle.

Why didn't my air bag go off in a collision? (Air bags are not designed to inflate in every collision.)

There are certain types of accidents in which the air bag would not be expected to provide additional protection. These include rear impacts, second or third collisions in multiple impact accidents, as well as low speed impacts. Damage to the vehicle indicates a collision energy absorption, and is not an indicator of whether or not an air bag should have inflated.

Air bag collision sensors (if equipped)

⚠ WARNING

To reduce the risk of an air bag deploying unexpectedly and causing serious injury or death:

- Do not hit or allow any objects to impact the locations where air bags or sensors are installed.
- Do not perform maintenance on or around the air bag sensors. If the location or angle of the sensors is altered, the air bags may deploy when they should not or may not deploy when they should.
- Do not install bumper guards or replace the bumper with a non-genuine part. This may adversely affect the collision and air bag deployment performance.
- We recommend that all repairs are conducted by an authorized HYUNDAI dealer.

Safety system of your vehicle

(1) SRS control module (if equipped)

(2) Front impact sensor (if equipped)



OBA037014R/OBA033015R/OBA037016



Air bag inflation conditions

Front air bag

Front air bags are designed to inflate in a frontal collision depending on the intensity, speed, or angles of impact of the front collision.

1

Although the driver's and front passenger's air bags are designed to inflate only in frontal collisions, they also may inflate in other types of collisions if the front impact sensors detect a sufficient impact.

If the vehicle chassis is impacted by bumps or objects on unimproved roads, the air bags may deploy. Drive carefully on unimproved roads or on surfaces not designed for vehicle traffic to prevent unintended air bag deployment.



Air bag non-inflation conditions

In certain low-speed collisions the air bags may not deploy. The air bags are designed not to deploy in such cases because they may not provide benefits beyond the protection of the seat belts.

Safety system of your vehicle



Front air bags are not designed to inflate in rear collisions, because occupants are moved backward by the force of the impact. In this case, inflated air bags would not provide any additional benefit.

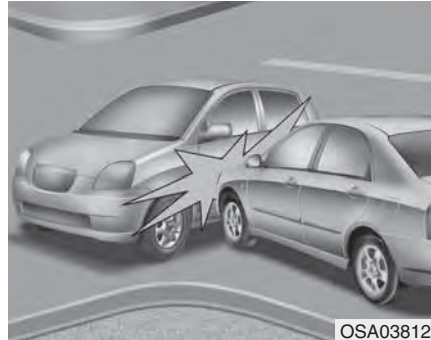

Front air bags may not inflate in side impact collisions, because occupants move in the direction of the collision, and thus in side impacts, front air bag deployment would not provide additional occupant protection.

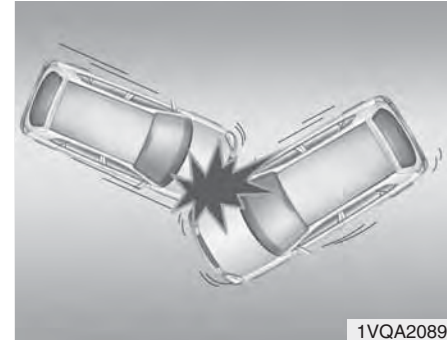

In an angled collision, the force of impact may direct the occupants in a direction where the air bags would not be able to provide any additional benefit, and thus the sensors may not deploy any air bags.

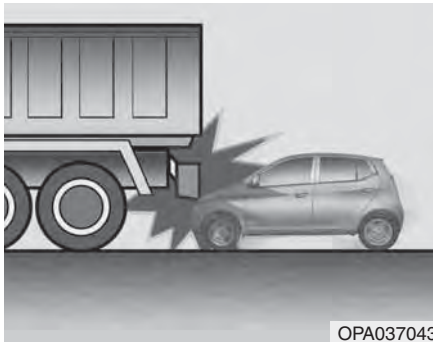

Just before impact, drivers often brake heavily. Such heavy braking lowers the front portion of the vehicle causing it to “ride” under a vehicle with a higher ground clearance. Air bags may not inflate in this “under-ride” situation because deceleration forces that are detected by sensors may be significantly reduced by such “underride” collisions.

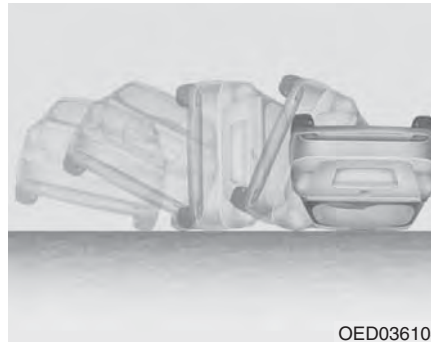

Air bags may not inflate in rollover accidents because air bag deployment could not provide protection to the occupants. However, side impact and curtain air bags may inflate when the vehicle is rolled over by a side impact collision, if the vehicle is equipped with side impact air bags and curtain air bags. Also, if the vehicle is equipped with a rollover sensor, side impact and curtain air bags may inflate in a rollover.

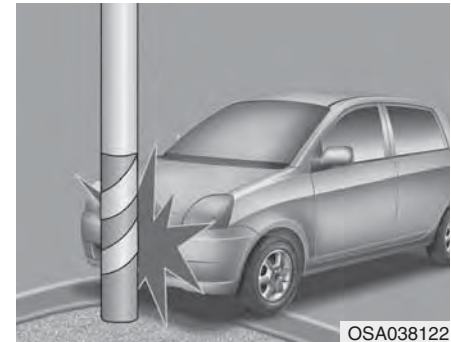

Air bags may not inflate if the vehicle collides with objects such as utility poles or trees, where the point of impact is concentrated and the collision energy is absorbed by the vehicle structure.

SRS care

The SRS is virtually maintenance-free and there are no parts you can safely service by yourself. If the SRS air bag warning light does not illuminate when the ignition switch is in the ON position, or continuously remains on, we recommend that the system be immediately inspected by an authorized HYUNDAI dealer.

We recommend any work on the SRS system, such as removing, installing, repairing, or any work on the steering wheel and the front passenger's panel be performed by an authorized HYUNDAI dealer. Improper handling of the SRS system may result in serious personal injury.

WARNING

To reduce the risk of serious injury or death, take the following precautions:

- Do not attempt to modify or disconnect the SRS components or wiring, including the addition of any kind of badges to the pad covers or modifications to the body structure.
- Do not place objects over or near the air bag modules on the steering wheel, instrument panel, or the front passenger's panel above the glove box.
- Clean the air bag pad covers with a soft cloth moistened with plain water. Solvents or cleaners could adversely affect the air bag covers and proper deployment of the system.
- We recommend that inflated air bags be replaced by an authorized HYUNDAI dealer.

(Continued)

(Continued)

- If components of the air bag system must be discarded, or if the vehicle must be scrapped, certain safety precautions must be observed. Consult an authorized HYUNDAI dealer for the necessary information. Failure to follow these precautions could increase the risk of personal injury.

Additional safety precautions

Passengers should not move out of or change seats while the vehicle is moving. A passenger who is not wearing a seat belt during a crash or emergency stop can be thrown against the inside of the vehicle, against other occupants, or be ejected from the vehicle.

Do not use any accessories on seat belts. Devices claiming to improve occupant comfort or reposition the seat belt can reduce the protection provided by the seat belt and increase the chance of serious injury in a crash.

Do not modify the front seats.

Modification of the front seats could interfere with the operation of the supplemental restraint system sensing components or side air bags.

Do not place items under the front seats. Placing items under the front seats could interfere with the operation of the supplemental restraint system sensing components and wiring harnesses.

Adding equipment to or modifying your air bag equipped vehicle

If you modify your vehicle by changing your vehicle's frame, bumper system, front end or side sheet metal or ride height, this may affect the operation of your vehicle's air bag system.

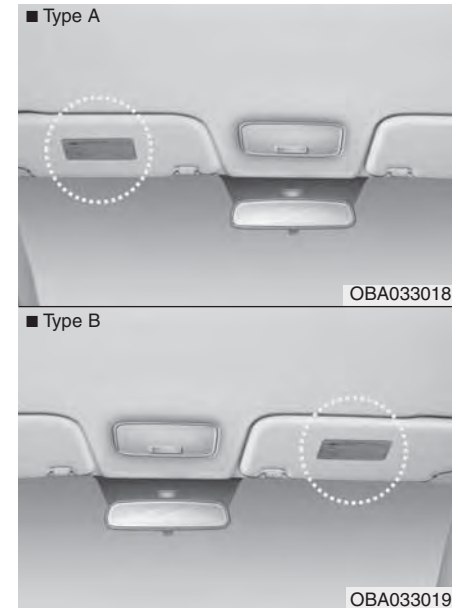

Air bag warning labels (if equipped)

Air bag warning labels are attached to alert the driver and passengers of potential risks of the air bag system. Be sure to read all of the information about the air bags that are installed on your vehicle in this Owners Manual.

Features of your vehicle

KEYS	6-3	TAILGATE	6-22
• Record your key number	6-3	• Opening the tailgate	6-22
• Key operations.....	6-3	• Closing the tailgate	6-22
• Immobilizer system.....	6-4	WINDOWS	6-23
REMOTE KEYLESS ENTRY	6-6	• Power windows	6-24
• Remote keyless entry system operations.....	6-6	• Manual windows	6-27
• Transmitter precautions	6-7	HOOD	6-28
• Battery replacement	6-8	• Opening the hood	6-28
SMART KEY	6-10	• Closing the hood	6-29
• Smart key function	6-10	FUEL FILLER LID	6-30
• Smart key precautions	6-11	• Opening the fuel filler lid	6-30
• Door lock/unlock in an emergency situation	6-12	• Closing the fuel filler lid.....	6-30
THEFT-ALARM SYSTEM	6-13	STEERING WHEEL	6-33
• Armed stage.....	6-13	• Electric power steering.....	6-33
• Theft-alarm stage	6-14	• Tilt steering	6-33
• Disarmed stage.....	6-14	• Horn	6-34
DOOR LOCKS	6-15	MIRRORS	6-35
• Operating door locks from outside the vehicle	6-15	• Inside rearview mirror	6-35
• Operating door locks from inside the vehicle.....	6-16	• Outside rearview mirror	6-35
• Impact sensing door unlock system.....	6-18	INSTRUMENT CLUSTER	6-39
• Speed sensing door lock system.....	6-18	• Gauges	6-40
• Child-protector rear door lock	6-19	• Warnings and indicators.....	6-44
TRUNK	6-20		
• Opening the trunk.....	6-20		
• Closing the trunk.....	6-21		

REARVIEW CAMERA	6-53
HAZARD WARNING FLASHER	6-53
LIGHTING	6-54
• Battery saver function	6-54
• Lighting control	6-54
• High beam operation	6-55
• Flashing headlights	6-55
• Turn signals and lane change signals	6-56
• Front fog light	6-56
• Headlight levelling device	6-57
• Daytime running light	6-57
WIPERS AND WASHERS	6-58
• Windshield wipers	6-58
• Windshield washers	6-59
• Rear window wiper and washer switch	6-59
INTERIOR LIGHT	6-60
• Room lamp	6-60
• Luggage room lamp	6-61
DEFROSTER	6-62
• Rear window defroster	6-62
MANUAL CLIMATE CONTROL SYSTEM	6-63
• Heating and air conditioning	6-64
• Climate control air filter	6-70
• Checking the amount of air conditioner refrigerant and compressor lubricant	6-70
AUTOMATIC CLIMATE CONTROL SYSTEM	6-71
• Automatic climate control	6-72
• Manual heating and air conditioning	6-73
WINDSHIELD DEFROSTING AND DEFOGGING	6-78
• Manual climate control system	6-78
• Automatic climate control system	6-79
STORAGE COMPARTMENT	6-80
• Center console storage	6-80
• Glove box	6-80
• Cool box	6-81
INTERIOR FEATURES	6-82
• Cigarette lighter	6-82
• Ashtray	6-82
• Cup holder	6-83
• Sunvisor	6-84
• Power outlet	6-84
• Floor mat anchor(s)	6-85
• Cargo area cover	6-85
AUDIO SYSTEM	6-86
• Antenna	6-86
• Audio remote control	6-87
• Aux, USB and iPod	6-88

KEYS

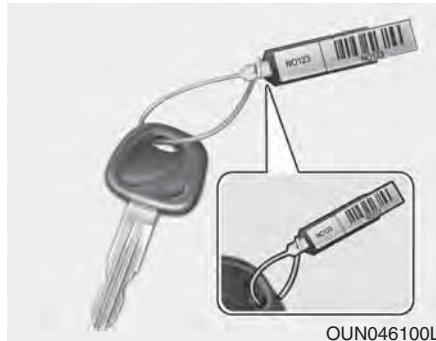

Record your key number

The key code number is stamped on the bar code tag attached to the key set. Should you lose your keys, we recommend that you contact an authorized HYUNDAI dealer. Remove the bar code tag and store it in a safe place. Also, record the code number and keep it in a safe and handy place, but not in the vehicle.



Key operations

- Used to start the engine.
- Used to lock and unlock the doors (or tailgate/trunk).

⚠ WARNING - Ignition key

Leaving children unattended in a vehicle with the ignition key is dangerous even if the key is not in the ignition switch. Children copy adults and they could place the key in the ignition switch. The ignition key would enable children to operate power windows or other controls, or even make the vehicle move, which could result in serious bodily injury or even death. Never leave the keys in your vehicle with unsupervised children.

⚠ WARNING

Use only HYUNDAI original parts for the ignition key in your vehicle. If an aftermarket key is used, the ignition switch may not return to ON after START. If this happens, the starter will continue to operate causing damage to the starter motor and possible fire due to excessive current in the wiring.

Immobilizer system (if equipped)

■ Type A

Your vehicle may be equipped with an electronic engine immobilizer system to reduce the risk of unauthorized vehicle use.

Your immobilizer system is comprised of a small transponder in the ignition key and electronic devices inside the vehicle.

With the immobilizer system, whenever you insert your ignition key into the ignition switch and turn it to ON, it checks and determines and verifies if the ignition key is valid or not.

If the key is determined to be valid, the engine will start.

If the key is determined to be invalid, the engine will not start.

To deactivate the immobilizer system:

Insert the ignition key into the key cylinder and turn it to the ON position.

To activate the immobilizer system:

Turn the ignition key to the OFF position. The immobilizer system activates automatically. Without a valid ignition key for your vehicle, the engine will not start.

WARNING

In order to prevent theft of your vehicle, do not leave spare keys anywhere in your vehicle. Your immobilizer password is a customer unique password and should be kept confidential. Do not leave this number anywhere in your vehicle.

* NOTICE

When starting the engine, do not use the key with other immobilizer keys around. Otherwise the engine may not start or may stop soon after it starts. Keep each key separate in order to avoid a starting malfunction.

CAUTION

Do not put metal accessories near the ignition switch.

Metal accessories may interrupt the transponder signal and may prevent the engine from starting.

* NOTICE

If you need additional keys or lose your keys, we recommend that you consult an authorized HYUNDAI dealer.

CAUTION

The transponder in your ignition key is an important part of the immobilizer system. It is designed to give years of trouble-free service, however you should avoid exposure to moisture, static electricity and rough handling. Immobilizer system malfunction could occur.

CAUTION

Do not change, alter or adjust the immobilizer system because it could cause the immobilizer system to malfunction. We recommend that the system be serviced by an authorized HYUNDAI dealer.

Malfunctions caused by improper alterations, adjustments or modifications to the immobilizer system are not covered by your vehicle manufacturer warranty.

■ **Type B**

Your vehicle is equipped with an electronic engine immobilizer system to reduce the risk of unauthorized vehicle use.

Your immobilizer system is comprised of a small transponder in the smart key and electronic devices inside the vehicle.

With the immobilizer system, whenever you turn the engine start/stop button to the ON position by pressing the button while carrying the smart key, it checks and determines and verifies if the smart key is valid or not.

If the key is determined to be valid, the engine will start.

If the key is determined to be invalid, the engine will not start.

To deactivate the immobilizer system:

Turn the engine start/stop button to the ON position by pressing the button while carrying the smart key.

To activate the immobilizer system:

Turn the engine start/stop button to the OFF position. The immobilizer system activates automatically. Without a valid smart key for your vehicle, the engine will not start.

 **WARNING**

In order to prevent theft of your vehicle, do not leave spare keys anywhere in your vehicle. Your Immobilizer password is a customer unique password and should be kept confidential. Do not leave this number anywhere in your vehicle.

*** NOTICE**

When starting the engine, do not use the key with other immobilizer keys around. Otherwise the engine may not start or may stop soon after it starts. Keep each key separate in order to avoid a starting malfunction.

 **CAUTION**

Do not put metal accessories near the smart key. The engine may not start because the metal accessories may interrupt the transponder signal from transmitting normally.

*** NOTICE**

If you need additional keys or lose your keys, we recommend that you consult an authorized HYUNDAI dealer.

 **CAUTION**

The transponder in your smart key is an important part of the immobilizer system. It is designed to give years of trouble-free service, however you should avoid exposure to moisture, static electricity and rough handling. Immobilizer system malfunction could occur.

 **CAUTION**

Do not change, alter or adjust the immobilizer system because it could cause the immobilizer system to malfunction. We recommend that the system be serviced by an authorized HYUNDAI dealer. Malfunctions caused by improper alterations, adjustments or modifications to the immobilizer system are not covered by your vehicle manufacturer warranty.

REMOTE KEYLESS ENTRY (IF EQUIPPED)

■ Remote key



OBA047263

■ Smart key



OBA043029

Remote keyless entry system operations

Remote key

- To unfold the key, press the release button then the key will unfold automatically.
- To fold the key, fold the key manually while pressing the release button.

⚠ CAUTION

Do not fold the key without pressing the release button. This may damage the key.

Smart key

- To remove the mechanical key, press and hold the release button (1) and remove the mechanical key(2).
- To reinstall the mechanical key, put the key into the hole and push it until a click sound is heard.

■ Remote key

- Type A



OHA041003/Q

- Type B



OHG040006L

■ Smart key



OBA043222IN

Lock (1)

1. Close all doors.
2. Press the lock button.
3. The hazard warning light will blink once to indicate that all doors are locked (the engine hood and tailgate/trunk must be closed).

*** NOTICE**

The doors will not lock if a door is opened.

Unlock (2)

1. Press the unlock button.
2. The hazard warning lights will blink twice to indicate that all doors are unlocked.

Tailgate/trunk unlock (3)

1. Press the tailgate/trunk unlock button for more than 1 second.
2. The hazard warning light will blink twice to indicate the tailgate/trunk is unlocked.

*** NOTICE**

- After unlocking the tailgate/trunk, the tailgate/trunk will lock automatically unless it is opened within 30 seconds.
- Once the tailgate/trunk is opened and then closed, the tailgate/trunk will lock automatically.
- The word "HOLD" is written on the button to inform you that you must press and hold the button.

Transmitter precautions*** NOTICE**

The transmitter will not work if any of following occurs:

- The ignition key is in the ignition switch.
- You exceed the operating distance limit (about 10 m [30 feet]).
- The battery in the transmitter is weak.
- Other vehicles or objects may be blocking the signal.
- The weather is extremely cold.
- The transmitter is close to a radio transmitter such as a radio station or an airport which can interfere with normal operation of the transmitter.

When the transmitter does not work correctly, open and close the door with the ignition key. If you have a problem with the transmitter, we recommend that you contact an authorized HYUNDAI dealer.

(Continued)

(Continued)

- If the transmitter is in close proximity to your cell phone or smart phone, the signal from the transmitter could be blocked by normal operation of your cell phone or smart phone. This is especially important when the phone is active such as making call, receiving calls, text messaging, and/or sending/receiving emails. Avoid placing the transmitter and your cell phone or smart phone in the same pants or jacket pocket and maintain adequate distance between the two devices.

CAUTION

Keep the transmitter away from water or any liquid and fire. If the inside of the transmitter gets damp (due to drinks or moisture), or is heated, internal circuit may malfunction, excluding the car from the warranty.

CAUTION

Changes or modifications not expressly approved by the party responsible for compliance could void the user's authority to operate the equipment. If the keyless entry system is inoperative due to changes or modifications not expressly approved by the party responsible for compliance, it will not be covered by your manufacturer's vehicle warranty.



Battery replacement

Type A

The transmitter uses a 3 volt lithium battery which will normally last for several years. When replacement is necessary, use the following procedure.

1. Insert a slim tool into the slot and gently pry open the transmitter center cover.

2. Replace the battery with a new one. When replacing the battery, make sure the battery positive "+" symbol faces up as indicated in the illustration.
3. Install the battery in the reverse order of removal.

For transmitter replacement, we recommend that you contact an authorized HYUNDAI dealer.



Type B

The remote key uses a 3 volt lithium battery which will normally last for several years. When replacement is necessary, use the following procedure.

1. Turn the screw (1) counterclockwise using a philips head screwdriver until the screw gets loose.
2. Insert a slim tool into the slot and gently pry open the remote key cover.

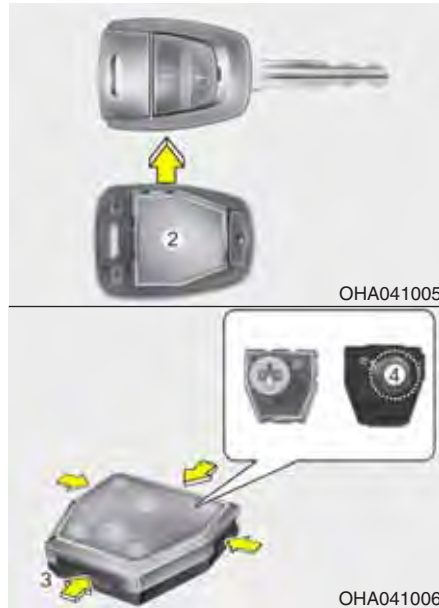

3. Open the inner remote key cover (2) by removing the hook from the slots (3).
4. Replace the battery (4) with a new battery (CR1220).
5. Install the battery in the reverse order of removal.

For remote key replacement, see an authorized HYUNDAI dealer for remote key reprogramming.

⚠ CAUTION

- *The remote key and smart key is designed to give you years of trouble-free use, however it can malfunction if exposed to moisture or static electricity. If you are unsure how to use your remote key and smart key or replace the battery, contact an authorized HYUNDAI dealer.*
- *Using the wrong battery can cause the remote key and smart key to malfunction. Be sure to use the correct battery.*
- *To avoid damaging the remote key and smart key, do not drop it, get it wet, or expose it to heat or sunlight.*

⚠ CAUTION

An inappropriately disposed battery can be harmful to the environment and human health. Dispose the battery according to your local law(s) or regulation.

SMART KEY (IF EQUIPPED)



Smart key function

1. Door lock
2. Door unlock
3. Tailgate/trunk unlock

With a smart key, you can lock or unlock a door and tailgate/trunk and even start the engine without inserting the key.

The functions of the buttons on a smart key are similar to the remote keyless entry. Refer to the “Remote keyless entry” in this section.



Carrying the smart key, you may lock and unlock the vehicle doors and tailgate/trunk.

Also, you may start the engine. Refer to the following, for more details.

Locking

1. Carry the smart key.
2. Close all doors.
3. Press the button of the outside door handle.
4. The hazard warning lights will blink once (the engine hood and tailgate/trunk must be closed).
5. Make sure that doors are locked by pulling the outside door handle.

* NOTICE

- The button will only operate when the smart key is within 0.7 m (28 in.) from the outside door handle.
- Even though you press the outside door handle button, the doors will not lock and the chime will sound for 3 seconds if any of following occur:
 - The smart key is in the vehicle.
 - The engine start/stop button is in ACC or ON position.
 - Any door except the tailgate/trunk is opened.

Unlocking

1. Carry the smart key.
2. Press the button of the front outside door handle.
3. All doors will unlock and the hazard warning lights will blink twice.

* NOTICE

- The button will only operate when the smart key is within 0.7 m (28 in.) from the outside door handle.
- When the smart key is recognized in the area of 0.7 m (28 in.) from the front outside door handle, other people can also open the doors.

Tailgate/trunk unlocking

1. Carry the smart key.
2. Press the tailgate/trunk handle switch.
3. The tailgate/trunk will unlock.

* NOTICE

- Once the tailgate/trunk is opened and then closed, the tailgate/trunk will lock automatically.
- The button will only operate when the smart key is within 0.7 m (28 in.) from the tailgate/trunk handle.

Smart key precautions

* NOTICE

- If, for some reason, you happen to lose your smart key, you will not be able to start the engine. Tow the vehicle, if necessary, we recommend that you contact an authorized HYUNDAI dealer.
- A maximum of 2 smart keys can be registered to a single vehicle. If you lose a smart key, we recommend that you contact an authorized HYUNDAI dealer.
- The smart key will not work if any of the following occurs:
 - The smart key is close to a radio remote key such as a radio station or an airport which can interfere with normal operation of the smart key.
 - The smart key is near a mobile two-way radio system or a cellular phone.
 - Another vehicle's smart key is being operated close to your vehicle.

When the smart key does not work properly, open and close the door with the mechanical key. If you have a problem with the smart key, we recommend that you contact an authorized HYUNDAI dealer.

(Continued)

(Continued)

- If the smart key is in close proximity to your cell phone or smart phone, the signal from the smart key could be blocked by normal operation of your cell phone or smart phone. This is especially important when the phone is active such as making call, receiving calls, text messaging, and/or sending/receiving emails. Avoid placing the smart key and your cell phone or smart phone in the same pants or jacket pocket and maintain adequate distance between the two devices.



CAUTION

Keep the smart key away from water or any liquid and fire. If the inside of the smart key gets damp (due to drinks or moisture), or is heated, internal circuit may malfunction, excluding the car from the warranty.

* NOTICE

Always have the smart key with you when leaving the vehicle. If the smart key is left near the vehicle, the vehicle battery may be discharged.



Door lock/unlock in an emergency situation

If the smart key does not operate normally, you can lock or unlock the doors by using the mechanical key.

1. Press and hold the release button (1) and remove the mechanical key (2).
2. Insert the key into the hole of the outside door handle. Turn the key toward the rear of the vehicle to unlock and toward the front of the vehicle to lock.
3. To reinstall the mechanical key, put the key into the hole and push it until a click sound is heard.

THEFT-ALARM SYSTEM (IF EQUIPPED)

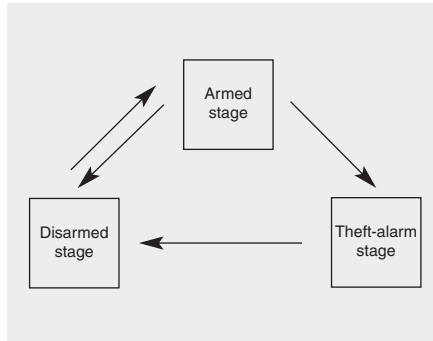

This system is designed to provide protection from unauthorized entry into the car. This system is operated in three stages: the first is the "Armed" stage, the second is the "Theft-alarm" stage, and the third is the "Disarmed" stage. If triggered, the system provides an audible alarm with the hazard warning light blinking.

Armed stage

The Theft Alarm System automatically sets 30 seconds after you lock the doors and the tailgate/trunk. For the system to activate, you must lock the doors and the tailgate/trunk from outside the vehicle with the remote key or smart key or by pressing the button on the outside of the door handles with the smart key in your possession.

The hazard warning lights will blink and the chime will sound once to indicate the system is armed.

Once the security system is set, opening any door, the tailgate/trunk, or the hood without using the remote key or smart key will cause the alarm to activate.

The theft alarm system will not set if the hood, the tailgate/trunk, or any door is not fully closed. If the system will not set, check the hood, the tailgate/trunk, or the doors are fully closed.

Do not arm the system until all passengers have left the vehicle. If the system is armed while a passenger(s) remains in the vehicle, the alarm may be activated when the remaining passenger(s) leave the vehicle. If any door (or tailgate/trunk) or engine hood is opened within 30 seconds after the system enters the armed stage, the system is disarmed to prevent unnecessary alarm.

Theft-alarm stage

The alarm will be activated if any of the following occurs while the system is armed.

- A door is opened without using the remote key or smart key.
- The tailgate/trunk is opened without using the remote key or smart key.
- The engine hood is opened.

The horn will sound and the hazard warning lights will blink continuously for approximately 27 seconds, unless the system is disarmed. To turn off the system, unlock the doors with the remote key or smart key.

Disarmed stage

The system will be disarmed when:

Remote key

- The door unlock button is pressed.

Smart key

- The door unlock button is pressed.
- The button of the front outside door is pressed while carrying the smart key.

After the doors are unlocked, the hazard warning lights will blink twice to indicate that the system is disarmed.

After pressing the unlock button, if any door (or trunk) is not opened within 30 seconds, the system will be rearmed.

* NOTICE - Non-Smart key

- If the system is not disarmed with the remote key, open the door with the key and insert the key into the ignition switch, turn the ignition switch to the ON position and wait for 30 seconds. Then the system will be disarmed.
- If you lose your keys, we recommend that you contact an authorized HYUNDAI dealer.

* NOTICE - Smart key

- If the system is not disarmed with the smart key, open the door with the mechanical key and start the engine. Then the system will be disarmed.
- If you lose your keys, we recommend that you contact an authorized HYUNDAI dealer.

CAUTION

Do not change, alter or adjust the immobilizer system because it could cause the immobilizer system to malfunction and we recommend that the system be serviced by an authorized HYUNDAI dealer.

Malfunctions caused by improper alterations, adjustments or modifications to the immobilizer system are not covered by your vehicle manufacturer warranty.

DOOR LOCKS

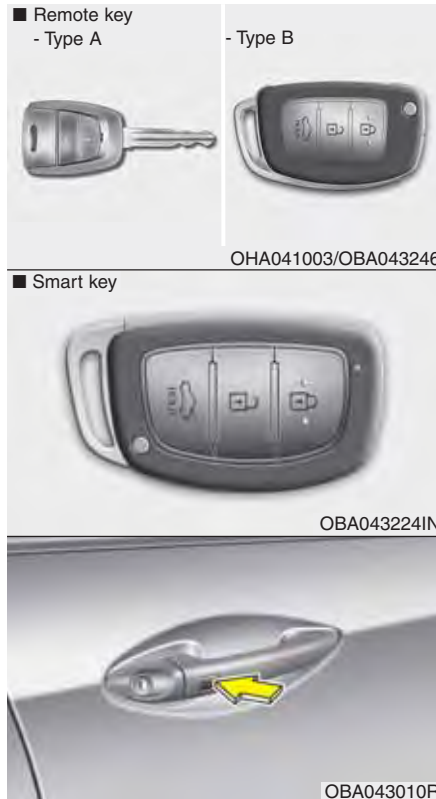

Operating door locks from outside the vehicle

Remote key/Smart key

- Doors can be locked and unlocked with the remote key or smart key.
- Doors can be locked and unlocked by pressing the button of the outside door handle with the smart key in your possession. (if equipped with smart key system)
- Once the doors are unlocked, they may be opened by pulling the door handle.
- When closing the door, push the door by hand. Make sure that doors are closed securely.

Mechanical key

- Turn the key toward the rear of the vehicle to lock and toward the front of the vehicle to unlock.
- If you lock/unlock the driver's (or passenger's) door with a key, all vehicle doors will lock/unlock automatically. (if equipped with central door lock system)
- Once the doors are unlocked, they may be opened by pulling the door handle.
- When closing the door, push the door by hand. Make sure that doors are closed securely.

* NOTICE

- In cold and wet climates, door lock and door mechanisms may not work properly due to freezing conditions.
- If the door is locked/unlocked multiple times in rapid succession with either the vehicle key or door lock switch, the system may stop operating temporarily in order to protect the circuit and prevent damage to system components.



To lock a door without the key, push the inside door lock button (1) to the “Lock” position and close the door (2). (if not equipped with central door lock system)

* NOTICE

The central door lock system will operate only when all doors and tailgate/trunk are closed.

* NOTICE

Always remove the ignition key, engage the parking brake, close all windows and lock all doors when leaving your vehicle unattended.



Operating door locks from inside the vehicle

With the door lock button

- To unlock a door, push the door lock button (1) to the “Unlock” position. The red mark (2) on the button will be visible.
- To lock a door, push the door lock button (1) to the “Lock” position. If the door is locked properly, the red mark (2) on the door lock button will not be visible.
- To open a door, pull the door handle (3) outward.
- Pushing the driver's (or passenger's) door lock button (1) to the “Lock” or “Unlock” position will lock or unlock all vehicle doors. (if equipped with central door lock system)

- If the inner door handle of the driver's door is pulled when the door lock button is in the lock position, the button will unlock and the door will open. (if equipped)
- The driver's (or passenger's) doors cannot be locked if a door (or tailgate/trunk) is opened. (if equipped)

* NOTICE

The central door lock system will operate only when all doors and tailgate/trunk are closed.

⚠ WARNING - Door lock malfunction

If a power door lock ever fails to function while you are in the vehicle, try one or more of the following techniques to exit:

- Operate the door unlock feature repeatedly (both electronic and manual) while simultaneously pulling on the door handle.
- Operate the other door locks and handles, front and rear.
- Lower a front window and use the key to unlock the door from outside.

⚠ WARNING

Do not pull the inner door handle of driver's (or passenger's) door while the vehicle is moving.



OBA043030R

With central door lock switch (if equipped)

Operate by pressing the central door lock switch.

- When pushing down on the front portion (1) of the switch, all vehicle doors will lock.
- When pushing down on the rear portion (2) of the switch, all vehicle doors will unlock.
- If the key is in the ignition switch and front door is opened, the doors will not lock even though the front portion (1) of central door lock switch is pressed.
- If the smart key is in the vehicle and any door is opened, the doors will not lock even though the front portion (1) of central door lock switch is pressed.

*** NOTICE**

If the doors are locked with the remote key or smart key, the doors cannot be unlocked with the central door lock/unlock switch. (if equipped)

⚠ WARNING

The doors should always be fully closed and locked while the vehicle is in motion. If the doors are unlocked, the risk of being thrown from the vehicle in a crash is increased.

WARNING

Do not leave children or animals unattended in your vehicle. An enclosed vehicle can become extremely hot, causing death or serious injury to unattended children or animals who cannot escape the vehicle. Children might operate features of the vehicle that could injure them, or they could encounter other harm, possibly from someone gaining entry to the vehicle.

WARNING

Always secure your vehicle

Leaving your vehicle unlocked increases the potential risk to you or others from someone hiding in your vehicle.

To secure your vehicle, while depressing the brake, move the shift lever to the P (Park) position, engage the parking brake, and place the ignition switch in the LOCK/OFF position, close all window, lock all doors, and always take the key with you.

WARNING

If people must spend a longer time in the vehicle while it is very hot or cold outside, there is risk of injuries or danger to life. Do not lock the vehicle from the outside when there are people in it.

WARNING

Opening a door when something is approaching may cause damage or injury. Be careful when opening doors and watch for vehicles, motorcycles, bicycles or pedestrians approaching the vehicle in the path of the door.

Impact sensing door unlock system (if equipped)

All doors will automatically unlock when an impact causes the air bags to deploy.

Speed sensing door lock system (if equipped)

All doors will be automatically locked after the vehicle speed exceeds 15 km/h. And all doors will be automatically unlocked when you turn the engine off or when you remove the ignition key. (if equipped)

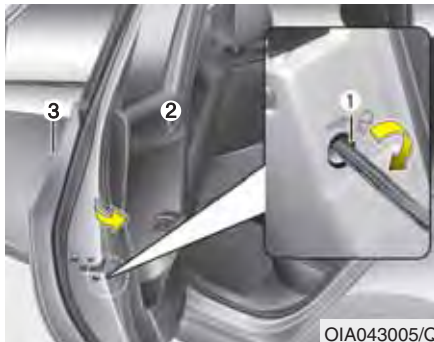

OIA043005/Q

Child-protector rear door lock

The child safety lock is provided to help prevent children from accidentally opening the rear doors from inside the vehicle. The rear door safety locks should be used whenever children are in the vehicle.

1. Open the rear door.
2. Insert a key (or screwdriver) into the hole (1) and turn it to the lock position located on the rear edge of the door. When the child safety lock is in the lock position, the rear door will not open even though the inner door handle (2) is pulled.

3. Close the rear door.

To open the rear door, pull the outside door handle (3).

Even though the doors may be unlocked, the rear door will not open by pulling the inner door handle (2) until the rear door child safety lock is unlocked.

⚠ WARNING - Rear door locks
 If children accidentally open the rear doors while the vehicle is in motion, they could fall out and be severely injured or killed. To prevent children from opening the rear doors from the inside, the rear door safety locks should be used whenever children are in the vehicle.

TRUNK

■ Type A



■ Type B



Opening the trunk

With the key

To open the trunk, insert the key and turn it clockwise.



With the transmitter or smart key

- To open the trunk, press the trunk unlock button for more than 1 second on the transmitter.
- To open the trunk, press the trunk unlock button for more than 1 second on the smart key or press the button (1) on the trunk handle with the smart key in your possession.



With the trunk lid release lever

To open the trunk from inside the vehicle, pull up the trunk lid release lever. Once the trunk is opened and then closed, the trunk is locked automatically.

* NOTICE

In cold and wet climates, door lock and door mechanisms may not work properly due to freezing conditions.

 **WARNING**

The trunk swings upward. Make sure no objects or people are near the rear of the vehicle when opening the trunk.

 **CAUTION**

Make certain that you close the trunk before driving your vehicle. Possible damage may occur to the trunk torsion bars and attached hardware if the trunk is not closed prior to driving.

Closing the trunk

To close, lower the trunk lid, then press down on it until it locks. To be sure the trunk lid is securely fastened, always check by trying to pull it up again.

 **WARNING**

The trunk lid should be always kept completely closed while the vehicle is in motion. If it is left open or ajar, poisonous exhaust gases may enter the car and serious illness or death may result.

 **WARNING**

No one should be allowed to occupy the trunk at any time. The trunk is a very dangerous location in the event of a crash.

TAILGATE



Opening the tailgate

- The tailgate is locked or unlocked by turning the key to the "Lock" or "Unlock" position. (if equipped)
- The tailgate is locked or unlocked when all doors are locked or unlocked with the key, remote key, smart key or central door lock/unlock switch. (if equipped with central door lock function)
- If unlocked, the tailgate can be opened by pulling up the tailgate outside handle. (Type A)
If unlocked, the tailgate can be opened by pressing the switch of the tailgate outside handle. (Type B)

* NOTICE

The central door lock system will operate only when all doors and tailgate are closed.

* NOTICE

In cold and wet climates, door lock and door mechanisms may not work properly due to freezing conditions.

⚠ WARNING

The tailgate swings upward. Make sure no objects or people are near the rear of the vehicle when opening the tailgate.

⚠ CAUTION

Make certain that you close the tailgate before driving your vehicle. Possible damage may occur to the tailgate lift cylinders and attaching hardware if the tailgate is not closed prior to driving.

Closing the tailgate

To close the tailgate, lower and push down the tailgate firmly. Make sure that the tailgate is securely latched.

⚠ WARNING

Always keep the tailgate lid completely closed while the vehicle is in motion. If it is left open or ajar, poisonous exhaust gases containing carbon monoxide (CO) may enter the vehicle and serious illness or death may result.

⚠ WARNING - Rear cargo area

Occupants should never ride in the rear cargo area where no restraints are available. To avoid injury in the event of an accident or sudden stops, occupants should always be properly restrained.

WINDOWS

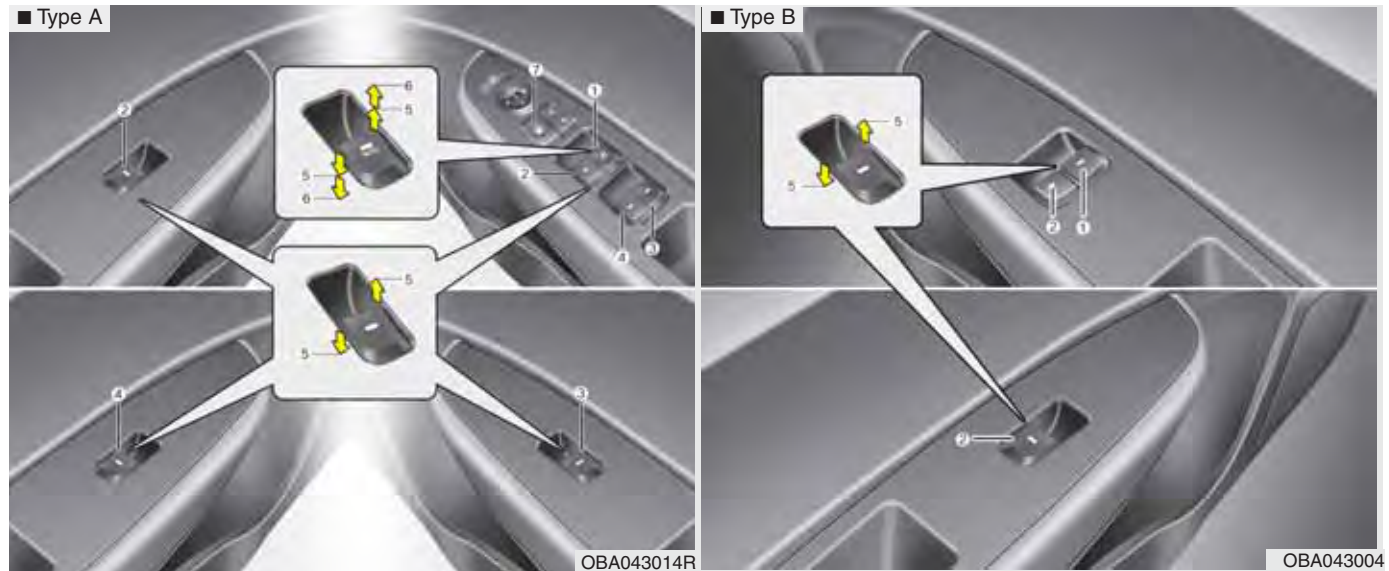

- (1) Driver's door power window switch
- (2) Front passenger's door power window switch
- (3) Rear door (right) power window switch
- (4) Rear door (left) power window switch
- (5) Window opening and closing
- (6) Automatic power window up/down
- (7) Power window lock button

* NOTICE

In cold and wet climates, power windows may not work properly due to freezing conditions.

Power windows

The ignition switch must be in the ON position for power windows to operate. Each door has a power window switch that controls the door's window. The driver has a power window lock button which can block the operation of rear passenger windows.

The power windows can be operated for approximately 30 seconds after the ignition key is removed or turned to the ACC or LOCK position. However, if the front doors are opened, the power windows cannot be operated even within the 30 seconds period.

WARNING

- To avoid serious injury or death, do not extend your head, arms or body outside the windows while driving.
- Do not install any accessories in the area of windows. It may impact jam protection.

* NOTICE

- In cold and wet climates, power windows may not work properly due to freezing conditions.
- While driving with the rear windows down, your vehicle may demonstrate a wind buffeting or pulsation noise. This noise is normal and can be reduced or eliminated by taking the following actions. If the noise occurs with one or both of the rear windows down, partially lower both front windows approximately one inch.



Window opening and closing (if equipped)

The driver's door has a master power window switch that controls all the windows in the vehicle.

To open or close a window, press down or pull up the front portion of the corresponding switch to the first detent position (5).



***Auto down window (if equipped)
(Driver's window)***

Pressing the power window switch momentarily to the second detent position (6) completely lowers the driver's window even when the switch is released. To stop the window at the desired position while the window is in operation, pull up and release the switch to the opposite direction of the window movement.

If the window can not be close because it is blocked by objects, remove the objects and close the window.



***Auto up/down window (if equipped)
(Driver's window)***

Pressing or pulling up the power window switch momentarily to the second detent position (6) completely lowers or lifts the window even when the switch is released. To stop the window at the desired position while the window is in operation, pull up or press down and release the switch.

If the power window does not operate normally, the automatic power window system must be reset as follows:

1. Turn the ignition switch to the ON position.
2. Close the driver's window and continue pulling up the driver's power window switch for at least 1 second after the window is completely closed.

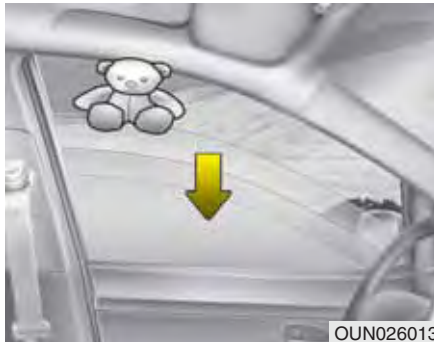

Automatic reversal (if equipped)

If the upward movement of the window is blocked by an object or part of the body, the window will detect the resistance and will stop upward movement. The window will then lower approximately 30 cm (11.8 in.) to allow the object to be cleared.

If the window detects the resistance while the power window switch is pulled up continuously, the window will stop upward movement then lower approximately 2.5 cm (1 in.). And if the power window switch is pulled up continuously again within 5 seconds after the window is lowered by the automatic window reversal feature, the automatic window reversal will not operate.

* NOTICE

The automatic reverse feature is only active when the "auto up" feature is used by fully pulling up the switch to the second detent.

⚠ WARNING

The automatic reverse feature doesn't activate while resetting power window system.

Make sure heads, other body parts or other objects are safely out of the way before closing the windows to avoid injuries or vehicle damage. Objects less than 4 mm (0.16 in.) in diameter caught between the window glass and the upper window channel may not be detected by the automatic reverse window and the window will not stop and reverse direction.



Power window lock button

- The driver can disable the power window switches on the rear passenger doors by pressing the power window lock button located on the driver's door to the LOCK position (pressed).
- When the power window lock button is in the LOCK position (pressed), the driver's master control cannot operate the rear passenger door power windows.

⚠ CAUTION

- *To prevent possible damage to the power window system, do not open or close two windows or more at the same time. This will also ensure the longevity of the fuse.*
- *Never try to operate the main switch on the driver's door and the individual door window switch in opposite directions at the same time. If this is done, the window will stop and cannot be opened or closed.*

⚠ WARNING - Windows

- NEVER leave the ignition key in the vehicle.
- NEVER leave any child unattended in the vehicle. Even very young children may inadvertently cause the vehicle to move, entangle themselves in the windows, or otherwise injure themselves or others.
- Always double check to make sure all arms, hands, head and other obstructions are safely out of the way before closing a window.
- Do not allow children to play with the power windows. Keep the driver's door power window lock button in the LOCK position (pressed). Serious injury can result from unintentional window operation by the child.
- Do not extend face or arms outside the window while driving.

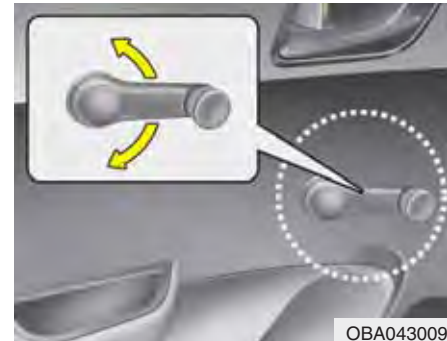

Manual windows (if equipped)

To raise or lower the window, turn the window regulator handle clockwise or counterclockwise.

⚠ WARNING

When opening or closing the windows, make sure your passenger's arms, hands and body are safely out of the way.

HOOD



Opening the hood

1. Park the vehicle and set the parking brake.
2. Pull the release lever to unlatch the hood. The hood should pop open slightly.

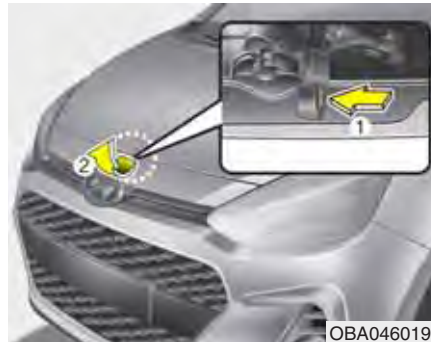

2. Go to the front of the vehicle, raise the hood slightly, push the secondary latch (1) inside of the hood center and lift the hood (2).

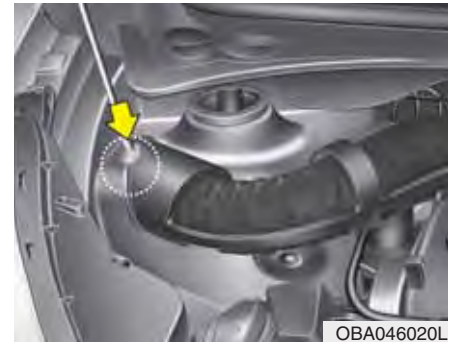

3. Pull out the support rod from the hood.
4. Hold the hood opened with the support rod.

⚠ WARNING - Hot parts
Grasp the support rod in the area wrapped in plastic. The plastic will help prevent you from being burned by hot metal when the engine is hot.

Closing the hood

1. Before closing the hood, check the following:
 - All filler caps in the engine compartment must be correctly installed.
 - Gloves, rags or any other combustible material must be removed from the engine compartment.
2. Return the support rod to its clip to prevent it from rattling.
3. Lower the hood halfway (lifted approximately 30cm from the closed position) and push down to securely lock in place. Then double check to be sure the hood is secure.

WARNING - Hood

- Before closing the hood, ensure that all obstructions are removed from the hood opening. Closing the hood with an obstruction present in the hood opening may result in property damage or severe personal injury.
- Do not leave gloves, rags or any other combustible material in the engine compartment. Doing so may cause a heat-induced fire.

WARNING

- Always double check to be sure that the hood is firmly latched before driving away. Driving with the hood opened may cause a total loss of visibility, which might result in an accident.
- The support rod must be inserted completely into the hole whenever you inspect the engine compartment. This will prevent the hood from falling and possibly injuring you.
- Do not move the vehicle with the hood raised. The view will be blocked and the hood could fall or be damaged.

FUEL FILLER LID



Opening the fuel filler lid

The fuel filler lid must be opened from inside the vehicle by pulling up the fuel filler lid opener.

* NOTICE

If the fuel filler lid does not open because ice has formed around it, tap lightly or push on the lid to break the ice and release the lid. Do not pry on the lid. If necessary, spray around the lid with an approved de-icer fluid (do not use radiator anti-freeze) or move the vehicle to a warm place and allow the ice to melt.

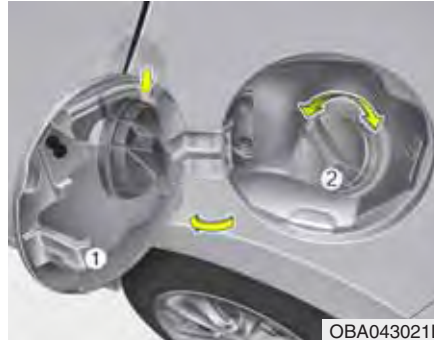

1. Stop the engine.
2. To open the fuel filler lid, pull the fuel filler lid opener up.
3. Pull open the fuel filler lid (1).
4. To remove the cap (2), turn the fuel filler cap counterclockwise.
5. Refuel as needed.

Closing the fuel filler lid

1. To install the cap, turn it clockwise until it "clicks". This indicates that the cap is securely tightened.
2. Close the fuel filler lid and push it lightly and make sure that it is securely closed.

⚠ WARNING - Refueling

- If pressurized fuel sprays out, it can cover your clothes or skin and subject you to the risk of fire and burns. Always remove the fuel cap carefully and slowly. If the cap is venting fuel or if you hear a hissing sound, wait until the condition stops before completely removing the cap.
- Do not "top off" after the nozzle automatically shuts off when refueling.
- Always check that the fuel cap is installed securely to prevent fuel spillage in the event of an accident.

⚠ WARNING - Refueling dangers

Automotive fuels are flammable materials. When refueling, please note the following guidelines carefully. Failure to follow these guidelines may result in severe personal injury, severe burns or death by fire or explosion.

- Read and follow all warning at the gas station facility.
- Before refueling note the location of the Emergency Petrol Shut-Off, if available, at the gas station facility.
- Before touching the fuel nozzle, you should eliminate potentially dangerous static electricity discharge by touching another metal part of the vehicle, a safe distance away from the fuel filler neck, nozzle, or other gas source.

(Continued)

(Continued)

- Do not get back into a vehicle once you have begun refueling since you can generate static electricity by touching, rubbing or sliding against any item or fabric (polyester, satin, nylon, etc.) capable of producing static electricity. Static electricity discharge can ignite fuel vapors resulting in rapid burning. If you must re-enter the vehicle, you should once again eliminate potentially dangerous static electricity discharge by touching a metal part of the vehicle, away from the fuel filler neck, nozzle or other petrol source.
- When using an approved portable fuel container be sure to place the container on the ground prior to refueling. Static electricity discharge from the container can ignite fuel vapors causing a fire. Once refueling has begun, contact with the vehicle should be maintained until the filling is complete.

(Continued)

(Continued)

Use only approved portable plastic fuel containers designed to carry and store petrol.

- Do not use cellular phones while refueling. Electric current and/or electronic interference from cellular phones can potentially ignite fuel vapors causing a fire.
- When refueling, always shut the engine off. Sparks produced by electrical components related to the engine can ignite fuel vapors causing a fire. Once refueling is complete, check to make sure the filler cap and filler door are securely closed, before starting the engine.
- DO NOT use matches or a lighter and DO NOT SMOKE or leave a lit cigarette in your vehicle while at a gas station especially during refueling. Automotive fuel is highly flammable and can, when ignited, result in fire.

(Continued)

(Continued)

- If a fire breaks out during refueling, leave the vicinity of the vehicle, and immediately contact the manager of the gas station and then contact the local fire department. Follow any safety instructions they provide.

 **CAUTION**

- *Make sure to refuel with unleaded (or leaded for some countries) fuel only. (Petrol engine only)*
- *If the fuel filler cap requires replacement, we recommend that you use parts for replacement from an authorized HYUNDAI dealer. An incorrect fuel filler cap can result in a serious malfunction of the fuel system or emission control system.*
- *Do not spill fuel on the exterior surfaces of the vehicle. Any type of fuel spilled on painted surfaces may damage the paint.*
- *After refueling, make sure the fuel cap is installed securely to prevent fuel spillage in the event of an accident.*

STEERING WHEEL

Electric power steering (if equipped)

Power steering uses the motor to assist you in steering the vehicle. If the engine is off or if the power steering system becomes inoperative, the vehicle may still be steered, but it will require increased steering effort.

The motor driven power steering is controlled by the power steering control unit which senses the steering wheel torque and vehicle speed to command the motor.

The steering wheel becomes heavier as the vehicle's speed increases and becomes lighter as the vehicle's speed decreases for better control of the steering wheel.

Should you notice any change in the effort required to steer during normal vehicle operation, we recommend that the system be checked by an authorized HYUNDAI dealer.

* NOTICE

The following symptoms may occur during normal vehicle operation:

- The EPS warning light does not illuminate.
- The steering effort is high immediately after turning the ignition switch on. This happens as the system performs the EPS system diagnostics. When the diagnostics is completed, the steering wheel will return to its normal condition.
- A click noise may be heard from the EPS relay after the ignition switch is placed in the ON or LOCK/OFF position.
- Motor noise may be heard when the vehicle is at a stop or at a low driving speed.
- The steering effort can suddenly increase, if the operation of the EPS system is stopped to prevent serious accidents when it detects malfunction of the EPS system by self-diagnosis.
- The steering effort increases if the steering wheel is rotated continuously when the vehicle is not in motion. However, after a few minutes, it will return to its normal conditions.

Tilt steering (if equipped)

Tilt steering allows you to adjust the steering wheel before you drive. You can also raise it to give your legs more room when you exit and enter the vehicle.

The steering wheel should be positioned so that it is comfortable for you to drive, while permitting you to see the instrument panel warning lights and gauges.

WARNING

- Never adjust the angle and height of the steering wheel while driving. You may lose steering control and cause severe personal injury, death or accidents.
- After adjusting, push the steering wheel both up and down to be certain it is locked in position.

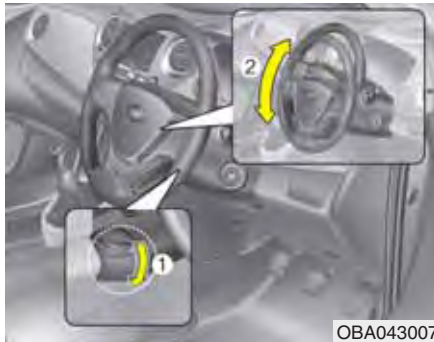

To change the steering wheel angle, pull down the lock release lever (1), adjust the steering wheel to the desired angle (2), then pull up the lock-release lever to lock the steering wheel in place. Be sure to adjust the steering wheel to the desired position before driving.



Horn

To sound the horn, press the horn symbol on your steering wheel. Check the horn regularly to be sure it operates properly.

* NOTICE

To sound the horn, press the area indicated by the horn symbol on your steering wheel (see illustration). The horn will operate only when this area is pressed.

⚠ CAUTION

Do not strike the horn severely to operate it, or hit it with your fist. Do not press on the horn with a sharp-pointed object.

MIRRORS

Inside rearview mirror

Before you start driving, adjust the rearview mirror to the center on the view through the rear window.

⚠️ WARNING - Rear visibility

Make sure your line of sight is not obstructed. Do not place objects in the rear seat, cargo area, or behind the rear headrests which could interfere with your vision through the rear window.

⚠️ WARNING

Do not adjust the rearview mirror while the vehicle is moving. This could result in loss of control, and an accident which could cause death, serious injury or property damage.



OBA043023L

Day/night rearview mirror (if equipped)

Make this adjustment before you start driving and while the day/night lever is in the day position.

Pull the day/night lever toward you to reduce glare from the headlights of the vehicles behind you during night driving.

Remember that you lose some rearview clarity in the night position.

Outside rearview mirror

Be sure to adjust the mirror angles before driving.

Your vehicle is equipped with both left-hand and/or right-hand outside rearview mirrors. The mirrors can be adjusted remotely with the remote switch (or lever). The mirror heads can be folded back to prevent damage during an automatic car wash or when passing through a narrow street.

⚠️ WARNING - Rearview mirrors

- The right outside rearview mirror is convex. In some countries, the left outside rearview mirror is also convex. Objects seen in the mirror are closer than they appear.
- Use your interior rearview mirror or direct observation to determine the actual distance of following vehicles when changing lanes.

CAUTION

Do not scrape ice off the mirror face; this may damage the surface of the glass. If ice should restrict movement of the mirror, do not force the mirror for adjustment. To remove ice, use a deicer spray, or a sponge or soft cloth with very warm water.

CAUTION

If the mirror is jammed with ice, do not adjust the mirror by force. Use an approved spray de-icer (not radiator antifreeze) to release the frozen mechanism or move the vehicle to a warm place and allow the ice to melt.

WARNING

Do not adjust or fold the outside rearview mirrors while the vehicle is moving. This could result in loss of control, and an accident which could cause death, serious injury or property damage.

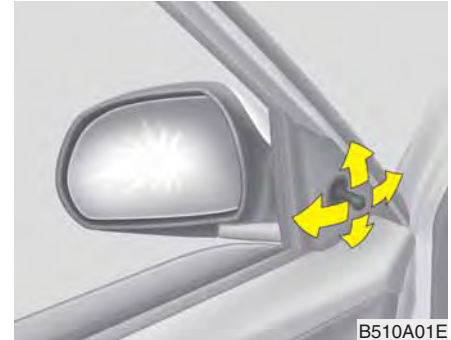

Remote control

Manual type (if equipped)

To adjust an outside mirror, move the control lever.



OBA043024R

Electric type (if equipped)

The electric remote control mirror switch allows you to adjust the position of the left and right outside rearview mirrors. To adjust the position of either mirror, the ignition switch should be in the ACC position. Move the lever (1) to R or L to select the right side mirror or the left side mirror, then press a corresponding point on the mirror adjustment control to position the selected mirror up, down, left or right. After the adjustment, put the lever into the neutral (center) position to prevent inadvertent adjustment.

⚠ CAUTION

- *The mirrors stop moving when they reach the maximum adjusting angles, but the motor continues to operate while the switch is pressed. Do not press the switch longer than necessary, the motor may be damaged.*
- *Do not attempt to adjust the outside rearview mirror by hand. Doing so may damage the parts.*



OBA043026R

Folding the outside rearview mirror

Electric Type (if equipped)

To fold the outside rearview mirror, depress the button. To unfold it, depress the button again.

⚠ CAUTION

The electric type outside rearview mirror operates even though the ignition switch is in the OFF position. However, to prevent unnecessary battery discharge, do not adjust the mirrors longer than necessary while the engine is not running.

⚠ CAUTION

In case it is an electric type outside rearview mirror, don't fold it by hand. It could cause motor failure.

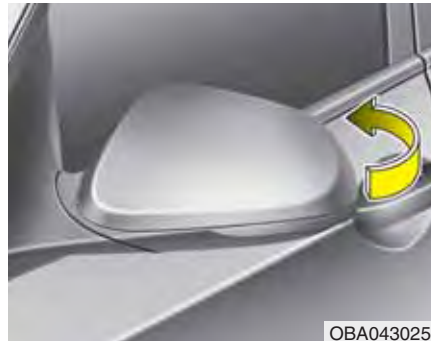

Manual type (if equipped)

To fold outside rearview mirror, grasp the housing of mirror and then fold it toward the rear of the vehicle.

INSTRUMENT CLUSTER

■ Petrol engine



1. Tachometer
2. Engine temperature gauge
3. Fuel gauge
4. Speedometer
5. Turn signal indicators
6. Warning and indicator lights
7. Odometer / Trip computer

■ Diesel engine



※ The actual cluster in the vehicle may differ from the illustration.
For more details refer to the "Gauges" in the next pages.

OBA043100IN/OBA043101IN

Features of your vehicle

■ Type A (km/h)



■ Type B (MPH)



Gauges

Speedometer

The speedometer indicates the forward speed of the vehicle.

The speedometer is calibrated in kilometers per hour.



Tachometer

The tachometer indicates the approximate number of engine revolutions per minute (rpm).

Use the tachometer to select the correct shift points and to prevent lugging and/or over-revving the engine.

CAUTION

Do not operate the engine within the tachometer's RED ZONE. This may cause severe engine damage.



Engine coolant temperature gauge (if equipped)

This gauge shows the temperature of the engine coolant when the ignition switch is ON.

Do not continue driving with an overheated engine. If your vehicle overheats, refer to "If the engine overheats" in chapter 6.

⚠ CAUTION

If the gauge pointer moves beyond the normal range area toward the "H" it indicates overheating that may damage the engine.

⚠ WARNING

Never remove the radiator cap when the engine is hot. The engine coolant is under pressure and could cause severe burns. Wait until the engine is cool before adding coolant to the reservoir.



OBA043108

Fuel gauge

The fuel gauge indicates the approximate amount of fuel remaining in the fuel tank. The fuel tank capacity is given in section 8. The fuel gauge is supplemented by a low fuel warning light, which will illuminate when the fuel tank is nearly empty.

On inclines or curves, the fuel gauge pointer may fluctuate or the low fuel warning light may come on earlier than usual due to the movement of fuel in the tank.

⚠ WARNING - Fuel gauge

Running out of fuel can expose vehicle occupants to danger.

You must stop and obtain additional fuel as soon as possible after the warning light comes on or when the gauge indicator comes close to the "0" level.

⚠ CAUTION

Avoid driving with a very low fuel level. Running out of fuel could cause the engine to misfire, damaging the catalytic converter.

Features of your vehicle



Odometer (km or mi)

The odometer indicates the total distance the vehicle has been driven. You will also find the odometer useful to determine when periodic maintenance should be performed.

*** NOTICE**

It is forbidden to alter the odometer of all vehicles with the intent to change the mileage registered on the odometer. The alteration may void your warranty coverage.



Tripmeter/Trip computer (if equipped)

The trip computer is a microcomputer-controlled driver information system that displays information related to driving, when the ignition switch is in the ON position. All stored driving information (except odometer) resets if the battery is disconnected.

Press the TRIP button for less than 1 second to select any mode as follows:

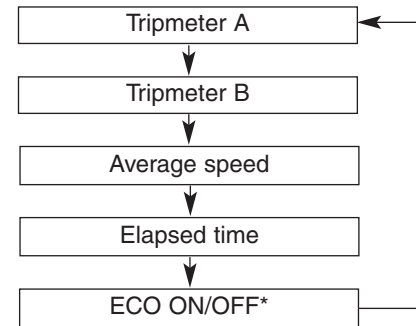

* if equipped



Tripmeter

TRIP A : Tripmeter A

TRIP B : Tripmeter B

This mode indicates the distance of individual trips selected since the last tripmeter reset.

The meter's working range is from 0.0 to 9999.9 km. (0.0 to 9999.9 miles). Pressing the RESET button for more than 1 second, when the tripmeter is being displayed, clears the tripmeter to zero (0.0).



Average speed (km/h or MPH)

This mode calculates the average speed of the vehicle since the last average speed reset.

Even if the vehicle is not in motion, the average speed is calculated while the engine is running.

For an accurate calculation, drive more than 300m (0.18 mile).

Pressing the RESET button for more than 1 second, when the average speed is being displayed, clears the average speed to zero (---).



Elapsed time (if equipped)

This mode indicates the total time traveled since the last driving time reset.

Even if the vehicle is not in motion, the driving time keeps going while the engine is running.

The meter's working range is from 00:00~99:59.

Pressing the RESET button for more than 1 second, when the driving time is being displayed, clears the driving time to zero (00:00).



ECO ON/OFF mode (if equipped)

You can turn the ECO indicator on/off on the instrument cluster in this mode.

If you push the RESET button more than 1 second in the ECO ON mode, ECO OFF is displayed in the screen and the ECO indicator turns off while driving.

If you want to display the ECO indicator again, press the RESET button more than 1 second in the ECO OFF mode and then ECO ON mode is displayed in the screen.

“FUSE ON” warning light (if equipped)



This warning light illuminates if the fuse switch in the fuse box is OFF.

Turn the fuse switch on, when the “FUSE ON” warning light illuminates.

For more details, refer to “Fuses” in chapter 7.

Warnings and indicators

All warning lights are checked by placing the ignition switch ON (do not start the engine). If any light that does not illuminate, we recommend that the system be checked by an authorized HYUNDAI dealer. After starting the engine, check to make sure that all warning lights are off. If any warning lights are still on, this indicates a situation that needs attention.

*Air bag warning light
(if equipped)*



This warning light will illuminate for approximately 6 seconds each time you place the ignition switch in the ON position.

This light also comes on when the Supplemental Restraint System (SRS) is not working properly. If the air bag warning light does not come on, or continuously remains on after operating for about 6 seconds when you placed the ignition switch in the ON position or started the engine, or if it comes on while driving, we recommend that the system be inspected by an authorized HYUNDAI dealer.

*Anti-lock brake system (ABS)
warning light
(if equipped)*



This warning light illuminates if the ignition switch is placed in the ON position and goes off after approximately 3 seconds if the system is operating normally. If the ABS warning light remains on, comes on while driving, or does not come on when the ignition switch is placed in the ON position, this indicates that the ABS may have malfunctioned. If this occurs, we recommend that the system be checked by an authorized HYUNDAI dealer. The normal braking system will still be operational, but without the assistance of the anti-lock brake system.

Electronic brake force distribution (EBD) system warning light



If these two warning lights illuminate at the same time while driving, your vehicle's ABS and EBD system may have malfunctioned.

In this case, your ABS and regular brake system may not work normally. We recommend that the system be checked by an authorized HYUNDAI dealer.

⚠ WARNING

If both ABS and Brake warning lights are on and stay on, your vehicle's brake system will not work normally during sudden braking. In this case, avoid high speed driving and abrupt braking. We recommend that the system be checked by an authorized HYUNDAI dealer.

Seat belt warning



As a reminder to the driver, the seat belt warning light will blink for approximately 6 seconds each time you place the ignition switch in the ON position regardless of belt fastening.

If the driver's seat belt is unfastened after the ignition switch is placed in the ON position, the seat belt warning light blinks again for approximately 6 seconds.

If the driver's seat belt is not fastened when the ignition switch is placed in the ON position or if it is unfastened after the ignition switch is placed in the ON position, the seat belt warning chime will sound for approximately 6 seconds. At this time, if the seat belt is fastened, the chime will stop at once. (if equipped)

Turn signal indicator



The left or right Turn Signal Indicator blinks when you signal a lane change or turn. If the arrow comes on but does not blink, blinks more rapidly than normal, or does not illuminate at all, a malfunction in the turn signal system is indicated. We recommend that you consult an authorized HYUNDAI dealer repairs.

High beam indicator



This indicator illuminates when the headlights are on and in the high beam position or when the turn signal lever is pulled into the Flash-to-Pass position.

Parking (position) light indicator



This indicator illuminates when the parking (position) light are on.

Engine oil pressure warning light



This warning light indicates the engine oil pressure is low.

If the warning light illuminates while driving:

1. Drive safely to the side of the road and stop.
2. With the engine off, check the engine oil level. If the level is low, add oil as required.

If the warning light remains on after adding oil or if oil is not available, we recommend that you call an authorized HYUNDAI dealer.

CAUTION

If the engine is not stopped immediately after the engine oil pressure warning light is illuminated, severe damage could result.

⚠ CAUTION

If the oil pressure warning light stays on while the engine is running, serious engine damage may result. The oil pressure warning light comes on whenever there is insufficient oil pressure. In normal operation, it should come on when the ignition switch is turned on, then goes off when the engine starts. If the oil pressure warning light stays on while the engine is running, there is a serious malfunction. If this happens, stop the vehicle as soon as it is safe to do so, turn off the engine and check the oil level. If the oil level is low, fill the engine oil to the proper level and start the engine again. If the light stays on with the engine running, turn the engine off immediately. In any instance where the oil light stays on when the engine is running, we recommend that the system be checked by an authorized HYUNDAI dealer.

Parking brake & brake fluid warning

This light illuminates if the ignition switch is turned ON and goes off in approximately 3 seconds if the parking brake is not applied.

Parking brake warning

This warning light is illuminated when the parking brake is applied with the ignition switch in the START or ON position. The warning light should go off when the parking brake is released.

Low brake fluid level warning

If the warning light remains on, it may indicate that the brake fluid level in the reservoir is low.

If the warning light remains on:

1. Drive carefully to the nearest safe location and stop your vehicle.
2. With the engine stopped, check the brake fluid level immediately and add fluid as required. Then check all brake components for fluid leaks.
3. Do not drive the vehicle if leaks are found, the warning light remains on or the brakes do not operate properly. We recommend that you contact an authorized HYUNDAI dealer.

Your vehicle is equipped with dual-diagonal braking systems. This means you still have braking on two wheels even if one of the dual systems should fail. With only one of the dual systems working, more than normal pedal travel and greater pedal pressure are required to stop the vehicle. Also, the vehicle will not stop in as short a distance with only a portion of the brake system working. If the brakes fail while you are driving, shift to a lower gear for additional engine braking and stop the vehicle as soon as it is safe to do so.

Features of your vehicle

To check bulb operation, check whether the parking brake and brake fluid warning light illuminates when the ignition switch is in the ON position.

WARNING

Driving the vehicle with a warning light on is dangerous. If the brake warning light remains on, we recommend that the system be checked by an authorized HYUNDAI dealer.

Front fog light indicator (if equipped)



This indicator illuminates when the front fog lights are ON.

Shift pattern indicator (if equipped)



The indicator displays which automatic transaxle shift lever is selected.

Manual transaxle shift indicator (if equipped)



This indicator informs you which gear is desired while driving to save fuel.

For example

 : Indicates that shifting up to the 3rd gear is desired (currently the shift lever is in the 2nd gear).

 : Indicates that shifting down to the 3rd gear is desired (currently the shift lever is in the 4th gear).

*** NOTICE**

When the system is not working properly, the up & down arrow indicator and gear are not displayed.

Charging system warning light



This warning light indicates a malfunction of either the generator or electrical charging system.

If the warning light illuminates while the vehicle is in motion:

1. Drive to the nearest safe location.
2. With the engine off, check the generator drive belt for looseness or breakage.
3. If the belt is adjusted properly, a problem exists somewhere in the electrical charging system. We recommend that the system be checked by an authorized HYUNDAI dealer.

Tailgate/trunk open warning light



This warning light illuminates when the tailgate/trunk is not closed securely.

Door ajar warning light



This warning light illuminates when a door is not closed securely.

⚠ CAUTION

Before driving the vehicle, you should confirm that the door / tailgate (or trunk) is fully closed.

Also, check there is no door / tailgate (or trunk) open warning light or message displayed on the instrument cluster.

Immobilizer indicator (if equipped)



This indicator illuminates when the immobilizer key is inserted and turned to the ON position to start the engine.

At this time, you can start the engine. The light goes off after the engine is running.

If this light blinks when the ignition switch is in the ON position before starting the engine, we recommend that the system be checked by an authorized HYUNDAI dealer.

Low fuel level warning light



This warning light indicates the fuel tank is nearly empty. When it comes on, you should add fuel as soon as possible. Driving with the fuel level warning light on or with the fuel level below “E” can cause the engine to misfire and damage the catalytic converter (if equipped).

Malfunction indicator light (MIL) (check engine light)



This indicator is part of the Engine Control System which monitors various emission control system components. If this indicator illuminates while driving, it indicates that a potential malfunction has been detected somewhere in the emission control system.

This indicator will also illuminate when the ignition switch is placed in the ON position, and will go off in a few seconds after the engine is started. If it illuminates while driving, or does not illuminate when the ignition switch is placed in the ON position, we recommend that the system be checked by an authorized HYUNDAI dealer.

Generally, your vehicle will continue to be drivable, we recommend that the system be checked by an authorized HYUNDAI dealer.

CAUTION

- *Prolonged driving with the Emission Control System Malfunction Indicator Light illuminated may cause damage to the emission control systems which could affect drivability and/or fuel economy.*
- *If the Emission Control System Malfunction Indicator Light illuminates, potential catalytic converter damage is possible which could result in loss of engine power. We recommend that the system be inspected by an authorized HYUNDAI dealer.*

CAUTION - Diesel engine

If the Emission Control System Malfunction Indicator Light blinks, some error related to the injection quantity adjustment will occur which could result in loss of engine power, combustion noise and poor emission. We recommend that the system be inspected by an authorized HYUNDAI dealer.

⚠ CAUTION - Diesel engine (if equipped with DPF)

When the malfunction indicator light blinks, it may stop blinking after driving the vehicle at more than 60km/h (37 mph) or at more than second gear with 1500 ~ 2000 engine rpm for a certain time (for about 25 minutes).

If the malfunction indicator light continues to blink in spite of the procedure, please visit an authorized HYUNDAI dealer and then check the DPF system.

If you continue to drive with the malfunction indicator light blinking for a long time, the DPF system can be damaged and fuel consumption can be worsen.

Key reminder warning chime (if equipped)

If the driver's door is opened while the ignition key is left in the ignition switch (ACC or LOCK position), the key reminder warning chime will sound. This is to prevent you from locking your keys in the vehicle. The chime sounds until the key is removed from the ignition switch or the driver's door is closed.

Glow indicator (Diesel engine)



The indicator illuminates when the ignition switch is in the ON position. The engine can be started after the indicator light goes off. The illuminating time varies according to the water temperature, air temperature and battery condition.

⚠ CAUTION

If the glow indicator light continues to illuminate or blink on and off after the engine has warmed up or while driving, we recommend that the system be checked by an authorized HYUNDAI dealer.

Features of your vehicle

Fuel filter warning light (Diesel engine)



If the warning lights up while the engine is running, it indicates that water has accumulated inside the fuel filter. If this happens, remove the water from the fuel filter. For more Information, refer to “Fuel filter” in chapter 7.



CAUTION

When the fuel filter warning light illuminates, the engine power (vehicle speed & idle speed) may decrease. If you keep driving with the warning light on, you may damage your vehicle's engine parts and injection system of the Common Rail. If this occurs, we recommend that the system be checked by an authorized HYUNDAI dealer.

Electric power steering (EPS) system warning light (if equipped)



This indicator light illuminates after the ignition key is placed in the ON position and then it will go off when the engine starts.

This light also comes on when the EPS has malfunctioned. If it comes on while driving, we recommend that the system be inspected by an authorized HYUNDAI dealer.

KEY OUT indicator (if equipped)



When the engine start/stop button is in the ACC or ON position, if a door is open, the system checks for the smart key. If the smart key is not in the vehicle, the indicator will blink, and if all doors are closed, the chime will also sound for about 5 seconds. The indicator will go off while the vehicle is moving. Keep the smart key in the vehicle.

REARVIEW CAMERA (IF EQUIPPED)



The rearview camera will activate when the back-up light is ON with the ignition switch ON and the shift lever in the R (Reverse) position.

This system is a supplemental system that shows behind the vehicle through the rearview display mirror while backing-up.

The rearview camera may be turned off by pressing the ON/OFF button (1) when the rearview camera is activated.

To turn the camera on again, press the ON/OFF button (1) again when the ignition switch is on and the shift lever in R (Reverse). Also, the camera will turn on automatically whenever the ignition switch is turned off and on again.

⚠ WARNING

- **This system is a supplementary function only. It is the responsibility of the driver to always check the inside/outside rearview mirror and the area behind the vehicle before and while backing up because there is a dead zone that can't see through the camera.**
- **Always keep the camera lens clean. If lens is covered with foreign matter, the camera may not operate normally.**

HAZARD WARNING FLASHER



The hazard warning flasher should be used whenever you find it necessary to stop the vehicle in a hazardous location. When you must make such an emergency stop, always pull off the road as far as possible.

The hazard warning lights are turned on and off by pushing in the hazard switch. This causes all turn signal lights to blink. The Hazard Warning Lights will operate even though the ignition switch is in the LOCK/OFF position.

LIGHTING

Battery saver function (if equipped)

- The purpose of this feature is to prevent the battery from being discharged. The system automatically turns off the exterior lights when the driver removes the ignition key and opens the driver-side door.
- With this feature, the parking lights will turn off automatically if the driver parks on the side of road at night.

If necessary, to keep the lights on when the ignition key is removed, perform the following :

- 1) Open the driver-side door.
- 2) Turn the parking lights OFF and ON again using the light switch on the steering column.



Lighting control

The light switch has a Headlight and a Parking light position.

To operate the lights, turn the knob at the end of the control lever to one of the following positions:

- (1) OFF position
- (2) Parking light position
- (3) Headlight position



Parking light position (⊘00⊘)

When the light switch is in the parking light position, the tail, license and instrument panel lights will turn ON.

* NOTICE

The ignition switch must be in the ON position to turn on the instrument panel lights.



Headlight position ()

When the light switch is in the headlight position, the head, tail, license and instrument panel lights will turn ON.

* NOTICE

The ignition switch must be in the ON position to turn on the headlights.



High beam operation

To turn on the high beam headlights, push the lever away from you. Pull it back for low beams.

The high beam indicator will light when the headlight high beams are switched on. To prevent the battery from being discharged, do not leave the lights on for a prolonged time whilst the engine is not running.

WARNING

Do not use high beam when there are other vehicles. Using high beam could obstruct the other driver's vision.



Flashing headlights

To flash the headlights, pull the lever towards you. It will return to the normal (low beam) position when released. The headlight switch does not need to be on to use this flashing feature.



OBA043217IN

Turn signals and lane change signals

To signal a turn, push down on the lever for a left turn or up for a right turn in position (A). To signal a lane change, move the turn signal lever slightly and hold it in position (B). The lever will return to the OFF position when released or when the turn is completed.

If an indicator stays on and does not flash or if it flashes abnormally, one of the turn signal bulbs may be burned out and will require replacement.

One-touch lane change function (if equipped)

To activate an one-touch lane change function, move the turn signal lever slightly and then release it. The lane change signals will blink 3 times.

*** NOTICE**

If an indicator flash is abnormally quick or slow, a bulb may be burned out or have a poor electrical connection in the circuit.



OBA043216IN

Front fog light (if equipped)

Fog lights are used to provide improved visibility and avoid accidents when visibility is poor due to fog, rain or snow etc. The fog lights will turn on when fog light switch (1) is turned to the ON position after the parking light is turned on.

To turn off the fog lights, turn the switch to the OFF position.

⚠ CAUTION

When in operation, the fog lights consume large amounts of vehicle electrical power. Only use the fog lights when visibility is poor or unnecessary battery and generator drain could occur.

*** NOTICE**

The ignition switch must be in the ON position to turn on the front fog light.



Headlight levelling device

To adjust the headlight beam level according to the number of passengers and loading weight in the luggage area, turn the beam levelling switch.

The higher the number of the switch position, the lower the headlight beam level. Always keep the headlight beam at the proper levelling position, or headlights may dazzle other road users.

Listed below are the examples of proper switch settings. For loading conditions other than those listed below, adjust the switch position so that the beam level may be the nearest as the condition obtained according to the list.

Loading condition	Switch position
Driver only	0
Driver + Front passenger	0
Full passengers	1
Full passengers + Maximum permissible loading	3
Driver + Maximum permissible loading	5

Daytime running light (if equipped)

Daytime Running Lights (DRL) can make it easier for others to see the front of your vehicle during the day. DRL can be helpful in many different driving conditions, and it is especially helpful after dawn and before sunset.

The DRL system will turn off the dedicated lamp when:

- The headlight (low beam) switch is ON.
- The engine is OFF
- The front fog light is ON.

WIPERS AND WASHERS

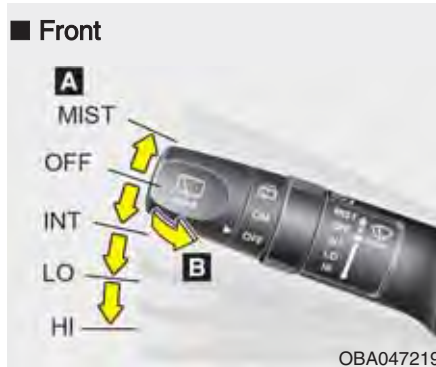

■ Front

- A : Wiper speed control**
- MIST – Single wipe
 - OFF – Off
 - INT – Intermittent wipe
 - LO – Low wiper speed
 - HI – High wiper speed
- B : Wash with brief wipes (front)**



■ Rear

- C : Rear wiper/washer control**
-  – Wash with brief wipes
(Returns to ON when released)
 - ON - Continuous wipe
 - OFF - Off

Windshield wipers

Operates as follows when the ignition switch is turned ON.

MIST : For a single wiping cycle, push the lever upward and release it with the lever in the OFF position. The wipers will operate continuously if the lever is pushed upward and held.

OFF : Wiper is not in operation

INT : Wiper operates intermittently at the same wiping intervals. Use this mode in a light rain or mist. To vary the speed setting, turn the speed control knob.

LO : Normal wiper speed

HI : Fast wiper speed

* NOTICE

If there is heavy accumulation of snow or ice on the windscreen, defrost the windscreen for about 10 minutes, or until the snow and/or ice is removed before using the windscreen wipers to ensure proper operation.



OBA043220IN

Windshield washers

In the OFF position, pull the lever gently toward you to spray washer fluid on the windshield and to run the wipers 1-3 cycles.

Use this function when the windshield is dirty.

The spray and wiper operation will continue until you release the lever.

If the washer does not work, check the washer fluid level. If the fluid level is not sufficient, you will need to add appropriate non-abrasive windshield washer fluid to the washer reservoir.

The reservoir filler neck is located in the front of the engine compartment on the driver side.

⚠ CAUTION

To prevent possible damage to the washer pump, do not operate the washer when the fluid reservoir is empty.

⚠ WARNING

Do not use the washer in freezing temperatures without first warming the windshield with the defrosters; the washer solution could freeze on contact with the windshield and obscure your vision.

⚠ CAUTION

- *To prevent possible damage to the wipers or windshield, do not operate the wipers when the windshield is dry.*
- *To prevent damage to the wiper blades, do not use petrol, kerosene, paint thinner, or other solvents on or near them.*
- *To prevent damage to the wiper arms and other components, do not attempt to move the wipers manually.*



OBA043218IN

Rear window wiper and washer switch (if equipped)

The rear window wiper and washer switch is located at the end of the wiper and washer switch lever. Turn the switch to desired position to operate the rear wiper and washer.

 - Spraying washer fluid and wiping
(Returns to ON when released)

ON - Normal wiper operation

OFF - Wiper is not in operation

INTERIOR LIGHT

⚠ CAUTION

*Do not use the interior lights for extended periods when engine is not running.
It may cause battery discharge.*



Room lamp

- **ON (1)**

The light stays on at all times.

⚠ CAUTION

Do not leave the switch in this position for an extended period of time when the engine is not running.

- **DOOR (2)**

The light comes on when a door is opened regardless of the ignition switch position.

When doors are unlocked by the remote key, the light comes on for approximately 30 seconds as long as a door is not opened. The light goes out gradually after approximately 30 seconds if the door is closed. However, if the ignition switch is ON or all doors are locked, the light will go out immediately.

If a door is opened with the ignition switch in the ACC or LOCK/OFF position, the light stays on for about 20 minutes. However, if a door is opened with the ignition switch in the ON position, the light stays on continuously.

- **OFF (3)**

The light stays off at all times even when a door is opened.

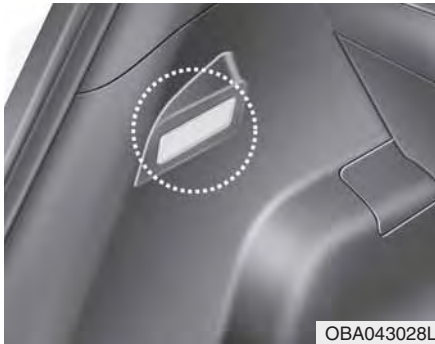

Luggage room lamp (if equipped)

The luggage room lamp comes on when the tailgate is opened.

DEFROSTER

⚠ CAUTION

To prevent damage to the conductors bonded to the inside surface of the rear window, never use sharp instruments or window cleaners containing abrasives to clean the window.

To prevent the battery from being discharged, operate the defroster only while the engine is running.

* NOTICE

If you want to defrost and defog the front windshield, refer to “Windshield Defrosting and Defogging” in this section.



Rear window defroster (if equipped)

The defroster heats the window to remove frost, fog and thin ice from the interior and exterior of the rear window, while the engine is running.

To activate the rear window defroster, press the rear window defroster button located in the center facia switch panel. The indicator on the rear window defroster button illuminates when the defroster is ON.

If there is heavy accumulation of snow on the rear window, brush it off before operating the rear defroster.

The rear window defroster automatically turns off after approximately 20 minutes or when the ignition switch is turned off. To turn off the defroster, press the rear window defroster button again.

MANUAL CLIMATE CONTROL SYSTEM (IF EQUIPPED)





- 1. Mode selection knob
- 2. Fan speed control knob
- 3. Temperature control knob
- 4. Air conditioning button*

* : if equipped

- 5. Air intake control button (recirculated air position)
- 6. Air intake control button (outside (fresh) air position)
- 7. Rear window defroster button*

OBA043151

Heating and air conditioning

1. Start the engine.
2. Set the mode to the desired position.
To improve the effectiveness of heating and cooling :
 - Heating: 
 - Cooling: 
3. Set the temperature control to the desired position.
4. Set the air intake control to the outside (fresh) air or recirculated air position.
5. Set the fan speed control to the desired speed.
6. If air conditioning is desired, turn the air conditioning system on.



OBA043152



OBA043153

Mode selection

The mode selection knob controls the direction of the air flow through the ventilation system.

Air can be directed to the floor, dashboard outlets, or windshield. Five symbols are used to represent Face, Bi-Level, Floor, Floor-Defrost and Defrost air position.



Face-Level (B, D, E)

Air flow is directed toward the upper body and face. Additionally, each outlet can be controlled to direct the air discharged from the outlet.



Bi-Level (B, D, C, E)

Air flow is discharged towards the face and floor.



Floor-Level (C, A, D)

Most of the air flow is directed to the floor, with a small amount of the air directed to the windshield and side window defrosters.



Floor/Defrost-Level (A, C, D, E)

Most of the air flow is directed to the floor and the windshield with a small amount directed to the side window defrosters.



Defrost-Level (A, D, E)

Most of the air flow is directed to the windshield with a small amount of air directed to the side window defrosters.



OBA043226IN

Instrument panel vents

The outlet vents can be opened or closed using the vent control lever.

Also, you can adjust the direction of air delivered from these vents using the vent control lever as shown.

Features of your vehicle

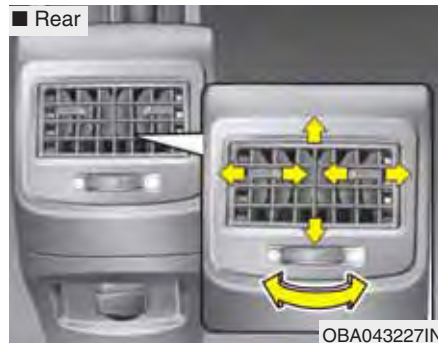

The outlet vents can be opened or closed separately using the thumbwheel.

Also, you can adjust the direction of air delivery from these vents using the vent control lever as shown.



Temperature control

The temperature control knob allows you to control the temperature of the air flowing from the ventilation system. To change the air temperature in the passenger compartment, turn the knob to the right for warm air or left for cooler air.



Air intake control

This is used to select outside (fresh) air position or recirculated air position. To change the air intake control position, push the control button.

Recirculated air position



The indicator light on the button illuminates when the recirculated air position is selected.

With the recirculated air position selected, air from the passenger compartment will be drawn through the heating system and heated or cooled according to the function selected.

Outside (fresh) air position



With the outside (fresh) air position selected, air enters the vehicle from outside and is heated or cooled according to the function selected.

* NOTICE

Prolonged operation of the heater in the recirculated air position (without air conditioning selected) may cause fogging of the windshield and side windows and the air within the passenger compartment may become stale.

In addition, prolonged use of the air conditioning with the recirculated air position selected will result in excessively dry air in the passenger compartment.

⚠ WARNING

- Continued use of the climate control system operation in the recirculated air position (without the air conditioning selected) may allow humidity to increase inside the vehicle which may fog the glass and obscure visibility.
- Do not sleep in a vehicle with the air conditioning or heating system on. It may cause serious harm or death due to a drop in the oxygen level and/or body temperature.
- Continued use of the climate control system operation in the recirculated air position can cause drowsiness or sleepiness, that may cause loss of vehicle control resulting in an accident. Set the air intake control to the outside (fresh) air position as much as possible while driving.



OBA043157

Fan speed control

The ignition switch must be in the ON position for fan operation.

The fan speed control knob allows you to control the fan speed of the air flowing from the ventilation system. To change the fan speed, turn the knob to the right for higher speed or left for lower speed.

Setting the fan speed control knob to the "0" position turns off the fan.



OBA043158

Air conditioning (if equipped)



Press the A/C button to turn the air conditioning system on (indicator light will illuminate). To turn the air conditioning system off, press the button again.

System operation

Ventilation

1. Set the mode to the  position.
2. Set the air intake control to the outside (fresh) air position.
3. Set the temperature control to the desired position.
4. Set the fan speed control to the desired speed.

Heating

1. Set the mode to the  position.
2. Set the air intake control to the outside (fresh) air position.
3. Set the temperature control to the desired position.
4. Set the fan speed control to the desired speed.
5. If dehumidified heating is desired, turn the air conditioning system on.
- If the windshield fogs up, set the mode to the  ,  position.

Operation Tips

- To prevent dust or unpleasant fumes from entering the vehicle through the ventilation system, temporarily set the air intake control to the recirculated air position. Be sure to return the control to the fresh air position when the irritation has passed to keep fresh air in the vehicle. This will help keep the driver alert and comfortable.
- Air for the heating/cooling system is drawn in through the grilles just ahead of the windshield. Care should be taken that these are not blocked by leaves, snow, ice or other obstructions.
- To prevent interior fog on the windshield, set the air intake control to the fresh air position and fan speed to the desired position, turn on the air conditioning system, and adjust the temperature control to a desired temperature.

Air conditioning

All HYUNDAI Air Conditioning Systems are filled with environmentally friendly R-134a refrigerant.

1. Start the engine. Push the air conditioning button.
 2. Set the mode to the  position.
 3. Set the air intake control to the recirculated air position. However, prolonged operation of the recirculated air position will excessively dry the air. In this case, change the air position.
 4. Adjust the fan speed control and temperature control to maintain maximum comfort.
- When maximum cooling is desired, set the temperature control to the extreme left, set the air intake control to the recirculated air position, then set the fan speed control to the highest speed.

*** NOTICE**

- **While using the air conditioning system, monitor the temperature gauge closely while driving up hills or in heavy traffic when outside temperatures are high. Air conditioning system operation may cause engine overheating. Continue to use the blower fan but turn the air conditioning system off if the temperature gauge indicates engine overheating.**
- **While opening the windows in humid weather air conditioning may create water droplets inside the vehicle. Since excessive water droplets may cause damage to electrical equipment, air conditioning should only be used with the windows closed.**

Air conditioning system operation tips

- If the vehicle has been parked in direct sunlight during hot weather, open the windows for a short time to let the hot air inside the vehicle escape.
- To help reduce moisture inside of the windows on rainy or humid days, decrease the humidity inside the vehicle by operating the air conditioning system.
- During air conditioning system operation, you may occasionally notice a slight change in engine speed as the air conditioning compressor cycles. This is a normal system operation characteristic.
- Use the air conditioning system every month only for a few minutes to ensure maximum system performance.
- When using the air conditioning system, you may notice clear water dripping (or even puddling) on the ground under the passenger side of the vehicle. This is a normal system operation characteristic.
- Operating the air conditioning system in the recirculated air position provides maximum cooling, however, continual operation in this mode may cause the air inside the vehicle to become stale.
- During cooling operation, you may occasionally notice a misty air flow because of rapid cooling and humid air intake. This is a normal system operation characteristics.

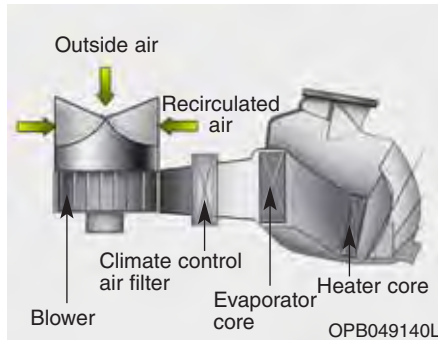

Climate control air filter

The climate control air filter installed in your vehicle filters the dust or other pollutants that come into the vehicle from the outside through the heating and air conditioning system. If dust or other pollutants accumulate in the filter over a period of time, the air flow from the air vents may decrease, resulting in moisture accumulation inside of the windshield even when the outside (fresh) air position is selected. If this happens, we recommend that the climate control air filter be checked by an authorized HYUNDAI dealer.

* NOTICE

- Check the filter according to the Maintenance Schedule in chapter 7. If the vehicle is being driven in severe conditions such as dusty, rough roads, more frequent climate control air filter inspections are required.
- When the air flow rate suddenly decreases, we recommend that the system be checked by an authorized HYUNDAI dealer.

Checking the amount of air conditioner refrigerant and compressor lubricant

When the amount of refrigerant is low, the performance of the air conditioning is reduced. Overfilling also has a negative impact on the air conditioning system. Therefore, if abnormal operation is found, we recommend that the system be inspected by an authorized HYUNDAI dealer.

* NOTICE

It is important that the correct type and amount of oil and refrigerant is used. Otherwise, damage to the compressor and abnormal system operation may occur.

WARNING

Improper service may cause serious injury to the person performing the service. For more detailed information, we recommend that you contact an authorized HYUNDAI dealer. Improper service may cause serious injury to the person performing the service.

AUTOMATIC CLIMATE CONTROL SYSTEM (IF EQUIPPED)



- | | |
|--------------------------------------|------------------------------------|
| 1. Front windshield defroster button | 6. Air intake control button |
| 2. Air conditioning button | 7. AUTO (automatic control) button |
| 3. Temperature control knob | 8. OFF button |
| 4. Fan speed control knob | 9. Mode selection button |
| 5. Rear window defroster button | 10. Climate control display |

OBA047160

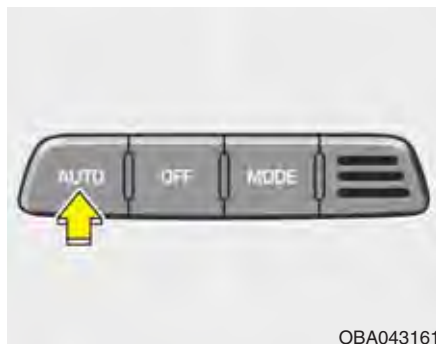

Automatic climate control

Adjusting the temperature setting will cause the airflow vents, air intake and fan to adjust automatically.

Using the automatic mode

Press the AUTO Button.

- The air conditioning system is automatically adjusted according to the current temperature setting
- You can adjust the temperature control knob to the desired temperature.

* For your convenience and to improve the effectiveness of the climate control, use the AUTO button and set the temperature to 23°C (73°F).

To turn the automatic operation off, press any button except the temperature control knob. If you press the mode selection button, the selected function will be controlled manually while other functions operate automatically.

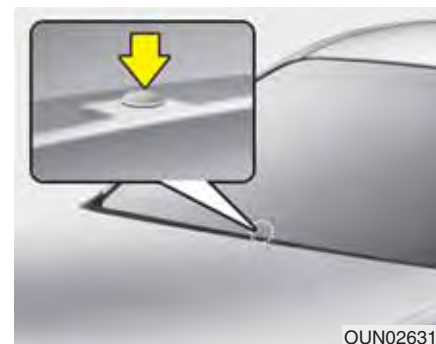



* NOTICE

Never place anything over the sensor located on the instrument panel to ensure better control of the heating and cooling system.

Manual heating and air conditioning

The heating and cooling system can be controlled manually by pushing buttons other than the AUTO button. In this case, the system works sequentially according to the order of buttons selected.

1. Start the engine.
 2. Set the mode to the desired position.
To improve the effectiveness of heating and cooling :
 - Heating: 
 - Cooling: 
 3. Set the temperature control to the desired position.
 4. Set the air intake control to the outside (fresh) air or recirculated air position.
 5. Set the fan speed control to the desired speed.
 6. If air conditioning is desired, turn the air conditioning system on.
- Press the AUTO button in order to convert to full automatic control of the system.

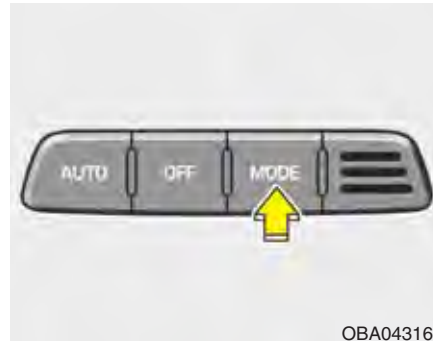

OBA043162

Mode selection

The mode selection button controls the direction of the air flow through the ventilation system.

The air flow outlet port is converted as follows:



Refer to the illustration in the “Manual climate control system”.



Floor & Defrost

Most of the air flow is directed to the floor and the windshield with a small amount directed to the side window defrosters.



Floor-Level

Most of the air flow is directed to the floor, with a small amount of the air being directed to the windshield and side window defrosters.



Bi-Level

Air flow is directed towards the face and the floor.



Face-Level

Air flow is directed toward the upper body and face. Additionally, each outlet can be controlled to direct the air discharged from the outlet.



Defrost-Level

Most of the air flow is directed to the windshield with a small amount of air directed to the side window defrosters.

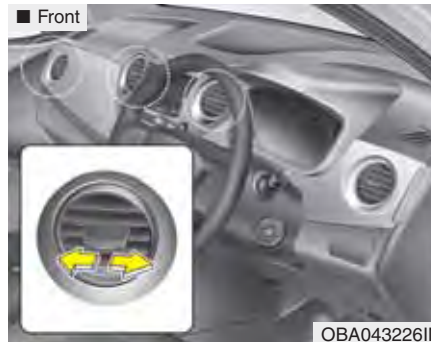

Instrument panel vents

The outlet vents can be opened or closed using the vent control lever. Also, you can adjust the direction of air delivered from these vents using the vent control lever as shown.



The outlet vents can be opened or closed separately using the thumbwheel. Also, you can adjust the direction of air delivery from these vents using the vent control lever as shown.



Temperature control

The temperature will increase to the maximum (HI) by turning the knob to the extreme right.

The temperature will decrease to the minimum (Lo) by turning the knob to the extreme left.

When you turn the knob, the temperature will increase or decrease by 0.5°C (1°F).

Temperature conversion (if equipped)

You can switch the temperature mode between Centigrade to Fahrenheit as follows:

While pressing the OFF button, press the AUTO button for 3 seconds or more.

The display will change from Centigrade to Fahrenheit, or from Fahrenheit to Centigrade.

If the battery has been discharged or disconnected, the temperature mode display will reset to Centigrade.



Air intake control

This is used to select outside (fresh) air position or recirculated air position.

To change the air intake control position, press the control button.

Recirculated air position



The indicator light on the button illuminates when the recirculated air position is selected.

With the recirculated air position selected, air from the passenger compartment will be drawn through the heating system and heated or cooled according to the function selected.

Outside (fresh) air position



The indicator light on the button will not illuminate when the outside (fresh) air position is selected.

With the outside (fresh) air position selected, air enters the vehicle from outside and is heated or cooled according to the function selected.

* NOTICE

Prolonged operation of the heater in the recirculated air position (without air conditioning selected) may cause fogging of the windshield and side windows and the air within the passenger compartment may become stale.

In addition, prolonged use of the air conditioning with the recirculated air position selected, will result in excessively dry air in the passenger compartment.

⚠ WARNING

- Continued use of the climate control system operation in the recirculated air position (without the air conditioning selected) may allow humidity to increase inside the vehicle which may fog the glass and obscure visibility.
- Do not sleep in a vehicle with air conditioning or heating system on. It may cause serious harm or death due to a drop in the oxygen level and/or body temperature.
- Continued use of the climate control system operation in the recirculated air position can cause drowsiness or sleepiness, that may cause loss of vehicle control resulting in an accident. Set the air intake control to the outside (fresh) air position as much as possible while driving.



Fan speed control

The ignition switch must be in the ON position for fan operation. The fan speed control knob allows you to control the fan speed of the air flowing from the ventilation system. To change the fan speed, turn the knob to the right for higher speed or left for lower speed.



Air conditioning

Press the A/C button to turn the air conditioning system on (indicator light will illuminate). Press the button again to turn the air conditioning system off.

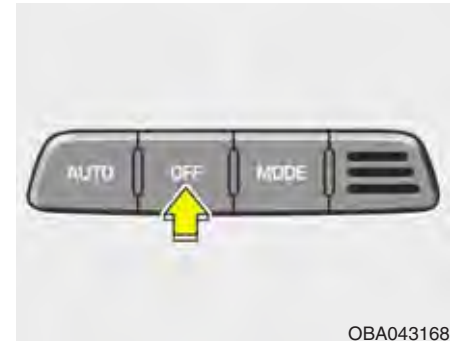



OFF mode

Press the OFF button to turn off the climate control system. However you can still operate the mode and air intake buttons as long as the ignition switch is in the ON position.

WINDSHIELD DEFROSTING AND DEFOGGING

WARNING - Windshield heating

Do not use the  or  position during cooling operation in extremely humid weather. The difference between the temperature of the outside air and the windshield could cause the outer surface of the windshield to fog up, causing loss of visibility. In this case, set the mode selection knob or button to the  position and fan speed control knob or button to the lower speed.

- For maximum defrosting, set the temperature control to the extreme right/hot position and the fan speed control to the highest speed.
- If warm air to the floor is desired while defrosting or defogging, set the mode to the floor-defrost position.
- Before driving, clear all snow and ice from the windshield, rear window, outside rear view mirrors, and all side windows.
- Clear all snow and ice from the hood and air inlet in the cowl grill to improve heater and defroster efficiency and to reduce the probability of fogging up inside of the windshield.



Manual climate control system

To defog inside windshield

1. Select any fan speed except "0" position.
2. Select desired temperature.
3. Select the  position.
4. The outside (fresh) air and air conditioning (if equipped) will be selected automatically.

If the air-conditioning (if equipped) and outside (fresh) air position are not selected automatically, press the corresponding button manually.

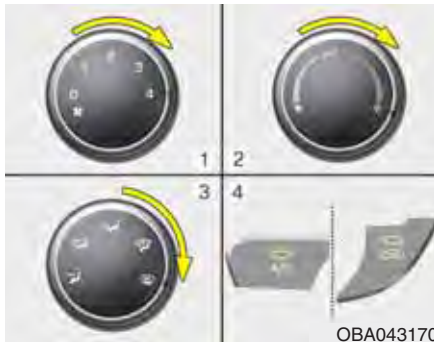

OBA043170

To defrost outside windshield

1. Set the fan speed to the highest (extreme right) position.
2. Set the temperature to the extreme hot position.
3. Select the  position.
4. The outside (fresh) air and air conditioning will be selected automatically.



OBA043171

Automatic climate control system

To defog inside windshield

1. Select desired fan speed.
2. Select desired temperature.
3. Press the defroster button ().
4. The air-conditioning will turn on according to the detected ambient temperature, outside (fresh) air position and higher fan speed will be selected automatically.

If the air-conditioning, outside (fresh) air position and higher fan speed are not selected automatically, adjust the corresponding button or knob manually.

If the  position is selected, lower fan speed is adjusted to a higher fan speed.



OBA043172

To defrost outside windshield

1. Set the fan speed to the highest position.
2. Set the temperature to the extreme hot (HI) position.
3. Press the defroster button ().
4. The air-conditioning will turn on according to the detected ambient temperature and outside (fresh) air position will be selected automatically.

If the  position is selected, lower fan speed is adjusted to a higher fan speed.

STORAGE COMPARTMENT

⚠ CAUTION

- *To avoid possible theft, do not leave valuables in the storage compartment.*
- *Always keep the storage compartment covers closed while driving. Do not attempt to place so many items in the storage compartment that the storage compartment cover can not close securely.*



Center console storage

These compartments can be used to store small items.

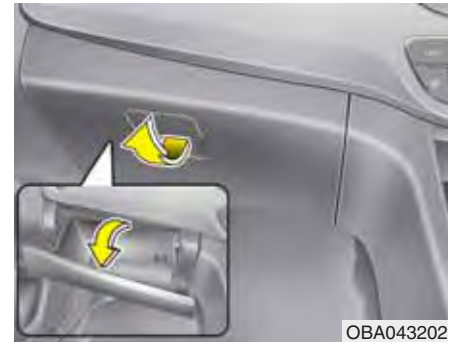

Glove box

To open the glove box, pull the handle and the glove box will automatically open. Close the glove box after use.

⚠ WARNING - Flammable materials

Do not store cigarette lighters, propane cylinders, or other flammable/explosive materials in the vehicle. These items may catch fire and/or explode if the vehicle is exposed to hot temperatures for extended periods.

⚠ WARNING

To reduce the risk of injury in an accident or sudden stop, always keep the glove box door closed while driving.



Cool box (if equipped)

You can keep beverage cans or other items cool in the glove box.

1. Turn on the air conditioning.
2. Slide the open/close lever (1) of the vent installed in the glove box to the open position.
3. When the cool box is not used, slide the lever (1) to the closed position.

* NOTICE

If some items in the cool box block the vent, the cooling effectiveness of the cool box is reduced.

⚠ WARNING

Do not put perishable food in the cool box because it may not maintain the necessary consistent temperature to keep the food fresh.

* NOTICE

If the temperature control knob is in the warm or hot position, warm or hot air will flow into the glove box.

INTERIOR FEATURES



Cigarette lighter (if equipped)

For the cigarette lighter to work, the ignition switch must be in the ACC or ON position.

To use the cigarette lighter, push it all the way into its socket. When the element is heated, the lighter will pop out to the "ready" position.

⚠ WARNING

- Do not hold the lighter in after it is already heated because it will over-heat.
- If the lighter does not pop out within 30 seconds, remove it to prevent overheating.

⚠ CAUTION

We recommend that you use parts for replacement from an authorized HYUNDAI dealer. The use of plug-in accessories (shavers, hand-held vacuums, and coffee pots, for example) may damage the socket or cause electrical failure.

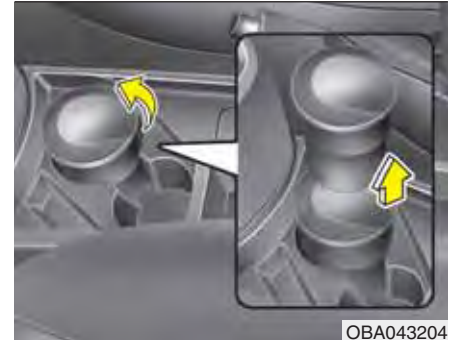

Ashtray (if equipped)

To use the ashtray, open the cover.

To clean or empty the ashtray, pull it out.

⚠ WARNING - Ashtray use

- Do not use the vehicle's ashtrays as waste receptacles.
- Putting lit cigarettes or matches in an ashtray with other combustible materials may cause fire.

Cup holder

⚠ WARNING - Hot liquids

- Do not place uncovered cups of hot liquid in the cup holder while the vehicle is in motion. If the hot liquid spills, you may burn yourself. Such a burn to the driver could lead to loss of control of the vehicle.
- To reduce the risk of personal injury in the event of a sudden stop or collision, do not place uncovered or unsecured bottles, glasses, cans, etc., in the cup holder while the vehicle is in motion.



Front

Cups or small beverage cans may be placed in the cup holders.



Rear (if equipped)

To use the center cup holder, pull down the armrest.

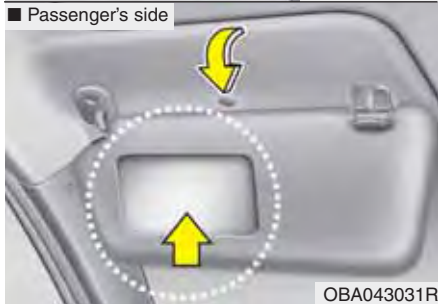
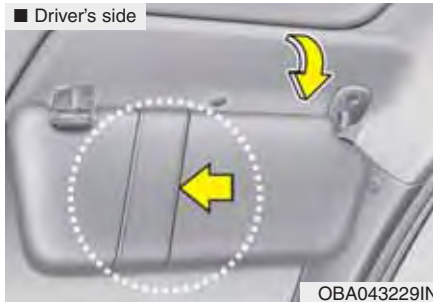

Sunvisor

Use the sunvisor to shield direct light through the front or side windows. A mirror (if equipped) and ticket holder (if equipped) is provided on the sunvisor.



Power outlet (if equipped)

The power outlet is designed to provide power for mobile telephones or other devices designed to operate with vehicle electrical systems. The devices should draw less than 10 amps with the engine running.

⚠ CAUTION

- Use the power outlet only when the engine is running and remove the accessory plug after use. Using the accessory plug for prolonged periods of time with the engine off could cause the battery to discharge.
- Only use 12V electric accessories which are less than 10A in electric capacity.
- Adjust the air-conditioner or heater to the lowest operating level when using the power outlet.
- Close the cover when not in use.
- Some electronic devices can cause electronic interference when plugged into a vehicle's power outlet. These devices may cause excessive audio static and malfunctions in other electronic systems or devices used in your vehicle.

⚠ WARNING

Do not put a finger or a foreign element (pin, etc.) into a power outlet and do not touch with a wet hand. You may get an electric shock.

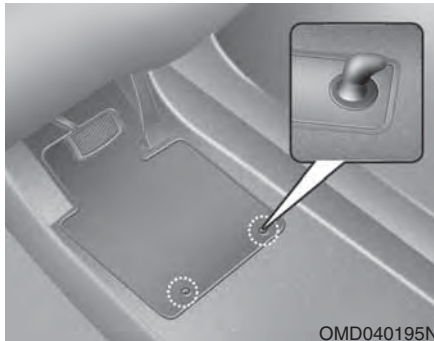

OMD040195N

Floor mat anchor(s)

When using a floor mat on the front floor carpet, make sure it attaches to the floor mat anchor(s) in your vehicle. This keeps the floor mat from sliding forward.



OBA043230IN

Cargo area cover (if equipped)

Use the cargo area cover to hide items stored in the cargo area. The cargo area cover can be uprighted or removed.

⚠ WARNING

- Do not place objects on the cargo area cover. Such objects may be thrown about inside the vehicle and possibly injure vehicle occupants during an accident or braking.
- Never allow anyone to ride in the luggage compartment. It is designed for luggage only.

⚠ CAUTION

Do not put luggage on the cover since it may be damaged or malformed.

AUDIO SYSTEM

* NOTICE

- If you install an aftermarket HID head lamp, your vehicle's audio and electronic device may malfunction.
- Prevent chemicals such as perfume, cosmetic oil, sun cream, hand cleaner and air freshener from contacting the interior parts because they may cause damage or discoloration.

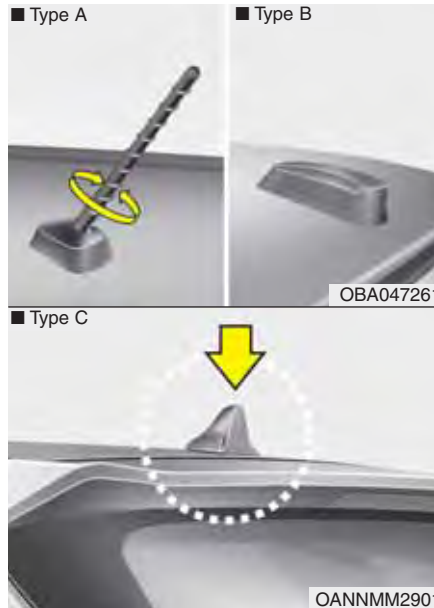

Antenna

Your car uses an antenna to receive both AM and FM broadcast signals.

Type A

This antenna is a removable type. To remove the antenna, turn it counterclockwise. To install the antenna, turn it clockwise.

Type C

The shark fin antenna receives transmitted data. (for example: GPS and DAB signals)

⚠ CAUTION

- Before entering a place with a low height clearance, be sure that the antenna is removed.
- Be sure to remove the antenna before washing the vehicle in an automatic car wash or it may be damaged.
- When reinstalling your antenna, it is important that it is fully tightened and adjusted to the upright position to ensure proper reception. But it could be removed when parking the vehicle.

⚠ CAUTION

Installation of aftermarket antenna may result in water leakage, wind noise, rattling & improper radio operation. We recommend to use the antenna available with an authorized HYUNDAI dealer.



OBA043228IN

Audio remote control (if equipped)

The steering wheel audio remote control button is installed to promote safe driving.



CAUTION

Do not operate the audio remote control buttons simultaneously.

VOL (+, -) (1)

- Press the button (+) to increase volume.
- Press the button (-) to decrease volume.

MUTE (2)

- Press the MUTE button to cancel sound.
- Press the MUTE button again to activate sound.

MODE (3)

Press the MODE button to select Radio or CD (compact disc).

SEEK (^ / \) (4)

The SEEK button has different functions base on the system mode. For the following functions the button should be pressed for 0.8 second or more.

RADIO mode

It will function as the AUTO SEEK select button.

CDP mode

It will function as the FF/REW button.

If the SEEK button is pressed for less than 0.8 second, it will work as follows in each mode.

RADIO mode

It will function as the PRESET STATION select buttons.

CDP mode

It will function as the TRACK UP/DOWN button.

Detailed information for audio control buttons is described in the following pages in this chapter.



Aux, USB and iPod (if equipped)

If your vehicle has an aux and/or USB(universal serial bus) port or iPod port, you can use an aux port to connect audio devices and an USB port to plug in an USB and also an iPod port to plug in an iPod.

* NOTICE

When using a portable audio device connected to the power outlet, noise may occur during playback. If this happens, use the power source of the portable audio device.

FM reception

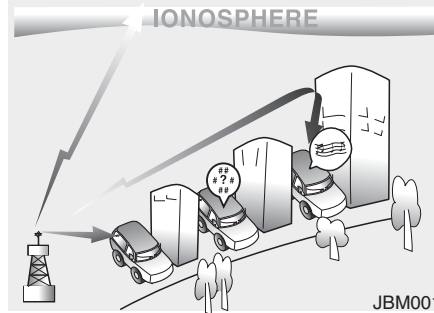

How vehicle audio works

AM and FM radio signals are broadcast from transmitter towers located around your city. They are intercepted by the radio antenna on your vehicle. This signal is then received by the radio and sent to your vehicle speakers.

When a strong radio signal has reached your vehicle, the precise engineering of your audio system ensures the best possible quality reproduction. However, in some cases the signal coming to your vehicle may not be strong and clear.

This can be due to factors, such as the distance from the radio station, closeness of other strong radio stations or the presence of buildings, bridges or other large obstructions in the area.

AM (MW, LW) reception

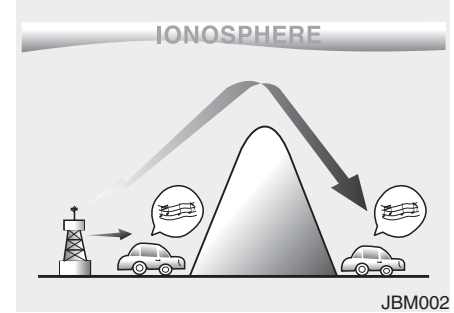

AM broadcasts can be received at greater distances than FM broadcasts. This is because AM radio waves are transmitted at low frequencies. These long, low frequency radio waves can follow the curvature of the earth rather than travelling straight out into the atmosphere. In addition, they curve around obstructions so that they can provide better signal coverage.

DRM Broadcasts can be received at greater distances. This is entirely a digital type of transmission. The transmission band width of DRM is same as AM. When a strong radio has reached your vehicle, the precise engineering of your audio system ensures the best possible quality reproduction. However, in some cases the signal coming to your vehicle may not be strong and clear. This can be due to factors, such as the distance from the radio station, presence of buildings, bridges tunnels or other large obstructions & power transmission lines in the area. During this obstructions or low signal reception then no sound from the audio is observed for very less time. Content from the audio is been played when signal is recovered.

FM radio station

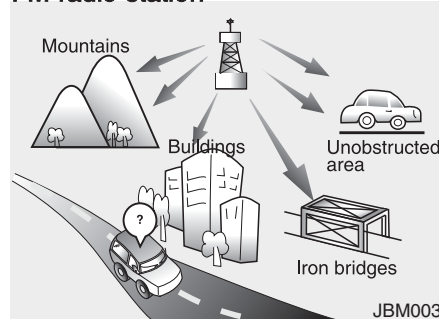

FM broadcasts are transmitted at high frequencies and do not bend to follow the earth's surface. Because of this, FM broadcasts generally begin to fade at short distances from the station. Also, FM signals are easily affected by buildings, mountains, or other obstructions. These can result in certain listening conditions which might lead you to believe a problem exists with your radio. The following conditions are normal and do not indicate radio trouble :

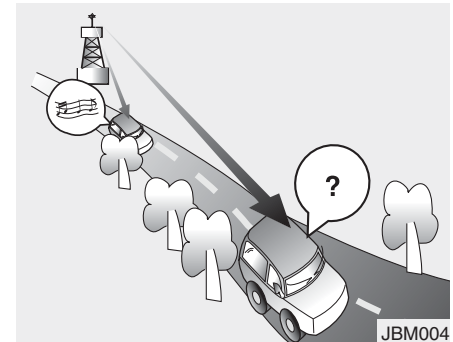

- Fading - As your vehicle moves away from the radio station, the signal will weaken and sound will begin to fade. When this occurs, we suggest that you select another stronger station.
- Flutter/Static - Weak FM signals or large obstructions between the transmitter and your radio can disturb the signal causing static or fluttering noises to occur. Reducing the treble level may lessen this effect until the disturbance clears.

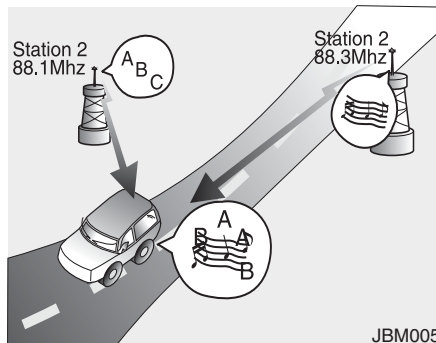

- **Station Swapping** - As a FM signal weakens, another more powerful signal near the same frequency may begin to play. This is because your radio is designed to lock onto the clearest signal. If this occurs, select another station with a stronger signal.
- **Multi-Path Cancellation** - Radio signals being received from several directions can cause distortion or fluttering. This can be caused by a direct and reflected signal from the same station, or by signals from two stations with close frequencies. If this occurs, select another station until the condition has passed.

Using a cellular phone or a two-way radio

When a cellular phone is used inside the vehicle, noise may be produced from the audio system. This does not mean that something is wrong with the audio equipment. In such a case, use the cellular phone at a place as far as possible from the audio equipment.

⚠ CAUTION

When using a communication system such as a cellular phone or a radio set inside the vehicle, a separate external antenna must be fitted. When a cellular phone or a radio set is used with an internal antenna alone, it may interfere with the vehicle's electrical system and adversely affect safe operation of the vehicle.

⚠ WARNING

Do not use a cellular phone while driving. Stop at a safe location to use a cellular phone.

iPod®

iPod® is a registered trademark of Apple Inc.

***Bluetooth®* Wireless Technology**

The Bluetooth® word mark and logos are registered trademarks owned by Bluetooth SIG, Inc. and any use of such marks by HYUNDAI is under license.

Other trademarks and trade names are those of their respective owners.



AUDIO (Without Touch Screen)

■ Type A



■ Type B



(With *Bluetooth*[®] Wireless Technology)

B4N3G0000EG/B4N3G0001EG

Feature of Your Audio

Head Unit

■ Type A



■ Type B



※ The actual features in the vehicle may differ from the illustration.

(1) MUTE

- Mute audio output.

(2) SETUP/CLOCK

When pressed quickly

- Moves to Setup screen.

When pressed and held

- Moves to the Time Settings.

(3) MENU

- Displays menus for the current mode.

(4) BACK

- Moves to previous screen.

(5) FOLDER

- Media(USB) mode: Searches folders.

(6) SEEK/TRACK

When pressed quickly

- Radio mode: Searches broadcast frequencies.
- Media mode: Changes track, file or title. (except AUX)

When pressed and held

- Radio mode: Frequency is controlled by 1 step quickly. When the button is released after pressing and holding, searches broadcast frequencies.

- Media mode: Rewinds or fast-forwards the song. (except BT Audio*, AUX)

* if equipped

(7) TUNE knob

- Radio mode: Changes frequency by turning the knob left/right.
- Media mode: Searches songs(files) by turning the knob left/right.

■ Type A



■ Type B



(8) DISP

- Turns off the screen.
- Each time the button is pressed, it sets the Screen Off → On → Off.

(9) RADIO

- Plays Radio(FM/AM/DRM) mode.
- Each time the button is pressed, the radio mode popup will be displayed or closed.
- The radio mode popup will not be displayed when [SETUP/CLOCK] button ► [Display] ► [Mode popup] is turned [Off].

(10) MEDIA

- Plays Media(USB(iPod®), BT Audio*, AUX) mode.
- Each time the button is pressed, the media mode popup will be displayed or closed.
- The media mode popup will not be displayed when [SETUP/CLOCK] button ► [Display] ► [Mode popup] is turned [Off].

* if equipped

(11) SCAN (Type A)

- Play all receivable stations for 5 seconds each. (Radio mode only)

(12) PHONE (Type B)

- Moves to Phone screen.
- If Bluetooth® is not connected, displays Bluetooth® Pair/Connection screen.

(13) POWER/VOL knob

- Power knob: Turns power On/Off by pressing the knob.
- Volume knob: Sets volume by turning the knob left/right.



(14) [1] ~ [6] (Preset)

When pressed quickly

- Radio mode: Receives saved frequencies(channels).
- Media mode(USB)
 - [1 RPT] button: Repeat/Repeat Folder
 - [2 SHFL] button: Shuffle Folder/Shuffle
- Media mode(iPod®)
 - [1 RPT] button: Repeat
 - [2 SHFL] button: Shuffle
- In case of Menu popup, the number menu is selected.

When pressed and held

- Radio mode: Saves frequencies (channels).

Steering Wheel Controls

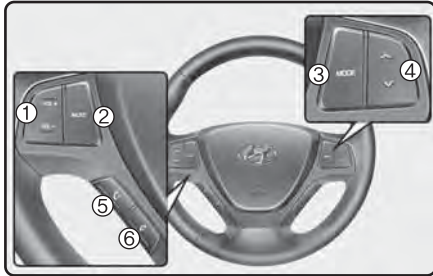

* The actual features in the vehicle may differ from the illustration.

(1) **VOLUME**

- Controls the audio volume.

(2) **MUTE**

- Mutes the audio volume.

(3) **MODE**

- Each time this is pressed, the mode is changed sequentially.
- If the media is not connected, the corresponding modes will be disabled.
- Press and hold to turn the Audio system on/off.
- When power is off, press button to turn power back on.

(4) **SEEK/TRACK**

- When pressed quickly
 - Radio mode: Searches broadcast frequencies saved to Presets.
 - Media mode: Changes track, file or title. (except AUX)
- When pressed and held
 - Radio mode: Frequency is controlled by 1 step quickly. When the button is released after pressing and holding, searches broadcast frequencies.
 - Media mode: Rewinds or fast-forwards the song. (except BT Audio*, AUX)

(5) **CALL** (if equipped)

- When pressed quickly
 - Moves to Phone screen.
 - When pressed in the incoming call screen, answers the call.
 - When pressed during call waiting, switches to waiting call.
- When pressed and held
 - Displays the last dialed number.
 - When pressed during a Bluetooth® Handsfree call, switches call back to Bluetooth® device(private mode).
 - When pressed while calling on the Bluetooth® device, switches call back to Bluetooth® Handsfree.
 - If Bluetooth® is not connected, displays Bluetooth® Pair/Connection screen.

(6) **END** (if equipped)

- When pressed during a call, ends the phone call.
- When pressed in the incoming call screen, rejects the call.

⚠ WARNING**- Audio System Safety Warnings**

- Do not stare at the screen while driving. Staring at the screen for prolonged periods of time could lead to traffic accidents.
- Do not disassemble, assemble, or modify the audio system. Such acts could result in accidents, fire, or electric shock.
- Using the phone while driving may lead to a lack of attention of traffic conditions and increase the likelihood of accidents. Use the phone feature after parking the vehicle.
- Heed caution not to spill water or introduce foreign objects into the device. Such acts could lead to smoke, fire, or product malfunction.

(Continued)

(Continued)

- Please refrain from use if the screen is blank or no sound can be heard as these signs may indicate product malfunction. Continued use in such conditions could lead to accidents (fires, electric shock) or product malfunctions.
- Do not touch the antenna during thunder or lightning as such acts may lead to lightning induced electric shock.
- Do not stop or park in parking-restricted areas to operate the product. Such acts could lead to traffic accidents.
- Use the system with the vehicle ignition turned on. Prolonged use with the ignition turned off could result in battery discharge.

⚠ WARNING - Distracted Driving

Driving while distracted can result in a loss of vehicle control that may lead to an accident, severe personal injury, and death. The driver's primary responsibility is in the safe and legal operation of a vehicle, and use of any handheld devices, other equipment, or vehicle systems which take the driver's eyes, attention and focus away from the safe operation of a vehicle or which are not permissible by law should never be used during operation of the vehicle.

 **CAUTION**

- *Operating the device while driving could lead to accidents due to a lack of attention to external surroundings. First park the vehicle before operating the device.*
- *Adjust the volume to levels that allow the driver to hear sounds from outside of the vehicle. Driving in a state where external sounds cannot be heard may lead to accidents.*
- *Pay attention to the volume setting when turning the device on. A sudden output of extreme volume upon turning the device on could lead to hearing impairment. (Adjust the volume to a suitable levels before turning off the device.)*

(Continued)

(Continued)

- *If you want to change the position of device installation, please inquire with your place of purchase or service maintenance center. Technical expertise is required to install or disassemble the device.*
- *Turn on the car ignition before using this device. Do not operate the audio system for long periods of time with the ignition turned off as such operations may lead to battery discharge.*
- *Do not subject the device to severe shock or impact. Direct pressure onto the front side of the monitor may cause damage to the LCD or touch screen.*

(Continued)

(Continued)

- *When cleaning the device, make sure to turn off the device and use a dry and smooth cloth. Never use tough materials, chemical cloths, or solvents (alcohol, benzene, thinners, etc.). As such materials may damage the device panel or cause color/quality deterioration.*
- *Do not place beverages close to the audio system. Spilling beverages may lead to system malfunction.*
- *In case of product malfunction, please contact your place of purchase or After Service center.*
- *Placing the audio system within an electromagnetic environment may result in noise interference.*
- *Prevent caustic solutions such as perfume and cosmetic oil from contacting the dashboard because they may cause damage or discoloration.*

Radio

Radio Mode

Change Mode: [RADIO] button

- You can change the radio mode through [RADIO] button.
- The radio mode popup will not be displayed when [SETUP/CLOCK] button ► [Display] ► [Mode popup] is turned [Off].

Search Frequency: [SEEK/TRACK] button

- Searches the previous/next broadcast frequencies.
 - Pressing the button: Changes the frequency.
 - Pressing and holding the button: Frequency is controlled by 1 step quickly. When the button is released after pressing and holding, searches broadcast frequencies.

Change Frequency: TUNE knob

- Changes frequency by turning the knob left/right. You can seek available frequencies manually.

Saved Frequency: [1] ~ [6] (Preset) buttons

- Pressing the button: Plays the frequency saved in the corresponding button.
- Pressing and holding the button: Saves the currently playing broadcast to the selected button and sound a BEEP.

FM/AM Mode



Displays Menu Popup when pressing the [MENU] button.

Auto Store

Saves broadcasts with superior reception to [1] ~ [6] buttons. If no frequencies are received, then the most recently received frequency will be broadcast.

Scan

The broadcast frequency increases and previews each broadcast for 5 seconds each. After scanning all frequencies, returns and plays the current broadcast frequency.

Sound Settings

Moves to Sound Settings.

DRM Mode

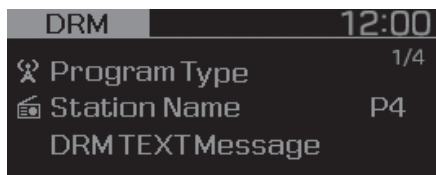

* The actual features may differ from the illustration.

* May change according to the transmission content of DRM.

Displays Menu Popup when pressing the [MENU] button.

Weather/News Report (DRM only)

Weather/News/Travel Announcement feature On/Off.

Presets

Displays saved presets.

Service List (DRM only)

Moves to the DRM Service List.

Auto Store

Saves broadcasts with superior reception to [1] ~ [6] buttons. If no frequencies are received, then the most recently received frequency will be broadcast.

Scan

The broadcast frequency increases and previews each broadcast for 5 seconds each. After scanning all frequencies, returns and plays the current broadcast frequency.

Sound Settings

Moves to Sound Settings.

* NOTICE

- The receiving of DRM signal is based on transmission (range & time) of all India radio.
- Some of the states of India are not started with DRM transmission.

Media

*** NOTICE - Using MP3**

Supported audio formats

Compressed audio formats	MPEG1 Audio Layer3
	MPEG2 Audio Layer3
	MPEG2.5 Audio Layer3
	Windows Media Audio Ver 7.X & 8.X

*** NOTICE**

File formats that do not comply with the above formats may not be properly recognized or play without properly displaying file names or other information.

Support for Compressed Files

1. Supported Bitrates (Kbps)

BIT RATE (kbps)	MPEG1	MPEG2	MPEG2.5	WMA
	Layer3	Layer3	Layer3	High Range
32	8	8	48	
40	16	16	64	
48	24	24	80	
56	32	32	96	
64	40	40	128	
80	48	48	160	
96	56	56	192	
112	64	64		
128	80	80		
160	96	96		
192	112	112		
224	128	128		
256	144	144		
320	160	160		

2. Sampling Frequencies (Hz)

MPEG1	MPEG2	MPEG2.5	WMA
44100	22050	11025	32000
48000	24000	12000	44100
3000	16000	8000	48000

- For MP3/WMA compression files, differences in sound quality will occur depending on the bitrate. (Higher sound quality can be experienced with higher bitrates.)

- This device only recognizes files with MP3/WMA extensions. Other file extensions may not be properly recognized.

3. Maximum number of recognized folders and files

- Folder: 1,000 folders for USB
- File: 5,000 files for USB
- There are no limitations to the number of recognized folder levels.

4. Text Display (Based on Unicode)

- Filenames: Maximum 40 English characters
- Foldernames: Maximum 40 English characters

*** NOTICE**

Using the scroll feature allows you to see the entire name of files with names that are too long to be displayed at once.

Language Support (Unicode Support)

- Korean: 2,604 characters
- English: 94 characters
- Common Chinese characters: 4,888 characters
- Special symbols: 986 characters

* NOTICE

Japanese/Simplified Chinese characters are not supported.

* NOTICE - Using the USB Devices

- Connect the USB device after turning on the engine. The USB device may become damaged if it is already connected when the ignition is turned on. The USB device may not operate properly if the car ignition is turned on or off with the USB device connected.
- Be careful for static electricity when connecting/disconnecting USB devices.
- Encoded MP3 Players will not be recognized when connected as an external device.
- When connecting an external USB device, the vehicle's audio system may not recognize the USB depending on what firmware is used by USB device or what files are on the USB.
- Only products formatted with byte/sectors under 64Kbyte will be recognized.
- This device recognizes USB devices formatted in FAT 12/16/32 file formats. This device does not recognize files in NTFS file format.

(Continued)

(Continued)

- Some USB devices may not be supported due to compatibility issues.
- Avoid contact between the USB connector and bodily parts or foreign objects.
- Repeated connecting/disconnecting of USB devices within short periods of time may result in product malfunction.
- A strange noise may occur when disconnecting the USB.
- Make sure to connect/disconnect external USB devices with the audio power turned off.
- The amount of time required to recognize the USB device may differ depending on the type, size or file formats stored on the USB. Such differences in time are not indications of malfunctions.
- The vehicle audio system only supports USB devices designed to play music files.
- USB images and videos are not supported.

(Continued)

(Continued)

- Do not use the USB I/F to charge batteries or USB accessories that generate heat. Doing so may lead to worsened performance or damage to the audio system.
- The audio system may not recognize the USB device if separately purchased USB hubs and extension cables are being used. Connect the USB device directly with the USB port of the vehicle.
- When using mass storage USB devices with separate logical drives, only files saved to the root drive can be played.
- Files may not properly operate if application programs are installed on the USBs.
- The audio system may not operate normally if MP3 Players, cellular phones, digital cameras, or other electronic devices (USB devices not recognized as portable disk drives) are connected with the audio system.

(Continued)

(Continued)

- Charging through the USB may not work for some mobile devices.
- The device may not support normal operation when using an atypical USB memory device (miniature, keychain, etc.). For best results, use a typical USB device that has a metal case.
- The device may not support normal operation when using formats such as HDD Type, CF, or SD Memory.
- The device will not support files locked by DRM (Digital Rights Management.).
- USB memory sticks used by connecting an Adaptor (SD Type or CF Type) may not be properly recognized.
- The device may not operate properly when using USB HDDs or USBs subject to connection failures caused by vehicle vibrations. (e.g. i-stick type)

(Continued)

(Continued)

- Avoid use of USB memory products that can also be used as key chains or mobile phone accessories. Use of such products may cause damage to the USB jack.
- Connecting an MP3 device or phone through various channels, such as AUX/BT or Audio/USB mode may result in pop noises or abnormal operation.
- Use USB 2.0 devices for better compatibility. Maximum device size supported is 32 GB.



*** NOTICE - Using an iPod®**

- iPod® is a registered trademark of Apple Inc.
- In order to use the iPod® with your vehicle's audio system, you must use a dedicated iPod® cable. (the cable that is supplied when purchasing iPod®/iPhone® products)
- If the iPod® is connected to the vehicle while it is playing, a high pitch sound could occur for approximately 1-2 seconds immediately after connecting. If possible, connect the iPod® to the vehicle with the iPod® stopped/paused.
- When the vehicle ignition is set to ACC or ON, connecting the iPod® through the iPod® cable will charge the iPod® through the car audio system.
- When connecting with the iPod® cable, make sure to fully insert the jack to prevent communication interference.

(Continued)

(Continued)

- When the EQ features of an external device, such as the iPod®, and the audio system are both active, EQ effects could overlap and cause sound deterioration and distortion. Whenever possible, turn off the EQ feature within the external device when it is connected to the audio system.
- Noise may occur when an iPod® or AUX device is connected. When such devices are not being used, disconnect the device for storage.
- When the iPod® or AUX device power is connected to the power jack, playing the external device may result in noise. In such cases, disconnect the power connection before use.
- Skipping or improper operation may occur depending on the characteristics of your iPod®/iPhone® device.

(Continued)

(Continued)

- If your iPhone® is connected to both the Bluetooth® and USB, the sound may not be properly played. In your iPhone®, select the Dock connector or Bluetooth® to change the sound output (source).
- iPod® mode cannot be operated when the iPod® cannot be recognized due to the playing of versions that do not support communication protocols, cases of iPod® abnormalities and defects.
- For fifth generation iPod® Nano devices, the iPod® may not be recognized when the battery level is low. Please charge the iPod® for use.
- The search/play orders shown within the iPod® device may differ from the orders shown within the audio system.
- If the iPod® malfunctions due to an iPod® device defect, reset the iPod® and try again. (To learn more, refer to your iPod® manual)

(Continued)

(Continued)

- Some iPod®s may not sync with the System depending on the version. If the Media is removed before the Media is recognized, then the system may not properly restore the previously operated mode. (iPad® charging is not supported.)
- Use an iPod® cable shorter than 1 meter in length such as the one originally supplied with a new iPod®, longer cables may lead to the audio system not recognizing the iPod®.

*** NOTICE - Using Bluetooth® (BT) Audio (if equipped)**

- Bluetooth® Audio Mode can be used only when a Bluetooth® phone has been connected.
- Bluetooth® Audio Mode will not be available when connecting mobile phones that do not support this feature.
- If a Bluetooth® Phone is being used to play music and receives an incoming or outgoing phone call, then the music will stop.
- Moving the Track up/down while playing Bluetooth® audio mode may result in pop noises with some mobile phones.
- Bluetooth® streaming audio may not be supported in some mobile phones.

(Continued)

(Continued)

- When returning to Bluetooth® Audio mode after ending a call, the mode may not automatically restart in some mobile phones.
- Receiving an incoming call or making an outgoing call while playing Bluetooth® Audio may result in audio interference.

Media Mode

Change Mode: [MEDIA] button

- Each time the button is pressed, the media mode popup will be displayed or closed.
- The media mode popup will not be displayed when [SETUP/CLOCK] button ► [Display] ► [Mode popup] is turned [Off].

You can select a menu in the mode popup by using the [1] ~ [6] (Preset) buttons or TUNE knob.

- If media device(USB, AUX) is connected, then it will automatically operate. Once it is disconnected, the previous mode will be restored.
- The Audio/AUX volume can also be controlled.

Repeat: [1 RPT] button

- Repeats the current song or repeats all songs within the current folder.
- iPod® mode: Repeat Song → Repeat Off
- USB mode: Repeat Song → Repeat Folder → Off

Shuffle: [2 SHFL] button

- Plays all songs within the current folder(category) or play all songs in random order.
- iPod® mode: Shuffle All → Shuffle Off
- USB mode: Shuffle Folder → Shuffle All → Off

Change Song/File: [SEEK/TRACK] button

[√ SEEK/TRACK] button

- Pressing the button: Plays the current song from the beginning. If the [√ SEEK/TRACK] button is pressed again within 1 second, the previous song is played.
- Pressing and holding the button: Rewinds the song.

[SEEK/TRACK ^] button

- Pressing the button: Plays the next song.
- Pressing and holding the button: Fast-forwards the song.

* NOTICE

BT Audio, AUX don't support Rewind/Fast-forward feature.

Search Song: TUNE knob (USB/iPod® only)

- Turning TUNE knob: Searches for songs(files).
- Pressing TUNE knob: Plays selected song(file).

* NOTICE

BT Audio, AUX don't support playlist feature.

Search Folder: [FOLDER] button

- Searches the previous/next folder. (USB)

* NOTICE

If a folder is selected by pressing the TUNE knob, the first file within the selected folder will be played.

USB

Displays Menu Popup when pressing the **[MENU]** button.

List

Moves to the list screen.

Repeat

Repeats the current song. Press it again to turn off.

Repeat Folder

Repeats songs within the current folder. Press it again to turn off.

Shuffle Folder

Randomly plays songs within the current folder. Press it again to turn off.

Shuffle

Randomly plays all songs. Press it again to turn off.

Information

Displays information of the current song.

Sound Settings

Moves to Sound Settings.

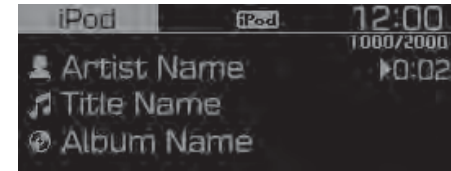
iPod®

Displays Menu Popup when pressing the **[MENU]** button.

List

Moves to the list screen.

Repeat

Repeats the current song. Press it again to turn off.

Shuffle

Plays all songs within the currently playing category in random order. Press it again to turn off.

Information

Displays information of the current song.

Sound Settings

Moves to Sound Settings.

BT Audio (if equipped)

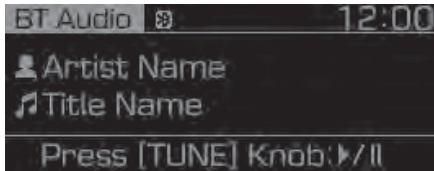

Displays Menu Popup when pressing the [MENU] button.

Sound Settings

Moves to Sound Settings.

* NOTICE

- Audio may not automatically start playing in some Bluetooth® devices. If the music in the Bluetooth® device is not played after changing to audio streaming mode, press the TUNE knob. Check if the music is playing in the Bluetooth® device after changing to audio streaming mode.
- Audio streaming may not be supported for some Bluetooth® devices.
- If Bluetooth® device is disconnected, BT Audio is ended.
- Bluetooth® connection is required to use BT Audio. Refer to the Bluetooth® manual for more information.

AUX

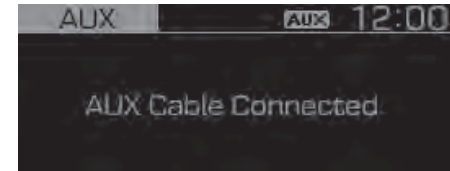

Displays Menu Popup when pressing the [MENU] button.

Sound Settings

Moves to Sound Settings.

* NOTICE

- AUX mode can be used only when an external audio player has been connected.
- If only a cable is connected to the AUX without an external device, the mode will be changed to AUX, but noise may occur. When an external device is not being used, remove the connector jack.
- When the external device power is connected to the power jack, playing the external device may output noise. In such cases, disconnect the power connection before use.

Bluetooth (if equipped)

* NOTICE - Using Bluetooth® (BT) Phone

What is *Bluetooth*® Wireless Technology?

- Bluetooth® refers to a short-distance wireless networking technology which uses a 2.45GHz frequency to connect various devices within a certain distance.
- Supported within PCs, external devices, Bluetooth® phones, PDAs, various electronic devices, and automotive environments, Bluetooth® to be transmitted at high speeds without having to use a connector cable.
- Bluetooth® Handsfree refers to a device which allows the user to conveniently make phone calls with Bluetooth® devices through the Multimedia system.
- The Bluetooth® Handsfree feature may not be supported in some Bluetooth® devices.

WARNING - Distracted Driving

- Focus on the road while driving. The driver's primary responsibility is in the safe and legal operation of the vehicle. Drivers should not use any hand held devices or other equipment or vehicle systems that distract the driver during vehicle operation.
- Do not stare at the multimedia screen for long periods of time while driving. Staring at the screen for prolonged periods of time can lead to traffic accidents and can result in personal injuries.

CAUTION - For Safe Driving

- *Bluetooth® is a feature that enables drivers to make hands-free calls. Connecting the head unit with a Bluetooth® phone allows the user to conveniently make calls, receive calls, and manage the phonebook. Before using Bluetooth®, carefully read the contents of this user's manual.*
- *Excessive use or operations while driving may lead to negligent driving practices and be the cause of accidents. Do not operate the device excessively while driving.*
- *Viewing the screen for prolonged periods of time is dangerous and may lead to accidents. When driving, view the screen only for short periods of time.*

(Continued)

(Continued)

- *Pairing Bluetooth® devices and use of other Bluetooth® features are not supported when the vehicle is in motion. For safety, please first park your vehicle.*

 **CAUTION**

- **For Connecting a Bluetooth® Phone**
- *Before connecting the head unit with the Bluetooth® device, check to see that the mobile device supports Bluetooth® features.*
- *Even if the mobile device supports Bluetooth®, the device will not be found during device searches if the device has been set to hidden state or the Bluetooth® power is turned off. Disable the hidden state or turn on the Bluetooth® power prior to searching/connecting with the head unit.*

(Continued)

(Continued)

- *If a Bluetooth® device becomes disconnected due to being out of communication range, turning the device OFF, or a Bluetooth® communication error, corresponding Bluetooth® devices are automatically searched and reconnected.*
- *If you do not want automatic connection with your Bluetooth® device, turn the Bluetooth® feature off in the Bluetooth® device.*
- *Only one Bluetooth® device can be connected at a time.*
- *Bluetooth® connection may become intermittently disconnected in some Bluetooth® devices. Follow these steps to try again.*

(Continued)

(Continued)

1. Turn the Bluetooth® function within the Bluetooth® device OFF/ON and try again.
2. Turn the Bluetooth® device power OFF/ON and try again.
3. Completely remove the Bluetooth® device battery, reboot, and then again.
4. Reboot the Multimedia System and try again.
5. Delete all paired devices from both of Bluetooth® device and Head Unit sides and then try again.

 **CAUTION**

- Upon Using Bluetooth® Phone

- If the Bluetooth® device is not connected, it is not possible to enter Phone mode. After connecting your Bluetooth® device to your car, use the Bluetooth® features.
- You will not be able to use the handsfree feature when your phone is outside of the cellular service area (e.g. in a tunnel, in a underground, in a mountainous area, etc.).
- If the cellular phone signal is poor or the vehicles interior noise is too loud, it may be difficult to hear the other person's voice during a call.
- Do not place the Bluetooth® device near or inside metallic objects, otherwise communications with Bluetooth® system or cellular service stations can be disturbed.

(Continued)

(Continued)

- Placing the audio system within an electromagnetic environment may result in noise interference.
- Some Bluetooth® devices may cause interference noise or malfunction to audio system. In this case, store the device in a different location may resolve the condition.
- While a device is connected through Bluetooth®, your device may discharge quicker than usual for additional Bluetooth®-related operations.
- The handsfree call volume and quality may differ depending on the Bluetooth® device.

(Continued)

(Continued)

- If Connection Priority is set upon vehicle ignition (IGN/ACC ON), the Bluetooth® device will be automatically connected. Even if you are outside, the Bluetooth® device will be automatically connected once you are in the vicinity of the vehicle. If you do not want to automatically connect your Bluetooth® device, turn off the Bluetooth® feature in your Bluetooth® device.
- In some Bluetooth® devices, starting the ignition while talking through Bluetooth® enabled handsfree call will result in the call becoming disconnected due to car handsfree call transfer. If you use your phone outside the vehicle, turn off the Bluetooth® feature in your phone.

Bluetooth® Connection

Before you can use the Bluetooth® feature, you must first pair/connect your Bluetooth® device to your car.

Pairing a New Device

Select [PHONE] button in the head unit or [CALL] button in the steering wheel remote control.

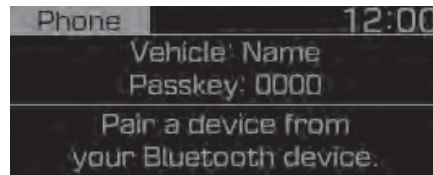

In your Bluetooth® device,

1. Pair your car after your Bluetooth® device detects the Bluetooth® device.
2. Enter the passkey(0000) or accept the authorization popup.
3. Connect Bluetooth®.

* NOTICE

- Up to 5 Bluetooth® devices can be paired.
- The default passkey is 0000.
- During a Bluetooth® device connection, another device cannot be paired.
- The Vehicle Name above is an example. Check the actual information on the product.
- Pairing and connecting a Bluetooth® enabled Bluetooth® device will work only when the Bluetooth® option within your Bluetooth® device has been turned on. (Methods of turning on the Bluetooth® enabled feature may differ depending on the Bluetooth® device.)
- After pairing is complete, a contacts download request is sent to the Bluetooth® device. Some Bluetooth® devices may require confirmation upon receiving a download request. Ensure your Bluetooth® device accepts the connection. Refer to your phone's user manual for additional information regarding phone pairing and connections.

Connecting Bluetooth® Devices

Press the [PHONE] button in the head unit or [CALL] button in the steering wheel remote control ► Select the name of the device to connect ► Connect Bluetooth®.

- Connects the Bluetooth® devices that you add.

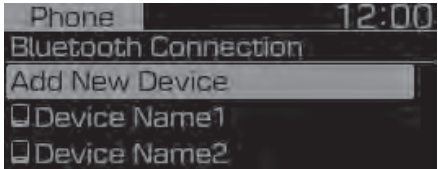

*** NOTICE**

- Only one Bluetooth® device can be connected at a time.
- Bluetooth® features supported within the vehicle are as follows. Some features may not be supported depending on your Bluetooth® device.
 - Outgoing/Incoming Handsfree calls
 - Operations during a call: Switch to Private, Switch to call waiting, MIC on/off
 - Downloading Call History
 - Downloading Contacts
 - Bluetooth® device Auto Connection
 - Bluetooth® Audio Streaming

Bluetooth Phone

Favorites

Press the [PHONE] button ► Select [Favorites].

- Displays Phone Menu screen.
- The connected device name is displayed in the top of the display.

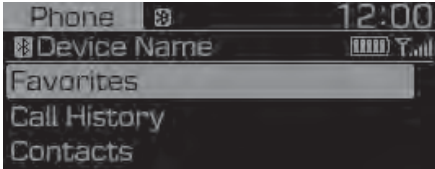

- : Call signal strength indicator.
- : Battery level of the Bluetooth® devices connected.

- Lists the phone numbers saved as Favorites. Select from the list to dial the number.



Displays Menu Popup when pressing the [MENU] button.

- Add New Favorites: Adds a phone number to Favorites.
- Delete ItemsRepeat: Deletes numbers that you select from Favorites.
- Delete All: Deletes all of the numbers from Favorites.

* NOTICE

- Up to 20 favorites can be saved in favorites of each device.
- Downloading favorites in your Bluetooth® device does not be supported.
- To save favorite, contacts should be downloaded.
- Contact saved in favorites will not be automatically updated if the contact has been updated in the phone. To update Favorites, delete the favorite and create a new favorite.

Call History

Select [PHONE] button ► Select [Call History].

- Displays all of your call history. Select from the list to dial the number.

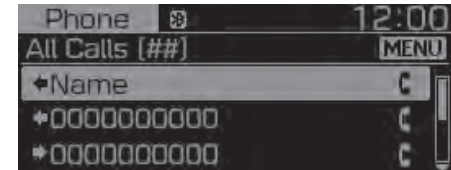

Displays Menu Popup when pressing the [MENU] button.

- Download: Downloads the call history information from your Bluetooth® device.
- All Calls: Lists the all call history.
- Dialed Calls: Lists the calls that you made.
- Received Calls: Lists the calls that you have received.
- Missed Calls: Lists the calls you missed.

* NOTICE

- Call history may not be saved in the call history list in some Bluetooth® devices.
- Calls from restricted ID's are not saved in the call history list.
- Up to 50 calls can be added in each Dialed Calls/Received Calls/Missed Calls list.
- The durations of each dialed/received call are not displayed in your car's Call History list.
- While the call history download is in progress, the status bar displays an icon (↕↓).
- If the call history download is turned off on the Bluetooth® device, the call history download will fail.
- Some devices require a device authentication for downloading your call history. If download fails, check if the Bluetooth® settings or display status are normal.

Contacts

Select [PHONE] button ► Select [Contacts].

- Displays the list of Contacts. Select from the list to dial the number.

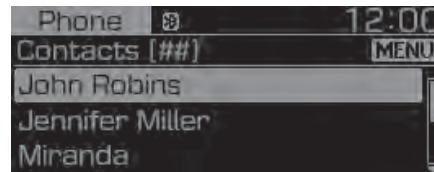

Displays Menu Popup when pressing the [MENU] button.

- Download: Downloads contacts from your Bluetooth® device.
- A-Z Jump: Finds a contact in an alphabetical order.

Requesting Download

Some devices require a device authentication for downloading your call history and contacts.

If download fails, check the Bluetooth® device settings or the screen state.

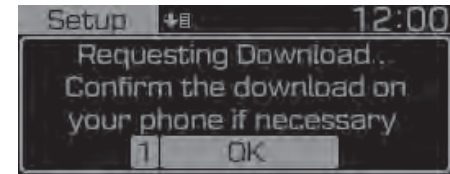

*** NOTICE**

- Up to 2000 phone numbers can be downloaded from a single, paired Bluetooth® device.
- You cannot edit or delete downloaded phone numbers from your car.
- Contacts can be viewed only when the Bluetooth® device is connected.
- Even if the Bluetooth® device is disconnected, the downloaded data will remain. (Note that deleting a paired device will also delete all downloaded Contacts and Call History data)
- Downloaded phone numbers may be lost depending on the condition of the head unit. Keep your important data in a safe place.
- The status bar displays a  while downloading contacts.
- The download will not be available if the contacts download function is turned off on your Bluetooth® device.
- Phone contact names should be saved in English or they may not be displayed correctly.

(Continued)

(Continued)

- The time of contacts/call history download may differ depending on the Bluetooth® devices.
- Some devices require a device authentication for downloading your contacts. If download fails, check your phone screen and confirm the download if necessary.

Accept/Reject Call

If there is an incoming call, a popup message will appear.



- To answer the incoming call, select [Accept] on the screen or press the [CALL] button on the steering remote control.
- To reject the call, select [Reject] on the screen or press the [END] button on the steering wheel control.

*** NOTICE**

In some Bluetooth® devices, the caller's number may not be displayed, and the Reject feature may not be supported.

Using the Menu During a Phone Call

When making a call, you can use the following menu items.

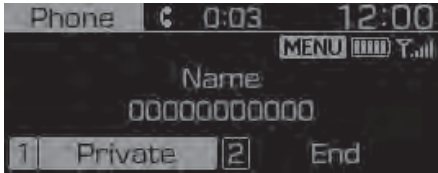

- (1) Private: Switches a voice call from the car Hands-free to the Bluetooth® device.
- (2) End: Ends a call.

Displays Menu Popup when pressing the [MENU] button.

- **Outgoing Volume:** Displays the Mic Volume settings. You can adjust the in-call volume that the other party hears (level 1 - 5).

*** NOTICE**

- **Up to 2000 phone numbers can be downloaded from a single, paired Bluetooth® device.**
- **If the caller's number is listed in Contacts, the caller's name will be displayed. Otherwise, only the number will be displayed. In some Bluetooth® devices, the phone number may not be displayed.**
- **In some Bluetooth® devices, the Use Private feature may not be supported.**
- **In some Bluetooth® devices, the Switch feature may not be supported.**
- **The phone number may not be properly displayed in some Bluetooth® devices.**
- **During a phone call on a Bluetooth® Handsfree, you cannot access other modes, such as Radio and Setup.**
- **Depending on handset types, the in-call volume the other party hears may differ. If the other party hears your voice too low or too loud, adjust the mic volume.**

Phone Settings

Select [PHONE] button ► Select [Phone Settings].

- Moves to a screen of Phone Settings. Refer to [Setup] ► [Phone Settings] manual for more information.

Setup

Display

Press the **[SETUP/CLOCK]** button ► Select **[Display]**.

- **Media Display:** When playing an MP3 file, select the desired display info from **[Folder/File]** or **[Artist/Title/Album]**.
- **Mode Popup:** During **[On]** state, press the **[RADIO]** or **[MEDIA]** button to display the mode change popup.
- **Text Scroll:** If MP3 file name is too long to display, the file name is scrolled from right to left.

Sound

Press the **[SETUP/CLOCK]** button ► Select **[Sound]**.

- **Position:** Selects the sound position.
- **Tone:** Selects the sound tone.
- **Speed Dependent Vol.:** Controls the volume level automatically according to the speed of the vehicle.

Date/Time

Press the **[SETUP/CLOCK]** button ► Select **[Date/Time]**.

- **Set Time:** Adjusts the number currently in focus to set the **[hour]**, and press the **TUNE** knob to set the **[minute]** and **[AM/PM]**.
- **Time Format:** Sets the 12/24 hour time format of the audio system.
- **Set Date:** Adjusts the number currently in focus to make the settings and press the **TUNE** knob to move to the next settings.
- **Display(Power Off):** Displays time/date on screen when the audio system turns power off.

Phone (if equipped)

Add new device

Press the **[SETUP/CLOCK]** button ► Select **[Phone]** ► Select **[Add new device]**.



- The following steps are the same as those described in the section **[Pairing a New Device]** on the previous page.

Connect/Disconnect Device

Press the **[SETUP/CLOCK]** button ► Select **[Phone]** ► Select **[Paired devices]**.

- Displays the paired Bluetooth® device list.
- From the paired device list, select the device you want to connect or disconnect.

* NOTICE

- Displays the icons when Bluetooth® device is connected.
 - : An icon appears when you make a Bluetooth® Audio connection.
 - : An icon appears when you make a Bluetooth® Handsfree connection.
- Only one Bluetooth® device can be connected at a time.
- Bluetooth® Handsfree and Bluetooth® Audio functions are supported. Handsfree and audio-supported devices, such as a Bluetooth® smartphone or audio, will function normally.
- If the system is not stable due to a vehicle- Bluetooth® device communication error, delete the paired device on each device and pair/connect the Bluetooth® device again.

Delete devices

Press the [SETUP/CLOCK] button ► Select [Phone] ► Select [Delete devices].

- Displays the paired Bluetooth® device list.
- When selecting from the list, the device is deleted.

* NOTICE

- When you delete a paired device, the Call History and Contacts stored in the head unit are also deleted.
- To re-use a deleted device, you must pair the device again.

Auto Connection priority

Press the [SETUP/CLOCK] button ► Select [Phone] ► Select [Connection priority].

- Select the device to want to set the connection priority of paired devices.
- If “None” is chosen, the Bluetooth® system will try to connect to the last connected device, then to all paired devices.

*** NOTICE**

- When the engine is running, the selected Bluetooth® device is automatically connected. If you fail to connect the selected device, the previously-connected device is automatically connected, and if it also fails, then it tries to connect all paired devices sequentially.
- Depending on auto connection priority, connection to a device may take time.
- If a Bluetooth® device becomes disconnected due to being out of communication range, turning the device OFF, or a Bluetooth® communication error, corresponding Bluetooth® devices are automatically searched and reconnected.
- Even if you are outside, the Bluetooth® device will be automatically connected once you are in the vicinity of the vehicle. If you do not want to automatically connect your Bluetooth® device, turn off the Bluetooth® feature in your Bluetooth® device.

(Continued)

(Continued)

- In some Bluetooth® devices, starting the ignition while talking through Bluetooth® enabled handsfree call will result in the call becoming disconnected due to car handsfree call transfer. If you use your phone outside the vehicle, turn off the Bluetooth® feature in your phone.

Language

Press the [SETUP/CLOCK] button ►
Select [Language].

- Changes the display language.

Display Off

Press the [SETUP/CLOCK] button ►
Select [Display Off].

- Audio operation is maintained and only the screen will be turned Off. In the Screen Off state, press any button to turn the Screen On again.

AUDIO (With Touch Screen)

■ Type C



(With *Bluetooth*[®] Wireless Technology)

B4H4G0000EG

Feature of Your Audio

Head unit

■ Type C



* The actual features in the vehicle may differ from the illustration.

(1) LCD screen

- Tap the screen to select a button.

(2) TUNE knob

- In Radio Mode
 - Turn to navigate through the FM/AM and DRM frequencies manually.

- In Media Mode
 - Turn to navigate through the songs list.
 - Press to select an item.

(3) SETUP

- Access Display, Sound, Date/Time, Bluetooth, System, Screen Saver and Display Off settings.

(4) PHONE

- Start Bluetooth® Phone mode.

(5) SEEK/TRACK

- Search for next station in radio mode.
- Change the current song in media mode.

(6) MEDIA

- Select USB(iPod®), Bluetooth®(BT) Audio, AUX or My Music.
- Display the media menu when two or more media are connected or when the **[MEDIA]** button is pressed in media mode.

■ Type C



(7) RADIO

- Start FM, AM and DRM Radio.

(8) POWER/VOL knob

- Turn to adjust the volume.
- Press to turn the device on or off.

(9) RESET

- Shutdown and restart the system.

Steering wheel remote control

※ The actual features in the may differ from the illustration.

(1) VOLUME

- Press to adjust the volume.

(2) MUTE

- Press to mute audio output.

(3) MODE

- Press the button to change the mode in the following order: Radio → Media.
- Press and hold the button to turn off.

(4) UP/DOWN

- Press the button in radio mode to cycle between the FM/AM and DRM frequencies in the order as stored in the presets.
- Press and hold the button in radio mode to search for the next available frequency.
- Press the button in media mode to change the current song.
- Press and hold the button in media mode to quick search through songs.

(5) CALL

- Pressing the button.
 - If not in Bluetooth® Handsfree mode or receiving a phone call.
 - First press: Display Dial Number screen.
 - Second press: Automatically display the most recently Dialed Call number.
 - Third press: Dial the phone number entered.
 - Press in the Incoming Call notification screen to accept the phone call.

- Press in Bluetooth® Handsfree mode to switch to the waiting call.
- Pressing and holding the button.
 - If not in Bluetooth® Handsfree mode or receiving a phone call, the most recently Dialed Call number is dialed.
 - Press in Bluetooth® Handsfree mode to transfer the call to your cell phone.
 - Press in cell phone mode to switch to Bluetooth® Handsfree mode.

(6) END

- Press in Bluetooth® Handsfree mode to end the phone call.
- Press in the incoming call screen to reject the call.

⚠ WARNING

- Audio System Safety Warnings

- Do not stare at the screen while driving. Staring at the screen for prolonged periods of time could lead to traffic accidents.
- Do not disassemble, assemble, or modify the audio system. Such acts could result in accidents, fire, or electric shock.
- Using the phone while driving may lead to a lack of attention of traffic conditions and increase the likelihood of accidents. Use the phone feature after parking the vehicle.
- Heed caution not to spill water or introduce foreign objects into the device. Such acts could lead to smoke, fire, or product malfunction.

(Continued)

(Continued)

- Please refrain from use if the screen is blank or no sound can be heard as these signs may indicate product malfunction. Continued use in such conditions could lead to accidents (fires, electric shock) or product malfunctions.
- Do not touch the antenna during thunder or lightening as such acts may lead to lightning induced electric shock.
- Do not stop or park in parking-restricted areas to operate the product. Such acts could lead to traffic accidents.
- Use the system with the vehicle ignition turned on. Prolonged use with the ignition turned off could result in battery discharge.

⚠ WARNING

- Distracted Driving

Driving while distracted can result in a loss of vehicle control that may lead to an accident, severe personal injury, and death. The driver's primary responsibility is in the safe and legal operation of a vehicle, and use of any handheld devices, other equipment, or vehicle systems which take the driver's eyes, attention and focus away from the safe operation of a vehicle or which are not permissible by law should never be used during operation of the vehicle.

⚠ CAUTION

- *Operating the device while driving could lead to accidents due to a lack of attention to external surroundings. First park the vehicle before operating the device.*
- *Adjust the volume to levels that allow the driver to hear sounds from outside of the vehicle. Driving in a state where external sounds cannot be heard may lead to accidents.*
- *Pay attention to the volume setting when turning the device on. A sudden output of extreme volume upon turning the device on could lead to hearing impairment. (Adjust the volume to a suitable levels before turning off the device.)*

(Continued)

(Continued)

- *If you want to change the position of device installation, please inquire with your place of purchase or service maintenance center. Technical expertise is required to install or disassemble the device.*
- *Turn on the car ignition before using this device. Do not operate the audio system for long periods of time with the ignition turned off as such operations may lead to battery discharge.*
- *Do not subject the device to severe shock or impact. Direct pressure onto the front side of the monitor may cause damage to the LCD or touch screen.*









(Continued)

(Continued)

- *When cleaning the device, make sure to turn off the device and use a dry and smooth cloth. Never use tough materials, chemical cloths, or solvents (alcohol, benzene, thinners, etc.). As such materials may damage the device panel or cause color/quality deterioration.*
- *Do not place beverages close to the audio system. Spilling beverages may lead to system malfunction.*
- *In case of product malfunction, please contact your place of purchase or After Service center.*
- *Placing the audio system within an electromagnetic environment may result in noise interference.*
- *Prevent caustic solutions such as perfume and cosmetic oil from contacting the dashboard because they may cause damage or discoloration.*

Information on status icons

Icons showing audio status are shown in the upper-right corner of the screen.

Icon	Description	
	Mute	Mute engaged
	Battery	Remaining battery life of a connected Bluetooth® device
	Handsfree + Audio streaming connection	Bluetooth® Handsfree call and audio streaming available
	Handsfree connection	Bluetooth® Handsfree call available
	Bluetooth audio streaming	Bluetooth® audio streaming available
	Downloading contacts	Downloading contacts through Bluetooth® wireless communications
	Downloading call history	Downloading call history through Bluetooth® wireless communications
	Line busy	Phone call in progress
	Mute mic	Mic muted during a call (caller cannot hear your voice)
	Phone signal strength	Display the phone signal strength for a cell phone connected by Bluetooth®

Radio

DRM

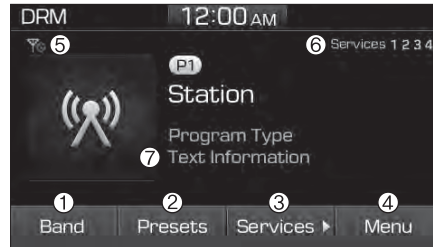

* The actual features may differ from the illustration. May change according to the transmission content of DRM.

(1) Band

Switch between FM, AM and DRM.

(2) Presets

View all presets.

(3) Services ▶

Cycle between the services available with the broadcasting frequency.

(4) Menu

Navigate to the menu screen.

(5) No signal

When no signal or weak signal in DRM Mode, Display No signal icon.

(6) Services Index

- Displays the number of services available with the broadcasting frequency.
- Highlights the currently receiving service.
- No. of services depends on the broadcasting station and it may vary from 1 ~ 4.

(7) Text Information

Text Information may or may not be available and it depends on the broadcasting station.

Switching between FM, AM and DRM

- Press the **[RADIO]** button on the audio system to switch between FM, AM and DRM.
- Select **[Band]** on the screen to switch between FM, AM and DRM.

Searching stations

Press the **[SEEK/TRACK]** button to search stations.

Presets

Save up to 40 frequently used stations. To listen to a preset, select the desired station list.

Press and hold the desired slot from 1 through 40. This saves the current station in the selected slot.

If the slot is empty, simply selecting saves the station to the slot.

Changing Service

- Select **[Services?▶]** in order to cycle between the available services from 1 → 2 → 3 → 4 → 1.
- Number of services depends on the broadcasting station and can vary between 1 ~ 4.

* NOTICE

- **The Receiving of DRM Signal is based on transmission (Range & time) of All India Radio.**
- **Some of the States of India are not started with DRM transmission.**

Menu

Select **[Menu]**, and select the desired function.

- **Weather/News Report:** Enable or disable Weather/News Report.
- **Scan:** All available stations are played for five seconds each.
- **Sound Settings:** Audio sound settings can be changed.

FM/AM

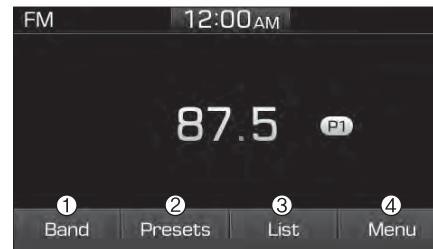

(1) Band

Switch between FM, AM and DRM.

(2) Presets

View all presets.

(3) List

View all available stations.

(4) Menu

Navigate to the menu screen.

Switching between FM, AM and DRM

- Press the **[RADIO]** button on the audio system to switch between FM, AM and DRM.
- Select **[Band]** on the screen to switch between FM, AM and DRM.

Searching stations

Press the **[SEEK/TRACK]** button to search stations.

List

A list of all available stations in the vehicle's current location is displayed. Select the desired station.

Favorite stations can be saved to **[Presets]** by selecting **[save]**.

Select the refresh icon  in order to update the list of available stations at the vehicle's current location while in FM/AM Mode.

Presets

Save up to 40 frequently used stations. To listen to a preset, select the desired station list.

Press and hold the desired slot from 1 through 40. This saves the current station in the selected slot.

If the slot is empty, simply selecting saves the station to the slot.

Menu

Select [Menu], and select the desired function.

- Scan: All available stations are played for five seconds each.
- Sound Settings: Audio sound settings can be changed.

Media

* NOTICE - Using MP3

Supported audio formats

Compressed audio formats	MPEG1 Audio Layer3
	MPEG2 Audio Layer3
	MPEG2.5 Audio Layer3
	Windows Media Audio Ver 7.X & 8.X

* File formats other than the formats above may not be recognized or playable. Information such as file-name may not be displayed.

Range of supported compressed file types

1. Bitrate range (Kbps)

	MPEG1	MPEG2	MPEG2.5	WMA
	Layer3			High Range
32	8	8	48	
40	16	16	64	
48	24	24	80	
56	32	32	96	
64	40	40	128	
80	48	48	160	
96	56	56	192	
112	64	64		
128	80	80		
160	96	96		
192	112	112		
224	128	128		
256	144	144		
320	160	160		

2. Sampling frequency (Hz)

MPEG1	MPEG2	MPEG2.5	WMA
44100	22050	11025	32000
48000	24000	12000	44100
32000	16000	8000	48000

- The sound quality of MP3/WMA compressed files may vary depending on the bitrate. (A higher bitrate can have better sound quality.)
- The product only recognizes files with the MP3 or WMA extension. Files without one of these extensions are not recognized.

3. Number of recognizable folders and files

- Folders: 2,000 for USB
- Files: 6,000 for USB
- No recognition limit for folder hierarchies

4. Character display range (Unicode)

- Filenames: Up to 64 English characters (64 Korean characters)
- Foldernames: Up to 32 English characters (32 Korean characters)

* The scroll feature can be used to display file and folder names that are too long to display on the screen.

Languages supported (Unicode support)

- Korean: 2,604 characters
 - English: 94 characters
 - Common Chinese characters: 4,888 characters
 - Special symbols: 986 characters
- * Japanese/Simplified Chinese characters are not supported.

* NOTICE - Using the USB Devices

- Starting the vehicle while a USB device is connected can damage the device. Please disconnect USB devices before starting the vehicle.
- Starting the vehicle or stopping the engine while an external USB device is connected can result in failure of the external USB device to operate.
- Be cautious of static electricity when connecting/disconnecting external USB devices.
- An encrypted MP3 player is not recognized when connected as an external device.
- External USB devices may not be recognized, depending on the state of the external USB device.
- Only products with byte/sectors formatted at 4 KB or lower are recognized.
- Only USB devices in FAT12/16/32 format are recognized; NTFS and ExFAT file systems are not recognized.
- Some USB devices are not recognized due to compatibility issues.

(Continued)

(Continued)

- Do not touch the USB connections.
- Connecting and disconnecting USB devices rapidly over a short period of time can cause equipment failure.
- Abnormal sounds may be audible when the USB device is disconnected.
- Turn the audio off before connecting or disconnecting external USB devices.
- Recognition may take longer depending on the type, capacity or file format of the external USB device. This is not a product malfunction.
- Use of USB devices for purposes other than playing music files is prohibited.
- Image display and video playback are not supported.
- Use of USB accessories, including charge and heat though the USB I/F, can lead to reduced product performance or malfunctions. Do not use USB devices or accessories for these purposes.

(Continued)

(Continued)

- Use of aftermarket USB hubs and extension cables can result in the vehicle's audio system failing to recognize your USB device. Connect the USB device directly to the multimedia port of your vehicle.
- When using high-capacity USB devices with logical drive divisions, only files saved on the highest level logical drive can be played.
If applications are loaded on a USB drive, file playback may fail.
- Some MP3 players, cell phones, digital cameras, etc. (USB devices that are not recognized as mobile storage) may not operate normally when connected.
- USB charging may not be supported by some mobile devices.
- Operation is guaranteed only for standard (Metal Cover Type) USB Memory drives.
- Operation of HDD, CF, SD and memory stick devices is not guaranteed.

(Continued)

(Continued)

- DRM (Digital Rights Management) files cannot be played.
- SD-type USB memory, CF-type USB memory, and other USB memory devices that require adapters for connection are not supported.
- Proper operation of USB HDDs or USB drives with connectors that loosen due to vehicle vibrations is not guaranteed. (iStick, etc.)
- USB products that are used as key chains or cell phone accessories may damage the USB jack and affect proper file playback. Please refrain from use. Use only products with plug connectors, as shown in the following illustration.
- When MP3 devices or cell phones are connected simultaneously through AUX, BT Audio and USB modes, a popping noise or malfunction may occur.
- Use USB 2.0 devices for better compatibility. Maximum device size supported is 32 GB.

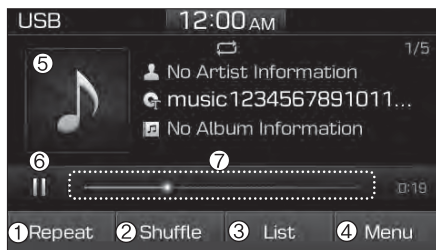

USB**(1) Repeat**

Enable/disable repeat play.

(2) Shuffle

Enable/disable shuffle play.

(3) List

View a list of all songs.

(4) Menu

Navigate to the menu screen.

(5) Album Image

View song info.

(6) Pause

Pause or play music.

(7) Playback progress

Select to skip to the desired location.

Playback

Press the **[MEDIA]** button, and select **[USB]**.

Connect a USB drive to the USB port to automatically play files on the USB drive.

Changing songs

Press the **[SEEK/TRACK]** button to play the previous or next song.

Press and hold the **[SEEK/TRACK]** button to rewind or fast forward the currently playing song.

Search songs by turning **TUNE** knob, and press the knob to play.

Selecting songs from a list

Select **[List]** to see a list of songs available for play.

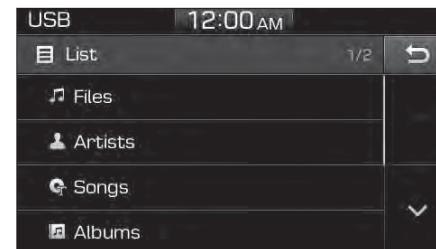

Select and play the desired song.

Repeat play

Select **[Repeat]** to enable or disable 'Repeat all', 'Repeat current song', 'Repeat folder' or 'Repeat category' play.



- Repeat all: All songs in the playlist are repeated.
- Repeat current song: The currently playing song is repeated.
- Repeat folder: All songs in the current folder are repeated.
- Repeat category: Repeat all songs in the current category.

* NOTICE

The repeat folder function is available only when songs are playing from the [File] category under [List].

Shuffle play

Select [Shuffle] to enable or disable 'Shuffle', 'Shuffle folder' or 'Shuffle category' play.

-  Shuffle: Songs are played in random order.
-  Shuffle folder: Songs within the current folder are played in random order.
-  Shuffle category: Songs within the current category are played in random order.

Menu

Select [Menu], and select the desired function.

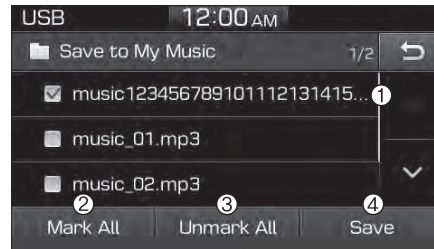

- Save to My Music: Songs on your USB device can be saved to My Music.

(1) File: Select a file to save.

(2) Mark All: Select all files.

(3) Unmark All: Deselect all files.

(4) Save: Save the selected file(s).

- Select the files you want to save, and select [Save]. This saves the selected files to My Music.
- Saving is canceled if phone calls are received or made while saving.
- Up to 6,000 files can be saved.
- The currently playing file on the USB device cannot be changed while saving.
- My Music cannot be used while saving.
- Up to 700 MB can be saved.
- Information: Detailed information on the currently playing song is displayed.
- Sound Settings: Audio sound settings can be changed.

*** NOTICE - Using an iPod®**

- To use the audio system’s iPod® control function, use the dedicated cable provided with your iPod®.
- Connecting the iPod® to the vehicle during play may result in a loud noise that lasts about one to two seconds. Connect the iPod® to the vehicle after stopping or pausing play.
- Connect the iPod® with the vehicle in the ACC ON state to begin charging.
- When connecting the iPod® cable, be sure to fully push the cable into the port.
- When EQ effects are enabled simultaneously on external devices, such as iPod®s and the audio system, the EQ effects may overlap, causing sound quality deterioration or distortion. Deactivate the EQ function for all external devices, if possible.
- Noise may occur when your iPod® or the AUX port is connected. Disconnect and store separately when not in use.

(Continued)

(Continued)

- There may be noise if the audio system is used with an iPod® or AUX external device connected to the power jack. In these cases, disconnect the iPod® or external device from the power jack.
- Play may be interrupted, or device malfunctions may occur depending on the characteristics of your iPod®/iPhone®.
- Play may fail if your iPhone® is connected through both Bluetooth® and USB. In this case, select Dock connector or Bluetooth® on your iPhone® to change the sound output settings.
- If your software version does not support the communication protocol or your iPod® is not recognized due to device failure, anomalies or defects, iPod® mode cannot be used.
- iPod® nano (5th generation) devices may not be recognized if the battery is low. Charge sufficiently before use.

(Continued)

(Continued)

- The search and song play order in the iPod® device may be different from the search order in the audio system.
- If the iPod® has failed due to an internal defect, please reset the iPod® (consult your iPod® manual).
- Depending on the software version, the iPod® may fail to sync with the system. If the media is removed or disconnected before recognition, the previous mode may not be restored (iPad® cannot be charged).
- Cables other than the 1-meter cable provided with iPod®/iPhone® products may not be recognized.
- When other music apps are used on your iPod®, the system sync function may fail due to malfunction of the iPod® application.

iPod®

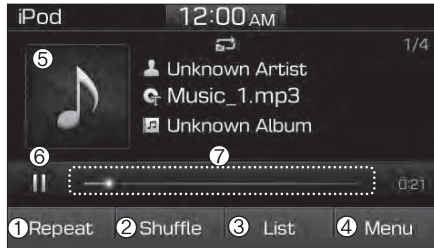

(1) Repeat

Enable/disable repeat play.

(2) Shuffle

Enable/disable shuffle play.

(3) List

View a list of all songs.

(4) Menu

Navigate to the menu screen.

(5) Album Image

View song info.

(6) Pause

Pause or play music.

(7) Playback progress

Select to skip to the desired location.

Playback

Connect your iPod® to the audio USB port, press the **[MEDIA]** button, and select [iPod].

Changing songs

Press the **[SEEK/TRACK]** button to play the previous or next song.

Press and hold the **[SEEK/TRACK]** button to rewind or fast forward the currently playing song.

Search songs by turning the **TUNE** knob, and press the knob to play.

Selecting songs from a list

Select [List] to see a list of songs available for play.

Select and play the desired song.

Repeat play

Select [Repeat] to enable or disable 'Repeat category', 'Repeat current song' play.

- Repeat category: Repeat all songs in the current category.
- Repeat current song: The currently playing song is repeated.

Shuffle play

Select [Shuffle] to enable or disable 'Shuffle category' play.

- Shuffle category: Songs within the current category are played in random order.

Menu

Select [Menu], and select the desired function.

- Information: Detailed info on the currently playing song is displayed.
- Sound Settings: Audio sound settings can be changed.

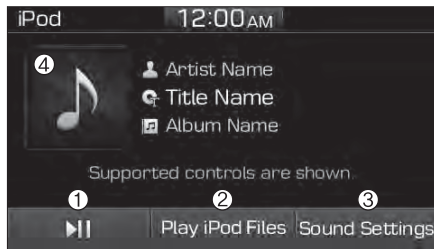
When other music programs are running

When songs saved on your iPod® are playing through a separate music app, the following screen is displayed.

- (1) Play/Pause: Pause or play music.
- (2) Play iPod Files: Play music saved on your iPod®.
- (3) Sound Settings: Audio sound settings can be changed.
- (4) Album Image: View playback info.

Play iPod Files

Select [Play iPod Files] to play songs saved on your iPod®. If there are no songs saved on your iPod®, the [Play iPod Files] is disabled.

*** NOTICE**

Operation cannot be carried out correctly due to iPod® application malfunction.

*** NOTICE - Using Bluetooth® (BT) Audio**

- Bluetooth® Audio mode can only be used if a Bluetooth®-enabled phone is connected. Only devices that support Bluetooth® audio can be used.
- If the Bluetooth®-enabled phone is disconnected during play, the music stops.
- When the TRACK UP/DOWN buttons are used during Bluetooth® audio streaming, a popping noise or sound interruptions may occur, depending on the cell phone device.
- Depending on the cell phone model, the audio streaming function may not be supported.
- If a phone call is made or received when music is playing in Bluetooth® Audio mode, the call may mix with the music.
- When returning to Bluetooth® Audio mode after ending a call, play might not resume automatically for some cell phone models.

⚠ CAUTION

- *Bluetooth® Handsfree is a feature that enables drivers to practice safe driving. Connecting the car audio system with a Bluetooth® phone allows the user to conveniently make calls, receive calls, and manage the phone book. Before using the Bluetooth®, carefully read the contents of this user's manual.*
- *Excessive use or operations while driving may lead to negligent driving practices and be the cause of accidents.*
- *Do not operate the device excessively while driving.*
- *Viewing the screen for prolonged periods of time is dangerous and may lead to accidents.*
- *When driving, view the screen only for short periods of time.*

Bluetooth® (BT) Audio

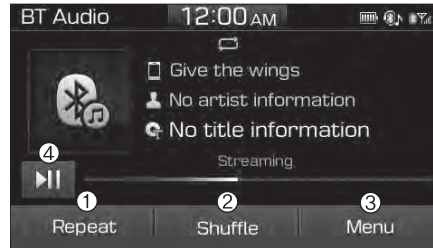

- (1) Repeat**
Enable/disable repeat play.
- (2) Shuffle**
Enable/disable shuffle play.
- (3) Menu**
Navigate to the menu screen.
- (4) Play/Pause**
Pause or play music.

*** NOTICE**

- **Some cell phone models may not support particular functions.**
- **Bluetooth® audio volume is synced with cell phone media volume.**

Playback

Press the **[MEDIA]** button, and select **[BT Audio]**.

Changing songs



Press the **[SEEK/TRACK]** button to play the previous or next song.

*** NOTICE**

Some cell phones may not support this function.

Repeat play

Select [Repeat] to enable or disable 'Repeat all', 'Repeat current song' or 'Repeat category' play.



-  Repeat all: All songs in the playlist are repeated.
-  Repeat current song: The currently playing song is repeated.
-  Repeat category: Repeat all songs in the current category.

*** NOTICE**

The repeat play function is engaged, depending on the operation of the connected Bluetooth® device.

Shuffle play

Select [Shuffle] to enable or disable 'Shuffle', 'Shuffle category' play.

-  Shuffle: Songs are played in random order.
-  Shuffle category: Songs within the current category are played in random order.

*** NOTICE**

The shuffle function is engaged, depending on the operation of the connected Bluetooth® device.

Menu

Select [Menu], and select the desired function.

- Connections: The currently connected Bluetooth® device can be changed.
- Information: Detailed information on the currently playing song is displayed.
- Sound Settings: Audio sound settings can be changed.

AUX**Running AUX**

Press the [MEDIA] button, and select [AUX].

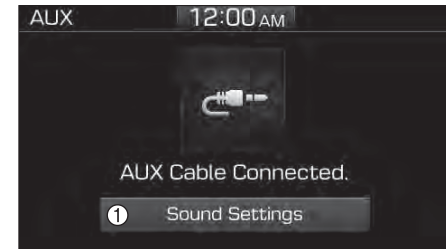

Connect the external device connection jack to the AUX terminal to run AUX.

- (1) Sound Settings: Audio sound settings can be changed.

My Music

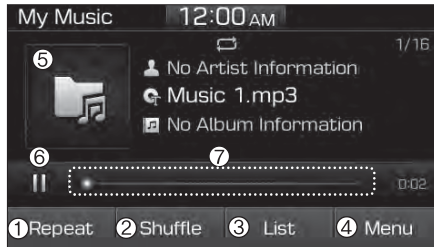

(1) Repeat

Enable/disable repeat play.

(2) Shuffle

Enable/disable shuffle play.

(3) List

View a list of all songs.

(4) Menu

Navigate to the menu screen.

(5) Album Image

View song info.

(6) Pause

Pause or play music.

(7) Playback progress

Select to skip to the desired location.

Playback

Press the **[MEDIA]** button, and select **[My Music]**.

- My Music cannot be selected if it does not contain music.
- Check the content of your USB drive before saving music to My Music.

Changing songs

Press the **[SEEK/TRACK]** button to play the previous or next song.

Press and hold the **[SEEK/TRACK]** button to rewind or fast forward the currently playing song.

Search songs by turning the **TUNE** knob and press the knob to play.

Selecting songs from a list

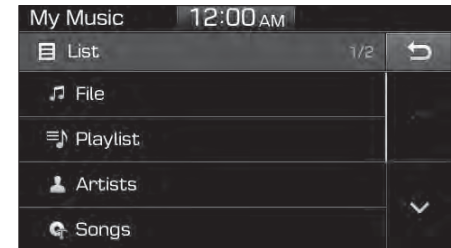

Select **[List]** to see a list of songs available for play.



Select and play the desired song.

Repeat play

Select **[Repeat]** to enable or disable 'Repeat all', 'Repeat current song' or 'Repeat category' play.

-  Repeat all: All songs in the playlist are repeated.
-  Repeat current song: The currently playing song is repeated.
-  Repeat category: Repeat all songs in the current category.

Shuffle play

Select [Shuffle] to enable or disable 'Shuffle', 'Shuffle category' play.

- Shuffle: Songs are played in random order.
- Shuffle category: Songs within the current category are played in random order.

Menu

Select [Menu], and select the desired function.

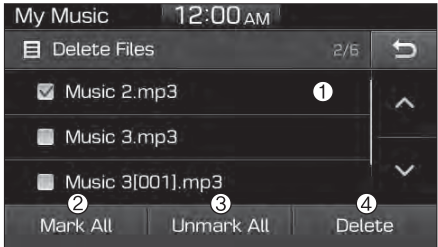

- Delete Files: You can delete files from My Music.
- (1) File: Select saved file.
 (2) Mark All: Select all files.
 (3) Unmark All: Deselect all files.

- (4) Delete: Delete the selected file(s).
- Select the file to delete, then select [Delete] to delete it.
 - Add to Playlist: Frequently played songs can be paired in a [Playlist].
 - Songs can be played from the [Playlist].
 - Information: Detailed info on the currently playing song is displayed.
 - Sound Settings: Audio sound settings can be changed.

Delete from Playlist

When a song in the playlist is playing, select [Menu] and select [Delete from Playlist].

Select the song to delete, then select [Delete].

Phone

*** NOTICE - Using Bluetooth® (BT) Phone**

- Bluetooth® is a near-field wireless networking technology that uses the 2.4 GHz frequency to connect various devices within a certain distance wirelessly.
- The technology is used in PCs, peripherals, Bluetooth® phones, tablet PCs, household appliances and automobiles. Devices supporting Bluetooth® can exchange data at high speeds without physical cable connections.
- Bluetooth® Handsfree devices enable convenient access to phone functions through cell phones equipped with Bluetooth®.
- Some Bluetooth® devices may not be supported by the Bluetooth® Handsfree function.

(Continued)

(Continued)

- **When Bluetooth® is connected and calls are attempted through a connected cell phone from outside the vehicle, the call is connected through the Bluetooth® Handsfree function of the vehicle.**
- **Please be sure to disconnect the Bluetooth® Handsfree function through your Bluetooth® device or the audio screen.**

Safety precautions

- The Bluetooth® Handsfree function helps drivers to drive safely. By connecting a Bluetooth®-enabled phone to the vehicle's audio system, phone calls can be made and received through the audio system and contacts can be managed. Consult the user manual before use.
- Excessive manipulation of controls while driving, making it difficult to pay attention to the road ahead, can lead to accidents. Do not operate the device excessively while driving.
- Looking at the screen for a prolonged time increases the risk of accidents. Keep time spent looking at the screen to a minimum.

Precautions when connecting Bluetooth® devices

- The vehicle supports the following Bluetooth® functions. Some Bluetooth® devices may not support some functions.
 - 1) Bluetooth® Handsfree phone calls
 - 2) Operations during a call (Private, Switch, Mic Vol. controls)
 - 3) Download call history saved to the Bluetooth® device
 - 4) Download contacts saved to the Bluetooth® device
 - 5) Automatic contacts/call history download when Bluetooth® is connected
 - 6) Automatic Bluetooth® device connection when the vehicle is started
 - 7) Bluetooth® audio streaming playback
- Before connecting the audio system to your device, make sure your device supports Bluetooth®.

- Even if your device supports Bluetooth®, a Bluetooth® connection cannot be established if the device's Bluetooth® function is switched off. Search and connect with the Bluetooth® function enabled.
 - Pair or connect Bluetooth® devices to the audio system with the vehicle at a standstill.
 - If a Bluetooth® connection is lost due to abnormal conditions while a Bluetooth® device is connected (communication range exceeded, device power OFF, communication errors, etc.), the disconnected Bluetooth® device is searched for and automatically reconnected.
 - If you want to disable the Bluetooth® device auto-connect function, turn the Bluetooth® function OFF on your device. Consult the user manuals for individual devices to see whether Bluetooth® is supported.
 - Handsfree call quality and volume may vary depending on the type of Bluetooth® device.
- Some Bluetooth® devices are subject to intermittent Bluetooth® connection failures. In this case, use the following method.
 - 1) Turn the Bluetooth® function off on your Bluetooth® device → Turn it on and try again.
 - 2) Delete the paired device from both the audio system and Bluetooth® device, then pair again.
 - 3) Power down your Bluetooth® device → Turn it on and try again.
 - 4) Completely remove the battery from your Bluetooth® device; reinsert it, reboot, and attempt connection.
 - 5) Restart the vehicle and reattempt connection.

Pairing a Bluetooth® device

Information on pairing Bluetooth® devices

- Pairing refers to the process of pairing Bluetooth® cell phones or devices with the system prior to connection. This is a necessary procedure for Bluetooth® connection and usage.
- Up to five devices can be paired.
- Pairing Bluetooth® device is not allowed while vehicle is moving.

Pairing the first Bluetooth® device

Press the [PHONE] button on the audio system or the [CALL] button on the steering wheel remote control → Search for the vehicle from the Bluetooth® device, and pair → Enter the passkey on the Bluetooth® device or approve passkey → Bluetooth® pairing completed.

1. When the [PHONE] button on the audio or the [CALL] button on the steering wheel remote control is pressed, the following screen is displayed. Devices can now be paired.

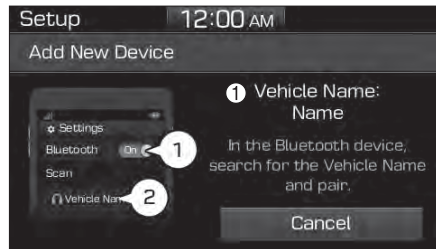

- (1) Vehicle Name: Searched name in Bluetooth® device.

* NOTICE

The vehicle name in the image above is an example. Refer to your device for the actual name of your device.

2. Search for available Bluetooth® devices in the Bluetooth® menu of your Bluetooth® device (cell phone, etc.).
3. Confirm that the vehicle name in your Bluetooth® device matches the vehicle name shown on the audio screen, then select it.
- 4-1. For devices that require passkey entry, a passkey entry screen is shown on your Bluetooth® device.
 - Enter the passkey '0000', in your Bluetooth® device.

- 4-2. For devices that require passkey confirmation, the following screen is shown on the audio system. A 6-digit passkey input screen is shown in the Bluetooth® device.

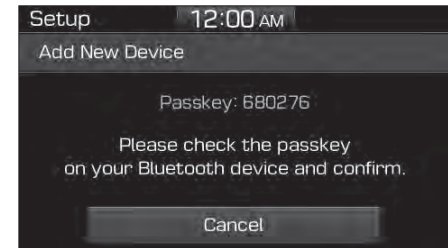

- After confirming that the 6-digit passkey on the audio screen and the Bluetooth® device are identical, select [OK] in your Bluetooth® device.

* NOTICE

The 6-digit passkey in the image above is an example. Refer to your vehicle for the actual passkey.

Pairing a second Bluetooth® device

Press the [SETUP] button on the audio system → Select [Bluetooth] → Select [Connections] → Select [Add New].

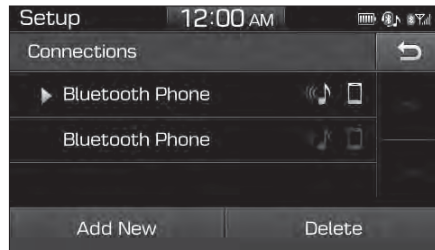

- The pairing procedure from this point is identical to [Pairing the first Bluetooth device].

*** NOTICE**

- Bluetooth® standby mode lasts for three minutes. If a device is not paired within three minutes, pairing is canceled. Start over from the beginning.
- For most Bluetooth® devices, a connection is established automatically after pairing. Some devices, however, require separate confirmation when connecting after pairing. Be sure to check your Bluetooth® device after pairing to confirm that it has connected.

Connecting Bluetooth® devices**If there are no connected devices**

Press the [PHONE] button on the audio system or the [CALL] button in the steering wheel remote control → List of paired Bluetooth® devices → Select the desired Bluetooth® device from the list → Connect Bluetooth®.

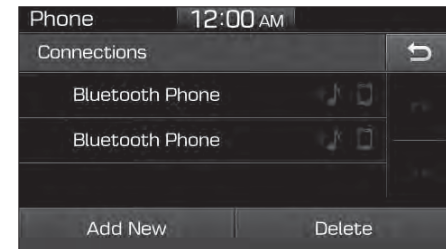

If there are connected devices

Press the [PHONE] button on the audio system → Select [Settings] → Select [Connections] → Select Bluetooth® device to connect → Select [Connect] → Connect Bluetooth®.

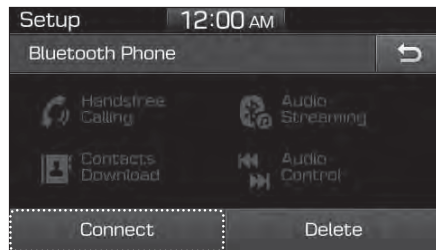

* NOTICE

- Only one Bluetooth® device can be connected at a time.
- When a Bluetooth® device is connected, other devices cannot be paired.

Accepting/rejecting phone calls

Receiving phone calls with Bluetooth® connected.



- (1) Caller name: If the caller number is in your contacts, the corresponding name is displayed.
- (2) Incoming phone number: Incoming phone number is displayed.
- (3) Accept: Accept call.
- (4) Reject: Reject call.

* NOTICE

- When the incoming call screen is displayed, audio mode and the settings screen cannot be shown. Only call volume control is supported.
- Some Bluetooth® devices may not support the call reject function.
- Some Bluetooth® devices may not support the phone number display function.

Operation during calls

Incoming call with Bluetooth® connected → Select [Accept].



- (1) Call duration: Call duration display.
- (2) Caller name: If the caller number is in your contacts, the corresponding name is displayed.
- (3) Incoming phone number: Incoming phone number is displayed.
- (4) Keypad: Number keypad for Automatic Response Service input is displayed.
- (5) Private: Call is transferred to a cell phone.
- (6) Outgoing Volume: Adjust outgoing voice volume.
- (7) End: End call.

* NOTICE

- Some Bluetooth® devices may not support the Private function.
- The outgoing voice volume may vary depending on the type of Bluetooth® device. If the outgoing voice volume is too high or low, adjust the Outgoing Volume.

Favorites

Press the [PHONE] button on the audio system → Select [Favorites] → Favorites list displayed.



- (1) Favorites list: A list of paired favorites is displayed.
Connect a call when selected.
- (2) Add to Favorites: Add a downloaded phone number to favorites.
- (3) Delete: Delete a saved favorite.

* NOTICE

- Up to 20 favorites can be paired for each paired Bluetooth® device.
- Favorites can be accessed when the Bluetooth® device they were paired from is connected.
- The audio system does not download favorites from Bluetooth® devices. Favorites must be newly saved before use.
- To add to favorites, contacts must be downloaded first.
- Saved favorites are not updated even if the contacts of the connected Bluetooth® device are changed. In this case, favorites need to be deleted and added again.

Call History

Press the [PHONE] button on the audio system → Select [Call History] → Call history is displayed.

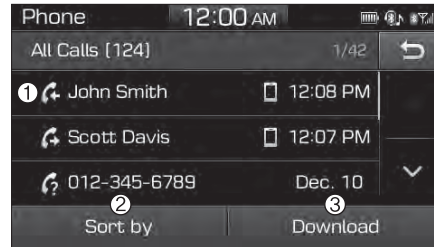

- (1) Call History: Display the downloaded call history list.
Connect a call when selected.
- (2) Sort by: Sort by All Calls, Dialed Calls, Received Calls or Missed Calls.
- (3) Download: Download call history from connected Bluetooth® devices.

* NOTICE

- Up to 50 dialed, received and missed calls are saved.
- When the latest call history is received, the existing call history is deleted.

Contacts

Press the [PHONE] button on the audio system → Select [Contacts] → Select letter (ABC) → Contacts displayed.

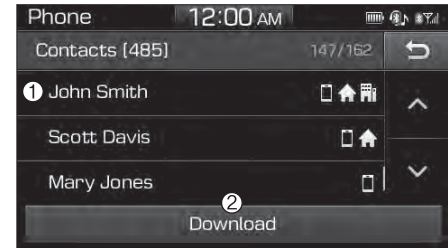

- (1) Contacts: Display downloaded contacts.
Connect a call when selected.
- (2) Download: Download contacts from connected Bluetooth® devices.

* NOTICE

- Up to 2,000 contacts can be saved.
- In some cases, additional confirmation from your Bluetooth® device is necessary when downloading contacts. If downloading of contacts unsuccessful, consult your Bluetooth® device's settings or the audio screen to approve the download.
- Contacts without phone numbers are not displayed.

Dial

Press the **[PHONE]** button on the audio → Select [Dial].

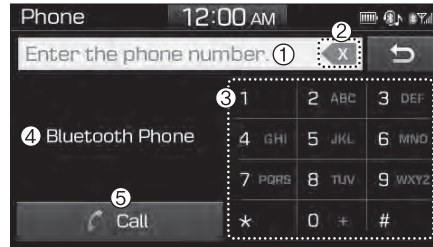

- (1) Phone number entry window: The phone number entered using the keypad is displayed.
- (2) Clear
 - Shortly press to delete individual digits.
 - Press and hold to delete the entire phone number.
- (3) Keypad: Enter phone number.
- (4) Bluetooth® Phone name
 - The name of the connected Bluetooth® device is displayed.
 - Contacts matching the keypad number/letter input are displayed.

(5) Call

- Enter and select a phone number to call.
- Select without entering a phone number to see the most recent dialed call.

Settings

Press the **[PHONE]** button on the audio → Select [Settings].

- For phone Setup, refer to Setup page → Select [Bluetooth].

Setup

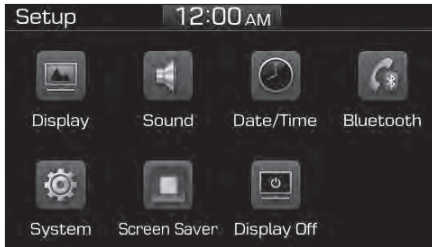

Access Display, Sound, Date/Time, Bluetooth, System, Screen Saver and Display Off settings.

Press the **[SETUP]** button on the audio system.

Display

Press the **[SETUP]** button on the audio system → Select [Display].

- Mode: Audio screen brightness can be adjusted to the time of day.
- Illumination: The brightness of the audio screen can be changed.
- Text Scroll: If text is too long to be displayed on the screen, enable the text scroll function.

Sound

Press the **[SETUP]** button on the audio system → Select [Sound].

- Position: Sound balance and panning can be adjusted.
- Tone: Sound tone color can be adjusted.

• Back-up Warning Priority:

- Automatically lower audio volume while reversing.

- Control the audio volume level automatically in R-Position.

If volume level over “5 level” then down to “5 level”.

If volume level under “5 level” then maintain the volume level.

Return the volume level when R-Position was cancelled.

In R-Position, if driver change the volume level then volume changed.

Apply the volume control option “On/Off” in “Setup”: Default is “On”.

- Speed dependent volume: Automatically adjust volume based on vehicle speed.
- Beep: Select whether to play a beep sound when the screen is touched.

Date/Time

Press the **[SETUP]** button on the audio system → Select [Date/Time].

- Set Time: Set the time displayed on the audio screen.
- Time Format: Choose between 12-hour and 24-hour time formats.
- Set Date: Set the date displayed on the audio screen.

Bluetooth

Press the [SETUP] button on the audio system → Select [Bluetooth].

- Connections: Control pairing, deletion, connection and disconnection of Bluetooth® devices.
- Auto Connection Priority: Set the connection priority of Bluetooth® devices when the vehicle is started.
- Download Contacts: Contacts can be downloaded from connected Bluetooth® devices.

*** NOTICE**

- When paired devices are deleted, the call history and contacts of the device saved to the audio system are deleted.
- For Bluetooth® connections with low connection priority, some time may be required for the connection to be established.
- Contacts can be downloaded only from the currently connected Bluetooth® device.
- If no Bluetooth® device is connected, the Download Contacts button is disabled.

System

Press the [SETUP] button on the audio system → Select [System].

- Memory Information: View My Music memory usage.
- Language: Change the user language.
- Default: Reset the audio system.

*** NOTICE**

The system resets to the default values, and all saved data and settings are lost.

Screen Saver

Set the information displayed when the audio system is switched off or the screen is turned off.

Press the [SETUP] button on the audio system → Select [Screen Saver].

- Analog: An analog clock is displayed.
- Digital: A digital clock is displayed.
- None: No information is displayed.

Display Off

To prevent glare, the screen can be turned off with the audio system in operation.

Press the [SETUP] button on the audio system → Select [Display Off].

*** NOTICE**

Use 'Screen Saver' to set the information to be displayed when the screen is turned off.

Driving your vehicle

BEFORE DRIVING	7-3	REAR PARKING ASSIST SYSTEM	7-28
• Before entering the vehicle.....	7-3	SPECIAL DRIVING CONDITIONS	7-30
• Before starting	7-3	• Hazardous driving conditions	7-30
KEY IGNITION SWITCH	7-4	• Rocking the vehicle.....	7-30
• Ignition switch position.....	7-4	• Smooth cornering	7-31
• Starting the engine	7-5	• Driving at night	7-31
ENGINE START/STOP BUTTON	7-7	• Driving in the rain.....	7-31
• Illuminated engine start/stop button.....	7-7	• Driving in flooded areas	7-32
• Engine start/stop button position.....	7-7	WINTER DRIVING	7-33
• Starting the engine	7-10	• Snow or icy conditions	7-33
MANUAL TRANSAXLE	7-13	VEHICLE WEIGHT	7-36
• Manual transaxle operation	7-13	• Overloading	7-36
• Good driving practices	7-15		
AUTOMATIC TRANSAXLE	7-16		
• Automatic transaxle operation	7-16		
• Parking	7-19		
• Good driving practices	7-20		
BRAKING SYSTEM	7-21		
• Power brakes	7-21		
• Disc brakes wear indicator	7-22		
• Rear drum brakes.....	7-22		
• Parking brake	7-22		
• Anti-lock Brake System (ABS).....	7-24		
• Good braking practices	7-27		

WARNING

Carbon monoxide (CO) gas is toxic. Breathing CO can cause unconsciousness and death.

Engine exhaust contains carbon monoxide which cannot be seen or smelled.

Do not inhale engine exhaust.

If at any time you smell engine exhaust inside the vehicle, open the windows immediately. Exposure to CO can cause unconsciousness and death by asphyxiation.

Be sure the exhaust system does not leak.

The exhaust system should be checked whenever the vehicle is raised to change the oil or for any other purpose. If you hear a change in the sound of the exhaust or if you drive over something that strikes the underneath side of the vehicle, we recommend that the exhaust system be checked as soon as possible by an authorized HYUNDAI dealer.

Do not run the engine in an enclosed area.

Letting the engine idle in your garage, even with the garage door open, is a hazardous practice. Run the engine only long enough to start the engine and to move the vehicle out of the garage.

Avoid idling the engine for prolonged periods with people inside the vehicle.

If it is necessary to idle the engine for a prolonged period with people inside the vehicle, be sure to do so only in an unenclosed area with the air intake set at "Fresh" and fan control to high so fresh air is drawn into the interior.

Keep the air intakes clear.

To assure proper operation of the ventilation system, keep the ventilation air intakes located in front of the windshield clear of snow, ice, leaves, or other obstructions.

If you must drive with the tailgate/trunk lid open:

Close all windows.

Open instrument panel air vents.

Set the air intake control at "Fresh", the air flow control at "Floor" or "Face", and the fan control to high.

BEFORE DRIVING

Before entering the vehicle

- Be sure that all windows, outside mirror(s), and outside lights are clean.
- Visually check the tires for uneven wear and damage.
- Check under the vehicle for any sign of leaks.
- Be sure there are no obstacles behind you if you intend to back up.

Before starting

- Make sure the hood, the tailgate/trunk, and the doors are securely closed and locked.
- Adjust the position of the seat and steering wheel.
- Adjust the inside and outside rearview mirrors.
- Verify all lights work.
- Fasten your seatbelt. Check that all passengers have fastened their seatbelts.
- Check the gauges and indicators in the instrument panel and the messages on the instrument display when the ignition switch is in the ON position.
- Check that any items you are carrying are stored properly or fastened down securely.

WARNING

All passengers must be properly belted whenever the vehicle is moving. Refer to “Seat belts” in section 3 for more information on their proper use.

WARNING - Driving under the influence of alcohol or drugs

NEVER drink or take drugs and drive. Drinking or taking drugs and driving is dangerous and may result in an accident and SERIOUS INJURY or DEATH.

Drunk driving is the number one contributor to the highway death toll each year. Even a small amount of alcohol will affect your reflexes, perceptions and judgment. Just one drink can reduce your ability to respond to changing conditions and emergencies and your reaction time gets worse with each additional drink.

Driving while under the influence of drugs is as dangerous or more dangerous than driving under the influence of alcohol.

You are much more likely to have a serious accident if you drink or take drugs and drive. If you are drinking or taking drugs, don't drive. Do not ride with a driver who has been drinking or taking drugs. Choose a designated driver or call a taxi.

KEY IGNITION SWITCH (IF EQUIPPED)

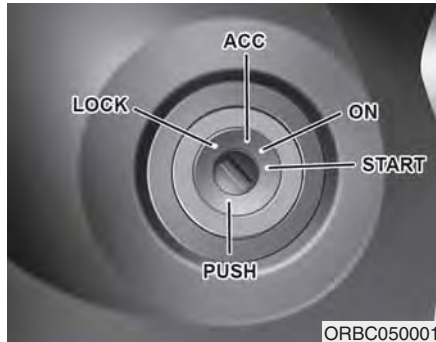

Ignition switch position

LOCK

The steering wheel locks to protect against theft. The ignition key can be removed only in the LOCK position. When turning the ignition switch to the LOCK position, push the key in slightly at the ACC position and turn the key towards the LOCK position.

ACC (Accessory)

The steering wheel is unlocked and electrical accessories are usable.

*** NOTICE**

If difficulty is experienced turning the ignition switch to the ACC position, turn the key while turning the steering wheel right and left to release the tension.

ON

The warning lights can be checked before the engine is started. This is the normal running position after the engine has started.

Do not leave the ignition switch in the ON position when the engine is not running to prevent the battery from discharging.

START

Turn the ignition switch to the START position to start the engine. The switch returns to the ON position when you let go of the key.

⚠ WARNING - Ignition switch

- **NEVER** turn the ignition switch to the LOCK or ACC position while the vehicle is in motion except in an emergency. This will result in the engine turning off and loss of power assist for the steering and brake systems. This may lead to loss of directional control and braking function, which could cause an accident.
- Before leaving the driver's seat, always make sure the shift lever is in 1st gear (for manual transaxle vehicle) or P (Park, for automatic transaxle vehicle) position, apply the parking brake, and turn ignition switch to the LOCK position. Unexpected vehicle movement may occur if these precautions are not followed.
- **NEVER** reach through the steering wheel for the ignition switch, or any other control, while the vehicle is in motion. The presence of your hand or arm in this area may cause a loss of vehicle control resulting in an accident.

Starting the engine

WARNING

Always wear appropriate shoes when operating your vehicle. Unsuitable shoes (high heels, ski boots, etc.) may interfere with your ability to use the brake, accelerator, and clutch (pedals).

Starting the petrol engine

1. Make sure the parking brake is applied.
2. **Manual Transaxle** - Depress the clutch pedal fully and shift the transaxle into Neutral. Keep the clutch pedal and brake pedal depressed while turning the ignition switch to the start position.
Automatic Transaxle - Place the transaxle shift lever in P (Park). Depress the brake pedal fully.
You can also start the engine when the shift lever is in the N (Neutral) position.
3. Turn the ignition switch to the START position. Hold the key (maximum of 10 seconds) until the engine starts and release it.

* NOTICE

- Whether the engine is cold or warm, always start the vehicle with your foot on the brake pedal. Do not depress the accelerator while starting the vehicle. Do not race the engine while warming it up.
- In extremely cold weather (below -18°C / 0°F) or after the vehicle has not been operated for several days, let the engine warm up without depressing the accelerator pedal.

CAUTION

To prevent damage to the vehicle:

- *Do not hold the ignition key in the START position for more than 10 seconds. Wait 5 to 10 seconds before trying again.*
- *If traffic and road conditions permit, you may put the shift lever in the N (Neutral) position while the vehicle is still moving and turn the ignition switch to the START position in an attempt to restart the engine.*
- *Do not push or tow your vehicle to start the engine.*

Starting the diesel engine

To start the diesel engine when the engine is cold, it has to be pre-heated before starting the engine and then has to be warmed up before starting to drive.

1. Make sure the parking brake is applied.
2. Depress the clutch pedal fully and shift the transaxle into neutral. Keep the clutch pedal and brake pedal depressed while turning the ignition switch to the start position.



3. Turn the ignition switch to the ON position to pre-heat the engine. Then the glow indicator light will illuminate.
4. If the glow indicator light goes out, turn the ignition switch to the START position and hold the key (maximum of 10 seconds) until the engine starts and release it.

*** NOTICE**

If the engine does not start within 10 seconds after the preheating is completed, turn the ignition key once more to the LOCK position for 10 seconds. Then turn the ignition switch to the ON position in order to preheat the engine again.

Starting and stopping the engine for turbocharger intercooler

1. Do not race or accelerate the engine immediately after starting it.
If the engine is cold, idle it for several seconds before sufficient lubrication is ensured in the turbocharger unit.
2. After high speed or extended driving, requiring a heavy engine load, idle the engine about 1 minute before turning it off.
This idle time will allow the turbocharger to cool prior to shutting the engine off.

CAUTION

Do not turn the engine off immediately after it has been subjected to heavy load. Doing so may cause severe damage to the engine or turbo charger unit.

ENGINE START/STOP BUTTON (IF EQUIPPED)**Illuminated engine start/stop button**

Whenever the front door is opened, the engine start/stop button will illuminate and will go off after about 30 seconds after the door is closed.

Engine start/stop button position*OFF***With manual transaxle**

To turn off the engine (START/RUN position) or vehicle power (ON position), stop the vehicle then press the engine start/stop button.

With automatic transaxle

To turn off the engine (START/RUN position) or vehicle power (ON position), press the engine start/stop button with the shift lever in the P (Park) position. When you press the engine start/stop button without the shift lever in the P (Park) position, the engine start/stop button will not change to the OFF position but to the ACC position.

Vehicles equipped with anti-theft steering column lock

The steering wheel locks when the engine start/stop button is in the OFF position to protect you against theft.

It locks when the door is opened.

If the steering wheel is not locked properly when you open the driver's door, the warning chime will sound. Try locking the steering wheel again. If the problem is not solved, we recommend that the system be checked by an authorized HYUNDAI dealer.

In addition, if the engine start/stop button is in the OFF position after the driver's door is opened, the steering wheel will not lock and the warning chime will sound. In such a situation, close the door. Then the steering wheel will lock and the warning chime will stop.

*** NOTICE**

If the steering wheel doesn't unlock properly, the engine start/stop button will not work. Press the engine start/stop button while turning the steering wheel right and left to release tension.

WARNING

To turn the engine off in an emergency:

Press and hold the engine start/stop button for more than two seconds OR Rapidly press and release the engine start/stop button three times (within three seconds).

If the vehicle is still moving, you can restart the engine without depressing the brake pedal by pressing the engine start/stop button with the shift lever in the N (Neutral) position.

ACC(Accessory)



With manual transaxle

Press the engine start/stop button when the button is in the OFF position without depressing the clutch pedal.

With automatic transaxle

Press the engine start/stop button while it is in the OFF position without depressing the brake pedal.

The steering wheel unlocks (if equipped with anti-theft steering column lock) and electrical accessories are usable.

If you leave the engine start/stop button in the ACC position for more than one hour, the battery power will turn off automatically to prevent the battery from discharging.

ON



With manual transaxle

Press the engine start/stop button when the button is in the ACC position without depressing the clutch pedal.

With automatic transaxle

Press the engine start/stop button while it is in the ACC position without depressing the brake pedal.

The warning lights can be checked before the engine is started. If you leave the engine start/stop button in the ON position for more than one hour, the battery power will turn off automatically to prevent the battery from discharging.

START/RUN**With manual transaxle**

To start the engine, depress the clutch and brake pedals and press the engine start/stop button with the shift lever in neutral.

With automatic transaxle

To start the engine, depress the brake pedal and press the engine start/stop button with the shift lever in the P (Park) or the N (Neutral) position. For your safety, start the engine with the shift lever in the P (Park) position.

*** NOTICE**

If you press the engine start/stop button without depressing the clutch pedal for manual transaxle vehicles or without depressing the brake pedal for automatic transaxle vehicles, the engine will not start and the engine start/stop button changes as follow:

OFF → ACC → ON → OFF or ACC

⚠ WARNING

- NEVER press the engine start/stop button while the vehicle is in motion except in an emergency. This will result in the engine turning off and loss of power assist for the steering and brake systems. This may lead to loss of directional control and braking function, which could cause an accident.
- Before leaving the driver's seat, always make sure the shift lever is in the P (Park) position, set the parking brake, press the engine start/stop button to the OFF position, and take the smart key with you. Unexpected vehicle movement may occur if these precautions are not followed.
- NEVER reach through the steering wheel for the engine start/stop button, or any other control, while the vehicle is in motion. The presence of your hand or arm in this area may cause a loss of vehicle control resulting in an accident.

Starting the engine



WARNING

Always wear appropriate shoes when operating your vehicle. Unsuitable shoes (high heels, ski boots, etc.) may interfere with your ability to use the brake and accelerator pedals.

Starting the petrol engine

*** NOTICE**

- The engine will start by pressing the engine start/stop button, only when the smart key is in the vehicle.
- Even if the smart key is in the vehicle, if it is far away from the driver, the engine may not start.
- When the Engine Start/Stop button is in the ACC or ON position, if any door is open, the system checks for the smart key. If the smart key is not in the vehicle, the indicator "KEY OUT" will blink, and if all doors are closed, the chime will also sound for about 5 seconds. The indicator will turn off while the vehicle is moving. Keep the smart key in the vehicle when using the ACC position or if the vehicle engine is ON.

1. Carry the smart key or leave it inside the vehicle.
2. Make sure the parking brake is firmly applied.
3. **Manual Transaxle** - Depress the clutch pedal fully and shift the transaxle into Neutral. Keep the clutch pedal and brake pedal depressed while starting the engine.

Automatic Transaxle - Place the transaxle shift lever in P (Park). Depress the brake pedal fully.

You can also start the engine when the shift lever is in the N (Neutral) position.

4. Press the engine start/stop button.

*** NOTICE**

- Whether the engine is cold or warm, always start the vehicle with your foot on the brake pedal. Do not depress the accelerator while starting the vehicle. Do not race the engine while warming it up.
- In extremely cold weather (below -18°C / 0°F) or after the vehicle has not been operated for several days, let the engine warm up without depressing the accelerator pedal.

Starting the diesel engine

To start the diesel engine when the engine is cold, it has to be pre-heated before starting the engine and then have to be warmed up before starting to drive.

1. Make sure the parking brake is applied.
2. **Manual Transaxle** - Depress the clutch pedal fully and shift the transaxle into Neutral. Keep the clutch pedal and brake pedal depressed while pressing the engine start/stop button to the START position.

Automatic Transaxle - Place the transaxle shift lever in the P (Park) position. Depress the brake pedal fully.

You can also start the engine when the shift lever is in the N (Neutral) position.

3. Press the engine start/stop button while depressing the brake pedal.



4. Continue depressing the brake pedal until the illuminated glow indicator goes off. (approximately 5 seconds)

5. The engine starts running when the glow indicator goes off.

*** NOTICE**

If the engine start/stop button is pressed once more while the engine is pre-heating, the engine may start.

Starting and stopping the engine for turbocharger intercooler

1. Do not race or accelerate the engine immediately after starting.

If the engine is cold, idle for several seconds before sufficient lubrication is ensured in the turbocharger unit.

2. After high speed or extended driving, requiring a heavy engine load, idle the engine about 1 minute before turning it off.

This idle time will allow the turbocharger to cool prior to shutting the engine off.

⚠ CAUTION

Do not turn the engine off immediately after it has been subjected to heavy load. Doing so may cause severe damage to the engine or turbocharger unit.

CAUTION

If the engine stalls while the vehicle is in motion, do not attempt to move the shift lever to the P (Park) position. If the traffic and road conditions permit, you may put the shift lever in the N (Neutral) position while the vehicle is still moving and press the engine start/stop button in an attempt to restart the engine.

* NOTICE

To prevent damage to the vehicle: Do not press the engine start/stop button for more than 10 seconds except when the stop lamp fuse is disconnected.

When the stop lamp fuse is blown, you can't start the engine normally. Replace the fuse with a new one. If you are not able to replace the fuse, you can start the engine by pressing the engine start/stop button for 10 seconds with the engine start/stop button in the ACC position.

For your safety always depress the brake and/or clutch pedal before starting the engine.



* NOTICE

If the smart key battery is weak or the smart key does not work correctly, you can start the engine by pressing the engine start/stop button with the smart key in the direction of the picture above.

MANUAL TRANSAXLE

■ Type A (for Petrol engine)



OBA053003

■ Type B (for Diesel engine)



OBA053003I

➔ The shift lever can be moved without pressing the button (1).

➔ The button (1) must be pressed up while moving the shift lever.

Manual transaxle operation

The manual transaxle has five forward gears. The transaxle is fully synchronized in all forward gears so shifting to either a higher or a lower gear is easily accomplished.

WARNING

Before leaving the driver's seat, always make sure the shift lever is in 1st gear when the vehicle is parked on a uphill and in R (Reverse) on a downhill, set the parking brake, and place the ignition switch in the LOCK/OFF position. Unexpected vehicle movement may occur if these precautions are not followed.

To shift to R (Reverse), make sure the vehicle has completely stopped, and then move the shift lever to neutral before moving into R (Reverse).

When you've come to a complete stop and it's hard to shift into 1st gear or R (Reverse):

1. Put the shift lever in neutral and release the clutch pedal.
2. Depress the clutch pedal, and then shift into first or R (Reverse) gear.

* NOTICE

During cold weather, shifting may be difficult until the transaxle lubricant has warmed up.

Using the clutch

The clutch pedal should be depressed all the way to the floor before:

- Starting the engine

The engine will not start without depressing the clutch pedal. (Vehicles equipped with engine start/stop button)

- Shifting

When releasing the clutch pedal, release it slowly. The clutch pedal should always be released while driving.



CAUTION

To prevent unnecessary wear or damage to the clutch:

- *Do not rest your foot on the clutch pedal while driving.*
- *Do not hold the vehicle with the clutch on an incline, while waiting for the traffic light, etc.*
- *Always depress the clutch pedal down fully to prevent noise or damage.*

Downshifting

Downshift when you must slow down in heavy traffic or drive up a steep hill to prevent engine load.

Also, downshifting reduces the chance of stalling and can accelerate when you need to increase your speed again.

When the vehicle is going downhill, downshifting helps maintain safe speed by providing brake power from the engine and enables less wear on the brakes.



CAUTION

To prevent damage to the engine:

- *When downshifting from 5th gear to 4th gear, be careful not to inadvertently push the shift lever sideways engaging the 2nd gear. A drastic downshift may cause the engine speed to increase to the point the tachometer will enter the red-zone.*
- *Do not downshift more than one gear at a time or downshift the gear when the engine is running at high speed (5,000 RPM or higher).*

Good driving practices

- Never take the vehicle out of gear and coast down a hill. This is extremely dangerous.
- Don't "ride" the brakes. This can cause the brakes and related parts to over-heat and malfunction.
When you are driving down a long hill, slow down and shift to a lower gear. Engine braking will help slow down the vehicle.
- Slow down before shifting to a lower gear. This will help avoid over-revving the engine, which can cause damage.
- Slow down when you encounter cross winds. This gives you much better control of your vehicle.
- Be sure the vehicle is completely stopped before you shift into R (Reverse) to prevent damage to the transaxle.
- Exercise extreme caution when driving on a slippery surface. Be especially careful when braking, accelerating or shifting gears. On a slippery surface, an abrupt change in vehicle speed can cause the drive wheels to lose traction and may cause loss of vehicle control resulting in an accident



 **WARNING**

To reduce the risk of **SERIOUS INJURY** or **DEATH**:

- **ALWAYS** wear your seatbelt. In a collision, an unbelted occupant is significantly more likely to be seriously injured or killed than a properly belted occupant.
- Avoid high speeds when cornering or turning.
- Do not make quick steering wheel movements, such as sharp lane changes or fast, sharp turns.
- The risk of rollover is greatly increased if you lose control of your vehicle at highway speeds.
- Loss of control often occurs if two or more wheels drop off the roadway and the driver over steers to reenter the roadway.
- In the event your vehicle leaves the roadway, do not steer sharply. Instead, slow down before pulling back into the travel lanes.
- **HYUNDAI** recommends you follow all posted speed limits.

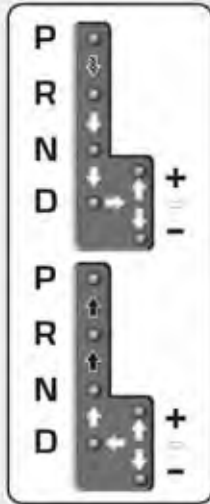
AUTOMATIC TRANSAXLE



-  Press the shift button, then move shift lever.
-  Depress the brake pedal, press the shift button, and then move shift lever.
-  Move shift lever.

OBA053004R

Automatic transaxle operation

The automatic transaxle has four forward speeds and one reverse speed. The individual speeds are selected automatically, depending on the position of the shift lever.

WARNING

To reduce the risk of serious injury or death:

- **ALWAYS** check the surrounding areas near your vehicle for people, especially children, before shifting a vehicle into D (Drive) or R (Reverse).
- Before leaving the driver's seat, always make sure the shift lever is in the P (Park) position, then set the parking brake, and place the ignition switch in the LOCK/OFF position. Unexpected and sudden vehicle movement can occur if these precautions are not followed.

The indicator in the instrument cluster displays the shift lever position when the ignition switch is in the ON position.

P (Park)

Always come to a complete stop before shifting into P (Park).

To shift from P (Park), you must depress firmly on the brake pedal and make sure your foot is off the accelerator pedal.

The shift lever must be in P (Park) before turning the engine off.

WARNING

- Shifting into P (Park) while the vehicle is in motion may cause you to lose control of the vehicle.
- After the vehicle has stopped, always make sure the shift lever is in P (Park), apply the parking brake, and turn the engine off.
- Do not use the P (Park) position in place of the parking brake.

R (Reverse)

Use this position to drive the vehicle backward.

CAUTION

Always come to a complete stop before shifting into or out of R (Reverse); you may damage the transaxle if you shift into R (Reverse) while the vehicle is in motion.

N (Neutral)

The wheels and transaxle are not engaged.

Use N (Neutral) if you need to restart a stalled engine, or if it is necessary to stop with the engine ON. Shift into P (Park) if you need to leave your vehicle for any reason.

Always depress the brake pedal when you are shifting from N (Neutral) to another gear.

WARNING

Do not shift into gear unless your foot is firmly on the brake pedal. Shifting into gear when the engine is running at high speed can cause the vehicle to move very rapidly. You could lose control and hit people or objects.

Driving your vehicle

D (Drive)

This is the normal driving position. The transaxle will automatically shift through a 4-gear sequence, providing the best fuel economy and power.

For extra power when passing another vehicle or driving uphill, depress the accelerator fully. The transaxle will automatically downshift to the next lower gear (or gears, as appropriate).



WARNING

NEVER allow anyone to ride in a seat with the headrest removed.



Sports mode

Whether the vehicle is stationary or in motion, sports mode is selected by pushing the shift lever from the D (Drive) position into the manual gate. To return to D (Drive) range operation, push the shift lever back into the main gate.

In Sports Mode, moving the shift lever backwards and forwards will allow you to select the desired range of gears for the current driving conditions.

- + (Up) : Push the lever forward once to shift up one gear.
- (Down) : Pull the lever backwards once to shift down one gear.

*** NOTICE**

- Only the four forward gears can be selected. To reverse or park the vehicle, move the shift lever to the R (Reverse) or P (Park) position as required.
- Downshifts are made automatically when the vehicle slows down. When the vehicle stops, 1st gear is automatically selected.
- When the engine rpm approaches the red zone the transaxle will upshift automatically.
- If the driver presses the lever to + (Up) or - (Down) position, the transaxle may not make the requested gear change if the next gear is outside of the allowable engine rpm range. The driver must execute upshifts in accordance with road conditions, taking care to keep the engine rpms below the red zone.
- When driving on a slippery road, push the shift lever forward into the + (Up) position. This causes the transaxle to shift into the 2nd gear which is better for smooth driving on a slippery road. Push the shift lever to the - (Down) side to shift back to the 1st gear.

Shift -lock system

For your safety, the automatic transaxle has a shift-lock system which prevents shifting the transaxle from P (Park) into R (Reverse) unless the brake pedal is depressed.

To shift the transaxle from P (Park) into R (Reverse):

1. Depress and hold the brake pedal.
2. Press the shift button.
3. Move the shift lever.

Parking

Always come to a complete stop and continue to depress the brake pedal. Move the shift lever into the P (Park) position, apply the parking brake, and place the ignition switch in the LOCK/OFF position. Take the Key with you when exiting the vehicle.

 **WARNING**

When you stay in the vehicle with the engine running, be careful not to depress the accelerator pedal for a long period of time. The engine or exhaust system may overheat and start a fire.

The exhaust gas and the exhaust system are very hot. Keep away from the exhaust system components.

Do not stop or park over flammable materials, such as dry grass, paper or leaves. They may ignite and cause a fire.

Good driving practices

- Never move the shift lever from P (Park) or N (Neutral) to any other position with the accelerator pedal depressed.
 - Never move the shift lever into P (Park) when the vehicle is in motion.
 - Be sure the vehicle is completely stopped before you attempt to shift into R (Reverse) or D (Drive).
 - Do not move the shift lever to N (Neutral) when driving. Doing so may result in an accident because of a loss of engine braking and the transaxle could be damaged.
 - Do not drive with your foot resting on the brake pedal. Even light, but consistent pedal pressure can result in the brakes overheating, brake wear and possibly even brake failure.
 - Slow down before shifting to a lower gear. Otherwise, the lower gear may not be engaged if the engine rpms are outside of the allowable range.
 - Always apply the parking brake when leaving the vehicle. Do not depend on placing the transmission in P (Park) to keep the vehicle from moving.
- Exercise extreme caution when driving on a slippery surface. Be especially careful when braking, accelerating or shifting gears. On a slippery surface, an abrupt change in vehicle speed can cause the drive wheels to lose traction and may cause loss of vehicle control resulting in an accident
 - Optimum vehicle performance and economy is obtained by smoothly depressing and releasing the accelerator.



WARNING

To reduce the risk of **SERIOUS INJURY** or **DEATH**:

- **ALWAYS** wear your seatbelt. In a collision, an unbelted occupant is significantly more likely to be seriously injured or killed than a properly belted occupant.
- Avoid high speeds when cornering or turning.
- Do not make quick steering wheel movements, such as sharp lane changes or fast, sharp turns.
- The risk of rollover is greatly increased if you lose control of your vehicle at highway speeds.
- Loss of control often occurs if two or more wheels drop off the roadway and the driver over steers to reenter the roadway.
- In the event your vehicle leaves the roadway, do not steer sharply. Instead, slow down before pulling back into the travel lanes.
- **HYUNDAI** recommends you follow all posted speed limits.

BRAKING SYSTEM

Power brakes

Your vehicle has power-assisted brakes that adjust automatically through normal usage.

If the engine is not running or is turned off while driving, the power assist for the brakes will not work. You can still stop your vehicle by applying greater force to the brake pedal than typical. The stopping distance, however, will be longer than with power brakes.

When the engine is not running, the reserve brake power is partially depleted each time the brake pedal is applied. Do not pump the brake pedal when the power assist has been interrupted.

Pump the brake pedal only when necessary to maintain steering control on slippery surfaces.

WARNING

Take the following precautions:

- Do not drive with your foot resting on the brake pedal. This will create abnormal high brake temperatures, excessive brake lining and pad wear, and increased stopping distances.
- When descending a long or steep hill, shift to a lower gear and avoid continuous application of the brakes. Applying the brakes continuously will cause the brakes to overheat and could result in a temporary loss of braking performance.
- Wet brakes may impair the vehicle's ability to safely slow down; the vehicle may also pull to one side when the brakes are applied. Applying the brakes lightly will indicate whether they have been affected in this way. Always test your brakes in this fashion after driving through deep water.

(Continued)

(Continued)

To dry the brakes, lightly tap the brake pedal to heat up the brakes while maintaining a safe forward speed until brake performance returns to normal. Avoid driving at high speeds until the brakes function correctly.

Disc brakes wear indicator

When your brake pads are worn and new pads are required, you will hear a high pitched warning sound from your front or rear brakes. You may hear this sound come and go or it may occur whenever you depress the brake pedal.

Please remember some driving conditions or climates may cause a brake squeal when you first apply (or lightly apply) the brakes. This is normal and does not indicate a problem with your brakes.



CAUTION

To avoid costly brake repairs, do not continue to drive with worn brake pads.

* NOTICE

Always replace brake pads as complete front or rear axle sets.

Rear drum brakes

Your rear drum brakes do not have wear indicators. Therefore, have the rear brake linings inspected if you hear a rear brake rubbing noise. Also have your rear brakes inspected each time you change or rotate your tires and when you have the front brakes replaced.

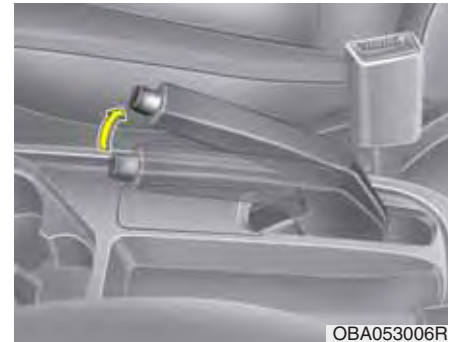

Parking brake

Always set the parking brake before leaving the vehicle, to apply:

Firmly depress the brake pedal.

Pull up the parking brake lever as far as possible.



WARNING

To reduce the risk of SERIOUS INJURY or DEATH, do not operate the parking brake while the vehicle is moving except in an emergency situation. It could damage the brake system and lead to an accident.

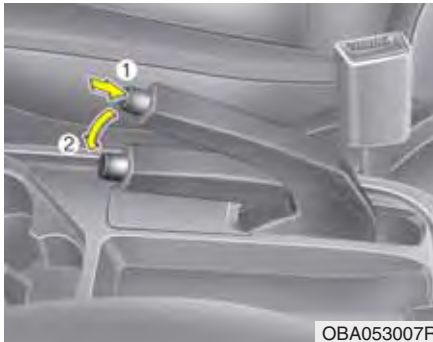

To release:

Firmly depress the brake pedal.

Slightly pull up the parking brake lever.

While pressing the release button (1), lower the parking brake (2).

If the parking brake does not release or does not release all the way, we recommend that the system be checked by an authorized HYUNDAI dealer.

WARNING

- Whenever leaving the vehicle or parking, always come to a complete stop and continue to depress the brake pedal. Move the shift lever into the 1st gear (for manual transaxle vehicle) or P (Park, for automatic transaxle vehicle) position, then apply the parking brake, and place the ignition switch in the LOCK/OFF position.

Vehicles with the parking brake not fully engaged are at risk for moving inadvertently and causing injury to yourself or others.

- NEVER allow anyone who is unfamiliar with the vehicle to touch the parking brake. If the parking brake is released unintentionally, serious injury may occur.
- Only release the parking brake when you are seated inside the vehicle with your foot firmly on the brake pedal.

CAUTION

- Do not apply the accelerator pedal while the parking brake is engaged. If you depress the accelerator pedal with the parking brake engaged, the warning will sound. Damage to the parking brake may occur.
- Driving with the parking brake on can overheat the braking system and cause premature wear or damage to brake parts. Make sure the parking brake is released and the Brake Warning Light is off before driving.



Check the Parking Brake Warning Light by placing the ignition switch to the ON position (do not start the engine).

This light will be illuminated when the parking brake is applied with the ignition switch in the START or ON position.

Before driving, be sure the parking brake is released and the Brake Warning Light is OFF.

If the Parking Brake Warning Light remains on after the parking brake is released while engine is running, there may be a malfunction in the brake system. Immediate attention is necessary.

If at all possible, cease driving the vehicle immediately. If that is not possible, use extreme caution while operating the vehicle and only continue to drive the vehicle until you can reach a safe location.

Anti-lock Brake System (ABS) (if equipped)

WARNING

An Anti-Lock Braking System (ABS) will not prevent accidents due to improper or dangerous driving maneuvers. Even though vehicle control is improved during emergency braking, always maintain a safe distance between you and objects ahead of you. Vehicle speeds should always be reduced during extreme road conditions. The braking distance for cars equipped with ABS may be longer than for those without these systems in the following road conditions.

- Drive your vehicle at reduced speeds during the following conditions:
- Rough, gravel or snow-covered roads.
- On roads where the road surface is pitted or has different surface height.
- Tire chains are installed on your vehicle.

(Continued)

(Continued)

The safety features of an ABS equipped vehicle should not be tested by high speed driving or cornering. This could endanger the safety of yourself or others.

ABS is an electronic braking system that helps prevent a braking skid. ABS allows the driver to steer and brake at the same time.

Using ABS

To obtain the maximum benefit from your ABS in an emergency situation, do not attempt to modulate your brake pressure and do not try to pump your brakes. Depress your brake pedal as hard as possible.

When you apply your brakes under conditions which may lock the wheels, you may hear sounds from the brakes, or feel a corresponding sensation in the brake pedal. This is normal and it means your ABS is active.

ABS does not reduce the time or distance it takes to stop the vehicle.

Always maintain a safe distance from the vehicle in front of you.

ABS will not prevent a skid that results from sudden changes in direction, such as trying to take a corner too fast or making a sudden lane change. Always drive at a safe speed for the road and weather conditions.

ABS cannot prevent a loss of stability. Always steer moderately when braking hard. Severe or sharp steering wheel movement can still cause your vehicle to veer into oncoming traffic or off the road.

On loose or uneven road surfaces, operation of the anti-lock brake system may result in a longer stopping distance than for vehicles equipped with a conventional brake system.

The ABS warning light () will stay on for several seconds after the ignition switch is in the ON position. During that time, the ABS will go through self-diagnosis and the light will go off if everything is normal. If the light stays on, you may have a problem with your ABS. We recommend that you contact an authorized HYUNDAI dealer as soon as possible



WARNING

If the ABS warning light () is on and stays on, you may have a problem with the ABS. Your power brakes will work normally. To reduce the risk of serious injury or death, we recommend that you contact your HYUNDAI dealer as soon as possible.



CAUTION

When you drive on a road having poor traction, such as an icy road, and apply your brakes continuously, the ABS will be active continuously and the ABS warning light () may illuminate. Pull your car over to a safe place and turn the engine off.

Restart the engine. If the ABS warning light is off, then your ABS system is normal. Otherwise, you may have a problem with your ABS system. We recommend that you contact an authorized HYUNDAI dealer as soon as possible.

* NOTICE

When you jump start your vehicle because of a drained battery, the engine may not run as smoothly and the ABS warning light () may turn on at the same time. This happens because of the low battery voltage. It does not mean your ABS is malfunctioning. Have the battery recharged before driving the vehicle.

Good braking practices

WARNING

Whenever leaving the vehicle or parking, always come to a complete stop and continue to depress the brake pedal. Move the shift lever into the 1st gear (for manual transaxle vehicle) or P (Park, for automatic transaxle vehicle) position, then apply the parking brake, and place the ignition switch in the LOCK/OFF position.

Vehicles with the parking brake not fully engaged are at risk for moving inadvertently and causing injury to yourself or others.

Wet brakes can be dangerous! The brakes may get wet if the vehicle is driven through standing water or if it is washed. Your vehicle will not stop as quickly if the brakes are wet. Wet brakes may cause the vehicle to pull to one side.

To dry the brakes, apply the brakes lightly until the braking action returns to normal, taking care to keep the vehicle under control at all times. If the braking action does not return to normal, stop as soon as it is safe to do so and we recommend that you call an authorized HYUNDAI dealer for assistance.

DO NOT drive with your foot resting on the brake pedal. Even light, but constant pedal pressure can result in the brakes overheating, brake wear, and possibly even brake failure.

If a tire goes flat while you are driving, apply the brakes gently and keep the vehicle pointed straight ahead while you slow down. When you are moving slowly enough for it to be safe to do so, pull off the road and stop in a safe location.

Keep your foot firmly on the brake pedal when the vehicle is stopped to prevent the vehicle from rolling forward.

REAR PARKING ASSIST SYSTEM (IF EQUIPPED)

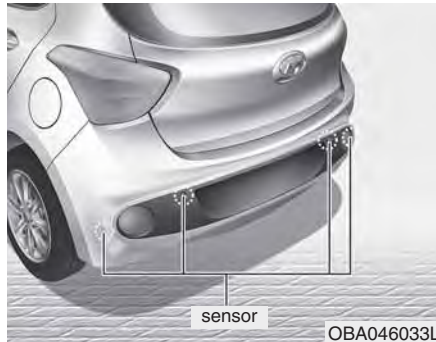

The Rear Parking Assist System aids the driver during backward movement of the vehicle by chiming if any object is sensed within the distance of about 120 cm (47 in) behind the vehicle. This is a supplemental system that senses objects within the range and location of the sensors, it can not detect objects in other areas where sensors are not installed.

* NOTICE

The system may not recognize objects less than 40 cm (15 in) from the sensor, or it may sense an incorrect distance.

WARNING

- **ALWAYS** look around your vehicle to make sure there are not any objects or obstacles before moving the vehicle in any direction to prevent a collision.
- Always pay close attention when the vehicle is driven close to objects, particularly pedestrians, and especially children.
- Be aware that some objects may not be visible on the screen or be detected by the sensors, due to the objects distance, size or material, all of which can limit the effectiveness of the sensor.

CAUTION

Do not push, scratch or strike the sensor with any hard objects that could damage the surface of the sensor. Sensor damage could occur.

Operation of the rear parking assist system

Operation condition

- This system will activate when the shift lever is in R (Reverse) with the ignition switch in the ON position.
- Sensing distance when backing up is approximately 120 cm (47 in) when you are driving less than 10 km/h (6 mph).
- When more than two objects are sensed at the same time, the closest one will be recognized first.

Types of warning sounds

- When an object is 120 cm (47 in) to 81 cm (32 in) from the rear bumper: Buzzer beeps intermittently.
- When an object is 80 cm (31 in) to 41 cm (16 in) from the rear bumper: Buzzer sounds two beeps intermittently.
- When an object is within 40 cm (15 in) of the rear bumper: Buzzer sounds continuously.

If the audible warning does not sound or if the buzzer sounds intermittently when shifting into R (Reverse) position, this may indicate a malfunction with the Parking Assist System. If this occurs, we recommend that your vehicle be checked by an authorized HYUNDAI dealer as soon as possible.

Non-operational conditions of rear parking assist system**The rear parking assist system may not operate normally when:**

- Moisture is frozen to the sensor.
- The sensor is covered or stained with foreign matter, such as snow or water, or the sensor cover is blocked.

There is a possibility of a parking assist system malfunction when:

- Driving on uneven road surfaces such as unpaved roads, gravel, bumps, or gradient.
- Objects generating excessive noise such as vehicle horns, loud motorcycle engines, or truck air brakes can interfere with the sensor.
- Heavy rain or water spray is present.
- Wireless transmitters or mobile phones are present near the sensor.
- The sensor is covered with snow.
- Any non-factory equipment or accessories have been installed, or if the vehicle bumper height or sensor installation has been modified.
- Trailer towing.

Detecting range may decrease when:

- Outside air temperature is extremely hot or cold.
- Undetectable objects smaller than about 1 m (40 in) and narrower than about 14 cm (6 in) in diameter.

The following objects may not be recognized by the sensor:

- Sharp or slim objects such as ropes, chains or small poles.
- Objects, which tend to absorb sensor frequency such as clothes, spongy material or snow.

**WARNING**

Your new vehicle warranty does not cover any accidents or damage to the vehicle or injuries to its occupants do to a rear parking assist system malfunction. Always drive safely and cautiously.

SPECIAL DRIVING CONDITIONS

Hazardous driving conditions

When hazardous driving conditions are encountered such as water, snow, ice, mud or sand:

Drive cautiously and allow extra distance for braking.

Avoid sudden movements in braking or steering.

If stuck in snow, mud, or sand, use second gear. Accelerate slowly to avoid spinning the drive wheels.

WARNING

Downshifting with an automatic transaxle, while driving on slippery surfaces can cause an accident. The sudden change in tire speed could cause the tires to skid. Be careful when downshifting on slippery surfaces.

Use sand, rock salt, or other non-slip material under the drive wheels to provide traction when stalled in ice, snow, or mud.

Rocking the vehicle

If it is necessary to rock the vehicle to free it from snow, sand, or mud, first turn the steering wheel right and left to clear the area around your front wheels. Then, shift back and forth between 1st and R (Reverse, for manual transaxle vehicle) or R (Reverse) and a forward gear (for automatic transaxle vehicle). Do not race the engine, and spin the wheels as little as possible.

To prevent transaxle wear, wait until the wheels stop spinning before shifting gears. Release the accelerator pedal while shifting, and press lightly on the accelerator pedal while the transaxle is in gear. Slowly spinning the wheels in forward and reverse directions causes a rocking motion that may free the vehicle.

WARNING

If the tires spin at high speed the tires can explode, and you or others may be injured. Do not attempt this procedure if people or objects are anywhere near the vehicle.

The vehicle can overheat causing an engine compartment fire or other damage. Spin the wheels as little as possible and avoid spinning the wheels at speeds over 56 km/h (35 mph) as indicated on the speedometer.

CAUTION

If you are still stuck after rocking the vehicle a few times, have the vehicle pulled out by a tow vehicle to avoid engine overheating, possible damage to the transaxle, and tire damage. See "Towing" in chapter 6.



Smooth cornering

Avoid braking or gear changing in corners, especially when roads are wet. Ideally, corners should always be taken under gentle acceleration.



Driving at night

Night driving presents more hazards than driving in the daylight. Here are some important tips to remember:

- Slow down and keep more distance between you and other vehicles, as it may be more difficult to see at night, especially in areas where there may not be any street lights.
- Adjust your mirrors to reduce the glare from other driver's headlights.
- Keep your headlights clean and properly aimed. Dirty or improperly aimed headlights will make it much more difficult to see at night.
- Avoid staring directly at the headlights of oncoming vehicles. You could be temporarily blinded, and it will take several seconds for your eyes to readjust to the darkness.



Driving in the rain

Rain and wet roads can make driving dangerous. Here are a few things to consider when driving in the rain or on slick pavement:

- Slow down and allow extra following distance. A heavy rainfall makes it harder to see and increases the distance needed to stop your vehicle.
- Replace your windshield wiper blades when they show signs of streaking or missing areas on the windshield.

- Be sure your tires have enough tread. If your tires do not have enough tread, making a quick stop on wet pavement can cause a skid and possibly lead to an accident. See “Tire Tread” in chapter 7.
- Turn on your headlights to make it easier for others to see you.
- Driving too fast through large puddles can affect your brakes. If you must go through puddles, try to drive through them slowly.
- If you believe your brakes may be wet, apply them lightly while driving until normal braking operation returns.

Hydroplaning

If the road is wet enough and you are going fast enough, your vehicle may have little or no contact with the road surface and actually ride on the water. The best advice is SLOW DOWN when the road is wet. The risk of hydroplaning increases as the depth of tire tread decreases, refer to “Tire Tread” in chapter 7.

Driving in flooded areas

Avoid driving through flooded areas unless you are sure the water is no higher than the bottom of the wheel hub. Drive through any water slowly. Allow adequate stopping distance because brake performance may be reduced. After driving through water, dry the brakes by gently applying them several times while the vehicle is moving slowly.

WINTER DRIVING



1VQA3005

Snow or icy conditions

You need to keep sufficient distance between your vehicle and the vehicle in front of you.

Apply the brakes gently. Speeding, rapid acceleration, sudden brake applications, and sharp turns are potentially very hazardous practices. During deceleration, use engine braking to the fullest extent. Sudden brake applications on snowy or icy roads may cause skids to occur.

To drive your vehicle in deep snow, it may be necessary to use snow tires or to install tire chains on your tires.

Always carry emergency equipment. Some of the items you may want to carry include tire chains, tow straps or chains, a flashlight, emergency flares, sand, a shovel, jumper cables, a window scraper, gloves, ground cloth, coveralls, a blanket, etc.

Snow tires

WARNING

Snow tires should be equivalent in size and type to the vehicle's standard tires. Otherwise, the safety and handling of your vehicle may be adversely affected.

If you mount snow tires on your vehicle, make sure to use radial tires of the same size and load range as the original tires. Mount snow tires on all four wheels to balance your vehicle's handling in all weather conditions. The traction provided by snow tires on dry roads may not be as high as your vehicle's original equipment tires. Check with the tire dealer for maximum speed recommendations.

* NOTICE

Do not install studded tires without first checking local and municipal regulations for possible restrictions against their use.

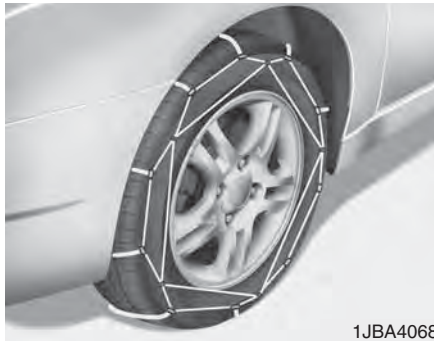

1JBA4068

Tire chains

Since the sidewalls of radial tires are thinner than other types of tires, they may be damaged by mounting some types of tire chains on them. Therefore, the use of snow tires is recommended instead of tire chains. Do not mount tire chains on vehicles equipped with aluminum wheels; if unavoidable use a wire type chain. If tire chains must be used, use genuine HYUNDAI parts and install the tire chain after reviewing the instructions provided with the tire chains. Damage to your vehicle caused by improper tire chain use is not covered by your vehicle manufacturer's warranty.

⚠ WARNING

The use of tire chains may adversely affect vehicle handling:

- Drive less than 30 km/h (20 mph) or the chain manufacturer's recommended speed limit, whichever is lower.
- Drive carefully and avoid bumps, holes, sharp turns, and other road hazards, which may cause the vehicle to bounce.
- Avoid sharp turns or locked wheel braking.

*** NOTICE**

- Install tire chains on the front tires. It should be noted that installing tire chains on the tires will provide a greater driving force, but will not prevent side skids.
- Do not install studded tires without first checking local and municipal regulations for possible restrictions against their use.

Chain installation

When installing tire chains, follow the manufacturer's instructions and mount them as tightly possible. Drive slowly (less than 30 km/h (20 mph)) with chains installed. If you hear the chains contacting the body or chassis, stop and tighten them. If they still make contact, slow down until the noise stops. Remove the tire chains as soon as you begin driving on cleared roads.

When mounting snow chains, park the vehicle on level ground away from traffic. Turn on the vehicle Hazard Warning Flasher and place a triangular emergency warning device behind the vehicle if available. Always place the vehicle in P (Park), apply the parking brake and turn off the engine before installing snow chains.

 **CAUTION*****When using tire chains:***

- *Wrong size chains or improperly installed chains can damage your vehicle's brake lines, suspension, body and wheels.*
- *Use SAE "S" class or wire chains.*
- *If you hear noise caused by chains contacting the body, retighten the chain to prevent contact with the vehicle body.*
- *To prevent body damage, retighten the chains after driving 0.5-1.0 km (0.3-0.6 miles).*
- *Do not use tire chains on vehicles equipped with aluminum wheels. If unavoidable, use a wire type chain.*
- *Use wire chains less than 15 mm (0.59 in) wide to prevent damage to the chain's connection.*

VEHICLE WEIGHT

Two labels on your driver's door sill show how much weight your vehicle was designed to carry: the Tire and Loading Information Label and the Certification Label.

Before loading your vehicle, familiarize yourself with the following terms for determining your vehicle's weight ratings, from the vehicle's specifications and the Certification Label:

Base Curb Weight

This is the weight of the vehicle including a full tank of fuel and all standard equipment. It does not include passengers, cargo, or optional equipment.

Vehicle Curb Weight

This is the weight of your new vehicle when you picked it up from your dealer plus any aftermarket equipment.

Cargo Weight

This figure includes all weight added to the Base Curb Weight, including cargo and optional equipment.

GAW (Gross Axle Weight)

This is the total weight placed on each axle (front and rear) - including vehicle curb weight and all payload.

GAWR (Gross Axle Weight Rating)

This is the maximum allowable weight that can be carried by a single axle (front or rear). These numbers are shown on the Certification Label. The total load on each axle must never exceed its GAWR.

GVW (Gross Vehicle Weight)

This is the Base Curb Weight plus actual Cargo Weight plus passengers weight.

GVWR (Gross Vehicle Weight Rating)

This is the maximum allowable weight of the fully loaded vehicle (including all options, equipment, passengers and cargo). The GVWR is shown on the Certification Label located on the driver's door sill.

Overloading

WARNING

The Gross Axle Weight Rating (GAWR) and the Gross Vehicle Weight Rating (GVWR) for your vehicle are on the Certification Label attached to the driver's (or front passenger's) door. Exceeding these ratings can cause an accident or vehicle damage. You can calculate the weight of your load by weighing the items (and people) before putting them in the vehicle. Be careful not to overload your vehicle.

What to do in an emergency

ROAD WARNING	8-2
• Hazard warning flasher	8-2
IN CASE OF AN EMERGENCY WHILE DRIVING	8-2
• If the engine stalls while driving	8-2
• If the engine stalls at a crossroad or crossing.....	8-2
• If you have a flat tire while driving	8-3
IF THE ENGINE DOES NOT START	8-3
• If the engine doesn't turn over or turns over slowly .	8-3
• If the engine turns over normally but does not start.	8-3
JUMP STARTING	8-4
IF THE ENGINE OVERHEATS	8-7
IF YOU HAVE A FLAT TIRE	8-8
• Jack and tools	8-8
• Changing tires	8-9
TOWING	8-13
• Towing service	8-13
• Removable towing hook (front).....	8-14
• Emergency towing.....	8-15

ROAD WARNING



Hazard warning flasher

The hazard warning flasher serves as a warning to other drivers to exercise extreme caution when approaching, overtaking, or passing your vehicle.

It should be used whenever emergency repairs are being made or when the vehicle is stopped near the edge of a roadway.

To turn the hazard warning flasher on or off, press the hazard warning flasher button with the ignition switch in any position. The button is located in the center console switch panel. All turn signal lights will flash simultaneously.

- The hazard warning flasher operates whether your vehicle is running or not.
- The turn signals do not work when the hazard flasher is on.

IN CASE OF AN EMERGENCY WHILE DRIVING

If the engine stalls while driving

- Reduce your speed gradually, keeping a straight line. Move cautiously off the road to a safe place.
- Turn on your hazard warning flashers.
- Try to start the engine again. If your vehicle will not start, we recommend that you consult an authorized HYUNDAI dealer.

If the engine stalls at a crossroad or crossing

- If the engine stalls at a crossroad or crossing, set the shift lever in the N (Neutral) position and then push the vehicle to a safe location.
- If your vehicle has a manual transaxle not equipped with a ignition lock switch, the vehicle can move forward by shifting to the 2(second) or 3(third) gear and then turning the starter without depressing the clutch pedal.

If you have a flat tire while driving

If a tire goes flat while you are driving:

- Take your foot off the accelerator pedal and let the vehicle slow down while driving straight ahead. Do not apply the brakes immediately or attempt to pull off the road as this may cause a loss of control. When the vehicle has slowed to such a speed that it is safe to do so, brake carefully and pull off the road. Drive off the road as far as possible and park on a firm level ground. If you are on a divided highway, do not park in the median area between the two traffic lanes.
- When the vehicle is stopped, turn on your hazard warning flashers, set the parking brake and put the transaxle in P (Park, for automatic transaxle vehicle) or reverse (for manual transaxle vehicle).
- Have all passengers get out of the vehicle. Be sure they all get out on the side of the vehicle that is away from traffic.
- When changing a flat tire, follow the instruction provided later in this chapter.

IF THE ENGINE DOES NOT START

If the engine doesn't turn over or turns over slowly

- If your vehicle has an automatic transaxle, be sure the shift lever is in N (Neutral) or P (Park) and the emergency brake is set.
- Check the battery connections to be sure they are clean and tight.
- Turn on the interior light. If the light dims or goes out when you operate the starter, the battery is discharged.

Do not push or pull the vehicle to start it. See instructions for "Jump starting".

 **WARNING**

Push or pull starting may cause the catalytic converter to overload which can lead to damage to the emission control system.

If the engine turns over normally but does not start

- Check the fuel level.
- With the ignition switch in the LOCK/OFF position, check all connectors at the ignition coils and spark plugs. Reconnect any that may be disconnected or loose.
- Check the fuel line in the engine compartment.

If the engine still does not start, we recommend that you call an authorized HYUNDAI dealer.

JUMP STARTING

Jump starting can be dangerous if done incorrectly. Follow the jump starting procedure in this section to avoid serious injury or damage to your vehicle. If in doubt about how to properly jump start your vehicle, we strongly recommend that you have a service technician or towing service do it for you.

CAUTION

- *Improper jump starting procedure can result in battery explosion and acid burn hazard.*
- *Loosely connected battery cables could damage the electronic control units.*
- *To disconnect battery terminals wait for at least 2 minutes to allow discharge of high voltage or it could lead to personal injury.*
- *While disconnecting, always disconnect the -VE terminal first and While connecting, always connect the -VE terminal last. .*

WARNING

To prevent **SERIOUS INJURY** or **DEATH** to you or bystanders, always follow these precautions when working near or handling the battery:



Always read and follow instructions carefully when handling a battery.



Wear eye protection designed to protect the eyes from acid splashes.



Keep all flames, sparks, or smoking materials away from the battery.



Hydrogen, a highly combustible gas, is always present in battery cells, is highly combustible, and may explode if ignited.



Keep batteries out of reach of children.



Batteries contain sulfuric acid which is highly corrosive. Do not allow acid to contact your eyes, skin or clothing.

(Continued)

(Continued)

If acid gets into your eyes, flush your

eyes with clean water for at least 15 minutes and get immediate medical attention. If acid gets on your skin, thoroughly wash the area. If you feel pain or a burning sensation, get medical attention immediately.

- When lifting a plastic-cased battery, excessive pressure on the case may cause battery acid to leak. Lift with a battery carrier or with your hands on opposite corners.
- Do not attempt to jump start your vehicle if your battery is frozen.
- NEVER attempt to recharge the battery when the vehicle's battery cables are connected to the battery.
- The electrical ignition system works with high voltage. NEVER touch these components with the engine running or when the ignition switch is in the ON position.

(Continued)

(Continued)

- Do not allow the (+) and (-) jumper cables to touch. It may cause sparks.
- The battery may rupture or explode

when you jump start with a low or frozen battery.

- Never attempt jump start if you observe cracks, leaks or other damage on Battery.

 **CAUTION**

To prevent damage to your vehicle:

- *Only use a 12-volt power supply (battery or jumper system) to jump start your vehicle.*
- *Do not attempt to jump start your vehicle by push-starting.*

*** NOTICE**



An inappropriately disposed battery can be harmful to the environment and human health. Dispose the battery according to your local law(s) or regulation.

Jump starting procedure

1. Position the vehicles close enough that the jumper cables will reach, but do not allow the vehicles to touch.
2. Avoid fans or any moving parts in the engine compartment at all times, even when the vehicles are turned off.
3. Turn off all electrical devices such as radios, lights, air conditioning, etc. Put the vehicles in P (Park, for automatic transaxle vehicle) or neutral (for manual transaxle vehicle), and set the parking brakes. Turn both vehicles OFF.

What to do in an emergency

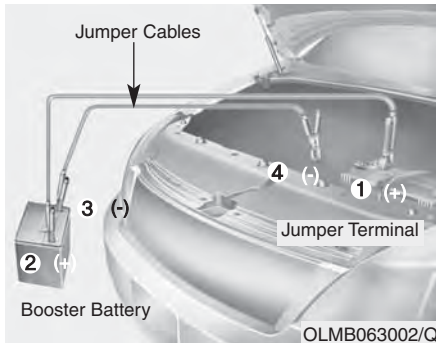

4. Connect the jumper cables in the exact sequence shown in the illustration. First connect one jumper cable to the red, positive (+) jumper terminal of your vehicle (1).
5. Connect the other end of the jumper cable to the red, positive (+) battery/jumper terminal of the assisting vehicle (2).
6. Connect the second jumper cable to the black, negative (-) battery/chassis ground of the assisting vehicle (3).

7. Connect the other end of the second jumper cable to the black, negative (-) chassis ground of your vehicle (4).

Do not allow the jumper cables to contact anything except the correct battery or jumper terminals or the correct ground. Do not lean over the battery when making connections.

8. Start the engine of the assisting vehicle and let it run at approximately 2,000 rpm for a few minutes. Then start your vehicle.

If your vehicle will not start after a few attempts, it probably requires servicing. In this event please seek qualified assistance. If the cause of your battery discharging is not apparent, we recommend that your vehicle be checked by an authorized HYUNDAI dealer.

Disconnect the jumper cables in the exact reverse order you connected them:

1. Disconnect the jumper cable from the black, negative (-) chassis ground of your vehicle (4).
2. Disconnect the other end of the jumper cable from the black, negative (-) battery/chassis ground of the assisting vehicle (3).
3. Disconnect the second jumper cable from the red, positive (+) battery/jumper terminal of the assisting vehicle (2).
4. Disconnect the other end of the jumper cable from the red, positive (+) jumper terminal of your vehicle (1).



WARNING

Never connect Jumper cable directly to the negative (-) terminal of discharged Battery (Your Vehicle Battery) or an Explosion may occur.

IF THE ENGINE OVERHEATS

If your temperature gauge indicates overheating, you will experience a loss of power, or hear loud pinging or knocking sound, the engine may be overheating. If this happens, you should:

1. Pull off the road and stop as soon as it is safe to do so.
2. Place the shift lever in P (Park, for automatic transaxle vehicle) or neutral (for manual transaxle vehicle) and set the parking brake. If the air conditioning is ON, turn it OFF.
3. If engine coolant is running out under the vehicle or steam is coming out from the hood, stop the engine. Do not open the hood until the coolant has stopped running or the steaming has stopped. If there is no visible loss of engine coolant and no steam, leave the engine running and check to be sure the engine cooling fan is operating. If the fan is not running, turn the engine off.

 **WARNING**

 While the engine is running, keep hands, clothing and tools away from the moving parts such as the cooling fan and drive belt to prevent serious injury.

4. Check for coolant leaking from the radiator, hoses or under the vehicle. (If the air conditioning had been in use, it is normal for cold water to be draining from it when you stop.)
5. If engine coolant is leaking out, stop the engine immediately and we recommend that you call an authorized HYUNDAI dealer for assistance.

 **WARNING**

 **NEVER** remove the radiator cap or the drain plug while the engine and radiator are hot. Hot coolant and steam may blow out under pressure, causing serious injury.

Turn the engine off and wait until the engine cools down. Use extreme care when removing the radiator cap. Wrap a thick towel around it, and turn it counterclockwise slowly to the first stop. Step back while the pressure is released from the cooling system. When you are sure all the pressure has been released, press down on the cap, using a thick towel, and continue turning counterclockwise to remove it.

IF YOU HAVE A FLAT TIRE

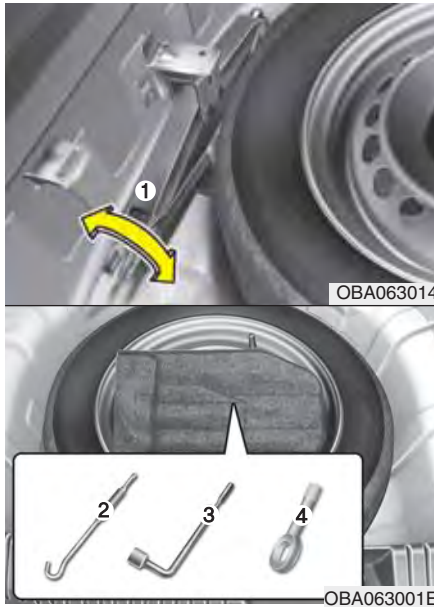

Jack and tools

- (1) Jack
- (2) Jack handle
- (3) Wheel lug nut wrench
- (4) Towing hook

The spare tire, jack, jack handle, wheel lug nut wrench are stored in the luggage compartment.

Pull up the floor cover of the luggage compartment to reach the jack behind the spare tire. (if equipped)

The jack is provided for emergency tire changing only.



Removing and storing the spare tire

Turn the tire hold-down wing bolt counterclockwise.

Store the tire in the reverse order of removal.

To prevent the spare tire and tools from “rattling” while the vehicle is in motion, store them properly.

Changing tires

WARNING

A vehicle can slip or roll off of a jack causing serious injury or death to you or those nearby. Take the following safety precautions:

- Do not get under a vehicle that is supported by a jack.
- NEVER attempt to change a tire in the lane of traffic. ALWAYS move the vehicle completely off the road on level, firm ground away from traffic before trying to change a tire. If you cannot find a level, firm place off the road, call a towing service for assistance.
- Be sure to use the jack provided with the vehicle.
- ALWAYS place the jack on the designated jacking positions on the vehicle and NEVER on the bumpers or any other part of the vehicle for jacking support.
- Do not start or run the engine while the vehicle is on the jack.
- Do not allow anyone to remain in the vehicle while it is on the jack.
- Keep children away from the road and the vehicle.

1. Park on a level, firm surface.
2. Move the shift lever into P (Park, for automatic transaxle vehicle) or neutral (for manual transaxle vehicle), apply the parking brake, and place the ignition switch in the LOCK/OFF position.
3. Press the hazard warning flasher button.



4. Remove the wheel lug nut wrench, jack, jack handle, and spare tire from the vehicle.
5. Block both the front and rear of the tire diagonally opposite of the tire you are changing.



6. Loosen the wheel lug nuts counter-clockwise one turn each in the order shown above, but do not remove any lug nuts until the tire has been raised off of the ground.



7. Place the jack at the designated jacking position under the frame closest to the tire you are changing. The jacking positions are plates welded to the frame with two tabs and a raised dot. Never jack any other position or part of the vehicle.



8. Insert the jack handle into the jack and turn it clockwise, raising the vehicle until the tire clears the ground. Make sure the vehicle is stable on the jack.

9. Loosen the lug nuts with the wheel lug nut wrench and remove them with your fingers. Remove the wheel from the studs and lay it flat on the ground out of the way. Remove any dirt or debris from the studs, mounting surfaces, and wheel.
10. Install the spare tire onto the studs of the hub.
11. Tighten the lug nuts with your fingers onto the studs with the smaller end of the lug nuts closest to the wheel.
12. Lower the vehicle to the ground by turning the jack handle counterclockwise.



13. Use the wheel lug nut wrench to tighten the lug nuts in the order shown. Double-check each lug nut until they are tight. After changing tires, we recommend that an authorized HYUNDAI dealer tighten the lug nuts to their proper torque as soon as possible. **The wheel lug nut should be tightened to 11~13 kg.m (79~94 lb.ft).**

If you have a tire gauge, check the tire pressure (see “Tires and Wheels” in chapter 8 for tire pressure instructions.). If the pressure is lower or higher than recommended, drive slowly to the nearest service station and adjust it to the recommended pressure. Always reinstall the valve cap after checking or adjusting tire pressure. If the cap is not replaced, air may leak from the tire. If you lose a valve cap, buy another and install it as soon as possible. After changing tires, secure the flat tire and return the jack and tools to their proper storage locations.

* NOTICE

Check the tire pressure as soon as possible after installing a spare tire. Adjust it to the recommended pressure.



CAUTION

Your vehicle has metric threads on the studs and lug nuts. Make certain during tire changing that the same nuts that were removed are reinstalled. If you have to replace your lug nuts make sure they have metric threads to avoid damaging the studs and ensure the wheel is properly secured to the hub. We recommend that you consult an authorized HYUNDAI dealer for assistance.

If any of the equipment such as the jack, lug nuts, studs, or other equipment is damaged or in poor condition, do not attempt to change the tire and call for assistance.

TOWING

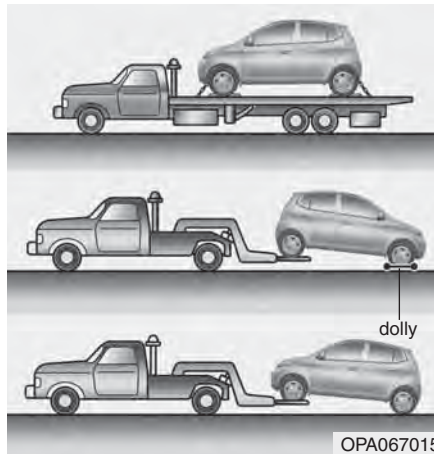

Towing service

If emergency towing is necessary, we recommend having it done by an authorized HYUNDAI dealer or a commercial tow-truck service. Proper lifting and towing procedures are necessary to prevent damage to the vehicle. The use of wheel dollies or flatbed is recommended.

It is acceptable to tow the vehicle with the rear wheels on the ground (without dollies) and the front wheels off the ground.

If any of the loaded wheels or suspension components are damaged or the vehicle is being towed with the front wheels on the ground, use a towing dolly under the front wheels.

When being towed by a commercial tow truck and wheel dollies are not used, the front of the vehicle should always be lifted, not the rear.



CAUTION

- *Do not tow the vehicle with the front wheels on the ground as this may cause damage to the vehicle.*
- *Do not tow with sling-type equipment. Use wheel lift or flatbed equipment.*

What to do in an emergency

When towing your vehicle in an emergency without wheel dollies :

1. Place the ignition switch in the ACC position.
2. Place the shift lever in N (Neutral).
3. Release the parking brake.

CAUTION

Failure to place the shift lever in N (Neutral) when being towed with the front wheels on the ground can cause internal damage to the transaxle.

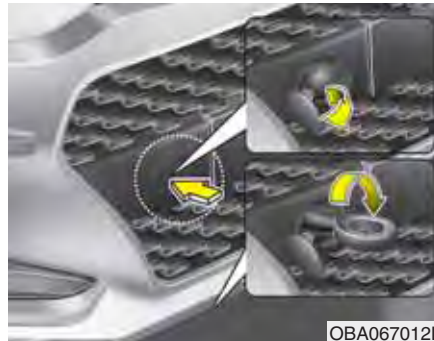

Removable towing hook (front) (if equipped)

5 Door

1. Open the tailgate, and remove the towing hook from the tool bag.
2. Remove the hole cover pressing the lower part of the cover on the front bumper.

4 Door

1. Open the trunk, and remove the towing hook from the tool bag.
2. Remove the hole cover on the front bumper by turning the grip counter-clockwise.

The grip is provided in the tool bag.



3. Install the towing hook by turning it clockwise into the hole until it is fully secured.
4. Remove the towing hook and install the cover after use.



Emergency towing

If towing is necessary, we recommend you to have it done by an authorized HYUNDAI dealer or a commercial tow truck service.

If towing service is not available in an emergency, your vehicle may be temporarily towed using a cable or chain secured to the emergency towing hook under the front (or rear) of the vehicle.

Use extreme caution when towing the vehicle. A driver must be in the vehicle to steer it and operate the brakes.

Towing in this manner may be done only on hard-surfaced roads for a short distance and at low speeds. Also, the wheels, axles, power train, steering and brakes must all be in good condition.

Always follow these emergency towing precautions:

- Place the ignition switch in the ACC position so the steering wheel is not locked.
- Place the shift lever in N (Neutral).
- Release the parking brake.
- Depress the brake pedal with more force than normal since you will have reduced braking performance.
- More steering effort will be required because the power steering system will be disabled.
- Use a vehicle heavier than your own to tow your vehicle.
- The drivers of both vehicles should communicate with each other frequently.
- Before emergency towing, check that the hook is not broken or damaged.

- Fasten the towing cable or chain securely to the hook.
- Do not jerk the hook. Apply steady and even force.

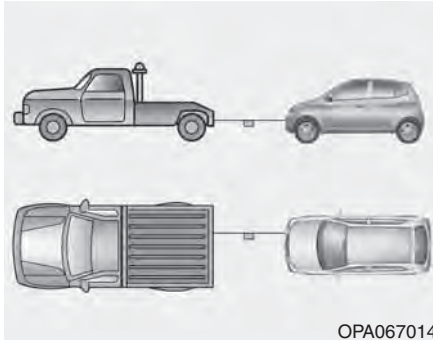

- Use a towing cable or chain less than 5 m (16 feet) long. Attach a white or red cloth (about 30 cm (12 inches) wide) in the middle of the cable or chain for easy visibility.
- Drive carefully so the towing cable or chain remains tight during towing.
- Before towing, check the automatic transaxle for fluid leaks under your vehicle. If the automatic transaxle fluid is leaking, flatbed equipment or a towing dolly must be used.

CAUTION

To avoid damage to your vehicle and vehicle components when towing:

- *Always pull straight ahead when using the towing hooks. Do not pull from the side or at a vertical angle.*
- *Do not use the towing hooks to pull a vehicle out of mud, sand or other conditions from which the vehicle cannot be driven out under its own power.*
- *Limit the vehicle speed to 15 km/h (10 mph) and drive less than 1.5 km (1 mile) when towing to avoid serious damage to the automatic transaxle.*

Maintenance

ENGINE COMPARTMENT	9-3	PARKING BRAKE	9-35
• Petrol engine	9-2	• Checking the parking brake	9-35
• Diesel engine.....	9-3	FUEL FILTER (FOR DIESEL)	9-36
MAINTENANCE SERVICES	9-5	• Draining water from the fuel filter	9-36
• Owner's responsibility	9-5	• Extracting air from the fuel filter	9-36
• Owner maintenance precautions	9-5	• Fuel filter cartridge replacement.....	9-37
OWNER MAINTENANCE	9-7	AIR CLEANER	9-38
• Owner maintenance schedule	9-7	• Filter replacement	9-38
SCHEDULED MAINTENANCE SERVICE	9-9	CLIMATE CONTROL AIR FILTER	9-40
• Maintenance schedule (for Petrol) engine.....	9-10	• Filter inspection.....	9-40
• Maintenance schedule (for Diesel) engine.....	9-16	WIPER BLADES	9-42
EXPLANATION OF SCHEDULED		• Blade inspection.....	9-42
MAINTENANCE ITEMS	9-24	• Blade replacement	9-42
ENGINE OIL	9-27	BATTERY	9-45
• Checking the engine oil level	9-27	• For best battery service	9-45
• Changing the engine oil and filter	9-28	• Battery capacity label	9-46
ENGINE COOLANT	9-29	• Battery recharging	9-46
• Checking the engine coolant	9-29	• Reset items	9-47
• Changing the engine coolant	9-31	TIRES AND WHEELS	9-48
BRAKE/CLUTCH FLUID	9-32	• Tire care	9-48
• Checking the brake/clutch fluid level	9-32	• Recommended cold tire inflation pressures	9-48
AUTOMATIC TRANSAXLE FLUID	9-33	• Checking tire inflation pressure.....	9-50
• Checking the automatic transaxle fluid level	9-33	• Tire rotation	9-51
• Changing the automatic transaxle fluid	9-34	• Wheel alignment and tire balance	9-52
WASHER FLUID	9-35	• Tire replacement	9-52
• Checking the washer fluid level	9-35	• Wheel replacement	9-53



- Tire traction 9-53
- Tire maintenance 9-53
- Tire sidewall labeling 9-54
- Low aspect ratio tire 9-57
- FUSES 9-59**
 - Instrument panel fuse replacement 9-60
 - Engine compartment panel fuse replacement 9-62
 - Main fuse (multi fuse) 9-62
 - Fuse/relay panel description 9-63
- LIGHT BULBS 9-71**
 - Headlight, position light, turn signal light, and front fog light bulb replacement 9-72
 - Side repeater light bulb replacement 9-74
 - Rear combination light bulb replacement 9-74
 - High mounted stop light 9-75
 - License plate light bulb replacement 9-76
 - Interior light bulb replacement 9-76
- APPEARANCE CARE 9-77**
 - Exterior care 9-77
 - Interior care 9-82

- EMISSION CONTROL SYSTEM 9-85**
 - Crankcase emission control system 9-85
 - Evaporative emission control system 9-85
 - Exhaust emission control system 9-86



ENGINE COMPARTMENT

■ Petrol engine

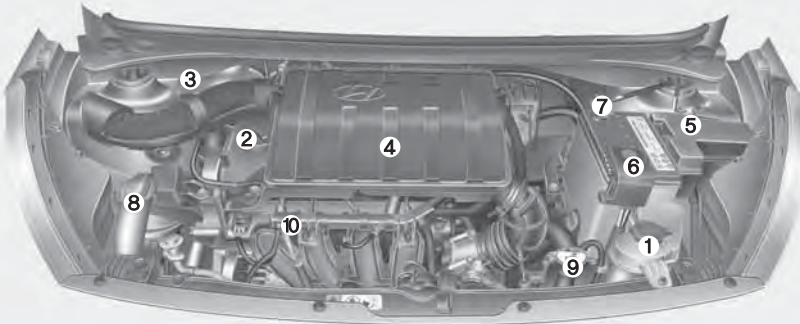

1. Engine coolant reservoir
2. Engine oil filler cap
3. Brake/clutch fluid reservoir
4. Air cleaner
5. Fuse box
6. Positive battery terminal
7. Negative battery terminal
8. Windshield washer fluid reservoir
9. Radiator cap
10. Engine oil dipstick

* The actual engine compartment in the vehicle may differ from the illustration.

OBA013006R

Maintenance

■ Diesel engine

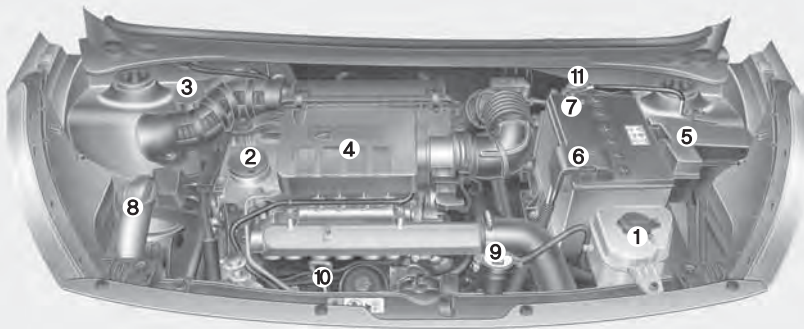

1. Engine coolant reservoir
2. Engine oil filler cap
3. Brake/clutch fluid reservoir
4. Air cleaner
5. Fuse box
6. Positive battery terminal
7. Negative battery terminal
8. Windshield washer fluid reservoir
9. Radiator cap
10. Engine oil dipstick
11. Fuel filter

* The actual engine compartment in the vehicle may differ from the illustration.

OBA013007R

MAINTENANCE SERVICES

You should exercise the utmost care to prevent damage to your vehicle and injury to yourself whenever performing any maintenance or inspection procedures.

Inadequate, incomplete or insufficient servicing may result in operational problems with your vehicle that could lead to vehicle damage, an accident, or personal injury.

Owner's responsibility

* NOTICE

Maintenance Service and Record Retention are the owner's responsibility.

We recommend in general that you have your vehicle serviced by an authorized HYUNDAI dealer.

You should retain documents that show proper maintenance has been performed on your vehicle in accordance with the scheduled maintenance service charts shown on the following pages. You need this information to establish your compliance with the servicing and maintenance requirements of your vehicle warranties.

Detailed warranty information is provided in your Service Passport.

Repairs and adjustments required as a result of improper maintenance or a lack of required maintenance are not covered when your vehicle is covered by warranty.

Owner maintenance precautions

Improper or incomplete service may result in problems. This section gives instructions only for the maintenance items that are easy to perform.

* NOTICE

Improper owner maintenance during the warranty period may affect warranty coverage. For details, read the Hyundai warranty policy in Chapter 2. If you're unsure about any servicing or maintenance procedure, we recommend that the system be serviced by an authorized HYUNDAI dealer.

Maintenance

WARNING - Maintenance work

- Performing maintenance work on a vehicle can be dangerous. You can be seriously injured while performing some maintenance procedures. If you lack sufficient knowledge and experience or the proper tools and equipment to do the work, we recommend that the system be serviced by an authorized HYUNDAI dealer.
- Working under the hood with the engine running is dangerous. It becomes even more dangerous when you wear jewelry or loose clothing. These can become entangled in moving parts and result in injury. Therefore, if you must run the engine while working under the hood, make certain that you remove all jewelry (especially rings, bracelets, watches, and necklaces) and all neckties, scarves, and similar loose clothing before getting near the engine or cooling fans.

WARNING - Diesel Engine

Never work on the injection system with the engine running or within 30 seconds after shutting off the engine. High-pressure pump, rail, injectors and high-pressure pipes are subject to high pressure even after the engine stopped. The fuel jet produced by fuel leaks may cause serious injury, if it touches the body. People using pacemakers should not move more than 30cm closer to the ECU or wiring harness within the engine room while the engine is running, since the high currents in the electronic engine control system produce considerable magnetic fields.

OWNER MAINTENANCE

The following lists are vehicle checks and inspections that should be performed at the frequencies indicated to help ensure safe, dependable operation of your vehicle.

Any adverse conditions should be brought to the attention of your dealer as soon as possible.

These Owner Maintenance Checks are generally not covered by warranties and you may be charged for labor, parts and lubricants used.

Owner maintenance schedule

When you stop for fuel:

- Check the engine oil level.
- Check the coolant level in the coolant reservoir.
- Check the windshield washer fluid level.
- Look for low or under-inflated tires.

WARNING

Be careful when checking your engine coolant level when the engine is hot. Scalding hot coolant and steam may blow out under pressure. This could cause burns or other serious injury.

While operating your vehicle:

- Note any changes in the sound of the exhaust or any smell of exhaust fumes in the vehicle.
- Check for vibrations in the steering wheel. Notice any increased steering effort or looseness in the steering wheel, or change in its straight-ahead position.
- Notice if your vehicle constantly turns slightly or “pulls” to one side when traveling on smooth, level road.
- When stopping, listen and check for unusual sounds, pulling to one side, increased brake pedal travel or “hard-to-push” brake pedal.
- If any slipping or changes in the operation of your transaxle occurs, check the transaxle fluid level.
- Check automatic transaxle P (Park) function.
- Check the parking brake.
- Check for fluid leaks under your vehicle (water dripping from the air conditioning system during or after use is normal).

Maintenance

At least monthly:

- Check the coolant level in the engine coolant reservoir.
- Check the operation of all exterior lights, including the stoplights, turn signals and hazard warning flashers.
- Check the inflation pressures of all tires including the spare.

At least twice a year (i.e., every Spring and Fall) :

- Check the radiator, heater and air conditioning hoses for leaks or damage.
- Check the windshield washer spray and wiper operation. Clean the wiper blades with clean cloth dampened with washer fluid.
- Check the headlight alignment.
- Check the muffler, exhaust pipes, shields and clamps.
- Check the lap/shoulder belts for wear and function.
- Check for worn tires and loose wheel lug nuts.

At least once a year :

- Clean the body and door drain holes.
- Lubricate the door hinges and checks, and hood hinges.
- Lubricate the door and hood locks and latches.
- Lubricate the door rubber weatherstrips.
- Check the air conditioning system.
- Inspect and lubricate the automatic transaxle linkage and controls.
- Clean the battery and terminals.
- Check the brake (and clutch) fluid level.

SCHEDULED MAINTENANCE SERVICE

Follow the Normal Maintenance Schedule if the vehicle is usually operated where none of the following conditions apply. If any of the following conditions apply, follow Maintenance Under Severe Usage Conditions.

Repeated driving short distance of less than 8 km (5 miles) in normal temperature or less than 16 km(10 miles) in freezing temperature

- Extensive engine idling or low speed driving for long distances
- Driving on rough, dusty, muddy, unpaved, graveled or salt-spread roads
- Driving in areas using salt or other corrosive materials or in very cold weather
- Driving in the condition of inflowing sand or dust into engine
- Driving in heavy traffic area
- Driving on uphill, downhill, or mountain road repeatedly
- Towing a trailer or using a camper, or roof rack
- Driving as a patrol car, taxi, other commercial use of vehicle towing
- Driving over 170 km/h (106 mile/h)
- Frequently driving in stop-and-go condition

If your vehicle is operated under the above conditions, you should inspect, replace or refill more frequently than the following Normal Maintenance Schedule. After the periods or distance shown in the chart, continue to follow the prescribed maintenance intervals.

Maintenance

NORMAL MAINTENANCE SCHEDULE - PETROL ENGINE

The following maintenance services must be performed to ensure good emission control and performance. Keep receipts for all vehicle emission services to protect your warranty. Where both kilometres and time are shown, the frequency of service is determined by whichever occurs first.

- *1 : Check the engine oil level and leak every 500 km (350 miles) or before starting a long trip.
- *2 : Driving in ambient temperature over 40 °C (104 °F) or driving at constant highway speeds must conform the severe driving condition.
- *3 : The engine oil level should be checked regularly and maintained properly. Operating with an insufficient amount of oil can damage the engine, and such damage is not covered by warranty.
- *4 : Inspect for excessive valve noise and/or engine vibration and adjust if necessary. We recommend that an authorized HYUNDAI dealer should perform the operation.
- *5 : When adding coolant, use only a qualified coolant additive for your vehicle and never mix hard water in the coolant filled at the factory. An improper coolant mixture can result in serious malfunction or engine damage.
- *6 : Manual transaxle fluid should be changed anytime the vehicle has been submerged in water.
- *7 : If good quality petrols that meet Europe Fuel standards (EN228) or equivalents including fuel additives is not available, one bottle of additive is recommended. Additives are available from your authorised HYUNDAI dealer along with information on how to use them. Do not mix other additives.
- *8 : Maintenance schedule depends on fuel quality. If there are some important matters like fuel flow restriction, surging, loss of power, difficulty in starting problems etc, we recommend replacing the fuel filter immediately regardless of the maintenance schedule and consulting with an authorised HYUNDAI dealer for details.
- *9 : Inspect drive belt tensioner, idler & alternator pulley, Starter and all chassis electrical items. Correct or replace, if necessary.
- *10 : For your convenience, it can be replaced prior to it's interval when you do maintenance of other items.

NORMAL MAINTENANCE SCHEDULE - PETROL ENGINE (CONT.)

MAINTENANCE ITEM	MAINTENANCE INTERVALS	Number of months or driving distance, whichever comes first									
		Kms×1,000	1.5	10	20	30	40	50	60	70	80
		Months	2	12	24	36	48	60	72	84	96
		Years	-	1	2	3	4	5	6	7	8
ENGINE BAY											
Engine oil & filter* ¹ * ² * ³		I	R	R	R	R	R	R	R	R	
Engine Timing Chain / belt		-	-	-	-	-	-	-	-	-	
Air cleaner filter		-	C	C	R	C	C	R	C	C	
Battery condition & specific gravity		-	I	I	I	I	I	I	I	I	
Throttle body		-	C	C	C	C	C	C	C	C	
Spark plugs * ¹⁰		-	Clean at every 10,000 km or 12 months. Replace at every 160,000 Km or 120 months								
Crankcase ventilation hose		I	I	I	I	I	I	I	I	I	
Tensioner/idler/damper pulley		Inspect when replacing the drive belt or timing belt/chain									
Power steering fluid and hoses		Not applicable									
Brake/Clutch fluid		I	I	I	R	I	I	R	I	I	
Engine coolant (topup & specific gravity) * ⁵		Inspect at every service; Replace first at 210,000 Km or 120 months; then at every 120,000 Km or 120 months									
Manual transaxle fluid* ⁶		-	-	-	-	-	-	I	-	-	
Automatic transaxle fluid		No check, No service required									

I : Inspect and if necessary adjust, top-up, clean or replace
R : Replace

C: Clean and Replace if necessary

Maintenance

NORMAL MAINTENANCE SCHEDULE - PETROL ENGINE (CONT.)

MAINTENANCE ITEM	MAINTENANCE INTERVALS	Number of months or driving distance, whichever comes first									
		Kms×1,000	1.5	10	20	30	40	50	60	70	80
		Months	2	12	24	36	48	60	72	84	96
		Years	-	1	2	3	4	5	6	7	8
VEHICLE ON FLOOR											
Wiper (wiper blade , washer fluid)		I	I	I	I	I	I	I	I	I	
Brake/Clutch (Pedal free play/Pipes/Hoses/Connectors)		I	I	I	I	I	I	I	I	I	
Fuel filler cap		-	I	I	I	I	I	I	I	I	
Climate control air filter		I	C	R	C	R	C	R	C	R	
Check AC system (refrigerant/Compressor)		I	I	I	I	I	I	I	I	I	
Cooling system (water pump,hoses) & leakage		I	I	I	I	I	I	I	I	I	
VEHICLE ON LIFT											
Steering gear rack, linkage and boots		I	I	I	I	I	I	I	I	I	
Exhaust system		I	I	I	I	I	I	I	I	I	
Fuel filter* ⁸		-	-	-	I	-	-	R	-	-	
Charcoal canister		-	-	-	-	-	-	I	-	-	
Fuel tank air filter		Not applicable									
Front & rear suspension (linkages & ball joints)		I	I	I	I	I	I	I	I	I	

I : Inspect and if necessary adjust, top-up, clean or replace

R : Replace

C : Clean and replace if necessary

NORMAL MAINTENANCE SCHEDULE - PETROL ENGINE (CONT.)

MAINTENANCE ITEM	MAINTENANCE INTERVALS	Number of months or driving distance, whichever comes first									
		Kms×1,000	1.5	10	20	30	40	50	60	70	80
		Months	2	12	24	36	48	60	72	84	96
		Years	-	1	2	3	4	5	6	7	8
Fuel lines, hoses and connections		I	I	I	I	I	I	I	I	I	
Driveshafts & boots		I	I	I	I	I	I	I	I	I	
Fluid leakages		I	I	I	I	I	I	I	I	I	
Front and rear wheel bearings & bushes		Inspect if required									
Front and rear disc/drum brakes & pads		I	I	I	I	I	I	I	I	I	
Parking brake (disc ,shoe & operation)		I	I	I	I	I	I	I	I	I	
Wheel Alignment & Balancing		-	Inspect if required								
Tyre Pressure,condition & rotation		-	TR	TR	TR	TR	TR	TR	TR	TR	
FINAL CHECKS											
Bolt and nuts on chasis and body		I	I	I	I	I	I	I	I	I	
Lubricate locks & hinges		I	L	L	L	L	L	L	L	L	
Check all electrical systems (Drive belts ,alternator)* ⁹		I	I	I	I	I	I	I	I	I	
Warning lights operation & G-Scan system check		I	I	I	I	I	I	I	I	I	
Ext & int. lights, horn & gauges		I	I	I	I	I	I	I	I	I	

I : Inspect and if necessary adjust, top-up, clean or replace
R : Replace

L : Lubricate
TR : Tyre Rotation

Maintenance

NORMAL MAINTENANCE SCHEDULE - PETROL ENGINE (CONT.)

MAINTENANCE ITEM	MAINTENANCE INTERVALS	Number of months or driving distance, whichever comes first									
		Kms×1,000	1.5	10	20	30	40	50	60	70	80
		Months	2	12	24	36	48	60	72	84	96
		Years	-	1	2	3	4	5	6	7	8
Power window / Sunroof operation (if equipped)		I	I	I	I	I	I	I	I	I	
All seat belt operation		I	I	I	I	I	I	I	I	I	
Road test		Inspect if required									

I : Inspect and if necessary adjust, top-up, clean or replace
R : Replace

L : Lubricate
TR : Tyre Rotation

MAINTENANCE UNDER SEVERE USAGE CONDITIONS - PETROL ENGINE

The following items must be serviced more frequently on cars mainly used under severe driving conditions. Refer to the chart below for the appropriate maintenance intervals.

I : Inspect and if necessary, adjust, correct, clean or replace R : Replace or change

Maintenance item	Maintenance operation	Maintenance intervals	Driving condition
Engine oil and engine oil filter	R	Replace every 5.000 km or 6 months	A, B, C, D, E, F, G, H, I, J
Air cleaner filter	R	Replace more frequently depending on the condition	C, E
Spark plugs	R	Replace more frequently depending on the condition	B, H
Manual transaxle fluid (if equipped)	R	Every 120,000 kms	C, D, E, G, H, I, J
Automatic transaxle fluid (if equipped)	R	Every 100,000 kms	A, C, D, E, F, G, H, I, J
Steering gear rack, linkage and boots	I	Inspect more frequently depending on the condition	C, D, E, F, G

Maintenance

MAINTENANCE UNDER SEVERE USAGE CONDITIONS - PETROL ENGINE

Maintenance item	Maintenance operation	Maintenance intervals	Driving condition
Front suspension ball joints	I	Inspect more frequently depending on the condition	C, D, E, F, G
Disc brakes and pads, calipers and rotors	I	Inspect more frequently depending on the condition	C, D, E, G, H
Drum brakes and linings (if equipped)	I	Inspect more frequently depending on the condition	C, D, E, G, H
Parking brake	I	Inspect more frequently depending on the condition	C, D, G, H
Driveshaft and boots	I	Inspect more frequently depending on the condition	C, D, E, F, G, H, I, J
Climate control air filter (if equipped)	R	Replace more frequently depending on the condition	C, E

Severe driving conditions

A : Repeated short distance driving

B : Extensive idling

C : Driving in dusty, rough roads

D : Driving in areas using salt or other corrosive materials or in very cold weather

E : Driving in the condition of inflowing sand or dust into engine

F : Driving in heavy traffic area

G : Driving in mountainous areas.

H : Towing a trailer

I : Driving for patrol car, taxi, commercial car or vehicle towing

J : Driving over 170 km/h (106 mile/h)

NORMAL MAINTENANCE SCHEDULE - FOR DIESEL ENGINE

The following maintenance services must be performed to ensure good emission control and performance. Keep receipts for all vehicle emission services to protect your warranty. Where both kilometres and time are shown, the frequency of service is determined by whichever occurs first.

- *1 : Check the engine oil level and leak every 500 km (350 miles) or before starting a long trip.
- *2 : Driving in ambient temperature over 40 °C (104 °F) or driving at constant highway speeds must conform the severe driving condition.
- *3 : The engine oil level should be checked regularly and maintained properly. Operating with an insufficient amount of oil can damage the engine, and such damage is not covered by warranty.
- *4 : Inspect for excessive valve noise and/or engine vibration and adjust if necessary. We recommend that an authorized HYUNDAI dealer should perform the operation.
- *5 : When adding coolant, use only deionised water or soft water for your vehicle and never mix hard water in the coolant filled at the factory. An improper coolant mixture can result in serious malfunction or engine damage.
- *6 : Manual transaxle fluid should be changed anytime the vehicle has been submerged in water.
- *7 : If good quality petrols that meet Europe Fuel standards (EN228) or equivalents including fuel additives is not available, one bottle of additive is recommended. Additives are available from your authorised HYUNDAI dealer along with information on how to use them. Do not mix other additives
- *8 : Maintenance schedule depends on fuel quality. If there are some important matters like fuel flow restriction, surging, loss of power, difficulty in starting problems etc, we recommend replacing the fuel filter immediately regardless of the maintenance schedule and consulting with an authorised HYUNDAI dealer for details.
- *9 : Inspect drive belt tensioner, idler & alternator pulley, Starter and all chassis electrical items. Correct or replace, if necessary.

Maintenance

NORMAL MAINTENANCE SCHEDULE - DIESEL ENGINE

MAINTENANCE ITEM	MAINTENANCE INTERVALS	Number of months or driving distance, whichever comes first									
		Kms×1,000	1.5	10	20	30	40	50	60	70	80
		Months	2	12	24	36	48	60	72	84	96
		Years	-	1	2	3	4	5	6	7	8
ENGINE BAY											
Engine oil & filter ^{*1 *2 *3}		I	R	R	R	R	R	R	R	R	
Drive belts		-	-	-	-	I	-	-	-	I	
Air cleaner filter		-	C	R	C	R	C	R	C	R	
Battery condition & specific gravity		-	I	I	I	I	I	I	I	I	
Crankcase ventilation hose		I	I	I	I	I	I	I	I	I	
Tensioner/idler/damper pulley		Inspect when replacing the drive belt or timing belt/chain									
Power steering fluid and hoses		Not applicable									
Brake/Clutch fluid		I	I	I	I	I	I	I	I	I	
Engine coolant (topup & specific gravity) ^{* 5}		Inspect at every service; Replace first at 210,000 Km or 120 months; then at every 120,000 Km or 120 months									
Manual transaxle fluid ^{* 6}		-	-	-	-	-	-	I	-	-	
Automatic transaxle fluid		Not applicable									

I : Inspect and if necessary adjust, top-up, clean or replace
R : Replace

C : Clean and Replace if necessary

NORMAL MAINTENANCE SCHEDULE - DIESEL ENGINE (CONT.)

MAINTENANCE ITEM	MAINTENANCE INTERVALS	Number of months or driving distance, whichever comes first									
		Kmsx1,000	1.5	10	20	30	40	50	60	70	80
		Months	2	12	24	36	48	60	72	84	96
		Years	-	1	2	3	4	5	6	7	8
VEHICLE ON FLOOR											
Wiper (wiper blade , washer fluid)		I	I	I	I	I	I	I	I	I	
Brake/Clutch (pedal free play/pipes/hoses/connectors)		I	I	I	I	I	I	I	I	I	
Fuel filler cap		-	I	I	I	I	I	I	I	I	
Climate control air filter		I	C	R	C	R	C	R	C	R	
Check AC system (refrigerant/compressor)		I	I	I	I	I	I	I	I	I	
Cooling system (water pump,hoses) & leakage		I	I	I	I	I	I	I	I	I	
VEHICLE ON LIFT											
4WD Shaft Differential Transfer case oil (if applicable)		Not applicable									
Steering gear rack, linkage and boots		I	I	I	I	I	I	I	I	I	
Exhaust system		I	I	I	I	I	I	I	I	I	
Fuel filter cartridge*8		-	-	R	-	R	-	R	-	R	
Fuel tank air filter		Not applicable									
Front & rear suspension (linkages & ball joints)		I	I	I	I	I	I	I	I	I	

I : Inspect and if necessary adjust, top-up, clean or replace

R : Replace

A : Add

C : Clean and replace if necessary

Maintenance

NORMAL MAINTENANCE SCHEDULE - DIESEL ENGINE (CONT.)

MAINTENANCE ITEM	MAINTENANCE INTERVALS	Number of months or driving distance, whichever comes first									
		Kms×1,000	1.5	10	20	30	40	50	60	70	80
		Months	2	12	24	36	48	60	72	84	96
		Years	-	1	2	3	4	5	6	7	8
Fuel lines, hoses and connections		I	I	I	I	I	I	I	I	I	
Driveshafts & boots		I	I	I	I	I	I	I	I	I	
Fluid leakages		I	I	I	I	I	I	I	I	I	
Front and rear wheel bearings & bushes		Inspect if required									
Front and rear disc/drum brakes & pads		I	I	I	I	I	I	I	I	I	
Parking brake (disc, shoe & operation)		I	I	I	I	I	I	I	I	I	
Wheel Alignment & Balancing (If required)		-	Inspect if required								
Tyre pressure, condition & rotation		-	TR	TR	TR	TR	TR	TR	TR	TR	
FINAL CHECKS											
Bolt and nuts on chasis and body		I	I	I	I	I	I	I	I	I	
Lubricate locks & hinges		I	L	L	L	L	L	L	L	L	
Check all electrical systems (Drive belts ,alternator)* ⁹		I	I	I	I	I	I	I	I	I	
Warning lights operation & G-Scan system check		I	I	I	I	I	I	I	I	I	
Ext & Int. lights, horn & gauges		I	I	I	I	I	I	I	I	I	

I : Inspect and if necessary adjust, top-up, clean or replace
R : Replace

A : Add
TR : Tyre Rotation

L : Lubricate

NORMAL MAINTENANCE SCHEDULE - DIESEL ENGINE (CONT.)

MAINTENANCE ITEM	MAINTENANCE INTERVALS	Number of months or driving distance, whichever comes first								
	Kms×1,000	1.5	10	20	30	40	50	60	70	80
	Months	2	12	24	36	48	60	72	84	96
	Years	-	1	2	3	4	5	6	7	8
Power window / Sunroof operation (if equipped)		I	I	I	I	I	I	I	I	I
All seat belt operation		I	I	I	I	I	I	I	I	I
Road test		Inspect if required								

I : Inspect and if necessary adjust, top-up, clean or replace
 R : Replace

A:Add
 TR : Tyre Rotation

L : Lubricate

Maintenance

MAINTENANCE UNDER SEVERE USAGE CONDITIONS - DIESEL ENGINE

The following items must be serviced more frequently on cars mainly used under severe driving conditions. Refer to the chart below for the appropriate maintenance intervals.

R : Replace I : Inspect and if necessary, adjust, correct, clean or replace

MAINTENANCE ITEM	Maintenance operation	Maintenance intervals	Driving condition
Engine oil and engine oil filter	R	Every 5,000 kms or 6 months	A, B, C, F, G, H, I, J, K, L
Air cleaner filter	R	Replace more frequently depending on the condition	C, E
Manual transaxle fluid (if equipped)	R	Every 120,000 kms	C, D, E, G, H, I, K
Steering gear rack, linkage and boots	I	Inspect more frequently depending on the condition	C, D, E, F, G

MAINTENANCE UNDER SEVERE USAGE CONDITIONS - DIESEL ENGINE

MAINTENANCE ITEM	Maintenance operation	Maintenance intervals	Driving condition
Front suspension ball joints	I	Inspect more frequently depending on the condition	C, D, E, F, G
Disc brakes and pads, calipers and rotors	I	Inspect more frequently depending on the condition	C, D, E, G, H
Parking brake	I	Inspect more frequently depending on the condition	C, D, G, H
Drive shaft and boots	I	Inspect more frequently depending on the condition	C, D, E, F, G, H, I, J, K, L
Climate control air filter (if equipped)	R	Inspect more frequently depending on the condition	C, E

Severe driving conditions

A : Repeated short distance driving

B : Extensive idling

C : Driving in dusty, rough roads

D : Driving in areas using salt or other corrosive materials or in very cold weather

E : Driving in the condition of inflowing sand or dust into engine

F : Driving in heavy traffic area

G : Driving in mountainous areas

H : Towing a trailer

I : Driving for patrol car, taxi, commercial car or vehicle towing

J : Driving in very cold weather

K : Driving over 170 km/h (106 mile/h)

L : Frequently driving in stop-and-go conditions

Maintenance

EXPLANATION OF SCHEDULED MAINTENANCE ITEMS

Engine oil and filter

The engine oil and filter should be changed at the intervals specified in the maintenance schedule. If the vehicle is being driven in severe conditions, more frequent oil and filter changes are required.

Drive belts

Inspect all drive belts for evidence of cuts, cracks, excessive wear or oil saturation and replace if necessary. Drive belts should be checked periodically for proper tension and adjusted as necessary.

Fuel filter (cartridge)

A clogged filter can limit the speed at which the vehicle may be driven, damage the emission system and cause multiple issues such as hard starting. If an excessive amount of foreign matter accumulates in the fuel tank, the filter may require replacement more frequently.

After installing a new filter, run the engine for several minutes, and check for leaks at the connections. We recommend that the fuel filter be replaced by an authorized HYUNDAI dealer.

Fuel lines, fuel hoses and connections

Check the fuel lines, fuel hoses and connections for leakage and damage. We recommend that the fuel lines, fuel hoses and connections be replaced by an authorized HYUNDAI dealer.

WARNING - Diesel only

Never work on the injection system with the engine running or within 30 seconds after shutting off the engine. High pressure pump, rail, injectors and high pressure pipes are subject to high pressure even after the engine stops. The fuel jet produced by fuel leaks may cause serious injury, if it touches the body. People using pacemakers should not move more than 30cm closer to the ECU or wiring harness within the engine room while the engine is running, since the high currents in the Common Rail system produce considerable magnetic fields.

Vapor hose and fuel filler cap

The vapor hose and fuel filler cap should be inspected at those intervals specified in the maintenance schedule. Make sure that a new vapor hose or fuel filler cap is correctly replaced.

Vacuum crankcase ventilation hoses (if equipped)

Inspect the surface of hoses for evidence of heat and/or mechanical damage. Hard and brittle rubber, cracking, tears, cuts, abrasions, and excessive swelling indicate deterioration. Particular attention should be paid to examine those hose surfaces nearest to high heat sources, such as the exhaust manifold.

Inspect the hose routing to assure that the hoses do not come in contact with any heat source, sharp edges or moving component which might cause heat damage or mechanical wear. Inspect all hose connections, such as clamps and couplings, to make sure they are secure, and that no leaks are present. Hoses should be replaced immediately if there is any evidence of deterioration or damage.

Air cleaner filter

When replacing the air cleaner filter, we recommend that you use HYUNDAI genuine parts.

Spark plugs (for Petrol engine)

Make sure to install new spark plugs of the correct heat range.

Cooling system

Check the cooling system components, such as the radiator, coolant reservoir, hoses and connections for leakage and damage. Replace any damaged parts.

Engine coolant

The engine coolant should be changed at the intervals specified in the maintenance schedule.

Manual transaxle fluid (if equipped)

Inspect the manual transaxle fluid according to the maintenance schedule.

Automatic transaxle fluid (if equipped)

Inspect the automatic transaxle fluid according to the maintenance schedule.

Maintenance

Brake hoses and lines

Visually check for proper installation, chafing, cracks, deterioration and any leakage. Replace any deteriorated or damaged parts immediately.

Brake fluid

Check the brake fluid level in the brake fluid reservoir. The level should be between "MIN" and "MAX" marks on the side of the reservoir. Use only hydraulic brake fluid conforming to DOT 3 or DOT 4 specification.

Parking brake

Inspect the parking brake system including the parking brake lever (or pedal) and cables.

Rear brake drums and linings

Check the rear brake drums and linings for scoring, burning, leaking fluid, broken parts, and excessive wear.

Brake pads, calipers and rotors

Check the pads for excessive wear, discs for run out and wear, and calipers for fluid leakage.

Suspension mounting bolts

Check the suspension connections for looseness or damage. Retighten to the specified torque.

Steering gear box, linkage & boots/lower arm ball joint

With the vehicle stopped and engine off, check for excessive free-play in the steering wheel.

Check the linkage for bends or damage. Check the dust boots and ball joints for deterioration, cracks, or damage. Replace any damaged parts.

Drive shafts and boots

Check the drive shafts, boots and clamps for cracks, deterioration, or damage. Replace any damaged parts and, if necessary, repack the grease.

Air conditioning refrigerant

Check the air conditioning lines and connections for leakage and damage.

ENGINE OIL

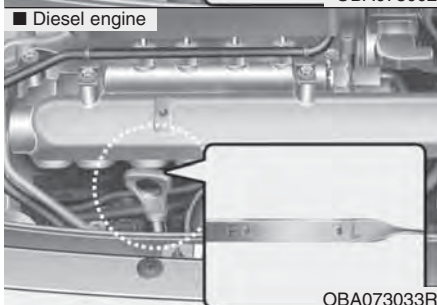
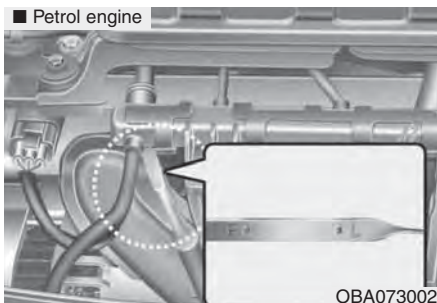

Checking the engine oil level

1. Be sure the vehicle is on level ground.
2. Start the engine and allow it to reach normal operating temperature.
3. Turn the engine off and wait for a few minutes (about 5 minutes) for the oil to return to the oil pan.
4. Pull the dipstick out, wipe it clean, and re-insert it fully.

⚠ WARNING - Radiator hose
Be very careful not to touch the radiator hose when checking or adding the engine oil as it may be hot enough to burn you.

5. Pull the dipstick out again and check the level. The level should be between F and L.

⚠ CAUTION
Do not overfill the engine oil. It may damage the engine.

⚠ CAUTION - Diesel engine
Overfilling the engine oil may cause severe dieseling due to churning effect. It may lead to engine damage accompanied with abrupt engine speed increment, combustion noise and white smoke emission.

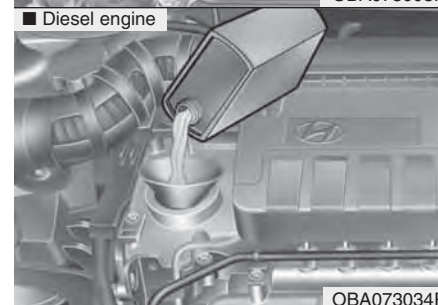
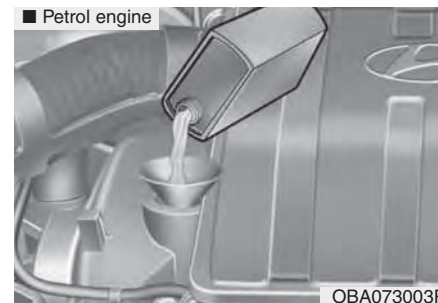

6. If it is near or at L, add enough oil to bring the level to F. **Do not overfill.**

Use a funnel to help prevent oil from being spilled on engine components.

Use only the specified engine oil. (Refer to "Recommended lubricants and capacities" in chapter 10.)

Maintenance

Changing the engine oil and filter

We recommend that the engine oil and filter be replaced by an authorized HYUNDAI dealer.



WARNING

Used engine oil may cause skin irritation or cancer if left in contact with the skin for prolonged periods of time. Used engine oil contains chemicals that have caused cancer in laboratory animals. Always protect your skin by washing your hands thoroughly with soap and warm water as soon as possible after handling used oil.

ENGINE COOLANT

The high-pressure cooling system has a reservoir filled with year round antifreeze coolant. The reservoir is filled at the factory.

Check the antifreeze protection and coolant level at least once a year, at the beginning of the winter season, and before traveling to a colder climate.

Checking the engine coolant level

WARNING



Removing radiator cap

- Never attempt to remove the radiator cap while the engine is operating or hot. Doing so might lead to cooling system and engine damage and could result in serious personal injury from escaping hot coolant or steam.
- Turn the engine off and wait until it cools down. Use extreme care when removing the radiator cap. Wrap a thick towel around it, and turn it counterclockwise slowly to the first stop. Step back while the pressure is released from the cooling system. When you are sure all the pressure has been released, press down on the cap, using a thick towel, and continue turning counterclockwise to remove it.

(Continued)

(Continued)

- Even if the engine is not operating, do not remove the radiator cap or the drain plug while the engine and radiator are hot. Hot coolant and steam may still blow out under pressure, causing serious injury.

WARNING



The electric motor (cooling fan) is controlled by engine coolant temperature, refrigerant pressure and vehicle speed. It may sometimes operate even when the engine is not running. Use extreme caution when working near the blades of the cooling fan so that you are not injured by a rotating fan blades. As the engine coolant temperature decreases, the electric motor will automatically shut off. This is a normal condition.

Maintenance

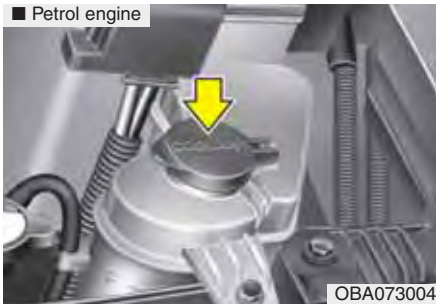

If the coolant level is low, add enough specified coolant to provide protection against freezing and corrosion. Bring the level to F (MAX), but do not overfill.

If frequent additions are required, we recommend that the system be inspected by an authorized HYUNDAI dealer.

Recommended engine coolant

- Use only soft (distilled) water in the coolant mixture.
- The engine in your vehicle has aluminum engine parts and must be protected by an ethylene-glycol-based coolant to prevent corrosion and freezing.
- DO NOT USE alcohol or methanol coolant or mix them with the specified coolant.
- Do not use a solution that contains more than 60% antifreeze or less than 35% antifreeze, which would reduce the effectiveness of the solution.

For mixture percentage, refer to the following table.

Ambient Temperature	Mixture Percentage (volume)	
	Antifreeze	Water
-15°C (5°F)	35	65
-25°C (-13°F)	40	60
-35°C (-31°F)	50	50
-45°C (-49°F)	60	40

Check the condition and connections of all cooling system hoses and heater hoses. Replace any swollen or deteriorated hoses.

The coolant level should be filled between F (MAX) and L (MIN) marks on the side of the coolant reservoir when the engine is cool.

■ Petrol engine

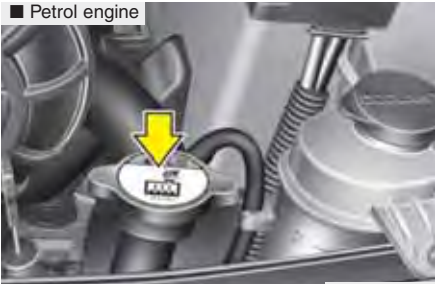

■ Diesel engine



WARNING

Radiator cap



Do not remove the radiator cap when the engine and radiator are hot. Scalding hot coolant and steam may blow out under pressure causing serious injury.

Changing the engine coolant

We recommend that the engine coolant be replaced by an authorized HYUNDAI dealer.

CAUTION

Put a thick cloth around the radiator cap before refilling the coolant in order to prevent the coolant from overflowing into the engine parts such as the generator.

WARNING - Coolant

- Do not use engine coolant or antifreeze in the washer fluid reservoir.
- Engine coolant can severely obscure visibility when sprayed on the windshield and may cause loss of vehicle control or damage to paint and body trim.

Maintenance

BRAKE/CLUTCH FLUID

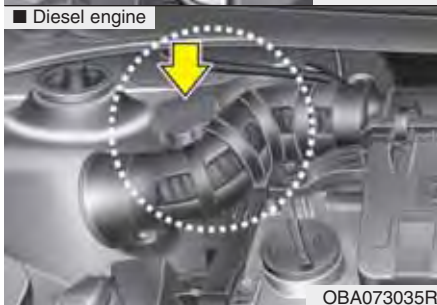
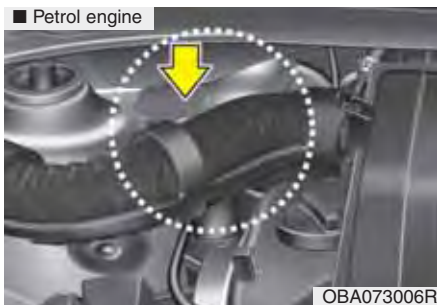

Checking the brake/clutch fluid level

Check the fluid level in the reservoir periodically. The fluid level should be between MAX and MIN marks on the side of the reservoir.

Before removing the reservoir cap and adding brake/clutch fluid, clean the area around the reservoir cap thoroughly to prevent brake/clutch fluid contamination. If the level is low, add fluid to the MAX level. The level will fall with accumulated mileage. This is a normal condition associated with the wear of the brake linings. If the fluid level is excessively low, we recommend that the system be checked by an authorized HYUNDAI dealer.

Use only the specified brake/clutch fluid. (Refer to "Recommended lubricants and capacities" in chapter 10.)

Never mix different types of fluid.

⚠ WARNING - Loss of brake fluid

In the event the brake system requires frequent additions of fluid, we recommend that the system be inspected by an authorized HYUNDAI dealer.

⚠ WARNING - Brake/clutch fluid

When changing and adding brake/clutch fluid, handle it carefully. Do not let it come in contact with your eyes. If brake/clutch fluid come in contact with your eyes, immediately flush them with a large quantity of fresh tap water. Have your eyes examined by a doctor as soon as possible.

⚠ CAUTION

Do not allow brake/clutch fluid to contact the vehicle's body paint, as paint damage will result. Brake/clutch fluid, which has been exposed to open air for an extended time should never be used as its quality cannot be guaranteed. It should be properly disposed. Don't put in the wrong kind of fluid. A few drops of mineral-based oil, such as engine oil, in your brake/clutch system can damage the system parts.

AUTOMATIC TRANSAXLE FLUID (IF EQUIPPED)



Checking the automatic transaxle fluid level

The automatic transaxle fluid level should be checked regularly.

Keep the vehicle on the level ground with the parking brake applied and check the fluid level according to the following procedure.

1. Place the shift lever in N (Neutral) position and confirm the engine is running at normal idle speed.
2. After the transaxle is warmed up sufficiently (fluid temperature 70~80°C (158~176°F), for example by 10 minutes usual driving, move the shift lever through all the positions then place the shift lever in "N (Neutral) or P (Park)" position.



3. Confirm that the fluid level is in "HOT" range on the level gauge. If the fluid level is lower, add the specified fluid in the fill hole. If the fluid level is higher, drain the fluid from the drain hole.
4. If the fluid level is checked in cold condition (fluid temperature 20~30°C (68~86°F) add the fluid to "C" (COLD) line and then recheck the fluid level according to the above step 2.

⚠ WARNING - Transaxle fluid
The transaxle fluid level should be checked when the engine is at normal operating temperature. This means that the engine, radiator, radiator hose and exhaust system etc., are very hot. Exercise great care not to burn yourself during this procedure.

Maintenance

CAUTION

- *Low fluid level causes transaxle slippage. Overfilling can cause foaming, loss of fluid and transaxle malfunction.*
- *The use of a non-specified fluid could result in transaxle malfunction and failure.*

WARNING - Parking brake

To avoid sudden movement of the vehicle, apply the parking brake and depress the brake pedal before moving the shift lever.

* NOTICE

“C” (COLD) range is for reference only and should NOT be used to determine the transaxle fluid level.

* NOTICE

A new automatic transaxle fluid should be red. The red dye is added so the assembly plant can identify it as automatic transaxle fluid and distinguish it from engine oil or antifreeze. The red dye, which is not an indicator of fluid quality, is not permanent. As the vehicle is driven, the automatic transaxle fluid will begin to look darker. The color may eventually appear light brown. Therefore, we recommend that the system be replaced by an authorized HYUNDAI dealer according to the Scheduled Maintenance at the beginning of this section.

Use only the specified automatic transaxle fluid. (Refer to “Recommended lubricants and capacities” in chapter 10.)

Changing the automatic transaxle fluid

We recommend that the system be replaced by an authorized HYUNDAI dealer.

WASHER FLUID



Checking the washer fluid level

The reservoir is translucent so that you can check the level with a quick visual inspection.

Check the fluid level in the washer fluid reservoir and add fluid if necessary. Plain water may be used if washer fluid is not available. However, use washer solvent with antifreeze characteristics in cold climates to prevent freezing.

⚠ WARNING - Engine coolant

- Do not use engine coolant or antifreeze in the washer fluid reservoir.
- Engine coolant can severely obscure visibility when sprayed on the windshield and may cause loss of vehicle control or damage to paint and body trim.
- Windshield Washer fluid agents contain some amounts of alcohol and can be flammable under certain circumstances. Do not allow sparks or flame to contact the washer fluid or the washer fluid reservoir. Damage to the vehicle or occupants could occur.
- Windshield washer fluid is poisonous to humans and animals. Do not drink and avoid contacting windshield washer fluid. Serious injury or death could occur.

PARKING BRAKE

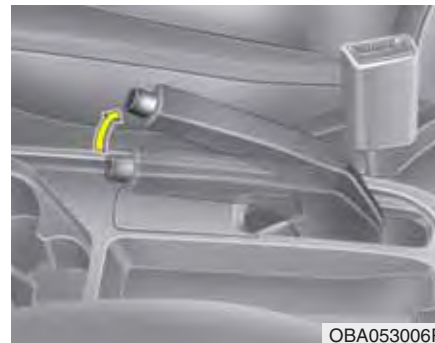

Checking the parking brake

Check the stroke of the parking brake by counting the number of “clicks” heard while fully applying it from the released position. Also, the parking brake alone should securely hold the vehicle on a fairly steep grade. If the stroke is more or less than specified, we recommend that the system be serviced by an authorized HYUNDAI dealer.

Stroke : 6~8 “clicks” at a force of 20 kg (44 lbs, 196 N).

Maintenance

FUEL FILTER (FOR DIESEL)

Draining water from the fuel filter

The fuel filter for diesel engine plays an important role of separating water from fuel and accumulating the water in its bottom.

If water accumulates in the fuel filter, the warning light comes on when the ignition switch is in the ON position.

CAUTION

If the water accumulated in the fuel filter is not drained at proper times, damages to the major parts such as the fuel system can be caused by water permeation in the fuel filter.

* NOTICE

It is recommended that water accumulated in the fuel filter should be removed by an authorized HYUNDAI dealer.

- Place a water trap under the fuel filter.
- Loosen the drain plug and drain water.
- After the water is drained, securely tighten the drain plug.
- After starting the engine, make sure the fuel filter warning light is off.

WARNING

Be sure to carefully wipe away any water drained out in this manner, because the fuel mixed in the water might be ignited and cause a fire.

Extracting air from the fuel filter

If you drive until you have no fuel left or if you replace the fuel filter, be sure to extract air from the fuel system as it makes you difficult to start the engine.

1. Remove the air vent bolt on the fuel filter.
2. Pump up and down until the fuel flows out of the fuel outlet nipple.

* NOTICE

- Use cloths when you extract air so that the fuel is not sprayed.
- Clean the fuel around the fuel filter or the injection pump before starting the engine to prevent fire.
- Finally, check each part if the fuel is leaking.



Fuel filter cartridge replacement

* NOTICE

When replacing the fuel filter cartridge, we recommend that you use **HYUNDAI** genuine parts.

Maintenance

AIR CLEANER

Filter replacement

It must be replaced when necessary, or according to the Maintenance Schedule.

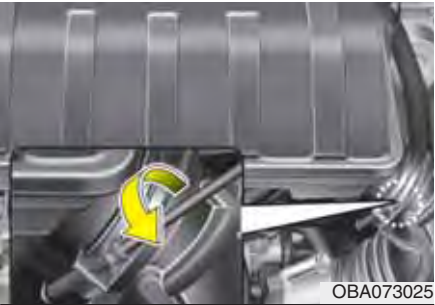

Petrol engine

1. Remove the intake hose clamp.
2. Loosen the air cleaner cover attaching clips and open the cover.



3. Replace the air cleaner filter.
4. Reassemble in the reverse order of removal.

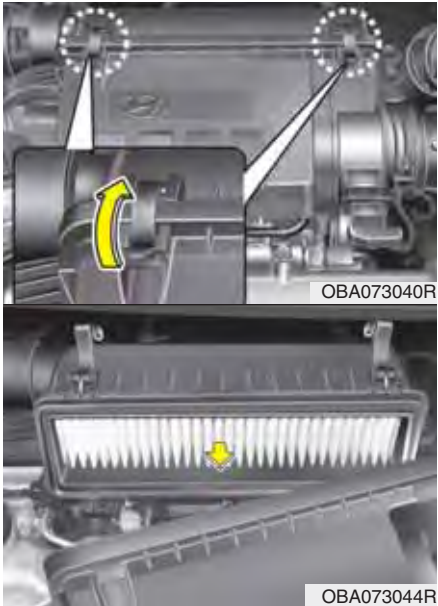

Replace the filter according to the Maintenance Schedule.

If the vehicle is operated in extremely dusty or sandy areas, replace the element more often than the usual recommended intervals. (Refer to "Maintenance under severe usage conditions" in this chapter.)

CAUTION

- **Do not drive with the air cleaner removed; this will result in excessive engine wear.**
- **When removing the air cleaner filter, be careful that dust or dirt does not enter the air intake, or damage may result.**
- **We recommend that you use parts for replacement from an authorized HYUNDAI dealer. Use of improper parts could damage the air flow sensor or turbo charger.**

Diesel engine

1. Loosen the air cleaner cover attaching clips and open the cover.
2. Replace the air cleaner filter.
3. Reassemble in the reverse order of removal.

Maintenance

CLIMATE CONTROL AIR FILTER (IF EQUIPPED)

Filter inspection

The climate control air filter should be inspected according to the Maintenance Schedule. If the vehicle is operated in severely air-polluted cities or on dusty rough roads for a long period, it should be inspected more frequently and replaced earlier. When you replace the climate control air filter, replace it performing the following procedure, and be careful to avoid damaging other components.

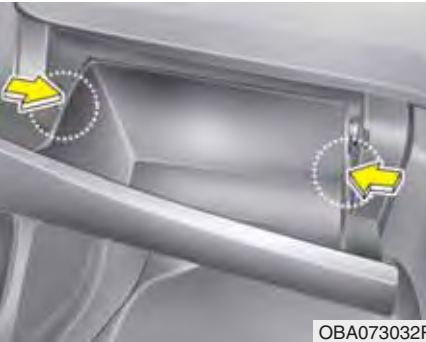

Filter replacement

1. With the glove box opened, push in both sides of the glove box as shown. This will ensure that the glove box stopper pins will get released from its holding location allowing the glove box to hang.



2. Remove the climate control air filter cover.



3. Pull out the air filter

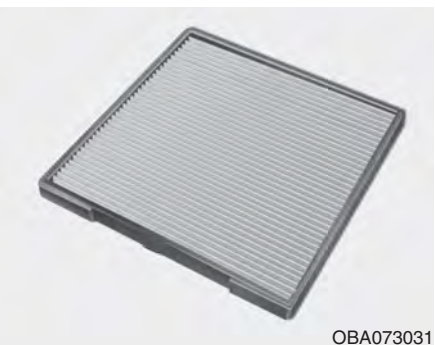

4. Replace the climate control filter.
5. Reassemble in the reverse order of disassembly.

* NOTICE

Install a new climate control air filter in the correct direction with the arrow symbol(↓) facing downwards. Otherwise, the climate control effects may decrease, possibly with a noise.

Maintenance

WIPER BLADES

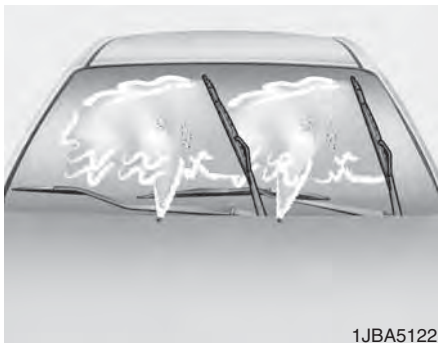

1JBA5122

Blade inspection

* NOTICE

Commercial hot waxes applied by automatic car washes have been known to make the windshield difficult to clean.

Contamination of either the windshield or the wiper blades with foreign matter can reduce the effectiveness of the windshield wipers. Common sources of contamination are insects, tree sap, and hot wax treatments used by some commercial car washes. If the blades are not wiping properly, clean both the window and the blades with a good cleaner or mild detergent, and rinse thoroughly with clean water.

CAUTION

To prevent damage to the wiper blades, do not use petrol, kerosene, paint thinner, or other solvents on or near them.

Blade replacement

When the wipers no longer clean adequately, the blades may be worn or cracked, and require replacement.

CAUTION

To prevent damage to the wiper arms or other components, do not attempt to move the wipers manually.

CAUTION

The use of a non-specified wiper blade could result in wiper malfunction and failure.

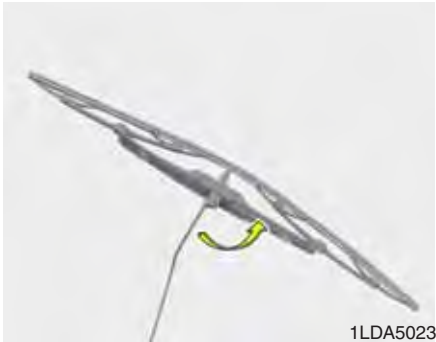

1LDA5023

Front windshield wiper blade

1. Raise the wiper arm and rotate the wiper blade assembly to expose the plastic locking clip.

⚠ CAUTION

Do not allow the wiper arm to fall against the windshield, since it may chip or crack the windshield.

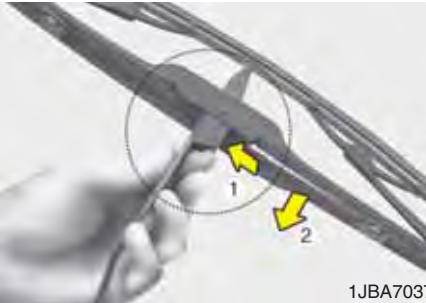

1JBA7037

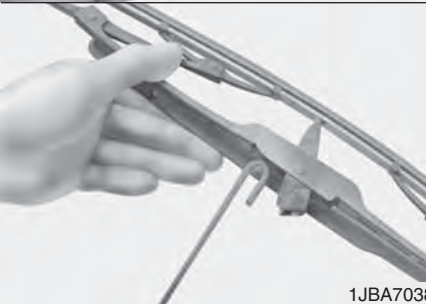

1JBA7038

2. Press the clip (1) and slide the blade assembly downward (2).
3. Lift it off the arm.
4. Install the blade assembly in the reverse order of removal.

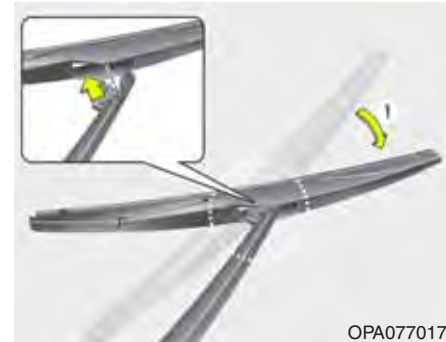

OPA077017

**Rear window wiper blade
(if equipped)**

1. Raise the wiper arm and rotate the wiper blade assembly (1).
2. Pull out the wiper blade assembly.

Maintenance



3. Install the new blade assembly by inserting the center part into the slot in the wiper arm until it clicks into place.
4. Make sure the blade assembly is installed firmly by trying to pull it slightly.

To prevent damage to the wiper arms or other components, we recommend that the wiper blade be replaced by an authorized HYUNDAI dealer.

BATTERY



For best battery service

- Keep the battery securely mounted.
- Keep the battery top clean and dry.
- Keep the terminals and connections clean, tight, and coated with petroleum jelly or terminal grease.
- Rinse any spilled electrolyte from the battery immediately with a solution of water and baking soda.
- If the vehicle is not going to be used for an extended time, disconnect the battery cables.

WARNING

To prevent **SERIOUS INJURY** or **DEATH** to you or bystanders, always follow these precautions when working near or handling the battery:



Always read and follow instructions carefully when handling a battery.



Wear eye protection designed to protect the eyes from acid splashes.



Keep all flames, sparks, or smoking materials away from the battery.



Hydrogen, a highly combustible gas, is always present in battery cells and may explode if ignited.



Keep batteries out of reach of children.



Batteries contain sulfuric acid which is highly corrosive. Do not allow acid to contact your eyes, skin or clothing.

(Continued)

(Continued)

If acid gets into your eyes, flush your eyes with clean water for at least 15 minutes and get immediate medical attention. If acid gets on your skin, thoroughly wash the area. If you feel pain or a burning sensation, get medical attention immediately.



The battery contains lead. Do not dispose of it after use. Please return the battery to an authorized HYUNDAI dealer to be recycled.

- When lifting a plastic-cased battery, excessive pressure on the case may cause battery acid to leak. Lift with a battery carrier or with your hands on opposite corners.
- Do not attempt to jump start your vehicle if your battery is frozen.
- NEVER attempt to recharge the battery when the vehicle's battery cables are connected to the battery.
- The electrical ignition system works with high voltage. NEVER touch these components with the engine running or when the ignition switch is in the ON position.

Maintenance

* NOTICE



An inappropriately disposed battery can be harmful to the environment and human health. Dispose the battery according to your local law(s) or regulation.

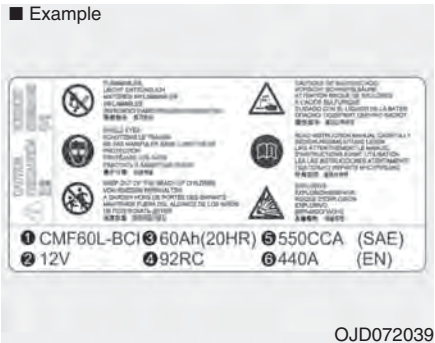

* The actual battery label in the vehicle may differ from the illustration.

Battery capacity label

1. CMF65L-BCI : HYUNDAI model name of battery
2. 12V : Nominal voltage
3. 60Ah(20HR) : Nominal capacity (in Ampere hours)
4. 92RC : Nominal reserve capacity (in min.)
5. 550CCA : Cold-test current (in amperes by SAE)
6. 440A : Cold-test current (in amperes by EN)

Battery recharging

Your vehicle has a maintenance-free, calcium-based battery.

- If the battery becomes discharged in a short time (because, for example, the headlights or interior lights were left on while the vehicle was not in use), recharge it by slow charging (trickle) for 10 hours.
- If the battery gradually discharges because of high electric load while the vehicle is being used, recharge it at 20-30A for two hours.

⚠ WARNING

Always follow these instructions when recharging your vehicle's battery to avoid the risk of **SERIOUS INJURY** or **DEATH** from explosions or acid burns:

- Before performing maintenance or recharging the battery, turn off all accessories and place the ignition switch in the LOCK/OFF position.
- Keep all flames, sparks, or smoking materials away from the battery.
- Always work outdoors or in an area with plenty of ventilation.
- Wear eye protection when checking the battery during charging.
- The battery must be removed from the vehicle and placed in a well ventilated area.
- Watch the battery during charging, and stop or reduce the charging rate if the battery cells begin boiling violently.

(Continued)

(Continued)

- The negative battery cable must be removed first and installed last when the battery is disconnected. Disconnect the battery charger in the following order:
 - (1) Turn off the battery charger main switch.
 - (2) Unhook the negative clamp from the negative battery terminal.
 - (3) Unhook the positive clamp from the positive battery terminal.

Reset items

Items should be reset after the battery has been discharged or the battery has been disconnected.

- Auto up/down window (See chapter 6)
- Climate control system (See chapter 6)
- Audio (See chapter 6)

Maintenance

TIRES AND WHEELS

Tire care

For proper maintenance, safety, and maximum fuel economy, you must always maintain recommended tire inflation pressures and stay within the load limits and weight distribution recommended for your vehicle.

Recommended cold tire inflation pressures

All tire pressures (including the spare) should be checked when the tires are cold. "Cold Tires" means the vehicle has not been driven for at least three hours or driven less than 1.6 km (one mile).

Recommended pressures must be maintained for the best ride, top vehicle handling, and minimum tire wear. For recommended inflation pressure refer to "Tire and wheels" in chapter 10.



All specifications (sizes and pressures) can be found on a label attached to the vehicle.

⚠ WARNING - Tire underinflation

Severe underinflation (70 kPa (10 psi) or more) can lead to severe heat build-up, causing blowouts, tread separation and other tire failures that can result in the loss of vehicle control leading to severe injury or death. This risk is much higher on hot days and when driving for long periods at high speeds.

 **CAUTION**

- *Underinflation also results in excessive wear, poor handling and reduced fuel economy. Wheel deformation also is possible. Keep your tire pressures at the proper levels. If a tire frequently needs refilling, we recommend that the system be checked by an authorized HYUNDAI dealer.*
- *Overinflation produces a harsh ride, excessive wear at the center of the tire tread, and a greater possibility of damage from road hazards.*

 **CAUTION**

- *Warm tires normally exceed recommended cold tire pressures by 28 to 41 kPa (4 to 6 psi). Do not release air from warm tires to adjust the pressure or the tires will be underinflated.*
- *Be sure to reinstall the tire inflation valve caps. Without the valve cap, dirt or moisture could get into the valve core and cause air leakage. If a valve cap is missing, install a new one as soon as possible.*

 **WARNING - Tire inflation**

Overinflation or underinflation can reduce tire life, adversely affect vehicle handling, and lead to sudden tire failure. This could result in loss of vehicle control and potential injury.

 **CAUTION - Tire pressure**

Always observe the following:

- *Check tire pressure when the tires are cold. (After vehicle has been parked for at least three hours or hasn't been driven more than 1.6 km (one mile) since startup.)*
- *Check the pressure of your spare tire each time you check the pressure of other tires.*
- *Never overload your vehicle. Be careful not to overload a vehicle luggage rack if your vehicle is equipped with one.*
- *Worn, old tires can cause accidents. If your tread is badly worn, or if your tires have been damaged, replace them.*

Maintenance

Checking tire inflation pressure

Check your tires once a month or more.

Also, check the tire pressure of the spare tire.

How to check

Use a good quality gage to check tire pressure. You can not tell if your tires are properly inflated simply by looking at them. Radial tires may look properly inflated even when they're underinflated.

Check the tire's inflation pressure when the tires are cold. - "Cold" means your vehicle has been sitting for at least three hours or driven no more than 1.6 km (1 mile).

Remove the valve cap from the tire valve stem. Press the tire gage firmly onto the valve to get a pressure measurement. If the cold tire inflation pressure matches the recommended pressure on the tire and loading information label, no further adjustment is necessary. If the pressure is low, add air until you reach the recommended amount.

If you overfill the tire, release air by pushing on the metal stem in the center of the tire valve. Recheck the tire pressure with the tire gage. Be sure to put the valve caps back on the valve stems. They help prevent leaks by keeping out dirt and moisture.

WARNING

- **Inspect your tires frequently for proper inflation as well as wear and damage. Always use a tire pressure gauge.**
- **Tires with too much or too little pressure wear unevenly causing poor handling, loss of vehicle control, and sudden tire failure leading to accidents, injuries, and even death. The recommended cold tire pressure for your vehicle can be found in this manual and on the tire label located on the driver's side center pillar.**
- **Worn tires can cause accidents. Replace tires that are worn, show uneven wear, or are damaged.**
- **Remember to check the pressure of your spare tire. HYUNDAI recommends that you check the spare every time you check the pressure of the other tires on your vehicle.**

Tire rotation

To equalize tread wear, it is recommended that the tires be rotated every 10,000 km or sooner if irregular wear develops.

During rotation, check the tires for correct balance.

When rotating tires, check for uneven wear and damage. Abnormal wear is usually caused by incorrect tire pressure, improper wheel alignment, out-of-balance wheels, severe braking or severe cornering. Look for bumps or bulges in the tread or side of tire. Replace the tire if you find either of these conditions. Replace the tire if fabric or cord is visible. After rotation, be sure to bring the front and rear tire pressures to specification and check lug nut tightness.

Refer to "Tire and wheels" in chapter 10.

With a full-size spare tire (if equipped)

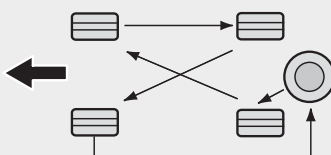

S2BLA790

Directional tires (if equipped)

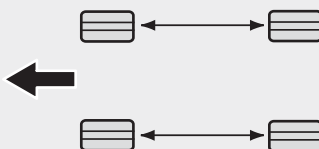

CBGQ0707A

Disc brake pads should be inspected for wear whenever tires are rotated.

* NOTICE

Rotate radial tires that have an asymmetric tread pattern only from front to rear and not from right to left.

⚠ WARNING

Do not mix bias ply and radial ply tires under any circumstances. This may cause unusual handling characteristics that could result in death, severe injury, or property damage.

Maintenance

Wheel alignment and tire balance

The wheels on your vehicle were aligned and balanced carefully at the factory to give you the longest tire life and best overall performance.

In most cases, you will not need to have your wheels aligned again. However, if you notice unusual tire wear or your vehicle pulling one way or the other, the alignment may need to be reset.

If you notice your vehicle vibrating when driving on a smooth road, your wheels may need to be rebalanced.

CAUTION

Improper wheel weights can damage your vehicle's aluminum wheels. Use only approved wheel weights.



Tire replacement

If the tire is worn evenly, a tread wear indicator will appear as a solid band across the tread. This shows there is less than 1.6 mm (1/16 inch) of tread left on the tire. Replace the tire when this happens.

Do not wait for the band to appear across the entire tread before replacing the tire.

 **WARNING** - Replacing tires
To reduce the chance of serious or fatal injuries from an accident caused by tire failure or loss of vehicle control:

- Replace tires that are worn, show uneven wear, or are damaged. Worn tires can cause loss of braking effectiveness, steering control, and traction.
- Do not drive your vehicle with too little or too much pressure in your tires. This can lead to uneven wear and tire failure.
- When replacing tires (or wheels), it is recommended to replace the two front or two rear tires (or wheels) as a pair. Replacing just one tire can seriously affect your vehicle's handling.

(Continued)

(Continued)

- Using tires and wheel other than the recommended sizes could cause unusual handling characteristics and poor vehicle control, resulting in a serious accident.
- Wheels that do not meet HYUNDAI's specifications may fit poorly and result in damage to the vehicle or unusual handling and poor vehicle control.
- The ABS works by comparing the speed of the wheels. Tire size can affect wheel speed. When replacing tires, all 4 tires must use the same size originally supplied with the vehicle. Using tires of a different size can cause the ABS (Anti-lock Brake System) to work irregularly.

Wheel replacement

When replacing the metal wheels for any reason, make sure the new wheels are equivalent to the original factory units in diameter, rim width and offset.

WARNING

A wheel that is not the correct size may adversely affect wheel and bearing life, braking and stopping abilities, handling characteristics, ground clearance, body-to-tire clearance, snow chain clearance, speedometer and odometer calibration, headlight aim and bumper height.

Tire traction

Tire traction can be reduced if you drive on worn tires, tires that are improperly inflated or on slippery road surfaces. Tires should be replaced when tread wear indicators appear. Slow down whenever there is rain, snow or ice on the road, to reduce the possibility of losing control.

Tire maintenance

In addition to proper inflation, correct wheel alignment helps to decrease tire wear. If you find a tire is worn unevenly, have your dealer check the wheel alignment.

When you have new tires installed, make sure they are balanced. This will increase vehicle ride comfort and tire life. Additionally, a tire should always be rebalanced if it is removed from the wheel.

Maintenance

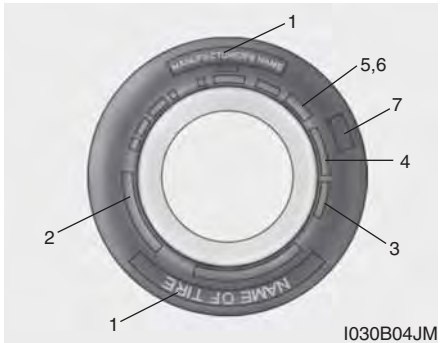

Tire sidewall labeling

This information identifies and describes the fundamental characteristics of the tire and also provides the tire identification number (TIN) for safety standard certification. The TIN can be used to identify the tire in case of a recall.

1. *Manufacturer or brand name*

Manufacturer or Brand name is shown.

2. *Tire size designation*

A tire's sidewall is marked with a tire size designation. You will need this information when selecting replacement tires for your vehicle. The following explains what the letters and numbers in the tire size designation mean.

Example tire size designation:

(These numbers are provided as an example only; your tire size designator could vary depending on your vehicle.)

165/60R14 64T

165 - Tire width in millimeters.

60 - Aspect ratio. The tire's section height as a percentage of its width.

R - Tire construction code (Radial).

14 - Rim diameter in inches.

64 - Load Index, a numerical code associated with the maximum load the tire can carry.

T - Speed Rating Symbol. See the speed rating chart in this section for additional information.

Wheel size designation

Wheels are also marked with important information that you need if you ever have to replace one. The following explains what the letters and numbers in the wheel size designation mean.

Example wheel size designation:

5.0JX14

5.0 - Rim width in inches.

J - Rim contour designation.

14 - Rim diameter in inches.

Tire speed ratings

The chart below lists many of the different speed ratings currently being used for passenger car tire. The speed rating is part of the tire size designation on the sidewall of the tire. This symbol corresponds to that tire's designed maximum safe operating speed.

Speed Rating Symbol	Maximum Speed
S	180 km/h (112 mph)
T	190 km/h (118 mph)
H	210 km/h (130 mph)
V	240 km/h (149 mph)
Z	Above 240 km/h (149 mph)

3. Checking tire life (TIN : Tire Identification Number)

Any tires that are over 6 years old, based on the manufacturing date, (including the spare tire) should be replaced by new ones. You can find the manufacturing date on the tire sidewall (possibly on the inside of the wheel), displaying the DOT Code. The DOT Code is a series of numbers on a tire consisting of numbers and English letters. The manufacturing date is designated by the last four digits (characters) of the DOT code.

DOT : XXXX XXXX OOOO

The front part of the DOT means a plant code number, tire size and tread pattern and the last four numbers indicate week and year manufactured.

For example:

DOT XXXX XXXX 1617 represents that the tire was produced in the 16th week of 2017.

⚠ WARNING - Tire age
Tires degrade over time, even when they are not being used. Regardless of the remaining tread, we recommend that tires generally be replaced after six (6) years of normal service. Heat caused by not climates or frequent high loading conditions can accelerate the aging process. Failure to follow this Warning can result in sudden tire failure, which could lead to a loss of control and an accident involving serious injury or death.

4. Tire ply composition and material

The number of layers or plies of rubber-coated fabric are in the tire. Tire manufacturers also must indicate the materials in the tire, which include steel, nylon, polyester, and others. The letter "R" means radial ply construction; the letter "D" means diagonal or bias ply construction; and the letter "B" means belted-bias ply construction.

5. Maximum permissible inflation pres-

Maintenance

sure

This number is the greatest amount of air pressure that should be put in the tire. Do not exceed the maximum permissible inflation pressure. Refer to the Tire and Loading Information label for recommended inflation pressure.

6. Maximum load rating

This number indicates the maximum load in kilograms and pounds that can be carried by the tire. When replacing the tires on the vehicle, always use a tire that has the same load rating as the factory installed tire.

7. Uniform tire quality grading

Quality grades can be found where applicable on the tire sidewall between tread shoulder and maximum section width.

For example:

TREADWEAR 200

TRACTION AA

TEMPERATURE A

Tread wear

The tread wear grade is a comparative rating based on the wear rate of the tire when tested under controlled conditions on a specified government test course. For example, a tire graded 150 would wear one-and-a-half times (1½) as well on the government course as a tire graded 100.

The relative performance of tires depends upon the actual conditions of their use, however, and may depart significantly from the norm due to variations in driving habits, service practices and differences in road characteristics and climate.

These grades are molded on the side-walls of passenger vehicle tires. The tires available as standard or optional equipment on your vehicles may vary with respect to grade.

Traction - AA, A, B & C

The traction grades, from highest to lowest, are AA, A, B and C. Those grades represent the tires ability to stop on wet pavement as measured under controlled conditions on specified government test surfaces of asphalt and concrete. A tire marked C may have poor traction performance.

▲ WARNING

The traction grade assigned to this tire is based on straight-ahead braking traction tests, and does not include acceleration, cornering, hydroplaning, or peak traction characteristics.

Temperature -A, B & C

The temperature grades are A (the highest), B and C representing the tire's resistance to the generation of heat and its ability to dissipate heat when tested under controlled conditions on a specified indoor laboratory test wheel.

Sustained high temperature can cause the material of the tire to degenerate and reduce tire life, and excessive temperature can lead to sudden tire failure. Grades B and A represent higher levels of performance on the laboratory test wheel than the minimum required by law.

⚠ WARNING - Tire temperature
The temperature grade for this tire is established for a tire that is properly inflated and not overloaded. Excessive speed, under-inflation, or excessive loading, either separately or in combination, can cause heat build-up and possible sudden tire failure. This can cause loss of vehicle control and serious injury or death.

Low aspect ratio tire (if equipped)

Low aspect ratio tires, the aspect ratio is lower than 50, are provided for sporty looks.

Because the low aspect ratio tires are optimized for handling and braking, it may be more uncomfortable to ride in and there is more noise compare with normal tires.

Maintenance

CAUTION

Because the sidewall of the low aspect ratio tire is shorter than the normal, the wheel and tire of the low aspect ratio tire is easier to be damaged. So, follow the instructions below.

- *When driving on a rough road or off road, drive cautiously because tires and wheels may be damaged. And after driving, inspect tires and wheels.*
- *When passing over a pothole, speed bump, manhole, or curb stone, drive slowly so that the tires and wheels are not damaged.*
- *If the tire is impacted, we recommend that you inspect the tire condition or contact an authorized HYUNDAI dealer.*
- *To prevent damage to the tire, inspect the tire condition and pressure every 3,000km.*

CAUTION

- *It is not easy to recognize the tire damage with your own eyes. But if there is the slightest hint of tire damage, have the tire checked or replaced because tire damage may cause air leakage from the tire.*
- *If the tire is damaged by driving on a rough road, off road, pothole, manhole, or curb stone, it will not be covered by the warranty.*

FUSES

■ Blade type



■ Cartridge type



■ Multi fuse

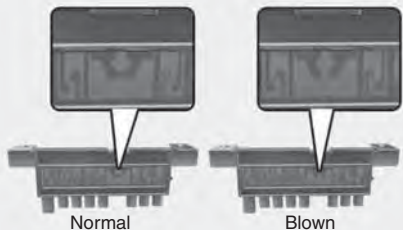

A vehicle's electrical system is protected from electrical overload damage by fuses.

This vehicle has 2 fuse panels, one located in the driver's side panel bolster, the other in the engine compartment near the battery.

If any of your vehicle's lights, accessories, or controls do not work, check the appropriate circuit fuse. If a fuse has blown, the element inside the fuse will melt.

If the electrical system does not work, first check the driver's side fuse panel.

Always replace a blown fuse with one of the same rating.

If the replacement fuse blows, this indicates an electrical problem. Avoid using the system involved and we recommend that you consult an authorized HYUNDAI dealer.

* NOTICE

Three kinds of fuses are used: blade type for lower amperage rating, cartridge type, and fusible link for higher amperage ratings.

⚠ WARNING - Fuse replacement

- Never replace a fuse with anything but another fuse of the same rating.
- A higher capacity fuse could cause damage and possibly a fire.
- Never install a wire or aluminum foil instead of the proper fuse - even as a temporary repair. It may cause extensive wiring damage and a possible fire.

⚠ CAUTION

Do not use a screwdriver or any other metal object to remove fuses because it may cause a short circuit and damage the system.

Maintenance

■ Type A



■ Type B

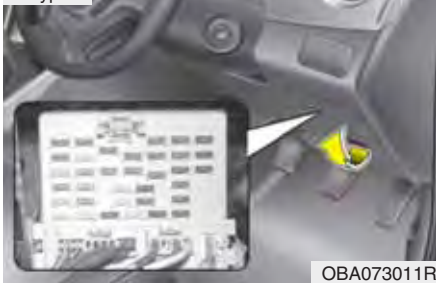

Instrument panel fuse replacement

1. Turn the ignition switch and all other switches off.
2. Open the fuse panel cover.

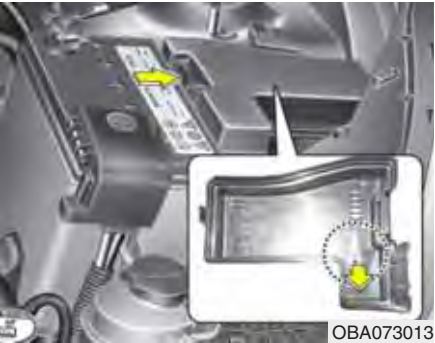

3. Pull the suspected fuse straight out. Use the removal tool provided in the engine compartment fuse panel.
4. Remove and check the suspected fuse; replace it if it is blown.
5. Push in a new fuse of the same rating, and make sure it fits tightly in the clips. If it fits loosely, we recommend that you consult an authorized HYUNDAI dealer.

In an emergency, if you do not have a spare, use a fuse of the same rating from a circuit you may not need for operating the vehicle, such as the cigarette lighter fuse.

If the headlights or other electrical components do not work and the fuses are OK, check the fuse block in the engine compartment. If a fuse is blown, it must be replaced.



Fuse switch (for Type A)

Always, put the fuse switch at the ON position.

If you move the switch to the OFF position, some items must be reset and remote key or smart key may not work properly.

CAUTION

- **Always place the fuse switch in the ON position while driving the vehicle. If the switch is in the OFF position, a warning will appear on the instrument cluster. (Refer to “Instrument Cluster” in chapter 6.)**
- **The theft alarm system will not activate with the fuse switch in the OFF position.**



Memory fuse (for Type B)

Your vehicle is equipped with the memory fuse to prevent battery discharge if your vehicle is parked without being operated for prolonged periods. Use the following procedures before parking the vehicle for prolonged periods.

1. Turn off the engine.
2. Turn off the headlights and tail lights.
3. Open the driver's side panel cover and pull up the memory fuse.

* NOTICE

- If the memory fuse is pulled up from the fuse panel, the warning chime, audio, clock and interior lamps, etc., will not operate. Some items must be reset after replacement. Refer to “Battery” in this chapter.
- Even though the memory fuse is pulled up, the battery can still be discharged by operation of the headlights or other electrical devices.

Maintenance



■ Diesel engine only

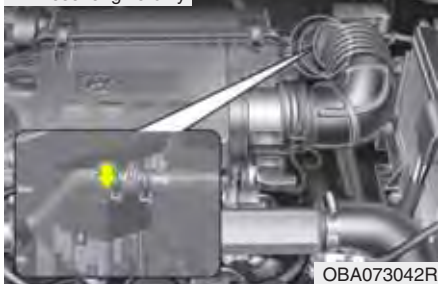

Engine compartment panel fuse replacement

1. Turn the ignition switch and all other switches off.
2. Remove the fuse box cover by pressing the tap and pulling the cover up.

3. Remove and check the suspected fuse; replace it if it is blown. To remove or insert the fuse, use the fuse puller in the engine compartment fuse panel.
4. Push in a new fuse of the same rating, and make sure it fits tightly in the clips. If it fits loosely, we recommend that you consult an authorized HYUNDAI dealer.

CAUTION

After checking the fuse box in the engine compartment, securely install the fuse box cover. If not, electrical failures may occur from water leaking in.



Main fuse (multi fuse)

If the main fuse is blown, it must be removed as follows:

1. Disconnect the negative battery cable.
2. Remove the nuts shown in the picture above.
3. Replace the fuse with a new one of the same rating.
4. Reinstall in the reverse order of removal.

* NOTICE

If the main fuse is blown, we recommend that you consult an authorized HYUNDAI dealer.



OBA073016IN

Fuse/relay panel description

Instrument panel fuse panel

Inside the fuse/relay panel covers, you can find the fuse/relay label describing the fuse/relay name and capacity.

* NOTICE



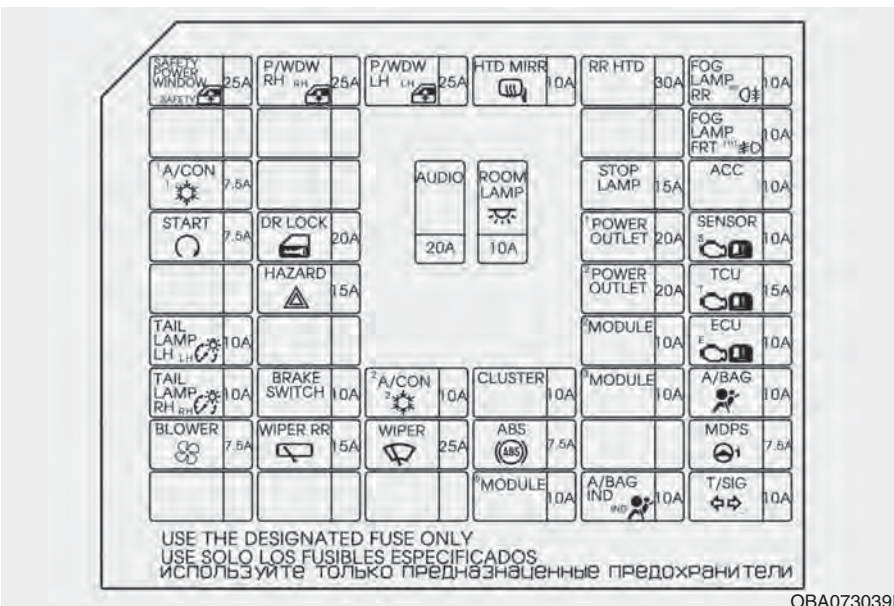







Not all fuse panel descriptions in this manual may be applicable to your vehicle. It is accurate at the time of printing. When you inspect the fuse panel in your vehicle, refer to the fuse panel label.









OBA073039R



Maintenance

Inner Compartment Fuse Panel

ITEM	Name	Symbol	Rating	Caution Information / Circuit Protected
FUSE	SAFETY P/WINDOW	SAFETY 	25A	NOT USED
	P/WINDOW RH	RH 	25A	P_WDW_SW_FRT, P_WDW_SW_FRT_RR_RHD_AD (POWER WINDOW SW DRIVER)
	O/SIDE MIRR HTD		10A	FATC UNIT, MTC UNIT, O/SIDE MIRROR, ECU (ENGINE CONTROL UNIT)
	REAR FOG LAMP	RR 	10A	NOT USED
	DOOR LOCK		20A	DR_L_LATCH_RHD, DR_L_ACT_DRV_RHD, DR_L_ACT_PASS_RHD, DR_L_ACT_RL, DR_L_ACT_RR, T_LID_LATCH, BCM
	P/WINDOW LH	LH 	25A	P_WDW_SW_FRT/P_WDW_SW_FRT_RR_RHD_AD (POWER WINDOW SW DRIVER) P_WDW_SW_PASS(POWER WINDOW SW ASSIST DOOR)
	DRL		10A	DRL LAMP LH/RH, BCM
	FRONT FOG LAMP	FRT 	10A	FRONT FOG LAMP LH/RH, CLUSTER
	PDM 1	1 	25A	SMK UNIT
	HAZARD		15A	BCM, SOUND RELAY, HAZARD SW
	STOP LAMP	STOP LAMP	15A	SSEM UNIT
	ACC	ACC	10A	AUDIO UNIT, POWER OUTLET RELAY

ITEM	Name	Symbol	Rating	Caution Information / Circuit Protected
FUSE	START		7.5A	START RELAY, ECU, SMK, INHIBIT SW
	PDM 2	² 	7.5A	SMK UNIT
	POWER OUTLET RR	² POWER OUTLET	20A	REAR POWER OUTLET
	POWER OUTLET FRT	¹ POWER OUTLET	20A	FRONT POWER OUTLET
	AIR CONDITIONER 1	¹ 	7.5A	FATC UNIT
	SENSOR	^S 	10A	F_WATER_SNSR, VACCUM PUMP RELAY (UH BLOCK)
	MODULE 3	³ MODULE	10A	FATC UNIT, CONSOLE SWITCH
	TAIL LAMP LH	^{LH} 	10A	H_LP_LH (HEAD LAMP LH), J_CONN_MAIN, RR COMBI LH
	MODULE 2	² MODULE	10A	AUDIO UNIT, STOP SW, BWS_SNSR_RL/RCL/RCR/RR
	TCU	^T 	15A	V_SPEED_SNSR_MT, SPEED_SNSR_IN, SPEED_SNSR_OUT, INHIBIT_SW_K, UH BLOCK
	TAIL LAMP RH	^{RH} 	10A	H_LP_RH(HEAD LAMP RH), RR COMBI RH
	BRAKE SWITCH	BRAKE SWITCH	10A	STOP SWITCH

Maintenance

ITEM	Name	Symbol	Rating	Caution Information / Circuit Protected
FUSE	AIRBAG INDICATOR		10A	CLUSTER
	T/SIGNAL LAMP		10A	HAZARD SW
	AUDIO	AUDIO	20A	AUDIO UNIT
	INTERIOR LAMP		10A	ROOM LAMP, LUGGAGE LAMP, CLUSTER, BCM, MTC UNIT, FATC UNIT, DIGITAL CLOCK, GLOVE LP, OBD-II, O/S MIRROR FOLDING

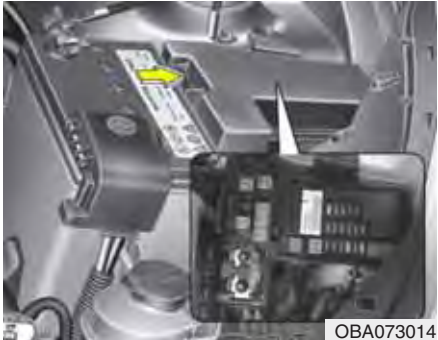

OBA073014

Engine compartment fuse panel

Inside the fuse/relay panel covers, you can find the fuse/relay label describing fuse/relay name and capacity.

*** NOTICE**



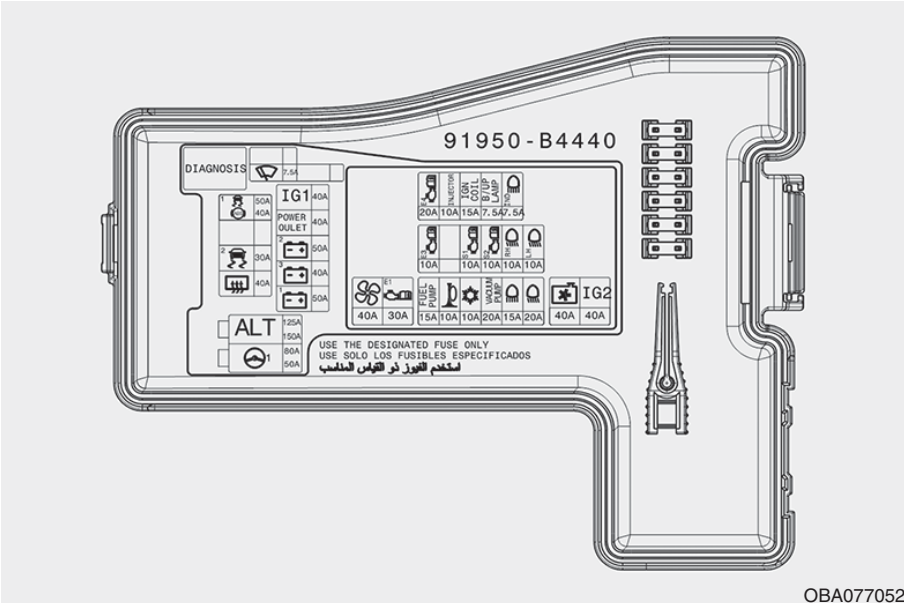





Not all fuse panel descriptions in this manual may be applicable to your vehicle. It is accurate at the time of printing. When you inspect the fuse panel in your vehicle, refer to the fuse panel label.



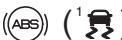







OBA077052





Maintenance

Engine compartment main fuse panel

Fuse Type	Fuse Name	Symbol	Fuse rating	Circuit Protected
MULTI FUSE	MDPS	 1	80A (50A)	D3FA (80A), G4LA (50A) : MDPS Unit
	ALT	ALT	125A (150A)	G4LA (125A): Alternator, Battery, All Fuses connected to Alternator fuse D3FA (150A): Alternator, Battery, All Fuses connected to Alternator fuse
FUSE	RR HTD		40A	Instrumental Fuse Block : [Rear Defogger Relay]
	ABS (ESC1)		40A (50A)	ABS Control Module, ESC1 not used
	ESC 2	 2	30A	Not Used
	B+1	 1	50A	Instrumental Fuse Block : [Fuse : F6/F9/F10/F13/F28, Memory Fuse (Leak Current Fuse) : F45/F46]
	B+3	 2	40A	Instrumental Fuse Block : [Tail Lamp Relay, Power Window Relay, Fuse : F1]
	B+2	 3	50A	Instrumental Fuse Block : [Fuse : F7/F11/F12/F16]
	POWER OUTLET	POWER OUTLET	40A	Instrumental Fuse Block : Power Outlet Relay
	IG1	IG1	40A	W/O Button Start : Ignition Switch With Button Start : PDM Relay Block (IG1, ACC Relay)
	FRT WIPER		7.5A	PCM, Front Wiper Motor, Multifunction Switch
	BLOWER		40A	Blower Motor Relay

Fuse Type	Fuse Name	Symbol	Fuse rating	Circuit Protected
FUSE	ECU1	^{E1} 	30A	Engine Control Relay, Fuse : ECU3 10A
	F/PUMP	F/PUMP	15A	F/Pump 1 Relay
	HORN		10A	Horn Relay, Burglar Alarm Horn Relay
	A/CON		10A	A/CON Relay
	VACUUM PUMP	VACUUM PUMP	20A	Not Used
	HEADLAMP DIPPED BEAM		20A	Head Lamp Low Beam
	HEADLAMP HIGH BEAM		15A	Head Lamp High Beam
	C/FAN		40A	Cooling Fan LO Relay, Cooling Fan HI Relay
	IG2	IG2	40A	Start Relay, Ignition Switch(W/O Button Start), PDM Relay Box(IG2 Relay) (With Button Start)
	ECU3	^{E3} 	10A	G4LA A/T : PCM
	SENSOR1	^{S1} 	10A	G4LA: PCM, Purge Control Solenoid Valve, Oil Control Valve #1/#2(IN/EX), Camshaft Position Sensor #1/#2(IN/EX), Oxygen Sensor(UP)/(DOWN)
SENSOR2	^{S2} 	10A	G4LA : PCM D3FA : Inlet Metering Valve	

Maintenance

	Fuse Name	Symbol	Fuse rating	Circuit Protected
FUSE	HEADLAMP DIPPED BEAMS		10A	Head Lamp Low LH
	HEADLAMP DIPPED BEAMS		10A	Head Lamp Low RH
	ECU4		20A	D3FA : ECM
	INJECTOR	INJECTOR	10A	PCM, Immobilizer Module, F/Pump Relay G4LA : Injector #1/#2/#3/#4 D3FA : WGT Vacuum, Camshaft Position Sensor, EGR Control Valve, Glow Relay
	IGN COIL	IGN COIL	15A	G4LA : Ignition Coil
	B/UP LAMP	B/UP LAMP	7.5A	A/T : PCM, Transaxle Range Switch, BCM, Instrument Cluster, Rear Combination Lamp LH/RH M/T : Back-Up Lamp Switch, Instrumental Fuse Block : [Fuse : F26]
	HEADLAMP HI INDICATOR		7.5A	Instrument Cluster

LIGHT BULBS

Consult an authorized HYUNDAI dealer to replace most vehicle light bulbs. It is difficult to replace vehicle light bulbs because other parts of the vehicle must be removed before you can get to the bulb. This is especially true for removing the headlight assembly to get to the bulb(s).

Removing/installing the headlight assembly can result in damage to the vehicle.

* NOTICE

After heavy driving, rain or washing headlight and taillight lenses could appear frosty. This condition is caused by the temperature difference between the lamp inside and outside. This is similar to the condensation on your windows inside your vehicle during the rain and doesn't indicate a problem with your vehicle. If the water leaks into the lamp bulb circuitry, we recommend that the system be checked by an authorized HYUNDAI dealer.

WARNING

Prior to replacing a light, depress the foot brake, move the shift lever into the P (Park, for automatic transaxle vehicle) or neutral (for manual transaxle vehicle), apply the parking brake, place the ignition switch in the LOCK/OFF position, and take the key with you when leaving the vehicle to avoid sudden movement of the vehicle and to prevent possible electric shock.

Be aware the bulbs may be hot and may burn your fingers.

CAUTION

Be sure to replace the burned-out bulb with one of the same wattage rating. Otherwise, it may cause damage to the fuse or electric wiring system.

Maintenance



OBA073018

Headlight, position light, turn signal light, and front fog light bulb replacement

- (1) Headlight (Low/High)
- (2) Parking (Position) light
- (3) Front turn signal light
- (4) Front fog light (if equipped)

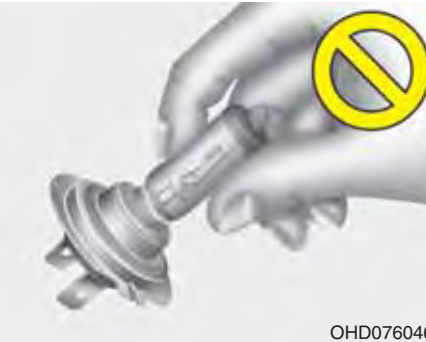

OHD076046

⚠ WARNING - Halogen bulbs

- Halogen bulbs contain pressurized gas that will produce flying pieces of glass if broken.
- Always handle them carefully, and avoid scratches and abrasions. If the bulbs are lit, avoid contact with liquids. Never touch the glass with bare hands. Residual oil may cause the bulb to overheat and burst when lit. A bulb should be operated only when installed in a headlight.

(Continued)

(Continued)

- If a bulb becomes damaged or cracked, replace it immediately and carefully dispose of it.
- Wear eye protection when changing a bulb. Allow the bulb to cool down before handling it.

* NOTICE

If the headlight aiming adjustment is necessary after the headlight assembly is reinstalled, consult an authorized HYUNDAI dealer.

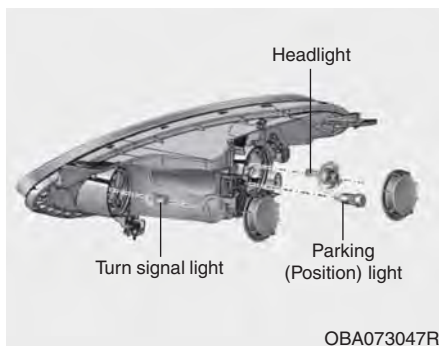

Headlight (Low/High)

1. Open the hood.
2. Remove the headlight bulb cover by turning it counterclockwise.
3. Disconnect the headlight bulb socket-connector.
4. Unsnap the headlight bulb retaining wire by depressing the end and pushing it upward.
5. Remove the bulb from the headlight assembly.
6. Install a new headlight bulb and snap the headlight bulb retaining wire into position by aligning the wire with the groove on the bulb.

7. Connect the headlight bulb socket connector.
8. Install the headlight bulb cover by turning it clockwise.

Turn signal light

1. Remove the turn signal light bulb cover by turning it counterclockwise.
2. Remove the socket from the assembly by turning the socket counterclockwise until the tabs on the socket align with the slots on the assembly.
3. Insert a new bulb by inserting it into the socket and rotating it until it locks into place.
4. Install the socket in the assembly by aligning the tabs on the socket with the slots in the assembly. Push the socket into the assembly and turn the socket clockwise.
5. Install the turn signal light bulb cover by turning it clockwise.

Parking (Position) light

1. Remove the socket from the assembly by pulling it straight out.
2. Remove the bulb from the socket by pulling it out.
3. Insert a new bulb by inserting it into the socket.
4. Install the socket in the assembly by pushing it in.

Maintenance

Front fog light bulb replacement

1. Reach your hand into the back of the front bumper.
2. Disconnect the power connector from the socket.
3. Remove the bulb-socket from the housing by turning the socket counter-clockwise until the tabs on the socket align with the slots on the housing.
4. Install the new bulb-socket into the housing by aligning the tabs on the socket with the slots in the housing. Push the socket into the housing and turn the socket clockwise.
5. Connect the power connector to the socket.
6. Reinstall the front bumper under cover.

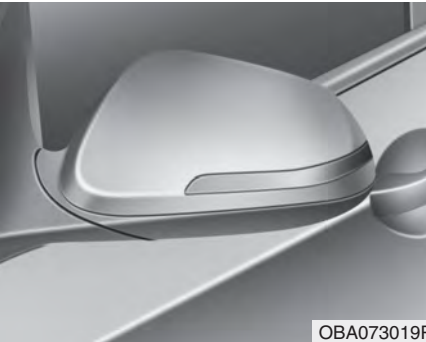

OBA073019R

Side repeater light bulb replacement (if equipped)

If the light bulb does not operate, we recommend that the vehicle be checked by an authorized HYUNDAI dealer.



OBA073020

Rear combination light bulb replacement

- (1) Stop and tail light
- (2) Back up light
- (3) Turn signal light

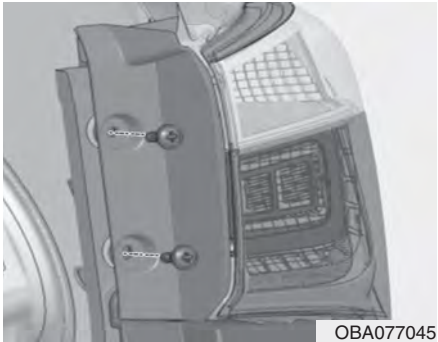

OBA077045

1. Open the tailgate/trunk
2. Loosen the light assembly retaining screws with a cross-tip screwdriver.
3. Remove the rear combination light assembly from the body of the vehicle.
4. Remove the socket from the assembly by turning the socket counterclockwise until the tabs on the socket align with the slots on the assembly.

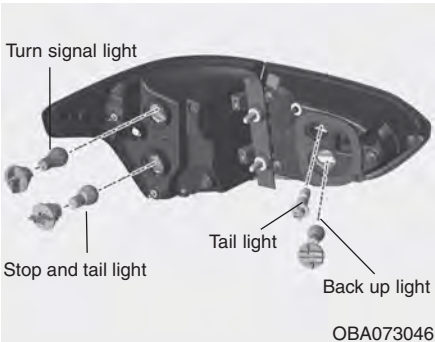

OBA073046

5. Remove the bulb from the socket by pressing it in and rotating it counterclockwise until the tabs on the bulb align with the slots in the socket. Pull the bulb out of the socket.
6. Insert a new bulb by inserting it into the socket and rotating it until it locks into place.
7. Install the socket in the assembly by aligning the tabs on the socket with the slots in the assembly. Push the socket into the assembly and turn the socket clockwise.
8. Reinstall the light assembly to the body of the vehicle.



OBA073021

High mounted stop light

If the light does not operate, we recommend that the vehicle be checked by an authorized HYUNDAI dealer.

Maintenance

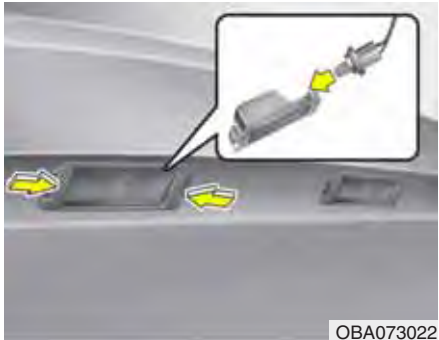

OBA073022

License plate light bulb replacement

1. Using a flat-blade screwdriver, remove the light assembly from the body of the vehicle by prying the housing and pulling the assembly out.
2. Separate the socket and the lens part by turning the socket counterclockwise until the tabs on the socket align with the slots on the lens part.
3. Remove the bulb by pulling it straight out.
4. Insert a new bulb in the socket.
5. Reassemble the socket and the housing part.
6. Reinstall the light assembly to the body of the vehicle.

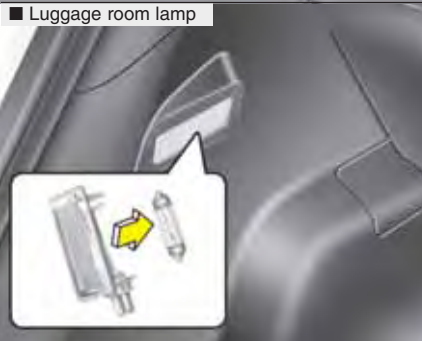
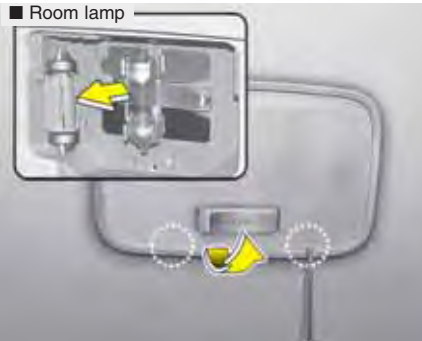

OTD079037/OBA073023

Interior light bulb replacement

1. Using a flat-blade screwdriver, gently pry the lens from the interior light housing.
2. Remove the bulb by pulling it straight out.
3. Install a new bulb in the socket.
4. Align the lens tabs with the interior light housing notches and snap the lens into place.



CAUTION

Be careful not to dirty or damage lens, lens tab, and plastic housings.

APPEARANCE CARE

Exterior care

Exterior general caution

It is very important to follow the label directions when using any chemical cleaner or polish. Read all warning and caution statements that appear on the label.

High-pressure washing

- When using high-pressure washers, make sure to maintain sufficient distance from the vehicle.
Insufficient clearance or excessive pressure can lead to component damage or water penetration.
- Do not spray the camera, sensors or its surrounding area directly with a high pressure washer. Shock applied from high pressure water may cause the device to not operate normally.
- Do not bring the nozzle tip close to boots (rubber or plastic covers) or connectors as they may be damaged if they come into contact with high pressure water.

Finish maintenance

Washing

To help protect your vehicle's finish from rust and deterioration, wash it thoroughly and frequently at least once a month with lukewarm or cold water.

If you use your vehicle for off-road driving, you should wash it after each off-road trip. Pay special attention to the removal of any accumulation of salt, dirt, mud, and other foreign materials. Make sure the drain holes in the lower edges of the doors and rocker panels are kept clear and clean.

Insects, tar, tree sap, bird droppings, industrial pollution and similar deposits can damage your vehicle's finish if not removed immediately.

Even prompt washing with plain water may not completely remove all these deposits. A mild soap, safe for use on painted surfaces, may be used.

After washing, rinse the vehicle thoroughly with lukewarm or cold water. Do not allow soap to dry on the finish.

CAUTION

Do not use strong soap, chemical detergents or hot water, and do not wash the vehicle in direct sunlight or when the body of the vehicle is warm.

WARNING - Wet brakes

After washing the vehicle, test the brakes while driving slowly to see if they have been affected by water. If braking performance is impaired, dry the brakes by applying them lightly while maintaining a slow forward speed.

Maintenance



CAUTION

- *Water washing in the engine compartment including high pressure water washing may cause the failure of electrical circuits located in the engine compartment.*
- *Never allow water or other liquids to come in contact with electrical/electronic components inside the vehicle as this may damage them.*

Waxing

Wax the vehicle when water will no longer bead on the paint.

Always wash and dry the vehicle before waxing. Use a good quality liquid or paste wax, and follow the manufacturer's instructions. Wax all metal trim to protect it and to maintain its luster.

Removing oil, tar, and similar materials with a spot remover will usually strip the wax from the finish. Be sure to re-wax these areas even if the rest of the vehicle does not yet need waxing.

CAUTION

- *Wiping dust or dirt off the body with a dry cloth will scratch the finish.*
- *Do not use steel wool, abrasive cleaners, or strong detergents containing highly alkaline or caustic agents on chrome-plated or anodized aluminum parts. This may result in damage to the protective coating and cause discoloration or paint deterioration.*

Finish damage repair

Deep scratches or stone chips in the painted surface must be repaired promptly. Exposed metal will quickly rust and may develop into a major repair expense.

* NOTICE

If your vehicle is damaged and requires any metal repair or replacement, be sure the body shop applies anti-corrosion materials to the parts repaired or replaced.

Bright-metal maintenance

- To remove road tar and insects, use a tar remover, not a scraper or other sharp object.
- To protect the surfaces of bright-metal parts from corrosion, apply a coating of wax or chrome preservative and rub to a high luster.
- During winter weather or in coastal areas, cover the bright metal parts with a heavier coating of wax or preservative. If necessary, coat the parts with non-corrosive petroleum jelly or other protective compound.

Underbody maintenance

Corrosive materials used for ice and snow removal and dust control may collect on the underbody. If these materials are not removed, accelerated rusting can occur on underbody parts such as the fuel lines, frame, floor pan and exhaust system, even though they have been treated with rust protection.

Thoroughly flush the vehicle underbody and wheel openings with lukewarm or cold water once a month, after off-road driving and at the end of each winter. Pay special attention to these areas because it is difficult to see all the mud and dirt. It will do more harm than good to wet down the road grime without removing it. The lower edges of the doors, rocker panels, and frame members have drain holes that should not clog with dirt; trapped water in these areas can cause rusting.

WARNING

After washing the vehicle, test the brakes while driving slowly to see if they have been affected by water. If braking performance is impaired, dry the brakes by applying them lightly while maintaining a slow forward speed.

Maintenance

Aluminum wheel maintenance

The aluminum wheels are coated with a clear protective finish.

- Do not use any abrasive cleaner, polishing compound, solvent, or wire brushes on aluminum wheels. They may scratch or damage the finish.
- Use only a mild soap or neutral detergent, and rinse thoroughly with water. Also, be sure to clean the wheels after driving on salted roads. This helps prevent corrosion.
- Avoid washing the wheels with high-speed car wash brushes.
- Do not use any acid detergent. It may damage and corrode the aluminum wheels coated with a clear protective finish.

Corrosion protection

Protecting your vehicle from corrosion

By using the most advanced design and construction practices to combat corrosion, we produce cars of the highest quality. However, this is only part of the job. To achieve the long-term corrosion resistance your vehicle can deliver, the owner's cooperation and assistance is also required.

Common causes of corrosion

The most common causes of corrosion on your car are:

- Road salt, dirt and moisture that is allowed to accumulate underneath the car.
- Removal of paint or protective coatings by stones, gravel, abrasion or minor scrapes and dents which leave unprotected metal exposed to corrosion.

High-corrosion areas

If you live in an area where your car is regularly exposed to corrosive materials, corrosion protection is particularly important. Some of the common causes of accelerated corrosion are road salts, dust control chemicals, ocean air and industrial pollution.

Moisture breeds corrosion

Moisture creates the conditions in which corrosion is most likely to occur. For example, corrosion is accelerated by high humidity, particularly when temperatures are just above freezing. In such conditions, the corrosive material is kept in contact with the vehicle's surfaces with moisture that slowly evaporate.

Mud is particularly corrosive because it dries slowly and holds moisture in contact with the vehicle. Although the mud appears to be dry, it can still retain moisture and promote corrosion.

High temperatures can also accelerate corrosion of parts that are not properly ventilated so the moisture can be dispersed. For all these reasons, it is particularly important to keep your vehicle clean and free of mud or accumulations of other materials. This applies not only to the visible surfaces but particularly to the underside of the vehicle.

To help prevent corrosion

You can help prevent corrosion from getting started by observing the following:

Keep your vehicle clean

The best way to prevent corrosion is to keep your vehicle clean and free of corrosive materials. Attention to the underside of the vehicle is particularly important.

- If you live in a high-corrosion area — where road salts are used, near the ocean, areas with industrial pollution, acid rain, etc.—, you should take extra care to prevent corrosion. In winter, hose off the underside of your vehicle at least once a month and be sure to clean the underside thoroughly when winter is over.

- When cleaning underneath the vehicle, give particular attention to the components under the fenders and other areas that are hidden from view. Do a thorough job; just dampening the accumulated mud rather than washing it away will accelerate corrosion rather than prevent it. Water under high pressure and steam are particularly effective in removing accumulated mud and corrosive materials.
- When cleaning lower door panels, rocker panels and frame members, be sure that drain holes are kept open so that moisture can escape and not be trapped inside to accelerate corrosion.

Keep your garage dry

Don't park your vehicle in a damp, poorly ventilated garage. This creates a favorable environment for corrosion. This is particularly true if you wash your vehicle in the garage or drive it into the garage when it is still wet or covered with snow, ice or mud. Even a heated garage can contribute to corrosion unless it is well ventilated so moisture is dispersed.

Maintenance

Keep paint and trim in good condition

Scratches or chips in the finish should be covered with "touch-up" paint as soon as possible to reduce the possibility of corrosion. If bare metal is showing through, the attention of a qualified body and paint shop is recommended.

Bird droppings : Bird droppings are highly corrosive and may damage painted surfaces in just a few hours. Always remove bird droppings as soon as possible.

Don't neglect the interior

Moisture can collect under the floor mats and carpeting and cause corrosion. Check under the mats periodically to be sure the carpeting is dry. Use particular care if you carry fertilizers, cleaning materials or chemicals in the vehicle.

These should be carried only in proper containers and any spills or leaks should be cleaned up, flushed with clean water and thoroughly dried.

Interior care

Interior general precautions

Prevent caustic solutions such as perfume and cosmetic oil from contacting the dashboard because they may cause damage or discoloration. If they do contact the dashboard, wipe them off immediately. See the instructions for the proper way to clean vinyl.

CAUTION

Never allow water or other liquids to come in contact with electrical/electronic components inside the vehicle as this may damage them.

Cleaning the upholstery and interior trim

Vinyl (if equipped)

Remove dust and loose dirt from vinyl with a whisk broom or vacuum cleaner. Clean vinyl surfaces with a vinyl cleaner.

Fabric (if equipped)

Remove dust and loose dirt from fabric with a whisk broom or vacuum cleaner. Clean with a mild soap solution recommended for upholstery or carpets. Remove fresh spots immediately with a fabric spot cleaner. If fresh spots do not receive immediate attention, the fabric can be stained and its color can be affected. Also, its fire-resistant properties can be reduced if the material is not properly maintained.

CAUTION

Using anything but recommended cleaners and procedures may affect the fabric's appearance and fire-resistant properties.

Leather (if equipped)

- Feature of Seat Leather
 - Leather is made from the outer skin of an animal, which goes through a special process to be available for us. Since it is a natural object, each part differs in thickness or density. Wrinkles may appear as a natural result of stretching and shrinking depending on the temperature and humidity.
 - The seat is made of stretchable fabric to improve comfort.
 - The parts contacting the body are curved and the side supporting area is high which provides driving comfort and stability.
 - Wrinkles may appear naturally from usage. It is not a fault of the product.

**CAUTION**

- *Wrinkles or abrasions which appear naturally from usage are not covered by warranty.*
- *Belts with metallic accessories, zippers or keys inside the back pocket may damage the seat fabric.*
- *Make sure not to wet the seat. It may change the nature of natural leather.*
- *Jeans or clothes which could bleach may contaminate the surface of the seat covering fabric.*

- Caring for the leather seats
 - Vacuum the seat periodically to remove dust and sand on the seat. It will prevent abrasion or damage of the leather and maintain its quality.
 - Wipe the natural leather seat cover often with dry or soft cloth.
 - Use of proper leather protective may prevent abrasion of the cover and helps maintain the color. Be sure to read the instructions and consult a specialist when using leather coating or protective agents.
 - Light colored (beige, cream beige) leather is easily contaminated and the stain is noticeable. Clean the seats frequently.
 - Avoid wiping with wet cloth. It may cause the surface to crack.

Maintenance

- Cleaning the leather seats
 - Remove all contaminations instantly. Refer to instructions below for removal of each contaminant.
 - Cosmetic products (sunscreen, foundation, etc.)
 - Apply cleansing cream on a cloth and wipe the contaminated spot. Wipe off the cream with a wet cloth and remove water with a dry cloth.
 - Beverages (coffee, soft drink, etc.)
Apply a small amount of neutral detergent and wipe until contaminations do not smear.
 - Oil
Remove oil instantly with absorbable cloth and wipe with stain remover used only for natural leather.
 - Chewing gum
Harden the gum with ice and remove gradually.

Cleaning the lap/shoulder belt webbing

Clean the belt webbing with any mild soap solution recommended for cleaning upholstery or carpet. Follow the instructions provided with the soap. Do not bleach or re-dye the webbing because this may weaken it.

Cleaning the interior window glass

If the interior glass surfaces of the vehicle become fogged (that is, covered with an oily, greasy or waxy film), they should be cleaned with glass cleaner. Follow the directions on the glass cleaner container.

CAUTION

Do not scrape or scratch the inside of the rear window. This may result in damage to the rear window defroster grid.

EMISSION CONTROL SYSTEM

The emission control system of your vehicle is covered by a written limited warranty. Please see the warranty information contained in the Service Passport in your vehicle.

Your vehicle is equipped with an emission control system to meet all emission regulations.

There are three emission control systems which are as follows.

- (1) Crankcase emission control system
- (2) Evaporative emission control system
- (3) Exhaust emission control system

In order to assure the proper function of the emission control systems, it is recommended that you have your vehicle inspected and maintained by an authorized HYUNDAI dealer in accordance with the maintenance schedule in this manual.

Caution for the Inspection and Maintenance Test (With Electronic Stability Control (ESC) system)

- To prevent the vehicle from misfiring during dynamometer testing, turn the Electronic Stability Control (ESC) system off by pressing the ESC switch.
- After dynamometer testing is completed, turn the ESC system back on by pressing the ESC switch again.

1. Crankcase emission control system

The positive crankcase ventilation system is employed to prevent air pollution caused by blow-by gases being emitted from the crankcase. This system supplies fresh filtered air to the crankcase through the air intake hose. Inside the crankcase, the fresh air mixes with blow-by gases, which then pass through the PCV valve into the induction system.

2. Evaporative emission control System

The Evaporative Emission Control System is designed to prevent fuel vapors from escaping into the atmosphere.

Canister

Fuel vapors generated inside the fuel tank are absorbed and stored in the onboard canister. When the engine is running, the fuel vapors absorbed in the canister are drawn into the surge tank through the purge control solenoid valve.

Purge Control Solenoid Valve (PCSV)

The purge control solenoid valve is controlled by the Engine Control Module (ECM); when the engine coolant temperature is low during idling, the PCSV closes so that evaporated fuel is not taken into the engine. After the engine warms up during ordinary driving, the PCSV opens to introduce evaporated fuel to the engine.

Maintenance

3. Exhaust emission control system

The Exhaust Emission Control System is a highly effective system which controls exhaust emissions while maintaining good vehicle performance.

Vehicle modifications

This vehicle should not be modified. Modification of your vehicle could affect its performance, safety or durability and may even violate governmental safety and emissions regulations.

In addition, damage or performance problems resulting from any modification may not be covered under warranty.

Engine exhaust gas precautions (carbon monoxide)

- Carbon monoxide can be present with other exhaust fumes. Therefore, if you smell exhaust fumes of any kind inside your vehicle, have it inspected and repaired immediately. If you ever suspect exhaust fumes are coming into your vehicle, drive it only with all the windows fully open. Have your vehicle checked and repaired immediately.

⚠ WARNING - Exhaust
Engine exhaust gases contain carbon monoxide (CO). Though colorless and odorless, it is dangerous and could be lethal if inhaled. Follow the instructions following to avoid CO poisoning.

- Do not operate the engine in confined or closed areas (such as garages) any more than what is necessary to move the vehicle in or out of the area.
- When the vehicle is stopped in an open area for more than a short time with the engine running, adjust the ventilation system (as needed) to draw outside air into the vehicle.
- Never sit in a parked or stopped vehicle for any extended time with the engine running.
- When the engine stalls or fails to start, excessive attempts to restart the engine may cause damage to the emission control system.

Operating precautions for catalytic converters (if equipped)

WARNING - Fire

A hot exhaust system can ignite flammable items under your vehicle. Do not park the vehicle over or near flammable objects, such as grass, vegetation, paper, leaves, etc.

Your vehicle is equipped with a catalytic converter emission control device.

Therefore, the following precautions must be observed:

- Use only UNLEADED FUEL for petrol engine.
- Do not operate the vehicle when there are signs of engine malfunction, such as misfire or a noticeable loss of performance.
- Do not misuse or abuse the engine. Examples of misuse are coasting with the ignition off and descending steep grades in gear with the ignition off.

- Do not operate the engine at high idle speed for extended periods (5 minutes or more).
- Do not modify or tamper with any part of the engine or emission control system. We recommend that the system be inspected by an authorized HYUNDAI dealer.
- Avoid driving with very low fuel level. If you run out of petrol, it could cause the engine to misfire damaging the catalytic converter.

Failure to observe these precautions could result in damage to the catalytic converter and to your vehicle. Additionally, such actions could void your warranties.

Diesel Particulate Filter (if equipped)

The Diesel Particulate Filter (DPF) system removes the soot emitted from the vehicle.

Unlike a disposable air filter, the DPF system automatically burns (oxidizes) and removes the accumulated soot according to the driving condition. In other words, the active burning by engine control system and high exhaust gas temperature caused by normal/high driving condition burns and removes the accumulated soot.

However, if the vehicle continues to be driven at low speed for long time, the accumulated soot may not be automatically removed because of low exhaust gas temperature. In this particular case, the amount of soot is out of detection limit, the soot oxidation process by engine control system may not happen and the malfunction indicator light may blink.

When the malfunction indicator light blinks, it may stop blinking by driving the vehicle at more than 60km/h (37 mph) or at more than second gear with 1500 ~ 2000 engine rpm for a certain time (for about 25 minutes).

Specifications & Consumer information

DIMENSIONS	10-2
ENGINE	10-2
BULB WATTAGE	10-2
TIRES AND WHEELS	10-3
RECOMMENDED LUBRICANTS AND CAPACITIES	10-4
• Recommended SAE viscosity number	10-5
RECOMMENDED FREQUENCY FOR VAS	10-6
VEHICLE IDENTIFICATION NUMBER (VIN)	10-7
VEHICLE CERTIFICATION LABEL	10-7
TIRE SPECIFICATION AND PRESSURE LABEL ..	10-8
ENGINE NUMBER	10-8
AIR CONDITIONER COMPRESSOR LABEL	10-8

Specifications & Consumer information

DIMENSIONS

Item	mm (in)
Overall length	3,995 (157.3)
Overall width	1,660 (65.4)
Overall height	1,520 (59.8)
Front tread	1,479 (58.2)
Rear tread	1,493 (58.8)
Wheelbase	2,425 (95.5)

ENGINE

Item	Kappa 1.2	U2 1.2
Displacement (cc)	1,197	1,186
Bore x Stroke (mm)	71.0x75.6	77.2x84.5
Firing order	1-3-4-2	1-2-3
No. of cylinders	4	3

BULB WATTAGE

Light Bulb		Wattage
Front	Headlights (High/Low)	60/55
	Front turn signal light	21
	Position lights	5
	Side repeater light*	5W/LED
	Front fog light*	35
	Daytime running light*	LED
Rear	Stop and tail light	21/5
	Rear turn signal light	21
	Back-up light	16
	High mounted stop light*	LED
Interior	License plate light	5
	Room lamps	8
	Luggage room lamp*	8

* : If equipped

TIRES AND WHEELS

Item	Tire size	Wheel size	Inflation pressure bar (psi)				Wheel lug nut torque kg•m (lb•ft, N•m)
			Normal load *1		Maximum load		
			Front	Rear	Front	Rear	
Full size tire	165/65R14	5.0J X 14	230 (33)	230 (33)	250 (36)	250 (36)	11~13 (79~94, 108~127)
	170/60R15	5.5J X 15					

Item	Tire size	Wheel size	Inflation pressure bar (psi)				Tiremaker (Can be any of the below)
			Normal load *1		Maximum load		
			Front	Rear	Front	Rear	
Spare tire	165/65R14	5.0J X 14	230 (33)	230 (33)	250 (36)	250 (36)	Apollo/Bridgestone/ Goodyear

*** NOTICE**

- Only the steel wheel is provided with the vehicle as a spare wheel.
- It is permissible to add 20 kPa (3 psi) to the standard tire pressure specification if colder temperatures are expected soon. Tires typically lose 7 kPa (1 psi) for every 7°C (12°F) temperature drop. If extreme temperature variations are expected, recheck your tire pressure as necessary to keep them properly inflated.
- An air pressure generally decreases, as you drive up to a high-altitude area above sea level. Thus, if you plan to drive a high-altitude area, check the tire pressures in advance. If necessary, inflate them to a proper level (Air inflation per altitude: +10 kPa/1 km (+2.4 psi/1 mile)).

Specifications & Consumer information

RECOMMENDED LUBRICANTS AND CAPACITIES

To help achieve proper engine and powertrain performance and durability, use only lubricants of the proper quality. The correct lubricants also help promote engine efficiency that results in improved fuel economy.

These lubricants and fluids are recommended for use in your vehicle.

Lubricant		Volume	Classification	
Engine oil ^{*1 *2} (drain and refill)	Petrol engine	3.6 l	ACEA B4*4	
	Diesel engine	4.7 l	ACEA A5*3 (or above)	
Manual transaxle fluid	Petrol engine	1.5 ~ 1.6 l	SAE 70W (HYUNDAI genuine transaxle fluid)	
	Diesel engine	1.6 ~ 1.7 l		
Automatic transaxle fluid	Petrol engine	6.1 l	ATF SP-IV	
Coolant	Diesel engine	6.1 l	MIXTURE, Antifreeze with water (Ethylene glycol base coolant for aluminum radiator)	
	Petrol engine	M/T		5.2 l
		A/T		5.1 l
Brake/Clutch fluid		0.7~0.8 l	FMVSS116 DoT-3 or DoT-4 (Do not mix DoT3 & DoT4 brake/clutch fluids)	
Fuel		43 l	-	

*1 : Refer to the recommended SAE viscosity numbers on the next page.

*2 : Engine oils labeled Energy Conserving Oil are now available. Along with other additional benefits, they contribute to fuel economy by reducing the amount of fuel necessary to overcome engine friction. Often, these improvements are difficult to measure in everyday driving, but in a year's time, they can offer significant cost and energy savings.

*3 : If the ACEA A5 engine oil is not available in your country, you are able to use ILSAC GF-3 (or above) or ACEA A3 (or above).

*4 : If the ACEA B4 engine oil is not available in your country, you are able to use API CH-4 (or above)

*5 : We recommend that you use the engine oils approved by HYUNDAI Motor India Ltd. We recommend that you consult an authorized HYUNDAI dealer for details.

Recommended SAE viscosity number

CAUTION

Always be sure to clean the area around any filler plug, drain plug, or dipstick before checking or draining any lubricant. This is especially important in dusty or sandy areas and when the vehicle is used on unpaved roads. Cleaning the plug and dipstick areas will prevent dirt and grit from entering the engine and other mechanisms that could be damaged.

Engine oil viscosity (thickness) has an effect on fuel economy and cold weather operation (engine start and engine oil flowability). Lower viscosity engine oils can provide better fuel economy and cold weather performance, however, higher viscosity engine oils are required for satisfactory lubrication in hot weather.

Using oils of any viscosity other than those recommended could result in engine damage. When choosing an oil, consider the range of temperature your vehicle will be operated in before the next oil change. Proceed to select the recommended oil viscosity from the chart.

		Temperature Range for SAE Viscosity Numbers									
Temperature	°C	-30	-20	-10	0	10	20	30	40	50	
	(°F)	-10	0	20	40	60	80	100	120		
Petrol Engine Oil *1											20W-50
											15W-40
											10W-30
											5W-30
Diesel Engine Oil											15W-40
											10W-30
											5W-30
											0W-30

*1. For better fuel economy, it is recommended to use the engine oil of a viscosity grade SAE 5W-20 (API SM / ILSAC GF-4). However, if the engine oil is not available in your country, select the proper engine oil using the engine oil viscosity chart.

Specifications & Consumer information

RECOMMENDED FREQUENCY FOR VALUE ADDED SERVICES

The Value Added Services (VAS) are not part of the Maintenance Schedule mentioned in section 9 and are not mandatory for maintaining the validity of the Basic Warranty of the vehicle. Owner may choose to avail these services to further enhance the performance of the vehicle.

We recommend that the below mentioned **VAS should be used only after two years from date of delivery** and as per the frequency mentioned below:

Classification	Type	VAS Product	Frequency
Engine	C	Throttle body cleaner	First at 30,000 km, then every 20,000 km

Below mentioned VAS may be used before completion of two years from the date of delivery and as per the frequency mentioned below:

Classification	Type	VAS Product	Frequency
Exterior	CT	Underbody coating	Once in a new car
Interior	C	Upholstery cleaning	Every 6 months

C – Clean

CT – Coat

VEHICLE IDENTIFICATION NUMBER (VIN)

■ Type A

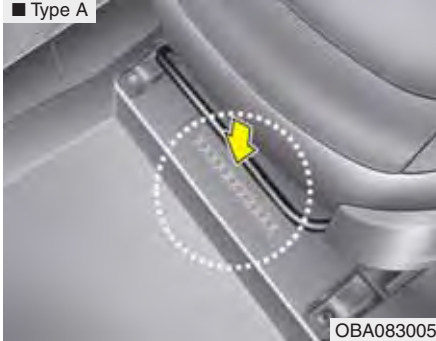

The vehicle identification number (VIN) is the number used in registering your vehicle and in all legal matters pertaining to its ownership, etc.

The number is punched below the driver's seat.

■ Type B



The VIN is also on a plate attached to the top of the dashboard. The number on the plate can easily be seen through the windshield from outside.

VEHICLE CERTIFICATION LABEL



The vehicle certification label attached on the driver's (or front passenger's) side center pillar gives the vehicle identification number (VIN).

Specifications & Consumer information

TIRE SPECIFICATION AND PRESSURE LABEL



OBA073010

The tires supplied on your new vehicle are chosen to provide the best performance for normal driving.

The tire label located on the driver's side center pillar gives the tire pressures recommended for your vehicle.

ENGINE NUMBER

■ Petrol engine

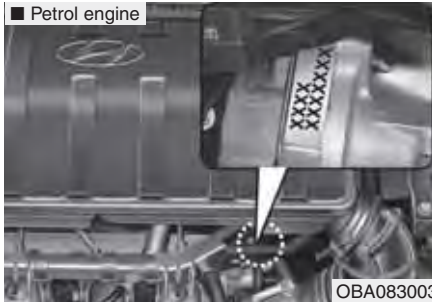

OBA083003

■ Diesel engine

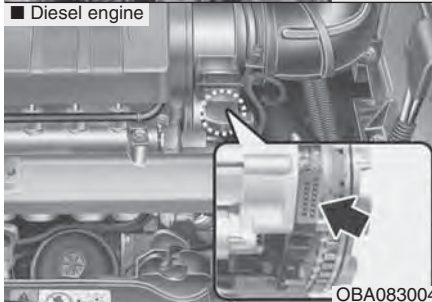

OBA083004

The engine number is stamped on the engine block as shown in the drawing.

AIR CONDITIONER COMPRESSOR LABEL



OHC081001

A compressor label informs you the type of compressor your vehicle is equipped with such as model, supplier part number, production number, refrigerant (1) and refrigerant oil (2).

Index

A

Air bag warning label5-40

Air bag warning light5-29

Air bags5-26

 Air bag warning label5-40

 Air bag warning light5-29

 Driver's and passenger's front air bag5-28

 SRS components and functions5-29

Air cleaner9-37

Air conditioner compressor label10-8

Air conditioner refrigerant and compressor lubricant 6-65

Air conditioning system

 Automatic climate control system6-66

 Manual climate control system6-58

Alarm system6-11

Antenna6-80

Anti-lock brake system (ABS)7-24

Appearance care9-82

 Exterior care9-82

 Interior care9-87

Ashtray6-77

Audio player6-95

Audio remote control6-81

Audio system6-80

 Antenna6-80

 Audio player6-95

 Aux, USB and iPod® port6-82

 CD player6-91

 Steering wheel audio control6-81

Automatic climate control system6-66

 Air conditioning6-72

 Air intake control6-70

 Automatic climate control6-67

 Climate control air filter6-65

 Fan speed control6-72

 Manual heating and air conditioning6-68

 Mode selection6-68

 OFF mode6-72

 Temperature control6-70

Automatic transaxle7-16

 Sports mode7-18

Automatic transaxle fluid9-33

Aux, USB and iPod® port6-82

Average speed (Trip computer)6-39

B

Battery9-45

Battery replacement

 Remote key6-7

 Smart key6-7

Battery saver function6-50

Before driving7-3

Brake fluid9-32

Brake system7-21

Anti-lock brake system (ABS)7-24
 Disc brake7-22
 Drum brake.....7-22
 Parking brake7-22
 Power brakes.....7-21
 Brake/clutch fluid9-32
 Bulb replacement.....9-77
 Bulb wattage10-2
 Button start/stop, see engine start/stop button7-7

Climate control air filter6-65, 9-40
 Clutch fluid9-32
 Combined instrument, see instrument cluster6-36
 Compressor label.....10-8
 Cool box.....6-76
 Coolant.....9-29
 Cooling fluid, see engine coolant.....9-29
 Crankcase emission control system.....9-88
 Cup holder6-78

C

Capacities (Lubricants).....10-4
 Care
 Exterior care9-82
 Interior care9-87
 Tire care9-48
 Cargo area cover.....6-80
 CD player6-92
 Center console storage.....6-75
 Central door lock switch6-16
 Certification label10-7
 Chains
 Tire chains.....7-34
 Checking tire inflation pressure.....9-50
 Child restraint system5-19
 Seat belt5-23
 Child-protector rear door lock.....6-17

D

Dashboard, see instrument cluster6-36
 Defogging (Windshield)6-73
 Defroster (Rear window)6-57
 Defrosting (Windshield)6-73
 Dimensions10-2
 Disc brake7-22
 Displays, see instrument cluster.....6-36
 Door locks6-13
 Central door lock switch.....6-15
 Child-protector rear door lock.....6-16
 Drinks holders, see cup holders6-78
 Driver's air bag5-28
 Driving at night7-31
 Driving in flooded areas.....7-32
 Driving in the rain.....7-31
 Drum brake7-22

E

ECO ON/OFF mode6-41

Elapsed time (Trip computer)6-40

Electric power steering (EPS)6-30

Emergency towing8-15

Emergency while driving8-2

Emission control system9-88

 Crankcase emission control system9-88

 Evaporative emission control System9-88

 Exhaust emission control system9-89

Engine10-2

Engine compartment (Diesel engine)4-5, 9-4

Engine compartment (Petrol engine)4-4, 9-3

Engine compartment panel fuse9-71

Engine coolant9-29

Engine coolant temperature gauge6-37

Engine does not start8-3

Engine number10-8

Engine oil9-27

Engine overheating8-7

Engine start/stop button7-7

Evaporative emission control System9-88

Exhaust emission control system9-89

Explanation of scheduled maintenance items9-24

Exterior care9-82

F

Flat tire

 Changing tires8-9

 Jack and tools8-8

 Removing and storing the spare tire8-8

Floor mat anchor(s)6-79

Fluid

 Automatic transaxle fluid9-33

 Brake/clutch fluid9-32

 Washer fluid9-35

Fog light6-52

Front seat adjustment5-4

Fuel filler lid6-27

Fuel filter9-37

Fuel gauge6-40

Fuel requirements3-3

Fuse switch9-62

Fuses9-59

 Engine compartment panel fuse9-60

 Fuse switch9-61

 Fuse/relay panel description9-63

 Instrument panel fuse9-60

 Main fuse9-62

G

Gauges6-37
 Glove box6-75

H

Hyundai New Vehicle Warranty2-2
 Hazard warning flasher6-49, 8-2
 Hazardous driving conditions7-30
 Headlight bulb replacement9-77
 Headlight leveling device6-53
 Headlight position6-51
 Headrest (front seat)5-5
 Headrest (rear seat)5-7
 Heating system
 Automatic climate control system6-67
 Manual climate control system6-58
 Height adjustment5-12
 High - beam operation6-51
 Hood6-25
 Horn6-31
 How to use this manual3-2

I

Ignition switch7-4
 Engine start/stop button7-7
 Key ignition switch7-4
 Immobilizer system6-4
 Indicator light6-41
 Inside rearview mirror6-32
 Instrument cluster6-36
 Gauges6-37
 Instrument panel fuse9-61
 Instrument panel overview4-3
 Interior care9-87
 Interior features6-77
 Ashtray6-77
 Cargo area cover6-80
 Cup holder6-78
 Floor mat anchor(s)6-79
 Power outlet6-79
 Sunvisor6-78
 Interior light6-56
 Room lamp6-56
 Luggage room lamp6-56
 Interior overview4-2

Index

J

- Jack and tools 8-8
- Jump starting 8-4

K

- Key ignition switch 7-4
- Keys
 - Immobilizer system 6-4
 - Key operations 6-3
 - Record your key number 6-3
- Label
 - Air bag warning label 5-40
 - Air conditioner compressor label 10-8
 - Tire sidewall labeling 9-54
 - Tire specification and pressure label 10-8
 - Vehicle certification label 10-7

L

- Lap belt 5-12
- Lap/shoulder belt 5-10
- Light bulbs 9-76
- Lighting 6-50
 - Battery saver function 6-50
 - Front fog light 6-52
 - Headlight leveling device 6-53

- Headlight position 6-51
- High - beam operation 6-51
- Parking light position 6-50
- Turn signals 6-52
- Lubricants and capacities 10-4
- Luggage room lamp 6-56

M

- Main fuse 9-62
- Maintenance
 - Explanation of scheduled maintenance items 9-24
 - Maintenance services 9-5
 - Owner maintenance 9-7
 - Scheduled maintenance service 9-9
 - Tire maintenance 9-53
 - Maintenance schedule 9-9
 - Maintenance services 9-5
- Manual climate control system 6-58
 - Air conditioning 6-63
 - Air intake control 6-61
 - Climate control air filter 6-65
 - Fan speed control 6-62
 - Heating and air conditioning 6-59
 - Mode selection 6-60
 - Temperature control 6-61
- Manual climate control system
 - Air conditioner refrigerant and compressor lubricant 6-65
- Manual transaxle 7-13

Mirrors	6-32
Inside rearview mirror	6-32
Outside rearview mirror	6-32
Odometer	6-39

O

Oil (Engine)	9-27
Outside rearview mirror	6-32
Overheating	8-7
Owner maintenance	9-7
Parking brake	7-22

P

Parking brake (Maintenance service)	9-35
Parking light position	6-50
Passenger seat under tray	5-6
Passenger's air bag	5-28
Power brakes	7-21
Power outlet	6-78
Power window lock button	6-23
Pre-tensioner seat belt	5-13

R

Rear parking assist system	7-27
Rearview	7-29
Rear seat adjustment	5-7
Rear seat folding	5-8
Rear window wiper and washer switch	6-54
Recommended cold tire inflation pressures	9-48
Recommended frequency for VAS	10-6
Recommended lubricants and capacities	10-4
Recommended SAE viscosity number	10-5
Remote key	6-5
Remote keyless entry	
Battery replacement	6-7
Remote key	6-7
Smart key	6-7
Replacement light bulb	9-77
Road warning	
Hazard warning flasher	8-2
Rocking the vehicle	7-30
Room lamp	6-56
Rotation (Tire)	9-51

S

Scheduled maintenance service9-9

Seat belt warning5-10

Seat belts

- High adjustment5-11
- Lap belt5-12
- Lap/shoulder belt5-10
- Pre-tensioner seat belt5-13
- Seat belt warning5-10

Seatback pocket5-6

Seats5-2

- Front seat adjustment5-4
- Headrest (front seat)5-5
- Headrest (rear seat)5-7
- Passenger seat under tray5-6
- Rear seat adjustment5-7
- Rear seat folding5-8
- Seatback pocket5-6

Smart key6-9

Smooth cornering7-31

Snow tires7-33

Spare tire

- Removing and storing the spare tire8-8

Special driving conditions7-30

- Driving at night7-31
- Driving in flooded areas7-32
- Driving in the rain7-31

- Hazardous driving conditions7-30
- Rocking the vehicle7-30
- Smooth cornering7-31

Speedometer6-37

Sports mode7-18

SRS components and functions5-29

Starting difficulties, see engine does not start8-3

Steering wheel6-30

- Electric power steering (EPS)6-30
- Horn6-31
- Tilt steering6-30

Storage compartment6-75

- Center console storage6-75
- Cool box6-76
- Glove box6-75

Sunvisor6-78

T

Tachometer6-37

Trunk6-18

Theft-alarm system6-11

Tilt steering6-30

Tire chains7-34

Tire rotation9-51

Tire specification and pressure label10-8

Tires and wheels9-48, 10-3

- Checking tire inflation pressure9-50

Low aspect ratio tire9-57
 Recommended cold tire inflation pressures9-48
 Tire care9-48
 Tire maintenance9-53
 Tire replacement9-52
 Tire rotation9-51
 Tire sidewall labeling9-54
 Tire traction9-53
 Wheel alignment and tire balance9-52
 Wheel replacement9-53
 Towing8-13
 Emergency towing8-15
 Towing hook8-14
 Towing hook8-14
 Transaxle
 Manual transaxle7-13
 Transaxle
 Automatic transaxle7-16
 Trip computer6-39
 Average speed6-40
 ECO ON/OFF mode6-41
 Elapsed time6-40
 Tripmeter6-40
 Tripmeter (Trip computer)6-39
 Turn signals6-52

V

Vehicle break-in process3-6
 Vehicle certification label10-7
 Vehicle identification number (VIN)10-7
 Vehicle weight7-36

W

Warning light6-41
 Washer fluid9-35
 Wheel alignment and tire balance9-52
 Wheel replacement9-53
 Windows6-20
 Power window lock button6-23
 Windshield washers6-55
 Windshield wipers6-54
 Winter driving7-33
 Snow tires7-33
 Tire chains7-34
 Wiper blades (Maintenance service)9-42
 Wipers and washers6-54
 Rear window wiper and washer switch6-55
 Windshield washers6-55
 Windshield wipers6-54

