



SiFive U74-MC Core Complex Manual

21G1.01.00

Copyright © 2019–2021 by SiFive, Inc. All rights reserved.

SiFive U74-MC Core Complex Manual

Proprietary Notice

Copyright © 2019–2021 by SiFive, Inc. All rights reserved.

SiFive U74-MC Core Complex Manual by SiFive, Inc. is licensed under Attribution-NonCommercial-NoDerivatives 4.0 International. To view a copy of this license, visit: <http://creativecommons.org/licenses/by-nc-nd/4.0>

Information in this document is provided “as is,” with all faults.

SiFive expressly disclaims all warranties, representations, and conditions of any kind, whether express or implied, including, but not limited to, the implied warranties or conditions of merchantability, fitness for a particular purpose and non-infringement.

SiFive does not assume any liability rising out of the application or use of any product or circuit, and specifically disclaims any and all liability, including without limitation indirect, incidental, special, exemplary, or consequential damages.

SiFive reserves the right to make changes without further notice to any products herein.

Contents

List of Tables	13
List of Figures	19
1 Introduction	23
1.1 About this Document	23
1.2 About this Release	24
1.3 U74-MC Core Complex Overview	24
1.4 S7 RISC-V Monitor Core	25
1.5 U7 RISC-V Application Cores	25
1.6 Interrupts	26
1.7 Debug Support	26
1.8 Compliance	26
2 List of Abbreviations and Terms	27
3 S7 RISC-V Core	30
3.1 Supported Modes	30
3.2 Instruction Memory System	30
3.2.1 Execution Memory Space	31
3.2.2 L1 Instruction Cache	31
3.2.3 Cache Maintenance	31
3.2.4 Coherence with an L2 Cache	32
3.2.5 Instruction Tightly-Integrated Memory (ITIM)	32
3.2.6 Instruction Fetch Unit	32
3.2.7 Branch Prediction	32
3.3 Execution Pipeline	34
3.4 Data Memory System	35
3.4.1 Data Tightly-Integrated Memory (DTIM)	36

3.5	Fast I/O.....	36
3.6	Atomic Memory Operations.....	36
3.7	Physical Memory Protection (PMP).....	37
3.7.1	PMP Functional Description	37
3.7.2	PMP Region Locking	37
3.7.3	PMP Registers.....	38
3.7.4	PMP and PMA	40
3.7.5	PMP Programming Overview	40
3.7.6	PMP and Paging	42
3.7.7	PMP Limitations	42
3.7.8	Behavior for Regions without PMP Protection	42
3.7.9	Cache Flush Behavior on PMP Protected Region.....	43
3.8	Hardware Performance Monitor.....	43
3.8.1	Performance Monitoring Counters Reset Behavior	43
3.8.2	Fixed-Function Performance Monitoring Counters	43
3.8.3	Event-Programmable Performance Monitoring Counters.....	44
3.8.4	Event Selector Registers.....	44
3.8.5	Event Selector Encodings	44
3.8.6	Counter-Enable Registers	46
3.9	L2 Performance Monitor	46
3.9.1	Control Port Register Map.....	46
3.9.2	L2PM Event Control	47
3.9.3	Event Selector Registers.....	49
3.9.4	Event Selector Encodings	49
3.9.5	Setting up the pmclientmask Register	52
3.9.6	Programming the L2pmevent registers	52
3.10	Ports.....	53
3.10.1	Front Port	53
3.10.2	Memory Port	54
3.10.3	Peripheral Port.....	54
3.10.4	System Port.....	54
4	U7 RISC-V Core.....	55

4.1	Supported Modes	55
4.2	Instruction Memory System.....	56
4.2.1	Execution Memory Space	56
4.2.2	L1 Instruction Cache.....	56
4.2.3	Cache Maintenance.....	57
4.2.4	Coherence with an L2 Cache	57
4.2.5	Instruction Fetch Unit.....	57
4.2.6	Branch Prediction.....	57
4.3	Execution Pipeline	59
4.4	Data Memory System.....	60
4.4.1	L1 Data Cache.....	61
4.4.2	Cache Maintenance Operations.....	61
4.4.3	L1 Data Cache Coherency	61
4.4.4	Coherence with an L2 Cache	61
4.5	Atomic Memory Operations.....	62
4.6	Floating-Point Unit (FPU).....	62
4.7	Virtual Memory Support	62
4.7.1	Address and Page Table Formats	64
4.7.2	Supervisor Address Translation and Protection Register (SATP).....	66
4.7.3	Supervisor Memory-Management Fence Instruction (SFENCE.VMA)	68
4.7.4	Scenarios Which Require SFENCE.VMA Instruction	69
4.7.5	Trap Virtual Memory	70
4.7.6	Virtual Address Translation Process.....	70
4.7.7	Virtual-to-Physical Mapping Example	71
4.7.8	MMU at Reset.....	74
4.8	Physical Memory Protection (PMP).....	74
4.8.1	PMP Functional Description	74
4.8.2	PMP Region Locking	75
4.8.3	PMP Registers.....	75
4.8.4	PMP and PMA	77
4.8.5	PMP Programming Overview	77
4.8.6	PMP and Paging	79
4.8.7	PMP Limitations	79

4.8.8	Behavior for Regions without PMP Protection	80
4.8.9	Cache Flush Behavior on PMP Protected Region	80
4.9	Hardware Performance Monitor	80
4.9.1	Performance Monitoring Counters Reset Behavior	80
4.9.2	Fixed-Function Performance Monitoring Counters	80
4.9.3	Event-Programmable Performance Monitoring Counters	81
4.9.4	Event Selector Registers	81
4.9.5	Event Selector Encodings	81
4.9.6	Counter-Enable Registers	83
4.10	L2 Performance Monitor	83
4.10.1	Control Port Register Map	84
4.10.2	L2PM Event Control	84
4.10.3	Event Selector Registers	86
4.10.4	Event Selector Encodings	86
4.10.5	Setting up the pmclientmask Register	90
4.10.6	Programming the L2pmevent registers	91
4.11	Ports	91
4.11.1	Front Port	91
4.11.2	Memory Port	92
4.11.3	Peripheral Port	92
4.11.4	System Port	92
5	Physical Memory Attributes and Memory Map	94
5.1	Physical Memory Attributes Overview	94
5.2	Memory Map	96
6	Programmer's Model	97
6.1	Base Instruction Formats	97
6.2	I Extension: Standard Integer Instructions	98
6.2.1	R-Type (Register-Based) Integer Instructions	99
6.2.2	I-Type Integer Instructions	100
6.2.3	I-Type Load Instructions	101
6.2.4	S-Type Store Instructions	102

6.2.5	Unconditional Jumps	103
6.2.6	Conditional Branches.....	104
6.2.7	Upper-Immediate Instructions.....	105
6.2.8	Memory Ordering Operations	105
6.2.9	Environment Call and Breakpoints	106
6.2.10	NOP Instruction.....	106
6.3	M Extension: Multiplication Operations.....	106
6.3.1	Division Operations	107
6.4	A Extension: Atomic Operations	107
6.4.1	Atomic Load-Reserve and Store-Conditional Instructions	107
6.4.2	Atomic Memory Operations (AMOs).....	108
6.5	F Extension: Single-Precision Floating-Point Instructions.....	109
6.5.1	Floating-Point Control and Status Registers.....	109
6.5.2	Rounding Modes.....	110
6.5.3	Single-Precision Floating-Point Load and Store Instructions	110
6.5.4	Single-Precision Floating-Point Computational Instructions	111
6.5.5	Single-Precision Floating-Point Conversion and Move Instructions.....	111
6.5.6	Single-Precision Floating-Point Compare Instructions.....	114
6.6	D Extension: Double-Precision Floating-Point Instructions	115
6.6.1	Double-Precision Floating-Point Load and Store Instructions.....	115
6.6.2	Double-Precision Floating-Point Computational Instructions	116
6.6.3	Double-Precision Floating-Point Conversion and Move Instructions	117
6.6.4	Double-Precision Floating-Point Compare Instructions.....	120
6.6.5	Double-Precision Floating-Point Classify Instruction	120
6.7	C Extension: Compressed Instructions.....	121
6.7.1	Compressed 16-bit Instruction Formats	121
6.7.2	Stack-Pointed-Based Loads and Stores	122
6.7.3	Register-Based Loads and Stores.....	122
6.7.4	Control Transfer Instructions.....	123
6.7.5	Integer Computational Instructions	125
6.8	B Extension: Bit Manipulation Instructions	127
6.8.1	Basic Bit Manipulation Instructions.....	128
6.8.2	Bit Permutation Instructions.....	129

6.8.3	Address Calculation Instructions	129
6.8.4	Add/Shift with Prefix Zero-Extend Instructions	130
6.8.5	Bit Manipulation Pseudoinstructions	130
6.9	Zicsr Extension: Control and Status Register Instructions	130
6.9.1	Control and Status Registers	132
6.9.2	Defined CSRs	132
6.9.3	CSR Access Ordering	136
6.9.4	SiFive RISC-V Implementation Version Registers	136
6.9.5	Custom CSRs	138
6.10	Base Counters and Timers	138
6.10.1	Timer Register	139
6.10.2	Timer API	139
6.11	Privileged Instructions	140
6.11.1	Machine-Mode Privileged Instructions	140
6.11.2	Supervisor-Mode Privileged Instructions	141
6.12	ABI - Register File Usage and Calling Conventions	142
6.12.1	RISC-V Assembly	143
6.12.2	Assembler to Machine Code	144
6.12.3	Calling a Function (Calling Convention)	146
6.13	Memory Ordering - FENCE Instructions	148
6.14	Boot Flow	149
6.15	Linker File	150
6.15.1	Linker File Symbols	151
6.16	RISC-V Compiler Flags	152
6.16.1	arch, abi, and mtune	152
6.17	Compilation Process	156
6.18	Large Code Model Workarounds	156
6.18.1	Workaround Example #1	157
6.18.2	Workaround Example #2	157
6.19	Pipeline Hazards	158
6.19.1	Read-After-Write Hazards	158
6.19.2	Write-After-Write Hazards	159
6.20	Reading CSRs	159

7	Custom Instructions and CSRs	161
7.1	CFLUSH.D.L1	161
7.2	CDISCARD.D.L1	161
7.3	CEASE	162
7.4	PAUSE	162
7.5	Branch Prediction Mode CSR.....	162
7.5.1	Branch-Direction Prediction.....	162
7.6	SiFive Feature Disable CSR	163
7.7	Other Custom Instructions	164
8	Interrupts and Exceptions	165
8.1	Interrupt Concepts	165
8.2	Exception Concepts	165
8.3	Trap Concepts	167
8.4	Interrupt Block Diagram	168
8.5	Local Interrupts.....	169
8.6	Interrupt Operation.....	170
8.6.1	Interrupt Entry and Exit	170
8.7	Interrupt Control and Status Registers	170
8.7.1	Machine Status Register (mstatus).....	171
8.7.2	Machine Trap Vector (mtvec).....	171
8.7.3	Machine Interrupt Enable (mie).....	173
8.7.4	Machine Interrupt Pending (mip).....	173
8.7.5	Machine Cause (mcause)	174
8.7.6	Minimum Interrupt Configuration	175
8.8	Supervisor Mode Interrupts.....	176
8.8.1	Delegation Registers (mideleg and medeleg)	176
8.8.2	Supervisor Status Register (sstatus)	177
8.8.3	Supervisor Interrupt Enable Register (sie)	178
8.8.4	Supervisor Interrupt Pending (sip).....	178
8.8.5	Supervisor Cause Register (scause).....	179
8.8.6	Supervisor Trap Vector (stvec)	180

8.8.7	Delegated Interrupt Handling	181
8.9	Interrupt Priorities	182
8.10	Interrupt Latency	182
8.11	Non-Maskable Interrupt	183
8.11.1	Handler Addresses	183
8.11.2	RNMI CSRs	183
8.11.3	MNRET Instruction	184
8.11.4	RNMI Operation	184
9	Core-Local Interruptor (CLINT)	185
9.1	CLINT Priorities and Preemption	185
9.2	CLINT Vector Table	186
9.3	CLINT Interrupt Sources	188
9.4	CLINT Interrupt Attribute	188
9.5	CLINT Memory Map	189
9.6	Register Descriptions	190
9.6.1	MSIP Register	190
9.6.2	Timer Registers	190
9.7	Supervisor Mode Delegation	191
10	Platform-Level Interrupt Controller (PLIC)	192
10.1	Memory Map	193
10.2	Interrupt Sources	197
10.3	Interrupt Priorities	198
10.4	Interrupt Pending Bits	198
10.5	Interrupt Enables	199
10.6	Priority Thresholds	200
10.7	Interrupt Claim Process	201
10.8	Interrupt Completion	201
10.9	Example PLIC Interrupt Handler	201
11	TileLink Error Device	203

12	Bus-Error Unit	204
12.1	Bus-Error Unit Overview	204
12.2	Memory Map	205
12.3	Reportable Errors.....	205
12.4	Functional Description	205
12.4.1	BEU Global Interrupt.....	206
12.4.2	BEU Local Interrupt	206
12.4.3	Global Interrupt Configuration	206
12.4.4	Static BEU Configurations	207
13	Level 2 Cache Controller	208
13.1	Level 2 Cache Controller Overview	208
13.2	Functional Description	208
13.2.1	Way Enable and the L2 Loosely-Integrated Memory (L2 LIM)	209
13.2.2	Way Masking and Locking.....	210
13.2.3	L2 Zero Device.....	212
13.2.4	L2 Features Access Summary	214
13.2.5	L2 Prefetcher	214
13.2.6	Error Correction Codes (ECC)	216
13.2.7	Coherence	216
13.3	Memory Map	216
13.4	Register Descriptions	218
13.4.1	Cache Configuration Register (Config)	218
13.4.2	Way Enable Register (wayEnable)	219
13.4.3	ECC Error Injection Register (ECCInjectError).....	219
13.4.4	ECC Directory Fix Registers (DirECCFix*)	219
13.4.5	ECC Directory Fail Registers (DirECCFail*).....	220
13.4.6	ECC Data Fix Registers (DatECCFix*)	220
13.4.7	ECC Data Fail Registers (DatECCFail*).....	220
13.4.8	L2 Cache ECC Error Injection and Correction	220
13.4.9	Cache Flush Registers (Flush*)	221
13.4.10	Way Mask Registers (wayMask*)	221
13.4.11	L2 Prefetch Control Registers	223

13.5	Procedure to Flush the L2 Cache	225
14	Power Management.....	226
14.1	Power Modes	226
14.2	Run Mode	226
14.3	WFI Clock Gate Mode	226
14.3.1	WFI Wake Up.....	226
14.4	CEASE Instruction for Power Down	227
14.5	Hardware Reset.....	227
14.6	Early Boot Flow.....	228
14.7	Interrupt State During Early Boot	228
14.8	Other Boot Time Considerations.....	229
14.9	Power-Down Flow	230
15	Debug	232
15.1	Debug Module	232
15.2	Trace and Debug Registers.....	235
15.2.1	Debug Control and Status Register (dcsr).....	237
15.2.2	Debug PC (dpc)	237
15.2.3	Debug Scratch (dscratch).....	237
15.2.4	Trace and Debug Select Register (tselect)	238
15.2.5	Trace and Debug Data Registers (tdata1-3).....	238
15.3	Breakpoints	239
15.3.1	Breakpoint Match Control Register (mcontrol).....	239
15.3.2	Breakpoint Match Address Register (maddress)	241
15.3.3	Breakpoint Execution	241
15.3.4	Sharing Breakpoints Between Debug and Machine Mode	242
15.4	Debug Memory Map.....	242
15.4.1	Debug RAM and Program Buffer (0x300–0x3FF)	242
15.4.2	Debug ROM (0x800–0xFFF)	243
15.4.3	Debug Flags (0x100–0x110, 0x400–0x7FF)	243
15.4.4	Safe Address	243
15.5	Debug Module Interface.....	243

15.5.1	Debug Module Status Register (dmstatus)	244
15.5.2	Debug Module Control Register (dmcontrol)	245
15.5.3	Hart Info Register (hartinfo)	246
15.5.4	Hart Array Window Register (hawindow)	247
15.5.5	Abstract Control and Status Register (abstractcs)	248
15.5.6	Abstract Command Register (command)	249
15.5.7	Abstract Command Autoexec Register (abstractauto)	249
15.5.8	Debug Module Control and Status 2 Register (dmcs2)	250
15.5.9	Abstract Commands	250
15.5.10	Multi-core Synchronization	252
15.5.11	System Bus Access	252
15.6	Debug Module Operational Sequences	253
15.6.1	Entering Debug Mode	253
15.6.2	Exiting Debug Mode	253
16	Error Correction Codes (ECC)	254
16.1	ECC Configuration	254
16.1.1	ECC Initialization	255
16.2	ECC Interrupt Handling and Error Injection	255
16.3	Hardware Operation Upon ECC Error	255
A	SiFive Core Complex Configuration Options	257
A.1	S7 Series	257
A.2	U7 Series	260
B	SiFive RISC-V Implementation Registers	263
B.1	Machine Architecture ID Register (marchid)	263
B.2	Machine Implementation ID Register (mimpid)	263
C	Floating-Point Unit Instruction Timing	264
C.1	S7 Floating-Point Instruction Timing	264
C.2	U7 Floating-Point Instruction Timing	266

References 269

Tables

Table 1	U74-MC Core Complex Feature Set.....	23
Table 2	RISC-V Specification Compliance	26
Table 3	Abbreviations and Terms.....	28
Table 4	S7 Feature Set.....	30
Table 5	Executable Memory Regions for the U74-MC Core Complex.....	31
Table 6	S7 Instruction Latency	35
Table 7	pmpXcfg Bitfield Description	39
Table 8	pmpaddrX Encoding Examples for A=NAPOT.....	40
Table 9	mhpmevent Register.....	45
Table 10	L2PM Partition	46
Table 11	L2PM Event Control.....	47
Table 12	L2 Performance Monitor Counters.....	48
Table 13	L2 Performance Monitor Counters, 32-Bit Access.....	48
Table 14	L2pmevent Register	50
Table 15	Master IDs in the L2 Cache Controller	52
Table 16	U7 Feature Set.....	55
Table 17	Executable Memory Regions for the U74-MC Core Complex	56
Table 18	U7 Instruction Latency	60
Table 19	PTE Configuration Bits.....	65
Table 20	PTE Encoding fields	66
Table 21	SATP MODE Values	67
Table 22	pmpXcfg Bitfield Description	76
Table 23	pmpaddrX Encoding Examples for A=NAPOT	77
Table 24	mhpmevent Register	82
Table 25	L2PM Partition	84
Table 26	L2PM Event Control.....	84
Table 27	L2 Performance Monitor Counters.....	85
Table 28	L2 Performance Monitor Counters, 32-Bit Access.....	86
Table 29	L2pmevent Register	88

Table 30	Master IDs in the L2 Cache Controller	90
Table 31	Physical Memory Attributes for External Regions	95
Table 32	Physical Memory Attributes for Internal Regions	95
Table 33	U74-MC Core Complex Memory Map. Physical Memory Attributes: R –Read, W –Write, X –Execute, I –Instruction Cacheable, D –Data Cacheable, A –Atomics.....	96
Table 34	Base Instruction Formats	97
Table 35	R-Type Integer Instructions.....	99
Table 36	R-Type Integer Instruction Description	99
Table 37	I-Type Integer Instructions	100
Table 38	I-Type Integer Instruction Description	101
Table 39	I-Type Load Instructions	102
Table 40	I-Type Load Instruction Description	102
Table 41	S-Type Store Instructions	103
Table 42	S-Type Store Instruction Description	103
Table 43	J-Type Instruction Description.....	104
Table 44	B-Type Instructions	104
Table 45	B-Type Instruction Description	104
Table 46	RISC-V Base Instruction to Assembly Pseudoinstruction Example	105
Table 47	Multiplication Operation Description	106
Table 48	Division Operation Description.....	107
Table 49	Atomic Load-Reserve and Store-Conditional Instruction Description.....	108
Table 50	Atomic Memory Operation Description.....	109
Table 51	Accrued Exception Flags.....	109
Table 52	Floating-Point Rounding Modes	110
Table 53	Single-Precision FP Load and Store Instructions Description	110
Table 54	Single-Precision FP Computational Instructions Description	111
Table 55	Single-Precision FP Conversion Instructions Description	112
Table 56	Single-Precision FP to FP Sign-Injection Instructions Description	113
Table 57	RISC-V Base Instruction to Assembly Pseudoinstruction Example	113
Table 58	Single-Precision FP Move Instructions Description	113
Table 59	Single-Precision FP Compare Instructions Description	114
Table 60	Single-Precision FP Classify Instruction Description	114
Table 61	Floating-Point Number Classes.....	115

Table 62	Double-Precision FP Load and Store Instructions Description.....	115
Table 63	Double-Precision FP Computational Instructions Description	116
Table 64	Double-Precision FP Conversion Instructions Description	118
Table 65	Double-Precision FP to FP Sign-Injection Instructions Description	119
Table 66	RISC-V Base Instruction to Assembly Pseudoinstruction Example	119
Table 67	Double-Precision FP Move Instructions Description	119
Table 68	Double-Precision FP Compare Instructions Description.....	120
Table 69	Double-Precision FP Classify Instruction Description	120
Table 70	Stack-Pointed-Based Load Instruction Description.....	122
Table 71	Stack-Pointed-Based Store Instruction Description	122
Table 72	Register-Based Load Instruction Description.....	123
Table 73	Register-Based Store Instruction Description	123
Table 74	Unconditional Jump Instruction Description.....	124
Table 75	Unconditional Control Transfer Instruction Description	124
Table 76	Conditional Control Transfer Instruction Description.....	124
Table 77	Integer Constant-Generation Instruction Description	125
Table 78	Integer Register-Immediate Operation Description.....	125
Table 79	Integer Register-Immediate Operation Description (con't).....	125
Table 80	Integer Register-Immediate Operation Description (con't).....	126
Table 81	Integer Register-Immediate Operation Description (con't).....	126
Table 82	Integer Register-Immediate Operation Description (con't).....	126
Table 83	Integer Register-Register Operation Description.....	126
Table 84	Integer Register-Register Operation Description (con't).....	127
Table 85	Count Leading/Trailing Zeroes Instructions Description	128
Table 86	Count Bits Set Instructions Description	128
Table 87	Logic-With-Negate Instructions Description.....	128
Table 88	Comparison Instructions Description	128
Table 89	Sign-Extend Instructions	129
Table 90	Bit Permutation Instructions Description.....	129
Table 91	Address Calculation Instructions Description.....	129
Table 92	Add/Shift with Prefix Zero-Extend Instructions Description.....	130
Table 93	Bit Manipulation Pseudoinstructions Description.....	130
Table 94	Control and Status Register Instruction Description	131

Table 95	CSR Reads and Writes	132
Table 96	User Mode CSRs	133
Table 97	Supervisor Mode CSRs.....	134
Table 98	Machine Mode CSRs.....	135
Table 99	Debug Mode Registers	136
Table 100	Core Generator Encoding of marchid.....	137
Table 101	Generator Release Encoding of mimpid.....	137
Table 102	Timer and Counter Pseudoinstruction Description.....	138
Table 103	Timer and Counter CSRs	139
Table 104	RISC-V Registers	142
Table 105	RISC-V Assembly and C Examples	144
Table 106	SiFive Feature Disable CSR	163
Table 107	SiFive Feature Disable CSR Usage.....	164
Table 108	Exception Priority.....	166
Table 109	Summary of Exception and Interrupt CSRs	167
Table 110	Machine Status Register (partial)	171
Table 111	Machine Trap Vector Register	172
Table 112	Encoding of mtvec . MODE	172
Table 113	Machine Interrupt Enable Register	173
Table 114	Machine Interrupt Pending Register.....	174
Table 115	Machine Cause Register	174
Table 116	mcause Exception Codes.....	175
Table 117	Machine Interrupt Delegation Register	177
Table 118	Machine Exception Delegation Register.....	177
Table 119	Supervisor Status Register (partial)	178
Table 120	Supervisor Interrupt Enable Register	178
Table 121	Supervisor Interrupt Pending Register	179
Table 122	Supervisor Cause Register	179
Table 123	scause Exception Codes.....	180
Table 124	Supervisor Trap Vector Register.....	181
Table 125	Encoding of stvec . MODE	181
Table 126	RNMI CSRs	183
Table 128	U74-MC Core Complex Interrupt IDs	188

Table 129	CLINT Register Map	190
Table 130	PLIC Memory Map.....	194
Table 131	PLIC Interrupt Source Mapping	197
Table 132	Mapping of global_interrupts Signal Bits to PLIC Interrupt ID	198
Table 133	PLIC Interrupt Priority Register	198
Table 134	PLIC Interrupt Pending Register 1	199
Table 135	PLIC Interrupt Pending Register 5	199
Table 136	PLIC Interrupt Enable Register 1 for Hart 0 M-Mode	200
Table 137	PLIC Interrupt Enable Register 5 for Hart 0 M-Mode	200
Table 138	PLIC Interrupt Priority Threshold Register	200
Table 139	PLIC Claim/Complete Register for Hart 0 M-Mode	201
Table 140	Register offsets within the Bus-Error Unit Memory Map	205
Table 141	Bus-Error Unit Error Events	205
Table 142	L2 Features Access Summary	214
Table 143	Register offsets within the L2 Cache Controller Control Memory Map	217
Table 144	Cache Configuration Register	218
Table 145	Way Enable Register	219
Table 146	ECC Error Injection Register	219
Table 147	Way Mask 0 Register	222
Table 148	Master IDs in the L2 Cache Controller	223
Table 149	basicCtrl Register	224
Table 150	additionalCtrl Register	224
Table 151	Debug Module Register Map Seen from the Debug Module Interface	233
Table 152	Debug Module Memory Map from the Perspective of the Core.....	234
Table 153	Debug Control and Status Registers.....	236
Table 154	Debug Control and Status Register	237
Table 155	Trace and Debug Select Register.....	238
Table 156	Trace and Debug Data Register 1	238
Table 157	Trace and Debug Data Registers 2 and 3.....	238
Table 158	tdata Types.....	239
Table 159	TDR CSRs When Used as Breakpoints	239
Table 160	Breakpoint Match Control Register	240
Table 161	NAPOT Size Encoding	241

Table 162	Debug Module Interface Signals	244
Table 163	Debug Module Status Register	245
Table 164	Debug Module Control Register	246
Table 165	Hart Info Register	247
Table 166	Abstract Control and Status Register	248
Table 167	Abstract Command Register	249
Table 168	Abstract Command Autoexec Register	249
Table 169	Debug Module Control and Status 2 Register	250
Table 170	Debug Abstract Commands	251
Table 171	Abstract Command Example for 32-bit Block Write	252
Table 172	System Bus vs. Program Buffer Comparison	253
Table 173	Memory Protection Summary	254
Table 174	Core Generator Encoding of marchid	263
Table 175	Generator Release Encoding of mimpid	263
Table 176	S7 Single-Precision FPU Instruction Latency and Repeat Rates	265
Table 177	U7 Single-Precision FPU Instruction Latency and Repeat Rates	266
Table 178	U7 Double-Precision FPU Instruction Latency and Repeat Rates	267

Figures

Figure 1	U7-MC Series Block Diagram	25
Figure 2	Example S7 Block Diagram	34
Figure 3	RV64 pmpcfg0 Register	38
Figure 4	RV64 pmpcfg2 Register	38
Figure 5	RV64 pmpXcfg bitfield	38
Figure 6	RV64 pmpaddrX Register.....	40
Figure 7	PMP Example Block Diagram	41
Figure 8	Event Selector Fields	44
Figure 9	Event Selector Fields	49
Figure 10	Example U7 Block Diagram	59
Figure 11	TLB Update Flow	63
Figure 12	Sv39 Virtual Address.....	64
Figure 13	Sv39 Physical Address.....	64
Figure 14	Sv39 PTE Format	64
Figure 15	RV64 Supervisor Address Translation Register (satp)	67
Figure 16	SFENCE.VMA Instruction.....	68
Figure 17	Linux User Application Memory Map Example	72
Figure 18	Hardware Table Walk Example.....	73
Figure 19	RV64 pmpcfg0 Register.....	75
Figure 20	RV64 pmpcfg2 Register.....	75
Figure 21	RV64 pmpXcfg bitfield	76
Figure 22	RV64 pmpaddrX Register	77
Figure 23	PMP Example Block Diagram	78
Figure 24	Event Selector Fields	81
Figure 25	Event Selector Fields	86
Figure 26	R-Type.....	97
Figure 27	I-Type	98
Figure 28	S-Type.....	98
Figure 29	B-Type.....	98

Figure 30	U-Type.....	98
Figure 31	J-Type	98
Figure 32	ADD Instruction Example.....	99
Figure 33	ADDI Instruction Example.....	101
Figure 34	LW Instruction Example	102
Figure 35	Store Instructions.....	102
Figure 36	SW Instruction Example	103
Figure 37	JAL Instruction.....	103
Figure 38	JALR Instruction	103
Figure 39	Branch Instructions	104
Figure 40	Upper-Immediate Instructions	105
Figure 41	FENCE Instructions	105
Figure 42	NOP Instructions	106
Figure 43	Multiplication Operations	106
Figure 44	Division Operations.....	107
Figure 45	Atomic Operations	107
Figure 46	Atomic Memory Operations.....	108
Figure 47	Floating-Point Control and Status Register	109
Figure 48	Single-Precision FP Load Instruction	110
Figure 49	Single-Precision FP Store Instruction.....	110
Figure 50	Single-Precision FP Computational Instructions.....	111
Figure 51	Single-Precision FP Fused Computational Instructions.....	111
Figure 52	Single-Precision FP to Integer and Integer to FP Conversion Instructions	111
Figure 53	Single-Precision FP to FP Sign-Injection Instructions	112
Figure 54	Single-Precision FP Move Instructions	113
Figure 55	Single-Precision FP Compare Instructions	114
Figure 56	Single-Precision FP Classify Instruction	114
Figure 57	Double-Precision FP Load Instruction	115
Figure 58	Double-Precision FP Store Instruction	115
Figure 59	Double-Precision FP Computational Instructions.....	116
Figure 60	Double-Precision FP Fused Computational Instructions.....	116
Figure 61	Double-Precision FP to Integer and Integer to FP Conversion Instructions	117
Figure 62	Double-Precision to Single-Precision and Single-Precision to Double-Precision FP	

Conversion Instructions	117
Figure 63 Double-Precision FP to FP Sign-Injection Instructions	118
Figure 64 Double-Precision FP Move Instructions.....	119
Figure 65 Double-Precision FP Compare Instructions	120
Figure 66 Double-Precision FP Classify Instruction.....	120
Figure 67 CR Format - Register	121
Figure 68 CI Format - Immediate	121
Figure 69 CSS Format - Stack-relative Store.....	121
Figure 70 CIW Format - Wide Immediate	121
Figure 71 CL Format - Load.....	121
Figure 72 CS Format - Store.....	121
Figure 73 CA Format - Arithmetic.....	121
Figure 74 CJ Format - Jump	121
Figure 75 Stack-Pointed-Based Loads.....	122
Figure 76 Stack-Pointed-Based Stores	122
Figure 77 Register-Based Loads.....	123
Figure 78 Register-Based Stores	123
Figure 79 Unconditional Jump Instructions.....	124
Figure 80 Unconditional Control Transfer Instructions	124
Figure 81 Conditional Control Transfer Instructions.....	124
Figure 82 Integer Constant-Generation Instructions	125
Figure 83 Integer Register-Immediate Operations.....	125
Figure 84 Integer Register-Immediate Operations (con't).....	125
Figure 85 Integer Register-Immediate Operations (con't).....	126
Figure 86 Integer Register-Immediate Operations (con't).....	126
Figure 87 Integer Register-Immediate Operations (con't).....	126
Figure 88 Integer Register-Register Operations.....	126
Figure 89 Integer Register-Register Operations (con't).....	127
Figure 90 Defined Illegal Instruction	127
Figure 91 Zicsr Instructions	130
Figure 92 Timer and Counter Pseudoinstructions	138
Figure 93 ECALL and EBREAK Instructions.....	140
Figure 94 Wait for Interrupt Instruction	141

Figure 95	Supervisor Memory-Management Fence Instruction.....	141
Figure 96	RISC-V Assembly Example	143
Figure 97	RISC-V Assembly to Machine Code	145
Figure 98	One RISC-V Instruction	146
Figure 99	Stack Memory during Function Calls.....	148
Figure 100	U74-MC Core Complex Interrupt Architecture Block Diagram.....	169
Figure 101	CLINT Block Diagram.....	185
Figure 102	CLINT Interrupts and Vector Table	186
Figure 103	CLINT Vector Table Example	187
Figure 104	CLINT Interrupt Attribute Example	189
Figure 105	PLIC Multi-Core Block Diagram.....	193
Figure 106	Bus-Error Unit Block Diagram	204
Figure 107	Organization of the SiFive L2 Cache Controller.....	209
Figure 108	Mapping of L2 Cache Ways to L2 LIM Addresses	210
Figure 109	Difference between L2 LIM and L2 Zero Device	213

Chapter 1

Introduction

SiFive's U74-MC Core Complex is a full-Linux-capable, cache-coherent 64-bit RISC-V processor available as an IP block. The SiFive U74-MC Core Complex is guaranteed to be compatible with all applicable RISC-V standards, and this document should be read together with the official RISC-V user-level, privileged, and external debug architecture specifications.



A summary of features in the U74-MC Core Complex can be found in Table 1.

U74-MC Core Complex Feature Set	
Feature	Description
Number of Harts	5 Harts.
S7 Core	1 × S7 RISC-V core.
U7 Core	4 × U7 RISC-V cores.
PLIC Interrupts	127 Interrupt signals, which can be connected to off-core-complex devices.
PLIC Priority Levels	The PLIC supports 7 priority levels.
Level 2 Cache	2 MiB 16-way L2 Cache.
Hardware Breakpoints	2 hardware breakpoints.
Physical Memory Protection Unit	PMP with 8 regions and a minimum granularity of 4096 bytes.

Table 1: U74-MC Core Complex Feature Set

The U74-MC Core Complex also has a number of on-core-complex configurability options, allowing one to tune the design to a specific application. The configurable options are described in Appendix A.

1.1 About this Document

This document describes the functionality of the U74-MC Core Complex 21G1.01.00. To learn more about the Evaluation RTL deliverables of the U74-MC Core Complex, consult the U74-MC Core Complex User Guide.

1.2 About this Release

This release of U74-MC Core Complex 21G1.01.00 is intended for evaluation purposes only. As such, the RTL source code has been intentionally obfuscated, and its use is governed by your Evaluation License.

1.3 U74-MC Core Complex Overview

The U74-MC Core Complex includes 1 × S7 and 4 × U7 64-bit RISC-V cores, along with the necessary functional units required to support the cores. These units include a Core-Local Interruptor (CLINT) to support local interrupts, a Platform-Level Interrupt Controller (PLIC) to support platform interrupts, physical memory protection, a Debug unit to support a JTAG-based debugger host connection, and a local cross-bar that integrates the various components together.

The U74-MC Core Complex memory system consists of a Data Cache, Data Tightly-Integrated Memory (DTIM), Instruction Cache, and Instruction Tightly-Integrated Memory (ITIM), with coherent L1 caches, a shared L2 cache, and a directory-based coherence manager. The U74-MC Core Complex also includes a Front Port, which allows external masters to be coherent with the L1 memory system and access to the TIMs, thereby removing the need to maintain coherence in software for any external agents.

All memories, including caches and TIMs, support Single Error Correction, Double Error Detection (SECEDED) ECC to provide improved reliability and address safety critical applications.

An overview of the SiFive U7-MC Series is shown in Figure 1. Refer to the docs/core_complex_configuration.txt file for a comprehensive summary of the U74-MC Core Complex configuration.

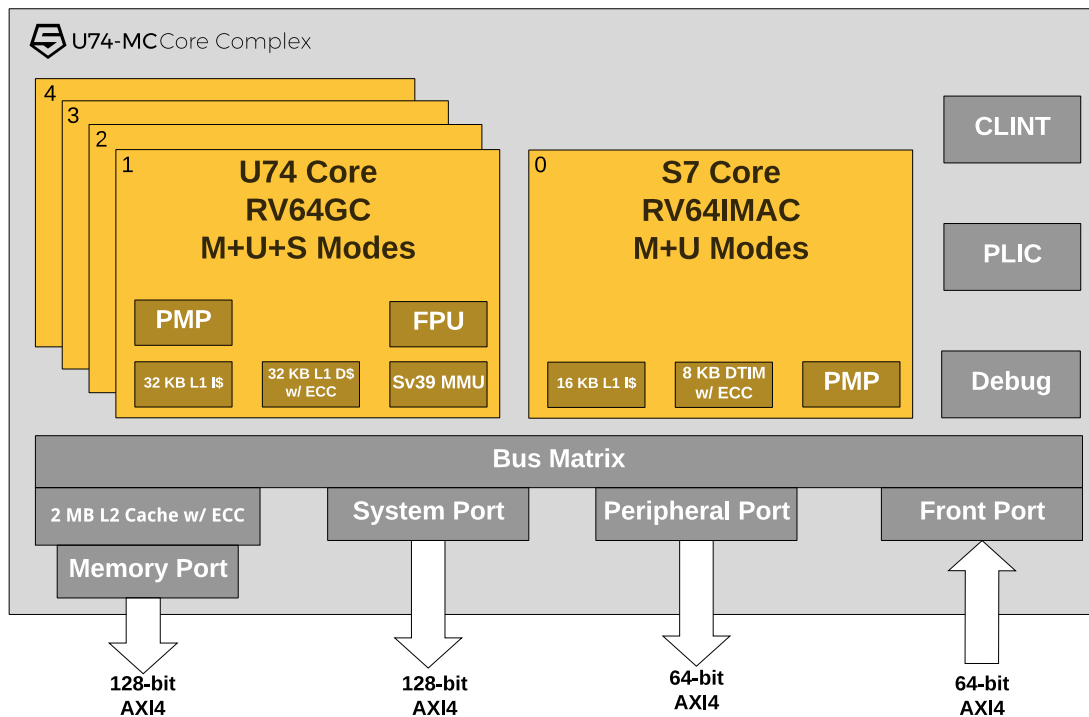

Figure 1: U7-MC Series Block Diagram

The U74-MC Core Complex memory map is detailed in Section 5.2, and the interfaces are described in full in the U74-MC Core Complex User Guide.

1.4 S7 RISC-V Monitor Core

The U74-MC Core Complex includes a 64-bit S7 RISC-V core, which has a dual-issue, in-order execution pipeline, with a peak execution rate of two instructions per clock cycle. The S7 core supports machine and user privilege modes, as well as standard Multiply (M), Atomic (A), Compressed (C), and Bit Manipulation (B) RISC-V extensions (RV64IMACB).

The monitor core is described in more detail in Chapter 3.

1.5 U7 RISC-V Application Cores

The U74-MC Core Complex includes four 64-bit U7 RISC-V cores, which each have a dual-issue, in-order execution pipeline, with a peak execution rate of two instructions per clock cycle. Each U7 core supports machine, supervisor, and user privilege modes, as well as standard Multiply (M), Single-Precision Floating Point (F), Double-Precision Floating Point (D), Atomic (A), Compressed (C), and Bit Manipulation (B) RISC-V extensions (RV64GCB).

The application cores are described in more detail in Chapter 4.

1.6 Interrupts

The U74-MC Core Complex provides the standard RISC-V M-mode timer and software interrupts via the Core-Local Interruptor (CLINT).

The U74-MC Core Complex also includes a RISC-V standard Platform-Level Interrupt Controller (PLIC), which supports 136 global interrupts with 7 priority levels pre-integrated with the on-core-complex peripherals.

Interrupts are described in Chapter 8. The CLINT is described in Chapter 9. The PLIC is described in Chapter 10.

1.7 Debug Support

The U74-MC Core Complex provides external debugger support over an industry-standard JTAG port, including 2 hardware-programmable breakpoints per hart.

Debug support is described in detail in Chapter 15, and the debug interface is described in the U74-MC Core Complex User Guide.

1.8 Compliance

The U74-MC Core Complex is compliant to the following versions of the various RISC-V specifications:

ISA	Version	Ratified	Frozen
RV64I Base Integer Instruction Set	2.0		Y
Extensions	Version	Ratified	Frozen
M Standard Extension for Integer Multiplication and Division	2.0	Y	
A Standard Extension for Atomic Instruction	2.0		Y
F Standard Extension for Single-Precision Floating-Point	2.0		Y
D Standard Extension for Double-Precision Floating-Point	2.0		Y
C Standard Extension for Compressed Instruction	2.0	Y	
B Standard Extension for Bit Manipulation	1.0		
Privilege Mode	Version	Ratified	Frozen
Machine-Level ISA	1.10		
User-Level ISA	1.10		
Supervisor-Level ISA	1.10		
Devices	Version	Ratified	Frozen
The RISC-V Debug Specification	0.13		

Table 2: RISC-V Specification Compliance

Chapter 2

List of Abbreviations and Terms

Term	Definition
AES	Advanced Encryption Standard
BHT	Branch History Table
BTB	Branch Target Buffer
CBC	Cipher Block Chaining
CCM	Counter with CBC-MAC
CFM	Cipher FeedBack
CLIC	Core-Local Interrupt Controller. Configures priorities and levels for core-local interrupts.
CLINT	Core-Local Interruptor. Generates per hart software interrupts and timer interrupts.
CTR	CounTeR mode
DTIM	Data Tightly Integrated Memory
ECB	Electronic Code Book
GCM	Galois/Counter Mode
hart	HARdware Thread
IJTP	Indirect-Jump Target Predictor
ITIM	Instruction Tightly Integrated Memory
JTAG	Joint Test Action Group
LIM	Loosely-Integrated Memory. Used to describe memory space delivered in a SiFive Core Complex that is not tightly integrated to a CPU core.
MDP	Memory Dependence Predictor
MSHR	Miss Status Handling Register
NLP	Next-Line Predictor
OFB	Output FeedBack
PLIC	Platform-Level Interrupt Controller. The global interrupt controller in a RISC-V system.
PMP	Physical Memory Protection
RAS	Return-Address Stack
RO	Used to describe a Read-Only register field.
ROB	Reorder Buffer
RW	Used to describe a Read/Write register field.
RW1C	Used to describe a Read/Write-1-to-Clear register field.
SHA	Secure Hash Algorithm
TileLink	A free and open interconnect standard originally developed at UC Berkeley.
TRNG	True Random Number Generator
WARL	Write-Any, Read-Legal field. A register field that can be written with any value, but returns only supported values when read.
WIRI	Writes-Ignored, Reads-Ignore field. A read-only register field reserved for future use. Writes to the field are ignored, and reads should ignore the value returned.

Table 3: Abbreviations and Terms

Term	Definition
WLRL	Write-Legal, Read-Legal field. A register field that should only be written with legal values and that only returns legal value if last written with a legal value.
WPRI	Writes-Preserve, Reads-Ignore field. A register field that might contain unknown information. Reads should ignore the value returned, but writes to the whole register should preserve the original value.
WO	Used to describe a Write-Only registers field.
W1C	Used to describe a Write-1-to-Clear register field.
RVV	RISC-V Vector ISA.
VLEN	Parameter which defines the number of bits in a single vector register.
SLEN	Parameter which specifies the striping distance.
ELEN	Parameter which defines the execution length.
SEW	Parameter which defines the selected element width.
LMUL	Vector register grouping factor.
DLEN	Vector ALU and memory datapath width.

Table 3: Abbreviations and Terms

Chapter 3

S7 RISC-V Core

This chapter describes the 64-bit S7 RISC-V processor core, instruction fetch and execution unit, L1 and L2 memory systems, Physical Memory Protection unit, Hardware Performance Monitor, and external interfaces.

The S7 feature set is summarized in Table 4.

Feature	Description
ISA	RV64IMACB
SiFive Custom Instruction Extension (SCIE)	Not Present
Modes	Machine mode, user mode
L1 Instruction Cache	16 KiB 2-way instruction cache
Instruction Tightly-Integrated Memory (ITIM)	16 KiB ITIM
Data Tightly-Integrated Memory (DTIM)	8 KiB DTIM
L2 Cache	2 MiB 16-way L2 cache with 2 banks
ECC Support	Single error correction, double error detection on the ITIM, DTIM, and L2 cache.
Fast I/O	Present
Physical Memory Protection	8 regions with a granularity of 64 bytes.

Table 4: S7 Feature Set

3.1 Supported Modes

The S7 supports RISC-V user mode, providing two levels of privilege: machine (M) and user (U). U-mode provides a mechanism to isolate application processes from each other and from trusted code running in M-mode.

See *The RISC-V Instruction Set Manual, Volume II: Privileged Architecture, Version 1.10* for more information on the privilege modes.

3.2 Instruction Memory System

This section describes the instruction memory system of the S7 Monitor core.

3.2.1 Execution Memory Space

The regions of executable memory consist of all directly addressable memory in the system. The memory includes any volatile or non-volatile memory located off the Core Complex ports, and includes the on-core-complex DTIM, ITIM, L2 LIM, and L2 Zero Device.

Table 5 shows the executable regions of the U74-MC Core Complex.

Base	Top	Description
0x0100_0000	0x0100_1FFF	S7 Hart 0 DTIM (8 KiB)
0x0180_0000	0x0180_3FFF	S7 Hart 0 ITIM
0x0800_0000	0x081F_FFFF	L2 LIM
0x0A00_0000	0x0A1F_FFFF	L2 Zero Device
0x2000_0000	0x3FFF_FFFF	Peripheral Port (512 MiB)
0x4000_0000	0x5FFF_FFFF	System Port (512 MiB)
0x8000_0000	0x9FFF_FFFF	Memory Port (512 MiB)

Table 5: Executable Memory Regions for the U74-MC Core Complex

All executable regions, except the ITIM, are treated as instruction cacheable. There is no method to disable this behavior.

Trying to execute an instruction from a non-executable address results in an instruction access trap.

3.2.2 L1 Instruction Cache

The L1 instruction cache is a 16 KiB 2-way set-associative cache. It has a line size of 64 bytes and is read/write-allocate with a random replacement policy. A cache line fill triggers a burst access outside of the Core Complex, starting with the first address of the cache line. There are no write-backs to memory from the instruction cache and it is not kept coherent with rest of the platform memory system. In multi-core systems, the instruction caches are not kept coherent with each other.

Out of reset, all blocks of the instruction cache are invalidated. The access latency of the cache is one clock cycle. There is no way to disable the instruction cache and cache allocations begin immediately out of reset.

The L1 instruction cache has parity error protection support.

3.2.3 Cache Maintenance

The instruction cache supports the FENCE . I instruction, which invalidates the entire instruction cache, as described in Section 6.13. Writes to instruction memory from the core or another master must be synchronized with the instruction fetch stream by executing FENCE . I.

3.2.4 Coherence with an L2 Cache

The L1 instruction cache is partially inclusive with the L2 Cache, described in Chapter 13. When a block of instruction memory is allocated to the L1 cache, it is also allocated to the L2 cache if the access was from the Memory Port. Instruction accesses to all other ports will not allocate to the L2 cache, only the L1 cache.

When a block is evicted from L1, it might still reside in the L2, which will reduce access time the next time the block is fetched.

If a hart modifies instruction memory (i.e., self-modifying code), then a `FENCE.I` instruction is required to synchronize the instruction and data streams. Even though `FENCE.I` targets the L1 instruction cache, no cache operation is required on the L2 cache to maintain instruction coherency.

3.2.5 Instruction Tightly-Integrated Memory (ITIM)

The S7 includes a 16 KiB ITIM in addition to the L1 instruction cache. ITIM accesses have the same performance as instruction cache hits, but can never suffer a miss. This makes the ITIM useful for storing code, which benefits from deterministic execution such as interrupt handlers.

The ITIM supports ECC protection, as described in Chapter 16.

3.2.6 Instruction Fetch Unit

The S7 instruction fetch unit is responsible for keeping the pipeline fed with instructions from memory. The instruction fetch unit delivers up to 8 bytes of instructions per clock cycle to support superscalar instruction execution. Fetches are always word-aligned and there is a one-cycle penalty for branching to a 32-bit instruction that is not word-aligned.

The S7 implements the standard Compressed (C) extension to the RISC-V architecture, which allows for 16-bit RISC-V instructions. As four 16-bit instructions can be fetched per cycle, the instruction fetch unit can be idle when executing programs comprised mostly of compressed 16-bit instructions. This reduces memory accesses and power consumption.

All branches must be aligned to half-word addresses. Otherwise, the fetch generates an instruction address misaligned trap. Trying to fetch from a non-executable or unimplemented address results in an instruction access trap.

3.2.7 Branch Prediction

The S7 instruction fetch unit contains sophisticated predictive hardware to mitigate the performance impact of control hazards within the instruction stream. The instruction fetch unit is decoupled from the execution unit, so that correctly predicted control-flow events usually do not result in execution stalls.

- A 16-entry branch target buffer (BTB), which predicts the target of taken branches and direct jumps;
- A 3.6 KiB branch history table (BHT), which predicts the direction of conditional branches;
- An 8-entry indirect-jump target predictor (IJTP);
- A 6-entry return-address stack (RAS), which predicts the target of procedure returns.

The BHT is a correlating predictor that supports long branch histories. The BTB has one-cycle latency, so that correctly predicted branches and direct jumps result in no penalty, provided the target is 8-byte aligned.

Direct jumps that miss in the BTB result in a one-cycle fetch bubble. This event might not result in any execution stalls if the fetch queue is sufficiently full.

The BHT, IJTP, and RAS take precedence over the BTB. If these structures' predictions disagree with the BTB's prediction, a one-cycle fetch bubble results. Similar to direct jumps that miss in the BTB, the fetch bubble might not result in an execution stall.

Mispredicted branches usually incur a four-cycle penalty, but sometimes the branch resolves later in the execution pipeline and incurs a six-cycle penalty instead. Mispredicted indirect jumps incur a six-cycle penalty.

Branch prediction is enabled out of reset and cannot be disabled. However, instruction speculation, fetching before a prediction is confirmed, must be enabled in the Feature Disable CSR, described in Chapter 7.

As instruction speculation can occur at any point after it has been enabled, data cacheable regions of memory (i.e., DDR) must be able to respond to instruction fetches immediately after instruction speculation is enabled. If DDR initialization is not completed before instruction speculation is enabled, the memory system must return a decode error (DECERR) for accesses made to DDR. The fetch unit will ignore errors associated with speculative accesses and continue to operate normally.

The Branch Prediction Mode CSR, also described in Chapter 7, provides a means to customize the branch predictor behavior to trade average performance for more predictable execution time.

3.3 Execution Pipeline

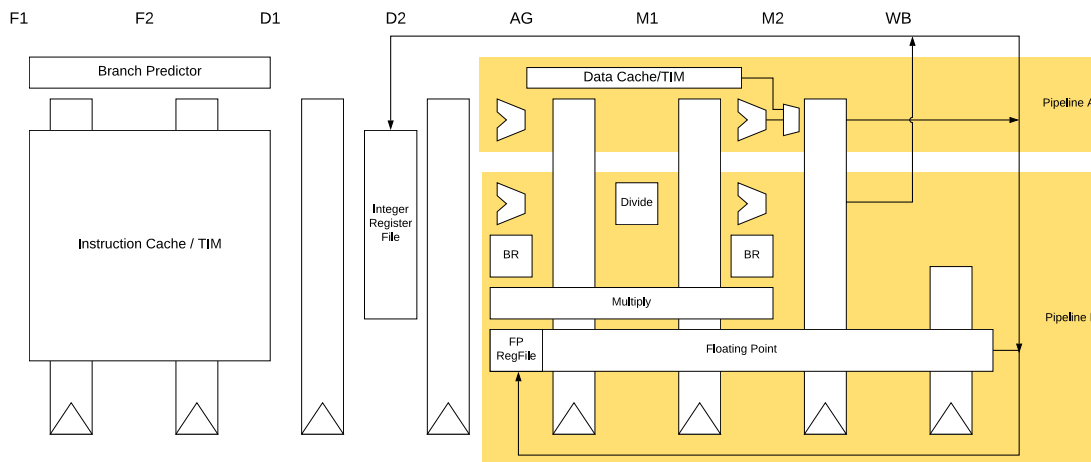

Figure 2: Example S7 Block Diagram

The S7 execution unit is a dual-issue, in-order pipeline. The pipeline comprises eight stages: two stages of instruction fetch (F1 and F2), two stages of instruction decode (D1 and D2), address generation (AG), two stages of data memory access (M1 and M2), and register write-back (WB). The pipeline has a peak execution rate of two instructions per clock cycle, and is fully bypassed so that most instructions have a one-cycle result latency:

- Integer arithmetic and branch instructions can execute in either the AG or M2 pipeline stage. If such an instruction's operands are available when the instruction enters the AG stage, then it executes in AG; otherwise, it executes in M2.
- Loads produce their result in the M2 stage. There is no load-use delay for most integer instructions. However, effective addresses for memory accesses are always computed in the AG stage. Hence, loads, stores, and indirect jumps require their address operands to be ready when the instruction enters AG. If an address-generation operation depends upon a load from memory, then the load-use delay is two cycles.
- Integer multiplication instructions consume their operands in the AG stage and produce their results in the M2 stage. The integer multiplier is fully pipelined.
- Integer division instructions consume their operands in the AG stage. These instructions have between a six-cycle and 68-cycle result latency, depending on the operand values.
- CSR accesses execute in the M2 stage. CSR read data can be bypassed to most integer instructions with no delay. Most CSR writes flush the pipeline, which is a seven-cycle penalty.

Instruction	Latency
LW	Three-cycle latency, assuming cache hit ¹
LH, LHU, LB, LBU	Three-cycle latency, assuming cache hit ¹
CSR Reads	One-cycle latency ²
MUL, MULH, MULHU, MULHSU	Three-cycle latency
DIV, DIVU, REM, REMU	Between six-cycle to 68-cycle latency, depending on operand values ³
¹ Effective address not ready in AG stage. Load to use latency = load to use delay + 1 ² cycle latency = cycle delay + 1 ³ The latency of DIV, DIVU, REM, and REMU instructions can be determined by calculating: Latency = 2 cycles + $\log_2(\text{dividend}) - \log_2(\text{divisor}) + 1$ cycle if the input is negative + 1 cycle if the output is negative	

Table 6: S7 Instruction Latency

The pipeline only interlocks on read-after-write and write-after-write hazards, so instructions may be scheduled to avoid stalls.

The pipeline implements a flexible dual-instruction-issue scheme. Provided there are no data hazards between a pair of instructions, the two instructions may issue in the same cycle, provided the following constraints are met:

- At most one instruction accesses data memory.
- At most one instruction is a branch or jump.
- At most one instruction is an integer multiplication or division operation.
- Neither instruction explicitly accesses a CSR.

3.4 Data Memory System

The data memory system consists of on-core-complex data and the ports in the U74-MC Core Complex memory map, shown in Section 5.2. The on-core-complex data memory consists of an 8 KiB Data Tightly-Integrated Memory (DTIM) and 2 MiB L2 cache. A design cannot have both data cache and DTIM.

As no data cache is present, all data accesses are non-cacheable. Data accesses that are not targeted at the DTIM are also called memory-mapped I/O accesses, or MMIOs.

The S7 pipeline allows for multiple outstanding memory accesses. The memory system includes the Fast I/O feature, described in Section 3.5, which improves the throughput of MMIOs. The number of outstanding MMIOs are implementation dependent. Misaligned accesses are not allowed to any memory region and result in a trap to allow for software emulation.

3.4.1 Data Tightly-Integrated Memory (DTIM)

The DTIM provides deterministic access time, which is important for applications with hard real-time requirements. The access latency is two clock cycles for words and double-words, and three clock cycles for smaller quantities.

Stores are pipelined and commit on cycles where the data memory system is otherwise idle. Loads to addresses currently in the store pipeline result in a five-cycle penalty.

The DTIM region can be used to store instructions, but it has no lasting performance advantage over other memory regions. Fetching from the DTIM first results in an instruction cache line fill and execution occurs from the instruction cache.

The DTIM is capable of supporting the RISC-V standard Atomic (A) extension. Note that atomic extension support has not been configured in the U74-MC Core Complex.

The DTIM supports ECC protection, as described in Chapter 16.

3.5 Fast I/O

The Fast I/O feature improves the performance of the memory-mapped I/O (MMIO) subsystem. This is achieved by predicting whether an access is I/O or not by examining the base address of a read or write.

Fast I/O enables a sustained rate of one MMIO operation per clock cycle. By contrast, when this feature is excluded, MMIO loads can only sustain half that rate. Fast I/O also decouples the MMIO load response from the cache-hit path. This way, MMIO requests and responses can happen on the same cycle, doubling the peak load throughput.

Note

Fast I/O is NOT an I/O port.

3.6 Atomic Memory Operations

The S7 core supports the RISC-V standard Atomic (A) extension on the Peripheral Port and internal memory regions.

The load-reserved (LR) and store-conditional (SC) instructions are special atomic instructions that are only supported in data cacheable regions. As the S7 core does not have a data cache, the LR and SC instructions will always generate a precise access exception.

Atomic memory operations are not supported on the System Port. Atomic operations that target the System Port will generate a precise access exception.

See Section 6.4 for more information on the instructions added by this extension.

3.7 Physical Memory Protection (PMP)

Machine mode is the highest privilege level and by default has read, write, and execute permissions across the entire memory map of the device. However, privilege levels below machine mode do not have read, write, or execute permissions to any region of the device memory map unless it is specifically allowed by the PMP. For the lower privilege levels, the PMP may grant permissions to specific regions of the device's memory map, but it can also revoke permissions when in machine mode.

When programmed accordingly, the PMP will check every access when the hart is operating in user mode. For machine mode, PMP checks do not occur unless the lock bit (L) is set in the `pmpcfgY` CSR for a particular region.

PMP checks also occur on loads and stores when the machine previous privilege level is user (`mstatus.MPP=0x0`), and the Modify Privilege bit is set (`mstatus.MPRV=1`). For virtual address translation, PMP checks are also applied to page table accesses in supervisor mode.

The S7 PMP supports 8 regions with a minimum region size of 64 bytes.

This section describes how PMP concepts in the RISC-V architecture apply to the S7. For additional information on the PMP refer to *The RISC-V Instruction Set Manual, Volume II: Privileged Architecture, Version 1.10*.

3.7.1 PMP Functional Description

The S7 PMP unit has 8 regions and a minimum granularity of 64 bytes. Access to each region is controlled by an 8-bit `pmpXcfg` field and a corresponding `pmpaddrX` register. Overlapping regions are permitted, where the lower numbered `pmpXcfg` and `pmpaddrX` registers take priority over higher numbered regions. The S7 PMP unit implements the architecturally defined `pmpcfgY` CSR `pmpcfg0`, supporting 8 regions. `pmpcfg2` is implemented, but hardwired to zero. Access to `pmpcfg1` or `pmpcfg3` results in an illegal instruction exception.

The PMP registers may only be programmed in M-mode. Ordinarily, the PMP unit enforces permissions on U-mode accesses. However, locked regions (see Section 3.7.2) additionally enforce their permissions on M-mode.

3.7.2 PMP Region Locking

The PMP allows for region locking whereby, once a region is locked, further writes to the configuration and address registers are ignored. Locked PMP entries may only be unlocked with a system reset. A region may be locked by setting the L bit in the `pmpXcfg` register.

In addition to locking the PMP entry, the L bit indicates whether the R/W/X permissions are enforced on machine mode accesses. When the L bit is clear, the R/W/X permissions apply only to U-mode.

3.7.3 PMP Registers

Each PMP region is described by an 8-bit `pmpXcfg` field, used in association with a 64-bit `pmpaddrX` register that holds the base address of the protected region. The range of each region depends on the Addressing (A) mode described in the next section. The `pmpXcfg` fields reside within 64-bit `pmpcfgY` CSRs.

Each 8-bit `pmpXcfg` field includes a read, write, and execute bit, plus a two bit address-matching field A, and a Lock bit, L. Overlapping regions are permitted, where the lowest numbered PMP entry wins for that region.

PMP Configuration Registers

For RV64 architectures, `pmpcfg1` and `pmpcfg3` are not implemented. This reduces the footprint since `pmpcfg2` already contains configuration fields `pmp8cfg` through `pmp11cfg` for both RV32 and RV64.

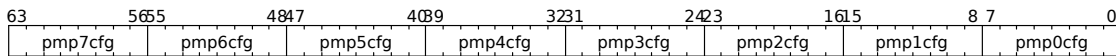

Figure 3: RV64 `pmpcfg0` Register

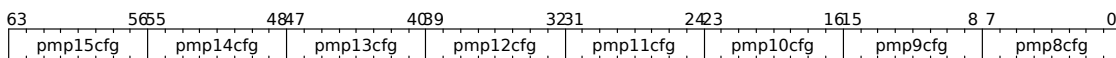

Figure 4: RV64 `pmpcfg2` Register

The `pmpcfgY` and `pmpaddrX` registers are only accessible via CSR specific instructions such as `csrr` for reads, and `csrw` for writes.

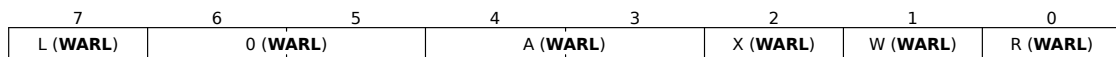

Figure 5: RV64 `pmpXcfg` bitfield

Bits	Description
0	R: Read Permissions <ul style="list-style-type: none"> • 0x0 - No read permissions for this region • 0x1 - Read permission granted for this region
1	W: Write Permissions <ul style="list-style-type: none"> • 0x0 - No write permissions for this region • 0x1 - Write permission granted for this region
2	X: Execute permissions <ul style="list-style-type: none"> • 0x0 - No execute permissions for this region • 0x1 - Execute permission granted for this region
[4:3]	A: Address matching mode <ul style="list-style-type: none"> • 0x0 - PMP Entry disabled. No PMP protection applied for any privilege level. • 0x1 - Top of range (TOR) region defined by two adjacent pmpaddr registers. The upper limit of region X is defined by pmpaddrX, and the base of the region is defined by pmpaddr(X-1). Address 'a' matches the region if $[pmpaddr(X-1) \leq a < pmpaddrX]$. If pmp0cfg defines a TOR region, then the base address of that region is 0x0, and pmpaddr0 defines the upper limit. Supports only a four byte granularity. • 0x2 - Naturally aligned four-byte region (NA4). Supports only a four-byte region with four byte granularity. • 0x3 - Naturally aligned power-of-two region (NAPOT), ≥ 8 bytes. When this setting is programmed, the low bits of the pmpaddrX register encode the size, while the upper bits encode the base address right shifted by two. There is a zero bit in between, we will refer to as the least significant zero bit (LSZB).
7	L: Lock Bit <ul style="list-style-type: none"> • 0x0 - PMP Entry Unlocked, no permission restrictions applied to machine mode. PMP entry only applies to S and U modes. • 0x1 - PMP Entry Locked, permissions enforced for all privilege levels including machine mode. Writes to pmpXcfg and pmpcfgY are ignored and can only be cleared with system reset.
Note: The combination of R=0 and W=1 is not currently implemented.	

Table 7: pmpXcfg Bitfield Description

Out of reset, the PMP register fields A and L are set to 0. All other hart state is unspecified by *The RISC-V Instruction Set Manual, Volume II: Privileged Architecture, Version 1.10*.

Some examples follow using NAPOT address mode.

Base Address	Region Size*	LSZB Position	pmpaddrX Value
0x4000_0000	8 B	0	(0x1000_0000 1'b0)
0x4000_0000	32 B	2	(0x1000_0000 3'b011)
0x4000_0000	4 KB	9	(0x1000_0000 10'b01_1111_1111)
0x4000_0000	64 KB	13	(0x1000_0000 14'b01_1111_1111_1111)
0x4000_0000	1 MB	17	(0x1000_0000 18'b01_1111_1111_1111_1111)
*Region size is $2^{(LSZB+3)}$.			

Table 8: pmpaddrX Encoding Examples for A=NAPOT

PMP Address Registers

The PMP has 8 address registers. Each address register pmpaddrX correlates to the respective pmpXcfg field. Each address register contains the base address of the protected region right shifted by two, for a minimum 4-byte alignment.

The maximum encoded address bits per *The RISC-V Instruction Set Manual, Volume II: Privileged Architecture, Version 1.10* are [55:2].

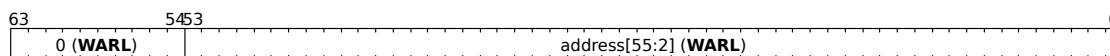

Figure 6: RV64 pmpaddrX Register

3.7.4 PMP and PMA

The PMP values are used in conjunction with the Physical Memory Attributes (PMAs) described in Section 5.1. Since the PMAs are static and not configurable, the PMP can only revoke read, write, or execute permissions to the PMA regions if those permissions already apply statically.

3.7.5 PMP Programming Overview

The PMP registers can only be programmed in machine mode. The pmpaddrX register should be first programmed with the base address of the protected region, right shifted by two. Then, the pmpcfgY register should be programmed with the properly configured 64-bit value containing each properly aligned 8-bit pmpXcfg field. Fields that are not used can be simply written to 0, marking them unused.

PMP Programming Example

The following example shows a machine mode only configuration where PMP permissions are applied to three regions of interest, and a fourth region covers the remaining memory map. Recall that lower numbered pmpXcfg and pmpaddrX registers take priority over higher numbered regions. This rule allows higher numbered PMP registers to have blanket coverage over the entire memory map while allowing lower numbered regions to apply permissions to specific regions of interest. The following example shows a 64 KB Flash region at base address 0x0, a

32 KB RAM region at base address 0x2000_0000, and finally a 4 KB peripheral region at base address base 0x3000_0000. The rest of the memory map is reserved space.

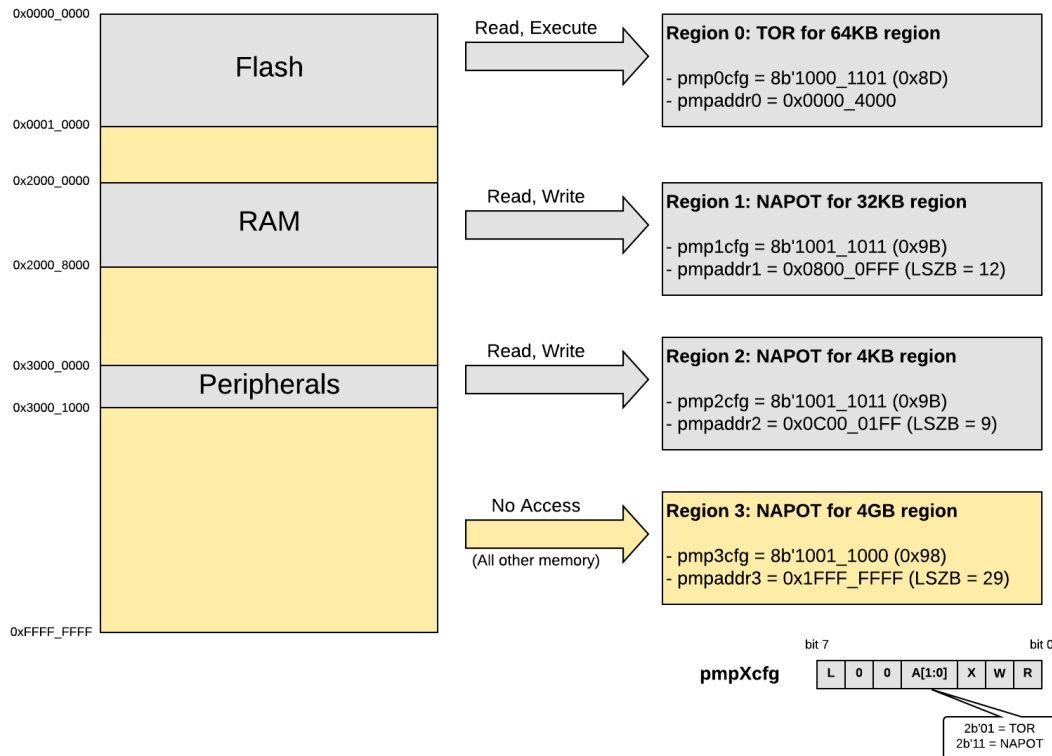

Figure 7: PMP Example Block Diagram

PMP Access Scenarios

The L, R, W, and X bits only determine if an access succeeds if all bytes of that access are covered by that PMP entry. For example, if a PMP entry is configured to match the four-byte range 0xC–0xF, then an 8-byte access to the range 0x8–0xF will fail, assuming that PMP entry is the highest-priority entry that matches those addresses.

While operating in machine mode when the lock bit is clear (L=0), if a PMP entry matches all bytes of an access, the access succeeds. If the lock bit is set (L=1) while in machine mode, then the access depends on the permissions set for that region. Similarly, while in Supervisor mode, the access depends on permissions set for that region.

Failed read or write accesses generate a load or store access exception, and an instruction access fault would occur on a failed instruction fetch. When an exception occurs while attempting to execute from a region without execute permissions, the fault occurs on the fetch and not the branch, so the mepc CSR will reflect the value of the targeted protected region, and not the address of the branch.

It is possible for a single instruction to generate multiple accesses, which may not be mutually atomic. If at least one access generated by an instruction fails, then an exception will occur. It might be possible that other accesses from a single instruction will succeed, with visible side effects. For example, references to virtual memory may be decomposed into multiple accesses.

On some implementations, misaligned loads, stores, and instruction fetches may also be decomposed into multiple accesses, some of which may succeed before an access exception occurs. In particular, a portion of a misaligned store that passes the PMP check may become visible, even if another portion fails the PMP check. The same behavior may manifest for floating-point stores wider than XLEN bits (e.g., the FSD instruction in RV32D), even when the store address is naturally aligned.

3.7.6 PMP and Paging

The Physical Memory Protection mechanism is designed to compose with the page-based virtual memory systems described in *The RISC-V Instruction Set Manual, Volume II: Privileged Architecture, Version 1.10*. When paging is enabled, instructions that access virtual memory may result in multiple physical-memory accesses, including implicit references to the page tables. The PMP checks apply to all of these accesses. The effective privilege mode for implicit page-table accesses is supervisor mode.

Implementations with virtual memory are permitted to perform address translations speculatively and earlier than required by an explicit virtual-memory access. The PMP settings for the resulting physical address may be checked at any point between the address translation and the explicit virtual-memory access. A mis-predicted branch to a non-executable address range does not generate a trap. Hence, when the PMP settings are modified in a manner that affects either the physical memory that holds the page tables or the physical memory to which the page tables point, M-mode software must synchronize the PMP settings with the virtual memory system. This is accomplished by executing an SFENCE.VMA instruction with $rs1=x0$ and $rs2=x0$, after the PMP CSRs are written.

If page-based virtual memory is not implemented, or when it is disabled, memory accesses check the PMP settings synchronously, so no fence is needed.

3.7.7 PMP Limitations

In a system containing multiple harts, each hart has its own PMP device. The PMP permissions on a hart cannot be applied to accesses from other harts in a multi-hart system. In addition, SiFive designs may contain a Front Port to allow external bus masters access to the full memory map of the system. The PMP cannot prevent access from external bus masters on the Front Port.

3.7.8 Behavior for Regions without PMP Protection

If a non-reserved region of the memory map does not have PMP permissions applied, then by default, supervisor or user mode accesses will fail, while machine mode access will be allowed.

Access to reserved regions within a device's memory map (an interrupt controller for example) will return 0x0 on reads, and writes will be ignored. Access to reserved regions outside of a device's memory map without PMP protection will result in a bus error. The bus error can generate an interrupt to the hart using the Bus-Error Unit (BEU). See Chapter 12 for more information.

3.7.9 Cache Flush Behavior on PMP Protected Region

When a line is brought into cache and the PMP is set up with the lock (L) bit asserted to protect a part of that line, a data cache flush instruction will generate a store access fault exception if the flush includes any part of the line that is protected. The cache flush instruction does an invalidate and write-back, so it is essentially trying to write back to the memory location that is protected. If a cache flush occurs on a part of the line that was not protected, the flush will succeed and not generate an exception. If a data cache flush is required without a write-back, use the cache discard instruction instead, as this will invalidate but not write back the line.

3.8 Hardware Performance Monitor

The S7 processor core supports a basic hardware performance monitoring (HPM) facility. The performance monitoring facility is divided into two classes of counters: fixed-function and event-programmable counters. These classes consist of a set of fixed counters and their counter-enable registers, as well as a set of event-programmable counters and their event selector registers. The registers are available to control the behavior of the counters. Performance monitoring can be useful for multiple purposes, from optimization to debug.

3.8.1 Performance Monitoring Counters Reset Behavior

The `instret` and `cycle` counters are initialized to zero on system reset. The hardware performance monitor event counters are not initialized on system reset, and thus have an arbitrary value. Users can write desired values to the counter control and status registers (CSRs) to start counting at a given, known value.

3.8.2 Fixed-Function Performance Monitoring Counters

A fixed-function performance monitor counter is hardware wired to only count one specific event type. That is, they cannot be reconfigured with respect to the event type(s) they count. The only modification to the fixed-function performance monitoring counters that can be done is to enable or disable counting, and write the counter value itself.

The S7 processor core contains two fixed-function performance monitoring counters.

Fixed-Function Cycle Counter (`mcycle`)

The fixed-function performance monitoring counter `mcycle` holds a count of the number of clock cycles the hart has executed since some arbitrary time in the past. The `mcycle` counter is read-write and 64 bits wide. Reads of `mcycle` return all 64 bits of the `mcycle` CSR.

Fixed-Function Instructions-Retired Counter (`minstret`)

The fixed-function performance monitoring counter `minstret` holds a count of the number of instructions the hart has retired since some arbitrary time in the past. The `minstret` counter is read-write and 64 bits wide. Reads of `minstret` return all 64 bits of the `minstret` CSR.

3.8.3 Event-Programmable Performance Monitoring Counters

Complementing the fixed-function counters are a set of programmable event counters. The S7 HPM includes two additional event counters, `mhpmcounter3` and `mhpmcounter4`. These programmable event counters are read-write and 64 bits wide. The hardware counters themselves are implemented as 40-bit counters on the S7 core series. These hardware counters can be written to in order to initialize the counter value.

3.8.4 Event Selector Registers

To control the event type to count, event selector CSRs `mhpmevent3` and `mhpmevent4` are used to program the corresponding event counters. These event selector CSRs are 64-bit **WARL** registers.

The event selectors are partitioned into two fields; the lower 8 bits select an event class, and the upper bits form a mask of events in that class.

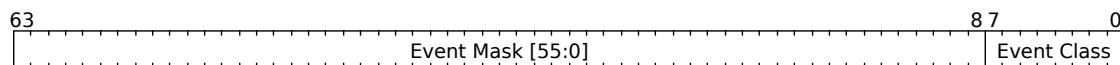

Figure 8: Event Selector Fields

The counter increments if the event corresponding to any set mask bit occurs. For example, if `mhpmevent3` is set to `0x4200`, then `mhpmcounter3` will increment when either a load instruction or a conditional branch instruction retires. An event selector of 0 means "count nothing".

3.8.5 Event Selector Encodings

Table 9 describes the event selector encodings available. Events are categorized into classes based on the Event Class field encoded in `mhpmeventX[7:0]`. One or more events can be programmed by setting the respective Event Mask bit for a given event class. An event selector encoding of 0 means "count nothing". Multiple events will cause the counter to increment any time any of the selected events occur.

Machine Hardware Performance Monitor Event Register	
Instruction Commit Events, mhpmeventX[7:0]=0x0	
Bits	Description
8	Exception taken
9	Integer load instruction retired
10	Integer store instruction retired
11	Atomic memory operation retired
12	System instruction retired
13	Integer arithmetic instruction retired
14	Conditional branch retired
15	JAL instruction retired
16	JALR instruction retired
17	Integer multiplication instruction retired
18	Integer division instruction retired
Microarchitectural Events, mhpmeventX[7:0]=0x1	
Bits	Description
8	Address-generation interlock
9	Long-latency interlock
10	CSR read interlock
11	Instruction cache/ITIM busy
12	Data cache/DTIM busy
13	Branch direction misprediction
14	Branch/jump target misprediction
15	Pipeline flush from CSR write
16	Pipeline flush from other event
17	Integer multiplication interlock
Memory System Events, mhpmeventX[7:0]=0x2	
Bits	Description
8	Instruction cache miss
9	Memory-mapped I/O access

Table 9: mhpmevent Register

Event mask bits that are writable for any event class are writable for all classes. Setting an event mask bit that does not correspond to an event defined in Table 9 has no effect for current implementations. However, future implementations may define new events in that encoding space, so it is not recommended to program unsupported values into the mhpmevent registers.

Combining Events

It is common usage to directly count each respective event. Additionally, it is possible to use combinations of these events to count new, unique events. For example, to determine the average cycles per load from a data memory subsystem, program one counter to count "Data cache/DTIM busy" and another counter to count "Integer load instruction retired". Then, simply divide

the "Data cache/DTIM busy" cycle count by the "Integer load instruction retired" instruction count and the result is the average cycle time for loads in cycles per instruction.

It is important to be cognizant of the event types being combined; specifically, event types counting occurrences and event types counting cycles.

3.8.6 Counter-Enable Registers

The 32-bit counter-enable register `mcounteren` controls the availability of the hardware performance-monitoring counters to the next-lowest privileged mode.

The settings in these registers only control accessibility. The act of reading or writing these enable registers does not affect the underlying counters, which continue to increment when not accessible.

When any bit in the `mcounteren` register is clear, attempts to read the cycle, time, instruction retire, or `hpmcounterX` register while executing in U-mode will cause an illegal instruction exception. When one of these bits is set, access to the corresponding register is permitted in the next implemented privilege mode, U-mode.

`mcounteren` is a **WARL** register. Any of the bits may contain a hardwired value of zero, indicating reads to the corresponding counter will cause an illegal instruction exception when executing in a less-privileged mode.

3.9 L2 Performance Monitor

Similar to the hardware performance monitor (HPM), the S7 processor core supports a L2 performance monitoring (L2PM) facility. It consists of a set of event-programmable counters and their event selector registers. The registers are available to control the behavior of the counters.

The L2PM for each L2 Cache in the system resides within a 16 KiB segment of MMIO CSR address space, starting at `0x0201_0000` (plus offset). The performance event selector and other control registers are configured in M-mode, and the event-programmable counters can be read in user mode.

3.9.1 Control Port Register Map

For each L2 Cache in the system, the 16 KiB region is partitioned as shown:

Offset	CSR Group	Size
0x0000	L2 Cache control	4 KiB
0x1000	Reserved	4 KiB
0x2000	L2PM event control	4 KiB
0x3000	L2PM event counters	4 KiB

Table 10: L2PM Partition

3.9.2 L2PM Event Control

Depending on configuration options chosen during core creation, up to 64 Performance Event Selectors (default = 6) are available.

Offset	Bits	Access	Description
0x2000	64	RW	L2pmevent0
0x2008	64	RW	L2pmevent1
0x2010	64	RW	L2pmevent2
0x2018	64	RW	L2pmevent3
0x2020	64	RW	L2pmevent4
0x2028	64	RW	L2pmevent5
0x2030	64	RW	L2pmevent6
0x2038	64	RW	L2pmevent7
...
0x21F8	64	RW	L2pmevent63
...
0x2800	64	RW	L2ClientFilter
...

Table 11: L2PM Event Control

The Performance Event Selectors (L2pmevent0-L2pmevent5) follow the definition of mhpmevent* as defined in the RISC-V ISA, with the following differences:

- L2pmevent* is always 64-bits wide
- In RV32 systems, L2pmevent* entries can be accessed using the low and high 32-bits, with the higher 32-bits of each L2pmevent aliased as L2pmevent*h.

L2 Counter Client Filter CSR (L2ClientFilter)

The L2 counter client filter register L2ClientFilter is a 64-bit **WARL** register that controls which client's performance events are excluded from incrementing the performance monitor counters. However, some events might not be attributed to a particular client in a specific implementation (for example, the L2 release event in SiFive's L2 cache design).

L2 Performance Monitor Counters (L2pmcounter*)

The L2 Performance Monitor counters (L2pmcounter*), follow the definition of mhpcounter* as defined in the RISC-V ISA. They are **WARL** registers that support up to 64 bits of precision on RV32 and RV64. The high 32-bits are aliased as L2pmcounter*h.

Offset	Bits	Access	Description
0x3000	64	RO	L2pmcounter0
0x3008	64	RO	L2pmcounter1
0x3010	64	RO	L2pmcounter2
0x3018	64	RO	L2pmcounter3
0x3020	64	RO	L2pmcounter4
0x3028	64	RO	L2pmcounter5
0x3030	64	RO	L2pmcounter6
0x3038	64	RO	L2pmcounter7
...
0x31F8	64	RO	L2pmcounter63
...
...

Table 12: L2 Performance Monitor Counters

Offset	Bits	Access	Description
0x3004	32	RO	L2pmcounter0h
0x300C	32	RO	L2pmcounter1h
0x3014	32	RO	L2pmcounter2h
0x301C	32	RO	L2pmcounter3h
0x3024	32	RO	L2pmcounter4h
0x302C	32	RO	L2pmcounter5h
0x3034	32	RO	L2pmcounter6h
0x303C	32	RO	L2pmcounter7h
...
0x31FC	32	RO	L2pmcounter63h
...
...

Table 13: L2 Performance Monitor Counters, 32-Bit Access

Note

If a counter is not implemented, such as when there is no L2PM, both the counter and its corresponding event selector are hard-wired to 0, meaning that the counter always returns 0.

3.9.3 Event Selector Registers

To control the event type to count, event selector CSRs L2pmevent0 through L2pmevent5 are used to program the corresponding event counters. These event selector CSRs are 64-bit **WARL** registers.

The event selectors are partitioned into two fields; the lower 8 bits select an event class, and the upper bits form a mask of events in that class.

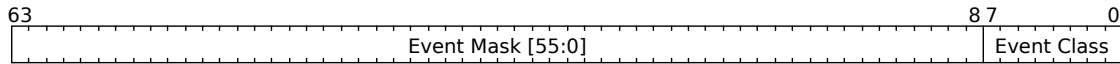

Figure 9: Event Selector Fields

The counter increments if the event corresponding to any set mask bit occurs.

3.9.4 Event Selector Encodings

Table 14 describes the event selector encodings available. Events are categorized into two classes based on the Event Class field encoded in L2pmeventX[7:0]. One or more events can be programmed by setting the respective Event Mask bit for a given event class. An event selector encoding of 0 means "count nothing". Multiple events will cause the counter to increment any time any of the selected events occur.

L2 Performance Monitor Event Register					
Transaction Events, L2pmeventX[7:0]=1					
Bits	Location	Opcode	Param	Can use clientFilter?	Description
0	Inner	PutFullData	-	Yes	
1	Inner	PutPartialData	-	Yes	
2	Inner	AtomicData	-	Yes	
3	Inner	Get	-	Yes	
4	Inner	Prefetch	read	Yes	
5	Inner	Prefetch	write	Yes	
6	Inner	AcquireBlock	NtoB	Yes	
7	Inner	AcquireBlock	NtoT	Yes	
8	Inner	AcquireBlock	BtoT	Yes	
9	Inner	AcquirePerm	NtoT	Yes	
10	Inner	AcquirePerm	BtoT	Yes	
11	Inner	Release	ToB	Yes	
12	Inner	Release	TtoN	Yes	
13	Inner	Release	BtoN	Yes	
14	Inner	ReleaseData	ToB	Yes	
15	Inner	ReleaseData	TtoN	Yes	
16	Inner	ReleaseData	BtoN	Yes	
17	Outer	ProbeBlock	toT	No	
18	Outer	ProbeBlock	toB	No	
19	Outer	ProbeBlock	toN	No	
L2 Query Result Events, L2pmeventX[7:0]=2					
Bits	Location	Opcode	Param	Can use clientFilter?	Description
0	Inner	PutFullData	-	Yes	Hit L2
1	Inner	PutPartialData	-	Yes	Hit L2
2	Inner	AtomicData	-	Yes	Hit L2
3	Inner	Get	-	Yes	Hit L2
4	Inner	Prefetch	-	Yes	Hit L2
5	Inner	AcquireBlock	-	Yes	Hit L2
6	Inner	AcquirePerm	-	Yes	Hit L2
7	Inner	Release	-	Yes	Hit L2
8	Inner	ReleaseData	-	Yes	Hit L2
9	Outer	Probe	-	No	Hit L2
10	Inner	PutFullData	-	Yes	Hit L2, "shared"
11	Inner	PutPartialData	-	Yes	Hit L2, "shared"
12	Inner	AtomicData	-	Yes	Hit L2, "shared"

Table 14: L2pmevent Register

13	Inner	Get	-	Yes	Hit L2, "shared"
14	Inner	Prefetch	-	Yes	Hit L2, "shared"
15	Inner	AcquireBlock	-	Yes	Hit L2, "shared"
16	Inner	AcquirePerm	-	Yes	Hit L2, "shared"
17	Outer	Probe	-	No	Hit L2, "shared"
18	Outer	Probe	-	No	Hit L2, "modified"
L2 Request Events, L2pmeventX[7:0]=3					
Bits	Location	Opcode	Param	Can use clientFilter?	Description
0	Outer	AcquireBlock	NtoB	No	L2 miss
1	Outer	AcquireBlock	NtoT	No	L2 miss
2	Outer	AcquireBlock	BtoT	No	L2 miss
3	Outer	AcquirePerm	NtoT	No	L2 miss
4	Outer	AcquirePerm	BtoT	No	L2 miss
5	Outer	Release	ToB	No	Eviction
6	Outer	Release	ToN	No	Eviction
7	Outer	Release	BtoN	No	Eviction
8	Outer	ReleaseData	ToB	No	Not applicable
9	Outer	ReleaseData	TtoN	No	Dirty Eviction
10	Outer	ReleaseData	BtoN	No	Not applicable
11	Inner	ProbeBlock	toT	No	Code miss hits other harts
12	Inner	ProbeBlock	toB	No	Load miss hits other harts
13	Inner	ProbeBlock	toN	No	Store miss hits other harts

Table 14: L2pmevent Register

Note: For the **Location** heading, "Inner" refers to the inner side of the L2 cache, i.e. transactions from the core and Front Port. "Outer" refers to the other side of the L2 Cache, i.e. read/write transactions from the L2 and probe requests from outside.

3.9.5 Setting up the pmclientmask Register

For each specific cluster configuration, the L2 may attach to different masters.

Master ID	Description
0	Debug
1	AXI4 Front Port ID#0
2	AXI4 Front Port ID#1
3	AXI4 Front Port ID#2
4	AXI4 Front Port ID#3
5	Hart 0 Fetch Unit
6	Hart 0 D-Cache MMIO
7	Hart 1 Fetch Unit
8	Hart 1 D-Cache
9	Hart 1 D-Cache
10	Hart 1 D-Cache MMIO
11	Hart 1 L2 Prefetcher
12	Hart 2 Fetch Unit
13	Hart 2 D-Cache
14	Hart 2 D-Cache
15	Hart 2 D-Cache MMIO
16	Hart 2 L2 Prefetcher
17	Hart 3 Fetch Unit
18	Hart 3 D-Cache
19	Hart 3 D-Cache
20	Hart 3 D-Cache MMIO
21	Hart 3 L2 Prefetcher
22	Hart 4 Fetch Unit
23	Hart 4 D-Cache
24	Hart 4 D-Cache
25	Hart 4 D-Cache MMIO
26	Hart 4 L2 Prefetcher

Table 15: Master IDs in the L2 Cache Controller

Note that the default value of pmclientmask is 0, therefore all clients' events are counted.

3.9.6 Programming the L2pmevent registers

The following example shows the use of 6 performance counters:

```
// directory lookup events: L1 miss
*pmEventSelect0 = 0x01          | // Event Set 1
    ( 0x01 << 6 ) | // innerAcquireBlockNtoB
    ( 0x01 << 7 ) | // innerAcquireBlockNtoT
    ( 0x01 << 8 ) | // innerAcquireBlockBtoT
    ( 0x01 << 9 ) | // innerAcquirePermNtoT
```

```

        (0x01 << 10)    // innerAcquirePermB2T
    ) << 8;
// directory lookup results: L1 miss hit L2
*pmEventSelect1 = 0x02    | // Event Set 2
    ( (0x01 << 5)    | // innerAcquireBlock_Hit
      (0x01 << 6)    // innerAcquirePerm_Hit
    ) << 8;
// directory lookup events: prefetch
*pmEventSelect2 = 0x01    | // Event Set 1
    ( (0x01 << 4 ) | // innerPrefetchRead
      (0x01 << 5 ) // innerPrefetchWrite
    ) << 8;
// prefetch hits L2
*pmEventSelect3 = 0x02    | // Event Set 2
    ( (0x01 << 4)    // innerPrefetch_Hit
    ) << 8;

// L1 request misses L2
*pmEventSelect4 = 0x03    | // Event Set3
    ( (0x01 << 0)    | // outerAcquireBlockNtoB
      (0x01 << 1)    | // outerAcquireBlockNtoT
      (0x01 << 2)    | // outerAcquireBlockBtoT
      (0x01 << 3)    | // outerAcquirePermNtoT
      (0x01 << 4)    // outerAcquirePermBtoT
    ) << 8;

```

3.10 Ports

This section describes the Port interfaces to the S7 core.

3.10.1 Front Port

The Front Port can be used by external masters to read from and write into the memory system utilizing any port in the Core Complex. The ITIM and DTIM can also be accessed through the Front Port.

Accesses from external masters through the Front Port have the same latency to either ITIM or DTIM, as Front Port instruction fetches are considered reads. In other words, code execution or data accesses to either ITIM or DTIM will have the same cycle count. Internal arbitration prioritizes access from the local hart over Front Port accesses, in the event that they happen at the same time.

If a Front Port access targets the Memory Port, a coherency manager is responsible for maintaining coherency with the L1 and L2 caches. A read access can be returned directly from the L1 or L2 cache without generating an external bus access. If a write from the Front Port targets a location in the L1 data cache, it results in the line being evicted and invalidated. The write will then allocate to the L2 cache.

Any Front Port access that targets the Memory Port and results in an L1 and L2 cache miss will allocate to the L2 cache.

The U74-MC Core Complex User Guide describes the implementation details of the Front Port.

Note

Logic in the core prevents non-debug-mode code from accessing the debug region. However, this logic does not intercept accesses from the Front Port. This means that it is possible for Front Port accesses to interfere with a debug session by writing to various offsets within the debug region. To work around this, do not access the debug module memory region via the Front Port.

3.10.2 Memory Port

The Memory Port is used to interface with memory that offers the highest performance for the U74-MC Core Complex, such as DDR. It supports cacheable accesses for data and instructions.

Consult Section 5.1 for further information about the Memory Port and its Physical Memory Attributes.

See the U74-MC Core Complex User Guide for a description of the Memory Port implementation in the U74-MC Core Complex.

3.10.3 Peripheral Port

The Peripheral Port is used to interface with lower speed peripherals and also supports code execution. When a device is attached to the Peripheral Port, it is expected that there are no other masters connected to that device.

Consult Section 5.1 for further information about the Peripheral Port and its Physical Memory Attributes.

See the U74-MC Core Complex User Guide for a description of the Peripheral Port implementation in the U74-MC Core Complex.

3.10.4 System Port

The System Port is used to interface with lower performance memory, like SRAM, memory-mapped I/O (MMIO), and higher speed peripherals. The System Port also supports code execution.

Consult Section 5.1 for further information about the System Port and its Physical Memory Attributes.

See the U74-MC Core Complex User Guide for a description of the System Port implementation in the U74-MC Core Complex.

Chapter 4

U7 RISC-V Core

This chapter describes the 64-bit U7 RISC-V processor core, instruction fetch and execution unit, L1 and L2 memory systems, Physical Memory Protection unit, Hardware Performance Monitor, and external interfaces.

The U7 feature set is summarized in Table 16.

Feature	Description
ISA	RV64GCB
SiFive Custom Instruction Extension (SCIE)	Not Present
Modes	Machine mode, user mode, supervisor mode
L1 Instruction Cache	32 KiB 2-way instruction cache
L1 Data Cache	32 KiB 4-way data cache
L2 Cache	2 MiB 16-way L2 cache with 2 banks
ECC Support	Single error correction, double error detection on the data cache and L2 cache.
Physical Memory Protection	8 regions with a granularity of 4096 bytes.
Memory Management Unit	Bare and Sv39 virtual memory support with fully-associative 40-entry L1 Data and Instruction TLBs, and a direct-mapped 512-entry L2 TLB.

Table 16: U7 Feature Set

4.1 Supported Modes

The U7 supports RISC-V supervisor and user modes, providing three levels of privilege: machine (M), user (U), and supervisor (S). U-mode provides a mechanism to isolate application processes from each other and from trusted code running in M-mode. S-mode adds a number of additional CSRs and capabilities.

See *The RISC-V Instruction Set Manual, Volume II: Privileged Architecture, Version 1.10* for more information on the privilege modes.

4.2 Instruction Memory System

This section describes the instruction memory system of the U7 Application core.

4.2.1 Execution Memory Space

The regions of executable memory consist of all directly addressable memory in the system. The memory includes any volatile or non-volatile memory located off the Core Complex ports, and includes the on-core-complex L2 LIM and L2 Zero Device.

Table 17 shows the executable regions of the U74-MC Core Complex.

Base	Top	Description
0x0100_0000	0x0100_1FFF	S7 Hart 0 DTIM (8 KiB)
0x0180_0000	0x0180_3FFF	S7 Hart 0 ITIM
0x0800_0000	0x081F_FFFF	L2 LIM
0x0A00_0000	0x0A1F_FFFF	L2 Zero Device
0x2000_0000	0x3FFF_FFFF	Peripheral Port (512 MiB)
0x4000_0000	0x5FFF_FFFF	System Port (512 MiB)
0x8000_0000	0x9FFF_FFFF	Memory Port (512 MiB)

Table 17: Executable Memory Regions for the U74-MC Core Complex

All executable regions are treated as instruction cacheable. There is no method to disable this behavior.

Trying to execute an instruction from a non-executable address results in an instruction access trap.

4.2.2 L1 Instruction Cache

The L1 instruction cache is a 32 KiB 2-way set-associative cache. It is virtually-indexed, physically-tagged with a line size of 64 bytes and is read/write-allocate with a random replacement policy. A cache line fill triggers a burst access outside of the Core Complex, starting with the first address of the cache line. There are no write-backs to memory from the instruction cache and it is not kept coherent with rest of the platform memory system. In multi-core systems, the instruction caches are not kept coherent with each other.

Out of reset, all blocks of the instruction cache are invalidated. The access latency of the cache is one clock cycle. There is no way to disable the instruction cache and cache allocations begin immediately out of reset.

The L1 instruction cache has parity error protection support.

4.2.3 Cache Maintenance

The instruction cache supports the `FENCE.I` instruction, which invalidates the entire instruction cache, as described in Section 6.13. Writes to instruction memory from the core or another master must be synchronized with the instruction fetch stream by executing `FENCE.I`.

4.2.4 Coherence with an L2 Cache

The L1 instruction cache is partially inclusive with the L2 Cache, described in Chapter 13. When a block of instruction memory is allocated to the L1 cache, it is also allocated to the L2 cache if the access was from the Memory Port. Instruction accesses to all other ports will not allocate to the L2 cache, only the L1 cache.

When a block is evicted from L1, it might still reside in the L2, which will reduce access time the next time the block is fetched.

If a hart modifies instruction memory (i.e., self-modifying code), then a `FENCE.I` instruction is required to synchronize the instruction and data streams. Even though `FENCE.I` targets the L1 instruction cache, no cache operation is required on the L2 cache to maintain instruction coherency.

4.2.5 Instruction Fetch Unit

The U7 instruction fetch unit is responsible for keeping the pipeline fed with instructions from memory. The instruction fetch unit delivers up to 8 bytes of instructions per clock cycle to support superscalar instruction execution. Fetches are always word-aligned and there is a one-cycle penalty for branching to a 32-bit instruction that is not word-aligned.

The U7 implements the standard Compressed (C) extension to the RISC-V architecture, which allows for 16-bit RISC-V instructions. As four 16-bit instructions can be fetched per cycle, the instruction fetch unit can be idle when executing programs comprised mostly of compressed 16-bit instructions. This reduces memory accesses and power consumption.

All branches must be aligned to half-word addresses. Otherwise, the fetch generates an instruction address misaligned trap. Trying to fetch from a non-executable or unimplemented address results in an instruction access trap.

4.2.6 Branch Prediction

The U7 instruction fetch unit contains sophisticated predictive hardware to mitigate the performance impact of control hazards within the instruction stream. The instruction fetch unit is decoupled from the execution unit, so that correctly predicted control-flow events usually do not result in execution stalls.

- A 16-entry branch target buffer (BTB), which predicts the target of taken branches and direct jumps;

- A 3.6 KiB branch history table (BHT), which predicts the direction of conditional branches;
- An 8-entry indirect-jump target predictor (IJTP);
- A 6-entry return-address stack (RAS), which predicts the target of procedure returns.

The BHT is a correlating predictor that supports long branch histories. The BTB has one-cycle latency, so that correctly predicted branches and direct jumps result in no penalty, provided the target is 8-byte aligned.

Direct jumps that miss in the BTB result in a one-cycle fetch bubble. This event might not result in any execution stalls if the fetch queue is sufficiently full.

The BHT, IJTP, and RAS take precedence over the BTB. If these structures' predictions disagree with the BTB's prediction, a one-cycle fetch bubble results. Similar to direct jumps that miss in the BTB, the fetch bubble might not result in an execution stall.

Mispredicted branches usually incur a four-cycle penalty, but sometimes the branch resolves later in the execution pipeline and incurs a six-cycle penalty instead. Mispredicted indirect jumps incur a six-cycle penalty.

Branch prediction is enabled out of reset and cannot be disabled. However, instruction speculation, fetching before a prediction is confirmed, must be enabled in the Feature Disable CSR, described in Chapter 7.

As instruction speculation can occur at any point after it has been enabled, data cacheable regions of memory (i.e., DDR) must be able to respond to instruction fetches immediately after instruction speculation is enabled. If DDR initialization is not completed before instruction speculation is enabled, the memory system must return a decode error (DECERR) for accesses made to DDR. The fetch unit will ignore errors associated with speculative accesses and continue to operate normally.

The Branch Prediction Mode CSR, also described in Chapter 7, provides a means to customize the branch predictor behavior to trade average performance for more predictable execution time.

4.3 Execution Pipeline

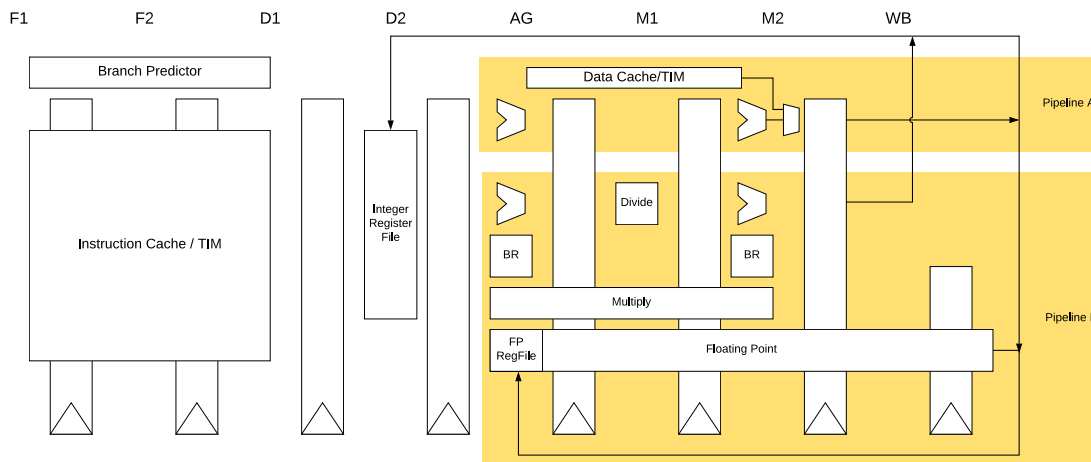

Figure 10: Example U7 Block Diagram

The U7 execution unit is a dual-issue, in-order pipeline. The pipeline comprises eight stages: two stages of instruction fetch (F1 and F2), two stages of instruction decode (D1 and D2), address generation (AG), two stages of data memory access (M1 and M2), and register write-back (WB). The pipeline has a peak execution rate of two instructions per clock cycle, and is fully bypassed so that most instructions have a one-cycle result latency:

- Integer arithmetic and branch instructions can execute in either the AG or M2 pipeline stage. If such an instruction's operands are available when the instruction enters the AG stage, then it executes in AG; otherwise, it executes in M2.
- Loads produce their result in the M2 stage. There is no load-use delay for most integer instructions. However, effective addresses for memory accesses are always computed in the AG stage. Hence, loads, stores, and indirect jumps require their address operands to be ready when the instruction enters AG. If an address-generation operation depends upon a load from memory, then the load-use delay is two cycles.
- Integer multiplication instructions consume their operands in the AG stage and produce their results in the M2 stage. The integer multiplier is fully pipelined.
- Integer division instructions consume their operands in the AG stage. These instructions have between a six-cycle and 68-cycle result latency, depending on the operand values.
- CSR accesses execute in the M2 stage. CSR read data can be bypassed to most integer instructions with no delay. Most CSR writes flush the pipeline, which is a seven-cycle penalty.

Instruction	Latency
LW	Three-cycle latency, assuming cache hit ¹
LH, LHU, LB, LBU	Three-cycle latency, assuming cache hit ¹
CSR Reads	One-cycle latency ²
MUL, MULH, MULHU, MULHSU	Three-cycle latency
DIV, DIVU, REM, REMU	Between six-cycle to 68-cycle latency, depending on operand values ³
¹ Effective address not ready in AG stage. Load to use latency = load to use delay + 1 ² cycle latency = cycle delay + 1 ³ The latency of DIV, DIVU, REM, and REMU instructions can be determined by calculating: Latency = 2 cycles + $\log_2(\text{dividend}) - \log_2(\text{divisor}) + 1$ cycle if the input is negative + 1 cycle if the output is negative	

Table 18: U7 Instruction Latency

The pipeline only interlocks on read-after-write and write-after-write hazards, so instructions may be scheduled to avoid stalls.

The pipeline implements a flexible dual-instruction-issue scheme. Provided there are no data hazards between a pair of instructions, the two instructions may issue in the same cycle, provided the following constraints are met:

- At most one instruction accesses data memory.
- At most one instruction is a branch or jump.
- At most one instruction is a floating-point arithmetic operation.
- At most one instruction is an integer multiplication or division operation.
- Neither instruction explicitly accesses a CSR.

See Appendix C for a complete list of floating-point unit instruction timings.

4.4 Data Memory System

The data memory system consists of on-core-complex data and the ports in the U74-MC Core Complex memory map, shown in Section 5.2. The on-core-complex data memory consists of a 32 KiB L1 data cache and 2 MiB L2 cache. A design cannot have both data cache and DTIM.

Data accesses are classified as cacheable, for those targeting the Memory Port; or non-cacheable, for those targeting any other port in the Core Complex. Non-cacheable data accesses are collectively called memory-mapped I/O accesses, or MMIOs.

The U7 pipeline allows for multiple outstanding memory accesses, but only allows one outstanding cache line fill. The number of outstanding MMIOs are implementation dependent. Misaligned accesses are not allowed to any memory region and result in a trap to allow for software emulation.

4.4.1 L1 Data Cache

The L1 data cache is a 32 KiB 4-way set-associative cache. It is virtually-indexed, physically-tagged with a line size of 64 bytes and is read/write-allocate with a random replacement policy. The cache operates in write-back mode; this means that if a cache line is dirty, it is written back to memory when evicted. Out of reset, all lines of the cache are invalidated.

The L1 data cache supports ECC protection, as described in Chapter 16.

The Memory Port address range is the only cacheable region of memory. A cache line fill triggers a burst access starting with the first address of the cache line. On a cache hit, the access latency is two clock cycles for words and double-words, and three clock cycles for smaller quantities. Stores are pipelined and commit on cycles where the data memory system is otherwise idle. Pending stores are stored in a buffer, which drains whenever there is an idle cycle or another store. Loads to addresses currently in the store pipeline result in a five-cycle penalty.

The data cache supports only one outstanding line fill. Once a cacheable access is made that misses, another cannot be issued until the line fill completes. However, other MMIOs can be issued before or after the line fill as long as there are no address or register hazards.

The data cache cannot be disabled and the properties of the Memory Port cannot be modified to prevent cacheable accesses.

4.4.2 Cache Maintenance Operations

The data cache supports `CFLUSH.D.L1` and `CDISCARD.D.L1`. The instruction `CFLUSH.D.L1` cleans and invalidates the specified line or all cache lines. The instruction `CDISCARD.D.L1` invalidates the specified line or all cache lines.

These custom instructions are further described in Chapter 7.

4.4.3 L1 Data Cache Coherency

All of the L1 data caches in the Core Complex are kept coherent with an integrated coherency manager. This is an automatic feature and cannot be disabled. The `CFLUSH.D.L1` and `CDISCARD.D.L1` instructions only affect the core that executed the instruction. They are not broadcast to all cores in the Complex.

4.4.4 Coherence with an L2 Cache

The L1 data cache is inclusive with the L2 cache, described in Chapter 13.

When a block of data is allocated to the L1 cache, it is also allocated to the L2 cache. When a block is evicted from the L1, the corresponding line in the L2 is then updated and marked dirty.

The custom instructions `CFLUSH.D.L1` and `CDISCARD.D.L1` only target the L1 data cache, and do not impact the L2 cache. The L2 cache controller contains flush capability, which performs a clean and invalidate operation of a line in the L2 cache. If the targeted line also resides in the L1 cache, then it too will be cleaned and invalidated. Section 13.4.9 describes how to flush the L2 cache.

4.5 Atomic Memory Operations

The U7 core supports the RISC-V standard Atomic (A) extension on the Memory Port, Peripheral Port, and internal memory regions.

Atomic instructions that target the Memory Port are implemented in the data cache and are not observable on the external data bus. The load-reserved (LR) and store-conditional (SC) instructions are special atomic instructions that are only supported in data cacheable regions. They will generate a precise access exception if targeted at uncacheable data regions.

Atomic memory operations are not supported on the System Port. Atomic operations that target the System Port will generate a precise access exception.

See Section 6.4 for more information on the instructions added by this extension.

4.6 Floating-Point Unit (FPU)

The U7 FPU provides full hardware support for the IEEE 754-2008 floating-point standard for 32-bit single-precision and 64-bit double-precision arithmetic. The FPU includes a fully pipelined fused-multiply-add unit and an iterative divide and square-root unit, magnitude comparators, and float-to-integer conversion units, all with full hardware support for subnormals and all IEEE default values.

Section 6.5 describes the 32-bit single-precision instructions. Section 6.6 describes the 64-bit double-precision instructions.

The FPU comes up disabled on reset. First initialize `fcsr` and `mstatus.FS` prior to executing any floating-point instructions. In the `freedom-meta1` startup code, write `mstatus.FS[1:0]` to `0x1`.

4.7 Virtual Memory Support

The U7 has support for virtual memory through the use of a Memory Management Unit (MMU). The MMU supports the Bare and Sv39 modes as described in *The RISC-V Instruction Set Manual, Volume II: Privileged Architecture, Version 1.10*. SiFive's Sv39 implementation provides a

39-bit virtual address space using 38-bits of physical address space. Supported page sizes include 4 KiB, 2 MiB, and 1 GiB gigapage. The default Linux page size (PAGESIZE) is 4 KiB.

The translation lookaside buffers (TLBs) are address translation caches within the MMU. Translation is accomplished through page table entries (PTE) that reside in the TLB region. A hardware page-table walker refills the TLBs upon a cache miss. The PTE entries are fetched from a region defined by the root page table base address in the Supervisor Address Translation and Protection (satp) CSR. Each PTE contains the information necessary to translate the virtual memory address to a physical address on the design.

There are both level 1 and level 2 TLB entries. Level 1 entries contain separate instruction buffers (ITLB) and data buffers (DTLB) since they are accessed in different pipeline stages. The ITLB and DTLB each contain 40 entries, which are fully associative. Level 2 TLB entries are unified, and contain 512 direct-mapped TLB entries. Level 2 TLB are all 4 KiB pages. A block diagram of the instruction and data memory access from the L2 into the MMU TLB is shown below.

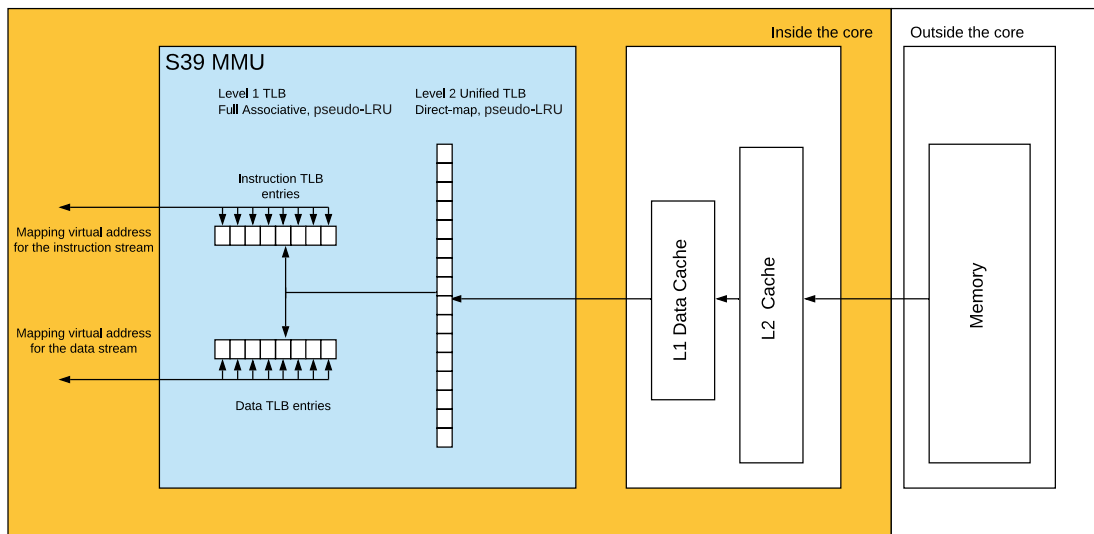

Figure 11: TLB Update Flow

Behaviors of the hardware are described below.

- When there is a TLB miss in the level 1 ITLB or DTLB, the level 2 unified TLB will populate the level 1 TLB with the correct PTE, if it exists.
- When there is a miss in both level 1 and level 2 TLB, a hardware page table walk will occur by the MMU to fill the TLB page table entry from the memory. The memory location where the hart will start fetching TLB page table entry from is determined by the physical page number (PPN) field in the Supervisor Address Translation and Protection (satp) CSR. The refill will occur from the data cache if it exists there, otherwise it will refill from the L2 cache. If L2 cache does not contain the data, then it will be fetched from system memory.
- Both level 1 and level 2 unified TLB page table entry replacement policy is pseudo-LRU.
- When level 1 TLB entry is evicted, this entry is not updated in the level 2 unified TLB.

- When the level 1 TLB entry is updated from level 2, the entry will reside in level 2 and will not be removed.
- Executing the `SFENCE.VMA` instruction will invalidate both level 1 and level 2 TLB entries.

4.7.1 Address and Page Table Formats

An Sv39 virtual address is partitioned as shown below.

Note that address bits [63:39] of every instruction fetch, load, and store operation must be equal to bit 38, or else a page-fault exception will occur.

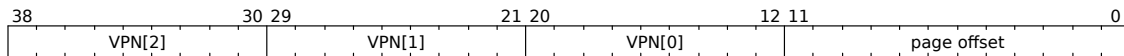

Figure 12: Sv39 Virtual Address

The 27-bit VPN is translated into a 44-bit PPN via a three-level page table, while the 12-bit page offset is untranslated.

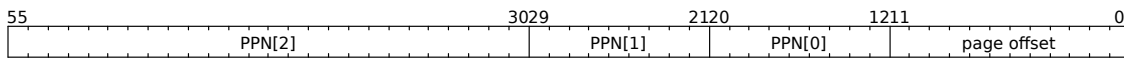

Figure 13: Sv39 Physical Address

Sv39 page tables contain 2^9 page table entries (PTEs), eight bytes each. A page table is exactly the size of a page and must always be aligned to a page boundary. As mentioned, `satp.PPN` holds the physical page number of the root page table. Any level of PTE may be a leaf PTE, and all page sizes (4 KiB, 2 MiB, and 1 GiB) must be virtually and physically aligned to a boundary equal to its size. A page-fault exception is raised if the physical address is insufficiently aligned.



Figure 14: Sv39 PTE Format

A description of the PTE configuration bits can be found in Table 19.

Bits	Description
0	V: Valid <ul style="list-style-type: none"> • 0x0 - Page table entry not valid • 0x1 - Page table entry valid
1	R: Readable <ul style="list-style-type: none"> • 0x0 - Page table entry not readable • 0x1 - Page table entry readable
2	W: Writable <ul style="list-style-type: none"> • 0x0 - Page table entry not writable • 0x1 - Page table entry writable
3	X: Executable <ul style="list-style-type: none"> • 0x0 - Page table entry not executable • 0x1 - Page table entry executable
4	U: User mode access <ul style="list-style-type: none"> • 0x0 - No access to user mode software • 0x1 - Access granted to user mode software
5	G: Global mapping <ul style="list-style-type: none"> • 0x0 - This mapping does not exist globally • 0x1 - This mapping exists globally
6	A: Accessed <ul style="list-style-type: none"> • 0x0 - Leaf page table entry has not been read, written, or fetched since the last time A was cleared • 0x1 - Leaf page table entry has been read, written, or fetched since the last time A was cleared
7	D: Dirty <ul style="list-style-type: none"> • 0x0 - The virtual page has not been written since the last time D was cleared • 0x1 - The virtual page has been written since the last time D was cleared
[9:8]	RSW: Supervisor software use <ul style="list-style-type: none"> • X - Open for supervisor software use

Table 19: PTE Configuration Bits

Page Table Configurations

Read, write, and execute permissions for Sv39 are summarized in Table 20. The value `PTE.V=1` indicates the PTE is valid, while `PTE.V=0` means all other bits in PTE are don't cares, and software can use these freely. The value `PTE.R=1` indicates the page is readable. Likewise, `PTE.W=1` indicates the page is writable, while `PTE.X=1` means the page is executable. When `PTE.V=0`, `PTE.R=0`, and `PTE.W=0`, this indicates the PTE is a pointer to the next level page table,

otherwise it is a leaf PTE. If a page is marked writable, it must also be marked readable. Combinations of PTE.W=1 and PTE.R=0 are not currently supported.

X	W	R	Meaning
0	0	0	Pointer to next level of page table
0	0	1	Read-only page
0	1	0	Reserved
0	1	1	Read-write page
1	0	0	Execute-only page
1	0	1	Read-execute page
1	1	0	Reserved
1	1	1	Read-write-execute page

Table 20: PTE Encoding fields

A fetch page-fault exception will occur if an instruction is fetched from a page that does not have execute permissions. A load page-fault exception will occur if a load or load-reserved instruction falls within a page without read permissions. A store page-fault exception will occur if a store, store-conditional, or AMO instruction falls within a page without write permissions.

The value PTE.U=1 indicates the page is accessible to user mode. Supervisor mode software may also perform loads and stores to a page marked with PTE.U=1, but only if sstatus.SUM=1. The sstatus.SUM bit modifies the privilege of supervisor mode loads and stores to virtual memory. Supervisor mode software may not execute code on any page marked with PTE.U=1.

Two schemes to manage the A and D bits are permitted:

- When a virtual page is accessed and the A bit is clear, or is written and the D bit is clear, a page-fault exception is raised.
- When a virtual page is accessed and the A bit is clear, or is written and the D bit is clear, the corresponding bit(s) are set in the PTE. The PTE update is atomic with respect to other accesses to the PTE, and memory access will not occur until the PTE update is visible globally.

For non-leaf PTEs, the D, A, and U bits are reserved for future use and must be cleared by software for forward compatibility.

It is important to note the U7 does not automatically set the accessed (A) and dirty (D) bits in a Sv39 Page Table Entry (PTE). Instead, the U7 MMU will raise a page fault exception for a read to a page with PTE.A=0 or a write to a page with PTE.D=0.

4.7.2 Supervisor Address Translation and Protection Register (SATP)

The satp register is a 64-bit read/write register used to control supervisor address translation and protection.



Figure 15: RV64 Supervisor Address Translation Register (satp)

- The `satp.PPN` field holds the physical page number (PPN) of the root page table, which is the supervisor physical address divided by 4 KiB.
- The `satp.ASID` is an address space identifier used to facilitate address-translation fences on a per-address-space basis.
- The `satp.MODE` field determines the selected address-translation scheme.

Translation Modes

Possible values for `satp.MODE` include:

<code>satp.MODE</code>	Description
0x0	Bare mode - no translation enabled
0x1 → 0x7	Reserved
0x8	Page-based 39-bit virtual addressing (Sv39)
0x9	Page-based 48-bit virtual addressing (Sv48)
0xA	Reserved for page-based 57-bit virtual addressing
0xB	Reserved for page-based 64-bit virtual addressing
0xC → 0xF	Reserved

Table 21: SATP MODE Values

When `satp.MODE=0x0`, supervisor virtual addresses are equal to supervisor physical addresses, and there is no additional memory protection beyond the physical memory protection scheme described in Section 4.8. In this case, the remaining fields in `satp` have no effect.

For RV64 architectures on SiFive designs, `satp.MODE=8` is used for Sv39 virtual addressing, and no other modes are currently supported.

Note that writing `satp` does not imply any ordering constraints between page-table updates and subsequent address translations. If the new address space's page tables have been modified, or if an ASID is reused, it may be necessary to execute an `SFENCE.VMA` instruction after writing `satp`, which will:

1. Synchronize page table writes and address translation hardware for higher privilege levels
2. Guarantee previous stores are ordered before all subsequent references from the hart to the memory management data structures
3. Flush Level 1 and L2 unified TLB entry.

Note

Content from Section 4.7.3 , Section 4.7.4, Section 4.7.5, and Section 4.7.6 are directly from *The RISC-V Instruction Set Manual, Volume II: Privileged Architecture, Version 1.10.*

4.7.3 Supervisor Memory-Management Fence Instruction (SFENCE.VMA)

The supervisor memory-management fence instruction SFENCE.VMA is used to synchronize updates to in-memory memory-management data structures with current execution.

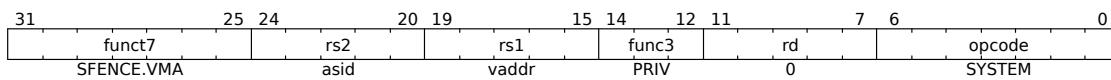

Figure 16: SFENCE.VMA Instruction

Instruction execution causes implicit reads and writes to these data structures; however, these implicit references are ordinarily not ordered with respect to explicit loads and stores. Executing an SFENCE.VMA instruction guarantees that any previous stores already visible to the current RISC-V hart are ordered before all subsequent implicit references from that hart to the memory-management data structures.

The SFENCE.VMA is used to flush any local hardware caches related to address translation. It is specified as a fence rather than a TLB flush to provide cleaner semantics with respect to which instructions are affected by the flush operation and to support a wider variety of dynamic caching structures and memory-management schemes. SFENCE.VMA is also used by higher privilege levels to synchronize page table writes and the address translation hardware.

SFENCE.VMA orders only the local hart's implicit references to the memory-management data structures.

Consequently, other harts must be notified separately when the memory-management data structures have been modified. One approach is to use 1) a local data fence to ensure local writes are visible globally, then 2) an interprocessor interrupt to the other thread, then 3) a local SFENCE.VMA in the interrupt handler of the remote thread, and finally 4) signal back to originating thread that operation is complete. This is, of course, the RISC-V analog to a TLB shoot-down.

For the common case that the translation data structures have only been modified for a single address mapping (i.e., one page or superpage), rs1 can specify a virtual address within that mapping to affect a translation fence for that mapping only. Furthermore, for the common case that the translation data structures have only been modified for a single address-space identifier,

rs2 can specify the address space. The behavior of SFENCE.VMA depends on rs1 and rs2 as follows:

- If rs1=x0 and rs2=x0, the fence orders all reads and writes made to any level of the page tables, for all address spaces.
- If rs1=x0 and rs2≠x0, the fence orders all reads and writes made to any level of the page tables, but only for the address space identified by integer register rs2. Accesses to global mappings are not ordered.
- If rs1≠x0 and rs2=x0, the fence orders only reads and writes made to the leaf page table entry corresponding to the virtual address in rs1, for all address spaces.
- If rs1≠x0 and rs2≠x0, the fence orders only reads and writes made to the leaf page table entry corresponding to the virtual address in rs1, for the address space identified by integer register rs2. Accesses to global mappings are not ordered.

When rs2≠x0, bits [SXLEN-1:ASIDMAX] of the value held in rs2 are reserved for future use and should be zeroed by software and ignored by current implementations. Furthermore, if [ASIDLEN < ASIDMAX], the implementation shall ignore bits ASIDMAX-1:ASIDLEN of the value held in rs2.

4.7.4 Scenarios Which Require SFENCE.VMA Instruction

The following common situations typically require executing an SFENCE.VMA instruction:

- When software recycles an ASID (i.e., reassociates it with a different page table), it should first change satp to point to the new page table using the recycled ASID, then execute SFENCE.VMA with rs1=x0 and rs2 set to the recycled ASID. Alternatively, software can execute the same SFENCE.VMA instruction while a different ASID is loaded into satp, provided the next time satp is loaded with the recycled ASID, it is simultaneously loaded with the new page table.
- If the implementation does not provide ASIDs, or software chooses to always use ASID 0, then after every satp write, software should execute SFENCE.VMA with rs1=x0. In the common case that no global translations have been modified, rs2 should be set to a register other than x0 but which contains the value zero, so that global translations are not flushed.
- If software modifies a non-leaf PTE, it should execute SFENCE.VMA with rs1=x0. If any PTE along the traversal path had its G bit set, rs2 must be x0; otherwise, rs2 should be set to the ASID for which the translation is being modified.
- If software modifies a leaf PTE, it should execute SFENCE.VMA with rs1 set to a virtual address within the page. If any PTE along the traversal path had its G bit set, rs2 must be x0; otherwise, rs2 should be set to the ASID for which the translation is being modified.
- For the special cases of increasing the permissions on a leaf PTE and changing an invalid PTE to a valid leaf, software may choose to execute the SFENCE.VMA lazily. After modifying the PTE but before executing SFENCE.VMA, either the new or old permissions will be used.

In the latter case, a page fault exception might occur, at which point software should execute `SFENCE.VMA` in accordance with the previous bullet point.

Speculation

The U7 will perform a speculative data access as a result of speculative ITLB refill. Changes in the `satp` register do not necessarily flush TLB entries. It is required to execute an `SFENCE.VMA` instruction after modifying page table entries in order to flush the cached translations. Exceptions only occur on accesses that are generated as a result of instruction execution, not access that are done speculatively.

ASID Usage for Supervisor Software

Supervisor software that uses ASIDs should use a nonzero ASID value to refer to the same address space across all harts in the supervisor execution environment (SEE) and should not use an ASID value of 0. If supervisor software does not use ASIDs, then the ASID field in the `satp` CSR should be set to 0.

4.7.5 Trap Virtual Memory

The `mstatus.TVM` (Trap Virtual Memory) bit supports intercepting supervisor virtual-memory management operations. When `TVM=1`, attempts to read or write the `satp` CSR or execute the `SFENCE.VMA` instruction while executing in S-mode will raise an illegal instruction exception. When `TVM=0`, these operations are permitted in supervisor mode. `TVM` is hard-wired to 0 when supervisor mode is not supported. The `TVM` mechanism improves virtualization efficiency by permitting guest operating systems to execute in supervisor mode, rather than classically virtualizing them in user mode. This approach obviates the need to trap accesses to most S-mode CSRs. Trapping `satp` accesses and the `SFENCE.VMA` instruction provides the hooks necessary to lazily populate shadow page tables.

4.7.6 Virtual Address Translation Process

For Sv39, `LEVELS` equals 3, and `PTESIZE` equals 8 in the steps below. A virtual address (`va`) is translated into a physical address (`pa`) as follows:

1. Let `a` be `satp.ppn × PAGESIZE`, and let `i = LEVELS - 1`.
2. Let `pte` be the value of the PTE at address `a + va.vpn[i] × PTESIZE`. If accessing `pte` violates a PMA or PMP check, raise an access exception corresponding to the original access type.
3. If `pte.v = 0`, or if `pte.r = 0` and `pte.w = 1`, stop and raise a page-fault exception corresponding to the original access type.
4. Otherwise, the PTE is valid. If `pte.r = 1` or `pte.x = 1`, go to step 5. Otherwise, this PTE is a pointer to the next level of the page table. Let `i = i - 1`. If `i < 0`, stop and raise a page-fault

exception corresponding to the original access type. Otherwise, let $a = \text{pte.ppn} \times \text{PAGE-SIZE}$ and go to step 2.

5. A leaf PTE has been found. Determine if the requested memory access is allowed by the `pte.r`, `pte.w`, `pte.x`, and `pte.u` bits, given the current privilege mode and the value of the `SUM` and `MXR` fields of the `mstatus` register. If not, stop and raise a page-fault exception corresponding to the original access type.
6. If $i > 0$ and $\text{pte.ppn}[i - 1 : 0] \neq 0$, this is a misaligned superpage; stop and raise a page-fault exception corresponding to the original access type.
7. If $\text{pte.a} = 0$, or if the memory access is a store and $\text{pte.d} = 0$, either raise a page-fault exception corresponding to the original access type, or:
 - a. Set `pte.a` to 1 and, if the memory access is a store, also set `pte.d` to 1.
 - b. If this access violates a PMA or PMP check, raise an access exception corresponding to the original access type.
 - c. This update and the loading of `pte` in step 2 must be atomic; in particular, no intervening store to the PTE may be perceived to have occurred in-between.
8. The translation is successful. The translated physical address is given as follows:
 - a. $\text{pa.pgoff} = \text{va.pgoff}$.
 - b. If $i > 0$, then this is a superpage translation and $\text{pa.ppn}[i - 1 : 0] = \text{va.vpn}[i - 1 : 0]$.
 - c. $\text{pa.ppn}[\text{LEVELS} - 1 : i] = \text{pte.ppn}[\text{LEVELS} - 1 : i]$.

4.7.7 Virtual-to-Physical Mapping Example

The following figure is a high-level view of how a virtual address is mapped to a physical address for a Linux application. When the Linux kernel creates a process, it will allocate multiple pages of physical memory to store the code and data. TLB MMU is used to:

- Translate the virtual addresses to physical addresses
- Provide uniform virtual memory layout for a user application
- Protect user applications unauthorized access to other address space

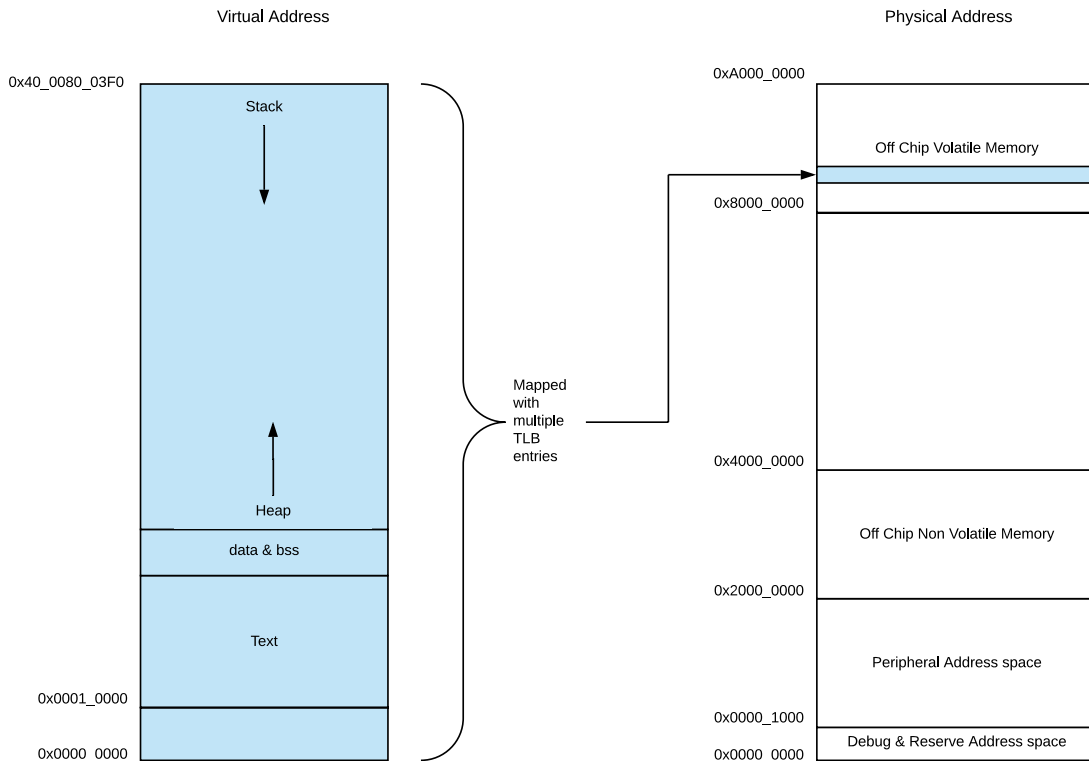

Figure 17: Linux User Application Memory Map Example

In this example, code beginning at VA=0x0001_0000 needs to be mapped to an address in off chip volatile memory.

When the hart tries to execute instructions at this address, it needs to use a matched TLB page table entry to do virtual address to physical address translation. If it can not be located in the level 1 instruction TLB, or the level 2 unified TLB, the hart will start hardware table walk from the TLB page table base address. The page table base address is obtained by multiplying `satp.PPN` by the level 2 PAGESIZE (4KiB).

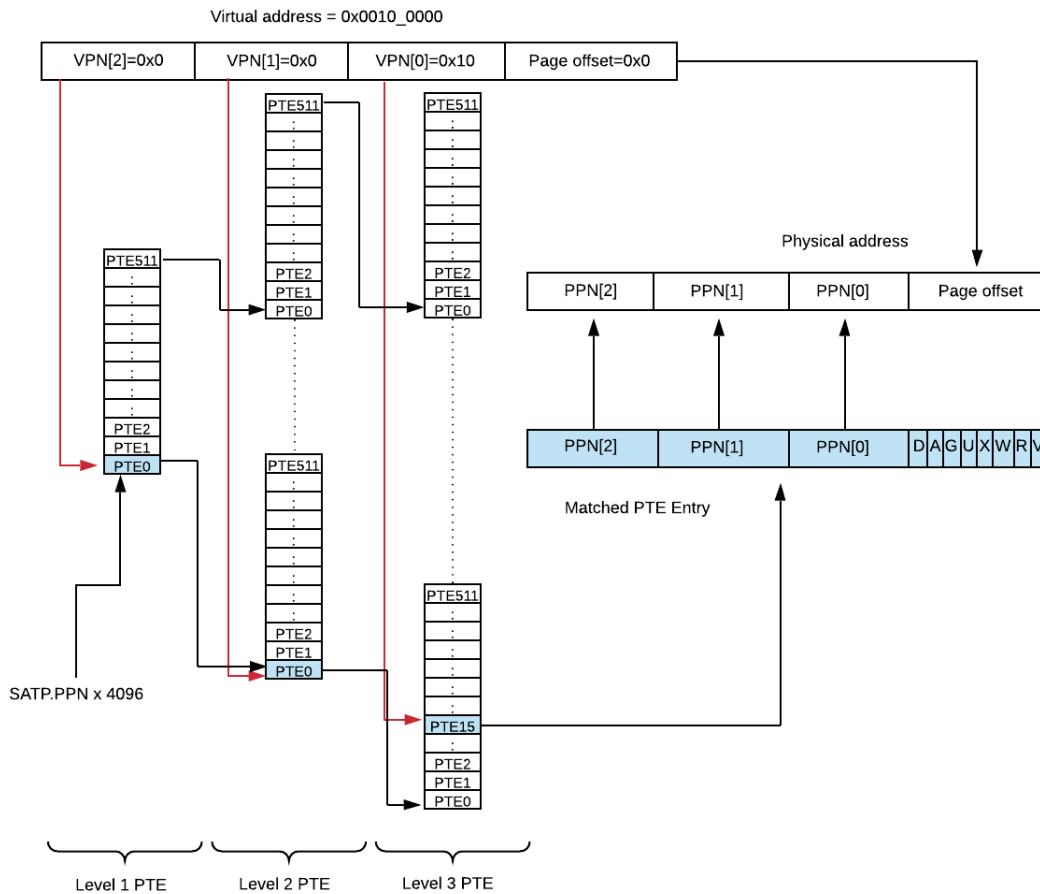

Figure 18: Hardware Table Walk Example

The TLB MMU will execute a page table walk in order to determine the correct mapping for a particular virtual address. Page table entries are pointers to the next level page table if the page is marked as not Readable ($R=0$), not Writable ($w=0$), and not Executable ($x=0$). Otherwise it is a leaf PTE.

In this example, there are 3 levels of page table entries. The hart will start the hardware table walk from the level 1 page table entry. In the Sv39 scheme, there are 512 page table entries in level 1 page table entry. A hart can quickly locate the entry using `VPN2` number, in this case, entry 0. The hart will continue the hardware table walk to the level 2 page table entry when the entry doesn't match.

There are 512 clusters of page table entries in level 2 and each cluster also has 512 TLB page table entries. In this example, `PPNs` in the level 1 entry 0 is used to locate the right cluster in the level 2 page entry. The hart will locate the entry using `VPN1` number, in this case, entry 0. The hart will continue a hardware table walk to level 3 page table entry when this entry does not match.

At the level 3 page table entry, there are 512x512 clusters of page table entries, and each cluster has 512 TLB page table entries. In this example, PPNs in the level 2 entry 0 is used to locate the correct cluster in the level 3 page entry. The hart then finds the entry using the VPN[0] value, which in this case, corresponds to entry 15.

When there is a match in level 3 page table entry, virtual address will map to physical address. The physical page number is combined with the page offset to give the complete physical address.

4.7.8 MMU at Reset

The TLB MMU is disabled by default out of reset. All accessed regions have a 1:1 virtual to physical mapping when the MMU is disabled. If the PMP is not yet enabled, all access permissions out of reset are determined by the static PMA values.

4.8 Physical Memory Protection (PMP)

Machine mode is the highest privilege level and by default has read, write, and execute permissions across the entire memory map of the device. However, privilege levels below machine mode do not have read, write, or execute permissions to any region of the device memory map unless it is specifically allowed by the PMP. For the lower privilege levels, the PMP may grant permissions to specific regions of the device's memory map, but it can also revoke permissions when in machine mode.

When programmed accordingly, the PMP will check every access when the hart is operating in supervisor or user modes. For machine mode, PMP checks do not occur unless the lock bit (L) is set in the `pmpcfgY` CSR for a particular region.

PMP checks also occur on loads and stores when the machine previous privilege level is supervisor or User (`mstatus.MPP=0x1` or `mstatus.MPP=0x0`), and the Modify Privilege bit is set (`mstatus.MPRV=1`). For virtual address translation, PMP checks are also applied to page table accesses in supervisor mode.

The U7 PMP supports 8 regions with a minimum region size of 4096 bytes.

This section describes how PMP concepts in the RISC-V architecture apply to the U7. For additional information on the PMP refer to *The RISC-V Instruction Set Manual, Volume II: Privileged Architecture, Version 1.10*.

4.8.1 PMP Functional Description

The U7 PMP unit has 8 regions and a minimum granularity of 4096 bytes. Access to each region is controlled by an 8-bit `pmpxcfg` field and a corresponding `pmpaddrX` register. Overlapping regions are permitted, where the lower numbered `pmpxcfg` and `pmpaddrX` registers take priority over higher numbered regions. The U7 PMP unit implements the architecturally

defined `pmpcfgY` CSR `pmpcfg0`, supporting 8 regions. `pmpcfg2` is implemented, but hardwired to zero. Access to `pmpcfg1` or `pmpcfg3` results in an illegal instruction exception.

The PMP registers may only be programmed in M-mode. Ordinarily, the PMP unit enforces permissions on S-mode and U-mode accesses. However, locked regions (see Section 4.8.2) additionally enforce their permissions on M-mode.

4.8.2 PMP Region Locking

The PMP allows for region locking whereby, once a region is locked, further writes to the configuration and address registers are ignored. Locked PMP entries may only be unlocked with a system reset. A region may be locked by setting the L bit in the `pmpXcfg` register.

In addition to locking the PMP entry, the L bit indicates whether the R/W/X permissions are enforced on machine mode accesses. When the L bit is clear, the R/W/X permissions apply to S-mode and U-mode.

4.8.3 PMP Registers

Each PMP region is described by an 8-bit `pmpXcfg` field, used in association with a 64-bit `pmpaddrX` register that holds the base address of the protected region. The range of each region depends on the Addressing (A) mode described in the next section. The `pmpXcfg` fields reside within 64-bit `pmpcfgY` CSRs.

Each 8-bit `pmpXcfg` field includes a read, write, and execute bit, plus a two bit address-matching field A, and a Lock bit, L. Overlapping regions are permitted, where the lowest numbered PMP entry wins for that region.

PMP Configuration Registers

For RV64 architectures, `pmpcfg1` and `pmpcfg3` are not implemented. This reduces the footprint since `pmpcfg2` already contains configuration fields `pmp8cfg` through `pmp11cfg` for both RV32 and RV64.

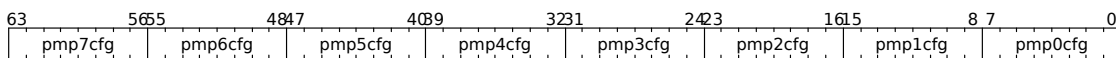

Figure 19: RV64 `pmpcfg0` Register

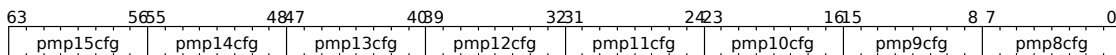

Figure 20: RV64 `pmpcfg2` Register

The `pmpcfgY` and `pmpaddrX` registers are only accessible via CSR specific instructions such as `csrr` for reads, and `csrw` for writes.

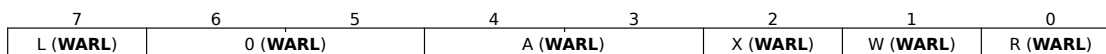

Figure 21: RV64 pmpXcfg bitfield

Bits	Description
0	R: Read Permissions <ul style="list-style-type: none"> • 0x0 - No read permissions for this region • 0x1 - Read permission granted for this region
1	W: Write Permissions <ul style="list-style-type: none"> • 0x0 - No write permissions for this region • 0x1 - Write permission granted for this region
2	X: Execute permissions <ul style="list-style-type: none"> • 0x0 - No execute permissions for this region • 0x1 - Execute permission granted for this region
[4:3]	A: Address matching mode <ul style="list-style-type: none"> • 0x0 - PMP Entry disabled. No PMP protection applied for any privilege level. • 0x1 - Top of range (TOR) region defined by two adjacent pmpaddr registers. The upper limit of region X is defined by pmpaddrX, and the base of the region is defined by pmpaddr(X-1). Address 'a' matches the region if $[pmpaddr(X-1) \leq a < pmpaddrX]$. If pmp0cfg defines a TOR region, then the base address of that region is 0x0, and pmpaddr0 defines the upper limit. Supports only a four byte granularity. • 0x2 - Naturally aligned four-byte region (NA4). Supports only a four-byte region with four byte granularity. Not supported on SiFive U7 series cores since minimum granularity is 4 KiB. • 0x3 - Naturally aligned power-of-two region (NAPOT), ≥ 8 bytes. When this setting is programmed, the low bits of the pmpaddrX register encode the size, while the upper bits encode the base address right shifted by two. There is a zero bit in between, we will refer to as the least significant zero bit (LSZB).
7	L: Lock Bit <ul style="list-style-type: none"> • 0x0 - PMP Entry Unlocked, no permission restrictions applied to machine mode. PMP entry only applies to S and U modes. • 0x1 - PMP Entry Locked, permissions enforced for all privilege levels including machine mode. Writes to pmpXcfg and pmpcfgY are ignored and can only be cleared with system reset.
Note: The combination of R=0 and w=1 is not currently implemented.	

Table 22: pmpXcfg Bitfield Description

Out of reset, the PMP register fields A and L are set to 0. All other hart state is unspecified by *The RISC-V Instruction Set Manual, Volume II: Privileged Architecture, Version 1.10*.

Some examples follow using NAPOT address mode.

Base Address	Region Size*	LSZB Position	pmpaddrX Value
0x4000_0000	8 B	0	(0x1000_0000 1'b0)
0x4000_0000	32 B	2	(0x1000_0000 3'b011)
0x4000_0000	4 KB	9	(0x1000_0000 10'b01_1111_1111)
0x4000_0000	64 KB	13	(0x1000_0000 14'b01_1111_1111_1111)
0x4000_0000	1 MB	17	(0x1000_0000 18'b01_1111_1111_1111_1111)
*Region size is $2^{(LSZB+3)}$.			

Table 23: pmpaddrX Encoding Examples for A=NAPOT

PMP Address Registers

The PMP has 8 address registers. Each address register pmpaddrX correlates to the respective pmpXcfg field. Each address register contains the base address of the protected region right shifted by two, for a minimum 4-byte alignment.

The maximum encoded address bits per *The RISC-V Instruction Set Manual, Volume II: Privileged Architecture, Version 1.10* are [55:2].

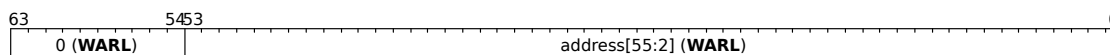

Figure 22: RV64 pmpaddrX Register

4.8.4 PMP and PMA

The PMP values are used in conjunction with the Physical Memory Attributes (PMAs) described in Section 5.1. Since the PMAs are static and not configurable, the PMP can only revoke read, write, or execute permissions to the PMA regions if those permissions already apply statically.

4.8.5 PMP Programming Overview

The PMP registers can only be programmed in machine mode. The pmpaddrX register should be first programmed with the base address of the protected region, right shifted by two. Then, the pmpcfgY register should be programmed with the properly configured 64-bit value containing each properly aligned 8-bit pmpXcfg field. Fields that are not used can be simply written to 0, marking them unused.

PMP Programming Example

The following example shows a machine mode only configuration where PMP permissions are applied to three regions of interest, and a fourth region covers the remaining memory map. Recall that lower numbered pmpXcfg and pmpaddrX registers take priority over higher numbered regions. This rule allows higher numbered PMP registers to have blanket coverage over the

entire memory map while allowing lower numbered regions to apply permissions to specific regions of interest. The following example shows a 64 KB Flash region at base address 0x0, a 32 KB RAM region at base address 0x2000_0000, and finally a 4 KB peripheral region at base address base 0x3000_0000. The rest of the memory map is reserved space.

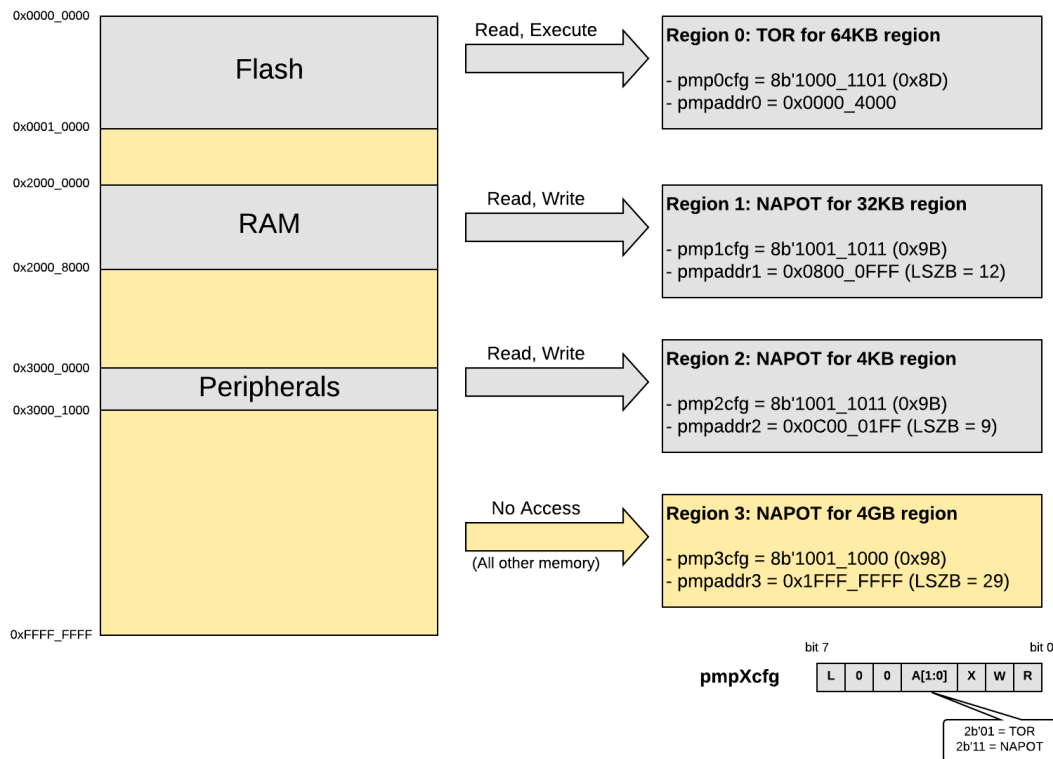

Figure 23: PMP Example Block Diagram

PMP Access Scenarios

The L, R, W, and X bits only determine if an access succeeds if all bytes of that access are covered by that PMP entry. For example, if a PMP entry is configured to match the four-byte range 0xC–0xF, then an 8-byte access to the range 0x8–0xF will fail, assuming that PMP entry is the highest-priority entry that matches those addresses.

While operating in machine mode when the lock bit is clear (L=0), if a PMP entry matches all bytes of an access, the access succeeds. If the lock bit is set (L=1) while in machine mode, then the access depends on the permissions set for that region. Similarly, while in Supervisor mode or User mode, the access depends on permissions set for that region.

Failed read or write accesses generate a load or store access exception, and an instruction access fault would occur on a failed instruction fetch. When an exception occurs while attempting to execute from a region without execute permissions, the fault occurs on the fetch and not

the branch, so the `mepc` CSR will reflect the value of the targeted protected region, and not the address of the branch.

It is possible for a single instruction to generate multiple accesses, which may not be mutually atomic. If at least one access generated by an instruction fails, then an exception will occur. It might be possible that other accesses from a single instruction will succeed, with visible side effects. For example, references to virtual memory may be decomposed into multiple accesses.

On some implementations, misaligned loads, stores, and instruction fetches may also be decomposed into multiple accesses, some of which may succeed before an access exception occurs. In particular, a portion of a misaligned store that passes the PMP check may become visible, even if another portion fails the PMP check. The same behavior may manifest for floating-point stores wider than XLEN bits (e.g., the FSD instruction in RV32D), even when the store address is naturally aligned.

4.8.6 PMP and Paging

The Physical Memory Protection mechanism is designed to compose with the page-based virtual memory systems described in *The RISC-V Instruction Set Manual, Volume II: Privileged Architecture, Version 1.10*. When paging is enabled, instructions that access virtual memory may result in multiple physical-memory accesses, including implicit references to the page tables. The PMP checks apply to all of these accesses. The effective privilege mode for implicit page-table accesses is supervisor mode.

Implementations with virtual memory are permitted to perform address translations speculatively and earlier than required by an explicit virtual-memory access. The PMP settings for the resulting physical address may be checked at any point between the address translation and the explicit virtual-memory access. A mis-predicted branch to a non-executable address range does not generate a trap. Hence, when the PMP settings are modified in a manner that affects either the physical memory that holds the page tables or the physical memory to which the page tables point, M-mode software must synchronize the PMP settings with the virtual memory system. This is accomplished by executing an `SFENCE.VMA` instruction with `rs1=x0` and `rs2=x0`, after the PMP CSRs are written.

If page-based virtual memory is not implemented, or when it is disabled, memory accesses check the PMP settings synchronously, so no fence is needed.

4.8.7 PMP Limitations

In a system containing multiple harts, each hart has its own PMP device. The PMP permissions on a hart cannot be applied to accesses from other harts in a multi-hart system. In addition, SiFive designs may contain a Front Port to allow external bus masters access to the full memory map of the system. The PMP cannot prevent access from external bus masters on the Front Port.

4.8.8 Behavior for Regions without PMP Protection

If a non-reserved region of the memory map does not have PMP permissions applied, then by default, supervisor or user mode accesses will fail, while machine mode access will be allowed. Access to reserved regions within a device's memory map (an interrupt controller for example) will return `0x0` on reads, and writes will be ignored. Access to reserved regions outside of a device's memory map without PMP protection will result in a bus error. The bus error can generate an interrupt to the hart using the Bus-Error Unit (BEU). See Chapter 12 for more information.

4.8.9 Cache Flush Behavior on PMP Protected Region

When a line is brought into cache and the PMP is set up with the lock (L) bit asserted to protect a part of that line, a data cache flush instruction will generate a store access fault exception if the flush includes any part of the line that is protected. The cache flush instruction does an invalidate and write-back, so it is essentially trying to write back to the memory location that is protected. If a cache flush occurs on a part of the line that was not protected, the flush will succeed and not generate an exception. If a data cache flush is required without a write-back, use the cache discard instruction instead, as this will invalidate but not write back the line.

4.9 Hardware Performance Monitor

The U7 processor core supports a basic hardware performance monitoring (HPM) facility. The performance monitoring facility is divided into two classes of counters: fixed-function and event-programmable counters. These classes consist of a set of fixed counters and their counter-enable registers, as well as a set of event-programmable counters and their event selector registers. The registers are available to control the behavior of the counters. Performance monitoring can be useful for multiple purposes, from optimization to debug.

4.9.1 Performance Monitoring Counters Reset Behavior

The `instret` and `cycle` counters are initialized to zero on system reset. The hardware performance monitor event counters are not initialized on system reset, and thus have an arbitrary value. Users can write desired values to the counter control and status registers (CSRs) to start counting at a given, known value.

4.9.2 Fixed-Function Performance Monitoring Counters

A fixed-function performance monitor counter is hardware wired to only count one specific event type. That is, they cannot be reconfigured with respect to the event type(s) they count. The only modification to the fixed-function performance monitoring counters that can be done is to enable or disable counting, and write the counter value itself.

The U7 processor core contains two fixed-function performance monitoring counters.

Fixed-Function Cycle Counter (`mcycle`)

The fixed-function performance monitoring counter `mcycle` holds a count of the number of clock cycles the hart has executed since some arbitrary time in the past. The `mcycle` counter is read-write and 64 bits wide. Reads of `mcycle` return all 64 bits of the `mcycle` CSR.

Fixed-Function Instructions-Retired Counter (`minstret`)

The fixed-function performance monitoring counter `minstret` holds a count of the number of instructions the hart has retired since some arbitrary time in the past. The `minstret` counter is read-write and 64 bits wide. Reads of `minstret` return all 64 bits of the `minstret` CSR.

4.9.3 Event-Programmable Performance Monitoring Counters

Complementing the fixed-function counters are a set of programmable event counters. The U7 HPM includes two additional event counters, `mhpmcounter3` and `mhpmcounter4`. These programmable event counters are read-write and 64 bits wide. The hardware counters themselves are implemented as 40-bit counters on the U7 core series. These hardware counters can be written to in order to initialize the counter value.

4.9.4 Event Selector Registers

To control the event type to count, event selector CSRs `mhpmevent3` and `mhpmevent4` are used to program the corresponding event counters. These event selector CSRs are 64-bit **WARL** registers.

The event selectors are partitioned into two fields; the lower 8 bits select an event class, and the upper bits form a mask of events in that class.

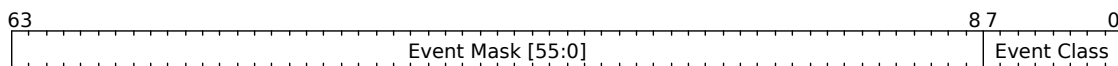

Figure 24: Event Selector Fields

The counter increments if the event corresponding to any set mask bit occurs. For example, if `mhpmevent3` is set to `0x4200`, then `mhpmcounter3` will increment when either a load instruction or a conditional branch instruction retires. An event selector of 0 means "count nothing".

4.9.5 Event Selector Encodings

Table 24 describes the event selector encodings available. Events are categorized into classes based on the Event Class field encoded in `mhpmeventX[7:0]`. One or more events can be programmed by setting the respective Event Mask bit for a given event class. An event selector encoding of 0 means "count nothing". Multiple events will cause the counter to increment any time any of the selected events occur.

Machine Hardware Performance Monitor Event Register	
Instruction Commit Events, mhpmeventX[7:0]=0x0	
Bits	Description
8	Exception taken
9	Integer load instruction retired
10	Integer store instruction retired
11	Atomic memory operation retired
12	System instruction retired
13	Integer arithmetic instruction retired
14	Conditional branch retired
15	JAL instruction retired
16	JALR instruction retired
17	Integer multiplication instruction retired
18	Integer division instruction retired
19	Floating-point load instruction retired
20	Floating-point store instruction retired
21	Floating-point addition retired
22	Floating-point multiplication retired
23	Floating-point fused multiply-add retired
24	Floating-point division or square-root retired
25	Other floating-point instruction retired
Microarchitectural Events, mhpmeventX[7:0]=0x1	
Bits	Description
8	Address-generation interlock
9	Long-latency interlock
10	CSR read interlock
11	Instruction cache/ITIM busy
12	Data cache/DTIM busy
13	Branch direction misprediction
14	Branch/jump target misprediction
15	Pipeline flush from CSR write
16	Pipeline flush from other event
17	Integer multiplication interlock
18	Floating-point interlock
Memory System Events, mhpmeventX[7:0]=0x2	
Bits	Description
8	Instruction cache miss
9	Data cache miss or memory-mapped I/O access
10	Data cache write-back
11	Instruction TLB miss
12	Data TLB miss
13	L2 TLB miss

Table 24: mhpmevent Register

Event mask bits that are writable for any event class are writable for all classes. Setting an event mask bit that does not correspond to an event defined in Table 24 has no effect for current implementations. However, future implementations may define new events in that encoding space, so it is not recommended to program unsupported values into the `mhpmevent` registers.

Combining Events

It is common usage to directly count each respective event. Additionally, it is possible to use combinations of these events to count new, unique events. For example, to determine the average cycles per load from a data memory subsystem, program one counter to count "Data cache/DTIM busy" and another counter to count "Integer load instruction retired". Then, simply divide the "Data cache/DTIM busy" cycle count by the "Integer load instruction retired" instruction count and the result is the average cycle time for loads in cycles per instruction.

It is important to be cognizant of the event types being combined; specifically, event types counting occurrences and event types counting cycles.

4.9.6 Counter-Enable Registers

The 32-bit counter-enable registers `mcounteren` and `scounteren` control the availability of the hardware performance-monitoring counters to the next-lowest privileged mode.

The settings in these registers only control accessibility. The act of reading or writing these enable registers does not affect the underlying counters, which continue to increment when not accessible.

When any bit in the `mcounteren` register is clear, attempts to read the cycle, time, instruction retire, or `hpmcounterX` register while executing in S-mode will cause an illegal instruction exception. When one of these bits is set, access to the corresponding register is permitted in the next implemented privilege mode, S-mode.

The same bit positions in the `scounteren` register analogously control access to these registers while executing in U-mode. If S-mode is permitted to access a counter register and the corresponding bit is set in `scounteren`, then U-mode is also permitted to access that register.

`mcounteren` and `scounteren` are **WARL** registers. Any of the bits may contain a hardwired value of zero, indicating reads to the corresponding counter will cause an illegal instruction exception when executing in a less-privileged mode.

4.10 L2 Performance Monitor

Similar to the hardware performance monitor (HPM), the U7 processor core supports a L2 performance monitoring (L2PM) facility. It consists of a set of event-programmable counters and their event selector registers. The registers are available to control the behavior of the counters.

The L2PM for each L2 Cache in the system resides within a 16 KiB segment of MMIO CSR address space, starting at 0x0201_0000 (plus offset). The performance event selector and other control registers are configured in M-mode, and the event-programmable counters can be read in user mode.

4.10.1 Control Port Register Map

For each L2 Cache in the system, the 16 KiB region is partitioned as shown:

Offset	CSR Group	Size
0x0000	L2 Cache control	4 KiB
0x1000	Reserved	4 KiB
0x2000	L2PM event control	4 KiB
0x3000	L2PM event counters	4 KiB

Table 25: L2PM Partition

4.10.2 L2PM Event Control

Depending on configuration options chosen during core creation, up to 64 Performance Event Selectors (default = 6) are available.

Offset	Bits	Access	Description
0x2000	64	RW	L2pmevent0
0x2008	64	RW	L2pmevent1
0x2010	64	RW	L2pmevent2
0x2018	64	RW	L2pmevent3
0x2020	64	RW	L2pmevent4
0x2028	64	RW	L2pmevent5
0x2030	64	RW	L2pmevent6
0x2038	64	RW	L2pmevent7
...
0x21F8	64	RW	L2pmevent63
...
0x2800	64	RW	L2ClientFilter
...

Table 26: L2PM Event Control

The Performance Event Selectors (L2pmevent0-L2pmevent5) follow the definition of mhpmevent* as defined in the RISC-V ISA, with the following differences:

- L2pmevent* is always 64-bits wide
- In RV32 systems, L2pmevent* entries can be accessed using the low and high 32-bits, with the higher 32-bits of each L2pmevent aliased as L2pmevent*h.

L2 Counter Client Filter CSR (L2ClientFilter)

The L2 counter client filter register `L2ClientFilter` is a 64-bit **WARL** register that controls which client's performance events are excluded from incrementing the performance monitor counters. However, some events might not be attributed to a particular client in a specific implementation (for example, the L2 release event in SiFive's L2 cache design).

L2 Performance Monitor Counters (L2pmcounter*)

The L2 Performance Monitor counters (`L2pmcounter*`), follow the definition of `mhpmcounter*` as defined in the RISC-V ISA. They are **WARL** registers that support up to 64 bits of precision on RV32 and RV64. The high 32-bits are aliased as `L2pmcounter*h`.

Offset	Bits	Access	Description
0x3000	64	RO	L2pmcounter0
0x3008	64	RO	L2pmcounter1
0x3010	64	RO	L2pmcounter2
0x3018	64	RO	L2pmcounter3
0x3020	64	RO	L2pmcounter4
0x3028	64	RO	L2pmcounter5
0x3030	64	RO	L2pmcounter6
0x3038	64	RO	L2pmcounter7
...
0x31F8	64	RO	L2pmcounter63
...
...

Table 27: L2 Performance Monitor Counters

Offset	Bits	Access	Description
0x3004	32	RO	L2pmcounter0h
0x300C	32	RO	L2pmcounter1h
0x3014	32	RO	L2pmcounter2h
0x301C	32	RO	L2pmcounter3h
0x3024	32	RO	L2pmcounter4h
0x302C	32	RO	L2pmcounter5h
0x3034	32	RO	L2pmcounter6h
0x303C	32	RO	L2pmcounter7h
...
0x31FC	32	RO	L2pmcounter63h
...
...

Table 28: L2 Performance Monitor Counters, 32-Bit Access

Note

If a counter is not implemented, such as when there is no L2PM, both the counter and its corresponding event selector are hard-wired to 0, meaning that the counter always returns 0.

4.10.3 Event Selector Registers

To control the event type to count, event selector CSRs L2pmevent0 through L2pmevent5 are used to program the corresponding event counters. These event selector CSRs are 64-bit **WARL** registers.

The event selectors are partitioned into two fields; the lower 8 bits select an event class, and the upper bits form a mask of events in that class.

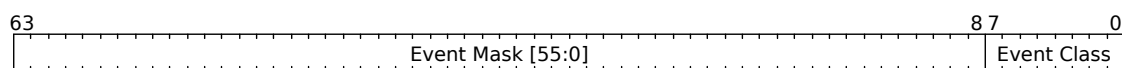

Figure 25: Event Selector Fields

The counter increments if the event corresponding to any set mask bit occurs.

4.10.4 Event Selector Encodings

Table 29 describes the event selector encodings available. Events are categorized into two classes based on the Event Class field encoded in L2pmeventX[7:0]. One or more events can be programmed by setting the respective Event Mask bit for a given event class. An event

selector encoding of 0 means "count nothing". Multiple events will cause the counter to increment any time any of the selected events occur.

L2 Performance Monitor Event Register					
Transaction Events, L2pmeventX[7:0]=1					
Bits	Location	Opcode	Param	Can use clientFilter?	Description
0	Inner	PutFullData	-	Yes	
1	Inner	PutPartialData	-	Yes	
2	Inner	AtomicData	-	Yes	
3	Inner	Get	-	Yes	
4	Inner	Prefetch	read	Yes	
5	Inner	Prefetch	write	Yes	
6	Inner	AcquireBlock	NtoB	Yes	
7	Inner	AcquireBlock	NtoT	Yes	
8	Inner	AcquireBlock	BtoT	Yes	
9	Inner	AcquirePerm	NtoT	Yes	
10	Inner	AcquirePerm	BtoT	Yes	
11	Inner	Release	ToB	Yes	
12	Inner	Release	TtoN	Yes	
13	Inner	Release	BtoN	Yes	
14	Inner	ReleaseData	ToB	Yes	
15	Inner	ReleaseData	TtoN	Yes	
16	Inner	ReleaseData	BtoN	Yes	
17	Outer	ProbeBlock	toT	No	
18	Outer	ProbeBlock	toB	No	
19	Outer	ProbeBlock	toN	No	
L2 Query Result Events, L2pmeventX[7:0]=2					
Bits	Location	Opcode	Param	Can use clientFilter?	Description
0	Inner	PutFullData	-	Yes	Hit L2
1	Inner	PutPartialData	-	Yes	Hit L2
2	Inner	AtomicData	-	Yes	Hit L2
3	Inner	Get	-	Yes	Hit L2
4	Inner	Prefetch	-	Yes	Hit L2
5	Inner	AcquireBlock	-	Yes	Hit L2
6	Inner	AcquirePerm	-	Yes	Hit L2
7	Inner	Release	-	Yes	Hit L2
8	Inner	ReleaseData	-	Yes	Hit L2
9	Outer	Probe	-	No	Hit L2
10	Inner	PutFullData	-	Yes	Hit L2, "shared"
11	Inner	PutPartialData	-	Yes	Hit L2, "shared"
12	Inner	AtomicData	-	Yes	Hit L2, "shared"

Table 29: L2pmevent Register

13	Inner	Get	-	Yes	Hit L2, "shared"
14	Inner	Prefetch	-	Yes	Hit L2, "shared"
15	Inner	AcquireBlock	-	Yes	Hit L2, "shared"
16	Inner	AcquirePerm	-	Yes	Hit L2, "shared"
17	Outer	Probe	-	No	Hit L2, "shared"
18	Outer	Probe	-	No	Hit L2, "modified"
L2 Request Events, L2pmeventX[7:0]=3					
Bits	Location	Opcode	Param	Can use clientFilter?	Description
0	Outer	AcquireBlock	NtoB	No	L2 miss
1	Outer	AcquireBlock	NtoT	No	L2 miss
2	Outer	AcquireBlock	BtoT	No	L2 miss
3	Outer	AcquirePerm	NtoT	No	L2 miss
4	Outer	AcquirePerm	BtoT	No	L2 miss
5	Outer	Release	ToB	No	Eviction
6	Outer	Release	ToN	No	Eviction
7	Outer	Release	BtoN	No	Eviction
8	Outer	ReleaseData	ToB	No	Not applicable
9	Outer	ReleaseData	TtoN	No	Dirty Eviction
10	Outer	ReleaseData	BtoN	No	Not applicable
11	Inner	ProbeBlock	toT	No	Code miss hits other harts
12	Inner	ProbeBlock	toB	No	Load miss hits other harts
13	Inner	ProbeBlock	toN	No	Store miss hits other harts
L2 Hardware Prefetcher Events, L2pmeventX[7:0]=4					
Bits	Location	Opcode	Param	Can use clientFilter?	Description
0				No	Demand miss hit L2 MSHR allo-

Table 29: L2pmevent Register

					cated by hint
--	--	--	--	--	------------------

Table 29: L2pmevent Register

Note: For the **Location** heading, "Inner" refers to the inner side of the L2 cache, i.e. transactions from the core and Front Port. "Outer" refers to the other side of the L2 Cache, i.e. read/write transactions from the L2 and probe requests from outside.

4.10.5 Setting up the pmclientmask Register

For each specific cluster configuration, the L2 may attach to different masters.

Master ID	Description
0	Debug
1	AXI4 Front Port ID#0
2	AXI4 Front Port ID#1
3	AXI4 Front Port ID#2
4	AXI4 Front Port ID#3
5	Hart 0 Fetch Unit
6	Hart 0 D-Cache MMIO
7	Hart 1 Fetch Unit
8	Hart 1 D-Cache
9	Hart 1 D-Cache
10	Hart 1 D-Cache MMIO
11	Hart 1 L2 Prefetcher
12	Hart 2 Fetch Unit
13	Hart 2 D-Cache
14	Hart 2 D-Cache
15	Hart 2 D-Cache MMIO
16	Hart 2 L2 Prefetcher
17	Hart 3 Fetch Unit
18	Hart 3 D-Cache
19	Hart 3 D-Cache
20	Hart 3 D-Cache MMIO
21	Hart 3 L2 Prefetcher
22	Hart 4 Fetch Unit
23	Hart 4 D-Cache
24	Hart 4 D-Cache
25	Hart 4 D-Cache MMIO
26	Hart 4 L2 Prefetcher

Table 30: Master IDs in the L2 Cache Controller

Note that the default value of pmclientmask is 0, therefore all clients' events are counted.

4.10.6 Programming the L2pmevent registers

The following example shows the use of 6 performance counters:

```
// directory lookup events: L1 miss
*pmEventSelect0 = 0x01          | // Event Set 1
      ( (0x01 << 6 ) | // innerAcquireBlockNtoB
        (0x01 << 7 ) | // innerAcquireBlockNtoT
        (0x01 << 8 ) | // innerAcquireBlockBtoT
        (0x01 << 9 ) | // innerAcquirePermNtoT
        (0x01 << 10) // innerAcquirePermB2T
      ) << 8;

// directory lookup results: L1 miss hit L2
*pmEventSelect1 = 0x02          | // Event Set 2
      ( (0x01 << 5) | // innerAcquireBlock_Hit
        (0x01 << 6) // innerAcquirePerm_Hit
      ) << 8;

// directory lookup events: prefetch
*pmEventSelect2 = 0x01          | // Event Set 1
      ( (0x01 << 4 ) | // innerPrefetchRead
        (0x01 << 5 ) // innerPrefetchWrite
      ) << 8;

// prefetch hits L2
*pmEventSelect3 = 0x02          | // Event Set 2
      ( (0x01 << 4) // innerPrefetch_Hit
      ) << 8;

// L1 request misses L2
*pmEventSelect4 = 0x03          | // Event Set3
      ( (0x01 << 0) | // outerAcquireBlockNtoB
        (0x01 << 1) | // outerAcquireBlockNtoT
        (0x01 << 2) | // outerAcquireBlockBtoT
        (0x01 << 3) | // outerAcquirePermNtoT
        (0x01 << 4) // outerAcquirePermBtoT
      ) << 8;
```

4.11 Ports

This section describes the Port interfaces to the U7 core.

4.11.1 Front Port

The Front Port can be used by external masters to read from and write into the memory system utilizing any port in the Core Complex.

If a Front Port access targets the Memory Port, a coherency manager is responsible for maintaining coherency with the L1 and L2 caches. A read access can be returned directly from the L1 or L2 cache without generating an external bus access. If a write from the Front Port targets a location in the L1 data cache, it results in the line being evicted and invalidated. The write will then allocate to the L2 cache.

Any Front Port access that targets the Memory Port and results in an L1 and L2 cache miss will allocate to the L2 cache.

The U74-MC Core Complex User Guide describes the implementation details of the Front Port.

Note

Logic in the core prevents non-debug-mode code from accessing the debug region. However, this logic does not intercept accesses from the Front Port. This means that it is possible for Front Port accesses to interfere with a debug session by writing to various offsets within the debug region. To work around this, do not access the debug module memory region via the Front Port.

4.11.2 Memory Port

The Memory Port is used to interface with memory that offers the highest performance for the U74-MC Core Complex, such as DDR. It supports cacheable accesses for data and instructions.

Consult Section 5.1 for further information about the Memory Port and its Physical Memory Attributes.

See the U74-MC Core Complex User Guide for a description of the Memory Port implementation in the U74-MC Core Complex.

4.11.3 Peripheral Port

The Peripheral Port is used to interface with lower speed peripherals and also supports code execution. When a device is attached to the Peripheral Port, it is expected that there are no other masters connected to that device.

Consult Section 5.1 for further information about the Peripheral Port and its Physical Memory Attributes.

See the U74-MC Core Complex User Guide for a description of the Peripheral Port implementation in the U74-MC Core Complex.

4.11.4 System Port

The System Port is used to interface with lower performance memory, like SRAM, memory-mapped I/O (MMIO), and higher speed peripherals. The System Port also supports code execution.

Consult Section 5.1 for further information about the System Port and its Physical Memory Attributes.

See the U74-MC Core Complex User Guide for a description of the System Port implementation in the U74-MC Core Complex.

Chapter 5

Physical Memory Attributes and Memory Map

This chapter describes the U74-MC Core Complex physical memory attributes and memory map.

5.1 Physical Memory Attributes Overview

The memory map is divided into different regions covering on-core-complex memory, system memory, peripherals, and empty holes. Physical memory attributes (PMAs) describe the properties of the accesses that can be made to each region in the memory map. These properties encompass the type of access that may be performed: execute, read, or write. As well as other optional attributes related to the access, such as supported access size, alignment, atomic operations, and cacheability.

RISC-V utilizes a simpler approach than other processor architectures in defining the attributes of memory accesses. Instead of defining access characteristics in page table descriptors or memory protection logic, the properties are fixed for memory regions or may only be modified in platform-specific control registers. As most systems don't require the ability to modify PMAs, SiFive cores only support fixed PMAs, which are set at design time. This results in a simpler design with lower gate count and power savings, and an easier programming interface.

External memory map regions are accessed through a specific port type and that port type is used to define the PMAs. The port types are Memory, Peripheral, and System. Memory map regions defined for internal memory and internal control regions also have a predefined PMA based on the underlying contents of the region.

The assigned PMA properties and attributes for U74-MC Core Complex memory regions are shown in Table 31 and Table 32 for external and internal regions, respectively.

The configured memory regions of the U74-MC Core Complex are listed with their attributes in Table 33.

Port Type	Access Properties	Attributes
Memory Port	Read, Write, Execute	Atomics+LR/SC, Data Cacheable, Instruction Cacheable, Instruction Speculation
Peripheral Port	Read, Write, Execute	Atomics, Instruction Cacheable
System Port	Read, Write, Execute	Instruction Cacheable

Table 31: Physical Memory Attributes for External Regions

Region	Access Properties	Attributes
Bus-Error Unit	Read, Write	Atomics
CLINT	Read, Write	Atomics
DTIM	Read, Write, Execute	Atomics
Debug	None	N/A
Error Device	Read, Write, Execute	Atomics
ITIM	Read, Write, Execute	Atomics, Instruction Speculation
L2 Cache Controller	Read, Write	Atomics
L2 LIM	Read, Write, Execute	Atomics
L2 Prefetcher	Read, Write	Atomics
L2 Zero Device	Read, Write, Execute	Atomics, Instruction Cacheable
PLIC	Read, Write	Atomics
Reserved	None	N/A

Table 32: Physical Memory Attributes for Internal Regions

All memory map regions support word, half-word, and byte size data accesses.

Atomic access support enables the RISC-V standard Atomic (A) Extension for atomic instructions. These atomic instructions are further documented in Section 3.6 for the S7 core and Section 4.5 for the U7 core. The load-reserved (LR) and store-conditional (SC) instructions are only supported on the data cacheable region, marked in Table 31 with "Atomics+LR/SC".

No region supports unaligned accesses. An unaligned access will generate the appropriate trap: instruction address misaligned, load address misaligned, or store/AMO address misaligned.

The Physical Memory Protection unit is capable of controlling access properties based on address ranges, not ports. It has no control over the attributes of an address range, however.

Note

The Debug and Error Device regions have special behavior. The Debug region is reserved for use from a Debugger, and all accesses to it from the core in non-Debug mode will trap. The Error Device will also trap all accesses, as described in Chapter 11.

5.2 Memory Map

The memory map of the U74-MC Core Complex is shown in Table 33.

Base	Top	PMA	Description
0x0000_0000	0x0000_0FFF		Debug
0x0000_1000	0x0000_2FFF		Reserved
0x0000_3000	0x0000_3FFF	RWX A	Error Device
0x0000_4000	0x00FF_FFFF		Reserved
0x0100_0000	0x0100_1FFF	RWX A	S7 Hart 0 DTIM (8 KiB)
0x0100_2000	0x016F_FFFF		Reserved
0x0170_0000	0x0170_0FFF	RW A	S7 Hart 0 Bus-Error Unit
0x0170_1000	0x0170_1FFF	RW A	U7 Hart 1 Bus-Error Unit
0x0170_2000	0x0170_2FFF	RW A	U7 Hart 2 Bus-Error Unit
0x0170_3000	0x0170_3FFF	RW A	U7 Hart 3 Bus-Error Unit
0x0170_4000	0x0170_4FFF	RW A	U7 Hart 4 Bus-Error Unit
0x0170_5000	0x017F_FFFF		Reserved
0x0180_0000	0x0180_3FFF	RWX A	S7 Hart 0 ITIM
0x0180_4000	0x01FF_FFFF		Reserved
0x0200_0000	0x0200_FFFF	RW A	CLINT
0x0201_0000	0x0201_3FFF	RW A	L2 Cache Controller
0x0201_4000	0x0202_FFFF		Reserved
0x0203_0000	0x0203_1FFF	RW A	U7 Hart 1 L2 Prefetcher
0x0203_2000	0x0203_3FFF	RW A	U7 Hart 2 L2 Prefetcher
0x0203_4000	0x0203_5FFF	RW A	U7 Hart 3 L2 Prefetcher
0x0203_6000	0x0203_7FFF	RW A	U7 Hart 4 L2 Prefetcher
0x0203_8000	0x07FF_FFFF		Reserved
0x0800_0000	0x081F_FFFF	RWX A	L2 LIM
0x0820_0000	0x09FF_FFFF		Reserved
0x0A00_0000	0x0A1F_FFFF	RWXI A	L2 Zero Device
0x0A20_0000	0x0BFF_FFFF		Reserved
0x0C00_0000	0x0FFF_FFFF	RW A	PLIC
0x1000_0000	0x1FFF_FFFF		Reserved
0x2000_0000	0x3FFF_FFFF	RWXI A	Peripheral Port (512 MiB)
0x4000_0000	0x5FFF_FFFF	RWXI	System Port (512 MiB)
0x6000_0000	0x7FFF_FFFF		Reserved
0x8000_0000	0x9FFF_FFFF	RWXIDA	Memory Port (512 MiB)
0xA000_0000	0xFFFF_FFFF		Reserved

Table 33: U74-MC Core Complex Memory Map. Physical Memory Attributes: **R**–Read, **W**–Write, **X**–Execute, **I**–Instruction Cacheable, **D**–Data Cacheable, **A**–Atomics

Chapter 6

Programmer's Model

The U74-MC Core Complex implements the 64-bit RISC-V architecture. The following chapter provides a reference for programmers and an explanation of the extensions supported by RV64GCB.

This chapter contains a high-level discussion of the RISC-V instruction set architecture and additional resources which will assist software developers working with RISC-V products. The U74-MC Core Complex is an implementation of the RISC-V RV64GCB architecture, and is guaranteed to be compatible with all applicable RISC-V standards. RV64GCB can emulate almost any other RISC-V ISA extension.

6.1 Base Instruction Formats

RISC-V base instructions are fixed to 32 bits in length and must be aligned on a four-byte boundary in memory. RISC-V ISA keeps the source (*rs1* and *rs2*) and destination (*rd*) registers at the same position in all formats to simplify decoding, with the exception of the 5-bit immediates used in CSR instructions.

The various formats are described in Table 34 below.

Format	Description
R	Format for register-register arithmetic/logical operations.
I	Format for register-immediate ALU operations and loads.
S	Format for stores.
B	Format for branches.
U	Format for 20-bit upper immediate instructions.
J	Format for jumps.

Table 34: Base Instruction Formats

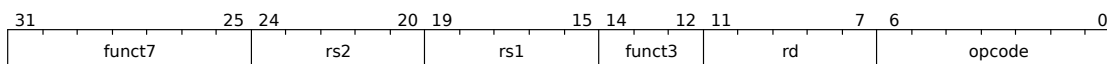

Figure 26: R-Type

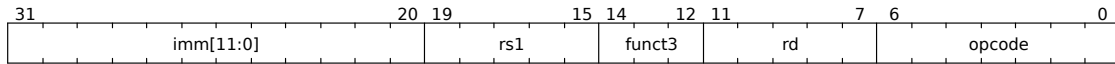

Figure 27: I-Type

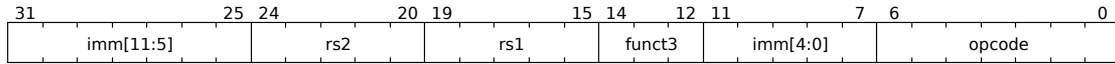

Figure 28: S-Type

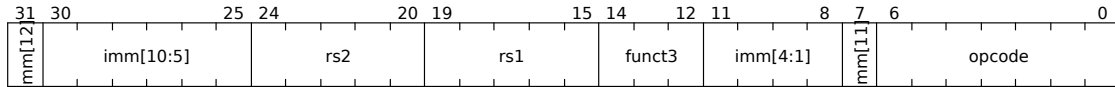

Figure 29: B-Type

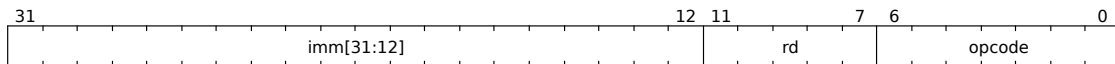

Figure 30: U-Type

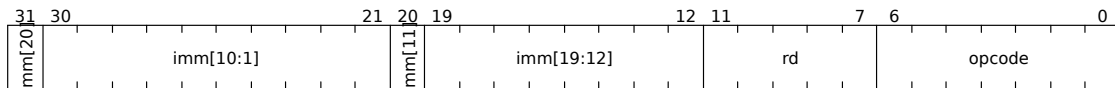

Figure 31: J-Type

The **opcode** field partially specifies an instruction, combined with **funct7 + funct3** which describe what operation to perform. Each register field (**rs1**, **rs2**, **rd**) holds a 5-bit unsigned integer (0-31) corresponding to a register number (x0 - x31). Sign-extension is one of the most critical operations on immediates (particularly for XLEN>32), and in RISC-V the sign bit for all immediates is always held in bit 31 of the instruction to allow sign-extension to proceed in parallel with instruction decoding.

6.2 I Extension: Standard Integer Instructions

This section discusses the standard integer instructions supported by RISC-V. Integer computational instructions don't cause arithmetic exceptions.

6.2.1 R-Type (Register-Based) Integer Instructions

funct7			funct3		opcode	Instruction
00000000	rs2	rs1	000	rd	0110011	ADD
01000000	rs2	rs1	000	rd	0110011	SUB
00000000	rs2	rs1	001	rd	0110011	SLL
00000000	rs2	rs1	010	rd	0110011	SLT
00000000	rs2	rs1	011	rd	0110011	SLTU
00000000	rs2	rs1	100	rd	0110011	XOR
00000000	rs2	rs1	101	rd	0110011	SRL
01000000	rs2	rs1	101	rd	0110011	SRA
00000000	rs2	rs1	110	rd	0110011	OR
00000000	rs2	rs1	111	rd	0110011	AND

Table 35: R-Type Integer Instructions

Instruction	Description
ADD rd, rs1, rs2	Performs the addition of rs1 and rs2, result stored in rd.
SUB rd, rs1, rs2	Performs the subtraction of rs2 from rs1, result stored in rd.
SLL rd, rs1, rs2	Logical left shift (zeros are shifted into the lower bits) shift amount is encoded in the lower 5 bits of rs2.
SLT rd, x0, rs2	Signed and compare sets rd to 1 if rs2 is not equal to zero, otherwise sets rd to zero.
SLTU rd, x0, rs2	Unsigned compare sets rd to 1 if rs2 is not equal to zero, otherwise sets rd to zero.
SRL rd, rs1, rs2	Logical right shift (zeros are shifted into the lower bits) shift amount is encoded in the lower 5 bits of rs2.
SRA rd, rs1, rs2	Arithmetic right shift, shift amount is encoded in the lower 5 bits of rs2.
OR rd, rs1, rs2	Bitwise logical OR.
AND rd, rs1, rs2	Bitwise logical AND.
XOR rd, rs1, rs2	Bitwise logical XOR.

Table 36: R-Type Integer Instruction Description

Below is an example of an ADD instruction.

add x18, x19, x10

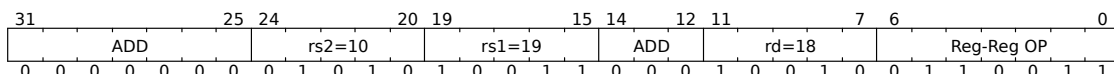

Figure 32: ADD Instruction Example

6.2.2 I-Type Integer Instructions

For I-Type integer instruction, one field is different from R-format. `rs2` and `funct7` are replaced by the 12-bit signed immediate, `imm[11:0]`, which can hold values in range `[-2048, +2047]`. The immediate is always sign-extended to 32-bits before being used in an arithmetic operation. Bits `[31:12]` receive the same value as bit 11.

imm			func3		opcode	Instruction
imm[11:0]		rs1	000	rd	0010011	ADDI
imm[11:0]		rs1	010	rd	0010011	SLTI
imm[11:0]		rs1	011	rd	0010011	SLTIU
imm[11:0]		rs1	100	rd	0010011	XORI
imm[11:0]		rs1	110	rd	0010011	ORI
imm[11:0]		rs1	111	rd	0010011	ANDI
00000000	shamnt	rs1	001	rd	0010011	SLLI
00000000	shamnt	rs1	101	rd	0010011	SRLI
01000000	shamnt	rs1	001	rd	0010011	SRAI

Table 37: I-Type Integer Instructions

One of the higher-order immediate bits is used to distinguish "shift right logical" (SRLI) from "shift right arithmetic" (SRAI).

Instruction	Description
ADDI	Adds the sign-extended 12-bit immediate to register <i>rs1</i> . Arithmetic overflow is ignored and the result is simply the low 64-bits of the result. <code>ADDI rd, rs1, 0</code> is used to implement the <code>MV rd, rs1</code> assembler pseudoinstruction.
SLTI	Set less than immediate. Places the value 1 in register <i>rd</i> if register <i>rs1</i> is less than the sign extended immediate when both are treated as signed numbers, else 0 is written to <i>rd</i> .
SLTIU	Compares the values as unsigned numbers (i.e., the immediate is first sign-extended to 64-bits then treated as an unsigned number). Note: <code>SLTIU rd, rs1, 1</code> sets <i>rd</i> to 1 if <i>rs1</i> equals zero, otherwise sets <i>rd</i> to 0 (assembler pseudo instruction <code>SEQZ rd, rs</code>).
XORI	Bitwise XOR on register <i>rs1</i> and the sign-extended 12-bit immediate and place the result in <i>rd</i> .
ORI	Bitwise OR on register <i>rs1</i> and the sign-extended 12-bit immediate and place the result in <i>rd</i> .
ANDI	Bitwise AND on register <i>rs1</i> and the sign-extended 12-bit immediate and place the result in <i>rd</i> .
SLLI	Shift Left Logical. The operand to be shifted is in <i>rs1</i> , and the shift amount is encoded in the lower 5 bits of the I-immediate field.
SRLI	Shift Right Logical. The operand to be shifted is in <i>rs1</i> , and the shift amount is encoded in the lower 5 bits of the I-immediate field.
SRAI	Shift Right Arithmetic. The operand to be shifted is in <i>rs1</i> , and the shift amount is encoded in the lower 5 bits of the I-immediate field (the original sign bit is copied into the vacated upper bits).

Table 38: I-Type Integer Instruction Description

Shift-by-immediate instructions only use lower 5 bits of the immediate value for shift amount (can only shift by 0-31 bit positions).

Below is an example of an ADDI instruction.

addi x15, x1, -50

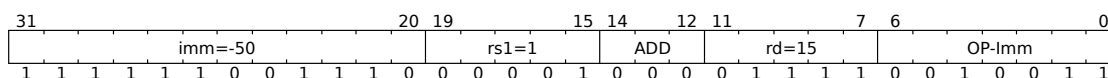

Figure 33: ADDI Instruction Example

6.2.3 I-Type Load Instructions

For I-Type load instructions, a 12-bit signed immediate is added to the base address in register *rs1* to form the memory address. In Table 39 below, **funct3** field encodes size and signedness of load data.

imm		func3		opcode	Instruction
imm[11:0]	rs1	000	rd	00000011	LB
imm[11:0]	rs1	001	rd	00000011	LH
imm[11:0]	rs1	010	rd	00000011	LW
imm[11:0]	rs1	100	rd	00000011	LBU
imm[11:0]	rs1	101	rd	00000011	LHU

Table 39: I-Type Load Instructions

Instruction	Description
LB rd, rs1, imm	Load Byte, loads 8 bits (1 byte) and sign-extends to fill destination 32-bit register.
LH rd, rs1, imm	Load Half-Word. Loads 16 bits (2 bytes) and sign-extends to fill destination 32-bit register.
LW rd, rs1, imm	Load Word, 32 bits.
LBU rd, rs1, imm	Load Unsigned Byte (8-bit).
LHU rd, rs1, imm	Load Unsigned Half-Word, which zero-extends 16 bits to fill destination 32-bit register.

Table 40: I-Type Load Instruction Description

Below is an example of a LW instruction.

lw x14, 8(x2)

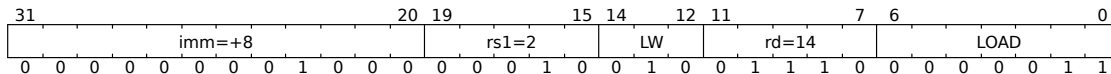

Figure 34: LW Instruction Example

6.2.4 S-Type Store Instructions

Store instructions need to read two registers: *rs1* for base memory address and *rs2* for data to be stored, as well as an immediate offset. The effective byte address is obtained by adding register *rs1* to the sign-extended 12-bit offset. Note that stores don't write a value to the register file, as there is no *rd* register used by the instruction. In RISC-V, the lower 5 bits of immediate are moved to where the *rd* field was in other instructions, and the *rs1/rs2* fields are kept in same place. The registers are kept always in the same place because a critical path for all operations includes fetching values from the registers. By always placing the read sources in the same place, the register file can read the registers without hesitation. If the data ends up being unnecessary (e.g. I-Type), it can be ignored.

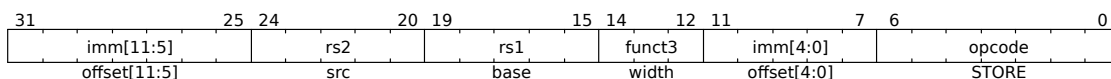

Figure 35: Store Instructions

imm			func3	imm	opcode	Instruction
imm[11:5]	rs2	rs1	000	imm[4:0]	01000011	SB
imm[11:5]	rs2	rs1	001	imm[4:0]	01000011	SH
imm[11:5]	rs2	rs1	010	imm[4:0]	01000011	SW

Table 41: S-Type Store Instructions

Instruction	Description
SB rs2, imm[11:0](rs1)	Store 8-bit value from the low bits of register rs2 to memory.
SH rs2, imm[11:0](rs1)	Store 16-bit value from the low bits of register rs2 to memory.
SW rs2, imm[11:0](rs1)	Store 32-bit value from the low bits of register rs2 to memory.

Table 42: S-Type Store Instruction Description

Below is an example SW instruction.

sw x14, 8(x2)

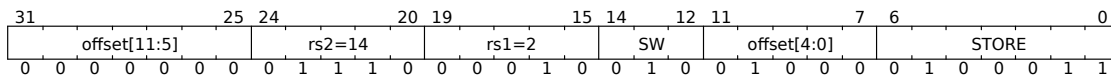

Figure 36: SW Instruction Example

6.2.5 Unconditional Jumps

The jump and link (JAL) instruction uses the J-type format, where the J-immediate encodes a signed offset in multiples of 2 bytes. The offset is sign-extended and added to the address of the jump instruction to form the jump target address. Jumps can therefore target a ± 1 MiB range. JAL stores the address of the instruction following the jump (pc+4) into register rd. The standard software calling convention uses x1 as the return address register and x5 as an alternate link register.

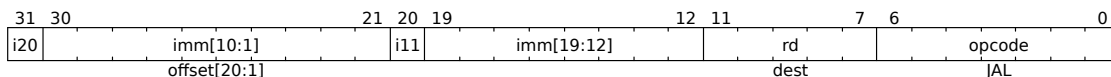

Figure 37: JAL Instruction

The indirect jump instruction JALR (jump and link register) uses the I-type encoding. The target address is obtained by adding the sign-extended 12-bit I-immediate to the register rs1, then setting the least-significant bit of the result to zero. The address of the instruction following the jump (pc+4) is written to register rd. Register x0 can be used as the destination if the result is not required.

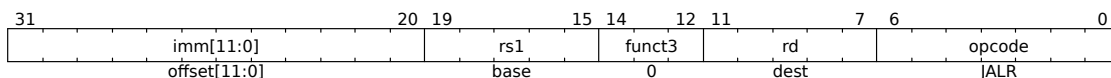

Figure 38: JALR Instruction

Both JAL and JALR instructions will generate an instruction-address-misaligned exception if the target address is not aligned to a four-byte boundary.

Instruction	Description
JAL rd, imm[20:1]	Jump and link
JALR rd, rs1, imm[11:0]	Jump and link register

Table 43: J-Type Instruction Description

6.2.6 Conditional Branches

All branch instructions use the B-Type instruction format. The 12-bit immediate represents values -4096 to +4094 in 2-byte increments. The offset is sign-extended and added to the address of the branch instruction to give the target address. The conditional branch range is ± 4 KiB.

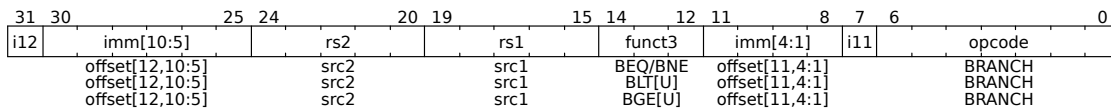

Figure 39: Branch Instructions

imm	rs2	rs1	func3	imm	opcode	Instruction
imm[12,10:5]	rs2	rs1	000	imm[4:1,11]	110011	BEQ
imm[12,10:5]	rs2	rs1	001	imm[4:1,11]	110011	BNE
imm[12,10:5]	rs2	rs1	100	imm[4:1,11]	110011	BLT
imm[12,10:5]	rs2	rs1	101	imm[4:1,11]	110011	BGE
imm[12,10:5]	rs2	rs1	110	imm[4:1,11]	110011	BLTU
imm[12,10:5]	rs2	rs1	111	imm[4:1,11]	110011	BGEU

Table 44: B-Type Instructions

Instruction	Description
BEQ rs1, rs2, imm[12:1]	Take the branch if registers rs1 and rs2 are equal.
BNE rs1, rs2, imm[12:1]	Take the branch if registers rs1 and rs2 are unequal.
BLT rs1, rs2, imm[12:1]	Take the branch if rs1 is less than rs2.
BGE rs1, rs2, imm[12:1]	Take the branch if rs1 is greater than or equal to rs2.
BLTU rs1, rs2, imm[12:1]	Take the branch if rs1 is less than rs2 (unsigned).
BGEU rs1, rs2, imm[12:1]	Take the branch if rs1 is greater than or equal to rs2 (unsigned).

Table 45: B-Type Instruction Description

ISA Base Instruction	Pseudoinstruction	Description
BEQ <i>rs, x0, offset</i>	BEQZ <i>rs, offset</i>	Take the branch if <i>rs</i> is equal to zero.

Table 46: RISC-V Base Instruction to Assembly Pseudoinstruction Example

Note

Software should be optimized such that the sequential code path is the most common path, with less-frequently taken code paths placed out of line. Software should also assume that backward branches will be predicted taken and forward branches as not taken, at least the first time they are encountered. Dynamic predictors should quickly learn any predictable branch behavior.

6.2.7 Upper-Immediate Instructions



Figure 40: Upper-Immediate Instructions

LUI (load upper immediate) is used to build 32-bit constants and uses the U-type format. LUI places the U-immediate value in the top 20 bits of the destination register *rd*, filling in the lowest 12 bits with zeros. Together with an ADDI to set low 12 bits, can create any 32-bit value in a register using two instructions (LUI/ADDI).

For example:

LUI x10, 0x87654 # x10 = 0x8765_4000

ADDI x10, x10, 0x321 # x10 = 0x8765_4321

AUIPC (add upper immediate to pc) is used to build pc-relative addresses and uses the U-type format. AUIPC forms a 32-bit offset from the 20-bit U-immediate, filling in the lowest 12 bits with zeros, and adds this offset to the address of the AUIPC instruction, then places the result in register *rd*.

6.2.8 Memory Ordering Operations

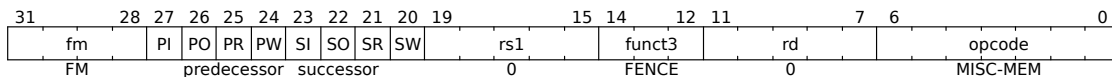

Figure 41: FENCE Instructions

The FENCE instruction is used to order device I/O and memory accesses as viewed by other RISC-V harts and external devices or coprocessors. Any combination of device input (I), device

output (O), memory reads (R), and memory writes (W) may be ordered with respect to any combination of the same. These operations are discussed further in Section 6.13.

6.2.9 Environment Call and Breakpoints

SYSTEM instructions are used to access system functionality that might require privileged access and are encoded using the I-type instruction format. These can be divided into two main classes: those that atomically read-modify-write control and status registers (CSRs), and all other potentially privileged instructions.

6.2.10 NOP Instruction

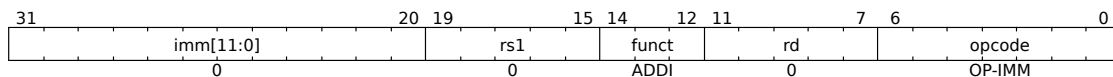

Figure 42: NOP Instructions

The NOP instruction does not change any architecturally visible state, except for advancing the pc and incrementing any applicable performance counters. NOP is encoded as **ADDI x0, x0, 0**.

6.3 M Extension: Multiplication Operations

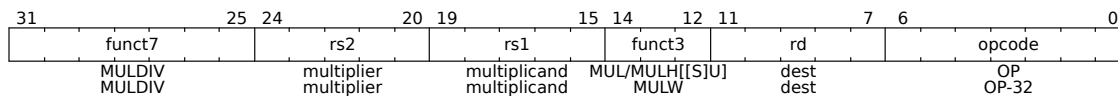

Figure 43: Multiplication Operations

Instruction	Description
MUL rd, rs1, rs2	Multiplication of rs1 by rs2 and places the lower 64-bits in the destination register.
MULH rd, rs1, rs2	Multiplication that return the upper 64-bits of the full 2×64-bit product.
MULHU rd, rs1, rs2	Unsigned multiplication that return the upper 64-bits of the full 2×64-bit product.
MULHSU rd, rs1, rs2	Signed rs1 multiple unsigned rs2 that return the upper 64-bits of the full 2×64-bit product.
MULW rd, rs1, rs2	RV64 instruction that multiplies the lower 32 bits of the source registers, placing the sign-extension of the lower 32 bits of the result into the destination register.

Table 47: Multiplication Operation Description

Combining MUL and MULH together creates one multiplication operation.

6.3.1 Division Operations

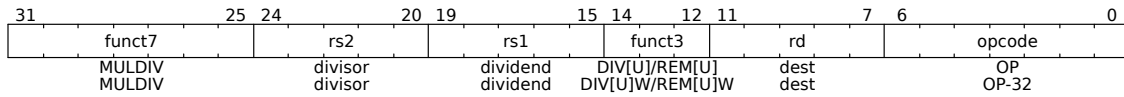

Figure 44: Division Operations

Instruction	Description
DIV rd, rs1, rs2	64-bits by 64-bits signed division of r1 by rs2 rounding towards zero.
DIVU rd, rs1, rs2	64-bits by 64-bits unsigned division of r1 by rs2 rounding towards zero.
REM rd, rs1, rs2	Remainder of the corresponding division.
REMU rd, rs1, rs2	Unsigned remainder of the corresponding division.
DIVW rd, rs1, rs2	RV64 instruction. Signed divide the lower 32 bits of rs1 by the lower 32 bits of rs2.
DIVUW rd, rs1, rs2	RV64 instruction. Unsigned divide the lower 32 bits of rs1 by the lower 32 bits of rs2.
REMW rd, rs1, rs2	Singed remainder.
REMUW rd, rs1, rs2	Unsigned remainder sign-extend the 32-bit result to 64 bits, including on a divide by zero.
MULDIV rd, rs1, rs	Multiply Divide.

Table 48: Division Operation Description

Combining DIV and REM together creates one division operation.

6.4 A Extension: Atomic Operations

Atomic operations are defined as operations that automatically read-modify-write memory to support sychronization between multiple RISC-V harts running in the same memory space.

6.4.1 Atomic Load-Reserve and Store-Conditional Instructions

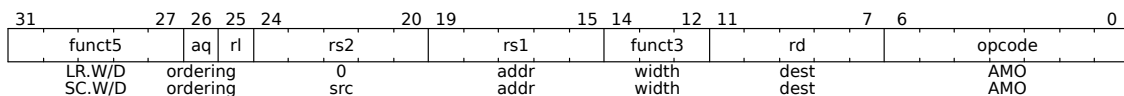

Figure 45: Atomic Operations

Instruction	Description
LR.W	Load Reserve. Loads a word from the address in <i>rs1</i> , places the sign-extended value in <i>rd</i> , and registers a reservation set—a set of bytes that subsumes the bytes in the addressed word.
SC.W	Store Conditional Conditionally writes a word in <i>rs2</i> to the address in <i>rs1</i> : the SC.W succeeds only if the reservation is still valid and the reservation set contains the bytes being written. If the SC.W succeeds, the instruction writes the word in <i>rs2</i> to memory, and it writes zero to <i>rd</i> . If the SC.W fails, the instruction does not write to memory, and it writes a nonzero value to <i>rd</i> . Executing an SC.W instruction invalidates any reservation held by this hart.
LR.D	RV64 - Loads doubleword.
SC.D	RV64 - Stores doubleword.

Table 49: Atomic Load-Reserve and Store-Conditional Instruction Description

For RV64, the sign-extended value of LR.W and SC.W is placed in *rd*.

Note

Only cores with data caches support the LR/SC instructions used by the A-Extension. Cores with DTIMs will *NOT*.

6.4.2 Atomic Memory Operations (AMOs)

The atomic memory operation (AMO) instructions perform read-modify-write operations for multiprocessor synchronization. These AMO instructions atomically load a data value from the address in *rs1*, place the value into register *rd*, apply a binary operator to the loaded value and the original value in *rs2*, then store the result back to the address in *rs1*.

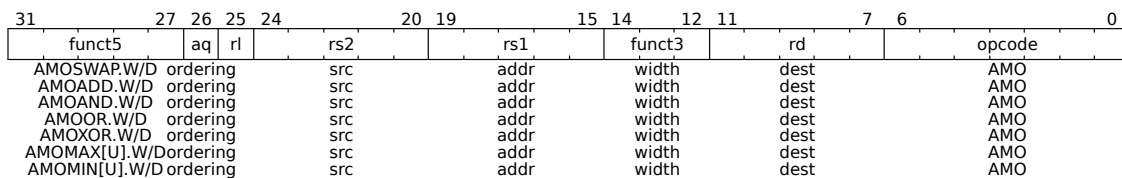

Figure 46: Atomic Memory Operations

Instruction	Description
AMOSWAP.W/D	Word / doubleword swap.
AMOADD.W/D	Word / doubleword add.
AMOAND.W/D	Word / doubleword and.
AMOOR.W/D	Word / doubleword or.
AMOXOR.W/D	Word / doubleword xor.
AMOMIN.W/D	Word / doubleword minimum.
AMOMINU.W/D	Unsigned word / doubleword minimum.
AMOMAX.W/D	Word / doubleword maximum.
AMOMAXU.W/D	Unsigned word / doubleword maximum.

Table 50: Atomic Memory Operation Description

For RV64, 32-bit AMOs always sign-extend the value placed in rd.

6.5 F Extension: Single-Precision Floating-Point Instructions

The F Extension implements single-precision floating-point computational instructions compliant with the IEEE 754-2008 arithmetic standard. The F Extension adds 32 floating-point registers, f0–f31, each 32 bits wide, and a floating-point control and status register fcsr. Floating-point load and store instructions transfer floating-point values between registers and memory, and instructions to transfer values to and from the integer register file are also provided.

6.5.1 Floating-Point Control and Status Registers

Floating-Point Control and Status Register, fcsr, is a RISC-V control and status register (CSR). The register selects the dynamic rounding mode for floating-point arithmetic operations and holds the accrued exception flags.

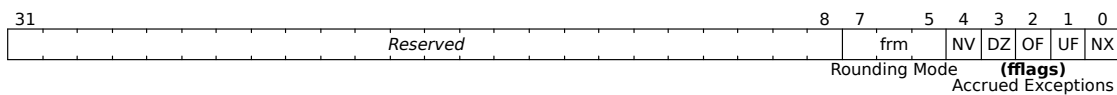

Figure 47: Floating-Point Control and Status Register

Flag Mnemonic	Flag Meaning
NV	Invalid Operation
DZ	Divide by Zero
OF	Overflow
UF	Underflow
NX	Inexact

Table 51: Accrued Exception Flags

The `fcsr` register can be read and written with the `FRCSR` and `FSCSR` instructions. The `FRRM` instruction reads the Rounding Mode field `frm`. `FRRM` swaps the value in `frm` with an integer register. `FRFLAGS` and `FSFLAGS` are defined analogously for the Accrued Exception Flags field `fflags`.

6.5.2 Rounding Modes

Floating-point operations use either a static rounding mode encoded in the instruction, or a dynamic rounding mode held in `frm`. A value of 111 in the instruction's `rm` field selects the dynamic rounding mode held in `frm`. If `frm` is set to an invalid value (101–111), any subsequent attempt to execute a floating-point operation with a dynamic rounding mode will raise an illegal instruction exception. Some instructions, including widening conversions, have the `rm` field, but are nevertheless unaffected by the rounding mode. Software should set their `rm` field to `RNE` (000).

Mode	Mnemonic	Meaning
000	RNE	Round to Nearest, ties to Even.
001	RTZ	Round towards Zero.
010	RDN	Round Down (towards $-\infty$).
011	RUP	Round Up (towards $+\infty$).
100	RMM	Round to Nearest, ties to Max Magnitude.
101		<i>Invalid. Reserved for future use.</i>
110		<i>Invalid. Reserved for future use.</i>
111	DYN	In instruction's <code>rm</code> field, selects dynamic rounding mode; In Rounding Mode register, <i>Invalid</i> .

Table 52: Floating-Point Rounding Modes

6.5.3 Single-Precision Floating-Point Load and Store Instructions

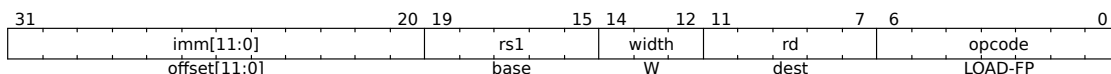

Figure 48: Single-Precision FP Load Instruction

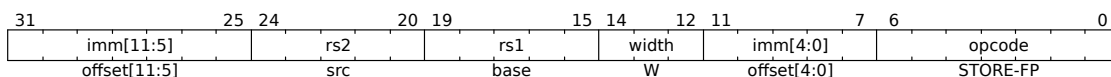

Figure 49: Single-Precision FP Store Instruction

Instruction	Operation	Description
FLW <code>rd, rs1, imm</code>	$f[rd] = M[x[rs1] + sext(offset)][31:0]$	Loads a single-precision floating-point value from memory into floating-point register <code>rd</code> .
FSW <code>imm, rs1, rs2</code>	$M[x[rs1] + sext(offset)] = f[rs2][31:0]$	Stores a single-precision value from floating-point register <code>rs2</code> to memory.

Table 53: Single-Precision FP Load and Store Instructions Description

6.5.4 Single-Precision Floating-Point Computational Instructions

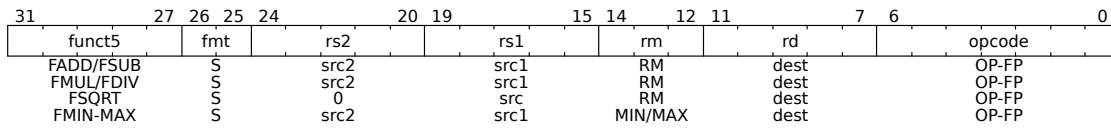

Figure 50: Single-Precision FP Computational Instructions

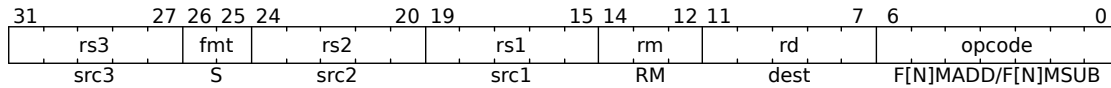

Figure 51: Single-Precision FP Fused Computational Instructions

Instruction	Operation	Description
FADD.S rd,rs1,rs2	$f[rd] = f[rs1] + f[rs2]$	Single-precision floating-point addition.
FSUB.S rd,rs1,rs2	$f[rd] = f[rs1] - f[rs2]$	Single-precision floating-point subtraction.
FMUL.S rd,rs1,rs2	$f[rd] = f[rs1] \times f[rs2]$	Single-precision floating-point multiplication.
FDIV.S rd,rs1,rs2	$f[rd] = f[rs1] \div f[rs2]$	Single-precision floating-point division.
FSQRT.S rd,rs1	$f[rd] = \sqrt{f[rs1]}$	Single-precision floating-point square root.
FMIN.S rd,rs1,rs2	$f[rd] = \min(f[rs1], f[rs2])$	Single-precision floating-point minimum-number.
FMAX.S rd,rs1,rs2	$f[rd] = \max(f[rs1], f[rs2])$	Single-precision floating-point maximum-number.
FMADD.S rd,rs1,rs2,rs3	$f[rd] = (f[rs1] \times f[rs2]) + f[rs3]$	Single-precision floating-point multiply and add.
FMSUB.S rd,rs1,rs2,rs3	$f[rd] = (f[rs1] \times f[rs2]) - f[rs3]$	Single-precision floating-point multiply and subtract.
FNMADD.S rd,rs1,rs2,rs3	$f[rd] = -(f[rs1] \times f[rs2]) + f[rs3]$	Single-precision floating-point multiply, negate, and add.
FNMSUB.S rd,rs1,rs2,rs3	$f[rd] = -(f[rs1] \times f[rs2]) - f[rs3]$	Single-precision floating-point multiply, negate, and subtract.

Table 54: Single-Precision FP Computational Instructions Description

6.5.5 Single-Precision Floating-Point Conversion and Move Instructions

Single-Precision Floating-Point Conversion Instructions

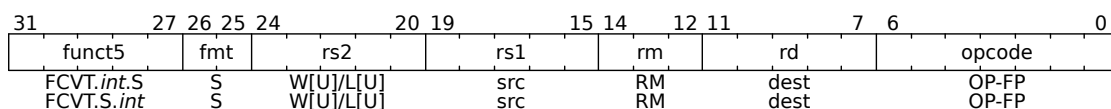

Figure 52: Single-Precision FP to Integer and Integer to FP Conversion Instructions

Instruction	Operation	Description
FCVT.W.S rd, rs1	$x[rd] = \text{sext}(s32_{f32}(f[rs1]))$	Converts a single-precision floating-point number to a signed 32-bit integer. Sign-extends the 32-bit result to the destination register width.
FCVT.S.W rd, rs1	$f[rd] = f32_{s32}(x[rs1])$	Converts a signed 32-bit integer to a single-precision floating-point number.
FCVT.WU.S rd, rs1	$x[rd] = \text{sext}(u32_{f32}(f[rs1]))$	Converts a single-precision floating-point number to an unsigned 32-bit integer. Sign-extends the 32-bit result to the destination register width.
FCVT.S.WU rd, rs1	$f[rd] = f32_{u32}(x[rs1])$	Converts an unsigned 32-bit integer to a single-precision floating-point number.
FCVT.L.S rd, rs1	$x[rd] = s64_{f32}(f[rs1])$	Converts a single-precision floating-point number to a signed 64-bit integer.
FCVT.S.L rd, rs1	$f[rd] = f32_{s64}(x[rs1])$	Converts a signed 64-bit integer to a single-precision floating-point number.
FCVT.LU.S rd, rs1	$x[rd] = u64_{f32}(f[rs1])$	Converts a single-precision floating-point number to an unsigned 64-bit integer.
FCVT.S.LU rd, rs1	$f[rd] = f32_{u64}(x[rs1])$	Converts an unsigned 64-bit integer to a single-precision floating-point number.

Table 55: Single-Precision FP Conversion Instructions Description

If the rounded result is not representable in the destination format, it is clipped to the nearest value and the invalid flag is set.

Single-Precision Floating-Point to Floating-Point Sign-Injection Instructions

The floating-point to floating-point sign-injection instructions produce a result that takes all bits except the sign bit from rs1. The sign-injection instructions provide floating-point MV, ABS and NEG.

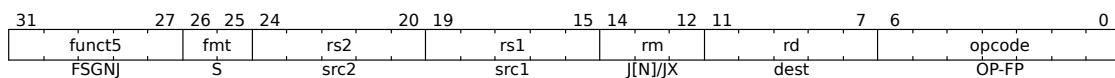

Figure 53: Single-Precision FP to FP Sign-Injection Instructions

Instruction	Operation	Description
FSGNJ.S rd, rs1, rs2	$f[rd] = \{f[rs2][31], f[rs1][30:0]\}$	Produces a result that takes all bits except the sign bit from rs1. The result's sign bit is rs2's sign bit.
FSGNJS rd, rs1, rs2	$f[rd] = \{-f[rs2][31], f[rs1][30:0]\}$	Produces a result that takes all bits except the sign bit from rs1. The result's sign bit is the opposite of rs2's sign bit.
FSGNJX.S rd, rs1, rs2	$f[rd] = \{f[rs1][31] \wedge f[rs2][31], f[rs1][30:0]\}$	Produces a result that takes all bits except the sign bit from rs1. The sign bit is the XOR of the sign bits of rs1 and rs2.

Table 56: Single-Precision FP to FP Sign-Injection Instructions Description

ISA Base Instruction	Pseudoinstruction	Description
FSGNJ.S rx, ry, ry	FMV.S rx, ry	Moves ry to rx.
FSGNJS rx, ry, ry	FNEG.S rx, ry	Moves the negation of ry to rx.
FSGNJX.S rx, ry, ry	FABS.S rx, ry	Moves the absolute value of ry to rx.

Table 57: RISC-V Base Instruction to Assembly Pseudoinstruction Example

Single-Precision Floating-Point Move Instructions

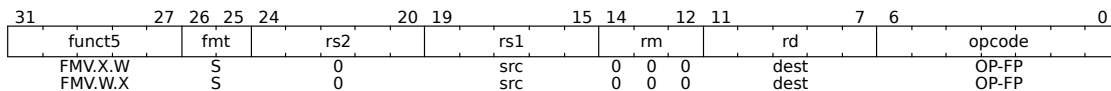

Figure 54: Single-Precision FP Move Instructions

Instruction	Operation	Description
FMV.X.W rd, rs1	$x[rd] = \text{sext}(f[rs1][31:0])$	Moves the single-precision value in floating-point register rs1 represented in IEEE 754-2008 encoding to the lower 32 bits of integer register rd. The higher 32 bits of the destination register are filled with copies of the floating-point number's sign bit.
FMV.W.X rd, rs1	$f[rd] = x[rs1][31:0]$	Moves the single-precision value encoded in IEEE 754-2008 standard encoding from the lower 32 bits of integer register rs1 to the floating-point register rd.

Table 58: Single-Precision FP Move Instructions Description

6.5.6 Single-Precision Floating-Point Compare Instructions

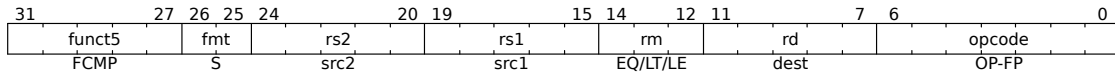

Figure 55: Single-Precision FP Compare Instructions

Instruction	Operation	Description
FEQ.S rd, rs1, rs2	$x[rd] = f[rs1] == f[rs2]$	Writes 1 to the integer register rd if rs1 is equal to rs2, 0 otherwise. Performs a quiet comparison; only sets the invalid operation exception flag if either input is a signaling NaN.
FLT.S rd, rs1, rs2	$x[rd] = f[rs1] < f[rs2]$	Writes 1 to the integer register rd if rs1 less than rs2, 0 otherwise. Performs signaling comparisons; sets the invalid operation exception flag if either input is NaN.
FLE.S rd, rs1, rs2	$x[rd] = f[rs1] \leq f[rs2]$	Writes 1 to the integer register rd if rs1 less than or equal to rs2, 0 otherwise. Performs signaling comparisons; sets the invalid operation exception flag if either input is NaN.

Table 59: Single-Precision FP Compare Instructions Description

Single-Precision Floating-Point Classify Instruction

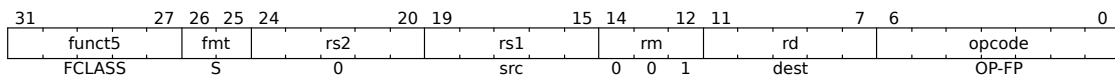

Figure 56: Single-Precision FP Classify Instruction

Instruction	Operation	Description
FCLASS.S rd, rs1	$x[rd] = \text{classify}_s(f[rs1])$	Examines the value in floating-point register rs1 and writes to integer register rd a 10-bit mask that indicates the class of the floating-point number.

Table 60: Single-Precision FP Classify Instruction Description

rd bit	Meaning
0	rs1 is $-\infty$
1	rs1 is negative normal number
2	rs1 is a negative subnormal number
3	rs1 is -0
4	rs1 is +0
5	rs1 is a positive subnormal number
6	rs1 is a positive normal number
7	rs1 is $+\infty$
8	rs1 is a signaling NaN
9	rs1 is a quiet NaN

Table 61: Floating-Point Number Classes

6.6 D Extension: Double-Precision Floating-Point Instructions

The D extension widens the 32 floating-point registers, f_0 – f_{31} , to 64 bits. The f registers can now hold either 32-bit or 64-bit floating-point values. When multiple floating-point precisions are supported, then valid values of narrower n-bit types, $n < \text{FLEN}$, are represented in the lower n bits of an FLEN-bit. Any operation that writes a narrower result to an f register must write all 1s to the uppermost FLEN-n bits to yield a legal NaN-boxed value. Floating-point n-bit transfer operations move external values held in IEEE standard formats into and out of the f registers, and comprise floating-point loads and stores and floating point move instructions.

6.6.1 Double-Precision Floating-Point Load and Store Instructions

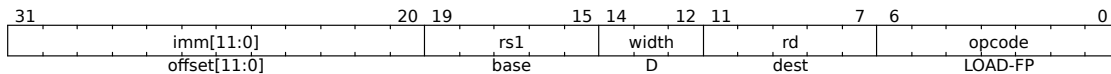

Figure 57: Double-Precision FP Load Instruction

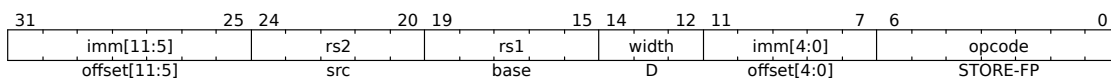

Figure 58: Double-Precision FP Store Instruction

Instruction	Operation	Description
FLD rd, rs1, imm	$f[\text{rd}] = M[x[\text{rs1}] + \text{sext}(\text{offset})][63:0]$	Loads a double-precision floating-point value from memory into floating-point register rd.
FSD imm, rs1, rs2	$M[x[\text{rs1}] + \text{sext}(\text{offset})] = f[\text{rs2}][63:0]$	Stores a double-precision value from the floating-point register rs2 to memory.

Table 62: Double-Precision FP Load and Store Instructions Description

FLD and FSD are only guaranteed to execute atomically if the effective address is naturally aligned and $XLEN \geq 64$. These instructions do not modify the bits being transferred; in particular, the payloads of non-canonical NaNs are preserved.

6.6.2 Double-Precision Floating-Point Computational Instructions

The double-precision floating-point computational instructions are defined analogously to their single-precision counterparts, but operate on double-precision operands and produce double-precision results.

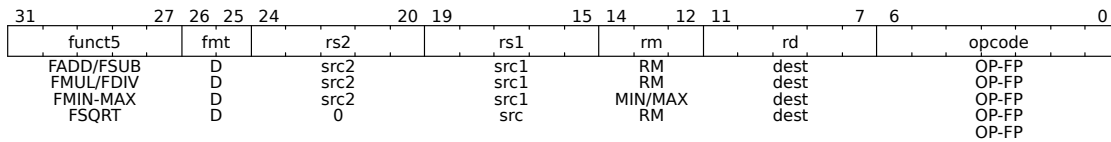

Figure 59: Double-Precision FP Computational Instructions

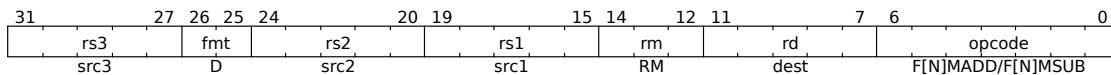

Figure 60: Double-Precision FP Fused Computational Instructions

Instruction	Operation	Description
FADD.D rd,rs1,rs2	$f[rd] = f[rs1] + f[rs2]$	Double-precision floating-point addition.
FSUB.D rd,rs1,rs2	$f[rd] = f[rs1] - f[rs2]$	Double-precision floating-point subtraction.
FMUL.D rd,rs1,rs2	$f[rd] = f[rs1] \times f[rs2]$	Double-precision floating-point multiplication.
FDIV.D rd,rs1,rs2	$f[rd] = f[rs1] \div f[rs2]$	Double-precision floating-point division.
FSQRT.D rd,rs1	$f[rd] = \sqrt{f[rs1]}$	Double-precision floating-point square root.
FMIN.D rd,rs1,rs2	$f[rd] = \min(f[rs1], f[rs2])$	Double-precision floating-point minimum-number.
FMAX.D rd,rs1,rs2	$f[rd] = \max(f[rs1], f[rs2])$	Double-precision floating-point maximum-number.
FMADD.D rd,rs1,rs2,rs3	$f[rd] = (f[rs1] \times f[rs2]) + f[rs3]$	Double-precision floating-point multiply and add.
FMSUB.D rd,rs1,rs2,rs3	$f[rd] = (f[rs1] \times f[rs2]) - f[rs3]$	Double-precision floating-point multiply and subtract.
FNMADD.D rd,rs1,rs2,rs3	$f[rd] = -(f[rs1] \times f[rs2]) + f[rs3]$	Double-precision floating-point multiply, negate, and add.
FNMSUB.D rd,rs1,rs2,rs3	$f[rd] = -(f[rs1] \times f[rs2]) - f[rs3]$	Double-precision floating-point multiply, negate, and subtract.

Table 63: Double-Precision FP Computational Instructions Description

6.6.3 Double-Precision Floating-Point Conversion and Move Instructions

Double-Precision Floating-Point Conversion Instructions

All floating-point to integer and integer to floating-point conversion instructions round according to the *rm* field.

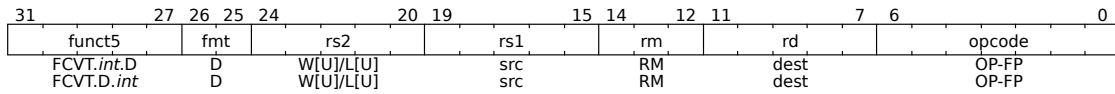

Figure 61: Double-Precision FP to Integer and Integer to FP Conversion Instructions

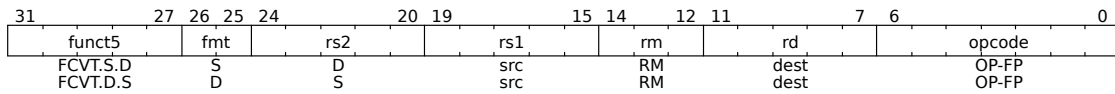

Figure 62: Double-Precision to Single-Precision and Single-Precision to Double-Precision FP Conversion Instructions

Instruction	Operation	Description
FCVT.W.D rd, rs1	$x[rd] = \text{sext}(s32_{f64}(f[rs1]))$	Converts a double-precision floating-point number to a signed 32-bit integer. Sign-extends the 32-bit result to the destination register width.
FCVT.D.W rd, rs1	$f[rd] = f64_{s32}(x[rs1])$	Converts a signed 32-bit integer to a double-precision floating-point number. Always produces an exact result and is unaffected by rounding mode.
FCVT.WU.D rd, rs1	$x[rd] = \text{sext}(u32_{f64}(f[rs1]))$	Converts a double precision floating-point number to an unsigned 32-bit integer. Sign-extends the 32-bit result to the destination register width.
FCVT.D.WU rd, rs1	$f[rd] = f64_{u32}(x[rs1])$	Converts an unsigned 32-bit integer to a double-precision floating-point number. Always produces an exact result and is unaffected by rounding mode.
FCVT.L.D rd, rs1	$x[rd] = s64_{f64}(f[rs1])$	Converts a double-precision floating-point number to a signed 64-bit integer.
FCVT.D.L rd, rs1	$f[rd] = f64_{s64}(x[rs1])$	Converts a signed 64-bit integer to a double-precision floating-point number.
FCVT.LU.D rd, rs1	$x[rd] = u64_{f64}(f[rs1])$	Converts a double-precision floating-point number to an unsigned 64-bit integer.
FCVT.D.LU rd, rs1	$f[rd] = f64_{u64}(x[rs1])$	Converts an unsigned 64-bit integer to a double-precision floating-point number.
FCVT.S.D rd, rs1	$f[rd] = f32_{f64}(f[rs1])$	Converts a double-precision floating-point number to a single-precision floating-point number.
FCVT.D.S rd, rs1	$f[rd] = f64_{f32}(f[rs1])$	Converts a single-precision floating-point number to a double-precision floating-point number.

Table 64: Double-Precision FP Conversion Instructions Description

Double-Precision Floating-Point to Floating-Point Sign-Injection Instructions

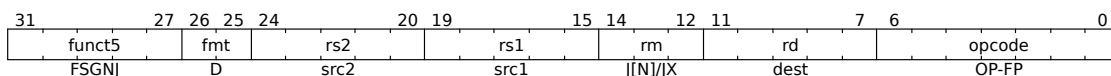

Figure 63: Double-Precision FP to FP Sign-Injection Instructions

Instruction	Operation	Description
FSGNJ.D rd, rs1, rs2	$f[rd] = \{f[rs2][63], f[rs1][62:0]\}$	Produces a result that takes all bits except the sign bit from rs1. The result's sign bit is rs2's sign bit.
FSGNJD.D rd, rs1, rs2	$f[rd] = \{-f[rs2][63], f[rs1][62:0]\}$	Produces a result that takes all bits except the sign bit from rs1. The result's sign bit is the opposite of rs2's sign bit.
FSGNJX.D rd, rs1, rs2	$f[rd] = \{f[rs1][63] \wedge f[rs2][63], f[rs1][62:0]\}$	Produces a result that takes all bits except the sign bit from rs1. The sign bit is the XOR of the sign bits of rs1 and rs2.

Table 65: Double-Precision FP to FP Sign-Injection Instructions Description

ISA Base Instruction	Pseudoinstruction	Description
FSGNJ.D rx, ry, ry	FMV.D rx, ry	Moves ry to rx.
FSGNJD.D rx, ry, ry	FNEG.D rx, ry	Moves the negation of ry to rx.
FSGNJX.D rx, ry, ry	FABS.D rx, ry	Moves the absolute value of ry to rx.

Table 66: RISC-V Base Instruction to Assembly Pseudoinstruction Example

Double-Precision Floating-Point Move Instructions

The RV64 architecture provides instructions to move bit patterns between the floating-point and integer registers.

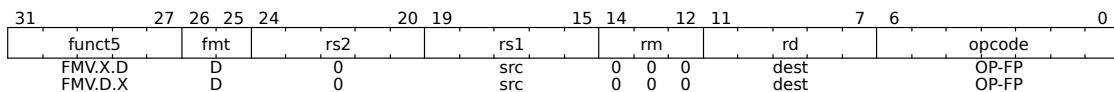

Figure 64: Double-Precision FP Move Instructions

Instruction	Operation	Description
FMV.X.D rd, rs1	$x[rd] = f[rs1][63:0]$	Moves the double-precision value in floating-point register rs1 to a representation in IEEE 754-2008 standard encoding in integer register rd.
FMV.D.X rd, rs1	$f[rd] = x[rs1][63:0]$	Moves the double-precision value encoded in IEEE 754-2008 standard encoding from the integer register rs1 to the floating-point register rd.

Table 67: Double-Precision FP Move Instructions Description

FMV.X.D and FMV.D.X do not modify the bits being transferred; in particular, the payloads of non-canonical NaNs are preserved.

6.6.4 Double-Precision Floating-Point Compare Instructions

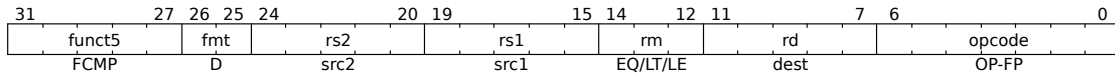

Figure 65: Double-Precision FP Compare Instructions

Instruction	Operation	Description
FEQ.D rd, rs1, rs2	$x[rd] = f[rs1] == f[rs2]$	Writes 1 to the integer register rd if rs1 is equal to rs2, 0 otherwise. Performs a quiet comparison; only sets the invalid operation exception flag if either input is a signaling NaN.
FLT.D rd, rs1, rs2	$x[rd] = f[rs1] < f[rs2]$	Writes 1 to the integer register rd if rs1 less than rs2, 0 otherwise. Performs signaling comparisons; sets the invalid operation exception flag if either input is NaN.
FLE.D rd, rs1, rs2	$x[rd] = f[rs1] \leq f[rs2]$	Writes 1 to the integer register rd if rs1 less than or equal to rs2, 0 otherwise. Performs signaling comparisons; sets the invalid operation exception flag if either input is NaN.

Table 68: Double-Precision FP Compare Instructions Description

6.6.5 Double-Precision Floating-Point Classify Instruction

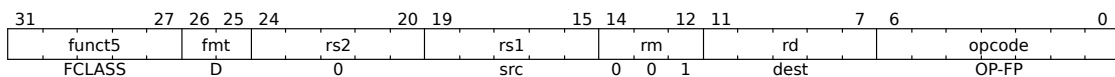

Figure 66: Double-Precision FP Classify Instruction

Instruction	Operation	Description
FCLASS.D rd, rs1	$x[rd] = \text{classify}_d(f[rs1])$	Examines the value in floating-point register rs1 and writes to integer register rd a 10-bit mask that indicates the class of the floating-point number.

Table 69: Double-Precision FP Classify Instruction Description

6.7 C Extension: Compressed Instructions

The C Extension reduces static and dynamic code size by adding short 16-bit instruction encodings for common operations. The C extension can be added to any of the base ISAs (RV32, RV64, RV128), and we use the generic term "RVC" to cover any of these. Typically, 50%–60% of the RISC-V instructions in a program can be replaced with RVC instructions, resulting in a 25%–30% code-size reduction. The C extension is compatible with all other standard instruction extensions. The C extension allows 16-bit instructions to be freely intermixed with 32-bit instructions, with the latter now able to start on any 16-bit boundary, i.e., IALIGN=16. With the addition of the C extension, no instructions can raise instruction-address-misaligned exceptions. It is important to note that the C extension is not designed to be a stand-alone ISA, and is meant to be used alongside a base ISA. The compressed 16-bit instruction format is designed around the assumption that x1 is the return address register and x2 is the stack pointer.

6.7.1 Compressed 16-bit Instruction Formats

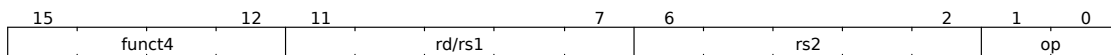

Figure 67: CR Format - Register

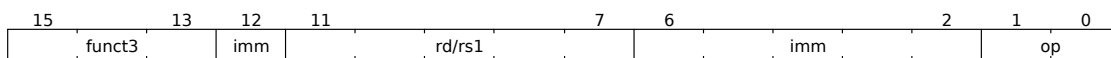

Figure 68: CI Format - Immediate

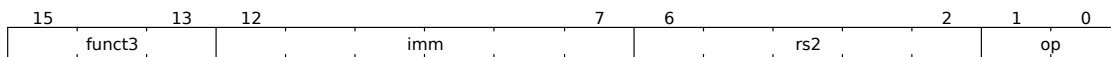

Figure 69: CSS Format - Stack-relative Store

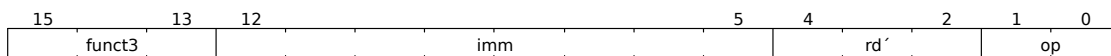

Figure 70: CIW Format - Wide Immediate

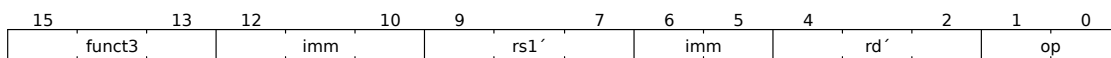

Figure 71: CL Format - Load

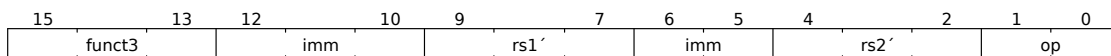

Figure 72: CS Format - Store

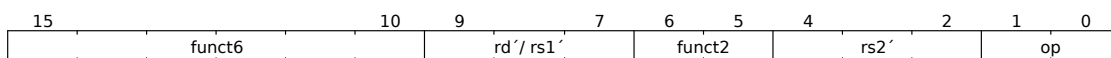

Figure 73: CA Format - Arithmetic

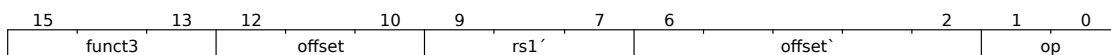

Figure 74: CJ Format - Jump

6.7.2 Stack-Pointed-Based Loads and Stores

The compressed load instructions are expressed in CI format.

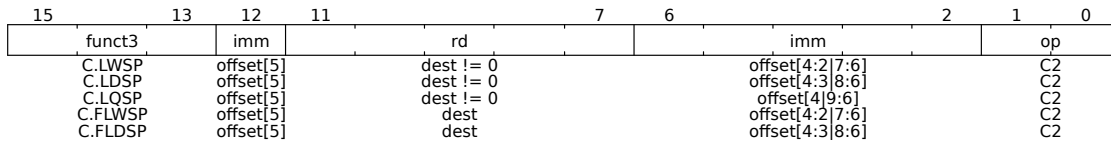

Figure 75: Stack-Pointed-Based Loads

Instruction	Description
C.LWSP	Loads a 32-bit value from memory into register rd.
C.LDSP	RV64C Instruction which loads a 64-bit value from memory into register rd.
C.LQSP	RV128C loads a 128-bit value from memory into register rd.
C.FLWSP	RV32FC Instruction that loads a single-precision floating-point value from memory into floating-point register rd.
C.FLDSP	RV32DC/RV64DC Instruction that loads a double-precision floating-point value from memory into floating-point register rd.

Table 70: Stack-Pointed-Based Load Instruction Description

The compressed store instructions are expressed in CSS format.

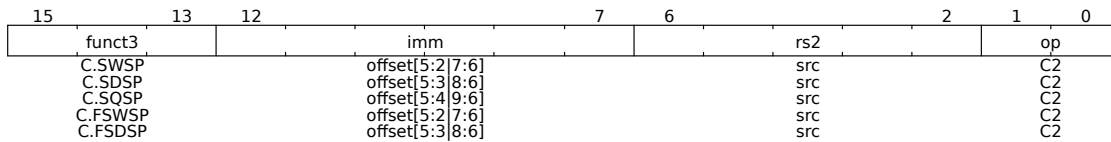

Figure 76: Stack-Pointed-Based Stores

Instruction	Description
C.LWSP	Loads a 32-bit value from memory into register rd.
C.SWSP	Stores a 32-bit value in register rs2 to memory.
C.SDSP	RV64C/RV128C instruction that stores a 64-bit value in register rs2 to memory.
C.SQSP	RV128C instruction that stores a 128-bit value in register rs2 to memory.
C.FSWSP	RV32FC instruction that stores a single-precision floating-point value in floating-point register rs2 to memory.
C.FSDSP	RV32DC/RV64DC instruction that stores a double-precision floating-point value in floating-point register rs2 to memory.

Table 71: Stack-Pointed-Based Store Instruction Description

6.7.3 Register-Based Loads and Stores

The compressed register-based load instructions are expressed in CL format.

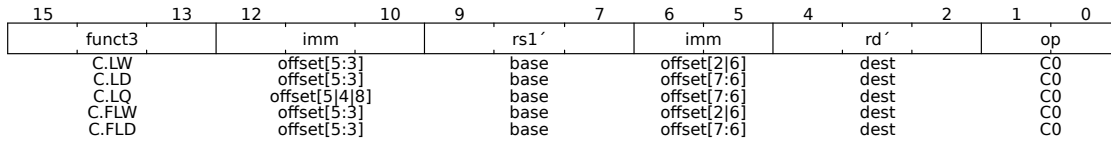

Figure 77: Register-Based Loads

Instruction	Description
C.LW	Loads a 32-bit value from memory into register rd.
C.LD	RV64C/RV128C-only instruction that loads a 64-bit value from memory into register rd.
C.LQ	RV128C-only instruction that loads a 128-bit value from memory into register rd.
C.FLW	RV32FC-only instruction that loads a single-precision floating-point value from memory into floating-point register rd.
C.FLD	RV32DC/RV64DC-only instruction that loads a double-precision floating-point value from memory into floating-point register rd.

Table 72: Register-Based Load Instruction Description

The compressed register-based store instructions are expressed in CS format.

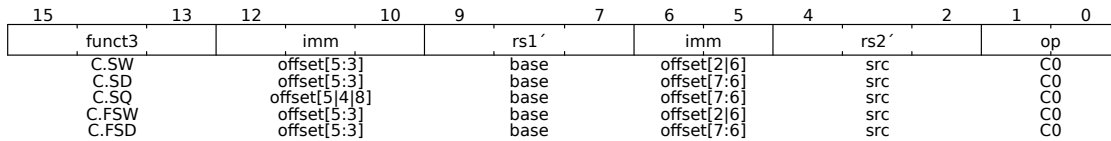

Figure 78: Register-Based Stores

Instruction	Description
C.SW	Stores a 32-bit value in register rs2 to memory.
C.SD	RV64C/RV128C instruction that stores a 64-bit value in register rs2 to memory.
C.SQ	RV128C instruction that stores a 128-bit value in register rs2 to memory.
C.FSW	RV32FC instruction that stores a single-precision floating-point value in floating point register rs2 to memory.
C.FSD	RV32DC/RV64DC instruction that stores a double-precision floating-point value in floating-point register rs2 to memory.

Table 73: Register-Based Store Instruction Description

6.7.4 Control Transfer Instructions

RVC provides unconditional jump instructions and conditional branch instructions.

The unconditional jump instructions are expressed in CJ format.

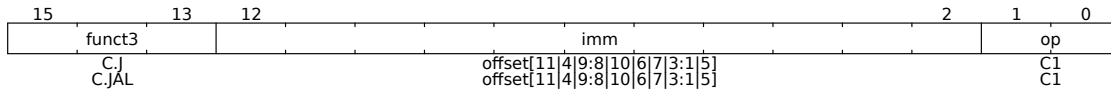

Figure 79: Unconditional Jump Instructions

Instruction	Description
C.J	Unconditional control transfer.
C.JAL	RV32C instruction that performs the same operation as C.J, but additionally writes the address of the instruction following the jump (pc+2) to the link register, x1.

Table 74: Unconditional Jump Instruction Description

The unconditional control transfer instructions are expressed in CR format.

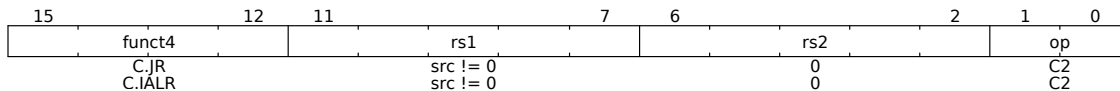

Figure 80: Unconditional Control Transfer Instructions

Instruction	Description
C.JR	Performs an unconditional control transfer to the address in register rs1.
C.JALR	Performs the same operation as C.JR, but additionally writes the address of the instruction following the jump (pc+2) to the link register, x1.

Table 75: Unconditional Control Transfer Instruction Description

The conditional control transfer instructions are expressed in CB format.

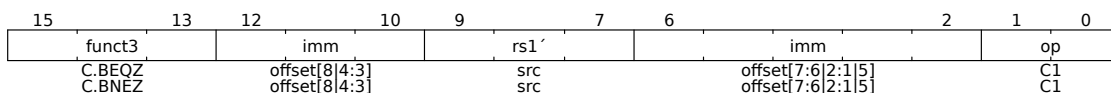

Figure 81: Conditional Control Transfer Instructions

Instruction	Description
C.BEQZ	Conditional control transfers. Takes the branch if the value in register rs1' is zero.
C.BNEZ	Conditional control transfers. Takes the branch if rs1' contains a nonzero value.

Table 76: Conditional Control Transfer Instruction Description

6.7.5 Integer Computational Instructions

Integer Constant-Generation Instructions

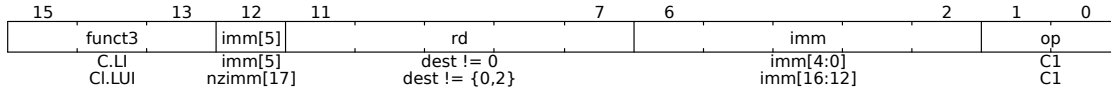

Figure 82: Integer Constant-Generation Instructions

Instruction	Description
C.LI	Loads the sign-extended 6-bit immediate, <code>imm</code> , into register <code>rd</code> .
C.LUI	Loads the non-zero 6-bit immediate field into bits 17–12 of the destination register, clears the bottom 12 bits, and sign-extends bit 17 into all higher bits of the destination

Table 77: Integer Constant-Generation Instruction Description

Integer Register-Immediate Operations

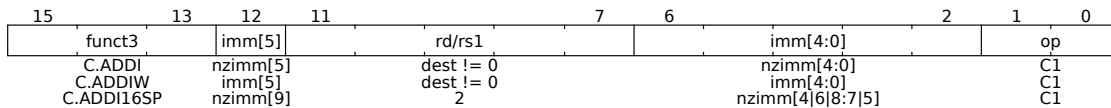

Figure 83: Integer Register-Immediate Operations

Instruction	Description
C.ADDI	Adds the non-zero sign-extended 6-bit immediate to the value in register <code>rd</code> then writes the result to <code>rd</code> .
C.ADDIW	RV64C/RV128C instruction that performs the same computation but produces a 32-bit result, then sign-extends result to 64 bits.
C.ADDI16SP	Adds the non-zero sign-extended 6-bit immediate to the value in the stack pointer (<code>sp=x2</code>), where the immediate is scaled to represent multiples of 16 in the range (-512,496). C.ADDI16SP is used to adjust the stack pointer in procedure prologues and epilogues.

Table 78: Integer Register-Immediate Operation Description

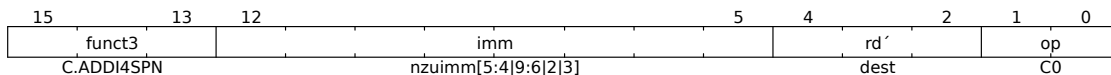

Figure 84: Integer Register-Immediate Operations (con't)

Instruction	Description
C.ADDI4SPN	Adds a zero-extended non-zero immediate, scaled by 4, to the stack pointer, <code>x2</code> , and writes the result to <code>rd'</code> .

Table 79: Integer Register-Immediate Operation Description (con't)

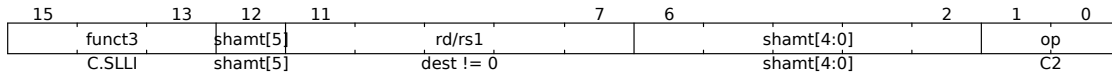

Figure 85: Integer Register-Immediate Operations (con't)

Instruction	Description
C.SLLI	Performs a logical left shift of the value in register rd then writes the result to rd. The shift amount is encoded in the shamt field.

Table 80: Integer Register-Immediate Operation Description (con't)

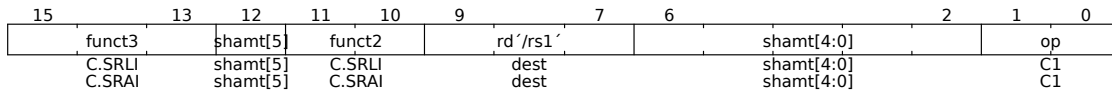

Figure 86: Integer Register-Immediate Operations (con't)

Instruction	Description
C.SRLI	Logical right shift of the value in register rd' then writes the result to rd'. The shift amount is encoded in the shamt field.
C.SRAI	Arithmetic right shift of the value in register rd' then writes the result to rd'. The shift amount is encoded in the shamt field.

Table 81: Integer Register-Immediate Operation Description (con't)

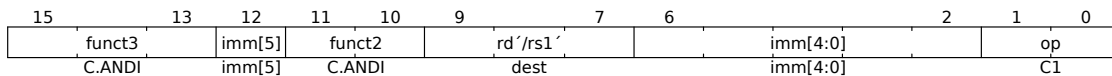

Figure 87: Integer Register-Immediate Operations (con't)

Instruction	Description
C.ANDI	Computes the bitwise AND of the value in register rd' and the sign-extended 6-bit immediate, then writes the result to rd'.

Table 82: Integer Register-Immediate Operation Description (con't)

Integer Register-Register Operations

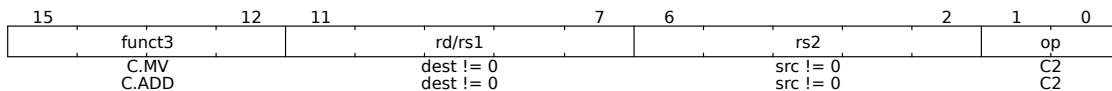

Figure 88: Integer Register-Register Operations

Instruction	Description
C.MV	Copies the value in register rs2 into register rd.
C.ADD	Adds the values in registers rd and rs2 and writes the result to register rd.

Table 83: Integer Register-Register Operation Description

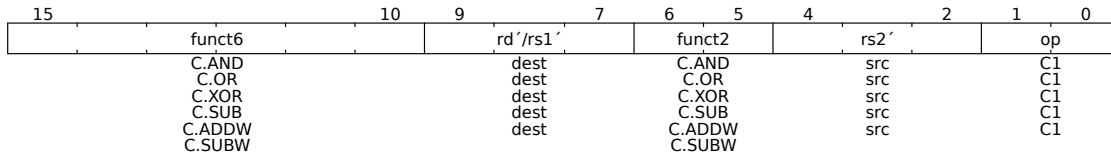

Figure 89: Integer Register-Register Operations (con't)

Instruction	Description
C.AND	Computes the bitwise AND of the values in registers rd' and rs2'.
C.OR	Computes the bitwise OR of the values in registers rd' and rs2'.
C.XOR	Computes the bitwise XOR of the values in registers rd' and rs2'.
C.SUB	Subtracts the value in register rs2' from the value in register rd'.
C.ADDW	RV64C/RV128C-only instruction that adds the values in registers rd' and rs2', then sign-extends the lower 32 bits of the sum before writing the result to register rd.
C.SUBW	RV64C/RV128C-only instruction that subtracts the value in register rs2' from the value in register rd', then sign-extends the lower 32 bits of the difference before writing the result to register rd.

Table 84: Integer Register-Register Operation Description (con't)

Defined Illegal Instruction

A 16-bit instruction with all bits zero is permanently reserved as an illegal instruction.

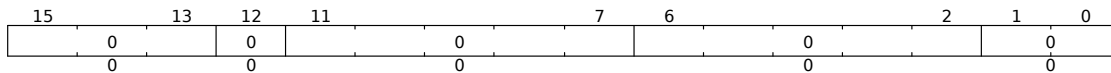

Figure 90: Defined Illegal Instruction

6.8 B Extension: Bit Manipulation Instructions

This section discusses the bit manipulation instructions supported by RISC-V.

6.8.1 Basic Bit Manipulation Instructions

Count Leading/Trailing Zeroes Instructions

Instruction	Description
CLZ rd, rs	Counts the number of 0 bits before the first 1 bit counting from the most significant bit. If the input is 0, the output is XLEN. If the input is -1, the output is 0.
CTZ rd, rs	Counts the number of 0 bits at the least significant bit end of the argument. If the input is 0, the output is XLEN. If the input is -1, the output is 0.
CLZW rd, rs	Performs the same computation as CLZ and sign-extends the 32-bit result to 64 bits.
CTZW rd, rs	Performs the same computation as CTZ and sign-extends the 32-bit result to 64 bits.

Table 85: Count Leading/Trailing Zeroes Instructions Description

Count Bits Set Instructions

Instruction	Description
CPOP rd, rs	Counts the number of 1 bits in a register.
CPOPW rd, rs	Performs the same computation as CPOP and sign-extends the 32-bit result to 64 bits.

Table 86: Count Bits Set Instructions Description

Logic-With-Negate Instructions

Instruction	Description
ANDN rd, rs1, rs2	Bitwise logical AND with rs2 inverted.
ORN rd, rs1, rs2	Bitwise logical OR with rs2 inverted.
XNOR rd, rs1, rs2	Bitwise logical XOR with rs2 inverted.

Table 87: Logic-With-Negate Instructions Description

Comparison Instructions

Instruction	Description
MIN rd, rs1, rs2	Minimum integer.
MINU rd, rs1, rs2	Unsigned minimum integer.
MAX rd, rs1, rs2	Maximum integer.
MAXU rd, rs1, rs2	Unsigned maximum integer.

Table 88: Comparison Instructions Description

Sign-Extend Instructions

Instruction	Description
SEXT.B rd, rs	Sign-extends a byte.
SEXT.H rd, rs	Sign-extends a half-word.

Table 89: Sign-Extend Instructions

6.8.2 Bit Permutation Instructions

A bit permutation essentially applies an invertible function to the bit addresses. Bit addresses are 6 bit values on RV64.

Instruction	Description
ROR rd, rs1, rs2	Rotate right shift the values from the opposite side of the register, in order.
ROL rd, rs1, rs2	Rotate left shift the values from the opposite side of the register, in order.
RORI rd, rs1, imm	Rotate right shift, and the shift amount is encoded in the lower 5 bits of the I-immediate field.
RORW rd, rs1, rs2	Performs the same computation as ROR and sign-extends the 32-bit result to 64 bits.
ROLW rd, rs1, rs2	Performs the same computation as ROL and sign-extends the 32-bit result to 64 bits.
RORIW rd, rs1, imm	Performs the same computation as RORI and sign-extends the 32-bit result to 64 bits.

Table 90: Bit Permutation Instructions Description

6.8.3 Address Calculation Instructions

Instruction	Description
SH1ADD rd, rs1, rs2	Shifts rs1 by 1 bit, then adds the result to rs2.
SH2ADD rd, rs1, rs2	Shifts rs1 by 2 bits, then adds the result to rs2.
SH3ADD rd, rs1, rs2	Shifts rs1 by 3 bits, then adds the result to rs2.
SH1ADD.UW rd, rs1, rs2	RV64B instruction that performs the same computation, except that bits [XLEN-1:32] of rs1 are cleared before the shift.
SH2ADD.UW rd, rs1, rs2	RV64B instruction that performs the same computation, except that bits [XLEN-1:32] of rs1 are cleared before the shift.
SH3ADD.UW rd, rs1, rs2	RV64B instruction that performs the same computation, except that bits [XLEN-1:32] of rs1 are cleared before the shift.

Table 91: Address Calculation Instructions Description

6.8.4 Add/Shift with Prefix Zero-Extend Instructions

Instruction	Description
ADD.UW rd, rs1, rs2	Identical to ADD, except that bits [XLEN-1:32] of rs1 are cleared before the add.
SLLI.UW rd, rs1, imm	Identical to SLLI, except that bits [XLEN-1:32] of rs1 are cleared before the shift.

Table 92: Add/Shift with Prefix Zero-Extend Instructions Description

6.8.5 Bit Manipulation Pseudoinstructions

The B Extension also implements a set of pseudoinstructions.

Instruction	Description
ZEXT.H rd, rs	Zero-extends a half-word.
REV8	Reverses the order of bytes in a word, thus performing endianness conversion.
ORC.B	Byte-wise reverse and or-combine.

Table 93: Bit Manipulation Pseudoinstructions Description

6.9 Zicsr Extension: Control and Status Register Instructions

RISC-V defines a separate address space of 4096 Control and Status registers associated with each hart. The defined instructions access counter, timers and floating point status registers.

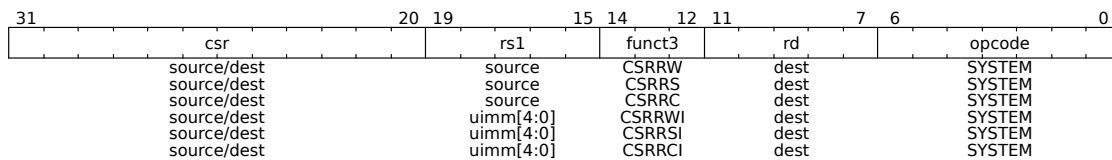

Figure 91: Zicsr Instructions

Instruction	Description
CSRRW rd, rs1 csr	Instruction atomically swaps values in the CSRs and integer registers.
CSRRS rd, rs1 csr	Instruction reads the value of the CSR, zeroextends the value to 64-bits, and writes it to integer register rd. The initial value in integer register rs1 is treated as a bit mask that specifies bit positions to be set in the CSR.
CSRRC rd, rs1 csr	Instruction reads the value of the CSR, zeroextends the value to 64-bits, and writes it to integer register rd. The initial value in integer register rs1 is treated as a bit mask that specifies bit positions to be cleared in the CSR.
CSRRWI rd, rs1 csr	Update the CSR using an 64-bit value obtained by zero-extending a 5-bit unsigned immediate (uimm[4:0]) field encoded in the rs1 field instead of a value from an integer register.
CSRRSI rd, rs1 csr	Update the CSR using an 64-bit value obtained by zero-extending a 5-bit unsigned immediate (uimm[4:0]) field encoded in the rs1 field instead of a value from an integer register.
CSRRCI rd, rs1 csr	If the uimm[4:0] field is zero, then these instructions will not write to the CSR.

Table 94: Control and Status Register Instruction Description

The CSRRWI, CSRRSI, and CSRRCI instructions are similar in kind to CSRRW, CSRRS, and CSRRC respectively, except in that they update the CSR using an 64-bit value obtained by zero-extending a 5-bit unsigned immediate (uimm[4:0]) field encoded in the rs1 field instead of a value from an integer register. For CSRRSI and CSRRCI, these instructions will not write to the CSR if the uimm[4:0] field is zero, and they shall not cause any of the size effects that might otherwise occur on a CSR write. For CSRRWI, if rd = x0, then the instruction shall not read the CSR and shall not cause any of the side effects that might occur on a CSR read. Both CSRRSI and CSRRCI will always read the CSR and cause any read side effects regardless of the rd and rs1 fields.

Table 95 shows if a CSR reads or writes given a particular CSR.

Register Operand				
Instruction	rd	rs1	read CSR?	write CSR?
CSRRW	x0	-	no	yes
CSRRW	!x0	-	yes	yes
CSRRS/C	-	x0	yes	no
CSRRS/C	-	!x0	yes	yes
Immediate Operand				
Instruction	rd	uimm	read CSR?	write CSR?
CSRRWI	x0	-	no	yes
CSRRWI	!x0	-	yes	yes
CSRRS/CI	-	0	yes	no
CSRRS/CI	-	!0	yes	yes

Table 95: CSR Reads and Writes

6.9.1 Control and Status Registers

The control and status registers (CSRs) are only accessible using variations of the CSRR (Read) and CSRRW (Write) instructions. Only the CPU executing the csr instruction can read or write these registers, and they are not visible by software outside of the core they reside on. The standard RISC-V ISA sets aside a 12-bit encoding space (csr[11:0]) for up to 4,096 CSRs. Attempts to access a non-existent CSR raise an illegal instruction exception. Attempts to access a CSR without appropriate privilege level or to write a read-only register also raise illegal instruction. A read/write register might also contain some bits that are read-only, in which case, writes to the read-only bits are ignored. Each core functionality has its own control and status registers which are described in the corresponding section.

6.9.2 Defined CSRs

The following tables describe the currently defined CSRs, categorized by privilege level. The usage of the CSRs below is implementation specific. CSRs are only accessible when operating within a specific access mode (user mode, debug mode, supervisor mode, or machine mode). Therefore, attempts to access a non-existent CSR raise an illegal instruction exception, and attempts to access a CSR without appropriate privilege level or to write a read-only register also raise illegal instruction exceptions.

Number	Privilege	Name	Description
User Trap Setup			
0x000	RW	ustatus	User status register.
0x004	RW	uie	User interrupt-enable register.
0x005	RW	utvec	User trap handler base address.
User Trap Handling			
0x040	RW	uscratch	Scratch register for use trap handlers.
0x041	RW	uepc	User exception program counter.
0x042	RW	ucause	User trap cause.
0x043	RW	ubadaddr	User bad address.
0x044	RW	uip	User interrupt pending.
User Floating-Point CSRs			
0x001	RW	fflags	Floating-Point Accrued Exceptions.
0x002	RW	frm	Floating-Point Dynamic Rounding Mode.
0x003	RW	fcsr	Floating-Point Control and Status Register (frm + fflags).
User Counter/Timers			
0xC00	RO	cycle	Cycle counter for RDCYCLE instruction.
0xC01	RO	time	Timer for RDTIME instruction.
0xC02	RO	instret	Instructions-retired counter for RDINSTRET instruction.
0xC03	RO	hpmcounter3	Performance-monitoring counter.
0xC04	RO	hpmcounter4	Performance-monitoring counter.
		...	
0xC1F	RO	hpmcounter31	Performance-monitoring counter.

Table 96: User Mode CSRs

Number	Privilege	Name	Description
Supervisor Trap Setup			
0x100	RW	sstatus	Supervisor status register.
0x102	RW	sedeleg	Supervisor exception delegation register.
0x103	RW	sideleg	Supervisor interrupt delegation register.
0x104	RW	sie	Supervisor interrupt-enable register.
0x105	RW	stvec	Supervisor trap handler base address.
0x106	RW	scounteren	Supervisor counter enable.
Supervisor Trap Handling			
0x140	RW	sscratch	Scratch register for supervisor trap handlers.
0x141	RW	sepc	Supervisor exception program counter.
0x142	RW	scause	Supervisor trap cause.
0x143	RW	stval	Supervisor bad address or instruction.
0x144	RW	sip	Supervisor interrupt pending.
Supervisor Protection and Translation			
0x180	RW	satp	Supervisor address translation and protection.

Table 97: Supervisor Mode CSRs

Number	Privilege	Name	Description
Machine Information Registers			
0xF11	RO	mvendorid	Vendor ID.
0xF12	RO	marchid	Architecture ID.
0xF13	RO	mimpid	Implementation ID.
0xF14	RO	mhartid	Hardware thread ID.
Machine Trap Setup			
0x300	RW	mstatus	Machine status register.
0x301	RW	misa	ISA and extensions.
0x302	RW	medeleg	Machine exception delegation register.
0x303	RW	mideleg	Machine interrupt delegation register.
0x304	RW	mie	Machine interrupt-enable register.
0x305	RW	mtvec	Machine trap-handler base address.
0x306	RW	mcounteren	Machine counter enable.
Machine Trap Handling			
0x340	RW	mscratch	Scratch register for machine trap handlers.
0x341	RW	mepc	Machine exception program counter.
0x342	RW	mcause	Machine trap cause.
0x343	RW	mtval	Machine bad address or instruction.
0x344	RW	mip	Machine interrupt pending.
Machine Memory Protection			
0x3A0	RW	pmpcfg0	Physical memory protection configuration.
0x3A1	RW	pmpcfg1	Physical memory protection configuration, RV32 only.
0x3A2	RW	pmpcfg2	Physical memory protection configuration.
0x3A3	RW	pmpcfg3	Physical memory protection configuration, RV32 only.
0x3B0	RW	pmpaddr0	Physical memory protection address register.
0x3B1	RW	pmpaddr1	Physical memory protection address register.
		...	
0x3BF	RW	pmpaddr15	Physical memory protection address register.
Machine Counter/Timers			
0xB00	RW	mcycle	Machine cycle counter.
0xB02	RW	minstret	Machine instruction-retired counter.
Machine Counter Setup			
0x320	RW	mcountinhibit	Machine counter-inhibit register.
0x323	RW	mhpmevent3	Machine performance-monitoring event selector.
0x324	RW	mhpmevent4	Machine performance-monitoring event selector.
		...	
0x33F	RW	mhpmevent31	Machine performance-monitoring event selector.
Debug/Trace Register (shared with Debug Mode)			
0x7A0	RW	tselect	Debug/Trace trigger register select.

Table 98: Machine Mode CSRs

Number	Privilege	Name	Description
0x7A1	RW	tdata1	First Debug/Trace trigger data register.
0x7A2	RW	tdata2	Second Debug/Trace trigger data register.
0x7A3	RW	tdata3	Third Debug/Trace trigger data register.

Table 98: Machine Mode CSRs

Number	Privilege	Name	Description
0x7B0	RW	dcsr	Debug control and status register.
0x7B1	RW	dpc	Debug PC.
0x7B2	RW	dscratch	Debug scratch register.

Table 99: Debug Mode Registers

6.9.3 CSR Access Ordering

On a given hart, explicit and implicit CSR access are performed in program order with respect to those instructions whose execution behavior is affected by the state of the accessed CSR. In particular, a CSR access is performed after the execution of any prior instructions in program order whose behavior modifies or is modified by the CSR state and before the execution of any subsequent instructions in program order whose behavior modifies or is modified by the CSR state.

Furthermore, a CSR read access instruction returns the accessed CSR state before the execution of the instruction, while a CSR write access instruction updates the accessed CSR state after the execution of the instruction. Where the above program order does not hold, CSR accesses are weakly ordered, and the local hart or other harts may observe the CSR accesses in an order different from program order. In addition, CSR accesses are not ordered with respect to explicit memory accesses, unless a CSR access modifies the execution behavior of the instruction that performs the explicit memory access or unless a CSR access and an explicit memory access are ordered by either the syntactic dependencies defined by the memory model or the ordering requirements defined by the Memory-Ordering PMAs. To enforce ordering in all other cases, software should execute a FENCE instruction between the relevant accesses. For the purposes of the FENCE instruction, CSR read accesses are classified as device input (I), and CSR write accesses are classified as device output (O). For more about the FENCE instructions, see Section 6.13. For CSR accesses that cause side effects, the above ordering constraints apply to the order of the initiation of those side effects but does not necessarily apply to the order of the completion of those side effects.

6.9.4 SiFive RISC-V Implementation Version Registers

`mvendorid`

The value in `mvendorid` is 0x489, corresponding to SiFive's JEDEC number.

marchid

The value in `marchid` indicates the overall microarchitecture of the core and at SiFive we use this to distinguish between core generators. The RISC-V standard convention separates `marchid` into open-source and proprietary namespaces using the most-significant bit (MSB) of the `marchid` register; where if the MSB is clear, the `marchid` is for an open-source core, and if the MSB is set, then `marchid` is a proprietary microarchitecture. The open-source namespace is managed by the RISC-V Foundation and the proprietary namespace is managed by SiFive.

SiFive's E3 and S5 cores are based on the open-source 3/5-Series microarchitecture, which has a Foundation-allocated `marchid` of 1. Our other generators are numbered according to the core series.

Value	Core Generator
0x8000_0007	7-Series Processor (E7, S7, U7 series)

Table 100: Core Generator Encoding of `marchid`

mimpid

The value in `mimpid` holds an encoded value that uniquely identifies the version of the generator used to build this implementation. If your release version is not included in Table 101, contact your SiFive account manager for more information.

Value	Generator Release Version
0x0000_0000	Pre-19.02
0x2019_0228	19.02
0x2019_0531	19.05
0x2019_0919	19.08p0p0 / 19.08.00
0x2019_1105	19.08p1p0 / 19.08.01.00
0x2019_1204	19.08p2p0 / 19.08.02.00
0x2020_0423	19.08p3p0 / 19.08.03.00
0x0120_0626	19.08p4p0 / 19.08.04.00
0x0220_0515	koala.00.00-preview and koala.01.00-preview
0x0220_0603	koala.02.00-preview
0x0220_0630	20G1.03.00 / koala.03.00-general
0x0220_0710	20G1.04.00 / koala.04.00-general
0x0220_0826	20G1.05.00 / koala.05.00-general
0x0320_0908	kiwi.00.00-preview
0x0220_1013	20G1.06.00 / koala.06.00-general
0x0220_1120	20G1.07.00 / koala.07.00-general
0x0421_0205	llama.00.00-preview
0x0421_0324	21G1.01.00 / llama.01.00-general

Table 101: Generator Release Encoding of `mimpid`

Reading Implementation Version Registers

To read the `mvendorid`, `marchid`, and `mimpid` registers, simply replace `mimpid` with `mvendorid` or `marchid` as needed.

In C:

```
uintptr_t mimpid;
__asm__ volatile("csrr %0, mimpid" : "=r"(mimpid));
```

In Assembly:

```
csrr a5, mimpid
```

6.9.5 Custom CSRs

SiFive implements some custom CSRs that are specific to the implementation. For these CSRs, including the Feature Disable CSR, consider Chapter 7.

6.10 Base Counters and Timers

RISC-V ISAs provide a set of up to 32×64-bit performance counters and timers that are accessible via unprivileged 64-bit read-only CSR registers 0xc00–0xc1f. The first three of these (CYCLE, TIME, and INSTRET) have dedicated functions; while the remaining counters, if implemented, provide programmable event counting.

The U74-MC Core Complex implements `mcycle`, `mtime`, and `minstret` counters, which have dedicated functions: cycle count, real-time clock, and instructions-retired, respectively. The timer functionality is based on the `mtime` register. Additionally, the U74-MC Core Complex implements event counters in the form of `mhpmcounter`, which is used to monitor user requested events.

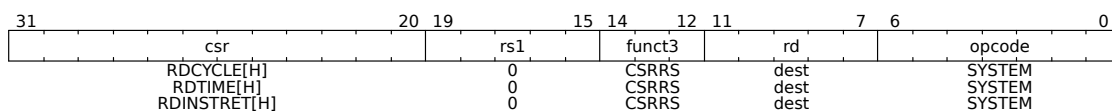

Figure 92: Timer and Counter Pseudoinstructions

Instruction	Description
RDCYCLE rd	Reads the 64-bits of the cycle CSR which holds a count of the number of clock cycles executed by the processor core on which the hart is running from an arbitrary start time in the past.
RDTIME rd	Generates an illegal instruction exception. The <code>mtime</code> register is memory mapped to the CLINT register space and can be read using a regular load instruction.
RDINSTRET rd	Reads the 64-bits of the instret CSR, which counts the number of instructions retired by this hart from some arbitrary start point in the past.

Table 102: Timer and Counter Pseudoinstruction Description

RDCYCLE, RDTIME, and RDINSTRET pseudoinstructions read the full 64 bits of the `cycle`, `time`, and `instret` counters. The RDCYCLE pseudoinstruction reads the low 64-bits of the cycle CSR (`mcycle`), which holds a count of the number of clock cycles executed by the processor core on which the hart is running from an arbitrary start time in the past. The RDTIME pseudoinstruction reads the low 64-bits of the time CSR (`mtime`), which counts wall-clock real time that has passed from an arbitrary start time in the past. The RDINSTRET pseudoinstruction reads the low 64-bits of the instret CSR (`minstret`), which counts the number of instructions retired by this hart from some arbitrary start point in the past. The rate at which the cycle counter advances is `rtc_clock`. To determine the current rate (cycles per second) of instruction execution, call the `metal_timer_get_timebase_frequency` API. The `metal_timer_get_timebase_frequency` and additional APIs are described in Section 6.10.2 below.

Number	Privilege	Name	Description
0xC00	RO	cycle	Cycle counter for RDCYCLE instruction
0xC01	RO	time	Timer for RDTIME instruction
0xC02	RO	instret	Instruction-retired counter for RDINSTRET instruction

Table 103: Timer and Counter CSRs

6.10.1 Timer Register

`mtime` is a 64-bit read-write register that contains the number of cycles counted from the `rtc_toggle` signal described in the U74-MC Core Complex User Guide. On reset, `mtime` is cleared to zero.

6.10.2 Timer API

The APIs below are used for reading and manipulating the machine timer. Other APIs are described in more detail within the Freedom Metal documentation. <https://sifive.github.io/freedom-metal-docs/>

Functions

`int metal_timer_get_cyclecount(int hartid, unsigned long long *cyclecount)`

Read the machine cycle count.

Return

0 upon success

Parameters

- `hartid`: The hart ID to read the cycle count of
- `cyclecount`: The variable to hold the value

`int metal_timer_get_timebase_frequency(int hartid, unsigned long long *timebase)`

Get the machine timebase frequency.

Return

0 upon success

Parameters

- `hartid`: The hart ID to read the cycle count of
- `timebase`: The variable to hold the value

int metal_timer_set_tick(int hartid, int second)

Set the machine timer tick interval in seconds.

Return

0 upon success

Parameters

- `hartid`: The hart ID to read the cycle count of
- `second`: The number of seconds to set the tick interval to

6.11 Privileged Instructions

The RISC-V architecture implements privileged instructions that can only be executed when the U74-MC Core Complex is operating in a privileged mode. The SYSTEM major opcode is used to encode all of the privileged instructions.

6.11.1 Machine-Mode Privileged Instructions

Environment Call and Breakpoint

These ECALL and EBREAK instructions cause a precise requested trap to the supporting execution environment. The ECALL instruction is used to make a service request to the execution environment. The EBREAK instruction is used to return control to a debugging environment.

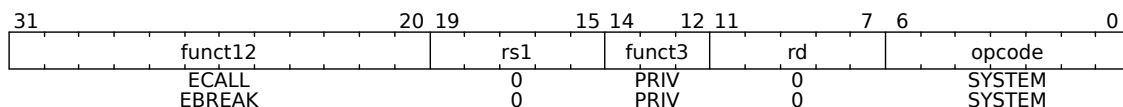

Figure 93: ECALL and EBREAK Instructions

Trap-Return Instructions

To return after handling a trap, there are separate trap return instructions per privilege level: MRET, SRET, and URET. MRET is always provided, while SRET must be provided if the respective privilege mode is supported. URET is only provided if user-mode traps are supported. An xRET instruction can be executed in privilege mode x or higher, where executing a lower-privilege xRET instruction will pop the relevant lower-privilege interrupt enable and privilege mode stack.

Wait for Interrupt

The Wait for Interrupt (WFI) instruction provides a hint to the U74-MC Core Complex that the current hart can be stalled until an interrupt might need servicing. Execution of the WFI instruction can also be used to inform the hardware platform that suitable interrupts should preferentially be routed to this hart.

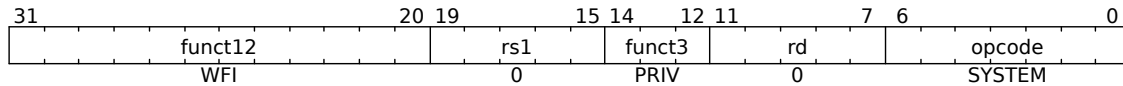

Figure 94: Wait for Interrupt Instruction

If an enabled interrupt is present or later becomes present while the hart is stalled, the interrupt exception will be taken on the following instruction, i.e., execution resumes in the trap handler and `mepc = pc + 4`. The WFI instruction can also be executed when interrupts are disabled. The operation of WFI must be unaffected by the global interrupt bits in `mstatus` (MIE/SIE/UIE) (i.e., the hart must resume if a locally enabled interrupt becomes pending), but should honor the individual interrupt enables (e.g, MTIE). WFI is also required to resume execution for locally enabled interrupts pending at any privilege level, regardless of the global interrupt enable at each privilege level. If the event that causes the hart to resume execution does not cause an interrupt to be taken, execution will resume at `pc + 4`, and software must determine what action to take, including looping back to repeat the WFI if there was no actionable event.

The suggested way to call WFI is inside an infinite loop as described below.

```
while (1) {
    __asm__ volatile ("wfi");
}
```

The WFI instruction is just a hint, and a legal implementation is to implement WFI as a NOP. In SiFive's implementation of WFI, the WFI instruction is issued and the core goes into internal clock gating state.

6.11.2 Supervisor-Mode Privileged Instructions

For S-Mode enabled cores, such as the U74-MC Core Complex one new supervisor-level instruction is provided in addition to SRET.

Supervisor Memory-Management Fence Instruction

The supervisor memory-management fence instruction `SFENCE.VMA` is used to synchronize updates to in-memory memory-management data structures with current execution.

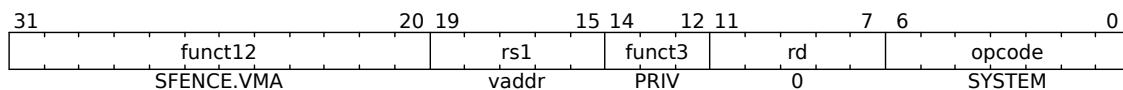

Figure 95: Supervisor Memory-Management Fence Instruction

Instruction execution causes implicit reads and writes to these data structures; however, these implicit references are ordinarily not ordered with respect to loads and stores in the instruction

stream. Executing an SFENCE.VMA instruction guarantees that any stores in the instruction stream prior to the execution of SFENCE.VMA are ordered before all implicit references subsequent to the SFENCE.VMA. Furthermore, executing an SFENCE.VMA guarantees that any implicit writes caused by instructions prior to the SFENCE.VMA are ordered before all loads and stores subsequent to the SFENCE.VMA.

6.12 ABI - Register File Usage and Calling Conventions

RV64GCB has 32 x registers that are each 64 bits wide.

Register	ABI Name	Description	Saver
x0	zero	Hard-wired zero	-
x1	ra	Return address	Caller
x2	sp	Stack pointer	Callee
x3	gp	Global pointer	-
x4	tp	Thread pointer	-
x5	t0	Temporary / alternate link register	Caller
x6-7	t1-2	Temporaries	Caller
x8	s0/fp	Saved-register / frame-pointer	Callee
x9	s1	Saved register	Callee
x10-11	a0-1	Function arguments / return values	Caller
x12-17	a2-7	Function arguments	Caller
x18-27	s2-11	Saved registers	Callee
x28-31	t3-6	Temporaries	Caller
Floating-Point Registers			
f0-7	ft0-7	FP temporaries	Caller
f8-9	fs0-1	FP saved registers	Callee
f10-11	fa0-1	FP arguments / return values	Caller
f12-17	fa2-7	FP arguments	Caller
f18-27	fa2-11	FP saved registers	Callee
f28-31	ft8-11	FP temporaries	Caller

Table 104: RISC-V Registers

The programmer counter PC hold the address of the current instruction.

- x1 / ra - holds the return address for a call.
- x2 / sp - stack pointer, points to the current routine stack.
- x8 / fp / s0 - frame pointer, points to the bottom of the top stack frame.
- x3 / gp - global pointer, points into the middle of the global data section.
 The common definition is: .data + 0x800. RISC-V immediate values are 12-bit signed values, which is +/- 2048 in decimal or +/- 0x800 in hex. So that global pointer relative accesses can reach their full extent, the global pointer point + 0x800 into the data section.

The linker can then relax LUI+LW, LUI+SW into gp-relative LW or SW. i.e. shorter instruction sequences and access most global data using LW at gp +/- offset

```
LW t0 , 0x800(gp)  
LW t1 , 0x7FF(gp)
```

- x4 / tp - thread pointer, point to thread-local storage (TLS-mostly used in linux and RTOS).
If you create a variable in TLS, every thread has its own copy of the variable, i.e. changes to the variable are local to the thread. This is a static area of memory that gets copied for each thread in a program. It is also used to create libraries that have thread-safe functions, because of the fact that each call to a function has its copy of the same global data, so it's safe.

6.12.1 RISC-V Assembly

RISC-V instructions have opcodes and operands.

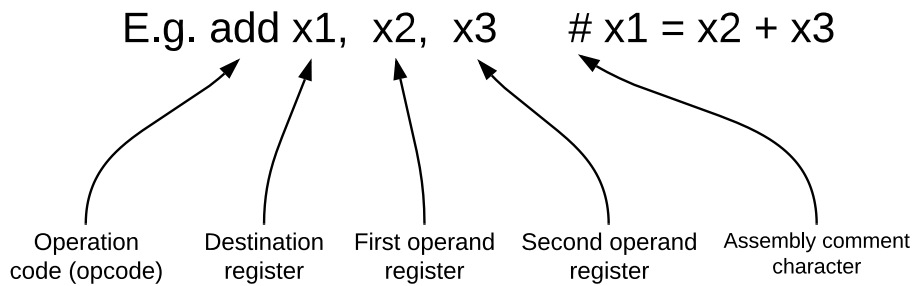

Figure 96: RISC-V Assembly Example

Assembly	C	Description
add x1, x2, x3	a = b + c	a=x1, b=x2, c=x3
sub x3, x4, x5	d = e - f	d=x3, e=x4, f=x5
add x0, x0, x0	NOP	Writes to x0 are always ignored
add x3, x4, x0	f = g	f=x3, g=x4
addi x3, x4, -10	f = g - 10	f=x3, g=x4
lw x10, 12(x13) # 12 = 3x4 add x11, x12, x10	int A[100]; g = h + A[3];	Reg x10 gets A[3] g=x11, h=x12
lw x10, 12(x13) # 12 = 3x4 add x10, x12, x10 sw x10, 40(x13) # 40 = 10x4	int A[100]; A[10] = h + A[3];	Reg x10 gets A[3] h=x12 Reg x10 gets h + A[3]
bne x13, x14, done add x10, x11, x12 done:	if (i == j) f = g + h;	f=x10, g=x11, h=x12, i=x13, j=x14
bne x10, x14, else add x10, x11, x12 j done else: sub x10, x11, x12 done:	if (i == j) f = g + h; else f = g - h;	f=x10, g=x11, h=x12, i=x13, j=x14

Table 105: RISC-V Assembly and C Examples

6.12.2 Assembler to Machine Code

The following flowchart describes how the assembler converts the RISC-V assembly code to machine code.

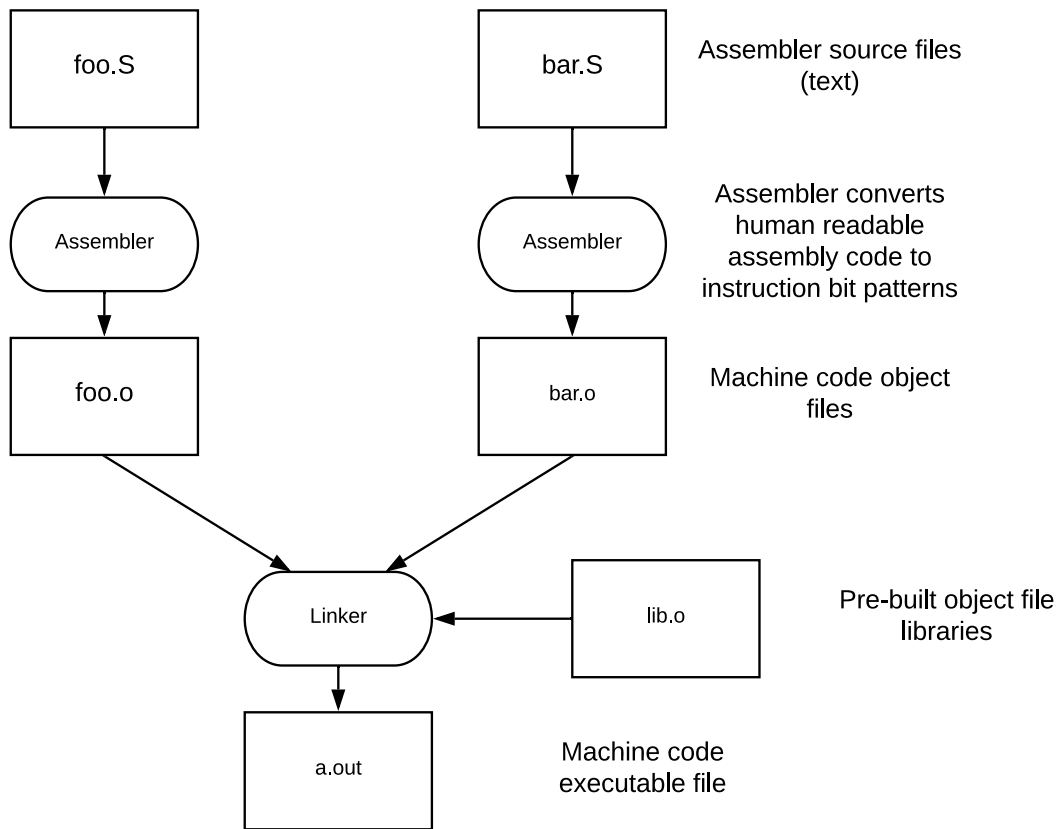

Figure 97: RISC-V Assembly to Machine Code

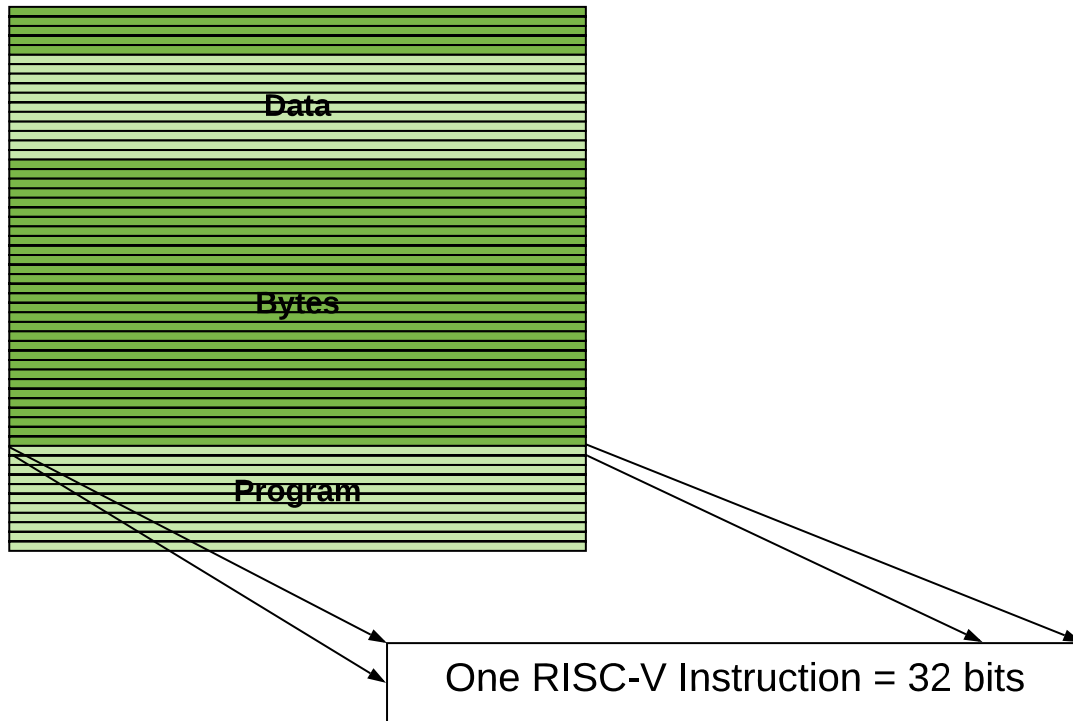

Figure 98: One RISC-V Instruction

6.12.3 Calling a Function (Calling Convention)

1. Put parameters in place where function can access them.
2. Transfer control to function.
3. Acquire local resources needed for function.
4. Perform function task.
5. Place result values where calling code can access and restore any registers might have used.
6. Return control to original caller.

Caller-saved The function invoked can do whatever it likes with the registers. Callee-saved If a function wants to use registers it needs to store and restore them.

Take, for example, the following function:

```
int leaf(int g, int h, int i, int j) {  
    int f;  
    f = (g+h) - (i+j);  
    return f;  
}
```

In this function above, arguments are passed in a0, a1, a2 and a3. The return value is returned in a0.

```
addi sp, sp, -8    # adjust stack for 2 items
sw s1, 4(sp)      # save s1 for use afterwards
sw s0, 0(sp)      # save s0 for use afterwards

add s0,a0,a1      # s0 = g + h
add s1,a2,a3      # s1 = i + j
sub a0,s0,s1      # return value (g + h) - (i + j)

lw s0, 0(sp)      # restore register s0 for caller
lw s1, 4(sp)      # restore register s1 for caller
addi s1, 4(sp)    # adjust stack to delete 2 items
jr ra             # jump back to calling routine
```

In the assembly above, notice that the stack pointer was decremented by 8 to make room to save the registers. Also, s1 and s0 are saved and will be stored at the end.

Nested Functions

In the case of nested function calls, values held in a0-7 and ra will be clobbered.

Take, for example, the following function:

```
int sumSquare(int x, int y) {
    return mult(x,x) + y;
}
```

In the function above, a function called sumSquare is calling mult. To execute the function, there's a value in ra that sumSquare wants to jump back to, but this value will be overwritten by the call to mult.

To avoid this, the sumSquare return address must be saved before the call to mult. To save the the return address of sumSquare, the function can utilize stack memory. The user can use stack memory to preserve automatic (local) variables that don't fit within the registers.

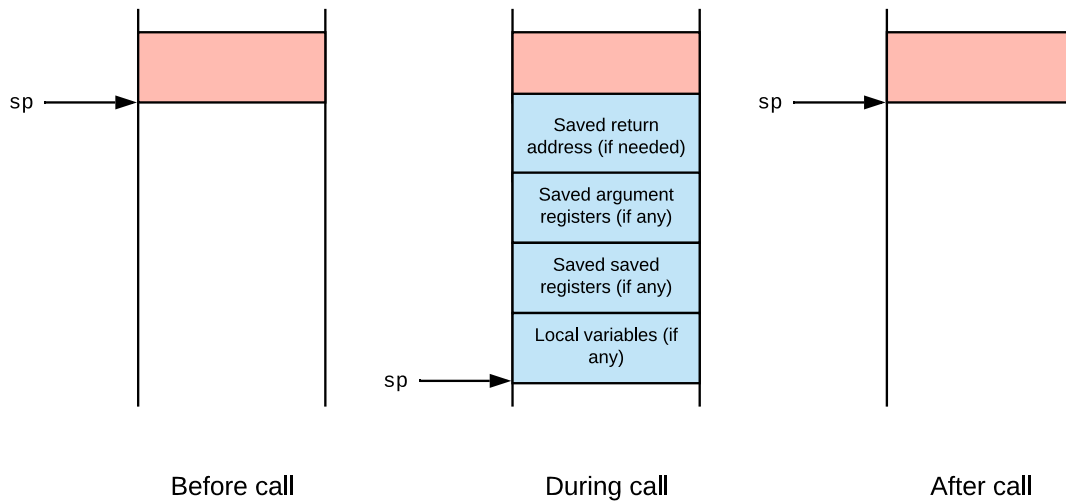

Figure 99: Stack Memory during Function Calls

Consider the assembly for sumSquare below:

```

sumSquare:
addi sp,sp,-8      # reserve space on stack
sw ra, 4(sp)      # save return address
sw a1, 0(sp)      # save y
mv a1,a0          # mult(x,x)
jal mult          # call mult
lw a1, 0(sp)      # restore y
add a0,a0,a1      # mult()+y
lw ra, 4(sp)      # get return address
addi sp,sp,8      # restore stack
mult:...
  
```

6.13 Memory Ordering - FENCE Instructions

In the RISC-V ISA, each thread, referred to as a hart, observes its own memory operations as if they executed sequentially in program order. RISC-V also has a relaxed memory model, which requires explicit FENCE instructions to guarantee the ordering of memory operations.

The FENCE instructions include FENCE and FENCE . I. The FENCE instruction simply ensures that the memory access instructions before the FENCE instruction get committed before the FENCE instruction is committed. It does not guarantee that those memory access instructions have actually completed. For example, a load instruction before a FENCE instruction can commit without waiting for its value to come back from the memory system. FENCE . I functions the same as FENCE, as well as flushes the instruction cache.

For example, without FENCE instructions:

Hart 1 executes:

Load X
Store Y
Store Z

Because of relaxed memory model, Hart 2 could see stores/loads arranged in any order:

Store Z
Load X
Store Y

With FENCE instructions:

Hart 1 executes:

Load X
Store Y
FENCE
Store Z

Hart 2 sees:

Store Y
Load X
Store Z

With FENCE instructions, Hart 2 is forced to see the Load X and the Store Y prior to the Store Z, but could arbitrarily see Store Y before Load X or Load X before Store Y. Functionally, FENCE instructions order the completion of older memory accesses prior to newer accesses. However, unnecessary FENCE instructions slow processes and can hide bugs, so it is essential to identify where and when FENCE should be used.

6.14 Boot Flow

This process is managed as part of the Freedom Metal source code. The freedom-metal boot code supports single core boot or multi-core boot, and contains all the necessary initialization code to enable every core in the system.

1. ENTRY POINT: File: freedom-metal/src/entry.S, label: `_enter`.
2. Initialize global pointer `gp` register using the generated symbol `__global_pointer$`.
3. Write `mtvec` register with `early_trap_vector` as default exception handler.
4. Clear feature disable CSR `0x7c1`.
5. Read `mhartid` into register `a0` and call `_start`, which exists in `crt0.S`.
6. We now transition to File: freedom-metal/gloss/crt0.S, label: `_start`.
7. Initialize stack pointer, `sp`, with `_sp` generated symbol. Harts with `mhartid` of one or larger are offset by $(_sp + _stack_size \times mhartid)$. The `__stack_size` field is generated in the linker file.

8. Check if `mhartid == __metal_boot_hart` and run the init code if they are equal. All other harts skip init and go to the Post-Init Flow, step #15.
9. Boot Hart Init Flow begins here.
10. Init data section to destination in defined RAM space.
11. Copy ITIM section, if ITIM code exists, to destination.
12. Zero out bss section.
13. Call `atexit` library function that registers the `libc` and `freedom-metal` destructors to run after `main` returns.
14. Call the `__libc_init_array` library function, which runs all functions marked with `__attribute__((constructor))`.
 - a. For example, PLL, UART, L2 if they exist in the design. This method provides full early initialization prior to entering the main application.
15. Post-Init Flow Begins Here.
16. Call the C routine `__metal_synchronize_harts`, where hart 0 will release all harts once their individual `msip` bits are set. The `msip` bit is typically used to assert a software interrupt on individual harts, however interrupts are not yet enabled, so `msip` in this case is used as a gatekeeping mechanism.
17. Check `misa` register to see if floating-point hardware is part of the design, and set up `mstatus` accordingly.
18. Single or multi-hart design redirection step.
 - a. If design is a single hart only, or a multi-hart design without a C-implemented function `secondary_main`, ONLY the boot hart will continue to `main()`.
 - b. For multi-hart designs, all other CPUs will enter sleep via WFI instruction via the weak `secondary_main` label in `crt0.S`, while boot hart runs the application program.
 - c. In a multi-hart design which includes a C-defined `secondary_main` function, all harts will enter `secondary_main` as the primary C function.

6.15 Linker File

The linker file generates important symbols that are used in the boot code. The linker file options are found in the `freedom-e-sdk/bsp` path.

There are usually three different linker file options:

- `metal.default.lds` — Use flash and RAM sections
- `metal.ramrodata.lds` — Place read only data in RAM for better performance
- `metal.scratchpad.lds` — Places all code + data sections into available RAM location

Each linker option can be selected by specifying `LINK_TARGET` on the command line.

For example:

```
make PROGRAM=hello TARGET=design-rtl CONFIGURATION=release  
LINK_TARGET=scratchpadsoftware
```

The `meta1.default.ld` linker file is selected by default when `LINK_TARGET` is not specified. If there is a scenario where a custom linker is required, one of the supplied linker files can be copied and renamed and used for the build. For example, if a new linker file named `meta1.newmap.ld` was generated, this can be used at build time by specifying `LINK_TARGET=newmap` on the command line.

6.15.1 Linker File Symbols

The linker file generates symbols that are used by the startup code, so that software can use these symbols to assign the stack pointer, initialize or copy certain RAM sections, and provide the boot hart information. These symbols are made visible to software using the `PROVIDE` keyword.

For example:

```
__stack_size = DEFINED(__stack_size) ? __stack_size : 0x400;  
PROVIDE(__stack_size = __stack_size);
```

Generated Linker Symbols

A description list of the generated linker symbols is shown below.

`__metal_boot_hart`

This is an integer number to describe which hart runs the main init flow. The `mhartid` CSR contains the integer value for each hart. For example, hart 0 has `mhartid==0`, hart 1 has `mhartid==1`, and so on. An assembly example is shown below, where `a0` already contains the `mhartid` value.

```
/* If we're not hart 0, skip the initialization work */  
la t0, __metal_boot_hart  
bne a0, t0, _skip_init
```

An example on how to use this symbol in C code is shown below.

```
extern int __metal_boot_hart;  
int boot_hart = (int)&__metal_boot_hart;
```

Additional linker file generated symbols, along with descriptions are shown below.

`__metal_chicken_bit`

Status bit to tell startup code to zero out the Feature Disable CSR. Details of this register are internal use only.

__global_pointer\$

Static value used to write the gp register at startup.

__sp

Address of the end of stack for hart 0, used to initialize the beginning of the stack since the stack grows lower in memory. On a multi-hart system, the start address of the stack for each hart is calculated using $(_sp + _stack_size \times mhartid)$

metal_segment_bss_target_start

metal_segment_bss_target_end

Used to zero out global data mapped to .bss section.

- Only `__metal_boot_hart` runs this code.

metal_segment_data_source_start

metal_segment_data_target_start

metal_segment_data_target_end

Used to copy data from image to its destination in RAM.

- Only `__metal_boot_hart` runs this code.

metal_segment_itim_source_start

metal_segment_itim_target_start

metal_segment_itim_target_end

Code or data can be placed in itim sections using the `__attribute__((section(".itim")))`.

- When this attribute is applied to code or data, the `metal_segment_itim_source_start`, `metal_segment_itim_target_start`, and `metal_segment_itim_target_end` symbols get updated accordingly, and these symbols allow the startup code to copy code and data into the ITIM area.
 - Only `__metal_boot_hart` runs this code.

Note

At the time of this writing, the boot flow does not support C++ projects

6.16 RISC-V Compiler Flags

6.16.1 arch, abi, and mtune

RISC-V targets are described using three arguments:

1. `-march=ISA`: selects the architecture to target.

2. `-mabi=ABI`: selects the ABI to target.
3. `-mtune=CODENAME`: selects the microarchitecture to target.

-march

This argument controls which instructions and registers are available for the compiler, as defined by the RISC-V user-level ISA specification.

The RISC-V ISA with 32, 32-bit integer registers and the instructions for multiplication would be denoted as RV32IM. Users can control the set of instructions that GCC uses when generating assembly code by passing the lower-case ISA string to the `-march` GCC argument: for example `-march=rv32im`. On RISC-V systems that don't support particular operations, emulation routines may be used to provide the missing functionality.

Example:

```
double dmul(double a, double b) {  
    return a * b;  
}
```

will compile directly to a FP multiplication instruction when compiled with the D extension:

```
$ riscv64-unknown-elf-gcc test.c -march=rv64imafdc -mabi=lp64d -o- -S -O3  
dmul:  
    fmul.d   fa0,fa0,fa1  
    ret
```

but will compile to an emulation routine without the D extension:

```
$ riscv64-unknown-elf-gcc test.c -march=rv64i -mabi=lp64 -o- -S -O3  
dmul:  
    add     sp,sp,-16  
    sd     ra,8(sp)  
    call   __muldf3  
    ld     ra,8(sp)  
    add     sp,sp,16  
    jr     ra
```

Similar emulation routines exist for the C intrinsics that are trivially implemented by the M and F extensions.

-mabi

`-mabi` selects the ABI to target. This controls the calling convention (which arguments are passed in which registers) and the layout of data in memory. The `-mabi` argument to GCC specifies both the integer and floating-point ABIs to which the generated code complies. Much like how the `-march` argument specifies which hardware generated code can run on, the `-mabi` argument specifies which software-generated code can link against. We use the standard naming scheme for integer ABIs (`i1p32` or `lp64`), with an argumental single letter appended to

select the floating-point registers used by the ABI (`ilp32` vs. `ilp32f` vs. `ilp32d`). In order for objects to be linked together, they must follow the same ABI.

RISC-V defines two integer ABIs and three floating-point ABIs.

- `ilp32`: `int`, `long`, and pointers are all 32-bits long. `long long` is a 64-bit type, `char` is 8-bit, and `short` is 16-bit.
- `lp64`: `long` and pointers are 64-bits long, while `int` is a 32-bit type. The other types remain the same as `ilp32`.

The floating-point ABIs are a RISC-V specific addition:

- `""` (the empty string): No floating-point arguments are passed in registers.
- `f`: 32-bit and smaller floating-point arguments are passed in registers. This ABI requires the F extension, as without F there are no floating-point registers.
- `d`: 64-bit and smaller floating-point arguments are passed in registers. This ABI requires the D extension.

arch/abi Combinations

- `march=rv32imafdc -mabi=ilp32d`: Hardware floating-point instructions can be generated and floating-point arguments are passed in registers. This is like the `-mfloat-abi=hard` argument to ARM's GCC.
- `march=rv32imac -mabi=ilp32`: No floating-point instructions can be generated and no floating-point arguments are passed in registers. This is like the `-mfloat-abi=soft` argument to ARM's GCC.
- `march=rv32imafdc -mabi=ilp32`: Hardware floating-point instructions can be generated, but no floating-point arguments will be passed in registers. This is like the `-mfloat-abi=softfp` argument to ARM's GCC, and is usually used when interfacing with soft-float binaries on a hard-float system.
- `march=rv32imac -mabi=ilp32d`: Illegal, as the ABI requires floating-point arguments are passed in registers but the ISA defines no floating-point registers to pass them in.

Example:

```
double dmul(double a, double b) {
    return b * a;
}
```

If neither the ABI or ISA contains the concept of floating-point hardware then the C compiler cannot emit any floating-point-specific instructions. In this case, emulation routines are used to perform the computation and the arguments are passed in integer registers:

```
$ riscv64-unknown-elf-gcc test.c -march=rv32imac -mabi=ilp32 -o- -S -O3
dmul:
    mv     a4,a2
```

```

mv    a5,a3
add   sp,sp,-16
mv    a2,a0
mv    a3,a1
mv    a0,a4
mv    a1,a5
sw    ra,12(sp)
call  __muldf3
lw    ra,12(sp)
add   sp,sp,16
jr    ra

```

The second case is the exact opposite of this one: everything is supported in hardware. In this case we can emit a single `fmul.d` instruction to perform the computation.

```

$ riscv64-unknown-elf-gcc test.c -march=rv32imafdc -mabi=ilp32d -o- -S -O3
    dmul:
        fmul.d  fa0,fa1,fa0
        ret

```

The third combination is for users who may want to generate code that can be linked with code designed for systems that don't subsume a particular extension while still taking advantage of the extra instructions present in a particular extension. This is a common problem when dealing with legacy libraries that need to be integrated into newer systems. For this purpose the compiler arguments and multilib paths designed to cleanly integrate with this workflow. The generated code is essentially a mix between the two above outputs: the arguments are passed in the registers specified by the `ilp32` ABI (as opposed to the `ilp32d` ABI, which could pass these arguments in registers) but then once inside the function the compiler is free to use the full power of the RV32IMAFDC ISA to actually compute the result. While this is less efficient than the code the compiler could generate if it was allowed to take full advantage of the D-extension registers, it's a lot more efficient than computing the floating-point multiplication without the D-extension instructions

```

$ riscv64-unknown-elf-gcc test.c -march=rv32imafdc -mabi=ilp32 -o- -S -O3
    dmul:
        add     sp,sp,-16
        sw     a0,8(sp)
        sw     a1,12(sp)
        fld    fa5,8(sp)
        sw     a2,8(sp)
        sw     a3,12(sp)
        fld    fa4,8(sp)
        fmul.d fa5,fa5,fa4
        fsd    fa5,8(sp)
        lw     a0,8(sp)
        lw     a1,12(sp)
        add    sp,sp,16
        jr     ra

```

6.17 Compilation Process

GCC driver script is actually running the preprocessor, then the compiler, then the assembler and finally the linker. If the user runs GCC with the `--save-temps` argument, several intermediate files will be generated.

```
$ riscv64-unknown-linux-gnu-gcc relocation.c -o relocation -O3 --save-temps
```

- `relocation.i`: The preprocessed source, which expands any preprocessor directives (things like `#include` or `#ifdef`).
- `relocation.s`: The output of the actual compiler, which is an assembly file (a text file in the RISC-V assembly format).
- `relocation.o`: The output of the assembler, which is an un-linked object file (an ELF file, but not an executable ELF).
- `relocation`: The output of the linker, which is a linked executable (an executable ELF file).

6.18 Large Code Model Workarounds

RISC-V software currently requires that linked symbols reside within a 32-bit range. There are two types of code models defined for RISC-V, **medlow** and **medany**. The **medany** code model generates `auipc/ld` pairs to refer to global symbols, which allows the code to be linked at any address, while **medlow** generates `lui/ld` pairs to refer to global symbols, which restricts the code to be linked around address zero. They both generate 32-bit signed offsets for referring to symbols, so they both restrict the generated code to being linked within a 2 GiB window. When building software, the code model parameter is passed into the RISC-V toolchain and it defines a method to generate the necessary instruction combinations to access global symbols within the software program. This is done using `-mcode1=medany/medlow`. For 32-bit architectures, we use the **medlow** code model, while **medany** is used for 64-bit architectures. This is controlled within the 'setting.mk' file in the `freedom-e-sdk/bsp` folder.

The real problem occurs when:

1. Total program size exceeds 2 GiB, which is rare
2. When global symbols within a single compiled image are required to reside in a region outside of the 32-bit space

Example for symbols within 32-bit address space:

```
MEMORY
{
ram (wxa!ri) : ORIGIN = 0x80000000, LENGTH = 0x4000
flash (rxai!w) : ORIGIN = 0x20400000, LENGTH = 0x1fc00000
}
```

Example for symbols outside 32-bit address space:

```
MEMORY
```

```
{
ram (wxa!ri) : ORIGIN = 0x100000000, LENGTH = 0x4000 /* Updated ORIGIN from
0x80000000 */
flash (rxai!w) : ORIGIN = 0x20400000, LENGTH = 0x1fc00000
}
```

If a software example uses the above memory map, and uses either medlow or medany code models, it will not link successfully. Generated errors will generally contain the following phrase:

relocation truncated to fit:

6.18.1 Workaround Example #1

Even if global symbols cannot be linked with the toolchain, we can still access any 64-bit addressable space using pointers. The following example is a straightforward approach to accessing data within any 64-bit addressable space:

```
// Create defines for new memory region
#define LARGE_DATA_SECTION_ADDRESS 0x100000000
#define LARGE_DATA_SECTION_SIZE_IN_BYTES 0x4000
#define DWORD_SIZE 8

int main(void) {

/*****
/* Example #1 - defining and accessing data outside 32-bit range using array
pointer */

*****/

uint32_t idx;
uint64_t *data_array, addr;

data_array = (uint64_t *)LARGE_DATA_SECTION_ADDRESS;
for (addr = 0, idx = 0; addr < LARGE_DATA_SECTION_SIZE_IN_BYTES; addr +=
DWORD_SIZE, idx++) {

// Simply writing data to our region outside of 32-bit range
data_array[idx] = addr;
}
}
```

6.18.2 Workaround Example #2

Here we use an existing freedom-metal data structure to define a new region and API to access attributes of the region.

```
#include <metal/memory.h> // required for data struct

// Create defines for new memory region
#define LARGE_DATA_SECTION_ADDRESS 0x100000000
#define LARGE_DATA_SECTION_SIZE_IN_BYTES 0x4000
#define DWORD_SIZE 8

// Create our struct using existing metal_memory type in freedom-metal
```

```
const struct metal_memory large_data_mem_struct;
const struct metal_memory large_data_mem_struct = {
    ._base_address = LARGE_DATA_SECTION_ADDRESS,
    ._size = LARGE_DATA_SECTION_SIZE_IN_BYTES,
    ._attrs = {.R = 1, .W = 1, .X = 0, .C = 1, .A = 0},
};

int main(void) {
    // Example #2 - Creating data structure which defines 64-bit addressable regions,
    // using existing structure type to define base addr, size, and permissions

    size_t _large_data_size;
    uintptr_t _large_data_base_addr;
    int _atomics_enabled, _cachable_enabled;
    uint64_t *large_data_array;

    _large_data_base_addr = metal_memory_get_base_address(&large_data_mem_struct);
    _large_data_size = metal_memory_get_size(&large_data_mem_struct);
    _atomics_enabled = metal_memory_supports_atomics(&large_data_mem_struct);
    _cachable_enabled = metal_memory_is_cachable(&large_data_mem_struct);

    large_data_array = (uint64_t *)_large_data_base_addr;

    // Access our new memory region
    // large_data_array[x] = 0x0;
    // ... add functional code ...

    return 0;
}
```

This example can be used if multiple data regions are required with different attributes. Once the base address is assigned from the required data structure, then pointers can be used to access memory, similar to Example #1 above. The existing struct and API format allows for multiple regions to be created easily.

6.19 Pipeline Hazards

The pipeline only interlocks on read-after-write and write-after-write hazards, so instructions may be scheduled to avoid stalls.

6.19.1 Read-After-Write Hazards

Read-after-Write (RAW) hazards occur when an instruction tries to read a register before a preceding instruction tries to write to it. This hazard describes a situation where an instruction refers to a result that has not been calculated or retrieved. This situation is possible because even though an instruction was executed after a prior instruction, the prior instruction may only have processed partly through the core pipeline.

Example:

- Instruction 1: $x1 + x3$ is saved in $x2$

- Instruction 2: $x2 + x3$ is saved in $x4$

The first instruction is calculating a value ($x1 + x3$) to be saved in $x2$. The second instruction is going to use the value of $x2$ to compute a result to be saved in $x4$. However, in the core pipeline, when operations are fetched for the second operation, the results from the first operation have not yet been saved.

6.19.2 Write-After-Write Hazards

Write-after-write (WAW) hazards occur when an instruction tries to write an operand before it is written by a preceding instruction.

Example:

- Instruction 1: $x4 + x7$ is saved in $x2$
- Instruction 2: $x1 + x3$ is saved in $x2$

Write-back of instruction 2 must be delayed until instruction 1 finishes executing.

In general, MMIO accesses stall when there is a hazard on the result caused by either RAW or WAW. So, instructions may be scheduled to avoid stalls.

6.20 Reading CSRs

There are several methods for reading the CSRs that are implemented in the U74-MC Core Complex. A full list of the defined RISC-V CSRs are described in Section 6.9.2.

1. Inline assembly using `csrr` instruction and the register name. For example, reading the `misa` CSR:

```
int misa;  
__asm__ volatile("csrr %0, misa" : "=r" (misa));
```

2. Using the Freedom Metal API `METAL_CPU_GET_CSR`. Again, reading the `misa` CSR:

```
int misa_value;  
METAL_CPU_GET_CSR(misa, misa_value);
```

In the second method, the first argument is the register name and the second is the variable to store the result in.

Both inline assembly and Freedom Metal API methods can receive the CSR number instead of its name. For example:

```
int mscratch;  
METAL_CPU_GET_CSR(0x340, mscratch_value); // reading mscratch csr
```

Note

Accessing CSRs has to be according to the privilege level you are in. Attempting to access a CSR in a privilege level higher than the current level of operation will result in an exception.

To access a privileged CSR, the user must switch to the appropriate privilege level. This can be done using the following Freedom Metal API:

```
metal_privilege_drop_to_mode(METAL_PRIVILEGE_USER,  
                             my_regfile,  
                             user_mode_entry_point);
```

The Freedom Metal API routines and more examples located in `freedom-e-sdk/software` directory.

Chapter 7

Custom Instructions and CSRs

These custom instructions use the SYSTEM instruction encoding space, which is the same as the custom CSR encoding space, but with `funct3=0`.

7.1 CFLUSH.D.L1

- Implemented as state machine in L1 data cache, for cores with data caches.
- Only available in M-mode.
- When `rs1 = x0`, CFLUSH.D.L1 writes back and invalidates all lines in the L1 data cache.
- When `rs1 != x0`, an illegal-instruction exception is raised.
- If the effective privilege mode does not have write permissions to the address in `rs1`, then a store access or store page-fault exception is raised.
- If the address in `rs1` is in an uncacheable region with write permissions, the instruction has no effect but raises no exceptions.
- Note that if the PMP scheme write-protects only part of a cache line, then using a value for `rs1` in the write-protected region will cause an exception, whereas using a value for `rs1` in the write-permitted region will write back the entire cache line.

7.2 CDISCARD.D.L1

- Implemented as state machine in L1 data cache, for cores with data caches.
- Only available in M-mode.
- Opcode `0xFC200073`: with optional `rs1` field in bits [19:15].
- When `rs1 = x0`, CDISCARD.D.L1 invalidates, but does not write back, all lines in the L1 data cache. Dirty data within the cache is lost.
- When `rs1 != x0`, CDISCARD.D.L1 invalidates, but does not write back, the L1 data cache line containing the virtual address in integer register `rs1`. Dirty data within the cache line is lost.
- If the effective privilege mode does not have write permissions to the address in `rs1`, then a store access or store page-fault exception is raised.

- If the address in `rs1` is in an uncacheable region with write permissions, the instruction has no effect but raises no exceptions.
- Note that if the PMP scheme write-protects only part of a cache line, then using a value for `rs1` in the write-protected region will cause an exception, whereas using a value for `rs1` in the write-permitted region will invalidate and discard the entire cache line.

7.3 CEASE

- Privileged instruction only available in M-mode.
- Opcode `0x30500073`.
- After retiring `CEASE`, hart will not retire another instruction until reset.
- Instigates power-down sequence, which will eventually raise the `cease_from_tile_x` signal to the outside of the Core Complex, indicating that it is safe to power down.

7.4 PAUSE

- Opcode `0x0100000F`, which is a `FENCE` instruction with predecessor set `W` and null successor set. Therefore, `PAUSE` is a `HINT` instruction that executes as a no-op on all RISC-V implementations.
- This instruction may be used for more efficient idling in spin-wait loops.
- This instruction causes a stall of up to 32 cycles or until a cache eviction occurs, whichever comes first.

7.5 Branch Prediction Mode CSR

This SiFive custom extension adds an M-mode CSR to control the current branch prediction mode, `bpm` at CSR `0x7C0`.

The U74-MC Core Complex's branch prediction system includes a Return Address Stack (RAS), a Branch Target Buffer (BTB), and a Branch History Table (BHT). While branch predictors are essential to achieve high performance in pipelined processors, they can also cause undesirable timing variability for hard real-time systems. The `bpm` register provides a means to customize the branch predictor behavior to trade average performance for a more predictable execution time.

The `bpm` CSR has a single, one bit field defined: Branch-Direction Prediction (`bdp`).

7.5.1 Branch-Direction Prediction

The **WARL** `bdp` field determines the value returned by the BHT component of the branch prediction system. A zero value indicates dynamic direction prediction and a non-zero value indicates

static-taken direction prediction. The BTB is cleared on any write to the bdp field and the RAS is unaffected by writes to the bdp field.

7.6 SiFive Feature Disable CSR

The SiFive custom M-mode Feature Disable CSR is provided to enable or disable certain microarchitectural features. In the U74-MC Core Complex, CSR 0x7C1 has been allocated for this purpose. These features are described in Table 106.

Warning

The features that can be controlled by this CSR are subject to change or removal in future releases. It is not advised to depend on this CSR for development.

A feature is fully enabled when the associated bit is zero. If a particular core does not support the disabling of a feature, the corresponding bit is hardwired to zero.

On reset, all implemented bits are set to 1, disabling all features. The bootloader is responsible for turning on all required features, and can simply write zero to turn on the maximal set of features. SiFive's Freedom Metal bootloader handles turning on these features; when using a custom bootloader, clearing the Feature Disable CSR must be implemented.

Note that arbitrary toggling of the Feature Disable CSR bits is neither recommended nor supported; they are only intended to be set from 1 to 0. A particular Feature Disable CSR bit is only to be used in a very limited number of situations, as detailed in the **Example Usage** entry in Table 107.

Feature Disable CSR	
CSR	0x7C1
Bit	Description
0	Disable data cache clock gating
1	Disable instruction cache clock gating
2	Disable pipeline clock gating
3	Disable speculative instruction cache refill
[8:4]	Reserved
9	Suppress corrupt signal on GrantData messages
[15:10]	Reserved
16	Disable short forward branch optimization
17	Disable instruction cache next-line prefetcher
[63:18]	Reserved

Table 106: SiFive Feature Disable CSR

Feature Disable CSR Usage	
Bit	Description / Usage
3	Disable speculative instruction cache refill Example Usage: A particular integration might require that execution from the System Port range be disallowed. Startup code would first configure PMP to prevent execution from the System Port range, followed by clearing bit 3 of the Feature Disable CSR. This would enable speculative instruction cache refill accesses, without allowing those to access the System Port range because PMP would prohibit such accesses.
9	Suppress corrupt signal on GrantData messages Example Usage 1: When running in debug mode on configurations having both ECC and a BEU, setting bit 9 of the Feature Disable CSR will suppress debug mode errors. Example Usage 2: Startup code could scrub errors present in RAMs at power-on, followed by clearing bit 9 of the Feature Disable CSR to allow normal operation.

Table 107: SiFive Feature Disable CSR Usage

7.7 Other Custom Instructions

Other custom instructions may be implemented, but their functionality is not documented further here and they should not be used in this version of the U74-MC Core Complex.

Chapter 8

Interrupts and Exceptions

This chapter describes how interrupt and exception concepts in the RISC-V architecture apply to the U74-MC Core Complex.

8.1 Interrupt Concepts

Interrupts are *asynchronous* events that cause program execution to change to a specific location in the software application to handle the interrupting event. When processing of the interrupt is complete, program execution resumes back to the original program execution location. For example, a timer that triggers every 10 milliseconds will cause the CPU to branch to the interrupt handler, acknowledge the interrupt, and set the next 10 millisecond interval.

The U74-MC Core Complex supports machine mode and supervisor mode interrupts. By default, all interrupts are handled in machine mode. For harts that support supervisor mode, it is possible to selectively delegate interrupts to supervisor mode.

The Core Complex also has support for the following types of RISC-V interrupts: local and global. Local interrupts are signaled directly to an individual hart with a dedicated interrupt exception code and fixed priority. This allows for reduced interrupt latency as no arbitration is required to determine which hart will service a given request and no additional memory accesses are required to determine the cause of the interrupt. Software and timer interrupts are local interrupts generated by the Core-Local Interruptor (CLINT). The U74-MC Core Complex contains no other local interrupt sources.

Global interrupts are routed through a Platform-Level Interrupt Controller (PLIC), which can direct interrupts to any hart in the system via the external interrupt. Decoupling global interrupts from the harts allow the design of the PLIC to be tailored to the platform, permitting a broad range of attributes like the number of interrupts and the prioritization and routing schemes.

Chapter 9 describes the CLINT. Chapter 10 describes the global interrupt architecture and the PLIC design.

8.2 Exception Concepts

Exceptions are different from interrupts in that they typically occur *synchronously* to the instruction execution flow, and most often are the result of an unexpected event that results in the pro-

gram to enter an exception handler. For example, if a hart is operating in supervisor mode and attempts to access a machine mode only Control and Status Register (CSR), it will immediately enter the exception handler and determine the next course of action. The exception code in the `mstatus` register will hold a value of `0x2`, showing that an illegal instruction exception occurred. Based on the requirements of the system, the supervisor mode application may report an error and/or terminate the program entirely.

There are no specific enable bits to allow exceptions to occur since they are always enabled by default. However, early in the boot flow, software should set up `mtvec.BASE` to a defined value, which contains the base address of the default exception handler. All exceptions will trap to `mtvec.BASE`. Software must read the `mcause` CSR to determine the source of the exception, and take appropriate action.

Synchronous exceptions that occur from within an interrupt handler will immediately cause program execution to abort the interrupt handler and enter the exception handler. Exceptions within an interrupt handler are usually the result of a software bug and should generally be avoided since `mepc` and `mcause` CSRs will be overwritten from the values captured in the original interrupt context.

The RISC-V defined synchronous exceptions have a priority order which may need to be considered when multiple exceptions occur simultaneously from a single instruction. Table 108 describes the synchronous exception priority order.

Priority	Interrupt Exception Code	Description
<i>Highest</i>	3	Instruction Address Breakpoint
	12	Instruction page fault
	1	Instruction access fault
	2	Illegal instruction
	0	Instruction address misaligned
	8, 9, 11	Environment call
	3	Environment break
	3	Load/Store/AMO address breakpoint
	6	Store/AMO address misaligned
	4	Load address misaligned
	15	Store/AMO page fault
	13	Load page fault
<i>Lowest</i>	7	Store/AMO access fault
	5	Load access fault

Table 108: Exception Priority

Refer to Table 116 for the full table of interrupt exception codes.

Data address breakpoints (watchpoints), Instruction address breakpoints, and environment break exceptions (EBREAK) all have the same Exception code (3), but different priority, as shown in the table above.

Instruction address misaligned exceptions (0x0) have lower priority than other instruction address exceptions because they are the result of control-flow instructions with misaligned targets, rather than from instruction fetch.

Some of the helpful CSRs for debugging exceptions and interrupts are described below:

CSR	Description
exception	SiFive Scope signal. Indicates the moment that an exception occurs in the write-back (commit) stage.
mcause	Contains the cause value of the exception/interrupt. See Section 8.7.5 for more description.
mepc	Contains the pc where the exception occurs.
mtval	If the cause is a load/store fault, this register has the value of the problematic address. If it is an invalid instruction, it provides the instruction that the core tried to execute.
mstatus	Contains the interrupt enables, privilege modes, and general status of execution. See Section 8.7.1 for more description.
mtvec	Contains the vector that the core will jump to when an exception occurs. If this is not a valid executable value, you may get a double-exception when jumping to the exception handler, so it is important to look at all these registers when the exception FIRST occurs. See Section 8.7.2 for more description.

Table 109: Summary of Exception and Interrupt CSRs

8.3 Trap Concepts

The term trap describes the transfer of control in a software application, where trap handling typically executes in a more privileged environment. For example, a particular hart contains three privilege modes: machine, supervisor, and user. Each privilege mode has its own software execution environment including a dedicated stack area. Additionally, each privilege mode contains separate control and status registers (CSRs) for trap handling. While operating in User mode, a context switch is required to handle an event in Supervisor mode. The software sets up the system for a context switch, and then an ECALL instruction is executed which synchronously switches control to the Environment call-from-User mode exception handler.

The default mode out of reset is Machine mode. Software begins execution at the highest privilege level, which allows all CSRs and system resources to be initialized before any privilege level changes. The steps below describe the required steps necessary to change privilege mode from machine to user mode, on a particular design that also includes supervisor mode.

1. Interrupts should first be disabled globally by writing `mstatus.MIE` to 0, which is the default reset value.
2. Write `mtvec` CSR with the base address of the Machine mode exception handler. This is a required step in any boot flow.
3. Write `mstatus.MPP` to 0 to set the previous mode to User which allows us to *return* to that mode.

4. Setup the Physical Memory Protection (PMP) regions to grant the required regions to user and supervisor mode, and optionally, revoke permissions from machine mode.
5. Write `stvec` CSR with the base address of the supervisor mode exception handler.
6. Write `medeleg` register to delegate exceptions to supervisor mode. Consider ECALL and page fault exceptions.
7. Write `mstatus.FS` to enable floating point (if supported).
8. Store machine mode user registers to stack or to an application specific frame pointer.
9. Write `mepc` with the entry point of user mode software
10. Execute `mret` instruction to enter user Mode.

Note

There is only one set of user registers (x1 - x31) that are used across all privilege levels, so application software is responsible for saving and restoring state when entering and exiting different levels.

8.4 Interrupt Block Diagram

The U74-MC Core Complex interrupt architecture is depicted in Figure 100.

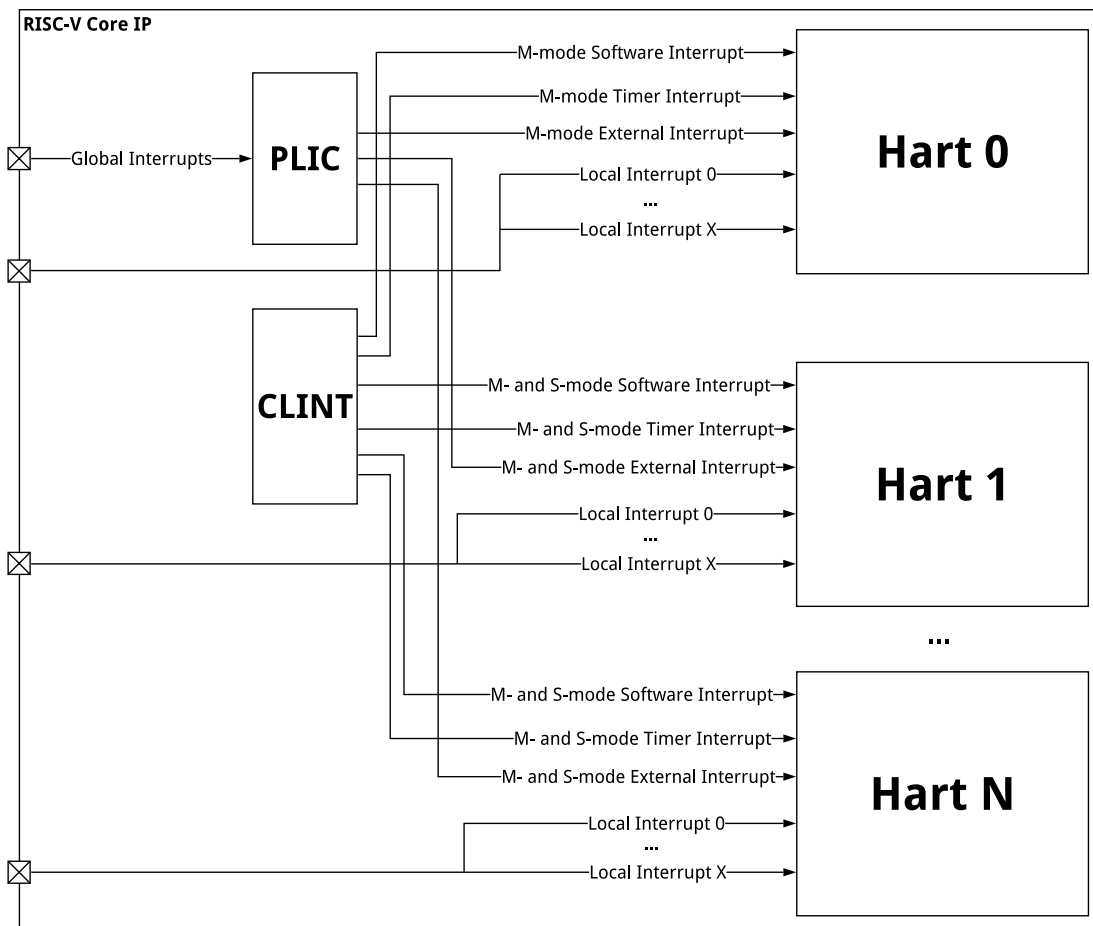

Figure 100: U74-MC Core Complex Interrupt Architecture Block Diagram

8.5 Local Interrupts

Software interrupts (Interrupt ID #3) are triggered by writing the memory-mapped interrupt pending register `msip` for a particular hart. Other harts are able to write `msip` to trigger a software interrupt on any other hart in the U74-MC Core Complex. This allows for efficient interprocessor communication. The `msip` register is described in Table 114.

Timer interrupts (Interrupt ID #7) are triggered when the memory-mapped register `mtime` is greater than or equal to the global timebase register `mtimecmp`, and both registers are part of the CLINT memory map. `mtimecmp` can be written by other harts to set up timer interrupts. The `mtime` and `mtimecmp` registers are generally only available in machine mode, unless the PMP grants user or supervisor mode access to the memory-mapped region in which they reside.

Global interrupts are usually first routed to the PLIC, then into the hart using external interrupts (Interrupt ID #11).

8.6 Interrupt Operation

Within a privilege mode m , if the associated global interrupt-enable $\{ie\}$ is clear, then no interrupts will be taken in that privilege mode, but a pending-enabled interrupt in a higher privilege mode will preempt current execution. If $\{ie\}$ is set, then pending-enabled interrupts at a higher interrupt level in the same privilege mode will preempt current execution and run the interrupt handler for the higher interrupt level.

When an interrupt or synchronous exception is taken, the privilege mode is modified to reflect the new privilege mode. The global interrupt-enable bit of the handler's privilege mode is cleared.

8.6.1 Interrupt Entry and Exit

When an interrupt occurs:

- The value of `mstatus.MIE` is copied into `mcause.MPIE`, and then `mstatus.MIE` is cleared, effectively disabling interrupts.
- The privilege mode prior to the interrupt is encoded in `mstatus.MPP`.
- The current `pc` is copied into the `mepc` register, and then `pc` is set to the value specified by `mtvec` as defined by the `mtvec.MODE` described in Table 112.

At this point, control is handed over to software in the interrupt handler with interrupts disabled. When an `mret` instruction is executed, the following occurs:

- The privilege mode is set to the value encoded in `mstatus.MPP`.
- The global interrupt enable, `mstatus.MIE`, is set to the value of `mcause.MPIE`.
- The `pc` is set to the value of `mepc`.

At this point, control is handed over to software.

At the software level, interrupt attributes can be applied to interrupt processing functions, as described in Section 9.4.

The Control and Status Registers (CSRs) involved in handling RISC-V interrupts are described in Section 8.7.

8.7 Interrupt Control and Status Registers

The U74-MC Core Complex specific implementation of interrupt CSRs is described below. For a complete description of RISC-V interrupt behavior and how to access CSRs, please consult *The RISC-V Instruction Set Manual, Volume II: Privileged Architecture, Version 1.10*.

8.7.1 Machine Status Register (mstatus)

The mstatus register keeps track of and controls the hart's current operating state, including whether or not interrupts are enabled. A summary of the mstatus fields related to interrupts in the U74-MC Core Complex is provided in Table 110. Note that this is not a complete description of mstatus as it contains fields unrelated to interrupts. For the full description of mstatus, please consult *The RISC-V Instruction Set Manual, Volume II: Privileged Architecture, Version 1.10*.

Machine Status Register (mstatus)			
CSR	0x300		
Bits	Field Name	Attr.	Description
0	Reserved	WPRI	
1	SIE	RW	Supervisor Interrupt Enable
2	Reserved	WPRI	
3	MIE	RW	Machine Interrupt Enable
4	Reserved	WPRI	
5	SPIE	RW	Supervisor Previous Interrupt Enable
6	Reserved	WPRI	
7	MPIE	RW	Machine Previous Interrupt Enable
8	SPP	RW	Supervisor Previous Privilege Mode
[10:9]	Reserved	WPRI	
[12:11]	MPP	RW	Machine Previous Privilege Mode

Table 110: Machine Status Register (partial)

Interrupts are enabled by setting the MIE bit in mstatus. Prior to writing mstatus.MIE=1, it is recommended to first enable interrupts in mie.

8.7.2 Machine Trap Vector (mtvec)

The mtvec register has two main functions: defining the base address of the trap vector, and setting the mode by which the U74-MC Core Complex will process interrupts. For Direct and Vectored modes, the interrupt processing mode is defined in the MODE field of the mtvec register. The mtvec register is described in Table 111, and the mtvec.MODE field is described in Table 112.

Machine Trap Vector Register (mtvec)			
CSR	0x305		
Bits	Field Name	Attr.	Description
[1:0]	MODE	WARL	MODE Sets the interrupt processing mode. The encoding for the U74-MC Core Complex supported modes is described in Table 112.
[63:2]	BASE[63:2]	WARL	Interrupt Vector Base Address. Operating in Direct Mode requires 4-byte alignment. Operating in Vectored Mode requires 256-byte alignment.

Table 111: Machine Trap Vector Register

MODE Field Encoding mtvec.MODE		
Value	Mode	Description
0x0	Direct	All asynchronous interrupts and synchronous exceptions set pc to BASE.
0x1	Vectored	Exceptions set pc to BASE, interrupts set pc to BASE + 4 × mcause.EXCCODE.
≥0x2	Reserved	

Table 112: Encoding of mtvec.MODE

Mode Direct

When operating in direct mode, all interrupts and exceptions trap to the mtvec.BASE address. Inside the trap handler, software must read the mcause register to determine what triggered the trap. The mcause register is described in Table 115.

When operating in Direct Mode, BASE must be 4-byte aligned.

Mode Vectored

While operating in vectored mode, interrupts set the pc to mtvec.BASE + 4 × exception code (mcause.EXCCODE). For example, if a machine timer interrupt is taken, the pc is set to mtvec.BASE + 0x1C. Typically, the trap vector table is populated with jump instructions to transfer control to interrupt-specific trap handlers.

In vectored interrupt mode, BASE must be 256-byte aligned.

All machine external interrupts (global interrupts) are mapped to exception code 11. Thus, when interrupt vectoring is enabled, the pc is set to address mtvec.BASE + 0x2C for any global interrupt.

8.7.3 Machine Interrupt Enable (mie)

Individual interrupts are enabled by setting the appropriate bit in the mie register. The mie register is described in Table 113.

Machine Interrupt Enable Register (mie)			
CSR	0x304		
Bits	Field Name	Attr.	Description
0	Reserved	WPRI	
1	SSIE	RW	Supervisor Software Interrupt Enable
2	Reserved	WPRI	
3	MSIE	RW	Machine Software Interrupt Enable
4	Reserved	WPRI	
5	STIE	RW	Supervisor Timer Interrupt Enable
6	Reserved	WPRI	
7	MTIE	RW	Machine Timer Interrupt Enable
8	Reserved	WPRI	
9	SEIE	RW	Supervisor External Interrupt Enable
10	Reserved	WPRI	
11	MEIE	RW	Machine External Interrupt Enable
[63:12]	Reserved	WPRI	

Table 113: Machine Interrupt Enable Register

8.7.4 Machine Interrupt Pending (mip)

The machine interrupt pending (mip) register indicates which interrupts are currently pending. The mip register is described in Table 114.

Machine Interrupt Pending Register (mip)			
CSR	0x344		
Bits	Field Name	Attr.	Description
0	Reserved	WIRI	
1	SSIP	RW	Supervisor Software Interrupt Pending
2	Reserved	WIRI	
3	MSIP	RO	Machine Software Interrupt Pending
4	Reserved	WIRI	
5	STIP	RW	Supervisor Timer Interrupt Pending
6	Reserved	WIRI	
7	MTIP	RO	Machine Timer Interrupt Pending
8	Reserved	WIRI	
9	SEIP	RW	Supervisor External Interrupt Pending
10	Reserved	WIRI	
11	MEIP	RO	Machine External Interrupt Pending
[63:12]	Reserved	WIRI	

Table 114: Machine Interrupt Pending Register

8.7.5 Machine Cause (mcause)

When a trap is taken in machine mode, `mcause` is written with a code indicating the event that caused the trap. When the event that caused the trap is an interrupt, the most-significant bit of `mcause` is set to 1, and the least-significant bits indicate the interrupt number, using the same encoding as the bit positions in `mip`. For example, a Machine Timer Interrupt causes `mcause` to be set to `0x8000_0000_0000_0007`. `mcause` is also used to indicate the cause of synchronous exceptions, in which case the most-significant bit of `mcause` is set to 0.

See Table 115 for more details about the `mcause` register. Refer to Table 116 for a list of synchronous exception codes.

Machine Cause Register (mcause)			
CSR	0x342		
Bits	Field Name	Attr.	Description
[9:0]	EXCCODE	WLRL	A code identifying the last exception.
[62:10]	Reserved	WLRL	
63	Interrupt	WARL	1, if the trap was caused by an interrupt; 0 otherwise.

Table 115: Machine Cause Register

Interrupt	Exception Code	Description
1	0	Reserved
1	1	Supervisor software interrupt
1	2	Reserved
1	3	Machine software interrupt
1	4	Reserved
1	5	Supervisor timer interrupt
1	6	Reserved
1	7	Machine timer interrupt
1	8	Reserved
1	9	Supervisor external interrupt
1	10	Reserved
1	11	Machine external interrupt
1	12–13	Reserved
1	14	Debug interrupt
1	≥15	Reserved
0	0	Instruction address misaligned
0	1	Instruction access fault
0	2	Illegal instruction
0	3	Breakpoint
0	4	Load address misaligned
0	5	Load access fault
0	6	Store/AMO address misaligned
0	7	Store/AMO access fault
0	8	Environment call from U-mode
0	9	Environment call from S-mode
0	10	Reserved
0	11	Environment call from M-mode
0	12	Instruction page fault
0	13	Load page fault
0	14	Debug
0	15	Store/AMO page fault
0	≥16	Reserved

Table 116: mcause Exception Codes

Note that there are scenarios where a misaligned load or store will generate an access exception instead of an address-misaligned exception. The access exception is raised when the misaligned access should not be emulated in a trap handler, e.g., emulating an access in an I/O region, as such emulation could cause undesirable side-effects.

8.7.6 Minimum Interrupt Configuration

The minimum configuration needed to configure an interrupt is shown below.

- Write `mtvec` to configure the interrupt mode and the base address for the interrupt vector table.
- Enable interrupts in memory mapped PLIC register space. The CLINT does not contain interrupt enable bits.
- Write `mie` CSR to enable the software, timer, and external interrupt enables for each privilege mode.
- Write `mstatus` to enable interrupts globally for each supported privilege mode.

8.8 Supervisor Mode Interrupts

The U74-MC Core Complex supports the ability to selectively direct interrupts and exceptions to supervisor mode, resulting in improved performance by eliminating the need for additional mode changes.

This capability is enabled by the interrupt and exception delegation CSRs; `mideleg` and `medeleg`, respectively. Supervisor interrupts and exceptions can be managed via supervisor versions of the interrupt CSRs, specifically: `stvec`, `sip`, `sie`, and `scause`.

Machine mode software can also directly write to the `sip` register, which effectively sends an interrupt to supervisor mode. This is especially useful for timer and software interrupts as it may be desired to handle these interrupts in both machine mode and supervisor mode.

The delegation and supervisor CSRs are described in the sections below. The definitive resource for information about RISC-V supervisor interrupts is *The RISC-V Instruction Set Manual, Volume II: Privileged Architecture, Version 1.10*.

8.8.1 Delegation Registers (`mideleg` and `medeleg`)

By default, all traps are handled in machine mode. Machine mode software can selectively delegate interrupts and exceptions to supervisor mode by setting the corresponding bits in `mideleg` and `medeleg` CSRs. The exact mapping is provided in Table 117 and Table 118 and matches the `mcause` interrupt and exception codes defined in Table 116.

Note that local interrupts may be delegated to supervisor mode.

Machine Interrupt Delegation Register (mideleg)			
CSR	0x303		
Bits	Field Name	Attr.	Description
0	Reserved	WARL	
1	SSIP	RW	Delegate Supervisor Software Interrupt
[4:2]	Reserved	WARL	
5	STIP	RW	Delegate Supervisor Timer Interrupt
[8:6]	Reserved	WARL	
9	SEIP	RW	Delegate Supervisor External Interrupt
[63:10]	Reserved	WARL	

Table 117: Machine Interrupt Delegation Register

Machine Exception Delegation Register (medeleg)		
CSR	0x302	
Bits	Attr.	Description
0	RW	Delegate Instruction Access Misaligned Exception
1	RW	Delegate Instruction Access Fault Exception
2	RW	Delegate Illegal Instruction Exception
3	RW	Delegate Breakpoint Exception
4	RW	Delegate Load Access Misaligned Exception
5	RW	Delegate Load Access Fault Exception
6	RW	Delegate Store/AMO Address Misaligned Exception
7	RW	Delegate Store/AMO Access Fault Exception
8	RW	Delegate Environment Call from U-Mode
9	RW	Delegate Environment Call from S-Mode
[11:0]	WARL	Reserved
12	RW	Delegate Instruction Page Fault
13	RW	Delegate Load Page Fault
14	WARL	Reserved
15	RW	Delegate Store/AMO Page Fault Exception
[63:16]	WARL	Reserved

Table 118: Machine Exception Delegation Register

8.8.2 Supervisor Status Register (sstatus)

Similar to machine mode, supervisor mode has a register dedicated to keeping track of the hart's current state called `sstatus`. `sstatus` is effectively a restricted view of `mstatus`, described in Section 8.7.1, in that changes made to `sstatus` are reflected in `mstatus` and vice-versa, with the exception of the machine mode fields, which are not visible in `sstatus`.

A summary of the `sstatus` fields related to interrupts in the U74-MC Core Complex is provided in Table 119. Note that this is not a complete description of `sstatus` as it also contains fields

unrelated to interrupts. For the full description of `sstatus`, consult the *The RISC-V Instruction Set Manual, Volume II: Privileged Architecture, Version 1.10*.

Supervisor Status Register (<code>sstatus</code>)			
CSR	0x100		
Bits	Field Name	Attr.	Description
0	Reserved	WPRI	
1	SIE	RW	Supervisor Interrupt Enable
[4:2]	Reserved	WPRI	
5	SPIE	RW	Supervisor Previous Interrupt Enable
[7:6]	Reserved	WPRI	
8	SPP	RW	Supervisor Previous Privilege Mode
[12:9]	Reserved	WPRI	

Table 119: Supervisor Status Register (partial)

Interrupts are enabled by setting the SIE bit in `sstatus` and by enabling the desired individual interrupt in the `sie` register, described in Section 8.8.3.

8.8.3 Supervisor Interrupt Enable Register (`sie`)

Supervisor interrupts are enabled by setting the appropriate bit in the `sie` register. The U74-MC Core Complex `sie` register is described in Table 120.

Supervisor Interrupt Enable Register (<code>sie</code>)			
CSR	0x104		
Bits	Field Name	Attr.	Description
0	Reserved	WPRI	
1	SSIE	RW	Supervisor Software Interrupt Enable
[4:2]	Reserved	WPRI	
5	STIE	RW	Supervisor Timer Interrupt Enable
[8:6]	Reserved	WPRI	
9	SEIE	RW	Supervisor External Interrupt Enable
[63:10]	Reserved	WPRI	

Table 120: Supervisor Interrupt Enable Register

8.8.4 Supervisor Interrupt Pending (`sip`)

The supervisor interrupt pending (`sip`) register indicates which interrupts are currently pending. The U74-MC Core Complex `sip` register is described in Table 121.

Supervisor Interrupt Pending Register (sip)			
CSR	0x144		
Bits	Field Name	Attr.	Description
0	Reserved	WIRI	
1	SSIP	RW	Supervisor Software Interrupt Pending
[4:2]	Reserved	WIRI	
5	STIP	RW	Supervisor Timer Interrupt Pending
[8:6]	Reserved	WIRI	
9	SEIP	RW	Supervisor External Interrupt Pending
[63:10]	Reserved	WIRI	

Table 121: Supervisor Interrupt Pending Register

8.8.5 Supervisor Cause Register (scause)

When a trap is taken in supervisor mode, `scause` is written with a code indicating the event that caused the trap. When the event that caused the trap is an interrupt, the most-significant bit of `scause` is set to 1, and the least-significant bits indicate the interrupt number, using the same encoding as the bit positions in `sip`. For example, a Supervisor Timer Interrupt causes `scause` to be set to `0x8000_0000_0000_0005`.

`scause` is also used to indicate the cause of synchronous exceptions, in which case the most-significant bit of `scause` is set to 0. Refer to Table 123 for a list of synchronous exception codes.

Supervisor Cause Register (scause)			
CSR	0x142		
Bits	Field Name	Attr.	Description
[62:0]	EXCCODE	WLRL	A code identifying the last exception.
63	Interrupt	WARL	1 if the trap was caused by an interrupt; 0 otherwise.

Table 122: Supervisor Cause Register

Supervisor Interrupt Exception Codes		
Interrupt	Exception Code	Description
1	0	Reserved
1	1	Supervisor software interrupt
1	2–4	Reserved
1	5	Supervisor timer interrupt
1	6–8	Reserved
1	9	Supervisor external interrupt
1	≥10	Reserved
0	0	Instruction address misaligned
0	1	Instruction access fault
0	2	Illegal instruction
0	3	Breakpoint
0	4	Reserved
0	5	Load access fault
0	6	Store/AMO address misaligned
0	7	Store/AMO access fault
0	8	Environment call from U-mode
0	9–11	Reserved
0	12	Instruction page fault
0	13	Load page fault
0	14	Reserved
0	15	Store/AMO Page Fault
0	≥16	Reserved

Table 123: scause Exception Codes

8.8.6 Supervisor Trap Vector (stvec)

By default, all interrupts trap to a single address defined in the `stvec` register. It is up to the interrupt handler to read `scause` and react accordingly. RISC-V and the U74-MC Core Complex also support the ability to optionally enable interrupt vectors. When vectoring is enabled, each interrupt defined in `sie` will trap to its own specific interrupt handler.

Vectored interrupts are enabled when the `MODE` field of the `stvec` register is set to 1.

Supervisor Trap Vector Register (stvec)			
CSR	0x105		
Bits	Field Name	Attr.	Description
[1:0]	MODE	WARL	MODE determines whether or not interrupt vectoring is enabled. The encoding for the MODE field is described in Table 125.
[63:2]	BASE[63:2]	WARL	Interrupt Vector Base Address. Must be aligned on a 128-byte boundary when MODE=1. Note, BASE[1:0] is not present in this register and is implicitly 0.

Table 124: Supervisor Trap Vector Register

MODE Field Encoding stvec.MODE		
Value	Name	Description
0x0	Direct	All exceptions and interrupts set pc to BASE
0x1	Vectored	Exceptions set pc to BASE, interrupts set pc to BASE + 4 × scause.EXCCODE
≥0x2	Reserved	

Table 125: Encoding of stvec.MODE

If vectored interrupts are disabled (stvec.MODE=0), all interrupts trap to the stvec.BASE address. If vectored interrupts are enabled (stvec.MODE=1), interrupts set the pc to stvec.BASE + 4 × exception code (scause.EXCCODE). For example, if a supervisor timer interrupt is taken, the pc is set to stvec.BASE + 0x14. Typically, the trap vector table is populated with jump instructions to transfer control to interrupt-specific trap handlers.

In vectored interrupt mode, BASE must be 128-byte aligned.

All supervisor external interrupts (global interrupts) are mapped to exception code of 9. Thus, when interrupt vectoring is enabled, the pc is set to address stvec.BASE + 0x24 for any global interrupt.

See Table 124 for a description of the stvec register. See Table 125 for a description of the stvec.MODE field. See Table 123 for the U74-MC Core Complex supervisor mode interrupt exception code values.

8.8.7 Delegated Interrupt Handling

Upon taking a delegated trap, the following occurs:

- The value of sstatus.SIE is copied into sstatus.SPIE, then sstatus.SIE is cleared, effectively disabling interrupts.

- The current pc is copied into the sepc register, and then pc is set to the value of stvec. In the case where vectored interrupts are enabled, pc is set to stvec.BASE + 4 × exception code (scause.EXCCODE).
- The privilege mode prior to the interrupt is encoded in sstatus.SPP.

At this point, control is handed over to software in the interrupt handler with interrupts disabled. Interrupts can be re-enabled by explicitly setting sstatus.SIE or by executing an SRET instruction to exit the handler. When an SRET instruction is executed, the following occurs:

- The privilege mode is set to the value encoded in sstatus.SPP.
- The value of sstatus.SPIE is copied into sstatus.SIE.
- The pc is set to the value of sepc.

At this point, control is handed over to software.

8.9 Interrupt Priorities

Individual priorities of global interrupts are determined by the PLIC, as discussed in Chapter 10.

U74-MC Core Complex interrupts are prioritized as follows, in decreasing order of priority:

- Machine external interrupts
- Machine software interrupts
- Machine timer interrupts
- Supervisor external interrupts
- Supervisor software interrupts
- Supervisor timer interrupts

8.10 Interrupt Latency

Interrupt latency for the U74-MC Core Complex is four `external_source_for_core_N_clock` cycles, as counted by the number of cycles it takes from signaling of the interrupt to the hart to the first instruction fetch of the handler.

Global interrupts routed through the PLIC incur additional latency of three clock cycles, where the PLIC is clocked by `clock`. This means that the total latency, in cycles, for a global interrupt is: $4 + 3 \times (\text{external_source_for_core_N_clock Hz} \div \text{clock Hz})$. This is a best case cycle count and assumes the handler is cached or located in ITIM. It does not take into account additional latency from a peripheral source.

8.11 Non-Maskable Interrupt

The `rnmi` (resumable non-maskable interrupt) interrupt signal is a level-sensitive input to the hart. Non-maskable interrupts have higher priority than any other interrupt or exception on the hart and cannot be disabled by software. Specifically, they are not disabled by clearing the `mstatus.mie` register.

8.11.1 Handler Addresses

The NMI has an associated exception trap handler address. This address is set by external input signals, described in the U74-MC Core Complex User Guide.

8.11.2 RNMI CSRs

These M-mode CSRs enable a resumable non-maskable interrupt (RNMI).

Number	Name	Description
0x350	<code>mnscratch</code>	Resumable Non-maskable scratch register
0x351	<code>mnepc</code>	Resumable Non-maskable EPC value
0x352	<code>mncause</code>	Resumable Non-maskable cause value
0x353	<code>mnstatus</code>	Resumable Non-maskable status

Table 126: RNMI CSRs

- The `mnscratch` CSR holds a 64-bit read-write register which enables the NMI trap handler to save and restore the context that was interrupted.
- The `mnepc` CSR is a 64-bit read-write register which on entry to the NMI trap handler holds the PC of the instruction that took the interrupt. The lowest bit of `mnepc` is hardwired to zero.
- The `mncause` CSR holds the reason for the NMI, with bit 63 set to 1, and the NMI cause encoded in the least-significant bits or zero if NMI causes are not supported. The lower bits of `mncause`, defined as the `exception_code`, are as follows:

<code>mncause</code>	NMI Cause	Function
1	Reserved	Reserved
2	<code>rnmi input pin</code>	External <code>rnmi_N</code> input
3	<code>bus error</code>	RNMI caused by BEU

Table 127: `mncause.exception_code` Fields

- The `mnstatus` CSR holds a two-bit field which on entry to the trap handler holds the privilege mode of the interrupted context encoded in the same manner as `mstatus.mpp`.

8.11.3 MNRET Instruction

This M-mode only instruction uses the values in `mnepc` and `mnstatus` to return to the program counter and privileged mode of the interrupted context respectively. This instruction also sets the internal `rnmie` state bits.

Encoding is same as MRET except with bit 30 set (i.e., `funct7=0111000`).

8.11.4 RNMI Operation

When an RNMI interrupt is detected, the interrupted PC is written to the `mnepc` CSR, the type of RNMI to the `mncause` CSR, and the privilege mode of the interrupted context to the `mnstatus` CSR. An internal microarchitectural state bit `rnmie` is cleared to indicate that processor is in an RNMI handler and cannot take a new RNMI interrupt. The internal `rnmie` bit when clear also disables all other interrupts.

Note

These interrupts are called non-maskable because software cannot mask the interrupts, but for correct operation other instances of the same interrupt must be held off until the handler is completed, hence the internal state bit.

The RNMI handler can resume original execution using the new MNRET instruction (described in Section 8.11.3), which restores the PC from `mnepc`, the privilege mode from `mnstatus`, and also sets the internal `rnmie` state bit, which reenables other interrupts.

If the hart encounters an exception while the `rnmie` bit is clear, the exception state is written to `mepc` and `mcause`, `mstatus.mpp` is set to M-mode, and the hart jumps to the RNMI exception handler address.

Note

Traps in the RNMI handler can only be resumed if they occur while the handler was servicing an interrupt that occurred outside of machine-mode.

Chapter 9

Core-Local Interruptor (CLINT)

This chapter describes the operation of the Core-Local Interruptor (CLINT). The U74-MC Core Complex CLINT complies with *The RISC-V Instruction Set Manual, Volume II: Privileged Architecture, Version 1.10*.

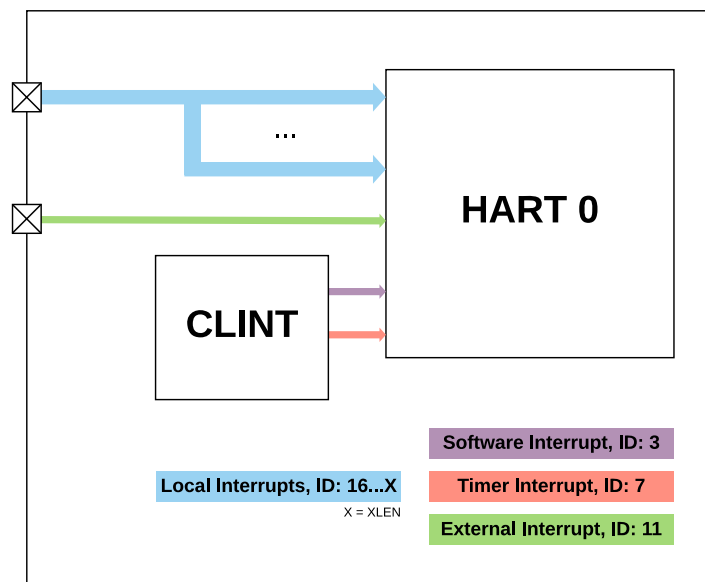

Figure 101: CLINT Block Diagram

The CLINT has a small footprint and provides software, timer, and external interrupts directly to the hart. The CLINT block also holds memory-mapped control and status registers associated with software and timer interrupts.

9.1 CLINT Priorities and Preemption

The CLINT has a fixed priority scheme based on interrupt ID, and nested interrupts (preemption) within a given privilege level is not supported. Higher privilege levels may preempt lower privilege levels, however. The CLINT offers two modes of operation, Direct mode and Vectored mode.

In Direct mode, all interrupts and exceptions trap to `mtvec.BASE`. In Vectored mode, exceptions trap to `mtvec.BASE`, but interrupts will jump directly to their vector table index. See Section 8.7.2 for more information about `mtvec.BASE`.

9.2 CLINT Vector Table

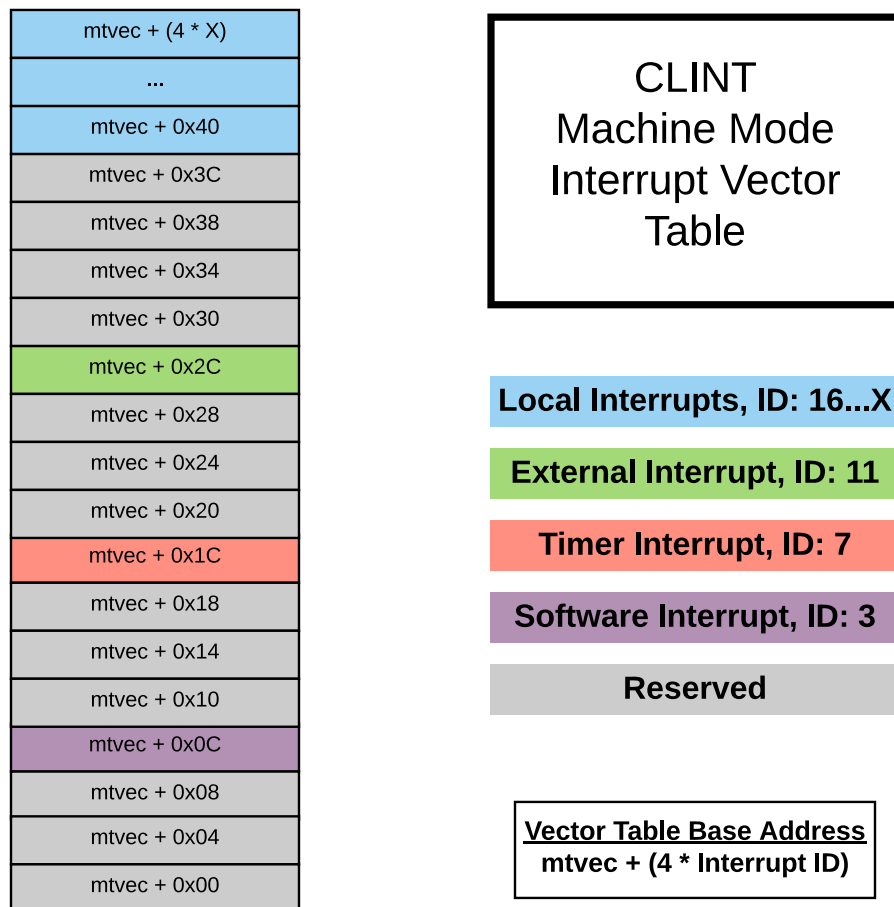

Figure 102: CLINT Interrupts and Vector Table

The CLINT vector table is populated with jump instructions, since hardware jumps to the index in the vector table first, then subsequently jumps to the handler. All exception types trap to the first entry in the table, which is `mtvec.BASE`.

An example CLINT vector table is shown below.

```

.weak default_exception_handler
.balign 4, 0
.global default_exception_handler

.weak software_handler
.balign 4, 0
.global software_handler

.weak timer_handler
.balign 4, 0
.global timer_handler

.weak external_handler
.balign 4, 0
.global external_handler

.option norvc
.weak __mtvec_clint_vector_table
#if __riscv_xlen == 32
.balign 128, 0
#else
.balign 256, 0
#endif
.global __mtvec_clint_vector_table
__mtvec_clint_vector_table:

IRQ_0:
    j default_exception_handler
IRQ_1:
    j default_vector_handler
IRQ_2:
    j default_vector_handler
IRQ_3:
    j software_handler
IRQ_4:
    j default_vector_handler
IRQ_5:
    j default_vector_handler
IRQ_6:
    j default_vector_handler
IRQ_7:
    j timer_handler
IRQ_8:
    j default_vector_handler
IRQ_9:
    j default_vector_handler
IRQ_10:
    j default_vector_handler
IRQ_11:
    j external_handler
IRQ_12:
    j default_vector_handler
IRQ_13:
    j default_vector_handler
IRQ_14:
    j default_vector_handler
IRQ_15:
    j default_vector_handler

```

Figure 103: CLINT Vector Table Example

9.3 CLINT Interrupt Sources

The U74-MC Core Complex supports the standard RISC-V software, timer, and external interrupts. These interrupt inputs are exposed at the top-level via the `local_interrupts` signals. Any unused `local_interrupts` inputs should be tied to logic 0. These signals are positive-level triggered.

See the U74-MC Core Complex User Manual for a description of this interrupt signal.

CLINT Interrupt IDs are provided in Table 128.

U74-MC Core Complex Interrupt IDs		
ID	Interrupt	Notes
0	Reserved	
1	SSIP	Supervisor Software Interrupt
2	Reserved	
3	MSIP	Machine Software Interrupt
4	Reserved	
5	STIP	Supervisor Timer Interrupt
6	Reserved	
7	MTIP	Machine Timer Interrupt
8	Reserved	
9	SEIP	Supervisor External Interrupt
10	Reserved	
11	MEIP	Machine External Interrupt
12–15	Reserved	

Table 128: U74-MC Core Complex Interrupt IDs

9.4 CLINT Interrupt Attribute

To help with efficiency of save and restore context, interrupt attributes can be applied to functions used for interrupt handling.

```
void __attribute__((interrupt))
software_handler (void) {
    // handler code
}
```

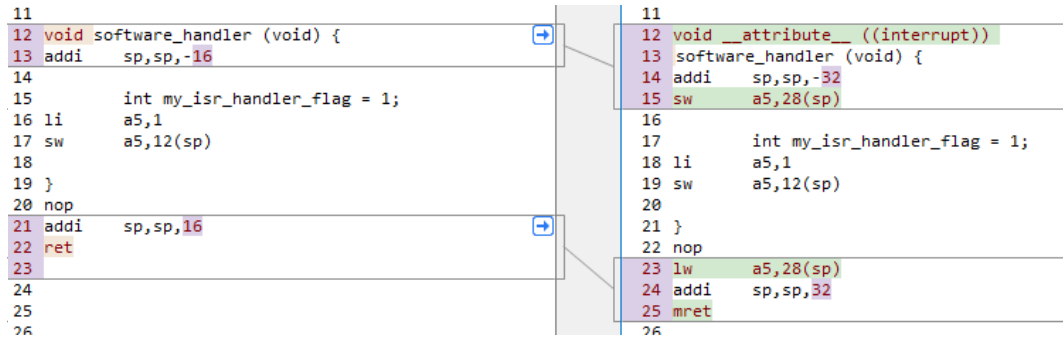

Figure 104: CLINT Interrupt Attribute Example

This attribute will save and restore registers that are used within the handler, and insert an `mret` instruction at the end of the handler.

9.5 CLINT Memory Map

Table 129 shows the memory map for CLINT on the U74-MC Core Complex. Note that there are no enable bits for specific interrupts within the CLINT memory map, as the enables for these interrupts reside in the `mie` CSR for each interrupt, and the `mstatus.mie` CSR bit, which enables all machine interrupts globally. See Section 8.7.3 for a description of the interrupt enable bits in the `mie` CSR, and Section 8.7.4 for a description of the interrupt pending bits in the `mip` CSR.

Address	Width	Attr.	Description	Notes
0x0200_0000	4B	RW	msip for hart 0	MSIP Registers (1-bit wide)
0x0200_0004	4B	RW	msip for hart 1	
0x0200_0008	4B	RW	msip for hart 2	
0x0200_000C	4B	RW	msip for hart 3	
0x0200_0010	4B	RW	msip for hart 4	
0x0200_0014			Reserved	
...				
0x0200_3FFF				
0x0200_4000	8B	RW	mtimecmp for hart 0	MTIMECMP Registers
0x0200_4008	8B	RW	mtimecmp for hart 1	
0x0200_4010	8B	RW	mtimecmp for hart 2	
0x0200_4018	8B	RW	mtimecmp for hart 3	
0x0200_4020	8B	RW	mtimecmp for hart 4	
0x0200_4028			Reserved	
...				
0x0200_BFF7				
0x0200_BFF8	8B	RW	mtime	Timer Register
0x0200_C000			Reserved	

Table 129: CLINT Register Map

9.6 Register Descriptions

This section describes the functionality of the memory-mapped registers in the CLINT.

9.6.1 MSIP Register

Machine mode software interrupts are generated by writing to the memory-mapped control register `msip`. Each `msip` register is a 32-bit wide **WARL** register, where the upper 31 bits are tied to 0. The least-significant bit is reflected in the MSIP bit of the `mip` CSR. Other bits in the `msip` register are hardwired to zero. On reset, each `msip` register is cleared to zero.

Software interrupts are most useful for interprocessor communication in multi-hart systems, as harts may write each other's `msip` bits to effect interprocessor interrupts.

9.6.2 Timer Registers

`mtime` is a 64-bit read-write register that contains the number of cycles counted from the `rtc_toggle` signal, which is described in the U74-MC Core Complex User Guide. A timer interrupt is pending whenever `mtime` is greater than or equal to the value in the `mtimecmp` register. The timer interrupt is reflected in the `mtip` bit of the `mip` register, described in Chapter 8.

On reset, `mtime` is cleared to zero. The `mtimecmp` registers are not reset.

9.7 Supervisor Mode Delegation

By default, all interrupts trap to machine mode, including timer and software interrupts. In order for supervisor timer and software interrupts to trap directly to supervisor mode, supervisor timer and software interrupts must first be delegated to supervisor mode.

Please see Section 8.8 for more details on supervisor mode interrupts.

Chapter 10

Platform-Level Interrupt Controller (PLIC)

This chapter describes the operation of the Platform-Level Interrupt Controller (PLIC) on the U74-MC Core Complex. The PLIC complies with *The RISC-V Instruction Set Manual, Volume II: Privileged Architecture, Version 1.10* and can support a maximum of 136 external interrupt sources with 7 priority levels.

The U74-MC Core Complex PLIC resides in the `clock` timing domain, allowing for relaxed timing requirements. The latency of global interrupts, as perceived by a hart, increases with the ratio of the `external_source_for_core_N_clock` frequency and the `clock` frequency.

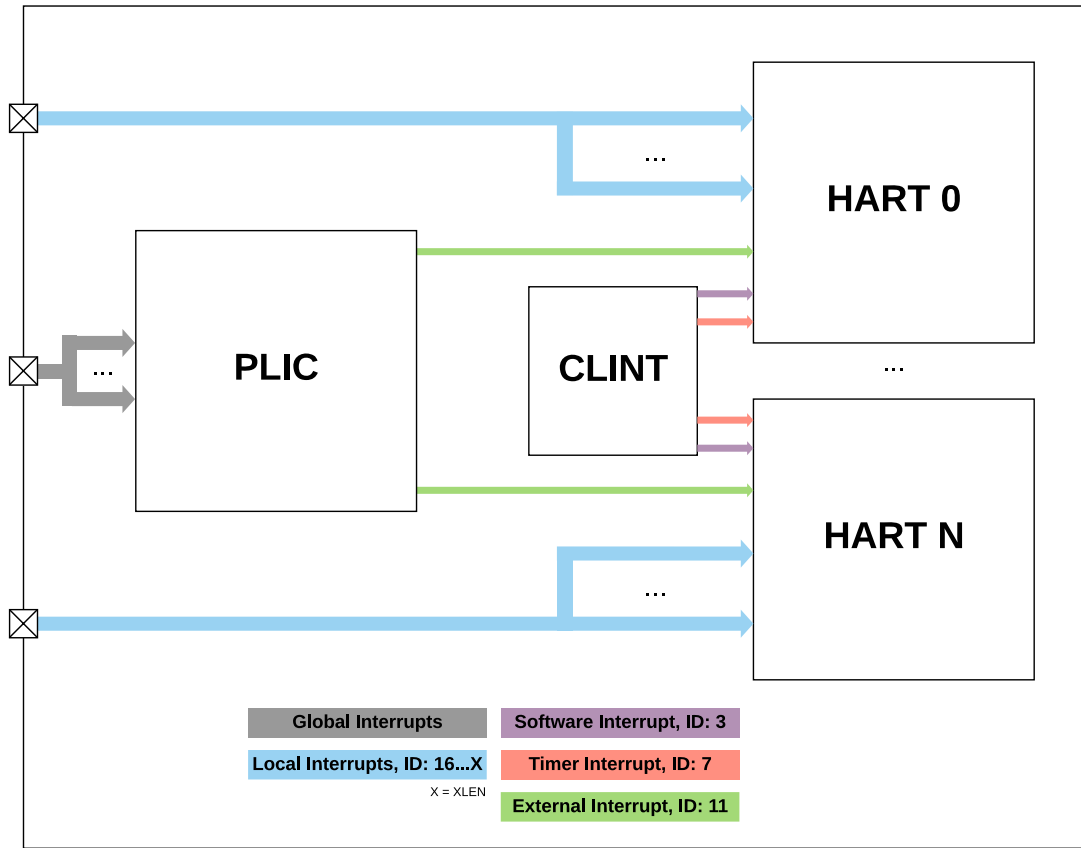

Figure 105: PLIC Multi-Core Block Diagram

10.1 Memory Map

The memory map for the U74-MC Core Complex PLIC control registers is shown in Table 130. The PLIC memory map only supports aligned 32-bit memory accesses.

Address	Width	Attr.	Description	Notes
0x0C00_0000			Reserved	
0x0C00_0004	4B	RW	Source 1 priority	See Section 10.3 for more information
...				
0x0C00_0220	4B	RW	Source 136 priority	See Section 10.4 for more information
0x0C00_0224			Reserved	
...				
0x0C00_1000	4B	RO	Start of pending array	See Section 10.4 for more information
...				
0x0C00_1010	4B	RO	Last word of pending array	See Section 10.5 for more information
0x0C00_1014			Reserved	
...				
0x0C00_2000	4B	RW	Start Hart 0 M-Mode interrupt enables	See Section 10.5 for more information
...				
0x0C00_2010	4B	RW	End Hart 0 M-Mode interrupt enables	See Section 10.5 for more information
0x0C00_2014			Reserved	
...				
0x0C00_2080	4B	RW	Start Hart 1 M-Mode interrupt enables	See Section 10.5 for more information
...				
0x0C00_2090	4B	RW	End Hart 1 M-Mode interrupt enables	See Section 10.5 for more information
0x0C00_2094			Reserved	
...				
0x0C00_2100	4B	RW	Start Hart 1 S-Mode interrupt enables	See Section 10.5 for more information
...				
0x0C00_2110	4B	RW	End Hart 1 S-Mode interrupt enables	See Section 10.5 for more information
0x0C00_2114			Reserved	
...				
0x0C00_2180	4B	RW	Start Hart 2 M-Mode interrupt enables	See Section 10.5 for more information
...				
0x0C00_2190	4B	RW	End Hart 2 M-Mode interrupt enables	See Section 10.5 for more information
0x0C00_2194			Reserved	
...				
0x0C00_2200	4B	RW	Start Hart 2 S-Mode interrupt enables	See Section 10.5 for more information
...				

Table 130: PLIC Memory Map

Address	Width	Attr.	Description	Notes
0x0C00_2210	4B	RW	End Hart 2 S-Mode interrupt enables	
0x0C00_2214			Reserved	
...				
0x0C00_2280	4B	RW	Start Hart 3 M-Mode interrupt enables	See Section 10.5 for more information
...				
0x0C00_2290	4B	RW	End Hart 3 M-Mode interrupt enables	
0x0C00_2294			Reserved	
...				
0x0C00_2300	4B	RW	Start Hart 3 S-Mode interrupt enables	See Section 10.5 for more information
...				
0x0C00_2310	4B	RW	End Hart 3 S-Mode interrupt enables	
0x0C00_2314			Reserved	
...				
0x0C00_2380	4B	RW	Start Hart 4 M-Mode interrupt enables	See Section 10.5 for more information
...				
0x0C00_2390	4B	RW	End Hart 4 M-Mode interrupt enables	
0x0C00_2394			Reserved	
...				
0x0C00_2400	4B	RW	Start Hart 4 S-Mode interrupt enables	See Section 10.5 for more information
...				
0x0C00_2410	4B	RW	End Hart 4 S-Mode interrupt enables	
0x0C00_2414			Reserved	
...				
0x0C20_0000	4B	RW	Hart 0 M-Mode priority threshold	See Section 10.6 for more information
0x0C20_0004	4B	RW	Hart 0 M-Mode claim/complete	See Section 10.7 for more information
0x0C20_0008			Reserved	
...				
0x0C20_1000	4B	RW	Hart 1 M-Mode priority threshold	See Section 10.6 for more information
0x0C20_1004	4B	RW	Hart 1 M-Mode claim/complete	See Section 10.7 for more information
0x0C20_1008			Reserved	

Table 130: PLIC Memory Map

Address	Width	Attr.	Description	Notes
...				
0x0C20_2000	4B	RW	Hart 1 S-Mode priority threshold	See Section 10.6 for more information
0x0C20_2004	4B	RW	Hart 1 S-Mode claim/complete	See Section 10.7 for more information
0x0C20_2008			Reserved	
...				
0x0C20_3000	4B	RW	Hart 2 M-Mode priority threshold	See Section 10.6 for more information
0x0C20_3004	4B	RW	Hart 2 M-Mode claim/complete	See Section 10.7 for more information
0x0C20_3008			Reserved	
...				
0x0C20_4000	4B	RW	Hart 2 S-Mode priority threshold	See Section 10.6 for more information
0x0C20_4004	4B	RW	Hart 2 S-Mode claim/complete	See Section 10.7 for more information
0x0C20_4008			Reserved	
...				
0x0C20_5000	4B	RW	Hart 3 M-Mode priority threshold	See Section 10.6 for more information
0x0C20_5004	4B	RW	Hart 3 M-Mode claim/complete	See Section 10.7 for more information
0x0C20_5008			Reserved	
...				
0x0C20_6000	4B	RW	Hart 3 S-Mode priority threshold	See Section 10.6 for more information
0x0C20_6004	4B	RW	Hart 3 S-Mode claim/complete	See Section 10.7 for more information
0x0C20_6008			Reserved	
...				
0x0C20_7000	4B	RW	Hart 4 M-Mode priority threshold	See Section 10.6 for more information
0x0C20_7004	4B	RW	Hart 4 M-Mode claim/complete	See Section 10.7 for more information
0x0C20_7008			Reserved	
...				
0x0C20_8000	4B	RW	Hart 4 S-Mode priority threshold	See Section 10.6 for more information
0x0C20_8004	4B	RW	Hart 4 S-Mode claim/complete	See Section 10.7 for more information
0x0C20_8008			Reserved	
...				

Table 130: PLIC Memory Map

Address	Width	Attr.	Description	Notes
0x1000_0000			End of PLIC Memory Map	

Table 130: PLIC Memory Map

10.2 Interrupt Sources

The U74-MC Core Complex has a total of 136 global interrupt sources, in addition to the local interrupts described in Table 128. 127 of these are external global interrupts, and the remainder are driven by various on-chip devices as listed in Table 131.

Note

In the *RISC-V Platform-Level Interrupt Controller Specification*, interrupt source 0 (ID 0) is unused, so the first usable PLIC Interrupt ID has a value of 1.

Table 131 describes the global interrupt sources on the U74-MC Core Complex.

PLIC Interrupt ID	Source
0	<i>Unused</i>
1	L2 Cache DirError
2	L2 Cache DirFail
3	L2 Cache DataError
4	L2 Cache DataFail
5–131	External Global Interrupts
132	S7 Hart 0 Bus-Error Unit
133	U7 Hart 1 Bus-Error Unit
134	U7 Hart 2 Bus-Error Unit
135	U7 Hart 3 Bus-Error Unit
136	U7 Hart 4 Bus-Error Unit

Table 131: PLIC Interrupt Source Mapping

Table 132 describes the mapping of external global interrupts to its corresponding top-level `global_interrupts` signal bit. This signal is positive-level triggered and not configurable. See the U74-MC Core Complex User Guide for further description of `global_interrupts`.

global_interrupts Signal	PLIC Interrupt ID	PLIC Pending / Enable Register
global_interrupts[0]	5	pending1[5] / enable1[5]
global_interrupts[1]	6	pending1[6] / enable1[6]
global_interrupts[2]	7	pending1[7] / enable1[7]
...		
global_interrupts[126]	131	pending5[3] / enable5[3]

Table 132: Mapping of global_interrupts Signal Bits to PLIC Interrupt ID

10.3 Interrupt Priorities

Each PLIC interrupt source can be assigned a priority by writing to its 32-bit memory-mapped priority register. The U74-MC Core Complex supports 7 levels of priority. A priority value of 0 is reserved to mean "never interrupt" and effectively disables the interrupt. Priority 1 is the lowest active priority, and priority 7 is the highest. Ties between global interrupts of the same priority are broken by the Interrupt ID; interrupts with the lowest ID have the highest effective priority. See Table 133 for the detailed register description.

PLIC Interrupt Priority Register (priority)				
Base Address		0x0C00_0000 + 4 × Interrupt ID		
Bits	Field Name	Attr.	Rst.	Description
[2:0]	Priority	RW	X	Global interrupt priority
[31:3]	Reserved	RO	0x0	

Table 133: PLIC Interrupt Priority Register

10.4 Interrupt Pending Bits

The current status of the interrupt source pending bits in the PLIC core can be read from the pending array, organized as 5 words of 32 bits. The pending bit for interrupt ID N is stored in bit $(N \bmod 32)$ of word $(N/32)$. As such, the U74-MC Core Complex has 5 interrupt pending registers. Bit 0 of word 0, which represents the non-existent interrupt source 0, is hardwired to zero.

A pending bit in the PLIC core can be cleared by setting the associated enable bit then performing a claim as described in Section 10.7.

PLIC Interrupt Pending Register 1 (pending1)				
Base Address		0x0C00_1000		
Bits	Field Name	Attr.	Rst.	Description
0	Interrupt 0 Pending	RO	0x0	Non-existent global interrupt 0 is hardwired to zero
1	Interrupt 1 Pending	RO	0x0	Pending bit for global interrupt 1
2	Interrupt 2 Pending	RO	0x0	Pending bit for global interrupt 2
...				
31	Interrupt 31 Pending	RO	0x0	Pending bit for global interrupt 31

Table 134: PLIC Interrupt Pending Register 1

PLIC Interrupt Pending Register 5 (pending5)				
Base Address		0x0C00_1010		
Bits	Field Name	Attr.	Rst.	Description
0	Interrupt 128 Pending	RO	0x0	Pending bit for global interrupt 128
...				
8	Interrupt 136 Pending	RO	0x0	Pending bit for global interrupt 136
[31:9]	Reserved	WIRI	X	

Table 135: PLIC Interrupt Pending Register 5

10.5 Interrupt Enables

Each global interrupt can be enabled by setting the corresponding bit in the enable registers. The enable registers are accessed as a contiguous array of 5 × 32-bit words, packed the same way as the pending bits. Bit 0 of enable word 0 represents the non-existent interrupt ID 0 and is hardwired to 0.

64-bit and 32-bit word accesses are supported by the enables array in SiFive RV64 systems.

PLIC Interrupt Enable Register 1 for Hart 0 M-Mode (enable1)				
Base Address		0x0C00_2000		
Bits	Field Name	Attr.	Rst.	Description
0	Interrupt 0 Enable	RO	0x0	Non-existent global interrupt 0 is hard-wired to zero
1	Interrupt 1 Enable	RW	X	Enable bit for global interrupt 1
2	Interrupt 2 Enable	RW	X	Enable bit for global interrupt 2
...				
31	Interrupt 31 Enable	RW	X	Enable bit for global interrupt 31

Table 136: PLIC Interrupt Enable Register 1 for Hart 0 M-Mode

PLIC Interrupt Enable Register 5 for Hart 0 M-Mode (enable5)				
Base Address		0x0C00_2010		
Bits	Field Name	Attr.	Rst.	Description
0	Interrupt 128 Enable	RW	X	Enable bit for global interrupt 128
...				
8	Interrupt 136 Enable	RW	X	Enable bit for global interrupt 136
[31:9]	Reserved	RO	0x0	

Table 137: PLIC Interrupt Enable Register 5 for Hart 0 M-Mode

10.6 Priority Thresholds

The U74-MC Core Complex supports setting of an interrupt priority threshold via the `threshold` register. The `threshold` is a **WARL** field, where the U74-MC Core Complex supports a maximum threshold of 7.

The U74-MC Core Complex masks all PLIC interrupts of a priority less than or equal to `threshold`. For example, a `threshold` value of zero permits all interrupts with non-zero priority, whereas a value of 7 masks all interrupts. If the `threshold` register contains a value of 5, all PLIC interrupt configured with priorities from 1 through 5 will not be allowed to propagate to the CPU.

PLIC Interrupt Priority Threshold Register (threshold)				
Base Address		0x0C20_0000		
Bits	Field Name	Attr.	Rst.	Description
[2:0]	Threshold	RW	X	Sets the priority threshold
[31:3]	Reserved	RO	0x0	

Table 138: PLIC Interrupt Priority Threshold Register

10.7 Interrupt Claim Process

A U74-MC Core Complex hart can perform an interrupt claim by reading the `claim_complete` register (Table 139), which returns the ID of the highest-priority pending interrupt or zero if there is no pending interrupt. A successful claim also atomically clears the corresponding pending bit on the interrupt source.

A U74-MC Core Complex hart can perform a claim at any time, even if the MEIP bit in its `mip` (Table 114) register is not set.

The claim operation is not affected by the setting of the priority threshold register.

10.8 Interrupt Completion

A U74-MC Core Complex hart signals it has completed executing an interrupt handler by writing the interrupt ID it received from the claim to the `claim_complete` register (Table 139). The PLIC does not check whether the completion ID is the same as the last claim ID for that target. If the completion ID does not match an interrupt source that is currently enabled for the target, the completion is silently ignored.

PLIC Claim/Complete Register for Hart 0 M-Mode (<code>claim_complete</code>)				
Base Address		0x0C20_0004		
Bits	Field Name	Attr.	Rst.	Description
[31:0]	Interrupt Claim/Complete for Hart 0 M-Mode	RW	X	A read of zero indicates that no interrupts are pending. A non-zero read contains the id of the highest pending interrupt. A write to this register signals completion of the interrupt ID written.

Table 139: PLIC Claim/Complete Register for Hart 0 M-Mode

The PLIC cannot forward a new interrupt to a hart that has claimed an interrupt, but has not yet finished the complete step of the interrupt handler. Thus, the PLIC does not support preemption of global interrupts to an individual hart.

Interrupt IDs for global interrupts routed through the PLIC are independent of the interrupt IDs for local interrupts. The PLIC handler may check for additional pending global interrupts once the initial claim/complete process has finished, prior to exiting the handler. This method could save additional PLIC save/restore context for global interrupts.

10.9 Example PLIC Interrupt Handler

Since the PLIC interfaces with the CPU through external interrupt #11, the external handler must contain an additional claim/complete step that is used to handshake with the PLIC logic.

```
void external_handler() {
```

```
//get the highest priority pending PLIC interrupt
uint32_t int_num = plic.claim_complete;

//branch to handler
plic_handler[int_num]();

//complete interrupt by writing interrupt number back to PLIC
plic.claim_complete = int_num;

// Add additional checks for PLIC pending here, if desired
}
```

If a CPU reads `claim_complete` and it returns 0, the interrupt does not require processing, and thus write-back of the claim/complete is not necessary.

The `plic_handler[]()` routine shown above demonstrates one method to implement a software table where the offset of the function that resides within the table is determined by the PLIC interrupt ID. The PLIC interrupt ID is unique to the PLIC, in that it is completely independent of the interrupt IDs of local interrupts.

Chapter 11

TileLink Error Device

The Error Device is a TileLink slave that responds to all requests with a TileLink denied error and all reads with a corrupt error. It has no registers. The entire memory range discards writes and returns zeros on read. Both operation acknowledgements carry an error indication.

The Error Device serves a dual role. Internally, it is used as a landing pad for illegal off-chip requests. However, it is also useful for testing software handling of bus errors.

Chapter 12

Bus-Error Unit

This chapter describes the operation of the SiFive Bus-Error Unit.

12.1 Bus-Error Unit Overview

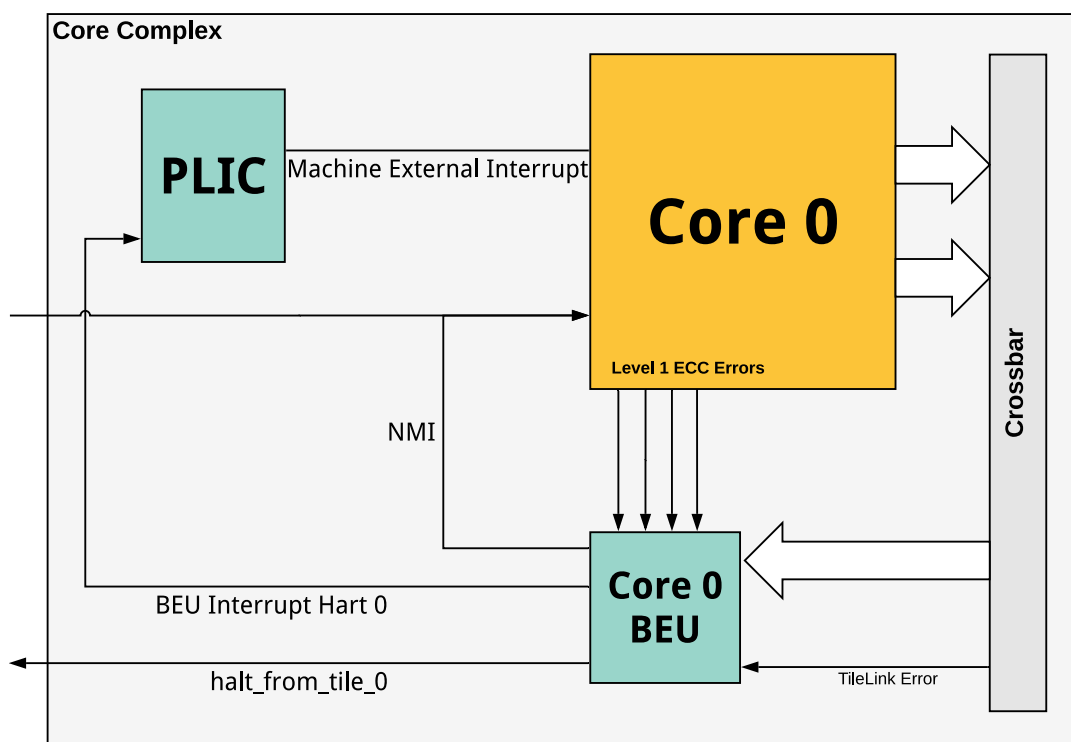

Figure 106: Bus-Error Unit Block Diagram

The Bus-Error Unit (BEU) is a per-processor device that records erroneous events and reports them using platform-level and hart-local interrupts. Figure 106 above shows the connections from the core to the BEU. The BEU can be configured to generate interrupts on correctable memory errors, uncorrectable memory errors, and/or TileLink bus errors. When an error occurs, the BEU will hold the address of the error and a code to describe the error.

12.2 Memory Map

The Bus-Error Unit memory map is shown in Table 140.

Offset	Name	Description
0x00	cause	Cause of error event
0x08	value	Physical address of error event
0x10	enable	Event enable mask
0x18	plic_interrupt	Platform-level interrupt enable mask
0x20	accrued	Accrued event mask
0x28	local_interrupt	Hart-local interrupt-enable mask

Table 140: Register offsets within the Bus-Error Unit Memory Map

The bitfields of `enable`, `plic_interrupt`, `accrued`, and `local_interrupt` are described in Table 141. The `cause` register represents which event occurred, and the `value` register contains the address of that error event. The `value` register will be updated when errors occur on memory that supports data cache. For example, the Memory Port has data cache support, where the System and Peripheral Ports do not.

12.3 Reportable Errors

Table 141 lists the events that the Bus-Error Unit may report.

Value	Description
0	<i>No error</i>
1	Instruction cache TileLink bus error
2	Instruction cache or ITIM correctable ECC error
3	ITIM uncorrectable ECC error
4	Reserved
5	Load/Store/PTW TileLink bus error
6	Data cache correctable ECC error
7	Data cache uncorrectable ECC error

Table 141: Bus-Error Unit Error Events

12.4 Functional Description

When one of the events listed in Table 141 occurs, the Bus-Error Unit can record information about that event and can generate an interrupt to the PLIC or locally to the hart. The `enable` register contains a mask of which events the BEU can record. Each bit in `enable` corresponds to an event in Table 141. For example, if `enable[5]` is set, the BEU will record TileLink bus errors. If `plic_interrupt[5]` is also set, then a global interrupt will be asserted to the platform-level interrupt controller (PLIC or CLIC). Alternatively, if `local_interrupt[5]` is set, then a

BEU error will result in a local interrupt to the hart. The `cause` register indicates the event the BEU has most recently recorded, e.g., a value of 5 indicates a TileLink bus error was recorded.

The `cause` value 0 is reserved to indicate "no error". `cause` is only written for events enabled in the `enable` register. Furthermore, `cause` is only written when its current value is 0; that is, if multiple events occur, only the first one is latched, until software clears the `cause` register.

The `value` register supplies the physical address that caused the event, or 0 if the address is unknown. The BEU writes the `value` register whenever it writes the `cause` register, such as when an event enabled in the `enable` register occurs or when `cause` contains 0.

The bit position in the `accrued` register indicates which events have occurred since the last time it was cleared by software. Its format is the same as the `enable` register. The BEU sets bits in the `accrued` register whether or not they are enabled in the `enable` register.

12.4.1 BEU Global Interrupt

The bit position in the `pllc_interrupt` register indicates which accrued events should generate an interrupt into the PLIC. An interrupt is generated when the same bit is set in both `accrued` and `pllc_interrupt`. The PLIC drives the machine external interrupt to the core, which has an interrupt ID of 11 (0xB). For designs with a CLIC, there is a configuration dependent interrupt number used for the BEU that routes through the CLIC. The exception code value, located in `mcause` (machine trap cause) CSR, will be 11 (0xB) when BEU interrupts are routed through the PLIC. The exception code value is independent of the PLIC interrupt number used to connect the BEU to the PLIC.

12.4.2 BEU Local Interrupt

The `local_interrupt` register indicates which accrued events should generate an interrupt directly to the hart associated with this Bus-Error Unit. An interrupt is generated when the same bit is set in both `accrued` and `local_interrupt`. BEU events are treated as RNMI events and trap to the RNMI interrupt vector address. Whether local interrupts are configured for direct mode or vectored mode of operation, BEU errors will always trap to `mtvec.BASE` address. In other words, when operating in vectored mode of operation, the BEU does not require an entry in the interrupt vector table. The exception handler should have software support to check for an `mcause` value of `0x8000_0000_0000_0080`, where bit 63 is set, indicating an interrupt occurred. This behavior is unique to the BEU due to the value of the exception code being greater than 64.

12.4.3 Global Interrupt Configuration

In addition to writing the BEU registers to enable interrupts, the `mstatus.MIE` CSR bit should be written to enable Machine level interrupts globally. The `mie.MEIE` CSR bit should also be configured to enable external interrupts when `pllc_interrupt` is enabled to route the PLIC interrupt from the BEU interrupts to the core. Refer to the local interrupt chapter for more details regarding interrupt configurations.

12.4.4 Static BEU Configurations

Errors reported through the BEU using local interrupts do not have an enable bit in the mie CSR, so it is always enabled. Additionally, there is no bit for the BEU in the mideleg CSR, so it cannot be delegated to a mode less privileged than M-mode.

Chapter 13

Level 2 Cache Controller

This chapter describes the functionality of the Level 2 Cache Controller used in the U74-MC Core Complex.

13.1 Level 2 Cache Controller Overview

The SiFive Level 2 Cache Controller is used to provide access to fast copies of memory for masters in a Core Complex. The Level 2 Cache Controller also acts as a directory-based coherency manager.

The SiFive Level 2 Cache Controller offers extensive flexibility, as it allows for several features in addition to the Level 2 Cache functionality. These include memory-mapped access to L2 Cache RAM for disabled cache ways, scratchpad functionality, way masking and locking, ECC support with error tracking statistics, error injection, and interrupt signaling capabilities.

These features are described in Section 13.2.

13.2 Functional Description

The U74-MC Core Complex L2 Cache is a 2 MiB 16-way set-associative cache. It has a line size of 64 bytes and is read/write-allocate with a random replacement policy. The cache operates in write-back mode only. The L2 Cache is composed of 2 banks. This subdivision into banks helps facilitate increased available bandwidth between CPU masters and the L2 Cache, as each bank has its own dedicated 128-bit TL-C inner port. As such, multiple requests to different banks may proceed in parallel.

The outer port of the L2 Cache Controller is a 128-bit TL-C port shared among all banks and typically connected to a DDR controller. The outer Memory Port of the L2 Cache Controller is shared among all banks and typically connected to cacheable memory. The overall organization of the L2 Cache Controller is depicted in Figure 107.

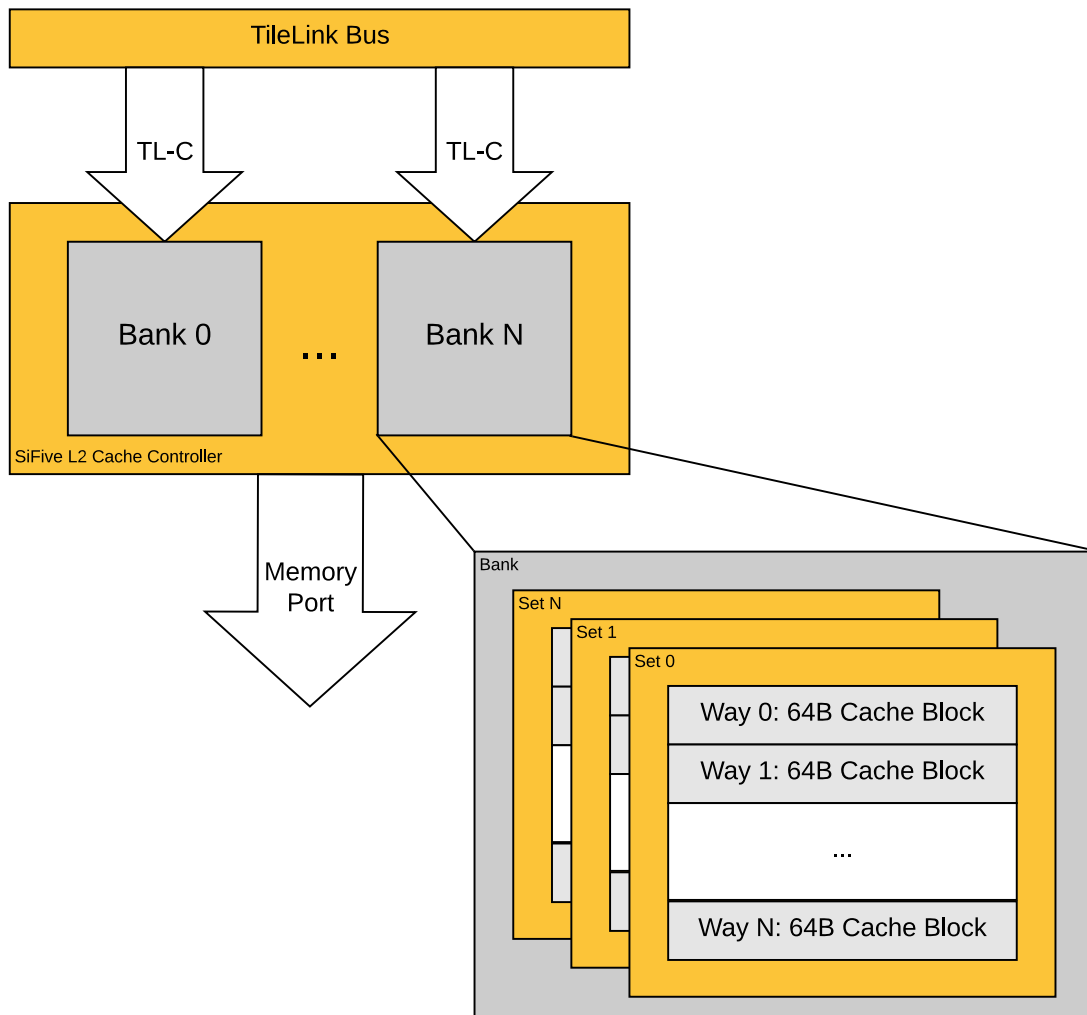

Figure 107: Organization of the SiFive L2 Cache Controller

13.2.1 Way Enable and the L2 Loosely-Integrated Memory (L2 LIM)

The SiFive Level 2 Cache Controller allows for its SRAMs to act either as direct-addressed memory in the Core Complex address space or as a cache that is controlled by the L2 Cache Controller, which can contain a copy of any cacheable address.

When cache ways are disabled, they are addressable in the L2 Loosely-Integrated Memory (L2 LIM) address space as described in the U74-MC Core Complex memory map in Section 5.2. The L2 LIM is an uncacheable port into unused L2 SRAM and provides deterministic access time. It is neither cached by the L1 data cache nor memory backed, as it is just a dedicated software-addressable, low latency, uncached memory. Fetching instructions or data from the L2 LIM provides deterministic behavior equivalent to an L2 Cache hit, with no possibility of a cache miss. Accesses to the L2 LIM are always given priority over cache way accesses, which target the same L2 Cache bank.

Out of reset, all ways, except for way 0, are disabled. Cache ways can be enabled by writing to the wayEnable register described in Section 13.4.2. Once a cache way is enabled, it cannot be disabled unless the U74-MC Core Complex is reset. The highest numbered L2 cache way is mapped to the lowest L2 LIM address space, and way 1 occupies the highest L2 LIM address range. As L2 cache ways are enabled, the size of the L2 LIM address space shrinks. The mapping of L2 cache ways to L2 LIM address space is shown in Figure 108, where N is the number of L2 cache ways, each of size 128 KiB (0x0002_0000).

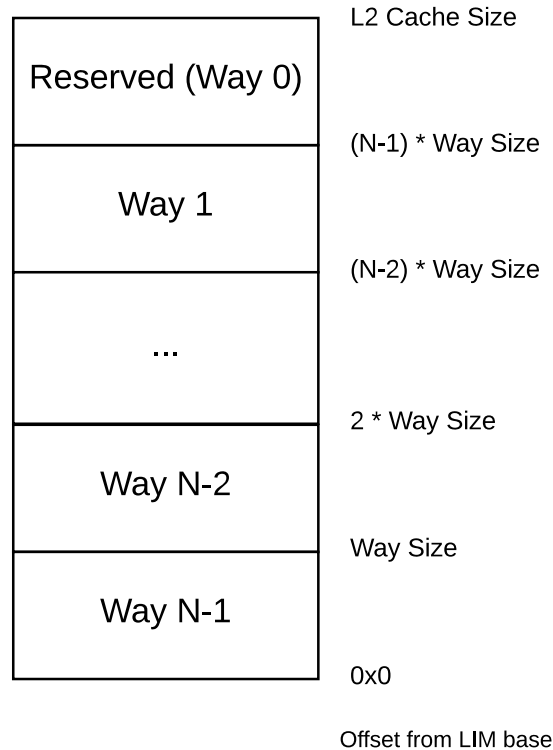

Figure 108: Mapping of L2 Cache Ways to L2 LIM Addresses

13.2.2 Way Masking and Locking

The SiFive L2 Cache Controller can control the amount of cache memory a CPU master is able to allocate into by using the wayMaskN register described in Section 13.4.10. Note that wayMaskN registers only affect allocations, and reads can still occur to ways that are masked. As such, it becomes possible to lock down specific cache ways by masking them in all wayMaskN registers. In this scenario, all masters can still read data in the locked cache ways but cannot evict data.

The following example shows how to lock the L2 cache ways:

```
int global_data = 0; // Handy to help avoid compiler optimizing away code.

void lock_data_into_way(char data, int nbytes, int way) {
// 1. Initialization: we will lock one way of data into the cache via core M
```

```

// Use U54 numbers -- fast simulator.
int masterid0 = 5; / Core's first L2 master ID for DCache. /
int masterid1 = 6; / Core's second L2 master ID for DCache, if any. */
#define MAX_L2_MASTER_IDS 8

// 2. Masking: set up the waymask registers: core M to only allow the selected way,
all other cores to disallow that way.
// These defines should be provided via <sifive/platform.h>
volatile uint64_t * masterid0_waymask = (uint64_t*)(CCACHE_CTRL_ADDR +
WAYMASK_OFFSET) + masterid0;
volatile uint64_t * masterid1_waymask = (uint64_t*)(CCACHE_CTRL_ADDR +
WAYMASK_OFFSET) + masterid1;
// Remember the old waymask for both of these; we will alter them before restoring.
uint64_t old_waymask0 = *masterid0_waymask;
uint64_t old_waymask1 = *masterid1_waymask;

// Assign the restrictive one-way masks to the locking master:
*masterid0_waymask = (1<<way);
*masterid1_waymask = (1<<way);

// Clear that way from all other masters.
for (int id = 0; id <= MAX_L2_MASTER_IDS; id++) {
if ((id == masterid0) || (id == masterid1)) continue;
volatile uint64_t * waymask = (uint64_t*)(CCACHE_CTRL_ADDR + WAYMASK_OFFSET) + id;
*waymask &= ~(1<<way); // Clear the newly-locked way from allocation by all other
masters.
}

// 3. Locking: on our locking core, access all of the data to be locked, carefully so
the compiler cannot optimize it away.
int running_total;
for (int offset = 0; offset < nbytes; offset += 64) { // Hard-coded to 64-byte cache
lines
running_total += data[offset];
}
global_data = running_total; // So the compiler cannot optimize away the accesses to
data[]

// 4. Restoring: now restore the locking core's waymasks, but ensure we do not allow
any new allocations into this way.
*masterid0_waymask = old_waymask0 & ~(1<<way);
*masterid1_waymask = old_waymask1 & ~(1<<way);
}

/*
If this is to be called to lock several portions of an array, make sure to
alter the data pointer, like the following (the sizeof() approach makes it so
that the code below works regardless of whether data[] is an array of bytes, words,
doubles, or structs):

for (way = 0; way < 7; way++) { // Lock into ways 0..6
lock_data_into_way(&data[way*bytes_per_way/sizeof(data[0])], bytes_per_way, way);
}

Note that one way must always be kept as cacheable by all masters.
*/

```

13.2.3 L2 Zero Device

The SiFive L2 Cache Controller has a dedicated scratchpad address region that allows for allocation into the cache using an address range that is not memory backed. This address region is denoted as the L2 Zero Device in the Section 5.2 memory map. Writes to the scratchpad region allocate into cache ways that are enabled and not masked.

A Zero Device ignores write data and always returns zero on reads. The U74-MC Core Complex provides a Zero Device behind the L2 Cache, similar to the Memory Port. When combined with locked L2 cache ways, which prevent eviction, locations within a Zero Device's address range appear to retain their value. This provides a mechanism to create L1 cacheable memory that is essentially backed by L2 SRAM until the way is released (and the value resets to zero). The L2 Zero Device is cacheable like the Memory Port. However, if dirty data is evicted and a write-back to the L2 Zero Device occurs, the Zero Device will discard the write data. Therefore, care must be taken with the scratchpad, as there is no memory backing this address space. Cache evictions from addresses in the scratchpad result in data loss.

The main advantage of the L2 Zero Device over the L2 LIM is that it is a cacheable region allowing for data stored to the scratchpad to also be cached in a master's L1 data cache, which results in faster access.

To understand the difference between the L2 LIM and the L2 Zero Device, consider Figure 109. Notice that the L2 LIM accesses the same blocks of memory as the main path into the L2 Cache, whereas the L2 Zero Device sits behind L2 Cache much like the Memory Port:

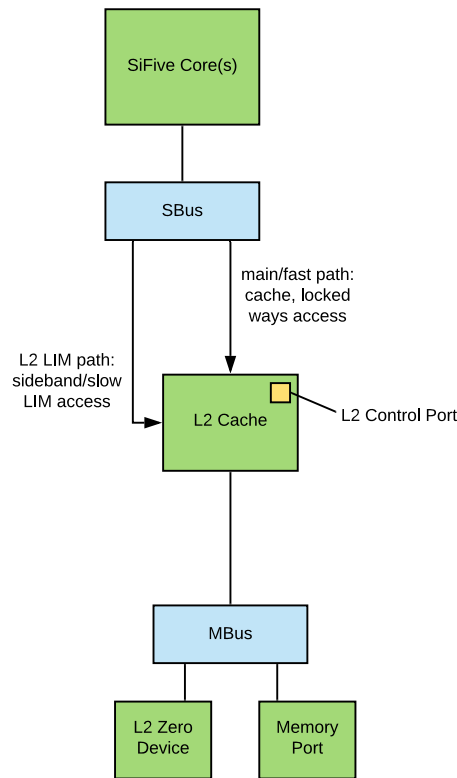

Figure 109: Difference between L2 LIM and L2 Zero Device

The recommended procedure for using the L2 Zero Device is as follows:

1. Use the `wayEnable` register to enable the desired cache ways
2. Designate a single master that will allocate into the scratchpad. For this procedure, we designate this master as Master S. All other masters (CPU and non-CPU) are denoted as Masters N.
3. Masters N: Write to the `wayMaskN` register to mask the ways that are to be used for the scratchpad. This prevents Masters N from evicting cache lines in the designated scratchpad ways.
4. Master S: Write to the `wayMaskN` register to mask all ways *except* the ways that are to be used for the scratchpad. At this point, Master S should only be able to allocate into the cache ways meant to be used as a scratchpad.
5. Master S: Write scratchpad data into the L2 Zero Device address range
6. Master S: Repeat steps 4 and 5 for each way to be used as scratchpad
7. Master S: Use the `wayMaskN` register to mask the scratchpad ways for Master S so that it is no longer able to evict cache lines from the designated scratchpad ways
8. At this point, the scratchpad ways should contain the scratchpad data, with all masters able to read, write, and execute from this address space, and no masters able to evict the scratchpad contents

13.2.4 L2 Features Access Summary

Table 142 describes the L2 features as a function of Way Enable and Way Mask.

Way Enable	Way Mask	Access Base Address	L2 Feature
0	X	0x0800_0000	LIM
1	0	0x8000_0000	Locked Ways — Fast Read access
1	0	0x0A00_0000	Zero Device — Fast Read access from scratchpad
1	1	0x8000_0000	Functional Cache, Locked Ways — Write data mode
1	1	0x0A00_0000	Zero Device — Write data to scratchpad

Table 142: L2 Features Access Summary

13.2.5 L2 Prefetcher

The SiFive L2 Cache Controller contains a prefetcher that allows the L2 to perform accesses to memory based on the patterns of data accesses made by the harts in the Core Complex. For instance, if a hart is reading every 100th byte of a large array and accesses are missing the L1 data cache, the prefetcher will detect this. It will then allocate the appropriate memory addresses to the L2 Cache so subsequent accesses to the array will hit in the L2 Cache. This reduces overall access time to the array and improves performance of the application.

Operation

The L2 Prefetcher can monitor 8 different data streams per hart, where a stream consists of a base address and a stride between memory addresses. Prefetches are automatically issued to the memory system when possible and a prefetch queue of 16 entries holds the accesses before they are issued. The range of a prefetch (or maximum stride length) in terms of cache lines is set by the Prefetch Advanced Control Register `window` field. For instance, if this is set to 0x4, then streams with a stride 256 bytes or greater will be ignored.

The initial number of prefetches (or prefetch distance) made per stream is set by the Prefetch Control Register `dist` field. The prefetching distance will adapt based on the success of the prefetching and the overall range of prefetching. If a hart continues to make direct accesses which match the stride of the stream, then additional prefetches will be made, and the prefetch distance can increase. It's possible that the direct accesses made by a hart will be too fast for the prefetcher, and the hart will have to wait for the L2 to populate. When this occurs, the L2 Prefetcher will increase the prefetch distance (i.e. emit more prefetches) to minimize the chance of this occurring. The threshold to increase the prefetching distance is set by the Prefetch Advanced Control Register `hitMSHRThrd` field.

The maximum number of prefetches emitted for a stream is limited by the Prefetch Control Register `maxAllowedDist` field. The prefetch distance will increase gradually, but at times this may not be fast enough. The speed of the ramp-up from the initial distance to the maximum is man-

aged automatically by the prefetcher. The Prefetch Control Register `linToExpThrd` setting can be used to fine-tune this adaptive ramp-up. The smaller the value of this field, the faster the prefetcher will reach the maximum prefetch distance.

Prefetches are issued only if there are idle L2 Miss Status Holding Registers (MSHRs). The Prefetch Advanced Control Register `qFullnessThrd` value is used to control when the prefetcher will stop issuing hints to the memory system. This 4-bit field allows the total number of MSHRs in the L2 Cache to be represented in fractions of 1/16th. For instance, a threshold value of `0xc` means that if 75% of the MSHRs are allocated, prefetches will be stalled until the number of MSHRs in use drops below 75% available. This setting allows the prefetcher to be tuned such that the direct accesses made by the Core Complex (from harts and Front Port masters) aren't stalled by the prefetcher.

The prefetcher monitors both reads and writes to memory and the strides can either be incrementing or decrementing addresses. Prefetching is disabled at reset, and must be enabled using the Prefetch Control Register `en` bit.

Retiring streams

It's unlikely that a prefetch stream will continue indefinitely for the life of an application, so the L2 Prefetcher accommodates two methods to retire old streams. This allows new streams to be tracked. A stream can be retired when the Ageout mechanism is enabled via the Prefetch Control Register `ageOutEn` bit. When this is set, the L2 Prefetcher will track the number of direct loads which don't match the stream. When the number of stream misses exceeds the value set in the Prefetch Control Register `numLdsToAgeOut` field, the stream will be retired.

The second way for a stream to be retired is through successfully hitting in the L2 cache without the need for prefetching. If enough consecutive accesses hit in the L2 cache which were not prefetched, then there is no need for the prefetcher to continue monitoring the stream. The Prefetch Advanced Control Register `hitCacheThrd` field sets this threshold for retiring the stream.

4 KiB Page Boundaries

The L2 Prefetcher can be programmed to cross 4 KiB page boundaries of memory. This is useful in an application environment in which there is no OS page protection, or where OS page protection can be ignored. When the Prefetch Control Register `crossPageEn` bit is set, prefetching can cross 4 KiB boundaries. When the Prefetch Control Register `crossPageEn` bit is clear, the Prefetch Control Register `crossPageOptmDis` bit controls the prefetch behavior. If the bit is clear, then the prefetcher pauses if a 4 KiB boundary is crossed. Prefetching will resume if the hart continues to make accesses that match the stride in the new 4 KiB page of memory. If the Prefetch Control Register `crossPageOptmDis` bit is set, then prefetching is terminated for the stream and the entry is made available for a new stream.

The L2 Prefetch Control Registers (Prefetch Control Register and Prefetch Advanced Control Register) are described in Section 13.4.11.

13.2.6 Error Correction Codes (ECC)

The SiFive Level 2 Cache Controller supports ECC. ECC is applied to both categories of SRAM used, the data SRAMs and the metadata SRAMs (index, tag, and directory information). The data SRAMs use Single-Error Correcting, Double-Error Detecting (SECCDED). The metadata SRAMs use Single-Error Correcting, Double-Error Detecting (SECCDED).

Whenever a correctable error is detected, the cache immediately repairs the corrupted bit and writes it back to SRAM. This corrective procedure is completely invisible to application software. However, to support diagnostics, the cache records the address of the most recently corrected metadata and data errors. Whenever a new error is corrected, a counter is increased and an interrupt is raised. There are independent addresses, counters, and interrupts for correctable metadata and data errors.

DirError, DirFail, DataError, and DataFail signals are used to indicate that an L2 metadata, uncorrectable L2 metadata, L2 data, or uncorrectable L2 data error has occurred, respectively. These signals are connected to the PLIC as described in Chapter 10 and are cleared upon reading their respective count registers.

13.2.7 Coherence

The SiFive L2 Cache is partially inclusive of the L1 instruction cache and is inclusive of the L1 data cache. When a block of data is allocated to the L1 cache, it is also allocated to the L2 Cache. When a block is evicted from the L1, the corresponding block in the L2 is then updated and marked dirty.

To understand how coherence is managed differently in the L2 Cache with respect to the L1 instruction and data caches, consider the following rules:

1. Only an instruction cache allocation from the Memory Port will land in the L2 Cache
2. An eviction from the L2 Cache does not cause an eviction from the instruction cache
3. An eviction from the instruction cache does not cause L2 Cache eviction either
4. A discard from the data cache does not invalidate the L2 Cache
5. Following a flush in the L2 Cache, the L2 Cache will back probe lines in L1 data cache

13.3 Memory Map

The L2 Cache Controller memory map is shown in Table 143.

Offset	Name	Description
0x0000	Config	Information about the Cache Configuration
0x0008	WayEnable	The index of the largest way which has been enabled. May only be increased.
0x0040	ECCInjectError	Inject an ECC Error
0x0100	DirECCFixLow	The low 32-bits of the most recent address to fail ECC
0x0104	DirECCFixHigh	The high 32-bits of the most recent address to fail ECC
0x0108	DirECCFixCount	Reports the number of times an ECC error occurred
0x0120	DirECCFailLow	The low 32-bits of the most recent address to fail ECC
0x0124	DirECCFailHigh	The high 32-bits of the most recent address to fail ECC
0x0128	DirECCFailCount	Reports the number of times an ECC error occurred
0x0140	DatECCFixLow	The low 32-bits of the most recent address to fail ECC
0x0144	DatECCFixHigh	The high 32-bits of the most recent address to fail ECC
0x0148	DatECCFixCount	Reports the number of times an ECC error occurred
0x0160	DatECCFailLow	The low 32-bits of the most recent address to fail ECC
0x0164	DatECCFailHigh	The high 32-bits of the most recent address to fail ECC
0x0168	DatECCFailCount	Reports the number of times an ECC error occurred
0x0200	Flush64	Flush the physical address equal to the 64-bit written data from the cache
0x0240	Flush32	Flush the physical address equal to the 32-bit written data << 4 from the cache
0x0800	WayMask0	Master 0 way enable mask register
0x0808	WayMask1	Master 1 way enable mask register
0x0810	WayMask2	Master 2 way enable mask register
0x0818	WayMask3	Master 3 way enable mask register
0x0820	WayMask4	Master 4 way enable mask register
0x0828	WayMask5	Master 5 way enable mask register
0x0830	WayMask6	Master 6 way enable mask register
0x0838	WayMask7	Master 7 way enable mask register
0x0840	WayMask8	Master 8 way enable mask register
0x0848	WayMask9	Master 9 way enable mask register
0x0850	WayMask10	Master 10 way enable mask register
0x0858	WayMask11	Master 11 way enable mask register
0x0860	WayMask12	Master 12 way enable mask register
0x0868	WayMask13	Master 13 way enable mask register
0x0870	WayMask14	Master 14 way enable mask register
0x0878	WayMask15	Master 15 way enable mask register
0x0880	WayMask16	Master 16 way enable mask register
0x0888	WayMask17	Master 17 way enable mask register
0x0890	WayMask18	Master 18 way enable mask register
0x0898	WayMask19	Master 19 way enable mask register
0x08A0	WayMask20	Master 20 way enable mask register

Table 143: Register offsets within the L2 Cache Controller Control Memory Map

Offset	Name	Description
0x08A8	WayMask21	Master 21 way enable mask register
0x08B0	WayMask22	Master 22 way enable mask register
0x08B8	WayMask23	Master 23 way enable mask register
0x08C0	WayMask24	Master 24 way enable mask register
0x08C8	WayMask25	Master 25 way enable mask register
0x08D0	WayMask26	Master 26 way enable mask register
0x2000	pmEventSelect0	performance monitor event select 0
0x2008	pmEventSelect1	performance monitor event select 1
0x2010	pmEventSelect2	performance monitor event select 2
0x2018	pmEventSelect3	performance monitor event select 3
0x2020	pmEventSelect4	performance monitor event select 4
0x2028	pmEventSelect5	performance monitor event select 5
0x2800	pmClientFilter	performance counter client disable mask
0x3000	pmEventCounter0	performance monitor event counter 0
0x3008	pmEventCounter1	performance monitor event counter 1
0x3010	pmEventCounter2	performance monitor event counter 2
0x3018	pmEventCounter3	performance monitor event counter 3
0x3020	pmEventCounter4	performance monitor event counter 4
0x3028	pmEventCounter5	performance monitor event counter 5

Table 143: Register offsets within the L2 Cache Controller Control Memory Map

13.4 Register Descriptions

This section describes the functionality of the memory-mapped registers in the Level 2 Cache Controller.

13.4.1 Cache Configuration Register (Config)

The Config Register can be used to programmatically determine information regarding the cache size and organization.

Cache Configuration Register (Config)				
Register Offset		0x0		
Bits	Field Name	Attr.	Rst.	Description
[7:0]	Banks	RO	0x2	Number of banks in the cache
[15:8]	Ways	RO	0x10	Number of ways per bank
[23:16]	lgSets	RO	0xA	Base-2 logarithm of the sets per bank
[31:24]	lgBlockBytes	RO	0x6	Base-2 logarithm of the bytes per cache block

Table 144: Cache Configuration Register

13.4.2 Way Enable Register (wayEnable)

The wayEnable register determines which ways of the Level 2 Cache Controller are enabled as cache. Cache ways that are not enabled are mapped into the U74-MC Core Complex's L2 LIM (Loosely-Integrated Memory) as described in the memory map in Section 5.2.

This register is initialized to 0 on reset and may only be increased. This means that, out of reset, only a single L2 cache way is enabled, as one cache way must always remain enabled. Once a cache way is enabled, the only way to map it back into the L2 LIM address space is by a reset.

Way Enable Register (wayEnable)				
Register Offset		0x8		
Bits	Field Name	Attr.	Rst.	Description
[7:0]	wayEnable	RW	0x0	The index of the largest way which has been enabled. May only be increased.

Table 145: Way Enable Register

13.4.3 ECC Error Injection Register (ECCInjectError)

The ECCInjectError register can be used to insert an ECC error into either the backing data or metadata SRAM. This function can be used to test error correction logic, measurement, and recovery.

ECC Error Injection Register (ECCInjectError)				
Register Offset		0x40		
Bits	Field Name	Attr.	Rst.	Description
[7:0]	ECCToggleBit	RW	0x0	Toggle (corrupt) this bit index on the next cache operation
[15:8]	Reserved			
16	ECCToggleType	RW	0x0	Toggle (corrupt) a bit in 0=data or 1=directory
[31:17]	Reserved			

Table 146: ECC Error Injection Register

13.4.4 ECC Directory Fix Registers (DirECCFix*)

The DirECCFixHigh and DirECCFixLow registers are read-only registers that contain the address of the most recently corrected L2 metadata error. This field supplies only the portions of the address that correspond to the affected set, since all ways are corrected together.

The DirECCFixCount register is a read-only register that contains the number of corrected L2 metadata errors. Reading this register clears the DirError interrupt signal described in Section 13.2.6.

13.4.5 ECC Directory Fail Registers (`DirECCFail*`)

The `DirECCFailLow` and `DirECCFailHigh` registers are read-only registers that contains the address of the most recent uncorrected L2 metadata error.

The `DirECCFailCount` register is a read-only register that contains the number of uncorrected L2 metadata errors. Reading this register clears the `DirFail` interrupt signal described in Section 13.2.6.

13.4.6 ECC Data Fix Registers (`DatECCFix*`)

The `DatECCFixLow` and `DatECCFixHigh` registers are read-only registers that contain the address of the most recently corrected L2 data error.

The `DataECCFixCount` register is a read-only register that contains the number of corrected L2 data errors. Reading this register clears the `DataError` interrupt signal described in Section 13.2.6.

13.4.7 ECC Data Fail Registers (`DatECCFail*`)

The `DatECCFailLow` and `DatECCFailHigh` registers are a read-only registers that contain the address of the most recent uncorrected L2 data error.

The `DatECCFailCount` register is a read-only register that contains the number of uncorrected L2 data errors. Reading this register clears the `DataFail` interrupt signal described in Section 13.2.6.

13.4.8 L2 Cache ECC Error Injection and Correction

Writes to the `ECCInjectError` register, described in Section 13.4.3, specifies a bit position within the combined `data+ECC` (or `directoryEntry+ECC`) granule to toggle or corrupt exactly 1 bit the next time an L2 entry is written.

The `ECCToggleBit` register specifies a hex value corresponding to which bit to toggle. For example, if you write a value of `0x47`, bit 71 will be toggled (consequently, for a write to an L2 data RAM that has 64 bits of data and 8 bits of ECC, writing a value $> 0x47$ will have no effect).

The error will be injected (i.e., the bit will be toggled/corrupted) on the next write. When there are multiple `data+ECC` granules comprising a cache line, error injection will always be applied to the first of these granules. For instance, when you have a 64+8 bit granule and a 64 byte line, it takes eight granules to make up a full cache line, and errors will be injected into the specified bit in the first of these eight granules. For metadata, this is a non-issue since there is only one `directoryEntry+ECC` granule for each cache line.

The error will not be reported until the corrupted entry is subsequently read and the error is detected/corrected; that is, this will be at an arbitrary time after the `ECCInjectError` Register is

written, unless a test specifically ensures that it reads the particular set and way that was corrupted due to that write.

The address reported in the fix/fail address registers (`DirECCFix` / `DirECCFail`, respectively) will always be the cache-line-size-aligned address of the start of the cache line in which the error was detected.

For error injection on the data, if the L1-L2 interface (and consequently, the width of the L2 data R/W interface) is larger than the ECC granule, the designated bit will actually be toggled on multiple granules; the number of granules being as many granules as make up the data interface. For example, if the L2 data interface is 128-bits wide and the data+ECC granule is 72-bits, two bits will get toggled — one per granule. This is, however, invisible to software since, when these bits are read, only a single corrected error will be reported and the address will be the start of the cache line as stated above.

For the reported fix address (`DirECCFix`) on corrected errors in the metadata, only the address bits corresponding to the set (i.e., the index) are captured. In contrast, address bits corresponding to the tag are not captured and they will read out as 0.

13.4.9 Cache Flush Registers (`Flush*`)

The U74-MC Core Complex L2 Cache Controller provides two registers that can be used for flushing specific cache blocks.

`Flush64` is a 64-bit write-only register that flushes the cache block containing the address written. `Flush32` is a 32-bit write-only register that flushes a cache block containing the written address left shifted by 4 bytes. In both registers all bits must be written in a single access for the flush to take effect.

The flush operation performs a write-back and invalidate, meaning the contents are written to memory and L2 and L1 cache lines are then invalidated.

13.4.10 Way Mask Registers (`wayMask*`)

The `wayMaskN` register allows a master connected to the L2 Cache Controller to specify which L2 Cache ways can be evicted by Master N. Masters can still access memory cached in masked ways. The mapping between masters and their L2 master IDs is shown in Table 148.

At least one cache way must be enabled. It is recommended to set/clear bits in this register using atomic operations.

Way Mask 0 Register (wayMask0)				
Register Offset		0x800		
Bits	Field Name	Attr.	Rst.	Description
0	WayMask0_0	RW	0x1	Enable way 0 for Master 0
1	WayMask0_1	RW	0x1	Enable way 1 for Master 0
2	WayMask0_2	RW	0x1	Enable way 2 for Master 0
3	WayMask0_3	RW	0x1	Enable way 3 for Master 0
4	WayMask0_4	RW	0x1	Enable way 4 for Master 0
5	WayMask0_5	RW	0x1	Enable way 5 for Master 0
6	WayMask0_6	RW	0x1	Enable way 6 for Master 0
7	WayMask0_7	RW	0x1	Enable way 7 for Master 0
8	WayMask0_8	RW	0x1	Enable way 8 for Master 0
9	WayMask0_9	RW	0x1	Enable way 9 for Master 0
10	WayMask0_10	RW	0x1	Enable way 10 for Master 0
11	WayMask0_11	RW	0x1	Enable way 11 for Master 0
12	WayMask0_12	RW	0x1	Enable way 12 for Master 0
13	WayMask0_13	RW	0x1	Enable way 13 for Master 0
14	WayMask0_14	RW	0x1	Enable way 14 for Master 0
15	WayMask0_15	RW	0x1	Enable way 15 for Master 0

Table 147: Way Mask 0 Register

Master ID	Description
0	Debug
1	AXI4 Front Port ID#0
2	AXI4 Front Port ID#1
3	AXI4 Front Port ID#2
4	AXI4 Front Port ID#3
5	Hart 0 Fetch Unit
6	Hart 0 D-Cache MMIO
7	Hart 1 Fetch Unit
8	Hart 1 D-Cache
9	Hart 1 D-Cache
10	Hart 1 D-Cache MMIO
11	Hart 1 L2 Prefetcher
12	Hart 2 Fetch Unit
13	Hart 2 D-Cache
14	Hart 2 D-Cache
15	Hart 2 D-Cache MMIO
16	Hart 2 L2 Prefetcher
17	Hart 3 Fetch Unit
18	Hart 3 D-Cache
19	Hart 3 D-Cache
20	Hart 3 D-Cache MMIO
21	Hart 3 L2 Prefetcher
22	Hart 4 Fetch Unit
23	Hart 4 D-Cache
24	Hart 4 D-Cache
25	Hart 4 D-Cache MMIO
26	Hart 4 L2 Prefetcher

Table 148: Master IDs in the L2 Cache Controller

13.4.11 L2 Prefetch Control Registers

The L2 Prefetcher control registers `basicCtrl` and `additionalCtrl` are described in the below tables.

Prefetch Control Register				
Bits	Field Name	Attr.	Rst.	Description
0	en	RW	0x0	Enable hardware prefetcher.
1	crossPageOptmDis	RW	0x0	Only works when crossPageEn == 0. Cross-page optimization disable: 0 - Entry goes into Pause state while crossing page boundary. Next time when the demand miss happens on the same page, it doesn't need to train again. 1 - The entry is invalidated in case of a cross-page.
[7:2]	dist	RW	0x3	Prefetch distance (size is HW generation time configurable).
[13:8]	maxAllowedDist	RW	0x3	Maximum allowed distance (size is HW generation time configurable).
[19:14]	linToExpThrd	RW	0x5	Linear-to-exponential threshold (size is HW generation time configurable).
20	ageOutEn	RW	0x5	Ageout mechanism enable.
[27:21]	numLdsToAgeOut	RW	0x40	Number of non-matching loads to edge out an entry (size is HW generation time configurable).
28	crossPageEn	RW	0x0	Enable prefetches to cross-pages. When crossPageEn == 1, the bit value of crossPageOptmDis does not matter, the prefetches will cross 4K boundary.
[31:29]	Reserved			

Table 149: basicCtrl Register

Prefetch Advanced Control Register				
Bits	Field Name	Attr.	Rst.	Description
[3:0]	qFullnessThrd	RW	0xE	Threshold number of Fullness (L2 MSHRs used/total available) to stop sending hits.
[8:4]	hitCacheThrd	RW	0x5	Threshold number of CacheHits for evicting SPF entry.
[12:9]	hitMSHRThrd	RW	0x2	Threshold number of MSHR hits for increasing SPF distance.
[18:13]	window	RW	0x6	Size of the comparison window for address matching.
[31:19]	Reserved			

Table 150: additionalCtrl Register

13.5 Procedure to Flush the L2 Cache

This section describes how to flush the L2 Cache using the Zero Device. Alternatively, there is a flush-by-address function in the L2 Controller space, described in Section 13.4.9. Note that using the Zero Device to flush the entire cache is faster than flushing by address.

To flush a single index+way:

1. Write wayMaskN to allow evictions from only the specified way
2. Issue a load (or store) to an address in the L2 Zero Device region that corresponds to the specified index

To flush the entire L2 cache:

1. Write wayMaskN to allow evictions from only way 0
2. Issue a series of loads (or stores) to addresses in the L2 Zero Device region that correspond to each L2 index (i.e., one load/store per 64 B, total of (way-size-in-bytes/64) loads or stores).
3. Write wayMaskN to allow evictions from only way 1
4. Repeat step 2
5. Repeat steps 3 and 4, moving through each way of the cache, until all ways have been flushed.

To flush a range of physical addresses much larger than a cache way:

1. Flush the whole cache as shown above

To flush a range of physical addresses not much larger than a cache way:

1. Use the existing flush-by-address mechanism and iterate over the addresses, or write wayMaskN to allow evictions from only way 0
2. Issue a series of loads (or stores) to addresses in the L2 Zero Device region that correspond to the L2 index associated with each 64 B chunk within the specified address range (i.e., one load/store per 64 B, total of (specified-address-range-in-bytes/64) load or stores).
3. Write wayMaskN to allow evictions from only way 1
4. Repeat step 2
5. Repeat steps 3 and 4, moving through each way of the cache, until all ways have been flushed (this should all be done with no intervening stores that could create new dirty lines)

Chapter 14

Power Management

The following chapter describes power modes and establishes flows for powering up, powering down, and resetting the hardware of the U74-MC Core Complex.

14.1 Power Modes

Power modes include normal run mode and wait-for-interrupt clock gating mode using the `WFI` instruction. Additionally, there is a full power down mode supported via the `CEASE` instruction. These modes are covered in detail below.

14.2 Run Mode

The hart is fully operational in run mode, and SiFive designs include the option to include coarse-grained architectural clock gating. When this feature is enabled in the hart, the I-Cache, D-Cache, integer pipeline, Debug Logic, and Floating Point Unit (FPU) each contain their own clock gate module. The clock gating feature will enable automatic clock gating of functional units when they are inactive, and allow the hart to gate its own clock(s) based on activity. To further reduce power while in run mode, users may choose to reduce `external_source_for_core_N_clock`, which is required to be changed synchronously to the rest of the clocks in the system. It is important to note that the clock relationships with the rest of the system must still be maintained if `external_source_for_core_N_clock` is reduced.

14.3 WFI Clock Gate Mode

WFI clock gating mode can be entered by executing the `WFI` instruction. The assembly-level instruction is simply `wfi`, and executing the C-code method using the GCC compiler can be accomplished with `asm("WFI")`.

14.3.1 WFI Wake Up

Wake up from a WFI occurs when the hart receives any interrupt. Depending on the software configuration, the hart will either immediately enter the interrupt handler, or resume execution on the instruction immediately after the WFI.

If interrupts are enabled and `mstatus.MIE=1`, then the hart will wake when an interrupt is enabled and becomes pending, and immediately enter the interrupt handler. Upon exit from the interrupt handler, program execution will resume at the instruction following the `WFI`.

If interrupts are enabled but `mstatus.MIE=0`, then the hart will wake when an interrupt is enabled and becomes pending, but will not enter the interrupt handler. It will simply resume at the instruction immediately after the `WFI` in this case.

To prevent an interrupt source from waking a hart, the enable bit for that interrupt must be written to 0 prior to executing the `WFI` instruction. If any interrupts are pending upon executing a `WFI` instruction, then the `WFI` is effectively treated as a `NOP` instruction.

Refer to Chapter 8 for more detail on interrupt configuration.

14.4 CEASE Instruction for Power Down

To fully power down, follow the steps described in Section 14.9, where the last step is to execute a `CEASE` instruction. Once the `CEASE` instruction is executed, the core will not retire another instruction until reset. The `CEASE` opcode is `0x30500073` and can be implemented in either assembly or C code. To create an assembly-level function using GCC, consider the following example.

```
.global _cease
.type      _cease, @function
_ceil:
    .word 0x30500073
    ret
```

The next example demonstrates how to implement the `CEASE` instruction within a function in C code.

```
static inline void cease()
{
    __asm__ __volatile__ (".word 0x30500073" : : : "memory"); // CEASE
}
```

14.5 Hardware Reset

The following list summarizes the hardware reset values required by the RISC-V Privileged Specification and applies to all SiFive designs.

1. Privilege mode is set to machine mode.
2. `mstatus.MIE` and `mstatus.MPRV` are required to be 0.
3. The `misa` register holds the full set of supported extensions for that implementation, and `misa.MXL` defaults to the widest supported ISA available, referred to as `MXLEN`.
4. The `pc` is set to the implementation specific reset vector.

5. The `mcause` register is set to `0x0` at reset.
6. The PMP configuration fields for address matching mode (A) and Lock (L) are set to 0, which defaults to no protection for any privilege level.

The internal state of the rest of the system should be completed by software early in the boot flow.

14.6 Early Boot Flow

For the early stages of boot, some of the first things software must consider are listed below:

- The global pointer (`gp` or `x3`) user register should be initialized to the `__global_pointer$` linker generated symbol and not changed at any point in the application program.
- The stack pointer (`sp` or `x2`) user register should be also set up as a standard part of the boot flow.
- All other user registers (`x1`, `x4` - `x31`) can be written to 0 upon initial power-on.
- The `mtvec` register holds the default exception handler base address, so it is important to set up this register early in the boot flow so it points to a properly aligned, valid exception handler location.
- Zero out the `bss` section, and copy data sections into RAM areas as needed.

14.7 Interrupt State During Early Boot

Since `mstatus.MIE` defaults to 0, all interrupts are disabled globally out of reset. Prior to enabling interrupts globally through `mstatus.MIE`, consider the following:

- Ensure no timer interrupts are pending by checking the `mip.MTIP` bit. The `mtime` register is 0 out of reset, and starts running immediately. However, the `mtimecmp` register does not have a reset value.

If no timer interrupt is required, leave `mie.MTIE` equal to 0 prior to enabling global interrupt with `mstatus.MIE`.

If the application requires a timer interrupt, write `mtimecmp` to a value in the future for the next timer interrupt before enabling `mstatus.MIE`.

- Write the remaining bits in the `mie` CSR to the desired value to enable interrupts based on the requirements of the system. This register is not defined to have a reset value.
- Each `msip` register in the Core-Local Interruptor (CLINT) or Core-Local Interrupt Controller (CLIC) address space is reset to 0, so no specific initialization is required for local software interrupts.

Since `msip` is memory-mapped, any hart in the system may trigger a software interrupt on another hart, so this should be considered during the boot flow on a multi-hart system.

- If a Platform-Level Interrupt Controller (PLIC) exists, check the PLIC pending status. The PLIC memory mapped pending bits are read-only, so the pending status should be cleared at the source if they reset to a non-zero status. Then, enable the PLIC interrupts as required by the system prior to enabling interrupts in the system via `mstatus.MIE`.

If an L2 Cache or Bus-Error Unit (BEU) is present, these interrupt IDs begin at 128, so the enable bits may lie in a different region of the memory map than other PLIC enable bits in the design.

- Wipe down memory if enabled with ECC. This can be done by writing `0x0` to memory with either store instructions issued by the CPU, or using a DMA controller. ECC errors are reported via the Bus-Error Unit (BEU).
- Check BEU registers to ensure no errors are reported and that the enable bits reflect the requirements of the application.

14.8 Other Boot Time Considerations

- Write `0` to enable the appropriate bits in the Feature Disable CSR as described in Table 106.
- Ensure the remaining bits in the `mstatus` CSR are written to the desired application specific configuration at boot time.
- If a design includes user and supervisor privilege levels, initialize `medeleg` and `mideleg` registers to `0` until supervisor-level trap handling is set up correctly using `stvec`.
- The `mcause`, `mepc`, and `mtval` registers hold important information in the event of a synchronous exception. If the synchronous exception handler forces reset in the application, the contents of these registers can be checked to understand root cause.
- The PMP address and configuration CSRs are required to be initialized if user or supervisor privilege levels are part of the design. By default, user and supervisor modes have no permissions to the memory map unless explicitly granted by the PMP.
- The `mcycle` CSR is a 64-bit counter on both RV32 and RV64 systems, and it counts the number of cycles executed by the hart. It has an arbitrary value after reset and can be written as needed by the application.
- Instructions retired can be counted by the `minstret` register, and this also has an arbitrary value after reset. This can be written to any given value.
- The `mhpmeventX` CSR selects which hardware events to count, where the count is reflected in `mhpmcounterX`. At any point, the `mhpmcounterX` registers can be directly written to reset their value when the `mhpmeventX` register has the proper event selected.
- For cores with an MMU, ensure the `satp` register holds the correct configuration for address translation.

- There is no requirement for boot time initialization to any of the registers within the Debug Module, unless there is an application specific reason to do so.
- All other CSRs during boot time initialization should be considered based on system and application requirements.

14.9 Power-Down Flow

Designate one core as primary and all others as secondary. For our Core IP product, coordination with an External Agent is required.

1. External Agent: Wait for communication from primary core to initiate the following steps:
 - a. Stop sending inbound traffic (both transactions and interrupts) into the core complex.
 - b. Wait until all outstanding requests to the Core Complex are completed, then
 - c. Wait until `cease_from_tile_x` is high for the primary core and all secondary cores.
 - d. Once `cease_from_tile_x` is high for primary core and all secondary cores, apply reset to the whole core complex.
2. Primary core:
 - a. The following sequence should be executed in machine mode and NOT out of a remote ITIM/DTIM.
 - b. Communicate with external agent to initiate cease power-down sequence.
 - c. Poll external agent until steps 1.a and 1.b are completed.
 - d. Disable all interrupts except those related to bus errors/memory corruption, and IPIs (if using enabled IPI to coordinate power-down sequence among cores).
 - i. Copy contents of any TIMs/LIMs into external memory.
 - ii. Primary core: if there is an L2 cache, flush it (all addresses at which cacheable physical memory exists).
 - iii. If there is no L2 cache, but there is a data cache, flush it using full-cache variant of `CFLUSH.D.L1`, if available; or per-line variant if not
 - e. Inform all secondary cores to proceed.
 - f. Wait until `cease_from_tile_x` is high for all secondary cores. Examples of how this can be accomplished:
 - i. Have an off-core-complex memory-mapped register that tracks the state of the `cease_from_tile_x` signals. Primary core polls this register.
 - ii. Wire the `cease_from_tile_x` signals back into interrupt wires. Corresponding interrupts can be disabled along with all others in the first step. Primary core polls the interrupt-pending bits for those interrupts.

- g. Disable all interrupts.
 - h. Execute CEASE instruction.
3. Secondary cores:
- a. The following sequence should be executed in machine mode and NOT out of a remote ITIM/DTIM.
 - b. Execute in an idle loop for notification sent in step 2.vii (could be via polling on an MMIO-accessible mailbox, polling on an IPI (disabled), or waiting on an IPI (enabled)).
 - c. Disable all interrupts except those related to bus errors/memory corruption, and IPIs (if using enabled IPI to coordinate power-down sequence among cores).
 - d. Copy contents of any TIMs/LIMs into external memory.
 - e. If there is no L2 cache but there is a data cache, flush it using full-cache variant of CFLUSH.D.L1 if available, or per-line variant if not:
 - f. Disable all interrupts.
 - g. Execute CEASE instruction.

Chapter 15

Debug

This chapter describes the operation of SiFive debug hardware, which follows *The RISC-V Debug Specification, Version 0.13*. Currently only interactive debug and hardware breakpoints are supported.

15.1 Debug Module

The Debug Module (DM) handles nearly all the functions related to debugging. It is a slave to both the Debug Module Interface (DMI) coming from the probe and a TileLink bus coming from the core(s). From the perspective of the core, the DM appears as a 4K block in the memory map. The DM memory map as seen from the perspective of the core is shown in Table 152 and the register map from the perspective of the DMI is shown in Table 151.

Most of the DM is clocked by the TileLink (system) clock. The `dmcontrol` register is accessible when the system clock is not running, mainly to be able to write to `haltreq` while the core is in reset due to `ndreset`. Doing so generates a debug interrupt and will interrupt the selected core immediately once it is out of reset or interrupt it during a WFI instruction.

DMI Address	Name	Description
0x11	dmstatus	Debug Module Status. See Table 163 for more information.
0x10	dmcontrol	Debug Module Control. See Table 164 for more information.
0x12	hartinfo	Hart Information. See Table 165 for more information.
0x14	hawindowse1	Read/Write. Select which window of up to 32 harts is visible in hawindow. Not used by SiFive since all SiFive systems have less than 32 harts.
0x15	hawindow	Read/Write. Window of 32 harts to be selected, in addition to the one selected by hartse1. Bit 0 corresponds to hart 0. A 1 will select the corresponding hart.
0x40	haltsum0	Read-only. Halt Summary 0: Bit n reads 1 if hart n is halted.
0x13	haltsum1	Read-only. Only present on systems with >32 harts, so not used by SiFive .
0x16	abstractcs	Abstract Control and Status. See Table 166 for more information.
0x18	abstractauto	Select whether access to particular DATA or PROGBUF locations will re-execute the last command. Used for block transfers or other repeating commands. See Table 168 for more information.
0x17	command	Initiate abstract command. See Table 167 for more information.
0x04-0x0F	data0 - data11	Read/Write DATA registers. 32-bit SiFive cores have 1 data register, 64-bit cores have 2.
0x20-0x2F	progbuf0 - progbuf15	Read/Write PROGBUF registers.
0x32	dmcs2	Fields to set up and read back Halt Group or Resume Group configuration. Present by default on systems with more than 1 hart or with any external triggers. See Table 169 for more information.
0x37-0x3F	sbXXXX	Read/Write. System Bus Access.

Table 151: Debug Module Register Map Seen from the Debug Module Interface

From the point of view of the core, the DM appears as a 4K block of memory. It is mapped into low memory so that memory references can use addresses relative to the \$zero register.

Note

Logic in the core prevents non-debug-mode code from accessing the debug region. However, this logic does not intercept accesses from the Front Port. This means that it is possible for Front Port accesses to interfere with a debug session by writing to various offsets within the debug region. If this occurs, the user may need to restart the debugger or reset the core to continue a debug session. To work around this, do not access the debug module memory region via the Front Port.

TL Address	Name	Attr.	Description
0x100	HALTED	WO	Written with hartid by ROM code when hart gets a debug interrupt or reenters ROM due to EBREAK. Sets halted[hartid]. If an abstract command was running, writing this also clears busy.
0x104	GOING	WO	Written by ROM code when it begins executing a command started by FLAGS[hartid].go. Clears FLAGS[hartid].go.
0x108	RESUMING	WO	Written with hartid by hart when it is about to resume. Sets resumeack[hartid] and clears halted[hartid] and FLAGS[hartid].resume.
0x10C	EXCEPTION	WO	Written by hart when it encounters an exception in debug mode. Sets cmderr to "exception".
0x300	WHERE TO	RO	JAL to ABSTRACT. This opcode is constructed by DM hardware and is needed because ABSTRACT is not a fixed address (depends on number of PROGBUF words selected in the configuration).
contiguous	ABSTRACT	RO	2 words constructed by DM hardware based on abstract command written from DTM. +0: If transfer set, construct instruction to load/store specific register to/from DATA[0] (32 bits) or DATA[1:0] (64 bits), else NOP. +4: If postexec set, then NOP to fall thru and execute PROGBUF, else EBREAK to return to ROM park loop.
contiguous	PROGBUF	RW	Configurable number (typically 16, max 16) of R/W words to be filled in by debugger and executed by hart.
contiguous	IMPEBREAK	RO	Optional - If present, reads as EBREAK to return to ROM park loop when execution runs off the end of PROGBUF. In E2, default is 2-word PROGBUF and IMPEBREAK present. Most others have 16-word PROGBUF and no IMPEBREAK.
0x380-0x3BF	DATA	RW	Configurable number (1 for 32-bit or 2 for 64-bit, max 12) of R/W words intended for use for data transfer between debugger and hart. Since it is contiguous with PROGBUF, the debugger may use DATA as an extension of PROGBUF.
0x400-0x7FF	FLAGS	RO	One byte flag per hart. Bit 0 (go): Set by writing an abstract command, cleared by ROM write to GOING. ROM will jump to WHERE TO.

Table 152: Debug Module Memory Map from the Perspective of the Core

TL Address	Name	Attr.	Description
			Bit 1 (resume): Set by writing 1 to resumereq[hartid]. Cleared by ROM write of hartid to RESUMING. ROM restores s0 then executes dret.
0x800-0xFFF	ROM	RO	<p>Debug interrupt or EBREAK enters at 0x800, saves s0, writes hartid to HALTED, then busy-waits for <code>FLAGS[hartid] > 0</code>.</p> <p>If <code>FLAGS[hartid].go</code>, write 0 to GOING, then jump to WHERETO.</p> <p>Else write hartid to RESUMING, then execute dret to return to user program.</p> <p>ROM Source Code: https://github.com/chipsalliance/rocket-chip/blob/master/scripts/debug_rom/debug_rom.S</p>

Table 152: Debug Module Memory Map from the Perspective of the Core

15.2 Trace and Debug Registers

This section describes the per hart Trace and Debug Registers (TDRs), which are mapped into the CSR space as follows:

CSR	Name	Allowed Access Mode	Description
0x7B0	dcsr	Debug	Debug Control and Status. See Table 154 for more information.
0x7B1	dpc	Debug	Debug PC. Stores execution address just before debug exception and to return to at dret.
0x7B2	dscratch0	Debug	Debug Scratch Register 0.
0x7A0	tselect	Debug, Machine	Trigger Registers. Most configs implement 2, 4, or 8 triggers. <ul style="list-style-type: none"> • tselect (0x7A0) selects a trigger. tdata1 is mcontrol, tdata2 is the address for comparison. • Triggers are all type 2 (address/data). • select is fixed at 0 meaning all triggers compare addresses only (no data value). • Load, store, execute, U-mode, S-mode, and M-mode filters all supported. • timing is fixed at 0 meaning breaks happen just before the event. • size is fixed at 0 meaning accesses of any size that cover any part of the trigger address range will fire. • match values: <ul style="list-style-type: none"> ◦ 0x0 - Single address ◦ 0x1 - Power-of-2 range, limited to 64 bytes in SiFive implementations. ◦ 0x2 - ≥ address ◦ 0x3 - < address ◦ Others not supported by SiFive. • chain is supported. When set, this trigger and the next must match at the same time to fire. Typically used for a range breakpoint using 2 triggers, one with match=0x2 and one with match=0x3. This is not a sequential trigger.
0x7A1	tdata1	Debug, Machine	
0x7A2	tdata2	Debug, Machine	
0x7A3	tdata3	Debug, Machine	

Table 153: Debug Control and Status Registers

The dcsr, dpc, and dscratch registers are only accessible in debug mode, while the tselect and tdata1-3 registers are accessible from either debug mode or machine mode.

15.2.1 Debug Control and Status Register (dcsr)

This register gives information about debug capabilities and status. Its detailed functionality is described in *The RISC-V Debug Specification, Version 0.13*.

Debug Control and Status Register (dcsr)			
CSR	0x7B0		
Bits	Field Name	Attr.	Description
[1:0]	prv	RW	Privilege level of processor prior to debug exception and to return to at dret.
2	step	RW	Set to 0x1 to single-step.
3	nmip	RO	Non-maskable interrupt pending. Not used by SiFive.
4	mprven	WARL	Not used by SiFive.
[7:5]	cause	RO	Indicates cause of most recent debug exception.
8	stoptime	WARL	0x1 will stop timers in debug mode. Not used by SiFive (timers continue).
9	stopcount	WARL	0x1 will stop counters in debug mode. Not used by SiFive (counters continue).
10	stepie	WARL	Enable interrupts when stepping. Not used by SiFive (interrupts disabled).
11	ebreaku	RW	EBREAK instructions in U-mode enter debug mode (vs. breakpoint exception).
12	ebreaks	RW	EBREAK instructions in S-mode enter debug mode.
13	ebreakm	RW	EBREAK instructions in M-mode enter debug mode.
[27:14]	Reserved		
[31:28]	xdebugver	RO	Version

Table 154: Debug Control and Status Register

15.2.2 Debug PC (dpc)

When entering debug mode, the current PC is copied here. When leaving debug mode, execution resumes at this PC.

15.2.3 Debug Scratch (dscratch)

This register is generally reserved for use by Debug ROM in order to save registers needed by the code in Debug ROM. The debugger may use it as described in *The RISC-V Debug Specification, Version 0.13*.

15.2.4 Trace and Debug Select Register (tselect)

To support a large and variable number of TDRs for tracing and breakpoints, they are accessed through one level of indirection where the `tselect` register selects which bank of three `tdata1-3` registers are accessed via the other three addresses.

The `tselect` register has the format shown below:

Trace and Debug Select Register (tselect)			
CSR	0x7A0		
Bits	Field Name	Attr.	Description
[31:0]	index	WARL	Selection index of trace and debug registers

Table 155: Trace and Debug Select Register

The `index` field is a **WARL** field that does not hold indices of unimplemented TDRs. Even if `index` can hold a TDR index, it does not guarantee the TDR exists. The `type` field of `tdata1` must be inspected to determine whether the TDR exists.

15.2.5 Trace and Debug Data Registers (tdata1-3)

The `tdata1-3` registers are 64-bit read/write registers selected from a larger underlying bank of TDR registers by the `tselect` register.

Trace and Debug Data Register 1 (tdata1)			
CSR	0x7A1		
Bits	Field Name	Attr.	Description
[27:0]	TDR-Specific Data		
[31:28]	type	RO	The type of trace and debug register selected by <code>tselect</code>

Table 156: Trace and Debug Data Register 1

Trace and Debug Data Registers 2 and 3 (tdata2/3)			
CSR	0x7A2 - 0x7A3		
Bits	Field Name	Attr.	Description
[31:0]	TDR-Specific Data		

Table 157: Trace and Debug Data Registers 2 and 3

The high nibble of `tdata1` contains a 4-bit type code that is used to identify the type of TDR selected by `tselect`. The currently defined types are shown below:

Value	Description
0x0	No such TDR register
0x1	Reserved
0x2	Address/Data Match Trigger
≥0x3	Reserved

Table 158: tdata Types

The dmode bit selects between debug mode (dmode=1) and machine mode (dmode=0) views of the registers, where only debug mode code can access the debug mode view of the TDRs. Any attempt to read/write the tdata1-3 registers in machine mode when dmode=1 raises an illegal instruction exception.

15.3 Breakpoints

The U74-MC Core Complex supports two hardware breakpoint registers per hart, which can be flexibly shared between debug mode and machine mode.

When a breakpoint register is selected with tselect, the other CSRs access the following information for the selected breakpoint:

CSR Name	Breakpoint Alias	Description
tselect	tselect	Breakpoint selection index
tdata1	mcontrol	Breakpoint match control
tdata2	maddress	Breakpoint match address
tdata3	N/A	Reserved

Table 159: TDR CSRs When Used as Breakpoints

15.3.1 Breakpoint Match Control Register (mcontrol)

Each breakpoint control register is a read/write register laid out in Table 160.

Breakpoint Match Control Register (mcontrol)				
CSR	0x7A1			
Bits	Field Name	Attr.	Rst.	Description
0	R	WARL	X	Address match on LOAD
1	W	WARL	X	Address match on STORE
2	X	WARL	X	Address match on Instruction FETCH
3	U	WARL	X	Address match on user mode
4	S	WARL	X	Address match on supervisor mode
5	Reserved	WPRI	X	Reserved
6	M	WARL	X	Address match on machine mode
[10:7]	match	WARL	X	Breakpoint Address Match type
11	chain	WARL	0x0	Chain adjacent conditions.
[15:12]	action	WARL	0x0	Breakpoint action to take.
[17:16]	size0	WARL	0x0	Size of the breakpoint. Always 0.
18	timing	WARL	0x0	Timing of the breakpoint. Always 0.
19	select	WARL	0x0	Perform match on address or data. Always 0.
[52:20]	Reserved	WPRI	X	Reserved
[58:53]	maskmax	RO	0x4	Largest supported NAPOT range
59	dmode	RW	0x0	Debug-Only access mode
[63:60]	type	RO	0x2	Address/Data match type, always 0x2

Table 160: Breakpoint Match Control Register

The `type` field is a 4-bit read-only field holding the value 0x2 to indicate this is a breakpoint containing address match logic.

The `action` field is a 4-bit read-write **WARL** field that specifies the available actions when the address match is successful. The value 0 generates a breakpoint exception. The value 1 enters debug mode. Other actions are not implemented.

The R/W/X bits are individual **WARL** fields, and if set, indicate an address match should only be successful for loads, stores, and instruction fetches, respectively. All combinations of implemented bits must be supported.

The M/S/U bits are individual **WARL** fields, and if set, indicate that an address match should only be successful in the machine, supervisor, and user modes, respectively. All combinations of implemented bits must be supported.

The `match` field is a 4-bit read-write **WARL** field that encodes the type of address range for breakpoint address matching. Three different match settings are currently supported: exact, NAPOT, and arbitrary range. A single breakpoint register supports both exact address matches and matches with address ranges that are naturally aligned powers-of-two (NAPOT) in size. Breakpoint registers can be paired to specify arbitrary exact ranges, with the lower-numbered breakpoint register giving the byte address at the bottom of the range and the higher-numbered

breakpoint register giving the address 1 byte above the breakpoint range, and using the `chain` bit to indicate both must match for the action to be taken.

NAPOT ranges make use of low-order bits of the associated breakpoint address register to encode the size of the range as follows:

address	Match type and size
a...aaaaaa	Exact 1 byte
a...aaaaa0	2-byte NAPOT range
a...aaaa01	4-byte NAPOT range
a...aaa011	8-byte NAPOT range
a...aa0111	16-byte NAPOT range
a...a01111	32-byte NAPOT range
...	...
a01...1111	2^{31} -byte NAPOT range

Table 161: NAPOT Size Encoding

The `maskmax` field is a 6-bit read-only field that specifies the largest supported NAPOT range. The value is the logarithm base 2 of the number of bytes in the largest supported NAPOT range. A value of 0 indicates that only exact address matches are supported (1-byte range). A value of 31 corresponds to the maximum NAPOT range, which is 2^{31} bytes in size. The largest range is encoded in `address` with the 30 least-significant bits set to 1, bit 30 set to 0, and bit 31 holding the only address bit considered in the address comparison.

To provide breakpoints on an exact range, two neighboring breakpoints can be combined with the `chain` bit. The first breakpoint can be set to match on an address using `action` of 2 (greater than or equal). The second breakpoint can be set to match on address using `action` of 3 (less than). Setting the `chain` bit on the first breakpoint prevents the second breakpoint from firing unless they both match.

15.3.2 Breakpoint Match Address Register (`address`)

Each breakpoint match address register is a 64-bit read/write register used to hold significant address bits for address matching and also the unary-encoded address masking information for NAPOT ranges.

15.3.3 Breakpoint Execution

Breakpoint traps are taken precisely. Implementations that emulate misaligned accesses in software will generate a breakpoint trap when either half of the emulated access falls within the address range. Implementations that support misaligned accesses in hardware must trap if any byte of an access falls within the matching range.

Debug-mode breakpoint traps jump to the debug trap vector without altering machine-mode registers.

Machine-mode breakpoint traps jump to the exception vector with "Breakpoint" set in the `mcause` register and with `badaddr` holding the instruction or data address that caused the trap.

15.3.4 Sharing Breakpoints Between Debug and Machine Mode

When debug mode uses a breakpoint register, it is no longer visible to machine mode (that is, the `tdrtype` will be 0). Typically, a debugger will leave the breakpoints alone until it needs them, either because a user explicitly requested one or because the user is debugging code in ROM.

15.4 Debug Memory Map

This section describes the debug module's memory map when accessed via the regular system interconnect. The debug module is only accessible to debug code running in debug mode on a hart (or via a debug transport module). The following addresses are offsets from the base address of the Debug Module. Note that the PMP must allow M-mode access to the debug module address range for debugging to be possible.

15.4.1 Debug RAM and Program Buffer (0x300–0x3FF)

The U74-MC Core Complex has 16 32-bit words of program buffer for the debugger to direct a hart to execute arbitrary RISC-V code. Its location in memory can be determined by executing `aiupc` instructions and storing the result into the program buffer.

The U74-MC Core Complex has two 32-bit words of debug data RAM. Its location can be determined by reading the `DMHARTINFO` register as described in the RISC-V Debug Specification. This RAM space is used to pass data for the Access Register abstract command described in the RISC-V Debug Specification. The U74-MC Core Complex supports only general-purpose register access when harts are halted. All other commands must be implemented by executing from the debug program buffer.

In the U74-MC Core Complex, both the program buffer and debug data RAM are general-purpose RAM and are mapped contiguously in the Core Complex memory space. Therefore, additional data can be passed in the program buffer, and additional instructions can be stored in the debug data RAM.

Debuggers must not execute program buffer programs that access any debug module memory except defined program buffer and debug data addresses.

The U74-MC Core Complex does not implement the `DMSTATUS.anyhavereset` or `DMSTATUS.allhavereset` bits.

15.4.2 Debug ROM (0x800–0xFFF)

This ROM region holds the debug routines on SiFive systems. The actual total size may vary between implementations.

15.4.3 Debug Flags (0x100–0x110, 0x400–0x7FF)

The flag registers in the debug module are used for the debug module to communicate with each hart. These flags are set and read used by the debug ROM and should not be accessed by any program buffer code. The specific behavior of the flags is not further documented here.

15.4.4 Safe Address

In the U74-MC Core Complex, the debug module contains the debug module address range in the memory map. Memory accesses to these addresses raise access exceptions, unless the hart is in debug mode. This property allows a "safe" location for unprogrammed parts, as the default `mtvec` location is `0x0`.

15.5 Debug Module Interface

The SiFive Debug Module (DM) conforms to *The RISC-V Debug Specification, Version 0.13*. A debug probe or agent connects to the Debug Module through the Debug Module Interface (DMI). The following sections describe notable spec options used in the implementation and should be read in conjunction with the RISC-V Debug Specification.

DMI is a simple read/write bus whose master is the DTM (if it exists, otherwise DMI passes through to customer logic) and whose slave is the Debug Module. The master sends a request to the slave and the slave responds with a response. A request is considered sent if `req_ready=1` indicating the master is sending a request and `req_valid=1` indicating the slave is accepting the request on this cycle. Similarly, the response is sent when both `resp_valid=1` indicating the slave is sending a response and `resp_ready=1` indicating the master is accepting it.

Note

It is the responsibility of the debugger to simulate virtual address accesses by accessing the page tables directly, then sending the translated physical address to hardware when doing the access.

Note

The Debug Module registers are not directly accessible from the core.

Group	Signal	Source	Description
System	clock	system	All signals timed to this clock. With JTAG DTM, this clock is the JTAG TCK.
	reset	system	Synchronous reset. Generated by power-on reset circuit.
Request Bus	req_ready	slave	Slave ready to receive request.
	req_valid	master	Master's request valid.
	req_addr	master	Configurable width address bus. 0x7 for SiFive.
	req_data	master	32-bit write data bus.
	req_op	master	<ul style="list-style-type: none"> • 0x0 = None • 0x1 = Read • 0x2 = Write • 0x3 = Reserved
Response Bus	resp_ready	master	Master is ready to receive response.
	resp_valid	slave	Slave response is valid.
	resp_data	slave	32-bit read data bus.
	resp_op	slave	<ul style="list-style-type: none"> • 0x0 = Success • 0x1 = Failure • 0x2 = Not used • 0x3 = Reserved

Table 162: Debug Module Interface Signals

15.5.1 Debug Module Status Register (dmstatus)

dmstatus holds the DM version number and other implementation information. Most importantly, it contains status bits that indicate the current state of the selected hart(s).

Debug Module Status Register (dmstatus)			
DMI Address		0x11	
Bits	Field Name	Attr.	Description
[3:0]	version	RO	Implementation version number.
4	Reserved		
5	hasresethaltreq	RO	1 if resethaltreq exists.
[7:6]	Reserved		
8	anyhalted	RO	Any currently selected hart is halted.
9	allhalted	RO	All currently selected harts are halted.
10	anyrunning	RO	Any currently selected hart is running.
11	allrunning	RO	All currently selected harts are running.
12	anyunavail	RO	Any currently selected hart is not available (i.e. is powered down). DM supports it, but not currently used by SiFive cores.
13	allunavail	RO	All currently selected harts are not available (i.e. is powered down). DM supports it, but not currently used by SiFive cores.
14	anynonexistent	RO	Any currently selected hart does not exist in the system.
15	allnonexistent	RO	All currently selected harts do not exist in the system.
16	anyresumeack	RO	Any currently selected hart has resumed execution.
17	allresumeack	RO	All currently selected harts have resumed execution.
18	anyhavereset	RO	Any currently selected hart has been reset, but reset has not been acknowledged.
19	allhavereset	RO	All currently selected harts have been reset, but reset has not been acknowledged.
[21:20]	Reserved		
22	impebreak	RO	1 if PROGBUF is followed by implicit EBREAK. Generally 1 for E2 cores, 0 otherwise.
[31:23]	Reserved		

Table 163: Debug Module Status Register

15.5.2 Debug Module Control Register (dmcontrol)

A debugger performs most hart controls through the `dmcontrol` register.

Debug Module Control Register (dmcontrol)			
DMI Address		0x10	
Bits	Field Name	Attr.	Description
0	dmactive	RW	0 resets the DM, 1 puts the DM in operational mode. Drives dmactive output that could be used by a system power controller to maintain power to the DM while it is being used. When 1, dmcontrol should be read back until dmactive=1, which indicates that the debug module is fully operational. When 0, the DM TileLink clock is gated off to save power.
1	ndmreset	RW	Write 1 to reset system (assert ndreset output). Write 0 to operate normally.
2	clrresethaltreq	RW	Clear reset-halt-request bit.
3	setresethaltreq	RW	When written to 1, the core will halt upon the next deassertion of its reset.
[15:4]	Reserved		
[25:16]	hartsel	RW	Selects the hart to operate on.
26	hasel	RW	Not supported.
27	Reserved		
28	ackhavereset	RW	Write 1 to acknowledge that a reset occurred on the selected hart.
29	Reserved		
30	resumereq	RW	Write 1 to request selected hart to resume, cleared to 0 automatically when hart resumes.
31	haltreq	RW	Write 1 to request selected hart to halt. Generates debug interrupt to the core. Write 0 once halted has been set by the DM.

Table 164: Debug Module Control Register

15.5.3 Hart Info Register (hartinfo)

hartinfo contains information about the currently selected hart.

Hart Info Register (hartinfo)			
DMI Address		0x12	
Bits	Field Name	Attr.	Description
[11:0]	dataaddr	RO	Address of DATA registers in hart memory map. 0x380 for SiFive.
[15:12]	datasize	RO	Number of DATA registers. 1 for 32-bit, 0x2 for 64-bit SiFive cores.
16	dataaccess	RO	DATA registers are shadowed in the hart memory map. 1 for SiFive.
[19:17]	Reserved		
[23:20]	nscratch	RO	Number of dscratch registers available for debugger. 1 for SiFive.
[31:24]	Reserved		

Table 165: Hart Info Register

15.5.4 Hart Array Window Register (hawindow)

This register contains a bitmap where bit 0 corresponds to hart 0, bit 1 to hart 1, etc. Any bits set in this register select the corresponding hart in addition to the hart selected by hartsel.

15.5.5 Abstract Control and Status Register (abstractcs)

Abstract Control and Status Register (abstractcs)			
DMI Address		0x16	
Bits	Field Name	Attr.	Description
[3:0]	datacount	RW	Number of DATA registers. 0x1 for 32-bit, 0x2 for 64-bit SiFive cores.
[7:4]	Reserved		
[10:8]	cmderr	RW	<p>Non-zero value indicates an abstract command error. Remains set until cleared by writing all ones. If set, no abstract commands are accepted.</p> <ul style="list-style-type: none"> • 0x0 - No error • 0x1 - Busy. Abstract command or register was accessed while command was running. • 0x2 - Not supported. Abstract command type not supported by hardware was attempted. • 0x3 - Exception. An exception occurred during execution of an abstract command. • 0x4 - Halt/resume. Abstract command attempted while hart was running or unavailable. • 0x5 - Bus. Bus error occurred during abstract command. Not used by SiFive. • 0x7 - Other. Abstract command failed for another reason. Not used by SiFive.
11	Reserved		
12	busy	RW	Reads as 1 while Abstract command is running, 0 if not.
[23:13]	Reserved		
[28:24]	progbufsize	RW	Number of 32-bit words in PROGBUF. Typically 16 for SiFive (some configs have less).
[31:29]	Reserved		

Table 166: Abstract Control and Status Register

15.5.6 Abstract Command Register (command)

Abstract Command Register (command)			
DMI Address		0x17	
Bits	Field Name	Attr.	Description
[15:0]	regno	RW	Select which register to read/write. SiFive only supports GPRs: 0x1000-0x101F.
16	write	RW	1=write register, 0=read register. Only done if transfer=1.
17	transfer	RW	1=do the register read/write, 0=don't.
18	postexec	RW	1=execute PROGBUF after the command, 0=don't.
19	aarpostincrement	RW	Not supported by SiFive.
[22:20]	aarsize	RW	0x2, 0x3, 0x4 select 32, 64, 128 bits, respectively.
23	Reserved		
[31:24]	cmdtype	RW	0=Access Register is the only type supported by SiFive.

Table 167: Abstract Command Register

15.5.7 Abstract Command Autoexec Register (abstractauto)

Abstract Command Autoexec Register (abstractauto)			
DMI Address		0x18	
Bits	Field Name	Attr.	Description
[11:0]	autoexecdata	RW	Bitmap of DATA registers [11:0]. 1 indicates DATA access initiates command.
[15:12]	Reserved		
[31:16]	autoexecprogbuf	RW	Bitmap of PROGBUF words [15:0]. 1 indicates PROGBUF access initiates command.

Table 168: Abstract Command Autoexec Register

15.5.8 Debug Module Control and Status 2 Register (dmcs2)

Debug Module Control and Status 2 Register (dmcs2)			
DMI Address		0x32	
Bits	Field Name	Attr.	Description
0	hgselect	RW	0=operate on harts, 1=operate on external triggers.
1	hgwrite	RW	When written with 1, the selected harts or external trigger is assigned to halt group haltgroup.
[6:2]	group	RW	Specify the halt group or resume group number that the selected harts or external triggers will be assigned to.
[10:7]	exttrigger	RW	Select which external trigger to act upon if hgwrite and hgselect are written to 1 in the same write.
11	groupType	RW	0=operate on Halt Group configuration, 1=operate on Resume Group configuration.
[31:11]	Reserved		

Table 169: Debug Module Control and Status 2 Register

15.5.9 Abstract Commands

Abstract commands provide a debugger with a path to read and write processor state and are used for extracting and modifying processor state such as registers and memory. Register `s0` is saved by the ROM and is available for use by the abstract command code. An abstract command is started by the debugger writing to `command`. In `command`, the debugger selects whether to load/store a register, execute `PROGBUF`, or both. Only GPR register transfers are supported currently. Many aspects of Abstract Commands are optional in the RISC-V Debug Spec and are implemented as described below.

cmdtype	Feature	Support
Access Register	GPR registers	Access Register command, register number 0x1000 - 0x101F
	CSR registers	Not supported. CSRs are accessed using the Program Buffer.
	FPU registers	Not supported. FPU registers are accessed using the Program Buffer.
	Autoexec	Both autoexecprogbuf and autoexecdata are supported.
	Post-increment	Not supported.
	Core Register Access	Not supported.
Quick Access		Not supported.
Access Memory		Not supported. Memory access is accomplished using the Program Buffer.

Table 170: Debug Abstract Commands

The use of abstract commands is outlined in the following example, describing how to read a word of target memory:

1. The debugger writes opcodes to PROGBUF to accomplish the desired function.
2. The debugger writes the desired memory address to DATA[0].
3. The debugger requests an abstract command specifying to load s0 from DATA[0], then execute PROGBUF. Writing to command while hart n is selected has the side effect of setting FLAGS[n].go. Writing to command also sets busy which is readable from the debugger, and indicates that an abstract command is in progress.
4. The ROM busy-wait loop being executed by hart n sees FLAGS[n].go set.
5. ROM code writes 0 to GOING which has the effect of clearing FLAGS[n].go.
6. ROM code jumps to WHERETO, then ABSTRACT which contains the opcode lw s0, 0(DATA) to load s0 from DATA[0]. Opcodes in ABSTRACT are constructed by DM hardware from command. If command.transfer=0, no register transfer is done and instead ABSTRACT[0] reads as NOP.
7. If a register read/write is all that is needed, the debugger would set command.postexec to 0. ABSTRACT[1] would then read as EBREAK.
8. If command.postexec=1, ABSTRACT[1] reads as NOP and execution falls through to PROGBUF which will have been previously written by the debugger with the opcodes lw s0, 0(s0), then sw s0, DATA(zero), then EBREAK.
9. EBREAK reenters ROM at address 0x800. ROM writes hartid to HALTED which has the side effect of clearing busy, telling the debugger that the abstract command is finished.
10. The debugger reads the result from DATA[0].

The autoexec feature of Abstract Commands is supported by SiFive hardware (and is used by OpenOCD for memory block read and write). Once an abstract command has been completed, the debugger can read or write a particular DATA or PROGBUF location to run the command again. For example, fast download can be accomplished by setting up PROGBUF for memory write, then repeatedly writing words to DATA[0]. Each write re-executes the register transfer and PROGBUF to store the word into memory. For a 32-bit block write, the abstract command would be set up like this:

ABSTRACT	<pre>regno=s1, write=1, transfer=1, postexec=1. DM constructs the instructions lw s1,0(DATA) // load s1 from debugger NOP // fall thru to PROGBUF</pre>
PROGBUF	<pre>sw s1, 0(s0) // store s1 to memory addi s0, s0, 4 // increment memory pointer ebreak // done</pre>

Table 171: Abstract Command Example for 32-bit Block Write

15.5.10 Multi-core Synchronization

The DM is configured with one Halt Group that may be programmed to synchronize execution between harts, or between hart(s) and external logic, such as a cross-trigger matrix. The Halt Group is configured using the `dmcs2` register.

Hart Array

The Hart Array is an internal bitmap that selects a subset of the harts in a system. Debug operations such as resume and halt are automatically applied to all the selected harts simultaneously.

To configure the Hart Array:

1. Set the `hase1` bit in the Debug Module `dmcontrol` register.
2. Set bits in the `hawindow` register corresponding to the harts to be selected. Bit 0 = hart 0, Bit 1 = hart 1, etc.

The Hart Array covers debug operations initiated by the debugger, but does not cover the case when harts halt due to other causes, such as breakpoints. This is handled with a Halt Group.

15.5.11 System Bus Access

System Bus Access (SBA) provides an alternative method to access memory. SBA operation conforms to the RISC-V Debug Spec and the description is not duplicated here. It implements a bus master that connects with the bus crossbar to allow access to the device's physical address space without involving a hart to perform accesses. SBA is controlled from the DMI using regis-

ters in the range 0x37 - 0x3F. By default, the maximum bus width supported by SBA is 64. Comparing Program Buffer memory access and SBA:

Program Buffer Memory Access	SBA Memory Access
Physical Address	Physical Address
Subject to Physical Memory Protection (PMP)	Not subject to PMP
Cache coherent	Cache coherent
Hart must be halted	Hart may be halted or running

Table 172: System Bus vs. Program Buffer Comparison

15.6 Debug Module Operational Sequences

The sections below describe the flow for entering into and exiting from debug mode. The user can halt and resume more than one hart at a time using the hart array mask.

15.6.1 Entering Debug Mode

To use debug mode, the DM must be enabled by writing 0x0000_0001 to `dmcontrol`.

The debugger can request a halt by writing 0x8000_0001 to `dmcontrol` to set `haltreq`. This generates a debug interrupt to the core.

The core enters debug mode and jumps to the debug interrupt handler located at 0x800 and serviced from the DM.

ROM code at 0x800 writes `hartid` into the HALTED register which has the effect of setting the halted bit for this hart. Halted bits are readable from the debugger and generally will be continually polled to check for breakpoints when a hart is running.

ROM code then busy-waits checking its hart-specific FLAGS register.

15.6.2 Exiting Debug Mode

The debugger writes 1 to `resumereq` in the `dmcontrol` register to restart execution. This clears `resumeack` and sets bit 1 of the FLAGS register for the selected hart.

The ROM busy-wait loop being executed by hart `n` sees `FLAGS[n].resume` set.

ROM code writes `hartid` to `RESUMING`, which has the effect of clearing `FLAGS[n].resume`, setting `resumeack`, and clearing `halted` for the hart.

ROM code then executes `dret` which returns to user code at the address currently in `dpc`.

The debugger sees `resumeack` and knows the resume was successful.

Chapter 16

Error Correction Codes (ECC)

Error correction codes (ECC) are implemented on various memories within the U74-MC Core Complex, allowing for the detection and, in some cases, correction of memory errors. The following SRAM blocks on the U74-MC Core Complex support ECC: instruction cache, data cache, L2 cache, ITIM, and DTIM.

The minimal case of an ECC error is a single-bit error that is detected, reported via interrupt handler, and corrected automatically by hardware without any software intervention. More difficult scenarios involve double or multi-bit errors that are still reported and tracked in hardware but are not correctable. The ECC hardware includes logic for detection and correction, in addition to 7 redundant bits per 32-bit codeword or 8 redundant bits per 64-bit codeword.

Name	Protection Type
Branch Predictor	None
D-Cache Data	SECDED ECC (32+7b)
D-Cache Tag	SECDED ECC
DTIM	SECDED ECC (32+7b)
I-Cache Data	Parity-Only (1b)
I-Cache Tag	Parity-Only (1b)
ITIM	SECDED ECC (64+8b)
L2 Cache Data	SECDED ECC (64+8b)
L2 Directory Tag	SECDED ECC
L2 TLB	None

Table 173: Memory Protection Summary

16.1 ECC Configuration

All blocks with ECC support are enabled globally through the Bus-Error Unit (BEU) configuration registers. The BEU is used to configure ECC reporting and enable interrupt handling via the global or local interrupt controller. The global interrupt controller is the Platform-Level Interrupt Controller (PLIC). The local interrupt controller is the Core-Local Interruptor (CLINT). The BEU registers `pllc_interrupt` and `local_interrupt` are used to route the errors to the respective interrupt controller. Additionally, the BEU can be used for TileLink bus errors.

16.1.1 ECC Initialization

Any SRAM block containing ECC functionality needs to be initialized prior to use. This does not include cache memory, since an internal state machine initializes data cache valid bits, and instruction cache valid bits are flops with reset. ECC will correct defective bits based on memory contents, so if memory is not first initialized to a known state, then the ECC will not operate as expected. It is recommended to use a DMA, if available, to write the entire SRAM or cache to zeros prior to enabling ECC reporting. If no DMA is present, use store instructions issued from the processor. Initializing memory with ECC from an external bus is not recommended. After initialization, ECC-related registers can be written to zero, and then ECC reporting can be enabled. 64-bit aligned writes are recommended.

The startup code in the `freedom-metal` repository provides a method to automatically initialize memory with ECC. This is accomplished using an assembly-level function `__metal_memory_scrub`, located in file `scrub.S`. The linker script provides the symbol `__metal_eccscrub_bit` as a flag to enable the startup code to initialize memory with ECC. It is important to note that this memory initialization is limited to 64 KB to support RTL simulation run times. If unexpected ECC errors occur, check the range of the startup initialization to ensure it covers the region used by the software application.

16.2 ECC Interrupt Handling and Error Injection

Single-bit errors are automatically repaired by the hardware.

BEU errors are always enabled and thus do not have a control bit in `mie` (Machine Interrupt Enable) CSR. Likewise, there is no dedicated control bit for BEU errors in the `mideleg` (Machine Interrupt Delegation) CSR, so it cannot be delegated to a lower privilege mode than M-mode. Error injection, and thus software handling of errors, can be accomplished manually by writing the BEU cause register. The BEU is further described in Chapter 12.

Monitoring overall ECC events can be accomplished in software via the interrupt handler.

The L2 Cache Controller contains hardware counters to track ECC events, and optionally inject ECC errors to test the software handling of ECC events. The L2 Cache Controller is further described in Chapter 13.

The exception code value is located in the `mcause` (Machine Trap Cause) CSR. When BEU interrupts are routed through the PLIC, the default exception code value will be 11 (0xB).

When ECC interrupts are routed through the CLINT, the default exception code value will be 128 (0x80). These exception codes are further detailed in Section 8.7.5.

16.3 Hardware Operation Upon ECC Error

Hardware will operate differently depending on which memory type encounters an ECC error:

- Instruction Cache: The error is corrected and the cache line is flushed.

- ITIM: Single-bit errors are corrected and written back to the RAM.
- Data Cache: The error is corrected and the cache line is invalidated and written back to the next level of memory.
- DTIM: Single-bit errors are corrected and written back to the RAM.
- L2 Cache: Single-bit correction for L2 data and metadata (metadata includes index, tag, and directory information). Double-bit detection only on the L2 data array.

Double-bit errors are reported at the Core Complex boundary via the `halt_from_tile_x` signal that, if asserted, remains high until reset.

Appendix A

SiFive Core Complex Configuration Options

This section lists the key configuration options of the SiFive S7 and U7 Series Core Complexes. The configuration for the U74-MC Core Complex is listed in `docs/core_complex_configuration.txt`.

A.1 S7 Series

The S7 Series comes with the following set of configuration options. Note that the configuration may be limited to a fixed set of discrete options.

Modes and ISA

- Configurable number of Cores (1 to 8). In the case where more than one core is selected, all cores are configured the same.
- Optional support for RISC-V user mode
- Optional M, F, D, B, and Zfh extensions
 - If M extension, configurable performance (1-cycle or 4-cycle)
- Optional SiFive Custom Instruction Extension (SCIE)

On-Chip Memory

- Instruction Cache with optional minimal settings (256 B, 2-way), or configurable size (4 KiB to 64 KiB) and associativity (2-, 4-, or 8-way)
- Optional Instruction-Tightly Integrated Memory (ITIM) with configurable size (4 KiB to 256 KiB) and base address
- Data Tightly-Integrated Memory (DTIM) or Data Cache:
 - If DTIM, then configurable size (4 KiB to 256 KiB) and base address
 - If Data Cache, then configurable size (4 KiB to 256 KiB) and associativity (2-, 4-, 8-, or 16-way)
- Optional Data Local Store (DLS) with the following options:

- Configurable size (4 KiB to 8 MiB)
- Configurable base address
- Configurable pipeline depth (0, 1, or 3 additional stages)
- Configurable number of banks (1 to 64)
- Optional L2 Cache with the following options:
 - Configurable size (128 KiB to 4 MiB), associativity (2-, 4-, 8-, 16-, or 32-way), and banks (1, 2, or 4)
 - Configurable number of L2 Hardware Prefetcher streams (4, 8, or 16) and queue size (4, 8, 12, or 16)
 - Configurable L1 to L2 bus width (64-, 128-, or 256-bit)
- Optional Fast I/O

Error Handling

- Optional Bus-Error Unit
- Optional ECC support

Ports

- Optional Memory Port, System Port, Peripheral Port, and Front Port
 - Each port has a configurable base address, width (32-, 64-, or 128-bit), size (64 KiB to 2 GiB), and protocol (AHB, AHB-Lite, APB, AXI4)
 - If AXI4 protocol, configurable AXI ID width (4, 8, or 16). Front, Memory, and System Ports only.
- Optional Core Local Port with configurable base address, width (32-, 64-, or 128-bit), and size (64 KiB to max. supported address)

Security

- Optional Physical Memory Protection, configurable up to 16 regions
- Optional Disable Debug Input
- Optional Password-protected Debug
- Optional Hardware Cryptographic Accelerator (HCA) with the following options:
 - Configurable base address
 - Optional AES-128/192/256
 - Optional AES-MAC
 - Optional SHA-224/256/384/512
 - Optional True Random Number Generator (TRNG)
 - Optional Public Key Accelerator (PKA) with the following parameters:

- Configurable PKA operation maximum width (256 or 384 bits)

Debug

- Optional Debug Module with the following options:
 - Configurable base address
 - Configurable debug interface (JTAG, cJTAG, or APB)
 - Configurable number of Hardware Breakpoints (0 to 16) and External Triggers (0 to 16)
 - Optional System Bus Access
- Configurable number of performance counters (0 to 8)
- Optional Raw Instruction Trace Port
- Optional Nexus Trace Encoder with the following options:
 - Configurable Trace Encoder Format (BTM or HTM)
 - Trace Sink (SRAM, ATB Bridge, SWT, System Memory, and/or PIB)
 - If SRAM Sink, configurable Trace Buffer size (256 B to 64 KiB)
 - If PIB Sink, configurable width (1-, 2-, 3-, 5-, or 9-bit) and optional PIB clock input
 - Optional Timestamp capabilities with configurable width (40, 48, or 56 bits) and source (Bus Clock, Core Clock, or External)
 - External Trigger Inputs (0 to 8) and Outputs (0 to 8)
 - Optional Instrumentation Trace Component (ITC)
 - Optional PC Sampling

Interrupts

- Optional Platform-Level Interrupt Controller (PLIC) with the following parameters:
 - Priority Levels (1 to 7)
 - Number of interrupts (1 to 511)
- A configurable number of Core-Local Interruptor (CLINT) interrupts (0 to 16)

Design For Test

- Configurable SRAM user-defined inputs (0 to 1024)
- Configurable SRAM user-defined outputs (0 to 1024)

Clocks and Reset

- Optional Clock Gating
- Configurable Reset Scheme (Synchronous, Asynchronous, Full Asynchronous with separate GPR reset)

Branch Prediction

- Configurable Branch Prediction (Area- or Performance-Optimized)

RTL Options

- Optional custom RTL module name prefix

A.2 U7 Series

The U7 Series comes with the following set of configuration options. Note that the configuration may be limited to a fixed set of discrete options.

Modes and ISA

- Configurable number of Cores (1 to 8). In the case where more than one core is selected, all cores are configured the same.
- Optional M, F, D, B, and Zfh extensions
- Optional SiFive Custom Instruction Extension (SCIE)
- Configurable Virtual Addressing Modes (Sv39 and/or Sv48)

On-Chip Memory

- Instruction Cache with configurable size (4 KiB to 64 KiB) and associativity (2-, 4-, or 8-way)
- Optional Instruction-Tightly Integrated Memory (ITIM) with configurable base address
- Data Cache with configurable size (4 KiB to 256 KiB) and associativity (2-, 4-, 8-, or 16-way)
- Optional Data Local Store (DLS) with the following options:
 - Configurable size (4 KiB to 8 MiB)
 - Configurable base address
 - Configurable pipeline depth (0, 1, or 3 additional stages)
 - Configurable number of banks (1 to 64)
- Optional L2 Cache with the following options:
 - Configurable size (128 KiB to 4 MiB), associativity (2-, 4-, 8-, 16-, or 32-way), and banks (1, 2, or 4)
 - Configurable number of L2 Hardware Prefetcher streams (4, 8, or 16) and queue size (4, 8, 12, or 16)
 - Configurable L1 to L2 bus width (64-, 128-, or 256-bit)

Error Handling

- Optional Bus-Error Unit
- Optional ECC support

Ports

- Optional System Port, Peripheral Port, and Front Port
 - Each port has a configurable base address, width (32-, 64-, or 128-bit), size (64 KiB to 2 GiB), and protocol (AHB, AHB-Lite, APB, AXI4)
 - If AXI4 protocol, configurable AXI ID width (4, 8, or 16). Front, Memory, and System Ports only.
- Optional Core Local Port with configurable base address, width (32-, 64-, or 128-bit), and size (64 KiB to max. supported address)

Security

- Optional Physical Memory Protection, configurable up to 16 regions
- Optional Disable Debug Input
- Optional Password-protected Debug
- Optional Hardware Cryptographic Accelerator (HCA) with the following options:
 - Configurable base address
 - Optional AES-128/192/256
 - Optional AES-MAC
 - Optional SHA-224/256/384/512
 - Optional True Random Number Generator (TRNG)
 - Optional Public Key Accelerator (PKA) with the following parameters:
 - Configurable PKA operation maximum width (256 or 384 bits)

Debug

- Optional Debug Module with the following options:
 - Configurable base address
 - Configurable debug interface (JTAG, cJTAG, or APB)
 - Configurable number of Hardware Breakpoints (0 to 16) and External Triggers (0 to 16)
 - Optional System Bus Access
- Configurable number of performance counters (0 to 8)
- Optional Raw Instruction Trace Port
- Optional Nexus Trace Encoder with the following options:
 - Configurable Trace Encoder Format (BTM or HTM)
 - Trace Sink (SRAM, ATB Bridge, SWT, System Memory, and/or PIB)

- If SRAM Sink, configurable Trace Buffer size (256 B to 64 KiB)
- If PIB Sink, configurable width (1-, 2-, 3-, 5-, or 9-bit) and optional PIB clock input
- Optional Timestamp capabilities with configurable width (40, 48, or 56 bits) and source (Bus Clock, Core Clock, or External)
- External Trigger Inputs (0 to 8) and Outputs (0 to 8)
- Optional Instrumentation Trace Component (ITC)
- Optional PC Sampling

Interrupts

- Optional Platform-Level Interrupt Controller (PLIC) with the following parameters:
 - Priority Levels (1 to 7)
 - Number of interrupts (1 to 511)
- A configurable number of Core-Local Interruptor (CLINT) interrupts (0 to 16)

Design For Test

- Configurable SRAM user-defined inputs (0 to 1024)
- Configurable SRAM user-defined outputs (0 to 1024)

Clocks and Reset

- Optional Clock Gating
- Configurable Reset Scheme (Synchronous, Asynchronous, Full Asynchronous with separate GPR reset)

Branch Prediction

- Configurable Branch Prediction (Area- or Performance-Optimized)

RTL Options

- Optional custom RTL module name prefix

Appendix B

SiFive RISC-V Implementation Registers

This section provides a reference to the SiFive RISC-V implementation version registers `marchid` and `mimpid`.

B.1 Machine Architecture ID Register (`marchid`)

Value	Core Generator
0x8000_0007	7-Series Processor (E7, S7, U7 series)

Table 174: Core Generator Encoding of `marchid`

B.2 Machine Implementation ID Register (`mimpid`)

Value	Generator Release Version
0x0000_0000	Pre-19.02
0x2019_0228	19.02
0x2019_0531	19.05
0x2019_0919	19.08p0p0 / 19.08.00
0x2019_1105	19.08p1p0 / 19.08.01.00
0x2019_1204	19.08p2p0 / 19.08.02.00
0x2020_0423	19.08p3p0 / 19.08.03.00
0x0120_0626	19.08p4p0 / 19.08.04.00
0x0220_0515	koala.00.00-preview and koala.01.00-preview
0x0220_0603	koala.02.00-preview
0x0220_0630	20G1.03.00 / koala.03.00-general
0x0220_0710	20G1.04.00 / koala.04.00-general
0x0220_0826	20G1.05.00 / koala.05.00-general
0x0320_0908	kiwi.00.00-preview
0x0220_1013	20G1.06.00 / koala.06.00-general
0x0220_1120	20G1.07.00 / koala.07.00-general
0x0421_0205	llama.00.00-preview
0x0421_0324	21G1.01.00 / llama.01.00-general

Table 175: Generator Release Encoding of `mimpid`

Appendix C

Floating-Point Unit Instruction Timing

This section provides a reference for the instruction timings of the single- and double-precision floating-point units in the U74-MC Core Complex.

C.1 S7 Floating-Point Instruction Timing

Single-precision floating-point unit instruction latency and repeat rates are described in Table 176.

Assembly	Operation	Latency	Repeat Rate
Sign Inject			
fabs.s rd, rs1	$f[rd] = f[rs1] $	2	1
fsgnj.s rd, rs1, rs2	$f[rd] = \{f[rs2][31], f[rs1][30:0]\}$	2	1
fsgnjn.s rd, rs1, rs2	$f[rd] = \{-f[rs2][31], f[rs1][30:0]\}$	2	1
fsgnjx.s rd, rs1, rs2	$f[rd] = \{f[rs1][31] \wedge f[rs2][31], f[rs1][30:0]\}$	2	1
Arithmetic			
fadd.s rd, rs1, rs2	$f[rd] = f[rs1] + f[rs2]$	5	1
fsub.s rd, rs1, rs2	$f[rd] = f[rs1] - f[rs2]$	5	1
fdiv.s rd, rs1, rs2	$f[rd] = f[rs1] \div f[rs2]$	9–36	8–33
fmul.s rd, rs1, rs2	$f[rd] = f[rs1] \times f[rs2]$	5	1
fsqrt.s rd, rs1	$f[rd] = \sqrt{f[rs1]}$	9–28	8–33
fmadd.s rd, rs1, rs2, rs3	$f[rd] = (f[rs1] \times f[rs2]) + f[rs3]$	5	1
fmsub.s rd, rs1, rs2, rs3	$f[rd] = (f[rs1] \times f[rs2]) - f[rs3]$	5	1
Negate Arithmetic			
fneg.s rd, rs1	$f[rd] = -f[rs1]$	2	1
fnmadd.s rd, rs1, rs2, rs3	$f[rd] = -(f[rs1] \times f[rs2]) - f[rs3]$	5	1
fnmsub.s rd, rs1, rs2, rs3	$f[rd] = -(f[rs1] \times f[rs2]) + f[rs3]$	5	1
Compare			
feq.s rd, rs1, rs2	$x[rd] = f[rs1] == f[rs2]$	4	1
fle.s rd, rs1, rs2	$x[rd] = f[rs1] \leq f[rs2]$	4	1
flt.s rd, rs1, rs2	$x[rd] = f[rs1] < f[rs2]$	4	1
fmax.s rd, rs1, rs2	$f[rd] = \max(f[rs1], f[rs2])$	2	1
fmin.s rd, rs1, rs2	$f[rd] = \min(f[rs1], f[rs2])$	2	1
Categorize			
fclass.s rd, rs1	$x[rd] = \text{classify}_s(f[rs1])$	4	1
Convert Data Type			
fcvt.w.s rd, rs1	$x[rd] = \text{sext}(s32_{f32}(f[rs1]))$	4	1
fcvt.l.s rd, rs1	$x[rd] = s64_{f32}(f[rs1])$	4	1
fcvt.s.w rd, rs1	$f[rd] = f32_{s32}(x[rs1])$	2	1
fcvt.s.l rd, rs1	$f[rd] = f32_{s64}(x[rs1])$	4	1
fcvt.wu.s rd, rs1	$x[rd] = \text{sext}(u32_{f32}(f[rs1]))$	4	1
fcvt.lu.s rd, rs1	$x[rd] = u64_{f32}(f[rs1])$	4	1
fcvt.s.wu rd, rs1	$f[rd] = f32_{u32}(x[rs1])$	2	1
fcvt.s.lu rd, rs1	$f[rd] = f32_{u64}(x[rs1])$	4	1
Move			
fmv.s rd, rs1	$f[rd] = f[rs1]$	2	1
fmv.w.x rd, rs1	$f[rd] = x[rs1][31:0]$	2	1
fmv.x.w rd, rs1	$x[rd] = \text{sext}(f[rs1][31:0])$	1	1
Load/Store			
flw rd, offset(rs1)	$f[rd] = M[x[rs1] + \text{sext}(\text{offset})][31:0]$	2	1
fsw rs2, offset(rs1)	$M[x[rs1] + \text{sext}(\text{offset})] = f[rs2][31:0]$	4	1

Table 176: S7 Single-Precision FPU Instruction Latency and Repeat Rates

*Instruction and data are in the instruction cache and data cache, respectively.

C.2 U7 Floating-Point Instruction Timing

Single-precision floating-point unit instruction latency and repeat rates are described in Table 177.

Assembly	Operation	Latency	Repeat Rate
Sign Inject			
fabs.s rd, rs1	$f[rd] = f[rs1] $	2	1
fsgnj.s rd, rs1, rs2	$f[rd] = \{f[rs2][31], f[rs1][30:0]\}$	2	1
fsgnjn.s rd, rs1, rs2	$f[rd] = \{-f[rs2][31], f[rs1][30:0]\}$	2	1
fsgnjx.s rd, rs1, rs2	$f[rd] = \{f[rs1][31] \wedge f[rs2][31], f[rs1][30:0]\}$	2	1
Arithmetic			
fadd.s rd, rs1, rs2	$f[rd] = f[rs1] + f[rs2]$	5	1
fsub.s rd, rs1, rs2	$f[rd] = f[rs1] - f[rs2]$	5	1
fdiv.s rd, rs1, rs2	$f[rd] = f[rs1] \div f[rs2]$	9–36	8–33
fmul.s rd, rs1, rs2	$f[rd] = f[rs1] \times f[rs2]$	5	1
fsqrt.s rd, rs1	$f[rd] = \sqrt{f[rs1]}$	9–28	8–33
fmadd.s rd, rs1, rs2, rs3	$f[rd] = (f[rs1] \times f[rs2]) + f[rs3]$	5	1
fmsub.s rd, rs1, rs2, rs3	$f[rd] = (f[rs1] \times f[rs2]) - f[rs3]$	5	1
Negate Arithmetic			
fneg.s rd, rs1	$f[rd] = -f[rs1]$	2	1
fnmadd.s rd, rs1, rs2, rs3	$f[rd] = -(f[rs1] \times f[rs2]) - f[rs3]$	5	1
fnmsub.s rd, rs1, rs2, rs3	$f[rd] = -(f[rs1] \times f[rs2]) + f[rs3]$	5	1
Compare			
feq.s rd, rs1, rs2	$x[rd] = f[rs1] == f[rs2]$	4	1
fle.s rd, rs1, rs2	$x[rd] = f[rs1] \leq f[rs2]$	4	1
flt.s rd, rs1, rs2	$x[rd] = f[rs1] < f[rs2]$	4	1
fmax.s rd, rs1, rs2	$f[rd] = \max(f[rs1], f[rs2])$	2	1
fmin.s rd, rs1, rs2	$f[rd] = \min(f[rs1], f[rs2])$	2	1
Categorize			
fclass.s rd, rs1	$x[rd] = \text{classify}_s(f[rs1])$	4	1
Convert Data Type			
fcvt.w.s rd, rs1	$x[rd] = \text{sxt}(s32_{f32}(f[rs1]))$	4	1
fcvt.l.s rd, rs1	$x[rd] = s64_{f32}(f[rs1])$	4	1
fcvt.s.w rd, rs1	$f[rd] = f32_{s32}(x[rs1])$	2	1
fcvt.s.l rd, rs1	$f[rd] = f32_{s64}(x[rs1])$	4	1
fcvt.wu.s rd, rs1	$x[rd] = \text{sxt}(u32_{f32}(f[rs1]))$	4	1
fcvt.lu.s rd, rs1	$x[rd] = u64_{f32}(f[rs1])$	4	1
fcvt.s.wu rd, rs1	$f[rd] = f32_{u32}(x[rs1])$	2	1
fcvt.s.lu rd, rs1	$f[rd] = f32_{u64}(x[rs1])$	4	1
Move			
fmv.s rd, rs1	$f[rd] = f[rs1]$	2	1
fmv.w.x rd, rs1	$f[rd] = x[rs1][31:0]$	2	1
fmv.x.w rd, rs1	$x[rd] = \text{sxt}(f[rs1][31:0])$	1	1
Load/Store			
flw rd, offset(rs1)	$f[rd] = M[x[rs1] + \text{sxt}(\text{offset})][31:0]$	2	1
fsw rs2, offset(rs1)	$M[x[rs1] + \text{sxt}(\text{offset})] = f[rs2][31:0]$	4	1

Table 177: U7 Single-Precision FPU Instruction Latency and Repeat Rates

*Instruction and data are in the instruction cache and data cache, respectively.

Double-precision floating-point unit latency and repeat rates are described in Table 178.

Assembly	Operation	Latency	Repeat Rate
Sign Inject			
fabs.d rd, rs1	$f[rd] = f[rs1] $	2	1
fsgnj.d rd, rs1, rs2	$f[rd] = \{f[rs2][63], f[rs1][62:0]\}$	2	1
fsgnjn.d rd, rs1, rs2	$f[rd] = \{-f[rs2][63], f[rs1][62:0]\}$	2	1
fsgnjx.d rd, rs1, rs2	$f[rd] = \{f[rs1][63] \wedge f[rs2][63], f[rs1][62:0]\}$	2	1
Arithmetic			
fadd.d rd, rs1, rs2	$f[rd] = f[rs1] + f[rs2]$	7	1
fsub.d rd, rs1, rs2	$f[rd] = f[rs1] - f[rs2]$	7	1
fdiv.d rd, rs1, rs2	$f[rd] = f[rs1] \div f[rs2]$	9–58	8–58
fmul.d rd, rs1, rs2	$f[rd] = f[rs1] \times f[rs2]$	7	1
fsqrt.d rd, rs1	$f[rd] = \sqrt{f[rs1]}$	9–57	8–58
fmadd.d rd, rs1, rs2, rs3	$f[rd] = (f[rs1] \times f[rs2]) + f[rs3]$	7	1
fmsub.d rd, rs1, rs2, rs3	$f[rd] = (f[rs1] \times f[rs2]) - f[rs3]$	7	1
Negate Arithmetic			
fneg.d rd, rs1	$f[rd] = -f[rs1]$	2	1
fnmadd.d rd, rs1, rs2, rs3	$f[rd] = -(f[rs1] \times f[rs2]) - f[rs3]$	7	1
fnmsub.d rd, rs1, rs2, rs3	$f[rd] = -(f[rs1] \times f[rs2]) + f[rs3]$	7	1
Compare			
feq.d rd, rs1, rs2	$x[rd] = f[rs1] == f[rs2]$	4	1
fle.d rd, rs1, rs2	$x[rd] = f[rs1] \leq f[rs2]$	4	1
flt.d rd, rs1, rs2	$x[rd] = f[rs1] < f[rs2]$	4	1
fmax.d rd, rs1, rs2	$f[rd] = \max(f[rs1], f[rs2])$	2	1
fmin.d rd, rs1, rs2	$f[rd] = \min(f[rs1], f[rs2])$	2	1
Categorize			
fclass.d rd, rs1	$x[rd] = \text{classify}_d(f[rs1])$	4	1
Convert Data Type			
fcvt.w.d rd, rs1	$x[rd] = \text{sext}(s32_{f64}(f[rs1]))$	4	1
fcvt.l.d rd, rs1	$x[rd] = s64_{f64}(f[rs1])$	4	1
fcvt.d.w rd, rs1	$f[rd] = f64_{s32}(x[rs1])$	2	1
fcvt.d.l rd, rs1	$f[rd] = f64_{s64}(x[rs1])$	6	1
fcvt.wu.d rd, rs1	$x[rd] = \text{sext}(u32_{f64}(f[rs1]))$	4	1
fcvt.lu.d rd, rs1	$x[rd] = u64_{f64}(f[rs1])$	4	1
fcvt.d.wu rd, rs1	$f[rd] = f64_{u32}(x[rs1])$	2	1
fcvt.d.lu rd, rs1	$f[rd] = f64_{u64}(x[rs1])$	6	1
fcvt.s.d rd, rs1	$f[rd] = f32_{f64}(f[rs1])$	2	1
fcvt.d.s rd, rs1	$f[rd] = f64_{f32}(f[rs1])$	2	1
Move			
fmv.d rd, rs1	$f[rd] = f[rs1]$	2	1
fmv.d.x rd, rs1	$f[rd] = x[rs1][63:0]$	6	1
fmv.x.d rd, rs1	$x[rd] = f[rs1][63:0]$	1	1
Load/Store			
fld rd, offset(rs1)	$f[rd] = M[x[rs1] + \text{sext}(\text{offset})][63:0]$	2	1
fsd rs2, offset(rs1)	$M[x[rs1] + \text{sext}(\text{offset})] = f[rs2][63:0]$	4	1

Table 178: U7 Double-Precision FPU Instruction Latency and Repeat Rates

*Instruction and data are in the instruction cache and data cache, respectively.

References

Visit the SiFive forums for support and answers to frequently asked questions:
<https://forums.sifive.com>

[1] A. Waterman and K. Asanovic, Eds., The RISC-V Instruction Set Manual, Volume I: User-Level ISA, Version 2.2, June 2019. [Online]. Available: <https://riscv.org/specifications/>

[2] ———, The RISC-V Instruction Set Manual Volume II: Privileged Architecture Version 1.11, June 2019. [Online]. Available: <https://riscv.org/specifications/privileged-isa>

[3] ———, SiFive TileLink Specification Version 1.8.0, August 2019. [Online]. Available: <https://sifive.com/documentation/tilelink/tilelink-spec>

[4] A. Chang, D. Barbier, and P. Dabbelt, RISC-V Platform-Level Interrupt Controller (PLIC) Specification. [Online]. Available: <https://github.com/riscv/riscv-plic-spec>