

Portable Density/Specific Gravity Meter

DA-130N

Operation Manual

Please read this manual thoroughly before actual use for measurement.

AN 59-00250-01 Ver.13
(98-595-0492)

Table of contents

Page





Safety Precautions.....	1
1. Introduction.....	3
2. About the manual.....	4
3. Supplied parts.....	5
4. Parts configuration.....	6
4.1 Front view.....	6
4.2 Side view.....	6
4.3 Rear view.....	7
4.4 Display window.....	8
4.5 Operating unit.....	9
5. Preparation for measurement by DA-130N.....	10
5.1 Loading the battery.....	10
5.2 Setting the sampling nozzle.....	11
5.3 Setting the memo pad.....	11
5.4 Test measurement.....	12
5.4.1 Precautions.....	12
5.4.2 Preliminary test.....	12
6. Setting temperature unit, measuring unit and mode.....	14
6.1 Temperature unit.....	14
6.2 Measuring unit.....	14
6.3 Configuration of measurement mode.....	19
7. Measurement.....	20
7.1 Precautions.....	20
7.1.1 Accuracy Check.....	20
7.2 Sample measurement.....	22
7.2.1 When the built-in syringe is used.....	22
7.2.1.1 Sampling test materials.....	22
7.2.1.2 Start measurement.....	22
7.2.1.3 Hold measurement data.....	22
7.2.1.4 Saving measurement data.....	22
7.2.2 The use of commercially available plastic syringe.....	23
7.2.2.1 Sampling.....	23
7.2.2.2 Start measurement.....	23
7.2.2.3 Hold measurement data.....	23
7.2.2.4 Saving measurement data.....	23
7.2.3 When the bellows pump is used.....	24
7.2.3.1 Sampling test materials.....	24
7.2.3.2 Start measurement.....	24
7.2.3.3 Hold measurement data.....	24
7.2.3.4 Saving measurement data.....	24
8. Calibration of measuring cell.....	25
8.1 Calibration with pure water.....	25

8.2 Calibration with standard liquid	26
8.2.1 Calibration with standard liquid of which density is known.....	26
8.3 Calibration with air	26
8.3.1 Calibration with air	26
8.3.2 How to dry the cell	27
8.3.3 Procedure of calibration with air	28
8.4 Calibration of displayed temperature.....	29
8.5 Recalibration.....	29
9. Application of data processing	30
9.1 Storage of measuring data.....	30
9.1.1 Auto saving	30
9.1.2 Manual storage	30
9.2 Making saved data	30
9.3 Deletion of stored data.....	30
9.4 Display of measurement data and external output	31
9.5 Setting external output.....	32
9.5.1 Data output to a personal computer via infrared communication	32
9.5.2 Data output to Printer.....	34
9.5.3 Data output to PC via RS-232C.....	35
10. Other useful functions.....	36
10.1 Selection of beep sound	36
10.2 Adjust brightness of LC display; Setting of Backlight: on/off.....	37
10.3 Setting Automatic Power Off.....	37
10.4 Version number check.....	37
10.5 Set Date	38
10.6 Set ID.....	38
11. Power source	39
11.1 Change the battery	39
11.2 Auto Power Off.....	39
12. Maintenance.....	40
13.  Cautions in use.....	41
14. Parts list.....	42
15. Troubleshooting	44
15.1 Error messages and their remedies	44
15.2 Exhibit no repeatability on measured value or show deviation on measured value.....	45
16. Technical data	46
17. Warranty and After-Sale Service	47
Appendix 1: Density of pure water (0~40°C)	48
Appendix 2: Temperature compensation coefficient for various liquids.....	48

Safety Precautions

Always observe these signs and introductions.

You must observe cautionary messages and warnings in order to protect yourself as well as prevent others from physical injury or property damages.

 Warning! This symbol means "Danger of severe injury or possible death".	 This symbol means prohibition of an act.
 Caution! This symbol means "Danger of injury or property damage".	 This symbol means mandatory.

 **Warning!**

Never overhaul or open the casing the unit except by an authorized KEM service person.



Danger exists of electric shock, fire or malfunction.

 **Caution!**

Do not use the unit in other way than instructed in the manual.



Danger exists of fire and electric shock, and may damage the unit.

 **Caution!**

Load the battery with correct polarity (plus/minus).



If the battery is loaded with reverse polarity, it will heat up and leak, causing fire, injury and contamination of the environment.

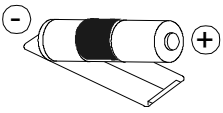

 **Caution!**

Do not use a battery other than specified or mix new and old batteries.



Danger exists of battery heated and leaking, causing fire, burn and contamination of the environment.

 **Caution!**

Do not heat or break the battery or discard it in water or in flame.



Danger exists of battery explosion, causing fire, injury and contamination of the environment.

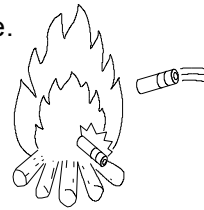

 **Caution!**

Do not use a leaking battery.



Danger exists of electric short circuit and fire by leaking battery.

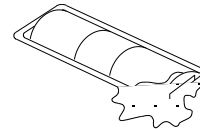

 **Caution!**

If battery liquid should touch your skin or clothes, immediately wash away with running water.



It may cause malfunctioning of the instrument.

1. Introduction

We appreciate your patronage purchasing KEM product the DA-130N Portable Density Specific Gravity Meter. By easy operation, you can obtain density and relative gravity of liquid as well as various concentrations. Please read this manual thoroughly before you use for actual measurement.

When delivered

1. Supplied parts P.5
Check the supplied parts to see if they are correctly shipped in number.
2. Preparation for measurement P.10
Set the supplied battery in the unit.
3. Preliminary test P.12
Measure water
(1) Prepare pure water for measurement.
(2) Check the measurement results on pure water.

Calibration of the meter

<Caution> If the pure water test did not result within 0.001g/cm^3 , the measuring cell has to be calibrated.

Sample measurement

4. Measurement P.18
Measure a sample. Prepare a sample and measure it.

Daily check

5. Calibration of measuring cell P.21
Calibrate the measuring cell. Prepare pure water.

2. About the manual

It is recommended to keep this manual near your system in order for quick reference.

Here in below, some important messages are described for your safety, security and assurance.

1. Where there exists a danger of physical injury or possible death

 Warning! Danger of physical injury or possible death if the warning is ignored.
--

2. Where there is a danger of property damage

 Caution! Property may be damaged if the instruction is not followed.

3. Where the instrument may perform its function correctly

Note! If handled or operated other than instructed, the instrument may not work to its specified performance and not satisfy the warranty term and conditions.

4. Meaning of mark or symbol in the manual

	This symbol means technical tips helpful in operating the unit or useful advice.
---	--

- * It is prohibited to copy a part or whole of this manual without consent of copyright.
- * If you should find any missing part or doubtful descriptions in this manual, please contact your sales representative or local dealer.
- * Manufacturer will not be liable for any damage or loss based on the data depicted in this manual.
- * This manual stipulates operating instruction for the standard model. If your unit is customer ordered, please refer to the accompanying specification and instructions.

3. Supplied parts

Make sure you have received all the necessary parts in the carton box. If you should find any missing part or broken parts, immediately contact your local dealer.

Supplied parts list

Part code	Part name	Qty	Remarks
64-00570-13	Alkaline Battery LR03 (AAA) (2pcs/set)	1 pc	
64-01151	Battery Holder	1 pc	
20-07606	Nozzle	1 pc	Tetrafluoroethylene resin
20-08076	Nozzle Screw	1 pc	
20-07607	Built-in Bellows	1 pc	
12-02895	DA-130N Operation Manual CD-ROM	1 pc	
59-00159	Quick Manual DA-130N	1 copy	Japanese
59-00159-01	Quick Manual DA-130N	1 copy	English
20-06461	Memo Pad	1 pc	



- The supplied alkaline dry cell (size “AAA”) is for the purpose of function test only.

It is recommended to replace them with new ones earlier.

4. Parts configuration

4.1 Front view

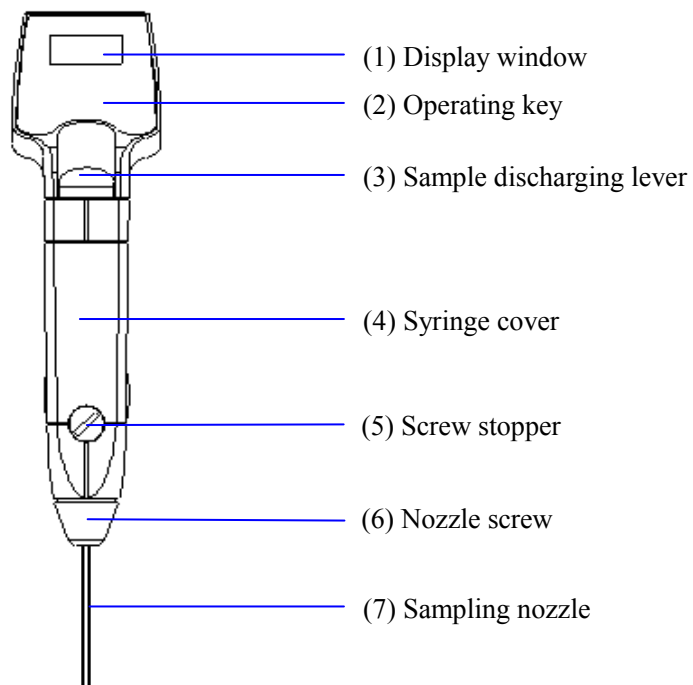

4.2 Side view

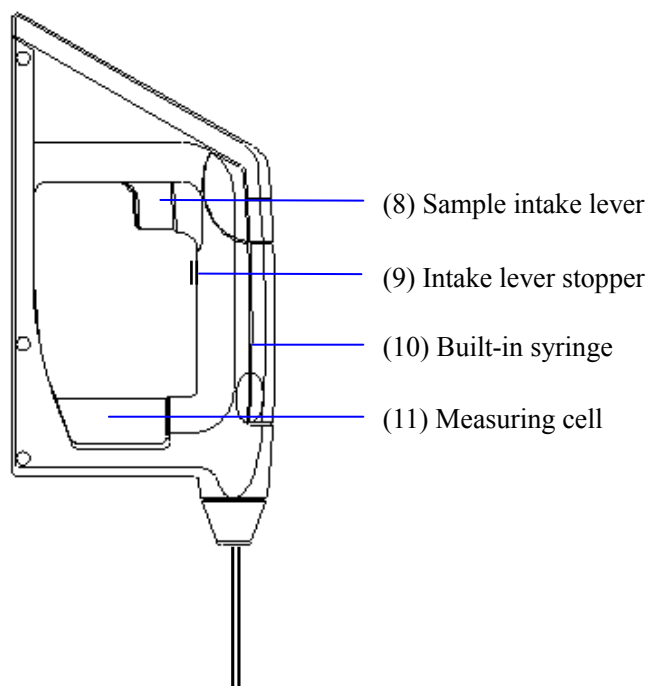



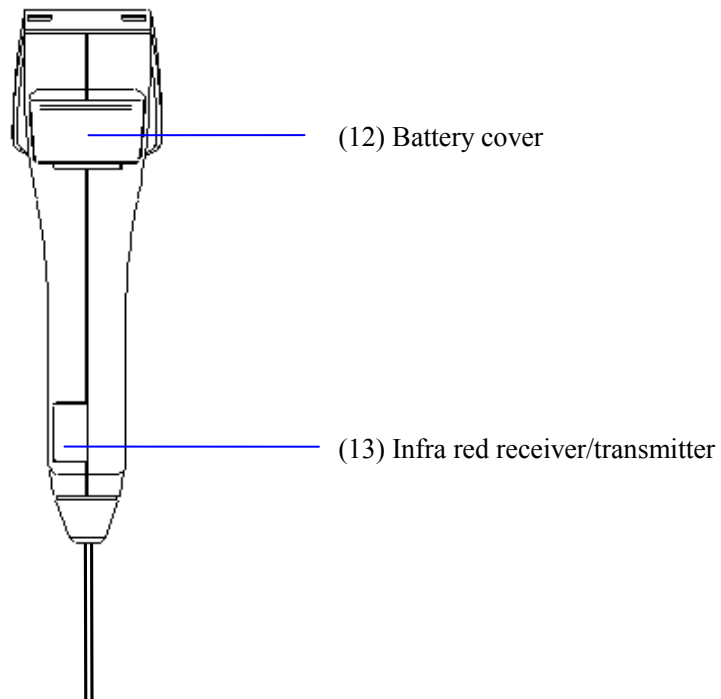

4.3 Rear view

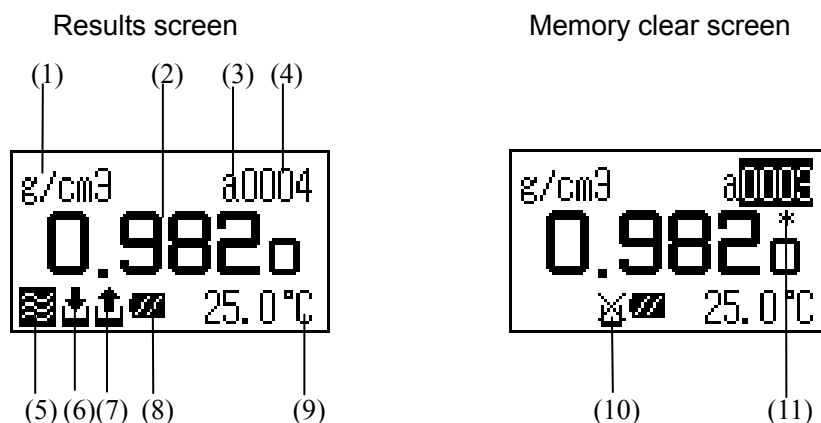

4.4 Display window



- (1) g/cm³ Shows unit for measurement data.
- (2) 0.9820 Shows measurement data in preset unit.
- (3) a Shows sample name (a to z or space)
- (4) 0004 Normal display shows sample number.
Error number will appear in case of error.
- (5)  Appears when Stability is set at Auto (automatic stability sense mode).
The measurement results are automatically held by the automatic sense.
- (6)  Appears when Memory in is set at Auto (saving). When measurement data is held, the results are automatically stored in the unit. When the data are saved, this symbol blinks.
- (7)  Appears when Memory out is set at Auto (output). When Printer or Personal computer is connected, the data is automatically output on data being held. This symbol blinks when data is being output.
- (8)  The battery capacity level is shown.
- (9) 25.0°C Shows measurement temperature (Celsius /Fahrenheit)
- (10)  Appears in data deletion mode on Memory clear.
- (11) * The “*” mark appears when data is marked with [mem. clr/all] key.

This mark is useful for data control to identify unnecessary data of measurement failure.

4.5 Operating unit

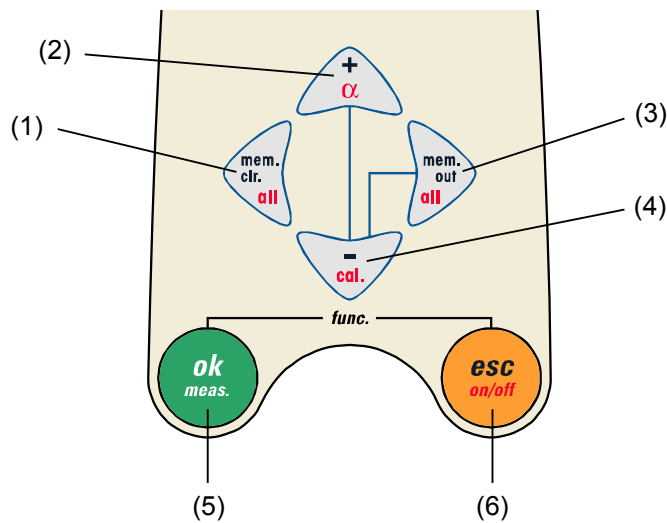

- (1) **[mem.clr./all] key:** Key to put “*” mark to identify data when data is output externally. When pressed for more than 2 seconds, all data can be cleared. Also this key shifts the cursor to the left for numerical entry.
- (2) **[+/ α] key:** Key to move the cursor upward on selection. It selects temperature compensation coefficient α by pressing for more than 2 seconds. This key also increments a number for numerical entry.
- (3) **[mem.out/all] key:** Key to output data externally. By pressing for more than 2 seconds, all data or certain data can be output. This key also moves the cursor to the right in numerical entry.
- (4) **[-/cal] key:** Key to shift the cursor downward on selection. Pressing for more than 2 seconds turns the mode to calibration. This key also decrements a number on numerical entry.
- (5) **[ok/meas.] key:** Key to start measurement or hold data on measuring screen. When pressed with [esc] key at the same time, it turns the mode to Function. This key also confirms the selection or numerical entry. This key stores the measurement data when Memory in is set at Manu and the data is held. This key executes data clear or data output.
- (6) **[esc/on/off] key:** Key to return the screen from Function to Measurement. This key also turns on the unit when pressed for more than 2 seconds while the unit is off, and turns it off when the unit is on.

5. Preparation for measurement by DA-130N

5.1 Loading the battery

Set the dry cells in the battery holder. Use alkaline dry cells (size “AAA”). Insert the cell while paying attention to the polarity direction. Remove the battery cover by pulling it out.

Slide in the battery holder all the way to the end, and put on the cover.

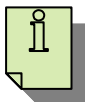
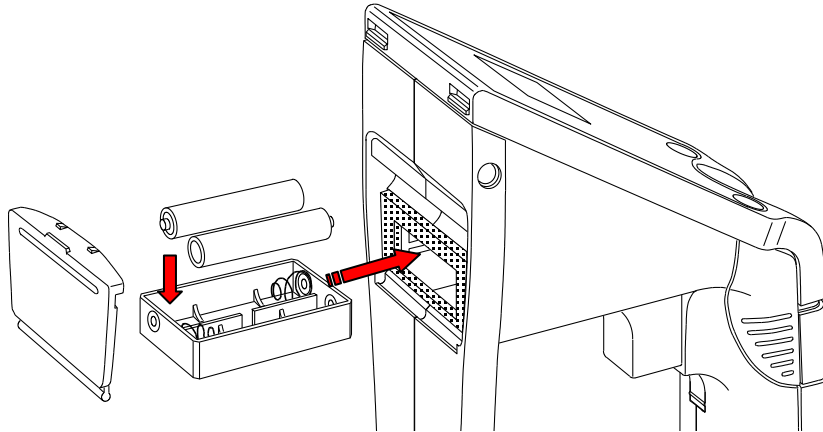

- Insert to see the flat bottom touch the spring.
- Press [On/Off] to check the display. If display does not appear, check the battery direction.
- When replace the battery, change all of the cell at the same time.
- Always use the same type of dry cell.

(Note) Do not use other dry cell than alkaline “AAA” type, e.g. NiCd dry cell

Press [On/Off] key for more than 2 seconds to turn on the power.

The below initial screen will appear and when it changes to measuring screen, the unit is working in normal condition.



Initial screen



Measuring screen (above is an example)

The battery capacity can be checked on the measuring screen.

- : Enough energy is stored (Level 3)
- : It is running down. (Level 2)
- : Almost no more energy. (Level 1)
- : Change the battery. (Level 0) * the alarm will sound.



- The above capacity level is just for as a guide.
- Beep sounds only when the power is turned on.

5.2 Setting the sampling nozzle

Attach the supplied sampling nozzle as illustrated:

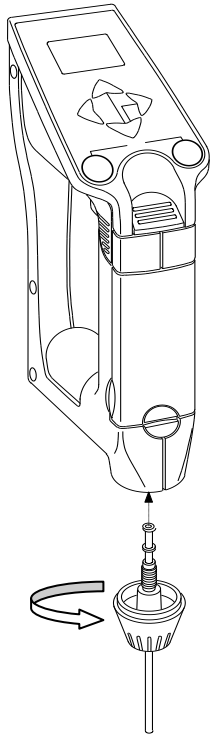

- Screw the sampling nozzle with the washer into the nozzle screw, and screw it in clockwise until it is securely fixed.
- Use your hand to avoid stripping the screw thread.

! Caution!

Do not use a tool like pliers.

5.3 Setting the memo pad

Fill necessary items in the memo pad, and put it on the main unit.

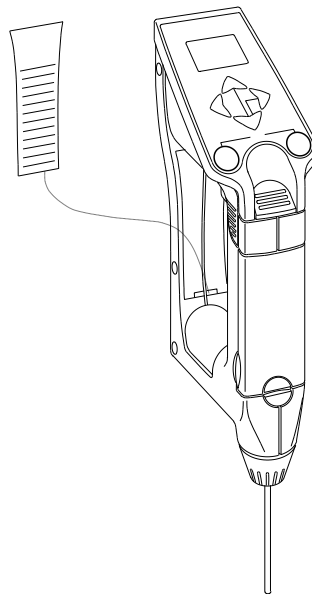

5.4 Test measurement

5.4.1 Precautions

1. When measuring a sample, make sure to hold the instrument so that the sampling nozzle becomes vertical to the ground.
2. When laying down the instrument between or after measurements, make sure to drain the remaining sample from the built-in syringe.

*Refer to “14. Parts list” for the optional device of Holding Stand.

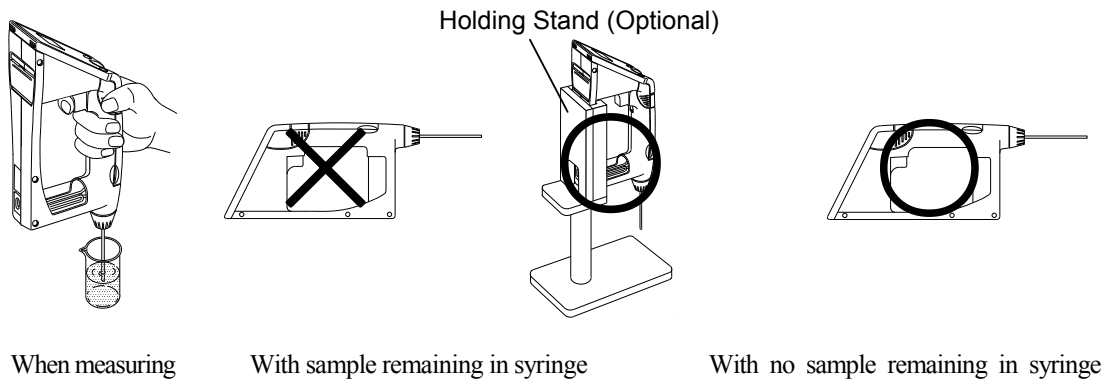

Caution

Do NOT lay down the instrument with a sample remaining in the built-in syringe.

The remaining sample may wear out the built-in syringe and thus there may be a leak from the syringe to the inside of the instrument, which could cause a failure or a malfunction.

5.4.2 Preliminary test

Leave temperature unit (Celsius), measurement unit (g/cm^3) and mode (Field) as initial value.

Sample in pure water using the syringe.

- After the measuring cell is filled with sample liquid, make sure there is no air bubble in the cell. Even a small bubble would deviate the results. If any bubbles are found, repeat sampling from the beginning.
- Always use the supplied sampling nozzle.

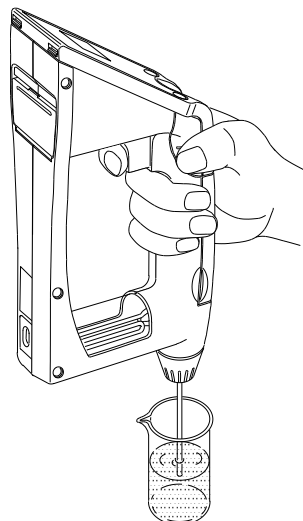

Example:

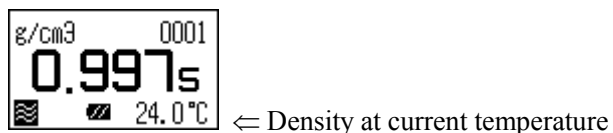

The display changes as above, and after confirming it is in the automatic stability sense mode, press [Meas.] key. When the display density is stabilized, the value will automatically change reversed as shown below. Read the data at this point as well as the temperature degree.

Example:

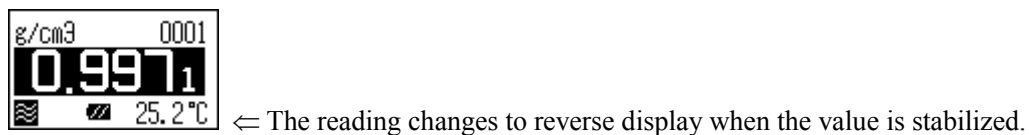

Look up to the pure water density table (appendix 1). If the results agree within $\pm 0.001 \text{g/cm}^3$, you can go for sample measurement.

Note!

If the results and theoretical value differ more than $\pm 0.001 \text{g/cm}^3$, recalibrate the measuring cell.

6. Setting temperature unit, measuring unit and mode

6.1 Temperature unit

Select Celsius or Fahrenheit.

While pressing [esc] key, press [ok/meas.] key to show Function screen.

Select <Temp. Unit> by [+], [-] key.

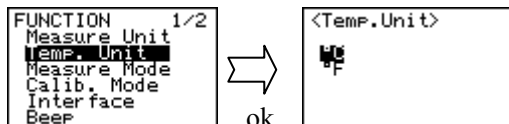

Select temperature unit with [+], [-] key and confirm by [ok/meas.] key.

6.2 Measuring unit

While pressing [esc] key, press [ok/meas.] key to show Function screen.

Select <Measure Unit> by [+], [-] key.



Select measurement data unit by moving the cursor with [+], [-] key, and confirm by [ok/meas.] key.

Twelve units are selective as below:

(1)	Density	(5)	API	(9)	Boume
(2)	Comp. Density	(6)	Brix	(10)	Plato
(3)	SG(t/t)	(7)	Alcohol	(11)	Proof
(4)	SG	(8)	H2SO4	(12)	Conc.

(1) Measurement of density

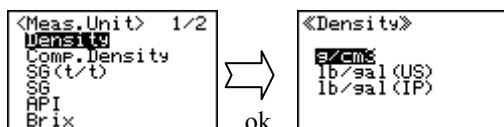

g/cm³ : Measurement of true density in g/cm³ at temperature on display

lb/gal(US) : Measurement by converting to US unit (1g/cm³=8.3454 lb/gal)

lb/gal(IP) : Measurement by converting to British unit(1g/cm³=10.0224 lb/gal)

(2) Measurement of temperature compensated density

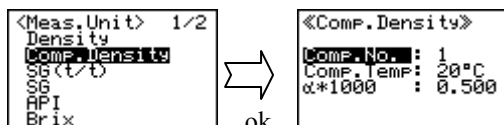

Measurement of true density in g/cm³ at preset temperature

It is necessary to configure temperature compensation coefficient of sample and converted temperature in advance.

10 coefficients for temperature compensation can be stored.

Comp. No. : Select out of 10 stored values.

Comp. Temp : Set compensation temperature.

$\alpha \times 1000$: Set value of (Temp. comp. coefficient of sample $\times 1000$)

The Comp. Density for Comp. Temp is obtained from the following formula based on the Density at measurement temperature (Temp.):

$$\text{Comp. Density} = \text{Density} \times \{1 + \alpha \times (\text{Temp} - \text{Comp. temp})\}$$

On the temperature compensation coefficients for typical solutions and how to determine the coefficients, refer to Appendix 2.

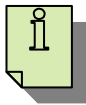

How to obtain temperature compensation coefficient: (depends on sample)

- (1) Using your unit, obtain density at measurement temperature at different ambient condition (indoor and outdoor), and calculate density change ($\alpha \times 10^3$) per 1°C from density difference at different temperature.
- (2) Temperature compensation coefficient can be obtained, using Hydrometer or Oscillation-type meter (e.g. KEM's DA-500), by changing measurement temperature.

The preset α value can be selected on the measuring screen.

While Comp. Density, SG, Conc. is selected, press [α] key for more than 2 seconds.



The α value appears on upper left on the screen. Pressing [+], [-] key displays $\alpha 0$ to $\alpha 9$ one after another. Choose desired α value and confirm by [ok/meas.] key.

(3) Measurement of specific gravity

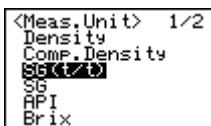

Measurement of true specific gravity at displayed measurement temperature

(4) Measurement of specific gravity temperature compensated

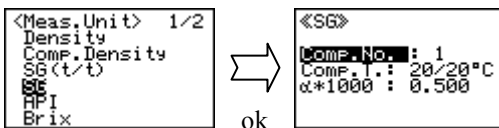

Measurement of true specific gravity at preset temperature

It is necessary to configure temperature compensation coefficient of sample and two reference temperature degrees in advance.

10 coefficients for temperature compensation can be stored

On the temperature compensation coefficients for typical solutions and how to determine the coefficients, refer to Appendix 2.



For how to obtain temperature compensation coefficient, refer to “(2) Density measurement at temperature compensated.”

(5) Measurement of API degree

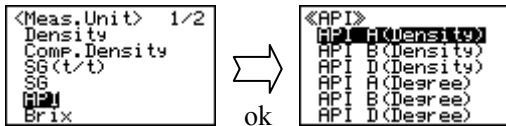

Measurement of density or API degree compensated in temperature to 15°C or 60°F for the product group A, B or D.

Selection of temperature, 15°C or 60°F, will be automatically made when setting the temperature unit.

Product group A: Crude oil

[Measurement of density: API A (Density) Measurement of API degree: API A (Degree)]

Product group B: Fuel, Petroleum products

[Measurement of density: API B (Density) Measurement of API degree: API B (Degree)]

Product group D: Lubricant

[Measurement of density: API D (Density) Measurement of API degree: API D (Degree)]

(6) Measurement of Brix concentration

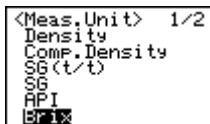

Measurement of Brix concentration (sucrose concentration expressed in weight %) based on density at 20°C

(7) Measurement of Alcohol concentration

When setting of temperature unit is Celsius

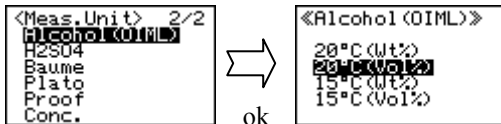

Measurement of alcohol concentration of Ethanol/Water mixed system in wt % or vol % at 15°C or 20°C calculated from the density at the measurement temperature.

When setting of temperature unit is Fahrenheit

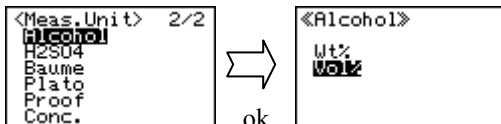

Measurement of alcohol concentration of Ethanol/Water mixed system in wt % or vol % at 60°F calculated from the density at the measurement temperature.

(8) Measurement of sulfuric acid concentration

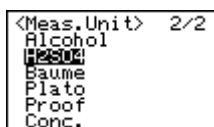

Measurement of sulfuric acid concentration in weight % from density measured at 20°C

(9) Measurement of Baume degree

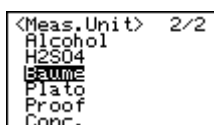

Measurement of Baume degree at converted temperature from density value measured at the measurement temperature

Set "Comp T" to "15/04°C" and input "α" in the previous (4), measurement of specific gravity with temperature compensated, followed by setting the unit at "Baume".

(10) Measurement of Plato degree

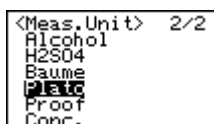

Measurement of Plato degree at 20°C from density obtained at measurement temperature

(11) Measurement of Proof degree

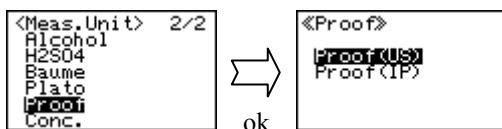

Measurement of Proof degree at 60°F from density obtained at measurement temperature

Proof degree is one of the units for alcohol content, and there is US Proof and British Proof. Each of them is different in conversion degree.

Proof (US) : Measure in US Proof unit (100v/v%=200 US Proof)

Proof (IP) : Measure in UK Proof unit (100v/v%=175 British Proof)

(12) Concentration measurement by setting desired concentration conversion formula

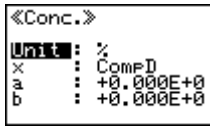

Set “Comp. Temp” and “α” in the previous (2), measurement of density with temperature compensated or in the previous (4), measurement of specific gravity with temperature compensated. Then, concentration can be calculated using the calculated “Comp D” or “SG”. User defined concentration conversion formula (Linear expression: $y = a + bx$)

Conc.(%)	Den.(g/cm ³) at 20°C	Conc.(%)	Den.(g/cm ³) at 20°C
10.0	0.9820	10.6	0.9842
10.1	0.9824	10.7	0.9845
10.2	0.9827	10.8	0.9849
10.3	0.9831	10.9	0.9852
10.4	0.9835	11.0	0.9855
10.5	0.9838		

For example from the above data, a conversion formula can be obtained as follows. Suppose take y for concentration and x for density, you can obtain $y=283.2x-268.1$ by the approximate formula from regression line using commercially available spread sheet software. Therefore, you input $-2.681E+2$ for coefficient ‘a’ and $2.832E+2$ for coefficient ‘b’.

Example of input:

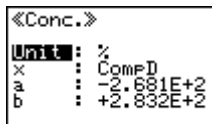

Example of measurement:



(when density is 0.9820 g/cm³)

6.3 Configuration of measurement mode

Configuration of stability sense and data storage method

While pressing [esc] key, press [ok/meas.] key to show Function screen.

Select <Measure Mode> with [+], [-] key.

```
FUNCTION 1/2
Measure Unit
Temp. Unit
Measure Mode
Calib. Mode
Interface
Beep
```

Press [ok/meas.].

Custom

```
<Measure Mode>
Sample Name : [ ]
Stability : Auto
Mode : Custom
Memory in : Auto
Memory out : Auto
```

Field

```
<Measure Mode>
Sample Name : [ ]
Stability : Auto
Mode : Field
```

Labo

```
<Measure Mode>
Sample Name : [ ]
Stability : Auto
Mode : Labo
```

Sample Name : Single alphabet (space, a to z) can be used for identification.

Stability : Setting automatic stability sense mode (Auto, Manu)

[Auto] Checks stability of density of sample automatically. If stabilized, the measurement data is automatically retained.

[Manu] After measurement, press [ok/meas.] key to hold desired measurement data

Mode : Setting automatic stability sense mode (Custom, Labo, Field)

[Custom] Selection of mode for automatic saving retained measurement results or output externally.

You can select Memory in or Memory out as follows:

Memory in : Setting storage method of measurement results

[Auto] When measurement results are retained, the value is automatically saved.

[Manu] After measurement results are retained, press [ok/meas.] key to save desired measurement data

Memory out : Setting output method of measurement results

[Auto] The measurement results are retained and the value is automatically printed out simultaneously.

[Manu] Press [mem.out/all] key to output the measurement data.

[Labo] The retained data is manually saved with [ok/meas.] key and automatically output externally.

Memory in to set to “Manu” and Memory out to “Auto” automatically.

[Field] The retained data is manually saved with [ok/meas.] key.

Memory in to set to “Manu” and Memory out to “Auto” automatically.

7. Measurement

7.1 Precautions

1. When measuring a sample, make sure to hold the instrument so that the sampling nozzle becomes vertical to the ground.
2. When laying down the instrument between or after measurements, make sure to drain the remaining sample from the built-in syringe.
*Refer to “5.4.1 Precautions” for details.



Caution

Do NOT lay down the instrument with a sample remaining in the built-in syringe.

The remaining sample may wear out the built-in syringe and thus there may be a leak from the syringe to the inside of the instrument, which could cause a failure or a malfunction.

7.1.1 Accuracy Check

1. Measure pure water before sample measurement to check the accuracy. The measurement has successfully been completed when the difference between the measured value and the theoretical one is within $\pm 0.001 \text{g/cm}^3$. You can carry on your sample measurement, accordingly.
2. You need to redo factor calibration when the difference is greater than $\pm 0.001 \text{g/cm}^3$.
3. See Article 8 for details of factor calibration.
Refer to Appendix 1 for the density of pure water at each temperature. If the density at your desired temperature is not in the table, calculate it from the table on a pro-rata basis.



- When sample temperature and ambient temperature differ significantly, the upper left corner on display blinks.



Here it blinks

When difference in temperature between sample in the cell and ambient comes within approximately $\pm 5^\circ\text{C}$, it stops blinking.

If the measurement data is going to be saved manually, not automatically, you have to wait until the data is stabilized after blinking stops.

- If the difference is significant (more than 20°C) and the sample temperature is low, it will cause measurement error with the measuring cell blurred. To avoid this, raise sample temperature close up to the ambient before sampling.
- When different kinds of sample are going to be measured, the measuring cell must be rinse cleaned each time before a different type of sample is measured.
- For measurement of highly viscous sample (more than $2000 \text{mPa}\cdot\text{s}$), refer to the sampling method by a plastic syringe separately sold.

- When the separately available plastic syringe is used for sampling, if you need excessive pressure in pushing the cylinder, stop injecting, and check the cell to see any solid clogged up and find out the cause for remedy. If you should give extraordinary force, the joint will come off and the sample or solvent will be splash out, leading to breaking the cell.
- Before starting a measurement, check the affect on all the sample liquid contact parts.
 - * Sampling nozzle - PTFE
 - * Measuring cell - Borosilicate glass
 - * Built-in syringe - PP polypropylene
 - * Bellows pump - PE polyethylene

Before starting a measurement of whatever kind or nature, be sure to prepare appropriate solvent or detergent.

- When sampling a test material into the cell, be careful not to allow air bubble blended especially for a sample of high viscosity. Take your time in sampling slowly and carefully. The possible cause for air bubble is considered to be: leaking at screw to fasten syringe or sampling nozzle or gas generated in the sample.
- Fill up the measuring cell completely.
- After a series of measurements is over, clean the system including inside wall of measuring cell to avoid any residue of sample.
- If the built-in syringe sticks, remove it and rinse clean thoroughly.

7.2 Sample measurement

7.2.1 When the built-in syringe is used

7.2.1.1 Sampling test materials

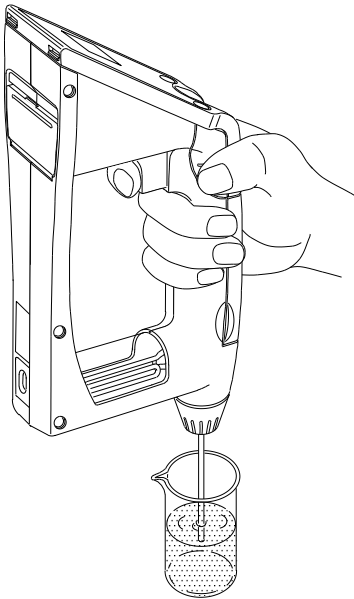

1. Make sure the sample discharging lever is pushed down to the bottom.
 2. If not, slowly push it down with your thumb.
 3. Dip the sampling nozzle in the sample liquid.
 4. Slowly pull the sampling lever with the forefinger.
- When the cell is filled with sample, release your finger.

⚠ Caution!

Be sure to rinse the built-in syringe by repeating sampling of pure water after a day's measurements. Failure can lead to the solidification of a sample (e.g. Sulfuric acid). If the syringe should be forced to be moved in this solidification state, it would scratch the inner surface, causing a possible leakage of a sample inside DA-130N.

7.2.1.2 Start measurement

Only when  is displayed (Stability:Auto), start measurement with [ok/meas.] key.

7.2.1.3 Hold measurement data

When  is displayed (Stability:Auto), the value will automatically turn to reversed when the reading stabilizes.

If  is not displayed (Stability:Manu), wait until the reading stabilizes, and press [ok/meas.] key. The reading will be withheld shown in reversed mode.

7.2.1.4 Saving measurement data

When  is displayed (memory in: Auto), the reading will be automatically saved if retained.

If  is not displayed (memory in: Manu), press [ok/meas.] key while the reading is withheld. The data at this point will be saved.

7.2.2 The use of commercially available plastic syringe

7.2.2.1 Sampling

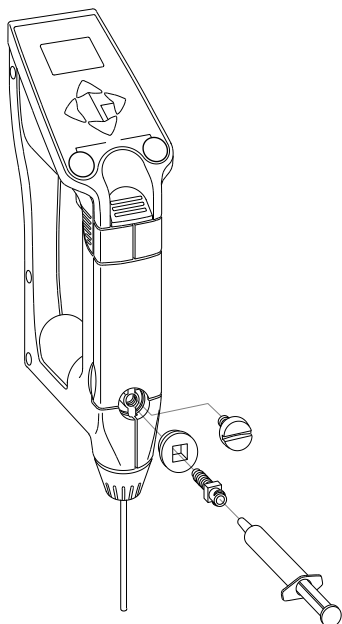

1. Lower the sample discharging lever to the bottom.
2. Push the intake lever stopper upward to lock it.
3. Remove the screw stopper with a coin. Do not lose the screw stopper.
4. After fixing optional grommet (20-08341), squeeze in the syringe adapter (12-04428-02).
5. Leave dipped the tip of sampling nozzle in the waste bottle.
6. Inject sample liquid into the cell with the syringe.
7. When the cell is filled with sample, leave the syringe as it is.

Caution!

When filling the sample with a syringe, push it as slowly as possible. If it is abruptly pushed, the unit can be broken as the result of detachment of the sample discharging lever.

7.2.2.2 Start measurement

Only when  is displayed (Stability:Auto), start measurement with [ok/meas.] key.

7.2.2.3 Hold measurement data

When  is displayed (Stability:Auto), the value will automatically turn to get reversed when the reading stabilizes.

If  is not displayed (Stability:Manu), wait until the reading stabilizes, and press [ok/meas.] key. The reading will be held in reversed mode.

7.2.2.4 Saving measurement data

When  is displayed (memory in: Auto), the reading will be automatically saved when retained.

If  is not displayed (memory in: Manu), press [ok/meas.] key while the reading is held. The data at this point will be saved.

7.2.3 When the bellows pump is used

7.2.3.1 Sampling test materials

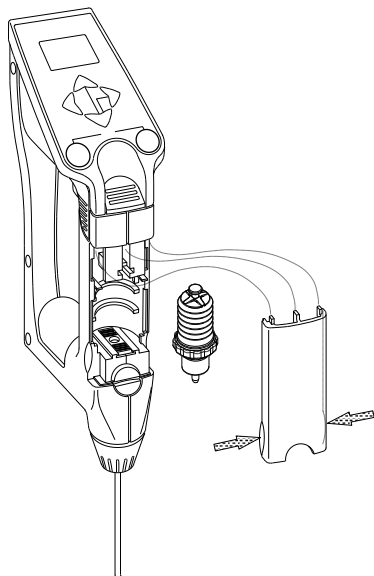

- Use the provided bellows pump when measuring a sample which contains particles or grains.
When measuring samples that may crystallize when they become dry:
- Slowly perform sampling while holding the equipment vertically.
- Remove the bellows pump and clean with the sample solution to get rid of the sample from the wimple area.
- Up to samples of 2000mPa·s of viscosity can be measured.

⚠ Caution!

Be sure to rinse the bellows pump by repeating sampling of pure water after a day's measurements. Failure can lead to the solidification of a sample (e.g. Sulfuric acid).

7.2.3.2 Start measurement

Only when  is displayed (Stability:Auto), start measurement with [ok/meas.] key.

7.2.3.3 Hold measurement data

When  is displayed (Stability:Auto), the value will automatically turn to reversed when the reading stabilizes.

If  is not displayed (Stability:Manu), wait until the reading stabilizes, and press [ok/meas.] key. The reading will be withheld shown in reversed mode.

7.2.3.4 Saving measurement data

When  is displayed (memory in: Auto), the reading will be automatically saved if retained.

If  is not displayed (memory in: Manu), press [ok/meas.] key while the reading is withheld. The data at this point will be saved.

8. Calibration of measuring cell

8.1 Calibration with pure water

- (1) Set STD Calib. Mode at “Off” on Function <Calib.Mode>.

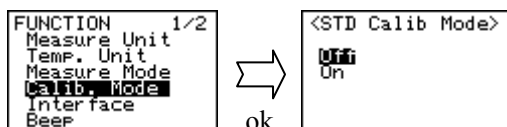

- (2) Press [esc] key 2 times to return to Main screen.
- (3) Sample pure water
Note: Make sure that there is no air bubble in the measuring cell.
- (4) The measuring cell with pure water can be calibrated automatically with the key entry as follows:
Press [cal.] key for more than 2 seconds to show inversed **CALIB(Water)** on display, showing calibration with pure water is in progress.



- (5) All calibrations are automatically stability sensed.
- (6) After calibration is over, the deviation from theoretical value will be shown so that you can check if the calibration has been successfully completed.



If the deviation from theoretical value falls within $\pm 0.001\text{g/cm}^3$, calibration is in success. Choose Execute?(Yes) and store the factor value in the unit.

If the deviation is more than $\pm 0.001\text{g/cm}^3$, select (No) and do not renew factor value. If a wrong value is stored, correct measurement data cannot be obtained.

When the deviation is more than $\pm 0.001\text{g/cm}^3$, recalibrate the measuring cell with pure water. If the deviation still differs significantly from theoretical value, there is a possibility of the measuring cell contaminated. Clean the cell thoroughly for recalibration with pure water.

If the deviation persists even with repeated rinsing of the cell, select “Execute?” --> ‘Yes’ after carrying out calibration, followed by checking to see if correct measurement results can be obtained with a standard liquid.

Note!

Be sure to set the ‘STD Calib. Mode’ to “Off” in the Function menu (Calib. Mode) before performing calibration with pure water.

8.2 Calibration with standard liquid

8.2.1 Calibration with standard liquid of which density is known

The measurement precision of DA-130N as specified can be usually maintained with pure water, however, if more precision is preferred, calibrate with standard liquid of which density is known within the range.

While pressing [esc] key, press [ok/meas.] key to show Function screen.

Choose <Calib. Mode> with [+], [-] key.

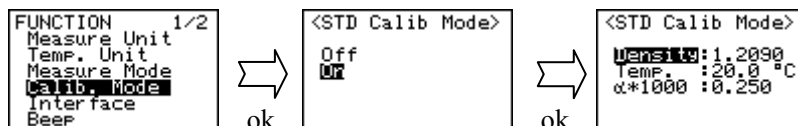

Off : With [α] key pressed, press [cal.] key to calibrate with air.
(not calibrate with standard)

On : With [α] key pressed, press [cal.] key to calibrate with standard.

Select “On” to configure density and temperature compensation coefficient of standard liquid.

Density : Set density (g/cm³) of standard liquid

Temp : Configure degree Celsius of density preset on Density

α * 1000 : Set the value of (temp comp value of standard × 1000)

For details, refer to the section “6.2 Measuring unit (2) Measurement of temperature compensated density.”

Note!

Be sure to set the ‘STD Calib. Mode’ to “Off” in the Function menu (Calib. Mode) before performing calibration with pure water.

8.3 Calibration with air

8.3.1 Calibration with air

Note!

The measurement precision of DA-130N as specified can be usually maintained with pure water, however, for the following condition, calibrate with air:

When there exists difference between the density value of dry air and the true value.

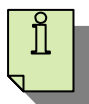

- The density of dry air in room temperature (10 to 35°C) is 0.0012 g/cm³.
- If there exists difference in value, calibration only with pure water will lead to a measurement error.
- For example; if the density of test sample is within the range 0.8 to 1.2 g/cm³, and the density of air is 0.0001 to 0.0058 g/cm³, measurement can be made within ± 0.001 g/cm³ of precision.
- You can determine whether calibration with air is necessary or not from the density of the sample you are going to test.

8.3.2 How to dry the cell

Preparation : a set of simple equipment is necessary as follows:

- Air pump : Air discharge rate 1 to 2L/min
(a pump for tropical fish can be used)
- Desiccant tube : silica gel 5 to 10g in tube

Connect the above to DA-130N as illustrated below:

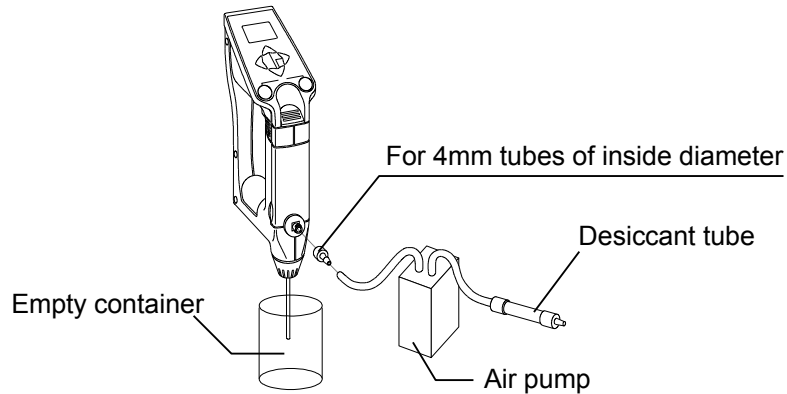

- (1) Thoroughly clean the measuring cell with pure water.
- (2) Clean with ethyl alcohol.



(Ethyl alcohol gets rid of dirt which cannot be removed with pure water, and hastens dry cleaning. If ethanol is unavailable, clean the cell thoroughly)

- (3) Purge air to dry the cell thoroughly and completely.
- (4) When the measuring cell is cleaned routinely:

Only cleaning with pure water : ca. 5 to 10 minutes to complete drying
Additional cleaning with ethanol : ca. 3 to 5 minutes to complete drying

- (5) Once purging air is stopped, leave the cell for more than 30 minutes.



(Calibrating before the cell temperature equilibrates with room temperature will result in failure)

When the optional manual pump is used to dry the cell.

- (1) Before connecting the kit, clean the cell with pure water and ethylalcohol.
- (2) Press the sample discharging lever all the way down, and push the sample intake lever upward to lock it.
- (3) With the adapter for the syringe attached, connect the kit as illustrated below, and feed air forcefully and manually.

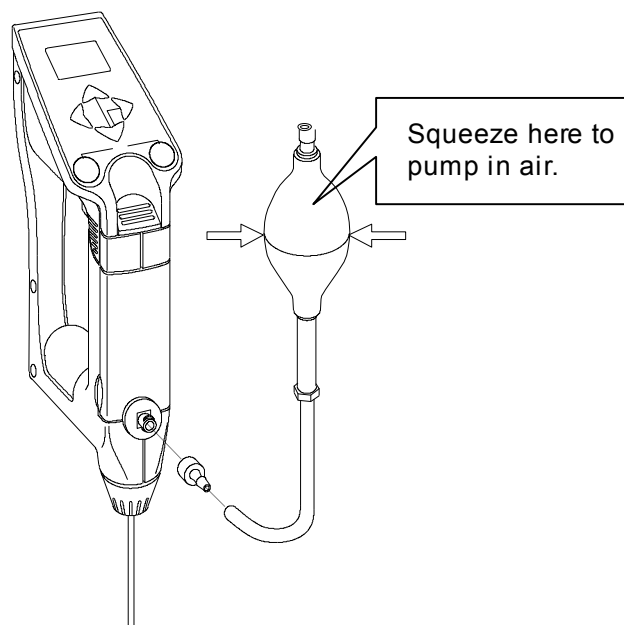

8.3.3 Procedure of calibration with air

When the measuring cell is in dried state, follow calibrating steps as below:

- (1) Set STD Calib. Mode at “Off” on Function <Calib.Mode>.

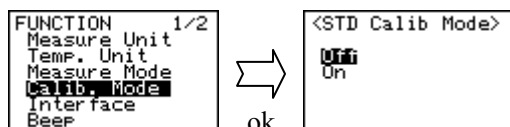

- (2) Press [esc] key 2 times to return to Main screen.
- (3) With [α] key pressed, press [cal.] key. The display shows CALIB(Air) in reverse mode, indicating calibrating with air.



When the display returns to Main, it means the calibration has been completed.

Normally, calibration will be completed within 2 minutes.

- (4) Proceed to calibration with pure water or reference solution.

See “8.1 Calibration with pure water” or “8.2 Calibration with standard liquid.”

Note!

Be sure to set the 'STD Calib. Mode' to "Off" in the Function menu (Calib. Mode) before performing calibration with air.

8.4 Calibration of displayed temperature

Ordinarily, there is no need for calibration since the instrument has been calibrated in plant before shipment. If you should observe difference in temperature between actual and displayed, follow the below steps for calibration:

Make sure that the automatic stability sense mode is set at 'manu' and 'memory in' at 'manu.' After confirming the display reaches equilibrium with ambient temperature, press [ok/meas.] key to reverse the reading on display and hold. Record the difference between displayed and actual temperatures.

With [cal.] key pressed, press [mem.out/all] key to blink the upper most digit on displayed temperature.

Input temperature with [+], [-] key. While shifting the digit with [mem.clr.], [mem.out] key, enter "(actual temp – displayed temp) = difference with [+], [-] key. When confirmed with [ok/meas.], the hold status is canceled, and the calibration on the displayed temperature will be completed.

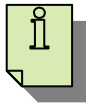

- The displayed temperature can be calibrated manually with key entry only when automatic stability sense mode is set at 'manu' and 'memory in' at 'manu.'

8.5 Recalibration

- Before you measure another kind of sample, you must clean the system.
- Insufficient clean will leave residue in the measuring cell, leading to incorrect density results.
- To check any residue in the cell, measure pure water.
- If measured value deviates more than $\pm 0.001 \text{g/cm}^3$, recalibration must be carried out.

9. Application of data processing

9.1 Storage of measuring data

The maximum number of data which can be stored in DA-130N memory is 1100 samples.

9.1.1 Auto saving

Set 'Memory In' for "Custom" mode at "Auto" of Function <Meas. Mode>.



↓ symbol appears on the lower-left on the screen display.

The measurement results are retained and at the same time saved automatically.

9.1.2 Manual storage

Select "Field" or "Labo" mode on Function <Meas. Mode>, or set Memory in to "Manu" in "Custom" mode.

Measurement results can be withheld and saved by pressing [ok/meas.] key.

Whether the resulting data may be saved either automatically or manually, the sample number at the upper-right corner on the display will increment.

9.2 Making saved data

This mark is useful for data management to identify unnecessary data or various different kinds of sample when switching to another.

1. Press [mem.clr] key to blink the latest sample number on upper right corner and turn on  mark at the bottom line.
2. Change sample number with [+], [-] key, and display measurement data of each sample number. Press [ok/meas.] key for the data you want to put the mark.
3. The "*" symbol is marked under the selected sample number, and this mark will appear while the data is printed out. This is useful for data management.
4. To erase "*" mark, press [ok/meas.] key on the screen of the data you want to eliminate.

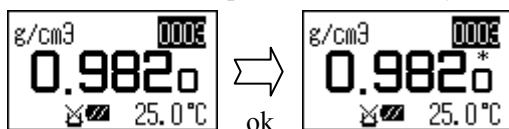

9.3 Deletion of stored data

- Clear all data at once

1. When [mem.clr] key is pressed for more than 2 seconds, the message, "Memory All Clear Execute? (Yes/No)" will appear.
2. Choose "Yes" and press [ok/meas.] key to erase all the data, and bring back the sample number to '0001.'

9.4 Display of measurement data and external output

You can recall the stored measurement data on display again, or output to the optional printer or PC.

- How to recall a measurement data on display

1. Press [mem.out] key to blink the sample number on upper right corner.

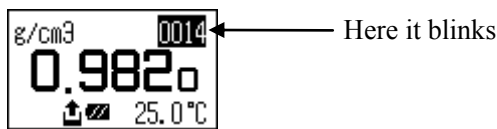

2. Change the sample number with [+], [-] key, and you can recall the stored data of specific sample number.

- How to output single sample measurement data

1. While a data is shown on display with [mem.out] key pressed, press [ok/meas.] key to blink  symbol and print out or output to PC.

- How to output a series of sample measurements or all of the data

1. With [mem.out] key pressed for more than 2 seconds, the message ‘Memory Out’, Execute? (All) will appear at the upper-left corner on the display.



2. Select “All” and press [ok/meas.] key to blink , and all the stored data will be printed out or output to PC.

3. After the data are output, the below message will be prompted asking whether to erase or not. If you want to erase it, choose “Yes” and execute with [ok/meas.] key.



4. If you output a series of sample measurements, select “Range” and press [ok/meas.] key, the range where you can make entry will appear as shown below. After entering the data that you want to output, execute with [ok/meas.] key.

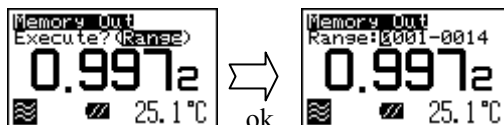

After the output is completed, the display will return to the initial screen display (meas. mode).

9.5 Setting external output

9.5.1 Data output to a personal computer via infrared communication

The DA-130N can transmit data to a personal computer with an infrared optical communication feature. For this purpose, install the data acquisition computer software (Mini Term). (It can be reached from our website (<http://www.kyoto-kem.com/en/index.html>)). Click “PRODUCT,” then click “DA-130N (Portable Model)” in the Density/Specific Gravity Meter section. The “Data communication Software for Portable Analyze” (98-439-0062) can be downloaded from there.)

You need to refer to the instruction manual for your computer as well as this manual.

Follow the instructions below for the setup to connect DA-130N to PC:

- (1) Preinstall the IrDA driver of Microsoft if the OS of your PC is ‘Windows95’ with the infrared feature.

When the preinstalled program is activated, the dialog box below will appear.

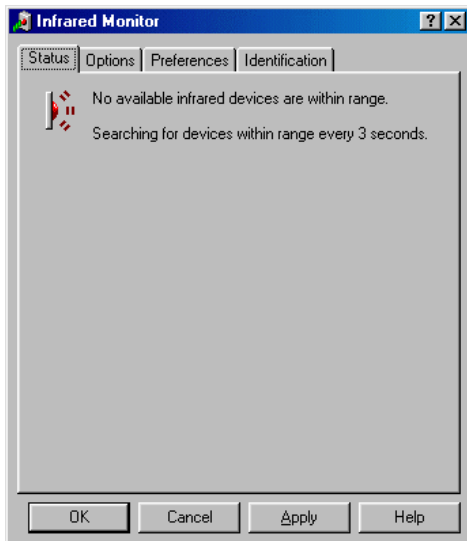

- (2) Make sure that the infrared port matches COM port on the option box screen of infrared monitor.

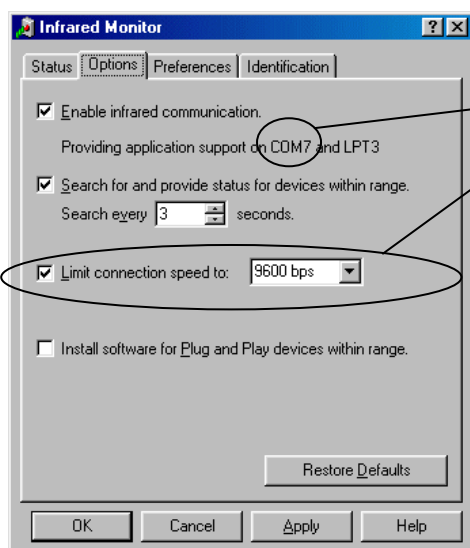

Select COM7 for Mini Term communication port.
(Set COM port No. and transmission rate at 9600 baud rate on 'Mini term'. No other settings are necessary.)

IrDA protocol: Data length 8 bit
 Parity none
 Stop bit 1

(These parameters are fixed.)

After you finish setting on this screen, activate Mini Term for further setting.

- (3) Setting the infrared interceptor for DA-130N and PC

Place the optical interceptor of DA-130N to face PC's receiver within. The maximum effective angle of DA-130N infrared receiver both left/right and up/down is 15 degree.

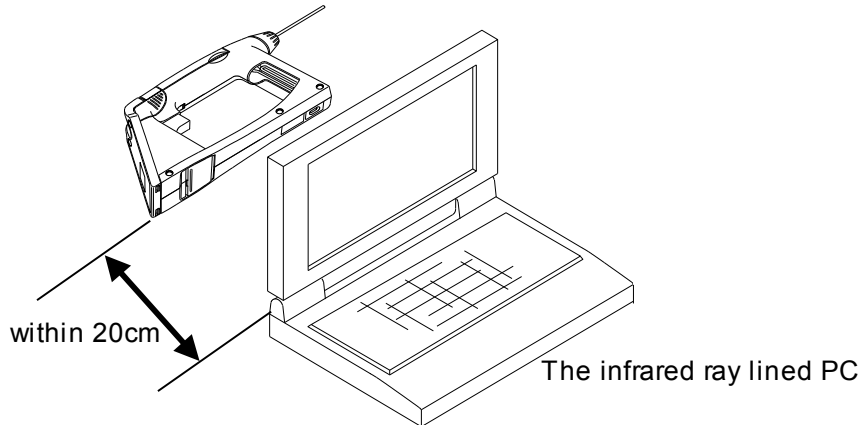

- (4) Select "IrDA"(infrared transmission) on Function-<Interface> of DA-130N.

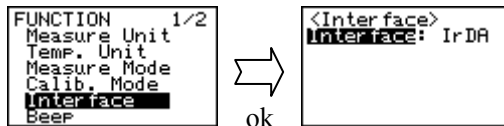

- (5) Press [mem.out] key on DA-130N to show the measurement results, and press [ok/meas.] key to blink . The data will be output to PC as well as appear on the screen display.

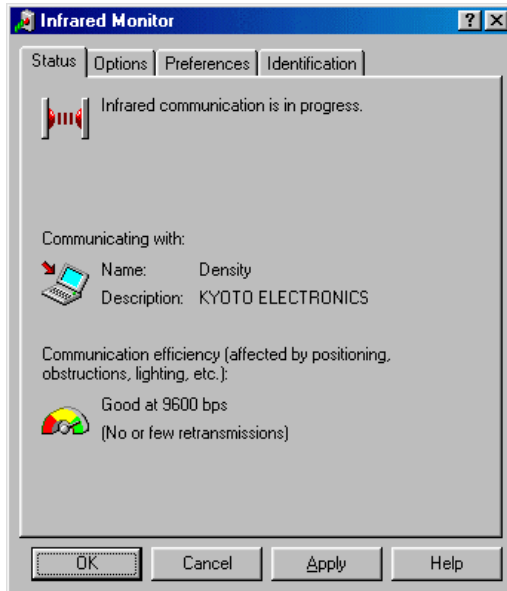

While the data is being output, the monitor screen shows the left messages.

9.5.2 Data output to Printer

In order to output data to an external printer, it is necessary to connect the optional infrared RS converter (69-00733) and polar converter (64-01127-01). The optional stand (12-04412) will help you easily set up infrared receiving unit of DA-130N. An example of setting the stand and an IDP-100 printer is described here in this manual. Install the main unit and infrared RS converter onto the stand as shown, and connect the polar converter (64-01127-01) to IDP-100 Printer, and then, connect the infrared RS converter.

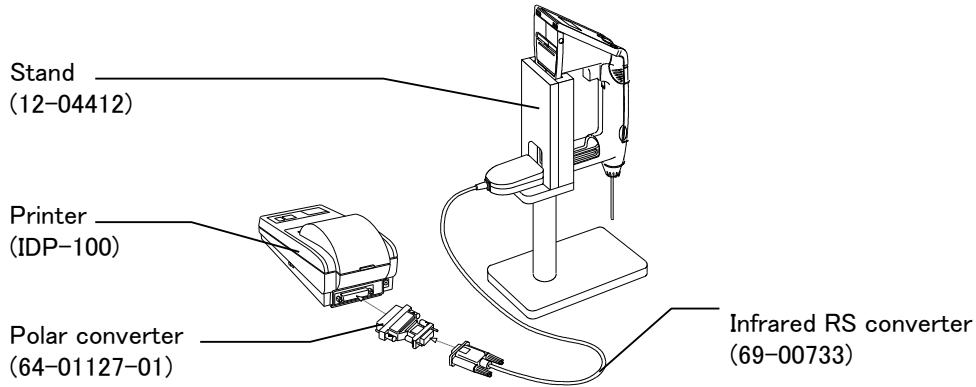

Select "PRN"(printer) on <Interface> of Function screen to make communication settings.

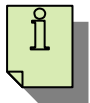
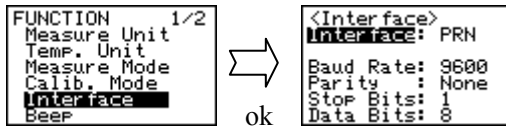

- The optional infrared RS converter (69-00733) works only at 9600 baud. Therefore, "Baud Rate" must be set at "9600."
- Communication with IDP-100 printer also works only at 9600 baud.

Printout Sample of Measurement Results:

```

Sample No. 0001
Date : 2003/10/28 14:03
0.9972 g/cm3
25.1 C
ID : SAMPLE-001

Sample No. 0002
Date : 2003/10/28 14:08
0.9965 g/cm3
25.3 C
ID : SAMPLE-001

Sample No. a0003
Date : 2003/10/28 14:13
0.9977 g/cm3
24.8 C
ID : SAMPLE-001

Sample No. b0004
Date : 2003/10/28 14:18
0.9980 g/cm3
24.5 C
ID : SAMPLE-001

Sample No. b0005*
Date : 2003/10/28 14:23
0.9910 g/cm3
24.5 C
ID : SAMPLE-001

Sample No. b0006
Date : 2003/10/28 14:28
0.9956 g/cm3
24.9 C
ID : SAMPLE-001
    
```

The marked data will appear with "*" symbol as a suffix to sample number.

9.5.3 Data output to PC via RS-232C

In order to output data to an external computer via RS-232C, it is necessary to connect the optional infrared RS converter (69-00733) as well as the data acquisition software (Mini Term). (It can be reached from our website (<http://www.kyoto-kem.com/en/index.html>). Click “PRODUCT,” then click “DA-130N (Portable Model)” in the Density/Specific Gravity Meter section. The “Data communication Software for Portable Analyzer” (98-439-0062) can be downloaded from there.) The optional stand (12-04412) will help you easily set up infrared receiving unit of DA-130N.

An example of using the stand is described here in this manual. Install the main unit and infrared RS converter onto the stand as shown below and connect the infrared RS converter to RS-232C of the computer.

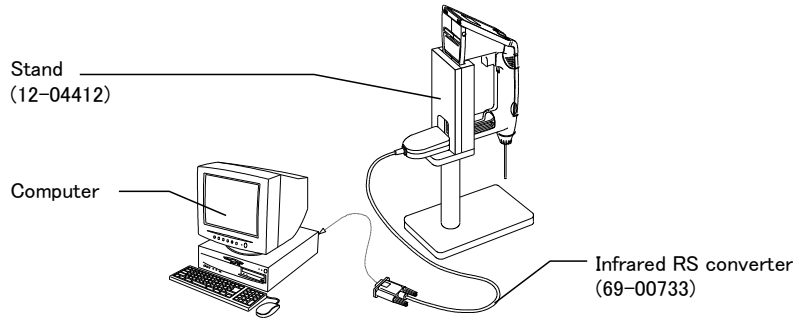

Select “RS” on <Interface> of the Function screen to make communication settings.

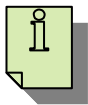
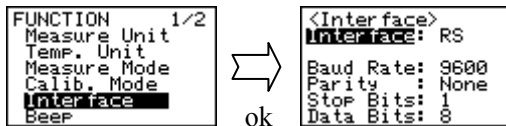

- The optional infrared RS converter (69-00733) works only at 9600 baud. Therefore, “Baud Rate” must be set at “9600.”

Output format of measurement results are shown as below:

Data		*1		Sample No.		*2	
Data queue	SIX		,			,	,
Byte start=0	1	1	1	4	1	1	1

Data	Date				Time			
Data queue		/		/	,	:	,	
Byte start=10	10				1	5		1

Data	Result							Unit											
Data queue	*	*	*	*	*	*	*	,	*	*	*	*	*	*	*	*	*	,	
Byte start=27	7							1	10										1

Data	Temperature				Unit		
Data queue	*	*	*	.	*	,	,
Byte start=46	5				1	1	1

Data	α	*3		α value			Identification										
Data queue	A		,	*	*		*	*	*						CR	CF	EOT
Byte start=54	1	1	1	5			10						1	1	1		

- *1 : Sample name (Blank, a to z)
- *2 : “*” is inserted when data is deleted. Blank except when data is deleted.
- *3 : The number of α (0 to 9)
- Blank from α to α value except when Comp.Density, S.G., Baume, or Conc. is selected for results unit.

10. Other useful functions

The DA-130N features various functions such as conversion of data unit or external data output.

With [esc] key pressed, push [ok/meas.] key to show Function screen.

Move the cursor with [+], [-] key and confirm by [ok/meas.] key.



- Beep : Select for beep or non-beep
- LCD : Setting for On/Off switch of the backlight and adjust brightness of LC display
- Power : Select for automatic power-off
- Version No. : Check version number of Main unit
- Date & Time : Set the date and time.
- Identification : Set the ID.

10.1 Selection of beep sound

When “On” is chosen, you can confirm every key entry with beep.

With [esc] key pressed, push [ok/meas.] key to show Function screen.

Choose <Beep> with [+], [-] key.

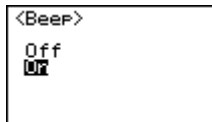

Select “On” or “Off” for beep sound.

- Off : No beep
- On : Beep on

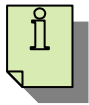

- “On” is selected initially.
- Also no error beep when “Off” is chosen.

10.2 Adjust brightness of LC display; Setting of Backlight: on/off



- Backlight: on/off

Can set conditions for on/off of backlight.

Auto off : Automatically turn off about 5 seconds after keying in for turning on.

Always off : Keep turning-off status.

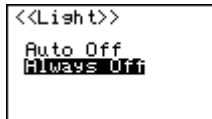

- Adjust Displayed Concentration

You can adjust the brightness of display screen as follows:

With [esc] key pressed, push [ok/meas.] key to show Function screen.

Choose < LCD Contrast > with [+], [-] key.



The brightness can be adjusted in nine steps with [mem.clr] and [mem.out] keys.

10.3 Setting Automatic Power Off

The auto power-off turns off the power of the unit if no key is pressed some period of time after start-up.

With [esc] key pressed, push [ok/meas.] key to show Function screen.

Choose “On” with [+], [-] key on < Auto Power Off > screen.

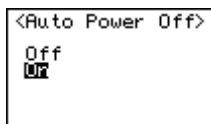

Note!

When “On” is selected and 15 minutes elapses without pressing any key, the power will be automatically shut down.

10.4 Version number check

A specified software number is input on products in the plant to identify the unit for production management.

With [esc] key pressed, push [ok/meas.] key to show Function screen.

Choose < Version No. > with [+], [-] key.

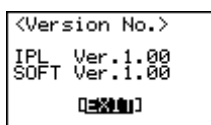

Press [ok/meas.] key to return to Function screen.

10.5 Set Date

DA-130N features a date setting and the set date can be output to a printer or a PC with measurement results.

Display the Function screen display by '[esc]+[ok/meas.]' key combination.

Select <Date & Time> using [+] or [-] key.

Select the menu option using [→] or [←] key. Select the number using [+] or [-] key. Hit [OK] key to confirm the entry.

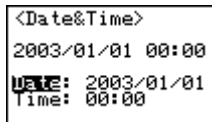

```
<Date&Time>
2003/01/01 00:00
DATE: 2003/01/01
Time: 00:00
```

10.6 Set ID

DA-130N features ID entry.

Display the Function screen display by '[esc]+[ok/meas.]' key combination.

Select <Identification> using [+] or [-] key.

Select the position using [→] or [←] key. Select the letter using [+] or [-] key. Hit [OK] key to confirm the entry.

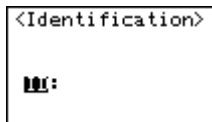

```
<Identification>
■■■:
```

Maximum number of characters for ID is ten.

11. Power source

This unit is powered by 2 alkaline dry cells of 1.5V LR03 (size AAA).

When the batteries become exhausted, the mark will appear on the display.

The normal life of the cell is 90 hours. If not in use, turn off the power.

11.1 Change the battery

The two AAA alkaline dry cells are housed in the back of the display unit.

When the batteries are replaced with new ones, make sure the display shows the initial screen display and changes to Main (measurement) display.

If it does not display as shown above, check if all of the dry cells are replaced or loaded in the correct direction.

- Remedy for alarm

When turns on, immediately stop measuring and turn off the power. Then, change the cells.

- Procedure to change the cells

Turn off the power first, and then replace all of the cells. Use the same kind of cells when replacing them.

Caution:

Do not use other battery than alkaline AAA dry cell, e.g. NiCd dry cell.

Cautions:

1. Always remove the batteries if the unit is not going to be used for a month or more. Otherwise, the batteries left in the unit may leak and cause damage.
2. The measurement data and parameters are stored in non-volatile memory. These data will not be erased even when the batteries are removed.

11.2 Auto Power Off

This function turns off the power of the unit when no key is pressed for 15 minutes after turning on the unit.

12. Maintenance

Replacement of the built-in syringe

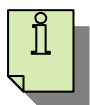

- Before replacement, repeat sampling to thoroughly clean up the line system.
- The interval of replacement depends on the nature of sample or frequency of measurements.

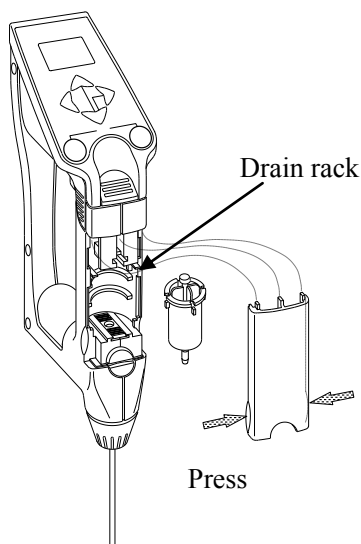

How to change the syringe:

- 1) Press down the sample discharging lever all the way, and remove the syringe cover by pulling it toward you as illustrated.
- 2) Turn the syringe 45° counterclockwise to release it from O-ring.
- 3) Slightly pull the sample drain-out lever toward you to pull out the syringe from O-ring.
- 4) Remove the syringe from drain rack, and replace it with new one.
- 5) Pull down the drain rack, and insert O-ring, and turn it clockwise until it stops.
- 6) After inserting 3 hooks on top of syringe cover into the main, install the syringe cover.

Replacement of the battery

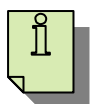

- Before replacing the batteries, turn off the power with [on/off] key.
- The measurement data and parameters are stored in nonvolatile memory. These data will not be erased even when the batteries are removed.

Cleaning the measuring cell



- Use a rinsing solution which will not corrode the liquid contact part.
 - If the measured sample is left in the measuring cell or the cell is not well cleaned, the residue inside may be solidified within the cell or at the contact part with the syringe, and the cell may be contaminated with stains and dirt. Always clean the system thoroughly using a rinsing solution after the day's work of measurements.
- (1) Fill the measuring cell with a rinsing solution using either the attached syringe or a plastic syringe.
 - (2) Leave a rinsing solution for some time if so necessary before draining it out.
 - (3) Repeat the steps, (1) and (2), for cleaning more thoroughly.

13. Cautions in use

This instrument is designed rigid enough to endure measurement work on site, however, if you handle the unit under any of the following conditions, it may malfunction or need to be repaired. This unit is not explosion-proof. Do not use it in such an area.

- (1) The unit has a not-sophisticated drip-proof construction (IP54), however, care must be taken not to have it drip wet.
- (2) The unit is not waterproof. If dipped in water, the inside electronic parts will be damaged.
- (3) The liquid contact parts are made of borosilicated glass, tetra ethylene fluoride and polypropylene. Do not use such sample liquid or solvent as may corrode the measuring cell (made of borosilicated glass). For example; Hydrogen fluoride acid
- (4) Avoid a place for storage under any of the following atmosphere:
 - **Corrosive gas**
 - **Direct sunlight**
 - **Dusty or humid room**
 - **Too hot or too cold atmosphere**
- (5) Never drop or give force to the unit since it is a precision meter with glass-made measuring cell. Also avoid using corrosive liquid as warned above.
- (6) Always well clean the measuring cell after a series of measurement for the day, and store the unit in dry atmosphere.
- (7) Keep the power turned off after use.
- (8) **Never overhaul the unit since it is close molded structure.**
If it should be disassembled, the unit will not be covered by warranty.
If any serious troubles, such as toxic smelling, smokes or water permeating into the unit, should occur, **immediately turn off the power and contact your local dealer.**

14. Parts list

<p>Quick Manual DA-130N (Japanese) 59-00159</p>	<p>Quick Manual DA-130N (English) 59-00159-01</p>	<p>Battery Holder 64-01151</p>	<p>Alkaline Battery LR03(AAA) (2pcs/set) 64-00570-13</p>	<p>Built-in Bellows (2pcs/set) 12-01566-10</p>
<p>DA-130N Operation manual 59-00250-01</p>				
<p>Memo pad (10sheets/set) 12-01566-11</p>				
<p>Built-in syringe 63-00812</p>				
<p>Nozzle screw 20-08076</p>				
<p>Sampling nozzle L=300 12-00498-01</p>				
<p>DA-130N Operation Manual CD-ROM 12-02895</p>				
Option				
<p>Tube Adapter Set 12-04428-01</p>	<p>Syringe Adapter Set 12-04428-02</p>	<p>IR-RS Converter 69-00733</p>	<p>Stand 12-04412</p>	
<p>Syringe 2mL (10pcs/set) 12-04479-10</p>	<p>Grommet 20-08341</p>	<p>Rubber Bulb kit 12-04428</p>	<p>RS-232C Conversion Adapter D09-9M25M 64-01127-01</p>	

Option

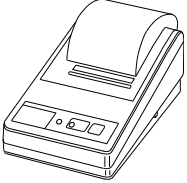
Part code	Part name	Qty	Remarks	Sketch
12-02028-30	Dot Matrix Printer	1 set	100V	
12-02028-31			120V	
12-02028-32			230V	

15. Troubleshooting

15.1 Error messages and their remedies

Error No.	Error	Remedies
E-01	Calibration error (1) No filling measuring cell with pure water (2) Air bubble in the cell (3) Air leak from joints (4) Foreign matter in cell (5) Wrong 'Calib. Mode' setting (6) Reduced sensitivity of cell (7) Broken measuring cell	<ul style="list-style-type: none"> · Sample water again · Sample water again · Check jointed parts · Clean with appropriate solvent · Set 'Calib. Mode' to "Off" for calibration with pure water or to "On" for calibration with standard liquid, before performing calibration. · Contact your local dealer · Contact your local dealer
E-02	Cell oscillation error (1) Foreign matter in the cell (2) Loose contact of cable with cell (3) Broken measuring cell	<ul style="list-style-type: none"> · Clean with appropriate solvent · Contact your local dealer · Contact your local dealer
E-03	Thermistor error (cell) (1) Abnormal thermistor to measure sample temperature	<ul style="list-style-type: none"> · Broke thermistor · Contact your local dealer
E-04	Thermistor (Ambient air) (1) Abnormal thermistor to measure ambient temperature	<ul style="list-style-type: none"> · Broke thermistor · Contact your local dealer
E-05	Data full error (1) Maximum number of data: 1100 ('FULL' mark appears on 'Sample No.')	<ul style="list-style-type: none"> · Delete sample data
E-06	Memory error	
E-07	Limit time over (1) Measurement takes more than 10 minutes	<ul style="list-style-type: none"> · Turn on power again and measure again. · If the error repeats, measure pure water to determine whether or not the cause is due to the sample. · If error arises on water measurement, contact your local dealer.
□	Battery alarm (1) Battery is running down.	<ul style="list-style-type: none"> · Replace batteries with new ones.

15.2 Exhibit no repeatability on measured value or show deviation on measured value

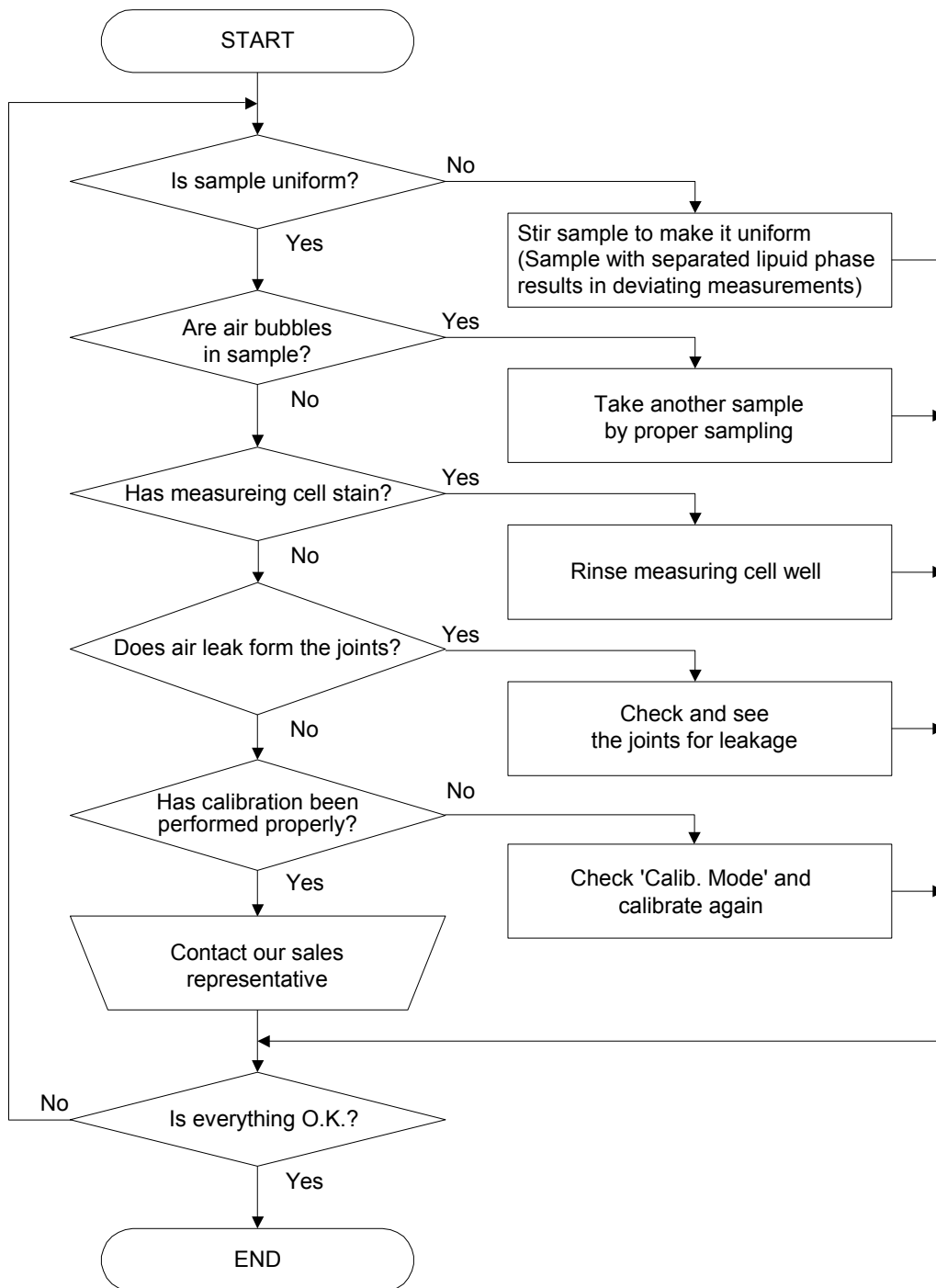

16. Technical data

Type and model	DA-130N Portable Density/Specific Gravity Meter
Measuring method	Natural Oscillation type
Measurement object	Liquid sample test materials
Range	0.0000 ~ 2.0000 g/cm ³
Precision	±0.001 g/cm ³
Resolution	0.0001 g/cm ³
Temperature range	0 ~ 40.0 °C
Display contents	Density and Relative gravity (with/without temperature compensated) Brix%, Alcohol wt%, Alcohol vol%, Proof, Baume, Plato, API, %H ₂ SO ₄ , Conc. (set by User), Temperature, Sample number, Stability sense, Data storage, External output, Battery capacity
Temperature compensation	Up to 10 entries for temperature compensation coefficient and converted temperature
Automatic calibration	All density values of pure water needed for auto calibration can be stored.
Number of data	1,100 samples
External output	PC or Printer can be connected. (not both) <ul style="list-style-type: none"> • IrDA interface is standard equipped. • Connection via RS-232C requires optional infrared RS converter (69-00733).
Weight	Approximately 360g
Power source	DC 3V (two pieces of 1.5V alkaline dry cell (“AAA”))
Battery life	Approximately 90 hours
Sampling method	Syringe-type hand pump

17. Warranty and After-Sale Service

- (1) We thank you very much for purchasing our product.

The product you have purchased passed strict factory inspection and testing prior to shipment, and maintenance service is performed under the quality system, however, if any defective parts or malfunctions should be found due to Manufacturer's craftsmanship, installation or insufficient description of operating manual, the quality is guaranteed for one year after the date of purchase by free of charge repair except for consumable parts, provided that the instrument or the parts have been in normal use and operation. This warranty, however, may not cover damages incurred under some use conditions even for the warranty period.

- (2) Please contact your local dealer for the after-sale services, such as repairing, during or after the warranty period.

- (3) Before asking us to repair the product, please carefully read the section, "15. Troubleshooting", for reconfirming the malfunction. Then, when you have to ask us for repairs, please let your local dealer know the following information:

Product serial number

Symptom of malfunctions

Your name and address / phone number

- (4) Please contact your local dealer on the purchase of the parts.

- (5) Quality Assurance (This warranty shall not cover any of the following incidents.)

- When splashing water on the unit or submerging it in water
- When operating the unit otherwise described in the sections for sampling and rinsing measuring cell
- When dropping the unit or giving it physical shock

- (6) Please keep in mind the following things/instructions for safety operations.

- This warranty shall not cover an accident resulting in injuries or death caused by erroneous handling or use of the product.
- This warranty shall not cover any damages incurred due to mishandling of measured data.
- Keep away from heat or flame and care should be taken of ventilation, when handling flammable samples/rinsing solution.
- This warranty shall not cover any accidents derived from work environment.
- Care should be taken not to have eyes and bare skin, face or hands splashed with sample or rinsing solution when operating the sampling nozzle or the syringe pump.
- Wear appropriate protective cleaning equipment — gloves, goggles, mask and like — depending on samples or rinsing solution.

Appendix 1: Density of pure water (0~40°C)

Temp. (°C)	Density (g/cm ³)	Temp. (°C)	Density (g/cm ³)	Temp. (°C)	Density (g/cm ³)	Temp. (°C)	Density (g/cm ³)
0	0.99984						
1	0.99990	11	0.99961	21	0.99799	31	0.99534
2	0.99994	12	0.99950	22	0.99777	32	0.99503
3	0.99996	13	0.99938	23	0.99754	33	0.99471
4	0.99997	14	0.99925	24	0.99730	34	0.99438
5	0.99996	15	0.99910	25	0.99705	35	0.99404
6	0.99994	16	0.99894	26	0.99679	36	0.99369
7	0.99990	17	0.99878	27	0.99652	37	0.99333
8	0.99985	18	0.99860	28	0.99624	38	0.99297
9	0.99978	19	0.99841	29	0.99595	39	0.99260
10	0.99970	20	0.99821	30	0.99565	40	0.99222

Appendix 2: Temperature compensation coefficient for various liquids

Substance	Range (°C)	$\alpha \times 10^3 / ^\circ\text{C}$	Substance	Range (°C)	$\alpha \times 10^3 / ^\circ\text{C}$
Ethanol	0~30	1.09	Benzene	6~30	1.21
<i>m</i> -Xylene	0~30	0.99	Methanol	6~30	1.18
<i>p</i> -Xylene	15~30	1.02	Acetone	0~30	1.42
Glycerine	15~30	0.49	Bromobenzene	0~30	0.91
Chloroform	0~30	1.26	Cyclohexane	0~30	1.20
Carbon tetrachloride	0~30	1.22	Isopropanol	0~30	1.06
Toluene	0~30	1.07	n-Nonane	0~30	1.08

Note!

The above alpha (α) is the coefficient for temperature compensation to convert the measured data at 30°C of sample temperature to that at 15°C.

The compensation coefficient will slightly differ if sample temperature or compensation temperature differs. If a precise temperature-compensated density is required, such coefficient should be obtained from the following formula, where temperature compensation coefficient (α) is obtained from the density (Comp. Density) at compensation temperature and the measured density (Density) at the measurement temperature (Temp):

$$a = \frac{(\text{Comp.Density} / \text{Density}) - 1}{\text{Temp} - \text{Comp.temp}}$$

Example: in the case of ethanol with 0.79351g/cm³ at 15°C, 0.78924g/cm³ at 20°C and 0.78495g/cm³ at 25°C, the temperature compensation coefficient can be obtained as follows when measured values on the samples at 15°C and 25°C are converted by compensation to those at 20°C.

KEM KYOTO ELECTRONICS
MANUFACTURING CO.,LTD.

Overseas Division: Yamawaki Bldg 9F 4-8-21 Kudan Minami,
Chiyoda-ku, Tokyo 102-0074 JAPAN

FAX: +81-3-3237-0537, Phone: +81-3-3239-7333

E-mail: kem.overseas-tokyo@kyoto-kem.com

URL:<http://www.kyoto-kem.com>

Factory: 56-2 Ninodan-cho, Shinden Kisshoin, Minami-ku, KYOTO
601-8317, JAPAN

FAX: +81-75-691-9961, Phone: +81-75-691-4122