

EPSON

ROBOT CONTROLLER

RC620

Rev.8

EM15XC3076F

ROBOT CONTROLLER

RC620 Rev.8

ROBOT CONTROLLER

RC620

Rev.8

Copyright © 2009-2015 SEIKO EPSON CORPORATION. All rights reserved.

FOREWORD

Thank you for purchasing our robot products.

This manual contains the information necessary for the correct use of the robot controller.

Please carefully read this manual and other related manuals before installing the robot system.

Keep this manual handy for easy access at all times.

RC620 robot controller consists of the following:

- RC620 CU (Control Unit)

- RC620 DU (Drive Unit)

This manual contains the information for the RC620 CU (Control Unit).

For RC620 DU (Drive Unit), refer to the *Robot Controller / Drive Unit RC620DU* manual.

The information for the robot controller is describes as below, indicating both RC620 CU and RC620 DU:

- Robot controller

- Controller

- RC620

The information for the either unit (CU or DU) is described as below:

- RC620CU Control Unit

- RC620DU Drive Unit

WARRANTY

The robot system and its optional parts are shipped to our customers only after being subjected to the strictest quality controls, tests, and inspections to certify its compliance with our high performance standards.

Product malfunctions resulting from normal handling or operation will be repaired free of charge during the normal warranty period. (Please ask your Regional Sales Office for warranty period information.)

However, customers will be charged for repairs in the following cases (even if they occur during the warranty period):

1. Damage or malfunction caused by improper use which is not described in the manual, or careless use.
2. Malfunctions caused by customers' unauthorized disassembly.
3. Damage due to improper adjustments or unauthorized repair attempts.
4. Damage caused by natural disasters such as earthquake, flood, etc.

Warnings, Cautions, Usage:

1. If the robot system associated equipment is used outside of the usage conditions and product specifications described in the manuals, this warranty is void.
2. If you do not follow the WARNINGS and CAUTIONS in this manual, we cannot be responsible for any malfunction or accident, even if the result is injury or death.
3. We cannot foresee all possible dangers and consequences. Therefore, this manual cannot warn the user of all possible hazards.

TRADEMARKS

Microsoft, Windows, and Windows logo are either registered trademarks or trademarks of Microsoft Corporation in the United States and/or other countries. Other brand and product names are trademarks or registered trademarks of the respective holders.

TRADEMARK NOTATION IN THIS MANUAL

Microsoft® Windows® XP Operating system

Microsoft® Windows® Vista Operating system

Microsoft® Windows® 7 Operating system

Throughout this manual, Windows XP, Windows Vista, and Windows 7 refer to above respective operating systems. In some cases, Windows refers generically to Windows XP, Windows Vista, and Windows 7.

NOTICE

No part of this manual may be copied or reproduced without authorization.

The contents of this manual are subject to change without notice.

Please notify us if you should find any errors in this manual or if you have any comments regarding its contents.

INQUIRIES

Contact the following service center for robot repairs, inspections or adjustments.

If service center information is not indicated below, please contact the supplier office for your region.

Please prepare the following items before you contact us.

- Your controller model and its serial number
- Your manipulator model and its serial number
- Software and its version in your robot system
- A description of the problem

SERVICE CENTER

--

MANUFACTURER

Seiko Epson Corporation

Toyoshina Plant

Robotics Solutions Operations Division

6925 Toyoshina Tazawa,

Azumino-shi, Nagano, 399-8285

Japan

TEL : +81-(0)263-72-1530

FAX : +81-(0)263-72-1495

SUPPLIERS

North & South America **Epson America, Inc.**

Factory Automation/Robotics

18300 Central Avenue

Carson, CA 90746

USA

TEL : +1-562-290-5900

FAX : +1-562-290-5999

E-MAIL : info@robots.epson.com

Europe

Epson Deutschland GmbH

Factory Automation Division

Otto-Hahn-Str.4

D-40670 Meerbusch

Germany

TEL : +49-(0)-2159-538-1391

FAX : +49-(0)-2159-538-3170

E-MAIL : robot.infos@epson.de

China

Epson (China) Co., Ltd.

Factory Automation Division

7F, Jinbao Building No. 89, Jinbao Street,

Dongcheng District, Beijing,

China, 100005

TEL : +86-(0)-10-8522-1199

FAX : +86-(0)-10-8522-1120

Taiwan

Epson Taiwan Technology & Trading Ltd.

Factory Automation Division

14F, No.7, Song Ren Road, Taipei 110,

Taiwan, ROC

TEL : +886-(0)-2-8786-6688

FAX : +886-(0)-2-8786-6677

Korea

Epson Korea Co., Ltd.

Marketing Team (Robot Business)

27F DaeSung D-Polis A, 606

Seobusaet-gil, Geumcheon-gu, Seoul, 153-803
Korea
TEL : +82-(0)-2-3420-6692
FAX : +82-(0)-2-558-4271

Southeast Asia

Epson Singapore Pte. Ltd.
Factory Automation System
1 HarbourFront Place, #03-02,
HarbourFront Tower One,
Singapore 098633
TEL : +65-(0)-6586-5696
FAX : +65-(0)-6271-3182

India

Epson India Pvt. Ltd.
Sales & Marketing (Factory Automation)
12th Floor, The Millenia, Tower A, No. 1,
Murphy Road, Ulsoor, Bangalore,
India 560008
TEL : +91-80-3051-5000
FAX : +91-80-3051-5005

Japan

Epson Sales Japan Corporation
Factory Automation Systems Department
Nishi-Shinjuku Mitsui Bldg.6-24-1
Nishishinjuku, Shinjuku-ku, Tokyo 160-8324
Japan
TEL : +81-(0)3-5321-4161

Before Reading This Manual

NOTE



Do not connect TP1 to the following Robot Controllers. Connecting to the following Robot Controllers may result in malfunction of the device since the pin assignments are different.

RC420 / RC520 / SRC5** / SRC-3** / SRC-2**

Be careful of the operating instructions of the TP1 when connecting it to the Robot

NOTE



Controller RC180/RC170, it is different from the explanation in this manual.

When using the TP1 with the RC180/RC170, refer to the *RC170 / RC180 Option Teach Pendant TP1*.

NOTE



Do not connect the followings to the TP port of RC620. Connecting to the followings may result in malfunction of the device since the pin assignments are different.

OPTIONAL DEVICE dummy plug

Operation Pendant OP500

Operator Pendant OP500RC

Operator Panel OP1

Jog Pad JP500

Teaching Pendant TP-3**

Security support for the network connection

The network connecting function (Ethernet) on our products assumes the use in the local network such as the factory LAN network. Do not connect to the external network such as Internet.

In addition, please take security measure such as for the virus from the network connection by installing the antivirus software.

Security support for the USB memory

Make sure the USB memory is not infected with virus when connecting to the Controller.

Safety

1. Safety	3
2. Conventions	3
3. Safety Precautions	4

Setup & Operation

1. Specifications	9
1.1 System Example.....	9
1.2 Standard Specifications.....	10
1.3 Outer Dimensions.....	13
2. Part Names and Functions	14
2.1 Part Names.....	14
2.2 Functions	16
2.3 LED and LCD.....	19
2.4 Safety Features	22
3. Installation	24
3.1 Unpacking.....	24
3.2 Environmental Requirements	24
3.2.1 Environment.....	24
3.2.2 Installation	25
3.3 Power Supply.....	26
3.3.1 Specifications.....	26
3.3.2 AC Power Cable.....	27
3.4 Cable Connection	27
3.4.1 Typical Cable Connection.....	28
3.4.2 Connecting Manipulator to Controller	29
3.5 Noise Countermeasures.....	30

4. Operation Mode (TEACH/AUTO)	31
4.1 Overview	31
4.2 Switch Operation Mode	31
4.3 Program Mode (AUTO).....	32
4.3.1 What is Program Mode (AUTO)?	32
4.3.2 Setup from EPSON RC+6.0.....	32
4.4 Auto Mode (AUTO)	33
4.4.1 What is Auto mode (AUTO)?	33
4.4.2 Setup from EPSON RC+ 6.0.....	33
4.4.3 Setup from Control Device	35
5. Memory Port	36
5.1 What is Controller Status Storage Function?	36
5.2 Before Using Controller Status Storage Function	36
5.2.1 Precautions	36
5.2.2 Adoptable USB Memory.....	37
5.3 Controller Status Storage Function	37
5.3.1 Controller Status Storage with Trigger Button	37
5.3.2 Controller Status Storage with Teach Pendant (Option)	38
5.3.3 Load Data with EPSON RC+ 6.0	38
5.3.4 Transfer with E-mail	39
5.4 Details of Data	40
6. LAN (Ethernet Communication) Port	41
6.1 About LAN (Ethernet Communication) Port	41
6.2 IP Address	42
6.3 Changing Controller IP Address	42
7. TP Port	44
8. EMERGENCY	45
8.1 Safety Door Switch and Latch Release Switch	46
8.1.1 Safety Door Switch.....	46
8.1.2 Latch Release Switch.....	47
8.1.3 Checking Latch Release Switch Operation	47

8.2	Emergency Stop Switch Connection.....	48
8.2.1	Emergency Stop Switch.....	48
8.2.2	Checking Emergency Stop Switch Operation.....	48
8.2.3	Recovery from Emergency Stop.....	48
8.3	Pin Assignments.....	49
8.4	Circuit Diagrams.....	50
8.4.1	Example 1: External emergency stop switch typical application	50
8.4.2	Example 2: External safety relay typical application.....	51
9. I/O Connector		52
9.1	Input Circuit.....	52
9.2	Output Circuit.....	54
9.3	Pin Assignment.....	56
10. I/O Remote Settings		57
11. R-I/O Connector		58
11.1	Input Circuit.....	58
11.2	Pin Assignment.....	59
12. Option Units		60
12.1	What are Option Units?	60
12.2	Expansion I/O Board	61
12.2.1	About Expansion I/O Board.....	61
12.2.2	Board Configuration (Expansion I/O)	61
12.2.3	Confirmation with EPSON RC+6.0	62
12.2.4	Input Circuit	62
12.2.5	Output Circuit.....	64
12.2.6	Pin Assignments.....	66
12.3	Fieldbus I/O Board.....	67
12.4	RS-232C Board	68
12.4.1	About RS-232C Board.....	68
12.4.2	Board Setup (RS-232C)	68
12.4.3	Verify with EPSON RC+5.0 (RS-232C)	69
12.4.4	RS-232C Software Communication Setup (RS-232C)	70
12.4.5	Communication Cable (RS-232C).....	70
12.5	PG Board.....	70

13. UPS	71
14. Option : Teach Pendant TP1	73
14.1 Function	73
14.1.1 Safety.....	73
14.1.2 Specifications.....	77
14.1.3 Installation.....	79
14.1.4 Operation Mode (TEACH / AUTO).....	84
14.1.5 Operation Panel (Key Description).....	86
14.1.6 Enable Switch	89
14.1.7 Warning Sound (Beep).....	89
14.2 Teaching Procedure	90
14.2.1 Jog Operation	90
14.2.2 Teaching	91
14.2.3 Direct Teaching	92
14.3 TEACH Mode	94
14.3.1 Jog & Teach	95
14.3.2 Point Editor	99
14.3.3 Robot	101
14.3.4 Motion Command	102
14.3.5 I/O Command	103
14.3.6 Jog Distance	104
14.3.7 Free Joints	105
14.3.8 Brake (For 6-Axis robots)	106
14.4 AUTO Mode	108
14.4.1 Program Command Display	109
14.4.2 I/O Monitor	110
14.4.3 Memory I/O Monitor	110
14.4.4 Task Monitor	111
14.4.5 System History	112
14.4.6 Controller Statuses Preservation	113
14.4.7 Date / Time	113
14.4.8 Brightness / Contrast	114
14.4.9 Language	114
14.4.10 Error	115
14.5 Password Setup	115
14.6 Troubleshooting	116

15. Option : RAID	117
15.1 Overview	117
15.2 Data Protection Status Confirmation	117
15.2.1 Normal Status	117
15.2.2 Status for Restore	118
15.3 Restoring the Data Protection Status	119
15.3.1 Shutdown the system	119
15.3.2 Replace the HDD	119
15.3.3 Restore the data protection status	119

Maintenance

1. Safety Precautions on Maintenance	123
1.1 Safety Precautions	123
1.2 Lockout / Tagout	124
2. Regular Maintenance Inspection	125
2.1 Schedule for Maintenance Inspection	125
2.2 Inspection Point	126
2.2.1 Inspection While the Controller is Turned OFF	126
2.2.2 Inspection While the Controller is Turned ON	126
3. Controller Structure	127
3.1 Location of Parts	127
3.2 Diagram of Cable Connections	127
3.3 Connector Pin Assignment	132
3.3.1 M/C Power Connector	132
3.3.2 M/C Signal Connector	133
4. Backup and Restore	134
4.1 What is Backup Controller?	134
4.2 Backup Data Types	135
4.3 Backup	136
4.4 Restore	137
5. Firmware Update	139
5.1 Updating Firmware	139
5.2 Firmware Upgrading Procedure	139

5.3	Controller Recovery	142
5.4	Firmware Initialization Procedure	143

6. Maintenance Parts Replacement Procedures 145

6.1	Fan / Fan Filter	146
6.1.1	Cleaning and Replacing the Fan Filters	145
6.1.2	Replacing the Large Fan	147
6.1.3	Replacing the Small Fan	149
6.2	Battery	151
6.2.1	Replacing the Small Fan	151
6.2.2	Replacing the UPS Battery	154
6.3	Motor Driver	157
6.3.1	Part Name	157
6.3.2	Replacing the Motor Driver (DMB side)	158
6.3.3	Replacing the Motor Driver (ADMB side)	161
6.4	CPU Board / BIOS Backup Battery / Memory	164
6.4.1	Normal	164
6.4.2	Faster	173
6.5	CF (Compact Flash)	186
6.6	Switching Power Supply	188
6.6.1	Switching Power Supply (15W)	188
6.6.2	Switching Power Supply (75W)	190
6.6.3	Switching Power Supply (ATX)	192
6.7	PCI Board	196
6.8	Special Board	198
6.8.1	Replacing the Special Option Board	198
6.8.2	Adding the Special Option Board	198
6.9	HDD	199
6.9.1	Standard (HDD without RAID option)	199
6.9.2	HDD with RAID option	199

7. Recovering the HDD 201

7.1	HDD Recovery Procedure (S/N 01/02-00501 to 01/02-01000)	201
7.1.1	Recovering Windows	201
7.2	HDD Recovery Procedure (S/N 01/02-01001 or later)	203
7.2.1	Backing up EPSON RC+ data	203
7.2.2	Recovering Windows	204
7.2.3	Restoring EPSON RC+ data	207

8. Troubleshooting	208
If the display is blank	208
9. Maintenance Parts List	209
9.1 RC620.....	209
9.2 Option TP1.....	210

Safety

This section contains information for safety of the Robot System.



1. Safety

Installation and transportation of robots and robotic equipment shall be performed by qualified personnel and should conform to all national and local codes.

Please read this manual and other related manuals before installing the robot system or before connecting cables. Keep this manual in a handy location for easy access at all times.

2. Conventions

Important safety considerations are indicated throughout the manual by the following symbols. Be sure to read the descriptions shown with each symbol.

 WARNING	This symbol indicates that a danger of possible serious injury or death exists if the associated instructions are not followed properly.
 WARNING	This symbol indicates that a danger of possible harm to people caused by electric shock exists if the associated instructions are not followed properly.
 CAUTION	This symbol indicates that a danger of possible harm to people or physical damage to equipment and facilities exists if the associated instructions are not followed properly.

3. Safety Precautions

Only trained personnel should design and install the robot system.

Trained personnel are defined as those who have taken robot system training class held by the manufacturer, dealer, or local representative company, or those who understand the manuals thoroughly and have the same knowledge and skill level as those who have completed the training courses.

The following items are safety precautions for qualified design or installation personnel:



WARNING



- Personnel who design and/or construct the robot system with this product must read the Safety chapter in User's Guide to understand the safety requirements before designing and/or constructing the robot system. Designing and/or constructing the robot system without understanding the safety requirements is extremely hazardous, may result in serious bodily injury and/or severe equipment damage to the robot system, and may cause serious safety problems.
- The Manipulator and the Controller must be used within the environmental conditions described in their respective manuals. This product has been designed and manufactured strictly for use in a normal indoor environment. Using the product in an environment that exceeds the specified environmental conditions may not only shorten the life cycle of the product but may also cause serious safety problems.
- The robot system must be used within the installation requirements described in the manuals. Using the robot system outside of the installation requirements may not only shorten the life cycle of the product but also cause serious safety problems.
- The interlock of the Safety Door must be functioning when the robot system is operated. Do not operate the system under the condition that the switch cannot be turned ON/OFF. (I.E. the condition where the switch is disabled)
(Example: Tape is put around the switch to hold it closed.) Operating the robot system when the switch is not functioning properly is extremely hazardous and may cause serious safety problems as the Safety Door input cannot fulfill its intended function.
- Connect input signal wires for Emergency Stop and Safety Door to the EMERGENCY connector so that the Emergency Stop switch in the Teach Pendant connected to the TP port always functions. (Refer to the typical application diagram in Setup & Operation 8.4 Circuit Diagrams.)

The following items are safety precautions for qualified design or installation personnel: (cont.)

 WARNING	<ul style="list-style-type: none"> ■ Do not open the cover(s) of the Controller except while maintaining it. Opening the cover(s) of the Controller is extremely hazardous and may result in electric shock even when its main power is OFF because of the high voltage charge inside the Controller. ■ Make sure that the power to the Controller is turned OFF before connecting or disconnecting any cables. Connecting or disconnecting any cables with the power ON is extremely hazardous and may result in electric shock and/or malfunction of the Controller. ■ Be sure to connect the cables properly. Do not allow unnecessary strain on the cables. (Do not put heavy objects on the cables. Do not bend or pull the cables forcibly.) The unnecessary strain on the cables may result in damage to the cables, disconnection, and/or contact failure. Damaged cables, disconnection, or a contact failure is extremely hazardous and may result in electric shock and/or improper function of the system. ■ When connecting the plug to fit the outlet in your factory, make sure that it is done by qualified personnel. When connecting the plug, be sure to connect the earth wire of the AC power cable colored green/yellow on the Controller to the earth terminal of the factory power supply. The equipment must be grounded properly at all times to avoid the risk of electric shock. Always use a power plug and receptacle. Never connect the Controller directly to the factory power supply. (Field wiring)
---	--

 CAUTION	<ul style="list-style-type: none"> ■ The serial number of the Manipulator that should be connected is indicated on the Connection Check Label on the Controller. Connect the Controller and the Manipulator correctly. Improper connection between the Controller and the Manipulator may cause improper function of the robot system and also safety problems. ■ When using remote I/O, always make sure of the following. Using the robot system under unsatisfactory conditions may cause malfunction of the system and/or safety problems. <ul style="list-style-type: none"> - Assign remote functions to inputs/outputs correctly and wire correctly when setting up remote I/O signals. - Make sure that the functions correspond to the correct input/output signals before turning ON the system. - When verifying the robot system operation, prepare for failures with initial settings or wiring. If the Manipulator functions unusually by the failures with initial settings or wiring, press the Emergency Stop switch immediately to stop the Manipulator.
---	--

The following items are safety precautions for qualified operator personnel:

 <p>WARNING</p>	<ul style="list-style-type: none">■ The interlock of the Safety Door must be functioning when the robot system is operated. Do not operate the system under the condition that the switch cannot be turned ON/OFF. (I.E. the condition where the switch is disabled) (Example: Tape is put around the switch to hold it closed.) Operating the robot system when the switch is not functioning properly is extremely hazardous and may cause serious safety problems as the Safety Door input cannot fulfill its intended function.
 <p>WARNING</p>	<ul style="list-style-type: none">■ Do not open the cover(s) of the Controller except while maintaining it. Opening the cover(s) of the Controller is extremely hazardous and may result in electric shock even when its main power is OFF because of the high voltage charge inside the Controller.

Setup & Operation

This section contains information for setup and operation of the Robot Controller.

1. Specifications

1.1 System Example

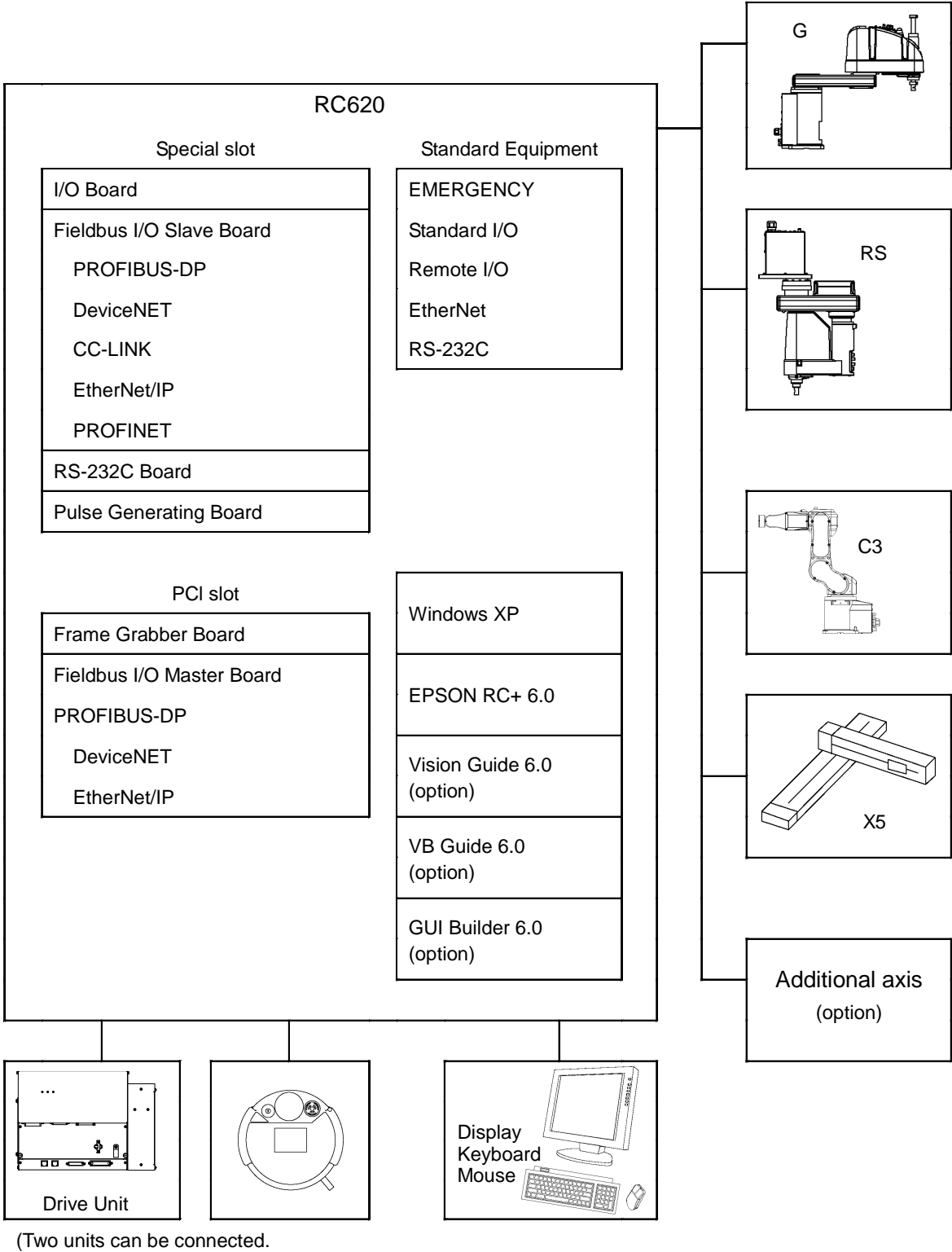

1.2 Standard Specifications

Item	Specification		
Model	Robot Controller RC620 control unit (UL specification: RC620-UL)		
CPU	Standard : Intel® Celeron™ M Processor High-speed (option) : Intel® Core™ Duo Processor		
Controllable axes	Up to eight (8) connectable AC servo motors (Limited by the total motor power.)		
Robot manipulator control	Programming language and Robot control software	EPSON RC+ 6.0 (a multi-tasking robot language)	
	Joint Control	Up to eight (8) joints Simultaneous control Software AC servo control	
	Speed Control	PTP motion : Programmable in the range of 1 to 100% CP motion : Programmable (Actual value to be manually entered.)	
	Acceleration/deceleration control	PTP motion : Programmable in the range of 1 to 100%; Automatic CP motion : Programmable (Actual value to be manually entered.)	
	Connectable Manipulator	Max. 16 units (Max. 20 axes)	
Positioning control	PTP (Point-To-Point control) CP (Continuous Path control)		
Memory capacity	Maximum Object Size : 8 MB Point data area : 1000 points (per file) Backup variable area : Max. 400 kB (Includes the memory area for the management table.) Approx. 4000 variables (Depends on the size of array variables.)		
Teaching method	Remote Direct MDI (Manual Data Input)		
External input/output signals (standard)	Standard I/O	Input : 24 Output : 16	Including 8 inputs, 8 outputs with remote function assignment change allowed
	Standard I/O (Drive Unit)	Input : 24 Output : 16	per Drive Unit
Communication interface (standard)	Ethernet	2 channel	Refer to <i>Setup & Operation: 6.1 LAN (Ethernet Communication) Port</i>
	RS-232C	1 or 2 channel	Depends on CPU Board

Item	Specification		
Special slot (Max. 4 slots)	I/O	Input : 32 per board Output : 32 per board	Addition of 4 boards allowed
	RS-232C	4ch per board	Addition of 2 boards allowed
	Fieldbus I/O slave	1ch per board PROFIBUS-DP DeviceNet CC-Link EtherNet/IP PROFINET	Addition of 1 board allowed
	Pulse Generator	Number of Controlling axis 4ch per board	Addition of 4 boards allowed
PCI slot	Frame grabber	Standard frame grabber Advanced frame grabber	Addition of 2 board allowed
	FieldbusI/O master	1ch per board PROFIBUS-DP DeviceNet EtherNet/IP	Addition of 1 board allowed
Safety features	<ul style="list-style-type: none"> - Emergency stop switch - Safety door input - Low power mode - Dynamic brake - Encoder cable disconnection error detection - Motor overload detection - Irregular motor torque (out-of-control Manipulator) detection - Motor speed error detection - Positioning overflow - servo error - detection - Speed overflow - servo error - detection - CPU irregularity detection - Memory check-sum error detection - Overheat detection at the Motor Driver Module - Relay welding detection - Over-voltage detection - AC power supply voltage reduction detection - Temperature error detection - Fan error detection 		
Power Source	AC 200 V to AC 240 V Single phase 50/60 Hz		
Maximum Power Consumption	2.5 kVA (Depending on the Manipulator model)		
Insulation Resistance	100 MΩ or more		
Rated Ambient Temperature	5 to 40 deg.C		
Rated Relative Humidity	20% to 80% (with no condensation)		

Item	Specification
Weight *1	4 axes spec : 22.5 kg
	6 axes spec : 24.5 kg
	8 axes spec : 25.5 kg

*1 Weight of the unit is indicated on the Controller itself.

Make sure to check the weight before units transfer or relocation and prevent throwing out your back at holding the unit.

Also, make sure to keep your hands, fingers, and feet safe from being caught or serious injury.

1.3 Outer Dimensions

NOTE  Dimension of RC620-UL is the same as RC620.

[Unit : mm]

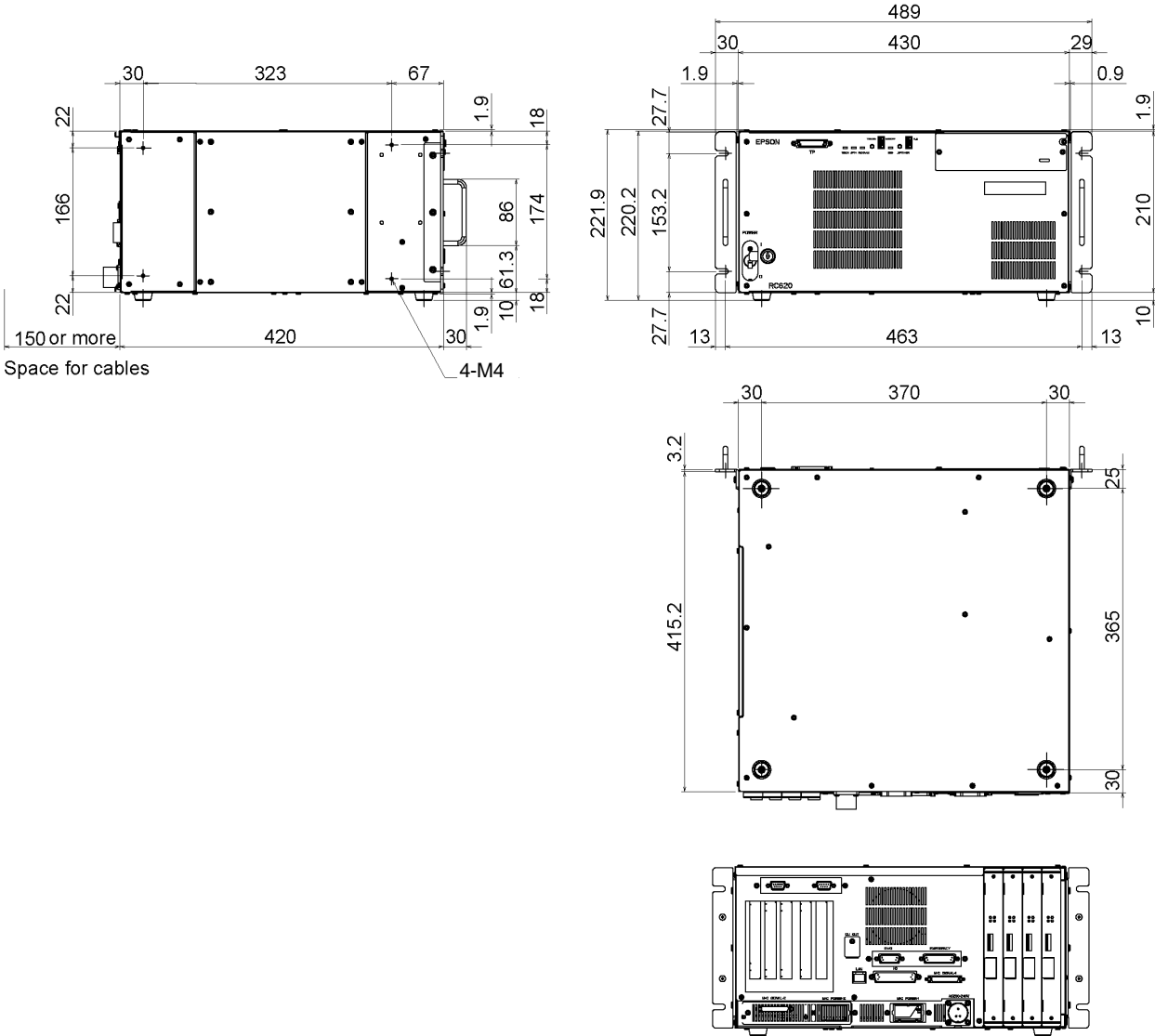

2. Part Names and Functions

2.1 Part Names

Front RC620

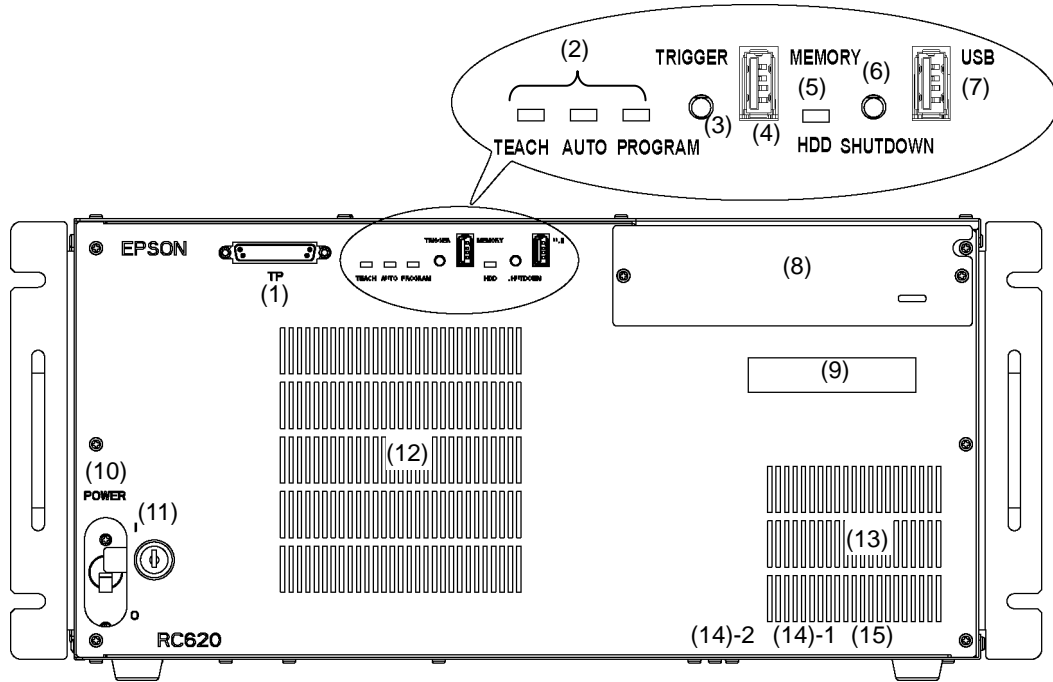

RC620-UL (Side and Back are the same as RC620.)

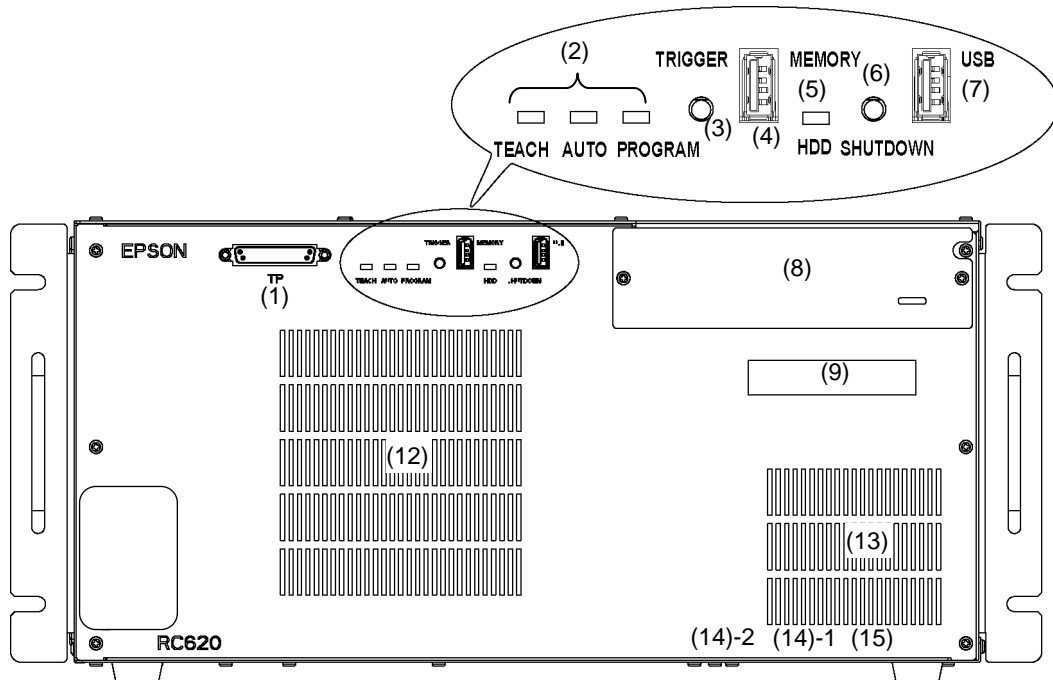

Side

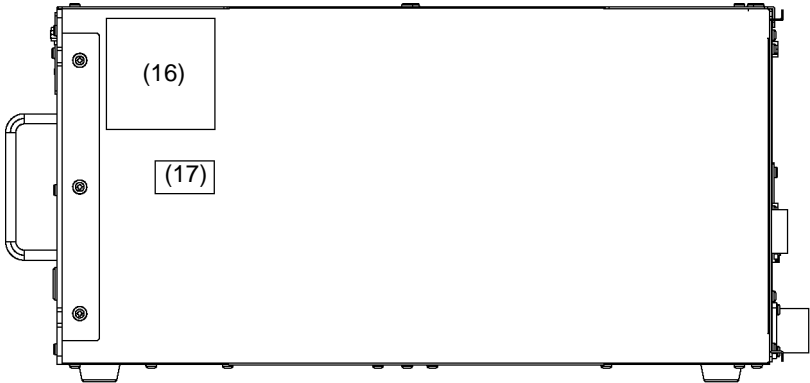

Back

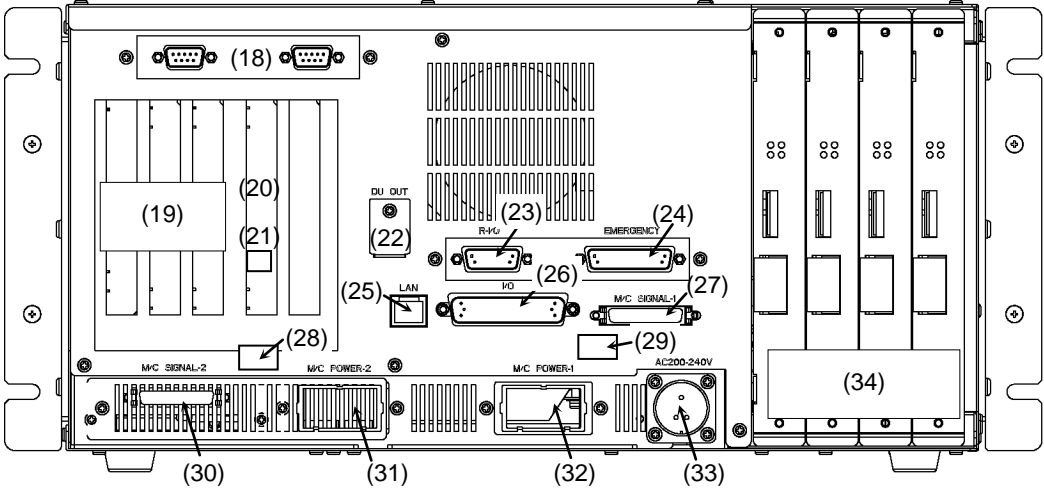

2.2 Functions

(1) TP port

Connects Teach Pendant TP1 (Option).

For details, refer to *Setup & Operation 7. TP Port*.



- When connecting the Teach Pendant (option) to the TP port, make sure the connector is right side up.

- Do not connect the following to the TP port of RC620. Connecting to the followings may result in malfunction of the device since the pin assignments are different.

OPTIONAL DEVICE dummy plug

Operation Pendant OP500

Operator Pendant OP500RC

Operator Panel OP1

Jog Pad JP500

Teaching Pendant TP-3**

(2) LED

The LED indicates current operation mode (TEACH, AUTO, or PROGRAM mode).

For details, refer to *Setup & Operation 2.3 LED and LCD*.

(3) Trigger Switch

This switch is for Controller status storage function using the USB memory.

For details, refer to *Setup & Operation 5. Memory Port*.

(4) Memory port

This port connects the common USB memory for Controller status storage function. Do not connect other USB devices except the USB memory.

For details, refer to *Setup & Operation 5. Memory Port*.

(5) HDD access LED

This LED displays the HDD access condition.

(6) Shutdown switch

If you want to shutdown the Windows when the keyboard is not connected, use this switch (turn it on).

Also, if for some reason you cannot shutdown normally, press this switch for more than 5 seconds, the ATX power inside the controller is turned off.

(7) USB port

This port is for the USB device such as USB memory.

(8) DVD drive (option)

You can install the optional DVD drive.

(9) LCD

The LCD of 2 lines × 20 characters displays the line number and the status of the controller (error number, warning number, status of Emergency Stop and Safety Door).

For details, refer to *Setup & Operation 2.3 LED and LCD*.

(10) POWER switch

Turns ON or OFF the Controller.

* This is not available for RC620-UL.

For details, refer to *Setup & Operation 3.3.2 AC Power Cable, For RC620-UL*.

(11) Lockout key for POWER switch

Lock the POWER switch in Off status. You need this method in the maintenance or repair of the robot system and make sure the power is locked in Off status and other operators cannot operate.

* This is not available for RC620-UL.

For details, refer to *Setup & Operation 3.3.2 AC Power Cable, For RC620-UL*.

(12) Large Fan Filter

A protective filter is installed in front of the fan to filter out dust.

Check the condition of the filter regularly and clean it when necessary. A dirty filter may result in malfunction of the robot system due to temperature rise of the Controller.

(13) Small Fan Filter

A protective filter is installed in front of the fan to filter out dust.

Check the condition of the filter regularly and clean it when necessary. A dirty filter may result in malfunction of the robot system due to temperature rise of the Controller.

(14) Controller Number label

The serial number of the Controller is indicated.

(15) Drive Unit Serial Number Label

The label indicates the DU number and serial number of Drive Unit. When connecting Drive Unit, this label is attached according to the number of Drive Unit(s).

(16) Signature label

The serial number of the Controller and other information are shown.

(17) MT label

The label indicates the specification number for the customized Manipulator and is attached only to the customized Manipulator. If your Manipulator indicates this label, it may require a specific maintenance procedure. In this case, make sure to contact your dealer before performing any maintenance procedures.

(18) Connector panel for CPU board (option)

This panel is for the installation of USB port and COM port on the CPU board.

Note that each CPU board type has different available connector.

(19) PCI slot

PCI board can be installed.

For the option, we provide the Frame Grabber board and Fieldbus I/O master board.

For details, refer to *Setup & Operation 11. Option Slot*.

(20) CPU board slot

CPU board can be installed.

(21) LAN (Ethernet communication) port 2

This port (LAN-2) is for the Controller and the Ethernet cable. The general port.

For details, refer to *Setup & Operation 6. LAN (Ethernet Communication) Port*.

(22) DU OUT connector (option)

This connector is for Drive Unit.

(23) R-I/O connector

This connector is for the input signals used for the real time I/O function.

(24) EMERGENCY connector

This connector is for input/output from/to Emergency Stop and Safety Door switches. For details, refer to the *Setup & Operation 8. EMERGENCY*.

(25) LAN (Ethernet communication) port1

This port (LAN-1) is for the Controller and the Ethernet cable. The SPEL⁺ dedicated port.

For details, refer to *Setup & Operation 6. LAN (Ethernet Communication) Port*.

(26) I/O connector

This connector is for input/output device. There are 24 inputs and 16 outputs.

For details, refer to *Setup & Operation 9. I/O Connector*.

(27) M/C SIGNAL connector 1

This connector is for signals such as the Manipulator's motor encoders etc.

Connect the Manipulator's dedicated signal cable.

(28) Connection Check label 2 (option)

The details of the Manipulator to be connected are recorded on the label as shown in the right. The label indicates the Manipulator model and Manipulator serial number.

MANIPULATOR	
G3-351S	00003

(29) Connection Check label 1

The details of the Manipulator to be connected are recorded on the label as shown in the right. The label indicates the Manipulator model and Manipulator serial number.

MANIPULATOR	
G3-351S	00002

(30) M/C SIGNAL connector 2 (option)

This connector is for signals such as the Manipulator's motor encoders etc.

Connect the Manipulator's dedicated signal cable.

(31) M/C POWER connector 2 (option)

This connector is for the Manipulator power source.

Connect the dedicated power cable attached to the Manipulator.

(32) M/C POWER connector 1

This connector is for the Manipulator power source.

Connect the dedicated power cable attached to the Manipulator.

(33) AC IN connector

This connector is for AC 200V power input.

For details, refer to *Setup & Operation 3.3.2 AC Power Cable*.

(34) Special slot

Option boards such as expansion I/O board, Fieldbus I/O slave board, RS-232C board, Pulse generating board can be installed.

For details, refer to *Setup & Operation 11. Option Slots*.

2.3 LED and LCD

LED and LCD

Four LEDs and a LCD (2 lines × 20 characters) are located on the front panel of the Controller.

LED

LED	Status
TEACH AUTO PROGRAM	LED (TEACH, AUTO, PROGRAM) turns ON according to the current operation mode (TEACH, Auto, Program).
HDD	It lights up during the HDD access.

LCD : Indicates the line number and Controller status (error number, warning number, Emergency Stop or Safeguard status)

From turning ON the Controller to completing startup

LED : All three LEDs blink.

LCD : The 1st line lights up and the 2nd line is turned off for approx. 10 seconds.

Then for few seconds, it displays as below:

EPSON Robot Controller

After Controller Startup

LED : LED (TEACH, AUTO, PROGRAM) turns ON according to the current operation mode (TEACH, Auto, Program).

LCD : The display varies depending on the controller status.

The basic layout is shown below:

1 st Line	<Status> EStop Safety
2 nd Line	<Message>

Status	Displays the controller condition. Blinking indicates that the controller is running.
EStop	Indicates the Emergency status.
Safety	Indicates the Safeguard Open.
Message	Displays a message according to the status.

In the Error status or Pause status, it displays as below. This is because the information of <status> is too many. (Estop : EP / Safety : SG)

1 st Line	<Status> EP SG
2 nd Line	<Message>

When several Controller statuses occurred at one time, the status indicated earlier on the following table is displayed. For an example, when both “Error” and “Teach” occurred at one time, “Error” is displayed.

Controller status	Display of LCD
Execute Controller status storage function to the USB memory	- - Status Backup
Complete Controller status storage to USB memory	-OK- Backup OK (for 2 seconds)
Failure of Controller status storage to USB memory	-NG- Backup Failed (for 2 seconds)
Wait for RC+ startup	---- Waiting for RC+
Error	Err2200 r01a03 Robot in use. Cannot *1
TEACH	---- Teach V.6.0.0.1
READY	---- Ready V.6.0.0.1 *2
PAUSE	Task123 P1234 Paused *2
START	Task123 L1234 Tasks Running *2

*1 For error numbers and warning numbers, refer to *SPEL⁺ Language Reference manual*.
The 1st line displays “Err” and 4 figures.

For the error numbers, refer to the *SPEL⁺ Language Reference manual*.

XX in rXXaYY is a robot number and YY is an axis number.

00 is displayed for errors unrelated to the robot or axis.

The 2nd line displays the error message.

If the message is long, scroll the message for display.

*2 The 2nd line displays the firmware version number.

However if the warning occurs, it displays the warning number. It displays the user message when Print #28 specifies the message.

*3 The 1st line displays “Task” and a task number in 3 figures, and “L” or “P” and an execution line in 4 figures. In initial status, execution line of task number 1 is displayed in three-digit.

Use Ton statement to change the displayed task number.

For details, refer to *SPEL⁺ Language Reference manual* or *Online Help*.

The 2nd line displays “Tasks Running” or “Paused”.

However if the warning occurs, it displays the warning number. It displays the user message when Print #28 specifies the message.

Particular Status Display

When particular status occurs, LCD displays the followings.

LCD	Status
Initialize Error 16	Controller startup failure *1
P_*** Controller startup mode	Controller startup failure
9999 Recovery Mode	Controller in Recovery mode Refer to <i>Maintenance 4. Backup and Restore</i> .
9998 AC Power Off	AC power supply drop is detected and software shut down.
9997 Controller shutdown	Software shut down is specified from the EPSON RC+ 6.0 (software) or the SPEL ⁺ program.

*1 When the Initialize Error occurs, reboot the Controller. If the Initialize Error is displayed again after the Controller is rebooted, please contact the supplier of your region.

2.4 Safety Features

The robot control system supports safety features described below. However, the user is recommended to strictly follow the proper usage of the robot system by thoroughly reading the attached manuals before using the system. Failure to read and understand the proper usage of the safety functions is highly dangerous.

Among the following safety features, the Emergency Stop Switch and Safety Door Input are particularly important. Make sure that these and other features function properly before operating the robot system.

For details, refer to the *Setup & Operation 8. EMERGENCY*.

Emergency Stop Switch

The EMERGENCY connector on the Controller has expansion Emergency Stop input terminals used for connecting the Emergency Stop switches.

Pressing any Emergency Stop switch can shut off the motor power immediately and the robot system will enter the Emergency Stop condition.

Safety Door Input

In order to activate this feature, make sure that the Safety Door Input switch is connected to the EMERGENCY connector at the Controller.

When the safety door is opened, normally the Manipulator immediately stops the current operation, and the status of Manipulator power is operation-prohibited until the safety door is closed and the latched condition is released. In order to execute the Manipulator operation while the safety door is open, you must change the mode selector key switch on the Teach Pendant to the "Teach" mode. Manipulator operation is available only when the enable switch is on. In this case, the Manipulator is operated in low power mode.

Low Power Mode

The motor power is reduced in this mode.

Executing a power status change instruction will change to the restricted (low power) status regardless of conditions of the safety door or operation mode. The restricted (low power) status ensures the safety of the operator and reduces the possibility of peripheral equipment destruction or damage caused by careless operation.

Dynamic Brake

The dynamic brake circuit includes relays that short the motor armatures. The dynamic brake circuit is activated when there is an Emergency Stop input or when any of the following errors is detected: encoder cable disconnection, motor overload, irregular motor torque, motor speed error, servo error (positioning or speed overflow), irregular CPU, memory check-sum error and overheat condition inside the Motor Driver Module.

Encoder Cable Disconnection Error Detection

The dynamic brake circuit is activated when the Motor Encoder Signal cable is disconnected.

Motor Overload Detection

The dynamic brake circuit is activated when the system detects that the load on the motor has exceeded its capacity.

Irregular Motor Torque (out-of-control manipulator) Detection

The dynamic brake circuit is activated when irregularity with motor torque (motor output) is detected (in which case the Manipulator is out of control).

Motor Speed Error Detection

The dynamic brake circuit is activated when the system detects that the motor is running at incorrect speed.

Positioning Overflow –Servo Error- Detection

The dynamic brake circuit is activated when the system detects that the difference between the Manipulator's actual position and commanded position exceeds the margin of error allowed.

Speed Overflow –Servo Error- Detection

The dynamic brake circuit is activated when the Manipulator's actual speed is detected to mark an overflow (the actual speed is outside the nominal range) error.

CPU Irregularity Detection

Irregularity of CPU that controls the motor is detected by the watchdog timer. The system CPU and the motor controlling CPU inside the Controller are also designed to constantly check each other for any discrepancies. If a discrepancy is detected, the dynamic brake circuit is activated.

Memory Check-sum Error Detection

The dynamic brake circuit is activated when a memory check-sum error is detected.

Overheat Detection at the Motor Driver Module

The dynamic brake circuit is activated when the temperature of the power device inside the Motor Driver module is above the nominal limit.

Relay Deposition Detection

The dynamic brake circuit is activated when relay deposition, junction error, or open fault is detected.

Over-Voltage Detection

The dynamic brake circuit is activated when the voltage of the Controller is above the normal limit.

AC Power Supply Voltage Drop Detection

The dynamic brake circuit is activated when the drop of the power supply voltage is detected.

Temperature Anomaly Detection

The temperature anomaly is detected.

Fan Malfunction Detection

Malfunction of the fan rotation speed is detected.

3. Installation

3.1 Unpacking

TP/OP bypass plug	1 unit (Installed before shipment)
Lockout key	2 key
EMERGENCY port connector	1 set
I/O connector	1 set
PS/2 cable	1 cable
IDE cable *1	1 cable
	(If the DVD drive is installed, the wiring is already arranged.)
Power cable (3 m)	1 cable
EPSON RC+ 6.0 installer	1 DVD
Manual installer *2	1 CD

- *1 Required to connect IDE device. Be careful not to lose.
- *2 Attached when the manual(s) in the EPSON RC+ 6.0 installer DVD is revised.

3.2 Environmental Requirements

 WARNING	<ul style="list-style-type: none"> ■ The Manipulator and the Controller must be used within the environmental conditions described in their manuals. This product has been designed and manufactured strictly for use in a normal indoor environment. Using the product in the environment that exceeds the conditions may not only shorten the life cycle of the product but also cause serious safety problems.
--	--

3.2.1 Environment

In order to optimize the robot system’s performance for safety, the Controller must be placed in an environment that satisfies the following conditions:



The Controller is not designed for clean-room specification. If it must be installed in a clean room, be sure to install it in a proper enclosure with adequate ventilation and cooling. Install Controller in a location that allows easy connection / disconnection of cables.

Item	Condition
Ambient temperature	5 to 40 deg.C (with minimal variation)
Ambient relative humidity	20% to 80% (with no condensation)
First transient burst noise	2 kV or less (Power supply wire) 1 kV or less (Signal wire)
Electrostatic noise	4 kV or less
Base table	Use a base table that is at least 100 mm off the floor. Placing the Controller directly on the floor could allow dust penetration leading to malfunction.

If the Controller must be used in an environment that does not fulfill the conditions mentioned above, take adequate countermeasures. For example, the Controller may be enclosed in a cabinet with adequate ventilation and cooling.

- Install indoors only.
- Place in a well-ventilated area.
- Keep away from direct sunlight and radiation heat.
- Keep away from dust, oily mist, oil, salinity, metal powder or other contaminants.
- Keep away from water.
- Keep away from shocks or vibrations.
- Keep away from sources of electronic noise
- Prevent the occurrence of strong electric or magnetic field.

3.2.2 Installation

The controller can be placed vertically and horizontally.

When you place it vertically, place the left side (from front side view) down.

Also, put the rubber feet on the bottom to the left side.

Use the same screws for securing the rubber feet.

Position of set screws for rubber feet

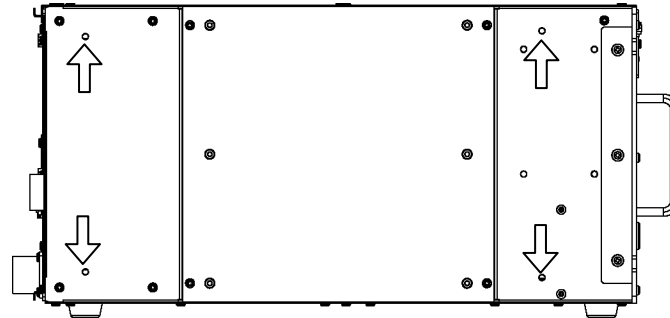

Make sure to keep the controller away from the peripherals for the air supply and exhaust.

Controller Front side: 100 mm // Rear side: 150 mm

The rear side exhausts the hot air (approx. 10 deg C higher than ambient temperature).

Therefore, make sure that heat sensitive devices are not placed near the outlet.

There must be room in front of the Controller so that the entire Controller can be pulled outward.

There must also be room behind the Controller so that one can attach and remove cables.

Use a base table that is at least 100 mm off the floor. Placing the Controller directly on the floor could allow dust penetration leading to malfunction.

3.3 Power Supply

3.3.1 Specifications

Ensure that the available power meets following specifications.

Item	Specification
Voltage	AC 200 V to AC 240 V
Phase	Single phase
Frequency	50/60 Hz
Momentary Power Interrupt	10 msec. Or less
Power Consumption	<p>Max. 2.5 kVA</p> <p>Actual consumption depends on the model, motion, and load of the Manipulator.</p> <p>For approximate power consumption of each model, refer to the followings.</p> <p>C3 : 1.2 kVA G1 : 0.5 kVA G3 : 1.1 kVA G6 : 1.5 kVA G10 : 2.4 kVA G20 : 2.4 kVA RS3 : 1.2 kVA RS4 : 1.4 kVA</p> <p>Refer to Manipulator manual for Manipulator rated consumption.</p> <p>Rated power consumption of X5 varies depending on the manipulator model. For details, please contact us.</p>
Peak Current	<p>When power is turned ON : approx. 80 A (2 msec.)</p> <p>When motor is ON : approx. 50 A (5 msec.)</p>
Leakage Current	Max. 10 mA
Ground Resistance	100 Ω or less

Install an earth leakage circuit breaker or a circuit breaker in the AC power cable line at 15 A or less rated electric current. Both should be a two-pole disconnect type. If you install an earth leakage circuit breaker, make sure to use an inverter type that does not operate by induction of a 10 kHz or more leakage current. If you install a circuit breaker, please select one that will handle the above mentioned "peak current".

The power receptacle shall be installed near the equipment and shall be easily accessible.

3.3.2 AC Power Cable

 WARNING	<ul style="list-style-type: none"> Make sure that cable manufacturing and connection are done by a qualified personal. When proceeding, be sure to connect the earth wire of the AC power cable colored green/yellow on the Controller to the earth terminal of the factory power supply. The equipment must be grounded properly at all times to avoid the risk of electric shock. Always use a power plug and receptacle for power connecting cable. Never connect the Controller directly to the factory power supply. (Field wiring)
---	---

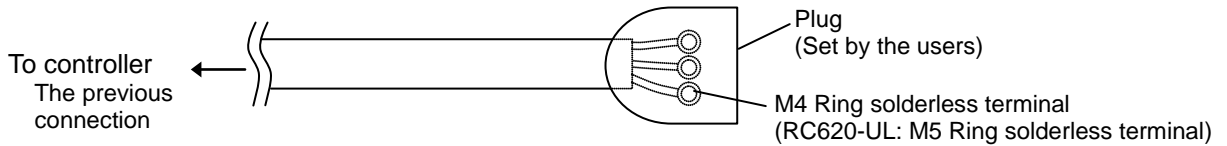

The AC plug is not attached to the AC power cable delivered at shipment.

Refer to the wire connection specification and attach a proper plug to the cable that is suitable for the factory power supply. (A plug is prepared as option.)

Cable Wire Connection Specification

Purpose	Color
AC power wire (2 cables)	Black
Ground wire	Green / Yellow

Cable length : 3 m (Standard)

For RC620-UL

 WARNING	<ul style="list-style-type: none"> Branch Circuit protection (Rated current: 15 A or less) shall be installed in the external AC power supplying side in accordance with the National Electrical Code. A disconnecting means shall be installed in accordance with the National Electrical Code and provide the ability for lockout and tagout.
---	--

3.4 Cable Connection

 WARNING	<ul style="list-style-type: none"> Make sure that the power to the Controller is turned OFF and the power plug is disconnected before connecting or disconnecting any cables. Connecting or disconnecting any cables with the power ON is extremely hazardous and may result in electric shock and malfunction of the Controller. Be sure to connect the cables properly. Do not allow unnecessary strain on the cables. (Do not put heavy objects on the cables. Do not bend or pull the cables forcibly.) The unnecessary strain on the cables may result in damage to the cables, disconnection, and/or contact failure. Damaged cables, disconnection, or contact failure is extremely hazardous and may result in electric shock and/or improper function of the system.
---	---

 CAUTION	<ul style="list-style-type: none"> The serial number of the Manipulator that should be connected is indicated on the Connection Check Label on the Controller. Connect the Controller and the Manipulator correctly. Improper connection between the Controller and the Manipulator may cause not only improper function of the robot system but also safety problems. Before connecting the connector, make sure that the pins are not bent. Connecting with the pins bent may damage the connector and result in malfunction of the robot system.
---	---

3.4.1 Typical Cable Connection

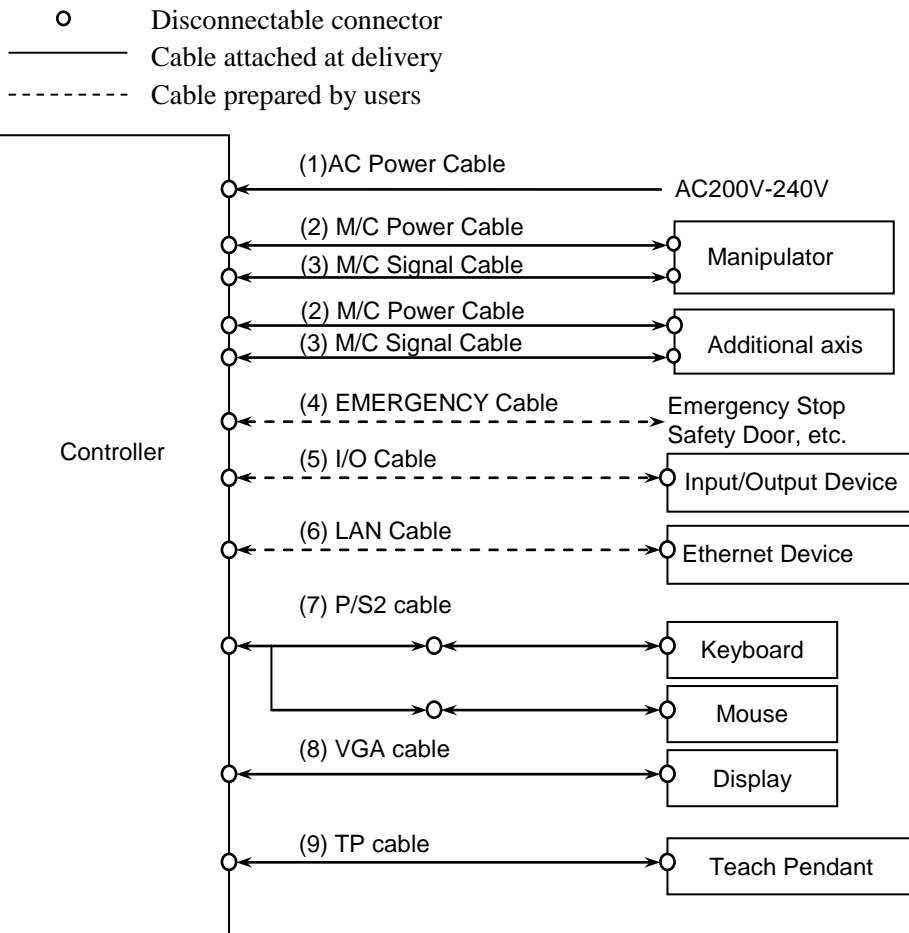



- (1) AC Power cable
 Cable for AC 200V power input to the Controller.
- (2) M/C Power cable
 Connect the motor power signals between the Manipulator and Controller. Insert the connectors on the Controller until you hear a “click”.
- (3) M/C Signal cable
 Connect the encoder signals between the Manipulator and the Controller. Secure this cable to the Controller for sure using the set screws on both sides of the Controller.
- (4) EMERGENCY cable
 The EMERGENCY connector has inputs to connect the Emergency Stop switch and the Safe Giard switch. For safety reasons, connect proper switches for these input devices.
 For details, refer to the *Setup & Operation 8. EMERGENCY*.

- (5) I/O cable
This connector is used for external input/output devices.
For details, refer to the *Setup & Operation 9. I/O Connector*.
- (6) LAN (EtherNet) cable
Connect the EtherNet device.
For details, refer to the *Setup & Operation 6. LAN (Ethernet Communication) Port*.
- (7) PS/2 cable
Dual-head cable for the connection of keyboard and mouse.
Use the cable attached to the product.
Check the mark of mouse and keyboard on the tip of the PS/2 cable and connect it correctly.
- (8) VGA cable
Connect the Display.
- (7) TP cable
Connect the option Teach Pendant.
For details, refer to the *Setup & Operation 7.TP Port*.

3.4.2 Connecting Manipulator to Controller

Connect the Manipulator to the Controller by using the Power cable and the Signal cable.

 WARNING	<ul style="list-style-type: none"> ■ Make sure that the power to the Controller is turned OFF before connecting or disconnecting any cables. Connecting or disconnecting any cables with the power ON is extremely hazardous and may result in electric shock and malfunction of the Controller. ■ Be sure to connect the cables properly. Do not allow unnecessary strain on the cables. (Do not put heavy objects on the cables. Do not bend or pull the cables forcibly.) The unnecessary strain on the cables may result in damage to the cables, disconnection, and/or contact failure. Damaged cables, disconnection, or contact failure is extremely hazardous and may result in electric shock and/or improper function of the system.
 CAUTION	<ul style="list-style-type: none"> ■ The serial number of the Manipulator that should be connected is indicated on the Controller. Connect the Controller and the Manipulator correctly. Improper connection between the Controller and the Manipulator may cause not only improper function of the robot system but also serious safety problems. ■ When connecting two manipulators to the Controller, make sure to refer to the serial number label and connect them correctly.



The Manipulator's serial number is indicated on the signature label on the back of the Manipulator.

3.5 Noise Countermeasures

To minimize electrical noise conditions, the following items must be observed in the system's cable wiring:

To minimize electrical noise condition, be sure of followings for wiring.

- The earth wire of the power supply should be grounded. (Ground resistance: 100 Ω or less) It is important to ground the frame of Controller not only for prevention from electric shock, but also for reducing the influence of electric noise around the Controller. Therefore, be sure to connect the earth wire (yellow/green) of the Controller's power cable to the ground terminal of the factory power supply. For details about the plug and AC power cable, refer to the *Setup & Operation 3.3 Power Supply*.
- Do not tap power from a power line that connects to any equipment which may cause noise.
- When you tap power for the Controller and the single-phase AC motor from the same power line, change the phase of one or the other. Ensure that they will not be the same phase.
- Use a twisted pair motor power line.
- Do not run AC power lines and DC power lines in the same wiring duct, and separate them by at least 200 mm. For example, separate the AC motor power line and the Controller power line by at least 200 mm from the sensor or valve I/O lines; and do not bundle both sets of wiring with the same cable tie. If more than one duct/cable must cross each other, they should cross perpendicularly. The preferable example is shown in the right figure.
- Wire as short as possible to the I/O connector and EMERGENCY connector. Use a shielded cable and clamp the shield to the attached connector interior. Make sure to keep away from the peripheral noise source as far as possible.
- Make sure that the induction elements used to connect to the Controller's I/O (such as relays and solenoid valves) have surge suppressors. If an induction element without a surge suppressor is used, make sure to connect a rectifying diode located at the induction element in parallel with it. In selecting a rectifying diode, make sure that it can handle the voltage and current incurred by the induction load.
- To start and change revolutions of the conveyer's (or the like's) AC motor (ex: an induction motor or three-phase induction motor) regularly or abruptly, make sure to install a spark suppressor between the wires. The spark suppressor is more effective when placed closer to the motor.
- As they are easily influenced by static electricity or the noise from power source, keep cable such as USB, Ethernet, RS-232C, or fieldbus away from peripheral noise sources.

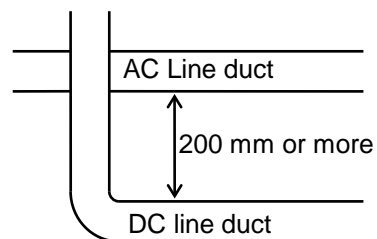

4. Operation Mode (TEACH/AUTO)

4.1 Overview

The Robot system has two operation modes TEACH mode and AUTO mode.

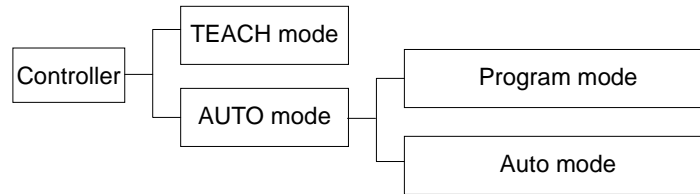

TEACH mode This mode enables point data teaching and checking close to the Robot using the Teach Pendant.
In this mode the Robot operates in Low power status.

AUTO mode This mode enables automatic operation (program execution) of the Robot system for the manufacturing operation, and also programming, debug, adjustment, and maintenance of the Robot system.
This mode cannot operate the Robots or run programs with the Safety Door open.

4.2 Switch Operation Mode

Change the operation mode using the mode selector key switch on the Teach Pendant.

TEACH mode Turn the mode selector key switch to “Teach” for TEACH mode.
Switching to TEACH mode pauses the program if it was running.
Only the background tasks continue running.
The operating Robot stops by Quick Pause.

AUTO mode Turn the mode selector key switch to “Auto” and turn on the latch release input signal for AUTO mode.

4.3 Program Mode (AUTO)

4.3.1 What is Program Mode (AUTO)?

Program mode is for programming, debug, adjustment, and maintenance of the Robot system.

Procedures for switching to the Program mode are the followings.

Set the start mode of the EPSON RC+ 6.0 to “Program” and start up the Controller.

4.3.2 Setup from EPSON RC+ 6.0

Switch the start mode to Program mode from the EPSON RC+ 6.0.

- (1) Select EPSON RC+ 6.0 menu | Setup | System Configuration to display the [System Configuration] dialog.

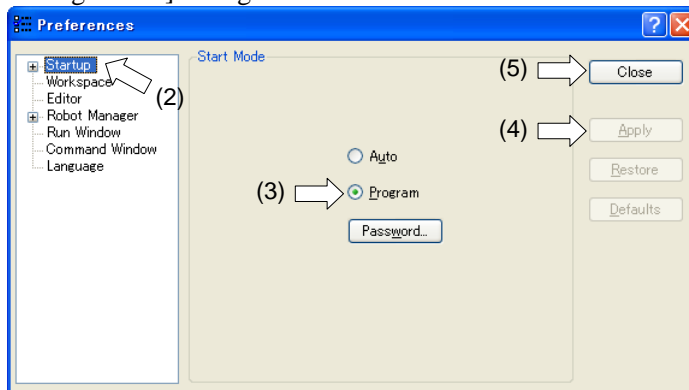

- (2) Select [Startup].
- (3) Select [Start mode]-<Program> button.
- (4) Click the <Apply> button.
- (5) Click the <Close> button.

4.4 Auto Mode (AUTO)

4.4.1 What is Auto mode (AUTO)?

Auto mode (AUTO) is for automatic operation of the Robot system.

Procedures for switching to the Auto mode (AUTO) are the followings.

A : Set the start mode of the EPSON RC+ 6.0 to “Auto” and start the Controller.

B : Set the Controller to the Independent mode.

NOTE Execute and stop the program from the control device specified by the EPSON RC+ 6.0.
 (Refer to 4.4.3 *Setup Control Device*.)



4.4.2 Setup EPSON RC+ 6.0

Switch the Start mode to Auto mode (AUTO).

- (1) Select EPSON RC+ 6.0 menu | Setup | System Configuration to display the [System Configuration] dialog.

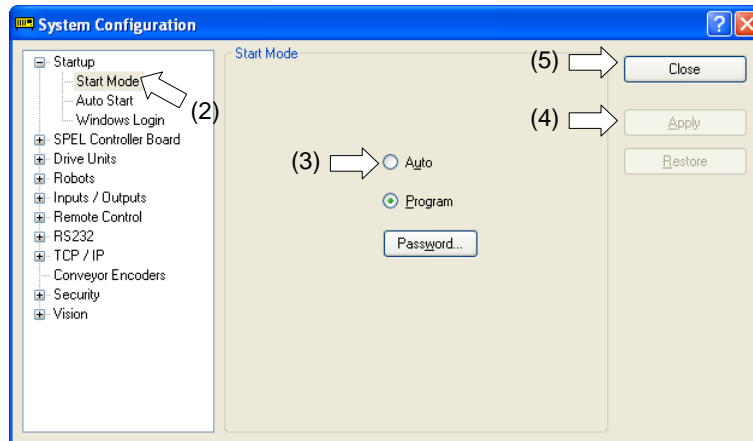

- (2) Select [Startup].
- (3) Select [Start Mode]-<Auto> button.
- (4) Click the <Apply> button.
- (5) Click the <Close> button.

Set the Controller to Independent mode.

- (1) Select EPSON RC+ 6.0 menu | Setup | System Configuration to display the [System Configuration] dialog.
- (2) Select SPEL Controller Board | Preference.

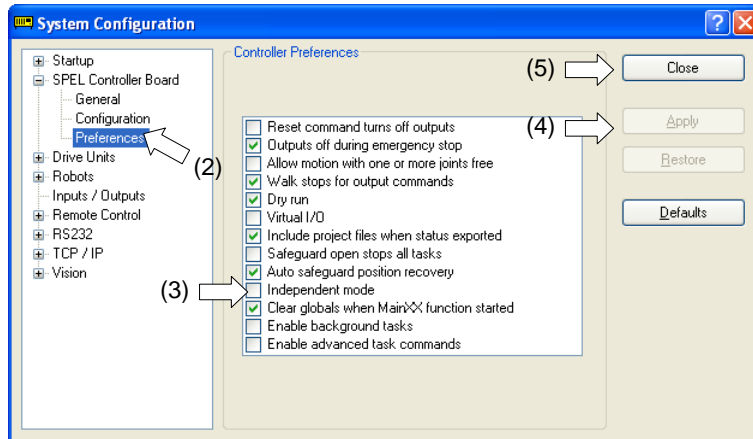

- (3) Check [Independent Mode] check box.
- (4) Click the <Apply> button.
- (5) Click the <Close> button.

For the details of Independent mode, refer to the *EPSON RC+6.0 Users Guide: 4.2.1 Startup Sequence – Cooperative mode and Independent mode*.

4.4.3 Setup from Control Device

Set the control device from EPSON RC+ 6.0.

- (1) Select EPSON RC+ 6.0 menu | Setup | System Configuration to display the [System Configuration] dialog.

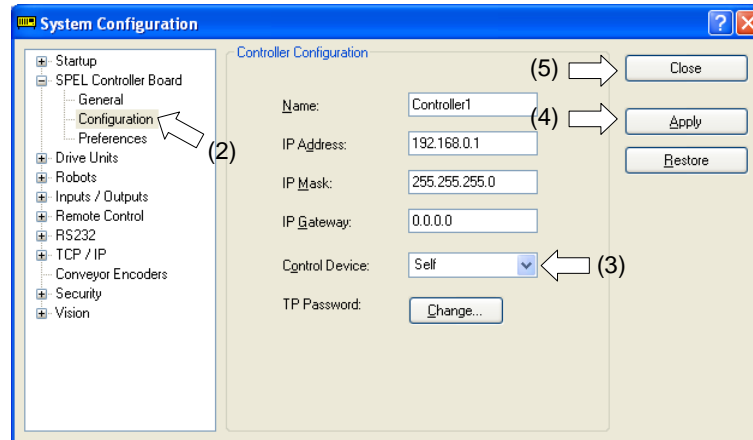

- (1) Select SPEL Controller Board | Configuration.
- (2) Select Setup Controller | Control Device to select the control device from the following two types.
Self Remote (I/O)
- (3) Click the <Apply> button.
- (4) Click the <Close> button.

5. Memory Port

Connect a commercial USB memory to the Controller memory port for following functions.

- Function for Controller status storage to the USB memory.
- Function for read & write to the USB memory from the SPEL⁺ program.

For the file operation of the USB memory, refer to the *SPEL⁺ Language Reference manual* or *Online Help - ChDisk* or *ROpen*.

 CAUTION	<ul style="list-style-type: none"> ■ Security support for the USB memory Make sure the USB memory is not infected with virus when connecting to the Controller. ■ If you power on the Controller with the USB memory inserted, the Controller cannot start up normally. Make sure the USB memory is not inserted before you power on the Controller.
--	--

5.1 What is Controller Status Storage Function?

This function saves various kinds of Controller data with one push to the USB memory. Data saved in USB memory is loaded to EPSON RC+ 6.0 to get the status of the Controller and the program simply and accurately.

The saved data can also be used for restoring the Controller. For details, refer to *Maintenance 4.4 Restore*.

5.2 Before Using Controller Status Storage Function

5.2.1 Precautions

 CAUTION	<ul style="list-style-type: none"> ■ Controller status storage function is available at any time and in any Controller status after starting the Controller. However, operations from the console including stop and pause are not available while executing this function. Also, this function influences the robot cycle time and the communication with EPSON RC+ 6.0. Other than only when it is necessary, do not execute this function when operating the robot.
--	---

- Make sure that the USB port is used only for USB memory even though the port on the Controller is a universal USB port.
- Insert the USB memory directly into the Controller memory port. Connection with cables or hubs between the Controller and the USB memory is not assured.
- Make sure that the USB memory is inserted or removed slowly.
- Do not edit the saved files with an editor. Operation of the robot system after data restoration to the Controller is not assured.

5.2.2 Adoptable USB Memory

Use USB memory that meets the following conditions.

- USB2.0, USB1.1 supported
- Without security function
 - USB memory with password input function cannot be used.
- No installation of a driver or software is necessary for Windows.
- Without encryption protection or security software.

Note that the conditions above are no guarantee of your USB memory availability with the Controller.

The Controller cannot recognize some types of the USB memory.

5.3 Controller Status Storage Function

5.3.1 Controller Status Storage with Trigger Button

Use this procedure to save the status of the Controller to USB memory.

- (1) Insert the USB memory into the memory port.
- (2) Wait approximately 10 seconds for USB memory recognition.
- (3) Press the trigger button on the Controller.

The LCD displays the following repeatedly during the data transfer.

- -
Status Backup

--
Status Backup

Wait for the display to turn back to the normal. (Data transfer time depends on the project size, etc..)

- (4) When the storage has been completed, LCD displays as below for two seconds.

-OK-
Backup OK

When the storage has failed, LCD displays as below for two seconds.

-NG-
Backup Failed

- (5) Remove the USB memory from the Controller.

NOTE



- USB memory with LED is recommended to check the status changes in procedure (2).
- When storage is executed during Motor ON status, it may fail to store the status. Use another USB memory or execute the storage during Motor OFF status.

5.3.2 Controller Status Storage with Teach Pendant (Option)

Use this procedure to save the status of the Controller to the USB memory.

- (1) Insert the USB memory into the Controller.
- (2) In the [Main Menu] screen, move the cursor to [Controller States...], and press the <OK> key. The following screen appears.

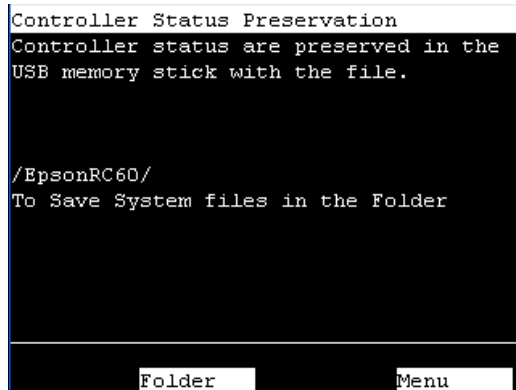

- (3) Select a folder to save the data.
The root directory is selected by default.
- (4) Press the <OK> key to save the status.

5.3.3 Load Data with EPSON RC+ 6.0

The following shows the procedure to read the data stored in the USB memory by EPSON RC+ 6.0 and display the Controller status.

- (1) Insert the USB memory into the PC with EPSON RC+ 6.0.
- (2) Make use that the following folder is indicated in the USB memory.
S_ serial number_data status was saved
→ Exmample: S_12345_200608074410
- (3) Copy the folder confirmed in procedure (2) to the “\EpsonRC60\Status” folder.
- (4) Select the EPSON RC+ 6.0 menu | Tools | Controller to display the [Controller Tools] dialog.

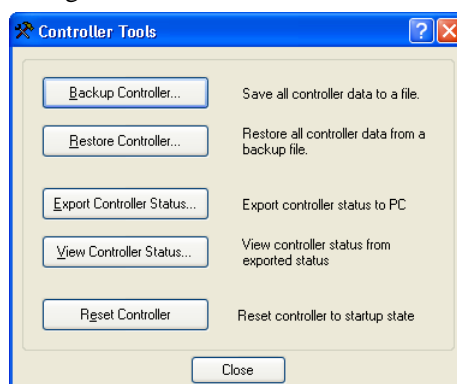

- (5) Click the <Export Controller Status...> button.

- (6) [Browse For Folder] dialog appears. Select the folder copied in procedure (3) and click the <OK> button.

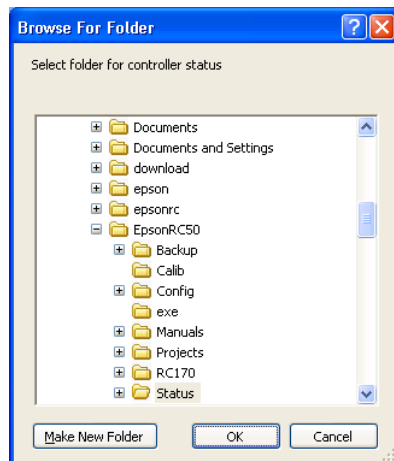

- (7) [Controller Status Viewer] dialog appears to confirm the Controller status. For details, refer to *View Controller Status* in *EPSON RC+ 6.0 User's Guide 5.11.7 Controller Command (Tools Menu)*.

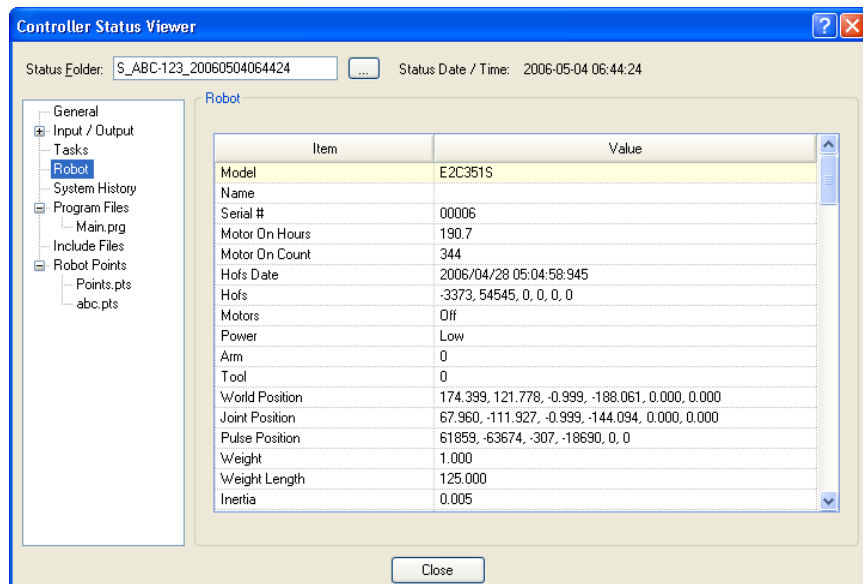

5.3.4 Transfer with E-mail

Follow this procedure to transfer the data by e-mail that was saved to the USB memory.

- (1) Insert the USB memory to a PC that supports sending of e-mail.
- (2) Make sure that the USB memory has following folders.
S_serial number_data status was saved
→ Example: S_12345_200608074410
- (3) Send all the folders by e-mail.



- Delete files that do not relate to the project before transfer.
- This function is used to send the data to the system director and EPSON from the end users for problem analysis.

5.4 Details of Data

The following data files are created by the Controller status storage function.

File Name	Outline	
Backup.txt	Information file for restore	File with information for Controller restore.
CurrentMnp01.PRM : CurrentMnp16.PRM	Robot parameter	Saves information such as ToolSet. (for each robot)
CurrentStatus.txt	Save status	Saves program and I/O status.
ErrorHistory.csv	Error history	
InitFileSrc.txt	Initial setting	Saves various settings of the Controller.
MCSys01.MCD : MCSys16.MCD	Robot setting	Saves information of connected robot. (for each robot)
SrcmcStat.txt	Hardware information	Saves installation information of hardware.
ProjectName.obj	OBJ file	Result of project build. Prg file is not included.
GlobalPreserves.dat	Global Preserve variables	Saves values of Global Preserve variables.
MCSRAM.bin MCSYSTEMIO.bin MCTABLE.bin MDATA.bin VXDWORK.bin	Inner information of Robot operation	
All files related to project except ProjectName.obj	Project	When [Include project files when status exported] check box is checked in EPSON RC+ 6.0 menu Setup System Configuration Controller Preference, the project file is stored. Includes program files.
ProjectName.vis VisHWConfig.dat	Vision	When the Vision Guide option is used, the file is stored.
RCSam.dat	RC+	When the Security option is used, the file is stored.

6. LAN (Ethernet Communication) Port

- NOTE**  - For Ethernet (TCP/IP) communication with robot application software, refer to *EPSON RC+ 6.0 Online Help* or *User's Guide 12. TCP/IP Communications*.
- Refer to *EPSON RC+6.0 option Vision Guide 6.0* manual for other details of connection of the Controller and the Smart Camera.
- This port is not used for EtherNet/IP. Use the port for fieldbusI/O board. For other details, refer to *Robot Controller RC620 option Fieldbus I/O manual*.



- Security support for the network connection
- The network connecting function (Ethernet) on our products assumes the use in the local network such as the factory LAN network. Do not connect to the external network such as Internet.
- In addition, please take security measure such as for the virus from the network connection by installing the antivirus software.

6.1 About the LAN (Ethernet Communication) Port

The RC620 Controller has two ports: LAN-1 and LAN-2. Both are Ethernet communication ports and support 100BASE-TX / 10 BASE-T. These two ports are used for the following purposes.

LAN-1 port (SPEL⁺ dedicated Ethernet port)

Connection with other Controller or PC

This port can be used as an Ethernet (TCP/IP) communication port to communicate between multiple controllers from robot application software.

Connection with Smart Camera (when the program starts running)

This port can be used for connection of the Controller and the Smart Camera when you execute commands such as VRun from the robot application software.

LAN-2 port (General Ethernet port)

General Ethernet connection from the application on the Windows

This port can be used for the general-use Ethernet connection from the application on the Windows or OS.

Connection with the Smart Camera (when creating the sequence)

This port can be used for the connection of the Controller and the Smart Camera when you create the Smart camera sequence or display the live image.



When using the Smart Camera, the both LAN-1 and LAN-2 must be connected.

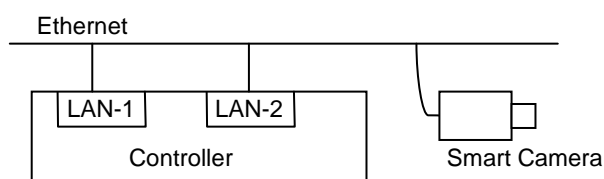

6.2 IP Address

Set the proper IP address or subnet mask depending on the Controller configuration to use the LAN port.

Use an address from the following Private Address List in the closed network environment such as P2P or production line. Also, make sure the address is not redundantly assigned inside the closed network.

In other cases, check with the network administrator.

Private Address List

10.0.0.1	to	10.255.255.254
172.16.0.1	to	172.31.255.254
192.168.0.1	to	192.168.255.254

Configuration of the controller at shipment:

LAN-1 port

IP Address : 192.168.0.1
 IP Mask : 255.255.255.0
 IP Gateway : 0.0.0.0

* LAN-1 port cannot automatically acquire the IP address (not support DHCP).

LAN-2 port

This port can acquire the IP address automatically.

6.3 Changing IP Address

6.3.1 LAN-1 port

Change the IP address of LAN-1 port.

- (1) Select the EPSON RC+ 6.0 menu | Setup | Controller to display the [Setup Controller] dialog.

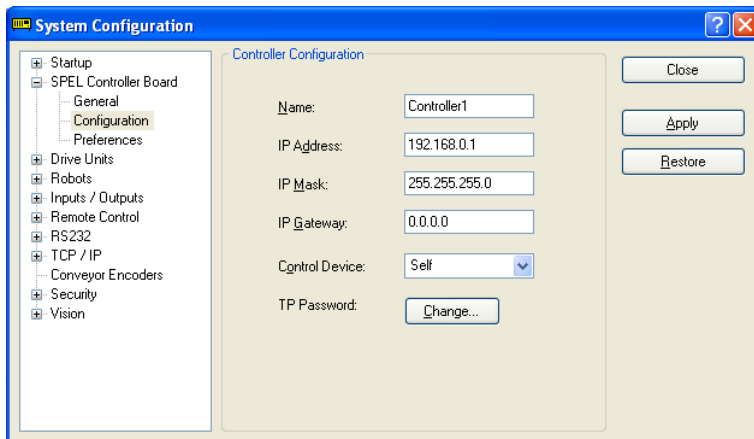

- (2) Enter the proper IP address and subnet mask and click the <Apply> button.
- (3) Click the <Close> button. The Controller reboots automatically.
 IP address configuration is completed and the Controller reboot dialog disappears.
- (4) Connect the Ethernet cable to the Controller LAN-1 port.



LAN-1 port cannot automatically acquire the IP address (not support DHCP).

6.3.2 LAN-2 port

The IP address of LAN-2 port can be changed in the normal steps of Windows.

7. TP Port

The TP port connects the Teach Pendant to the Controller.

For the details, refer to *Setup & Operation 13. Option: Teach Pendant*.

Example

When nothing is connected to the TP port, Emergency Stop status occurs in the Controller.

When the Teach Pendant is not connected, connect the TP/OP bypass plug.

Typical cable connection

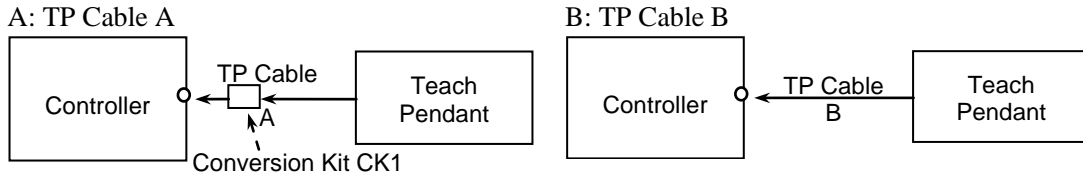

The shape of the cable connector used in connection A differs to connection B.

TP Cable A : Circular connector to connect to the conversion kit CK1.

TP Cable B : D-sub connector to connect directly to the Controller.



- Do not connect TP1 to the following Robot Controllers. Connecting to the following Robot Controllers may result in malfunction of the device since the pin assignments are different. RC420 / RC520 / SRC5** / SRC-3** / SRC-2**

- Do not connect the following devices to the TP port of RC620. Connecting these devices may result in malfunction of the device since the pin assignments are different.

OPTIONAL DEVICE dummy plug

Operation Pendant OP500

Jog Pad JP500

Operator Pendant OP500RC

Teaching Pendant TP-3**

- Be careful of the operating instructions of the TP1 when connecting it to the Robot Controller RC180/RC170, it is different from the explanation in this manual *Setup & operation 13. Option: Teach Pendant*.

When using the TP1 with the RC180/RC170, refer to the *RC170 / RC180 Option Teach Pendant*.

Teach Pendant Connection

- (1) Make sure the Controller and manipulator are surely connected.
- (2) Connect the Teach Pendant connector to the TP port on RC620 Controller.
- (3) Turn on the RC620 Controller.

Teach Pendant connection and disconnection from the Controller are allowed when the Controller power is ON.



When the Teach Pendant connector is removed from the Controller with the mode selector key switch of the Teach Pendant in the “Teach” position, the operation mode will remain in the TEACH mode. The operation mode cannot be switched to AUTO mode. Be sure to remove the Teach Pendant after switching the operation mode to “Auto” mode.

8. EMERGENCY



The details of safety requirements for this section are described in the *Users Guide 2. Safety*. Please refer to them to keep the robot system safe.

Connect a safeguard switch or Emergency Stop switch to the Controller EMERGENCY connector for safety.

When nothing is connected to the EMERGENCY connector, the Controller does not operate normally.



- Before connecting the connector, make sure that the pins are not bent. Connecting with the pins bent may damage the connector and result in malfunction of the robot system.

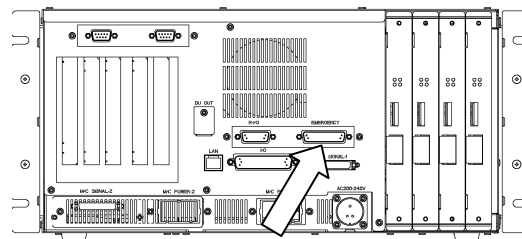

EMERGENCY connector

8.1 Safety Door Switch and Latch Release Switch

The EMERGENCY connector has input terminals for the Safety Door switch and the Emergency Stop switch. Be sure to use these input terminals to keep the system safe.

Connector	Standard
EMERGENCY connector (Controller side)	D-sub 25 male pin Mounting style #4 - 40

* The E-STOP BOX, connector cable, terminal block, and connector kit are offered as options.

8.1.1 Safety Door Switch



- The interlock of the Safety Door must be functioning when the robot system is operated. Do not operate the system under the condition that the switch cannot be turned ON/OFF (e.g. The tape is put around the switch.). Operating the robot system when the switch is not functioning properly is extremely hazardous and may cause serious safety problems as the Safety Door input cannot fulfill its intended function.

In order to maintain a safe working zone, a safeguard must be erected around the Manipulator. The safeguard must have an interlock switch at the entrance to the working zone. The Safety Door that is described in this manual is one of the safeguards and an interlock of the Safety Door is called a Safety Door switch. Connect the Safety Door switch to the Safety Door input terminal on the EMERGENCY connector.

The Safety Door switch has safety features such as temporary hold-up of the program or the operation-prohibited status that are activated whenever the Safety Door is opened.

Observe the followings in designing the Safety Door switch and the Safety Door.

- For the Safety Door switch, select a switch that opens as the Safety Door opens, and not by the spring of the switch itself.
- The signal from the Safety Door (Safety Door input) is designed to input to two redundant signals. If the signals at the two inputs differ by two seconds or more, the system recognizes it to be a critical error. Therefore, make sure that the Safety Door switch has two separate redundant circuits and that each connects to the specified pins at the EMERGENCY connector on the Controller.
- The Safety Door must be designed and installed so that it does not close accidentally.

8.1.2 Latch Release Switch

The controller software latches these conditions:

- The safety door is open.
- The operation mode is set to “TEACH”.

The EMERGENCY connector has an input terminal for a latch release switch that cancels the latched conditions.

Open : The latch release switch latches conditions that the safety door is open or the operation mode is “TEACH”.

Closed : The latch release switch releases the latched conditions.



When the latched TEACH mode is released while the safety door is open, the status of Manipulator power is operation-prohibited because the safety door is open at that time. To execute a Manipulator operation, close the safety door again, and then close the latch release input.

8.1.3 Checking Latch Release Switch Operation

After connecting the safety door switch and latch release switch to the EMERGENCY connector, be sure to check the switch operation for safety by following the procedures described below before operating the Manipulator.

- (1) Turn ON the Controller while the safety door is open in order to boot the controller software.
- (2) Make sure that the Controller LCD displays the one of the following.

SG	Safety
----	--------
- (3) Make sure that “Safety” is displayed on the main window status bar.
- (4) Close the safety door, and turn ON the switch connecting to the latch release input. Make sure that the “Safety” is dimmed on the status bar.

The information that the safety door is open can be latched by software based on the latch release input condition.

Open : The latch release switch latches the condition that the safety door is open. To cancel the condition, close the safety door, and then close the safety door latch release input.

Closed : The latch release switch does not latch the condition that the safety door is open.



The latch release input also functions to acknowledge the change of to TEACH mode. In order to change the latched condition of TEACH mode, turn the mode selector key switch on the Teach Pendant to “Auto”. Then, close the latch release input.

8.2 Emergency Stop Switch Connection

8.2.1 Emergency Stop Switch

If it is desired to add an external Emergency Stop switch(es) in addition to the Emergency Stop on the Teach Pendant and Operator Panel, be sure to connect such Emergency Stop switch(es) to the Emergency Stop input terminal on the EMERGENCY connector.

The Emergency Stop switch connected must comply with the following:

- It must be a push button switch that is “normally closed”.
- A button that does not automatically return or resume.
- The button must be mushroom-shaped and red.
- The button must have a double contact that is “normally closed”.



The signal from the Emergency Stop switch is designed to use two redundant circuits. If the signals at the two circuits differ by two seconds or more, the system recognizes it as a critical error. Therefore, make sure that the Emergency Stop switch has double contacts and that each circuit connects to the specified pins on the EMERGENCY connector at the Controller. Refer to the *Setup & Operation 8.4 Circuit Diagrams*.

8.2.2 Checking Emergency Stop Switch Operation

Once the Emergency Stop switch is connected to the EMERGENCY connector, continue the following procedure to make sure that the switch functions properly. For the safety of the operator, the Manipulator must not be powered ON until the following test is completed.

- (1) Turn ON the Controller to boot the controller software while pressing the Emergency Stop switch.
- (2) Make sure that the Controller LCD displays the one of the following.

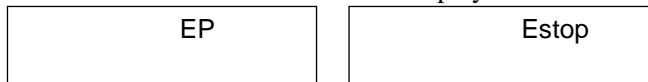

- (3) Make sure that “E.Stop” is displayed on the status bar on the main window.
- (4) Release the Emergency Stop Switch.
- (5) Execute the RESET command.
- (6) Make sure that LCD display in step (2) is turned off and that “E-Stop” is dimmed on the main window status bar.

8.2.3 Recovery from Emergency Stop

To recover from the emergency stop condition, follow the procedure of safety check as required by the system.

After safety check, the operations below are required to recover from the emergency stop condition.

- Release the Emergency Stop Switch
- Execute the RESET command

8.3 Pin Assignments

The EMERGENCY connector pin assignments are as follows:

Pin No.	Signal	Function	Pin No.	Signal	Function
1	ESW11	Emergency Stop switch contact (1) ^{*3}	14	ESW21	Emergency Stop switch contact (2) ^{*3}
2	ESW12	Emergency Stop switch contact (1) ^{*3}	15	ESW22	Emergency Stop switch contact (2) ^{*3}
3	ESTOP1+	Emergency Stop circuit 1 (+)	16	ESTOP2+	Emergency Stop circuit 2 (+)
4	ESTOP1-	Emergency Stop circuit 1 (-)	17	ESTOP2-	Emergency Stop circuit 2 (-)
5	NC	^{*1}	18	SDLATCH1	Safety Door Latch Release
6	NC	^{*1}	19	SDLATCH2	Safety Door Latch Release
7	SD11	Safety Door input (1) ^{*2}	20	SD21	Safety Door input (2) ^{*2}
8	SD12	Safety Door input (1) ^{*2}	21	SD22	Safety Door input (2) ^{*2}
9	24V	+24V output	22	24V	+24V output
10	24V	+24V output	23	24V	+24V output
11	24VGND	+24V GND output	24	24VGND	+24V GND output
12	24VGND	+24V GND output	25	24VGND	+24V GND output
13	NC				

*1 Do not connect anything to these pins.

*2 A critical error occurs if the input values from the Safety Door 1 and Safety Door 2 are different for two or more seconds. They must be connected to the same switch with two sets of contacts.

*3 A critical error occurs if the input values from the Emergency Stop switch contact 1 and Emergency Stop switch contact 2 are different for two or more seconds. They must be connected the same switch with two sets of contacts.

Emergency Stop switch output rated load	+30 V 0.3 A or under	1-2, 14-15 pin
Emergency Stop rated input voltage range Emergency Stop rated input current	+24 V $\pm 10\%$ 47.5mA +24 V input	3-4, 16-17 pin
Safety Door rated input voltage range Safety Door rated input current	+24 V $\pm 10\%$ 10 mA/+24 V input	7-8, 20-21 pin
Latch Release rated input voltage range Latch Release rated input current	+24 V $\pm 10\%$ 10 mA/+24 V input	18-19 pin



The total electrical resistance of the Emergency Stop switches and their circuit should be 1 Ω or less.

8.4 Circuit Diagrams

8.4.1 Example 1: External emergency stop switch typical application

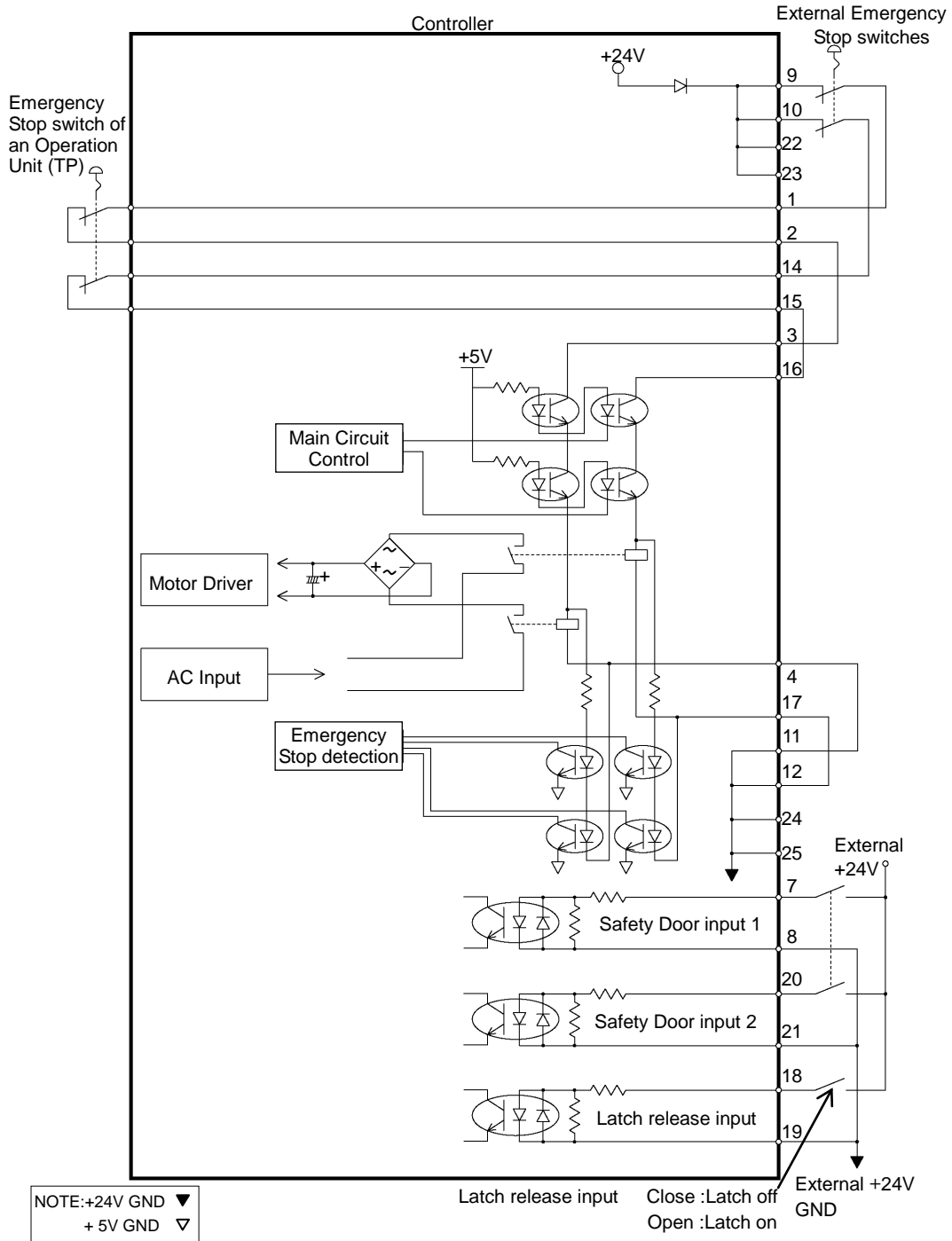

8.4.2 Example 2: External safety relay typical application

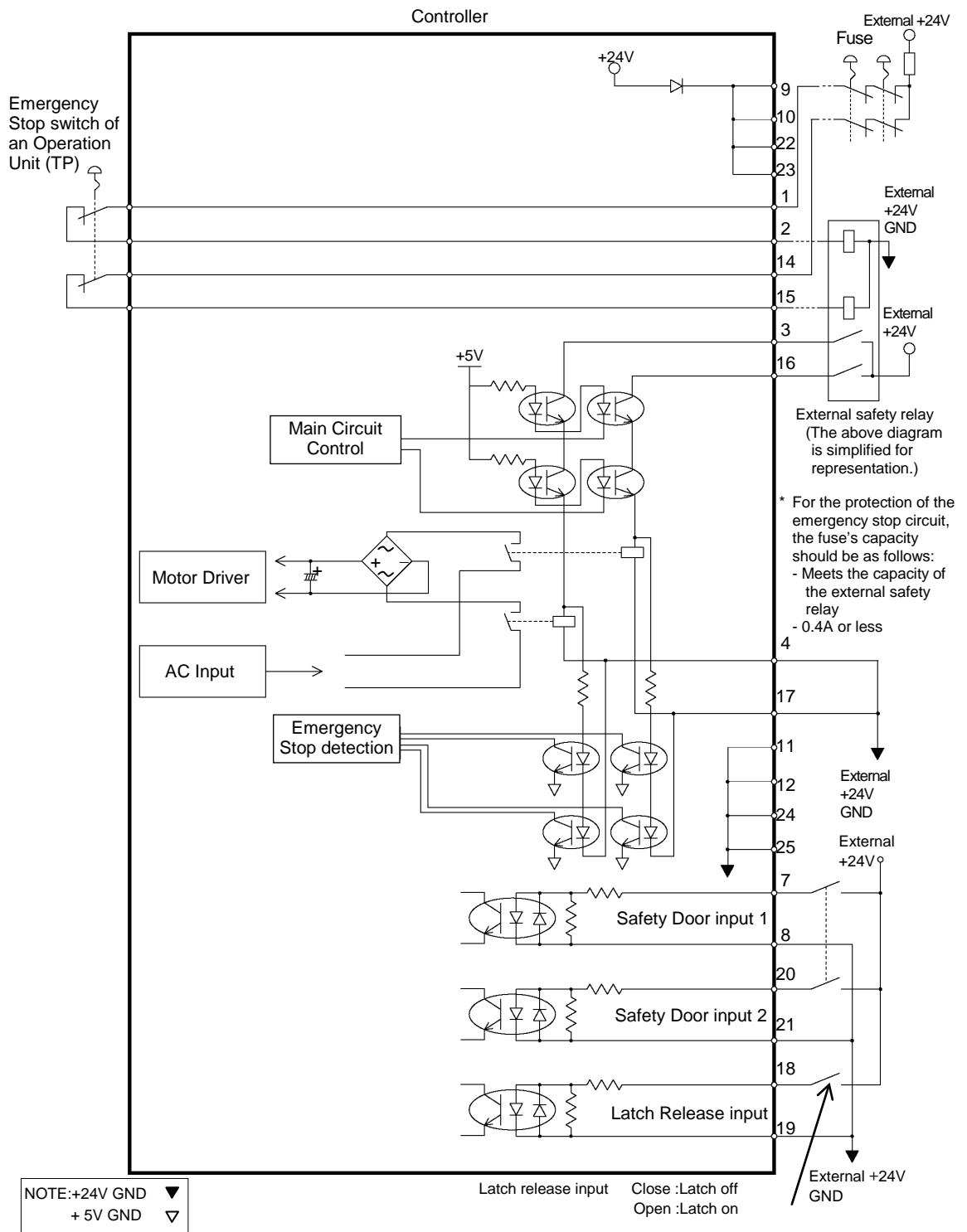

9. I/O Connector

The I/O connector is for connecting your input/output equipment to the system.

		Pins	Bit number
Control Unit	Input	24	0 to 23
	Output	16	0 to 15
Drive Unit 1	Input	24	32 to 55
	Output	16	32 to 47
Drive Unit 2	Input	24	256 to 279
	Output	16	256 to 271

For details of the expanded I/O to be installed to the Special slot, refer to *Setup & Operation 11.2. Expansion I/O Board*.

For cable wiring, refer to the *Setup & Operation 3.5 Noise Countermeasures* in order to prevent noise.

9.1 Input Circuit

Input Voltage Range	: +12 to 24 V \pm 10%
ON Voltage	: +10.8 V (min.)
OFF Voltage	: +5 V (max.)
Input Current	: 10 mA (TYP) at +24 V input

Two types of wiring are available for use with the two-way photo coupler in the input circuit.

Typical Input Circuit Application 1

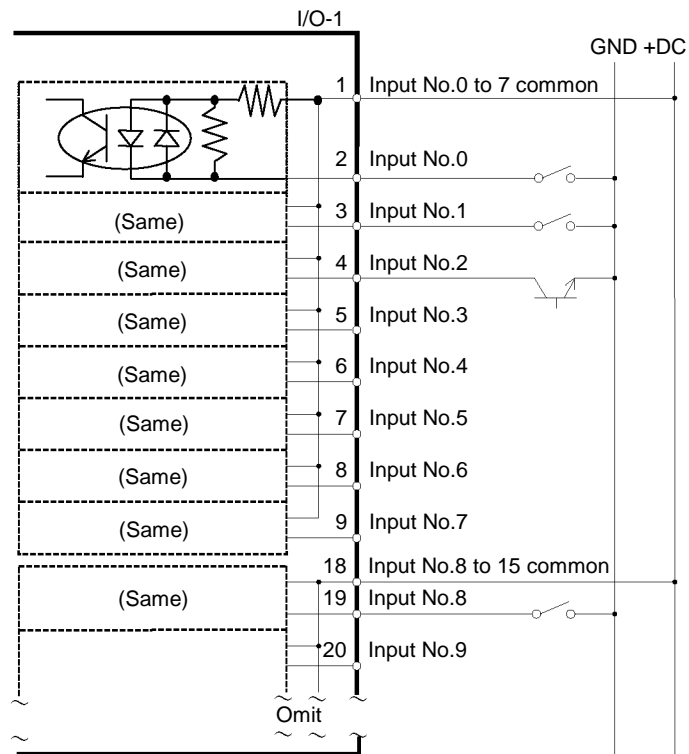

Typical Input Circuit Application 2

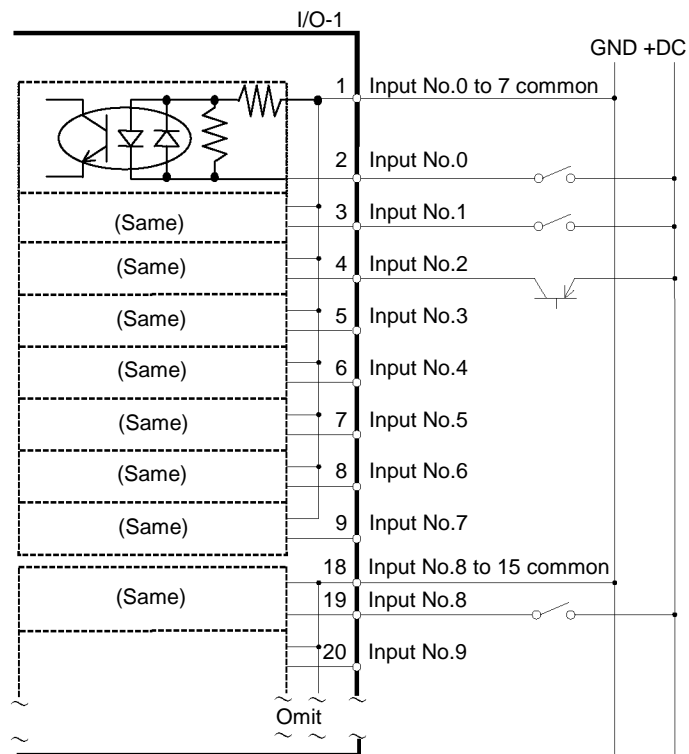

9.2 Output Circuit

Rated Output Voltage	: +12 V to 24 V \pm 10%
Maximum Output Current	: TYP 100 mA/1 output
Output Driver	: PhotoMOS Relay
On-State Resistance (average)	: 23.5 Ω or less

Two types of wiring are available for use with the nonpolar photoMOS relay in the output circuit.

Typical Output Circuit Application 1

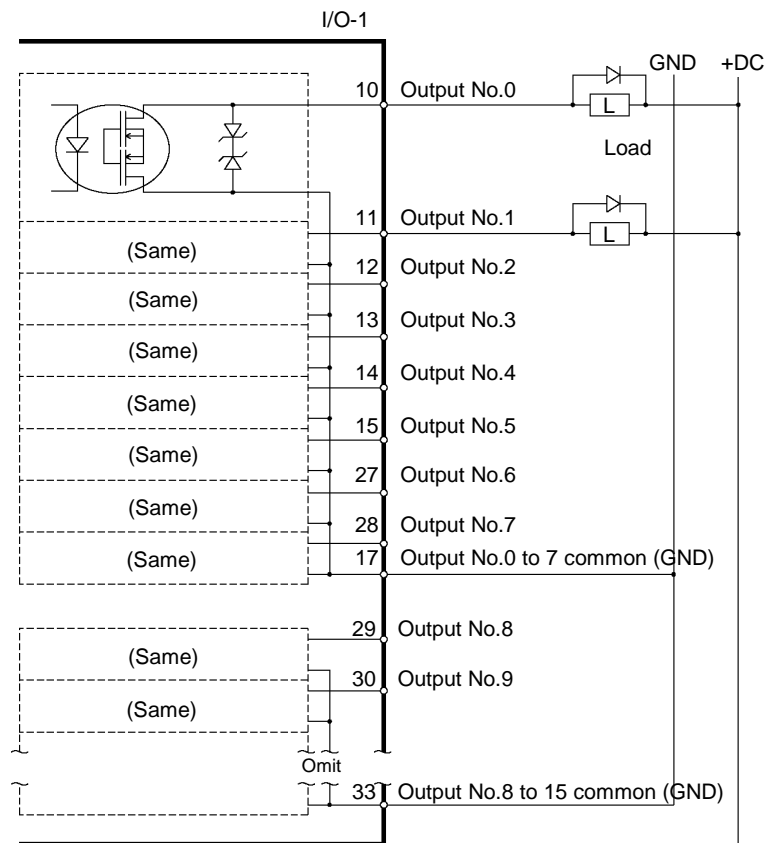

Typical Output Circuit Application 2

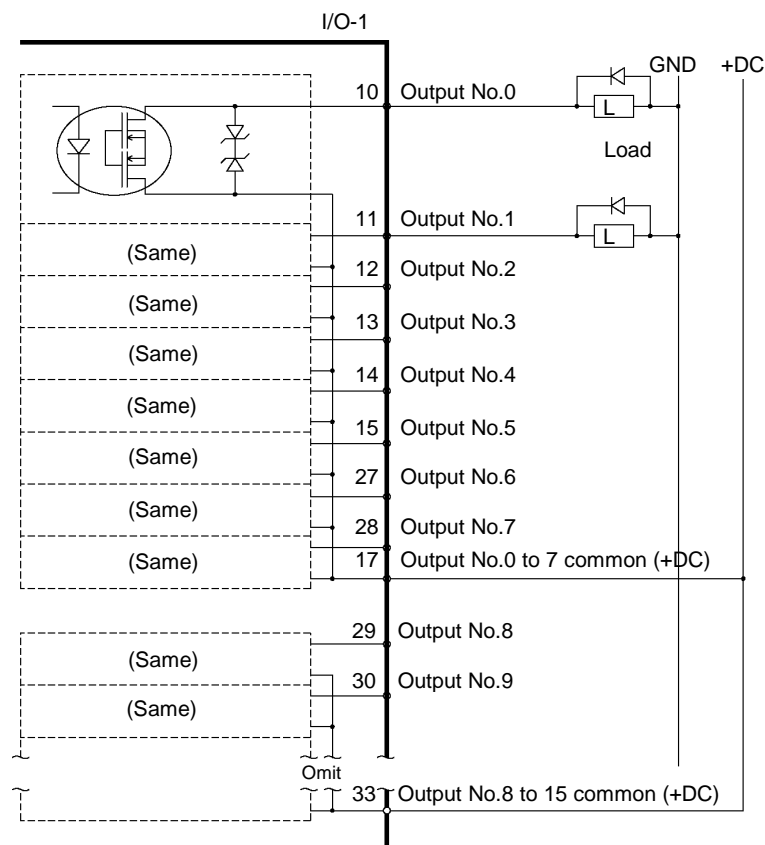

9.3 Pin Assignments

Pin No.	Signal Name	Pin No.	Signal Name	Pin No.	Signal Name
1	Input common No. 0 to 7	18	Input common No. 8 to 15	34	Input common No. 16 to 23
2	Input No. 0	19	Input No. 8	35	Input No. 16
3	Input No. 1	20	Input No. 9	36	Input No. 17
4	Input No. 2	21	Input No. 10	37	Input No. 18
5	Input No. 3	22	Input No. 11	38	Input No. 19
6	Input No. 4	23	Input No. 12	39	Input No. 20
7	Input No. 5	24	Input No. 13	40	Input No. 21
8	Input No. 6	25	Input No. 14	41	Input No. 22
9	Input No. 7	26	Input No. 15	42	Input No. 23
10	Output No. 0	27	Output No. 6	43	Output No.11
11	Output No. 1	28	Output No. 7	44	Output No.12
12	Output No. 2	29	Output No. 8	45	Output No.13
13	Output No. 3	30	Output No. 9	46	Output No.14
14	Output No. 4	31	Output No.10	47	Output No.15
15	Output No. 5	32	NC	48	NC
16	NC	33	Output common No. 8 to 15	49	NC
17	Output common No. 0 to 7			50	NC

Connector	Standard
I/O Connector (Controller side)	D-sub 50 male pin Mounting style #4 - 40

* The I/O connector, I/O connector cable, terminal block, and I/O connector kit are offered as options.

10. I/O Remote Settings

This section describes the functions of input and output signals.

For details, refer to the *EPSON RC+ Users Guide 10. Remote Control*.

The remote functions may be assigned to your standard I/O board(s), expansion I/O board(s), or fieldbus I/O board(s) to enhance robot system control - either from an operational unit of your choice or a sequencer.

Remote function is not initially assigned.

To accept external remote inputs, assign the remote function and the control device is remote.

The user can defines the I/O number that a remote function is assigned to using software configuration.

For details about I/O cable connection, refer to sections on *Setup & Operation 9. I/O Connector*, *11.2. Expansion I/O Board (Option)*, *11.3 Fieldbus I/O Board (Option)*, and *Robot Controller RC620 option Fieldbus I/O manual*.



- When using remote I/O, always make sure of the following. Using the robot system under unsatisfactory conditions may cause malfunction of the system and/or safety problems.
 - Assign remote functions to inputs/outputs correctly and wire correctly when setting up remote I/O signals.
 - Make sure that the functions correspond to the correct input/output signals before turning ON the system.
 - When verifying the robot system operation, prepare for failures with initial settings or wiring. If the Manipulator functions unusually by the failures with initial settings or wiring, press the Emergency Stop switch immediately to stop the Manipulator.



- Remote function is available when virtual I/O is enabled.
- When you set up a remote I/O signal, please either keep a written record of the settings or store the data in a file for later reference.
- When you set up a fieldbus I/O signal to the remote function, response depends on the baud rate of the fieldbus. For details of fieldbus response, refer to *Robot Controller RC620 option Fieldbus I/O manual*.

11. R-I/O Connector

This function is available with the controller (Serial No. 01-05001 or later / 02-05001 or later).

The R-I/O connector is for connecting the input signals of the real time I/O function.

		Pins	Bit number
Control Unit	Input	2	24,25
Drive Unit 1	Input	2	56,57
Drive Unit 2	Input	2	280,281

By inputting trigger signals to the R-I/O, you can keep and get the operating robot position when trigger is detected. If you use this function with Vision, you can create an application of parts pickup, alignment, and assembly by robots without stopping.

For details, refer to *EPSON RC+6.0 Users Guide - Real time I/O*.

In the case of 6-axis robot, this function can not be used.

11.1 Input Circuit

Input Voltage Range : +24 V ±10%

Input Current : 10 mA (TYP) at +24 V input

The following two types of wiring are available in the input circuit.

Typical Input Circuit Application 1

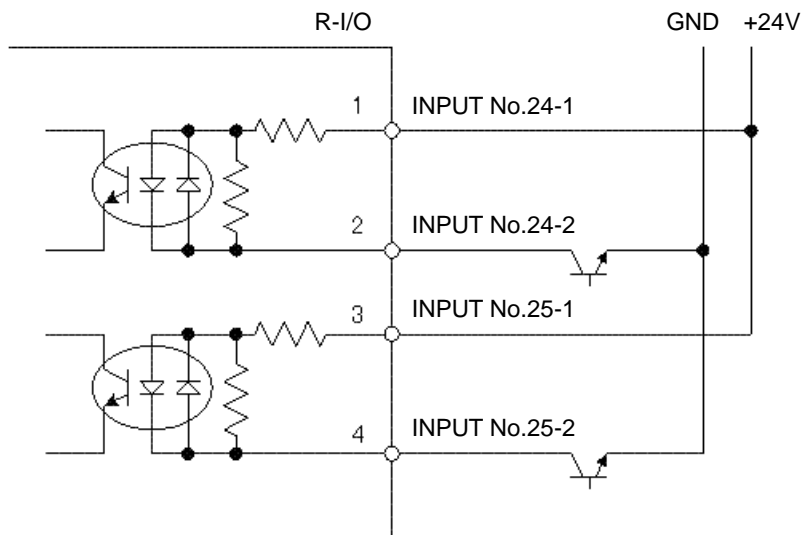

Typical Input Circuit Application 2

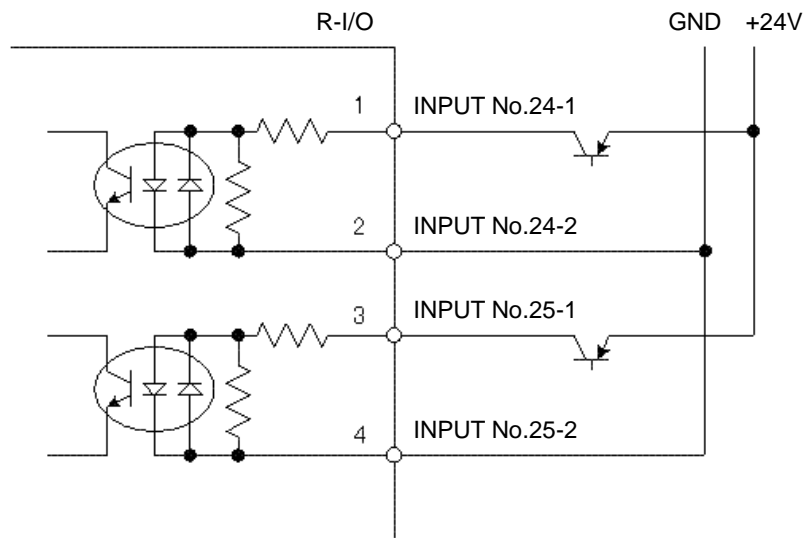

11.2 Pin Assignments

Pin No.	Signal Name
1	INPUT No24-1
2	INPUT No24-2
3	INPUT No25-1
4	INPUT No25-2
5 to 15*	NC

* For the pins 5 to 15, do not connect anything.

Connector	Standard
I/O Connector (Controller side)	D-sub 50 male pin Mounting style #4 - 40



- When using R-I/O connector, be careful of the following points. If you use the R-I/O connector without meeting the necessary conditions, it may cause the system failure and/or safety problems.
 - Use a shielded cable and route the cables as far from the surrounding noise sources as possible.
For details, refer to *Setup & Operation: 3.5 Noise Countermeasures*.
 - Make sure to check the cable routing before turning on the power supply.

12. Option Slots

12.1 What are Option slots?

The RC620 Controller has Special slots for the option board and PCI slots for the PCI board.

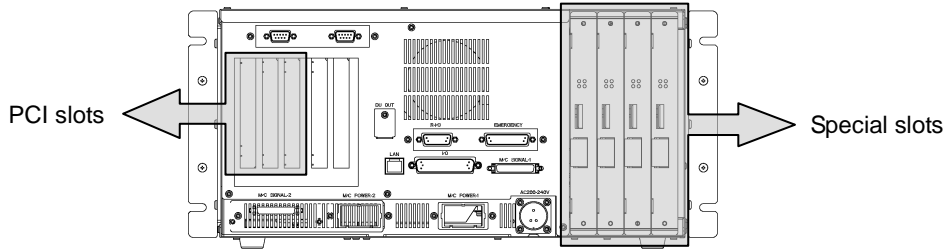

Max. 4 option boards can be installed to the Special slots. As the option board, the following 4 types are provided.

- Expanded I/O board
- RS-232C board
- Fieldbus I/O slave board (Refer to the *RC620 Option Fieldbus I/O manual.*)
- Pulse generator board (Refer to the *RC620 OptionPG Motion system manual.*)

Max. 3 PCI boards can be installed to the PCI slots. As the option board, the following 2 types are provided.

- Frame grabber board (Refer to the *EPSON RC+ 6.0 Option Vision Guide 6.0 manual.*)
- Fieldbus I/O master board (Refer to the *RC620 Option Fieldbus I/O manual.*)

NOTE



Of the PCI slots, a slot next to the CPU board has to limit the height of parts on the board to avoid the interference with the CPU board. Available height is less than 10 mm.

NOTE



To set the screw for securing the PCI board in the PCI slot, apply the torque described below. If you set the screw too tight, the screw hole will be broken.
Tightening torque: approx. 1 N·m

12.2 Expansion I/O Board

12.2.1 About Expansion I/O Board

Each additional expansion I/O board provides 32 inputs and 32 outputs.

CN1: 16 inputs / 16 outputs

CN2: 16 inputs / 16 outputs

The number of I/Os that can be expanded is maximum 4 boards and 128 inputs and outputs.

The input and output bit numbers are assigned as follows. (Bit number is assigned from CN1.)

Input Bit #	Output Bit #	Applicable Hardware
0 to 23	0 to 15	STANDARD I/O
64 to 95	64 to 95	The 1 st Expansion I/O board
96 to 127	96 to 127	The 2 nd Expansion I/O board
128 to 159	128 to 159	The 3 rd Expansion I/O board
160 to 191	160 to 191	The 4 th Expansion I/O board

12.2.2 Board Configuration (Expansion I/O)

Board Appearance

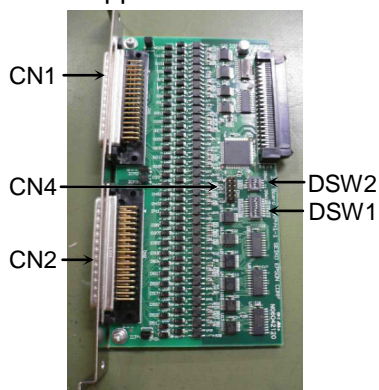

Switch and Jumper Configuration

Setup the DSW1 and DSW2. CN4 is all open.

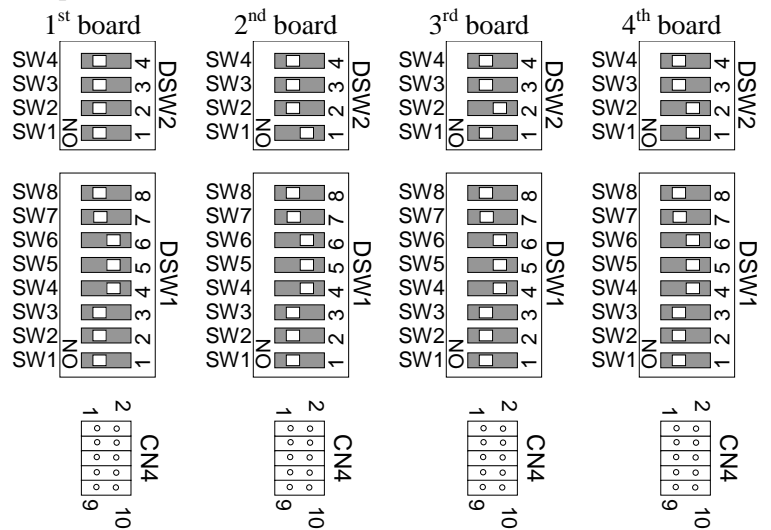

12.2.3 Confirmation of Operation Using EPSON RC+ 6.0

When an expansion I/O board is mounted to the option unit, the Controller software automatically identifies the expansion I/O board. Therefore, no software configuration is needed.

Correct identification can be confirmed from EPSON RC+ 6.0.

- (1) Select the EPSON RC+ 6.0 menu-[Setup]-[System Configuration] to display the [System Configuration] dialog.
- (2) Select the [Inputs / Outputs].

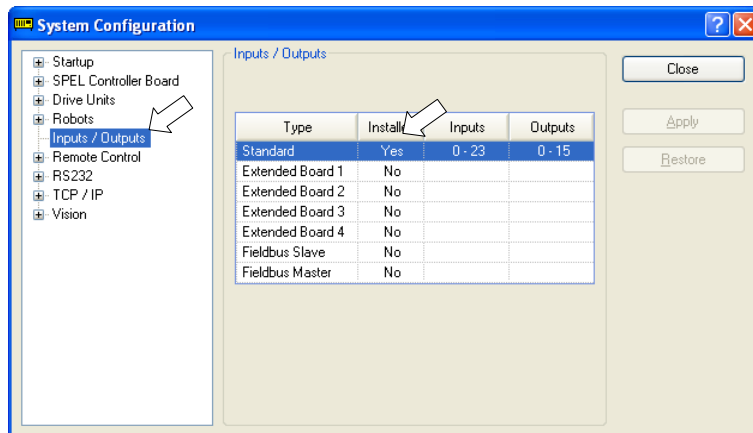

- (3) Make sure that “Yes” is displayed in the Installed column.
The expansion I/O board is identified by the Controller software. Corresponding Input and Output is available.

12.2.4 Input Circuit

- Input Voltage Range : + 12 V to 24 V \pm 10%
- ON Voltage : + 10.8 V (Min.)
- OFF Voltage : + 5 V (Max.)
- Input Current : 10 mA (TYP) at + 24 V input

Two types of wiring are available for use with the two-way photo coupler in the input circuit.

Protected Expansion I/O Board
Typical Input Circuit Application 1

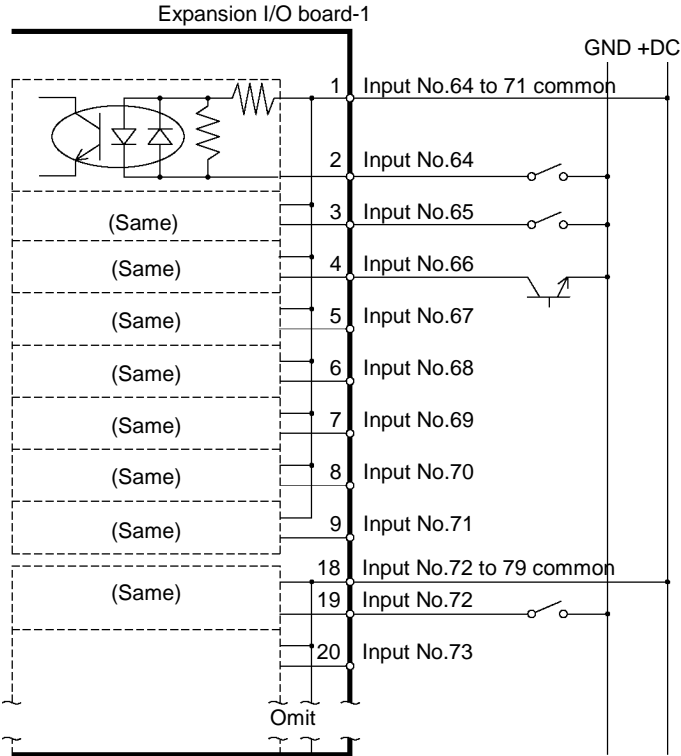

Protected Expansion I/O Board
Typical Input Circuit Application 2

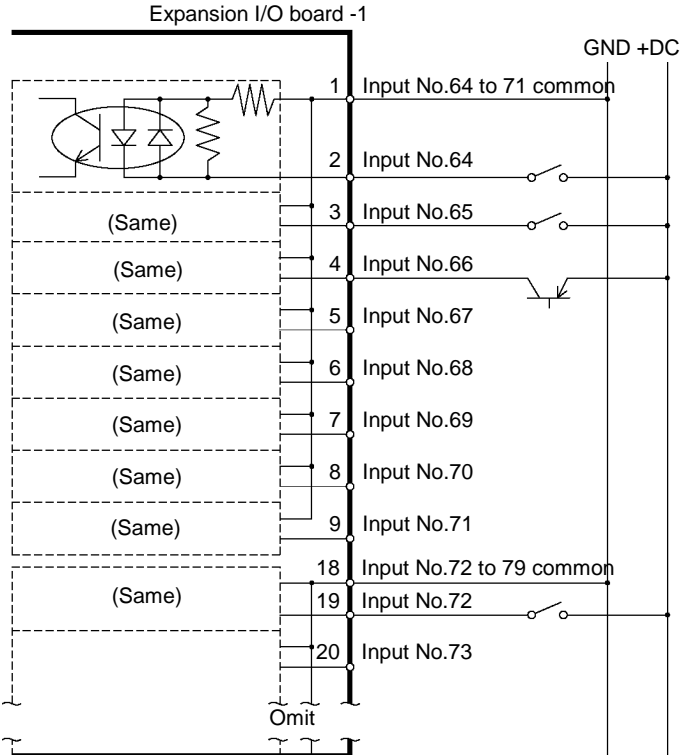

12.2.5 Output Circuit

- Rated Output Voltage : +12 V to 24 V ±10%
- Maximum Output Current : TYP 100 mA/1 output
- Output Driver : PhotoMOS Relay
- On-State Resistance (average) : 23.5 Ω or less

Two types of wiring are available for use with the nonpolar photoMOS relay in the output circuit.

Protected Expansion I/O Board
 Typical Output Circuit Application 1
 Expansion I/O-1

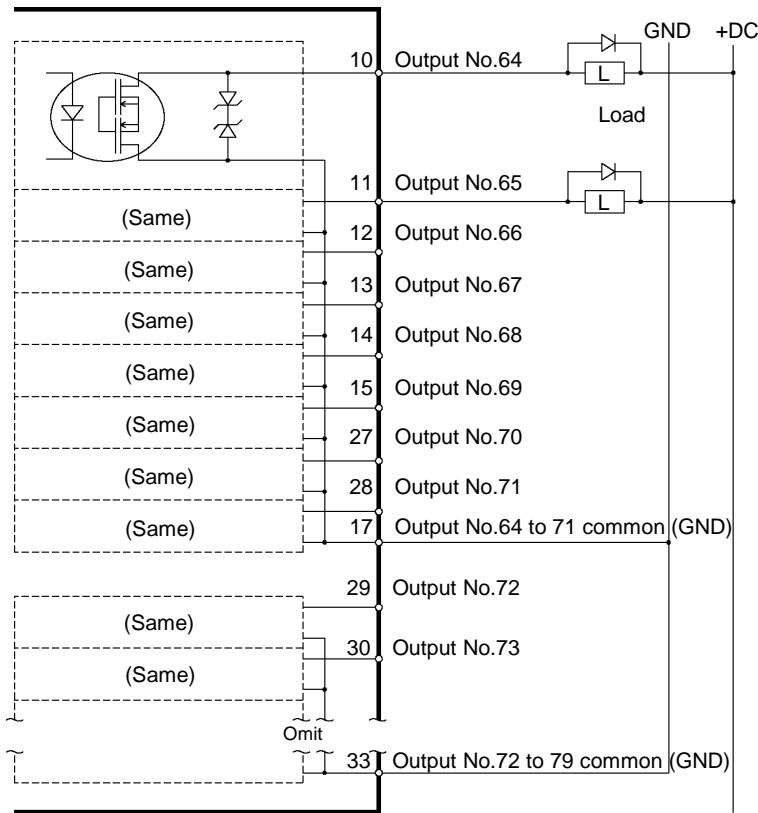

Protected Expansion I/O Board
Typical Output Circuit Application 2
Expansion I/O-1

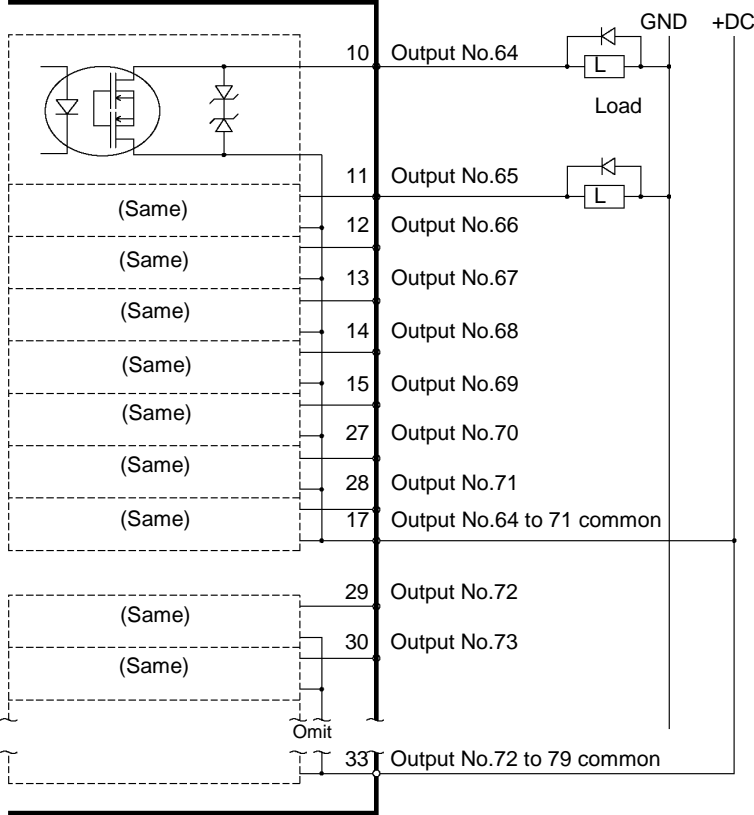

12.2.6 Pin Assignments

Pin Assignment table of the 1st Expansion I/O board.

Connector 1 Pin Assignments

Pin No.	Signal Name	Pin No.	Signal Name	Pin No.	Signal Name
1	Input common No.64 to 71	18	Input common No.72 to 79	34	NC
2	Input No.64	19	Input No.72	35	NC
3	Input No.65	20	Input No.73	36	NC
4	Input No.66	21	Input No.74	37	NC
5	Input No.67	22	Input No.75	38	NC
6	Input No.68	23	Input No.76	39	NC
7	Input No.69	24	Input No.77	40	NC
8	Input No.70	25	Input No.78	41	NC
9	Input No.71	26	Input No.79	42	NC
10	Output No.64	27	Output No.70	43	Output No.75
11	Output No.65	28	Output No.71	44	Output No.76
12	Output No.66	29	Output No.72	45	Output No.77
13	Output No.67	30	Output No.73	46	Output No.78
14	Output No.68	31	Output No.74	47	Output No.79
15	Output No.69	32	NC	48	NC
16	NC	33	Output common No.72 to 79	49	NC
17	Output common No.64 to 71			50	NC

Connector	Standard
I/O Connector (Controller side)	D-sub 50 male pin Mounting style #4 - 40

* The I/O connector, I/O connector cable, terminal block, and I/O connector kit are offered as options.

Connector 2 Pin Assignments

Pin No.	Signal Name	Pin No.	Signal Name	Pin No.	Signal Name
1	Input common No.80 to 87	18	Input common No.88 to 95	34	NC
2	Input No.80	19	Input No.88	35	NC
3	Input No.81	20	Input No.89	36	NC
4	Input No.82	21	Input No.90	37	NC
5	Input No.83	22	Input No.91	38	NC
6	Input No.84	23	Input No.92	39	NC
7	Input No.85	24	Input No.93	40	NC
8	Input No.86	25	Input No.94	41	NC
9	Input No.87	26	Input No.95	42	NC
10	Output No.80	27	Output No.86	43	Output No.91
11	Output No.81	28	Output No.87	44	Output No.92
12	Output No.82	29	Output No.88	45	Output No.93
13	Output No.83	30	Output No.89	46	Output No.94
14	Output No.84	31	Output No.90	47	Output No.95
15	Output No.85	32	NC	48	NC
16	NC	33	Output common No.88 to 95	49	NC
17	Output common No.80 to 87			50	NC

Connector	Standard
I/O Connector (Controller side)	D-sub 50 male pin Mounting style #4 - 40

* The I/O connector, I/O connector cable, terminal block, and I/O connector kit are offered as options.

12.3 Fieldbus I/O Board

The Fieldbus I/O board has the following 2 types.

- Fieldbus I/O master board
- Fieldbus I/O slave board

For the details, refer to the *RC620 Controller Option Fieldbus I/O manual*.

12.4 RS-232C Board

12.4.1 About the RS-232C Board

The RS-232C option accepts four ports expansion per board. A maximum of two boards, eight ports expansion is available for RS-232C board.

Port numbers are assigned as follows.

Port No.	Supported hardware
#1 to #4	First RS-232C board
#5 to #8	Second RS-232C board

12.4.2 Board Setup (RS-232C)

Board Appearance

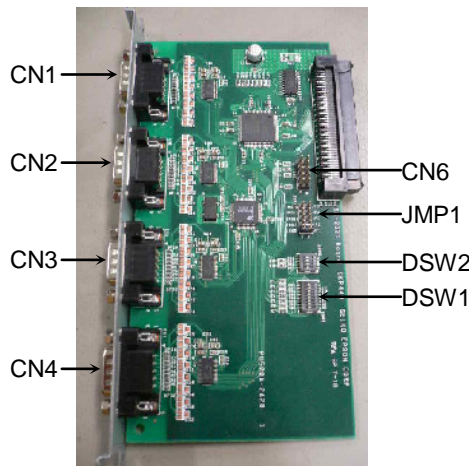

Switch and Jumper Configuration

Set DSW1, DSW2 and JMP1.

CN6 is all open.

1st board

2nd board

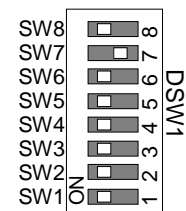
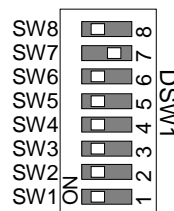
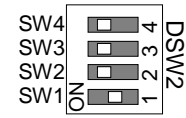
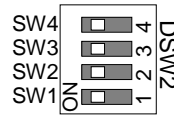
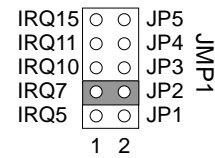
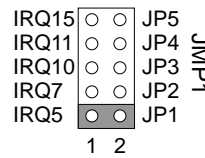
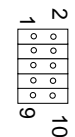
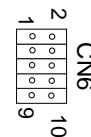

12.4.3 Verify with EPSON RC+ 6.0 (RS-232C)

When an RS-232C board is mounted in as option slot, the Controller software automatically identifies the RS-232C board. Therefore, no software configuration is needed.

Correct identification can be confirmed from EPSON RC+ 6.0.

- (1) Select the EPSON RC+ 6.0 menu-[Setup]-[System Configuration] to display the [System Configuration] dialog.
- (2) Select the [RS-232C].

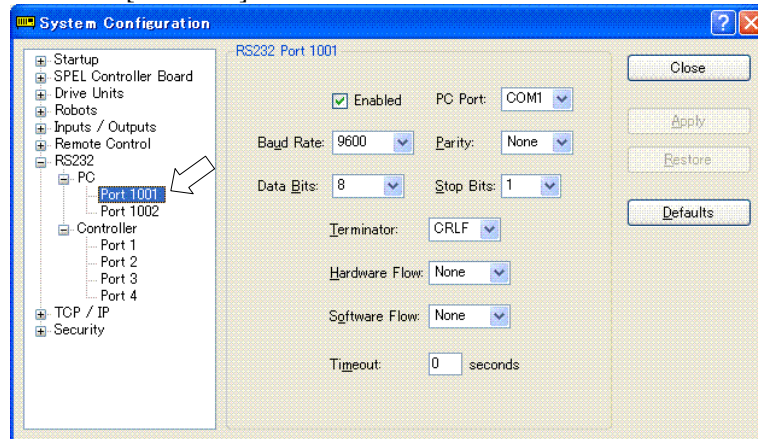

NOTE

RC620 controller has one or two communication ports as standard. When using the communication ports, you should enable the port #1001 and #1002 by checking the [Enabled] check box.

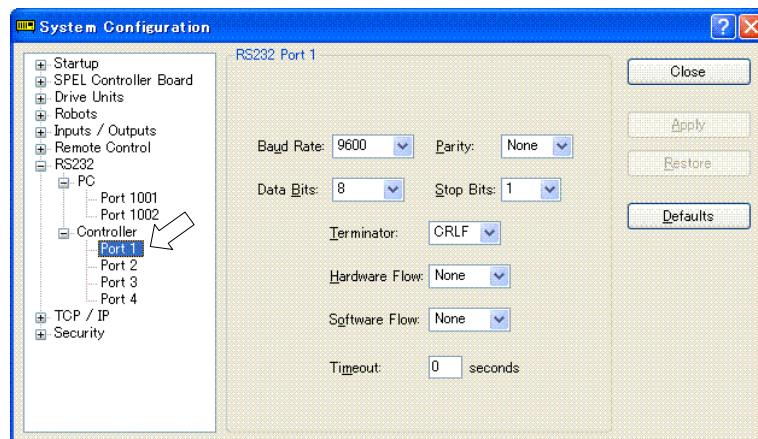

NOTE

If no RS-232C board is installed, controller of the RS-232C will not be displayed.

RS-232C is automatically recognized by the controller software. Communication with external equipment is available.

12.4.4 RS-232C Software Communication Setup (RS-232C)

Available communication settings are as follows.

Item	Specification
Baud Rates	110, 300, 600, 1200, 2400, 4800, 9600, 14400, 19200, 38400, 57600, 115200
Data bit length	7, 8
Stop bit length	1, 2
Parity	Odd, even, NA
Terminator	CR, LF, CRLF

Refer to *EPSON RC+ 6.0 Online Help* or *11. RS-232C Communications* for RS-232C communication from the Robot application.

12.4.5 Communication Cable (RS-232C)

Prepare a communication cable as described in this section.

Connector	Standard
RS-232C Connector (Controller side)	D-sub 9 male pin Mounting style #4 - 40



Use twisted pair cable for shielded wire.

Clamp the shield to the hood for noise prevention.

Pin assign of the RS-232C connector is as follows.

Pin No	Signal	Function	Signal Direction
1	DCD	Data carrier detect	Input
2	RXD	Receive data	Input
3	TXD	Send data	Output
4	DTR	Terminal ready	Output
5	GND	Signal ground	-
6	DSR	Data set ready	Input
7	RTS	Request to send	Output
8	CTS	Clear to send	Input
9	RI	Ring indicator	Input

12.5 PG Board

The PG board is used in the following 2 methods. For the details, refer to the each manual.

- When used as the conveyor encoder
Refer to the *EPSON RC+ 6.0 Users Guide 15. Conveyor Tracking*.
- When used as the PG motion system
Refer to the *RC620 Robot Controller option PG Motion System manual*.

13. UPS

The UPS (Uninterruptible Power Supply) protects the hard disk data (including Windows and applications) from being damaged by power failure or power-off without shutdown.



- Utilize the UPS only for protecting the data from damages caused by power failure or power-off without shutdown. If the UPS is turned OFF over and over intentionally while Windows is operating, the life cycle of UPS battery will be shortened and the UPS may perform insufficiently.
- Complete the shutdown of Windows within two minutes. If Windows is not shut down within the battery backup time of the UPS, the data may be damaged.

The UPS consists of the battery and the ATX power inside the Controller. The UPS provides backup power only for the 3.3V, 5V, and 12V power supplies that are necessary to operate the CPU, hard disk, and the control board. The UPS does not back up the power supply of Manipulator or Encoder Power Supply. Therefore, when a power failure or power-off without shutdown occurs while the Manipulator is operating, an error such as an encoder communication error occurs and the Manipulator makes an emergency stop.

Normal Shutdown of Robot System

Exit EPSON RC+ 6.0 and shut down Windows. After the Windows shutdown, make sure the LCD panel is turned OFF and then turn OFF the power switch of the Controller.

Automatic Shutdown by UPS service in Robot System

For RC620, the UPS service of the Windows functions and automatically shuts down the system when a power failure or power-off without shutdown occurs.

- While Windows is starting up
 - A power failure or voltage drop occurs and the power does not recover.
 - The power switch is turned OFF accidentally and the switch is left OFF.

→ Windows starts up and then it is shut down automatically.

A power failure or voltage drop occurs and the power recovers promptly.
The power switch is turned OFF accidentally and the switch is turned ON.

→ Windows, EPSON RC+ start up normally.



- When Windows is hung, even if you turn OFF the Controller, Windows remains hung until the ATX power battery is completely discharged. In this case, turn OFF the UPS ON/OFF switch. Then, press the SHUTDOWN switch on the front of Controller for more than 5 seconds. The ATX power output will be turned OFF.

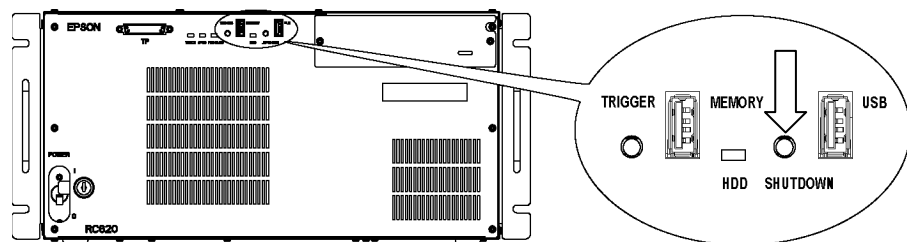

- After Windows starts up (in normal status)
A power failure or voltage drop occurs.
The power switch is turned OFF accidentally.

→ The UPS automatically shuts down EPSON RC+ and Windows when detecting power-off. After Windows is shut down, the ATX power output is turned off and the LCD panel of the Controller lights.

UPS Battery



- When handling the UPS battery (nickel hydride battery), observe the following precautions for safe use.
 - Be sure to use the battery supplied as the maintenance parts from EPSON. (Refer to Maintenance 9. Maintenance Parts List.)
 - Do not allow the positive (+) and negative (-) electrodes to short circuit.
 - Do not discard batteries into fire or heat them to high temperature.
 - Do not disassemble or alter batteries.
 - Do not apply a strong shock to the battery.
 - Stop using the battery if you see any signs of change of color or damage to the battery.

Recycling of Battery

Dispose of the used battery appropriately in accordance with the laws and acts of your national or local government. If you cannot dispose of a used battery properly, please inquire of your EPSON robot supplier how to dispose of it.

Charging Battery

Turning ON the Controller will automatically charge the UPS battery.

To completely charge a discharged UPS battery, turn ON the Controller and keep it energized for at least 2 hours after the backup operation.

Life Cycle of Battery

The battery is expendable. To maintain the Controller function, make sure to replace the battery regularly and appropriately for the use condition.

The life cycle of the battery depends on the ambient temperature, number of backup cycles, and backup time.

To prolong the life cycle of the battery, complete the shutdown of Windows within 2 minutes.

Relation between the life cycle of battery and the ambient temperature:

- When the ambient temperature is 20 deg.C: approx. 10 years
- When the ambient temperature is 25 deg.C: approx. 8 years
- When the ambient temperature is 30 deg.C: approx. 5 years and 7 months
- When the ambient temperature is 35 deg.C: approx. 4 years
- When the ambient temperature is 40 deg.C: approx. 2 years and 9 months

Note that the life cycle above is for the reference and it does not guarantee the backup in this period.

Also, the battery must be replaced before 10 years in any circumstances.

14. Option : Teach pendant TP1

Here describes the functions and operating instructions of the Teach Pendant TP1 – Option for the Robot controller.

14.1 Function

14.1.1 Safety

For details of Safety, refer to *Safety* Chapter in the *User's Guide*. Please read and understand the chapter before using the robot system.





- Only trained personnel should design and install the robot system. Trained personnel are defined as those who have taken robot system training and maintenance training classes held by the manufacturer, dealer, or local representative company, or those who understand the manuals thoroughly and have the same knowledge and skill level as those who have completed the training courses.
- Only authorized personnel who have taken the safety training should be allowed to execute teaching or calibration of the robot system.
The safety training is the program for industrial robot operator that follows the laws and regulations of each nation. The personnel who have taken the safety training acquire knowledge of industrial robots (operations, teaching, etc.).
The personnel who have completed the robot system-training class held by the manufacturer, dealer, or locally-incorporated company are allowed to maintain the robot system.
- Only authorized personnel who have taken the safety training should be allowed to maintain the robot system.
The safety training is the program for industrial robot operator that follows the laws and regulations of each nation. The personnel who have taken the safety training acquire knowledge of industrial robots (operations, teaching, etc.), knowledge of inspections, and knowledge of related rules/regulations. The personnel who have completed the robot system-training and maintenance-training classes held by the manufacturer, dealer, or locally incorporated company are allowed to maintain the robot system.

 <p>WARNING</p>	<ul style="list-style-type: none"> ■ Immediately press the EMERGENCY STOP switch whenever you suspect any danger. The Teach Pendant is equipped with an EMERGENCY STOP switch. Before operating the Teach Pendant, make sure that the EMERGENCY STOP switch on the Teach Pendant functions properly. Operating the Teach Pendant when the switch does not function properly is extremely hazardous and may result in serious bodily injury and/or serious damage to the equipment, as the switch cannot fulfill its intended function in an emergency. When nothing appears on its display window, the Teach Pendant is not connected with the Controller. In this case, the EMERGENCY STOP switch on the Teach Pendant will not function. ■ If the Teach Pendant is not connected to the controller, DO NOT place it within easy reach during operation. You might press the EMERGENCY STOP switch on the unconnected Teach Pendant by mistake to stop the robot system in an emergency. Pressing the EMERGENCY STOP switch on the disconnected Teach Pendant in an emergency is extremely hazardous and may cause serious safety problems.
--	--

 <p>WARNING</p>	<ul style="list-style-type: none"> ■ When entering the safeguarded area for teaching, change the mode of the Teach Pendant to TEACH and take out the key for the mode selector key switch and then enter the safeguarded area with the key. Leaving the key in the mode selector key switch is extremely hazardous and may cause serious safety problems as someone else may inadvertently change the mode to the automatic operation.
--	---

 <p>WARNING</p>	<ul style="list-style-type: none"> ■ Be sure to connect the cables between the Controller and the Teach Pendant properly. Do not allow unnecessary strain on the cables. (Do not put heavy objects on the cables. Do not bend or pull the cables forcibly.) The unnecessary strain on the cables may result in damage to the cables, disconnection, and/or contact failure. Damaged cables, disconnection, or contact failure is extremely hazardous and may result in electric shock and/or improper function of the system. Do not use the cables near heat or fire.
--	---

 <p>CAUTION</p>	<ul style="list-style-type: none"> ■ Do not shock the Teach Pendant physically or place any object on Teach Pendant. A liquid crystal display is used for the Teach Pendant display. If the display is damaged, liquid crystal may leak out. Liquid crystal is harmful. If it sticks on your skin or clothes, immediately wash your skin and clothes thoroughly with clean water and soap immediately.
--	---

 CAUTION	<ul style="list-style-type: none"> ■ The Teach Pendant must be used within the environmental conditions described in this manual. This product has been designed and manufactured strictly for use in a normal indoor environment. Using this product in the environment that exceeds the conditions may not only shorten the life cycle of the product but also cause serious safety problems. ■ Do not disassemble, repair, or modify the Teach Pendant by yourself. Improper disassembly, repair, or modification of the Teach Pendant may cause not only improper function of the robot system but also serious safety problems.
--	--

EMERGENCY STOP

 WARNING	<ul style="list-style-type: none"> ■ Immediately press the EMERGENCY STOP switch whenever you suspect any danger. The Teach Pendant is equipped with an EMERGENCY STOP switch. Before operating the Teach Pendant, make sure that the EMERGENCY STOP switch on the Teach Pendant functions properly. Operating the Teach Pendant when the switch does not function properly is extremely hazardous and may result in serious bodily injury and/or serious damage to the equipment, as the switch cannot fulfill its intended function in an emergency. When nothing appears on its display window, the Teach Pendant is not connected with the Controller. In this case, the EMERGENCY STOP switch on the Teach Pendant will not function.
--	---

When the EMERGENCY STOP switch is pushed, stops the programs execution and halts the robot excitation. Programs and point data will not be damaged.

When pushed, the EMERGENCY STOP switch mechanically holds that state and electrically holds the emergency stop state.

Reset EMERGENCY STOP

Follow these steps to reset Emergency Stop condition.

- (1) Remove the cause of the Emergency Stop and verify that it is safe to operate the robot again.
- (2) Release the EMERGENCY STOP switch. To release the mechanical latch, turn the EMERGENCY STOP switch to the right.
- (3) Turn the Teach Pendant mode selector key switch to “Teach”.

- (4) Press the <Reset> key on the operation panel to reset the Emergency Stop.
- (5) Make sure that the E-STOP lamp on the operation panel is OFF.

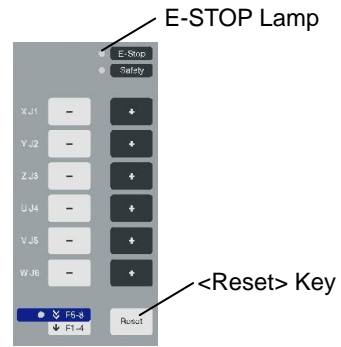

Mode Selector Key Switch

The mode selector key switch is used to select TEACH or AUTO operation mode. For safety, if the mode is changed during program execution, all tasks except the background tasks will be stopped.

Mode switching during task execution

AUTO→TEACH

- (1) Press the <Stop> button to stop all tasks normally.
- (2) Turn the mode selector key switch to “Teach”.

TEACH→AUTO

Turn the mode selector key switch to “Auto” and close the latch release input.

Using Teach Pendant in Safeguarded Area

When the mode selector switch of the Teach Pendant is switched to “Teach” mode, the operator can jog and move the robot to predefined points in slow speed when the enable switch is gripped and the safeguard is open.

Personnel that will be using the Teach Pendant should be thoroughly trained on how to use it.

Follow these guidelines when using the Teach Pendant in the safeguarded area:

- (1) Before entering the safeguarded area to use the Teach Pendant, turn the mode selector key switch to “Teach”.
- (2) Enter the safeguarded area and perform the teaching operations.
- (3) Leave the safeguarded area and close the safeguard.
- (4) Return the mode selector key switch to “Auto”.
- (5) Close the latch release input.
(For details on the pin assignments of the EMERGENCY connector, refer to *Setup & Operation 9.3 Pin Assignments* in the RC620 controller manual.)

14.1.2 Specifications

Part Names and Functions

Front view

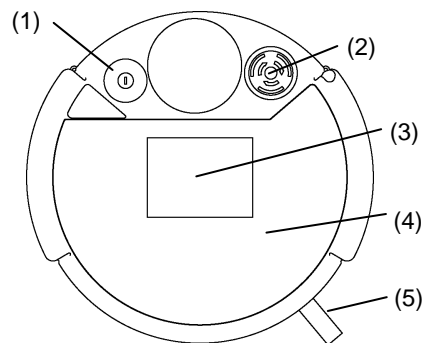

Back view

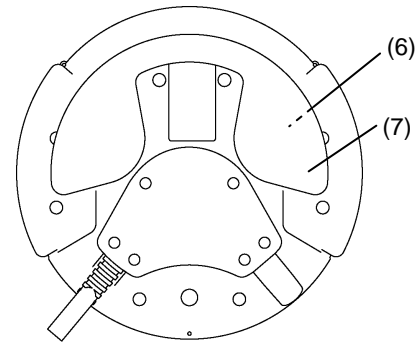

(1) **Mode Selector Key switch**

The mode selector key switch is used to change the operation mode between TEACH and AUTO. The mode can be fixed by pulling out the key. When the mode is switched while a program is executing, the program will be stopped.

Close the latch when switching the mode from TEACH to AUTO.

For the procedure to switch the mode, refer to *Operation: 14.1.1 Safety - Mode Selector Key Switch*.

(2) **EMERGENCY STOP switch**

When this switch is pushed, the Emergency Stop state is held both mechanically and electrically. Pushing the switch stops the program, removes power to robot motors and stops the manipulator motion immediately.

To cancel the Emergency Stop state, first turn the EMERGENCY STOP switch to the right to release the mechanical latch. Switch the mode selector key switch to "Teach". Press the <Reset> key to reset the electrically held Emergency Stop state. The E-STOP lamp goes OFF.

For the procedure to reset the Emergency Stop state, refer to *Operation: 14.1.1 Safety - EMERGENCY STOP*.

(3) **Display**

Displays various kinds of information.

(4) **Operation Panel**

Teaching operation, automatic operation and data input are available.

(5) **Connection Cable**

This is a cable to connect the Teach Pendant and the Controller.

The connector is attached at the end of the cable.

(6) Enable switch

This is a three-position switch. Motion and I/O output commands are available while the switch is gripped when the Teach Pendant is operated in TEACH mode. The switch turns ON when it is at the midpoint, and it turns OFF when it is fully gripped or released.

(7) Handle

Use this part as the hand strap while operating the Teach Pendant.

Standard Specifications

Item		Specification
General specifications	Rated voltage	DC24 V
	Electric power consumption	6 W or less
	Weight	1075 g (include EMERGANCY STOP switch and the mode selector key switch, excluding cables)
Display specifications	Display element	F-STN type Black and white LCD
	Contrast	8-level (Gray scale)
	Back light	LED (Color : White)
Serial interface specifications	Electrical characteristics	Compliant with RS-422A standard

Outer Dimensions

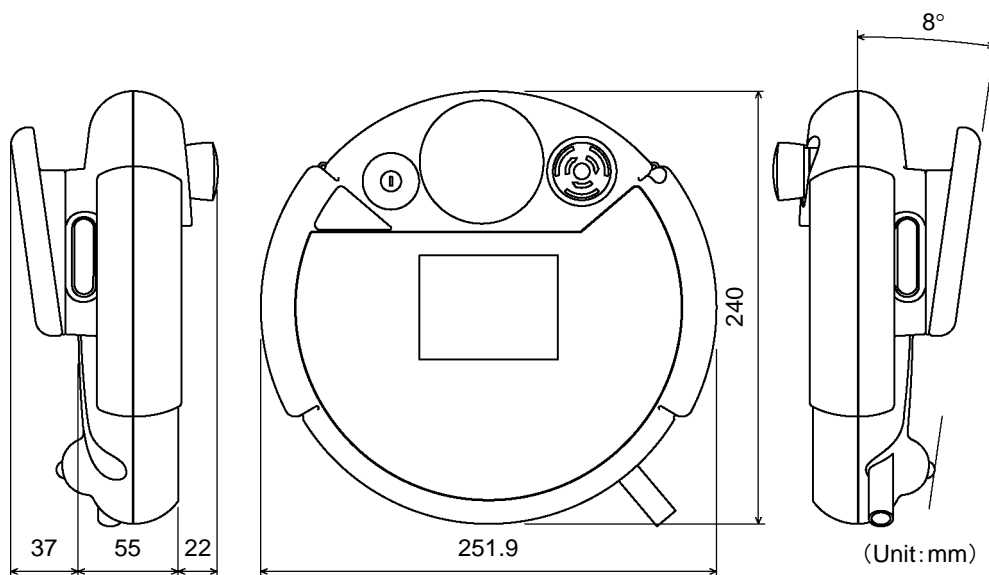

NOTE

Use the installation metal in the attachment when attaching the Teach Pendant to a panel, or the like.

14.1.3 Installation

Contents

TP1 (with cables)	: 1 unit
Mode selector key	: 2 units

Environmental Conditions

The Teach Pendant must be used in an environment that conforms to the following requirements to ensure safe and reliable operation.

Item	Condition
Ambient temperature	0 to 50 deg C (with minimal variation)
Ambient relative temperature	5 to 95%
Protection structure	IP65 (excluding the connector)
Environment	<ul style="list-style-type: none"> - Keep away from dust, oily smoke, salinity, metal powder and other contaminants. - Keep away from flammable or corrosive solvents and gases.

Operating Precautions

 CAUTION	<ul style="list-style-type: none"> ■ Do not drop the Teach Pendant or hit hard against other objects to avoid damage, as the case of the Teach Pendant may be damaged since the main body is made of resin. ■ Use the hand strap to prevent dropping the Teach Pendant during operation. ■ Do not hit the touch panel of the Teach Pendant against a hard object or put excessive pressure on it. The touch panel is made of glass. Therefore, if excessive pressure is put on it, it may be damaged. ■ Do not press or rub the surface of the front panel push buttons with a hard object such as a tool. The surface of the buttons may be damaged as they are easily scratched. ■ Wipe the dirt and oils adhering to the surface of the Teach Pendant display with a soft cloth dampened with a neutral detergent or an alcohol solvent. ■ If using the mounting bracket, check that the bracket and screws are not bent or loosened.
---	--

Connection

This section indicates the connection of the Controller and the Teach Pendant.

 CAUTION	<ul style="list-style-type: none"> ■ Be sure to connect the cables of Controller and Teach Pendant properly. Do not allow unnecessary strain on the cables. (Do not put heavy objects on the cables. Do not bend or pull the cables forcibly.) The unnecessary strain on the cables may result in damage to the cables, disconnection, and/or contact failure. Damaged cables, disconnection, or contact failure is extremely hazardous and may result in improper function of the system. ■ Make sure that the pins are not bent when connecting the connector. Connecting the connector with the pin bent may cause malfunction and result in improper function of the system. ■ The connector connected to the end of the cable is a general-purpose type connector. When connecting the connector, note that the waterproof efficiency and dustproof efficiency of the connector do not comply with IP65. ■ When connecting the Teach Pendant TP1 to the TP port, be careful of the connector inserting direction (up/down). It may cause malfunction and result in improper function of the system.
--	--

Typical cable connection

The Teach Pendant is connected to TP port of controller RC620.

NOTE - When nothing is connected to the TP port, Emergency Stop status occurs to the Controller. When the Teach Pendant is not connected, connect the TP/OP bypass plug.

Example

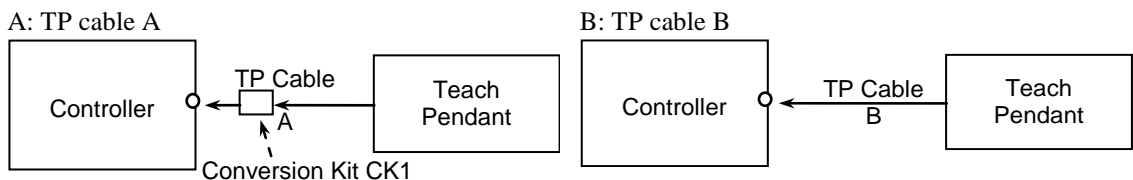

NOTE - The shape of the cable connector used in connection A differs to connection B.
 TP Cable A : Circular connector to connect to the conversion kit CK1.
 TP Cable B : D-sub connector to connect directly to the Controller.

- Do not connect TP1 to the following Robot Controllers. Connecting to the following Robot Controllers may result in malfunction of the device since the pin assignments are different. **RC420 / RC520 / SRC5** / SRC-3** / SRC-2****

- Be careful of the operating instructions of the TP1 when connecting it to the Robot Controller RC180/RC170, it is different from the explanation in this manual. When using the TP1 with the RC180/RC170, refer to the *RC170 / RC180 Option Teach Pendant TP1*.

Connection to the Controller

- (1) Make sure that the Controller and the Robot is connected properly.
- (2) Connect the connector of the Teach Pendant cable to the TP port of Controller RC620.
- (3) Turn ON the controller RC620.



- Teach Pendant insert and removal from the Controller RC620 are available when the Controller power is ON.
- When Teach Pendant connector is removed from the Controller RC620 with the mode selector key switch of Teach Pendant that is in “Teach” position, the operation mode will remain in TEACH mode. The operation mode cannot be switched to AUTO mode. Make sure to remove the Teach Pendant after switching the operation mode to “Auto” mode.

Power Supply

The power of the Teach Pendant is supplied via the TP port on the Controller RC620. The Controller and the Teach Pendant communication, the following screen will appear on the display of the Teach Pendant.

TEACH mode

```

Jog&Teach          Robot   : 01
Current Position   Speed   : Low
X: 240.844 Y: 444.916 Z: 297.694
U: 97.473 V: 58.101 W: -66.214
Point :0          robot1.PTS
Label  :
Jog Mode: World  Tool Local Joint ECP
Local:00 Tool:00 Arm:00 ECP:00
Jog Dist: Long Medium Short Cont Jog
X : 1.000 Y : 1.000 Z : 1.000
U : 1.000 V : 1.000 W : 1.000
Edit Pnt  RB Ctrl  Motion  I/O Cmd
    
```

AUTO mode

```

Print          Ready
Menu
    
```

Wall Bracket (Option)

Outer Dimension

[Unit :mm]

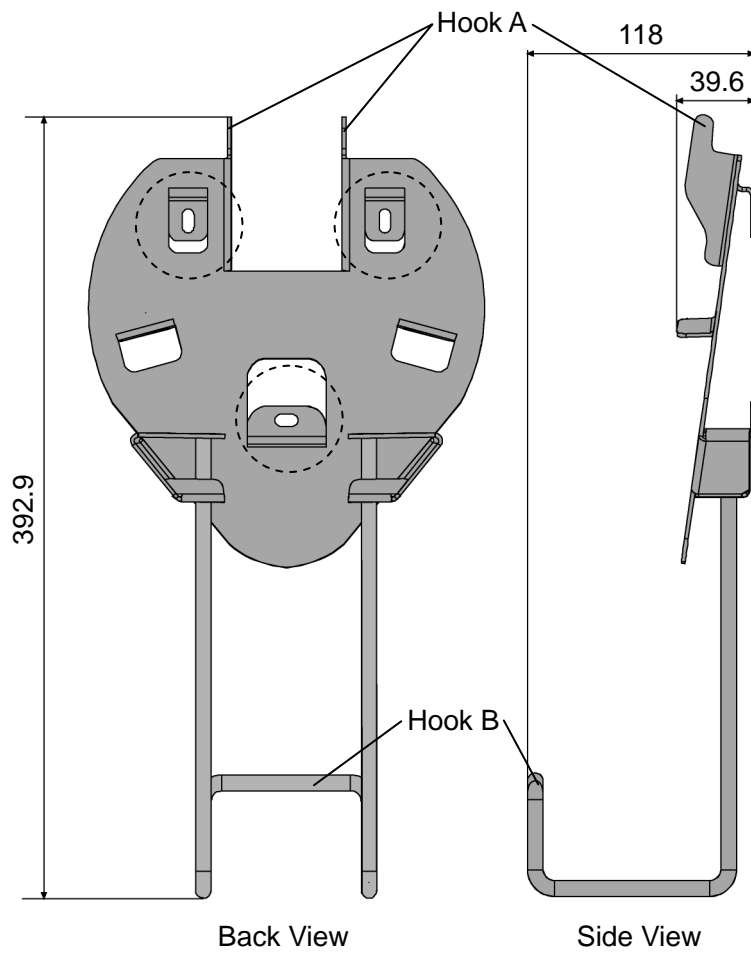
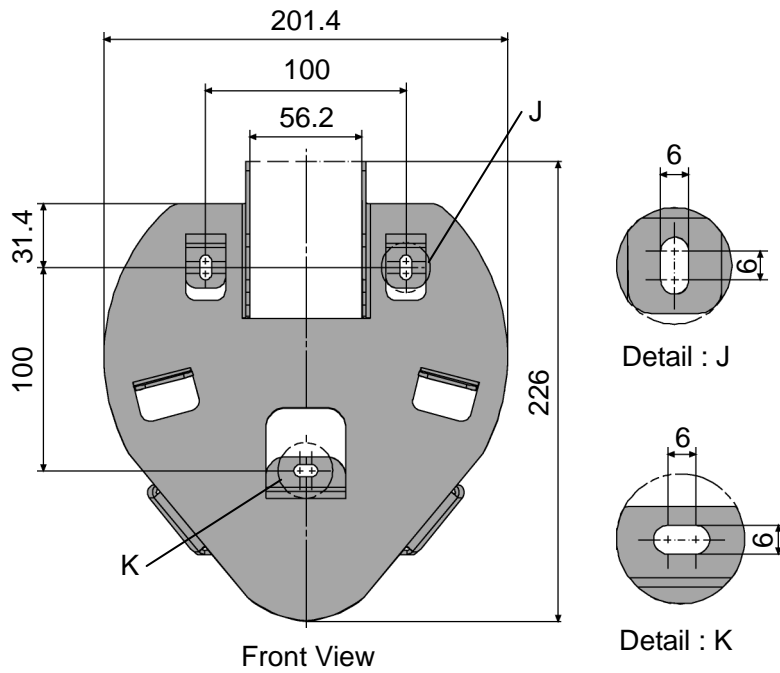

Mount and Use

Mount the Teach Pendant with the wall bracket in the following procedures.

- (1) Secure the wall bracket to the wall with three screws (positions are indicated by dotted line in the *Outer Dimension*).
- (2) Hang the handle of the Teach Pendant to Hook A.
- (3) Hang the cable of the Teach Pendant to Hook B.

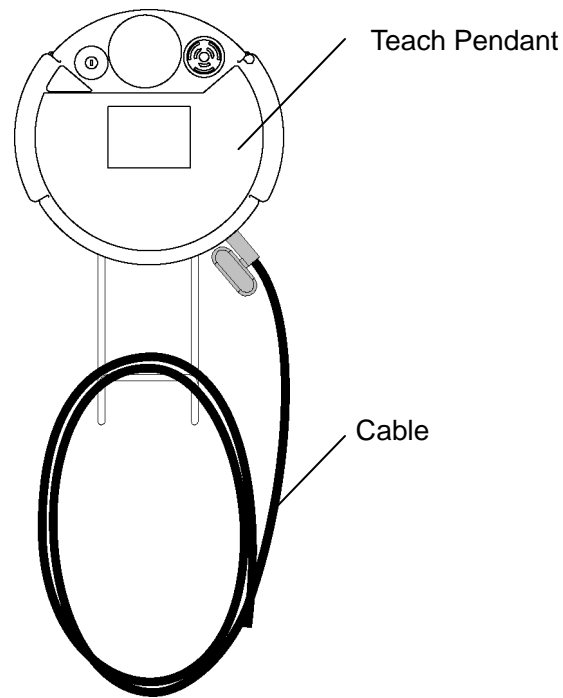

14.1.4 Operation Mode (TEACH/AUTO)

NOTE  A coordinate point including the arm pose is defined as “position (point),” and the data is called “point data.”

Outline

Robot system has two operation modes TEACH mode and AUTO mode.

TEACH mode This mode enables point data teaching and check close from the Robot using the Teach Pendant.

Robot operates in Low power status.

AUTO mode This mode enables automatic operation (program execution) of the Robot system at the manufacture operation, besides, programming, debug, adjustment, and maintenance of the Robot system.

This mode cannot operate Robots or run program with the Safety Door open.

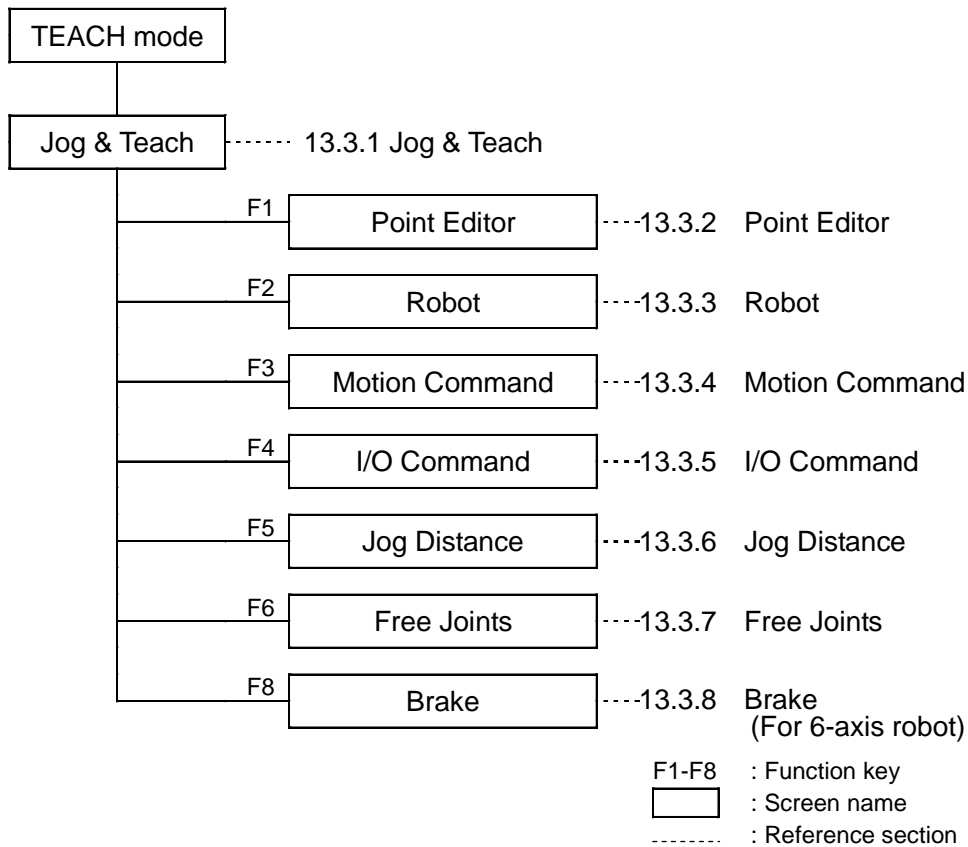

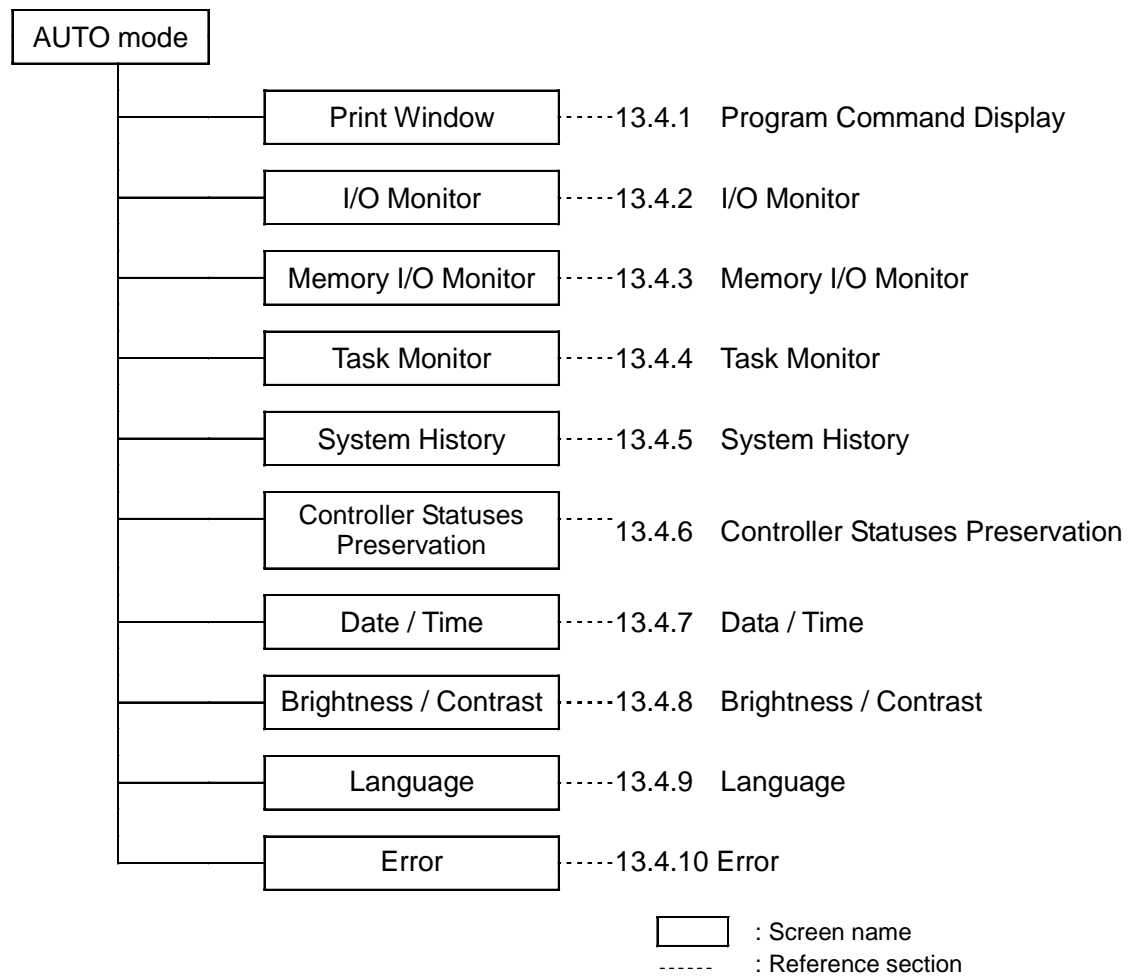

Switch Operation Mode

Change the TEACH mode and AUTO mode with the mode selector key switch on the Teach Pendant.

- TEACH mode** Turn the mode selector key switch to “Teach” for TEACH mode.
 Pauses the executing program when operation mode is switched to TEACH mode.
 The operating Robot stops by Quick Pause.
- AUTO mode** Turn the mode selector key switch to “Auto” and change the latch release input signal to ON position for AUTO mode.

14.1.5 Operation Panel (Key Description)

Key Description

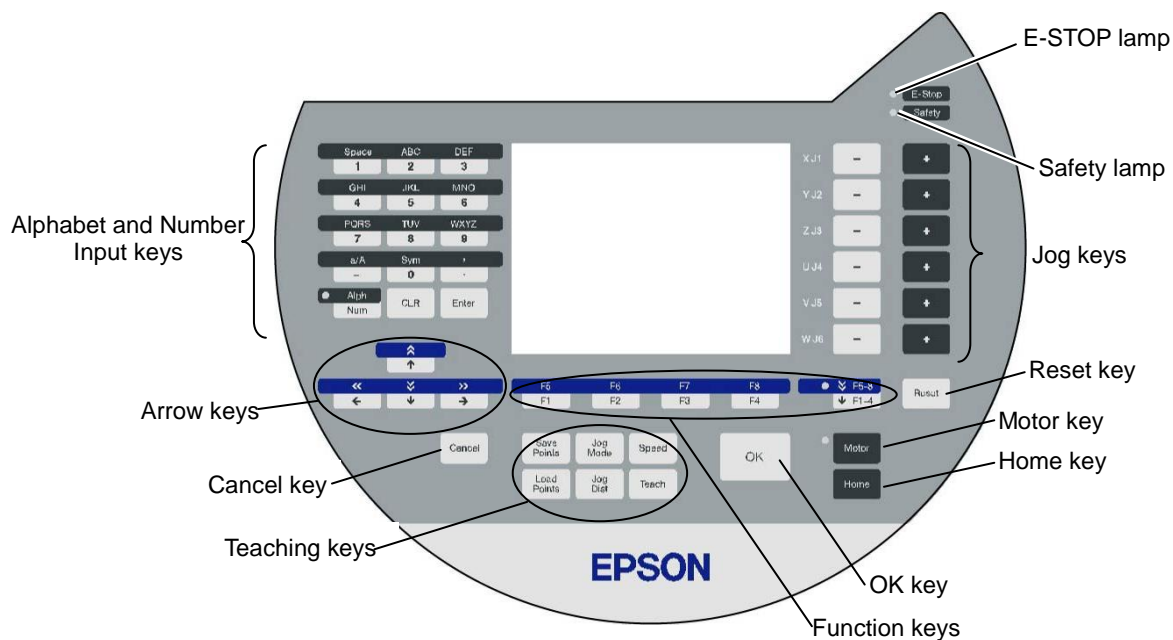

Alphabet and Number Input Keys

Input mode alphabet/number switches by turning ON/OFF the “Alph” lamp.
 Press the <Alph/Num> key to turn ON/OFF the “Alph” lamp.

Alph	Mode	Key	Function
OFF	Number input mode	From 0 to 9 - (minus) .(period)	Number input
ON	Alphabet input mode	ABC to WXYZ	Alphabet input
		SP (space)	Space input
		a/A	Case selector
		Sym	Symbol input
Common		CLR	Clear number and alphabet
		Enter	Set number and alphabet

Arrow Keys

Mode switches by turning ON/OFF the “F5-8” lamp.

Press the <F1-4 / F5-8> key to turn ON/OFF the “F5-8” lamp.

F5-8	Mode	Key	Function
OFF	Normal mode	↑	+1 the value Move the cursor up
		↓	-1 the value Move the cursor down
		←	Move the cursor to the left Jog key switch: J4, J5, J6 - J7, J8, J9
		→	Move the cursor to the right Jog key switch: J4, J5, J6 - J7, J8, J9
ON	Scroll mode	^	+10 the value Move to previous page
		v	-10 the value Move to next page

Function Keys

Press the <F5-8> key to turn ON/OFF the “F5-8” lamp. The display will be changed.

Example : Jog&Teach Screen

“F5-8” OFF

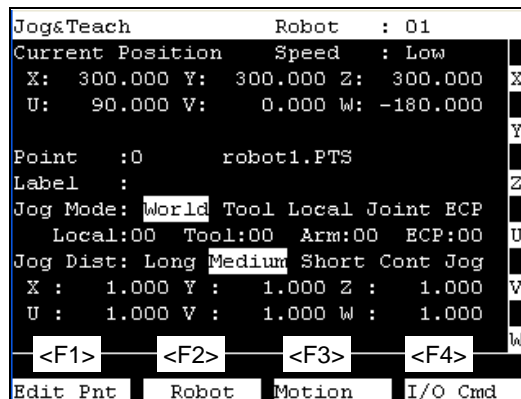

“F5-8” ON

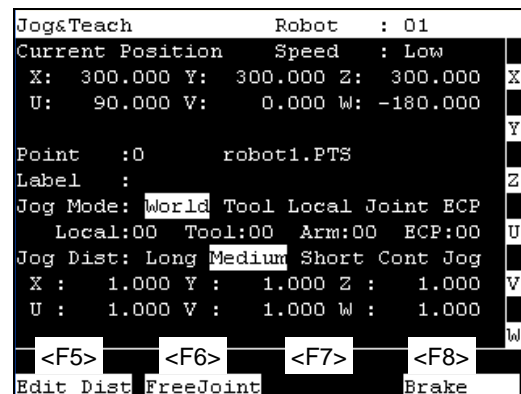

Example : Press the <F3> key to display the Motion screen.



When a function key is not assigned to a screen, the key is invalid. Example : <F7>

Jog Keys

Jog key is available only in TEACH mode.

Key	Function
-	Moves the target joint (X to W, J1 to J6) to - direction
+	Moves the target joint (X to W, J1 to J6) to + direction

Teaching Keys

Teaching key is available only in TEACH mode.

Key	Function
Save Points	Saves the point data to a file
Load Points	Reads the point data from a file
Jog Mode	Specifies the Jog mode
Jog Dist	Specifies the Jog distance
Speed	Specifies the Jog speed
Teach	Saves the current position data

Other keys

Key	Function
Cancel	<p> Cancels the setting and go back to the previous screen Click the No button.</p>
OK	<p> Saves the setting and move on to the next screen Click the Yes button.</p>
Reset	Sets the initial setup status
Motor*,**	Switches the motor power ON/OFF
Home*	Moves the robot to home position

* Keys with this mark are available only in TEACH mode.

** For RC620-UL, the enable switch must be turned on.

Lamp

Lamp	Function
E-Stop	Turns ON when the EMERGENCY STOP switch is pressed
Safety	Turns ON when the safeguard is open

14.1.6 Enable Switch

In TEACH mode, several operations require use of the 3-position enable switch located on the left rear of the pendant. The enable switch can be operated either hand.

When the enable switch is required to execute an operation, you must grip the switch to the center (enable) position. To do this, pull the switch with the left hand fingers until it just stops at the center detent. If you pull harder, or let go, then the switch will be disengaged and the operation will be canceled.

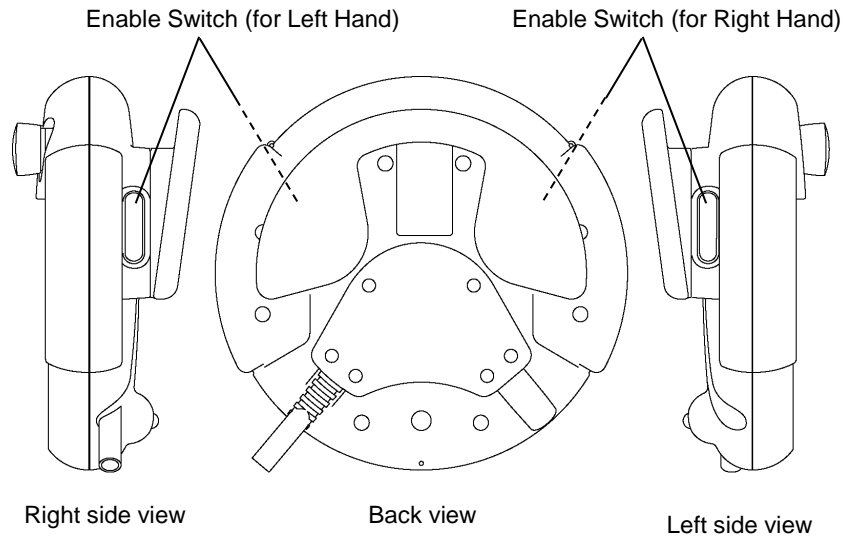

For RC620-UL:

When the enable switch is off, the manipulator is in Motor Off status.

How to press the Enable switch

Grip the enable switch by the finger on the hand holding the handler.

Example : When gripping by the left hand

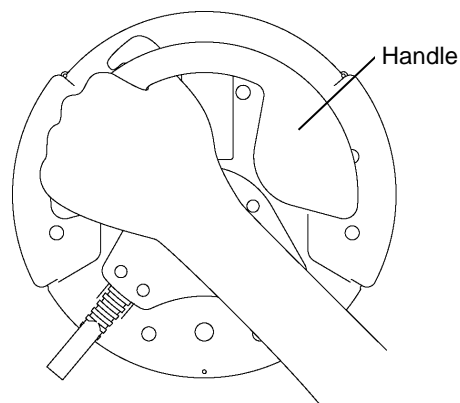

14.1.7 Warning Sound (Beep)

The Teach Pendant beeps when the robot passes the singularity.

14.2 Teaching Procedure

The basic jog operation and teaching procedure is indicated.
 Switch the mode selector switch to “Teach” to display the following screen.

```

Jog&Teach      Robot  : 01
Current Position Speed  : Low
X: 300.000 Y: 300.000 Z: 300.000
U: 90.000 V: 0.000 W: -180.000

Point :0      robot1.PTS
Label  :
Jog Mode: World Tool Local Joint ECP
        Local:00 Tool:00 Arm:00 ECP:00
Jog Dist: Long Medium Short Cont Jog
X : 1.000 Y : 1.000 Z : 1.000
U : 1.000 V : 1.000 W : 1.000

Edit Pnt  Robot  Motion  I/O Cmd
    
```



- A coordinate point including the arm pose is defined as “position (point),” and the data is called “point data.”
- When the RC620 robot controller starts up, [Robot] is 01. If you want to change the robot setting, refer to *14.3.3 Robot*.

14.2.1 Jog Operation

Move the Robot to the teaching position by one of the following operation (Step Jog operation, Continuous Jog operation).

Step Jog Operation

In Step Jog, moves the Robot by pressing the Jog key each time.
 Jog distance of the Robot is configured beforehand.
 Press the <Jog Dist> key to specify the [Jog Dist] (Long, Medium, Short).
 Execute the step jog by gripping the enable switch as pressing the Jog key.

Continuous Jog Operation

In Continuous Jog, moves the Robot while pressing the Jog key.
 Press the <Jog Dist> key to select “Cont Jog” for the [Jog Dist].
 Execute the continuous jog by gripping the enable switch as pressing the Jog key.



To execute the continuous jog, press some jog keys at a time. For example, press the <+X> and <+Y> keys together for the continuous jog diagonally.

14.2.2 Teaching

Apply the Robot position to the specified point number.

- (1) Specify the point number by changing the value in the [Point] using the <↑> and <↓> keys in the [Jog & Teach] screen.

[Label] display changes by changing the point number.

- (2) Press the <Teach> key. The following screen appears.

```

Teach          Robot   : 01
Ready to assign current position
to point.
Point          :2
Continue?

```

When the point number is already used, the following screen appears.

```

Teach          Robot   : 01
Ready to assign current position
to point.
Point          :0
Overwrite?

```

- (3) Press the <OK> key to assign the robot position.
- (4) Press the <Save Points> key to display the following screen.

```

Save Points    Robot   : 01
Point File Name:
robot1.PTS

```

- (5) Press the <OK> key to save the file.



Press the <Cancel> key to returns to the [Jog & Teach] screen without saving the changes of the file.

14.2.3 Direct Teaching

“Direct teach” is a way to teach the Robot directly by setting the teaching joint to servo-OFF.

Apply the Robot position to the specified point number.



The 6-axis robot cannot be moved by hand, execute the jog instead.

- (1) Specify the point number by changing the value in the [Point] using the <↑> and <↓> keys in the [Jog & Teach] screen.
[Label] display changes by changing the point number.
- (2) Press the <F5-8> key, <F6> key, the following screen appears.

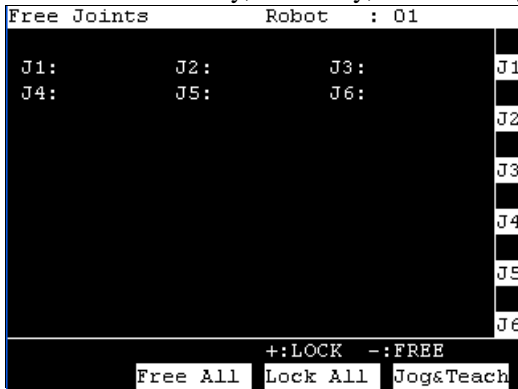

Set each joint to servo ON or OFF.

<Jog+> key :Lock :Servo OFF the joint

<Jog-> key :Free :Servo ON the joint

<F2> key :All Lock :Servo OFF all the joint

<F3> key :All Free :Servo ON all the joint



For the Jog keys operation, refer to *Operation: 14.3.1 Jog & Teach - Jog key*.

- (3) Servo OFF joint can be moved with hands.
- (4) Press the <F4> key to display the [Jog & Teach] screen.
- (5) Move the Robot arm to the position to teach.

- (6) Press the <Teach> key, the following screen appears.

```

Teach          Robot : 01
Ready to assign current position
to point.
Point         :2
Continue?

```

When the point number is already used, the following screen appears.

```

Teach          Robot : 01
Ready to assign current position
to point.
Point         :0
Overwrite?

```

- (7) Press the <OK> key to assign the robot position.
- (8) Press the <Save Points> key to display the following screen.

```

Save Points    Robot : 01
Point File Name:
robot1.PTS

```

- (9) Press the <OK> key to save the file.



Press the <Cancel> key to returns to the [Jog & Teach] screen without saving the changes of the file.

14.3 TEACH Mode

Switch the mode selector key switch to “Teach” to enter the TEACH mode. In this mode, jog, teaching, operation commands, I/O commands, and other operations and commands can be executed using the Teach Pendant.

Note, however, that the program cluster cannot be executed.

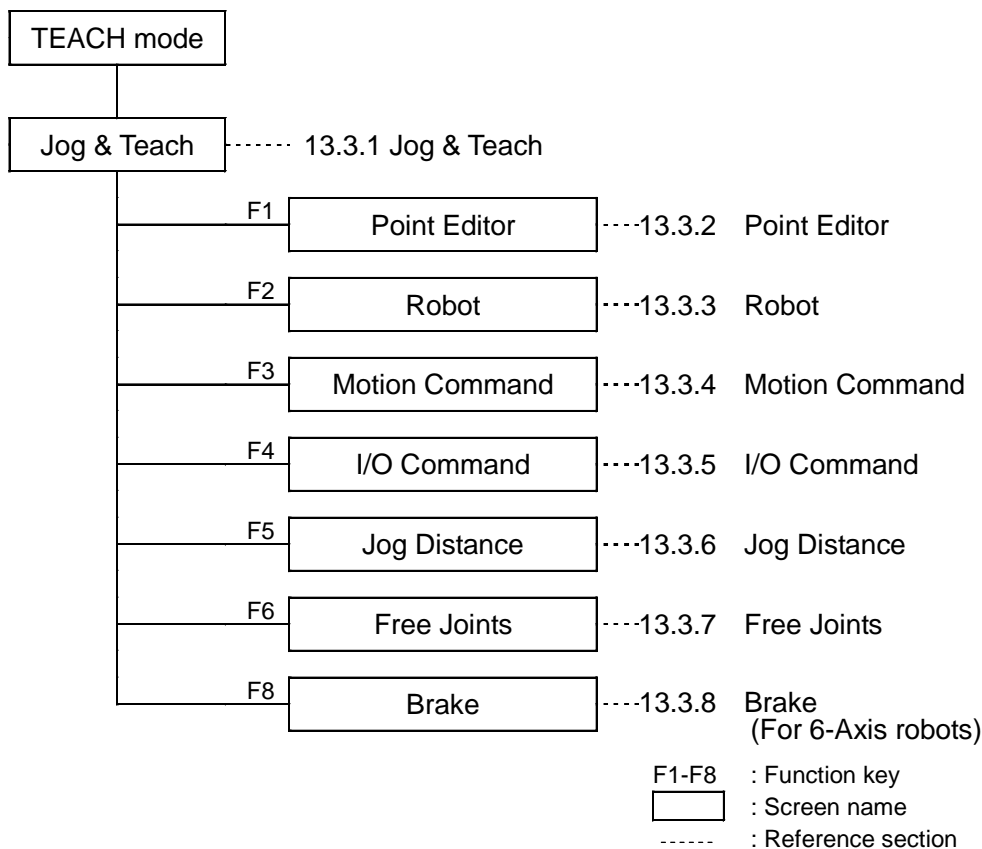

NOTE A coordinate point including the arm pose is defined as “position (point),” and the data is called “point data.”

Specifying Jog Speed

Press the <Speed> key and select the speed at [Speed]. (Low, High)

Low : Low jog speed

High : High jog speed

Jog key

The moving direction or joint is displayed in the left side of the Jog key.

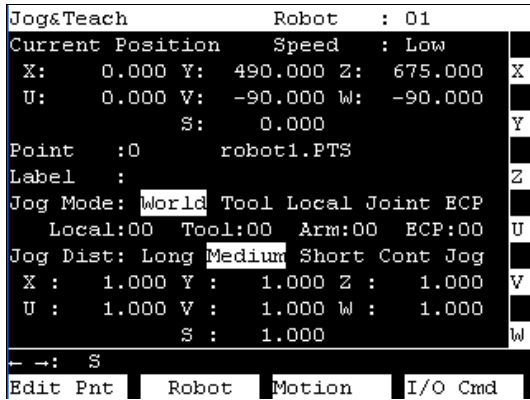

NOTE



If the robot has 6 or more axes, the three keys shown below are switched when pressing the <<> <>> keys.

Example: [U, V, W] → [R, S, T] / [J4, J5, J6] → [J7, J8, J9]

When the additional S axis is set on the 6-axis robot, the key display is changed as shown below to move the additional S axis.

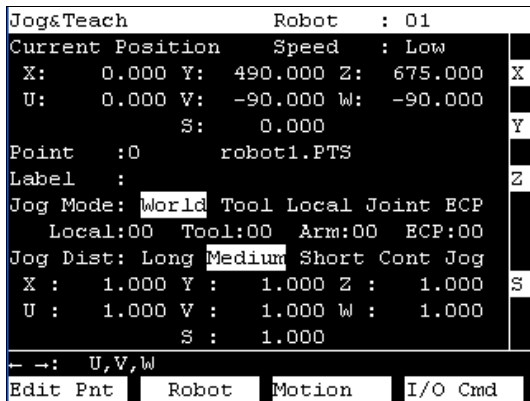

When the Jog keys are not displayed, the robot cannot move by pressing keys.

Executing Step Jog

By step jog operation, the robot moves when the Jog key is pressed.

Set the distance that the robot moves beforehand.

- (1) Press the <Jog Dist> key and select the distance at [Jog Dist].

Long : Long jog distance

Medium : Medium jog distance

Short : Short jog distance

NOTE



When the <F5-8> key lights up its LED, the toggle of <Jog Dist> key is the opposite direction.

- (2) To execute step jog, grip the Jog key with the enable switch held down.

Executing Continuous Jog

With continuous jog, the robot moves continuously while the Jog key is held down.

- (1) Press the <Jog Dist> key and select “Cont Jog” at [Jog Dist].

When the <F5-8> key lights up its LED, the toggle of <Jog Dist> key is the opposite direction.

- (2) To execute continuous jog, grip the enable switch while pressing the Jog key.

ON/OFF

Refer to 14.3.7 Free Joints.

Motor ON/OFF

Press the <Motor> key to switch the motor ON and OFF.



This can be executed at any time in TEACH mode.

For RC620-UL:

This can be executed when the enable switch is on.

Executing Return to Home

Press the <Home> key to return the robot to its home position.

Teaching

The robot position is assigned to the specified point number.

- (1) Press the <Teach> key. The following screen appears.

```

Teach          Robot : 01
Ready to assign current position
to point.
Point          :2
Continue?
  
```

When the point number is already used, the following screen appears.

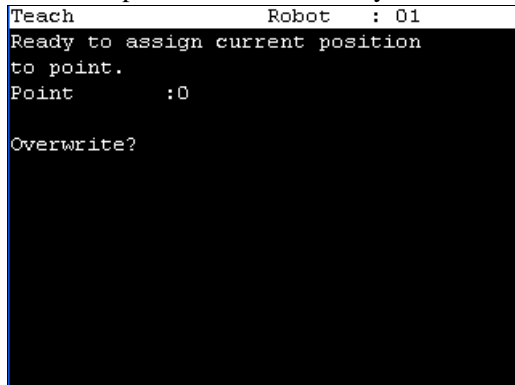

- (2) Press the <OK> key to assign the point data.
- (3) Press the <Save Points> key.



This can also be executed in the [Point Editor] screen.

Saving Point File

- (1) Press the <Save Points> key. The following screen appears.

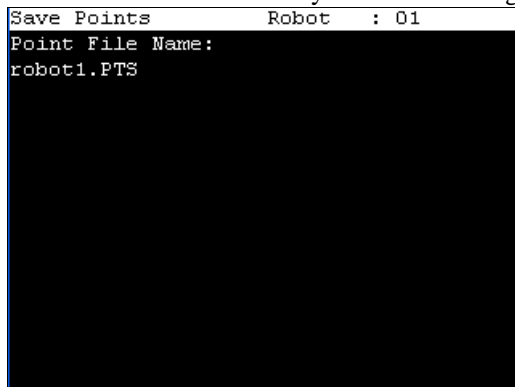

- (2) Press the <OK> key to save the positions to the file.



This can also be executed in the [Point Editor] screen.

Loading Point File

- (1) Press the <LoadPoints> key. The following screen appears. Move the cursor to select a file.

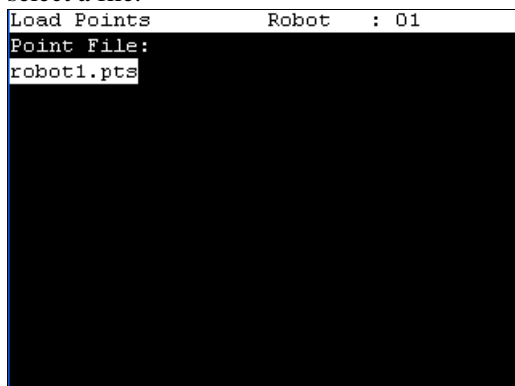

- (2) Press the <OK> key to load the point data in the file memory.



This can also be executed in the [Point Editor] screen.

```
Load Points      Robot : 01
Changes were made to
robot1.PTS

Save?

Yes      No
```

Select whether if you want to save the point file.

- F2 : Save the new settings and load the point file.
 F3 : Destroy the new settings and load the point file.
 Cancel : Return to the previous screen.



This can also be executed in the [Point Editor] screen.

14.3.2 Point Editor

This section indicates settings in the [Point Editor] screen.

- (1) Press the <F1> key in the [Jog & Teach] screen. The following screen appears.

```
Point Editor      Robot : 01
robot1.PTS
Point : 0 Label :
Position
X:          Local: 00
Y:          Hand : Righty Lefty
Z:          Elbow: Above  Blow
U:          Wrist: NoFlip Flip
V:          J4Flag: 0      1
W:          J6Flag: 000

Label  Position  Delete  Jog&Teach
```

- (2) Set the data items currently displayed in the [Point Editor] screen.

See (described hereinafter) : Specifying Point Number Changing Point Label
 Changing Coordinate Data and Pose Flag
 Deleting Point Data

- (3) Note down the robot position.

See (described hereinafter) : Teaching

- (4) Back up the point data to a file.

See (described hereinafter) : Saving Point File

Specifying Point Number

There are two ways to specify the point number.

- (1) Specify the point number by changing the value in the [Point] using the <↑> and <↓> keys.
Change the point number to change the indication at [Label].
- (2) Change the [Point] values directly and press the <Enter> key.
Change the point number to change the indication at [Label].

Changing Point Label

- (1) Press the <F1> key and move the cursor to [Label].
- (2) Enter the label name at [Label] to set the name.
- (3) Press the <Enter> key.
- (4) Press the <OK> key to apply the memory.

Changing Coordinate Data and Pose Flag

- (1) Press the <F2> key and move the cursor to [Position: X].
- (2) Move the cursor, and set the coordinate data/pose flag.



To change the orientation flag, point to the orientation flag and press the <F2> key.

- (3) Press the <OK> key to apply the memory.

Deleting Point Data

Press the <F3> key to delete the point data.

14.3.3 Robot

This section indicates settings in the [Robot] screen.

Press the <F2> key in the [Jog & Teach] screen. The following screen appears.

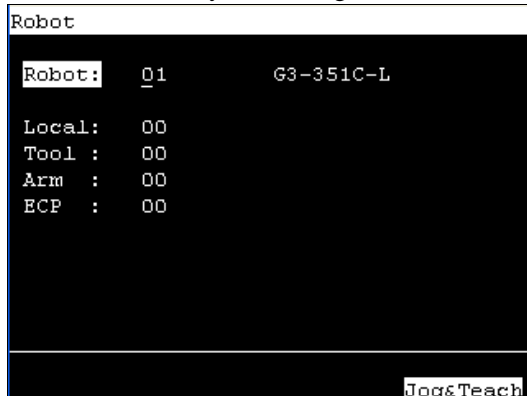

When a value has been changed, press the <Enter> key to apply the value, and be sure to press the <OK> key to save the settings.

Changing Robot Number

- (1) Press the <↑> <↓> keys and move the cursor to [Robot].
- (2) Change the robot number.
- (3) Press the <Enter> key.
- (4) [Label] display changes by changing the robot number.
- (5) Press the <OK> key to save the settings.



The display of the [Robot] is changed in the step (3). Save the robot setting before changing the numbers of Arm, Tool, Local, and ECP.

Changing the numbers of Arm, Tool, Local, ECP



Set the robot number first and then change the numbers of Arm, Tool, Local, and ECP.

- (1) Press the <↑> <↓> keys and move the cursor to item
- (2) Change the number.
- (3) Press the <Enter> key.
- (4) Press the <OK> key to save the settings.

14.3.4 Motion Command

6-Axis robots

This item indicates the procedure for executing motion commands when using 6-Axis robots

- (1) Press the <F3> key in the [Jog & Teach] screen. The following screen appears.

Move the cursor to the desired motion command, and press the <OK> key.



- (2) The motion command screen appears.
Set the information required for the motion command, and press the <Enter> key to apply the settings.
- (3) Press the <OK> key to execute the motion command.



To execute motion command, grip the enable switch while pressing the <OK> key.

Robots except 6-Axis robots

This item indicates the procedure for executing motion commands when using the robots except the 6-axis robots.

- (1) Press the <F3> key in the [Jog & Teach] screen. The following screen appears.

Move the cursor to the desired motion command, and press the <OK> key.

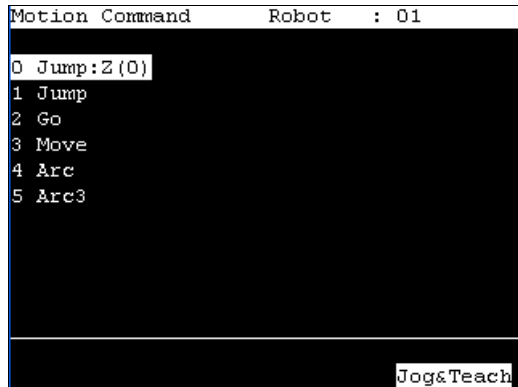

- (2) The motion command screen appears.
Set the information required for the motion command, and press the <Enter> key to apply the settings.
- (3) Press the <OK> key to execute the motion command.



To execute motion command, grip the enable switch while pressing the <OK> key.

14.3.5 I/O Command

This section indicates settings in the [I/O Command] screen.

Press the <F4> key in the [Jog & Teach] screen. The following screen appears.

```
I/O Command      Robot : 01
Inputs
Bit#  Status  Label
  0   On     Sensor1
  1   On     Sensor2
  2   On
  3   On
  4   On
  5   On
  6   On
  7   On
Outputs  Jog&Teach
```

Switching Input/Output Status Display

Press the <F3> key to switch between the “Inputs” status and the “Outputs” status display.

Output Bit ON/OFF

- Press the <F3> key to display the “Outputs” status.

```
I/O Command      Robot : 01
Outputs
Bit#  Status  Label
  0   Off     Vacuum
  1   Off
  2   Off
  3   Off
  4   Off
  5   Off
  6   Off
  7   Off
ON     OFF     Inputs  Jog&Teach
```

- Move the cursor to the output bit that you want to change.
- Switch the ON/OFF status of the output bit.
 - <F1> key: On
 - <F2> key: Off

14.3.6 Jog Distance

This section indicates settings in the [Jog Distance] screen.

Press the <F5> key in the [Jog & Teach] screen. The following screen appears.

```
Jog Distance      Robot : 01
Jog Mode: World Tool Local Joint ECP
Jog Dist: Long Medium Short

X : 1.000        [ mm ]
Y : 1.000        [ mm ]
Z : 1.000        [ mm ]
U : 1.000        [ deg ]
V : 1.000        [ deg ]
W : 1.000        [ deg ]

Default          Jog&Teach
```

When a value has been changed, press the <Enter> key to apply the value, and be sure to press the <OK> key to save the settings.

Changing Jog Distance

Set the jog distance.

NOTE



- The current jog mode and jog distance are displayed.
- You can change these settings by pressing the <Jog Mode> or <Jog Dist> key.
- When the <F5-8> key lights up its LED, the toggles of <Jog Mode> and <Jog Dist> keys are the opposite direction.

- (1) Press the <↑> <↓> keys and move the cursor to change an item.
- (2) Change the Jog Distance.
- (3) Press the <Enter> key.
- (4) Press the <OK> key to save the settings.

Default

Press the <F1> key to return jog distance data to their defaults.

14.3.7 Free Joints

This section indicates settings in the [Free Joints] screen.

Press the <F6> key in the [Jog & Teach] screen. The following screen appears.

```
Free Joints      Robot   : 01
J1:             J2:             J3:             J1
J4:             J5:             J6:             J2
                                                    J3
                                                    J4
                                                    J5
                                                    J6
+:LOCK  -:FREE
Free All Lock All Jog&Teach
```

Specify On/Off for each joint.

When performing direct teaching (manually moving the robot by hand to perform teaching), set the joint to Off.

Press the <Jog Dist> key and select “Free Joint” at [Jog Dist].

Set On/Off for each joint.

- <+> key : Lock : Sets the joint to Off.
- <-> key : Free : Sets the joint to On.
- <F2> key : All Lock : Sets all joints to Off.
- <F3> key : All Free : Sets all joints to On.

For the Jog keys operation, refer to *Operation: 14.3.1 Jog & Teach - Jog key*.

14.3.8 Brake (6-Axis robots only)

This section indicates the brake ON / OFF switching for each joint.



When you use the 6-axis robot, the <F8> key is displayed.

- (1) Press the <F8> key in the [Jog & Teach] screen. The following screen appears.

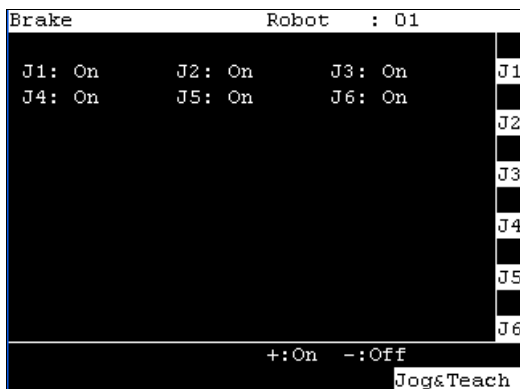

The following screen appears when the password is set up.

Enter the password (1 to 16 characters) and press the <OK> key.

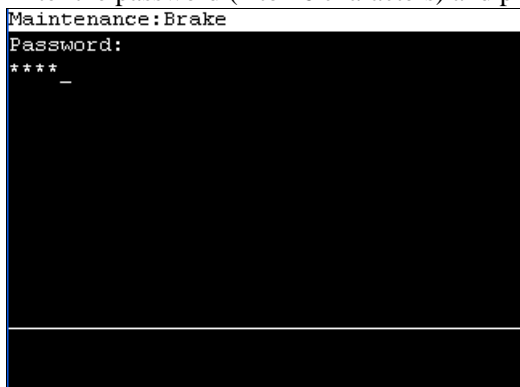

For password setting, refer to *Operation 14.5. Password Setup*.

To turn the brake ON

- (2) Press the <Jog+> key of the joint whose brake On/Off setting is to be switched.
- (3) Press the <OK> key. The brake is locked.

To turn the brake OFF

- (2) Press the <Jog-> key of the joint whose brake On/Off setting is to be switched.
- (3) The brake Off confirmation message appears. Confirm the message and press the <F1> key.

```
Brake          Robot   : 01
Warning:

BRAKE OFF can be cause the specified
joint to fall.Ensure that the joint is
properly supported.

Do you want to continue?
```

- (4) The brake is released, and the specified joint moves manually.

NOTE



For the Jog keys operation, refer to *Operation: 14.3.1 Jog & Teach - Jog key*.

14.4 AUTO Mode

Switch the mode selector key switch to “Auto” to enter the AUTO mode.

AUTO mode is used for the automatic operation (executing programs) in the field running and state reference of the robot system.

Note, however, that the program cluster cannot be executed.

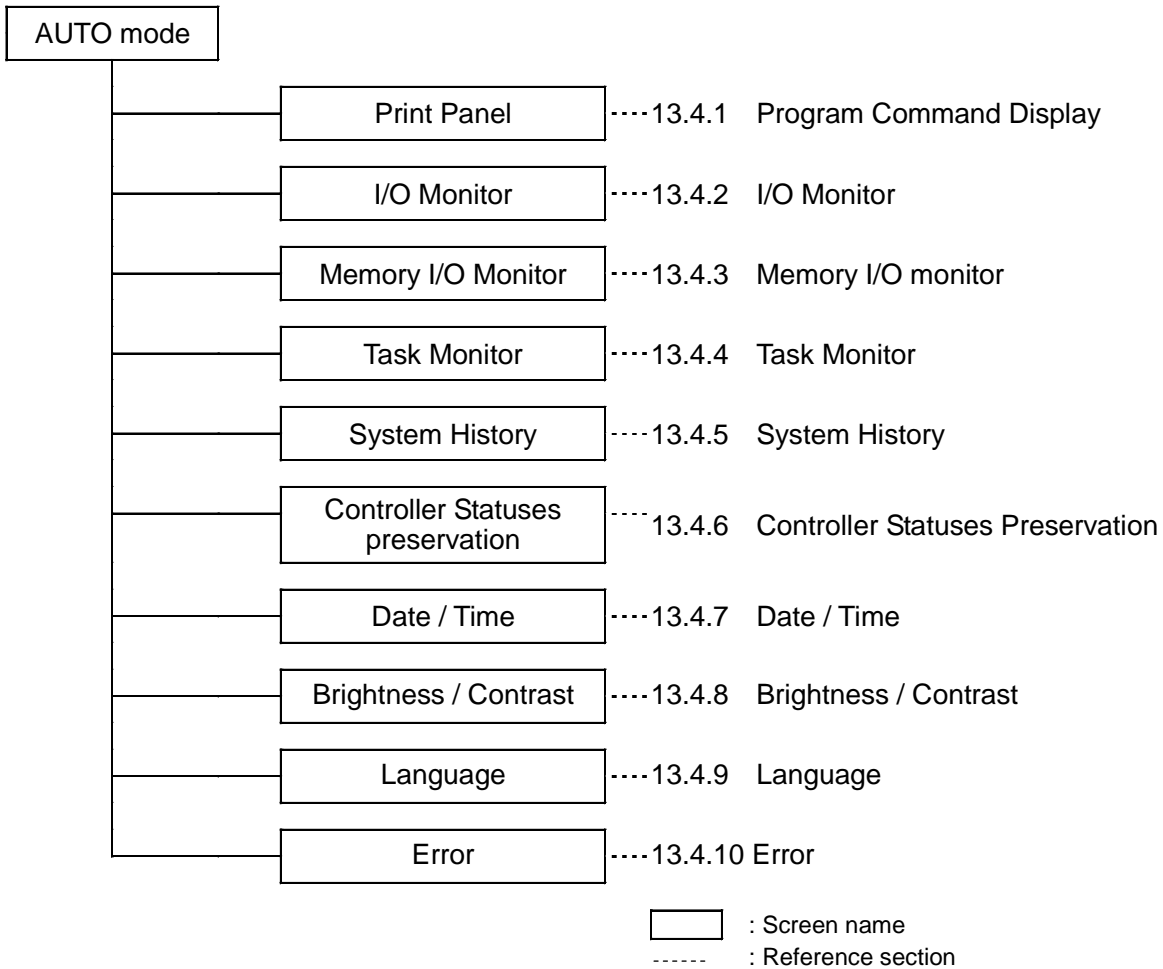

Switch the mode selector key switch to “Auto” to display the [Print] screen. Follow the description on the screen and press the <F4> key to display the [Main Menu] screen.

```

Main Menu
0 Print Panel
1 I/O Monitor
2 Memory I/O Monitor
3 Task Monitor
4 System History
5 Controller Status...
6 Date / Time
7 Brightness / Contrast
8 Language
  
```



TIP Menus with “...” at the end have following procedures after selecting the menu and cannot be executed only by pressing the <OK> key.

14.4.1 Program Command Display

The [Print] screen appears when the mode selector key switch is switched to “Auto”.
To display the [Print] screen from the [Main Menu] screen, move the cursor to [0 Print Panel], and press the <OK> key.

When only a message appears

Program Example :

```
PRINT #24, "Test Print"
```

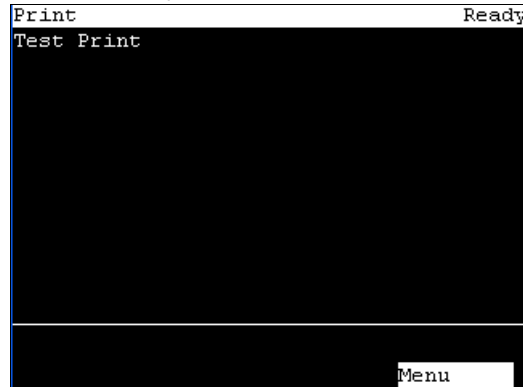

<F4> The [Main Menu] screen appears.

When a message appears and a response is requested

Program Example :

```
PRINT #24, "Test Print"
```

```
INPUT #24, a$
```

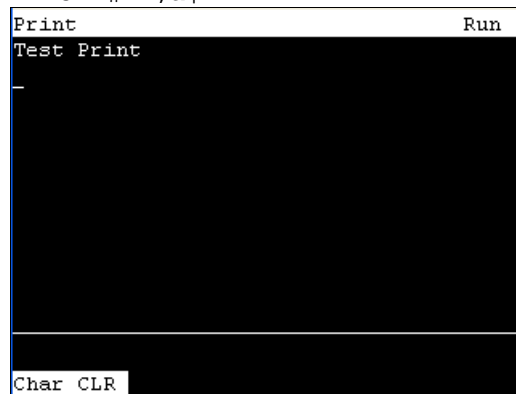

Input the response to the message at the cursor position. (Characters or numerical values)

<F1> Deletes all entered characters or numerical values.

14.4.2 I/O Monitor

This screen displays the bit status of I/O.

In the [Main Menu] screen, move the cursor to [1 I/O Monitor], and press the <OK> key.

Displays the item Bit #, Status # and label in this order from the left.

I/O status (Inputs, bit units)

I/O Monitor		
Inputs:		
Bit#	Status	Label
0	Off	Sensor0
1	Off	Sensor1
2	Off	
3	Off	
4	Off	
5	Off	
6	Off	
7	Off	

Outputs Byte Menu

“*” (asterisk) is displayed before the label name for remote setting display to separate remote setting and I/O label.

- <F1> Switches between Inputs and Outputs.
- <F2> Switches the I/O status display (Bit units or Byte units).
- <F4> The [Main Menu] screen appears.

14.4.3 Memory I/O Monitor

This screen displays the bit status of memory I/O.

In the [Main Menu] screen, move the cursor to [2 Memory I/O Monitor], and press the <OK> key.

Displays the item Bit#, Status, and Label in this order from the left.

Memory I/O status (bit units)

Memory I/O Monitor		
Bit#	Status	Label
0	Off	Ready
1	Off	Busy
2	Off	
3	Off	
4	Off	
5	Off	
6	Off	
7	Off	

Byte Menu

- <F2> Switches the I/O status display (Bit units or Byte units).
- <F4> The [Main Menu] screen appears.

14.4.4 Task Monitor

This screen displays the status of tasks.

In the [Main Menu] screen, move the cursor to [3 Task Monitor], and press the <OK> key.

Displays the item Number, Status, Type, and Name in this order from the left.

Task Monitor			
Normal Task			
#	Status	Type	Name
1	Run	NOR	main
2	Run	NOR	Task2
3	Run	NOR	Task3
4			
5			
6			
7			
8			
9			
10			

Line BG TRAP Menu

When the task name is too long to display the whole name, a tilde is attached at the end of the task name as “LongTaskName_1234567890~”.

<F1> Displays the status and line number (Six digits) of all tasks in the program specified by the cursor.

Task Monitor			
Normal Task			
#	Line	Type	Name
1	000010	NOR	main
2	000016	NOR	Task2
3	000021	NOR	Task3
4			
5			
6			
7			
8			
9			
10			

Status BG TRAP Menu

<F2> Switches the task status display (Back ground task or Normal task).

Task Monitor			
BG Task			
#	Line	Type	Name
65	000011	BG	BGMAIN
66			
67			
68			
69			
70			
71			
72			
73			
74			

Status Normal TRAP Menu

<F3> Switches the task status display (Trap task or Back ground task).

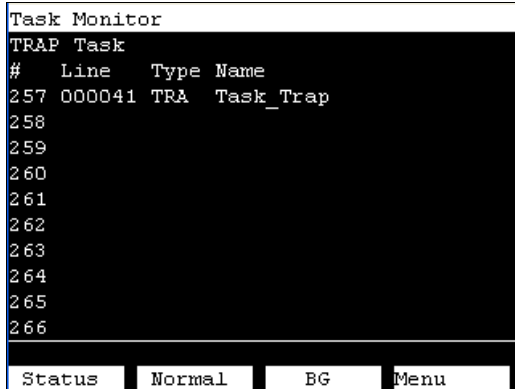

<F4> The [Main Menu] screen appears.

14.4.5 System History

This screen displays a history of errors, operations and warnings that occurred in the past. In the [Main Menu] screen, move the cursor to [4 System History], and press the <OK> key.

Displays the item type, Number, Robot#, Joint #, Task #, Date, and Time in this order from the left.

[System History] main screen

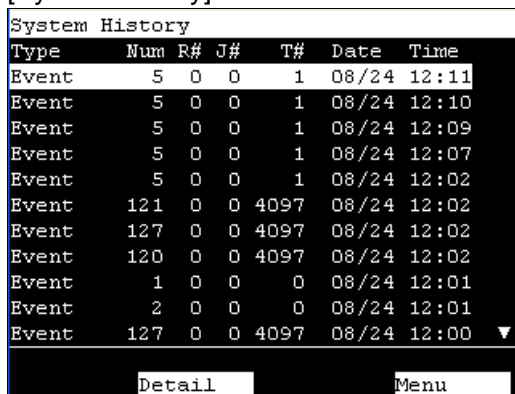

<F4> The [Main Menu] screen appears.

<F2> Displays the details of the error specified by the cursor.

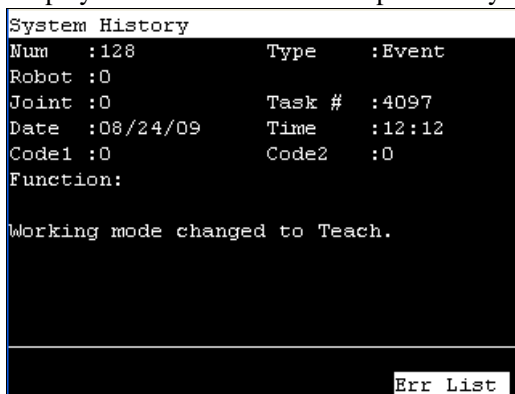

14.4.6 Controller Statuses Preservation

Indicate the procedure to save the status of the Controller to the USB memory.

- (1) Insert the USB memory into the Controller.
- (2) In the [Main Menu] screen, move the cursor to [5 Controller States...], and press the <OK> key.

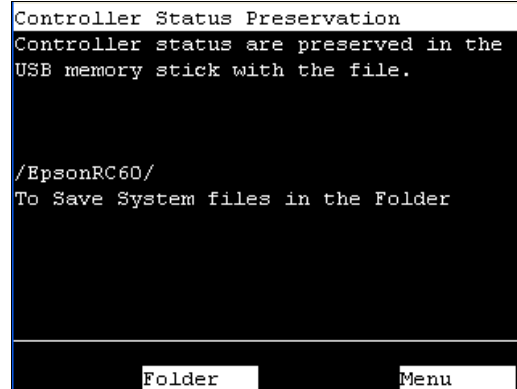

<F2> The [Folder select] screen appears.

<F4> Returns to the [Main Menu] screen.

- (3) Press the <F2> key. Select a folder to save the data.
The root directory is selected by default.
- (4) Press the <OK> key to save the status.
- (5) Press the <OK> key again to return to the [Main Menu] screen.

14.4.7 Date / Time

This screen displays the Controller's date and time.

- (1) In the [Main Menu] screen, move the cursor to [6 Date / Time], and press the <OK> key.
- (2) Able to check the date and time.

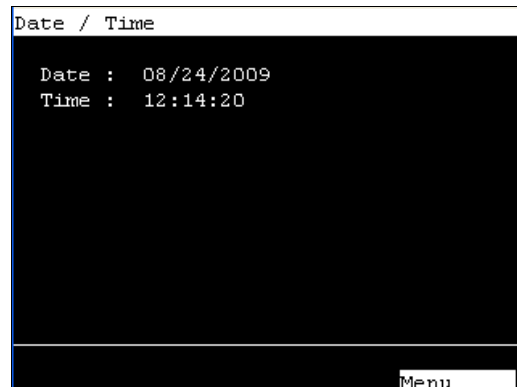

<F4> Returns to the [Main Menu] screen.

14.4.8 Brightness / Contrast

- (1) In the [Main Menu] screen, move the cursor to [7 Brightness / Contrast], and press the <OK> key.
- (2) Adjust the brightness and contrast. Press the <OK> key to save the status.

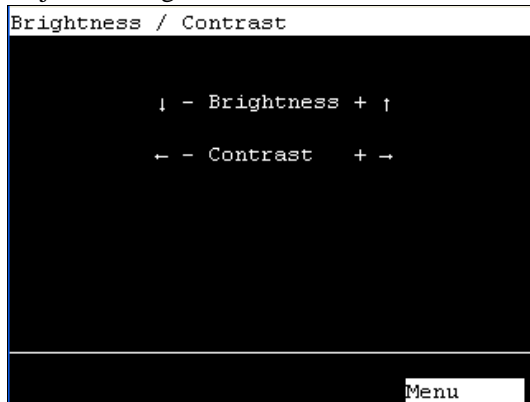

- < ↓ >< ↑ > These arrow keys can adjust the brightness.
- < ← >< → > These arrow keys can adjust the contrast.
- <F4> Returns to the [Main Menu] screen.

14.4.9 Language

- (1) In the [Program Mode] screen, move the cursor to the last line, and press the <↓> key. The following screen appears.
In the [Main Menu] screen, move the cursor to [8 Language...] and press the <OK> key.
- (2) Move the cursor to the desired display language, and press the <OK> key.



The new display language setting is enabled after the next startup.

- <F4> Returns to the [Main Menu] screen.

14.4.10 Error

Error # and Error message appears when an error occurs

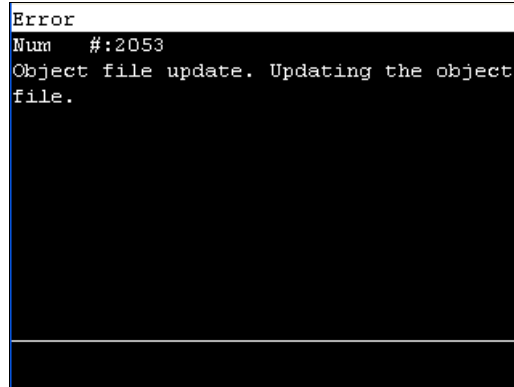

<OK> Moves to the screen before the error occurred.

14.5 Password Setup

Setup a password to limit operators for the brake equipment (6-axis robot only).

TEACH mode..... [Jog&Teach]-[Brake] 6-Axis robot only

Follow the procedure below to set the password.

- (1) Select EPSON RC+6.0 menu-[Setup]-[System Configuration]-[SPEL Controller Board]-[Configuration] to display the following screen.

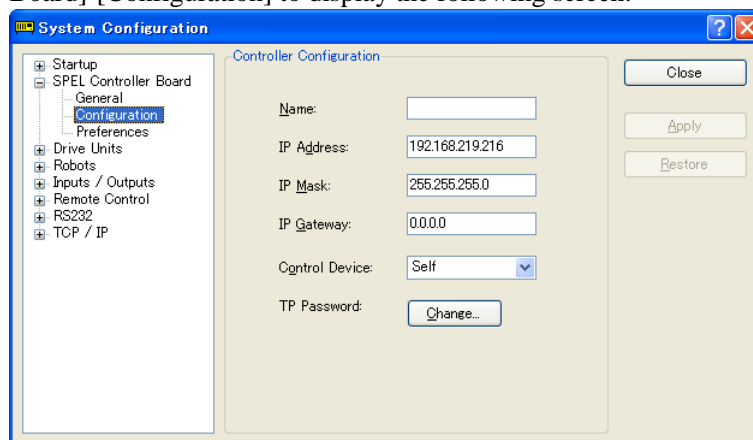

- (2) Click the <Change> button at "TP Password."

- (3) The following dialog appears.

Enter a password within 16 alphanumeric characters from the keyboard and click the <OK> button.

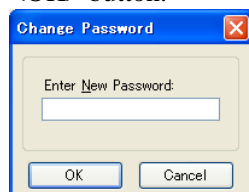

- (4) Click the <Apply> button and reboot the Controller.

14.6 Troubleshooting

If the condition does not change after performing the countermeasure above, the unit may have suffered a breakdown.

Please contact the service center or the manufacturer.

Display panel is blank

- The Controller supplies DC24V.
Check that the Controller RC620 is ON.
- Check that the Controller RC620 is connected to the TP port of the Controller properly.

An Error code appears and the Robot does not operate normally

- Please refer to the error code indicated in the following manual.
EPSON RC+6.0 SPEL+ Language reference

Robot does not move by pressing the Jog key

- Execute the Motor On command to energize the Robot motor.
(Refer to Motor On in the SPEL+ Language Reference)
- Energize the Robot motor.
(Refer to SLock in the SPEL+ Language Reference)
- Short jog distance may be selected.
Check the value in the [Jog Distance] screen and change the setting to long distance if needed.
(Refer to *Setup & Operation 14.3.6 Jog Distance*)

Operation mode does not switch from TEACH mode to AUTO mode

- Send the latch release input signal to release the latch status.

15. Option: RAID

Here describes the functions and operating instructions of the RAID – Option for the Robot controller.

15.1 Overview

RAID option provides the function of RAID1 (mirroring).

 CAUTION	<ul style="list-style-type: none"> ■ Do not remove the HDD with RAID system because it may break the RAID system. Do not remove the HDD except when it has a failure. ■ The S.M.A.R.T runs incorrectly. Check the disk status from the Intel Matrix Storage Console.
---	--

15.2 Data Protection Status Confirmation

Execute the **Intel Matrix Storage Console** from the Windows | Start | All programs | Intel(R) Matrix Storage Manager.

15.2.1 Normal Status

When the mirroring runs normally, it displays “System Functioning normally.” on the Intel Matrix Storage Console.

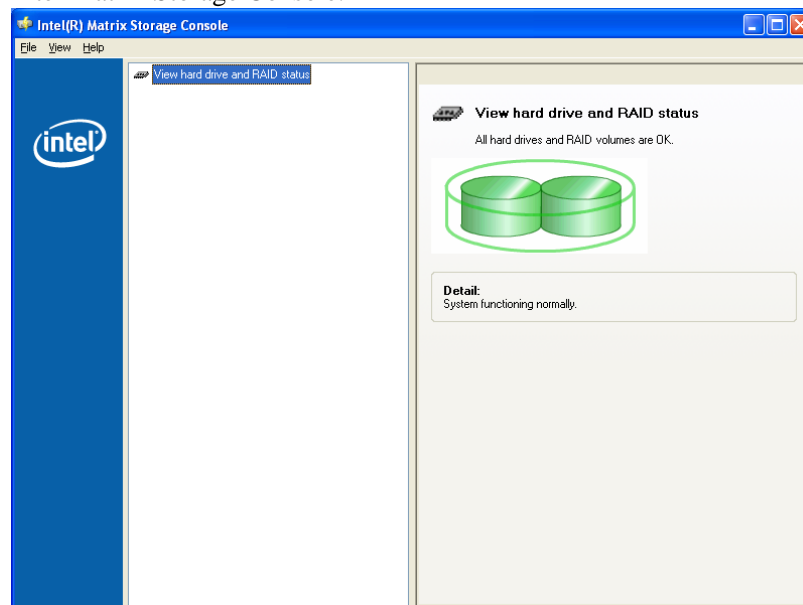

15.2.2 Status for Restore

When the mirroring brakes and requires the restoration, it displays “A hard drive is missing, the system is functioning normally. However, data protection is no longer available.” on the Intel Matrix Storage Console.

NOTE

Check the port number that running normally, and restore the data protection status. To do so, refer to *15.4 Restoring the Data Protection Status*.

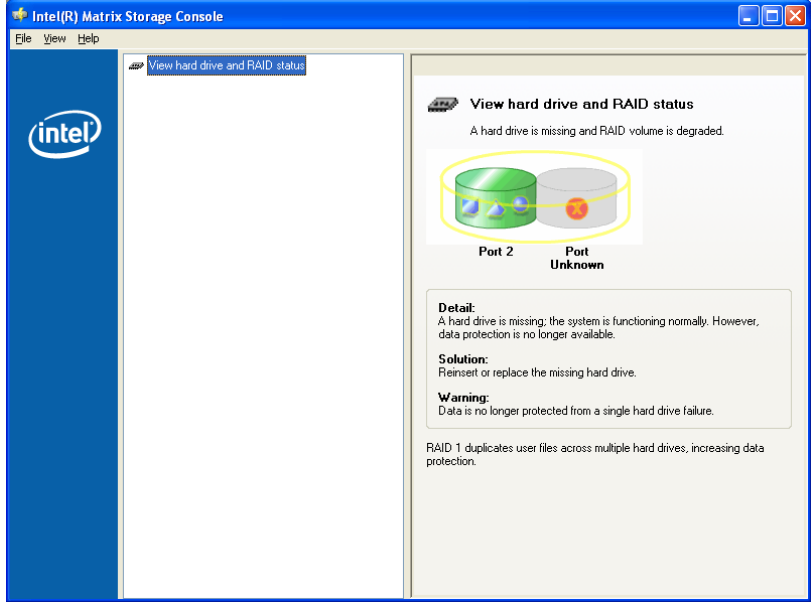

NOTE

When this icon  is shown on the Windows task tray, it indicates that the restoration is necessary.

HDD No.	1	2
	↓	↓
Port No.	0	2

15.3 Restoring the Data Protection Status

Follow the instruction below and restore the data protection status.

- 15.4.1 Shutdown the system
- 15.4.2 Replace the HDD
- 15.4.3 Restore the data protection status

15.3.1 Shutdown the system

- (1) Check the port which is normally running.



To check the port which is normally running, execute the **Intel Matrix Storage Console** from Start | All programs | Intel(R) Matrix Storage Manager.

- (2) Shutdown the system.

15.3.2 Replace the HDD

Refer to *Maintenance 6.9 HDD* and replace the HDD.

15.3.3 Restore the data protection status

- (1) Start up the Controller.
- (2) Execute the **Intel Matrix Storage Console** from Start | All programs | Intel(R) Matrix Storage Manager.
- (3) Click the <Restore RAID 1 data protection>.

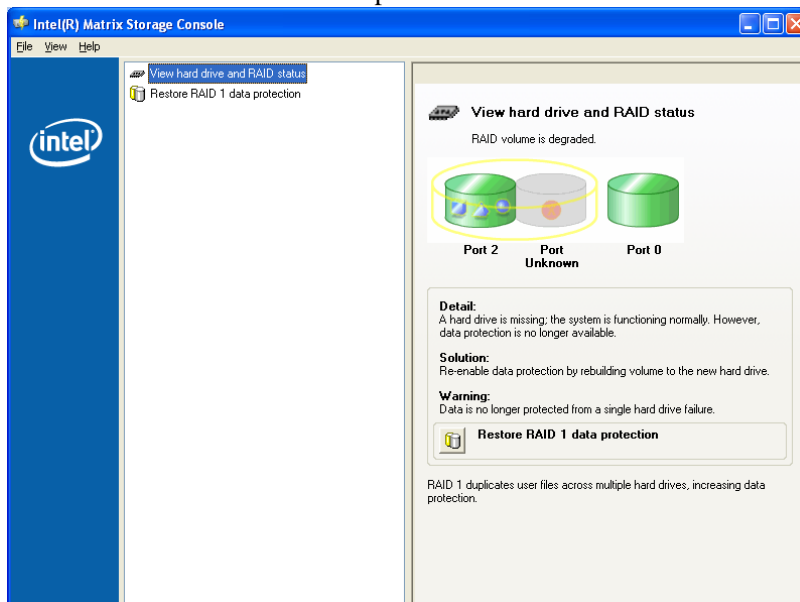

- (4) Click the <Rebuild RAID volume now>.

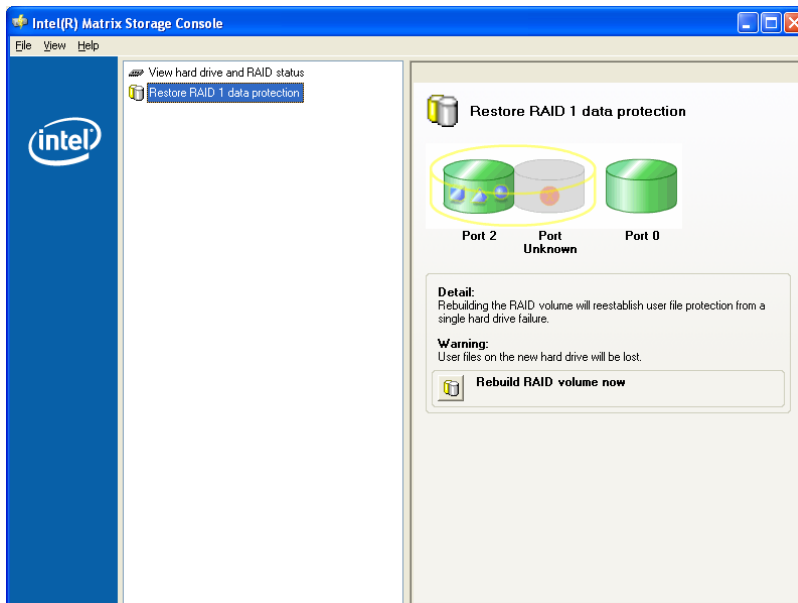

- (5) Click the <Yes> button.

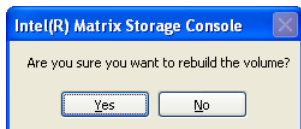

The restoration (rebuild of the volume) starts.
This process requires approx. 40 minutes.

- (6) When the restoration is completed, it displays as below.

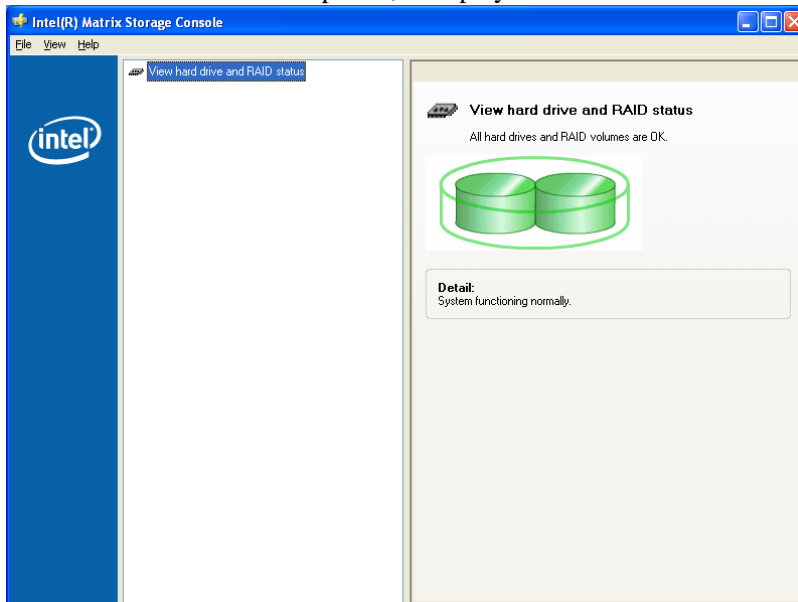



- (7) Exit the Intel Matrix Storage Console.

Maintenance

This section contains maintenance procedures for the Robot Controller.

1. Safety Precautions on Maintenance

1.1 Safety Precautions

 <p>WARNING</p>	<ul style="list-style-type: none"> ■ Only authorized personnel who have taken the safety training should be allowed to execute teaching or calibration of the robot system. The safety training is the program for industrial robot operator that follows the laws and regulations of each nation. The personnel who have taken the safety training acquire knowledge of industrial robots (operations, teaching, etc.). The personnel who have completed the robot system-training class held by the manufacturer, dealer, or locally-incorporated company are allowed to maintain the robot system. ■ Only authorized personnel who have taken the safety training should be allowed to maintain the robot system. The safety training is the program for industrial robot operator that follows the laws and regulations of each nation. The personnel who have taken the safety training acquire knowledge of industrial robots (operations, teaching, etc.), knowledge of inspections, and knowledge of related rules/regulations. The personnel who have completed the robot system-training and maintenance-training classes held by the manufacturer, dealer, or locally-incorporated company are allowed to maintain the robot system. Make sure to use only dedicated/specified maintenance parts especially for the optional boards or any other parts in the Controller to be replaced. Using non-specified parts may cause serious damage to the robot system and/or serious safety problems. ■ Do not remove any parts that are not covered in this manual. Follow the maintenance procedure strictly as described in this manual. Do not proceed using any methods other than described in this manual when you do replace a part or maintain the equipment. Improper removal of parts or improper maintenance may cause not only improper function of the robot system but also serious safety problems.
 <p>WARNING</p>	<ul style="list-style-type: none"> ■ Before performing any maintenance procedure, always make sure that the main power of the Controller is turned OFF, unplug the power supply, and that the high voltage charged area is completely discharged. Performing any maintenance procedure while the main power is ON or the high voltage charged area isn't discharged completely is extremely hazardous and may result in electric shock and/or cause serious safety problems.
 <p>CAUTION</p>	<ul style="list-style-type: none"> ■ Do not touch the Motor Driver modules, Switching Power Supply, and Regeneration Module directly in the Controller. The metal resistance of these can become very hot and may result in a burn. If you maintain them, examine the surface temperatures and wear protective gloves if necessary. ■ Do not shock, shake, or drop any parts during maintenance. When the parts related with data are shocked physically, they may be damaged and may also cause data loss during data loading/saving.

 CAUTION	<ul style="list-style-type: none"> ■ Do not lose the screws removed at maintenance. When the screw is dropped into the Controller, be sure to take it out. Leaving the screw in the Controller may cause short circuit and may result in equipment damage to the parts and/or robot system. ■ Make sure that the power rating (wattage) of a new Motor Driver module is correct. Using a Motor Driver module with improper power rating (wattage) in the Controller may cause improper function of the robot system and errors. ■ The serial number of the Manipulator that should be connected is indicated on the Connection Check Label on the Controller. Connect the Controller and the Manipulator correctly. Improper connection between the Controller and the Manipulator may cause not only improper function of the robot system but also serious safety problems.
--	--

NOTE  Before performing maintenance on the Controller, all the data must be copied as a backup. The details of data backup/restore are described in the *Maintenance 4. Backup and Restore*.

1.2 Lockout / Tagout

Lockout / tagout is a method to prevent any one from turning ON the robot system by mistake while someone else is within the safeguarded area for maintenance or repair. When performing maintenance and repair, lockout and tagout using the following procedure.

- (1) Turn OFF the POWER switch.
- (2) Turn the key towards the direction of arrow shown below with the POWER switch in OFF position.

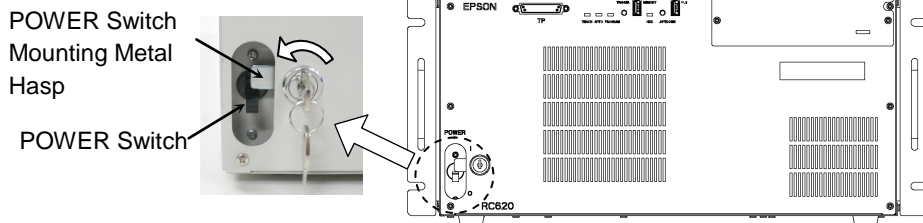

- (3) Unplug the power supply plug of the Controller from the power supply socket.
- (4) Attach a note to the POWER switch or the power supply plug to prevent any one from turning ON the robot system by mistake.

RC620-UL:

For maintenance and repair, make sure to lockout and tagout the external disconnecting means.

2. Regular Maintenance Inspection

Performing regular maintenance inspection properly is essential for preventing trouble and maintaining safety. This chapter describes the schedules for maintenance inspection and procedures.

Be sure to perform the maintenance inspections in accordance with the schedules.

2.1 Schedule for Maintenance Inspection

Inspection points are divided into five stages: daily, monthly, quarterly, biannual, and annual. Inspection points are added at every stage.

If the robot system is operated for 250 hours or more per month, inspection points must be added every 250 hours, 750 hours, 1500 hours, and 3000 hours operation.

	Inspection Point				
	Daily inspection	Monthly inspection	Quarterly inspection	Biannual inspection	Annual inspection
1 month (250 h)	Inspect every day	✓			
2 months (500 h)		✓			
3 months (750 h)		✓	✓		
4 months (1000 h)		✓			
5 months (1250 h)		✓			
6 months (1500 h)		✓	✓	✓	
7 months (1750 h)		✓			
8 months (2000 h)		✓			
9 months (2250 h)		✓	✓		
10 months (2500 h)		✓			
11 months (2750 h)		✓			
12 months (3000 h)		✓	✓	✓	✓
13 months (3250 h)		✓			
⋮	⋮	⋮	⋮	⋮	⋮

2.2 Inspection Point

2.2.1 Inspection While the Controller is Turned OFF

Inspection Point	Inspection Location	Daily	Monthly	Quarterly	Biannual	Annual
Visually check for external defects. Clean up if necessary.	External appearance of Controller	✓	✓	✓	✓	✓
Clean the fan filter	Front side		✓	✓	✓	✓
Battery	Front side	Ever 5 years				
UPS Battery	Front side	*				

* Life of UPS battery depends on the temperature around the battery. For details, refer to 12. UPS.

2.2.2 Inspection While the Controller is Turned ON

Inspection Point	Inspection Location	Daily	Monthly	Quarterly	Biannual	Annual
Check whether unusual sound or vibration is occurring.	Entire Controller	✓	✓	✓	✓	✓
Make a backup of data.	Project and system data	Whenever data is changed.				

3. Controller Structure

3.1 Location of Parts

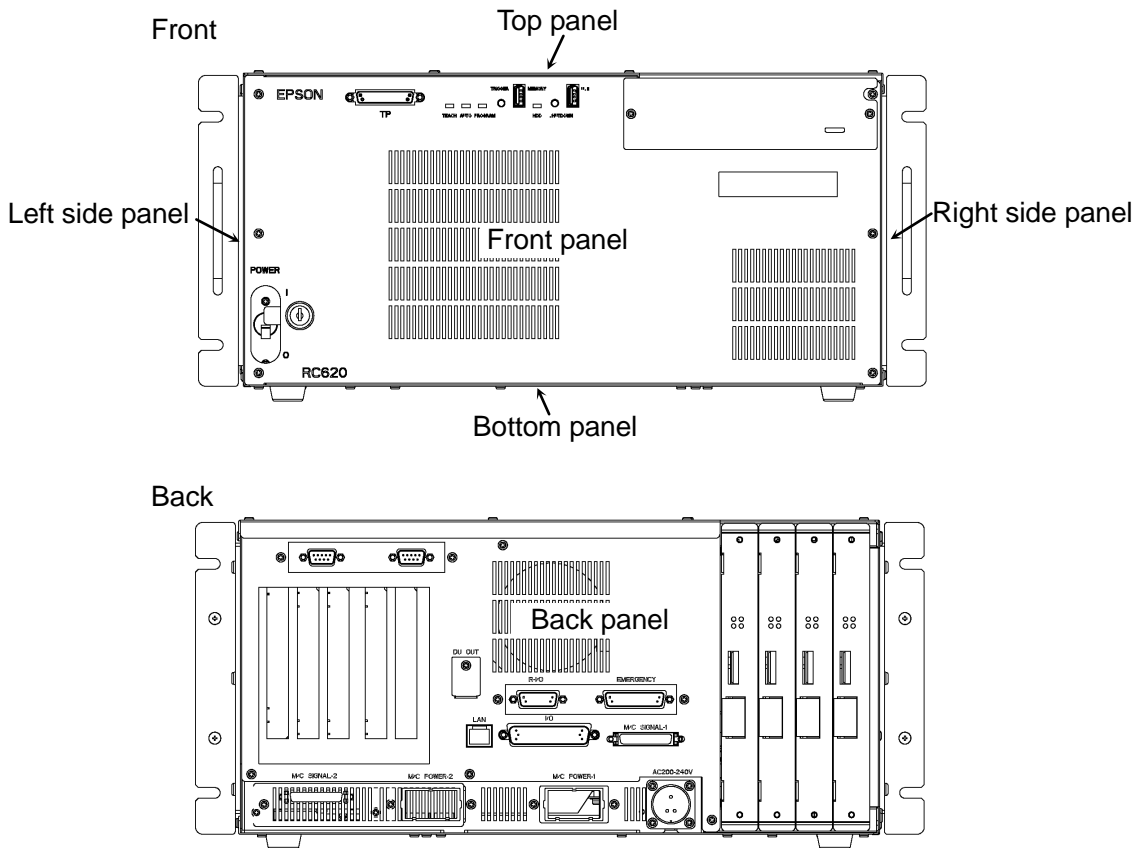























3.2 Diagram of Cable Connections



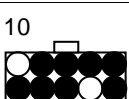













For the connections of controller inner cables, refer to the following diagram.

The diagram is a simplified development view inside the Controller.

The numbers indicated such as (1), (2), (3) correspond to the following cable list.

Cable List

No.	Connection	Connector pin Quantity	Wire Quantity	Connector pin Quantity	Connection	Note
1	AC Input Connector		3	–	Circuit protector, FG	
2	Circuit protector	–	2	–	Noise filter	
3	Noise filter	–	6	8 	DPB	
4	DPB	5 	3	5 	Switching Power Supply (15V)	
5	DPB	5 	3	5 	Switching Power Supply (24V)	
6	DPB	5 	3	3	PC Power Supply	
7	DPB	8 	6	8 	DMB	
8	DPB	6 	3	5 	Regenerative Control Board	
9	DPB	8 	6	8 	ADMB	*2
10	Switching Power Supply (15V)	4 	4	4 	DMB	
11	Switching Power Supply (24V)	6 	4	4 	DPB	
12	PC Power Supply	10 	8	6,6,4,4	DMB, ADMB, HDD, DVD drive	
13	UPS Battery Connector	3 	2	3 	ATX Power Supply	
14	PC Power Supply	16,2	18	18	PCI-BPB	
15	PC Power Supply Relay Connector	4 	8	4,4	HDD1, HDD2	
16	DMB	80	80<F>	80	BPB	
17	DPB	26	26<F>	25(D-SUB)	EMERGENCY	
18	DMB	8 	8	15(D-SUB)	Real-time I/O Connector	
19	CPU (Standard)	9 	8	4,10	DMB, FPB	
20	CPU (Standard)	10,12	7	10	PCI-BPB	

No.	Connection	Connector pin Quantity	Wire Quantity	Connector pin Quantity	Connection	Note
21	CPU (High speed)	9 	8	4,10	DMB, FPB	*3
22	CPU (High speed)	6,16,4	10	10	PCI-BPB	*3
23	CPU	7	7<M>	7	HDD1	
24	CPU	7	7<M>	7	HDD2	*4
25	CPU	26	26<F>	26	DVD drive	*5
26	DMB	50	20	4,4,4,4,2,2	M/C power connector	
27	DMB	3 	3	3 	FAN1	
28	DMB	16	16	20	LCD module	
29	DMB	40	36,4	40	FPB	
30	DMB	2 	2	2 	Battery	
31	DMB	6 	6	6 	FPB	
32	DMB	34	34<F>	34	DPB	
33	DMB	4 	4	4 	ADMB	*2
34	DMB	2 	2	2 	ADMB	*2
35	DMB	2 	2	—	Regenerative thermostat	*1
36	Regenerative Board	4 	2	—	Regenerative Resistance	*1
37	DMB	3 	3	3 	FAN2	
38	PCI-BPB	4 	4	4 	FPB	
39	ADMB	100	50<F>, 50<F>	100	DMB	*2
40	M/C power Connector	50	32	4,4,4,4 4,4,9,2,2,2	DMB/ADMB	*6
41	ADMB	9	8	9	DMB	*6
42	ADMB	26	26	26	A-EIB	*7
43	ADMB	50	16	4,4,4,4,2,2	Additional Axes M/C power connector (M1-M4)	*7
44	ADMB	50	8	4,4,2	Additional Axes M/C power connector (M1, M2)	*8

<F> : Flat cable

<M>: Molding cable

*1 : When connect to regeneration module

*2 : When use Axis #5 to Axis #8

*3 : When connect to CPU board (High Speed type)

*4 : When connect to RAID option

*5 : When connect to DVD drive

*6 : When connect to Six axis manipulator

*7 : When connect to additional axes with M/C SIGNAL-2

*8 : When connect to additional axes with M/C POWER-2

3.3 Connector Pin Assignment

Pin assignments differ depending on the manipulator type.

The following tables show the pin assignments for the M/C power connector and M/C signal connectors. For EMERGENCY and TP connectors, refer to *Setup & Operation*.

3.3.1 M/C Power Connector

G / RS / X5 series

	E	D	C	B	A	
1	1W		1V		1U	1
2	2W		2V		2U	2
3	3W		3V		3U	3
4	4W		4V		4U	4
5						5
6						6
7						7
8		FG	FG	FG	FG	8
9						9
10						10

C3 series

	E	D	C	B	A	
1	1W		1V		1U	1
2	2W		2V		2U	2
3	3W		3V		3U	3
4	4W		4V		4U	4
5	5W		5V		5U	5
6	6W		6V		6U	6
7						7
8	FG5	FG4	FG3	FG2	FG1	8
9	FG6		BR3	BR2	BR1	9
10		GND	BR6	BR5	BR4	10

3.3.2 M/C Signal Connector

	G / RS	C3	X5		G / RS	C3	X5
1	-	-	ENC_GND	26	ENC_GND	ENC_GND	ENC_GND
2	1S+	1S+	1S+	27	1S-	1S-	1S-
3	2S+	2S+	2S+	28	2S-	2S-	2S-
4	3S+	3S+	3S+	29	3S-	3S-	3S-
5	ENC_5V	ENC_5V	ENC_5V	30	-	EMC_5V	ENC_5V
6	ENC_GND	ENC_GND	ENC_GND	31	-	ENC_GND	ENC_GND
7	4S+	4S+	4S+	32	4S-	4S-	4S-
8	-	5S+	-	33	-	5S-	-
9	-	6S+	-	34	-	6S-	-
10	ENC_5V	ENC_5V	ENC_5V	35	-	ENC_5V	ENC_5V
11	ENC_GND	ENC_GND	ENC_GND	36	-	ENC_GND	ENC_GND
12	-	-	-	37	-	-	-
13	-	-	-	38	-	-	-
14	-	-	-	39	-	-	-
15	ENC_5V	ENC_5V	ENC_5V	40	-	-	EMB_J2
16	ENC_GND	ENC_GND	ENC_GND	41	-	-	-
17	-	-	EMB_J1	42	-	-	EMB_J4
18	-	-	-	43	-	-	-
19	-	-	-	44	-	-	-
20	ENC_5V	ENC_5V	ENC_5V	45	-	-	ENC_5V
21	-	-	-	46	-	-	-
22	MPOWER	MPOWER	-	47	-	-	-
23	EMB_J3	-	EMB_J3	48	-	-	-
24	-	-	24V	49	24V	24V	24V
25	-	24VGND	24VGND	50	24VGND	24VGND	24VGND

4. Backup and Restore

4.1 What is the Backup Controller Function?

The controller configuration set by EPSON RC+ 6.0 can be stored with the “Backup Controller” function.

The Controller settings can be restored easily using the data previously stored with “Backup Controller” after a configuration mistake or Controller problem.

Be sure to execute “Backup Controller” before changing the Controller setup, before maintenance, or after teaching.

For some problems, backup may not be available before maintenance has to be performed. Be sure to backup the data after making changes, before problems occur.

NOTE  “Controller Status Storage” is one of the RC620 functions. It saves the Controller setup data the same as with “Backup Controller,” and additional data such as the Controller status.

There data can be used as the backup data at restoring.

The methods for “Controller Status Storage” are as follows:

- A : “Controller status storage to USB memory”
For details, refer to *Setup & Operation 5. Memory Port*.
- B : “Export Controller Status function” in EPSON RC+ 6.0.
For details, refer to *EPSON RC+ User’s Guide 5.9.9 Import Command (Project Menu)*.

4.2 Backup Data Types

The table below shows the files created with “Backup Controller”.

File Name	Overview	
Backup.txt	Information file for restore	File including information for restoring the Controller.
CurrentMnp01.PRM : CurrentMnp16.PRM	Robot parameters	Stores information for each robot such as TISet.
InitFileSrc.txt	Initial configuration	Stores various Controller parameters.
MCSys01.MCD : MCSys16.MCD	Robot configuration	Stores information for each connected robot.
ProjectName.obj	OBJ file	Result of project building. Prg file is not included.
All the files related to Project	Project related	All the project files transferred to the Controller. Includes program files when EPSON RC+ 6.0 is configured to transfer source code to the Controller.
GlobalPreserves.dat	Global Preserve variables	Stores values of Global Preserve variables.
ProjectName.vis VisHWConfig.dat	Vision related	Stores the file when Vision Guide option is used.
RCSam.dat	RC+ related	Stores the file when the security option is used.

4.3 Backup

Backup the Controller status from the Teach Pendant (Option) or EPSON RC+ 6.0.

- (1) Select EPSON RC+ 6.0 menu | Tools | Controller to display the [Controller Tools] dialog.

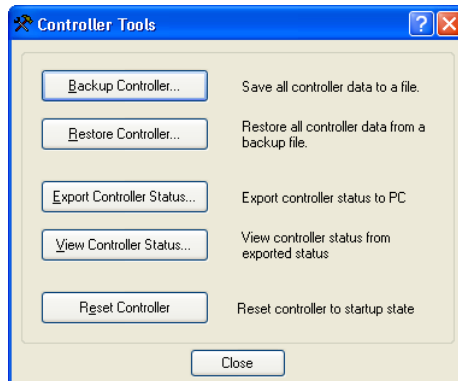

- (2) Click the <Backup Controller...> button to display the [Browse For Folder] dialog.

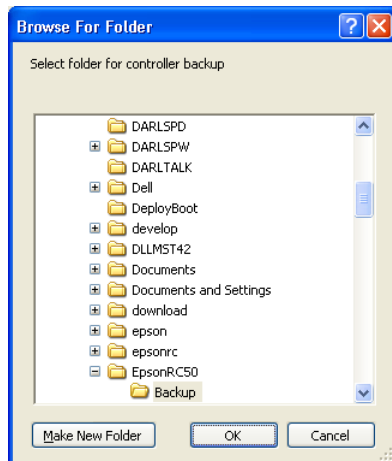

- (3) Specify the folder to save the backup data. Create a new folder if desired.
- (4) Click the <OK> button. A folder is created in the specified folder containing the backup data with a name in the following format.

B_ serial_number_date status was saved

→ Example: B_12345_200608074410

- (5) The following message appears when backup is completed.

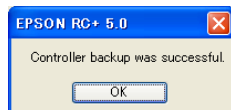

- (6) Click the <OK> button to complete the backup.



CAUTION

- Do not edit the backup files. Otherwise, operation of the robot system after data restoration to the Controller is not assured.

4.4 Restore

Restore the Controller status from the EPSON RC+ 6.0.

 CAUTION	<ul style="list-style-type: none"> ■ Make sure that the data used for restore was saved previously for same Controller. ■ Do not edit the backup files. Otherwise, operation of the robot system after data restoration to the Controller is not assured.
---	---

- (1) Select the EPSON RC+ 6.0 menu-[Tools]-[Controller] to display the [Controller Tools] dialog.

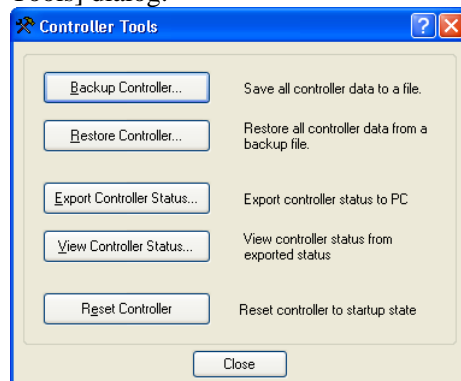

- (2) Click the <Restore Controller...> button to display the [Browse For Folder] dialog.

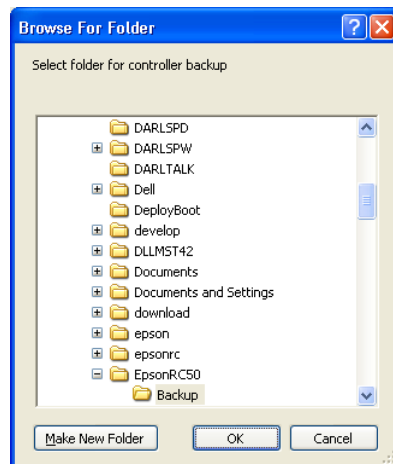

- (3) Specify the folder that contains the backup data. Backup data folders are named using the following format:

B_serial number_date status was saved

→ Example: B_12345_200608074410



Data saved with the Controller status storage function can also be specified for restore. Specify the following folder.

S_serial number_data status was saved

→ Example: S_12345_200608074410

- (4) Click the <OK> button to display the dialog to select the restore data.

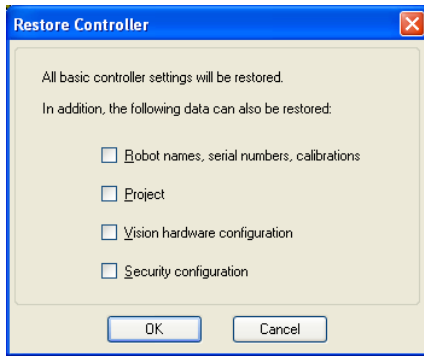

Robot name, serial #, calibration

This checkbox allows you to restore the robot name, robot serial number, Hof's data, and CalPI's data. Make sure that the correct Hof's data is restored. If the wrong Hof's data is restored, the robot may move to wrong positions.

The default setting is unchecked.

Project

This checkbox allows you to restore the files related to projects.

The default is unchecked.

When a project is restored, the values of Global Preserve variables are loaded.

For details about Global Preserve variable backup, refer to *EPSON RC+ 6.0 User's Guide 5.10.10 Display Variables Command (Run Menu)*.

Vision hardware configuration checkbox

This checkbox allows you to restore the vision hardware configuration.

For details, refer to the *EPSON RC+ 6.0 option: Vision Guide 6.0*.

This is not checked by the default setting.

Security configuration checkbox

This checkbox allows you to restore the security configuration.

For details, refer to *14. Security*.

This is not checked by the default setting.

- (5) Click the <OK> button to restore the system information.



Restore the system configuration saved using Backup Controller only for the same system.

When different system information is restored, the following warning message appears.

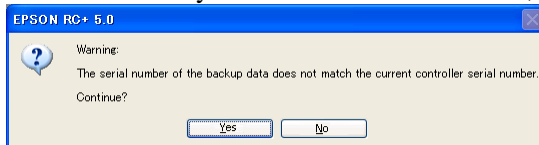

Click the <No> button (do not restore data) except for special situations such as controller replacement.

5. Firmware Update

This chapter describes the firmware upgrade procedure and data file initialization.

5.1 Updating Firmware

Firmware (software stored in non-volatile memory) and data files necessary to control the Controller and the Robot are preinstalled in the Controller. Controller configuration set from EPSON RC+ is always saved in the Controller.

Controller firmware is supplied by CD-ROM as needed. Please contact us for information.

5.2 Firmware Upgrade Procedure

The firmware upgrade procedure is described as follows:

- (1) Turn ON the Controller.
- (2) Shutdown the development software EPSON RC+ 6.0.
- (3) Copy the content of “firmware CD-ROM” to the USB memory and insert the USB memory to the controller USB port.
- (4) Execute “Ctrlsetup60.exe”. The following dialog appears.
- (5) Select the <Upgrade> option button and click the <Next> button.

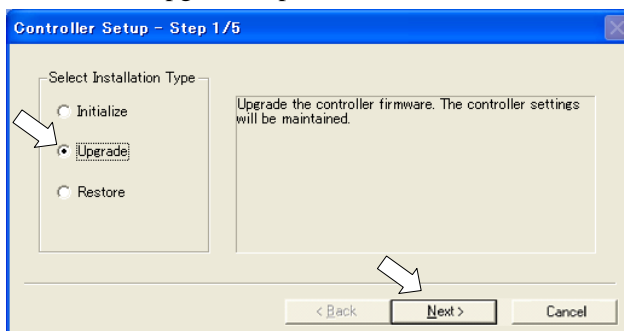

- (6) Confirm the message shown below and Click the <Next> button.

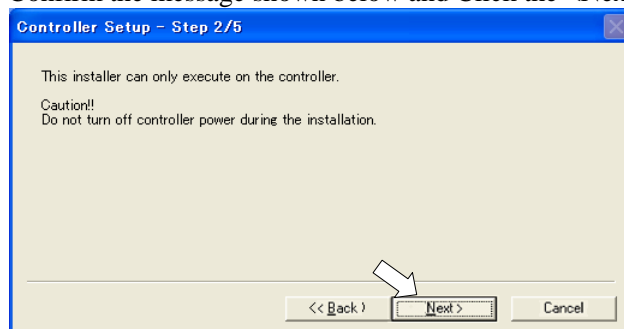

- (7) Check the current firmware version and the new firmware version and click the <Install> button.

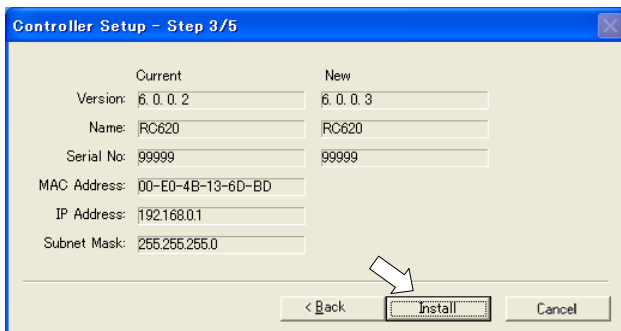

- (8) The firmware registration starts. It takes several minutes to complete. Do not power off the Controller during registration process.

NOTE

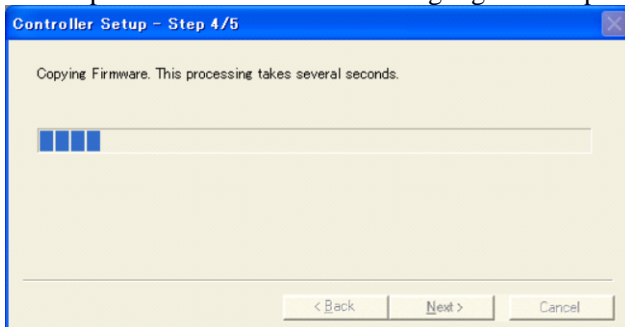

- (9) Continuous data file registration starts.

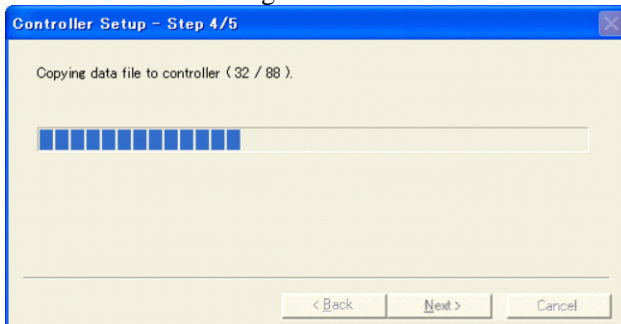

- (10) The following dialog appears when registration has completed. Click the <Next> button to reboot the Controller.

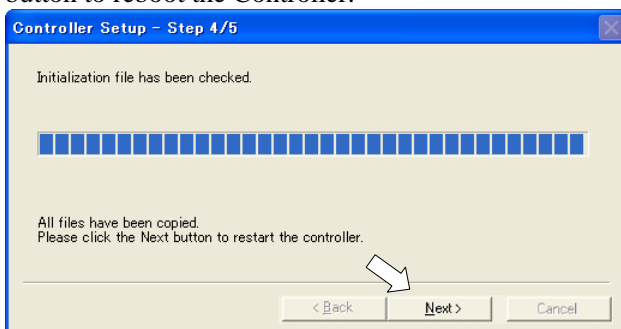

(11) The following dialog appears after the Controller reboot. Click the <Finish> button.

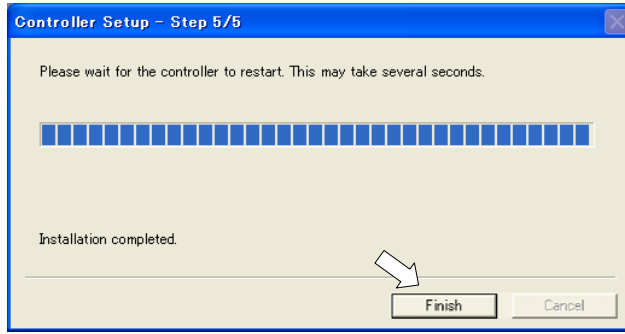

The firmware upgrade is complete.

5.3 Controller Recovery

If the Controller becomes inoperable, use the procedures described in this section to recover.



Controller Backup is recommended for easy recovery of the Controller operation. For details of Controller Backup, refer to *Maintenance 4. Backup and Restore*.

The following two conditions describe the Controller error status after turning on the Controller.

Condition A The Controller automatically changes to Recovery mode and the LCD is displayed as below.

9999 Recovery Mode

RC+ startup normally but is unable to function normally.

Condition B The Controller LCD cannot be “Wait for RC+ startup” or “READY”. Cannot communicate with the Controller using the development PC. RC+ is unable to function normally.

Countermeasure for the error status is as follows.

Condition A Follow the Firmware Initialization Procedure in *Maintenance 5.4* to initialize the firmware.

Condition B Execute the following steps:

- (1) Turn OFF the Controller.
- (2) Push the trigger button located on the front side of the Controller and while holding the button in, turn ON the Controller. Continue to hold in the trigger button for 30 seconds. This will cause the Controller to start in Recovery mode.
- (3) Make sure that the LCD displays as below.

9999 Recovery Mode

- (4) Follow the Firmware Initialization Procedure in *Maintenance 5.4* from step (3) to initialize the firmware.

5.4 Firmware Initialization Procedure

The firmware initialization procedure described in this section.

- (1) Turn ON the Controller.
- (2) Shutdown the development software EPSON RC+ 6.0.
- (3) Copy the content of “firmware CD-ROM” to the USB memory and insert the USB memory to the controller USB port.
- (4) Execute “Ctrlsetup60.exe”.
- (5) Select the <Initialize> option button and click the <Next> button.

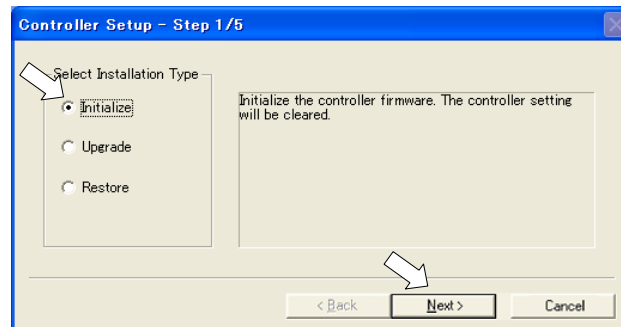

- (6) Confirm the message shown below and Click the <Next> button.

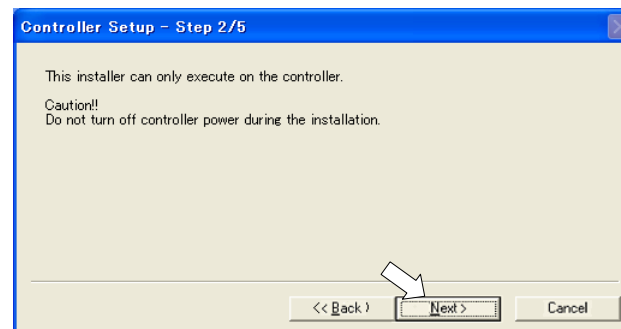

- (7) Check the version information and click the <Install> button.

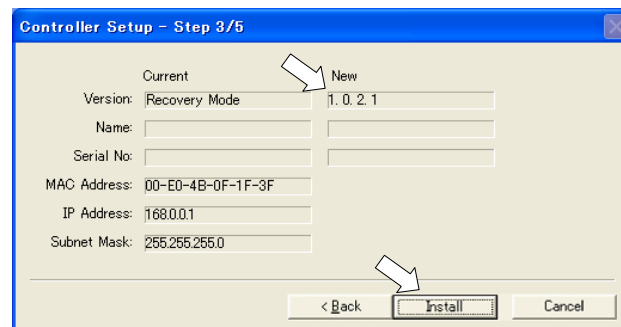

(8) Firmware and data file registration starts. It takes several minutes to complete.



Do not unplug the USB cable during transfer or turn OFF the Controller or the development PC.

Do not power off the Controller during the registration process.

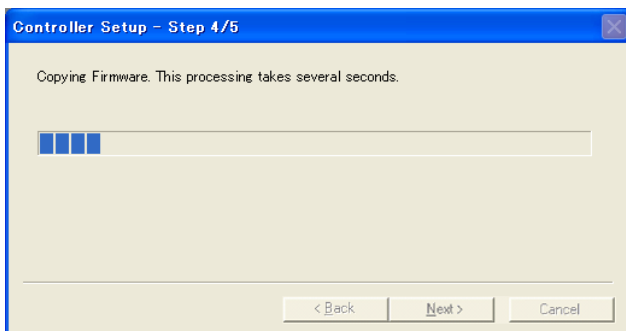

(9) The following dialog appears when registration is completed. Click the <Next> button to reboot the Controller.

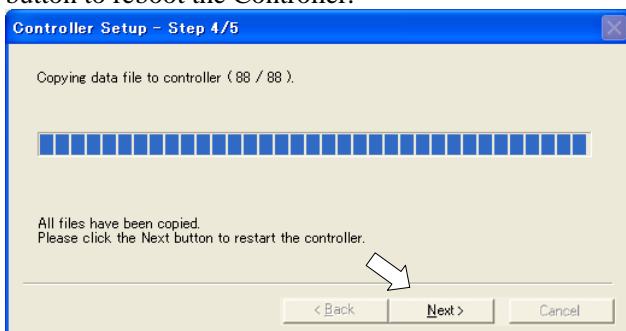

(10) The following dialog appears after the Controller reboot. Click the <Finish> button.

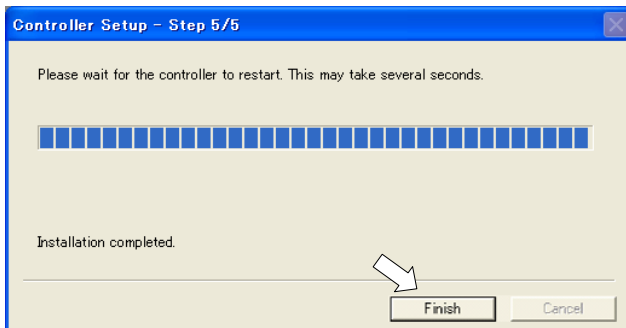

The firmware upgrade is completed.

Start EPSON RC+ 6.0 and restore the Controller settings.

For details of restoring the operating system, refer to *Maintenance 4. Backup and Restore*.

6. Maintenance Parts Replacement Procedures



- Before performing any maintenance procedure, always make sure that the main power of the Controller is turned OFF and that the high voltage charged area is completely discharged. Performing any maintenance procedure while the main power is ON or the high voltage charged area is not discharged completely is extremely hazardous and may result in electric shock and/or cause serious safety problems.



- Be careful not to damage cables.
- Be sure not to drop any screws into the Controller.
- Some cables can be connected even if they are 180-degree turned in the opposite direction. Make sure that you can install the cables correctly by taking pictures or notes during the replacement work.

6.1 Fan / Fan Filter

Inspect the fan filter periodically and clean it when needed. If the filter is not kept clean, the temperature inside the Controller may get too high and the Controller may not operate properly.

For the inspection schedule of the fan filter, refer to *Maintenance 2. Regular Maintenance Inspection*.

6.1.1 Cleaning and Replacing the Fan Filters

Fan Filters Removal

- (1) Turn OFF the Controller.
- (2) Remove cables from TP port and USB port on the front panel if they are connected.
- (3) Remove 6 screws and the front panel.
- (4) Remove the fan filters (large one and small one) to the direction shown in the photo.

Clean the filters when needed.

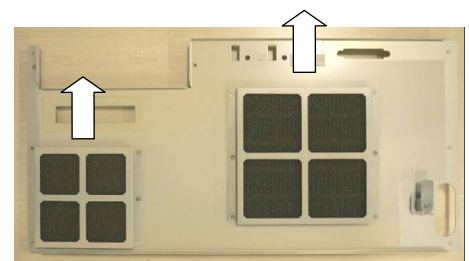
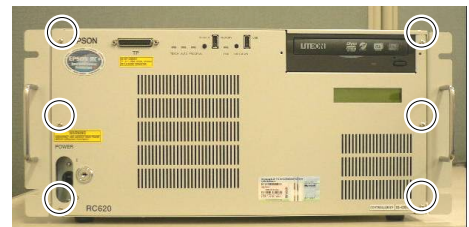
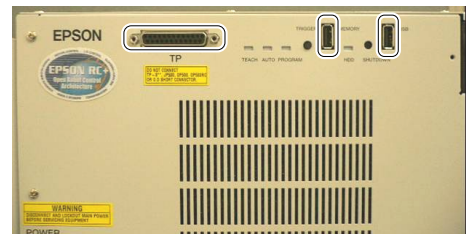

Fan Filters
Installation

- (1) Mount the fan filters (large one and small one) to the front panel.
- (2) Secure the front panel using 6 screws to the Controller.
- (3) If you removed cables from TP port and USB port, connect them again.
- (4) Plug in the power connector. Turn ON the Controller and make sure that the Controller starts properly without any vibration or abnormal noise.

6.1.2 Replacing the Large Fan

Large Fan Removal

- (1) Turn OFF the Controller.
- (2) Remove cables from TP port and USB port on the front panel if they are connected.

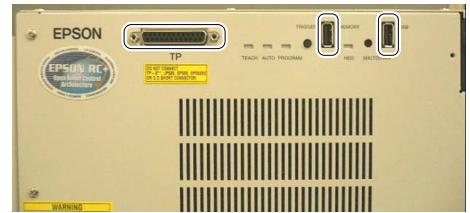

- (3) Remove 6 screws and the front panel.

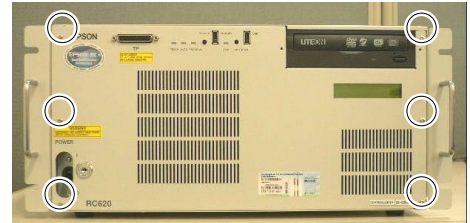

- (4) Remove 2 screws securing the Large Fan and the fan cover.

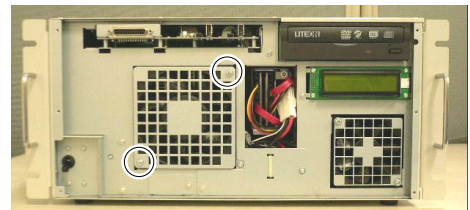

- (5) Pull out the Large Fan.

NOTE  The fan cable is connected to the main chassis. Be sure to pull it out slowly.

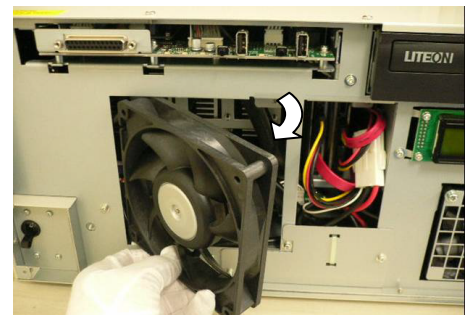

- (6) Pull out the connector of Large Fan from the DMB board to the direction shown in the photo.

Remove the Large Fan.

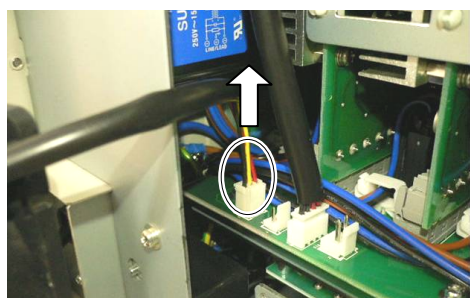

Large Fan
Installation

- (1) Connect the cable connector of Large Fan to the DMB board.

Refer to *Maintenance: 3.2 Diagram of Cable Connections*.

- (2) Insert the Large Fan into the chassis.

Pass the cable connector of Large Fan and Small Fan through the path shown in the photo.

Pass the cable of Small Fan below the Large Fan.



Be careful not to catch the cable of Large Fan between the Controller and the fan.

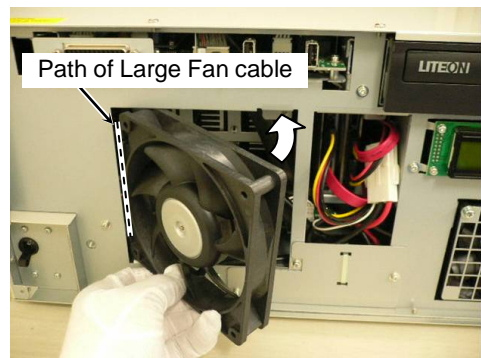
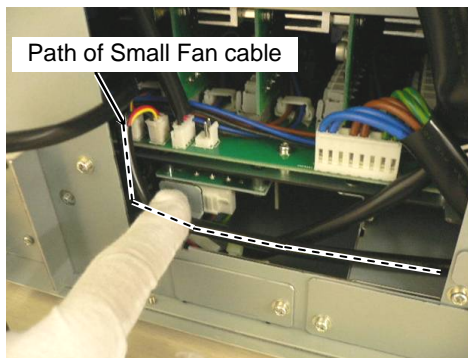

- (3) Secure the Large Fan and the fan cover (Large) using 2 screws to the Controller.
- (4) Secure the front panel using 6 screws to the Controller.
- (5) If you removed the cables from TP port and USB port, connect them again.
- (6) Plug in the power connector. Turn ON the Controller and make sure that the Controller starts properly without any vibration or abnormal noise.

6.1.3 Replacing the Small Fan

Small Fan Removal

- (1) Turn OFF the Controller.
- (2) Remove the Large Fan.
Refer to *Maintenance: 6.1.2 Replacing the Large Fan.*
- (3) Remove the UPS Battery.
Refer to *Maintenance: 6.2.2 Replacing the UPS Battery.*
- (4) Remove 2 screws securing the Small Fan and fan cover (Small).
Remove the fan cover (Small).

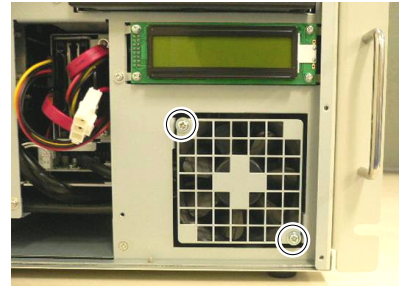

- (5) Pull out the cable connector of Small Fan from the DMB board to the direction shown in the photo.

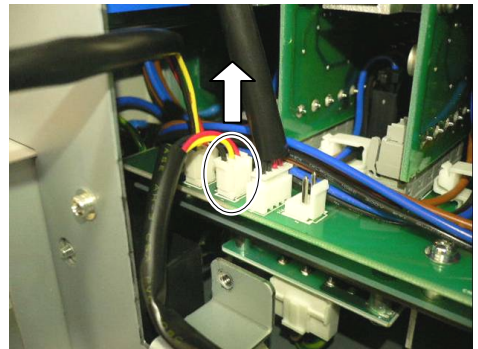

- (6) Remove the Small Fan from the Controller and pull out the fan cable to the direction shown in the photo.



NOTE Be sure to pull the Small Fan slowly and avoid the other cables to prevent the fan connector from being trapped.

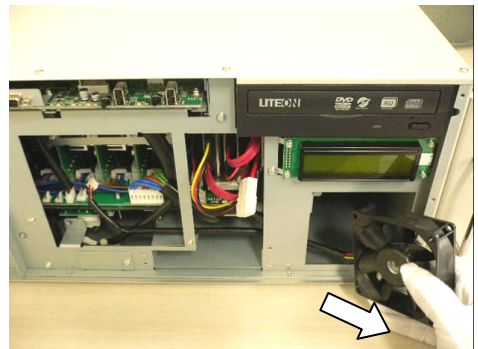

Small Fan Installation

- (1) Pass the cable of Small Fan through the way shown in the photo.



Avoid the peripheral cables because the fan connector can be caught in the cables.

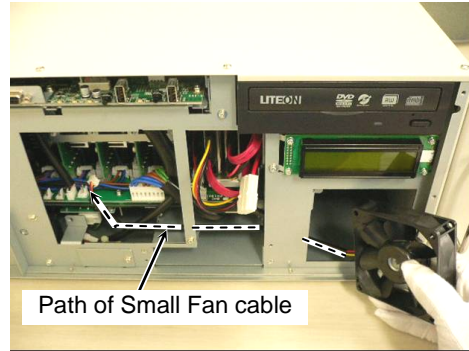

- (2) Connect the connector of Small Fan to the DMB.

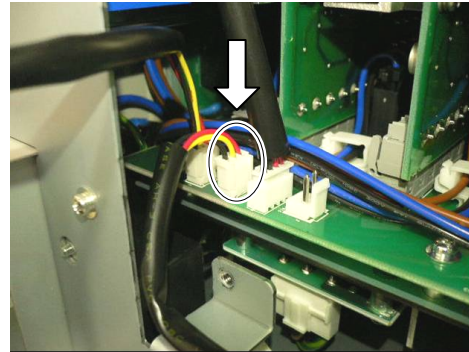

- (3) Insert the Small Fan into the chassis in the direction shown in the photo.



Be careful not to catch the cable between the chassis and fan.



- (4) Attach the fan cover (Small) to the Small Fan and secure them using 2 screws.

- (5) Mount the UPS battery.

Refer to Maintenance: 6.2.2 Replacing the UPS Battery.

- (6) Mount the Large Fan.

Refer to Maintenance: 6.1.2 Replacing the Large Fan.

- (7) Secure the front panel using 6 screws.

- (8) If you removed the cables from TP port and USB port, connect them again.

- (9) Plug in the power connector. Turn ON the Controller and make sure that the Controller starts properly without any vibration or abnormal noise.

6.2 Battery

6.2.1 Replacing the Battery (Lithium Battery)

 CAUTION	<ul style="list-style-type: none"> ■ Lithium batteries contain flammable materials such as lithium, organic solvents, etc. If misused, batteries may generate heat, explode or catch fire. Observe the following precautions for safe use of lithium batteries. <ul style="list-style-type: none"> - Be sure to use the battery supplied as the maintenance parts from EPSON. (Refer to <i>Maintenance 9. Maintenance Parts List</i>.) - Do not allow the positive (+) and negative (-) electrodes to short circuit. - Do not discard batteries into fire or heat them to high temperature. - Do not disassemble or alter batteries. - Do not apply a strong shock to the battery. - Stop using the battery if you see any signs of change of color or damage to the battery. - When discarding batteries, insulate the terminals by wrapping them with tape, etc. - Discarding batteries according to the regulations.
--	---

NOTE  Before starting battery replacement, turn on the controller for approximately one minute in order to charge the data saving capacitor.

Make sure to finish the battery replacement within 10 minutes to prevent data loss.

Battery
(Lithium Battery)
Removal

- (1) Backup the Controller data.
Refer to *Maintenance 4. Backup and Restore*.
- (2) Turn OFF the Controller.
- (3) Remove cables from TP port and USB port on the front panel if they are connected.

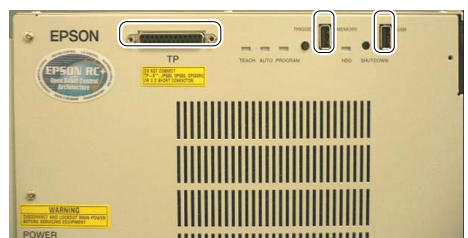

- (4) Remove 6 screws and the front panel.

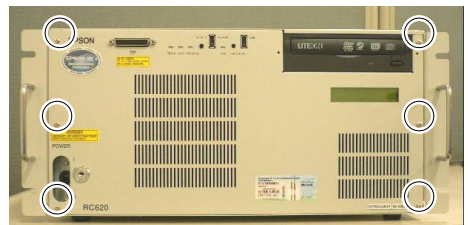

- (5) Remove a screw of the battery fittings located below the Large Fan.



- (6) Pull out the battery fittings and disconnect the relay connector.

NOTE  The lithium battery cable is connected to the main chassis. Be sure to pull it out slowly.

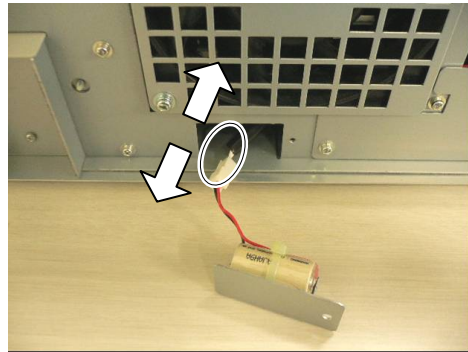

- (7) Cut off the wire tie by nippers and remove the lithium battery.

NOTE  Be careful not to scratch the battery when cutting off the wire tie.

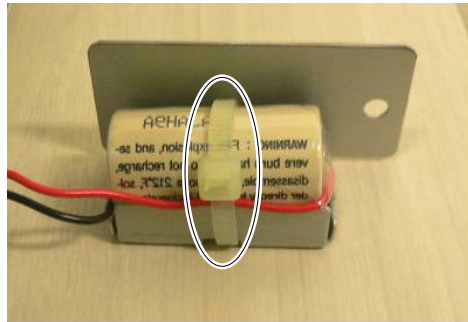

Battery Installation

- (1) Put a new lithium battery in position and secure it with a new wire tie.



NOTE Bind the lithium battery below the battery level as shown in the photo.

Cut off the redundant part of tie by nippers.

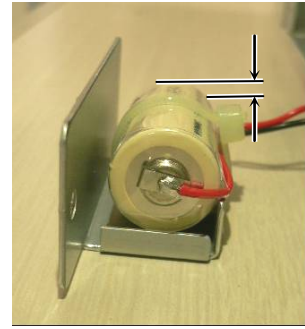

- (2) Connect the relay connector.
- (3) Insert the lithium battery (with plate) into the chassis.



NOTE Be careful not to catch cables and connectors.

- (4) Hold an edge of the lithium battery (with plate) and secure it using a screw.



- (5) Secure the front panel using 6 screws.
- (6) If you removed the cables from TP port and USB port, connect them again.
- (7) Plug in the power connector. Turn ON the Controller and make sure that the Controller starts properly without any vibration or abnormal noise.

6.2.2 Replacing the UPS Battery

 CAUTION	<p>■ When handling the UPS battery (nickel hydride battery), observe the following precautions for safe use.</p> <ul style="list-style-type: none"> - Be sure to use the battery supplied as the maintenance parts from EPSON. (Refer to <i>Maintenance 9. Maintenance Parts List</i>.) - Do not allow the positive (+) and negative (-) electrodes to short circuit. - Do not discard batteries into fire or heat them to high temperature. - Do not disassemble or alter batteries. - Do not apply a strong shock to the battery. - Stop using the battery if you see any signs of change of color or damage to the battery.
--	--

Recycling of Battery

Dispose of the used battery appropriately in accordance with the laws and acts of your national or local government. If you cannot dispose of a used battery properly, please inquire of your EPSON robot supplier how to dispose of it.

UPS Battery Removal

- (1) Turn OFF the Controller.
- (2) Remove cables from TP port and USB port on the front panel if they are connected.
- (3) Remove 6 screws and the front panel.
- (4) Remove 2 screws of the UPS battery fittings.
- (5) Pull out the UPS battery fixing plate until you can see the relay connector.



The UPS battery cable is connected to the main chassis. Be sure to pull it out slowly.

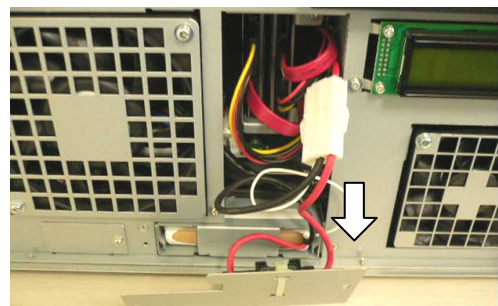
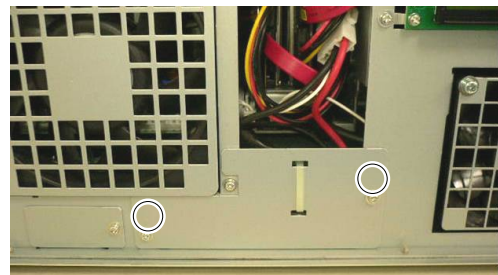
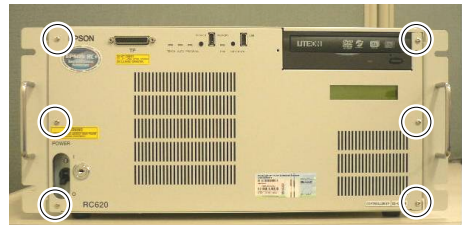
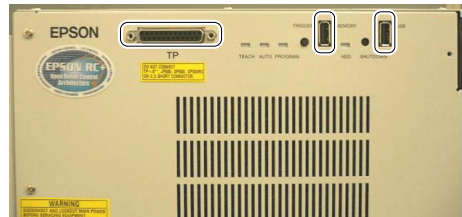

- (6) Push the relay connector latch and disconnect the connector.

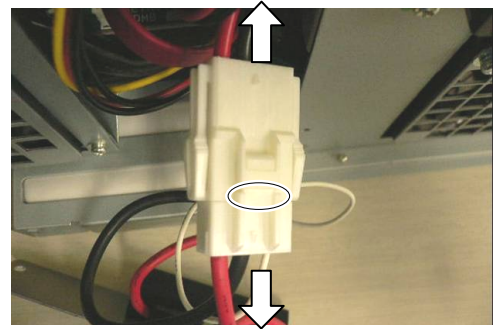

- (7) Pull out the UPS battery and cut off the wire tie binding the UPS battery fuse.

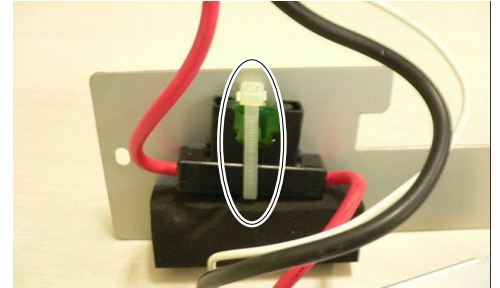

UPS Battery
Installation

- (1) Put a new UPS battery fuse on the UPS battery fixing plate and secure it with an attached wire tie.

NOTE  Position the cable tie as show in the photo.

Cut off the redundant part of tie by nippers.

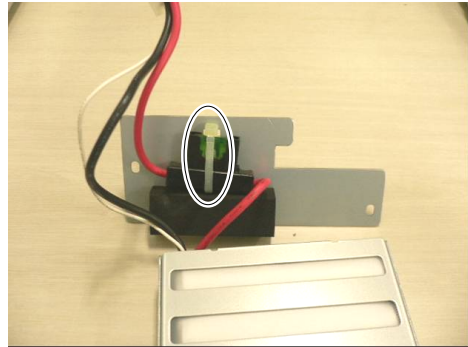

- (2) Connect the relay connector.

- (3) Insert the UPS battery, fuse (with plate), and relay connector into the chassis.

NOTE Be sure not to catch cables and connectors.

 If it is difficult to insert the cables and connectors, adjust the fuse position.

- (4) Mount the UPS battery fixing plate using 2 screws to the main chassis.

- (5) Secure the front panel using 6 screws.

- (6) If you removed the cables from TP port and USB port, connect them again.

- (7) Plug in the power connector. Turn ON the Controller and make sure that the Controller starts properly without any vibration or abnormal noise.

6.3 Motor Driver

6.3.1 Part Name

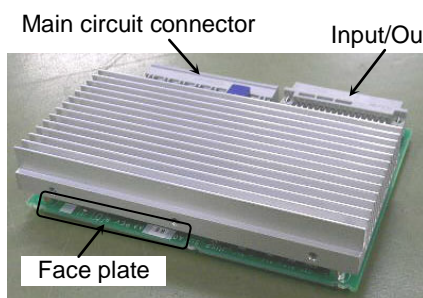

50 W, 100 W, 200 W, 400 W

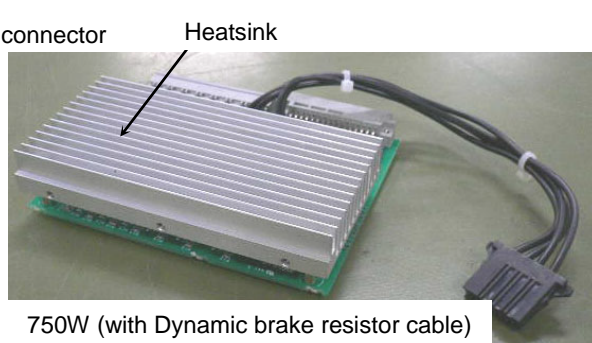

For the wattage of the motor driver, see the model type described on the face plate.

Also, the wattage of the installed motor driver corresponds with the wattage of the driving motor.

Model type	Wattage
JUSP-SU021A*	50 W
JUSP-SU028A*	100 W
JUSP-SU065A*	200 W
JUSP-SU085A*	400 W
JUSP-SU169A*	750 W
TTCA-021A	50W
TTCA-028A	100W
TTCA-065A	200W
TTCA-085A	400W
TTCA-169A	750W

* This means one alphanumeric letter.

6.3.2 Replacing the Motor Driver (DMB side)

 <p>CAUTION</p>	<p>■ Record the relation of the model type and wattage when removing the motor driver to install a new motor driver of correct wattage. If you install a motor driver of wrong wattage, the robot system cannot operate properly.</p>
--	---

Motor Driver
(DMB side)
Removal

- (1) Turn OFF the controller power and disconnect the power plug.
- (2) Remove 10 screws on the top panel and remove the top panel.

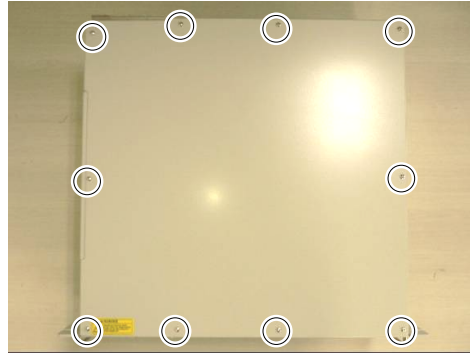

- (3) Remove 2 cables connected to the switching power supply (15 W).
When G1 / G3 / G6 / C3 / RS manipulator is connected, go on to the removal step (5).
When G10 / G20 manipulator is connected, go on to the removal step (4).

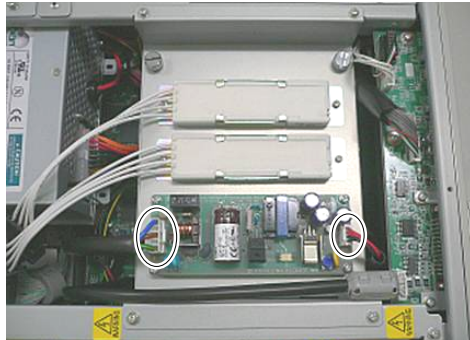

- (4) When replacing one axis (or two axes) of the 750W motor driver, pull out the connector of the cement resistor pinching its both ends.

(Be sure to pull out the connector which is connected to the motor driver you are replacing.)

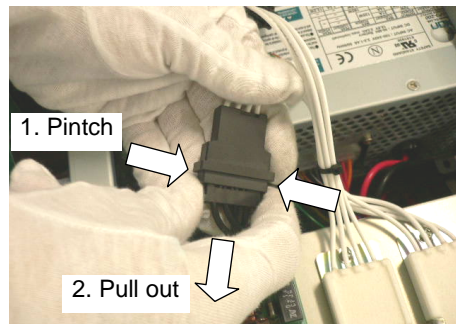
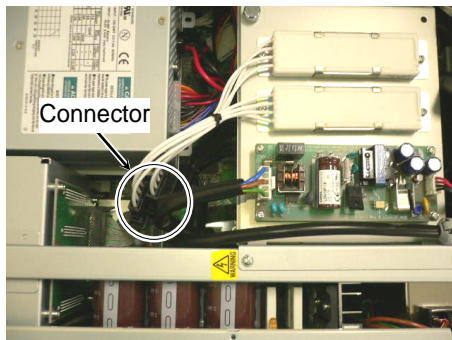

- (5) Remove 2 finger screws and the plate on which the switching power supply is mounted.

NOTE  Use these finger screws to pull out the motor driver.

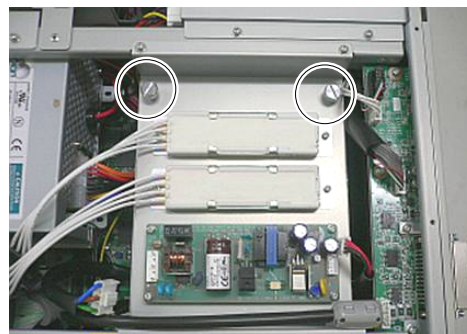

- (6) Remove 5 finger screws and motor driver mounting bracket.

Motor Driver

- 1: Axis #1
- 2: Axis #2
- 3: Axis #3
- 4: Axis #4



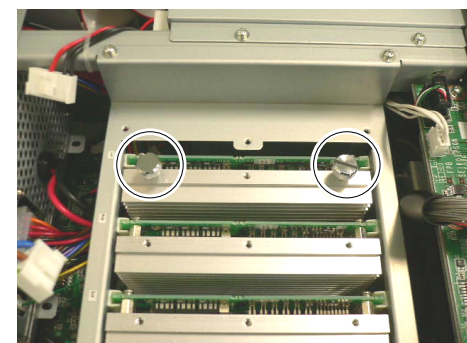

- (7) Set 2 finger screws removed in the step (5) in the screw holes on the heatsink of motor driver.

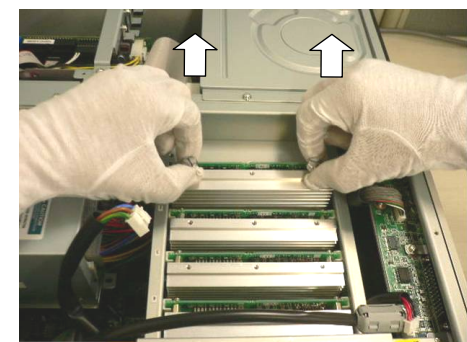

- (8) Pinch 2 finger screws and apply equal force to the right and left sides to pull out the motor driver.



NOTE  When the G10 series / G20 series manipulator is connected, cable and connector are connected to the motor driver Axis #1 and Axis #2. When pulling out the motor driver, be careful not to catch the connectors between the chassis.

 CAUTION	<ul style="list-style-type: none"> ■ Be careful not to cut your finger. The joint of motor driver connectors can be very tight. For that, if you pull the motor driver forcibly, the connector may be pulled out suddenly and you may get a cut on your finger with the motor driver heatsink.
---	---

Motor Driver
(DMB side)
Installation

When G1 / G3 / G6 / C3 / RS manipulator is connected, start with the installation step (3).

When G10 / G20 manipulator is connected, start with the installation step (1).

- (1) When connecting the motor driver (750 W), insert it slowly along the guide rail, passing the connector of motor driver through the back of motor driver guide plate.

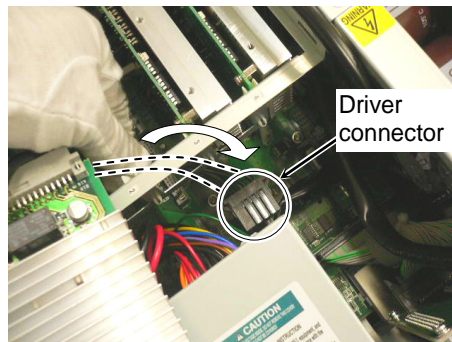

- (2) Connect the motor driver connector you are replacing with the connector of cement resistor.



NOTE There are two connectors for the cement resistor. The motor driver connector can be connected with either one. Choose one so that you can connect easily.

- (3) Slowly insert the motor driver along the guide rail of motor driver guide plate so that the motor driver top side is less than 5 mm higher than the guide plate.

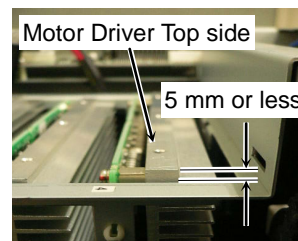

- (4) Slowly slide down the motor driver so that the motor driver top side is 1 mm or less higher than the guide plate.

- (5) Secure the motor driver mounting bracket using 5 screws.

- (6) Secure the plate, on which the switching power supply is mounted, to the chassis using 2 finger screws.



- (7) Connect cable No. (4) and (10) with the switching power supply (15 W).

Refer to *Maintenance*:
3.2 Diagram of Cable Connections.

- (8) Place the top panel and secure it with 10 screws.

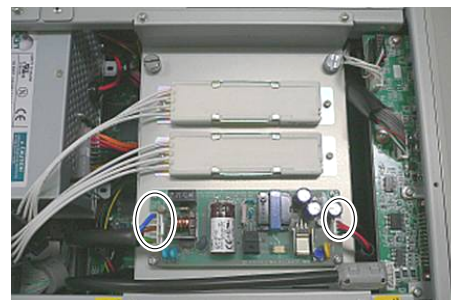

- (9) Plug in the power connector. Turn ON the Controller and make sure that the Controller starts properly without any vibration or abnormal noise.

6.3.3 Replacing the Motor Driver (ADMB side)

Motor Driver
(ADMB side)
Removal

- (1) Turn OFF the Controller power and disconnect the power plug.
- (2) Remove 10 screws for the top panel and remove the front panel.

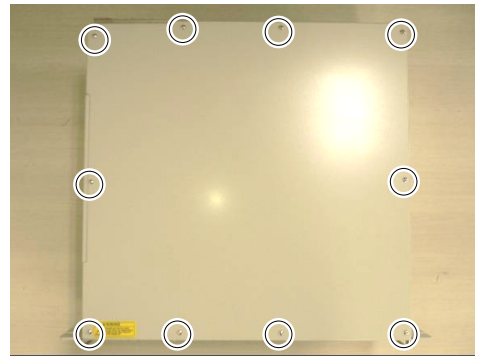

- (3) Remove a screw of the CPU fixing plate and remove the CPU fixing plate.



- (4) If the DVD drive is mounted, remove the cables No. (25), (12)-4.

Refer to *Maintenance*:
3.2 Diagram of Cable Connections.

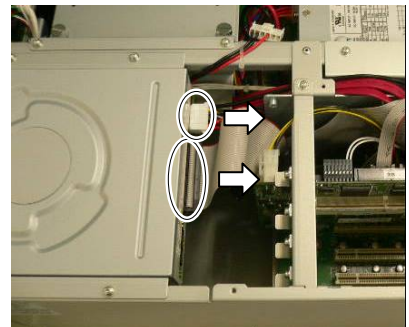

- (5) Remove 4 screws for the DVD drive fixing plate and remove the DVD drive fixing plate.

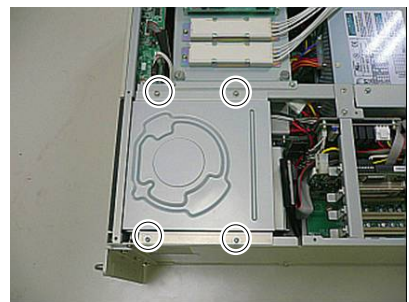

- (6) Remove 5 set screws of the side panel (Right side).



- (7) Remove the side panel (Right side) to the direction shown in the photo.

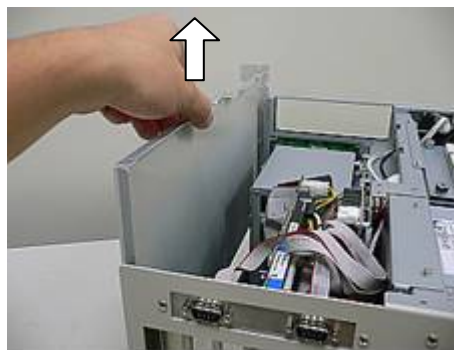

- (8) Remove 2 finger screws of the plate on which the switching power supply is mounted.

NOTE Use these finger screws to pull out the motor driver.

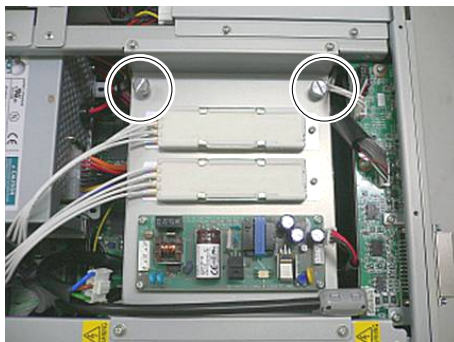

- (9) Remove 5 screws and the motor drive mounting bracket.

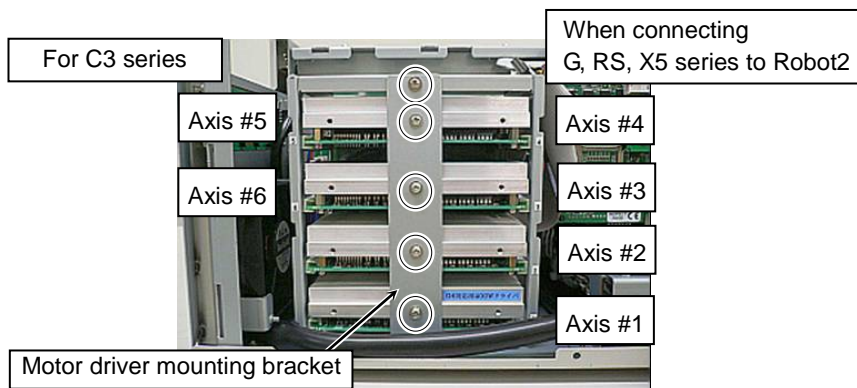

- (10) Set 2 finger screws removed in the step (8) in the screw holes on the heatsink of motor driver.

Pull out the motor driver applying equal force to the right and left sides.

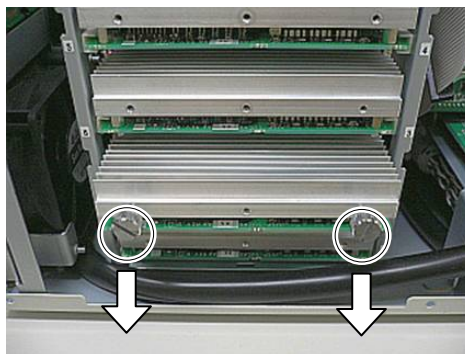

- Be careful not to cut your finger. The joint of motor driver connectors can be very tight. For that, if you pull the motor driver forcibly, the connector may be pulled out suddenly and you may get a cut on your finger with the motor driver heatsink.

Motor Driver
(ADMB side)
Installation

- (1) Slowly insert the motor driver along the guide rails until the surface height differences of the motor driver comes to 5 mm or less.

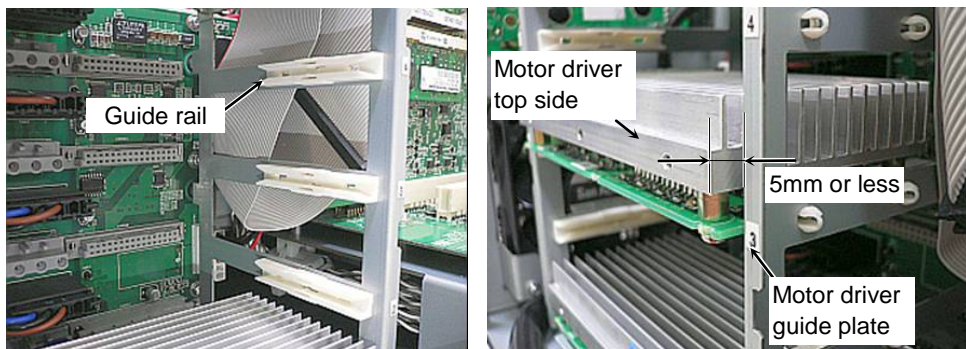

- (2) Slowly push the motor driver until the surface height differences of the motor driver comes to 1 mm or less from the guide plate.
- (3) Insert the motor driver mounting bracket into the slit of motor driver guide plate and secure it using 5 screws.
- (4) Insert the side panel (Right side) in the direction shown in the photo and secure it using 5 screws.

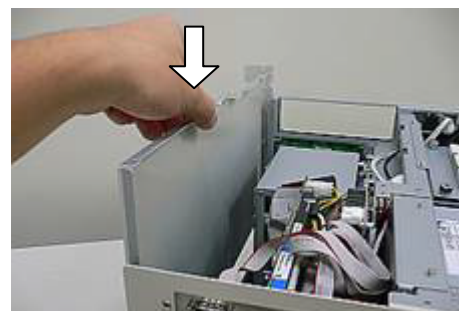

- (5) Mount the DVD drive fixing plate and secure using 4 screws.
- (6) If the DVD drive is mounted:



NOTE Connect the cable No. (25), (12)-4 to the DVD drive.

Refer to *Maintenance:*
3.2 *Diagram of Cable Connections.*

Make sure the wrong insertion stop key is visible when connecting the flat cable to the DVD drive.

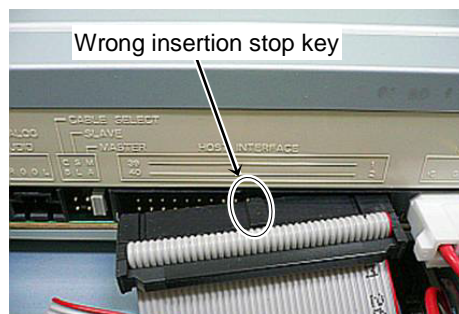

- (7) Insert the CPU fixing plate into the slit of the side panel (Right side) and secure using a screw.

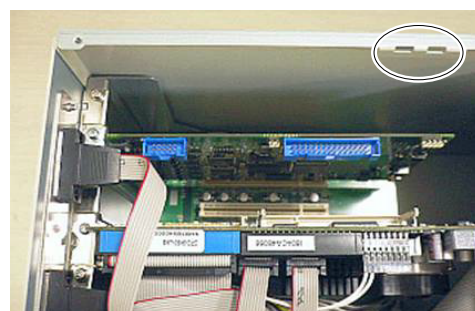

- (8) Secure the top panel using 10 screws.
- (9) Plug in the power connector. Turn ON the Controller and make sure that the Controller starts properly without any vibration or abnormal noise.

6.4 CPU Board / BIOS Backup Battery / Memory

- NOTE There are two types of RC620 as below according to the CPU board mounted.
- ☞ RC620 : Intel® Celeron™ M Processor : 6.4.1 Normal
 - RC620 + (Option) : Intel® Core™ Duo Processor : 6.4.2 Faster

Different procedures are instructed for each type. Follow the corresponding procedure to replace the maintenance parts.

6.4.1 Normal

6.4.1.1 CPU Board (Normal)

- NOTE Some of the cables connecting with the CPU board may confuse you about the direction to insert. Therefore, make sure that you can install the cables correctly by taking pictures or notes during the replacement work.

CPU Board
(Normal)
Removal

- (1) Turn OFF the Controller and unplug the power connector.
- (2) Disconnect the external cables from the CPU board if they are connected.
USB device LAN Display COM port, etc

- (3) Remove 10 screws and the top panel.

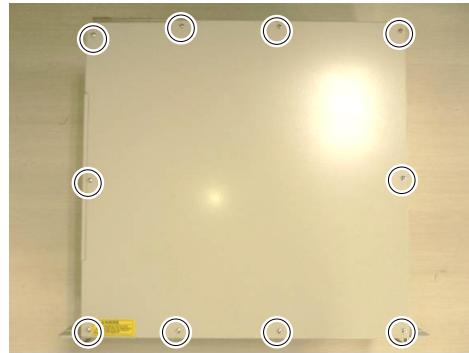

- (4) Remove a screw for the CPU board holder assembly and remove the holder assembly.



- (5) Remove a screw for the CPU board in the controller rear side.

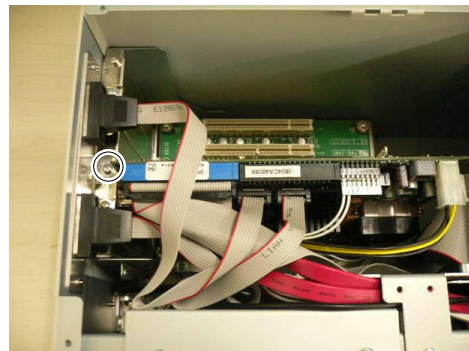

- (6) Remove the following connectors from the CPU board.

Cable No. (19), (20), (23)



If RAID option is set:

Remove Cable No. (24)

If DVD drive is connected:

Remove Cable No. (25)

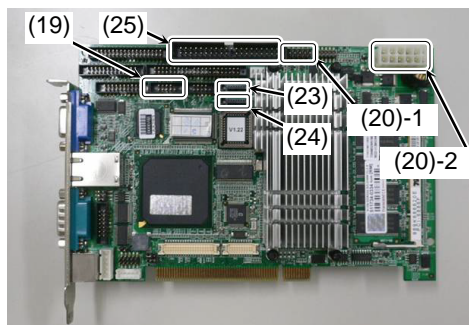

Refer to *Maintenance: 3.2 Diagram of Cable Connections*.

- (7) Make sure all cables are disconnected and remove the CPU board from PCI-BPB slot.

CPU Board
(Normal)
Installation

- (1) Connect the following connectors holding the CPU board near PCI-BPB.
Cable No. (19), (20), (23)



If RAID option is set:
Connect Cable No. (24)

If DVD drive is connected:
Connect Cable No. (25)

Refer to *Maintenance: 3.2 Diagram of Cable Connections*.

Cable No. (19) direction

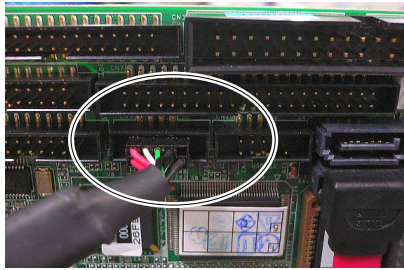

Cable No. (20)-1 direction

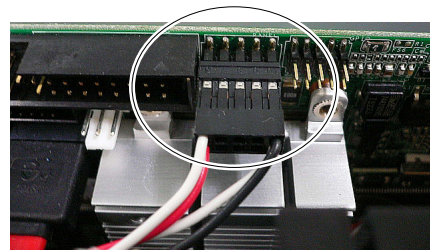

Align the pins of CPU board with the connector's center (from all directions) and connect them.

- (2) Insert the board holder assembly into the hole on the side panel (Right) and secure it using a screw.

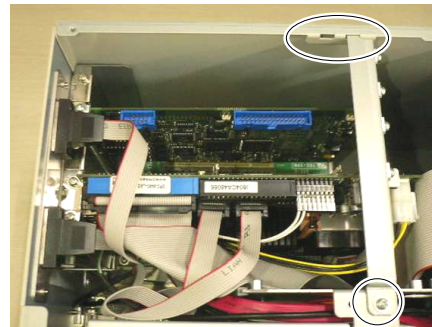

- (3) Loosen a screw holding the CPU board.

Put the CPU board in position and set the screw.

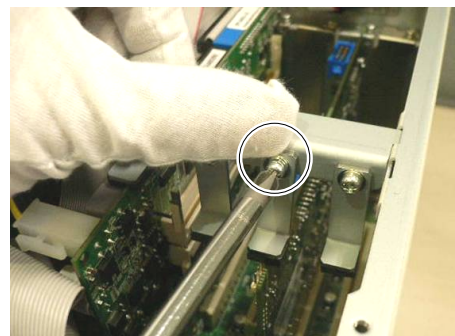

Make sure the CPU board is firmly placed.

(Photo shows the holder assembly for the PCI Board.)

- (4) Place the top panel and secure it using 10 screws.
- (5) If you disconnected the external cables from the CPU board, connect them again.
USB device LAN Display COM port, etc.
- (6) Plug in the power connector. Turn ON the Controller and make sure that the Controller starts properly without any vibration or abnormal noise.

6.4.1.2 BIOS Backup Battery (Normal)

 CAUTION	<ul style="list-style-type: none"> ■ Lithium batteries contain flammable materials such as lithium, organic solvents, etc. If misused, batteries may generate heat, explode or catch fire. Observe the following precautions for safe use of lithium batteries. <ul style="list-style-type: none"> - Be sure to use the battery supplied as the maintenance parts from EPSON. - Do not allow the positive (+) and negative (-) electrodes to short circuit during maintenance. - Do not discard batteries into fire or heat them to high temperature. - Do not disassemble or alter batteries. - Discarding batteries according to the regulations.
---	--

BIOS Backup Battery (Normal) Removal

- (1) Remove the CPU board.
 Refer to *Maintenance: 6.4.1.1 CPU Board (Normal)*.
- (2) Remove the BIOS backup battery placed behind the CPU board.

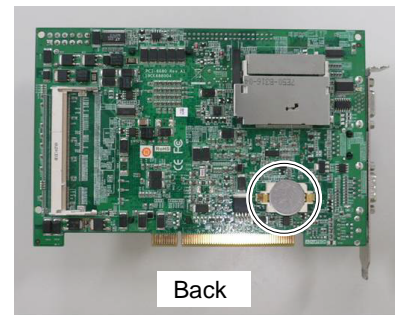
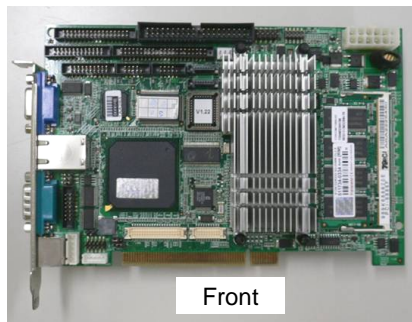

NOTE  Remove the BIOS backup battery while pressing the latch of battery holder in the direction shown in the photo.

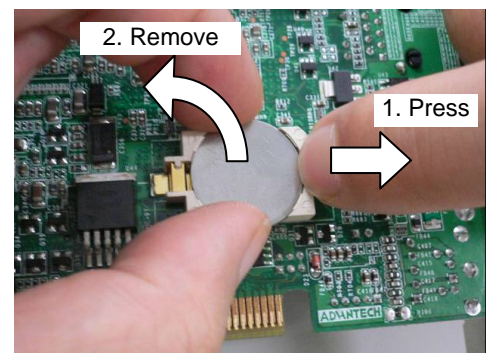
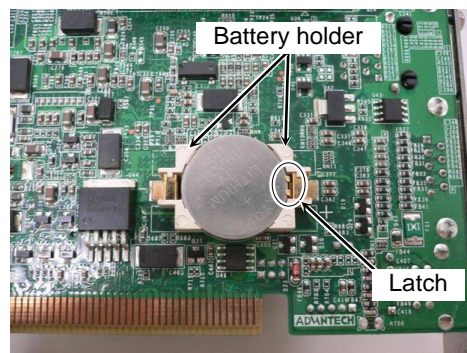

BIOS
Backup Battery
(Normal)
Installation

- (1) Place a battery on the battery holder on the CPU board.
- Push down the battery until it is firmly secured with latch.

NOTE
 Make sure the latch is in the same state as shown in the photo.

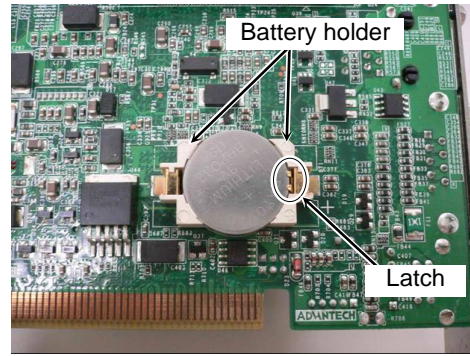

- (2) Mount the CPU board.

Refer to *Maintenance: 6.4.1.1 CPU Board (Normal)*.

- (3) Connect the following items to the Controller.

- | | |
|----------|------------|
| Keyboard | Mouse |
| Display | Power plug |

NOTE
 Connect the keyboard with PS/2 port of the CPU board.

If you use the USB keyboard, connect it with PS/2 port using PS/2 branch cable (attached to the Controller).



- (4) Turn ON the Controller power and keep pressing the <Delete> key. BIOS window will be displayed.

- (5) Change the BIOS setting as below.

Select the [Integrated Peripherals] from the Main menu.

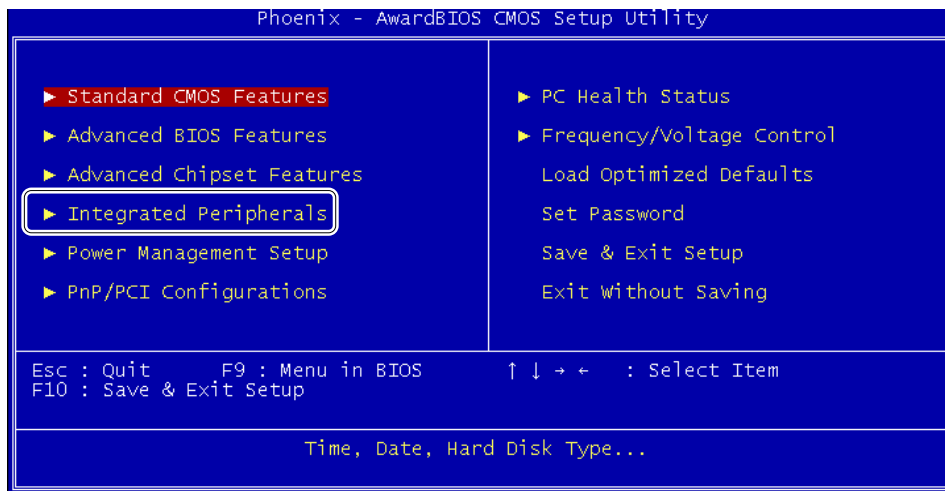

Select the [OnChip IDE Device].

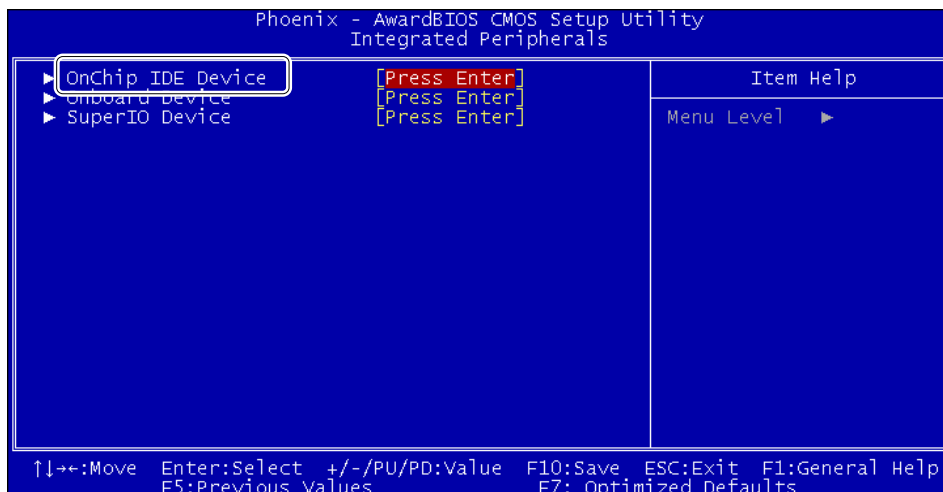

Select the following in this order.

[On Chip Serial ATA Settings]

[On-Chip Serial ATA]

[Enhanced Mode]

Set the [Serial ATA Port 0 Mode] to “SATA0 Master”.

Go back to the Main menu and select the [Save & Exit Setup].

Select “Y” and save the changed BIOS setting.

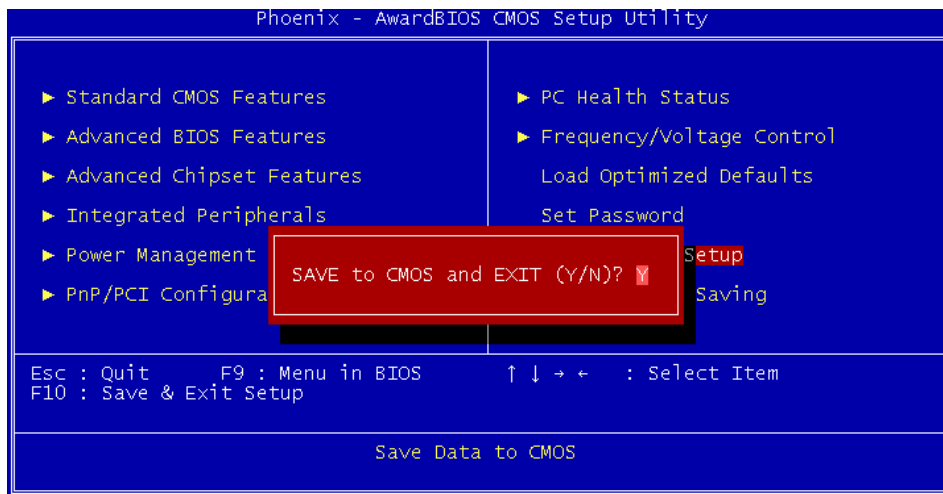

(6) Make sure the Controller operate properly without any trouble.

6.4.1.3 Memory (Normal)



When you replace / add the CPU board memory

If you install 2 memories on the CPU board:

Make sure that 2 memories have the same specification.

If you install “2 DDR memories 1GB (our option)” on the CPU board:

Remove the standard memory installed in Slot 1 before installing the option memories.



The structure of Slot 1 and Slot 2 are the same. To remove the memory of Slot 2, follow the procedure described below. Slot 2 is located on opposite surface of the CPU board from Slot 1.

Memory (Normal) Removal

- (1) Turn OFF the Controller and unplug the power connector.
- (2) Remove the CPU board.

Refer to *Maintenance: 6.4.1.1 CPU Board (Normal)*.

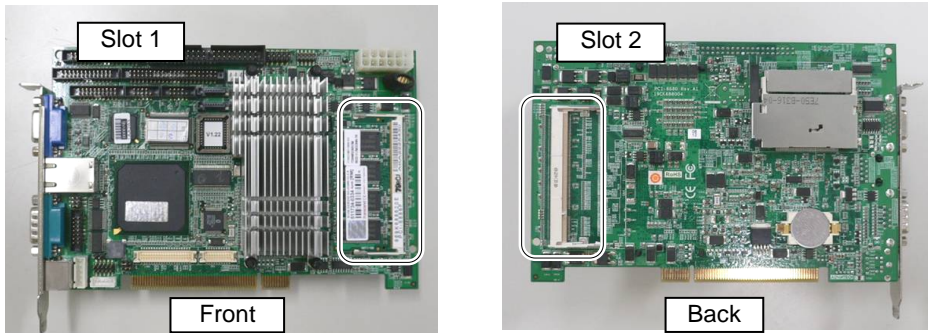

- (3) To remove the memory, push the latches of memory slot on the back side of CPU board outward lightly.

The photos below show Slot 1.

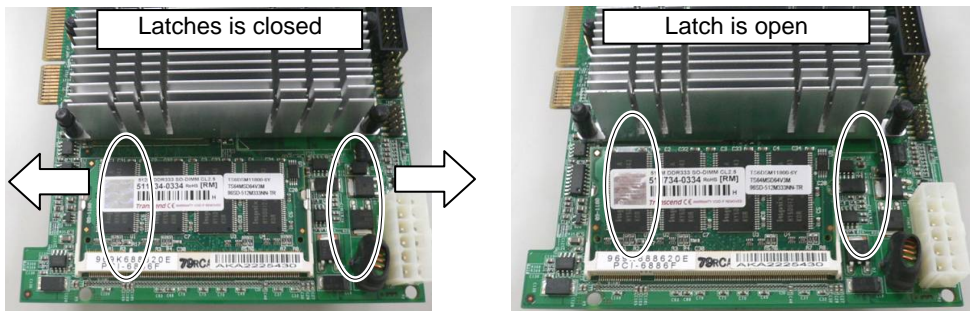

- (4) After the latches are open, pull out the memory straight.

NOTE  Do not apply too much force on the memory, otherwise the connector area will be broken.

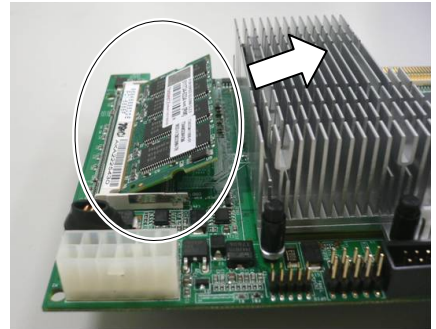

Memory
(Normal)
Installation

- (1) Refer to the photo and insert a new memory slowly into the slot on CPU board.

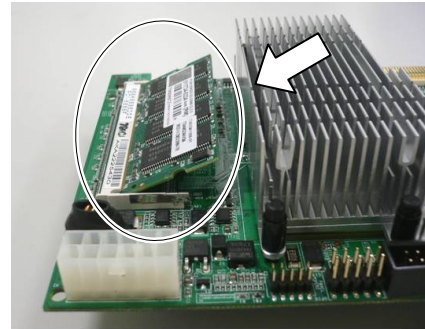

NOTE  Do not apply too much force on the memory, otherwise the connector area will be broken.

- (2) Push the memory connector into the slot all the way.
- (3) Slowly lay flat the memory until it is firmly secured with latches.

NOTE  When the memory is laid flat, the latches automatically catch and secure the memory.

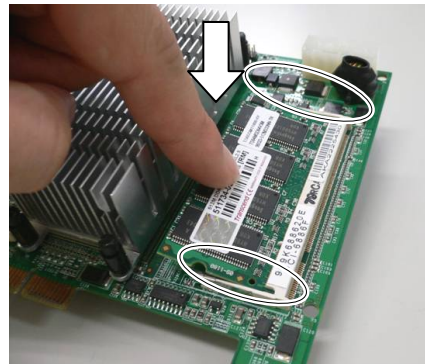

- (4) Mount the CPU board.

Refer to *Maintenance: 6.4.1.1 CPU Board (Normal)*.

- (5) Plug in the power connector. Turn ON the Controller and make sure that the Controller starts properly without any vibration or abnormal noise.

6.4.2 Faster

6.4.2.1 CPU Board (Faster)



Some of the cables connecting with the CPU board can be connected even they are 180-degree turned in the opposite direction. Make sure that you can install the cables correctly by taking pictures or notes during the replacement work.

CPU Board
(Faster)
Removal

- (1) Turn OFF the Controller and unplug the power connector.
- (2) Disconnect the following external cables from the CPU board if they are connected.
USB device LAN Display COM port
- (3) Remove 10 screws and the top panel.

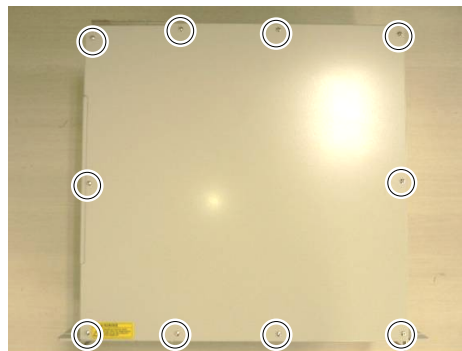

- (4) Remove a screw for the CPU board holder assembly and remove the holder assembly.

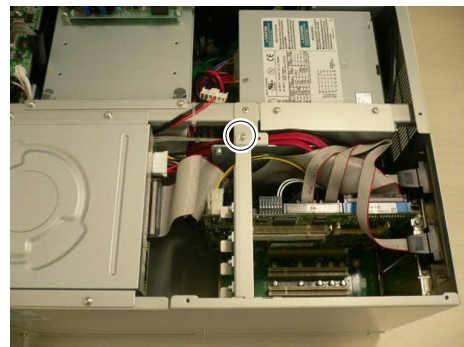

- (5) Remove a screw securing the CPU board in the controller rear side.



- (6) Remove two screws for the COM panel on the back panel.



- (7) Remove the following connectors from the CPU board (Faster).
Cable No. (21), (22), (23), COM1, 2

If RAID option is set:

Remove Cable No. (24)

If DVD drive is connected:

Remove Cable No. (25)

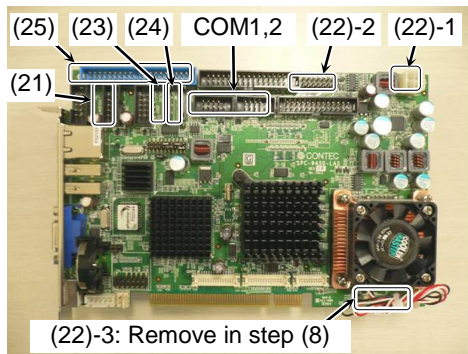

Refer to *Maintenance: 3.2 Diagram of Cable Connections*.

- (8) Slightly pull out the CPU board (Faster) from PCI-BPB slot and while holding the board with one hand, remove Cable No. (22)-3.



Cable of the CPU board is connected with PCI-BPB. Be sure to pull the board slowly.

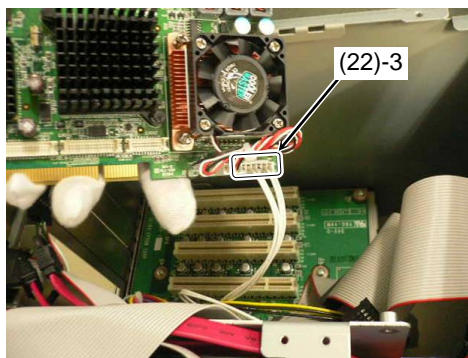

- (9) Make sure all cables are disconnected and remove the CPU board from PCI-BPB slot.

CPU Board
(Faster)
Installation

- (1) Connect Cable No. (22)-3 holding the CPU board (Faster) near PCI-BPB slot.

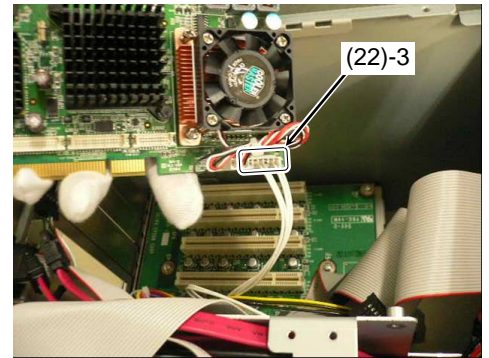

- (2) Holding the CPU board (Faster) near PCI-BPB, connect the following connectors.
Cable No. (21), (22), (23) , COM1, 2

If RAID option is set:

Connect Cable No. (24)

If DVD drive is connected:

Connect Cable No. (25)

Refer to *Maintenance: 3.2 Diagram of Cable Connections*.

Cable No. (22)-2 direction

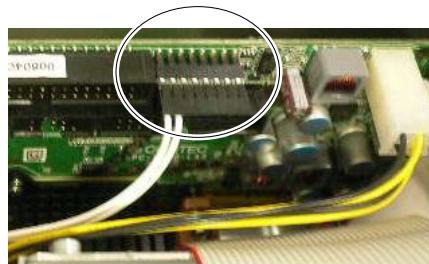

Cable No. (21) direction

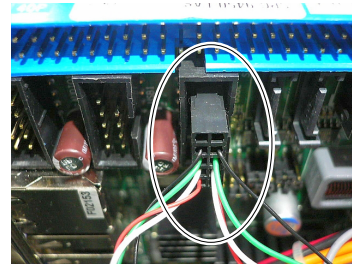

Align the pins of CPU board with the connector's center (from all directions) and connect them.

- (3) Insert the CPU board into PCI-BPB slot and secure it using a screw.
- (4) Insert the board holder assembly into the hole on the side panel (Right) and secure it using a screw.

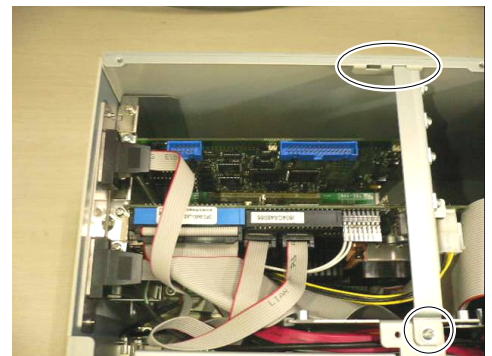

- (5) Loosen a screw holding the CPU board.

Put the CPU board in position and set the screw.

NOTE  Make sure the CPU board is firmly placed.

(Photo shows the holder for the PCI Board.)

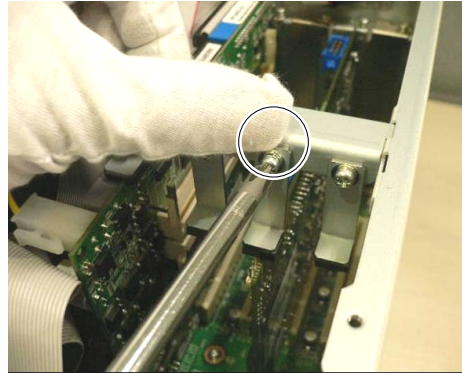

- (6) Place the top panel and secure it using 10 screws.
- (7) If you disconnected the following external cables from the CPU board, connect them again.
- USB device LAN Display COM port
- (8) Plug in the power connector. Turn ON the Controller and make sure that the Controller starts properly without any vibration or abnormal noise.

6.4.2.2 BIOS Backup Battery (Faster)

 CAUTION	<ul style="list-style-type: none"> ■ Lithium batteries contain flammable materials such as lithium, organic solvents, etc. If misused, batteries may generate heat, explode or catch fire. Observe the following precautions for safe use of lithium batteries. <ul style="list-style-type: none"> - Be sure to use the battery supplied as the maintenance parts from EPSON. - Do not allow the positive (+) and negative (-) electrodes to short circuit during maintenance. - Do not discard batteries into fire or heat them to high temperature. - Do not disassemble or alter batteries. - Discarding batteries according to the regulations.
--	--

BIOS Backup Battery (Faster) Removal

- (1) Remove the CPU board.
 Refer to *Maintenance: 6.4.2.1 CPU Board (Faster)*.
- (2) Remove the BIOS backup battery which is located as shown in the photo.

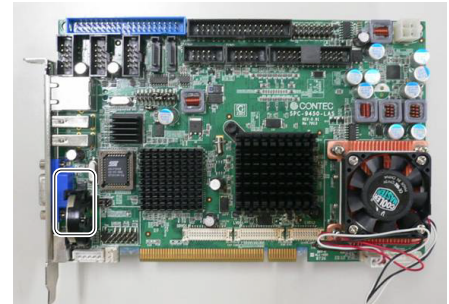

Slowly slide the battery on the CPU board to the direction in the photo.

NOTE  Be sure to remove the battery with care, otherwise the plastic part of the battery will be broken if you apply too much force on it.

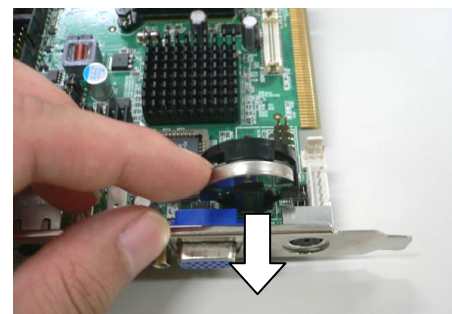
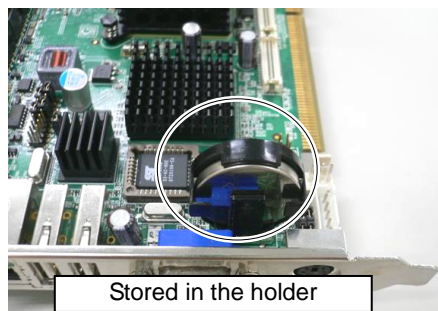

- (3) Pull out the battery diagonally from the battery holder.

BIOS
Backup Battery
(Faster)
Installation

- (1) Insert the battery diagonally into the battery holder.

NOTE  The battery has front and back sides. When inserting the battery, make sure that “+” mark of the battery is visible.



- (2) Make sure that the battery is firmly inserted in the holder and mount the CPU board on the Controller.

Refer to *Maintenance: 6.4.2.1 CPU Board (Faster)*.

- (3) Connect the following items to the Controller.

Keyboard	Mouse
Display	Power plug

Connect the keyboard with PS/2 port of the CPU board.

NOTE  If you use the USB keyboard, connect it with PS/2 port using PS/2 branch cable (attached to the Controller).

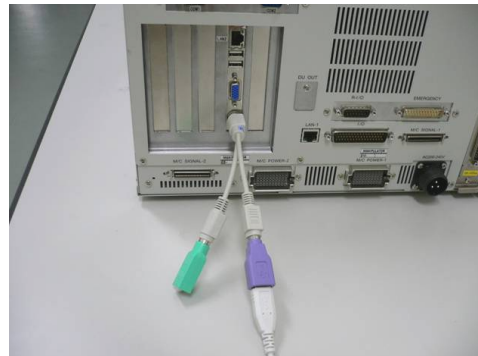

- (4) Turn ON the Controller power and keep pressing the <Delete> key. BIOS window will be displayed.

(5) Change the BIOS setting as below.

Select the [Standard CMOS Features] from the Main menu.

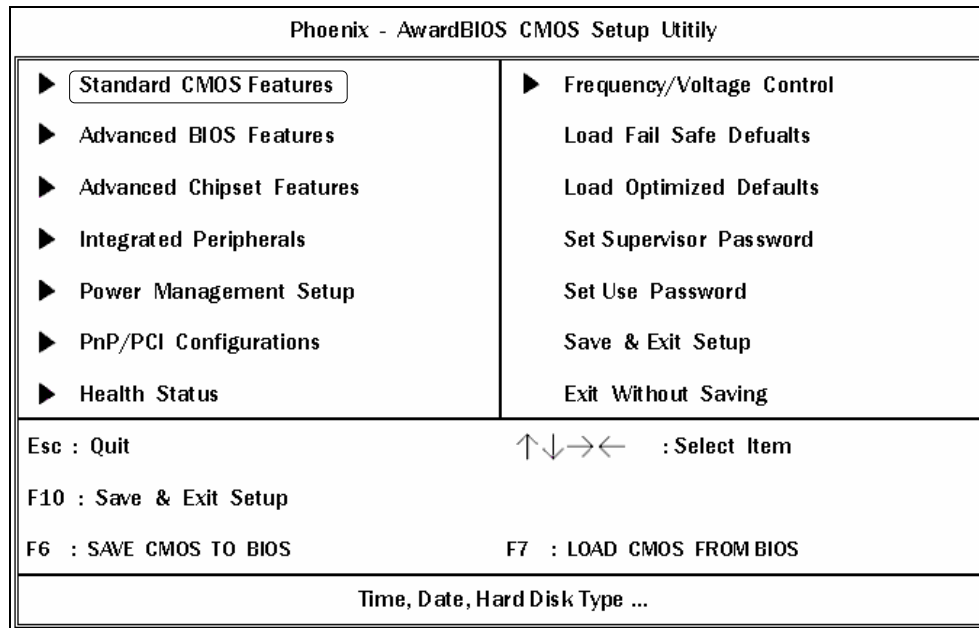

Set the following settings.

[Drive A] : NONE

[Halt on] : All , But Keyboard

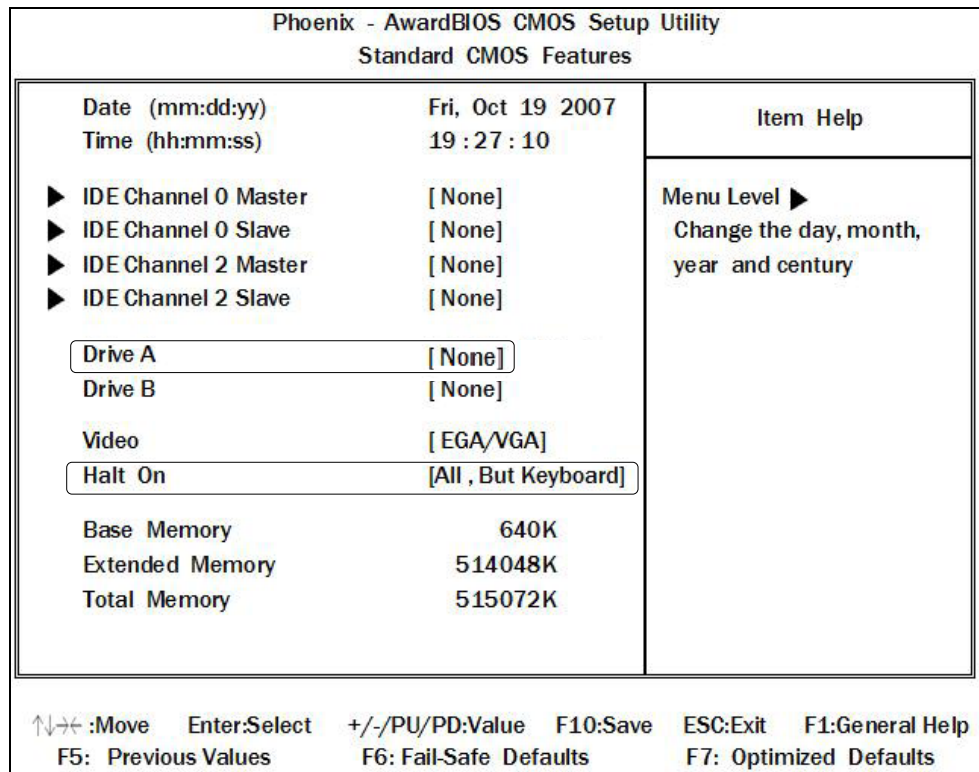

Go back to the Main menu and select the [Integrated Peripherals].

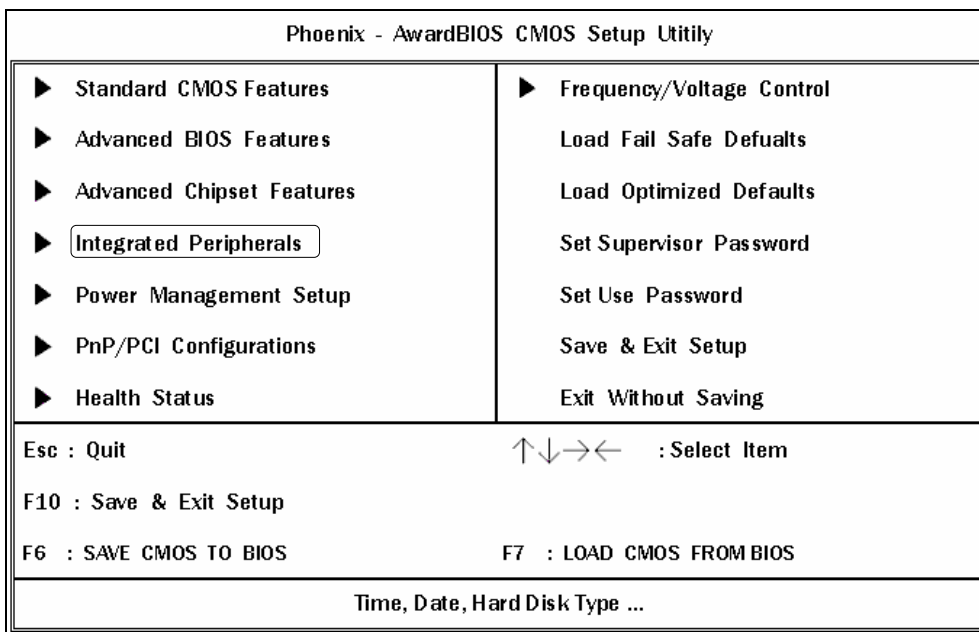

Select the [On-Chip IDE Device].

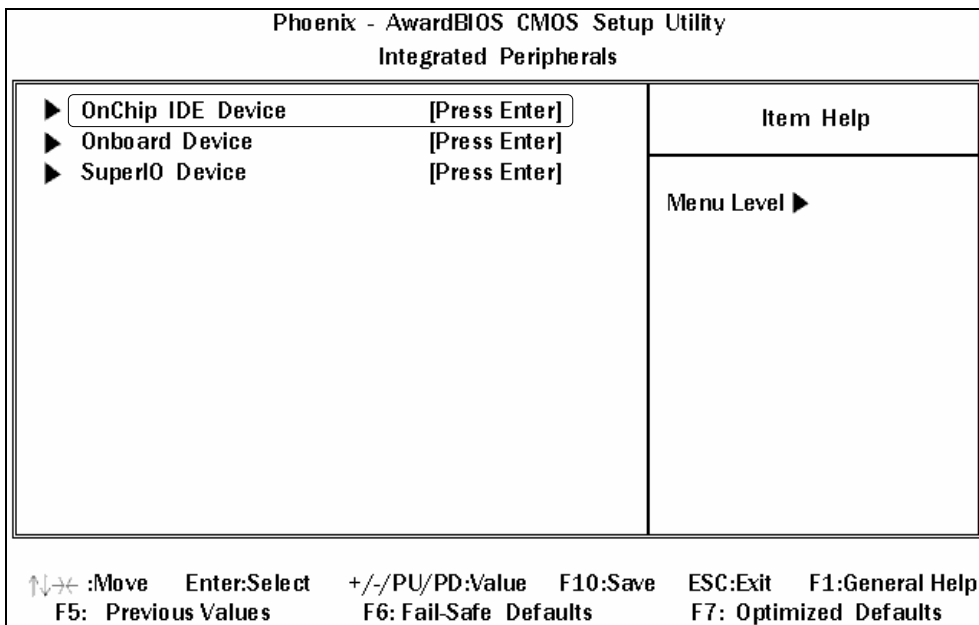

Select the [OnChip Serial ATA].

Phoenix - AwardBIOS CMOS Setup Utility		Item Help
OnChip IDE Device		
HDD Select	[UDMA33]	
IDE HDD Block Mode	[Enabled]	
IDE DMA transfer access	[Enabled]	
On-Chip Primary PCI IDE	[Enabled]	Menu Level ►
IDE Primary Master PIO	[Auto]	
IDE Primary Slave PIO	[Auto]	
IDE Primary Master UDMA	[Auto]	
IDE Primary Slave UDMA	[Auto]	
** On-Chip Serial ATA Setting **		
SATA Mode	[IDE]	
On-Chip Serial ATA	[Enhance Mode]	
SATA PORT Speed Settings	[Disabled]	
x PATA IDE Mode	Secondary	
SATA Port	P0,P2 is Primary	

↑↓:Move Enter:Select +/-/PU/PD:Value F10:Save ESC:Exit F1:General Help
 F5: Previous Values F6: Fail-Safe Defaults F7: Optimized Defaults

Set the [On-Chip Serial ATA] to “Enhanced Mode”.

On-Chip Serial ATA	
Disabled []
Combined Mode []
Enhanced Mode [█]
SATA Only []

↑↓:Move ENTER:Accept ESC:Abort

Go back to the [OnChip IDE Device] window and select the [SATA PORT Speed Settings].

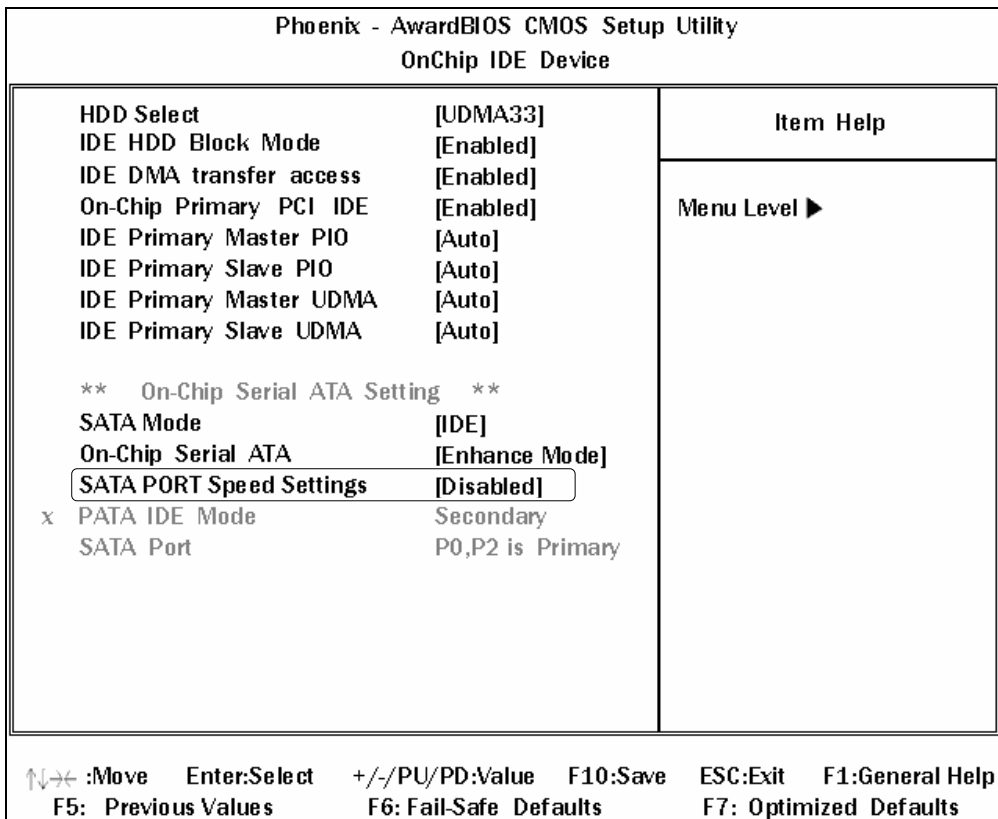

Set the [SATA PORT Speed Settings] to “Disabled”.

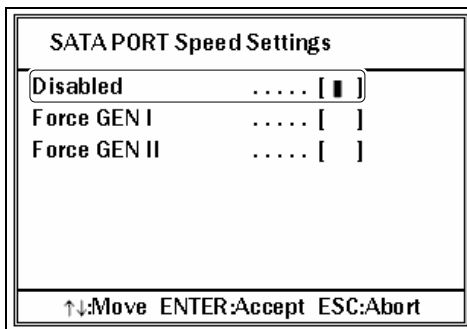

Select the [Save & Exit Setup] from the Main menu.

Select “Y” and save the changed BIOS setting.

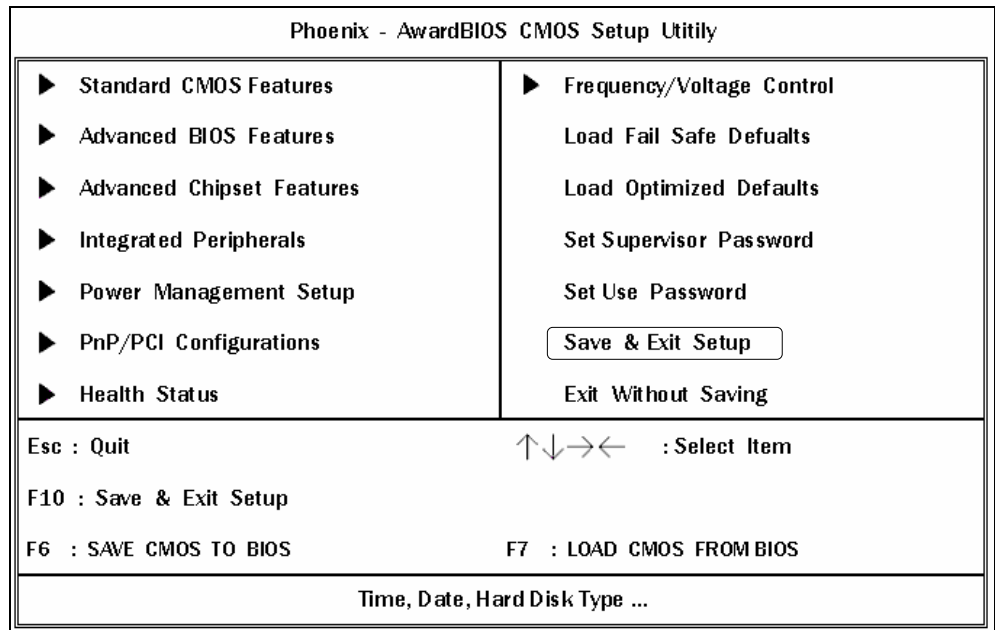

(6) Make sure the Controller operate properly without any trouble.

6.4.2.3 Memory (Faster)



When you replace / add the CPU board memory

If you install 2 memories on the CPU board:

Make sure that 2 memories have the same specification.

If you install “2 DDR memories 1GB (our option)” on the CPU board (Normal):

Refer to 6.4.1.3 Memory (Normal) and remove the standard memory before installing the option memories.



The structure of Slot 1 and Slot 2 are the same. To remove the memory of Slot 2, follow the procedure described below. Slot 2 is located next to Slot 1.

Memory (Faster) Removal

- (1) Turn OFF the Controller and unplug the power connector.
- (2) Remove the CPU board.

Refer to *Maintenance: 6.4.2.1 CPU Board (Faster)*.

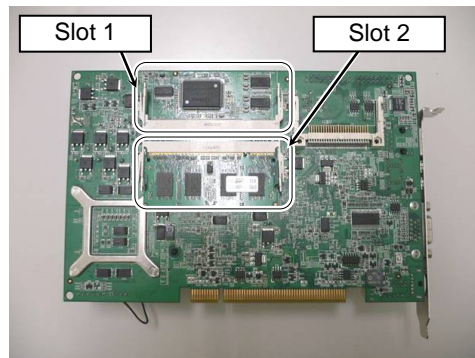

- (3) To remove the memory, pull the latches of memory slot on the back side of CPU board outward lightly.

The photos below show Slot 1.

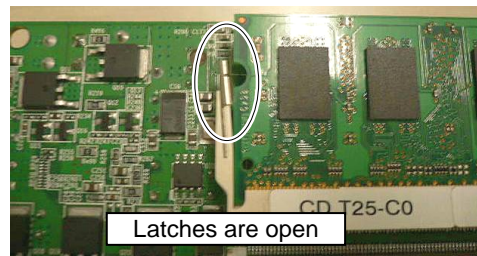
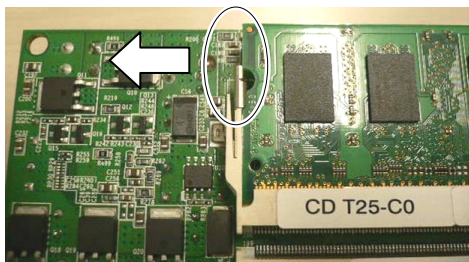

- (4) After the latches are open, pull out the memory straight.



Do not apply too much force on the memory, otherwise the connector area will be broken.

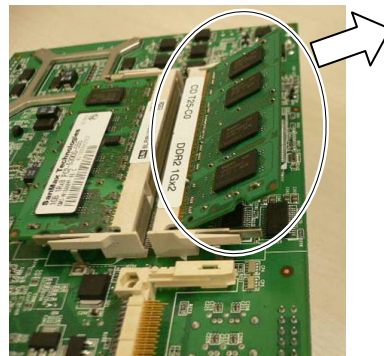

Memory
(Faster)
Installation

- (1) Refer to the photo and insert a new memory slowly into the slot on CPU board.

NOTE

Do not apply too much force on the memory, otherwise the connector area will be broken.

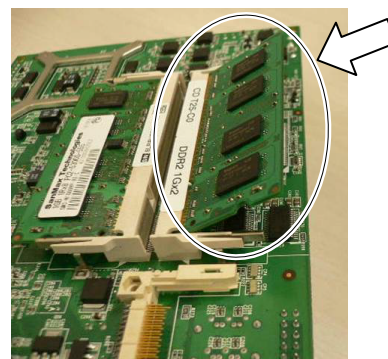

- (2) Push the memory connector into the slot all the way.

- (3) Slowly lay flat the memory until it is firmly secured with latches.

NOTE

When the memory is laid flat, the latches automatically catch and secure the memory.

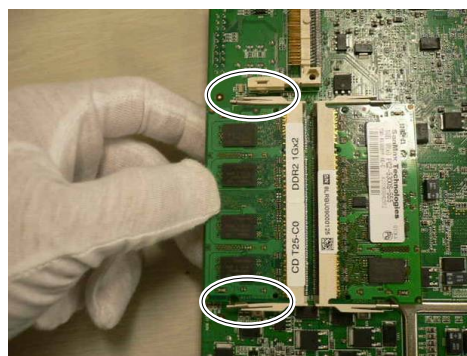

- (4) Mount the CPU board.

Refer to *Maintenance: 6.4.2.1 CPU Board (Faster)*.

- (5) Plug in the power connector. Turn ON the Controller and make sure that the Controller starts properly without any vibration or abnormal noise.

6.5 CF (Compact Flash)

- CF
(Compact Flash)
Removal
- (1) Turn OFF the Controller and unplug the power connector.
 - (2) Remove 8 screws and boards inserted in the Special option slots.



- (3) Loosen a screw for the CF holder assembly and rotate the holder assembly by 90 degrees.



- (4) Pull out the CF in the direction shown in the photo.

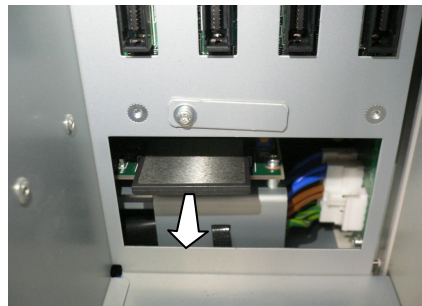

CF
(Compact Flash)
Installation

- (1) Insert the new CF along the guide rail.
Make sure the CF is along the guide rail and insert it slowly.

- (2) Secure the CF holder assembly using a screw at the position shown in the photo.

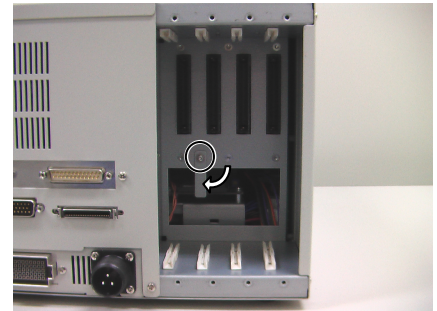

- (3) Put back the removed boards to the original lot and secure them using 8 screws.
- (4) Connect the power plug and power on the Controller. Check if the controller can startup normally.

6.6 Switching Power Supply

6.6.1 Switching Power Supply (15W)

Switching
Power Supply
(15W)
Removal

- (1) Turn OFF the Controller and unplug the power connector.
- (2) Remove 10 screws and the top panel.

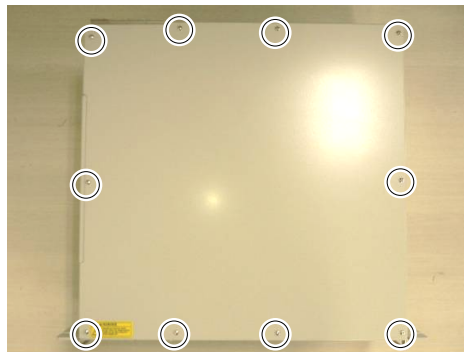

- (3) Remove the Cable No. (4), (10) connected with Switching Power Supply (15W).

Refer to *Maintenance:*
3.2 Diagram of Cable Connections.

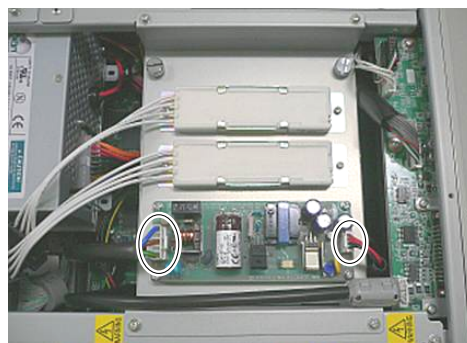

- (4) Remove 4 screws securing the Switching Power Supply and remove the Power Supply.



Switching
Power Supply
(15W)
Installation

- (1) Mount the Switching Power Supply (15W) using 4 screws to the fixing plate of the Switching Power Supply.



- (2) Connect the Cable No. (4), (10) with the Switching Power Supply (15W).

Refer to *Maintenance:*
3.2 *Diagram of Cable Connections.*

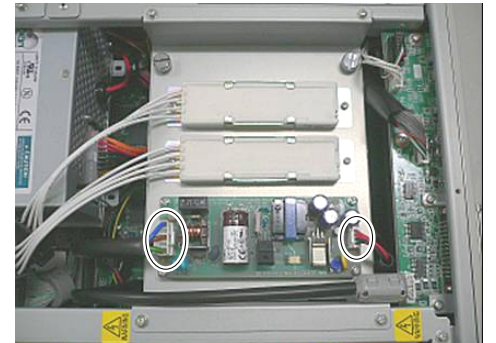

- (3) Place the top panel and secure it using 10 screws.
- (4) Plug in the power connector. Turn ON the Controller and make sure that the Controller starts properly without any vibration or abnormal noise.

6.6.2 Switching Power Supply (75W)

Switching Power Supply (75W) Removal

- (1) Turn OFF the Controller and unplug the power connector.
- (2) Remove 3 screws (M4 pan head) and fixing plate.

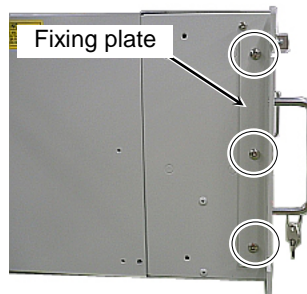

- (3) Change the Controller's direction and put the DPB down.



- (4) Remove 16 screws and the bottom panel.

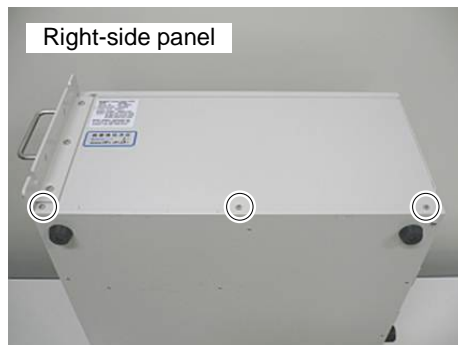
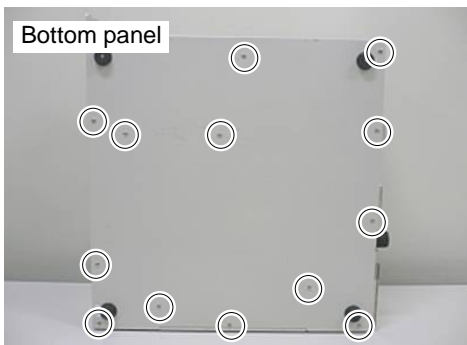

- (5) Remove Cable No. (5), (11) connecting with the Switching Power Supply (75W).

Refer to *Maintenance: 3.2 Diagram of Cable Connections.*

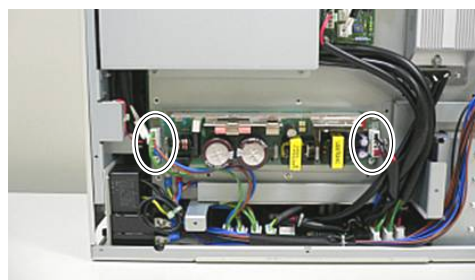

- (6) Remove 4 screws and remove the Switching Power Supply (75W) from the Controller.



Switching
Power Supply
(75W)
Installation

- (1) Secure the Switching Power Supply (75W) to the Controller using 4 screws.
Refer to the photo for the direction of the Switching Power Supply.

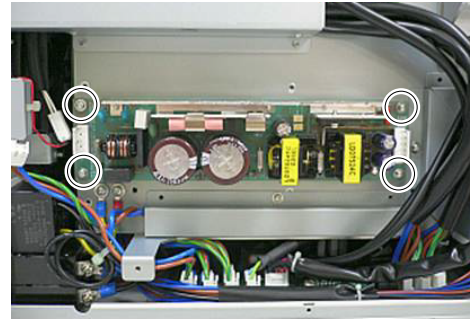

- (2) Connect Cable No. (5), (11) with the Switching Power Supply (75W).
Refer to *Maintenance: 3.2 Diagram of Cable Connections*.
- (3) Place the bottom panel and secure it using 16 screws.
- (4) Put the Controller back to the original position.
- (5) Secure the fixing plate using 3 screws (M4 pan head).
- (6) Plug in the power connector. Turn ON the Controller and make sure that the Controller starts properly without any vibration or abnormal noise.

6.6.3 Switching Power Supply (ATX)

Switching Power Supply (ATX) Removal

- (1) Turn OFF the Controller and unplug the power connector.
- (2) Remove 10 screws and the top panel.

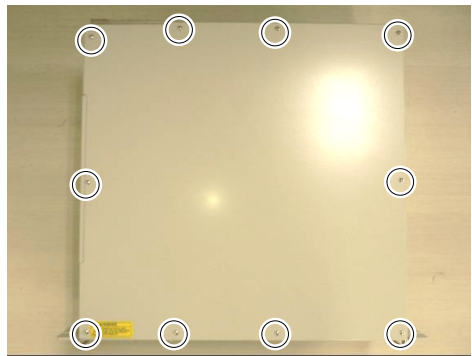

- (3) If COM panel is mounted:
Remove 2 screws for the COM panel.

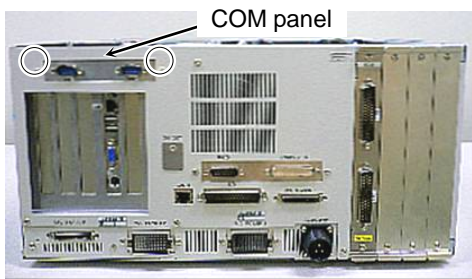

- (4) Remove 6 screws and the back panel.

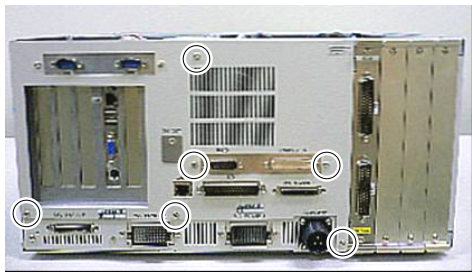

- (5) Remove the Cable No. (6) connecting with the Switching Power Supply (ATX) and 3 screws.

Refer to *Maintenance: 3.2 Diagram of Cable Connections.*

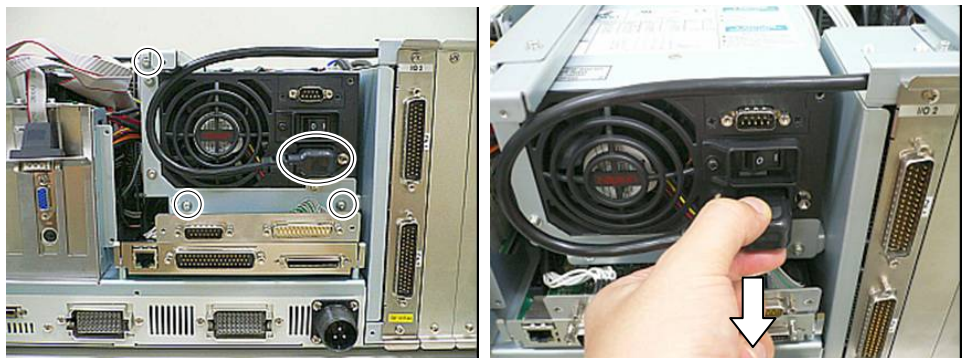

- (6) Pull out the Switching Power Supply (ATX) as shown in the photo.

Remove the 2 connected cables.



- (7) Remove the following cables.

Cable No. (12), (14)

Refer to *Maintenance: 3.2 Diagram of Cable Connections*.

If the UPS option is mounted:

Remove Cable No. (13).

Push the connector's latch with your finger to release.

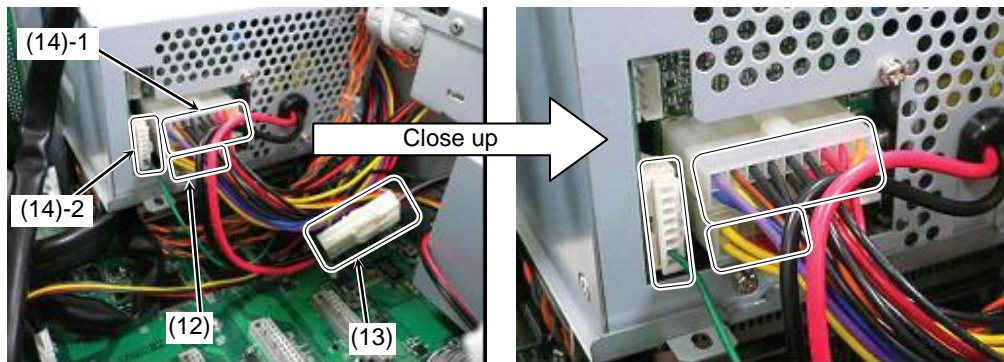

- (8) Pull out the Switching Power Supply (ATX) to the direction shown in the photo.

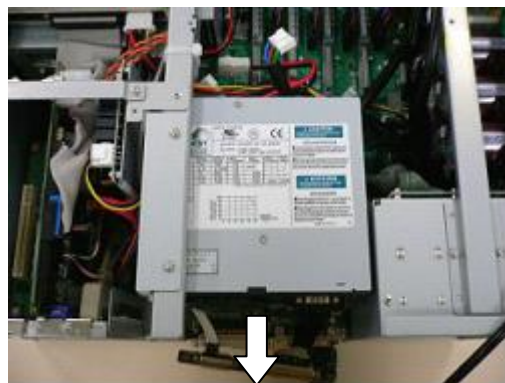

- (9) Remove 3 screws and fixing plate for the Switching Power Supply (ATX).



Switching Power Supply (ATX) Installation

- (1) Mount the fixing plate to a new Switching Power Supply (ATX) using 3 screws.
- (2) Insert the Switching Power Supply (ATX) into the Controller as shown in the photo and connect the following connectors.

Cable No. (12), (14)

Refer to *Maintenance: 3.2 Diagram of Cable Connections*.

If UPS option is mounted:

Connect Cable No. (13).

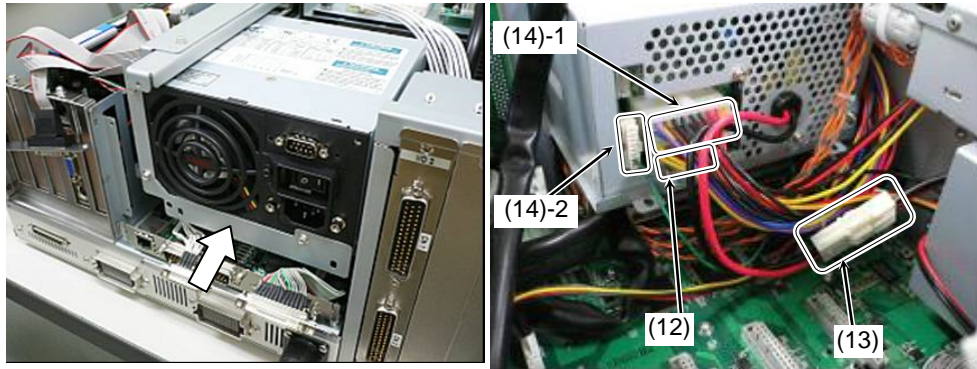

- (3) Be careful not to catch cables and slowly insert the Switching Power Supply (ATX) all the way.

Make sure that tabs of the Switching Power Supply (ATX) fit into the sockets of the Controller.

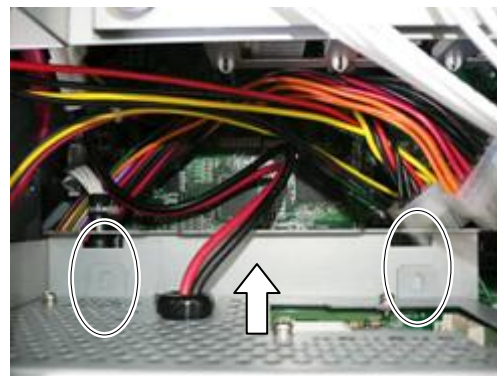

- (4) Secure the Switching Power Supply (ATX) to the Controller using 3 screws.



- (5) Connect the Cable No. (6) with the Switching Power Supply (ATX).

Refer to *Maintenance:*
3.2 *Diagram of Cable Connections.*

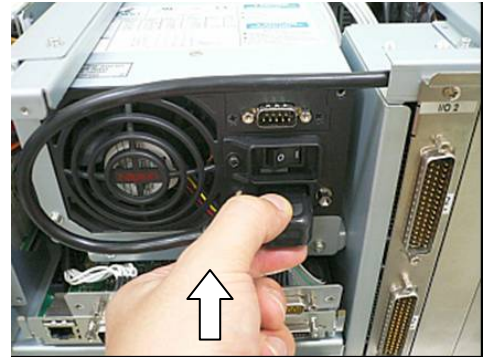

- (6) Hold the back panel as shown in the photo and secure the plate for EMERGENCY connector and R-I/O connector using 2 screws.



- (7) Mount the back panel to the Controller using 4 screws.

- (8) If COM panel is mounted:
Secure the COM panel using 2 screws.

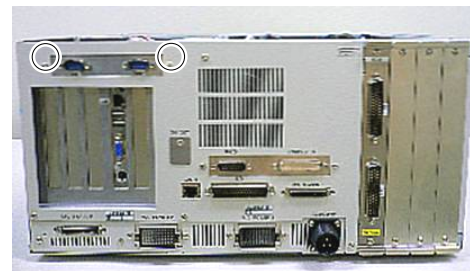

- (9) Place the top panel and secure it using 10 screws.

- (10) Plug in the power connector. Turn ON the Controller and make sure that the Controller starts properly without any vibration or abnormal noise.

6.7 PCI Board

PCI Board Removal

- (1) Turn OFF the Controller and unplug the power connector.
- (2) Disconnect the external cables from the PCI Board if they are connected.
- (3) Remove 10 screws and the top panel.

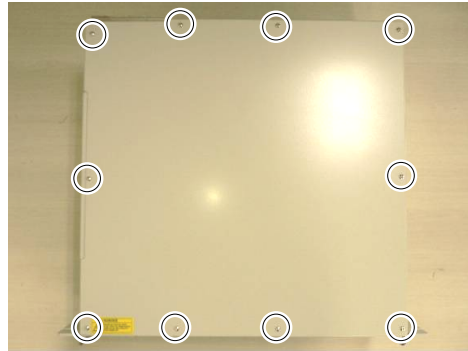

- (4) Remove a screw for the CPU holder assembly and remove the holder assembly.

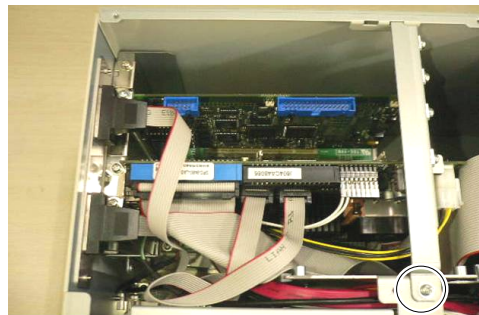

- (5) If the CPU (Faster) is connected:
Remove 2 screws of COM panel attached on the back panel.



- (6) Remove a screw securing the PCI Board on the Controller rear side.

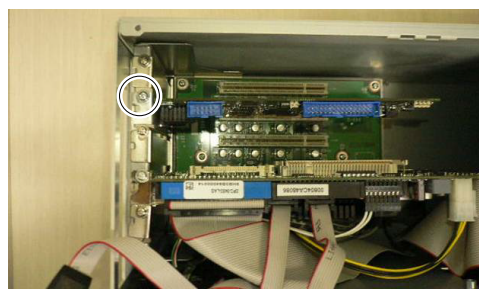

- (7) Remove the PCI Board from the PCI-BPB slot.

PCI Board Installation

- (1) Insert the PCI Board into the PCI-BPB slot and secure using a screw.

NOTE  Be sure to tighten the screw with proper tension. Otherwise, the screw hole will be broken.

- (2) Insert the board holder assembly into the hole of the side panel (Right) and secure it using a screw.

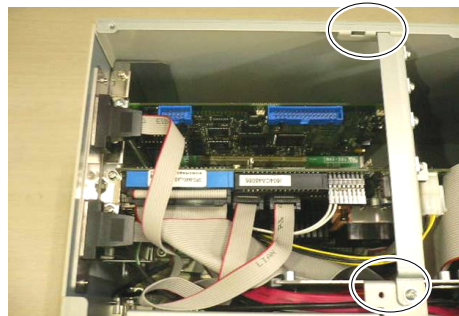

- (3) Loosen the screw holding the PCI Board.

Put the PCI Board in position and set the screw.

NOTE  Make sure that the PCI Board is firmly placed.

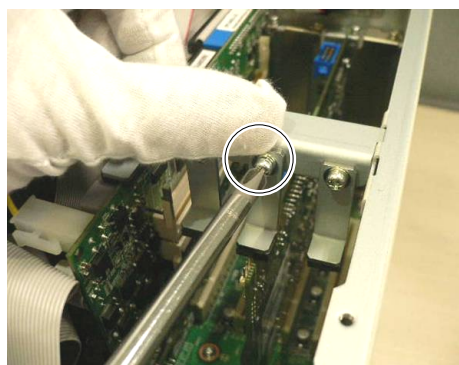

- (4) Place the top panel and secure it using 10 screws.
- (5) If you disconnected the external cables from the PCI Board, connect them again.
- (6) Plug in the power connector. Turn ON the Controller and make sure that the Controller starts properly without any vibration or abnormal noise.

6.8 Special Board

6.8.1 Replacing the Special Board

Special Board Removal

- (1) Turn OFF the Controller and unplug the power connector.
- (2) Disconnect the external cables from the Special Board if they are connected.
- (3) Remove 2 screws and pull out the Special Board.

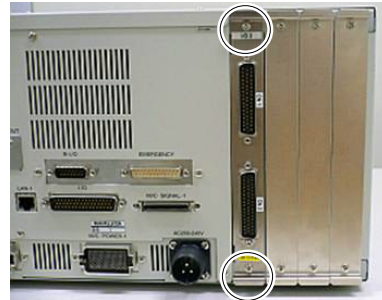

Special Board Installation

- (1) According to the slot to which you insert a board, set the Special Board switch. Refer to *Maintenance: 11. Option Slots*.
- (2) Insert the Special Board into the slot along the guide rail and secure using 2 screws.
- (3) Connect the cables with the Special Board.
- (4) Plug in the power connector. Turn ON the Controller and make sure that the Controller starts properly without any vibration or abnormal noise.

6.8.2 Adding the Special Board

- (1) Turn OFF the Controller and unplug the power connector.
- (2) According to the slot to which you insert a board, set the Special Board switch. Refer to *Maintenance: 11. Option Slots*.
- (3) Remove 2 screws and remove the panel.



- (4) Insert the Special Board into the slot along the guide rail and secure using 2 screws.
- (5) Plug in the power connector. Turn ON the Controller and make sure that the Controller starts properly without any vibration or abnormal noise.

6.9 HDD

Replacement procedure of HDD is different depending on the absence or presence of the RAID option.

6.9.1 Standard (HDD without RAID option)

Follow the replacement instruction described in the attachment paper *RC620 Maintenance Parts: Procedure for Replacing HDD and Setting Up* coming with a new HDD.

6.9.2 HDD with RAID option

 CAUTION	<p>■ Do not apply any shock to the HDD during the maintenance work. Otherwise, not only the part may be broken and the data also may be broken during read / save.</p>
---	--

NOTE  Before replacing the hard disk, make sure to backup the data of necessary project and system and after replacing, restore the data.

For the details of data backup / restore, refer to *Maintenance 4.3 Data Backup*.

HDD Removal

- (1) Shutdown the Windows and power off the Controller.
- (2) Remove 6 screws securing the front panel and remove the front panel.

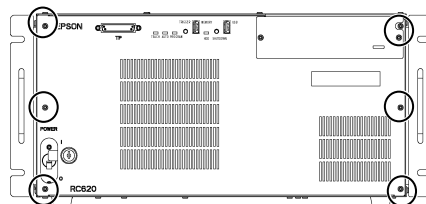

- (3) Remove the cables connected to the HDD.

NOTE  Be careful not to break the HDD connector.

- (4) Remove 2 set screws of the HDD fittings and pull out the HDD with fittings forward.

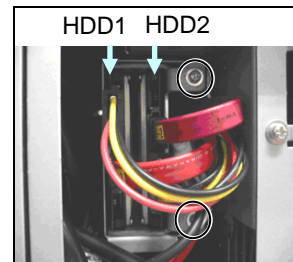

NOTE  Be careful not to drop the screws.

- (5) Remove the set screws (4 flat head screws) for the HDD and remove the HDD from the fittings. The photos below show HDD1.



The relation of HDD numbers and port numbers is:

HDD number	1	2
	↓	↓
Port number	0	2

HDD
Installation

- (1) Mount the new HDD to the HDD fittings. (4 flat head screws)
- (2) Mount the HDD fittings on the Controller and secure using 2 screws.
- (3) Connect the cables to HDD.

NOTE  Make sure to check the label indication on the cables and connect them to HDD correctly.

Route the cables carefully. If you add extra stress on the cables, it may cause the connection failure.

Power cable is for both HDD1 and 2.

- (4) Mount the front panel.

7. Recovering the HDD

This section describes how to recover the current HDD in the RC620 controller with the Embedded OS installed.

The recovery procedure differs according to the controller RC620 serial number. Refer to the appropriate section and recover the current HDD.

Serial No.	Refer to
01-00501 to 01-01000 02-00501 to 02-01000	7.1 HDD Recovery Procedure (S/N 01/02-00501 to 01/02-01000)
01-01001 or later 02-01001 or later	7.2 HDD Recovery Procedure (S/N 01/02-01001 or later)

7.1 HDD Recovery Procedure (S/N 01/02-00501 to 01/02-01000)

Recovery Step		Reference
1	Back up the current data	Maintenance 4.3 Backup
2	Windows recovery	Maintenance 7.2 Recovering Windows
3	Restore the backup data	Maintenance 4.4 Restore

To recover the HDD, prepare the following.

Item	Note
PS/2 keyboard	When using USB keyboard.
PS/2 mouse	When using USB mouse.



- When recovering Windows, USB keyboard and USB mouse are not available. Make sure to use PS/2 keyboard and PS/2 mouse.
- The recovery data is built in the RC620 controller HDD with the Embedded OS installed. However, depending on the HDD status, the recovery work does not work. When you cannot recover, replace the HDD.

7.1.1 Recovering Windows



- When the Windows is recovered, all the data in the HDD will be erased. Make sure to make a back up of data before recovering Windows. The procedure for backup is described in *Maintenance: 4.3 Backup*.



When you accidentally select “RC620 Recovery”, the recovery tool runs. In this case, press <N> key in the step (4) below to reboot the RC620 controller.

- (1) Connect the PS/ keyboard and the PS/2 mouse to the RC620.
(The USB keyboard and the USB mouse cannot be used in Windows recovery.)
- (2) Turn ON the RC620 controller power supply.

- (3) The message “Select the operating system” appears.

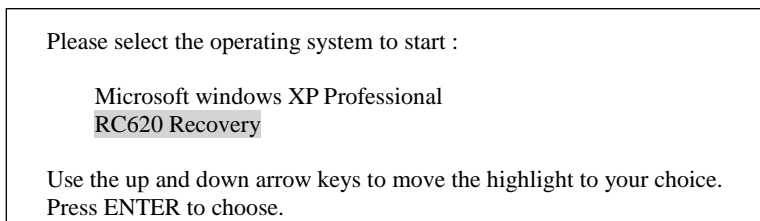

Use the up/down keys on the keyboard and select “RC620 Recovery”. Then, press the <Enter> key.

NOTE 

In the “Select the operating system” timer is set. Five seconds after the “Select the operating system” is displayed, the select window automatically closes and the RC620 starts normally. When recovering Windows, use the up/down keys on the keyboard as the RC620 starts and stop the timer of “Select the operating system”.

- (4) The recovery tool runs and the message below appears.

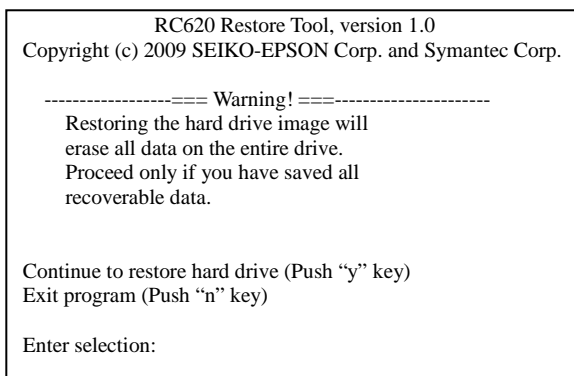

Read the message and press the <Y> key. Then press the <Enter> key.

NOTE 

If you press the <N> key, Windows recovery does not start. If you accidentally run the “RC620 Recovery”, press the <N> key and then <Enter> key.

- (5) Restoring starts.

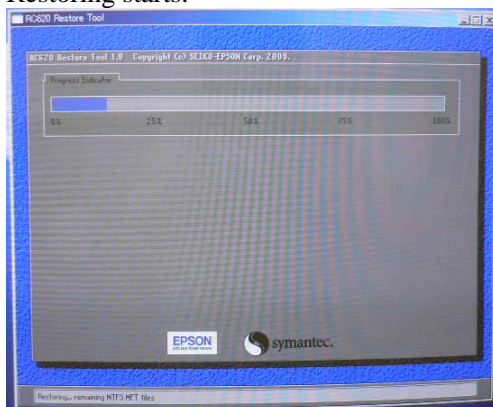

- (6) When the restoration is completed, the message below appears.

Drive restore was successful. Please reboot your system. Press any key to continue . . .

Press any key on the keyboard to reboot the RC620 controller.

7.2 HDD Recovery Procedure (S/N 01/02-01001 or later)

Recovery Step		Reference	
1	Back up the current data	Maintenance	4.3 Backup
2	Back up the current EPSON RC+ data	Maintenance	7.1.1 Backing up EPSON RC+ data
3	Windows recovery	Maintenance	7.1.2 Recovering Windows
4	Restore the EPSON RC+ data	Maintenance	7.1.3 Restoring EPSON RC+ data
5	Restore the backup data	Maintenance	4.4 Restore

To recover the HDD, prepare the following.

Item	Note
RC620 Recovery Disk	Attached to the controller.
PS/2 keyboard	When using USB keyboard.
PS/2 mouse	When using USB mouse.
USB DVD-ROM drive	When DVD drive is <u>not</u> installed.



- When recovering Windows, USB keyboard and USB mouse are not available. Make sure to use PS/2 keyboard and PS/2 mouse.
- The recovery data is built in the RC620 controller HDD. However, depending on the HDD status, the recovery work does not work. When you cannot recover, replace the HDD.

7.2.1 Backing up EPSON RC+ data

- (1) Exit EPSON RC+ if it is running.
- (2) Copy the all files in the following folders in HDD to a USB memory or other memory medium.

C:\EpsonRC60\Backup
 C:\EpsonRC60\Calib
 C:\EpsonRC60\Config
 C:\EpsonRC60\Projects
 C:\EpsonRC60>Status

7.2.2 Recovering Windows



CAUTION

- When the Windows is recovered, all the data in the HDD will be erased. Make sure to make a back up of data before recovering Windows. The procedure for backup is described in *Maintenance: 4.3 Backup*.



NOTE

When you accidentally start the RC620 controller while the Recovery Disk is being inserted, the recovery software runs. In this case, see the step (11) below and reject the Recovery Disk, and then reboot the RC620 controller.

- (1) Connect the PS/2 keyboard and the PS/2 mouse to the RC620 controller.
(The USB keyboard and the USB mouse cannot be used in Windows recovery.)
Also, when you use USB DVD-ROM drive, connect it to the RC620 controller.
- (2) Power ON the RC620 controller.
- (3) Press the <Delete> key and show the BIOS setup menu.
- (4) Select “Advanced BIOS Features” and press the <Enter> key. The [Advanced BIOS Features] window appears.
- (5) Record the current setting of “First Boot Device”. Then, change this setting to “CD-ROM” in case of the embedded DVD-ROM drive, change it to “USB CD-ROM” in case of the USB DVD-ROM drive.
- (6) Press the <ESC> key and return to the BIOS setup menu.
- (7) Insert the RC620 Recovery Disk into the DVD-ROM drive.
- (8) Select “Save & Exit Setup” and press the <Enter> key.
- (9) The [Save to CMOS and Exit (Y/N)?] dialog appears. Press the <Y> key.
- (10) The recovery software runs and [License] dialog appears. Check the “I accept the terms in the License Agreement” check box and click the <Accept> button.

(11) The main menu of the recovery software opens.

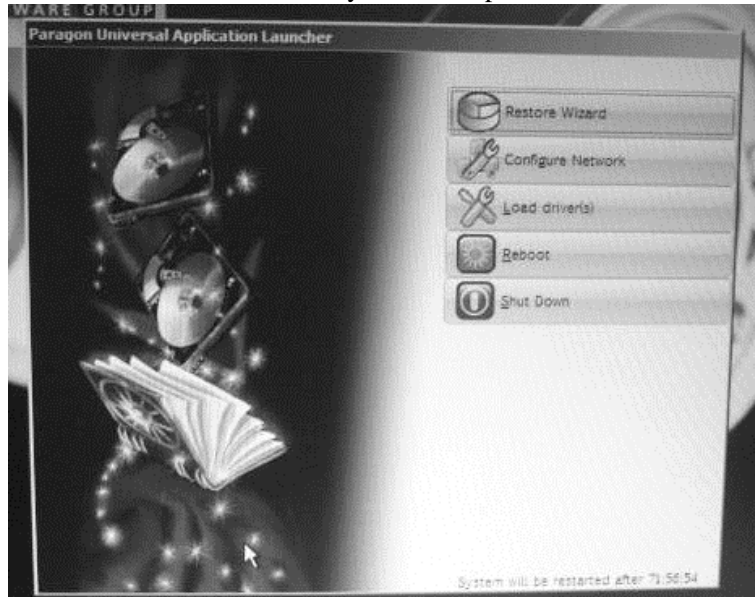

NOTE At this point, if you select <Reboot> or <Shut Down>, Windows recovery does not start.



If you accidentally start the RC620 controller while the Recovery Disk is being inserted, reject the Recovery Disk and click on the <Reboot> or <Shut Down>.

(12) Click the <Restore Wizard>.

(13) The [Welcome to the Restore Wizard] page appears. Click the <Next> button.

(14) The [Browse for Archive] page appears.

Select "Recovery, Disk 0, partition 2 (Primary, NTFS)" from the [Look in] dropdown list.

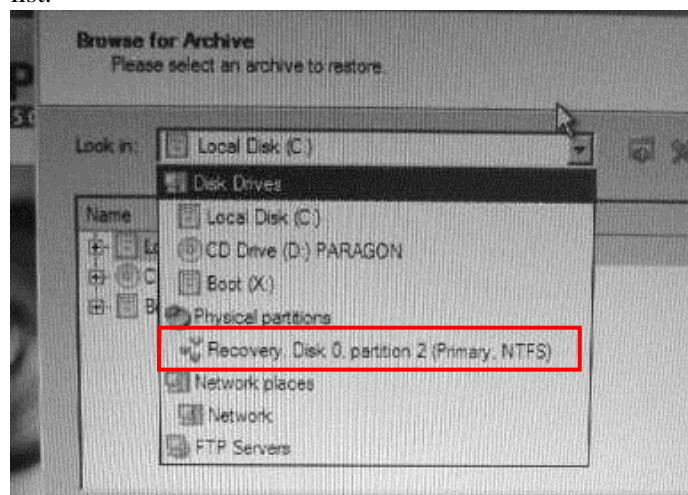

(15) Select “Recovery, Disk 0, partition 2 (Primary, NTFS)” - “RC620”.

The [Archive File Details] appears and click the <Next>.

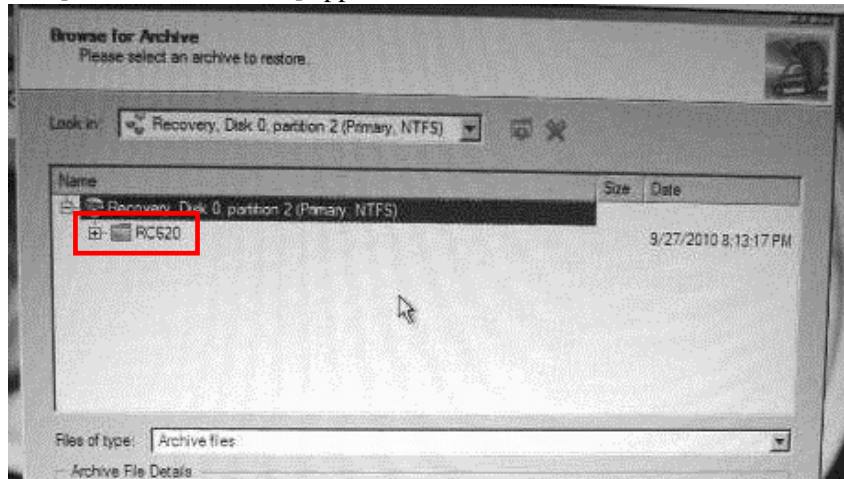

(16) The [Which folders and files to restore] page appears. Click the <Next> button.

(17) The [Where to restore] page appears. Make sure that “Hard Disk 0” - “Local Disk (C:)” is selected as the destination and click the <Next> button.

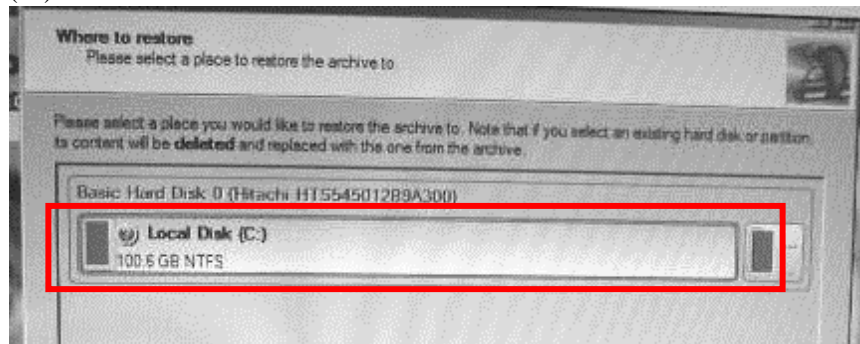

(18) The [Restore results] page appears. Confirm that the data is restored in the destination selected in the step (17) and click the <Next> button.

(19) The [Ready to restore from the archive] page appears. Confirm the warning and select “Yes, apply the changes physically” and click the <Next> button.

(20) It starts the recovery.

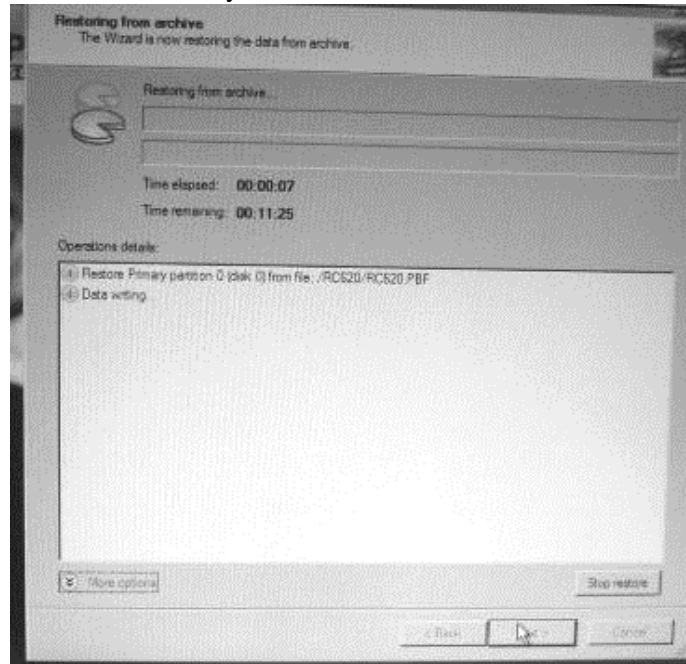

(21) When the recovery is complete, the [Completing the Restore Wizard] page appears. Click the <Finish> button.

(22) The main menu of the Recovery Disk appears and reject the Recovery Disk and click the <Reboot> button to reboot the RC620 controller.

(23) Press the <Delete> key and show the BIOS setup menu.

(24) Select “Advanced BIOS Features” and press the <Enter>. The [Advanced BIOS Features] window appears.

(25) Change the setting of “First Boot Device” to the original you recorded in the step (5).

(26) Press the <ESC> key and return to the BIOS setup menu.

(27) Select “Save & Exit Setup” and press the <Enter> key.

(28) The [Save to CMOS and Exit (Y/N)?] dialog appears. Press the <Y> key.

(29) Windows starts up.

7.2.3 Restoring EPSON RC+ data

(1) Exit EPSON RC+ if it is running.

(2) Copy and overwrite the files backed up in “Backing up EPSON RC+ data” to HDD.

8. Troubleshooting

If the display is blank

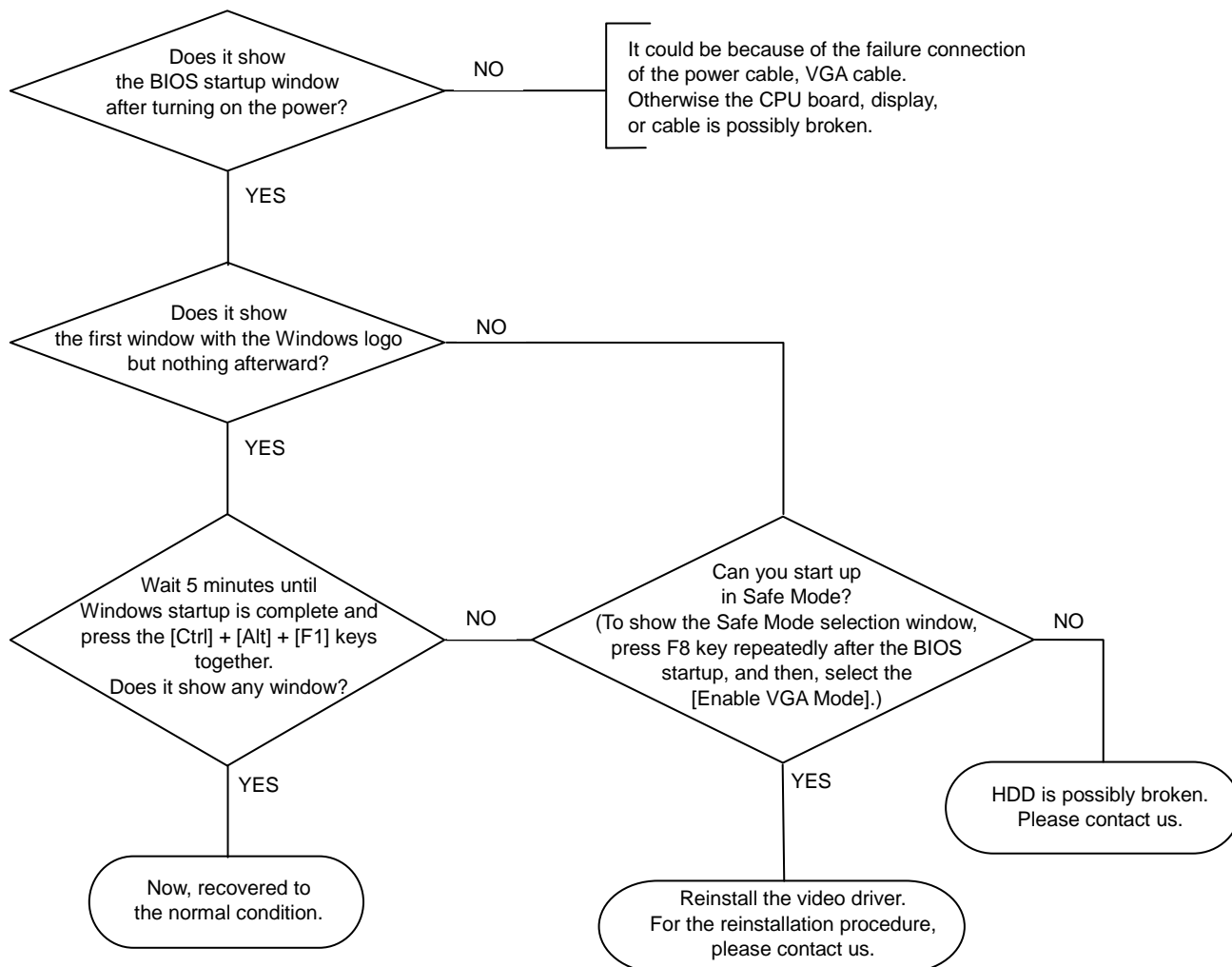

9. Maintenance Parts List

9.1 RC620

Part Name		Code	Note
Fan (A)		R13B060506	
Fan (B)		R13B060507	
Fan Filter	For Fan (A)	R13B060508	
	For Fan (B)	R13B060509	
Battery		R13B060003	CR17335SE (Sanyo Electric Co.)
UPS Battery		R13B060004	BS03A-H16/2.5L (with cover) (Internal battery: BP03A-H16/2.5L)
Motor Driver	50 W	R13B070101	
	100 W	R13B070102	
	200 W	R13B070103	
	400 W	R13B070104	
	750 W	R13B070105	
CPU Board	2 GHz	R13B040006	
	1 GHz	R13B040007	
DDR Memory	512 MB	R12B110604	One Memory
	1 GB	R12B110603	One Memory
	1 GB	R12B110606	Two Memories
DDR2 Memory	1 GB	R12B110602	One Memory
HDD		R12B110419	
CF (Compact Flash)		R13B110605	S/N: 0*-03000 or earlier
		R13B110609	S/N: 0*-03001 or later
Mouse		R13A110300400	
Keyboard	English	R12B110303	
	Japanese	R12B110302	
TP/OP Bypass Plug		R13B060705	
E.STOP BOX		R12B040714	

(* 1: Normal CPU, 2: Faster CPU)

Real Part

Part Name		Code	Note
Expansion I/O Board		R12B040301	Option
RS-232C Board		R12B040705	Option
DeviceNet Board		R12B040706	Option
PROFIBUS-DP Board		R12B040707	Option
CC-Link Board		R12B040708	Option
EtherNet/IP Board		R12B040719	Option

Windows Part

Part Name		Code	Note
DeviceNet Board		R12B040701	Option
PROFIBUS-DP Board		R12B040702	Option
EtherNet/IP Board		R12B040720	Option

9.2 Option TP1

Part Name		Code	Note
TP1 (with cables)	Type A	R12B120101	Cable: Circular connector (5 m)
	Type B	R12B120102	Cable: D-sub connector (5 m)
	Type C	R12B120103	Cable: Circular connector (15 m)
	Type D	R12B120104	Cable: D-sub connector (15 m)
Key		R13B060901	Mode selector key
Wall Bracket		R12B120105	Option
Conversion Kit		R12B120111	Option CK1