



**RED LION®**

# PUMP SPECIALIST TRAINING MANUAL



**HOTLINE: 1.888.885.9254**

**[redlionproducts.com](http://redlionproducts.com)**





# RED LION®

## ABOUT US

---

Backed by the heritage of a global leader in the development and manufacturing of systems and components that move water, the Red Lion® brand remains at the forefront of product innovation by listening to its customers, adapting to the market, and continuing to invest in research and development. This innovative product portfolio is supported by unparalleled service to provide you with current solutions to your water pumping challenges.

---





# TABLE OF CONTENTS

## Course Summary

<b>Topic 1:</b>	
INTRODUCTION.....	4
<b>Topic 2:</b>	
PUMPING FUNDAMENTALS.....	8
<b>Topic 3:</b>	
SYSTEM PRESSURE.....	10
<b>Topic 4: a)</b>	
PUMP TYPES.....	11
<b>Topic 4: b)</b>	
PRESSURE TANKS.....	21
<b>Topic 5:</b>	
PUMP & TANK SELECTION.....	22
<b>Topic 6:</b>	
INSTALLATION INFORMATION.....	24
<b>Topic 7:</b>	
PUMP ACCESSORIES.....	27
<b>Topic 8:</b>	
LAWN & IRRIGATION.....	29
<b>Topic 9:</b>	
WASTEWATER.....	30
<b>Topic 10:</b>	
MULTI-PURPOSE PUMPS.....	37
<b>Topic 11:</b>	
GAS ENGINE DRIVES.....	39
<b>Topic 12:</b>	
CROSS SELL & UP SELL.....	40
EXERCISE A: Pump Sizing Components.....	41
EXERCISE B: Pump Sizing Calculations.....	42
<b>Glossary Of Terms.....</b>	<b>44</b>



## COURSE SUMMARY

This course is designed to provide the following:

- Training
- Make you well informed so you are at ease and confident while selling Red Lion products
- Give you the skills you require to be recognized at your store and in your community as a trained Red Lion Pump Expert.

### Topic 1:

## INTRODUCTION

Water is essential for life. The human body is 80% water, and it's recommended that the average person drinks a minimum of two quarts a day. In order to be able to get that water, it's important to identify sources of water. About 97% of all the earth's water is saltwater, and undrinkable. Only a very small percentage is readily available, either as groundwater or surface water (lakes and rivers).

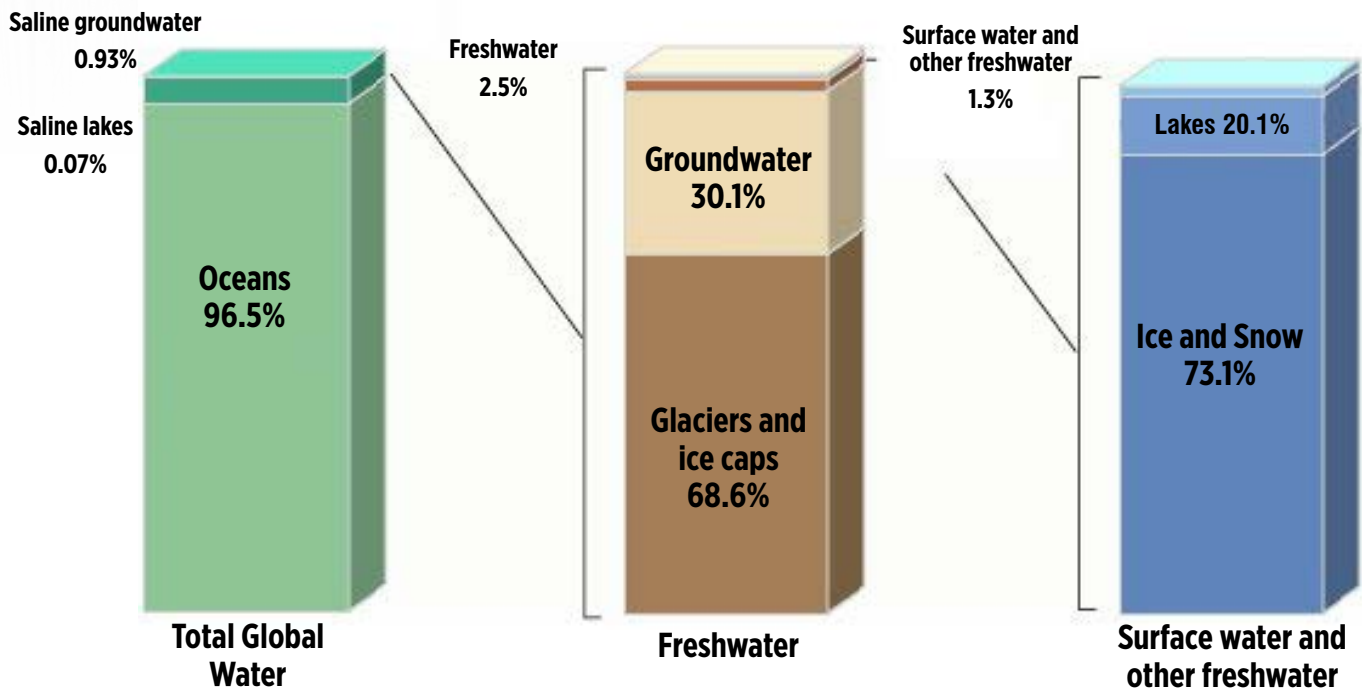



## Water Cycle

The water cycle is a continuous process of evaporation and precipitation. When water falls as rain or snow, some of it collects as surface water. The rest seeps into the earth to become groundwater. The latter flows slowly underground and emerges again as surface water. Evaporation of the surface water takes place and the cycle starts again. Not one extra drop of water exists today that did not exist a million years ago.

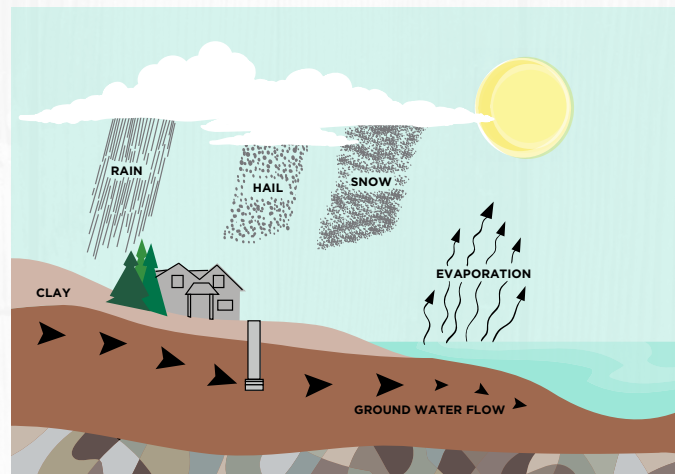

## History Of Water Pumps

The ancient Egyptians developed some of the first means of lifting and pumping water. Many wells were in use in biblical times. Even today we marvel at the ingenuity of the Roman engineers; some of the aqueducts they built are still in use. Electricity provided the first major breakthrough for using pumping equipment in farms and summer homes.



Roman aqueduct, the Pont du Gard, near Nimes, France



## Wells

Wells are holes drilled into the ground to utilize underground water sources. Professional well drillers use large drilling machinery called rigs to drill wells. During drilling, a drilling bit is rotated to form the well. Once drilled, a steel casing is placed in the hole to prevent cave-in and pollution. A well screen is normally attached at the bottom of the casing to keep out sand and gravel while permitting the flow of water.

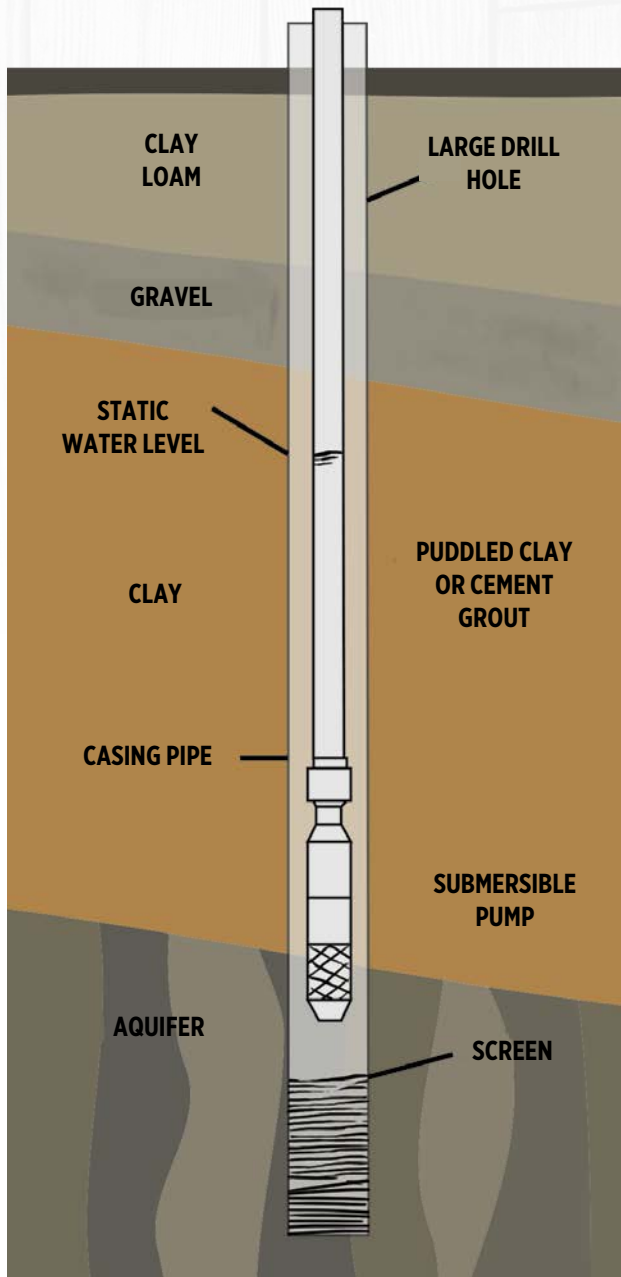
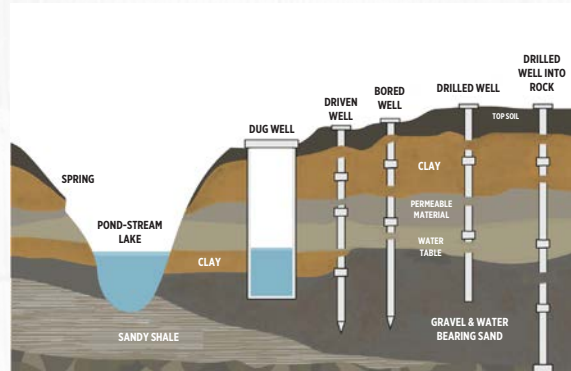

A well driller should give the homeowner a “Well Driller’s Report” providing information like:

- Well depth and screen location
- Diameter and condition of the well
- The strata penetrated
- The depth at which water was found
- Well replenishment rate

Replenishment rate is the maximum rate of flow that a well is able to provide without being pumped dry. This is also known as the well’s capacity, and is measured in gallons per minute, or gpm for short.





## Static Water Level

**Static water level** is the distance below the ground where water is found when no pumping is occurring. Think of it as the resting level of the water. **Note:** The static water level should not be used to size a pump.

When sizing a pump, the **pumping water level** should be used. This is taken from the well driller's report.

The **pumping water level** is the distance below ground where the water is found when the well is being pumped at its rated capacity.

**Drawdown** is the distance that the water level drops below the static water level when the well is being pumped at its rated capacity.

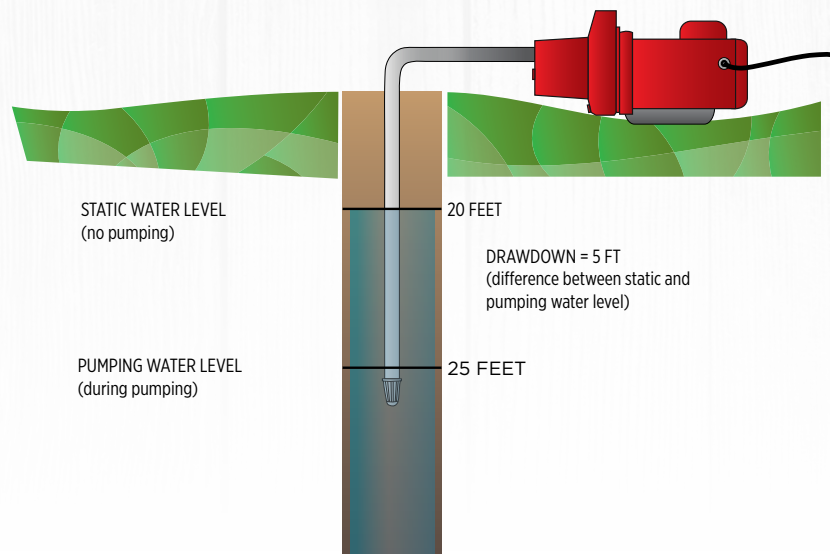

## String Method

An alternative way to size up your well when a well driller's report isn't available is by using a string, float, and weight.

Lower the weight carefully until you feel the float hit the water. The string at that point marks the static water level. If you allow the pump to run while the string is lowered, you can repeat the process and find the pumping water level. The distance between the static water level and the pumping water level will be the drawdown of the well.

Wells are generally 4" in diameter all the way to the bottom.



## Topic 2: PUMPING FUNDAMENTALS

Water is essential for life. There are two basic principles underlying the workings of virtually all pumps that are now being installed for private water systems. The first, often referred to as suction pressure or suction force, is actually the result of atmospheric pressure. The second, known as centrifugal force, is a factor in the operation of every type of rotary pump.

**Atmospheric pressure:** At sea level, the atmosphere has a weight (or pressure) of about 14.7 pounds per square inch (psi). The weight of this air is responsible for operation of all types of suction pumps.

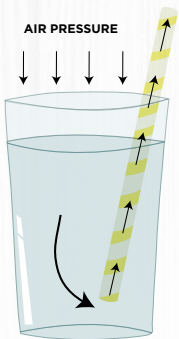

Visualize a drinking straw in a glass of soda, or a pipe inserted in a body of water. If a partial vacuum is created inside the straw or pipe, liquid will flow into it. While this action is commonly called “suction,” it is actually the result of atmospheric pressure pushing the liquid into the space where a vacuum exists.

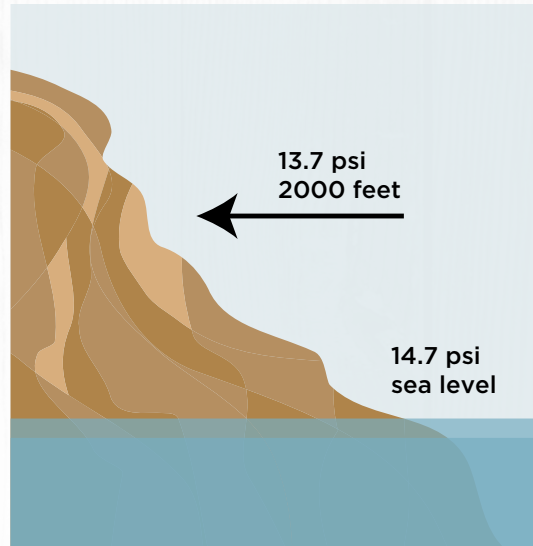

As the altitude increases, air pressure decreases.

How high can such a vacuum lift a column of water? If the suction was perfect, i.e., a complete vacuum, there would be no force to counteract the 14.7 psi of atmospheric pressure. One psi can lift a column of water 2.31 feet. Therefore, in a perfect vacuum, suction force could theoretically lift a column  $2.31 \times 14.7$ , or 33.95 feet. However, for a variety of reasons, including the impossibility of a perfect vacuum, 25 feet is the accepted maximum lift of suction-type pumps.

### Suction Lift

Suction lift is the vertical height from the pumping water level to the suction port of the pump.

Pumping water level + height of pump above ground = suction lift

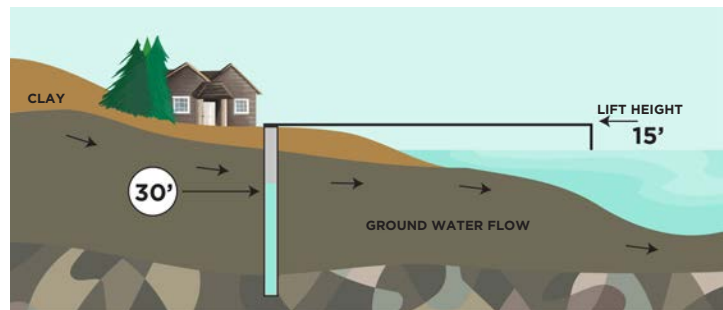

## Centrifugal Force

**Centrifugal Force:** This is nothing more than the tendency of any rotating object to move outward from the axis or center of rotation.

Consider a pail of water being swung in a circle. Although the pail may be tipped almost horizontal to the earth's surface, the water doesn't spill out because centrifugal force keeps it in place. Now imagine that a hole is punched in the bottom of the pail. The water flows out in a steady stream.

In practice, the pump creates centrifugal force with a bladed wheel known as an impeller. Water enters the pump housing, or "volute," at the hub of the wheel. The rotating impeller creates a centrifugal effect which causes the water to flow outward from the axis. As water is thrown to the outer edge, there is a reduction in pressure at the "eye" of the impeller, creating a partial vacuum.

It has the same characteristics as a hurricane. The lowest pressure is in the center, or eye, of the hurricane. Water is pulled in to replace the water that has been thrown from the center of the impeller.

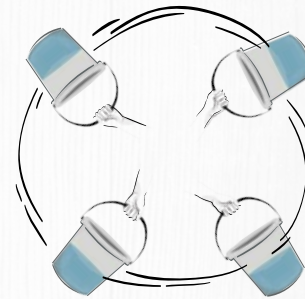

Water stays inside the bucket as it is rotated due to centrifugal force.

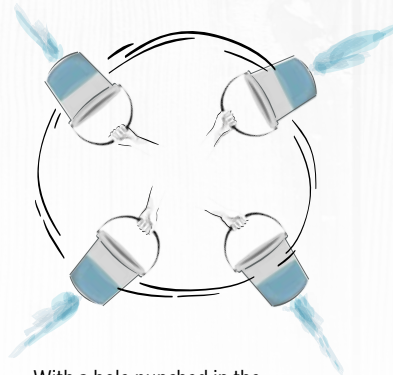

With a hole punched in the bottom of the bucket, the water exits out of the bottom again by centrifugal force.

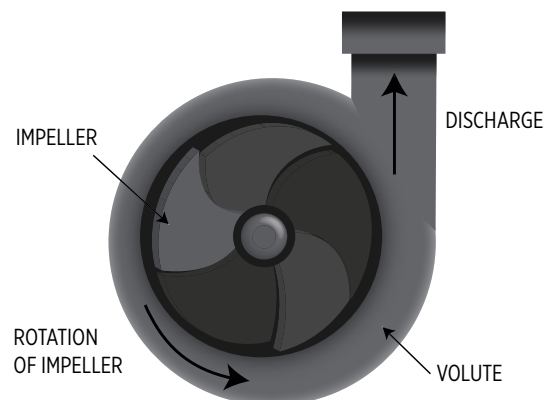

The spinning action of the impeller generates centrifugal force.



## Topic 3: SYSTEM PRESSURE

- System pressure is the pressure that is required by the system to properly operate a home water system
- Most domestic systems operate at a pressure of 30 psi
- Red Lion pumps are factory preset to operate at a 30/50 pressure setting; 30 psi to start, 50 psi to shut-off
- This is a benefit in a replacement market where the original unit may have operated at 20/40 psi settings

\* Remember: psi = pounds per square inch

### Pressure System Components

To function properly and automatically, a pressure system requires several key components:

- A pump to provide water under pressure
- A tank to provide a reserve of water under pressure, allowing the pressure switch to function properly
- A pressure switch to automatically turn the pump on/off at a preset pressure, which extends the life of the motor
- A foot valve

### Friction Loss

Because water has weight and moves through pipe, there are two surfaces rubbing together. This creates friction or resistance, which results in a loss of pressure. The loss in pressure is called friction loss. Think of it like drawing from a milkshake (i.e. using a small straw versus using a big one).

Smaller pipes increase the friction loss. Higher flow rates and longer pipe also increase friction loss, reducing capacity and pressure. Any elbows or tees will also add to total friction loss.

In a normal sizing application for a typical household, friction losses are very small and no calculations are required. Please use recommended pipe sizes for installation.

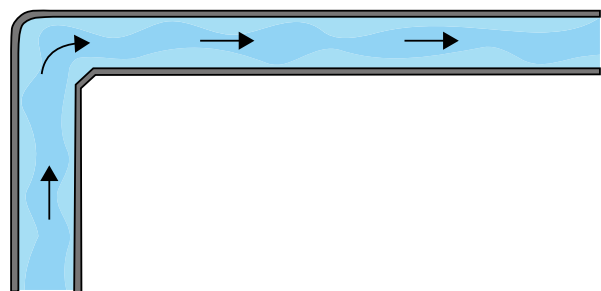
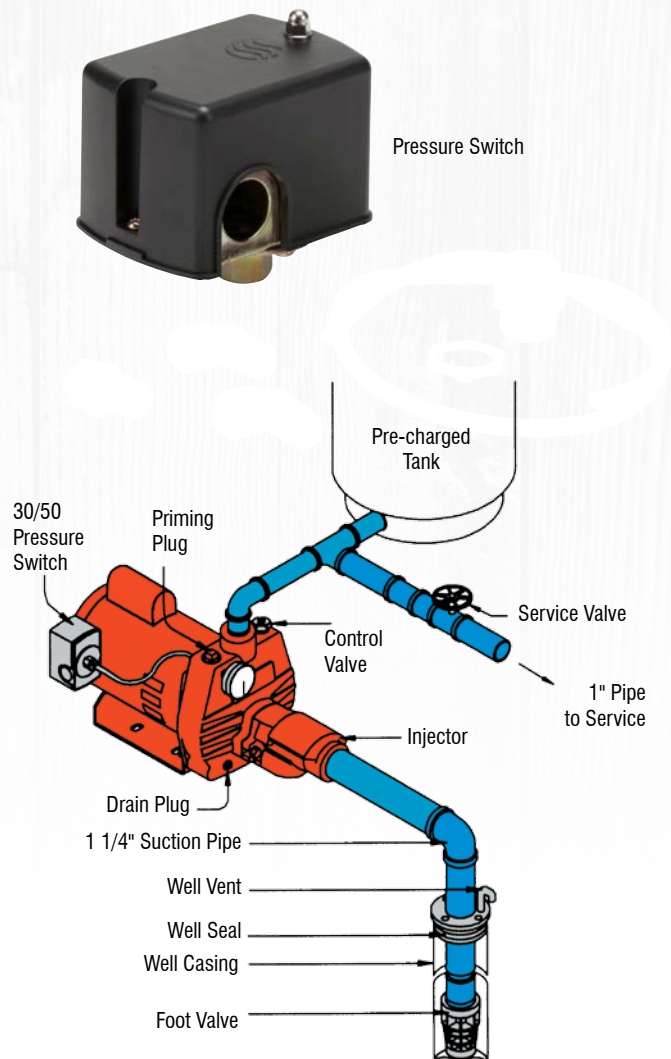

## Topic 4: a) PUMP TYPES

For this training booklet, we will focus on:

### 1. Shallow Well Jet Pumps



RJS-50-PREM 1/2 HP  
RJS-75-PREM 3/4 HP  
RJS-100-PREM 1 HP

### 2. Convertible Jet Pumps



RJC-50-PREM 1/2 HP  
RJC-75-PREM 3/4 HP

### 3. Deep Well Submersible Pumps



RL12G05-2W1V 1/2 HP  
RL12G05-2W2V 1/2 HP  
RL12G07-2W2V 3/4 HP  
RL12G10-2W2V 1 HP  
RL12G15-3W2V 1-1/2 HP

## 1. SHALLOW WELL JET PUMPS

A shallow well jet pump can be used in all applications where there is an adequate supply of water available within a vertical distance of 25 feet or less from the suction port of the pump to the pumping water level.

The shallow well jet pump is the most economical pump and is used for drawing water from cisterns, lakes, or shallow wells.

The “jet” action is done with a nozzle and venturi located inside the injector nose of the casing. By forcing the water through the nozzle, the water develops additional pressure and creates a suction. However, because this pump relies on atmospheric pressure, the total suction lift won't be able to exceed 25 feet.

## Red Lion RJS-PREM Series Premium Shallow Well Jet Pumps

### Applications

Ideal for the supply of fresh water to rural homes, farms, and cabins that have suction lifts down to 25 feet. Able to handle the water demands of large homes, cottages and farms.

### Features

- Self priming
- Rugged cast iron casing
- 1¼" NPT suction, 1" NPT discharge
- 30/50 psi pressure switch
- Glass-filled thermoplastic impeller and diffuser
- Pressures up to 65 psi
- Flow rates to 23 U.S. gpm
- Can be set for use with 115 V or 230 V
- Repair kits available

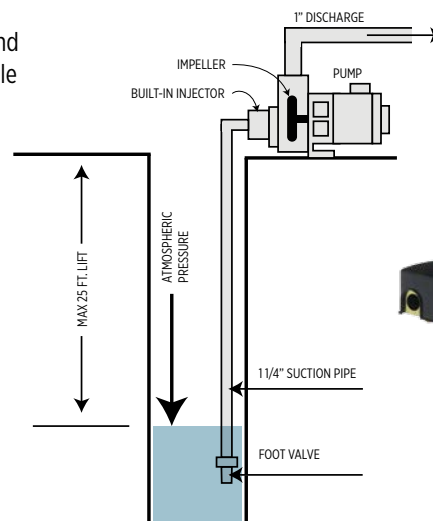



## RJS-PREM Series Premium Shallow Well Jet Pump Cutaway

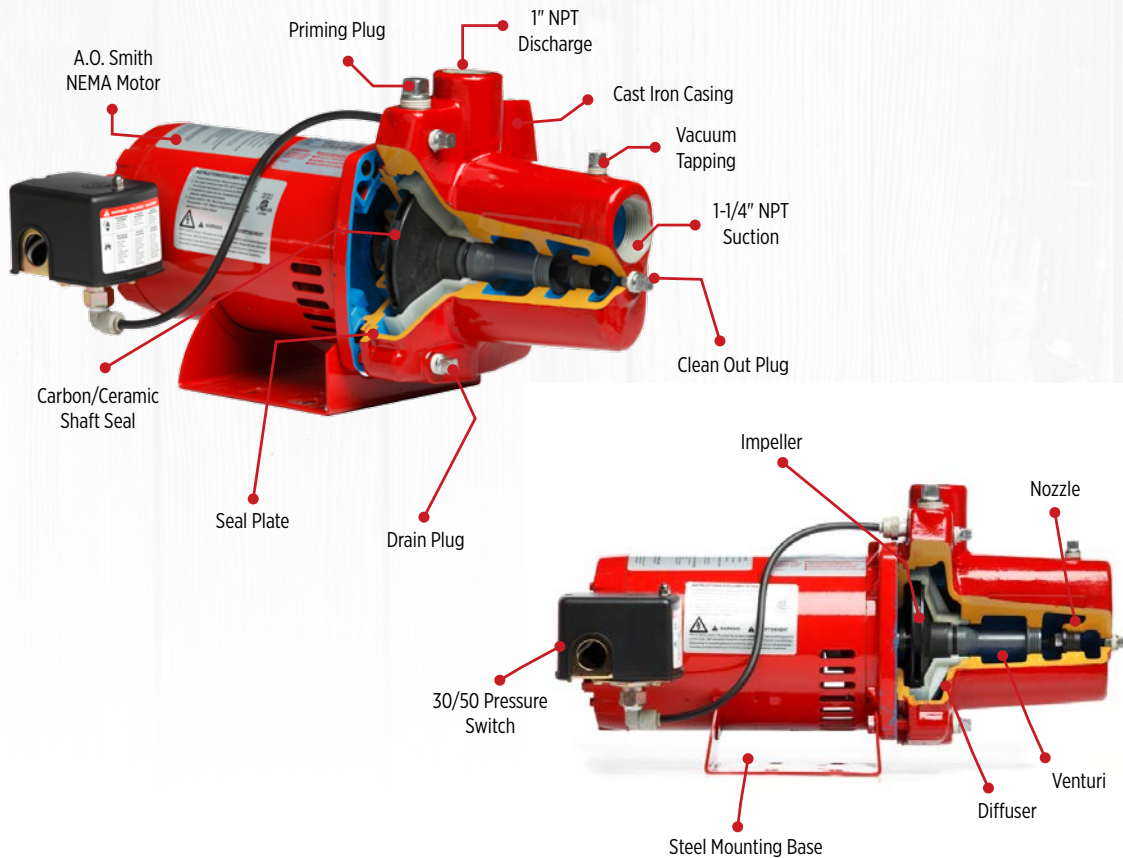

### How to change the voltage

Many motors are dual voltage. Always check the motor to make certain that the electrical power supply matches the voltage change device.

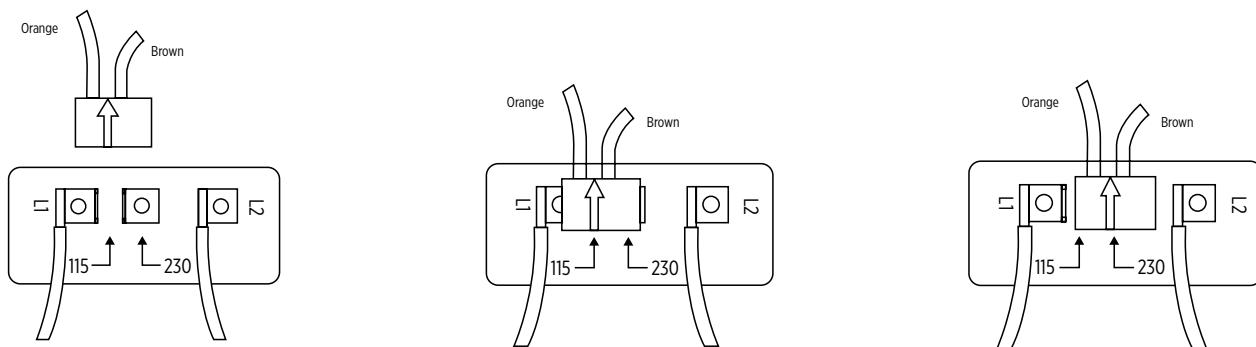

In Figure #1, the motor's switch is shown before the black voltage change device is pressed down onto the voltage terminals.

In Figures #2 and #3 above, line up the white arrow to the appropriate voltage required.

**NOTE:** White lead wires on L1 and L2 are not to be moved.

## Red Lion RL-SWJ Series Shallow Well Jet Pumps

### Applications

Ideal for the supply of fresh water to rural homes, farms, and cabins that have suction lifts down to 25 feet.

### Features

- Self-priming
- Rugged cast iron casing
- 1 1/4" FNPT suction, 1" FNPT discharge
- 30/50 psi pressure switch included
- Pressures up to 74 psi
- Flow rates up to 17 U.S. gpm
- Can be set for use with 115 V or 230 V
- Repair kits available

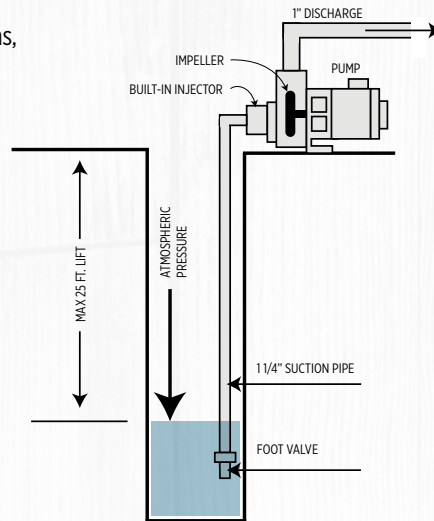



## RL-SWJ Series Shallow Well Jet Pump Cutaway

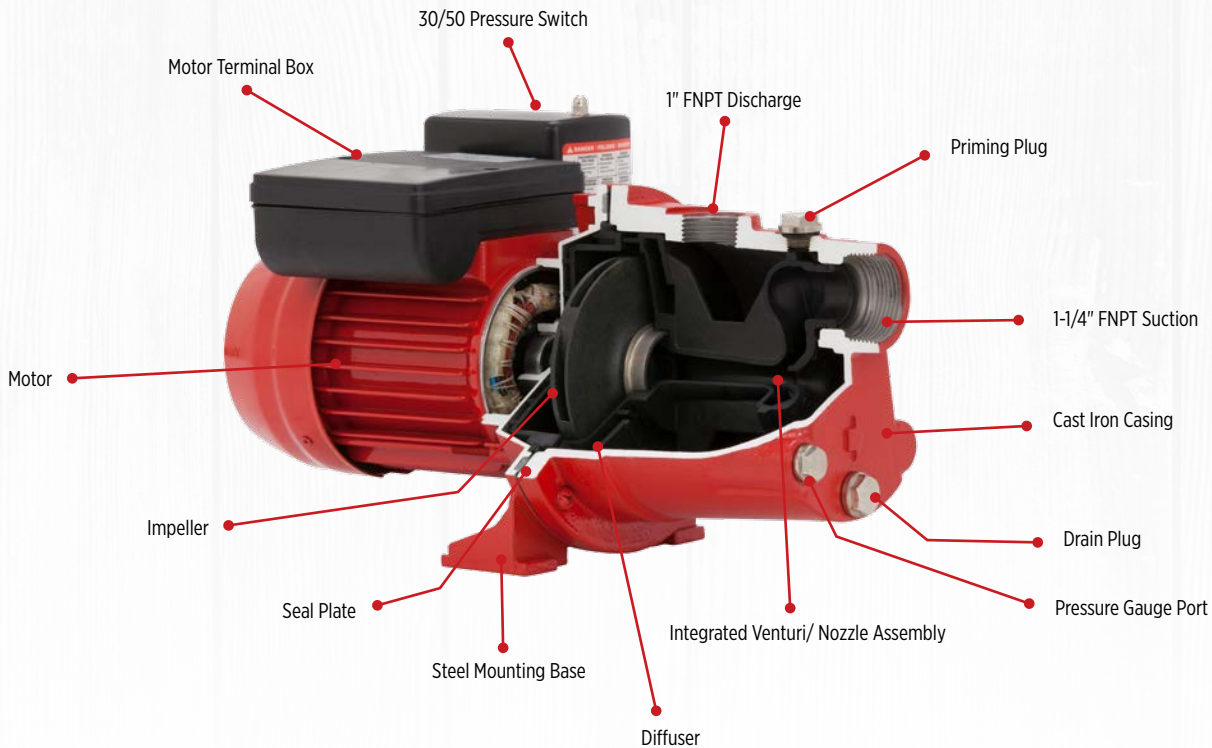

### How to change the voltage

The voltage of the pump must MATCH the voltage of the power source.

1. Using a cross-head screwdriver, loosen the 2 screws on top of the black motor terminal box. (See Figure 1.)
2. Remove the black motor terminal box cover.
3. Locate the black voltage switch with the red voltage indicator near the center of the motor terminal box.  
The number appearing on the voltage switch is the voltage setting of the pump. (See Figure 2.)
4. If your voltage setting for your existing power supply is different than the voltage indicated on the voltage switch of the pump, hold the voltage indicator with one hand, place your fingernail between the two ridges (see Figure 2) and slide the voltage switch to the left or right to change it. Ensure the number showing on the voltage indicator matches the voltage of your power source.
5. Replace the motor terminal box cover and tighten the screws from step (a).

**Figure 1**

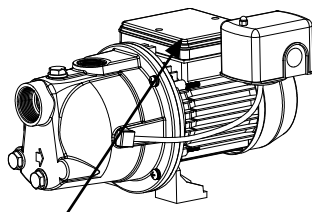

Motor Terminal Box

**Figure 2**

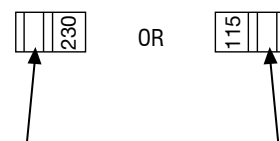

Place fingernail between these two ridges and slide left or right

## Red Lion RJS-75SS Stainless Steel Shallow Well Jet Pumps

### Applications

Ideal for the supply of fresh water to rural homes, farms, and cabins that have suction lists down to 25 feet.

### Features

- Self-priming
- Corrosion-resistant stainless steel pump housing
- 1" FNPT suction and discharge
- 30/50 psi pressure switch included
- Pressures up to 71 psi
- Flow rates up to 12 U.S. gpm
- Can be set for use with 115 V or 230 V
- Repair kits available

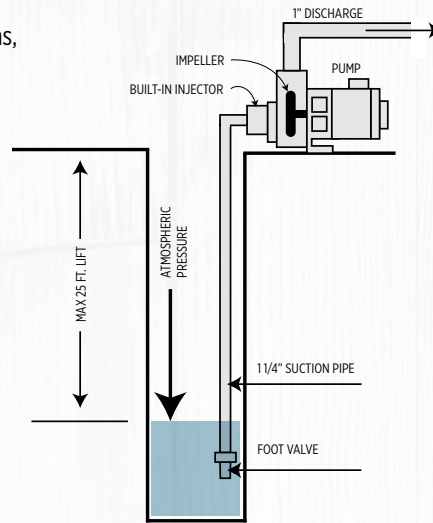



## RJS-75SS Stainless Steel Shallow Well Jet Pump Cutaway

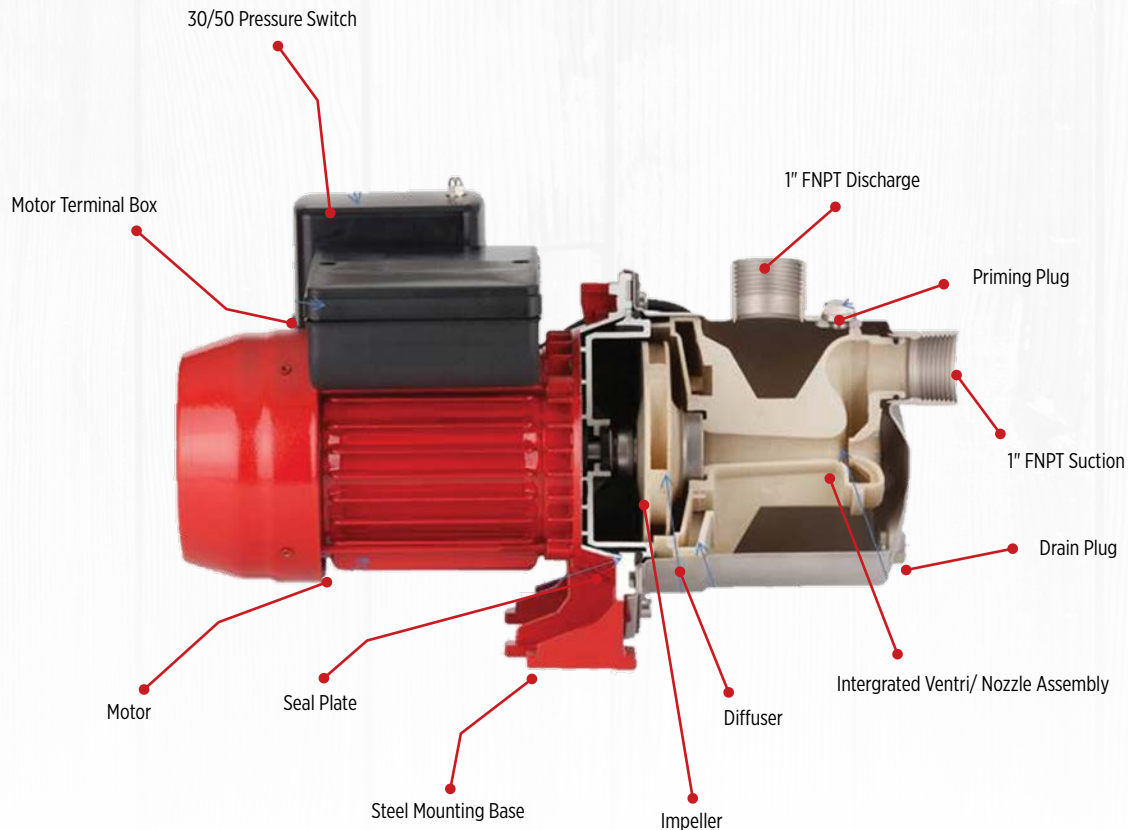

### How to change the voltage

The voltage of the pump must MATCH the voltage of the power source.

1. Using a Phillips screwdriver, loosen the 2 screws on top of the black motor terminal box (See Figure 1).
2. Remove the black motor terminal box cover.
3. Locate the black voltage switch inside the motor terminal box next to the pressure switch. The number appearing on the voltage switch is the voltage setting of the pump (See Figure 2).
4. If your voltage setting for your existing power supply is different than the voltage indicated on the voltage switch of the pump, hold the voltage indicator with one hand, place your fingernail between the two ridges (see Figure 2) and slide the voltage switch to the left or right to change it. Ensure the number showing on the voltage indicator matches the voltage of your power source.
5. Replace the motor terminal box cover and tighten the screws from step (a).

**Figure 1**

Motor Terminal Box

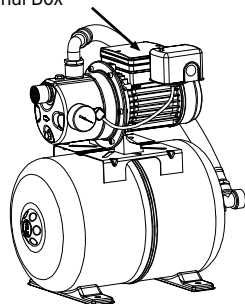

**Figure 2**

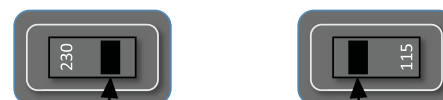

Place screwdriver where indicated and slide left or right

## 2. CONVERTIBLE JET PUMPS

A convertible jet pump can be used for most shallow well installations, and can also be “converted” for deep well applications at no extra cost. These pumps are constructed so that they have a removable injector assembly. By removing the injector from the casing of the pump and placing it in the well, the shallow well unit has been changed into a deep well unit.

The deep well configuration also uses two pipes. One pipe is used to carry water down to the jet. This pipe is referred to as the “drive pipe”. The second, “return” pipe, returns water back to the pump coming up from the jet and venturi. The return pipe, or suction pipe, is larger than the drive pipe because it carries all of the water from the jet, as well as the “new” water that is being drawn from the well.

### Red Lion RJC-PREM Convertible Jet Pumps

#### Applications

Ideal for the supply of fresh water to rural homes, farms, and cabins that have suction lifts down to 90 feet.

#### Features

- Rugged cast iron casing
- 1¼" NPT suction, 1" NPT discharge
- 30/50 psi pressure switch
- Glass-filled thermoplastic impeller and diffuser
- Deep well injector, venturi, nozzle, and brass flow control valve included
- Change venturi in deep well applications greater than 40 feet
- Pressures up to 87 psi
- Flow rates to 20 U.S. gpm

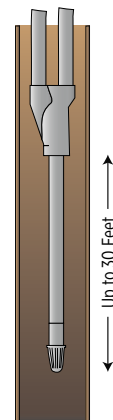
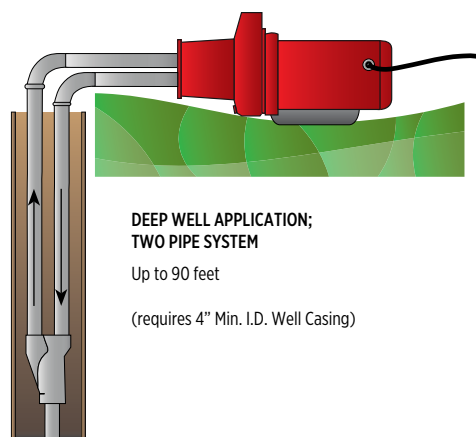
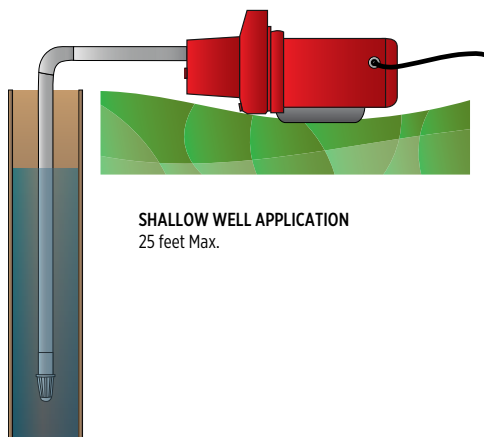



## Convertible Jet Pump Cutaway

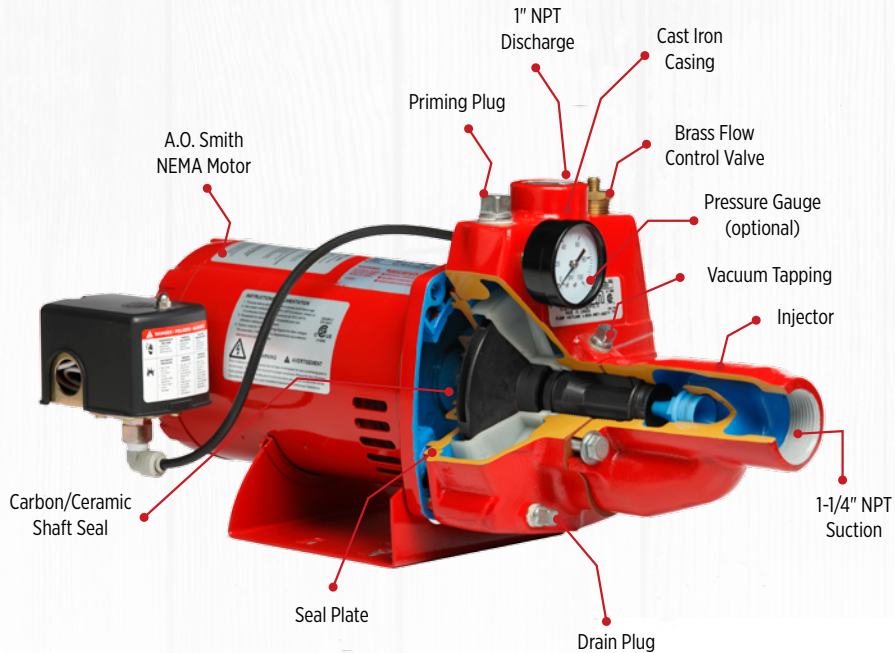

\*Pressure gauge included on pump and tank system only

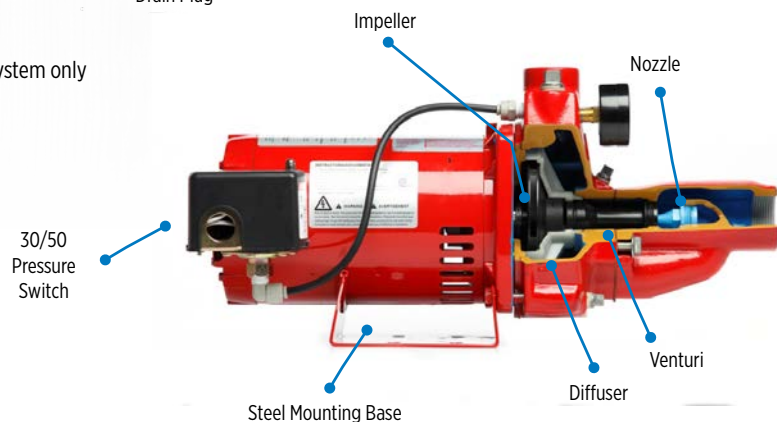

## When replacing an existing pump

- What is the current pump's horsepower?
- What is its voltage?
- What is the flow (capacity) required? (Normally 1 gpm minimum for each fixture)
- Is it a shallow well or deep well jet? (One suction pipe or two)
- Is it a 4" Submersible?
- Is it a 2-wire or 3-wire version?

In retrofit applications, it is always best to match the horsepower of the pump that is being replaced. By switching to a higher horsepower pump without first checking the well conditions, the replacement pump might be oversized and pump at a higher flow rate than the well is able to replenish.

### 3. DEEP WELL SUBMERSIBLE PUMPS

Although they look completely different, the deep well submersible pumps are actually a centrifugal pump. The pump and motor are joined together and submerged in water. This gives the pump a tremendous advantage over any other centrifugal pump. Most of its energy goes into “pushing” the water rather than fighting gravity and atmospheric pressure to draw water to it.

The submersible pump itself consists of several compact impellers, called “stages.” The number of stages in any pump depends on how far the water has to be lifted and on how much pressure is needed. The submersible motor is waterproof and is attached to the pump directly below the water intake screen.

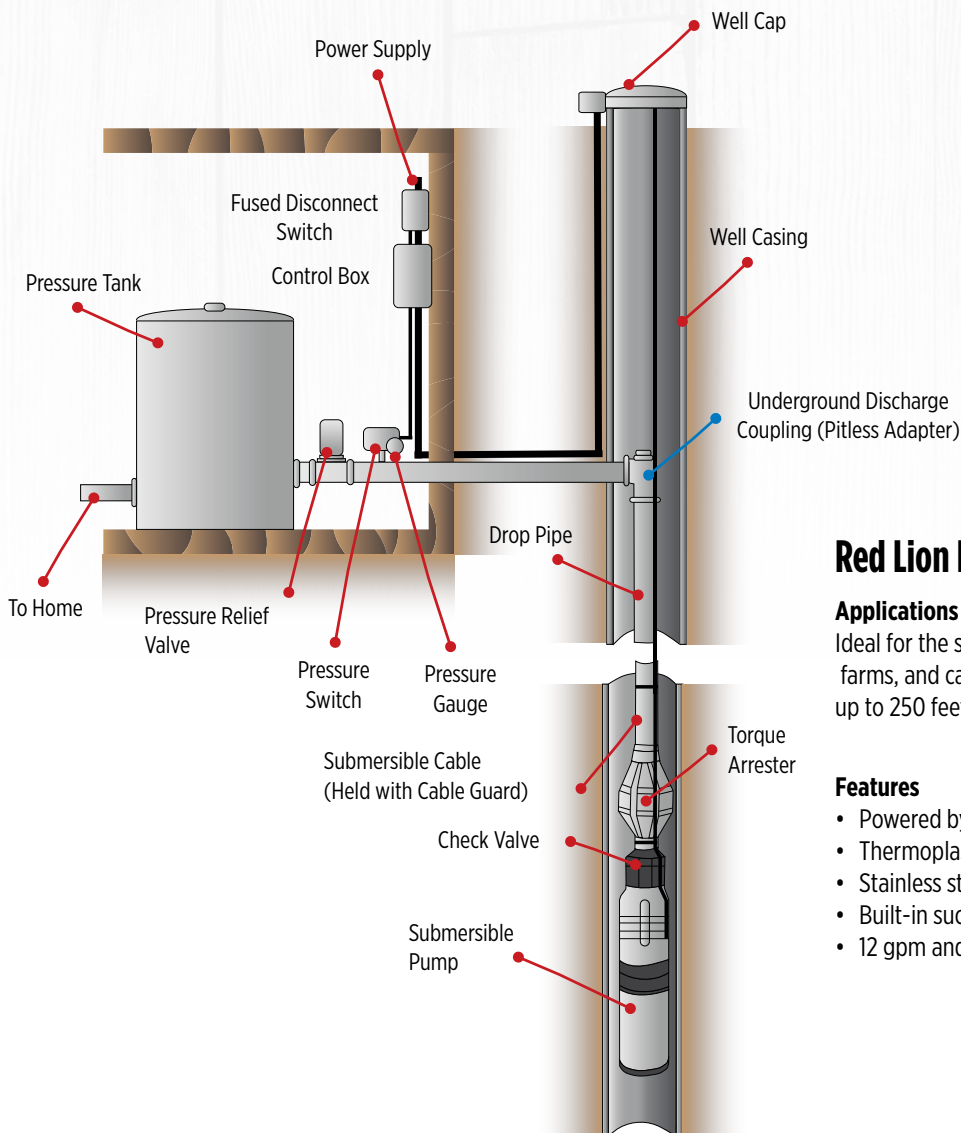

**\*3-wire application**  
 (For diagram of 2-wire setup, please see page 26)

### Red Lion Deep Well Submersibles

#### Applications

Ideal for the supply of fresh water to rural homes, farms, and cabins that require lifting water up to 250 feet.

#### Features

- Powered by industry standard 2- or 3-wire motors
- Thermoplastic discharge and motor bracket
- Stainless steel pump shell
- Built-in suction screen and check valve
- 12 gpm and 22 gpm models available





## Inside a Deep Well Submersible

A common miscommunication with retail customers leaves them unaware that “2-wire” pumps actually have three wires, and “3-wire” pumps have four. This is due to the ground wire that is not counted. Ground wires are green in color.

Red Lion deep well submersibles are available in three distinct categories:

- As a 2-wire, deep well pump only, or
- As a 2-wire, deep well ‘sub pac’, or
- As a 3-wire, deep well pump only

All motors require a “starting mechanism.” The 2-wire starting mechanism, called a “biac switch,” is located inside of the submersible motor making it a simpler installation for a ‘Do-It-Yourselfer’ compared to a 3-wire pump installation. A 3-wire pump uses an additional wire and requires a separate control box containing the start mechanism for the style of pump.

The deep well pump only comes with a check valve with no fittings included, just a pump and motor.

The deep well ‘sub pac’ comes ready for a complete installation within one box. The ‘sub pac’ includes:

- Pump with internal check valve
- 100 to 250 feet of power cable factory-spliced to the motor
- A pressure switch with low pressure cutout
- Pressure relief valve
- Pressure gauge
- Tank cross

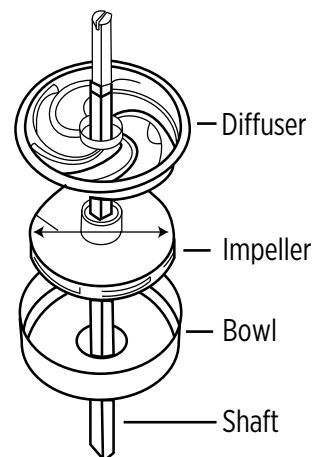
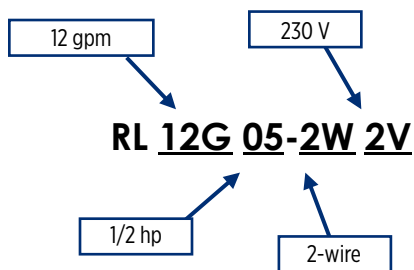
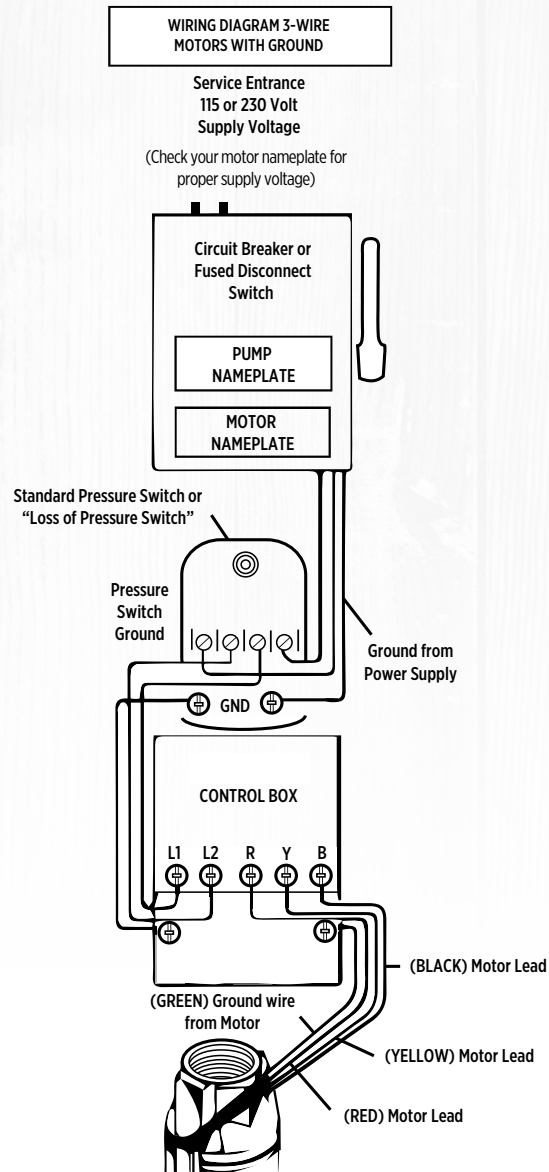

## Topic 4: b) **PRESSURE TANKS**

A pressure tank is needed in an automatic water system for several good reasons. First, it stores a reserve supply of water under pressure so the motor and pump do not cycle so often. This saves electricity because it takes more power to start a motor than to keep it running. Reducing the number of starts also saves wear on the motor and pump.

Sometimes water is used faster than the well or pump can supply, at which a large tank then acts as a standby reserve for such peak periods.



### IN-LINE INSTALLATION

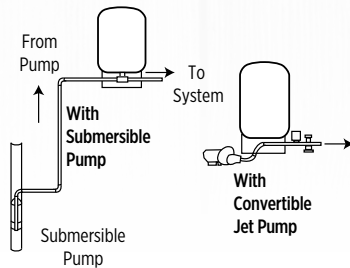

### HORIZONTAL

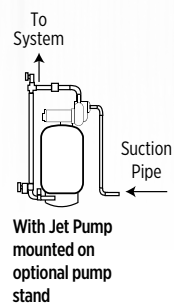

### VERTICAL

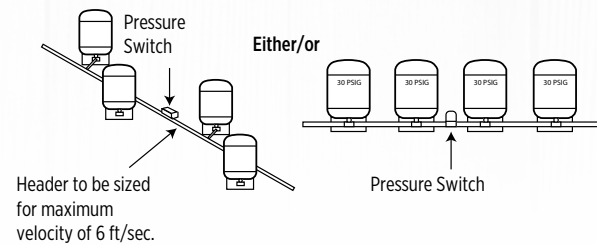

**Note:** Can be installed in series or parallel

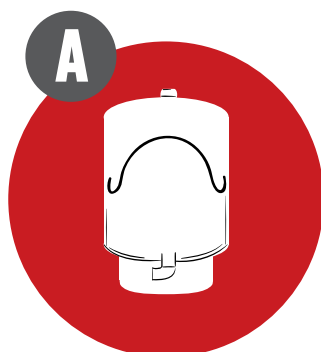

Inside the pressure tank, there is a rubber diaphragm that permanently separates the air cushion from the water. The water is contained inside the special poly-pro liner and never touches the steel.

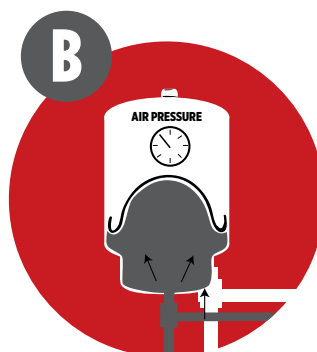

As the water enters, the diaphragm begins to invert and the air pressure in the tank increases. When the pressure reaches 50 psi, the pump stops. The water pressure in the tank is also 50 psi.

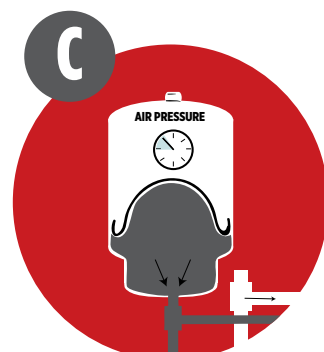

When tap water is drawn, the air pressure behind the diaphragm forces water from the tank. When the air pressure in the tank again reaches 30 psi, the pump starts replacing the water drawn from the tank.



## Topic 5: PUMP & TANK SELECTION Inside a Deep Well Submersible

**Remember:** No pump can get more water out of a well, or faster, than the water that flows into it. The well capacity should therefore be greater than that of the pump being installed. Before selecting a pump, information is required on:

- The depth of the well
- The distance to the static water level
- The draw down
- The diameter of the well casing

For home use, a very simple and accurate method has been developed to determine the capacity of the system. The capacity in gallons per minute (gpm) should equal the number of fixtures in the home. This takes into account all usage for kitchen, bath, appliances, and sprinkling. For instance...

In a small home with one bathroom including a bathtub (1), water closet (2), and lavatory (3), plus an outlet in the kitchen (4), and one outside wall faucet (5), a water system with a capacity of 12 gpm would be required.

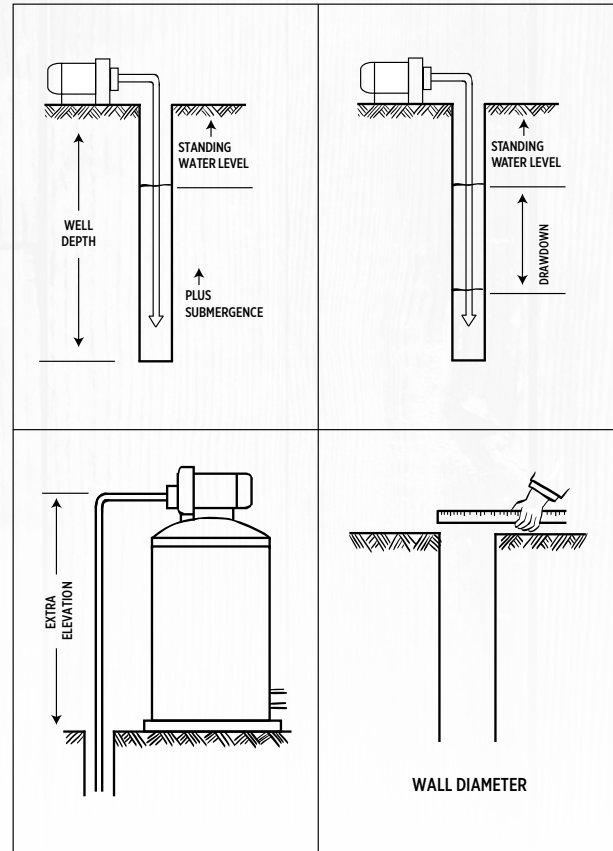

Approximate Water Needs	Gallons per Day
Each Member of Family	25-50
A Milking Cow	35
A Horse or Beef Animal	15
Each Hog	4
Each Sheep	2
Each 100 Chickens	6
Each 50 Turkeys	6
Fire Protection	50+

Average Fixture Capacity	Gallons per Min.
Bathtub, sink or laundry tub	10
Toilet or Shower	5
Garden Hose 3/4"	5
Garden Hose 1/2"	3
Automatic Washer	5
Dishwasher	2
Water Softener	7

# 1-2-3 Easy Guide To Pump & Tank Selection

1

## DEPTH TO THE PUMPING WATER LEVEL

**0–25 feet:** Shallow well or convertible jet pump, install in shallow (single pipe) configuration.

**25–90 feet:** Convertible jet pump, installed in deep (two pipe) configuration or deep well submersible pump.

**0–250 feet:** Deep well submersible pump.

**250+ feet:** Call pump hotline: 1-888-956-0000

“**Pumping water level**” is the depth to the water while the well is being pumped. It is usually deeper than the depth to the water when the pump is not running. For a lake or cistern installation, it is the depth to the surface of the water.

**For Jet pumps,** it is the vertical distance from the pumping water level to the suction opening of the pump.

**For Submersible pumps,** it is the vertical distance from the pumping water level to the point of water usage.

New installation information is available on the **Well Driller’s Report**. For replacement installations, use the equivalent style and horsepower pump, providing it was suitable when it was operational.

**NOTE:** A foot valve or check valve is required for proper operation of any system. The suction line must extend at least 5' below the pumping water level and be at least 10' above the well bottom.

## PUMP CHART

Read across the top of the chart for correct pumping water level in feet. Read down the side for correct flow required (gpm). The letter(s) corresponds to the minimum recommended pump options. Higher horsepower models of the same categories may be substituted for jet pumps.

Flow Req. (GPM)	Pumping Water Level in Feet								
	5	15	25	50	80	100	150	200	250
3	A,D	A,D	A,D,G	D,G	D,G	G	G,H	H,I	I
4	A,D	A,D	A,D,G	D,G	E,G	G,H	G,H	H,I	I
5	A,D	A,D	A,E,G	D,G	F,G	G,H	G,H	H,I	I
6	A,D	A,D	B,E,G	D,G	G	G,H	H	I	I
7	A,D	A,D	B,E,G	F,G	G,H	G,H	H	I	I
8	A,D	A,E	C,F,G	G	G,H	G,H	H	I	I
9	A,D	A,E	C,G	G	G,H	G,H	I	I	J
10	A,D	B,E	C,G	G,H	G,H	G,H	I	I	J
11	A,E	B,E	G	G,H	H	H	I	J	J
12	A,E	C,E	G	G,H	H	H	I,J	J	J
13	B,E	C,F	G	G,H	H,I	I,J	J	J	J
14	B,E	C,F	G	I	I,J	J	J	J	J
15	B,E	C		I	J				
16	C,E	C							
17	C,E	C							

NOTE: For depths greater than 250', consult tech support

Shallow Well Jet Pumps	Convertible Jet Pumps	Deep Well Submersible Pumps
A = RJS-50-PREM ½ hp B = RJS-75-PREM ¾ hp C = RJS-100-PREM 1 hp	D = RJC-50 ½ hp E = RJC-75 ¾ hp F = RJC-100 1 hp	G = RL12G05 ½ hp H = RL12G07 ¾ hp I = RL12G10 1 hp J = RL12G15 1½ hp

2

## HOW MUCH WATER IS REQUIRED

The gpm (gallons per minute) of the pump must equal the total number of fixtures. Fixtures include all faucets, toilets, and water consuming appliances (do not include water treatment appliances, such as a hot water tank or water filter). Example: A house with one full bathroom (sink, tub/shower, toilet), kitchen sink, basement sink, outside faucet, washing machine, and dishwasher would require 8 gpm.

3

## MINIMUM WELL DIAMETER

**2½"** – Jet pumps in shallow well applications (depth less than 25') should be installed using 1¼" suction piping with a foot valve. **4"** – Convertible jet pumps used in deep well applications (depth greater than 25') and deep well submersible pumps.



## TANK CHART

**NOTE:** Refer to Step 2 above.

The easy way to size a tank is take the gpm system requirement that you determined in Step 2, multiply by 3 and go to the next largest tank size.

**Example:** 8 gpm x 3 = 24 gallons – therefore use an RL33 tank.

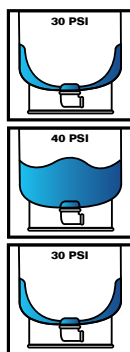

Tank Capacities	Total Tank Volume (gal)	Drawdown @ 30/50 PSI (gal)
RL2	2.1	0.7
RL4	4.8	1.5
RL6H	5.3	1.6
RL8	8.5	2.6
RL14H	14	4.3
RL14	14	4.8
RL20	20	6.8
RL33	33	11.3
RL44	44	15
RL81	81	27.6
RL119	119	40.6



## Topic 6: **INSTALLATION INFORMATION**

### **Shallow Well Jet Pump - Red Lion RJS Series or RL-SWJ Series**

Suitable for applications where the plumbing water level does not exceed 25 feet. Requires a single 1-1/4" pipe. May be used in wells 2-1/2" or larger in diameter.

#### **Sand Point**

Used in areas where the soil is soft, and the sand and the water level is fairly high or near ground level (approximately 30 feet maximum). Available with a fine or coarse screen, depending on sand conditions – gravel points are also available where the screen is in the inside of the point.

#### **Typical Sand Point Application**

- Sand Point is at least 5' feet below ground water level and no more than 20-25' below intake of pump.
- Output requirement of pump is less than available water at source.
- Sand Point screen is clean and free of any sedimentary build-up.

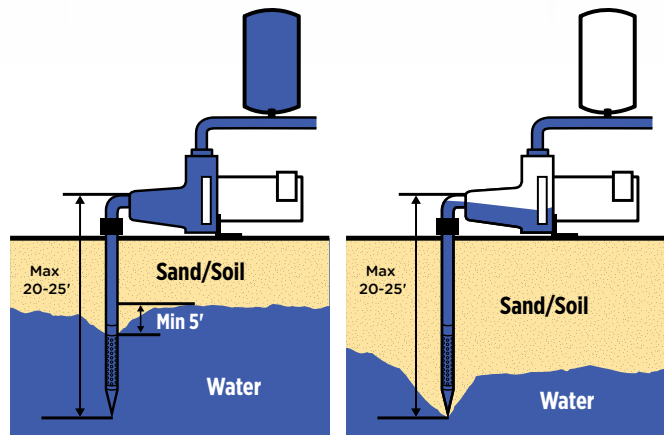
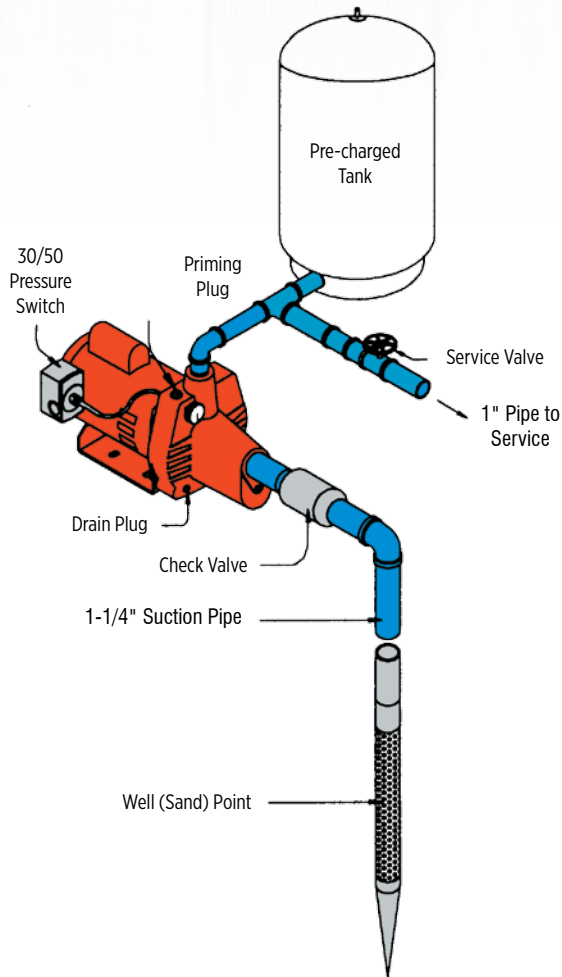
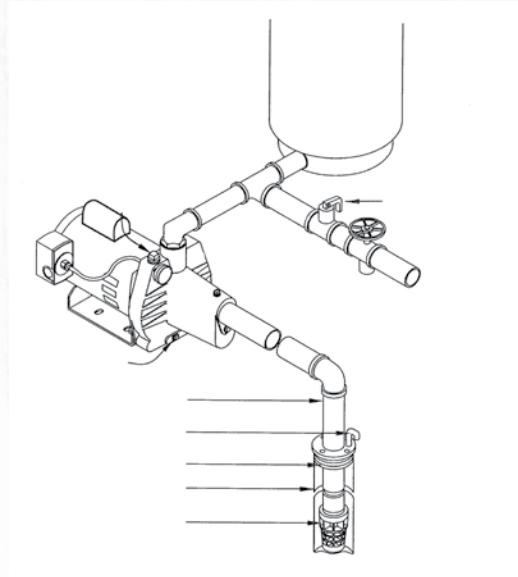

**Note:** In second image, pump output has exceeded available water at source and pump has lost prime

## Convertible Jet Pump - Red Lion RJC Series

### Shallow Well Configuration

Suitable for applications where the pumping water level does not exceed 25 feet. Requires a single 1-1/4" suction pipe. May be used in wells 2-1/2" or larger in diameter.

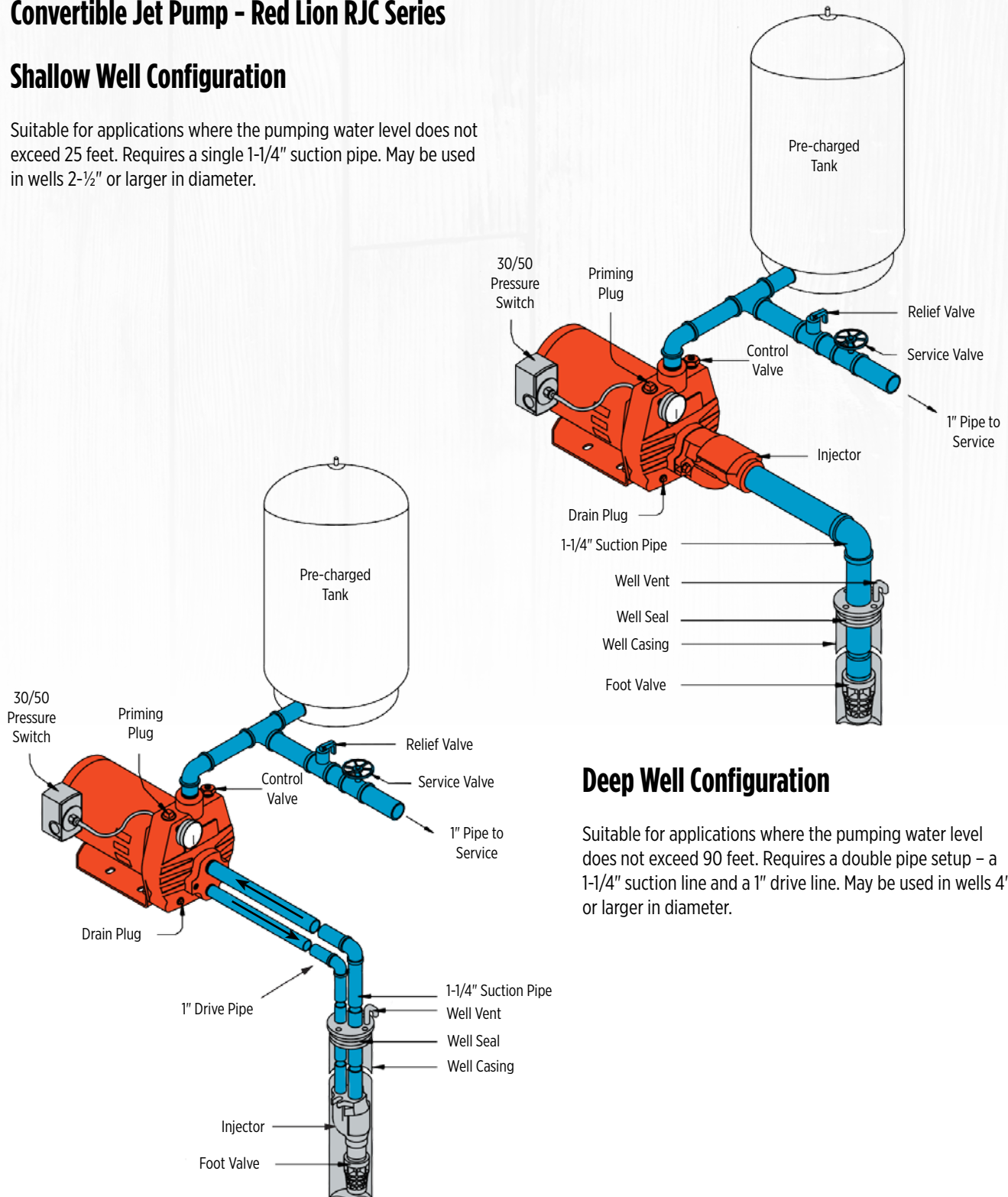

### Deep Well Configuration

Suitable for applications where the pumping water level does not exceed 90 feet. Requires a double pipe setup – a 1-1/4" suction line and a 1" drive line. May be used in wells 4" or larger in diameter.

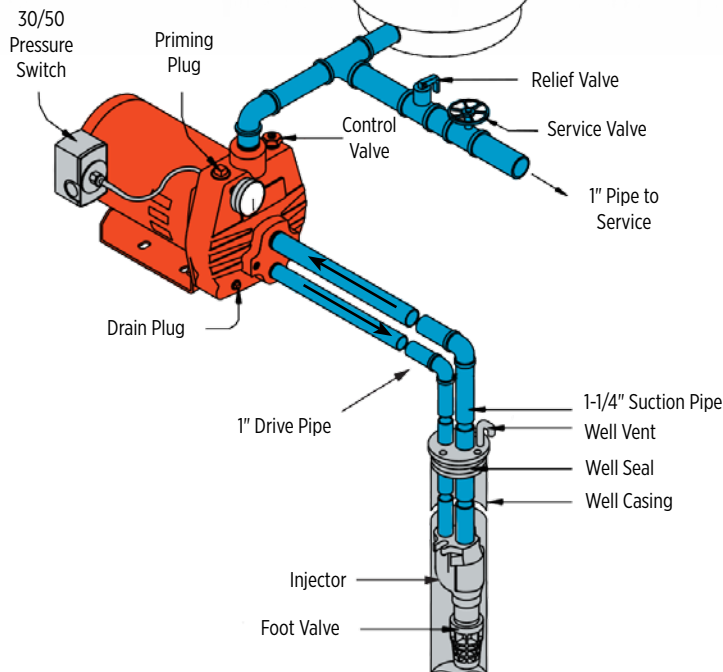



## Deep Well Submersible Pump - Red Lion RL Series

Suitable for applications where the plumbing water level does not exceed **250** feet. May be used in wells 4" or larger in diameter. To complete the installation, the following is required:

- Submersible pump sub pac which includes pressure switch, pressure gauge, service tee, relief valve, submersible cable, and built-in check valve
- Pressure tank
- Torque arrester (optional)
- Well seal
- Pitless adapter
- 1" discharge piping

### Installation Checkpoints

- **Voltage rating and connection** – The installer should cross check the power supply voltage with a voltmeter and the motor name plate voltage. If the motor is a dual voltage motor, he/she should make certain that the connection agrees with the connection diagram supplied with the motor.
- **Overload and short circuit protection** – Most pump motors are designed to include overload protection. However, they should always be provided with their own branch circuit protection. Dual element (motor) fuses sized to the service factor amperes should always be used. If a circuit breaker panel is used, separate fusing is still recommended.
- **Wiring** - Most manufacturers provide wiring recommendations for the motor as to size and length from the load center. These should always be followed on the conservative side.

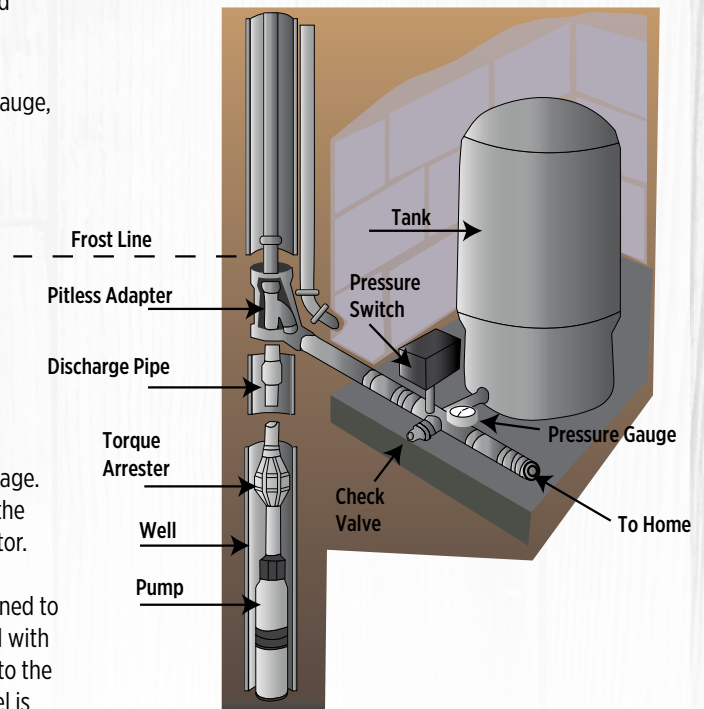

**Note:** 2-wire installation\* (For 3-wire setup, please see page 19)

## Cable Selection Guide For Deep Well Submersibles

### Canadian

Cable selection in feet based on a 3% voltage drop, two- or three-wire cable, 60 Hz.

Motor		(AWG) Copper Wire Size		
HP	Volts	14	12	10
1/2	115	60	95	150
	230	240	390	610
3/4	230	180	285	455
1	230	150	240	375
1-1/2	230	115	185	285

### U.S.A.

Cable selection in feet based on a 5% voltage drop, two- or three-wire cable, 60 Hz.

Motor		(AWG) Copper Wire Size		
HP	Volts	14	12	10
1/2	115	100	160	250
	230	400	650	1020
3/4	230	300	480	760
1	230	250	400	630
1-1/2	230	190	310	480

## Recommended Maximum Flow Rates

Pipe Diameter	Gallons Per Hour (gph)	Gallons Per Minute (gpm)
3/4"	750	12.5
1"	1000	17
1-1/4"	2100	35
1-1/2"	3000	50
2"	4800	80
3"	9000	150
4"	16000	267

## Topic 7:

# PUMP ACCESSORIES

We have learned about how a pump works and how to size a pump. We must now apply that knowledge and tie in the other elements that make up the entire “Water System.” It’s not much good to us unless we can harness that energy and make it work for us when we want it to. We don’t have time now to cover everything because there are hundreds of accessories that can be added to a water system to customize it to fit an application.

## Well Seal

A sanitary well seal closes the well casing at ground level preventing polluted water, or waste, from entering the fresh water supply. It also stops insects or small animals from being trapped. They seal a rubber compression section in between two cast iron or plastic ends and as you tighten them together, the rubber forms the seal inside the casing.

## Pressure Gauge

The gauge indicates the pressure of the pump as controlled by the pressure switch – it is not required for the actual pump operation; (some newer switches have the pressure switch and pressure gauge in one box).

## Pitless Adapter

In colder climates, the drop pipe needs to leave the casing at some point below the freeze line, so a pitless adapter does just that. It goes through the casing and the pump, and the drop pipe hangs on it.

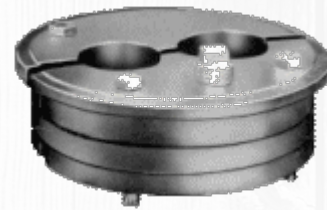
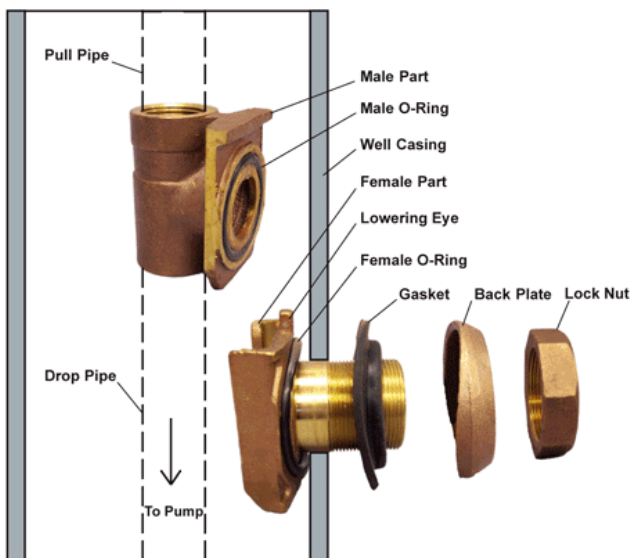



## Pump Accessories (continued)

### Yard hydrants

A yard hydrant is designed with a bronze shut-off valve below the frost line. Because of this shut-off valve, it can be installed anywhere water is supplied under pressure (that is, anywhere on the discharge line – never on the suction side).



### Check or foot valves

Valves are used to keep the water running back into the well. Remember that a check valve will hold pressure on one side and vacuum on the other, so as long as you have a watertight system, you should not have any air in the lines. If air will leak in, water will leak out.

### Filters

Filters deliver cleaner water for household use. Replaceable cartridge-type filters will remove rust and dirt, and help to reduce bacteria and any bad tastes or odors (for cold water only!). Filters are also a good investment for campers or mobile homes where unknown new water supplies have to be contended with while traveling.



## Pressure Switch

The **pressure regulating switch** stops and starts the pump at pre-set pressure, (usually 30 psi on and 50 psi off). This makes the water system automatic.

The pressure switch is usually mounted to a jet pump. The main power is connected to the switch (and not to the motor). With a submersible application, the control box is usually wall mounted separately with the pump's submersible cable leading to the control box, and the main power supply again leads into the control box.



Pressure Switch

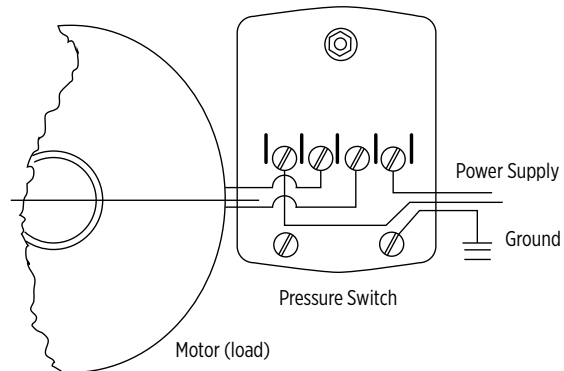

## Topic 8: LAWN & IRRIGATION

Sprinkler pumps are self-priming centrifugals designed to produce high water volume and relatively low pressure. Their flow rate varies with horsepower, vertical distance from the water source, and the size of pipe used. Most sprinkler heads use 2 to 3 gallons per minute. The maximum vertical distance that the pump can be located from the water is 20 to 25 feet. A typical 1 hp pump would produce about 20 gpm at 40 psi with a 5' suction lift.

For best performance, the pump should be placed as close to the water source as possible. Water sources include open water sources such as lakes, ponds, wells, cisterns, and multiple drive point (well point) systems. Piping used should be the same size as the inlet or discharge size of the pump. Typical applications are sprinkler systems that have single or multiple zones with more than 2 to 3 heads per zone. These pumps can also be used as general water transfer pumps.

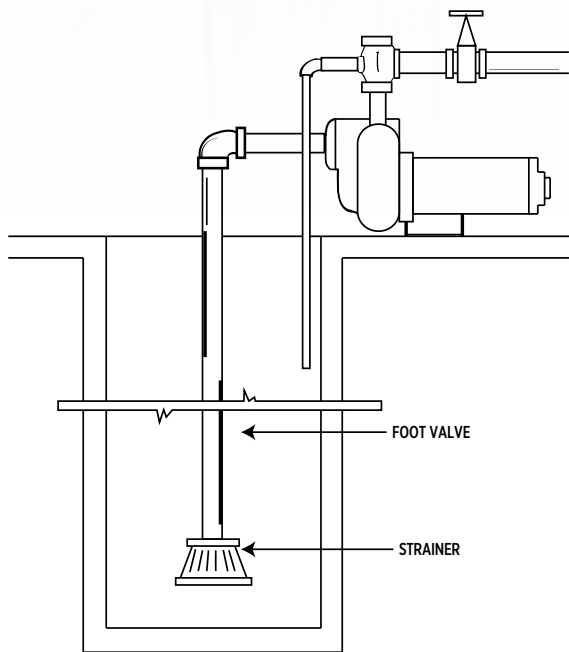

Pumping from a ditch, lake, pond, cistern, or open well.

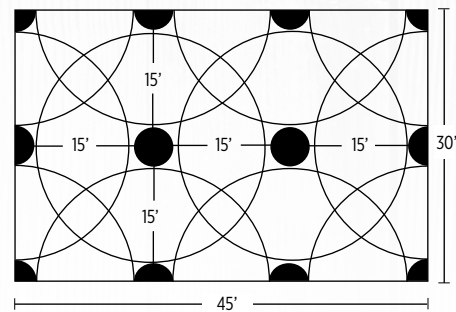

**Example 1**  
(of a typical front yard) Using full, half, and quarter circle patterns. Advantages: Full coverage with no water on sidewalks, using 12 sprinklers.

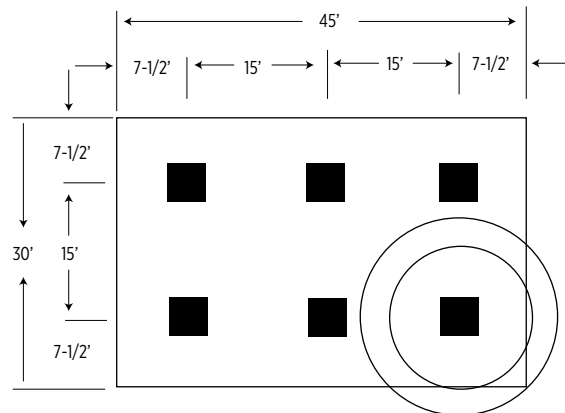

**Example 2**  
Alternate Plan (more economical) using only 6 sprinklers, requiring an "overthrow", if this is no problem on sidewalk or street.



## Topic 9: **WASTEWATER**

### 1. SUMP PUMPS

Sump pumps are primarily used in the basement of a home or business to remove unwanted seepage water. They are usually located in a sump basin in a corner of the basement. Submersible pumps are able to be completely immersed in water and still function properly. Applications include basements, crawl spaces, elevator pits, transformer vaults, underground passageways, construction sites, and other water transfer applications requiring a high volume.



### Pump Housing

Depending on the model, Red Lion pump housings are constructed with reinforced thermoplastic, cast iron, or stainless steel. While all models feature quality material and workmanship, the reinforced thermoplastic housing is corrosion- and rust-resistant. The cast iron housing is stronger, heavier, and more durable. Our premium stainless steel models combine corrosion resistance with the strength and durability of the cast iron housing and features the longest warranty.

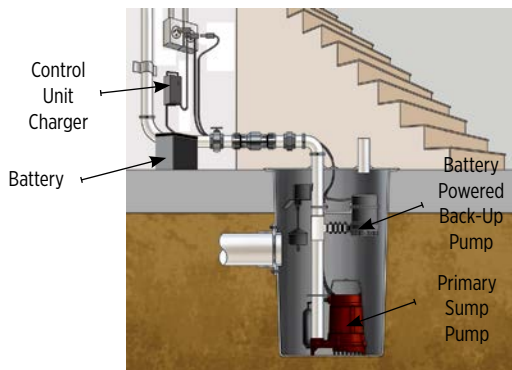

**Submersible Sump Pump with Battery Backup**

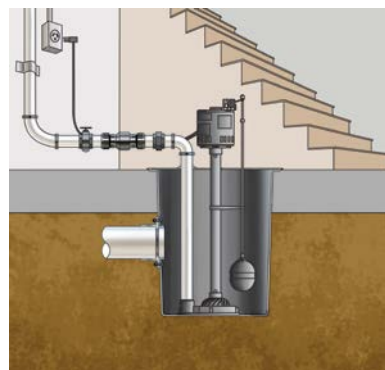

**Pedestal Sump Pump**

## Type of Switch

There are two types of switches that Red Lion offers on their sump pumps. Both offer reliability and effectiveness, and provide efficient service in moving large volumes of water.



**Tethered float switch** – The tethered float switch is a buoy device attached with a cord that raises and lowers with the water level, activating a switch inside the pump telling it to turn on, drain the water, and then turn off once water level has subsided.



**Vertical float switch** – The vertical float switch is a buoy device attached with a rod that raises and lowers with the water level; activating a switch attached outside the pump telling it to turn on, drain the water, and then turn off once the water level has subsided. This style allows for installation in confined areas.

## Sump Pump Cutaway





## 2. EFFLUENT PUMPS

Effluent pumps are designed to pump filtered effluent from a septic tank to a leach field. They are typically designed to handle 1/2" solids. However, many effluent pumps are used as sump pumps and dewater pumps where grass clippings, leaves, or other small debris might clog the screen of the typical sump pump.

When used in a septic system, the proper pump must be chosen for the application. To determine the pump with the correct performance characteristics, several things must be known about the application; capacity or flow to be produced by the pump, and the total head of the system must be known.

An enhanced flow septic system utilizes the pump to transfer the effluent to a distribution box. The effluent then gravity-flows into the distribution lines (leach field – perforated pipes). A low pressure pipe septic system doses the distribution system with small amounts of waste several times a day using the pump to pressurize the leach field pipe. This is the most efficient system.



**Friction Loss (Head)**  
Determined by the diameter of the pipe, length of the pipe, number, and types of fittings, and pump capacity.

### Operating Pressure

In a low pressure pipe septic system, this is the amount of pressure required to properly dose the distribution piping. This pressure, usually one to three psi, is specified by the engineer designing the system.

**Static Head**  
The distance from the lowest point of the effluent in the tank to the point of discharge.



**1/2" to 3/4" solids handling capacity**

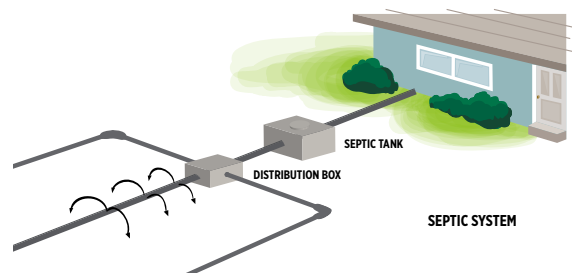

Disadvantages include location choices for the distribution or leach field, inability to control the amount of effluent discharged, and potential clogging of the distribution pipes.

**Note:** Check your municipality for local installation guidelines.

## Septic Tank Effluent Pump System

An effluent pump can be located in a separate chamber in the septic tank, or in a separate pump-out chamber. This allows the leach field to be located in the best area to prevent groundwater pollution. The amount of effluent can be controlled through dosing the field with small amounts of effluent during a 24-hour period for the most efficient dispersal into the soil. Pressure dosing helps prevent clogging of the distribution pipe.

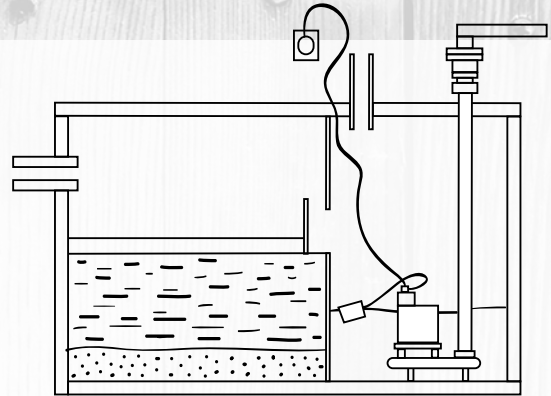

## Self Priming Effluent Pumps

Self priming effluent pumps are surface mounted pumps. Unlike the submersible effluent pumps, both the pump and liquid level control box are installed in the house basement where they are readily available for future servicing. The pump uses an open-style impeller and a switch (such as electrodes, diaphragm switch, or float switch) that is suspended in the second chamber, or pump out chamber of the septic tank. The casing of the pump is designed to keep water over the eye of the impeller, and therefore, allows the pump to RE-PRIME itself. The pump will need to be primed initially for first-time use.

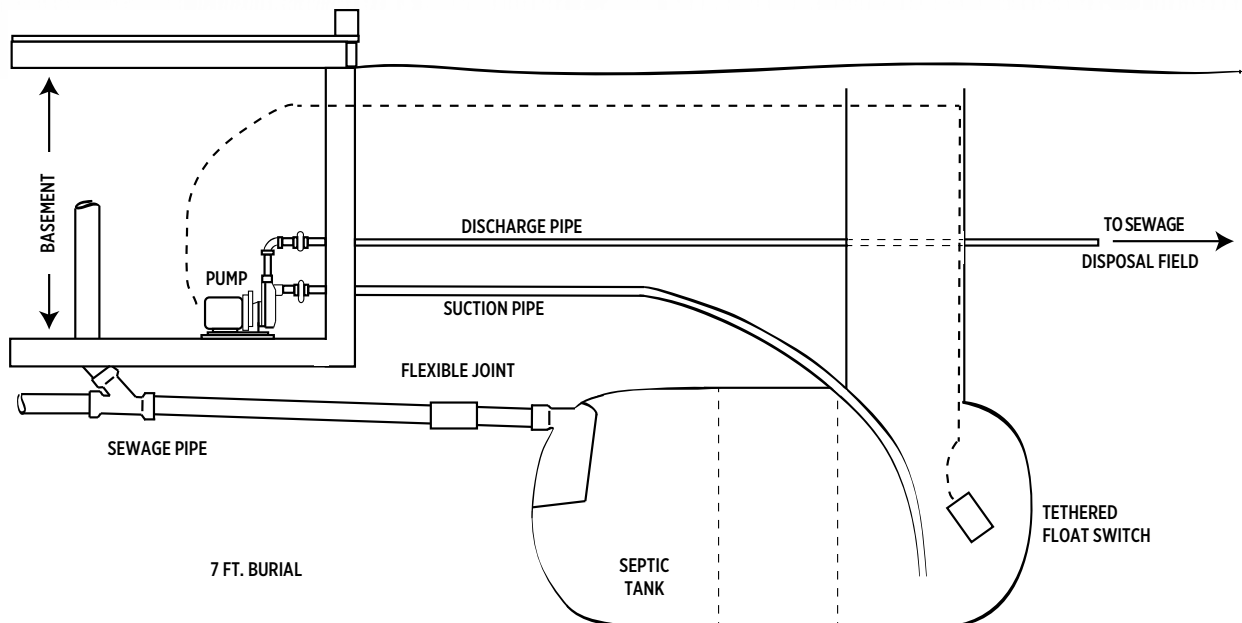



## Selecting an Effluent Pump

In most cases, the guest is replacing an existing pump. Determine the horsepower of your current pump. This will be located on the identification plate of your existing pump. Select a pump with the same horsepower as your existing pump.

If this is a new installation, you must consider:

- How many bathrooms are in the house?
- Is there a washing machine and/or dishwasher?
- How far is it to the drainage system or is the excess water to be pumped just outside the building?

Refer to the charts on page 36 to determine the horsepower needed for the number of fixtures.

Higher hp pumps will flow at a faster rate and give you the ability to pump the material a farther distance from the building. 1/3 hp is the minimum hp recommended for home applications.

Smaller solids up to 3/4" in diameter can be handled by using an effluent pump. If solids up to 2" in diameter are to be pumped, a sewage pump is required.

Effluent pumps can be used in a sump installation because they can handle solids up to 3/4", which would prevent leaves, grass clippings, and other small debris from clogging the pump.

## Typical Sump Installation

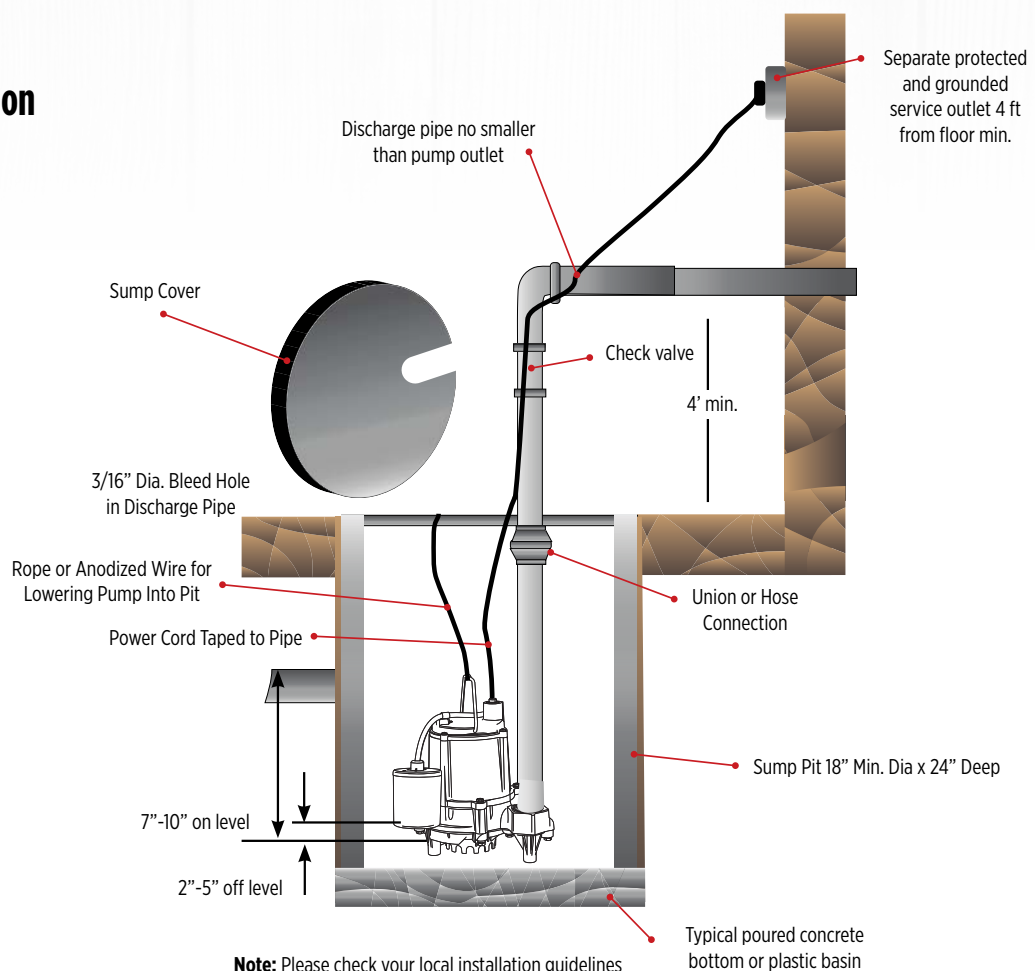

### 3. SEWAGE PUMPS

Sewage pumps are designed to handle 2" solids and generally produce more flow than their effluent counterparts. These pumps are used to pump raw waste from a residence or business where gravity drainage is impossible to a gravity sewer, a septic tank, or a lift station.

Never use a sewage pump for a sump pump application. Because of the power of the sewage pump it will cycle on and off too frequently, which can shorten the life of the motor.

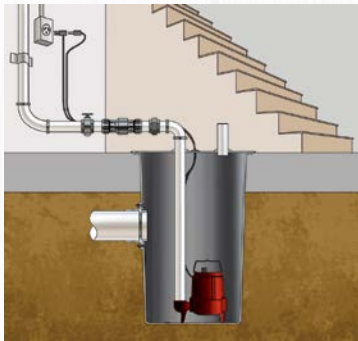

**2" solids handling capacity**

### Sewage Pump Cutaway

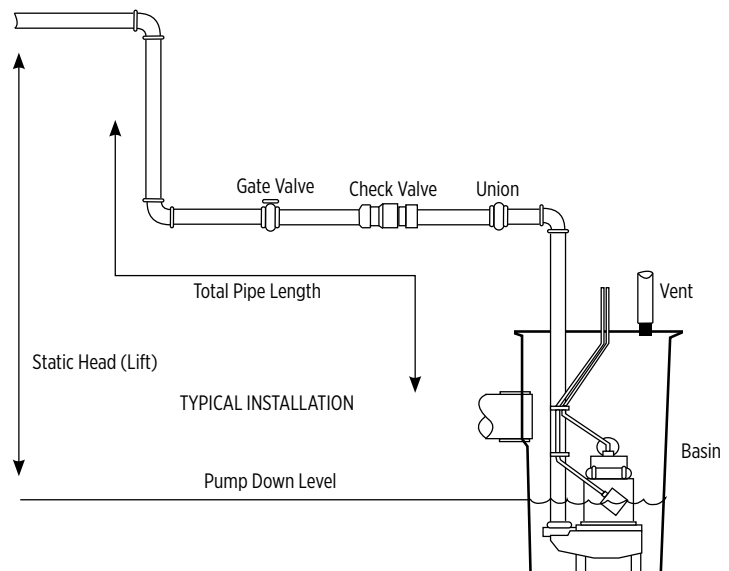
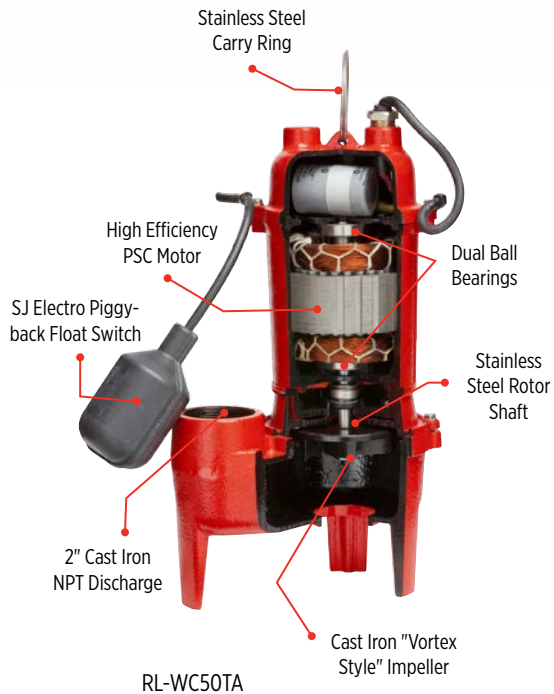



## Replacing an Existing Sewage Pump

### 1. Determine the size of your current pump.

Check the identification plate to determine the horsepower (hp) needed. Generally, you will want to select +a pump with the same horsepower as your current pump.

### 2. Determine the size and type of discharge pipe you have.

Sewer lines are 2" in diameter or larger, so it is important to measure the line. Additionally, verify whether your line is made of PVC, ABS, galvanized steel, or copper to calculate the friction loss.

## New Installation

The selection of the correct sewage pump for an application is determined by the capacity required and the total head of the system. The capacity or flow requirement is calculated using a fixture unit value chart that assigns a fixture unit value to the fixtures that will be dispersing waste into the sewage basin (collection point). The flow required of a pump is determined by totaling the fixture unit values and a graph of the fixture units compared to pump capacity.

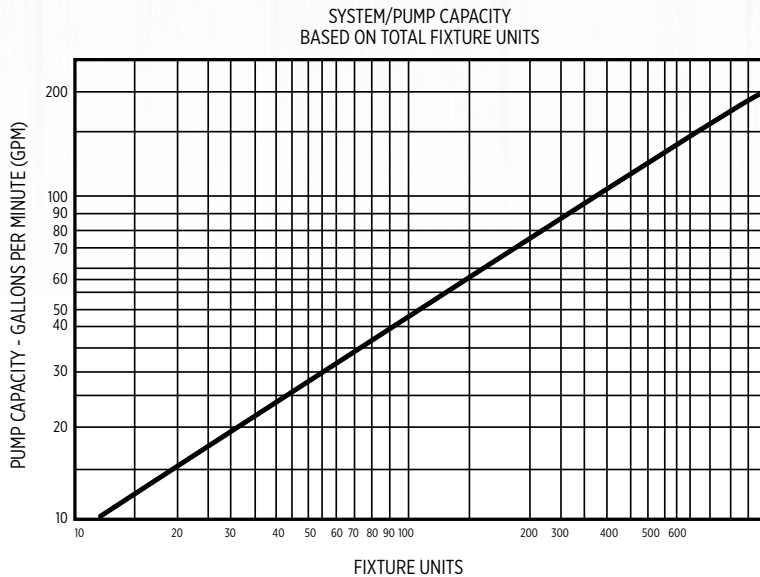

A home with a total fixture unit value of 45 would require a pump capable of pumping about 25 gpm at the Total Dynamic Head of the system.

Most sewage pumps are shown in gph not gpm - multiply the gpm requirement by 60. (25 gpm x 60 = minimum 1500 gph)

Fixture Description	Unit Value	Total Used
Bathroom group, consisting of a sink, bathtub or shower, and direct flush toilet	10	
Bathroom group, consisting of a sink, bathtub or shower, and flush tank toilet	6	
Bathtub with 1-1/2" trap	2	
Bathtub with 2" trap	3	
Bidet with 1-1/2" trap	3	
Dishwasher (domestic type)	2	
Kitchen sink (domestic)	2	
Kitchen sink (domestic with waste grinder)	3	
Sink with 1-1/2" trap	1	
Laundry sink (2-compartment)	2	
Shower stall	2	
Shower (group), per head	3	
Toilet (flush valve)	7	
Toilet (flush tank)	3	
Swimming pools (per 1000 gal. capacity)	1	
Unlisted fixture with 1-1/4" trap size	2	
Unlisted fixture with 1-1/2" trap size	3	
Unlisted fixture with 2" trap size	4	
Unlisted fixture with 2-1/2" trap size	5	
Unlisted fixture with 3" trap size	6	
Unlisted fixture with 4" trap size	7	
Water softener (domestic)	4	
Washing machine	2	
<b>TOTAL</b>		

## Topic 10: **MULTI-PURPOSE PUMPS**

Multi-purpose pumps are used for general dewatering or water transfer applications. They are small enough to carry, and may have a garden hose intake and/or discharge connections or adapters for the user's convenience. Applications include pumping out spas and above ground swimming pools, emptying water beds or water heaters, removing standing water from low lying areas, bailing boats, pumping out flooded basements, irrigating lawns and gardens, and boosting water pressure.

Removing or transferring water from basements, rooftops, hot tubs, crawl spaces, and general dewatering

**Models: MP16, MP25, MP50, MP25A, and RL50CON**

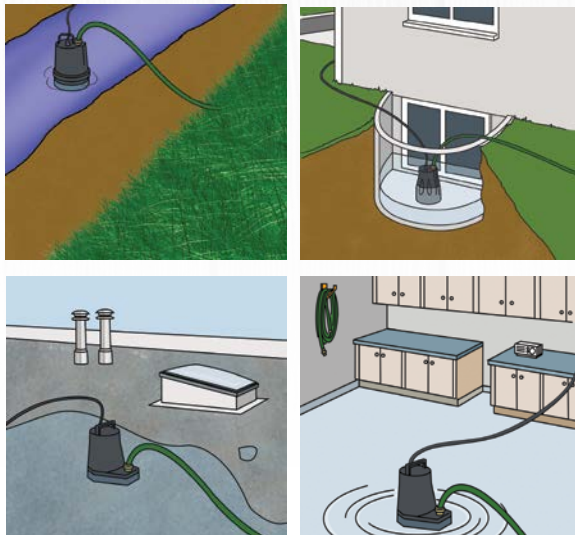

RL-MP25A

RL-MP16

Heavy-duty applications such as dewatering construction sites, ponds, and ditches.

Removing condensation build-up from air handlers, boilers, furnaces, ice makers, and dehumidifiers

**Models: C15, C20ST**



C20ST

MPTC

Boosting household water pressure for washing vehicles, sidewalks, and driveways, or for use in general water transfer applications

**Model: MPTC**



RL50CON



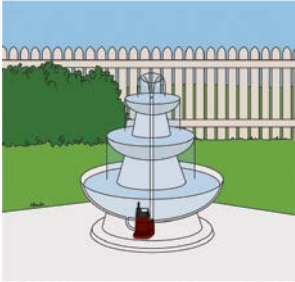

Dewatering and water feature applications  
**Models: RL-160U, RL-250U**



RL-160U

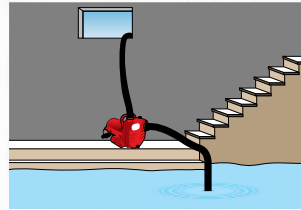
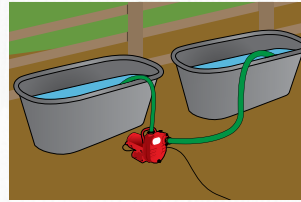

Pumping out flooded basements,  
 livestock watering, flood irrigation,  
 and general dewatering  
**Model: RL-50**

Draining waterbeds, hot water tanks, appliances,  
 aquariums, and other emergency dewatering needs  
**Models: MPFVK115, MPFV12, MPDP, MPTC**

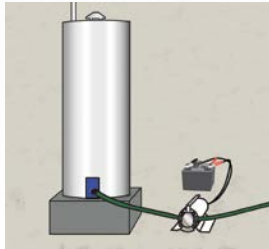

MPFVK115

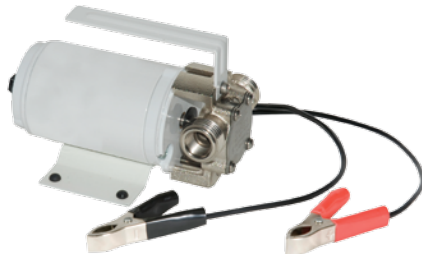

MPFV12



MPDP

## Topic 11: **GAS ENGINE DRIVES**

### What does an engine drive pump do?

The majority of gasoline powered pumps sold in North America are referred to as general purpose, utility, or transfer. This is simply moving liquid from one point to another. Pump construction can be a variety of materials. Preference is given to lightweight and portability.

### Types of engine drive pumps

#### Agricultural

Pumps designed to handle today's agricultural chemicals (fertilizer, herbicides, and pesticides) would fall into this category. Construction is either a poly derivative or cast iron. Aluminum is usually not used as it does not provide strong chemical resistance. Solids handling is not required. The seal elastomer is usually EPDM or fluorelastomer.

#### Semi-Trash

A pump is considered semi-trash if it has some solids handling capabilities. The pump impeller is usually semi-open vane clearance to pass a spherical solid  $\frac{1}{2}$ " to  $\frac{3}{4}$ " diameter. The mechanical seal faces are usually of a hard material like silicon carbide. This is for abrasion resistance. Typical application is drainage, construction dewatering, etc.

#### Trash

Similar in application to a semi-trash pump, except that solids handling is typically 50% of suction port size (usually greater than 1" solids), and most manufacturers allow for a removable casing to allow access to internal hydraulics for cleaning and repair.



2RLAG-1L



6RLPG-2K

Category	Construction	Application Examples
<b>General Purpose</b>	Poly Aluminum Cast Iron	Water Transfer Flood Control
<b>Agricultural</b>	Poly Cast Iron Aluminum	Chemical Transfer (Fertilizer) Nursery Trailer
<b>Solids Handling</b>	Aluminum Cast Iron	Construction Semi-Trash Trash
<b>High Pressure</b>	Aluminum Cast Iron	Irrigation Fire Fighting

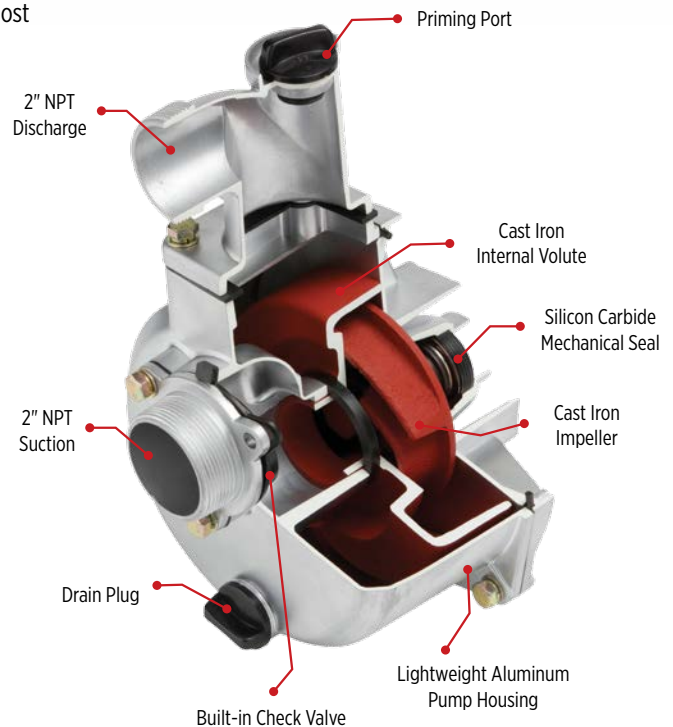



## Topic 12: **CROSS SELL & UP SELL**

Cross-selling is selling your customer other items to go along with their Red Lion purchase. Here are some examples of how you can do this:

- Jet pump sale... sell a
- New pressure tank
  - Foot valve
  - Pressure gauge, etc.

Up-selling is when you persuade your customer to move to a larger or higher quality product from their initial choice:

- Up sell from...
- A convertible jet to a deep well submersible
  - Smaller tank to a larger one

### WARRANTY GUIDE



Standard Features



Enhanced Features



Premium Features

## Serial Numbers

Below is an example of the Red Lion serialized label that was implemented in 2004.

In the below example, the lower right corner is where the serial number and date code reside. The first two digits in the serial number are the year the product was manufactured. The below product was manufactured in 13, indicating the year 2013. The next letter is the month of manufacture. The chart below shows which letter corresponds to which month. In the example below, D indicates April.



**YEAR = 2013**      **MONTH = APRIL**

Month	Letter Code	Month	Letter Code
January	A	July	G
February	B	August	H
March	C	September	J
April	D	October	K
May	E	November	L
June	F	December	M

To qualify for date code warranty, the return month must be the same month or before, during the stated product warranty time frame. If our example above has a two year warranty, the warranty expires on April 30, 2015.

**Please note: Replacement products are warranted for the remainder of the original warranty period.**

## EXERCISE A: Pump Sizing Components

**NOTE:** Exercises A & B are simple, theoretical pump knowledge assessments. Actual pump installations may vary due to numerous unmentioned factors. These exercises are not intended as tools to use when choosing and installing a pump application.

### Data Needed

- Depth of well
- Well recovery rate
- Standing water level
- Pumping water level
- Can be obtained from a Well Driller's Report

### Guidelines for Domestic Applications

- A pump's pumping capacity should never be more than the well recovery rate.
- A rate of 5-10 gpm is best if well recovery rate will allow it.
- If possible, try to have a flow rate equal to 1 gpm per water fixture drawing from the well (DO NOT exceed well recovery rate).
- If available, use a 1-1/4" pipe (approx. 75% less friction loss when compared to a 1" pipe).
- Can be obtained from a Well Driller's Report

### Diagram Legend

1. Elevation from top of well to pressure tank
2. Distance from water level to top of well
3. Amount of drawdown
4. Distance from pumping water level to bottom of well

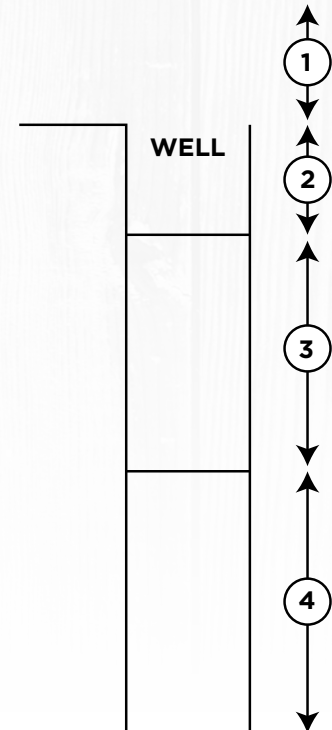

- 1 psi of pressure will lift water up to 2.31 feet.
- Bungalows can usually operate on a 20/40 psi pressure switch.
- 2 story houses usually require pumps to run at a 30/50 psi pressure setting.
- Submersible pumps must never be placed any lower than 10 feet above the well bottom to avoid sucking up debris.

## EXERCISE B: Pump Sizing Calculations

**NOTE:** Exercises A & B are simple, theoretical pump knowledge assessments. Actual pump installations may vary due to numerous unmentioned factors. These exercises are not intended as tools to use when choosing and installing a pump application.

### Pumping Level

1. Top of well to pressure tank (home) \_\_\_\_\_ ft
2. Top of well to static water level \_\_\_\_\_ ft
3. Drawdown (static water level to pumping water level) \_\_\_\_\_ ft
4. Well to house vertical height \_\_\_\_\_ ft

### TOTAL HEAD REQUIRED

Add 1, 2, 3, and 4 and then a \_\_\_\_\_ ft beside

\_\_\_\_\_ ft

Now that you have calculated the total head needed, you should be able to recognize which pump model is needed for this application. The larger total head you need, the more power you need in your submersible pump.

Note that these calculations are made without factoring in any complications that may arise in actual installations.

Keep in mind that deep well submersible pumps will not operate at their best unless they are positioned vertically. Submersibles placed in lakes and other open sources are not to be on an angle of more than 40 degrees. Horizontally-placed pumps may not pump to the capacity indicated, and placing them in this way can cause serious damage to the pump itself.

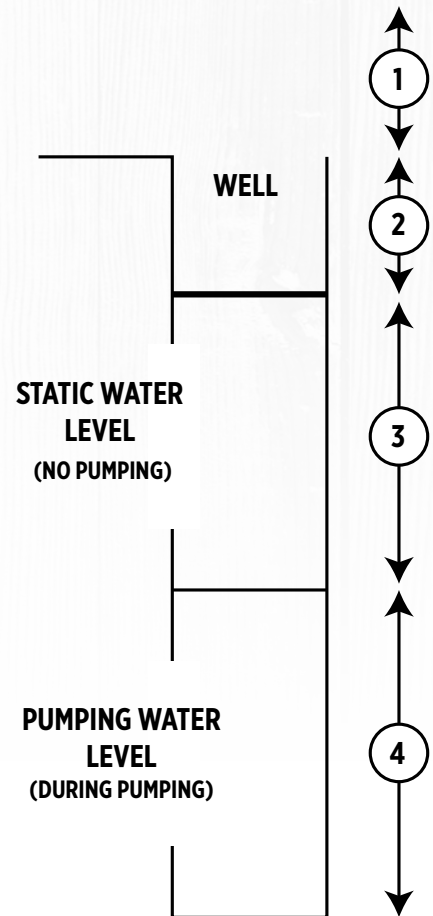



## Friction Loss Chart

Nom. Pipe Size	3/4"			1"			1-1/4"			1-1/2"			2"		
Material	Steel	Copper	Plastic	Steel	Copper	Plastic	Steel	Copper	Plastic	Steel	Copper	Plastic	Steel	Copper	Plastic
I. D. / US GPM	0.824	0.822	0.824	1.049	1.062	1.049	1.38	1.368	1.38	1.61	1.6	1.61	2.067	2.062	2.067
1															
2	1.93	1.21	1.04	0.6	0.35	0.32									
2.5	2.91	1.82	1.57	0.92	0.55	0.48									
3	4.08	2.56	2.21	1.26	0.73	0.68									
3.5	5.42	3.4	2.93	1.7	1	0.9									
4	6.94	4.36	3.74	2.14	1.24	1.15	0.56	0.36	0.3	0.27	0.17	0.14			
4.5	8.63	5.4	4.66	2.68	1.58	1.45	0.69	0.42	0.39	0.34	0.21	0.18			
5	10.5	6.57	5.66	3.42	1.88	1.75	0.85	0.55	0.46	0.41	0.25	0.22			
5.5	12.4	7.79	6.75	3.9	2.3	2.1	1	0.62	0.53	0.49	0.3	0.26			
6	14.7	9.22	7.95	4.54	2.63	2.45	1.2	0.77	0.65	0.57	0.36	0.31			
6.5	17	10.7	9.25	5.3	3.12	2.84	1.38	0.88	0.72	0.66	0.42	0.36			
7	19.6	12.2	10.6	6.08	3.58	3.25	1.59	1.02	0.86	0.76	0.48	0.41			
7.5	22.3	13.9	12	6.92	4.03	3.68	1.82	1.16	0.98	0.86	0.54	0.46			
8	25	15.7	13.5	7.73	4.5	4.16	2.04	1.31	1.1	0.96	0.61	0.52			
8.5	27.9	17.6	15.1	8.76	5.08	4.62	2.3	1.47	1.21	1.07	0.68	0.58			
9	31.1	19.5	16.8	9.72	5.6	5.17	2.55	1.62	1.35	1.19	0.75	0.65			
9.5	34.5	21.6	18.6	10.7	6.18	5.72	2.82	1.79	1.5	1.32	0.83	0.72			
10	37.8	23.7	20.4	11.7	6.77	6.31	3.08	1.98	1.67	1.45	0.92	0.79	0.43	0.27	0.23
11	45.1	28.2	24.4	14.1	8.08	7.58	3.7	2.32	1.98	1.74	1.1	0.95	0.51	0.32	0.27
12	53	33.2	28.6	16.4	9.47	8.85	4.31	2.75	2.33	2.04	1.29	1.1	0.6	0.37	0.32
13	61.5	38.5	33.2	18.9	11	10.3	5.01	3.18	2.71	2.37	1.49	1.28	0.7	0.43	0.37
14	70.5	44.2	38	21.8	12.6	11.8	5.73	3.64	3.1	2.71	1.71	1.46	0.8	0.49	0.43
16	90.2	56.6	48.6	27.9	16.2	15.1	7.34	4.68	3.96	3.47	2.2	1.87	1.03	0.63	0.55
18	112	70.4	60.5	34.7	20.1	18.7	9.13	5.81	4.93	4.31	2.75	2.33	1.28	0.78	0.69
20	136	83.5	73.5	42.1	24.4	22.8	11.1	7.1	6	5.24	3.31	2.83	1.55	0.96	0.84
25				63.9	36.9	34.6	16.8	10.7	9.06	7.9	5	4.26	2.35	1.45	1.27
30				89.2	51.6	48.1	23.5	15	12.7	11.1	7	6	3.29	2.03	1.78
35				119	68.7	64.3	31.2	20	16.9	14.7	9.35	7.94	4.37	2.71	2.36
40				152	88	82	40	25.6	21.6	18.9	12	10.2	5.6	3.47	3.03
45				189	109	102	49.4	31.9	27	23.4	14.9	12.6	6.96	4.31	3.76
50							60.4	38.7	32.6	28.5	18.1	15.4	8.46	5.24	4.57
55							71.9	46.5	39.1	34	21.5	18.4	10.1	6.22	5.46
60							84.7	54.1	45.6	40	25.3	21.6	11.9	7.34	6.44
65							99.1	63	53.4	46.4	29	25.1	13.8	8.5	7.42
70							114	72.2	61.5	53.2	33.8	28.7	15.8	9.78	8.53
75							129	82.1	69.4	60.4	38	32.6	17.9	11.1	9.68
80							144	92.4	77.9	68.1	43.1	36.8	20.2	12.5	10.9
85							161	104	87	76.2	47.6	41.2	22.5	14	12.2
90							179	115	96.6	84.7	53.6	45.7	25.1	15.6	13.6
95										93.6	58.8	50.5	27.8	17.2	15

Loss of head in feet due to friction per 100 feet of pipe.  
 (Based on C = 100 for steel, C = 130 for copper, and C = 140 for plastic)

Friction loss occurs when water is being pushed up a pipe. As the water is pulled upward, the pipe that it travels in restricts the space in which it can go. Smaller pipes have more friction loss because there is more restriction on the water. To use this graph, first find your gpm number (or as close as possible) on the left side of the chart. Once you have found it, find your type of piping by size and material type. After you have found this, move along the lines until your two columns meet each other. The number you come to will be the amount of friction loss per hundred feet. This does not include the elevation of the pump. Example: A pump that is pumping at 10 gpm through a 1-1/4" copper pipe system will lose 1.98 feet worth of head for every 100 feet of pipe.

## GLOSSARY OF TERMS

**Air volume control**

Designed to maintain the air charge in a standard water storage tank. Pre-charged tanks do not require an air volume control.

**Atmospheric pressure**

A force exerted upon the earth's surface by the weight of air extending to a height of 25 miles above the earth. At sea level 14.7 pounds per square inch.

**Barb fitting**

A part of a fitting that a hose slides over which contains ridges which helps lock the hose to the fitting. The hose is then secured with a clamp.

**Basin (sewage)**

A container connected to a sink, toilet, washer or dishwasher that is used to collect refuse that comes from these appliances. Once collected, the waste is pumped from the basin to a pipe or septic tank.

**Black water**

Also known as sewage or wastewater. Water containing solids up to 2" in diameter.

**Centrifugal force**

The force created by a spinning or rotating impeller resulting in the movement of water outward from the center point. A pump uses an impeller to create centrifugal force.

**Check valve**

Allow water to move in only one direction which prevents water from returning to its source.

**Control box**

Installs above ground. Contains electrical starting components for 3-wire submersible deep well pumps. 2-wire submersible deep well pumps do not use a control box.

**Convertible jet pump**

For both deep wells (where pumping water levels are as far as 90 feet below the pump) and shallow wells (where pumping water levels are no more than 25 feet below the pump). Pump/tank packages are also available.

**Cut-in pressure setting**

The point at which the pressure switch turns the pump on.

**Deep well**

Well with a depth to water greater than 25 feet.

**Deep well pump (submersible)**

For use on wells where pump water levels are up to 400 feet below point of use. Pump is submerged underwater in the well.

**Depth to water**

The vertical measurement from pump level down to water level of water source. Pump height above water.

**Discharge**

The opening by which water is removed by the pump.

**Discharge pressure**

The amount of force or pressure of the water being discharged from the pump.

**Dual voltage motor**

Pump motor can then be operated on 115 Volts or 230 Volts.

# GLOSSARY OF TERMS

**Effluent**

Water containing solids up to ½" in diameter generated from activities such as dishwashing, bathing, laundry, etc.) Also known as gray water.

**FNPT**

Female National Pipe Thread – a U.S. standard for tapered threads used on threaded pipes and fittings. (The female end is larger than the male end).

**Foot valve**

Installs on the end of the pump suction pipe to prevent water from draining back to source. Includes strainer to minimize suction of debris into the pump.

**Friction loss**

A loss in pressure caused by friction when liquid moves through a pipe.

**GHT**

Garden Hose Thread (¾").

**GPH**

Gallons per hour.

**GPM**

Gallons per minute.

**Gray water**

Also known as effluent. Water containing solids up to ½" in diameter generated from activities such as dishwashing, bathing, laundry, etc.

**Head**

The vertical distance from:

the top of the well to the pressure tank

+ the top of the well to the static water level

+ the drawdown (static water level to the pumping water level)

+ the vertical distance from the well to the house

**HP**

Horsepower (power of motor).

**Intake**

The opening by which water is sucked into the pump.

**Jet pump**

A centrifugal pump which requires a jet to help build additional water pressure.

**MNPT**

Male National Pipe Thread – a U.S. standard for tapered threads used on threaded pipes and fittings. (The male end is smaller than the female end).

**Multi-stage jet pump**

For use on deep wells only with pumping water levels as far as 210 feet below the pump.

**NPT**

National Pipe Thread – a U.S. standard for tapered threads used on threaded pipes and fittings.

**PSI**

Pounds per square inch. A volumetric pressure measurement.



## GLOSSARY OF TERMS

### **Pre-charged tank**

A water storage tank pre-charged with air at the factory featuring a vinyl bag to separate water from the air which prevents waterlogging. This tank design provides greater drawdown than standard tanks. Pre-charged tanks do not require an air volume control.

### **Pressure**

A force usually expressed in pounds per square inch.

### **Pressure switch**

The switch that automatically turns the pump on and off at specified pressures of 30/50 psi and 40/60 psi.

IMPORTANT: always replace an old switch with a new switch with the same pressure settings.

### **Pressure operation - 30/50**

Pressure switch turns pump on at 30 psi and off at 50 psi.

### **Pressure operation - 40/60**

Pressure switch turns pump on at 40 psi and off at 60 psi.

### **Priming the pump**

The initial filling of a jet or centrifugal pump with water so that air can be removed.

### **Pump capacity**

The amount of water a pump is capable of moving at a given pressure.

### **Pumping water level**

The distance below ground where the water is found when the well is being pumped at its rated capacity.

Static Water Level + Drawdown = Pumping Water Level.

### **Safety relief valve**

Required for all submersible pump and pressure boosting installations to prevent over-pressurization of water storage tank and system piping that could develop from pressure switch malfunction.

### **Sewage**

Water containing solids up to 2" in diameter. Also known as black water.

### **Sewage basin**

A container connected to a sink, toilet, washer or dishwasher that is used to collect refuse that comes from these appliances. Once collected, the waste is pumped from the basin to a pipe or septic tank.

### **Shallow well**

Well with a depth of water of 25 feet or less.

### **Shallow well pump**

For use in wells where pump water levels are no more than 25 feet below the pump. Features a built-in jet.

### **Sizing**

Properly matching product to application for best performance.

### **Standard tank**

A pressurized water storage tank where air comes in contact with water. Requires air volume control for proper operation.

### **Static water level**

The distance below ground where water is found when no pumping occurs.

## GLOSSARY OF TERMS

**Submersible deep well pump**

For use on wells where pump water levels are up to 400 feet below point of use. Pump is submerged underwater in the well.

**Suction lift**

The vertical height from the pumping water level to the suction part of the pump.

**Tank**

Stores air and water under pressure to provide for automatic pump operation and a source of water when pump is not running.

**TEFC design**

Totally enclosed, fan cooled design.

**Waterlogging**

The absorption of air into water stored in a water storage tank which greatly reduces the amount of usable water drawdown available from the tank.

**Water storage tank**

Stores air and water under pressure to provide for automatic pump operation and a source of water when pump is not running.

**Well capacity**

Also known as the well's replenishment rate or well recovery rate. It is the rate at which the well refills with water – measured in gpm. This information is found on the Well Driller's Report.

**Well recovery rate**

Also known as the well's replenishment rate or well capacity. It is the rate at which the well refills with water – measured in gpm. This information is found on the Well Driller's Report.

**Well replenishment rate**

Also known as the well's recovery rate or well capacity. It is the rate at which the well refills with water – measured in gpm. This information is found on the Well Driller's Report.





**RED LION**®

[redlionproducts.com](http://redlionproducts.com)

**Hotline: 1.888.885.9254**

**US Address: 301 N. MacArthur Blvd. | Oklahoma City, OK | 73127-6616 | U.S.A.**

05-17 FORM # 995634 REV. 004