

Automated Method Development Utilizing Software-Based Optimization and Direct Instrument Control

Dr. Frank Steiner,¹ Andreas Brunner,¹ Fraser McLeod,¹ Dr. Sergey Galushko²
¹Dionex Corporation, Germering, Germany; ²ChromSword, Mühlthal, Germany

INTRODUCTION

HPLC method development is still considered to be one of the crucial bottlenecks that impede productivity in analytical laboratories. Due to the variety of parameters such as stationary phase, pH and composition of mobile phase, and column temperature, finding the optimum conditions for the analysis normally requires substantial efforts both in experimental work and result evaluation.

This presentation describes an integrated solution based on ChromSwordAuto[®] and UltiMate[®] 3000 RSLC instrumentation. This system provides fully automatic method development and optimization, starting with a small number of initial experiments but exploring the entire design space through software intelligence to find the best analysis conditions. Screening of columns, solvents, buffers, and instrument parameters as well as fine tuning, robustness studies, and documentation are implemented in one platform. The systems are used effectively for all stages of drug discovery and drug development projects where rapid or sophisticated method development and optimization are key requirements. Thanks to the very fast separation of UHPLC, all this can be accomplished in the shortest time possible.

INSTRUMENT AND METHOD SETUP

A set of UHPLC columns is screened for the analysis of pharmaceutical samples on an integrated HPLC system designed for ultrafast automated method scouting. The system comprises:

- A pump with quaternary gradient capabilities at pressures up to 80 MPa, extended with an additional 10-position, 11-port solvent selection valve.
- A split-loop (flow-through) autosampler with very short cycle times.
- A powerful diode array detector with data collection rates up to 100 Hz, providing compound identification based on UV-vis spectra.
- Two high-pressure 6-position, 7-port column selection valves integrated in the thermostatted column compartment for maximum scouting flexibility.
- Intelligent software for easy parameter permutation, fully automated system control, and automated identification of the optimum chromatograms from the large data set.

Now sold under the
Thermo Scientific brand

Thermo
S C I E N T I F I C

The following method parameters were used during the method scouting study:

- Flow rate 1.0 mL/min
- Gradient 15%–95%B in 15 min, 2.5 min equilibration (for screening)
- UV detection at 254 nm, 3D field from 210 nm to 360 nm
- Injection volume 10 µL
- Column compartment at 30 °C (temperature optimization not considered)

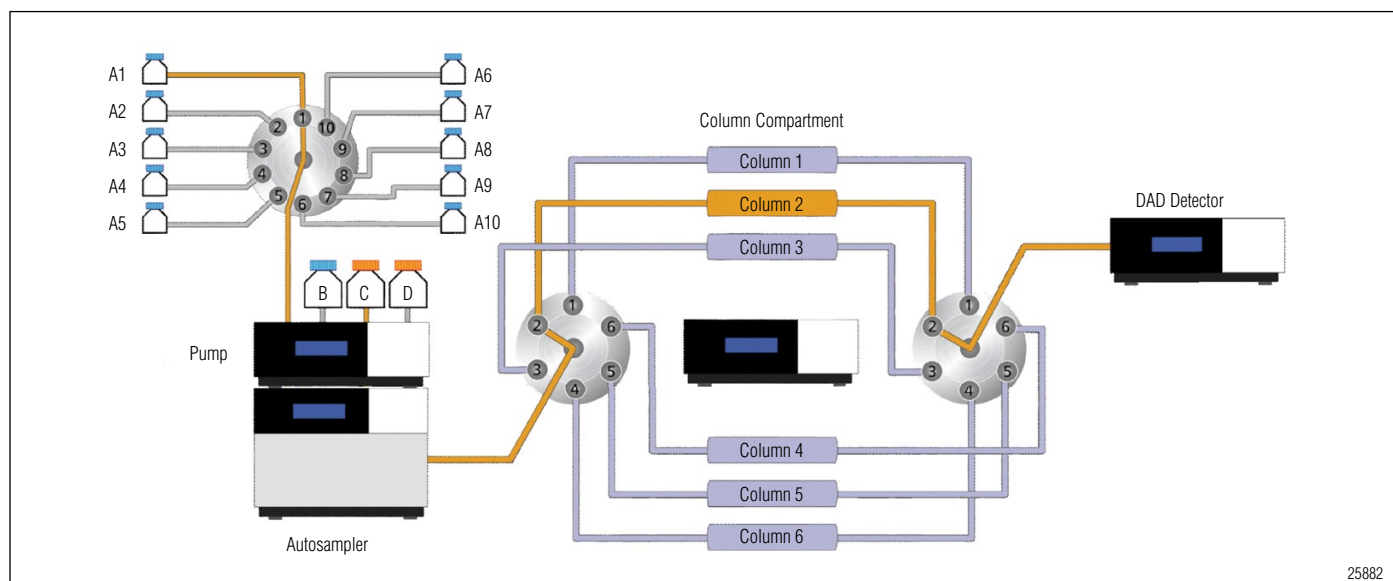

Figure 1. System configuration for automated method scouting with optional 10-position solvent selection valve.

Aqueous Mobile Phases (A)	Organic Modifiers (B)	Columns (100 x 4.6 mm)
1% v/v TFA, pH 2.0 10 mM potassium phosphate, pH 3.0	acetonitrile	Luna® C18
10 mM ammonium acetate, pH 5.0	methanol	Luna Phenyl-Hexyl
5 mM potassium phosphate, pH 6.5		Inertsil® ODS 3
5 mM sodium borate, pH 9.5		Aqua™ C18
		Luna CN

SOFTWARE SETUP

The UltiMate 3000 Method Scouting System is controlled using the Chromeleon® Chromatography Data System (CDS) software. In this solution, this setup is combined with the ChromSwordAuto chromatographic method development software. The package supports rapid development of separation methods in HPLC with a minimum number of experiments. The combination of ChromSwordAuto, Chromeleon, and the UltiMate 3000 Method Scouting System provides a system capable of developing completely new methods or optimizing existing ones quickly and in a fully automated way.

2 Automated Method Development Utilizing Software-Based Optimization and Direct Instrument Control

THE METHOD DEVELOPMENT PROCESS

Figure 2 shows the steps usually involved in method development. ChromSwordAuto can utilize information about the physico-chemical characteristics of the analytes to preselect a suitable subset of mobile and stationary phases. In an initial screening step, the software runs a set of experiments using different combinations of mobile and stationary phases to find a column with suitable selectivity and initial elution composition. In the subsequent fine method optimization, method conditions are varied further in order to find the best conditions possible. Finally, robustness testing can be performed to verify the method conditions to be robust against typical parameter changes in everyday use.

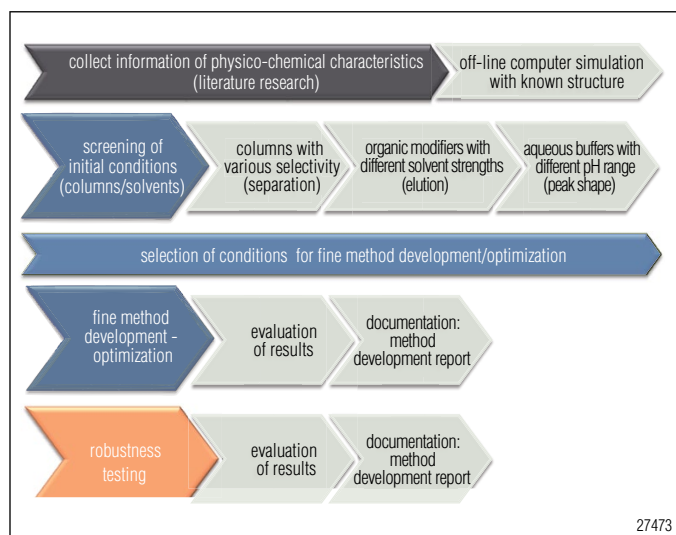

Figure 2. The method development process.

APPLICATION EXAMPLE: SEPARATION OF SIX ANALOGS

In this pharmaceutical application, six analogs with different substituents (see core structure in Figure 3) had to be separated by either isocratic or gradient elution. Each of them contained both primary amine and carboxylic acid functional groups, as well as degradation impurities in the form of cyclic amides. pKa values varied from 5–9 depending on substituents. The application and the automated optimization have been published formerly.¹

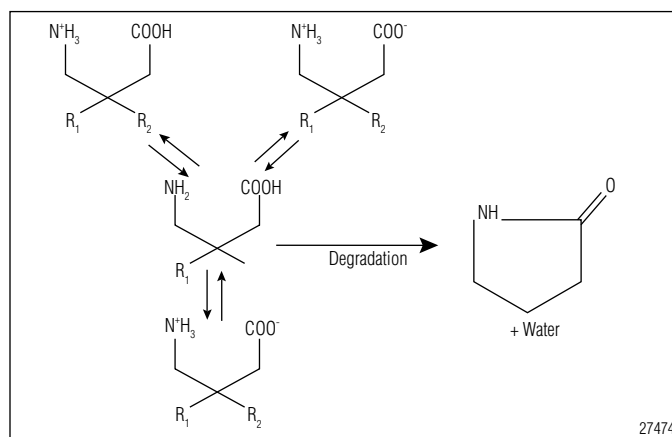

Figure 3. Core structure of pharmaceutical compounds, acid-base equilibria, and ring formation (analog differ in R_1 and R_2).

RESULTS AND DISCUSSION

Based on the combination of the conditions described in the Instrument and Method Setup section, a fully automated experimental screening is accomplished first. The chromatographic results for all five columns combined with either 10 mM phosphate buffer at pH 3.0 or 5 mM phosphate buffer at pH 6.5, running in either a CH₃CN or a CH₃OH gradient are compared (20 different conditions) in Figure 4. From these results, the following conclusions can be drawn:

1. Although the bonding chemistry of the columns used differs widely, the influence of the mobile phase on selectivity and peak shape clearly prevails.
2. The difference between CH₃CN and CH₃OH is much more pronounced at pH 3.0 than at pH 6.5.
3. Peak shapes are generally better with CH₃CN, but the difference is insignificant on some columns at pH 6.5.
4. Column Z (Luna Phenyl-Hexyl) shows the best peak shapes relative to its peers.
5. Based on the best compromise between overall peak resolution and peak shape, the combination of column Z with pH 6.5 and CH₃OH is the most promising approach for the given separation challenge.

In Figure 5, the applied workflow is depicted and the most promising conditions are highlighted. Based on this intermediate result, the setup automatically runs a fine optimization under consideration of frame conditions set by the operator. The fine optimization is performed for both an isocratic and a gradient method. It is based on Column Z running at pH 6.5 with methanol as organic modifier.

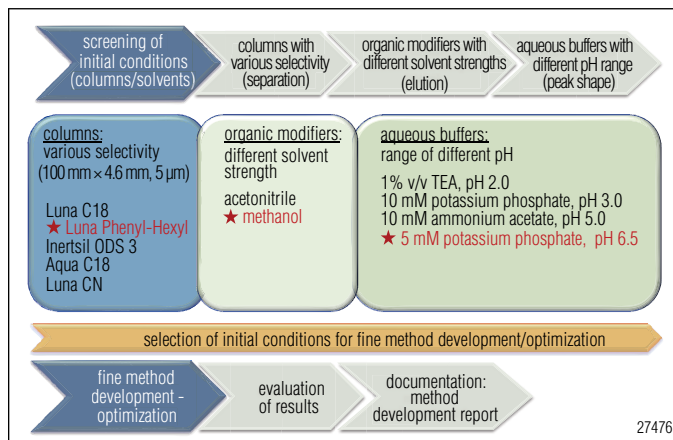

Figure 5. Graphic representation of the applied workflow and the intermediate results from the initial screening phase (best conditions marked in red with asterisk).

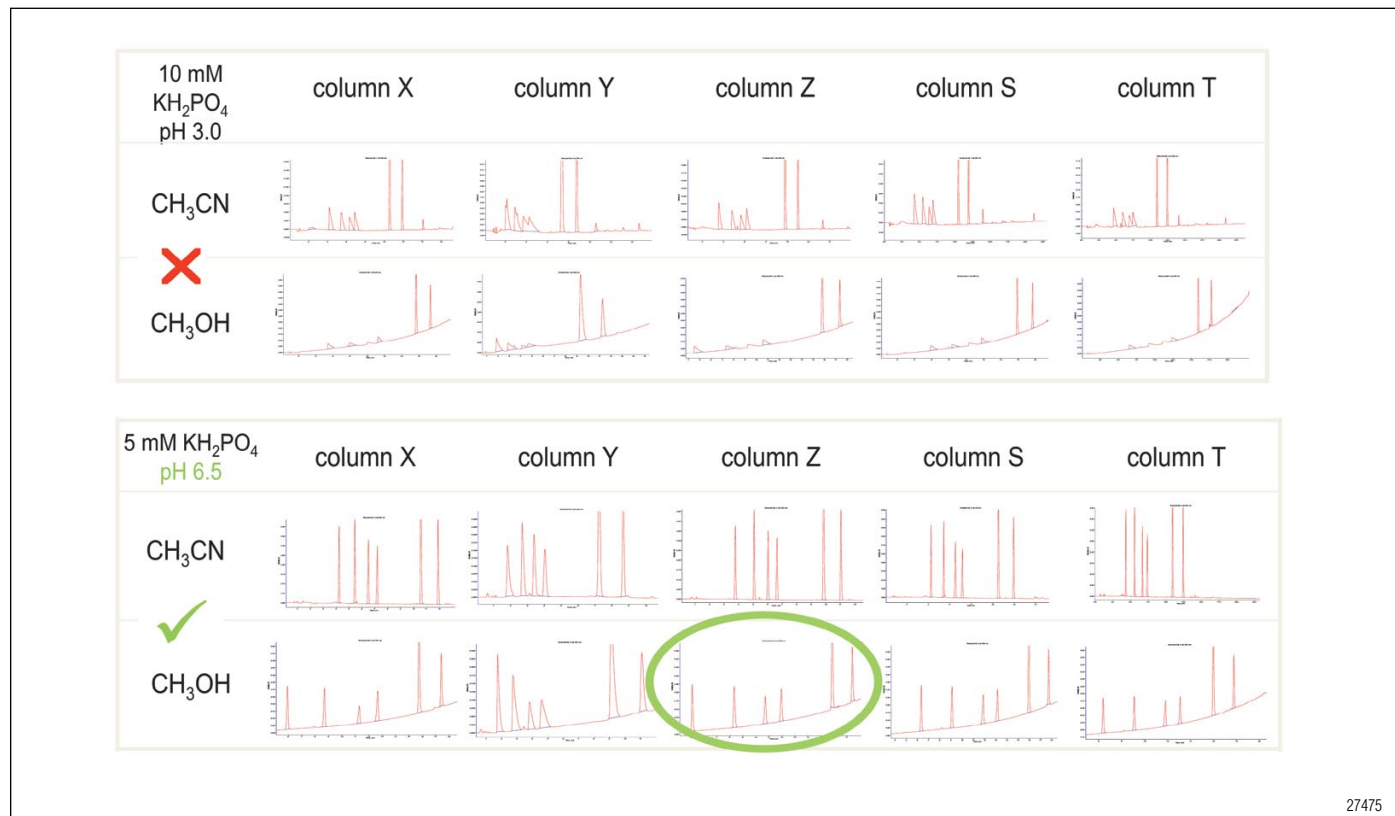

Figure 4. Chromatographic results of screening phase with generic gradients. Combination of five different columns with two different buffers and two different organic modifiers (time axes are not to scale).

4 Automated Method Development Utilizing Software-Based Optimization and Direct Instrument Control

Figure 6 shows the best buffer/methanol composition as an outcome of the fine optimization as well as the optimal gradient profile together with the resulting chromatograms for comparison. It can be seen that general conditions reveal excellent peak shapes for all six analytes. Both the isocratic and the gradient method fulfill the general requirements for routine analysis. This can be further consolidated in a fully automated robustness testing (not described in this poster). The gradient method separates the six compounds faster, but given the required re-equilibration, run times are similar. Overall the gradient method is superior with respect to the equal distribution of the peaks along the chromatogram (resolution).

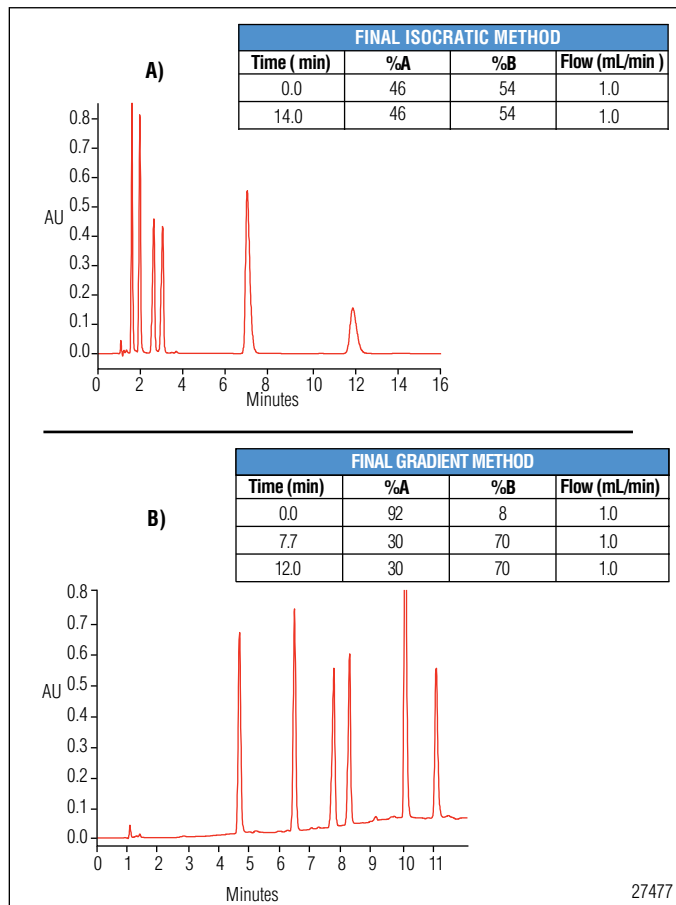

Figure 6. Results of automated fine optimization for A) isocratic, and B) gradient mode.

A ChromSwordAuto-based, fully automated optimization has also been run for an impurity profiling method with an active pharmaceutical ingredient (API) of the described compound class. The resulting method had to be MS-compatible which limited the selection of applicable buffers. Figure 7A) shows the result with the fine optimized gradient profile run in an LC-MS method. The same sample was given to an experienced chromatographer for manual method development. The result of the manual development is depicted in Figure 7B). One can see that the impurity eluting closely in front of the API peak is not resolved with the manually developed method. The automated development required 24 h for the screening and 24 h for the fine optimization, while the manual development lasted close to eight working days and resulted in an inferior method.

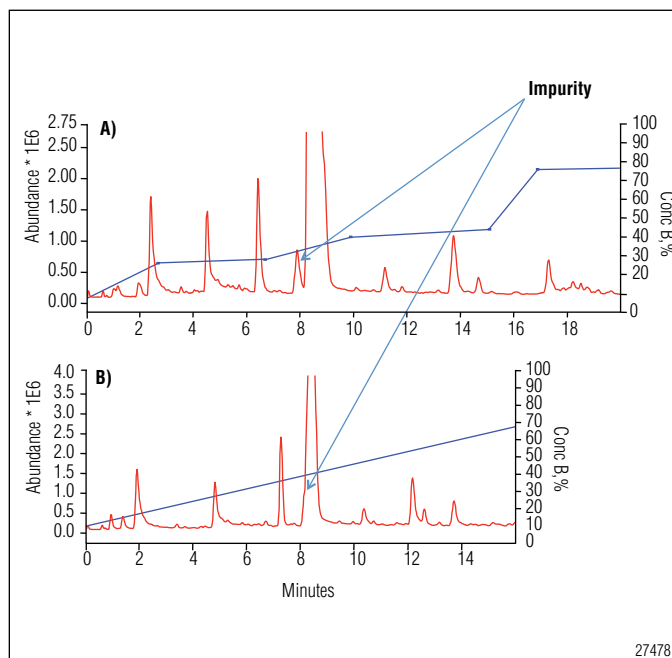

Figure 7. Comparison of A) ChromSwordAuto-based, and B) manually developed method for real life sample impurity profiling.

CONCLUSIONS

The automated solution based on a combination of ChromSwordAuto software, Chromeleon software, and the UltiMate 3000 Method Scouting system can significantly reduce the labor and time spent for method development and fine optimization.

Even for challenging applications, the results of the automated fine optimization are available within 48 h, and the resulting method is superior compared to methods developed manually in close to eight working days.

If required, robustness testing and kinetical method optimization (flow/gradient volume) are also available with the described setup.

REFERENCES

1. Hewitt, E.F.; Lukulay, P.; Galushko, S. Implementation of a Rapid and Automated High Performance Liquid Chromatography Method Development Strategy for Pharmaceutical Drug Candidates. *J. Chromatogr., A* **2006**, *1107*, 79–87.

ChromSwordAuto is a registered trademark of Dr. Sergey Galushko Software Entwicklung.
Aqua is a trademark and Luna is a registered trademark of Phenomenex, Inc.
Inertsil is a registered trademark of GL Sciences, Inc.
Chromeleon and UltiMate are registered trademarks of Dionex Corporation.

Passion. Power. Productivity.



Dionex Corporation

1228 Titan Way
P.O. Box 3603
Sunnyvale, CA
94088-3603
(408) 737-0700

North America

U.S./Canada (847) 295-7500

South America

Brazil (55) 11 3731 5140

Europe

Austria (43) 1 616 51 25 Benelux (31) 20 683 9768; (32) 3 353 4294
Denmark (45) 36 36 90 90 France (33) 1 39 30 01 10 Germany (49) 6126 991 0
Ireland (353) 1 644 0064 Italy (39) 02 51 62 1267 Sweden (46) 8 473 3380
Switzerland (41) 62 205 9966 United Kingdom (44) 1276 691722

Asia Pacific

Australia (61) 2 9420 5233 China (852) 2428 3282 India (91) 22 2764 2735
Japan (81) 6 6885 1213 Korea (82) 2 2653 2580 Singapore (65) 6289 1190
Taiwan (886) 2 8751 6655

www.dionex.com



LPN 2553-01 7/10
©2010 Dionex Corporation