



Mooney Aircraft Corporation

P.O. BOX 72, KERRVILLE, TEXAS 78029-0072 PHONE (512) 896-6000

SPECIAL LETTER 92-1
DATE: April 20, 1992

SUBJECT: Mooney M20J 2900 POUND GROSS WEIGHT INCREASE, RETROFIT KITS

MODEL/S/N AFFECTED: M20J, Mooney 205, 201, ATS, MSE; S/N 24-1686 thru 24-3200, 24-3202 thru 24-3217

TIME OF COMPLIANCE: At owners discretion.

INTRODUCTION: The gross weight of 1991 and later M20J aircraft has been increased from 2740 pounds to 2900 pounds. This increase in useful load is retrofitable to some earlier M20J aircraft. See S/N's listed above. The incorporation of this retrofit is up to the discretion of the aircraft owner/operator.

Five kits are provided for incorporation of: (1) the proper airspeed indicator, (2) the applicable AFM Supplement required for each listed series of S/N aircraft and (3) the inspection of the rudder static balance limits.

CAUTION

This Special Letter is to advise M20J owners (for S/N's listed above only) of the opportunity to incorporate this new configuration, if desired. HOWEVER, it is essential that the Serial Number of each aircraft and the number of the Pilot's Operating Handbook and Airplane Flight Manual (POH/AFM) being used for each aircraft be provided to the Service Parts Dept. at the time of the retrofit kit order. This will assist in assuring that the proper set of components are being provided for your aircraft.

INSTRUCTIONS:

1. Procure correct retrofit kit listed below. (Refer to S/N and POH/AFM of existing aircraft)
2. Retrofit Kit (for specific aircraft serial numbers) may be ordered direct from Mooney Service Parts Department, (512) 257-8601, using Master Card, Visa or C.O.D. The kits are priced at \$1,750.00 net.
3. See instructions shown on field of Mooney 940071 drawing.
4. Install correct airspeed indicator supplied in appropriate kit.
5. Incorporate **proper** AFM Supplement into the appropriate POH/AFM for aircraft S/N

In addition:

6. Refer to Mooney Service Bulletin M20-252, dated 4-6-92. The INSTRUCTIONS shown therein **MUST** be followed for the above S/N aircraft to complete retrofit incorporation of the 2900 pound gross weight increase for these M20J's.

NOTE

When complying with this Special Letter, the instructions of SB M20-252, dated 4-6-92 or subsequent revision, must be accomplished on the above serial numbered aircraft even though the Serial Numbers on SB M20-252 do not specifically refer to the above aircraft.

WARRANTY: N/A

REFERENCE: DATA:

1. Mooney drawing number 940071
2. Mooney Service Bulletin M20-252, dated 4-6-92 (or subsequent revision)
3. M20J Service and Maintenance Manual, No. 121, Chapter 27.

PARTS LIST: CAUTION – ORDER CORRECT KIT FOR YOUR AIRCRAFT – REFER TO S/N & POH/AFM LISTED

Mooney Kit Number SL92-1-1 (for S/N's 24-1686 THRU 24-2999)			
ITEM	P/N	DESCRIPTION	QUANTITY
1.	940071-501	RETROFIT DRAWING	1
2.	POH/AFM # 3210 (Rev. A or B)	AFM SUPPLEMENT PAGES	1
3.	820308-537	INDICATOR, AIRSPEED	1

Mooney Kit Number SL92-1-2 (for S/N's 24-3000 THRU 24-3056)			
ITEM	P/N	DESCRIPTION	QUANTITY
1.	940071-503	RETROFIT DRAWING	1
2.	# POH/AFM # 1233(A)	AFM SUPPLEMENT PAGES	1
3.	820308-539	INDICATOR, AIRSPEED	1

SUBJECT: Mooney M20J 2900 POUND GROSS WEIGHT INCREASE, RETROFIT KITS (con't.)

PARTS LIST: (con't.)

Mooney Kit Number SL92-1-3 (for S/N's 24-3000 THRU 24-3078)			
ITEM	P/N	DESCRIPTION	QUANTITY
1.	940071-503	RETROFIT DRAWING	.1
2.	# POH/AFM # 1233(B)	AFM SUPPLEMENT PAGES	.1
3.	820308-539	INDICATOR, AIRSPEED	.1

POH/AFM #1233(B) MAY BE USED FOR 24-3000 THRU 24-3078 AIRCRAFT. HOWEVER, AIRCRAFT SERIAL NUMBER'S 24-3000 THRU 24-3056 MAY BE USING POH/AFM # 1233(A). BE SURE WHICH POH/AFM IS BEING USED PRIOR TO ORDERING THE APPROPRIATE KIT.

Mooney Kit Number SL92-1-4 (for S/N's 24-3079 THRU 24-3153)			
ITEM	P/N	DESCRIPTION	QUANTITY
1.	940071-503	RETROFIT DRAWING	.1
2.	POH/AFM # 3200(A)	AFM SUPPLEMENT PAGES	.1
3.	820308-539	INDICATOR, AIRSPEED	.1

Mooney Kit Number SL92-1-5 (for S/N's 24-3154 THRU 24-3200, 24-3202 THRU 24-3217)			
ITEM	P/N	DESCRIPTION	QUANTITY
1.	940071-505	RETROFIT DRAWING	.1
2.	POH/AFM # 3201	AFM SUPPLEMENT PAGES	.1
3.	820308-535	INDICATOR, AIRSPEED	.1

FIGURES/
 TABLES:

Refer to M20J S & M No. 121, Chapter 27, Figure 27-18 and 27-19 for the rudder balance inspection portion of the procedures.

CAUTION

Use the balance limits specified in Service Bulletin M20-252. The S & M will be revised in the near future to reflect the new limits for the 2900 pound gross weight aircraft.

MOONEY AIRCRAFT CORPORATION

PO BOX 72 KERRVILLE, TX 78029-0072

SERVICE BULLETIN

THIS BULLETIN IS FAA APPROVED FOR ENGINEERING DESIGN

SB M20-252

DATE: 4-6-92

SUBJECT: MOONEY M20J RUDDER BALANCE WEIGHT INSPECTION

MODEL/
S/N AFFECTED: 24-3201, 24-3218 THRU 24-3256 (EXCLUDING 24-3239 & 24-3251)

TIME OF
COMPLIANCE: WITHIN NEXT 15 FLIGHT HOURS

INTRODUCTION: The continual evaluation of data and testing of various systems on M20 Series aircraft models has led, among other things, to the introduction of the 2900 pound gross weight M20J aircraft. An analysis of computer data has determined that a slight change to the rudder static balance limits are necessary on the 2900 pound gross weight M20J. These new limits are listed in INSTRUCTIONS below. The possibility exists that the rudders on some of the affected aircraft listed herein may be outside these new limits. Therefore, it is mandatory that this Service Bulletin be complied with as indicated.

INSTRUCTIONS:

1. Remove rudder from empennage of the aircraft per M20J Service and Maintenance (S & M) manual, No. 121, Section 27-20-00, paragraphs 2, A, B, C,
2. Check rudder balance per M20J S & M, Section 27-92-00 thru 27-93-01 & Tables 27-18 and 27-19 (See **CAUTIONS** below).

CAUTION: Table 27-18 - Use GAUGE WEIGHT DISTANCE LIMITS of: + 6.69 in. to + 10.68 in. for 2900 pound aircraft. - The + 3.37 in. to + 10.68 in. limits remain in effect for 2740 pound gross weight aircraft.

CAUTION: Table 27-19 - Use ABSOLUTE BALANCE LIMITS of: + 15.50 in. lbs. to + 12.50 in. lbs. for 2900 pound aircraft. - The + 18.00 in. lbs. to + 12.50 in. lbs. limits remain in effect for 2740 pound gross weight aircraft.

3. If rudder balance falls within the above limits, re-install rudder on the aircraft per M20J S & M, Section 27-20-00, paragraph 2, D. Proceed to Step 8.

If rudder does not fall within the above limits, proceed to Step 4.

4. Temporarily add additional weight (washers or any other items) until static balance falls within limits. Remove temporary weights and weigh them to see approximately how much additional weight was needed to balance within limits. If 2.66 oz. or less is needed, the addition of washers described in Step 5 will provide the necessary added weight (ie. 16 each AN970-3 washers weigh 2.66 oz.)
5. If balance just exceeds limit, one method is to remove the balance weight attach screws, one at a time and add washers under screw head (up to two under each screw) as required to balance rudder within the 2900 pound limits. If necessary, proceed to each attaching screw and add washers. It is recommended that the washers be distributed among all 8 attaching screws for a neater appearance. Either AN960-10 or AN970-3 washers may be used. However, for **each washer** added under screw head, the length of the NAS623-3 screw **MUST BE** increased by one dash number. (See Service Bulletin Kit for Part Numbers. You will need to request the quantity of washers and/or screws desired)
6. If greater than 2.66 oz. is required, remove the balance weight and weigh it together with the temporary weights. The total weight of these should be the specified weight of the new 460011-503 balance weight ordered. The maximum 460011-503 balance weight available is 2.88 pounds.
7. Re-check rudder after each change to the balance weight per S & M manual procedures until within limits.
8. Enter compliance statement in Airframe log book and return aircraft to service.

WARRANTY: Mooney Aircraft Corporation will allow up to 2.5 hours labor to inspect the rudder balance. If the rudder is out of balance, up to an additional 2.0 hours will be approved to balance and repaint as necessary. The necessary weights and hardware can be ordered through the nearest Mooney Service Center. Warranty credit will be allowed for this Service Bulletin effort if necessary paperwork is received by Service Parts within 180 days of the date of this Service Bulletin.

SB M20-252
DATE: 4-6-92

REFERENCE
DATA: N/A

PARTS LIST: KIT PART NUMBER - SB M20-252-1

ITEM	P/N	DESCRIPTION	QTY	
1.	460011-503	WEIGHT, BALANCE	.1	*
2.	AN960-10	WASHER	.16	**
3.	AN970-3	WASHER, LARGE OD	.16	**
4.	NAS623-3-2	SCREW	.8	**
5.	NAS623-3-3	SCREW	.8	**

* Order weight as needed. 2.88 pounds is heaviest weight available from MAC.

** Use as required per Step 5

FIGURES/
TABLES: Refer to M20J Service and Maintenance Manual, No. 121, Chapter 27, FIGURE 27-18 and 27-19.

CAUTION

Use the limits depicted in this SB for 2900 pound gross weight aircraft until S & M can be revised.

PILOT'S OPERATING HANDBOOK and FAA APPROVED AIRPLANE FLIGHT MANUAL

Mooney M20J

THIS HANDBOOK INCLUDES THE MATERIAL
REQUIRED TO BE FURNISHED TO THE PILOT
BY CAR PART 3, AND CONSTITUTES THE
FAA APPROVED AIRPLANE FLIGHT MANUAL.

COMPLIANCE WITH ALL THE MATERIAL IN
THIS FLIGHT MANUAL IS MANDATORY.

DO NOT REMOVE FROM AIRCRAFT.

This book meets GAMA Specification No. 1,
Specification For Pilot's Operating Handbook,
issued Feb. 15, 1975 and revised Dec. 31, 1981.

MOONEY AIRCRAFT CORPORATION
P.O. BOX 72, KERRVILLE, TEXAS 78029-0072

SERIAL NUMBER: _____

REGISTRATION NUMBER: _____

FAA APPROVED: *C. L. Stone* _____

for Don P. Watson, Manager
Aircraft Certification Division
FEDERAL AVIATION ADMINISTRATION
Department of Transportation
Southwest Region
Fort Worth, Texas

FAA APPROVED in Normal Category based on CAR, PART
3; applicable to Model M20J S/N listed above only.

ISSUED 6-2-86

MANUAL NUMBER 1233

CONGRATULATIONS . . .

WELCOME TO MOONEY'S NEW DIMENSION IN SPEED AND ECONOMY. YOUR DECISION TO SELECT A MOONEY HAS PLACED YOU IN AN ELITE AND DISTINCTIVE CLASS OF AIRCRAFT OWNERS. WE HOPE THAT YOU FIND YOUR MOONEY A UNIQUE FLYING EXPERIENCE, WHETHER FOR BUSINESS OR PLEASURE, THE MOST PROFITABLE EVER.

-NOTICE-

This manual is provided as an operating guide for the Mooney Model M20J. It is important that you--regardless of your previous experience--carefully read the handbook from cover to cover and review it frequently.

All information and illustrations in the manual are based on the latest product information available at the time of publication approval and all sections including attached supplements are mandatory for proper operation of the aircraft. The right is reserved to make changes at any time without notice. Every effort has been made to present the material in a clear and convenient manner to enable you to use the manual as a reference. Your cooperation in reporting presentation and content recommendations is solicited.

REVISING THE MANUAL

The "i" pages of this manual contain a "List of Effective Pages" containing a complete current listing of all pages i.e., Original or Revised. Also, in the lower right corner of the outlined portion, is a box which denotes the manual number and issue or revision of the manual. It will be advanced one letter, alphabetically, per revision. With each revision to the manual a new "List of Effective Pages" and a "Log of Revisions" page(s) will be provided to replace the previous ones.

This handbook will be kept current by Mooney Aircraft Corporation when the information card in front of this handbook has been completed and mailed to Mooney Aircraft Corporation, P.O. Box 72, Kerrville, TX 78029-0072.

MOONEY M20J

LIST OF EFFECTIVE PAGES

ORIGINAL..... 6-2-86
A..... 8-15-86

Always destroy superseded pages when inserting revised pages.

TITLE PAGE.....Original
"A" page.....Original
i.....A
ii.....Original
ii/ivBLANK.....A
v/viBLANK.....Original
1-1 thru 1-15/16BLANK.....Original
2-1 thru 2-19/20BLANK.....Original
3-1 thru 3-15.....Original
3-16.....A
3-17 thru 3-20.....Original
4-1 thru 4-20.....Original
5-1 thru 5-43/44BLANK.....Original
6-1 thru 6-29/30BLANK.....Original
7-1 thru 7-47/48BLANK.....Original
8-1 thru 8-16.....Original
9-1 thru 9-3/4BLANK.....Original
10-1 thru 10-18.....Original

1233 Rev. A

REV. A 8-15-86

ISSUED 6-2-86

MOONEY M20J

LIST OF EFFECTIVE PAGES

1233 ORIGINAL

PILOT'S OPERATING HANDBOOK AND AIRPLANE FLIGHT MANUAL
 LOG OF REVISIONS

WARNING: This manual may not include the latest revisions.

REVISION NUMBER	REVISED PAGES	DESCRIPTION OF REVISIONS	FAA APPROVED	DATE
A	3-16	Added CAUTION	<i>C. J. Starn</i>	8-15-86

The revised portions of affected pages are indicated by vertical black lines in the margin.

REV. A 8-15-86
 ISSUED 6-2-86

SECTION I
GENERAL

MOONEY M20J

TABLE OF CONTENTS

TITLE	PAGE
THREE VIEW.....	1-2
INTRODUCTION.....	1-3
DESCRIPTIVE DATA.....	1-3
ENGINE.....	1-3
PROPELLER.....	1-4
FUEL.....	1-4
OIL.....	1-4
LANDING GEAR.....	1-5
MAXIMUM CERTIFICATED WEIGHTS.....	1-5
STANDARD AIRPLANE WEIGHTS.....	1-5
CABIN & ENTRY DIMENSIONS.....	1-5
BAGGAGE SPACE AND ENTRY DIMENSIONS.....	1-6
SPECIFIC LOADINGS.....	1-6
IDENTIFICATION PLATE.....	1-6
SYMBOLS, ABBREVIATIONS & TERMINOLOGY.....	1-7
GENERAL AIRSPEED TERMINOLOGY & SYMBOLS.....	1-7
ENGINE POWER TERMINOLOGY.....	1-8
ENGINE CONTROLS & INSTRUMENTS TERMINOLOGY.....	1-9
AIRPLANE PERFORMANCE & FLIGHT PLANNING TERMINOLOGY.....	1-9
METEOROLOGICAL TERMINOLOGY.....	1-10
WEIGHT & BALANCE TERMINOLOGY.....	1-11
MEASUREMENT CONVERSION TABLES.....	1-13

SECTION I
GENERAL
MOONEY M20J

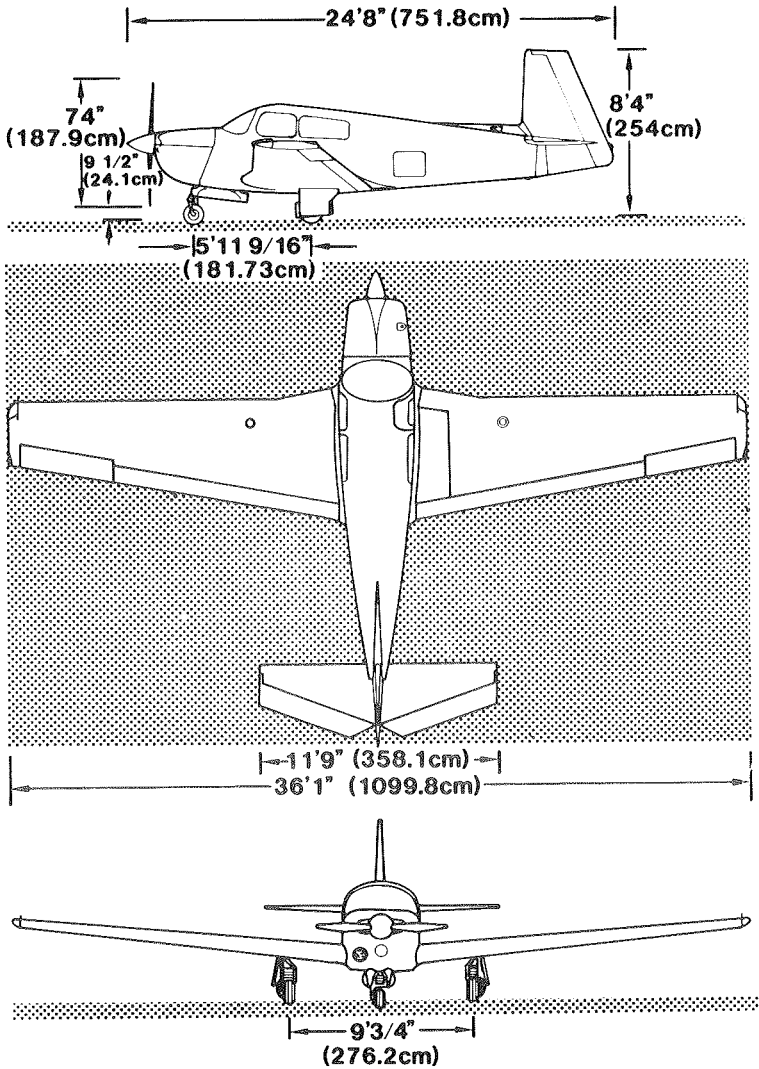

FIGURE 1-1 THREE VIEW

SECTION I
GENERAL

MOONEY M20J

INTRODUCTION

This Pilot's Operating Handbook contains 10 sections and includes the material required to be furnished to the pilot by CAR Part 3. Section IX contains supplemental data supplied by Mooney Aircraft Corporation.

Section I contains information of general interest to the pilot. It also contains definitions of the terminology used in this Pilot's Operating Handbook.

DESCRIPTIVE DATA

ENGINE

Number of engines.....1
Engine Manufacturer.....AVCO Lycoming
Model.....IO-360-A3B6D
Recommended TBO.....1800 Hours
Type.....Reciprocating, aircooled,
fuel injected.
Number of cylinders.....4, Horizontally
opposed
Displacement.....361 Cu. In. (5915.7 cc)
Bore.....5.125 In. (13.02 cm)
Stroke.....4.375 In. (11.11 cm)
Compression ratio.....8.7:1
Fuel System
Type.....Fuel Injection Flow
Make.....Bendix, RSA-5-AD1
Fuel-Aviation Gasoline.....100 or 100LL
min. grade

Accessories

Magnetos.....Bendix D4LN 2021
or D4LN3021
(With Tachometer breaker points)
Spark Plugs.....18 MM X .750-20
Thd. Connection
Alternator.....Prestolite 28 Volts, 70A
Starter.....Prestolite 24 Volts

Ratings:

Maximum Continuous Sea
Level BHP-RPM.....200 - 2700

SECTION I
GENERAL

MOONEY M20J

PROPELLER

Number.....1
Manufacturer.....McCauley*
Model Number.....B2D34C214/90DHB-16E or -16EP*
Number of Blades.....2
Diameter.....Max. 74.0 in. (187.9 cm)*
 Min. 73.0 in. (185.4 cm)*
Type.....Constant Speed
Governing.....Hydraulically controlled
 by engine oil
Blade Angles @ 30 in. Sta.:
 Low.....13.9 degrees +/- .2 degrees*
 High.....33.0 degrees +/- .5 degrees*

*OPTION: Hartzell HC-C2YK-1BF/F7666A-3Q
 73.0" (185.42 cm) (No cutoff allowed)
 Blade Angles: @30 in. sta.
 Low: 14.1 degrees +/- .1 degree
 High: 29.3 degrees to 31.3 degrees
 Spinner: Hartzell No. A2295

FUEL

Minimum Fuel Grade (Color).....100/130 (Green)
 100 LL (Blue)
Total Capacity.....66.5 U.S. Gal.
 (251.8 Liters)
 (55.4 Imp. Gal.)
Usable.....64.0 U.S. Gal.
 (242.4 Liters)
 (53.3 Imp. Gal.)

OIL

Total Oil Capacity.....8 Qts. (7.57 Liters)
Oil Capacity Minimum for Flight.....5 Qts.
 (4.73 Liters)
Oil Filter.....Full Flow
Oil grades, specifications and changing
recommendations are contained in Section VIII.

SECTION I
GENERAL

MOONEY M20J

LANDING GEAR

TYPE: Electrically operated, fully retractable tricycle gear with rubber shock discs. The main wheels have hydraulically operated disc brakes. The nose wheel is fully steerable 14 degrees left or right of center.

Wheel Base.....71 9/16 in. (181.73 cm)
Wheel Thread.....108 3/4 in. (276.2 cm)
Tire Size:
Nose.....5.00 x 5 (6 ply)
Main.....6.00 x 6 (6 ply)
Tire Pressure:
Nose.....49 PSI
Main.....30 PSI
Min. Turning Radius
(No brakes applied).....41 ft. (12.5 m)

MAXIMUM CERTIFICATED WEIGHTS

Maximum Loading (unless limited by C.G. envelope)
Gross Weight.....2740 Lbs. (1243 Kg)
Baggage Area.....120 Lbs. (54.4 Kg)
Hat Rack.....10 Lbs. (4.54 Kg)
Cargo (Rear Seats
Folded Down).....340 Lbs. (154.2 Kg)

STANDARD AIRPLANE WEIGHTS

Basic Empty Weight.....See Page 1-11
Useful Load.....Varies with installed
equipment. See Section
VI for specific airplane
weight (pg. 6-5).

CABIN AND ENTRY DIMENSIONS

Cabin Width (Maximum).....43.5 In. (110.5 cm)
Cabin Length (Maximum).....114 In. (290 cm)
Cabin Height (Maximum).....44.5 In. (113 cm)
Entry Width (Minimum).....29.0 In. (73.4 cm)
Entry Height (Minimum).....35.0 In. (88.9 cm)

SECTION I
GENERAL

MOONEY M20J

BAGGAGE SPACE AND ENTRY DIMENSIONS

Compartment Width.....24 In. (60.9 cm)
Compartment Length.....35 In. (88.9 cm)
Compartment Height.....35 In. (88.9 cm)
Compartment Volume.....17.0 Cu. Ft. (.476
cubic meters)
Cargo Area (with rear
seat folded down).....33.0 Cu. Ft. (.924
cubic meters)
Entry Height (Minimum).....20.5 In. (52.1 cm)
Entry Width.....17.0 In. (43.2 cm)
Ground to Bottom of Sill...46.0 In. (116.8 cm)

SPECIFIC LOADINGS

Wing Loading @ Maximum Gross
Weight.....16.4 Lbs./Sq. Ft.
(80.07 Kg/sq. m)
Power Loading @ Maximum
Gross Weight.....13.7 Lbs./HP
(6.21 Kg/HP)

IDENTIFICATION PLATE

All correspondence regarding your airplane should include the Serial Number as depicted on the identification plate. The identification plate is located on the left hand side, aft end of the tail cone, below the horizontal stabilizer leading edge.
The aircraft Serial Number and type certificate are shown.

SECTION I
GENERAL

MOONEY M20J

SYMBOLS, ABBREVIATIONS
& TERMINOLOGY

GENERAL AIRSPEED TERMINOLOGY & SYMBOLS

GS	GROUND SPEED - Speed of an airplane relative to the ground.
KCAS	KNOTS CALIBRATED AIRSPEED - The indicated speed of an aircraft, corrected for position and instrument error. Calibrated airspeed is equal to true airspeed in standard atmosphere at sea level.
KIAS	KNOTS INDICATED AIRSPEED - The speed of an aircraft as shown on its airspeed indicator. IAS values published in this handbook assume zero instrument error.
KTAS	KNOTS TRUE AIRSPEED - The airspeed of an airplane relative to undisturbed air which is KCAS corrected for altitude, temperature and compressibility.
Va	MANEUVERING SPEED - The maximum speed at which application of full available aerodynamic control will not overstress the airplane.
Vfe	MAXIMUM FLAP EXTENDED SPEED - The highest speed permissible with wing flaps in a prescribed extended position.
Vle	MAXIMUM LANDING GEAR EXTENDED SPEED - The maximum speed at which an aircraft can be safely flown with the landing gear extended.
Vlo	MAXIMUM LANDING GEAR OPERATING SPEED - The maximum speed at which the landing gear can be safely extended or retracted.

SECTION I
GENERAL

MOONEY M20J

- Vne NEVER EXCEED SPEED or MACH NUMBER - The speed limit that may not be exceeded at any time.
- Vno MAXIMUM STRUCTURAL CRUISING SPEED - The speed that should not be exceeded except in smooth air and then only with caution.
- Vs STALLING SPEED - The minimum steady flight speed at which the airplane is controllable.
- Vso STALLING SPEED - The minimum steady flight speed at which the airplane is controllable in the landing configuration.
- Vx BEST ANGLE-OF-CLIMB SPEED - The airspeed which delivers the greatest gain of altitude in the shortest possible horizontal distance.
- Vy BEST RATE-OF-CLIMB SPEED - The airspeed which delivers the greatest gain in altitude in the shortest possible time with gear and flaps up.

ENGINE POWER TERMINOLOGY

- BHP BRAKE HORSEPOWER - The power developed by the engine.
- MCP MAXIMUM CONTINUOUS POWER - The maximum power for take off, normal, abnormal or emergency operations.
- MP MANIFOLD PRESSURE - Pressure measured in the engine's induction system and is expressed in inches of mercury (Hg).
- RPM REVOLUTIONS PER MINUTE - Engine speed.
- NRP NORMAL RATED POWER.

SECTION I
GENERAL

MOONEY M20J

ENGINE CONTROLS & INSTRUMENTS TERMINOLOGY

- Propeller Control Control used to select engine speed.
- Throttle Control Control used to select engine power, from the lowest through the highest power settings.
- Mixture Control Provides a mechanical linkage to fuel injector mixture control to control size of fuel feed aperture, therefore the air/fuel mixture. It is primary method to shut engine down.
- EGT A temperature measuring system that senses EXHAUST GAS TEMPERATURE (EGT) in the exhaust pipe. The EGT gauge is the primary indication for mixture leaning in cruise flight at 75% power or less.
- Tachometer Instrument that indicates engine rotational speed. Speed is shown as propeller revolutions per minute (RPM).
- Propeller Governor Device that regulates RPM of engine/propeller by increasing or decreasing propeller pitch through a pitch change mechanism in propeller hub.

AIRPLANE PERFORMANCE AND FLIGHT PLANNING
TERMINOLOGY

- Demonstrated Crosswind Velocity The velocity of the crosswind component for which adequate control of the airplane during takeoff and landing test was actually demonstrated during certification. The value shown is not considered to be limiting.
- g Acceleration due to gravity.
- Service Ceiling The maximum altitude at which aircraft at gross weight has the capability of climbing at the rate of 100 ft/min.

SECTION I
GENERAL

MOONEY M20J

Unusable Fuel Fuel remaining after a runout test has been completed in accordance with governmental regulations.

Usable Fuel Fuel available for airplane propulsion.

METEOROLOGICAL TERMINOLOGY

AGL Above ground level.

Density Altitude Altitude as determined by pressure altitude and existing ambient temperature. In standard atmosphere (ISA) density and pressure altitude are equal. For a given pressure altitude, the higher the temperature, the higher the density altitude.

Indicated Pressure Altitude The number actually read from an altimeter when, and only when, the barometric subscale has been set to 29.92 inches of mercury or 1013.2 millibars.

ISA INTERNATIONAL STANDARD ATMOSPHERE assumes that (1) The air is a dry perfect gas; (2) The temperature at sea level is 15 degrees Celsius (59 degrees F); (3) The pressure at sea level is 29.92 inches Hg (1013.2 mb); (4) The temperature gradient from sea level to the altitude at which the temperature is -56.5 degrees C (-69.7 degrees F) is -0.00198 degrees C (-0.003564 degrees F) per foot.

OAT OUTSIDE AIR TEMPERATURE - The free air static temperature, obtained either from inflight temperature indications or ground meteorological sources. It is expressed in degrees Celsius (previously Centigrade).

Pressure Altitude The indicated pressure altitude corrected for position and instrument error. In this handbook, altimeter

SECTION I
GENERAL

MOONEY M20J

instrument errors are assumed to be zero.

Station Pressure Actual atmospheric pressure at field elevation.

WEIGHT AND BALANCE TERMINOLOGY

Arm The horizontal distance from the reference datum to the center of gravity (C.G.) of an item.

Basic Empty Weight The actual weight of the airplane and includes all operating equipment (including optional equipment) that has a fixed location and is actually installed in the aircraft. It includes the weight of the unusable fuel and full oil.

Center of Gravity (C.G.) The point at which an airplane would balance if suspended. Its distance from the reference datum is found by dividing the total moment by the total weight of the airplane.

C.G. Arm The arm obtained by adding the airplane's individual moments and dividing the sum by the total weight.

C.G. in percent MAC Center of Gravity expressed in percent of mean aerodynamic chord.

C.G. Limits The extreme center of gravity locations within which the airplane must be operated at a given weight.

MAC Mean Aerodynamic Chord.

Maximum Weight The maximum authorized weight of the aircraft and its contents as listed in the aircraft specifications.

SECTION I
GENERAL

MOONEY M20J

Moment	The product of the weight of an item multiplied by its arm. (Moment divided by a constant is used to simplify balance calculations by reducing the number of digits.)
Reference Datum	An imaginary vertical plane from which all horizontal distances are measured for balance purposes.
Station	A location along the airplane fuselage usually given in terms of distance from the reference datum.
Tare	The weight of chocks, blocks, stands, etc. used when weighing an airplane, and is included in the scale readings. Tare is deducted from the scale reading to obtain the actual (net) airplane weight.
Useful Load	The basic empty weight subtracted from the maximum weight of the aircraft. This load consists of the pilot, crew if applicable, fuel, passengers, and baggage.

SECTION I
GENERAL

MOONEY M20J

MEASUREMENT CONVERSION TABLES

LENGTH	
U. S. Customary Unit	Metric Equivalents
1 inch	2.54 centimeters
1 foot	0.3048 meter
1 yard	0.9144 meter
1 mfl (statute, Land)	1, 609 meters
1 mile (nautical, international)	1, 852 meters

AREA	
U. S. Customary Unit	Metric Equivalents
1 square inch	6.4516 sq. centimeters
1 square foot	929.030 sq. centimeters
1 square yard	0.836 sq. meter

VOLUME OR CAPACITY	
U. S. Customary Unit	Metric Equivalents
1 cubic inch	16.387 cubic centimeters
1 cubic foot	0.028 cubic meter
1 cubic yard	0.765 cubic meter

U.S. Customary Liquid Measure	Metric Equivalents
1 fluid ounce	29.573 milliliters
1 pint	0.473 liter
1 quart	0.946 liter
1 gallon	3.785 liters

SECTION I
GENERAL

MOONEY M20J

VOLUME OR CAPACITY (CONT.)		
U.S. Customary Dry Measure		Metric Equivalents
1 pint		0.551 liter
1 quart		1.101 liters
British Imperial Liquid and Dry Measure	U. S. Equivalents	Metric Equivalents
1 fluid ounce	0.961 U.S. fluid ounce, 1.734 cubic inches	28.412 milliliters
1 pint	1.032 U.S. dry pints, 1.201 U.S. liquid pts., 34.678 cubic inches	568.26 milliliters
1 quart	1.032 U.S. dry quarts 1.201 U.S. liquid qts., 69.354 cubic inches	1.136 liters
1 gallon	1.201 U.S. 277.420 cubic inches	4.546 liters

SECTION I
GENERAL

MOONEY M20J

WEIGHT	
U. S. Customary Unit (Avoirdupois)	Metric Equivalents
1 grain	64.79891 milligrams
1 dram	1.772 grams
1 ounce	28.350 grams
1 pound	453.59237 grams

SECTION II
LIMITATIONS

MOONEY M20J

TABLE OF CONTENTS

TITLE	PAGE
INTRODUCTION.....	2-2
AIR SPEED LIMITATIONS.....	2-3
AIR SPEED INDICATOR MARKINGS.....	2-4
POWER PLANT LIMITATIONS.....	2-5
POWER PLANT INSTRUMENT MARKINGS.....	2-6
WEIGHT LIMITS.....	2-7
CENTER OF GRAVITY (GEAR DOWN).....	2-7
NOISE LIMITS.....	2-7
MANEUVER LIMITS.....	2-8
FLIGHT LOAD FACTOR LIMITS.....	2-8
KINDS OF OPERATION LIMITS.....	2-8
FUEL LIMITATIONS.....	2-9
OPERATING ALTITUDE LIMITATIONS.....	2-10
OTHER INSTRUMENTS & MARKINGS.....	2-10
DECALS & PLACARDS.....	2-10
CABIN INTERIOR.....	2-10
FUSELAGE INTERIOR.....	2-16
EXTERIOR.....	2-16
INFORMATIONAL.....	2-18
OPTIONAL.....	2-19/2-20
	BLANK

SECTION II
LIMITATIONS

MOONEY M20J

INTRODUCTION

Section II includes operating limitations, instrument markings, and basic placards necessary for the safe operation of the airplane, its engine, standard systems and standard equipment. The limitations included in this section have been approved by the Federal Aviation Administration. When applicable, limitations associated with optional systems or equipment such as autopilots are included in Section IX.

! NOTE !

The airspeeds listed in the Airspeed Limitations chart (Figure 2-1) and the Airspeed Indicator Markings chart (Figure 2-2) are based on Airspeed Calibration data shown in Section V with the normal static source. If the alternate static source is being used, ample margins should be observed to allow for the airspeed calibration variations between the normal and alternate static sources as shown in Section V.

Your Mooney is certificated under FAA Type Certificate No. 2A3 as a Mooney M20J.

SECTION II
LIMITATIONS

MOONEY M20J

AIRSPEED LIMITATIONS

Airspeed limitations and their operational significance are shown in Figure 2-1. This calibration assumes zero instrument error.

	SPEED	KCAS	KIAS	REMARKS
V NE	Never Exceed Speed	195	198	Do not exceed this speed.
V NO	Maximum Structural Cruising Speed	174	176	Do not exceed this speed except in smooth air, and then with caution.
V A	Maneuvering Speed:lb/Kg			Do not make full or abrupt control movements above this speed.
	1941/880	95	97	
	2250/1021	103	105	
	2470/1120	108	110	
	2740/1243	114	116	
V FE	Maximum Flap Extended Speed			Do not exceed these speeds with given flap settings.
	0-15degrees	126	132	
	15° - full down	109	115	
V LE	Maximum Landing Gear Extended Speed	162	165	DO NOT exceed this speed with LDG GR extended.
V LO	Max. Speed for GR. OPS.			DO NOT extend or retract LDG GR above these speeds.
	GR. Retract.	104	107	
	GR. Extend.	138	140	
	Maximum Pilot Window Open Speed	130	132	Do not exceed this speed with pilot window open.

FIGURE 2-1 AIRSPEED LIMITATIONS

SECTION II
LIMITATIONS

MOONEY M20J

AIRSPPEED INDICATOR MARKINGS

Airspeed indicator markings, their color code and operational significance are shown in Figure 2-2.

MARKING	IAS VALUE OR RANGE (KIAS)	SIGNIFICANCE
White Arc - Full Flap Operating Range	55-115	Lower limit is maximum weight V_{SO} at most FWD CG in landing configuration. Upper limit is maximum speed permissible with full flaps extended.
Green Arc - (Normal Operating Range)	63-176	Lower limit is maximum weight V_S at most FWD CG with flaps retracted. Upper limit is maximum structural cruising speed.
Yellow Arc (Caution Range)	176-198	Operations must be conducted with caution and only in smooth air.
Radial Red Line	198	Maximum speed for all operations.

FIGURE 2-2 AIRSPPEED INDICATOR MARKINGS

SECTION II
LIMITATIONS

MOONEY M20J

POWER PLANT LIMITATIONS

Number of Engines.....1
Engine Manufacturer.....Avco Lycoming
Engine Model Number.....IO-360-A3B6D
Engine Operating Limits for

Takeoff and Continuous Operations:

Maximum Power.....200 BHP
Maximum Engine Speed.....2700 RPM
Transient Engine RPM Limit.....2970 RPM for
3 seconds or less
Max. Cylinder Head Temperature....475 Degrees F
(246 Degrees C)
Maximum Oil Temperature.....245 Degrees F
(118 Degrees C)

Oil Pressure

Normal Operating.....30-80-PSI
Minimum (IDLE ONLY).....25 PSI
Maximum (cold oil).....100 PSI

Fuel Pressure

Minimum-----14 PSI
Maximum-----30 PSI

Fuel Grade (Color).....100/130 (Green)
100LL (Blue)

Propeller Manufacturer.....McCaughey*
Propeller Model No...B2D34C214/90DHB-16E or -16EP*
Propeller Diameter:

Min.....73.0 In. (185.4 cm)*
Max. (No cutoff allowed)...74.0 In. (187.9 cm)*

Propeller Blade Angles @ 30 In. sta.:

Low.....13.9 Degrees +/- .2 Degrees*
High.....33.3 Degrees +/- .5 Degrees*

Propeller Operating Limits.....2700 RPM

*OPTION: Hartzell HC-C2YK-18F/F7666A-3Q
73.0 In. (185.4 cm) (No Cutoff Allowed)
Low: 14.1 +/- .1 Degree
High: 29.3 Degrees to 31.3 Degrees

100LL fuel is calibrated at 5.82 lb/gal.

100/130 octane fuel is calibrated at 6.0 lb/gal.

NOTE

No cutoff allowed on propeller when
de-ice boots are installed.

SECTION II
LIMITATIONS

MOONEY M20J

POWER PLANT INSTRUMENT MARKINGS

INSTRUMENT	YELLOW ARC (CAUTION RANGE)	GREEN ARC NORMAL OPERATING	REDLINE MAXIMUM LIMIT
Tachometer	1500-1950	1950-2700	2700 RPM
Cylinder Head Temperature		300-450 Degrees F 149-232 (Deg. C)	475 Degrees F 246 (Deg. C)
Oil Temperature	75 Deg. Min. Grnd. Run-up *** NO REDLINE	150-245 Degrees F 65-118 (Deg. C)	245 Degrees F 118 (Deg. C)
Oil Pressure	(IDLE ONLY) 25 - 60 * **	60-90 PSI	100 PSI
Fuel Pressure	Radial Red Line Min. 14 PSI	14-30 PSI	30 PSI

* Yellow arc (starting and warm-up range).....

90-100 PSI

**Radial red line (minimum idling).....25 PSI

*** Needle moves off White Dot.

! NOTE !

Refer to AVCO Lycoming Engine Maintenance and Operators Manual Section on Engine Specifications and Operating Limits for recommended cruise power and temperature limitations.

SECTION II
LIMITATIONS

MOONEY M20J

WEIGHT LIMITS

Maximum Weight (takeoff
and landing).....2740 lb. (1243 Kg.)
Maximum Weight in Baggage
Compartment.....120 lb. (54.4 Kg.) @
Fus. Sta. 95.5
Maximum Weight in Hatrack.....10 lb. (4.54 Kg.) @
Fus. Sta. 119.0
Maximum Weight in Cargo Area
(Rear seats folded down).....340 lbs. (154.2
Kg) @ Fus. Sta. 70.7

CENTER OF GRAVITY (GEAR DOWN)

Most Forward-41.0 In. (Fus. Sta. in IN.)
13.4% MAC.....2250 lb.
(1021 Kg.)
Intermediate Forward-41.8 In. (Fus. Sta. in In.)
14.7% MAC.....2470 lb.
(1120 Kg.)
Forward Gross-45.0 IN. (Fus. Sta. in IN.)
20.1% MAC.....2740 lb.
(1243 Kg.)
Aft Gross-50.1 IN. (Fus. Sta. in IN.)
38.7% MAC.....2740 lb.
(1243 Kg.)
MAC (at Wing Sta. 93.83).....59.18 In.

Datum (station zero) is 5 inches aft of the center
line of the nose gear attaching bolts, and 33
inches forward of the wing leading edge at wing
station 59.25.

NOISE LIMITS

The certificated noise level for the M20J at 2740
lbs. (1243 Kg.) maximum weight is 74.0 dB (A). No
determination has been made by the Federal
Aviation Administration that the noise levels of
this airplane are or should be acceptable or
unacceptable for operation at, into, or out of,
any airport.

SECTION II
LIMITATIONS

MOONEY M20J

MANEUVER LIMITS

This airplane must be operated as a Normal Category airplane. Aerobatic maneuvers, including spins, are prohibited.

Extreme sustained sideslips may result in fuel venting thereby causing fuel fumes in the cabin.

//////////
///WARNING///
//////////

Takeoff maneuvers, prolonged sideslips or steep descents when the selected fuel tank contains less than 8 gallons (48.0 lbs., 30.3 liters, 6.6 IMP. Gal.) of fuel have not been demonstrated and may cause loss of power.

NOTE

Up to 290 foot altitude loss may occur during stalls at maximum weight.

Slow throttle movement required at airspeed above 165 KIAS. Above 165 KIAS, rapid throttle movement may result momentary propeller RPM overspeed.

FLIGHT LOAD FACTOR LIMITS

Maximum Positive Load Factor

Flaps Up.....+3.8 g.
Flaps Down (33 Degrees).....+2.0 g.

Maximum Negative Load Factor

Flaps Up.....-1.5 g.
Flaps Down.....0.0 g.

KINDS OF OPERATION LIMITS

This is a Normal Category airplane approved for VFR/IFR day or night operations when equipped in accordance with FAR 91.

SECTION II
LIMITATIONS

MOONEY M20J

DO NOT OPERATE IN KNOWN ICING CONDITIONS.

TAKEOFFS WITH COWL FLAPS INOPERATIVE
ARE PROHIBITED

Autopilot Limitations - See Section IX.

FUEL LIMITATIONS

NOTE

A reduced fuel quantity indicator is installed in each tank. The bottom tip of these indicators shows the 25 U.S. gallon (94.7 liters) (20.8 IMP. Gal.) usable fuel level in each tank.

NOTE

An optional visual fuel quantity gauge may be installed on top of each tank and is to be used as a reference for refueling tanks only.

Standard Tanks (2)	
	33.25 U.S. Gal. each.....(125.9 Liters)
	(27.7 Imp. Gal.)
Total Fuel:	66.5 U.S. Gal.....(251.8 Liters)
	(55.4 Imp. Gal.)
Usable Fuel:	64.0 U.S. Gal.....(247.4 Liters)
	(53.3 Imp. Gal.)
Unusable Fuel:	2.5 U.S. Gal.....(9.5 Liters)
	(2.1 Imp. Gal.)
Fuel Grade (and Color):	100/130 minimum grade aviation fuel (green). 100LL (low lead) aviation fuel (blue) with a lead content limited to 2 cc per gallon is also approved.

SECTION II
LIMITATIONS

MOONEY M20J

~~~~~  
~ CAUTION ~  
~~~~~

To reduce the possibility of ice formation within the aircraft or engine fuel system it is permissible to add ISO-PROPYL alcohol to the fuel supply in quantities NOT TO EXCEED 1% of the total fuel volume per tank. DO NOT add other additives to the fuel system due to potential deteriorating effects within the fuel system.

OPERATING ALTITUDE LIMITATIONS

If this airplane is not equipped with an approved oxygen system and flight operations above 12,500 feet are desired, this airplane must be, (1) equipped with supplemental oxygen in accordance with FAR 23.1441, (2) operated in accordance with FAR 91 or FAR 135.

OTHER INSTRUMENTS AND MARKINGS

The following standard equipment is normally vacuum operated.

1. Artificial horizon.
2. Directional Gyro.

DECALS AND PLACARDS

CABIN INTERIOR

The following placards must be installed inside the cabin at the locations specified.

SECTION II LIMITATIONS

MOONEY M20J

OPERATIONAL LIMITATIONS	
<p>THIS AIRPLANE MUST BE OPERATED AS A NORMAL CATEGORY AIRPLANE IN COMPLIANCE WITH THE OPERATING LIMITATIONS STATED IN THE FORM OF PLACARDS, MARKINGS AND MANUALS. NO AEROBATIC MANEUVERS, INCLUDING SPINS, ARE APPROVED. MAXIMUM SPEED WITH LANDING GEAR EXTENDED, 165 KIAS. MAXIMUM SPEED TO RETRACT GEAR, 107 KIAS. MAXIMUM SPEED TO EXTEND GEAR, 140 KIAS. MAXIMUM MANEUVERING FLIGHT LOAD FACTOR - FLAPS UP +3.8, -1.5; DN +2.0, -0.</p>	
EMERGENCY MANUAL GEAR EXTENSION	
<ol style="list-style-type: none"> 1. PULL LANDING GEAR CIRCUIT BREAKER. 2. PUT GEAR SWITCH IN GEAR DOWN POSITION. 3. PUSH RELEASE TAB FORWARD AND LIFT UP RED HANDLE. 4. PULL T-HANDLE STRAIGHT UP (12 TO 20 INCHES). 5. ALLOW T-HANDLE TO RETURN TO ORIGINAL POSITION. 6. REPEAT UNTIL GEAR DOWN LIGHT COMES ON (12 TO 20 PULLS) IF TOTAL ELECTRICAL FAILURE - SEE MECHANICAL INDICATOR. 	
CAUTION	
<ol style="list-style-type: none"> 1. TURN OFF STROBE LITES WHEN TAXIING NEAR OTHER ACFT OR WHEN FLYING IN FOG OR IN CLOUDS. STD POSITION LITES MUST BE USED FOR ALL NIGHT OPERATIONS. 2. IN CASE OF FIRE TURN OFF CABIN HEAT. 3. DO NOT SCREW VERNIER CONTROLS CLOSER THAN 1/8" FROM NUT FACE. 	

On Left Side Panel

DEFROSTER PULL ON	CABIN HEAT PULL ON	CABIN VENT PULL ON
----------------------	-----------------------	-----------------------

CHECK LIST		
T	CONTROLS	RUN-UP DOOR
A	FUEL	PROP WINDOW
K	INSTRUMENTS	WING FLAPS RAM AIR
E	TRIM	SEAT LATCH MIXTURE
O	COWL FLAPS	BELT/HARNESS BOOST PUMP
F	CONDUCT TRIM CHECK PRIOR TO FLIGHT, SEE PILOT'S OPERATING HANDBOOK.	
L	BELT/HARNESS	MIXTURE GEAR
D	FUEL	WING FLAPS PROP
G	BOOST PUMP	RAM AIR

DO NOT OPEN
ABOVE 132 KIAS

On Pilots Window

Console Below Controls

SECTION II
LIMITATIONS

MOONEY M20J

PULL FOR
ALTERNATE
STATIC SOURCE

On Lower Left
Instrument
Panel

AVOID CONT. OPERATION BETWEEN
1500 & 1950 RPM W/POWER SETTINGS
BELOW 15" HG. MANIFOLD PRESSURE.

On Right Instrument Panel Adjacent
to Tachometer (McCauley propeller only).

RAM AIR PARK BRAKE
PULL ON PULL ON

On Lower Console Below Controls

← PUSH TO RELEASE

Between Seats on
Emergency Gear
Extension Release





MIKE



PHONE

Lower Left
Instrument Panel

AVIONICS MASTER ON  OFF	+ + + + + + +	WARNING: FOR AVIATION EMERGENCY USE ONLY. UNLICENSED OPERATION UNLAWFUL. ELT ON  ARM
--	---------------	---

ELT Placard - Top Right Instrument Panel
(Legend Varies With Equipment Installed)

SECTION II
LIMITATIONS

MOONEY M20J

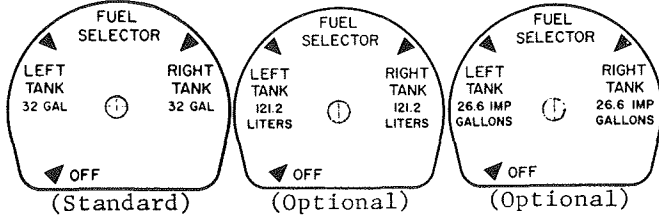

- Floor Board Aft of Console -

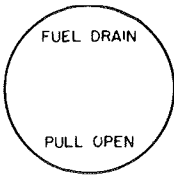

Floor Board Fwd Of Pilot Seat

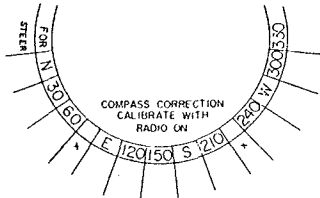

On Magnetic Compass

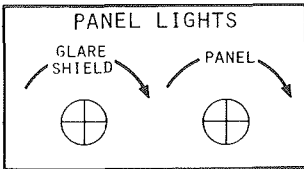

Right Lower Radio Panel

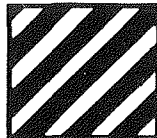

RED
WHITE

On Retract Tube
(Displayed thru window on floorboard when LDG. GR. is retracted.)

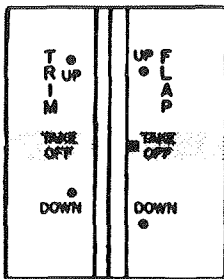

On Lower Engine Control Console



Above Inside Door Handle

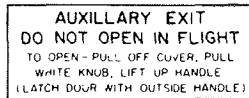

Above Inside Baggage Door Handle

SECTION II
LIMITATIONS

MOONEY M20J

FLAPS UP

Right Console
Above and Below
Flap Switch

FLAPS DN

GEAR



DOWN



On Retract Tube

(Displayed thru window in
floorboard when LDG. GR.
is extended.)

THROTTLE
PUSH INCREASE

PROP
PUSH INCREASE

MIXTURE
PUSH RICH

Above Each Control on Lower Instrument Panel

WARNING: DO NOT EXCEED 10 LBS (4.5 Kg) IN THIS COMPARTMENT
USE FOR STORAGE OF LIGHT SOFT ARTICLES ONLY
SEE AIRCRAFT LOADING SCHEDULE DATA
FOR BAGGAGE COMPARTMENT ALLOWABLE



Above Baggage Compartment On Hatrack Shelf.

WARNING: DO NOT EXCEED 120 LBS
(54.4 Kg) IN THIS COMPARTMENT
SEE AIRCRAFT LOADING SCHEDULE DATA
FOR BAGGAGE COMPARTMENT ALLOWABLE

On Top Baggage Door Jamb.

WARNING:
DO NOT EXCEED 170 LBS
(77.1 Kg) ON THIS SEAT BACK.
SEE AIRCRAFT LOADING SCHEDULE DATA
FOR BAGGAGE COMPARTMENT ALLOWABLE

On Forward End of Rear Seat Bottom Structure

SECTION II
LIMITATIONS

MOONEY M20J

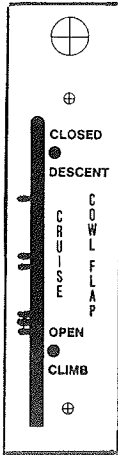

**COWL FLAP
CLOSED**

On Console Above
& Below Cowl Flap
Switch
(Under Mixture Control)

**COWL FLAP
OPEN**

On Lower Console Below
Flap Switch

**FLAP EXTENSION SPEED
MAXIMUM**

15°	132 KIAS
FULL	115 KIAS

Above Flap Switch

SECTION II
LIMITATIONS

MOONEY M20J

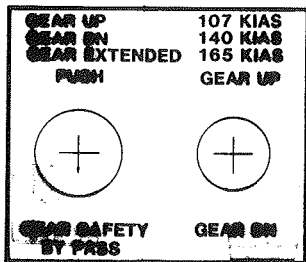

Upper Center
Instrument Panel

GLARE
SHIELD PANEL

Under Right Radio
Panel (Fuses)

- LOAD + - ALT +

Under circuit
Breaker Panel
(Fuses)

FUSELAGE INTERIOR

The following placards must be installed inside the fuselage at the locations specified.

MAINTAIN ↓

LEVEL HERE

On Hydraulic
Brake Reservoir

EXTERIOR:

The following placards must be installed on the exterior of the aircraft at the locations specified.

TIRE PRESSURE 30 LBS.

On Main Gear Doors

SECTION II
LIMITATIONS

MOONEY M20J

TIRE PRESSURE 49 LBS

On Nose Gear Door

**FUEL-100 (GREEN) OR
100 LL (BLUE) MIN. OCT.**

32 U.S. GAL

STANDARD

**FUEL-100 (GREEN) OR
100 LL (BLUE) MIN OCT**

121.2 LITERS USEABLE

OPTIONAL

On Fuel Tank Caps

**FUEL-100 (GREEN) OR
100 LL (BLUE) MIN OCT
26.6 IMP GAL USEABLE
OPTIONAL**



TOWING LIMITS

**WARNING
DO NOT EXCEED
TOWING LIMITS**



On Nose Gear Leg

DO NOT PUSH

On Leading Edge of
Horizontal Stabilizer
and Trailing Edge of
Both Sides of Rudder

NO STEP

On Inboard End Of Flaps, Wing Leading
Edges and Wing Ahead Of Flaps

HOIST POINT

On Underside of Wings (2 pcs)

SECTION II
LIMITATIONS

MOONEY M20J

FUEL DRAIN Under each Wing near Sump Drains.	PITOT DRAIN Under Left Hand Wing Leading Edge near Fuselage
GASCOLATOR DRAIN Under Fuselage Aft of Nose Wheel Well	STATIC DRAIN Under Tailcone Aft of Wing Trailing Edge

INFORMATIONAL:

The following placards are not required for airworthiness but are provided for informational purposes or aesthetics.

IMPORTANT INSTRUCTIONS

ALWAYS ADD WATER - NEVER ADD ACID.
NEVER FILL OVER BAFFLE NOR MORE THAN
1/4" OVER THE TOPS OF SEPARATORS.
FULLY CHARGED SPECIFIC GRAVITY - 1.275
RECHARGE REQUIRED WHEN SP. GR. REACHES 1.225
CHARGING RATES:
START - 4 AMPERES FINISH - 2 AMPERES
MAXIMUM TEMPERATURE ON CHARGE - 120° F (49° C)
KEEP CHARGED — PREVENT FREEZING
CARE SHOULD BE TAKEN NOT TO SPILL BATTERY
ACID WHEN SERVICING OR REMOVING BATTERY

Above Battery On Aft Side
Baggage Compartment
Bulkhead

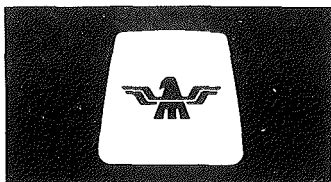

Front Center of
Control Wheels

DIM OFF BRT
CABIN LIGHT

On Headliner By
Interior Light Switches

AIR VENT
— OPEN —>

On Headliner Near
overhead shutoff valve.

SECTION II
LIMITATIONS

MOONEY M20J



CRUISE POWER SCHEDULE

1. BEST POWER IS 55°C RICH OF PEAK EST. 2. ECONOMY CRUISE IS 1/4°C RICH OF PEAKEST

NOTE: ADD 4" M.P. FOR EACH 10°C DAY TEMPERATURE SURPASS THE DESIRED M.P. USE THE NEXT HIGHER RPM/TEMPERATURE CORRECTION TO M.P.	ALTITUDE FEET DAY	RPM	75% POWER (100 BHP)		65% POWER (110 BHP)		60% POWER (120 BHP)		55% POWER (130 BHP)														
			2400	2500	2600	2700	2400	2500	2600	2700	2400	2500	2600	2700	2400	2500	2600	2700					
FUEL CONSUMPTION PER HOUR	6.3	10.4	10.3	10.8	9.7	9.8	9.9	10.2	9.1	9.3	9.4	9.6	8.4	8.6	8.7	8.8	9.1	7.8	8.1	8.2	8.3	8.6	
DAY TEMPERATURE	12.0	12.2	12.3	12.5	11.3	11.5	11.7	11.9	10.3	10.8	11.0	11.2	9.9	10.0	10.2	10.4	10.7	9.2	9.4	9.5	9.6	10.0	
DAY BELOW STANDARD	27.0	28.3	28.4	28.5	28.5	28.3	28.3	28.0	26.0	25.8	25.6	25.6	25.1	25.0	24.7	24.7	24.5	23.3	23.3	23.3	23.3	21.0	18.0
DAY ABOVE STANDARD	26.8	25.6	24.4	23.3	23.3	24.1	23.0	23.0	23.3	22.6	21.9	21.7	20.3	20.3	20.1	20.1	19.3	18.2	18.2	18.2	18.2	16.9	15.0
6000			24.4	23.2	24.9	23.9	22.9	21.8	23.3	22.4	21.5	20.3	21.7	21.7	20.3	20.1	19.1	18.2	18.2	18.2	18.2	16.6	17.6
8000			24.1	23.1	24.4	23.6	22.7	21.7	22.2	22.1	21.3	20.4	21.3	20.6	19.8	19.1	18.2	18.2	18.2	18.2	18.2	16.6	17.6
10000			23.6		22.7	21.7							21.2	20.4	19.8	19.0	18.2	18.2	18.2	18.2	18.2	16.6	17.6
15000					22.7	21.7							21.1	20.2	19.6	18.8	18.2	18.2	18.2	18.2	18.2	16.6	17.6
18000													21.4									19.3	18.3
20000																						19.6	18.9
25000																						19.6	18.9
30000																						19.3	18.3
35000																						19.3	18.3
40000																						19.3	18.3
45000																						19.3	18.3
50000																						19.3	18.3
55000																						19.3	18.3
60000																						19.3	18.3
65000																						19.3	18.3
70000																						19.3	18.3
75000																						19.3	18.3
80000																						19.3	18.3
85000																						19.3	18.3
90000																						19.3	18.3
95000																						19.3	18.3
100000																						19.3	18.3

FOR MORE DETAILED INFORMATION CONSULT THE POH - SECTION V.

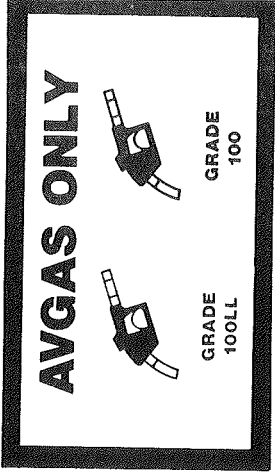

WING-AFT of FUEL FILLER CAPS

ON Pilots Sunvisor

OPTIONAL:
See Section IX Supplements For Optional Placards
Required.

SECTION III
EMERGENCY PROCEDURES

MOONEY M20J

TABLE OF CONTENTS

TITLE	PAGE
INTRODUCTION.....	3-2
AIRSPEDS FOR EMERGENCY OPERATIONS.....	3-3
ANNUNCIATOR PANEL WARNING LIGHTS.....	3-4
ENGINE.....	3-5
POWER LOSS-DURING TAKEOFF ROLL.....	3-5
POWER LOSS-AFTER LIFTOFF & DURING CLIMB.....	3-5
POWER LOSS - IN FLIGHT.....	3-5
ENGINE RESTART PROCEDURE-IN FLIGHT.....	3-6
ENGINE ROUGHNESS.....	3-7
COWL FLAPS FAILURE-FULL CLOSED POSITION.....	3-7
HIGH CYLINDER HEAD TEMPERTURE.....	3-8
HIGH OIL TEMPERATURE.....	3-8
LOW OIL PRESSURE.....	3-8
ENGINE DRIVEN FUEL PUMP FAILURE.....	3-9
FIRES.....	3-10
ENGINE FIRE - GROUND.....	3-10
ENGINE FIRE - IN FLIGHT.....	3-10
ELECTRICAL FIRE - IN FLIGHT.....	3-11
EMERGENCY DESCENT PROCEDURE.....	3-12
GLIDE.....	3-13
LANDING EMERGENCY.....	3-13
POWER OFF - GEAR RETRACTED OR EXTENDED.....	3-13
POWER ON - GEAR RETRACTED.....	3-14
SYSTEM EMERGENCIES.....	3-14
PROPELLER.....	3-14
FUEL.....	3-14
ELECTRICAL.....	3-14
LANDING GEAR.....	3-15
OXYGEN.....	3-17
ALTERNATE STATIC SOURCE.....	3-17
UNLATCHED DOOR IN FLIGHT.....	3-17
ICE PROTECTION.....	3-18
EMERGENCY EXIT OF AIRCRAFT.....	3-19
SPINS.....	3-19
OTHER EMERGENCIES.....	3-20

SECTION III
EMERGENCY PROCEDURES

MOONEY M20J

INTRODUCTION

This section provides the recommended procedures to follow during adverse flight conditions. The information is presented to enable you to form, in advance, a definite plan of action for coping with the most probable emergency situations which could occur in the operation of your airplane.

As it is not possible to have a procedure for all types of emergencies that may occur, it is the pilot's responsibility to use sound judgement based on experience and knowledge of the aircraft to determine the best course of action. Therefore, it is considered mandatory that the pilot read the entire manual, especially this section before flight.

When applicable, emergency procedures associated with optional equipment such as autopilots are included in Section IX.

NOTE

All airspeeds in this section are indicated (IAS) and assume zero instrument error unless stated otherwise.

SECTION III
EMERGENCY PROCEDURES

MOONEY M20J

AIRSPEEDS FOR EMERGENCY OPERATIONS

ENGINE FAILURE after TAKEOFF

Wing Flaps UP.....85 KIAS
Wing Flaps DOWN.....75 KIAS

MAXIMUM GLIDE SPEED

2740 lbs/1243 Kg.....91 KIAS
2500 lbs/1134 Kg.....88 KIAS
2300 lbs/1043 Kg.....85 KIAS

MANEUVERING SPEED

2740 lbs/1243 Kg.....116 KIAS
2470 lbs/1120 Kg.....110 KIAS
2250 lbs/1021 Kg.....105 KIAS

PRECAUTIONARY LANDING with ENGINE POWER

Flaps DOWN.....75 KIAS

EMERGENCY DESCENT (GEAR UP)

Smooth Air.....198 KIAS
Turbulent Air
2740 lb/1243 Kg.....116 KIAS
2470 lb/1120 Kg.....110 KIAS
2250 lb/1021 Kg.....105 KIAS

EMERGENCY DESCENT (GEAR DOWN)

Smooth Air.....165 KIAS
Turbulent Air
2740 lb/1243 Kg.....116 KIAS
2470 lb/1120 Kg.....110 KIAS
2250 lb/1021 Kg.....105 KIAS

SECTION III
EMERGENCY PROCEDURES

MOONEY M20J

ANNUNCIATOR PANEL WARNING LIGHTS

WARNING LIGHT

FAULT & REMEDY

Gear Unsafe LDG. GR. in transit or not fully extended or retracted. Refer to "Failure of Landing Gear to Extend Electrically", pg. 3-15 or "Failure of Landing Gear to Retract", page 3-16.

Left or Right Fuel Low 2 1/2 to 3 gallons of usable fuel remain in the respective tanks. Switch to fuller tank.

VAC (Flashing) Suction is below 4.25 In. Hg.

VAC (Steady) Suction is above 5.5 In. Hg.

NOTE

Attitude and directional gyros are unreliable when VAC light is illuminated (steady or flashing). Vacuum system should be checked and/or adjusted as soon as practicable.

Volts (Flashing) Low voltage. Refer to "Alternator Low Voltage" on page 3-15.

Volts (Steady) Overvoltage or tripped Voltage Relay. Refer to "Alternator Failure" on page 3-14.

Ram Air Ram Air light is ON when landing gear is extended. Close Ram Air before landing.

Start Power ON Switch or relay has malfunctioned and starter is energized. Flight should be terminated as soon as practicable. Engine damage may result.

SECTION III
EMERGENCY PROCEDURES

MOONEY M20J

ENGINE

POWER LOSS - DURING TAKEOFF ROLL

Throttle.....CLOSED
Brakes.....APPLY (Maximum)
Fuel Selector.....OFF
Magneto/Starter Switch.....OFF
Master.....OFF

POWER LOSS - AFTER LIFTOFF AND DURING CLIMB

Airspeed.....85 KIAS
Fuel selector.....OTHER TANK (fullest tank)
Throttle.....Full FORWARD
Propeller.....Full Forward (High RPM)
Mixture.....Full RICH
Magneto switch.....Verify on BOTH
Fuel Boost Pump.....ON

If engine does not restart, proceed to POWER OFF
LANDING, page 3-9.

POWER LOSS - IN FLIGHT

Immediately upon noting any condition that could eventually lead to an engine failure (loss of oil or fuel system pressure, or rough engine operation) perform the following checks if time and altitude permit.

Low Fuel Quantity.....Fuel selector to fullest tank
Low Fuel Pressure.....Aux. fuel pump on-off if no improvement noted
Mixture Control.....Full RICH
Magneto/Starter Switch.....Switch to LEFT and RIGHT single magneto operation; if no improvement, switch to BOTH

If no improvement is noted, proceed to LAND as soon as practicable.

SECTION III
EMERGENCY PROCEDURES

MOONEY M20J

ENGINE RESTART PROCEDURES - IN FLIGHT

Airspeed.....85 KIAS
Fuel Selector.....Verify on FULLEST TANK
Throttle.....OPEN 1/4 Travel
Propeller.....2700 RPM
Mixture.....FULL RICH
Fuel Pressure.....Verify in Green Arc

If no fuel pressure is noted:

Fuel Boost Pump.....ON
Magneto Starter/Swtich.....Check on "BOTH"
If engine does not restart after initial attempts:
Mixture.....IDLE CUTOFF (Initially)
then advance slowly toward RICH
until engine starts

After engine restarts:

Throttle.....Adjust as required
Propeller.....Adjust as required
Mixture.....RELEAN as power is restored

If engine does not restart establish best glide
speed and proceed to POWER OFF LANDING, page 3-13.

SECTION III
EMERGENCY PROCEDURES

MOONEY M20J

ENGINE ROUGHNESS

Engine Instruments.....CHECK
Fuel Selector.....OTHER TANK
Mixture.....READJUST for smooth operation
Magneto/Starter.. ..Select R then L then BOTH.

If roughness disappears on single
magneto, adjust power and continue.

//////////
///WARNING///
//////////

The engine may quit completely when one
magneto is switched off, if the other
magneto is faulty. If this happens,
close throttle to idle and mixture to
idle cutoff before turning magnetos ON
to prevent a severe backfire. When
magnetos have been turned back on,
proceed to POWER LOSS - IN FLIGHT on
page 3-5.

Severe roughness may be sufficient to cause
propeller separation. Do not continue to operate
a rough engine unless there is no other
alternative.

Throttle.....REDUCE--check if a lesser throttle
setting causes roughness to decrease.

If severe engine roughness cannot be eliminated
LAND as soon as practicable.

COWL FLAPS FAILURE IN FULL CLOSED POSITION

Acceptable engine operating temperatures can always be
maintained during flight with the cowl flaps failed in
the full closed position using the following:

Power.....AS REQUIRED
Mixture.....RICH
Airspeed.....120 KIAS
Cylinder Head & Oil Temperature.....MONITOR
in the normal operating range.

SECTION III
EMERGENCY PROCEDURES

MOONEY M20J

HIGH CYLINDER HEAD TEMPERATURE

Mixture.....READJUST to proper EGT/fuel
 flow for power being used
Cowl Flap.....OPEN as required
Airspeed.....INCREASE
Power.....REDUCE if temperature cannot
 be maintained within limits

HIGH OIL TEMPERATURE

NOTE

Prolonged high oil temperature indications will usually be accompanied by a drop in oil pressure. If oil pressure remains normal, then a high temperature indication may be caused by a faulty gauge or thermocouple.

Cowl Flaps.....OPEN as required
Airspeed.....INCREASE
Power.....REDUCE
Prepare for possible engine failure if temperature continues high.

LOW OIL PRESSURE

Monitor.....Oil temperature and pressure
Pressure below 25 PSI.....Expect engine failure,
 proceed to POWER OFF landing
 page 3-13.

SECTION III
EMERGENCY PROCEDURES

MOONEY M20J

FIRES

ENGINE FIRE-GROUND

Mixture.....IDLE CUTOFF (Full Aft)
Fuel Selector Valve.....OFF
Magneto/Starter Switch.....OFF
Master Switch.....OFF
Fire..... Extinguish with Fire Extinguisher

ENGINE FIRE-IN FLIGHT

Fuel Selector Valve.....OFF
Throttle.....CLOSED (Full Aft)
Mixture Control.....IDLE CUTOFF (Full Aft)
Magneto/Starter Switch.....OFF
Cabin Ventilation & Heating Controls.....CLOSED
(Controls Forward)
Cowl Flaps.....CLOSED
Landing Gear.....DOWN or UP, depending
on terrain
Wing Flaps.....EXTEND, as necessary

NOTE

If fire is not extinguished, attempt to increase airflow over the engine by increasing glide speed and open cowl flaps. Proceed with a POWER OFF landing as described on page 3-13. Do not attempt an engine restart.

SECTION III
EMERGENCY PROCEDURES

MOONEY M20J

ELECTRICAL FIRE- IN FLIGHT (Smoke in Cabin)

Master Switch.....OFF

//////////
///WARNING///
//////////

Stall warning is not available with
master switch OFF. Gear warning is not
available with master switch OFF.

Cabin Ventilation.....OPEN

Heating Controls.....CLOSED (Control Forward)

Circuit Breakers.....CHECK to identify faulty
circuit if possible

LAND as soon as practicable.

If electrical power is essential for the flight,
attempt to identify and isolate the faulty circuit
as follows:

Master switch.....ON

Select ESSENTIAL switches ON one at a time, and
permit a short time to elapse before activating
an additional circuit.

SECTION III
EMERGENCY PROCEDURES

MOONEY M20J

EMERGENCY DESCENT PROCEDURE

In the event an emergency descent from high altitude is required, rates of descent of at least 3,000 feet per minute can be obtained with idle power, flaps UP & cowl flaps CLOSED with the aircraft in two different configurations:

Configuration No. 1: Gear Down, 165 KIAS

Configuration No. 2: Gear UP , 198 KIAS

For an emergency descent from altitude, Configuration No. 1 is recommended. The angle of descent is greater and at 165 KIAS the ride will be smoother, resulting in less pilot workload.

THEREFORE:

The following procedure should be used for an emergency descent:

Power.....IDLE
Airspeed.....140 KIAS
Landing Gear.....EXTEND
Airspeed.....Increase to 165 KIAS
 after landing gear is extended.
Wing Flaps.....UP
Cowl Flaps.....CLOSED
Power During Descent.....AS REQUIRED to Maintain
 Cylinder Head Temperature
 300 Degrees F (149 Degrees C) minimum.

SECTION III
EMERGENCY PROCEDURES

MOONEY M20J

GLIDE

MAXIMUM GLIDE DISTANCE
MODEL M20J

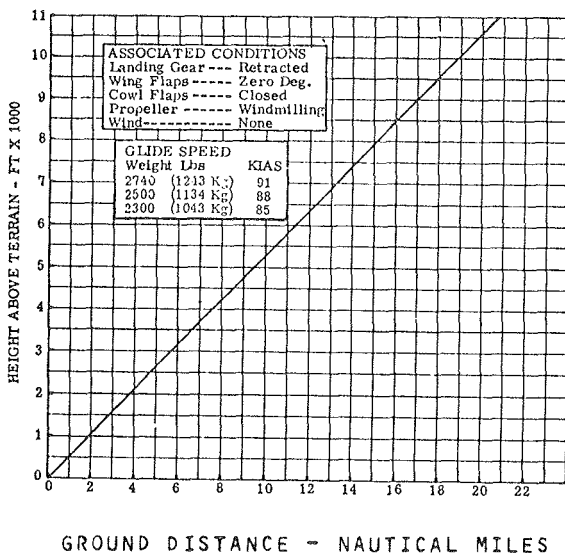

LANDING EMERGENCY

POWER OFF-GEAR RETRACTED OR EXTENDED

Emergency Locator Transmitter.....ARMED
 Seat Belts and Shoulder Harnesses.....SECURE
 Cabin Door.....UNLATCHED
 Fuel Selector.....OFF
 Mixture.....IDLE CUTOFF
 Magneto/Starter.....OFF
 Flaps.....Full DOWN (33 Degrees)
 Gear.....DOWN or UP Depending on Terrain
 Approach Speed.....71 KIAS
 Master.....OFF, prior to landing

SECTION III
EMERGENCY PROCEDURES

MOONEY M20J

POWER ON - GEAR RETRACTED

Emergency Locator Transmitter.....ARMED
Seat Belts and Shoulder Harnesses.....SECURE
Cabin Door.....UNLATCHED
When sure of making landing area:
Fuel Selector.....OFF
Throttle.....CLOSED
Mixture.....IDLE CUTOFF
Magneto/Starter.....OFF
Flaps.....Full DOWN (33 Degrees)
Master.....OFF
Approach Speed.....As Slow As Possible
Wings.....Keep LEVEL

SYSTEMS EMERGENCIES

PROPELLER

PROPELLER OVERSPEED

Throttle.....RETARD
Oil Pressure.....CHECK
Propeller...DECREASE, set if any control available
Airspeed.....REDUCE
Throttle.....AS REQUIRED to maintain RPM
below 2700 RPM

FUEL

LOW FUEL FLOW

Check Mixture.....ENRICH
Fuel Selector.....Fullest TANK
If condition persists, use Boost Pump if necessary
and LANDING should be made as soon as practicable.

ELECTRICAL

ALTERNATOR FAILURE (Voltage warning light
illuminated steady)

Avionics Master.....OFF
Master.....OFF, then ON
If warning Light is still illuminated, the
following steps are required:
Alternator Field Circuit Breaker.....PULL
Non-essential Electrical Equipment.....OFF
LAND as soon as practicable.

SECTION III
EMERGENCY PROCEDURES

MOONEY M20J

ALTERNATOR LOW VOLTAGE (Voltage warning light flashing)

Alternator Field Switch.....OFF then ON
If warning light still flashing, the following are required:

Alternator Field Circuit Breaker.....PULL
Non-essential electrical Equipment.....OFF
LAND as soon as practicable.

NOTE

A tripped main alternator circuit breaker can only be caused by a shorted alternator circuit and cannot be corrected by resetting the breaker. This should be verified by attempting to reset the breaker not more than one time. If this fails, turn the alternator field switch OFF.
Turn off all non-essential electrical equipment and terminate the flight as soon as practical.

Repair the malfunctioning alternator prior to the next flight.

LANDING GEAR

FAILURE OF LANDING GEAR TO EXTEND ELECTRICALLY

Airspeed.....140 KIAS or less
Landing Gear Actuator Circuit Breaker.....PULL
Gear Switch.....DOWN
Manual Gear Extension
Mechanism.....LATCH FORWARD, LEVER BACK
to engage manual extension mechanism

NOTE

Slowly pull "T" handle 1 to 2 inches (2.5 to 5.1 cm) to rotate clutch mechanism and allow it to engage drive shaft.

SECTION III
EMERGENCY PROCEDURES

MOONEY M20J

T-Handle.....PULL
(12 to 20 times and RETURN until gear
is down and locked, GEAR DOWN light
illuminated, STOP when resistance is
felt. System may become damaged.
Visual Gear Down Indicator.....CHECK ALIGNMENT
by viewing from directly above the indicator.

~ CAUTION ~
~ ~ ~ ~ ~

Continuing to pull on T-Handle after GEAR DOWN
light ON will bind actuator;electrical retraction
MAY NOT be possible until binding is eliminated.

~ CAUTION ~
~ ~ ~ ~ ~

Malfunction of landing gear requires
maintenance inspection and repair prior
to activating electrical system.

Return lever to normal position and secure with
latch. Reset Landing Gear Actuator Circuit
Breaker.

//////////
///WARNING///
//////////

Do not operate landing gear electrically
with manual extension system engaged.

FAILURE OF LANDING GEAR TO RETRACT

("GR SAFETY BY PASS", both gear annunciator lights
illuminated and gear warning horn activated.)

"GR SAFETY BY PASS SWITCH".....DEPRESS until
gear fully retracted
"GEAR UNSAFE" and "GEAR DOWN" Lights.....OUT
"GEAR RELAYS" Circuit Breaker.....PULL (warning
horn off)
Gear Extension.....RESET "GEAR RELAYS"
Circuit Breaker
Gear Switch.....DOWN
Check "Airspeed Safety Switch" as soon as practicable.

! NOTE !

If above procedures do not initiate
retraction process, check emergency
manual extension lever on floor for
proper position.

SECTION III
EMERGENCY PROCEDURES

MOONEY M20J

OXYGEN

Refer to Section IX if aircraft is equipped with oxygen.

ALTERNATE STATIC SOURCE

The alternate static air source should be used whenever it is suspected that the normal static air sources are blocked. Selecting the alternate static source changes the source of static air for the altimeter, airspeed indicator and rate-of-climb from the outside of the aircraft to the cabin interior.

When the alternate static air source is in use adjust the indicated airspeed and altimeter readings according to the appropriate alternate static source airspeed and altimeter calibration tables in Section V.

The static air source valve is located in the lower left portion of the pilot's flight panel above the pilot's left knee.

Alternate Static Source.....PULL ON
Airspeed and Altimeter
Readings.....CHECK Calibrations Tables,
SECTION V

UNLATCHED DOOR IN FLIGHT

If the cabin door is not properly closed it may come unlatched in flight. This may occur during or just after take-off. The door will trail in a position approximately 3 inches (7.6 cm) open, but the flight characteristics of the airplane will not be affected. Return to the field in a normal manner. If practicable, during the landing flare have a passenger hold the door to prevent it from swinging open.

If it is deemed impractical to return and land, the door can be closed in flight, after reaching a safe altitude, by the following procedures:

Airspeed.....96 KIAS
Pilot's Storm Window.....OPEN

SECTION III
EMERGENCY PROCEDURES

MOONEY M20J

Aircraft.....RIGHT SIDESLIP (Right bank
with left rudder)
Door.....PULL SHUT & LATCH

ICE PROTECTION

//////////
///WARNING///
//////////

DO NOT OPERATE IN KNOWN ICING CONDITIONS.

The Model M20J is NOT APPROVED for flight into known icing conditions and operation in that environment is prohibited. However, if those conditions are inadvertently encountered or if flight into heavy snow is unavoidable, the following procedures are recommended until further icing conditions can be avoided:

Ram Air.....OFF
//////////
///WARNING///
//////////

Operating with Ram Air ON during flight in icing conditions or in heavy snow may result in partial or total loss of engine power. Make sure the Ram Air is OFF when flying in these conditions. Also, do not turn the Ram Air ON again when re-entering clear air until all ice and snow has melted from the aircraft.

Pitot Heat.....ON
Propeller De-Ice.....ON (if installed)
Alternate Static Source.....ON (if required)
Cabin Heat.....OFF
until engine operation is normal.

---- AVOID FURTHER ICING CONDITIONS ----

SECTION III
EMERGENCY PROCEDURES

MOONEY M20J

EMERGENCY EXIT OF AIRCRAFT

CABIN DOOR

PULL latch handle AFT.
OPEN door and exit aircraft.

BAGGAGE COMPARTMENT DOOR

Fold rear seat backs forward, CLIMB OVER.
PULL off plastic cover.
PULL white button.
Lift red handle "UP".
OPEN door and exit aircraft.
To verify re-engagement of outside latch mechanism, open outside handle fully, close inside red handle to engage pin into cam slide of latch mechanism, push in on white button until it snaps in place. Replace cover.
Operate outside handle in normal manner.

SPINS

/////////////////
///WARNING///
/////////////////

Up to 2000 feet of altitude may be lost in a one turn spin and recovery; therefore, stalls at low altitude are extremely critical.

NOTE

The best spin recovery technique is to avoid flight conditions conducive to spin entry. Low speed flight near stall should be approached with caution and excessive flight control movements in this flight regime should be avoided. Should an unintentional stall occur the aircraft should not be allowed to progress into a deep stall. Fast, but smooth stall recovery will minimize the risk of progressing into a spin. If an unusual post stall attitude develops and results in a spin, quick application of antispin procedures should shorten the recovery.

INTENTIONAL SPINS ARE PROHIBITED. In the event of

SECTION IV
NORMAL PROCEDURES

MOONEY M20J

TABLE OF CONTENTS

TITLE	PAGE
INTRODUCTION.....	4-2
PREFLIGHT INSPECTION.....	4-3
BEFORE STARTING CHECK.....	4-6
STARTING ENGINE.....	4-7
FLOODED ENGINE STARTING.....	4-8
WARM ENGINE STARTING.....	4-8
BEFORE TAXI.....	4-9
TAXI.....	4-9
BEFORE TAKEOFF.....	4-9
TAKEOFF PROCEDURES.....	4-11
TAKEOFF.....	4-12
CLIMB.....	4-13
CLIMB (NORMAL).....	4-13
CLIMB (BEST RATE).....	4-13
CLIMB (BEST ANGLE).....	4-14
CRUISE.....	4-15
DESCENT.....	4-16
APPROACH FOR LANDING.....	4-17
GO AROUND (BALKED LANDING).....	4-18
LANDING.....	4-19
TAXI AFTER LANDING.....	4-20
SHUTDOWN.....	4-20
SECURING THE AIRCRAFT.....	4-20

SECTION IV
NORMAL PROCEDURES

MOONEY M20J

INTRODUCTION

This section describes the recommended procedures for the conduct of normal operations for the airplane. All of the required (FAA regulations) procedures and those necessary for operation of the airplane as determined by the operating and design features of the airplane are presented.

These procedures are provided to present a source of reference and review and to supply information on procedures which are the same for all aircraft. Pilots should familiarize themselves with the procedures given in this section in order to become proficient in the normal operations of the airplane.

Normal procedures associated with those optional systems and equipment which require handbook supplements are provided by Section IX (Supplements).

SECTION IV
 NORMAL PROCEDURES

MOONEY M20J

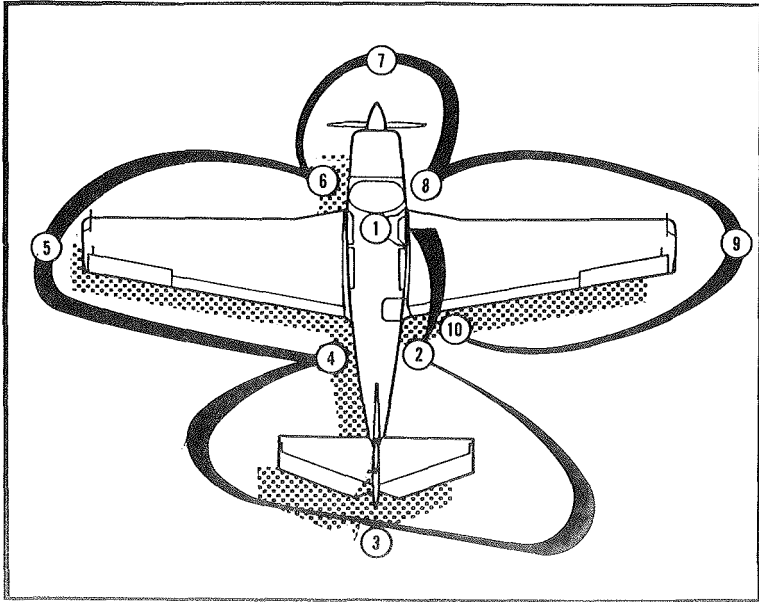

PREFLIGHT WALK AROUND DIAGRAM

PREFLIGHT INSPECTION

1. Cockpit -
- Gear Switch.....DOWN
 - Magneto/Starter Switch.....OFF
 - Master Switch.....ON
 - Internal/External Lights.....CHECK
 - Fuel Gauges, Quantity.....CHECK
 - Master Switch.....OFF
 - Fuel Selector.....R: PULL gascolator ring
(5 seconds)
 - Fuel Selector.....L: PULL gascolator ring
(5 seconds)

SECTION IV
NORMAL PROCEDURES

MOONEY M20J

2. Right Tail Cone Area -
Instrument Static Port.....UNOBSTRUCTED
Right Fuselage.....CHECK skin condition
Tail tiedown.....REMOVE

3. Empennage -
Elevator and rudder attach points and control
linkage attachments.....CHECK
General skin condition.....CHECK
Remove all ice, snow, or frost.

4. Left Tail Cone Area -
Fresh Air Vent (on Dorsal Fin).....CLEAR
Instrument Static Port.....UNOBSTRUCTED

Left Fuselage.....CHECK Skin condition
Tailcone Access Door.....SECURED
Static System Drain.....Push Plunger UP
(Hold 3-5 Seconds)

5. Left wing -
Skin condition.....Remove all ice, snow, or frost.
Flap and attach points.....CHECK
Aileron and attach points.....CHECK
Control linkages.....CHECK
Wing tips and lights.....CHECK
Left wing leading edge.....CHECK
Pitot tube.....UNOBSTRUCTED
(Heat element OPERATIVE)
Stall Switch Vane.....UNOBSTRUCTED
Fuel Tank.....CHECK QUANTITY. SECURE CAP

NOTE

A reduced fuel indicator is located in the filler neck. This indicator is used to indicate useable fuel capacity of 25 U.S. gallons (94.7 liters) (20.8 IMP. Gal.)

NOTE

The optional visual fuel quantity gauge is to be used for partial refueling purposes only; DO NOT use for preflight check.

Tiedown.....REMOVE

SECTION IV
NORMAL PROCEDURES

MOONEY M20J

Tank Vent.....UNOBSTRUCTED
Wheel chock.....REMOVE
Left main gear, shock discs and tire.....CHECK
Left main gear doors.....CHECK
Fuel tank sump drain.....DRAIN Until Clear
Pitot System Drain.....Push plunger UP
(Hold for 3-5 seconds)
Gascolator Drain Valve....CLOSED (Check for drips)

6. Left Cowl Area -

Windshield.....CLEAN
Left Side Engine Cowl Fasteners.....SECURED

7. Propeller -

Blades.....CHECK for nicks, cracks, oil
leaks, rotational movement. CHECK de-ice boots (if
installed).
Spinner.....CHECK for security, cracks
Cooling Air and Induction Intake.....UNOBSTPUCTED
Landing Light.....CHECK Lens & Bulb
Nose Gear, shock discs and tire.....CHECK
Nose Gear Door.....CHECK for Loose Linkage
Wheel Chock.....REMOVE

8. Right Cowl Area -

Right Side Engine Cowl Fasteners.....SECURED
Engine Oil Level.....CHECK (full for extended
flight. Minimum qty. 6 qts.)
Exhaust Pipe.....SECURED
Cowl Flap.....CHECK
Windshield.....CLEAN
Cabin Cooling Vent.....UNOBSTRUCTED

9. Right Wing -

Fuel Tank Sump Drain.....DRAIN until clear
Right Main Gear, shock discs and tire.....CHECK
Right Main Gear Doors.....CHECK
Wheel Chock.....REMOVE
Tank Vent.....UNOBSTRUCTED
Tiedown.....REMOVE
Right Wing Leading Edge.....CHECK

Fuel Tank.....CHECK QUANTITY. SECURE CAP

SECTION IV
NORMAL PROCEDURES

MOONEY M20J

NOTE

The reduced fuel indicator is located in the filler neck. This indicator is used to indicate usable fuel capacity of 25 U.S. gallons (94.7 liters) (20.8 IMP. gal.)

NOTE

The optional visual fuel quantity gauge is to be used for partial refueling purposes only; DO NOT use for preflight check.

Wing Tip and Lights.....CHECK
Aileron and attach points.....CHECK
Flap and attach points.....CHECK
Control linkages.....CHECK
Skin condition.....REMOVE ice, snow or frost

10. Baggage Door.....SECURED

BEFORE STARTING CHECK

Preflight Inspection.....COMPLETED
Seats, seat belts and
Shoulder Harness.....ADJUST & SECURE
Magneto/Starter Switch.....OFF
Master Switch.....OFF
Alternator Field Switch.....OFF
Avionics Master Switch.....OFF
Fuel Boost Pump.....OFF
Alternate Static Source.....Push OFF
Internal/External Lights.....OFF
Pitot Heat.....OFF
Throttle.....CLOSED
Propeller.....HIGH RPM
Mixture.....IDLE CUTOFF
Cowl Flaps.....VERIFY OPEN
Parking Brakes.....SET
Flap Switch.....Flaps UP
Cabin Heat.....PUSH OFF
Defrost.....PUSH OFF
Cabin Vent.....AS DESIRED
Fuel Selector.....FULLEST TANK
Compass Slave Switch.....ON (if installed)

SECTION IV
NORMAL PROCEDURES

MOONEY M20J

Circuit Breakers.....CHECK
Emergency Locator Transmitter.....ARM
Radios.....SET FREQUENCIES (Non-digital radios)
Landing Gear Switch.....DOWN
Internal/External Lights.....OFF
Passengers..Emergency/General information briefing
Refer to Section IX for Optional Equipment Checks.
Obtain local information prior to engine start.

STARTING ENGINE

NOTE

When starting engine using an approved external power source no special starting procedure is necessary. Use normal starting procedures below. (Auxiliary Power Cable Adapter is available from Mooney Aircraft Corporation).

Throttle.....1/4 OPEN
Propeller.....HIGH RPM
Mixture.....Full Forward (RICH)
Master Switch.....ON
Alternator Field Switch.....ON
Annunciator Lights.....PRESS TO TEST
(All lights except "START POWER ON" should illuminate.
Fuel Boost Pump.....ON to Establish Pressure, then OFF
Mixture.....IDLE-CUTOFF
Propeller Area.....CLEAR
Magneto/Starter Switch.....TURN and PUSH to start, release to both when engine starts.

NOTE

Cranking should be limited to 30 seconds, and several minutes allowed between cranking periods to permit the starter to cool.

Mixture.....Move slowly and smoothly to RICH
Throttle.....Set at 1000 to 1200 RPM
Engine Oil Pressure.....if MINIMUM OIL PRESSURE is not indicated within 30 seconds, STOP ENGINE and determine problem.
Voltmeter.....Check for 27-28 Volts
(To verify alternator is ON LINE)

SECTION IV
NORMAL PROCEDURES

MOONEY M20J

NOTE

Use recommended engine break-in procedures as published by engine manufacturer.

FLOODED ENGINE STARTING

Fuel Boost Pump.....OFF
Throttle.....FULL FORWARD
Mixture.....IDLE CUTOFF
Magneto/Starter Switch.....TURN and PUSH to
start, release to both when engine starts.
Throttle.....Retard to 1200 RPM
Mixture.....Full forward (RICH)
Engine Oil Pressure.....if MINIMUM OIL PRESSURE
is not indicated within 30 seconds,
STOP ENGINE and determine problem

WARM ENGINE STARTING

Fuel Boost Pump.....OFF
Throttle.....Slightly open
Mixture.....Full Aft (IDLE-CUTOFF)
Magneto/Starter Switch.....TURN and PUSH to
start, release to both when engine starts.
Throttle.....1000 to 1200 RPM
Engine Oil Pressure.....If MINIMUM OIL PRESSURE
is not indicated within 30 seconds, STOP ENGINE
and determine problem.

SECTION IV
NORMAL PROCEDURES

MOONEY M20J

BEFORE TAXI

Avionics Master Switch.....ON
External Lights.....As desired
Directional Gyro.....SET or SLAVE SWITCH - ON
Instruments.....Normal Operation
Radios.....CHECK (Set Frequencies)
Altimeter.....SET
Fuel Selector.....Switch tanks, verify
engine runs on other tank
Cowl Flaps.....CHECK OPERATION
(Then position OPEN or AS REQUIRED)

NOTE

In cold weather, ground operations may be conducted with cowl flaps partially or fully closed to keep engine temperatures in normal operating ranges prior to takeoff. However, if cowl flaps are fully closed, monitor engine temperatures to avoid exceeding maximum allowable limits.

TAXI

NOTE

It may be necessary to increase RPM slightly to prevent flashing of the "LOW VOLTS" light.

Parking Brake.....Release
Brakes.....Check during Taxi
Directional Gyro....Proper indication during turns
Turn Coordinator....Proper indication during turns
Artificial Horizon.....Erect during turns
Taxi.....Minimum power

BEFORE TAKEOFF

NOTE

A thorough pre-takeoff check is recommended, however EXCESSIVE time spent conducting a pre-takeoff check list will effect fuel economy.

SECTION IV
NORMAL PROCEDURES

MOONEY M20J

Parking Brake.....SET
Fuel Selector.....FULLEST TANK
Throttle.....1200 RPM
Propeller.....HIGH RPM
Mixture.....Full Forward (RICH)
Cowl Flaps.....FULL OPEN or AS REQUIRED
Alternate Air.....VERIFY CLOSED
Ram Air.....CLOSED
Alternator.....CHECK

PROPER ALTERNATOR OPERATION IS CHECKED AS FOLLOWS:

Alt. Rocker Switch....OFF(ALT output/load 0%)
Volts.....Approx. 24V(HIGH/LOW VOLT
Annun. flashes)
Alt. Rocker Switch...ON (Alt output/load increases)
Volts.....Approx. 28V(HIGH/LOW VOLT
Annun. extinguishes)

Alternator Field Switch.....Verify ON
(after above check)
Oil Temperature.....75 Degrees F Minimum
(Needle moves off white dot)

~~~~~  
~ CAUTION ~  
~~~~~

Do not operate the engine at run-up speed unless the oil temperature is 75 Degrees F. minimum. Operation of the engine at too high a speed before reaching minimum oil temperature may cause loss of oil pressure.

Throttle.....1900-2000 RPM
Magnetos.....CHECK, Both to L, Both to R,
Both, (Maximum 175 RPM drop each magneto, 50
RPM Difference)

SECTION IV
NORMAL PROCEDURES

MOONEY M20J

NOTE

An absence of RPM drop may be an indication of faulty magneto grounding or improper timing. If there is doubt concerning ignition system operation, RPM checks at a leaner mixture setting or higher engine speed will usually confirm whether a deficiency exists.

Propeller.....CYCLE/return to high RPM (3 times)
Throttle.....Retard to IDLE RPM
Trim.....Takeoff setting
Flaps.....Check operation...SET TAKEOFF POSITION
Controls.....Check free and correct movement
Cabin Door.....CHECK SECURED
Seat Belts and Shoulder Harness.....SECURED
Avionics and Auto Pilot.....Check (Refer to
Section IX)
Annunciator Lights.....Press to Test
Internal/External Light.....As Desired
Rotating Beacon/Strobe Lights.....ON
Pilots Window.....CLOSED
Emergency Gear Extension Red Handle.....DOWN
and LATCHED
Parking Brake.....Release

TAKEOFF PROCEDURES

NOTE

Move the engine controls slowly and smoothly. In particular, avoid rapid opening and closing of the throttle as the engine is equipped with a counterweighted crank shaft and there is a possibility of detuning the counter-weights with subsequent engine damage.

Proper engine operation should be checked early in the takeoff roll. Any significant indication of rough or sluggish engine response is reason to discontinue the takeoff.

SECTION IV
NORMAL PROCEDURES

MOONEY M20J

When takeoff must be made over a gravel surface, it is important that the throttle be applied slowly. This will allow the aircraft to start rolling before a high RPM is developed, and gravel or loose material will be blown back from the prop area instead of being pulled into it.

TAKEOFF

Electric Fuel Boost Pump.....ON at start of
takeoff roll
Power.....FULL THROTTLE and 2700 RPM
Aircraft Attitude.....Lift Nose Wheel at
63 KIAS
Climb Speed.....71 KIAS
Landing Gear.....Retract in Climb Before
Attaining an Airspeed of
107 KIAS
Wing Flaps.....Retract in Climb
Electric Fuel Boost Pump.....OFF, CHECK
Pressure

NOTE

See Section V, page 5-15, for takeoff distances and aircraft weight versus speed table.

TAKEOFF (Maximum Performance)

Electric Fuel Boost Pump.....ON at Start of
Takeoff roll
Power.....Full Throttle and 2700 RPM
Aircraft Attitude.....Lift Nose Wheel at
62 KIAS
Climb Speed.....66 KIAS until clear of obstacle,
then accelerate to 91 to 100 KIAS
Landing Gear.....Retract in Climb After
Clearing Obstacle
Wing Flaps.....Retract After Clearing Obstacle
Electric Fuel Boost Pump.....OFF, Check Pressure

SECTION IV
NORMAL PROCEDURES

MOONEY M20J

CRUISE

Upon reaching cruise altitude, accelerate to cruise airspeed; retrim aircraft as necessary for level flight. Set manifold pressure and RPM for desired power setting per Cruise Power Chart in Section V. Position cowl flaps as required to maintain the oil and cylinder head temperature within their normal operating ranges.

! NOTE !

When cruising in conditions where the OAT is well above standard, it may be necessary to OPEN cowl flaps slightly in order to keep engine temperatures in the green arc. When cowl flaps are OPEN during cruise, the following effects on cruise speed will result:

Cowl Flaps 1/4 open (1st Index)
Approximate loss in TAS.....2 KTAS
Cowl Flaps 1/2 open (2nd Index)
Approximate loss in TAS.....4 KTAS

When cruising at 75 percent power or less, lean the mixture after cruise power is established in accordance with one of the following methods:

- A. Leaning using exhaust gas temperature gauge (EGT) (if installed).
1. Lean the mixture exhaust gas temperature peaks on the EGT indicator.

ECONOMY CRUISE - Enrich mixture (push mixture control forward) until the EGT indicator drops 14 degrees C (25 degrees F.) below peak.

BEST POWER MIXTURE - Enrich mixture until EGT indicator drops 55 degrees C (100 degrees F.) below peak.

SECTION IV
NORMAL PROCEDURES

MOONEY M20J

NOTE

Compared to Economy Cruise, Best Power mixture will result in an increase in fuel flow and a reduction in range.

2. Changes in altitude and power settings require the peak EGT to be rechecked and the mixture re-set.
- B. Leaning without exhaust gas temperature gauge (EGT).
1. Slowly move mixture control lever aft from "FULL RICH" position toward "LEAN" position.
 2. Continue leaning until slight loss of power is noted (loss of power may or may not be accompanied by roughness).
 3. Enrich until engine runs smoothly and power is regained.

When increasing power always return mixture to full rich, then increase RPM before increasing manifold pressure; when decreasing power decrease manifold pressure before reducing RPM. Always stay within the established operating limits, and always operate the controls slowly and smoothly.

DESCENT

Mixture.....LEAN to 14 deg. C rich of peak EGT
as required for smooth engine operation
Power.....As Required to keep CHT in
Green Arc (300 degrees F minimum)

~ CAUTION ~

Avoid continuous operation between 1500 and 1950 RPM with power settings below 15" Hg. manifold pressure.

SECTION IV
NORMAL PROCEDURES

MOONEY M20J

NOTE

Exercise caution with power settings below 15" Hg manifold pressure at airspeeds between 70 - 113 KIAS to preclude continuous operation in the 1500 - 1950 RPM restricted range.

~ CAUTION ~

Avoid long high speed descents at low manifold pressure as the engine can cool excessively.

Cowl Flaps.....FULL CLOSED
Ram Air.....OFF before entering dusty air layers

NOTE

Plan descents to arrive at pattern altitude on downwind leg for maximum fuel efficiency and minimum aircraft noise.

APPROACH FOR LANDING

Internal/External Lights.....As desired
Seat Belts/ Shoulder Harness.....FASTENED
Landing Gear.....Extend below 140 KIAS
(Gear down light on - Check visual indicator on floor)
Mixture.....FULL RICH
Propeller.....HIGH RPM
Fuel Boost Pump.....ON
Fuel Selector.....FULLEST TANK
Wing Flaps.....AS DESIRED
TAKEOFF POSITION--below 132 KIAS
FULL DOWN-----below 115 KIAS

SECTION IV
NORMAL PROCEDURES

MOONEY M20J

~~~~~  
~ CAUTION ~  
~~~~~

The landing gear may retract during landing roll if landing gear switch is inadvertently placed in the UP position.

TAXI

Throttle.....1000 to 1200 RPM
Flaps.....RETRACT
Cowl Flaps.....FULL OPEN
Trim.....RESET to Takeoff
Radios.....As required
Lighting.....As required

SHUTDOWN

Parking brake.....SET
Throttle.....1000 to 1200 RPM (until cylinder head temperature starts to drop)
Avionics Master.....OFF
Internal/External Lights.....OFF
Magneto/Starter Switch.....Grounding Check
Mixture.....IDLE CUTOFF
Magneto/Starter Switch.....OFF when propeller stops
Alternator Field Switch.....OFF
Master Switch.....OFF
Oxygen System (if equipped).....OFF

SECURING THE AIRCRAFT

Magneto/Starter.....OFF/Key removed
Master Switch.....VERIFY OFF
Avionics Master.....VERIFY OFF
Electrical Switches.....VERIFY OFF
Parking Brake.....RELEASE and install wheel chocks
For extended parking.....Control wheel SECURED
with seat belts, cabin vents closed, tie down
aircraft at wing and tail points.

SECTION V
PERFORMANCE

MOONEY M20J

TABLE OF CONTENTS

TITLE	PAGE
INTRODUCTION.....	5-3
USE OF PERFORMANCE CHARTS.....	5-3
PERFORMANCE CONSIDERATIONS.....	5-5
RANGE ASSUMPTIONS.....	5-5
USE OF COWL FLAPS.....	5-5
MAIN GEAR LOWER DOOR REMOVAL.....	5-6
TEMPERATURE CONVERSION.....	5-7
AIRPEED CALIBRATION PRIMARY STATIC SYSTEM (GEAR UP).....	5-8
AIRPEED CALIBRATION PRIMARY STATIC SYSTEM (GEAR DOWN).....	5-9
AIRPEED CALIBRATION ALTERNATE STATIC SYSTEM	5-10
ALTIMETER CORRECTION PRIMARY STATIC SYSTEM (GEAR UP, FLAPS UP).....	5-11
ALTIMETER CORRECTION PRIMARY STATIC SYSTEM (GEAR DN, FLAPS DN).....	5-12
ALTIMETER CORRECTION ALTERNATE STATIC SYSTEM.....	5-13
STALL SPEED VS ANGLE OF BANK.....	5-14
NORMAL TAKEOFF DISTANCE.....	5-15
MAXIMUM PERFORMANCE TAKEOFF DISTANCE.....	5-16
NORMAL TAKEOFF DISTANCE - GRASS SURFACE.....	5-17
MAXIMUM PERFORMANCE TAKEOFF DISTANCE -GRASS SURFACE.....	5-18
RATE OF CLIMB.....	5-19
TIME DISTANCE & FUEL TO CLIMB.....	5-20
CRUISE & RANGE DATA CONDITION.....	5-22
CRUISE POWER SCHEDULE.....	5-23
SPEED POWER VS ALTITUDE.....	5-25
RANGE 75% POWER.....	5-26
RANGE 65% POWER.....	5-27
RANGE 55% POWER.....	5-28
RANGE 45% POWER.....	5-29
ENDURANCE 75% POWER.....	5-30
ENDURANCE 65% POWER.....	5-31
ENDURANCE 55% POWER.....	5-32
ENDURANCE 45% POWER.....	5-33
TIME-FUEL-DISTANCE TO DESCEND.....	5-34
NORMAL LANDING DISTANCE.....	5-35
MAXIMUM PERFORMANCE LANDING DISTANCE.....	5-36
NORMAL LANDING DISTANCE - GRASS SURFACE.....	5-37
MAXIMUM PERFORMANCE LANDING DISTANCE -GRASS SURFACE.....	5-38

SECTION V
PERFORMANCE

MOONEY M20J

TABLE OF CONTENTS

TITLE	PAGE
MISSION PROFILE CHARTS.....	5-39

SECTION V PERFORMANCE

MOONEY M20J

INTRODUCTION

Performance data charts on the following pages are presented so that the pilot can derive the information needed to plan flights with reasonable accuracy. The performance data and charts presented are calculated based upon actual flight tests, using average piloting techniques, the airplane and engine in good condition and the engine power control system properly adjusted. The flight test data has been corrected to international standard atmosphere conditions and then expanded analytically to cover various airplane gross weights, operating altitudes and outside air temperatures.

It is not possible to make allowances in the charts for varying levels of pilot technique, proficiency or environmental conditions. The effect of soft runways, winds aloft or airplane configuration changes must be evaluated by the pilot. However, the performance data on the charts can be duplicated, by following the stated procedures, in a properly maintained, standard M20J.

Mechanical or aerodynamic modifications to the aircraft are not authorized since they can affect the performance or flight characteristics of the aircraft.

USE OF PERFORMANCE CHARTS

Performance data is presented in tabular or graphical form to illustrate the effect of different variables. Example problems are shown on each chart to demonstrate how each chart is used. Only on those charts whose use is obvious is no example given.

Generally, three items are required before entering each performance chart: (1) aircraft weight, (2) outside air temperature and (3) aircraft pressure altitude. The aircraft weight can be calculated utilizing the information provided in Section VI of this handbook. Outside air temperature is obtained by reading the OAT gauge in the instrument cluster. Set the

SECTION V
PERFORMANCE

MOONEY M20J

aircraft's altimeter to 29.92 in. Hg. and read the indicated (pressure) altitude. (BE SURE TO RETURN THE ALTIMETER TO THE LOCAL BAROMETRIC PRESSURE SETTING AFTER OBTAINING PRESSURE ALTITUDE).

Performance information derived by extrapolation beyond the limits shown on the charts should not be used for flight planning purposes. REMEMBER--To get chart performance, follow the chart procedures.

OPERATIONAL PROCEDURES FOR MAXIMUM FUEL EFFICIENCY

For maximum fuel efficiency in the M20J, proper mixture leaning during cruise flight must be accomplished. The IO-360-A3B6D engine in the M20J has been designed to attain maximum fuel efficiency, at desired cruise power, at 14 degrees C rich of peak EGT. EGT is usually a more accurate indication of engine operation and fuel burn than indicated fuel flow. Therefore it is recommended that the mixture be set using EGT as the primary reference instead of setting to a particular fuel flow.

The following procedure is recommended for setting cruise power and leaning to best economy at 75% power or less:

1. After leveling off, set the manifold pressure and RPM for the desired cruise power in accordance with the cruise power schedule on page 5-23. At this point, the mixture control is at full rich from the climb.
2. Next, slowly move the mixture control toward lean while observing the EGT indicator. If leaning the mixture causes the original manifold pressure setting to change, use the throttle to maintain that desired cruise manifold pressure and continue leaning until best economy setting is obtained.

SECTION V
PERFORMANCE

MOONEY M20J

PERFORMANCE CONSIDERATIONS

RANGE ASSUMPTIONS

Range data climb allowance is based on climbing at maximum continuous power to cruise altitude.

Range reserves of 45 minutes at cruise power have been allowed on Range Data. Other conditions used in the Ranges shown are listed on each chart.

USE OF COWL FLAP

When in level cruise flight with outside air temperatures well above standard or when cruising at very high altitudes, it may be necessary to open the cowl flaps to keep engine temperatures in the normal operating range. Since the cowl flaps in the M20J are multi-position, numerous open settings are available to keep cylinder head and oil temperatures in the green arc under the most adverse conditions.

Using the cowl flap's position indicator as a reference, the following cowl flap's open positions are given along with their effects on cruise speed:

Cowl flaps closed to cowl flap's indicator - 1/4 open, (Indicator positioned at first index);
(approximate loss in TAS) 2 Kts.
Cowl flaps closed to cowl flap's indicator - 1/2 open, (Indicator positioned at second index);
(approximate loss in TAS) 4 Kts.

An appropriate adjustment to the range data shown for the cowl flaps closed condition can be made based on the flight time planned with the cowl flaps partially open. For example, using the above speed decrement for the cowl flaps 1/2 open for a 5 hour flight will result in the following decrease in range:

5 hr. x 4 Kts.=20 N.M. reduction in range

SECTION V
PERFORMANCE

MOONEY M20J

MAIN GEAR LOWER DOOR REMOVAL

If numerous takeoffs and landings are to be conducted on soft fields or in tall grass, or if ice and snow are likely to be present on runway and taxiway surfaces for extended periods, it may be advantageous to remove the lower doors installed on each main landing gear. These doors can be damaged during operations in soft field conditions, or a heavy accumulation of packed snow or ice inside the doors could prevent proper landing gear operation.

If these small gear doors are removed, a decrease in cruise speed and range can be expected and should be considered in preflight planning. To be conservative, the following figures should be used:

A. Decrease true airspeed at cruise by approximately 5 Kts.

B. Decrease range by as much as 50 N.M. for 64.0 gallon fuel capacity.

SECTION V
PERFORMANCE

MOONEY M20J

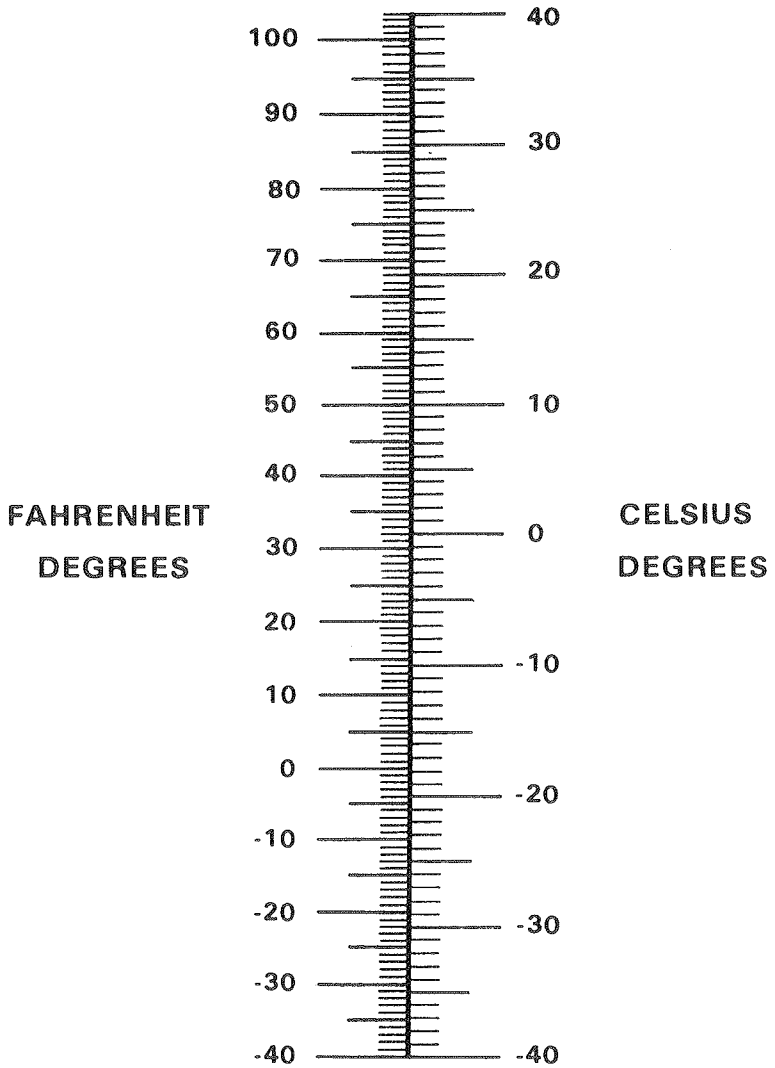

TEMPERATURE CONVERSION

SECTION V
PERFORMANCE

MOONEY M20J

AIRSPEED CALIBRATION

AIRSPEED CALIBRATION

PRIMARY STATIC SYSTEM

FLAPS AND GEAR UP, POWER ON

EXAMPLE:

Given: 173 Knots IAS

Find: 170 Knots CAS

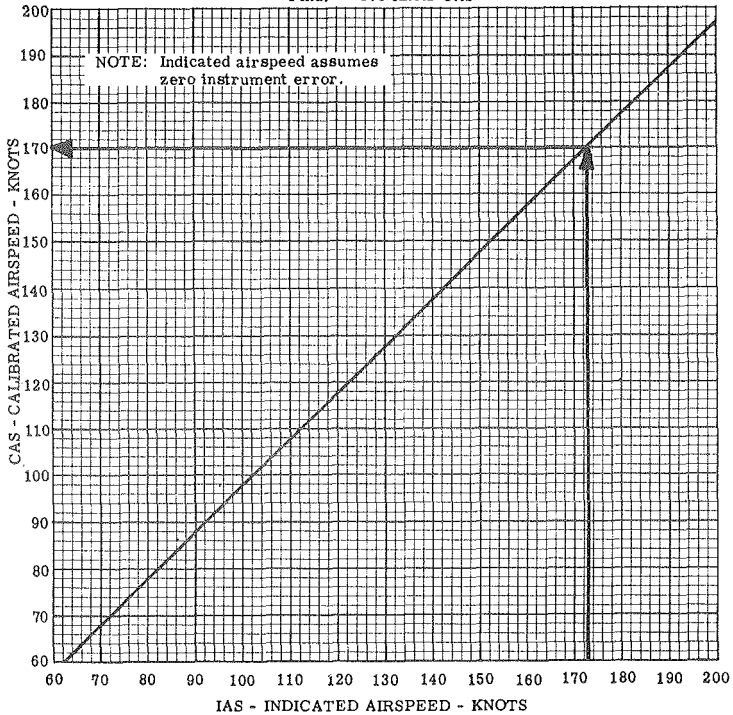

SECTION V
PERFORMANCE

MOONEY M20J

AIRSPEED CALIBRATION

PRIMARY STATIC SYSTEM

FLAPS AND GEAR DOWN

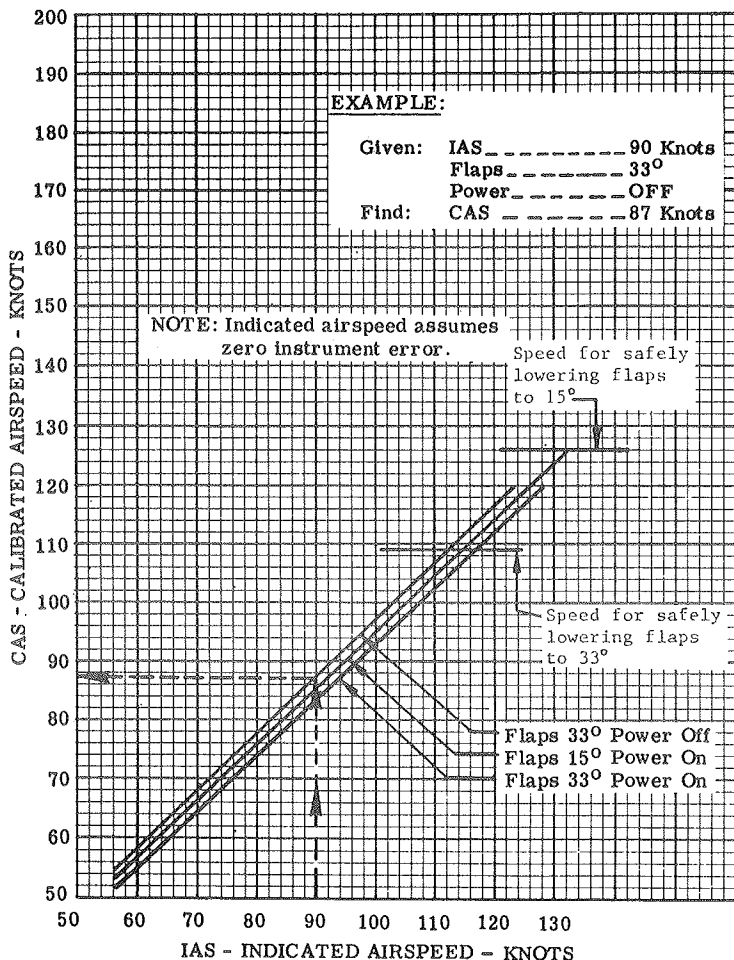

SECTION V
PERFORMANCE

MOONEY M20J

**AIRSPEED CALIBRATION
ALTERNATE STATIC SYSTEM**

IAS KIAS	Gear & Flaps Up KIAS	Gear & Flaps Down (15°) KIAS	Gear & Flaps Down (33°) KIAS
61	--	-2	-3
70	-2	-3	-5
78	-3	-4	-7
87	-3	-6	-8
96	-4	-7	-10
104	-5	-7	-10
113	-5	-7	-10
122	-6	--	--
130	-6	--	--
139	-6	--	--
148	-6	--	--
156	-6	--	--
165	-3	--	--
174	-3	--	--
182	-4	--	--
191	-4	--	--
200	-5	--	--

The minus sign indicates subtraction of the given numbers from KIAS to obtain KCAS assuming zero instrument error

CONDITIONS: Storm Window and Vents: Closed
Defroster: ON
POWER: ON

SECTION V
PERFORMANCE

MOONEY M20J

ALTIMETER CORRECTION

ALTIMETER CORRECTION
PRIMARY STATIC SYSTEM
FLAPS & GEAR UP & POWER ON

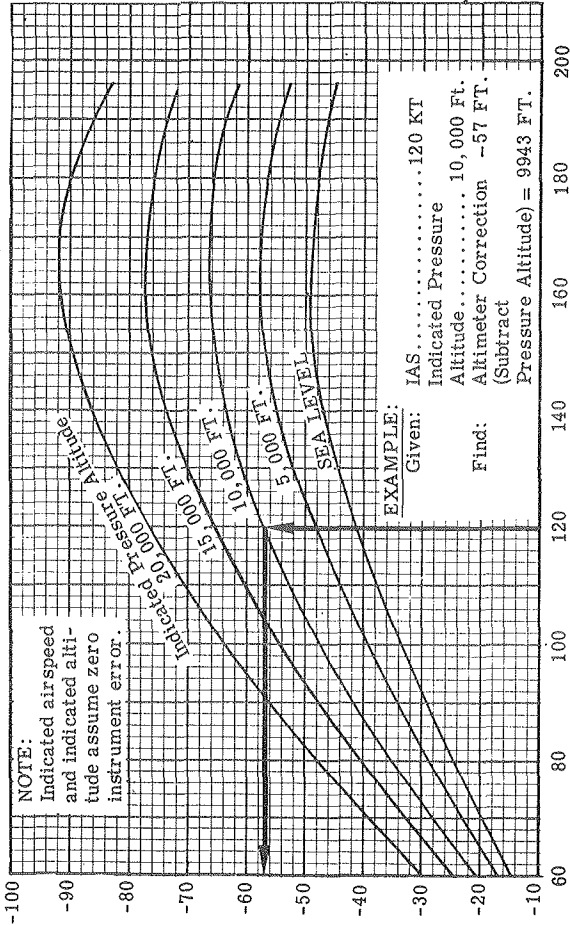

* ALTIMETER CORRECTION - FEET

IAS - INDICATED AIRSPEED KNOTS
*The minus sign indicates subtraction of the altimeter correction from indicated pressure to obtain corrected pressure altitude.

SECTION V
PERFORMANCE

MOONEY M20J

**ALTIMETER CORRECTION
PRIMARY STATIC SYSTEM**

FLAPS AND GEAR DOWN

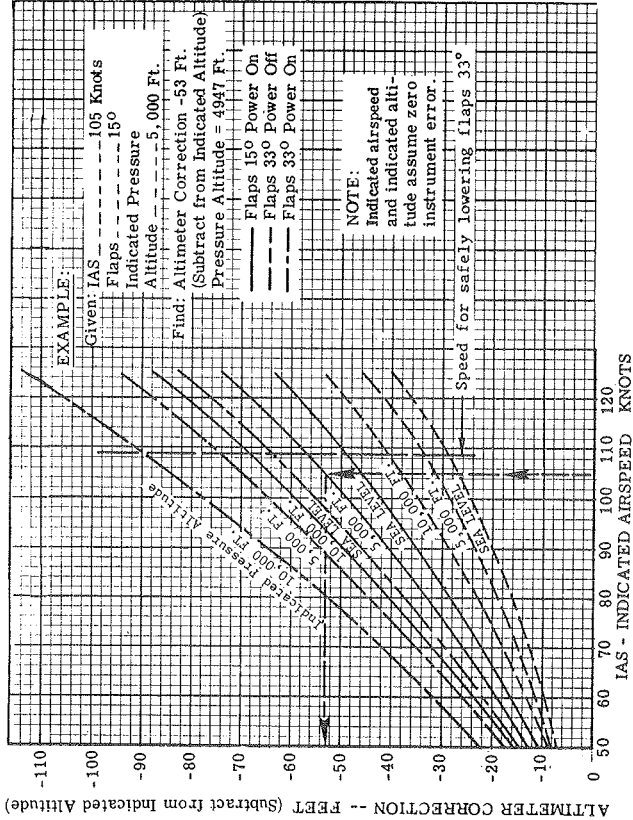

SECTION V
PERFORMANCE

MOONEY M20J

**ALTIMETER CORRECTION
ALTERNATE STATIC SYSTEM**

CONDITIONS: Storm Window and Vents: Closed; Defroster: On, Power: On

KIAS	SEA LEVEL 10,000 FT.					
	Gear & Flaps Up	Gear & Flaps Down		Gear & Flaps Up		
		150	330		150	330
61	--	-10	-21	-4	-15	-28
70	-17	-20	-35	-21	--28	-39
78	-26	-37	-55	-36	-50	-76
87	-32	-54	-71	-43	-71	-99
96	-40	-55	-82	-55	-77	-102
104	-54	-63	-96	-73	-86	-130
113	-54	--	--	-84	--	--
122	-64	--	--	-87	--	--
130	-72	--	--	-99	--	--
139	-75	--	--	-101	--	--
148	-99	--	--	-134	--	--
156	-54	--	--	-73	--	--
165	-54	--	--	-73	--	--
174	-68	--	--	-94	--	--
182	-64	--	--	-83	--	--
191	-75	--	--	-103	--	--
200	-91	--	--	-125	--	--

NOTE: The minus sign indicates subtraction of the given numbers from the indicated pressure altitude to obtain pressure altitude assuming zero instrument error.

SECTION V
PERFORMANCE

MOONEY M20J

STALL SPEED vs ANGLE OF BANK

ASSOCIATED CONDITIONS:

Forward C.G.

Power Idle

GROSS WEIGHT	GEAR AND FLAP POSITION	ANGLE OF BANK											
		0°			30°			45°			60°		
		KCAS	KIAS	KCAS	KIAS	KCAS	KIAS	KCAS	KIAS	KCAS	KIAS	KCAS	KIAS
2740 LBS (1243 KGS)	GEAR UP, 0° Flaps 0°	59.0	61.0	63.5	65.5	70.0	72.0	83.5	85.5				
	GEAR DOWN, FLAPS 15°	56.5	60.0	60.5	64.0	67.0	71.0	80.0	84.0				
	GEAR DOWN, 0° FLAPS 33°	53.0	54.0	57.0	59.0	63.0	65.0	75.0	77.0				
	GEAR UP, FLAPS 0°	56.5	58.5	60.5	62.5	67.0	69.0	79.5	81.5				
2500 LBS (1134 KGS)	GEAR DOWN, 0° FLAPS 15°	54.0	57.0	58.0	61.5	64.0	68.0	76.5	80.5				
	GEAR DOWN, FLAPS 33°	50.5	51.5	54.5	55.5	60.0	61.5	71.5	73.5				
	GEAR UP, 0° FLAPS 0°	54.0	56.0	58.0	60.0	64.5	66.5	76.5	78.5				
2300 LBS (1032 KGS)	GEAR DOWN, FLAPS 15°	52.0	55.0	55.5	58.5	61.5	65.0	73.0	77.0				
	GEAR DOWN, FLAPS 33°	48.5	49.0	52.0	52.5	57.5	60.0	68.5	70.5				

NOTE:

up to 290 feet altitude loss may occur during stalls at maximum weight.

EXAMPLE:

Weight 2500 LBS (1134 KGS)
Landing Gear Down
Flaps 15°
Angle of Bank 45°
Stall Speed 64.0 KCAS (68.0 KIAS)

SECTION V PERFORMANCE

MOONEY M20J

NORMAL TAKEOFF DISTANCE

TAKEOFF WEIGHT - LBS (KGS)	TAKEOFF SPEED - KIAS	SPEED AT 50 FT - KIAS
2140 (11243)	63	71
2500 (11344)	60	68
2300 (1043)	58	65

- NOTE**
- 1) MAXIMUM DEMONSTRATED CROSSWIND VELOCITY IS 11 KNOTS
 - 2) CONDITIONS OF HIGH HUMIDITY CAN RESULT IN AN INCREASE OF UP TO 10% TO THE TAKEOFF DISTANCE

ASSOCIATED CONDITIONS

- POWER FULL THROTTLE,
2700 RPM (BEFORE
BRAKE RELEASE)
- LANDING GEAR EXTENDED
UNTIL OBSTACLE CLEARED
- WING FLAPS 15°
- CONFLAPS FULL OPEN
- RUNWAY SURFACE PAVED,
LEVEL & DRY
- MIXTURE SMOOTH OPERATION

EXAMPLE: →

- OUT 15°C
- PRESSURE 1500 FT.
- ALTITUDE
- WEIGHT 2500 LBS. (1134 KGS)
- HEADWIND 6 KTS
- COMPONENT
- GROUND 750 FT. (229 m)
- ROLL
- TOTAL TAKEOFF 1575 FT. (480 m)
- OBSTACLE 150 FT. (45.7 m)

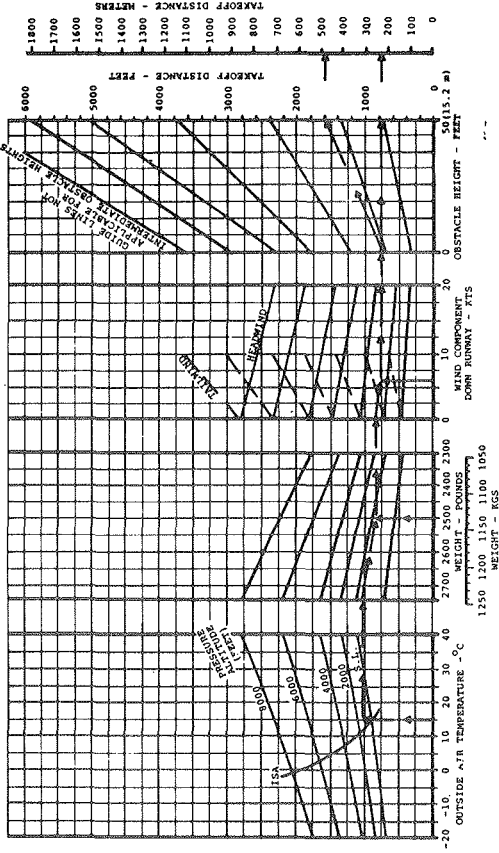

SECTION V PERFORMANCE

MOONEY M20J

MAXIMUM PERFORMANCE TAKEOFF DISTANCE

TAKEOFF WEIGHT - LBS (KGS)	TAKEOFF SPEED		SPEED AT	
	KIAS	KIAS	50 FT. - KIAS	100 FT. - KIAS
2740 (1243)	62	62	66	66
2500 (1134)	60	60	63	63
2300 (1043)	57	57	60	60

NOTE 1) MAXIMUM DEMONSTRATED CROSSWIND VELOCITY IS 11 KNOTS.
2) CONDITIONS OF HIGH HUMIDITY CAN RESULT IN AN INCREASE OF UP TO 10% TO THE TAKEOFF DISTANCE.

ASSOCIATED CONDITIONS:

POWER FULL THROTTLE
(before brake release)
LANDING GEAR FULLY EXTENDED
OBSTACLE CLEARED
WING FLAPS FULL OPEN
CORN FLAPS 15°
RUNWAY PAVED, LEVEL
SURFACE & DRY
MIXTURE LEAN FOR
SMOOTH OPERATION

EXAMPLE: →
OAT 15°C
PRESSURE 1500 FT.
ALTITUDE 2500 LBS.
WEIGHT (1134 KG)
HEADWIND COMPONENT 6 KTS.
GROUND ROLL 750 FT. (229 M)
TOTAL TAKEOFF 1325 FT.
(404 M)
(50 FT. OBSTACLE)(150 FT. OBSTACLE)WEIGHT - KGS

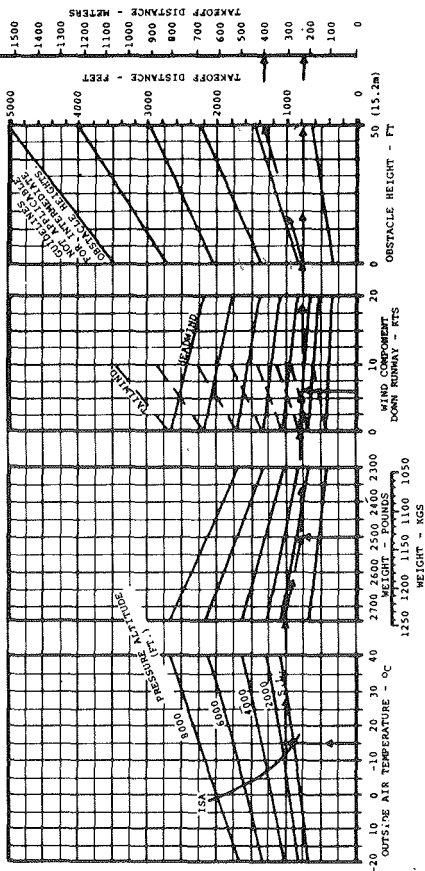

SECTION V
PERFORMANCE
MOONEY M20J

NORMAL TAKEOFF DISTANCE-GRASS SURFACE

TAKEOFF WEIGHT - LBS (KGS)	TAKEOFF SPEED	SPEED AT 50 FT. - KIAS
2340 (1064)	61	71
2300 (1043)	60	68
2300 (1043)	58	65

NOTE 1) MAXIMUM DEMONSTRATED CROSSWIND VELOCITY IS 11 KNOTS
2) CONDITIONS OF HIGH HUMIDITY CAN RESULT IN AN INCREASE OF UP TO 10% TO THE TAKEOFF DISTANCE

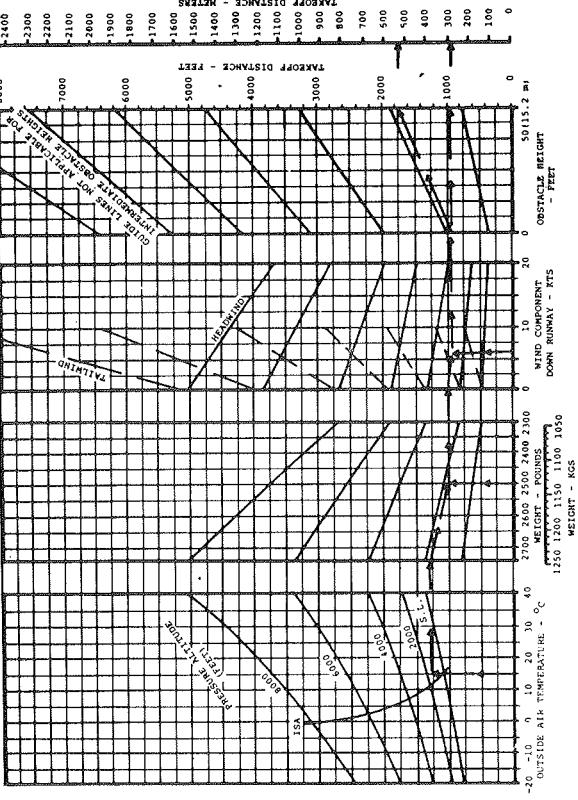

- ASSOCIATED CONDITIONS
- POWER: 2300 RPM (BEFORE BRAKE RELEASE)
 - LANDING: DOWN UNTIL GEAR
 - WING FLAPS: FULL OPEN
 - COMB FLAPS: SHORT LEVEL
 - SURFACE: DRY GRASS
 - MIXTURE: LEAN FOR SMOOTH OPERATION

EXAMPLE: →
 DAY: 15°C
 PRESSURE: 1500 FT
 ALTITUDE: 1500 FT
 WEIGHT: 2500 LBS (1114 KGS)
 HEADWIND COMPONENT: 6 KTS
 CRUISE: 925 FT (282m)
 ROLL: 1730 FT (527m)
 TOTAL TAKEOFF DISTANCE (150 FT OBSTACLE): 1730 FT (527m)

SECTION V PERFORMANCE

MOONEY M20J

MAXIMUM PERFORMANCE TAKEOFF DISTANCE - GRASS SURFACE

TAKEOFF WEIGHT - LBS KGS	TAKEOFF SPEED		SPEED AT 50 FT - KIAS	
	IAS	KIAS	IAS	KIAS
2140 (1243)	62	66	65	69
2300 (1334)	60	64	63	67
2450 (1425)	57	61	60	64

- NOTE: 1) MAXIMUM DEMONSTRATED CROSSWIND VELOCITY IS 11 KTS.
 2) CONDITIONS OF HIGH HUMIDITY CAN RESULT IN AN INCREASE OF UP TO 10% TO THE TAKEOFF DISTANCE.

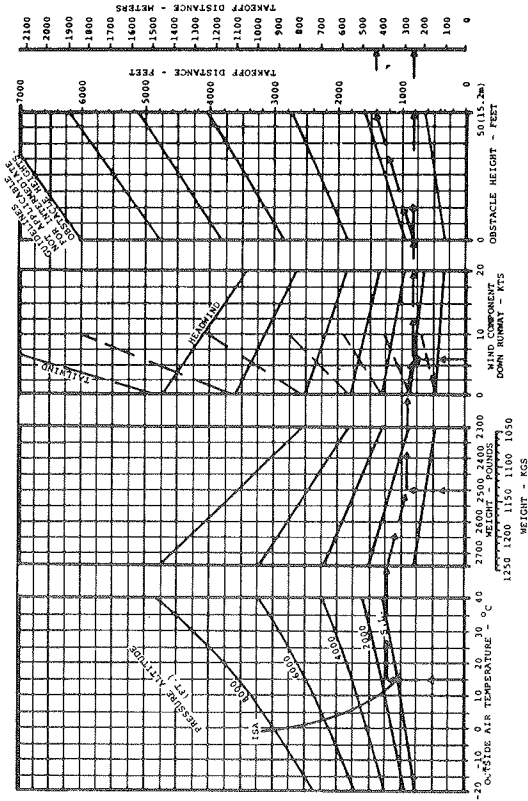

ASSOCIATED CONDITIONS:

- POWER FULL THROTTLE 2700 RPM
- WING FLAPS FULL OPEN UNTIL LANDING GEAR DOWN UNTIL OBSTACLE CLEARED
- WING FLAPS 15°
- COML FLAPS FULL OPEN
- RUNWAY SHORT, LEVEL, DRY GRASS SURFACE
- MIXTURE CLEAN FOR SMOOTH OPERATION

EXAMPLE: →

- DAY 15°C
- PRESSURE 1500 FT.
- WIND 2500 LBS. (1134 KGS)
- WEIGHT 6 KTS.
- HEADWIND 830 FT. (250 m)
- COMPONENT 1400 FT. (56 FT. OBSTACLE) (427 m)
- GROUND ROLL
- TOTAL TAKEOFF DISTANCE

SECTION V PERFORMANCE

MOONEY M20J

RATE OF CLIMB

GEAR UP, FLAPS UP, COR. FLAPS OPEN, RAM AIR ON, 2700 RPM, FULL THROTTLE, FULL RICH

WEIGHT (LBS)	CLIMB SPEEDS - KIAS	
	5000 FT.	20000 FT.
1700 (770)	81	79
1900 (863)	80	78
2100 (956)	79	77
2300 (1043)	78	76
2500 (1130)	77	75
2700 (1217)	76	74
2900 (1304)	75	73
3100 (1391)	74	72
3300 (1478)	73	71
3500 (1565)	72	70
3700 (1652)	71	69
3900 (1739)	70	68
4100 (1826)	69	67
4300 (1913)	68	66
4500 (1999)	67	65
4700 (2086)	66	64

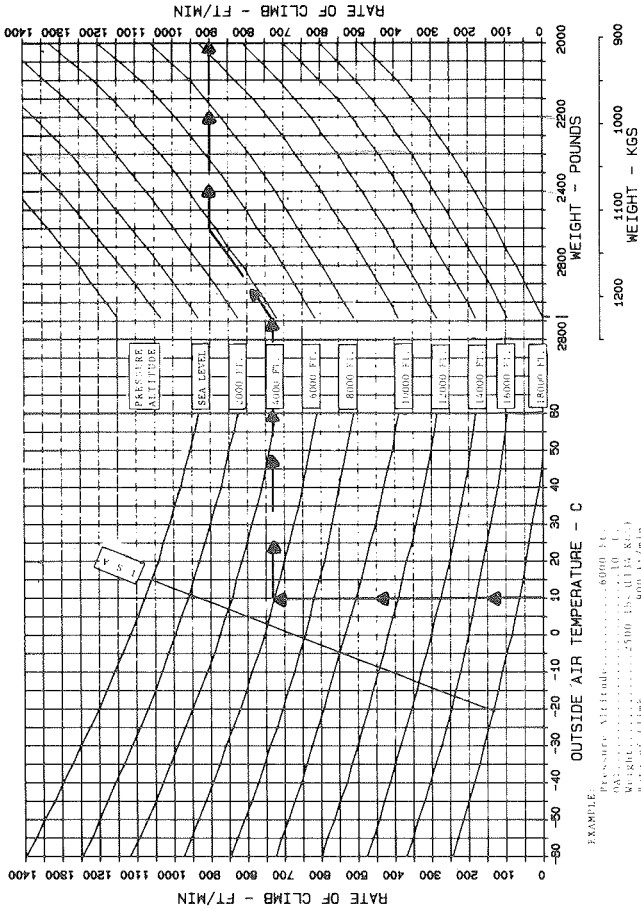

EXAMPLE: Pressure Altitude.....6000 FT.
 OAT.....10 C
 Weight.....1100 Pounds
 Rate of Climb.....2100 FT./Min.
 Airspeed.....900 KIAS
 Climb Speed.....81 KIAS

SECTION V
PERFORMANCE

MOONEY M20J

TIME, FUEL AND DISTANCE TO CLIMB

Associated Conditions for the Time, Fuel and
Distance to Climb graph on the following page:

Climb Speed: V_y from Climb Performance graph
on the preceding page.

Power: 2700 RPM, Full Throttle

Mixture: Full Rich

Ram Air: On

Cowl Flaps: Full Open

Landing Gear: Up

Wing Flaps: Up

Fuel Density 6.0 Lbs./Gal. (.72 Kg/liter)

NOTE:

1. Distances shown are based on zero wind.
2. Add 9 LBS. of fuel for start, taxi and takeoff.

SECTION V
PERFORMANCE

MOONEY M20J

TIME-FUEL-DISTANCE TO CLIMB

2700 RPM, FULL THROTTLE, GEAR UP, FLAPS UP

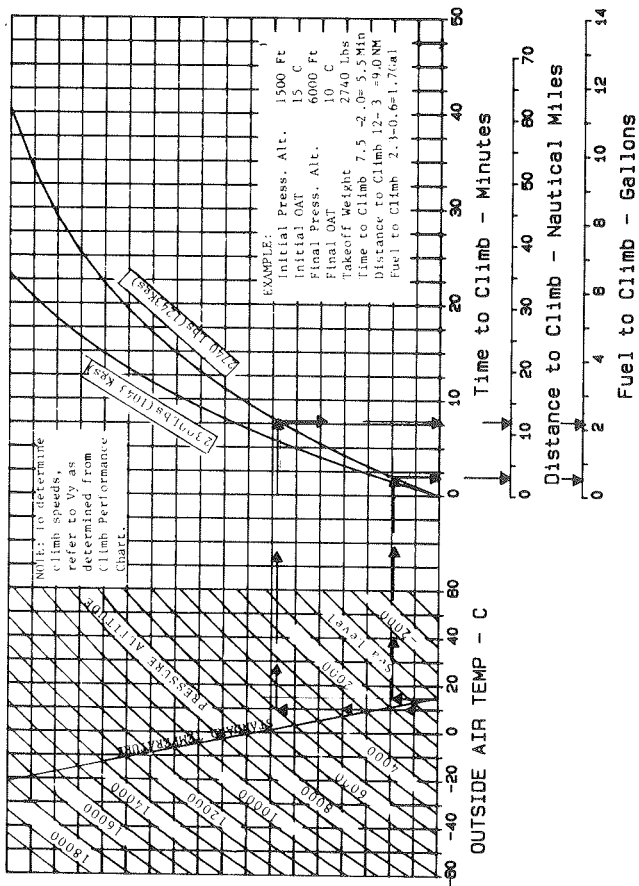

SECTION VI
PERFORMANCE

MOONEY M20J

CRUISE & RANGE DATA CONDITIONS

1. All Cruise and Range Data tables allow for: warm up, taxi, take-off, climb at maximum power at best rate of climb speed (V_y) to cruise altitude, cruise to destination at the specified power and mixture setting, descent to pattern altitude and a 45 minute fuel reserve at the same altitude and power setting. The data is also based on 64 U.S. gallons of usable fuel, standard atmosphere and no wind.
2. To obtain the performance shown by the Cruise and Range Data Tables on non-standard days, increase or decrease the manifold pressure approximately .4 in. Hg. for each 10° C variation in outside air temperature. Increase manifold pressure for air temperatures above standard and decrease manifold pressure for air temperatures lower than standard.

Mooney M20J

CRUISE POWER SCHEDULE

EXAMPLE:
 CRUISE ALT. 6000 FT.
 OAT 10°C
 POWER 65%
 RPM 2600
 M.P. 22.0 (7°C correction)

1. BEST POWER IS 55°C RICH OF PEAK EGT . 2. ECONOMY CRUISE IS 14°C RICH OF PEAK EGT .

NOTE: ADD .4" M.P. FOR EACH 10°C OAT ABOVE STANDARD DAY TEMPERATURE. SUBTRACT .4" M.P. FOR EACH 10°C OAT BELOW STANDARD DAY TEMPERATURE. IF OAT ABOVE STANDARD PRECLUDES OBTAINING THE DESIRED M.P. USE THE NEXT HIGHER RPM/M.P. WITH APPROPRIATE TEMPERATURE CORRECTION TO M.P.	PRESSURE ALTITUDE FEET STD. DAY	RPM	75% POWER (150 BHP)				70% POWER (140 BHP)				65% POWER (130 BHP)			
			2400	2500	2600	2700	2400	2500	2600	2700	2400	2500	2600	2700
		FUEL FLOW	BEST ECON.	10.3	10.4	10.5	10.8	9.7	9.8	9.9	10.2	9.2	9.3	9.4
	BEST POWER	12.0	12.2	12.3	12.5	11.3	11.5	11.7	11.9	10.5	10.8	11.0	11.2	
	STANDARD TEMP.	MANIFOLD PRESSURE - INCHES OF MERCURY												
S.L.	15°C	27.0	25.8	24.5	23.5	25.5	24.3	23.0	22.0	24.0	22.9	21.7	21.0	
2000	11°C	26.8	25.6	24.4	23.3	25.1	24.1	23.0	22.0	23.6	22.6	21.6	20.6	
4000	7°			24.4	23.2	24.9	23.9	22.9	21.8	23.3	22.4	21.5	20.5	
6000	3°			24.1	23.1	24.4	23.6	22.7	21.7	22.8	22.1	21.3	20.4	
8000	-1°				23.6			22.7	21.7			21.2	20.4	
10000	-5°								21.4			21.1	20.2	
12000	-9°													
14000	-13°													

NOTE: ADD .4" M.P. FOR EACH 10°C OAT ABOVE STANDARD DAY TEMPERATURE. SUBTRACT .4" M.P. FOR EACH 10°C OAT BELOW STANDARD DAY TEMPERATURE. IF OAT ABOVE STANDARD PRECLUDES OBTAINING THE DESIRED M.P., USE THE NEXT HIGHER RPM/M.P. WITH APPROPRIATE TEMPERATURE CORRECTION TO M.P.

SECTION V
 PERFORMANCE
 MOONEY M20J

Mooney M20J

CRUISE POWER SCHEDULE

1. BEST POWER IS 55°C RICH OF PEAK EGT . 2. ECONOMY CRUISE IS 14°C RICH OF PEAK EGT .

PRESSURE ALTITUDE FEET STD. DAY	RPM	60% POWER (120 BHP)						55% POWER (110 BHP)						45% POWER (90 BHP)							
		2200	3300	2400	2500	2600	2700	2200	2300	2400	2500	2600	2700	2000	2100	2200	2300	2400	2500	2600	2700
		FUEL FLOW		BEST ECON.		BEST POWER		BEST ECON.		BEST POWER		BEST ECON.		BEST POWER		BEST ECON.		BEST POWER		BEST ECON.	
STANDARD TEMP.		MANIFOLD PRESSURE - INCHES OF MERCURY																			
S.L.	15°C	34.2	33.4	22.5	21.5	20.5	19.5	22.5	21.8	21.0	20.0	19.9	18.0	21.0	20.0	19.0	18.3	17.5	16.9	16.3	15.4
2000	11°C	24.0	23.0	22.0	21.1	20.2	19.3	22.2	21.3	20.4	19.6	18.8	18.0	20.5	19.6	18.7	18.0	17.2	16.6	16.0	15.3
4000	7*	23.7	22.7	21.7	20.9	20.1	19.2	22.0	21.1	20.2	19.5	18.7	17.9	20.4	19.5	18.6	17.9	17.1	16.5	15.8	15.3
6000	3*	23.6	22.5	21.3	20.6	19.9	19.1	22.0	20.9	19.8	19.2	18.6	17.8	20.4	19.4	18.3	17.6	16.8	16.3	15.7	15.2
8000	-1*			21.3	20.6	19.8	19.0	22.0	20.9	19.8	19.2	18.6	17.8	20.3	19.3	18.2	17.4	16.5	16.1	15.7	15.1
10000	-5*			21.0	20.4	19.8	18.8			19.5	18.9	18.3	17.6			18.2	17.4	16.5	16.1	15.6	15.0
12000	-9*					19.6	18.8			19.3	18.8	18.2	17.5			18.0	17.2	16.4	16.0	15.5	14.9
14000	-13*											17.9	17.3					16.2	15.8	15.4	14.7

NOTE: ADD .4" M.P. FOR EACH 10°C OAT ABOVE STANDARD DAY TEMPERATURE. SUBTRACT .4" M.P. FOR EACH 10°C OAT BELOW STANDARD DAY TEMPERATURE. IF OAT ABOVE STANDARD PRECLUDES OBTAINING THE DESIRED M.P., USE THE NEXT HIGHER RPM/M.P. WITH APPROPRIATE TEMPERATURE CORRECTION TO M.P.

SECTION V
PERFORMANCE
MOONEY M20J

SECTION V PERFORMANCE

MOONEY M20J

SPEED POWER VS ALTITUDE

(GEAR UP, FLAPS UP, CONFL FLAPS CLOSED)

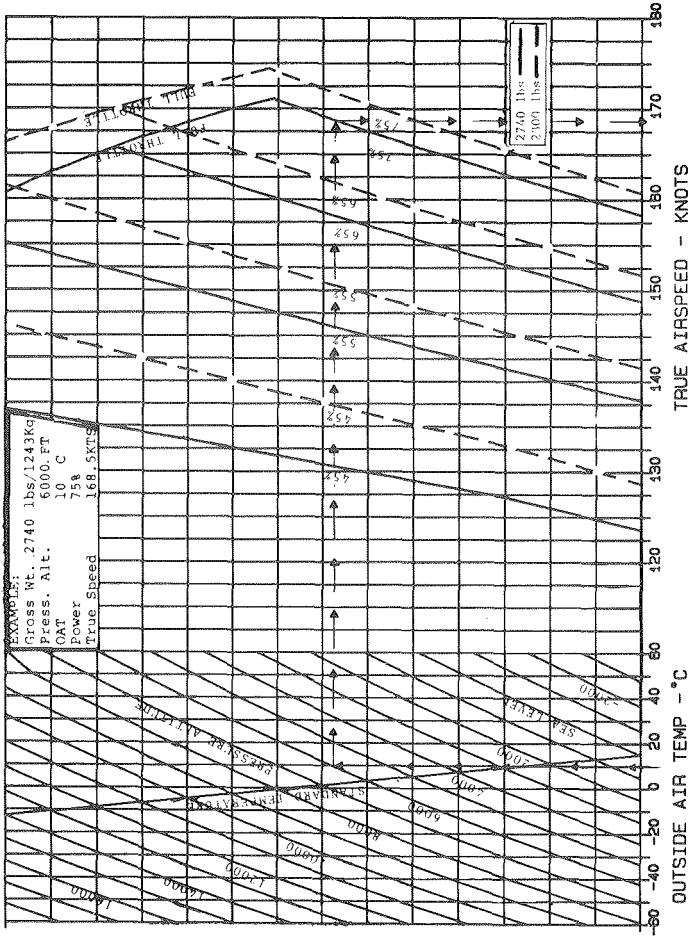

SECTION V PERFORMANCE MOONEY M20J

RANGE 75% POWER - 2740 LBS (1243 KGS)

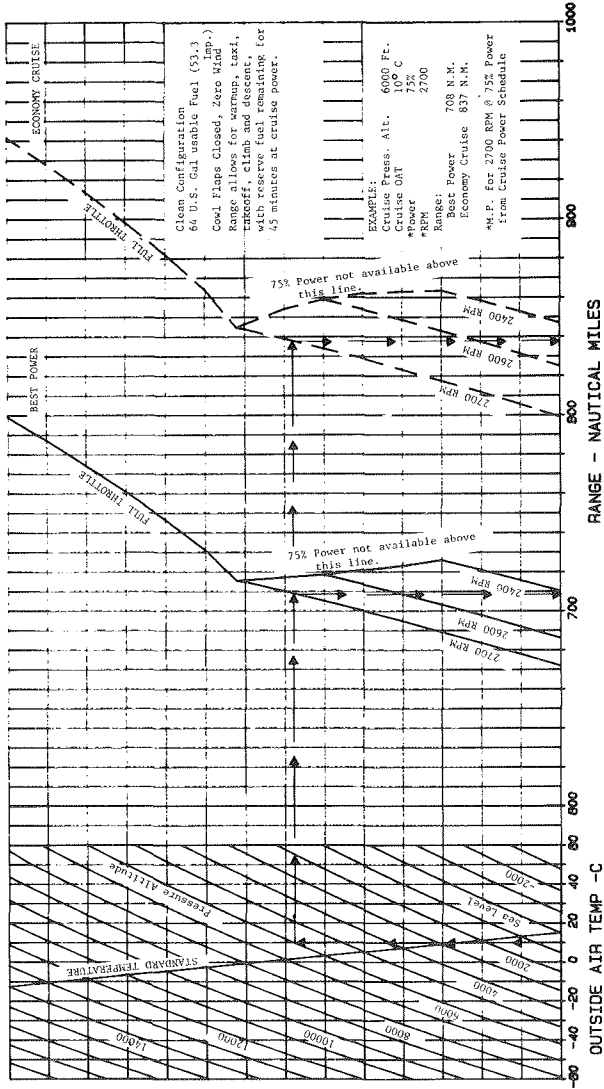

SECTION V
PERFORMANCE

MOONEY M20J

RANGE 65% POWER - 2740 LBS (1243 KGS)

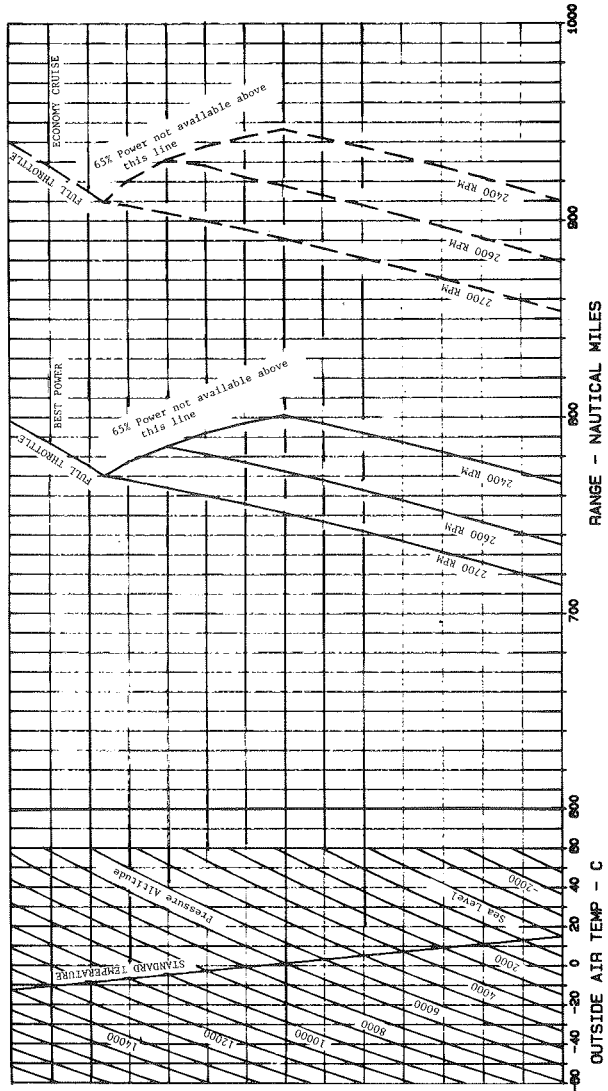

SECTION V
PERFORMANCE

MOONEY M20J

RANGE 55% POWER - 2740 LBS (1243 KGS)

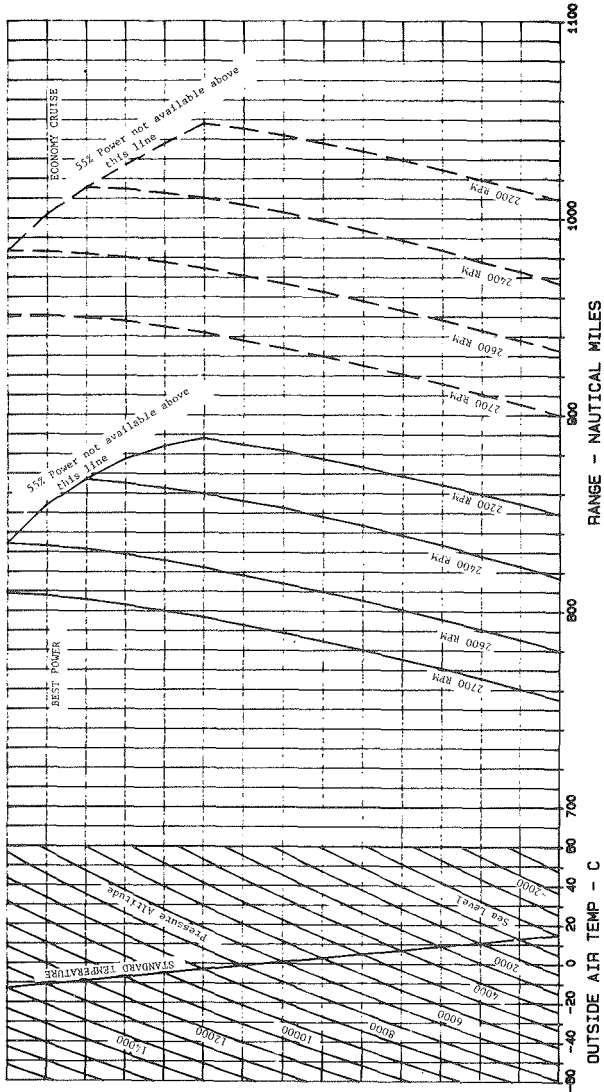

SECTION V
PERFORMANCE

MOONEY M20J

RANGE 45% POWER - 2740 LBS (1243 KGS)

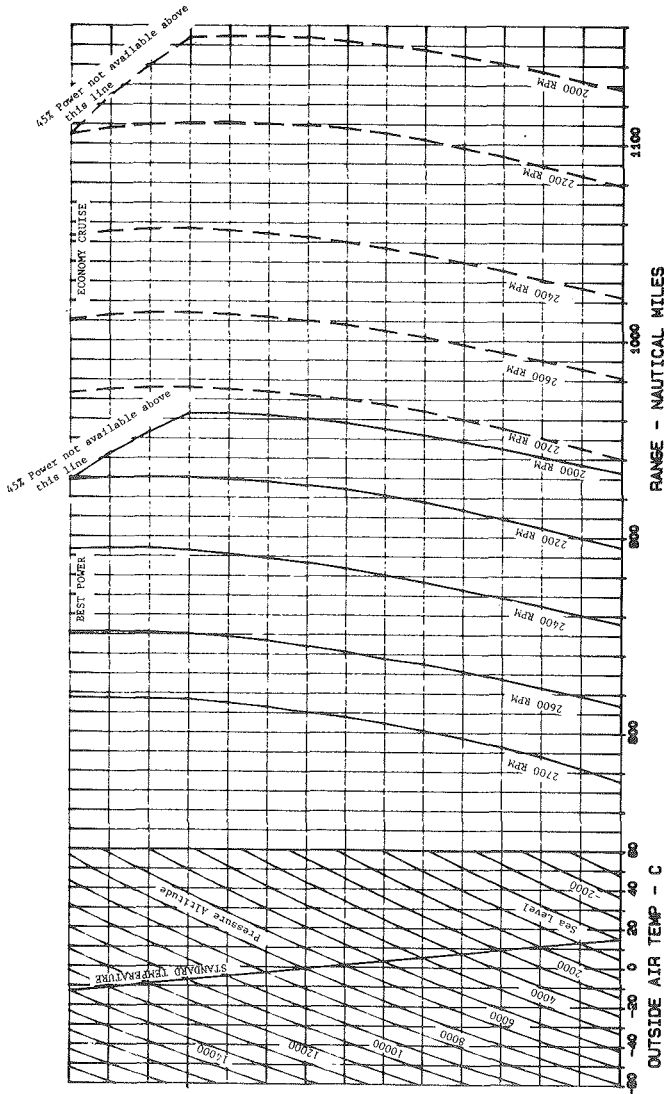

SECTION V PERFORMANCE

MOONEY M20J

ENDURANCE 75% POWER - 2740 LBS (1243 KGS)

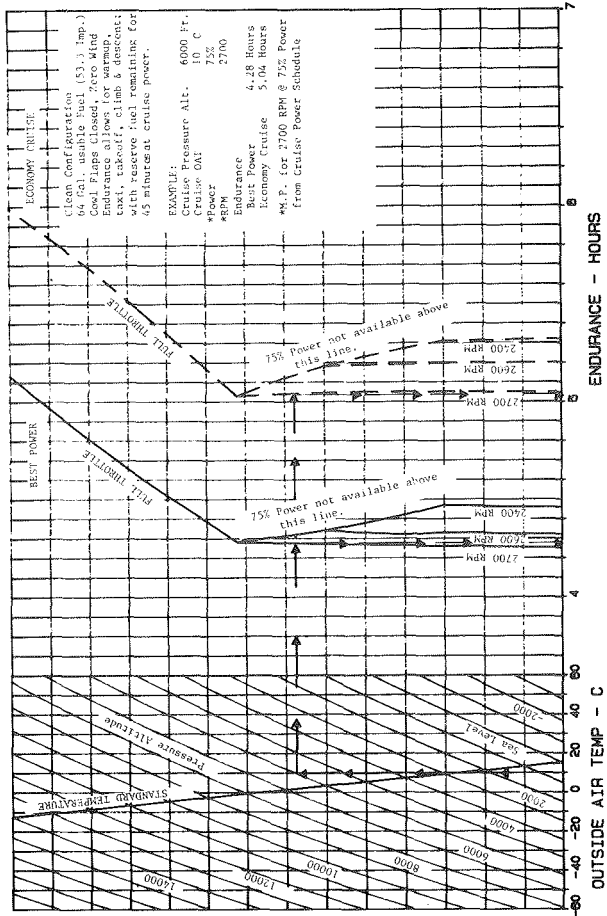

SECTION V
PERFORMANCE

MOONEY M20J

ENDURANCE 65% POWER - 2740 LBS (1243 KGS)

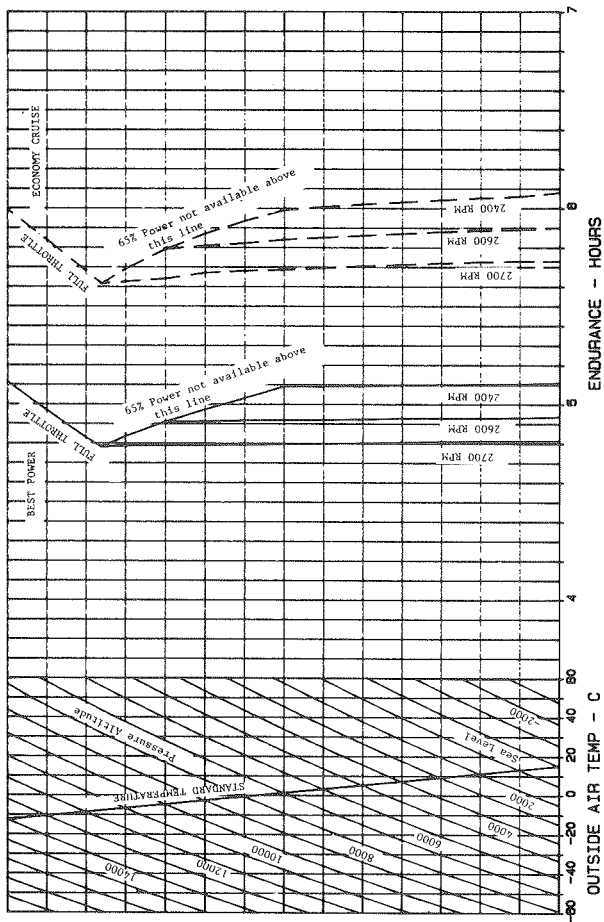

SECTION V
PERFORMANCE

MOONEY M20J

ENDURANCE 55% POWER - 2740 LBS (1243 KGS)

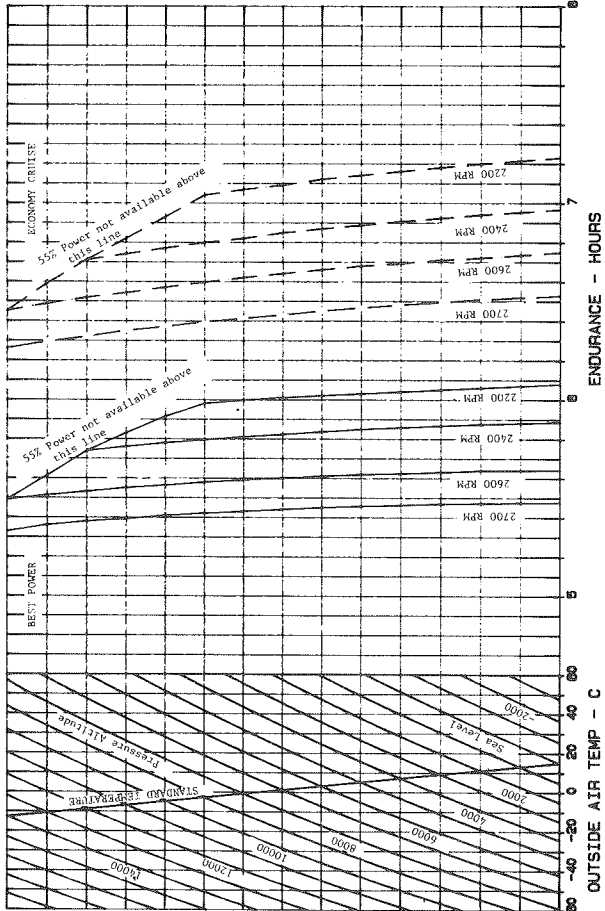

SECTION V
PERFORMANCE

MOONEY M20J

ENDURANCE 45% POWER - 2740 LBS (1243 KGS)

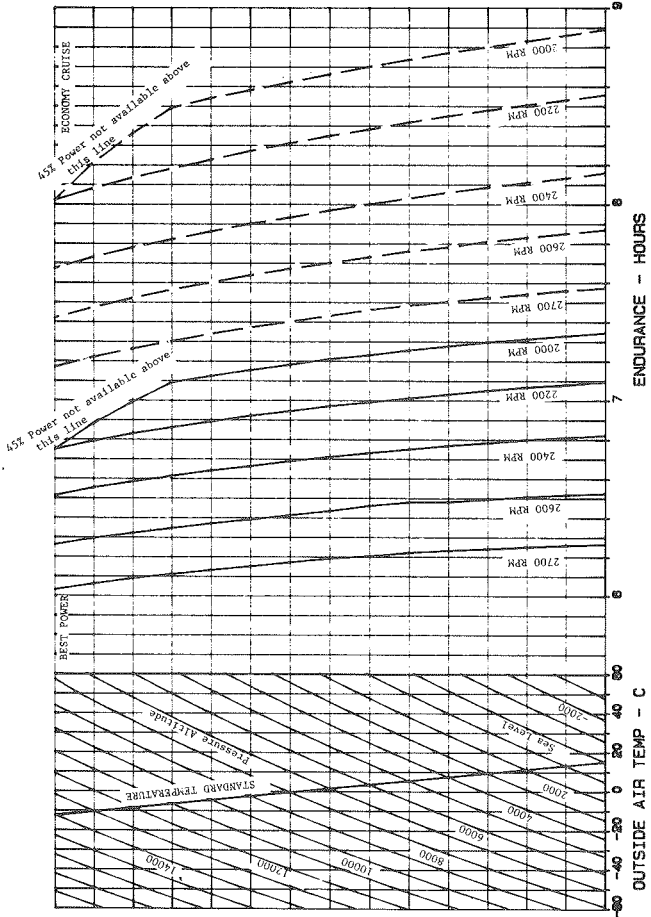

SECTION V
PERFORMANCE

MOONEY M20J

TIME-FUEL-DISTANCE TO DESCEND

150 KIAS DESCENT SPEED

EXAMPLE:

Initial Pressure Alt.6000 Ft.
Final Pressure Alt.1500 Ft.
Fuel to descend0.8 - 0.2 = 0.6 gals.
Time to descend8.0 - 2.0 = 6.0 Mins.
Distance to descend ..21.0 - 5.0 = 16.0 NM

ASSOCIATED CONDITIONS:

Power: 2400 RPM-MAP as required to maintain 750 FPM rate of descent.
Landing Gear: UP
Flaps: UP
Cowl Flaps: UP
Mixture: 14° C Rich of Peak

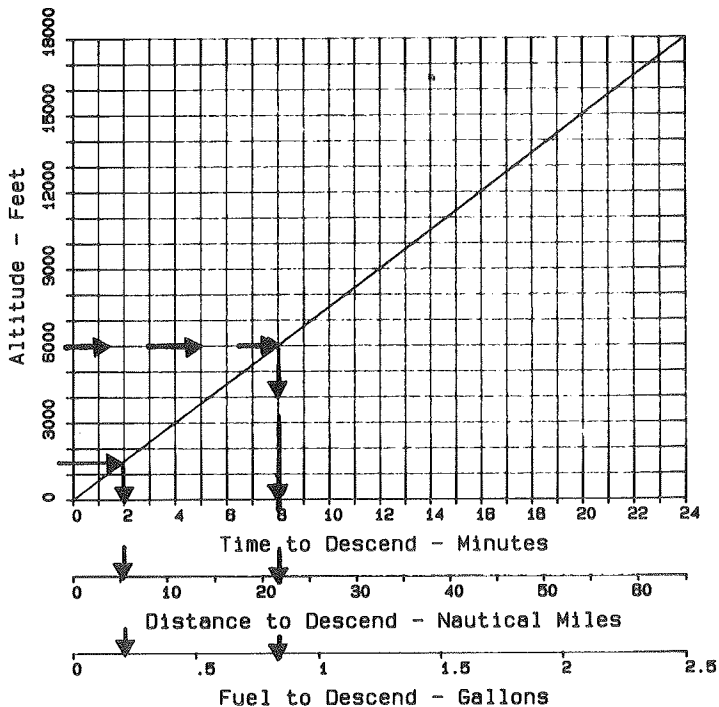

SECTION V
PERFORMANCE

MOONEY M20J

NORMAL LANDING DISTANCE

LANDING WEIGHT - LBS (KGS)	APPROACH SPEED - KIAS
2740 (1243)	71
2500 (1133)	65
2300 (1043)	65

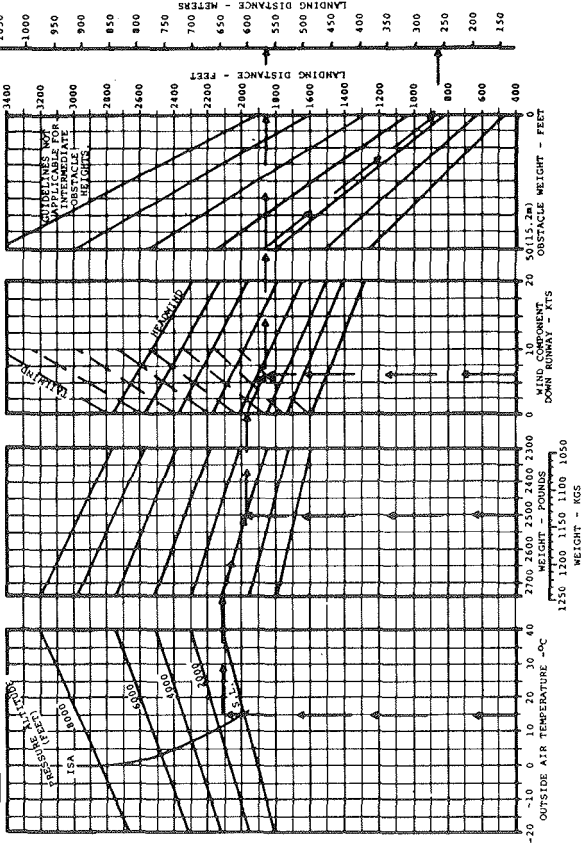

ASSOCIATED CONDITIONS:

- POWER: IDLE
- LANDING GEAR: DOWN
- WING FLAPS: FULL DOWN (31°)
- RUNWAY: PAVED, DRY
- SURFACE: LEVEL
- BRAKING: MAXIMUM

EXAMPLE: →

- OAT: 15°C
- PRESSURE: 1500 FT.
- ALTITUDE: 1500 FT.
- WEIGHT: 2500 LBS. (1134 KGS)
- HEADWIND COMPONENT: 5 KTS.
- GROUND ROLL: 860 FT. (262 M)
- DISTANCE TO CLEAR OBSTACLE: 1860 FT. (567 M)
- LANDING DISTANCE (150 FT. OBSTACLE): 1860 FT. (567 M)

MAXIMUM PERFORMANCE LANDING DISTANCE

LANDING WEIGHT - LBS KGS	APPROACH SPEED - KIAS
2700 (1224)	52
2500 (1134)	62
2300 (1044)	59

ASSOCIATED CONDITIONS

- POWER: IDLE
- LANDING: DOWN
- GEAR: DOWN
- FLAPS: FULL DOWN
- RUNWAY: PAVED, DRY
- SURFACE: LEVEL, DRY
- BRAKING: MAXIMUM

EXAMPLE: →

OUT	15°C
PRESSURE ALTITUDE	1500 FT
WEIGHT	2500 LBS (1134 KGS)
HEADWIND COMPONENT	6 KTS
GROUND ROLL DISTANCE (2076)	680 FT
TOTAL LANDING DISTANCE (4726)	1550 FT
DISTANCE (50 FT OBSTACLE)	1100 FT

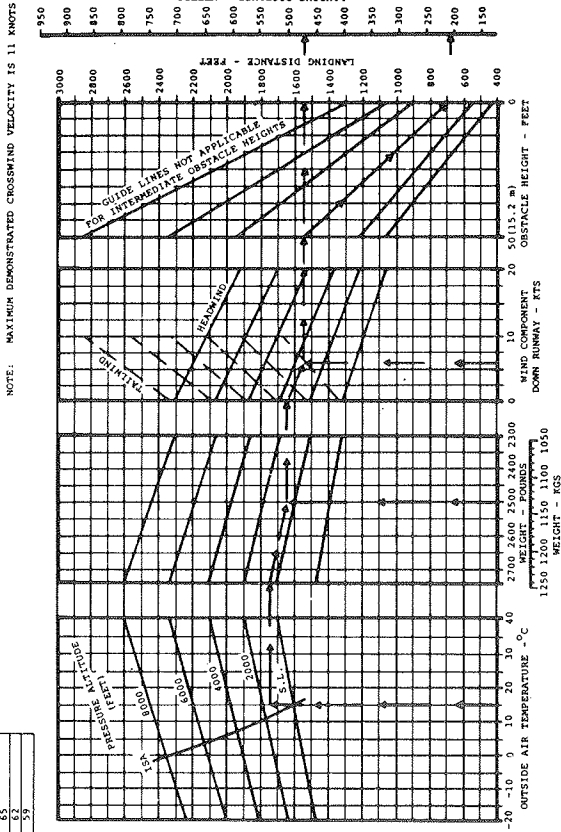

SECTION V PERFORMANCE MOONEY M20J

SECTION V
PERFORMANCE

MOONEY M20J

NORMAL LANDING DISTANCE-GRASS SURFACE

LANDING WEIGHT - LBS (KGS)		APPROACH SPEED - KIAS	
2100 (953)	11	71	
2300 (1043)	11	71	
2500 (1133)	11	71	

ASSOCIATED CONDITIONS:

POWER IDLE
LANDING DOWN
WING FLAPS FULL DOWN (37°)
MIXING VALVE OPEN
RUNWAY SHORT, DRY
SURFACE GRASS, LEVEL
BRAKING MAXIMUM

EXAMPLE:

OAT 15°C
PRESSURE 1300 FT.
ALTITUDE 5000 FT.
WEIGHT (1133 KGS)
HEADWIND 6 KTS.
GROUND ROLL 1270 FT.
(387 m)
TOTAL LANDING 2280 FT.
DISTANCE (695 m)
(50 FT. OBSTACLE)

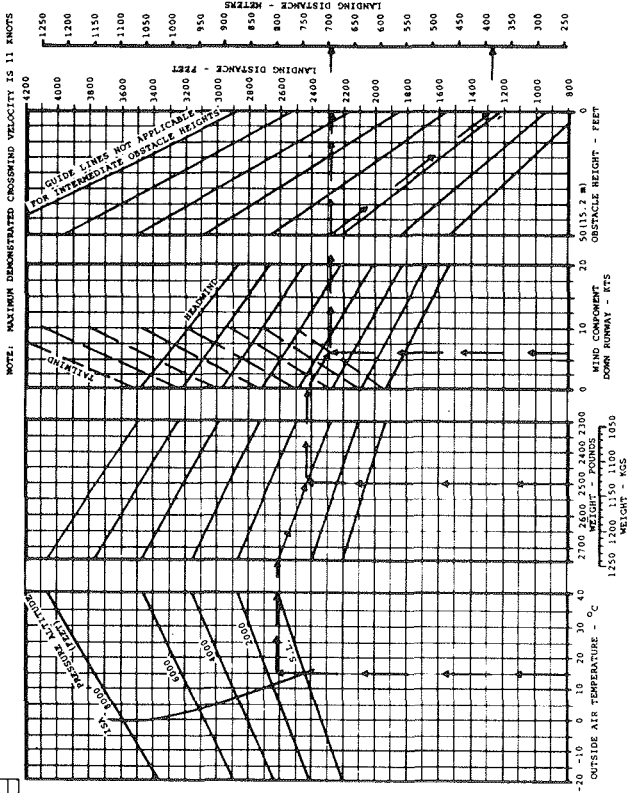

SECTION V
PERFORMANCE
MOONEY M20J

MAXIMUM PERFORMANCE LANDING DISTANCE-GRASS SURFACE

LANDING WEIGHT - LBS (KGS)	APPROACH SPEED - KIAS
2140 (1143)	65
2300 (1134)	62
2380 (1087)	59

ASSOCIATED CONDITIONS:

- POWER: IDLE
- LANDING GEAR: DOWN
- WING FLAPS: FULL DOWN
- RUNWAY: SMOOTH GRASS, LEVEL
- SURFACE: GRASS, LEVEL
- BRAKING: MAXIMUM

EXAMPLE: →
 DAT: 15°C
 PRESSURE: 1500 FT.
 ALTITUDE: 2500 LBS.
 WEIGHT: (1134 KGS)
 HEADWIND COMPONENT: 6 KTS.
 GROUND ROLL: 1030 FT.
 (314 M.)
 TOTAL LANDING DISTANCE: 1900 FT.
 (579 M.)
 (50 FT. OBSTACLE)

NOTE: MAXIMUM DEMONSTRATED CROSSWIND VELOCITY IS 11 KNOTS

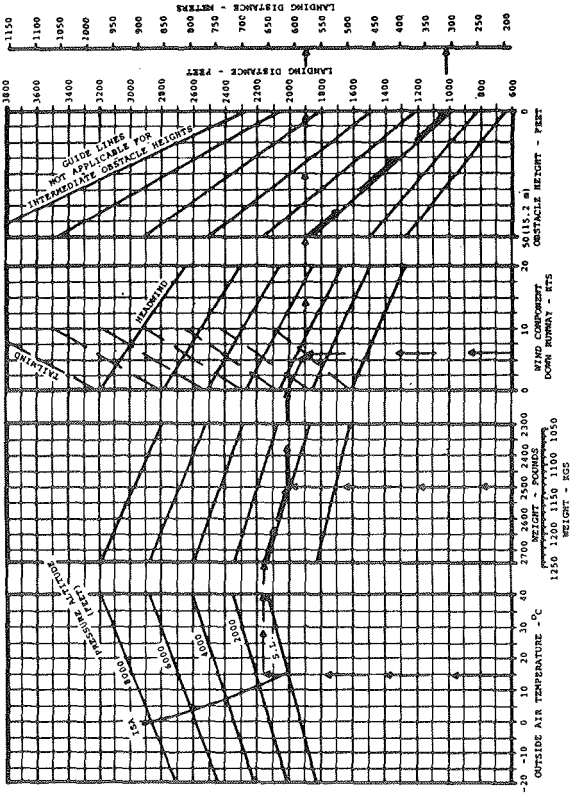

SECTION V
PERFORMANCE

MOONEY M20J

MISSION PROFILE CHARTS

The Mission Profile Charts are presented as a flight planning aid. They can provide information to assist in the selection of altitude and power settings to fly as well as provide the flight time and fuel used to fly a given distance.

The charts are based on the following:

- Fuel used to warmup, taxi and takeoff.
- Time and fuel to climb at maximum power.
- Time and fuel to cruise at 2600 RPM with economy cruise mixture.
- Cruise with cowl flaps closed and with gear and flaps UP.
- Time and fuel to descend at 750 fpm at 150 KIAS.
- Zero wind.
- Gross weight.

CAUTION

Zero wind conditions seldom occur. In addition, varying atmospheric conditions, aircraft weight, the mechanical condition of the aircraft and piloting techniques all affect the actual flight time and fuel used during a flight.

It is the pilots responsibility to determine the actual operating conditions and plan the flight accordingly.

SECTION V
PERFORMANCE

MOONEY M20J

MISSION PROFILE -- 200 N.M.

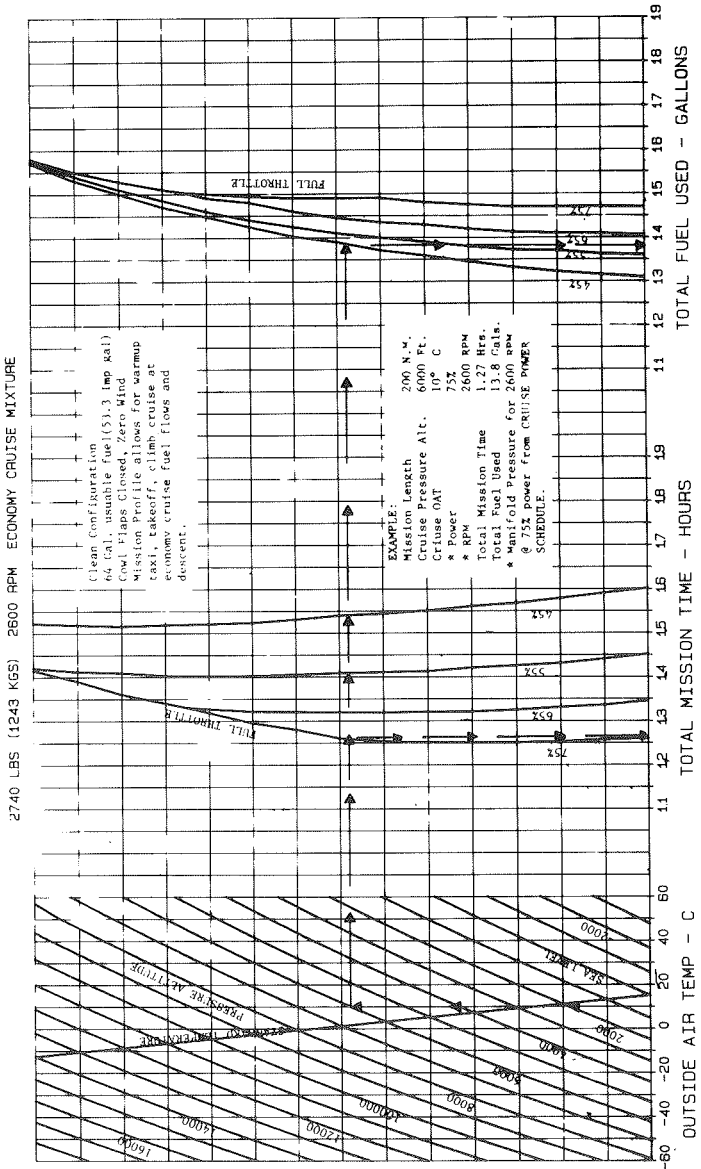

SECTION V
PERFORMANCE
MOONEY M20J

MISSION PROFILE - 400 N.M.
2740 LBS (1243 KGS) 2600 RPM ECONOMY CRUISE MIXTURE

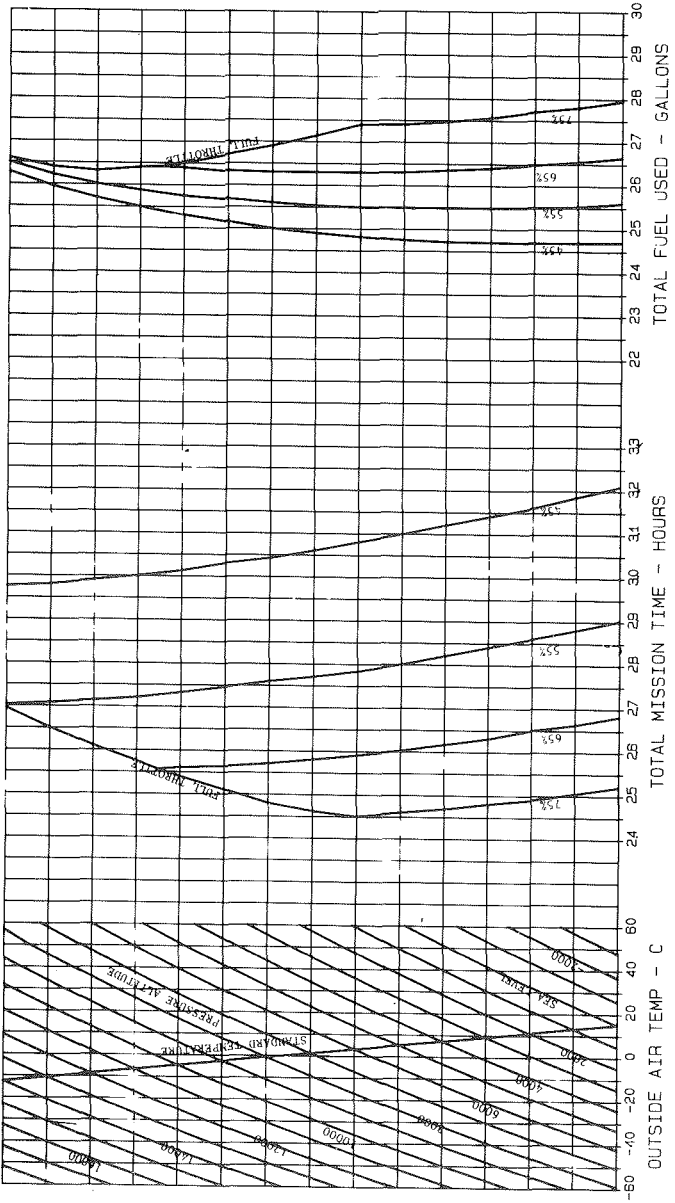

SECTION V
 PERFORMANCE
 MOONEY M20J

MISSION PROFILE - 600 N.M.

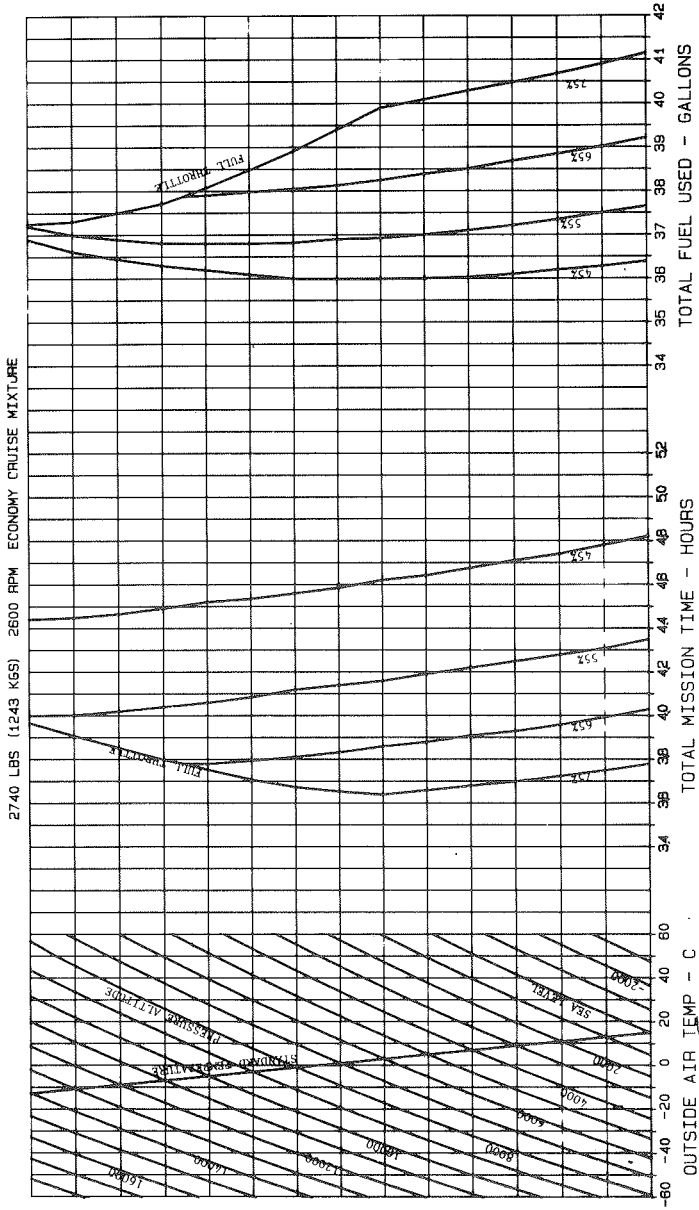

SECTION V
PERFORMANCE

MISSION PROFILE - 800 N.M.

2740 LBS (1243 KGS) 2800 RPM ECONOMY CRUISE MIXTURE

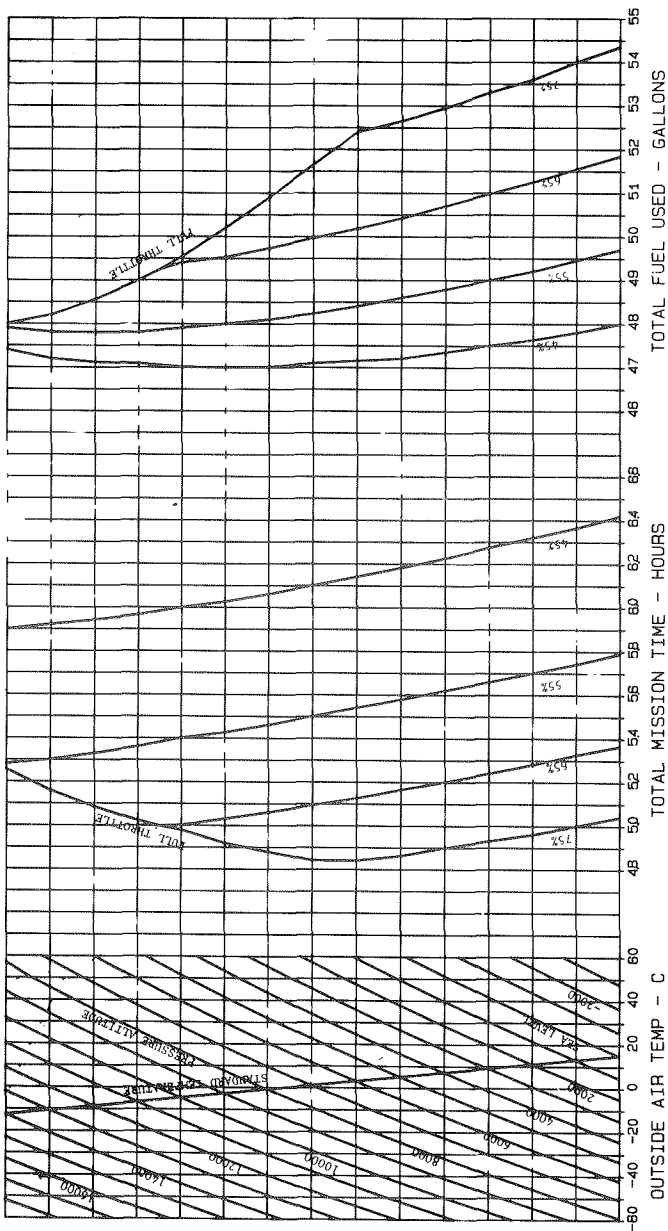

SECTION VI
WEIGHT AND BALANCE

MOONEY M20J

TABLE OF CONTENTS

TITLE	PAGE
INTRODUCTION.....	6-2
AIRPLANE WEIGHING PROCEDURE.....	6-3
OWNERS WEIGHT & BALANCE RECORD.....	6-6
PILOTS LOADING GUIDE.....	6-7
PROBLEM FORM.....	6-9
LOADING COMPUTATION GRAPH.....	6-9
CENTER OF GRAVITY MOMENT ENVELOPE.....	6-10
CENTER OF GRAVITY LIMITS.....	6-10
EQUIPMENT LIST.....	6-11

NOTE:

The empty weight, center of gravity, and equipment list for the airplane as delivered from Mooney Aircraft Corporation is contained in this section. The use of this section is valid for use with the airplane identified below when approved by Mooney Aircraft Corporation.

MODEL - M20J

AIRCRAFT SERIAL NO. _____

AIRCRAFT REGISTRATION NO. _____

Mooney Aircraft Corp. Approval Signature & Date

SECTION VI
WEIGHT AND BALANCE

MOONEY M20J

INTRODUCTION

This section describes the procedure for calculating loaded aircraft weight and moment for various flight operations. In addition, procedures are provided for calculating the empty weight and moment of the aircraft when the removal or addition of equipment results in changes to the empty weight and center of gravity. A comprehensive list of all Mooney equipment available for this airplane is included in this section. Only those items checked (X) were installed at Mooney and are included in the empty weight-and-balance data.

The aircraft owner and pilot has the responsibility of properly loading the aircraft for safe flight. Data presented in this section will enable you to carry out this responsibility and insure that your airplane is loaded to operate within the prescribed weight and center-of-gravity limitations.

At the time of delivery, Mooney Aircraft Corporation provides the empty weight and center of gravity data for the computation of individual loadings. (The empty weight and C.G. (gear extended) as delivered from the factory is tabulated on page 5-6 when this manual is supplied with the aircraft from the factory.)

FAA regulations also require that any change in the original equipment affecting the empty weight and center of gravity be recorded in the Aircraft Log Book. A convenient form for maintaining a permanent record of all such changes is provided on page 5-6. This form, if properly maintained, will enable you to determine the current weight-and-balance status of the airplane for load scheduling. The weight-and-balance data entered as your aircraft left the factory, plus the record you maintain on page 6-6, is all of the data needed to compute loading schedules.

The maximum certificated gross weight for the Model M20J under all operating conditions is 2740 pounds (1243 Kg). Maximum useful load is

SECTION VI
WEIGHT AND BALANCE

MOONEY M20J

determined by subtracting the corrected aircraft empty weight from its maximum gross weight. The aircraft must be operated strictly within the limits of the Center-of-Gravity Moment Envelope shown on page 5-8.

AIRPLANE WEIGHING PROCEDURE

(A) LEVELING: Place a spirit level on the leveling screws above the tailcone access door when leveling the aircraft longitudinally. Level the aircraft by increasing or decreasing air pressure in the nose wheel tire.

(B) WEIGHING: To weigh the aircraft, select a level work area and:

1. Check for installation of all equipment as listed in the Weight & Balance Record Equipment List.

2. Top off both tanks with full fuel. Subtract usable fuel 64.0 gal. (242.4 liters, 53.3 Imp. Gal.) @ 5 lb/gal=384.0 lbs. (174.2 Kg.) from total weight as weighed, (Use 5.32 lb/gal for 100LL fuel).

OPTIONAL METHOD - Ground aircraft and defuel tanks as follows:

a. Disconnect fuel line at electric boost pump outlet fitting.

b. Connect to output fitting a flexible line that will reach fuel receptacle.

c. Turn fuel selector valve to the tank to be drained, and remove filler cap from fuel filler port.

d. Turn on boost pump until tank is empty. Repeat steps c. and d. to drain the other tank.

e. Replace 1.25 gal. (4.7 liters, 1.0 Imp. Gal.) fuel @ 5.0 lb./gal. into each tank (unusable fuel). (Use 5.32 lb/gal. for 100LL fuel).

f. Replace filler caps.

3. Fill oil to capacity-8 qts. (7.5 liters).

4. Position front seats in full forward position.

5. Position flaps in full up position.

6. Position a 2000-pound (907.2 Kg.) capacity

SECTION VI
WEIGHT AND BALANCE

MOONEY M20J

scale under each of the three wheels.

7. Level aircraft as previously described making certain nose wheel is centered.

8. Weigh the aircraft and deduct any tare from each reading.

9. Find reference point by dropping a plumb bob from center of nose gear trunnion (retracting pivot axis) to the floor. Mark the point of intersection.

10. Locate center line of nose wheel axle and main wheel axles in the same manner.

11. Measure the horizontal distance from the reference point to main wheel axle center line. Measure horizontal distance from center line of nose wheel axle to center line of main wheel axles.

NOTE

Depending on the aircraft C.G. location the distance from the centerline of the main wheel axles to the trunnion reference point may be longer than the center line of the nose wheel axle.

12. Record weights and measurements, and compute basic weight and CG as follows:

NOTE: Wing jack points are located at Fus. Sta. 56.658 in.
Nose jack point is located at Fus. Sta. 3.415 in.

SECTION VI WEIGHT AND BALANCE

MOONEY M20J

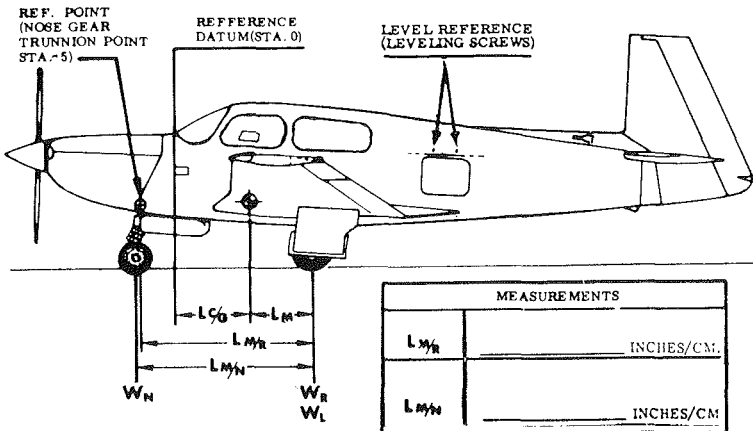

SCALE POSITION AND SYMBOL	SCALE READING	TARE	NET WEIGHT
Nose Wheel (W_N)			
Right Main Wheel (W_R)			
Left Main Wheel (W_L)			
Basic Empty Weight, as Weighed (W_T)			(if fuel has been drained)
As Weighed (WT)			(if fuel has not been drained)

a. CG Forward of Main Wheels:

$$\frac{\text{LBS/KG}}{\text{Weight of Nose}} \times \frac{\text{IN/CM}}{\text{Distance Between Main and Nose Wheel Axle Centers}} \rightarrow \frac{\text{LBS/KG}}{\text{Total Weight of Aircraft}} = \frac{\text{IN/CM}}{\text{CG Forward of Main Wheels}}$$

$$(W_N) \quad (L_{MN}) \quad (W_T) \quad (L_M)$$

b. CG Aft of Datum (Station 0):

$$\frac{\text{IN/CM}}{\text{Distance from Center Nose Gear Trunion to Center of Main Wheel Axles (Horizontal)}} - \frac{\text{5 IN (12.7 CM)}}{\text{Distance from Nose Gear Trunion to Datum}} = \frac{\text{IN/CM}}{\text{Result of Computation Above}} = \frac{\text{IN/CM}}{\text{CG (FUS. STA.) Distance Aft of Datum. (Empty Weight CG)}}$$

$$(L_{MN}) \quad \text{Constant} \quad (L_M) \quad (L_{CG})$$

If fuel has not been drained, the usable fuel must be analytically subtracted to determine the basic empty wt. and c.g. Use the loading calculation procedure shown on page 6-7.

Weight	Lbs.	C.G. (in)	Moment $\frac{\text{lb-in}}{1000}$
As Weighed (wt)			
Usable fuel	-	48.43	-
Basic Empty Wt.			

OWNERS WEIGHT AND BALANCE RECORD
 (ENTER BELOW ALL WEIGHT CHANGE DATA FROM AIRCRAFT LOG BOOK)

AIRPLANE MODEL - M20J		SERIAL NUMBER _____				FAA REGISTRATION NO. _____			
DATE	DESCRIPTION OF MODIFICATION	WEIGHT CHANGE				RUNNING EMPTY WEIGHT			
		ADDED (+)		REMOVED (-)		Wt. (Pounds)	Moment /1000	Arm (Inches)	Useful Load
		Wt. (Pounds)	Arm (Inches)	Wt. (Pounds)	Arm (Inches)				
	BASIC EMPTY WEIGHT AS DELIVERED (W _T) (INCLUDES FULL OIL - 8 QTS)	---	---	---	---				

SECTION VI
 WEIGHT AND BALANCE
 MOONEY M20J

SECTION VI
WEIGHT AND BALANCE

MOONEY M20J

PILOT'S LOADING GUIDE

LOADING CALCULATION PROCEDURE

Proper loading of the aircraft is essential for maximum flight performance and safety. This section will assist you in determining whether the aircraft loading schedule is within the approved weight and center-of-gravity limits.

To figure an actual loading problem for your aircraft, proceed as follows:

Step 1. Refer to the latest entry on page 6-5 for the current empty weight and moment.

NOTE

Since the engine oil is normally kept at the full level, the oil weight and moment is included in basic empty weight and is constant in calculating all loading problems.

Step 2: Note the pilot's weight and the position his seat will occupy in flight. Find this weight on the left scale of the Loading Computation Graph (page 6-7) and cross the graph horizontally to the graph for #1 and #2 seats. When this point is located, drop down to the bottom scale to find the value of the moment/1000 due to the pilot's weight and seat position.

Repeat the procedure for the co-pilot and enter these weights and moment/1000 values in the proper subcolumns in the Propter Form on page 6-7.

Step 3: Proceed as in Step 2 to account for the passengers in seats 3 and 4. Enter the weight and value of moment/1000 in the proper columns.

Step 4: Again proceed as in Step 2 to account for the amount of fuel carried, and enter the weight and moment/1000 values in the proper columns.

SECTION VI
WEIGHT AND BALANCE

MOONEY M20J

Step 5: Once more proceed as in Step 2 to account for the baggage to be carried and enter the figures in the proper columns.

Step 6: Total the weight columns. This total must be 2740 Pounds or less. Total the Moment/1000 column. DO NOT FORGET TO SUBTRACT NEGATIVE NUMBERS.

Step 7: Refer to the Center-of-Gravity Moment Envelope (page 6-8). Locate the loaded weight of your airplane on the left scale of the graph and trace a line horizontally to the right. Locate the total moment/1000 value for your airplane on the bottom scale of the graph and trace a line vertically above this point until the horizontal line for weight is intersected. If the point of intersection is within the shaded area, your aircraft loading is acceptable. If the point of intersection falls outside the shaded area, you must rearrange the load before takeoff.

SECTION VI
WEIGHT AND BALANCE

MOONEY M20J

PROBLEM FORM

FAA REGISTRATION NO. _____		M20J SERIAL NO. _____			
Step	ITEM	Sample Problem Pilot & Two Pass.		Your Problem	
		Weight (LBS)	Moment (LB-INCH. /1000)	Weight (LBS)	Moment (LB-INCH. /1000)
1	Aircraft Basic Empty Weight, W_T (From Page 6-8) Includes Full Oil = 8 QT. @ 7.5 LBS/QT (Sta - 11.5) (Sump assumed full for all flights)	1716.0	15.36		
2	Pilot Seat (#1)*	170.0	6.0 (2nd Pos.)		
	Copilot Seat (#2)*	170.0	5.8 (Fwd. Pos.)		
3	Left-Rear Seat (#3) or Cargo Area	170.0	12.00		
	Right-Rear Seat (#4) or Cargo Area				
4	Fuel (Max. Usable 64 Gal., 384 LBS. @ sta. 48.43) (242.4 liter, 174.2 Kg)	312.0	15.11		
5	Baggage (Max. 120 LBS @ Sta 95.5)	110.0	10.23		
	Hat Rack (Max. 10 LBS @ Sta 119.0)	3.0	.36		
6	Loaded Aircraft Weight	2645.0	 	 	
	Total Moment/1000	 	124.76	 	
7	Refer to Page 6-8, Center-of-Gravity Moment Envelope, to determine whether your aircraft loading is acceptable.				

*Obtain the moment/1000 value for each seat position (FWD, MID, or AFT.) from loading computation graph below.

CAUTION

Cargo loaded in rear seat area, with seat backs folded down, should have center of gravity over fuselage station 70.7.

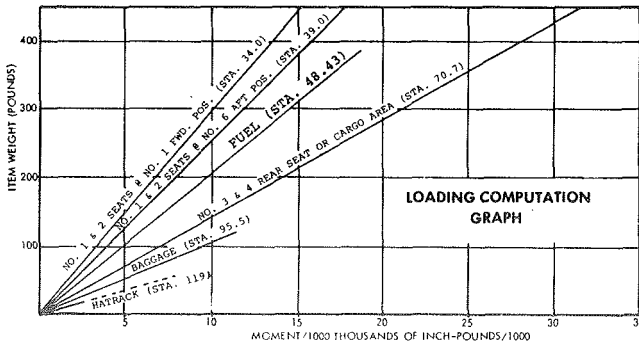

SECTION VI
WEIGHT AND BALANCE

MOONEY M20J

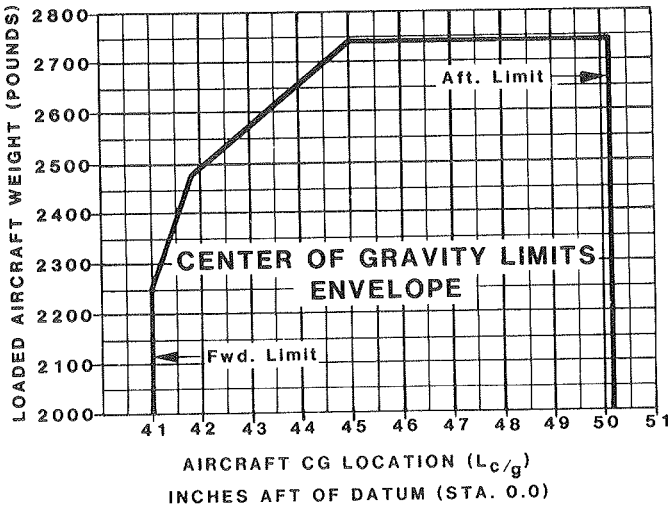
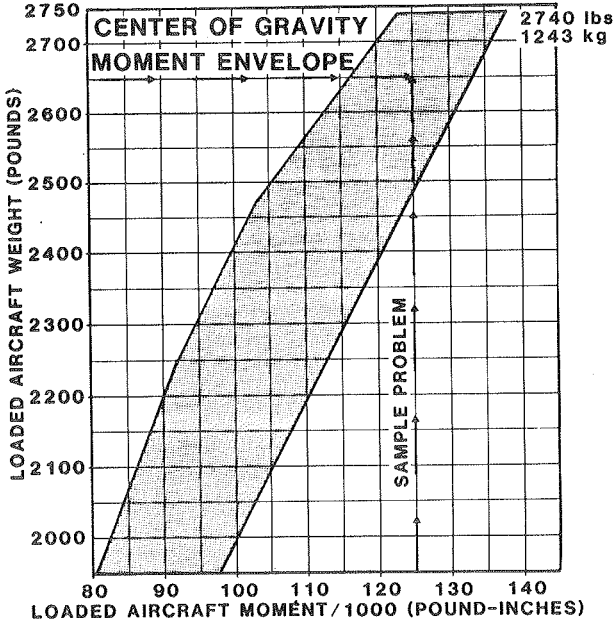

SECTION VI
WEIGHT AND BALANCE

MOONEY M20J

EQUIPMENT LIST

The following equipment list is a listing of all items approved at the time of publication of this manual for the Mooney M20J.

Only those items having an X in the "Mark If Installed" column and dated were installed at Mooney.

If additional equipment is to be installed it must be done in accordance with the reference drawing or a separate FAA approval.

NOTE

Positive arms are distances aft of the airplane datum. Negative arms are distances forward of the airplane datum.

Asterisks (*) after the item weight and arm indicate complete assembly installations. Some major components of the assembly are listed and indented on the lines following. The summation of the major components will not necessarily equal the complete assembly installation.

6-12

EQUIPMENT LIST

ITEM NO.	ITEM DESCRIPTION	REF. DRAWING	WEIGHT (POUNDS)	ARM (INCHES)	MARK IF INSTALLED			
					MO	DAY	YEAR	
	Powerplant and Accessories							
1A	Engine, Lycoming IO360-A3B6D (Includes Starter, Prestolite 70 Amp Alternator, and Oil Filter)	600363	330.00*	-15.76*	X			
2A	Oil Radiator (Stewart Warner)	620052	2.4	-3.8	X			
3A	Valve, Oil Quick Drain (Net Change)	600363	0.00	-14.00	X			
4A-1	Propeller - Constant Speed (McCauley - B2D34C214/90DHB-16E or -16EP)	680031	49.50	-35.50				
5A	Governor, Propeller (McCauley C290D5/T17)	660115	2.75	-1.40	X			

SECTION VI
WEIGHT AND BALANCE
MOONEY M20J

ISSUED 6-2-86

EQUIPMENT LIST

MO				
DAY				
YEAR				

ITEM NO.	ITEM DESCRIPTION	REF. DRAWING	WEIGHT (POUNDS)	ARM (INCHES)	MARK IF INSTALLED			
	A. Powerplant and Accessories (CONT).							
6A	Spinner Installation	680031	4.80	-35.00	X			
7A	Induction Air Filter	600355	1.00	-25.50	X			
8A	Fuel Selector Valve	610152	0.9	26.25	X			
4A-2	Propeller - Constant Speed (Hartzell - HC-(C2YK-1BF/F7666A-3Q)	680031	54.25	-35.50				

SECTION VI
WEIGHT AND BALANCE
MOONEY M20J

EQUIPMENT LIST

ITEM NO.	ITEM DESCRIPTION	REF. DRAWING	WEIGHT (POUNDS)	ARM (INCHES)	MARK IF INSTALLED			
					MO	DAY	YEAR	
	B. Electrical System							
1B	Battery	800351	27.5	110.80	X			
2B	Regulator	800351	.6	4.00	X			
3B	Heated Pitot Installation	820252	1.15	41.85	X			
4B	Cigarette Lighter	800351	.17	19.50	X			
5B								
6B	Fuel Pump	610152	2.4	15.0	X			
7B	Stall Warning Indicator (Mallory)	800351	1.00	50.00	X			
8B	Gear Warning Indicator (Mallory)	800351	1.00	50.00	X			
9B	Strobe Light, Wingtip Instl	800351	3.08	53.00	X			
10B	Strobe Light, Tail Instl	800351	0.8	215.82	X			
11B	Safety Switch, Air Speed	800351	.20	15.0	X			

SECTION VI
WEIGHT AND BALANCE
MOONEY M20J

SECTION VI
WEIGHT AND BALANCE

MOONEY M20J

ITEM NO.	ITEM DESCRIPTION	REF. DRAWING	WEIGHT (POUNDS)	ARM (INCHES)	MARK IF INSTALLED	MO.		
						DAY	YEAR	
	B. ELECTRICAL SYSTEM (cont)							
12B	Landing Lights	650180	.75	-20.5	X			
13B	Actuator, Flap	750097	5.1	103.12	X			
14B	Fuel Qty. Transmitter, Inbd (2 ea)	610152	.45	48.0	X			
15B	Fuel Qty. Transmitter, Outbd (2 ea)	610152	.45	48.5	X			
16B	Actuator, Landing Gear	560260	11.2	39.0	X			
17B	E.L.T.	810152	2.1	121.0	X			

EQUIPMENT LIST

ITEM NO.	ITEM DESCRIPTION	REF. DRAWING	WEIGHT (POUNDS)	ARM (INCHES)	MO			
					DAY	YEAR		
	C. WHEELS TIRES & BRAKES							
1C	Two Main Wheel & Brake Assys	520029	13.72*	64.4	X			
	Wheel Assy (2)	520029	11.00	63.98	X			
	Brake Assy (2)	520029	2.72	65.98	X			
2C	Nose Wheel Assy	540000	2.60	-5.3	X			
3C	Two Main Wheel Tire Assys (6-Ply Rating Tires, 6.00X6 , Type III, with regular tubes)	520029	17.0	63.98	X			
4C	Nose Wheel Tire Assy (6-ply rating tire, 5.00 X 5 Type III, with regular tube)	540000	7.00	-5.3	X			

SECTION VI
WEIGHT AND BALANCE
MOONEY M20J

6-16

ISSUED 6-2-86

ISSUED 6-2-86

6-17

EQUIPMENT LIST

ITEM NO.	ITEM DESCRIPTION	REF. DRAWING	WEIGHT (POUNDS)	ARM (INCHES)	MO. DAY YEAR		
	C. WHEELS TIRES & BRAKES (cont)						
5C	Brake Master Cylinder (2ea)	850109	3.0	8.3	X		
6C	Hydraulic Reservoir	850109	.3	108.75	X		
7C	Valve, Parking Brake	850109	.6	-1.45	X		

SECTION VI
WEIGHT AND BALANCE
MOONEY M20J

SECTION VI
WEIGHT AND BALANCE

MOONEY M20J

EQUIPMENT LIST					MO	DAY	YEAR
ITEM NO.	ITEM DESCRIPTION	REF. DRAWING OR PART NO.	WEIGHT (POUNDS)	ARM (INCHES)	MARK IF INSTALLED		
	P. Instruments						
1D	Attitude Gyro	820071	2.28	17.46			
2D	Directional Gyro	820071	2.44	16.80			
3D	Clock-Electric	820071	.4	19.60	X		
4D	Gage OAR/ECT	820071	.54	18.50	X		
5D	Indicator - Vertical Speed	820071	.90	18.50	X		
6D	Turn Coordinator	820071	2.40	16.50	X		
7D	Manifold Press.	820071	1.00	18.48	X		
8D	Altimeter	820071	1.00	18.70			
9D	Airspeed Indicator	820071	.66	18.80	X		
10D	Magnetic Compass	820071	.50	21.9	X		
11D	Cluster Gauge	820071	1.16	19.3	X		

SECTION VI
WEIGHT AND BALANCE

MOONEY M20J

ITEM NO.	ITEM DESCRIPTION	REF. DRAWING	WEIGHT (POUNDS)	ARM (INCHES)	MARK IF INSTALLED	YEAR	NO		
							DAY	MONTH	YEAR
	D. Instruments (cont.)								
12D	Tachometer, Electric (2 In.)	820071	.8	18.0	X				
13D	Alternate Static Air Source	820252	.25	18.5	X				
14D	Annunciator Panel	820071	.70	17.5	X				
15D	Hour Meter Instl.	950241	.29	18.50	X				
16D	Fuel Flow Instl.	600363	.88	1.95	X				

EQUIPMENT LIST

SECTION VI
WEIGHT AND BALANCE

MOONEY M20J

ITEM NO.	ITEM DESCRIPTION	REF. DRAWING	WEIGHT (POUNDS)	ARM (INCHES)	MO			MARK IF INSTALLED
					DAY	YEAR		
	E. Vacuum System							
1E	Vacuum System Instl	860052	6.30 [*]	10.19			X	
	Vacuum Pump	860052	2.0	-5.00			X	

SECTION VI
WEIGHT AND BALANCE

MOONEY M20J

ITEM NO.	ITEM DESCRIPTION	REP. DRAWING	WEIGHT (POUNDS)	ARM (INCHES)	MARK IF INSTALLED	MO		
						DAY	YEAR	
	P. Cabin Accommodations							
1F	Sun VISORS	130291	1.0	33.00	X			
2F	Shoulder Harness, Front & Back (Set of four)	140205	8.4	76.48	X			
3F	Belt Assy, Rear Occupant Lap (2)	130291	2.0	71.00	X			
4F	Belt Assy, Front Occupant Lap(2)	130291	2.0	35.00	X			

SECTION VI
WEIGHT AND BALANCE

MOONEY M20J

ITEM NO.	ITEM DESCRIPTION	REF. DRAWING	WEIGHT (POUNDS)	ARM (INS.)	MO			
					DAY	YR	MARK IF INSTALLED	
	G, Avionics, Autopilots & Misc.							
1G								
2G								
3G								
4G								
5G								
6G								
7G								
8G								
9G								
10G								
11G								

SECTION VI
WEIGHT AND BALANCE

MOONEY M20J

ITEM NO.	ITEM DESCRIPTION	REF. DRAWING	WEIGHT (POUNDS)	ARM (INCHES)	MO		
					DAY	YEAR	MARK IF INSTALLED
	9. Avionics, Autopilots & Misc. (CONT)						
12G							
13G							
14G							
15G							
16G							
17G							
18G							
19G							
20G							
21G							
22G							

SECTION VI
WEIGHT AND BALANCE

MOONEY M20J

ITEM NO.	ITEM DESCRIPTION	REF. DRAWING	WEIGHT (POUNDS)	ARM (INCHES)	MARK IF INSTALLED	EQUIPMENT LIST		
						MO	DAY	YEAR
	H. Auxiliary Equipment							
1H	Tow Bar (Stowed)	010001	2.12	95.5				
2H	Jack Points (Stowed)	010000	.10	119.0	X			
3H	Wing Tie Down Rings (Stowed)	010002	.10	119.0	X			
4H	Fuel Sampler Cup (Stowed)	610010	.05	119.0	X			
5H	Engine Operators Manual (Avco-Lycoming)	010025	.75	119.0	X			
6H	Aircraft P. O. H./AFM	010025	1.50	119.0	X			
7H	Cargo "D" Rings	010027	.16	119.0	X			
8H	Cargo Restraint Belts	140233	1.0	119.0	X			

EQUIPMENT LIST

ITEM NO.	ITEM DESCRIPTION	REF. DRAWING	WEIGHT (POUNDS)	ARM (INCHES)	MARK IF INSTALLED	MO			
						DAY			
						YEAR			
	I. Optional Equipment								
1I	Oxygen System Instal. 77.1 Ft ³	870007	37.2	125.0					
2I	Curtains	950163	2.9	64.00					
3I	Headrest Assy-FRONT	140313	1.56	45.00					
4I	HEADREST ASSY.-REAR	140313	1.56	80.00					
5I	Aux. Power Receptacle Instl	950254	2.60	111.00					
6I	Oxygen System Instal. 115.7 Ft ³	870007	43.85	125.0					
7I	Rotating Beacon Installation	800351	1.68	168.00					
8I'	Brake Instl, Dual	950239	3.00	15.0					
9I	Fire Extinguisher Instl	950251	5.25	60.5					
10I	Fixed Step Assy	840071	2.16	108.0					

SECTION VI
WEIGHT AND BALANCE
MOONEY M20J

EQUIPMENT LIST

MO
DAY
YR

ITEM NO.	ITEM DESCRIPTION	REF DRAWING	WEIGHT (POUNDS)	ARM (INS.)	MARK IF INSTALLED			
	I, Optional Equipment (Cont)							
11I	Seat, Pilot, Vert. Adjust. NET	140215	+3.0	**				
12I	Seat, Copilot, Vert. Adjust. CHG.	140215	+3.0	**				
13I	Seat, Pilot, Special Edition NET	140235	+3.25	**				
14I	Seat, Copilot, Special Edition CHG.	140235	+3.25	**				
15I	Prop De-Ice Boots	690001	4.4	-18.2				
16I								
17I	Descent Rate Control.	950155	12.5	70.0				
18I	Rudder Pedal Extension	720115	.5	15.00				
19I	Static Discharge Instl.	950253	N/A	N/A				
20I	AM/FM/Cassette System	810152	4.05	14.06				

SECTION VI
WEIGHT AND BALANCE
MOONEY M20J

EQUIPMENT LIST

ITEM NO.	ITEM DESCRIPTION	REF. DRAWING	WEIGHT (POUNDS)	ARM (INCHES)	MO.				
					DAY				
					YEAR				
					MARK IF INSTALLED				
	I. Optional Equipment (Cont.)								
21I	Oxygen Refill Hose Adapter	870025	4.5	***					
22I	Aux. Power Cable Adapter	880042	6.8	***					
23I	Standby Vacuum Pump Instl.	860060	12.04	98.4					
24I	Inboard Arm Rest Instl.	140295	0.8	34.5					
25I	Lumbar Support	140300	0.75	35.0					

**ARM WILL VARY WITH SEAT POSITION BETWEEN STA. 34.0 AND 39.0

***ARM WILL VARY WITH LOCATION STORED. THE PILOT IS RESPONSIBLE TO COMPUTE WEIGHT AND BALANCE DATA IF THESE ITEMS ARE STORED IN THE AIRCRAFT DURING FLIGHT.

SECTION VI
WEIGHT AND BALANCE
MOONEY M20J

SECTION VI
WEIGHT AND BALANCE

MOONEY M20J

EQUIPMENT LIST

Item No.	Item Description	Ref. Drawing	Weight (Pounds)	Arm (Ins.)	MO		
					DAY	YR	Mark If Installed
	I. Optional Equip. (Cont.)						
26I	Wing Tip Recognition Lights	210410	2.0	53.0			
27I	Tow Bar (Folding)	010034	2.6	95.5			
28I	Inboard Arm Rest Instl,	140295	.8	34.5			
29I	Lumbar Support	140300	.75	35.0			
30I							
31I							

SECTION VI
WEIGHT AND BALANCE

MOONEY M20J

EQUIPMENT LIST

Item No.	Item Description	Ref. Drawing	Weight (Pounds)	Arm (Ins.)	MO			Mark If Installed
					DAY	YR		
	I. Optional Equip. (Cont.)							

SECTION VII
AIRPLANE AND SYSTEMS DESCRIPTION

MOONEY M20J

TABLE OF CONTENTS

TITLE	PAGE
INTRODUCTION.....	7-3
AIRFRAME.....	7-3
FLIGHT CONTROLS DESCRIPTION.....	7-4
AILERON SYSTEM.....	7-4
ELEVATOR SYSTEM.....	7-5
RUDDER SYSTEM.....	7-5
TRIM SYSTEM.....	7-5
WING FLAPS.....	7-5
INSTRUMENT PANEL.....	7-7
FLIGHT PANEL & INSTRUMENTS.....	7-7
SWITCHES AND CONTROLS.....	7-12
ANNUNCIATOR & SWITCH PANEL.....	7-20
GROUND CONTROL.....	7-22
NOSE GEAR STEERING.....	7-22
TAXIING AND GROUND HANDLING.....	7-22
LANDING GEAR.....	7-23
CONSTRUCTION.....	7-23
RETRACTION SYSTEM.....	7-23
WHEEL BRAKES.....	7-24
EMERGENCY EXTENSION SYSTEM.....	7-24
WARNING SYSTEM.....	7-25
STEERING.....	7-25
CABIN.....	7-25
BAGGAGE COMPARTMENT.....	7-25
SEATS.....	7-27
SEAT BELTS.....	7-27
SAFETY HARNESS.....	7-27
DOORS, WINDOWS & EXITS.....	7-28
CABIN DOOR.....	7-28
PILOT'S WINDOW.....	7-29
EMERGENCY EXITS.....	7-20
ENGINE.....	7-29
GENERAL.....	7-29
ENGINE CONTROLS.....	7-30
ENGINE INSTRUMENTS.....	7-31
ENGINE OPERATION AND CARE.....	7-32
OIL SYSTEM.....	7-33
IGNITION SYSTEM.....	7-33
ENGINE COOLING.....	7-34
ENGINE STARTING SYSTEM.....	7-34
ACCESSORIES.....	7-34
PROPELLER.....	7-35
FUEL SYSTEM.....	7-36

SECTION VII
AIRPLANE AND SYSTEMS DESCRIPTION

MOONEY M20J

ELECTRICAL SYSTEM.....	7-38
Alternator & Battery.....	7-38
SCHEMATIC.....	7-39
CIRCUIT BREAKER PANEL.....	7-40
Annunciator Panel.....	7-41
ELT Panel.....	7-42
LIGHTING SYSTEM.....	7-42
CABIN ENVIRONMENT.....	7-43
PITOT PRESSURE & STATIC SYSTEM.....	7-44
STALL WARNING SYSTEM.....	7-45
EMERGENCY LOCATOR TRANSMITTER.....	7-45
REMOTE SWITCH OPERATION.....	7-46

SECTION VII AIRPLANE AND SYSTEMS DESCRIPTION

MOONEY M20J

INTRODUCTION

Acquiring a working knowledge of the aircraft's controls and equipment is one of your important first steps in developing a fully efficient operating technique. This Airplane and Systems Section describes location, function, and operation of systems' controls and equipment. It is recommended for you, the pilot, to familiarize yourself with all controls and systems while sitting in the pilot's seat and rehearsing the systems operations and flight procedures portions of this manual.

AIRFRAME

The M20J is an all metal, low wing, high performance airplane. The fuselage has a welded, tubular-steel cabin frame covered with non-structural aluminum skins. Access to the cabin is provided by a door located on the right side of the fuselage. A door is provided aft of the rear seat for access to the baggage compartment. The aft fuselage is of semi-monocoque construction.

Seating in the cabin is provided for the pilot and three passengers.

The M20J has a tapered wing that is a full-cantilever-laminar-flow type. The airfoil varies from a NACA 63 (sub 2) -215 at the wing root to a NACA 64 (sub 1) -412 at the wing tip.

An aerodynamically designed cover is attached to the wing tip and contains the wing navigation and anti-collision lights. The wing has full wrap-around skins with flush riveting over the forward top and bottom two thirds of the leading edge.

The empennage consists of the vertical and horizontal stabilizers and the rudder and elevator surfaces. The entire empennage pivots around attaching points on the aft fuselage to provide pitch attitude trim.

The tricycle landing gear allows maximum taxi vision and ground maneuvering. Hydraulic disc brakes and a steerable nose wheel aid in positive

SECTION VII
AIRPLANE AND SYSTEMS DESCRIPTION

MOONEY M20J

directional control during taxiing and crosswind landings.

The landing gear is electrically retracted and extended. A gear warning horn, a gear position indicator on the floorboard and a green "gear down" light help prevent inadvertent gear-up landings. A manual emergency gear extension system is provided for use in the event of an electrical failure.

FLIGHT CONTROLS DESCRIPTION

The aircraft has dual flight controls and can be flown from either the pilot or co-pilot seat. Dual pairs of foot pedals control the rudder and nose wheel steering mechanisms. Push-pull tubes, rather than conventional cable systems, actuate the all-metal flight control surfaces. Rod-end bearings are used throughout the flight control systems. These bearings are simple and require little maintenance other than occasional lubrication. Specially designed aluminum-alloy extrusions, that permit flush skin attachment, form the leading edges of the rudder and elevators. A spring-loaded interconnect device indirectly joins the aileron and rudder control systems to assist in lateral stability during flight maneuvers. Longitudinal pitch trim is achieved through a trim control system that pivots the entire empennage around the tailcone attachment points.

Aileron System

The ailerons are of all-metal construction with beveled trailing edges. Three hinges of machined, extruded aluminum attach the ailerons to the aft wing spar outboard of the wing flaps. The ailerons link to the control wheel through push-pull tubes and bellcranks. Lead counterweights balance the system.

SECTION VII
AIRPLANE AND SYSTEMS DESCRIPTION

MOONEY M20J

Elevator System

Elevator construction is essentially the same as that of the ailerons. Both elevators attach to stabilizer at four hinge points. Push-pull tubes and bellcranks link the elevators to the control yoke. Lead counterweights balance the elevators.

Rudder System

The rudder attaches to the aft vertical fin spar at four hinge points. Push-pull tubes and bellcranks link the rudder to the rudder pedals.

Trim System

To provide pitch trim control, the entire empennage pivots around its main hinge points. The system consists of a manually operated actuator that operates a series of torque tubes and universal joints connected to a jack screw on the aft tailcone bulkhead. A trim control wheel, located between the pilot and co-pilot seats, allows the pilot to set stabilizer angle. Trim position is indicated by a pointer located on the lower console. This indicator is geared to the trim control wheel mechanism and indicates stabilizer position relative to the aircraft thrust line.

Wing Flaps

The wing flaps are electrically operated and interconnected through push-pull tubes and bellcranks. Total flap area is 17.98 square feet.

Nominal travel is 0 to 33 degrees and limit switches prevent travel above or below these limits. The flap position is controlled by a preselect switch located on the lower control console. Also located on the control console is a flap position indicator which shows which preselect option has been selected: ie., full up, takeoff (15 deg) or full down position. A cable attached to the flap jackshaft operates the flap position indicator.

Generally, aircraft trim requirements will change

SECTION VII
AIRPLANE AND SYSTEMS DESCRIPTION

MOONEY M20J

with use of the flaps. Lowering of the flaps will cause a nose down pitching condition which can be easily corrected by application of nose up trim. Conversely, retraction of the flaps from a trimmed flight condition will cause a nose up pitching condition.

Use of the flaps should always be within the operational limits established in Section II. The flaps are very effective in lowering landing speed and can be used to slow the aircraft to approach speeds.

SECTION VII
AIRPLANE AND SYSTEMS DESCRIPTION

MOONEY 420J

INSTRUMENT PANEL

The instrument panel is designed to provide functional grouping of all flight, radio, engine instruments, switches and controls required to operate various systems. All flight instruments are grouped on the shock-mounted panel directly in front of the pilot. The radio console and annunciator panel is at the center of the instrument panel. Power plant instruments are grouped on the co-pilot's panel. Flap, stabilizer and cowl flap position indicators are on the lower center console.

FLIGHT PANEL & INSTRUMENTS

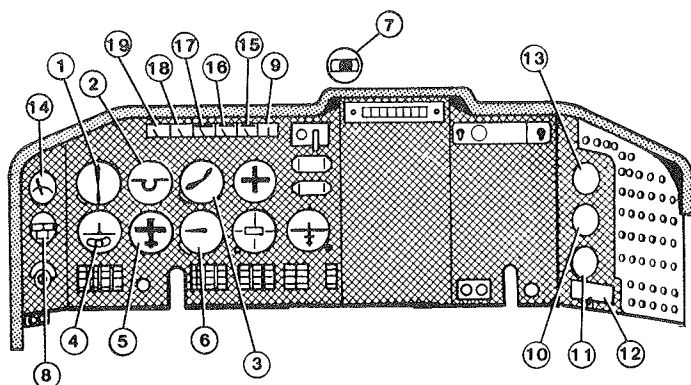

FIGURE 7-1

Flight instruments operate: (1) by air drawn into an evacuated case, (2) by barometric pressure or barometric-impact air pressure differences, (3) by variations in electric current due to mechanically varied resistance, or (4) by reference to the earth's magnetic field.

1. AIRSPEED INDICATOR

The airspeed indicator registers airspeed in knots. The air pressure difference between the pitot tube and the static ports on each side of the tailcone operates the airspeed indicator.

SECTION VII
AIRPLANE AND SYSTEMS DESCRIPTION

MOONEY M20J

2. ATTITUDE INDICATOR (if Installed)

The vacuum-powered attitude indicator indicates aircraft attitude relative to straight-and-level flight. Bank attitude is presented by a pointer at the top of the indicator relative to the bank scale which is marked in increments of 10 degrees, 20 degrees, 30 degrees, 45 degrees, 60 degrees and 90 degrees either side of the center mark. Pitch attitude is presented by an airplane silhouette in relation to the horizon bar. The knob at the bottom of the instrument is provided for adjustment of the silhouette to the horizon bar for a more accurate flight attitude indication. Vacuum pressure for satisfactory operation is 4.25 +/- .25 to 5.50 + .2/ - .0 IN Hg. Various styles may be installed at this position.

3. ALTIMETER

The altimeter operates by absolute pressure, and converts barometric pressure to altitude reading in feet above mean sea level. The altimeter has a fixed dial with three pointers to indicate hundreds, thousands, and tens-of-thousands of feet. Barometric pressure is sensed through the static ports. A knob adjusts a movable dial, behind a small window in the face of the main dial, to indicate local barometric pressure and to correct the altimeter reading for prevailing conditions.

4. TURN COORDINATOR (if installed)

The turn coordinator takes the place of a turn and bank indicator and operates from an electric power source. The turn coordinator is independent of the flight reference gyros. The turn coordinator displays variations in roll and yaw to the pilot by means of a damped miniature aircraft silhouette display - this provides the pilot with the essential information to execute a "proper turn".

SECTION VII
AIRPLANE AND SYSTEMS DESCRIPTION

MOONEY M20J

5. GYROSCOPIC HEADING INDICATOR (Directional Gyro) (If Installed)

The directional gyro displays airplane heading on a compass card in relation to a fixed simulated airplane image and index. The directional indicator will precess slightly over a period of time. Therefore, the compass card should be set in accordance with the magnetic compass just prior to takeoff, and occasionally re-adjusted on extended flights. A knob on the lower left edge of the instrument is used to adjust the compass card to correct for any precession. Vacuum pressure for satisfactory operation is the same as the artificial horizon/attitude indicator.

6. VERTICAL SPEED INDICATOR

The vertical speed indicator converts barometric pressure changes in the static lines to aircraft ascent or descent rate readings in feet per minute. This indicator has a single needle and two adjoining scales that read from 0 to 2000 feet per minute. The recessed, slotted screw at the lower left of the instrument case is used to "zero" the indicator when the aircraft is on the ground.

7. MAGNETIC COMPASS

The magnetic compass is liquid-filled, with expansion provisions to compensate for temperature changes. It is equipped with compensating magnets adjustable from the front of the case. Access to the compass light and the compensating magnets is provided by pivoted covers. No maintenance is required on the compass except an occasional check on a compass rose with adjustment of the compensation card, if necessary, and replacement of the lamp.

8. CLOCK

The electric clock with a sweep second hand, may be set by the pilot by pulling the knob and turning either left or right.

9. CYLINDER HEAD TEMPERATURE (CHT)

The cylinder head temperature indications are controlled by an electrical resistance type temperature probe installed in the number three cylinder, and receives power from the aircraft electrical system. The instrument is calibrated in degree F.

SECTION VII
AIRPLANE AND SYSTEMS DESCRIPTION

MOONEY M20J

10. Tachometer
The tachometer is an electronic meter which counts pulses generated by another set of breaker points in the magneto. The instrument is calibrated in revolutions per minute (RPM).
11. MANIFOLD PRESSURE
The manifold pressure gauge is of the direct reading type and is mounted below the engine tachometer. The gauge is calibrated in inches of mercury and indicates the pressure in the induction air manifold.
12. Fuel Flow
The fuel flow gauge is an electric instrument which operates from information provided by a flow transducer. The gauge is digital and indicates fuel flow volume in the metered portion of the engine fuel system.
The FT-101 Fuel Gauge System has two functions:
(1) Normal digital read out of fuel flow during engine operation in gallons per hour and (2) with test/used button pushed for ¼ seconds or less will indicate the quantity of fuel used from the tanks since last filling. Do not push "Reset" while master switch is on until tanks are topped off again.
The fuel flow gauge IS NOT to be used as a reference for leaning the engine during manual operation; use the EGT gauge for this reference.
13. EGT/OAT GAUGE--A thermocouple probe in No. 3 exhaust pipe transmits temperature variations to the indicator which serves as a visual aid during leaning. Exhaust Gas Temp. varies with fuel-air ratio, power & RPM. The OAT gauge provides free stream outside air temperature in degrees centigrade.
14. VOLT/LOADMETER
The volt/loadmeter measures the % of output from the alternator, the bus load and the bus voltage when the switch is pressed.
15. OIL TEMPERATURE GAUGE
The oil temperature gauge is an electric instrument connected electrically to a temperature bulb in the engine. Temperature changes of the engine oil change the electrical resistance in the bulb thereby allowing more or less current to flow

SECTION VII
AIRPLANE AND SYSTEMS DESCRIPTION

MOONEY M20J

through the indicating gauge. The instrument is calibrated in degree F.

16. OIL PRESSURE GAUGE The electric oil pressure gauge uses a transducer which varies resistance with pressure, as reference.

17. FUEL PRESSURE GAUGE

The fuel pressure gauge is of the electric type, using a transducer as reference, and is calibrated in pounds per square inch and indicates the pressure to the fuel injector.

18 & 19. FUEL QUANTITY INDICATORS

The fuel quantity indicators are used in conjunction with two float-operated variable-resistance transmitters in each fuel tank. The tank-full position of the transmitter float produces a maximum resistance through the transmitters, permitting minimum current flow through fuel quantity indicator and maximum pointer deflection. The instruments are calibrated in gallons of fuel.

SECTION VII
AIRPLANE AND SYSTEMS DESCRIPTION

MOONEY M20J

SWITCHES & CONTROLS

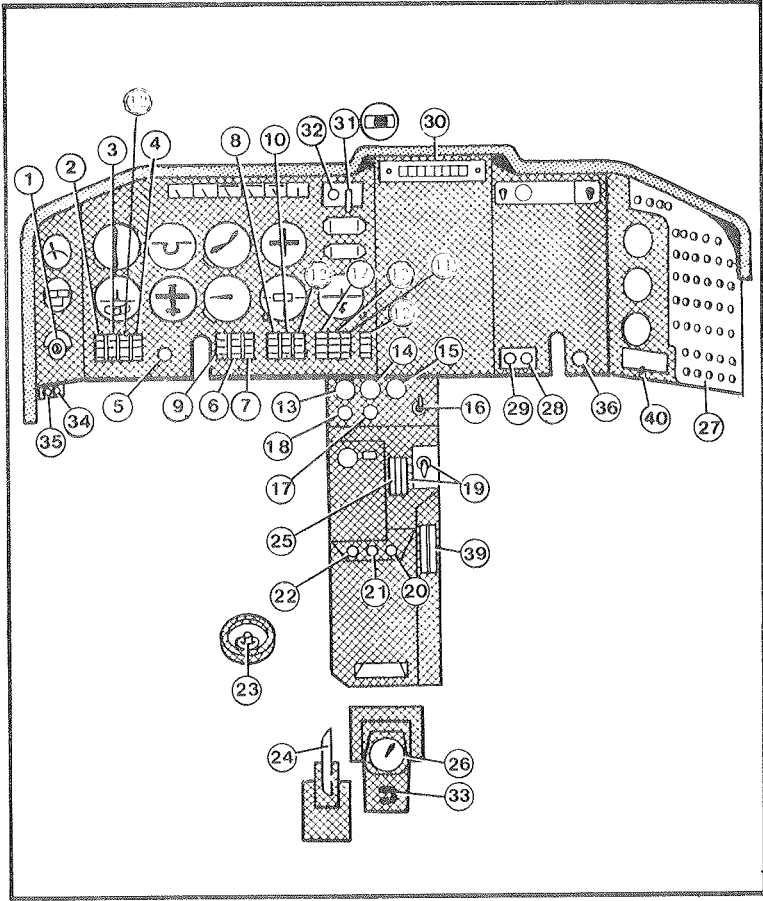

FIGURE 7-2

SECTION VII
AIRPLANE AND SYSTEMS DESCRIPTION

MOONEY M20J

1. Magneto/Starter Switch

The magneto/starter switch combines both ignition and starting functions. Turning the ignition key clockwise through R, L, and BOTH to the START MAG position and then pushing forward on the key and receptacle engages the starter. Releasing the key when the engine starts allows the switch to return, by spring action, to the BOTH position. In the OFF position both magnetos are grounded. At the R position the left magneto grounds. At the L position the right magneto grounds. At either START position or the BOTH position both magnetos are hot and the ignition system is ON.

2. Master Switch

The master switch operates the battery relay which controls battery power to the main ship bus bar. This switch cuts the alternator field power from main bus to the alternator. This switch also cuts off all ship power except the cabin and baggage overhead lights and the electric clock.

3. Alternator Switch

This switch cuts the alternator field power from main bus to the alternator.

4. Boost Pump Switch

Pushing ON or OFF the switch/circuit breaker controls operation of the electric fuel boost pump. Use of the fuel boost pump should be limited to starting, takeoff, switching fuel tanks, landing and emergency situations. The fuel boost pump is capable of supplying fuel to the engine at the rated quantities and pressures to permit the engine to develop rated power.

5. Alternate Static Source Valve

Pulling alternate static source valve to full aft position changes the source of static air for the altimeter, airspeed indicator and rate-of-climb indicator from outside of the aircraft to cabin interior. Airspeed and altimeter readings are affected slightly when alternate static source is used (Refer to Section V).

SECTION VII
AIRPLANE AND SYSTEMS DESCRIPTION

MOONEY M20J

6. Strobe Light Switch/Circuit Breaker
Pushing ON the strobe light combination switch/circuit breaker turns on the wing tip and tail strobe lights. Should a short occur, the combination switch/circuit breaker will automatically trip to the OFF position.

7. Navigation Light Switch/Circuit Breaker
Pushing ON the navigation light combination switch/circuit breaker turns on the wing tip and tail navigation lights. Should a short occur, the combination switch/circuit breaker will automatically trip to the OFF position.

8. Recognition Light Switch/Circuit Breaker
(If installed)
Pushing ON the recognition light combination switch/circuit breaker turns on the recognition light. Should a short occur, the combination switch/circuit breaker will automatically trip to the OFF position.

9. Landing Light Switch
Pushing ON the landing light switch turns the landing light on. Should a short occur, the circuit breaker at the top of the circuit breaker panel will automatically trip to the OFF position. The landing light should not be operated when the engine is not running to preclude overheating of the lamp.

10. Pitot Heat Switch/Circuit Breaker
Pushing ON the pitot heat combination switch/circuit breaker turns on the heating elements within the pitot tube. Should a short occur, the combination switch/circuit breaker will automatically trip to the OFF position.

11. Electric Trim Switch/Circuit Breaker
(If installed)
This switch is normally left in the ON position and serves as both a circuit protector and as a master disconnect for the electric trim system in the event of a malfunction.

12. OPTIONAL

13. Throttle Control
Pushing the throttle control forward increases the manifold pressure thereby increasing the engine

SECTION VII
AIRPLANE AND SYSTEMS DESCRIPTION

MOONEY M20J

power. Pulling the control aft decreases the manifold pressure thereby decreasing the engine power.

14. Propeller Control

Pushing the propeller control forward increases engine RPM; pulling the control aft decreases the engine RPM. The control is of the vernier type and fine adjustments of RPM can be obtained by turning the knob clockwise to increase RPM and counterclockwise to decrease RPM. The knob should not be turned in any closer than 1/8" to the panel nut face.

15. Mixture Control

The mixture control allows the pilot to adjust the fuel-air ratio (mixture) of the engine. Pushing the control forward richens the mixture. Pulling the control full aft closes the idle cutoff valve shutting down the engine. The control is of the vernier type and fine adjustments of the mixture can be obtained by turning the knob clockwise to richen the mixture, and counterclockwise to lean. The knob should not be turned in any closer than 1/3" to the panel nut face.

16. Cowl Flap Switch

The cowl flap switch activates the electric cowl flap actuator (motor) to open and close the cowl flaps. Placing the switch in the lower position opens the cowl flaps. This allows additional airflow to properly cool the engine on the ground and during lowspeed, high power climbs. During cruise, placing the switch in the upper position closes the cowl flaps reducing the airflow through the engine. When full open or closed is selected the actuator will automatically shut off when the cowl flaps have reached that position. The switch will remain in that selected position. To keep oil and cylinder head temperatures within the normal operating ranges (green arc of the temperature gauges) the cowl flaps may be positioned at any angle from closed to full open. This may be accomplished by momentarily positioning the switch in either the upper or lower position. When the cowl flaps have reached a desired intermediate position, as shown on the indicator, place the switch to the center (OFF) position.

SECTION VII
AIRPLANE AND SYSTEMS DESCRIPTION

MOONEY M20J

17. Parking Brake Control

Depressing the brake pedals and pulling the parking brake control sets the parking brake. Pushing in the parking brake control releases the parking brake.

18. RAM AIR Control

Pulling Ram Air control allows the use of unfiltered air. The use of ram air must be limited to clear dust-free air and must not be used during any ground operations.

19. Flap Switch and Indicator

The flap switch, in a recess on the right of the console, operates the electrically-actuated wide span wing flaps. The flap switch incorporates a preselect feature for TAKEOFF and FULL DOWN positions. Move switch down to first position to obtain TAKEOFF flaps (15 degrees). Pull switch handle out and push down to second position to select FULL DOWN flaps (33 degrees). When flap selector is moved UP to either TAKEOFF position or FULL UP position the flaps will retract to the selected position. A pointer in the center console indicates flap position.

NOTE

Placing switch in the UP position retracts the flaps completely.

19. Flap Position Indicator

Wing flap position is mechanically indicated thru a cable mounted directly to the flap jackshaft. A pointer in the flap position indicator indicates flap position. The intermediate mark in the pointer range is the flap TAKEOFF setting (15 degrees).

20. Cabin Vent Control (Fresh Air)

Pulling the cabin vent control aft opens the vent, located on the right side of the airplane. Optimum use of the cabin vent control is described in the Cabin Environment Section.

SECTION VII
AIRPLANE AND SYSTEMS DESCRIPTION

MOONEY M20J

21. Cabin Heat Control

Pulling the cabin heat control turns on cabin heat. To lower cabin temperature the cabin heat control is pushed forward toward the OFF position. Optimum use of the cabin heat control is described in the Cabin Environment Section.

22. Defrost Control

Pulling the defrost control decreases air flow to the lower cabin and increases air flow to the windshield in the front of the glareshield area. Optimum use of the defrost control is described in the Cabin Environment Section. The optional blower motor switch is activated when the control is pulled aft. This turns on a fan within the ventilation system to move more air over the windshield.

23. Gascolator Control

The gascolator, located to the left of the console on the floorboard, allows the pilot to drain condensed water or any sediment from the lowest point in the fuel line. To activate the gascolator drain pull the ring upward, to stop drainage release the ring.

24. Trim Control Wheel

Rotating the trim control wheel forward lowers the nose; rearward rotation raises the nose of the aircraft.

25. Trim Position Indicator

Stabilizer trim position indicator is mechanically activated thru a cable assembly attached to the trim wheel mechanism. Trim position indications are shown on the console.

26. Fuel Selector Valve

The fuel selector valve located on the floorboard is a three-position valve which allows the pilot to select either the left or right fuel tank. Turning the valve to OFF shuts off all fuel to the engine. At full throttle the engine will stop from fuel starvation in 2 to 3 seconds.

27. Circuit Breaker Panel

Push-to-reset and push-pull circuit breakers automatically break the electrical current flow if a system receives an overload.

SECTION VII
AIRPLANE AND SYSTEMS DESCRIPTION

MOONEY M20J

28. Radio Light Switch and Dimmer

Turning the radio light switch knob clockwise turns ON the radio and indicator lights. Continued turning clockwise increases light intensity. This control also operates the internal instrument lights.

29. Panel Light Switch and Dimmer

Turning the panel light switch knob clockwise turns ON the instrument lights located in the glareshield. Continued turning clockwise increases the lighting intensity.

30. Annunciator Panel

See description of functions elsewhere in this section.

31. Landing Gear Switch

The electric gear switch, identifiable by its wheel shaped knob, is a two-position switch. Pulling aft and lowering the knob lowers the landing gear while pulling aft and raising the knob raises the gear.

NOTE

Failure to "Pull" knob out prior to movement may result in a broken switch.

32. Gear Safety Override Switch (Gr Safety By Pass)

The gear safety override switch is a manual means of electrically bypassing the Airspeed Safety Switch. In the event the gear control switch is inadvertently placed in the gear-up position, the gear Airspeed Safety Switch prevents the gear being retracted before takeoff speed of approximately 65 +7, -4 KTS is reached. Should it be necessary to retract at a lower airspeed the GR SAFETY BY PASS switch may be pressed until the gear is completely retracted.

~ ~ ~ ~ ~
~ CAUTION ~
~ ~ ~ ~ ~

The activation of the gear safety override switch overrides the safety

SECTION VII
AIRPLANE AND SYSTEMS DESCRIPTION

MOONEY M20J

features of the airspeed switch and can cause the gear to start retracting while on the ground.

33. Gear Down Position Indicator (Floorboard)
The illuminated gear-down position indicator at the back of the fuel selector panel aft of the center console has two marks that align when the gear is down and illuminates when the green GEAR DOWN light is on. A red-white striped decal shows when landing gear is not in the down position.

34. Microphone Jack

35. Headset Jack

36. Cigar Lighter

37. NOT USED

38. NOT USED

39. Cowl Flap's Position Indicator Cowl flap's position is indicated through a mechanical cable assembly attached to the electric actuator bellcrank linkage. Cowl flap position is indicated on the console indicator.

40. Fuel Flow Memory Switch

The "Fuel Totalizer" memory is connected to the aircraft battery through the "Fuel Flow Memory" switch. This is normally left in the "ON" position at all times so that "Fuel Used" information is retained from one flight to the next until reset. The memory switch may be turned OFF to prevent battery drain if the aircraft is to be stored for extended periods of time. Some optional "Fuel Totalizer" systems do not contain a memory switch.

41. NOT USED

42. Avionics Master Switch

43. E.L.T. Switch

SECTION VII
AIRPLANE AND SYSTEMS DESCRIPTION

MOONEY M20J

ANNUNCIATOR AND SWITCH PANELS

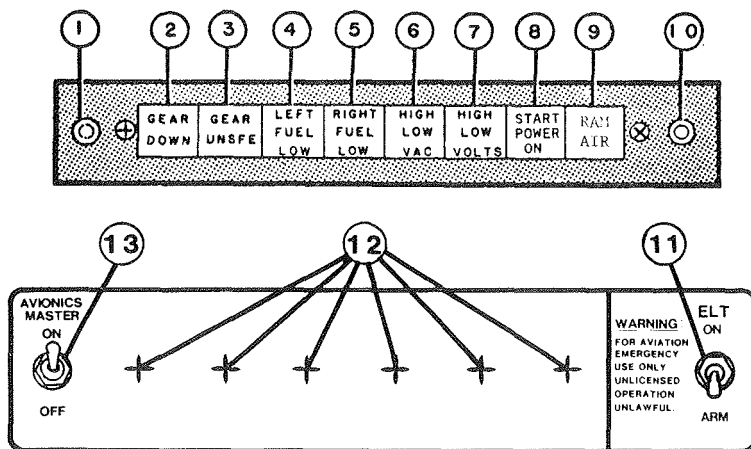

FIGURE 7-3

1. PRESS-TO-TEST SWITCH

Press red press-to-test switch (3-5 sec.) with master switch ON to illuminate all annunciator light bulbs, excluding START POWER ON indicator. Defective bulbs should be replaced prior to the next flight.

2 & 3. GEAR SAFETY INDICATOR

The green GEAR DN light and a red GEAR UNSFE light provide visual gear position signals. The green light (GEAR DN) shows continuously when the gear is fully extended. with the navigation lights on, the GEAR DN light is dim for night operation. All gear lights are out when the gear is fully retracted. GEAR UNSFE light is on between gear fully extended and gear fully retracted position.

4 & 5. FUEL LOW INDICATORS

LEFT and/or RIGHT, red, FUEL LOW annunciator light comes on when there is a 2-1/2 to 3 gallons of

SECTION VII
AIRPLANE AND SYSTEMS DESCRIPTION

MOONEY M20J

useable fuel remaining in the respective tanks. Press to test switch must be held for 3-5 seconds for low fuel warning circuit to activate.

6. VACUUM MALFUNCTION INDICATOR (VAC-HIGH/LOW)

The red VAC annunciator light indicates a malfunction of improper adjustment of air suction system. Air suction is available for operation of the attitude gyro, and also the directional gyro, and will be shown in inches of mercury. The designated suction range is 4.25 to 5.5 inches of mercury. The VAC light will blink when suction is below 4.25 inches of mercury and gives a steady light when suction is above 5.5 inches of mercury. In either case the gyros should not be considered reliable during this warning time.

7. VOLTAGE IRREGULARITY INDICATOR
(VOLTS-HIGH/LOW)

The red VOLTS annunciator light comes on designating improper voltage supply. A red blinking light designates low, or no voltage from the alternator; a steady light indicates over voltage or a trippage of the voltage relay.

8. START POWER ON INDICATOR

The START POWER ON light illuminates when the starter switch or relay has malfunctioned and the starter is engaged while the engine is running. Shut the engine off as soon as practicable. This light does not illuminate when Press-to-Test switch is pushed.

9. RAM AIR POSITION INDICATOR

The amber RAM AIR annunciator light is a reminder that ram air system is in operation when the gear comes down and should be turned OFF to re-route air through air filter.

10. DIM SWITCH

The DIM switch may be activated when the low fuel lights come on bright. The switch will dim both low fuel lights but will not turn them off. To

SECTION VII
AIRPLANE AND SYSTEMS DESCRIPTION

MOONEY M20J

restore the display to bright, press the test switch.

11. EMERGENCY LOCATOR TRANSMITTER SWITCH

The ELT switch manually activates the emergency locator transmitter located in the tailcone. To activate the system pull the switch out and raise. Failure to pull out can result in a breakage of the switch. Reference should be made to the Emergency Locator Transmitter description in this section for proper and lawful usage of the ELT.

12. OPTIONAL EQUIPMENT CONTROL SWITCHES

Refer to Section IX for description and operation of optional equipment installed in this aircraft.

13. AVIONICS MASTER SWITCH

The avionics master switch operates a relay supplying power to the avionics bus bar. Since the relay is energized to cut the power to the avionics bus, failure of the relay coil will still allow power to the avionics bus. Energizing the starter automatically energizes the relay and disconnects the radios from the bus.

GROUND CONTROL

NOSE GEAR STEERING

The nose gear steering system consists of steering horn on the gear leg linked to the rudder pedals by push-pull tubes and bellcranks. Gear retraction automatically disengages the steering mechanism from the nose wheel and centers the nose wheel for entry into the wheelwell.

TAXIING AND GROUND HANDLING

The aircraft can be easily taxied with minimum use of brakes. Minimum turning radius is 41 feet without use of brakes. A manual tow bar can be used to ground handle the aircraft. Care must be used to not swivel the nose wheel beyond 14 degrees from center. Adjustable steering stops are incorporated on nose gear leg assembly.

SECTION VII
AIRPLANE AND SYSTEMS DESCRIPTION

MOONEY M20J

~~~~~  
~ CAUTION ~  
~~~~~

Exceeding the swivel angle limits may cause structural damage.

LANDING GEAR

CONSTRUCTION

The landing gear legs are constructed of chrome-molybdenum tubular steel, heat-treated for greater strength and wear resistance. Main gear attaching points have metal backings imbedded in the gear mounting box attached to the wing spar. The nose gear mounts on the cabin tubular steel frame. Rubber discs in all gear leg assemblies absorb the shock of taxiing and landing.

RETRACTION SYSTEM

The landing gear is electrically retracted and extended. The gear switch operates a landing gear actuator relay. Pulling the wheel-shaped knob out and moving it to the upper detent raises the gear. However, an Airspeed Safety Switch, mounted on back of the airspeed indicator, is incorporated in the electrical system to prevent landing gear retraction while on the ground and until a safe takeoff speed is reached, (approximately 65 +7, -4 KIAS). The up limit switch will stop the gear in its retracted position. Moving the control knob to its lower detent lowers the gear. The properly rigged down limit switch will stop the gear actuating motor when proper force has been exerted to hold the landing gear in the down-and-locked position. Bungee springs preload the retraction mechanism in an overcenter position to hold the gear down. A landing gear safety bypass switch override is provided next to the gear switch should the gear fail to retract. Depressing and holding this switch manually bypasses the airspeed safety switch and allows the gear to retract.

~~~~~  
~ CAUTION ~  
~~~~~

Never rely on the safety switch to keep

SECTION VII
AIRPLANE AND SYSTEMS DESCRIPTION

MOONEY M20J

the gear down during taxi, takeoff or landing. Always make certain that the landing gear switch is in the down position during these operations.

WHEEL BRAKES

The main gear wheels incorporate self-adjusting disc-type hydraulic brakes. The pilot's rudder pedals have individual toe-actuated brake cylinders linked to the rudder pedals. Depressing the toe pedals and pulling parking brake control on console sets the brakes. Pushing parking brake control forward releases the brakes.

It is not advisable to set parking brake when brakes are overheated, after heavy braking or when outside temperatures are unusually high. Trapped hydraulic fluid may expand with heat and damage the system. Wheel chocks and tiedowns should be used for long-term parking.

EMERGENCY EXTENSION SYSTEM

An emergency gear extension mechanism is provided to allow manual lowering of landing gear. The control mechanism is located between and aft of the pilot and co-pilot seats. The red lever must be released and pulled up (aft) to disengage the gear from the electric drive and engage the manual extension mechanism. The mechanism has a spring retracted pull cable which manually drives the electric gear actuator to extend the gear. 12-20 pulls are required to fully extend and lock the gear down. The electrical extension or retracting system will not operate if the manual extension lever is not properly positioned.

SECTION VII
AIRPLANE AND SYSTEMS DESCRIPTION

MOONEY M20J

WARNING SYSTEM

The landing gear warning system consists of: 1) landing gear condition lights, GREEN for "GEAR DOWN" and RED for "GEAR UNSAFE", and 2) a warning horn activated when the gear is not down-and-locked and the throttle is set at 12 inches or less manifold pressure. The green light shows continuously when gear is fully extended. The red light shows whenever the gear is in transit or not locked down but is off when gear is fully retracted. A visual gear-position indicator, located on floorboard aft of the fuel selector, shows when the gear is down when the indicator marks align. The gear down light is dimmed when navigation lights are turned on.

STEERING

Rudder pedal action steers the nose wheel. Gear retraction relieves the rudder control system of its nose wheel steering and centers the wheel to permit retraction into the nose wheel well. The minimum turning radius on the ground is 41 feet. Adjustable steering stops have been incorporated on nose gear leg assembly.

~~~~~  
~ CAUTION ~  
~~~~~

The nose wheel must not be swiveled beyond 14 degrees either side of center. To exceed these limits may cause structural damage.

CABIN

BAGGAGE COMPARTMENT

The baggage compartment is located aft of the rear passenger seat. The standard compartment has 17 cubic feet of baggage or cargo space. A maximum of 120 pounds may be loaded in this area. There are two pairs of floor tiedown straps provided. Children should not be allowed to occupy this space unless the optional child's seat is provided. Additional cargo space may be made available by rear seat back cushion (fold seat back forward and

SECTION VII
AIRPLANE AND SYSTEMS DESCRIPTION

MOONEY M20J

slide cover up and off frame; store as desired) then fold rear seat back down. Both seats can be folded down together or independent of each other. The hat rack compartment is restricted to 10 pounds.

The cargo tiedown rings are to be inserted in holes provided in web of front seat rails. The cargo belts attach to these rings and to standard seat belt harness to retain cargo. Refer to Figure 7-5 for typical restraint.

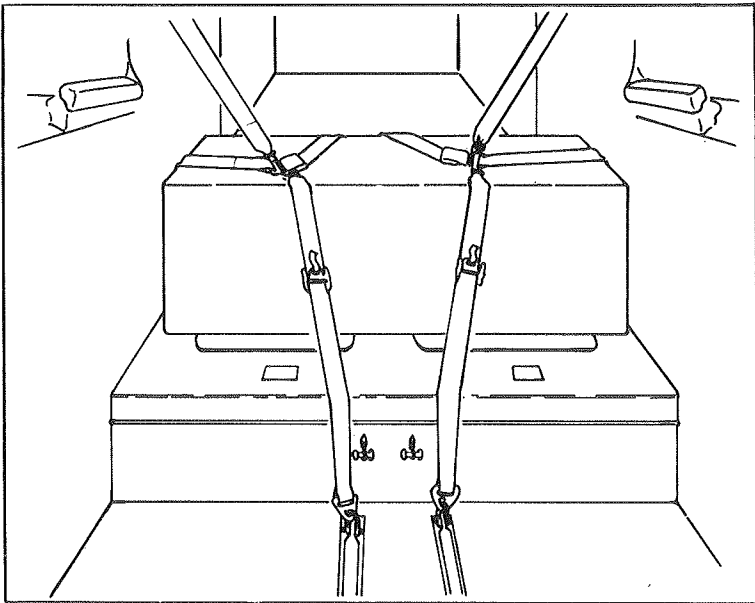

FIGURE 7-4

~~~~~

~ CAUTION ~

~~~~~

Proper loading and retention of cargo is mandatory. See Loading Computation Graph, page 6-7.

SECTION VII
AIRPLANE AND SYSTEMS DESCRIPTION

MOONEY M20J

SEATS

The front seats are individually mounted and may be adjusted fore and aft to fit individual comfort preferences. The front seat back may be adjusted by turning hand crank until seat back is in desired position.

Both optional front seat configurations allow vertical seat height adjustment by turning a hand crank or knob to raise or lower the entire seat assembly.

One optional front seat has an airline type button release to recline the seat back. The seat back on this seat assembly is spring loaded to the upright position.

The rear seat backs have four (4) adjustment positions. Each seat can be adjusted independent of the other by pulling up on respective release handles located on left or right of aircraft centerline on forward spar. This allows adjustment from approximately 10 degree to 40 degree recline position.

SEAT BELTS

Safety belts, if worn properly, keep occupants firmly in their seats in rough air and curing maneuvers. The belts are mechanically simple and comfortable to wear. They are attached to the seat, which can be moved without readjusting the belt. Shoulder harnesses are provided for front and rear seat occupants and MUST be fastened for take-off and landing operations.

SAFETY HARNESS

The single diagonal type harness is designed so the chest strap crosses diagonally from the outboard shoulder to an attachment point as low on the inboard hip as possible. Care should be taken to conform with this location in adjusting the chest strap and inboard belt length. This diagonal configuration places the body center-of-gravity inside the triangle formed by the chest strap and lap belt. The lap belt should

SECTION VII
AIRPLANE AND SYSTEMS DESCRIPTION

MOONEY M20J

be adjusted comfortably tight. As a result the body is restricted from rolling out toward the unrestricted shoulder, or "open" side of the harness, upon forward impact. Refer to Figure 7-6 for proper seat belt/harness adjustment.

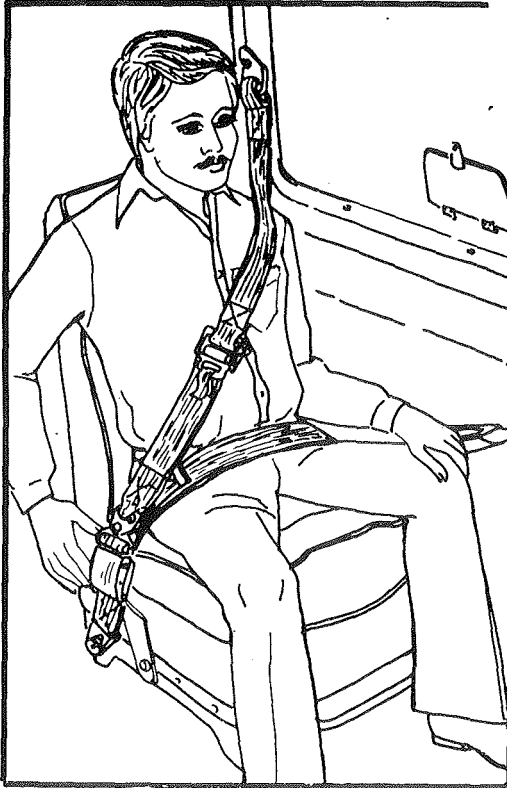

FIGURE 7-5

DOORS, WINDOWS & EXITS

CABIN DOOR

Access to the cabin is provided by a door located on the right side of the fuselage. This door has inside and outside operating handles. The outside door handle can be locked with a key specifically provided for it. The door has two latching

SECTION VII
AIRPLANE AND SYSTEMS DESCRIPTION

MOONEY M20J

mechanisms, one located at the top of the door and one at the aft, center of the door.

Should the door come open in flight the flying qualities of the aircraft will not be affected. Procedures for closing the door in flight are contained in Section III.

PILOT'S WINDOW

A fresh air pilot's window is located in the left main cabin window. This window is generally used for fresh air for prolonged ground operations. The window should not be opened in flight above 132 KIAS.

EMERGENCY EXITS

The cabin door is the primary emergency exit from the cabin. If an emergency exists where a probable crash landing will occur, the door should be unlatched to prevent jamming of the door during the crash.

The baggage compartment access door can be used as a means of auxiliary exit. The door can be opened from the inside even though locked. To open, pull off cover, pull the white knob and lift up red handle. To verify re-engagement of outside latch mechanism; open outside handle fully, close inside handle to engage pin in cam slide of latch mechanism; push in on white button until it snaps in place in hole. Replace cover. Operate outside handle in normal method.

ENGINE

GENERAL

The engine installed in this aircraft is an AVCO-Lycoming Model IO-360-A386D. The IO series engine is a four cylinder direct drive, horizontally opposed, air cooled engine of 361 cubic inches displacement.

The engine incorporates a Bendix D4LN-3021 dual magneto (with tachometer breaker points) and a

SECTION VII
AIRPLANE AND SYSTEMS DESCRIPTION

MOONEY M20J

RSA-5AD1 Bendix fuel injector.

This engine is normal rotation (clockwise) as viewed from the rear of the engine. A detailed specification listing of the engine is contained in Section I.

ENGINE CONTROLS

The engine controls are centrally located, between the pilot and co-pilot, on the engine control console. The throttle knob regulates manifold pressure. Pushing the knob forward increases the setting; pulling the knob aft decreases the setting.

The propeller control, with its crowned blue knob, controls engine RPM through the propeller governor. Pushing the knob forward increases engine RPM; pulling the knob aft decreases RPM.

The mixture control, with its red fluted knob, establishes the fuel-air ratio (mixture). Pushing the knob full forward sets the mixture to full-rich, pulling the knob aft leans the mixture, and pulling the knob to its maximum aft travel position closes the idle cutoff valve, shutting down the engine. Precise mixture settings can be established by observing the EGT gauge on the pilot's right hand instrument panel while adjusting the mixture control.

The propeller and mixture controls are vernier type and fine adjustments can be made by turning the knobs clockwise or counter-clockwise. The vernier controls should not be turned closer than 1/8" to the panel nut face. The throttle has an integral friction device.

The cowl flaps are electrically actuated and may be positioned in any location from FULL OPEN to FULL CLOSED in order to maintain oil and cylinder head temperatures within their normal operating ranges. This may be accomplished by placing the cowl flap switch, located under the mixture control, in the UP or DOWN position. Observe the position indicator, located on center console below the flap switch, until the desired position

SECTION VII
AIRPLANE AND SYSTEMS DESCRIPTION

MOONEY M20J

is obtained and then return the switch to the CENTER or OFF position.

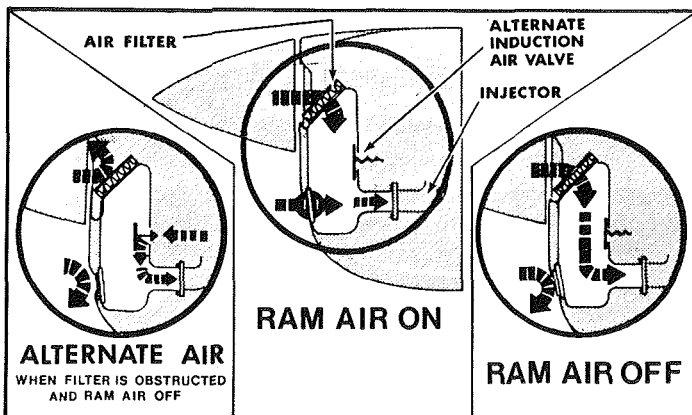

FIGURE 7-6
ENGINE AIR INDUCTION SYSTEM

The ram air control located directly below the throttle control allows the selection of filtered induction air or unfiltered direct ram air. Using ram air will increase manifold pressure by allowing engine induction air to partially bypass induction air filter. The use of ram air must be limited to clean, dust free air. The engine will operate on direct unfiltered air when ram air control is pulled ON. When ram air is ON, the ram air annunciator light located above the center radio panel will illuminate when the landing gear is down. Should the induction air filter clog, a spring loaded door in the induction system will open by induction vacuum to allow alternate air to enter the engine.

ENGINE INSTRUMENTS

Engine instruments operate electrically, except manifold pressure and tachometer, through variations in resistance caused by pressure or temperature changes, or by variations in current

SECTION VII
AIRPLANE AND SYSTEMS DESCRIPTION

MOONEY M20J

output caused by varying engine RPM or alternator output. The tachometer receives its signal from the breaker points in the magneto via the magneto/starter switch.

Cylinder head temperature, oil pressure, and oil temperature gauges are located above the flight instruments. EGT, tachometer, manifold pressure and fuel flow are located to the right of the radio panel. Color arcs on instrument faces mark operating ranges. Proper interpretation of engine instrument readings is essential for selecting optimum control settings and for maintaining maximum cruise fuel economy. (Refer to Section II for Limitations).

ENGINE OPERATION AND CARE

The life of the engine is determined by the care it receives. Maximum efficiency and engine service life can be expected when a good maintenance program is followed. Poor maintenance results in faulty engine performance and reduced service life. Efficient engine operation demands careful attention to cleanliness of air, fuel, oil and maintaining operating oil temperatures within the required limits. Servicing of the engine should be accomplished by qualified personnel. Refer to AVCO LYCOMING Overhaul and Service Manuals.

The engine receives a run-in operation before leaving the factory. Therefore, no break-in schedule need be followed. Mineral oil (MIL-L-6082 should be used for the first oil change period at (25 Hours). Continue to use mineral oil for 50 operating hours or until oil consumption stabilizes, then change to oil conforming to Lycoming Specification 301F.

The minimum grade aviation fuel for this engine is 100/130 or 100 LL. In case the grade required is not available, use a higher rating. Never use a lower rated fuel. Only aviation gasolines compounded to specifications ASTM-910 or MIL-G-5572E are approved.

Operational procedures for adverse environmental conditions can be found in the engine operator's manual.

SECTION VII
AIRPLANE AND SYSTEMS DESCRIPTION

MOONEY M20J

OIL SYSTEM

The engine has a full-pressure wet sump oil system with an 8 quart (7.6 liters) capacity. A conventional dip stick is provided for determining the oil quantity.

An automatic bypass control valve routes oil flow around the oil cooler when operating temperatures are below normal or when the cooling radiator is blocked. The propeller governor boosts engine oil pressure for operation of the propeller. It controls oil pressure going to the propeller hub to maintain or change propeller blade angles. This oil flows through the propeller shaft to reach the propeller.

IGNITION SYSTEM

The magneto ignition system features two electrically independent ignition circuits in one housing. The right magneto fires the lower right and upper left spark plugs, and the left magneto fires the lower left and upper right spark plugs. The magneto/starter switch has five positions: OFF, R (right), L (left), BOTH, and START. In the OFF position both magnetos are grounded. At the R position the left magneto grounds. At the L position the right magneto grounds. At the BOTH position both magnetos are HOT and the ignition system is ON. For safety the magneto/starter switch must be OFF and key removed when the engine is not running. Turning the magneto/starter switch to START and pushing in closes the starter solenoid, engages the starter and allows the impulse coupling to automatically retard the magneto until the engine is at its retard firing position. The spring action of the impulse is then released to spin the rotating magnet and produce the spark to fire the engine. After the engine starts, the impulse coupling flyweights do not engage due to centrifugal action. The coupling then acts as a straight drive and the magneto fires at the normal firing position of the engine. The magneto/starter switch is spring loaded to return from START to the BOTH position when released.

SECTION VII
AIRPLANE AND SYSTEMS DESCRIPTION

MOONEY M20J

~~~~~  
~ CAUTION ~  
~~~~~

DO NOT operate the starter in excess of 30 seconds or re-engage the starter without allowing it time to cool.

//////////
//WARNING//
//////////

DO NOT turn the propeller when the magnetos are NOT grounded. Ground the magneto points before removing switch wires or electrical plugs. All spark plug leads can be removed as an alternate safety measure.

ENGINE COOLING

The down-draft engine cooling system provides ground and inflight power plant cooling. Engine baffling directs air over and around the cylinders and out the cowl flap openings. Opening the cowl flaps allows proper air flow on the ground and during low-speed high-power climbs. Push the cowl flap switch DOWN to open the cowl flaps. The cowl flaps can be partially opened, if necessary to maintain the oil and cylinder head temperature within the normal operating range.

ENGINE STARTING SYSTEM

Engine starting power is provided by a 24 Volt starter. Ignition is provided by impulse coupled magnetos. A starter engaged warning light (START POWER ON) is incorporated as standard equipment in the annunciator panel.

ACCESSORIES

VACUUM PUMP

An engine-driven vacuum pump supplies suction for the vacuum-operated gyroscopic flight instruments. Air entering the vacuum-powered instruments is filtered; hence, sluggish or erratic operation of vacuum-driven instruments may indicate that a clogged vacuum filter element is preventing adequate air intake. A vacuum annunciator light is provided to monitor system operation.

SECTION VII
AIRPLANE AND SYSTEMS DESCRIPTION

MOONEY M20J

ALTERNATOR

Electrical power is supplied by an engine belt driven 28 Volt, 70 ampere alternator.

PROPELLER

The propeller is an all metal, two blade, constant speed unit. Constant propeller rotational speed (RPM) is maintained by a balance of air load and engine rotational forces. The propeller governor regulates the flow of engine oil to a piston in the propeller dome. The piston is linked by a sliding rod and fork arrangement to propeller blades. Governor oil pressure works against the piston and a spring to increase propeller blade pitch, thus decreasing propeller and engine RPM. Centrifugal twisting moments on the propeller blades work to decrease propeller blade pitch and increase RPM. Control of these and other forces to maintain a constant RPM is provided by the propeller control lever in the cockpit.

The propeller control lever, linked by cable to the propeller governor, determines a wide range of in-flight RPM. Pushing the lever forward selects higher RPM. Pulling the lever aft selects lower RPM. When in flight the RPM should not fluctuate significantly, regardless of throttle setting.

The propeller may be operated within the full range of RPM indicated by the tachometer, up to the red radial line. In cruise, always use the power setting charts provided. On cold days during run-up, exercise the propeller several times to flow warm oil into the propeller hub. This assures propeller governing for takeoff.

SECTION VII
AIRPLANE AND SYSTEMS DESCRIPTION

MOONEY M20J

FUEL SYSTEM

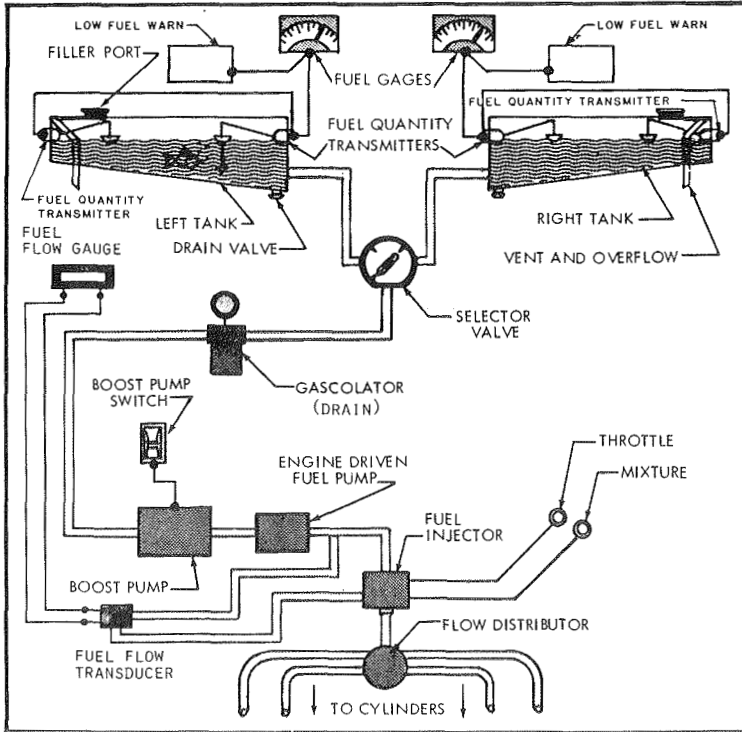

FUEL SYSTEM SCHEMATIC
FIGURE 7-7

Fuel is carried in two integral sealed sections of the forward inboard area of the wings. Total usable fuel capacity is 64 gallons (242.4 liters)(53.3 Imp. Gal.). Both tanks have fuel level indicators visible through the filler ports. These indicators show the 25-gallon (94.7 liters)(20.8 Imp. Gals.) level in each tank. There are sump drains at the lowest point in each tank for taking fuel samples to check for sediment contamination or condensed water accumulation.

SECTION VII
AIRPLANE AND SYSTEMS DESCRIPTION

MOONEY M20J

The recessed three-position fuel selector handle aft of the console on the floor allows the pilot to set the selector valve to LEFT tank, RIGHT tank, or OFF position. The gascolator, located to the left of the selector valve in the floorboard, is for draining condensed water and sediment from the lowest point in the fuel lines before the first flight of the day and after each refueling.

Fuel feeds from one tank at a time to the selector valve and through the electric fuel pump (boost pump) enroute to the engine-driven pump and the fuel injector unit. The electric fuel pump is capable of supplying sufficient pressure and fuel flow for rated engine performance should the engine driven pump fail.

Electric fuel-level transmitters in the tanks operate the fuel gauges. The master switch actuates the fuel quantity indicator system to maintain an indication of fuel remaining in each tank. The fuel pressure gauge registers fuel pressure in the line to the injector. Vents in each fuel tank allow for overflow and ventilation.

The optional, visual fuel quantity indicators located in each wing tank are to be used for PARTIAL FUEL LOADING only and not for preflight inspection purpose.

Fuel Flow is presented digitally and indicates volume of fuel being used in GPH (pounds or liters optional) and/or total fuel used. Optional fuel flow systems are available and each depicts its information differently. Refer to appropriate operational procedure for specific data. A "Fuel Flow Memory" switch (FT-101 System) is located in the top of the right hand radio panel to shut off the memory circuit if the aircraft is to be stored for long periods of time.

SECTION VII
AIRPLANE AND SYSTEMS DESCRIPTION

MOONEY M20J

ELECTRICAL SYSTEM

ALTERNATOR & BATTERY

A 24-volt, 22-ampere-hour storage battery (in the tailcone) and a 70 ampere self-rectifying alternator supply electrical power for equipment operation. The volt/loadmeter depicts % of alternator output. A power loss in the alternator or voltage regulator will be shown as a zero reading on the volt/loadmeter; a discharged battery will be indicated by a high reading on alternator output with low bus load. The voltage regulator adjusts alternator output to current load while maintaining a constant voltage level. A voltage warning light illuminates steadily when voltage limits are exceeded and flashes when voltage is low.

~~~~~

~CAUTION~

~~~~~

Starting with an external power source should not be done while the battery is completely depleted. It will not accept the high charge rate from the alternator and electrical failure may result.

SECTION VII
AIRPLANE AND SYSTEMS DESCRIPTION

MOONEY M20J

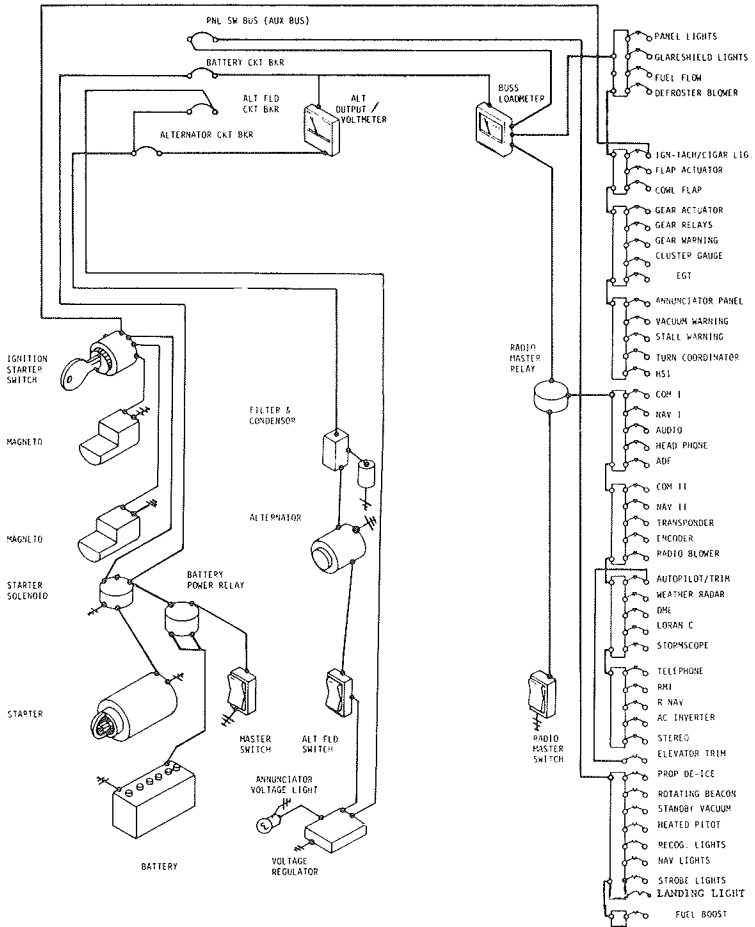

SCHEMATIC
FIGURE 7-8

SECTION VII
AIRPLANE AND SYSTEMS DESCRIPTION

MOONEY M20J

CIRCUIT BREAKER PANEL

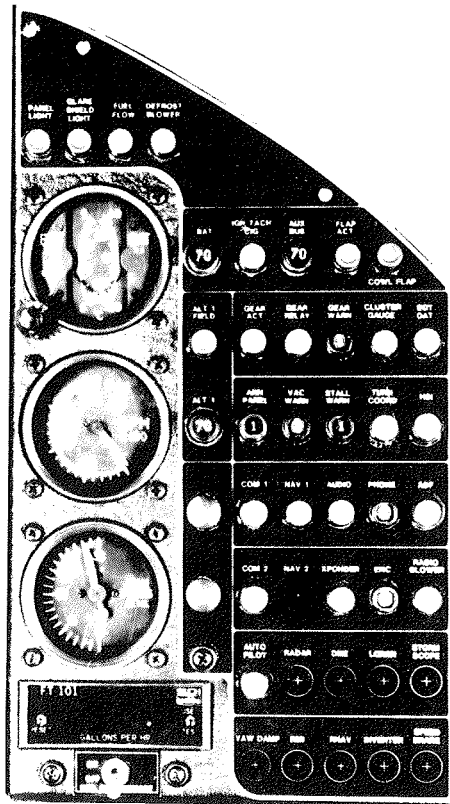

FIGURE 7-9

Push-pull, or rocker switch-circuit breakers automatically break the electrical current flow if the system or unit receives an overload, thus preventing damage to electrical wiring.

The main circuit breaker panel is in the extreme right panel. Figure 7-9 illustrates the main circuit breaker panel with its push-pull circuit breakers. All rocker switch-circuit breakers are at the bottom of the flight panel.

SECTION VII
AIRPLANE AND SYSTEMS DESCRIPTION

MOONEY M20J

The alternator push-pull circuit breaker on the main breaker panel furnishes an emergency overload break between alternator and the main buss. Since the alternator is incapable of output in excess of the circuit breaker capacity, a tripped breaker normally indicates a fault within the alternator. Since the alternator is then cut out of the power circuit, the storage battery supplies electrical power in steadily diminishing output with master switch on.

The alternator field has a push-pull circuit breaker to furnish an emergency break in the alternator field excitation circuit in the event of alternator or voltage regulator malfunction. If regulator output voltage exceeds limits, the red voltage warning light illuminates steadily.

Turning off radio master switch and then turning master switch OFF and ON, will reset the voltage regulator. The overvoltage annunciator light should remain out. If overvoltage light comes on again, pulling out alternator field circuit breaker cuts alternator out of the power circuit. Once again the battery is the only source of electrical power; therefore, all electrical equipment not essential for flight should be turned off and the flight terminated as soon as practical to correct the malfunction.

! NOTE !

The circuit breakers installed in the panel may vary depending on installed equipment per customer order.

ANNUNCIATOR PANEL

The landing gear lights, low fuel lights, voltage light, vacuum warning light, starter engaged light and alternate air light are grouped in the annunciator panel. A test switch and dim switch, are also found in the panel; each of the lights and switches are discussed elsewhere in this section.

SECTION VII
AIRPLANE AND SYSTEMS DESCRIPTION

MOONEY M20J

ELT PANEL

The ELT Panel houses the remote ELT Switch and provides room for other switches as required for optional avionics installations. (See Section IX for Avionics Systems installed in this aircraft).

LIGHTING SYSTEM

INSTRUMENT & PLACARD LIGHTS

All placards are floodlighted by lights from the glareshield. There are two rheostat knobs on the right hand radio panel. The left control regulates the intensity of the placard lighting. The right control provides avionic and instrument lighting. Rotating the knobs clockwise turns on and increases light intensity.

MAP LIGHT

The map light switch is located on the center of the pilot's control wheel (co-pilot's optional). The right hand rheostat controls the map light intensity.

CABIN LIGHTING

Four headliner lights illuminate the cabin. The forward lights are controlled by the BRIGHT-OFF-DIM switch located in the headliner above the co-pilot. The rear cabin lights are controlled by another BRIGHT-OFF-DIM switch located above the rear seat, easily accessible from the baggage door for assistance with night loading. These are connected directly to battery.

EXTERIOR LIGHTING

Conventional navigation and high intensity strobe lights are installed on the wing tips and on the rudder trailing edge. A landing/taxi light is installed in the lower engine cowling. All exterior lights are controlled by rocker type switches on the lower right hand portion of the pilots panel.

SECTION VII
AIRPLANE AND SYSTEMS DESCRIPTION

MOONEY M20J

The high intensity wing tip and tail strobe lights are required for night operation, but should be turned off when taxiing near other aircraft, or flying in fog or clouds. The conventional position lights must be used for all night operations.

Optional recognition lights may be installed in wing tips for use when requested by ATC.

CABIN ENVIRONMENT

HEATING & VENTILATION SYSTEMS

Three ventilating systems provide cabin environmental conditions controlled to individual pilot and passenger preferences. Fresh air heated by an engine exhaust muff and cool air from an airscoop on the co-pilot side, can be individually controlled and mixed to desired temperatures. The side fresh-air system has adjustable outlets near pilot's and co-pilot's knees.

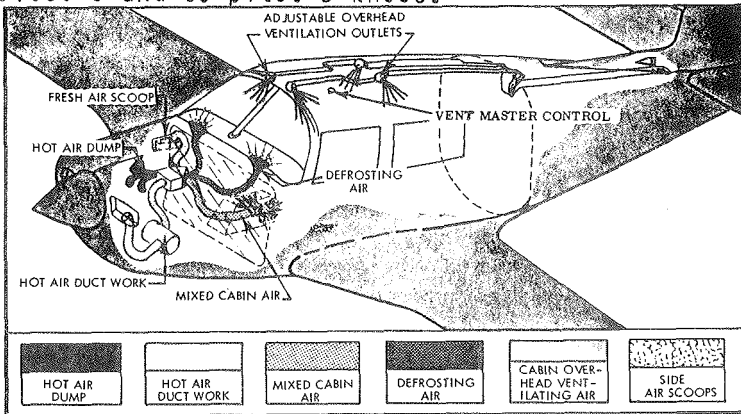

FIGURE 7-10

The cabin overhead ventilating system works independently of cabin heating and ventilating system. Fresh air enters an intake on the dorsal fin and is controlled by individual outlets above each seat. A master air vent control regulates flow of air through the individual overhead outlets. This control is located above the pilots seat back on the overhead panel.

SECTION VII
AIRPLANE AND SYSTEMS DESCRIPTION

MOONEY M20J

The cabin heat control is marked CABIN HEAT. Pulling cabin heat control aft supplies heat to cabin and defroster system. The cabin vent control is marked VENT. Pulling vent control aft supplies fresh air to lower cabin and defrost system. Hot and cold air may be mixed by adjusting both heat and vent controls. These controls may be adjusted between full open and full closed. The right side airscoop has outlets under the side panel for installation of radio cooling ducts. Cabin heat will be more effective with cowl flap closed.

WINDSHIELD DEFROSTING SYSTEM

The windshield defrost system takes air from the cabin air distribution system and distributes this over the windshield interior surface any time heat and/or fresh air valves are opened. Pulling defrost control full aft decreases flow to cabin and forces maximum air to flow through defrost ducts. An optional defrost blower motor system is available to force more air over the windshield if desired.

PITOT PRESSURE & STATIC SYSTEM

A pitot tube, mounted on lower surface of the left wing, picks up airspeed indicator ram air. A heated pitot prevents pitot tube icing when flying in moisture-laden air. A pitot system drain valve is located on forward bottom skin of left wing just outboard of wing fillet. Static ports on each side of tailcone supply static air pressure for the altimeter, airspeed indicator, and vertical speed indicator. A static system drain valve is located on fuselage bottom skin below tailcone access door. An alternate static pressure source valve is installed in the flight panel just left of the pilots control column. Alternate static air is taken from the cockpit and will affect flight instrument readings. Performance variation charts in Section V depict the difference between primary and alternate static indications.

SECTION VII
AIRPLANE AND SYSTEMS DESCRIPTION

MOONEY M20J

STALL WARNING SYSTEM

The electrical stall warning system uses a vane-actuated switch, installed in the left wing leading edge, to energize stall warning horn located in the cabin. The stall warning switch is adjusted to provide aural warning at 4.4 to 8.7 Knots before the actual stall is reached and will remain on until the aircraft flight attitude is changed toward a non-stalled condition.

! NOTE !

Do not attempt to adjust prestall warning speed by bending the vane. This part has been heat treated and cannot be bent without damaging or breaking the vane.

EMERGENCY LOCATOR TRANSMITTER

The Emergency Locator Transmitter (ELT) is located in the tailcone and is accessible by removing the radio access panel on the left side of the fuselage. The emergency locator transmitter meets the requirements of FAR 91.52 and is automatically activated by a longitudinal force of 5 to 7 g's. The ELT transmits a distress signal on both 121.5 MHz and 243.0 MHz for a period of from 48 hours in low temperature areas and up to 100 hours in high temperature areas. The unit operates on a self-contained battery. The battery should be checked at annual inspections.

The battery has a useful life of four years. However, to comply with FAA regulations it must be replaced after two years of shelf life. The battery should also be replaced if the transmitter has been used in an emergency situation or if accumulated test time exceeds one hour. The replacement date is marked on the transmitter label.

On the unit itself is a three position selector switch placarded "OFF", "ARM", "ON". The "ARM" position is provided to set the unit to the automatic position so that it will transmit only after impact and will continue to transmit until

SECTION VII
AIRPLANE AND SYSTEMS DESCRIPTION

MOONEY M20J

the battery is drained to depletion or until the switch is manually moved to the "OFF" position. The "ARM" position is selected when the transmitter is installed at the factory and the switch should remain in that position whenever the unit is installed in the airplane. The "ON" position is provided so the unit can be used as a portable transmitter or in the event the automatic feature was not triggered by impact or to periodically test the function of the transmitter.

Select the "OFF" position when changing the battery, when rearming the unit if it has been activated for any reason, or to discontinue transmission.

NOTE

If the switch has been placed in the "ON" position for any reason, the "OFF" position has to be selected before selecting "ARM". If "ARM" is selected directly from the "ON" position the unit will continue to transmit in the "ARM" position.

E.L.T. REMOTE SWITCH OPERATION

A pilot's remote switch, located above the radio panel, is provided to allow the transmitter to be controlled from inside the cabin. The pilot's remote switch is placarded "ON", "ARM". The unit will start transmitting with switch in "ON" position and will stop when remote switch is returned to "ARM" position during cockpit checkout.

SECTION VII
AIRPLANE AND SYSTEMS DESCRIPTION

MOONEY M20J

NOTE

If for any reason a test transmission is necessary, the operator must first obtain permission from a local FAA FCC representative (or other applicable Authority) or in accordance with current regulations. Test transmission should be kept to a minimal duration. Testing of ELT should be conducted only during the first five (5) minutes after any hour and no longer than three (3) audible sweeps.

The ELT should be checked during the ground check to make certain the unit has not been accidentally activated. Check by tuning a radio receiver to 121.5 MHz. If there is an oscillating sound, the locator may have been activated and should be turned off immediately. Reset to the "ARM" position and check again to insure against outside interference.

SECTION VIII
HANDLING, SERVICE & MAINTENANCE

MOONEY M20J

TABLE OF CONTENTS

TITLE	PAGE
INTRODUCTION.....	8-2
GROUND HANDLING.....	8-3
TOWING.....	8-3
TIEDOWN.....	8-4
JACKING.....	8-4
SERVICING.....	8-5
REFUELING.....	8-5
ENGINE LUBRICATION.....	8-7
INDUCTION AIR FILTER.....	8-9
GEAR AND TIRE.....	8-11
BATTERY SERVICE.....	8-11
HYDRAULIC BRAKE RESERVOIR SYSTEM.....	8-12
MAINTENANCE.....	8-12
PROPELLER CARE.....	8-12
EXTERIOR CARE.....	8-13
INTERIOR CARE.....	8-14
AIRPLANE FILE.....	8-15

SECTION VIII
HANDLING, SERVICE & MAINTENANCE

MOONEY M20J

INTRODUCTION

This section contains factory recommended procedures for proper ground handling, routine care and servicing of your Mooney.

As required by Federal Aviation Regulations, all civil aircraft of U.S. registry must undergo a complete inspection (ANNUAL) each twelve calendar months. In addition to the required ANNUAL inspection, aircraft operated commercially (for hire) must have a complete inspection every 100 hours of operation. All inspections must be performed by a designated representative of the FAA.

The FAA may require other inspections by the issuance of airworthiness directives applicable to the airplane, engine, propeller and other components. It is the responsibility of the owner/operator to ensure compliance with all applicable airworthiness directives and, when the inspections are repetitive, to take appropriate steps to prevent inadvertent noncompliance.

Scheduling of ALL maintenance is the responsibility of the aircraft operator. A general knowledge of the aircraft is necessary to perform day-to-day service procedures and to determine when unusual service or shop maintenance is needed.

Service information in this section of the manual is limited to service procedures which the operator will normally perform or supervise. Reference should be made to FAR Part 43 for information regarding preventive maintenance which may be performed by a licensed pilot.

It is wise to follow a planned schedule of lubrication and preventive maintenance based on climatic and flying conditions encountered in your locality.

Keep in touch with your Mooney Service Center and take advantage of his knowledge and experience. He knows your airplane and how to maintain it.

SECTION VIII
HANDLING, SERVICE & MAINTENANCE

MOONEY M20J

Should an extraordinary or difficult problem arise concerning the repair or upkeep of your Mooney, consult the Customer Service Department, Mooney Aircraft Corporation, P.O. Box 72, Kerrville, TX. 78029-0072. Telephone: Area Code 512-896-6C00.

All correspondence regarding your airplane should include the MODEL and SERIAL NUMBER. These numbers can be found on an identification plate located on the lower aft portion of the left side of the tailcone. The model and serial number must also be used when consulting either the Service & Maintenance Manual or Parts Manual.

Service & Maintenance and Parts Manuals may be obtained for your airplane from your Mooney Marketing or Service Center.

GROUND HANDLING

TOWING

For maneuvering the aircraft in close quarters, in the hangar, or on the ramp, use the tow bar furnished with the aircraft loose equipment. The towbar attaches to the nose gear crossbar. One man can move the aircraft providing the ground surface is relatively smooth and the tires are properly inflated.

When no towbar is available, or when assistance in moving the aircraft is required, push by hand: (1) on the wing leading edges, and (2) on the inboard portion of propeller blades adjacent to the propeller hub. Towing by tractor or other powered equipment is NOT RECOMMENDED.

~~~~~  
~ CAUTION ~  
~~~~~

Exercise care not to turn the nose wheel past its normal swivel angle of 14 degrees either side of center. Exceeding the turn limits shown on the turn indicator may cause structural damage.

SECTION VIII
HANDLING, SERVICE & MAINTENANCE

MOONEY M20J

TIEDOWN

As a precaution against wind damage, always tie down the aircraft when parked outside. Removable wing tiedown eye-bolts, supplied with the loose equipment, screw into wing receptacles marked HOIST POINT just outboard of each main gear.

Replace these eyebolts with jack point fixtures when it is necessary to lift the aircraft with jacks. The tail tiedown point is part of the tail skid.

To tie down the aircraft:

- a. Park the airplane facing the wind.
- b. Fasten the co-pilot seat belt through the flight control wheel. Pull seat belt snug so flight controls are immobilized.
- c. Fasten strong ground-anchored chain or rope to the installed wing tiedown eyebolts, and place wheel chocks fore and aft of each wheel.
- d. Fasten a strong ground-anchored chain or rope through the tail skid.

JACKING

When it is necessary to raise the aircraft off the ground:

- a. Install jack points in tiedown mounting holes
outboard of each main gear.
- b. Use standard aircraft jacks at both wing hoist points (wing tiedown eyebolt receptacles)
outboard of the main gears. While holding jack point in place, raise jack to firmly contact jack point.
- c. Raise aircraft, keeping wings as nearly level as possible.
- d. Use a yoke-frame jack under propeller to lift the nose.
- e. Secure safety locks on each jack.

SECTION VIII
HANDLING, SERVICE & MAINTENANCE

MOONEY M20J

~~~~~  
~ CAUTION ~  
~~~~~

Do not raise the aircraft on jacks out of doors when wind velocity is over 8 KTS. When lowering aircraft on jacks, bleed off pressure on all jacks simultaneously and evenly to keep aircraft level as it is lowered.

NOTE

Individual wheels may be raised without raising the entire aircraft. Wheels not being raised should be chocked fore and aft.

SERVICING

REFUELING

Integral sealed tanks in the forward inboard sections of the wings carry the fuel. With the aircraft standing on level ground, service each fuel tank after flight with 100/130 or 100LL octane aviation-grade gasoline. The visual quantity gauge located on top of each tank should be used as a reference for partial refueling only.

Before filling the fuel tanks when planning a maximum weight flight configuration, consult the Weight & Balance Record for loading data.

SECTION VIII
HANDLING, SERVICE & MAINTENANCE

MOONEY M20J

~~~~~  
~ CAUTION ~  
~~~~~

Never use aviation fuel of a lower grade than 100/130 or 100 LL octane. Aviation fuel grades can be distinguished by their color: 80 octane is red, 100 LL octane is blue, 100/130 octane is green.

Fuel samples from the sump drain of each tank should be taken before the first flight of the day to check for water or sediment contamination. Fuel samples taken immediately after refueling may not show water or sediment due to mixing action of refueling process.

//////////
///WARNING///
//////////

Allow five minutes after refueling for water and sediment to settle in the tank and fuel selector valve drain before taking fuel samples or draining the gascolator.

Tank sump drains are near each wing root forward of the wheel wells. A small plastic cup is supplied in the loose equipment kit for obtaining fuel samples. To collect a fuel sample, insert the cup actuator prong in the sump drain receptacle and push upward to open the valve momentarily and drain fuel into the cup. If water is in the fuel, a distinct line separating the water from the gasoline will be seen through the transparent cup wall. Water, being heavier, will settle to the bottom of the cup, while the colored fuel will remain on top. Continue taking fuel samples until all water is purged from the tank.

The fuel tank gascolator control is on the cabin floor forward of the pilot's seat. To flush the gascolator sump and the lines leading from the wing tanks to the selector valve, turn the selector handle to the left, and pull the fuel drain control for about five seconds. Repeat the procedure for the right tank, being sure that the fuel drain control ring is returned to the closed position and that the drain valve is not leaking.

SECTION VIII
HANDLING, SERVICE & MAINTENANCE

MOONEY M20J

ENGINE LUBRICATION

Operate the new engine at full power within the limitations given in Section II. Before every flight, check the engine oil level and replenish as necessary.

Check engine oil level after engine has been stopped long enough for oil to drain back into sump. The oil filler cap access door is located in the top cowling. Any lubricating oil, either straight mineral or compounded, must conform with AVCO Lycoming Spec No. 301F to be acceptable for use in engines. New or newly overhauled engines should be operated on aviation grade straight mineral oil during the first 25 HOURS of operation or until oil consumption has stabilized. The aircraft is delivered from Mooney with multi-viscosity straight mineral oil.

The engine is equipped with an external oil filter and the engine oil change intervals may be extended from 50 HOUR to 100 HOUR INTERVALS providing the external filter element is changed at 50-HOUR INTERVALS.

~~~~~  
~ CAUTION ~  
~~~~~

If an engine has been operating on straight mineral oil for several hundred hours, a change to additive oil should be undertaken with caution.

If the engine is in an extremely dirty condition, the switch to additive oil should be deferred until after engine has been overhauled. When changing from straight mineral oil to additive or compounded oil, after several hundred hours of operation on straight mineral oil, take the following precautionary steps:

SECTION VIII
HANDLING, SERVICE & MAINTENANCE

MOONEY M20J

- a. DO NOT MIX additive oil and straight mineral oil. Drain straight mineral oil from engine,
change filter and fill with additive oil.
- b. DO NOT operate engine longer than FIVE HOURS before again changing oil.
- c. Check oil filter for evidence of sludge or plugging. CHANGE oil and REPLACE oil filter element every 10 HOURS if sludge is evident. Resume normal oil drain periods after sludge conditions improve.

Your Mooney Service Center will change the engine oil in addition to performing all other service and inspection procedures needed when you bring your airplane in for its 50-hour, 100-hour, or annual inspections.

~~~~~  
~ CAUTION ~  
~~~~~

Excessive oil sludge buildup indicates that the oil system needs servicing at less than 50-hour intervals.

When changing or adding oil AVCO Lycoming specifies the following grades of oil to use for various ambient air temperatures.

VISCOSITY CHART

Average Ambient Air Temperature	MIL-L-6082	MIL-22851
Above 80 Deg. F	SAE 60	SAE 60
Above 60 Deg. F	SAE 50	SAE 40 or SAE 50
30 Deg. to 90 Deg. F	SAE 40	SAE 40
0 Deg. to 70 Deg. F	SAE 30	SAE 30, SAE 40 or SAE 20W-40
0 Deg. to 90 Deg. F	-----	SAE 20W-50
Below 10 Deg. F	SAE 20	SAE 30 or SAE 20W-30

*Refer to the latest edition of AVCO Lycoming Service Instruction No. 1014.

Your Mooney Service Center has approved brands of lubricating oil and all consumable materials necessary to service your airplane.

SECTION VIII
HANDLING, SERVICE & MAINTENANCE

MOONEY M20J

INDUCTION AIR FILTER SERVICING

The importance of keeping the induction air filter clean cannot be over-emphasized. A clean filter promotes fuel economy and longer engine life. The dry-type filter can usually be washed six to eight times before replacement is necessary. Replace the induction air filter every 500 HOURS or at ONE YEAR intervals, whichever occurs first.

1. To clean the dry-type induction air filter:
 - a. Remove the engine cowling.
 - b. Unbolt filter element and remove.
 - c. Direct a jet of air against down or clean side of filter (opposite to normal airflow). Keep air nozzle at least two inches from filter element. Cover entire filter area with air jet.

~~~~~  
~ CAUTION ~  
~~~~~

Do not use a compressor unit with a nozzle pressure greater than 100 PSI.

- d. After cleaning, inspect filter and gasket for damage. Discard a ruptured filter or broken gasket.

NOTE

If filter shows an accumulation of carbon, soot, or oil, continue with cleaning steps e through h.

- e. Soak filter in nonsudsing detergent for 15 minutes; then agitate filter back and forth for two to five minutes to free filter element of deposits.

SECTION VIII
HANDLING, SERVICE & MAINTENANCE

MOONEY M20J .

NOTE

A Donaldson D-1400 Filter Cleaner is also recommended. Do not use solvents.

- f. Rinse filter element with a stream of clear water until rinse water is clear.
- g. Dry filter thoroughly. Do not use a light bulb or air heated above 180 degrees F. (82 Deg. C) for filter drying.
- h. Inspect for damage and ruptures by holding filter before a light bulb. If damage is evident, replace filter with a new one.

SECTION VIII
HANDLING, SERVICE & MAINTENANCE

MOONEY M20J

GEAR & TIRE SERVICE

The aircraft is equipped with 6-ply standard-brand tires and tubes. Keep the main gear tires inflated at 30 PSI and the nose tire at 49 PSI for maximum service life. Proper inflation will minimize tire wear and impact damage. Visually inspect the tires at preflight for cracks and ruptures, and avoid taxi speeds that require heavy braking or fast turns. Keep the gear and exposed gear retraction system components free of mud and ice to avert retraction interference and binding.

The gear warning horn may be checked in flight by retarding the throttle with the gear up. The gear horn should sound with an intermittent note at about 12 inches manifold pressure.

BATTERY SERVICE

The 24 volt 22-ampere-hour electrical storage battery is located in the tailcone, aft of baggage compartment bulkhead, accessible through tailcone access panel. Check battery fluid level every 25 FLIGHT HOURS or each 30 DAYS whichever comes first.

To service the battery, remove the battery box cover and check the terminals and connectors for corrosion. Add distilled water to each battery cell as necessary; keep the fluid at one-quarter inch over the separator tops.

Check the fluid specific gravity for a reading of 1.265 to 1.275. A recharge is necessary when the specific gravity is 1.240 or lower. Start charging at four amperes and finish at two amperes; do not allow battery temperature to rise above 125 degrees F. during recharging. Keep the battery at full charge to prevent freezing in cold weather and to prolong service life.

SECTION VIII
HANDLING, SERVICE & MAINTENANCE

MOONEY M20J

~~~~~  
~ CAUTION ~  
~~~~~

The alternator and voltage regulator operate only as a one-polarity system. Be sure the polarity is correct when connecting a charger or booster battery.

If corrosion is present, flush the battery box with a solution of baking soda and water. Do not allow soda to enter the battery cells. Keep cable connections clean and tightly fastened, and keep overflow lines free of obstruction.

HYDRAULIC BRAKE RESERVOIR SYSTEM

The brake system hydraulic reservoir is located in the tailcone above the battery. To service, remove the tailcone access panel and check fluid level every 50 HOURS of operation. Fluid level should be no higher than two (2) inches below the filler cap. Use only hydraulic fluid (Red) conforming to specification MIL-H-5606. DO NOT FILL reservoir while parking brake is set.

MAINTENANCE

PROPELLER CARE

The high stresses to which propeller blades are subjected makes their careful inspection and maintenance vitally important. Check the blades for nicks, cracks, or indications of other damage before each flight. Nicks tend to cause high-stress concentrations in the blades which, if ignored, may result in cracks. It is very important that all nicks and scratches be polished out prior to next flight. It is not unusual for the propeller blades to have some end play or fore and aft movement as a result of manufacturing tolerances in the parts. This has no adverse effect on propeller performance or operation and is no cause for concern if the total movement at the blade tip does not exceed .12 inches. With the first turn, centrifugal force firmly seats the blades, rigidly and positively against the retention bearing in the propeller hub.

SECTION VIII
HANDLING, SERVICE & MAINTENANCE

MOONEY M20J

Preflight inspection of the propeller blades should include, in addition to the foregoing, an occasional wiping with an oily cloth to clean off grass and bug stains. NEVER USE AN ALKALINE CLEANER ON THE BLADES; remove grease and dirt with tetrachloride or Stoddard solvent. McCauley recommends the propeller be removed and overhauled every 1500 HOURS of operation. Hartzell recommends the optional propeller be removed and overhauled every 1500 HOURS of operation.

Your Mooney Service Center will answer any questions you may have concerning blade repair and inspection.

EXTERIOR CARE

As with any paint applied to a metal surface, an initial curing period is necessary for developing the desired qualities of durability and appearance. Therefore, DO NOT APPLY WAX TO THE NEW AIRCRAFT EXTERIOR UNTIL TWO OR THREE MONTHS AFTER DELIVERY. Wax substances will seal paint from the air and prevent curing. Wash the exterior to prevent dirt from working into the curing paint. Hold buffing to a minimum until curing is complete and there is no danger of disturbing the undercoat.

~~~~~  
~ CAUTION ~  
~~~~~

Before washing the exterior, be certain the brake discs are covered, a pitot cover is in place, and all static-air buttons are masked off.

Remove grease or oil from the exterior by wiping with a cotton cloth saturated in kerosene. Flush away loose dirt and mud deposits before washing the exterior with an aircraft-type washing compound mixed in warm water. Use soft cleaning cloths or a chamois, and USE ONLY MILD LIQUID TYPE DETERGENTS, avoid harsh or abrasive detergents that might scratch or corrode the surface. It is essential that ALL CLEANING COMPOUNDS AND APPLICATION CLOTHS BE FREE OF ABRASIVES, GRIT, OR OTHER FOREIGN MATTER. Use a prewax cleaner to remove a heavy oxidation film. For nonoxidized or

SECTION VIII
HANDLING, SERVICE & MAINTENANCE

MOONEY M20J

precleaned surfaces, apply a good exterior finish wax recommended for protection of urethane enamel finishes. Carefully follow the manufacturer's instructions. A heavier coating of wax on the leading edge of the wings, empennage, and nose section will help reduce drag and abrasion in these areas.

If fuel, hydraulic fluid, or any other dye-containing substance is found on the exterior paint, wash the area at once to prevent staining. Immediately flush away spilled battery acid, and treat the area with a baking soda and water solution, followed by a thorough washing with a mild aircraft detergent and warm water.

Before wiping the windows or windshield, flush the exterior with clear water to remove particles of dirt. Household window cleaning compounds should not be used as some contain abrasives or solvents which could harm plexiglas. An anti-static plexiglas cleaner is good for cleaning and polishing the windshield and windows.

INTERIOR CARE

Normal household cleaning practices are recommended for routine interior care. Frequently vacuum clean the seats, rugs, upholstery panels, and headliner to remove as much surface dust and dirt as possible. Occasionally wash the leather or vinyl upholstery and kick panels with a mild soap solution to prevent dirt from working into the surface. Wipe clean with a slightly damp cloth and dry with a soft cloth. NEVER APPLY FURNITURE POLISHES. Foam-type shampoos and cleaners for vinyl, leather, textiles, and plastic materials are good for removing stains and reconditioning the entire interior. Spray dry cleaners are also recommended. Grease spots on fabric should be removed with a jelly-type spot lifter.

SECTION VIII
HANDLING, SERVICE & MAINTENANCE

MOONEY M20J

~~~~~  
~ CAUTION ~  
~~~~~

Never use denatured alcohol, benzene, carbon tetrachloride, acetone, or gasoline for cleaning plexiglas or interior plastics. Carefully follow the manufacturer's instructions when using commercial cleaning and finishing compounds.

Do not saturate fabrics with a solvent which could damage the backing and padding materials. To minimize carpet wetting, keep foam type cleaners as dry as possible and gently rub in circles. Use a vacuum cleaner to remove foam and to dry the materials.

Use a damp cloth or a mild soap solution to clean interior plastic, vinyl trim and metal surfaces.

AIRPLANE FILE

Certain miscellaneous data, information and licenses are a part of the airplane file. The following is a checklist of documents that must either be carried in the airplane or available on request of the proper authority.

1. To be displayed in the airplane at all times:
 - a. Aircraft Airworthiness Certificate (FAA Form 8100-2).
 - b. Aircraft Registration Certificate (FAA Form 8050-3).
 - c. Aircraft Radio Station License, if transmitter installed (FCC Form 556).
2. To be carried in the airplane during all flight operations:
 - a. Pilot's Operating Handbook (including FAA approved Flight Manual).
 - b. weight and balance, and associated papers (latest copy of the Repair and Alteration Form, FAA Form 337, if applicable).

SECTION VIII
HANDLING, SERVICE & MAINTENANCE

MOONEY M20J

c. Equipment List.

! NOTE !

The original weight and balance data and Equipment List are contained in Section VI of this manual; the manual is supplied with each new airplane purchased from Mooney Aircraft Corporation. It is recommended that copies of Section VI be made and stored in a safe place.

3. To be made available upon request:
- a. Airplane Log Book.
 - b. Engine Log Book.

Since the Regulations of other nations may require other documents and data, owners of airplanes not registered in the United States should check with their own aviation officials to determine their individual requirements.

SECTION IX
SUPPLEMENTAL DATA

MOONEY M20J

SECTION IX
SUPPLEMENTAL DATA

MOONEY M20J

INTRODUCTION

FAA approved data pertaining to Limitations, Normal Procedures, Emergency Procedures, and effects on performance for certain optional equipment installed in the airplane are contained in this section. Commonly installed items of optional equipment whose function and operation do not require detailed instructions are described by Section VII.

SECTION X
SAFETY INFORMATION

MOONEY M20J

TABLE OF CONTENTS

INTRODUCTION.....	10-2
GENERAL.....	10-3
GENERAL SOURCES OF INFORMATION.....	10-4
RULES AND REGULATIONS.....	10-4
FAR, PART 39, AIRWORTHINESS DIRECTIVES.....	10-5
AIRMAN INFORMATION, ADVISORIES, AND NOTICES, FAA AIRMAN'S INFORMATION MANUAL.....	10-5
ADVISORY INFORMATION.....	10-5
GENERAL INFORMATION ON SPECIFIC TOPICS.....	10-6
FLIGHT PLANNING.....	10-6
INSPECTIONS-MAINTENANCE.....	10-7
WALK AROUND INSPECTIONS.....	10-8
COCKPIT CHECKS.....	10-8
FLIGHT OPERATIONS.....	10-8
GENERAL.....	10-8
TURBULENT WEATHER.....	10-8
FLIGHT IN TURBULENT AIR.....	10-9
MOUNTAIN FLYING.....	10-10
VFR-LOW CEILINGS.....	10-10
VFR AT NIGHT.....	10-11
VERTIGO-DISORIENTATION.....	10-11
STALLS, SPINS AND SLOW FLIGHT.....	10-12
STANDARD PROCEDURE FOR SPIN RECOVERY.....	10-13
VORTICES-WAKE TURBULENCE.....	10-13
TAKE-OFF AND LANDING CONDITIONS.....	10-14
MEDICAL FACTS FOR PILOTS.....	10-15
GENERAL.....	10-15
FATIGUE.....	10-15
HYPOXIA.....	10-16
HYPERVENTILATION.....	10-16
ALCOHOL.....	10-17
DRUGS.....	10-17
SCUBA DIVING.....	10-17
ADDITIONAL INFORMATION.....	10-18

SECTION X
SAFETY INFORMATION

MOONEY M20J

INTRODUCTION

The best of engineering know-how and manufacturing craftsmanship have gone into the design and building of your Mooney Aircraft. Like any high performance airplane, it operates most efficiently and safely in the hands of a skilled pilot.

We urge you to be thoroughly familiar with the contents of your operating manuals, placards, and check list to insure maximum utilization of your airplane. When the airplane has changed ownership, some of these may have been misplaced. If any are missing, replacements should be obtained from any Mooney Marketing or Service Center as soon as possible.

For your added protection and safety, we have added this special section to the Pilot's Operating Handbook to refresh your knowledge of a number of safety subjects. You should review these subjects periodically.

Topics in this section are mostly excerpts from FAA Documents and other articles pertaining to the subject of safe flying. They are not limited to any particular make or model airplane and do not replace instructions for particular types of airplanes.

Your Mooney Aircraft was designed and built to provide you with many years of safe and efficient transportation. By maintaining it properly and flying it prudently, you should realize its full potential.

SECTION X
SAFETY INFORMATION

MOONEY M20J

GENERAL

Flying is one of the safest modes of travel. Remarkable safety records are being established each year. As a pilot you are responsible to yourself, your relatives, to those who travel with you, to other pilots and to ground personnel to fly wisely and safely.

The following materials in this Safety section covers several subjects in limited detail. Here are some condensed Do's and Don'ts.

-----DO'S-----

1. Be thoroughly familiar with your airplane and be current in it, or get a check ride.
2. Pre-plan all aspects of your flight-including weather. FLY YOUR PLAN.
3. Use services available-FSS, Weather Bureau, etc.
4. Pre-flight you airplane thoroughly.
5. Use your check lists.
6. Have more than enough fuel for takeoff, the planned trip, and adequate reserve.
7. Be sure your weight loading and C.G. are within limits.
8. Be sure articles and baggage are secured.
9. Check freedom of all controls.
10. Maintain appropriate airspeed in takeoff, climb, descent and landing.
11. Avoid other aircraft wake turbulence.
12. Switch fuel tanks before engine starvation occurs.
13. Practice engine out, emergency landing gear extension and other emergency procedures at safe altitude; preferably with a check pilot.
14. Use caution in mountainous terrain.
15. Keep your airplane in good mechanical condition.
16. Stay informed and alert, fly in a sensible manner.

-----DON'TS-----

1. Don't take off with frost, ice or snow on the aircraft surfaces.
2. Don't take off with less than minimum

SECTION X
SAFETY INFORMATION

MOONEY M20J

- recommended fuel, plus reserves.
3. Don't fly in a reckless, show off, careless manner.
 4. Don't fly in thunderstorms or severe weather.
 5. Don't fly in possible icing conditions. If you encounter icing conditions, alter altitude or course to minimize exposure.
 6. Don't apply controls abruptly or with high forces that could exceed design loads of the airplane.
 7. Don't fly when physically or mentally exhausted.
 8. DON'T TRUST TO LUCK.

GENERAL SOURCES OF INFORMATION

There is a wealth of information available to the pilot created for the sole purpose of making your flying easier, faster, and safer. Take advantage of this knowledge and be prepared for an emergency in the remote event that one should occur. You as a pilot also have certain responsibilities under government regulations. These are designed for your own protection. Compliance is not only beneficial but mandatory.

RULES AND REGULATIONS

Federal Aviation regulations, Part 91, General Operating and Flight Rules, is a document of law governing operation of aircraft and the owner's and pilot's responsibilities.

This document covers such subjects as:

- Responsibilities and authority of the pilot in command
- Certificates required
- Liquor and drugs
- Flight plans
- Pre-flight action
- Fuel requirements
- Flight rules
- Maintenance, preventative maintenance, alterations, inspections and maintenance records

These are only some of the topics covered. It is

SECTION X
SAFETY INFORMATION

MOONEY M20J

the owner's and pilot's responsibility to be thoroughly familiar with all items in FAR Part 91 and to follow them.

FEDERAL AVIATION REGULATIONS, PART
39, AIRWORTHINESS DIRECTIVES

This document specifies that no person may operate a product to which an airworthiness directive issued by the FAA applies, except in accordance with the requirements of that airworthiness directive.

AIRMAN INFORMATION, ADVISORIES, AND
NOTICES - FAA AIRMAN'S INFORMATION
MANUAL

This document contains a wealth of pilot information for nearly all realms of flight, navigation, ground procedures and medical information. Among the subjects are:

- Controlled Air Space
- Services Available to Pilots
- Radio Phraseology and Technique
- Airport Operations
- Clearances and Separations
- Pre-flight
- Departures - IFR
- Enroute - IFR
- Arrival - IFR
- Emergency Procedures
- Weather
- Wake Turbulence
- Medical Facts for Pilots
- Bird Hazards
- Good Operating Practices
- Airport Location Directory

We urge all pilots to be thoroughly familiar with and use the information in this manual.

ADVISORY INFORMATION

Airmen can subscribe to services to obtain FAA NOTAMS and Airman Advisories, and these are also available at FAA Flight Service Stations.

SECTION X
SAFETY INFORMATION

MOONEY M20J

NOTAMS are documents that have information of a time-critical nature that would affect a pilot's decision to make a flight; for example, an airport closed, terminal radar out of service, enroute navigational aids out of service, etc.

GENERAL INFORMATION
ON SPECIFIC TOPICS

FLIGHT PLANNING

FAR Part 91 requires that each pilot in command, before beginning a flight, familiarize himself with all available information concerning that flight.

All pilots are urged to obtain a complete preflight briefing. This would consist of weather; local, enroute and destination, plus alternates, enroute navaid information. Also airport runways active, length of runways, take off and landing distances for the airplane for conditions expected should be known.

The prudent pilot will review his planned enroute track and stations and make a list for quick reference. It is strongly recommended a flight plan be filed with Flight Service Stations even though the flight may be VFR. Also, advise Flight Service Stations of changes or delays of one hour or more and remember to close the flight plan at destination.

The pilot must be completely familiar with the performance of the airplane and performance data in the airplane manuals and placards. The resultant effect of temperature and pressure altitude must be taken into account in determining performance if not accounted for on the charts. Applicable FAA manuals must be aboard the airplane at all times including the weight and balance forms and equipment lists.

The airplane must be loaded so as not to exceed the weight and the weight and balance loading center of gravity (c.g.) limitations. Also, that at least minimum fuel for takeoff is aboard and sufficient for the trip, plus reserves. Oil in

SECTION X
SAFETY INFORMATION

MOONEY M20J

the engines should be checked and filled as required.

INSPECTIONS - MAINTENANCE

In addition to maintenance inspections and preflight information required by FAR Part 91, a complete pre-flight inspection is imperative. It is the responsibility of the owner and operator to assure that the airplane is maintained in an airworthy condition and proper maintenance records are kept.

While the following items cannot substitute for the pre-flight specified for each type of airplane, they will serve as reminders of general items that should be checked.

SPECIAL CONDITIONS CAUTIONARY NOTICE

Airplanes operated for Air Taxi or other than normal operation and airplanes operated in humid tropics or cold and damp climates, etc., may need more frequent inspections for wear, corrosion and or lack of lubrication. In these areas periodic inspections should be performed until the operator can set his own inspection periods based on experience.

NOTE

The required periods do not constitute a guarantee that the item will reach the period without malfunction, as the aforementioned factors cannot be controlled by the manufacturer.

Corrosion, and its effects, must be treated at the earliest possible opportunity. A clean dry surface is virtually immune to corrosion. Make sure that all drain holes remain unobstructed. Protective films and sealants help to keep corrosive agents from contacting metallic surfaces. Corrosion inspections should be made most frequently under high-corrosion-risk operating conditions, such as in regions of heavy

SECTION X
SAFETY INFORMATION

MOONEY M20J

airborne salt concentrations (e.g., near the sea) and high-humidity areas (e.g., tropical regions).

WALK AROUND INSPECTIONS

All airplane surfaces free of ice, frost or snow.
Tires properly inflated.
All external locks, covers and tie downs removed.
Fuel sumps drained.
Fuel quantity, adequate for trip, plus reserve, (visually checked) and access doors secured.
Oil quantity checked and access doors secured.
Check general condition of airplane, engine, propeller, exhaust stacks, etc.
All external doors secured.

COCKPIT CHECKS

Flashlight available.
Required documents on board.
Use the check list.
All internal control locks removed (If installed).
Check freedom of controls.
Cabin and baggage door properly closed.
Seat belts and shoulder harnesses fastened.
Passengers briefed.
Engine and propeller operating satisfactorily.
All engine gauges checked for proper readings.
Cowl flap in proper position.
Fuel selector in proper position.
Fuel quantity checked by gauges.
Altimeter setting checked.

FLIGHT OPERATIONS

GENERAL

The pilot should be thoroughly familiar with all information published by the manufacturer concerning the airplane and is required by FAA to operate in accordance with the FAA Approved Airplane Flight Manual and/or placards installed.

TURBULENT WEATHER

A complete weather briefing prior to beginning a flight is the start of assurance of a safe trip. Updating of weather information enroute is another

SECTION X
SAFETY INFORMATION

MOONEY M20J

assurance. However, the wise pilot also knows weather conditions change quickly at times and treats weather forecasting as professional advice rather than as absolute fact. He obtains all the advice he can, but still stays alert through knowledge of weather changes, observations, and conditions.

Plan the flight to avoid areas of severe turbulence and thunderstorms. It is not always possible to detect individual storm areas or find the in-between clear areas.

Thunderstorms, squall lines and violent turbulence should be regarded as extremely dangerous and MUST be avoided. Hail and tornadic wind velocities can be encountered in thunderstorms that can destroy any airplane, just as tornados destroy nearly everything in their path on the ground.

A roll cloud ahead of a squall line or thunderstorm is visible evidence of violent turbulence, however, the absence of a roll cloud should not be interpreted as denoting the lack of turbulence.

FLIGHT IN TURBULENT AIR

Even though flight in severe turbulence is to be avoided, flight in turbulent air may be encountered under certain conditions.

Flying through turbulent air presents two basic problems, to both of which the answer is PROPER AIRSPEED. On the one hand, if you maintain an excessive airspeed, you run the risk of structural damage or failure; on the other hand, if your airspeed is too low, you may stall.

If turbulence encountered in cruise or descent becomes uncomfortable to the pilot or passengers, the best procedure is to reduce speed to the maneuvering speed, which is listed in the Limitations Section of the FAA Approved Airplane Flight Manual and Pilots Operating Handbook. This speed gives the best assurance of avoiding excessive stress loads, and at the same time providing margin against inadvertent stalls due to gusts.

SECTION X
SAFETY INFORMATION

MOONEY M20J

Beware of overcontrolling in attempting to correct for changes in altitude; applying control pressure abruptly will build up G-forces rapidly and could cause damaging structural stress loads. You should watch particularly your angle of bank, making turns as wide and shallow as possible, and be equally cautious in applying forward or back pressure to keep the nose level. Maintain straight and level attitude in either up or down drafts. Use trim sparingly to avoid being grossly mistrimmed as the vertical air columns change velocity and direction.

MOUNTAIN FLYING

Avoid flight at low altitudes over mountainous terrain, particularly near the lee slopes. OBSERVE PUBLISHED MINIMUM ENROUTE ALTITUDES (MEA). If the wind velocity near the level of the ridge is in excess of 25 knots and approximately perpendicular to the ridge, mountain wave conditions are likely over and near the lee slopes. If the wind velocity at the level of the ridge exceeds 50 knots, a strong mountain wave is probable with strong up and down drafts and severe or extreme turbulence. The worst turbulence will be encountered in and below the rotor zone which is usually 8 to 10 miles downwind from the ridge. This zone is characterized by the presence of "roll clouds" if sufficient moisture is present; alto cumulus standing lenticular clouds are also visible signs that a mountain wave exists, but their presence is likewise dependent on moisture. Mountain wave turbulence can, of course, occur in dry air and the absence of such clouds should not be taken as any assurance that mountain wave turbulence will not be encountered. A mountain wave downdraft may exceed the climb capability of your airplane. AVOID MOUNTAIN WAVE DOWNDRAFTS.

VFR - LOW CEILINGS

If you are not instrument rated, avoid "VFR On Top" and "Special VFR". Being caught above an undercast when an emergency descent is required (or at destination) is an extremely hazardous

SECTION X SAFETY INFORMATION

MOONEY M20J

position for the VFR pilot. Accepting a clearance out of certain airport control zones with no minimum ceiling and one-mile visibility as permitted with "Special VFR" is not a recommended practice for VFR pilots.

Avoid areas of low ceilings and restricted visibility unless you are instrument proficient and have an instrument equipped airplane. Then proceed with caution and have planned alternates.

VFR AT NIGHT

When flying VFR at night, in addition to the altitude appropriate for the direction of flight, pilots should maintain a safe minimum altitude as dictated by terrain, obstacles such as TV towers, or communities in the area flown. This is especially true in mountainous terrain, where there is usually very little ground reference and absolute minimum clearance is 2,000 feet. Don't depend on your being able to see obstacles in time to miss them. Flight on dark nights over sparsely populated country can be almost the same as IFR and should be avoided by untrained pilots.

VERTIGO - DISORIENTATION

Disorientation can occur in a variety of ways. During flight, inner ear balancing mechanisms are subjected to varied forces not normally experienced on the ground. This combined with loss of outside visual reference can cause vertigo. False interpretations (illusions) result and may confuse the pilot's conception of the attitude and position of his airplane.

Under VFR conditions the visual sense, using the horizon as a reference, can override the illusions. Under low visibility conditions (night, fog, clouds, haze, etc.) the illusions predominate. Only through awareness of these illusions, and proficiency in instrument flight procedures, can an airplane be operated safely in a low visibility environment.

Flying in fog, dense haze or dust, cloud banks, or very low visibility, with strobe lights, and

SECTION X
SAFETY INFORMATION

MOONEY M20J

particularly rotating beacons turned on frequently causes vertigo. They should be turned off in these conditions, particularly at night.

All pilots should check the weather and use good judgement in planning flights. The VFR pilot should use extra caution in avoiding low visibility conditions.

Motion sickness often precedes or accompanies disorientation and may further jeopardize the flight.

STALLS, SPINS AND SLOW FLIGHT

Stalls, and slow flight should be practiced at safe altitudes to allow for recovery. Any of these maneuvers should be performed at an altitude in excess of 6,000 feet above ground level.

Spins may be dangerous and should be avoided. In fact, most airplanes are placarded against intentional spins. Spins are preceded by stalls. A prompt and decisive stall recovery protects against inadvertent spins.

All airplanes are required to have flight characteristics that give adequate advance warning of an impending stall or they must be equipped with an artificial stall warning device. Keep the artificial system in good working order. Do not operate the airplane with the device made inoperative by the use of circuit breakers or other means.

Stalls should be practiced at safe altitudes for ample recovery. Should a spin be encountered inadvertently, spin recovery should be initiated immediately.

SECTION X
SAFETY INFORMATION

MOONEY M20J

pronounced wake turbulence will be. Wing tip vortices from large heavy airplanes are very severe at close range, degenerating with time, wind and space. These are rolling in nature from each wing tip. In test, vortex velocities of 133 knots have been recorded. Exhaust velocities from large airplanes at takeoff have been measured at 25 mph, 2100 feet behind medium large airplanes.

Encountering the rolling effect of wing tip vortices within two minutes or less after passage of large airplanes is hazardous to light airplanes. This roll effect can exceed the maximum counter roll obtainable in an airplane.

The turbulent areas may remain for as long as three minutes or more, depending on wind conditions, and may extend several miles behind the airplane. Plan to fly slightly above or to the upwind side of the other airplane's flight path.

Because of the wide variety of conditions that can be encountered, there is no set rule to follow to avoid wake turbulence in all situations. However, the Airman's Information Manual goes into considerable detail for a number of wake turbulence avoidance procedures. Use prudent judgment and allow ample clearance time and space following or crossing the wake turbulence of other airplanes in all takeoff, climb out, approach and landing operations. Be observant of wake turbulence from all aircraft, regardless of size.

The Airman's Information Manual contains a section on wake turbulence. FAA Advisory Circular AC 90-230 is also recommended reading.

TAKE-OFF AND LANDING CONDITIONS

When taking off on runways covered with water or freezing slush, the landing gear should remain extended for approximately ten seconds longer than normal, allowing the wheels to spin and dissipate the freezing moisture. The landing gear should then be cycled up, then down, wait approximately five seconds and then retract again. Caution must be exercised to insure that the entire operation

SECTION X
SAFETY INFORMATION

MOONEY M20J

is performed below Maximum Landing Gear Operating Airspeed.

Use caution when landing on runways that are covered by water or slush which cause hydroplaning (aquaplaning), a phenomenon that renders braking and steering ineffective because of the lack of sufficient surface friction. Snow and ice covered runways are also hazardous. The pilot should also be alert to the possibility of the brakes freezing.

Use caution when taking off or landing during gusty wind conditions. Also be aware of the special wind conditions caused by buildings or other obstructions located near the runway in a crosswind pattern.

MEDICAL FACTS FOR PILOTS

GENERAL

Modern industry's record in providing reliable equipment is very good. When the pilot enters the airplane, he becomes an integral part of the man-machine system. He is just as essential to a successful flight as the control surfaces. To ignore the pilot in pre-flight planning would be as senseless as failing to inspect the integrity of the control surfaces or any other vital part of the machine. The pilot himself has the responsibility for determining his reliability prior to entering the airplane for flight.

While piloting an airplane, an individual should be free of conditions which are harmful to alertness, ability to make correct decisions, and rapid reaction time.

FATIGUE

Fatigue generally shows reaction times and causes foolish errors due to inattention. In addition to the most common cause of fatigue, insufficient rest and loss of sleep, the pressure of business, financial worries and family problems, can be important contributing factors. If your fatigue is a factor prior to a given flight, don't fly.

SECTION X
SAFETY INFORMATION

MOONEY M20J

To prevent fatigue effects during long flights, keep mentally active by making ground checks and radio navigation position plots.

HYPOXIA

Hypoxia in simple terms is a lack of sufficient oxygen to keep the brain and other body tissues functioning properly. There is wide individual variation in susceptibility to hypoxia. In addition to progressively insufficient oxygen at higher altitudes, anything interfering with the blood's ability to carry oxygen can contribute to hypoxia (anemias, carbon monoxide, and certain drugs). Also, alcohol and various drugs decrease the brain's tolerance to hypoxia.

Your body has no built in alarm system to let you know when you are not getting enough oxygen. It is impossible to predict when or where hypoxia will occur during a given flight, or how it will manifest itself. A major early symptom of hypoxia is an increased sense of well-being (referred to as euphoria). This progresses to slow reactions, impaired thinking ability, unusual fatigue, and dull headache feeling.

The symptoms are slow but progressive, insidious in onset, and are most marked at altitudes starting above ten thousand feet. Night vision, however, can be impaired starting at altitudes lower than 10,000 feet. Heavy smokers may experience early symptoms of hypoxia at altitudes lower than nonsmokers. Use oxygen on flights above 10,000 feet and at any time when symptoms appear.

HYPERVENTILATION

Hyperventilation or overbreathing, is a disturbance of respiration that may occur in individuals as a result of emotional tension or anxiety. Under conditions of emotional stress, fright, or pain, breathing rate may increase, causing increased lung ventilation, although the carbon dioxide output of the body cells does not increase. As a result, carbon dioxide is "washed out" of the blood. The most common symptoms of hyperventilation are: dizziness; hot and cold

SECTION X
SAFETY INFORMATION

MOONEY M20J

sensations; tingling of the hands, legs and feet; tetany; nausea; sleepiness; and finally unconsciousness.

Should symptoms occur that cannot definitely be identified as either hypoxia or hyperventilation try three or four deep breaths of oxygen. The symptoms should improve markedly if the condition was hypoxia (recovery from hypoxia is rapid). If the symptoms persist, discontinue use of oxygen and consciously slow your breathing rate until symptoms clear and then resume normal breathing rate. Normal breathing can be aided by talking aloud.

ALCCHOL

Common sense and scientific evidence dictate that you not fly as a crew member while under the influence of alcohol. Even small amounts of alcohol in the human system can adversely affect judgment and decision making abilities. FAR 91.11 states "(a) No person may act as a crew member - (1) within 8 hours after the consumption of any alcoholic beverage."

Tests indicate that as a general rule, 2 ounces of alcohol at 15,000 feet produce the same adverse effects as 6 ounces at sea level. In other words, the higher you get, "the higher you get".

DRUGS

Self-medication or taking medicine in any form when you are flying can be extremely hazardous. Even simple home or over-the-counter remedies and drugs such as aspirin, antihistamines, cold tablets, cough mixtures, laxatives, tranquilizers, and appetite suppressors, may seriously impair the judgment and coordination needed while flying. The safest rule is to TAKE NO MEDICINE before or while flying, except on the advice of your Aviation Medical Examiner.

SCUBA DIVING

Flying shortly after any prolonged scuba diving could be dangerous. Under the increased pressure

SECTION X
SAFETY INFORMATION

MOONEY M20J

of the water, excess nitrogen is absorbed into your system. If sufficient time has not elapsed prior to takeoff for your system to rid itself of this excess gas, you may experience the bends at altitudes even under 10,000 feet, where most light planes fly.

ADDITIONAL INFORMATION

In addition to the coverage of subjects in this section, the National Transportation Safety Board and the Federal Aviation Administration periodically issue general aviation pamphlets concerning aviation safety, and in greater detail. These can be obtained at FAA Offices, Weather Stations, Flight Service Stations, or Airport Facilities. These are very good sources of information and are highly recommended for study. Some of these are titled:

Airman's Information Manual
12 Golden Rules for Pilots
Weather or Not
Disorientation
Plane Sense
Weather Info Guide for Pilots
Wake Turbulence
Don't Trust to Luck, Trust to Safety
Thunderstorm - TRW
IFR-VFR Either Way Disorientation Can be Fatal