

EASY-KLEEN

PRESSURE SYSTEMS LTD.

MANUFACTURER OF HIGH PRESSURE CLEANING EQUIPMENT

Owner's Manual

**Commercial and Industrial Hot Water Gas
and Diesel Driven, Oil Fired**



1-800-315-5533 • service@easykleen.com • www.easykleen.com

Easy-Kleen Pressure Systems

1-800-315-5533

This manual contains operational information that is specific for commercial and industrial (Bull Moose and Grizzly) hot water, gas and diesel driven, oil fired machines.

Read the following instructions carefully before attempting to assemble, install, operate, or service this pressure washer. Failure to comply with these instructions could result in personal injury and/or property damage.

Table of Contents

IMPORTANT SAFETY INFORMATION.....	3
SPECIFICATIONS	7
INTRODUCTION.....	9
OPERATING INSTRUCTIONS	10
CHEMICAL APPLICATION.....	12
WINTER PUMP/ COIL PROTECTION	13
GENERAL MAINTENANCE.....	13
MAINTENANCE CHECKLIST.....	15
GLOSSARY OF TERMS.....	17
COMPONENT IDENTIFICATION	18
QUICK DIAGNOSTICS AND SOLUTIONS GUIDE.....	25
WIRING DIAGRAMS.....	27
MANUFACTURER’S WARRANTY	31
SERVICEMANUAL.....	33

IMPORTANT SAFETY INFORMATION

The safe operation of our pressure washing systems is the **FIRST** priority of Easy-Kleen. This will only be achieved by following the operation and maintenance instructions as explained in this manual and all other enclosed manuals.

This manual contains essential information regarding the safety hazards, operations, and maintenance associated with this machine. The manual should always remain with the machine, including if it is resold.

ALL CAUTIONS AND SAFETY WARNINGS MUST BE FOLLOWED TO AVOID INJURY OR DAMAGE TO EQUIPMENT.

THIS EQUIPMENT IS TO BE USED ONLY BY TRAINED OPERATORS AND MUST ALWAYS BE ATTENDED DURING OPERATION.



WARNING: To reduce the risk of injury, read operating instructions carefully before using.

1. Read the instructions in this manual carefully before attempting to assemble, install, operate or service this pressure washer. Failure to comply with the instructions could result in personal injury and/or property damage.



WARNING: Use protective eyewear and clothing when operating equipment in order to avoid personal injuries.



WARNING: This machine exceeds 85db. Appropriate ear protection must be worn.



WARNING: Risk of explosion. Operate only where open flame or torch is permitted.

WARNING: Flammable liquids can create fumes which can ignite, causing property damage or severe injury.

2. Be thoroughly familiar with all controls and know how to stop the machine in the event of an emergency.



WARNING: Risk of fire. Do not add fuel when operating machine.

3. Never use gasoline, crankcase draining, or waste oil in your burner fuel tank. Never run pump dry or let the pump run with the trigger gun released for more than 2 minutes. The minimum clearance to any combustible material is 12 inches.



WARNING: Keep water spray away from electrical wiring.

4. All electrically powered equipment must be grounded at all times to prevent fatal electric shocks. Do not spray water on or near electrical components. Do not touch electrical components while standing in water or when hands are wet. Always make sure machine is disconnected from power source before servicing.



WARNING: Risk of asphyxiation. Use this product only in a well ventilated area.

5. Use equipment in a well-ventilated area to avoid carbon monoxide poisoning or death. This machine must never be connected to a Type B gas vent.



WARNING: Risk of injection or severe injury to persons. Keep clear of nozzle spray.

6. High pressure spray can cause serious injuries. Never point pressurized spray at any person or animal. Handle the spray assembly with care.



WARNING: Risk of injury. Hot surfaces can cause burns.



WARNING: Hot discharge fluid. Do not touch or direct discharge stream at persons.



WARNING: Trigger gun kicks back. Hold with both hands.

7. Hold firmly to the gun and wand during start up and operation of the machine. Do not attempt to make adjustments while the trigger gun is in operation.

8. Make sure all quick coupler fittings are properly secured before operating pressure washer.



WARNING: Risk of injury from falls when using ladder.

9. Do not overreach or stand on anything unstable. Keep a good balance and make sure to keep a steady footing at all times.



WARNING: Protect from freezing.

10. It is important to keep your machine from freezing in order to keep it in its best working condition. Failure to protect your machine from freezing may cause damage to the machine and personal injuries may occur as a result.



WARNING: Risk of Injury

11. For machines with a 12 V burner: Disconnect battery ground terminal before servicing.

12. Protect high pressure hoses from sharp objects and vehicles. Inspect condition of hoses prior to use, or serious injury could occur.

13. Do not pass acids or other caustic or abrasive fluids through the pump.

14. Never run pump dry of water or oil or let the pump run with the trigger gun released for more than 2 minutes.
15. Do not attempt to operate this machine if fatigued or under the influence of alcohol, prescription medications, or drugs.
16. Some of the maintenance procedures involved in this machine require a certified technician (these steps are indicated throughout this manual). Do not attempt to perform these repairs if you are not qualified.

If you need further explanation of any of the information in this manual, suspend any activity involving the equipment and call our toll free number for assistance, 1-800-315-5533.

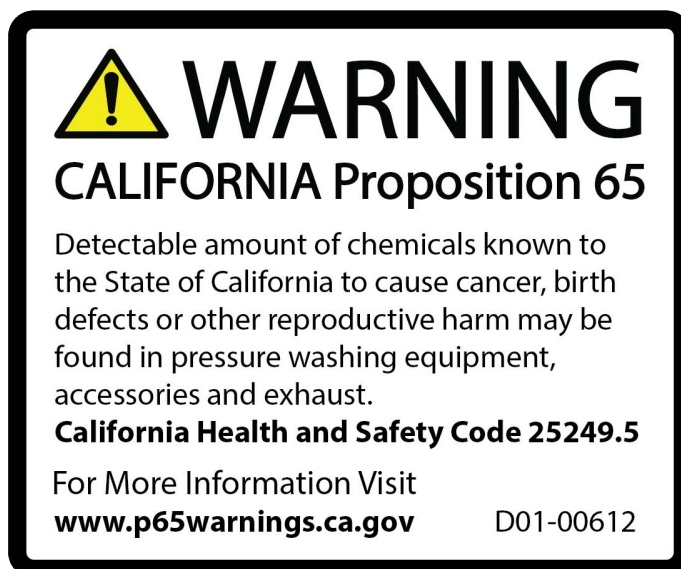

SPECIFICATIONS

Commercial Hot Water Gas - Oil Fired								
MODEL	GPM	PSI	BURNER OIL PRESSURE (PSI)	BTU	HP/ ENGINE	DRIVE	ELECTRIC START	BURNER
EZO2703G	3	2700	130	300,000	6.5 KOHLER	DIRECT	NO	120V
EZO4035G-K-GP-R	3.5	4000	130	350,000	14 KOHLER	DIRECT	NO	120V
EZO4035G-H-GP-R	3.5	4000	130	350,000	13 HONDA	DIRECT	NO	120V
EZO4035G-K-GP-120	3.5	4000	130	350,000	14 KOHLER	DIRECT	YES	120V
EZO4035G-H-GP-120	3.5	4000	130	350,000	13 HONDA	DIRECT	YES	120V
EZO4035G-L-GP-12	3.5	4000	130	350,000	15 LIFAN	DIRECT	YES	12V
EZO4035G-K-GP-12	3.5	4000	130	350,000	14 KOHLER	DIRECT	YES	12V
EZO4035G-H-GP-12	3.5	4000	130	350,000	13 HONDA	DIRECT	YES	12V
EZO3504G-K	4	3500	130	400,000	14 KOHLER	GEARBOX	YES	12V
EZO3504G-H	4	3000	130	400,000	13 HONDA	GEARBOX	YES	12V

Commercial Hot Water Diesel - Oil Fired								
MODEL	GPM	PSI	BURNER OIL PRESSURE (PSI)	BTU	HP/ ENGINE	DRIVE	ELECTRIC START	BURNER
EZO4035D-K-GP-12	3.5	4000	130	350,000	9.8 KOHLER	DIRECT	YES	12V
EZO3504D-K	4	3500	130	400,000	9.8 KOHLER	GEARBOX	YES	12V

Industrial Hot Water Gasoline – Oil Fired (Grizzly Series)						
MODEL*	GPM	PSI	BURNER OIL PRESSURE (PSI)	BTU	HP/ENGINE	DRIVE
EZO3004G	4	3000	160	400,000	13 HONDA	BELT
EZO3504BG	4	3500	160	400,000	14 KOHLER	GEARBOX
EZO3504G	4	3500	160	400,000	14 KOHLER	BELT
EZO3505G	5	3500	130	500,000	20 HONDA	BELT
EZO3506G	6	3500	145	600,000	25 KOHLER	BELT
EZO3008G	8	3000	155	800,000	25 KOHLER	BELT
EZO3010G	10	3000	130	1,000,000	38 KOHLER	BELT
EZO3708G	8	3700	130	800,000	38 KOHLER	BELT
EZO5005G	5	5000	130	500,000	25 KOHLER	BELT
EZO6004G	4	6000	160	400,000	25 KOHLER	BELT
EZO6006G	6	6000	145	600,000	38 KOHLER	BELT
EZO7004G	4	7000	160	400,000	25 KOHLER	BELT

*-GG – has a generator

*-ST – steam kit

Industrial Hot Water Diesel – Oil Fired (Bull Moose Series)						
MODEL	GPM	PSI	BURNER OIL PRESSURE (PSI)	BTU	HP/ENGINE	DRIVE
EZO3204D	4	3200	160	400,000	9.8 KOHLER	BELT
EZO3506D	6	3500	145	600,000	26 KOHLER	BELT
EZO3508D	8	3500	130	800,000	26 KOHLER	BELT
EZO3010D	10	3000	130	1,000,000	26 KOHLER	BELT
EZO5005D	5	5000	130	500,000	26 KOHLER	BELT
EZO5010D	10	5000	130	1,000,000	58 KUBOTA	GEARBOX
EZO6004D	4	6000	160	400,000	26 KOHLER	BELT
EZO7004D	4	7000	160	400,000	26 KOHLER	BELT
EZO8008D	8	8000	130	1,000,000	58 KUBOTA	GEARBOX

INTRODUCTION

Thank you for selecting a quality Easy-Kleen product. We are pleased to have you included among the many satisfied owners of Easy-Kleen cleaning machines. Years of engineering have gone into the development of these fine products and only top quality components and materials are used throughout. Each machine is carefully tested and inspected before leaving our plant to ensure years of dependable performance.

To continue to receive satisfactory performance, remembering that this machine represents a substantial investment on your part, and if properly cared for and maintained it will return this investment many times over. As with all mechanical equipment, your machine requires proper operation and maintenance as outlined in this manual for maximum trouble free life.

This manual has been prepared under the direction of our engineering and service technicians. Their experience in designing, manufacturing, installing and servicing our equipment from our company's inception is condensed in this manual. They know what information the end user needs in order to get the optimum performance from their pressure washer. Please read carefully.

This manual contains information that will be specific for your pressure washer, as well as similar models.

Carefully review any additional manuals that have been included with your system and follow ALL ADDITIONAL OPERATING INSTRUCTIONS AND SAFETY NOTICES. They are specific for the quality components that have been used to manufacture your machine and are an integral part of the operating and maintenance procedures.

The management & staff at Easy-Kleen are proud of the equipment that we design and manufacture and we thank you for making us your # 1 choice in pressure washers. If you have any questions please do not hesitate to call us, 1-800-315-5533.

Our goal is that you will be satisfied with the performance, quality, and service you receive from Easy-Kleen and that if you need to replace this machine in years to come, you will give us the opportunity to continue supplying equipment to your company.

PLEASE READ MANUALS CAREFULLY BEFORE USING MACHINE. EXAMINE MACHINE AND CRATE CAREFULLY FOR SHIPPING DAMAGE OR MISSING PARTS. REPORT PROMPTLY ANY SHORTAGES OR DAMAGE CLAIMS TO FREIGHT CARRIER OR DEALER.

OPERATING INSTRUCTIONS

1. **Perform pre-start maintenance** inspection on all applicable systems prior to operating the machine. This is essential for the safe, effective and efficient operation. You will get optimum performance from your system ONLY if these instructions and inspections are followed. Any indication that the pressure washing system was not operated and maintained according to these instructions may cancel the manufacturers' warranty.

Location – Be sure to install in an area that has sufficient air ventilation to support combustion of oil in burner.

Controls – Make sure all controls turned to the off position.

Pump – Oil level - Level the pressure washer. Be sure oil level in the pump is correct on dip stick. If the level is low, add the correct oil to the proper level. **USE ONLY SAE 30 W NON-DETERGENT OIL OR HYDRAULIC 68. DO NOT OVER FILL.**

Gas Engine - Gasoline level– The engine is a 4 cycle and uses regular octane, unleaded fuel. **DO NOT USE MIXED FUEL.** Refer to the engine operation manual included with your pressure-washing unit.

Gas Engine - Oil level – The engine is a 4 cycle and uses 10W30 detergent oil. Refer to Glossary or engine manual.

Diesel Engine – Refer to engine operation manual included with your pressure washing unit for oil and fuel recommendations.

Oil Fired Burner - Oil Tank Level – #2 Furnace oil is recommended for the burner oil tank, as it burns cleaner and the burner requires less maintenance. Diesel fuel may be used as an alternative. Do not overfill burner tank.

Visually inspect all electrical components to assure they are in good condition, showing No signs of exposure, breakage or splicing.

Visually inspect all hoses, nozzles and guns to assure they are in good condition. If replacements are necessary they must be rated to withstand the machines operating pressure and temperatures.

2. **Attach high-pressure hose** to hot water outlet quick connector. Attach the other end of high pressure hose (with quick coupler) to spray gun. Ensure that quick disconnect connections are tightly locked together. Apply a sharp pull on hose to confirm they are secured.

Attach wand nozzle specific to task requirements (i.e. chemical or pressure wash).

[Quick Coupling Operation – Pull back sleeve end and insert male end into nozzle quick coupler, release sleeve and confirm connection by pulling on the nozzle].

3. **Attach water source** to water inlet located on pump. The water source must be attached with a good quality standard garden type hose (1/2" minimum is required). Connect male fitting into the female pump inlet fitting. Make sure that the inlet screen/filter is intact and fitted correctly. Turn on water source. **WATER MUST BE IN SUFFICIENT SUPPLY, AND PRESSURE MUST BE BETWEEN 20 –60 PSI TO ENSURE PROPER AND SAFE OPERATION.** Specific attention should be given if using a well water supply. Ensure water is flowing from end nozzle with the trigger gun pulled. Deplete system of all air.

4. **Start Gas/Diesel Engine**

Refer to instructions in engine manual. **MAKE SURE THAT THE ENGINE EXHAUST IS NOT FACING ANY FLAMMABLE MATERIALS.**

5. **Burner operation**

Be sure water is flowing through water heater coil before turning on BURNER switch. Turn thermostat to desired temperature. Burner will ignite and remain in operation as long as there is sufficient water flow to satisfy the pressure switch and temperature control.

IF YOU EXPERIENCE IGNITION FAILURE, DO NOT ATTEMPT TO RESTART BURNER! EXCESS FUEL AND VAPORS MAY HAVE ACCUMULATED AND THE CHAMBER MAY BE HOT. THE UNIT MUST COOL DOWN BEFORE RESTART CAN BE ATTEMPTED.

Warning: Condensation on Coil

When cold water is being pumped through the heater coil and the burner is firing, condensation may form at times on the coil and drip down into the burner compartment. This can be particularly noticeable on cold, humid days giving the false appearance of a leaking coil. A leaking coil or system will be evident if the pump keeps cycling with the trigger released. The pump head pressure should read '0'.

Electrically Operated Burners – These models generate 12V from the gasoline engine and provide the necessary power for the burner. **IF YOU REQUIRE UPGRADES OR MODIFICATIONS TO YOUR EXISTING ELECTRICAL SYSTEM IN ORDER TO OPERATE YOUR PRESSURE WASHER, THEY MUST BE PERFORMED BY A LICENSED ELECTRICIAN AND BE COMPLETED IN ACCORDANCE TO ALL APPLICABLE CODES IN YOUR AREA OF OPERATION.** The power supply must be adequate for your specific unit. Make sure to verify the data plate for your machine's specific requirements (i.e. voltage, amperage, etc.).

6. **Pressure adjustment** - The pressure regulator (unloader) is located on the pump (see pages 19, 21 & 23 diagrams). It controls the pressure being generated by the pressure washer. This regulator may be adjusted to the desired pressure by turning the adjustment knob. Turning the adjustment knob clockwise will increase the pressure. **NEVER OPERATE SYSTEM AT A HIGHER PSI THAN THE MAXIMUM RATING.** This machine has been adjusted to operate at a specific maximum pressure as per the machine specifications. Pressure may be reduced for lighter use by turning the Pressure Regulator/Unloader counter clockwise. If continuing to turn the unloader clockwise does not increase the pressure, then this implies the maximum has been reached for

the system. Any further turning of the unloader will cause the pressure to spike when the wand trigger is released, resulting in possible damage to the machine. To avoid this effect, loosen the unloader (counter-clockwise) until the pressure just starts to drop (see pump head pressure gauge) and until it no longer exceeds the maximum pressure rating for the machine.

7. You are now ready to start the cleaning operation - Pull trigger on the pressure wand assembly to start cleaning. To stop the pressurized water, release the trigger. **DO NOT LEAVE UNIT RUNNING WHEN NOT IN USE.**

8. To stop Burner operation – Turn BURNER switch to ‘PUMP’ (or to ‘OFF’ for Auto start stop models) and run pump for two minutes with trigger gun pulled to allow coil to cool down. After cooling period is complete, turn off main power to motor by turning BURNER switch to ‘OFF’ (turn PUMP switch to ‘OFF’ if equipped with auto start stop). Squeeze and release the trigger for the second time in order to relieve the pump system of pressure.

9. Prior to storage – Inspect pressure washer for any damage or required maintenance. If your machine is to be exposed to cold weather, please refer to winter pump/coil instructions found in this manual. If possible, do not allow unit to remain outside in the elements.

10. Warning – If unit is left running while not in use, pump damage may occur. Do not leave unit running while not in use!

11. Battery Specifications for electric start systems only – Rating: 165CCA, 190 CA or better, dimensions: 8” x 5” x 6” (applies to commercial units).

CHEMICAL APPLICATION

Downstream Chemical Injection: Standard (Direct Drive Units) High Pressure Soap (Optional Feature)

NOTE: Do not remove back flow preventer as chemical may flow back into potable water source. For standard chemical injection, ensure the black nozzle is properly fitted at the end of the wand. The chemical injector will not function if this nozzle is not fitted.

1. Chemical preparation – Select detergent/chemical that best suits your cleaning task. Prepare dilution according to the manufacturer’s instructions. The volume of chemical being used may be adjusted at valve located on the chemical injector. Note: for EK Pumps, the volume is preset and cannot be adjusted.

2. Insert the intake hose, located on the chemical injector at the pump, into the chemical being used.

3. Fit black nozzle on the standard wand, or for the dual wand, turn adjustment knob on, and adjust for required flow rate. For high pressure soap systems, the black nozzle is not needed; use one of the other wand nozzles.
4. To apply chemical, engage trigger on pressure wand assembly. Turn chemical injector's nipple to adjust flow. For the high pressure soap systems, open ball valve and engage trigger.
5. Chemical can now be applied through pressure wand assembly. It will take 5 – 15 seconds for chemical to travel to spray nozzle. The volume of chemical being used may be adjusted at the chemical injector.
6. For best results apply chemical from bottom to top, and allow for proper penetration time prior to rinsing. Do not allow chemical to dry. Rinse from bottom to top and then top to bottom.

WINTER PUMP/ COIL PROTECTION

The following procedure MUST be used when the pressure washing unit is stored at temperatures below freezing.

1. All water must be drained or blown (via compressed air) from system. Connect a short piece of male fitted ½" garden type hose on to the female inlet on the pump.
2. Place the open end of the hose into a wide mouthed container of full strength, winter rated, vehicle windshield washing fluid or Anti-Freeze, **RATED FOR MINIMUM -40°C**.
3. Connect the pressure wand assembly.
4. Start the engine and engage the trigger on the pressure gun. Operate the system until the fluid runs the same color as the windshield washing fluid. Your machine is now prepared for storage.
5. Disconnect fluid supply, blow out with compressed air, and cap end.

GENERAL MAINTENANCE

Burner Maintenance

NOTE: Repair of the burner is to be done by authorized and trained burner professionals only.

The oil filter cartridge should be replaced every year to prevent fuel contamination and plugging of fuel pump and nozzle of oil burner. The nozzle should also be replaced at least once every year or twice if used daily and if poor combustion begins to occur. See the included burner manual for more information on burner.

Final adjustments to burner include fuel pressure adjustment for controlling water temperature (tighten fuel pressure adjustment screw slightly to increase desired output temperature) and air band adjustment for combustion efficiency. A combustion test kit should be used for these final adjustments. Check SPECIFICATIONS chart (page 7) for the burner oil pressure corresponding to your model and be sure not to exceed this pressure. See included burner manual for more information and a parts break down of the burner.

If the burner floods with oil: run machine with heat on until all excess oil is burned off (this can take up to a couple of hours). If excess oil is not properly dealt with, the ceramic casing can absorb excess oil, causing a fire hazard. **DO NOT LEAVE MACHINE UNATTENDED WHILE MACHINE IS FLOODED.**

General Maintenance and Care

If the water heater is likely to be exposed to freezing weather then it should be winterized according to the winter pump/coil protection procedure in the previous section. Alternate methods may not completely protect the components. Damage from freezing is not a warrantable item.

Water Condition

Use a softener on your water system if local water is known to be high in mineral content. The advantages of soft water are very beneficial: prevents scale buildup in heater coil, cleans better with considerably less detergent, prevents streaking on painted surfaces and glass when rinsing.

Descaling Heater Coil Procedure

NOTE: Descaling of the heater coil is to be done by authorized and trained professionals only.

The best way to acidize the coil is with a circulation pump capable of handling acids.

1. Fill a plastic container with a suitable acid diluted with water to desired strength.
2. Connect discharge from the circulating pump to the hot water outlet on the water heater with a suitable hose. Connect the inlet of the circulating pump to the acid container with suction hose from the pump module and use it as a return hose to the acid container. As acid dissolves the scale it becomes neutralized, so about every five minutes add more acid to the container until all the scale has been removed from the coil. Flush out coil thoroughly with water after descaling.

MAINTENANCE CHECKLIST

Maintenance for Pump

Daily

1. Check oil for proper level and adjust accordingly.
2. Examine the quality of the oil.
3. Check pump for oil and/or water leaks.
4. Inspect and clean inlet filters.

Weekly

1. Examine all fittings, components, hoses, connections, and nozzles for damages, loose parts, or leaks. – Replace accordingly—

Recommendation for Oil Changes and Component Replacement

1. Change the oil in the pump after the first 50 hours and every 500 hours after the initial oil change. Use SAE 30 W Non-Detergent for GP Pumps and Hydraulic 68 for EK Pumps.
2. Change all other components on the pump as needed.

Maintenance for Gasoline Engine

Daily

1. Check oil for proper level and adjust accordingly.
2. Examine the quality of the oil
3. Examine the air cleaner element

Weekly

1. Examine engine components for damages, loose parts, or leaks.

Recommended Schedule for Oil Changes and Component Replacements

1. Change engine oil after first 5 hours and every 100 hours after the initial oil change. Use 10w-30 engine oil.
2. Replace Spark Plug every 100 hours.
3. Change air cleaner element every 100 hours.
4. Check fuel filters every 300 hours.
5. Change all other components on engine as needed.

GLOSSARY OF TERMS

PSI – Pounds per square inch. Pressure washers are designed and rated to operate at a specific PSI. Operating at pressures exceeding the maximum rating could result in damage to the unit and/or SEVERE PERSONAL INJURY.

GPM – Gallons per minute. The orifice on the pressure wand assembly has been selected to deliver up to the maximum GPM for your machine.

PRESSURE WAND ASSEMBLY – This refers to the gun, wand, and nozzle.

PUMP – The pump moves the water through the system and delivers it to the pressure wand assembly.

UNLOADER VALVE – Is a valve located at the head of the pump for unloading water back into the bypass when the trigger gun is shut off. It also reduces the load on pump when gun is off.

OIL, PUMP – The oil used within the pump to lubricate its operation. Important to use only SAE 30 W Non Detergent (GP Pump) or Hydraulic 68 (EK Pump) in the pump (see diagram).

OIL, GASOLINE ENGINE – Gasoline Engines need appropriate lubricant. Use 10W30 detergent oil.

BURNER – The burner heats the water in hot water pressure washers. It is located under the coil and may be powered by furnace oil or diesel fuel.

BACK FLOW PREVENTER – Device to prevent flow backwards into potable water supply.

MAXIMUM WORKING PRESSURE The water heater coils are designed to operate safely at normal working pressure. Each machine is equipped with a safety pressure relief valve which prevents over pressurization of the high pressure system. It is an important safety device and must not be tampered with in any way.

TEMPERATURE CONTROL- The water heater is equipped with a temperature control which shuts down the burner in the event of excessive outlet temperature caused by insufficient water flow through the heater coil. Do not set thermostat above 195°F

PRESSURE SWITCH - A high pressure switch is used to control the burner. It is part of the burner control system (see diagrams pages 19, 21 & 23).

FLOW SWITCH – A flow switch is installed on the outlet of the high pressure pump and will shut off the pump and motor in the absence of water flow as well as turning it back on when flow is detected (by squeezing the trigger).

COMPONENT IDENTIFICATION

Commercial Model:



Direct Driven Pump Assembly:

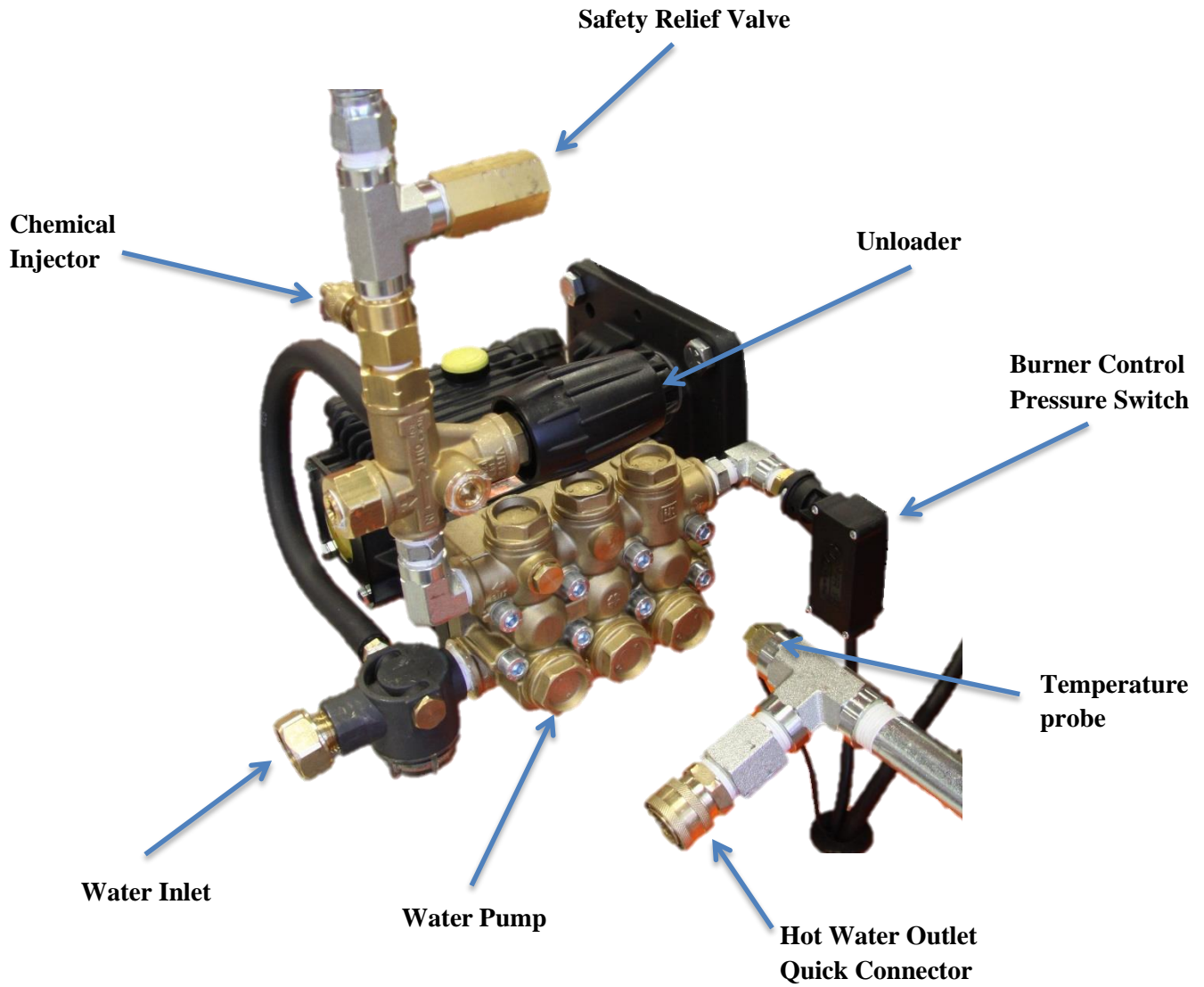

Bull Moose Series Industrial Model:

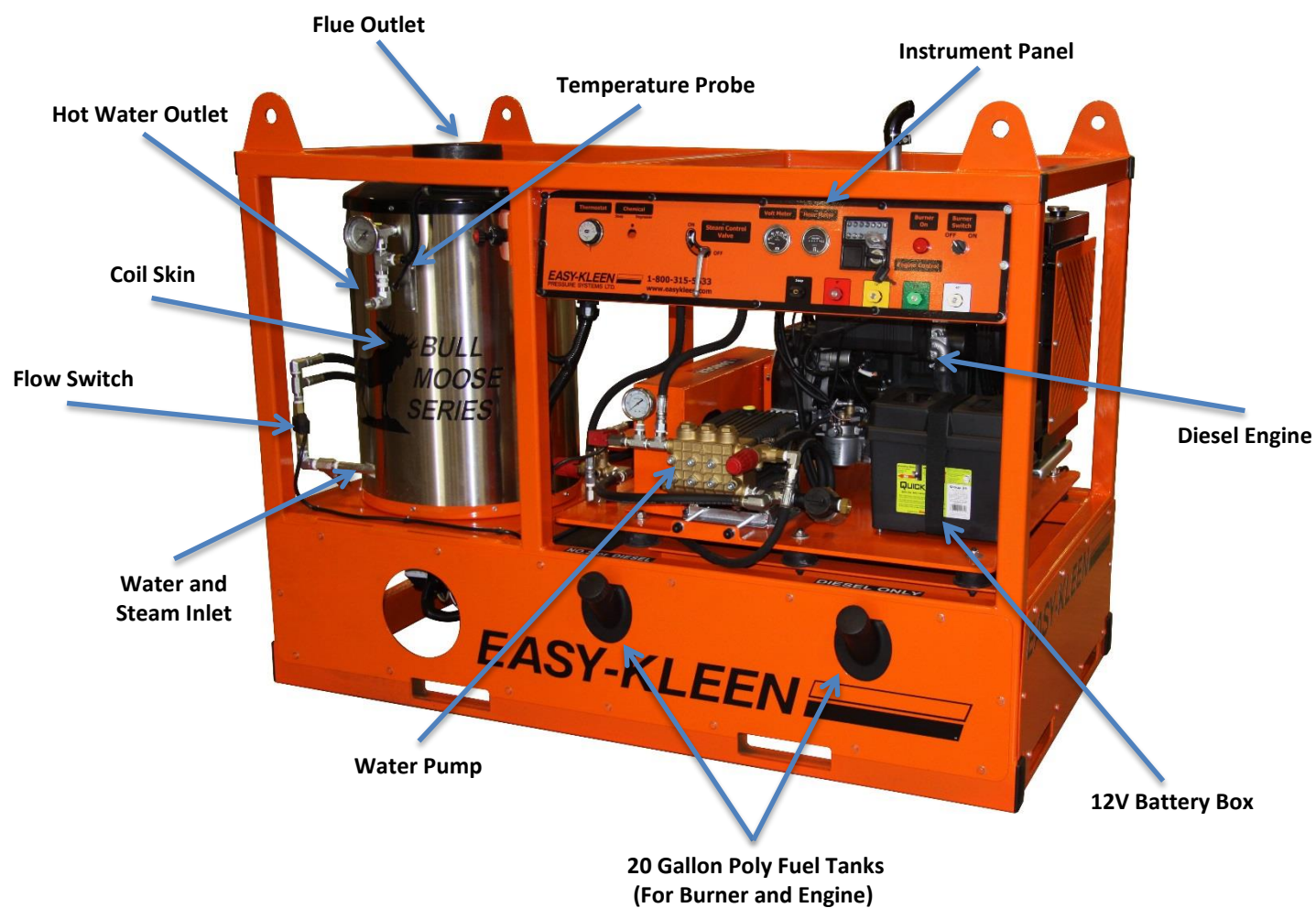

*Model shown with *optional* steam kit.

Bull Moose Pump Assembly with Optional Steam Kit:

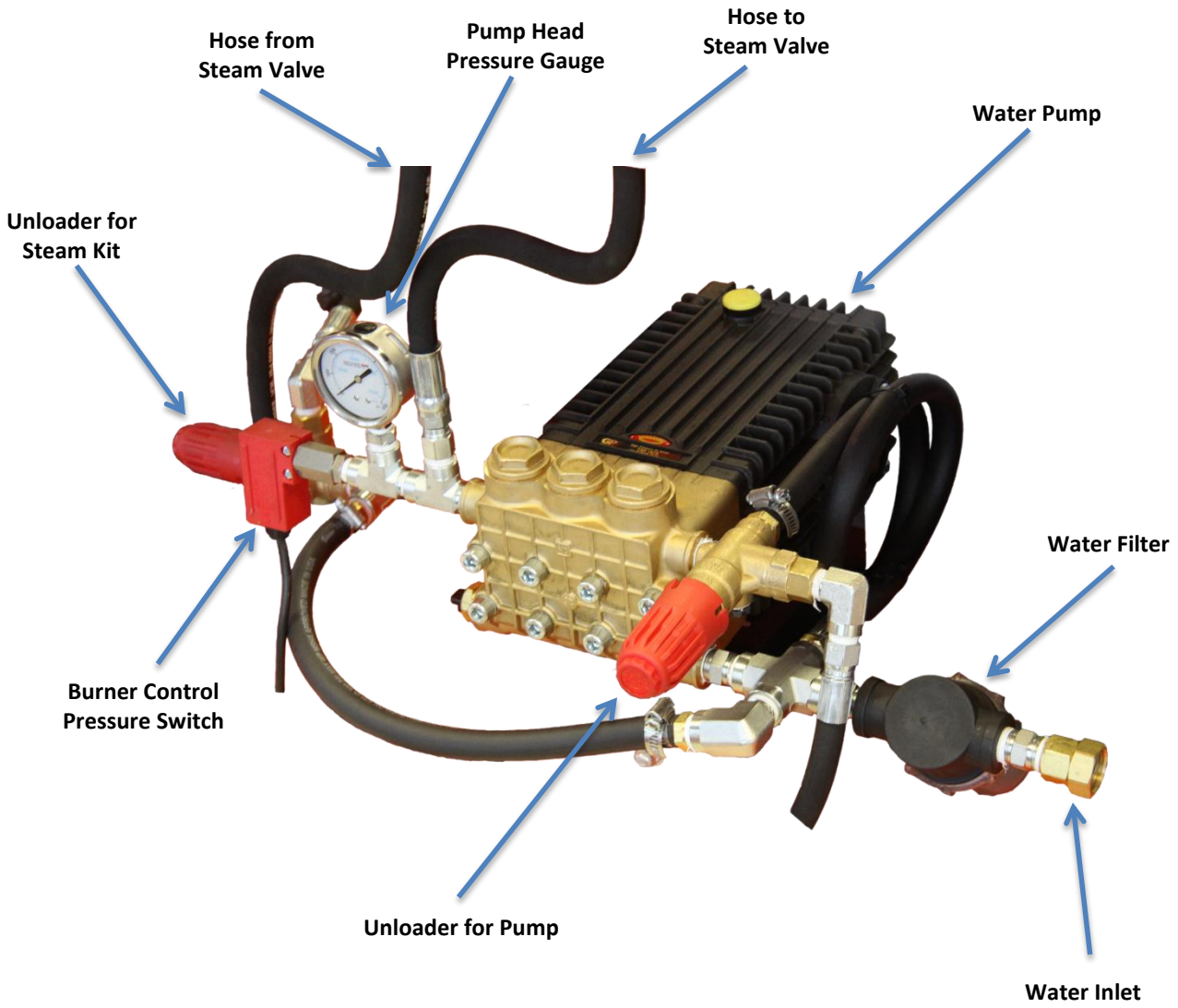

Grizzly Series Industrial Model:

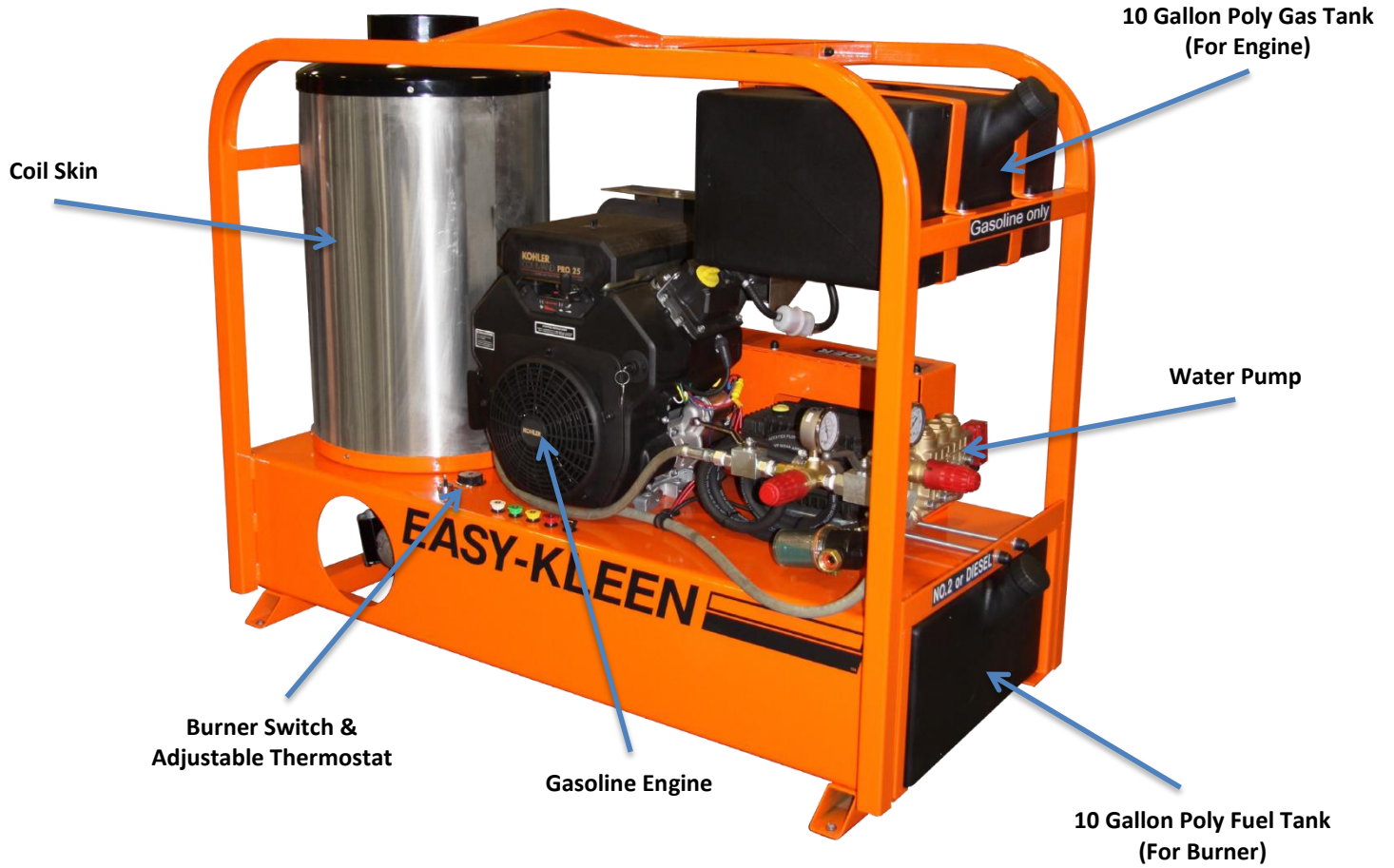

Grizzly Series Pump Assembly:

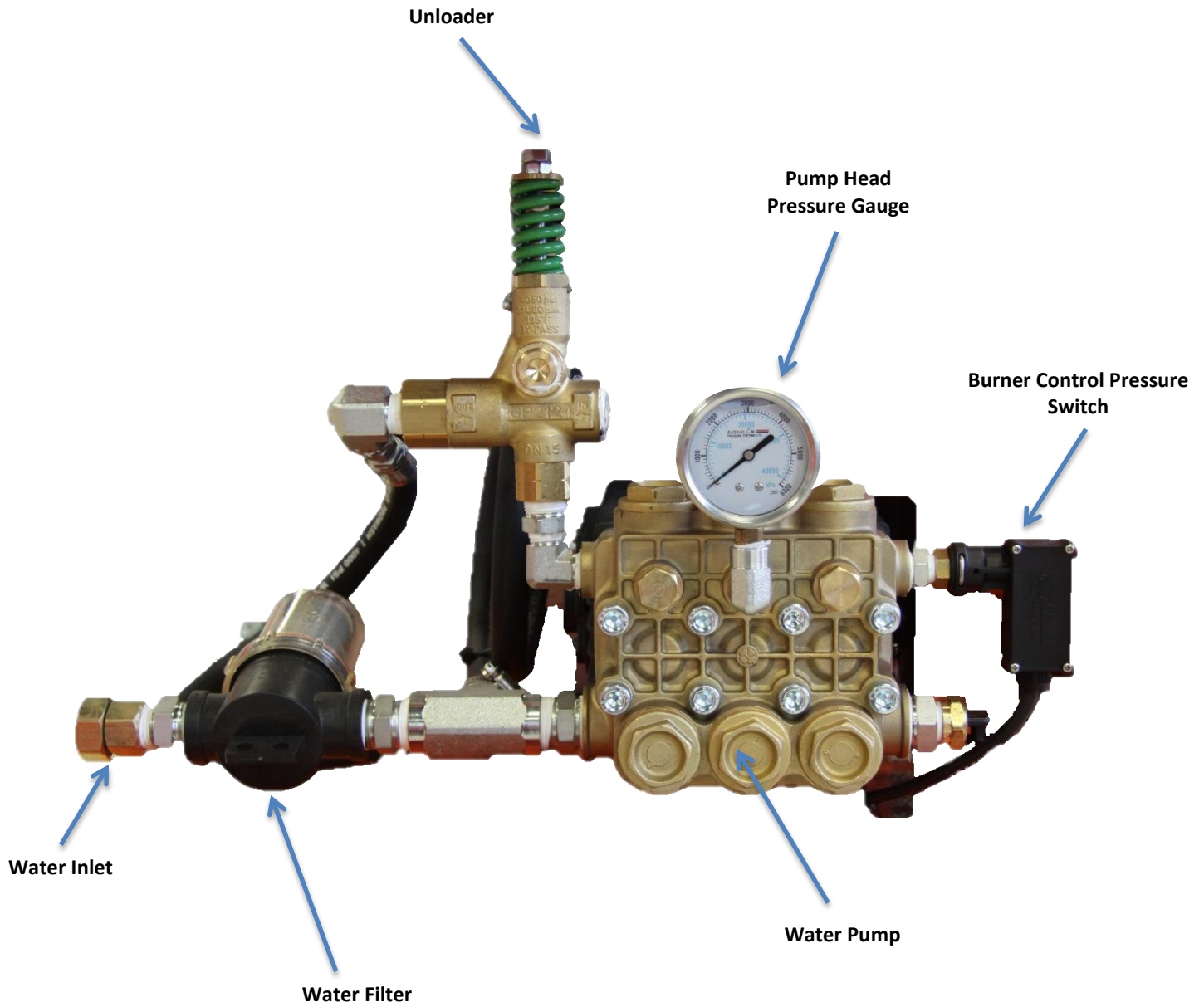

Hot Water Tank Interior (Top Cover Removed):

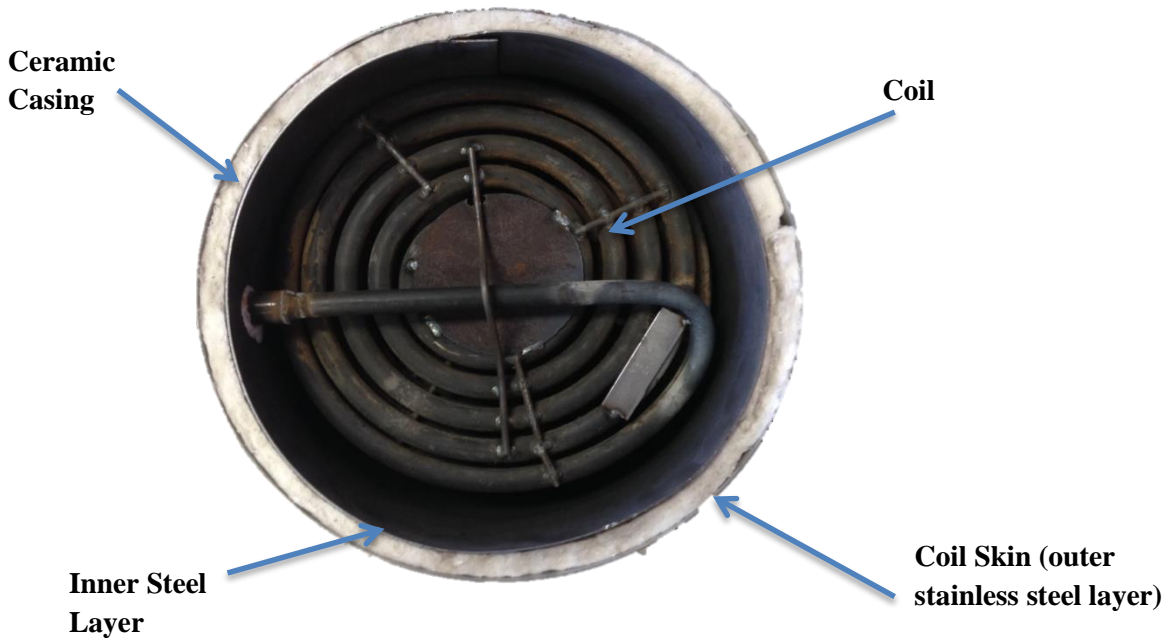

Pressure Wand Assembly:

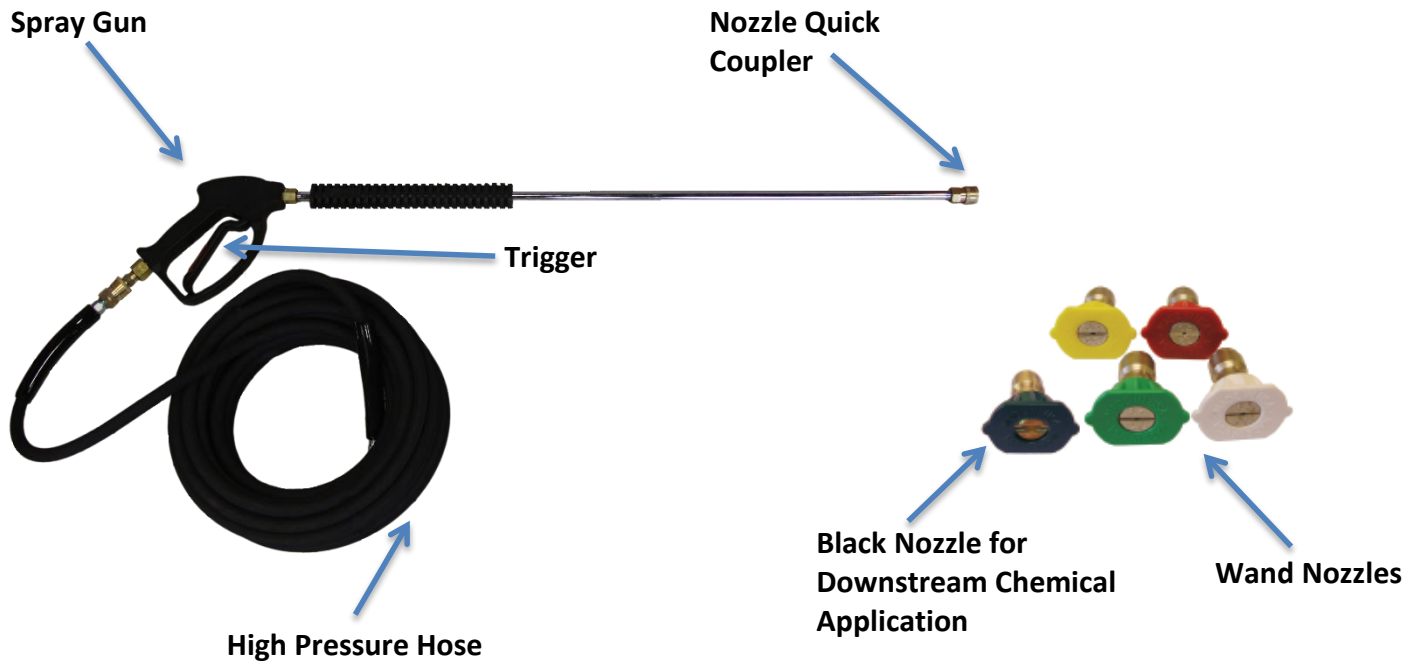

QUICK DIAGNOSTICS AND SOLUTIONS GUIDE

PUMP		TYPE OF OIL
EK Pump		Hydraulic 68 (650ml)
GP Pump		30W SAE Non-Detergent
PROBLEM	POSSIBLE CAUSES	SOLUTIONS
PRESSURE		
No pressure or Very low pressure	Metal in oil	<ul style="list-style-type: none"> - Examine oil in pump to see if there is metal in oil. - If you find traces or pieces of metal, your pump has damaged components.
	Dirt in water	<ul style="list-style-type: none"> - Verify if there is dirt in nozzle tip or in valves in pump. - If nozzle is plugged, clean or replace it. - If valves in pump are clogged, clean valves. - If valves in pump are damaged or pitted, replace valves.
	Wrong nozzle size	<ul style="list-style-type: none"> - Make sure you have the right nozzle size. The black nozzle will drop pressure in order to use chemical injector and is only for soap or chemical. If you are not using soap, use a different color.
Pressure too high	Wrong nozzle size	<ul style="list-style-type: none"> - Make sure you have the right nozzle size.
	Unloader adjusted improperly or damaged	<ul style="list-style-type: none"> - Check pressure of pump with a pressure gauge and adjust to desired pressure. - If you cannot reduce pressure, replace unloader.
LOSS OF BATTERY CHARGE (12 VOLT SYSTEM)		
Burner fan does not shut down or burner fan starts up when machine is not in use	Thermostat is stuck or damaged	<ul style="list-style-type: none"> - Make sure thermostat is working properly. Take dial off thermostat button. Turn the 2 screws about a quarter of a turn to the left (counterclockwise). Put dial back on. Try to shut off thermostat. - If you don't hear a click when you turn the dial completely over, replace thermostat. <p>NOTE : The newer 12 volt models now have an on/off switch that is designed to cut off current between the battery and burner in order to preserve the battery's charge. If you have a model that does not have this switch, please call us for more info.</p>

PROBLEM	POSSIBLE CAUSES	SOLUTIONS
BURNER		
No hot water	Dead battery	<ul style="list-style-type: none"> - Make sure your battery is fully charged. - If the battery's charge is not full, please replace or re-charge your battery.
	Damaged thermostat	<ul style="list-style-type: none"> - Make sure thermostat is connected properly. - If burner fan does not come on when you turn thermostat dial, replace thermostat.
	Damaged pressure switch	<ul style="list-style-type: none"> - Make sure pressure switch is connected properly to burner unit. Take cover off pressure switch by unscrewing the 4 screws on the front part of the switch (switch is located on pump). Without touching the contacts that conduct current, push on the little button found on the micro switch (button is located directly above the part that attaches directly into pump). - If burner comes on, replace pressure switch. - If burner does not come on, make sure there is current going through switch (consult a professional for this if you do not know how to do this properly as you can get severely injured by the electrical current connected to your machine). If current properly flows through pressure switch to burner, check ignitor.
	Damaged ignitor	<ul style="list-style-type: none"> - Please call a repair center for help to conduct tests on the ignitor. - If you see vapor coming out the top of the coil when you try to turn the burner on while the machine is in use, fuel is passing through the system properly but the ignitor is unable to produce a spark. Replace the ignitor. - If you don't see vapor, check the fuel line.
	Plugged filter or no fuel	<ul style="list-style-type: none"> - Make sure you have enough fuel in the tank. - If you have fuel, make sure the filter and fuel line are not plugged or damaged.

CIRCUIT DIAGRAM

GAS ENGINE WITH ELECTRIC START AND 12V DC BURNER OIL FIRED

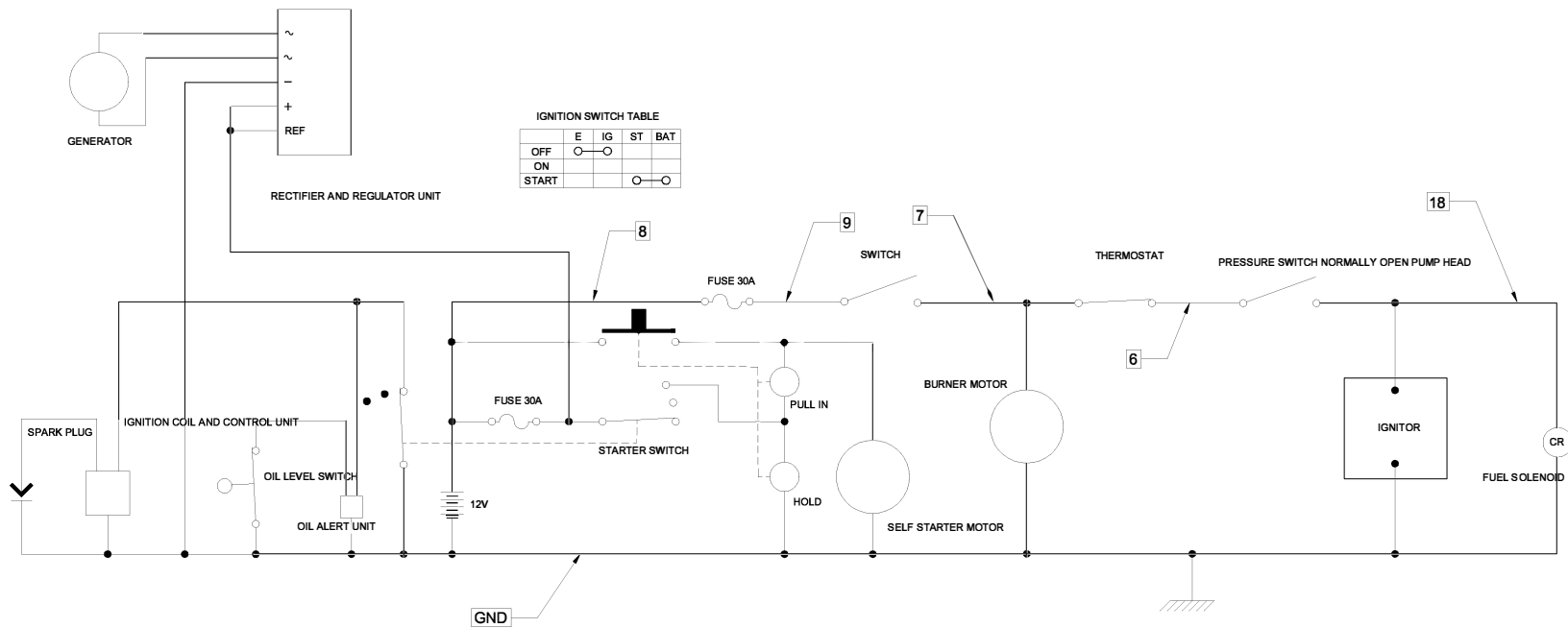

CIRCUIT DIAGRAM

GAS ENGINE WITH ELECTRIC START 110V AC BURNER OIL FIRED WITH GENERATOR

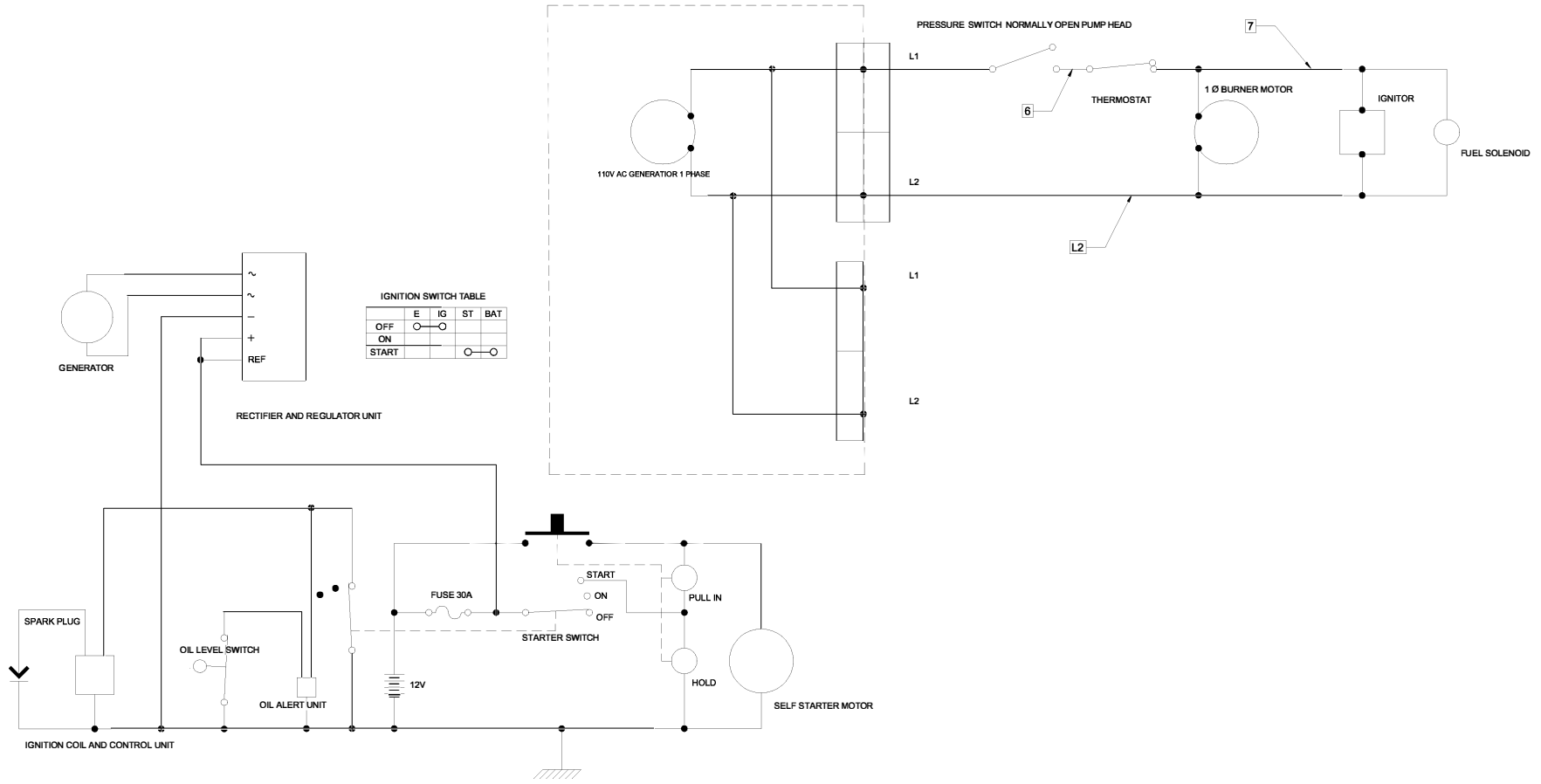

IGNITION SWITCH TABLE

	E	IG	ST	BAT
OFF	○	○	○	○
ON	○	○	○	○
START	○	○	○	○

CIRCUIT DIAGRAM

26HP DIESEL ENGINE WITH ELECTRIC START 120V AC BURNER
OIL FIRED AND GENERATOR

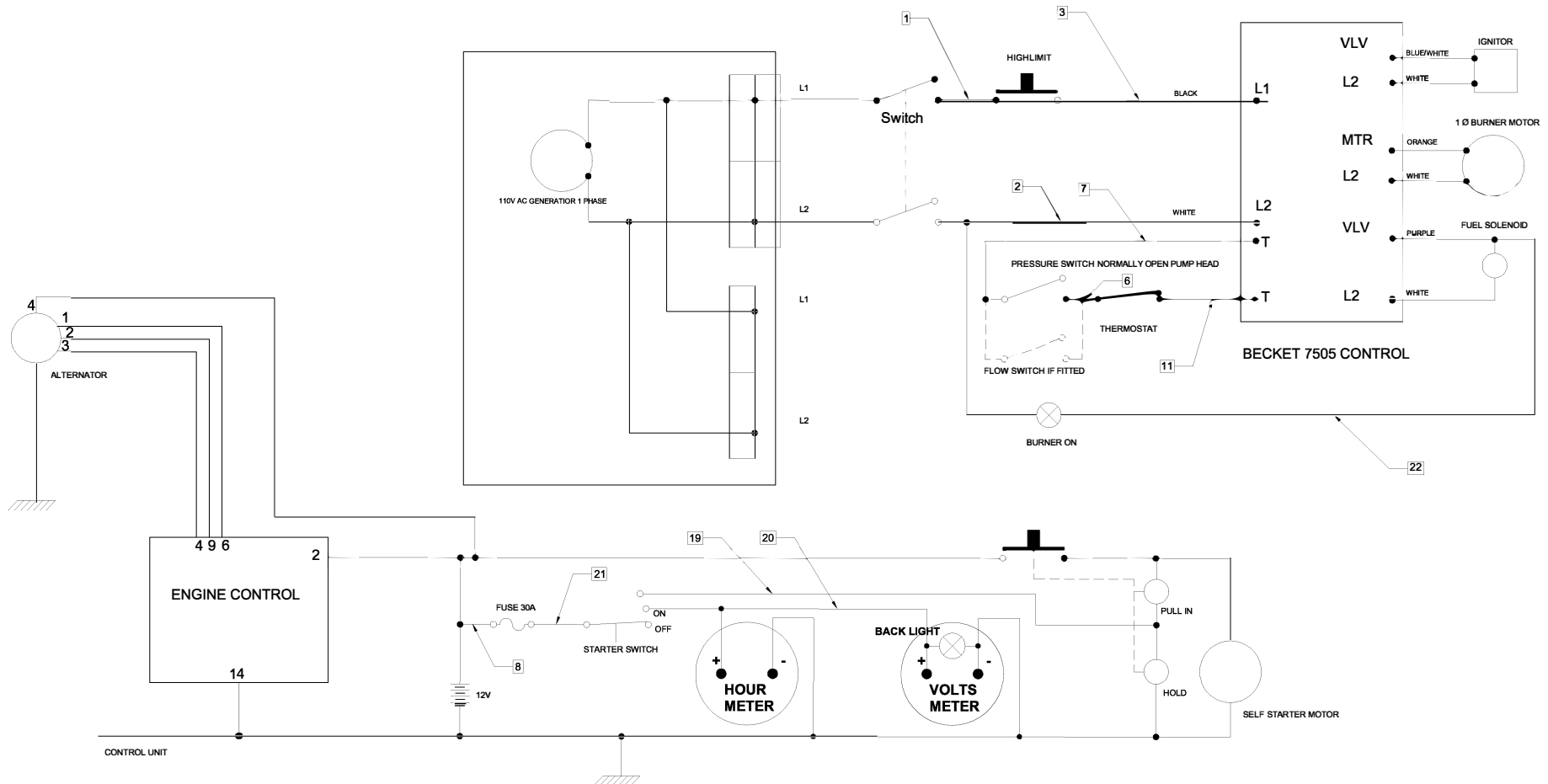

CIRCUIT DIAGRAM

58HP DIESEL ENGINE WITH ELECTRIC START 120V AC BURNER WITH GENERATOR OIL FIRED

120V AC ELECTRICAL CIRCUIT

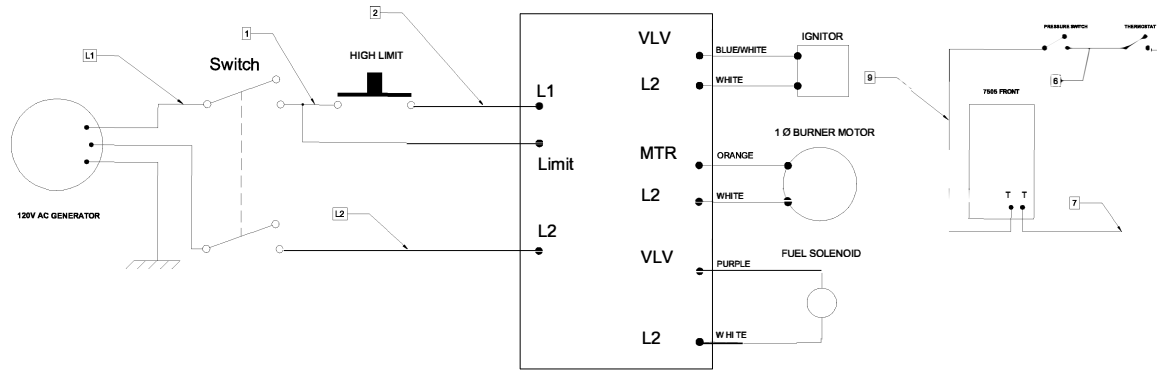

12V DC ELECTRICAL CIRCUIT

BECKET 7505 CONTROL

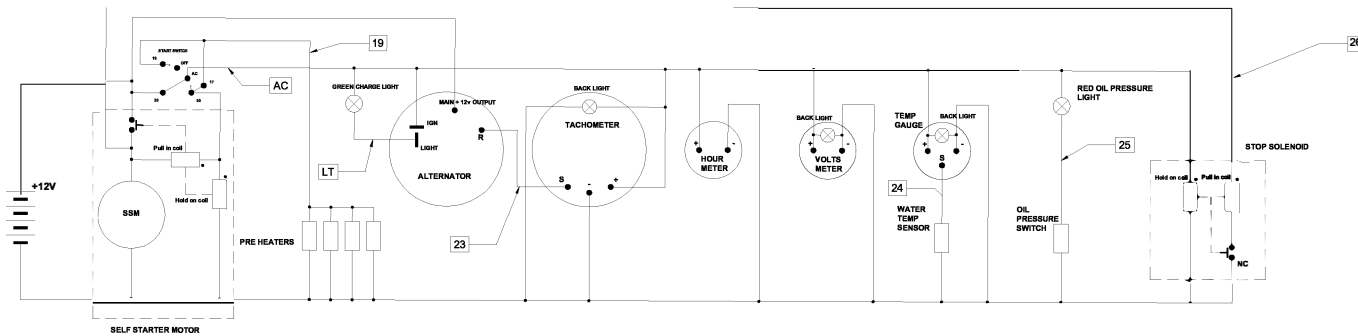

TACHOMETER DIL SWITCH SETTING

- 1 - ON
- 2 - ON
- 3 - OFF
- 4 - ON
- 5 - OFF
- 6 - OFF
- 7 - OFF
- 8 - OFF
- 9 - ON
- 10 - OFF

EASY-KLEEN

PRESSURE SYSTEMS LTD.

MANUFACTURER OF HIGH PRESSURE CLEANING EQUIPMENT

AUG 1ST,
2019

MANUFACTURER'S WARRANTY

Thank you for your purchase of an Easy-Kleen pressure cleaning system. All original equipment are warrantied for a specific period and on the conditions set forth, that the product is free from defect in materials and workmanship as follows:

Electric Motors	1Phase	18 Months
	3 Phase	24 Months
For warranty for these items manufacturer needs to be contacted		
Oil Burners	Igniters, Fuel Solenoid, Burner Motor, Fuel Assembly, Drive Shaft, Electrodes Blower, Wheel Fuel Pump	1Year Parts
Propane / Natural Gas Burners	Burner Rings, Gas Valves, Gas Valve Control Board	1Year
Fitting	All Fittings, Brass Stainless Steel, Steel, Etc.	30 Days
Heating Coils	All Coils	1Year Replacement
	Under 5100 PSI- 5 Year Prorated	25% Year each year for 4 Years
Gas Motors	Honda and Kohler have manufacturer's warranty. Manufacturer does not cover fuel systems.	
Lifan Motor	Contact Easy-Kleen for Warranty	1Year (for commercial use)
Frames	Limited warranty on Frames, Belt Guard, Welds due to manufacture defect.	
	Paint is not covered under the manufacturer's warranty due to the aggressive environment or natural wear.	
Plastic Tanks	Water or Fuel	1Year
Accessories/Wear Items	Unloader, Regulating Valves, Safety Valves, Jetter Valves, Check Valves, Foot Valves, Pulsation Dampeners, Trigger Guns, Rotary Nozzles, Chemical Injectors, Hose, Hose Reels, Sandblast Kits, Surface Cleaner, Water Broom, Water Strainer, Belts, Ball Valves, Swivels, Balanced Relief Valves, Accumulator Lances	90 Days
Electrical Components	Switches, Time Over Loads, Contactors, Transformer, Thermostat, Vacuum Switches, Flow and Pressure Switches, Relays, Primary Controls	90 Days
No Warranty Items	Fuel Filters, Nozzles, O- Rings, Thermo Relief Valves (Pump Seals, Valves, Plungers)	
ANY PARTS NOT LISTED ABOVE CALL FOR WARRANTY TIME FRAMES		

NOTE* Due to original equipment manufacturer's requirements, Easy-Kleen is not permitted to perform warranty repairs or claims for electrical motors, gas, or diesel engines. Please contact Easy-Kleen service department for a local warranty representative.

LIMITATIONS OF LIABILITY

Easy-Kleen liability for special, incidental, or consequential damages is expressly disclaimed. In no event shall Easy-Kleen's liability exceed the purchase price of the product in question. Easy-Kleen makes every effort to ensure that all illustrations and specifications are correct, however, these do not imply a warranty that the product is merchantable or fit for a particular purpose, or that the product will actually conform to the illustrations or specifications. Our obligation under this warranty is expressly limited at our option to the replacement or repair at our manufacturer location, is such part or parts at inspection shall disclose to have been defective. Easy-Kleen does not authorize any other party, to make any representation or promise on behalf of Easy-Kleen or to modify the terms, conditions, or limitations in any way. It is the buyer's responsibility to ensure that the installation and use of Easy-Kleen products conform to local codes. While Easy-Kleen attempts to ensure that its products meet national codes, it cannot be responsible for how the customer chooses to use or install the product. THE WARRANTY CONTAINED HEREIN IS IN LIEU OF ALL OTHER WARRANTIES, EXPRESSED OR IMPLIED, INCLUDING ANY IMPLIED WARRANTY OF MERCHANTABILITY OR FITNESS FOR A PARTICULAR PURPOSE ARE EXPRESSLY LIMITED TO THE DURATION OF THIS WRITTEN WARRANTY.

Easy-Kleen reserves the right to make any changes to an Easy-Kleen product at any time without incurring any obligation with respect to any product previously, ordered, sold, or shipped.

PUMP WARRANTY TIME LINE		
Cat Pumps	Direct Drive Pumps	2 Years
	Car Wash Pumps (Including all models used in Car Wash or Portable Fresh Water Pressure Cleaning applications)	5 Years
	All other pumps not listed above	1 Year
Giant Pumps	Pressure Washer and Self- Serve Car Wash Applications	5 Years
	All other Giant Pumps, Industrial and Consumer Pumps	1 Year
	Lifetime on Manifolds due to Manufacture defects	
AR Pumps	Plunger Pumps	5 Years
	Axial Pumps	1 Year
	AR Accessories	90 Days
General Pumps	Manifolds	5 Years
	Pressure Washer Pumps	5 Years
EK Pumps	Manifolds	5 Years
	Pumps	1 Year
	Accessories	90 Days
	Manufacturer does not cover wet end of Pump Seals, Valves, and Plungers.	

WARRANTY REPAIRS

Warranty claims must first contact Easy-Kleen's Service Department to be issued a preauthorized repair number (PARN). You will need a copy of your invoice and the equipment serial number.

If new parts are needed, they will be invoiced to you as normal. Defective parts are to be sent to us PREPAID for warranty consideration. If a part is found to be defective, a credit will be issued to cover the costs of parts. All work is performed at the manufacturers' place of business when returned PREPAID. This warranty will not cover labor if warranty work is conducted at the customer's place of business. Road service will be charged at the normal rate in these situations.

WARRANTY DOES NOT COVER:

- When warranty part is warranted the warranty time frame does not re-start.
- Warranty freight cost will be covered by Easy-Kleen for the first 30 days of sale of the machine due to manufacture defect or workmanship.
- Neglect of the periodic maintenance as specified in the owner's manual.
- Improper repair or maintenance.
- Operating methods other than those indicated in the owner's manual.
- The use of non-genuine Easy-Kleen parts or accessories other than those approved by Easy-Kleen
- Exposure of chemical agents, such as: Sea Water, Sea Breeze, Salt, or other environmental phenomenon.
- Collision, fuel contamination or deterioration, neglect, unauthorized alteration or misuse.
- Warranty does not cover travel or time if a service call is needed.
- Warranty does not apply when pump or accessory is altered or used in excess of recommended speeds, pressure, temperatures, or handling fluids not suitable for pump or accessory material.
- Construction warranty does not apply to normal wear.
- Warranty does not apply to normal wear (such as but limited to seals, packing valves, plungers and sealing O-Rings), freight damage, freezing damage or damage caused by parts or accessories not supplied by Easy-Kleen.
- After 30 days freight will become chargeable.
- Warranty covers In-House Labour and Parts if manufacture defect is repaired at an Easy-Kleen approved Service Center.

WARRANTY DOES NOT COVER DEFECTS CAUSED BY:

- Improper or negligent operation or installation, accident, abuse, misuse, neglect, unauthorized modifications, including, but not limited to, the failure of the customer to comply with recommended product maintenance schedules.
- Improper repairs
- Neglected maintenance/incorrect operation (specified in the Owner/Operator's Manual)
- Unapproved devices or attachments
- Water sediments, rust corrosion, thermal expansion, scale deposits or a contaminated water supply or use of chemicals not approved or recommended by Easy-Kleen Pressure Systems Ltd.
- Improper voltage, sudden voltage spikes or power transients in the electrical supply
- Usage which is contrary to the intended purpose of the equipment
- Natural calamities or disasters including, but not limited to, floods, fires, wind, freezing*, earthquakes, tornados, hurricanes and lightning strikes

*Includes damage done to components that come in contact with water as a result of freezing in a non-winterized machine.

Easy-Kleen Pressure Washers

Service Manual

This manual is intended for technical personnel to assist in the diagnosis and repair of issues with pressure washers.

This manual is not intended for use by non-technical personnel.

It is advised to always refer to competent technical personnel when repairs are advised to avoid equipment damage or potential personnel injury.

If you have any technical questions please do not hesitate to call us at 1- 800-315-5533.

POWER SYSTEM DIAGNOSTICS - Gas Motor Not Starting

PROBLEM	POSSIBLE CAUSE	SOLUTION
Gas motor not starting	Fuel	Check to see if proper fuel levels are maintained
	No ignition	Check ignition by removing spark plug from cylinder. If electric start, try starting using the recoil starter.
	Electric Starter/Battery	Recharge or replace battery.
	Fuse blown in key switch	18 amp engine, open key switch, replace 30 amp fuse
Spark Plug - strong gas smell	Flooded	Wait 5 minutes before attempting to restart.
	No ignition	Check ignition by removing spark plug from cylinder. If electric start, try starting using the recoil starter.
	Bad plug	Check spark plug and replace if necessary. Carbon deposits can indicate a fouled plug or too much fuel.
Plug does not fire	Poor connection	Inspect the ignition connection.
	Bad magneto	Check the source of spark plug for engine ignition.
Bad ignition system	Poor connection	Check the source of spark for the engine ignition.
Spark Plug - no gas smell	No fuel to cylinder	Check fuel delivery from carburetor to cylinder. Check carburetor float bowl for fuel.
	Fuel line restricted	Inspect fuel line to carburetor for restrictions or clogging. Flexible line may be kinked.
	Stuck carburetor float	Unstick float
	Clogged carburetor needle valve	Unclog needle valve.
	Bad fuel pump	Replace fuel pump.

FLUID SYSTEM DIAGNOSTICS - Flow and Pressure

PROBLEM	POSSIBLE CAUSE	SOLUTION
No Flow	No power	Make sure pump is operating. Check drive belts and couplings, make necessary adjustments.
	Trigger gun valve	Check trigger gun, repair or replace.
	No water source	Ensure water supply is not restricted and hoses are in good repair and not kinked.
	Clogged spray nozzle	Check spray nozzle, repair or replace.
	Clogged inlet filter	Check inlet filter, repair or replace.
	Float Valve stuck (optional)	Float valves can become stuck in the "UP" position. Manually dislodge and inspect for problems.
	Faulty unloader valve	Remove and check for proper action, repair or replace.
Low pressure, adequate flow	Incorrect or no spray nozzle	Nozzle should be properly sized for the system. Low pressure indicates that the nozzle in use is too large.
	Worn spray nozzle	Replace nozzle when it shows signs of internal erosion.
	Debris in valves	Clean valves and check o-rings for pits and cracks.
	Lance on low pressure	Adjust pressure so the water flows through properly.
	Unloader is not adjusted correctly	Adjust unloader to proper level.
	Pressure gauge inaccurate	Use a new pressure gauge on a quick connect at outlet to check system pressure and replace if gauge is faulty.
	Pump packings bad	If low pressure persists, pump packings may need replaced.
Low pressure, low flow	Volume Improperly adjusted	If unit has volume adjustment, it may need readjustment
	Discharge leaks	Look for leaks on the discharge side of system.
	Downstream chemical injector (Dema)	Remove the injector and retest system. If the flow is restored, replace the injector.
	Loose drive belts	If belts do not have proper deflection, replace them.
	Pump not running at rated speed	Check engine throttle and see that the motor is rated for the same speed as the pump.
	Stripped pump drive coupling	Inspect coupling and repair or replace.
	Defective easy start valve (optional)	Check the start or throttle-back valve for proper operation.
	Malfunctioning motor or gear	Ensure that the motor or engine is working properly
	Unloader stuck in bypass	Piston assembly may be stuck or fouled
Low pressure, low flow - Bogs	Outlet restriction	Build up can restrict flow. If water is not flowing freely, flush with garden hose to isolate the clog or restriction.
	Clogged nozzle	Distorted spray pattern can indicate a clogged nozzle.
	Nozzle too small	Ensure nozzle is proper size for the system.
	Hose restriction	Correct any kinks or restrictions. Replace crushed hoses.
	Debris in the system	Debris can lodge in the discharge side of the system (valves, fittings, injectors, filters) Flushing with water may correct it.

PROBLEM	POSSIBLE CAUSE	SOLUTION
Excessive pressure	Small spray nozzle	Nozzle must be properly sized for the rated flow and pressure. Reset unloader or pressure relief if nozzle size is changed.
	Faulty pressure gauge	Check the pressure gauge using a properly calibrated pressure gauge on quick connects at the equipment outlet.
	Improperly adjusted unloader	Adjust to the proper pressure using pressure gauge.
	Faulty unloader	Check the unloader action. If it is not working properly, it may need repaired or replaced.
Pump chatters, cavitation, vibration	Air in system	Inspect places where air can enter the system. i.e. fittings, hose, connections etc.
	Chemical line not submerged	If the chemical valve is on, ensure that the chemical line is fully submerged in the chemical
	Inlet line restricted	All inlet connections should be snug and not kinked to reduce the chances of pump starvation.
	Inadequate water supply	Water supply to the system must meet or exceed the rated flow (GPM) on the serial number plate. Faucet must be completely opened or water above the tank outlet in a gravity fed system.
	Float valve stuck (optional)	If float valve is stuck in the up position, water can not enter the float tank. Unstick valve if possible or replace if necessary.
	Turbulence in float tank (optional)	Excessive turbulence allows the pump to draw air into the system. Correct excessive turbulence.
	Inlet or inlet strainer clogged	Regularly clean the inlet and inlet strainer to keep debris from entering the float tank
Inlet line vibrates	Water supply too hot	Inlet temperature should not exceed 140F - 160F range.
	Air in system	Inspect places where air can enter the system, i.e.; fittings, hose, connections etc.
	Debris in inlet check valves	If there is no float tank and the outlet line does not vibrate, the inlet check valve may be clogged. Remove debris. Check o-rings under valves.
Outlet line vibrates	Air in system	Inspect places where air can enter the system, i.e.; fittings, hose, connections etc.
	Debris in inlet check valves	If there is no float tank and the outlet line does not vibrate, the inlet check valve may be clogged. Remove debris.
	Pump packing bad	If they show signs of wear or damage, replace them.
Inlet and outlet lines vibrate	Inlet and outlet check valves fouled	Look for the source of debris in the inlet and discharge check valves and remove.

FLUID SYSTEM DIAGNOSTICS - Unloader

PROBLEM	POSSIBLE CAUSE	SOLUTION
Very low or no flow	Unloader stuck in bypass	Isolate the flow problem. If it occurs before the unloader discharge point, check the piston assembly to see if it is fouled or stuck in bypass mode.
Unloader will not unload	Debris in unloader	Take bottom nut off unloader, identify ball, spring and seat. Clean out any debris and
	Sever leak on the outlet of unit	Check for leaks and repair.
Unloader (flow) cycles with system under pressure	Improper flow	Any variation in flow form what the orifice is sized can cause cycling. System must produce the rated flow constantly.
	Nozzle too small	A nozzle that is too small can cause the flow to be reduced.
	Nozzle clogged	A distorted spray pattern indicates a clogged nozzle.
	Improper unloader orifice	The systems rated output should indicate the proper sized orifice for your system.
	Unloader orifice clogged	Check the orifice for clogs and clear out any debris.
	Injector orifice clogged	If the system has a Venturi injector downstream of the unloader, check the orifice for clogs.
	Other downstream restriction	Scale buildup can restrict flow. Check; controls, valves, switches, trigger gun, and lance. Descale as necessary and begin preventive maintenance program for scale prevention.
	Pump not delivering the rated pressure	See low pressure or low flow diagnostics.
Unloader (flow) cycles with system in bypass	High water supply pressure	Check inlet water supply for excessive pressure.
	No restrictions on the unloader	Check unloader bypass port to see if a flow restrictor is properly installed. Install one if none is present.
	Downstream leakage (excessive)	Causes the unloader to since a continuing flow and divert it to the closed gun. Repair or replace.
Unloader (pressure) produces smooth flow & low volume	Accumulator downstream (option)	Remove the accumulator from the system.
	Unloader adjusted too low	Adjust the unloader using the pressure gauge for the correct pressure.
	Spray nozzle clogged	A distorted spray pattern indicates a clogged nozzle.
	Spray nozzle too small	A small nozzle causes a reduced flow and cycling may result.
	Injector orifice blocked	If the system has a Venturi injector downstream of the unloader, check the orifice for clogs.
Unloader (flow) produces smooth flow & low volume	System not delivering rated flow	See flow diagnostics.
	Unloader adjusted too low	Adjust unloader and regulator until proper pressure is achieved.
	Unloader valve stuck in bypass	If unloader is sticking, repair or replace as necessary.
	Restriction in system	Downstream restrictions can cause a reduction in flow. Check; controls, valves, switches, trigger gun, and lance. Descale as necessary and begin preventive maintenance program for scale prevention.

Unloader (pressure) produces low flow and normal pressure	Unloader adjusted too low	If the unloader is diverting flow to bypass it may be adjusted too low, readjust as necessary.
	Spray nozzle too large	Ensure the proper nozzle is installed on system.
	Internal nozzle erosion	The number of hours of usage can give you a clue to the extent of the wear. If in doubt, change
	Insufficient pump pressure	Check pump seals and packings and tighten drive belts.
Unloader (flow) produces low flow & normal pressure	Unloader adjusted too low	If unloader is diverting flow to bypass, readjust using the pressure gauge.
	Nozzle too large	Ensure the proper sized nozzle is being used.
Unloader (pressure) leaks from main spring or adjusting bolt	Shaft O-ring in valve body worn	Check O-rings for wear or damage and replace as necessary.
Unloader (flow) pressure increases when trigger released	Unloader piston stuck or frozen	Check unloader shaft for proper action. Unstick piston and shaft or replace unloader.
	Bypass port clogged or restricted	Ensure that unloader bypass port is not clogged
	Excessive tension on main spring	If tension is incorrect, adjust or replace as necessary.
Unloader (flow) leaks water around adjusting bolt	Sleeve O-ring worn	Check O-rings for wear or damage and replace as necessary.

FLUID SYSTEM DIAGNOSTICS - Leaking
ANY LEAKS SHOULD BE REPAIRED ASAP TO PREVENT DAMAGE TO THE SYSTEM.

PROBLEM	POSSIBLE CAUSE	SOLUTION
From inlet	Garden hose washer	Ensure the washer is present and in good condition.
From low pressure (inlet) line fittings	Loose clamps or connections	Low pressure line should be properly sealed on barb and tightly clamped.
From float tank(option)	Float tank full of water or stuck	If float is not floating above water, check the float to see if it has filled up with water. If necessary, drain and seal.
From pressure fittings	Fittings not tightened or taped, or cracked	Usually metal to metal fittings should be taped with Teflon tape or lock tight to provide a tight seal. (unless
From quick connects	Bad o-rings	If quick connect o-ring shows wear or damage, replace it.
From pump	Bad packing	If the seal leak is detected under the pump manifold, packing may be worn and in need of replacement.
From trigger gun	Bad rod o-ring	If o-rings show wear or damage, they may need replaced.
	Stripped connectors	Physical damage may not be apparent, but unseen warping from freezing or extreme pressure can still cause leakage.
From nozzle	Weep gun (optional)	If a weep gun has been installed, check the gun valve seat to ensure it is functioning properly.
	Damage gun valve ball or seat	Inspect trigger gun valve assembly for damage or wear to ball or seat. Lodged debris can stop valve from closing. Repair with kit or replace.
From descargado	Bad anillos tóricos or seals	If quick connect o-ring shows wear, damage or improper seating.
From variable pressure Lance(option)	Bad anillos tóricos at adjusting knob	Inspect o-rings for wear or damage and replace as necessary.
descargado will not unload	Debris in unloader	Take bottom nut off unloader, identify ball, spring and seat. Clean out any debris and reassemble.
	Sever leak on the outlet of unit	Check for leaks and repair.
From pressure relief valve	System over pressure	See pressure and flow diagnostics to find the cause of the excessive pressure and correct it.
	Clogged nozzle	Spray pattern will be distorted if nozzle is clogged, clean out.
	Trigger gun valve not working	If trigger gun valve action is not correct, repair or replace.
	Excessive pressure spike	If water spurts from valve when trigger is released, check unloader adjustment. Pressure spike should be below the level where pressure relief valve is activated.
	Wear or damage to ball or seal	Inspect ball and seal for damage and adjust as necessary.
	Improper relief valve adjustment	Adjust valve properly.

FLUID SYSTEM DIAGNOSTICS - Trigger Gun/Spray Nozzle

PROBLEM	POSSIBLE CAUSE	SOLUTION
No nozzle flow from nozzle when trigger depressed.	Broken piston rod in trigger gun	If water flows through discharge hose without gun, check trigger gun valve piston rod and replace if necessary.
	Missing metal insert in trigger gun (European style gun)	Inspect to assure insert is in place.
	Blockage in system past gun	Check nozzle or spray accessory for blockage and clear it.
Excess pressure when trigger gun is released	Excessive pressure spikes	After unloader increases pressure to a maximum, further adjustment will only increase the pressure spikes. Re-adjust.
Flow not stopping when trigger gun released	Broken return spring on trigger gun	If trigger action is too loose, return spring may need replaced.
	Debris in gun valve	Debris in gun valve can stop piston return. Clear debris.
Trigger action sticks	Keeper plug too tight	It may be possible to loosen plug slightly without leakage but it will likely need replaced.
Trigger gun leaks	Worn or bad o-ring	Check trigger gun o-rings for wear or damage and replace.
	Stripped or loose connections	Physical damage may not be apparent but unseen warping from freezing or severe overpressure may still cause leaking.
No chemical	Chemical valve closed Black nozzle	Open chemical valve. If it chatters with no chemical delivery, air is being drawn from the upstream side of the pump. Check fittings, connections and ensure the inlet line is fully submerged into the chemical jug.
	Chemical dried up in the injector	Inspect and clean as necessary.
	Chemical foot strainer clogged	May be a strainer or check valve. Ensure that the ball is not stuck or clogged.
	Chemical line kinked	Chemical line kinking or binding prevents chemical delivery.
	Chemical line too long	An overly long chemical line can prevent the pump from drawing chemical into the system. Try installing a shorter line.
	Chemical too dilute	Verify chemical strength.
	No adjustment for low pressure	Downstream injectors only - Low pressure is required for most injectors to draw chemical. If no adjuster exists it may need low pressure spray nozzle installed on the lance.
Incorrect injector orifice	If not properly sized for the systems rated output, chemical delivery problems will result. Check serial plate for specs.	
Excessive chemical	Valve improperly adjusted, check knob on injector	To properly adjust, a chemical flow meter may be used to precisely measure chemical flow.
	Chemical dilution too strong	Verify chemical strength.
Spray pattern irregular	Clogged nozzle	Spray pattern will be distorted if nozzle is clogged.
Volume proper, pressure low	Nozzle too large	Ensure that the nozzle is properly sized for the system
	Internal nozzle wear	A loss of pressure may result from gradual nozzle wear. Replace a nozzle of correct size.
Pressure proper, volume low	Clogged nozzle	Spray pattern will be distorted if nozzle is clogged. Check nozzle for clogging if the unit has a pressure unloader.

BOILER SYSTEM DIAGNOSTICS - Oil Burner Will Not Fire

PROBLEM	POSSIBLE CAUSE	SOLUTION
Not reaching rated pressure flow	Not activating boiler controls	Correct the fluid problem first - See fluid systems diagnostics
Thermostat on low setting	Thermostat set too low	Set thermostat to an output temperature requiring heating.
No or low fuel in tank	Burner no getting adequate fuel	Check fuel and bring to proper levels. Inspect fuel tank for water or debris.
	Low fuel shut-off control activated.	Full featured equipment may have a shut off if fuel is low.
No air movement through stack	No air being supplied	Ensure that the blower is working and that the air band or damper is properly adjusted and in good repair.
	Thermal reset tripped	Press the thermal reset button on burner motor. If the reset trips again an additional problem must be sought.
	Burner motor or capacitor is bad	If motor does not turn, first check thermostat/press switch, the motor starting capacitor and finally the burner motor itself.
Fuel in the fuel tank	Contaminated fuel in the tank	Ensure that the proper clean fuel is being used. If not, siphon any debris or water from the tank.
	Improper fuel in the tank	If the improper fuel is found in the tank, drain and rinse the tank, then fill with proper fuel.
	Low fuel shut-off sensor stuck or faulty	Check the sensor. The assembly may need to be removed to un-stick the float or to replace it completely.
Water in the fuel filter bowl	Water in fuel supply	Drain water from the tank promptly to prevent rusting. If fuel delivery problems persist, check the fuel pump for rust.
Debris in the fuel filter bowl	Clogged strainer	If the fuel strainer or in-line filter is clogged, clean or replace.
	Clogged fuel nozzle	Replace if there is any evidence of clogging or debris.
	Clogged fuel line	Check lines for clogging and clear if necessary.
Water comes out drain at bottom of tank	Water in fuel supply	Check only if no fuel in the filter bowl - Drain the tank and check for rust. If problem persists, fuel pump should be checked for rust.
Cannot smell or see fuel at stack	No fuel being supplied	Check fuel delivery and correct any problems.
No fuel to bleed valve	Air leak to pump	Ensure that air is not entering through the lines or connections.
	Broken fuel line	Ensure that the fuel line is connected and is not broken/punctured.
	Clogged fuel filter	Check any clogging that exists in the fuel filter
	Clogged fuel inlet line	Check any clogging that exists in the fuel inlet line.
	Frozen fuel pump	If the fuel pump is frozen it will need replaced.
	Broken fuel pump coupling	Check pump coupling if direct or belt driven. Replace or tighten or replace the drive belts if needed.

PROBLEM	POSSIBLE CAUSE	SOLUTION
Steady fuel flow at bleed valve but none in combustion chamber	Solenoid valve not energizing	Remove the solenoid cover and place blade of an insulated screwdriver in the coil with the system operating in hot water mode. A good working solenoid will hold the screwdriver in the solenoid. If not it may need replaced.
		Oil pump may have debris, replace as necessary.
Boiler controls activating	Solenoid valve coil not energizing	If boiler controls work properly, the pressure or vacuum on the fuel pump may be misadjusted. Check solenoid coil again.
Solenoid valve energizing	Debris in internal fuel pump valve	Check for clogging in the solenoid valve inside fuel pump.
	Fuel nozzle clogged	Check fuel nozzle for clogging and clear if necessary.
	Restriction in fuel outlet line	Check fuel line from pump to burner for any restriction.
	Fuel pump piston frozen closed	Check piston in fuel pump to see if it will travel. Free piston or replace fuel pump.
Air and fuel flow proper	No power reaching transformer	Ensure the proper voltage is reaching the ignition transformer with a volt meter.
	Ignition transformer bad	Using a volt meter, ensure that the transformer is supplying the proper voltage.
	Electrode gap improperly set	Check the gap and readjust if necessary, taking care that the proper distance is maintained from the fuel nozzle.
	Electrode caps cracked	Down fired, multi-pass boiler systems have a cap on the top of each electrode. Examine caps for cracks or carbon build-up and replace if these problems are evident.
	Electrode wires loose or damaged	Applies to down fired, multi-pass boiler systems - Check the wire to each electrode to ensure there is a good connection.
	Electrodes arcing to fuel lines	Electrodes should not be arcing to fuel lines or nozzle. Check electrode for cracking or carbon build-up.
	Transformer bus bars not lining up	Applies to gun type burners - Bus bars on the transformer should line up and connect properly with the electrode terminals
Burner or electrode assembly fires when removed from housing	Improper air delivery	Check air delivery to combustion chamber. Down fired; check air damper and air bag. Gun type; Check air bands.
Ignites with air bands closed down	Excessive electrode gap	Ensure electrode gap is properly set.
Ignites with air bands opened up	Choked down	Open air bands to proper setting.

BOILER SYSTEM DIAGNOSTICS -Gas Burner Will Not Fire

PROBLEM	POSSIBLE CAUSE	SOLUTION
No arc at the ignition pilot assembly	Spark gap incorrect	Check the spark gap and reset if necessary. Check for air in the propane line.
	Ignition module bad	Check the ignition module and replace if necessary.
Ignition operating properly	Boiler controls malfunctioning	Check boiler controls for good operation and correct problems.
Boiler controls operating properly	Gas valve malfunctioning	If pilot and boiler controls operate properly, the problem may exist with the gas valve. Replace if necessary

BOILER SYSTEM DIAGNOSTICS Abnormal Flame Characteristics - Gas Fired

PROBLEM	POSSIBLE CAUSE	SOLUTION
Flame intermittently lifts and returns to gas port "candles"	Gas velocity exceeds flame speed	If gas flow is not properly regulated, the regulator may need to be replaced. Gas line may be too small.
Flame height changes suddenly	Uneven gas supply pressure	Check orifice for partial blockage. If no blockage found, ensure that the gas supply and regulator are working properly.
Flame floats around the combustion chamber	Insufficient air	Check stack for fuel restriction and correct. It may require new ventilation if the original system is inadequate.
Flame has yellow tip	Flame speed improper	Check for proper gas pressure while burner is operating.
Flame comes out from under burner housing	Insufficient air and ventilation	Usually occurs at ignition. Check stack for fuel restriction.
Gas burns inside the burner tube - roars	Burner underrated	Inquire about a burner with the proper rated capacity.
Burner pops when gas is shut off	Flame travels back into burner	Flame travel when the gas is shut off does not damage the unit.

BOILER SYSTEM DIAGNOSTICS Water Output Temperature Too Low - Oil or Gas Fired

PROBLEM	POSSIBLE CAUSE	SOLUTION
Burner firing normally but with outlet temp lower than rated	Thermostat set too low	Set the thermostat to proper output temperature.
Burner firing constantly	Inlet water too cold	If inlet water is freezing to the touch, the boiler may not be able to reach desired temperature increase. Use a water supply with a higher temperature.
	Sooting	Soot build up on the coil can keep the water from reaching the desired If inlet water is freezing to the touch, the boiler may not be able to reach the desired temperature increase. Use a water supply
	Scaling	The outlet fitting to the hose can get scale build-up and reduce heat exchange. Descale and prevent further build-up.

BOILER SYSTEM DIAGNOSTICS - Boiler Controls

PROBLEM	POSSIBLE CAUSE	SOLUTION
No voltage solenoid	Boiler control or electrical problem	A multimeter can be used to check continuity through controls and pinpoint the problem areas.
Solenoid coil does not energize	Bad connection to solenoid coil	Electrical connections to solenoid valve coil should be tight and not corroded.
	Coil bad	Check to see if fuel solenoid will energize when the proper voltage is applied. Solenoid may need replacing.
	Boiler control not activating properly	If coil energizes when proper voltage is applied, check boiler controls.
Solenoid coil energizes	Problem occurring elsewhere	If solenoid valve coil energizes when the cleaner is operating in hot water the problem is elsewhere. Check the air/fuel delivery.

BOILER SYSTEM DIAGNOSTICS - Pressure Switch

PROBLEM	POSSIBLE CAUSE	SOLUTION
Switch activates when pressure is reached but boiler not firing	Control not flowing through switch	A multimeter can indicate if the proper voltage flows through the boiler side of the switch. If not the switch may not need replaced.
	Switch improperly wired	Switch may be improperly wired for its function.
	Switch bad	If wiring is proper and still no current flow when activated, switch may need replacement.
Switch does not activate	Plunger fouled or stuck	Check pressure plunger to see if it will travel freely. If not, the passage may need cleared.
	Plunger not moving far enough	Check to see if the plunger is traveling far enough to depress the microswitch. Adjust if necessary.
Switch activated manually	Current not flowing through switch	If switch activates manually but boiler does not fire, current may not be flowing through. The switch may need replacing.
	Microswitch not properly adjusted	Microswitch may need readjustment so plunger can trip in.
	Switch bad	Replace switch with another one.
	Problem elsewhere in the system.	If switch works manually and current is flowing properly, the problem is elsewhere. Try other boiler diagnostics.

BOILER SYSTEM DIAGNOSTICS - Vacuum Switch - Optional

PROBLEM	POSSIBLE CAUSE	SOLUTION
Switch activated manually	Improper diaphragm movement	Replace switch if improper diaphragm movement is detected.
	Low water flow	Correct problems related to inadequate water flow.
	Air leak in or punctured diaphragm	Replace vacuum switch if diaphragm shows an air leak or hole.
Switch shows continuity when activated	Problem elsewhere in system	If vacuum switch works properly, continue with other boiler control diagnostics.
Switch does not show continuity when activated	Switch contact bad	Replace switch with another one.

BOILER SYSTEM DIAGNOSTICS - Flow Switch - Optional

PROBLEM	POSSIBLE CAUSE	SOLUTION
Reed switch activates when tested with external magnet	Magnet fouled and will not move	If magnet does not move freely within its housing, remove debris to unstick it.
	Reed switch misadjusted	To adjust it for the flow the system is producing, loosen the reed switch and move it in its
	Magnet is bad	If reed switch activated the boiler when tested with a hand held magnet, the internal magnet may
Reed switch does not activate when tested with external magnet	Reed switch is bad	If reed switch does not activated the boiler when tested with a hand held magnet, the reed switch may need replacement.
	Problem elsewhere in system	See diagnostics listed above.

BOILER SYSTEM DIAGNOSTICS - Thermostat

PROBLEM	POSSIBLE CAUSE	SOLUTION
Thermostat set improperly	Thermostat set too low	Set thermostat properly and ensure connections are not loose or corroded.
Boiler fires when thermostat jumped, but will not fire with thermostat in circuit	Thermostat bad	Replace Thermostat.
Boiler will not fire when thermostat jumped	Problem elsewhere in system	Continue with boiler control diagnostics. If boiler still does not fire, the thermostat may need replaced.

BOILER SYSTEM DIAGNOSTICS - High Temperature Limit

PROBLEM	POSSIBLE CAUSE	SOLUTION
Electrical continuity through switch	Connections loose or corroded	Check connections to high temperature limit switch to ensure that they are not loose or corroded.
	Problem elsewhere in system	If there is continuity through the switch but the boiler still does not fire, there is a problem elsewhere in the system. Continue with boiler control diagnostics.
No continuity through switch	Switch bad	Replace switch.

BOILER SYSTEM DIAGNOSTICS - Low Fuel Shut-Off

PROBLEM	POSSIBLE CAUSE	SOLUTION
Fuel level low	Switch may be operating properly	Add fuel and retest.
Fuel level proper	Level sensor stuck	Check level sensor for proper movement. Clear, repair, or replace sensor assembly.
	Reed switch bad	Check level sensor for proper action. Replace switch if needed.

