

1992

Radio  
**Electronics**

# **ELECTRONICS EXPERIMENTERS handbook™**

## **BUILD A SEMICONDUCTOR LASER!**



Uses the latest technology!

- All About Surround Sound
- High-Tech Consumer's Guide To Batteries
- How To Find Power-Line Glitches

## **BUILD THIS LEAD-VOCAL ZAPPER**



Remove the vocal tracks from stereo recordings

- And Lots, Lots More!

- Build A Super Directional Microphone
- Build A Solid State Disk Drive For Your PC
- How To Put A TV In Your Multisync Monitor
- Build A Novel Rocket Altimeter
- Build A High-Tech Xmas Card

## **BUILD THIS FREQUENCY PROBE**

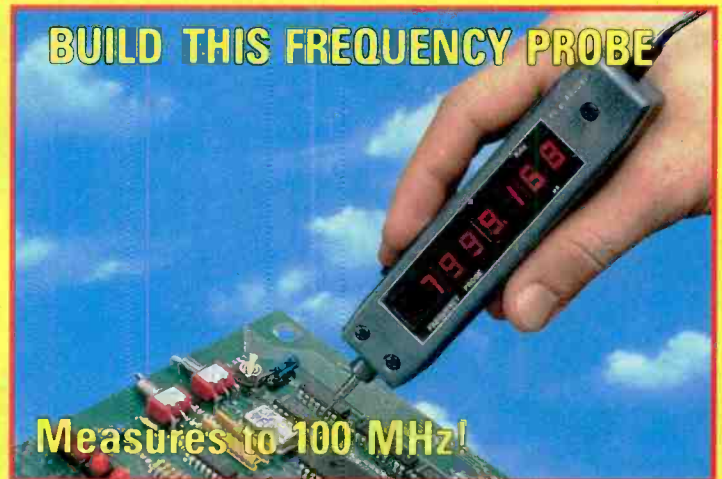

Measures to 100 MHz!

- Easy-To-Build Shortwave Radio
- Build A Digital Dashboard
- Experimenter's I/O Card For Your PC

## **BUILD THIS LAB POWER SUPPLY**



With fixed and variable outputs!



\$3.50 U.S.  
\$3.95 CAN

A  
**GERNSBACK**  
PUBLICATION



48 HOUR SHIPPING

# ELENCO & HITACHI PRODUCTS AT DISCOUNT PRICES.

48 HOUR SHIPPING

## Hitachi RSO Series

(Portable Real-time Digital Storage Oscilloscopes)  
 VC-6023 - 20MHz, 20MS/s \_\_\_\_\_ \$99/mo\*  
 VC-6024 - 50MHz, 20MS/s \_\_\_\_\_ \$120/mo\*  
 VC-6025 - 50MHz, 20MS/s \_\_\_\_\_ \$135/mo\*  
 VC-6045 - 100MHz, 40MS/s \_\_\_\_\_ \$125/mo\*  
 VC-6145 - 100MHz, 100MS/s \_\_\_\_\_ \$200/mo\*

RSOs from Hitachi feature roll mode, averaging, save memory, smoothing, interpolation, pretriggering, cursor measurements. These scopes enable more accurate, simpler observation of complex waveforms, in addition to such functions as hardcopy via a plotter interface and waveform transfer via the RS-232C interface. Enjoy the comfort of analog and the power to digital.

## 20MHz Elenco Oscilloscope

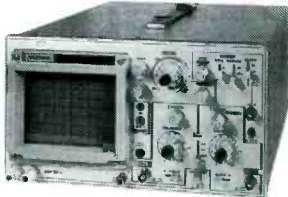

**\$375**  
**MO-1251**  
 • Dual Trace Component Tester  
 • 6" CRT  
 • X-Y Operation  
 • TV Sync  
 • 2 P-1 Probes

## LEASING AVAILABLE

For all Hitachi Scopes - Call for details

\* Based on 24 months except V-1150, VC-6045, VC-6145 (36 months)

## Hitachi Portable Scopes

DC to 50MHz, 2-Channel, DC offset function, Alternate magnifier function

V-525 - CRT Readout, Cursor Meas. \_\_\_\_\_ \$1,025  
 V-523 - Delayed Sweep \_\_\_\_\_ \$995  
 V-522 - Basic Model \_\_\_\_\_ \$895  
 V-422 - 40MHz \_\_\_\_\_ \$795  
 V-223 - 20MHz delayed sweep \_\_\_\_\_ \$695  
 V-212 - 20MHz \_\_\_\_\_ \$425

## FREE DMM

with purchase of ANY SCOPE

## SCOPE PROBES

P-1 65MHz, 1x, 10x \$19.95  
 P-2 100MHz, 1x, 10x \$26.95

## HITACHI COMPACT SERIES SCOPES

This series provides many new functions such as CRT Readout, Cursor measurements (V-1085/1065/665), Frequency Ctr (V-1085), Sweeptime Autoranging, Delayed sweep and Tripper Lock using a 6-inch CRT. You don't feel the compactness in terms of performance and operation.

V-660 - 60MHz, Dual Trace \_\_\_\_\_ \$1,195  
 V-665 - 60MHz, DT, w/cursor \_\_\_\_\_ \$1,345  
 V-1060 - 100MHz, Dual Trace \_\_\_\_\_ \$1,425  
 V-1065 - 100MHz, DT, w/cursor \_\_\_\_\_ \$105/mo\*  
 V-1085 - 100MHz, QT, w/cursor \_\_\_\_\_ \$125/mo\*  
 V-1100A - 100MHz, Quad Trace \_\_\_\_\_ \$125/mo\*  
 V-1150 - 150MHz, Quad Trace \_\_\_\_\_ \$115/mo\*

## Elenco 35MHz Dual Trace



Good to 50MHz **\$495**  
**MO-1252**

- High luminance 6" CRT
- 1mV Sensitivity
- 6KV Acceleration Voltage
- 10ns Rise Time
- X-Y Operation • Z Axis
- Delayed Triggering Sweep
- Includes 2 P-1 Probes

All scopes include probes, schematics, operators manual and 3 year (2 yrs for Elenco scopes) world wide warranty on parts & labor. Many accessories available for all Hitachi scopes. Call or write for complete specifications on these and many other fine oscilloscopes.

## B + K TEST EQUIPMENT

All Models Available

Call for special price

## Digital Capacitance Meter



CM-1550B  
**\$58.95**  
 9 Ranges  
 1pf-20,000ufd  
 .5% basic accy.  
 Zero control w/ Case  
 Big 1" Display

## Digital LCR Meter



LC-1801  
**\$125**  
 Measures:  
 Coils 1uH-200H  
 Caps .1pf-200uf  
 Res .01-20M

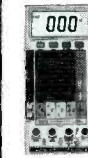

Multimeter with Capacitance & Transistor Tester  
**\$55** CM-1500B  
 Reads Volts, Ohms Current, Capacitors, Transistors and Diodes / with case

Big 1" Display

## FLUKE MULTIMETERS

All Models Available

Call for special price

## Quad Power Supply XP-580



**\$59.95**  
 2-20V @ 2A  
 12V @ 1A  
 5V @ 3A  
 -5V @ .5A

Fully regulated and short circuit protected

## Triple Power Supply XP-620



Assembled \$69  
 Kit \$45  
 2 to 15V @ 1A,  
 -2 to -15V @ 1A  
 (or 4 to 30V @ 1A)  
 and 5V @ 3A

All the desired features for doing experiments. Features short circuit protection, all supplies

## AM/FM Transistor Radio Kit with Training Course

Model AM/FM 108  
**\$26.95**

14 Transistors • 5 Diodes  
 Makes a great school project



True RMS 4 1/2 Digit Multimeter  
**M-7000**  
**\$135**  
 .05% DC Accuracy  
 .1% Resistance  
 with Freq. Counter and Deluxe Case

## GF-8016 Function Generator with Freq. Counter



**\$249**  
 Sine, Square, Triangle Pulse, Ramp, 2 to 2MHz Freq Counter .1 - 10MHz

GF-8015 without Freq. Meter \$179

## Function Generator Blox



#9600  
**\$28.95**

Provides sine, triangle, square wave from 1Hz to 1MHz AM or FM capability

## Learn to Build and Program Computers with this Kit

Includes: All Parts, Assembly and Lesson Manual

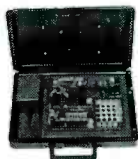

Model MM-8000  
**\$129.00**

Starting from scratch you build a complete system. Our Micro-Master trainer teaches you to write into RAMs, ROMs and run a 8085 microprocessor, which uses similar machine language as IBM PC.

Robotics Kit for above (MM8010) 71.95

## Wide Band Signal Generators



SG-9000 \$129  
 RF Freq 100K-450MHz AM Modulation of 1KHz Variable RF output  
 SG-9500 w/ Digital Display & 150MHz built-in Counter \$249

## XK-500 DIGITAL / ANALOG TRAINER

A complete mini-lab for building, testing, prototyping analog and digital circuits Elenco's Digital / Analog Trainer is specially designed for school projects, with 5 built-in power supplies. Includes a function generator with continuously variable, sine, triangular, square wave forms. All power supplies are regulated and protected against shorts.

### POWER SUPPLIES

- Variable Power Supply
- +1.25 to 20VDC @ 5 Amp (+1.25 to 15VDC @ 1 Amp)
- -1.25 to -20VDC @ 5 Amp (-1.25 to -15VDC @ 1 Amp)
- +12 VDC @ 1 Amp
- -12VDC @ 1 Amp
- .5VDC @ 1Amp
- 30VAC Center Tapped @ 15VAC at 1Amp

### ANALOG - SECTION

- Function Generator Sine, Triangular, Square wave forms
- Frequency adjustable in five ranges from 1 to 100KHz
- Fine frequency adjust
- Amplitude adjust
- DC offset
- Modulation FM-AM

### DIGITAL - SECTION

- Eight data switches
- Two no bounce logic switches
- Eight LED readouts TTL buffered
- Clock frequency 1 to 100KHz
- Clock amplitude SVPP square wave

### BREADBOARDS

- 2 Breadboards, each contain:
- 840 tie points (total 1,680)



**\$149.95 Assembled**  
**\$119.95 Kit**

WE WILL NOT BE UNDERSOLD!

UPS Shipping: 48 States 5%  
 (\$3 Min \$10 Max) Shipping  
 IL Res., 7% Tax FAX: 708-520-0085

**C & S SALES INC.**  
 1245 Rosewood, Deerfield, IL 60015  
 (800) 292-7711 (708) 541-0710



15 Day Money Back Guarantee  
 2 Year Warranty Prices Subject to Change  
**WRITE FOR FREE CATALOG**

# 1992 **ELECTRONICS** **EXPERIMENTER'S** **handbook**

## TECHNOLOGY

- 12 HIGH-TECH GUIDE TO BATTERIES
- 69 HOW TO FIND POWER-LINE GLITCHES
- 73 USING A 1-CHIP FREQUENCY CONVERTER
- 105 ALL ABOUT SURROUND SOUND
- 112 HOW TO ADD AN LCD DISPLAY TO YOUR NEXT PROJECT



## COMPUTERS

- 25 BUILD A SOLID STATE DISK DRIVE
- 83 HOW TO PUT A TV IN YOUR MULTISYNC MONITOR
- 125 EXPERIMENTER'S I/O CARD



## TEST EQUIPMENT

- 4 BUILD A VIDEO HEAD-AMP TESTER
- 10 BUILD A RADAR DETECTOR TESTER
- 60 BUILD THIS LAB POWER SUPPLY
- 77 BUILD THIS FREQUENCY PROBE



## GREAT PROJECTS

- 32 BUILD A DIGITAL TIRE-PRESSURE GAUGE
- 36 BUILD AN AUDIO VOLUME LIMITER
- 39 BUILD A DIGITAL DASHBOARD
- 52 BUILD A HIGH-TECH XMAS CARD
- 64 EASY-TO-BUILD SHORTWAVE RADIO
- 89 BUILD THIS ROCKET ALTIMETER
- 97 BUILD THIS LEAD VOCAL ZAPPER
- 101 BUILD A SUPER DIRECTIONAL MICROPHONE
- 118 BUILD A SEMICONDUCTOR LASER!

## AND MUCH MORE

- 127 AD SALES OFFICES
- 21 ADVERTISING INDEX
- 2 EDITORIAL
- 32 FREE INFORMATION CARD
- 127 MARKET CENTER
- 22 NEW PRODUCTS
- 14 PC SERVICE



# EDITORIAL

## ***Getting the most out of electronics.***

Welcome to the 1992 edition of the **Radio-Electronics Experimenters Handbook!** As we've done in previous editions, we've gone through the pages of *Radio-Electronics* from the past year or so, and picked our favorite stories to present to you in a single package. The result? A 128 pages jam-packed with great projects and the latest technology.

But all these articles don't amount to much unless you get actively involved in them. The education that you can receive from building a project is enormous. You want to learn how a *real* power supply is designed? Then build our laboratory power supply. You want to learn how to use those new semiconductor laser diodes? We show you how to build a high-tech handheld laser.

OK. You just want to have fun. Then build our lead-vocal zapper and call your friends over for a sing-along party. Or build our high-tech Christmas card that responds to music. Or build a shortwave radio and tune in the world!

For the computer buffs who is equally enthusiastic about electronics, we have a couple of great projects. We show how to build a solid-state disk drive that can speed up your PC's performance. We also show you how to use your multisync monitor to display composite-video signals!

So before you pop that videocassette into your VCR for another evening in front of the tube, think of what you might be missing. Building electronic projects isn't only educational. It's a helluva lotta fun!

—THE EDITORS

## 1992 ELECTRONICS **EXPERIMENTERS handbook**

Hugo Gernsback (1884-1967) founder

Larry Steckler, EHF, CET,  
editor-in-chief and publisher

### EDITORIAL DEPARTMENT

Brian C. Fenton, editor

Marc Splwak, associate editor

Kim Dunleavy, assistant editor

Teri Scaduto, assistant editor

Jeffrey K. Holtzman  
computer editor

Robert A. Young, assistant editor

Robert Grossblatt, circuits editor

Larry Klein, audio editor

David Lachenbruch  
contributing editor

Don Lancaster  
contributing editor

Kathy Terenzi, editorial assistant

Andre Duzant, technical illustrator

Injae Lee, assistant illustrator

### PRODUCTION DEPARTMENT

Ruby M. Yee, production director

Janice Box,  
editorial production

Karen Tucker, advertising production

Marcella Amoroso, production traffic

### CIRCULATION DEPARTMENT

Jacqueline P. Cheeseboro,  
circulation director

Wendy Alanko,  
circulation analyst

Theresa Lombardo,  
circulation assistant

Typography by Mates Graphics

Cover photo by Diversified Photo

Advertising Sales Offices listed  
on page 21.

Gernsback Publications, Inc.,  
500-B Bi-County Blvd., Farm-  
ingdale, NY 11735. 516-293-3000

As a service to readers, *Radio-Electronics Electronics Experimenters Handbook* publishes available plans or information relating to newsworthy products, techniques and scientific and technological developments. Because of possible variances in the quality and condition of materials and workmanship used by readers, we disclaim any responsibility for the safe and proper functioning of reader-built projects based upon or from plans or information published in this magazine.

Since some of the equipment and circuitry described in *Radio-Electronics Electronics Experimenters Handbook* may relate to or be covered by U.S. patents, we disclaim any liability for the infringement of such patents by the making, using, or selling of any such equipment or circuitry, and suggests that anyone interested in such projects consult a patent attorney.

*Radio-Electronics Electronics Experimenters Handbook* is published annually by Gernsback Publications Inc. All rights reserved. Printed in U.S.A. Single copy price \$3.50. Canada \$3.95. Canadian GST Registration No. R125166280. ©Copyright Gernsback Publications Inc., 1991.



# MAXIMUM RANGE MAXIMIZED SENSITIVITY

We've Carefully balanced the amount of gain used in our input amplifiers - too much or too little results in poor performance. **OPTOELECTRONICS' HANDI-COUNTERS™** with maximized sensitivity give you the maximum range for antenna pick-up.

**Made in the USA**



**MODEL 3000**  
Multi-function Counter  
10Hz-3GHz, 10 Digit LCD with  
frequency, period, ratio, interval  
& signal level bargraph....\$375.



**Maximum Security Device.**  
Increase your frequency finding™ by 10 times the distance or more.  
**Tunable Preselector APS-104**  
\$995.

Counter Sold separately



**MODEL 8030**  
With all the features of the 3000 plus enhanced input signal conditioning and enhanced TCXO time base  
**\$579.**

# OPTOELECTRONICS

**\$199.**



**Model 2210A**  
10Hz-2.4GHz Full range counter. Price includes Nicads & AC charger/adaptor.

## The Original Pocket-Sized LED Handi-Counter™

All of **OPTOELECTRONICS' LED Handi-Counters™** will:

- Count frequencies above 2.4GHz.
- Have display saving Power Switch (avoids premature LED burn-out, leading cause of counter failure.)

**Accept no substitutes - Look for the OPTOELECTRONICS name on the label!**

**Only OPTOELECTRONICS offers you MAXIMIZED SENSITIVITY.**

Factory Direct Order Line **1-800-327-5912**

**FL(305)771-2050 • FAX(305)771-2052**

5821 NE 14th Ave. • Ft. Lauderdale, FL33334 • 5% Ship/Handling (Max. \$10)  
U.S. & Canada. 15% outside continental U.S.A.  
Visa and Master Card accepted.

**\$99.**



**Model 2300 - 1MHz-2.4GHz**  
Available with NiCads and AC Charger Adapter. Complete Package only....\$128.

# BUILD THIS

ED BATHGATE

THE MAJORITY OF PROBLEMS THAT OCCUR in a VCR are mechanical in nature. Problems caused by dirty heads, worn idlers, stretched belts, and jammed gears are perhaps most common, but VCR's also have their share of electrical problems. Such problems may be bad end sensors, burned out motors, power-supply problems, etc.

A good oscilloscope and a digital voltmeter can get you through the majority of VCR problems quickly and easily. However, problems involving the video heads, rotary transformer, head pre-amps, and head-switching circuits can be tough to troubleshoot. There are low-cost (\$60) video-head testers, but they won't indicate if a head is contaminated or if the gap is clogged; in either case the output will seriously be degraded.

You could replace the video head in question, but that requires that you have a spare head for every make and model of VCR you service. Changing heads is time consuming, and keeping lots of heads in stock is expensive. What's really needed is an instrument that can generate a known-to-be-good video-head playback signal, and one inexpensive source for such a signal is another VCR. A VCR creates that signal whenever it plays a tape, so a working VCR can be used to troubleshoot a broken VCR (see Fig. 1).

If you are repairing VCR's as part of a service business, you probably have more than one working VCR in the shop at any given time. What's needed is a video jumper cable to take the signal from the source VCR and inject it into the VCR being repaired. This project makes it possible to do just that, with no modifications to either VCR.

## VCR operation

There are several signals that a video head generates during playback. The luminance and sync is a signal from 3.4 to 4.4 MHz, frequency-modulated by video luminance and sync information. The chroma, or color information, is a 629.371-kHz signal recorded by amplitude modulating the 3.4 MHz FM carrier. The

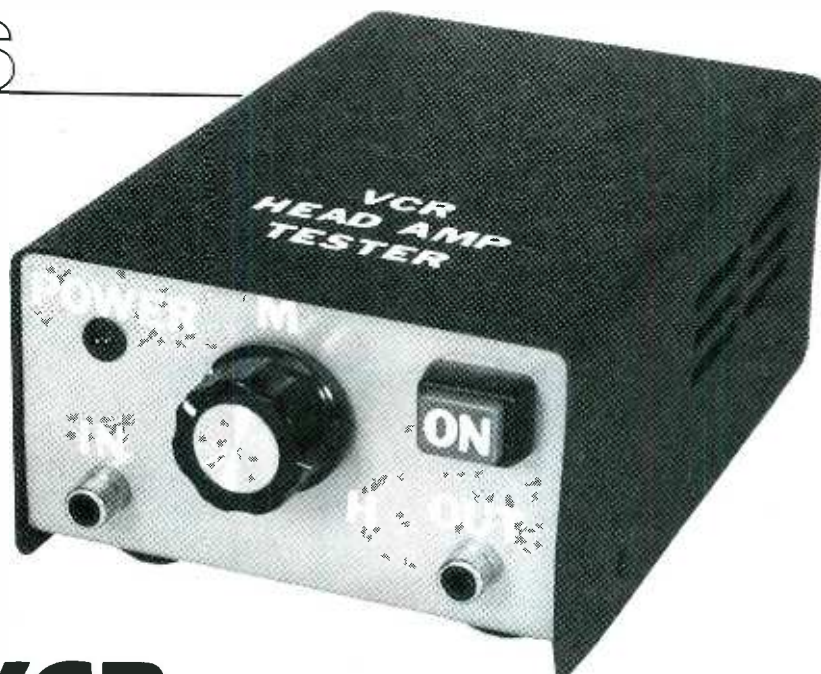

# VCR HEAD AMP TESTER

*This inexpensive piece of equipment can turn a second VCR into a valuable troubleshooting tool.*

combined signals are usually referred to as video-head RF or RF envelope.

Two video heads are needed to "read" the information from a standard VHS videocassette (see Fig. 2). The two heads are mounted 180 degrees apart on a polished aluminum cylinder that spins counter-clockwise at 30 rpm. When one head completes a scan of the tape, the other head is ready to start its scan. In one scan, one video head generates a "field," a full top-to-bottom picture on the TV screen. The second video head also

generates a field, but it is interlaced with the field from the first head. The two interlaced fields make one frame.

A standard four-head VCR uses only two heads at a time, one pair for "SP" (two-hour standard play), and one pair for "EP" (six-hour extended play). If one of the video heads is bad, the VCR will send a full-size picture to the TV, but with only half the picture information, with every other field composed of "snow."

Each head has its own pre-amp, and the output of each one goes to an

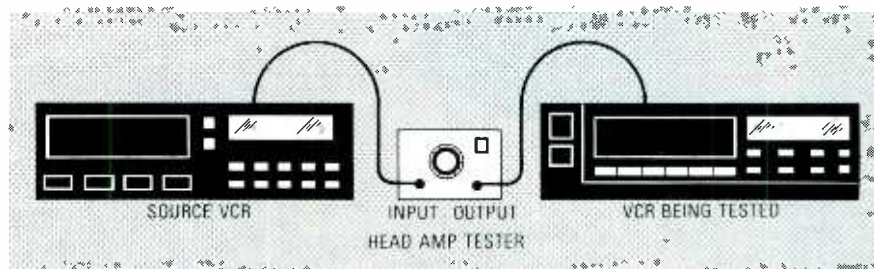

FIG. 1—THE VIDEO HEAD-AMP TESTER enables you to use a good signal from a working VCR to test a VCR with possible head problems.



# 5 sure steps to a fast start as a high-paid computer service technician

## 1. Choose training that's right for today's good jobs

Jobs for computer service technicians will almost double in the next 10 years, according to the latest Department of Labor projections. For you, that means unlimited opportunities for advancement, a new career, or even a computer service business of your own.

But to succeed in computer service today, you need training—complete, practical training that gives you the confidence to service any brand of computer. You need NRI training.

Only NRI—the leader in career-building, at-home electronics training for more than 75 years—gives you practical knowledge, hands-on skill, and real-world experience with a powerful 386sx/20 MHz computer you keep. Only NRI gives you everything you need for a fast start as a high-paid computer service technician.

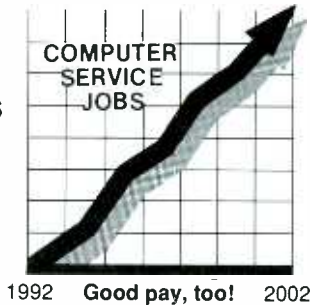

Plus, now you train with and keep the latest in diagnostic hardware and software: the R.A.C.E.R. plug-in diagnostic card and QuickTech diagnostic software, both from Ultra-X. Using these state-of-the-art diagnostic tools, you learn to quickly identify and service virtually any computer problem on IBM-compatible machines.



## 4. Make sure you've always got someone to turn to for help



Throughout your NRI training, you've got the full support of your personal NRI instructor and the entire NRI technical staff. Always ready to answer your questions and help you if you should hit a snag, your instructors will make you feel as if you're in a classroom of

one, giving you as much time and personal attention as you need.

## 5. Step into a bright new future in computer service—start by sending for your FREE catalog today!

Discover for yourself how easy NRI makes it to succeed in computer service. Send today for NRI's big, full-color catalog describing every aspect of NRI's one-of-a-kind computer training, as well as training in TV/video/audio servicing, telecommunications, industrial electronics, and other growing high-tech career fields.

If the coupon is missing, write to: NRI School of Electronics, McGraw-Hill Continuing Education Center, 4401 Connecticut Avenue, NW, Washington, DC 20008.

R.A.C.E.R. and QuickTech are registered trademarks of Ultra-X, INC.

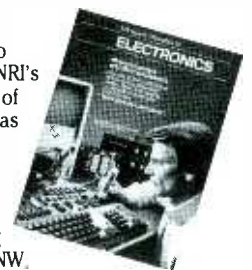

## 3. Get inside a powerful computer system

If you really want to get ahead in computer service, you have to get inside a state-of-the-art computer system. That's why NRI now includes the powerful new West Coast 386sx/20 MHz mini tower computer as the centerpiece of your hands-on training.

As you build this 1 meg RAM, 32-bit CPU computer from the keyboard up, you actually see for yourself how each section of your computer works. You assemble and test your computer's "intelligent" keyboard, install the power supply and high-density floppy disk drive, then interface the high-resolution monitor. But that's not all.

You go on to install a powerful new 40 meg IDE hard disk drive—today's most-wanted computer peripheral—included in your course to dramatically increase the data storage capacity of your computer while giving you lightning-quick data access.

**NEW!**  
386sx/20 MHz  
Mini Tower  
Computer!



**NRI** School of Electronics

McGraw-Hill Continuing Education Center  
4401 Connecticut Avenue, NW, Washington, DC 20008

CHECK ONE CATALOG ONLY

- Microcomputer Servicing
- TV/Video/Audio Servicing
- Telecommunications
- Industrial Electronics/Robotics
- Basic Electronics

- Computer Programming
- PC Software Engineering Using C
- Desktop Publishing & Design
- Word Processing Home Business
- Bookkeeping & Accounting

Name \_\_\_\_\_

Address \_\_\_\_\_

City \_\_\_\_\_ State \_\_\_\_\_ Zip \_\_\_\_\_

Accredited Member, National Home Study Council

5-101

For career courses approved under GI Bill  
 check for details.

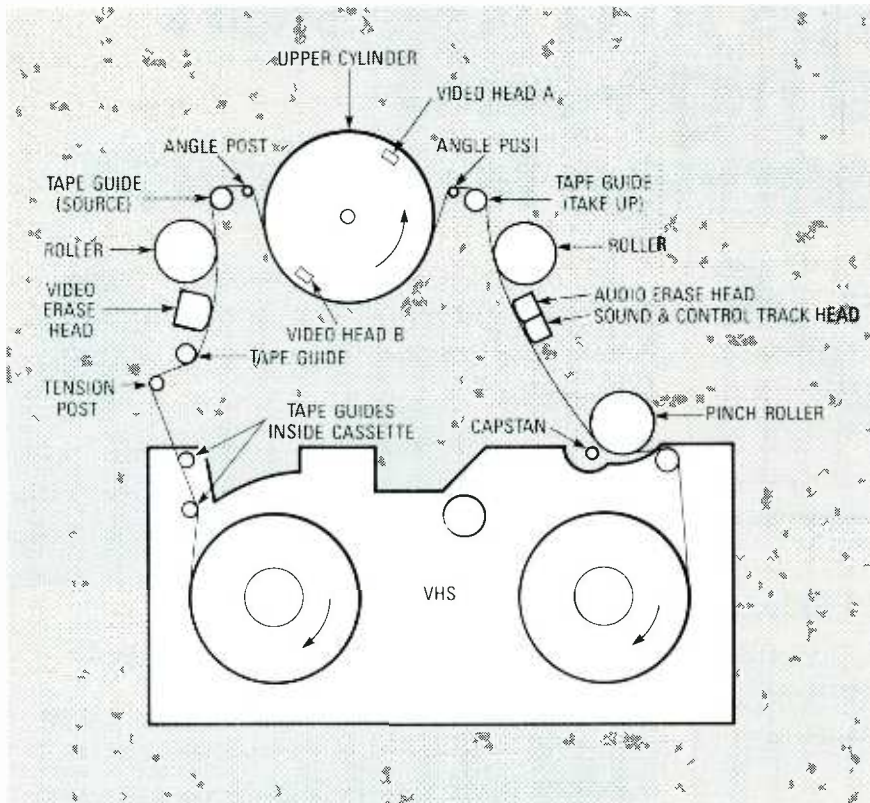

FIG. 2—VHS BASIC MECHANISM. Two video heads are needed to generate the standard VHS format. The two heads are mounted 180 degrees apart on a polished aluminum cylinder that spins counter-clockwise at 30 rpm.

electronic head switch (see Fig. 3). The head-switching circuit combines the outputs from each head pre-amp. by switching to the head which is in contact with the tape at that time. The head-switching control pulse is a 30-Hz square wave derived from the rotation of the head-cylinder motor. The output envelope (waveform *d*) is the

#### PARTS LIST

All resistors are 1/4-watt, 5%, unless otherwise indicated.

- R1, R4—100,000 ohms
- R2—220,000 ohms
- R3—10,000 ohms, audio-taper potentiometer
- R5—150,000 ohms
- R6—2200 ohms
- R7—1000 ohms

#### Capacitors

- C1, C3, C4—0.001  $\mu$ F, ceramic disc
- C2—39 pF, ceramic disc

#### Semiconductors

- LED1—red light-emitting diode
- Q1, Q2—2N2222 NPN transistor

#### Other components

- J1, J2—RCA-type jack
- S1—SPST on/off switch

**Miscellaneous:** Coaxial cable, PC board, metal case, solder, etc.

sum of the two individual head pre-amp envelopes (waveforms *a* and *b*).

If the head-switching pulse is not present, or if it's distorted or inverted in phase, the symptoms will be similar to bad heads or a bad pre-amp. Some examples of bad waveforms are shown in Fig. 4. Waveforms *a* to *d* are caused by mechanical misalignment of the tape guides, and the waveforms in *e* and *f* indicate proper alignment of the tape guides, but show a problem with the video heads, pre-amps, or head switcher.

#### Head-amp tester circuitry

The schematic for the tester is shown in Fig. 5. The input is an RF envelope from a working VCR, applied to Q1 through coupling-capacitor C1. Q1 is connected as an emitter follower, with a high-impedance input and a low-impedance output, and a voltage gain of 1.

Potentiometer R3 is used as the emitter load for Q1 and level control for the signal applied to Q2. Capacitor C2 is for improving the frequency response of R3. Transistor Q2 is also a 2N2222, wired in the same configuration as Q1, but with a lower output impedance in order to drive circuits in the VCR under test. The circuit draws

only 12 mA, so a 9-volt battery is well suited for the project.

#### Construction

The circuit should be built on a PC board, because RF as high as 4.5 MHz will be present. A single-sided board was used in the author's prototype with no problems. The board layout is very simple and can be drawn by hand directly on the copper with an etch-resist pen. See Fig. 6 for a parts-placement diagram; a foil pattern is provided in PC Service.

The assembled circuit should be mounted in a shielded box and coaxial leads should be used for input and output. Keep the lead length as short as possible (2-foot leads were used on the prototype with no problems).

#### Checkout

After assembly, check the voltages on Q1 and Q2, and the current draw, to verify proper circuit operation. Connect the VCR to be used as the signal

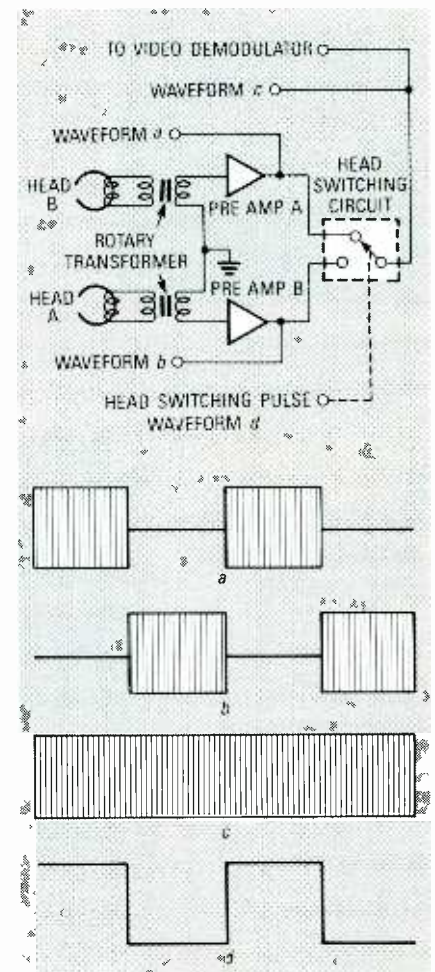
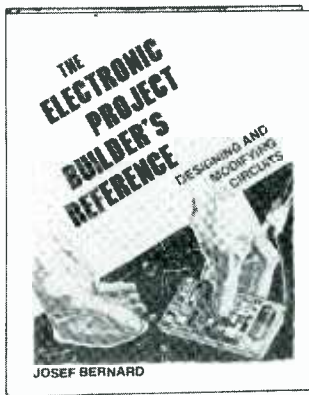
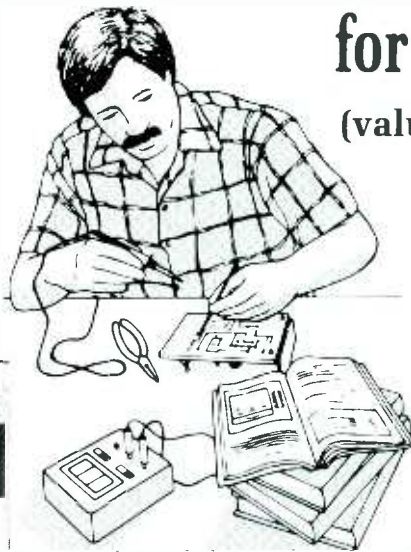

FIG. 3—EACH HEAD HAS ITS OWN PRE-amp, and the output of each one goes to an electronic switch that combines the outputs from each head pre-amp.



# SELECT 5 BOOKS for only \$4.95 (values to \$112.75)



3260P \$14.95

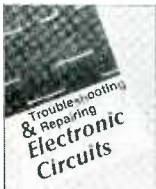

3258 \$27.95  
Counts as 2



3321P \$16.95



3241P \$16.95



3279 \$36.95  
Counts as 2

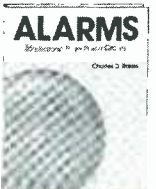

2996P \$14.95



2980P \$19.95



2790P \$14.95



3485 \$27.95  
Counts as 2

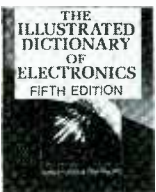

3345 \$39.95  
Counts as 2



2883P \$18.95



2800P \$16.95



2613P \$17.95



3329 \$29.95  
Counts as 2



2867P \$18.95

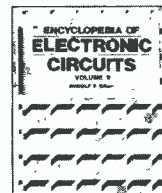

1938 \$61.00  
Counts as 3



2925P \$9.95



2865P \$14.95



3527 \$29.95  
Counts as 2

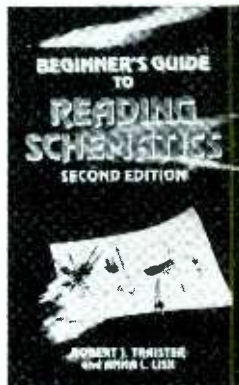

3632 \$18.95

Your most complete source for electronics books for over 25 years.



3414 \$39.95  
Counts as 2



3072P \$16.95



3374P \$16.95



3528 \$26.95  
Counts as 2

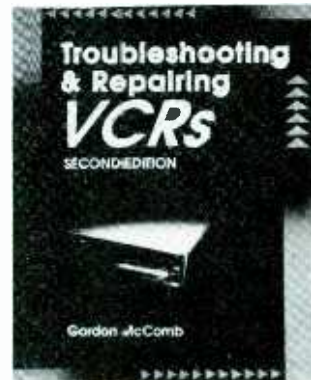

3777 \$32.95  
Counts as 2

**Membership Benefits • Big Savings.** In addition to this introductory offer, you keep saving substantially with members' prices of up to 50% off the publishers' prices. • **Bonus Books.** Starting immediately, you will be eligible for our Bonus Book Plan, with savings of up to 80% off publishers' prices. • **Club News Bulletins.** 15 times per year you will receive the Book Club News, describing all the current selections—mains, alternates, extras—plus bonus offers and special sales, with scores of titles to choose from. • **Automatic Order.** If you want the Main Selection, do nothing and it will be sent to you automatically. If you prefer another selection, or no book at all, simply indicate your choice on the reply form provided. You will have at least 10 days to decide. As a member, you agree to purchase at least 3 books within the next 12 months and may resign at any time thereafter. • **Ironclad No-Risk Guarantee.** If not satisfied with your books, return them within 10 days without obligation! • **Exceptional Quality.** All books are quality publishers' editions especially selected by our Editorial Board. (Publishers' Prices Shown)



1367P \$24.95  
Counts as 2



3275 \$22.95



**ELECTRONICS BOOK CLUB<sup>SM</sup>**  
Blue Ridge Summit, PA 17294-0810

Please accept my membership in the Electronics Book Club and send the 5 volumes listed below, billing me \$4.95. If not satisfied, I may return the books within ten days without obligation and have my membership cancelled. I agree to purchase at least 3 books at regular Club prices during the next 12 months and may resign any time thereafter. A shipping/handling charge and sales tax will be added to all orders.

--	--	--	--	--

Name \_\_\_\_\_  
Address \_\_\_\_\_  
City \_\_\_\_\_  
State \_\_\_\_\_ Zip \_\_\_\_\_ Phone \_\_\_\_\_  
Signature \_\_\_\_\_

Valid for new members only. Foreign applicants will receive special ordering instructions. Canada must remit in U.S. currency. This order subject to acceptance by the Electronics Book Club. REX991



2880P \$14.95



2926 \$25.95



3343 \$29.95  
Counts as 2



3475 \$27.95  
Counts as 2

©1991 ELECTRONICS BOOK CLUB  
Blue Ridge Summit, PA 17294-0810

All books are hardcover unless number is followed by a "P" for paperback

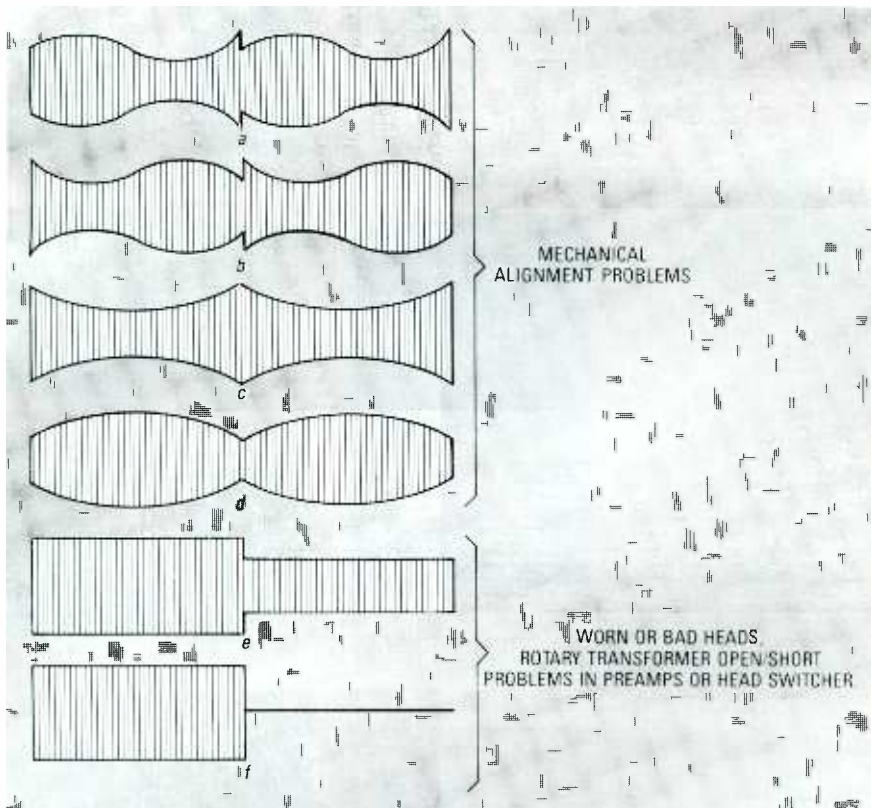

FIG. 4—IMPROPER WAVEFORMS. Waveforms a-d are caused by mechanical misalignment of the tape guides. The waveforms in e and f indicate proper alignment, but show that there's a problem with either the video heads, pre-amps, or head switcher.

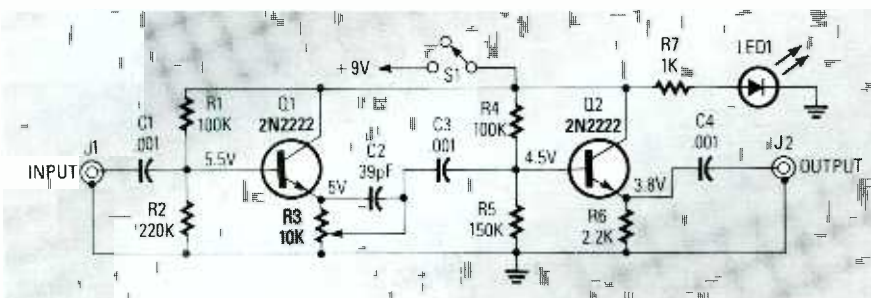

FIG. 5—THE SCHEMATIC for the head-amp tester.

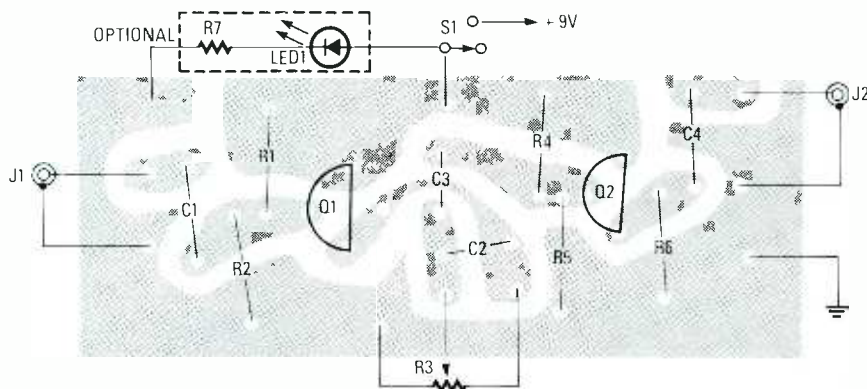

FIG. 6—PARTS-PLACEMENT DIAGRAM. Use the foil pattern provided in PC Service to make your own board.

source to a TV or monitor, and play a tape to use as the test signal; it can be a test pattern, or a home-made record-

ing of the news or some other show. Use an oscilloscope to check out the head RF envelope (Fig. 3-c), from the

source VCR for proper flatness. The RF envelope should be between 100- and 500-mV p-p in most VCR's.

Now turn on and connect the head-amp tester to the source VCR at the same point in the circuit that you measured the RF envelope (Fig. 3-c) with the oscilloscope. There may be a slight amount of signal degradation but if the entire picture disappears, it is loading down the source and the output signal will be unusable.

Check the output signal of the head-amp tester with the oscilloscope; it should be the same amplitude as the input signal with the level control at maximum. The output should be 0-V with the level control at minimum.

### Using the tester

To substitute a signal in place of bad or questionable video heads, first put the source VCR into play, connect the head-amp tester, and adjust the output for 5-10-mV p-p. Put the VCR to be tested into play with a blank tape, and connect the output of the tester to the input of one of the head amps. That may be done at the connector end of the cable between the rotary transformer and the head amps. You can also capacitively inject the signal by clipping the output lead over the insulation of a non-shielded wire (no electrical connection), and increasing the output level to about  $\frac{1}{2}$  to  $\frac{3}{4}$  of maximum. Signals can also be injected into the input and output of the head switcher. The output level should be high and direct electrical connections should be made.

The rotary transformer (one that can couple a signal from a rotating drum to the rest of the circuitry) can be tested with the VCR under test in "stop" mode, but the source VCR must be in "play" to supply a signal. Connect the output lead directly across one head at a time, and measure the output at the pre-amp input connector. You should disconnect the pre-amp connector from the pre-amps if possible. The signal from the rotary transformer should be equal or greater in voltage than the applied signal voltage. Test each head and the corresponding transformer winding.

The head-amp tester is not going to replace any major test equipment, but it does help you to troubleshoot some problems. And, after all, why wouldn't you want all the help you can get?

R-E





**KELVIN** Electronics

UP TO  
**50% OFF**

Kelvin Meters backed by a  
2 Yr Warranty - Parts & Labor

**KELVIN DIGITAL MULTIMETERS**



**100 Basic**  
DC VOLTAGE  
AC VOLTAGE  
DC CURRENT  
RESISTANCE  
CONTINUITY  
Test - Buzzer  
DIODE TEST  
BATTERY TEST  
3 1/2 Digit LCD  
LOW BATTERY  
ACCURACY  
± 0.5% RDG

**150 Basic+**  
DC VOLTAGE  
AC VOLTAGE  
DC CURRENT  
RESISTANCE  
CONTINUITY  
Test - Buzzer  
DIODE TEST  
TRANSISTOR HFE  
BATTERY TEST  
3 1/2 Digit LCD  
LOW BATTERY  
ACCURACY  
± 0.5% RDG

**200 Advanced**  
DC VOLTAGE  
AC VOLTAGE  
DC CURRENT  
RESISTANCE  
CONTINUITY  
Test - Buzzer  
DIODE TEST  
TRANSISTOR HFE  
3 1/2 Digit LCD  
LOW BATTERY  
ACCURACY  
± 0.5% RDG

**KELVIN 100 Basic \$19.95**  
**KELVIN 150 Basic+ \$29.95**  
**KELVIN 200 Advanced \$39.95**

**PRO 400 with 20MHz Freq Counter**



FREQUENCY COUNTER TO 20MHZ - IDEAL FOR TROUBLE SHOOTING  
AC/DC VOLTAGE RANGES  
AC/DC CURRENT RANGES  
5 CAPACITANCE RANGES  
LOGIC TEST  
CONTINUITY TESTER/Buzzer  
DIODE CHECK  
TRANSISTOR HFE TEST  
LED TEST VERIFY GOOD/BAD  
DISPLAY - 3 1/2 DIGIT LCD  
ACCURACY - ± 0.5%  
IMPEDANCE - 10 Mega Ohm

**KELVIN PRO 400 \$69.95**

**Protective Cases**  
For Models 100, 150, 200 ..... \$2.95 Case For Model Pro 400 ..... \$9.95

**DIGITAL TRAINER**



Trainer Manual (100 Pgs) gives detailed instructions. An excellent training tool covering topics for High School (Beginner - Advanced), Trade School (Beginner - Intermediate) & College.

**A PERFECT FIT WITHIN ANY DIGITAL CURRICULUM & YOUR CLASSROOM TEXTBOOK**

**FEATURES**  
■ ONE DIGIT TRUE HEXADECIMAL DISPLAY WITH BUILT IN LOGIC (MEMORY, DECODER, DRIVERS) FULL ALPHA CHARACTERS  
■ TWO INDEPENDENT CLOCKS USER ADJUSTABLE FREQUENCY & DUTY CYCLES  
■ BREADBOARD-500 PT PROTO-TYPE AREA TWO POWER DISTRIBUTION BUSES (GND VCC)  
■ 4 DATA BIT SWITCHES  
■ MOMENTARY PUSH BUTTON SWITCH (SPDT)  
■ 4 LED DISPLAYS w/IC DRIVERS  
■ POWER SUPPLY: WALL PLUG-IN TYPE U.L. LISTED  
■ VOLTAGE REG: +5 VOLTS, SHORT CIR. OVERLOAD PROTECT  
■ HOOK-UP WIRES  
■ COMPACT CARRYING CASE  
■ INSTRUCTION MANUAL FOR BEGINNER TO ADVANCED USERS

**MADE WITH PRIDE IN THE USA**

**THE KELVIN LDT™ Laptop Digital Trainer**

**ONLY \$99.95**

Stock No. 840460

**WALL TRANSFORMERS**

**WALL TRANSFORMER**

STOCK NO. TYPE - Female

220069 9V DC/500 mA ..... \$3.95 ea  
220068 12V DC/500 mA ..... \$4.25 ea

**MALE JACK**

STOCK NO. TYPE

370048 2.1 mm Male  
\$.49 ea ..... \$.39 /10+

**BREADBOARDS**

STOCK NO. TYPE

680093 ..... \$4.25 ea  
680097 ..... \$5.95 ea  
680098 2 1380 ..... \$11.75 ea  
680100 4 2390 ..... \$22.95 ea

**COMPONENTS**

Stock No. TYPE YOUR COST

600021 555 TIMER ..... \$.20 EA  
600029 555 DUAL TIMER ..... \$.40 EA  
600039 LM566 PLL ..... \$.60 EA  
600018 741C OP-AMP ..... \$.30 EA  
600026 1458 OP-AMP ..... \$.35 EA  
630041 2N2222 ..... \$.18 EA  
630383 PN2222 ..... \$.08 EA  
600023 7805 VOLTAGE REG ..... \$.36 EA

**SILICON CONTROLLED RECTIFIER**  
(Similar to GE C106C1) 40 AMP, 100 PIV  
600014 ..... \$.89 EA

**WIRE JUMPER KIT**  
Pre-cut, Pre-Stripped

330289 140 Piece Set ..... \$ 4.75  
330290 350 Piece Set ..... \$ 7.75

**AUTHORIZED DEALER**



**FLUKE 70 Series II FLUKE 3 YEAR WARRANTY**

**BEST BUY ..... NEW Series II**

**FLUKE 70 Series II ..... \$ 63**  
**FLUKE 73 Series II ..... \$ 89**  
**FLUKE 75 Series II ..... \$127**  
**FLUKE 77 Series II ..... \$149**  
**FLUKE 79 Series II ..... \$169**

**FLUKE 83 ..... \$199**  
**FLUKE 85 ..... \$229**  
**FLUKE 87 ..... \$269**  
**FLUKE 86 ..... \$367**  
**FLUKE 88 ..... \$423**  
**FLUKE 8062A ..... \$329**  
**FLUKE 8060A ..... \$395**  
**FLUKE 8010A ..... \$329**  
**FLUKE 8012A ..... \$359**  
**FLUKE 8050A ..... \$439**

**FLUKE 37 ..... \$249**  
**FLUKE 45 ..... \$579**

**SCOPES**

**20 MHz SCOPE..... \$345**  
Dual Trace 2 Yr Warranty-Parts & Labor



**SCOPE PROBES**

60 MHz, X1 & X10 SPECIAL ..... \$18.95  
700072 ..... \$18.95  
150 MHz, X10 ..... \$39.95  
700073 ..... \$39.95

**BATTERIES**

**Duracell / Eveready 9V Alkaline Battery**

\$1.95 ea  
\$1.75 ea/10+

**9V Battery SNAP & HOLDER**

Snap \$.15 ea \$.10 ea/100+  
Holder \$.20 ea \$.10 ea/100+

**HEAVY DUTY NI-CAD RECHARGEABLE BATTERIES**

STOCK NO. TYPE YOUR COST

220039 AAA ..... \$3.30 ea  
220025 AA ..... \$2.85 ea  
220027 C ..... \$6.00 ea  
220037 D ..... \$6.00 ea  
220038 9V ..... \$8.90 ea

**NI-CAD BATTERY CHARGER**

4 Cell Charger for AAA, AA, C, D or 9V  
STOCK NO. YOUR COST

220035 SPECIAL ..... \$9.95 ea

**LED CENTER**

SPECIAL SPECIAL SPECIAL

**RED LED As Low As 5¢ ea/1000+ Qty**

**JUMBO LED**

TYPE - T 1 3/4, 5mm

STOCK NO. YOUR COST 1000+ Qty

260020 Red \$.06 ea/100+ \$.05 ea  
260027 Green \$.08 ea/100+ \$.07 ea  
260026 Yellow \$.08 ea/100+ \$.07 ea

**LED HOLDER for T 1 3/4 SIZE, BLACK**  
Stock No. 250019  
\$.10 ea / 100+ Qty  
\$.06 ea / 1000+ Qty



**0.37" 7 SEGMENT LED READCUT**

STOCK NO. TYPE COST 20+ Qty

260022 Anode \$.95 ea \$.75 ea  
260090 Cathode \$1.25 ea \$.99 ea

**0.6" 7 SEGMENT LED READCUT**

STOCK NO. Anode Jumbo COST \$1.15 ea 20+ Qty \$ .99 ea



**RED LED DISPLAY Bar Graph**

STOCK NO. Color YOUR COST 10+ Qty

260058 Red \$1.99 ea \$1.79 ea  
260088 Green \$1.99 ea \$1.79 ea  
260089 Yellow \$1.99 ea \$1.79 ea

**MOVING SIGN DISPLAY**  
for Fabricating Your Own Moving Sign Display

50 mm STOCK NO. 260091 \$5.95 ea \$5.45 ea 20+

**TEST ACCESSORIES**

**IC CLIPS SOLDER TYPE SPRING LOADED**

STOCK NO. COLOR COST 25+ Qty

990104 BLACK \$.65 ea \$.50 ea  
990105 RED \$.65 ea \$.50 ea

**IC TEST LEAD SET**

5 COLOR CODED 18" LEADS WITH MINIATURE HOOK-ON PRODS AT BOTH ENDS

STOCK NO. YOUR COST 3+ Qty

990108 \$8.95 ea \$8.25 ea  
990108 \$8.95 ea \$8.25 ea

**DOUBLE BANANA JACK**

STOCK NO. YOUR COST 3+ Qty

600056 \$2.30 ea \$2.07 ea

**FEMALE BNC TO DUAL BANANA PLUG**

STOCK NO. YOUR COST 3+ Qty

990103 \$2.95 ea \$2.75 ea

**DUAL BANANA BINDING POST TO MALE BNC PLUG**

STOCK NO. YOUR COST 3+ Qty

600058 \$5.95 ea \$4.95 ea

**BNC TEST CABLES 3 FT.**

**MALE TO MALE**

STOCK NO. YOUR COST 3+ Qty

990101 \$3.45 ea \$2.95 ea

**PROJECT PARTS**

**Soldering IRON**  
with STAND, BLUE LONG LIFE TIP  
Stock No. 990098  
\$4.50 ea

**Project Speaker**  
2" 8 Ohm, 1 Watt  
Stock No. 350009  
\$9.95

**Project BUZZER**  
3 - 9 Volt DC, 80 db  
Stock No. 680089  
\$1.59 ea  
\$1.39 ea / 10+ Qty

**HORN ALARM**  
Loud Penetrating Sound  
Stock No. 640001  
\$.75 ea  
\$.69 ea / 10+ Qty

**DC MOTOR**  
for SOLAR/ROBOTIC  
Stock No. 852211  
\$.50 ea  
\$.45 ea / 20+ Qty

**XENON STROBE TUBE**

Stock No. 260050  
\$2.95 ea  
\$2.50 ea / 20+ Qty

**TRIGGER COIL**  
for Xenon Strobe Tube  
Stock No. 320037  
\$1.25 ea  
\$.89 ea / 20+ Qty

**INFRARED LED IR Pair, LED infrared transmitter and receiver**

Stock No. 260061  
\$2.79 ea

**NEON LAMP**  
NE2, Long Leads  
Stock No. 260003  
\$.15 ea  
\$.12 ea / 100+ Qty

**PHOTO CELL CADMIUM SELENIDE**

Stock No. 260017  
\$.99 ea

**PHOTO CELL SULPHIDE**

Stock No. 260018  
\$.99 ea

**PUSH-BUTTON SWITCH**  
PUSH-ON, PUSH-OFF  
Stock No. 270021  
\$.55 ea  
\$.49 ea / 100+ Qty

**SUB-MINIATURE MOMENTARY SWITCH**

Stock No. 990002  
\$.35 ea  
\$.28 ea / 100+ Qty

**MINIATURE TOGGLE SWITCH**

Stock No. 270034  
\$.90 ea Type - SPST  
\$.79 ea / 50+ Qty

**KELVIN ELECTRONICS**

**CIRCLE RESPONSE CARD or WRITE for our CATALOG full of WHOLESALE PRICED ITEMS.**

**OVER 10,000 ITEMS IN STOCK**

**ELECTRONIC COMPONENTS & TECHNOLOGY ACTIVITIES**

VISA & MASTERCARD ACCEPTED  
\$20 MINIMUM ORDER  
MINIMUM FREIGHT \$5

**KELVIN** Electronics  
7 Fairchild Avenue, Plainview, NY 11803

Call: 1 (800) 645-9212  
1 (516) 349-7620  
FAX: 1 (516) 349-7830



# BUILD THIS

# RADAR DETECTOR TESTER

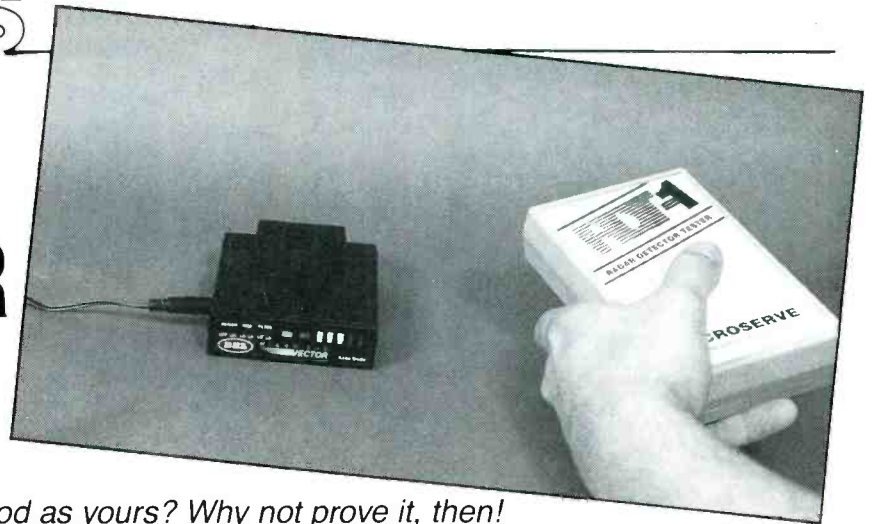

Is your friend's radar detector as good as yours? Why not prove it, then!

JOHN B. AYER

HAVE YOU EVER WONDERED HOW SENSITIVE your radar detector is? Or have you ever had someone tell you that their detector was better than yours? Until now, the average radar-detector owner had no way to prove or disprove any claims made by the manufacturers concerning the performance of the various detectors on the market.

The radar-detector tester pictured in this article is an easy-to-build, low-power X- or K-band radar transmitter. With the device's low-level emissions, you do not need a license to use it. The average detection range is 12 feet, which is more than enough to determine the sensitivity of your radar detector. You can then do a side-by-side test with your friend who's been telling you his detector is better!

## Operation

The heart of the circuit (see Fig. 1) is a one-transistor oscillator that operates at a fundamental frequency of 1169.44 MHz. The 9th harmonic of

that frequency is 10.525 GHz, which happens to be the center of the X-band police radar assignment. The K-band unit operates at a fundamental of 1857.7 MHz with the 13th harmonic falling at 24.150 GHz. As you probably have guessed, 24.150 GHz is right in the center of the K-band police radar assignment.

The oscillator uses a microwave transistor in order to maximize the X- or K-band output. The fundamental frequency is determined by the tuned circuit that is attached to the base of the transistor. The tuned circuit consists of a 50-ohm strip line that is etched onto a PC board, and then cut to the proper length during the tuning procedure.

The printed circuit board is made out of double-sided copper-clad teflon with fiberglass reinforcement. The teflon is necessary because of the high frequencies involved (standard G-10 epoxy printed circuit boards act like short circuits at frequencies above 3 GHz). Although teflon sounds exotic, it isn't, and it is readily available from the suppliers listed in the parts list.

Some people may not be familiar with strip-line circuitry. Any line that is etched on one side of a double-sided PC board will have inductance along its length and capacitance through the dielectric (the fiberglass, teflon, etc.) to the ground plane (the copper plating on the other side of the board). In a properly designed strip line, the inductance and capacitance cancel each other leaving the designer with just a resistive impedance to wor-

ry about. As it turns out, the width of the line and the thickness of the dielectric determine the resistive impedance.

In this particular case, it was determined that 50 ohms was the optimum impedance. After deciding which PC-board material would be best suited for this project, the following equation was used to determine the width of the strip line needed:

$$Z_o = (87/\sqrt{E_r + 1.41}) \times L_n[5.98H/(T + .8W)],$$

$Z_o$  = characteristic impedance (50 ohms)

$E_r$  = dielectric constant (2.48)

$L_n$  = natural logarithm

$H$  = thickness of dielectric (0.0156 inches)

$W$  = width of line (0.038 inches)

$T$  = thickness of copper cladding (0.0004 inches)

Once the width of the line is determined, all that's needed to finish the job is to determine the length of the line for the target frequency. (The oscillator is similar to a pipe organ where the length and diameter of a pipe determines the tone that is produced; the length of the strip line determines the resonant frequency.)

## Construction

Etch the circuit board using the pattern provided in PC Service; a ready-made board is also available. The transistor has four leads; two are connected to the emitter, and you must determine which they are. Use an ohmmeter if you are not sure. (The

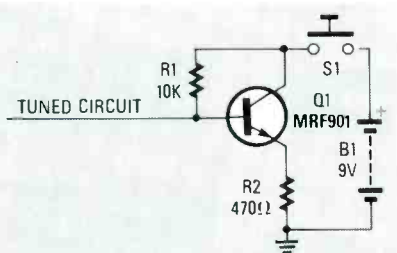
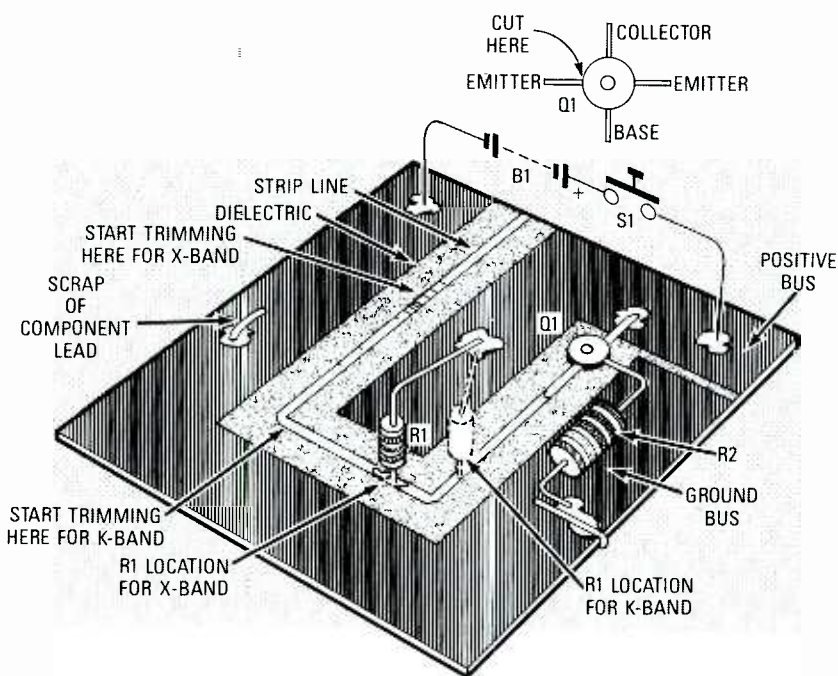

FIG. 1—THE HEART OF THE X-BAND UNIT is a one-transistor oscillator that operates at a fundamental frequency of 1169.44 MHz; the 9th harmonic of that frequency is 10.525 GHz, which happens to be the center of the X-band police radar assignment.





**FIG. 2—PARTS-PLACEMENT DIAGRAM.** Resistor R1 must be in a different location, depending on whether you're building an X- or K-band unit. Also, when aligning the unit, the strip line must be cut in a different location depending on the type of unit.

emitter leads are the only two that will exhibit a dead short from one to the other.) Cut off the left-hand emitter lead, as shown in Fig. 2.

After removing the extra lead, place the transistor in the hole on the board so that the base lead is on the strip line and the collector lead is on the positive bus, and solder them in place (see Fig. 2). Place R2 on the board and, keeping both leads as short as possible, solder one of its leads to the remaining emitter lead of Q1. The other resistor lead should go through the hole in the PC board, and soldered on both sides (a through hole, if you will). A scrap piece of component lead must go through the other hole on the left side of the board, and also soldered on both sides (another through hole).

Cut one lead of R1 so that it's 1/8-inch long. Refer to Fig. 2 for proper placement of R1 for either the X or K band. Then solder the shortened lead of R1 to the strip line so that the resistor is standing on end. The longer lead of the resistor should then be soldered to the positive bus of the PC board (see Fig. 2).

Using a silicone adhesive, glue the PC board into the enclosure that you have selected. DO NOT use a metal enclosure. The microwaves need to escape from the box, and you will

### PARTS LIST

- R1—10,000 ohms, 1/4-watt resistor
- R2—470 ohms, 1/2-watt resistor
- Q1—MRF-901 Motorola transistor for X band, or NE68137 California Eastern Laboratories transistor for K band.
- B1—9-volt battery
- S1—push-button switch
- PC-board material—6 × 6-inch piece of 0.0158-inch thick teflon-fiberglass (Taconic Plastics, part number TLT-9-0150-C1/C1)
- Plastic project case

**Note: A complete parts kit is available from MICROSERVE, 60 Thompson Street, Maynard, MA 01754. Besides the parts, the kit also includes a custom plastic enclosure with an integrated battery holder and decorative face plate. X-band kits are \$55, and K-band kits are \$65. Shipping and tax extra. Spare parts list available on request.**

#### Motorola Semiconductor Products

- 3102 N 56th St.
- Phoenix, AZ 85018
- 602-952-3000 or 800-521-6274
- California Eastern Laboratories**
- 3260 Jay St.
- Santa Clara, CA 95054
- 408-988-3500
- Taconic Plastics LTD.**
- Petersburg, NY 12138
- 518-658-3202

defeat the entire project by using a metal box. Be sure to orient R1 so that it's closest to the front of the box, because most of the radiation is emitted from that point.

Attach the battery and switch as shown in Fig. 2, being careful not to reverse the polarity. Route wires away from the strip line and components, because stray wires can de-tune the oscillator. Construction is now complete and you are ready to tune the transmitter (see Fig. 3).

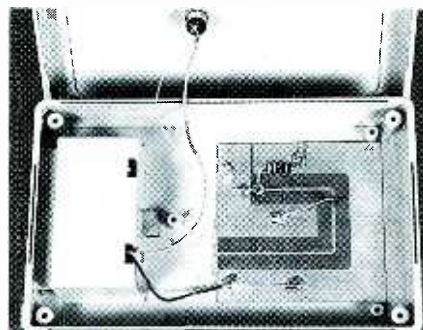

**FIG. 3—GLUE THE PC BOARD** into the plastic enclosure using a silicone-type adhesive.

### Alignment

To align the unit, you will need a radar detector and an X-acto knife with a fine blade. Turn on the radar detector and the tester. Now make an initial cut in the strip line starting at the point specified in Fig. 2, for either the X- or K-band unit. Be sure to cut all the way across and through the copper trace. If your detector does not sound an alarm, make another cut about 1/16-inch closer to the transistor. At some point your detector will sound an alarm, and the tester will be properly tuned. Be careful not to cut too much at one time, because if you go too far you will have to carefully solder the line back together.

However, if you go just a *little* too far, you can save some work by cutting nicks in the remaining strip line (cuts that go part way across the strip line). That has the effect of making the strip line electrically longer.

If you find that your range is limited you may have tuned to the wrong harmonic resulting in low output. It will be necessary to experiment with different line lengths to achieve maximum range.

Your tester is now ready for use. Simply hold the unit near a detector and turn it on. The range of the X-band transmitter is about 12 feet, while the range for the K-band unit is about 5 to 10 feet.

BATTERIES ARE BECOMING A BIGGER part of all our lives, and many innovative new products coming to market either use or contain them. Battery-powered products are no longer limited to just toys and handheld vacuums. Serious products—like handheld transceivers, portable scopes, or laptop computers—are often battery-operated. However, while batteries provide mobility, they're also often the culprits when a product fails.

Many of us still consider batteries to be the ultimate black boxes: mysterious devices that work only when they feel like it. However, they're really not that difficult to understand and use effectively. Here are some questions and answers to help you create better designs using them.

• **I know there are many kinds of batteries. What's the best type for my application?**

Choosing a battery type means knowing something about both

batteries and how they'll be used in your equipment. Batteries are commonly classed as either primary or secondary. Primary cells include the disposable varieties such as carbon-zinc, alkaline, and lithium cells that can't be recharged.

Secondary cells include the varieties based on either nickel-cadmium (Ni-Cd) or lead-acid cell chemistries, that are rechargeable several times without degradation. So first, consider your equipment. Specific questions include: What is the drain rate? How often will the equipment be used? And, finally, is recharging feasible?

Low current drain, short duty cycles, and remote operation favor the use of primary batteries for watches, hearing aids, garage door openers, and retrofit smoke detectors. Obviously, the application parameters for secondary batteries are basically the opposite of those for primary cells. In applications involving high

current drain or extended usage, the cost of replacement of disposable batteries may be prohibitive. Such applications are logical for rechargeable secondary batteries as long as recharging power can be provided.

• **Based on drain rate and duty cycle, my application could go either way. What are the performance differences among various battery types?**

Table 1 provides a comparison of various common battery types, both primary and secondary. The first point of interest is the nominal cell voltage; more sophisticated concepts like energy density will be covered later. Also, all batteries have one or more cells, operating at voltages fixed by the electrochemistry of a given cell. Note that the operating voltages are shown as decreasing in Table 1; the initial value refers to the fully charged state, while the final value refers to the end of run-time, or useful life.

# BATTERY TECHNOLOGY

**Here are some important Q&A's about batteries to enable you to use them more effectively.**

MARK DEWEY\*



\*Gates Energy Products



**TABLE 1—CHARACTERISTICS OF COMMON BATTERY TYPES**

Characteristic	Primary Cells		Secondary Cells	
	Carbon-Zinc (LeClanche)	Alkaline	Lead-acid (sealed (SLA), wound, gel.)	Ni-Cd (sealed; wound)
<b>Chemistry:</b>				
Anode	Zn	Zn	Pb	Cd
Cathode	MnO <sub>2</sub>	MnO <sub>2</sub>	PbO <sub>2</sub>	NiOOH
Electrolyte (all aqueous solutions)	NH <sub>4</sub> Cl and ZnCl <sub>2</sub>	KOH	H <sub>2</sub> SO <sub>4</sub>	KOH
<b>Cell voltage:</b>				
Nominal	1.5	1.5	2.0	1.2
Open-circuit	1.5–1.75	1.5	2.1	1.25
**Operating	1.25–1.15	1.25–1.15	2.0–1.5	1.25–1.00
End	0.8	0.9	1.75	0.9
<b>Operating temperature (°C)</b>	–5–45	–20–55	–40–55	–40–70
<b>Energy density (20°C) for cylindrical cells</b>				
*Wh/kg	85	85	35	30
*Wh/liter	100	220	70	80
<b>Advantages</b>	Lowest cost; good for non-critical use under moderate conditions; variety of shapes and sizes; readily available	High capacity compared with zinc-carbon; good low temperature	Low cost; readily available; good high-rate, high- and low-temperature operation	Sealed, no maintenance; good low temperature and high-rate performance, long cycle life
<b>Limitations</b>	Low energy density; poor low temp., high-rate performance	Moderate cost	Relatively low cycle life; limited energy density; poor charge retention; hydrogen evolution	Higher initial cost than lead-acid
<b>Major types available</b>	Cylindrical bobbin cells to 30 Ah; flat cells	Button and cylindrical cells to 20 Ah	Prismatic, cylindrical, wound cells, 200-400 Ah	Button cells to 0.5 Ah; cylindrical cells to 10 Ah

\*Wh: Watt-hour.

\*\*Values are deliberately decreasing

The nominal voltages of all cells are fixed by their electrochemistry (more below). The two major primary cells, carbon-zinc and alkaline, both produce 1.5 volts, while lithium versions produce 3.0 volts. The carbon-zinc cell is referred to in Table 1 as a "Leclanche" cell, named after the French chemist George Leclanche, who discovered it in 1866. Under the Ni-Cd cell listings, one of the the cathode material has the unusual formula of NiOOH, which is nickel oxy-hydroxide.

Of the major secondary cells, Ni-Cd cells produce 1.2 volts/cell, and lead-acid cells 2.0 volts/cell. Higher voltages, up to 240 volts, are commercially available from

series cells. In 12-volt car batteries, all cells are connected internally. However, certain cell potentials, like 4 volts, may be possible from one cell type, but not from others.

Cell chemistry also causes voltage "droop" during discharge, which may affect a given application. While flashlights merely dim as their battery voltage decreases, many electronic circuits are highly sensitive to even slight drops in input voltage. Figure 1 compares the performance of primary carbon-zinc and alkaline "D" cells with secondary Ni-Cd and sealed-lead cells, for a discharge current of 800 milliamps.

The carbon-zinc voltage profile falls rapidly with discharge, with

a runtime under four hours. The voltage of an alkaline cell also falls off steadily, but its runtime is roughly quadruple that of a carbon-zinc cell. The Ni-Cd cell has a voltage profile that's nearly flat for most of its life, but only half the terminal potential of an alkaline cell. The Ni-Cd cell has a first recharge life that roughly equals the total life of an alkaline cell.

The stability of Ni-Cd cells at high current drains is why they're used in portable items: drills can draw up to 30 amps under load. The internal resistance of a Ni-Cd cell is 5–15 milliohms due to its construction, making such high current drains possible. A spiral nylon separator

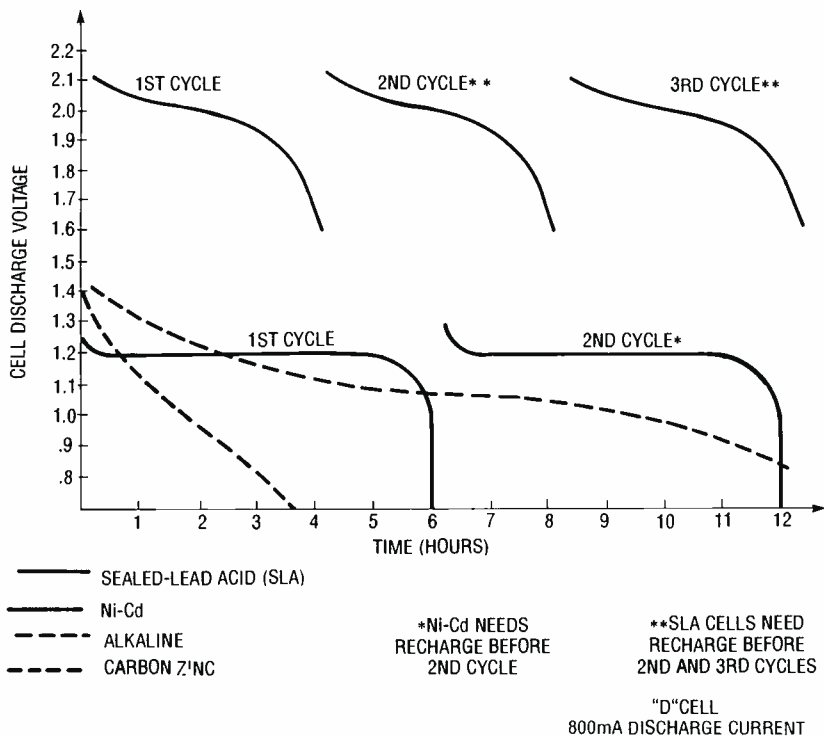

FIG. 1—THE VOLTAGE PROFILES OF PRIMARY and secondary D-cells are compared for a discharge current of 800 milliamps. The carbon-zinc voltage profile falls rapidly with discharge, with a runtime under four hours. Alkaline performance falls off steadily, but runtime is quadruple that of carbon-zinc.

isolating the electrodes goes in a steel can used as the negative terminal, and is filled with electrolyte that transmits mobile charge. The steel it's sealed in is used as the positive terminal, as shown in Fig. 2.

Whereas Ni-Cd cells have a large anode-nylon-cathode surface area due to their spiral design, alkaline cells have an annular (or doughnut-shaped) cross section. Powdered anode material fills an inner ring, and compressed cathode material fills an outer ring. They're isolated by a porous fiber separator as shown in Fig. 3, giving a higher internal resistance, and limiting the available current drain.

Note that in Fig. 3, the top positive electrode is the cathode, while the bottom negative electrode is the anode. At first glance, that might seem odd, since most of us are normally accustomed to the reverse usage encountered with diodes. However, since a battery is an electrolytic (or electrochemical) cell, the labels for the terminals of a battery follow chemical, not electrical usage.

Earlier, there was a reference to how the electrochemistry of a battery fixes its terminal poten-

tial; let's now examine that aspect in more depth. The chemical process in a battery is an oxidation-reduction, also called a "re-

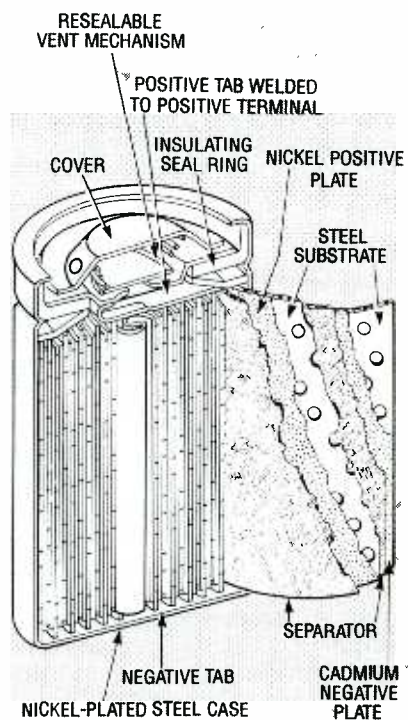

FIG. 2—NI-Cd CELLS EXHIBIT an internal resistance of 5-15 milliohms due to their construction, making stable current drain possible.

dox" reaction.

The anode is the terminal where material is oxidized, or where electrons are removed from or given up, and is usually called negative or minus (" - "), or where mobile electrons exit into a wire. The cathode is the terminal where material is reduced, or where electrons are accepted, and is usually called positive, plus (" + "), or the terminal where mobile electrons enter from a wire.

An electrolyte is the wet (or at least damp) ionic medium, through which mobile free electrons released by oxidation at the cathode travel to the anode, to propagate the electrolytic reaction of a battery. Table 1 lists the materials used for all three parts of the most common batteries.

The term "electrolytic" has the same meaning here that it has for capacitors, with certain variations. An electrolytic capacitor is polarized like a battery, and may well explode if its DC working voltage (WVDC) is exceeded (especially for reverse polarity), just as many primary nonrechargeable batteries will if recharged.

A battery, by contrast, is basically a fuel cell, maintaining terminal potential by electrochemical means until its fuel is exhausted. That is, the very selection of electrode metals and electrolyte is what determines the terminal potential of a battery, and a battery thus supplies charge *without* having to be charged initially.

All an electrolytic capacitor can do is store a charge fed into it, and dissipate the charge by generating an exponential current into a resistance. It stores charge (whereas a battery generates it spontaneously), and its potential decays exponentially, just as with any other capacitor. However, the electrolytic medium used allows the packaging of larger capacitance values than would otherwise be possible for a given volume. Nonetheless, batteries and electrolytic capacitors are at least second (or maybe even first) cousins.

#### ● What are cell capacity ratings based on?

Battery manufacturers rate cell capacities in amp-hours (Ah), a *continued on page 18*



# PC SERVICE

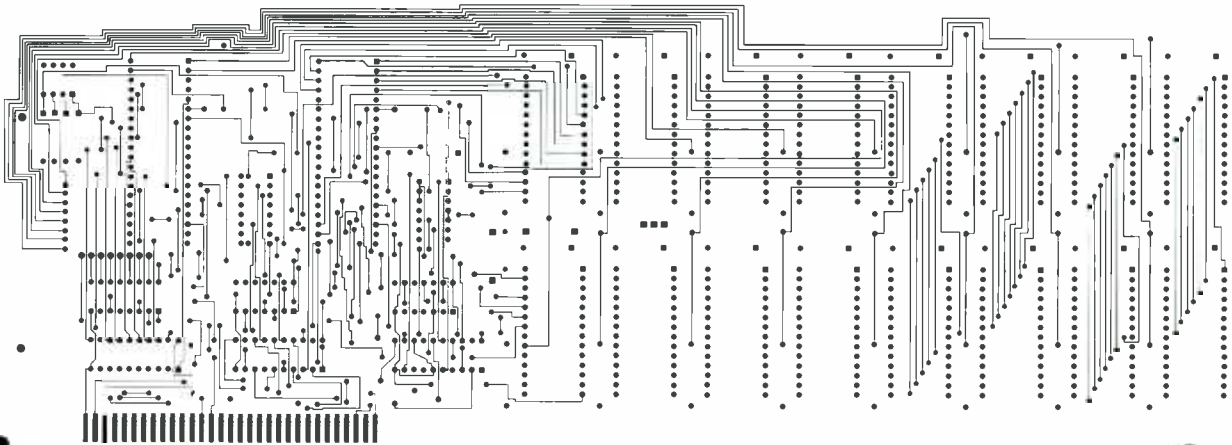

12 $\frac{5}{8}$  INCHES

HERE'S THE SOLDER SIDE of the RAM disk at half the actual size.

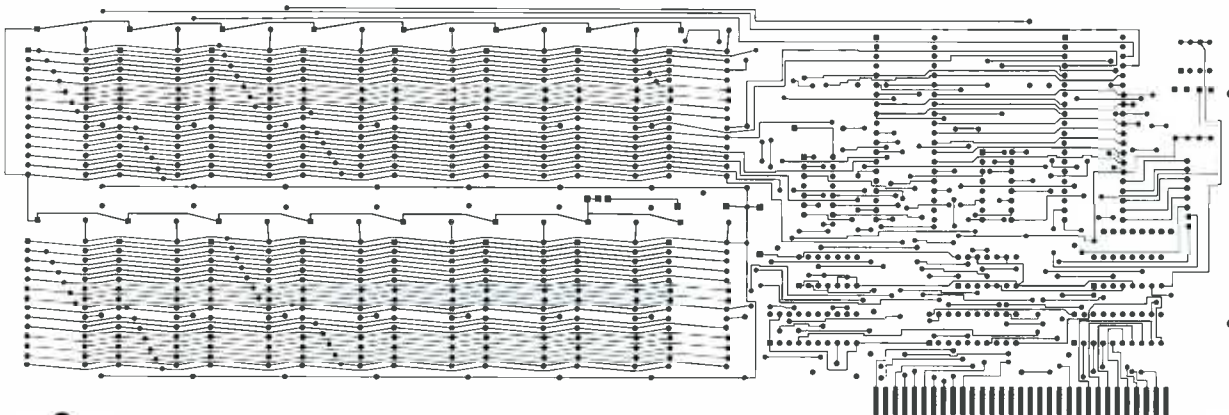

12 $\frac{5}{8}$  INCHES

HERE'S THE COMPONENT SIDE of the RAM disk at half the actual size.

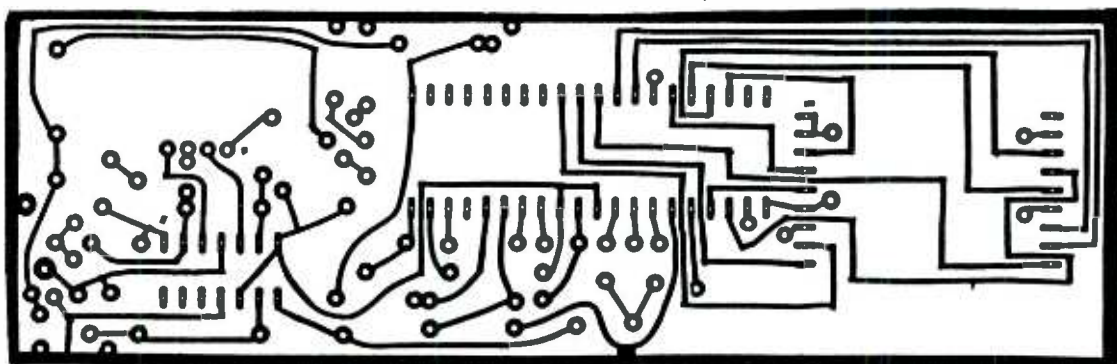

5 $\frac{5}{16}$  INCHES

USE THIS PATTERN for the pressure gauge.

**DISCOVER  
EXPERIMENT  
LEARN  
ADVANCE  
ELECTRONICS  
LASERS  
CAD-CAM  
HOME STUDY  
HEATHKIT  
HOMEWORKS!**

Now you can learn beginning to advanced electronics at home, with the same courses used today in the world's top colleges and tech schools, and pay a lot less! You'll learn just what you want, when you want, at your own pace. The complete story is in our free catalog, Homeworks by Heathkit.

Order yours today, call toll-free:

**1-800-44-HEATH**  
(1-800-444-3284)

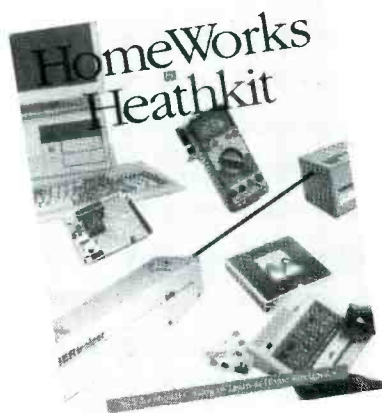

**YES!** Please send me a FREE copy of the Homeworks by Heathkit Catalog.

Send to: Heath Company, Dept. 021-090  
Benton Harbor, Michigan 49022

Name \_\_\_\_\_

Address \_\_\_\_\_

City \_\_\_\_\_

State \_\_\_\_\_ Zip \_\_\_\_\_

EID 240

CIRCLE 8 ON FREE INFORMATION CARD

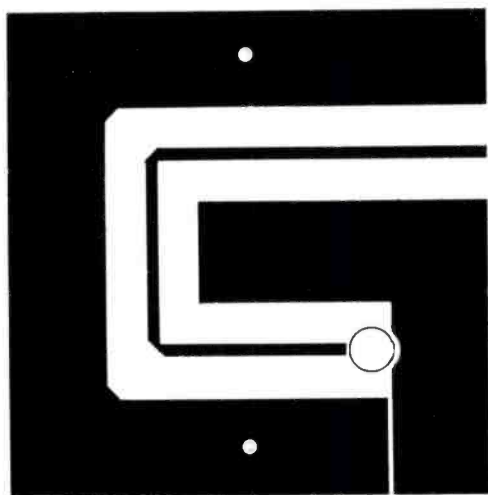

2 1/2 INCHES  
RADAR-DETECTOR TESTER foil pattern.

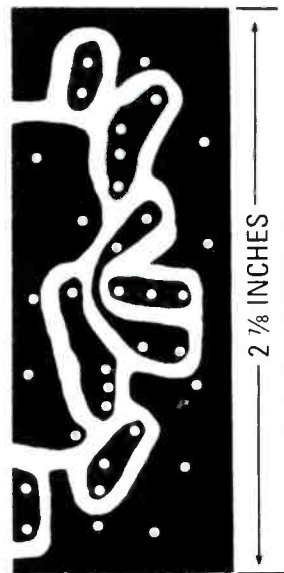

2 7/8 INCHES  
HEAD-AMP TESTER foil pattern.

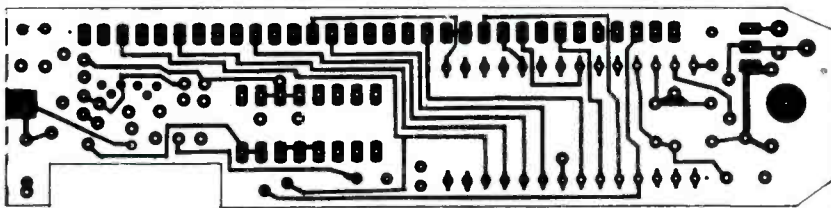

4 3/8 INCHES  
SOLDER SIDE of the frequency probe.

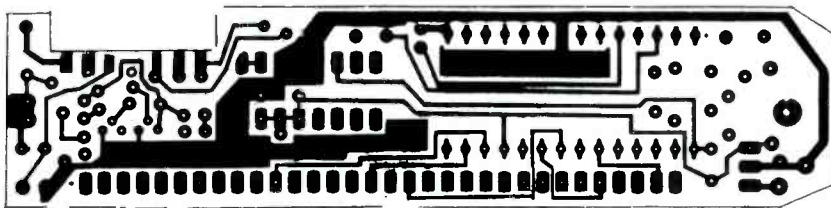

4 3/8 INCHES  
COMPONENT SIDE of the frequency probe.

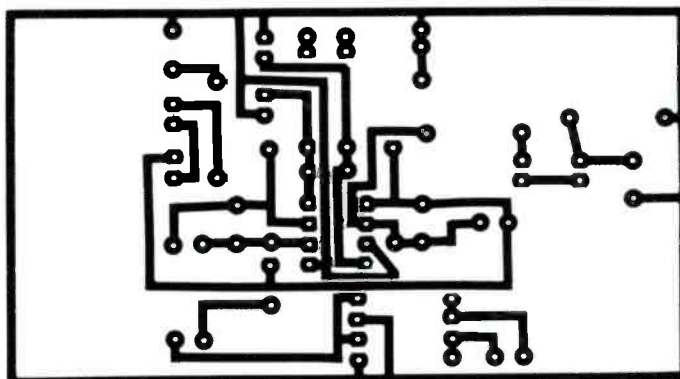

3 1/2 INCHES  
AUDIO VOLUME LIMITER FOIL PATTERN.



# PC SERVICE

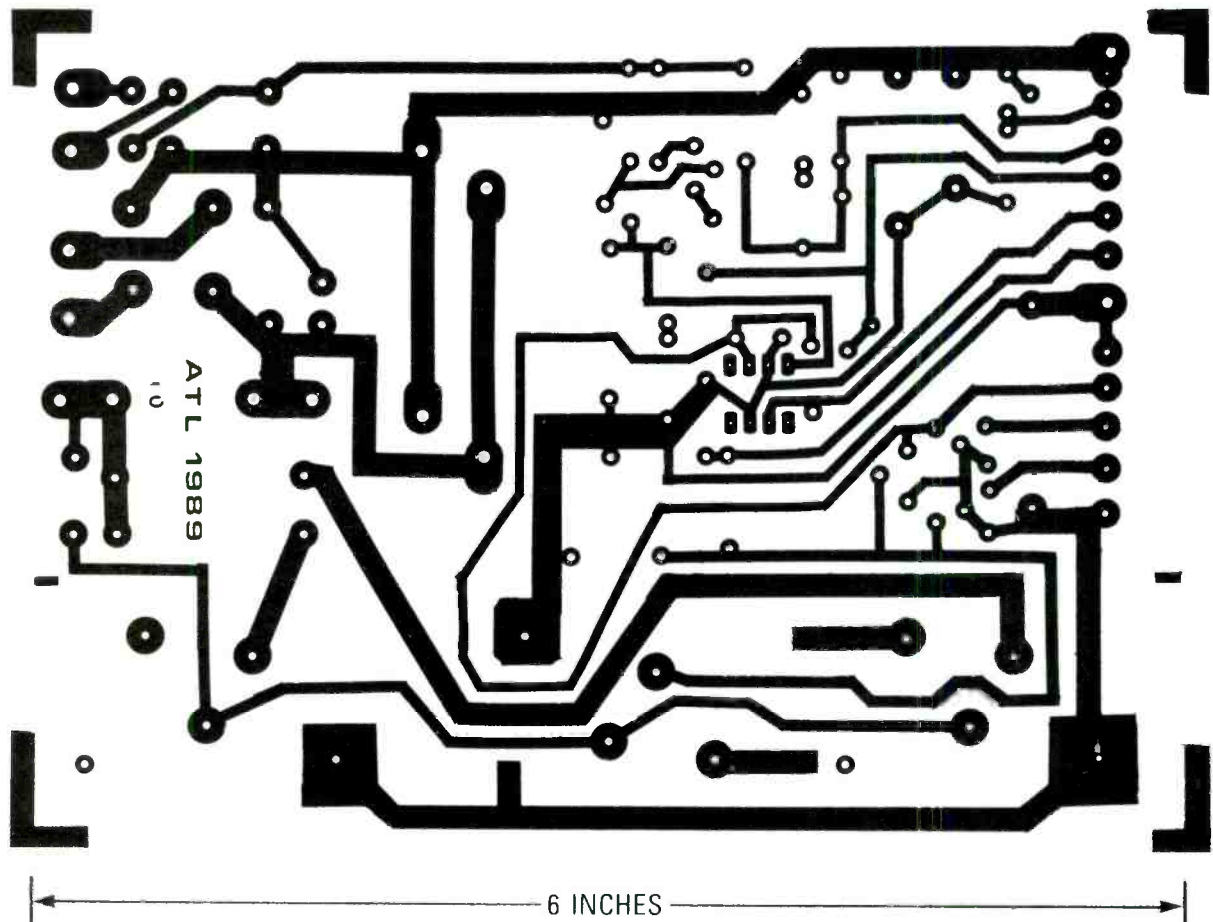

UNIVERSAL POWER SUPPLY FOIL PATTERN.

"The SEMIANALYZER is the most complete test equipment on the bench" — R. Hohl, GMC, MI



**\$399**

- CHECKS AND IDENTIFIES SEMICONDUCTORS IN CIRCUIT
  - MEASURES VOLTAGE BREAKDOWN, LEAKAGE, NOISE OF CAPACITORS, SEMICONDUCTORS, NEONS, LEDS, SWITCHES
  - SIGNAL TRACER WITH ALC AND 3½ DIGIT DC VOLTMETER
  - OPTIONAL PLUG-IN IR REMOTE CONTROL TESTER PROBE
  - 60 DAY SATISFACTION OR MONEY-BACK GUARANTEE
  - "THE SEMIANALYZER SPEEDS UP SERVICE ON TV AND VCR"
- AJ'S TV-SAT-VCR Service, IA

## PORTABLE TESTER FOR MICROWAVE OVENS

**\$329**



- MEASURES COMPONENTS AT HIGH-VOLTAGE LOADS
- IN-CIRCUIT TEST OF HV DIODE, CAPACITOR, MAGNETRON
- MEASURES UP TO 5000V AC OR DC IN TWO RANGES
- ALSO CHECKS TRIACS, TRANSISTORS, MOSFETS, SCRs
- 60 DAY SATISFACTION OR MONEY-BACK GUARANTEE

Southgate Electronics Distributor

(305) 720-4497

275 Rock Island Road, North Lauderdale, FL 33068

CIRCLE 22 ON FREE INFORMATION CARD

## BATTERY TECHNOLOGY

continued from page 14

unit of charge, not energy. A 1-

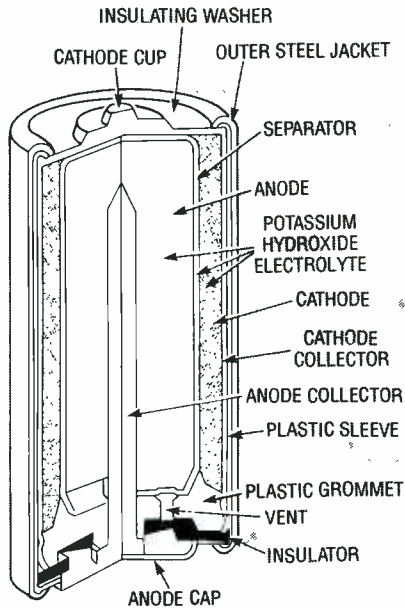

FIG. 3—THIS IS A CROSS section of an alkaline cell showing its annular construction.

amp current corresponds to the motion of 1 coulomb (C) of charge past a given point in 1 second (s), or

$$1 \text{ amp} = 1 \text{ C/s,}$$

where,

$$1 \text{ C} = 6.25 \times 10^{18} \text{ electrons/s.}$$

The individual electron is often denoted by the variable  $e^-$ , so the above relation would appear as

$$1 \text{ C} = 6.25 \times 10^{18} e^-.$$

The metric unit of charge is the coulomb, while that of energy is the joule (J). The potential energy (or potential work)  $W$  contained in a battery is related to its total available charge  $q$  and terminal voltage  $V$  by

$$W = q \times V.$$

The variable  $W$  is used for energy to avoid confusion with  $E$  and  $V$ , normally reserved for voltage, although many texts use  $E$  for total energy (kinetic and potential) and  $V$  for potential energy as well, so you should know the context to avoid confusion. Thus, an "AA" Ni-Cd cell that can maintain a 0.6-amp load for one hour is said to contain

$$\begin{aligned} q &= 0.6 \text{ Ah,} \\ &= (0.6) \times \\ &\quad \left( \frac{6.25 \times 10^{18} e^-}{\text{C}} \right) \left( \frac{1 \text{ C}}{\text{s}} \right) \left( \frac{3600 \text{ s}}{\text{hr}} \right) (1 \text{ hr}) \\ &= 1.35 \times 10^{22} e^-, \\ &= 2160 \text{ C} \end{aligned}$$

of available charge. Such a cell has a terminal potential of

$$V = 1.2 \text{ volts,}$$

so the total energy nominally available from it is

$$W = q \times V = 0.6 \text{ C} \times 1.2 \text{ volts} = 0.72 \text{ J.}$$

As discussed earlier, Table 1 mentions the concept of energy density of cylindrical batteries, and uses another energy unit called the unit watt-hour (Wh), used with the electric meter on most houses. Electric utilities measure energy in watt-hours, not joules, since the numbers are more convenient.

The watt (W) is a unit of power, not energy, defined as

$$1 \text{ W} = 1 \text{ J/s.}$$

The variable for power is  $P$ : if

$$P > 0 \text{ W,}$$

then  $P$  normally refers to power expended or dissipated, like the loss from a resistor. Whereas, if

$$P < 0 \text{ W,}$$

the reverse is normally true, that power is being supplied, rather than expended. Thus, a watt-hour is equivalent to

$$\begin{aligned} 1 \text{ Wh} &= \left( \frac{1 \text{ J}}{\text{s}} \right) \left( \frac{3600 \text{ s}}{\text{hr}} \right) (1 \text{ hr}) \\ &= 3600 \text{ J,} \end{aligned}$$

There are two energy density values per cell in Table 1, one relative to mass, and the other to volume. Thus, for the carbon-zinc cell, for the value relative to mass

$$\begin{aligned} \frac{65 \text{ Wh}}{\text{kg}} &= \left( \frac{65 \text{ Wh}}{\text{kg}} \right) \left( \frac{3600 \text{ J}}{\text{Wh}} \right) \\ &= \frac{2.34 \times 10^5 \text{ J}}{\text{kg}} \end{aligned}$$

A similar argument follows for energy density relative to volume.

However, the same cell, if providing less current, can provide more useful energy, since there's then less internal battery heat loss. If the same "AA" cell were discharged over five hours, it could sustain a 130-milliamp load, for an observed capacity of

$$q = 650 \text{ milli-Ah.}$$

NO COMPLICATED ELECTRONICS, NO EXPENSIVE INSTRUMENTS:

## Home study course shows you how to make good money in VCR repair.

An amazing fact: you can do more than four out of five VCR repairs with ordinary tools and basic fix-it procedures. Our home study program shows you how.

Learn all of the systems, mechanisms, and parts of almost all brands of VCRs. With *no* expensive instruments. *No* complicated electronics. *No* fancy workshop. The step-by-step texts and close personal attention from your instructor make learning easy.

Texts, course materials, and tool kit are sent to your home. Graduate ready to make up to \$50.00 or more per hour in your own spare-time or full-time business.

**Send today for your free career booklet. Or call 800-223-4542**



Name \_\_\_\_\_  
Address \_\_\_\_\_  
City \_\_\_\_\_ State \_\_\_\_\_ Zip \_\_\_\_\_

**The School of VCR Repair**

2245 Perimeter Park, Dept. VM351, Atlanta, Georgia 30341



Cells are generally marketed using five-hour ratings, but any comparison of cells from different manufacturers should use equivalent ratings.

Battery manufacturers define C as rated capacity; the italics are used to avoid confusion with the coulomb. Charge and discharge currents are then discussed as multiples or fractions of C. The advantage is that we can discuss battery currents, not cell sizes or ratings; C for many manufacturers is based on a one-hour interval. Thus, an "AA" Ni-Cd cell has a rated capacity of

$$C = 600 \text{ milli-Ah.}$$

For example, under that convention, we could write

$$2 \times C = 1.2 \text{ Ah.}$$

or,

$$C/10 \text{ hours} = 60 \text{ milliamps.}$$

Ni-Cd cells are recharged by applying DC opposite to that generated during discharge, whether pure, half-, or full-wave rectified. Minimum commercial recharge rates used are about C/20, or taking 20 hours to recharge to rated capacity. But since charging isn't 100% efficient, especially when it's so slow, some 36-48 hours would realistically be needed.

● **Is there a danger of overcharging a Ni-Cd battery?**

Recharging efficiency decreases as it nears completion. The final few percent is returned as the cell approaches "overcharge," where Ni-Cd cells generate gaseous oxygen (O<sub>2</sub>). At low recharge current, continuous overcharge isn't damaging, since the cell electrochemically recombines the total oxygen volume, letting Ni-Cd cells be totally sealed.

For safety, venting is designed into the cell cover. If overcharged at current above a recommended limit, the oxygen is expelled via such a vent, which then reseals. Repeated venting does dry out water from the electrolyte, causing damage manifested as decreased lifetime for a given load.

Also distinguishing primary cells from Ni-Cd cells is the property of charge retention. Alkaline cells can maintain full charge in ambient environments for up to four years, especially if they're re-

frigerated, whereas most Ni-Cd cells will lose some 1-2% of their rated capacity per day. That's why many commercial Ni-Cd cell applications use trickle charging (as low 0.02C) when the battery reaches an overcharge condition.

● **I've heard a great deal about charge rates, especially "quick" and "fast" charging. What's the distinction?**

Battery manufacturers have met market demands for cells with faster recharge rates. "Standard" charging is at a rate of 0.1 C, or 16-20 hours. "Quick" charging is at a rate of 0.33C, or 4-5 hours. Cells are available that can sustain continuous overcharge, with 100% oxygen recombination, at up to 0.33C, eliminating the need for trickle charging. "Fast" charging has become the industry standard, being a rate of 1.0C or higher, up to 2C-4C; recharge shutoff is done to prevent oxygen venting, even though it does no damage.

● **Explain how cells are configured to make batteries. Don't I need certain additional knowledge about performance?**

Assembling cells into batteries can appear, at least superficially, to be a rather trite exercise. However, knowing correct cell performance doesn't necessarily guarantee uniform, successful battery performance. Experienced product designers and hobbyists alike are aware that battery assembly can involve some important concerns, not the least of which is cell reversal. Ni-Cd cells are typically series-connected for higher voltage, and capacity is achieved using cells of adequate size.

Ni-Cd cells are typically connected in series for batteries. Runtime, or capacity, is met by using cells of sufficient size to meet the requirement. Cells of even the same size and manufacture lot can exhibit actual capacities that vary up to 8% of a mean. In multicell batteries, such variances can cause some cells to give up the last of their usable capacity, while others are still viable. If the extent of discharge is deep enough to bring one or more cells to zero voltage, cell reversal can occur.

● **Explain cell reversal.**

**DIGITAL VIDEO STABILIZER  
ELIMINATES ALL VIDEO COPY  
PROTECTIONS**



While watching rental movies, you will notice annoying periodic color darkening, color shift, unwanted lines, flashing or jagged edges. This is caused by the copy protection jamming signals embedded in the video tape, such as Macrovision copy protection. Digital Video Stabilizer: RXII completely eliminates all copy protections and jamming signals and brings you crystal clear pictures.

**WARNING :**  
**SCO**  
**Electronics and RXII dealers do not encourage people to use the Digital Video Stabilizer to duplicate rental movies or copyrighted video tapes. RXII is intended to stabilize and restore crystal clear picture quality for private home use only.**

- FEATURES:**
- Easy to use and a snap to install
  - State-of-the-art integrated circuit technology
  - 100% automatic - no need for any troublesome adjustments
  - Compatible to all types of VCRs and TVs
  - The best and most exciting Video Stabilizer in the market
  - Light weight (8 ounces) and Compact (1x3.5x5")
  - Beautiful deluxe gift box
  - Uses a standard 9 Volt battery which will last 1-2 years.

(Dealers Welcome)

To Order: \$59.95 ea + \$4 for FAST UPS SHIPPING  
**1-800-445-9285** OR **516-568-9850**  
Visa, M/C, COD M-F: 9-6 (battery not included)  
SCO ELECTRONICS INC.  
Dept. CREF 581 W. Merrick Rd. Valley Stream NY 11580  
Unconditional 30 days Money Back Guarantee

CIRCLE 17 ON FREE INFORMATION CARD

**CABLE TV  
DESCRAMBLERS**

**How You Can Save Money on  
Cable Rental Fees**

**Bullet Proof**



- 1 Unit 5+
- |                           |                                      |   |
|---------------------------|--------------------------------------|---|
| BEST Super Tri-Bi Auto/   | Var. Gain Adjustment \$119.95...\$85 | <b>US Cable'll Beat<br/>Anyone's Price<br/>Advertised in<br/>this Magazine!</b> |
| Jerrold Super Tri-Bi ...  | \$109.95...\$79                      |   |
| Scientific Atlanta .....  | \$109.....\$79                       |   |
| Pioneer .....             | \$109.....\$79                       |   |
| Panasonic TZPC145.....    | \$99.95...\$79                       |   |
| Stargate Converter.....   | \$95.....\$69                        |   |
| Digital Video Stabilizer. | \$59.95...\$29                       |   |
- Wireless Video Sender. \$59.95...\$49.95

**30 Day Money Back Guarantee**

**FREE 20 page Catalog**

Visa, M/C, COD or send money order to:

**U.S. Cable TV Inc.** Dept. KREF1  
4100 N. Powerline Rd., Bldg. F-4  
Pompano Beach, FL 33073

**1-800-772-6244**

**For Our Record**

I, the undersigned, do hereby declare under penalty of perjury that all products purchased, now and in the future, will only be used on Cable TV systems with proper authorization from local officials or cable company officials in accordance with all applicable federal and state laws. FEDERAL AND VARIOUS STATE LAWS PROVIDE FOR SUBSTANTIAL CRIMINAL AND CIVIL PENALTIES FOR UNAUTHORIZED USE.

Date: \_\_\_\_\_

Signed: \_\_\_\_\_

**No Florida Sales!**

CIRCLE 18 ON FREE INFORMATION CARD

The voltage of a cell is the stored potential or electromotive force (EMF) capable of driving current through a circuit. When a cell is reversed, its energy is expended to the point where any further current drain is into the cell, such that the circuit drives the cell, instead of the reverse, as shown in Fig. 4. During reversal, cell voltage can go as low as  $-1.4$  volts, generating gaseous hydrogen ( $H_2$ ), which doesn't recombine and has to be vented.

The solution to cell reversal is to understand and design for applications where cells have the

potential for repeated reversal. Product designers can choose to use a cutoff circuit to terminate discharge based on battery voltage, to prevent cell reversal. Motorized products draw high current, so when their performance decays before the onset of reversal, they should be shut off. Modern Ni-Cd cells are more tolerant of cell reversal. Modern Ni-Cd cells repeatedly tested to 40% reversal at 10C have suffered no degradation.

Finally, if all Ni-Cd cells in a battery pack are overcharged, reversal is less likely since they all

begin to discharge from the same

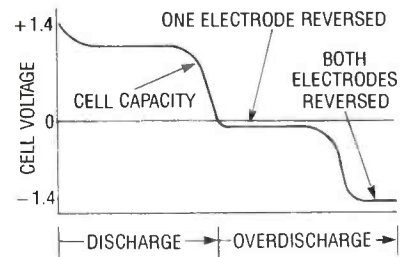

FIG. 4—IN CELL REVERSAL, the stored energy of a cell is expended to the point where the circuit drives the cell, instead of the reverse.

point. Building batteries from cells of equal capacities reduces the effect of individual cell variation at the end of discharge, and minimizes the chance of reversal.

• **Memory continues to be a much-discussed problem in Ni-Cd batteries. How is memory avoided?**

No discussion of Ni-Cd cells would be complete without mentioning the "memory" effect. The term memory was coined in the early 1960's during early NASA satellite flights. Satellite batteries have strict discharge/recharge regimes and receive very little overcharge. Such precise regimes were the result of NASA computer-controlled energy management, and are seldom duplicated commercially.

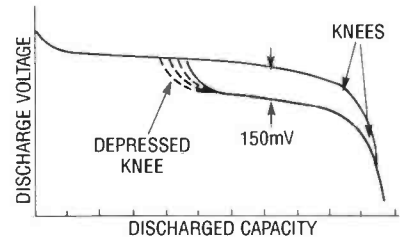

FIG. 5—IN NI-Cd "MEMORY," cells repeatedly discharged only partially to the same extent, and then recharged soon won't discharge beyond the "memorized" level.

If Ni-Cd cells are repeatedly discharged only partially to the same extent (or thereabouts) and then fully recharged, they reach a point where they won't discharge further than the "memorized" location in their discharge profile. Today, the term "memory" is a misnomer, since it's now applied to a much wider range of similar problems.

Voltage depression and poor capacity are two common exam-

**WORKING WITH**  
**Shape Memory Wires**

**Book and Sample Kit only**  
**\$29.90**  
Plus \$4.00 P&H  
CA orders add tax

## Discover Muscle Wires!™

These amazing metal alloy filaments actually *contract in length* when powered and relax when unpowered! Read about them in our new book "Working with Shape Memory Wires" — 96 pages of history, methods, circuits, devices and 14 hands-on projects.

And our new Muscle Wire Sample Kit has 20 cm each of 50, 100 and 150  $\mu$ m dia Flexinol wire, and 20 cm of 150  $\mu$ m BioMetal wire.

Use Muscle Wires with Robotics, Railroads, R/C and Scale Models, Electronics, Computers and anywhere you need small, strong, electric motion *without motors or solenoids!*

Order Today and "Get Moving"!

**Mondo-tronics, Inc.**      ★ Flyer Request Line (24 hrs): 415-351-5367  
**2476 Verna Court**        ★ Credit Card Orders by FAX: 415-351-6955  
**San Leandro, CA 94577**    ★ Computer Info/Order BBS: 415-351-5410  
Check, MO, Visa, MC (300 to 2400 baud, N, 8, 1)

CIRCLE 23 ON FREE INFORMATION CARD

## SUPER LONG PLAY TAPE RECORDERS

**12 Hour Model — USES 120 TAPE \$119.00\***

Modified Panasonic Slimline, high quality AC-DC provide 6 continuous hours of quality recording & playback on each side of cassette for 12 hours total. Includes • Voice level control • Digital counter, etc. TDK — 120 Cassette Furnished.

**PHONE RECORDING ADAPTER**

Records calls automatically. All Solid state connects to your telephone jack and tape recorder. Starts recording when phone is lifted. Stops when you hang up. **\$28.50\*** FCC APPROVED

**VOX VOICE ACTIVATED CONTROL SWITCH**

Solid state. Self contained. Adjustable sensitivity. Voices or other sounds automatically activate and control recorder. Uses either recorder or remote mike. **\$28.50\***

\* Add for ship. & handling Phone Adapter & Vox \$2.00 each. Recorders \$5.00 each. Calif. Res. add tax. Mail order, VISA, MIC, COD's OK. Money Back Guarantee. Quantity discounts available. Dealer Inquiries invited. Free data.

**AMC SALES INC.** Dept. A 9335 Lubec Street  
 Box 928, Downey, CA 90241  
 Phones (213) 859-8519 1-800-926-2488  
 FAX (213) 923-1478  
 Mon-Fri 8-5 PAC TIME

CIRCLE 20 ON FREE INFORMATION CARD

# ATTENTION! ELECTRONICS TECHNICIANS

**EARN YOUR B.S.E.E. DEGREE THROUGH HOME STUDY**

Our New and Highly Effective Advanced-Placement Program for experienced Electronic Technicians grants credit for previous Schooling and Professional Experience, and can greatly reduce the time required to complete Program and reach graduation. No residence schooling required for qualified Electronic Technicians. Through this Special Program you can pull all of the loose ends of your electronics background together and earn your B.S.E.E. Degree. Upgrade your status and pay to the Engineering Level. Advance Rapidly! Many finish in 12 months or less. Students and graduates in all 50 States and throughout the World. Established Over 40 Years! Write for free Descriptive Literature.

## COOK'S INSTITUTE OF ELECTRONICS ENGINEERING

4251 CYPRESS DRIVE  
 JACKSON, MISSISSIPPI 39212

CIRCLE 27 ON FREE INFORMATION CARD



ples, often mistaken for memory, manifested as shortened run-time, as shown in Fig. 5. Devices frequently won't operate at voltages below a specific design value, or will exhibit reduced performance, at best. Causes include low recharging, excess recharge current, excess battery heat during recharge, improper recharge termination voltage, or wearout.

During standard or quick recharging, Ni-Cd cells need some overcharging, since recharging isn't 100% efficient. If they're not fully recharged, they can't deliver their rated capacity. Excessive overcharge currents can cause overheating in Ni-Cd battery packs. In overcharge, the energy provided to the battery is predominantly converted to heat, since the chemical conversions are complete, or nearly so. Such overcharging accelerates wearout or causes voltage depression or poor capacity, although improved Ni-Cd cell designs have lower sensitivity. Such improvements, along with careful application, insure long life.

● **Does the electrolyte in a Ni-Cd cell ever leak?**

Ni-Cd cells can undergo storage leakage, especially in radio applications, if left on. However, even if turned off, solid-state power supplies often allow leakage current. In other words, the battery is not completely disconnected from the load circuit even when the power is turned off. Over a period of time, ranging from one week to two months, leading to minor battery leakage. Even if designed to prevent such an occurrence, a minor short may occur, insufficient to affect performance even when turned on, but resulting in what's known as "creep" leakage.

In the above cases, "creep" usually manifests itself as white fuzz around the top seal of a cell. To avoid it, turn power switches off when equipment isn't in use. In radios unused for extended periods, remove the batteries, and replace them when needed. Even if creep does occur, a Ni-Cd cell can be recharged, with proper care.

● **Ni-Cd cells have been around a long time, and yet the application of that technology is grow-**

**ing and changing. What technology improvements, if any, have occurred that we should be aware of, and is there anything better available on the horizon?**

Ni-Cd manufacturers are continuously seeking to improve product capabilities and quality.

Increased capacity means longer run times; for many years, makers have boosted capacity by over 10% a year, itself driving research into new electrochemical couples. Rechargeable lithium and Ni-metal hydride cells are prominent contenders, with significant increases in energy density over Ni-Cd cells, but their availability is still limited.

Safety continues to impede broad acceptance of lithium cells. Metal-hydride is progressing steadily, and is also equivalent in voltage to that of Ni-Cd cells. Broad acceptance of metal-hydride depends on its ability to be successfully used in several environments. Ni-Cd cells offer such flexibility today, at reasonable prices. Also, the prices of newer technologies will further impede broad acceptance. In our next article, we'll spotlight some recent ingenious and innovative applications of batteries. R-E

## LASERS

### HELIUM NEON LASER MODULE

This Module contains a HeNe Tube and matching Power Supply, all in one housing. All that is needed to make the Laser operate is a 12 volt source along with a switch and pilot light. Comes with instructions and a 1 year warranty.

Makes an ideal Science Fair Project

Output: 0.5mW continuous @ 633 nm (Red)

Power Requirements: 12 VDC @ 600mA.

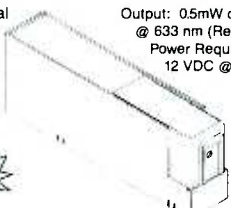

Cat # HNKD-10

**\$59.00**

Complies with C.D.R.H. regulations

### 2mW He-Ne LASER KIT



The Kit includes the Laser Head and matching power supply, along with instructions. Requires 110 VAC, 19 watts to operate. Kit complies with C.D.R.H. regulations.

Cat. # HNK-20X

**\$99.00**

**FOR FAST SERVICE**  
Call to Ship COD add \$8.00 for S & H. AZ residents add 6.5% sales tax.

**TOLL FREE #**  
for orders only  
**800-722-0392**  
Mon - Fri. 8 a.m. - 6 p.m.

**FREE CATALOG** — Call, Write or Fax Today!

## MEREDITH INSTRUMENTS

P.O. Box 1724 • 5035 N. 55th Ave., #5 • Glendale, AZ 85301  
Phone: (602) 934-9387 Fax: (602) 934-9482

CIRCLE 28 ON FREE INFORMATION CARD

## ADVERTISING INDEX

Free Information Number	Page
20 AMC .....	20
— Antique Electronics .....	127
— CB City .....	127
6 C&S Sales .....	CV2
10 Chenesko .....	51
27 Cooks .....	20
24 Datak Corp. ....	128
— Electronics Book Club .....	7
— Electronics Engineers B.C. ....	23
8 Heath .....	16
— Information Unlimited. ....	24
25 Jensen Tools .....	21
16 Kelvin Electronics .....	9
28 Meredith Instruments .....	21
5 Ming Engineering .....	CV3
23 Mondotronics .....	20
15 Mouser .....	51
— NRI Schools .....	5
19 Optoelectronics .....	3
21 Panavise .....	22
14 School of VCR Repair .....	18
17 SCO Electronics .....	19
22 Southgate Electronics .....	17
— Startek .....	CV4
18 U.S. Cable .....	19
9 Worldwide Components .....	127

FREE Catalog

### All the tools & test equipment you need for hobby or work!

**Electrical, electronics, computers, communications, sound systems — all the tools, meters and other equipment you need to do a professional job!**

Top technicians and field service personnel prize their Jensen tool kits. Our new 232-page Master Catalog will show you why. You'll discover hard-to-find items, the latest high-tech developments, soldering stations, wire & cable accessories and many more quality products you want and need. **Send for your free copy today!**



**JENSEN TOOLS INC.**

7815 South 46th St.,  
Phoenix, AZ 85044-5399  
Phone: (602) 968-6231  
FAX: (800) 366-9662



CIRCLE 25 ON FREE INFORMATION CARD

R-E EXPERIMENTERS HANDBOOK

# NEW PRODUCTS

Use the Free Information Card for more details on these products.

**ACCEL TECHNOLOGIES** calls its *Tango-Route PRO* the most powerful autorouter running on IBM-PC's and compatibles, and claims that designers will typically experience 20%–300% faster routing than with comparable, high-end PC-based autorouters. *Tango-Route PRO* features a unique "reconstruct" autorouting algorithm that passes remove and re-place connections for fast, high completion of all current printed circuit board technologies, including multi-layer through-hole, fine line, and SMD. In addition, manufacturing improvement algorithms ensure high yields, lower the cost

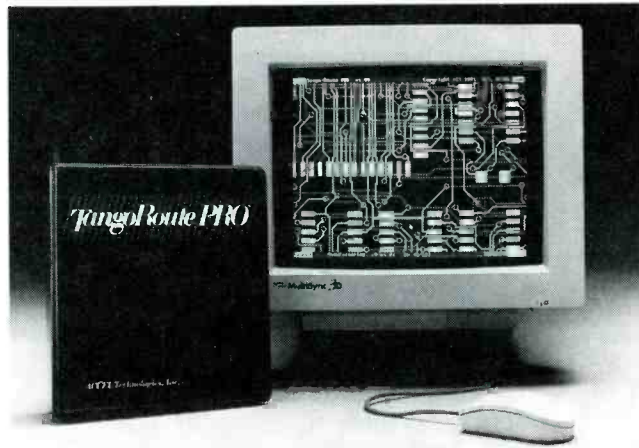

CIRCLE 11 ON FREE INFORMATION CARD

of fabrication, and enhance board aesthetics. Easy access is provided by the ACCEL productivity interface, a Windows-like, menu-driven interface that can be used by professional de-

signers and novices alike. Prompts and on-line help are available to provide cues to proper operation of the unit.

*Tango-Route PRO* analyzes the current board, its

placement, and the user-defined design rules. Then it applies heuristics gathered from routing hundred of boards to the process of selecting optimal defaults. When the user selects this automated method of operation, it will automatically determine the best routing grid or grids, routing passes, layer directionality, and via grids. That reduces setup time and allows the user to get up and running quickly.

*Tango-Route PRO* has a suggested list price of \$5500.—**ACCEL Technologies, Inc.**, 6825 Flanders Drive, San Diego, CA 92121; Phone: 619-554-1000; Fax: 619-554-1019. **R-E**

## Ready, Willing and Able.

### 324 PanaVise Electronic Work Center ▶

This economical package makes work areas more efficient and manageable. Parts, tools, solder, soldering iron holder and PC board are exactly where you want them! Features famous PanaVise "tilt, turn and rotate" control. Solder spool holder self-centers the feed, and the soldering iron holder keeps the iron at an easy-to-reach angle. Rugged, sturdy and tough, it also accepts all regular PanaVise interchangeable heads.



### ◀ 301 Standard PanaVise

Here's the world's best small vise and the perfect introduction to PanaVise quality and convenience. One control knob locks work firmly into position! Also accepts all regular PanaVise interchangeable heads.

### ▲ 396 Wide Opening Head PanaVise

Combine our 300 Standard Base (which accepts all PanaVise interchangeable heads) with our 366 Wide Opening Head to create a versatile work-holding tool. Ribbed neoprene jaw pads hold circuit boards or other objects securely; reverse them for deep "v" grooves that can hold delicate cylindrical objects.



**PANA VISE**®

1485 Southern Way  
Sparks, Nevada 89431  
Tel: (702) 353-2900  
Fax: (702) 353-2929



# Take Any 3 PROFESSIONAL BOOKS for only \$9<sup>95</sup>

when you join the **ELECTRONICS ENGINEERS' BOOK CLUB**

values to \$132.40



9255 \$97.50  
Counts as 3

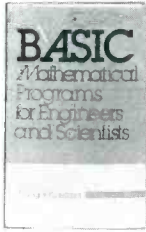

8225P \$19.95



053570-1 \$64.95  
Counts as 2

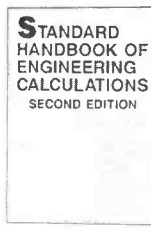

028735-X \$79.50  
Counts as 3

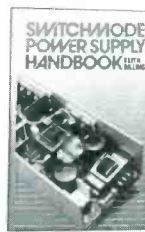

9305 \$59.50  
Counts as 3



057537-1 \$39.95

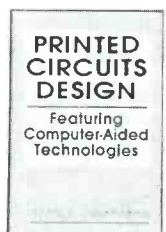

10016 \$39.95  
Counts as 2

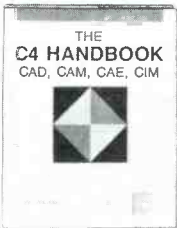

3098 \$44.50  
Counts as 2

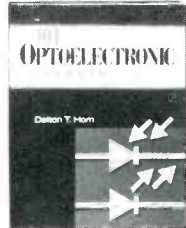

3205 \$24.95

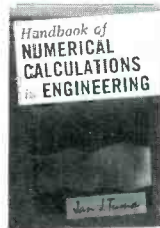

9321 \$57.50  
Counts as 2



3199 \$52.00  
Counts as 2



3147 \$38.95

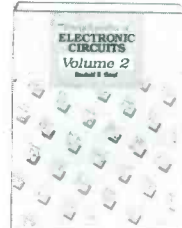

3138 \$60.00  
Counts as 2



2672 \$49.50



033559-1 \$27.95

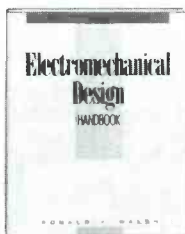

3102 \$49.95  
Counts as 2

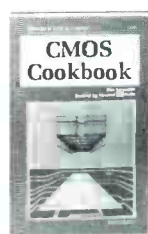

9244P \$18.95



3203 \$46.95  
Counts as 2



3375 \$32.95

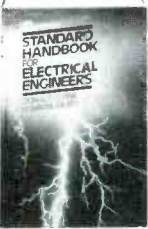

020975-8 \$99.50  
Counts as 3

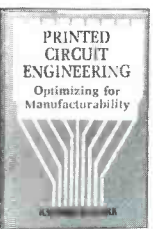

9245 \$46.95  
Counts as 2

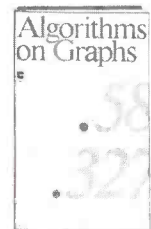

3429 \$29.95

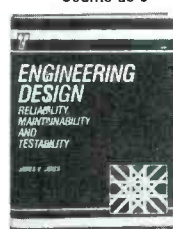

3151 \$42.95

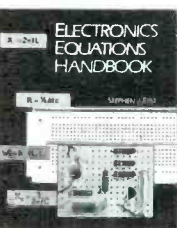

3241P \$16.95

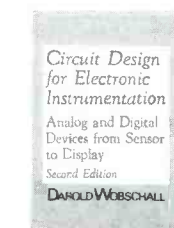

071231-X \$54.95  
Counts as 2



10037 \$44.95  
Counts as 2

## How the Club Works

**YOUR BENEFITS:** You get 3 books for \$9.95 plus shipping and handling when you join. You keep on saving with discounts of up to 50% off as a member.

**YOUR PROFESSIONAL BOOKSTORE BY MAIL:** Every 3-4 weeks, you will receive the Electronics Engineers' Book Club News describing the Main Selection and Alternates, as well as bonus offers and special sales, with scores of titles to choose from.

**AUTOMATIC ORDER:** If you want the Main Selection, do nothing and it will be sent to you automatically. If you prefer another selection, or no selection at all, simply indicate your choice on the reply form provided. You will have at least 10 days to decide. As a member, you agree to purchase at least 3 books within the next 2 years and may resign at any time thereafter.

**BONUS BOOKS:** Starting immediately, you will be eligible for our Bonus Book Plan, with savings of up to 80% off publishers' prices.

**IRONCLAD NO-RISK GUARANTEE:** If not satisfied with your books, return them within 10 days without obligation!

**EXCEPTIONAL QUALITY:** All books are quality publishers' editions especially selected by our Editorial Board. (Publishers' Prices Shown)

The Electronics Engineers and Designers Book Club and the Electronics and Control Engineers' Book Club have joined forces to bring you all the best titles from the most prominent electronics publishers.

### ELECTRONICS ENGINEERS' BOOK CLUB

Blue Ridge Summit, PA 17294-0860

**YES!** Please accept my membership in the ELECTRONICS ENGINEERS' BOOK CLUB and send the 3 volumes listed below, billing me \$9.95. If not satisfied, I may return the books within ten days without obligation and have my membership cancelled. I agree to purchase at least 3 books at regular Club prices during the next 2 years and may resign any time thereafter. A shipping/handling charge and sales tax will be added to all orders.

Name \_\_\_\_\_  
 Address \_\_\_\_\_  
 City \_\_\_\_\_  
 State \_\_\_\_\_ Zip \_\_\_\_\_ Phone \_\_\_\_\_

Valid for new members only. Foreign applicants will receive special ordering instructions. Canada must remit in U.S. currency. This order subject to acceptance by the Electronics Engineers' Book Club. RPIF991X

All books are hardcover unless number is followed by a "P" for paperback.  
 ©1991 EEBC, Blue Ridge Summit, PA 17294-0860

P-R EXPERIMENTERS HANDBOOK

# AMAZING ELECTRONIC PRODUCTS and KITS

## NEW CONCEPT! Mystery Levitating Device



**Remember War of the Worlds?** Objects float in air and move to the touch. Defies gravity, amazing gift, conversation piece, magic trick or great science project.

ANT1K Easy to Assemble Kit / Plans ..... \$14.50

## Combination Solid State Tesla Coil & Variable 100,000VDC Generator



Operates 12-19 VDC for Field Use or 115 VAC For Laboratory Use

### Experiments Using Tesla Coil:

- Plasma in a Jar/Tornado, Furnace
- Kirlian Photography
- Wireless Energy Transmission
- Induction Fields • Pyrotechnic Effects
- Corona and Brush Discharge
- Energizer for Neon Plasma Tubes

### Experiments Using Hi Volts DC:

- Plasma Blaster Driller/Cutter
- Anti-Gravity/Force Fields
- Ion Reaction Motors
- Lightning Generation
- High Ion Source
- Ozone For Air Purification
- Electrification of People & Objects
- Particle Accelerators/Atom Smashing
- High Energy Capacity Charging

HVM7 Plans Complete System ..... \$10.00  
HVM7K Complete System Kit/Plans ..... \$149.50  
TCL4K Tesla Coil Only Kit/Plans ..... \$79.50  
115/19AC Wall Adapter for 115AC ..... \$9.50

## Solar Power! All New!

Free, Clean, Safe and Plenty for All

SOL1 4" Dia., .5V, 2A Silicon Cell & Plans ... \$7.50  
SOL2 6x12", 14V, .2A Amorphous Cell & Plans \$6.50

### Solar Energy Kits / Build The Following:

SOLM1 Motor Kit For Science Fair ..... \$14.50  
SOLIT1 12" Multi-color Neon Outside Lite Kit \$34.50  
SOLCH1 Charger Kit With 6V 9A Battery .. \$24.50  
SOLSHK1 Shocker Kit For Objects, Fence, Bug Zapper ..... \$29.50

## Solar Furnace

Use the power of the sun to build a device that can melt metal! Easy to build, excellent science fair project.

SOLFUR1+ Data Sheets, w/Big Fresnel Lens \$14.50

## Plasma Fire Saber

Produces the spectacular effect that captured the fantasy of millions of movie fans. Visible plasma field is controlled by grip pressure and adjusts saber length. Active energy field produces weird & bizarre effects. Excellent for special effects. Specify photon blue, neon red, phasor green, or starfire purple.

PFS2 Plans .... \$8.00 PFS2K Kit/Plans \$49.50

Special Offer PFS20 Assembled reg \$89<sup>50</sup>, \$59.50

**Dancing Plasma Lights** - Neat electronic circuit causes the discharge in fluorescent and gas lamps to move to sounds and music. This is one of the best devices to use with your stereo music system for a fantastic display effect. Easy and simple to install.

DPL1KM Easy To Assemble Electronic Kit . \$29.50

## Dancing Plasma Lights

Connects between telephone and recorder • No power req needed  
• Undetectable • Crystal Clear • Extends Tape Time  
Special Offer! TAT30 Ready to Use . reg 24<sup>50</sup> \$14.50

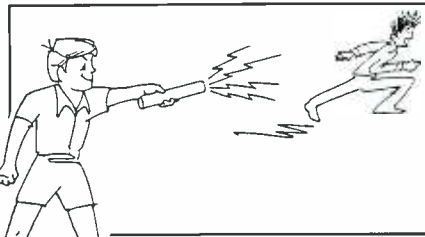

## Shocker Force Field / Vehicle Electrifier

Neat little device allows you to make hand and shock balls, shock wands and electrify objects, charge capacitors. Great pay back for those wise guys who have wronged you!

SHK1KM Easy To Assemble Electronic Kit . \$19.50

## 100,000V Intimidator / Shock Wand Module

Build an electrical device that is effective up to 20 feet. May be enclosed for handheld, portable field or laboratory applications.

ITM2KM Easy to Assemble Electronic Kit . . \$49.50

## Blaster Blitzer Device

Our answer to legal, effective personal protection. 20 shot capacity disables attacker for up to 30 minutes. Also marks subject for identification. Mini spray can with 8-10 ft range.

BLTZ1 Ready to Use ..... \$12.50

## Invisible Pain Field Generator

Shirt pocket size electronic device produces time variant complex shock waves of intense directional acoustic energy capable of warding off aggressive animals, etc.

IPG7 Plans .... \$8.00 IPG7K Kit / Plans \$49.50  
IPG70 Assembled ..... \$74.50

## Homing / Tracking Transmitter

Beeper device, 3 mile range.  
HOD1 Plans .... \$10.00 HOD1K Kit/Plans \$49.50

## Listen Thru Walls, Floors

Highly sensitive stethoscope mike.  
STETH1 Plans ... \$6.00 STETH1K Kit/Plans \$49.50

## 3 Mile FM Wireless Mike

Crystal clear, ultrasensitive pickup transmits voices and sounds to FM radio. Excellent security system, warns of intrusion. Become your neighborhood disk jockey! Monitor children and invalids.  
FMV1 Plans .... \$7.00 FMV1K Kit/Plans . \$39.50

## Telephone Transmitter - 3 Miles!

Automatically transmits both sides of a telephone conversation to an FM radio. • Tunable Frequency  
• Undetectable on Phone • Easy to Build & Use  
• Up to 3 Mile Range • Only transmits during phone use  
VWPM7 Plans .... \$6.00 VWPM7K Kit/Plans \$39.50

## Automatic Telephone Recording Device

Connects between telephone and recorder • No power req needed  
• Undetectable • Crystal Clear • Extends Tape Time  
Special Offer! TAT30 Ready to Use . reg 24<sup>50</sup> \$14.50

**Body Heat Telescope** - At last! A device that can detect people and animals at considerable distances. Excellent for intrusion alarms, detecting hot spots on objects and people.

BHT1 Plans .... \$10.00 BHT1K Kit/Plans \$99.50

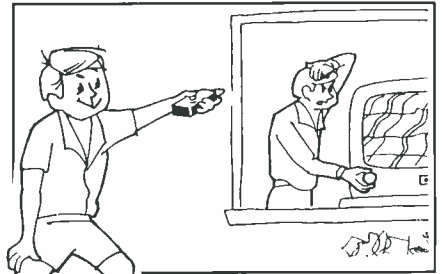

## TV & FM Joker / Jammer

Shirt pocket device allows you to totally control and remotely disrupt TV or radio reception. Great gag to play on family or friends. Discretion required.

EJK1KM Easy to Assemble Electronic Kit . \$14.50

## Visible Beam Laser

High Brightness red HeNe laser visible for miles. Produce your own light show - see HoloDiscs (below). Projects a beam of red lite clearly visible under most circumstances. Can be used to intimidate by projection of a red dot on target subject. Also may be used to "listen in" utilizing our laser window bounce method #LLIS1. Easy to Build Modules Produce A Working Visible Laser:  
LAS1KM Kit w/ 1 MW Laser Tube, Class II . \$69.50  
LAS3KM Kit w/ 2.5 MW Laser Tube, Class IIIA \$99.50

## Holo Discs™ Laser Lite Shows

All new patented concept! Produce your own animated special effect lite shows. Uses one of our laser module systems (see LAS1KM and LAS3KM above). Multi-programming disc with full instructions. Extremely simple to use. HODSK1 Holo Disc™ & Instructions \$49.50

## "Laser Bounce" Listener System

allows you to hear sounds from an area via a lite beam reflected from a window or other similar object. System uses our ready-to-use LATR1 Laser Terminator gun site as the transmitter. The receiver section is supplied as an easy-to-build kit, including our cushioned HS10 headsets. Order # LLIST20 System, includes our LATR1 Ready-to-Use Laser Gun Site, LLR1K Special Receiver Kit, and HS10 Headset, all for only \$299.50

## Visible Red Laser Diodes

670NM Toshiba. All new, full spec. #VRD1 3mw Laser Diode & Plans to Build a Complete System . \$49.50

## See In The Dark Viewing

Device uses invisible infrared illumination for seeing in total darkness. Excellent demonstration of night vision, along with observing lasers and other IR sources. Functional unit, many useful applications  
SD5 Plans ..... \$10.00  
SD5K Kit/Plans Basic \$299.50  
6032A 1st Gen Image Tube \$99.50  
IC16 2nd Gen Image Tube \$129.50  
PBK3K Power Supply Kit ..... \$44.50



## INFORMATION UNLIMITED

Dept PE11 , Box 716, Amherst, NH 03031  
Phone: 603-673-4730 FAX 603-672-5406  
MC, VISA, COD, Checks Accepted. Please Add \$5.00 Shipping & Handling

## Catalog

with many more items  
FREE with Order,  
Or Send \$1 P&H



Order by Mail,  
or by 24 Hour  
Orders-Only Phone:  
**800-221-1705**



# BUILD A SOLID-STATE DISK DRIVE



*Retain important PC data with  
this inexpensive battery-backed RAM disk.*

Wouldn't it be nice if you didn't lose memory contents every time you turned off your PC? And wouldn't it be nice to have a RAM disk that didn't tap into your regular memory, whether conventional (0-640K), extended (above 1 MB), or expanded (bank-switched beneath 1 MB)?

If you think that either would be nice, then you'll be interested in our static RAM disk. It's a full-length card for any 8- or 16-bit expansion slot; you can install 32K-512K of static CMOS RAM's on the board. The board has provision for an optional battery backup system so the card will retain its contents even after the main system loses power. That capability could be useful in remote data logging.

You can build the board for well under \$100, not counting the cost of the RAM. A double-sided PC board is available, as are complete kits and assembled units. The complete assembly-language source code for the RAM disk is also available, allowing custom modifications.

## Hardware overview

The circuit consists of three main sections: the RAM array, the bus interface circuit, and the battery backup circuit. Figure 1 shows a block diagram.

The static RAM portion consists of a maximum of sixteen 32K $\times$ 8 CMOS static RAM's (SRAM's), divided into two banks. The address and data lines of all SRAM's in both banks are driven by IC1, an 8255 configured as a triple parallel port. Port A drives the low-order address lines (A0-A7), Port B drives the high-order address lines (A8-A14), and Port C drives the data lines (D0-D7).

A second 8255, IC2, drives the chip select ( $\overline{CS}$ ) inputs of all SRAM's. Port A drives IC11-IC18, Port B drives IC19-IC26, and Port C is not used.

The bus interface consists of a group of buffers and gates that isolate the circuit from the PC expansion bus, and they're also used to decode a set of I/O port addresses for passing data and control information.

The battery-backup circuit consists mostly of several diodes that isolate the optional battery from the PC's power source. We'll discuss the hardware in more detail next time.

## Software success

Success for the PC has come about in part because of the expandability of the system. A good part of that versatile expandability is due to the concept of the *device driver*.

A device driver provides a means of adding special features to DOS in such a way that those features appear to be an integral part of DOS. In fact, DOS itself comes with several built-in device drivers.

- ANSI.SYS is a device driver that provides a standard way of dealing with the display system.
- DRIVER.SYS is a device driver that lets you add high-density floppy disks to older machines, and to refer to the same physical disk drive by several different drive letters.
- VDISK.SYS is a device driver that emulates a disk drive using either conventional or extended memory.

Manufacturers of special equipment often supply their own device drivers. For example, network interface cards, CD-

ROM drives, and some types of hard disks require device drivers.

What all device drivers share is the fact that, if a driver is to be used, it must be loaded from disk every time a PC boots. How does DOS know which device driver or drivers to load? Via the CONFIG.SYS file.

CONFIG.SYS is simply an ASCII text file; each driver that DOS is supposed to load must be specified on a separate line in the file. (CONFIG.SYS also specifies several operational parameters particular to your machine; see your DOS manual for details.)

The structure of a device driver line in CONFIG.SYS is as follows. Spaces are shown for clarity, but must not be included, except between the name of the driver and the optional parameters.

```
DEVICE = [drive:[\PATH]  
          [DRVNAM][PARMS]
```

First comes the phrase DEVICE = . Then comes an optional drive and an optional path and subdirectory where the driver is stored. If no drive is specified, the boot drive is assumed. If no path is specified, the root of the boot drive is assumed.

Next is the name of the driver itself. The name must follow normal DOS file-naming conventions: a name with a maximum of eight characters, plus a three-

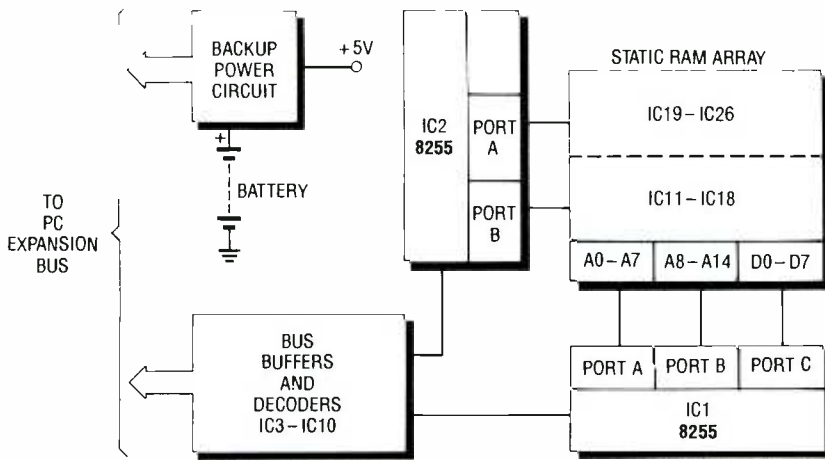

**FIG. 1.** THE STATIC RAM DISK consists of three major subsystems: an array of as many as sixteen 32K CMOS static RAM's, a bus-interface circuit, and a battery-backup circuit.

character extension. Common extensions include SYS and BIN, but neither is required. Last come any optional parameters the driver might require.

As you've probably guessed by now, the SRAM disk uses a device driver to talk to DOS.

### Types of device drivers.

There are two types of device drivers: character and block. As the names suggest, a character driver deals with information character by character, and an end of the driver in memory. In addition, it must initialize the hardware as required. The initialization routine is usually located last in the device driver file, so that after it does its job, the system can reclaim the memory that was formerly occupied by that driver.

The task of the strategy routine is to get a pointer to the DOS request header. The DOS request header is an array of bytes that communicates what type of activity DOS is trying to request from the driver. The address of the byte array is passed to the driver using register pair ES:BX.

The interrupt routine is what does the actual work. It can perform various types of operations, some of which are mandatory for block drivers, and others for character drivers. We'll discuss some of the more important operations now.

MediaCheck detects whether the storage media was removed or tampered with. BuildBPB

(Build BIOS Parameter Block) deals with that occurrence. For example, DOS calls BuildBPB whenever it detects that a floppy disk has been changed. In our driver, MediaCheck always returns an OK sign to DOS. Because of that, BuildBPB will be called only once, when the drive is initialized.

The input and output routines pass sectors of data to and from the disk. They use a buffer area specified by DOS in the request header. The number of bytes per transfer can not exceed 64K (the maximum size of a memory segment). If a file is larger than 64K, DOS will read or write the file in 64K chunks until the entire file has been transferred.

### Structure of a driver

Every device driver has a device header that occupies the first few bytes of the file. Our device header is shown in Table 1. The first entry (Nexdev) is there to provide a means of letting DOS link each device driver to the next. DOS fills in the links as it loads each driver: the last driver in the chain

## Parts List

### Resistors

All resistors are 1/4-watt, 5%, unless otherwise noted.

R1-R5..... 4700 ohms

R6-R21..... 22,000 ohms

### Capacitors

C1-C16..... 0.01  $\mu$ F polyester

C17..... 10  $\mu$ F, 10 volts, electrolytic

### Semiconductors

D1, D2..... 1N914 switching diode

IC1, IC2..... 8255 programmable peripheral interface

IC3..... 74LS245 bidirectional bus buffer

IC4, IC5..... 74LS244 octal bus driver

IC6..... 74LS138 three-to-eight line decoder

IC7..... 74LS85 four-bit comparator

IC8..... 74LS04 hex inverter

IC9..... 74LS00 quad NAND gate

IC10..... 74LS08 quad AND gate

IC11-IC26..... 43256-10 Static RAM

### Other Components

SW1..... four-position DIP switch

B1..... four AA cells, with holder (optional)

has -1 (FFFFh) in the Nexdev field.

The next entry is the attribute variable, whose value depends on the type of device. Our driver uses a value of 2000h, which is the setting for a non-IBM block device. If you run CHKDSK on the RAM drive, it returns a *Probable non-IBM disk* warning because of that value, but otherwise functions normally.

The next two entries are the ad-

**TABLE 1—DEVICE HEADER**

nexdev	DD	-1	
attribute	DW	02000H	
	DW	STRATEGY	
	DW	INTERRUPT	
	DB	1	; number of devices
	DB	(7) DUP ?	; used for char name
			; if char driver



dresses of the strategy and interrupt routines.

The last entry is an eight-byte field that is used differently for block and character devices. For a character device, you would assign a name like CON, PRN, LPT1, etc. For a block device, the first byte contains the number of physical devices that are being controlled by the driver, and the remaining seven bytes are undefined.

### The BPB

Another important data structure in a device driver is the BIOS parameter block, or BPB. The BPB is a data structure that tells DOS everything it needs to know about the format in which information is stored on the specified device. The BPB is located in the first sector of a disk, and it includes several items, as shown in Table 2.

The first item in the BPB contains the number of bytes per sector. The next item specifies the number of sectors per cluster. If you're unfamiliar with the term *cluster* (also known as the allocation unit), it specifies the smallest number of sectors that can be allocated to store a file. For example, if ten clusters were allocated to a file, and if the BPB defined four clusters per sector, then the file would consist of forty sectors. Even if a file is only a single byte in length, it requires a full cluster on the disk.

Different versions of DOS use different cluster sizes. DOS 3.3 generally allocates four sectors per cluster (depending on overall disk size); DOS 2.x allocated 8 sectors per cluster.

The default allocation unit in the static RAM disk is one sector/cluster, but you could alter that value to be any power of two (2<sup>0</sup>, 2<sup>1</sup>, 2<sup>3</sup>, etc.).

The next item in the BPB is the number of sectors reserved for the boot sector. The boot sector of the BPB contains a short program that starts the process of loading DOS from disk. DOS itself contains the remainder of the loader program.

The next entry specifies the number of File Allocation Tables (FAT's). DOS uses the file allocation

table to keep track of which sectors have been used, which are free, and which are physically damaged. DOS normally maintains two copies of the FAT; to conserve space, our driver maintains one.

Next in the BPB comes the number of directory entries. This value specifies the number of files that can be present in the root directory of a disk. (Subdirectories are actually files, so the number of subdirectories is limited only by the available disk space.) DOS 3.3 typically allows 512 directory entries; again, to conserve space, our driver allows 16.

The next BPB entry contains the total number of sectors contained on the disk. This value represents the total size of the disk, including space occupied by boot sectors, FAT's, etc. In our case, the total number of sectors (TS) can be determined from this formula:

$$TS = (32768/512) * (\text{number of SRAM's})$$

The next entry is called the media descriptor; it specifies the type of media being used, the number of sides, etc. Our driver uses the code for a single-sided floppy-disk drive.

Following the media descriptor is a field that specifies the number of sectors that must be allocated to each copy of the FAT.

Several other fields in the BPB are defined for use with physical disk drives, including the number of sectors per track, the number of disk heads, and the number of hidden sectors. Our

TABLE 2—BIOS PARAMETER BLOCK

BPB	EQU	\$	
BPB_SS	DW	512	; sector size in bytes
BPB_AU	DB	1	; sectors per cluster
BPB_RS	DW	1	; sectors for boot sector
BPB_NF	DB	1	; # of FAT tables
BPB_DS	DW	16	; # of Directory entries
BPB_TS	DW	1024	; # of total sector
BPB_MD	DB	0FEH	; media descriptor
BPB_FS	DW	4	; # of sectors/FAT(S)
BPB_ST	DW	00	; These variables would be
BPB_NH	DW	00	; drive
BPB_H5	DW	00	; used for a real disk
BPB_PRT	DW	BPB	; Pointer to this table

### Ordering Information

Note: The following are available

from

Hatronics

145 Lincoln Street

Montclair, NJ 07042

(201) 783-7264

(201) 245-6614 (BBS, join the

Hatronics conference)

Assembled and tested unit, OK ... \$135

Assembled and tested unit,  
256K ..... \$255

Assembled and tested unit,  
512K ..... \$395

A silicon boot board, (which allows  
the PC to boot from the RAM  
Drive) ..... \$42.00

All orders add \$10 for shipping and  
handling. ... New Jersey orders add 6%  
sales tax.

driver does not need to use any of those fields.

Obviously, the subject of device drivers is complex; for detailed information, the best work that was found by the author is called *Writing MS-DOS Device Drivers* by Robert S. Lai.

### Hardware details

The circuit consists of three main sections: a bus interface, a battery backup circuit, and the static RAM array. Figure 1 shows the complete schematic diagram.

The PC bus interface consists of IC3, IC4, and IC5. The latter are a pair of 74LS244's (three-state octal bus drivers) that buffer the address lines. A bi-directional three-state octal buffer (IC3, a 74LS245) buffers the data

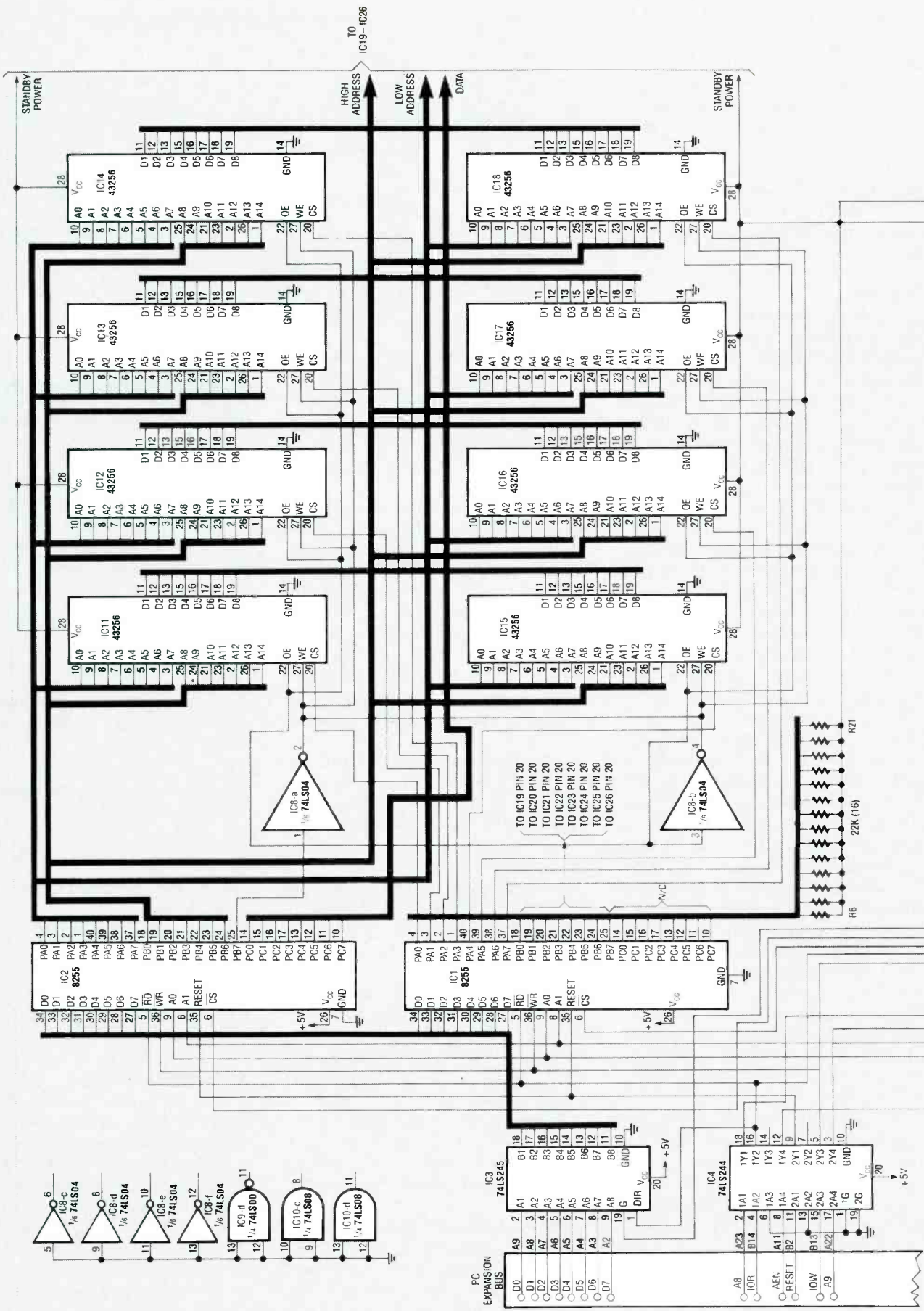
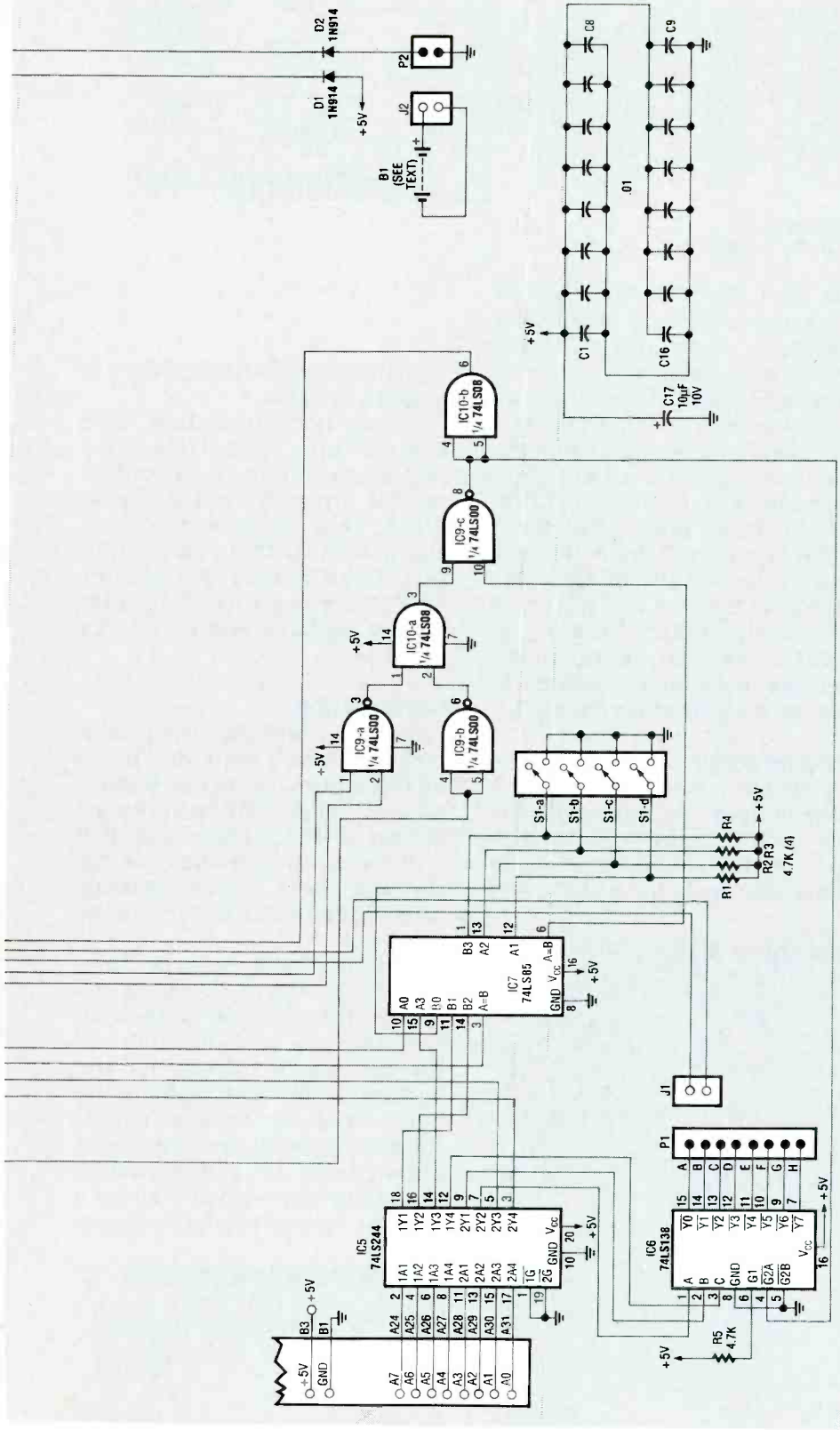

FIG. 1. THE SRAMDISK'S COMPLETE SCHEMATIC.





lines.

The  $\overline{\text{IOR}}$  (I/O Read) line from the expansion bus drives the data direction input of IC3; the decoding circuitry discussed below drives IC3's gate input (pin 19).

The decoding circuitry consists of IC6, IC7, and several gates in IC9 and IC10. Two outputs from IC6, a 74LS138 3-to-8 line decoder, drive the  $\overline{\text{CS}}$  inputs of the parallel ports (IC1 and IC2). In a multi-board system, the first board uses the two low-order outputs ( $\overline{\text{Y0}}, \overline{\text{Y1}}$ ) of IC6; subsequent boards use higher-order outputs. Address lines A0 and A1 select one of four registers (three data ports and one control port) in the selected port (IC1 or IC2). Address lines A2–A4 drive IC6, which provides an output select every four addresses.

For IC6 to be enabled, its  $\overline{\text{G2A}}$  must be driven low. For that to happen, several conditions must be met. First, AEN from the bus must be low. If it is not low, a DMA operation is taking place. Second, either  $\overline{\text{IOR}}$  or  $\overline{\text{IOW}}$  must be active (low). When those conditions are met, pin 3 of IC10 will go high.

Another necessary condition is that the A=B output of IC7 be high. That IC is a four-bit magnitude comparator; it has three outputs that reflect the state of two four-bit sets of inputs. If the binary-weighted A inputs are less than the binary-weighted B inputs, the A=B output goes high. The A=B and AB outputs function similarly. To compare more than four bits, you can cascade IC's by connecting outputs of one stage to corresponding inputs of the next. The lowest-order stage requires its A=B input to be high.

In our circuit, A9 from the bus drives the A=B input, and A5–A8 drive the comparison inputs. DIP switch S1 is connected to the other group of comparison inputs. The A5 and A8 address lines actually drive the A3 and A0 inputs, and A6 and A7 drive the B2 and B1 inputs respectively. The other A and B inputs are connected to the poles of S1. The net effect is that pin 6 goes high when A9 is high and when A5–A8 match the DIP-switch settings.

Table 1 shows the switch set-

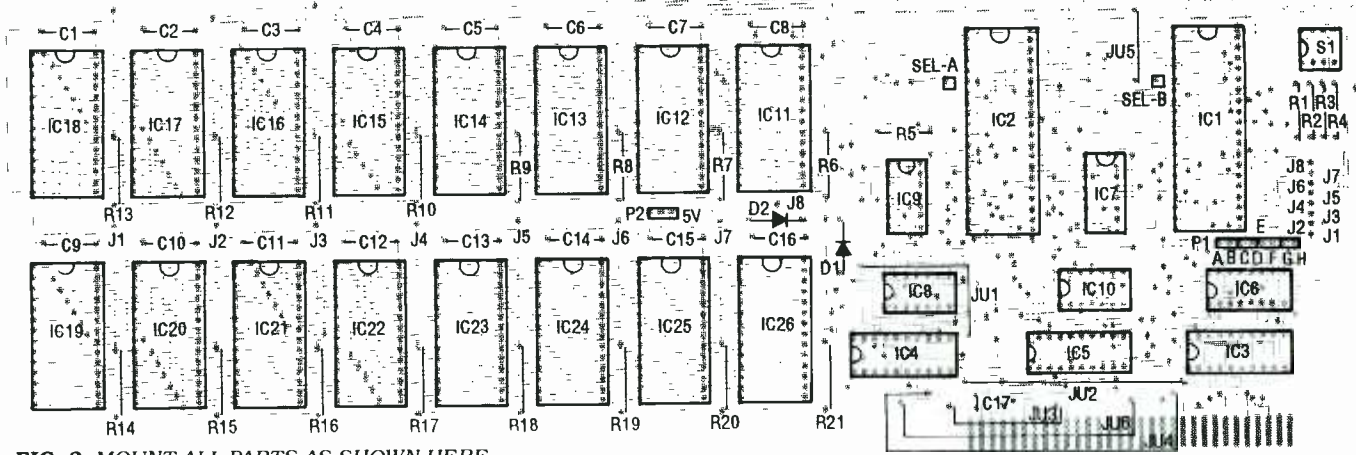

**FIG. 2. MOUNT ALL PARTS AS SHOWN HERE. MAKE SURE THE FOLLOWING VERSION OF THE PARTS LIST RUNS. THERE ARE A FEW DIFFERENCES FROM PART 1.**

tings for various I/O port addresses. In each line of the table, the address shown is 512 more than the sum of the binary switch weights. The reason is that A9 is also decoded, so the minimum address is 512.

When pin 6 of IC7 and pin 3 of IC10 go high, pin 8 of IC9 goes low, thus enabling IC6-d, one of the port IC's. In addition, after inversion by IC10-b, the pin-8 output also enables IC3, the data-bus buffer. At that point a byte will be read or written (depending on the states of  $\overline{IOR}$  and  $\overline{IOW}$ ) to the appropriate port of the selected port IC.

**SRAM array**

Each SRAM has fifteen address lines, eight data lines, an output-enable ( $\overline{OE}$ ) line, a write-enable ( $\overline{WE}$ ) line, and a read/write ( $\overline{RW}$ )

line. Port A of IC1 drives the low-order address lines of all SRAM's; the lower seven bits of port B drive the high-order address lines; and port C drives the data lines. The high bit of port B (PB7) functions as a pseudo read/write line that drives the  $\overline{OE}$  lines, and, after inversion by IC8-a and IC8-b, also the  $\overline{WE}$  lines. Last, the A and B ports of IC2 drive the chip-select inputs of the SRAM's, one bit per SRAM. Port C of IC2 is not used in the present design; you could modify our circuit to decode an additional 8 SRAM's or use the port for other things.

**Data retention**

The battery-backup circuitry is quite simple. Five volts from the bus feeds all of the logic and parallel ports. In addition, bus power also feeds the SRAM's and

up battery feeds the SRAM's and pull-ups via D2.

The author successfully used several types of batteries for backup, including a 0.1-Farad capacitor formerly sold by Radio Shack, four AA cells, and a rechargeable cordless phone battery (Radio Shack number 32-173). If you use a rechargeable battery, install a jumper in D2's position.

**Construction**

You can build the circuit on a prototype board with an XT-type bus interface, or you can build it on a PC board. Foil patterns are shown in PC Service; a drilled and etched board with plated-through holes is also available from the source mentioned in the parts list.

As shown in Fig. 2, on the front side of the board install all resistors, then IC sockets, then capacitors, then the DIP switch and the two header blocks for the backup battery and the decoding block. Then, on the back side of the board, install the six jumpers shown in Fig. 2. Connect a pair of wire-wrap wires to each pin of a two-pin female header; connect

**TABLE 1—I/O PORT ADDRESSES**

S1-d (256)	S1-c (128)	S1-a (64)	S1-b (32)	Address (decimal)
ON	ON	ON	ON	512
ON	ON	ON	OFF	544
ON	ON	OFF	ON	576
ON	ON	OFF	OFF	608
ON	OFF	ON	ON	640
ON	OFF	ON	OFF	672
ON	OFF	OFF	ON	704
ON	OFF	OFF	OFF	736
OFF	ON	ON	ON	768
OFF	ON	ON	OFF	800
OFF	ON	OFF	ON	832
OFF	ON	OFF	OFF	864
OFF	OFF	ON	ON	896
OFF	OFF	ON	OFF	928
OFF	OFF	OFF	ON	960
OFF	OFF	OFF	OFF	992

**TABLE 2—BOARD SELECT**

Board	IC2, Pin 6	IC1, Pin 6
1	A	B
2	C	D
3	E	F
4	G	H



```

5 CLS
10 PRINT"*****"
20 PRINT"*"
30 PRINT"          SRAM INITIALIZATION PROGRAM"
40 PRINT"*"
50 PRINT"          COPYRIGHT HATRONICS"
60 PRINT"*"
70 PRINT"*****"
80 PRINT" THIS PROGRAM WILL INITIALIZE THE FIRST 32K "
90 PRINT" THIS WILL SET UP THE FAT AND DIRECTORY AREAS "
95 PRINT
97 INPUT" WHAT PORT ADDRESS "; PO%
99 IF PO%=0 THEN GOTO 130
100 PRINT" ARE YOU SURE YOU WANT TO DO THIS ??? Y or N "
110 AS=INKEY$: IF AS="Y" OR AS="y" THEN GOTO 140
120 IF AS="" GOTO 110
130 PRINT" ABORTED !!!": END
140 DIM S2(16)
150 S2(1)=254:S2(2)=253:S2(3)=251:S2(4)=247
160 S2(5)=239:S2(6)=223:S2(7)=191:S2(8)=127
170 P1A=PO%:P2A=PO%+16:P1B=PO%+1:P2B=PO%+17
175 P1C=PO%+2:P2C=PO%+18:P1D=PO%+3:P2D=PO%+19
180 OUT P1D,128
190 OUT P2D,128
200 OUT P2B,255
210 OUT P2A,255
220 P%=P2A
230 PRINT" INITIALIZING FIRST 32K"
240 IF BA =2 THEN P%=P2B
250 FOR S = 0 TO 127
260 FOR T = 0 TO 255
270 OUT P1A,T:OUT P1B,S+128
280 OUT P1C,0
290 OUT P%,S2(S):OUT P%,255
300 NEXT T
310 NEXT S
320 PRINT " END INITIALIZATION":END

```

the other ends of the two wires to the pads by the  $\bar{cs}$  inputs of IC1 and IC2 (pin 6). Then connect the female header to the desired pair of pins on P1. Choose A + B, C + D, E + F, or G + h, and make sure that the wire from IC2 goes to the lower-order pin (A, C, E, or G). In a multi-board system, use the jumper settings shown in Table 2.

The board is a little too tall to fit in an XT-style case. Either use an AT case, or trim the board to a height of about four inches. Doing so will cut through several traces, which can then be replaced by jumper wires. Make sure you don't remove any more than the top eight traces to keep the additional jumpers to a minimum.

If you trim the board, the additional jumpers should be added between the correspondingly numbered pads J1...J8. For example, run a jumper from J1 under the DIP switch to J1 by C9, from J2 under the DIP switch to J2 by C10, etc.

If you're not going to install all sixteen SRAM's, install the

SRAM's in part-number order (IC11, IC12,...IC26).

Check your work carefully for solder bridges and cold solder joints. Fix any problems, and then set S1 to a value unused by any other adapter in your system. Try 768 if you're not sure; that address is reserved by IBM for prototype boards.

Then power down your PC and insert the board into a vacant expansion slot.

### Initialization

Power your PC up; if it doesn't boot normally, power down quickly, check the board again, and correct any mistakes.

Before you can use the board, you must initialize it. Run the BASIC program shown in Listing 1; that program performs a function similar to DOS's FORMAT command. If you don't keep a battery attached to the board, you'll have to run the BASIC program each time you boot. In that case, you may want to modify the program so that it automatically uses the correct port address and so that it returns to DOS after it

### Parts List

All resistors are 1/4-watt, 5% unless otherwise noted.

R1-R5 ..... 4700 ohms  
R6-R21 ..... 22,000 ohms

### Capacitors

C1-C16 ..... 0.01  $\mu$ F polyester  
C17 ..... 10  $\mu$ F, 10 volts, electrolytic

### Semiconductors

D1, D2 ..... 1N914 switching diode  
IC1, IC2 ..... 8255 Programmable peripheral interface  
IC3 ..... 74LS245 Bidirectional bus buffer  
IC4, IC5 ..... 74LS244 Octal bus driver  
IC6 ..... 74LS138 Three-to-eight line decoder  
IC7 ..... 74LS85 Four-bit comparator  
IC8 ..... 74LS04 Hex inverter  
IC9 ..... 74LS00 Quad NAND gate  
IC10 ..... 74LS08 Quad AND gate  
IC11-IC26 ..... 43256-10 Static RAM

### Other Components

SW1 ..... Four-position DIP switch  
B1 ..... Four AA cells (with holder) (optional)  
J1 ..... 2-position, single-row, 0.1" female header  
J2 ..... 2-position, single-row, 0.1" female header  
P1 ..... 8-position, single-row, 0.1" male header  
P2 ..... 2-position, single-row, 0.1" male header

finishes executing. In other words, change all END statements to SYSTEM statements. Then you could execute the program from your AUTOEXEC.BAT like this: GWBASIC SFORMAT.

The author is working on an enhancement that will allow the driver to optionally initialize the board each time you boot. Both the initialization program and the device driver are available from the RE-BBS, 516-293-2283, 300/1200, 8N1. The file called SRAMDISK.EXE is a self-extracting ZIP file that contains the BASIC program, the executable version of the device driver, and the source for the device driver. Run SRAMDISK.EXE on a disk  
*continued on page 51*

# DIGITAL PRESSURE GAUGE

*Now you can take pressure readings the modern way using our electronic pressure gauge.*

**ANTHONY J. CARISTI**



MOST OF US ARE FAMILIAR WITH AN ORDINARY pressure gauge, such as that used for tires that measures pressure in pounds per square inch (psi). They are usually analog devices with an indicator bar or a moving needle whose movements depend on the specific pressure. However, with the advance of solid-state technology, it is possible to construct an accurate electronic pressure gauge with a resolution as low as 0.1 psi.

Our digital pressure gauge operates from a 9-volt battery, so it is completely portable. The circuit uses only 4 milliamperes, so battery life will be extremely long. A large two-digit LCD is used to display pressure readings, but we'll also show you how to build it with a 3½-digit display.

The full-scale range of the pressure gauge is determined by the selection of the pressure sensor; in this case we have used a 0–100 psi semiconductor sensor, manufactured by Sensym (1255 Reamwood Ave, Sunnyvale CA 94089). Other sensors are available in full-scale ranges of 1, 5, 15, 30, 100, and 150 psi. Using a 15-psi sensor, for example, would result in a display resolution of 0.1 psi with a two-digit readout.

Pressure is measured by connecting a flexible hose between the sensor and source of pressure. If the project is to be used for differential pressure measurements, two hoses must be connected to the sensor and the device under test. Vacuum measurements require only one hose connection.

## The circuit

The sensor is a differential device, which allows two pressure connections, and it measures the difference between the two. The sensor also permits vacuum measurements when one side of the sensor is exposed to the atmosphere and vacuum applied to the other. Pressure and vacuum measurements may be taken on any non-corrosive and non-toxic media such as air, dry gases, etc. The portable nature of the unit allows it to be used almost anywhere, such as for checking tire pressure or a compressed air tank.

The heart of this project is a differential piezoresistive pressure sensor which is constructed using integrated-circuit technology. It consists of four resistors connected in a Wheatstone bridge configuration, which are deposited on a silicon diaphragm that separates two chambers of the sensor housing. Each side of the diaphragm can be exposed to a pressure source by means of "ports" called P1 and P2. Any pressure difference between port P1 and port P2 will be detected by the sensor, providing a differential pressure reading. Figure 1 shows a closeup of the sensor.

The common pressure gauge which many people are familiar with is, in reality, a differential pressure gauge, with atmospheric pressure (14.7 psi) being the reference pressure. Thus, when no pressure is applied to the sensing port of the common gauge,

the reading is zero. The same goes for our gauge; pressure is applied to P2 while P1 is exposed to the atmosphere.

When the pressure sensor is at rest, there is no stress on the silicon diaphragm and the values of the resistors are essentially equal. The Wheatstone bridge is thus balanced and its output voltage is virtually zero. During a pressure measurement, any difference in pressure between the two ports of the sensor result in mechanical stress of the silicon diaphragm and a change in the values of the four resistors. Two resistors increase in value and two de-

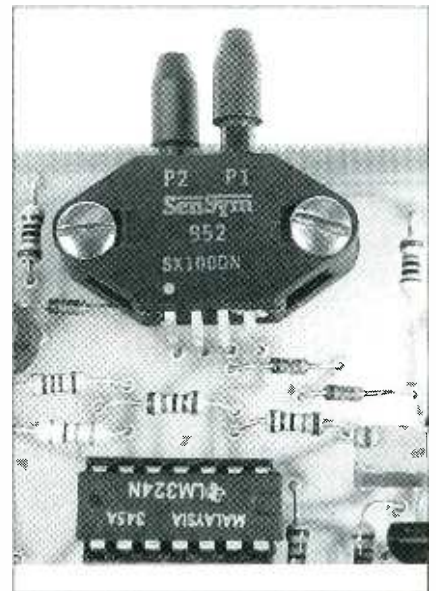

**FIG. 1—HERE IS A CLOSEUP** of the semiconductor pressure sensor.



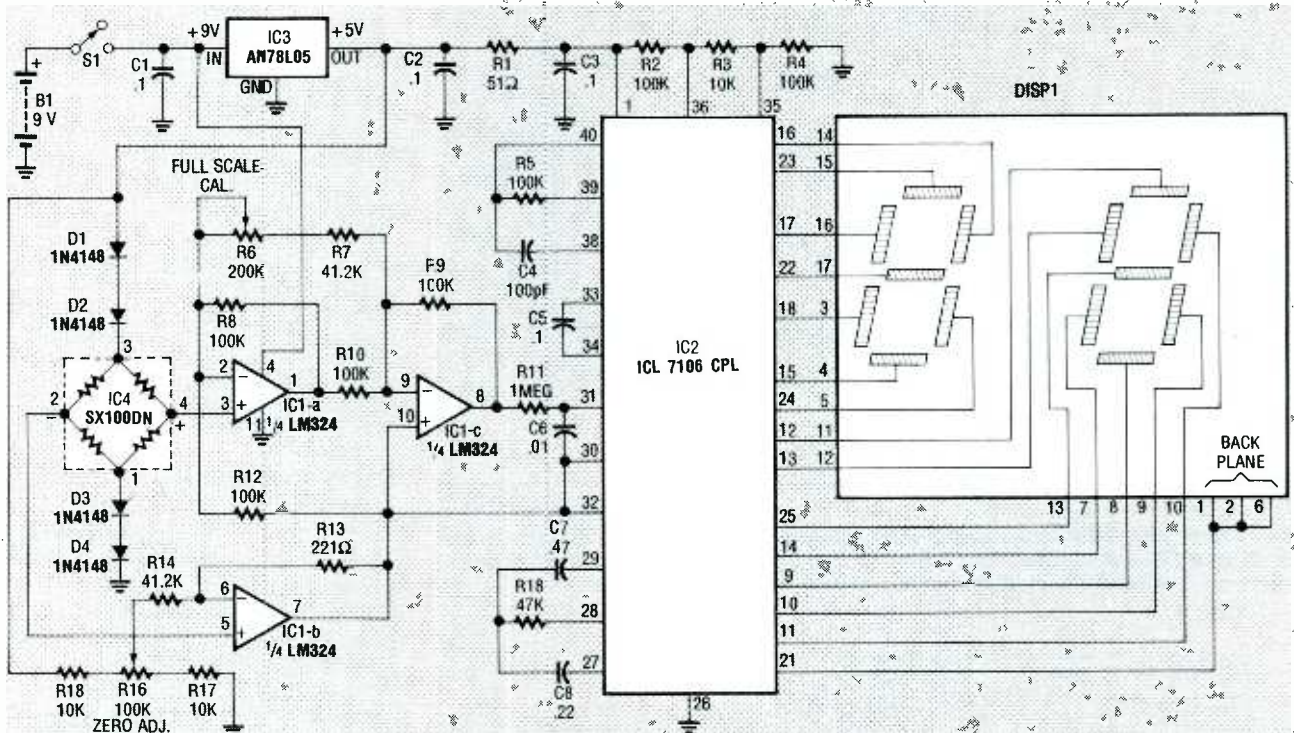

FIG. 2—SCHEMATIC DIAGRAM of the electronic pressure gauge. It uses a Sensym semiconductor pressure sensor.

crease. That causes the Wheatstone bridge to become unbalanced, producing an output voltage which is proportional to the difference in pressure between the two ports of the sensor. That voltage, which in the millivolt range, is amplified and used to provide the drive signal to the display section of the circuit.

The schematic diagram is shown in Fig. 2. In order to preserve the accuracy of the pressure measurement with respect to variations in battery terminal voltage, IC3, a fixed 5-volt regulator, maintains a constant power source which feeds the sensor bridge. A set of four silicon diodes, D1 through D4, has been placed in the circuit to temperature compensate the bridge. That eliminates changes in calibration of the circuit due to ambient temperature effects.

Three sections of IC1, an LM324N quad op-amp, amplify the millivolt output of the bridge to a useful level for the analog-to-digital (A/D) converter circuit that follows.

When there is no pressure applied to the sensor, the voltage between terminals 2 and 4 of the sensor is essentially zero; however, there may be a small output voltage, called zero offset. To compensate for that error, potentiometer R16 allows a small DC voltage to be fed to the amplifier cir-

cuit which negates the offset voltage of the sensor.

When the sensor is exposed to 100 psi, the output of the bridge circuit will generate approximately 34 millivolts. However, there may be variations in output voltage of as much as 30% between different sensors. To compensate for any given sensor, the amplifier gain is adjustable by means of potentiometer R6.

The display section consists IC2, which is a combination A/D converter/7-segment decoder/display driver, capable of driving a 3½-digit LCD (we've used only a two-digit display, DSP1). It is driven by the voltage between pins 7 and 8 of op-amp IC1. The sensitivity of the A/D converter is set by the reference voltage applied between pins 35 and 36. The reference voltage, which is about 238 millivolts, is set by the divider composed of R2, R3, and R4.

In this project only two digits are required since the resolution of the project is 1 psi and full scale is 100 psi. However, note that if you measure exactly 100 psi, the readout will display 00, since the hundreds digit is not present.

Note that for readings greater than 99 psi, or for 0.1 psi resolution, the circuit can be modified to use the most significant and least significant digits

of the A to D chip. In this case you'd need to use a 3½-digit readout, and its decimal place would be illuminated as required. If you wish to use a 3½-digit LCD, Fig. 3 shows the additional connections to the A/D converter that are required. However, note that the 3½-digit display is a 40-pin device that won't fit on the provided PC board. You must either hardwire it or design your own board.

Because of the characteristics of the pressure sensor, the display will read up-scale regardless of which port of the sensor is pressurized. However, you should use the same port for which the project was calibrated. If the project is to be used for vacuum or differential pressure measurements, the display will indicate the pressure difference in psi, with no polarity indication. The A to D converter used in this circuit does have an output terminal to indicate polarity, but it is not used.

### Construction

The project is constructed on a single-sided PC board. A foil pattern is provided in PC Service. The circuit can also be hard wired on a perforated construction board if you wish. The parts-placement diagram is shown in Fig. 4. Note that the LCD readout is mounted on the copper side of the

3 1/2-DIGIT DISPLAY

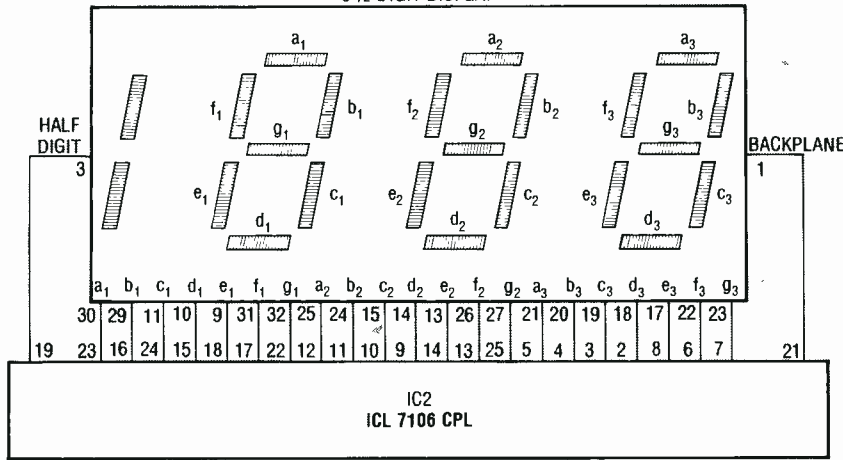

FIG. 3—HERE ARE THE ADDITIONAL CONNECTIONS to the A/D converter that are required for a 3 1/2-digit display. Note that the 40-pin display won't fit on the PC board—you'll have to hardwire it or design your own board.

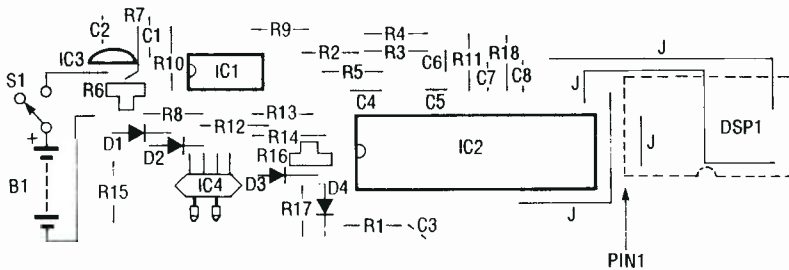

FIG. 4—PARTS-PLACEMENT DIAGRAM. Note that the LCD readout is mounted on the copper side of the board.

board. That allows the relatively flat side of the PC board to be mounted next to the side of a suitable enclosure containing a cutout or window to expose the readout for viewing.

You should use sockets for both of the IC's. Especially for IC2, which is a 40-pin chip and not inexpensive. The cost of a socket is minor compared to the IC itself, and you can never predict when an IC will have to be removed from a PC board. Once the sockets are in place, continue installing components, but do not insert the IC's yet.

The 5-volt regulator, IC3, looks like a small transistor; simply solder it directly to the board, and be sure to watch its orientation. Also be sure that the diodes are properly oriented.

The circuit requires four jumpers; the short jumper wire between pins 2 and 6 of the LCD can be a piece of bare wire, but the other three should be insulated to avoid shorts.

Many of the resistors specified in the parts list are metal-film types which exhibit excellent temperature stability. Since we want the project's

calibration to remain stable with varying temperature, you should not substitute other types of resistors.

The LCD and the pressure sensor are fragile and must be handled carefully to avoid breakage. It is suggested that the readout be mounted to the board last. You may wish to use a socket for the readout, and you can make one by taking an ordinary 18-pin DIP socket and cutting it in half lengthwise. Remember, the socket (and readout) will be placed on the copper side of the board, so you must allow some space between the plastic of the socket and the board itself to allow room for soldering.

Before mounting the LCD, take note of where pin 1 is. If you look at Fig. 5, the black border around it has a marking on one side. Looking at that marking, pin 1 is where you'd normally see it on any ordinary IC.

The pressure sensor may be fastened to the board using two #4 machine screws and nuts, but be very careful not to over-tighten them. Note that pin 1 of the sensor is marked with a small dot; mount it as shown in Fig.

PARTS LIST

All resistors are 1/4-watt, 5%, carbon, unless otherwise indicated.

- R1—51 ohms
- R2, R4, R8—R10, R12—100,000 ohms, 1% metal film
- R3, R15, R17—10,000 ohms, 1% metal film
- R5—100,000 ohms
- R6—200,000 ohms, PC-mount potentiometer
- R7, R14—41,200 ohms, 1% metal film
- R11—1 megohm
- R13—221 ohms, 1% metal film
- R16—100,000 ohms, PC-mount potentiometer
- R18—47,000 ohms

Capacitors

- C1—C3, C5—0.1 μF, ceramic disc
- C4—100 pF, ceramic disc
- C6—0.01 μF, ceramic disc
- C7—0.47 μF, ceramic disc
- C8—0.22 μF, ceramic disc

Semiconductors

- IC1—LM324N quad op-amp
- IC2—ICL7106CPL 3 1/2-digit A/D converter (Intersil)
- IC3—AN78L05 5-volt regulator
- IC4—differential semiconductor pressure sensor, SX01DN for 1 psi full scale, SX05DN for 5 psi full scale, SX15DN for 15 psi full scale, SX30DN for 30 psi full scale, SX100DN for 100 psi full scale, SX150DN for 150 psi full scale (Sensym, 1255 Reamwood Ave., Sunnyvale CA 94089)

- D1—D4—1N4148 silicon diode
- DSP1—two-digit LCD module (DigiKey LCD001)
- Optional—3 1/2-digit module (Digikey LCD002)

Other components

- S1—SPST toggle or slide switch, N.O.
- B1—9-volt battery
- Miscellaneous: battery clip, enclosure, IC sockets, hose w/fitting, clamps, wire, solder, etc.

**Note: The following are available from A. Caristi, 69 White Pond Road, Waldwick, NJ 07463: Etched and drilled PC board, \$14.95; pressure sensor, \$36.50; set of 12 1% metal-film resistors, \$5.75; IC1, \$2.00; IC2, \$15.00; IC3, \$2.00. Add \$2.75 postage and handling per order.**

4. The four terminals of the sensor are very fragile, and must be carefully bent into position using a needle-nose pliers to support the leads next to the body of the part. If you attempt to bend the leads without such support, you risk breaking the wires. If you attempt to bend the leads with-



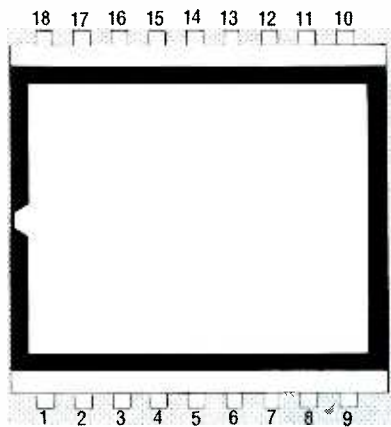

**FIG. 5—THE BLACK BORDER** around the display has a marking on one side. Using the marking as a reference, pin 1 is where you'd normally see it on any ordinary IC.

out such support, you risk breaking the wires.

A suitable pressure hose must be connected to port P2 of the sensor, and secured with a small metal clamp that has been designed to handle high pressures. Such clamps can be obtained from automotive supply outlets. It cannot be over-stressed that pressures greater than 10 psi are substantial, and the hose and clamp must be able to withstand such force.

If you want to use the project to measure tire pressure, you need a hose from a bicycle shop with a fitting at the end that depresses the valve stem during a pressure measurement. You might be able to take an old tire pressure gauge and modify it for use with our digital pressure gauge. As with the pressure-sensor connection, you will need to clamp the valve fitting to the hose.

You may wish to use a normally open pushbutton switch for your project. That will prevent accidentally

leaving the power on and depleting the battery.

Be sure to use a connector clip for the battery to ease replacement when necessary. The battery should be securely mounted in the project's enclosure so that it does not rattle around and break anything.

When you have completed assembly, examine the circuit board very carefully for bad solder connections and inadvertent short circuits, especially between adjacent IC terminals. Bad solder joints often are dull, rough blobs of solder. Correct any problems that you find. Figure 6 shows both sides of the completed unit.

### Checkout

To check out the project you will need a DC voltmeter, as well as a source of air pressure such as a portable air tank. Be sure tank pressure is not over 100 psi. For the preliminary checkout it is not necessary to know the precise pressure of the source, but it should be in the range near the maximum measurement capability of the project.

Before putting IC1 and IC2 in their sockets, set the calibration potentiometers to mid-position. Connect a 9-volt battery, and turn on power.

Measure the voltage across C2; you should obtain a reading between 4.8 and 5.2 volts DC. If you do not obtain the correct reading, do not proceed with the checkout until you troubleshoot the problem. Check IC3 for proper orientation. Check the terminal voltage of the battery to verify that it is delivering at least 7 volts. Disconnect the battery and measure the resistance across C2 to verify that you do not have a short circuit between the 5-volt bus and ground.

When you are satisfied that the 5-volt regulator is operating properly, disconnect the battery from the project and insert the IC's into their sockets. Be sure to follow the orientation as indicated in Fig. 4.

Reconnect the battery to the project and turn the power switch on. No pressure is to be applied to the sensor at this time. The display should indicate a two digit reading, and adjustment of R16 should allow you to set the reading to 00.

If you don't get any display, check that the LCD is properly mounted on the copper side of the board. Check IC2 to be sure that it is properly oriented in its socket. Check the 5-volt regulator to verify that power is being applied the circuit. If your meter is capable of measuring DC current, you can check the current draw from the battery to determine if it is approximately 4 milliamperes, which is the normal current draw of the project.

If you obtain a display but the illuminated segments of the digits are not entirely correct, the most likely cause is open or short circuits at the output connections of IC2 which drive the readout. Disconnect IC2 and the battery from the project and locate the fault using an ohmmeter.

Note that the display may, on occasion, indicate 01 instead of 00. This is not to be construed as a defect in the circuit; it merely means that your zero adjustment is not centered exactly.

When you are satisfied that the zero adjustment of the display is correct, you may apply full pressure to the P2 port of the sensor. When that is done, the readout will indicate some number. Adjust R6 for a display equal to the pressure of the source, if known.

*continued on page 38*

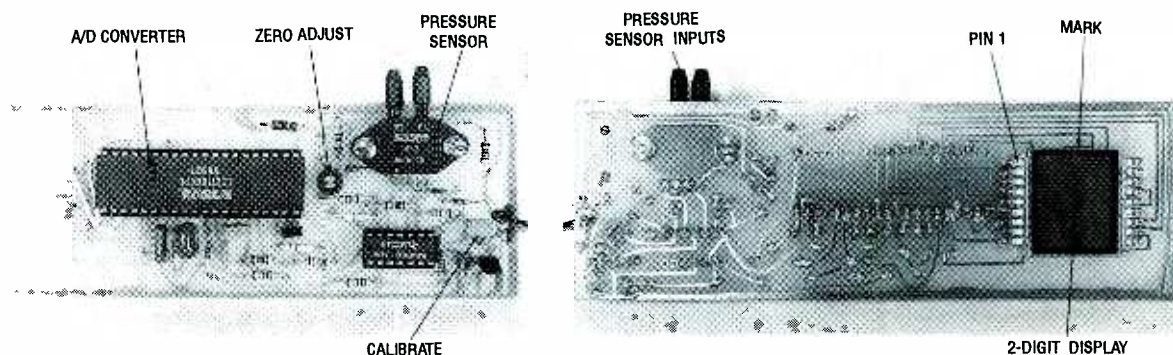

**FIG. 6—HERE ARE BOTH SIDES** of the completed unit. notice how the display goes on the foil side.

# BUILD THIS



*Limit your audio volume to prevent clipping and distortion.*

LOWELL D. JOHNSON

HAVE YOU EVER BEEN ANNOYED BY A paging system that makes the speaker difficult to understand, or by a stage-show performer who rattles the speakers by singing loudly into a microphone? Most people assume that the equipment is malfunctioning, and that repairs are needed. However, in many cases that's not so; and the real culprit that's causing the distortion is audio-level mismatching.

Basically, if the gain of an audio amplifier is adjusted for a small input signal, and a large signal is applied, then the amplifier is driven beyond its capabilities and distortion results, even though the amplifier is working perfectly. And, if the amplifier is adjusted for a strong input signal, and a weak signal is applied, then it is difficult to understand what the speaker is saying. In either case, it sounds awful, and the message doesn't get across. However, if you build the circuit described in this article, it will eliminate those kinds of problems; the circuit maintains a constant output-voltage level, regardless of the input signal.

The circuit produces no clipping, which would flatten the peaks of the signal, and virtually zero distortion, because the shape of the output signal

is a true replica of the shape of the input signal. The circuit introduces little noise, so none is heard at the output. Pumping, or changes in amplifier gain that can be detected by the listener, is almost imperceptible. Transient spike handling is excellent—if it weren't, the limiter would not be fast enough to control instantaneous fast-rising spikes, such as a percussive sound.

Volume limiters aren't always desirable. For example, the circuit we'll present was installed in a church PA system to compensate for the different voice levels of the various members of the congregation who made short an-

nouncements. Everyone loved it—except the minister. After the sermon, he very strongly requested that a switch be installed that could disable the limiter. It seems that he preached fire-and-brimstone, and he *wanted* to rattle the speakers.

## Circuitry

Figure 1 shows the block diagram of the audio limiter. Amplifier IC1-a can change its gain from  $\frac{1}{100}$ th to  $\times 100$ , depending on the net effect of its feedback loop. That way, the overall gain of the circuit is such that the output level remains constant. If we put a potentiometer in the feedback loop of IC1-a that we could continuously adjust to maintain a steady output level, that would do the trick. However, that would be extremely impractical, as well as being boring; what we need is a resistor that can instantly change its value in accordance with the output voltage of IC1-a. An optically coupled Light-Dependent Resistor, or LDR would do the trick.

An optocoupler is a device that contains both a light source (an LED) and some kind of light-sensitive device (in this particular case it happens to be an LDR) inside one package.

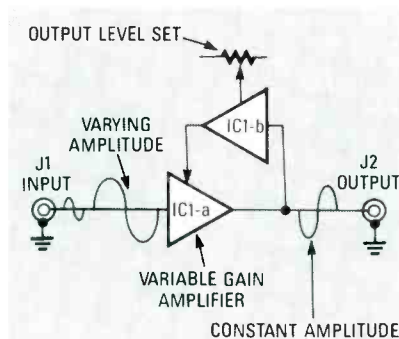

FIG. 1—BLOCK DIAGRAM of the audio limiter. The feedback loop of IC1-a controls the gain of the circuit.



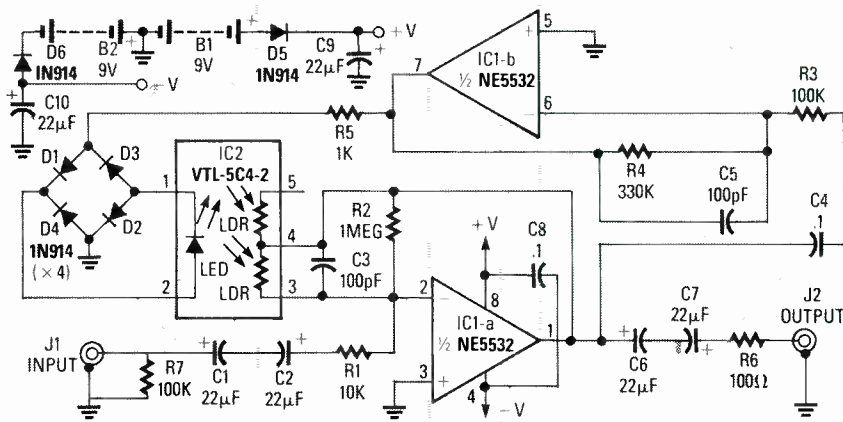

FIG. 2—SCHEMATIC OF THE VOLUME LIMITER. IC1-a is connected as an inverting amplifier whose gain is controlled by the LDR portion of an optocoupler.

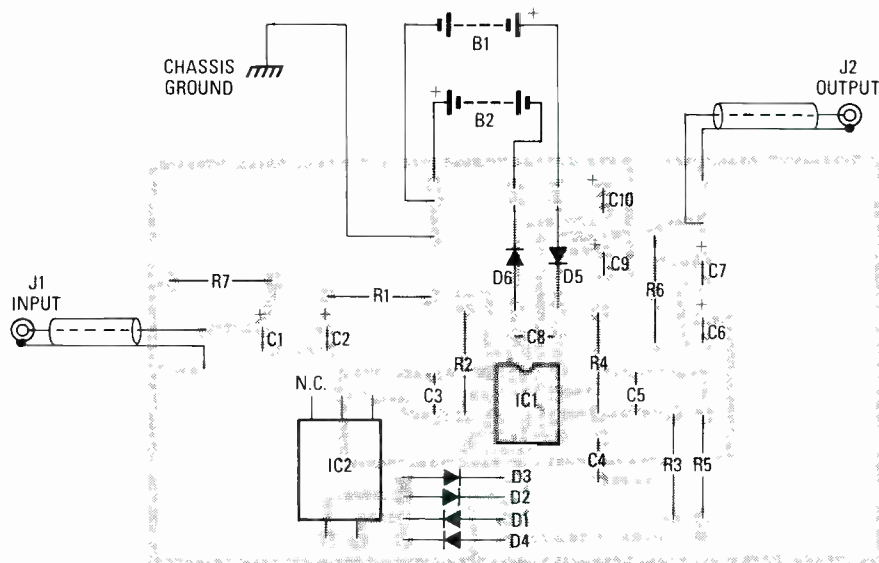

FIG. 3—FOLLOW THIS PARTS-PLACEMENT DIAGRAM if you are using the PC board.

**PARTS LIST**

- All resistors are ¼-watt, 5%.**  
 R1—10,000 ohms  
 R2—1 megohm  
 R3, R7—100,000 ohms  
 R4—300,000 ohms  
 R5—1000 ohms  
 R6—100 ohms
- Capacitors**  
 C1, C2, C6, C7, C9, C10—22µF, 35 volts, electrolytic  
 C3, C5—100 pF, 50 volts  
 C4, C8—0.1 µF, 50 volts
- Semiconductors**  
 IC1—NE5532 low-noise audio amp  
 IC2—VTL-5C4-2 optocoupler (Vactec)  
 D1–D6—1N914 diode

- Other components**  
 J1, J2—RCA jacks  
**Miscellaneous:** power supply, project case, wire, solder, etc.  
**Note:** A kit of parts, a PC board, and assembly instructions (power supply and enclosure not included) is available for \$48.00 from Woods Electronics Inc., 4233 Spring St. #117, La Mesa, CA 91941 (619) 265-2551 (order # AVL-42889-K). An assembled and tested unit is also available for \$57.00 (order # AVL-42889-A). Add \$4 shipping and handling. CA residents add 8¼% sales tax. Other kits are also available. Contact Woods Electronics for details.

with the leads of both brought out to external pins, much like an IC. When

the LED is turned on via an external input voltage, the LDR's resistance is

very small, and when the LED is turned off, the LDR's resistance becomes very large. The resistance of the LDR can therefore be varied at a very fast rate, according to the intensity of the light from the LED. So let's use the LDR portion of an optocoupler in the feedback loop of our amplifier to produce a gain-controlling circuit.

Now, to be more specific, we need an optocoupler with an LDR that can reduce its resistance instantly when its input signal reaches the limiting threshold, thereby reducing the gain of the amplifier to just below the threshold. Then we'd like it to stay at that value until the input signal became weaker, and then gradually increase the gain until the threshold is reached. Fortunately, the VTL-5C4-2 from Vactec Inc. (10900 Page Blvd., St. Louis, MO 63132) has exactly those characteristics. When the light source is illuminated, the resistance decreases in a matter of microseconds (very fast with respect to audio frequencies), and when the light source is removed, the resistance increases over a period of seconds (very slow with respect to audio frequencies). Those combined characteristics can form a limiting circuit that produces a constant output level, but whose action is not easy—in fact, quite difficult—for the listener to detect.

Figure 2 shows the schematic of the volume limiter. IC1-a is connected as an inverting amplifier; ignoring the LDR (assume that its resistance is very high so that it doesn't affect the feedback loop), the gain is  $R2/R1$ , or 100. Standard low-impedance-microphone preamplifiers have a gain of 100. Thus, the output at IC1-a pin 1 will be about 2 volts p-p.

The second half of the amplifier, IC1-b, is connected to the output through C4, and its gain is  $R4/R3$ , or 3. The optocoupler's LED turns on when the voltage across it is about 2 volts. The higher the current through it, the brighter it illuminates. On positive peaks, it is in series with D1 and D2, and on negative peaks it is in series with D3 and D4. Since D1–D4 are silicon diodes, about 0.7 volts is dropped across each one before they begin to conduct. Therefore, the total positive voltage across the bridge required to illuminate the LED is  $0.7V + 0.7V + 2V$ , or slightly less than 3.4 volts. The same voltage with a negative polarity appearing across

the bridge will also illuminate the LED.

As the AC signal at IC1-b pin 7 approaches 6.8-volts AC, the LED receives short bursts of current, and the LDR instantly reduces in value to a point where it reduces the gain of IC1-a, thereby reducing the output of IC1-b pin 7 to less than 6.8 volts AC. Because of the slow recovery time of the LDR, it appears effectively as a fixed resistor and therefore produces virtually no distortion. The output voltage, 6.8-volts AC, when divided by the gain of IC1-b, is about 2-volts p-p, which is a standard line level. Since the LDR can go below 100 ohms, the gain of IC1-a can be reduced to  $LDR/R1$ , or  $1/100$ th. That means that signals up to 200-volts p-p can be applied to the input (although you'll never have an input with that magnitude), while maintaining the output at a line level; any input signal ranging from microphone-level to 200 volts will produce a clean line-level output.

The NE5532 (IC1) is a relatively expensive dual op-amp with very-low-noise characteristics. If you can tolerate some noise, feel free to use a 741, 324, or any other general-purpose audio op-amp. If you do, note that the pin numbers may change. Also, C1, C2, C6, and C7 are used to block DC. If no DC exists in your design, then you may omit them. R6 is included for spike protection; if no dangerous spikes will exist, you may omit that resistor, too. Capacitors C3, C5, and C8 are included as standard practice, but if no undesirable effects occur, you may omit them. Use any regulated supply voltage, such as two 9-volt batteries or a  $\pm 12$ -volt DC supply. Just don't exceed the maximum voltage ratings of the IC that you decide to use.

If you want to operate without a negative supply, then connect IC1 pin 4 to ground, and create a  $V_{CC}/2$  supply with another unity-gain op-amp section and a voltage divider. Then connect all the ground connections except for the input and output grounds to that, and connect IC1 pin 8 to  $V_{CC}$  (just reference everything up to  $V_{CC}/2$ ). Always use at least 15-volts DC—preferably 24-volts DC. Also, the optocoupler used for the project is a dual-element type; they are more versatile. However, you can use the VTL-5C4 (the single-element version) if you like.

### Building the circuit

Because IC1-a may have a gain of up to 100, you must keep the leads short in that circuit. Ground loops can defeat any circuit, so keep all power-supply grounds together on one side of the board. Also, remember to use shielded wire on the input and output connections. You can use point-to-point wiring on perforated construction board, but it's best to use the foil pattern provided in PC Service to make a board and use that instead. A ready-to-use PC board is also available from the source mentioned in the parts list.

Figure 3 shows the parts-placement diagram for the audio limiter. Be sure to check for solder shorts and all of that other bad stuff before powering up and testing the circuit. RCA-type jacks are probably the best choice for J1 and J2, but use whatever best suits your application and your current audio equipment.

To test the circuit, simply connect a microphone, and observe the output on an oscilloscope, or listen to it through a headset (to cut out feedback). The output should remain at the same level, regardless of whether you whisper or scream into the microphone. A note of caution: Remember that the limiter works to correct the gain by looking at seldom-encountered maximum peaks. If you feed in a sine wave, you will notice that the output indeed remains constant, no matter what the input voltage, but a "blip" appears on each and every peak (which would imply high distortion). In a normal audio signal, not all peaks are the same amplitude, and only seldom-occurring maximum peaks are acted upon. Since they occur very infrequently (as compared to audio frequencies), the distortion of the limiter is actually very low—you won't even notice it.

R-E

## DIGITAL PRESSURE GAUGE

*continued from page 35*

### Final calibration

The best way to calibrate your pressure gauge is to compare it to the reading of a known, accurate gauge. Additionally, if you plan to use the gauge to measure pressure which is normally less than full-scale capability, it would be prudent to calibrate it at this pressure level rather than at full scale. Use the setup in Fig. 7, remembering that all hose connections must be securely clamped. The

setup allows the pressure source to be applied simultaneously to both gauges.

Adjust R6 so that the digital read-out agrees with the reference gauge. After adjustment of R6, remove the pressure from the sensor and check the display, which should read zero. If there is some offset from zero, repeat the adjustment for R16 and R6.

Battery life should be as long as 1 or 2 years if the project is used intermittently. The display will change in appearance when the battery needs to be replaced, and it will disappear altogether when the battery is totally exhausted.

R-E

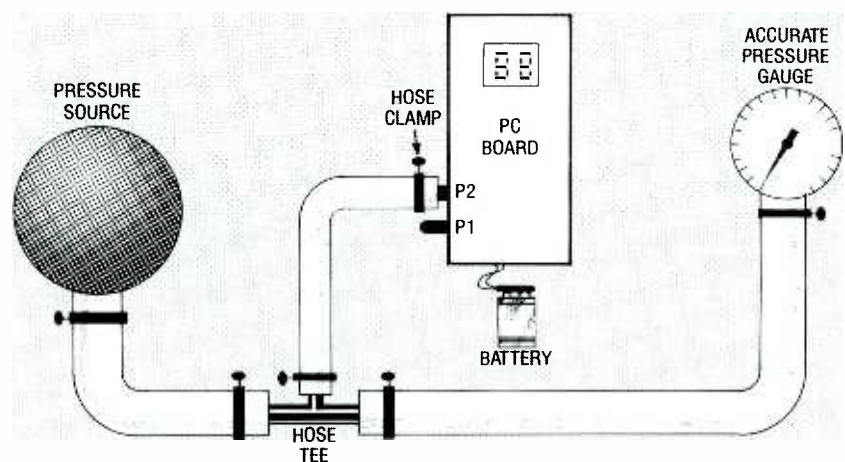

FIG. 7—TO CALIBRATE THE GAUGE, use this setup. Remember that all hose connections must be securely clamped.



# BUILD R-E's DIGITAL DASHBOARD

*Update your dashboard  
with six accurate,  
good-looking  
gauges.*

ROSS ORTMAN

THE ELECTRONICS CONTENT OF TODAY'S automobiles is higher than ever before. Electronics can be found in everything from the ignition system to the instrument cluster, commonly called your dashboard. That's what tells you of your vehicle's performance, and warns you of possible problems. However, some gauges are simply not found on some dashboards, or there may be just an idiot light, which, if you're lucky, will warn you of a problem—but usually after a problem has occurred. If you want to monitor certain functions, the most reliable and accurate gauges are a must.

We'll look at six digital gauges: voltage, oil pressure, water temperature, fuel level, vacuum, and an auxiliary gauge for displaying any temperature, be it outside air, inside air, transmission, oil, or whatever else you wish to monitor.

The digital voltmeter measures and displays the voltage level of the automobile's electrical system. The correct voltage level is a good indication of a healthy charging system which, in turn, will extend the life of the battery. A failure in the automobile's charging system can, of course, leave you stranded.

Proper oil pressure is very important to the operation of your automobile's engine. Without it, the oil would not be pumped into bearings, journals, and over moving metal parts. The end result would be a seized or badly damaged engine. The digital oil-pressure gauge keeps you informed as to how well your engine is being lubricated.

The digital water-temperature gauge is used to monitor the engine's cooling system, which is designed to

maintain constant engine temperature. Without a temperature gauge, the first indication of an overheating engine is usually the steam that comes from under the hood, which is often too belated to prevent engine damage.

Next to the speedometer, the fuel gauge is probably the most watched instrument in the dashboard. The digital fuel gauge presented here displays the level of fuel left in the tank on a scale of 0 to 99%.

The digital vacuum gauge measures the intake-manifold vacuum in inches of mercury (in. Hg). Normal driving usually produces a vacuum reading between 16 and 22 in. Hg. The general rule of thumb is, the higher the vacuum level, the better the gauge reading, and the better the gas mileage.

As you probably already know, an automobile uses many other fluids besides the water and antifreeze in the radiator. And, just like the coolant in the radiator, many of those fluids get hot under use. Since excessive heating indicates a potentially serious problem, it is advantageous to

monitor such things as the oil, transmission fluid, differential fluid, etc. In addition to automotive operating parameters, convenience items such as outside air temperature and inside air temperature can also be monitored.

## Circuitry

A block diagram, which describes the circuitry that's common to all of the gauges, is shown in Fig. 1. The central component of each digital

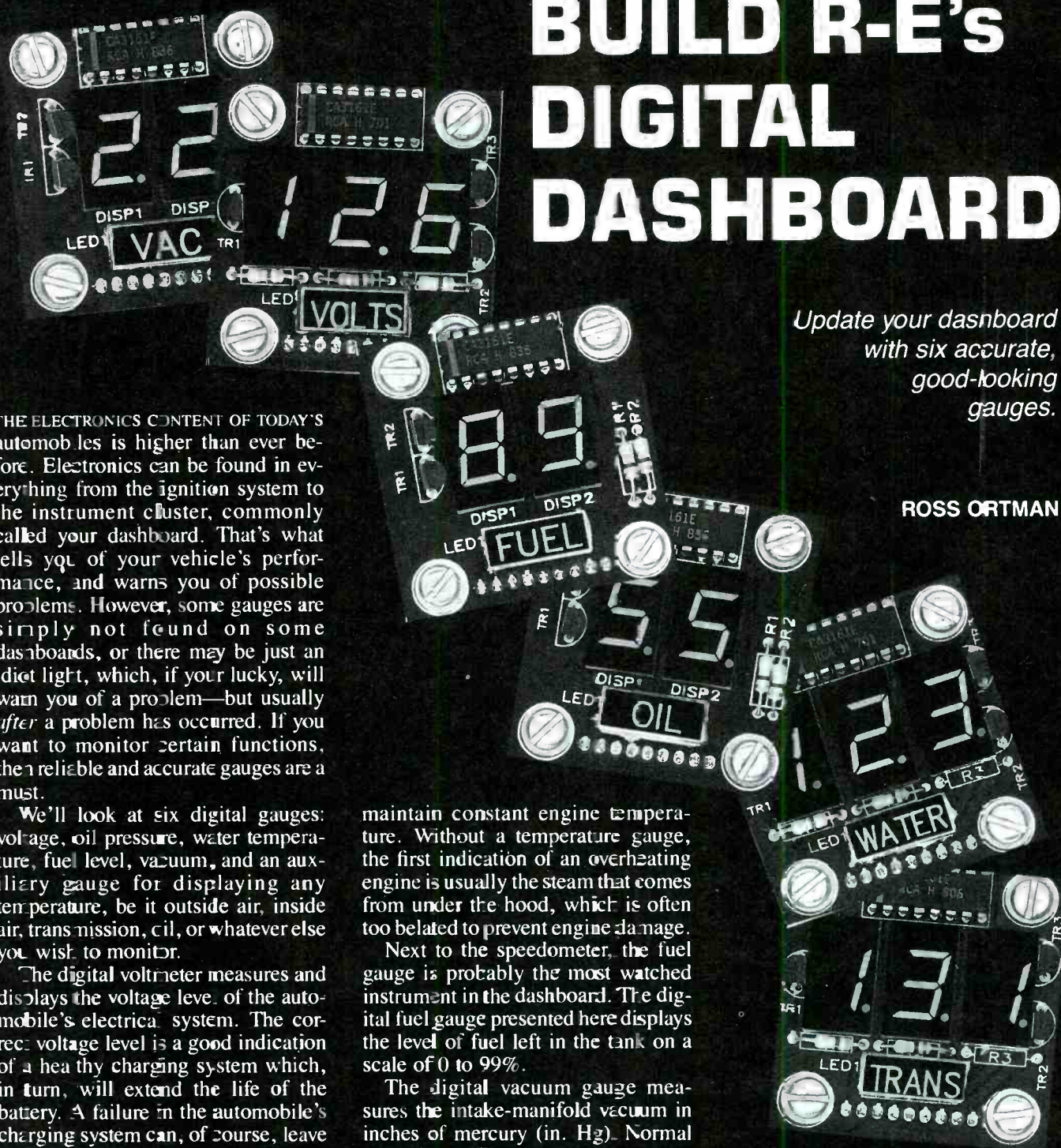



gauge is the A/D converter. Because it is common to all of the gauges, it deserves a thorough explanation. The CA3162E A/D converter and the CA3161E display driver form an accurate, low-cost, three-digit analog to digital converter system that can operate from a single 5-volt supply.

The basic operation of the A/D converter is based on the dual slope system. Here, an integrating capacitor is charged to a level determined by the input voltage. That is accomplished by converting the input voltage to a relative current and using that current to charge the integrating capacitor for a predetermined time. After that charge time, the voltage-to-current converter is removed and a current source of opposite polarity is connected to the capacitor. The time required to discharge the capacitor to its original value is measured to deter-

mine the original input voltage level.

The CA3161E has a differential input which greatly simplifies circuit design. The full-scale input is 0.999 volts which results in a reading of "999" on a three-digit display. The resolution, or smallest change the A/D converter can show, is 1 mV.

The CA3162E also controls the display multiplexing and updating. Using multiplexing, the parts count is greatly reduced, and, although only one digit is lighted at a time, it appears that all the digits are on all the time.

The Binary Coded Decimal (BCD) output of the CA3162E is sent to the CA3161E display decoder/driver, which supplies segment current to each of the displays. Because the display driver contains internal current limiting, external current-limiting resistors are not needed.

Let's take a closer look at each individual gauge. The gauges are very similar to each other, so we will not repeat descriptions for similar sections. The same goes for the display boards.

### Voltage gauge

The voltage gauge displays the voltage of the automobile's electrical system on a three-digit readout with 0.1-volt resolution. The gauge will display voltages from 8 to 19.9 volts. Because the input of the A/D converter has a maximum input of 0.999 volts, the input voltage to the meter must be divided by 100. That way, the A/D's actual input voltage ranges from 0.080 to 0.199. That results in a reading of "080" to "199," and by fixing the decimal point to the second digit, a resulting display of "08.0" to "19.9" is obtained.

The voltage gauge schematic is shown in Fig. 2. Power is supplied to the voltmeter through P1. The unit is protected from excessive current by fuse F1. Diode D2 assists in protecting from reverse battery connection, and also clamps any momentary negative spikes on the automobile's electrical system. Diode D2 allows only positive voltage to reach the 5-volt regulator, IC1, that reduces the vehicle's 12 to 13.8 volts to the 5-volt level needed by the gauge's circuitry.

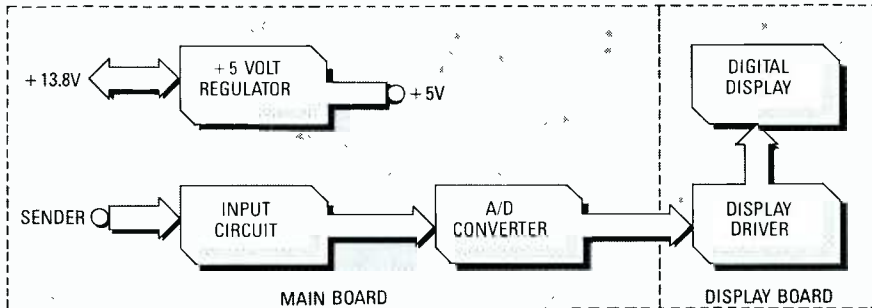

FIG. 1—BLOCK DIAGRAM COMMON to all of the gauges. The central component of each digital gauge is the A/D converter.

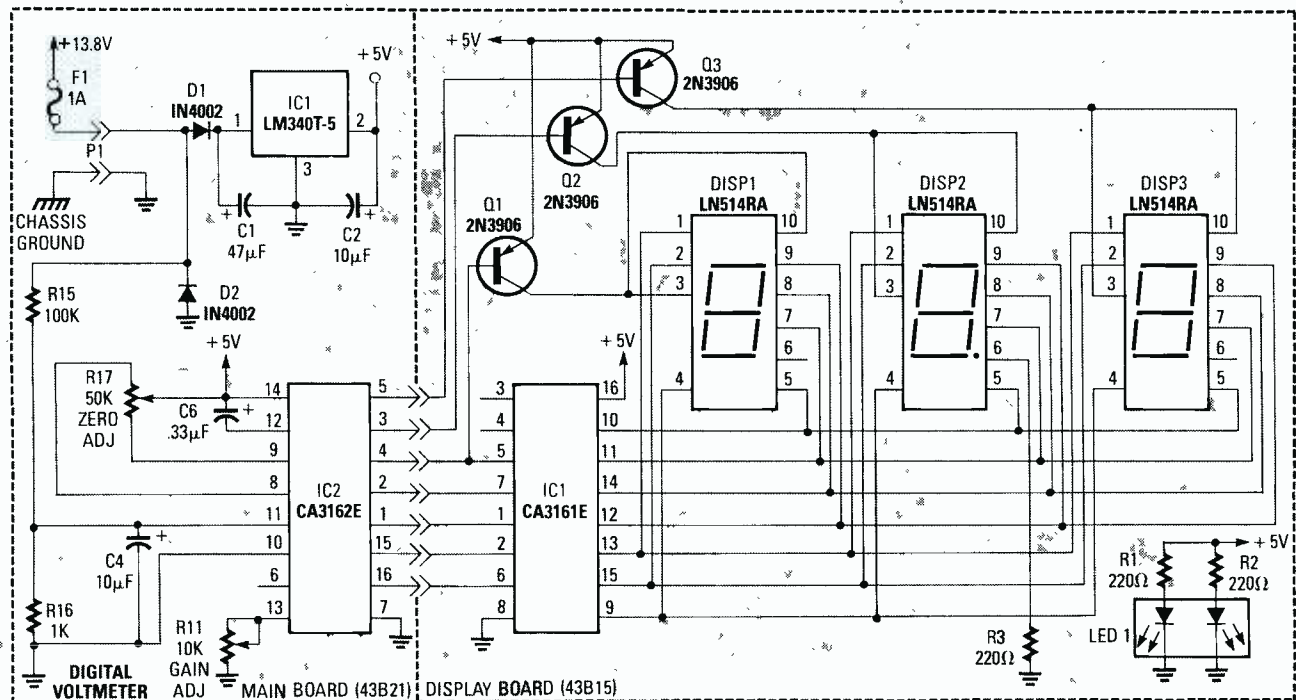

FIG. 2—THE DIGITAL VOLTAGE GAUGE displays the voltage level of your automobile's electrical system.



### VOLTAGE GAUGE

All resistors are 1/4-watt, 5%, unless otherwise indicated.

- R1-R10, R12-R14—not used
- R11—10,000 ohms, PC-mounted trimmer potentiometer
- R15—100,000 ohms
- R16—1000 ohms
- R17—50,000 ohms, PC-mounted trimmer potentiometer

### Capacitors

- C1—47  $\mu$ F, 25 volts, electrolytic
- C2, C5—10  $\mu$ F, 35 volts, electrolytic
- C3, C4—not used
- C6—0.33  $\mu$ F, 50 volts, stacked film

### Semiconductors

- IC1—LM340T-5, 5-volt regulator
- IC2—CA3162E, A/D converter
- D1, D2—1N4002 diode

**Miscellaneous:** 43B21 main PC board, 3-digit display board, in-line fuse holder, 1-amp fuse, four 6-32  $\times$  0.625" standoffs, eight 5/16-inch #6 screws, bronze or red plexiglass, mounting hardware, hookup wire

Capacitors C1 and C2 help reduce voltage transients and fluctuations.

The A/D converter (IC2) converts the input voltage to a relative digital value, and C6 is the integrating capacitor that was discussed earlier. A divide-by-100 network, that provides the proper input voltage for the A/D converter, is formed by R15 and R16. Capacitor C4 filters the A/D input

voltage to ensure stable readings. A zero-adjust is provided by R17 and a gain-adjust by R11.

Once the input voltage has been converted, its digital value is sent to the display section. There, IC1 of the display board receives multiplexed BCD information and outputs that information to the three seven-segment displays, one at a time. The multiplexing is controlled by IC2. Current to each display is switched by Q1, Q2, and Q3. For example, when Q1 is on, current is delivered to DISP1, the most significant digit of the display. To display a "138," the CA3162E would send a binary 0001 to the CA3161E, which would then turn on the necessary segments to display a "1" on the first digit. After a predetermined time, the system moves on to the second and third digits and finally repeats itself. Because the voltmeter is designed to display 0.1-volt increments, the decimal point on DISP2 is kept on all of the time by R3. A "VOLTS" annunciator is formed by LED1, which is a pre-formed module containing two LED's, and limiting resistors R1 and R2. The module has a plastic "lens" over it that is all black except for the clear letters V-O-L-T-S.

### Oil pressure

The oil-pressure gauge, shown in Fig. 3, displays engine oil pressure

### OIL-PRESSURE GAUGE

All resistors are 1/4-watt, 5%, unless otherwise indicated.

- R1—470 ohms
- R2-R8, R10, R12-R16—not used
- R9—100,000 ohms
- R11—10,000 ohms, PC-mounted trimmer potentiometer
- R17—50,000 ohms, PC-mounted trimmer potentiometer

### Capacitors

- C1—47  $\mu$ F, 25 volts, electrolytic
- C2, C3, C4—10  $\mu$ F, 35 volts, electrolytic
- C5—not used
- C6—0.33  $\mu$ F, 50 volts, stacked film

### Semiconductors

- IC1—LM340T-5, 5-volt regulator
- IC2—CA3162E, A/D converter
- D1, D2—1N4002 diode

**Miscellaneous:** 43B21 main PC board, 15G5 oil-pressure sender, 2-digit display board, in-line fuse holder, 1-amp fuse, four 6-32  $\times$  0.625" standoffs, eight 5/16-inch #6 screws, bronze or red plexiglass, mounting hardware, hookup wire

from 0 to 80 psi (pounds per square inch) with 1-psi resolution. The input voltage to the A/D converter must therefore range from 0 to 0.80 volts. The oil pressure is sensed by the oil-pressure sending unit which converts pressure to electrical resistance. In the case of the sending unit used here, pressure is converted to resistance

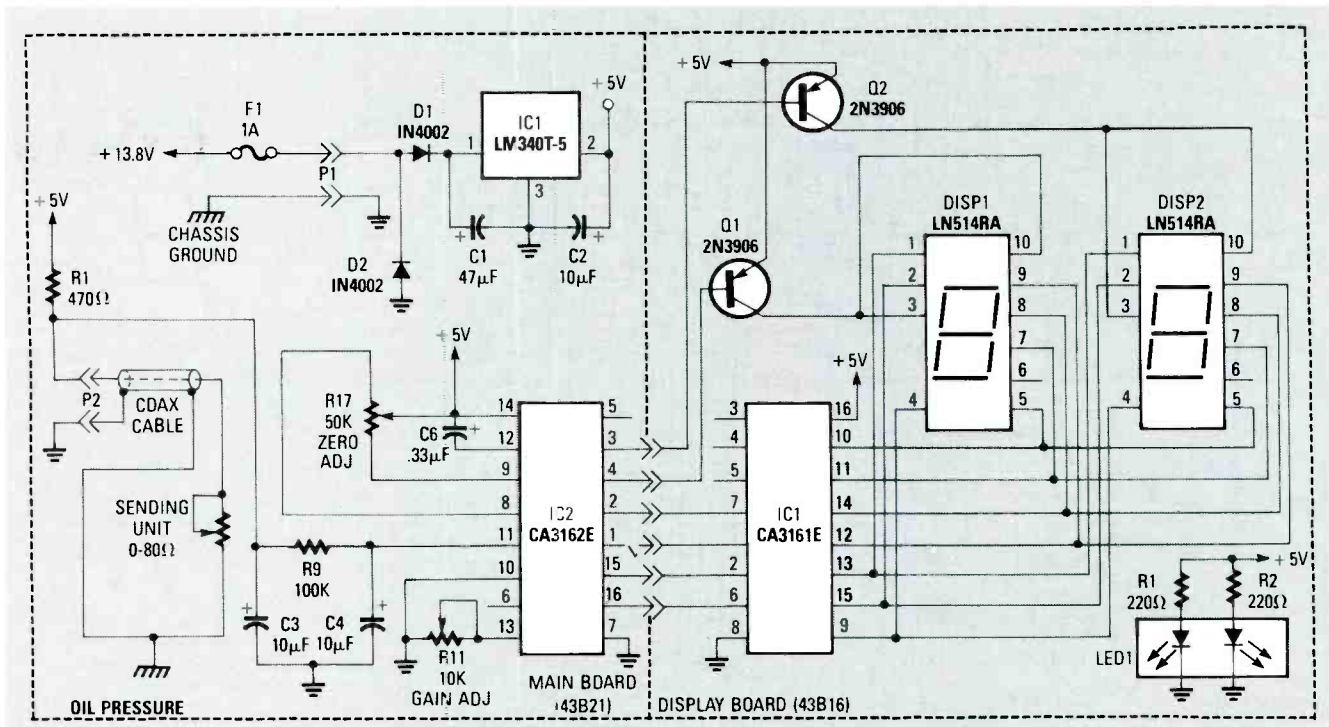

FIG. 3—THE OIL-PRESSURE GAUGE displays engine oil pressure from 0 to 80 psi with 1-psi resolution.

with an approximate 1:1 ratio. That is, with 60 pounds of oil pressure, the sender's resistance is approximately 60 ohms, with a 0.6-volt drop across it. With no oil pressure, the sender's resistance is zero ohms. The voltage drop across the sending unit is then filtered and read directly by the A/D converter. The regulator and A/D converter sections are similar to the voltmeter, and the display section is identical except for one less digit.

The sending unit and R1 on the main board form a resistive divider. The voltage drop across the sending unit equates to 0.01 volt/psi. That is, for every psi of oil pressure, the voltage across the sender increases by approximately 10 millivolts. The relative voltage across the sender is then filtered by C3, R9, and C4 to maintain a more stable reading. An "OIL" annunciator (LED1) specifies the reading of the gauge.

## Water

The water-temperature gauge, shown in Fig. 4, displays the automobile's coolant-system temperature on a three-digit readout with 1-degree resolution. The actual temperature is obtained by measuring the resistance across a standard automotive temper-

ature sending unit, which is essentially a thermistor contained in a brass enclosure. Because the sending unit's resistance is inversely proportional to temperature (the greater the temperature, the lower the resistance), the differential input of the A/D converter is used. That means that the A/D converter CA3162E measures the difference between its positive and negative inputs (pins 11 and 10, respectively).

A reference voltage, set by R6, R7, and R8 is applied to the positive input at pin 11. The negative input (pin 10) is connected to the temperature-sending unit via a resistor network. As the temperature of the sending unit increases, its resistance will decrease, lowering the voltage across it. When the lower voltage is seen at the negative input of the A/D converter, and compared to the level set at the positive input, the temperature reading will rise. The opposite happens as the sending unit cools; its resistance becomes greater and more voltage is applied to the negative input. The temperature reading then decreases as the negative input gets closer in potential to the positive input. A reading of 0 will result when the positive and negative inputs are equal. Note that

## WATER-TEMPERATURE GAUGE

All resistors are 1/4-watt, 5%, unless otherwise indicated.

- R1—100 ohms, 1/2-watt
- R2—430,000 ohms
- R3, R7—10,000 ohms, PC-mounted trimmer potentiometer
- R4, R8—22,000 ohms
- R5, R9, R11—R16—not used
- R6—470,000 ohms
- R10—2200 ohms
- R17—50,000 ohms, PC-mounted trimmer potentiometer

## Capacitors

- C1—47  $\mu$ F, 25 volts, electrolytic
- C2, C5—10  $\mu$ F, 35 volts, electrolytic
- C3, C4—not used
- C6—0.33  $\mu$ F, 50 volts, stacked film

## Semiconductors

- D1, D2—1N4002 diode
- IC1—LM340T-5, 5-volt regulator
- IC2—CA3162E, A/D converter

**Miscellaneous:** 43B21 main PC board, 14G11 water-temperature sender, 3-digit display board, in-line fuse holder, 1-amp fuse, four 6-32  $\times$  0.625" standoffs, eight 5/16-inch #6 screws, bronze or red plexiglass, mounting hardware, hookup wire.

the negative input is limited to a maximum of 1.2 volts.

The regulator and display sections

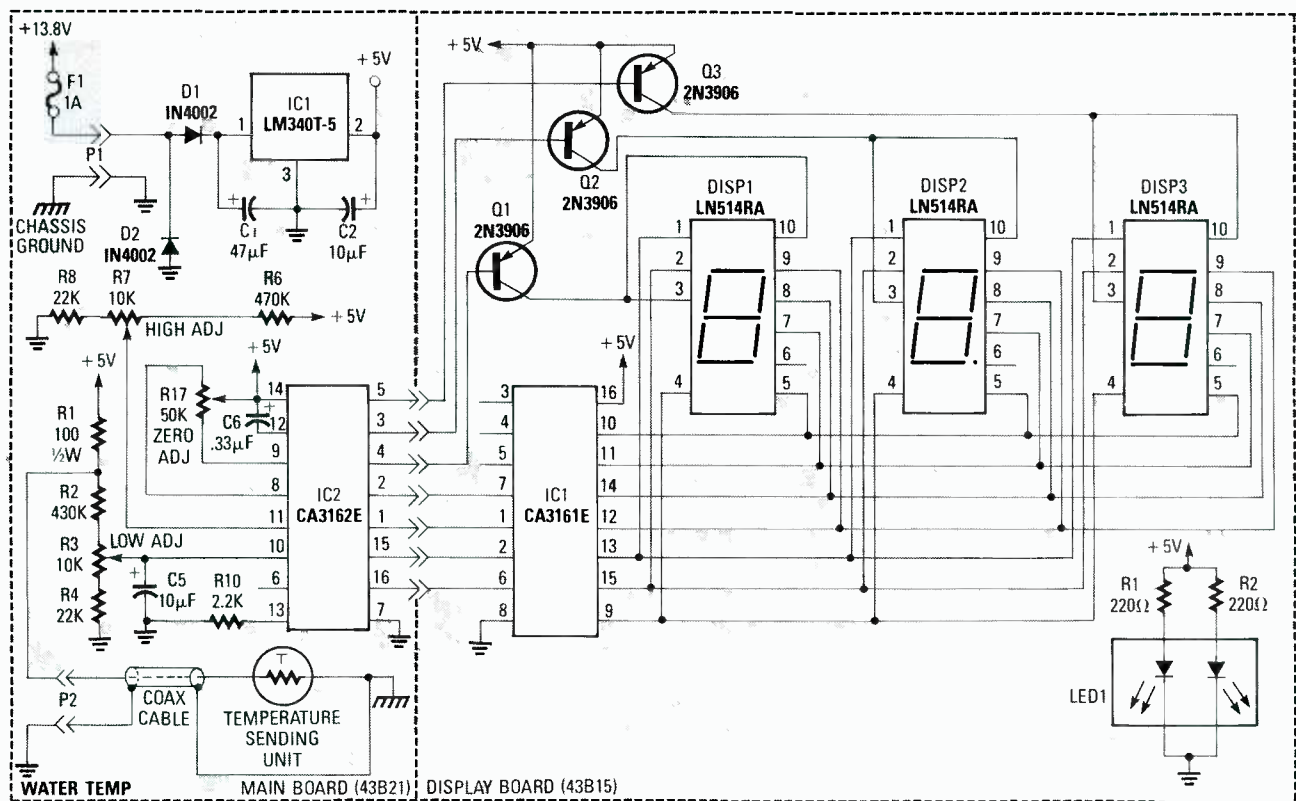

FIG. 4—THE WATER-TEMPERATURE GAUGE displays the automobile's coolant-system temperature on a three-digit readout with 1-degree resolution.





### FUEL GAUGE

All resistors are ¼-watt, 5%, unless otherwise indicated.

R1—470 ohms  
R2, R5, R10, R12, R14, R15, R16—100,000 ohms  
R3—33,000 ohms  
R4—47,000 ohms  
R6—1.8 megohms  
R7, R19—100,000 ohms, PC-mounted trimmer potentiometer  
R8—10,000 ohms, PC-mounted trimmer potentiometer  
R9—200,000 ohms, PC-mounted trimmer potentiometer  
R11—2700 ohms  
R13—8200 ohms  
R17—22,000 ohms  
R18—1000 ohms  
R20—470,000 ohms  
R21—50,000 ohms, PC-mounted trimmer potentiometer  
R22—2200 ohms

### Capacitors

C1—47 µF, 25 volts, electrolytic  
C2, C3—10 µF, 35 volts, electrolytic  
C4—0.33 µF, 50 volts, stacked film

### Semiconductors

IC1—LM340T-5, 5-volt regulator  
IC2—LM324, quad op-amp  
IC3—CA3162E, A/D converter  
D1, D2—1N4002 diode

**Miscellaneous:** 43B20 main PC board, 2-digit display board, 0.1" 3-conductor header, 2-conductor jumper, in-line fuse holder, 1-amp fuse, four 6-32 × 0.625" standoffs, eight ⅝-inch #6 screws, bronze or red plexiglass, mounting hardware, hookup wire.

After the zero offset is adjusted, the next step is to adjust for the "full" reading. That is accomplished by changing the gain of IC2, by placing a jumper in the "A" position.

When using a sending unit that decreases in resistance as the tank is filled, the "B" jumper is used. That way, after passing through R2 and an inverting amplifier, the higher sending-unit voltage from an "empty" reading is offset by R8 to produce an output at pin 14 of IC2 that is near 0.41 volts. Divided down to 0.21 volts by R14 and R15, the output at pin 1 of IC2 is at the proper 0.21-volt zero reference. The "empty" voltage is adjusted by R19. Components R20 and C3 are used to average the input voltage to avoid erratic readings caused by the sloshing of gasoline in the fuel tank. The zero adjustment of the A/D converter is set by R17, and LED1, with an appropriate lens, is used as a "FUEL" annunciator.

### Temperature

The miscellaneous temperature gauge, shown in Fig. 6, displays temperature by measuring the voltage drop across a typical silicon diode, which is determined by the formula  $V_D = 2\text{mV per degree Celsius}$ , where  $V_D$  is the voltage drop. Because the temperature gauge is calibrated to read out in degrees Fahrenheit, the voltage across the diode is scaled accordingly. The temperature is then displayed on a three-digit readout with 1-degree resolution.

Because the voltage across the di-

### MISCELLANEOUS TEMPERATURE GAUGE

All resistors are ¼-watt, 5%, unless otherwise indicated.

R1—R4, R9, R10, R15, R16—not used  
R5—2200 ohms  
R6—6800 ohms  
R7—1000 ohms, PC-mounted trimmer potentiometer  
R8—470 ohms  
R11—10,000 ohms, PC-mounted trimmer potentiometer  
R12—10,000 ohms  
R13—1000 ohms  
R14—220 ohms  
R17—50,000 ohms, PC-mounted trimmer potentiometer

### Capacitors

C1—47 µF, 25 volts, electrolytic  
C2, C5—10 µF, 35 volts, electrolytic  
C3, C4—not used  
C6—0.33 µF, 50 volts, stacked film

### Semiconductors

IC1—LM340T-5, 5-volt regulator  
IC2—CA3162E, A/D converter  
D1, D2—1N4002 diode

**Miscellaneous:** 43B21 main PC board, 1N4148 diode for temperature probe, 3-digit display board, coax cable, in-line fuse holder, 1-amp fuse, four 6-32 × 0.625" standoffs, eight ⅝-inch #6 screws, bronze or red plexiglass, mounting hardware, hookup wire.

ode is inversely proportional to temperature, the differential input of the A/D converter is used in the same manner as the water-temperature gauge. Note that the positive input at pin 11 is connected only to a reference voltage set by R6, R7, and R8. The negative input (pin 10) is connected to the 1N4148 diode temperature probe via a resistor network. As the temperature of the diode increases, the voltage across it will decrease resulting in a lower voltage at the negative input of the A/D converter and, when compared to the level set at the positive

input, the reading will rise. Just the opposite happens as the diode cools.

Resistors R13 and R14 form a voltage-divider network that provides a reference of 0.9 volts for the second divider network consisting of R12 and R5. That second divider scales the relative voltage developed across the temperature probe to coincide with the range of the A/D converter. It is also used to bias the temperature-probe diode. For example, suppose the voltage across the diode at 32 degrees Fahrenheit is 0.6 volts. Then, 0.654 volts would be delivered to the negative input of the A/D converter. With the positive input of the A/D converter calibrated to 0.686 volts, "032" would be displayed on the digital readout. As the temperature-probe diode heats to 212 degrees Fahrenheit, the drop is reduced to 0.4 volts. We would now have 0.49 volts at the negative A/D converter input. The display will now read "212."

Although the negative input is not a full 180 millivolts lower than at 32 degrees, the gain control of the A/D converter compensates for that. The compensation also allows the converter to have an adjustment window so tolerance effects can be calibrated

### VACUUM GAUGE

All resistors are ¼-watt, 5%, unless otherwise indicated.

R1, R2—10,000 ohms  
R3, R8—100,000 ohms  
R4—22,000 ohms  
R5—1000 ohms  
R6—680,000 ohms  
R7, R10—200,000 ohms PC mounted trimmer potentiometer  
R9—82,000 ohms  
R11—50,000 ohms PC mounted trimmer potentiometer  
R12—2200 ohms

### Capacitors

C1—47 µF, 25 volts, electrolytic  
C2, C3—10 µF, 35 volts, electrolytic  
C4—0.33 µF, 50 volts, stacked film

### Semiconductors

IC1—Sensym SX30DN vacuum sensor (Dakota Digital #69G18 includes mounting bracket)  
IC2—LM324, quad op-amp  
IC3—LM340T-5, 5-volt regulator  
IC4—CA3162E, A/D converter  
D1, D2—1N4002 diode

**Miscellaneous:** 43B17 main PC board, 2-digit display board, in-line fuse holder, 1-amp fuse, four 6-32 × 0.625" standoffs, eight ⅝-inch #6 screws, bronze or red plexiglass, mounting hardware, hookup wire.



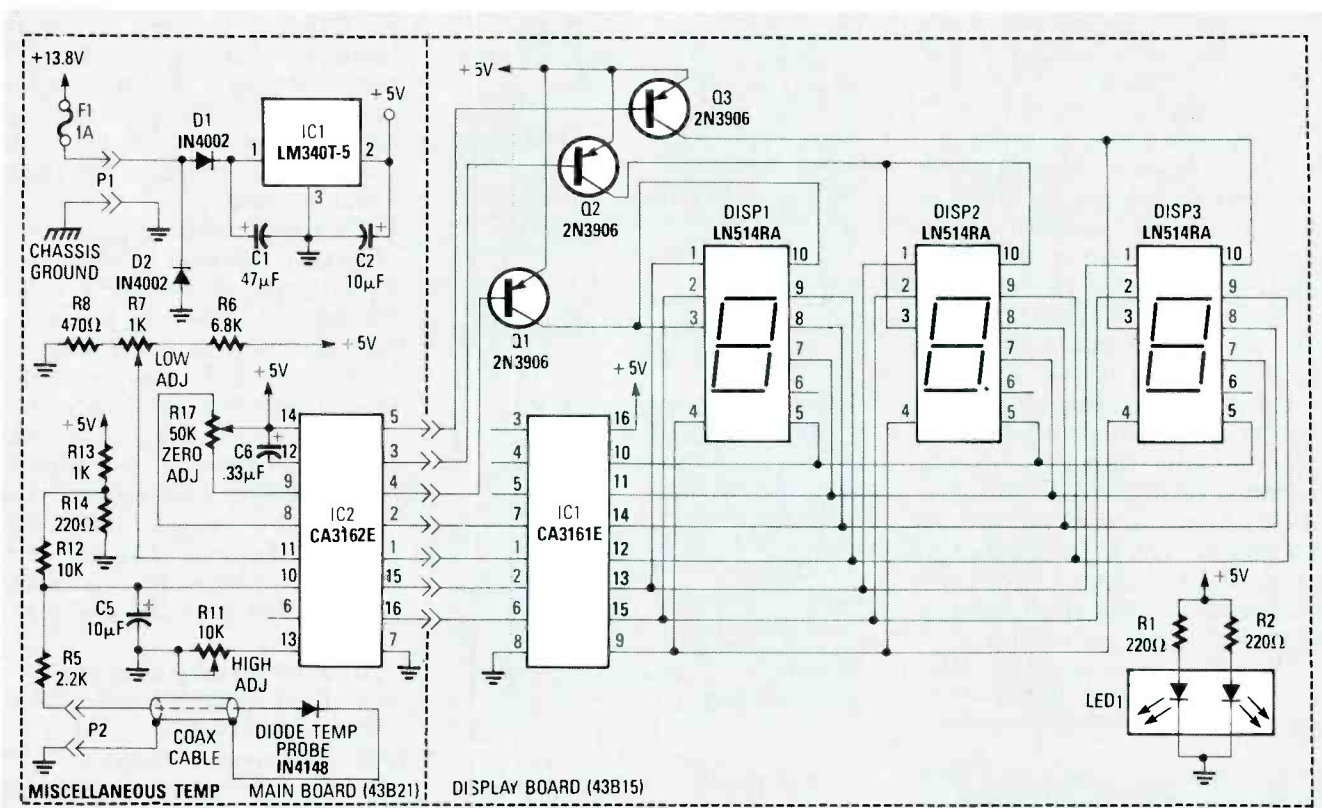

FIG. 6—THE MISCELLANEOUS TEMPERATURE GAUGE displays temperature by measuring the voltage drop across a typical silicon diode.

out. Looking at the remaining circuitry, C5 is used to filter the input voltage for stable readings. Resistors R6, R7,

and R8 form a resistive divider that sets the upper reference voltage, with a range of 0.284 to 0.889 volts. The

low-temperature calibration is adjusted via R7, while the high-temperature calibration is adjusted via R11.

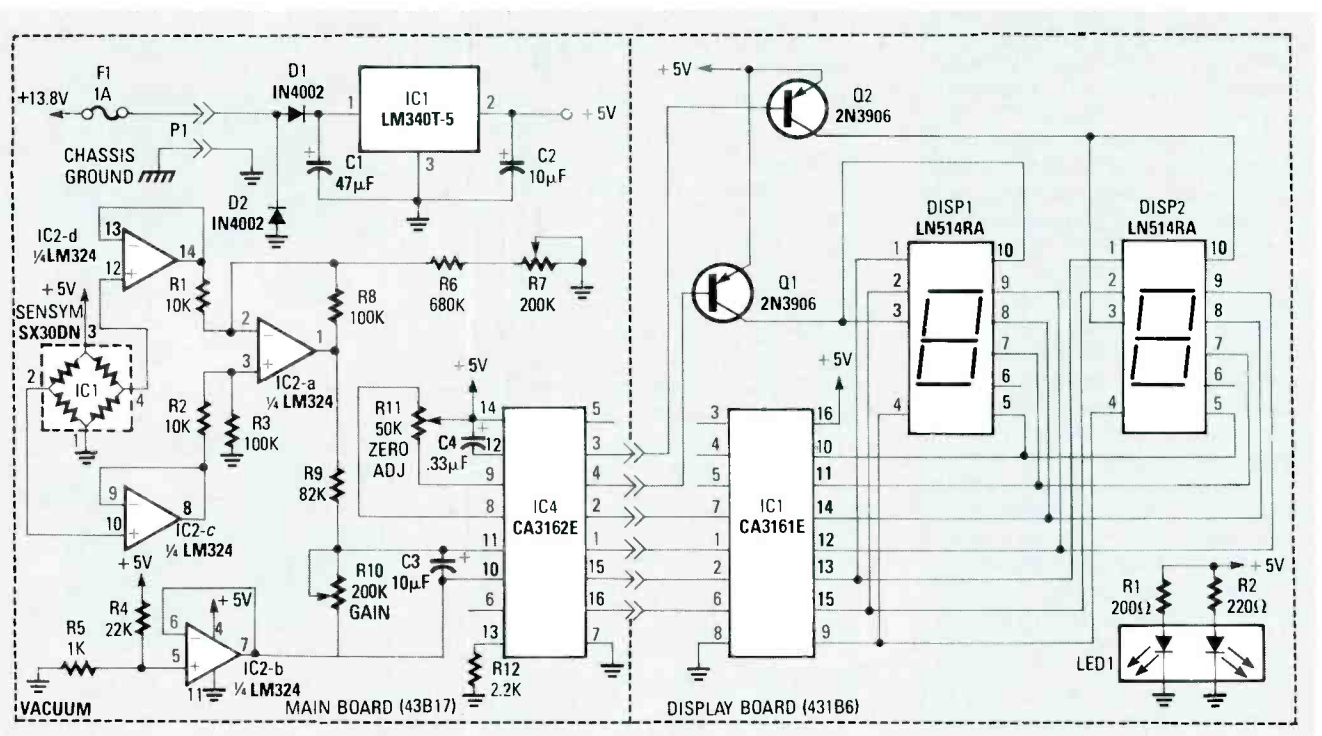

FIG. 7—THE VACUUM GAUGE uses a Sensym SX30DN solid-state vacuum/pressure sensor to monitor the intake-manifold vacuum during engine operation. Between 0 and 30 inches of mercury can be displayed.

A three-digit display is used, and the annunciator can be created to read anything you choose—"IN," "OUT," "TRANS," "OIL," etc..

The vacuum gauge, shown in Fig. 7, uses a solid-state vacuum/pressure sensor (IC1, Sensym SX30DN) to monitor the intake-manifold vacuum during engine operation. Between 0 and 30 inches (in.) of mercury (Hg.) can be displayed with 1 in. Hg. resolution. The sensor consists of a piezo resistive element housed in a dual ported plastic enclosure. The piezo element changes its resistance as it is flexed or bent. Because a specific amount of flexing is caused by a specific force or pressure, the value of that pressure can be determined by measuring the sensor's resistance. Vacuum has the same effect as it pulls the element instead of pushing it.

The pressure/vacuum sensor (IC1) is essentially a bridge circuit with its outputs at pins 2 and 4. Because it is a

**Note: The following items are available from Dakota Digital, 11301 Kuhle Drive, Sioux Falls, SD 57107 (605) 332-6513, (800) 852-3228: a PC-board set for each gauge (includes main PC board and display board) is \$6.95. A parts kit for each gauge (includes PC boards, components, and manual) is \$29.95 each. Each gauge assembled and tested is \$39.95. Stock numbers are as follows: voltage-gauge kit #2005-KIT, assembled and tested #3005-UNIT; oil-pressure gauge kit #2006-KIT, assembled and tested #3006-UNIT (order oil-pressure sender separately); water-temperature gauge kit #2007-KIT, assembled and tested #3007-UNIT (order water-temperature sender separately); miscellaneous temperature gauge kit #2008-KIT, assembled and tested #3008-UNIT; fuel-gauge kit #2009-KIT, assembled and tested #3009-UNIT; vacuum-gauge kit #2010-KIT, assembled and tested #3010-UNIT (order vacuum sensor separately). Oil-pressure sender (#15G5), \$15.50; water-temperature sender (#14G11), \$5.50; vacuum sender (#69G18), \$19.95; RCA CA3161E driver (#69G16), \$1.95; RCA CA3162 A/D converter (#69G15), \$7.95. All orders add 4% shipping and handling (\$1.50 minimum), Visa and Mastercard accepted.**

### 3-DIGIT DISPLAY BOARD

All resistors are 1/4-watt, 5%, unless otherwise indicated.

R1, R2—220 ohms  
R3—220 ohms (voltmeter only)

#### Semiconductors

IC1—CA3161E, Display driver  
DISP1—DISP3—0.43" 7-segment C.A. LED display (Panasonic, LN514RA)  
Q1—Q3—2N3906 PNP transistor  
LED1—5- × 15-mm LED, (Panasonic LN0202RP)

### 2-DIGIT DISPLAY BOARD

All resistors are 1/4-watt, 5%, unless otherwise indicated.

R1, R2—220 ohms

#### Semiconductors

IC1—CA3161E, display driver  
DISP1, DISP2—0.43" 7-segment C.A. LED display (Panasonic LN514RA)  
Q1, Q2—2N3906 PNP transistor  
LED1—5- × 15-mm LED, (Panasonic LN0202RP)

bridge, its outputs change proportionally to one another when vacuum or pressure is applied. When both ports have the same pressure, the outputs at pins 2 and 4 are identical. As vacuum is applied to port 2, the output at pin 2 rises while pin 4 is reduced. There is now a difference between the two outputs of the bridge, and that difference represents how much vacuum is present.

The first two sections of IC2 are used as buffers to isolate the bridge circuit of IC1. IC2-a is used as a differential amplifier, and R1—R3 and R8 determine the gain. Resistors R6 and R7 are used to offset the differential amplifier so that its normal "zero" output is 0.21 volts above ground. The gain of the differential amplifier is set to give an output approximately 60% higher than that needed by the A/D converter. The voltage level is then reduced by R9 and R10, which is also used to set the full scale of the gauge. The input voltage to the A/D converter is averaged by C3 for stable readings. Resistors R4 and R5 set the 0.21-volt "ground" reference which is buffered at the output of IC2, pin 7. The vacuum value is displayed on a two digit readout. A "VAC" annunciator on the display board indicates the reading of the gauge.

### Construction

Each digital gauge is built using

two different PC boards. The display board contains the seven-segment displays along with the driver components, as well as the annunciator light bar. The main board contains the A/D converter, all input circuitry, and the 5-volt regulator.

The boards are mounted one on top of another, separated by standoffs. A typical gauge is shown in Fig. 8. With the display board facing toward you, the main board is mounted directly behind it, with its components also facing toward you. Electrical connections from board to board are made using short pieces of bare wire between matching pads on both boards. A piece of 9-conductor ribbon cable can be used instead. Once assembled, the boards can be folded apart to allow for easy testing, troubleshooting, or calibrating.

Each gauge uses either a two- or three-digit display board. Table 1 shows which boards are to be used with each gauge. When stuffing the three digit display board, begin with R1 and R2 as shown in Fig. 9, and install R3 only if the board is to be used with the voltage gauge, as R3 supplies power to the decimal point. Install DISP1—DISP3 and LED1, keeping them flat against the board,

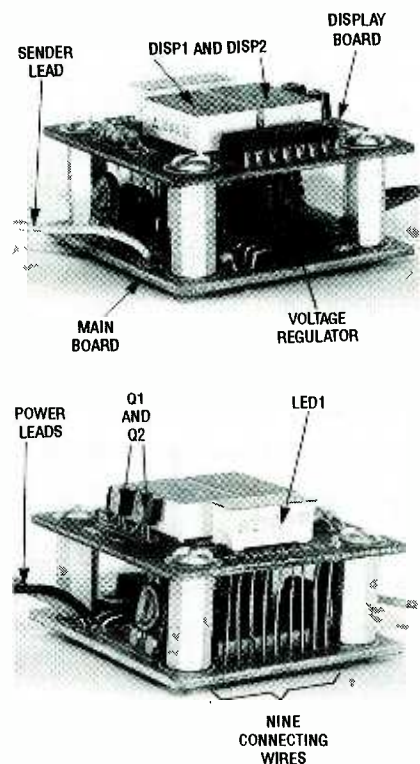

FIG. 8—THE BOARDS ARE MOUNTED one on top of another, separated with standoffs. A typical gauge is shown here.



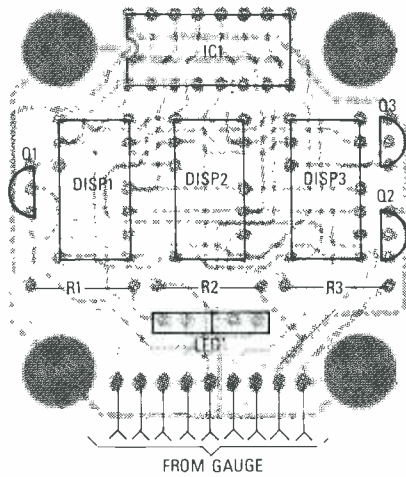

FIG. 9—WHEN STUFFING THE THREE-digit display board, install R3 only if the board is to be used with the voltage gauge. Otherwise it is not used.

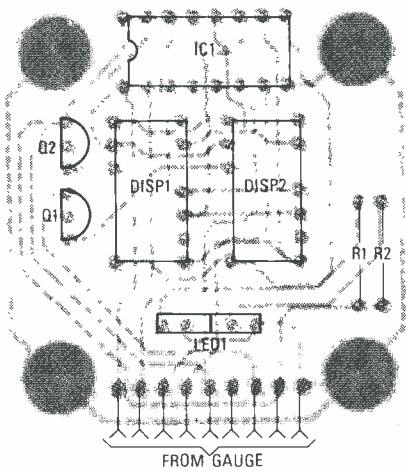

FIG. 10—THE TWO-DIGIT DISPLAY BOARD is the same as the three-digit board, but uses only DISP1 and DISP2.

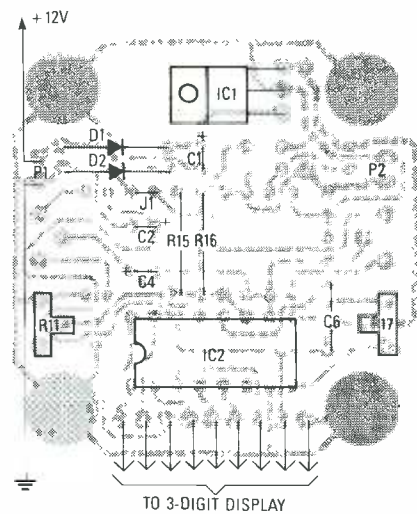

FIG. 11—VOLTAGE GAUGE parts placement. Solder the parts to the board in smallest-to-largest order, clipping and saving the leads.

TABLE 1

Digital Gauge	Main Board	Display Board
Voltmeter	43B21	43B15 3-digit
Oil Pressure	43B21	43B16 2-digit
Water Temp	43B21	43B15 3-digit
Misc Temp	43B21	43B15 3-digit
Fuel	43B20	43B16 2-digit
Vacuum	43B17	43B16 2-digit

and then install Q1–Q3. The transistors must be installed to a height just below the height of the displays. Using a good silicone sealant or other similar glue, secure a photographic legend or some other form of annunciator lettering to the LED light bar. If the two-digit display board is to be used, install everything in the same manner as the three digit board, but use only DISP1 and DISP2, and Q1 and Q2 (see Fig. 10).

Although the use of sockets is normally recommended, IC1 must be kept below the height of the seven-segment displays. Therefore, IC1 must be soldered directly to the board. Be careful when soldering the IC.

Referring to Table 1, note that the same main board is used for the voltage, oil-pressure, water-temperature, and miscellaneous temperature gauges. However, the actual components soldered to the board are different for each gauge, and not all PC pads are used on all boards. Install only the components specified in each parts-placement diagram.

Figure 11 shows the component placement for the voltage gauge. Solder the parts to the board in smallest-to-largest order, clipping and saving the leads. The parts-placement diagram for the oil-pressure gauge is shown in Fig. 12, the water-temperature gauge in Fig. 13, and the miscellaneous temperature gauge in Fig. 14.

The fuel gauge and vacuum gauge each has its own main board. Figure 15 shows the parts-placement diagram for the fuel gauge, and Fig. 16 for the vacuum gauge. Note that the resistors and diodes on the fuel- and vacuum-gauge main boards must be installed standing on end. Be sure to observe the polarity of the diodes.

After all of the components are installed on each board, solder a red wire containing a fuse holder and fuse

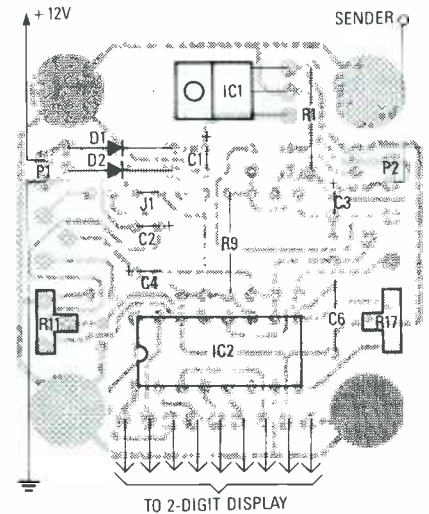

FIG. 12—OIL-PRESSURE GAUGE parts placement.

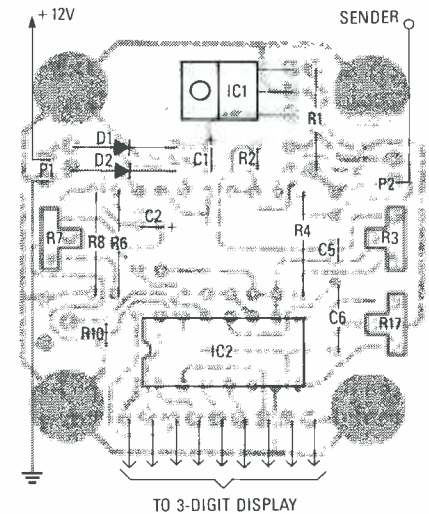

FIG. 13—WATER-TEMPERATURE gauge parts placement.

into its respective hole. A black ground wire is soldered into the hole next to the power wire.

The oil-pressure, water-temperature, and fuel gauges all need one sender wire attached to the main board. Cut a 4-inch piece of wire and solder one end to the main-board location marked P2, "sender," and be

sure to put it in the hole that is farthest from the upper-right-hand corner of the board. Next, crimp on a 1/4-inch female solderless terminal to the other end of the wire. You will then need an appropriate length of wire that will run out to the actual sender, and you should crimp on a 1/4-inch male solderless terminal to one end, and set it aside for now.

The miscellaneous temperature gauge will need both a sender wire and a ground return wire. Install the sender wire as previously described, and cut a 4" piece of black wire to be soldered into the hole just above the sender wire. A 1/4-inch male solderless terminal goes on the end of the ground return wire.

The main boards are now ready to be connected to the display boards. The first step is to place the four stand-offs between the boards and secure them with eight 5/16-inch #6 screws. Assemble the boards with the foil side of the display board facing the component side of the main board. The holes for the board-to-board connecting wire should line up on the same edge. After the two boards are secured to each other, lay the assembly face down and begin inserting pieces of bare wire or scraps of component leads through the holes in the main board and down into the respective holes in the display board. After a few wires have been inserted, solder the connections. Continue until all nine wires have been installed.

The temperature probe for the miscellaneous temperature gauge is constructed from the 1N4148 diode, a 10-foot length of coax cable, and a male and female crimp-on connector. On one end of the coax cable, strip off about 3/4-inch of the outer insulation, unbraid the outer conductor, and twist toward one side. Next, strip about 1/4-inch of the cable's inner insulation.

Position the 1N4148 diode so that the band, or cathode, is touching the outer conductor of the coax cable. The diode will lay right against the inner-conductor insulation. Very carefully solder both sides of the diode, the cathode side to the outer conductor and the anode side to the inner conductor. After clipping the excess lead length, coat the diode and exposed wires with a good quality epoxy or sealer. Apply several coats to ensure a good seal. Only the end of the cable with the diode is coated. On the other end of the cable, strip and

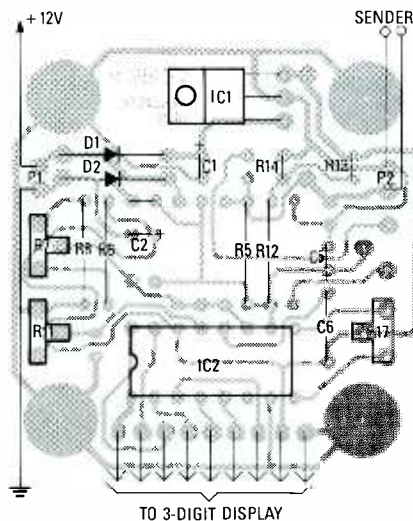

FIG. 14—MISCELLANEOUS temperature gauge parts placement.

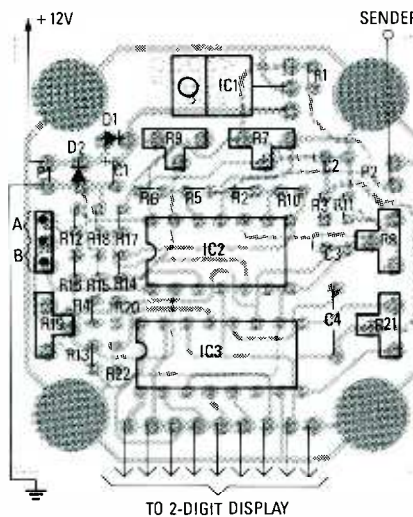

FIG. 15—PARTS-PLACEMENT DIAGRAM for the fuel gauge.

separate the inner and outer conductors. Crimp the male terminal to the center conductor and the female terminal to the shield.

The solid-state vacuum sensor is mounted to the vacuum gauge by first removing the two screws near IC3 that hold the main board to the standoffs. Place the sensor bracket on the back side of the main board and align the holes on the two tabs with the board mounting holes and reinsert the two screws (see Fig. 17). Next, insert the sensor leads into the main board with the lettering on the sensor body facing away from the bracket. Insert the remaining hardware and tighten the sensor to the bracket. Do not overtighten the mounting screws as you damage the sensor. It is a good idea to only hand tighten the screws and apply a

small drop of glue to keep them from coming loose. Very carefully solder the leads of the sensor to the board, working from the back side of the board. Be careful not to melt the case of the sensor with the soldering iron.

### Calibration

After the gauges are completely assembled, turn all the calibration potentiometers to the center of their rotation. Next, connect each gauge to a 12-volt DC power supply or battery. At this point, all the display digits should light as should the LED light bar.

The calibration process for all of the digital gauges begins with zeroing the A/D converter. To do that, pins 10 and 11 of the CA3162E A/D converter must be shorted together. Use a small screwdriver or jumper wire. Once connected, the display should now read zero or very close to it. Adjust the zero calibration potentiometer (see each schematic for exact potentiometer number) so that the display reads "000" or "00." Then remove the jumper.

The voltage gauge is calibrated by connecting a good quality bench voltmeter across the power supply that is used to power the gauge. Carefully adjust R11, the gain adjust potentiometer, so the reading is the same as the reading on your bench voltmeter.

The calibration process for the oil-pressure gauge requires connecting a precision 47-ohm resistor to the sensor lead and carefully adjusting R11 so the reading is at "47." Actually, any resistor between 33 and 91 ohms can be used to calibrate the unit. Just set the display to coincide with the value of the resistor.

The water-temperature gauge is calibrated by connecting the sending unit and adjusting for freezing and boiling temperatures. First, prepare a bowl of water with several ice cubes in it, and a pot of boiling water. Place the sending unit in the boiling water with its base submerged in the water and the terminal above the water line. After waiting about a minute for the sending unit to stabilize, adjust the "high adjust" potentiometer (R7) for a reading of "212" on the display. Next, place the sending unit in the ice water using the same precautions not to let the center terminal come in contact with the water. Wait a minute for the sending unit to stabilize and adjust the "low adjust" potentiometer (R3)



for a reading of "032" on the display. Repeat the high- and low-adjustment procedures until a good balance has been reached.

To calibrate the fuel gauge, you must determine the empty and full resistance of your vehicle's sender. For most Fords, it's 73 ohms empty to 10 ohms full. GM vehicles run from 0 ohms empty to 90 ohms full, and AMC, marine, and most aftermarket senders use the scale of 244 ohms empty to 33 ohms full. The calibration range of our fuel gauge will easily accept the input from virtually any brand of sending unit.

Obtain two resistor values that are very close to the empty and full resistances of the sending unit that will be used. If your system requires you to use the "A" circuit, you will begin calibrating the fuel gauge by first turning R9 fully counterclockwise. With the "empty" resistance connected to the lead wire, adjust R7 for a reading between "00" and "05." Because the gauge has a large RC circuit for averaging, allow plenty of time for the reading to settle. Next, connect the "full" resistance and adjust R9 for a reading between "95" and "99." It is usually better to have some headroom to avoid over-range and under-range conditions due to sending-unit tolerance. After the empty and full settings are adjusted, repeat the two steps until a good balance has been reached.

If the "B" circuit is being used, begin the procedure by turning R19 fully clockwise. Connect the "empty" resistance and adjust R8 for a reading of "00" to "05" on the display. Reconnect to the "full" resistance and adjust R19 for a reading between "95" and "99." Repeat the two steps until a good balance has been obtained.

The calibration procedures for the miscellaneous temperature gauge are almost identical to the water-temperature gauge. Prepare a bowl of water with several ice cubes and a pot of boiling water. Place the temperature probe in the boiling water, wait 30 seconds for it to stabilize, and adjust R11 for a reading of "212" on the display. Next, place the sending unit in the ice water. Wait another 30 seconds for the sending unit to stabilize, and adjust the "low adjust" potentiometer (R7) for a reading of "032" on the display. Repeat the high- and low-

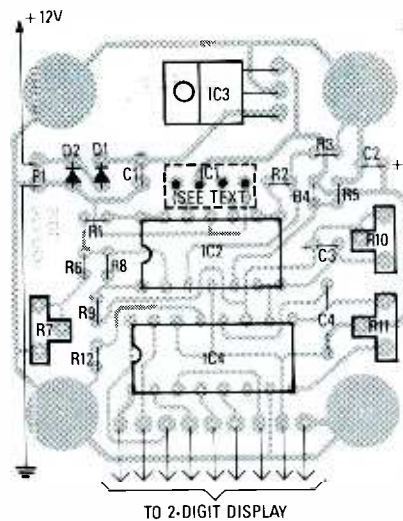

**FIG. 16—PARTS-PLACEMENT DIAGRAM FOR THE vacuum gauge.**

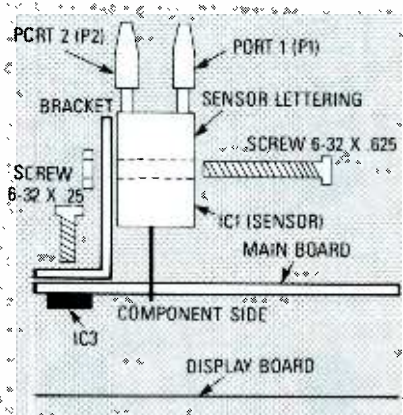

**FIG. 17—PLACE THE SENSOR BRACKET on the back side of the main board and align the holes on the two tabs with the board mounting holes.**

adjustment procedures until a good balance has been reached.

The calibration process for the vacuum gauge begins by turning R10 fully clockwise and adjusting R7 for a reading of "00" on the display. That zeros the offset of the pressure/vacuum sending unit. Next, connect a piece of 1/64-inch vacuum line to P2 (port 2) on the sending unit. The other end must go to an accurate vacuum source that you will use as a standard for full-scale calibration of the vacuum gauge. The vacuum source can be a hand-held vacuum pump that has an accurate dial gauge, or you can connect the vacuum gauge and an automotive tune-up vacuum gauge to a running engine and use its reading as your standard. Once a known amount of vacuum is connected to the vacuum gauge, adjust R10 for a full-scale reading.

## Installation

A good enclosure will protect the units from shock, dirt, and shorting. The enclosure must also have a front panel that will enhance the viewing of the displays. That is especially important for bright days, where bare LED displays can be very difficult to read.

The digital gauges can be mounted by the same bolts that hold the two boards together. That allows the point of mounting to be from the front or back of the unit. For rear mounting, the screws that hold the main board to the spacers are removed. From here, additional spacers are used to mount the unit to a panel located behind the digital gauge. The length of the spacers will depend on how far the mounting panel is from the front panel. The unit can also be mounted directly to the front panel by removing the screws holding the display board to the spacers. Here again, additional spacers will be used to keep the unit away from the front panel and provide a secure mounting. If mounted from the front panel, use an attractive screw that will enhance the look of the front panel. Hex-head screws, Allen screws, or Torx screws can be used. As with any type of enclosure, you will also need to drill or cut vent holes to allow heat to escape.

For the front panel, bronze or smoked plexiglass is recommended. That material is not only durable, but it will also keep outside light from shining into the display area and allow the LED's to shine through, thus creating a more visible and readable display. Red filter plexiglass will also work well as long as only red LED's are used. The front panel should be masked to allow only the LED's and annunciator to show, thus hiding the rest of the display board. Masking can be done by taping over the area where the displays will be located and painting the uncovered area black on the back side.

Both the oil-pressure gauge and the water-temperature gauge require sending units to be mounted to the engine. The oil-pressure sending unit mounts directly to the block of the engine. Its 1/8-inch pipe thread fits GM motors directly while Ford motors, along with some other manufacturers using 1/4-inch thread, will require a 1/4-to 1/8-inch adapter. The water-temperature sending unit is made to mount directly to the block or water pump of a Ford motor using standard 3/8-inch

pipe thread. GM motors will require a 1/2- to 3/8-inch adapter. Should your application be somewhat different, adapters and fittings can be obtained from your local hardware or automotive store.

You may also wish to keep your original gauge or idiot light that came factory with your car. That can be done in one of two ways. A "T" fitting can be used to mount both the original sender and the new sender. Otherwise you have to find another location that is occupied by a plug that can be replaced with the sending unit. That lets you keep your automobile's factory dashboard functions intact.

When connecting the fuel gauge to the fuel sender, the easiest method is to find the factory wiring harness connection that runs back to the fuel tank. A second option is to run a new wire. The original fuel gauge cannot be connected to the same sender that the new digital fuel gauge is using. The two will interfere with each others readings.

When connecting any of the gauges to the motor or fuel tank, be sure that the sender has a good connection to chassis ground. Failure to properly ground the gauge or the sender will result in erratic or incorrect readings.

The temperature probe for the miscellaneous temperature gauge can be mounted in one of several ways. When monitoring air temperature, inside or out, the probe should be placed in an area where a good average temperature exists. Inside, that may be under the dash, away from any heating or cooling vents and out of any sunlight. Outside, under the front grill area of the car will provide the most accurate point as it is out of the sun and not affected too much by engine heat.

If the goal is to measure the temperature of the transmission fluid, engine oil, differential, or coolant, mount the sensor in a manner that maintains good thermal contact to the outer plate of the item being monitored. Heat sink compound should also be used to ensure good thermal contact. For example, when monitoring oil temperature, mount the sensor to the bottom, back side of the oil pan, where there will be very little air movement to cool the sensor.

Remove one of the oil pan bolts and manufacture a bracket that will hold the probe to the oil pan. This can be a

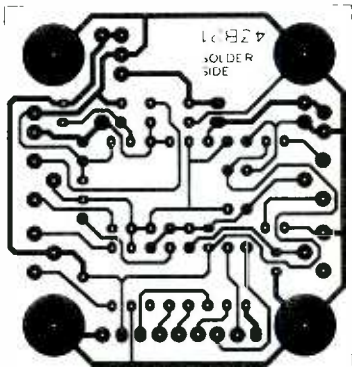

1 13/16 INCHES  
VOLTS, OIL, WATER, AND MISC. TEMP.

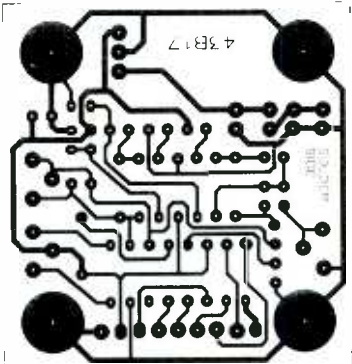

1 13/16 INCHES  
VACUUM GAUGE FOIL PATTERN.

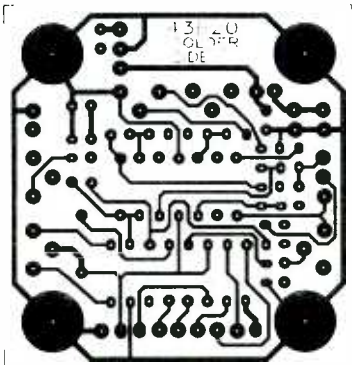

1 13/16 INCHES  
SOLDER SIDE OF THE FUEL GAUGE.

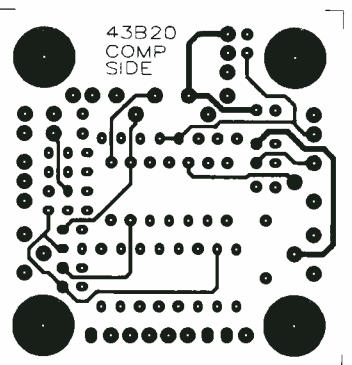

1 13/16 INCHES  
COMPONENT SIDE OF THE FUEL GAUGE.

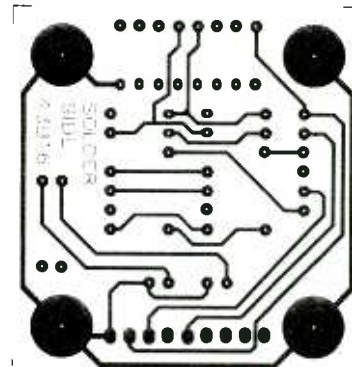

1 13/16 INCHES  
2-DIGIT DISPLAY SOLDER SIDE.

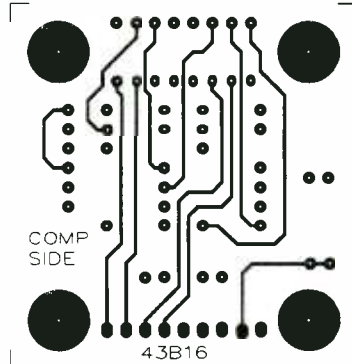

1 13/16 INCHES  
2-DIGIT DISPLAY COMPONENT SIDE.

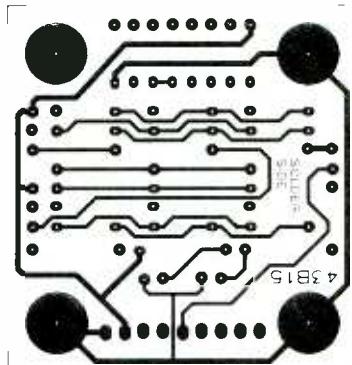

1 13/16 INCHES  
3-DIGIT DISPLAY SOLDER SIDE.

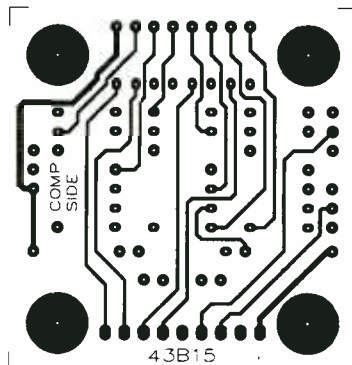

1 13/16 INCHES  
3-DIGIT DISPLAY COMPONENT SIDE.



simple piece of aluminum or thin steel cut in such a way so when the oil pan bolt is inserted through the bracket and into the block, the sensor will be lightly compressed between the bracket and the oil pan. Do not make it too tight, as excessive pressure on the 1N4148 diode will break its glass housing. You may want to hold the sensor by the cable near the diode to be safe. Apply heat sink compound to the sensor and the oil pan where contact is to be made. Be sure the oil pan is free of dirt. Then route the coax cable up through the firewall to the location of the gauge.

The vacuum gauge is connected to the intake manifold via 7/64-inch vacuum hose. Run the hose through a location in the firewall and to the intake manifold, or vacuum "T" usually located near the rear of the engine compartment. Connect the vacuum hose to P2 (port 2) on the sending unit.

Once a suitable panel or enclosure has been constructed, and the gauges mounted to it, install the assembly into the vehicle and connect the power to a source that is on only when the ignition key is placed in the "on" position.

Be sure to secure any hookup wires so they will not present a hazard to you or your vehicle. Your new digital gauge system is now ready to display important vehicle information and keep you up to date on its condition and performance. **R-E**

### RAM DISK DRIVE

*continued from page 31*

with at least 150K of free disk space. Check with the author at the address given in the parts list for the latest version of the initialization program and device driver.

The next task is to add the device driver to your CONFIG.SYS file. Until you are sure things are working the way you want, you may want to boot from floppy, not your hard disk. Later, after you arrive at the correct configuration, copy the device driver to your hard disk and edit its CONFIG.SYS.

The device driver line in CONFIG.SYS takes the form:

```
device = a:ramdev.sys /768 #16
          $016 %2
```

The first parameter specifies the board's base address, in this case 768. Next comes the number of SRAM's installed (16), followed by the number of directory entries (016), and last by the number of sectors per allocation unit (2). Each parameter must contain the number of digits shown (three, two, three, and one, respectively). Add a leading zero (or leading zeros) if necessary. In addition, for proper operation, you must prefix the base address with a slash, the number of IC's with a pound sign, the number of directory entries with a dollar sign, and sector number with a percent sign.

Edit the CONFIG.SYS of your boot disk to add the appropriate values, and then reboot. If all is working well, you should be able to use the static ram disk just like any other kind of drive in your computer.

It is also possible to boot your computer using the static ram disk. That, however, requires an add-on "silicon boot board." See the "Ordering Information" box for more details. **R-E**

# FREE CATALOG

Call (800) 992-9943

Over 35,000  
Electronic Components

Call Today for Your  
FREE SUBSCRIPTION

If You Order Today,  
WE SHIP TODAY!!

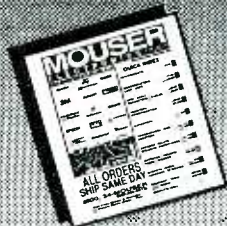

## MOUSER ELECTRONICS

(800) 992-9943

Stocking Locations Across America.

CIRCLE 15 ON FREE INFORMATION CARD

## Toner Cartridge Recharge

### Kits—Supplies—Service

Everything you need to recharge toner cartridges used with Canon based laser printers and personal copiers.

Use with HP: LaserJet, LaserJet II, IID, IIP, III, IIIP

Apple: LaserWriter, LaserWriter IINT, IINTX, QMS:

Kiss, PS-800, PS-810, Canon: LB-P8A1, A2, II, OKI, NEC, Ricoh, etc.

With our *Kits—Supplies—Service* you can start your own profitable recharge business or just recharge your own cartridges.

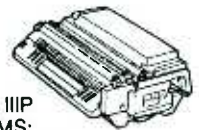

Model	Recharge Kits/Supplies	Dealers Please Call
TR-300	Recharge Kit for CX type laser printer engines.	\$21.95
TR-302	Recharge Kit for SX type laser printer engines.	\$26.30
TR-304	Recharge Kit for HP IIP (LPB-4) laser printer.	\$21.95
TR-325	Recharge Kit for PC-10/12/14/20/24/25 copier.	\$25.50
TR-370	Recharge Kit for Sharp Z-50/55/70 copier.	\$34.95
4080	Replacement Toner Kit for Ricoh 4080 laser.	\$35.95ea/6
6000	Replacement Toner Kit for Ricoh 6000 laser.	\$14.25ea/6
9710	200 grms of high quality black toner for CX.	\$9.95ea/12
9730	250 grms of high quality black toner for SX.	\$12.50ea/12
8011-Blue/Br	200 grms of Blue/Brown toner for CX & SX.	\$22.95ea/12
8057	150 grms of high quality black toner for PC.	\$10.95ea/12
Felt-CX,SX	replacement treated felt for all models.	\$0.90ea/12
SS-CX,SX	seal strips for sealing in toner for reshipping	\$0.85ea/12
DPP	Drum Padding Powder (pixie dust)	\$12.95
EverDrum™	OPC drum life extender agent. 40+ applications	\$41.95
C2094	3M Toner Vacuum with attachments.	\$199.95

Instructions Available Free to Customers!

Call 800-221-3516 ask for our catalog.



Cheneko Products, Inc.  
2221 Fifth Ave., S4, Ronkonkoma, NY 11779  
Call: 516-467-3205, Fax: 516-467-3223

CIRCLE 10 ON FREE INFORMATION CARD

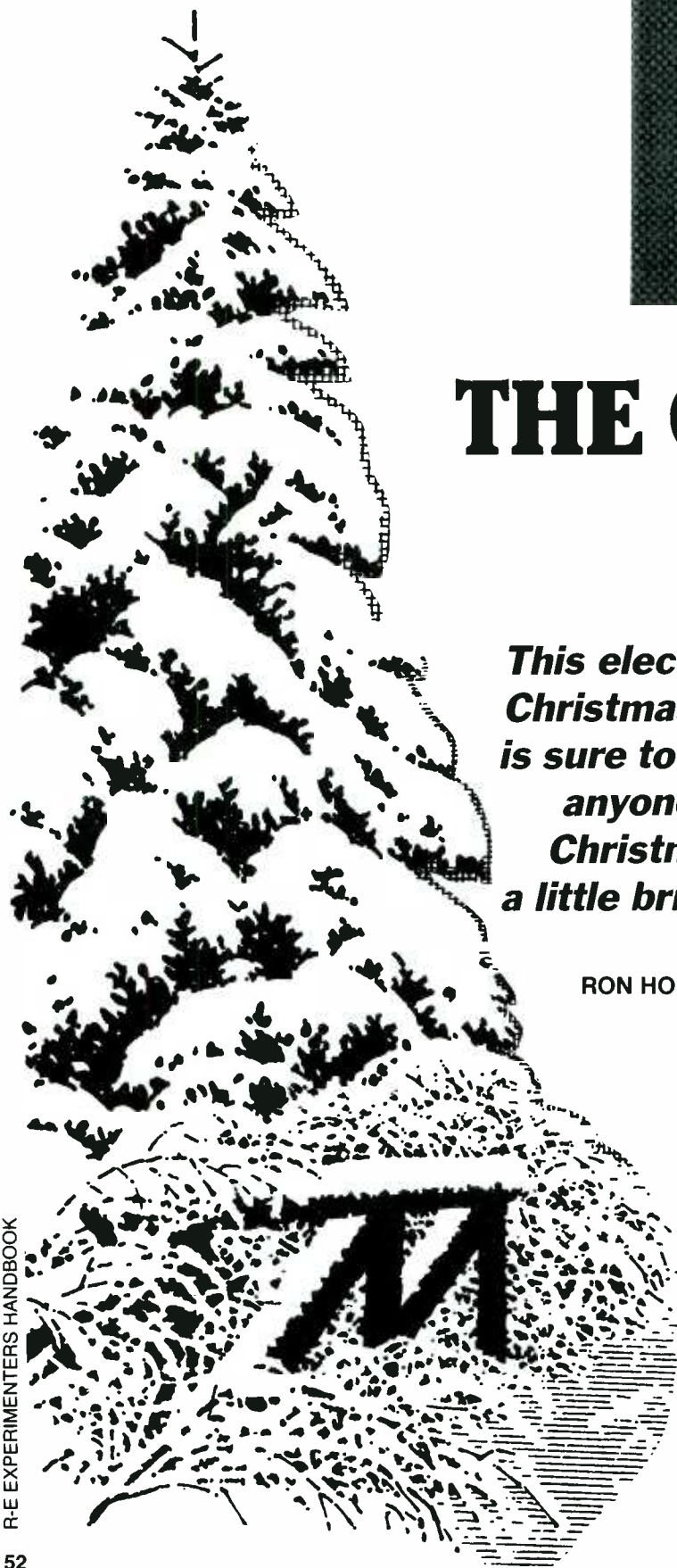

# THE CHRISTMAS CARD

*This electronic Christmas tree is sure to make anyone's Christmas a little brighter.*

RON HOLZWARH

HERE'S A PROJECT THAT YOU'LL BE happy to display in your front window this Christmas season—it also makes a great gift that anyone else would love to display in his or her window. The electronic Christmas tree is actually made from a printed circuit board with traces that form the branches of the tree. Different colored LED's mounted on the board simulate Christmas-tree lights. A built-in microphone picks up any audio signals—such as Christmas music—and different strings of LED's light according to the spectral distribution of the audio within a frequency band selected by the constructor. When installed in the custom metal frame, all of the electronics and the batteries are hidden behind the black mat and protected by the front glass. The end result is an attractive little Christmas tree whose lights will blink in unison with any kind of audio.

The photographs cannot convey the effect of the flashing lights, nor the vivid impression of seeing sound. Music becomes a quickly moving pattern of dancing lights. In fact, any sound becomes an interesting display as the microphone, which tops the tree, picks up any sound in the room. For the hearing-impaired,



it opens up a new window to sound.

The project is also good for those who wish to learn about audio. For example, the tuning fork option only receives frequencies very near A440. But, it is hard to vocalize anything at any pitch without generating a display. In fact, singing notes far lower than A440 generates various displays. In addition, inflections, such as the rise in pitch that usually accompanies the conclusion of a question, are quite visible.

The unit is powered from four AA batteries, although an AC adapter jack is also included so that battery power can be conserved. It is a good idea to use an AC adapter whenever possible, as battery life is limited to about eight hours, depending on the volume level of the audio signal (more or less LED's will light), and the options selected.

The strings of LED's can be more accurately thought of as bar graphs. The device includes an amplitude-discrimination circuit that selects the harmonics of greatest amplitude and displays those harmonics in bar mode, at which time all others are in dot mode.

An interesting experiment would be to interface the board with other circuitry. The outputs of the drivers are TTL- and CMOS-compatible. Since most LED posts can be wire-wrapped, wiring selected outputs to an input port is easy. The device can then function as a front end to allow your computer to monitor sound waves without the complexity of digital filtering. The outputs can also be used to operate relays, allowing lights of any power level to be used.

### Circuit operation

Although the circuit may at first seem complicated, it really isn't. Figure 1 shows a block diagram of the circuit. Signals from the microphone are amplified, filtered, and automatically adjusted for gain in the automatic gain control (AGC) section. The sections that follow are duplicated four times. All four sections are identical except for the frequencies that they handle. Each section has a level-adjust potenti-

ometer, a bandpass filter, level shifter, demodulator and discriminator, and a display driver. Each display driver drives a separate LED bar graph at the output. Three of the bar graphs (A-C) contain ten individual LED's, and one of them (D) contains twenty.

Let's take a look at the schematic in Fig. 2. Power for the unit is supplied by the 4 AA batteries mounted on the board or supplied through the power jack (J1) on the back of the board. Since a bridge rectifier (consisting of diodes D1-D4) is used, DC of either polarity can be used, as well as AC. The batteries are disconnected whenever a plug is in the power jack.

Two large electrolytic capacitors, C19 and C20, damp any transients caused by power surges when a large number of LED's are lit. A voltage divider is formed by IC14, an LM336-2.5, which operates much like a Zener diode, but without nearly as much variation in reference voltage. The device has three terminals, and physically looks like a transistor. However, the third terminal is not needed in this application, so the device is drawn in the schematic as a Zener diode. The reference voltage from IC14 is divided and then wired to op-amp IC1-c which is in a buffer configuration. The output of IC1-c (pin 8) then serves as an analog ground for later portions of the circuit.

The output from the electret microphone (MIC1) appears as an AC waveform. It is amplified by IC1-b, which is configured as a non-inverting amplifier with an adjustable gain set by potentiometer R8.

The next stage is a bandpass filter (IC1-a), which selects the frequencies to be used by later portions of the circuit. Following the initial filter is the AGC that limits the signal when the output reaches approximately 1.1 volts peak-to-peak. The gain will increase slowly during periods of silence, reaching maximum sensitivity after approximately three

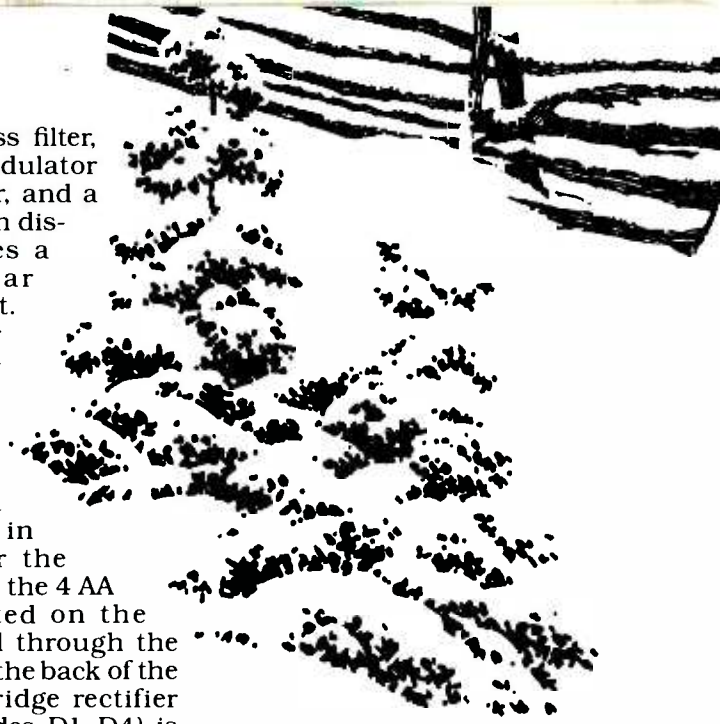

seconds.

The AGC section consists of op-amp IC1-d configured as a non-inverting amplifier. When the output of IC1-d increases, Q2 turns on and allows a small amount of current to flow into C4. That will raise the gate voltage of Q1, effectively lowering the resistance of R12, thus decreasing the gain of the amplifier as a whole. In the rest of the discussion, only one filter (filter A which controls bargraph A) will be described, as the others are identical except for a few resistor values.

A level-adjust potentiometer (R17) is next, followed by a buffer (IC2-a). As the potentiometer setting is increased, the amplitude of the filter output increases, causing more LED's to light at the output.

The stage that follows is nothing more than a summing amplifier. The input signal is summed with a portion of the output from the filter that follows. With a little positive feedback from the filter output, the Q is increased. Within the feedback network is another filter which has a resistive divider attached to it that causes it to act as a unity-gain filter.

The next section is the level shift, which is necessary since the output of the filter appears as an oscillation about the analog ground. The display drivers require an input measured from true ground, hence the level shift section is needed to amplify the

output as well as lower the waveform so that it is relative to ground.

The output of the level-shift section, which is a series of half sine waves, goes through D7 to a resistor and capacitor in parallel (R61 and C14). Note that this is similar to a conventional AM demodulator. The resistor values control the rate at which the display falls back to a zero state. Increasing the resistor values will make the display fall back (turn off) at a slower rate.

The output of the demodulator goes to the amplitude discriminator, which is an op-amp configured as a comparator. Germanium diode D11 will conduct whenever one of the filter outputs reaches 0.2 volts. Thus, C18 will charge and remain at 0.2 volts below the highest DC level. That causes the comparator for the filter output of the highest DC level to switch its output to a high state. That output connects to the control input of one section of a 4066 bilateral switch which connects power to pin 9 of the corresponding LED driver putting it in bar mode.

Resistor R65 is of a much larger value than R61–R64. Thus, when the filter output begins to decrease, the driver returns to dot mode and does not go back to bar mode until the output increases. The time constant is set so that the voltage has significantly decreased in about one second, so the rhythm of the music is displayed as the LED's shift to bar mode at each beat. Varying the RC time constant will make the device operate differently.

Bargraph D is driven by two drivers (IC12 and IC13) stacked end-to-end. They are made to function exactly as the others as far as the dot-to-bar mode transition is concerned. The display drivers (IC9–IC13) control the lighting of the LED's according to the input voltage. A databook should be consulted if you wish to know more about the operation of the display drivers.

### Filters and Q

The Q of a filter defines how narrow the passband is. It is equal to the center frequency divided by the difference in frequency between the -3-dB points. The -3-dB frequency is

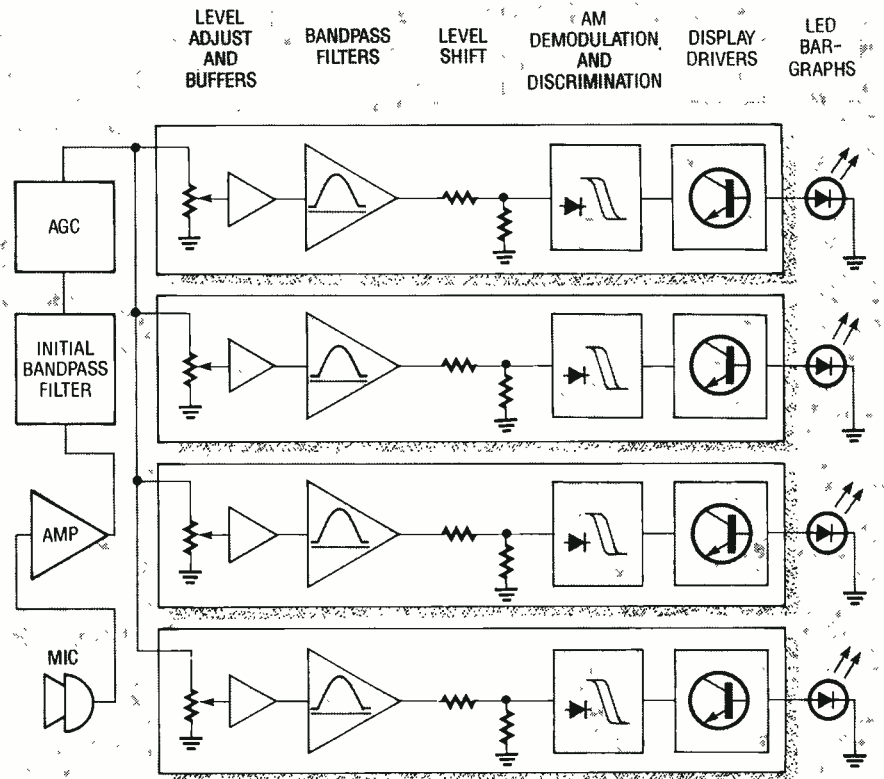

FIG. 1—BLOCK DIAGRAM OF THE CIRCUIT. Signals from the microphone are amplified, filtered, and automatically adjusted for gain.

the frequency at which the peak-to-peak voltage is attenuated by one half from that at the center frequency, assuming a constant voltage at the input.

Assuming we want a center frequency of 440 Hz, which is the American tuning standard for musical instruments, and we want A flat (415.3 Hz), one half step down, to be a -3-dB frequency, and A sharp (466.16 Hz), for the other -3-dB point,  $440 / (466.16 - 415.3) = 8.65$ . That would be the Q required for an attenuation of one half when stepping up or down one key on a piano.

Interestingly enough, the same Q is required to accomplish that across the entire keyboard. This is a necessary consequence of our tuning scale, which is now defined as the twelfth root of two multiplied repeatedly at each step. A logarithmic scale was thus developed by musicians centuries before mathematicians had opened their eyes, so to speak— $17/8$  has been used for the approximation of this factor, which results in an error of less than one percent. It has been used for the construction of

guitars and similar stringed instruments for over three hundred years.

The Delyiannis-Friend bandpass filter (the type used in this project) was first described by T. Delyiannis in 1968. It has a number of advantages over some other filters, such as reduced sensitivity to component tolerances, minimal parts count, and a relatively easy-to-understand design algorithm. It has been described as a bridged-T RC circuit with an op-amp to provide negative feedback.

There are only two parameters needed to design a bandpass filter. They are the center frequency desired for the passband, and the Q, or quality factor. The bandpass filter in its simplest configuration is shown in Fig. 3. That filter has a bandpass center frequency of  $1/2\pi$  Hz. The first step in designing is to assign numerical values—that is, substitute the Q required. Assuming a Q of 4,  $1/2Q = 0.125$ , and  $4Q^2 = 64$ .

After assigning numerical values for each of the components, the filter is scaled up in frequency by dividing the capacitor values



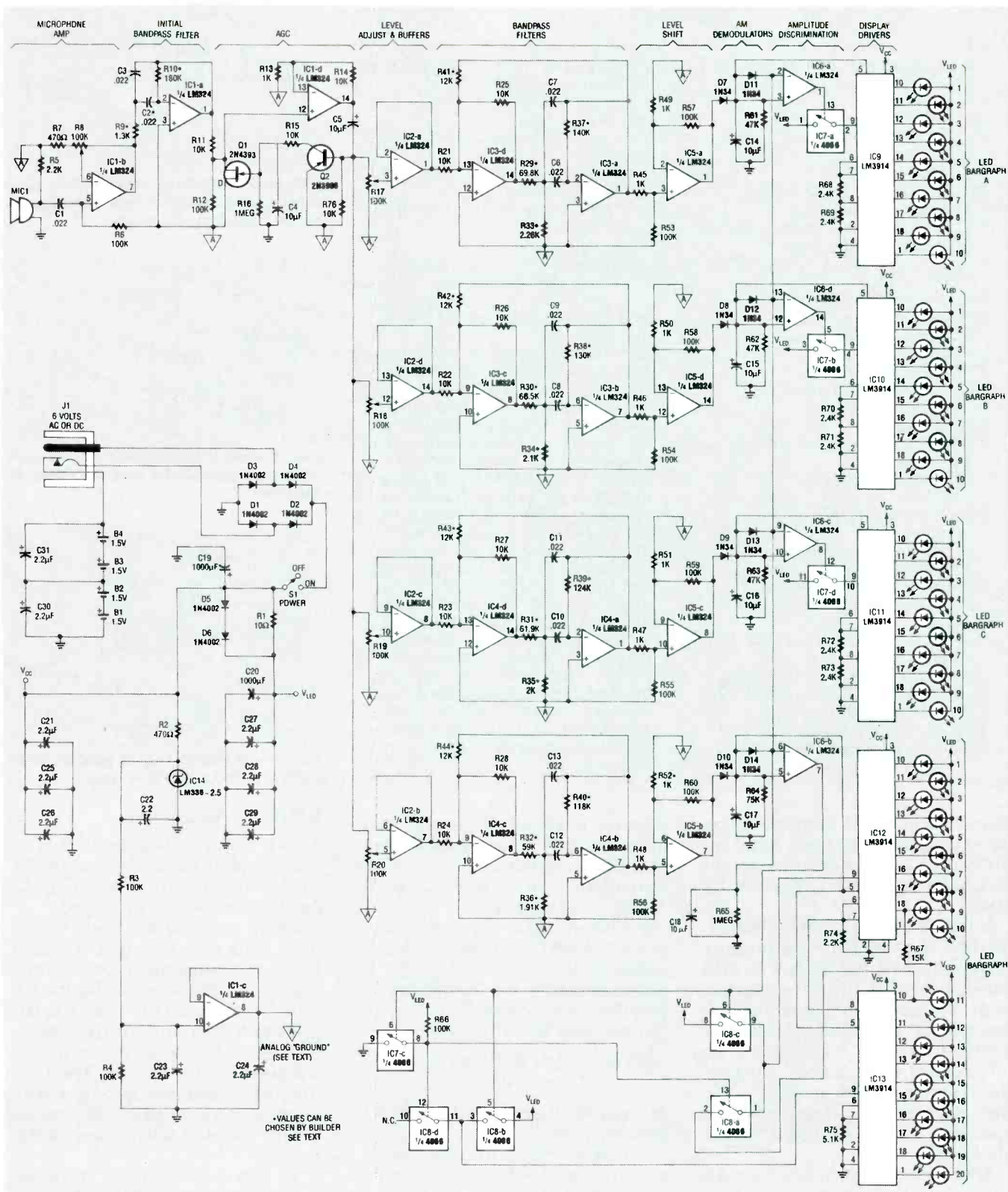

FIG. 2—CHRISTMAS TREE SCHEMATIC. Power for the unit is supplied by the 4 AA batteries or via the power jack on the back of the unit.

by the difference in frequency required. Assume the frequency required is 440 Hz. The difference in frequency required is equal to:

$$f_{NEW}/f_{OLD} = 440/(1/2\pi) = 880\pi$$

The capacitor value (0.125 F) is then divided by this number, giving  $4.52 \times 10^{-5}$ , the new capacitor value for our filter.

The next step, scaling to real-

istic values, is best described by an analogy. In an RC network, the time constant remains unchanged if the capacitor value is divided by any constant, just as long as the resistor values are multiplied by the same constant.

## PARTS LIST

All resistors are 1/4-watt, 5%, unless otherwise indicated.

R1—10 ohms  
 R2, R7—470 ohms  
 R3, R4, R6, R12, R53—R60, R66—100,000 ohms  
 R5, R74—2200 ohms  
 R8, R17—R20—100,000 ohms, multiturn potentiometer  
 R9, R10, R29—R44—option dependent, see text and Table 1  
 R11, R14, R15, R21—R28, R76—10,000 ohms  
 R13, R45—R52—1000 ohms  
 R16, R65—1 megohm  
 R61—R63—47,000 ohms  
 R64—75,000 ohms  
 R67—15,000 ohms  
 R68—R73—2400 ohms  
 R75—5100 ohms

### Capacitors

C1—C3, C6—C13—0.022  $\mu$ F, 5% metal film  
 C4, C21—C29—2.2  $\mu$ F, tantalum  
 C5, C14—C18—10  $\mu$ F, tantalum  
 C19, C20—1000  $\mu$ F, electrolytic

### Semiconductors

IC1—IC6—LM324 quad op-amp  
 IC7, IC8—CD4066 quad bilateral switch  
 IC9—IC13—LM3914 bar/dot LED driver  
 IC14—LM336Z-2.5-volt reference  
 Q1—2N4393 or 2N3972 MOSFET  
 Q2—2N3906 PNP transistor  
 D1—D6—1N4002 rectifier diode  
 D7—D14—1N34 germanium diode

Bargraph1—Bargraph4—50 LED's, assorted colors (3 groups of 10, 1 group of 20—see text)

### Other components

MIC1—1-volt PC-mount electret microphone  
 J1—coaxial barrel-type power jack (Shogyo SJ-0202)  
 S1—C&K 7000-series right-angle SPDT switch  
 B1—B4—AA battery

**Miscellaneous:** PC board, two battery holders (Keystone 2223), metal frame and cover glass, six 5/8-inch spacers, solder, a bit of Christmas spirit, etc.

**Note:** The following is available from ART WORKS, Box 753, St. Francis, Kansas 67756: PC board, \$35 each (three or more, \$30 each); Partial kit, including PC board, all components including S1, J1, battery holders, and all 1% resistors listed (does not include LED's, frame, or spacers), \$90 each (three or more, \$80 each); Complete kit, including all of the above, plus 50 LED's in four colors, spacers, flat-black metal frame, front glass and mat, \$125 each (three or more, \$100 each). All prices include shipping and handling. Check or money order only. Please order early—we will do our best, but cannot guarantee delivery in less than 30 days. When making technical inquiries please include a SASE.

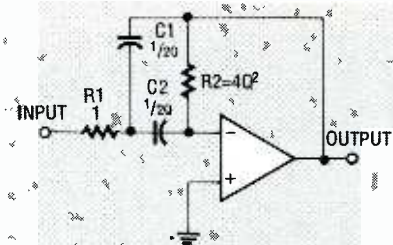

FIG. 3—A BANDPASS FILTER in its simplest configuration. It has a bandpass center frequency of  $1/2\pi$  Hz.

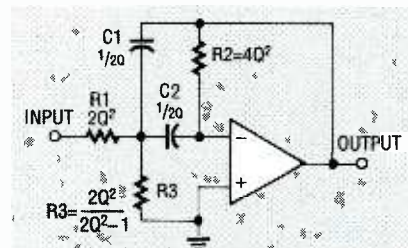

FIG. 4—WHEN DESIGNING a unity-gain filter, a voltage divider must be added to the input.

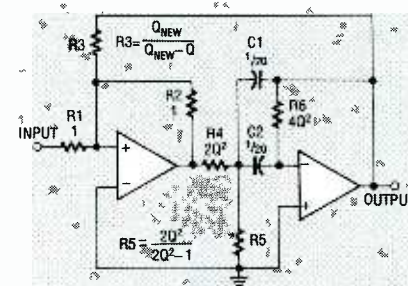

FIG. 5—TO RAISE THE Q, positive feedback is added to the filter input.

The same concept happens to be true in an op-amp filter. That is, the center frequency (and Q) will be unchanged when this step is taken.

A capacitor value of 0.022  $\mu$ F results in realistic component values across the entire audio band, provided the Q is not too high. So, since the capacitor values will all be 0.022  $\mu$ F, we can divide  $4.52 \times 10^{-5}$  by  $0.022 \times 10^{-6}$ , resulting in 2,055. Both of the resistor values in Fig. 3 are then multiplied by that constant, resulting in 2,055 and 131,533 kilohms.

At this point, it is a good idea to check your work. The values just obtained should be substituted into the following equation:

$$f = \frac{1}{2\pi C \sqrt{R1R2}}$$

$$= \frac{1}{2\pi(0.022 \times 10^{-6} \times \sqrt{2.055K \times 131.533K})}$$

The result should be the original frequency. That equation can

also be used to check the variance in center frequency when standard component values are substituted, or to analyze an already existing filter.

In designing a unity-gain filter, a voltage divider must be added to the input, as shown in Fig. 4. Since the new R1 is one half of R2, that value is easy to calculate. For the new R3, the factor

$$2Q^2/2Q^2 - 1 = \frac{2(16)/2(16) - 1}{= 1.032}$$

is then multiplied by the old R1, resulting in 2121.5.

To raise, or enhance the Q, positive feedback is added to the filter input, as in Fig. 5. The values for R1, R2, and R3 of Fig. 5 do not need to have the same scale factor as used before. A fine value for R1 and R2 is 10K; R3 will then be

$$10K(Q_{NEW}/Q_{NEW} - Q)$$

or, for our example,

$$10K(Q_{NEW}/Q_{NEW} - 4)$$

where  $Q_{NEW}$  is the desired Q of the complete filter. The last step is to determine the closest standard value for each resistor.

There are four versions of the unit that can be built without having to make any calculations. The four versions are the broadband option, the lower-four-guitar-strings option, the upper-four-guitar-strings option, and the tuning fork option. The tuning fork option is a good general-purpose version that will provide a nice display with most audio inputs.

To use any of those options, you must refer to Table 1; it shows the resistor values you'll need to use for the four filters to achieve the specified frequencies. Also, depending on which option you choose, the initial bandpass filter must be set up accordingly.

To use Table 1, first refer to the top section to determine the re-



sistor values for the initial band-pass filter, the other four band-pass frequencies, and any special provisions for the particular option. Then, from the bottom section, determine the resistor values for the other four filters according to the frequencies listed in the top section. The resistor numbers shown (R29, R33, and R37) are for filter A. For filter B, add 1 to the resistor number (for example, R29 becomes R30, etc.). For filter C, add 2 to the resistor number, and for filter D, add 3.

Although you can assign any of the four frequencies to any of the four filters, the display will be most interesting if you use the lowest frequency for filter A, next highest for B, and so on. Note that where it says to delete a component, you should leave it out but DO NOT jumper the pads on the board. Where it says to jumper a component, you should leave it out and solder a jumper between the pads.

### Construction

If you like, you can etch your own PC board since the foil patterns for the double-sided board are provided. However, an etched, drilled, plated-through, and silkscreened board is available from the source mentioned in the parts list. Keep in mind that the cosmetic effect of the green mask, silver branches, and white snow will be lost if you make your own board. Locating the components for installation is also easier using the pre-made silkscreened board. Complete and partial kits for the Christmas tree are also available.

Before beginning construction, you have to decide on how you want your LED's arranged. The author's intention was to make each detected harmonic a separate color. However, you are free to arrange the LED's in any pattern you choose, and you can also use whatever colors you like. In any case, the silk screening on the pre-made board indicates which bar graph each light belongs to: there are short white lines between the LED leads. The lines going up (from left to right) are for bargraph A, the horizontal lines are for bargraph B, and the ones going down (from left to right) are for bargraph C. Bar-

TABLE 1

#### Lower Four Guitar Strings Option: (E3, A3, D4, G4)

Initial Filter Q = 1.5 Center Frequency = 270 Hz  
R9 = 9.1K R10 = 82K R41-R44 = 11K

#### Upper Four Guitar Strings Option: (D4, G4, B4, E5)

Initial Filter Q = 1.5 Center Frequency = 470 Hz  
R9 = 5.1K R10 = 47K R41-R44 = 11K

#### Tuning Fork Option: (A4 flat, A4, A4 sharp, B4)

Initial Filter Q = 5.8 Center Frequency = 470 Hz  
R9 = 1.3K R10 = 180K R41-R44 = 12K

#### Broadband Option: (E2, A3, B4, F6 sharp)

(Jumper C2, delete C3)  
R9 = 1K R10 = 100K delete R41-R44

Note (frequency)	R29	R33	R37
E3 (164.81 Hz)	174K	5.62K	348K
A3 (220 Hz)	133K	4.22K	261K
D4 (293.66 Hz)	97.6K	3.16K	196K
G4 (392 Hz)	73.2K	2.37K	147K
A4 flat (415.3 Hz)	69.8K	2.26K	140K
A4 (440 Hz)	66.5K	2.10K	130K
A4 sharp (466.16 Hz)	61.9K	2K	124K
B4 (493.88 Hz)	59K	1.91K	118K
E5 (659.26 Hz)	44.2K	1.40K	88.7K
E2 (82 Hz)	11K	delete	680K
A3 (220 Hz)	4.22K	delete	261K
B4 (493.88 Hz)	1.8K	delete	118K
F6 sharp (1480 Hz)	620 ohms	delete	39K

NOTE: All versions except the broadband option require 1% resistors.

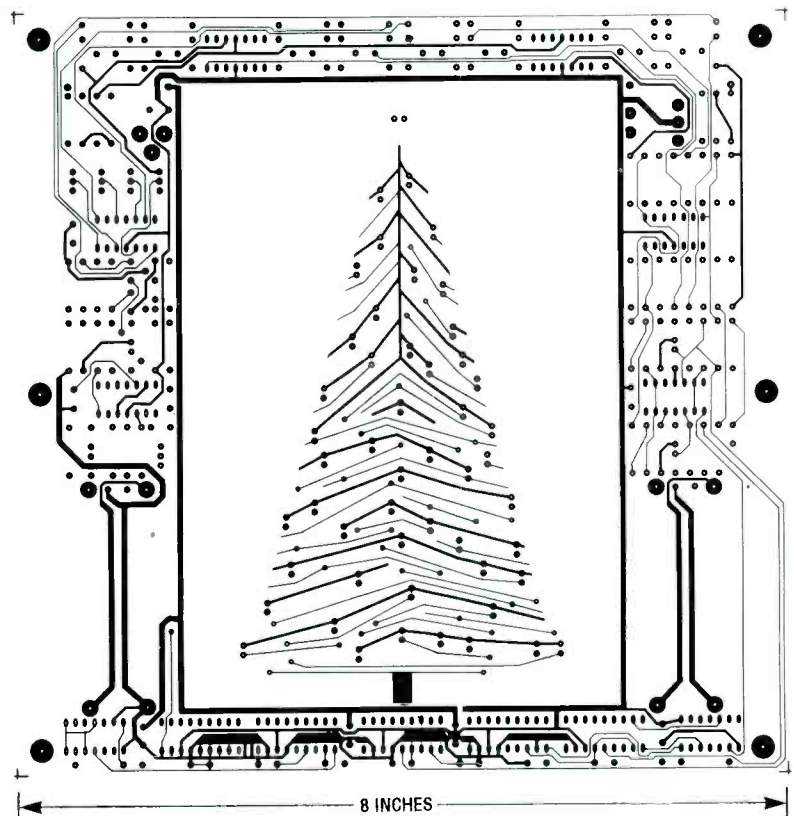

COMPONENT SIDE of the Christmas tree at half the actual size.

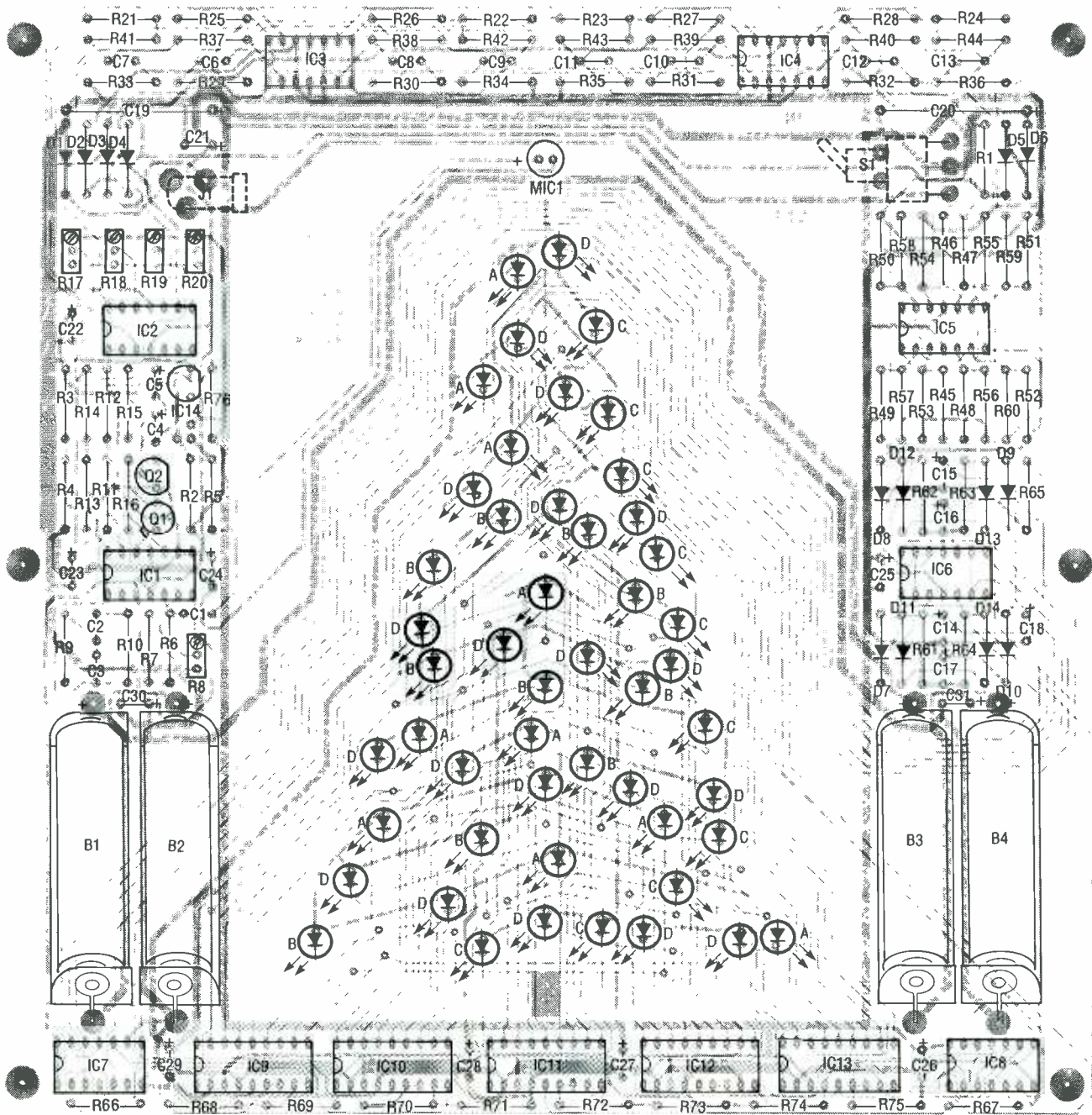

FIG. 6—ALL OF THE COMPONENTS mount on the front of the board, with the exception of J1 and S1; they mount on the solder side. Use a separate color for each LED bargraph.

graph D is indicated by the absence of a short white line.

When installing the components, start with the LED's, as shown in the parts-placement diagram of Fig. 6. The letters next to the LED's indicate which bargraph they belong to. You should probably spend a minute or so looking at how the LED's are arranged on the printed circuit board because, once the device is assembled, the pattern becomes very confusing and the short white lines are covered by the LED's.

The LED's are installed with the cathode (the flat side) toward the bottom of the board. It's best to first solder one lead of each LED and then check for uniform positioning. Straighten them out where necessary, and then solder the other leads. Remember, that if you want to interface your tree to other circuitry later on, to leave enough extra lead on the back of the board to allow a wire-wrap connection to be made. Be sure to work carefully, so that you'll be able to bring out this project for many a Christmas to come. If you

install all the components properly, it's very likely that the device will operate correctly right off the bat.

From the photo in Fig. 7, you can see the six spacers that are installed on the board to hold it in place within the metal frame. It's a good idea to install the spacers now, since they will protect the LED's from being damaged and can also support the board steadily. Now continue installing the rest of the components on the board.

You must now decide what fre-



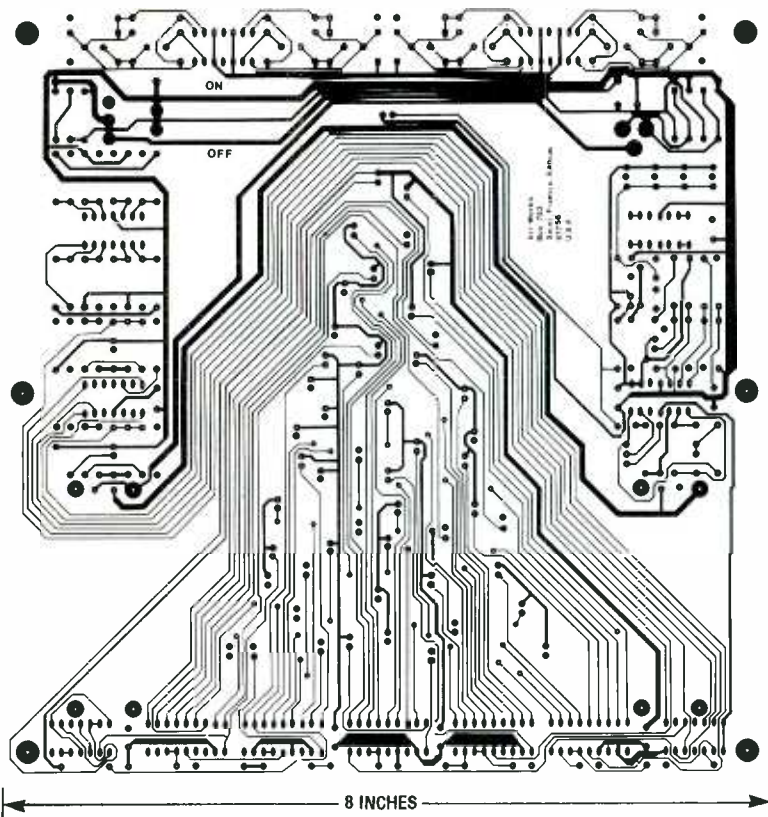

SOLDER SIDE of the Christmas tree at half the actual size.

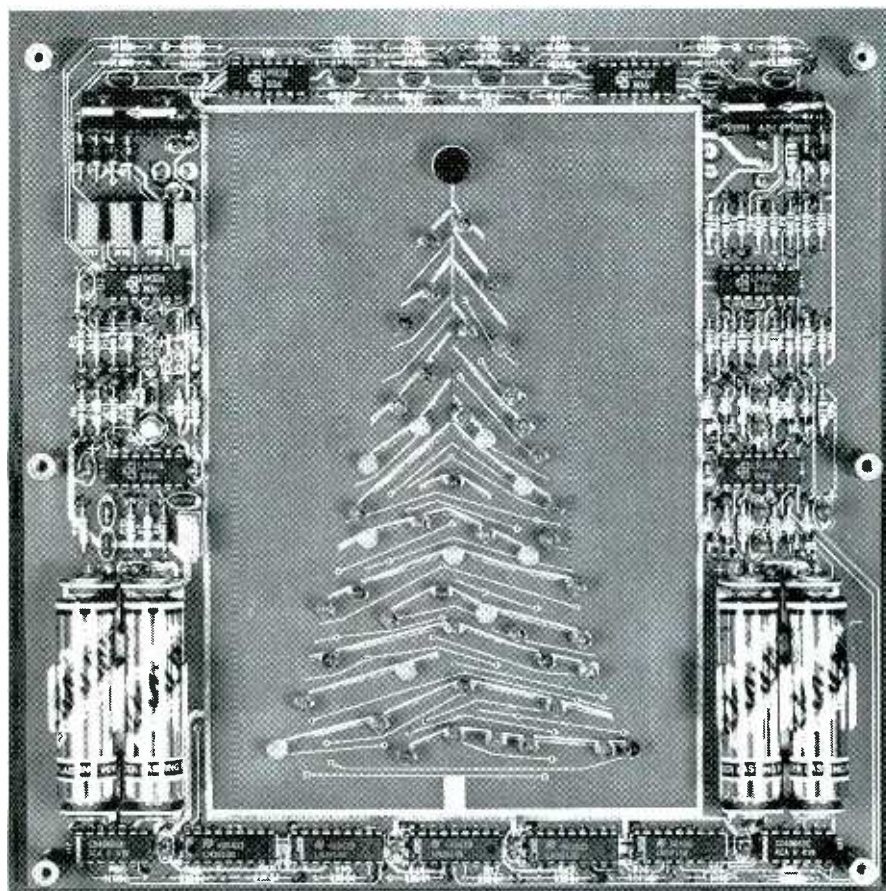

FIG. 7—THE SPACERS THAT HOLD THE BOARD in place in the metal frame should be installed early to prevent damage to soldered components.

quencies your Christmas tree will respond to. If your device is to be an assistance to the hearing-impaired, the broadband option will be the best, as both low frequencies and the high pitch of a police siren will be detected. For a musical version, you will have to make a decision based on your instrument of choice. Perhaps you can consult with a musician friend on this. You can re-tune the device at any time by simply changing a few resistors. All the components required for each suggested version are included in the kit. Remember that the initial filter must be "in harmony" with the other filters. They cannot detect frequencies that the initial filter doesn't pass. Refer to Table 1 when choosing frequency determining resistor values, or you are free to calculate your own values.

A word to the wise: put a set of batteries in the holders before soldering them. If you don't, the contacts on the battery holders are too close together which makes battery changing extremely difficult. Also, remember that the ON/OFF switch and the DC power jack mount on the solder side of the board as indicated by the dashed lines in Fig. 6.

### Checkout

After checking for incorrectly installed components, poor solder joints, and shorts, and making sure to correct any problems, install a set of batteries or connect a 6-volt power source to the power jack. Turning the power switch on will cause many of the LED's to light. After which point, they will step down to position one, then go out. This is normal operation as the device approaches steady state. Slowly increase the gain of the initial amplifier by turning R8 clockwise. Go back and forth between one of the level-adjust potentiometers and R8, increasing them a little bit each time until one of the bargraphs responds to the sound of your voice. Make sure that none of the potentiometers are set too high, as troublesome oscillations may occur.

Alternatively, connect a voltmeter to the junction of R15 and R16 and increase the setting of R8 until speaking directly into

*continued on page 96*



# BUILD THIS

# UNIVERSAL LABORATORY POWER SUPPLY

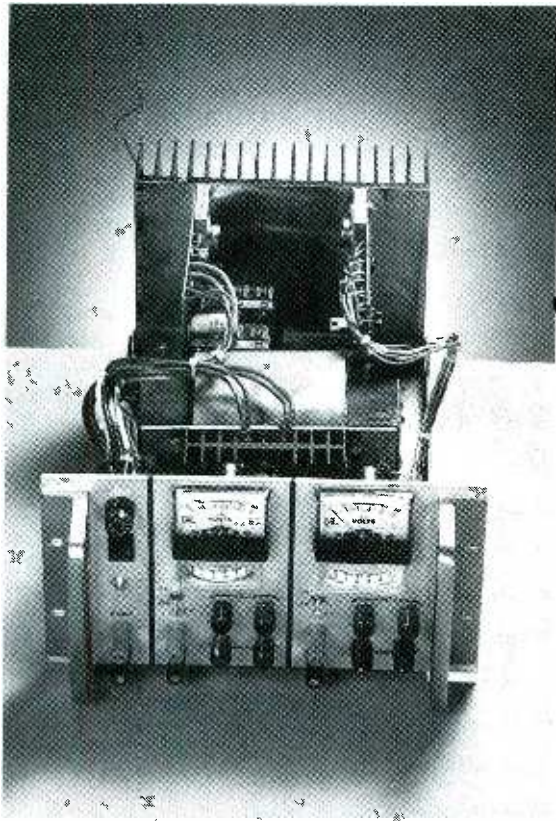

*This universal power supply offers high performance and flexibility at low cost.*

REINHARD METZ

TABLE 1—PERFORMANCE SUMMARY

Characteristic	Capability
Number of supplies	2 (fully floating)
Voltage range	0–50 VDC
Current range	0–5 A
Coarse vs. fine control ratio (both current and voltage)	1:10
Voltage regulation	0.01% line, 0.1% load
Current limiter	0.5%

NOTE: (a) There's a current-limiting LED;  
(b) Has internal +5 VDC, 0–3 A supply.

WHILE NUMEROUS BENCH POWER SUPPLIES have emerged over the years, few combine the performance, flexibility, and low cost of the version described here. This article describes a well-regulated, modular, lab-grade power supply with dual 0–50-volt, 0–5-amp DC supplies, and a single 5-volt, 3-amp DC supply. It uses two identical custom PC boards, one for each 50-volt supply. There's also a customized heat sink with space for both PC boards that minimizes point-to-point wiring in the 50-volt supplies. However, because of the modular design, you can customize the configuration as needed. See Table 1 for a performance summary.

### Circuit description

Figure 1 is the schematic of the power supply. The value of the design lies in the use of IC1, an LM317HVK adjustable series-pass voltage regulator, for broad-range performance. The "HVK" suffix specifies the high-voltage version of the regulator. The

remainder supplies voltage-setting and current-limiting functions. The input to IC1 comes from the output of BR1, which is filtered by C1 and C2 to about +60-volts DC, and the input for current-sense comparator IC2 comes from BR2, which also acts as a negative bias supply for regulation down to ground.

The purpose of IC1 is to maintain the out terminal at 1.25-volts DC above the ADJ terminal. The current drain at the ADJ terminal is very low (nominally 25  $\mu$ A) and, as a result, R15 and R16 (the coarse and fine voltage adjustments) and R8 form a voltage divider, with 1.25 volts appearing across R8. The bottom end of R16 connects to a –1.3-volt reference level generated by D7 and D8, letting the R8-R15 divider set the output voltage all the way down to ground when  $R15 + R16 = 0$  ohms. In general, the output voltage is determined by:

$$\frac{(V_{OUT} - 1.25 + 1.3)}{(R15 + R16)} = 1.25/R8.$$

Thus, the maximum value from each variable supply board is:

$$V_{OUT} = (1.25 / R8) \times (R15 + R16) = 50.18 \text{ volts DC.}$$

Using potentiometers R15 and R16

to control the voltage,  $V_{OUT}$  ranges from 0–50 volts DC. As current demand increases, the drop across R2 increases, and at about 0.65 volts (which corresponds to about 20 mA), Q1 and Q2 turn on, becoming the main current path. Also, R3 and R4 ensure that Q1 and Q2 share the load equally. Current limiting is provided by IC2. Its noninverting input uses the output voltage as a reference, and its inverting input is connected to the



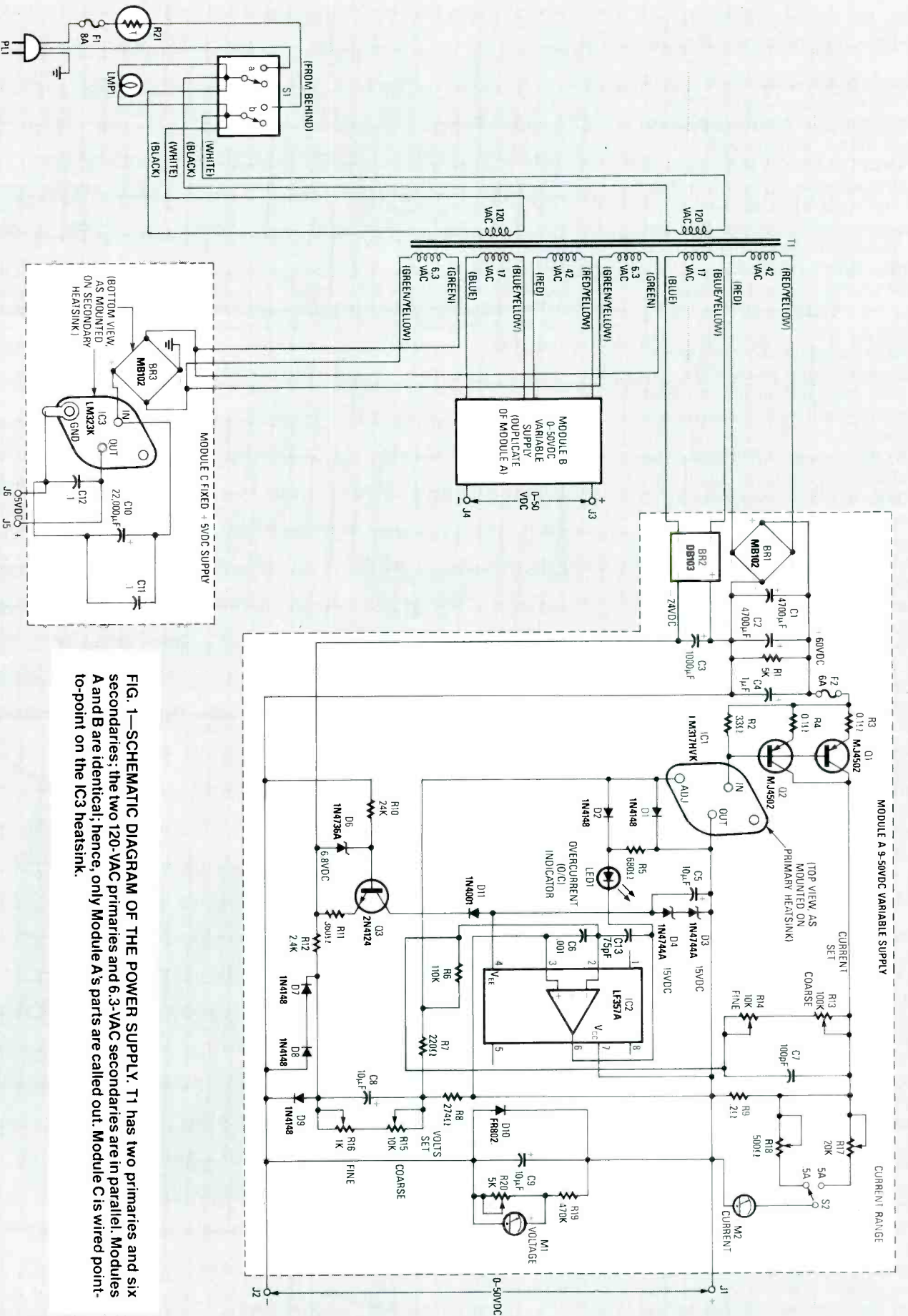

FIG. 1—SCHEMATIC DIAGRAM OF THE POWER SUPPLY. T1 has two primaries and six secondaries; the two 120-VAC primaries and 6.3-VAC secondaries are in parallel. Modules A and B are identical; hence, only Module A's parts are called out. Module C is wired point-to-point on the IC3 heatsink.

voltage divider created by R6 and current-limit potentiometers R13 and R14.

The drop across R6 is about 1.25 volts, the reference voltage mentioned above as being the difference between the OUT and ADJ terminals of IC1. Current from Q1 and Q2 flows through R9, creating a drop across R13 + R14. Thus, IC2 trips when the drop across R9 creates current through R13 and R14, causing the voltage at the non-inverting input to exceed  $V_{OUT}$ .

That sets the current limit point at:  $(I_{OUT} \times 0.2)/(R13 + R14) = 1.25/100K$ ;  $I_{OUT} = 0-5$  amps. That corresponds to a range of about 0-5 amps. At the current limit point, IC2's output goes low, pulling the ADJ lead down via D2 and lighting LED1. Additional current for D5 is provided by R5. As the ADJ lead is pulled low, the output follows, until the output current drops to a level corresponding to the setting of R13 and R14.

Since the output voltage can be anywhere from 0-50 volts, the power supply for IC2 must track that range using D3, D4, and Q3. Next, D9 ensures that the output voltage doesn't rise when the supply is shut off, while D10 protects against supply back-feeding. Finally, M1 monitors voltage and M2 monitors current. The power supply is modular; each PC board is used for one 50-volt supply, and includes all parts other than those for the front panel and the 5-volt supply. Since a dual 50-volt version may be popular, T1 accommodates two supplies and the 5-volt supply, and a custom heat sink for the two PC boards is available.

### Construction

The transformer is mounted on a 6- x 5- x 1-inch L-bracket in the center of the supply, and the heatsinks for IC1 and BR1 go on the back of the transformer bracket. A 6- x 8- x 6- x 11-inch U-shaped cover of 1/16-inch aluminum completes the assembly. Complete all drilling and preparation before assembly, but install only the transformer and its bracket for now, to make wiring easier for you.

Next, assemble the PC board(s) for the 50-volt supplies; Fig. 3 shows the parts placement diagram. Install all components except Q1, Q2, and IC1. Check resistor values as you go, and mount the heat sink for BR1 before installation. Don't forget to observe

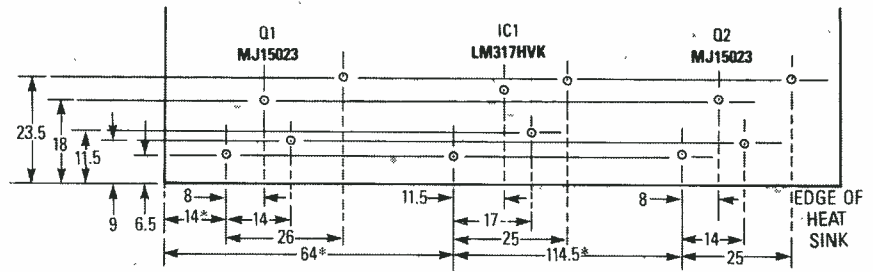

FIG. 2—POWER SUPPLY HEAT SINK LAYOUT. All marked dimensions are in millimeters, all mounting holes are 1/4-inch in diameter, all lead holes are 3/16-inch in diameter, and add 3 mm to all dimensions with an (\*) to align the PC boards.

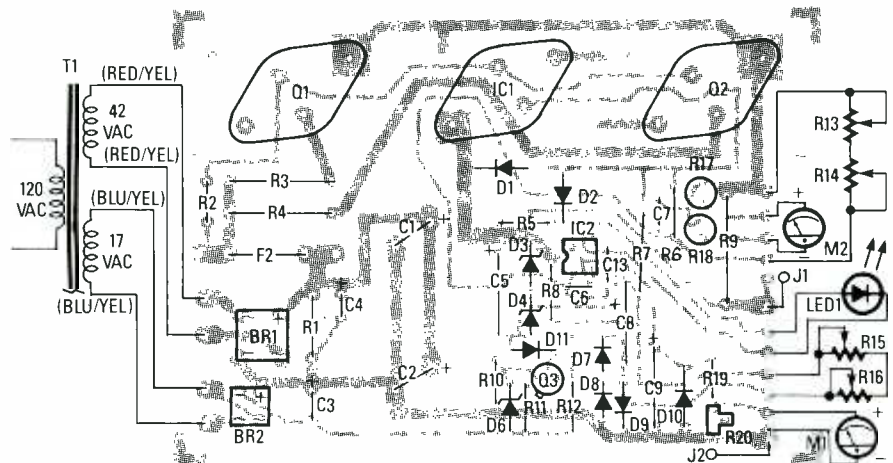

FIG. 3—PARTS PLACEMENT DIAGRAM FOR 50-volt supply. Only one primary and the two relevant secondaries of T1 have been depicted, for brevity.

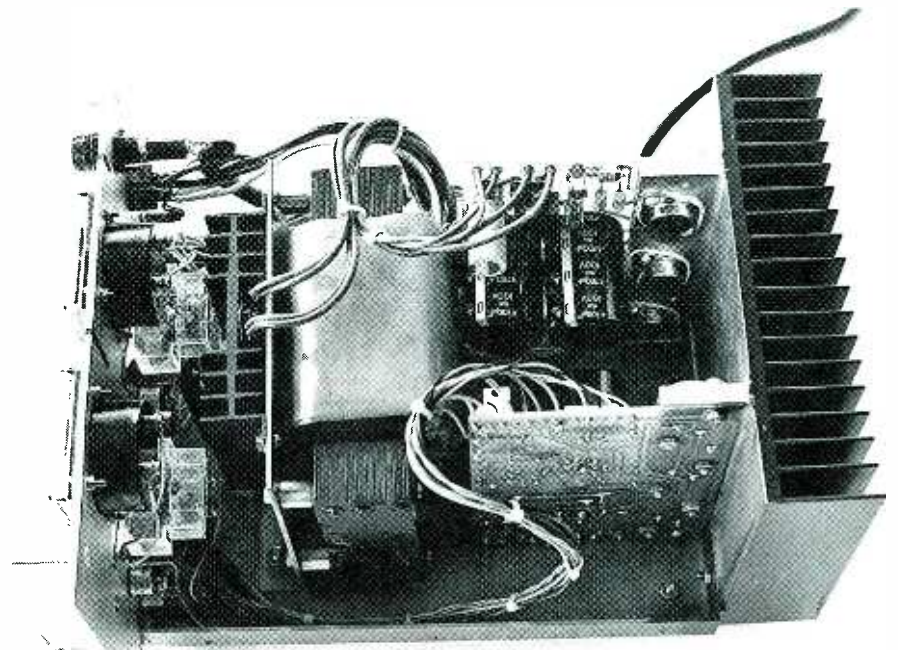

FIG. 4—PROTOTYPE OF THE POWER SUPPLY. Note the custom PC board heatsink at right, and how S1, F1, LMP1, and R21 are wired.

polarities on all the electrolytic capacitors. Use the alignment holes with 6-32 screws for the PC board(s). In-

stall Q1, Q2, and IC1, using mica insulators, heat sink compound, and 6-32 screws. Check for shorts from



## PARTS LIST

All resistors are ¼-watt, 5%, unless otherwise indicated.

R1—5000 ohms, 1-watt  
 R2—33 ohms  
 R3, R4—0.1, 3-watt  
 R5—680 ohms  
 R6—115,000 ohms, 1%  
 R7—220 ohms  
 R8—274 ohms, 1%  
 R9—0.2 ohm, 5-watt  
 R10—24,000 ohms  
 R11—360 ohms  
 R12—2400 ohms  
 R13—100,000-ohm potentiometer  
 R14, R15—10,000-ohm potentiometer  
 R16—1000-ohm potentiometer  
 R17—20,000-ohm PC-board-mounted potentiometer  
 R18—500-ohm PC-board-mounted potentiometer  
 R19—470,000 ohms  
 R20—5000-ohm PC-board-mounted potentiometer  
 R21—thermistor in-rush protector (Keystone KC003L)

### Capacitors

C1, C2—4700  $\mu$ F, 100 volts  
 C3—1000  $\mu$ F, 50 volts, Panasonic P6272  
 C4—1  $\mu$ F, 63 volts  
 C5—10  $\mu$ F, 50 volts  
 C6—0.001  $\mu$ F, ceramic disc  
 C7—100 pF, mica  
 C8, C9—10  $\mu$ F, 50 volts  
 C10—22,000  $\mu$ F, 16 volts (Panasonic P6420)  
 C11, C12—0.1  $\mu$ F, ceramic disc  
 C13—75 pF

### Semiconductors

IC1—LM317HVK adjustable, series-pass, high-voltage regulator  
 IC2—LF357A JFET input, 8-pin DIP comparator  
 IC3—LM323K 5-volt DC regulator in TO-3 case  
 D1, D2, D7, D8, D9—1N4148 germanium diode  
 D3, D4—1N4744A, 15-volt, 1-watt Zener diode  
 D6—1N4736A, 6.8-volt, 1-watt Zener diode  
 D10—FR802 8-amp, 100-volt fast-recovery silicon rectifier (TO-220 package)  
 BR1, BR3—MB102 10-amp, 200-volt bridge rectifier  
 BR2—DB103 1-amp, 200-volt bridge rectifier  
 Q1, Q2—MJ5023 or ECG68 PNP silicon transistor  
 Q3—ECG123 or 2N3700 1 watt general purpose NPN silicon transistor  
 LED1—yellow light-emitting diode

### Other components

F1—8-amp fast-blow fuse  
 F2—6-amp fast-blow fuse  
 T1—600 VA transformer; 120-volt AC primary; two 42-volt, 5-amp secondaries; two 17-volt, 250-mA secondaries; and one 7-volt, 3-amp secondary  
 PL1—120-volt AC pilot light  
 M1—50 mA meter (GC Electronics 20-1110)  
 M2—100  $\mu$ A meter (Jewell 81T)  
 S1—120-volt, 10-amp DPST switch  
 S2—SPDT switch

J1, J3, J5—red banana jack  
 J2, J4, J6—black banana jack

**Miscellaneous:** 8-inch wide  $\times$  6-inch high  $\times$  11-inch deep aluminum case with ⅛-inch predrilled aluminum plate as front panel (including holes for handles) and 8- $\times$  11- $\times$  ⅜-inch steel plate with a 1-inch lip on the bottom, two front-panel-mounted case handles, 6- $\times$  8- $\times$  3-⅛-inch dual-supply main heatsink, heat-sink for 5-volt DC regulator with TO-3 case, heat sink for BR1, 3-wire power cord, knobs, four rubber feet, panel-mounted fuse holder (for F1), two PC-board mounted fuse clips (for F2), PC board (Digi-Key #F040), three TO-3 transistor insulator kits, silicone grease, wire, solder, etc.

**NOTE:** The following parts are available from A&T LABS, P.O. Box 4884, Wheaton, IL 60187; plated PC board with parts placement silkscreen, \$19.00; 600 VA custom dual-supply transformer (T1), \$69.00; custom dual-supply main heatsink, \$42.00; LM317HVK (IC1), \$8.00; MJ15023 (Q1 and Q2), \$6.50 each; M1, \$18.00. Send check or money order, except for COD orders via UPS in the U.S. If you don't order T1, add 5% shipping and handling for U.S., and 10% for Canada. If you order T1, add 12% for U.S., and 17% for Canada; Illinois residents add 6.75% sales tax.

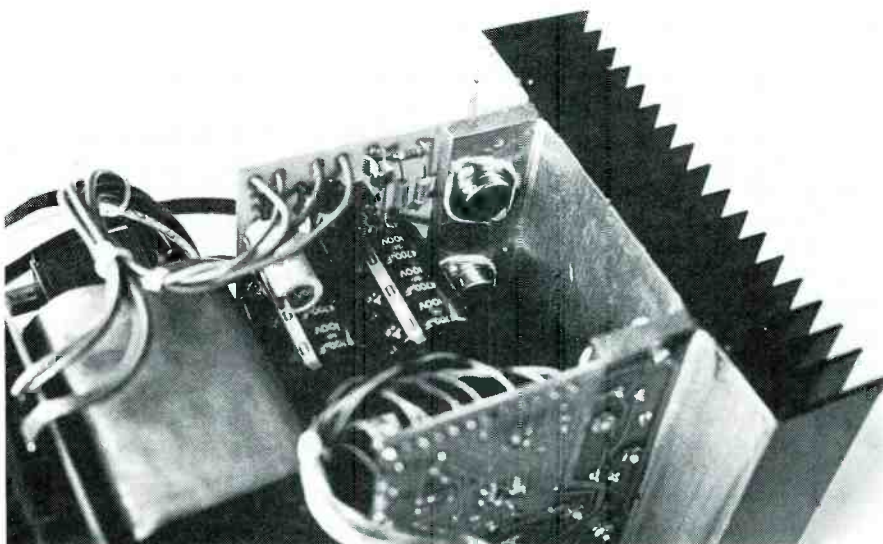

FIG. 5—PRIMARY HEAT SINK ASSEMBLY CLOSE UP. You can see how Q1 and IC1 are attached, the silicone grease used for heat transfer, and how the heatsink is attached to the PC boards. The mica insulators aren't clearly visible from this perspective.

Q1, Q2, or IC1 to the heatsink. Note that BR1 and BR3 have different pin

connections than BR2.

A variety of meters can be used

with this design. Sensitivity differences are compensated with PC-board-mounted resistors and potentiometers. The values in the parts list call for 50  $\mu$ A/2500 ohms for M1, and 100  $\mu$ A/700 ohms for M2. In most cases, panel meters require some faceplate disassembly or removal to mark them for 50 volts and 5 amps DC at full scale. Assuming sensitivities of  $I_V$  and  $R_V$  for M1 and  $I_I$  and  $R_I$  for M2, the resistor values are:

- $R19 = 25/I_V$ ,  $R20 = 2 \times R_V$ .
- $R17 = 2 \times (1.0/I_I - R_I)$ , for 5 amps full-scale.
- $R18 = 2 \times (0.1/I_I - R_I)$ , for 0.5 amp full-scale.
- $R18 = 2 \times (0.2/I_I - R_I)$ , for 1 amp full-scale.

Proceed with the point-to-point wiring from the PC board to the front panel. Those wires should all termi-

*continued on page 128*

# TUNE IN THE WORLD

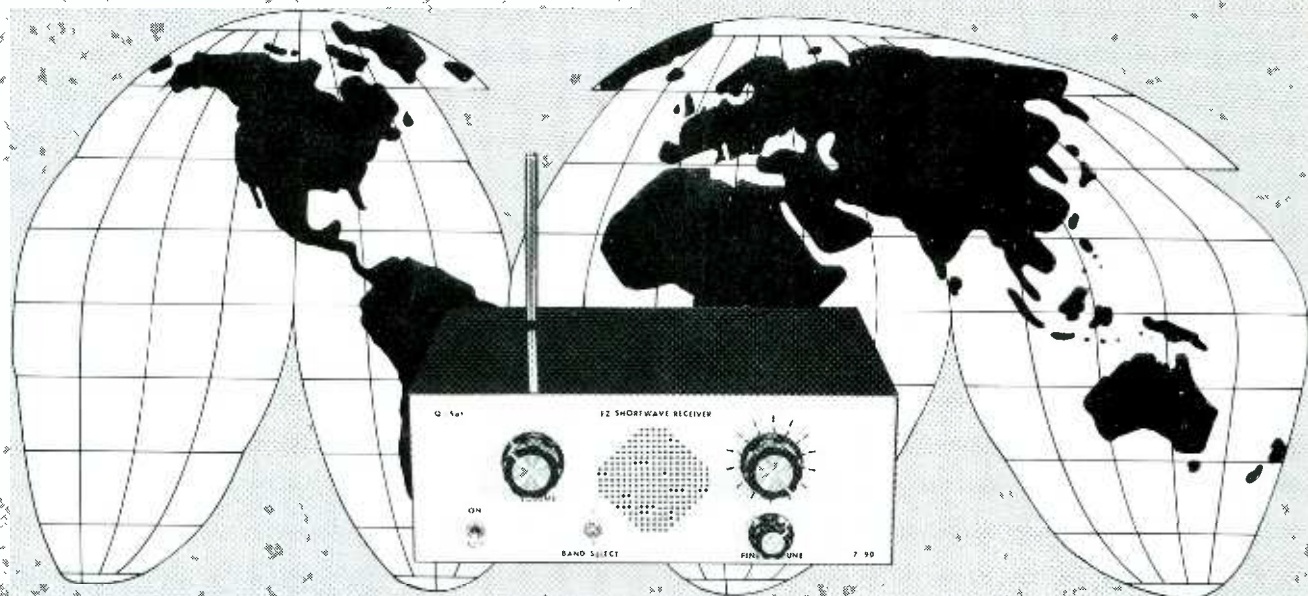

## With R-E's EZ Shortwave Receiver

*If you're looking for a fun project that won't break the budget, here's a shortwave receiver that's not short on performance.*

RODNEY A. KREUTER WA3ENK

IF YOU'VE ALWAYS WONDERED WHAT you might hear on shortwave radio but didn't have the time or the money to get involved with it, then our simple, inexpensive shortwave receiver is the perfect project for you. It will have you tuning in on shortwave in no time—as a matter of fact, the first evening after the prototype was completed, stations from Germany, England, Cuba, Canada and France were easily copied.

The shortwave receiver is not a crystal set with an audio amplifier. It's a true superheterodyne that tunes 8.5 to 11 MHz in two bands and includes a 455-kHz IF filter, automatic gain control (AGC), tracking RF tuning, and a very sensitive detector. It's sensitivity of under a microvolt puts it in a class with some high-performance receivers.

### Theory of operation

The shortwave receiver takes a very straightforward approach to the classic superheterodyne receiver. The basic block diagram of our "superhet" is shown in Fig. 1, and the schematic is shown in Fig. 2.

The RF input tank, unlike many simple designs, provides "tracking," in that the input tuned circuit changes frequency when the oscillator is tuned. RF tuning is performed by D1, and oscillator tuning by D5. Both diodes are Motorola MV209 varactors, which act as voltage-variable capacitors. RF energy is coupled into pins 1 and 2 of IC1, the Signetics NE602 double-balanced mixer.

The mixer combines the incoming RF signal with the local oscillator and produces an intermediate frequency or IF of 455 kHz. Both mixer and oscillator functions are provided by IC1. Table 1 shows its specifications.

To simplify construction and enhance performance, a ceramic IF filter, FL1, is used instead of a more common tunable IF transformer. That results in a very clean IF that never needs tuning. The filters are available with bandwidths from 4 to 12 kHz to suit individual needs. The shortwave receiver will accept filters with input and output impedances of 2000 ohms.

Turning to the detector circuit,

D2 and D3 provide a 1.2-volt bias for diode D4 and Q3. The bias keeps both D4 and Q3 slightly on, so only a small signal is necessary for detection, reducing the gain needed before the detector and improving sensitivity.

The signal at the base of Q3 contains two components. The AC component is the demodulated audio, and the DC component is proportional to the strength of the incoming signal. The DC component is filtered by R20 and C17 and is used to provide an AGC signal to Q2 via AGC amplifier Q4. That helps to reduce fading that is so common on the shortwave bands.

The audio output stage, IC2, is a Motorola MC34119 audio amplifier. It provides about 1/4-watt of audio into speakers of 8 to 64 ohms. No large output-coupling capacitors are needed, but a large power-supply decoupling capacitor provides excellent stability.

The prototype operates on a 9-volt battery and, if you listen at moderate volumes, they give you reasonable service. For longer service, use a pack of 6 or 8 "AA" cells, or an AC supply.





**TABLE 1—BASIC SPECIFICATIONS OF THE NE602**

**PARTS LIST**

Power supply	4.5V-8V	
Current consumption	2.4 ma.	(typical)
Maximum mixer frequency	500 MHz	(typical)
Maximum oscillator Frequency	200 MHz	(typical)
Noise figure	5 dB	(typical at 45 MHz)
Mixer gain	15 dB	(typical at 45 MHz)
Third order intercept	-17 dBm	(maximum)
Mixer input resistance	1.5k	(typical)
Mixer input capacitance	3 pF	(typical)
Mixer output resistance	1.5K	(typical)
Mixer output capacitance	3 pF	(typical)

All resistors are 1/4-watt, 5%.

- R1, R12—470 ohms
- R2—15,000 ohms
- R3, R11—3300 ohms
- R4, R6, R10—100 ohms
- R5—2200 ohms
- R7—220 ohms
- R8—5600 ohms
- R9—22,000 ohms
- R13, R14, R17, R24, R27—10,000 ohms
- R15, R20—220,000 ohms
- R16, R25—10,000 ohms, potentiometer
- R18, R21—470,000 ohms
- R19—10 ohms
- R22—4700 ohms
- R23—50,000 ohms, potentiometer
- R26—1000 ohms

**Capacitors**

- C1—9-60 pF trimmer
- C2—82 pF, ceramic
- C3—100 μF, 16 volts, electrolytic
- C4, C21—10 μF, 16 volts, electrolytic
- C5-C7, C9, C10, C13, C17—0.1 μF (poly-ester or ceramic)
- C8, C11, C12, C25—0.01 μF, ceramic
- C14—470 μF, 16 volts, electrolytic
- C15—4.7 μF, 16 volts, electrolytic
- C1—1 μF, 16 volts, electrolytic
- C18-C20—100 pF, NPO
- C22, C24—0.001 μF, ceramic
- C23—47 pF, NPO

**Semiconductors**

- D1, D5—Motorola MV209 varactor
- D2-D4—1N4148 diode
- FL1—455-kHz ceramic filter (8-kHz bandwidth Toko HCFM2-455C)
- IC1—Signetics NE602N mixer
- IC2—Motorola MC34119 audio amplifier
- IC3—78L05 5-volt regulator
- Q1-Q4—2N3904 NPN transistor

**Other components**

- L1—3 turns #30 wire on L2's toroid core
- L2—21 turns #30 wire tapped at 17 turns on T-37-2 Micro Metals toroid
- L3—24 turns #30 wire tapped at 19 turns on T-37-2 Micro Metals toroid
- S1—DPDT switch
- S2, S3—SPST switch
- SPKR—8-64 ohm speaker
- J1—BNC connector

**Miscellaneous:** PC board, metal cabinet, wire, solder, etc.

**Note:** The following items are available from Q-Sat, P.O. Box 110, Boalsburg, PA 16827. A PC board only (# EZSW-PCB) is \$7 plus \$1 shipping; a partial kit that includes a PC board (does not include potentiometers, switches, connectors, speaker, or case # EZSW-KIT) is \$27 plus \$2 shipping; a kit for the AM reject filter (# AMREJ-KIT) is \$3 plus \$1 shipping; a kit for the active antenna (# ACTANT-KIT, see text) is \$15 plus \$2 shipping. Pennsylvania residents must add 6% sales tax. Allow 3-5 weeks for delivery.

very hard to eliminate. Remember that the output of a mixer is the sum and difference of two frequencies. For example, suppose we wanted to receive WWV on 10 MHz using an IF of 455 kHz. Using low oscillator injection, we would generate a local oscillator of 10 MHz minus 455 kHz, or 9.545 MHz.

However, if a frequency of 9.09 MHz was also present at the mixer input, we'd also have an output frequency of 455 kHz because 9.545 MHz minus 9.09 MHz equals 455 kHz. That other undesired frequency (9.09 MHz) is called the image frequency. Some sophisticated techniques, such as image-reject mixers or up-converting receivers are available, but almost all receivers reject the 9.09 MHz at the input tank. The tracking RF tank on our shortwave receiver helps a great deal, but doesn't eliminate the problem.

Overload performance is another important aspect concerning a shortwave receiver. If the RF tank is tuned to 10 MHz, it will let 10-MHz signals pass and attenuate—but not eliminate—signals of all other frequencies. If a 50,000-watt AM station is located close to the tank, some of the signal will get through. If enough of it does, you'll hear the AM station as well as the shortwave.

Tests on our active antenna (**Radio-Electronics**, February 1989) proved that an AM-reject filter was necessary to "clean up" our own local 50-kilowatt station. A high-pass filter that will attenuate AM stations by 40 dB is shown in Fig. 3; its low-frequency cutoff is about 2.2 MHz. The filter can be constructed on a piece of perforated construction

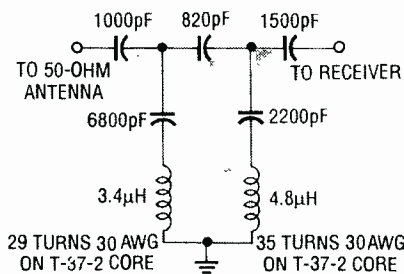

**FIG. 3—THIS HIGH-PASS FILTER will attenuate AM stations by 40 dB. Its low-frequency cutoff is about 2.2 MHz.**

board using point-to-point wiring.

**Construction**

Even though this is a low-frequency project, a PC board is recommended; you can make your own from the provided foil pattern or buy a finished version from the source mentioned in the parts list. Figure 4 shows the parts-placement diagram.

Inductors L1, L2, and L3 are wound on toroid cores, so they're much smaller than air-wound coils, and can still be "tuned" by stretching or compressing the turns on the toroids. Remember that a turn is counted on a toroid every time the wire passes through the center of the core. After you tune the coils, the wire can be held in place with epoxy.

Any speaker from 8 to 64 ohms will work with the MC34119. Expect slightly less audio output with higher-impedance speakers. The speaker leads should be twisted tightly and kept short.

If you use stereo headphones, don't connect the ground. Just feed the speaker output through resistors (you'll need to experiment with the value) to the left and right channels. Note that the MC34119 does not ground reference the speaker.

All receivers need a good antenna; this one is no exception. Although the first field trials were conducted in a state park with 30



feet of wire thrown over a tree limb, a good antenna will greatly improve reception. A dipole will give good results, but if you're cramped for space, try an active antenna (see **Radio-Electronics**, February 1989). A good ground also helps.

The receiver should be installed in a metal cabinet to reduce the effects of hand capacitance and provide some shielding from strong local AM stations. Figure 5 shows the prototype receiver. Note that the active antenna and the 2.2-MHz high-pass filter are used in the prototype, although they are not mandatory. The holes for the speaker were made using a neat trick: Draw the outline on a piece of perforated construction board, and tape the board to the cabinet. Then use the board as a drill guide.

Table 2 is a guide to let you modify the receiver for frequency ranges other than 8.5 to 11.5 MHz (actually 8.5–10 MHz for band 1 and 10–11.5 MHz for band 2) used in the prototype. Don't think of L2 and L3 as tapped coils, but rather as "selectable" coils. For example, L3 is specified as a 24-turn coil with a tap at 19 turns. What that really means is that a coil of either 19 turns or 24 turns is switch-selectable. You could even wind a 45-turn coil with taps at 14, 15, 17, 19, 24, 29, and 34 turns for L3. With the right switch (good luck finding one), you could tune 5 to 16 MHz in 8 bands. Remember that it has to switch the capacitors, as well.

Since the coils must be hand-wound, there will be some variation. Wire size was calculated for no. 30 wire. Other wire sizes may be used but you will find it hard to get as many as 45 turns on a T-37-2 core with larger wire. The spacing of the wire on the core will also change the tuning frequency. The values are given as reasonable starting points. If you wish to build the receiver for some frequency other than the prototype, follow these steps:

- 1) Build the unit completely except for the two coils.
- 2) Using Table 2, wind the oscillator coil. Tack the coil into the circuit from ground to the junction of C20, C22, and C23. (That way you won't need the band switch.)

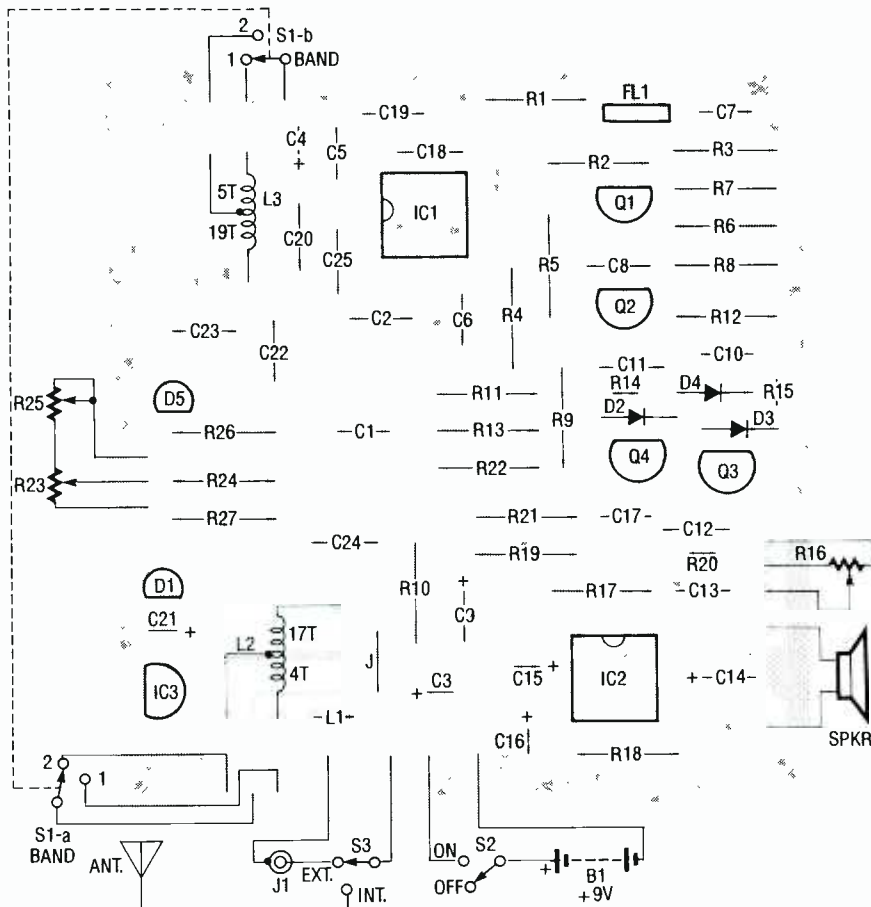

FIG. 4—PARTS-PLACEMENT DIAGRAM. Be sure to install the circuit in a metal project case to help reduce interference.

TABLE 2

Frequency (MHz)	C2 (pF)	C18, C19 (pF)	C23 (pF)	L1, L2 (Ant) (# of turns on T-37-2 core)	L3 (Osc) (# of turns on T-37-2 core)
5	100	120	68	5 41	45
6	100	120	68	4, 30	34
7	82	100	47	4, 26	29
8	82	100	47	3, 22	24
10	82	100	47	3, 17	19
12	82	100	47	2, 15	17
14	68	82	33	2, 14	15
15	68	82	33	2, 13	14

TABLE 3

	NE602	MC34119	Q1	Q2	Q3	Q4
Pin 1	1.27 V	0V	0.95 V	0.80 V	0.27 V	0V
Pin 2	1.27 V	4.15 V	1.61 V	1.45 V	0.82 V	0.58 V
Pin 3	0V	4.11 V	2.56 V	3.30 V	9.17 V	7.41 V
Pin 4	3.64 V	3.97 V				
Pin 5	3.59 V	4.14 V				
Pin 6	4.99 V	9.09 V				
Pin 7	4.33 V	0V				
Pin 8	5.05 V	4.20 V				

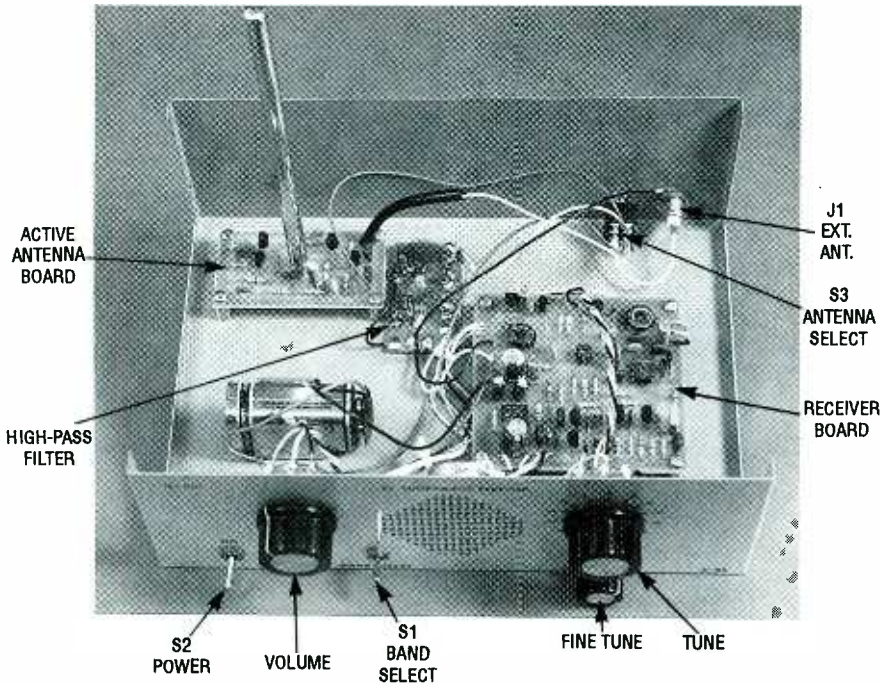

FIG. 5—THE INSIDE OF THE PROTOTYPE RECEIVER. Note that the active antenna and the 2.2-MHz high-pass filter are used in the prototype, although they are not mandatory.

3) Lightly couple a high-impedance scope or frequency counter to pin 7 of IC1; note that the NE602 will not drive a 50-ohm input without a buffer. A 10-pF series capacitor is therefore recommended.

4) Turn the tuning and fine tuning, if you are using one, completely counterclockwise and measure the frequency. Now turn the tuning and fine tuning all the way clockwise and measure the new frequency. If it's lower than the first frequency, you've got the

potentiometer in backwards. 5) Add 0.455 MHz to the two frequencies that you have just measured. This is your tuning range.

If you are building the unit for a higher frequency range, say on the order of 14 or 15 MHz, you will find that the tuning range is 2 or 3 MHz. On the other hand, units built for 3 or 4 MHz will tune only about 0.5 MHz. That is caused by the rather small capacitance change of the MV209. Typically, capacitance vs. (reverse) voltage of the MV209 is 40 pF at 1 volt, 26 pF at 5 volts, 14 pF at 10 volts, and 9 pF at 20 volts.

Low-frequency tuned circuits require more capacitance than high-frequency tuned circuits. Since the change in capacitance of the MV209 is fixed, it becomes a smaller percentage change with low-frequency tanks than with high-frequency tanks. And you can forget about a series or parallel combination of MV209's. The percentage works out the same as a single one. If you require more tuning range, the best method is to

provide a separate, stable tuning voltage of up to 20 volts. Since the current drawn by the diodes is in the microamp range, a separate 9-volt battery may be used. Just remember that as the battery ages, the tuning range will change.

6) If you are satisfied with the tuning range, wind the antenna coil with a turn or two less than the oscillator coil. This is necessary because the input tuned circuit operates at 0.455 MHz higher in frequency than that of the oscillator.

The varactors used in this receiver only need to vary by about 15 pF to cover 8.5 to 10.0 MHz or 10.0 MHz to 11.5 MHz. That can be from 25 to 40 pF, or 0 to 15 pF, or any combination that gives a change of about 15 pF. When the bias voltage is changed from 1 to 5 volts, the capacitance really changes from about 40 pF to 26 pF. If a well-regulated supply of higher than 5 volts but less than 20 volts is available, it may be used to increase the tuning range. Since we're running it on a 9-volt battery, we decided to regulate down to 5 volts. If you decide to operate the varactor on a higher voltage, remember that the NE602 is rated at a maximum of 8 volts. The high side of the tuning potentiometer can be connected to a higher voltage as long as the connection from the PC board to the high side of the potentiometer is left disconnected.

Tuning 1500 kHz with a single-turn potentiometer can be tricky. A "poor mans ten turn" can be made by putting a 10K potentiometer in series with the normal 50K potentiometer for fine tuning. Be careful with the leads going to the potentiometers; any AC signal will "modulate" the oscillator with disastrous results. Since the tuning of a varactor isn't linear with voltage, you may want to experiment with different potentiometers, such as linear, log, or audio.

### Troubleshooting

If you have any problems, the DC voltages shown in Table 3 should help. All voltages were taken with a new 9-volt alkaline battery powering the receiver. The volume control is about 1/3 with no signal input. Total current is 22 milliamps.

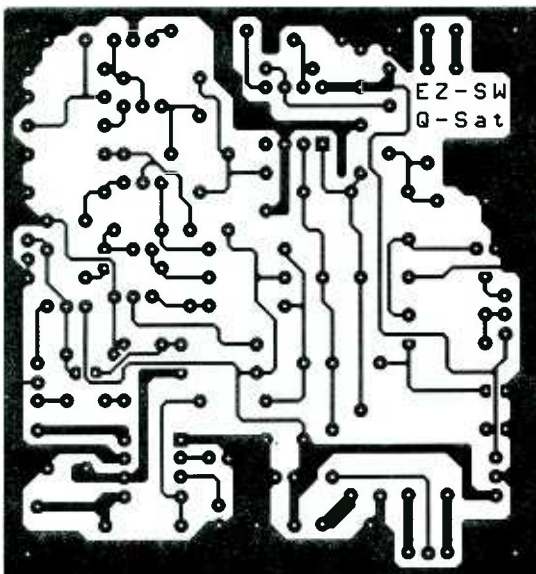

THE FOIL PATTERN for the single-sided board.



## GLITCHES IN THE POWER LINE

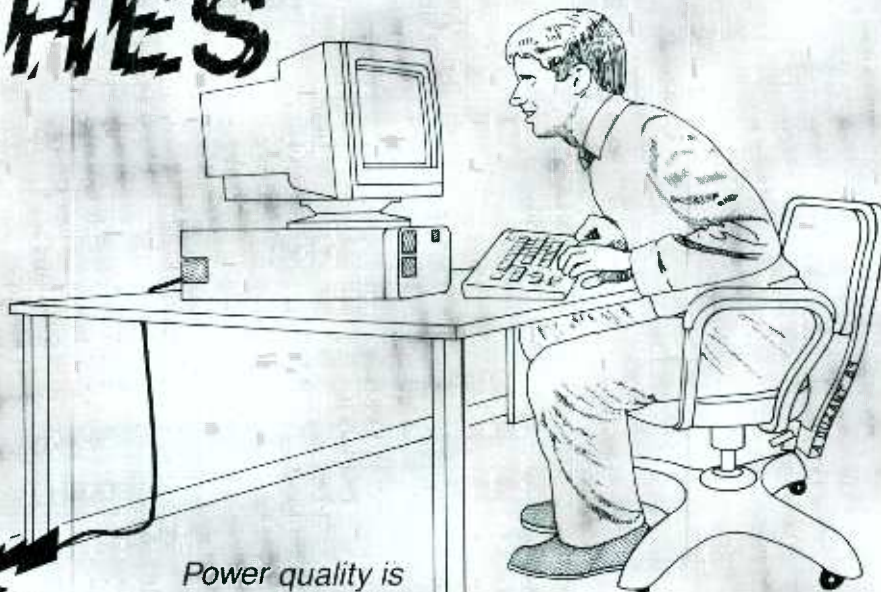

*Power quality is becoming an issue for just about everyone!*

VINCE T. MIGLIORE

THERE'S A GLITCH IN YOUR POWER LINE and it's going to find you. Imagine that you're right in the middle of saving a file on your PC, or recording a program on your microprocessor-controlled stereo or VCR, and a power-line glitch causes the system to reset. Why? You may never even attempt to find out if it happens only once every month or two, but you should.

In business and industry, the problem becomes more than an inconvenience. Computers, communication devices, sensitive medical instruments, chemical processes, and the like, can succumb to power-line disturbances. A power problem can spell disaster for a small business who can't find a solution.

Power problems can be especially frustrating for the electronics hobbyist. Even you, the solitary electronics buff, can be glitched at home. Your PC boards may burn out for no obvious reason, your PC data may be scrambled, your 10-meter transceiver may run hot, your VCR or stereo may drop dead, and the lights may dim when your refrigerator's compressor turns on. Knowing the causes and cures of power-line disturbances is valuable, technically and financially.

You don't have to be a research scientist or utility engineer to discover glitches and take action against them.

The most common way to clean up the power lines is to rely on surge suppressors. But clean power means more than no impulses. It also means eliminating any voltage sags, outages, impulses, surges, frequency errors, harmonics, grounding problems, high-frequency noise, wave-shape faults, or RF interference.

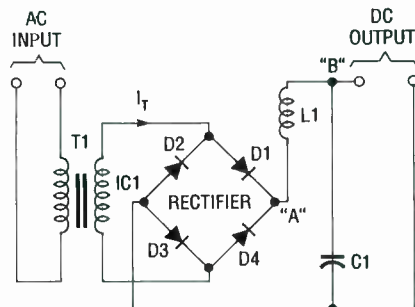

**FIG. 1—TYPICAL BRIDGE RECTIFIER, with voltage waveform shaped by an LC filter network. If only a pure resistive network were connected across points A, the waveform shown in Fig. 2-a would be seen with the aid of an oscilloscope.**

### Causes

Contrary to popular opinion, the vast majority of power problems

aren't caused by power utilities, but by their customers. Occasionally, albeit rarely, utilities are at fault, like when distribution loads are switched, or when large power-factor-correction capacitors kick in. Sometimes lightning or a car can hit a power pole, wreaking havoc with power lines. Such an interruption, if miles away, may not make your lights blink, but the resulting power line hash can blow your PC. Most often, however, transients can travel along a power line from other customers, especially if you're near an industrial area. Major offenders are arc welders or electric-train yards.

However, the above are exceptions, and maybe 95% of disturbances are caused by either home equipment, or faulty or inadequate home wiring. Most utilities bend over backwards to locate problems on their end like low voltages, distribution or switching faults, or line harmonics. Sometimes they'll even attach a monitor or strip-chart recorder to your meter to help find a problem.

### Harmonics

One of the most common AC power problems is harmonic distur-

tion, or the unwanted generation of power-line voltage components at frequencies that are multiples of 60 Hz. Linear loads that draw power in proportion to the square of voltage exhibit far fewer problems. With rectifiers, however, strange things start happening to current waveforms. Figure 1 shows a full-wave bridge rectifier, while Fig. 2 shows the relevant voltages and currents.

The voltage across points A and C in Fig. 2-a is a full-wave, rectified sinusoid provided that only a purely resistive load were connected. Across points B and C, the LC filter produces the waveform shown in Fig. 2-b. The current from the bridge rectifier charges capacitor C1 for a small portion of each half cycle as shown in Fig. 2-c, and it supplies power to the load during that brief period. Capacitor C1 provides the power that drives the DC load for the remainder of the half cycle. Inductor L1 smooths the sharp points in the rectified voltage curve at *b*, but its effect on the following discussion is nil.

As the rectifier voltage drops to zero, the charge in C1 drives the DC load. Thus, current flows through transformer T1 for only a small portion of the sinusoid, as shown in Fig. 2-c, driving the DC load and recharging C1, so the energy is concentrated in short pulses. This pulsed current generates harmonics, making a transformer run hotter than it would for a pure 60-Hz sinusoid with RMS power identical to that of the corrupt

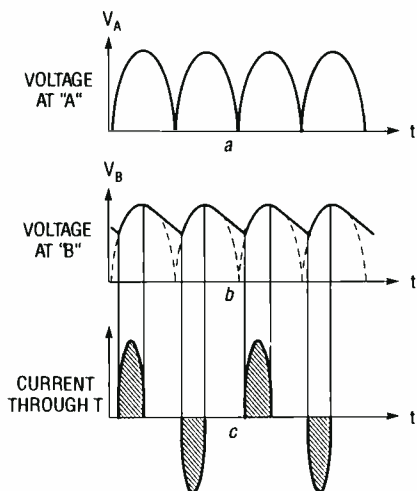

**FIG. 2—VOLTAGE AND CURRENT WAVEFORMS at different points in the power supply. At (a) is the voltage exiting the bridge rectifier, presuming either a resistive load or no load at all, instead of the LC filter; at (b) is the voltage exiting the LC filter, and at (c) is the current drawn through the transformer.**



**FIG. 3—THE BMI 2400 POWERSCOPE power-transient measurement and recording system for single-phase DC, or single- or 3-phase AC. The instrument monitors sags, surges, impulses, waveshape faults, line-frequency variations, and high-frequency noise for single-phase AC or DC, has a built-in RS-232 bus to be used with an external processor to analyze total harmonic distortion and frequency spectral content, and has a full range of available accessories, including temperature and humidity sensors.**



**FIG. 4—THE BMI 4800 POWERSCOPE. While similar to the BMI 2400 in physical appearance, it has considerably more processing power, with up to four main and eight probe channels.**

sinusoid with its harmonics. This is because the magnetic domains reverse polarity more rapidly than for the pure sinusoid, owing to the harmonics, heating the transformer core.

The bridge rectifier shown in Fig. 1 is waning in popularity, although harmonic generation is identical for more recent versions. Most computers and hi-tech gear now use switched-mode power supplies; those varieties are highly nonlinear and a major source of harmonics. If several loads are on one circuit, expect hot motors and transformers. In short, if you're serving up hash, everyone at the table tastes it!

### Latest instrumentation

Power-line monitors range from simple beepers or lights that tell you when line voltages and/or currents are out of range, to printing versions that record values numerically and graphically. Two major manufacturers of such gear are Basic Measuring Instruments or BMI (335 Lakeside Drive, Foster City, CA 94404, 415-570-5355), and Dranetz Technologies (1000 New Durham Road,

Edison, NJ 08818, 201-287-3680 or 800-DRAN-TEC).

BMI has three major instruments, the 2400 and 4800 PowerScopes, shown in Figs. 3 and 4, respectively, and the 3030 Power Demand Analyzer (not covered here). They combine oscilloscopes, strip-chart recorders, and RF interference meters in a single portable cabinet to capture transients varying from a few milliseconds to several hours in duration. Note the calculator keyboard, single-line display, and thermal strip-chart graphic printers on each.

Both versions of the PowerScope monitor sags, surges, impulses, waveshape faults, line-frequency variations, and high-frequency noise for single-phase or 3-phase AC or DC power lines, and have a built-in RS-232 bus. They can be combined

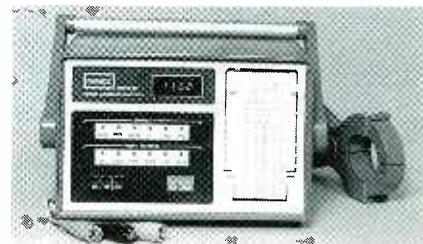

**FIG. 5—THE DRANETZ SERIES 901 POWER HARMONIC ANALYZER, similar to a BMI 2400. In one printout for a instant in time, the device records line voltage, the current used, total power, power factor, harmonic power, fundamental power, and a breakdown of the power in the individual harmonic frequencies above the fundamental (in other words, its spectral content).**

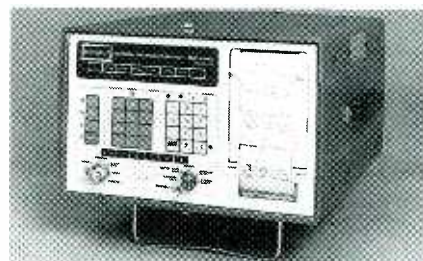

**FIG. 6—THE DRANETZ SERIES 626G Universal Disturbance Analyzer, similar to a BMI 4800. This device has several add-on modules that increased the scope of the unit with event monitors.**



**FIG. 7—THE DRANETZ SERIES 656 Disturbance Waveform Analyzer. Note the built-in CRT, full keyboard, dual floppies, and thermal printer.**



with the *A-600 Parallel Processor* to analyze total harmonic distortion and frequency spectral content (such as in the *BMI 2460*), and have a full range of accessories, including temperature and humidity sensors.

The *BMI 4800* does everything the *BMI 2400* does, but has more processing power. Whereas the *BMI 2400* has two main and four environmental or probe channels, the *BMI 4800* has up to four main channels and eight probe channels. Both models can be configured to take measurements every 1, 3, 6, 12, or 24 hours, and can do both high-resolution graphics, strip-charts, and text summaries, the sole exception being that the *BMI 2400* can't do high-resolution graphics using the probe channels—only the main ones.

The *Dranetz Technologies* gear is comparable in scope and complexity to that from *BMI*. Their *Series 901 Power Harmonic Analyzer*, shown in Fig. 5, is comparable to the *BMI 2400*, and the *Series 626 Universal Disturbance Analyzer* shown in Fig. 6 and *DRAN-SCAN Multipoint Power Monitoring and Analysis System* (not shown) are comparable to the *BMI 4800*.

The *Dranetz Series 656 Disturbance Waveform Analyzer* shown in Fig. 7 has a built-in CRT and full keyboard, two floppy disk drives, and internal thermal printer. Their *Series 800 Electric Power/Demand Analyzers* (not shown) are also available, and are similar to the *BMI 3030*. Both *BMI* and *Dranetz* also have extensive power analysis software for any external controllers used with their monitoring instruments.

### Typical power-line disturbances

The graphs shown in Figs. 8–12 were made using *BMI* gear, and those shown in Figs. 13–16 were made using *Dranetz* gear; they're of similar format. The user selects thresholds and monitors power. Whenever an impulse, voltage sag, or other disturbance occurs, it's graphed as shown in Figs. 8 and 9. Note that the sinusoidal peaks are somewhat flattened where current or voltage reaches a local maximum. If switching loads change a waveshape, that too is recorded. Fortunately, most disturbances have characteristic "signatures." Figure 10 shows a typical motor starting-voltage sag; the in-rush current drops the voltage to 84.5 volts RMS.

Nov 22 1987

INTRATECH COMPUTER

LINE AMPS INITIAL WAVE SHP 2:26:43 PM

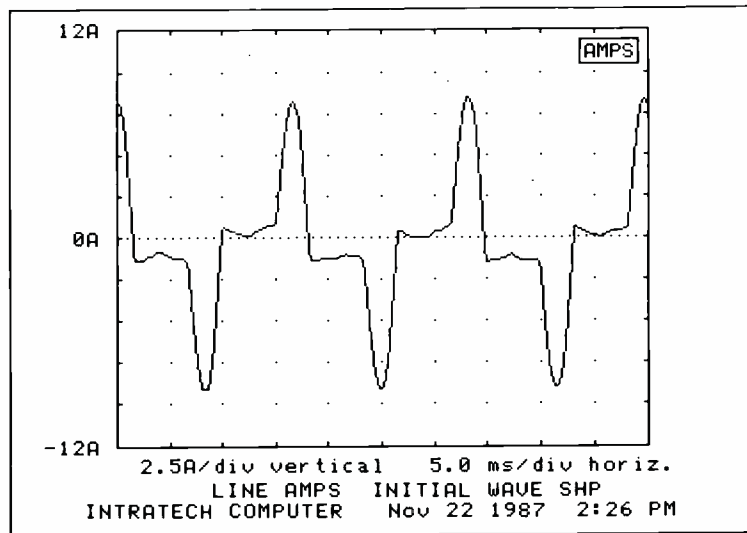
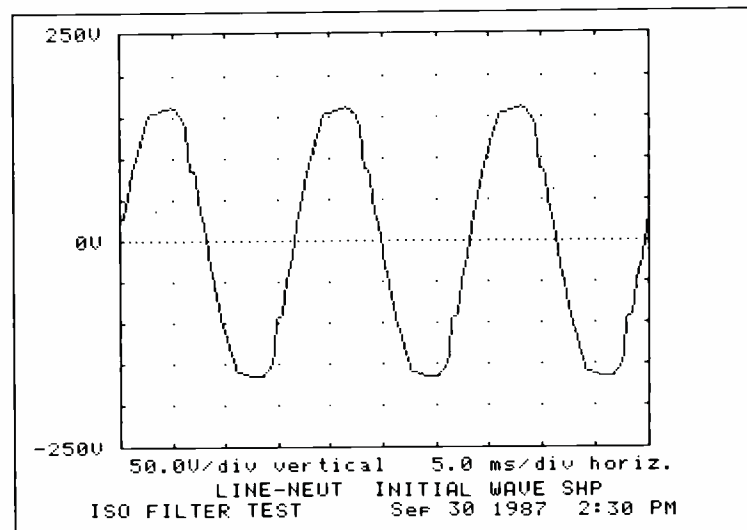

**FIG. 8—BMI-GENERATED INITIAL WAVESHAPE REPORT** for current for a circuit. Note that the current is drawn in pulses that could seriously compromise the operation of delicate instruments operating on the same or a nearby power line.

Sep 30 1987

ISO FILTER TEST

LINE-NEUT INITIAL WAVE SHP 2:30:11 PM



**FIG. 9—VOLTAGE WAVEFORM IN A CIRCUIT** with harmonics. The voltage sinusoid is distorted at positive and negative peaks, where current flow is maximum.

Nov 27 1987

AIR COMPRESSOR

LINE-NEUT VOLTAGE SAG 11:58:21.32AM

80.2 Urms minimum  
>16.0 seconds below threshold

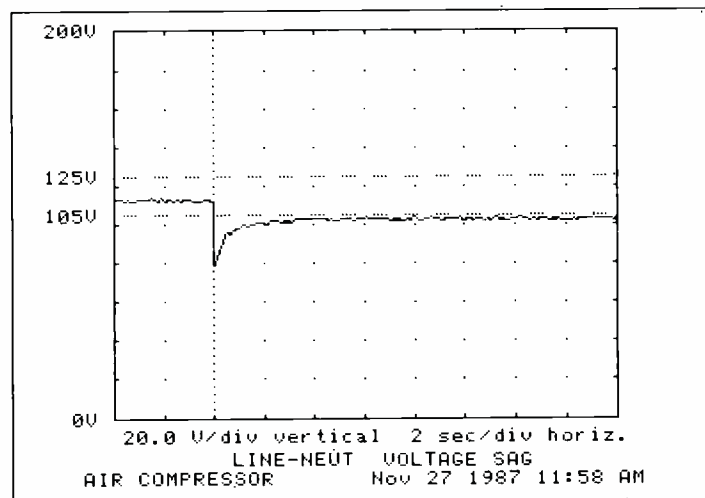

**FIG. 10—TYPICAL MOTOR-START SIGNATURE.** As the motor stabilizes, voltage returns to normal.

INTRATECH J BOX Sep 27 1987  
 LINE-NEUT IMPULSE 12:02:32.54PM

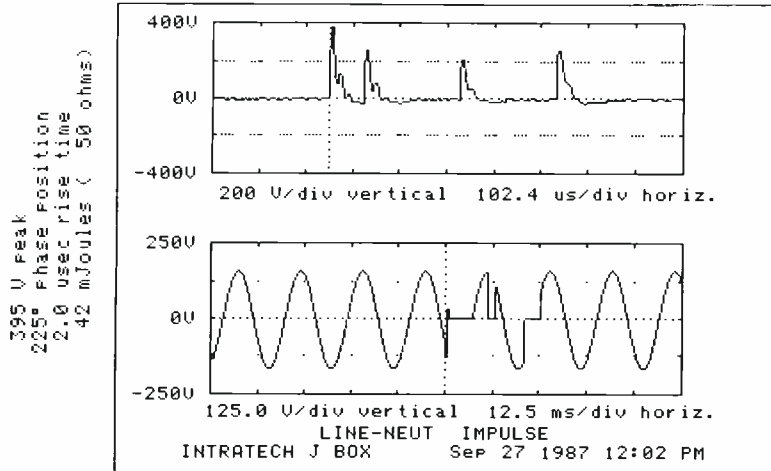

FIG. 11—IMPULSES DUE TO LOOSE WIRING. Sharp-edged dropouts on the sinusoid indicate that the problem is nearby.

INTRATECH GENERATOR Oct 04 1987  
 LINE-NEUT HF NOISE SURGE 11:01:31.32AM

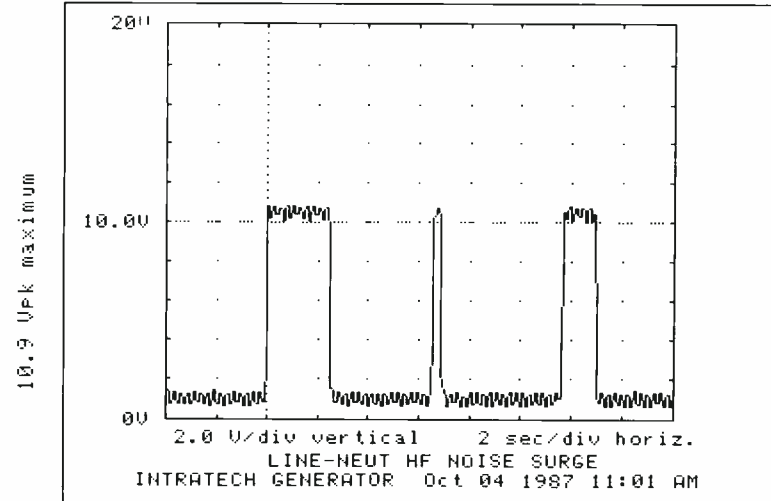

FIG. 12—VOLTAGE SURGES CAUSED BY HIGH-FREQUENCY NOISE. Note the 10-volt peaks that may ride through a power supply to damage memory and program chips in a computer.

Event #336 Ch.A 6/11/89 22:33:36.72

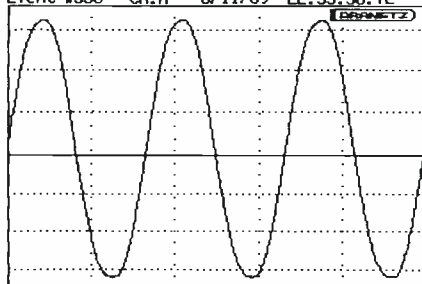

FIG. 13—A NORMAL POWER SINUSOID. The time was 11:33 P.M., when most heavy industrial machinery isn't powered.

Event #11 Ch.H 1/10/89 13:47:30.73

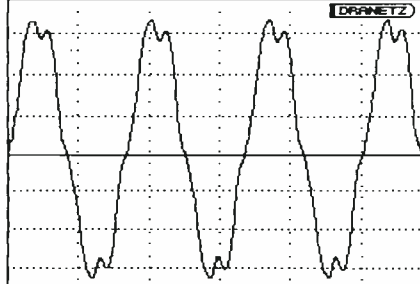

FIG. 14—HARMONIC DISTORTION. This graph was taken at 1:49 P.M. at the same site as that in Fig. 13.

When the motor stabilizes, the voltage returns to near-normal; the low threshold was 105 volts. The potential was below 105 volts for 1.2 seconds, enough to make a computer lose data, shut down, and reboot. If you found that disturbance on a line with sensitive equipment, you'd

move the motor to another circuit. A common problem in amateur radio shacks and utility communication gear are impulses due to loose wiring; a typical signature is shown in Fig. 11. The top part shows four impulses. The lower part shows how the voltage dropped out and returned a few times

Event #487 Ch.A 6/12/89 06:11:36.12

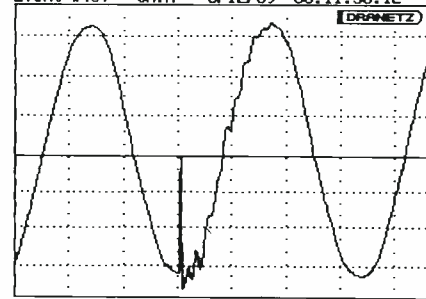

FIG. 15—A POWER GLITCH. Just imagine what the added pulse would do to a counter circuit.

Event #8 Ch.B 8/18/89 11:23:10.58

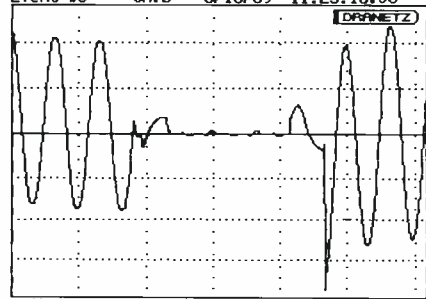

FIG. 16—A BRIEF POWER OUTAGE. Just imagine what this would do to your PC's memory!

over a couple of cycles.

Note the sharp transitions, indicating loose wiring nearby. Had the disturbance occurred farther away, the transitions would've been slower, smoother, and less well-defined, as a result of impedance encountered as the impulse propagated. Power-monitor graphs sometimes need interpretation, but are fairly interesting, and expand your knowledge of power-line problems.

Figure 12 shows bursts of line-to-neutral high-frequency noise, in this case RF interference, while transmitting the letter "K" in Morse code (dah-di-dah) from an amateur radio shack. High-frequency noise is common in such settings, but can also be caused by a CB radio, walkie-talkie, or taxi transmitter. You should check your own transmitter, if you have one, for both neutralization and shielding. The disturbance shown here is only 10 volts, but digital logic circuits work on 5 volts DC. If RF interference can induce 10 volts on a power line, such a level can wreak havoc with even otherwise well-shielded computers or instruments.

Some other waveforms, acquired from Dranetz gear, are shown in Figs.

*Continued on page 76*



## SINGLE-CHIP FREQUENCY CONVERTER

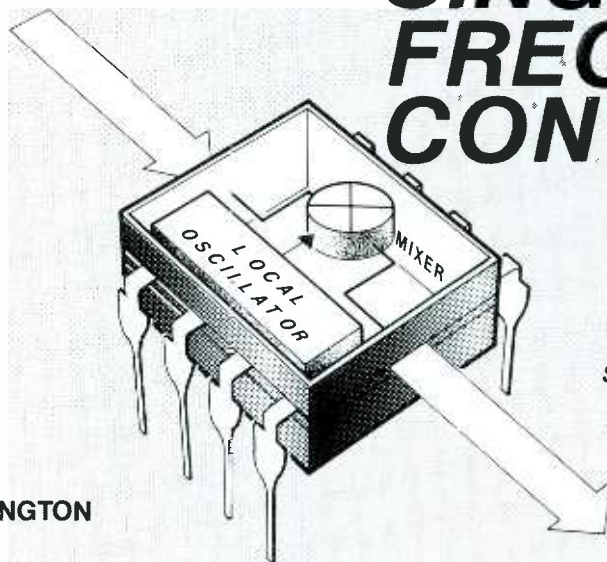

MICHAEL A. COVINGTON

*Introducing a general-purpose single-chip frequency converter which should greatly simplify your RF designs.*

FREQUENCY CONVERTERS ARE BASIC building blocks of RF equipment. You'll find them wherever there's a need to shift the RF carrier of a signal from one frequency to another, such as in any modern radio receiver.

Frequency conversion, or heterodyning, is the process of mixing an incoming signal with that of a Local Oscillator (LO), as shown in Fig. 1. Two signals result from mixing, their frequencies being the sum and difference of those of the originals. Thus, a 9-MHz input and a 2-MHz LO yield outputs of 7 and 11 MHz.

Building a frequency converter is easier now than it's ever been because of a new IC, the Signetics NE602. The NE602 contains an LO and double-balanced mixer in an 8-pin DIP, as shown in Fig. 2, a block diagram of the IC. The NE602 was originally designed for VHF receiver front ends, since the LO works up to 200 MHz, and the mixer to 500 MHz. However, it has plenty of uses at lower frequencies as well, and this article will explore them.

### Circuit description

The NE602 uses a double-balanced mixer, producing only the sum and difference frequencies, not that of the RF input or LO. You can thus connect

the output of an NE602 directly to a receiver without overloading it. With a conventional mixer, you'd have to add a tuned LC circuit to eliminate the LO output. The NE602 LO is also well isolated from its RF input; you can thus connect a receiving antenna directly to the RF input terminals of the IC without worrying about radiating the LO signal back out through the antenna. This is important in direct-conversion receivers, where the LO frequency is so close to that of the input, that the two can't be isolated by a tuned LC circuit.

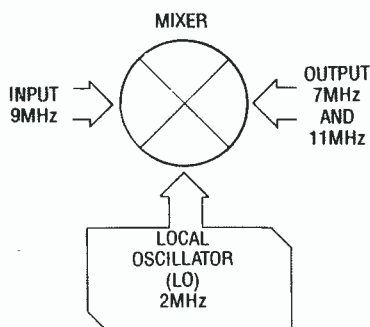

**FIG. 1.—FREQUENCY CONVERSION PRODUCES outputs at the sum and difference of input and LO frequencies. In the case of the NE602, since it's double-balanced, both the input and LO signals are absent from the output.**

The combination of the differential amplifier and mixer in the NE602 is known as a Gilbert cell. The mixer has on-board voltage regulation, and draws 2.5–3 mA at 4.5–8 volts. For best performance, bypass the power supply with a 0.04- $\mu$ F capacitor as close to the IC as possible. The absolute maximum supply voltage is 9.0 volts, but a 9-volt battery often exceeds that, and 9-volt wall transformers often deliver as much as 11 volts. For safety, use 1000-ohm dropping resistor R1 as shown in Fig. 3; using a Zener diode, you can use automotive power supplies up to 18 volts.

The RF input and mixer output can be either single-ended or balanced as shown in Figs. 4 and 5. Using a balanced input reduces harmonics, while a balanced output gives better suppression of the input RF and LO signals. However, even in the simplest single-ended configuration, the NE602 gives much better performance than the one-transistor mixer commonly found in receivers.

The input and output impedances of the NE602 are about 1.5K at low frequencies, and decrease with increasing frequency. The input signal should be weak to prevent harmonics; the third-order intercept point is for a -15 dBm input, but the recommended

level is -25 dBm or below. That corresponds to 68.87 millivolts into 1.5K if you use direct coupling, or 12.82 millivolts into 52 ohms if you use impedance matching. The NE602 works well with microvolt-level signals from antennas.

The input signal is amplified prior to mixing; the voltage gain is about 10. Thus, a receiving converter built with the NE602 can increase a receiver's sensitivity. The NE602 LO is a transistor with connections to its base and emitter, with biasing han-

dled on the chip. That makes it easy to build many different oscillator types with few external components.

Figure 6 shows some of the main versions; there are many others. The NE602 can be used as an oscillator without the mixer. One way is to sample the LO output at pin 7; a better way is to unbalance the mixer and use it to amplify the LO signal, as shown in Fig. 7. The unbalance is created by a 10K resistor from one input pin to ground, which changes the bias voltage slightly. The output level of such an oscillator is about 0.5 VAC P-P.

### Basic crystal oscillator

Many frequency converters are crystal-controlled; Fig. 8 shows the most basic version. The low side of XTAL1 and C2 can be returned either to ground or to  $V_{CC}$ ; the latter is more compact, because pins 6 and 7 are adjacent to  $V_{CC}$  (pin 8). The values of C1 and C2 are important. If C1 is too large, or C2 is too small, there's too much feedback and the oscillator waveform is distorted, with a strong third harmonic. If C1 is too small or C2 is too large, oscillation doesn't occur.

Some suggested values for C1 and C2 are shown in Fig. 6 along with formulae for calculating them. At high frequencies, C1 can be somewhat than the value shown because stray capacitance does some of the work. The values shown are for the best sinusoid. If you want to be sure that a relatively inactive crystal will oscillate and don't mind harmonics, make C1 three times larger. The third harmonic from such a circuit could be used for VHF. There's also a lower frequency limit; the unmodified circuit will oscillate with a 455-kHz ceramic resonator, but not a 100-kHz crystal. Adding 22K from pin 7 to ground will increase the oscillator gain, and improve your chances with low-frequency crystals.

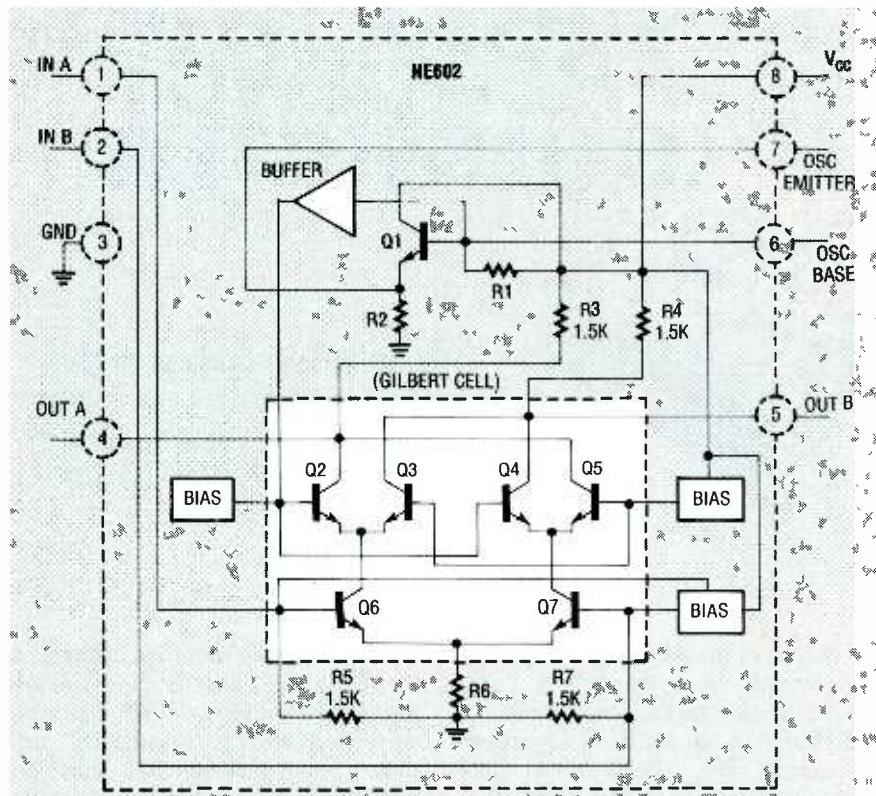

FIG. 2.—NE602 EQUIVALENT CIRCUIT WITH PINOUTS. The combination of differential amplifier Q6-Q7 and mixers Q2-Q3 and Q4-Q5 is called a Gilbert cell.

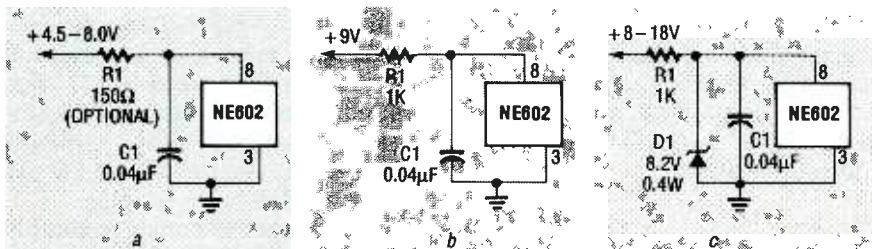

FIG. 3.—NE602 POWER SUPPLY OPTIONS. Here, (a)–(c) show an RC-filter used as both current limiter (R1) and integrator (C1), as well as for isolation. In (a), +4.5–8.0 volts DC is the normal operating range of the NE602. In (b), R1 drops voltage, and is used since a +9-volt battery can go higher, and a +9-volt wall supply can produce up to 11 volts. In (c), an +8–18-volt DC supply is regulated using 8.2-volt Zener D1.

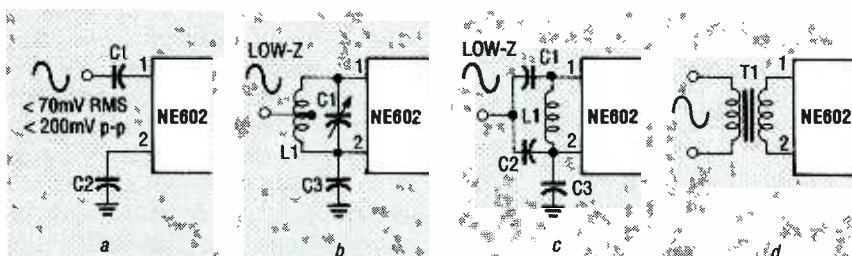

FIG. 4.—MIXER RF INPUT CONFIGURATIONS. Here, (a)–(c) are for single-ended coupling, (a) being for no impedance matching, (b) for inductive matching, (c) for capacitive matching. By contrast, (d) is for a balanced input with reduced second harmonic.

### Precise frequency control

A crystal won't necessarily oscillate at its exact rated frequency. There are two kinds, series- and parallel-resonant. They're electrically identical, the only difference being that series-resonant crystals are cut to an exact frequency, whereas parallel-resonant crystals are cut slightly longer, so as to resonate independently slightly below their rated frequency. For that reason, parallel-resonant



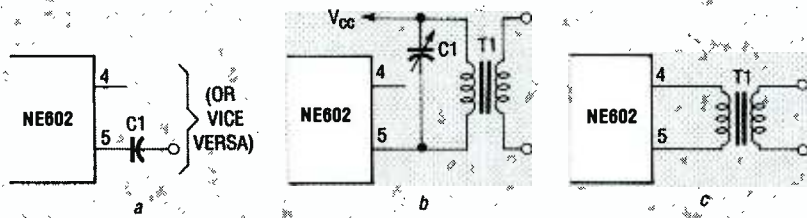

FIG. 5.—OUTPUT CONFIGURATIONS. Here, (a) is the simplest single-ended approach without impedance matching, (b) is a single-ended approach for a tuned LC circuit load, and (c) is for a balanced approach for better suppression of input and LO signals.

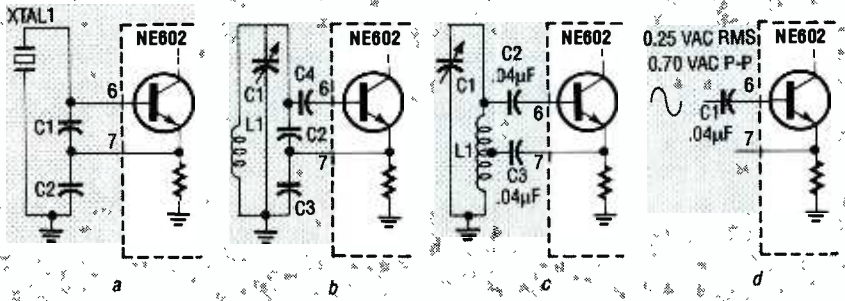

FIG. 6.—BASIC NE602 OSCILLATOR CIRCUITS; (a) is Colpitts crystal-controlled, (b) is Colpitts LC-tank-controlled, (c) is Hartley LC-tank-controlled, and (d) is controlled by an external oscillator. Many other configurations are possible.

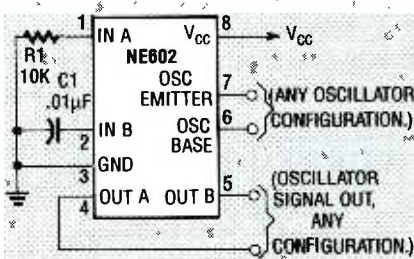

FIG. 7.—THIS IS A GENERAL CONFIGURATION for an NE602. To make an LO signal appear at OUT A (pin 4) and OUT B (pin 5), IN A (pin 1) is grounded through R1.

crystals need external capacitors (usually 32 pF) to increase their actual frequency of oscillation to their rated value. In Fig. 8, C1 is this capacitor, but it's usually larger than 32 pF and has less effect than the one depicted here.

Thus, at 10 MHz, parallel-resonant crystals oscillate about 100 parts per million (ppm) below their rated frequency, while series crystals resonate about 300 ppm above. A parallel-resonant crystal can be pulled up to its rated frequency using a small variable capacitor in series with it, as in Fig. 9, letting you adjust the oscillator as desired. However, even without this capacitor, the frequency error won't be more than 300 ppm (0.03%).

**Overtone crystal oscillator**

Above 20 MHz, crystals oscillate in overtone mode, and the oscillator

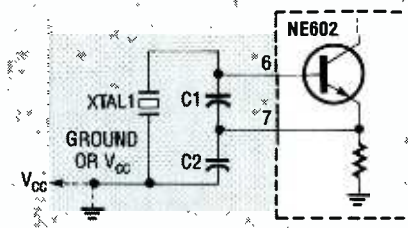

f MHz	C1=100pF/√f	C2=1000pF/f
1	100	1000
2	70	500
4	50	250
10	32	100
20	22	50

FIG. 8.—FUNDAMENTAL COLPITTS CRYSTAL OSCILLATOR. Note that the juncture of XTAL1 and C2 can go to either ground or V<sub>CC</sub>.

needs a tuned LC circuit to select the desired harmonic. For example, a 27-MHz third-harmonic crystal can resonate at 9 MHz (fundamental) or 45 MHz (fifth harmonic). The NE602

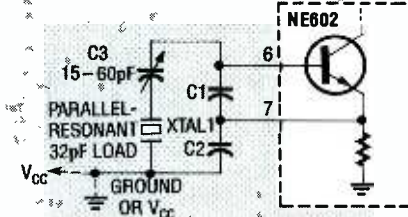

FIG. 9.—A VARIATION ON FIG. 8, including C3 to adjust the frequency of XTAL1 (parallel-resonant), bringing it up to its rated value.

data sheet recommends a modified Colpitts oscillator for overtone crystals, but the Butler oscillator in Fig. 10 gives much better results. Its crystal is series-resonant, and L<sub>1</sub> and C1 are tuned to the crystal frequency.

This circuit is reliable to at least 60 MHz. Just adjust L<sub>1</sub> and C1 until oscillation occurs. By adjusting this tuned LC circuit, you can trim the frequency by about 50 ppm; for greater variation, use a parallel-resonant crystal in series with a variable capacitor for adjustments.

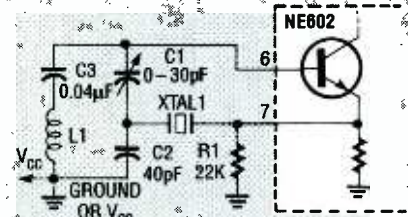

FIG. 10.—BUTLER OVERTONE CRYSTAL OSCILLATOR, with C1 as trimmer. Here: L<sub>1</sub>≈1300 µH, and both L<sub>1</sub> and C1 have to be tuned to the frequency of XTAL1.

**Frequency doubler**

Figure 11 shows a crystal-controlled frequency doubler with no tuned LC circuits. That circuit is useful in the 20–40 MHz range, but the same method could be used with overtone crystal oscillators for even higher output frequencies.

The doubling is achieved by feeding the LO from pin 7 into the mixer. The output is 2×f (where f is the oscillator fundamental frequency), while the difference frequency is zero (or DC), disappearing due to capacitive coupling.

The output still contains some energy at the LO frequency and isn't pure, but is good enough for hobbyist purposes. A tuned LC circuit can easily provide pure output. Of the oscillators shown here, this is the only one that can't be used with the mixer, because one mixer input is occupied (although you could feed a signal to the other mixer input).

Figure 12 shows a Colpitts LC oscillator using coils and capacitors. Here, L<sub>1</sub> forms a resonant circuit with C1 and C2 in series, plus C4 in parallel. Also, C3 blocks DC from pin 6 to V<sub>CC</sub> or ground; it has little effect on the resonant frequency. Figure 12 also gives formulas for component values. At very high frequencies, a 22K resistor from pin 7 to ground (not V<sub>CC</sub>) will change the bias point and increase gain.

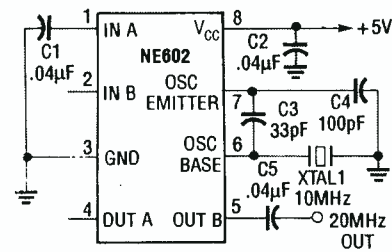

FIG. 11.—THIS FREQUENCY DOUBLER PRODUCES a sine wave at twice the frequency OF XTAL1. Note that output is taken only from OUT B (pin 5), while OUT A (pin 4) is left open.

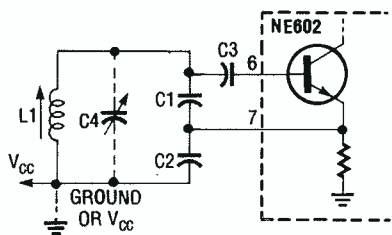

FIG. 12.—COLPITTS LC OSCILLATOR. Here:  $L1 \approx 7 \mu\text{H}/f$ ,  $C1 \approx C2 \approx C3 \approx 2400 \text{ pF}/f$ , where  $f$  is in MHz.

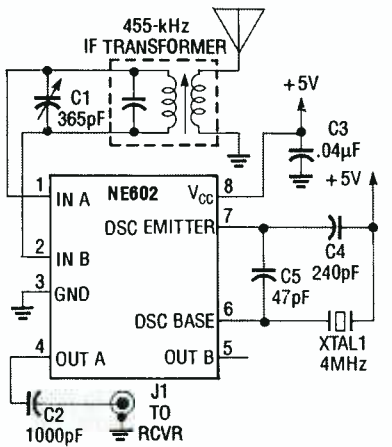

FIG. 13.—THIS RCVR DOWN-CONVERTS LONGWAVE signals from 350–500 kHz up to 4.35–4.5 MHz, enabling them to be received via a shortwave receiver plugged into J1.

### Longwave receiver converter

Figure 13 shows a frequency converter front end for a shortwave receiver to receive longwave signals (350–500 kHz). It mixes the incoming signal with the 4-MHz signal from the LO. For example, 400 kHz incoming produces 4.4 and 3.6 MHz. The shortwave receiver will receive the signal if tuned to either frequency. The input has a tuned LC circuit to prevent spurious response.

If the receiver is set to 4.4 MHz, then without the tuned LC circuit you'd listen to 400 kHz and 8.4 MHz, because each gives a 4.4-MHz output when mixed with the LO. The tuned

LC circuit at the input selects one and rejects the other. This circuit was attached to a shortwave receiver, and immediately received several long-wave navigational beacons in nearby states. A long wire antenna works, but loops pick up less noise because they are directional.

### Direct-conversion receiver

A frequency converter can shift frequencies up or down. However, if you shift an RF signal down to audio, you get an audio signal. This is called direct-conversion reception, and can demodulate Single-Sideband (SSB) and Morse code Continuous-Wave (CW) transmissions. It demodulates AM, but there's a whine if the tuning isn't perfect.

Figure 14 shows such a direct-conversion receiver for the 40 meter band (7.5 MHz), that was able to receive several amateur radio stations using a 3-foot whip antenna. The design could be refined; tuning would be easier with a variable capacitor instead of an adjustable coil.

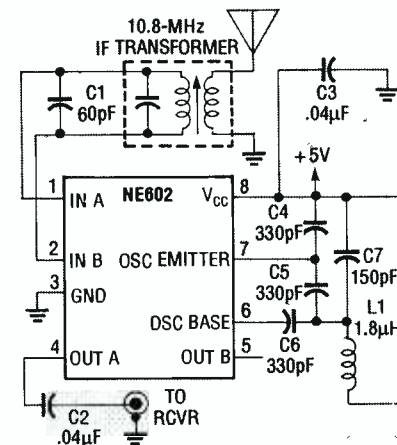

FIG. 14.—DIRECT-CONVERSION RECEIVER for the 40-meter (7-MHz) amateur radio band, where CW is directly down-converted to audio.

### Conclusion

There are basically three RF circuit types—amplifiers, oscillators, and frequency converters. The NE602 makes frequency conversion easier than ever. Both it and related IC's will eventually become basic building blocks of RF design. This article has only scratched the surface of the possibilities for the NE602. In an IF section, it makes a good product detector. By mixing audio with RF, it can act as an AM or DSB modulator. By mixing audio with audio, the

NE602 can be the heart of an ultrasonic listener (by down-converting high-frequency audio) or a speech scrambler to add security to telephone conversations.

You can get NE602's at \$2.75 each, plus \$4.50 per order postage and handling, from Radiokit, P.O. Box 973, Pelham, NH 03076, (603) 635-2235; there's no minimum order. They are also available from Digi-Key, Arrow Electronics, Schweber Electronics, and many other Signetics distributors, with \$25.00 typical minimum orders. Be sure to specify whether you want the NE602N (8-pin DIP) or NE602D (surface mount package).

You also may prefer to order the NE602A, which will be replacing the NE602 imminently; it has somewhat improved intercept characteristics, resulting in less harmonic generation and intermodulation distortion. To specify the desired package type, you'd refer to the NE602AN or NE602AD. We would like to thank Phil Anzalone, Ali Fotowat, and Craig Hirtz of Signetics for their invaluable assistance in preparing this article.

R-E

## POWER LINE GLITCHES

*continued from page 72*

13–16. Figure 13 shows a normal power sinusoid, Fig. 14 shows harmonic distortion, Fig. 15 shows a brief glitch, and Fig. 16 shows a brief power outage.

### Conclusion

Those graphs shown in Figs. 8–16 show only a few of many possible disturbances. Power glitches are common and readily identified. Most are easily fixed, the culprit often being poor wiring, bad grounding, or load switching—all can be corrected cheaply. The most common, practical countermeasure is to install a separate power line from the circuit-breaker box involved to the device being interfered with, like a PC.

Power monitors make identification easy, but they're generally too expensive, and would be needed too infrequently, to warrant purchase by the average hobbyist. They can, however, be rented for short periods, on an as-needed basis, letting you derive the benefits of their technology without making a major investment.

R-E



# BUILD THIS

TEST EQUIPMENT HAS SURE COME A long way since the days of the bulky analog meter. The newest generation of portable test gear boasts features that would make technicians of a decade ago green with envy. Single instruments can measure everything: voltage, resistance, capacitance, logic levels, and even frequency. In fact, an entire test bench of equipment can now be packed away in a shirt pocket, and carried easily to the source of the trouble.

As good as those new meters are, they still have a few limitations that can be rather disconcerting at times. Frequency measurement is a good example. The highest range on most portable DVM-sized instruments is usually less than 1 MHz, and the 3½- to 4½-digit LED displays on most meters don't offer much resolution. It seems as if most manufacturers add frequency measurement as an afterthought. As newer designs hit the market, those shortcomings will improve. But why wait? You can build the frequency probe described here. It offers benchtop performance at a fraction of what you'd expect to pay.

The frequency probe is a unique combination of a logic probe and an 8-digit, 100-MHz frequency counter. It uses only three IC's,

# 100 MHz FREQUENCY PROBE

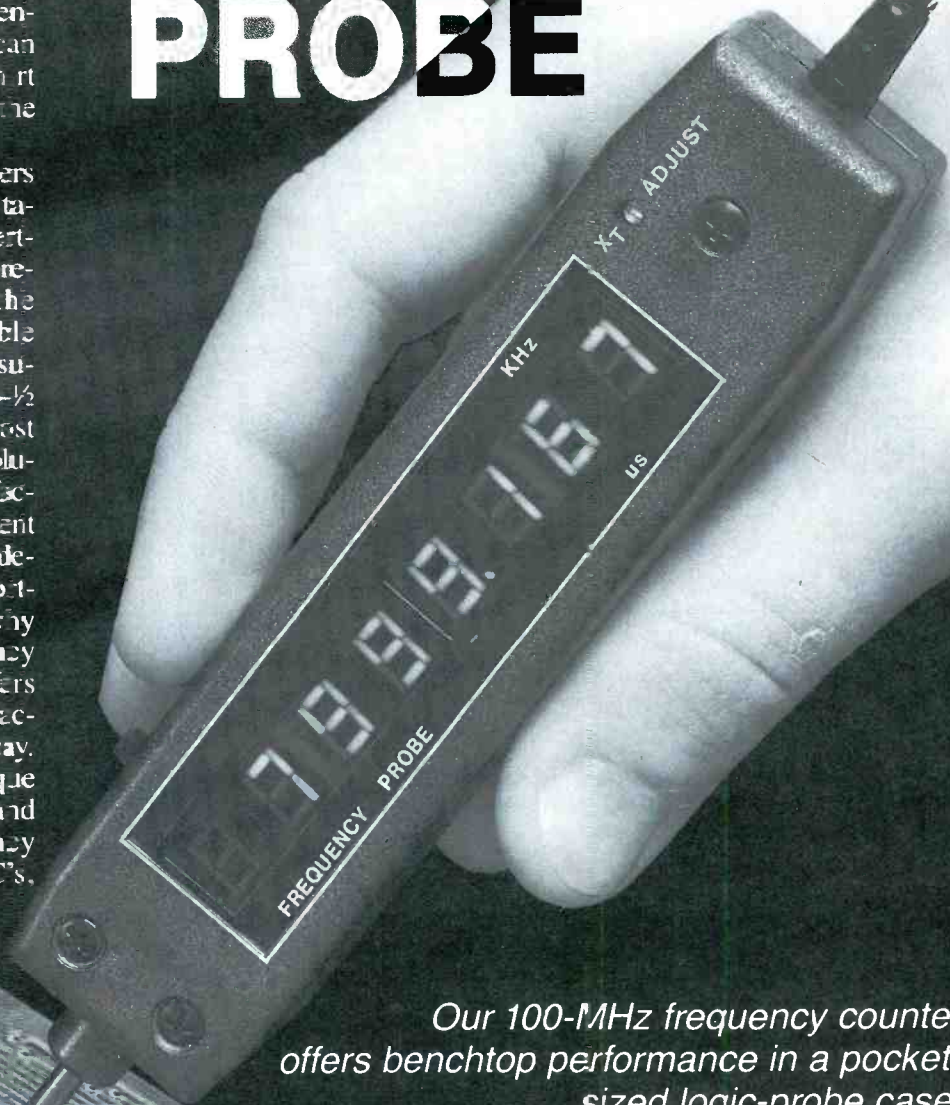

*Our 100-MHz frequency counter offers benchtop performance in a pocket-sized logic-probe case.*

MICHAEL A. LASHANSKY



**TABLE 1—FREQUENCY PROBE SPECIFICATIONS**

Parameter	Waveform Type	Condition	Performance (*)	
			Frequency	Period
Measurement Range	Any	Unmodified PC Board, XTAL1 is 1 MHz	00000.000—99999.999 X 1 kHz, 10-s gate	00000.500—99999.999 X 1 $\mu$ s, 10-s gate
		Modified PC Board (see text), XTAL1 is 1 MHz	000000.00—099999.99 X 1 kHz, 1-s gate	000000.50—099999.99 X 10 $\mu$ s, 1-s gate
		Unmodified PC Board, XTAL1 is 10 MHz	00000.000—0999.999 X 10 kHz, 1-s gate	00000.500—99999.999 X 10 $\mu$ s, 1-s gate
		Modified PC Board (see text), XTAL1 is 10 MHz	000000.00—009999.99 X 10 kHz, 0.1-s gate	000000.50—099999.99 X 1 $\mu$ s, 0.1-s gate
Input Sensitivity	Sinusoid	N/A	35 mV p-p	
	Square	N/A	50 mV p-p	
Maximum Period	Any	N/A	2 MHz	
Logic High	Any	N/A	3 VDC	
Logic Low	Any	N/A	1.8 VDC	
Supply Voltage	Any	N/A	4.5–15 VDC	
Maximum Current	Any	N/A	190 mA DC	
Input Impedance	Any	n/A	51 ohms	

(\*) NOTE: All leading zeros are suppressed during normal operation of the frequency probe for both frequency and period measurement, and are reproduced here merely for illustration.

and fits in a standard logic-probe case, modified for the purposes of the 8-digit LED display. Table 1 lists the probe's specifications. It features switchable AC/DC coupling and both frequency- and period-measurement capability. The builder of the probe can modify the useful frequency range by selecting a different crystal, and can also modify the gate time (or sampling time) by making a simple PC-board modification. The effects of the modifications are summarized in Table 1, and we'll discuss how they're made shortly.

The probe can be powered either by the circuit-under-test, or by connecting its leads to +9-volts DC.

Building the probe isn't difficult, but it requires care and patience, because the components are very tightly packed.

**Circuit operation**

Figure 1 shows the block diagram of the frequency probe. The input can be AC- or DC-coupled to the divide-by-10 prescaler, whose output is fed to the main counter section and the LED display block. That counts the prescaler pulses, and includes the necessary logic for the 8-digit LED display. The logic block indicates with LED1 and LED2 which coupling mode is in use, and indicates logic levels.

The frequency-probe schematic is

shown in Fig. 2. S1 either DC-couples the input through R1, or AC-couples it through C1. The center pole of S1 goes to the clock-pulse input (CP) of IC1, a National Semiconductor 11C90 prescaler. The 11C90 is an ECL divide-by-10 prescaler, uses +5 volts, has TTL-output, and operates over a DC–650 MHz bandwidth with only an RF-bypass capacitor on V<sub>CC</sub>. Input sensitivity for AC-coupling is 350 mV p-p from DC–100 MHz, and 250 mV p-p above 100 MHz. The frequency response of the 11C90 is shown in Fig. 3, but that's the guaranteed minimum, and actual performance can exceed it substantially. S2 is located between the frequency counter and the LED display, and selects between the frequency- and period-measurement modes.

Triggering is simplified in IC1 by connecting the reference terminal (pin 15) to clock pulse (pin 16). By doing so, the probe input is automatically centered about the input threshold. A 50% duty cycle gives the fastest operation, and since the flip-flops are master-slaves with offset input thresholds, there are no minimum frequency restrictions. That ensures that the circuit will operate with inputs with very slow rise and fall times. The 11C90 can divide-by-10 or -11 depending on the levels on pins 1 and 2 (M1 and M2). A logic low on those pins places the divider into divide-by-11 mode, while tying them high produces divide-by-10 mode. IC1 is enabled by tying pin 1 (CHIP ENABLE) and pin 14 (ASYNC MASTER SET) low.

There are two V<sub>EE</sub> terminals (pins 12 and 13). The TTL output operates from the same V<sub>CC</sub> and V<sub>EE</sub> levels as the counter, but a separate pin is used for the TTL V<sub>EE</sub>. That minimizes noise coupling when the TTL-output switches, and reduces power consumption by leaving pin 12 open when the ECL outputs are used. Because the IC operates linearly with the transistors always on, the current drawn can go up to 80 mA, with 35 mA typical. Thus, the IC's run pretty warm, but heat-sinking isn't needed.

The TTL-output of IC1 is pulled up to CMOS levels by R6 and connected to the clock input of IC2, an ICM7216B frequency counter. The 7216B has gating, timebase, latching, decoding, and 8-digit LED display-driver circuitry. In addition, the 7216B measures period, frequency ratios (f<sub>A</sub>/f<sub>B</sub>), time intervals, or total



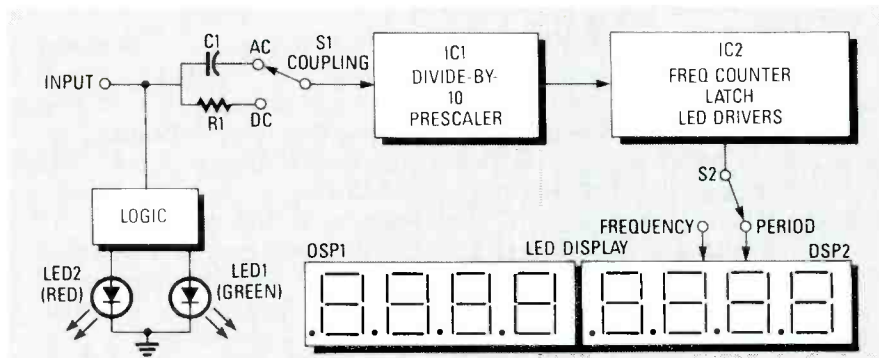

FIG. 1—FREQUENCY PROBE BLOCK DIAGRAM; the input is either AC- or DC-coupled to the divide-by-10 prescaler (IC1) then sent on to the counting (IC2) and LED display (DSP1 and DSP2) blocks.

counts. Due to limited space, only the frequency and period functions were used.

The 7216B has a 10-MHz crystal timebase, and accepts inputs up to 10-MHz, which are divided internally by  $10^5$ . Inputs are gated with that clock for a period determined by the RANGE INPUT (pin 14) setting, and passed to the main counter. The RANGE INPUT automatically adjusts the LED display

decimal place, and allows longer gate periods for lower frequency inputs. When prescalers like IC1 are used, XTAL1 should be scaled accordingly. Thus, the input was divided-by-10 using IC1 and a 1-MHz crystal. That multiplies the internal gate time by 10 (from the original range times), allowing 100-MHz measurements with 1-Hz resolution.

Also, the 7216B has 10-ms, 100-

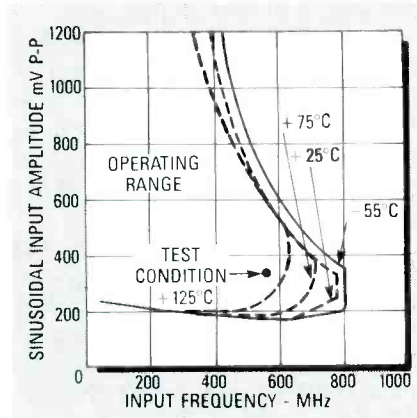

FIG. 3—SENSITIVITY OF IC1 AS A FUNCTION of sinusoidal input amplitude in mV p-p vs. frequency, for  $-55^{\circ}\text{C}$ ,  $25^{\circ}\text{C}$ ,  $75^{\circ}\text{C}$ , and  $125^{\circ}\text{C}$ .

ms, 1-s, and 10-s gate times. Selection of the gate time and decimal-point location is achieved by connecting the range input (pin 14) through R10 to digit-driver terminals D1-D4 (pins 4-7). The digit-drivers are time-multiplexed with the range, control, external decimal point, and func-

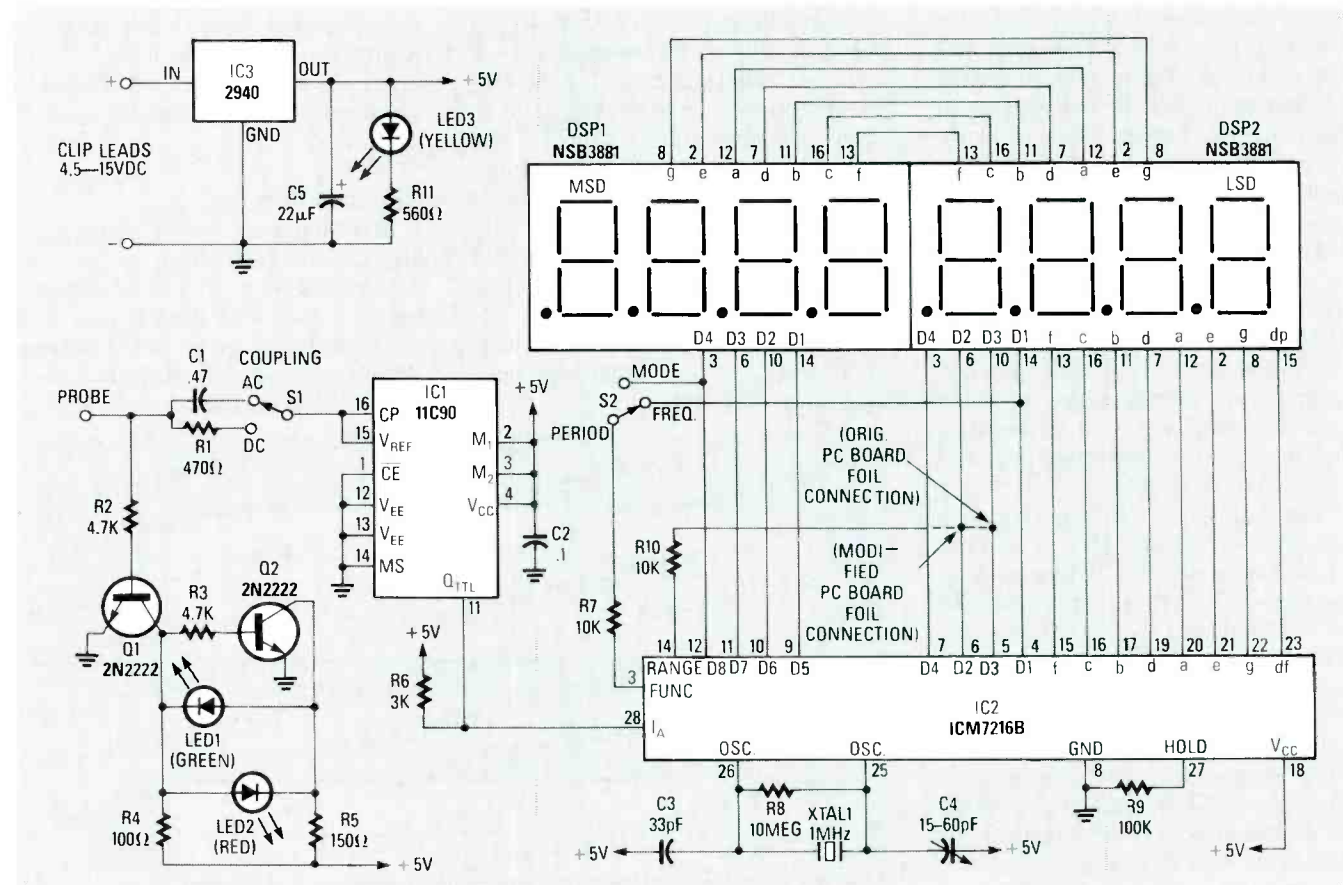

FIG. 2—SCHEMATIC DIAGRAM FOR THE FREQUENCY PROBE. Note the dotted line connecting R10 with pins 5 or 6 of IC2; that variable connection controls the decimal point and total count appearing on DSP1 and DSP2. The relative intensities and durations of ON/OFF time for LED1 (green) and LED2 (red) give a rough indication of logic level and duty cycle.

tion selects to save on pin count. The range was fixed at 1 s, or 100 counts of the 10-Hz reference counter (100 Hz/10). That gave a 10-s gate time, which is inconvenient at times, but necessary for 1-Hz resolution from DC–100 MHz, without using space-grabbing range-select switches.

To achieve a 1-s gate, you can either modify the PC board by connecting the RANGE input (pin 14) to D2 (pin 6), or you can use a 10-MHz crystal. If you modify the PC board, the decimal place shifts one digit right (XXXX-XX.XX instead of XXXX.XXX), and the least-significant digit means 10 Hz, not 1 Hz. The interpretation of the display remains as multiples of 1 kHz, but the absolute range of the probe increases from 10 MHz to 100 MHz. To do that, cut the foil on the component side from pin 5 of IC2, and solder a jumper from the foil side to pin 6.

If you change the crystal frequency, the decimal place stays unchanged (XXXX.XXX before and after); the LED display value reads in multiples of 10 kHz instead of 1 kHz. A 1-MHz crystal provides a 10-s gate, and a 10-MHz crystal provides a 1-s gate. The longer the gate, the more accurate the measurement, but the measurement itself will take longer. If you use a 10-s gate, the probe might slip off a connector or IC pin before the 10 seconds are up.

The best of both worlds would be to go with a 10-MHz crystal, because you'll save some money (\$2.00 for 10-MHz vs. \$12.00 for 1-MHz), and you'll also be able to take quicker, easier measurements. After all, a 10-s gate isn't that much more accurate than a 1-s gate, as to warrant the additional cost (see Table 1).

The 7216B crystal goes between pins 25 (OSC IN) and 26 (OSC OUT) in parallel with R8. Pin 26 goes to  $V_{CC}$  through C3; use a nonpolarized (NPO) version to minimize frequency drift due to temperature. Trimmer C4 on pin 5 lets the user adjust the oscillator output to 1 MHz for maximum accuracy. S2 selects the counter operating mode (FREQUENCY or PERIOD). The pole of S2 is connected through R7 to the FUNCTION INPUT (pin 3) of IC2. In the PERIOD position, S2 goes to D8 (pin 12), so IC2 is in period counting mode. In FREQUENCY position, S2 is connected to D1 (pin 4). Also, R7 and R8 prevent false triggering due to AC-coupled signals from the multi-

plexed digit drivers, which is a problem at higher multiplex frequencies.

Next, DSP1 and DSP2 are each 4-digit, common-cathode, multiplexed LED displays with the segment anodes wired together to form a single LED display. Each digit has a separate cathode which is sourced by IC2. Current-limiting resistors aren't needed with NSB3881 LED displays, but if a high-efficiency LED display is substituted, use 40-ohm resistors on the segment drivers. The LED display multiplex rate is directly related to the crystal frequency. For a 10-MHz crystal, the multiplex rate of the LED display is 500 Hz; the 1-MHz crystal yielded a 50-Hz rate. As was shown in Fig. 2, pin 28 (HOLD) is grounded through R9, which pulls pin 28 low, and allows the internal counter contents to be displayed after each measurement cycle.

Power is supplied by IC3, a National Semiconductor 2940 low-voltage dropout +5-volt regulator. Ordinary voltage regulators need an input voltage at least 2 volts above the desired output. The 2940, however, needs only an additional 500 mV, so if you put in 5 volts you're guaranteed 4.5 volts out. That's a must for the frequency probe, since it's supposed to operate from 4.5–15 volt supplies. IC1 and IC2 need from 4.5–6 volts maximum, so some voltage regulation is needed. That's not a problem if you attach the power leads to 12 volts, but the probe may be rendered useless when measuring 5-volt signals, because the output of a +5-volt regulator with a 5-volt input will be a maximum of 3 volts.

The 2940 is, however, noisy, and needs a filter capacitor, sometimes on each side. The output capacitor (C3) takes up considerable PC-board space. The level-indicating circuit composed of Q1, Q2, R2–R5, LED1, and LED2, is a easy way to indicate logic levels and the position of S1. The probe tip goes to the base of Q1 through R2, and when brought low or allowed to float, Q1 is cutoff and Q2 conducts, since the base is positive with regard to the emitter. With Q2 conducting, LED1 should light. Touching the probe to a logic high makes Q1 and Q2 complement states (Q1 conducting and Q2 cutoff), and LED2 should light.

That feature indicates the position of S1 since, in DC-coupled mode, the reference voltage of IC1 is coupled through R1 and R2 to the base of Q1. That's about 3 volts (a logic high), so LED2 should light. In AC-coupled mode, no DC voltage from IC1 is passed to the base of Q1, and it's allowed to float (a logic low), so LED1 lights. That's a useful way of visually checking the coupling mode with no signal applied. When a low frequency is applied, LED1 and LED2 should light, and a rough idea of duty cycle, whether high or low, can be made by inspection.

## Construction

You should use the PC board in the kit (see the parts list), because it's double-sided with plated-through holes. If you wish to etch your own, foil patterns are given in PC Service. Before soldering the PC board, use a metal file along the edges to get it to

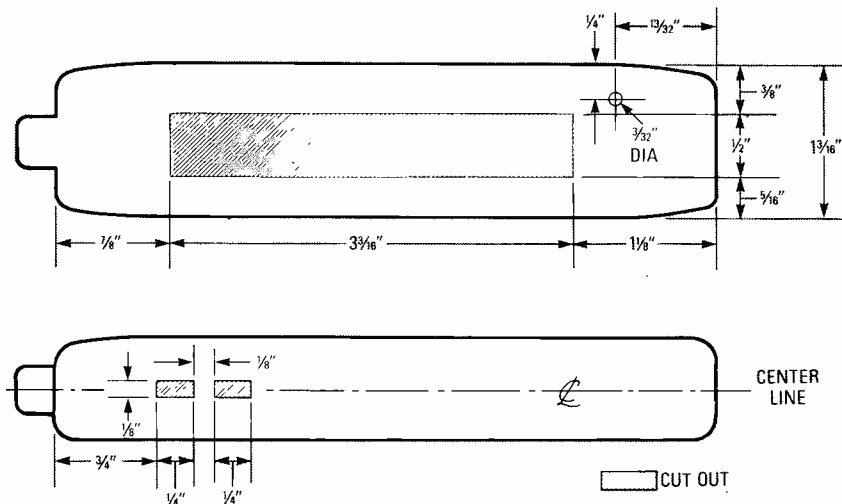

FIG. 4—THE FREQUENCY PROBE CASE. Cutout dimensions for DSP1, DSP2, and C4 are shown in (a). Cutout dimensions for S1 and S2 are shown in (b).



## PARTS LIST

All resistors are 1/8-watt, 5%, unless otherwise indicated.

- R1—470 ohms, 1/4-watt
- R2, R3—4700 ohms
- R4—100 ohms, 1/4-watt
- R5—150 ohms, 1/4-watt
- R6—3000 ohms
- R7, R10—10,000 ohms
- R8—10 Megohms, 1/4-watt
- R9—100,000 ohms
- R11—560 ohms, 1/4-watt

### Capacitors

- C1—0.47  $\mu$ F, ceramic
- C2—0.1  $\mu$ F, ceramic
- C3—33 pF, nonpolarized (NPO) ceramic
- C4—15–60 pF trimmer (Active Components # 17016)
- C5—22  $\mu$ F, tantalum

### Semiconductors

- IC1—11C90 National Semiconductor 650-MHz, divide-by-10 prescaler
- IC2—ICM7216B Intersil 8-digit, frequency counter/timer
- IC3—2940 National Semiconductor +5-volt regulator
- Q1, Q2—2N2222 NPN transistor
- DSP1, DSP2—NSB3881 National Semiconductor 4-digit, 7-segment LED display

- LED1—green light-emitting diode (miniature)
- LED2—red light-emitting diode (miniature)
- LED3—yellow light-emitting diode (miniature)

### Other components

- XTAL1—1- or 10-MHz crystal (case size HC49)
- S1, S2—SPDT switch (Active Components # 22196)

**Miscellaneous:** Logic-probe case with probe tip and clip leads (Global Industries # CPT-1), solder, wire, etc.

**NOTE:** A complete kit of parts, logic-probe case, and carrying case is available for \$159.95 U.S. or \$179.95 Canadian from Tristar Electronics, 66A Brockington Crescent, Nepean, Ontario, Canada K2G 5L1, (818) 228-7223. The kit without the PC board is \$139.95 U.S. or \$159.95 Canadian. The PC board alone is \$20.00. All orders require \$8.00 for shipping and handling. Next-day delivery is available at an extra charge. Please call to inquire about rates to your area. Please allow 4–6 weeks for delivery. Canadian residents please add 7% GST and Ontario residents please add an additional 8% provincial sales tax.

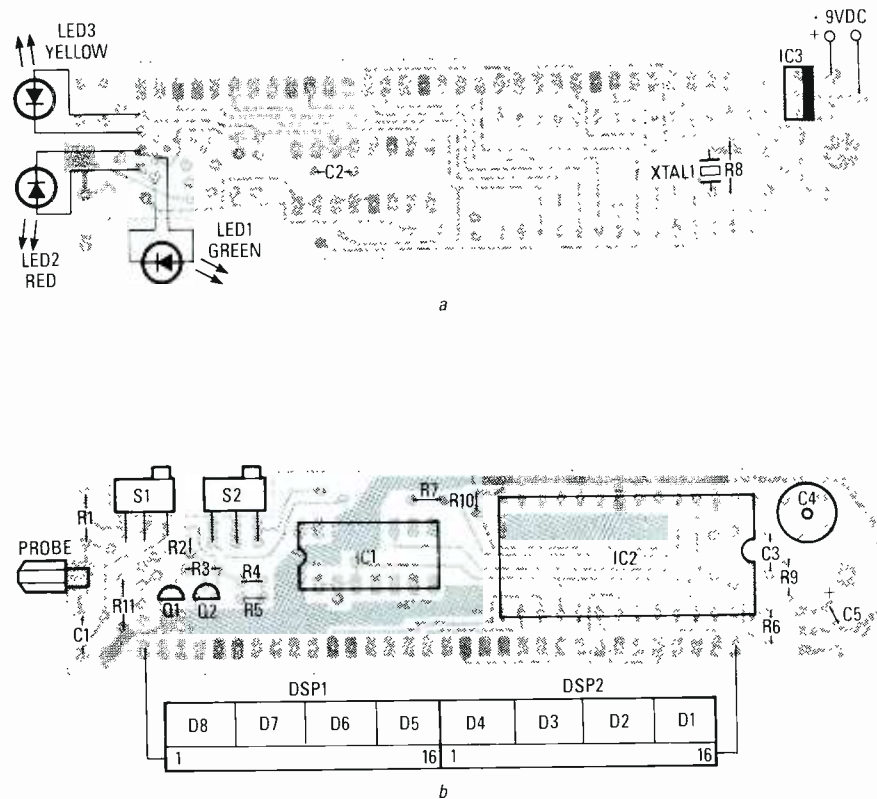

FIG. 5—THE PARTS-PLACEMENT DIAGRAM for the frequency probe, showing the foil (a) and component (b) sides. In (a), both IC3 and XTAL1 are bent flat.

fit in the case. If you're using the case in the parts list, clip the four plastic standoffs extending from the top with a pair of wire cutters as close to the base as possible. Next, cut the openings for the LED display and switches in the case as shown in Figs. 4-a and b. The case is polyethylene, so it can be cut initially with an X-acto knife, and finished with a jeweler's file or emery board.

Solder S1 and S2 first; clip the leads so their length is identical to that of the pads. Next, place each on top of its pads, and secure with solder, tweezers, or tape. Solder the three terminals to the pads, and repeat for the other switch. The bodies of S1 and S2 should fit snugly into the recess in the PC board, and the fronts of both switches should line up with the edge of the PC board. Then, solder all parts except IC3 and LED1–LED3, which go on the foil side. When soldering a component on a two-sided PC board without plated-through holes, you must solder the leads on both sides of the board. You must also solder short pieces of wire through any holes that do not have component leads going through them. Mount C2 on the foil side, leaving a slight space. Solder the leads as they go through the component side, clip as close as possible.

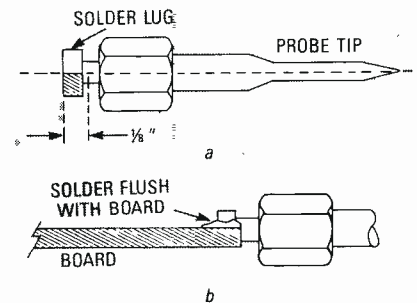

FIG. 6—TO MOUNT THE LOGIC PROBE TIP onto the frequency probe PC board, file 1/8-inch of the bottom of the hex-nut-shaped solder lug flat down to the centerline of the logic probe tip. Then, solder it flush to the correct pad on the component side of the PC board.

and inspect for poor solder joints. Care here will go a long way to having the probe work on power-up.

Next, install XTAL1; it lies flat along the PC board surface, so bend the leads at a 90° angle as close to the crystal housing as possible. Use heat-shrink tubing or electrical tape to insulate the housing against the foils. Next, solder R8, IC1, and IC2, inserting from the component side, and solder all the pins on the foil side. Solder the rest of the component-side components, paying attention to the parts-placement diagram of Fig. 5-a and b. Also, R2–R7 and R10 are mounted

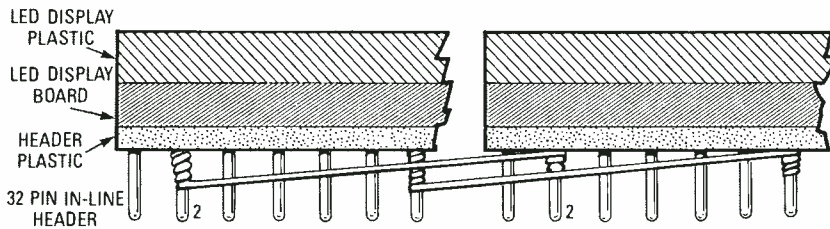

FIG. 7—YOU MUST CONNECT pins 2, 7, 8, 11, 12, 13, and 16 of DSP1 to the corresponding pins of DSP2 using wirewrap.

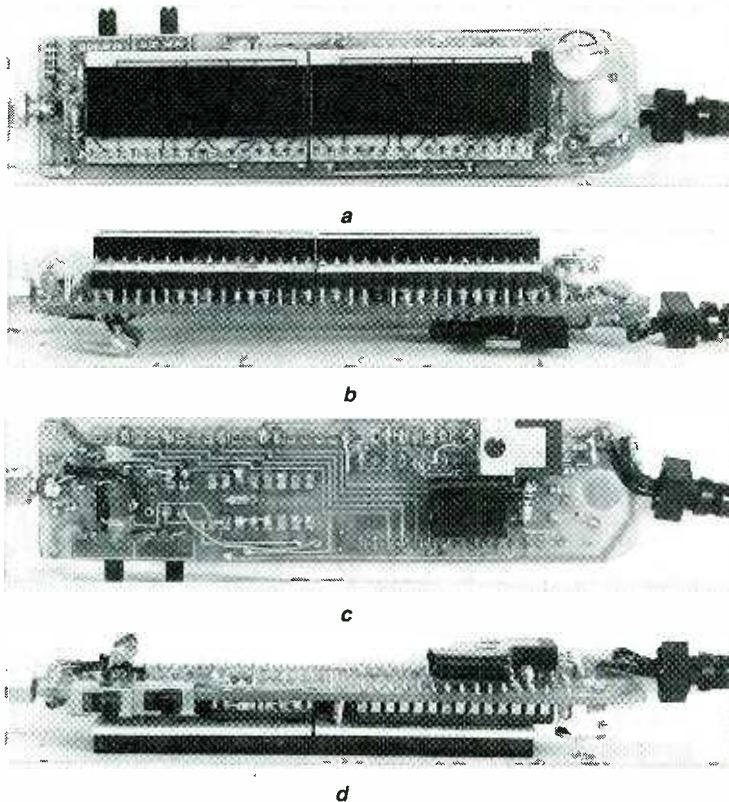

FIG. 8—THE PROTOTYPE OF THE FREQUENCY PROBE; note the callouts. Views are shown from the component side (a), edge-on showing the header strip for DSP1 and DSP2 (b), from the foil side (c), and edge-on showing C4, IC2, IC1, S1 and S2, from left to right (d).

vertically, and R1, R9, and R11 horizontally on the PC board.

The foil layout for C4 should accept different size trimmers, but they shouldn't exceed 0.5-inch in height or diameter. Strip 1 inch of insulation from the leads of the alligator clips. Solder the white stripped lead to the positive pad on the foil side, and the black lead to the negative pad. The probe tip should be 0.125 inch down to its center line as shown in Fig. 6-a, and soldered flush to the component side as shown in Fig. 6-b. Once the probe is soldered, let it sit for awhile because it'll get pretty hot.

The 8-digit LED display is composed of two National Semiconductor NSB3881 4-digit displays DSP1 and DSP2, and their segment anodes have

to be wired together to form one complete display. Insert a 32-pin, single in-line male header through the underside of the LED display boards (LED side up), so that the LED display sits on the header insulation strip. Solder the LED display to the header from the top; don't apply excessive heat, or the LED display pads may lift. Using wirewrap or fine insulated wire, connect the pins of DSP1 indicated in Fig. 7 to the corresponding pins of DSP2.

If you use wirewrap, use 4–5 turns because you'll need to leave about 1/4-inch of header pin bare to insert into the PC board. Wirewrap is recommended, and once the pin has been wrapped, a little solder will ensure that the connection is sound. Once

DSP1 and DSP2 are wired correctly, insert the header into the PC board until the back of the LED display board touches the top of IC1 and IC2, and solder the header in place.

Fig. 8 shows the prototype from several perspectives, with component callouts. Fig. 8-a was taken from above and shows DSP1, DSP2, and the component side of the PC board, Fig. 8-b from the side of the header for DSP1 and DSP2, Fig. 8-c shows the PC board from the foil side, and Fig. 8-d shows the fronts of S1 and S2. The completed PC board fits very tightly in the PC board case, so there are several specific actions to take to ensure proper operation. Just note that there are several minor differences between the prototype and the plans we're giving you, so don't worry if you see something in the photos that does not agree with the plans.

### Checkout and calibration

To check out the probe, connect the alligator clips to a 9-volt battery; the LED display should read 0.000 if it works. If not, use a meter to check voltages. Look for +5 volts on pin 3 of IC3; if it's not +5 volts, the display might be upside down. If it keeps changing, or segments flicker on and off, there's probably a cold joint. If you lightly flex the PC board, you'll usually find the trouble. If the LED display reads 0.000, you can calibrate the probe.

Connect a 500-Hz signal to the probe tip, and adjust C4 until the LED display reads correctly. Aim for maximum accuracy at the low end, because errors there will be substantial, compared to signals at 50 MHz or more. Next, try different frequency signals, and adjust C4 until satisfied. You don't need a function generator to check high-end operation; the average household has sources of suitable high-frequency test signals. Two examples used on the prototype were a Fisher-Price remote infant monitor (50 MHz), and an R/C model-car transmitter (72 MHz). To do that, just connect the clips to 9-volts DC, hold the probe nearby, and read the LED display.

The frequency probe can be used for RF, but is primarily for high-frequency logic circuits. When measuring a signal, use the second or later gating for best accuracy. Once you've gained experience with the probe, you'll be surprised by its simplicity. R-E



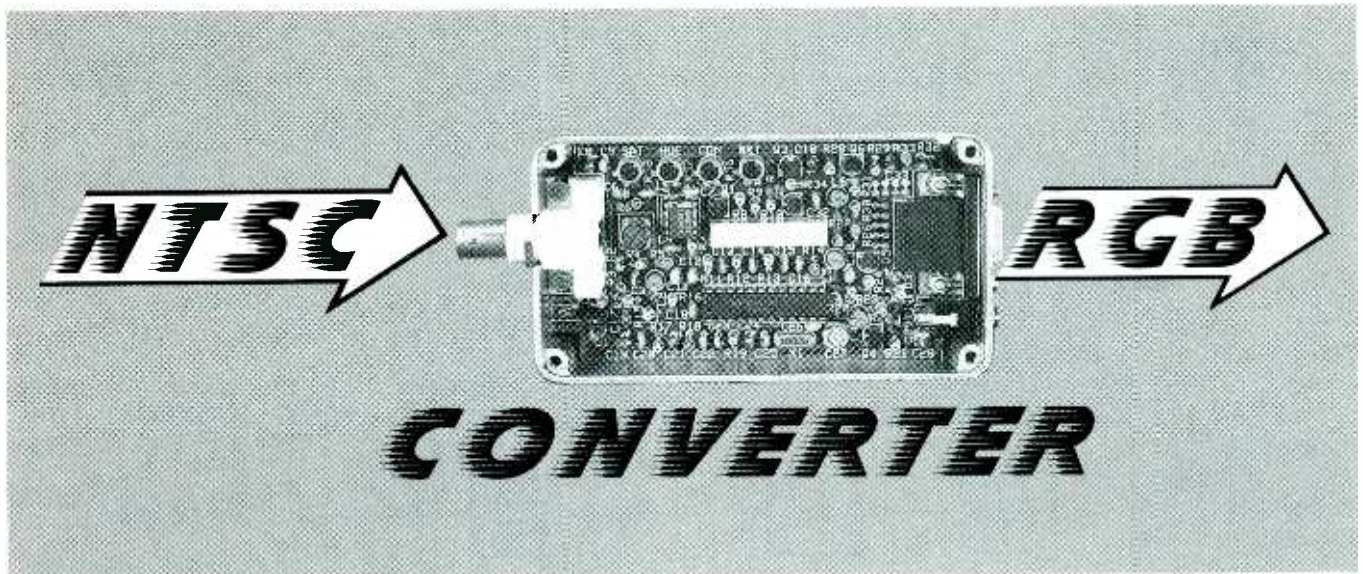

## Put in a TV in your multi sync monitor.

JIM HARRIGFELD

IN ESSENCE, A TV AND A COMPUTER monitor are more alike than they are different. As a matter of fact, a monitor is really just a TV in disguise less a few circuit boards and knobs.

At one time, when computers used teletypewriters for display, television pictures were considered high-resolution. Today, even the best TV sets cannot compare with the latest breed of computer monitors in terms of resolution, stability, convergence, and fidelity. So wouldn't it be nice if you could simply connect a VCR or camcorder to your monitor and enjoy some of that extra fidelity?

This article will show you how to build a simple decoder that will take any standard NTSC video signal (from a VCR, camera, tuner, or what have you), and convert it into the analog RGB signals that computer monitors work with. The circuit costs \$100 to build, and requires no fancy test equipment to align. In addition, if you would like to build one, partial and complete kits are available.

### Some basics

A color monitor has a simple interface. It generally requires four separate signals to operate: red, green, blue, and sync. Sync tells the monitor where and when to start each scan line, and the RGB signals determine how much red, green, or blue to dis-

play in the picture at any instant in time.

The composite video signal used in a television is more complicated, because it combines all the RGB signals, as well as other timing information, into a single high-frequency signal. In the United States, this signal is based on the NTSC/RS-170A video standard.

The disadvantage of composite video is that a great amount of processing is required to combine and encode the separate signals into one composite signal. The advantage of composite video, of course, is that the signal may be broadcast over the air or sent down a single piece of coaxial cable. But to be displayed, eventually the signal must be broken down into its individual red, green, blue, and sync components. By contrast, the advantage of the RGB system is that no decoding circuitry is required, so circuit designs are simpler and cheaper. The disadvantage of the RGB system is that several wires and multi-pin connectors are required to make connections.

Given the similarity between a television and a monitor, what exactly is required to display NTSC video on an RGB monitor? First and foremost, we need an analog monitor that is capable of scanning at standard NTSC video rates (60 Hz vertical, 15,750 Hz horizontal). These requirements immediately eliminate

most fixed-frequency digital monitors—i.e., most CGA and EGA types. However, most multi-frequency type monitors work beautifully.

We also need a video source. You can choose any VCR, video camera, camcorder, or component tuner that has a video output in the NTSC/RS-170A format. Those devices usually have some kind of audio output that you can use to drive a pair of headphones or your home stereo system.

Of course, there's still one thing missing: a gadget that can be used to convert the composite video from your source device into the separate RGB signals that your monitor understands.

### About the circuit

Figure 1 shows a block diagram of the circuit, and Fig. 2 shows the complete schematic. The heart of the circuit is IC2, a TDA3330. That highly integrated Motorola IC is specifically designed to break a composite video signal down into its individual components. The TDA3330 requires three inputs to operate: chroma (color information), luminance (brightness information), and burst flag (timing information).

The other major component is IC1, an LM1881 video-sync separator made by National Semiconductor. It extracts most of the important timing information

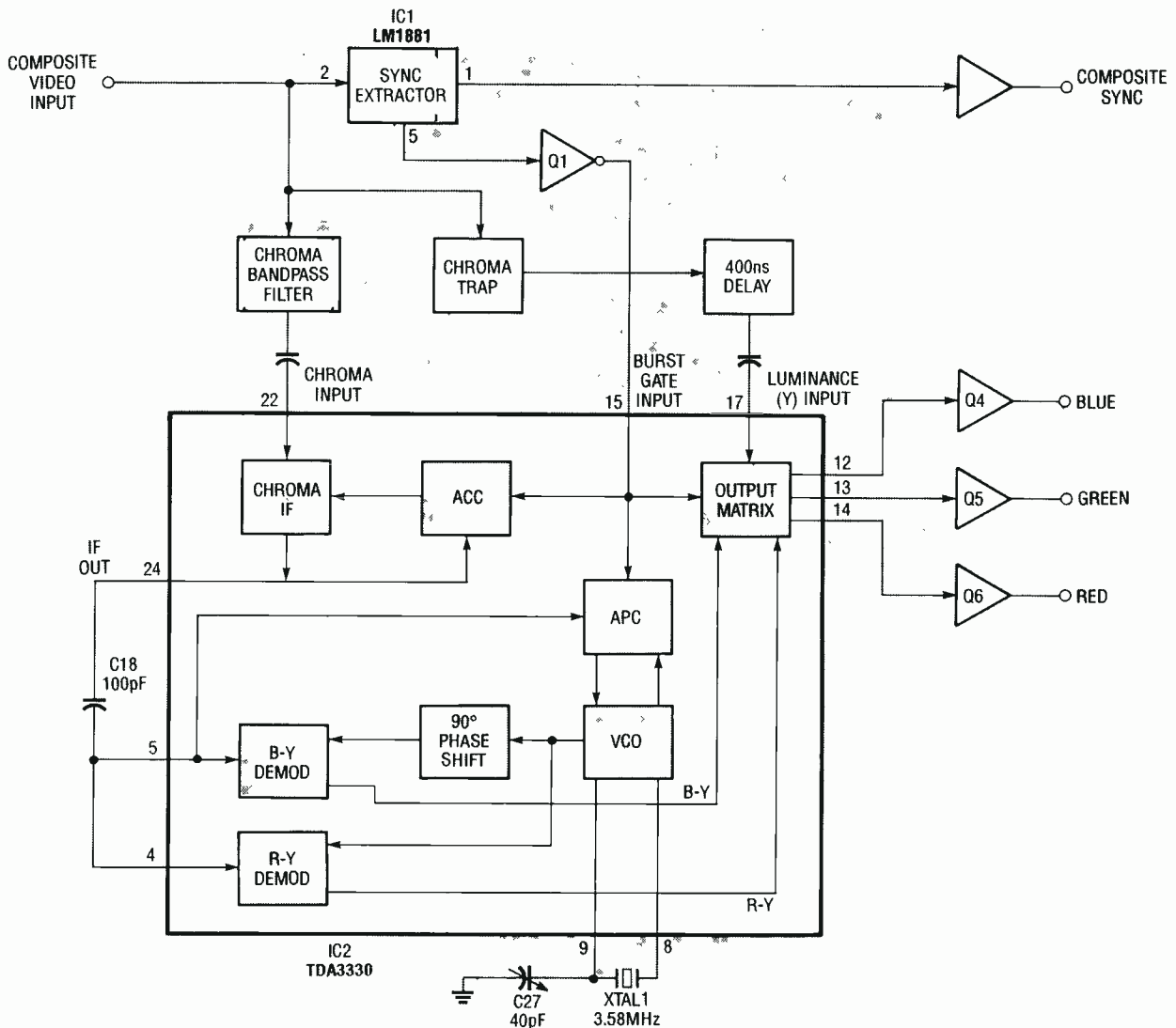

FIG. 1—BLOCK DIAGRAM. IC1 derives the sync signal and timing information. IC2 uses the latter to decode the red, green, and blue outputs.

from a standard video signal, and it needs only three external (passive) components to operate. Our circuit uses two of its three outputs: composite sync, which after buffering becomes one of our outputs; and the burst flag, which is inverted by Q1 to furnish the necessary timing information to IC2.

The other signals that are needed by IC2 are derived from the composite video input signal by means of several passive filters. The chroma bandpass filter consists of R2, L2, C11, and C12. That circuit works by allowing only 3.58-MHz signals to pass into pin 22 of IC2, while blocking all others. The luminance input (pin 17) is just the opposite, in that the 3.58-MHz component must be blocked and all other frequencies allowed to pass

through. That is accomplished with the chroma trap consisting of L1, R3, R4, C2, and C3. Basically, the output of the chroma trap is monochrome video. To meet NTSC timing requirements, that signal must also be delayed (by R5, R14, and L3) before entering IC2.

With proper input signals, IC2 requires only a few more passive components to enable it to lock on to the incoming signals. Once locked, the IC performs all I/Q demodulation, quadrature decoding, R-Y, and B-Y processing, and it then delivers red, green, and blue signals at pins 14, 13, and 12, respectively. Those signals are buffered in turn by Q4, Q5, and Q6, which are set up as emitter followers designed to drive 75-ohm loads.

The circuit has four controls

for setting operational characteristics. The brightness control (R35) sets the black level of the RGB outputs; for most applications, it should be set at minimum. The three other controls (hue, R37; saturation, R38; and contrast, R36) work much like their counterparts on a standard TV. After they have been properly adjusted, none of those controls should require operator intervention. The brightness control shifts the black level without affecting the overall peak-to-peak amplitude of the signal. On the other hand, the contrast control varies the peak-to-peak amplitude without affecting the black level.

Figure 3 shows several waveforms and timing relationships for a color-bar input signal at several points in the circuit: (a) The



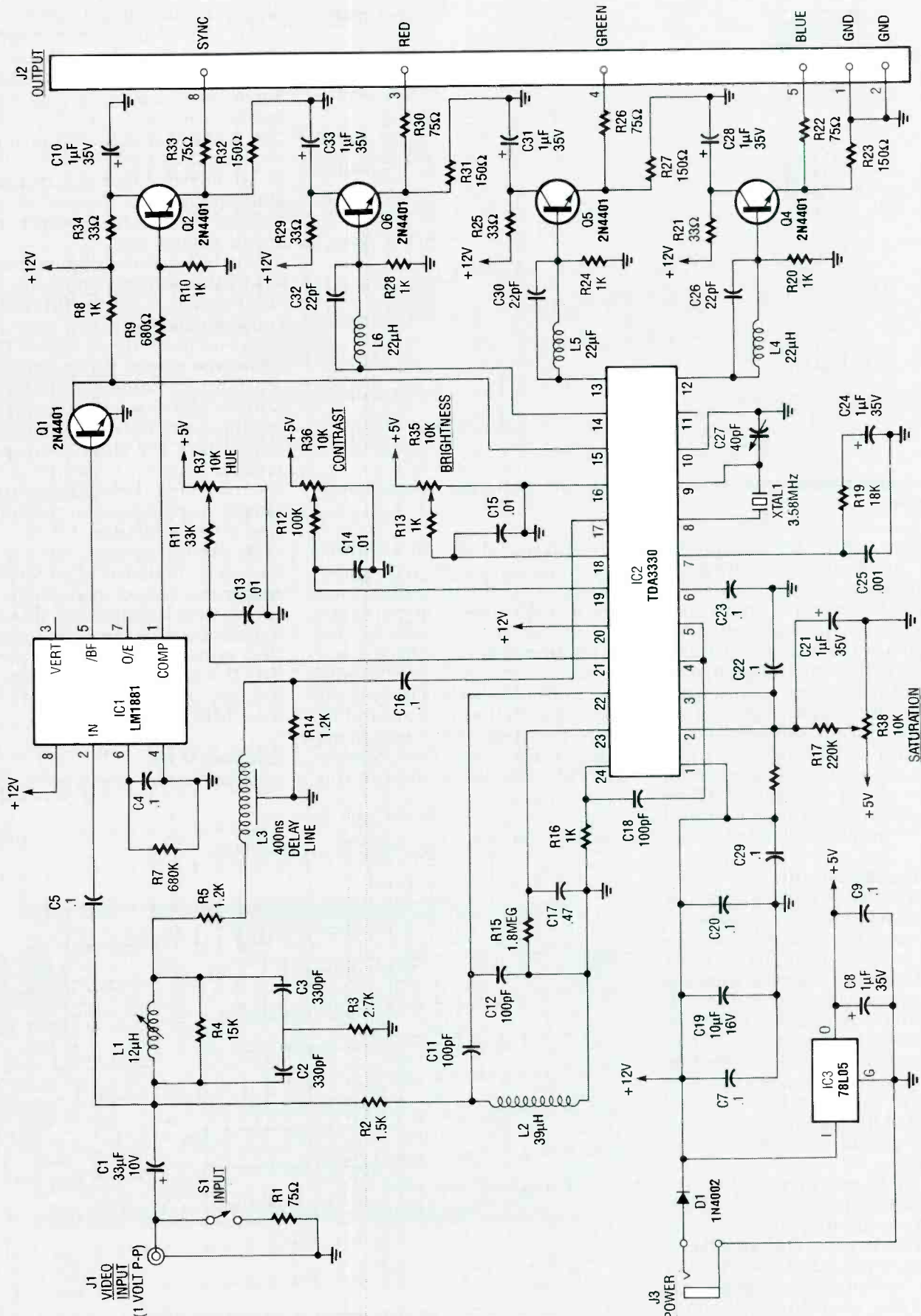

FIG. 2—COMPLETE SCHEMATIC. The circuit accepts a 1-volt peak-to-peak composite input, and delivers RGB and sync outputs, also with a swing of 1 volt peak-to-peak.

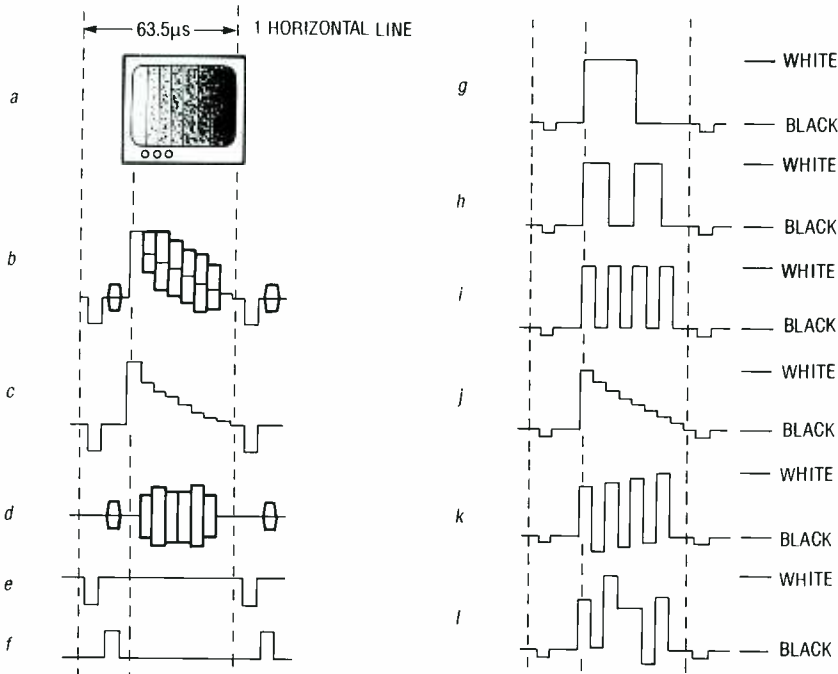

FIG. 3—SAMPLE WAVEFORMS. At (a) is a color-bar input; the text describes the remaining signals.

color-bar input. (b) Composite video across one scan line. (c) The luminance input (pin 17) of IC2. (d) The chroma input (pin 22) of IC2. (e) The composite sync output. (f) The burst-flag input (pin 15) of IC2. (g) The green output (Q5). (h) The red output (Q6). (i) The blue output (Q4). (j) All outputs with the saturation control (R38) at minimum. (k) The blue output with the saturation control (R38) too high. (l) The blue output with the hue control (R37) improperly adjusted.

### Building the circuit

With the high frequencies that are involved, stray capacitance and crosstalk will almost certainly cause problems with most breadboarding and wirewrap techniques. Therefore, we recommend that you use a PC board for the project. Patterns for the board are provided if you wish to make your own; boards are also available commercially, as discussed in the parts list. If you use our board, Fig. 4 shows the parts layout.

All parts except possibly IC2 (the TDA3330) are readily available from the mail-order houses advertising in **Radio-Electronics**. If you purchase a partial kit, be careful in selecting capacitors. Only tantalum or monolithic DIP types are suitable, as

electrolytic, Mylar, or ceramic disc types may not fit in the allotted space on the printed circuit board. Also note that resistors and inductors are mounted vertically. Bend one of the leads back parallel to the body of the part and mount the body of the part in the hole with the bent lead, and then pass the bent lead through the other hole. Mount the inductors (except L3) in the

same manner. This method saves space and also furnishes you with good debug/test points.

We also strongly recommend the use of IC sockets. If you are unable to locate a 24-pin socket for IC2, you can use 16- and 8-pin sockets mounted end-to-end. The pads around the trimmer potentiometers have been laid out so that several types of trimmers may be installed. Just be sure to mount the trimmer's wiper arm in the correct pad.

The board was designed to accept PC-mounted connectors for J1 (input), J2 (output), and J3 (power). However, you may not want or need these types. Our prototype uses a BNC connector for J1, but a simple RCA jack may suffice. Likewise, J2 and J3 may be eliminated entirely or changed depending on what your particular application involves. Switch S1 may be replaced with a simple jumper/header combination for most setups.

For best operation, the board should be installed in a shielded enclosure. The template in Fig. 5 shows hole locations for mounting the board in the project box that is mentioned in the parts list. The board is held in place in the box by the connector hardware (J1-J3).

### Hooking it up

Regardless of the type of con-

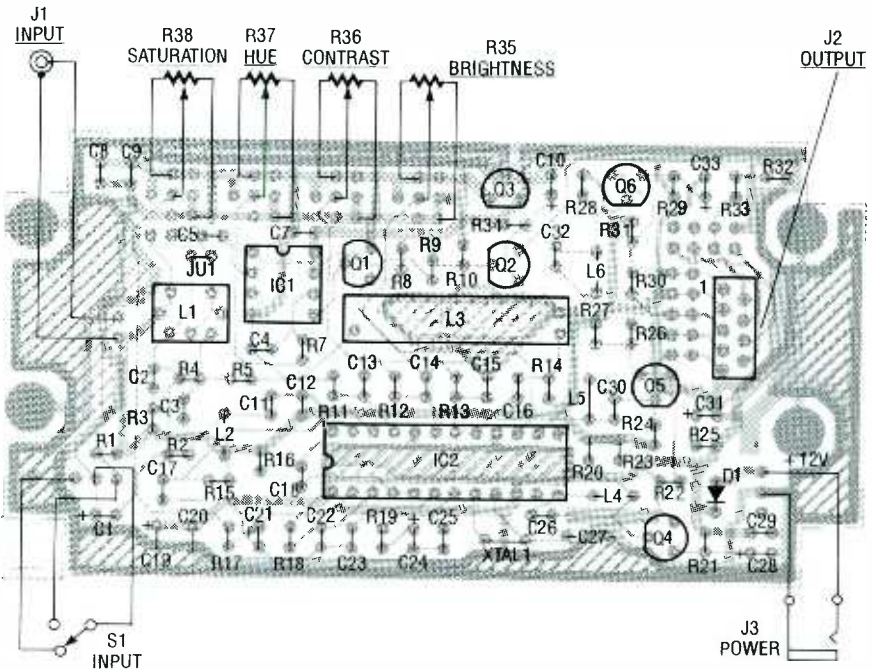
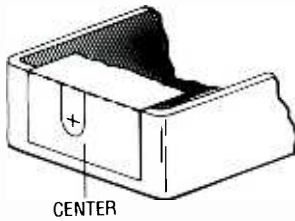

FIG. 4—PARTS LAYOUT. All parts, including the variable resistors and the I/O jacks, mount on the board.





- FOLD ALONG DOTTED LINE
- ALIGN FOLD ON TOP OF BOX AND CENTER - TAPE ON
- PUNCH CENTERS

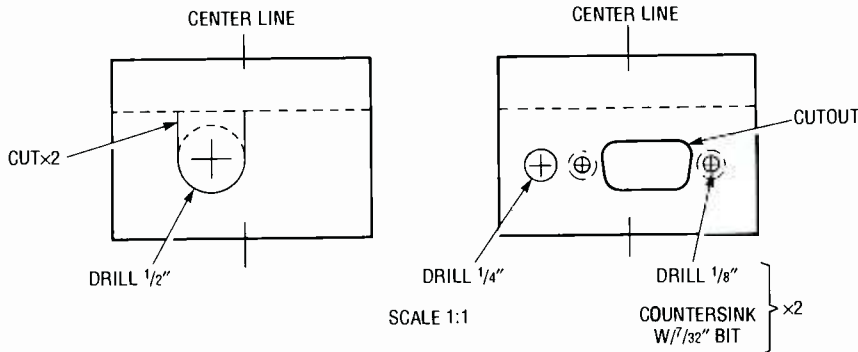

FIG. 5—DRILLING TEMPLATE. If you use our board and the box mentioned in the parts list, drill the box as shown here.

### PARTS LIST

All resistors are 1/4-watt, 5%, unless otherwise noted.

- R1, R22, R26, R30, R33—75 ohms
- R2—1500 ohms
- R3—2700 ohms
- R4—15,000 ohms
- R5, R14—1200 ohms
- R6—not used
- R7—680,000 ohms
- R8, R10, R13, R16, R20, R24, R28—1000 ohms
- R9—680 ohms
- R11, R18—33,000 ohms
- R12—100,000 ohms
- R15—1.8 megohms
- R17—220,000 ohms
- R19—18,000 ohms
- R21, R25, R29, R34—33 ohms
- R23, R27, R31, R32—150 ohms
- R35—R38—10,000 ohms, cermet potentiometer, Panasonic #SOGA01B1

#### Capacitors

- C1—33  $\mu$ F, 10 volts, tantalum
- C2, C3—330 pf, 50 volts, monolithic
- C4, C5, C7, C9, C16, C20, C22, C23, C29—0.1  $\mu$ F, 50 volts, monolithic
- C6—not used
- C8, C10, C21, C24, C28, C31, C33—1  $\mu$ F, 35 volts, tantalum
- C11, C12, C18—100 pF, 50 volts, monolithic
- C13—C15—0.01  $\mu$ F, 50 volts, monolithic
- C17—0.47  $\mu$ F, 50 volts, monolithic
- C19—10  $\mu$ F, 16 volts, tantalum
- C25—0.001  $\mu$ F, 50 volts, monolithic
- C26, C30, C32—22 pf, 50 volts, monolithic
- C27—5—30 pF, trimmer

#### Semiconductors

- IC1—LM1881N video sync separator (National)
- IC2—TDA3330 NTSC to RGB decoder (Motorola)
- IC3—78L05 low-power 5-volt regulator
- Q1, Q2, Q4—Q6—2N4401
- Q3—not used
- D1—1N4002 rectifier diode

#### Other components

- J1—PC-mount BNC connector (AMP #226978-1)
- J2—9-pin D connector, female, PC mount
- J3—3.5mm mono phone jack
- L1—12  $\mu$ H variable inductor (Toko #A119ANS-T1034)
- L2—47  $\mu$ H fixed inductor (Toko #34BLS-470K)
- L3—400 ns delay line (Toko #1321LNP-1436P)
- L4—L6—22  $\mu$ H fixed inductor (Toko #34BLS-220K)
- S1—SPST, PC board right-angle mount
- XTAL1—3.579-MHz crystal
- Miscellaneous: Metal case—(Hammond #1590B), 12-volt regulated wall transformer, solder, etc..

**Note:** The following items are available from Harmonic Research, Inc., 193 Villanova Drive, Paramus, NJ 07652 (201) 652-3277: Enhanced kit including all parts except wall transformer, \$115.00; Partial enhanced kit including all parts except box, S1 and external jacks, \$94.50; Etched, drilled, and silk-screened PC board, \$20; TDA3330 (IC2), \$4.75, wall transformer, \$4.75. All orders add \$3.50 for shipping and handling. New Jersey residents add appropriate sales tax. The enhanced kit accepts S-video as well as composite-video signals.

nectors that you use, the input should be wired using high-quality coaxial cable for best results. Your VCR or camera may have come from the factory with a cable of this type. Otherwise you can buy or build an input cable with RG59U coax and either BNC or RCA connectors.

The output cable depends on your application and use. Refer to your monitor's manual to determine its input wiring requirements. The decoder's output (J3) is a DB-9 connector that conforms to the PC standard. Many multi-frequency monitors adhere to that standard; but it's a good idea to check the manual just to be sure. With a little luck, you should be able to unplug the cable from the display adapter in your PC and plug it directly into the decoder.

If you're not so lucky, you'll have to wire up a cable or an adapter. In addition, we left a row of pads just behind J2 on the PC board; you might find it easier to simply cut the traces between the two rows and add jumpers to reconfigure the pinout of J2. That could save you from having to modify a cable.

The power supply for the NTSC converter can be any well-regulated 12-volt supply that is capable of furnishing 250 mA of current on a continuous basis. Apply power to J3 through a 1/8" phono plug with positive tip and grounded shield.

### Testing and adjustment

Before applying power, check the PC board for solder splashes, bad or shorted connections, etc.. Do not install the IC's in their sockets yet; rather, first apply power to the circuit and check for smoke and overheated components. Using a DMM, verify that pins 1 and 20 of IC2, and pin 8 of IC1, are all about +12 volts. In addition, verify that the positive side of C8 is +5 volts.

After everything checks out, remove power from the board, install the IC's in their sockets, and make the external connections. A color-bar generator is nice for making the adjustments, but if you don't have access to one, any stable video signal will do. Use a camera or an off-the-air signal; don't try to set up from a tape. Turn the saturation, hue, and

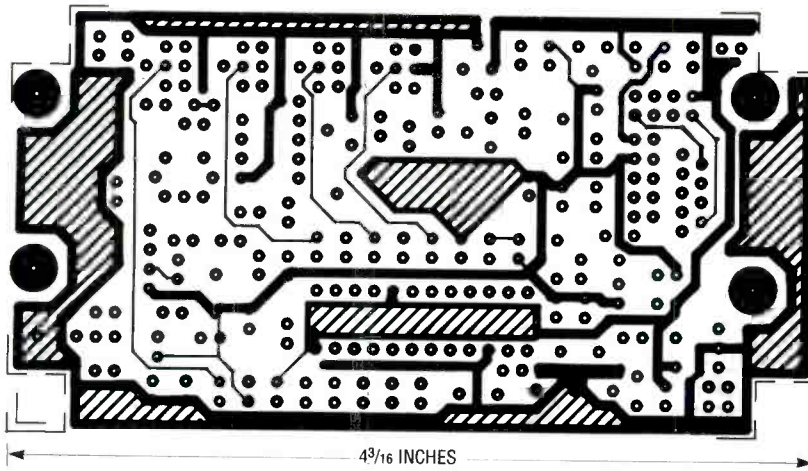

HERE'S THE COMPONENT SIDE OF THE NTSC/RGB CONVERTER

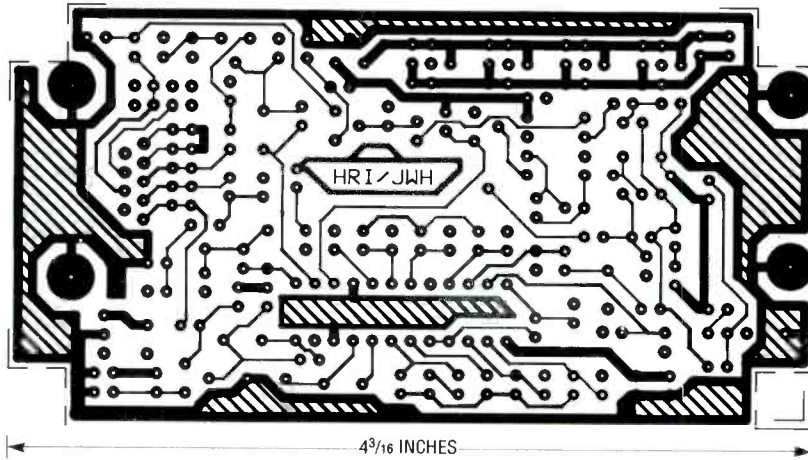

HERE'S THE SOLDER SIDE OF THE NTSC/RGB CONVERTER.

contrast controls (R36–R38) to maximum, and the brightness control (R35) to minimum.

**Adjusting without test equipment.** With everything hooked up and the monitor on, plug in the power supply. You should immediately see some kind of picture, although it will probably be black and white and possibly flashing on and off. Adjust C27 with a small screwdriver for the most stable picture and the best color. You may find two spots where performance seems equal; either will do. Next, adjust L1 for the deepest, richest color. Then adjust the saturation, hue, and contrast controls for the most natural look, just as you would on a normal television. You should leave the brightness control set at minimum unless you have a specific reason for wanting the black level set higher than it already is. That's all it takes to adjust the unit, and you will probably be very close to the optimum settings.

#### Adjustment with color-bar generator and oscilloscope.

With S1 closed, verify with the scope that you have a 1-volt peak-to-peak signal similar to that shown in Fig. 3-a at the input connector. Next, verify that a burst-flag pulse is present at pin 15 of IC2. That signal should look like the waveform shown in Fig. 3-f, and must be at least eight

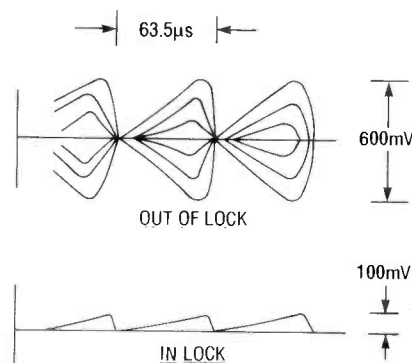

FIG. 6—VCO LOCK AT PIN 7 OF IC2. In (a) is an incorrectly adjusted signal; (b) shows the correct waveshape.

volts in amplitude. Also, verify that you have a chroma signal similar to that shown in Fig. 3-d at pin 22 of IC2. If you examine pin 17 with a scope, it will probably resemble something halfway between Fig. 3-b and Fig. 3-c. Adjust L1 for minimum subcarrier by making the signal look like in Fig. 3-c as much as possible.

Continue adjustments by connecting the scope probe to pin 7 of IC2 and referring to Fig. 6. An out-of-lock waveform is shown in Fig. 6-a; adjust C1 until you obtain a stable waveform as shown in Fig. 6-b. There will probably be two spots in the adjustment range where lock occurs; either is OK. That signal is the VCO lock, and once set, you should be able to see nice, stable signals at the RGB outputs (pins 12–14 of IC2). Refer to the output waveforms in Fig. 3 and watch your monitor while adjusting the saturation, hue, and contrast controls to your liking. Outputs should be set anywhere from 0.7 to 1.0 volt peak-to-peak.

#### I want my MTV/2!

After making all of the adjustments to the unit itself, leave them alone; instead use the brightness and contrast controls on your monitor to compensate for ambient lighting. The decoder should be able to lock on to anything that comes anywhere close to NTSC video, but it can't deal with some of the copy-protection schemes that many pre-recorded tapes use. However, you may be able to compensate by running the composite video signal through a descrambler or stabilizer first.

You may notice that some video looks better on your monitor than on a TV, whereas other video looks worse. The reason is that a high-resolution display cannot improve a low-resolution input, and in some cases the high resolution might even bring out some unwanted artifact that a low-resolution display would cover up.

Some day, with all the hoopla over HDTV and multimedia, video and graphics displays will most likely merge. We will be running our CAD program on the same screen that we sit back and watch STAR WARS 15 on. Until then, projects like this will inch us a little closer.

R-E



# ROCKET ALTIMETER

*Four...three...two...one...  
ignition! Model rocketry  
catches up with  
technology with this  
electronic altimeter.*

JOHN FLEISCHER

THE SPORT OF MODEL ROCKETRY allows hobbyists to manage their own miniature space program. Small-scale rockets, usually constructed from paper, plastic, and balsa wood, are routinely launched with commercially made solid-fuel motors. Reaching altitudes between 100 feet and several miles, model rockets are safely recovered by parachute to allow repeated flights and to reduce the risk of personal injury.

In NAR (National Association of Rocketry) contest events, a visual tracking system using triangulation is used to determine the peak altitude of each model. The contestant who launches his rocket out-of-sight, or through the clouds, will receive a "track lost" rating instead of altitude points. Visual tracking, dependent upon weather conditions and operator skill, can often be difficult, and the sport flyer who wants to know how high his model went will rarely take the time to set up and operate visual trackers.

Our rocket altimeter was developed to help contest and sport rocketeers determine their models' altitude without tracking. This airborne "flight-recorder" is an all-CMOS microcomputer that is coupled to an atmospheric pressure sensor via signal-conditioning circuitry. Powered by a 9-volt battery, the unit is small enough to be launched in a D-, E-, or F-motor powered model rocket. (The letters indicate the relative power of each engine; in alphabetical order, each engine is twice as powerful as the previous one.) The unit takes a pressure sample every  $\frac{1}{4}$  second and stores 1000 data values in memory during the flight.

The completed system contains two sections: the flight-recorder section that goes up in the rocket, and an LCD module that's used to display flight data back on the ground. When the rocket returns to Earth, the LCD module is connected to the flight recorder and the peak altitude achieved can be displayed in 50-foot increments, along with a  $\frac{1}{4}$ -speed "playback" of the entire flight. Rocketeers now

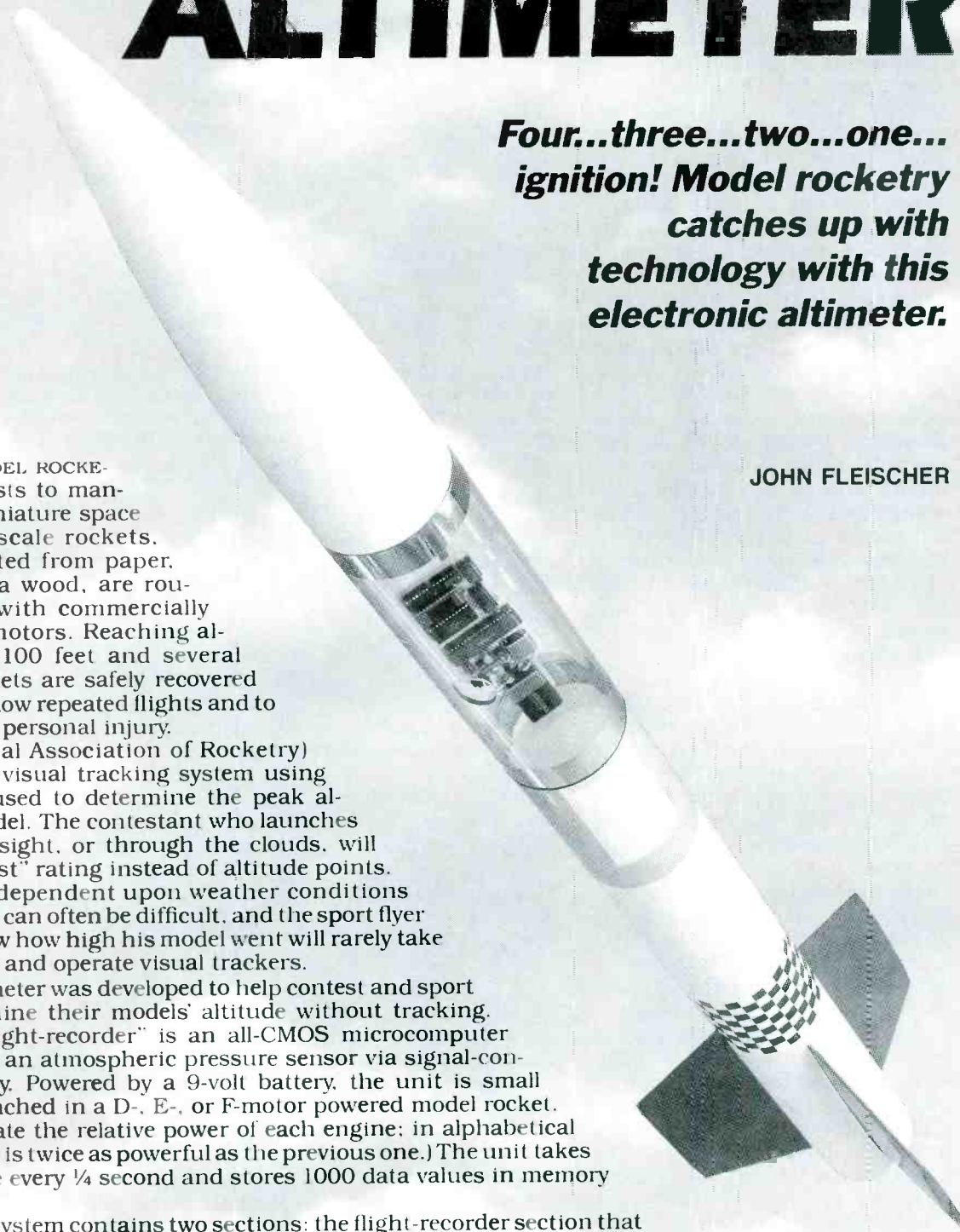

have a reliable and accurate means to measure the altitude that a model reaches. The data obtained can then be used to calculate the speed and acceleration of the rocket.

Figure 1 shows the construction and pinout of the SCX15AN pressure sensor used in the altimeter. The sensor, manufactured by Sensym (1255 Reamwood Ave., Sunnyvale, CA 94089), is a low-cost (about \$42) piezoresistive IC in a strain-gauge bridge configuration. The monolithic circuitry inside the sensor (see Fig. 2) is deposited on a silicon chip that has a cavity etched out to form a diaphragm. A port is on top, and a vacuum reference cavity is on the bottom. The result is a sensor that measures absolute barometric pressure. Output voltage ( $V_1 - V_2$ ) ranges from 10–50 mV, and is proportional to atmospheric pressure—which, of course, varies with altitude. Although the entire unit is not temperature compensated, the sensor itself is, by means of two built-in thermistors. Best accuracy for the altimeter is achieved in the 55–75°F range. Outside that range, a shift of 2% for every 10°F will occur.

Figure 3 shows the block diagram of the system. The pressure sensor is buffered with an LM324 op-amp to feed an LM331 voltage-to-frequency (V/F) converter. At ground level, a signal of about 3.7 kHz will be output by the V/F converter. As the atmospheric pressure decreases (with increasing altitude), that frequency also decreases; at 15,000 feet, the signal is about 2.9 kHz. An RCA 1802 microprocessor calculates the altitude data from the frequency input.

The entire system is made up from three separate PC boards, although only two ever leave the ground. The pressure sensor, the LM324 buffer, the V/F converter, and other support circuitry is located on an "analog" PC board, and the microprocessor and data-logging circuitry are on a "CPU" board. The two boards are held together with screws, and electrical connections are jumpered between the two. The display module is built on a separate PC board, and it stays on the ground; the module must be con-

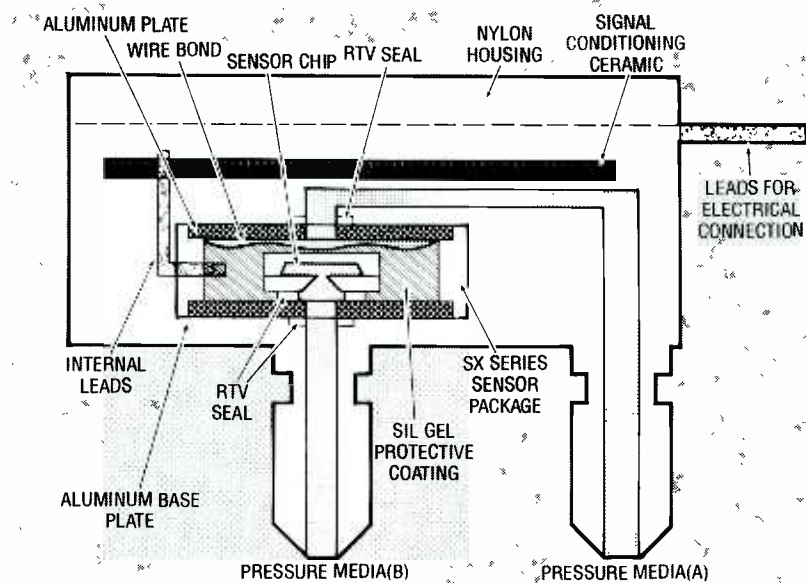

FIG. 1—THE MONOLITHIC CIRCUITRY inside the SCX15AN pressure sensor is deposited on a silicon chip that has a cavity etched out to form a diaphragm. A port is on top, and a vacuum reference cavity is on the bottom. The result is a sensor that measures absolute barometric pressure, which is then converted to altitude.

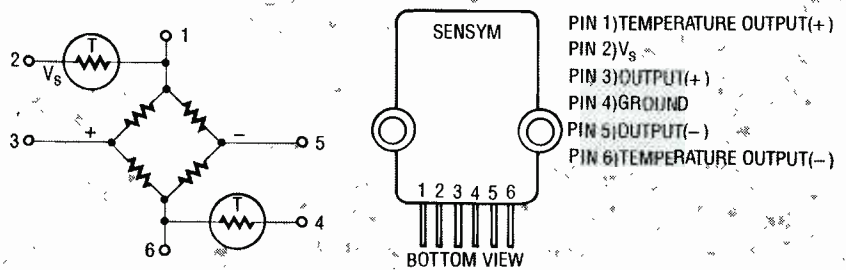

FIG. 2—THE SENSOR'S OUTPUT VOLTAGE ( $V_1 - V_2$ ) ranges from 10–50 mV, and is proportional to atmospheric pressure.

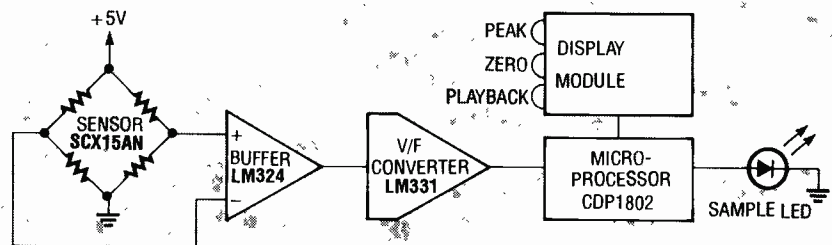

FIG. 3—THE BLOCK DIAGRAM OF THE SYSTEM. The pressure sensor is buffered with an op-amp to feed a voltage-to-frequency (V/F) converter. At ground level, a signal of about 3.7 kHz will be output by the V/F converter; at 15,000 feet, the signal is about 2.9 kHz.

nected to the other two boards via a ribbon cable to play back flight information.

Figure 4 shows the schematic of the CPU board; it gets its input from the analog board and logs the data every 1/4 second. The circuit consists of the microprocessor which calculates the altitude, the EPROM containing the operating software, and the RAM where the altitude data is

stored. Figure 5 shows the schematic of the analog board; the pressure sensor is located on this board. The output from the sensor is buffered and fed to the V/F converter, which provides the frequency input for the microprocessor. Figure 6 shows the schematic of the display module board. It is basically made up of the display driver and the display itself, but also contains the con-



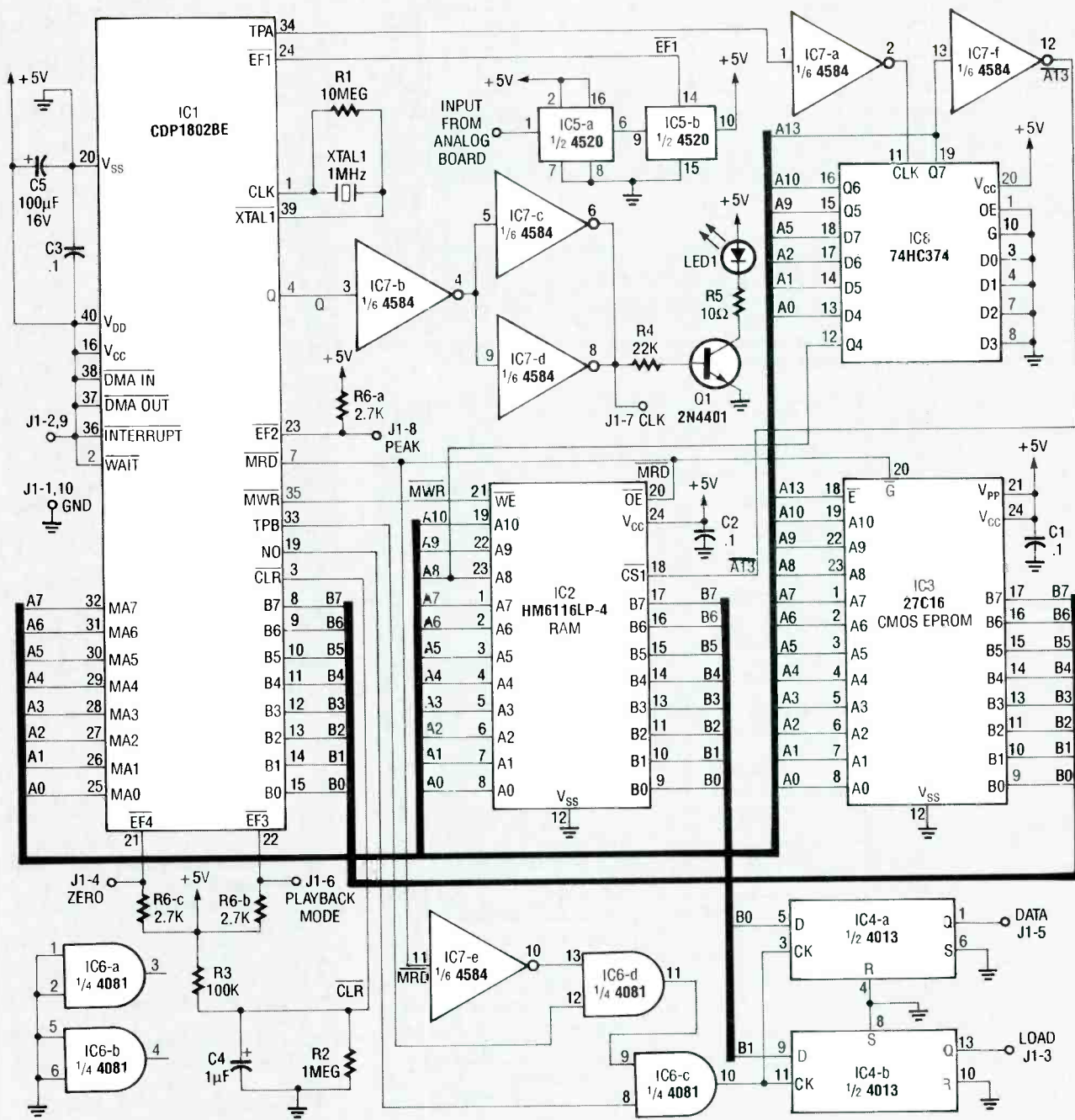

FIG. 4—THE SCHEMATIC OF THE CPU BOARD. It logs the data to be read back when the rocket returns to Earth.

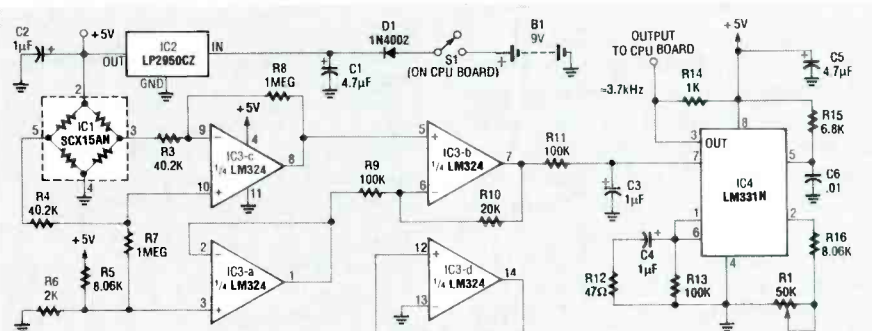

FIG. 5—THE ANALOG BOARD outputs a frequency that's proportional to altitude. The sensor (IC1) is located on this board.

trol switches. Power for the display module comes from the other two boards via the ribbon cable.

The software for the altimeter is available on the R-E BBS—516-293-2283. (For those who prefer to type, the machine code for the EPROM is shown in Listing 1.) The flowchart for the program is shown in Fig. 7. The software handles data logging (the sample LED flashes every 1/4 second), mode switch input, and LCD interfacing.

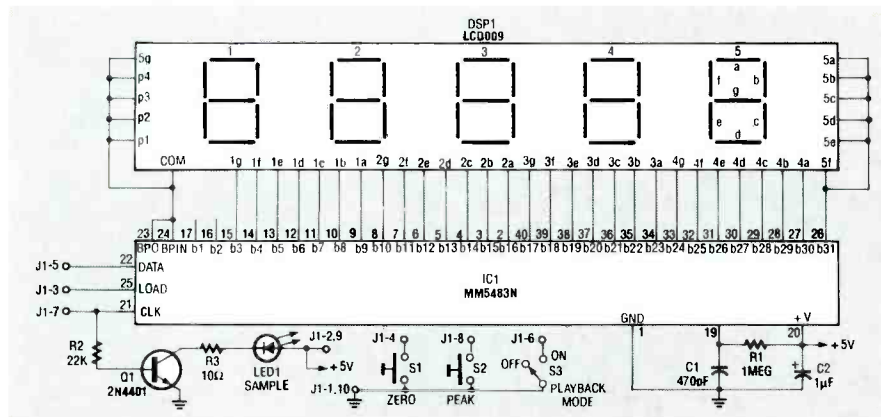

FIG. 6—THE DISPLAY MODULE stays on the ground; when the rocket is retrieved, the data from the CPU board is displayed on this module.

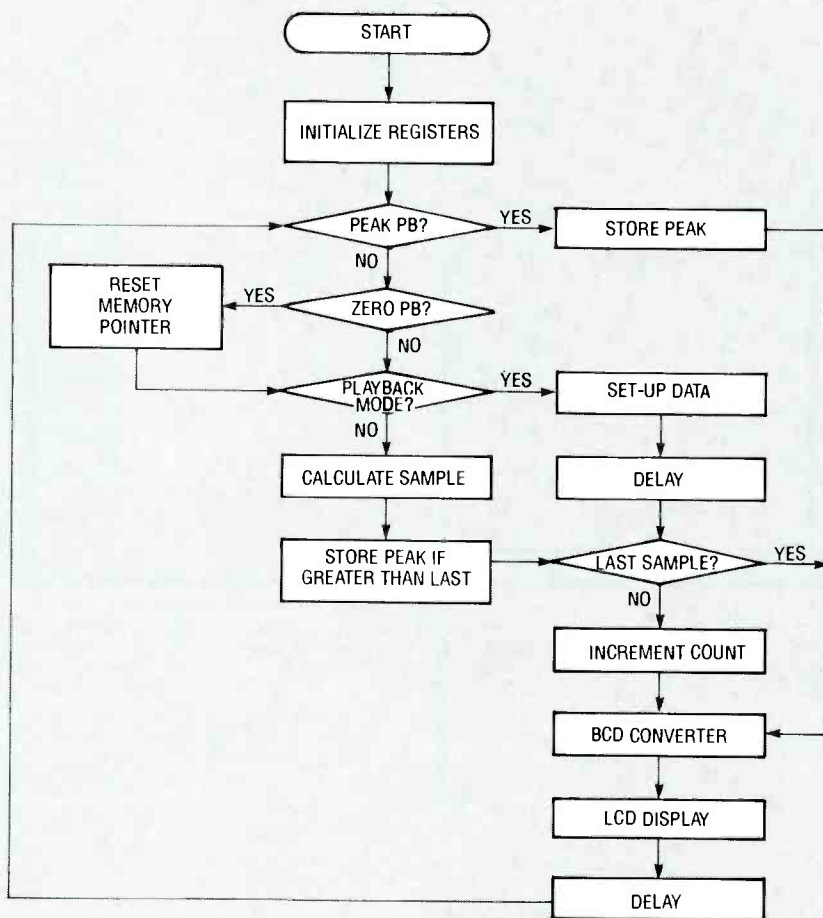

FIG. 7—THE SOFTWARE FOR THE ALTIMETER HANDLES data logging, mode switch input, and LCD interfacing.

### Construction

Three printed-circuit boards are used. The pressure sensor and analog section are combined on a single-sided PC board. The CPU board is double-sided, as is the board for the display module. If the holes in either of the double-sided boards are not plated-through, feed-through wires must be used instead. All pads on the top and bottom of the boards must be soldered to the compo-

nent lead or feed-through wire. (The boards available from the source mentioned in the parts list are plated-through.)

To assemble the CPU board, follow the parts-placement diagram shown in Fig. 8. Install the resistors, capacitors, connector, switch, LED, and transistor. The crystal may be fastened to the board with foam tape or RTV silicone cement. IC sockets should be used to ease any future repairs

### CPU BOARD

All resistors are ¼-watt, 5%, unless otherwise noted.

- R1—10 megohms
- R2—1 megohm
- R3—100,000 ohms
- R4—22,000 ohms
- R5—10 ohms
- R6—2700 ohms, SIP resistor (cut to fit board)

### Capacitors

- C1—C3—0.1 µF, monolithic
- C4—1 µF, 25 volts, tantalum
- C5—100 µF, 16 volts, electrolytic

### Semiconductors

- IC1—CDP1802CE microprocessor (GE/RCA)
- IC2—HM6116LP-4 RAM
- IC3—27C16 CMOS EPROM
- IC4—4013 dual D-type flip flop
- IC5—4520 dual synchronous up counter
- IC6—4081 quad 2-input AND gate
- IC7—4584 hex Schmitt trigger
- IC8—MM74HC374N octal tri-state D-type flip-flop
- LED1—red light-emitting diode
- Q1—2N4401 NPN transistor

### Other components

- XTAL1—2 MHz crystal
- S1—PC-mount slide switch
- J1—10-pin header

**Miscellaneous:** 10-conductor ribbon cable, 3 ¼-inch #6 spacers, 3 #6-32 × ½-inch screws and nuts, PC board, IC sockets, wire, solder, etc..

### ANALOG BOARD

All resistors are ¼-watt, 5%, unless otherwise noted.

- R1—50,000 ohms, 25-turn trimmer potentiometer
- R2—not used
- R3, R4—40,200 ohms, ½-watt, 1%, metal-film
- R5, R16—8060 ohms, ½-watt, 1%, metal-film
- R6—2000 ohms, ½-watt, 1%, metal-film
- R7, R8—1 megohm, ½-watt, 1%, metal-film
- R9, R13—100,000 ohms, ½-watt, 1%, metal-film
- R10—20,000 ohms, ½-watt, 1%, metal-film
- R11—100,000 ohms, 5% resistor, 1/4W
- R12—47 ohms
- R14—1000 ohms
- R15—6800 ohms, ½-watt, 1%, metal-film

### Capacitors

- C1, C5—4.7 µF, 16 volts, tantalum
- C2—C4—1 µF, 25 volts, tantalum
- C6—0.01 µF, 50 volts, 5% film-type

### Semiconductor

- IC1—SCX15AN pressure sensor
- IC2—LP2950CZ-5.0, 5-volt regulator
- IC3—LM324N op-amp
- IC4—LM331N voltage-to-frequency converter
- D1—1N4002 diode

**Miscellaneous:** 9-volt battery and clip, PC board, IC sockets, wire, solder, etc..



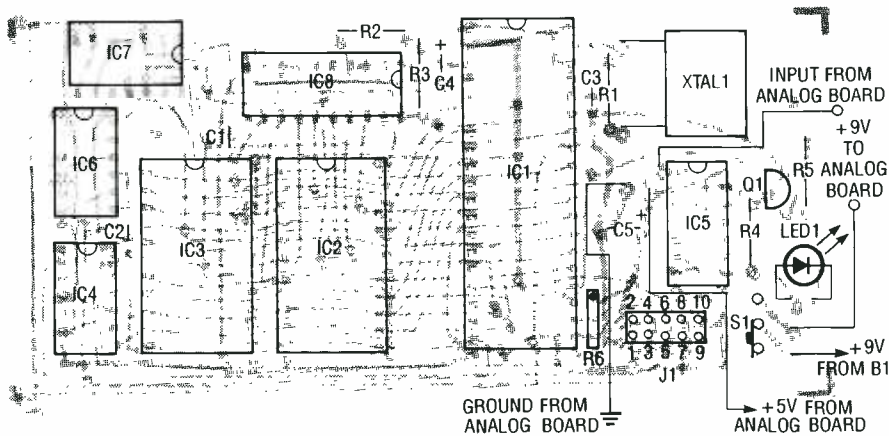

FIG. 8—WHEN ASSEMBLING THE CPU BOARD, the crystal should be fastened to the board with foam tape or RTV silicone cement to prevent damage due to vibration.

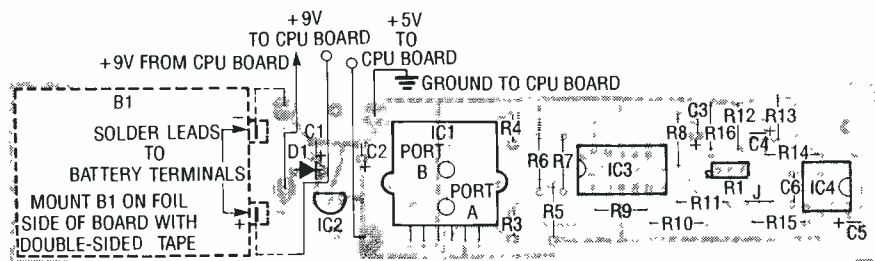

FIG. 9—THE ANALOG-BOARD PARTS LAYOUT. Carefully install the pressure sensor and, if you ever clean the PC board, do not allow any solvent or moisture to enter the sensor port.

### DISPLAY MODULE

All resistors are 1/4-watt, 5%, unless otherwise noted.

R1—1 megohm  
R2—22,000 ohms  
R3—10 ohms

Capacitors  
C1—470 pF, ceramic disc  
C2—1 μF, 25 volts, tantalum

Semiconductors  
IC1—MM5483N display driver  
DSP1—LCD009 LCD module  
LED1—red light-emitting diode  
Q1—2N4401 NPN transistor

Other components  
J1—10-pin header  
S1, S2—momentary pushbutton switch  
S3—SPST toggle switch

Miscellaneous: 4 #6-32 × 1-inch screws and nuts, 8 1/4-inch #6 spacers, case, clear plastic sheet for display window, 40-pin wirewrap socket strip, PC board, wire, solder, etc.

Note: The following items are available from Transolve Corporation, 4060 E42, Cleveland, Ohio 44105 (216) 341-5970: Pressure sensor, \$42 + \$2 shipping; PC board set, \$35 + \$2 shipping; complete kit (except case), \$135 + \$3 shipping; EPROM only, \$15 + \$1 shipping; machined case and custom EPROM's available on request. For large-scale rocket kits contact North Coast Rocketry, P.O. Box 24468, Mayfield Heights, Ohio 44124. For more information on model rocketry in general, contact the National Association of Rocketry, 1331 Edgewood Dr., Altoona, WI 54720.

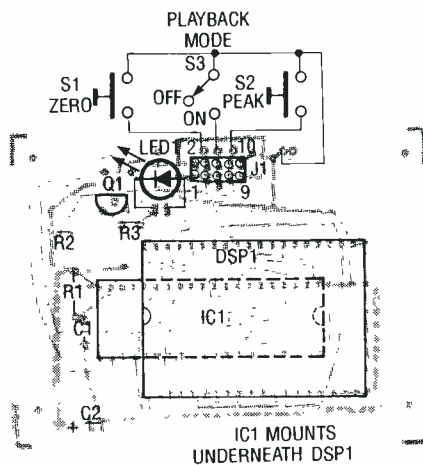

FIG. 10—DISPLAY BOARD parts-placement diagram. The LCD module is plugged into wire wrap socket strips above IC1.

(Transolve Corp. will not service any non-socketed unit).

Follow the analog-board parts layout shown in Fig. 9, and install the resistors, jumper wire, diode, and capacitors. Note that C6 must be a film-type capacitor—a disc capacitor will cause excessive drift with temperature. Next install the trimmer potentiometer and the IC's. Carefully install the pressure sensor as

shown. If you ever clean the PC board, do not allow any solvent or moisture to enter the sensor port, or you'll damage it. You must test the analog board before attaching it to the CPU board.

The display board parts-placement diagram is shown in Fig. 10. Install the resistors, capacitors, connector, LED, and IC1. The LCD module is plugged into wire-wrap socket strips above IC1. Space the top of the strips 1/4-inch from the board. Make sure the LCD pins are perfectly straight, and press the display into the socket strips. The finished analog/CPU assembly is shown in Fig. 11, and the display module in Fig. 12.

### Testing and calibration

Connect a 9-volt battery to the + and - battery input pads on the analog board. Connect your DVM and scope ground leads to battery -. The regulator output (IC3 pin 4) should measure 5 volts. Set R1 to midpoint. Connect scope probe to IC4 pin 3; this output signal should be a short, negative-going pulse, repeating at about 3.7 kHz. Adjust R1 to obtain that value. Use a frequency counter if one is available. Apply suction to sensor port A (draw a vacuum with your mouth) and verify that the signal frequency decreases slightly.

If the analog board is functioning, it can now be attached to the CPU board. The wire attachment points are designated in the three parts layouts. The 9-volt battery's positive lead connects to the CPU board, and the 9 volts from the CPU board is jumped over to the analog board. Also remember to connect ground, +5 volts, and the analog output between the two boards. A rocket is a very high vibration environment, so the 9-volt battery snap must be taped on, or the leads must be soldered to the battery. After the electrical connections are made between the two boards, the analog board is fastened to the CPU board with three screws, spacers, and nuts.

Wire the pushbutton and toggle switches to the display PC board as shown in the display-module parts-placement diagram. One of the normally open pushbuttons is used to select

PEAK, and the other ZERO. The toggle switch selects the playback mode (when closed). Install the header connectors on the ribbon cable that goes between the CPU and display boards, and connect the two boards together.

Turn the power switch on and open the playback switch. The sample LED on the CPU and display boards should be flashing four times per second. A value of several thousand feet should be displayed. Adjust R1 on the analog board for a reading of 100 feet, then 50 feet, and the unit will then be calibrated for ground level. Do not adjust past that threshold, or the altitude mea-

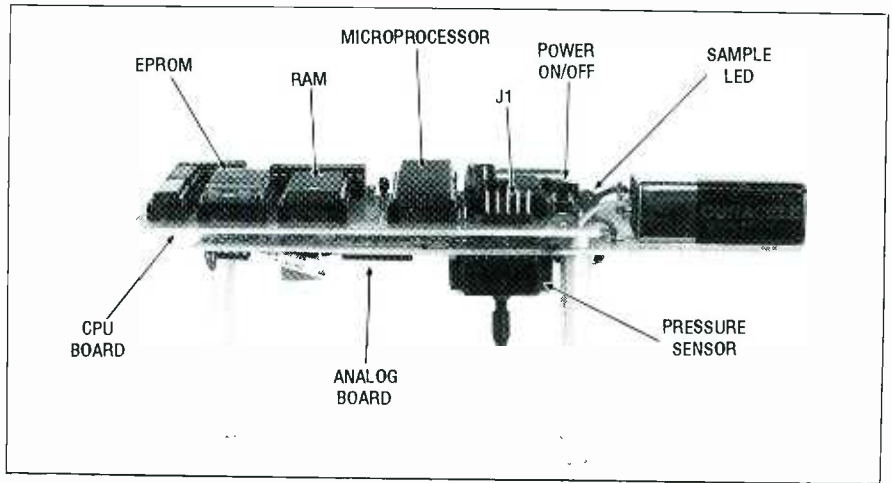

FIG. 11—THE FINISHED ANALOG/CPU ASSEMBLY. It fits in the payload section of a rocket.

LISTING 1

```

000000 c0 00 c5 f8 00 b3 f8 fa a3 7a e3 65 7b 7a 7b 7a
000010 f8 20 b5 b1 f8 06 a5 f8 02 a1 f8 00 b2 f8 f0 a2
000020 f8 02 55 e1 82 f4 a2 e5 02 f2 32 31 f8 fb a3 30
000030 34 f8 fa a3 7a e3 65 7b 7a 05 fe 55 3a 27 11 81
000040 fb 06 3a 1a f8 fb a3 7a e3 65 7b 7a 65 65 f8 00
000050 a9 b9 19 99 fb 10 3a 52 c0 00 db f8 00 a4 b4 3c
000060 5f 34 61 14 3c 63 f8 00 a5 f8 05 b5 c0 01 85 fb
000070 00 3a 6c c0 01 0e f8 05 a1 f8 20 b1 e1 f8 00 73
000080 73 73 51 c4 c4 f8 05 a1 01 32 90 f8 00 51 30 95
000090 f8 05 51 30 bb 21 01 fb 09 32 a1 f8 01 f4 51 30
0000a0 bb f8 00 73 01 fb 09 32 af f8 01 f4 51 30 bb f8
0000b0 00 73 01 fb 09 32 bb f8 01 f4 51 24 94 3a 85 84
0000c0 3a 85 c0 00 03 f8 00 a6 b6 a7 b7 f8 20 ad bd c0
0000d0 01 c0 c4 c4 c4 c4 c4 c4 c4 c4 c4 c4 c4 c4
0000e0 ea c0 01 45 c0 01 07 c0 01 00 c0 01 78 c4 c4 c4
0000f0 fc 60 da f2 66 b6 be e0 fe e6 00 01 02 00 c4 c4
000100 96 b4 86 a4 c0 00 76 f8 00 a7 b7 f8 20 ad bd c0
000110 00 df c4 c4 c4 c4 c4 c4 c4 c4 c4 c4 c4 c4 c4
000120 84 af 96 be 86 ae 9f 3a 2c 8f 32 36 2f 9e 3a 33
000130 8e 32 26 2e 30 26 9e 3a 3c 8e 32 3e 30 42 94 b6
000140 84 a6 c0 01 a0 f8 00 a4 b4 3c 49 34 4b 14 3c 4d
000150 f8 00 a5 f8 05 b5 94 3a 61 84 fb 01 3a 61 c0 01
000160 70 24 25 95 3a 56 30 5e c4 c4 c4 c4 c4 c4 c4 c4
000170 94 5d 1d 84 5d 1d 30 1e 4d b4 4d a4 f8 00 a9 b9
000180 19 99 fb 30 3a 80 30 a0 c4 c4 c4 c4 c4 c4 c4 c4
000190 c4 c4 c4 c4 c4 c4 c4 c4 c4 c4 c4 c4 c4 c4 c4
0001a0 97 fb 03 3a af 87 fb f0 3a af 2d 2d c0 00 76 17
0001b0 30 ac c4 c4 c4 c4 c4 c4 c4 c4 c4 c4 c4 c4 c4
0001c0 f8 20 a5 b5 f8 00 55 15 f8 01 55 15 95 fb 28 3a
0001d0 c4 c0 00 db c4 c4 c4 c4 c4 c4 c4 c4 c4 c4 c4 c4
0001e0 c4 c4 c4 c4 c4 c4 c4 c4 c4 c4 c4 c4 c4 c4 c4
0001f0 c4 c4 c4 c4 c4 c4 c4 c4 c4 c4 c4 c4 c4 c4 c4
000200 c4 ...

```

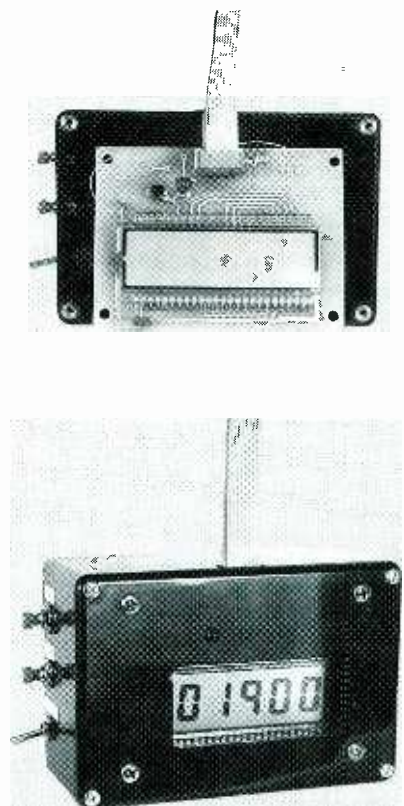
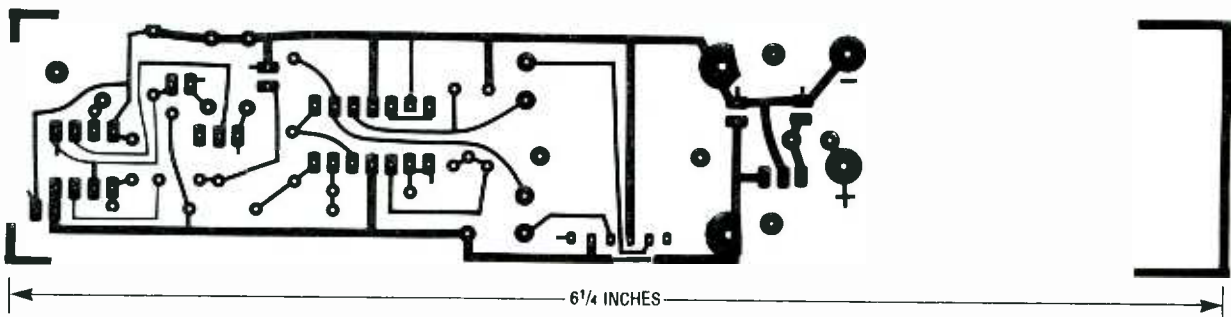

FIG. 12—THE DISPLAY MODULE can be housed in any kind of project case you can find.



THE ANALOG BOARD USES THIS FOIL PATTERN.



surements may be inaccurate. If the potentiometer adjustment is far off, the microprocessor may

not cycle. If a 50-foot reading cannot be achieved, your altitude above sea level may be excessive.

In that case, simply adjust the value of R16 on the analog board: increase it by 1K to decrease the reading by 1000 feet, or decrease it by 1K to increase the reading by 1000 feet. Note that the potentiometer has enough range to allow for "simulated flights" of thousands of feet.

If the unit doesn't run, check for correct parts placement, solder bridges, and other defects. Verify that a 2-MHz signal exists on IC1 pin 1. The crystal circuit has a very high impedance. Any moisture or contamination may prevent oscillation (rosin flux won't hurt). Touching pins 1 or 39 of the microprocessor can cause the program to crash! Spraying the crystal area with clear lacquer is recommended. To reset the program, turn the power off for 5 seconds, then turn it back on. Removing the battery power will erase data. Switching the PLAYBACK switch to off will resume data logging at whatever sample was last displayed. The unit must be reset (turn off for 5 seconds, then on) before the next flight.

#### Prepare for launch

Mount the flight-recorder in the rocket payload section. Pack it securely with foam or some other support so that it will not rattle during flight. Punch several 1/4-inch holes in the body tube near the sensor. An access port may be cut out to allow the ribbon cable to be attached.

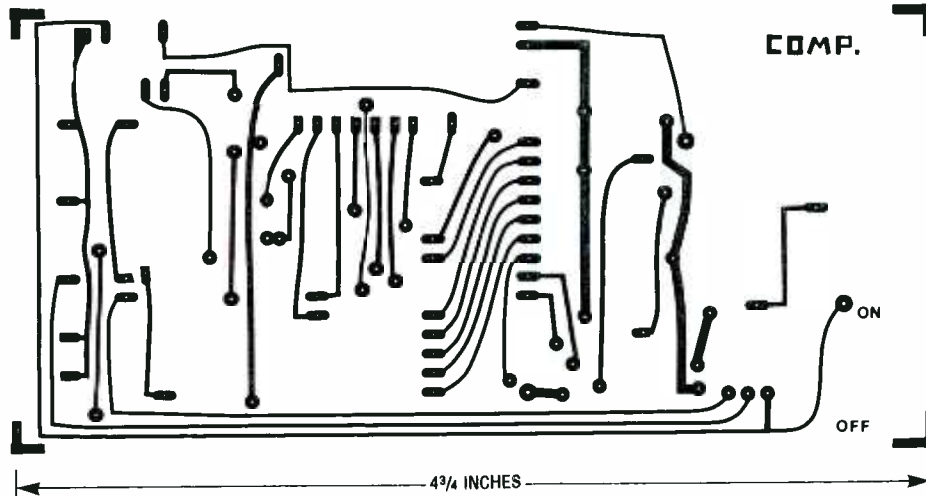

THE COMPONENT SIDE OF THE CPU BOARD.

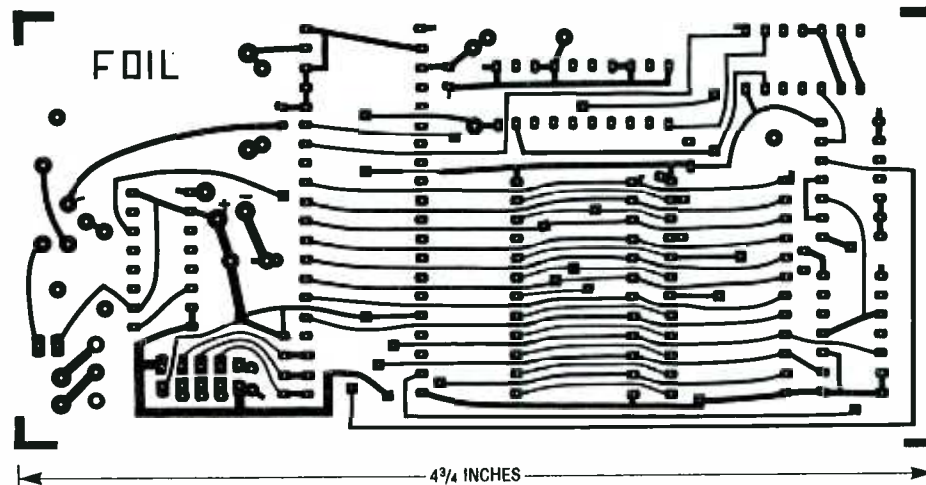

THE SOLDER SIDE OF THE CPU BOARD.

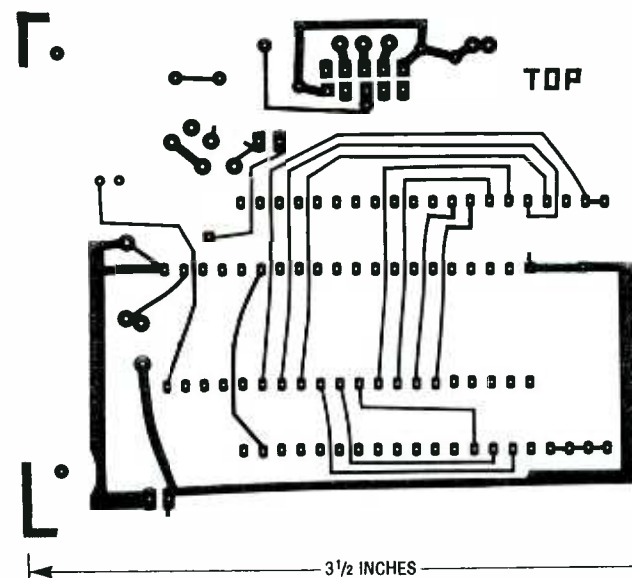

DISPLAY MODULE COMPONENT SIDE.

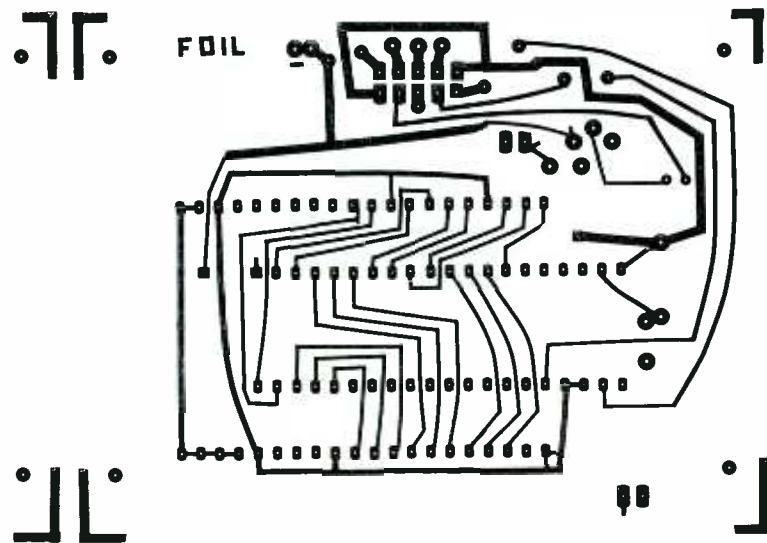

DISPLAY MODULE SOLDER SIDE.

Activate the unit with the display connected and verify ground calibration (a 50-foot reading). Unplug the display, verify that the sample LED is flashing, and secure the hatch.

Before launching, however, it is important to observe certain safety precautions in order to avoid unnecessary injury or property damage. First of all, always use properly constructed rockets, launchers, and factory-loaded NAR-certified rocket engines. A model rocket should always have a parachute recovery system. Never launch a rocket with a flammable, explosive, or live payload. Make sure that the launch area is free of obstructions such as trees, power lines, and low-flying planes. Also avoid launching rockets on windy days or when clouds will obstruct your view of the rocket. To avoid fire hazards, never launch a rocket from ground covered with dry grass or shrubs. Always make sure that nobody is near the launch site, especially children.

Launch the rocket using a remote ignition system. About four minutes of data will be stored, including the time on launch pad. When you recover the rocket, plug in the display, press the PEAK button, and the peak altitude achieved will be displayed.

Next, switch the playback toggle to the closed position. Press the ZERO button (hold it for two sample LED flashes) and release. This will start playback from location zero at  $\frac{1}{4}$  speed (one sample per second). The flight can be played back as many times as desired by pushing ZERO. The ZERO button must be pushed at any time to restart.

### Conclusion

The collected data may be used to determine the performance of a model rocket. Many modelers are flying high-performance composite motors in their "birds" allowing altitudes of thousands of feet to be reached. Use of the altimeter can help optimize rocket designs to get maximum altitude for a given engine size.

Non-rocket uses of the system might include kites, hot-air balloons, hang-gliders, skydivers, and mountain climbers. Whatever your application, be careful...and have fun!

R-E

## CHRISTMAS CARD

*continued from page 59*

the microphone causes a voltage to appear. Do not increase the setting until R17 through R20 are adjusted so as to give a complete range through each bargraph. The best bet for making these adjustments is to play a stereo audio source (actually, any source will do) at a normal listening level. Simply adjust the potentiometers for what you consider to be a pleasing or most Christmas-like interpretation of the sound.

If you have any problems with the device, the first thing to do is decrease the setting (counterclockwise) of all the potentiometers. A filter that still oscillates after decreasing the potentiometers most likely has an incorrect component or one that does not meet its tolerance.

For high-Q versions of the circuit, sometimes the component tolerance is such that the filter will begin to oscillate when presented with a large input. If that's the case, all you must do is interchange the two filter capacitors; this old technician's trick usually works, assuming that there aren't any problems with the other components.

If you still have problems, check that the analog ground is stable. A variation on that line will cause serious problems with the operation of the unit. If you cannot find the problem, the best thing to do is to shut off the display by lifting one lead of both R1 and D5. With the load of the display removed, it's easier to locate problems.

The finished, working board can be installed in any kind of housing you like, although the custom black metal frame adds a nice touch, as does the mat that keeps the circuitry from view. After installing the unit in the frame you may want to readjust the potentiometers, since the frame and front glass seem to couple the microphone to the surrounding air. Vibrations picked up by the device will also produce a display; a fan operating nearby is almost always displayed. Have fun, and don't forget to have a merry Christmas, as well!

R-E

**TOURISM**  
A VISION OF AMERICA

When Americans head out on the open road, we appreciate how great America really is, and our freedom to travel. Now, more than ever in the past, people from the world over can visit America. Foreign visitors strengthen our global relations and in 1989, they added \$43 billion\* to our economy. As our number one export, tourism improves the USA's balance of trade with other nations.

Tourism Works For America... and for you.

\*Preliminary 1989 Estimates, Source: U.S. Travel and Tourism Administration

TOURISM WORKS FOR AMERICA  
BUCK The Tourist Dollar

The National Travel and Tourism Awareness Council

The poster features a stylized landscape with a large, dark, jagged rock formation on the right. At the bottom, there is a small cartoon character of a tourist with a hat and a sign that says "BUCK The Tourist Dollar". The text is arranged in a clean, sans-serif font.



# BUILD R-E's VOCAL STRIPPER



*Build this lead vocal filter and test your singing ability.*

TERRY J. WEEDER

ALMOST EVERYONE ENJOYS LISTENING TO music, and just about as many people enjoy singing along to their favorite songs. If you're one of the many people who loves to sing, you may be interested in a clever audio device that filters out lead vocals from a stereo recording, leaving just the background music. For under \$50.00, you can build this unique audio filtering device. Impress your friends with this Karaoke-like audio system and enjoy hours of singing pleasure.

Filtering out the vocal tracks from a recording is not as simple as merely eliminating the mid-range frequencies. Along with

the vocals, the midrange frequencies contain a large portion of the music. Vocal filtering is quite easy, however, if you take advantage of the way stereo recordings are mixed.

## Stereo mixing

When mixing is done in a studio, each instrument or voice is assigned a position relative to left (L) and right (R) channels. Some instruments are recorded at higher levels on the right channel so that their sounds seem to come from the right side of the stage. Others are recorded on the left channel for the opposite effect. Lead vocals and instru-

ments such as the bass drum and bass guitar are usually recorded at the same level on both channels so they seem to come from center stage. That is what makes lead vocal filtering possible.

Vocal signals, which consist primarily of mid-high range frequencies, can be filtered out by a series of filtering stages shown in Fig. 1. Bass instruments, corresponding to a lower frequency range, can be diverted to a final mixing stage so that the music is not filtered out along with the vocals.

A signal from one channel is inverted and subtracted from the

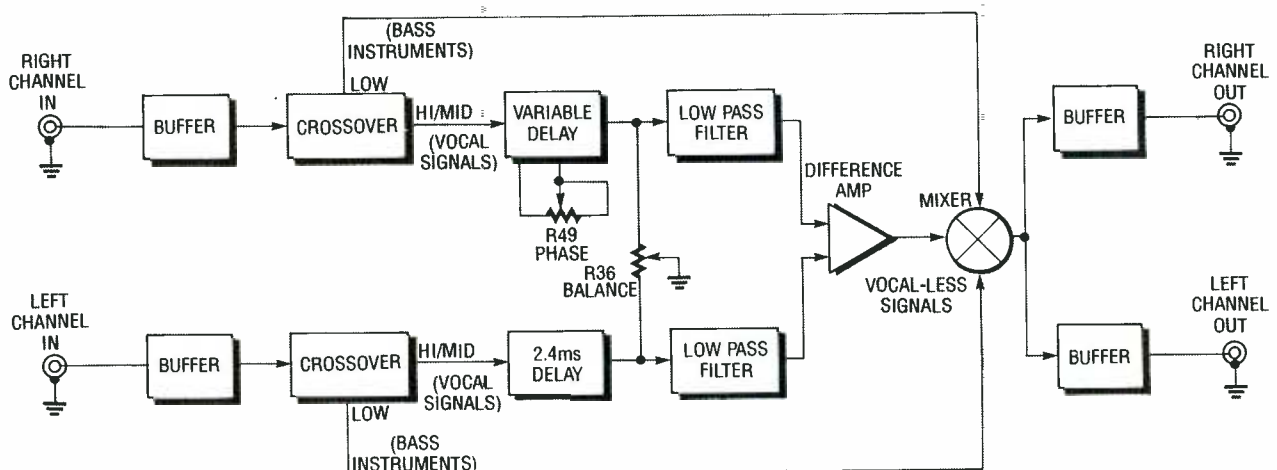

FIG 1—BLOCK DIAGRAM OF FILTER NETWORK. Right channel signal is inverted and subtracted from the left channel, cancelling the lead vocals. Low frequencies are bypassed by an active crossover and remixed with the difference signal, without the vocals.

other (L-R), which causes the lead vocals that are common to both channels to cancel out. The music common to the left and right channel remains unchanged. Unfortunately, along with the lead vocals, all low frequencies are common to both channels and must bypass the cancellation circuit. A simple active crossover removes the low frequencies so that they can be remixed with the vocal-less signal at a later stage.

From the active crossover stage, all midrange and high fre-

quencies pass through a variable delay stage, which is used to align the left and right channel signals so that they are exactly in phase with each other. Proper signal cancellation is achieved only when both signals are in phase. The low-pass filter filters out unwanted high frequencies from the variable delay stage. The output of the low-pass filter enters a difference amp, where the lead vocal signals cancel, and is then remixed with the low frequencies at the final mixing stage.

### Here's how it works

The schematic of the lead vocal filter is shown in Fig. 2. The left and right channel signals are coupled through C1 and C2 to buffer amps IC4-a and IC4-b. From the buffer amps, the left and right channel signals pass through active crossovers IC5-a and IC5-b, sending all low frequencies to a final mixer IC6-c, and all middle and high frequencies to analog delay lines IC1 and IC2, RD5106 256-sample bucket-brigades. Integrated circuit IC2 delays the left channel signal by

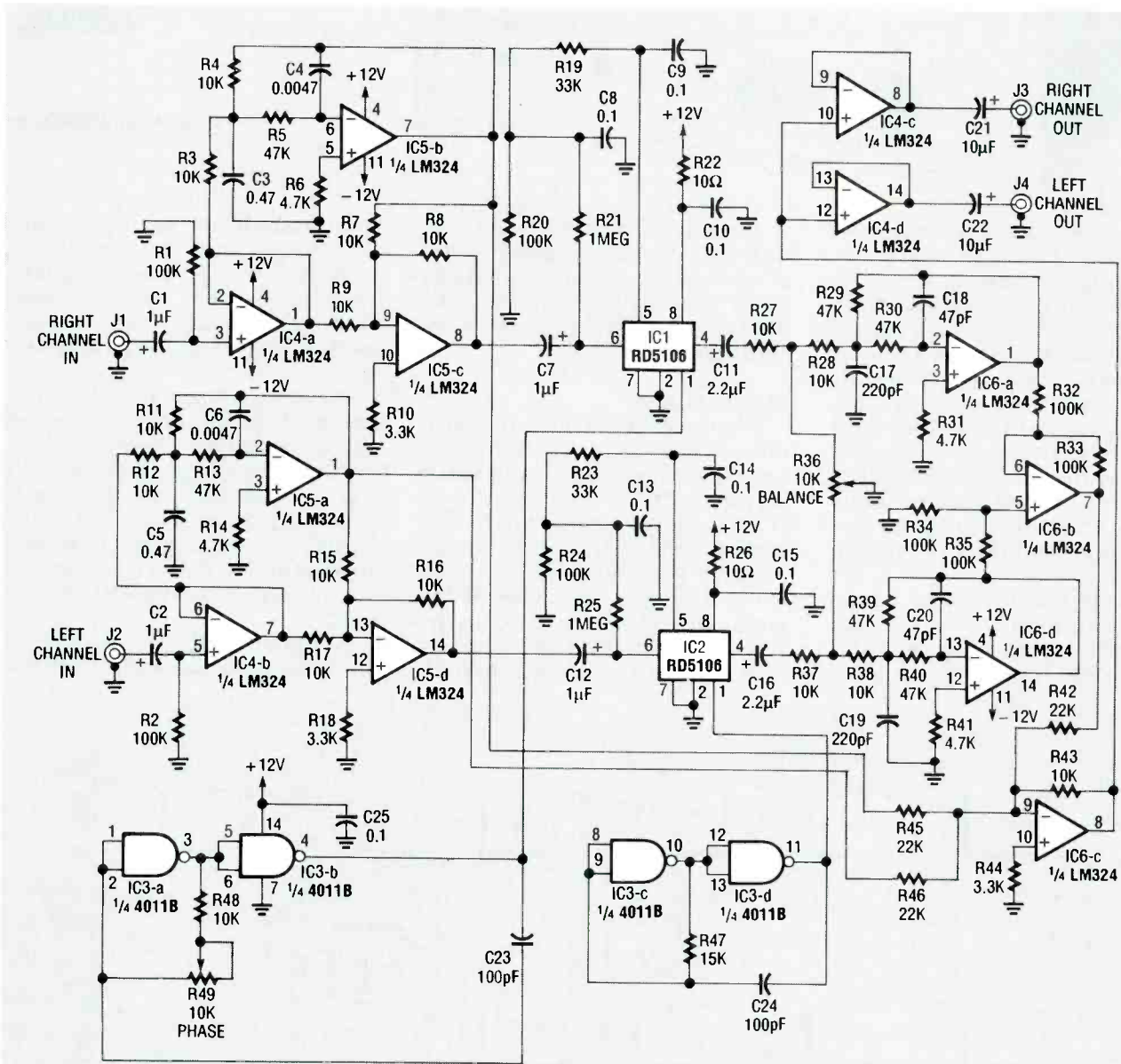

FIG. 2—SCHEMATIC OF LEAD VOCAL FILTER. Right and left channel signals pass through IC4-a and -b buffer amps into active crossover IC5; low frequencies are sent to IC6-c mixer, middle and high frequencies are sent to analog delay lines of IC1 and IC2. That output passes through IC6-a and -d to filter high frequency sample steps. IC6-b signals are remixed with low frequencies by IC6-c and are sent to final output via IC4-c and -d buffers.



2.4 ms, set by the fixed-frequency clock generated by  $\frac{1}{2}$ -IC3, R47, and C24. The right channel signal is delayed by IC1 with a variable-frequency clock generated by  $\frac{1}{2}$ -IC3, R48, R49, and C23. Potentiometer R49 is used for phase adjustment.

The output of each delay line

**All resistors are  $\frac{1}{4}$ -watt, 5%, unless otherwise indicated.**

R1, R2, R20, R24, R32, R33-R35—100,000 ohms

R3, R4, R7-R9, R11, R12, R15, R16, R17, R27, R28, R37, R38, R43, R48—10,000 ohms

R5, R13, R29, R30, R39, R40—47,000 ohms

R6, R14, R31, R41—4700 ohms

R10, R18, R44—3300 ohms

R19, R23—33,000 ohms

R21, R25—1 megohm

R22, R26—10 ohms

R36, R49—10,000 ohms, potentiometer

R42, R45, R46—22,000 ohms

R47—15,000 ohms

**Capacitors**

C1, C2, C7, C12—1  $\mu$ F tantalum

C3, C5—0.47  $\mu$ F tantalum

C4, C6—0.0047  $\mu$ F Mylar

C8, C9, C10, C13, C14, C15, C25—0.1  $\mu$ F Mylar

C11, C16—2.2  $\mu$ F tantalum

C17, C19—220 pF ceramic disc

C18, C20—47 pF ceramic disc

C21, C22—10  $\mu$ F electrolytic

C23, C24—100 pF ceramic disc

**Semiconductors**

IC1, IC2—RD5106 256-sample bucket brigade analog delay line, EG & G-Reticon

IC3—4011 quad two-input NAND gate

IC4-IC6—LM324 quad op-amp

**Miscellaneous:** Perforated circuit board standoffs, mounting hardware, hookup wire, shielded cable, 18-AWG power supply cord, strain relief, and four RCA jacks for J1-J4.

**Power supply parts**

F1—0.5 amp fuse and fuseholder

T1—24 VAC center-tapped transformer

BR1—1.5-amp bridge rectifier, 100 PIV

C1, C2—1000  $\mu$ F, 25 volts, electrolytic

C3, C4—10  $\mu$ F, 16 volts, electrolytic

C5, C6—0.1  $\mu$ F, ceramic disc

D1, D2—12-volt Zener diode

R1, R2—220 ohms

R3—1000 ohms

S1—SPST switch, 1 amp

LED1—light emitting diode, any color

**Note:** The following are available from Weeder Technologies, 14773 Lindsey Rd., Mt. Orab, Ohio 45154: An etched, drilled, and plated PC board, \$13.00; all (board mounting) components, \$27.00; An assembled and tested circuit board \$69.00; power supply components (less per-board, fuse, fuseholder and switch), \$11.50. Include \$2.00 for shipping and handling, \$3.50 if order includes power supply. Ohio residents add 5.5% sales tax.

from IC1 and IC2 passes through low-pass-filters IC6-a and -d, and their associated parts, to filter out high-frequency sample-steps produced by IC1 and IC2. Balance control R36 is adjusted for equal amplitude of the left and right channels. IC6-b is a difference amplifier which cancels all lead vocals that are common to both channels. The resulting signal from IC6-b is remixed with low frequencies by IC6-c and is then sent to the output via buffers IC4-c and IC4-d.

**Construction**

The easiest way to go about constructing the vocal filter circuit is to use a PC board. An

etched and drilled PC board is available from the source in the Parts List or you can make your own from the foil pattern provided here. Mount the vocal filter components as shown in the parts placement diagram, Fig. 3. Use shielded wire to connect the RCA jacks, and ground them properly, either by mounting them to a grounded chassis or by soldering ground wires to their cases. The DC power supply leads from the power-supply board should be twisted to reduce noise transmission.

If you don't use PC mounted potentiometers for R49 and R36, be sure to keep their connecting leads short and twist them to re-

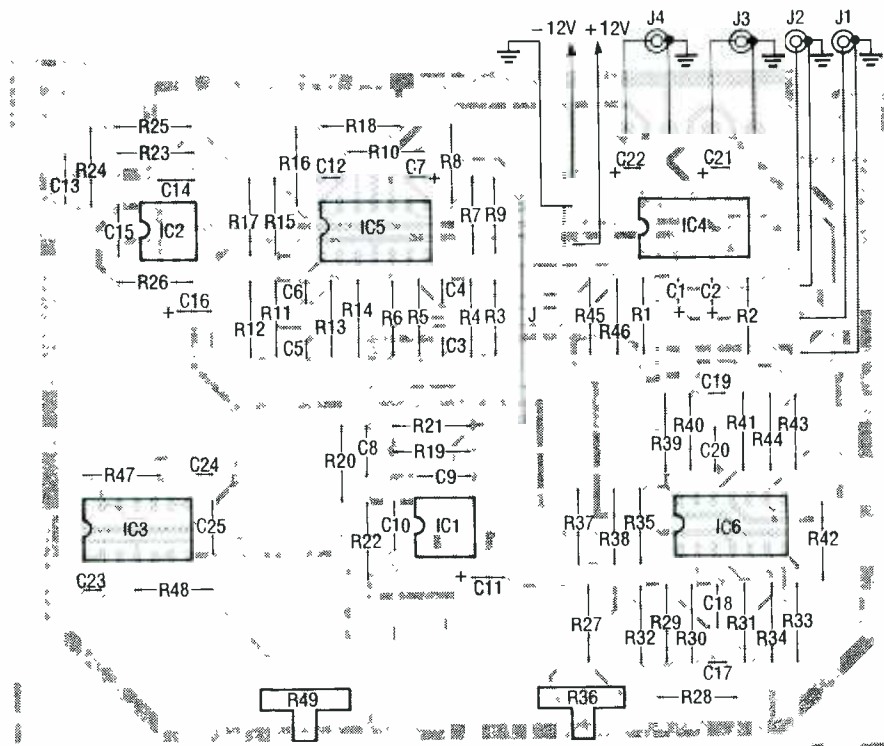

FIG. 3—PARTS PLACEMENT DIAGRAM. Remember to connect the jumper lead, use shielded cables for the RCA jacks and twist the supply leads before soldering to the LED and main PC board.

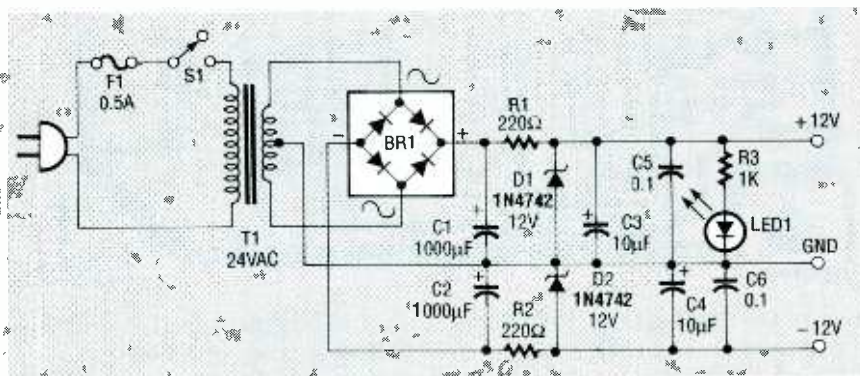

FIG. 4—POWER SUPPLY SCHEMATIC for the lead vocal filter circuit.

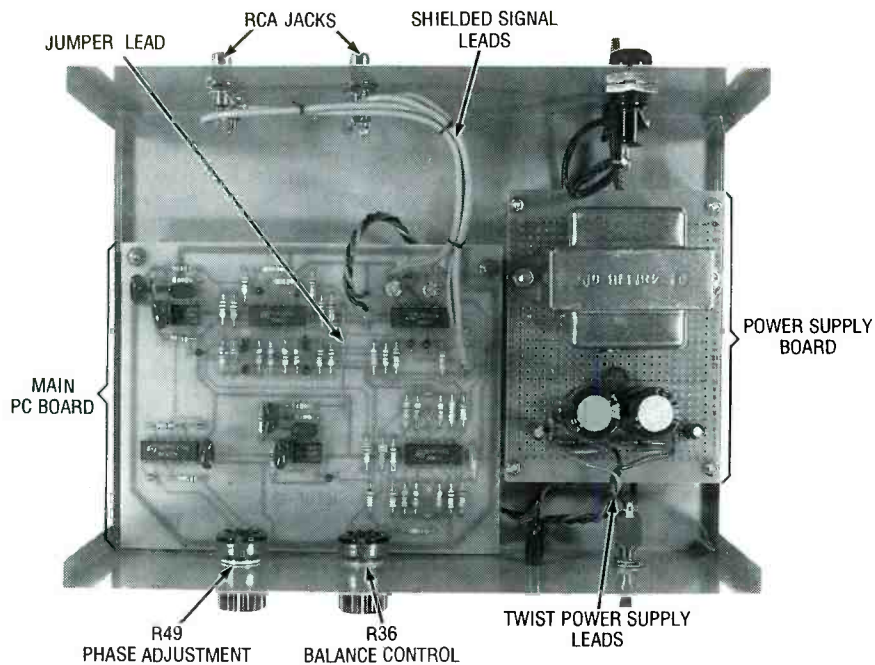
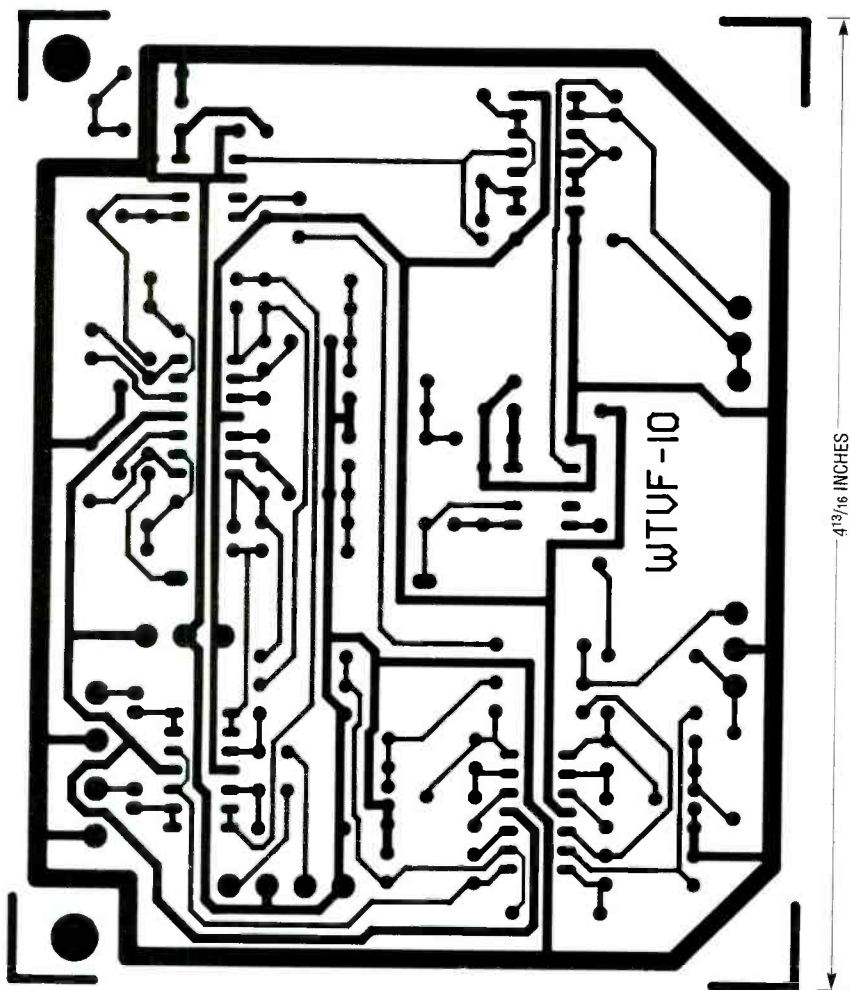

FIG. 5—AN INTERNAL VIEW OF THE LEAD VOCAL FILTER.



duce noise and hum pickup. It is preferable, though, to use shielded leads for these connections. These potentiometers

should be grounded by mounting to a grounded chassis.

A simple power supply, like the one shown in Fig. 4, may be used

for this device. The power supply can be mounted on a perforated circuit board, as long as you closely follow the component connections shown on the schematic. Although optimum performance is obtained with a  $\pm 12$  volt supply, the vocal filter gives good results using two 9-volt batteries connected in series with the junction being connected to ground.

The power supply and main PC board should be adequately enclosed before operating the vocal filter. A metal enclosure is recommended, as a 120-volt line potential is exposed in the power supply circuit (see Fig. 5).

### Hook up and operation

The vocal filter should be connected into the tape loop of your stereo system. Use shielded cables with phono connectors to connect inputs J1 and J2 to the "record" tape monitor jacks on your stereo, and outputs J3 and J4 to the "play" side. To use the vocal filter with a tape deck that normally uses tape monitor jacks of the tape deck into J1 and J2 of the vocal filter. Plug J3 and J4 into the input or "play" jacks of the stereo. Make sure you apply power to the vocal filter before turning on the stereo; sensitive components in the vocal filter may be damaged if a signal is applied before power is turned on.

Set R36 to its middle position, play a stereo sound track or tune in an FM stereo broadcast, and switch in the tape monitor. Adjust R49 for minimum lead vocals, then adjust R36. Repeat until the vocals are suppressed.

If you think the vocal filter is not working, tune in to a mono FM broadcast. If you can't find one, tune to a stereo station, and adjust the tuning knob so the stereo light goes off. If the vocal filter is working, you should be able to adjust R36 and R49 to filter out all music except low frequencies.

With a little help from **Radio Electronics**, you now have the know-how to build a fairly simple audio filtering device in just a few short evenings. Once completed, you can use this system to practice singing alone, or be creative and have all your friends over for a *Karaoke* party!

R-E



THERE ARE SEVERAL WAYS TO CAPTURE and listen to sounds at a distance. Obviously, you could always set microphones at a location of interest, and transmit the sounds by wire or radio to your position. However, that's not always convenient or practical in certain cases of surveillance, or when dealing with bird calls or animal sounds.

Another option is to use a sensitive, directional microphone similar to those used in network TV broadcasts of football or other sporting events. Such microphones typically have parabolic reflectors for focusing sound onto them. The microphone we'll describe here uses a different approach, yet is perfect for long-distance monitoring or surveillance.

### Theory

The major criteria that determine microphone performance are directional sensitivity and frequency response (bandwidth). Just as frequency response and directional sensitivity in antennas are changed by varying the lengths, diameters, and relative angles of metal radiators or reflectors, the analogous characteristics of microphones can be adjusted by similar geometric variations. One lesser known antenna type, normally used in microwave applications, is the horn antenna. The horn microphone presented in this article is designed using analogous principles which could, incidentally, also be applied with equal validity to the design of a loudspeaker, for reasons discussed below.

A very helpful concept in either acoustic or electromagnetic design is to think of a microphone, loudspeaker, or antenna, as just a transducer. This concept can be extended still further, if you consider a transducer of wave-propagated energy that focuses such energy onto a receptor to be a lens. Consider the similarities, taking the antenna first, since it's the more obvious. Both antennas and lenses focus and collect electromagnetic energy, the only difference being that light is at a much higher frequency range, and obeys the laws of optics. (Actually, microwave antennas also exhibit quasi-optical physical phenomena.)

Consider for a moment; don't both electromagnetic radiation and light exhibit the same phenomena of reflection, refraction, absorption or attenuation, and polarization? And in

# SUPER DIRECTIONAL MICROPHONE

like fashion, acoustic energy also exhibits the same phenomena. Just as antennas are *electromagnetic* lenses, so too are microphones and loudspeakers *acoustic* lenses.

Not only are microphones and loudspeakers acoustic transducers or lenses, but also acoustic filters. Just as all filters have frequency and phase response, so too do microphones and loudspeakers. However, here, as with antennas, two types of filtering occur: directional and frequency.

Another term for directional sensitivity is directivity, often a desirable trait, since it prevents spurious sound from entering from undesired directions. A microphone with uniform directivity is termed omnidirectional; however, flat directional response doesn't imply flat frequency response. A microphone can either have a flat response over the audio spectrum (20 Hz–20 kHz), or be tailored for greater sensitivity over specific audio bands. The acoustic horn presented here has very high directivity over the entire audio spectrum.

The last property microphones and speakers have in common is re-

ciprocality, which lets a microphone work equally well as a loudspeaker of identical design, both directionally and in frequency response; this property also holds true for antennas.

### Different microphone types

Most microphones are omnidirectional, as shown in Fig. 1. Figure 1-a shows the basic shape of an omnidirectional microphone with the main axis, while Fig. 1-b shows a linear polar plot of relative sensitivity  $P(\theta)$  (dynes/cm<sup>2</sup>) as a function of angle  $\theta$  about the main axis; all curves are normalized to 1 at the peak of the main beam. The main beam can be at any angle, although it's normally depicted at 0°. If several people sit around a table, an omnidirectional microphone at the center will pick them all up equally well. Any plane that passes through the main axis will exhibit this sensitivity response.

The second most common microphone type is the *cardioid*, shown in Fig. 2-a, which has greater directivity toward the front over most of the audio range. The sensitivity pattern shown in Fig. 2-b looks like the mathemati-

*A novel super-directional microphone that outperforms many costly commercial designs.*

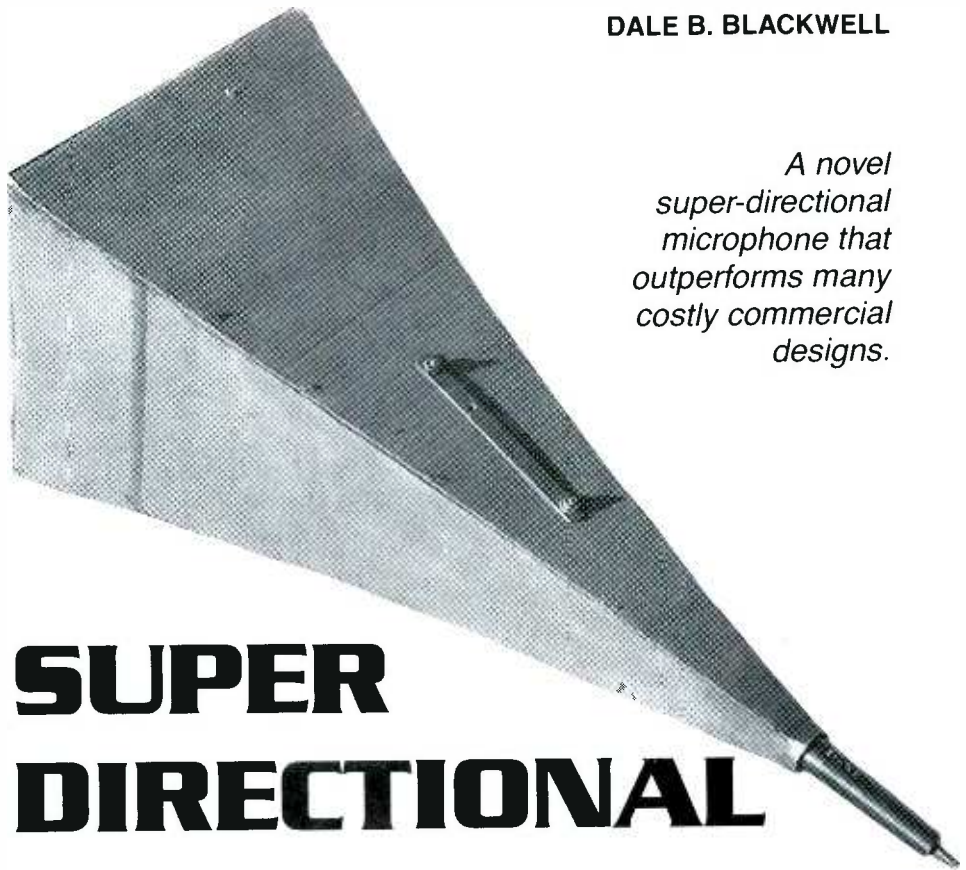

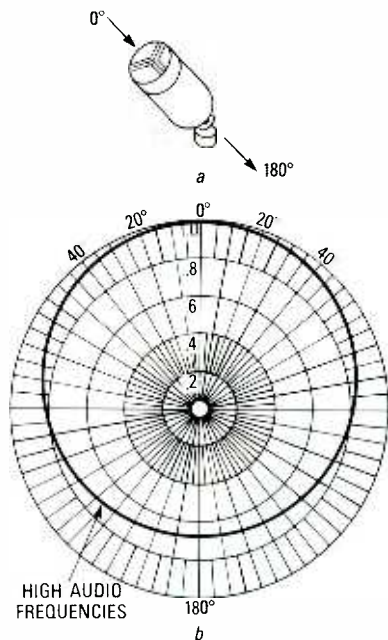

FIG. 1—AN OMNIDIRECTIONAL microphone, shown in (a), has uniform directional sensitivity to sound pressure  $P(\theta)$ ; the main axis is out the indicated. In (b) is shown a polar plot of directional sensitivity; the response is identical in any plane through the main axis.

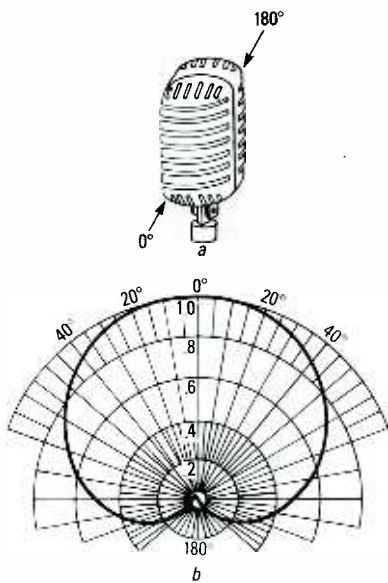

FIG. 2—A CARDIOID microphone, shown in (a), has greater sensitivity from the front than the rear. The  $0^\circ$  and  $180^\circ$  directions are along its main axis, pointing through the main face. The sound pressure sensitivity  $P(\theta)$  shown in (b) was taken through a plane normal to the main axis.

cal curve called a cardioid (heart-shaped), hence the name. An orchestra in a night club might use a cardioid microphone so that only their music is picked up, not sounds

from the audience. The power function is of the form:

$$P(\theta) = P_{\text{ref}}[1 + \cos(\theta)], \\ = 2 \times P_{\text{ref}} \cos^2(\theta/2).$$

At  $\theta = 0^\circ$ , the sensitivity is maximized. The sensitivity goes to zero (a null) at  $\theta = 180^\circ$ .

The ribbon element microphone shown in Fig. 3-a is the industry standard, well-known from all the photos of radio stars in front of them. It's sensitive from both front and rear, producing the figure-8 pattern shown in Fig. 3-b. A microphone that picks up equally well in opposite directions is advantageous in a talk show where the guest sits opposite the host.

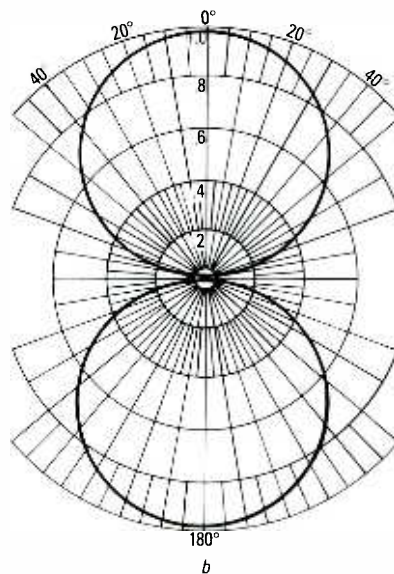
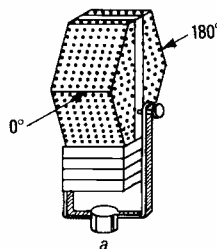

FIG. 3—A BIDIRECTIONAL microphone, shown in (a), is uniformly sensitive to sound from front and rear, but less sensitive from the side; the main axis is the same as that for a cardioid microphone. Note, however, that  $P(\theta)$  in (b) has two lobes, not one, with two maxima and two minima (zeros, or nulls).

### Increasing directivity

Experimenting with basic microphone directivity patterns yield more specialized designs that are much more sensitive from the front. Figure 4-a shows a parabolic reflector micro-

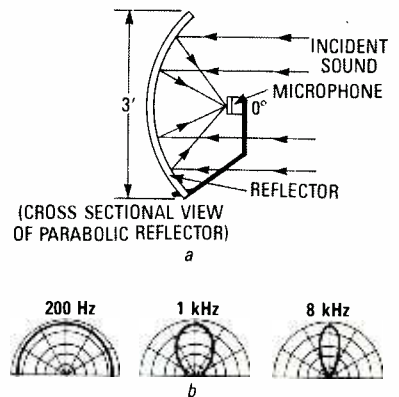

FIG. 4—THE DIRECTIVITY OF A parabolic reflector microphone increases with frequency. In (a), the incident parallel rays converge to the focal point, where the microphone is located. In (b) are shown linear polar plots of acoustic power at four frequencies.

phone; all parallel rays, wherever they strike the curve, are reflected to the focal point, where the microphone is located. Parabolic microphones are also especially directive at higher audio frequencies, as shown in the sensitivity patterns of Fig. 4-b.

As shown in Fig. 5-a, the line (shotgun) microphone is another commercial directive version, albeit not quite as focused as a parabolic reflector. The line microphone has either a single long tube with spaced openings, or several tubes of increasing length, in front of the microphone element. The sensitivity patterns in Fig. 5-b aren't for differing frequencies, but for different tube lengths, being integral multiples of  $\lambda/2$ , or half a wavelength.

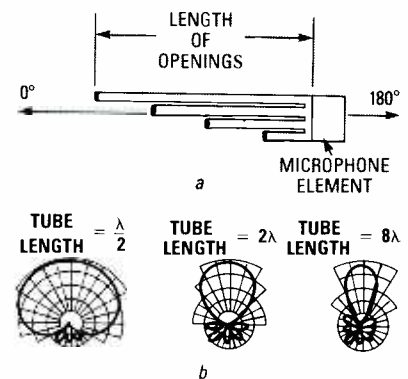

FIG. 5—A LINE (SHOTGUN) microphone becomes more directive as the length of its tubes increase. It's not as directive as a parabolic reflector, and either has one long tube with spaced openings, or several tubes of increasing length each with one opening, right in front of the diaphragm.



Both the reflector and line microphones are directive, but neither compares with the narrow beam of the horn shown in Fig. 6. Figure 6-a shows the geometry of the basic horn shell for the horn microphone prototype, while Fig 6-b shows the directivity patterns for different frequencies.

All microphones, of whatever type, work equally well when the same basic shape is used in a loudspeaker due to reciprocity. The narrow beam of a horn stems from the ability to match the impedance between a small microphone diaphragm and free air, making the small microphone diaphragm (or receptor) seem as large as the mouth of the horn.

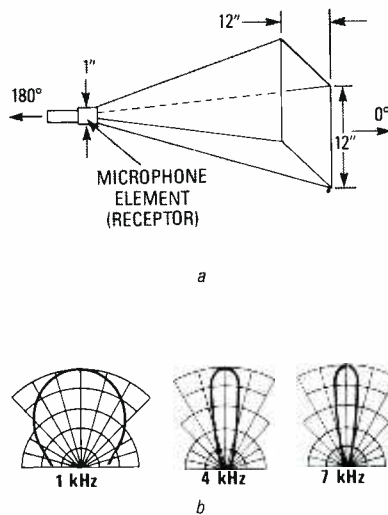

FIG. 6—HORN MICROPHONES ARE VERY directive; they match acoustic impedance from diaphragm to open air. In (a) are the prototype dimensions; the narrow beamwidth makes the receptor act as large as the mouth, due to phasing and pressure effects, so the incident volume is greater from the front, than sides or rear. In (b) are directivity plots for 1, 4, and 7 kHz.

### Horn microphone

The high directivity of all horn microphones stems from phasing and pressure effects, making the volume at the receptor greater from the front, than from the sides or rear. The mouth, length, shape, and frequency range to be received, all determine the directivity. One reason for the high directivity is that audio wavelengths are made comparable to the mouth size. The relation is  $\lambda = C/f$ , where  $\lambda$  is wavelength (cm),  $C$  is speed of sound (340 m/s), and  $f$  is frequency in Hz.

Since 1 ft = 30.48 cm, then from 20

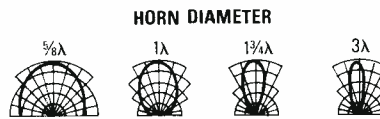

FIG. 7—AS HORN MOUTH SIZE increases relative to wavelength, directivity increases, since audio wavelength is comparable to mouth size. Shown are directional patterns of decreasing beamwidth, for four horn diameters relative to  $\lambda$ .

Hz to a few hundred Hz, the wavelengths are over a foot. At  $f = 1.115483$  kHz, then  $\lambda = 1$  ft, so the 1-foot diameter horn presented here should be quite directive at that frequency. Figure 7 shows additional directivity patterns, but not for explicit frequencies. Note that those patterns are for various mouth sizes relative to wavelength. As the ratio of mouth size to wavelength increases, so does directivity. Another way to achieve higher directivity is to increase horn length for a given mouth size. As shown in Fig. 8, to achieve this, the horn angle  $\alpha$  must be reduced.

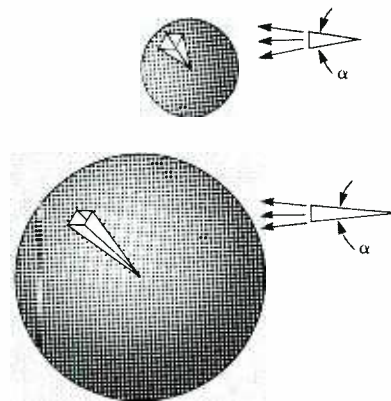

FIG. 8—ANOTHER WAY TO ACHIEVE directivity in a horn microphone is to increase length versus mouth size, requiring that horn angle  $\alpha$  be reduced.

Horns of different shapes are commonly used as loudspeakers, with the exponential, hyperbolic, and conical versions the most common, in that order. Horns are uniquely able to transform and match acoustic impedances. The horn loudspeaker is an acoustic transformer, changing large pressures and small volume currents in the throat to small pressures and large volume currents in its mouth; horn microphones do the reverse.

As shown in Fig. 9, the conical horn has a gradual impedance-trans-

formation curve as cutoff frequency is approached, with a smooth transition from a high-directivity pattern to one of lower directivity. Such smooth transitions are more desirable than the abrupt low-frequency cutoff of both exponential and hyperbolic horns.

In the horn of Fig. 6-a, the transition from square horn to receptor is smoothed into a cone using modeling clay. At the higher audio frequencies, the conical walls reflect the short wavelengths (a few inches or less) down to the microphone diaphragm, helping to optimize high-end audio directivity for a narrower beamwidth.

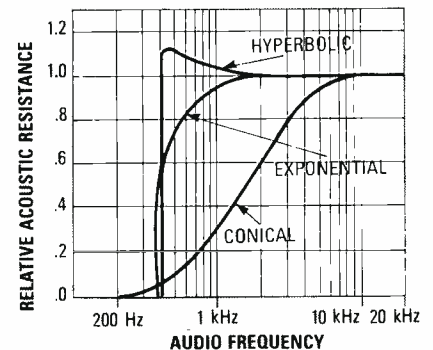

FIG. 9—RELATIVE ACOUSTIC resistance for several horn microphones of size and bandwidth similar to Fig. 6. Each works just as well as a loudspeaker by reciprocity, with the exponential, hyperbolic, and conical the most common.

### Construction

The horn presented here can be made using low-cost materials and a little time. Because sound pressure waves exert low force, light-weight materials can be used. Figure 10 shows the prototype, made from cor-

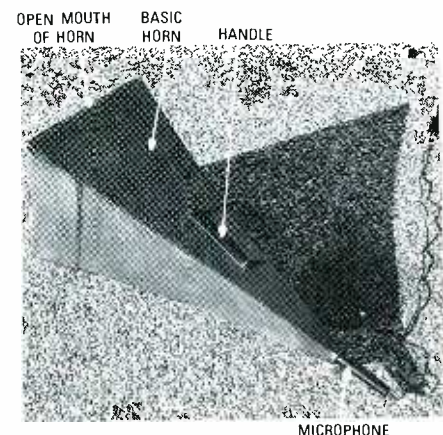
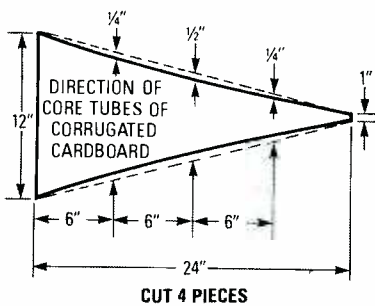
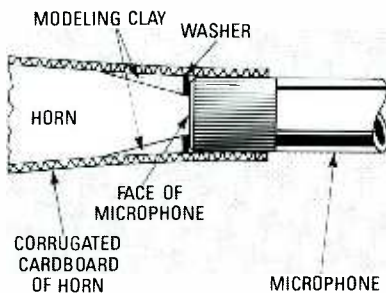

FIG. 10—THE PROTOTYPE HORN WAS made from corrugated cardboard; a removable extension with larger mouth and a carrying handle was added. At high audio frequencies, the walls reflect short wavelengths of a few inches or less to the diaphragm, to optimize directivity.



**FIG. 11—HERE'S THE CUTOUT FOR ONE side of the basic horn; note the direction of the corrugated ribs. The edges have slight curvature so the sides have added strength, and don't resonate easily. The edges were taped, and paper glue was used on the inner and outer corners. The small end was cut to a 1-inch diameter, and the microphone slides in and is held by the four sides. A metal washer slipped into the throat face acts as a stop, yet lets the sound reach the diaphragm.**

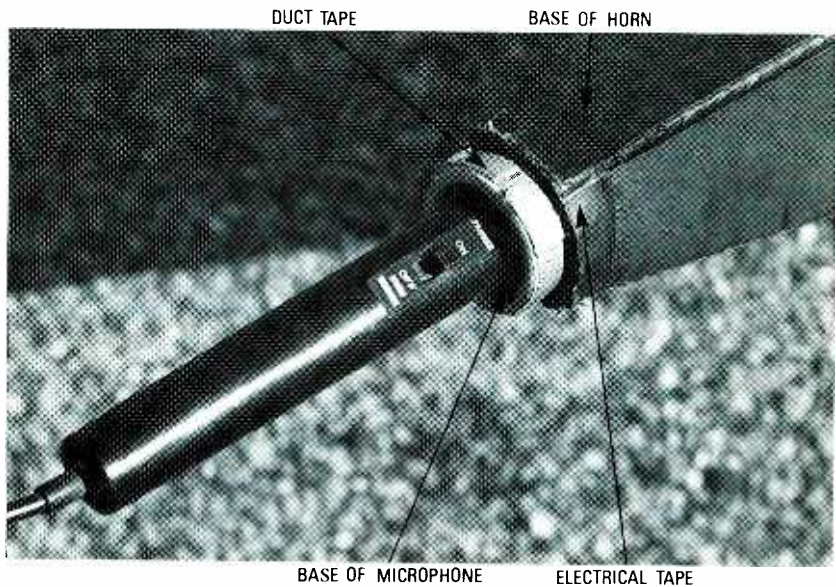

**FIG. 12—WHEN MOUNTING THE microphone in the horn, the washer aperture should be at least 75% of the diaphragm diameter. The modeling clay smoothed the transition from the square horn to the washer opening, so that the sound wasn't restricted from reaching the diaphragm.**

rugated cardboard, cut to the correct size and glued together, with a carrying handle added. The horn was constructed, assembled, and tested; then, a removable extension was added to gauge the benefits of a larger mouth.

The basic horn was built with four sides from the pattern in Fig. 11. The edges have slight curvature for additional strength, so they won't resonate easily. The edges were taped enough to hold them in place, and simple white paper glue was applied to both the outside and inside corners. The small end was cut to a 1-inch diameter, letting the microphone slide in and be held by the four cardboard sides. A metal washer slipped into the throat against the microphone face acts as a position stop, while letting the sound reach the diaphragm.

As Fig. 12 shows, modeling clay smoothed the transition from the

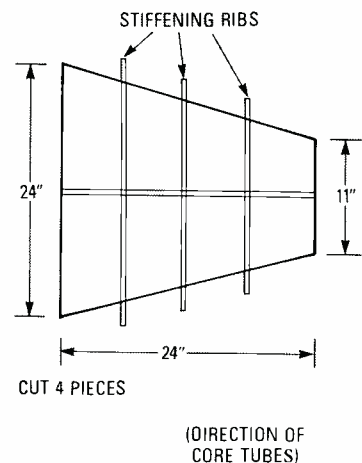

**FIG. 13—A CLOSE-UP VIEW OF THE EXTERIOR of the neck. The cardboard is tapered, producing an opening of proper size for the microphone, and the microphone is inserted. Note the silvery ring at the base of the horn, just behind the base of the horn. The bottom of the microphone protrudes from the base of the horn, and was sealed mechanically and acoustically with duct tape, while the base of the horn was stiffened with electrical tape.**

square horn to the round washer opening, so the sound wasn't prevented from reaching the diaphragm. The washer needs an opening at least 75% of the microphone diameter. Figure 13 shows a close-up view of the exterior of the neck of the horn. You can see how the cardboard is tapered to produce an opening of the proper size for the microphone, and how the microphone is inserted.

Note the silvery ring at the base of the horn in Fig. 13, just in front of where the microphone apparently ends. The base of the microphone protrudes from the base of the horn, and is sealed mechanically and acoustically with duct tape. The extension in Figs. 14 and 15 slips over the front of the basic horn, to extend the length and expand the mouth, and two 1/4-20 screws with washers hold both sections together.

By adding the extension, the mouth was increased in size from 1 × 1 ft to 2 × 2 ft, quadrupling the area. Also, the new size is one wavelength across at  $f=557.742$  Hz, matching wavelengths down to lower audio frequencies and increasing directivity beyond that of the basic horn alone. The larger diameter and greater total area improves pick-up, raising the theoretical pressure level by 3 dB. In practice, the horn picks up more at lower frequencies because the impedance matching at those frequencies is improved.



**FIG. 14—HORN EXTENSION CUTOUT; the ribs stiffen the cardboard. The extension slips over the horn, extending its length and expanding its mouth, and two 1/4-20 screws with washers hold both together. The mouth is now 2 × 2 ft, one wavelength across at  $f=557.742$  Hz, matching wavelengths down to lower audio frequencies, improving directivity, raising the pressure level by 3 dB, and providing better low-frequency pick-up, since impedance matching is improved.**

### Testing

The preliminary tests were conducted at a large parking lot at a local beach. In actual use, aim the horn in the direction of the desired sound, and plug the microphone into a tape recorder, allowing playback later on. In evaluating the prototype, all tests were recorded to allow detailed sound pressure evaluation of an individual

(Continued on page 128)





Everything you need to know about the varieties of surround sound, in the theater and at home.

# ALL ABOUT SURROUND SOUND

JOSEF BERNARD

"MOVIES ARE BETTER THAN EVER!" screamed the advertising banners in the middle of the 1950's as theatrical audiences dwindled and stay-at-home TV audiences grew. Hollywood tried everything it could think of to maintain its hold on the vanishing moviegoer: Cinerama, 3-D, CinemaScope, VistaVision, Todd-AO, six-track stereo sound, eight-track stereo sound, Smell-O-Vision (no kidding!), and other schemes now better forgotten. One or two of the concepts and techniques that were introduced during that period proved to have some worth and they or their descendants are with us still today. The stereo and surround sound we enjoy from our audio and video equipment at home are among the benefits that have been derived, at least in part, from the motion picture industry's frantic '50's efforts.

## Early attempts

Of the early efforts to provide realistic sound in a theatrical environment, perhaps the best remembered (if it is remembered at all) is Walt

Disney Studios' *Fantasound*, a fourteen-track process that was used for Leopold Stokowski's orchestral accompaniment to 1940's animated *Fantasia*. Each member of an array of microphones spread out before the orchestra picked up the sound emanating from its region. The signal from each mike was recorded on its own soundtrack and during playback was reproduced by a speaker positioned behind the screen in a location corresponding to that of the mike during recording. The effect was a realistic spread of the orchestra before the theatrical audience.

With the cinematic wide-screen spectaculars of the '50's came multi-track stereophonic—actually, surround—sound. Mike Todd's wide-screen extravaganza *Around the World in 80 Days* included such effects as a train (with the theatergoer as passenger) crossing a rickety old bridge; you could hear the steam engine in front of you and the clickety-

clack of the wheels on the rails being reflected from the girders of the bridge on either side of you as you passed them. Wow!

At home, in the late '50's and early '60's, record players (there weren't many audiophiles with turntables back then) and a very few tape recorders went stereophonic. By that time it had been realized that a more-or-less convincing soundstage could be recreated in front of the listener from just two channels of sound, one carrying left-ear information and the other carrying that for the right ear. The term "binaural" was sometimes used in place of "stereophonic," but its use soon became reserved for a specific method for stereophonic recording and listening, one with which most people did not wish to become involved because of its inconvenience.

The binaural technique, which enjoys a very limited—but extremely spirited—popularity today requires special recording techniques, and

binaural recordings must properly be auditioned through earphones. Only two microphones are used. The idea is to reproduce as closely as possible the sound of a performance (or environment) as it is perceived by the ear. To this end, binaural recording techniques have used models of the human head (and ear) fitted with microphones (see Fig. 1), and even microphone mounts that were affixed to real, live, human heads. When prepared properly and with care, a binaural recording can provide the listener with a surround sound experience that includes not only front, sides and rear, but up and down as well. Earphones must be used to deliver the sound directly to the ear and preserve the phase relationships of the signal as recorded.

In the late 1970's, home discophiles could have their choice of two systems for four-channel recordings (SQ and QS), with two speakers in front and two behind (see Fig. 2). Both used matrixing systems to encode the quadraphonic (sometimes spelled "quadriphonic") signals on black vinyl records, and required new designs in cartridges and styli to retrieve the signals from the record grooves. The two systems offered to the public were incompatible and that, together with a surfeit of gimmicky recordings similar to the "Ping-Pong Stereo" ones that fortunately disappeared quickly from the two-channel scene, caused the quadraphonic movement to founder and sink with only a few diehard survivors left today. There weren't many people who wanted to listen to the Tijuana Brass while sitting right smack in the middle of the band; maybe just a few frustrated horn players.

### Extracting ambience

After the failure of quadraphony, the place and purpose of surround sound were reexamined and it was decided that, for the most part, audio channels in addition to the front two conventionally used for stereo should be subordinate to them. It would be OK to have more than two channels, but the main audio information should come from in front of the listener and the secondary channels used more to provide a feeling of ambience—to recreate the original (or a simulated) recording environment.

In the 1970's, a simple way to recover ambience information from



**FIG. 1—IN TRUE BINAURAL RECORDING, a mechanical replica of the human head and ears ensures the proper capture of phase relationships. This is the MKE 2002 binaural dummy-head stereo-microphone setup from Sennheiser. To hear the special stereo effects, the recording must be listened to with high-quality headphones.**

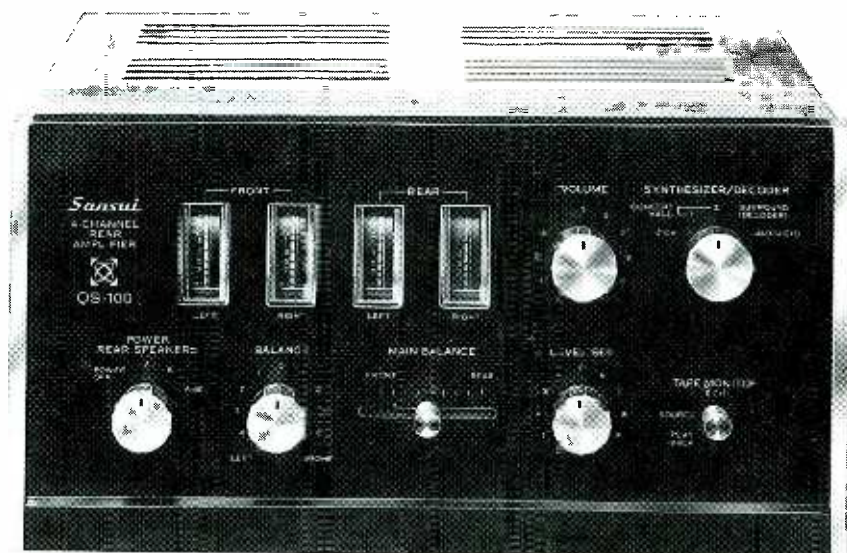

**FIG. 2—THE QS-100 4-CHANNEL Converter/Synthesizer/Amplifier from Sansui. This is an example of a quadraphonic amplifier in the QS format.**

conventional stereo recordings was proposed. That ambience information—which consists largely of sounds from outside the soundstage located between the stereo microphones (assuming, for the sake of simplicity, that just two are used)—may simply be sound reflected from the walls and ceiling of a concert hall, or it may come from sources such as

instruments positioned intentionally outside the bounds of the soundstage, as illustrated in Fig. 3. One of the ways that the ear pinpoints sound sources is by determining phase relationships. If, for example, the sound waves heard from a pair of speakers by the left and right ears are in phase, the sound source is perceived as being between the two speakers. If the



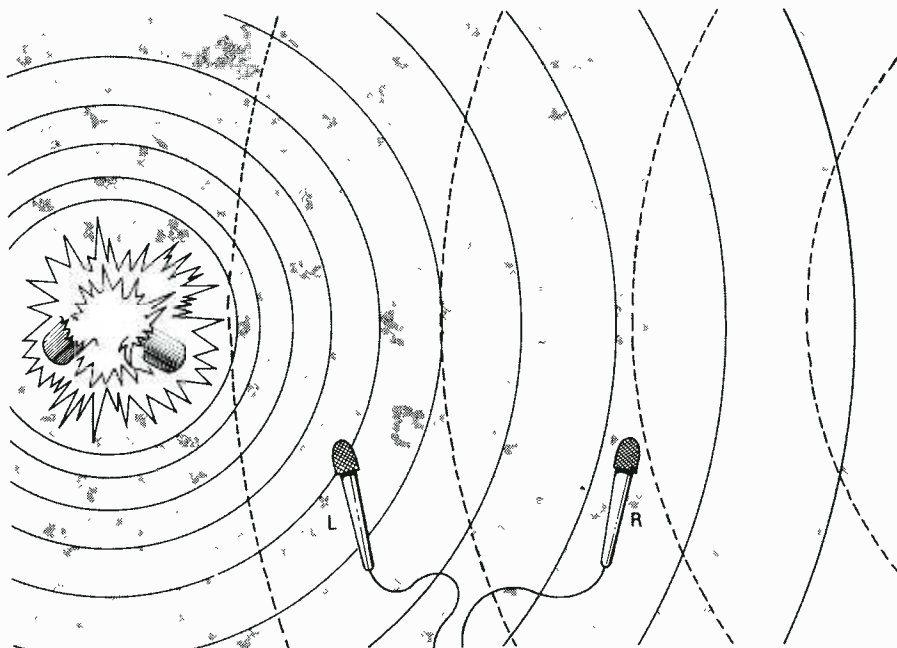

FIG. 3—AMBIENCE INFORMATION recorded as a left-minus-right difference signal can be used to expand a soundstage and even to localize sounds coming from beyond the bounds set by the locations of the microphones or speakers.

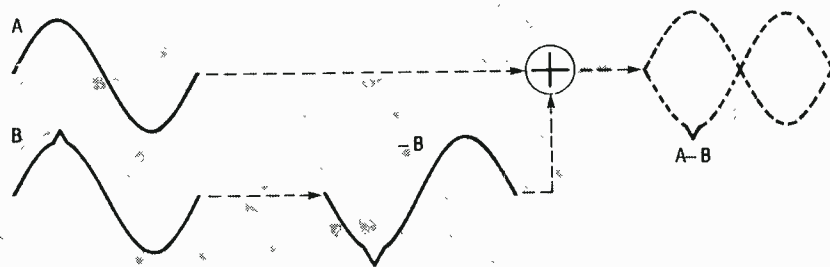

FIG. 4—BY INVERTING THE POLARITY of one of a pair of signals and then summing the two, you can obtain the difference between them.

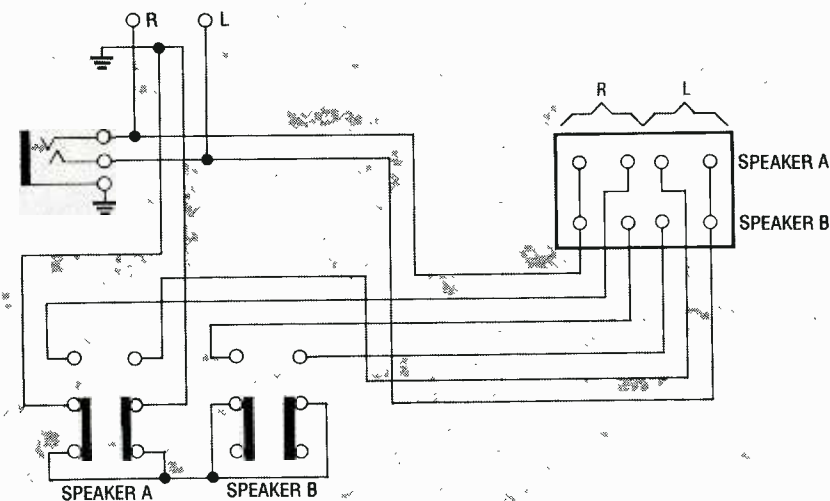

FIG. 5—THE MATRIX SURROUND CIRCUIT used in receivers such as Teac's AG-75 extracts ambience information from a pair of stereo signals by finding the difference between them.

waves are out of phase, the sound seems to come from "beyond" the speakers, and some recordings intentionally include out-of-phase material

to provide special auditory effects.

Out-of-phase information can be described mathematically as the difference between the left and right sig-

nals, or  $L-R$ . The relationship between an "L" waveform and an "R" one is depicted in Fig. 4. By inverting the phase of the right signal—thereby creating a " $-R$ " one—and adding that signal to the normal "L" one, the " $L-R$ " difference signal representing ambience information is obtained. By connecting a third (ambience channel) speaker between the "hot" speaker terminals of a stereo amplifier, an  $L-R$  signal is obtained and reproduced through that speaker. If you place the speaker behind you, and adjust its volume so that it's unobtrusive, recordings that contain a goodly amount of natural ambience material will take on a spaciousness that can make you feel a lot more like you're listening to a performance in a real performance environment rather than your living room.

### Matrix surround sound

A number of today's stereo receivers include a feature called "matrix surround sound," or just "matrix surround," the "sound" having disappeared somewhere. The term "matrix" refers to the way the signals are combined to obtain the "surround" signal. The process is a passive one—there is no special encoding or decoding matrixing circuitry used. Figure 5 shows a circuit used in one matrix-surround receiver. When the A SPEAKERS button is engaged, normal stereo sound is heard from the speakers connected to the A terminals; when the B SPEAKERS switch is closed, the output of the amplifier is fed to a second set. When both switches are closed, the A speakers reproduce the normal stereo signal; what goes to the B's speakers, however, is now the difference between the left- and right-channel signals. It turns out that matrix surround is nothing more than a "ready-to-use" version of the "third channel" ambience system described above. Place the B speakers behind you, and you have an ambience synthesizer. You also get a free surprise, which is a subject to which we'll return.

Some sound equipment also boasts a "Hall Surround" mode. While there is definitely a Ray Dolby involved in Dolby Surround (see below), there is no Mr. Hall of the same prominence involved in audio processing. The term "hall" refers simply to a large room (as a concert hall); presumably time delay or reverb effects are added

to the rear channel sound to give a feeling of spaciousness.

### Sonic holography

In photography, holography is a process that yields three-dimensional images from a single piece of film without the need for special viewing apparatus (as opposed to the older method that requires a separate picture for each eye—the system used, for example, by View Master reels). Sonic holography produces a sonic image having depth, and a degree of surround effect, using just a pair of stereo speakers.

Sonic Holography, which is a technique patented by Carver Corporation, works on the principle that when we listen to a pair of stereo speakers the phase relationships contained in the recorded or broadcast material are muddled by right-channel sound "leaking" to the left ear, and left-channel sound similarly showing up at the right. What the process does (see Fig. 6) is to inject some degree of out-of-phase right-channel information into the left-channel signal (and vice-versa). If that is done with the right time delay, the out-of-phase right-channel signal mixed with the left-channel one will arrive at the ear at the same time as the right-speaker "leakage" does, and the in-phase and out-of-phase signals will cancel one another. What's left will be pure left- and right-channel sound as engineered, providing a sense of depth and expanse otherwise impossible in a two-speaker system.

Material that contains a lot of natural or synthetic L-R information can

be astonishing when heard through a sonic-holography system. The soundstage appears to extend far beyond the backs of the speakers—indeed, the speakers almost seem to disappear—and "offstage" sounds often seem to originate from places far beyond the left-right bounds of the conventional stereo soundstage.

The original Carver sonic holography process requires some effort to make it work at its best. Speaker positioning is extremely critical to the effect, and speaker-to-listener distances must be measured extremely carefully, and the corresponding left and right ones matched to within an inch or so of one another. The benefits of sonic holography also are restricted to only one or two listeners at a time. The effect is heard only from a highly sensitive "sweet spot," and moving just a foot or so out of it destroys the illusion.

In some of its equipment Carver now offers what it calls a Precognition Matrix, which is intended to broaden the sonic-holograph soundstage created from motion picture soundtracks. The precognition circuitry works by detecting the (normally inaudible to the ear) rise in noise-floor level when additional tracks are mixed into the stereo master. By changing the mix of left and minus-right-channel information, the apparent soundstage can be widened dynamically to follow that of the material being reproduced, allowing more listeners to benefit from the sonic holography process. Because the change in noise-floor level occurs several milliseconds before the actual

onset of the new audio material, the processor can respond without missing a note of music or other material.

For those who want everything (or nearly everything), Carver also produces an AM/FM stereo receiver that incorporates both Sonic Holography and Dolby Pro Logic Surround, which will be discussed below.

### Other two-speaker systems

There are several other single-ended systems that attempt to recreate a measure of ambience from just the information contained in the two channels of an ordinary stereo signal.

The system that seems to have attracted the most attention of late is the SRS system developed by Hughes Aircraft and licensed by Sony for use in some of its television receivers. Basically, the process extracts the L-R ambience information and processes it through frequency, timing, and phase adjustments to simulate the way the recorded information would have been perceived by the human ear. The effect is an artificial analog of the binaural process described earlier, using loudspeakers instead of earphones. The Hughes SRS system is described in detail in the September 1989 issue of **Radio-Electronics**.

Most "simple" surround systems, though, are just variations—and minor ones, at that—of the L-R matrix process. Sometimes the term "digital" gets thrown in, but the digital portion of these processes often has to do just with creating the out-of-phase L-R signal, and maybe adding some time delay for increased "spaciousness."

### Dolby Stereo

Although it has been in use since 1975, Dolby Stereo, one of a number of audio processes to come from the laboratories headed by Ray Dolby, first came to national cinematic attention with George Lucas' *Star Wars* in 1977. Anyone who's seen the full-blown version of that film will never forget the opening scene, where the massive battle cruiser looms onto the screen, appearing—to both eye and ear—to come from behind and above the theatergoer. What an introduction to Dolby Stereo!

Movies with stereo soundtracks—most of them musicals—were not rarities prior to that, but the Dolby process added one or two things to mere lateral directionality. The first

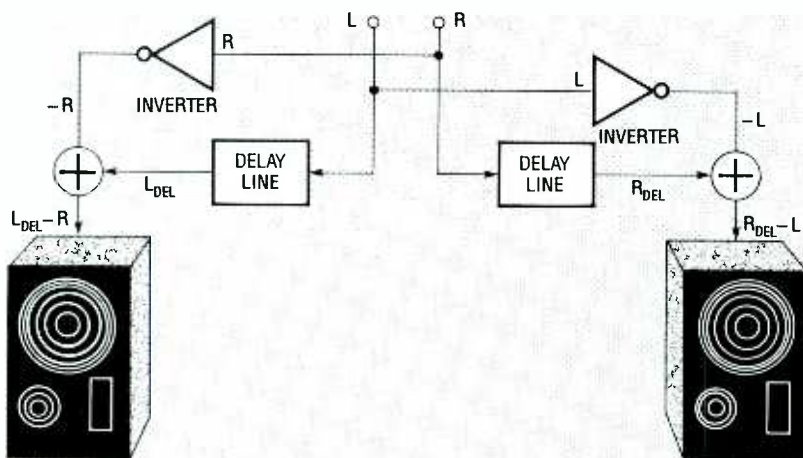

FIG. 6—CARVER'S SONIC HOLOGRAPHY process compensates for signal "muddying" that occurs during ordinary stereo reproduction by using signal cancellation techniques.



was Dolby A noise reduction, which (as you'll know if you ever heard the *Star Wars* soundtrack cranked way up, as it was in most theaters) gave optical-soundtrack sound a much greater dynamic range than it had enjoyed before. The second, and perhaps more significant from an entertainment point of view, benefit of Dolby Stereo was that it added, in a rather elegant and easy-to-achieve manner, *true* stereo. That is, the sound field, which had previously been zero-dimensional (monophonic) or one-dimensional (conventional stereo), now took on another dimension and gained front-to-back depth as well. The word "stereo" derives from the Greek word meaning "solid," and with Dolby Stereo, movie sound fields took on solidity.

Although there is a six-track version of Dolby Stereo, in which each soundtrack carries discrete (non-matrixed) information for a single output channel, the process used for most theatrical releases requires only two tracks. With the Dolby process, those two tracks can provide up to four channels of sound. Figure 7 shows how Dolby Stereo works. The left and right channels contain the usual left- and right-channel information; a movie theater without a Dolby Stereo decoder (or a home videotape viewer using just a stereo VCR) would perceive a nearly-normal left- and right-channel soundtrack. (With only monophonic facilities, the two channels would be mixed to produce a single composite output.) With a Dolby decoder, though, two more channels of sound become available. The first is a front-center channel. This is a mixture of the left- and right-channel signals—a composite mono signal in effect—that fills in the audio "hole" that might be perceived by a moviegoer sitting close to the center of a wide screen.

The really interesting part of a Dolby Stereo soundtrack, though, is the fourth, surround, channel. It is encoded on the stereo tracks as "L-R." "Wait a minute!" you say. "That's the same information that you can extract from ordinary stereo for a matrix-surround rear channel system. What's the big deal?" The big deal, it turns out, is in *what* information is encoded in that difference signal. Matrix surround uses natural, or at least natural-sounding, ambience information. What the Dolby process uses is

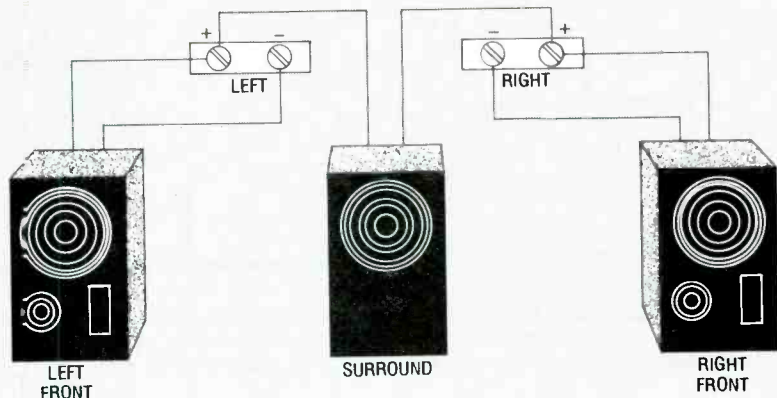

### DOLBY SURROUND

Once you know how Dolby Surround information is encoded on a stereo soundtrack—namely in the form of an L-R difference signal—it is easy to extract it. While surround decoders bearing the Dolby "double-D" logo contain extra circuitry to provide such things as bandpass filtering and Dolby-B noise-reduction decoding, you can have surround sound—using the Dolby-encoded information—from your stereo VCR or other stereo source such as an over-the-air or cable broadcasts of films containing surround-encoded material for about \$25—including the cost of the speaker!

The easiest method to reproduce the L-R "surround" signal, whether it contains natural ambience information or Dolby Surround programming, is simply to subtract the right-channel signal from the left-channel one at the speaker terminals. You can do that by connecting a speaker, which will become your rear surround speaker, between the two positive ("+") speaker terminals as shown in the figure. Signals common to both channels will not be reproduced (or will be reproduced at a reduced level), but the differences between the two—the L-R information—will. Since that is exactly what the Dolby process uses, the third speaker reproducing that signal will become the surround device.

The process is not perfect (otherwise there would be no market for the more complex and expensive de-

VICES being sold as Dolby Surround decoders), but it will give you pretty amazing results from good material at a rock-bottom price.

If you connect the surround speaker directly to your amplifier's usual speaker-output terminals, you should use an L-pad in the line to let you control the level, and thereby the balance, of the surround effect sound. You don't want the effect to be overwhelming; most of the time there should be so little of it that you're not aware it's there, although if you were to eliminate it suddenly you would be struck by its absence as the sound-field collapsed.

Be careful when adding a third speaker to your system in that way. Putting the impedance of the extra speaker across that of the other two will change the impedance of the entire system, and may reduce it below the minimum impedance recommended for your amplifier. At very low output levels that may not matter, but at higher ones it can put an unacceptable strain on the amp.

A slightly more complex way, but one reeking less of brute-force, to obtain surround sound using that method would be to mix the line-level signals from a pair of your amplifier's tape output jacks in the same way you would combine the speaker-output ones—by using the two inner conductors of the TAPE OUT cables—and feed that signal to a separate small mono amp driving the surround speaker.

R-E

much more controlled. However, for the curious, a method for obtaining a surround effect from Dolby-encoded material without the use of a decoder is described in the box above. It's primitive, but effective.

Cinematic sound is an extremely artificial medium—even such a simple effect as the sound of an actor's footsteps as he walks from one side of a scene to the other is much more easily created on an engineering con-

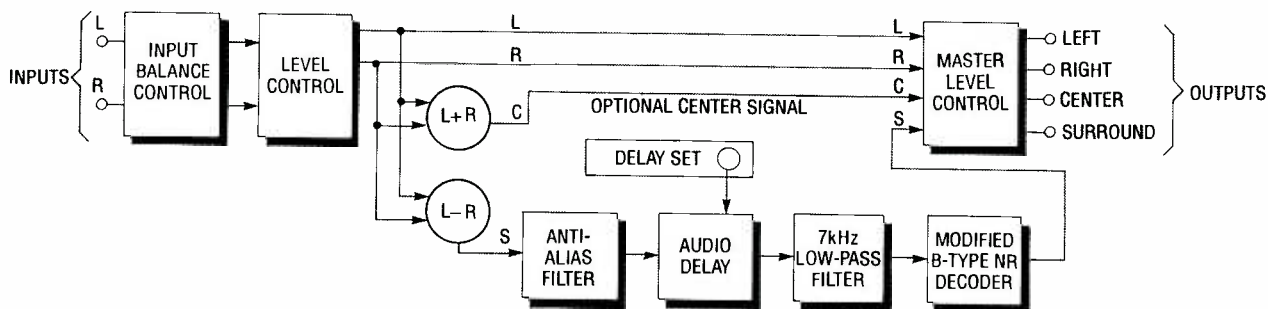

FIG. 7—THEATRICAL DOLBY STEREO encodes four channels of sound on two soundtracks. The Dolby decoder derives a center channel by summing the left and right channels, and surround information by subtracting the right from the left.

sole with a couple of pan pots than on the soundstage during filming. Most of a film's soundtrack is realized in post-production—and that tightly controlled environment makes it relatively easy to put on the surround track exactly what is wanted, without having to rely on natural material.

If you listen carefully to a plain stereo playback of a Dolby Stereo soundtrack, you can frequently detect the presence of the surround effects—they appear to come from outside the speakers' soundstage, the way out-of-phase ambience information may. That is clearly evident in a film such as *Back to the Future*, when the time-travelling DeLorean comes *swooshing* toward or away from the camera. If all four channels of sound are reproduced, you hear the car moving from front to rear, or vice-versa. In plain-vanilla stereo, though, you can plainly hear the car noises coming from the far-left and far-right—off-stage, as it were.

In creating an L - R surround signal, the Dolby Stereo process does two things. The first is to cut off the rear-channel signal at 7 kHz. That is done for several reasons. The first has to do with eliminating signal leakage and distracting crosstalk from the surround channel. Another big reason has to do with economy. There is no need for high fidelity in a surround channel—most of the time the sound there is for "presence"—that is, you are only unconsciously aware of it. The track is meant to be unobtrusive, not to have you constantly aware of its presence. It's only if the surround channel suddenly fails that you should become consciously aware of its presence (or absence).

That limited frequency response is the reason behind those cheap-looking, PA-type speakers you may have

noted in movie theaters equipped for Dolby Surround. It's not that the theater-owner is a cheapskate; simply that there is nothing on the surround track to justify the expense of a better speaker. As far as low frequencies go—the rumble of the engines of the Empire spaceship, for example—they are carried as ordinary left and right information. Since your ears cannot determine where frequencies below about 120 Hz originate, they can be reproduced from low-frequency drivers located anywhere. The visual content of the film will cue you as to where the sound is supposed to be coming from.

The second thing that is done to the rear-channel signal is to encode it using a modified form of Dolby B noise reduction. The modification consists of adding only five dB of processing instead of the normal ten dB. The use of Dolby B provides a degree of noise reduction and assists in reducing front-channel signal leakage, while the low level of processing prevents the encoded surround signal from significantly altering the nature of the left- and right-channel signals heard up front.

In the decoding process, a third element is added to Dolby Stereo: time delay. A delay of between 15 and 30 ms is added to the rear-channel signal to take advantage of a phenomenon known as the Haas effect. The Haas effect causes the mind to identify the source of a sound as that from which it is first heard and to ignore the same sound arriving later at the ear. That "first arrival" effect ensures that front-channel sounds are clearly identified as originating from before the viewer, even if they also come from behind him to some extent. Dolby Stereo decoders also make use of steering logic, discussed

below, to add further directionality to the decoded soundtrack.

Before leaving the theatrical Dolby Process, we should mention one called "THX." THX is a trademark owned by George Lucas' Lucasfilm (the name has its origin in the title of Lucas' first feature-length work, a science-fiction film called *THX-1138*). THX offers a "guaranteed minimum" quality of sound in a particular theater from an ordinary Dolby Stereo soundtrack. THX engineers install and adjust the sound-reproduction equipment in a "THX" theater to meet specific standards of performance. In a THX theater, you can listen to the soundtrack on essentially the same system that the sound was mixed on. However, THX will do nothing for you at home.

### Dolby Surround and Pro Logic

Dolby Surround is the name given to one of the two home versions of Dolby Stereo. It starts with the same two stereo soundtracks that are on the film (now on longitudinal or Hi-Fi tracks on a videocassette). And, as is done in theatrical installations, the surround channel is dematrixed, Dolby-B decoded, and time delayed before being amplified and fed to a pair of rear speakers. Only one surround speaker is actually necessary, but two—reproducing the same surround signal—give a "fuller" effect. To derive a monophonic center channel, useful in preventing a center "hole" when the left and right speakers are widely separated, some Dolby Surround decoders mix the left- and right track information. That is not, strictly speaking, necessary, since center information appears equally on both tracks and can be heard appearing from a "phantom" speaker situated



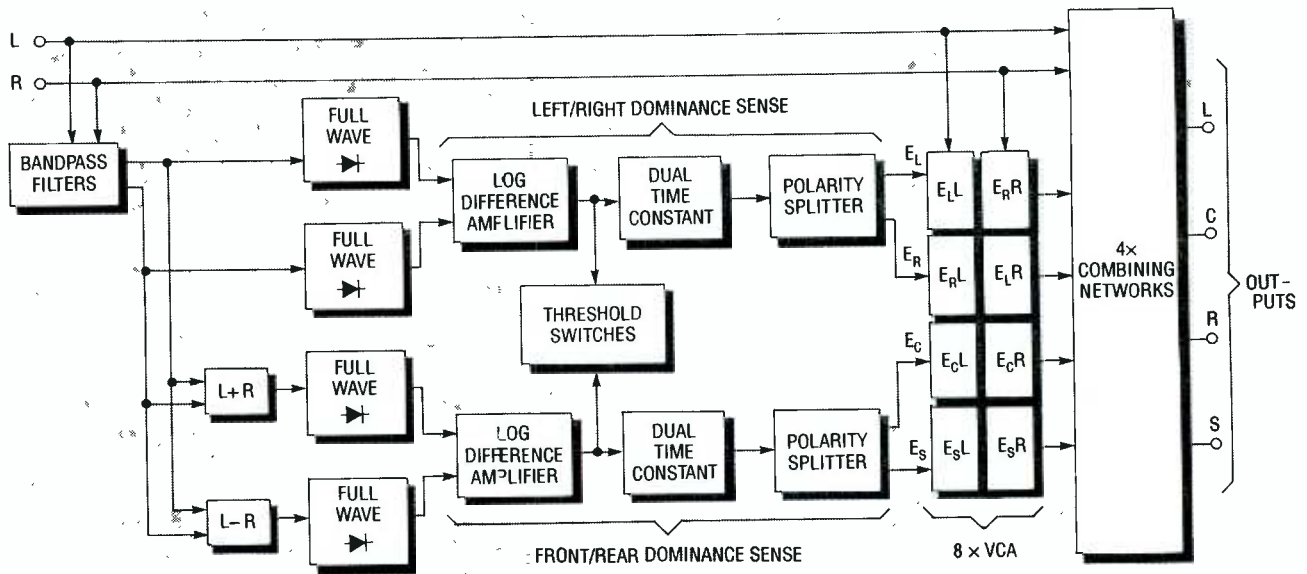

FIG. 8—THE ADAPTIVE MATRIX used in the Dolby Pro Logic Surround process can provide up to 30 dB of separation between opposite or adjacent channels. That affords an extremely high degree of directionality.

between the two front ones. A few Dolby Surround processors can also output a front-and-back mix to side speakers. Finally, most processors on the market also feature a subwoofer output. That has nothing to do with the Dolby process; it's more a convenience than anything else.

Dolby Pro Logic Surround is the ultimate in Dolby Surround processing. While the original Dolby Surround process is primarily a passive one (all the equipment does, essentially, is decode the matrixed information), Pro Logic decoders contain active circuits that provide a surround effect as good as—if not better than—that in the best movie theater. The active addition to a Dolby Pro Logic decoder is known as steering logic.

The purpose of the steering logic circuitry in a Dolby Pro Logic decoder is to sense the direction of soundtrack dominance—that is, to determine from what direction the loudest sound on the track seems to originate—and to generate control signals that increase gain in the appropriate (left, right, center, surround) combination of channels to give a directional vector. Figure 8 illustrates the workings of the adaptive matrix within a Pro Logic decoder. By comparing the left and right and center and surround signal pairs, and taking the logarithms of their values (logarithms are used, in part, because human senses work in a logarithmic rather than linear fashion), a pair of

bipolar control signals is generated, which are used to adjust the gain of eight voltage-controlled amplifiers (four for each input channel). The outputs of those VCA's, together with the original left- and right-channel signals, provide a total of ten control signals. When those signals are applied to the four output channels, a total of forty summed directional components are available. Separation between any pair of channels—adjacent or opposite—is 30 dB, compared to Dolby Surround's 3 dB of adjacent separation, and 40 dB of opposite separation.

Pro Logic decoders are two-speed devices. When only one sound source is dominant, they run in their "slow" mode. But when there are two distinct sound sources (by definition, only one can be "dominant" at a time), the Pro Logic circuitry goes into a "fast,"

time-division multiplexing mode where it gives its attention first to one source, and then to the other. It switches back and forth between the two so quickly that its efforts are unnoticed by the listener.

Dolby Pro Logic decoders include as a matter of course center-channel and subwoofer outputs. As is the case with the surround channel, the center-channel amplifier and speaker need not have the frequency response of the equipment used for the left and right channels. High- and low frequencies will be reproduced by those systems and by the subwoofer, if one is used. With a good-quality hi-fi-soundtrack videotape, and with even a modest array of home sound equipment, you can experience a quality of cinematic sound at home that you would be hard-pressed to find in any theatrical environment.

R-E



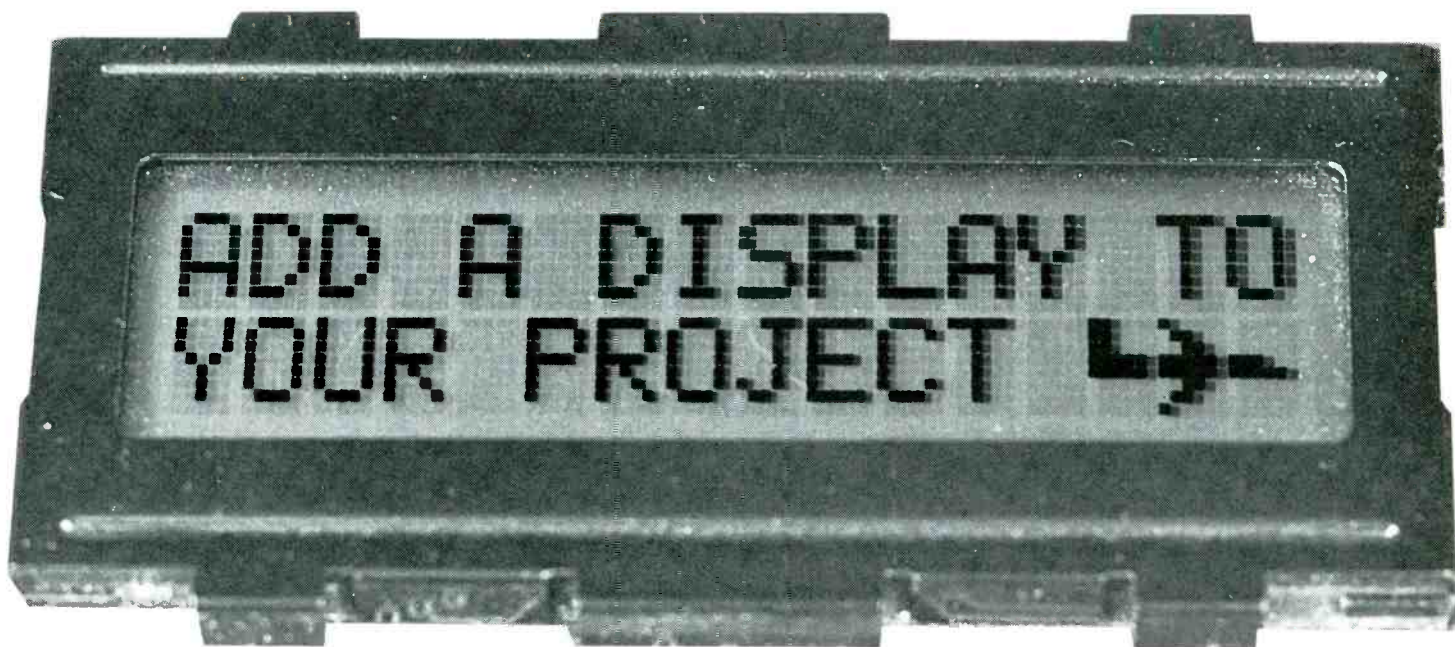

*The days of LED indicators and segmented displays are numbered. Now you can add an alpha-numeric LCD to your home project easily and inexpensively.*

**STEVEN AVRITCH**

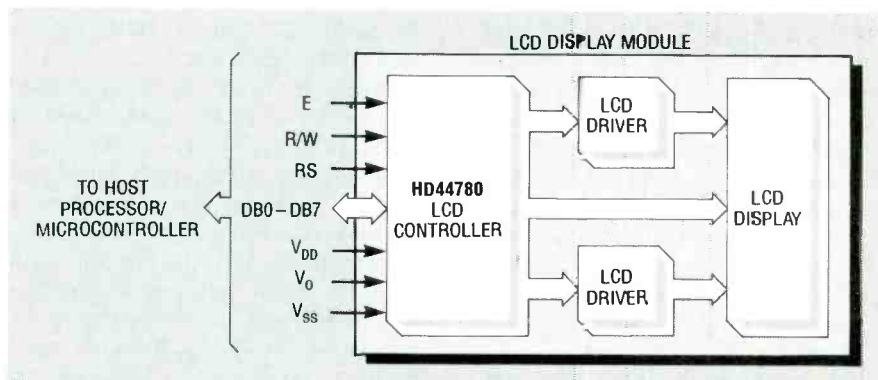

**FIG. 1—MOST SMALL LCD MODULES use the Hitachi HD44780 LCD controller chip.**

HAVE YOU EVER AVOIDED A PROJECT BECAUSE it required a display that could handle numbers, letters, and symbols? Have you ever given up on a project because the display had to be at least 10, 20, maybe even 40 characters long?

You can solve all of those problems by using a simple and inexpensive alpha-numeric LCD module which contains a controller chip that does most of the work for you! This article will show you how to use LCD's with a simple microcontroller- or micro-

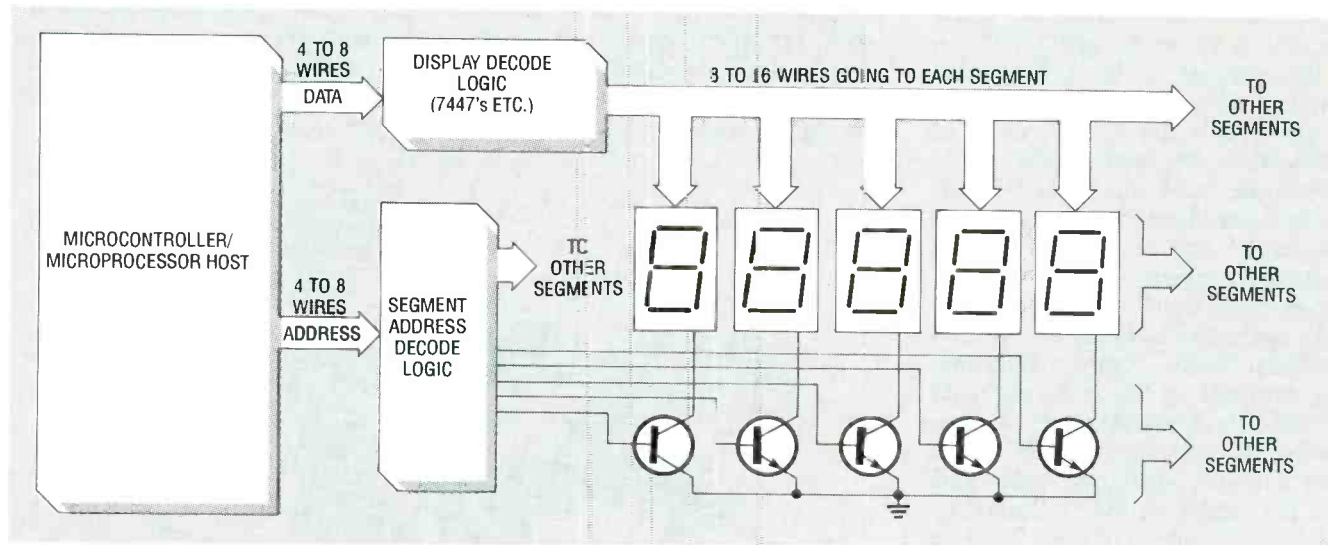

**FIG. 2—MULTIPLEXING REQUIRES the microprocessor to continually update the display, and the amount of external wiring must be increased as additional digits are added.**



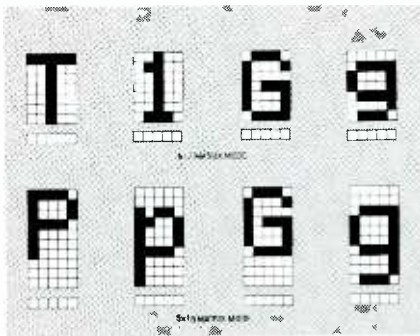

FIG. 3—HERE ARE SOME EXAMPLES OF letters formed using the 5×7 and 5×10 dot-matrix formats.

processor-based design. Note that most small LCD modules use the Hitachi HD44780 LCD controller chip (see block diagram in Fig. 1). This article will therefore be limited to a discussion of LCD modules that use, or are compatible with, the HD44780 controller format. Common LCD modules include those manufactured by Optrex, Epson, Hitachi, Amperex, and Densitron.

Multi-character readouts are usually constructed using individually wired, multiplexed display segments. The host microprocessor sequentially flashes the desired character on each digit of the display, one at a time. The microprocessor is fast enough so that the naked eye sees the display as it should appear. That method of multiplexing the digits of a display is often used because it reduces the amount of external hardware required compared to non-multiplexed systems. However, multiplexing requires the microprocessor to continually update the display, and the amount of external wiring must be increased as additional digits are added (see Fig. 2).

For example, a 10-digit numeric display requires approximately 100 wires and over 20 components. (A 10-digit alpha-numeric display requires even more wires.) The equivalent display (including alpha-nums) implemented with an LCD module would require only 10 wires and 2 components: the LCD module and a potentiometer for contrast control. Using an LCD module, a designer can add a display containing up to 80 characters with as little as 10 wires, 7 of which connect the display module to the host microcontroller/processor, plus 1 power, 1 ground, and 1 LCD drive wire for contrast control. That's all!

The software interface between the host and the display module is just as

simple as the wiring. The display modules automatically handle all refresh and multiplexing functions. The host needs only to write the data to be displayed and a few control codes (such as display on, display off, scroll left, scroll right, etc.) to the module; the on-board LCD controller chip does the rest.

LCD modules have not been used heavily in the past because of their

high costs. However, the cost of the modules has since dropped considerably, and they are now commonly found in many of the popular electronics supply houses. For example, a 32-character display (2 lines, 16 characters per line, 16×2) is available from Digi-Key for approximately \$23. Similar displays can be obtained through surplus houses for approximately \$8–\$10.

#### LISTING 1

```

DISLET      STX     TEMPX      SAVE INDEX REGISTER
            STA     PORTA      PUT CHARACTER ON BUS
            BCLR   1,PORTB     SET R/W TO WRITE
            BSET   2,PORTB     SET RS TO DATA
            BSET   0,PORTB     TURN ON ENABLE
            BCLR   0,PORTB     TURN OFF ENABLE
            BCLR   2,PORTB     SET RS TO CONTROL
            LDX     #S20
            DELAY1  DELAY1     DELAY 120 us
            BNE     DELAY1     ASSUMING 1 us
            LDX     TEMPX      RESTORE INDEX REGISTER
            RTS
    
```

#### LISTING 2

```

CONTROL     STX     TEMPX      SAVE INDEX REGISTER
            STA     PORTA      PUT CONTROL CODE ON BUS
            BCLR   1,PORTB     SET R/W TO WRITE
            BCLR   2,PORTB     SET RS TO CONTROL
            BSET   0,PORTB     TURN ENABLE ON
            BCLR   0,PORTB     TURN ENABLE OFF
            LDX     #SFF
            DELAY2  DELAY2     DELAY FOR CONTROL
            BNE     DELAY2     DELAY 4
            CMP     #S02
            BHI     DELAY4
            JSR     ENDCNTL
            DECX
            DELAY3  DELAY3     RESTORE INDEX REGISTER
            LDX     TEMPX      RETURN
            ENDCNTL  RTS
    
```

#### LISTING 3

```

INIT        LDA     #S01      CLEAR DISPLAY
            JSR     CONTROL
            LDA     #S02      RETURN DISPLAY TO HOME POSITION
            JSR     CONTROL
            LDA     #S38      SET UP FOR 2 LINES, 8 BIT INTERFACE,
            JSR     CONTROL      AND 5X7 MATRIX FORMAT
            LDA     #S06      SET UP FOR CURSOR SHIFT WITH DATA WRITE
            JSR     CONTROL
            LDA     #S0C      SET UP FOR DISPLAY ON, CURSOR OFF,
            JSR     CONTROL      NO STEADY CURSOR (NO BLINK)
            RTS
    
```

#### LISTING 4

```

CGINIT     LDA     #S40      SET UP FOR WRITES TO CG RAM
            JSR     CONTROL
            CLR     DATCNT     CLEAR BYTE COUNTER
            LDX     DATCNT     LOAD BYTE COUNTER
            LDA     PLANE,X     LOAD CG RAM DATA INTO ACCUMULATOR
            JSR     DISLET     WRITE BYTE TO CG RAM
            INC     DATCNT     INCREMENT COUNTER FOR NEXT BYTE
            LDA     DATCNT
            CMP     #24
            BNE     NEXT
            LDA     #S80      SET UP FOR WRITES TO DD RAM
            JSR     CONTROL
            LDA     #S02      INITIALIZE DISPLAY TO HOME POSITION
            JSR     CONTROL
            RTS
    
```

TABLE 1—CONTROL OPERATIONS

Instruction	RS	R/W	DB7	DB6	DB5	DB4	DB3	DB2	DB1	DB0	Description and execution time
Clear	0	0	0	0	0	0	0	0	0	1	Clears Display Returns cursor to home position (1.64 ms)
Home	0	0	0	0	0	0	0	0	1	X	Return cursor to home position Return shifted display to home position (40 μs)
Mode	0	0	0	0	0	0	0	1	I/D	S	Control automatic RAM address INC/DEC and whether display shifts on writes (40 μs)
Display ON/OFF	0	0	0	0	0	0	1	D	C	B	Controls display ON/OFF Controls cursor ON/OFF Cursor blink ON/OFF (40 μs)
Cursor or display shift	0	0	0	0	0	1	S/C	R/L	X	X	Shifts cursor and/or display without changing display RAM (40 μs)
Function set	0	0	0	0	1	D/L	N	F	X	X	Set interface to 4 or 8 bits Set number of display lines Sets character font (40 μs)
Set CG RAM address	0	0	0	1	Address (CG)					Set address for subsequent writes to character generator. (CG) RAM. (40 μs)	
Set DD RAM address	0	0	1	Address (DD)					Set address for subsequent writes to display (DD) RAM (40 μs)		
Read busy flag & address	0	1	BF	Address Counter					Read status of busy flag (BF) and present address counter value (1 μs)		
Write data to CG or DD RAM	1	0	Data to be written to DD or CG RAM. DD/CG destination based on last "set DD/CG RAM address" control command					Writes data to HD44780 (40 μs)			
Read data from CG or DD RAM	1	1	Data read from DD or CG RAM. Source of data (CG or DD) based on last "set DD/CG RAM address" control command					Reads data from HD44780 (40 μs)			

I/D = 1: Increment address pointer on each subsequent read/write  
0: Decrement address pointer on each subsequent read/write

2 = 1: Shift cursor with display  
0: Hold cursor fixed

S/C = 1: Shift display (without changing DD RAM)  
0: Shift cursor only

R/L = 1: Shift operations occur to the right  
0: Shift operations occur to the left

DL = 1: 8-bit data-bus interface  
0: 4-bit data-bus interface

N = 1: 2-line display  
0: 1-line display

F = 1: 5 × 10 dot character font  
0: 5 × 7 dot character font

BF = 1: Busy  
0: Not busy

Most of the small, inexpensive LCD modules contain a Hitachi HD44780 LCD Controller chip. That means that most of LCD modules follow the same standard format, have the same 14-pin interface, and are therefore compatible and interchangeable. The HD44780 is capable of controlling any size display up to 2 lines long and 40 characters wide with the same hardware interface. Commonly available display sizes include 16 × 1, 16 × 2, 20 × 2, 24 × 2, and 40 × 2 formats. That means that you can change the size of your display by simply plugging in a larger module. No other hardware modifications are required; only the software drivers specific to the application would need to change.

The LCD modules recognize standard ASCII code for letters (upper and lower case) and numbers in addition to a variety of symbols including ?, !, \$AK, %, and ', just to name a

few. In all, the LCD module supports 192 alpha-numeric characters and 32 special symbols. The modules also

LISTING 5

PLANE	FCB	\$00
	FCB	\$00
	FCB	\$00
	FCB	\$00
	FCB	\$1C
	FCB	\$1F
	FCB	\$00
	FCB	\$00
	FCB	\$00
	FCB	\$10
	FCB	\$10
	FCB	\$0C
	FCB	\$06
	FCB	\$1F
	FCB	\$1F
	FCB	\$06
	FCB	\$0C
	FCB	\$10
	FCB	\$18
	FCB	\$18
	FCB	\$18
	FCB	\$1F
	FCB	\$1F
	FCB	\$00
	FCB	\$00
	FCB	\$00

allow you to customize up to 8 user-defined characters of your own. On one home project the author customized three characters that, when displayed together, formed an airplane as can be seen in the photo.

The LCD modules are dot-matrix type displays with each character being formed from a 5-dot-wide by 7-dot-high block (5 × 7 font) or a 5-dot-wide by 10-dot-high block (5 × 10 font). The font is selected by issuing a control command as discussed later in this article.

There is also a cursor line under each character. The 5 × 10 font is better suited for certain lower-case letters such as g, y, and p (i.e. letters with descenders that go below the line that they're written on). Figure 3 shows examples of letters formed using the 5 × 7 and 5 × 10 dot-matrix formats for comparison. It should be noted that the 5 × 10 matrix font limits the display to one line regardless of whether the LCD module is a one-line or two-line display.

Features of LCD modules

The LCD modules support a variety a display features that can accommodate just about any application. The following is a brief description of their features:

- Display on/off—allows the user to turn the display on and off from the host processor.
- Cursor on/off—user may select to display the cursor or suppress it.
- Cursor blink—the user may select a steady cursor or a blinking cursor. The character above the cursor also blinks.
- Scroll left/right—scrolls the data on the display.
- Return home—returns the cursor to the home position (address 0) and returns the display to the original position (if it had been previously scrolled)

Software interface

The software interface between the LCD module and a processor or microcontroller is relatively simple. There are two basic types of software operations: control operations (i.e. display on/off, cursor blink/noblink, etc.) and data operations. The control operations set up the features of the display, while the data operations write the actual data to be displayed to the LCD module.

The LCD module's on-board



HD44780 controller chip contains 80 bytes of display RAM and is capable of supporting up to a 40x2 display (each byte of display RAM corresponds to a digit of the display). Smaller LCD modules simply do not display the full 80 bytes of RAM. The display RAM is organized in the following format:

LINE 1:

Character position: 1 2 3 4 5 6 7 8  
9...40

RAM address 0 1 2 3 4 5 6 7  
8...27(hex)

LINE 2:

Character position: 1 2 3 4 5 6 7 8  
9...40

RAM address 40 41 42 43 44 45 46 47  
48...67(hex)

Smaller modules simply do not display the upper character positions associated with the upper addresses. For example, a 16x2 display uses addresses 00-0F (hex) for line 1 and 40-4F (hex) for line 2.

The HD44780 also contains 64 bytes of character-generator RAM. That is used to store the character patterns of the 8 user-defined characters (8 bytes per character). Once a user-defined character is set up in character-generator RAM, it may be accessed just as any other regular character. NOTE: in the 5x10 matrix mode, only four user-defined characters are supported, with each character requiring 11 bytes of character-generator RAM.

### Software drivers

The host must contain two basic software drivers to support the LCD modules, the Control Write and Data Write drivers. The minimum functions that the software drivers must perform are:

Control Write:

- Sets up DB0-DB7 with the desired control code
- Sets the R/W line to logic zero
- Sets the RS line to logic zero
- Strokes the ENABLE line

Data Write:

- Sets up DB0-DB7 with the desired character
- Sets R/W line to logic zero
- Sets the RS line to logic one
- Strokes the ENABLE line

The user may also read data and control signals from the HD44780. Control Read and Data Read drivers are similar to the write drivers except that the R/W line is set to a logic one. Refer to Table 1 for a complete listing

TABLE 2—USER DEFINABLE CHARACTERS

CHARACTER CODES (DD RAM DATA)	CG RAM ADDRESS	CHARACTER PATTERN (CG RAM DATA)
7 6 5 4 3 2 1 0	5 4 3 2 1 0	7 6 5 4 3 2 1 0
0 0 0 0 0 0 0 0 (00 HEX)	0 0 0 0 0 0 0 0 0 0 0 1 0 0 0 0 1 0 0 0 0 1 0 0 0 0 0 1 1 0 0 0 1 1 1 0 0 0 1 1 1 1	X X X 0 0 0 0 X X X 0 0 0 0 X X X 1 1 1 1 X X X 1 1 1 1 X X X 0 0 0 0 X X X 0 0 0 0 X X X 0 0 0 0

NOSE SECTION

CHARACTER CODES (DD RAM DATA)	CG RAM ADDRESS	CHARACTER PATTERN (CG RAM DATA)
7 6 5 4 3 2 1 0	5 4 3 2 1 0	7 6 5 4 3 2 1 0
0 0 0 0 0 0 0 1 (01 HEX)	0 1 0 0 0 0 0 1 0 0 0 1 0 1 0 1 0 0 0 1 0 1 0 1 0 1 0 1 0 1 0 1 1 0 0 0 0 1 1 0 0 1 0 1 1 1 0 1	X X X 0 1 0 0 X X X 0 1 0 1 X X X 1 1 0 0 X X X 1 1 0 1 X X X 1 1 0 1 X X X 1 1 0 0 X X X 1 1 0 1 X X X 1 1 0 1

BODY SECTION

CHARACTER CODES (DD RAM DATA)	CG RAM ADDRESS	CHARACTER PATTERN (CG RAM DATA)
7 6 5 4 3 2 1 0	5 4 3 2 1 0	7 6 5 4 3 2 1 0
0 0 0 0 0 0 1 0 (02 HEX)	0 1 0 0 0 0 0 1 0 0 0 1 0 1 0 0 1 0 0 1 0 0 1 0 0 1 0 1 0 0 0 1 0 1 0 1 0 1 0 1 0 1 0 1 0 1 1 1	X X X 1 1 0 0 X X X 1 1 0 0 X X X 1 1 0 0 X X X 1 1 0 0 X X X 1 1 0 0 X X X 1 1 0 0 X X X 1 1 0 0 X X X 1 1 0 0

TAIL SECTION

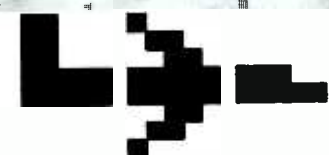

COMPLETE AIRPLANE

### LISTING 6

```

JSR INIT          INITIALIZE DISPLAY
LDA #S80          SET UP FOR DD RAM WRITES
JSR CONTROL      RETURN DISPLAY TO HOME POSITION
LDA #S02
JSR CONTROL
LDA 'P'
JSR DISLET      LOAD AND DISPLAY EACH LETTER
LDA 'L'          OF THE WORD 'PLANE'
JSR DISLET
LDA 'A'
JSR DISLET
LDA 'N'
JSR DISLET
LDA 'E'
JSR DISLET
LDA ' '
JSR DISLET
LDA #S02        ASCII CODE FOR AIRPLANE TAIL SECTION
JSR DISLET
LDA #S01        ASCII CODE FOR AIRPLANE BODY SECTION
JSR DISLET
LDA #S00        ASCII CODE FOR AIRPLANE NOSE SECTION
JSR DISLET

```

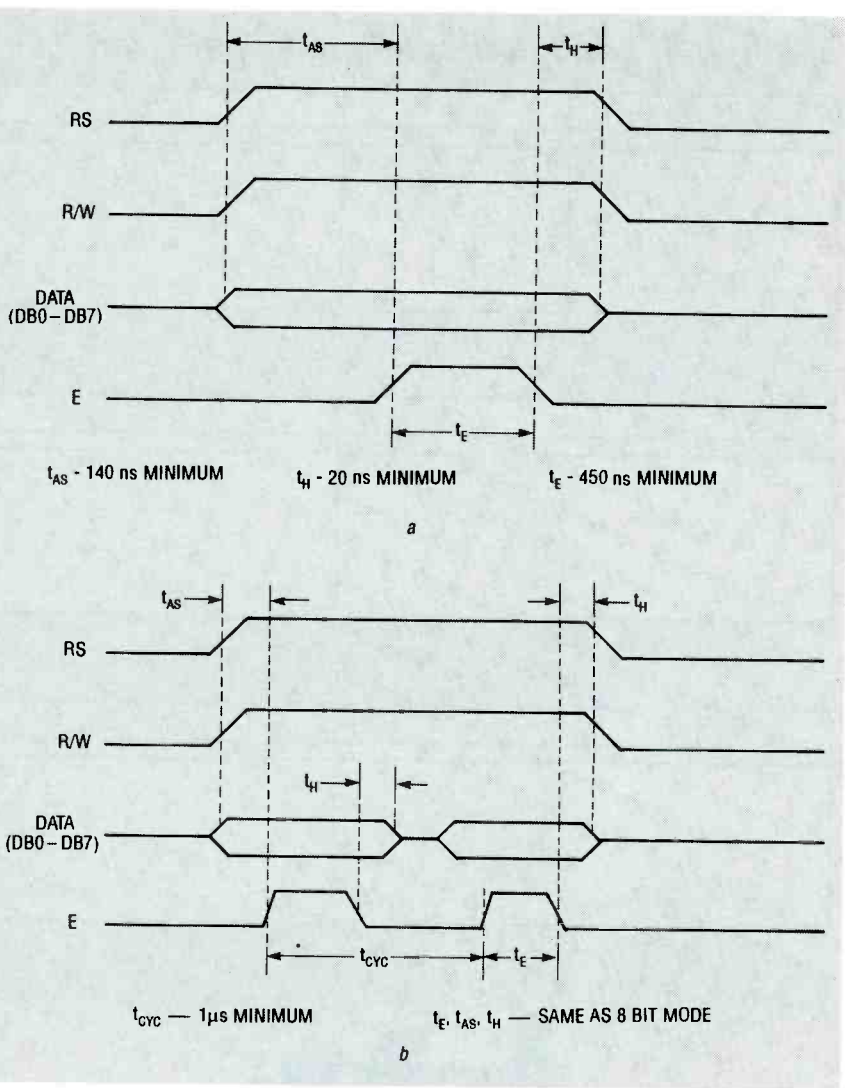

FIG. 4—THE TIMING REQUIREMENTS for the 8-bit mode (a) and the 4-bit mode (b).

of the control codes and status flags available with the HD44780 LCD controller chip.

### Subroutines for the MC68705

The following subroutines show the software drivers for data and control writes. The examples shown here are written in Motorola 6800-series assembler code and are targeted for the MC68705 microcontroller. These short routines can be easily translated into other assembly languages that can be used with other microcontrollers/microprocessors.

The Data Write subroutine (Listing 1) displays letters and symbols. The ASCII code of the letter/symbol to be displayed must be loaded into the Accumulator before calling the Data Write subroutine. Before the Control Write subroutine (Listing 2) can be called, the code of the control operation to be performed (from Table 1) must be loaded into the Accumulator.

### Display initialization

The first operation that the software must perform is the initialization of the display. Initialization includes clearing the display and issuing the appropriate control commands that set the display up with the desired features. The INIT subroutine (Listing 3) is a sample initialization routine for a 16×2 display. The INIT routine sets the display up for 2 line, 5×7-font format, 8-bit interface mode, and suppressed cursor. Also, the INIT routine sets up the display to shift the cursor one position to the right on every data write.

The display module requires 10 milliseconds to initialize after power is applied. The host must wait at least 10 milliseconds before writing to the display following power-up.

### CG RAM initialization

The CGINIT routine (Listing 4) illustrates the operations required to

set up 3 of the 8 user-defined characters. The characters defined in the routine form an airplane when displayed together. Table 2 illustrates how each of the three user-definable characters are generated. Listing 5 shows the 24 data bytes that must be written to CG RAM to form the three user-defined characters that form the airplane.

### Displaying actual data

Once the display has been properly initialized, displaying data is as simple as writing out the proper ASCII codes with a series of Data Write operations. Remember, the "SET DD RAM ADDRESS" command must precede the data operations to ensure that the data goes to DD RAM and not CG RAM. Similarly, data writes to CG RAM must be preceded by a "SET CG RAM ADDRESS" command. For example, the routine in Listing 6 will display the letters "PLANE" followed by the airplane symbol (assuming that the user-defined Character Generator RAM is set up as defined in Listing 5).

### Hardware interface

There are a variety of ways to interface an LCD module to a host processor or microcontroller. A microcontroller such as a Motorola MC68705 (see **Radio-Electronics**,

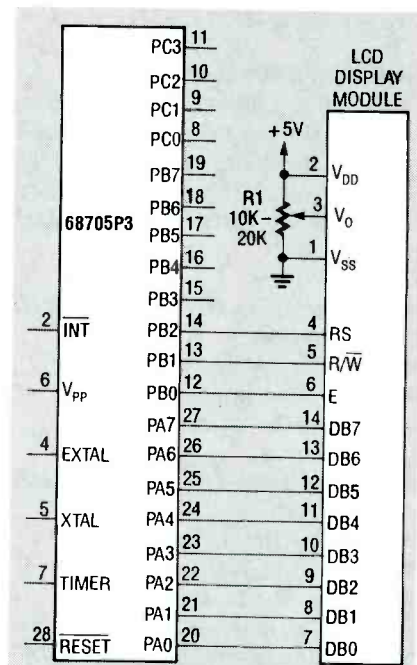

FIG. 5—TO INTERFACE A MICROCONTROLLER to a HD44780-based LCD module, simply connect the control and data lines of the module directly to the port pins of the microcontroller.



September 1989, for information on the MC68705) is easy to interface with because it has port pins that can be dedicated to the LCD module.

LCD modules with an on-board HD44780 LCD controller chip have two hardware interface modes: a 4-bit mode and an 8-bit mode. In the 4-bit mode, each data byte is transferred to the LCD module with two write operations. The 4-bit mode utilizes only the upper four data-bus lines (DB4-DB7). In the 8-bit mode, data bytes are transferred with a single write operation which saves time by using all eight data-bus lines (DB0-DB7). The only advantage to using the 4-bit interface mode is a saving of four data-bus lines. The 8-bit mode is slightly easier to interface with (with respect to software), so you should therefore use the 8-bit mode unless the project that you've designed uses a microcontroller that has a limited number of available port pins. Figure 4 shows the timing requirements for the 8- and 4-bit mode.

### Microcontroller interface

Interfacing a microcontroller to a HD44780-based LCD module is as simple as connecting the control and data lines of the module directly to the port pins of the microcontroller as shown in Fig. 5. Note that R1 is the contrast control for the display.

### Microprocessor interface

Interfacing the HD44780-based LCD module to a processor (such as the Zilog Z80 8-bit CPU) requires some additional logic as shown in Fig. 6. That logic establishes the LCD module as being an I/O device in addition to providing the required setup time on the RS line (The RS line must be stable for 140 nanoseconds before

### ORDERING INFORMATION

The following items are available from Simple Design Implementations (SDI), P.O. Box 9303, Forestville, CT 06010 (203) 582-8526: Experimenter's kit (contains 16 x 1 OPTREX LCD module, programmed MC68705P3, contrast-control potentiometer, perforated construction board, IC socket, software listings, schematic, and instructions), \$29.95 + \$3 S/H; Same experimenter's kit with 40 x 2 display, \$39.95 + \$3 S/H; Programmed MC68705P3 and instructions, \$15.95 + \$2.50 S/H.

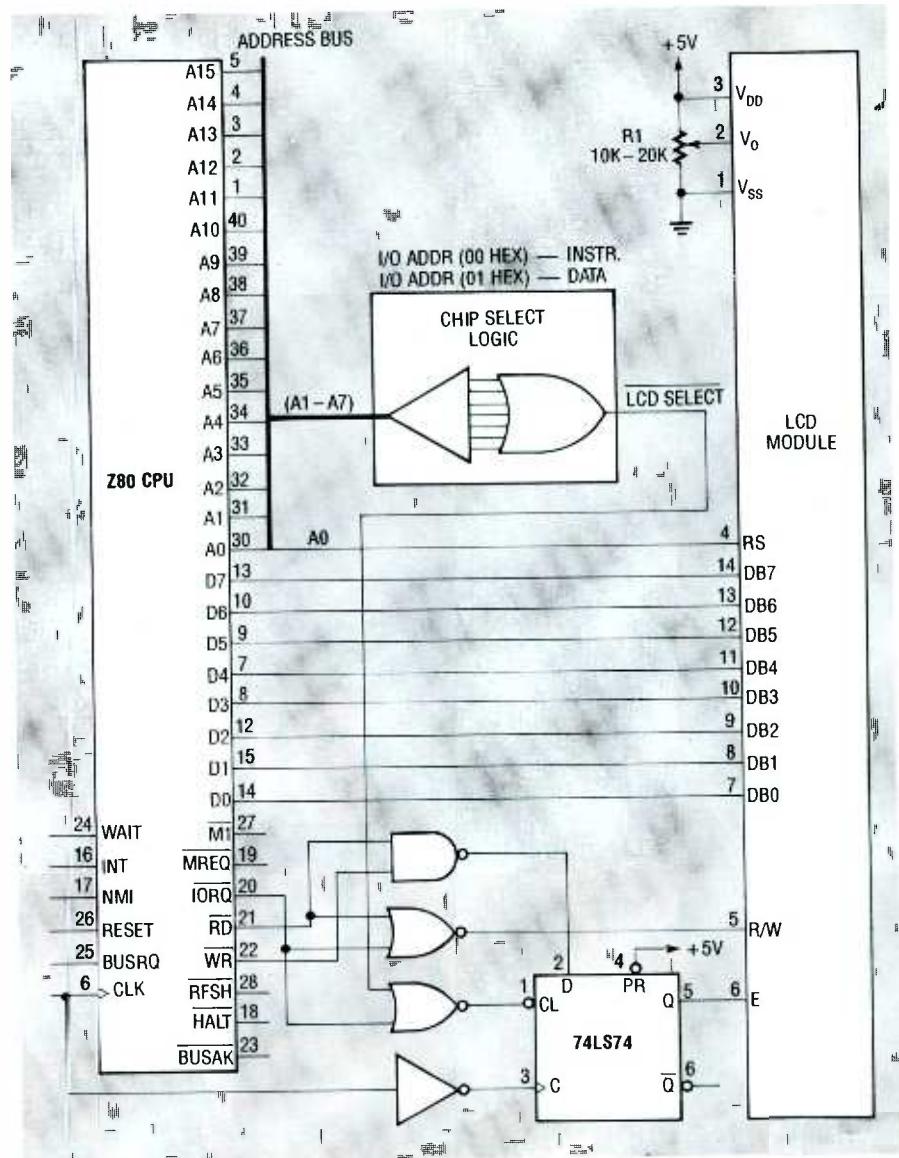

FIG. 6—INTERFACING THE HD44780-BASED LCD module to a microprocessor requires some additional logic.

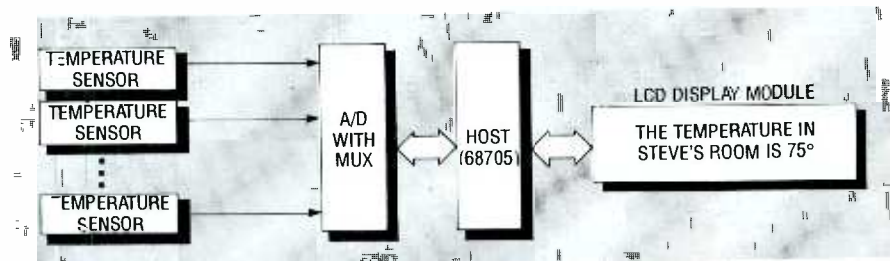



FIG. 7—TRY USING AN LCD MODULE to build a multi-zone thermometer that displays temperatures throughout your house with your own custom messages.

the ENABLE line is strobed). In that configuration, the LCD module is accessed using "IN" and "OUT" instructions for reads and writes respectively. Data operations are distinguished from control operations by the address of the I/O operation; address 00 (hex) is a control operation and address 01 (hex) is a data operation. The I/O address of the LCD module can be changed by changing

the chip-select decode logic.

As a suggestion for your own project using an LCD module, why don't you try to build a multi-zone thermometer that displays temperatures throughout your house with simple, non-cryptic messages. For example, you could display "THE TEMPERATURE IN STEVE'S ROOM IS 72°." A block diagram of such a project is shown in Fig. 7.



**WARNING!!** This article deals with and involves subject matter and the use of materials and substances that may be hazardous to health and life. Do not attempt to implement or use the information contained herein unless you are experienced and skilled with respect to such subject matter, materials and substances. Neither the publisher nor the author make any representations as to the accuracy of the information contained herein and disclaim any liability for damages or injuries, whether caused by or resulting from inaccuracies of the information, misinterpretations of the directions, misapplication of the information or otherwise.

# BUILD A SEMICONDUCTOR LASER SYSTEM



***Visible-light laser diodes are here! In the first article of its kind, we'll show you how to build a handheld, rechargeable, semiconductor laser system.***



THE INTRODUCTION OF LASERS IN 1963 has brought about many changes in our lives, from the supermarket check-out counter to "Star Wars" weapon technology. Very few scientific developments have had as much of an impact on both the technological and everyday world.

"Laser" is an acronym for "light amplification by stimulated emission of radiation." Lasers are used in many applications, including gun sites, pointers, printers, construction and surveying aids, compact-disc players, bar-code readers, light shows, and several others. The helium-neon gas laser is one of the most familiar types, with its bright red directional beam. It's been a workhorse for years, despite its fragile glass laser tube and its requirements for costly high-voltage power supplies. But laser diodes promise to open a whole new world of applications. To demonstrate how they can be used, we've developed a handheld battery-powered laser that runs on four rechargeable batteries. The batteries are inductively charged using a special charger. The unit is shown in Fig. 1. How is that possible?

The recently developed TOLD-9200-series of laser diodes from Toshiba emit coherent laser light in the visible spectrum, and don't require a high-voltage power supply. Because they're small, low-cost, and fairly rugged, laser diodes are well-suited for many applications.

Before proceeding further, let's review some basic laser theory, but first we must talk about regular light for a minute. When you turn on a light bulb, light energy is emitted in what is referred to as "spontaneous" form. It is an integration of many individual atomic energy level changes, each producing its own little "packet" or photon of light energy, with each photon having a particular phase.

In the case of a light bulb, electrical energy "pumps" the filament electrons to higher-than-normal atomic energy levels (see Fig. 2). Photons are emitted when the electrons return to their initial states and give up that energy in the form of light. The frequency of the light is dependent on the

difference between the previously excited and normal energy level states: the larger the difference in energy levels, the lower the wavelength of light. The light produced by the process of spontaneous emission is incoherent or random (see Fig. 3).

Unlike spontaneous emission, laser light is highly directional. The radiant energy is released in-step, or in synchronism, resulting in coherent reinforced light where all of the waves are in phase. In other words, all of the rays are parallel and at the same wavelength. To achieve that requires that the number of excited atoms in the higher energy state exceeds that of the initial or rest state. That condition, referred to as "population inversion," normally doesn't occur in nature and must be "forced" or pumped.

Given a population inversion, each energized atom is then "stimulated" to return to its lower energy state by the emission energy, or incident light of an adjacent atom (see Fig. 4). The result is coherent light waves as shown in Fig. 5. An optical cavity with mirrored ends is usually necessary to provide the right amount of stimulated energy for laser light. As shown in Fig. 6, the light is reflected back and forth within its confines until it is a powerful beam that is allowed to exit the cavity as useful laser light energy.

A laser diode is similar to an ordinary light-emitting diode (LED) in that both are composed of a semiconductor PN junction (see Fig. 7). An electrical potential causes a flow of holes and electrons that, upon recombination, emit light. The LED produces spontaneous light, while the laser emits light by stimulated emission. The laser diode also contains two reflecting mirrors that form what's called a Fabry-Perot cavity, and permit the emitted light to be highly directional, an important laser property.

In spite of a laser diode's apparent physical ruggedness, it is very sensitive to temperature changes, electrical transients, and operating-current parameters. It is totally unforgiving of errors, so our circuitry and construction techniques must take that into consideration.

### Safety first

Before proceeding, you should be aware of the potential hazards associated with lasers. Laser diodes can produce a continuous power in excess of 3 milliwatts. **That energy, when collimated, or viewed near-field, can cause retinal damage, so never look directly into the laser beam or through any lenses when the system is activated.** The laser that we are building is a Class IIIa device, and must be in compliance with U.S. safety standards for laser products (21 CFR 1040.10 and 1040.11).

Our device must bear a label like the one shown in Fig. 8. It must also have a label certifying that it conforms to classification specifications. At the output it must have the following label: **"Avoid Exposure, Visible Laser Radiation is Emitted From This Aperture."** Safety glasses should be worn when working with laser devices of this power. Laser Peripherals, Hingham, MA is a good source; their model #DO-40 is suggested.

To prevent damage to the laser diodes, be sure not to exceed maximum ratings, even momentarily; or you could destroy the diode or cause it to require more current to produce its rated output (which will quickly lead to failure). Transients or spikes from switching both on and off can also destroy the device. Heat-sinking is required; the amount depends on whether the device will be used intermittently or continuously. Keep in mind that a temperature rise reduces the output for a given current, and merely supplying more current will lead to a thermal problem.

Be aware of electrostatic discharge when handling laser diodes. Normally, assembly requires grounded irons, wrist straps, floor mats, etc. However, the hobbyist can either work on a hot humid day or use a vaporizer or humidifier to maintain a degree of moisture in the air—that will reduce the static charge.

Do not operate the unit near high-frequency or high-power pulse circuitry, an RF field, a Tesla coil, plasma, magnetic discharge, etc. Never stress the diode leads or distort the hermetically sealed case. The device

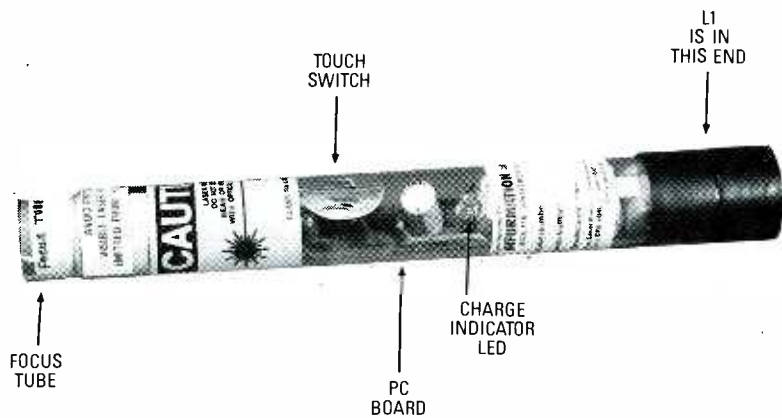

FIG. 1—OUR HAND-HELD LASER is powered from four rechargeable Ni-Cd batteries, which are inductively charged.

should fit snugly into the heat sink cavity with minimal force. Never touch the window because scratches and contaminants will distort and decrease the optical output. Use a cotton swab and ethyl alcohol to clean the window.

### Circuitry

A laser diode operates like an ordinary forward-biased diode and shows the operating curve in Fig. 9. The vertical axis corresponds to optical output while the horizontal axis is the forward diode current.  $I_{OP}$  is the operating current, which determines the optical output. Lasing starts at the threshold value ( $I_{TH}$ ). The maximum rated input current must never be exceeded. However, anything below  $I_{TH}$  will produce the effects of a regular LED. The curve shows a very steep slope where laser operation takes place, and the input-current "window" on the horizontal axis is very narrow; consequently the driver circuit must operate within those limits or you'll end up with one of the worlds most expensive medium-powered LEDs.

The schematic of the hand-held laser is shown in Fig. 10. The Toshiba 9200 laser diode (D3) is actually an assembly that contains a laser-emitting section (LD) and a photodiode section (PD). The photodiode allows the circuit to monitor the laser diode's output and to produce the feedback necessary to control the circuit and protect the diode from voltage transients.

The laser diode is connected in series with current-limiting resistor R4 and the collector of Q4. The current through Q4 is con-

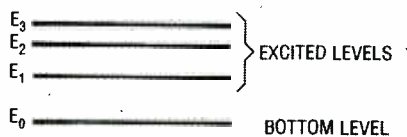

FIG. 2—LIGHT IS THE RESULT of radiation produced within an individual atom by an electron being "pumped" to a higher than normal energy level by an external energy source.

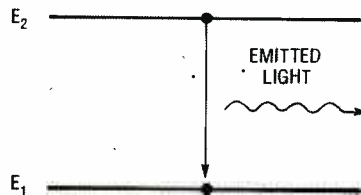

FIG. 3—A LIGHT BULB EMITS "spontaneous" light, which does not allow the energy packets to reinforce one another in phase or position.

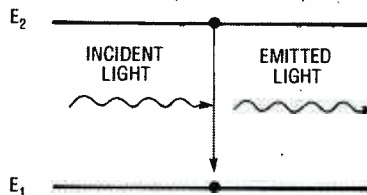

FIG. 4—WHEN MORE EXCITED ATOMS exist in the higher energy state than in the initial or rest state, each energized atom is "stimulated" to return to its lower energy state by the emission energy, or incident light of an adjacent atom.

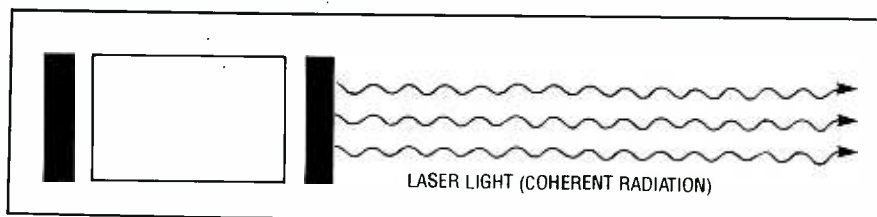

FIG. 5—A LASER BEAM IS THE RESULT of an "in lock step" train of coherent light waves.

trolled by Q3. Zener diode D2 maintains the voltage across Q3, and R3 limits the Zener current. The collector current of Q3, which is also the base current of Q4, is controlled by its base which is connected across R5 and R6. Current from the photodiode develops a voltage across those resistors that is proportional to the optical output energy. That constitutes the feedback required for output stabilization. Increased output causes Q3 to conduct less base current to Q4, resulting in less laser diode current. Potentiometer R6 presets the value of quiescent current. Capacitor C5 limits transients at the base of Q4 while C4 limits them from the  $V_{CC}$  line.

The system turns on when Q2 is conducting and close to saturation. Touch-switch S1's electrodes consist of small pieces of metallic tape that, when bridged by finger contact, cause a small amount of base current to flow into Q1. The collector current of Q1 flows into the base of Q2, causing it to saturate and supply current to the laser diode. Base current to Q1 is limited by R2, while R1 and C2 reduce the circuit's sensitivity to stray AC or static fields that could cause premature turn-on.

The laser is powered by four rechargeable Ni-Cd batteries. They are charged by induction coupling to the charging module. The batteries are connected in series with rectifier diode D1, LED1, and the pickup coil, L1. High-frequency energy from the charger is coupled into the coil, and is rectified and filtered by C1. When the batteries are being charged LED1 turns on.

The charger schematic is shown Fig. 11, and a photograph of a prototype unit is shown in Fig. 12. It uses a 120-to-12 volt AC step-down transformer, T1, whose output is rectified by diodes D4-D7; capacitor C6 removes any ripples. Switch S2



supplies power to the circuit, and LED2 indicates when the power is on. The ground lead of PL1 is connected directly to the metal chassis of the charger.

The rectified 12–14 volts DC energizes a simple oscillator circuit consisting of Q5 in series with L2. That winding couples energy into the pick-up coil (L1) of the laser section for battery charging. To charge the batteries, the pickup coil physically slides over the coil assembly of the charger module. No electrical connections are necessary to provide the charging current.

Coil L3 (which is wound on the same ferrite core as is L2), and resistor R9 provide the necessary

### PARTS LIST FOR THE LASER

All resistors are ¼-watt, 5%, unless otherwise noted.

R1—5.6 megohms  
 R2—1000 ohms  
 R3, R5—470 ohms  
 R4—15 ohms, ½-watt  
 R4-a—100 ohms (optional, see text)  
 R6—5000 ohms, trimmer potentiometer

#### Capacitors

C1—100 µF, 16 volts, electrolytic  
 C2—0.1 µF, 16 volts, ceramic disc  
 C3—0.01 µF, 16 volts, ceramic disc  
 C4—1 µF, 16 volts, electrolytic  
 C5—10 µF, 16 volts, electrolytic

#### Semiconductors

D1—1N4001 diode  
 D2—1N5221 Zener diode (2.4 volts)  
 D3—TOLD 9200 laser diode (Toshiba)

LED1—yellow light-emitting diode  
 LED3—red light-emitting diode (for the simulated laser diode)

Q1, Q3—PN2907 NPN transistor  
 Q2, Q4—PN2222 NPN transistor  
 Q5—L14G3 or ECG3036 phototransistor (for the simulated laser diode)

#### Other components

B1–B4—1.25-volt Ni-Cd cell, VARTA 100 R.S.

L1—pickup coil, 10 turns #18 wire, ½-inch diameter

S1—2 pieces of adhesive-backed metal tape (see text)

**Miscellaneous:** PC board or perforated construction board, small transistor socket (for laser diode), special aluminum heatsink and diode retainer with hardware, #24 vinyl wire, #20 vinyl wire, 7¼-inch long by 1-inch diameter by ⅛-inch wall thickness (transparent or colored), ⅜-inch plastic rear cap, 1⅝-inch by ⅞-inch focus tube, 1×6 mm short focal length lens, 1-inch plastic caps, ⅞-inch diameter shoulder washer (to mount lens on), warning labels, etc.

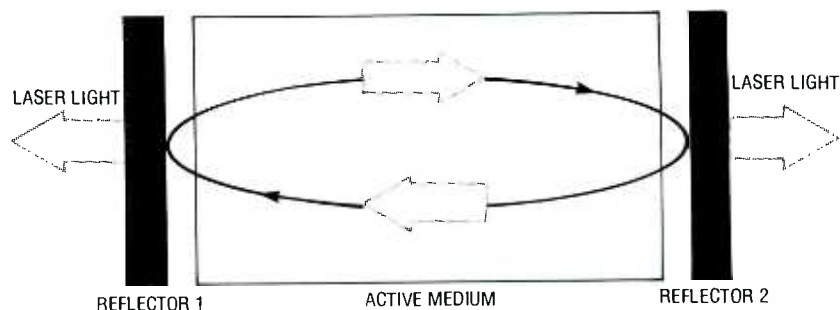

FIG. 6—AN OPTICAL CAVITY having mirrored ends provides the right amount of stimulated energy for laser light. Light is reflected back and forth within its confines until it is a powerful beam that is allowed to exit the cavity as useful laser radiation.

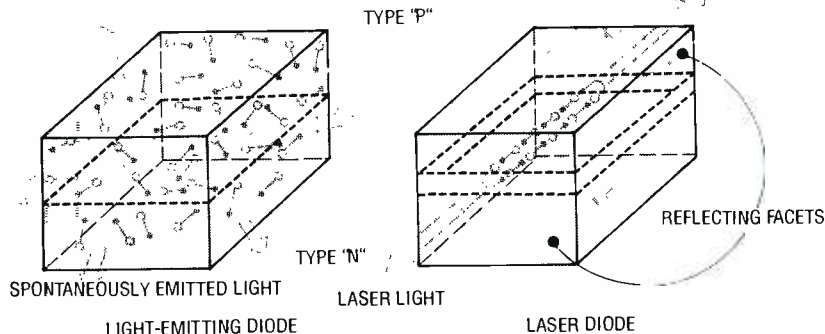

FIG. 7—A LASER DIODE IS SIMILAR to an ordinary LED, except that the LED produces spontaneous light, while the laser emits light by stimulated emission where the wavelengths and temporal relation are coherent. A laser diode also contains two reflecting mirrors that form a cavity and permit the emitted light to be highly directional.



FIG. 8—ANY LASER DEVICE must contain warning labels according to the specific type of device. Our hand-held laser must display this warning, in addition to a label stating that it conforms to specifications and a warning at the laser aperture.

feedback to sustain oscillation. Resistor R8 initiates the action by turning Q5 on. A resonating capacitor (C7) is connected across L2 to adjust the frequency to approximately 250 kHz.

### Construction

All of the parts are available from the source mentioned in the parts list. A foil pattern has been provided if you wish to etch your own board for the laser unit, and a parts-placement diagram is

shown in Fig. 13.

If you wish, you can certainly install the circuit in any kind of housing that you like—you don't have to follow our unit exactly. Just make sure you follow the circuitry and the precautions concerning the laser diode.

The specifications for L1 are described in the parts list. Position it as shown in the handle of the laser so that it can slide over the charging coil (L2). DO NOT install the laser diode in the circuit at this time; install only its socket. The circuit must be checked and calibrated beforehand. Don't forget to build the "simulated laser diode" shown in Fig. 10. It is used later on for testing and calibrating the laser system, without the fear of damaging the actual laser diode.

A cylindrical plastic enclosure houses the board, the batteries, and the optics. After the board is finished and checked out, it slides inside the plastic tube and the leads for S1 (the touch switch) are brought outside through two small holes. (Wait until we check out the board before installing it in the tube.) Two

pieces of metal tape are used for the contacts. The lens is secured at the end of another tube using an appropriately sized washer. The lens assembly then slides in and out of the main tube, allowing you to focus the beam.

The charger circuit can be built on a small piece of perforated construction board and wired according to the schematic in Fig. 11. In the prototype, Q6 is heatsinked by attaching it to the surface of the metal cabinet. It must be insulated, so use a nylon screw and a mica washer to mount it (or use a separate heatsink). Coils L2 and L3 are wound on a ferrite core (see parts list), then wrapped with tape. The as-

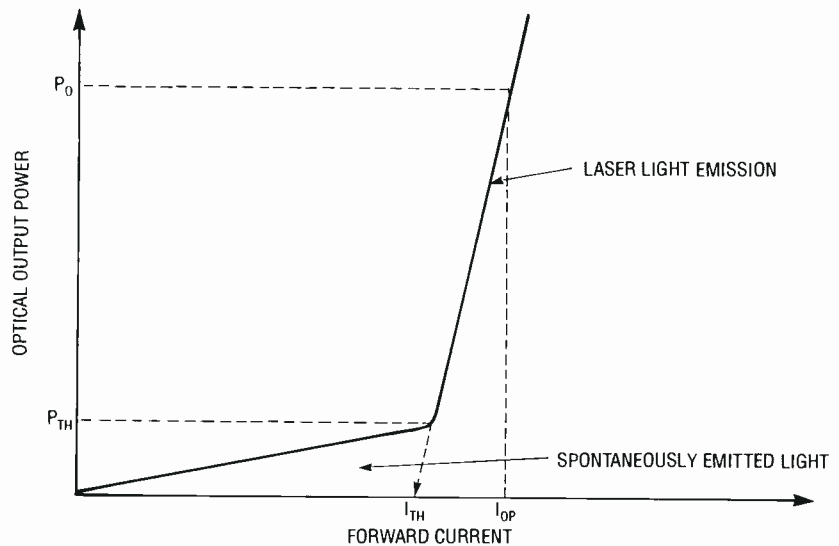

FIG. 9—A LASER DIODE OPERATES similarly to a forward-biased diode. The vertical axis corresponds to optical output while the horizontal axis is the forward diode current.  $I_{OP}$  is the operating current, and anything below  $I_{TH}$  will produce the effects of an LED.

#### PARTS LIST FOR THE CHARGER

All resistors are 1/4-watt, 5%, unless otherwise noted.

R7—470 ohms  
R8—22,000 ohms  
R9—10,000 ohms

#### Capacitors

C6—1000  $\mu$ F, 16 volts, electrolytic  
C7—0.047  $\mu$ F, 50 volts, Mylar

#### Semiconductors

D4—D7—1N4001 diode  
LED2—green light-emitting diode  
Q6—D40D5 or NTE210 NPN power transistor

#### Other components

L2, L3—coils wound on ferrite core (core is 1-inch in length, 1/4-inch diameter) L2 is 10 turns #24 wire, L3 is 10 turns #30 wire.

T1—120/12-volt AC step-down transformer, 100 mA

S2—SPST switch

PL1—3-wire line cord

**Miscellaneous:** perforated construction board, 6-32  $\times$  1/2-inch nylon screw and nut with mica washer (to mount Q6 to case), 2 1/2-inch plastic tube to fit over laser tube, metal cabinet (or use separate heatsink for Q6), line cord bushing, LED mounting bushing, double-sided tape, hardware, wire nuts, #24 vinyl wire, epoxy, etc.

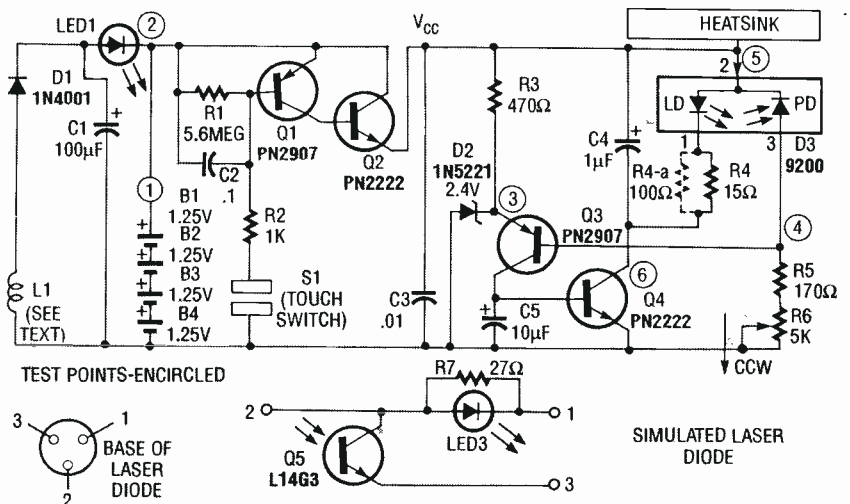

FIG. 10—HERE'S THE SCHEMATIC of the hand-held laser. The laser diode (D3) consists of the laser-diode (LD) and photodiode (PD) sections. That allows monitoring of the output energy and produces the feedback necessary to control the circuit.

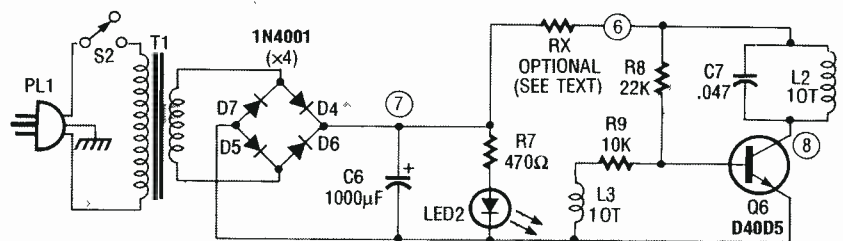

FIG. 11—THE CHARGER SCHEMATIC, charging current is inductively coupled to the hand-held laser. Reverse L3 if circuit does not oscillate.

into a grounded AC outlet and check for 12–14 volts DC at test point 7 on the charger schematic. Check to see that LED2 turns on when you close S2.

Open up the lead at test point TP6 on the charger and check for

a reading of 100–125 milliamps (assuming the batteries aren't already charged). In rare cases, if the current is excessively high, a resistor (RX) may be required as shown in the schematic to limit it. If a scope is available you may

sembly is then centered in the charger tube and secured with epoxy filler (see Fig. 12).

Figure 14 shows how the laser section and the charger go together. If you don't follow the prototype exactly, simply follow Fig. 14 as a rough layout.

#### Checkout

First make sure you do not have the laser diode in the circuit at this time. Plug the charger



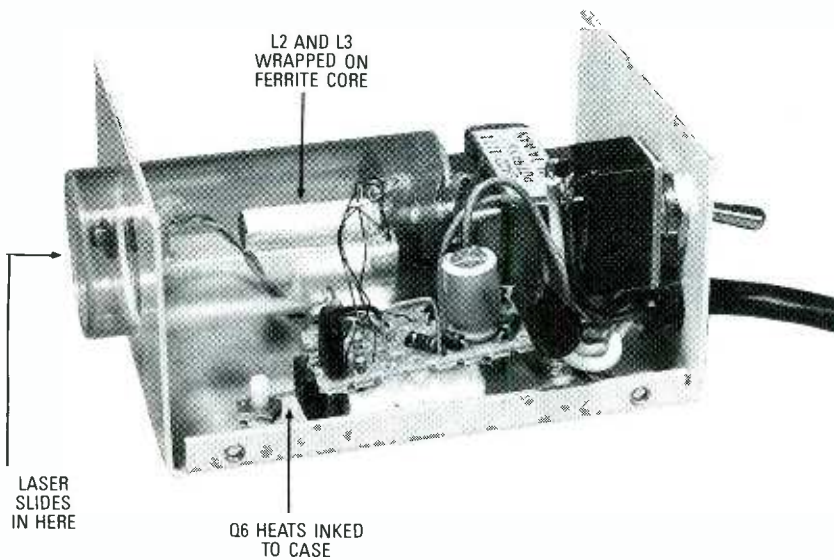

**ORDERING INFORMATION**

The following are available from Information Unlimited, P.O. Box 716, Amherst, NH 03031; Fax 603-672-5406; Order 800-221-1705: 2-3 mW visible red laser diode (9200), 670 nm, \$49.50; 3-5 mW diode (9211), 670 nm, \$69.50; 3-5 mW laser diode, (IRLD1), 810 nm, \$29.50; small lens, 1×6 mm, \$9.50; Heatsink (HS1), \$9.50; PC board (PCVRL2), \$9.50, laser head kit (VRL2-LHK), does not include laser diode, \$59.50; Charger module kit (VRL2-CMK), \$34.50; laser light receiver (laser bounce), \$49.50.

**FIG. 12—THIS IS THE CHARGING UNIT;** the amount of current coupled to it depends on how far the laser is inserted into the charger. in the charger, more or less current is coupled to it.

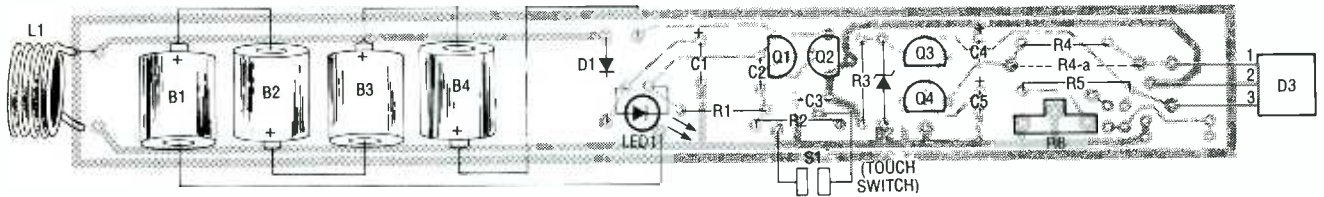

**FIG. 13—PARTS-PLACEMENT DIAGRAM** for the laser. Do not install the laser diode until everything has been thoroughly tested.

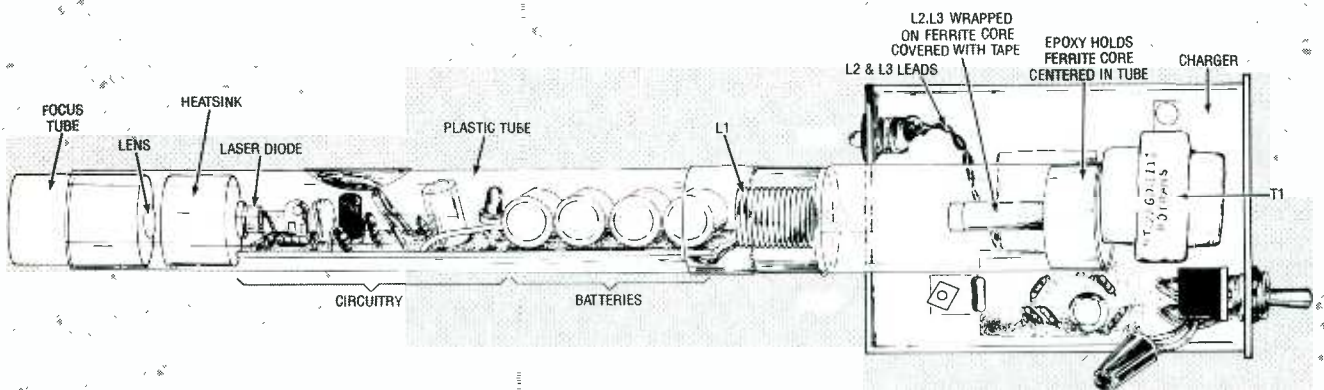

**FIG. 14—The laser section has L1 built inside the handle;** it slides over L2 in the charger.

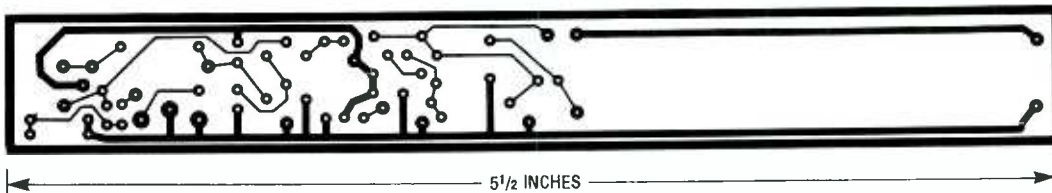

**THIS FOIL PATTERN** for the hand-held laser can be used if you wish to etch your own board.

want to verify an approximate sine-wave shape of 25-30 volts peak to peak at a frequency of 250-300 kHz at test point TP8.

This verifies proper operation of the charger.

Connect an ammeter in series with test point 1 on the laser.

Slide coil L1 of the laser over the ferrite core of L2 on the charger. Check for a current reading of 10-25 milliamps and that the charge indicator (LED1) is lit.

The laser may be positioned in the charger socket for either a fast charge of 20 milliamps at a 6-8 hour rate, or the recommended 10 milliamps at a

14 hour rate. Monitor the charging current as you slide the laser in and out of the charger.

Make sure that the batteries are fully charged before you proceed with the following. Remove the laser from the charger. Note that the current goes to zero and LED1 goes out. Check on the lowest meter range; any current flowing into the circuit above a fraction of a microamp will cause premature discharging of the batteries. Check for defective components, flux paths, excessive moisture, etc., if any current is detected in this step.

Using the negative lead of B4 as a ground point, check for 5.6 volts at test point TP2. Adjust R6 to a maximum value (fully counter-clockwise in our layout). Short out the touch-switch leads and note a current of 10–15 milliamps. Remove the short and bridge the leads with dampened fingers; the current flow should be slightly less than the previous reading. This verifies the control circuit.

If you haven't yet built the simulated laser diode (shown in Fig. 10), do so now, and insert it into the circuit. Short out the touch switch and note a current of 75–85 milliamps. The LED should be glowing brightly. Adjust R6 in a clockwise direction to its midpoint and note the current increasing to over 100 mA.

Check for a smooth control, as any jumps can spell disaster, especially at the end of the potentiometer travel. Short the phototransistor section of test laser diode with a 470-ohm resistor to ground. You should note that the current increases further.

The current will also increase if you interrupt the optical link between the phototransistor and the LED. That verifies that the feedback circuit is operating properly. CAUTION: Re-adjust R6 back to maximum resistance (fully CCW). As a reminder, adjustment of R6 must be done with the batteries fully charged.

Remove the touch-switch short. With a metal screwdriver, short out all pins of the laser-diode socket. Do not go any further if you suspect a high-static electrical condition. Wait for a damp day or use a humidifier or vaporizer in your work area. Make sure the touch-switch leads are sepa-

## Applications and Notes

Reprinted with permission from Toshiba's TOLD9200-series application guide.

### An Example of Driving Circuit for TOLD9200

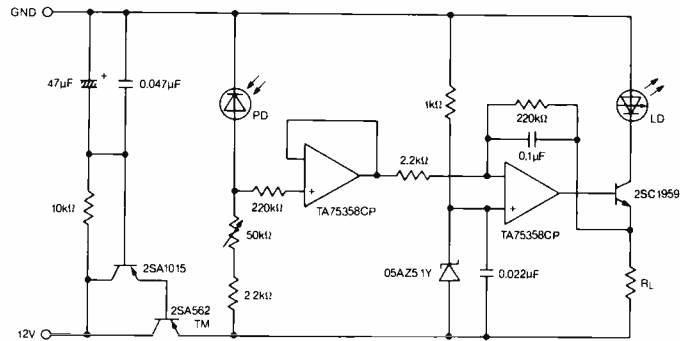

#### Note:

- Use the laser diode after attaching it to a heat sink. Use a larger heat sink during the evaluation stage of deciding the operating condition. A copper or aluminum heat sink is recommended.
- Set the variable resistance VR (50kΩ) for its maximum value, then turn a power supply on. And regulate VR to adjust optical output power.
- When adjusting the optical output power, monitor both the drive current and the optical output power, never exceed the maximum optical output power rating. To monitor the optical output power, use an optical power meter or a calibrated photodiode that has a large active area. In case of using the above driving circuit, the heat sink will have positive potential.

#### • An Example of the Design of a Heat Sink

The relationship among the case temperature  $T_c$ , ambient temperature  $T_a$ , and the thermal resistance of the heat sink  $\theta_t$  is shown in the following simplified equation:

$$\theta_t \div \frac{T_c - T_a}{I_{op} \times V_{op}} - (\theta_s + \theta_c)$$

$\theta_s$ : Thermal resistance of insulator sheet  
 $\theta_c$ : Contact thermal resistance

#### Example:

In the case of  $T_c = 50^\circ\text{C}$ ,  $T_a = 45^\circ\text{C}$ ,  $I_{op} = 100\text{mA}$ ,  $V_{op} = 2.5\text{V}$ ,  $\theta_s = 0$  (no insulator sheet),  $\theta_c = 8^\circ\text{C/W}$ , from the above equation:

$$\theta_t \div \frac{50 - 45}{0.1 \times 2.5} - 8 = 12^\circ\text{C/W}$$

Heat sink thermal resistance must be  $12^\circ\text{C/W}$  or less.

From the figure on the right, the surface area of the aluminum heat sink—assuming it is 2mm thick—must be  $25\text{cm}^2$  in order to obtain a thermal resistance of  $12^\circ\text{C/W}$  or less.

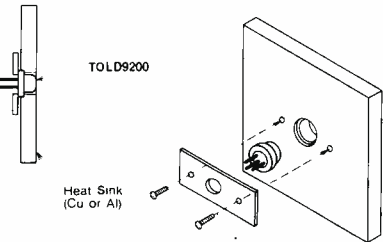
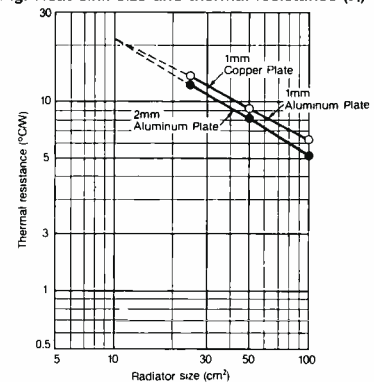

Fig. Heat sink size and thermal resistance ( $\theta_t$ )



#### IMPORTANT NOTICES

The circuit examples illustrated herein are presented only as a guide for the performances of the applications of our products.

Keep in mind that no responsibility is assumed by TOSHIBA for its use, nor for any infringements of patents or other rights of the third parties which may result from its use, and that no license is granted by implication or otherwise under any patent rights of TOSHIBA.

rated and that the meter reads zero current. Carefully insert the diode into the socket.

Bridge the switch with your finger and note the laser diode lighting and a meter current of 70–80 milliamps. The laser diode should be lasing at this level. Short out the touch switch and note slightly higher current.

At this point your laser is producing about 0.5 to 0.7 milliwatts—so you might want to stop here. However, the actual laser-diode current is the meter reading (70–80 mA) minus the 10–20 milliamps at the touch-switch leads, which is still well below the

allowed maximum. So it is possible to get more power out of the laser diode. However, if you do decide to challenge Murphy's laws, the next step should be done with a laser power meter. That's because the output level is critical when adjusting for maximum. We used a *Metrologic* model number 45-540 laser power meter.

Couple the head of the power meter to the laser diode and set it for the 20-milliwatts range. Use a piece of clay for temporarily securing them together. Short out the touch switch and note a

*continued on page 127*



# BUILD THIS EXPERIMENTER'S I/O CARD

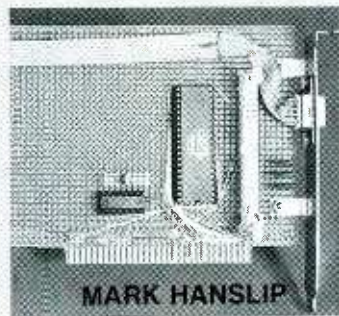

A computer by itself can't do much; it needs some way of communicating with the outside world. It needs to be able to sense external conditions (a switch closure, for example), and it needs to be able to control circuitry (a relay, for example). The principles of interfacing those types of devices are not difficult; we'll show how easy it is by building an experimenter's card for the IBM PC expansion bus.

The card contains three eight-bit parallel ports, but is built from just a few components, thereby making construction simple and inexpensive. We'll describe several circuits for interfacing LED's, switches, and other devices to the card, as well the software required to configure and use the I/O ports. We'll also show you how easy it is to set up and use the card with simple BASIC programs.

## The 8255 PPI

The heart of the design is the 8255 Programmable Peripheral Interface, or PPI. The 8255 was originally designed for use with the 8080 microprocessor, but it is also used with 8088 designs including the PC family.

The 8255 has three eight-bit TTL-compatible I/O ports (A-C), and it can operate in three different modes. Depending on the mode, the lines in each port act differently.

In Mode 0, Ports A and B can operate as either inputs or outputs, and Port C is divided into two four-bit groups, either of which can operate as inputs or outputs.

In Mode 1, Ports A and B can again act as either inputs or out-

puts. However, the two four-bit ports in Port C are used for handshaking and control purposes in conjunction with Ports A and B. In Mode 1, the Port C lines might be used to strobe data (supplied on either Port A or port B) into a printer, and to detect its "busy" signal.

Last, in Mode 2, Port A is used for eight-bit bidirectional bus I/O, Port C is used for control and status information, and Port B is not used at all. For further details on operating modes, consult Intel's *Microsystem Components Handbook*, Volume 2.

You select among the various modes by writing a value to a special control port; Table 1 shows the control-port values required to achieve various I/O combinations. Our examples all work in Mode 0.

## The PC interface

With Intel microprocessors, communications between the CPU and various devices is accomplished through I/O (Input/Output) ports. Just as each house on a street has its own address, each piece of hardware connected to an Intel processor has its own port address. For example, serial port COM1 is located at address 03F8h. IBM's Technical Reference Manuals list the specific port addresses associated with specific pieces of hardware.

Our project uses 32 port addresses between 0200h and 02FFh. In order to avoid conflict with other devices, those 32 addresses can start at one of eight locations in that range; you select the desired starting address via a jumper block, as shown in Table

2. Both hex and decimal values are shown; if you're programming in BASIC, you'll probably find the decimal values useful.

As shown in Fig. 1, the address ranges are decoded by IC2, a 74LS138 demultiplexer. The 74LS138 takes three inputs and decodes the various combinations thereof into eight exclusive outputs. The IC also has one active-high ( $G_1$ ) and two active-low ( $\overline{G_2A}$  and  $\overline{G_2B}$ ) enable inputs.

Address lines A8 and A9 drive the control inputs, along with AEN (Address Enable), which is low when the microprocessor can access the expansion bus. When A8 and AEN are low and A9 is high, IC2 will decode address lines A5-A7, providing a single active-low output. In that way, the 256-byte page of I/O space beginning at 0200h is divided into eight 32-byte chunks. The eight outputs of IC2 are brought to the jumper block, which passes one enable signal on to the 8255.

The 8255 itself has only 4 ports. Port A is always at the base address, port B is at base + 1, port C is at base + 2, and the control port is at base + 3. Lines

TABLE 1—8255 PORT CONFIGURATION

Control Word	Port			
	Hex	Decimal	A B C	
80	128	Out	Out	Out
82	130	Out	In	Out
85	133	Out	Out	In
87	135	Out	In	In
88	136	In	Out	Out
8A	138	In	In	Out
8C	140	In	Out	In
8F	143	In	In	In

TABLE 2—JUMPER POSITIONS AND PORT ADDRESSES

Position	Address	
	Hex	Decimal
1	200	512
2	220	544
3	240	576
4	260	608
5	280	640
6	2A0	672
7	2C0	704
8	2E0	736

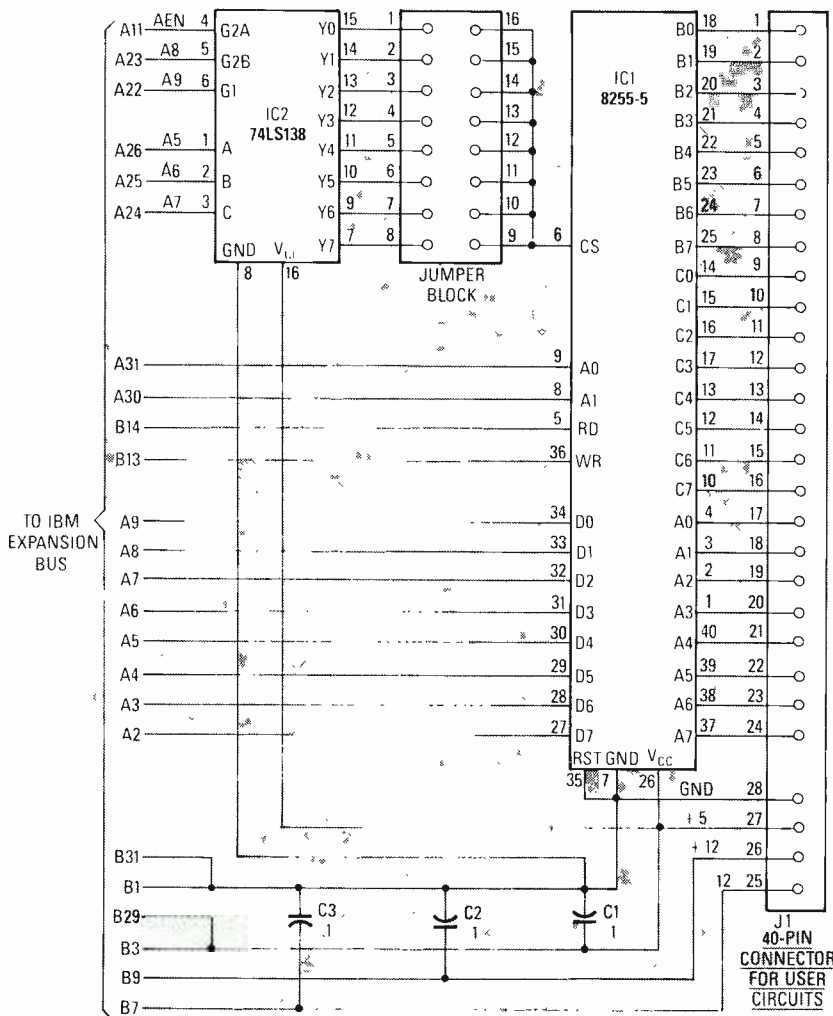

**FIG. 1—ADD THREE 8-BIT PARALLEL PORTS** for I/O experiments using this simple circuit. The jumper block lets you assign port addresses from 0200h to 02FFh.

A0 and A1 select which port is addressed, and  $\overline{RD}$  and  $\overline{WR}$  determine whether data is read or written, respectively.

For example, if you short jumper position three, the base address would be 0240h, so you would access Port A at 0240h, Port B at 0241h, Port C at 0242h, and the control port at 0243h.

### Construction

The circuit is built on a standard prototyping card for the 8-bit IBM PC bus. All required parts are standard items that can be obtained from most mail-order suppliers. Component placement isn't critical, but lead lengths should be minimized. To avoid damage during construction, it's best to use sockets for all IC's. Neither IC used in this project is particularly sensitive to

static damage, but you can never be too careful.

Start with the 6 wires that run from the bus connector to IC2. (By the way, looking at the component side of your motherboard, the "B" side of each expansion slot is on the left and the "A" side on the right, and the connectors are numbered from 1 to 31 from the rear of the board to the front.) Take your time, and check each solder joint for shorts with adjacent pins.

Then connect the eight wires

### PARTS LIST

- IC1—8255A-5 parallel interface
- IC2—74LS138 3-to-8 line decoder
- C1—C3—0.1  $\mu$ F
- J1—40-pin header connector
- Jumper block (2 rows, 8 positions)
- PC bus prototyping board
- Sockets, wire, etc.

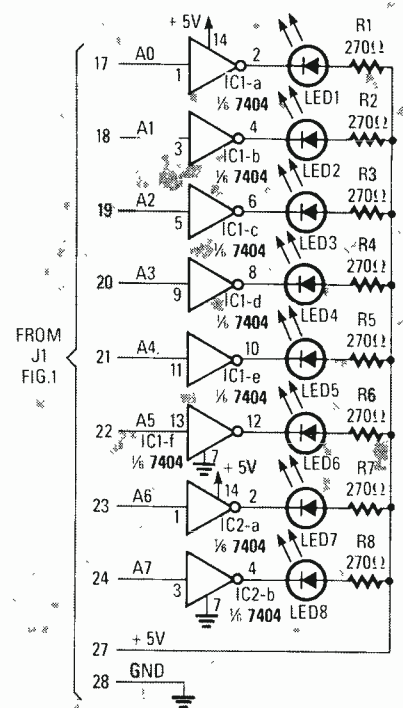

**FIG. 3—FOR OUTPUT DISPLAY, add eight LED'S, eight resistors, and two 7404's.**

from IC2 to the jumper block, continue with the eight data-bus wires from the bus connector to the 8255, then the six control wires to the 8255. Then connect the 24 wires from the port outputs of IC1 to J1. The author used a 40-pin header connector for J1 in the prototype. Many projects require a source of +5 volts, so power and ground lines are also brought to J1.

### Programming examples

The following examples assume that the jumper is in position three, so that the 8255 is connected to port 0240h.

When power is first applied, ports A, B, and C are all configured as inputs. To reconfigure the port, you must write the appropriate value to the correct port. For example, by connecting eight LED's to Port A as shown in Fig. 3, you could view the binary counting sequence using this program:

- ```

10 OUT 579.128
20 A = 0
30 OUT 576.A
40 A = A + 1
50 IF A 255 GOTO 20
60 GOTO 30

```



## SEMICONDUCTOR LASER

continued from page 124

power output of 0.5 milliwatts or so. Slowly rotate R6 noting the "indicated output" on the power meter increasing. Note how "slope" sensitive it is when comparing it to the change on the current meter. That is a direct indication of the slope efficiency of the device as shown in Fig. 9.

**Adjust to an output of 2.4 milliwatts—any more would constitute a more severe optical hazard, and would require a "DANGER" label. An output below 2.4 milliwatts requires only a "CAUTION" class IIIa label. Safety glasses should be worn at this point.**



PROTOTYPE VERSION of the simulated laser diode. A hole drilled in the block provides a light path.

Remove the touch-switch short and bridge it with damp fingers; Note the power still going to 2.4 milliwatts, but the current reading on the meter is lower. This verifies the power-control circuitry is functioning properly.

This completes the electronic testing. It is suggested that you return R6 to its lower output adjustment before proceeding. And, again, always make sure that the batteries are fully charged before re-adjusting R6.

R-E

## I/O CARD

continued from previous page

If one LED doesn't seem to light, run this program:

```
10 OUT 579,128
20 OUT 576,255
```

All of the LEDs should light. If one doesn't, check your wiring.

Reading input values is just as simple. The following program would continually read and dis-

play the contents of port B, to which various switches (Fig. 4-a, Fig. 4-b) and sensors (Fig. 4-c) might be connected:

```
10 OUT 579,130
20 A=INP 577
30 IF A
40 GOTO 20
```

That program sets up Port B for input, and then reads the value of the port. If the value is less than 255 (in other words, if at least one line is low), the value is printed.

R-E



**WORLD WIDE  
COMPONENT  
DISTRIBUTORS**

- **JAPANESE SEMICONDUCTORS**  
2SA, 2SB, 2SC, 2SD, AN's, HA's, LA's, STK's, UPC's
- **MRO**
- **REPLACEMENT TYPES**  
COMPARABLE TO ECG/NTE TYPES

**TOLL FREE: 1-800-222-6268**  
(201) 467-6264 • FAX: (201) 467-8519  
18 Stern Avenue, Springfield, NJ 07081  
**QUALITY COMPONENTS AT COMPETITIVE PRICES**

CIRCLE 9 ON FREE INFORMATION CARD

### ADVERTISING SALES OFFICE

**Gernsback Publications, Inc.**  
500-B Bi-County Blvd.  
Farmingdale, NY 11735  
1-(516) 293-3000  
President: Larry Steckler  
For Advertising ONLY  
516-293-3000 Fax 1-516-293-3115  
Larry Steckler  
publisher  
Christina Estrada  
assistant to the President  
Arline Fishman  
advertising director  
Denise Haven  
advertising assistant  
Kelly McQuade  
credit manager

**Subscriber Customer Service**  
1-800-288-0652

**Order Entry for New Subscribers**  
1-800-999-7139 7:00 AM - 6:00 PM M-F MST

**SALES OFFICES  
EAST/SOUTHEAST**

**Stanley Levitan**, Eastern Sales Manager  
Radio-Electronics  
1 Overlook Ave.  
Great Neck, NY 11021  
1-516-487-9357, 1-516-293-3000  
Fax 1-516-487-8402

**MIDWEST/Texas/Arkansas/Okla.**  
**Ralph Bergen**, Midwest Sales Manager  
Radio-Electronics  
One Northfield Plaza, Suite 300  
Northfield, IL 60093-1214  
1-708-446-1444  
Fax 1-708-559-0562

**PACIFIC COAST/Mountain States**  
**Marvin Green**, Pacific Sales Manager  
Radio-Electronics  
5430 Van Nuys Blvd. Suite 316  
Van Nuys, CA 91401  
1-818-986-2001  
Fax 1-818-986-2009

## MARKET CENTER

### CB RADIO OWNERS!

We specialize in a wide variety of technical information, parts and services for CB radios, 10-Meter and FM conversion kits, repair books, plans, high-performance accessories. Thousands of satisfied customers since 1976! Catalog \$2.

**CBC INTERNATIONAL**  
P.O. BOX 31500EH, PHOENIX, AZ 85046



### TUBES - 2000 TYPES DISCOUNT PRICES!

Early, hard-to-find, and modern tubes. Also transformers, capacitors and parts for tube equipment. Send \$2.00 for 28 page wholesale catalog.

**ANTIQUE ELECTRONIC SUPPLY**  
6221 S. Maple Ave. • Tempe, AZ 85283 • 602-820-5411

### PLANS AND KITS

**HOBBY**/broadcasting/HAM/CB/surveillance transmitters, amplifiers, cable TV, science, bugs, other great projects! Catalog \$1.00. **PANAXIS**, Box 130-FX, Paradise, CA 95967.

### BUSINESS OPPORTUNITIES

**YOUR** own radio station! Licensed/unlicensed AM, FM, TV, cable. Information \$1.00. **BROADCASTING**, Box 130-FX, Paradise, CA 95967.

**LET** the government finance your small business. Grants/loans to \$500,000 yearly. Free recorded message: (707) 449-8600. (KS2).

## MICROPHONE

*continued from page 104*

speaking, in a normal voice, 100 ft from the mouth. The resultant recording was quite intelligible even above seagulls squawking overhead, the surf, and car noises 500 ft away.

The higher audio frequencies so necessary for speech intelligibility tend to be very directive. Noticeable roll-off occurred 5° away from the main axis of the horn; in fact, speech wasn't understandable when the horn microphone wasn't pointed directly at someone. Beyond 10–15° off-axis, a voice vanished completely into background noise. However, seagulls and birds 75–100 ft away sounded like they were 2 ft in front of a regular microphone.

Surprisingly, the extension didn't really improve directivity, and apparently wasn't worth the effort, given the time and effort needed, as well as

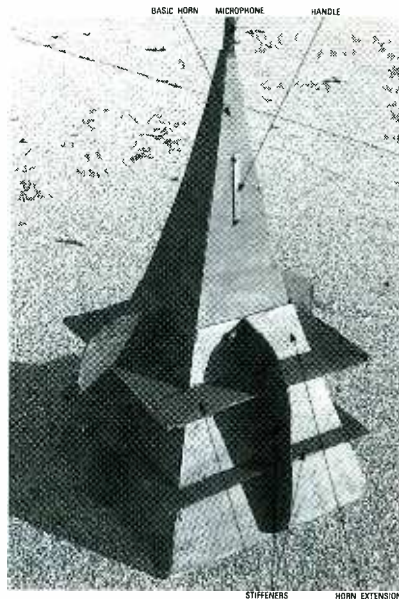

**FIG. 15—HERE'S THE COMPLETED HORN MICROPHONE.** At the top is the receptor microphone, then comes the basic horn, and lastly, the horn extension is shown with its support ribs.

its size. Frequency response tests with polar pattern measurements would be needed for verification of this, and to optimize the extension performance. However, recording bird calls and animal sounds is a perfect application for this horn, since both the horn and extension are small enough for field use, and give excellent performance over the full audio range. **R-E**

## POWER SUPPLY

*continued from page 63*

nate in a row on one end of the PC board. Figure 4 shows the general chassis layout, and Fig. 5 shows the juncture between the PC boards and the custom heatsink close up. Use 16-gauge or heavier wire for the leads to J1–J4, and twisted pairs to R13–R14 and R15–R16. If you're including the 5-volt supply, install BR3, C10, C11, and IC3 with the secondary heatsink using point-to-point wiring. Connect T1, wire the primaries, and mount the primary heatsink and front panel. You should now be ready to turn on the supply.

### Checkout

Install F1 and F2, apply power, and check for +60 volts DC across C1 and C2. Check for a bias supply of –25 volts DC across C3. Vary R15 and R16, and observe the output voltage change. When the current limiter is fully counterclockwise, the output voltage may be zero, regardless of adjustments. When current limiting occurs, LED1 should glow. Short the supply output and set the current limit as desired, or calibrate the front panel. Since the supplies are floating, they can be connected in series or parallel for greater voltage or current, as needed. **R-E**

# REALMAGIC!

*An ETCHED  
circuit board  
from a  
Printed PAGE  
in just 3 Hours*

The ER-4 PHOTO ETCH KIT gives you the tools, materials and chemicals to make your own printed circuit boards. The patented Pos-Neg™ process copies artwork from magazines like this one without damaging the page. Use the circuit patterns, tapes and drafting film to make your own 1X artwork. Or try the Direct Etch™ system (also included), to make single circuit boards without artwork. The ER-4 is stocked by many electronic distributors, or order direct. Add \$3.50 for handling and shipping. **ER-4 PHOTO ETCH KIT** (NV and CA residents add sales tax) . . . **\$38.00** **DATAK'S COMPLETE CATALOG** lists hundreds of printed circuit products and art patterns. Also contains dry transfer letter sheets and electronic title sets for professional looking control panels. **WRITE FOR IT NOW!**

**DATAK Corporation • 55 Freeport Blvd. • Sparks, NV 89431**

**CIRCLE 24 ON FREE INFORMATION CARD**



# ELECTRONICS

1

2

3

A DIVISION OF MING E&P, INC.

ORDER TOLL FREE  
1-800-669-4406



## RF TRANSMITTER & RECEIVER

#TX-88 \$10.95



#RE-99 \$21.95

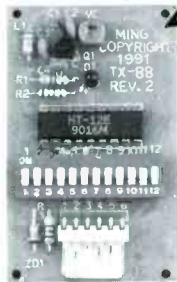

Tiny PCB level transmitter powered by 12VDC with a range of 100'-200' within line-of-sight. Capable of multi-channel signals and 4096 possible code combinations. SIZE: 1.5" x 2.38" x 0.38"

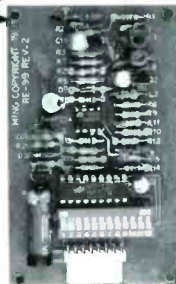

Small PCB level receiver powered by 12VDC with IC's included for both single or multi-channel decoding. 8 bit address codes and 4 bit data codes. SIZE: 2.25" x 3.75" x 0.5"

#RC-99 Combination of TX-88 & RE-99 \$29.95

## DIGITAL VOICE MODULE

#DVM-58C \$89.95

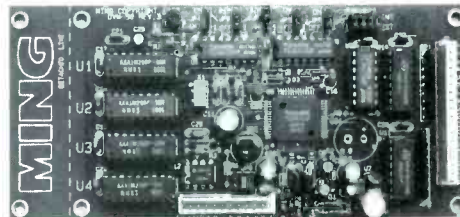

- Record and playback up to 2 minutes of your message on optional 4Mb of DRAM (32K bps). **1 Meg DRAM included.**
- Up to 16 variable-length messages - each w/direct trigger.
- Very low standby current, only **8 mA** w/4 Mega DRAM.
- "ENDLESS RECORDING MODE" for continuous recording.
- "REPEAT MODE" and "VOX" can be enabled.
- Selectable bit sampling rates of 16K or 32K bps
- "EOS" (end of sentence) output lets you control other devices at the end of a message in the playback mode.
- PCB dimensions- 5.75" x 2.75" x 0.5".

## IC TESTER / IDENTIFIER

HT-21 HANDY TESTER \$195.00

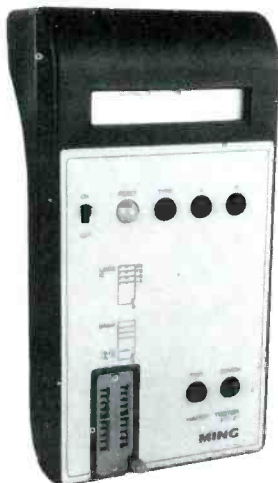

- Tests TTL 74, CMOS 40/45 and DRAM 4164-411000, 4416-4425 series IC's.
- Identifies any unknown IC number on TTL 74 and CMOS 40/45 series.
- 1 x 16 LCD dot matrix display.
- Automatic power shut-off to conserve battery life.
- Up to 500 hours of operation on a single 9V alkaline battery.
- 9V AC adapter included.
- Lightweight at only 9 oz.
- Dimensions 3.5" x 7" x 2".

Stop guessing with your IC's, the HT-21 Handy Tester is a complete stand alone system which is portable, powerful and a very affordable device for IC testing and identifying either in-house or in the field.

## DIGITAL VOICE RECORDER #DVR-120M \$149.95

Incorporating the #DVM-58C Digital Voice Module within an ABS enclosure and including the following:

- 4 Mega DRAM
- Internal playback speaker
- Record/playback pushbuttons
- Reset pushbutton
- MIC and LINE OUT jacks
- 12V AC adapter
- Microphone
- Terminal strip connector

## DIGITAL VOICE MODULE #DVM-2804 \$49.95

(EPROM not included)

A compact digital voice module designed for playback of pre-recorded message(s) from an EPROM IC.

- Up to 5 separate messages from direct trigger inputs
- Dual socket design accepts a 256K EPROM for a total of 8 seconds or a 1 Meg EPROM for a total of 32 seconds of message(s) playback.
- Built-in 0.5W amplifier.
- SMT design, SIZE: 2.75" x 1.75" x 0.875"

## DIGITAL VOICE PROGRAMMING TOOL #DVMP \$495.00

This programming tool is designed to be used with your existing EPROM programmer for the purpose of programming voice data onto EPROM IC's for digital voice modules such as the #DVM-2804.

### MAIL ORDERS:

977 S. Meridian Ave.  
Alhambra, CA 91803

### FAX ORDERS:

(818) 576-8748

TECHNICAL SUPPORT  
(818) 281-4065

ALL PRICES SUBJECT TO  
CHANGE WITHOUT NOTICE

### VISA, MC & DISCOVER CREDIT CARDS ACCEPTED

#### FREIGHT CHARGES ADD:

UPS - Ground \$ 5.00  
Second day (blue) \$ 8.00  
Next Day (red) \$15.00

C.O.D. ADD: \$ 4.00

CALIF. RESIDENTS ADD: 7% Sales Tax

### CANADIAN ORDERS:

All orders must be PREPAID by check or credit card (VISA, MC).  
Add a flat rate of US\$15.00 for shipping and handling by U.S. POST OFFICE (air).



# STARTEK INTERNATIONAL INC

## FREQUENCY COUNTERS

GREAT NEW MODELS - SUPER LOW PRICES

# 10 HZ to 3.5 GHZ

- StarCab™ ALUMINUM CABINET
- 8 RED LED DIGITS
- 3 GATE TIMES
- DISPLAY HOLD
- MMIC AMPLIFIERS
- 3-5 HR BATTERY
- NI-CAD'S & ADP
- YEAR WARRANTY
- MADE IN USA

### THE NEW MODEL 3500

FROM THE ORIGINATOR OF THE "HAND HELD" COUNTERS IN THE StarCab™ STYLE CABINETS, WITH EXPERIENCE PRODUCING OVER TWO DOZEN SUCCESSFUL FREQUENCY COUNTER MODELS SINCE 1975, FRED HUFFT- W4PLM HAS DESIGNED THE 3500 WITH UNPRECEDENTED FREQUENCY RANGE, FEATURES AND QUALITY IN A VERY AFFORDABLE "POCKET SIZED" COUNTER.

COMPUTER DESIGN AND STATE OF THE ART COMPONENTS PROVIDE UNCOMPROMISED RELIABILITY AND PERFORMANCE.

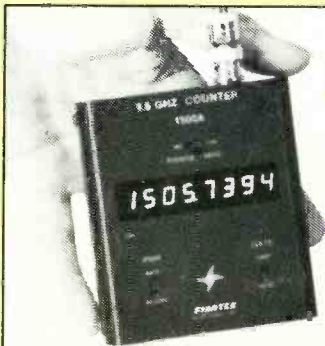
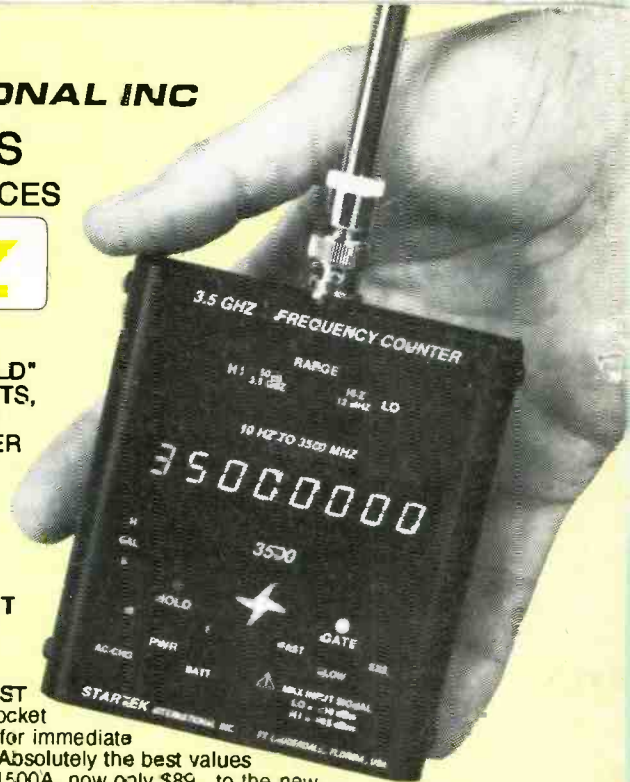

### A VERY SPECIAL OFFER

MODEL 1500A

# \$66\*

\* Buy this quality 1500 MHz Counter for only \$66. when purchased with the following items:

- 1500A FREQ COUNTER ~~\$89.00~~ 66.00
- INSTALLED NI-CAD PACK 20.00
- 110VAC ADP/CHARGER 9.00
- 12VDC AUTO ADP/CHGR 9.00
- VINYL CARRY CASE 12.00
- TELESCOPING ANTENNA 12.00

#SO-15 ~~\$151.00~~ 128.00

### ONLY \$128. FOR ALL 6 ITEMS

TO SUBSTITUTE MODEL 1500HS ORDER #SO-HS \$175.  
2500 #SO-25 225.  
3500 #SO-35 265.

### FIND FREQUENCIES FAST

with any of these great pocket sized counters, available for immediate delivery from STARTEK. Absolutely the best values in the industry, from the 1500A, now only \$89., to the new 2500 & 3500. These new full range counters feature a 1 megohm input 10 Hz to 12 MHz, a 50 ohm RF input 10 MHz to 2.4 GHz / to 3.5 GHz for the 3500. The 2500 & 3500 both feature MMIC amplifiers for maximum sensitivity, three gate times for maximum display resolution of .1 Hz to 12 MHz and 10 Hz to 2400 & 3500 MHz, a DISPLAY HOLD switch and LED indicator to hold a reading and suspend gating until turned off. Our DISPLAY HOLD switch works properly, it does not change the GATE selection when turned off, like some competitive units. All of our counters use LSI circuitry, sub-miniaturized components and low power design for portable operation of 3-5 hours from internal 600 mA/Hr NiCad batteries. For ULTRA HIGH SENSITIVITY the 1500HS can't be beat with typical sensitivity of <.5 to <1 mV RMS from 10 MHz to 500 MHz. Our 1500A offers great quality and performance at minimal cost. All counters have a full year parts & labor limited warranty. Check out our VERY SPECIAL OFFER for any model packaged with several of our most popular accessories.

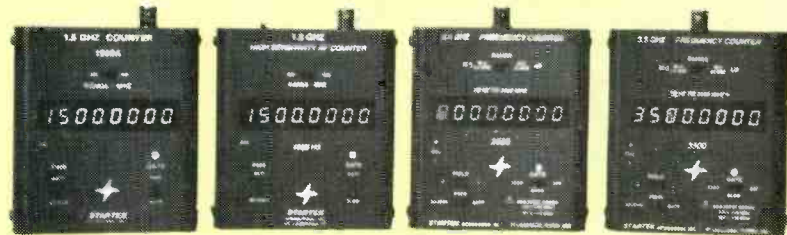

**1500A**  
ECONOMY MODEL

1-1500 MHZ  
2 GATE TIMES  
LESS NI-CADS & AC ADP

**\$89.**

**1500 HS**  
ULTRA HIGH SENSITIVITY

1 MHZ-1500 MHZ  
2 GATE TIMES  
DISPLAY HOLD

**\$159.**

**2500**  
FULL RANGE +HI-Z INPUT

10 HZ-2400 MHZ  
3 GATE TIMES  
DISPLAY HOLD

**\$210.**

**3500**  
EXT RANGE +HI-Z INPUT

10 HZ-3500 MHZ  
3 GATE TIMES  
DISPLAY HOLD

**\$250.**

#### ■ OPTIONS for the 1500A

- #BP-15 NiCads for 1500A (installed) \$ 20.00
- #AC-15 110 VAC adp/chgr for 1500A 9.00
- ACCESSORIES for all models
- #TA-90 Telescoping BNC antenna 12.00
- #RD-800 800 MHZ Rubber Duck-BNC 29.00
- #CC-90 Black vinyl zipper carry case 12.00
- #DC-690 12VDC Auto adaptor/charger 9.00

#### ■ PROBES

- #LP-22 Probe, Low Pass/Audio \$22.00 use with 2500 & 3500. Attenuates RF noise.
- #P-110 Probe, freq counter or scope use, 1X, 10X, 20a MHZ scope use. 39.00

### 1.8 GHZ PRESCALER - AMP & SIGNAL BAR GRAPH



Extend range of any counter capable of counting 16 MHZ or higher to 1600 MHZ with super sensitivity of 1-5 mV typ. 10 segment LED BAR GRAPH displays RF signal strength. StarCab™ aluminum cabinet. 110 VAC adaptor included.

MODEL AP-90  
FACTORY ASSEMBLED  
1 YEAR WARRANTY

# \$99

NEED MORE INFO - CALL  
HAL MANDERY-KK4UN  
SALES ENGINEER

ORDERS ONLY - TOLL FREE  
**800-638-8050**

INFORMATION (305) 561-2211

TERMS: Shipping-handling charges for Florida add \$4 + tax, US & Canada add 5% (\$4 min, \$8 max), all others add 10% of total. COD fee \$3.75. Payment by VISA, MC, DISCOVER, COD for CASH or MC. Prices and specifications are subject to change without notice.

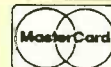

## STARTEK INTERNATIONAL INC

398 NE 38th ST., FT. LAUDERDALE, FL 33334

FAX (305) 561-9133