



PRODUCT BRIEF Halo™ Pulse Compression Radar

A REVOLUTION IN RADAR

External Final
Don Korte, PM
April 15th, 2015

SIMRAD
Go With Confidence



Product Overview

SIMRAD

Go With Confidence

Halo™ - Product Description - Styling



Halo™ - Arrays



Halo™- Main Components



Antennas: 3ft , 4ft, 6ft

Pedestal

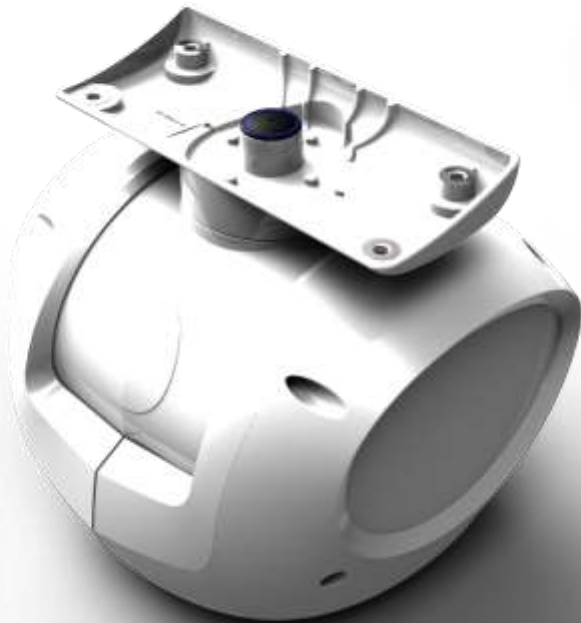

RI-12 Interface box



Halo™ - Product Description - Models

▶ Solid-State Pulse Compression Radar Technology

- Superior target detection and definition
- 300' to 72nm instrumented radar ranges – model dependent
- 3-4X shorter (~6m) min range than conventional pulse radars
- Meets latest, tough EU RF emission regulations
- Works exclusively with SIMRAD NSS and NSO evo2 MFD systems



HALO-6

6' Array
72nm Range
1.2° Beamwidth
<0.8° Target
Separation @ High

▶ Commercial Grade - built for long life, reliable duty cycle

- No magnetron – uses 25W GaN technology
- No maintenance for brushless motor
- No degradation of performance over lifecycle



HALO-4

4' Array
64nm Range
1.8° Beamwidth
<1.2° Target
Separation @ High

▶ Shares benefits from both Simrad “Broadband” 4G FMCW and Conventional “Pulse” Radars

- Updated Navico digital signal processing (DSP)
- Outstanding Auto USE Modes (Custom, Harbour, Offshore, Bird, Weather)
- See weather cells clearly >64nm HALO-4, >48nm HALO-3, >72nm HALO-6

▶ High Performance 4G-like features and MORE

- Dual Range split PPI mode with 10 MARPA targets each
- Beam sharpening with control on all models
- High speed mode – up to 48RPM (quiet running)
- No Tuning EVER Required - Super Fast Range changes
- Instant On – Low Power STBY – Low Radiation Hazard
- Sector Blanking is included
- Low Probability of Intercept with Frequency/Time Agility



HALO-3

3' Array
48nm Range
2.4° Beamwidth
<1.6° Target
Separation @ High

Halo™ - System Overview



HALO™ Pulse Compression Radar Compatibility

▶ ALL Halo Radars work with:

- ALL size SIMRAD NSS evo2 Multifunction displays
- ALL size SIMRAD NSO evo2 Multifunction displays
- MFDs and GoFree Wireless Modules allow radar data to be viewed on a wireless device, such as iPad, using our GoFree screen mirror application. This is not streaming video, but a radar screen replication.

▶ SPECIAL NOTE:

- *Older, SIMRAD non-evo2 version MFDs such as NSS, NSO, NSE do not function with Halo. Also all LOWRANCE MFDs do not function with Halo.*







Halo™- Integration

▶ Multifunction Displays, Systems, and Control

- Compatible only with newest multifunction NSO/NSS evo2 .
- Uses same cable as 3G/4G – available in 10/20/30m. 20m is standard.
- New Radar Processor box RI-12 has and same yellow Ethernet network connectors as 3G/4G. Uses N2K BLACK MICRO-C connectors – same COM interface as on the multifunction displays. Interface cables are provided.
- Radar control inputs can be via MFD touch screen, Rotary Knob, or by using a remote.
- Wiring is simple and easy. See the included System Builder slides #82 and forward.

Halo™ - Competitor Comparison

	FURUNO	RAYMARINE	GARMIN	SIMRAD HALO™
				
	"UHD" Models 3.5' DRS4A 4kW; 4' DRS6A 6kW	4 models HD/SHD Series 4/6'HD 4kW; 4/6'SHD 4kW	3 models xHD2 Series 4' xHD2 4kW; 4/6'xHD2 6kW	3 models SIMRAD HALO™ Pulse Compression Radar 3'/4'/6'
Range	48/64nm	72nm all models (Range scale)	36/48/72nm	48/64/72nm
Closest target to Radar	30m	30m	30m	6m (20') – BIG WINNER!
300' Usable Range	×	×	×	✓
Safe Distance from Array (100W/m ² : 10W/m ²)	1.2m/1.2m/2.4m No Data	Data not published	1.4/1.7/1.7/2/2.5/2.8m 4.5/15.1/5.5/6.2/7.8/8.7m	TBD
Warm up Time	90-180sec	75sec all models	90-180sec	16-25sec Instant On
Operating Power (min/max/standby at high wind rating)	No Data - PS box	Typ:70/30/Sleep 1.2W	55/145W	40/150/6.5W @ 13.8Vdc
Scanner rotation speed	24/36/48rpm	24 (48 with SHD +E/G series)	24/48rpm	Variable 16/24/36/48rpm
True Dual Range	✓	✓	✓	✓ With NSS and NSOevo2
Interface - radar data	Ethernet (NavNet 3D)	Ethernet (Seatalk HS)	Ethernet	Ethernet
Beam sharpening	×	✓ (SHD)	×	YES – all lengths
Advanced MARPA	✓ Yes – 30 target APRA	× – Basic 10 target only	× – Basic 10 target only	✓ - 20 target dual range mode
Advanced Use modes + GSR - GAIN/SEA/RAIN	✓ GSR – USER Modes are display dependent	✓ GSR - Harbour/Offshore/ BIRD/Buoy/ Coastal	✓ GSR - Offshore/Harbor/BIRD	✓ GSR- Custom./Harbor/Offshore/BIRD/Weather + future
Auto STC	✓	✓	✓	✓
Directional Sidelobe Suppression	✓	✓	unknown	✓
Scan-to-scan integration	✓	×	unknown	×
3G/4G + Pulse same boat simultaneous operation	×	×	×	✓ (Needs >9ft vertical separation)



Key Features/Selling Points – Top 5

▶ Globally Unique and Revolutionary with High Performance

- Halo Radar delivers a maximum range comparable to traditional 6kW pulse radar, at up to 48/64/72nm with the HALO-3/4/6-foot open array antenna. It offers unprecedented 6m (20ft) minimum range, peering into that pulse-radar blind spot where once only FMCW (3G/4G) Broadband Radar could operate and has unique BIRD finder and Auto “Hands Off” USER modes.

▶ Unmatched Target Resolution – Beam Sharpening

- Whether you’re looking at a flock of birds or a string of channel markers, separating one radar target from another is key. Beam Sharpening with Target Separation Control provides unmatched target resolution, granting the Halo Pulse Compression Radar’s 3/4/6-foot open array antenna the same effective target resolution as a 4/6/8-foot array without beam sharpening.

▶ Dual Range

- With Dual Range, Halo Radar functions like two arrays in one – monitor two distance ranges simultaneously with independent displays, controls, and totally independent MARPA target tracking. Take full advantage of Halo Radar’s combination of short-, mid-, and long-range performance to keep an eye on faraway weather cells, while monitoring channel markers and high speed watercraft up close. Dual Range operation is available with Simrad NSS and NSO display systems and our DSP technology has NO target detection degradation in Dual Range mode.

▶ Instant ON with Quiet Running

- Less startup time (16-25 sec), no tuning, no magnetron lifetime issues, and no motor brushes that ever wear out. Helical gear design assures very low rotational acoustical noise – even at 48RPM.

▶ BLUE BLING

- Display your Halo Radar on the water with soft-glow, dual-beam Blue LED accent lighting, integrated into the pedestal and customizable with 4-level brightness control.

Halo™ - Product Description



HALO™ Pulse Compression Radars have:

- ▶ Solid State Broadband X-Band 25W Transceiver in pedestal using Pulse Compression Technology - no magnetron lifetime degradation or AFC tuning issues – EVER.
- ▶ Unprecedented Target Resolution using Beamsharpening (with Target Separation Control) for all the open array antennas. Makes a 4' look like a 6' Array and a 6' look like an 8' array.
- ▶ Two Radars in one. Versatile Dual Range (like 4G) with independent controls and up to 20 MARPA targets total in dual mode.
- ▶ Auto Harbour and Offshore Modes with no Captain diddling required.
- ▶ Fast Updating and SUPER QUIET High Speed Operation up to 48RPM max (radar mode dependent).
- ▶ A serious fishing BIRD Finder Mode, and allows future USE Modes.
- ▶ Instant ON with minimum warmup time.
- ▶ Highest Reliability with solid state Brushless Motor driver - no motor brushes to ever wear out and replace. Sealed bearings/gearbox and Delrin Polymer Helical Gears never need greasing.
- ▶ Operates from either 12 or 24V systems with new RI-12 Interface box.
- ▶ Only 3X the standby power of 4G.
- ▶ Meets upcoming Low Emission standards for radars. Latest EU OOB spectrum emissions are met even with shortest 40ns short pulse.



Halo™ - Safety benefits

HALO™ Pulse Compression Radars have only 25w peak RF power

- ▶ An open array is never quite huggable for servicing dealers but Halo gets as close as possible and 100% safe outside the swing circle of the antenna for all models for anyone

Model	100W/m ² – occupational safe distance	10W/m ² – public safe distance
All Halo Radar Models	0 meters – touchable anywhere	.28 meters (.92ft)

- ▶ Halo has the same peak power as a VHF radio (25W) and transmits only 10% of the time max.
- ▶ Safe to operate in a marina – when operating at short ranges, Halo emits a fraction the energy of even Broadband radar.
- ▶ Has Sector Blanking with up to 4 zones for max safety
- ▶ Operate with a clear conscience...



Halo™- Ease of Use

- ▶ Setup is 100% easy.....Just:
 - Select antenna size – 3/4/6'
 - Set antenna height – default is 13 ft
 - Set the BEARING ZERO to align with your vessels lubber line
- ▶ No Range Offset is ever needed
- ▶ No AFC tuning is required
- ▶ Auto Harbour/Offshore/Bird/Weather optimized out of the box. No fiddling needed
- ▶ An over-ride CUSTOM control allows any setting desired
- ▶ Off/Low/Med/High Blue Light control is selected in STBY mode. OFF is default.
- ▶ Put in Transmit mode (Tx) and you have a radar picture



Halo™- USER Modes Advantages

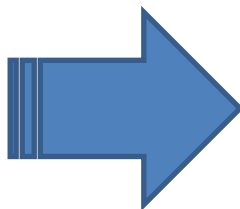
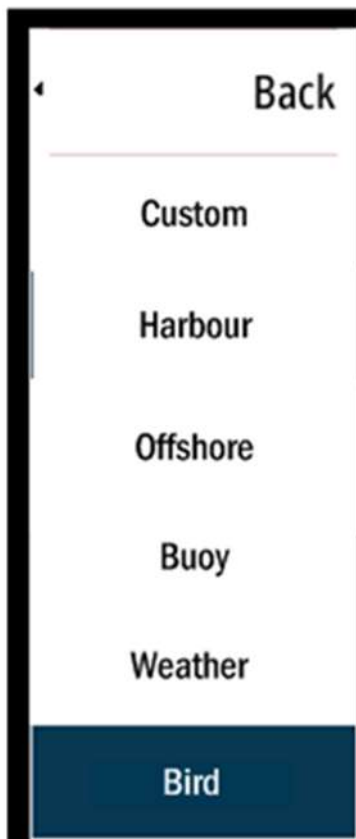

- ▶ Custom: Manual Control
- ▶ Harbour: Best resolution to provide a clear image in a congested environment. Sea clutter control is optimized to suppress wind-borne chop and handle strong close land targets.
- ▶ Offshore: Low resolution to present isolated point targets as large and easy-to-see returns. Sea clutter control is optimized to handle large fetch/chop and swells.
- ▶ Weather: Wide image aperture and high resolution to provide a 'fine grained' image of rain so that it can be easily distinguished from land masses.
- ▶ Bird: Maximized small target detection and fine resolution. Halo sees BIRDS through rain drizzle like no other pulse radar can.
- ▶ Use Modes operate independently in Dual Range mode



Halo™- USER Modes Selection

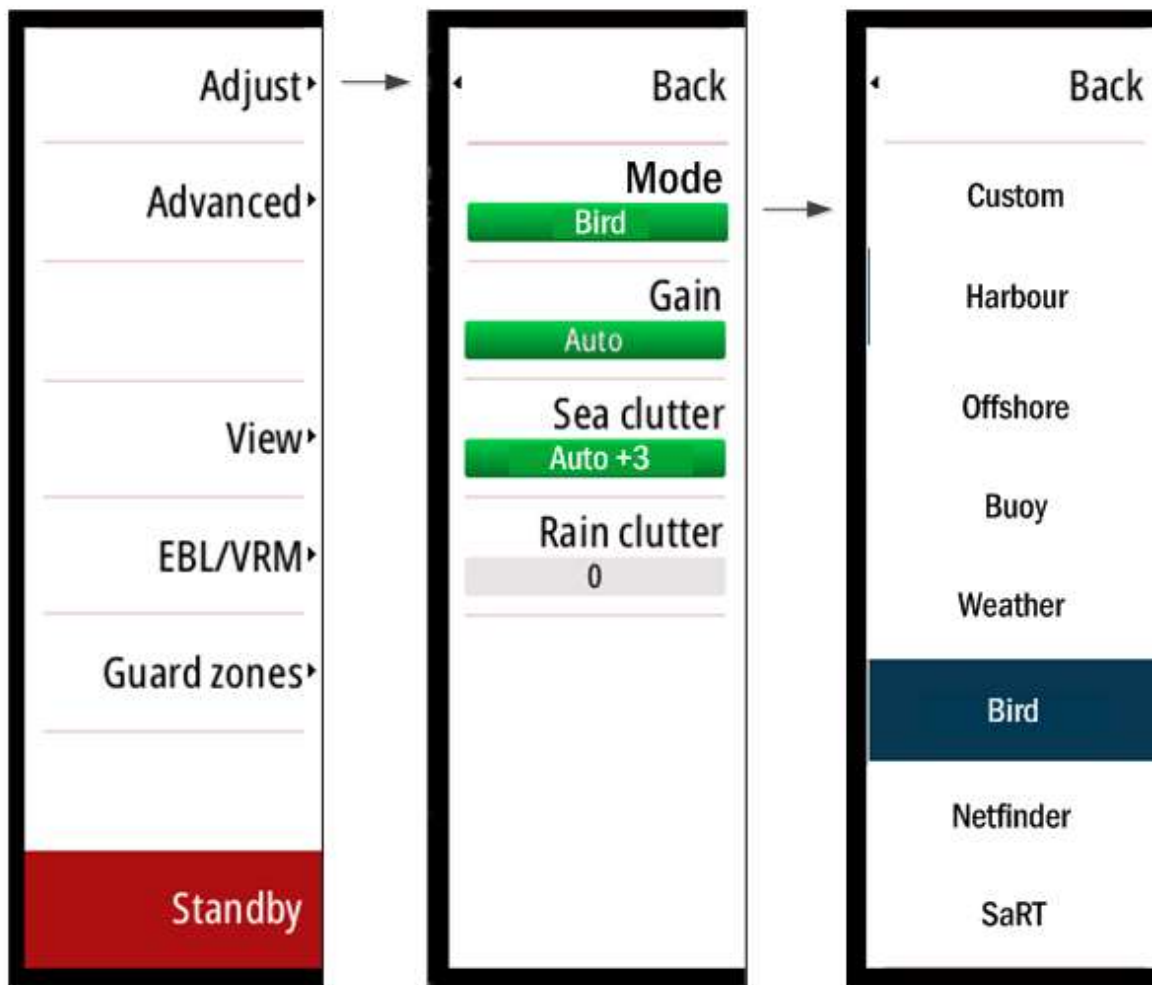

SPECIAL NOTE:

Release #1 (RTM1) does not include:

- ▶ Buoy
- ▶ Netfinder
- ▶ SaRT

Latest Software Versions for MFD and Halo are on SIMRAD website. Check for updates regularly for latest functionality.

Minimum baseline code:

- ▶ NSS_evo2: V2.0-51.1.80
- ▶ NSO_evo2: V3.0-51.1.80
- ▶ Halo: V5.1.0 or later

Sector Blanking functionality will be provided in late May with:

- ▶ NSS_evo2: V3.0-52.x.xx
- ▶ NSO_evo2: V4.0-52.x.xx
- ▶ Halo: V5.1.x

Halo™ - Other Key Features/Selling Points

Unique Product Features	Customer Benefit
Range	Halo-3 with 48nm; Halo-4 with 64nm; Halo-6 with 72nm
Operational Modes	Hands off “out of the box” radar operation. Has Custom, Harbor, Offshore, BIRD , Weather. Other USER modes added as an upgrade later.
“Best in Class” Quiet Scanner	Even lower acoustic rotational noise than competition belt drive designs used in some Super HD models
High Speed	Up to 48 RPM Note: Rotational speed is Mode and MFD model dependent
Directional Sidelobe Reduction	Advanced signal processing allows you to see small targets better next to large targets such as ships and bridges
Sector Blanking	Up to 4 sectors and any angle
Low electromagnetic emissions	Meets Radar Low Emission Standard ITU-R SM.1541-4 (09/2011) – “Unwanted emissions in the out-of-band domain - NOT as safe as 3G/4G. “Cannot be hugged”. - Can run in anchorages and marinas
Connectivity and Installation	Connects to range of SIMRAD evo2 multi-function displays via Ethernet using RI-12 Interface box. Same radar cable to scanner as 3G/4G. Easier to install with small diameter connectors and thinner/lighter cabling than competitor Open Arrays. Various Radar Mounts are available from 3 major suppliers Scanstrut, Seaview, and Edson



Halo™ - Product Description - Models

Halo System Part Numbers:

Halo P/N	Navico EAN	Description
000-11468-001	9420024128794	HALO RADAR, NO ARRAY w/RI12/20M CBL
000-11469-001	9420024128800	HALO 3 RADAR, w/3' ARRAY/RI12/20M CBL
000-11470-001	9420024128817	HALO 4 RADAR, w/4' ARRAY/RI12/20M CBL
000-11471-001	9420024128824	HALO 6 RADAR, w/6' ARRAY/RI12/20M CBL

SPECIAL NOTE:

Release #1
excludes sales
of:

000-11468-001

000-11463-001

Halo Individual Component Part numbers:

Halo P/N	Navico EAN	Description
000-11463-001	9420024128749	PEDESTAL, RADAR, HALO
000-11464-001	9420024128756	ANTENNA, RADAR, HALO, 3FT
000-11465-001	9420024128763	ANTENNA, RADAR, HALO, 4FT
000-11466-001	9420024128770	ANTENNA, RADAR, HALO, 6FT
000-11467-001	9420024128787	IF BOX, RADAR, HALO, RI-12

IMPORTANT NOTE:

HALO 3 and HALO 4 will be available June 1. HALO 6 antenna will follow on/about August 1. There will be a break in pedestal serial numbers when HALO 6 is shipped.



Halo™ - Product Description – RI-12

ALL Halo Models use SIMRAD's new, universal RI-12 Radar Interface Box:

- ▶ Designed to accommodate either vessel 12 and 24 volt systems and used for all Halo models
- ▶ Rugged screw in power connector block (DC cable not supplied – see slide #84 for details)
- ▶ Supplies 36Vdc to the pedestal in Tx mode – STATUS LED is Green when ON. Red when not.
- ▶ EZ to connect NMEA 2000 – Micro-C (cable supplied) and a COMS LED
- ▶ Supplies parking voltage control to pedestal using low current
- ▶ Ethernet 10_100BaseT output with ETHERNET LED (pigtail adapter supplied for Internal RJ45 to external Navico Yellow)
- ▶ EZ Removable access cover with captive screws
- ▶ Silicon Rubber cable glands





Technology and Design

SIMRAD

Go With Confidence



Halo™ - Radar Technologies

Pulse

- First radar invented for use in Military in the 1930's
- Uses a Magnetron (Vacuum tube) as the transmitter device – about 2000 hrs lifetime
- Uses very high powered fixed frequency short pulse transmission
- Pollute the radio spectrum – Emission restricted sales starts from mid 2015

FMCW

- Frequency Modulated Continuous Wave
- Solid State (no magnetron)
- Very low power continuous frequency swept transmission
- Coherent - Clean (remains within the allocated spectrum)

Halo™

- The Halo™ name means the latest in Pulse Compression Radar Technology
- Solid State (no magnetron) - Over 10,000 hrs design lifetime
- Low-medium power frequency swept interweaved pulse burst transmissions
- Coherent - Clean (emissions remains totally within the allocated spectrum)
- Interoperability with any conventional pulse radar on the same vessel



Halo™- What made it possible...

- ▶ X-band pulse compression radar has only become possible outside the military around the last 5 years or so.
- ▶ The first non-military X-band marine pulse compression radar was the Kelvin-Hughes' Sharpeye. This radar can only be made in small volumes and is extremely expensive.
- ▶ What has made Halo Pulse Compression radar affordable for the recreational marine market?
- ▶ Solid State transmit power: Gallium Nitride (GaN) X-band power amplifier devices. The use of GaN has become widespread in other industries including 4G cellular infrastructure and the increasing volumes there have reduced the cost of GaN devices dramatically. In fact some devices cost less than a magnetron at the moment and are going down quickly in cost as well as up in power. There are military restrictions on some devices at the moment.
- ▶ Processing Power: Pulse compression radar requires huge amounts of signal processing power and high speed memory. The only type of device capable enough is an FPGA (Field Programmable Gate Array). For a given cost FPGA processing power and memory available has increased many fold in the past 5 years. *Halo uses the most powerful FPGA ever used in a recreation marine product.*



Halo™ - Radar Technologies

Range

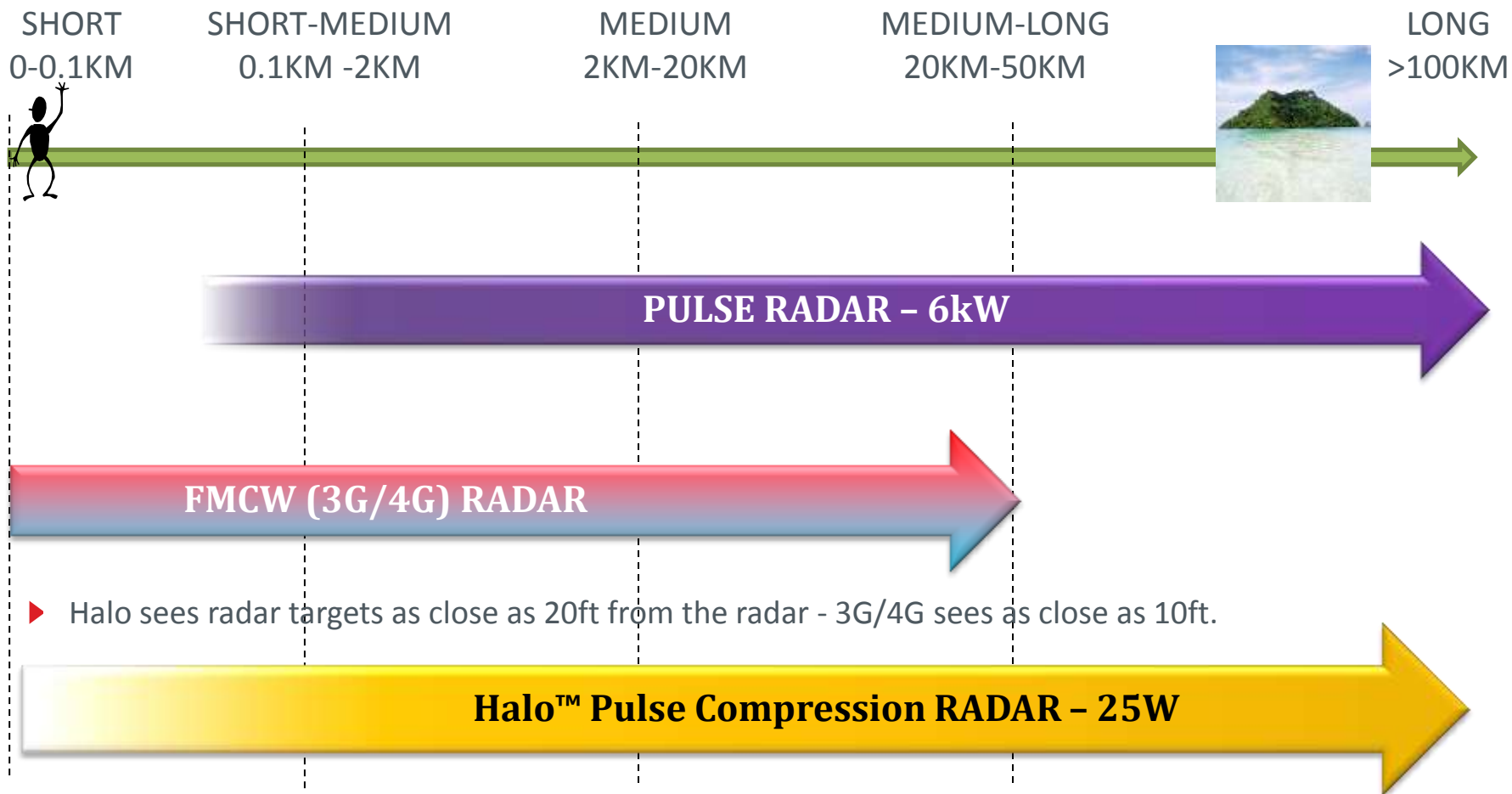

▶ Halo sees radar targets as close as 20ft from the radar - 3G/4G sees as close as 10ft.



Halo™ - What Is It?

HALO™ Pulse Compression Radar has Combined Characteristics

Pulse Features

- ❑ Utilizes a Magnetron (Vacuum Tube radio technology)
- ❑ Very high power pulse, short duration
- ❑ Poor short range, good medium range, excellent long range.

FMCW Features

- ❑ Solid State (no magnetron)
- ❑ Very low power continuous wave transmission
- ❑ Excellent short range, good medium range, adequate long range.

HALO™

- ✓ Solid State (no magnetron)
- ✓ Low power pulsed Tx
- ✓ Good short range, excellent medium range, good to excellent long range (Tx Power dependent)



Halo™ - Conventional Pulse Radar

Short high-power pulse

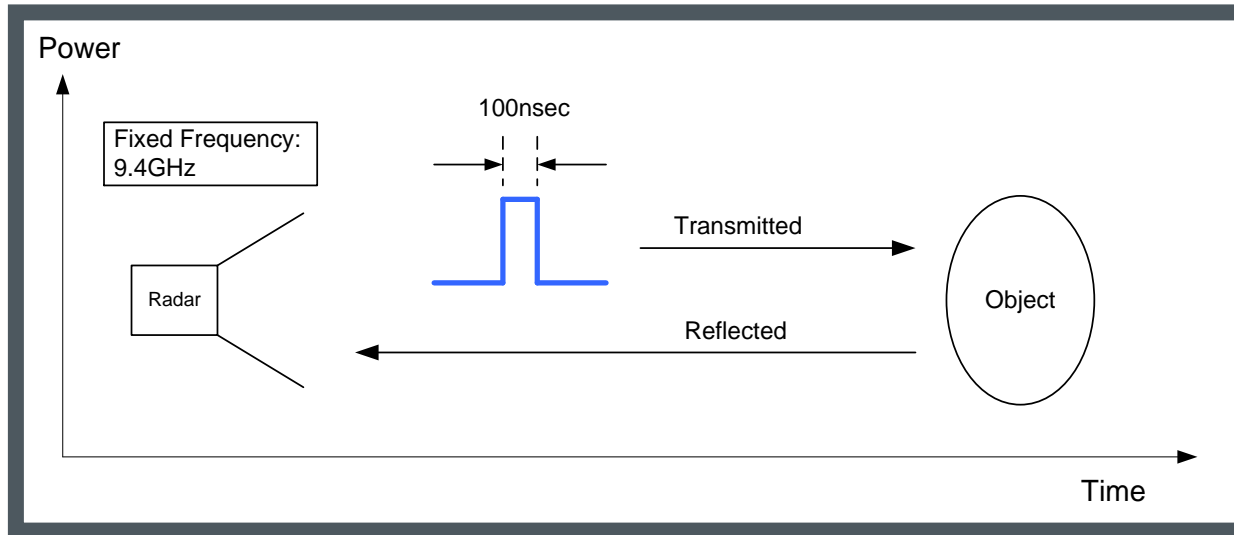

- ▶ The radar transmits a powerful, but very short pulse, at fixed frequency.
- ▶ The pulse propagates outwards in a direction determined by the angle of the rotating radar antenna at the time of transmission.
- ▶ The radar then switches to receive mode to listen for reflections.
- ▶ If the pulse reflects off an object, it will return to the receiver with a delay proportional to the distance of the object from the transmitter.
- ▶ The antenna angle at the time of pulse transmission equals the direction of the object.



Halo™ - How Navico 3G/4G Works

Navico Broadband Radar - Long Swept Frequency Modulated pulse

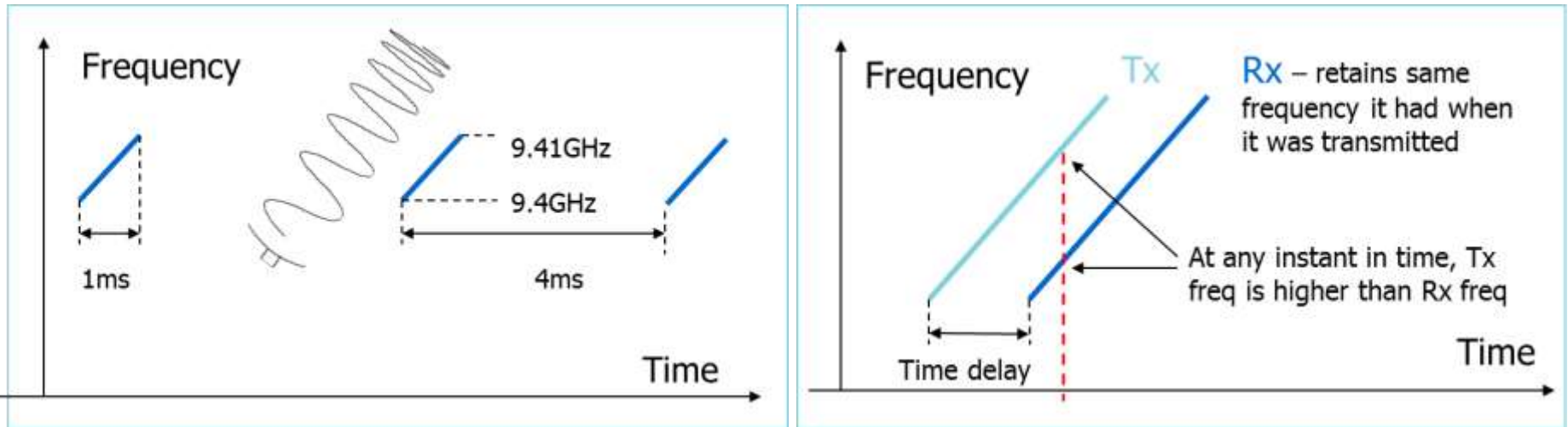

- ▶ FMCW = Frequency Modulated Continuous Wave (a Frequency Diversity mode)
- ▶ The transceiver transmits a 'rising tone' (Tx wave) with linear increasing frequency – at the same time the signals are received – full duplex operation.
- ▶ The wave propagates out at transmitter frequency. If it reflects off an object, it will return to the receiver, still at the frequency it had when originally transmitted.
- ▶ Meanwhile the transmitter continues to output an increasing frequency, the difference between the currently transmitted and currently received frequencies, coupled with the known rate of frequency increase, allows a time of flight to be calculated, from which we can calculate a distance.



Halo™ - How Halo™ Works

Navico Halo Pulse Compression - Medium power FM 'Chirp'

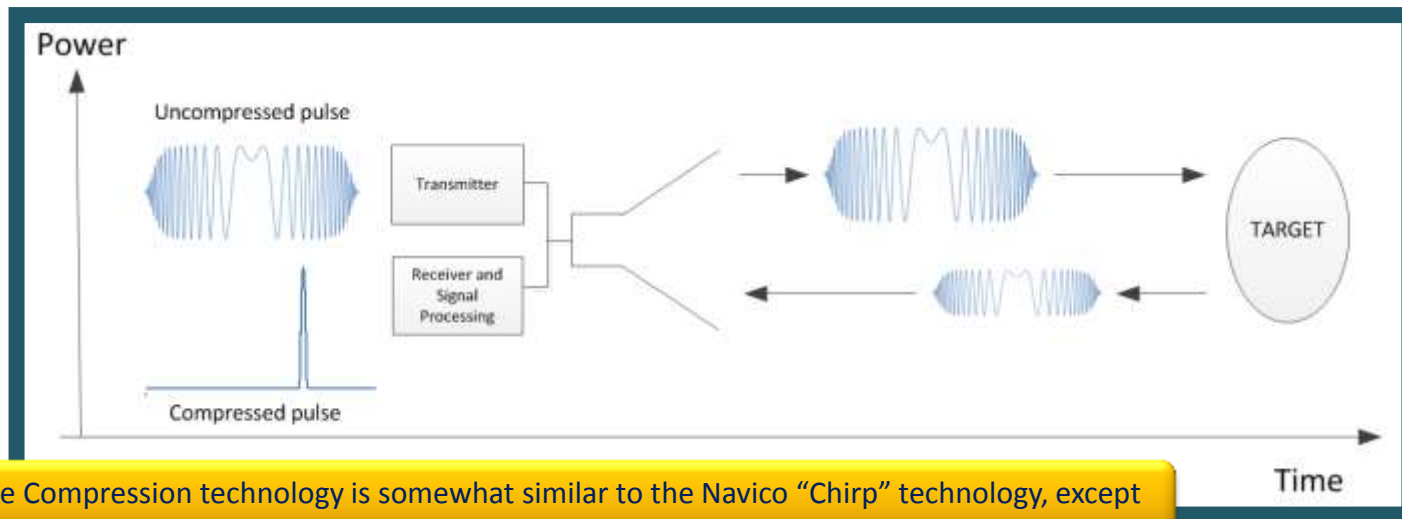

Halo™ Pulse Compression technology is somewhat similar to the Navico “Chirp” technology, except for custom modulation/Burst RF Transmission sequences and applied to radar instead of sonar.

- ▶ A ‘chirp’ is transmitted and propagates outwards with direction according to the angle of the rotating radar antenna at the time of transmission.
- ▶ The radar then switches to receive mode to listen for echoes.
- ▶ If the chirp reflects off an object, the echo will return to the receiver with a time delay proportional to the distance of the object from the transmitter.
- ▶ Halo ‘compresses’ chirp into a pulse up 150 times shorter using signal processing and measures the time delay to determine the range of the target.
- ▶ The antenna angle at the time of pulse transmission equals the direction of the object.



Halo™ - 6 Radars in 1 - 'Chirp Burst'

Navico Halo Pulse Compression - FM 'Chirp Burst'

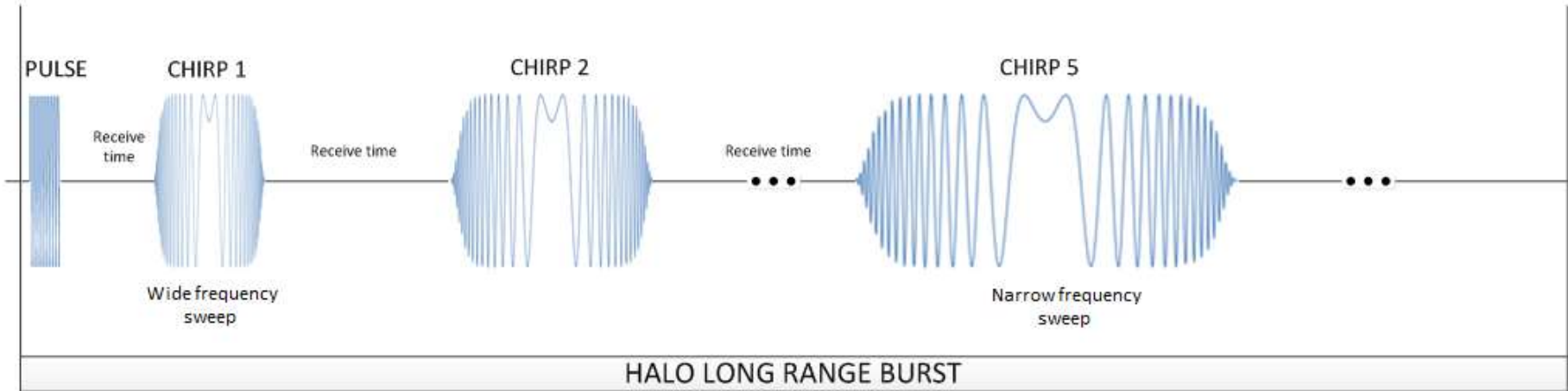

- ▶ Simple pulse compression method of transmitting a single chirp is not possible or practical:
 - A short chirp gives good minimum range but poor long range target detection
 - A long chirp gives poor minimum range but good long range target detection
- ▶ -> Transmitting a blend of short through long Chirps gets both excellent minimum range (about 6m – 20ft) and high performance target detection (similar to a 6kW radar) at all ranges.
- ▶ Halo transmits a short 40ns pulse and up to 5 variable length chirps up to 96us in a 'Burst' to cover the full radar range from 300' to 72nm. 500-2800 bursts per second are transmitted.
- ▶ A combined radar data IMAGE of all 6 pulses is stitched together using high speed DSP software and sent to the MFD.



Halo™- Image Composition

Each chirp covers sub-range of the full radar range. For example:

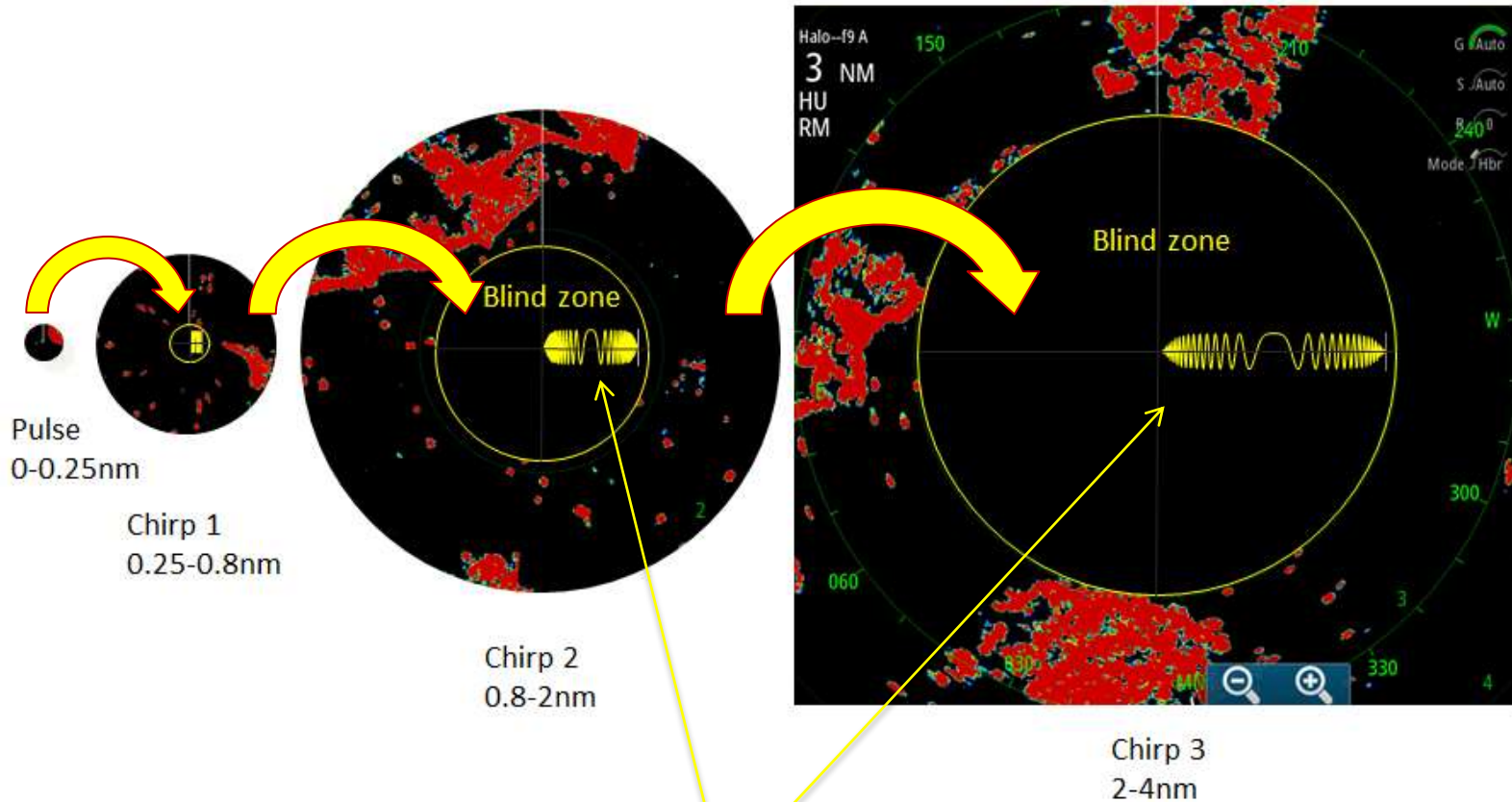

- ▶ NOTE: Each pulse/Chirp covers up to the blind range of the next longer chirp. LONG Tx times creates huge dead zones (main bang time) that have to be managed well in DSP.
- ▶ A Radar Mile = 12.1us to target and back, so a 96us long pulse = ~7.9nm. Conventional Pulse Radars on Long Range = 1 to 1.2us (~0.1nm). Halo compresses the long pulse to a 100:1 high resolution pulse in DSP.



Halo™- Image Composition

The sub-ranges are seamlessly joined together to build a complete radar image



- ▶ NOTE: It is important to match STC values across the chirp boundaries or a target discontinuity will occur. Notice the smooth, clean target image crossing the chirp1 and chirp 2 range edges.



Halo™ - How Halo™ Works

Halo™ Pulse Compression – How is a 25W Halo a 6kW equivalent?

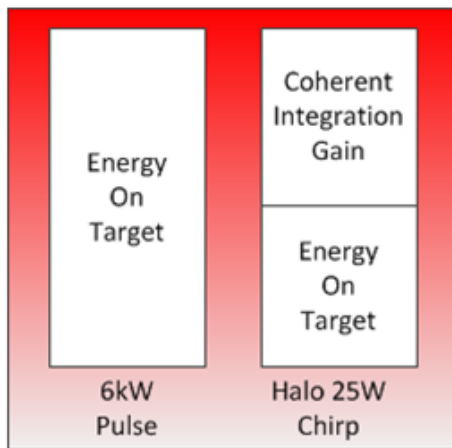
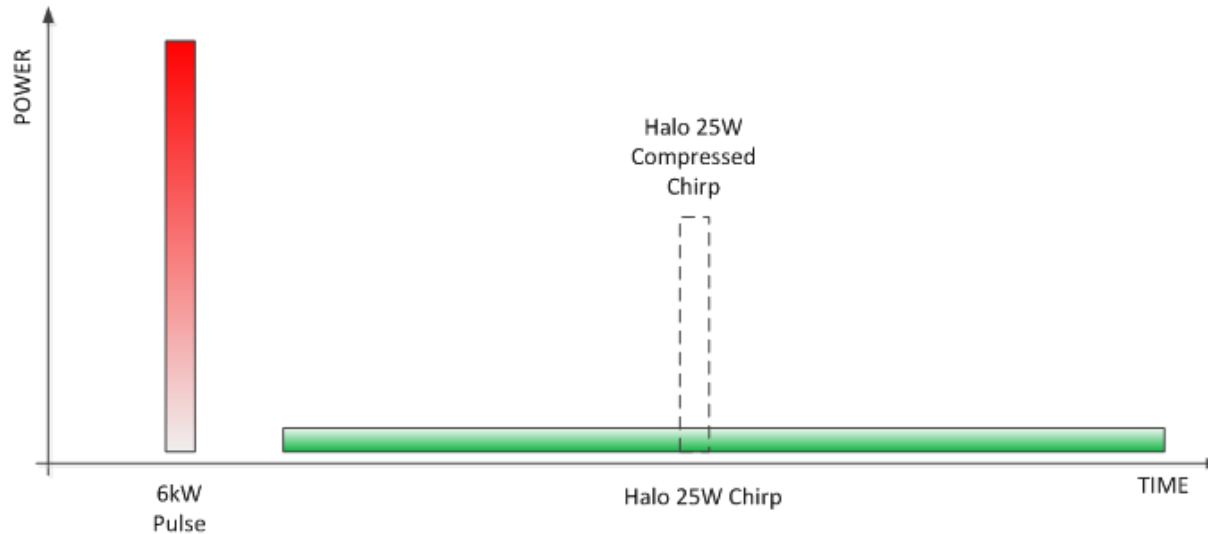

- Pulse energy = Power x Time (Joules). E.g.
 - 6kW LP = 6000W x 1usec = 6mJ
 - 25W Halo single chirp = 25W x 100usec = 2.5mJ
- Halo Transmitter and receiver are frequency locked together i.e. Coherent
- Because of Coherence, the energy from a number of Chirps can be added together to increase total energy on target.
(A magnetron radar is non-coherent so integration gain is far more limited)
- Halo has no power loss over its 10,000hr operational life. Whereas a magnetron can lose up to 30% power output over 2000hrs.

Halo™ - 25W has target detection like 6kW

HALO radars target detection performance is below with Noise Rejection = HIGH. HALO-4 has similar target detection performance as SIMRAD 6kW TX06S-1.

- ▶ SPECIAL NOTE: IMO standard IEC 62388 target detection specs are met with a HALO-6/HALO-4 installed 15m high. *Beacon /Racon triggering range is around 1nm - less than the 5nm IMO spec.*

Targets to Detect	Radar Cross Section - RCS (m2)	Target Height (m)	Minimum range of detection (nm) Antenna height = 3m				Minimum range of detection (nm) Antenna height = 15m		
			Halo-3 (3ft OA)	Halo-4 (4ft OA)	Halo-6 (6ft OA)	TX06S-1 6kW (4ft OA)	IMO 62388	Halo-4 (4ft OA)	Halo-6 (6ft OA)
Shorelines to 60m	50,000	50	13.0	15.3	18.4	15.9	20	21.3	25.6
Shorelines to 6m	5,000	5	4.8	5.6	6.7	6.1	8	10.1	12.1
Shorelines to 3m	2,500	2.5	3.6	4.2	5.0	4.6	6	7.6	9.1
SOLAS ships >5000gt	50,000	10	7.1	8.3	10.0	8.8	11	13.5	16.2
SOLAS ships >500gt	1800	5	4.3	5.1	6.1	5.6	8	9.6	11.5
Small vessel with radar reflector meeting IMO Performance Standards	7.5	4	2.4	2.8	3.4	2.9	5.0	5.4	6.5
Navigation buoy with corner reflector.	10	3.5	2.3	2.7	3.2	2.8	4.9	5.3	6.4
Typical Navigation Buoy	5	3.5	2.0	2.3	2.8	2.6	4.6	5.0	6.0
Small vessel of length 10 m with no radar reflection	2.5	2.5	1.6	1.9	2.3	2.1	3.4	4.2	5.0
Typical Channel Marker	1	1	0.9	1	1.2	1.1	2.0	2.4	2.9
Large Flocks of Diving Birds	Highly Variable	1-15	2 - 3	3-4	4-5	3-4.5	NA	NA	NA

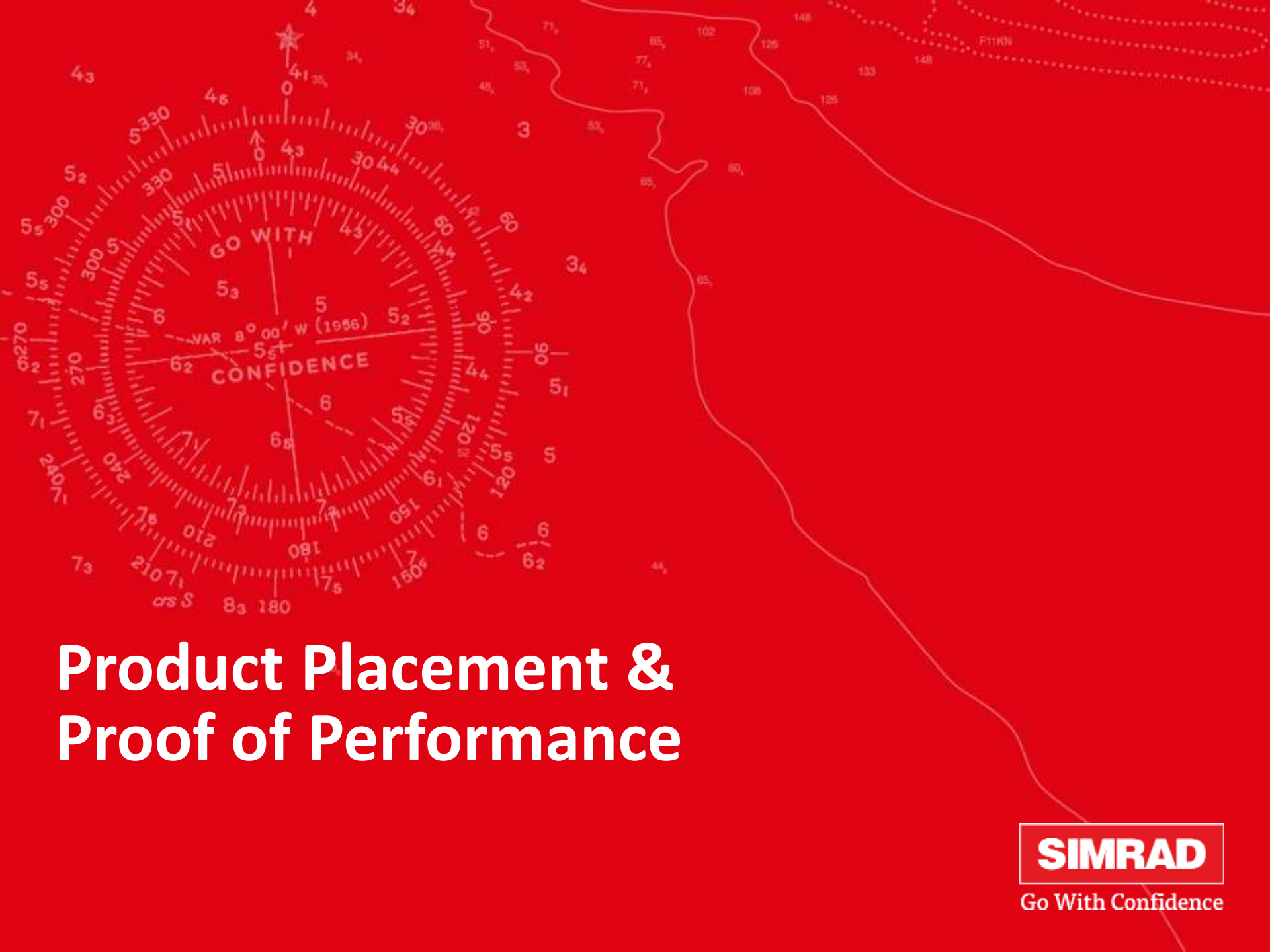

Product Placement & Proof of Performance

SIMRAD

Go With Confidence

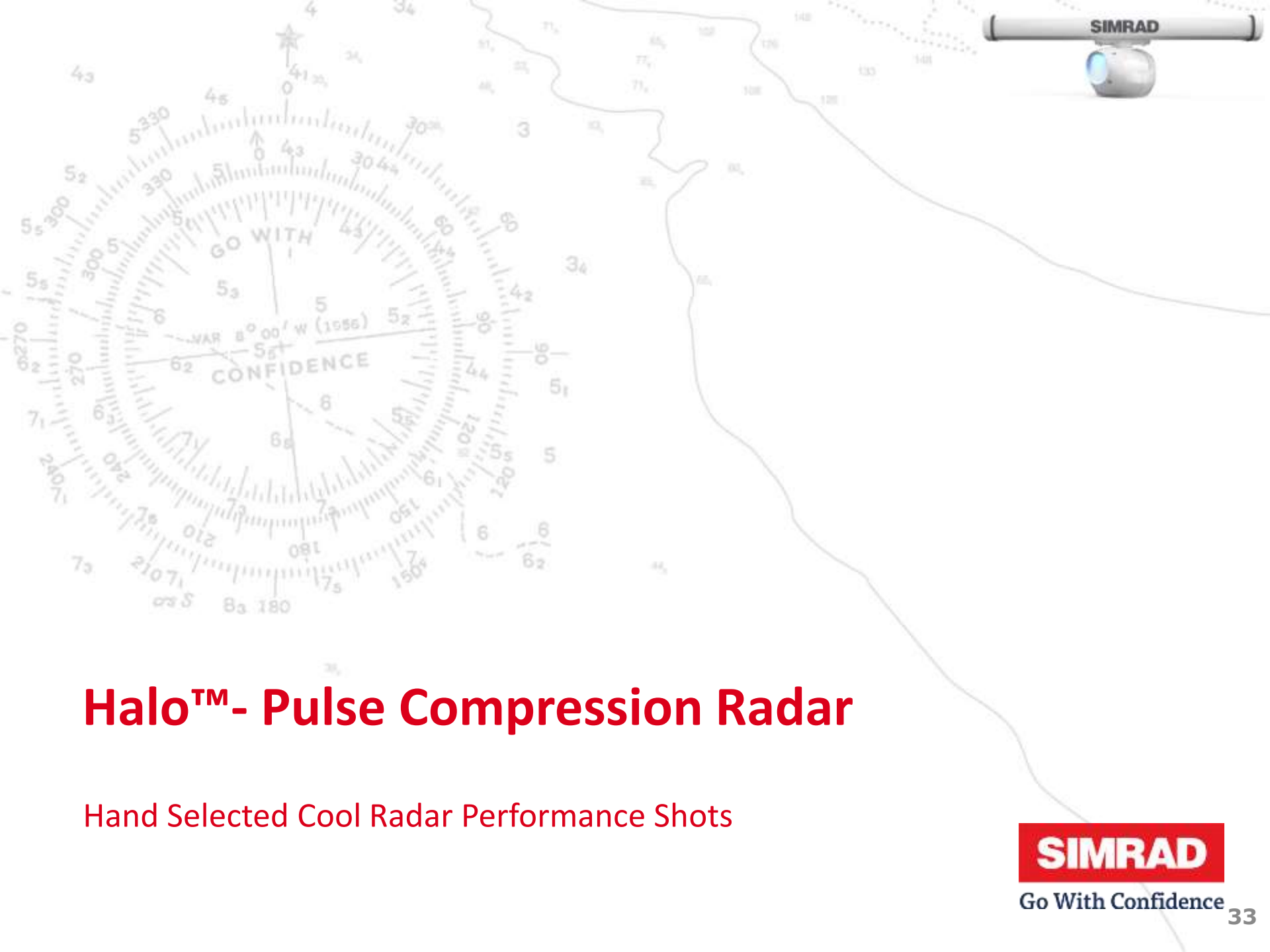

Halo™- Pulse Compression Radar

Hand Selected Cool Radar Performance Shots



Go With Confidence 33



Halo™ - Proof of Performance



▶ Halo-4 + Garmin 6kW 4' xHD



▶ Halo4 + Garmin 6kW 4 xHD



▶ Halo4 + Ray 4kW



Halo™ - Proof of Performance



HALO 4 + Furuno 6kW 4' DRS-6A

Halo™ - Proof of Performance



▶ Halo™ with 6' Array + TX06S-1 6kW 4'

▶ Halo™ with 4' Array + TX06S-1 6kW 4'



Halo™ - Proof of Performance



- ▶ NZ SEALINK with Halo™ + 4G running with daily ferry service

- ▶ Local NZ Charter Boat



Halo™ - Long Range – past 65nm

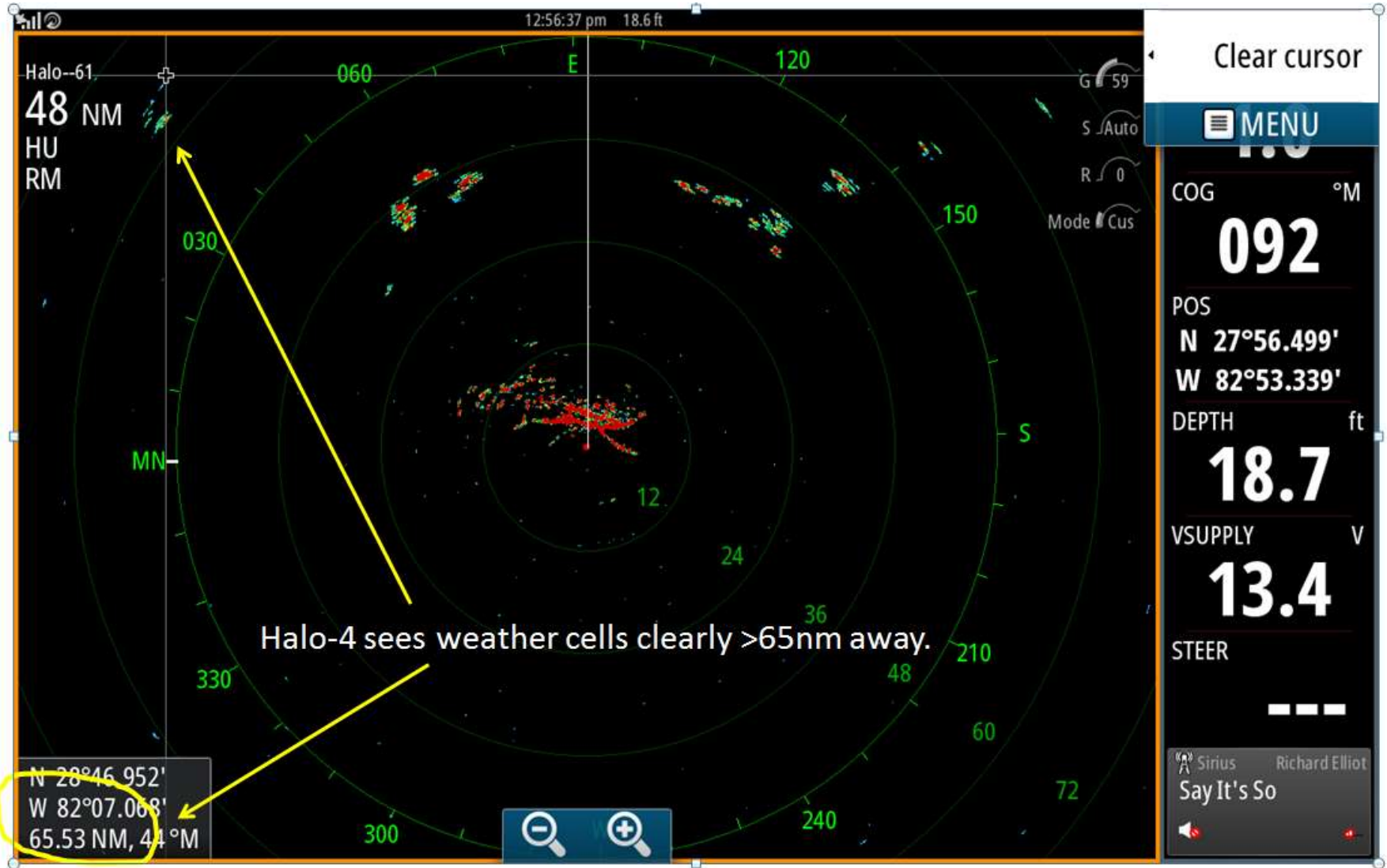



Halo™ - Fine Grained Weather

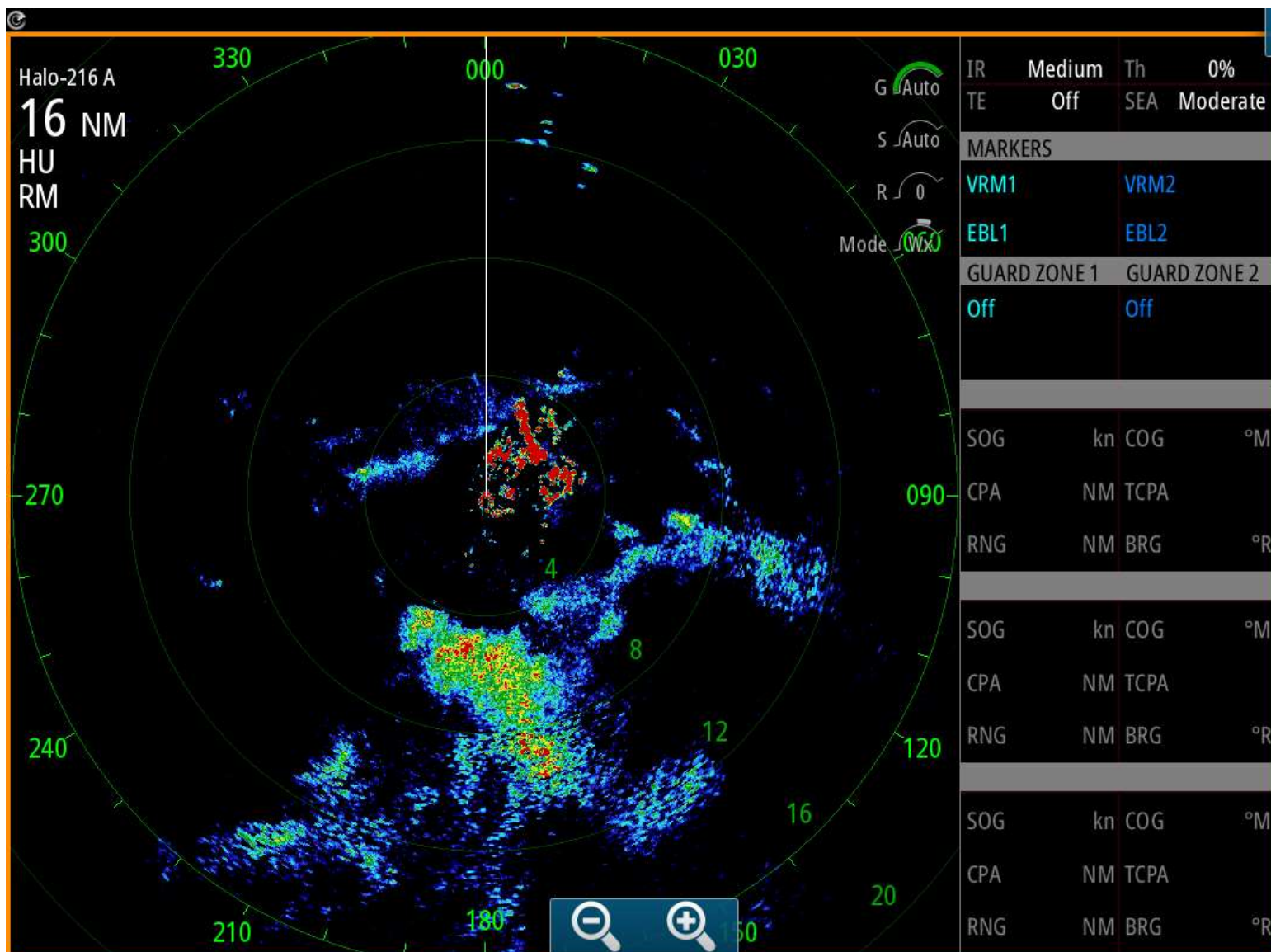



Halo™- Beam Sharpening – like 4G

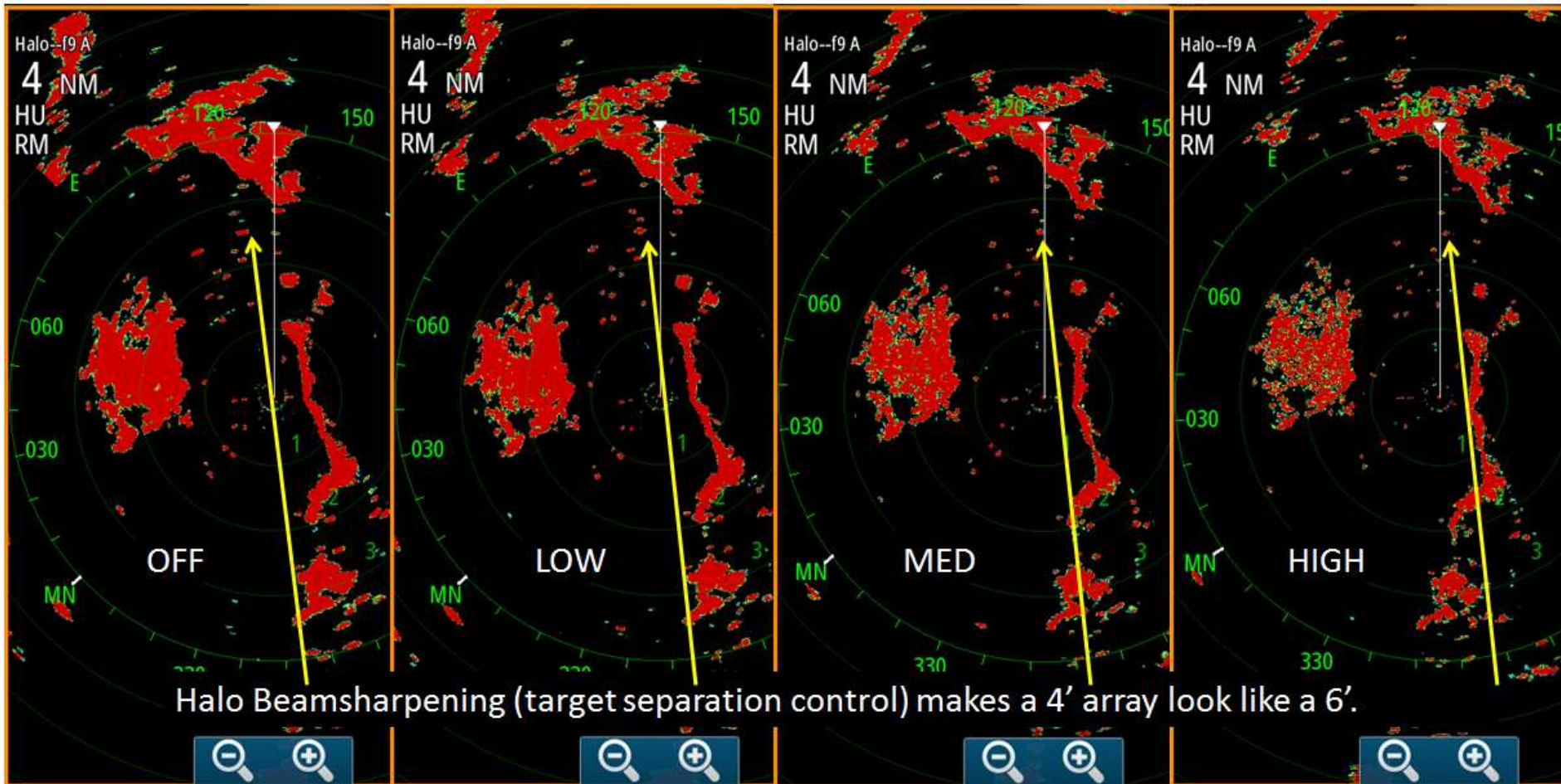

- ▶ **NOTE:** ALL Halo models have Beam Sharpening – 6' array has an unprecedented 0.8 degrees



Halo™ - Beam Sharpening – like 4G

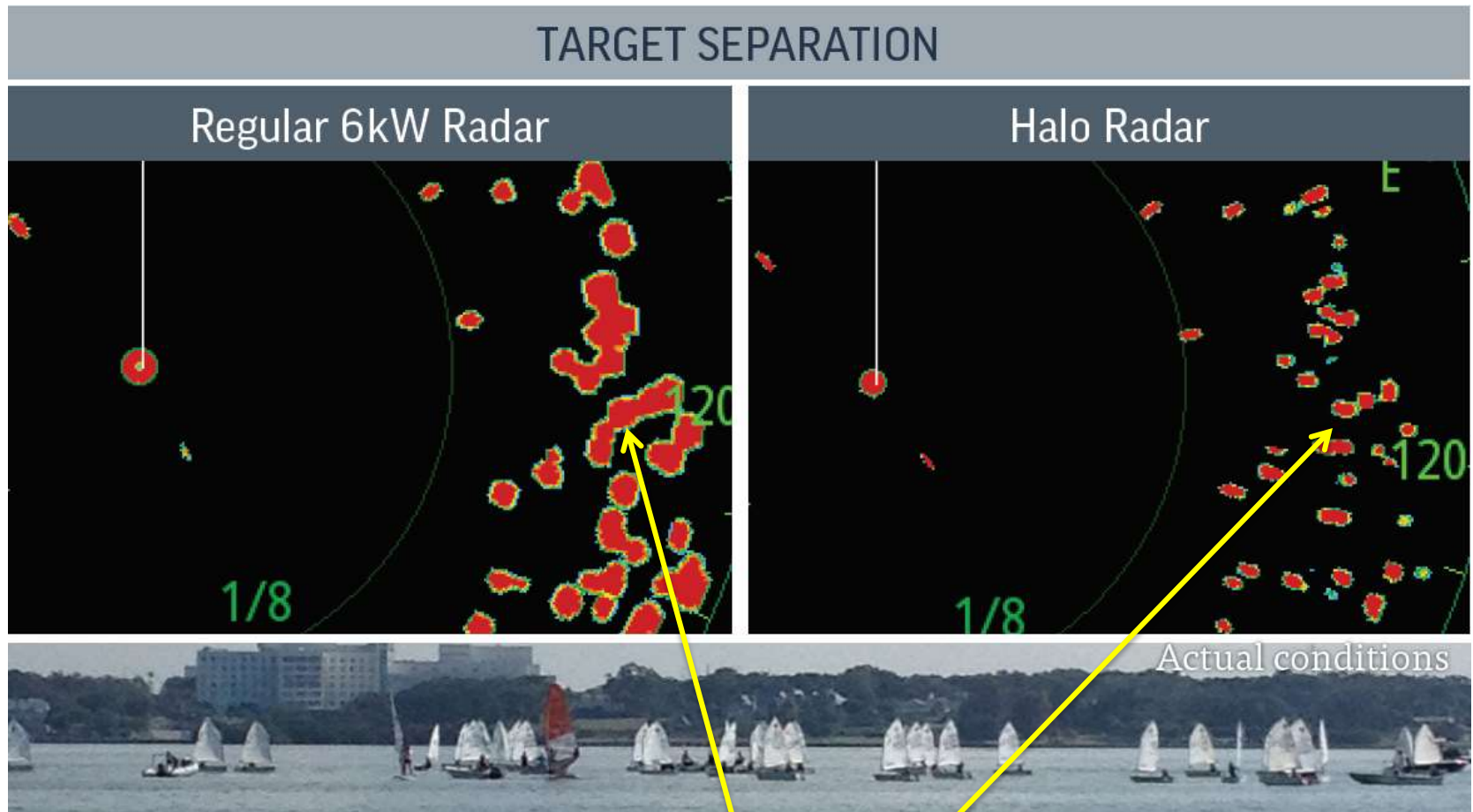

- ▶ SUPERIOR TARGET SEPARATION
- ▶ Halo™ shows clear separation of even the smallest targets, as seen in this sailing dingy race.



Halo™ - Rock Jetty in NZ

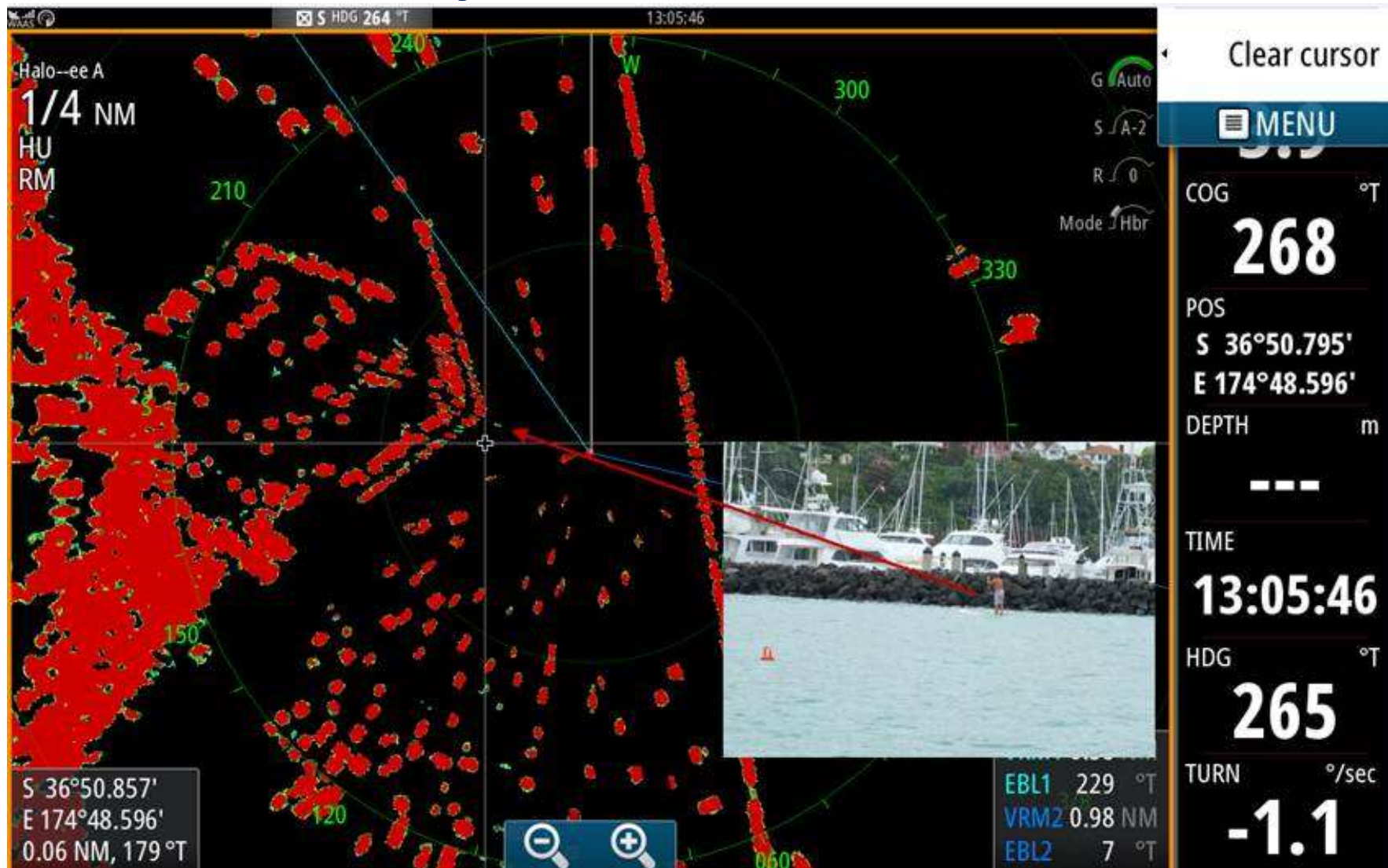



Halo™ - Proof of Performance



- ▶ Literally thousands of on-water radar hours have been logged with all these and other vessels. Feedback has been gathered and code improvements carefully incorporated.



- ▶ The best BIRD FINDING boat in the world (Whales and Dolphins Tour Vessel) is located in Auckland. They are partners and have had both Halo™ and our TX06S-1 6kW 4' radars on board.



Halo™ - Dual Range

14:03:52

Halo-110 A
64 NM
NU
RM

Halo-110 B
300 ft
NU
RM

Sees targets 20' from the radar

Any Range – Anywhere
Far and Near.
Halo has totally independent
Dual Range Screens.
Note: Cursor shows 20' main bang.

S 36°50.717'
E 174°48.672'
20 ft, 342°T

Clear cursor

MENU

COG °T
071

POS
S 36°50.720'
E 174°48.672'

DEPTH m

TIME
14:03:51

HDG °T
073

TURN °/sec
1.8

Halo™ - Short Range + smallest main bang



- ▶ Halo™ easily sees Kayaks and paddle boarders

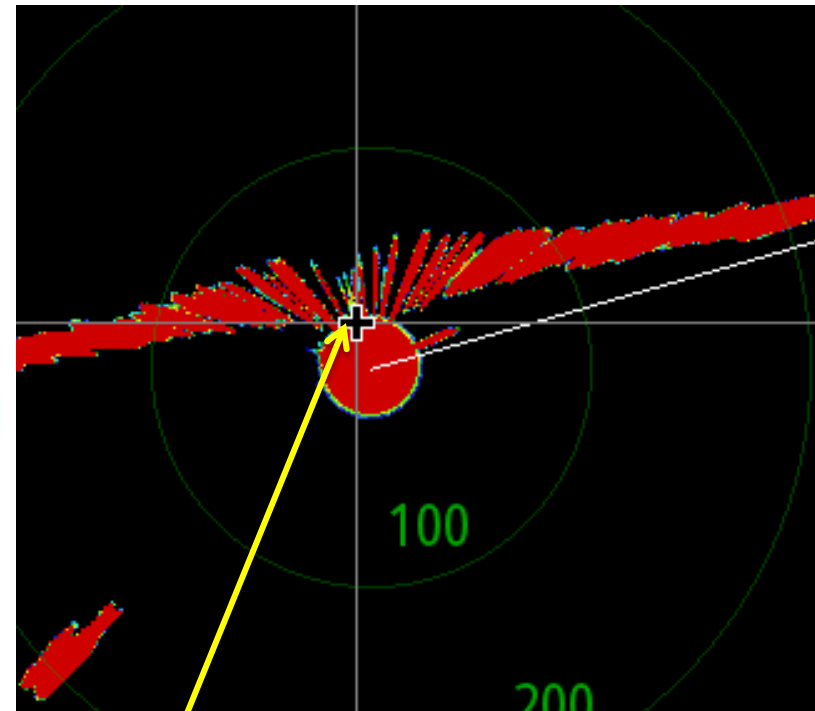

- ▶ REAL 20' (9m) Main Bang - No competition here! Other pulse radars are at least 85' and more

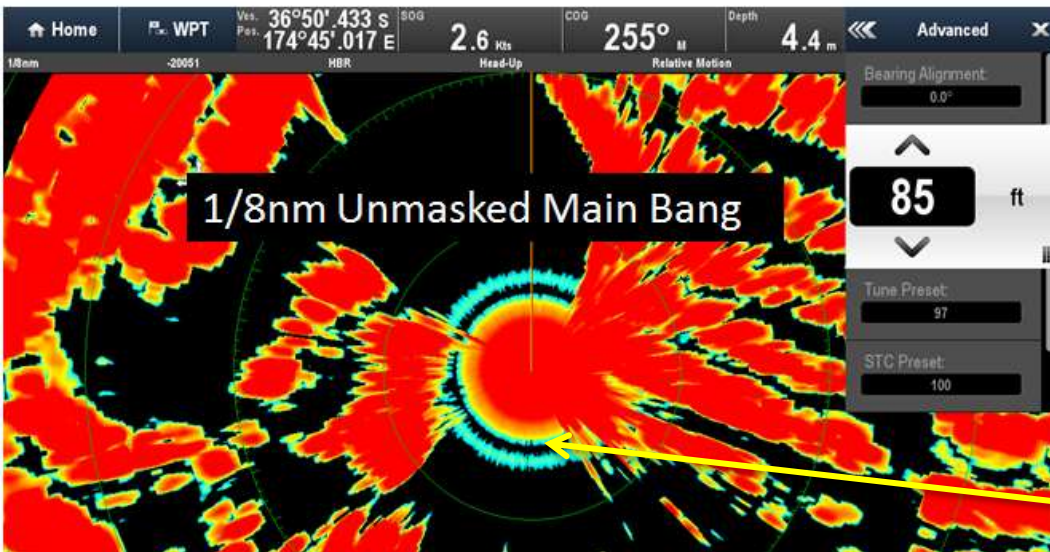



Halo™- Trails with Fast Update

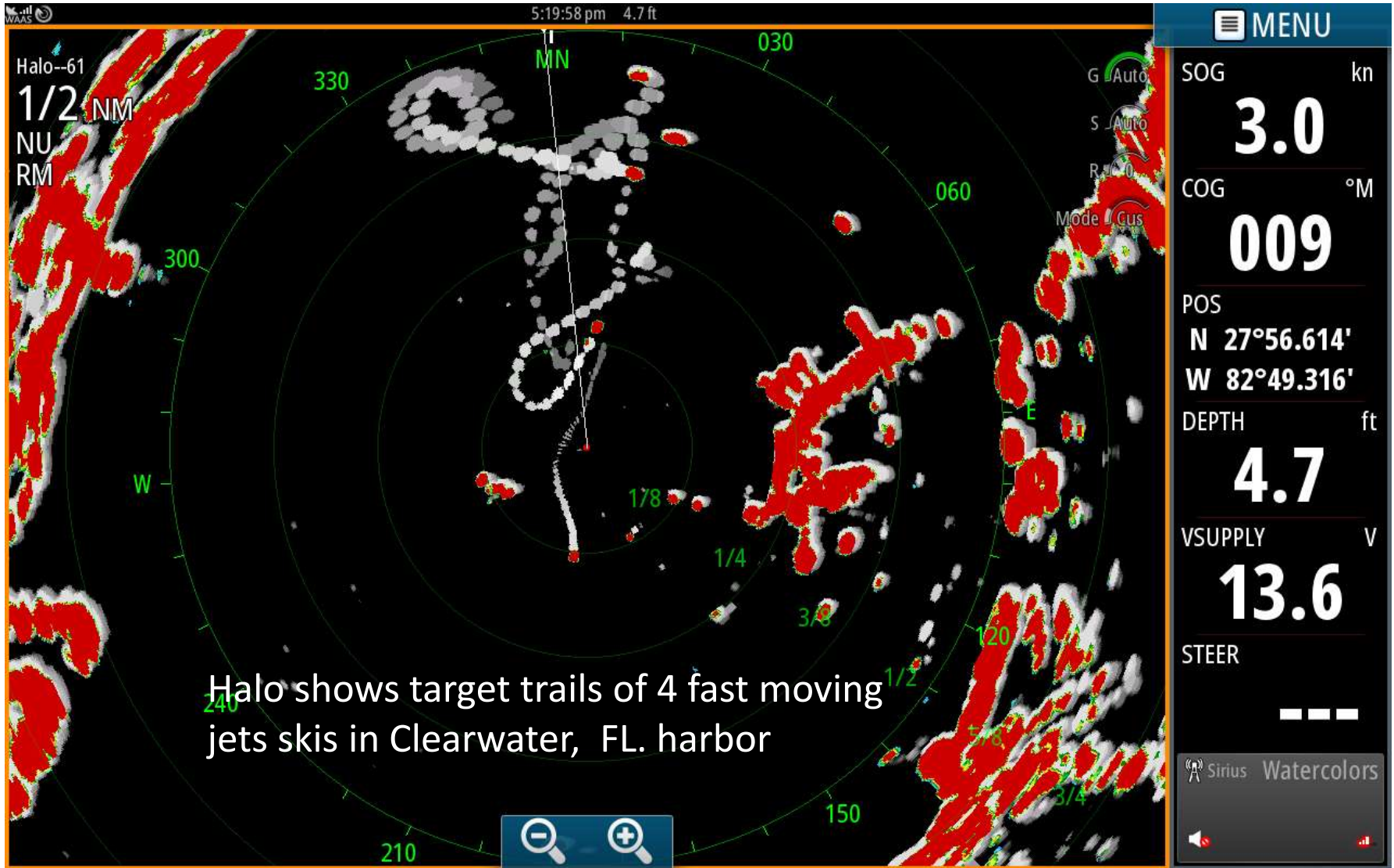



Halo™ - Birdfinder Radar

Got BIRDS?





Halo™ - Birdfinder Radar

We Do....FISH ON!





Halo™ - Birdfinder Radar



- ▶ Birds mean fish. In NZ, Halo's dedicated BIRD mode means it's easy to find flocks of birds – >3.5nm here. Notice that this mode does not fill the screen with high gain clutter. DSP magic.



Halo™ - Birdfinder Radar

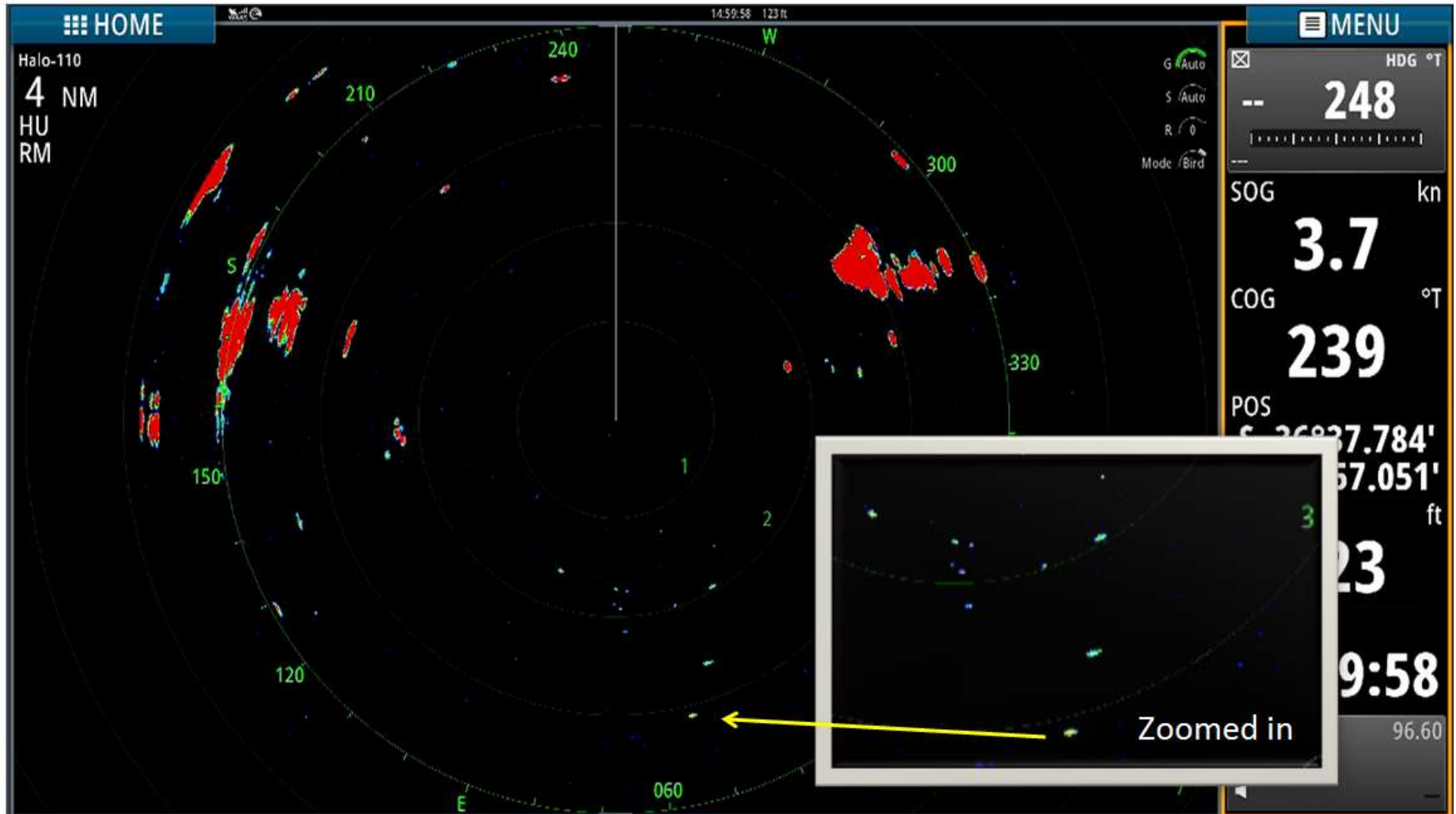

- ▶ More “spread out”, individual large birds are even seen

Halo™- BONUS – Halo Target detection in Rain

The unique properties of pulse compression mean Halo sees through rain better at short range (best for collision avoidance) while still seeing distant rain (that you want to avoid) as well as conventional pulse radar. This applies regardless of what user range the radar is operating on.

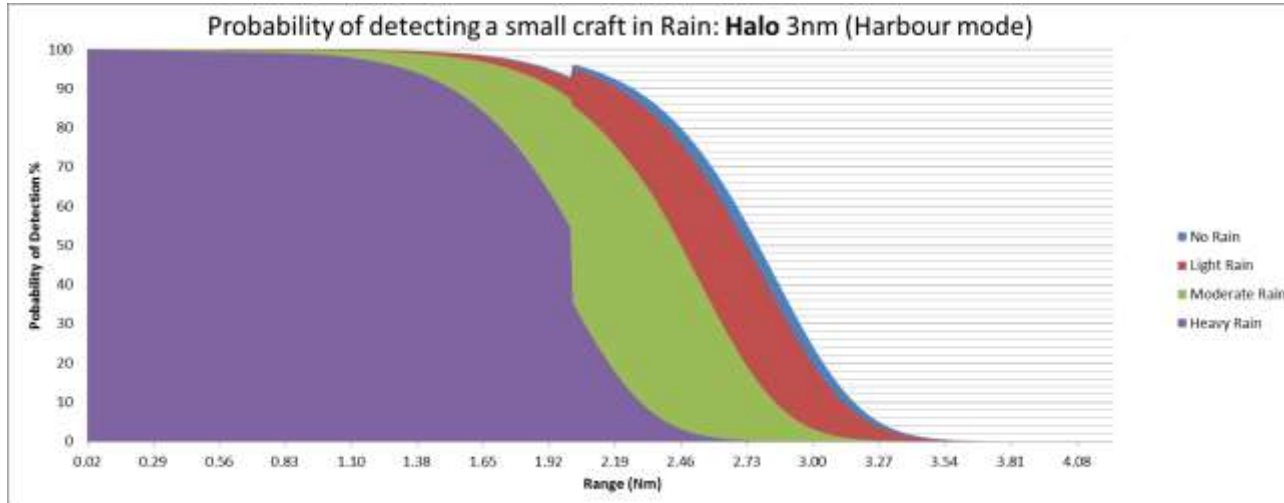

NOTE:

- ▶ Halo sees BIRDS through light Rain that competition pulse radars cannot possibly see due to clutter.

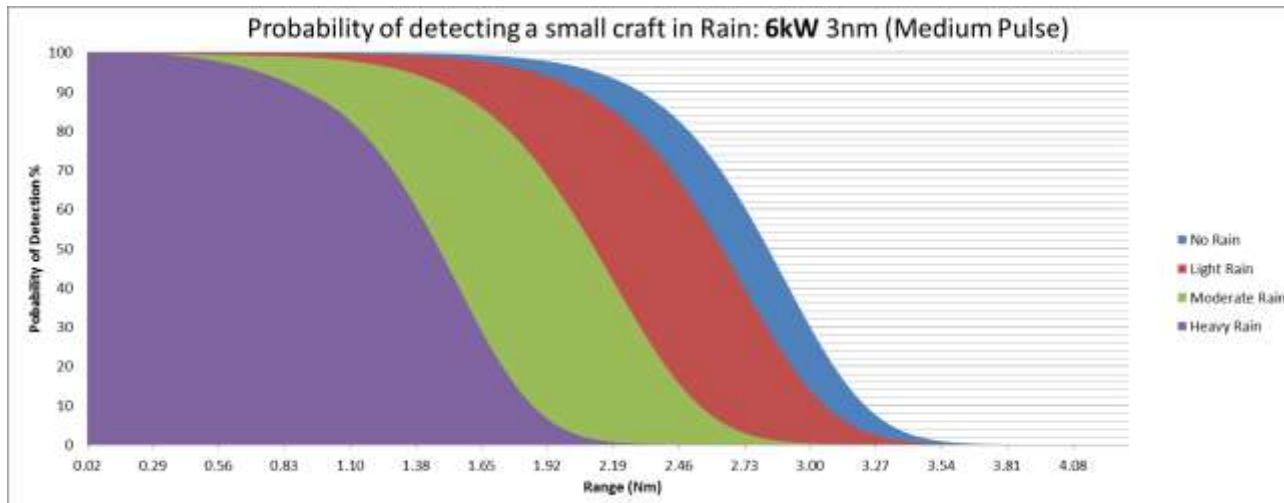

Antenna height = 5m was used for these simulator plots.



Halo™ - Sector Blanking

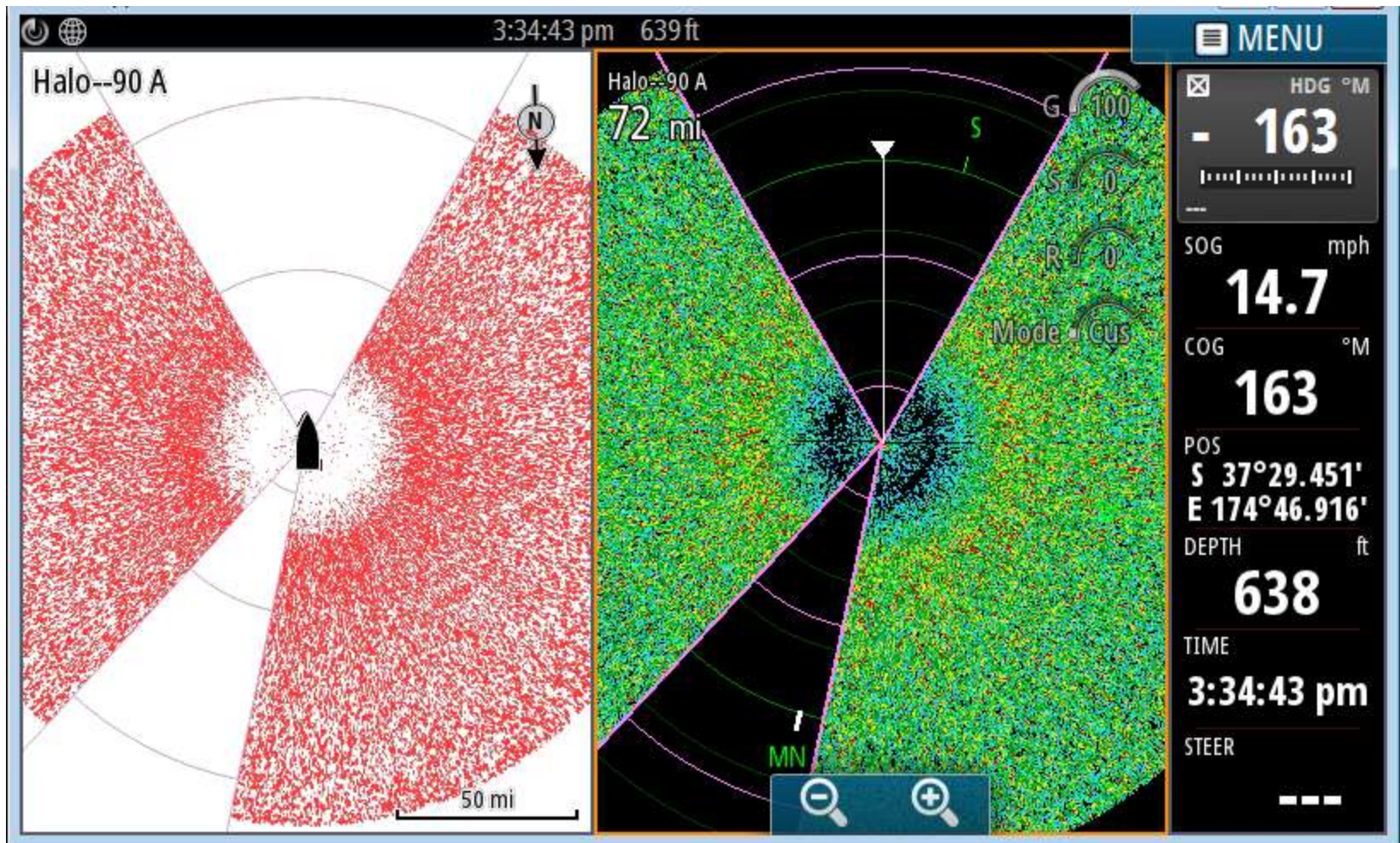

- ▶ Halo Sector blanking (available in release #2 code in May) has up to 4 zones with 3 magenta arcs



Halo™ - Sector Blanking

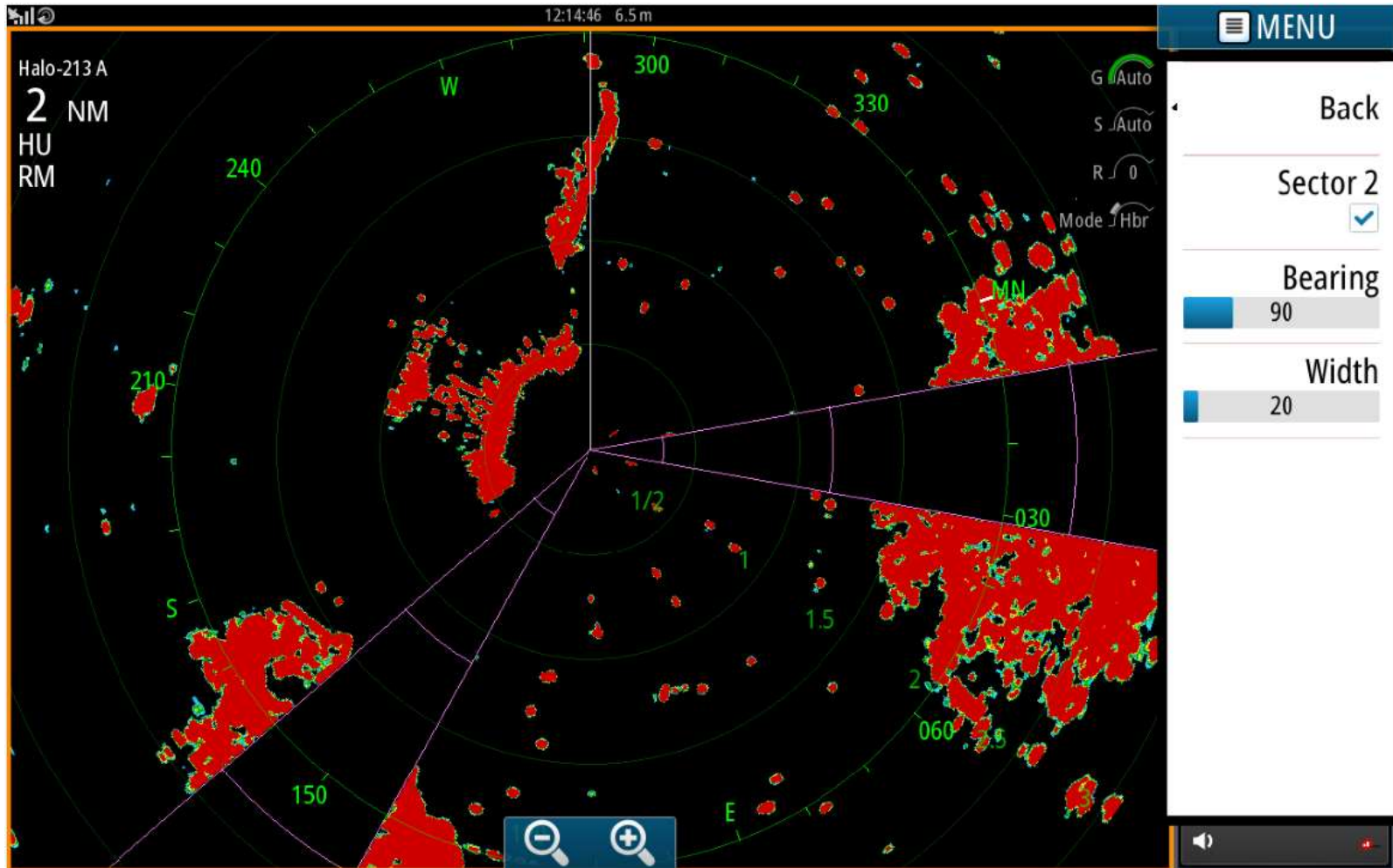

▶ Halo Sector Blanking on water showing 2 zones with 3 magenta arcs



Halo™ - Sector Blanking

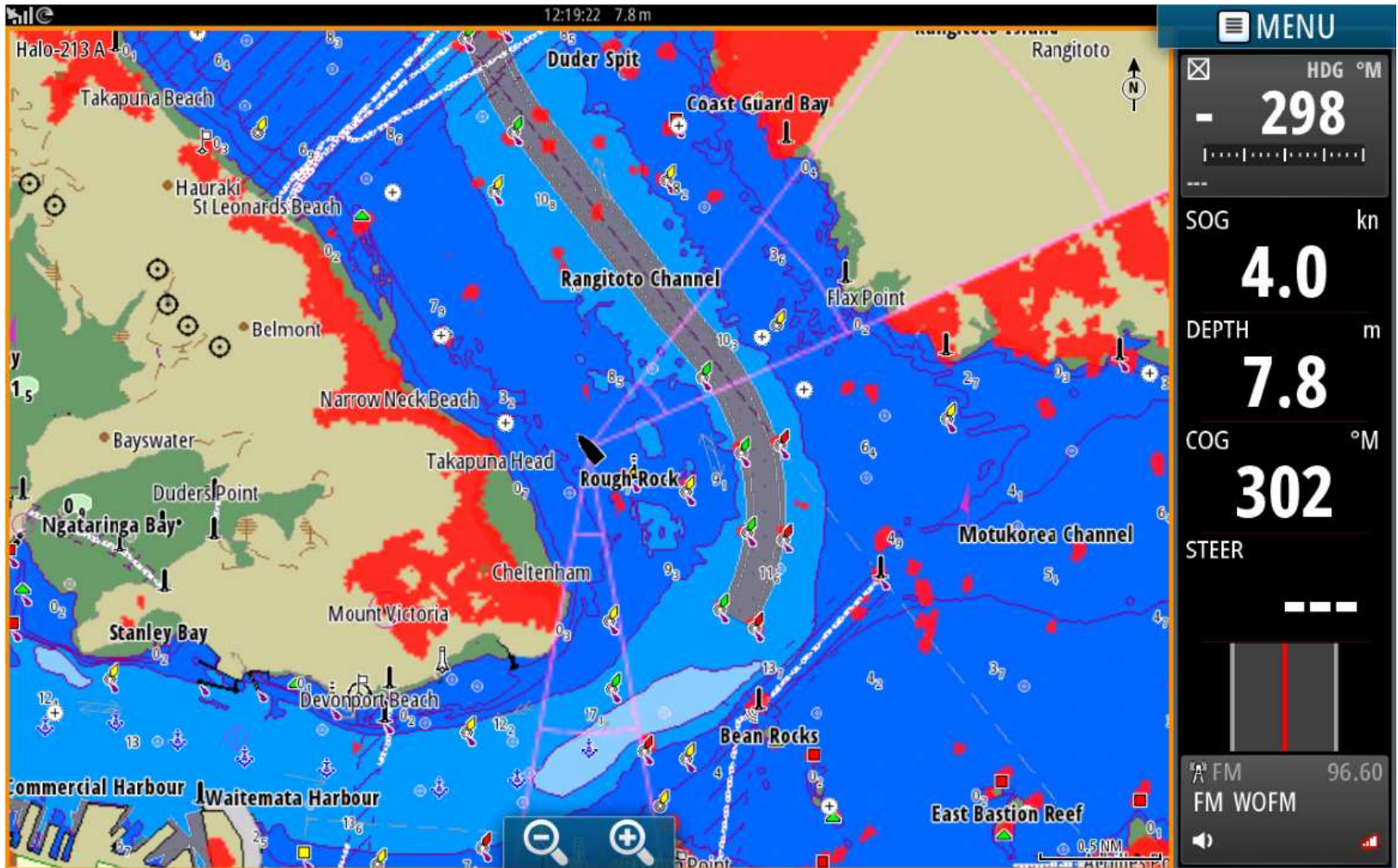

- ▶ Halo Sector on water showing 2 zones with 3 magenta arcs with chart overlay



Halo™ - Actual Results

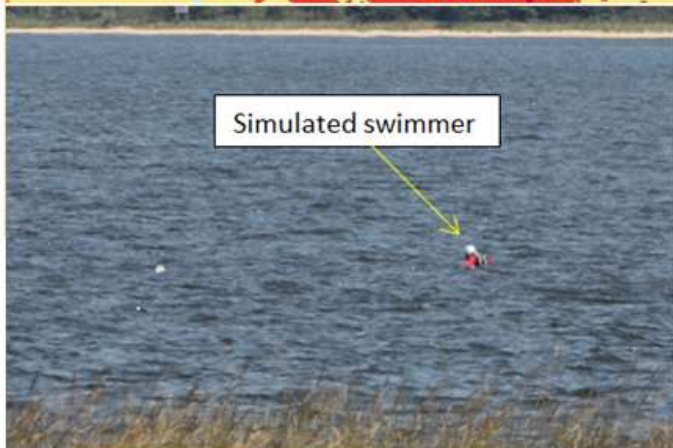
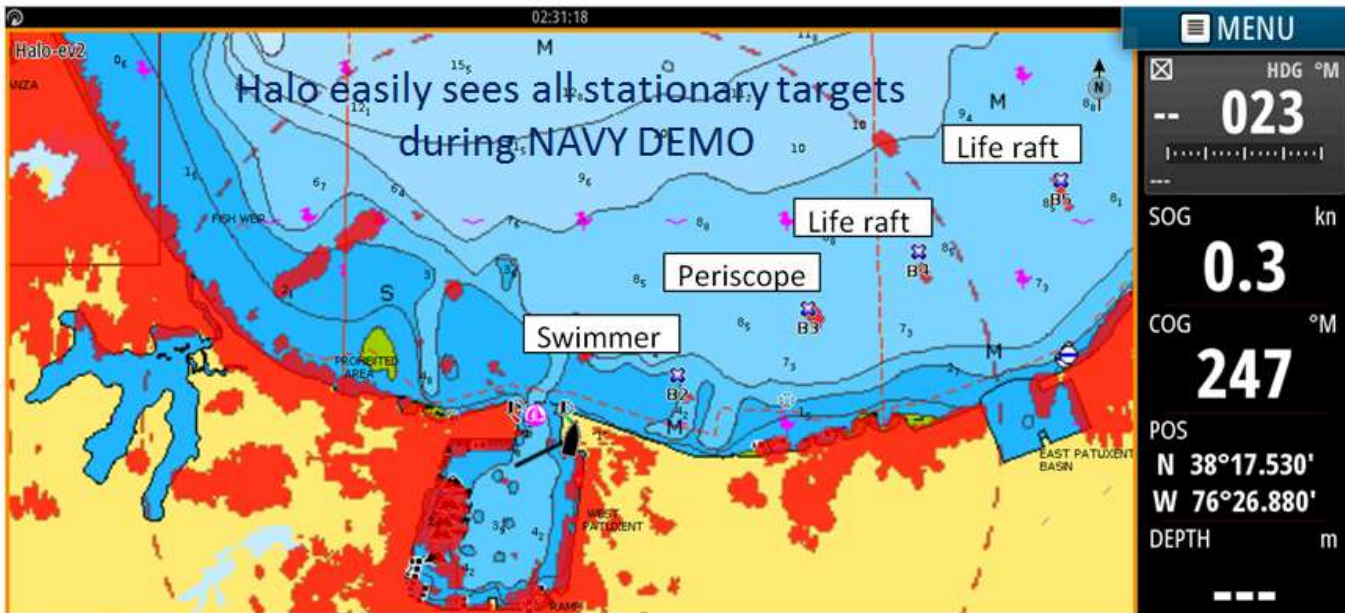



Halo™ - Actual Results

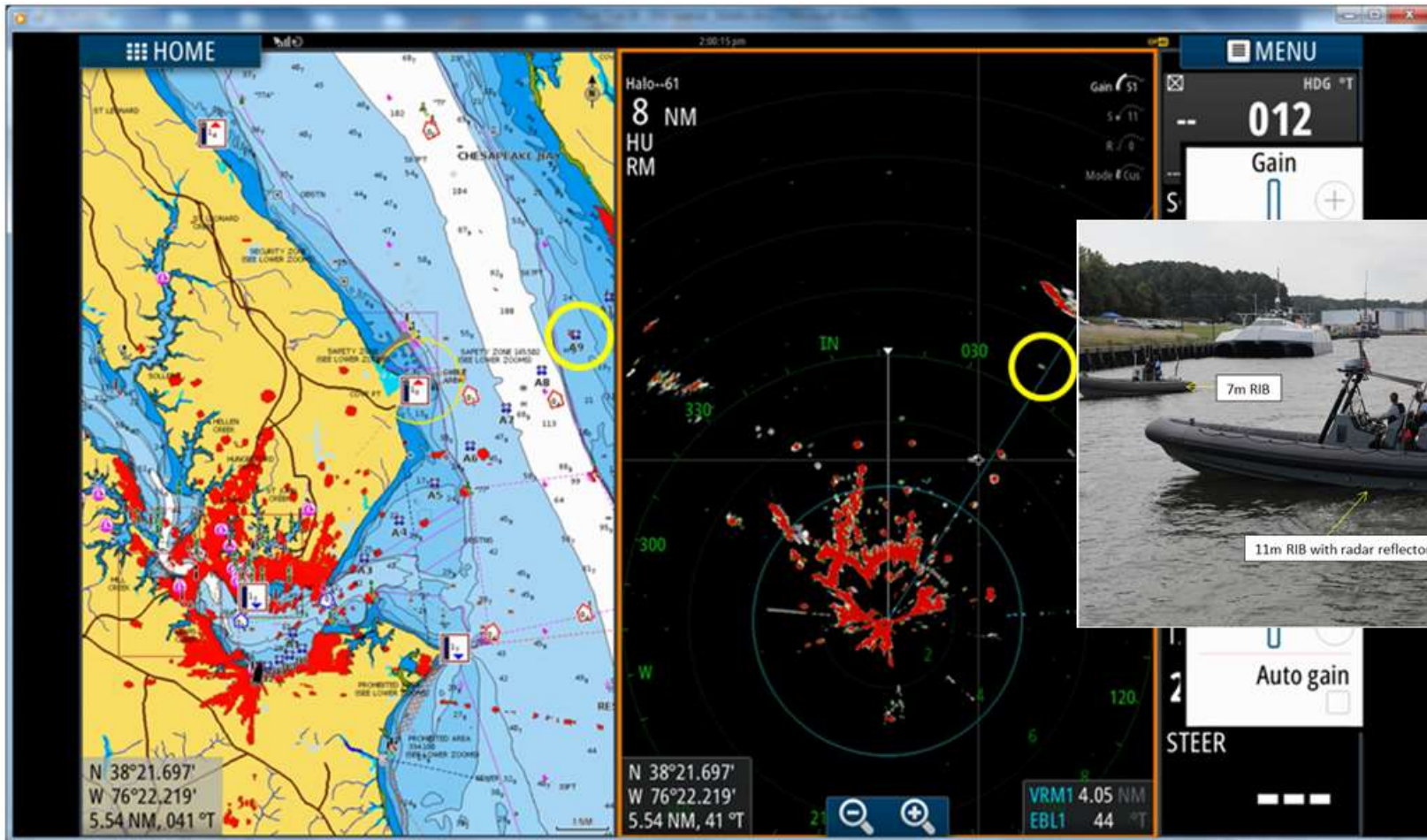

- ▶ Halo easily sees all targets and 11m RIB to ~9nm – horizon limits – radio confirmed

Halo™ - Live



- ▶ Our fully loaded Yellowfin DEMO at Hawk's Cay Jan 2015 Media Event

Halo™ - Blue Light



Now the really COOL part....

Our HALO pedestal has BLUE BLING

Recessed, illuminated, soft glow Blue LED accent pedestal lighting with 4 level control

NAVICO Legal Disclaimer Statement:

Halo™ Pulse Compression Radar's blue 4 level static accent pedestal lighting may not be approved for use in your boating location. Please check your local boating regulations before turning the blue accent lights ON.

Halo™ - Blue Light



PARTY TIME



Our HALO Radar is badly needed here

BLUE all over





Advanced User Functionality and Specs

SIMRAD

Go With Confidence



Halo™ - Construction Features

- ▶ Stunning styling with unique blue night lighting
- ▶ Designed for long maintenance free operation
 - Brushless motor
 - Helical gear transmission
 - Solid state transmitter – no loss of performance over product 10,000hr lifetime
- ▶ Commercial grade build quality
 - Heavy duty die cast Aluminium pedestal construction
 - High shock rating
 - Quality stainless steel fittings



Halo™ - Smooth and Quiet

Sound levels: Radar rotational sound level comparisons: 29 January 2014

Brand	Model	Antenna size	24RPM (dba)	48RPM (dba)
SIMRAD	HALO 4 (25W) (helical gears)	4'	45	43*
Raymarine	RA104SHD (4kW) (smooth Belt Drive)	4'	44	51
Garmin	GMR604xHD (6kW)	4'	49	57
SIMRAD	TX06S-1 (6kW)	4'	50	n/a

- ▶ Measurements were taken in the radar RF chamber with isolation foam. Before each reading, the ambient noise level in the chamber was measured and recorded at 35.5dba
- ▶ The SIMRAD HALO radar was 8dba quieter than Ray at high speeds and just 1dba more at 24RPM. Garmin was 6dba more than Ray at high speed. After 190 hrs of running continuously at 48RPM, the HALO sound level with the 6' array was 45 dba.

WolframAlpha Decibel Calculator
Determine the perceived loudness of a sound

Half loudness ≡ level	-10 dB	Double loudness ≡ level	+10 dB
Half sound pressure ≡ level	-6 dB	Double sound pressure ≡ level	+6 dB
Half power ≡ level	-3 dB	Double power ≡ level	+3 dB
Four times power ≡ level	+6 dB	Ten times power ≡ level	+10 dB
Double distance ≡ level	-6 dB	Double sources (Double power) ≡	+3 dB

IMPORTANT NOTE:
 Twice (2X) sound pressure on dba scale is a 6dBa difference.
 43dBa sounds as quiet as a refrigerator



Halo™ - Technical Specifications

Description	Halo™ Pulse Compression Scanner with Radar Interface Box RI-12. (20m cable supplied).	
Type of emission	FCC/IC/R&TTE Type Certification FCC ID: RAYHALO IC ID: 4697A-HALO R&TTE: Emissions compliant to SM1541-4 (including -40dB/dec future design objectives)	
Environmental rating	Operating Temperature: -25 to +55°C Relative humidity: IEC60945 Exposed product Shock and Vibration: IEC60945 Exposed product and 20G, 100,000 cycle UV: IEC60945 Exposed product Waterproofing: IPX6	
Relative wind velocity	70 knots for 3', 4', and 6' antenna at 48rpm with RI-12	
Power consumption @ 13.8Vdc	150W (peak) at maximum wind velocity 40W (average) at zero wind velocity 6.5W (average) for Scanner + RI-12 in Standby mode	
DC input	RI-12 - DC 10.8V to 31.2V (12/24 DC Voltage Systems) Scanner voltage input is 36V nominal generated by RI-12	
Power Up time	16-25 seconds from POWER OFF to transmit	
Outside dimensions (Array Swing Circle)	Height: 448mm 3 ft model: Array Swing Circle Diameter 1141mm (3.5ft) 4 ft model: Array Swing Circle Diameter 1431mm (4.5 ft) 6 ft model: Array Swing Circle Diameter 2045mm (6.5 ft)	
Weights:	Pedestal: 18.75 Kg (41.3lb) RI-12: 1.6 Kg (3.5lb) 10m (33 ft) Cable: 1.1 Kg (2.4lb) 20m (66 ft) Cable: 2.3 Kg (5.0lb) 30m (100 ft) Cable: 3.4 Kg (7.5lb)	Antenna 3': 4.1 Kg (9.0 lb) Antenna 4': 4.9 Kg (10.8 lb) Antenna 6': 6.5 Kg (14.3 lb)



Halo™ - Technical Specifications

Description	Halo™ Pulse Compression Scanner with Radar Interface Box RI-12. (20m cable supplied).
Instrumented Range	3 ft model: 48nm 4 ft model: 64nm 6 ft model: 72nm
Plane of polarization	Horizontal Polarization
Beam width	3 ft model: 2.4°+/-10% (-3dB width) – 1.7deg with Beamsharpening Mode ON 4 ft model: 1.8°+/-10% (-3dB width) – 1.3deg with Beamsharpening Mode ON 6 ft model: 1.2°+/-10% (-3dB width) - 0.8deg with Beamsharpening Mode ON Vertical 25°+/-20% (-3dB width)
Side lobe level	3 ft model: Below -23dB max. (within ±10°) Below -30dB max. (outside ±10°) 4 ft model: Below -23dB max. (within ±10°) Below -30dB max. (outside ±10°) 6 ft model: Below -23dB max. (within ±10°) Below -30dB max. (outside ±10°)
Rotation	Approx. 24 to 48 rpm (Min 20rpm at Max 70 kts). Software controlled in Modes
Transmitter frequency	Synthesized – Upper half of X-Band @ 9.41 – 9.495GHz
Peak power output	25W±10% under any transmit condition – up to 10% Duty Cycle max
Transmitter	Solid State module – at least 10 years or 10,000 hrs lifetime



Halo™- Technical Specifications

Description	Halo™ Pulse Compression Scanner with Radar Interface Box RI-12. (20m cable supplied).
SART/RACON Triggering (Future)	Yes – trigger distance: about 1nm – weather, sea state, and SART position dependent
Duplexer	Circulator and isolator
Mixer	MIC front-end
IF section	Center frequency: 28.625MHz Bandwidth: 40 MHz max.* Sampling Rate: 16bit 115MSPS *Narrower bandwidths defined by signal processing
Noise figure	5dB (Average) at front-end input.
Communications Ports	Ethernet 10/100 Base-T for radar data and control NMEA2000/NMEA-0183 for NMEA data via RI-12
Motor	Brushless with solid state commutation with electromagnetic braking for parking.
Interconnecting cable length	Uses same 3G/4G Broadband Radar cable Available in 10m, 20m and 30m (20m packed in Carton)
Maximum allowable cable length	30m



Halo™ - Dimensional Drawings - all models

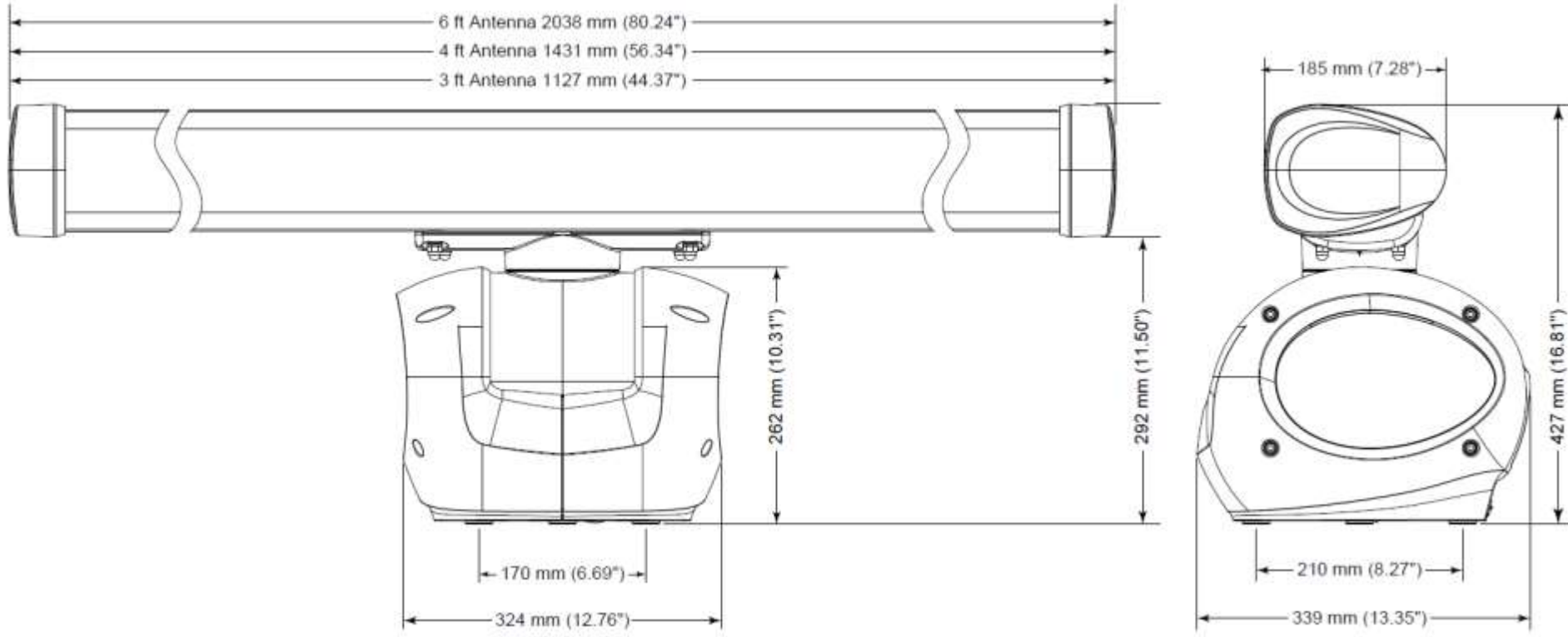

Halo™ - Dimensional Drawings



Antenna rotation – maximum rotation

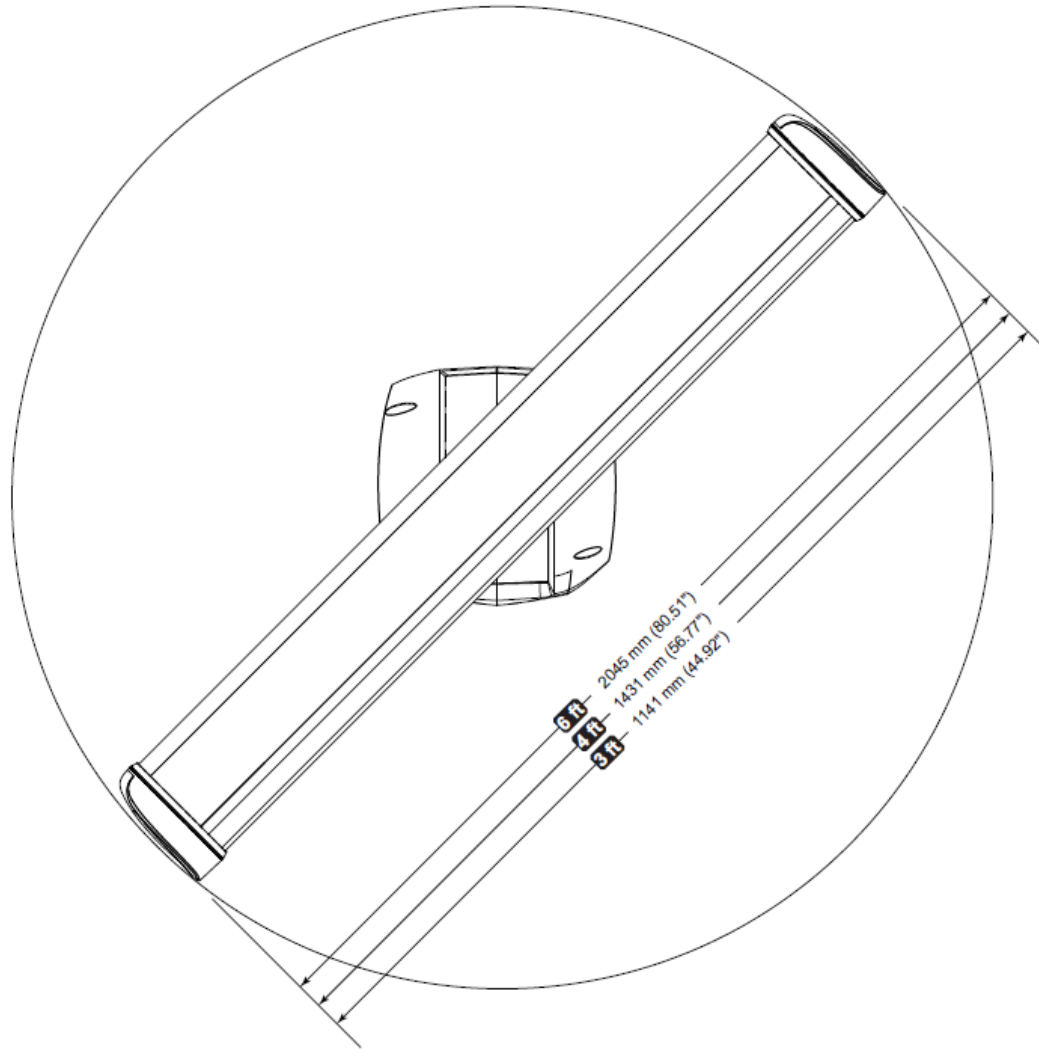



Halo™ - Dimensional Drawing RI-12

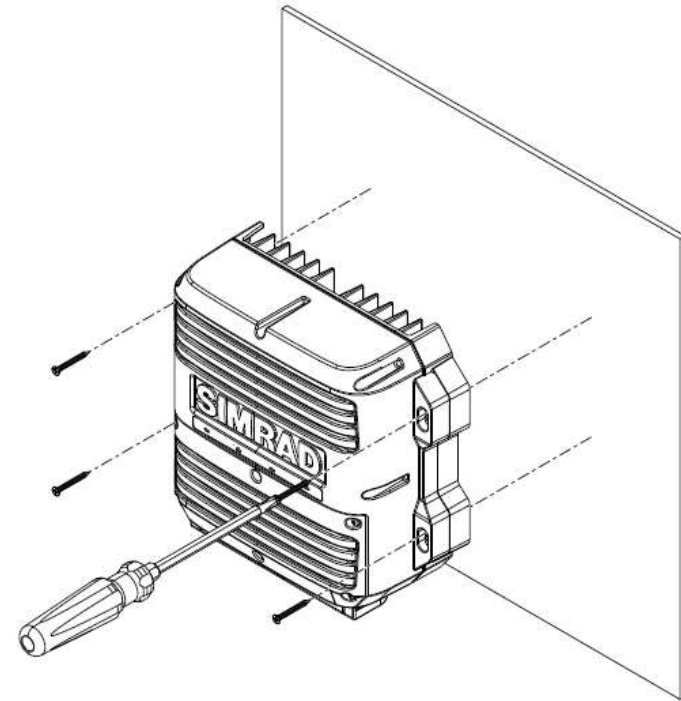
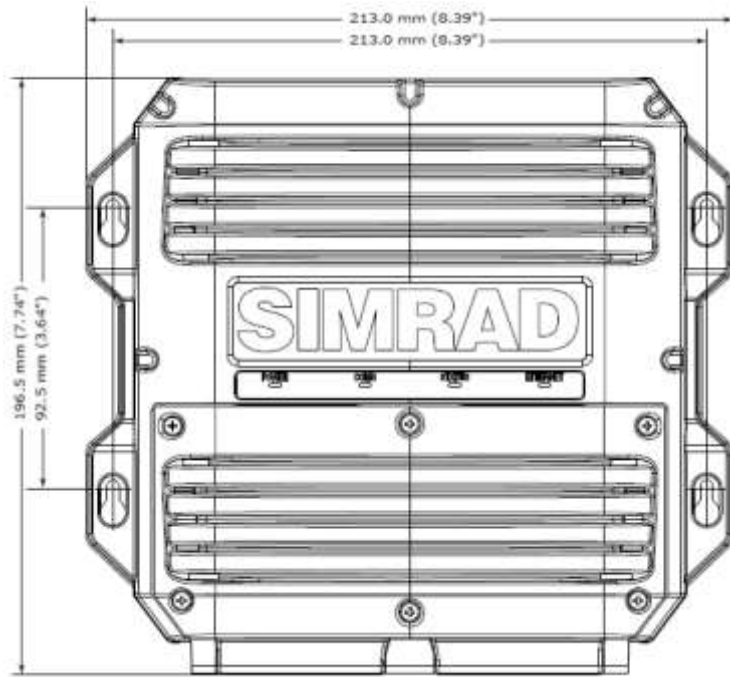

→ **Note:** Where possible, mount the processor in a way that the LEDs indicators may be viewed if required for diagnostic purposes.

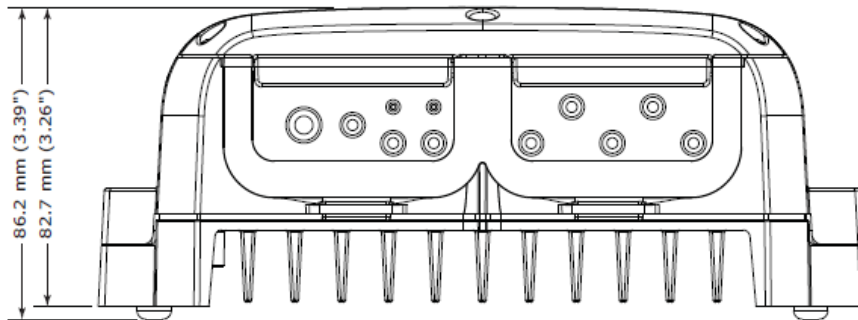

► **Note:**

- It is best to mount the RI-12 vertically



Halo™ - Mounting Antenna Tips

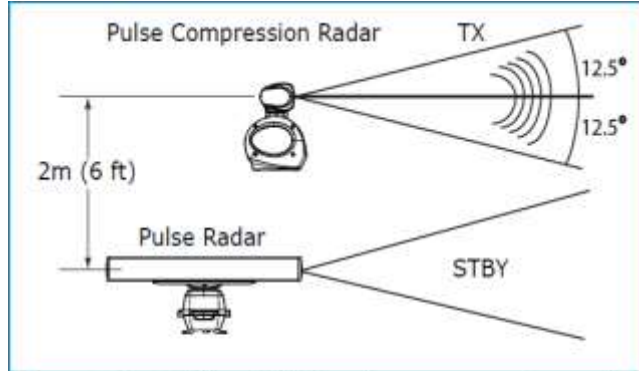

Do not install the Halo® pulse compression radar on the same beam plane as a conventional pulse radar. A pulse radar must be set to STBY or OFF any time the Halo® radar is being operated.

► NOTE:

- A dual radar installation of 3G or 4G on same vessel as Halo needs to have vertical separation of at least 3m (9 ft).



If possible ensure that the location site provides the scanner with a clear view all round the vessel.



Installations on power boats that have a steep planing angle, it is recommended to tilt the scanner angle down at the front. (Beam angle is 12.5° either side of center).



Halo™- Mounting Antenna Tips

The radar's ability to detect targets depends greatly on the position of its scanner. The ideal location for the scanner is high above the vessel's keel line where there are no obstacles.

A higher installation position increases the radar ranging distance, but it also increases the minimum range around the vessel where targets cannot be detected.

When you're deciding on the location, please consider:

The length of the interconnection cable supplied with your radar is usually sufficient. If you think you'll need a longer cable, consult your dealer before installation, because a longer cable may reduce the performance of the radar.

If the roof of the wheelhouse is the highest existing location, consider installing a radar mast or a pedestal on which you can mount the scanner. You may also need to construct a working platform for your own safety during installation and servicing work.

If you mount the scanner on a pedestal or base, ensure that rain and sea spray can drain away from it rapidly.

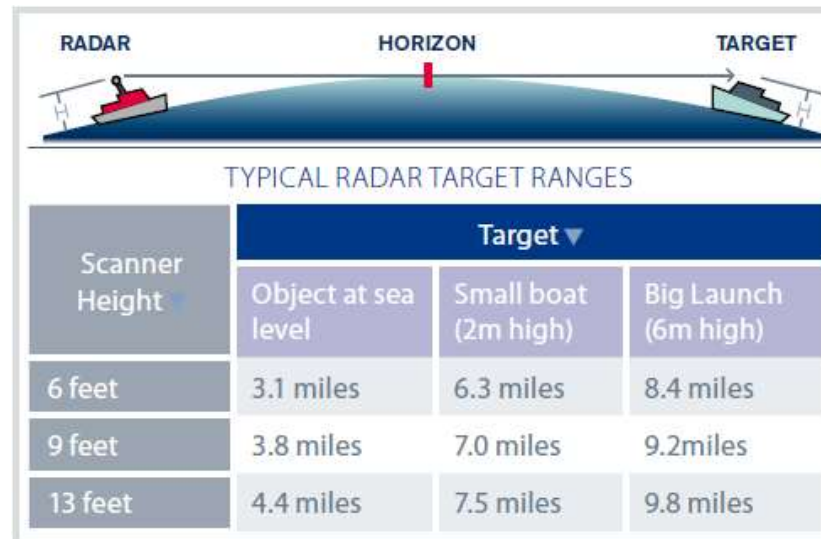



Halo™- Mounting Antenna Tips

Best Performance

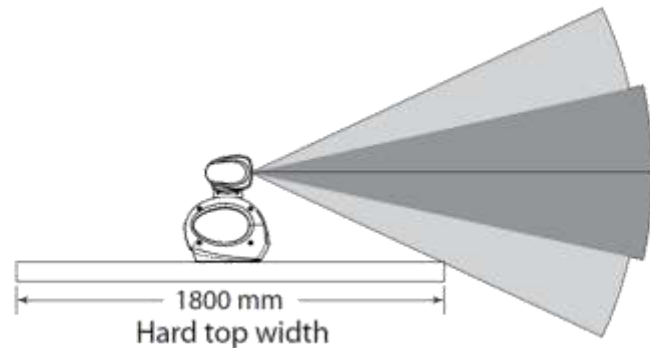

For best performance, the radar should be positioned to allow the beams to clear the superstructure of the boat.

Below is a guide to determine scanner height in relation to a vessels hard top overall width.

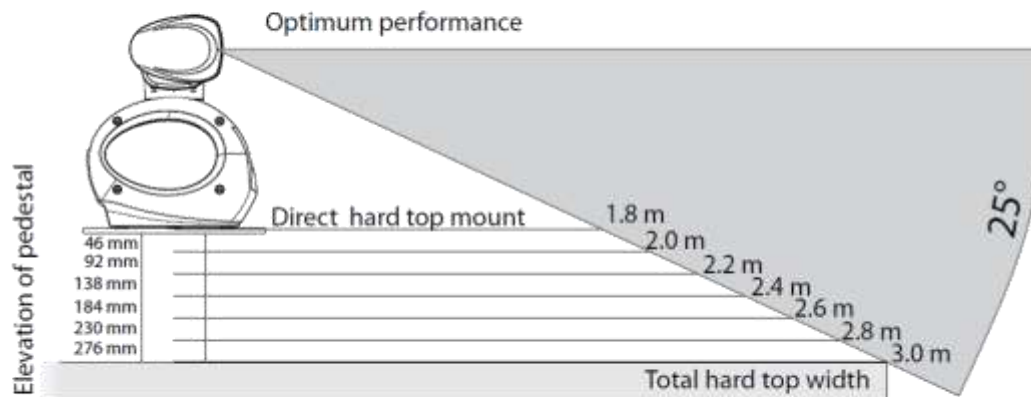

Every Increase of 200 mm of hard top width over 1.8m wide: Increase height by 46 mm.



Halo™- Mounting Antenna Tips

DON'T DO THIS!

- DON'T install the scanner too high up, where its weight will alter the stability of the vessel and cause degrade the radar picture over short ranges.
- DON'T install the scanner close to lamps or exhaust outlets. The heat emissions may cause the equipment to break down. Soot and smoke will degrade the performance of the radar.
- DON'T install the scanner close to the antennas of other equipment such as direction finders, VHF antennas, GPS equipment etc, as it may cause interference.
- DON'T install the scanner where a large obstruction (such as an exhaust stack) is at the same level as the beam. The obstruction is likely to generate false echoes and/or shadow zones when sector blanking is used.
- DON'T install the scanner where it will be subjected to strong vibrations (such as a derrick post) because these vibrations will degrade the performance of the radar.
- DON'T install an open array close to halyards or flags because the wind could wrap these around the antenna and jam it.

⚠ Warning: *DON'T install the scanner inside of the recommended compass safe distances of any navigation instruments such as the magnetic compass and the chronometer.*

Halo™- Installation & Mounting Pedestal

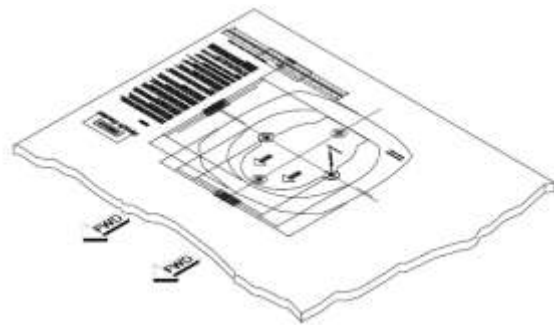

Drill pilot holes. Then use a 12.5 mm (1/2") drill bit to drill the four holes where shown on the mounting template.

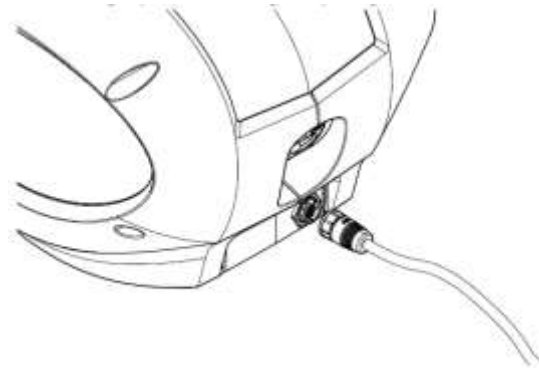
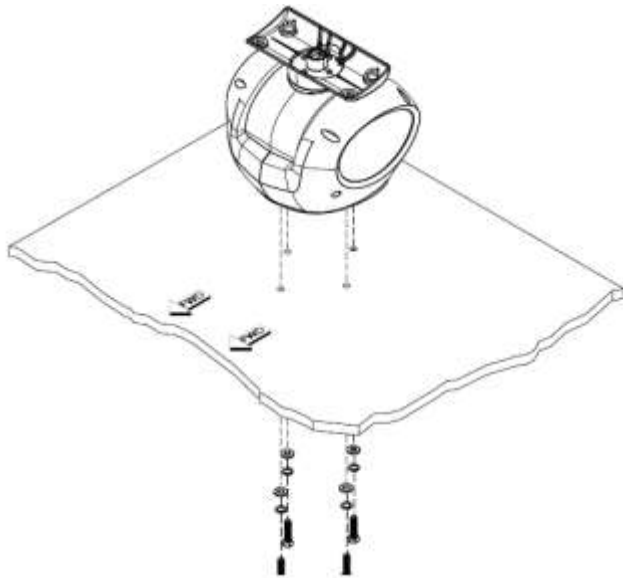
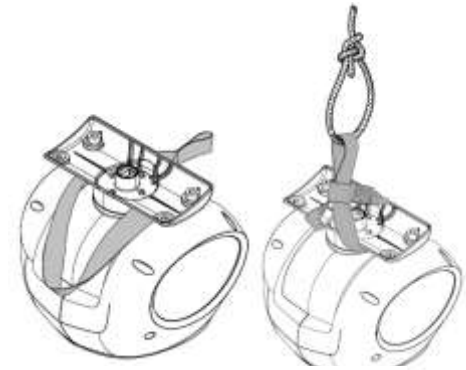
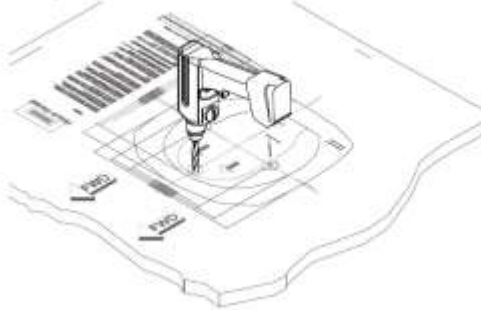



Halo™ - Installation Reference Tools

Radar installation manual is on SIMRAD website. Below is Halo Drill Template – included.

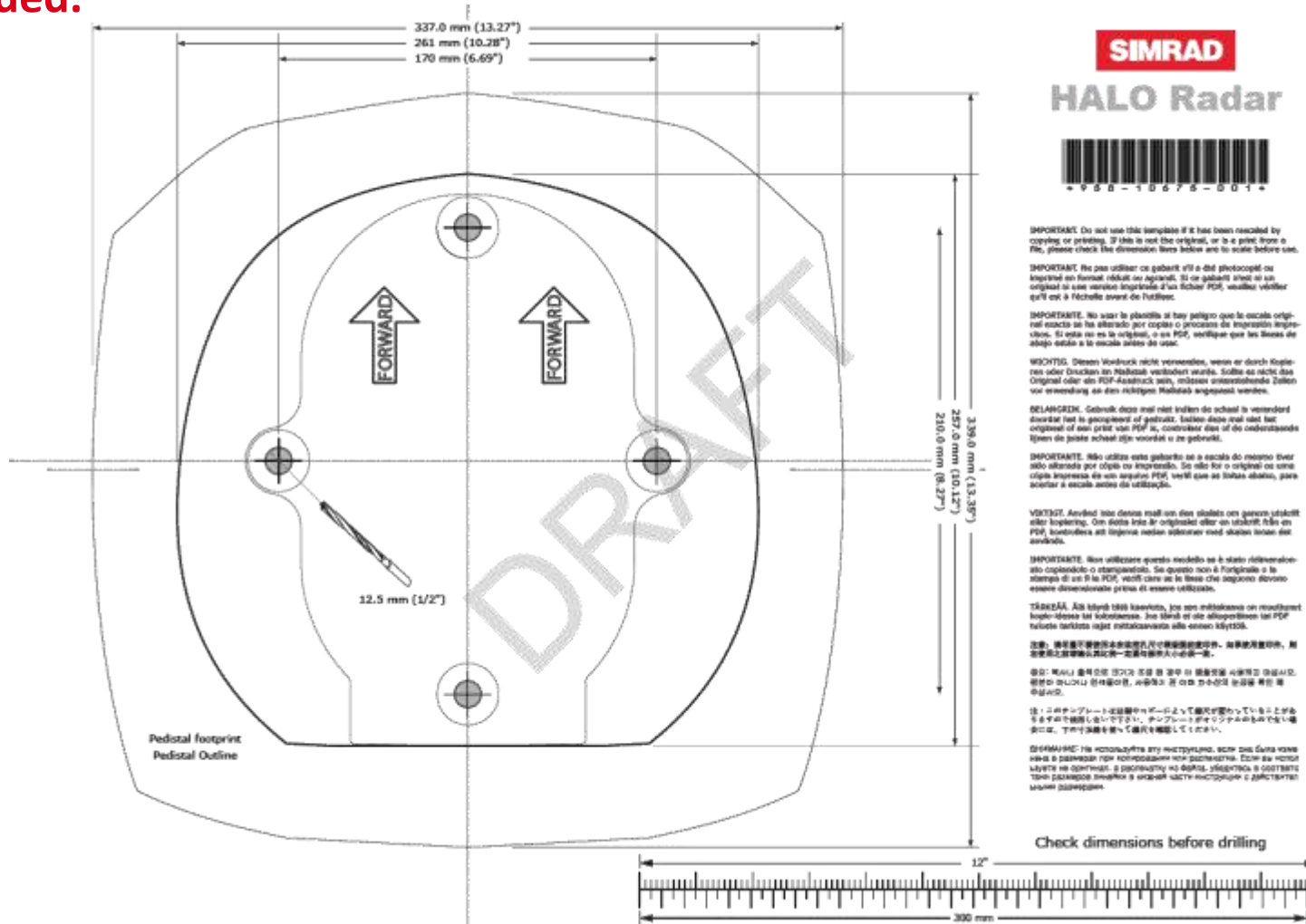

Halo™- Installation & Mounting Antenna

- ▶ Remove the protective cap from the pedestal and the protective tape on the antenna that protects the wave guide. Only remove the waveguides protective cap immediately before installing the antenna
- ▶ Carefully lower the antenna on to the pedestal. The antenna can only fit one way

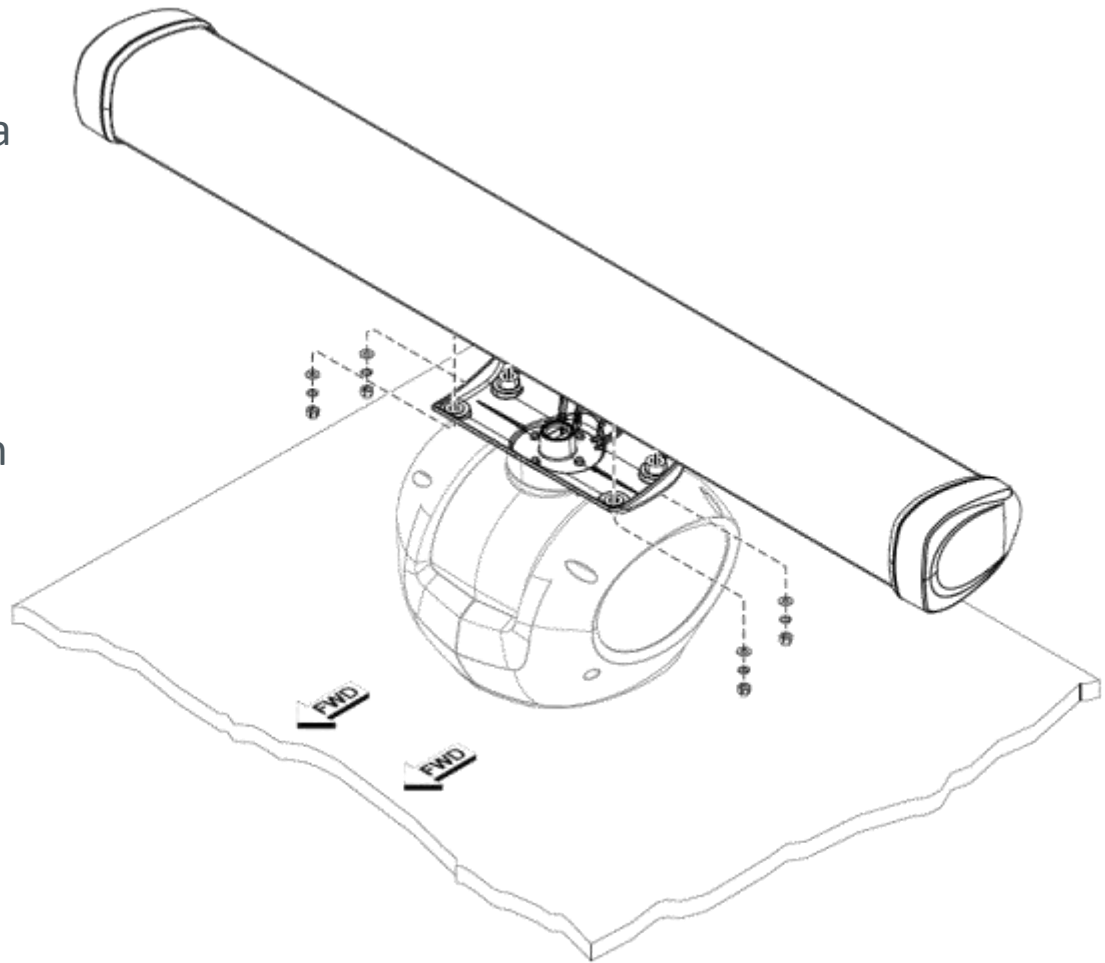

Halo™- Installation & Mounting

Pedestal Pole mount



Pole mount: Recessed cable connection

The interconnection cable can be optionally connected underneath the pedestal by moving the 14 pin connector at the rear of the pedestal to a bracket underneath the pedestal.

Remove the retaining nut and pull back the connector and fly lead.

Fit the supplied blanking plug where the connector used to be.

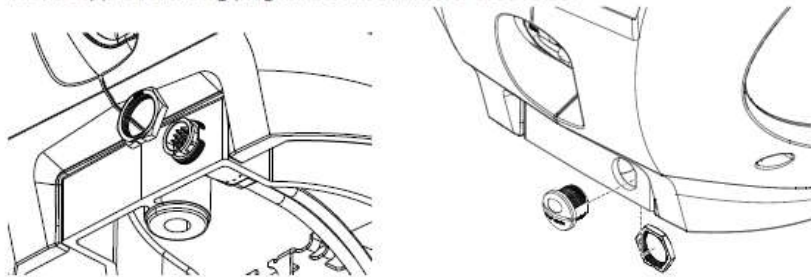

Re-route the internal fly lead to the bracket and secure with the nut.

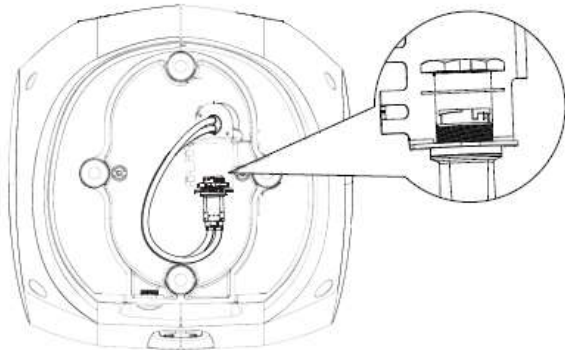

Connect the interconnection cable. Take care to align the connector correctly to avoid bending the pins. Secure the locking collar by rotating clockwise until it clicks.

Lower the pedestal carefully over the bolt holes so that they are aligned.

Place a flat washer and spring washer onto each bolt, as shown.

Insert bolts into the drilled holes and locate into the pedestals threaded mounting holes and tighten securely.

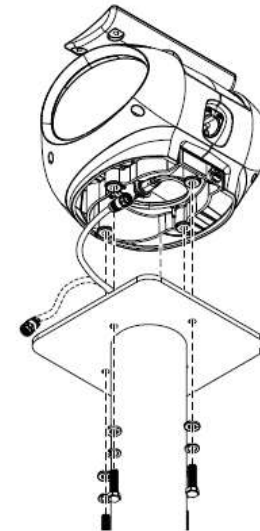



Halo™ - Pedestal Box Contents

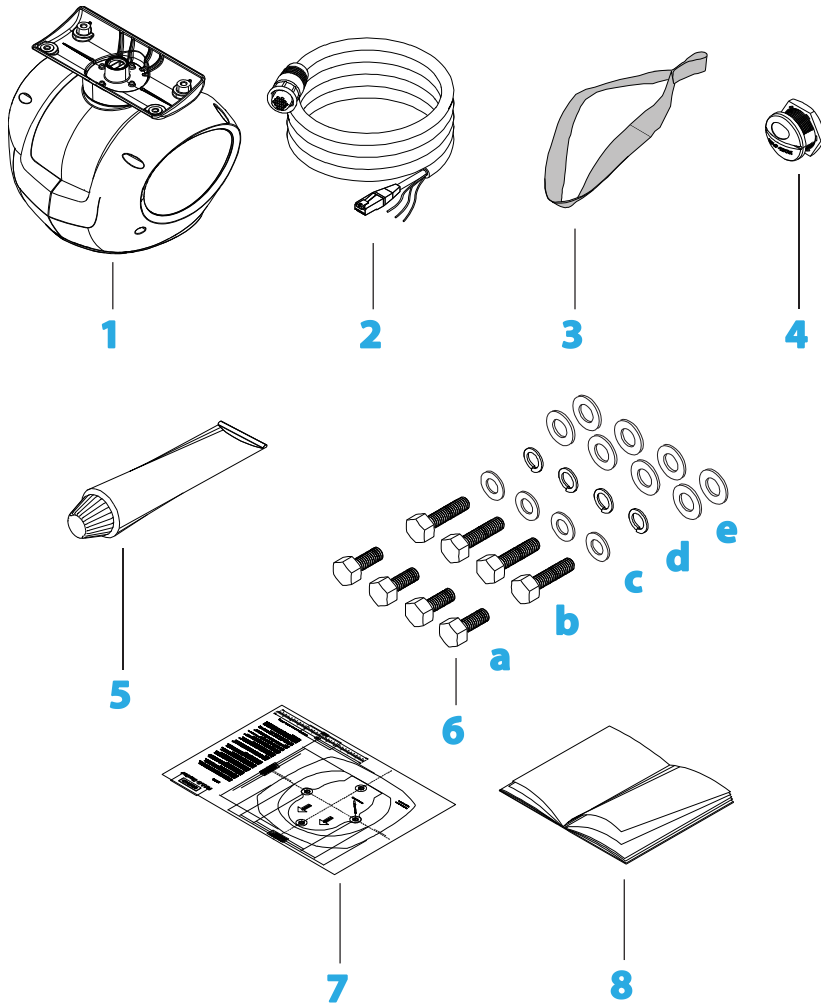

Key	Part No.	Description	Qty
1	000-11463-001	Radar pedestal	1
2	AA010212	Interconnection cable (20 m (65 ft) (other lengths available))	1
3	089-0483-00	Lifting strap	1
4	072-3263-001	Blanking plug (used when interconnection cable is not rear exit)	1
5	024-0305-00	Anti-corrosion grease	1
6	000-12514-001	Pedestal mounting bolts and washers	
		a) Bolts, hex head, M12 x 35 mm, 316 s/s	4
		b) Bolts, hex head , M12 x 50 mm, 316 s/s	4
		c) Flat washer M12 x 36 x 3, 316 s/s	4
		d) Spring washer M12, 316 s/s	4
		e) Nylon isolating washer M12 x 38	8
7	988-10678-001	Drill template	1
8	988-01676-001	Installation Manual	1

NOTE: RI-12 contents on next sheet are also in the HALO Pedestal Box



Halo™- Antenna Box + RI-12 Contents

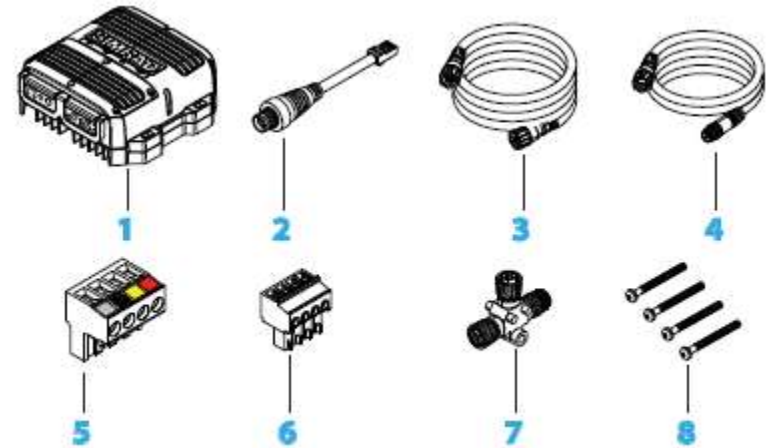
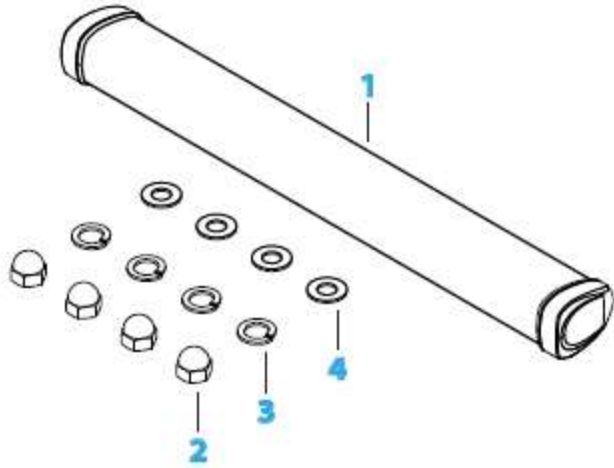

Key	Part No.	Description	Qty
1	Halo Antenna (one of the following)		1
	000-11464-001	3 ft (3.70 ft Antenna 1127 mm (44.37"))	
	000-11465-001	4 ft (4.70 ft Antenna 1431 mm (56.34"))	
	000-11466-001	6 ft (6.69 ft Antenna 2038 mm (80.24"))	
2	000-12515-001	Antenna Mount Kit	
		2) Dome nuts M8, 316 s/s	4
		3) Spring washer, M8, 316 s/s	4
		4) flat washer M8x16x1.2, 316 s/s	4

Key	Part No.	Description	Qty
1	000-11467-001	RI-12 Radar Interface Module	1
2	000-11246-001	Ethernet adapter. RJ45 male to 5 pin female 150 mm (5.9")	1
3	000-0127-51	Ethernet cable 1.8m (6ft)	1
4	000-0127-53	Micro-C drop cable 1.8m (6ft)	1
5	CN000759-G	Connector for the pedestal interconnection cable	1
6	037-0522-02	MConnector for Aux In (NMEA 0183, remote power and park brake)	
7	000-0119-79	Micro-C T Joiner	1
8	003-9729-00	Mounting hardware	1

RI-12 contents are in the Pedestal Box



Halo™ - Nameplates

HALO™ Pulse Compression Radar

Part: 000-11463-001 FCC ID: RAYHALO
Model: HALO RADAR IC: 4697A-HALO



SERIAL #: 1409030001

Compass Safe Distance: STD 0.7m Steer 0.5m

Designed in New Zealand **CE 0560** Made in New Zealand
B&G LOWRANCE SIMRAD

HALO™ Pulse Compression Radar

Part: 000-11467-001 FCC ID: RAYRI12
Model: RI-12 IC: 4697A-RI12



SERIAL #: 1409030001

Compass Safe Distance: STD 0.7m Steer 0.5m

Designed in New Zealand **CE 0560** Made in New Zealand
B&G LOWRANCE SIMRAD

HALO™ Pulse Compression Radar

Part: 000-11464-001
Model: HALO ANTENNA-3FT



SERIAL #: 1409030001

Compass Safe Distance: STD 0.7m Steer 0.5m

Designed in New Zealand **CE 0560** Made in New Zealand
B&G LOWRANCE SIMRAD

HALO™ Pulse Compression Radar

Part: 000-11466-001
Model: HALO ANTENNA-6FT



SERIAL #: 1409030001

Compass Safe Distance: STD 0.7m Steer 0.5m

Designed in New Zealand **CE 0560** Made in New Zealand
B&G LOWRANCE SIMRAD

HALO™ Pulse Compression Radar

Part: 000-11465-001
Model: HALO ANTENNA-4FT



SERIAL #: 1409030001

Compass Safe Distance: STD 0.7m Steer 0.5m

Designed in New Zealand **CE 0560** Made in New Zealand
B&G LOWRANCE SIMRAD

IMPORTANT NOTE:

- ▶ FCC PART 80 Type Certification Approved
- ▶ Pending:
IC Canada, CE, SoO, DoC and final compass safe distance

GRANT OF EQUIPMENT
AUTHORIZATION

Certification
Issued Under the Authority of the
Federal Communications Commission
By:



Halo™- FCC GRANT

Timco Engineering, Inc.
849 NW State Road 45
P.O. Box
370,
Newberry, FL 32669

Date of Grant: 04/10/2015
Application Dated: 04/10/2015

Navico Auckland Limited
44 Arrenway Drive
Rosedale
Auckland, 0632
New Zealand

Attention: John Scott , COO & EVP Product Management

NOT TRANSFERABLE

EQUIPMENT AUTHORIZATION is hereby issued to the named GRANTEE, and is VALID ONLY for the equipment identified hereon for use under the Commission's Rules and Regulations listed below.

FCC IDENTIFIER: RAYHALO
Name of Grantee: Navico Auckland Limited
Equipment Class: Marine Radar
Notes: HALO PULSE COMPRESSION MARINE RADAR

<u>Grant Notes</u>	<u>FCC Rule Parts</u>	<u>Frequency Range (MHZ)</u>	<u>Output Watts</u>	<u>Frequency Tolerance</u>	<u>Emission Designator</u>
	80	9400.0 - 9495.0	25.0	106.27 PM	106MP0N

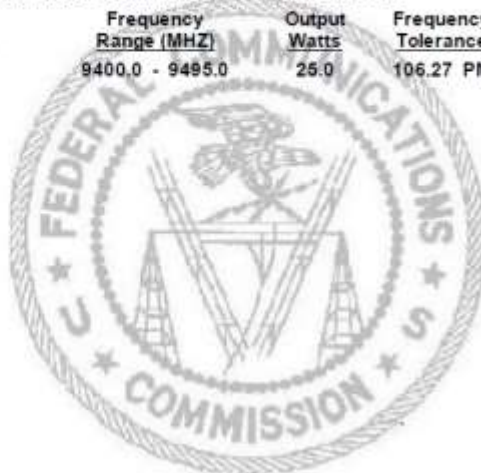

IMPORTANT NOTE:

- ▶ FCC PART 80 Type Certification is completed
- ▶ Pending:
IC Canada, CE, SoO, DoC, and final compass safe distance





Halo™ - System Builder Capture

No SIM 13:35

SIMRAD Simrad System Builder

Halo | Broadband | HD Radar

Halo Pulse Compression Radar

	<p>HALO 3' radar HALO 3 RADAR, w/3'</p> <p>000-11469-001</p>
	<p>HALO 4' radar HALO 4 RADAR, w/4'</p> <p>000-11470-001</p>
	<p>HALO 6' radar HALO 6 RADAR, w/6'</p> <p>000-11471-001</p>



Halo™ - System Builder Capture

SIMRAD Simrad System Builder

► Ethernet ✓ NMEA2000 ✓ SimNet

Power Use

Batt.	Nom.	Max.
-	371W	432W
12V	30.9A	36.0A
24V	15.5A	18.0A

\$44503.18

Products ► System NMEA2000 ► Quote

Navigation Systems

Radar

Echosounder

Autopilot

AIS

Communications

Halo Pulse Compression Radar

- HALO 3' radar
HALO 3 RADAR, w/B
000-11469-001
- HALO 4' radar
HALO 4 RADAR, w/B
000-11470-001
- HALO 6' radar
HALO 6 RADAR, w/B
000-11471-001



Halo™- Installation Manual- Wiring - RI-12

- ▶ 2 WIRE DC Power cable is custom for each installation and is not provided

Power for the radar is connected to the RI-12 Interface module. The radar requires either a 12 or 24V DC supply capable of delivering 20 Amps continuous.

The RI-12 is protected against reverse polarity, over voltage and under voltage. The RI-12 must be connected to a dedicated fuse/circuit breaker. The fuse/circuit breaker should be labeled accordingly.

Voltage	Cable length			
	2 m (6.6 ft)	5 m (16.4 ft)	10 m (32 ft)	20 m (66 ft)
12V DC	2.1 mm (12-AWG)	3.3 mm (8-AWG)	4.1 mm (6-AWG)	N/A
24V DC	1.3 mm (14-AWG)	2.1 mm (12-AWG)	3.3 mm (8-AWG)	4.1 mm (6-AWG)

Note: The RI-12 has an optional remote power control mode that can enable a compatible multifunction display or ignition switch to control the power state of the radar (see "Remote power control" on page 22)

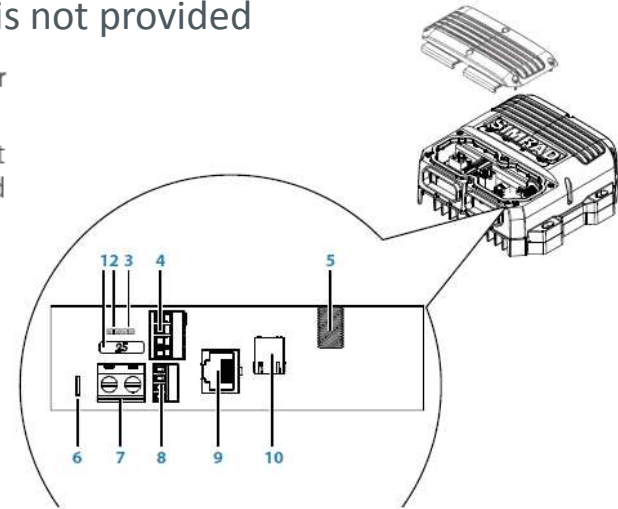

Key	Name	Description
1	FUSE	25 Amp Blade Fuse
2	Power control: REMOTE	Remote power control activation jumper. Move to REMOTE position so radar power state is controlled by a multifunction display or switch (see "Remote power control" on page 24)
3	Power control: AUTO	Radar will turn on when power is applied to the main power connector. Remote power wire on AUX IN port is ignored
4	SCANNER POWER	Phoenix connector: Provides 36 V DC upto the pedestal and power for the park brake. Connect the four wires of the interconnection cable matching the color coded sticker on the connector
5	NMEA 2000	Micro-C: NMEA 2000 network connection
6	SCREEN	No connect
7	- SUPPLY+	12-24 V DC input
8	AUX IN	Phoenix connector: NMEA 0183 data input, remote power on and DC input for the antenna park brake
9	SCANNER	RJ45: Ethernet data from the pedestal. Connect the RJ45 connector of the interconnection cable.
10	NETWORK/MFD	RJ45: Connects the radar to the navigation Ethernet network

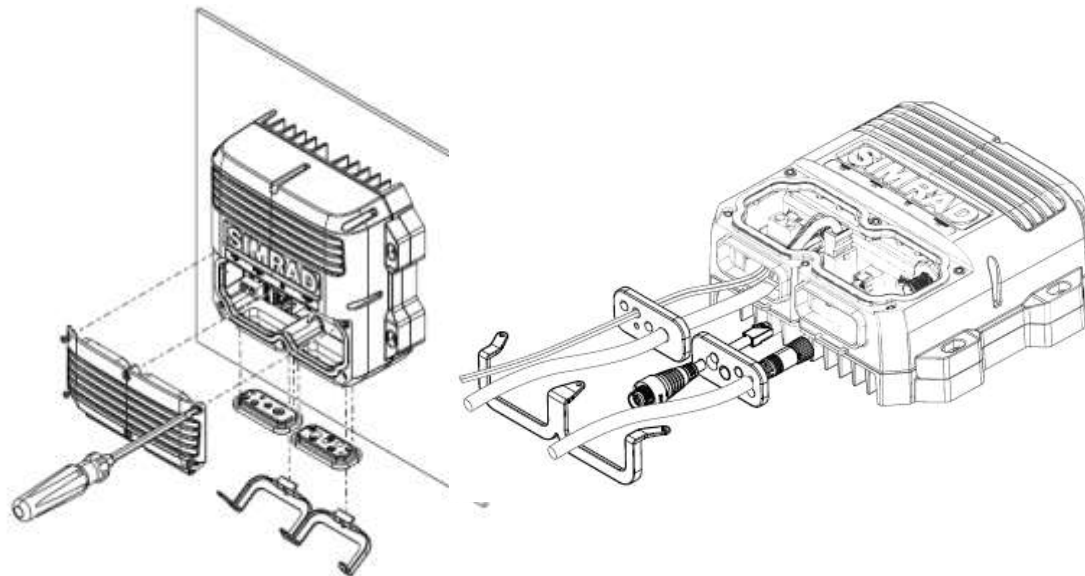



Halo™- Options & Accessories

HALO™ Pulse Compression Radar Mounting Options

- ▶ Hardware Mounting kits
- ▶ Radar Plate and Tower mounts
 - Scanstrut
 - Edson
 - Seaview



Halo™ - Options & Accessories

Individual Halo Hardware Mounting Kits

000-12515-001	HALO, ANTENNA MOUNTING KIT
000-12514-001	HALO, PEDESTAL MOUNTING KIT

Qty	000-12514-001	HALO, PEDESTAL MOUNTING KIT
1	072-0482-01	POLY BAG 4" X 6" AUTOBAG
1	051-3190-00	LBL WH POLYESTER 50x11mm BLANK
4	089-0485-00	BOLT, HEX, M12x35, 316 s/s
4	089-0486-00	BOLT, HEX, M12x50, 316 s/s
4	089-0487-00	WASHER, FENDER, M12x36x3, 316 s/s
4	089-0488-00	WASHER, SPRING, M12, 316 s/s
8	089-0489-00	WASHER, ISOLATING M12x38 NYLON

Qty	000-12515-001	HALO, ANTENNA MOUNTING KIT
1	072-0482-01	POLY BAG 4" X 6" AUTOBAG
1	051-3190-00	LBL WH POLYESTER 50x11mm BLANK
4	089-0491-00	NUT, DOME, M8, 316 s/s
4	089-0492-00	WASHER, FLAT, M8x16x1.2, 316 s/s
4	089-0493-00	WASHER, SPRING, M8, 316 s/s



Halo™ - Service Spares

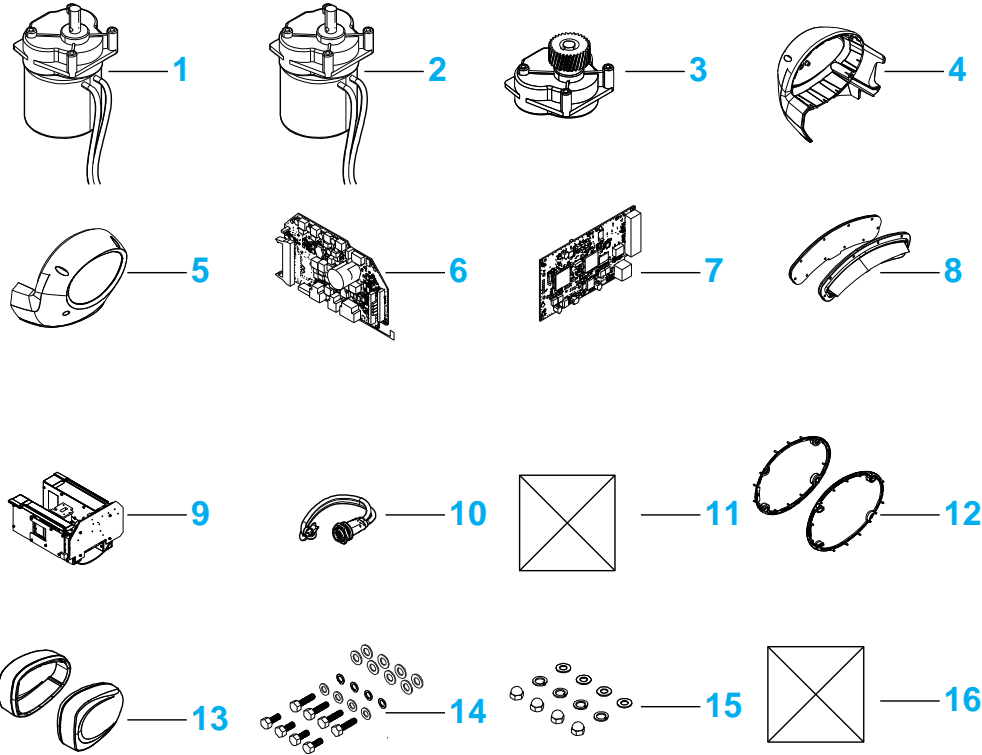



Key	Part No.	Description
1	151-10435-001	HALO SPARE,MOTOR ASSY,TYPE-1 (AA)
2	151-10436-001	HALO SPARE,MOTOR ASSY,TYPE-2 (AN)
3	151-10437-001	HALO SPARE,GEAR ASSY
4	151-10438-001	HALO SPARE,PED END CAP W/LED,RIGHT
5	151-10439-001	HALO SPARE,PED END CAP W/LED,LEFT
6	151-10440-001	HALO SPARE,CPU ASSY
7	151-10441-001	HALO SPARE,PSU ASSY
8	151-10442-001	HALO SPARE,LED ASSY,LEFT & RIGHT
9	151-10443-001	HALO SPARE,RF BRICK ASSY,TUNED
10	151-10444-001	HALO SPARE,PED CABLE KIT
11	151-10445-001	HALO SPARE,PED SCREW KIT
12	151-10446-001	HALO SPARE,PED SEAL KIT
13	151-10447-001	HALO SPARE,ANT END CAP,IN+OUT 1SET
14	000-12514-001	HALO SPARE,PED MOUNTING KIT
15	000-12515-001	HALO SPARE,ANT MOUNT KIT
16	151-10450-001	HALO SPARE,WARRANTY + TAMPER STICKERS

IMPORTANT NOTE:

► These -151 parts are used for SIMRAD radar servicing dealers ONLY.



Halo™ - SCANSTRUT® Mounts

Radar Fit Model	P/N	Description	Image
HALO-3/4/6	APT6003	150mm (6") Aluminium PowerTower® for all open array	
		http://www.scanstrut.com/products/product-page.php?range_id=10002&type=Powerboats	
HALO-3/4	DPT-40-SO3	Dual PowerTower® for 40cm satcom + 4' open array radars	
		http://www.scanstrut.com/products/product-page.php?range_id=10003&type=Powerboats	
HALO-3/4	DPT-60-SO3	Dual PowerTower® for 60cm satcom + up to 4' open array radars	
		http://www.scanstrut.com/products/product-page.php?range_id=10003&type=Powerboats	

► These are available from Scanstrut direct.



Halo™ - EDSON® Mounts

This new Halo mounting plate Edson part number 68575.

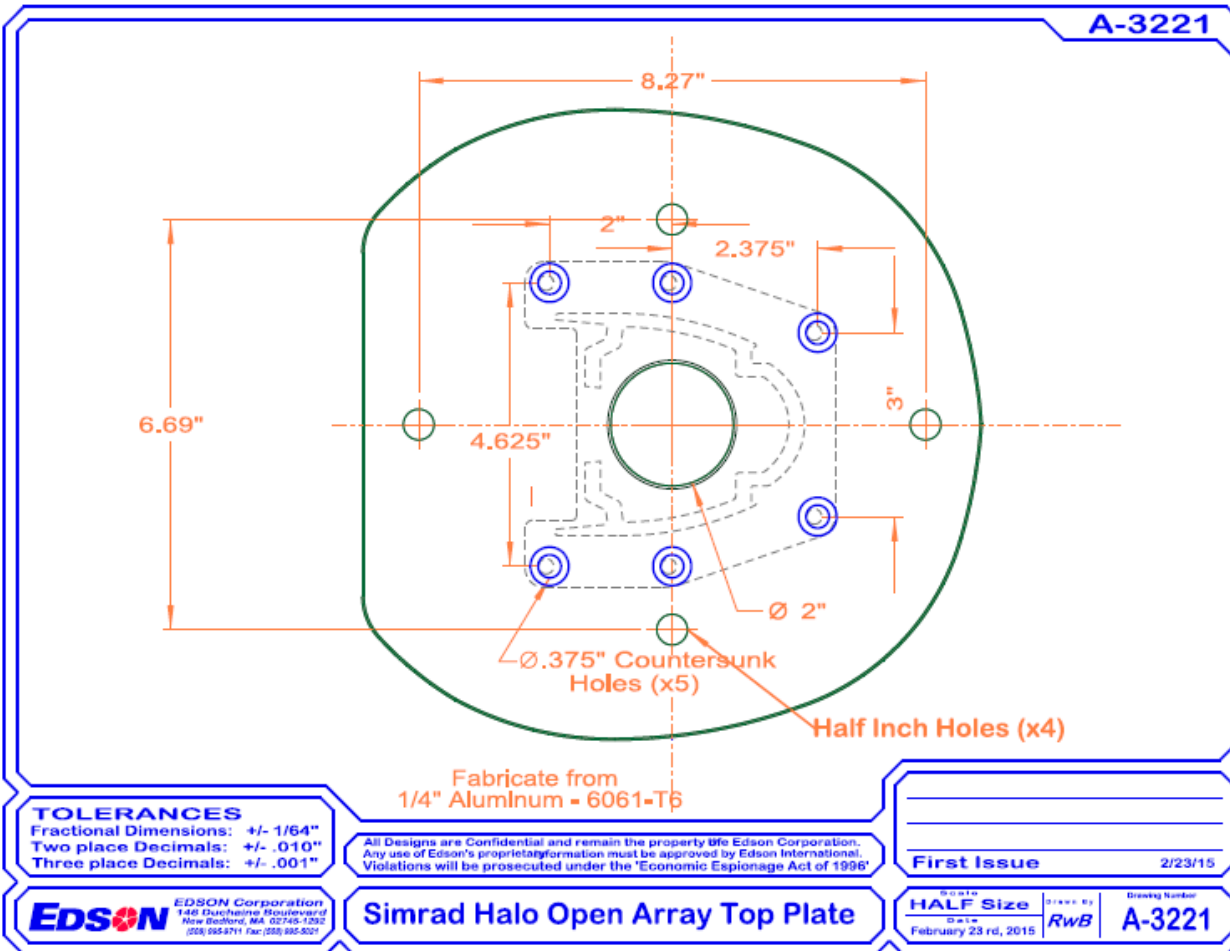





- ▶ It fits:
 - 68110 6" Tower for open arrays
 - 68120 12" Tower for open arrays
 - 68250 Dual tower for open arrays and sat domes
 - 68350 Triple tower
- ▶ The 3/4' Halo array will work on all of the towers listed.
- ▶ The 6' Halo array will only work on:
 - 68110 6" Tower for open arrays
 - 68120 12" Tower for open arrays

http://www.edsonmarine.com/marinestore/index.php?main_page=product_info&cPath=87_322_324_335&products_id=1799

▶ These are available from Edson direct.



Halo™- EDSON® Mounts

Radar Fit Model	P/N	Description	Image
HALO-3/4/6	68110 with plate 68575	150mm (6") Tower for all open array http://www.edsonmarine.com/marinestore/index.php?main_page=product_info&cPath=87_322_323_327&products_id=1767	
HALO-3/4/6	68120 with plate 68575	300mm (12") Tower for all open array http://www.edsonmarine.com/marinestore/index.php?main_page=product_info&cPath=87_322_323_327&products_id=1618	
HALO-3/4	68250 with plate 68575	Dual Tower for open arrays and sat domes http://www.edsonmarine.com/marinestore/index.php?main_page=product_info&cPath=87_322_323_329&products_id=1630	
HALO-3/4	68350 with plate 68575	Triple Tower http://www.edsonmarine.com/marinestore/index.php?main_page=product_info&cPath=87_322_323_330&products_id=1632	

▶ These are available from Edson direct.

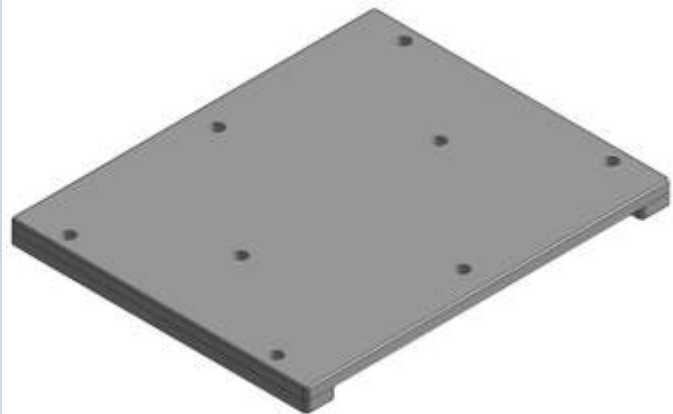

Halo™- EDSON® Mounts

Radar Fit Model	P/N	Description	Image
HALO-3/4/6	68950	Hardtop Mounting Plate	 A 3D rendering of a rectangular, grey metal mounting plate. The plate has a slightly raised edge on one side and features eight circular mounting holes arranged in two rows of four.

http://www.edsonmarine.com/marinestore/index.php?main_page=product_info&cPath=87_322_323_382&products_id=1800

- ▶ This is available from Edson direct.

Halo™ - Seaview® Mounts



Easy 3 step process to build a modular mount for Halo Radars.

- ▶ Step 1: Pick your style of mount
- ▶ Step 2: Select the top mounting plate to fit Halo
- ▶ Step 3: Choice optional accessory



PMA-57-M1 + ADA-R1
+ ADA-HALO3
(shown with optional
light bar)





Halo™- Seaview® Mounts

Step 1: Select a Mount for Halo

FORWARD LEANING

- 18" - 24" closed dome radars
- Up to 6' open array radars using 5" mount only



PART NUMBERS

PMF-57-M1 5" (127mm) tall forward leaning mount

AFT LEANING

- 18" - 24" closed dome radars
- Up to 6' open array radars using 5" mount only



PART NUMBERS

PMA-57-M1 5" (127mm) tall aft leaning mount

▶ These are all available from Seaview direct.

PMA-DM2-M2

- Up to 4.5' open array radars
- 16" - 24" satdomes



PMA-DM3-M1

- Up to 4.5' open array radars
- 16" - 18" satdomes



ARCH-2M2

- Up to 4.5' open array radars
- 16" - 24" satdomes
- Cameras



Halo™ - Seaview® Mounts

Step 2: Select a Top Plate for Halo

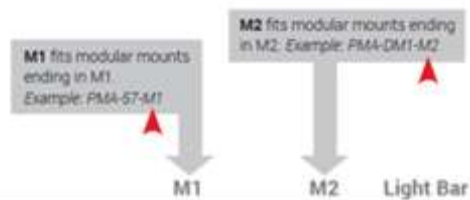

SIMRAD MODELS	PART NUMBERS		
3G, 4G	ADA-R1	N/A	LTB-R
DX64S	ADA-R2	N/A	LTB-R
HALO (1,127mm / 3'7")	ADA-R1 + ADA-HALO3	N/A	LTB-OA
HALO (1,431mm / 4'7")	ADA-R1 + ADA-HALO3	N/A	LTB-OA
HALO (2,058mm / 6'7")	ADA-R1 + ADA-HALO3	N/A	LTB-OA6
TX06S	ADA-R1	N/A	LTB-OA
TX10S	ADA-R1	N/A	LTB-OA6

Use ADA-R1 + ADA-HALO3 SKU for all length Halo models

The Seaview top plates are made from a pre-drilled aluminum plate that has been incased in a UV resistant ABS plastic. Drill templates come with all Seaview top plates. Simply drill the holes that are marked to your specific Simrad electronic. This makes for a very clean installation with no unnecessary holes.



Step 3: Select accessories – Light bars, etc.

- ▶ For all Halo mounts, go to http://seaviewglobal.com/system/attachments/Simrad_Catalog_ver1.pdf



Halo™ - Seaview® Mounts

Adapter Plates and Wedges: A Special Adapter plate and wedge is available

- ▶ Simrad HALO special adapter plate is a great solution when replacing an existing Simrad 3G/4G, Raymarine or Garmin closed dome radar. Mounting holes pick up these existing radar brand domes **and our new Simrad HALO open array mount**. All Halo holes are inside the plate with no drill holes required in the boat itself in the Halo mounting area. Very useful for OEMs in tight center console top channels.



- ▶ Use ADA-HALO2 for all length Halo models

- ▶ These are available from Seaview direct.



4°Direct mount radar wedge

PART NUMBERS	
RW4-2	3G, 4G
RW4-6	DX645
RW4-7	HALO (1,127mm / 4.47")
RW4-7	HALO (1,431mm / 5.67")
RW4-7	HALO (2,032mm / 8.0")
RW4-5	Tx060, 1.0m

3-4" is most commonly need to compensate for planing attitude. This is why Seaview only offers the 4° direct mount wedge.

- ▶ If a wedge is needed, use RW4-7 for all length Halo models

Halo™- Software Version/Language Packs

- ▶ Release #1 Software Versions for MFD (NSS_evo2: V2.0-51.1.80 and NSO_evo2: V3.0-51.1.80 and up) and Halo (V5.1.0 and up) are posted on SIMRAD website. Sector Blanking will be functional end of May with MFD (NSS_evo2: V3.0-52.x.xx and NSO_evo2: V4.0-52.x.xx and up) and Halo (V5.1.x and up). Check for updates regularly.
- ▶ Language controls are in NSS/NSO evo2





Halo™ - System Resets

- ▶ In very rare cases of a lockup, just Power the radar off and on. It is best to turn off all boat DC power and back ON again. Try that if a Radar ON/OFF does not work. This will fix any systems issue. DO not plug or unplug COM or Ethernet cables with operating.
- ▶ If no solution, try to go to the radar installation screen and check all parameters and software version are latest, as below. Radar default codes appear like this.

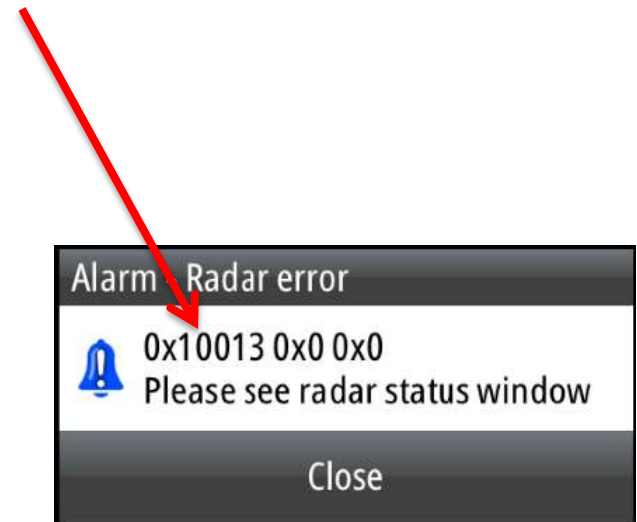

SIMRAD

Go With Confidence