

# VNA Master™

MS2024A/MS2026A and  
MS2034A/MS2036A

Vector Network Analyzer  
2 MHz to 6 GHz

Spectrum Analyzer  
9 kHz to 7.1 GHz



**User Guide**

# **VNA Master™**

## **Model MS2024A, MS2026A, MS2034A, MS2036A**

**Vector Network Analyzer 2 MHz to 6 GHz**

**Spectrum Analyzer 9 kHz to 7.1 GHz**

The Anritsu logo consists of the word "Anritsu" in a bold, sans-serif font. The letter "A" is stylized with a diagonal slash through it.

---

Anritsu Company  
490 Jarvis Drive  
Morgan Hill, CA 95037-2809  
USA

P/N: 10580-00166  
Revision: C  
Printed: February 2008  
Copyright 2007-2008 Anritsu Company

## **WARRANTY**

The Anritsu product(s) listed on the title page is (are) warranted against defects in materials and workmanship for one year from the date of shipment.

Anritsu's obligation covers repairing or replacing products which prove to be defective during the warranty period. Buyers shall prepay transportation charges for equipment returned to Anritsu for warranty repairs. Obligation is limited to the original purchaser. Anritsu is not liable for consequential damages.

## **LIMITATION OF WARRANTY**

The foregoing warranty does not apply to Anritsu connectors that have failed due to normal wear. Also, the warranty does not apply to defects resulting from improper or inadequate maintenance by the Buyer, unauthorized modification or misuse, or operation outside of the environmental specifications of the product. No other warranty is expressed or implied, and the remedies provided herein are the Buyer's sole and exclusive remedies.

## **DISCLAIMER OF WARRANTY**

DISCLAIMER OF WARRANTIES. TO THE MAXIMUM EXTENT PERMITTED BY APPLICABLE LAW, ANRITSU COMPANY AND ITS SUPPLIERS DISCLAIM ALL WARRANTIES, EITHER EXPRESS OR IMPLIED, INCLUDING, BUT NOT LIMITED TO, IMPLIED WARRANTIES OF MERCHANTABILITY AND FITNESS FOR A PARTICULAR PURPOSE, WITH REGARD TO THE SOFTWARE PRODUCT. THE USER ASSUMES THE ENTIRE RISK OF USING THE PROGRAM. ANY LIABILITY OF PROVIDER OR MANUFACTURER WILL BE LIMITED EXCLUSIVELY TO PRODUCT REPLACEMENT.

NO LIABILITY FOR CONSEQUENTIAL DAMAGES. TO THE MAXIMUM EXTENT PERMITTED BY APPLICABLE LAW, IN NO EVENT SHALL ANRITSU COMPANY OR ITS SUPPLIERS BE LIABLE FOR ANY SPECIAL, INCIDENTAL, INDIRECT, OR CONSEQUENTIAL DAMAGES WHATSOEVER (INCLUDING, WITHOUT LIMITATION, DAMAGES FOR LOSS OF BUSINESS PROFITS, BUSINESS INTERRUPTION, LOSS OF BUSINESS INFORMATION, OR ANY OTHER PECUNIARY LOSS) ARISING OUT OF THE USE OF OR INABILITY TO USE THE SOFTWARE PRODUCTS, EVEN IF ANRITSU COMPANY HAS BEEN ADVISED OF THE POSSIBILITY OF SUCH DAMAGES. BECAUSE SOME STATES AND JURISDICTIONS DO NOT ALLOW THE EXCLUSION OR LIMITATION OF LIABILITY FOR CONSEQUENTIAL OR INCIDENTAL DAMAGES, THE ABOVE LIMITATION MAY NOT APPLY TO YOU.

## **TRADEMARK ACKNOWLEDGMENTS**

Windows, Windows 2000, and Windows XP are registered trademarks of Microsoft Corporation. Acrobat Reader is a registered trademark of Adobe Corporation. MATLAB is a registered trademark of The MathWorks Corporation. Intel Pentium is a trademark of the Intel Corporation. VxWorks, WindML Target, and Wind USB Runtime are registered trademarks of Wind River Systems, Inc. NI is a trademark of National Instruments Corporation. Master Software Tools (MST), FlexCal, and VNA Master are registered trademarks of Anritsu Company.

## **NOTICE**

Anritsu Company has prepared this manual for use by Anritsu Company personnel and customers as a guide for the proper installation, operation and maintenance of Anritsu Company equipment and computer programs. The drawings, specifications, and information contained herein are the property of Anritsu Company, and any unauthorized use or disclosure of these drawings, specifications, and information is prohibited; they shall not be reproduced, copied, or used in whole or in part as the basis for manufacture or sale of the equipment or software programs without the prior written consent of Anritsu Company.

## **UPDATES**

Updates, if any, can be downloaded from the Documents area of the Anritsu web site at <http://www.us.anritsu.com>.

# DECLARATION OF CONFORMITY

**Manufacturer's Name:** ANRITSU COMPANY

**Manufacturer's Address:** Microwave Measurements Division  
490 Jarvis Drive  
Morgan Hill, CA 95037-2809  
USA

declares that the product specified below:

**Product Name:** Hand-Held 2-port VNA

**Model Number:** MS2024A, MS2026A

conforms to the requirement of:

EMC Directive 89/336/EEC as amended by Council Directive 92/31/EEC & 93/68/EEC  
Low Voltage Directive 73/23/EEC as amended by Council directive 93/68/EEC

## **Electromagnetic Interference:**

**Emissions:** CISPR 11:1990/EN55011: 1991 Group 1 Class A  
EN 61000-3-2:1995 Class A  
EN 61000-3-3:1995 Class A

**Immunity:** EN 61000-4-2:1995/EN61326-1: 1997 - 4kV CD, 8kV AD  
EN 61000-4-3:1997/ EN61326-1: 1997- 3V/m  
EN 61000-4-4:1995/ EN61326-1997: 1997 - 0.5kV SL, 1kV PL  
EN 61000-4-5:1995/ EN61326-1997: 1997 - 1kV L-L, 2kV L-E  
EN 61000-4-6:1994/EN61326: 1998 - 3V  
EN 61000-4-11:1994/EN61326: 1998 - 100% @ 20msec

## **Electrical Safety Requirement:**

**Product Safety:** EN61010-1: 2001

  
Eric McLean, Corporate Quality Director

Morgan Hill, CA

2 NOV 2005  
Date

European Contact: For Anritsu product EMC & LVD information, contact Anritsu LTD, Rutherford Close,  
Stevenage Herts. SG1 2FF UK. (FAX 44-1438-740202)

# DECLARATION OF CONFORMITY

**Manufacturer's Name:** ANRITSU COMPANY

**Manufacturer's Address:** Microwave Measurements Division  
490 Jarvis Drive  
Morgan Hill, CA 95037-2809  
USA

declares that the product specified below:

**Product Name:** VNA Master

**Model Number:** MS203xA

conforms to the requirement of:

EMC Directive 89/336/EEC as amended by Council Directive 92/31/EEC & 93/68/EEC  
Low Voltage Directive 73/23/EEC as amended by Council directive 93/68/EEC

## **Electromagnetic Conformity: EN61326-1:1997 A1:1998 A2:2001 A3:2003**

**Emissions:** EN55011:1998 A1:1999 A2:2002 Group 1 Class A

**Immunity:** EN 61000-4-2:1995 A1:1998 A2:2001 - 4kV CD, 8kV AD  
EN 61000-4-3:2002 A1:2002 - 3V/m  
EN 61000-4-4:2004 - 0.5kV SL, 1kV PL  
EN 61000-4-5:1995 A1:2001 - 1kV L-L, 2kV L-E  
EN 61000-4-6:1996 A1:2001 - 3V  
EN 61000-4-11:1994 A1:2001 - 1 cycle @ 100%

## **Electrical Safety Requirement:**

**Product Safety:** The Product Complies when used with Company supplied Power Supply (tested to IEC 60950-1:2001)

Morgan Hill, CA

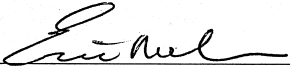
  
Eric McLean, Corporate Quality Director

16 OCT 2006  
Date

European Contact: For Anritsu product EMC & LVD information, contact Anritsu LTD, Rutherford Close, Stevenage Herts, SG1 2EF UK, (FAX 44-1438-740202)

# CHINESE RoHS STATEMENT

产品中有毒有害物质或元素的名称及含量

For Chinese Customers Only YLYB

部件名称	有毒有害物质或元素					
	铅 (Pb)	汞 (Hg)	镉 (Cd)	六价铬 [Cr(VI)]	多溴联苯 (PBB)	多溴二苯醚 (PBDE)
印刷电路板 (PCA)	×	○	×	×	○	○
机壳、支架 (Chassis)	×	○	×	×	○	○
LCD	×	×	×	×	○	○
其他(电缆、风扇、 连接器等) (Appended goods)	×	○	×	×	○	○

○：表示该有毒有害物质在该部件所有均质材料中的含量均在 SJ/T11363-2006 标准规定的限量要求以下。  
 ×：表示该有毒有害物质至少在该部件的某一均质材料中的含量超出 SJ/T11363-2006 标准规定的限量要求。

环保使用期限



这个标记是根据 2006/2/28 公布的「电子信息产品污染控制管理办法」以及 SJ/T 11364-2006 「电子信息产品污染控制标识要求」的规定，适用于在中国销售的电子信息产品的环保使用期限。仅限于在遵守该产品的安全规范及使用注意事项的基础上，从生产日起算的该年限内，不会因产品所含有害物质的泄漏或突发性变异，而对环境污染，人身及财产产生深刻地影响。

注) 电池的环保使用期限是 5 年。生产日期标于产品序号的前四码 (如 S/N 0728XXXX 为 07 年第 28 周生产)。

## EPCD DIRECTIVE 2002/96/EC PRODUCT DISPOSAL

Equipment marked with the Crossed-out Wheelie Bin symbol complies with the European Parliament and Council Directive 2002/96/EC (the "WEEE Directive") in the European Union.



For Products placed on the EU market after August 13, 2005, please contact your local Anritsu representative at the end of the product's useful life to arrange disposal in accordance with your initial contract and the local law.

## **CE CONFORMITY MARKING**

Anritsu affixes the CE Conformity marking onto its conforming products in accordance with Council Directives of The Council Of The European Communities in order to indicate that these products conform to the EMC and LVD directive of the European Union (EU).



## **C-tick CONFORMITY MARKING**

Anritsu affixes the C-tick marking onto its conforming products in accordance with the electromagnetic compliance regulations of Australia and New Zealand in order to indicate that these products conform to the EMC regulations of Australia and New Zealand.



## **NOTES ON EXPORT MANAGEMENT**

This product and its manuals may require an Export License or approval by the government of the product country of origin for re-export from your country.

Before you export this product or any of its manuals, please contact Anritsu Company to confirm whether or not these items are export-controlled.

When disposing of export-controlled items, the products and manuals need to be broken or shredded to such a degree that they cannot be unlawfully used for military purposes.

## **MERCURY NOTIFICATION**

This product uses an LCD backlight lamp that contains mercury. Disposal may be regulated due to environmental considerations. Please contact your local authorities or, within the United States, the Electronics Industries Alliance ([www.eiae.org](http://www.eiae.org)) for disposal or recycling information.



# SOFTWARE LICENSES

VxWorks Runtime  
License 2000-1189



WindML Target License  
2000-1372



NI Device License  
2000-1486



WindRiver USB Runtime License  
2000-1421



---

## Safety Symbols

---

To prevent the risk of personal injury or loss related to equipment malfunction, Anritsu Company uses the following symbols to indicate safety-related information. For your own safety, please read the information carefully *before* operating the equipment.

### Symbols Used in Manuals

#### Danger



This indicates a very dangerous procedure that could result in serious injury or death, or loss related to equipment malfunction, if not performed properly.

#### WARNING



This indicates a hazardous procedure that could result in light-to-severe injury or loss related to equipment malfunction, if proper precautions are not taken.

#### CAUTION:



This indicates a hazardous procedure that could result in loss related to equipment malfunction if proper precautions are not taken.

### Safety Symbols Used on Equipment and in Manuals

The following safety symbols are used inside or on the equipment near operation locations to provide information about safety items and operation precautions. Ensure that you clearly understand the meanings of the symbols and take the necessary precautions *before* operating the equipment. Some or all of the following five symbols may or may not be used on all Anritsu equipment. In addition, there may be other labels attached to products that are not shown in the diagrams in this manual.



This indicates a prohibited operation. The prohibited operation is indicated symbolically in or near the barred circle.



This indicates a compulsory safety precaution. The required operation is indicated symbolically in or near the circle.



This indicates a warning or caution. The contents are indicated symbolically in or near the triangle.



This indicates a note. The contents are described in the box.



These indicate that the marked part should be recycled.

## For Safety

### WARNING



Always refer to the operation manual when working near locations at which the alert mark, shown on the left, is attached. If the operation, etc., is performed without heeding the advice in the operation manual, there is a risk of personal injury. In addition, the equipment performance may be reduced. Moreover, this alert mark is sometimes used with other marks and descriptions indicating other dangers.

### WARNING

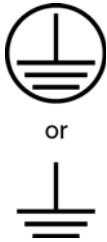

When supplying power to this equipment, connect the accessory 3-pin power cord to a 3-pin grounded power outlet. If a grounded 3-pin outlet is not available, use a conversion adapter and ground the green wire, or connect the frame ground on the rear panel of the equipment to ground. If power is supplied without grounding the equipment, there is a risk of receiving a severe or fatal electric shock.

### WARNING



This equipment can not be repaired by the operator. Do not attempt to remove the equipment covers or to disassemble internal components. Only qualified service technicians with a knowledge of electrical fire and shock hazards should service this equipment. There are high-voltage parts in this equipment presenting a risk of severe injury or fatal electric shock to untrained personnel. In addition, there is a risk of damage to precision components.

### WARNING



Use two or more people to lift and move this equipment, or use an equipment cart. There is a risk of back injury if this equipment is lifted by one person.

### CAUTION:



Electrostatic Discharge (ESD) can damage the highly sensitive circuits in the instrument. ESD is most likely to occur as test devices are being connected to, or disconnected from, the instrument's front and rear panel ports and connectors. You can protect the instrument and test devices by wearing a static-discharge wristband. Alternatively, you can ground yourself to discharge any static charge by touching the outer chassis of the grounded instrument before touching the instrument's front and rear panel ports and connectors. Avoid touching the test port center conductors unless you are properly grounded and have eliminated the possibility of static discharge.

Repair of damage that is found to be caused by electrostatic discharge is not covered under warranty.

# Table of Contents

---

## Chapter 1 — General Information

- 1-1 Introduction . . . . . 1-1
- 1-2 Identifying the Models. . . . . 1-2
- 1-3 Description . . . . . 1-3
- 1-4 MS2024A Options. . . . . 1-4
- 1-5 MS2026A Options. . . . . 1-5
- 1-6 MS2034A Options. . . . . 1-5
- 1-7 MS2036A Options. . . . . 1-5
- 1-8 Standard and Optional Accessories . . . . . 1-6
- 1-9 Soft Carrying Cases and Tilt Bails . . . . . 1-11
  - VNA Master Soft Carrying Case . . . . . 1-11
  - VNA Master Tilt Bail Stand . . . . . 1-13
- 1-10 Preventive Maintenance . . . . . 1-14
- 1-11 Calibration Requirements – Vector Network Analyzer . . . . . 1-14
- 1-12 Calibration Requirements – Spectrum Analyzer. . . . . 1-14
- 1-13 Annual Verification . . . . . 1-14
- 1-14 ESD Cautions . . . . . 1-15
- 1-15 Battery Replacement . . . . . 1-15

## Chapter 2 — Quick Start Guide

- 2-1 Introduction . . . . . 2-1
- 2-2 Turning the VNA Master On for the First Time . . . . . 2-1
- 2-3 Front Panel Overview . . . . . 2-2
  - Battery Charge LED (green) . . . . . 2-3
  - Charge Fault LED (red) . . . . . 2-3
  - Fan Inlet and Exhaust Ports . . . . . 2-3
- 2-4 Typical Vector Network Analyzer Display . . . . . 2-4
- 2-5 Typical Spectrum Analyzer Display . . . . . 2-5

## Table of Contents (Continued)

---

2-6	Front Panel Keys . . . . .	2-5
	Esc Key . . . . .	2-5
	Enter Key . . . . .	2-6
	Arrow Keys . . . . .	2-6
	Shift Key . . . . .	2-6
	Back Key . . . . .	2-6
	Code (+/-) Key . . . . .	2-6
	Number Keypad . . . . .	2-6
	Rotary Knob . . . . .	2-6
	Function Hard Keys . . . . .	2-6
	Soft Keys . . . . .	2-7
2-7	Soft Key Types . . . . .	2-7
	Select . . . . .	2-7
	Input . . . . .	2-7
	Toggle . . . . .	2-7
	Switching . . . . .	2-8
2-8	Parameter Setting . . . . .	2-8
2-9	Text Entry . . . . .	2-8
2-10	Test Panel Connectors . . . . .	2-11
	MS202xA Test Panel Connectors . . . . .	2-11
	MS203xA Test Panel Connectors . . . . .	2-12
	External Power . . . . .	2-12
	LAN Connection . . . . .	2-12
	USB Interface - USB Type Mini-B . . . . .	2-13
	USB Interface - USB Type A . . . . .	2-14
	Headset Jack . . . . .	2-14
	Ext Trigger . . . . .	2-14
	Ext Freq Ref. . . . .	2-14
	RF Detector . . . . .	2-14
	SPA RF In . . . . .	2-14
	VNA Reflection/RF Out . . . . .	2-14
	VNA RF In . . . . .	2-14
	GPS Antenna Connector . . . . .	2-14
	Compact Flash . . . . .	2-15
	Symbols and Indicators . . . . .	2-15
	Cal Status On . . . . .	2-15
	Cal Status Off . . . . .	2-15
	Cal Status Flex On . . . . .	2-15
	Battery Symbol . . . . .	2-15
	Single Sweep . . . . .	2-16

## Table of Contents (Continued)

---

### Chapter 3 — Vector Network Analyzer

3-1	Introduction . . . . .	3-1
3-2	VNA First Time Use . . . . .	3-1
	Selecting the Measurement . . . . .	3-1
	Setting the Frequency Range . . . . .	3-2
	Setting the Start and Stop Frequencies . . . . .	3-2
	Setting a Signal Standard . . . . .	3-2
3-3	Calibration . . . . .	3-3
	Standard Calibrations . . . . .	3-3
	FlexCal Calibration . . . . .	3-3
	1-Port Calibration . . . . .	3-3
	2-Port Calibration . . . . .	3-4
	1-Port Calibration Procedure (OSL) . . . . .	3-4
	2-Port Calibration Procedure (OSLT) . . . . .	3-5
3-4	Using Trace Math . . . . .	3-8
	Example . . . . .	3-8
	Comparing Return Loss . . . . .	3-8
3-5	Using Limit Lines . . . . .	3-10
	Setting up Non-segmented Limit Lines . . . . .	3-10
	Setting up Segmented Limit Lines . . . . .	3-11
3-6	VNA Measurements . . . . .	3-12
	Return Loss/VSWR . . . . .	3-12
	Cable Loss (Field Menus Only) . . . . .	3-14
	Distance-To-Fault (DTF)/Fault Location . . . . .	3-15
	2-Port Gain Measurements . . . . .	3-19
	Phase Measurements . . . . .	3-21
	1-Port Phase Measurement . . . . .	3-21
	2-Port Phase Measurement . . . . .	3-22
	Smith Chart . . . . .	3-22
	Group Delay . . . . .	3-23

## Table of Contents (Continued)

---

3-7	VNA Key Functions . . . . .	3-25
	Introduction . . . . .	3-25
	Amplitude Menu (Field Menu) . . . . .	3-26
	Calibration Menu . . . . .	3-27
	File Menu . . . . .	3-29
	Freq/Dist Menu . . . . .	3-33
	Limit Menu . . . . .	3-35
	Marker Menu . . . . .	3-38
	Measurement Menus (Field and VNA) . . . . .	3-40
	Measurement Menu (VNA Menus) . . . . .	3-42
	Measurement Menu (Field Menus) . . . . .	3-45
	Mode Menu . . . . .	3-47
	Preset Menu . . . . .	3-48
	Save/Recall Menu . . . . .	3-49
	Scale Menu (VNA Menus) . . . . .	3-49
	Sweep Menu . . . . .	3-51
	System Menu . . . . .	3-54
	Trace Menu . . . . .	3-57

### Chapter 4 — Spectrum Analyzer

4-1	Introduction . . . . .	4-1
4-2	Getting Started . . . . .	4-1
	Spectrum Analyzer Mode . . . . .	4-1
	Hard Keys and Soft Keys . . . . .	4-1
4-3	Making Spectrum Analyzer Measurements . . . . .	4-2
	Required Equipment . . . . .	4-2
	Making a Measurement . . . . .	4-2
	Selecting a Signal Standard . . . . .	4-3
	Setting Bandwidth Parameters . . . . .	4-3
4-4	Resolution Bandwidth . . . . .	4-5
4-5	Video Bandwidth . . . . .	4-5
4-6	Sweep Limitations . . . . .	4-6
4-7	Attenuator Functions . . . . .	4-6
4-8	Preamplifier Operation . . . . .	4-6
	Preamplifier Measurement Example . . . . .	4-6
4-9	Field Measurements . . . . .	4-8
4-10	Occupied Bandwidth Measurement . . . . .	4-8
	% Down Method . . . . .	4-8
	dBc Down Method . . . . .	4-8
	Required Equipment . . . . .	4-8
	Procedure . . . . .	4-8

## Table of Contents (Continued)

---

4-11	Channel Power Measurement . . . . .	4-9
4-12	GSM Channel Power Measurement . . . . .	4-10
	Required Equipment . . . . .	4-10
	Procedure . . . . .	4-10
4-13	GSM Adjacent Channel Power Measurement . . . . .	4-11
	Required Equipment . . . . .	4-11
	Procedure . . . . .	4-11
4-14	Out-of-Band Spurious Emission Measurement . . . . .	4-12
	Required Equipment . . . . .	4-12
	Procedure . . . . .	4-12
4-15	In-Band/Out-of-Channel Measurements . . . . .	4-13
4-16	In-Band Spurious Measurement . . . . .	4-14
	Required Equipment . . . . .	4-14
	Procedure . . . . .	4-14
4-17	Field Strength . . . . .	4-16
	Required Equipment . . . . .	4-16
	Procedure . . . . .	4-16
	Antenna Calculations . . . . .	4-17
4-18	AM/FM/SSB Demodulation . . . . .	4-18
	Demodulation Procedure . . . . .	4-18
4-19	Carrier to Interference Ratio Measurement . . . . .	4-19
	Procedure . . . . .	4-19
4-20	SPA Function Menu Tree . . . . .	4-22
	Introduction . . . . .	4-22
4-21	Amplitude . . . . .	4-23
	Description . . . . .	4-23
4-22	BW (Bandwidth) . . . . .	4-26
4-23	File . . . . .	4-28
4-24	Freq (Frequency) . . . . .	4-34
4-25	Limit . . . . .	4-37
4-26	Marker . . . . .	4-43
4-27	Measure . . . . .	4-47
4-28	Mode . . . . .	4-51
4-29	Preset . . . . .	4-51
4-30	Span . . . . .	4-52
4-31	Sweep . . . . .	4-54
4-32	System . . . . .	4-57
4-33	Trace . . . . .	4-61



## Table of Contents (Continued)

---

### Chapter 5 — Power Meter

5-1	Introduction . . . . .	5-1
5-2	Procedure . . . . .	5-1
	Changing the Display Units . . . . .	5-1
	Displaying Relative Power . . . . .	5-1
	Set the Limit Lines . . . . .	5-2
5-3	Power Meter Mode Menus . . . . .	5-4
5-4	Amplitude Menu . . . . .	5-4
5-5	Average Menu . . . . .	5-6
5-6	Freq (Frequency) Menu . . . . .	5-7
5-7	Limit Menu . . . . .	5-9

### Chapter 6 — Power Monitor, Option 5

6-1	Introduction . . . . .	6-1
6-2	Procedure . . . . .	6-1
	Zeroing the Power Monitor . . . . .	6-1
	Measuring High Input Power Levels . . . . .	6-1
	Display Power in dBm or in Watts . . . . .	6-2
	Relative Power . . . . .	6-2

### Chapter 7 — Built-In Bias Tee, Option 10

7-1	Introduction . . . . .	7-1
7-2	2-Port Gain Measurements . . . . .	7-2
	Example 1 . . . . .	7-2
7-3	Bias Tee Menu . . . . .	7-4
	Bias Tee Option . . . . .	7-4
	Bias Tee Menu Soft Keys . . . . .	7-5

### Chapter 8 — Vector Voltmeter, Option 15

8-1	Introduction . . . . .	8-1
8-2	Getting Started . . . . .	8-1
8-3	Using Vector Voltmeter Mode for the First Time . . . . .	8-2
8-4	Simple Measurement Using CW Display . . . . .	8-2
8-5	Simple Relative Measurements using CW Display . . . . .	8-6
8-6	Vector Voltmeter Measurements Using Table Display . . . . .	8-7
8-7	Vector Voltmeter Mode Menus . . . . .	8-9
	CW Menu . . . . .	8-9
	Table Menu . . . . .	8-11
	Save/Recall Menu . . . . .	8-12
	Calibration Menu . . . . .	8-12

## Table of Contents (Continued)

---

### Chapter 9 — Interference Analyzer, Option 25

9-1	Introduction . . . . .	9-1
9-2	Spectrogram Measurement . . . . .	9-1
	Procedure . . . . .	9-1
9-3	Signal Strength . . . . .	9-4
	Procedure . . . . .	9-4
9-4	RSSI (Received Signal Strength Indicator). . . . .	9-6
9-5	Freq (Frequency) Menu . . . . .	9-8
9-6	Amplitude Menu . . . . .	9-11
9-7	BW (Bandwidth) Menu . . . . .	9-13
9-8	Measurements Menu . . . . .	9-15
9-9	Spectrum Menu . . . . .	9-16
9-10	Spectrogram Menu . . . . .	9-21
9-11	Signal Strength Menu . . . . .	9-23
9-12	RSSI (Received Signal Strength Indicator) Menu. . . . .	9-25
9-13	Marker Menu. . . . .	9-27

### Chapter 10 — Channel Scanner, Option 27

10-1	Introduction . . . . .	10-1
10-2	Sample Channel Scanner Setup Procedure. . . . .	10-2
10-3	Custom Setup . . . . .	10-3
	Procedure . . . . .	10-3
	Custom Setup Example. . . . .	10-4
10-4	Scanner Menu . . . . .	10-5
10-5	Amplitude Menu . . . . .	10-7
10-6	Custom Setup Menu. . . . .	10-8
10-7	Measurements Menu . . . . .	10-9

### Chapter 11 — High Accuracy Power Meter

11-1	Introduction . . . . .	11-1
11-2	Getting Started with HAPM. . . . .	11-2
11-3	HAPM Operation Procedure . . . . .	11-3
11-4	HAMP Menus . . . . .	11-6
	Zero/Cal Menus . . . . .	11-6
	Amplitude Menu . . . . .	11-7
	Averages Menu . . . . .	11-9
	Limits Menu . . . . .	11-10
	Mode Menu . . . . .	11-11

## Table of Contents (Continued)

---

### Chapter 12 — GPS Receiver, Option 31

12-1	Introduction	12-1
12-2	Activating the GPS Feature	12-1
12-3	GPS Menu	12-2
12-4	GPS Info Window	12-3
	Tracked Satellites	12-3
	Latitude and Longitude	12-3
	Altitude	12-3
	UTC	12-3
	Fix Available	12-3
	Almanac Complete	12-4
	Antenna Status	12-4
12-5	Saving and Recalling Traces with GSP Information	12-4
	Saving Traces with GPS Information	12-4
	Recalling GPS Information	12-4

### Chapter 13 — Master Software Tools

13-1	Introduction	13-1
13-2	Features	13-1
13-3	System Requirements	13-2
13-4	Installation	13-2

### Appendix A — Signal Standards

A-1	Signal Standards	A-1
-----	------------------	-----

### Appendix B — Error Messages

B-1	Introduction	B-1
B-2	Self Test or Application Self Test Error Messages	B-1
B-3	Operation Error Messages	B-3
B-4	Interference Analyzer Information Messages	B-10
B-5	Interference Analyzer Error Messages	B-12
B-6	Channel Scanner Information Messages	B-14
B-7	Channel Scanner Error Messages	B-15

### Appendix C — Windowing

C-1	Introduction	C-1
C-2	Windowing Examples	C-1

### Appendix D — Tower Mounted Amplifiers

D-1	Introduction	D-1
-----	--------------	-----

## Table of Contents (Continued)

---

### Appendix E — Coaxial Cable Technical Data

E-1	Coaxial Cable Technical Data .....	E-1
-----	------------------------------------	-----

### Appendix F — Formulas

F-1	VNA Master Formulas .....	F-1
	Reflection Coefficient .....	F-1
	Return Loss .....	F-1
	VSWR .....	F-1
	Smith Chart .....	F-1
	Electrical Length .....	F-1
	Propagation .....	F-2
	Cable Loss .....	F-2
	Fault Resolution .....	F-2
	Maximum Horizontal Distance .....	F-2
	Suggested Span .....	F-2

### Appendix G — More About DHCP

G-1	Introduction .....	G-1
G-2	Using DHCP .....	G-1
G-3	Static IP Address .....	G-1
	IP Address .....	G-1
	Default Gateway .....	G-1
	Subnet Mask .....	G-2
	Example 1 .....	G-2
	Example 2 .....	G-2
G-4	Operating System Tools .....	G-2
	Ipconfig Tool .....	G-2
	Ping Tool .....	G-3

## **Table of Contents (Continued)**

---

# Chapter 1 — General Information

## 1-1 Introduction

This chapter covers general information including a description, optional accessories, preventive maintenance, ESD verifications, and calibration requirements for the VNA Master models listed below. This user guide supports both VNA Master plus VNA Master plus Spectrum Analysis models. Throughout this manual, the following terms apply:

- VNA Master or MS20xxA refers to the MS2024A, MS2026A, MS2034A, or MS2036A
- MS202xA refers to either the MS2024A or MS2026A
- MS203xA refers to either the MS2034A or the MS2036A

**Table 1-1.** Analyzer Frequency Range

Model	Frequency Range	
	Vector Network Analyzer	Spectrum Analyzer
MS2024A	2 MHz to 4 GHz	Not Applicable
MS2026A	2 MHz to 6 GHz	Not Applicable
MS2034A	2 MHz to 4 GHz	9 kHz to 4 GHz (Note 1)
MS2036A	2 MHz to 6 GHz	9 kHz to 7.1 GHz (Note 1)

Note 1: Units with serial numbers below 073700 sweep down to 100 kHz only.

## 1-2 Identifying the Models

The MS202xA is differentiated from the MS203xA by the front panel model number label. In addition, the MS203xA is larger and contains additional connections for spectrum analysis as summarized in the following pictures and table.

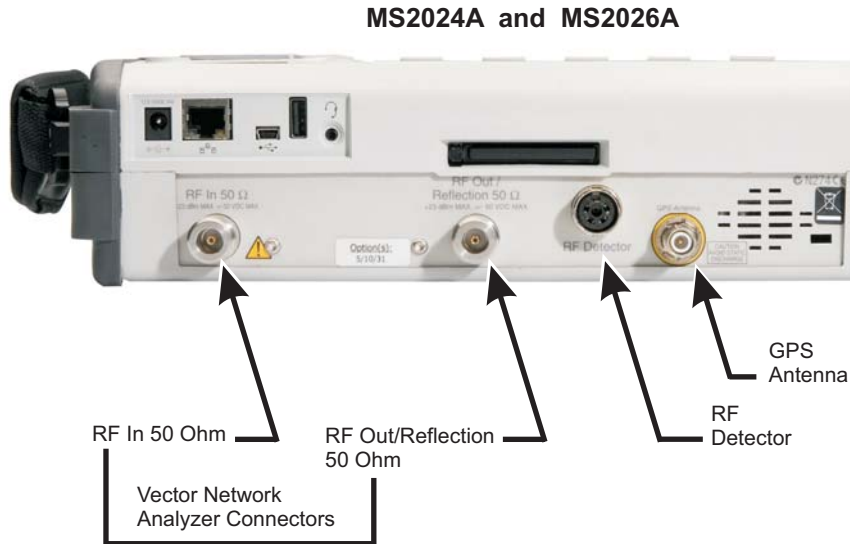

**Figure 1-1.** MS2024A and MS2026A Connectors

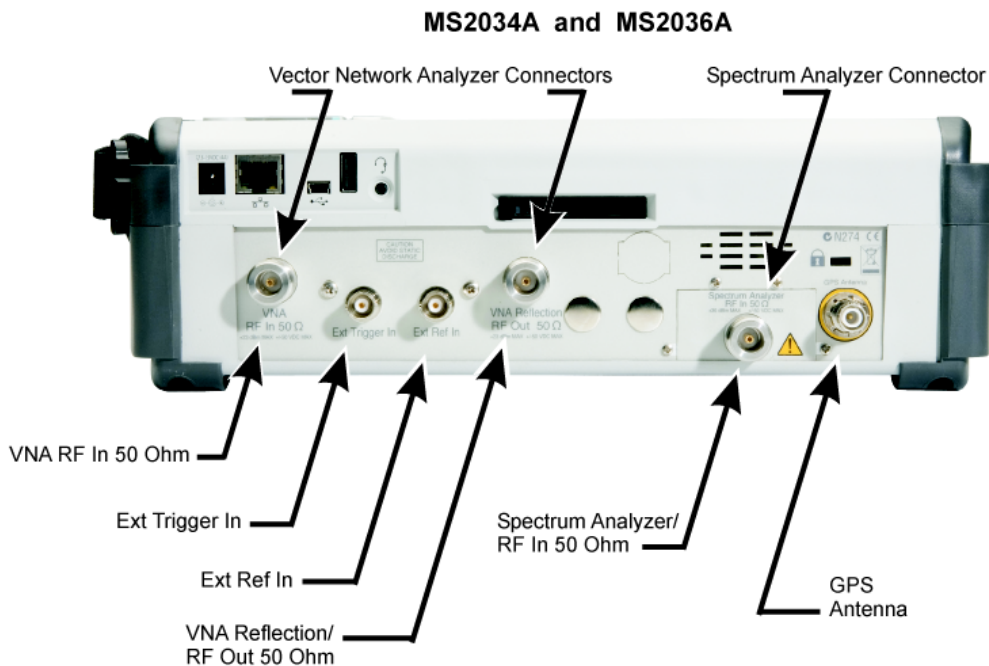

**Figure 1-2.** MS2034A and MS2036A Connectors

**Table 1-2.** Instrument Model Identification

Part Number	Size	Weight
MS202xA	31.5 x 21.1 x 7.82 cm (12.4 x 8.3 x 3.1 in.)	2.9 kg (6.4 lbs)
MS203xA	31.5 x 21.1 x 9.71 cm (12.4 x 8.3 x 3.8 in.)	4 kg (9 lbs)

## 1-3 Description

The Anritsu VNA Master instruments, starting with the MS202xA series, are portable handheld vector network analyzers (VNAs) featuring precise performance and essential RF capabilities. These VNA Master instruments are designed to conduct accurate vector-corrected 1-port magnitude, phase, and fault location measurements and 1-path 2-port magnitude, phase, and group delay measurements from 2 MHz to 6 GHz.

The MS203xA series adds spectrum analysis capabilities to the MS202xA series. This one instrument provides all essential RF capabilities in a portable, high-performance platform.

[Table 1-3 on page 1-4](#) summarizes the VNA Master measurement capabilities by model number.



**Table 1-3.** Measurement Capabilities

Model Number	VNA Frequency	SPA Frequency	Measurements
MS2024A Handheld VNA Master	2 MHz to 4 GHz	N/A	Return loss, cable loss, VSWR, 1-port phase, 2-port phase, smith chart, 2-port gain, group delay, Distance-to-Fault
MS2034A Handheld VNA Master plus Spectrum Analysis	2 MHz to 4 GHz	9 kHz to 4 GHz	MS2024A measurements plus high performance spectrum analysis, channel scanner, and interference analysis. (See Note 1 below.)
MS2026A Handheld VNA Master	2 MHz to 6 GHz	N/A	Return loss, cable loss, VSWR, 1-port phase, 2-port phase, smith chart, 2-port gain, group delay, Distance-to-Fault
MS2036A Handheld VNA Master plus Spectrum Analysis	2 MHz to 6 GHz	9 kHz to 7.1 GHz	MS2026A measurements plus high performance spectrum analysis, channel scanner, and interference analysis. (See Note 1 below.)

Note 1: Units with serial numbers below 0737000 sweep down to 100 kHz only.

## 1-4 MS2024A Options

Anritsu VNA Master options are dependent upon the model purchased, as summarized in this and the following sections. Options for the MS2024A 2-port VNA Master, 2 MHz to 4 GHz are:

- MS2024A-005 Power Monitor (requires external detector)
- MS2024A-010 Built-in Bias-Tee
- MS2024A-015 Vector Voltmeter
- MS2024A-019 High Accuracy Power Meter (sensors not included)
- MS2024A-031 GPS Receiver (includes GPS antenna)

## 1-5 MS2026A Options

Options for the MS2026A 2-port VNA Master, 2 MHz to 6 GHz are:

- MS2026A-005 Power Monitor (requires external detector)
- MS2026A-010 Built-in Bias-Tee
- MS2026A-015 Vector Voltmeter
- MS2024A-019 High Accuracy Power Meter (sensors not included)
- MS2026A-031 GPS Receiver (includes GPS antenna)

## 1-6 MS2034A Options

Options for the MS2034A 2-port VNA Master, 2 MHz to 4 GHz Vector Network Analysis, 9 kHz to 4 GHz Spectrum Analysis are:

- MS2034A-005 Power Monitor (requires external detector)
- MS2034A-010 Built-in Bias-Tee
- MS2034A-015 Vector Voltmeter
- MS2024A-019 High Accuracy Power Meter (sensors not included)
- MS2034A-025 Interference Analysis, 9 kHz to 4 GHz, (requires external antenna)
- MS2034A-027 Channel Scanner, 9 kHz to 4 GHz, (requires external antenna)
- MS2034A-031 GPS Receiver (includes GPS antenna):

<b>Note</b> Units with serial numbers below 0737000 sweep down to 100 kHz only.
---

## 1-7 MS2036A Options

Options for the MS2036A 2-port VNA Master, 2 MHz to 6 GHz Vector Network Analysis, 9 kHz to 7.1 GHz Spectrum Analysis:

- MS2036A-005 Power Monitor (requires external detector)
- MS2036A-010 Built-in Bias-Tee
- MS2036A-015 Vector Voltmeter
- MS2024A-019 High Accuracy Power Meter (sensors not included)
- MS2036A-025 Interference Analysis, 9 kHz to 7.1 GHz (requires external antenna)
- MS2036A-027 Channel Scanner, 9 kHz to 7.1 GHz (requires external antenna)
- MS2036A-031 GPS Receiver (includes GPS antenna)

<b>Note</b> Units with serial numbers below 0737000 sweep down to 100 kHz only.
---

## 1-8 Standard and Optional Accessories

The standard accessories are slightly different depending upon whether the MS202xA or the MS203xA has been purchased, as shown in the following table. These standard accessories are supplied with the VNA Master:

**Note** Units with serial numbers below 0737000 sweep down to 100 kHz only.

**Table 1-4.** Standard Accessories

MS202xA Part Number	MS203xA Part Number	Description
10580-00166	10580-00166	User Guide
65729	65681	Soft Carrying Case
2300-498	2300-498	Master Software Tools CD ROM
633-44	633-44	Rechargeable Li-Ion Battery
40-168	40-168	AC-DC Adapter
806-141	806-141	Automotive Cigarette Lighter 12 VDC Adapter
3-2000-1498	3-2000-1498	Cable USB A/5-pin / Mini-B; 3 m (10 ft.)
2000-1371	2000-1371	Ethernet Cable 2.13 m (7 ft.)
3-2000-1500	3-2000-1500	256 MB Compact Flash Module
3-806-152	3-806-152	Ethernet Crossover Cable, 2.13 m (7 ft.)
2000-1520-R	2000-1520-R	2 GB USB Flash Drive
N/A	1091-27	N-m/SMA-f Adapter
N/A	1091-172	N-m/BNC-f Adapter

The following optional accessories are available for the VNA Master:

**Table 1-5.** Coaxial Calibration Components

Part Number	Description
<b>N Connector Components</b>	
OSLN50-1	Precision N(m) Open/Short/Load, 42 dB, 6 GHz
OSLNF50-1	Precision N(f) Open/Short/Load, 42 dB, 6 GHz
22N50	Precision N(m) Short/Open, 18 GHz
22NF50	Precision N(f) Short/Open, 18 GHz
SM/PL-1	Precision N(m) Load, 42 dB, 6.0 GHz
SM/PLNF-1	Precision N(f) Load, 42 dB, 6.0 GHz
<b>TNC Connector Components</b>	
1091-53	Precision TNC(m) Open, 18 GHz, 50 $\Omega$
1091-54	Precision TNC(m) Short, 18 GHz, 50 $\Omega$

**Table 1-5.** Coaxial Calibration Components (*Continued*)

Part Number	Description
1015-55	Precision TNC(m) Load, 18 GHz, 50 $\Omega$
1091-55	Precision TNC(f) Open, 18 GHz, 50 $\Omega$
1091-56	Precision TNC(f) Short, 18 GHz, 50 $\Omega$
1015-54	Precision TNC(f) Load, 18 GHz, 50 $\Omega$
<b>Precision 3.5 mm Components</b>	
23L50	Precision 3.5 mm(m) Short, 9 GHz
23LF50	Precision 3.5 mm(f) Short, 9 GHz
24L50	Precision 3.5 mm(m) Open, 9 GHz
24LF50	Precision 3.5 mm(f) Open, 9 GHz
28L50R	Precision 3.5 mm(m) Load, 9 GHz
28LF50R	Precision 3.5 mm(f) Load, 9 GHz
<b>Precision Open/Short/Load Components</b>	
2000-767	Precision Open/Short/Load, 7/16(m), 4.0 GHz
2000-768	Precision Open/Short/Load, 7/16(f), 4.0 GHz

**Table 1-6.** Precision Adapters

Part Number	Description
34NN50A	N(m)-N(m), DC to 18 GHz, 50 $\Omega$
34NFN50	N(f)-N(f), DC to 18 GHz, 50 $\Omega$

**Table 1-7.** Adapters

Part Number	Description
<b>N to SMA Adapters</b>	
1091-26	N(m)-SMA(m), DC to 18 GHz, 50 $\Omega$
1091-27	N(m)-SMA(f), DC to 18 GHz, 50 $\Omega$
1091-80	N(f)-SMA(m), DC to 18 GHz, 50 $\Omega$
1091-81	N(f)-SMA(f), DC to 18 GHz, 50 $\Omega$
<b>N Adapters</b>	
510-102	N(m)-N(m), 90° right angle, DC to 11 GHz, 50 $\Omega$
<b>DIN Adapters</b>	
510-90	7/16 DIN(f)-N(m), DC to 7.5 GHz, 50 $\Omega$
510-91	7/16 DIN(f)-N(f), DC to 7.5 GHz, 50 $\Omega$

**Table 1-7.** Adapters (Continued)

Part Number	Description
510-92	7/16 DIN(m)-N(m), DC to 7.5 GHz, 50 $\Omega$
510-93	7/16 DIN(m)-N(f), DC to 7.5 GHz, 50 $\Omega$
510-96	7/16 DIN(m)-7/16 DIN(m), DC to 7.5 GHz, 50 $\Omega$
510-97	7/16 DIN(f)-7/16 DIN(f), DC to 7.5 GHz, 50 $\Omega$
<b>TNC Adapters</b>	
513-62	Adapter, TNC(f) to N(f), 18 GHz, 50 $\Omega$
1091-315	Adapter, TNC(m) to N(f), 18 GHz, 50 $\Omega$
1091-324	Adapter, TNC(f) to N(m), 18 GHz, 50 $\Omega$
1091-325	Adapter, TNC(m) to N(m), 18 GHz, 50 $\Omega$
1091-317	Adapter, TNC(m) to SMA(f), 18 GHz, 50 $\Omega$
1091-318	Adapter, TNC(m) to SMA(m), 18 GHz, 50 $\Omega$
1091-323	Adapter, TNC(f) to TNC(f), 18 GHz, 50 $\Omega$
1091-326	Adapter, TNC(m) to TNC(m), 18 GHz, 50 $\Omega$

**Table 1-8.** Test Port Cables Armored

Part Number	Description
15NN50-1.5C	1.5 meters, N(m)-N(m), 6 GHz, 50 $\Omega$
15NN50-3.0C	3.0 meters, N(m)-N(m), 6 GHz, 50 $\Omega$
15NN50-5.0C	5.0 meters, N(m)-N(m), 6 GHz, 50 $\Omega$
15NNF50-1.5C	1.5 meters, N(m)-N(f), 6 GHz, 50 $\Omega$
15NNF50-3.0C	3.0 meters, N(m)-N(f), 6 GHz, 50 $\Omega$
15NNF50-5.0C	5.0 meters, N(m)-N(f), 6 GHz, 50 $\Omega$
15ND50-1.5C	1.5 meters, N(m)-7/16 DIN(m), 6 GHz, 50 $\Omega$
15NDF50-1.5C	1.5 meters, N(m)-7/16 DIN(f), 6 GHz, 50 $\Omega$

**Table 1-9.** Port Antennas

Part Number	Description
<b>Individual Antennas</b>	
2000-1030	SMA(m), 1.71 to 1.88 GHz, 50 $\Omega$
2000-1031	SMA(m), 1.85 to 1.99 GHz, 50 $\Omega$
2000-1032	SMA(m), 2.4 to 2.5 GHz, 50 $\Omega$
2000-1035	SMA(m), 896 to 941 MHz, 50 $\Omega$
2000-1200	SMA(m), 806 to 869 MHz, 50 $\Omega$

**Table 1-9.** Port Antennas (*Continued*)

Part Number	Description
2000-1361	SMA(m), 5725 to 5825 MHz, 50 $\Omega$
2000-1473	SMA(m), 870 to 960 MHz, 50 $\Omega$
2000-1474	SMA(m), 1.71 to 1.88 GHz, 50 $\Omega$
2000-1475	SMA(m), 1920 to 1980, 2.11 to 2.17 GHz, 50 $\Omega$
Antenna Kit	
61532	Antenna Kit: 2000-1030, 2000-1031, 2000-1032, 2000-1035, 2000-1200, and 2000-1361

**Table 1-10.** Limiter

Part Number	Description
1N50C	Limiter, N(m) to N(f), 50 $\Omega$ , 0.01 to 18 GHz

**Table 1-11.** Attenuators

Part Number	Description
42N50-20	Attenuator, 20 dB, 50 $\Omega$ , DC to 18 GHz, N(m)-N(f)
42N50A-30	Attenuator, 30 dB, 50 $\Omega$ , DC to 18 GHz, N(m)-N(f)

**Table 1-12.** GPS Antenna

Part Number	Description
2000-1410	Magnet Mount GPS Antenna with 4.6m (15 ft) cable

**Table 1-13.** Hard Transit Case

Part Number	Description
760-243-R	Hard Transit Case

**Table 1-14.** High Accuracy Power Sensor Accessories for use with Option 019

Part Number	Description
PSN50	High Accuracy Power Sensor, 50 MHz to 6 GHz, -30 to +20 dBm
MS24106A	USB Power Sensor, 50 MHz to 6 GHz, -40 to +23 dBm
3-2000-1498	USB A/Mini-B cable; 3m (10 ft.)

**Table 1-14.** High Accuracy Power Sensor Accessories for use with Option 019 (*Continued*)

Part Number	Description
3-1010-122	Attenuator (Bi-directional), 20 dB, 5 Watt, DC to 12.4 GHz; N(m)-N(f)
3-1010-123	Attenuator (Bi-directional), 30 dB, 50 Watt, DC to 8.5 GHz; N(m)-N(f)
3-1010-124	Attenuator (Bi-directional), 40 dB, 100 Watt, DC to 8.5 GHz; N(m)-N(f)

**Table 1-15.** Miscellaneous Accessories

Part Number	Description
633-44	Rechargeable Battery, Li-Ion
2000-1374	Dual External, Li-Ion Changer with Universal Power Supply
66864	Rack Mount (MS202xA only)

**Table 1-16.** 560 Series Detectors for use with Option 005

Model	Frequency Range	Impedance	Return Loss	Input Connector	Frequency Response
560-7N50B	0.01 to 20 GHz	50 $\Omega$	15 dB, <0.04 GHz 22 dB, <8.00 GHz 17 dB, <18.0 GHz 14 dB, <20.0 GHz	N(m)	$\pm 0.5$ dB, <18 GHz $\pm 1.25$ dB, <20 GHz
560-7S50B	0.01 to 20 GHz	50 $\Omega$	15 dB, <0.04 GHz 22 dB, <8.00 GHz 17 dB, <18.0 GHz 14 dB, <20.0 GHz	WSMA (m)	$\pm 0.5$ dB, <18 GHz $\pm 2.0$ dB, <20 GHz

The Anritsu 560 Series Detectors use zero-biased Schottky diodes. The measurement range is from  $-40$  dBm to  $+20$  dBm using single cycle per sweep AC detection, and uses auto-zeroing with DC detection during the frequency sweep. Optional extender cables can be used with the VNA Master with Option 5 installed. For additional detectors, refer to the Anritsu web site, <http://www.anritsu.com/>.

**Table 1-17.** Detector Extender Cables

Part Number	Description
800-109	7.6m (25 ft)
800-110	15.2m (50 ft)
800-111	30.5m (100 ft)
800-112	61.0m (200 ft)

Optional detector extender cables are useful for connecting a VNA Master and a Detector for 2-port measurements.

## 1-9 Soft Carrying Cases and Tilt Bails

The soft carrying cases are slightly different for the MS202xA and MS203xA because the MS203xA is larger. The tilt bail is factory-installed on the VNA Master for use with or without the soft carrying case.

### VNA Master Soft Carrying Case

The instrument can be operated while in the soft carrying case. On the back of the case is a large storage pouch for accessories and supplies.

To install the instrument into the soft carrying case, perform the following:

1. The front panel of the case is secured with hook and loop fasteners. Fully open the front panel of the case.
2. Place the soft carrying case face down on a stable surface, with the front panel fully open and laying flat.
3. Fully open the zippered back of the case.

**Note** Two zippers are located around the back of the case. The zipper closer to the instrument compartment of the case opens the case back and allows access to install and remove the unit. The other zipper closer to the back of the case opens a support panel that can be used to provide support for improved stability and air flow while in the case. This support panel also contains the storage pouch.

4. Insert the unit face down into the case, taking care that the connectors are properly situated in the case top opening. [Figure 1-3](#) shows the instrument in the case.



**Figure 1-3.** Instrument Inserted Into the Soft Carrying Case



5. Close the back panel and secure it with the zipper.



**Figure 1-4.** VNA Master Installed in Soft Case

The soft carrying case includes a detachable shoulder strap that can be connected to the D-rings on the upper corners of the case as required for comfort or convenience.

### VNA Master Tilt Bail Stand

The supplied Tilt Bail can be used for desktop operation. The tilt bail provides a backward tilt for improved stability and air flow.

To deploy the tilt bail, pull the bottom of the tilt bail away from the back of the unit.



**Figure 1-5.** Tilt Bail Extended on VNA Master

To store the tilt bail, push the bottom of the bail toward the back of the unit and snap the bottom of the bail into the clip on the back of the unit.

## 1-10 Preventive Maintenance

VNA Master preventive maintenance consists of cleaning the unit and inspecting and cleaning the RF connector on the instrument and all accessories. Clean the VNA Master with a soft, lint-free cloth dampened with water or water and a mild cleaning solution.

**CAUTION:** To avoid damaging the display or case, do not use solvents or abrasive cleaners.

Clean the RF connectors and center pins with a cotton swab dampened with denatured alcohol. Visually inspect the connectors. The fingers of N(f) connectors and the pins of N(m) connectors should be unbroken and uniform in appearance. If you are unsure whether the connectors are good, then gauge the connectors to confirm that their dimensions are correct.

Visually inspect the test port cable(s). The test port cable should be uniform in appearance, not stretched, kinked, dented, or broken.

## 1-11 Calibration Requirements – Vector Network Analyzer

The VNA Master is a field portable unit operating in the rigors of the test environment. An Open-Short-Load (OSL) or Open-Short-Load-Through (OSLT) calibration should be performed prior to making a measurement in the field.

The VNA Master has no field-adjustable components. The OSL calibration components, however, are crucial to the integrity of the calibration and should be periodically verified to ensure performance. This is especially important if the components have been dropped or over-torqued.

**Note** For best calibration results (compensation for all measurement uncertainties), ensure that the calibration is performed at the end of the test port or optional extension cable; that is, at the same point that the device that is to be tested will be connected.

**Note** For best results, use an Anritsu phase stable Test Port Extension Cable. Use of a typical laboratory cable to extend the VNA Master test port to the device under test, or any cable bending subsequent to the OSL or OSLT calibration, may cause uncompensated phase reflections inside the cable. These reflections will cause measurement errors that will be more pronounced at higher frequencies.

## 1-12 Calibration Requirements – Spectrum Analyzer

The VNA Master loads factory calibration data during start-up, eliminating the need for daily calibration checks.

## 1-13 Annual Verification

Anritsu recommends an annual calibration and performance verification of the VNA Master and the calibration components by local Anritsu service centers. Anritsu service centers are listed on our web site at [www.anritsu.com](http://www.anritsu.com).

## 1-14 ESD Cautions

The MS202xA and MS203xA, like other high performance instruments, are susceptible to ESD damage. Very often, coaxial cables and antennas build up a static charge, which, if allowed to discharge by connecting directly to the MS202xA or MS203xA without first discharging the static charge, may damage the instrument input circuitry. Operators should be aware of the potential for ESD damage and must take all necessary precautions.

Operators should exercise practices outlined within industry standards such as JEDEC-625 (EIA-625), MIL-HDBK-263, and MIL-STD-1686, which pertain to ESD and ESDS devices, equipment, and practices. Because these standards apply to the MS202xA and MS203xA, it is recommended that any static charges that may be present be dissipated before connecting coaxial cables or antennas to the MS202xA or MS203xA. This may be as simple as temporarily attaching a short or load device to the cable or antenna prior to attaching to the MS202xA or MS203xA. It is important to remember that the operator may also carry a static charge that can cause damage. Following the practices outlined in the above standards will help ensure a safe environment for both personnel and equipment.

## 1-15 Battery Replacement

The battery can be replaced without the use of tools. The battery compartment is located on the lower left side of the instrument. Slide the battery door down (towards the bottom of the instrument) to remove the door. Remove the battery pack from the instrument by pulling straight out on the battery lanyard. Replacement is the opposite of removal.

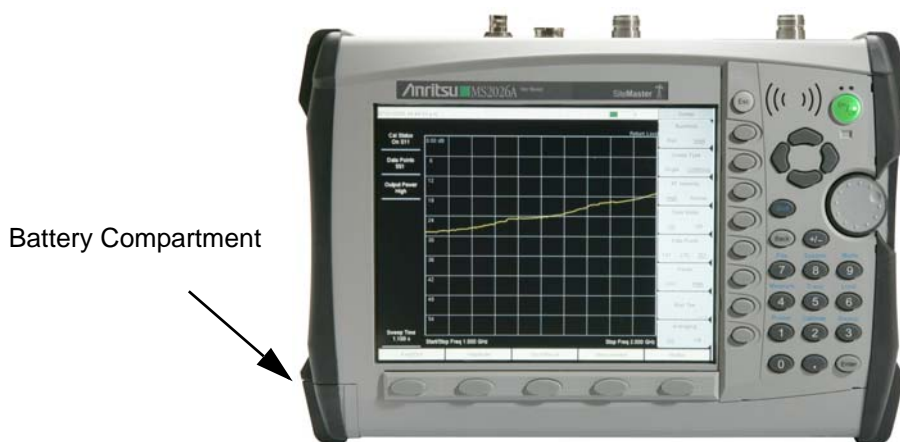

**Figure 1-6.** Battery Compartment

The battery supplied with the VNA Master may need charging before use. The battery can be charged in the VNA Master, using either the AC-DC Adapter (40-168) or the 12 Volt DC adapter (806-141), or separately in the optional Dual Battery Charger (2000-1374).

**CAUTION:** When using the Automotive Cigarette Lighter 12 VDC Adapter, Anritsu Part Number 806-141, always verify that the supply is rated for a minimum of 60 Watts at 12 VDC, and that the socket is clear of any dirt or debris. If the adapter plug becomes hot to the touch during operation, then discontinue use immediately.

**CAUTION:** Use only Anritsu approved batteries, adapters and chargers with these instruments.

# Chapter 2 — Quick Start Guide

## 2-1 Introduction

This chapter gives a brief overview of the Anritsu MS202xA VNA Master and Anritsu MS203xA VNA Master handheld instruments. The intent of this chapter is to provide the user with a starting point for making basic measurements. For more detailed information, refer to the specific measurement mode chapters later in this manual.

## 2-2 Turning the VNA Master On for the First Time

The Anritsu VNA Master is capable of nearly three hours of continuous operation from a fully charged, field-replaceable battery (refer to [“1-15 Battery Replacement”](#) on page 1-15 in [Chapter 1, “General Information”](#)). The VNA Master can also be operated from a 12 VDC source (which will also simultaneously charge the battery). This can be achieved with either the Anritsu AC-DC Adapter (Anritsu part number 40-168) or 12 VDC Automotive Cigarette Lighter Adapter (Anritsu part number 806-141). Both items are included as standard accessories (refer to [“Standard and Optional Accessories”](#) on page 1-6).

**Caution**

When using the Automotive Cigarette Lighter 12 VDC Adapter, Anritsu Part Number 806-141, always verify that the supply is rated for a minimum of 60 Watts at 12 VDC, and that the socket is clear of any dirt or debris. If the adapter plug becomes hot to the touch during operation, then discontinue use immediately.

To turn on the VNA Master, press the **On/Off** front panel button (Figure 2-1).



**Figure 2-1.** VNA Master On/Off Button (MS2026A shown)

The VNA Master requires approximately thirty-five seconds to complete the power-on cycle and load the application software. At the completion of this process, the instrument is ready to use.

The VNA Master performs a self test during each power-on cycle. If the self test fails, then refer to “[B-2 Self Test or Application Self Test Error Messages](#)” on page B-1 in [Appendix B, “Error Messages”](#). For maximum accuracy, letting the instrument warm up for approximately 15 minutes is a good practice before performing a calibration.

## 2-3 Front Panel Overview

The VNA Master menu-driven interface is easy to use and requires little training. Hard keys on the front panel are used to initiate function-specific menus. Five function hard keys are located below the display. These keys vary in function depending upon the current mode of operation.

Located to the right of the display, the VNA Master has 21 hard keys and a rotary knob. Nine of these hard keys (the number keys) are dual purpose, depending upon the current mode of operation. The dual-purpose keys are labeled with a number on the key itself, and with the alternate function printed on the panel above the key. Use the **Shift** key to access the functions printed on the panel above the key. The **Escape** key (labeled **Esc** and used for aborting data entry) is the round button located above the eight soft keys. Both the rotary knob and the keypad can be used to change the value of an active parameter. The rotary knob can also be pressed to duplicate the action of the **Enter** key.

The eight soft keys are located to the right of the display. They change function depending upon the current mode of operation and menu selection. The current soft key function is indicated at the top of the active function block, which is located to the right of the display. The active function block displays a label for each active soft key. If a soft key has no function in the current mode, then the active function block display is blank adjacent to that soft key. The locations of all of the keys are shown in [Figure 2-2 “Front Panel Overview”](#).

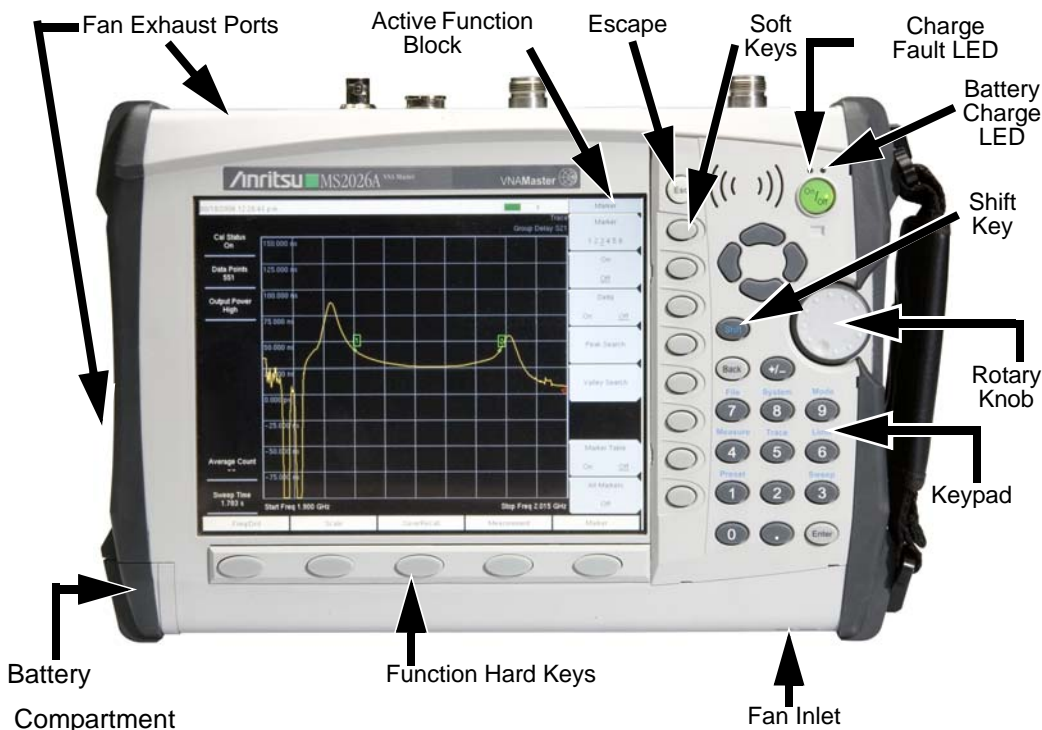

**Figure 2-2.** Front Panel Overview

Other features on the front panel include:

### Battery Charge LED (green)

The Battery Charge LED will flash if the battery is charging and will remain on and steady when the battery is fully charged.

### Charge Fault LED (red)

The Charge Fault LED will remain on and steady under a battery charger fault condition. Fault conditions include a battery cell voltage that is too low to charge, or a battery temperature outside the temperature range ( $-5^{\circ}\text{C}$  to  $+50^{\circ}\text{C}$ ) to charge.

### Fan Inlet and Exhaust Ports

The fan inlet and exhaust ports must be kept clear of obstructions at all times for proper ventilation and cooling of the instrument.



## 2-4 Typical Vector Network Analyzer Display

Figure 2-3 illustrates some of the key information areas of the vector network analyzer display on the VNA Master for both MS202xA and MS203xA models. The measurement and the display type may not be the same as currently shown on your instrument. The purpose of the figure is to show the general areas of the display, which are labeled in the figure. Refer to Section “3-7 VNA Key Functions” on page 3-25 in Chapter 3, “Vector Network Analyzer” for more detailed soft key descriptions.

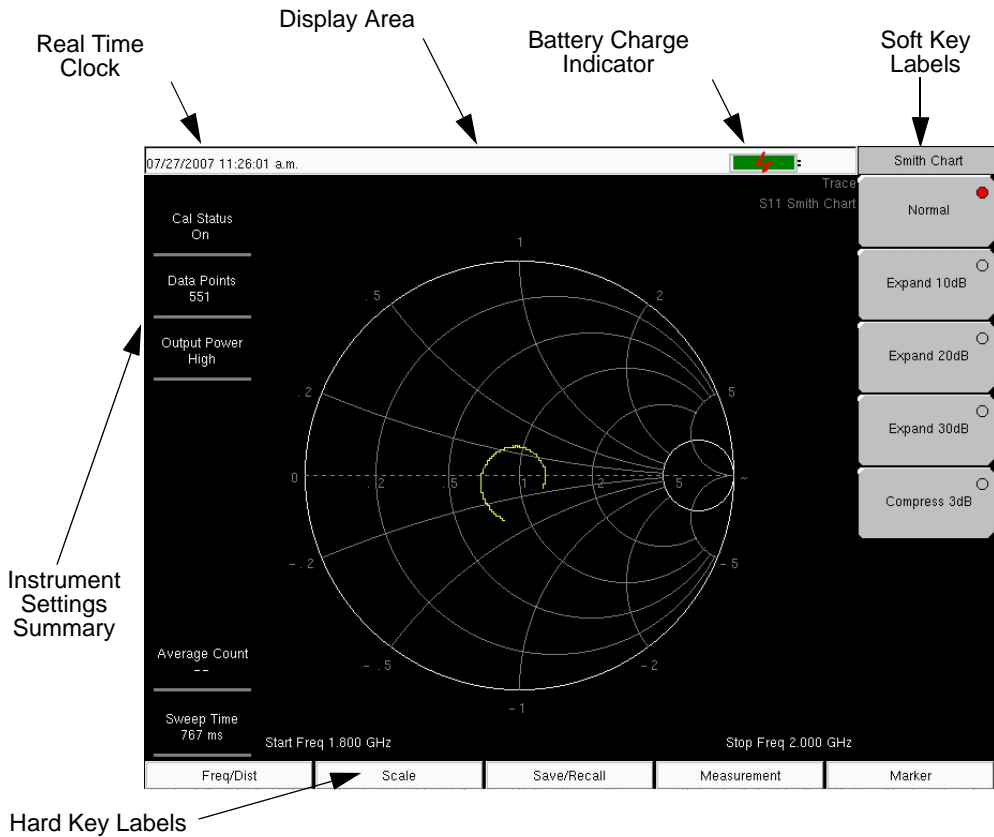

Figure 2-3. Vector Network Analyzer Smith Chart Display

## 2-5 Typical Spectrum Analyzer Display

Figure 2-4 illustrates some of the key information areas of the Spectrum Analyzer display of the VNA Master. Spectrum Analyzer functions are in MS203xA models only. For more detailed key descriptions, refer to Chapter 4, “Spectrum Analyzer”. For measurement details, refer to Section “4-3 Making Spectrum Analyzer Measurements” on page 4-2 and subsequent sections.

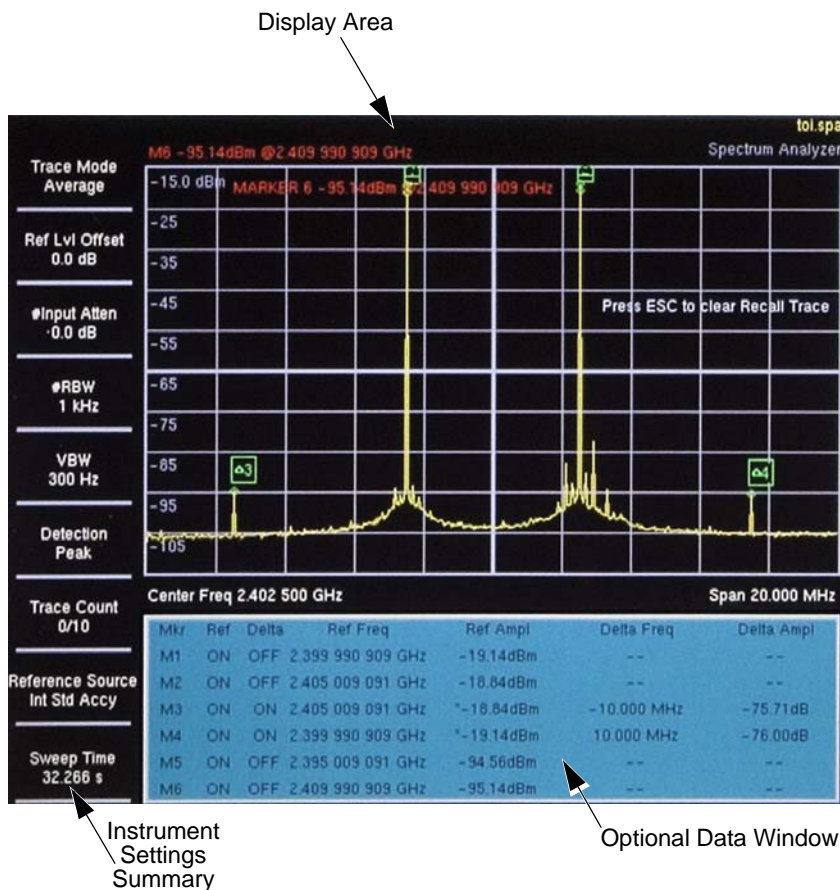

Figure 2-4. Spectrum Analyzer Display Overview

## 2-6 Front Panel Keys

The term hard key refers to all of the buttons on the instrument face except for the vertical row of gray buttons adjacent to the measurement display. The eight vertically arranged gray buttons are called soft keys, and they are used to activate virtual soft key buttons within the measurement display screen.

### Esc Key

Pressing this key cancels any setting that is currently being made.

## Enter Key

Press this key to finalize data input. Pressing the rotary knob performs this same function.

## Arrow Keys

The four arrow keys (between the rotary knob and the **Esc** key) are used to scroll up, down, left, or right. The arrow keys can often be used to change a value or to change a selection from a list. This function is similar to the function of the rotary knob. The arrow keys are also used to move markers.

## Shift Key

Pressing the **Shift** key and then a number key executes the function that is indicated in blue text above the number key. When the **Shift** key is active, its icon is displayed in the upper right corner of the measurement display area between the battery charge indicator and the soft key menu label.



**Figure 2-5.** Shift Key Icon

## Back Key

Press this key to delete only one character, one number, or the range that is specified by the cursor.

## Code (+/-) Key

Press this key to change the sign of numbers that are entered with the number keys.

## Number Keypad

These keys are used to directly input numbers.

## Rotary Knob

Turning the rotary knob changes numerical values, scrolls through selectable items from a list, and moves markers. Values or items may be within a dialog box or an edit window.

Pressing this knob finalizes the input function in the same manner as pressing the **Enter** key.

## Function Hard Keys

These five function keys are horizontally arranged adjacent to the measurement display screen along the lower edge. These buttons have no labels. As with the soft keys, they are positioned to accompany virtual key labels that are displayed to match instrument modes and functions. These function hard key labels change to match specific instrument Mode settings. Each Mode has a specific set of Function Hard Keys. For details about the Mode settings, refer to the section [“Mode Menu” on page 3-47](#) in [Chapter 3, “Vector Network Analyzer”](#).

## Soft Keys

These eight gray keys have no labels. They are arranged adjacent to the measurement display screen along the right-hand edge. They are positioned to accompany virtual soft key labels that are displayed to match instrument modes and measurement functions. These soft key labels (also called the Active Function Block) change as instrument measurement settings change. The following soft key descriptions describe how these keys are used:

## 2-7 Soft Key Types

### Select

A **Select** soft key has a small circle in the upper right corner of the virtual key face and is used to select the function or item that is displayed on the virtual soft key label. When not selected, the circle is gray. When selected, the circle is red to indicate that the function is active.

Press the key to make the selection. Press a different key to make a different selection.

A **Select** soft key may also be a **Switching** soft key. These keys show both a gray circle and an arrow mark (->).

A **Select** soft key may change to a **Switching** soft key when active. These keys show only the gray circle when not active, but show the arrow mark as well as the red circle when active. Refer to section “Switching” on this page.

### Input

An **Input** soft key is used to select an item or a value. This type of soft key displays the setting parameter and the setting value on the virtual key face. When the key is pressed, a select box or edit box may open on the display screen, or the key face may turn a darker gray color to show that the setting is being made. At any time before finalizing the input, press the escape (**Esc**) key to abort the change and retain the previously existing setting.

To set or select an item or a value, use the number keys, the arrow keys, or the rotary knob. Press the rotary knob or the **Enter** key to finalize data input. If a value is being selected or entered, then the soft key Active Function Block may change to provide one or more soft keys for units, such as Hz or dB. Pressing a unit soft key sometimes finalizes the data input in the same manner as pressing the **Enter** key. If more than one unit key is displayed, then pressing the **Enter** key without first pressing a unit key selects a specific unit by default.

With some functions, only a specific set of values are valid. When scrolling with the **Up/Down** arrow keys or the rotary knob, only valid values are offered. If different values are set with the number keypad, then those values might not be accepted. Even if different values are accepted on the soft key face, the values may not be valid for the selected measurement.

### Toggle

A **Toggle** soft key displays the setup item and the toggle states. Toggle states may be On and Off or may be a selection of types or values such as Data Points: 137, 275, or 551.

Each press of the **Toggle** soft key moves the selection to the next value or item in sequence. The selected item or value is underlined on the virtual key face.

## Switching

A **Switching** soft key is used to open an additional soft key menu, and it has an arrow mark (-->) in the lower right corner of the virtual key face.

Some **Select** soft keys become **Switching** soft keys after being pressed (after becoming active). These keys do not display the arrow mark until their circle is red. An additional press, after the circle is red and the arrow mark is displayed, opens the additional soft key menu. Refer to section “[Select](#)” on page 2-7.

The **Switching** soft key that is labeled More opens a menu with additional soft key functions. The **Switching** soft key that is labeled Back returns to a previous soft key menu. The Back key has the arrow mark (<--) in the lower left corner of the virtual key face.

## 2-8 Parameter Setting

Pop-up list boxes or edit boxes are used to provide selection lists and selection editors. Scroll through a list of items or parameters with the arrow keys or the rotary knob. Select numerical values by scrolling with the arrow keys or rotary knob or by entering the digits directly from the number keypad. These list boxes and edit boxes frequently display a range of possible values or limits for possible values.

Finalize the input by pressing the rotary knob or the **Enter** key. At any time before finalizing the input, press the escape (**Esc**) key to abort the change and retain the previously existing setting.

Some parameters (such as for antennas or couplers) can be added to list boxes by creating them and importing them through the use of Master Software Tools.

## 2-9 Text Entry

When entering text (as when saving a measurement) the soft key menu for Text Entry displays the characters (alphabet, hyphen, and underscore) in 6 letters per soft key. Characters can be entered by using the rotary knob or by using the soft keys.

The rotary knob scrolls through the characters in a pop-up window and is pressed to select each character in sequence.

Alternatively, press the a b c / d e f soft key (for example) to open another soft key menu with a separate key for each of these letters. The menu returns to the complete character set after each individual letter is entered.

Use the arrow keys to navigate within a name or character string. Use the **Shift** key for capital letters. Press the **Enter** key or the rotary knob to finalize a text entry.

Refer to [Figure 2-6](#), [Figure 2-7](#), and [Figure 2-8](#).

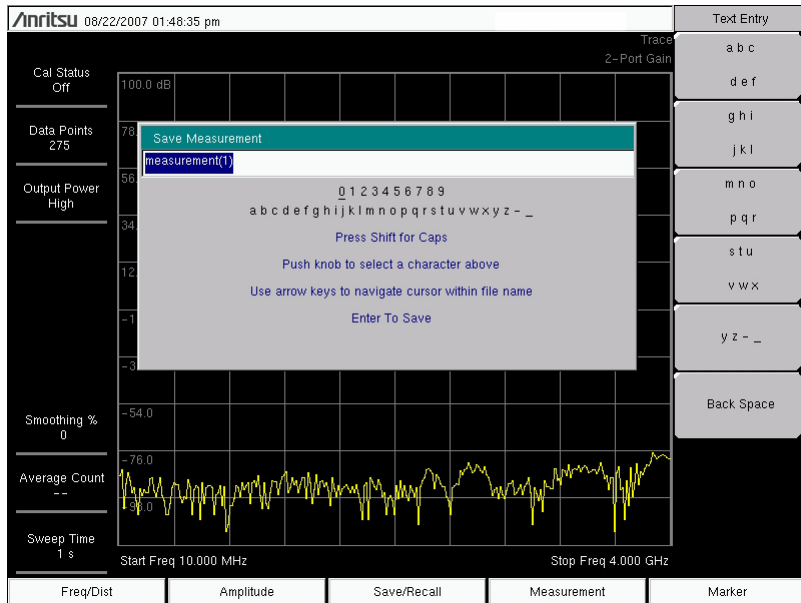

Figure 2-6. Text Entry Menu – Lower Case

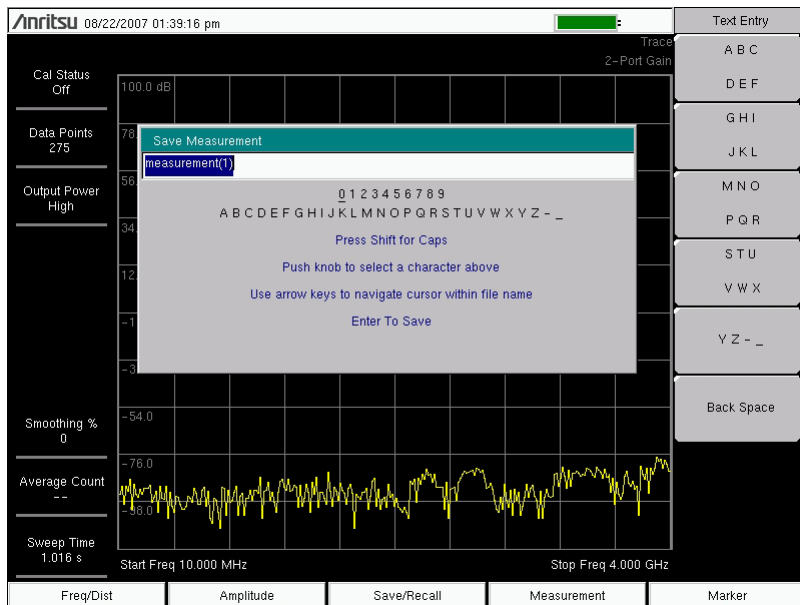

Figure 2-7. Text Entry Menu – Upper Case

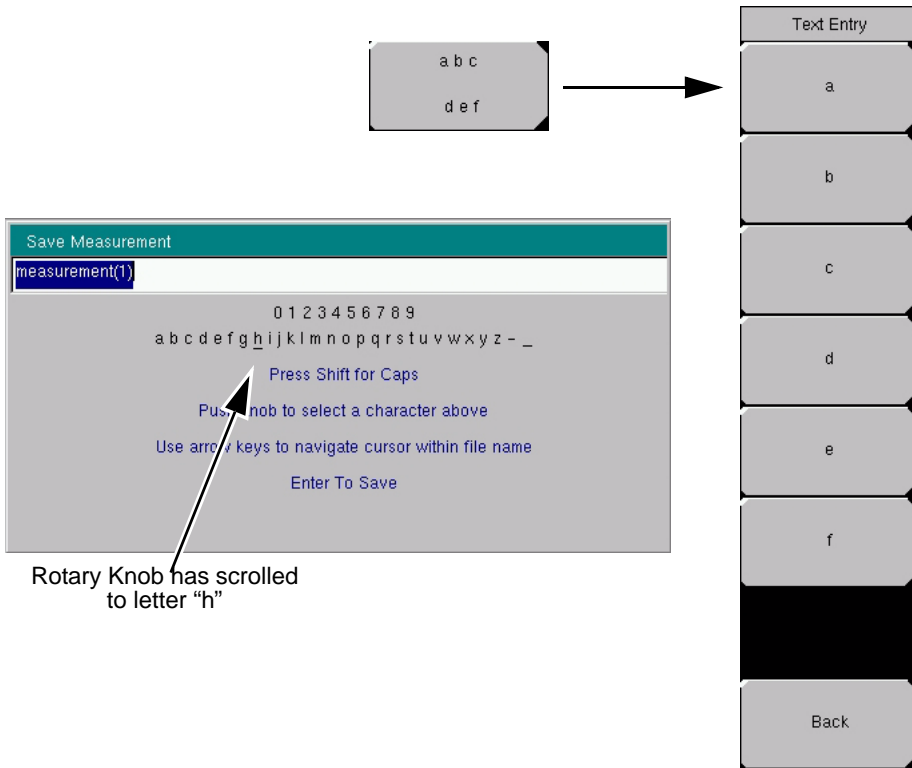

Figure 2-8. Text Entry Menu – Selecting Characters

## 2-10 Test Panel Connectors

The MS202xA (shown in [Figure 2-9](#)) can be differentiated from the MS203xA by the front panel model number label as well as by major differences in the connectors on the unit top. The MS203xA shown in [Figure 2-10](#) is slightly larger and contains additional connections for spectrum analysis.

### MS202xA Test Panel Connectors

The connectors and indicators located on the test panel of the MS202xA are shown in [Figure 2-9](#) and are described below.

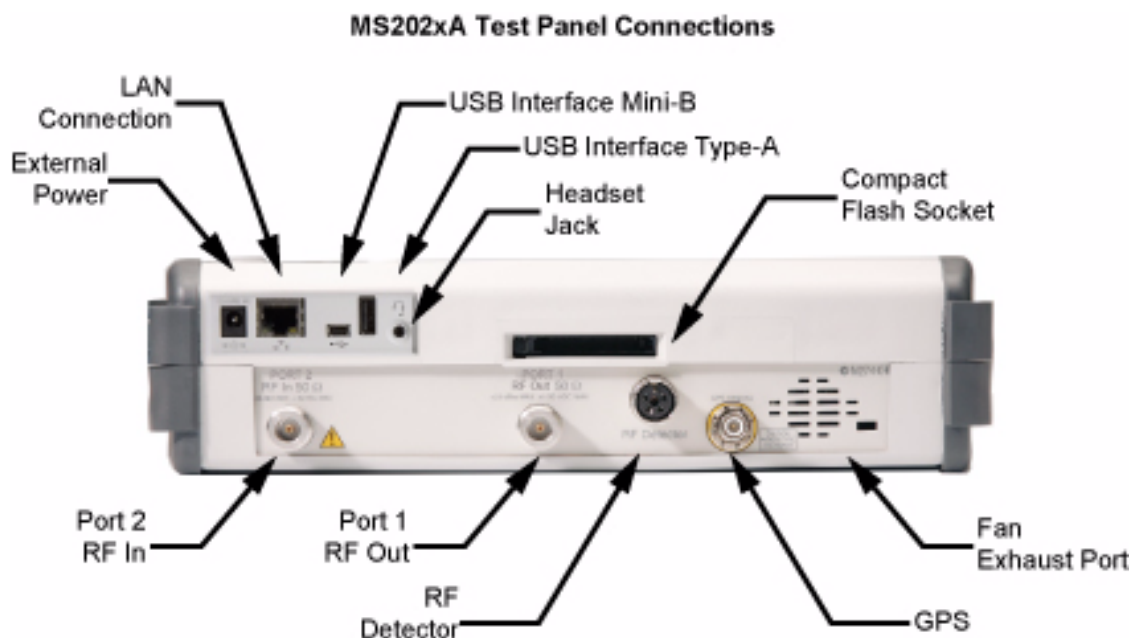
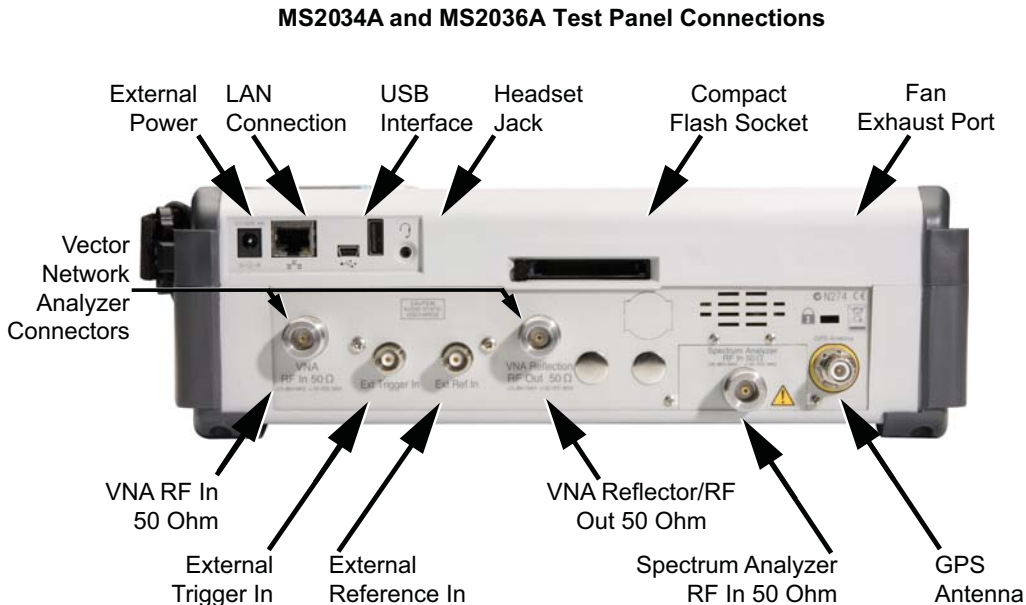

**Figure 2-9.** MS2024A and MS2026A Test Panel Connectors



## MS203xA Test Panel Connectors

The connectors and indicators located on the test panel of the MS203xA are shown in [Figure 2-10](#) and are described below.



**Figure 2-10.** MS2034A and MS2036A Test Panel Connectors

### External Power

The external power connector is used to power the unit and for battery charging. Input is 12 to 15 VDC at up to 5.0 A. A green flashing indicator light near the power switch shows that the instrument battery is being charged by the external charging unit. The indicator is steadily illuminated when the battery is fully charged.

#### Warning

When using the AC-DC Adapter, always use a three-wire power cable connected to a three-wire power line outlet. If power is supplied without grounding the equipment in this manner, then the user is at risk of receiving a severe or fatal electric shock.

### LAN Connection

The RJ-45 connector is used to connect the VNA Master to a local area network. Integrated into this connector are two LEDs. The amber LED indicates the presence of LAN voltages—a live LAN connection—while the green LED flashes to show that LAN traffic is present. The instrument IP address is set by pressing the **Shift** key, then the **System** (8) key followed by the System Options soft key and the Ethernet Config soft key. The instrument Ethernet address can be set automatically using DHCP, or manually by entering the desired IP address, gateway address, and subnet mask.

Dynamic Host Configuration Protocol (DHCP) is an Internet protocol that automates the process of setting IP addresses for devices that use TCP/IP and is the most common method of configuring a device for network use. To determine if a network is set up for DHCP, connect the VNA Master to the network and select DHCP protocol in the Ethernet Config menu.

Turn the VNA Master off, and then on. If the network is set up for DHCP, then the assigned IP address should be displayed briefly after the power-on sequence.

**Note** In order to acquire an address from a DHCP protocol network, the VNA Master **MUST** be connected to the network **BEFORE** being switched on.

To display the IP address with the instrument on, press the **Shift** key, then the **System** key, then the System Options soft key and the Ethernet Config soft key. The IP address will be displayed as shown in [Figure 2-11](#). For more information about DHCP, refer to [Appendix G, “More About DHCP”](#).

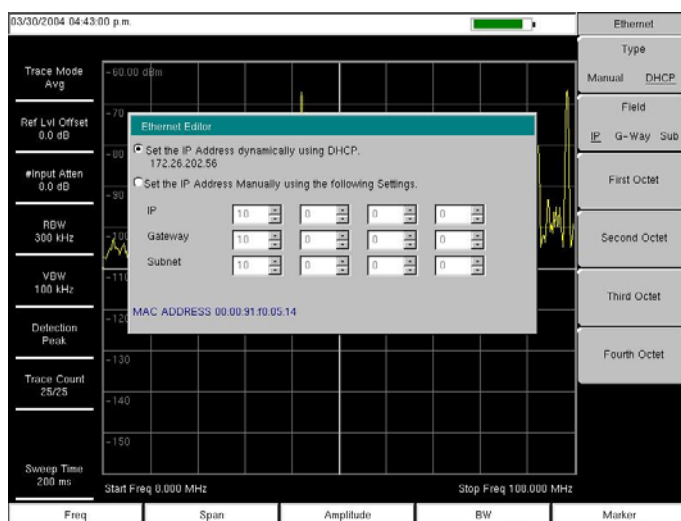

**Figure 2-11.** IP Address Assigned Using DHCP

## USB Interface - USB Type Mini-B

The USB 2.0 interface can be used to connect the VNA Master directly to a PC. The first time that the VNA Master is connected to a PC, the normal USB device detection will be performed by the computer operating system. The CD-ROM that is shipped with the instrument contains a driver (for Windows 2000 and Windows XP) that is installed when Master Software Tools is installed. Drivers are not available for earlier versions of the Windows operating system. During the driver installation process, place the CD-ROM in the computer drive and specify that the installation wizard should search the CD-ROM for the driver.

**Note** For proper detection, Master Software Tools should be installed on the PC prior to connecting the VNA Master to the PC USB port. Refer to [Chapter 13, “Master Software Tools”](#) for more information.

## USB Interface - USB Type A

The VNA Master can also act as a USB Host, which allows various USB Flash Memory devices to be connected to the instrument for storing measurements and setups.

## Headset Jack

The headset jack provides audio output from the built-in AM/FM/SSB demodulator for testing and troubleshooting wireless communication systems. The jack accepts a 2.5 mm 3-wire miniature phone plug such as those commonly used with cellular telephones.

## Ext Trigger

A TTL signal applied to the External Trigger female BNC input connector causes a single sweep to occur. This mode is used in zero span, and triggering occurs on the rising edge of the signal. After the sweep is complete, the resultant trace is displayed until the next trigger signal arrives.

## Ext Freq Ref

The BNC female connector is used for connection of an external frequency reference or external trigger. Select the Ext Ref Freq soft key under the System menu to select the frequency of the external reference from the list that is presented. The amplitude of the External Reference should be between -10dBm and +10 dBm.

## RF Detector

The RF detector connector is used for Power Monitor measurements (Option 5). Refer to the table of available RF Detectors in section in [Chapter 1, “General Information”](#).

## SPA RF In

This is a 50  $\Omega$  Type-N female connector.

## VNA Reflection/RF Out

This connector provides RF output at 50  $\Omega$  impedance for reflection measurements. Maximum input is +23 dBm at  $\pm 50$  Vdc.

## VNA RF In

This is a 50  $\Omega$  Type-N female connector. Maximum input is +23dBm at +/- 50 Vdc.

## GPS Antenna Connector

This GPS antenna connection is for GPS only (Option 31 only).

**Note**

The GPS antenna connection on the VNA Master is fitted with a reverse BNC connector to help prevent damage to the GPS circuitry. A DC voltage is present on this connector. Do not connect anything other than the Anritsu GPS antenna (part number 2000-1410) to this port.

## Compact Flash

The VNA Master accepts a 256 MB Compact Flash Memory Module, Anritsu Part Number 3-2000-1500 or other commercially available equivalent. The contents of the internal memory can be copied to and from a removable Compact Flash card. It must be a minimum of 256 MB to be able to hold the entire contents of the internal flash memory and can be as large as 512 MB.

## Symbols and Indicators

The following symbols and indicators convey the instrument status or condition on the display.

### Cal Status On

The VNA Master has been calibrated using a standard calibration with discrete Open, Short, and Load components. For more information on calibration, see [“Calibration Menu” on page 3-27](#).

### Cal Status Off

The VNA Master has not been calibrated.

### Cal Status Flex On

The VNA Master has been calibrated using FlexCal™ with discrete Open, Short, and Load Components. For more information on calibration, see [“Calibration Menu” on page 3-27](#).

## Battery Symbol

The battery symbol above the display indicates the charge remaining in the battery. The colored section that is inside the symbol changes size and color with the charge level.



**Figure 2-12.** Battery Symbol

- Green: Battery is 30% to 100% charged.
- Yellow: Battery is 10% to 30% charged.
- Red: Battery is 0% to 10% charged. When the Battery Indicator is red, approximately 8 to 10 minutes of battery life remain.

When the battery is charging, either from the AC-DC Adapter (40-168) or the 12 Volt DC adapter (806-141), the symbol will change to that shown in [Figure 2-13](#):

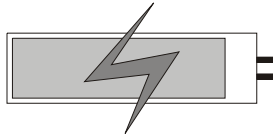

**Figure 2-13.** Battery Symbol While charging

The Battery Charge LED will flash when the battery is charging and remain on and steady when the battery is fully charged.

**Note** Use only Anritsu approved batteries, adapters, and chargers with this instrument.

The battery symbol is replaced by a red plug body to indicate that the instrument is running from external power and is not charging the battery (or the battery is not present). When the external AC adaptor is connected, the battery automatically receives a charge, and the battery symbol with the lightning bolt is displayed ([Figure 2-13](#)). When the battery is fully charged, the charging circuit shuts off and the red plug body is displayed, as shown in [Figure 2-14](#).



**Figure 2-14.** Battery Not Charging or Not Available

### **Hold**

The VNA Master is on hold. To resume sweeping, toggle from Hold to Run in the Sweep menu.

### **Single Sweep**

Single Sweep is selected. Single or Continuous sweep can be selected under the Sweep Menu.

# Chapter 3 — Vector Network Analyzer

## 3-1 Introduction

This chapter provides an overview of the vector network analyzer capabilities of the Anritsu VNA Master, which is available in both MS202xA and MS203xA models. The intent of this chapter is to provide the user with a starting point for making basic measurements.

The VNA Master offers a wide range of display options for 1-port and 1-path 2-port vector corrected measurements. The Application Options menu contains the Meas Menu soft key that allows the selection of Field or VNA measurement menus. Although the Field and VNA measurement menus use different names for the measurements, the actual measurements are the same. Cable Loss measurements are available only in the Field menu.

## 3-2 VNA First Time Use

Before conducting a measurement in vector network analyzer mode, select a measurement, specify the frequency range, and perform a calibration. The following paragraphs further explain these steps.

### Selecting the Measurement

The Measurement Menu (refer to [“Measurement Menus \(Field and VNA\)” on page 3-40](#)) can be accessed by pressing the **Measurement** function hard key below the display or by pressing the **Shift** key followed by the **Measure (4)** key. All VNA Master measurements can be found in the Measurement Menu.

The Measurement Menu can be changed between two different settings (Field or VNA). For users already familiar with the Anritsu Site Master measurement nomenclature, the Field setting will likely be more comfortable. The VNA setting is designed to more closely resemble the menu of a bench top VNA, and allows access to more advanced features of the VNA Master.

Change between the Field Menu and the VNA Menu (for S11 Log Magnitude and S21 Log Magnitude measurements) by pressing the **Shift** key followed by the **System (8)** key, and selecting Applications Options. Press the Meas Menu soft key to toggle between Field and VNA.

VNA Menu measurements included for S11 Reflection are:

- Log Magnitude
- VSWR
- Phase
- Smith Chart
- Log Magnitude Fault Location
- VSWR Fault Location
- Group Delay S11

The measurements included for S21 Transmission are:

- Log Magnitude
- Phase
- Group Delay S21

Field Menu measurements include:

- VSWR
- Return Loss
- Cable Loss
- DTF Return Loss
- DTF VSWR
- 2-Port Gain
- Smith Chart
- 1-Port Phase
- 2-Port Phase

## Setting the Frequency Range

Regardless of the type of measurement that is being made, the frequency range for the desired measurement must be set before calibrating the VNA Master. Changing the frequency after calibrating the VNA Master will invalidate the calibration. Press the **Freq/Dist** function hard key (below the display) to bring up the Frequency (Freq) menu ([on page 3-33](#)).

## Setting the Start and Stop Frequencies

Set the Start Frequency by pressing Start Freq soft key and entering the desired frequency in Hz, kHz, MHz, or GHz using the keypad, the arrow keys, or the rotary knob.

Set the Stop Frequency by pressing the Stop Freq soft key and entering the desired frequency in Hz, kHz, MHz, or GHz using the keypad, the arrow keys, or the rotary knob.

<b>Note</b>	If a Start Frequency is entered that is higher than the current Stop Frequency, Stop Frequency will automatically adjust to be equal to the entered Start Frequency. Similarly, if a Stop Frequency that is lower than the current Start Frequency is entered, Start Frequency will automatically adjust to be equal to the Stop Frequency.
-------------	---

The frequency range can also be set using the Center Freq and Freq Span soft keys. For example, to set a frequency range of 1850 to 1990 MHz, set the Center Frequency to 1920 MHz and the Frequency Span to 140 MHz.

## Setting a Signal Standard

The Signal Standard list contains common frequency standards and displays the standard name, frequency of operation, and channel number.

- Selecting the Signal Standard soft key will display the list.
- Use the rotary knob or **Up/Down** arrow keys to highlight the desired signal standard.
- Once highlighted, press **Enter** to select the highlighted standard.

The Center Frequency and Span will automatically tune to the first channel of the selected standard. Press Channel to enter the Channel number for the selected Frequency Standard. Appendix A contains a table of the signal standards that are available in the instrument firmware. The Signal Standard table can be edited and custom signal standards can be defined using Master Software Tools (For detailed information on the signal standard table, refer to [Chapter 13, “Master Software Tools”](#)).

## 3-3 Calibration

For accurate results, the VNA Master must be calibrated at the ambient temperature after allowing for warm up time (approximately 15 minutes) and before making any measurements. The VNA Master must be recalibrated whenever the setup frequency changes or whenever a test port extension cable is added, removed, or replaced. Refer to [“Calibration Menu” on page 3-27](#).

The VNA Master offers two modes of calibration:

- Standard
- FlexCal™

### Standard Calibrations

Standard calibrations use Open, Short, and Load components to calibrate 551 discrete frequency points between the current start and stop frequencies. As the VNA Master performs subsequent measurements, only these 551 frequency points are measured. Any changes to the frequency settings of the VNA Master will invalidate the calibration. Standard calibrations provide the most accurate measurement data available.

### FlexCal Calibration

For occasions when users need a reasonably accurate measurement with greater flexibility, VNA Master also offers FlexCal. This calibration method uses the Open, Short and Load components to calibrate 551 data points across the entire frequency range of the instrument. By using a FlexCal™, users have the freedom to change frequency settings of the instrument, allowing the ability to zoom in and take a closer look at items of interest. When data points do not fall precisely on calibrated frequencies, VNA Master will interpolate between the two closest data points.

### 1-Port Calibration

The 1-port calibration is an OSL (open/short/load) calibration that removes source match, directivity, and frequency response errors.



## 2-Port Calibration

The 2-port calibration is a 1-path 2-port OSLIT (open/short/load/isolation/through) calibration that removes transmission response errors and transmission source match errors in addition to reflection error terms.

### 1-Port Calibration Procedure (OSL)

1. If a test port extension cable is to be used, then connect the cable to the RF Out connector on the VNA Master. The calibration components will be connected at the end of the extension cable.

#### Note

If a Test Port Extension Cable is to be used, then the VNA Master must be calibrated with the Test Port Extension Cable in place. The Test Port Extension Cable should be a phase stable cable. It is used as an extension cable on the test port to ensure accurate and repeatable measurements. This phase stable cable can be moved and bent while making a measurement without causing errors in the measurement.

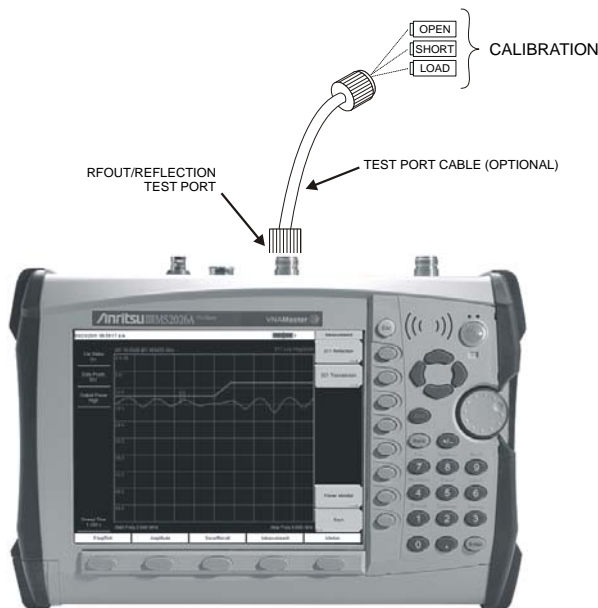

**Figure 3-1.** 1-Port Calibration

2. Set the frequency range as described in [“Setting the Frequency Range”](#) on page 3-2.
3. Press the **Shift** key and then the **Calibrate** (2) key.
4. Verify that the Device Under Test (DUT) connector, as shown on the DUT Connector soft key, is appropriate for the test setup. To choose a different connector, press the DUT

Connector soft key and use the rotary knob or Up/Down arrow keys to highlight the appropriate connector and press the rotary knob or **Enter** to select.

**Note**

If none of the connectors that are shown in the DUT Connector Selector list are suitable for the application, then two selections, User 1 and User 2, can be custom defined.

To edit the characteristics, select User 1 or User 2 and press **Enter**. Press the Configure DUT User 1 or Configure DUT User 2 soft key. The menu allows editing of the offset lengths for the Open and Short, and the capacitance values for the Open.

To change a value, press the appropriate soft key, enter the proper value using the numeric keypad, and press **Enter** to accept.

When all values are correct, press the Back soft key to return to the Calibration menu.

5. Press the Start Cal soft key.
6. Connect the Open to the RF Out port (or to the end of the test port extension cable) and press the **Enter** key.
7. When prompted, connect the short to the RF Out port (or to the end of the test port extension cable) and press the **Enter** key.
8. When prompted, connect the Load to the RF Out port (or to the end of the test port extension cable) and press the **Enter** key.
9. Verify that calibration has been performed properly by checking that the Cal Status On message is now displayed at the top of the status window.

## 2-Port Calibration Procedure (OSLT)

1. If a test port extension cable is to be used on the VNA Master, then connect the cable to the RF Out connector or to the RF In connector (or to both if two extension cables are used). The calibration components will be connected at the end of the extension cable. Refer to the note following “[1-Port Calibration Procedure \(OSL\)](#)” on page 3-4 regarding the use of a test port extension cable.
2. Set the frequency range as described in “[Setting the Frequency Range](#)” on page 3-2.
3. Press the **Shift** key and then the **Calibrate** (2) key.
4. Verify that the Device Under Test (DUT) connector, as shown on the DUT Connector soft key, is appropriate for the test setup. To choose a different connector, press the DUT

Connector soft key and use the rotary knob or Up/Down arrow keys to highlight the appropriate connector and press the rotary knob or **Enter** to select.

**Note**

If none of the connectors shown in the DUT Connector Selector list are suitable for the application, then two selections (User 1 and User 2) can be custom defined.

To edit the characteristics, select User 1 or User 2 and press **Enter**. Press the Configure DUT User 1 or Configure DUT User 2 soft key. The menu allows editing of the offset lengths for the Open and Short, and the capacitance values for the Open.

To change a value, press the appropriate soft key, enter the proper value using the numeric keypad, and press **Enter** to accept.

When all values are correct, press the Back soft key to return to the Calibration menu.

5. Press the Cal Power soft key to set the power level to Low (–35 dBm) or High (0 dBm).
6. Select Low for active devices to prevent saturation of either the DUT or the RF Input on the VNA Master. Select High for passive devices. For additional information, refer to [“2-Port Gain Measurements” on page 3-19](#).
7. Press the Start Cal soft key.
8. Connect the Open to the RF Out port (or to the end of the test port extension cable) and press the **Enter** key.
9. When prompted, connect the short to the RF Out port (or to the end of the test port extension cable) and press the **Enter** key.
10. When prompted, connect the Loads to the RF Out port (or to the end of the test port extension cable) and to the RF In port (or to the end of the test port extension cable) and press the **Enter** key.
11. Connect the RF Out port to the RF In port, including any test port extension cables used in the prior steps, and press the **Enter** key.

12. Verify that calibration has been performed properly by checking that the Cal Status On message is now displayed at the top of the status window.

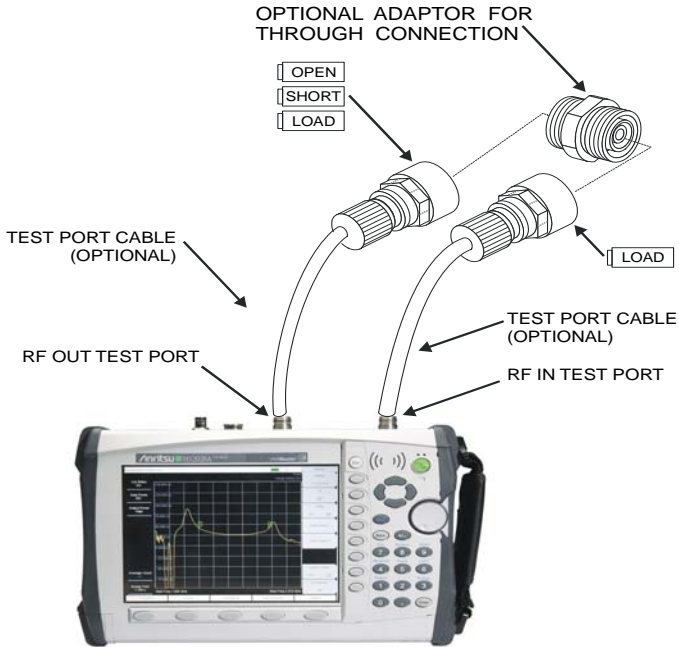

Figure 3-2. 2-Port Calibration

## 3-4 Using Trace Math

The Trace Math menu (on page 3-57) is an excellent tool for comparing two traces. Traces can be uploaded by using Master Software Tools. Store those traces in memory and compare a stored trace with a more recent trace. The trace math menu can be used to add or subtract logarithmic data (multiply and divide linear data).

The Trace Math menu is accessed by pressing the **Shift** key and the **Trace** (5) key.

### Example

The function hard keys may differ on your instrument from those in Figure 3-3, depending upon selected instrument options. To view the same function hard keys and soft key menu as in this figure and example, follow these preliminary steps:

- Ensure that the instrument is in Vector Network Analyzer mode.
- Press the **Shift** key and the **System** (8) key, then press the Application Options soft key.
- The Meas Menu soft key toggles between **Field** and **VNA**. The active measurement function is underlined.
- Press the soft key (if necessary) until Field is underlined, then press the Back key.
- The Measurement soft key menu now displays Field measurement options.

### Comparing Return Loss

Comparing the Return Loss data for two five meter cables, Cable A and Cable B.

1. Press the **Measurement** function hard key and select the Return Loss soft key.
2. Connect Cable B to the VNA Master RF Out port.
3. Press the **Shift** key and the **Trace** (5) key.
4. Press the Copy Trace To Display Memory soft key.
5. Connect Cable A to the VNA Master RF Out port and perform the same Return Loss measurement over the same frequency range.
6. Select the Show Memory soft key to view the Return Loss measurement of Trace B.

7. Press the Trace Minus Memory soft key to look at the difference in Return Loss between the two cables.

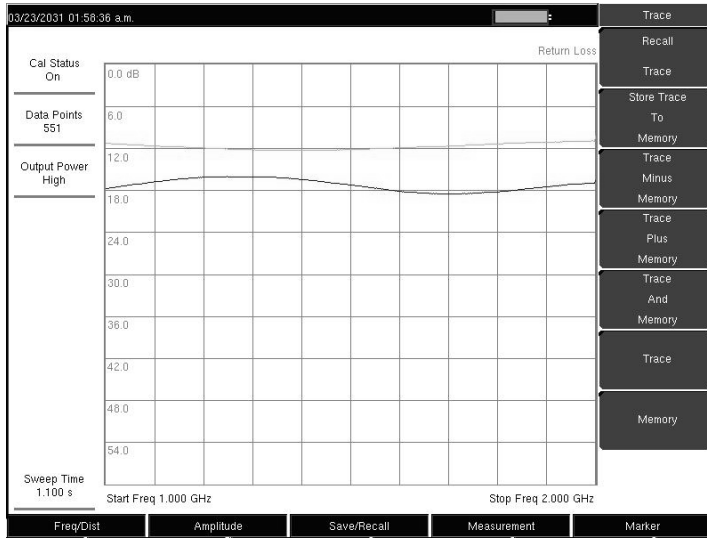

**Figure 3-3.** Trace Menu Showing Trace and Memory (Field Measurement Menu Shown)

## 3-5 Using Limit Lines

To access the functions under the Limit menu (on page 3-35), select the **Shift** key, then the **Limit** (6) key.

Two types of limit lines can be specified, lower limit lines and upper limit lines. Limit lines can be used for visual reference only, or for pass/fail criteria using the limit alarm. Limit alarm failures are reported whenever a signal is above the upper limit line or below the lower limit line.

Each limit line can consist of a single segment, or as many as 40 segments across the entire frequency span of the instrument. These limit segments are retained regardless of the current frequency span of the instrument, allowing the configuring of specific limit envelopes at various frequencies of interest without having to re-configure them each time the frequency is changed. To clear the current limit setup configuration and return to a single limit segment starting at the current start frequency and ending at the current stop frequency, press the Clear Limit soft key.

### Setting up Non-segmented Limit Lines

1. Press the **Shift** key, then the **Limit** (6) key.
2. Press the On/Off soft key to turn on the upper or lower limit line.
3. Press the Limit Edit soft key.
4. Press the Move Limit soft key and use the number keys to enter the new limit value and press the **Enter** key. The Move Limit soft key will move the entire limit line so that the active limit point will move to the new limit value. The Limit value can also be adjusted by using the up and down arrow keys or the rotary knob.

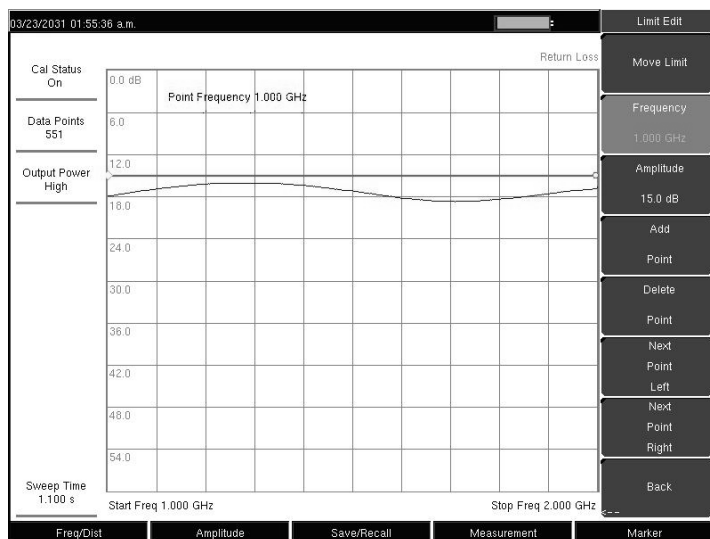
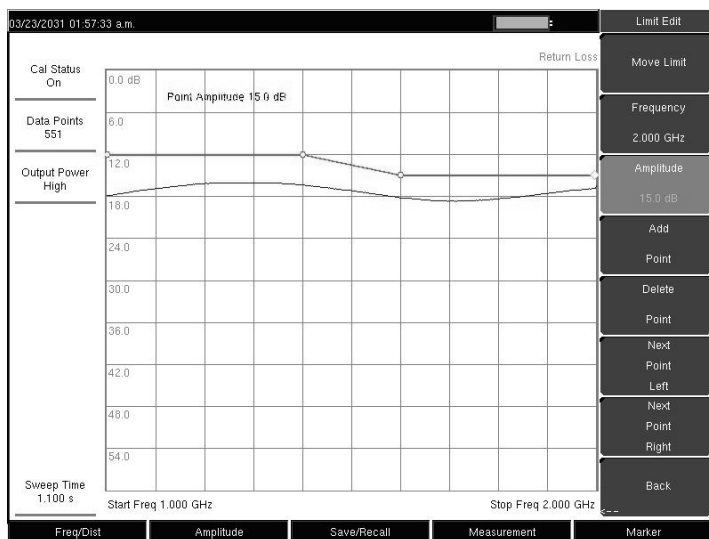

Figure 3-4. Non-segmented Limit Lines

## Setting up Segmented Limit Lines

Segmented Limit Lines can be useful if there are different specifications for different frequency ranges. The following procedure creates segmented Limit Lines for a Return Loss Measurement. Limits are set to 12 dB between 1000 MHz and 1400 MHz and 15 dB between 1600 MHz and 2000 MHz.

1. Press the **Shift** key, then the **Limit (6)** key.
2. Press the On/Off soft key to turn on the upper or lower limit line.
3. Press the Limit Edit soft key.
4. Press the Move Limit soft key and use the number keys to enter a limit value of 12 dB. The limit value can also be moved using the up and down arrow keys or the rotary knob.
5. Press the Frequency soft key and use the number keys to enter 1000 MHz.
6. Press the Add Point soft key.
7. Press the Frequency soft key and use the number keys to enter 1400 MHz.
8. Press the Add Point soft key.
9. Press the Frequency soft key and use the number keys to enter 1600 MHz.
10. Press the Point Value soft key and use the number keys to enter 15 dB.
11. Press the Next Point Right soft key to select the limit point at the far right of the display.
12. Press the Frequency soft key and use the number keys to enter 2000 MHz.
13. Press the Point Value soft key and use the number keys to enter 15 dB.



**Figure 3-5.** Segmented Limit Lines



## 3-6 VNA Measurements

The following sections provide detailed descriptions of the various Vector Network Analyzer measurements using the VNA Master.

### Return Loss/VSWR

Return Loss is used to characterize RF components and systems. The Return Loss indicates how well the system is matched by taking the ratio of the reflected signal to the incident signal, measuring the reflected power in dB. The 1-port Measurement data can also be displayed linearly as VSWR. In addition, this information can be transferred to a PC for additional analysis by using Master Software Tools, as described in [Chapter 13](#). Refer also to [“Measurement Menu \(VNA Menus\)” on page 3-42](#). In the following example procedure, the instrument may be in the Field measurement menu application, as in [“Example” on page 3-8](#), or may be in the VNA measurement menu application.

#### Procedure

1. If a test port extension cable is to be used, then connect it to the RF Out connector on the VNA Master.
2. Press the **Measurement** function hard key and select Return Loss (Field menu) or S11 Reflection | Log Magnitude (VNA menu).
3. Press the **Freq/Dist** function hard key and set the Start Frequency and Stop Frequency.
4. Press the **Shift** key, then the **Calibrate** (2) key.
5. Press the Start Cal soft key and perform a 1-port calibration at the connector or at end of the extension cable. Follow the instructions on the display or refer to [“Calibration” on page 3-3](#) for more details.
6. When the Calibration is finished, Cal Status On should be displayed in the upper left part of the display and the trace should be centered around 0 dB when the short or open is connected.
7. Connect the test port extension cable to the Device Under Test (DUT).
8. Press the **Save/Recall** function hard key and save the measurement.

9. Press the **Measurement** function hard key and select the VSWR soft key to view the match in VSWR (Field menu), or select the S11 Reflection | VSWR soft keys (VNA menu).

Figure 3-6 is displaying the Measurement menu of the Field menu setting.

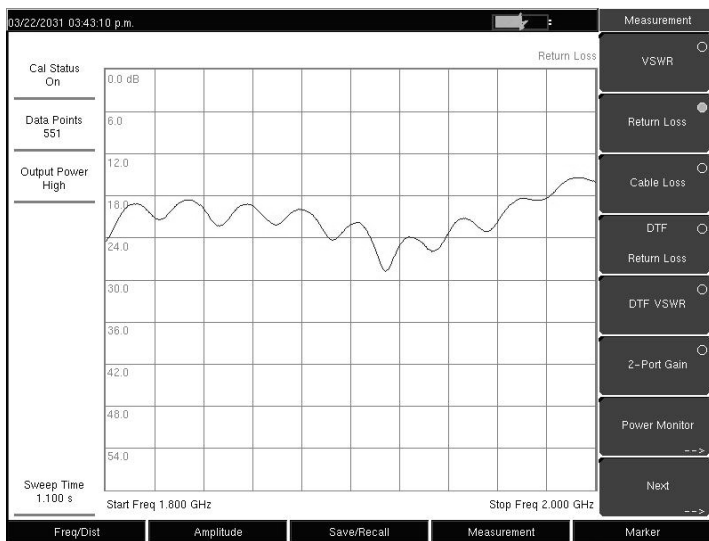

Figure 3-6. Return Loss Measurement, Antenna System (Field Measurement Menu Shown)

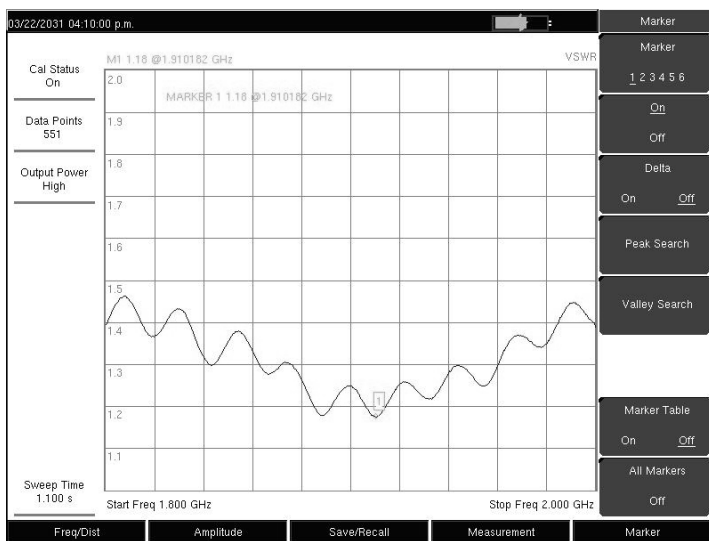

Figure 3-7. VSWR Measurement, Antenna System (Field Measurement Menu Shown)

## Cable Loss (Field Menus Only)

The transmission feed line insertion loss test verifies the signal attenuation level of the cable. This test can be done using the Cable Loss or Return Loss Measurement with a short or an open connected at the end of the system. The advantage of using the Cable Loss measurement is that the VNA Master takes care of the math and that no computations are needed. Cable Loss is a Return Loss measurement that also takes into consideration that the signal travels in both directions. Refer to [“Measurement Menu \(Field Menus\)” on page 3-45](#).

### Procedure

1. If a test port extension cable is to be used, then connect it to the RF Out connector on the VNA Master.
2. Ensure that the instrument is in Vector Network Analyzer mode and press the **Shift** key and the **System** (8) key, then press the Application Options soft key.
3. The Meas Menu soft key toggles between **Field** and **VNA**. The active measurement function is underlined.
4. Press the soft key (if necessary) until Field is underlined, then press the Back key.
5. The Measurement soft key menu now displays field measurement options.
6. Press the **Measurement** function hard key and select Cable Loss.
7. In [Figure 3-8](#), the Measurement soft key menu shows Cable Loss selected (small red light simulated in soft key face). Also, the instrument settings summary displays “Cable Loss 5.8 dB” to the left of the measurement display area.
8. Press the **Freq/Dist** function hard key and set the Start Frequency and Stop Frequency.
9. Press the **Shift** key, then the **Calibrate** (2) key.
10. Press the Start Cal soft key and perform a 1-port OSL calibration at the connector or at end of the extension cable. Follow the instructions on the display or refer to [Chapter 3](#) for more details.
11. When the Calibration is finished, Cal Status On should be displayed in the upper part of the instrument settings summary, and the trace should be centered around 0 dB when the short or open is connected.
12. Connect the test port extension cable to the Transmission Line.

13. Press the **Save/Recall** function hard key and save the measurement. Note that the average Cable Loss value, (peak + valley)/2, is displayed in the instrument settings summary area of the window.

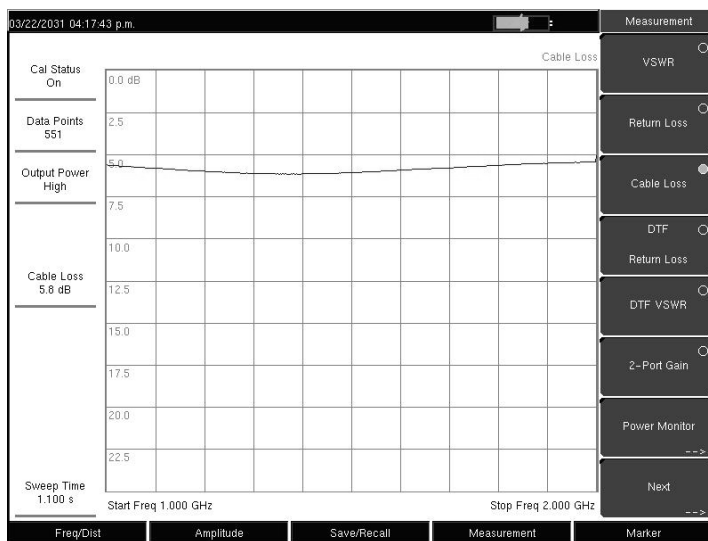

**Figure 3-8.** Cable Loss of Transmission Line

### Distance-To-Fault (DTF)/Fault Location

The DTF or Fault Location measurement displays return loss or VSWR values versus distance. If the frequency measurements fail or indicate a problem in the system, then the DTF measurement can be used to identify and pinpoint the exact location of the problem. The DTF measurement shows the return loss value of all of the individual components, including connector pairs and cable components.

When measuring cable distance, DTF measurements can be made with an open or a short connected at the end of the cable. The peak indicating the end of the cable should be between 0 dB and 5 dB.

An open or short should not be used when DTF is used for troubleshooting because the open or short will reflect everything, and the true value of a connector might be misinterpreted. A good connector could look like a failing connector.

A 50 Ohm load is the best termination for troubleshooting DTF problems because it will be 50 Ohm over the entire frequency range. The antenna can also be used as a terminating device, but the impedance of the antenna will change over different frequencies because the antenna is designed to have only 15 dB or better return loss in the passband of the antenna.

DTF measurement is a frequency domain measurement, and the data is transformed to the time domain using mathematics. The distance information is obtained by analyzing how much the phase is changing when the system is swept in the frequency domain.

Frequency selective devices such as TMAs (Tower Mounted Amplifiers), duplexers, filters, and quarter wave lightning arrestors will change the phase information (distance information) if they are not swept over the correct frequencies. Care needs to be taken when setting up the frequency range whenever a TMA is present in the path. For more TMA details, refer to [Appendix D, "Tower Mounted Amplifiers"](#).

Because of the nature of the measurement, maximum distance range and fault resolution are dependent on the frequency range and number of data points. The VNA Master will take care of all the math, but knowing whether the cable is longer than DMax is important. The only way to be able to improve the horizontal range is to reduce the frequency span or to increase the number of data points. Similarly, the fault resolution is inversely proportional to the frequency range and the only way to improve the fault resolution is to widen the frequency span.

The VNA Master is equipped with a cable list, which includes most of the common cables that are used today. After the correct cable has been selected, the VNA Master will update the propagation velocity and the cable attenuation values to correspond with the cable. These values can also be entered manually and can be uploaded via Master Software Tools. Incorrect propagation velocity values will affect the distance accuracy, and inaccurate cable attenuation values will affect the accuracy of the magnitude value.

	(Cable Name)	(Prop. Vel)	(F1 CL1)	(F2 CL2)	(F3 CL3)
Data	(311201)	(0.92)	(1000 0.016)	(1000 0.016)	(1000 0.016)
	(311501)	(0.8)	(1000 0.023)	(1000 0.023)	(1000 0.023)
Start	(311601)	(0.8)	(1000 0.026)	(1000 0.026)	(1000 0.026)
Stop	(311901)	(0.8)	(1000 0.038)	(1000 0.038)	(1000 0.038)
Fault	(352001)	(0.8)	(1000 0.038)	(1000 0.038)	(1000 0.038)
	(AV45-50 7/8)	(0.91)	(1000 0.004)	(2000 0.006)	(2500 0.006)
	(AV47-50 1-5/8)	(0.92)	(1000 0.002)	(2000 0.003)	(2500 0.004)
	(CR50 540PE)	(0.88)	(1000 0.007)	(2000 0.01)	(2500 0.012)
	(CR50 1078PE)	(0.88)	(1000 0.004)	(2000 0.006)	(2500 0.006)
	(CR50 1873PE)	(0.88)	(1000 0.002)	(2000 0.003)	(2500 0.004)
	(EC4-50 1/2)	(0.88)	(1000 0.007)	(2000 0.011)	(2500 0.012)
	(EC4.5-50 5/8)	(0.88)	(1000 0.006)	(2000 0.008)	(2500 0.009)
	(EC5-50 7/8)	(0.88)	(1000 0.004)	(2000 0.006)	(2500 0.007)
	(EC6-50 1-1/4)	(0.88)	(1000 0.003)	(2000 0.004)	(2500 0.005)
	(EC7-50A 1-5/8)	(0.89)	(1000 0.023)	(2000 0.036)	(2500 0.012)
	(EC7-50 1-5/8)	(0.88)	(1000 0.002)	(2000 0.004)	(2500 0.004)
	(EC12-50 2-1/4)	(0.88)	(1000 0.002)	(2000 0.003)	(2500 0.004)
	(EFX2-50)	(0.85)	(1000 0.012)	(2000 0.018)	(2500 0.02)
	(FLC 12-50J)	(0.88)	(1000 0.008)	(2000 0.011)	(2500 0.013)

**Figure 3-9.** Cable List Example

### Example 1

[Figure 3-10](#) shows a DTF measurement of a cable with an open or a short at the end of the test port extension cable. This measurement is made to determine the length of the cable. The return loss value marking the end of the cable will be between 0 dB and 5 dB.

### Procedure

1. Press the **Measurement** function hard key and select DTF Return Loss or Log Magnitude Fault Location.
2. Press the **Freq/Dist** function hard key and set the Start Frequency and Stop Frequency.
3. Press the Next soft key and use the Units soft key to select meters or feet.
4. Use the Data Points soft key to select the number of Data Points.

5. Press the Back soft key and use the Stop Dist soft key to enter the Stop Distance. Make sure that Stop Distance is smaller than Dmax.
6. Press the **Shift** key, then the **Calibrate** (2) key.
7. Press the Start Cal soft key and perform a 1-port OSL calibration at the connector or at end of the extension cable. Follow the instructions on the display or refer to [Chapter 3](#) for more details.
8. When the Calibration is finished, Cal Status On should be displayed in the upper left part of the display and the trace should be 0 dB when the short or open is connected.
9. Press the **Marker** function hard key and select the Peak Search soft key.

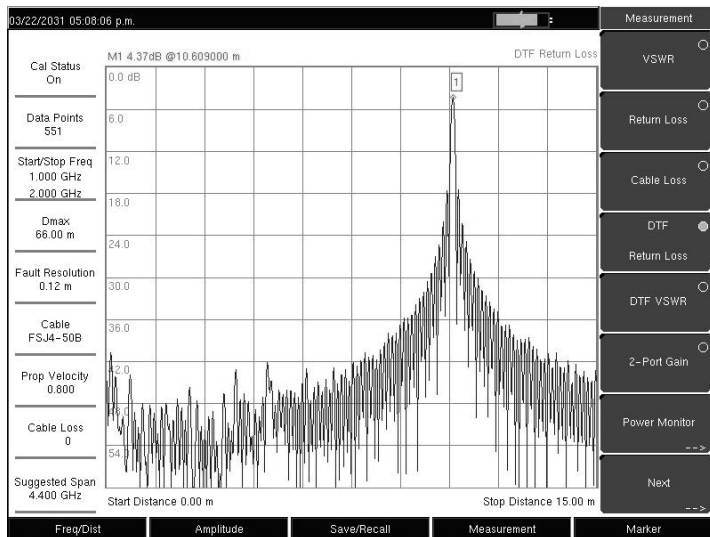
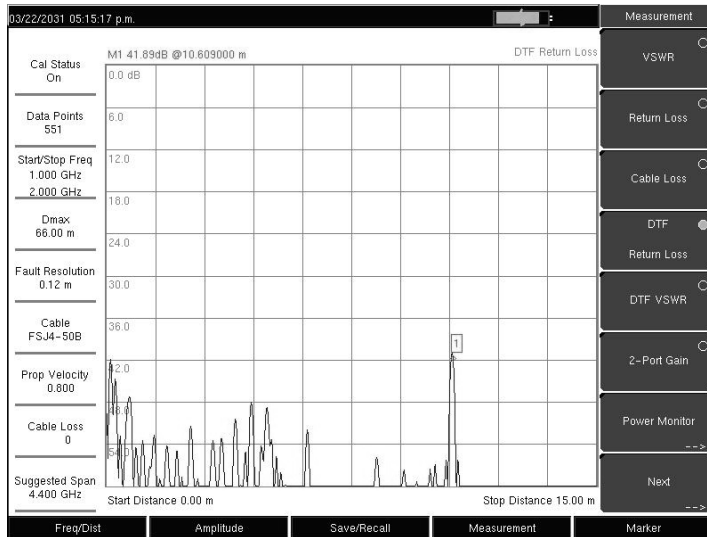
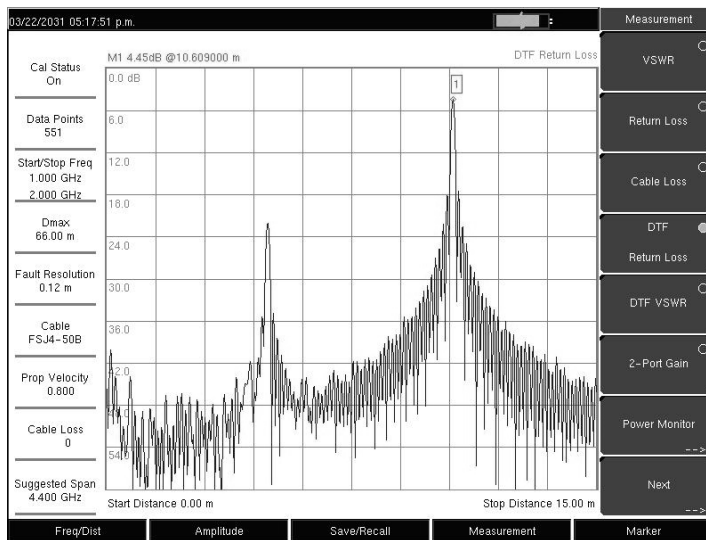

Figure 3-10. DTF Measurement With a Short at the End of Cable



**Figure 3-11.** DTF Measurement of Good Cable With a Load



**Figure 3-12.** DTF Measurement of Cable With a Fault

**Fault Resolution**

Fault resolution is the ability of the system to separate two closely spaced discontinuities. If the fault resolution is 10 feet and two faults are 5 feet apart, then the VNA Master will not be able to show both faults unless Fault Resolution is improved by widening the frequency span.

$$\text{Fault Resolution (m)} = \frac{1.5 \times 10^8 \times vp}{\Delta F}$$

**DMax**

DMax is the maximum horizontal distance that can be analyzed. The Stop Distance can not exceed  $D_{\max}$ . If the cable is longer than  $D_{\max}$ , then  $D_{\max}$  needs to be improved by increasing the number of datapoints or by lowering the frequency span ( $\Delta F$ ). Note that the datapoints can be set to 137, 275, or 551.

$$D_{\max} = (\text{Datapoints} - 1) \times \text{Fault Resolution}$$

**Suggested Span**

If the frequency span is set to the suggested span, the Stop Distance will equal Dmax giving the best fault resolution for the given conditions. With Stop Dist entered in meters, the following relationship can be obtained:

$$\text{Suggested Span (Hz)} = \frac{(\text{Datapoints} - 1) \times (1.5 \times 10^8 \times \text{vp})}{\text{Stop Distance (meters)}}$$

**2-Port Gain Measurements**

Two power levels are available with 2-port measurements: High (0 dBm) and Low (-35 dBm). The low power setting should be used when making direct gain measurements of amplifiers. This will help to ensure that the amplifier is operating in the linear region. The High power setting is ideal when characterizing passive devices but can also be used when making relative gain or antenna-to-antenna isolation measurements in the field.

The Variable Bias Tee Option (Option 10) can be used to place between +12V and +24V on the center conductor of the RF In port. It is designed to deliver 500 mA at +12V and 250 mA at +24V.

Also refer to “[Bias Tee](#)” on page 3-52 in the sweep menu section.

**Example 1**

This example describes an S21 measurement of an attenuator. [Figure 3-13](#) displays the results of this example when using the VNA measurement menu. The example is also valid in the Field measurement menu. The difference between these two choices requires a different soft key selection, as stated in 2.

**Procedure**

1. If a test port extension cable is to be used, then connect it to the RF Out connector on the VNA Master.
2. Press the **Measurement** function hard key and select S21 Transmission | Log Magnitude (VNA menu) or 2-Port Gain (Field menu).
3. Press the **Shift** key, then the **Sweep** (3) key.
4. Select the **Power** soft key and set power to High.
5. Press the **Freq/Dist** function hard key and set the Start Frequency and Stop Frequency.
6. Press the **Shift** key, then the **Calibrate** (2) key.
7. Press the **Start Cal** soft key and perform a 2-port OSL calibration at the connector or at end of the extension cable. Follow the instructions on the display or refer to “[Calibration](#)” on page 3-3 for more details.



8. When the Calibration is finished, Cal Status On should be displayed in the upper left part of the display, and the trace should be a flat trace at 0 dB.
9. Connect an attenuator between the test port extension cable and the RF In port.

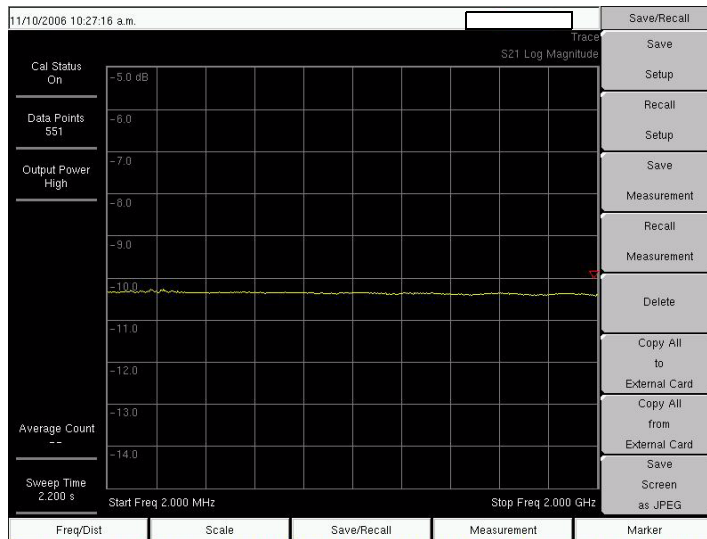

**Figure 3-13.** S21 Log Magnitude Measurement (VNA Measurement Menu Shown)

### Example 2

This example describes a Gain measurement of a TMA (Tower Mounted Amplifier) using the built-in bias tee (Option 10). [Figure 3-14](#) shows the Field measurement menu in use.

### Procedure

1. Press the **Measurement** function hard key and select S21 Transmission | Log Magnitude (VNA menu) or 2-Port Gain (Field menu).
2. Press the **Freq/Dist** function hard key and set the Start Frequency and Stop Frequency.
3. Connect test port extension cables to the RF Out port and the RF In port.
4. Press the **Shift** key, then the **Sweep** (3) key.
5. Select the Power soft key and set power to Low.
6. Press the Start Cal soft key and perform a 2-port OSL calibration at the end of the extension cables.
7. Connect the RF Out cable to the ANT port of the TMA.
8. Connect the RF In cable to RX port of the TMA.
9. Press the **Shift** key, then the **Sweep** (3) key.
10. Select the Bias Tee soft key and enter the appropriate voltage for the amplifier. Note that the voltage will be applied to the center conductor of the RF In port.
11. Turn on the Bias Tee by pressing the Bias Tee On/Off soft key.

- Press the **Marker** function hard key and turn on Marker 1 by pressing the Marker soft key to select the number 1 and pressing the On/Off soft key.

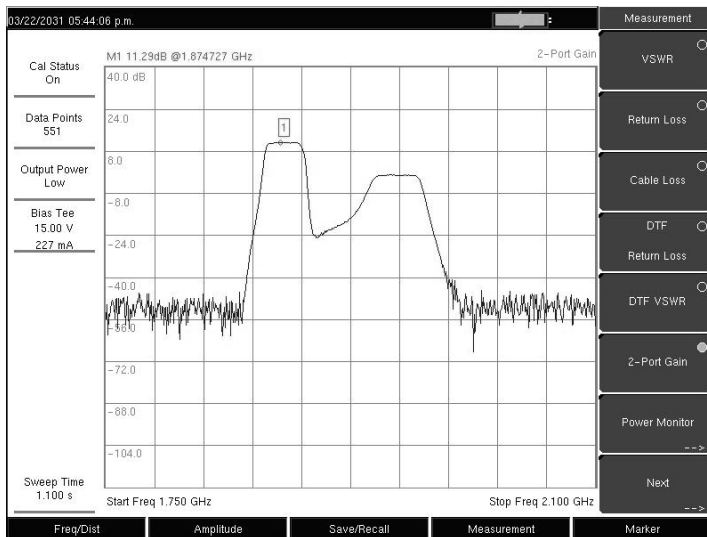

**Figure 3-14.** 2-Port Gain of a TMA (Field Measurement Menu Shown)

## Phase Measurements

The VNA Master can display both S11 and S21 phase. 2-Port Phase measurements can use both High (0 dBm) and Low (-30 dBm) power settings.

### 1-Port Phase Measurement

The following example compares the phase of two cables using a 1-port phase measurement. The dynamic range and phase uncertainty are better with 2-port phase measurements.

#### Procedure

- Press the **Measurement** function hard key and select Next | 1-Port Phase (Field menu) or S11 Reflection | Phase (VNA menu).
- Press the **Freq/Dist** function hard key and set the Start Frequency and Stop Frequency.
- Press the Start Cal soft key and perform a 1-port calibration at the desired reference plane.
- Connect Cable A to the RF Out reference plane.
- Press the **Shift** key, then the **Trace** (5) key.
- Select the Copy Trace to Display Memory soft key.
- Remove Cable A and connect Cable B to the RF Out reference plane.
- Select the Trace Minus Memory soft key to view the difference in phase between the two cables.

## 2-Port Phase Measurement

The following example compares the phase of two cables using a 2-port phase measurement. [Figure 3-15](#) shows an S21 Phase measurement (using the VNA measurement menu).

### Procedure

1. Press the **Measurement** function hard key and select Next | 1-Port Phase (Field menu) or S11 Reflection | Phase (VNA menu).
2. Press the **Freq/Dist** function hard key and set the Start Frequency and Stop Frequency.
3. Press the Start Cal soft key and perform a 2-port calibration at the end of a phase stable cable.
4. Connect Cable A (the reference cable) between the RF Out and RF In connectors.
5. Press the **Shift** key, then the **Trace** (5) key.
6. Select the Copy Trace to Display Memory soft key.
7. Remove Cable A and connect Cable B (the cable under evaluation).
8. Select the Trace Minus Memory soft key to view the difference in phase between the two cables.

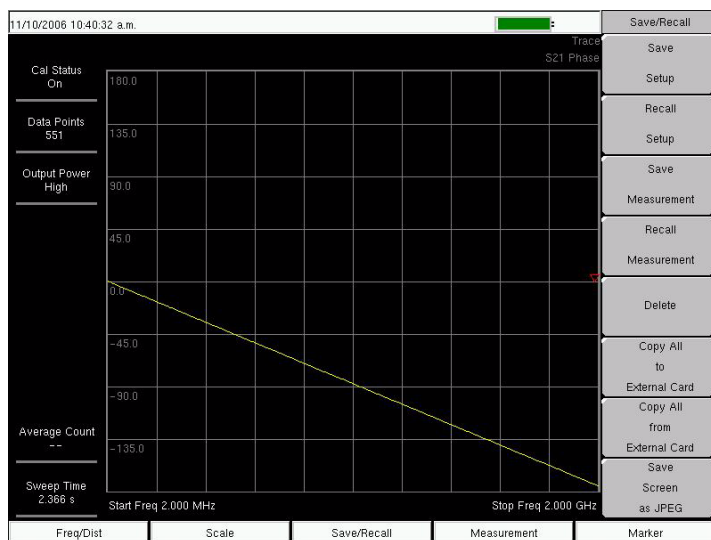

**Figure 3-15.** S21 Phase Measurement (VNA Measurement Menu Shown)

## Smith Chart

The VNA Master can display 1-port measurements in a standard Normalized 50 Ohm or 75 Ohm Smith Chart. When markers are used, the real and imaginary components of the Smith Chart value are displayed.

Anritsu Master Software Tools includes more options and a calculator that can easily show the values of the return loss, VSWR, or reflection coefficient of a specific Smith Chart.

Limit Lines in a Smith Chart will appear as circles (constant reflection coefficient) and can be entered in VSWR units.

### Smith Chart Measurement

The following example shows how a Smith Chart can be used to measure the match of an antenna. In this example procedure, the instrument is using the VNA measurement menu.

#### Procedure

1. Ensure that the instrument is in Vector Network Analyzer mode and press the **Shift** key and the **System** (8) key, then press the Application Options soft key. The Meas Menu soft key toggles between **Field** and **VNA**. The active measurement function is underlined.
2. Press the soft key (if necessary) until VNA is underlined, then press the Back key.
3. The Measurement soft key menu now displays VNA measurement options.
4. Press the **Measurement** function hard key and select S11 Reflection.
5. Select the Smith Chart soft key.
6. Press the **Freq/Dist** function hard key and set the Start Frequency and Stop Frequency.
7. Press the Start Cal soft key and perform a 1-port calibration.
8. Connect the antenna to the RF Out connector on the VNA Master.

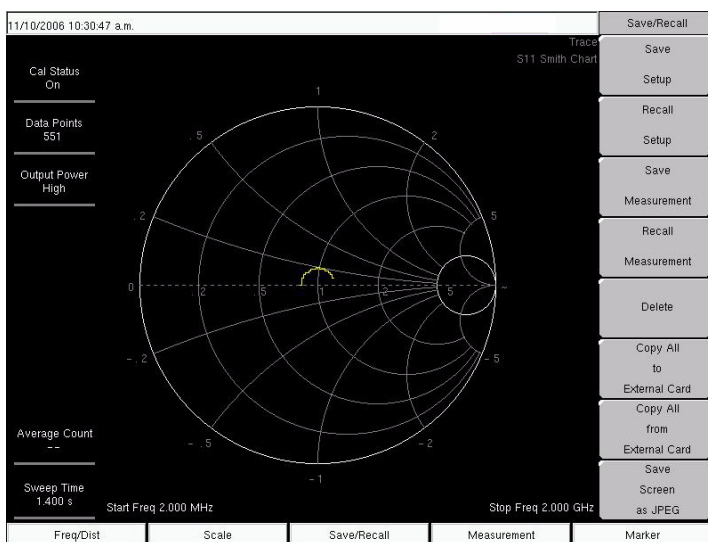

**Figure 3-16.** Smith Chart Measurement (VNA Measurement Menu Shown)

### Group Delay

The VNA Master can display 1-port and 2-port measurements in a Group Delay format. The Group Delay provides the time required for the stimulus signal to travel through the Device Under Test. Group Delay is determined by looking at the change in phase for a given change in frequency. At least two data points must be measured to provide the change in frequency.

The Aperture setting allows the user to adjust the number of data points the VNA Master measures before calculating the group delay. The aperture can be set from 2% to 20% of the total sweep.

**Procedure**

1. Press the **Measurement** key and select the S21 Transmission or S11 Reflection soft key.

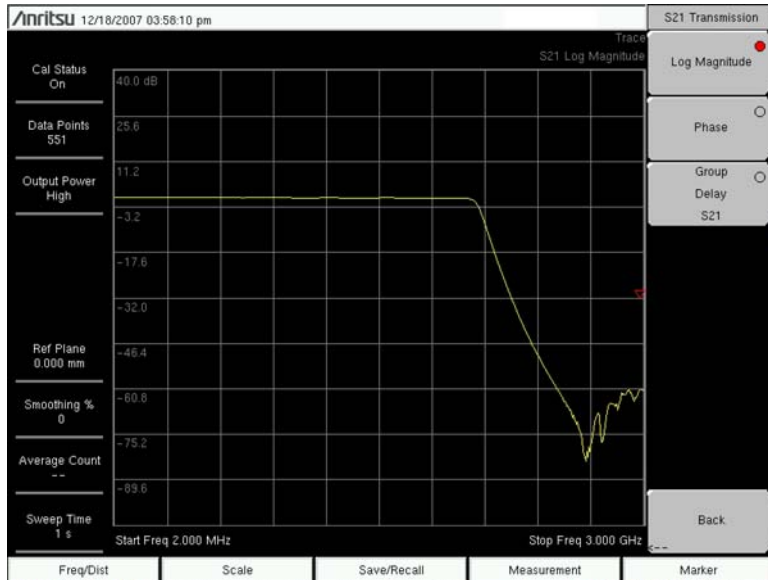

**Figure 3-17.** S21 Transmission Display with Soft Key Menu

2. Select the Group Delay S21 or the Group Delay S11 soft key.
3. Press the **Scale** key and use the soft keys to adjust the scaling and aperture for the group delay measurement.

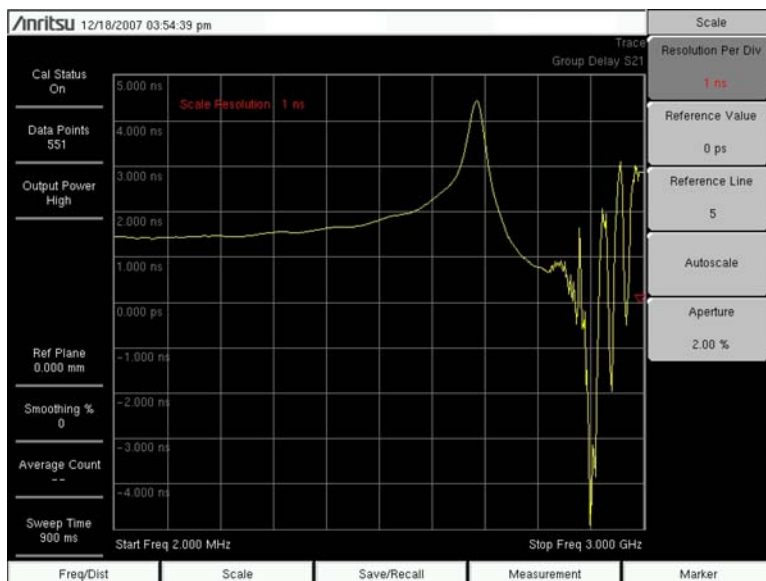

**Figure 3-18.** Group Delay Display with Scale Soft Menu

## 3-7 VNA Key Functions

### Introduction

The following section is a quick reference to the principal menus in the VNA Master. For more specific information on a particular measurement, refer to the specific chapters for the measurement being made. The key function menus are presented in this order:

- “Amplitude Menu (Field Menu)” on page 3-26
- “Calibration Menu” on page 3-27
- “File Menu” on page 3-29
- “Freq/Dist Menu” on page 3-33
- “Limit Menu” on page 3-35
- “Marker Menu” on page 3-38
- “Measurement Menus (Field and VNA)” on page 3-40
- “Measurement Menu (VNA Menus)” on page 3-42
- “Measurement Menu (Field Menus)” on page 3-45
- “Mode Menu” on page 3-47
- “Preset Menu” on page 3-48
- “Save/Recall Menu” on page 3-49
- “Scale Menu (VNA Menus)” on page 3-49
- “Sweep Menu” on page 3-51
- “System Menu” on page 3-54
- “Trace Menu” on page 3-57

---

## Amplitude Menu (Field Menu)

---

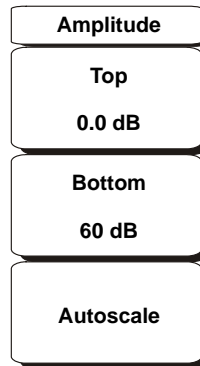

---

**Figure 3-19.** Amplitude Menu

To access the functions under the Amplitude menu, select the **Amplitude** function hard key.

**Top**

Sets the top amplitude value.

**Bottom**

Sets the bottom amplitude value.

**Autoscale**

Adjusts the Top and Bottom values so that the trace will be shown in the middle of the display.

Calibration Menu

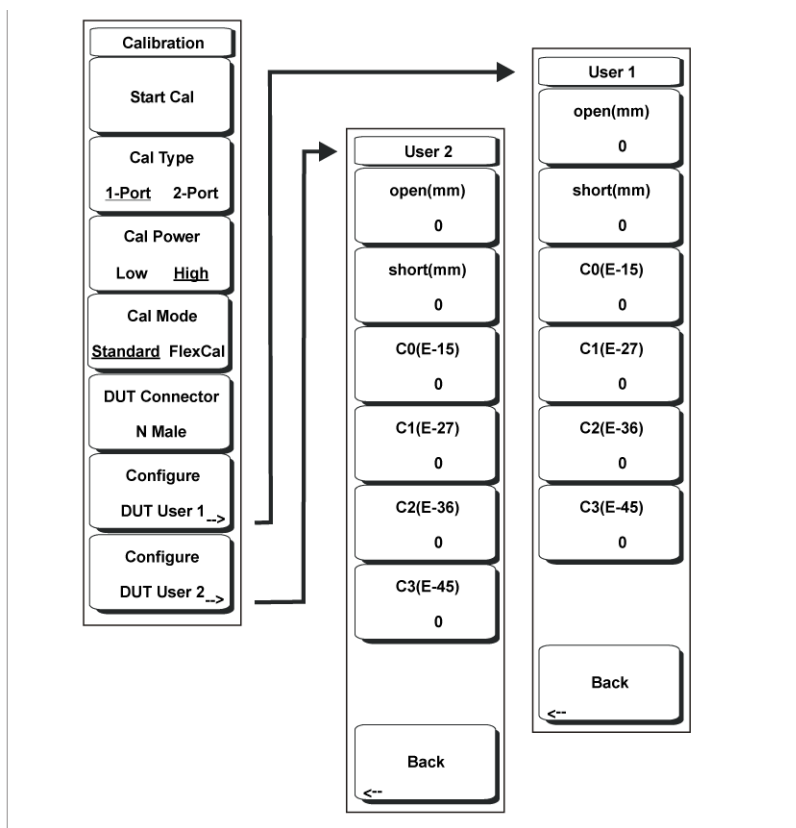

Figure 3-20. Calibration Menu

To access the Calibration Menu, press the **Shift** key, then the **Calibration** (2) key.

**Start Cal**

Press this soft key to begin the VNA calibration process for the current sweep settings – calibration type, power, DUT connector and frequency settings. Calibration will always use 551 data points during the calibration process, but will return to the selected number of data points when the calibration is complete.

**Cal Type**

Toggles between a 1-port and 2-port calibration. 1-port calibrations allow measurements of the reflective properties of the Device Under Test (DUT). 2-port calibrations allow the instrument to measure the transmission and reflective properties of the DUT. The 2-port calibration used by the VNA Master is a one-path, two port method.

**Cal Power**

Toggles the output power of the RF Output port between High (0 dBm nominal) and Low (-35 dBm nominal). High power is typically used for passive devices, while Low power is intended for active devices with gain, where the higher RF power could saturate the DUT and cause erroneous measurements.



### Cal Mode Standard/FlexCal

Toggles between a Standard calibration and a FlexCal.

Standard calibration will calibrate 551 data points evenly spaced between the current start and stop frequencies. After a Standard cal, the VNA Master will only make measurements at these calibrated frequency points. This provides the most accurate data.

FlexCal™ will calibrate 551 data points spread across the entire frequency span of the VNA Master. A unit with a FlexCal™ will allow the frequency settings to be changed without turning off the calibration. For each display point, the VNA Master will interpolate the correction between the closest two calibrated frequency points, sacrificing some slight accuracy for increased flexibility.

### DUT Connector

This soft key allows the ability to change the connector type of the DUT. The default is N(m), since that is what is required to mate to the VNA Master's N(f) RF port connectors. Pressing this soft key brings up a selection box of commonly used connector types, plus two choices that are user-defined.

### Configure DUT User x

Pressing this soft key opens a menu that allows entry of custom calibration coefficients – offset lengths, in mm, of the Open and Short calibration components, as well as the four capacitive fringe coefficients of the Open components.

#### Open (mm)

Press this soft key to enter the offset length in mm of the Open calibration component. Values can range from 0 to 1000 mm.

#### Short (mm)

Press this soft key to enter the offset length in mm of the Short calibration component. Values can range from 0 to 1000 mm.

#### C0(E-15)

Press this soft key to enter the custom value for the term 1 coefficient ( $\times 10^{-15}$  Farads) for the user-defined Open component. Values can range from 0 to 2000.

#### C1(E-27)

Press this soft key to enter the custom value for the term 2 coefficient ( $\times 10^{-27}$  Farads / Hz) for the user-defined Open component. Values can range from 0 to 2000.

#### C2(E-36)

Press this soft key to enter the custom value for the term 3 coefficient ( $\times 10^{-36}$  Farads / Hz<sup>2</sup>) for the user-defined Open component. Values can range from 0 to 2000.

#### C3(E-45)

Press this soft key to enter the custom value for the term 4 coefficient ( $\times 10^{-45}$  Farads / Hz<sup>3</sup>) for the user-defined Open component. Values can range from 0 to 2000.

#### Back

Returns to soft key menu to the Calibration menu.

## File Menu

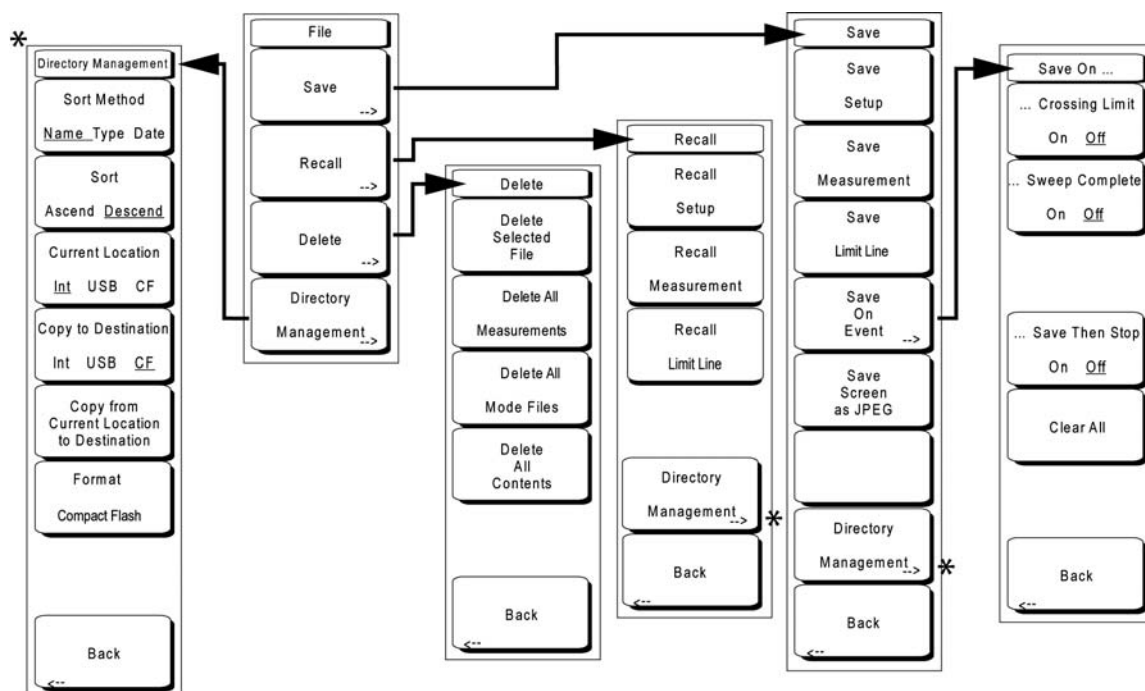

Figure 3-21. File Menu

To access the File Menu, press the **Save/Recall** function hard key or press the **Shift** key, then the **File** (7) key or the **Save/Recall** function hard key.

## Save

Measurements may be saved to the internal memory, an external Type-1 Compact Flash module, or a USB Flash Drive. Anritsu recommends saving to external storage if a large number of measurements are to be saved. The instrument is shipped with a Compact Flash module and a USB Flash Drive. In order to hold the entire contents of the internal memory, external memory devices must be at least 256 MB. Compact Flash modules greater than 512 MB storage capacity may not function properly.

For information on external memory part numbers, see Section "1-8 Standard and Optional Accessories" on page 1-6.

## Save Setup

Opens a dialog box to name and save the current operating settings, allowing them to be recalled later to return the instrument to the state it was in at the time the setup was saved. The saved setup can be named using the keypad to select numbers, the rotary knob to highlight a number or character and pressing the knob to select, or by selecting the soft key for each letter. Use the **Shift** key to select an upper case letter. Use the **Left/ Right** directional arrows to move the cursor position. Press **Enter** to save the setup.

### Save Measurement

Initiates a dialog box to name and save the active trace. The saved measurement trace can be named using the keypad to select numbers, the rotary knob to highlight a number or character and pressing the knob to select, or by selecting the soft key for each letter. Use the **Shift** key to select an upper case letter. Use the **Left/Right** directional arrows to move the cursor position. Press **Enter** to save the measurement trace. Measurements are saved in a directory called /usr on the Compact Flash memory module and the USB Flash Drive.

#### Note

If a measurement has been previously saved, the Save Measurement dialog box will open with the previously saved name displayed.

To save the new measurement with a similar name (for example, Trace-1, Trace-2, etc.) simply press the Right directional arrow and add the changes.

To create a completely new name, use the keypad, the rotary knob or select the soft key for each letter.

### Save Limit Line

Not available in VNA Mode.

### Save On Event...

Not available in VNA mode.

### Save Screen as JPEG

This function saves a measurement trace as a graphics file. The saved measurement can be named using the keypad to select numbers, the rotary knob to highlight a number or character and pressing the knob to select, or by selecting the soft key for each letter. Use the **Shift** key to select an upper case letter. Use the **Left/Right** directional arrows to move the cursor position. Press **Enter** to save the measurement after entering the file name. The file is saved in the internal memory with the specified name, with .jpg appended.

### Directory Management

Brings up the Directory Management soft menu. For a description of the directory management menu and soft keys, see “[Directory Management](#)” on [page 3-32](#).

### Back

The Back key returns to the previous menu.

### Recall

Brings up the Recall setup menu.

### Recall Setup

This soft key brings up a selection box that allows selection and recall of a previously stored instrument setup in the current storage location. Use the rotary knob or the **Up/Down** arrow keys to highlight the saved setup, and press **Enter**, the rotary knob, or the Recall soft key to select. All current instrument settings are replaced by the stored setup information. Press the **Esc** key to cancel the recall.

### Recall Measurement

This function brings up a selection box that allows recall of a previously stored measurement trace. Use the rotary knob or the **Up/Down** arrow keys to highlight the saved measurement trace, and press **Enter**, the rotary knob, or the Recall soft key to select. Press the **Esc** key to cancel the recall.

If the setup of the recalled trace is functionally the same as the current sweep setup, then the recalled trace is displayed as a green trace. The active sweep is then displayed in yellow. If the setup of the recalled trace is different from the current sweep setup, then the recalled trace is displayed alone, this time in yellow, along with the message Press ESC to clear Recall Trace.

Upon pressing the **Esc** key, a dialog box appears with the message Press Escape to keep old settings, or Enter to use Recalled Values. If the **Esc** key is pressed, then the recalled trace disappears, and only the active sweep is displayed. The system sweep settings (that were in effect before the trace was recalled) are restored. Pressing **Enter** loads the sweep settings that are associated with the recalled trace, and the VNA Master begins making measurements using those sweep settings.

**Note**

Recalling the sweep settings of the recalled trace destroys the current calibration information, and the VNA Master needs to be calibrated at the recalled settings before valid measurements can be made.

### Recall Limit Line

Not available in VNA Mode

### Directory Management

Brings up the Directory Management soft menu. For a description of the directory management menu and soft keys, see “[Directory Management](#)” on [page 3-32](#).

### Back

Returns to the previous menu.

### Delete

Brings up a selection box that shows all stored setups and traces in the currently selected location (See *Directory Management on page 4-28*.) The list shows the setup and measurement names, the type (stp for a saved setup, spa for a saved trace, jpg for a JPEG file) and the date and time the information was saved. Use the rotary knob or the **Up/Down** arrow keys to highlight the file to be deleted, and press **Enter**, or the Delete soft key to delete. Press the **Esc** key to cancel the operation. Note that there is no mechanism to retrieve deleted files.

### Delete Selected File

Use the up and down arrow buttons or the rotary knob to select the file that is to be deleted. Press **Enter** to confirm that you want to delete the file or **Esc** to exit without deleting.

### Delete ALL Measurements

Deletes all measurements of the current mode in the currently selected storage location. The memory from which measurements will be deleted is set in the Directory Management menu and is the Current Location.

**Delete ALL Mode Files**

Deletes all measurements of the type saved in the current operating mode of the instrument. In addition all jpg and setup files (regardless of the mode) are deleted.

**Delete ALL Contents**

Deletes all measurements, jpg files and setup files of ALL measurement types.

**Back**

The Back key returns to the previous menu.

**Directory Management**

Brings up the Directory Management soft menu. Note that the Directory Management menu is available from the File, Recall, and Save menus.

**Sort Method Name Type Date**

File lists can be sorted by the name of the file, the type of file (SPA file, STP file, etc.) or by the date that the file was saved.

**Sort Ascend Descend**

Selects whether the selected sort is sorted from lowest to highest (ascending) or highest to lowest (descending). When sorting by name, the sort will place file names that start with numbers before file names that start with letters (an ASCII sort).

**Current Location Int USB CF**

This choice lets you select where measurements and setups will be saved. Pressing the soft key selects the storage location to be the internal memory, USB Flash drive, or Compact Flash memory module. The “current location” and the “copy to destination” will never be the same. Changing the current location to save files causes the “copy to destination” to be automatically changed if the selected storage location is the same as the selected current location.

**Copy to Destination Int USB CF**

This choice lets you select where measurements and setups in the “current location” will be copied. The “current location” and the “copy to destination” may not be the same. If you change the destination to which the instrument will copy files, the current location is automatically changed if the current location is the same as the selected copy to destination.

**Copy From Current Location To Destination**

Pressing this soft key causes all measurements, setups, and jpg files that are stored in the user-selected “current location” to be copied to the “copy to destination”. If no storage module is installed in the instrument, an error message is displayed.

**Format Compact Flash**

This selection erases all files on an installed Compact Flash module. A message is displayed warning that all files will be erased. Press Enter to confirm that you want to erase, or Esc to quit without erasing. In addition to erasing all files stored on the Compact Flash, the /usr directory is created for storage of measurements, setups and jpg files.

**Back**

The Back key returns to the previous menu.

---

## Freq/Dist Menu

---



---

**Figure 3-22.** Freq/Dist Menu

The tuning frequency range for the VNA Master can be entered in several different ways depending upon what makes the most sense for the user or for the application. The center frequency and span can be specified, the start and stop frequencies can be entered, or a signal standard and channel number can be selected from the built-in list.

### Start Frequency

Press the **Freq** key followed by the Start Freq soft key and enter the desired frequency using the keypad, the arrow keys, or the rotary knob. If a start frequency that is higher than the current stop frequency is entered, then the start frequency is set the same as the stop frequency. For a higher frequency range, set the Stop Freq to the desired frequency, then enter the Start Freq.

### Stop Frequency

Press the **Freq** key followed by the Stop Freq soft key and enter the desired frequency using the keypad, the arrow keys, or the rotary knob. If a stop frequency lower than the current start frequency is entered, then the stop frequency is set the same as the start frequency. For a lower frequency range, set the Start Freq to the desired frequency, then enter the Stop Freq.

### Center Frequency

Press the **Freq** key followed by the Center Freq soft key and enter the desired frequency using the keypad, the arrow keys, or the rotary knob. If entering a frequency using the keypad, then the soft key labels change to GHz, MHz, kHz, and Hz. Select the appropriate units key. Selecting the **Enter** key has the same affect as using the MHz soft key.

### Span

Press the **Freq** key followed by the Span soft key and enter the desired span. The Span menu is used to set the frequency range over which the instrument will sweep. For the VNA Master, the span can be set from 0 Hz to the maximum frequency of the unit.

The soft key shows the current value for span in units of GHz, MHz, kHz, or Hz. When the Span button is pressed, span becomes the active parameter and may be changed. Use the keypad, the directional arrow keys or the rotary knob to increase or decrease the span frequency. If the span is changed using the Up/Down arrow keys, then the span changes by the value of the Frequency Step for each key press.

### Signal Standard

Use the Up/Down arrow keys or the rotary knob to highlight a signal standard and press **Enter** to select.

When a signal standard is selected, the center frequency and span (for the first channel of the particular standard) are automatically tuned. Other settings, such as channel spacing and integration bandwidth, are also automatically entered. [Appendix A](#) contains a table of the signal standards that are in the instrument firmware.

### Channel #

Use the Up/Down arrow keys, the keypad, or the rotary knob to select a channel number for the selected signal standard. The center of the channel is tuned to the center of the display screen.

## Limit Menu

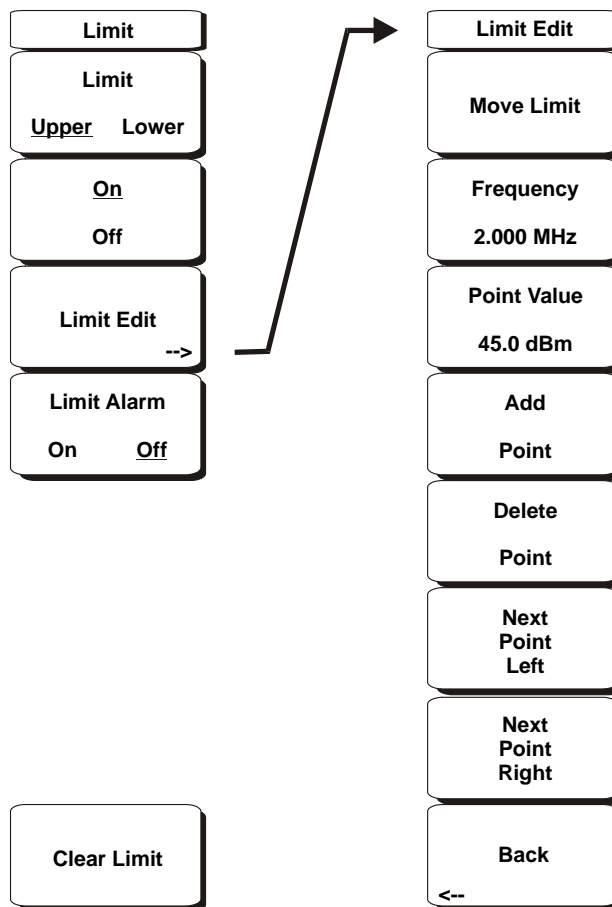

**Figure 3-23.** Limit Menu

To access the Limit Menu, press the **Shift** key, then the **Limit** (6) key.

Two types of limit lines can be specified, lower limit lines and upper limit lines. Limit lines can be used for visual reference only, or for pass/fail criteria using the limit alarm. Limit alarm failures are reported whenever a signal is above the upper limit line or below the lower limit line.

Each limit line can consist of a single segment, or as many as 40 segments across the entire frequency span of the instrument. These limit segments are retained regardless of the current frequency span of the instrument, allowing the configuring of specific limit envelopes at various frequencies of interest without having to reconfigure them each time that the frequency is changed. To clear the current limit setup configuration and return to a single limit segment (starting at the current start frequency and ending at the current stop frequency), press the Clear Limit soft key.



### Limit Upper/Lower

This soft key selects which limit line will be active for editing. The limit line that is currently selected for editing is underlined.

### On/Off

This soft key turns the active limit line (upper or lower) on or off.

### Limit Edit

The submenu that is displayed by this soft key allows creating or editing of single limit lines or multi-segment limit lines. The currently active limit point is marked by a red circle on the display.

#### Move Limit

This soft key allows an entire single limit line or multi-segment limit line to be moved up or down by the amount that is entered by using the keypad, the Up/Down arrow keys, or the rotary knob. The units for this amount will be the current display units as selected under the **Amplitude** menu.

#### Frequency

The frequency of each point in a limit line can be individually set. When a new point is added, it takes on a value halfway between two existing points, or the stop frequency of the current sweep if there is no point higher in frequency than the one being added. Refer to the [Add Point](#) soft key description later in this chapter for more details. Use the keypad, the Left/Right arrow keys, or the rotary knob to change the frequency of a point.

#### Amplitude

The amplitude of each limit point can also be individually set. By default, when a new point is added, it takes on the amplitude that is on the limit line at the frequency where the point was added. Use the keypad, using the  $\pm$  key as the minus sign, the Up/Down arrow keys, or the rotary knob to move the point to the desired value. The unit of the amplitude limit is the same as the current vertical amplitude unit. Refer to the [Add Point](#) soft key description in the next section for more details.

#### Add Point

The precise behavior of this soft key depends upon which limit point is active at the time that the key is pressed. If the active limit point is somewhere in the middle of a multi-segment limit line, then a new limit point will be added halfway between the currently active point and the point immediately to its right. The amplitude of the point will be such that it falls on the limit line. For example, if a limit point is at 2.0 GHz with an amplitude of -30 dBm and the next point is 3.0 GHz with an amplitude of -50 dBm, then the added point will be at 2.5 GHz with an amplitude of -40 dBm. The frequency and amplitude values of the new point can be adjusted as needed with the Frequency and Amplitude soft keys.

If the last limit point is active (assuming that it is not at the right edge of the display), then the new limit point will be placed at the right edge of the display at the same amplitude as the point immediately to its left.

Points may not be added beyond the current sweep limits of the instrument.

**Delete Point**

This soft key deletes the currently active point. The active point becomes the one immediately to the left of the point that was deleted.

**Next Point Left**

This soft key selects the limit point immediately to the left of the active point, making it active for editing or deletion. With each key press, the indicator of which point is active moves one limit point to the left until it reaches the left edge of the screen.

**Next Point Right**

This soft key selects the limit point immediately to the right of the active point, making it active for editing or deletion. With each key press, the indicator (of which point is active) moves one limit point to the right until it reaches the right edge of the screen.

**Back**

Returns to the higher-level Limit menu.

**Limit Alarm On/Off**

For the currently active limit line, this soft key selects (on or off) whether an alarm beep will occur when a data point exceeds the limit.

**Clear Limit**

This soft key deletes all limit points for the currently active limit line and defaults to a single limit, whose amplitude value will be selected to make it visible on the screen. The other limit line is not altered.

## Marker Menu



**Figure 3-24.** Marker Menu

To access the functions under the Marker menu, select the **Marker** function hard key.

### Marker 1 2 3 4 5 6

Use this soft key to select the active marker. The underlined marker number is the active marker. Each press of the soft key moves the underline to the next marker number.

### On/Off

This soft key makes the active marker, selected by the Marker soft key above, active for editing. If the associated Delta marker is on and active for editing, pressing this button will toggle so that the Reference marker becomes active for editing. It does this without changing the value of the associated Delta marker. However, if the marker (or Reference marker) is currently active for editing, pressing the On/Off key causes the selected marker and the associated Delta marker to be turned off.

### Delta On/Off

If the Delta marker is off, or on, but not active for editing, pressing this soft key makes the Delta marker active for editing. If the delta marker is currently active for editing, pressing the On/Off key causes the delta marker to be turned off, and the associated Reference marker to become active for editing. The Reference marker must be On before the associated Delta marker can be turned on.

**Peak Search**

This soft key places the currently active marker on the highest signal amplitude currently displayed on screen.

**Valley Search**

This soft key places the currently active marker on the lowest signal amplitude currently displayed on screen.

**Marker Table**

Pressing this soft key causes a table to be displayed below the sweep window. In addition to the marker frequency and amplitude, the table also shows delta frequencies and amplitude deltas for all markers that have deltas entered for them.

**All Markers Off**

This soft key turns off all markers and the marker table.

## Measurement Menus (Field and VNA)

The VNA Measurement Menu lists the following measurement types:

- S11 Reflection
- S21 Transmission

### ***S11 Reflection***

The S11 Reflection measurement choices are:

- Log Magnitude
- VSWR
- Phase
- Smith Chart
- Log Magnitude Fault Location
- VSWR Fault Location
- Group Delay S11

### ***S21 Transmission***

The S21 Transmission measurement choices are:

- Log Magnitude
- Phase
- Group Delay S21

### ***Field Measurement Types***

The Field Measurement Menu lists the following measurement types:

- VSWR
- Return Loss
- Cable Loss
- DTF Return Loss
- DTF VSWR
- 2-Port Gain
- Smith Chart
- 1-Port Phase
- 2-Port Phase

**Procedure**

To select the Measurement Menu, press the **Measurement** function hard key, or press the **Shift** key and then the **Measure** (4) key.

To change the Measurement Menu between the Field Menu and the VNA Menu:

1. Press the **Shift** key and then the **System** (8) key.
2. Select the Applications Options soft key.
3. Press the Meas Menu soft key to toggle VNA or Field.

## Measurement Menu (VNA Menus)

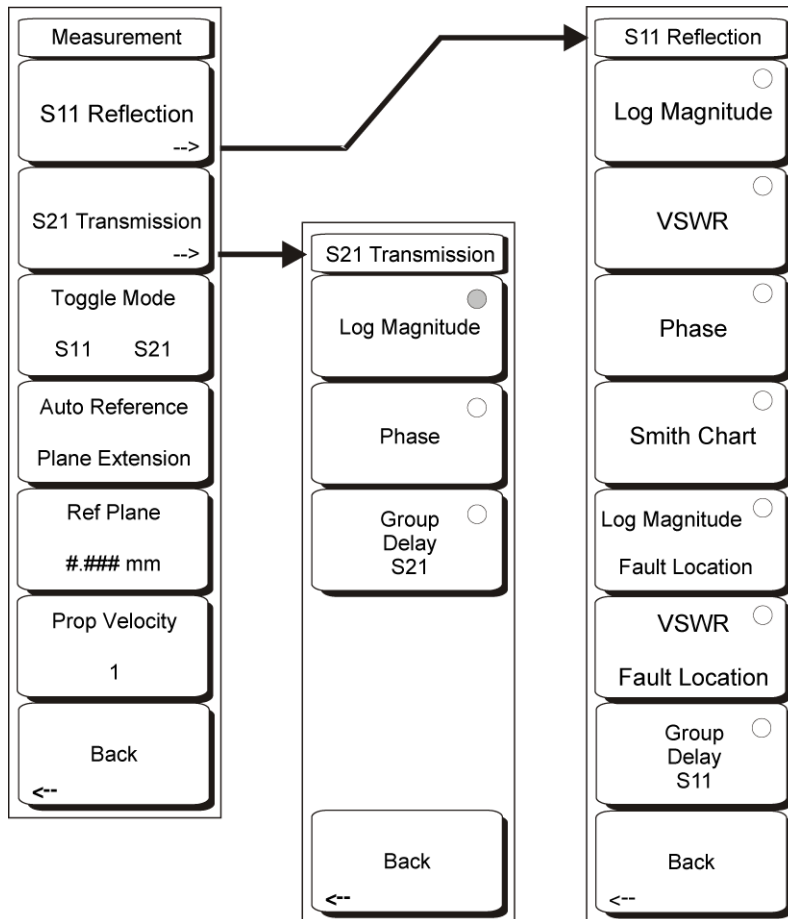

**Figure 3-25.** VNA Measurement Menu

While the VNA Master is in VNA mode and is set for the VNA Measurement application option, press the **Measurement** function hard key or press the **Shift** key then the **Measure** (4) button. The Measurement menu is used to select the measurement format. For details about setting this option, refer to “[System Menu](#)” on page 3-54. The nomenclature in the VNA Menus is intended to be familiar to users who work with traditional bench top VNAs.

### S11 Reflection

This soft key opens the S11 Reflection menu.

#### Log Magnitude

Directs the instrument to make a 1-port measurement and display the magnitude result in dB. Return Loss is expressed as a positive number, in other words, a larger numeric value represents more loss in the DUT.

#### VSWR

Directs the instrument to make a 1-port measurement and display the magnitude result in Voltage Standing Wave Ratio (VSWR).

**Phase**

Directs the instrument to make a 1-port measurement and display the phase result in degrees. Measured data is formatted such that the result is between +180 degrees and –180 degrees.

**Smith Chart**

Directs the instrument to make a 1-port measurement and display the result on a 50-ohm impedance Smith Chart

**Log Magnitude Fault Location**

Directs the instrument to make a 1-port measurement and display the magnitude result as dB loss versus distance. Return Loss is expressed as a positive number, in other words, a larger numeric value represents more loss in the DUT.

**VSWR Fault Location**

Directs the instrument to make a 1-port measurement and display a calculated magnitude result as VSWR versus distance.

**Group Delay S11**

Directs the instrument to make a 1-port measurement and display a calculated result in Group Delay versus frequency.

**Back**

Returns to the Measurement menu.

**S21 Transmission**

This soft key opens the S21 Transmission menu.

**Log Magnitude**

Directs the instrument to make a 2-port measurement and display the magnitude result as dB loss or gain. In 2-port Gain measurements, a positive result indicates gain in the DUT. Loss in the DUT is displayed as a negative result.

**Phase**

Directs the instrument to make a 2-port measurement and display the phase result in degrees. Measured data is formatted such that the result is between +180 degrees and –180 degrees.

**Group Delay S21**

Directs the instrument to make a 2-port measurement and display a calculated result in Group Delay versus frequency.

**Back**

Returns to the Measurement menu.

**Toggle Mode S11 S21**

Toggles between the most recent measurement displays (Log Magnitude, Phase, etc.) of S11 Reflection and S21 Transmission as a way to quickly transition between the two.



**Auto Reference Plane Extension**

Will use the current data to automatically determine the best length to mathematically extend the reference plane (plane of calibration) to remove cable length from the measurement, based on the current value of Propagation Velocity (see description for the “**Prop Velocity #**” soft key below). The resultant display will “unwrap” phase displays to allow a better view of the phase properties of the Device Under Test.

**Ref Plane #.### mm**

Allows the user to manually enter a distance to which the Reference Plane (Plane of Calibration) will be extended. This will calculate and remove from the measurement data an appropriate amount of linear phase rotation based on Propagation Velocity and the distance entered here.

**Prop Velocity #**

Used by the Reference Plane Extension functions. Allows the user to enter the propagation velocity of electrical signals in the cable length being removed by the Reference plane extension calculations. Values are expressed as a decimal ratio compared to the speed of light in a vacuum (e.g. 1 = speed of light, 0.5 = 1/2 the speed of light).

**Back**

Returns to the previous menu.

## Measurement Menu (Field Menus)

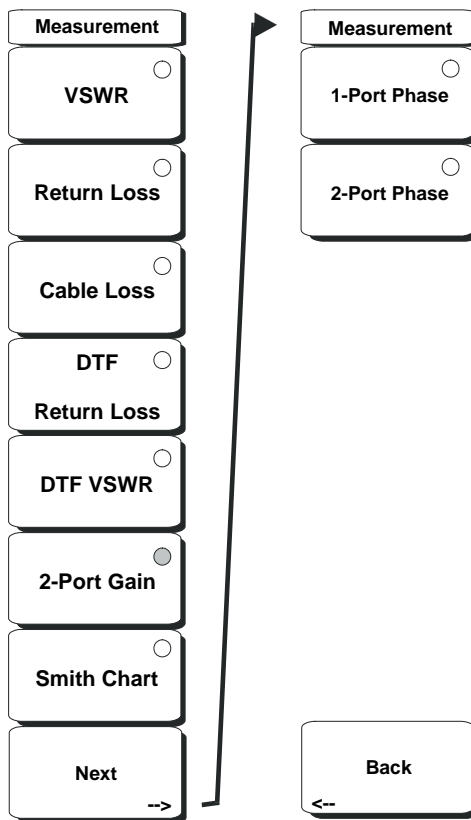

**Figure 3-26.** Field Measurement Menu

While the VNA Master is in VNA mode and is set for the Field Measurement application option, press the **Measurement** function hard key or press the **Shift** key then the **Measure** (4) button. The Measurement menu is used to select the measurement format. For details about setting this option, refer to [“System Menu” on page 3-54](#).

### VSWR

Select the VSWR soft key to view the match in VSWR.

### Return Loss

Return Loss is used to characterize RF components and systems. The Return Loss indicates how well the system is matched by taking the ratio of the reflected signal to the incident signal and measuring the reflected power in dB.

### Cable Loss

The cable loss test verifies the signal attenuation level of the cable.

**DTF Return Loss and DTF VSWR**

The DTF measurement displays return loss (or VSWR) values versus distance. If the frequency measurements fail or indicate a problem in the system, then the DTF measurement can be used to identify and pinpoint the exact location of the problem. The DTF measurement shows the return loss value of all the individual components including connector pairs and cable components.

**2-Port Gain**

This function is used to measure the gain of the Device Under Test (DUT).

**Smith Chart**

This function displays the measurement results as a Smith Chart.

**Next**

This soft key opens an additional menu.

**1-Port Phase**

This function is used for phase matching of the cables. 1-port phase displays the phase difference, in degrees, between the reflected signal and the incident signal.

**2-Port Phase**

This function is used for phase matching of the cables. 2-port phase displays the phase difference, in degrees, between the signal that is transmitted through the DUT and the incident signal.

**Back**

This soft key returns the display to the previous (Measurement) menu.

## Mode Menu

To access the Mode Menu, press the **Shift** key, then the **Mode** (9) key. The Mode Selector window opens.

A sample list of Mode Selector choices:

- Spectrum Analyzer
- Vector Network Analyzer
- Vector Volt Meter
- Power Meter
- Interference Analyzer
- Channel Scanner

Use the rotary knob or Up/Down arrow keys to highlight the desired mode and press **Enter** to select. Press the **Esc** key to close the Mode Selector window without making any changes.

The available mode selections will vary with the options installed in the particular VNA Master.

---

## Preset Menu

---

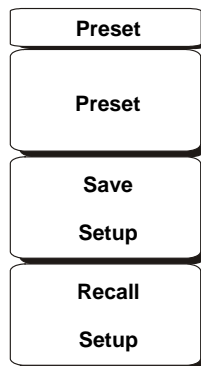

---

**Figure 3-27.** Preset Menu

To access the Preset Menu, press the **Shift** key, then the **Preset (1)** key. The Preset menu is used to preset the VNA Master. Additional selections are possible to save and recall setups.

### Preset

This soft key resets sweep conditions to default state of full band sweep, 275 data points, S21 Log Mag display, High output power, continuous sweep, and it turns off markers, limits, and calibration.

### Save Setup

This soft key opens a dialog box to name and save the current operating settings, allowing them to be recalled later in order to return the instrument to the state it was in at the time that the setup was saved. The saved setup can be named by using the keypad to select numbers, by using the rotary knob to highlight a number or character and pressing the knob to select, or by selecting the soft key for each letter. Use the **Shift** key to select an upper case letter. Use the Left/Right directional arrows to move the cursor position. Press **Enter** to save the setup.

### Recall Setup

This soft key brings up a selection box that allows selection and recall of a previously stored instrument setup. Use the rotary knob or the Up/Down arrow keys to highlight the saved setup and then press **Enter**, the rotary knob, or the Recall soft key to select. All current instrument settings are replaced by the stored setup information. Press the **Esc** key to cancel the recall.

## Save/Recall Menu

For more information on the Save/Recall menu, see “File Menu” on page 3-29.

## Scale Menu (VNA Menus)

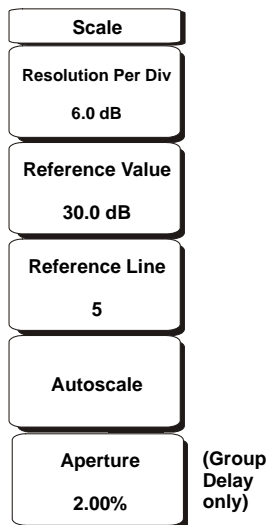

**Figure 3-28.** Scale Menu

Press the **Scale** function key to access the Scale menu. The Scale menu is used to set the measurement display for optimum viewing.

### Resolution Per Div

Sets the number of units displayed between horizontal graticules. Use the Up/Down arrow keys, the keypad, or the rotary knob to set this parameter, then press the **Enter** key or the rotary knob.

### Reference Value

Sets the value of the Reference Line. Use the Up/Down arrow keys, the keypad, or the rotary knob to set this parameter, then press the **Enter** key or the rotary knob.

### Reference Line

Sets which horizontal graph graticule is at the reference value. The reference line is indicated by a small red triangle along the right edge of the graph. Use the Up/Down arrow keys, the keypad, or the rotary knob to set this parameter, then press the **Enter** key or the rotary knob.

### Autoscale

Press the Autoscale soft key to automatically adjust the Top and Bottom amplitude values so that the trace for the current measurement is shown in the middle of the display.

**Aperture (Group Delay measurements only)**

This soft key appears only when Group Delay has been selected in the measurement menu. Group delay is a measurement of “Change in phase / change in frequency.” The aperture setting is used by the VNA Master to determine how large a change in frequency to use in this calculation. The value can be set from 2% to 20% of the display.

Use the **Up/Down** arrow keys, the keypad, or the rotary knob to set this parameter, then press the **Enter** key or the rotary knob. When using the keypad to enter a value, a % (Percent) soft key appears in the active function block. The value can also be entered by pressing the % (Percent) soft key.

## Sweep Menu

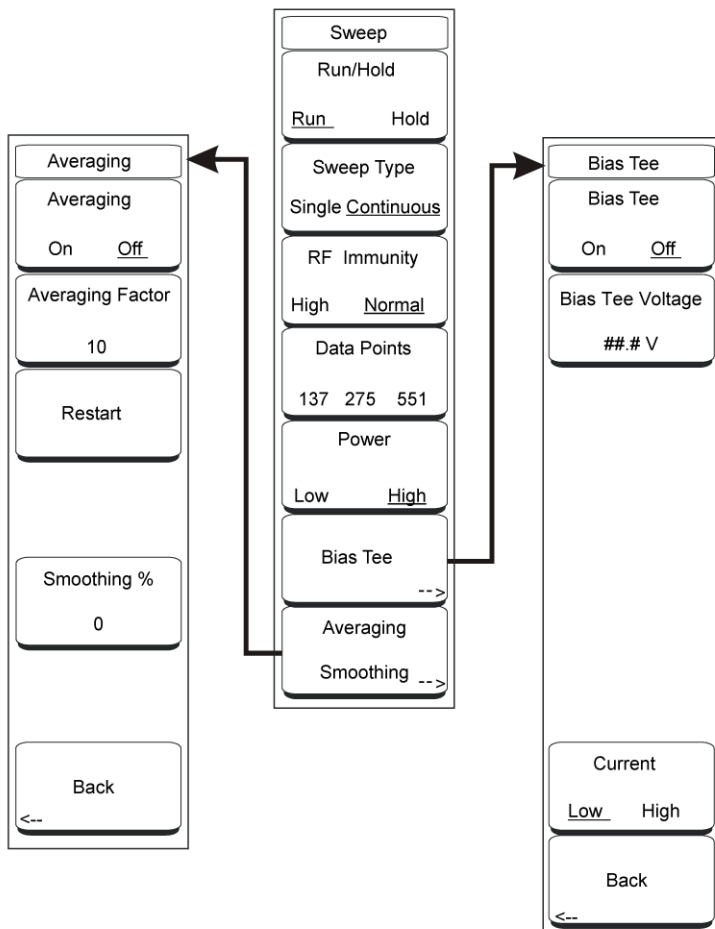

**Figure 3-29.** Sweep Menu

To access the Sweep Menu, press the **Shift** key then the **Sweep** (3) key. All of the variables that affect the sweep can be found in this menu.

#### Run/Hold

Press this soft key to select Run or Hold. The currently selected condition is underlined. Hold pauses the sweep. To resume sweeping, press the soft key to select Run.

#### Sweep Type

Press the soft key to select Single or Continuous. The currently selected condition is underlined. Selecting Single Sweep will allow the instrument to sweep once and hold. While in Single sweep, pressing the Run/Hold button will initiate a sweep. Press the Sweep Type soft key again to resume continuous sweeping.

Note that the unit may still be in Hold. Press the Run/Hold soft key to start the continuous sweep.



### RF Immunity

Press the soft key to select High or Normal. The VNA Master uses a special dithering technique to improve immunity to interfering signals. Selecting High turns the dithering on. Selecting Normal turns the dithering off.

Selecting RF Immunity Normal reduces sweep time (increases sweep speed) for both frequency and DTF measurements. In a controlled environment, this reduced immunity should not be a problem. In the field however, there can be stray signals from nearby or co-located transmitters that can affect frequency and DTF measurements. Making the same measurement with RF Immunity set to both High and Normal with no appreciable difference between the two settings is a good indicator that it is safe to make the measurements with RF Immunity set to Normal.

### Data Points

Press the soft key to select 137, 275 or 551 data points. The resolution can be changed before or after calibration. The VNA Master uses the highest setting of 551 data points for calibration regardless of the display setting.

### Power

With 2-port measurements, the power level can be changed between High and Low output power. Press the soft key to select High or Low. Low (approximately -35 dBm) allows for 2-port measurements where the output level could saturate an active device, such as an amplifier. High (approximately 0 dBm), can be used for all other measurements. Output power levels can only be changed for 2-port measurements. The power level is set to High for 1-port measurements.

### Bias Tee

The Variable Bias Tee Option (Option 10) is available for all models of the VNA Master. In addition to this section, refer to [“2-Port Gain Measurements” on page 3-19](#) and the associated [“Example 2” on page 3-20](#).

The built-in variable power supply can be turned on as needed to place between +12V and +24V on the center conductor of the RF In port. For +12V and +15V settings, the current can be set to Low or High. The status window to the left of the display shows the current and voltage information that can be stored as well.

Press the Bias Tee soft key to open the Bias Tee menu.

#### Bias Tee On/Off

This soft key toggles the bias tee function On and Off.

#### Bias Tee Voltage #.# V

Allows entry of the Bias Tee voltage to be placed on the center conductor of the RF In port. Values can be between 12.0 and 24.0 V in increments of 0.1 V.

#### Current Low/High

This soft key toggles the bias tee current between Low and High.

#### Back

Use this soft key to return to the Sweep menu.

### Averaging Smoothing

This soft key opens the Averaging menu.

#### Averaging On/Off

This soft key toggles between averaging and no averaging.

**Averaging Factor**

Press the soft key, then use the arrow keys, the keypad, or the rotary knob to set the averaging factor. Press the **Enter** key or the rotary knob to enter the value.

**Restart**

Press this soft key to start a new averaging sequence.

**Smoothing % #**

Smoothing is a mathematical function that calculates a rolling average of the trace data. This provides a way to look at the general shape of a measurement while smoothing out smaller variations. The value is the amount of the display that is incorporated into the rolling average. Valid entries range from 0% (no smoothing) to 20% (maximum smoothing).

**Back**

Use this soft key to return to the Sweep menu.

System Menu

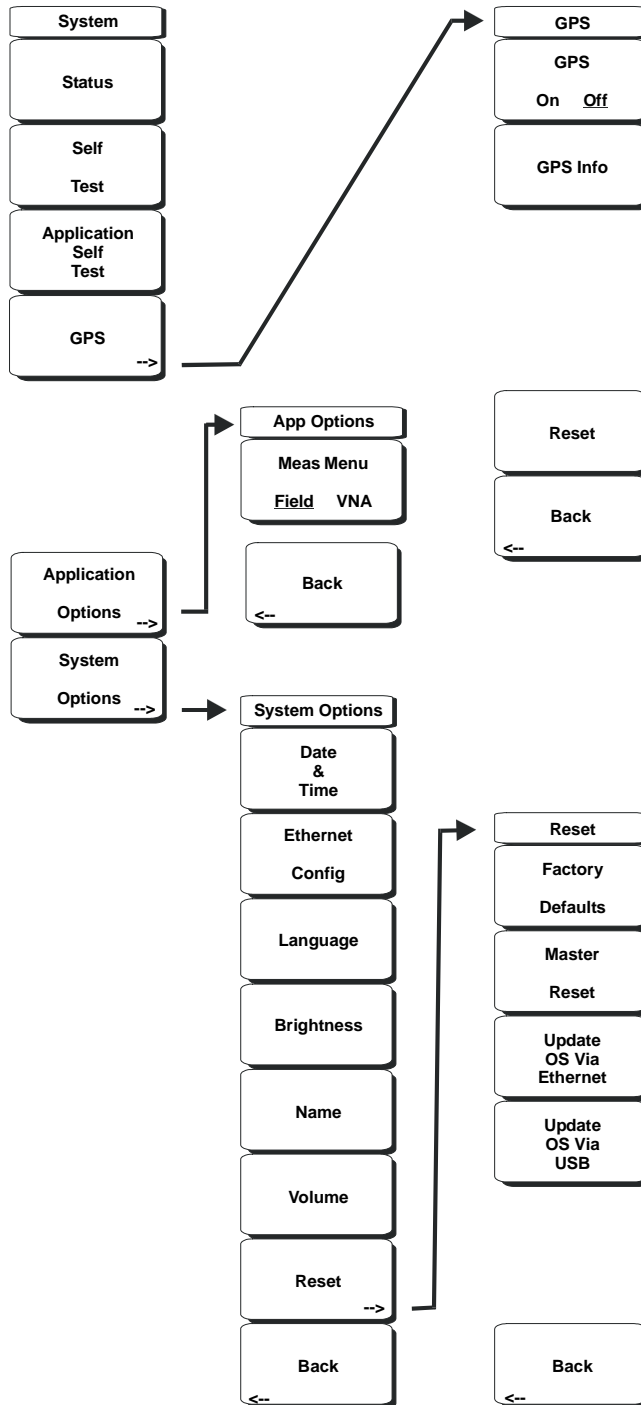

Figure 3-30. System Menu

To access the System Menu, press the **Shift** key, then the **System** (8) key. The System menu is used to interact with the system attributes of the VNA Master. Self Test, GPS, Application Options, and System Options can be found in this menu.

#### Status

Pressing this soft key displays the current system status, including the operating system and firmware versions, temperatures, and other details, such as current battery information. Press **Esc** or **Enter** to return to normal operation.

#### Self Test

This soft key initiates a series of diagnostic tests that test the components of the instrument. A display lists the individual tests with a pass or fail indication. Press **Esc** or **Enter** to return to normal operation.

#### Application Self Test

This soft key initiates a series of diagnostic tests that are related to the performance of the VNA Master. A display lists the individual tests with a pass or fail indication. Press **Esc** or **Enter** to return to normal operation.

#### GPS

This soft key will only appear if the GPS option is installed in the unit. For information about using this feature, refer to [Chapter 12, “GPS Receiver, Option 31”](#).

#### Application Options

The Application Options menu contains the Meas Menu soft key. Press the soft key to select Field or VNA measurement menus within the Vector Network Analyzer mode. Press the Back soft key to return to the System menu.

#### System Options

The System Options menu contains the following soft keys:

##### Date and Time

This soft key brings up a dialog box for setting the current date and time. Use the keypad, the arrows, or the rotary knob to select the date and time.

##### Ethernet Configuration

This soft key bring up a dialog box to set the IP address of the instrument. Use the Manual/DHCP soft key to select whether the address will be entered manually or supplied automatically by a network DHCP server. If manual is selected, then use the soft keys or the arrow keys to select the field to be modified. For more information on LAN connections and DHCP, refer to [“LAN Connection” on page 2-12 in Chapter 2, “Quick Start Guide”](#).

##### Language

This soft key allows selection from a list of built-in languages. Use the rotary knob or Up/Down arrow keys to highlight a selection and press **Enter** to select. The languages currently available are English, French, German, Spanish, Japanese, Chinese, Korean, and Italian. In addition, two custom languages may be selected if they have been defined in the Master Software Tools Software Language Editor and loaded into the unit. For more information how to create custom defined languages, refer to [Chapter 13, “Master Software Tools”](#).

### Brightness

The brightness of the display can be adjusted to optimize viewing under a variety of lighting conditions. Use the keypad, the Up/Down arrow keys, or the rotary knob to select a brightness level from 1–9 and press **Enter** to select.

### Name

The VNA Master can be named by using the keypad to select numbers, the rotary knob to highlight a number or character (pressing the knob to select), or by selecting the soft key for each letter. Use the **Shift** key to select an upper case letter. Use the Left/ Right directional arrows to move the cursor position. Press **Enter** to save the name.

### Volume

This soft key opens a dialog box to change the speaker volume of the unit. Use the keypad, the Up/Down arrow keys, or the rotary knob to select a volume level from 0–90 and press **Enter** to select.

### Reset

Opens a menu of reset and update options.

#### Factory Defaults

Restores the instrument to the factory default values, including Ethernet, language, and brightness settings. Press the **Enter** key to initiate the reset, and turn the unit off and then on again to complete. Press **Esc** to return to normal operation without resetting.

#### Master Reset

This will restore factory setting to all system parameters, including Time/Date, Ethernet, language, and brightness settings. Also, all user files in the internal memory are deleted, and the original language and antenna files are restored. Press the **Enter** key to initiate the reset, and turn the unit off and then on again to complete. Press **Esc** to return to normal operation without resetting.

#### Update OS Via Ethernet

This soft key should only be used in conjunction with Anritsu Master Software Tools to update the instrument operating system using an Ethernet connection. Use this soft key only as instructed by MST.

#### Update OS Via USB

This soft key should only be used in conjunction with Anritsu Master Software Tools to update the instrument operating system using a USB-connected device. Use this soft key only as instructed by MST.

#### Back

Returns to the previous menu.

---

## Trace Menu

---

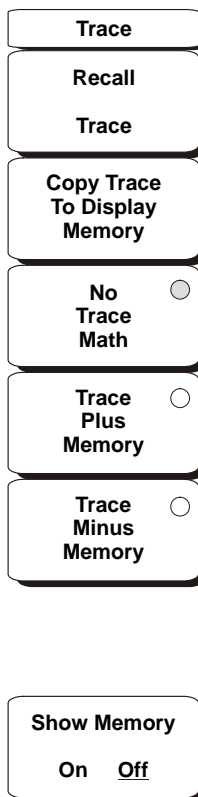

---

**Figure 3-31.** Trace Menu

To access the Trace Menu, press the **Shift** key, then the **Trace** (5) key.

### Recall Trace

This function brings up a selection box that allows recall of a previously stored measurement trace. Use the rotary knob or the Up/Down arrow keys to highlight the saved measurement trace, and press **Enter**, the rotary knob, or the Recall soft key to select. Press the **Esc** key to cancel the recall.

If the setup of the recalled trace is functionally the same as the current sweep setup, then the recalled trace is displayed as a green trace. The active sweep is then displayed in yellow.

If the setup of the recalled trace is different from the current sweep setup, then the recalled trace is displayed alone, this time in yellow, along with the message Press ESC to clear Recall Trace. Upon pressing the **Esc** key, a dialog box appears with the message Press Escape to keep old settings, or Enter to use Recalled Values. If the **Esc** key is pressed,

then the recalled trace disappears, and only the active sweep is displayed. The system sweep settings (that were in effect before the trace was recalled) are restored. Pressing **Enter** loads the sweep settings that are associated with the recalled trace, and the VNA Master begins making measurements using those sweep settings.

<b>Note</b>	Recalling the sweep settings of the recalled trace destroys the current calibration information, and the VNA Master needs to be calibrated at the recalled settings before valid measurements can be made.
-------------	--

#### Copy Trace to Display Memory

This function copies the current trace to the display memory.

#### No Trace Math

When this soft key is selected, the active trace is shown as is.

#### Trace Plus Memory

This function displays the result of logarithmically adding the active trace and the memory trace.

#### Trace Minus Memory

This function displays the difference between the active trace and the memory trace.

#### Show Memory

This function displays the trace in the display memory as a green measurement trace.

# Chapter 4 — Spectrum Analyzer

## 4-1 Introduction

Spectrum analyzer measurements include the use of additional functions beyond frequency, span, amplitude and marker functions. The first section of this chapter presents the soft key menus available when Spectrum Analyzer mode is selected. The next section focuses on resolution bandwidth, video bandwidth, sweep, and attenuator functions. The Field Measurements section presents brief examples demonstrating field strength, occupied bandwidth, channel power, adjacent channel power ratio, and carrier to interference ratio (C/I) tests.

## 4-2 Getting Started

### Spectrum Analyzer Mode

To prepare for spectrum analyzer measurements, the MS203xA must be configured for Spectrum Analyzer Mode, as follows:

1. Select the **Shift** key, then the **Mode** (9) key.
2. Use the directional arrow keys or the rotary knob to highlight Spectrum Analyzer and press the **Enter** key to select.

For additional information about the Mode menu, refer to [“Mode Menu” on page 3-47 in Chapter 3, “Vector Network Analyzer”](#).

### Hard Keys and Soft Keys

For a general description of these key functions, refer to section [“2-6 Front Panel Keys” on page 2-5 in Chapter 2, “Quick Start Guide”](#).



## 4-3 Making Spectrum Analyzer Measurements

### Required Equipment

- Anritsu MS203xA VNA Master
- Optionally, an antenna that is appropriate for the frequency range to be measured

### Making a Measurement

To make a measurement, locate and display the signals of interest by selecting the desired frequency, span, and amplitude value, as explained below.

**Note**

In most cases, information and parameters can be entered into the VNA Master through the keypad, the directional arrows, or the rotary knob. The numerical keypad enters the information directly. The up and down arrow keys change a frequency parameter by the value entered through the Freq Step soft key (default value is 1 MHz). The left and right arrow keys change the frequency parameter by one graticule, that is, one-tenth of the total span. The rotary knob changes the frequency parameter by one pixel per step. Choose whichever method is most convenient to enter the required information.

1. Connect the input signal or antenna to the RF In test port.

#### Set the Frequency

2. Press the **Freq** key to display the Frequency menu. The measurement frequency can be set using 3., 4., or 5., below.
3. To enter a center frequency, select the Center Freq soft key and enter the desired center frequency.
4. To set a specific frequency band, select the Start Freq soft key and enter the desired start frequency, then select the Stop Freq soft key and enter the desired stop frequency.

#### Set the Span

5. To set the span, press the **Span** key to display the Span menu and enter the span. For a full span, select the Full Span soft key. Selecting a full span will override any previously set Start and Stop frequencies. For a single frequency measurement, select the Zero Span soft key.

**Note**

To quickly move the span value up or down, select the Span Up 1-2-5 or Span Down 1-2-5 soft keys. These keys facilitate a zoom-in, zoom-out feature in a 1-2-5 sequence.

#### Set the Amplitude

6. Press the **Amplitude** key.
7. Press the Reference Level soft key and use the **Up/Down** arrow keys or the keypad to set the reference level. Press **Enter** to set the reference level.

8. Press the Scale soft key and use the **Up/Down** arrow keys or the keypad to enter the desired scale. Press **Enter** to set the scale.

**Note**

Press the Amplitude soft key and select Auto Atten coupling of the attenuator setting and the reference level to help ensure that harmonics and spurs are not introduced into the measurements. Refer to section [“4-7 Attenuator Functions”](#) on page 4-6 for more information.

## Selecting a Signal Standard

Selecting a signal standard sets the center frequency, channel spacing, integration bandwidth, and span for the first channel of the selected standard. For more information about available signal standards, see [Appendix A, “Signal Standards”](#) which lists standards in table format.

To select a signal standard:

1. Press the **Freq** key to display the Frequency menu.
2. Press the Signal Standard soft key and use the Up/Down arrow keys or the rotary knob to highlight the desired signal standard. Press **Enter** to select the highlighted signal standard.
3. Press the Channel# soft key to choose the required channel. By default, if a channel number has not yet been entered, then the lowest channel number for that standard is automatically selected. The channel numbers that can be selected correspond to the channel numbering schemes of the various signal standards.

## Setting Bandwidth Parameters

Both resolution bandwidth (RBW) and video bandwidth (VBW) can be automatically or manually coupled to the frequency span. That is, the wider the span, the wider the RBW. The ratio of the span width to the resolution bandwidth is 300:1 by default and, if necessary, can be changed as follows:

1. Press the BW key.
2. Select the Span/RBW soft key. The current Span/RBW ratio is shown as part of the soft key label. Change the value using the keypad, the directional arrows, or the rotary knob.

When auto coupling between the span and the RBW is selected, it is indicated on the left side of the display as RBW XXX, where XXX is the bandwidth value. If manual RBW coupling is selected, then a “#” symbol is shown in front of RBW on the left side of the display, and the resolution bandwidth can be adjusted independently of the span. If a nonexistent resolution bandwidth is entered, then the instrument selects the next higher resolution bandwidth. If a value greater than the widest RBW is entered, then the widest RBW will be selected.

Auto coupling of the VBW links the video bandwidth to the resolution bandwidth, so that the wider the RBW, the wider the VBW. Auto coupling is indicated on the left side of the display as VBW XXX. If manual VBW coupling is selected, then a “#” symbol is shown in front of VBW on the left side of the display, and the video bandwidth can be adjusted independently of the RBW. If a nonexistent video bandwidth is entered, then the instrument will select the next higher video bandwidth. If a value greater than the widest VBW is entered, then the widest VBW will be selected.

The ratio of the resolution bandwidth to the video bandwidth can be changed by pressing the **BW** key, the RBW/VBW soft key, and then using the keypad, the directional arrows, or the rotary knob to set the ratio. The current value of the ratio is shown as part of the soft key label.

## 4-4 Resolution Bandwidth

Resolution Bandwidth is determined by the intermediate frequency (IF) filter bandwidth. The spectrum analyzer traces the shape of the IF filter as it tunes past a signal. If more than one IF filter is used in a spectrum analyzer, the narrowest one dominates and is considered the resolution bandwidth. The choice of resolution bandwidth depends on several factors. Filters take time to settle. That is, when a signal first appears at the input of the filter, it will take a while before the signal appears at the output. Additionally, the output of the filter will take some time to settle to the correct value, so that it can be measured. The narrower the filter bandwidth (resolution bandwidth) the longer the settling time needs to be and so the slower the sweep speed.

The choice of resolution bandwidth will depend upon the signal being measured. If two closely-spaced signals are to be measured individually, then a narrow bandwidth is required. If a wider bandwidth is used, then the energy of both signals will be included in the measurement. Thus, the wider bandwidth does not have the ability to look at frequencies selectively but instead simultaneously measures all signals falling within the resolution bandwidth. Therefore, a broadband measurement would include all signals and noise within the measurement bandwidth into a single measurement.

On the other hand, a narrow-band measurement will separate the frequency components, resulting in a measurement that includes separate peaks for each signal. There are advantages to each. The ultimate decision will depend upon the type of measurement required by the user.

There is always some amount of noise present in a measurement. Noise is often broadband in nature; that is, it exists at a broad range of frequencies. If the noise is included in the measurement, the measured value could be in error (too large) depending upon the noise level. With a wide bandwidth, more noise is included in the measurement. With a narrow bandwidth, less noise enters the resolution bandwidth filter, and the measurement is more accurate. If the resolution bandwidth is narrower, the noise floor will drop on the spectrum analyzer display. This is because the IF filter of the analyzer has been made narrower in bandwidth, which lets in less noise. As the measured noise level drops, smaller signals that were previously obscured by the noise can now be measured.

## 4-5 Video Bandwidth

Spectrum analyzers typically use another type of filtering after the detector called video filtering. This filter also affects the noise on the display but in a different manner than the resolution bandwidth. In video filtering, the average level of the noise remains the same but the variation in the noise is reduced. Hence, the effect of video filtering is a “smoothing” of the signal noise. The resultant effect on the analyzer's display is that the noise floor compresses into a thinner trace, while the position of the trace remains the same.

Changing the video bandwidth (VBW) does not improve sensitivity, but it does improve discernability and repeatability when making low-level measurements. As a general rule of thumb, most field spectrum analyzer measurements are made at a video bandwidth that is a factor of 10 to 100 less than the resolution bandwidth. In the MS203xA VNA Master, this ratio can be specified in the BW menu. For a resolution bandwidth of 30 kHz, the typical video bandwidth setting options are either 3 kHz or 300 Hz.

## 4-6 Sweep Limitations

With some spectrum analyzers, the user has control over sweep time (the elapsed time of each sweep, sometimes called scan time). An analyzer cannot be swept arbitrarily fast while maintaining its specified accuracy, but will have a sweep rate limitation depending upon the resolution bandwidth, video bandwidth, and frequency range selected. The sweep rate is not usually chosen by the user but is determined by the frequency range swept divided by the sweep time. The limitation on sweep rate comes from the settling or response time of the resolution and video bandwidth filters. If an analyzer is swept too quickly, the filters do not have time to respond, and the measurement is inaccurate. Under such conditions, the analyzer display tends to have a “smeared” look to it, with the spectral lines being wider than normal and shifted to the right.

Fortunately, the Anritsu VNA Master is designed to relieve the user from having to calculate the sweep speed or experiment to discover a sweep speed that yields accurate results. When changing the RBW and VBW with VNA Master, the sweep speed automatically changes to the fastest sweep speed that will yield accurate results. The sweep speed will be faster for a wide RBW or VBW and slower for a narrow RBW or VBW. The sweep speed can also be changed manually, by pressing the SWEEP key and selecting the Min Sweep Time soft key. Enter a sweep time from 0.05 ms to 4294 seconds. If the minimum sweep time entered by the user is less than the value needed to assure accurate results, the value that delivers accurate results will be used. Regardless of the minimum sweep time setting, the VNA Master will never sweep faster than the RBW and VBW settings will allow. VNA Master is designed to assure that no uncalibrated measurement conditions will occur.

## 4-7 Attenuator Functions

Attenuation adjusts the hand held spectrum analyzer input attenuator. In Auto mode, as the reference level is increased, the attenuation is increased. In Manual mode, the input attenuation can be adjusted using the keypad or the Up/Down arrow keys. The attenuator range is 0 dB to 65 dB, in 5 dB steps. When the preamplifier is on, input attenuation can be either 0 dB or 10 dB.

## 4-8 Preamplifier Operation

The preamplifier can be turned on and off by pressing the **Amplitude** key, then selecting the Preamp On/Off soft key. The preamplifier has a gain of approximately 25 dB and generally will lower the noise floor by that amount. When the preamplifier is on, input attenuation can be either 0 dB or 10 dB.

### Preamplifier Measurement Example

Figure 4-1 and Figure 4-2 show the same signal with the preamplifier off and then on. Notice that when the preamplifier is turned on, the noise floor drops significantly allowing spectral regrowth components that were lost in the noise without the preamplifier to become easily visible.

**Note**

Screen captured images are provided as examples. The image and measurement details shown on your instrument may differ from the examples in this user guide.

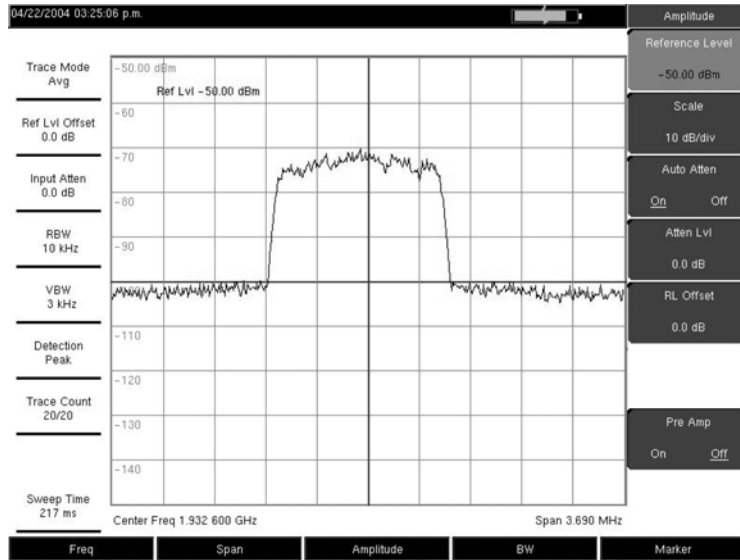

Figure 4-1. Preamplifier Off

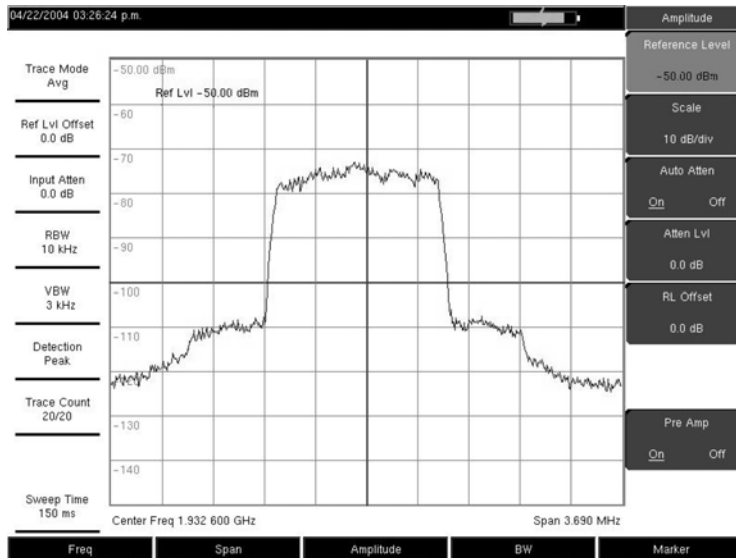

Figure 4-2. Preamplifier On

## 4-9 Field Measurements

In Spectrum Analyzer mode, smart one-button measurements are built into the Anritsu VNA Master for field strength, occupied bandwidth, channel power, adjacent channel power ratio, and carrier to interference ratio (C/I) tests. In addition, AM/FM/SSB demodulation is available to aid in the identification of interfering signals. This section presents brief examples demonstrating the use of these measurements.

## 4-10 Occupied Bandwidth Measurement

Occupied bandwidth (OBW) is a common measurement performed on radio transmitters. This measurement calculates the bandwidth containing the total integrated power occupied in a given signal bandwidth. There are two different methods of calculation depending upon the technique used to modulate the carrier.

### % Down Method

The occupied frequency bandwidth is calculated as the bandwidth containing the specified percentage of the transmitted power.

### dBc Down Method

The occupied frequency bandwidth is defined as the bandwidth between the upper and lower frequency points at which the signal level is a desired number of dB below the peak carrier level.

### Required Equipment

- Anritsu MS203xA VNA Master
- Test Port Extension Cable, Anritsu part number 15NNF50 - 1.5C
- 30 dB, 50 Watt, bi-directional, DC – 18 GHz, N(m) – N(f), Attenuator, Anritsu 42N50A-30 (required if the power level being measured is >+30 dBm)

### Procedure

1. Using the test port extension cable and the 30 dB, 50 watt, bi-directional attenuator (if needed) connect the MS203xA to the appropriate transmitter test port or signal source.
2. Press the **Freq** key followed by the Center Freq soft key and enter the center frequency using the keypad, the arrow keys, or the rotary knob. If entering a frequency using the keypad, the soft key labels change to GHz, MHz, kHz, and Hz. Select the appropriate units key. Selecting the **Enter** key has the same affect as the MHz soft key.
3. If the attenuator was connected in [Step #1.](#), then press the **Amplitude** key and select the RL Offset soft key and set the reference level offset to –30 dB to compensate for the loss in the attenuator.
4. Press the **Amplitude** key then press the Reference Level soft key to set the appropriate reference level.
5. Press the Atten Lvl soft key to set the input attenuation level or leave Auto Atten set to On.
6. Press the **BW** key to set the resolution bandwidth and video bandwidth if desired.

7. Press the **Shift** key then the **Measure** (4) key followed by the OCC BW soft key. Choose the measurement method (dBc Down or % Down) by pressing the Method soft key. The selected method is underlined.
8. Press the dBc or % soft keys to adjust the settings as needed. Common values are 99% and 30 dBc.
9. Press the On/Off soft key to start the measurement. An information box will appear below the graph while occupied bandwidth measurement is on.

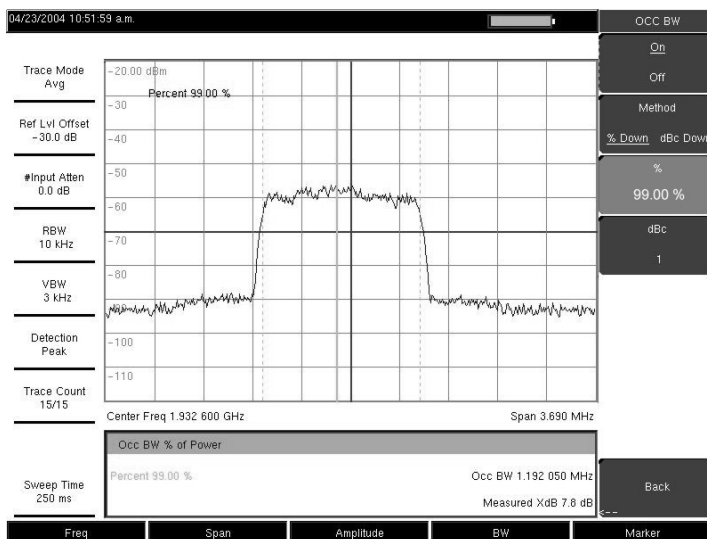

**Figure 4-3.** Occupied Bandwidth Results Using the Percentage of Power Method

Figure 4-3 shows the occupied bandwidth results using the percent of power method on a CDMA signal. Occupied Bandwidth is a constant measurement; after it is turned on, it remains on until it is turned off by pressing the On/Off soft key again. Occupied bandwidth is calculated at the end of each sweep.

## 4-11 Channel Power Measurement

Channel power measurement is one of most common measurements for a radio transmitter. This test measures the output power, or channel power, of a transmitter over the frequency range. Out-of-specification power measurements indicate system faults, which can be in the power amplifiers or in filter circuits. Channel Power measurements can be used to validate transmitter performance, comply with government regulations, or to keep overall system interference at a minimum.

Frequency and span settings for many signal standards can be automatically set by pressing the **Frequency** key and then the Signal Standard soft key. Choose the desired standard and press **Enter**. Press the Channel # soft key to enter the channel number at which the measurement is to take place.



## 4-12 GSM Channel Power Measurement

Global Systems for Mobile (GSM) communication is a globally accepted standard for digital cellular communication. There are a number of frequency bands allocated to GSM mobile phones that use a combination of Frequency Division Multiple Access (FDMA) and Time Division Multiple Access (TDMA). Within each band are approximately one hundred available carrier frequencies on 200 kHz spacing (FDMA), and each carrier is broken up into time-slots so as to support eight separate conversations (TDMA). GSM uses the Gaussian Minimum Shift Keying (GMSK) modulation method.

### Required Equipment

- MS203xA VNA Master
- Test Port extension cable, Anritsu 15NNF50 - 1.5C

### Procedure

1. Using the test port extension cable, connect the signal source to the RF In test port of the Anritsu MS203xA VNA Master.
2. Press the **Amplitude** key and select the Reference Level soft key to set the reference level to  $-20$  dBm. Adjust the values given in this procedure to match your measurement conditions.
3. Press the **Scale** soft key and set the scale to 10 dB/division.
4. Press the **BW** key and verify that RBW Auto and VBW Auto are On.
5. Press the **Freq** key followed by the Signal Standard soft key. Scroll through the dialog box using the rotary knob or Up/Down arrow keys to highlight the GSM900 standard for the measurement and press **Enter**.
6. Press the **Channel#** soft key and enter the channel number using the keypad, the arrow keys, or the rotary knob. For this example, select Channel 60.
7. Press the **Shift** key then the **Measure** (4) key and press the Channel Power soft key.
8. Select the Center Freq soft key and verify that the center frequency of the VNA Master is set to that of the GSM signal, in this case 947.0 MHz.
9. Select the Int BW soft key and enter 200 kHz for the integration bandwidth, or set the integration bandwidth appropriate for the particular application.
10. Select the Span soft key and enter 800 kHz as the channel span, or set the channel span to a value appropriate for the particular application.
11. Make the measurement by pressing the Measure soft key. The MS203xA displays the measurement results in the message area.

<b>Note</b>	Channel Power is a constant measurement. After it is turned on, it will remain on until it is turned off by pressing the On/Off soft key again.
-------------	---

## 4-13 GSM Adjacent Channel Power Measurement

### Required Equipment

- Anritsu MS203xA VNA Master
- 30 dB, 50 watt, Bi-Directional, DC - 18 GHz, N(m) - N(f), Attenuator, Anritsu 42N50A-30 (if required for the power level being measured)
- Test Port extension cable, Anritsu 15NNF50 - 1.5C

### Procedure

1. Using the test port extension cable and 30 dB attenuator, connect the signal source to the input of the attenuator, and connect the output of the attenuator to the RF In test port of the MS203xA.
2. If the attenuator was connected in 1., press the **RL Offset** soft key and set the reference level offset to  $-30$  dB to compensate for the loss of the attenuator.
3. Press the **Amplitude** key and select the Reference Level soft key to set the reference level to 60 dBm.
4. Press the **Atten Lvl** soft key to set the input attenuation level needed for the measurement. This value depends on the input power level and any external attenuator. Enter an attenuation level to achieve roughly  $-40$  dBm at the input mixer.
5. Press the **BW** key and verify that RBW Auto and VBW Auto are On.
6. There are two ways to set the measurement parameters. If the signal standard and channel are known, press the **Freq** key and set the Signal Standard and Select Channel soft keys for the signal to be measured then skip to 12. If the signal standard and channel are not known, follow the procedure from [Step #7.](#) through [Step #12.](#) below.
7. Press the **Freq** key, select the Center Freq soft key, and enter the desired center frequency.
8. Press the **Shift** key then the **Measure** key and select the ACPR soft key.
9. Select the Main Ch BW soft key, and enter the main channel bandwidth.
10. Select the Adj Ch BW soft key, and enter the adjacent channel bandwidth.
11. Select the Ch Spacing soft key, and enter the channel spacing.
12. Make the measurement by pressing the On/Off soft key. The detection method is automatically changed to RMS Average.
13. Solid vertical lines are drawn on the display to indicate the main channel. Dashed vertical lines define the adjacent channels. The MS203xA will display the measurement results in the message area.

**Note**

Adjacent Channel Power Ratio is a constant measurement. After it is turned on, it will remain on until it is turned off by pressing the On/Off soft key again.

## 4-14 Out-of-Band Spurious Emission Measurement

### Required Equipment

- MS203xA VNA Master
- Test Port extension cable, Anritsu 15NNF50 - 1.5C

### Procedure

1. Using the test port extension cable, connect the signal source to the RF In test port of the MS203xA.
2. Press the **Freq** key, select the Center Freq soft key, and enter the center frequency.
3. Press the **Span** key. Set the span wide enough to include the primary channel bandwidth and upper and lower channel bandwidths.
4. Press the **Amplitude** key, then press the Reference Level soft key and set the reference level to  $-20$  dBm.
5. Press the Auto Atten soft key set the attenuation to On.
6. Press the **BW** key and use the RBW and VBW soft keys to set the resolution bandwidth to 3 kHz and the video bandwidth to 300 Hz.
7. Press the **Marker** key and press the Marker 1 2 3 4 5 6 soft key to select marker 1. The underlined number indicates the active marker.
8. Press the On/Off soft key and use the arrow keys, the keypad and the knob to move the marker over one of the spurs.
9. Compare the value of the marker to the specified allowable level of out-of-band spurious emissions for the corresponding channel transmit frequency.

10. Repeat [Step #8](#), and [Step #9](#), for the remaining spurs. Use either Marker 1 again, or choose another marker. [Figure 4-4](#) shows a simulated out-of-band spurious signal 21.000 MHz from the carrier using a delta marker.

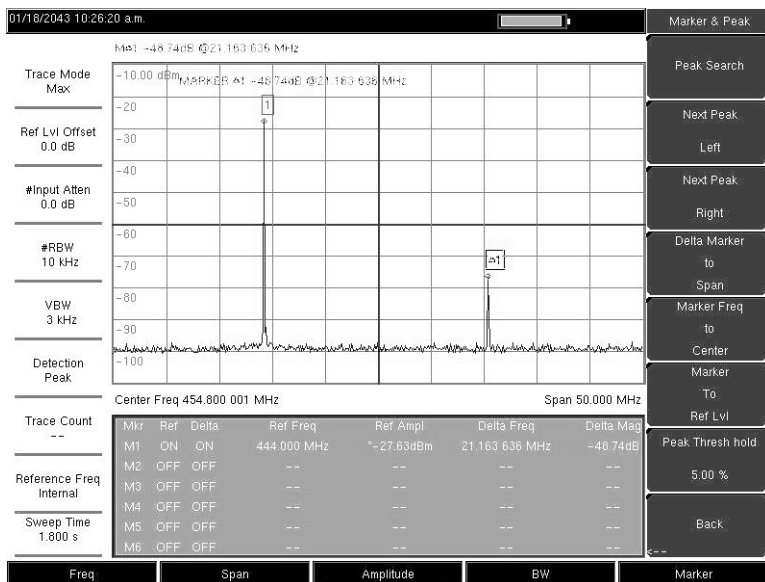

**Figure 4-4.** Simulated Out-of-Band Spurious Emission Measurement

## 4-15 In-Band/Out-of-Channel Measurements

The in-band/out-of-channel measurements are those measurements that measure distortion and interference within the system band, but outside of the transmitting channel. These measurements include in-band spurious emissions and adjacent channel power ratio (also called spectral regrowth). There are stringent regulatory controls on the amount of interference that a transmitter can spill to neighboring channels. In order to determine compliance with the allowable level of spurious emissions, two parameters need to be specified:

- Measurement channel bandwidth
- Allowable level of spurious emissions

## 4-16 In-Band Spurious Measurement

### Required Equipment

- MS203xA VNA Master
- 30 dB, 50 watt, Bi-Directional, DC - 18 GHz, N(m) - N(f), Attenuator, Anritsu 42N50A-30
- Test Port extension cable, Anritsu 15NNF50 - 1.5C

### Procedure

1. Using the test port extension cable and 30 dB, 50 watt, Bi-directional attenuator, connect the MS203xA to appropriate transmit test port.
2. Press the **Freq** key, select the Center Freq soft key, and enter the center frequency.
3. Press the **Span** key. Set the span wide enough to include the primary channel bandwidth and upper and lower channel bandwidths.
4. Press the **Amplitude** key and then press the Reference Level soft key to set the reference level to  $-20$  dBm.
5. Select the RL Offset soft key to set the reference level offset to  $-30$  dB to compensate for the loss of the attenuator
6. Press the Auto Atten soft key set the attenuation to On.
7. Press the **BW** key and use the RBW and VBW soft keys to set the resolution bandwidth to 10 kHz and the video bandwidth to 300 Hz.
8. Press the **Marker** key and press the Marker 1 2 3 4 5 6 soft key to select marker 1. The underlined number indicates the active marker.
9. Press the On/Off soft key and use the arrow keys, the keypad and the knob to move the marker over one of the spurs.
10. Compare the value of the marker to the specified allowable level of in-band/out-of-channel spurious emissions for the corresponding channel transmit frequency.
11. Repeat [Step #9.](#) and [Step #10.](#) for the remaining spurs. Use either Marker 1 again, or choose another marker.

Figure 4-5 shows a simulated in-band spur at 1.627272 MHz from the carrier frequency ( $f_c$ ) of 444.001820 MHz and is measured by M1. The delta marker on M1 shows the signal at  $f_c + 1.627272$  MHz to be 60.60 dB down from the carrier. These values should be compared against the specification for the transmitter being tested.

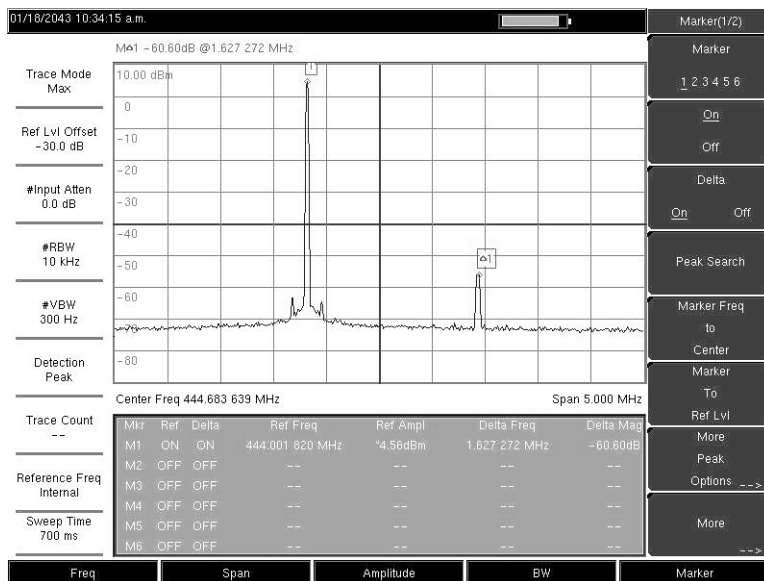

Figure 4-5. In-band Spurious Measurement

**Note** The resolution bandwidth of a spectrum analyzer is determined by the intermediate frequency (IF) filter bandwidth. The MS203xA traces the shape of the IF filter as it sweeps past a signal.

Therefore, if two equal amplitude signals are very close to each other, the measurement result can appear to be one single response because the IF or resolution bandwidth is not small enough to resolve the two signals.

Similarly, if two signals are not equal in amplitude but are very close together, the smaller signal may not be seen because it is hidden under the large response.

## 4-17 Field Strength

### Required Equipment

- Anritsu MS203xA VNA Master
- Portable Antenna for which antenna factors or antenna gain and bandwidth data are available.

### Procedure

1. Press the **Shift** key then the **Measure** key and press the Field Strength soft key.
2. Press the Antenna soft key and use the Up/Down arrow keys or the rotary knob to select the desired antenna. Press the **Enter** key to select.

<b>Note</b>	Select an antenna from the standard list available in the MS203xA, or use the Antenna Editor feature of Anritsu Master Software Tools to define a custom antenna and upload the antenna information to the MS203xA antenna list.
-------------	--

3. Connect the antenna to the MS203xA.
4. Press the **Freq** key, select the Center Freq soft key, and enter the center frequency.
5. Press the **Span** key. Set the span wide enough to include the primary channel bandwidth and upper and lower channel bandwidths.
6. Press the **BW** key and verify that RBW Auto and VBW Auto are On.
7. To change the units of measurement, press the **Amplitude** hard key, then press the Units soft key and select dBm, dBV, dBmV, or dB $\mu$ V.
8. Select either the Volts or Watts soft key, as required. The MS203xA automatically adjusts the measurement by the antenna factors selected. Marker values will be displayed in the same units as selected for the amplitude.

## Antenna Calculations

The following is a list of various antenna calculations should you find it necessary to convert from one to another:

### **Conversion of Levels from W to V**

Conversion of signal levels from W to V in a 50 ohm system:

$$P = \frac{V^2}{R}$$

where:

P = power in Watts

V = voltage level in Volts

R = resistance in ohms

Note that:

$$1\text{mW} = 10^{-3}\text{W} \quad \text{and} \quad 1\mu\text{V} = 10^{-6}\text{V}$$

For power in dBm, and voltage in dB ( $\mu\text{V}$ ):

$$V_{\text{dB}(\mu\text{V})} = P_{\text{(dBm)}} + 107\text{dB}.$$

### **Power Density**

Power density to field strength. An alternate measure of field strength to electric field is power density:

$$P_d = \frac{E^2}{120\pi}$$

where:

E = field strength in V/m

P = Power density in W/m

### **Power Density at a Point**

Power density at a point is equal to:

$$P_d = \frac{P_t \times G_t}{4 \times \pi \times r^2}$$

In the far field, where electric and magnetic fields are related by the impedance of free space, where:

$P_d$  = power density in W/m

$P_t$  = power transmitted in Watts

$G_r$  = gain of transmitting antenna

r = distance from the antenna in meters



## 4-18 AM/FM/SSB Demodulation

The VNA Master built-in demodulator for AM, narrowband FM, wideband FM and single sideband (selectable USB and LSB) allows a technician to hear an interfering signal to ease identification. The demodulated signal can be heard using either the built-in speaker, or through a monaural headset connected to the 2.5-mm jack on the test panel.

### Demodulation Procedure

1. Press the **Shift** key followed by the **Measure** (4) key and the AM/FM Demod soft key.
2. Press the Demod Type soft key and select FM Wide Band, FM Narrow Band, AM, USB, or LSB to match the modulation format of the signal.
3. Press the Back soft key.
4. Press the Demod Freq soft key and use the keypad or rotary knob to enter the center frequency of the signal to be demodulated. For USB and LSB signals, fine tune the signal by adjusting the Beat Freq Osc. By default the BFO frequency is set to zero, meaning that the re-injected carrier is exactly at the demodulation frequency. The Beat Freq Osc soft key allows adjustment of the beat frequency oscillator to fine tune the signal through a span of  $\pm 10,000$  Hz.
5. Press the On/Off soft key to enable the measurement.
6. Press the Volume soft key and use the **Up/Down** arrow keys or rotary knob to change the audio volume from 0% to 100%. For most headsets a volume of 40% is adequate.
7. The Demod Time soft key sets the time the VNA Master will demodulate the signal. Enter a value from 100 ms to 500 seconds.

## 4-19 Carrier to Interference Ratio Measurement

Carrier to Interference Ratio (C/I) Measurement is a two-step process, first measuring the carrier level and then, with the carrier turned off, measuring the remaining signals and noise in the band of interest. After the two measurements are complete, the ratio of the carrier level to the noise plus interference is displayed using three assumptions:

- The interferer is a narrowband frequency hopping signal (NB FHSS)
- The interferer is a wideband frequency hopping signal (WB FHSS)
- The interferer is a broadband signal (BB).

The primary application for this type of measurement is determining the magnitude of interference problems for 802.11b, 802.11g and 802.11a access points (hot spots).

### Procedure

1. Press the **Frequency** key followed by the Signal Standard soft key. Select the appropriate signal standard based on the signal to be measured and press **Enter**.
2. Press the Select Channel soft key, select the operating channel of the access point being measured and press **Enter**.
3. Press the **Shift** key followed by the **Measure** (4) key and the C/I soft key.
4. Press the Center Freq soft key and enter the desired frequency, unless a Signal Standard and Channel have already been selected in the **Frequency** menu.
5. If needed, press the Span soft key and set an appropriate span width for the signal to be measured.
6. If the signal environment includes slow frequency hopping signals, such as cordless telephones, press the Min Sweep Time soft key to set a sweep time of one second or more to give a good chance of capturing instances of the interfering signal.
7. Press the On/Off soft key and follow the on-screen prompts to complete the measurement.

<b>Note</b>	Access to the transmitter is required to complete this procedure as the transmitted carrier must be turned off for the second portion of the measurement.
-------------	---

8. After the measurement is complete, the measurement box gives results for the three different signal types. Some measurement results may show as Error, and this is to be expected.

The following figures show the C/I measurement steps, ready to measure the carrier, with the carrier measured, and the measurement results.

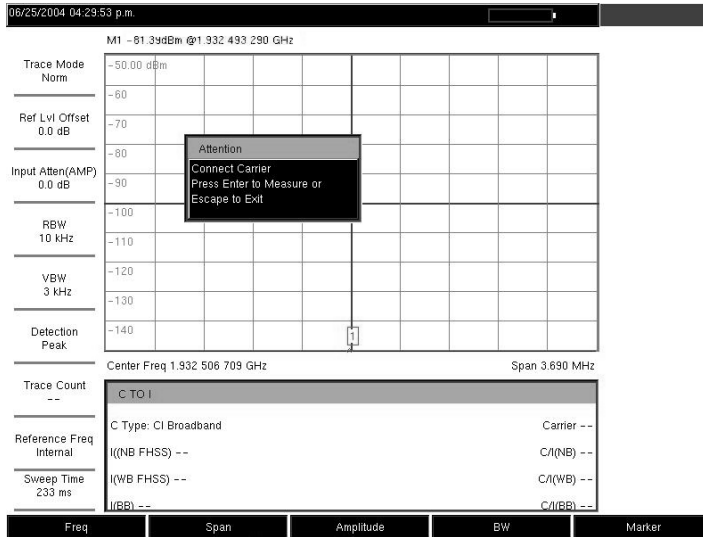

Figure 4-6. C/I Measurement, Ready to Measure the Carrier

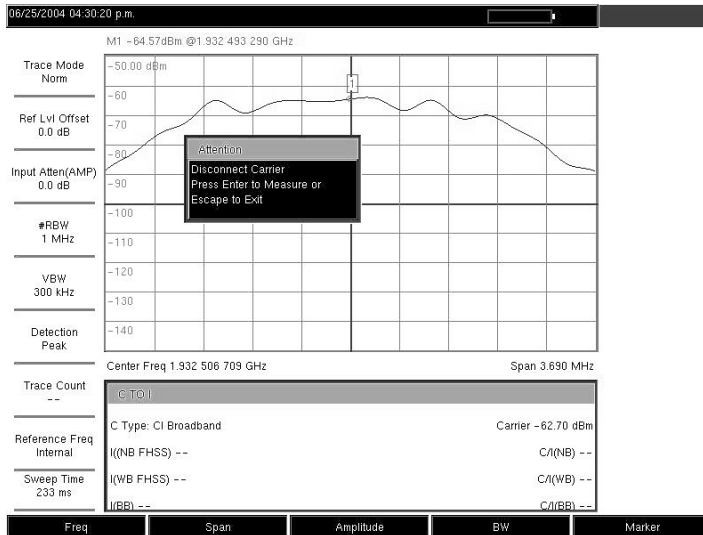

Figure 4-7. C/I Measurement, Carrier Measured

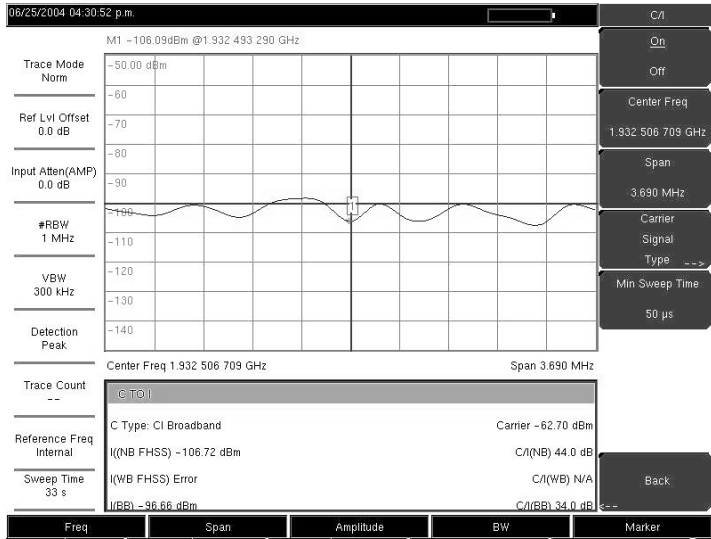

Figure 4-8. C/I Measurement, Results

## 4-20 SPA Function Menu Tree

### Introduction

This chapter describes the VNA Master keys and how to use them. The major key sections are arranged in alphabetical order. The soft key menus under those key selections are listed in the order that they appear on the instrument, from top to bottom.

The following menu trees provide overviews of the spectrum analyzer (SPA) capabilities of the VNA Master while in spectrum analyzer mode. These menu trees are presented in alphabetical order for easy access.

- Amplitude Menu
- BW (Bandwidth) Menu
- File Menu
- Freq (Frequency) Menu
- Limit Menu
- Marker Menu
- Measure Menu
- Mode Menu
- Preset Menu
- Sweep Menu
- System Menu
- Trace Menu

The five function hard keys are located below the display and are used to initiate function-specific menus:

- Frequency
- Span
- Amplitude
- Bandwidth
- Marker

In addition, 21 hard keys and a rotary knob are located to the right of the display. Eight of the hard keys are dual purpose, depending upon the current mode of operation. The dual-purpose keys are labeled with a number on the key itself and with the alternate function printed on the panel *above* the key. Use the **Shift** key to access the functions printed on the panel. The **Escape** key, used for aborting data entry, is the round button that is located above the soft keys. The rotary knob and the keypad can both be used to change the value of an active parameter.

Eight soft keys are located to the right of the display. They change function depending upon the current menu selection. The current soft key function is indicated in the active function block (soft key menu) on the right of the display.

## 4-21 Amplitude

### Description

The **Amplitude** hard key is located below the display. The Amplitude menu soft keys are shown in [Figure 4-9](#).

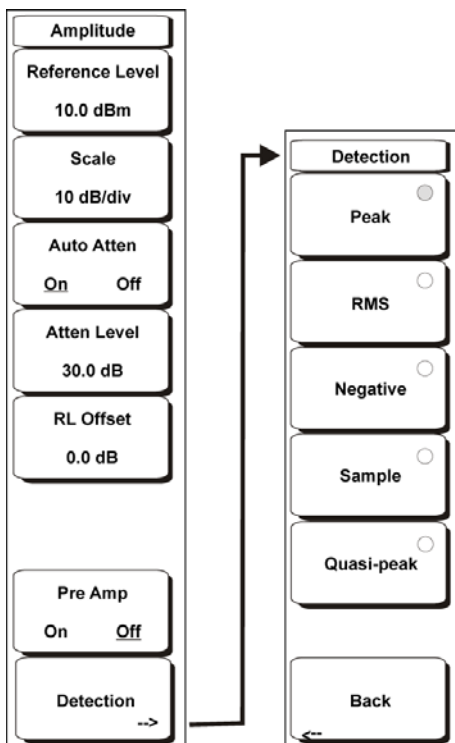

**Figure 4-9.** Amplitude Menu Soft Keys

#### Reference Level

The reference level is the top graticule line on the display, and can be set from +30 dBm to –150 dBm. A value may be entered from the key pad, using the  $\pm$  key as the minus sign. After entering the value press the dBm soft key or the **Enter** key. The **Up/Down** arrow keys change the reference level in 10 dB steps, and the **Left/Right** arrow keys change the value by 1 dB. The rotary knob changes the value by 0.1 dB per detent.

The reference level value may be modified by the reference level offset value, discussed later in this chapter.

#### Scale

The scale can be set in 1 dB steps from 1 dB per division to 15 dB per division. The value can be changed using the keypad, the rotary knob or the **Up/Down** arrow keys.

#### Auto Atten On/Off

Input attenuation can be either tied to the reference level (On) or manually selected (Off). When input attenuation is tied to the reference level, attenuation is increased as higher reference levels are selected to make sure the instrument input circuits are not saturated by large signals that are likely to be present when high reference levels are required.

#### Atten Lvl

Input attenuation can be set from 0 dB to 65 dB, in 5 dB steps. Select this soft key and use the keypad, rotary knob, or the **Up/Down** arrow keys to change the attenuation value. When the Preamplifier is turned on, the allowed attenuation settings are 0 dB and 10 dB.

#### RL Offset

Reference Level Offset compensates for the presence of input attenuation or gain external to the instrument. Enter a positive value to compensate for an external amplifier or a negative value to compensate for an external attenuator. Use the  $\pm$  key to enter the negative sign when a negative attenuation value is being entered.

#### Pre Amp On/Off

This soft key turns the low-noise front-end preamplifier on or off. The preamplifier in the MS203xA lowers the noise floor by approximately 25 dB. To assure accurate measurement results, the largest signal into the instrument input when the preamplifier is turned on should be less than  $-50$  dBm.

#### Detection

Several detection methods tailor the performance of the instrument to meet specific measurement requirements. In general, there are more measurement points across the screen than display points. The various detection methods are different ways of dealing with selecting which measurement point will be shown at each display point.

**Peak**

This method causes the largest measurement point to be shown for each display point, and assures that a narrow peak is not missed.

**RMS**

This method performs a root-mean-square calculation of all the measurement points in each display point. It is particularly useful in displaying the average value of noise.

**Negative**

This method causes the smallest measurement point to be shown for each display point. Typically this mode is used to help detect small discrete signals in the presence of nearly equal values of noise. The display points that contain only noise will tend to show lower amplitudes than those that contain discrete signals.

**Sample**

This is the fastest detection method since for each display point only one frequency point is measured. Use this method when speed is of paramount importance and the possibility of missing a narrow peak is not important.

**Quasi-peak**

When this selection is made, resolution bandwidths and video bandwidths of 220 Hz, 9 kHz and 120 kHz are available. This detection method is designed to meet CISPR requirements.

**Back**

Returns to the previous menu.



## 4-22 BW (Bandwidth)

The **BW** hard key is located below the display. The BW menu soft keys are shown in [Figure 4-10](#).

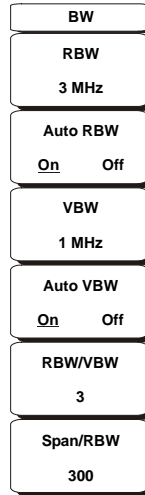

**Figure 4-10.** BW Menu Soft Keys

### RBW

The current resolution bandwidth value is displayed in this soft key. The RBW can be changed using the keypad, the **Up/Down** arrow keys, or the rotary knob. The range is 1 Hz to 3 MHz in a 1-3 sequence, from 1 Hz to 3 Hz to 10 Hz, and so on.

### Auto RBW

When Auto RBW is On, the instrument selects the resolution bandwidth based on the current span width. The ratio of span width to RBW can be specified using the Span/RBW soft key.

### VBW

The current video bandwidth value is displayed in this soft key. The VBW can be changed using the keypad, the **Up/Down** arrow keys, or the rotary knob. The range is 1 Hz to 3 MHz in a 1-3 sequence.

### Auto VBW

When Auto VBW is On, the instrument selects the video bandwidth based on the resolution bandwidth. The ratio of video bandwidth to resolution bandwidth can be set using the RBW/VBW soft key.

### RBW/VBW

This soft key displays the ratio between resolution bandwidth and video bandwidth. To change the ratio, select this soft key and use the keypad, the **Up/Down** arrow keys, or the rotary knob to select a new ratio. The default ratio is 3. When the quasi-peak detector is selected, the RBW/VBW ratio is changed to 1.

### Span/RBW

This soft key displays the ratio between the span width and the resolution bandwidth. The default value is 300, meaning that the span width is approximately 300 times the resolution bandwidth. The value is approximate because resolution bandwidth filters come in discrete steps while span width can be set to any value up to the maximum frequency of the instrument. To change the ratio, select this soft key and use the keypad, the **Up/Down** arrow keys, or the rotary knob to select a new ratio.

## 4-23 File

To access the functions under the File menu, select the **Shift** key, then the **File** (7) key. The File menu soft keys are:

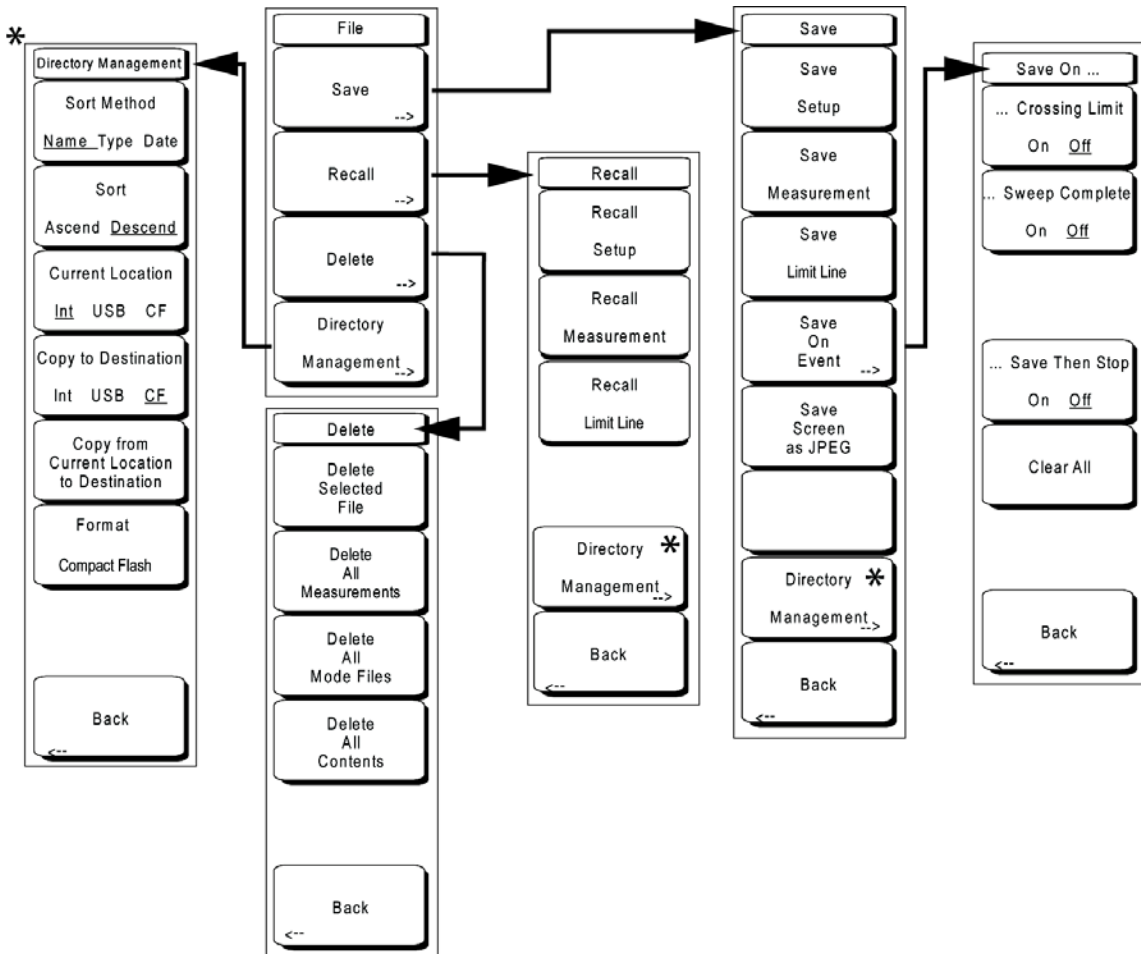

**Figure 4-11.** File Menu Soft Keys

### Save

Measurements may be saved to the internal memory, an external Type-1 Compact Flash module, or a USB Flash Drive. Anritsu recommends saving to external storage if a large number of measurements are to be saved. The instrument is shipped with a Compact Flash module and a USB Flash Drive. In order to hold the entire contents of the internal memory, external memory devices must be at least 256 MB. Compact Flash modules greater than 512 MB storage capacity may not function properly.

For information on external memory part numbers, see Section ["1-8 Standard and Optional Accessories"](#) on page 1-6.

### Save Setup

Opens a dialog box to name and save the current operating settings, allowing them to be recalled later to return the instrument to the state it was in at the time the setup was saved. The saved setup can be named using the keypad to select numbers, the rotary knob to highlight a number or character and pressing the knob to select, or by selecting the soft key for each letter. Use the **Shift** key to select an upper case letter. Use the **Left/ Right** directional arrows to move the cursor position. Press **Enter** to save the setup.

### Save Measurement

Initiates a dialog box to name and save measurement data for all three current trace locations: A, B, and C. The saved measurement can be named using the keypad to select numbers, the rotary knob to highlight a number or character and pressing the knob to select, or by selecting the soft key for each letter. Use the **Shift** key to select an upper case letter. Use the **Left/Right** directional arrows to move the cursor position. Press **Enter** to save the measurement trace. Measurements are saved in a directory called /usr on the Compact Flash memory module or the USB Flash Drive.

#### Note

If a measurement has been previously saved, the Save Measurement dialog box will open with the previously saved name displayed. To save the new measurement with a similar name (for example, Trace-1, Trace-2, etc.) simply press the Right directional arrow and add the changes. To create a completely new name, use the keypad, the rotary knob, or select the soft key for each letter.

**Table 4-1.** SPA File Storage on Compact Flash Modules

Memory Size	Approximate # of SPA Files Stored
256 MB	8,900
512 MB	17,800

### Save Limit Line

Pressing this soft key opens a dialog box to save the current upper and lower limit lines. You can name the saved limit line yourself or accept the name that is suggested by the instrument (which is based on a previously saved name). If you decide not to save the limit line, press **Esc** to stop the save dialog.

### Save On Event...

The instrument can be configured to automatically save a measurement if a selected condition is satisfied. As measurements are saved, an on-screen message indicates approximately how many more files can be saved. Over 3000 spectrum analyzer measurements can be saved before the internal memory is full. The number of measurements that can be stored in the Compact Flash memory depends on the size of the memory module. When measurements are saved, they are saved into subdirectories that are automatically created in the /usr subdirectory. The names are based on the date and time. Each subdirectory can contain a maximum of 1000 measurements.

#### ... Crossing Limit On/Off

When Crossing Limit is On, and an upper or lower limit line is set, if any point in a measurement exceeds either the upper or lower limit line, the

measurement is automatically saved at the end of the sweep. The saved measurement is named “LIM” followed by the date and time in the format: LIMyyyymmddhhmmss. The time value in the file name will generally be slightly earlier than the measurement time stamp shown in the file list, since the file name is created at the time the limit violation is noted and the time stamp is the time at which the measurement file is actually saved.

If a limit line has not been set, selecting this soft key results in the on-screen message:

“You must have a limit ON first.”

#### ... Sweep Complete On/Off

When Sweep Complete is On, the measurement is automatically saved at the end of a sweep. This is particularly useful for very slow sweeps. The saved measurement is named “EOS” with a file name in the format: EOSyyyymmddhhmmss.

#### Save Then Stop On/Off

When the Save Then Stop soft key is set to On, the instrument will save just one measurement when the Crossing Limit or Sweep Complete soft keys are set to On, and the qualifying event occurs. Sweeping stops after a measurement is saved. If it is set to Off, sweeping continues after a measurement is saved and more measurements may be saved. The default for this selection is Off.

#### Note

This feature should be used with care. With **Save Then Stop** set to **Off** (the default) a large number of measurements can be saved when the Crossing Limit or Sweep Complete soft keys are set to On, making it time-consuming to retrieve saved measurements or to delete unwanted measurements. When there are many saved measurements, the time required to display a file list can be several minutes. When it is necessary to save many measurements, it is best to save them to the memory module and then read them directly into a computer.

#### Clear All

Pressing this soft key turns off both save on event conditions and sets Save then Stop to Off, the default state.

#### Back

The Back key returns to the previous menu.

#### Save Screen as JPEG

This function saves a measurement trace as a graphics file. The saved measurement can be named using the keypad to select numbers, the rotary knob to highlight a number or character and pressing the knob to select, or by selecting the soft key for each letter. Use the **Shift** key to select an upper case letter. Use the **Left/Right** directional arrows to move the cursor position. Press **Enter** to save

the measurement after entering the file name. The file is saved in the internal memory with the specified name, with .jpg appended.

**Note**

If a measurement has been previously saved, the Save Measurement dialog box will open with the previously saved name displayed. To save the new measurement with a similar name (for example, Trace-1, Trace-2, etc.) simply press the Right directional arrow and add the changes. To create a completely new name, use the keypad, the rotary knob or select the soft key for each letter.

#### Directory Management

For information on the Directory Management soft key and menu, see [“Directory Management” on page 4-32](#).

#### Back

The Back key returns to the previous menu.

#### Recall

This soft key brings up the Recall options menu.

#### Recall Setup

This soft key brings up a selection box that allows selection and recall of a previously stored instrument setup in the current storage location. Use the rotary knob or the **Up/Down** arrow keys to highlight the saved setup, and press **Enter**, the rotary knob, or the **Recall** soft key to select. All current instrument settings are replaced by the stored setup information. Press the **Esc** key to cancel the recall.

#### Recall Measurement

This soft key brings up a selection box that allows recall of a previously stored measurement from the currently selected storage location. Use the rotary knob or the **Up/Down** arrow keys to highlight the saved measurement trace, and press **Enter**, the rotary knob, or the **Recall** soft key to select.

The recalled traces A, B, and C will be shown as information-only traces, along with the live traces currently on the display. The name of the recalled measurement, along with the setup information for each of its traces, will be displayed in the area below the graph.

Press the **Shift** key and the **Trace (5)** key to access operations concerning the recalled traces. The recalled traces can be viewed or blanked, cleared completely from memory, or moved into live trace locations to be used for trace math and marker operations.

#### Recall Limit Line

Pressing this soft key opens a dialog box to recall a saved limit line. The dialog box presents a list of saved limit lines. Highlight the desired limit line and press **Enter**. If you decide not to recall a limit line, then press **Esc** to stop the dialog. If the save limit is a relative limit, then it is recalled centered about the current center frequency. If the saved limit is an absolute limit, then it is recalled to the frequency at which it was created. If you recall an absolute limit, or if it is off screen, then you will see the left or right limit off-screen indicator on the edge of the screen.

## Directory Management

For information on the Directory Management soft key and menu, see “[Directory Management](#)” on page 4-32.

### Delete

Brings up a selection box that shows the first 1000 stored setups and traces in the currently selected location (see “[Directory Management](#)” on page 4-32). The list shows the setup and measurement names, the type (stp for a saved setup, spa for a saved trace, jpg for a JPEG file) and the date and time the information was saved. Use the rotary knob or the **Up/Down** arrow keys to highlight the file to be deleted, and press **Enter**, or the Delete soft key to delete. Press the **Esc** key to cancel the operation. Note that there is no mechanism to retrieve deleted files.

### Delete Selected File

Use the up and down arrow buttons or the rotary knob to select the file that is to be deleted. Press **Enter** to confirm that you want to delete the file or **Esc** to exit without deleting.

### Delete ALL Measurements

Deletes all measurements of the current mode in the currently selected storage location. The memory from which measurements will be deleted is set in the Directory Management menu and is the Current Location.

### Delete ALL Mode Files

Deletes all measurements of the type saved in the current operating mode of the instrument. In addition all jpg and setup files (regardless of the mode) are deleted.

### Delete ALL Contents

Deletes all measurements, jpg files and setup files of all measurement types. All contents of external devices are deleted (CF and USB memory). For internal memory, all user files are deleted. Use with caution.

### Back

The Back key returns to the previous menu.

## Directory Management

This soft key brings up the Directory Management menu. Note that the Directory Management menu is available from both the Recall and Save menus.

### Sort Method Name Type Date

File lists can be sorted by the name of the file, the type of file (SPA file, STP file, etc.) or by the date that the file was saved.

### Sort Ascending Descending

Selects whether the selected sort is sorted from lowest to highest (ascending) or highest to lowest (descending). When sorting by name, the sort will place file names that start with numbers before file names that start with letters (an ASCII sort).

### Current Location Int USB CF

This choice lets you select where measurements and setups will be saved. Pressing the soft key toggles between storing files on the internal memory, USB flash drive or a Compact Flash memory module. The “current location” and the “copy to destination” may not be the same. Changing the current location to save

files causes the “copy to destination” to be automatically changed if the selected storage location is the same as the selected current location.

#### Copy to Destination Int USB CF

This choice lets you select where measurements and setups in the “current location” will be copied. The “current location” and the “copy to destination” may not be the same. If you change the destination to which the instrument will copy files, the current location is automatically changed if the current location is the same as the selected copy to destination.

#### Copy From Current Location To Destination

Pressing this soft key causes all measurements, setups and jpg files stored in the user selected “current location” to be copied to the “copy to destination”. If no storage module is installed in the instrument, an error message is displayed.

#### Format Compact Flash

This selection erases all files on an installed Compact Flash module. A message is displayed warning that all files will be erased. Press Enter to confirm that you want to erase and Esc to quit without erasing. In addition to erasing all files stored on the Compact Flash, the /usr directory is created for storage of measurements, setups and jpg files.

#### Back

The Back key returns to the previous menu.



## 4-24 Freq (Frequency)

The tuning frequency range for the VNA Master can be entered in several different ways depending on what makes the most sense for the user or for the application. The center frequency and span can be specified, the start and stop frequencies can be entered, or a signal standard and channel number can be selected from the built-in list. The **Freq** hard key is located below the display. The Freq menu soft keys are shown in [Figure 4-12](#).

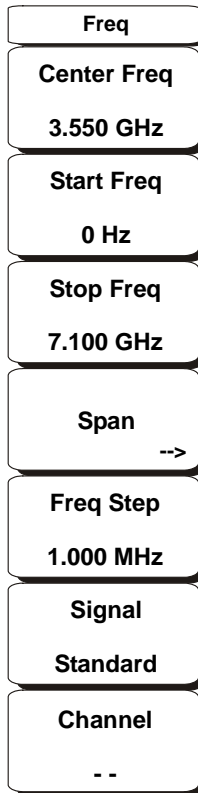

Figure 4-12. Freq Menu Soft Keys

### Center Frequency

Press the **Freq** key followed by the Center Freq soft key and enter the desired frequency using the keypad, the arrow keys, or the rotary knob. If entering a frequency using the keypad, the soft key labels change to GHz, MHz, kHz, and Hz. Select the appropriate units key. Selecting the **Enter** key has the same affect as the MHz soft key.

#### Note

When using the up and down arrows, the frequency moves in steps that are defined by the value that was entered using the Freq Step soft key.

When using the left or right arrow keys, the frequency of the active parameter moves by 10% of the current frequency span. If the instrument is in zero span, then the left and right arrows do nothing.

Turning the rotary knob changes the active frequency parameter in increments of one display point for each click of the knob.

The width across the screen is 551 display points.

### Start Frequency

Press the **Freq** key followed by the Start Freq soft key and enter the desired frequency using the keypad, the arrow keys, or the rotary knob. If a start frequency higher than the current stop frequency is entered, the stop frequency will be changed to yield a 10 Hz span.

### Stop Frequency

Press the **Freq** key followed by the Stop Freq soft key and enter the desired frequency using the keypad, the arrow keys, or the rotary knob. If a stop frequency lower than the current start frequency is entered, the start frequency will be changed to yield a 10 Hz span.

### Span

Press the **Freq** key followed by the Span soft key and enter the desired span. The Span menu is used to set the frequency range over which the instrument will sweep:

- For the MS2034A, the span can be set from 10 Hz to 4.0 GHz.
- For the MS2036A, the span can be set from 10 Hz to 7.1 GHz.

Span can also be set to zero span for all models.

The soft key shows the current value for span in units of GHz, MHz, kHz, or Hz. When the Span button is pressed, span becomes the active parameter and may be changed. Use the keypad, the directional arrow keys or the rotary knob to increase or decrease the span frequency. If the span is changed using the **Up/Down** arrow keys, the span changes by the value of the Frequency Step for each key press.

### Freq Step

Press the **Freq** key followed by the Freq Step soft key to enter the desired frequency step size. The frequency step specifies the amount by which a frequency will change when the **Up/Down** arrow keys are pressed. The center frequency, start frequency, and stop frequency values can be changed using Freq Step. The active parameter will be changed by the frequency step when the Up/Down arrow keys are pressed. If Freq Step is the active parameter, nothing happens when the arrow keys are pressed. The frequency step size can be any value from 1 Hz to 7.1 GHz, 13 GHz, or 20 GHz with a resolution of 1 Hz. Use the keypad or the rotary knob to change the Frequency Step size.

### Signal Standard

Use the **Up/Down** arrow keys or the rotary knob to highlight a signal standard and press **Enter** to select.

When a signal standard is selected, the center frequency and span for the first channel of the particular standard is automatically tuned. Other settings, such as channel spacing and integration bandwidth, are also automatically entered.

[Appendix A, "Signal Standards"](#) contains a table of the signal standards that are in the instrument firmware.

### Channel #

Use the **Up/Down** arrow keys, the keypad, or the rotary knob to select a channel number for the selected signal standard. The center of the channel is tuned to the center of the spectrum analyzer display.

## 4-25 Limit

To access the functions under the Limit menu, select the **Shift** key, then the **Limit** (6) key. The Limit menu soft keys are:

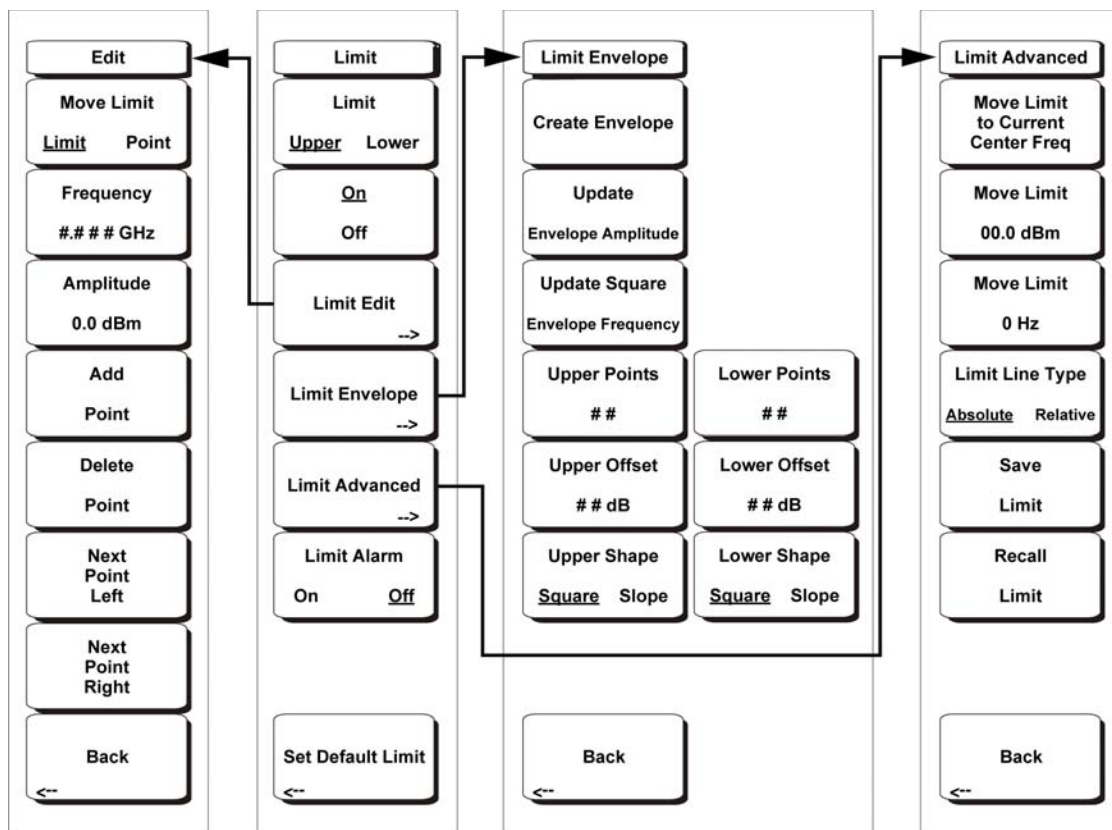

**Figure 4-13.** Limit Menu Soft Keys

Two types of limit lines can be specified, lower limit lines and upper limit lines. Limit lines can be used for visual reference only, or for pass/fail criteria using the limit alarm. For more information on the Limit Alarm functions, see section [“Limit Alarm On/Off” on page 4-42](#). Limit alarm failures are reported whenever a signal is above the upper limit line or below the lower limit line. Each limit line can consist of a single segment, or as many as 40 segments across the entire frequency span of the instrument. These limit segments are retained regardless of the current frequency span of the instrument, which allows the configuring of specific limit envelopes at various frequencies of interest without having to re-configure them each time the frequency is changed.

### Limit Upper/Lower

This soft key selects which limit line will be active for editing. The limit line that is currently selected for editing is underlined.

### On/Off

This soft key turns the active limit line (upper or lower) on or off.

### Limit Edit

This soft key displays a submenu that allows creating or editing of single or multi-segment limit lines. The currently active limit point is marked by a red circle on the display.

#### Move Limit Limit/Point

Selects whether activity from the Frequency and Amplitude soft keys (described below) affect the entire limit or only the active limit point. Values shown in the Frequency and Amplitude soft keys represent values for the current limit point. If Move Limit is set to Limit, any change to these values for the active point will result in similar changes for all points in the limit.

#### Frequency, ## Hz

The frequency of each inflection point in a limit line can be individually set. When a new point is added, it takes on a value halfway between two existing points, or it takes on the stop frequency of the current sweep if no point is higher in frequency than the one being added. See the Add Point soft key description for more details. Use the keypad, the Left/Right arrow keys, or the rotary knob to change the frequency of an inflection point.

#### Amplitude, ### dBm

The amplitude of each inflection point can also be individually set. By default, when a new point is added, it takes on the amplitude that is on the limit line at the frequency where the point was added. Use the keypad (using the  $\pm$  key to set a negative value), the **Up/Down** arrow keys, or the rotary knob to move the point to the desired value. The unit of the amplitude limit is the same as the current vertical amplitude unit. See the Add Point soft key description in the next paragraph for more details.

#### Add Point

The precise behavior of this soft key depends upon which inflection point is active at the time that the key is pressed. If the active limit point is somewhere in the middle of a multi-segment limit line, then a new limit point is added that is halfway between the currently active point and the point immediately to its right. The amplitude of the inflection point will be such that it falls on the limit line. For example, if a limit point exists at 2.0 GHz with an amplitude of -30 dBm, and if the next point is 3.0 GHz with an amplitude of -50 dBm, then the added point will be at 2.5 GHz with an amplitude of -40 dBm. The frequency and amplitude values of the new point can be adjusted as needed with the Frequency and Amplitude soft keys.

If the last limit point is active (assuming it is not at the right edge of the display), then the new limit point will be placed at the right edge of the display at the same amplitude as the point immediately to its left. Points may not be added beyond the current sweep limits of the instrument.

#### Delete Point

This soft key deletes the currently active point. The active point becomes the point that is immediately to the left of the point that was deleted.

#### Next Point Left

This soft key selects the inflection point that is immediately to the left of the current active point, making this newly selected point active for editing or deletion. With each key press, the selection of the active point moves to the left of

the previously active point, until the selected active point is on the left side of the display.

#### Next Point Right

This soft key selects the limit point that is immediately to the right of the current active point, making this newly selected point active for editing or deletion. With each key press, the selection of the active point moves to the right of the previously active point, until the selected active point is on the right side of the display.

#### Back

Press this soft key to return to the Limit soft key menu.

### Limit Envelope

A limit envelope is very useful when you want to easily detect new signals in the presence of other preexisting signals. Use the limit envelope function to automatically create upper or lower limit lines that are based upon the on-screen measured spectrum analysis values. For a display example of a limit envelope, see [Figure 4-14 “Example Limit Envelope, Square” on page 4-41](#). Press this soft key to open the Limit Envelope soft key menu.

#### Create Envelope

Press this soft key to generate the envelope using the Limit Envelope characteristics. If the default results are not satisfactory, then you can make adjustments to the amplitude and frequency of each inflection point, and you can add or delete inflection points.

#### Update Envelope Amplitude

While working on your envelope (or if your signal amplitude changes), you may want to adjust the amplitude of the current limit without changing the frequencies of the inflection points. Pressing this soft key makes those amplitude adjustments without frequency adjustments.

#### Update Square Envelope Frequency

Press this soft key to adjust the envelope frequency. If the magnitudes of two adjacent limit inflection points are the same (a horizontal line), then the frequencies of the next two limit inflection points are tested.

If the magnitudes of two adjacent limit inflection points are further than two sweep points apart (a gradual slope indicating a narrower span), then the second inflection point is brought back closer to the first inflection point so that the slope increases to near vertical.

If the magnitudes of two adjacent limit inflection points are closer than two sweep points apart (so close that the second inflection point may not be able to be displayed), then the second inflection point is pushed further out from the first inflection point so that the slope becomes near vertical.

If the user has adjusted the magnitude of some limit inflection points so that the horizontal lines are no longer horizontal, then the algorithm will probably have difficulty with the update, and unintended results may occur.

Upper Points, ## (if Upper Limit is selected)

or

Lower Points, ## (if Lower Limit is selected)

Use this soft key to define how many inflection points you want for the selected upper or lower limit envelopes. The value can be between 2 and 41. Note that the upper and lower limit lines do not need to have the same number of points.

Upper Offset, ## dB (if Limit is toggled to Upper)

or

Lower Offset, ## dB (if Limit is toggled to Lower)

This soft key is used to define how far away from the measured signal the upper or lower envelope will be placed. The limits are  $\pm 100$  dB. For an upper envelope, usually the value will be positive in order to place the envelope above the signal. For a lower envelope, the value will usually be negative in order to place the envelope below the signal.

Upper Shape, Square/Slope (if Limit is toggled to Upper)

or

Lower Shape, Square/Slope (if Limit is toggled to Lower)

With this soft key you can choose whether the default for the upper or lower envelope will be with flat tops and reasonably vertical lines to change level or whether the envelope will have sloped lines between adjacent inflection points. When the square envelope type is selected, two inflection points are used for each horizontal segment. You can toggle between a square envelope and a sloped envelope by pressing this soft key.

**Back**

Press this soft key to return to the Limit soft key menu

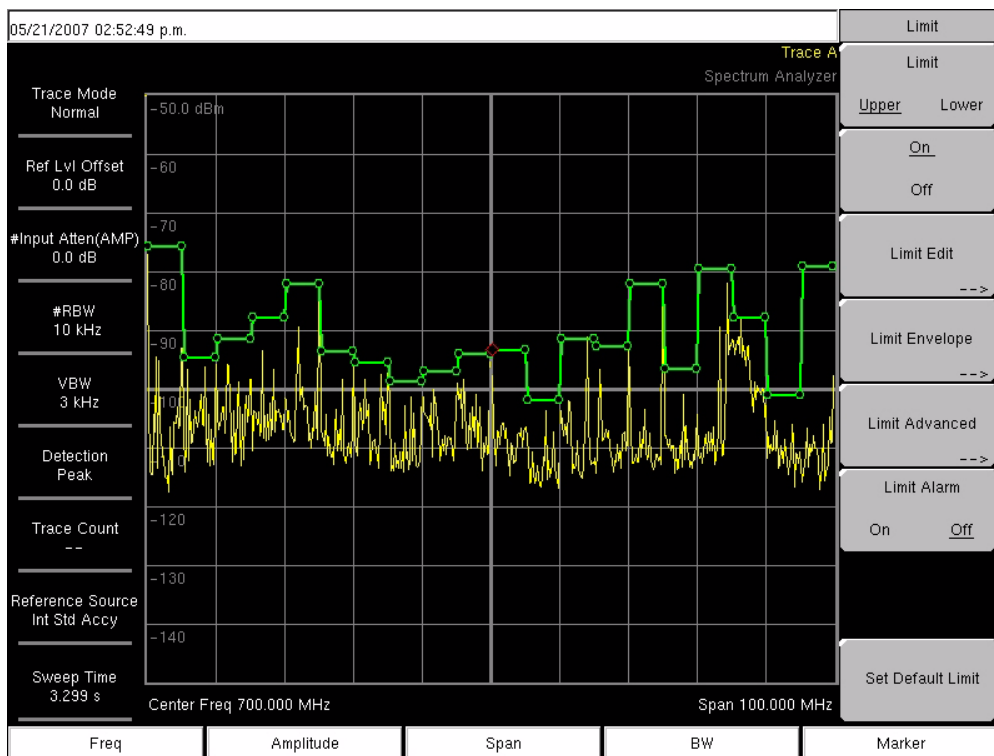

**Figure 4-14.** Example Limit Envelope, Square

#### Limit Advanced

The advanced limit line section offers several useful functions. In this section, you can create either an absolute limit line (which is one based upon the frequencies that are entered for each inflection point) or a relative limit line (which is based upon the delta frequencies between the center frequency and the inflection points). Both types of limit lines can be saved and recalled.

Press this soft key to open the Limit Advanced soft key menu.

#### Move Limit to Current Center Freq

Pressing this soft key moves the center of the existing limit line to the center frequency of the measurement. The span of the existing limit line is not changed by doing this. Use this soft key as an easy way to get an existing limit line on screen. If no limit line is turned on, a new, flat default limit line is turned on and is located 2.5 divisions (2.5 graticule lines) from the top of the screen for the upper limit line or 2.5 divisions from the bottom of the screen for the lower limit line.

#### Move Limit, ## dB

or

#### Move Limit, ## dBm

If the limit line is flat, then use this soft key to move the limit line to an absolute power point in dBm. If the limit line is not flat, then use this soft key to move the limit line up or down by the selected number of dB. Use the keyboard to enter the



desired value. The entire line moves by the amount that is entered. The limit line can also be moved by using the rotary knob. Turn the rotary knob clockwise to move the line to higher power levels.

#### Move Limit, ## Hz

Pressing this soft key allows you to adjust the frequencies of the limit line. All inflection points are moved by the value entered. The rotary knob can also be used to make this adjustment. Turn the rotary knob clockwise to move the limit line to higher frequencies.

#### Limit Line Type, Absolute/Relative

You can choose to have either limit line be either absolute or relative. The upper and lower limit lines may be different. This soft key may be used at any time while working with limit lines. Absolute limit lines set the limit inflection points based upon the entered frequencies for each point. Relative limit lines set the limit inflection points relative to the current center frequency. Regardless of how a limit line is set up, saved, or recalled, it can be changed between absolute and relative by toggling with this soft key.

#### Save Limit

Pressing this soft key opens a dialog to save the current upper and lower limit lines. You can name the saved limit line yourself or accept the name that is suggested by the instrument (which is based upon a previously saved name). If you did not intend to save the limit line, then press Esc to stop the dialog and avoid saving the limit line.

#### Recall Limit

Pressing this soft key opens a dialog box to recall a saved limit line. The dialog box presents a list of saved limit lines. Highlight the desired limit line and press Enter. If you decide not to recall a limit line, then press Esc to stop the dialog.

If the saved limit is a relative limit, then it is recalled centered about the current center frequency. If the saved limit is an absolute limit, then it is recalled to the frequency at which it was created.

If you recall an absolute limit, and if it is off screen, then you will see the left or right limit off-screen indicator on the edge of the screen.

#### Back

Press this soft key to return to the Limit soft key menu.

#### Limit Alarm On/Off

Pressing this soft key toggles the alarm function ON and OFF for the currently active limit line. When ON, an alarm beep will occur when a data point exceeds the limit.

#### Set Default Limit

Pressing this soft key deletes all limit points for the currently active limit line and sets the default limit line value, which is a single limit whose position is 1 (one) graticule line from the top of the screen (for the upper limit line) or 2 graticule lines from the bottom of the screen (for the lower limit line), depending upon which limit is active. The inactive limit line is not altered.

## 4-26 Marker

Press the **Marker** function hard key to open the Marker menu. The Spectrum Analyzer is equipped with six markers. Any or all markers can be employed simultaneously. The **Marker** hard key is located below the display. The Marker menu soft keys are:

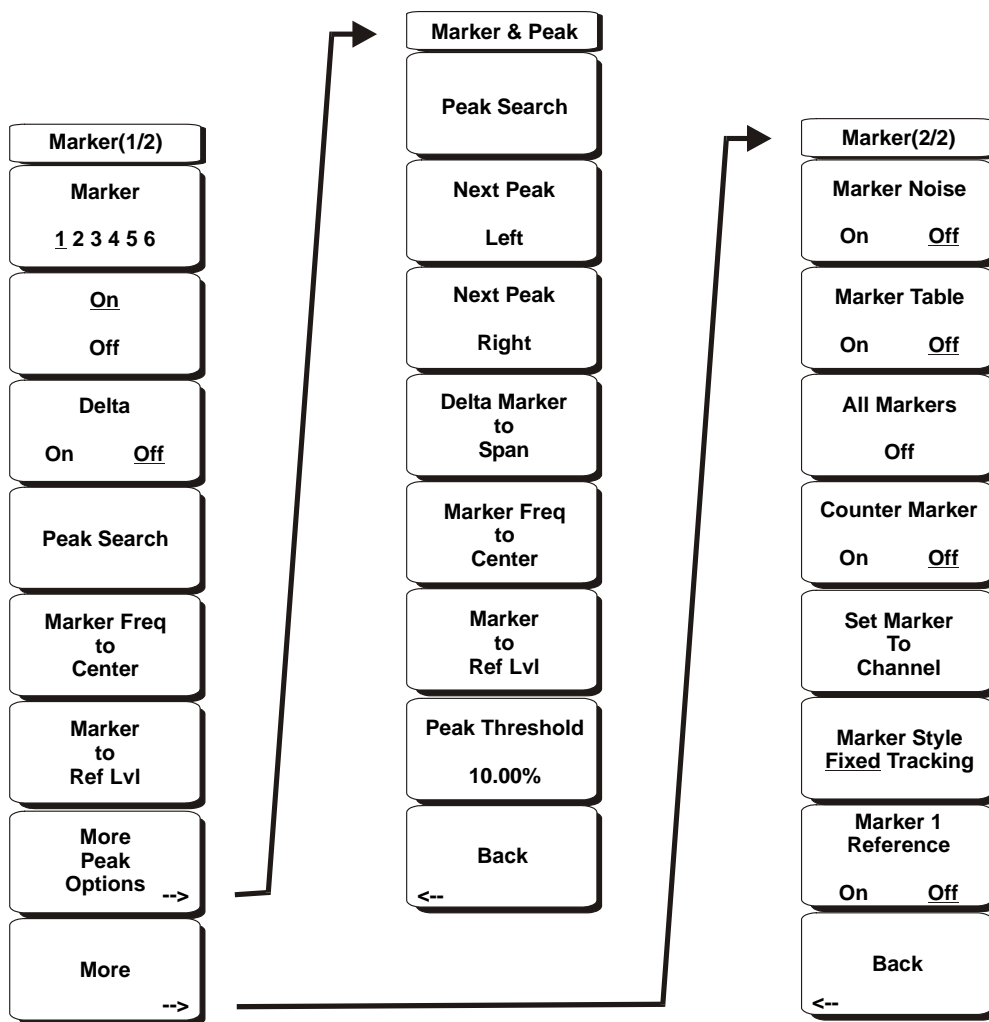

Figure 4-15. Marker Menu Soft Keys

Marker 1 2 3 4 5 6

Use this soft key to select the active marker. The underlined marker number is the active marker. Each press of the soft key moves the underline to the next marker number. Pressing the **Shift** button causes subsequent button presses to move from higher marker numbers to lower numbers. Press the **Shift** button again to change back to the original direction.

**On/Off**

This soft key makes the marker selected by the **Marker** soft key above active for editing. If the marker is currently active for editing, pressing the **On/Off** key causes the marker, and any associated Delta marker, to be turned off.

**Delta On/Off**

If the Delta marker is on, but not active for editing, pressing this soft key makes the Delta marker active for editing. If the marker is currently active for editing, pressing the **On/Off** key causes the Delta marker to be turned off and sets the corresponding reference marker active for editing.

**Peak Search**

This soft key places the currently active marker on the highest signal amplitude currently displayed on screen.

**Marker Freq to Center**

This soft key changes the center frequency to place the currently active marker at the center of the display.

**Marker to Ref Lvl (Level)**

This soft key causes the amplitude of the currently active marker to become the reference level, which is the top horizontal line of the display.

**More Peak Options**

This soft key brings up a **Marker & Peak** secondary menu of soft keys for additional peak searching options.

**Peak Search**

This soft key places the currently active marker on the highest amplitude signal currently on screen.

**Next Peak Left**

From the current position of the active marker, the instrument searches to the left (toward lower frequencies) for a peak signal that rises at least a certain amount above the previous valley. If no such peak is found, the marker is placed at the left end of the trace. The **Peak Threshold** soft key allows the user to specify the performance of peak searching.

**Next Peak Right**

From the current position of the active marker, the instrument searches to the right (toward higher frequencies) for a peak signal that rises at least a certain amount above the previous valley. If no such peak is found, the marker is placed at the right end of the trace. The **Peak Threshold** soft key allows the user to specify the performance of peak searching.

**Delta Marker to Span**

Sets the total span width to the value of the delta marker. If the delta marker is zero, the span is set to 10 Hz. If there is no delta marker, or the delta marker value is set to less than 10 Hz, then the span will be set to 10 Hz. **Delta Marker to Span** is not available when the analyzer is set to **Zero Span**.

**Marker Freq to Center**

Sets the center frequency to the frequency of the currently active marker.

**Marker to Ref Lvl**

Sets the amplitude of the currently active marker to the top graticule line as the reference level.

**Peak Threshold**

This soft key allows the user to specify how far above the average noise floor a signal must rise before it is considered a peak.

**Back**

Returns to the higher-level menu.

**More**

Opens the Marker (2/2) submenu that contains additional Marker options.

**Marker Noise**

This marker option turns the markers into noise markers with units of dBm/Hz. When this option is selected, the detection method is automatically changed to RMS and the displayed value is compensated for the noise bandwidth of resolution bandwidth filter. Marker Noise is not available when the analyzer is set to Zero Span.

**Marker Table**

Pressing this soft key causes a table to be displayed below the sweep window. The table is automatically sized to display all markers that are turned on. In addition to the marker frequency and amplitude, the table also shows delta frequencies and amplitude deltas for all markers that have deltas entered for them.

**All Markers Off**

This soft key turns off all markers and the marker table.

**Counter Marker On Off**

Sets the frequency counter mode for all markers. Marker frequency values are normally limited in resolution to individual display pixels. Each pixel may represent multiple frequencies. Using Counter Marker in association with Marker to Peak will result in the exact frequency of the peak within the pixel to a resolution of 1 Hz.

**Set Marker To Channel**

If a signal standard has been selected, pressing this soft key brings up a dialog box to select a channel. Select a channel number for the current signal standard, and the active marker will be set to the center frequency of the channel.

If no signal standard has been selected, a message “No standard selected. Press Enter or Escape to Continue.” is displayed. Press either button to leave the settings as they were before the soft key was pressed.

**Marker Style Fixed Tracking**

This soft key changes the behavior of the reference markers. If **Fixed** is selected, reference markers stay at the amplitude they were at when the associated delta marker was turned on. If **Tracking** is selected, the amplitude of the reference marker changes as the signal amplitude is changed. Note that the reference marker tracks the amplitude, not the frequency of a signal.

### Marker 1 Reference On Off

This soft key selects whether Marker 1 is the reference for all six delta markers, or whether each of the six reference markers has an associated delta marker. When Marker 1 Reference is turned ON, Marker 1 is set to the current frequency. The six delta markers are distributed evenly across the screen unless the frequency is in the AM broadcast band. When the frequencies are in the AM band, the delta markers are set to  $\pm 10.2$  kHz,  $\pm 25$  kHz, and  $\pm 75$  kHz and the marker table is also turned on.

### Back

Returns to the previous menu.

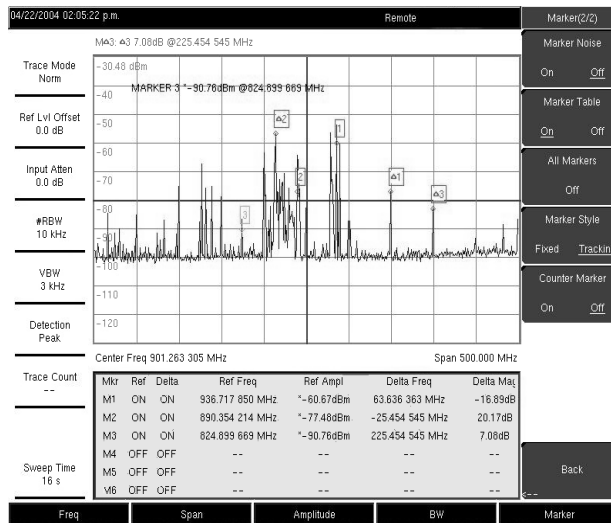

Figure 4-16. Markers

### Note

When using the up and down arrows, the active marker moves in steps defined by the value entered using the Freq Step soft key.

When using the left or right arrow keys, the active marker moves by one division.

## 4-27 Measure

To access the functions under the Measure menu, select the **Shift** key, then the **Measure** (4) key. The Measure menu soft keys are shown in [Figure 4-17](#).

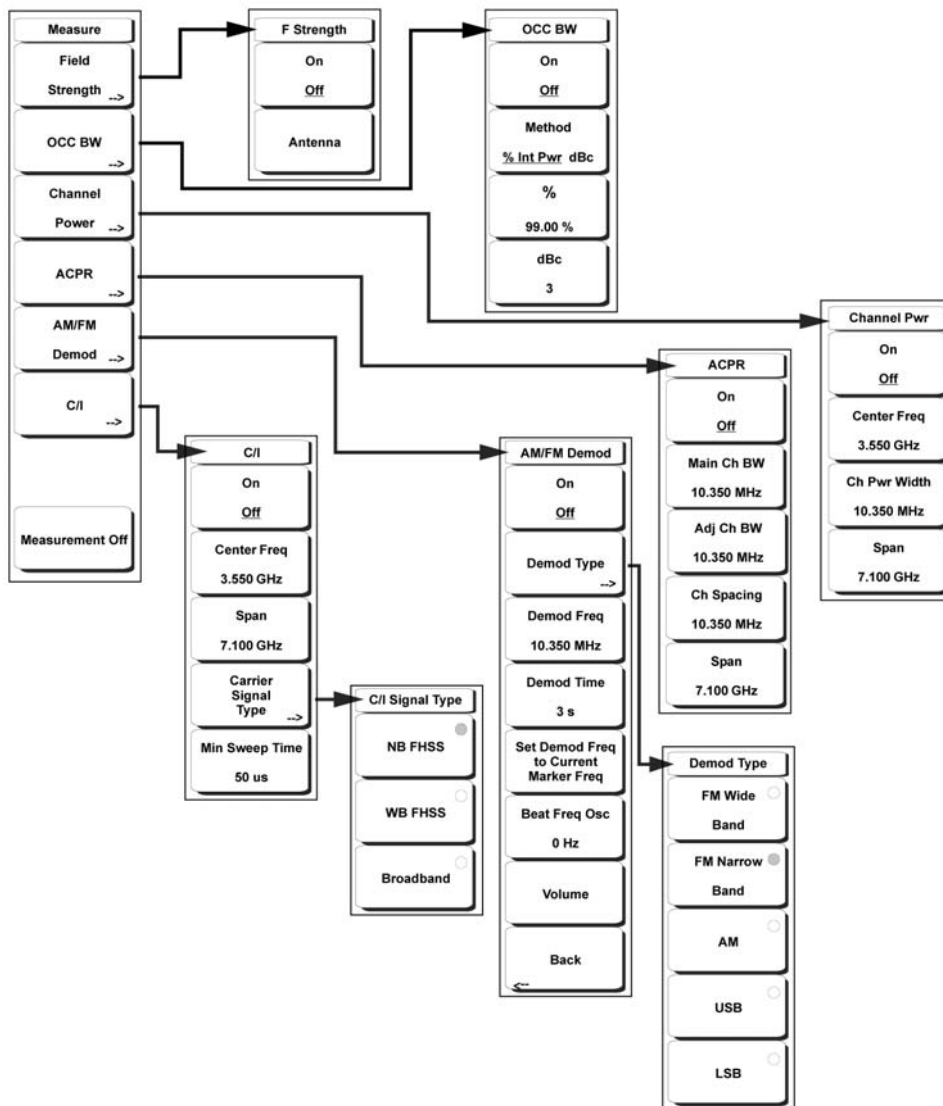

**Figure 4-17.** Measure Menu Soft Keys

### Field Strength

This measurement allows the use of an antenna with known gain characteristics and measures the field strength over the frequency range of the antenna in units of dBm/meter, dBV/meter, dBmV/meter, dBμV/meter, volts/meter or watts/meter.

On Off

Turns field strength measurements on or off.

### Antenna

This soft key brings up a dialog box that lists all the antennas for which the instrument has data, including both standard antennas and custom antenna that have been added using Master Software Tools. Use the Up/Down arrow keys or the rotary knob to select the desired antenna and press **Enter**.

### Back

Returns to the previous menu.

### OCC BW

Activates the occupied bandwidth menu. Select either % or dBc method of occupied bandwidth measurement.

#### Method % Down/dBc Down

Select either the % of Power (default) or dB Down measurement method as displayed in the message area.

#### % (Percent of Power)

Use the keypad, the directional arrow keys or the rotary knob to enter the percent of power, from 0% to 100%.

#### dBc

Use the keypad, the directional arrow keys or the rotary knob to enter the dBc value (0 dB to 100 dB).

### Back

Returns to the previous menu.

### Channel Power

Activates the Channel Power measurement function. Channel Power and Channel Power Density are measured based on the selection in the Units menu.

#### On Off

Begins or ends the channel power measurement. When the measurement is on, Ch Pwr will appear below the display. The detection method will automatically be changed to RMS Average when the measurement is started. The detection method can be modified by pressing the **Shift** and the **Sweep** keys and selecting the Detection soft key.

#### Center Freq

Activates the center frequency function, and sets the center frequency of the VNA Master for the channel power measurement. Use the keypad, the directional arrow keys or the rotary knob to enter the center frequency.

#### Ch Pwr Width

Sets the integration bandwidth for channel power measurement. Modifying this value automatically adjusts the channel span to maintain the same ratio. Use the keypad, the directional arrow keys or the rotary knob to enter the integration bandwidth.

#### Span

Sets the channel span for channel power measurement. Use the keypad, the directional arrow keys or the rotary knob to enter the channel span.

### Back

Returns to the previous menu.

## ACPR

Accesses a menu of Adjacent Channel Power Ratio measurement options:

### On Off

Begins or ends the ACPR measurement.

### Main Ch BW

Sets the bandwidth of the main channel for ACPR measurement. Use the keypad, the directional arrow keys or the rotary knob to enter the a specific frequency. When using the keypad, select the GHz, MHz, kHz, or Hz soft key to accept the frequency input. Changing this value automatically changes the adjacent channel bandwidth and channel spacing.

### Adj Ch BW

Sets the bandwidth of the adjacent channels for ACPR measurement. Use the keypad, the directional arrow keys or the rotary knob to enter the a specific frequency. When using the keypad, select the GHz, MHz, kHz, or Hz soft key to accept the frequency input.

### Ch Spacing

Sets the channel spacing between the main and adjacent channels. Use the keypad, the directional arrow keys or the rotary knob to enter the a specific frequency. When using the keypad, select the GHz, MHz, kHz, or Hz soft key to accept the frequency input. This value must be greater than or equal to half of the main channel bandwidth, plus half of the adjacent channel bandwidth.

### Back

Returns to the previous menu.

## AM/FM Demod

The user can select AM, Narrow Band FM (300  $\mu$ s de-emphasis), Wide Band FM (50  $\mu$ s de-emphasis), Upper Sideband or Lower Sideband.

### On Off

Turns AM/FM Demodulation on or off.

### Demod Type

Provides soft keys to select the type of signal to be demodulated:

- FM Wide Band
- FM Narrow Band
- AM
- USB
- LSB

### Demod Freq

Use the keypad, the directional arrow keys or the rotary knob to enter the center frequency of the signal to be demodulated. This frequency does not have to be within the current frequency sweep range to which the instrument is set.

### Demod Time

Use the keypad, the directional arrow keys or the rotary knob to increase or decrease the demodulation time, and press the **Enter** key to select. The demodulation time can be set from 100 milliseconds to 500 seconds. The



instrument sweeps one time for every demodulation period. Sweeping pauses during the demodulation time.

#### Set Demod Freq to Current Marker Freq

Sets the demodulation frequency to the frequency of the current marker.

#### Beat Freq Osc

Sets the beat frequency of the oscillator to exactly set the demodulation frequency of USB and LSB signals.

#### Volume

The current volume setting is displayed on the screen. Use the Up/Down arrow keys or rotary knob to change the volume, and press the **Enter** key to select.

#### Back

Returns to the previous menu.

#### C/I

The Carrier to Interference ratio is a two-step measurement sequence that first measures the amplitude of a carrier, then, with the carrier turned off, measures the amplitude of all other interfering signals within the channel bandwidth.

#### On Off

Starts and stops the carrier to interference measurement.

#### Center Freq

Use the keypad, the directional arrow keys or the rotary knob to enter the center frequency.

#### Span

Use the keypad, the directional arrow keys or the rotary knob to enter the frequency span.

#### Carrier Signal Type

Opens a menu to select the carrier signal type.

##### NB FHSS (Narrow Band Frequency Hopping Spread Spectrum)

Use this setting when the signal being measured is 802.11b.

##### WB FHSS (Wide Band Frequency Hopping Spread Spectrum)

Use this setting when the signal being measured is 802.11a or 802.11g.

##### Broadband

Use this setting when the signal being measured is a digital modulation format such as CDMA, GSM, and so forth.

#### Back

Returns to the previous menu.

#### Min Sweep Time

Set the minimum sweep time for the measurement.

#### Back

Returns to the previous menu.

#### Measurement Off

Pressing this soft key turns off any active measurement, including demodulation.

## 4-28 Mode

To access the functions under the Mode menu, select the **Shift** key, then the **Mode** (9) key. The mode list in a particular instrument depends upon the options that are purchased for that instrument.

## 4-29 Preset

To access the functions under the Preset menu, select the **Shift** key, then the **Preset** (1) key. The Preset menu soft keys are shown in [Figure 4-18](#).



**Figure 4-18.** Preset Menu Soft Keys

### Preset

This key resets the instrument to the default starting conditions of full band sweep, 10 dBm log reference level, 10 dB/division scaling, 0 dB reference level offset, all measurements turned off and trigger set to free run.

### Save Setup

Opens a dialog box to name and save the current operating settings, allowing them to be recalled later to return the instrument to the state it was in at the time the setup was saved. The saved setup can be named using the keypad to select numbers, the rotary knob to highlight a number or character and pressing the knob to select, or by selecting the soft key for each letter. Use the **Shift** key to select an upper case letter. Use the Left/Right directional arrows to move the cursor position. Press **Enter** to save the setup.

### Recall Setup

This soft key brings up a selection box that allows selection and recall of a previously stored instrument setup. Use the rotary knob or the Up/Down arrow keys to highlight the saved setup, and press **Enter**, the rotary knob, or the Recall soft key to select. All current instrument settings are replaced by the stored setup information. Press the **Esc** key to cancel the recall.

## 4-30 Span

The Span menu is used to set the frequency range over which the instrument will sweep. For the MS2034A, the span can be set from 10 Hz to 4.0 GHz. For the MS2036A, the span can be set from 10 Hz to 7.1 G. The Span can also be set to zero span for all models.

Press the **Span** function key located below the display to access the Span menu. The Span menu soft keys are shown in [Figure 4-19](#).



**Figure 4-19.** Span Menu Soft Keys

### Span

This soft key shows the current value for span in units of GHz, MHz, kHz, or Hz. When the Span button is pressed, span becomes the active parameter and may be changed. Use the keypad, the directional arrow keys or the rotary knob to increase or decrease the span frequency. If the span is changed by using the up and down arrow keys, the span changes by the value of the Frequency Step entered in the Frequency menu.

### Span Up 1-2-5

This is a convenient way to quickly arrive at a wider span value. The first time the soft key is pressed, the span value increases to the nearest even value that starts with 1, 2, or 5. For example if the span is 1.8 MHz, pressing the soft key for the first time changes the span to 2.0 MHz, the next press takes the value to 5.0 MHz and so on.

### Span Down 1-2-5

This is a convenient way to narrow the frequency span. The first time the soft key is pressed, the span value decreases to the nearest even value that starts with 1, 2, or 5. For example if the span is 1.8 MHz, pressing the soft key for the first time changes the span to 1.0 MHz, the next press takes the value to 500 kHz, then 200 kHz and so on.

#### Full Span

Pressing this button sets the span to cover the entire tunable spectrum of the instrument.

#### Zero Span

This soft key sets zero span. In this mode the display shows amplitude changes at a single frequency. This function is frequently used to allow the easy monitoring of power variations over time. For example, if information about the amplitude of an 802.11a access point signal is needed, the access point frequency would be set as the center frequency, resolution bandwidth would be set to a value wide enough to encompass the signal and the tester would walk around the access point usable area while the VNA Master records the amplitude using slow sweep.

#### Last Span

This soft key returns the span to the most recent span value immediately before a change was made.

## 4-31 Sweep

To access the functions under the Sweep menu, select the **Shift** key, then the **Sweep (3)** key. The Sweep menu soft keys are shown in [Figure 4-20](#).

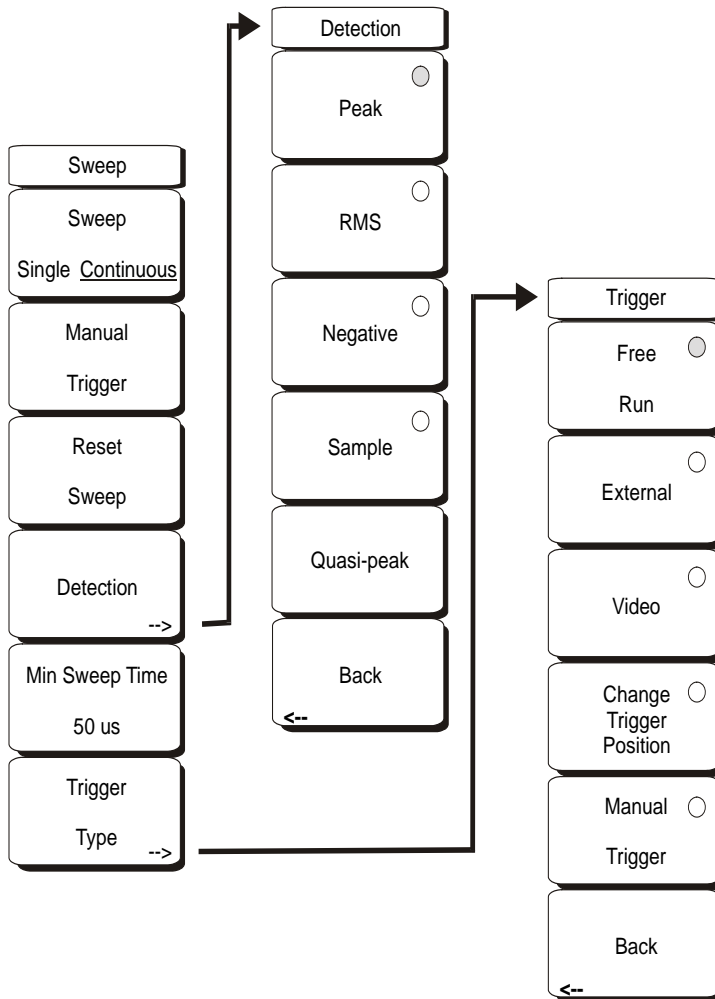

**Figure 4-20.** Sweep Menu Soft Keys

### Sweep Single/Continuous

This soft key toggles between continuous sweep and single sweep. In single sweep mode, the results of a sweep are displayed on the screen while the instrument awaits a trigger event to start a new sweep.

### Manual Trigger

Pressing this soft key causes the instrument to make a single sweep when the instrument is in single sweep mode. This key has no function when the instrument is in continuous sweep mode.

### Reset Sweep

This soft key stops the current sweep, clears trace averaging results, clears the maximum hold results, if selected, and restarts the sweep at the left side of the screen.

### Detection

Several detection methods tailor the performance of the instrument to meet specific measurement requirements. In general, there are more measurement points across the screen than display points. The various detection methods are different ways of dealing with selecting which measurement point will be shown at each display point.

#### Peak

This method causes the largest measurement point to be shown for each display point, and assures that a narrow peak is not missed.

#### RMS

This method performs a root-mean-square calculation of all the measurement points in each display point, and is particularly useful in displaying the average value of noise.

#### Negative

This method causes the smallest measurement point to be shown for each display point. Typically this mode is used to help detect small discrete signals in the presence of nearly equal values of noise. The display points that contain only noise will tend to show lower amplitudes than those that contain discrete signals.

#### Sample

This is the fastest detection method since for each display point only one frequency point is measured. Use this method when speed is of paramount importance and the possibility of missing a narrow peak is not important.

#### Quasi-peak

Selects the quasi-peak detector. When the quasi-peak detector is selected, the allowed resolution bandwidths are 200 Hz, 9 kHz, and 120 kHz. Also, the RBW/VBW ratio is set to 1 so that the video bandwidth is the same as the resolution bandwidth.

#### Back

Returns to the previous menu.

### Min Sweep Time

This function allows a minimum sweep time to be specified. Use the keypad, the directional arrow keys or the rotary knob to set the minimum sweep time from 10 microseconds to 600 seconds. When using the keypad, the available time units are minutes, seconds, milliseconds, and microseconds.

If the required sweep time for accurate measurement is longer than the specified minimum, then the time required for accurate measurements will prevail.

### Trigger Type

Sets the type of trigger to be used.

#### Free Run

In this mode, a new sweep is started immediately upon completion of an old sweep. No trigger event is required to initiate a sweep.

**External**

A TTL signal applied to the External Trigger BNC input connector causes a single sweep to occur. This mode is used in zero span, and triggering occurs on the rising edge of the signal. After the sweep is complete, the resultant trace is displayed until the next trigger signal arrives.

**Video**

This mode is used in zero span to set the power level at which a sweep is initiated. The power level can be set from  $-120$  dBm to  $+20$  dBm. The trigger is based on the measured signal level. If no signal reaches or exceeds the trigger level, there will be no trace on the screen. This mode is used in Zero Span.

**Change Trigger Position**

This soft key is used in conjunction with video triggering to set the horizontal position on the display where a signal that meets the video triggering criterion will be placed. The value can be from 0% to 100%. Zero percent places the triggering event at the left edge of the screen while 100% places the triggering at the right edge of the screen. When the trigger position is any value other than 0%, the portion of the trace before the trigger event is displayed very quickly since the trace data is stored in memory. The portion of the trace after the trigger point is displayed on the screen at the normal rate as the signal is swept. This mode is used in Zero Span.

**Manual Trigger**

Pressing this soft key causes the instrument to make a single sweep when the instrument is in single sweep mode. This key has no function when the instrument is in continuous sweep mode.

**Back**

Returns to the previous menu.

## 4-32 System

To access the functions under the System menu, select the **Shift** key, then the **System (8)** key. The System menu soft keys are shown in [Figure 4-21](#).

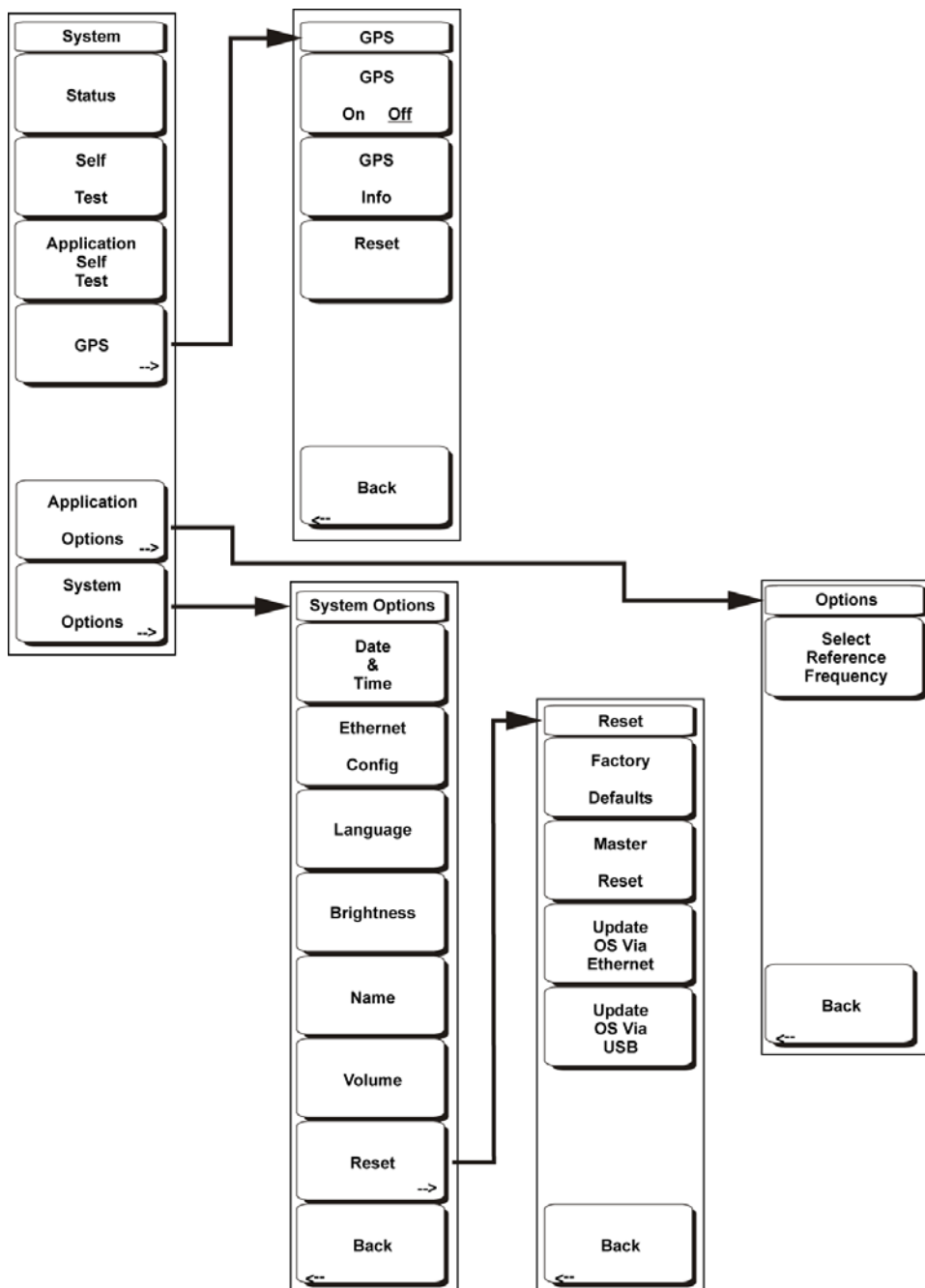

Figure 4-21. System Menu Soft Keys



### Status

Pressing this soft key displays the current system status, including the operating system and firmware versions, temperatures and other details such as current battery information. Press **Esc** or **Enter** to return to normal operation.

### Self Test

This soft key initiates a series of diagnostic tests that test the components of the instrument. A display will list the individual tests with a pass or fail indication. Press **Esc** or **Enter** to return to normal operation.

### Application Self Test

This soft key initiates a series of diagnostic tests related to the performance of the spectrum analyzer. A display will list the individual tests with a pass or fail indication. Press **Esc** or **Enter** to return to normal operation.

### GPS Options

If the GPS option is installed, the GPS menu will be displayed. Opens the GPS soft menu.

#### GPS On/Off

Turns the GPS on or off.

#### GPS Info

Displays the current GPS information.

#### Reset

Resets the GPS for a new location.

#### Back

Returns to the previous (System) menu.

### Application Options

This soft key presents a menu to select application options.

#### Impedance 50 Ohm/75 Ohm/Other

Select either 50 ohm, 75 ohm, or other impedance value. Selecting 75 ohm selects the 7.5 dB loss of the Anritsu 12N50-75B or 12N75B adapter. For other adapters, select Other and enter the appropriate loss.

#### Ext Ref Freq

Select the frequency of the external reference from the list presented. Valid frequencies are 1 MHz, 1.2288 MHz, 1.544 MHz, 2.048 MHz, 2.4576 MHz, 4.8 MHz, 4.9152 MHz, 5 MHz, 9.8304 MHz, 10 MHz, 13 MHz and 19.6608 MHz at amplitude from -10 dBm to +10 dBm.

#### Back

Returns to the previous menu.

### System Options

This key opens the System Options soft menu and a selection of system option soft keys.

#### Date and Time

This soft key brings up a dialog box for setting the current date and time. Use the soft keys or the Left/Right arrow keys to select the field to be modified. Use the keypad, the Up/Down arrow keys or the rotary knob to select the date and time. Select **Enter** to accept the changes, or press the **Esc** key to return to normal operation without changing anything.

### Ethernet Configuration

This soft key brings up a dialog box to set the IP address of the instrument.

### Type Manual/DHCP

This softkey selects whether the address will be entered manually, or supplied automatically by a network DHCP server. If Manual is selected, use the soft keys or the Left/Right arrow keys to select the field to be modified. Use the keypad, the Up/Down arrow keys or the rotary knob to enter the input. Select **Enter** to accept the changes, or press the **Esc** key to return to normal operation without changing anything.

### Language

This soft key brings up a selection box allowing selection from a list of built-in languages for the VNA Master displays. The languages currently available are English, French, German, Spanish, Japanese, Chinese, Korean, and Italian. In addition, up to two custom languages may be selected if they have been defined using the Master Software Tools software and loaded into the instrument. Two custom languages may be loaded into the instrument. If a mode does not have language translations available, English is the default language. Select **Enter** to accept the change, or press the **Esc** key to return to normal operation without changing anything.

### Brightness

The brightness of the display can be adjusted to optimize viewing under a wide variety of lighting conditions. Use the keypad, the Up/Down arrow keys or the rotary knob to select a brightness level from 1 to 9, 9 being the brightest. Select **Enter** to accept the change.

### Name

Opens a dialog box to name the instrument. The unit can be named using the keypad to select numbers, the rotary knob to highlight a number or character and pressing the knob to select, or by selecting the soft key for each letter. Use the **Shift** key to select an upper case letter. Use the Left/Right directional arrows to move the cursor position. Press **Enter** to save the name.

### Volume

The current volume setting is displayed on the screen. Use the keypad, the **Up/Down** arrow keys or the rotary knob to select a volume level from 0 to 99 and press the **Enter** key to accept the change.

### Reset

Opens a the Reset soft menu of reset and update options.

**Factory Defaults**

Restores the instrument to the factory default values, including Ethernet, language and brightness settings. Press the **Enter** key to initiate the reset, and turn the unit off, then on again to complete. Press **Esc** to return to normal operation without resetting.

**Master Reset**

This will restore factory setting to all system parameters, including Time/Date, Ethernet, language and brightness settings. Also, all user files in the internal memory are deleted, and the original language and antenna files are restored. Press the **Enter** key to initiate the reset, and turn the unit off, then on again to complete. Press **Esc** to return to normal operation without resetting.

**Update OS Via Ethernet**

This soft key should only be used in conjunction with Anritsu Master Software Tools (MST) to update the instrument operating system using an Ethernet connection. Use this soft key only as instructed by MST.

**Update OS Via USB**

This soft key should only be used in conjunction with Anritsu Master Software Tools (MST) to update the instrument operating system using a connected USB device. Use this soft key only as instructed by MST.

**Back**

Returns to the previous menu.

## 4-33 Trace

To access the functions under the Trace menu, select the **Shift** key and then the **Trace** (5) key. The Anritsu VNA Master is capable of displaying up to six traces. Trace A shows live data, Traces B and C can show stored or trace math data, and the Recalled A-C traces allow the user to see three recalled traces without overwriting the three current traces.

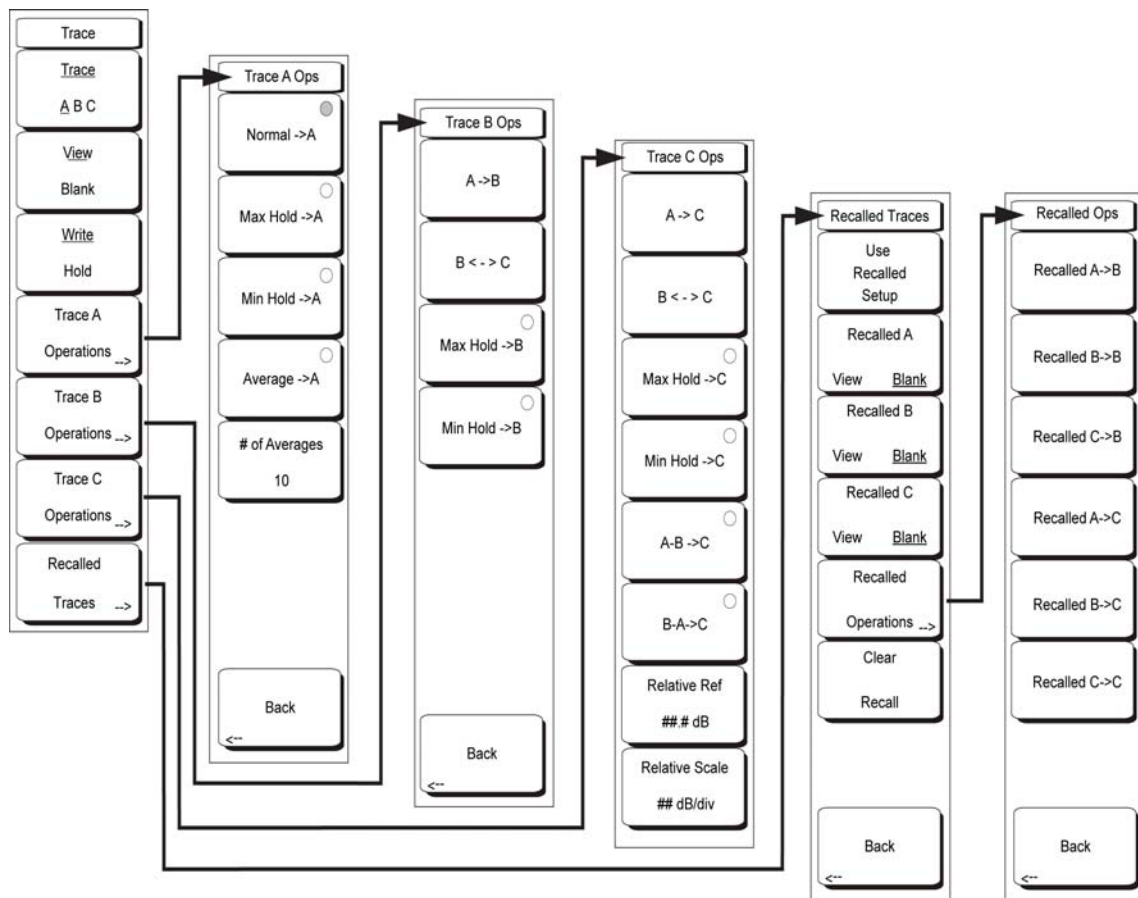

**Figure 4-22.** Trace Menu Soft Keys

### Trace A, B, C

This soft key selects which trace is the active trace. The active trace is the one that is underlined. As the key is pressed, the underline advances from A to B to C and back to A.

### View Blank

This soft key toggles the currently active trace to be either visible or hidden.

### Write/Hold

Selects if the currently active trace will continue to sweep and be updated or to hold the current trace on screen. This is not applicable to Trace B or Trace C unless trace math involving Trace A is active.

### Trace A Operations

Allows the user to select from the operations that can be applied to Trace A.

#### Normal -> A

The trace displays current data for the current sweep.

#### Max Hold -> A

The trace shows the cumulative maximum value of each display point over many sweeps.

#### Min Hold -> A

The trace shows the cumulative minimum value of each display point over many sweeps.

#### Average -> A

The trace shows an exponential average of a number of traces, determined by the # of Averages key, below.

#### # of Averages

Sets the number of traces that are used for the calculation of the average display value from 1 to 65535.

#### Back

Returns to the previous menu.

### Trace B Operations

Allows the user to select from the operations that can be applied to Trace A.

#### A -> B

Copies the contents of Trace A into Trace B. Doing so overwrites the previous contents of Trace B.

#### B <--> C

Swaps the contents of Traces B and C.

#### Max Hold -> B

Trace B shows the cumulative maximum value of each display point over many sweeps.

#### Min Hold -> B

The trace shows the cumulative minimum value of each display point over many sweeps.

#### Back

Returns to the previous menu.

### Trace C Operations

Allows the user to select from the operations that can be applied to Trace C.

#### A -> C

Copies the contents of Trace A into Trace C. Doing so overwrites the previous contents of Trace C.

#### B <--> C

Swaps the contents of Traces B and C.

**Max Hold -> C**

The trace shows the cumulative maximum value of each display point over many sweeps

**Min Hold -> C**

The trace shows the cumulative minimum value of each display point over many sweeps.

**A - B -> C**

Subtracts the value of trace B from trace A and places the results in Trace C. This function is very useful for observing the changes in values of live Trace A compared to a trace stored in Trace B. When trace math is active, a relative scale shows on the right side of the graph, and is applied to Trace C. This allows the user to optimize the display of Trace C without affecting the display of Traces A and B.

**B - A -> C**

Subtracts the value of Trace A from Trace B and places the results in Trace C. This function is very useful for observing the changes in values of live Trace A compared to a trace stored in Trace B. When trace math is active, a relative scale shows on the right side of the graph, and is applied to Trace C. This allows the user to optimize the display of Trace C without affecting the display of Traces A and B.

**Relative Ref #dB**

Sets the value applied to the top graticule for the relative scale that appears on the right side of the graph when trace math is active. Change this value by using the rotary knob, **Up/Down** arrows, or entering the value on the numeric keypad and pressing the **dB** soft key or the **Enter** key. This entry is valid only when trace math is active

**Rel Scale, # dB/div**

Sets the value applied to the scaling of the relative scale that appears on the right side of the graph when trace math is active. Change this value by using the rotary knob, **Up/Down** arrows, or entering the value on the numeric keypad and pressing the **dB** soft key or the **Enter** key.

This entry is valid only when trace math is active.

### Recalled Traces

Brings up the Recalled Traces menu with available operations for measurement traces that have been recalled from a storage device.

#### Use Recalled Setups

Pressing this soft key will change the instrument sweep state from its current settings to those that apply to Trace Recalled A. Frequency, amplitude, attenuation, detection method, RBW, and VBW are all among those settings that will convert to the Recalled A settings

#### Recalled A View/Blank

This soft key toggles the Recalled A trace to be either visible or hidden.

#### Recalled B View/Blank

This soft key toggles the Recalled B trace to be either visible or hidden.

#### Recalled C View/Blank

This soft key toggles the Recalled C trace to be either visible or hidden.

#### Recalled Operations

Pressing this soft key brings up the Recalled Ops menu to allow recalled traces to be moved into active trace locations so that Trace math and marker operations can be performed.

##### Recalled A -> B

Copies the contents of Trace Recalled A into Trace B. Doing so overwrites the previous contents of Trace B.

##### Recalled B -> B

Copies the contents of Trace Recalled B into Trace B. Doing so overwrites the previous contents of Trace B.

##### Recalled C -> B

Copies the contents of Trace Recalled C into Trace B. Doing so overwrites the previous contents of Trace B.

##### Recalled A -> C

Copies the contents of Trace Recalled A into Trace C. Doing so overwrites the previous contents of Trace C.

##### Recalled B -> C

Copies the contents of Trace Recalled B into Trace C. Doing so overwrites the previous contents of Trace C.

##### Recalled C -> C

Copies the contents of Trace Recalled C into Trace C. Doing so overwrites the previous contents of Trace C.

##### Back

Returns to the previous menu.

#### Clear Recall

Removes the recalled traces from memory so that they are no longer available for display.

##### Back

Returns to the previous menu.

# Chapter 5 — Power Meter

## 5-1 Introduction

The Internal Power Meter is a standard feature on the VNA Master. The VNA Master can display measured power in dBm, dBV, dBmV, dB $\mu$ V, Volts, or Watts. No external sensor is required. The internal Power Meter frequency span can be set from 1 kHz to 100 MHz. The Full Band soft key conveniently sets the frequency range to 100 MHz on the current center frequency to simulate a broadband measurement.

The Max and Min values of the analog display can be set in the Amplitude Menu. The scale of the analog display reflects the Unit selection. Relative Power is a useful feature to obtain the power reading with respect to a certain power level. For instance, if the power level at the input is 10 dBm, the Relative Power can be turned on and the display will now show 0 dB. 15 dBm would show as 5 dB with the Relative turned on at 10 dBm.

## 5-2 Procedure

The following procedure demonstrates power meter setup options.

1. On the VNA Master, select the **Shift** key, then the **Mode (9)** key.
2. Use the directional arrow keys or the rotary knob to highlight Power Meter and press the **Enter** key to select.
3. Press the **Freq** function hard key to set the desired frequency sweep. Choose the appropriate soft keys and enter the start and stop frequency, the center frequency and the span, or select the Signal Standard soft key and select the channel and Uplink or Downlink or select the full band.

### Changing the Display Units

The power reading can be displayed in dBm or Watts. To change the displayed units:

1. Press the **Amplitude** function hard key.
2. Press the Units soft key and select the display units.
3. Press the Back soft key to return to the Power Meter menu.

### Displaying Relative Power

Relative power can be selected through the Amplitude menu.

1. With the desired base power level input to the VNA Master, press the **Amplitude** function hard key.
2. Select the Relative soft key.

<b>Note</b> Relative power is displayed as dB.
--



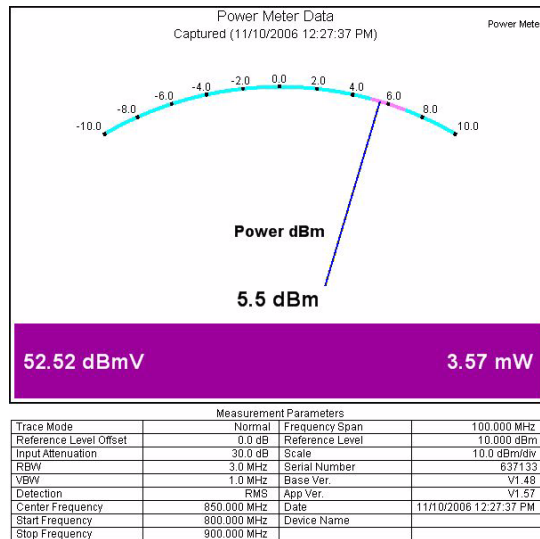

**Figure 5-1.** Sample Power Meter Display

## Set the Limit Lines

Maximum and minimum limits can be set. The following is the procedure for setting the limits.

1. On the VNA Master, select the **Limit** function hard key, or select the **Shift** key, then the **Limit (6)** key.
2. Press the Upper Limit soft key and use the directional arrow keys, key pad or the rotary knob set the desired upper limit, then press **Enter**.
3. Press the Lower Limit soft key and use the directional arrow keys, key pad or the rotary knob set the desired lower limit, then press **Enter**.

If the power is between the limits, then the measurement display is green.

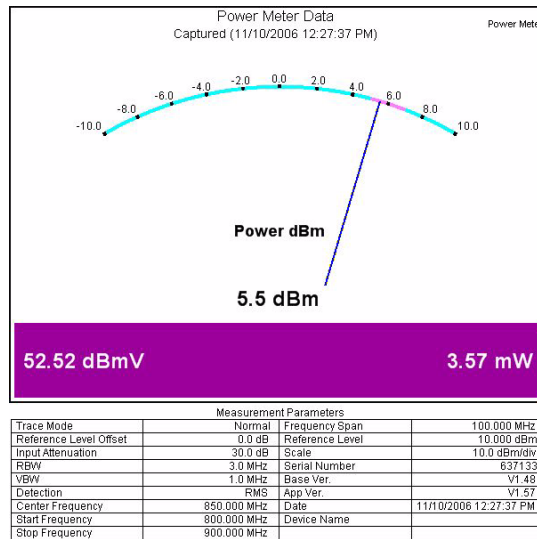

Figure 5-2. Power Meter Display, Passed

If the power is not between the limit lines, then the measurement display is red.

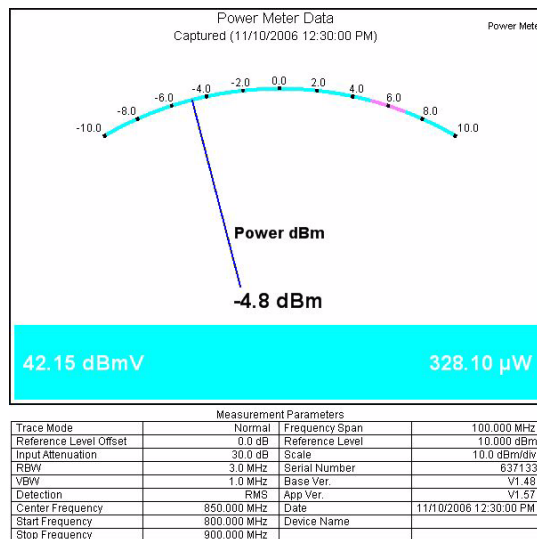

Figure 5-3. Power Meter Display, Failed

## 5-3 Power Meter Mode Menus

There are four Power Meter Mode menus:

- Amplitude Menu
- Average Menu
- Freq (Frequency) Menu
- Limit Menu

Each is described in greater detail in the sections below.

## 5-4 Amplitude Menu

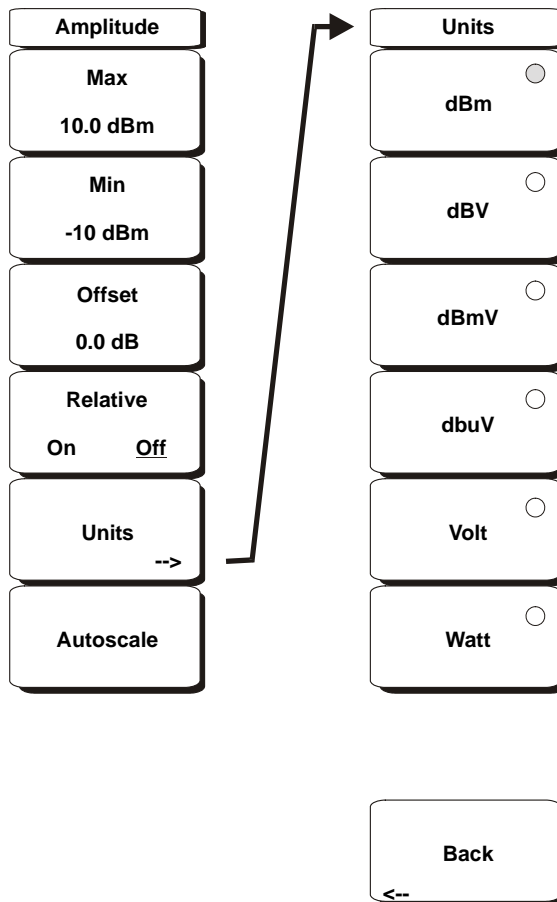

Figure 5-4. Power Meter Mode Amplitude Menu

**Max**

Sets the maximum value on the display.

**Min**

Sets the minimum value on the display.

**Offset**

A value of  $\pm 100$  dB can be entered.

**Relative**

Selects whether relative power is on or off. This measurement shows the relative level of the desired base power level input to the VNA Master. When on, the message **Relative: On nnn dB** (where nnn dB is the current relative value) will show in the message area. The units will automatically revert to dBm if necessary.

**Units**

Displays the Units menu. Choose from the menu of amplitude-related units.

dBm

dBV

dBmV

dB $\mu$ V

Volt

Watt

Back

Return to the Amplitude menu.

<b>Note</b> Changing the units will turn Relative off, if it was on.
--

**Autoscale**

Adjusts the Top and Bottom values so that the needle will be shown in the middle of the analog display.

---

## 5-5 Average Menu

---

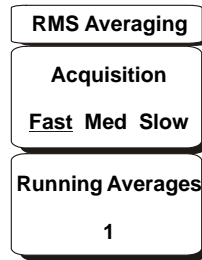

---

**Figure 5-5.** Power Meter Mode Average Menu

### Acquisition

Sets the measurement speed. Choose either Fast, Medium or Slow.

### Running Average

Sets the average of the number of traces. Enter the desired number using the keypad, rotary knob or the arrow keys.

## 5-6 Freq (Frequency) Menu

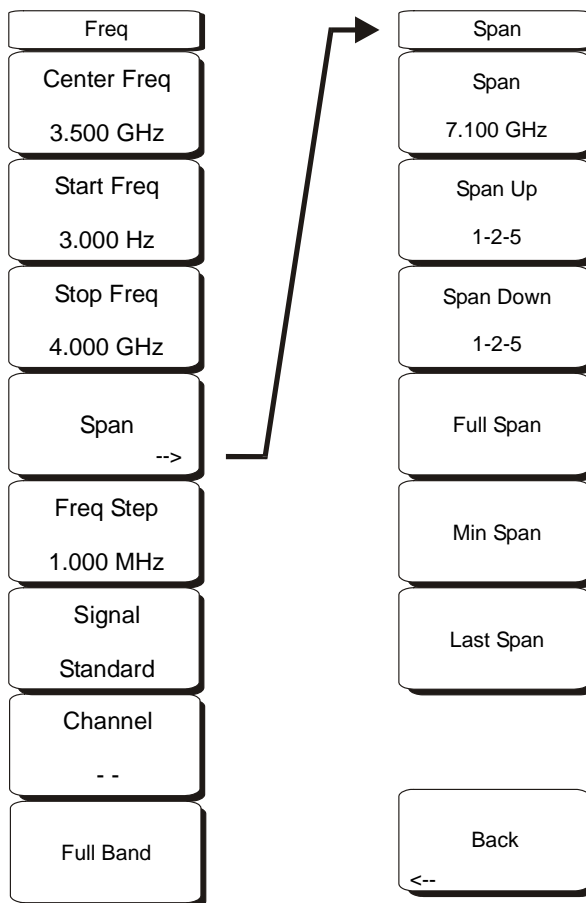

**Figure 5-6.** Power Meter Mode Freq Menu

### Center Freq

Sets the frequency at the center of the measurement. Frequencies can be entered in units of GHz, MHz, kHz, or Hz. Enter the frequency by using the keypad, rotary knob or the arrow keys. When the center frequency is entered, the labeling below the analog display shows the center frequency and the span in the most appropriate units based on the value.

### Start Freq

Enter a start frequency by using the keypad, rotary knob or the arrow keys. If the entered start frequency is greater than the current stop frequency, then the stop frequency is automatically adjusted to be 1 kHz greater than the start frequency (min span).

**Stop Freq**

Enter a stop frequency by using the keypad, rotary knob or the arrow keys. If the entered stop frequency is lower than the current start frequency, then the start frequency is automatically adjusted to be 1 kHz less than the stop frequency (max span).

**Span**

Opens the Span menu.

**Span**

Sets the width of the measurement window in GHz, MHz, kHz, or Hz. The center frequency and span are displayed in the message area at the bottom of the status window. Entering the span can be done with the keypad and selecting units (GHz, MHz, kHz or Hz) with the soft keys, or with the arrow keys to change an already selected frequency, finish with ENTER, or press ESC to restore.

**Span Up 1 - 2 - 5**

Increases the span to the next multiple of 1, 2 or 5.

**Span Down 1 - 2 - 5**

Decreases the span to the next multiple of 1, 2 or 5.

**Full Span**

Sets the span to 100 MHz on the current center frequency. Adjusts the center frequency if it is at the edge of the limit of the instrument.

**Min Span**

Changes the span to 1 kHz.

**Last Span**

Returns the span to the previous value.

**Back**

Returns to the Freq menu.

**Freq Step**

Sets the interval used by the arrow keys. Enter the step amount using the keypad, rotary knob or the arrow keys.

**Signal Standard**

Opens the signal standard menu, showing the currently selected signal standard and a complete list of signal standards.

**Channel**

Sets the channel information for the selected standard. If the particular standard has not been used before, then the channel number will default to the lowest legal channel number for that standard. If that standard has been used before, then the last used channel will be the default.

**Full Band**

Sets the frequency of the unit to a 100 MHz span on the current center frequency.

---

## 5-7 Limit Menu

---

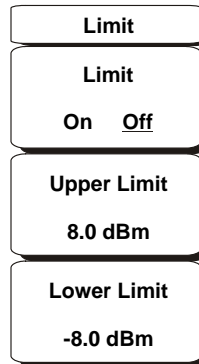

---

**Figure 5-7.** Power Meter Mode Limit Menu

**Limit**

Turns the limits on or off.

**Upper Limit**

Sets the upper limit.

**Lower Limit**

Sets the lower limit.





# Chapter 6 — Power Monitor, Option 5

## 6-1 Introduction

When equipped with Option 5, Power Monitor, the VNA Master can be used for making power measurements with broadband RF detectors, such as those listed in [Table 1-16 on page 1-10](#). The power monitor displays the measured power results in dBm or Watts.

## 6-2 Procedure

1. On the VNA Master, press the **Shift** key, then the **Mode** (9) key.
2. Use the directional arrow keys or the rotary knob to highlight Power Monitor and then press the **Enter** key.
3. Connect the power sensor to the VNA Master RF Detector port.

### Zeroing the Power Monitor

1. With no power applied to the Power Detector input, press the Zero soft key. Wait for a few seconds while the VNA Master accumulates data samples of the quiescent power.
2. When complete, Zero: On is displayed in the message area.

### Measuring High Input Power Levels

1. Insert an attenuator between the DUT and the RF Detector to protect the VNA Master so that the power level is less than or equal to +16 dBm.
2. Press the Offset soft key and enter the attenuation, in dB, using the keypad, the arrow keys, or the rotary knob.

3. Press the **Enter** key to complete the entry.

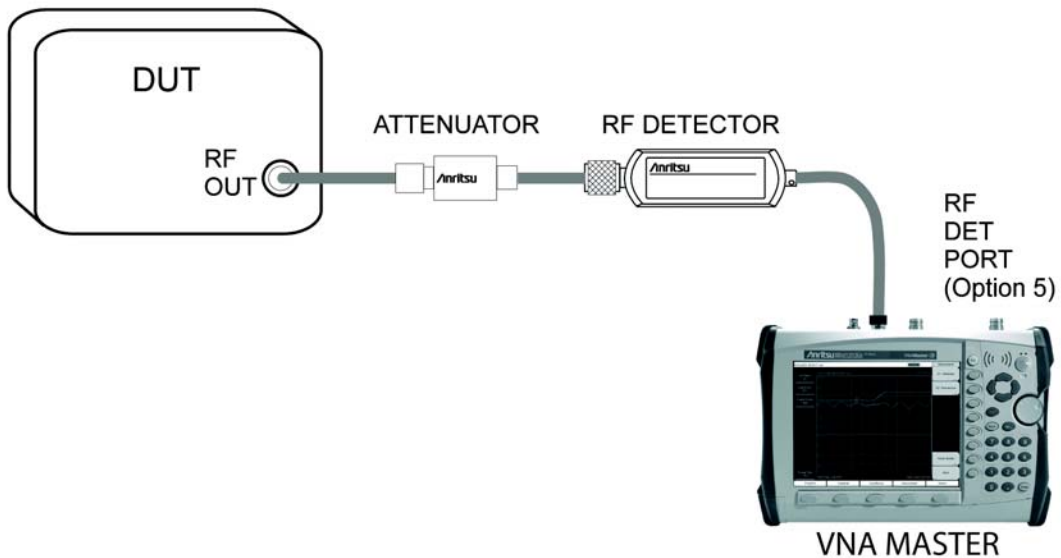

**Figure 6-1.** Power Measurement Setup With Attenuator

### Display Power in dBm or in Watts

Press the Units soft key to toggle between dBm and Watts.

### Relative Power

1. With the desired base power level input to the VNA Master, press the Relative soft key. The power reading will show 100% because it is measuring the same power level.
2. If the power is lowered by 3 dB, then the relative power will show 50%.
3. If the power in Watts is increased from 1 to 2 Watts, then the relative power will show 200%.

In [Figure 6-2](#), the Units are set for dBm, the Relative Power function is Off, the Offset is 1 dBm, and the Zero function is set to Off. The figure is intended to illustrate the general layout of the Power Monitor display.

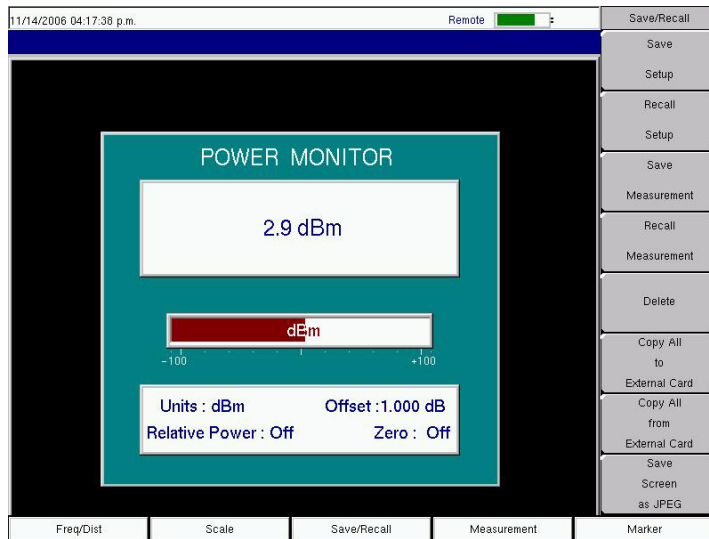

Figure 6-2. Power Monitor Display



# Chapter 7 — Built-In Bias Tee, Option 10

## 7-1 Introduction

Option 10 provides a bias tee that is installed inside the VNA Master. The bias arm is connected to a 12 VDC-to-24 VDC power source that can be turned on as needed to place the voltage on the center conductor of the RF In port. This supply of bias implies it is only useful when conducting two-port transmission measurements. This voltage can be used to provide power to block down-converters in satellite receivers and can be used to power some tower-mounted amplifiers.

The bias can be turned on only when the instrument is in Vector Network Analyzer mode. When bias is turned on, the bias voltage and current are displayed in the upper left corner of the display. The 12 VDC-to-24 VDC power supply is designed to continuously deliver a maximum of 6 Watts.

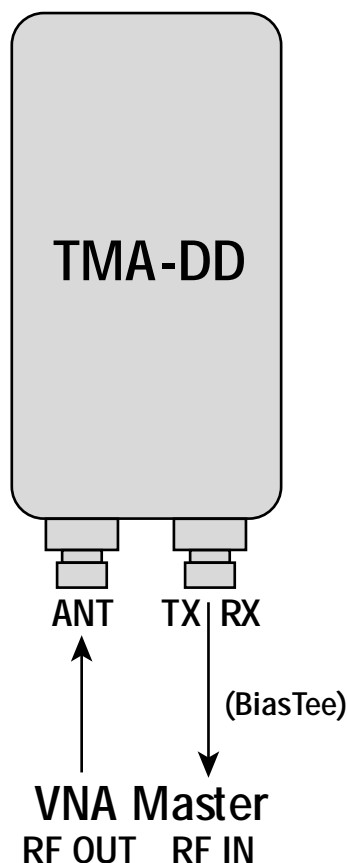

Figure 7-1. Variable Bias Tee

## 7-2 2-Port Gain Measurements

Two power levels are available with 2-port measurements: High (0 dBm) and Low (-35 dBm). The low power setting should be used when making direct gain measurements of amplifiers. This will ensure that the amplifier is operating in the linear region. The High power setting is ideal when characterizing passive devices but can also be used when making relative gain or antenna-to-antenna isolation measurements in the field.

The Variable Bias Tee Option (Option 10) can be used to place between +12V and +24V on the center conductor of the RF In port. It is designed to deliver 500 mA at +12V and 250 mA at +24V.

Also refer to “[Bias Tee Option](#)” on [page 7-4](#) in the sweep menu section.

### Example 1

This example describes an S21 measurement of an attenuator.

#### Procedure

1. Ensure that the instrument is in Vector Network Analyzer mode and press the **Shift** key and the **System** (8) key, then press the Application Options soft key.
2. The Meas Menu soft key toggles between Field and VNA. The active measurement function is underlined.
3. Press the soft key (if necessary) until VNA is underlined, then press the Back key.
4. The Measurement soft key menu now displays VNA measurement options.
5. If a test port extension cable is to be used, then connect it to the RF Out connector on the VNA Master.
6. Press the **Measurement** function hard key and select S21 Transmission | Log Magnitude.
7. Press the **Shift** key, then the **Sweep** (3) key.
8. Select the Power soft key and set power to High.
9. Press the **Freq/Dist** function hard key and set the Start Frequency and Stop Frequency.
10. Press the **Shift** key, then the **Calibrate** (2) key.
11. Press the Start Cal soft key and perform a 2-port OSL calibration at the connector or at end of the extension cable. Follow the instructions on the display or refer to section “[3-3 Calibration](#)” on [page 3-3](#) for more details.
12. When the Calibration is finished, Cal Status On should be displayed in the upper left part of the display, and the trace should be a flat trace at 0 dB.

13. Connect an attenuator between the test port extension cable and the RF In port.

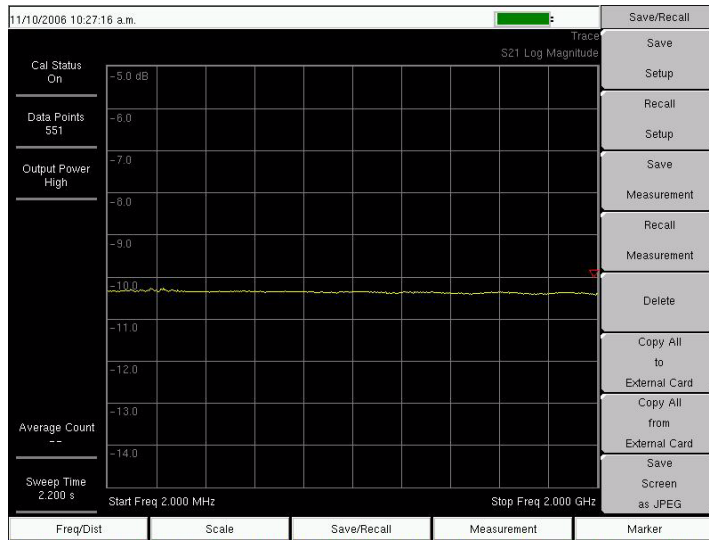

**Figure 7-2.** S21 Log Magnitude (VNA Measurement Menu)



## 7-3 Bias Tee Menu

To access the Bias Tee menu, press the **Shift** key then the **Sweep** (3) key. Press the Bias Tee soft key to open the Bias Tee menu.



**Figure 7-3.** Bias Tee Menu

For additional information about the Sweep menu, refer to [“Sweep Menu” on page 3-51](#).

### Bias Tee Option

The Variable Bias Tee Option (Option 10) is available for all models of the VNA Master. In addition to this section, refer to [“2-Port Gain Measurements” on page 7-2](#) and the associated [“Example 1” on page 7-2](#).

The built-in variable power supply can be turned on as needed to place between +12V and +24V on the center conductor of the RF In port. For +12V and +15V settings, the current can be set to Low or High. The status window to the left of the display shows the current and voltage information that can be stored as well.

Press the Bias Tee soft key to open the Bias Tee menu.

**Bias Tee Menu Soft Keys****Bias Tee On/Off**

This soft key toggles the bias tee function On and Off.

**Bias Tee Voltage ###.# V**

Allows entry of the Bias Tee voltage to be placed on the center conductor of the RF In port. Values can be between 12.0 and 24.0 V in increments of 0.1 V.

**Current Low/High**

This soft key toggles the bias tee current between Low and High.

**Back**

Use this soft key to return to the Sweep menu.



# Chapter 8 — Vector Voltmeter, Option 15

## 8-1 Introduction

When equipped with option 15, the VNA Master is a convenient tool for ensuring phase match between RF cables, especially in the field where access to AC power is typically limited. This mode is called Vector Voltmeter mode (VVM) because it can replace a vector voltmeter, which is becoming obsolete. With the convenience of a user interface that is similar to a vector voltmeter, an engineer or technician can use a familiar display and highly integrated solution for phase matching cables.

## 8-2 Getting Started

As shown in the following block diagram (Figure 8-1), the VNA Master contains the Vector Voltmeter receiver, signal source, and couplers for conducting both 1-port and 2-port measurements at a selected CW frequency.

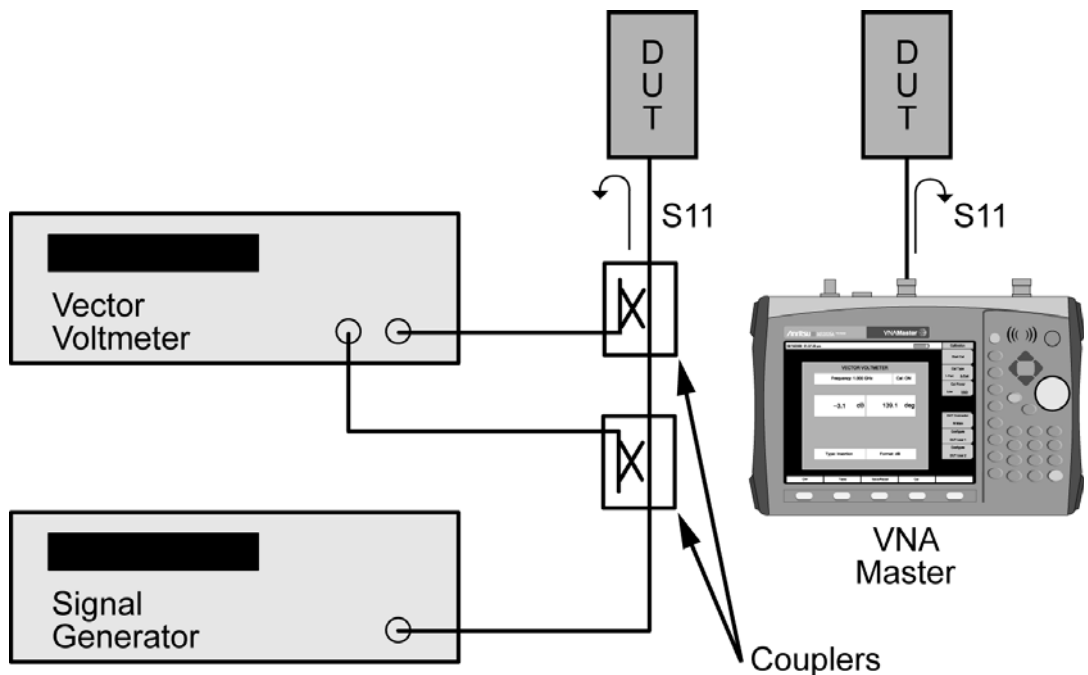

**Figure 8-1.** Vector Voltmeter within VNA Master

A setup comparison between a vector voltmeter and the VNA Master is shown for conducting an S11 measurement.

## 8-3 Using Vector Voltmeter Mode for the First Time

Before conducting a measurement in vector voltmeter mode, select a CW frequency and perform a calibration. During calibration, choose between a 1-port or 2-port calibration depending upon whether return or insertion type measurements, respectively, are desired.

When making a 1-port connection to the DUT (device under test), select the Return measurement type and perform a 1-port calibration. When making a 2-port connection to the DUT, select the Insertion measurement type and perform a 2-port calibration. The following paragraphs further explain these steps.

## 8-4 Simple Measurement Using CW Display

1. Select **Shift** and **Mode** and **Enter** to use the Vector Voltmeter function.
2. Select the **CW** display function hard key.
3. Press CW Frequency soft key.
4. Press the **Cal** function hard key.
5. Press the Cal Type soft key for 1-Port or 2-Port.
6. Press the Cal Mode soft key, if necessary, to underline Standard.

<b>Note</b>	Due to the use of interpolated calibration data, FlexCal™ is not recommended for Vector Voltmeter mode. Use Standard calibration mode for greatest measurement accuracy.
-------------	--

7. Press the Cal Power soft key. Choose High for the best measurement accuracy. If conducting measurements on active devices, then choose Low Cal Power to avoid compression.
8. Press DUT Connector to select a specific connector type (or select Configure User 1 or Configure User 2 when using a custom calibration kit).
9. As shown in [Figure 8-2](#), press Start Cal to begin Open-Short-Load (OSL) calibration. For two-port measurements, refer to [Figure 8-3](#) for Open-Short-Load-Isolation-Through (OSLIT) calibration. In order to ensure a good calibration, be careful to follow the on-screen messages for connecting the calibration components in the proper sequence.

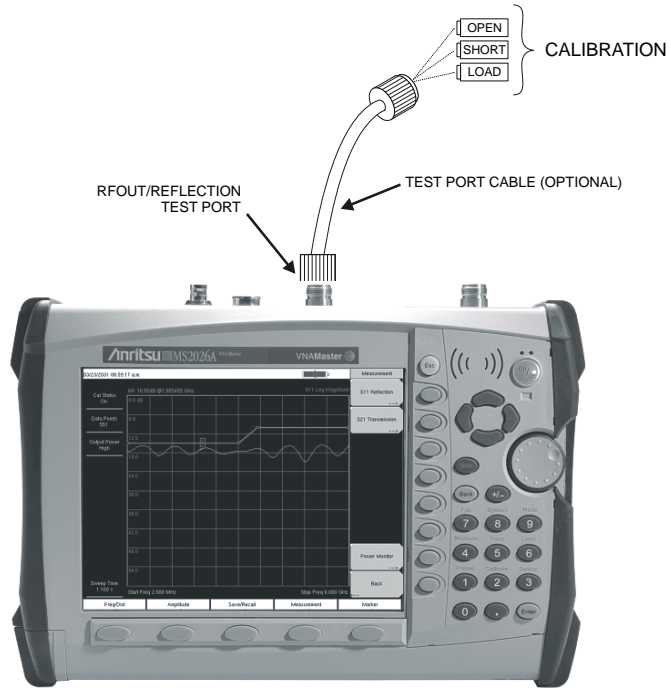
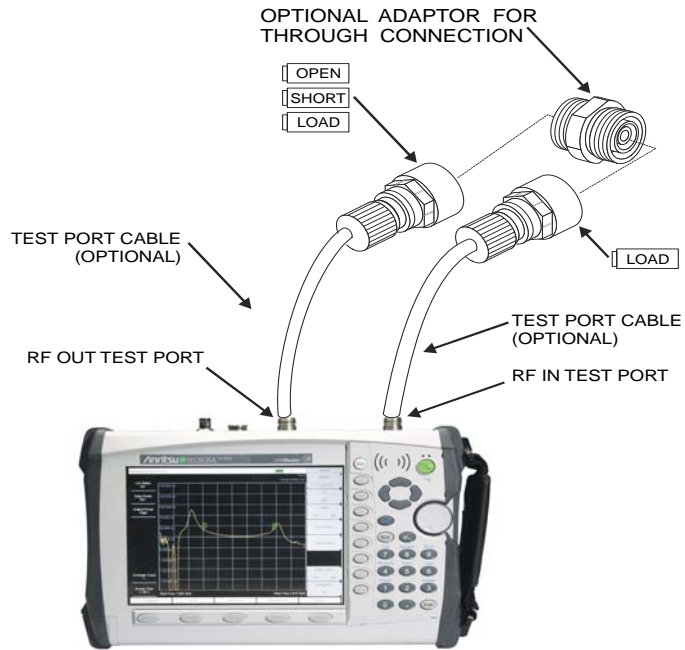

Figure 8-2. 1-Port Calibration



**Figure 8-3.** 2-Port Calibration

10. After calibration, press the **CW** function hard key to display the CW menu.

11. Connect the DUT for measurement. The display should appear similar to the image in [Figure 8-4](#).

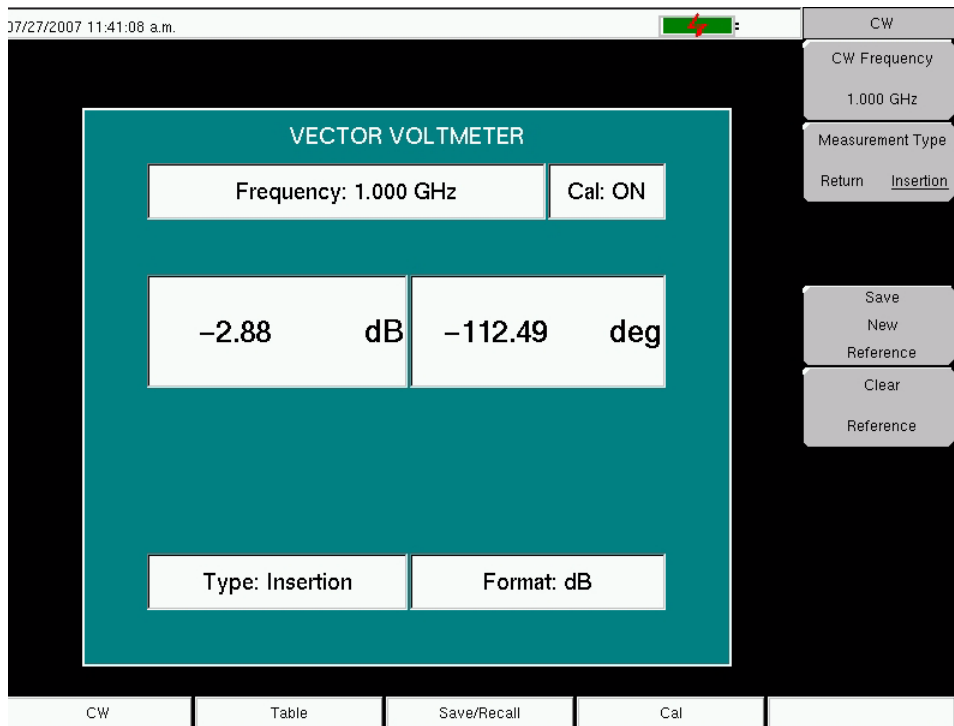

**Figure 8-4.** Continuous Wave Menu

12. Specify Measurement Type to be Return for a 1-port DUT. After a 2-port calibration, both Return and Insertion measurement types can be viewed.
13. Choose to view the measurement results for the return measurement as dB, VSWR, or Impedance by pressing the Return Meas. Format soft key. For insertion measurements, only the dB selection is available.

This completes the procedure for performing a simple measurement using the vector voltmeter mode.



## 8-5 Simple Relative Measurements using CW Display

The operations for relative measurements are described in the following steps.

1. From the **CW** menu, preset the Vector Voltmeter Mode for relative measurements by pressing the Clear Reference soft key.
2. Connect the first DUT (device under test).
3. Save the measurement result of the first DUT by pressing the Save New Reference soft key.
4. As shown in [Figure 8-5](#), the Vector Voltmeter saves the current measurement in a new reference window and converts the main measurement window to display the difference between the current measurement and the saved reference. In other words, saving a reference will normalize the results to the current measurement. When relative measurements are displayed, REL is indicated in the main measurement window.

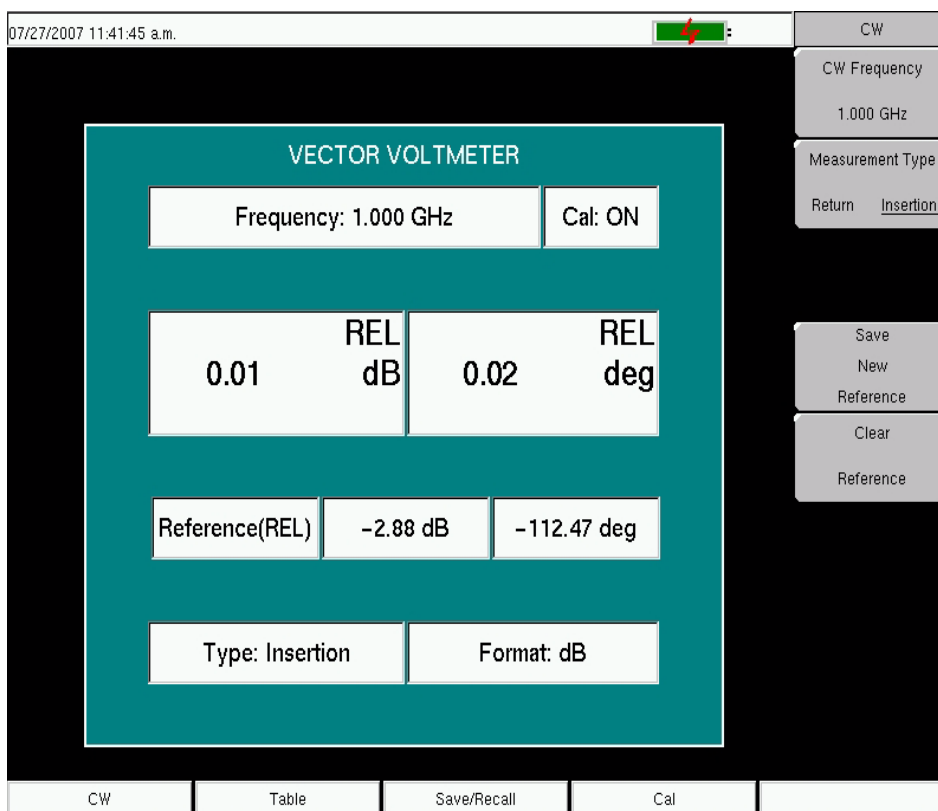

**Figure 8-5.** Continuous Wave Menu with Relative Measurements

5. Connect the second DUT and view the difference between the first and second DUT measurements.
6. To create a new reference, press the Clear Reference soft key followed by the Save New Reference soft key

This completes the procedure for relative measurements.

## 8-6 Vector Voltmeter Measurements Using Table Display

The Vector Voltmeter includes a convenient table display for comparing up to five cables. With this feature, the user can save the first cable measurement as a reference, can view the differences among the other cables, and can output a final report showing both absolute and relative values of all the cables. The following steps describe an overview of the procedure for using this feature.

1. Press the **Table** function hard key.
2. The setup procedure, including calibration, is the same as 4. through 9. in the procedure described in section “[Simple Measurement Using CW Display](#)” on page 8-2. Specify CW Frequency and perform the appropriate 1-port or 2-port calibration.
3. After calibration, press the **Table** function hard key.
4. Preset the Vector Voltmeter Mode for relative measurements by pressing the Clear Reference soft key.
5. Connect the DUT for measurement. The display appears similar to that shown in [Figure 8-6](#).

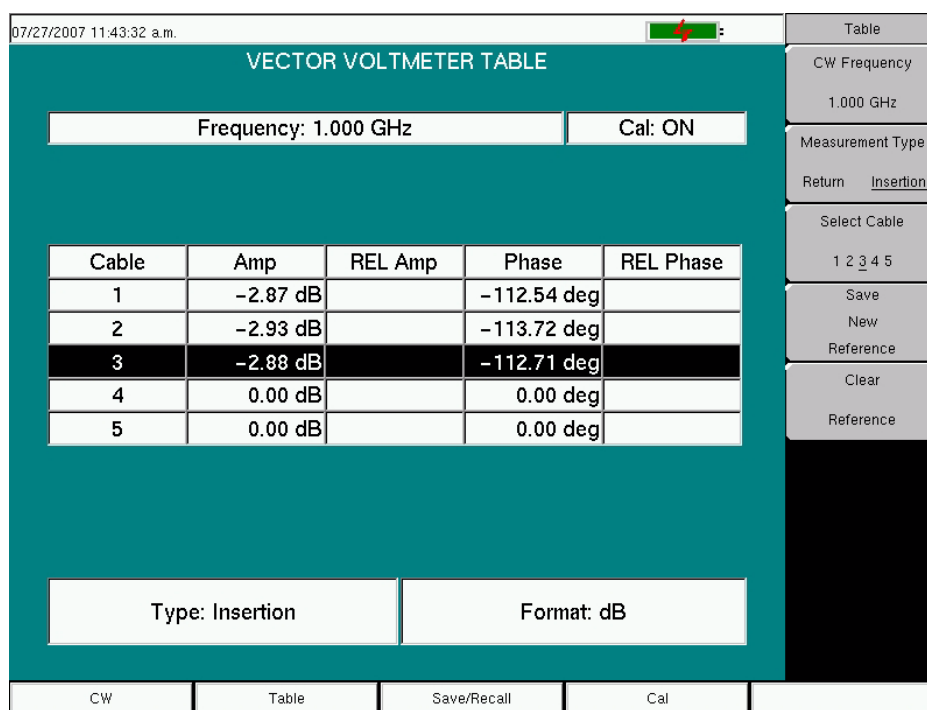

**Figure 8-6.** Vector Voltmeter Measurement Table

6. Save the measurement result of the first DUT by pressing the Save New Reference soft key.
7. As shown in [Figure 8-7](#), the VNA Master saves the current measurement in a new reference window above the table and updates the REL Amp and REL Phase columns

to display the difference between the current measurement and the saved reference measurement.

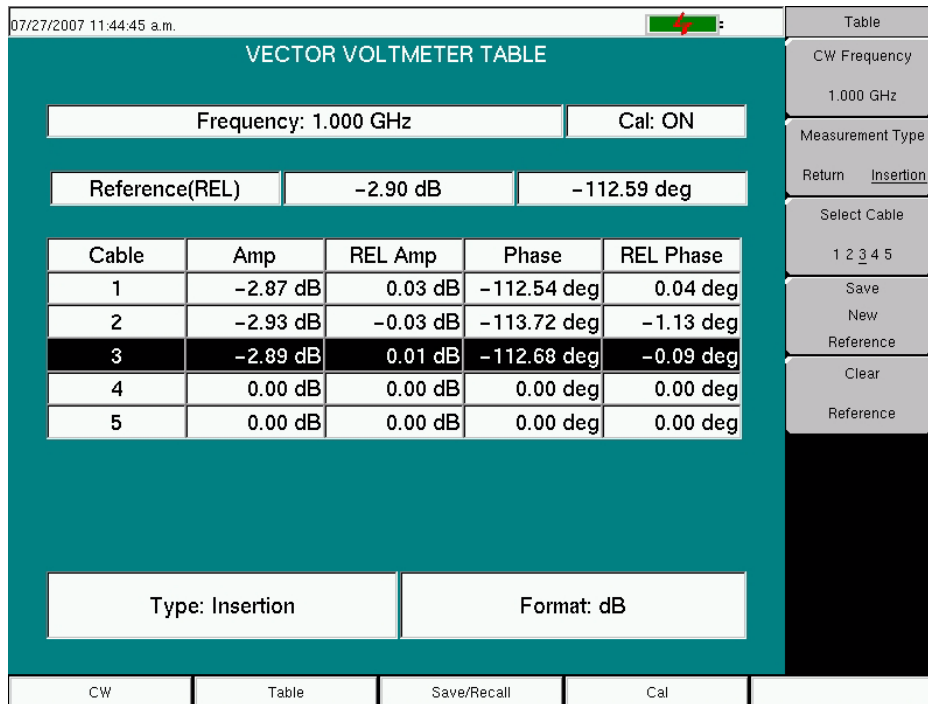

**Figure 8-7.** Vector Voltmeter Relative Measurement Table

- Before disconnecting the first DUT, save the results in the current row by using the Select Cable soft key to move to another row in the table. When selecting a new cable, the VNA Master saves the results and updates measurements for the next cable in the table.

**Note** Be sure to keep the DUT connected until a new cable has been selected in order to ensure that the proper values are saved in the table for the final report.

- Connect the second DUT and view the difference between the first and second DUT measurements. Be careful to avoid selecting another cable when you are done with the measurement. Saved data can be overwritten.
- To create a new reference, press the Clear Reference soft key followed by the Save New Reference soft key. Consider the possibility of changing the reference by using Select Cable to choose cable 1 again.

This completes the procedure for relative measurements using the table display.

## 8-7 Vector Voltmeter Mode Menus

In the Vector Voltmeter mode, the function hard keys display the following labels: “**CW**”, “**Table**”, “**Save/Recall**”, and “**Cal**”. The fifth function hard key has no function in the Vector Volt Meter mode.

### CW Menu

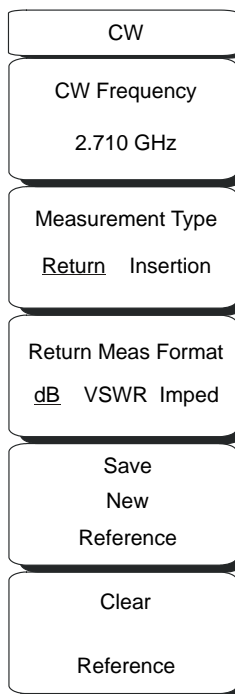

**Figure 8-8.** CW Menu

In Continuous Wave, the meter displays the selected frequency and indicates if calibration is ON or OFF for that specific frequency. The instrument must be calibrated for each chosen frequency.

The return measurement format units are displayed near the center of the vector volt meter window. For dB format, the units are dB and deg (degrees). For VSWR format, the units are VSWR. For Imped (impedance) format, the units are Ohms and jOhms.

The measurement type and format are displayed at the bottom of the Vector Voltmeter window.

CW Frequency #.### GHz, MHz, kHz, Hz

Press this soft key to set the desired measurement frequency. Enter the desired frequency using the keypad, the arrow keys, or the rotary knob. If entering a frequency using the keypad, then the soft key labels change to GHz, MHz, kHz, and Hz. Select the appropriate units key. Selecting the **Enter** key has the same affect as using the MHz soft key.

**Measurement Type: Return – Insertion**

Press the Measurement Type soft key to toggle between return and insertion.

**Return Meas Format: dB – VSWR – Imped**

Press the Return Meas Format soft key toggle among dB, VSWR, and Imped (impedance).

**Save New Reference**

Press this soft key to save the current measurement as the reference measurement.

Entering a reference puts the Vector Voltmeter in relative measurement mode.

**Clear Reference**

Pressing this soft key removes the reference measurement from memory, and the

Vector Voltmeter exits the relative measurement mode.

---

**Table Menu**

---

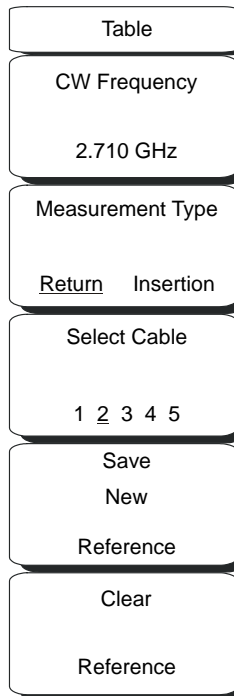

---

**Figure 8-9.** Table Menu

**CW Frequency #.### GHz, MHz, kHz, GHz**

Press this soft key to set the desired measurement frequency. Enter the desired frequency using the keypad, the arrow keys, or the rotary knob. If entering a frequency using the keypad, then the soft key labels change to GHz, MHz, kHz, and Hz. Select the appropriate units key. Selecting the **Enter** key has the same affect as using the MHz soft key.

**Measurement Type: Return – Insertion**

Press the Measurement Type soft key to toggle between return and insertion.

**Select Cable: 1 2 3 4 5**

One of the five cable numbers is underlined to indicate which cable is selected. Change to a different cable by pressing the Select Cable soft key. The data in the selected cable row is highlighted in the displayed table.

**Save New Reference**

Press this soft key to save the current measurement as the reference measurement. Entering a reference puts the Vector Voltmeter in relative measurement mode.

**Clear Reference**

Pressing this soft key removes the reference measurement from memory, and the Vector Voltmeter exits the relative measurement mode.

### **Save/Recall Menu**

For a description of the soft keys in the Save/Recall menu, refer to [“Save/Recall Menu” on page 3-49](#) in [Chapter 3, “Vector Network Analyzer”](#).

### **Calibration Menu**

For description of the Calibration menu items and options, refer to [“Calibration Menu” on page 3-27](#) in [Chapter 3, “Vector Network Analyzer”](#).

# Chapter 9 — Interference Analyzer, Option 25

## 9-1 Introduction

Many wireless networks operate in complicated signal environments. Three or four base station antennas may be located onto the same tower and can create interference problems, which can affect system capacity and coverage.

The Interference Analyzer option adds three measurement capabilities to the VNA Master:

- Spectrogram
- Signal Strength
- RSSI (Received Signal Strength Indicator)

The instrument also has a spectrum mode which displays signals in a traditional Spectrum Analyzer view.

The following menus are available in Interference Analyzer (Option 25) mode.

## 9-2 Spectrogram Measurement

A Spectrogram is a three dimensional representation of frequency, time and power useful for identifying intermittent interference. Color is used to represent power levels. [Figure 9-1](#) shows a sample spectrogram display in a Field measurement menu.

### Procedure

The following procedure demonstrates one example of an Interference Analyzer Spectrogram setup.

1. Select the **Shift** key, then the **Mode (9)** key, using rotary knob or Up/Down arrow keys select Interference Analyzer and press the **Enter** key to select.
2. Press the **Freq** function hard key.
3. Select the Signal Standard soft key and select the desired air interface standard from the dialog box displayed. Alternatively, choose the appropriate soft keys and enter the center, start and stop frequencies and the span.
4. For the most effective spectrogram display, press the **Amplitude** key, select the Reference Level soft key and set the reference level such that the largest signal to be displayed will be near the top of the Spectrum Analyzer area of the screen. The reference value required can be determined by observing the color of the highest signal and changing the reference level to place that value near the top of the Spectrum Analyzer area.
5. Select the Scale soft key and set the scale value to place the lowest signal near the bottom of the screen. In general, 4 or 5 dB/division will be good starting values.
6. Select the **BW** function hard key and set Auto RBW and Auto VBW On, or set the applicable RBW and VBW values by selecting the RBW and VBW soft keys.



7. Press the **Measurements** function hard key and the Spectrogram soft key twice.
8. Set the time between sweeps by selecting the Sweep Interval soft key, or set the total time for a full spectrogram by selecting the Time Span soft key.
9. To change the time between sweeps, press the Sweep Interval soft key and use the rotary knob or keypad to set the time from 0 seconds to 660 seconds. Entering the time interval value causes the corresponding time span value to be automatically computed. The time span can be viewed or changed by selecting the Time Span soft key and using the rotary knob or keypad to set the span. As expected, changing the time span will automatically change the sweep interval.

<b>Note</b>	Setting a Sweep Interval value >0 will change the detection method to Max Hold, so that any event within the time interval will be captured to the screen. This allows for extended measurement times to be set.
-------------	--

10. To set the total time span for a complete display, press the Time Span soft key and use the rotary knob or keypad to enter a time between 1 and 4320 minutes (72 hours). Entering a time span value causes the corresponding sweep interval value to be automatically computed and shown when the Sweep Interval soft key is pressed.
11. The instrument can be set so that spectrogram plots can be automatically saved when the display is full. Press the Auto Save soft key to toggle auto save On or Off.
12. The Time Cursor soft key is used to turn on the horizontal time cursor. Use the **Up/Down** arrow key to move the cursor vertically through the spectrogram. The date and time that the measurement at the cursor position was taken is displayed at the top of the screen.

<b>Note</b>	When the Time Cursor is activated and not on the zero trace position, the unit will automatically stop making measurements
-------------	--

13. Press the **Marker** key to place up to six markers on the signal and display the power and frequency at each marker position.

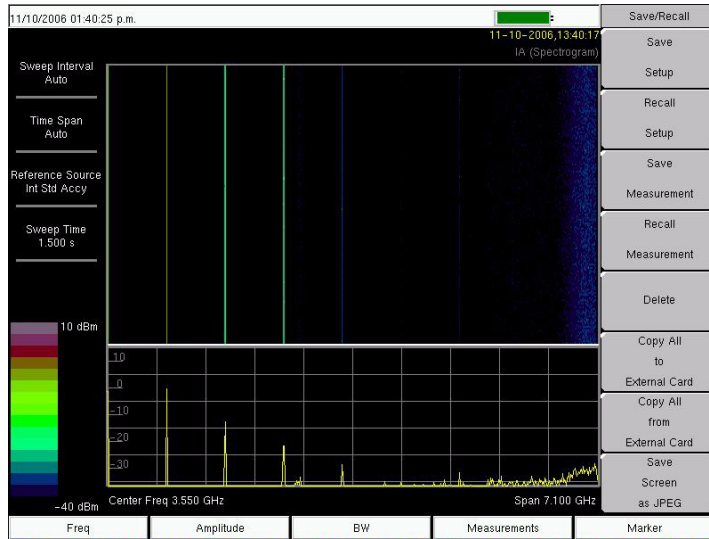

**Figure 9-1.** Interference Analyzer Mode Sample Spectrogram Display

## 9-3 Signal Strength

The Signal Strength meter is useful for tracking down the source of an interfering signal. This measurement is done at a single frequency in zero span. The power at a frequency (in dBm and watts) is displayed along with an optional audible indicator. Connect a directional antenna and the frequency of the audible indicator increases as the measured signal strength increases. This mode is especially useful when attempting to locate an emitter using a directional antenna.

For field strength measurements, antenna factors are included. Antenna factors for all antennas offered by Anritsu are stored in the unit. Custom antenna factors can be created and downloaded into the instrument using Anritsu Master Software Tools software.

### Procedure

The following procedure demonstrates a common Interference Analyzer Signal Strength setup.

1. Select the **Shift** key, then the **Mode** (9) key, using rotary knob or **Up/Down** arrow keys select Interference Analyzer and press the **Enter** key to select.
2. Press the **Freq** function hard key to set the desired frequency. Select the **Center** soft key, and use the soft keys to tune the center frequency to place the signal of interest in the center of the display.
3. Connect the appropriate directional antenna to the spectrum analyzer RF In port and press the **Measurements** key.
4. Press the **Signal Strength** soft key twice to activate the signal strength measurement menu.
5. Press the **Auto Scale** soft key to automatically scale the display range, or set the desired and maximum and minimum values by selecting the **Max Level** and **Min Level** soft keys.
6. Press the **Speaker On/Off** soft key to turn on the audio output.

7. If necessary, press the Volume soft key to set the speaker or headphone volume to a comfortable level. Use the Up/Down arrow keys to adjust the volume.

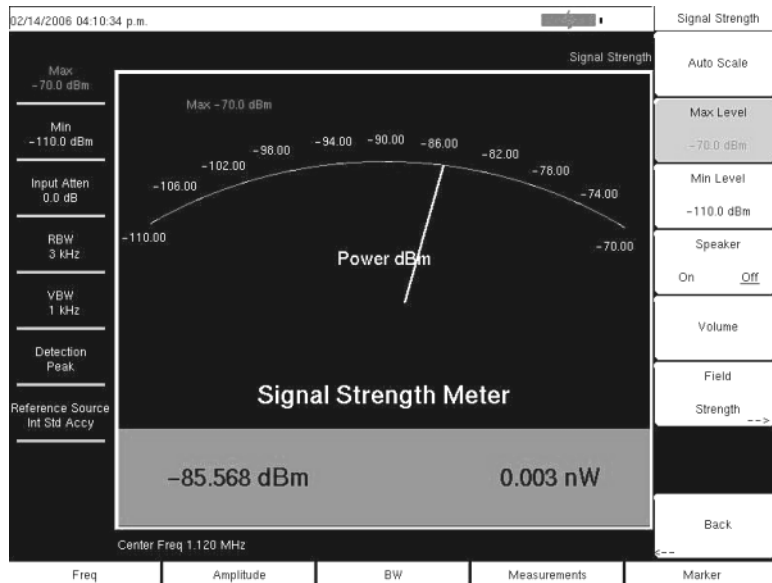

**Figure 9-2.** Interference Analyzer Mode Signal Strength Display

## 9-4 RSSI (Received Signal Strength Indicator)

The Received Signal Strength Indicator, RSSI, is useful for observing signal strength at a single frequency over time.

### **Procedure**

The following procedure demonstrates a common Interference Analyzer RSSI setup. To select Interference Analyzer mode:

1. Select the **Shift** key, then the **Mode** (9) key, using rotary knob or Up/Down arrow keys select Interference Analyzer and press the **Enter** key to select.
2. Press the **Freq** function hard key to set the desired frequency. Select the Center soft key, and use the soft keys to tune the center frequency to place the signal of interest in the center of the display.
3. Press the **Measurements** key and select the RSSI soft key twice to bring up the RSSI menu.
4. Press the Time Interval soft key to set the time between adjacent measurement points. This time may be set from 70 ms to 1 minute.
5. Press the Time Span soft key to set the overall time span for the RSSI measurement. This time can be set from zero, to give manual control of the time span, to a maximum of seven days. After the specified time span, the measurement is halted. Depending on the time interval selected, the data will scroll to the left once the trace fills the screen.
6. Press the Auto Scale key to automatically set the reference level and scale factor to place the trace on the screen.

**Note**

The Time Span only captures the last display, not the entire time of the Time Span. Use a longer time interval to extend the effective trace capture time.

7. To store the RSSI data, press the Auto Save On/Off soft key to turn on data logging. The data is named Log - followed by the time at which the data was stored. Each screen full of 551 data points will be stored as a separate display, and up to seven days of data can be saved. The unit saves the data in the saved trace directory and it can be recalled by selecting recall trace measurement.

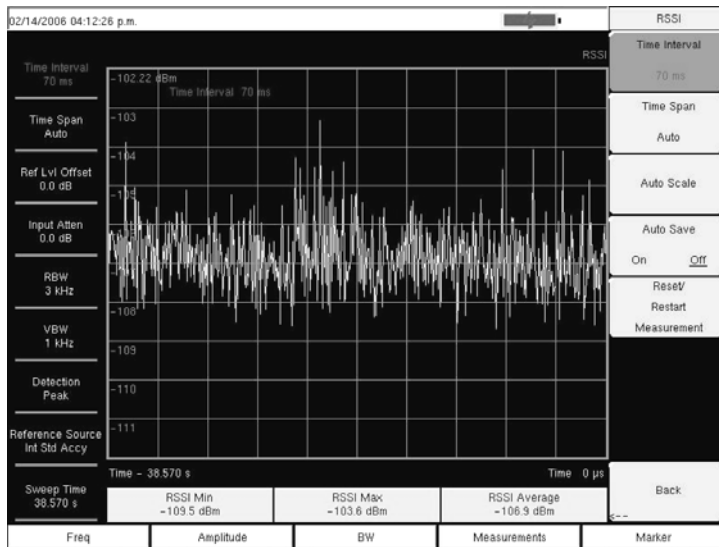
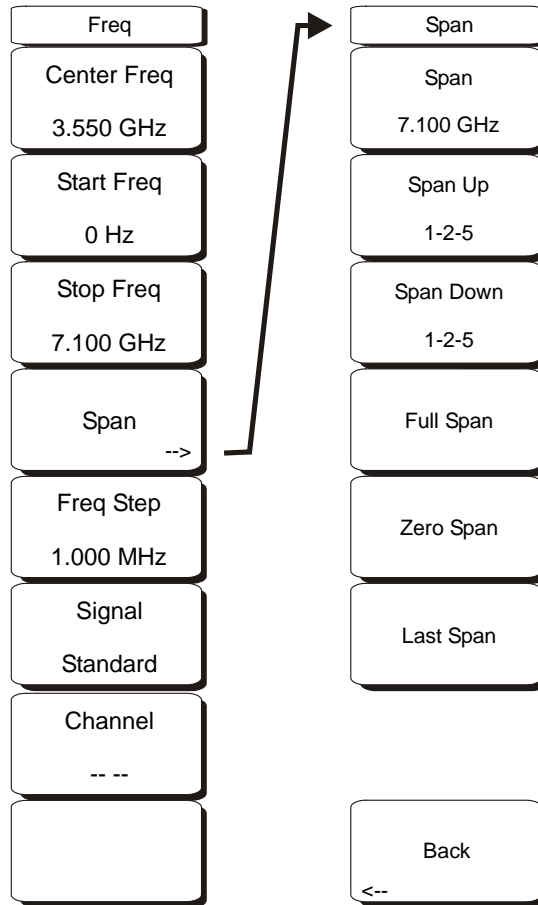

Figure 9-3. Interference Analyzer Mode RSSI Display

## 9-5 Freq (Frequency) Menu



**Figure 9-4.** Interference Analyzer Mode Freq Menu

The tuning frequency range for the VNA Master can be entered in several different ways depending on what makes the most sense for the user or for the application. The center frequency and span can be specified, the start and stop frequencies can be entered, or a signal standard and channel number can be selected from the built-in list.

### Center Freq

Press the **Freq** key followed by the Center Freq soft key and enter the desired frequency using the keypad, the arrow keys, or the rotary knob. If entering a frequency using the keypad, then the soft key labels change to GHz, MHz, kHz, and Hz. Select the appropriate units key. Selecting the **Enter** key has the same affect as the MHz soft key.

When using the up and down arrows, the frequency moves in steps defined by the value entered using the Freq Step soft key.

When using the left or right arrow keys, the frequency of the active parameter moves by 10% of the current frequency span. If the instrument is in zero span, then the left and right arrows do nothing.

#### Note

Turning the rotary knob changes the active frequency parameter in increments of one display point for each click of the knob. In normal mode, the screen display is 551 pixels wide, and in full-screen mode, the screen display is 661 pixels wide. Choose whichever display is more convenient. Use the Trace menu soft key, Full Screen On/Off, to change the display mode. This feature is available only in spectrum analyzer mode.

### Start Freq

Press the **Freq** key followed by the Start Freq soft key and enter the desired frequency using the keypad, the arrow keys, or the rotary knob. If a start frequency higher than the current stop frequency is entered, then the stop frequency will be changed to yield a 10 Hz span.

### Stop Freq

Press the **Freq** key followed by the Stop Freq soft key and enter the desired frequency using the keypad, the arrow keys, or the rotary knob. If a stop frequency lower than the current start frequency is entered, then the start frequency will be changed to yield a 10 Hz span.

### Span

The span function is available only in Spectrum view. Press the **Freq** key followed by the Span soft key and enter the desired span. The Span menu is used to set the frequency range over which the instrument will sweep. For the VNA Master, the span can be set from 10 Hz to the maximum frequency of the unit. The span can also be set to zero.

The soft key shows the current value for span in units of GHz, MHz, kHz, or Hz. When the Span button is pressed, span becomes the active parameter and may be changed. Use the keypad, the directional arrow keys, or the rotary knob to increase or decrease the span frequency.



### Freq Step

Press the **Freq** key followed by the Freq Step soft key to enter the desired frequency step size. The frequency step specifies the amount by which a frequency will change when the **Up/Down** arrow key is pressed. The center frequency, start frequency, and stop frequency values can be changed using Freq Step. The active parameter will be changed by the frequency step when the **Up/Down** arrow keys are pressed. If Freq Step is the active parameter, then nothing happens when the arrow keys are pressed. The frequency step size can be any value from 1 Hz to the maximum frequency of the unit with a resolution of 1 Hz.

Use the keypad or the rotary knob to change the Frequency Step size.

### Signal Standard

Use the **Up/Down** arrow keys or the rotary knob to highlight a signal standard and press **Enter** to select.

When a signal standard is selected, the center frequency and span for the first channel of the particular standard is automatically tuned. Other settings, such as channel spacing and integration bandwidth, are also automatically entered.

[Appendix A, “Signal Standards”](#) contains a table of the signal standards that are in the instrument firmware.

### Channel # #

Use the **Up/Down** arrow keys, the keypad, or the rotary knob to select a channel number for the selected signal standard. The center of the channel is tuned to the center of the VNA Master display.

## 9-6 Amplitude Menu

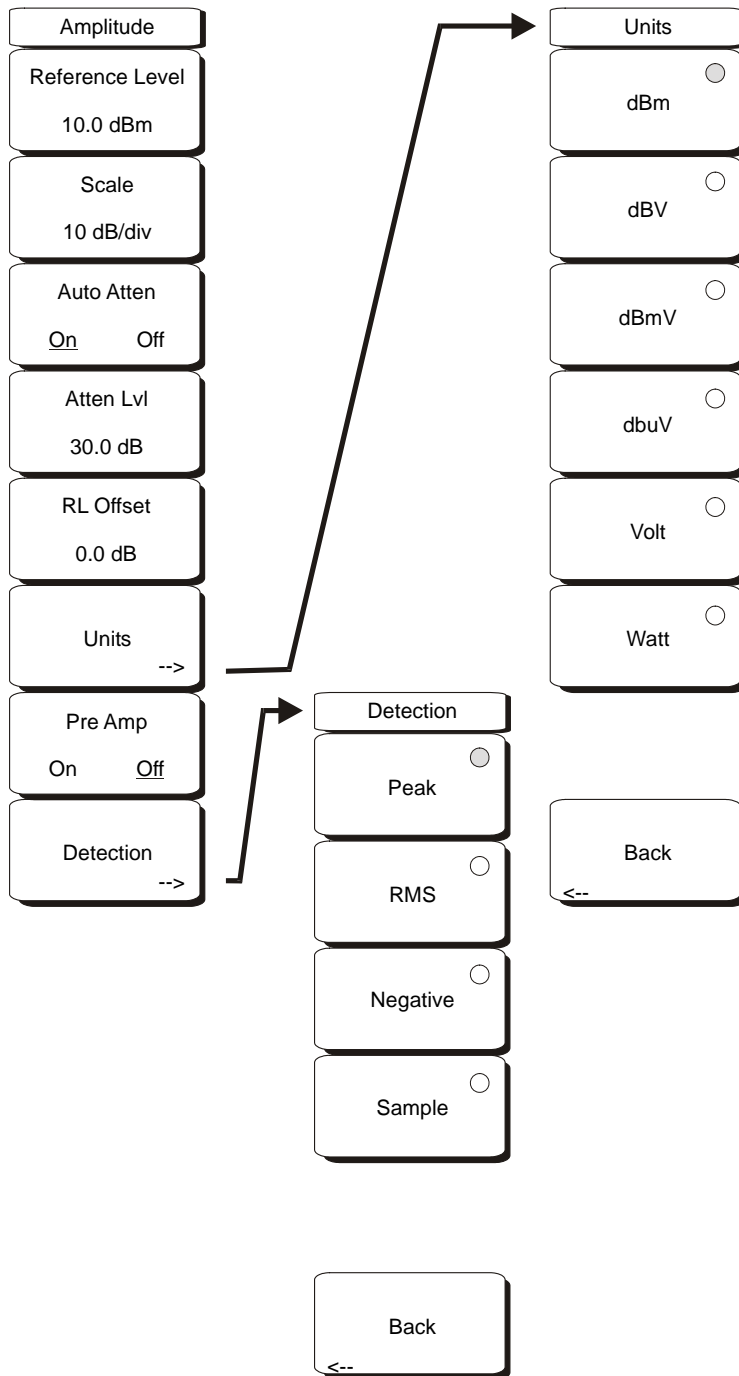

**Figure 9-5.** Interference Analyzer Mode Amplitude Menu

### Reference Level

The reference level is the top graticule line on the display, and can be set from +30 dBm to -150 dBm. A negative value may be entered from the key pad, using the  $\pm$  key as the minus sign. After entering the value press the dBm soft key or the **Enter** key. The Up/Down arrow keys change the reference level in 10 dB steps, and the Left/Right arrow keys change the value by 1 dB. The rotary knob changes the value by 0.1 dB per detent.

The reference level value may be modified by the reference level offset value to compensate for an external attenuator, as discussed later in this chapter.

### Scale

The scale can be set in 1 dB steps from 1 dB per division to 15 dB per division. The value can be changed using the keypad, the rotary knob or the Up/Down arrow keys.

### Auto Atten On/Off

Input attenuation can be either tied to the reference level (On) or manually selected (Off). When input attenuation is tied to the reference level, attenuation is increased as higher reference levels are selected to make sure the instrument input circuits are not saturated by large signals that are likely to be present when high reference levels are required.

### Atten Lvl

Input attenuation can be set from 0 dB to 65 dB, in 5 dB steps. Select this soft key and use the keypad, the rotary knob or the Up/Down arrow keys to change the attenuation value. When the Preamplifier is turned on, the allowed attenuation settings are 0 dB and 10 dB.

### RL Offset

Reference Level Offset compensates for the presence of input attenuation or gain external to the instrument. Enter a positive value to compensate for an external amplifier or a negative value to compensate for an external attenuator. Use the  $\pm$  key to enter the negative sign when a negative attenuation value is being entered.

### Units

The Units soft key is available only in the Spectrum view. Select the display units from this soft key menu:

- dBm
- dBV
- dBmV
- dB $\mu$ V
- Volt
- Watt

Back

Press the Back soft key to return to the Amplitude menu.

### Pre Amp On/Off

This soft key turns the low-noise front-end preamplifier on or off. The preamplifier lowers the noise floor by approximately 25 dB. To assure accurate measurement results, the largest signal into the instrument input when the preamplifier is turned on should be less than -50 dBm.

---

## 9-7 BW (Bandwidth) Menu

---

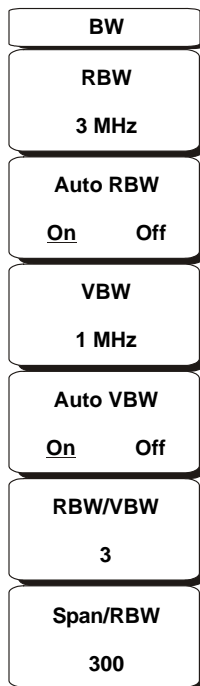

---

**Figure 9-6.** Interference Analyzer Mode BW Menu

### RBW

The current resolution bandwidth value is displayed in this soft key. The RBW can be changed using the keypad, the **Up/Down** arrow keys, or the rotary knob. The range is 10 Hz to 3 MHz in a 1-3-10 sequence, from 10 Hz to 30 Hz to 100 Hz, and so on.

### Auto RBW

When Auto RBW is **On**, the instrument selects the resolution bandwidth based on the current span width. The ratio of span width to RBW can be specified using the **Span/RBW** soft key.

### VBW

The current video bandwidth value is displayed in this soft key. The VBW can be changed using the keypad, the **Up/Down** arrow keys, or the rotary knob. The range is 1 Hz to 3 MHz in a 1-3 sequence.

### Auto VBW

When Auto VBW is **On**, the instrument selects the video bandwidth based on the resolution bandwidth. The ratio of video bandwidth to resolution bandwidth can be set using the **RBW/VBW** soft key.

### RBW/VBW

This soft key displays the ratio between resolution bandwidth and video bandwidth. To change the ratio, select this soft key and use the keypad, the **Up/Down** arrow keys, or the rotary knob to select a new ratio. The default ratio is 3.

### Span/RBW

This soft key displays the ratio between the span width and the resolution bandwidth. The default value is 300, meaning that the span width is approximately 300 times the resolution bandwidth. The value is approximate because resolution bandwidth filters come in discrete steps while span width can be set to any value up to the maximum frequency of the unit. To change the ratio, select this soft key and use the keypad, the **Up/Down** arrow keys, or the rotary knob to select a new ratio.

## 9-8 Measurements Menu

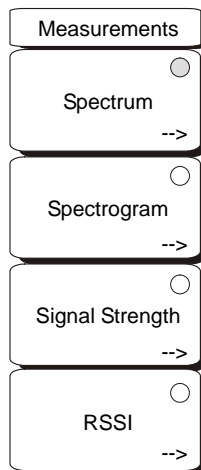

**Figure 9-7.** Interference Analyzer Mode Measurements Menu

**Note**

The red circle on the soft key indicates the currently active measurement. The arrow does not appear on the soft key until after the key has been pressed and the function has become active. Then the additional menu is available.

### Spectrum

Selecting the Spectrum soft key sets the instrument to a traditional Spectrum Analyzer display. When Spectrum is active, pressing the Spectrum soft key again opens a menu for Spectrum Analyzer measurements.

### Spectrogram

Selecting the Spectrogram soft key sets the instrument to display a spectrogram. When Spectrogram is active, pressing the Spectrogram soft key again opens a menu of spectrogram settings.

### Signal Strength

Selecting the Signal Strength soft key sets the instrument to display signal strength. When Signal Strength is active, pressing the Signal Strength soft key again opens a menu of signal strength settings.

### RSSI

Selecting the RSSI soft key sets the instrument to display RSSI (Received Signal Strength Indicator). When RSSI is active, pressing the RSSI soft key again opens a menu of RSSI settings.

# 9-9 Spectrum Menu

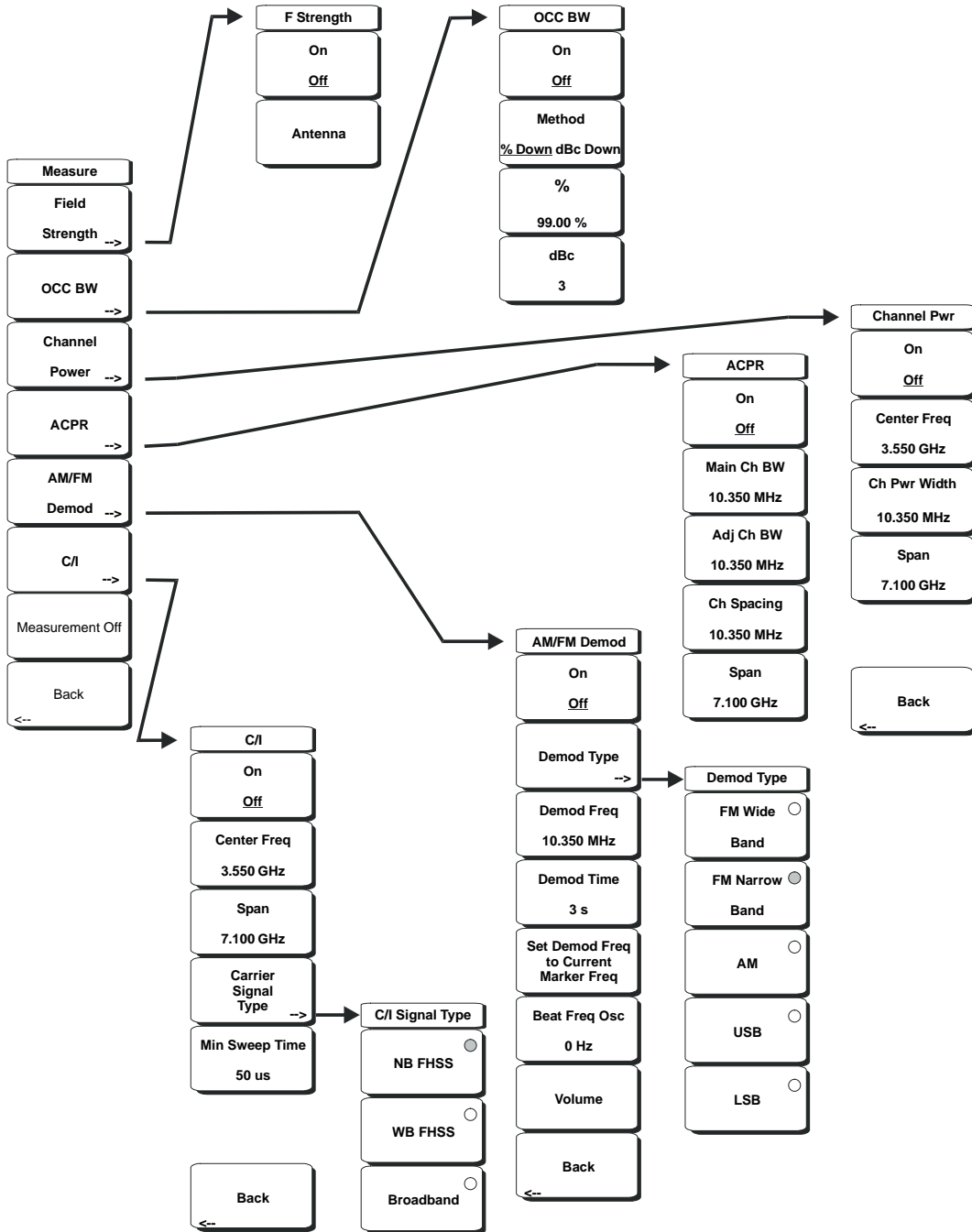

Figure 9-8. Interference Analyzer Mode Spectrum Menu

### Field Strength

This measurement allows the use of an antenna with known gain characteristics and measures the field strength over the frequency range of the antenna in units of dBm/meter<sup>2</sup>, dBV/meter<sup>2</sup>, dBmV/meter<sup>2</sup>, dBμV/meter<sup>2</sup>, volts/meter, or watts/meter.

#### On/Off

Turns field strength measurements on or off.

#### Antenna

This soft key brings up a dialog box that lists all the antennas for which the instrument has data, including both standard antennas and custom antenna that have been added using Master Software Tools ([Chapter 13](#)). Use the Up/Down arrow keys or the rotary knob to select the desired antenna and press **Enter**.

#### Back

Returns to the previous menu.

### OCC BW

Activates the occupied bandwidth menu. Select either % or dBc method of occupied bandwidth measurement.

#### Method % Down/dBc Down

Select either the % of Power (default) or dB Down measurement method as displayed in the message area.

#### %

Use the keypad, the directional arrow keys or the rotary knob to enter the percent of power, from 0 to 99%.

#### dBc

Use the keypad, the directional arrow keys or the rotary knob to enter the dBc value (0 dB to 100 dB).

#### Back

Returns to the previous menu.

### Channel Power

Activates the Channel Power measurement function. Channel Power and Channel Power Density are measured based on the selection in the Units menu.

#### On/Off

Begins or ends the channel power measurement. When the measurement is on, Ch Pwr will appear below the display. The detection method will automatically be changed to RMS Average when the measurement is started. The detection method can be modified by pressing the **Shift** and the **Sweep** keys and selecting the Detection soft key.

#### Center Freq

Activates the center frequency function, and sets the center frequency of the VNA Master for the channel power measurement. Use the keypad, the directional arrow keys or the rotary knob to enter the center frequency.

#### Ch Pwr Width

Sets the integration bandwidth for channel power measurement. Modifying this value automatically adjusts the channel span to maintain the same ratio. Use the



keypad, the directional arrow keys or the rotary knob to enter the integration bandwidth.

#### Span

Sets the channel span for channel power measurement. Use the keypad, the directional arrow keys or the rotary knob to enter the channel span.

#### Back

Returns to the previous menu.

### ACPR

Accesses a menu of Adjacent Channel Power Ratio measurement options:

#### On/Off

Begins or ends the ACPR measurement.

#### Main Ch BW

Sets the bandwidth of the main channel for ACPR measurement. Use the keypad, the directional arrow keys or the rotary knob to enter the a specific frequency. When using the keypad, select the GHz, MHz, kHz, or Hz soft key to accept the frequency input. Changing this value automatically changes the adjacent channel bandwidth and channel spacing.

#### Adj Ch BW

Sets the bandwidth of the adjacent channels for ACPR measurement. Use the keypad, the directional arrow keys or the rotary knob to enter the a specific frequency. When using the keypad, select the GHz, MHz, kHz, or Hz soft key to accept the frequency input.

#### Ch Spacing

Sets the channel spacing between the main and adjacent channels. Use the keypad, the directional arrow keys or the rotary knob to enter the a specific frequency. When using the keypad, select the GHz, MHz, kHz, or Hz soft key to accept the frequency input. This value must be greater than or equal to half of the main channel bandwidth, plus half of the adjacent channel bandwidth.

#### Back

Returns to the previous menu.

### AM/FM Demod

The user can select AM, Narrow Band FM (300  $\mu$ s de-emphasis), Wide Band FM (50  $\mu$ s de-emphasis), Upper Sideband, or Lower Sideband.

#### On/Off

Turns AM/FM Demodulation on or off.

#### Demod Type

Provides soft keys to select the type of signal to be demodulated:

FM Wide Band  
FM Narrow Band  
AM  
USB  
LSB

#### Demod Freq

Use the keypad, the directional arrow keys or the rotary knob to enter the center frequency of the signal to be demodulated. This frequency does not have to be within the current frequency sweep range to which the instrument is set.

#### Demod Time

Use the keypad, the directional arrow keys or the rotary knob to increase or decrease the demodulation time, and press the **Enter** key to select. The demodulation time can be set from 100 milliseconds to 500 seconds. The instrument sweeps one time for every demodulation period. Sweeping pauses during the demodulation time.

#### Set Demod Freq to Current Marker Freq

Sets the demodulation frequency to the frequency of the current marker.

#### Beat Freq Osc

Sets the beat frequency of the oscillator to exactly set the demodulation frequency of USB and LSB signals.

#### Volume

The current volume setting is displayed on the screen. Use the Up/Down arrow keys or rotary knob to change the volume, and press the **Enter** key to select.

#### Back

Returns to the previous menu.

#### C/I

The Carrier to Interference ratio is a two-step measurement sequence that first measures the amplitude of a carrier, then, with the carrier turned off, measures the amplitude of all other interfering signals within the channel bandwidth.

#### On/Off

Starts and stops the carrier to interference measurement.

#### Center Freq

Use the keypad, the directional arrow keys or the rotary knob to enter the center frequency.

#### Span

Use the keypad, the directional arrow keys or the rotary knob to enter the frequency span.

**Carrier Signal Type**

Opens a menu to select the carrier signal type.

**NB FHSS (Narrow Band Frequency Hopping Spread Spectrum)**

Use this setting when the signal being measured is 802.11b.

**WB FHSS (Wide Band Frequency Hopping Spread Spectrum)**

Use this setting when the signal being measured is 802.11a or 802.11g.

**Broadband**

Use this setting when the signal being measured is a digital modulation format such as CDMA, GSM, and so forth.

**Back**

Returns to the previous menu.

**Min Sweep Time**

Set the minimum sweep time for the measurement.

**Back**

Returns to the previous menu.

## 9-10 Spectrogram Menu

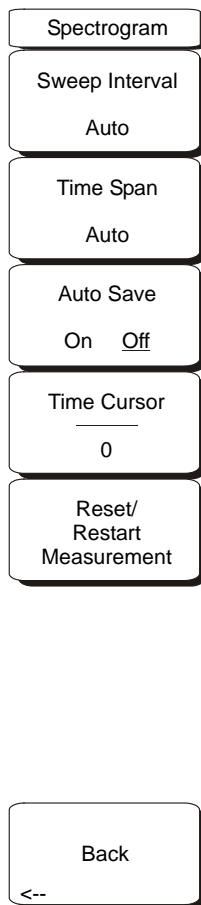

**Figure 9-9.** Interference Analyzer Mode Spectrogram Menu

### Sweep Interval

Press the Sweep Interval soft key and use the rotary knob or keypad to set the time from 1 millisecond to 60 seconds. Setting this value to 0 seconds causes the instrument use auto sweep interval.

### Time Span

To set the total time span for a display, press the Time Span soft key and use the rotary knob or keypad to enter a time between 60 seconds (1 minute) and 259,200 seconds (72 hours). When the time span is reached, the measurement stops. When set to zero (Auto) time span, the measurement runs continuously. Entering a time span value causes the corresponding sweep interval value to be automatically computed and shown when the Sweep Interval soft key is pressed. The VNA Master always displays time span in seconds.

**Auto Save**

When the Time Span is set to an interval other than Auto, the spectrogram plots can be automatically saved when the waterfall display is full by pressing the Auto Save soft key.

**Time Cursor**

The Time Cursor is used to view the spectrum at any spot in the spectrogram display. Press the Time Cursor soft key to turn on the horizontal time cursor. Use the Up/Down arrow key to move the cursor vertically through the spectrogram. The date and time that the measurement at the cursor position was taken is displayed at the top of the screen.

**Reset/Restart Measurement**

Resets or restarts the measurement.

## 9-11 Signal Strength Menu

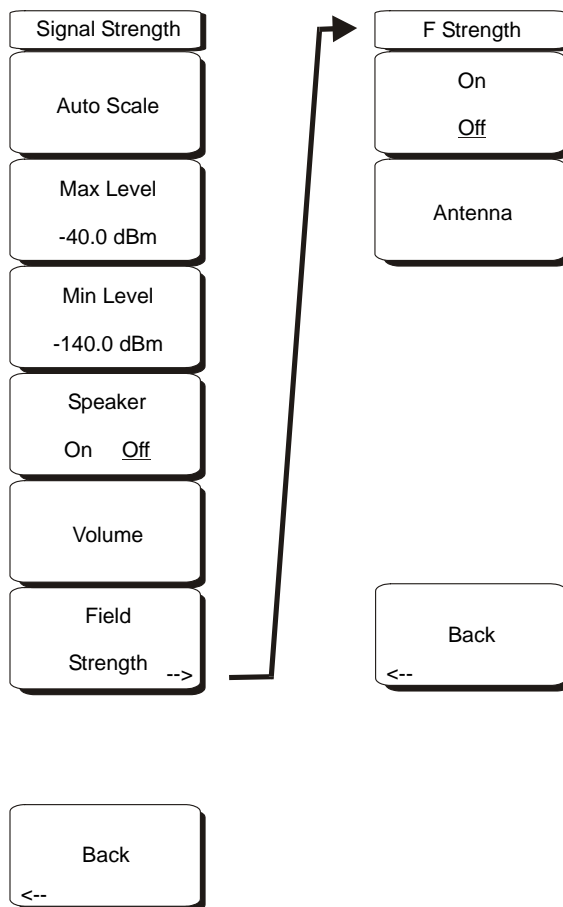

**Figure 9-10.** Interference Analyzer Mode Signal Strength Menu

### Auto Scale

Press the Auto Scale soft key to automatically scale the display range.

### Max Level

Set the desired maximum display range value by selecting the Max Level soft key.

### Min Level

Set the desired maximum display range value by selecting the Max Level soft key.

### Speaker On/Off

Press the Speaker On/Off soft key to turn on the audio output.

### Volume

If necessary, press the Volume soft key to set the speaker or headphone volume to a comfortable level. Use the Up/Down arrow keys to adjust the volume.

**Field Strength**

This measurement allows the use of an antenna with known gain characteristics and measures the field strength over the frequency range of the antenna in units of dBm/meter<sup>2</sup>, dBV/meter<sup>2</sup>, dBmV/meter<sup>2</sup>, dBμV/meter<sup>2</sup>, volts/meter, or watts/meter.

**On/Off**

Turns field strength measurements on or off.

**Antenna**

This soft key brings up a dialog box that lists all the antennas for which the instrument has data, including both standard antennas and custom antenna that have been added using Master Software Tools. Use the Up/Down arrow keys or the rotary knob to select the desired antenna and press **Enter**.

**Back**

Returns to the previous menu.

**Back**

Returns to the previous menu.

---

## 9-12 RSSI (Received Signal Strength Indicator) Menu

---

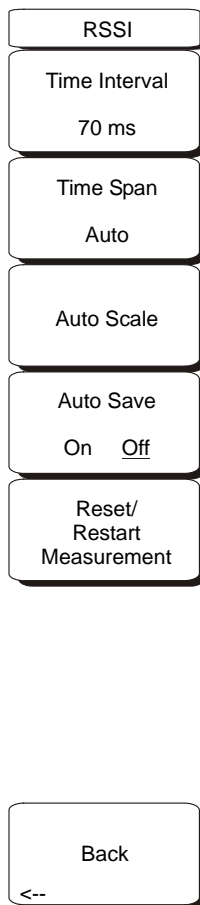

**Figure 9-11.** Interference Analyzer Mode RSSI Menu

### Time Interval

Press the Time Interval soft key to set the time between adjacent measurement points. This time may be set from 70 ms to 1 minute.

### Time Span

Press the Time Span soft key to set the overall time span for the RSSI measurement. This time can be set from zero, to give manual control of the time span, to a maximum of seven days. After the specified time span, the measurement is halted. Depending on the time interval selected, the data will scroll to the left once the trace fills the screen.

### Auto Scale

Press the Auto Scale soft key to automatically set the reference level and scale factor to place the trace on the screen.



**Auto Save On/Off**

To store the RSSI data, press the Auto Save On/Off soft key to turn on data logging. The data is named Log - followed by the time at which the data was stored. Each screen full of 551 data points will be stored as a separate display, and can be saved for up to seven days. The unit saves the data in the saved trace directory and it can be recalled by selecting recall trace measurement. Auto Save can be used only when Time Span is in Manual.

**Reset/Restart Measurement**

Resets or Restarts the measurement. The RSSI trace is erased and begins anew at the right side of the display.

**Back**

Returns to the previous menu.

## 9-13 Marker Menu

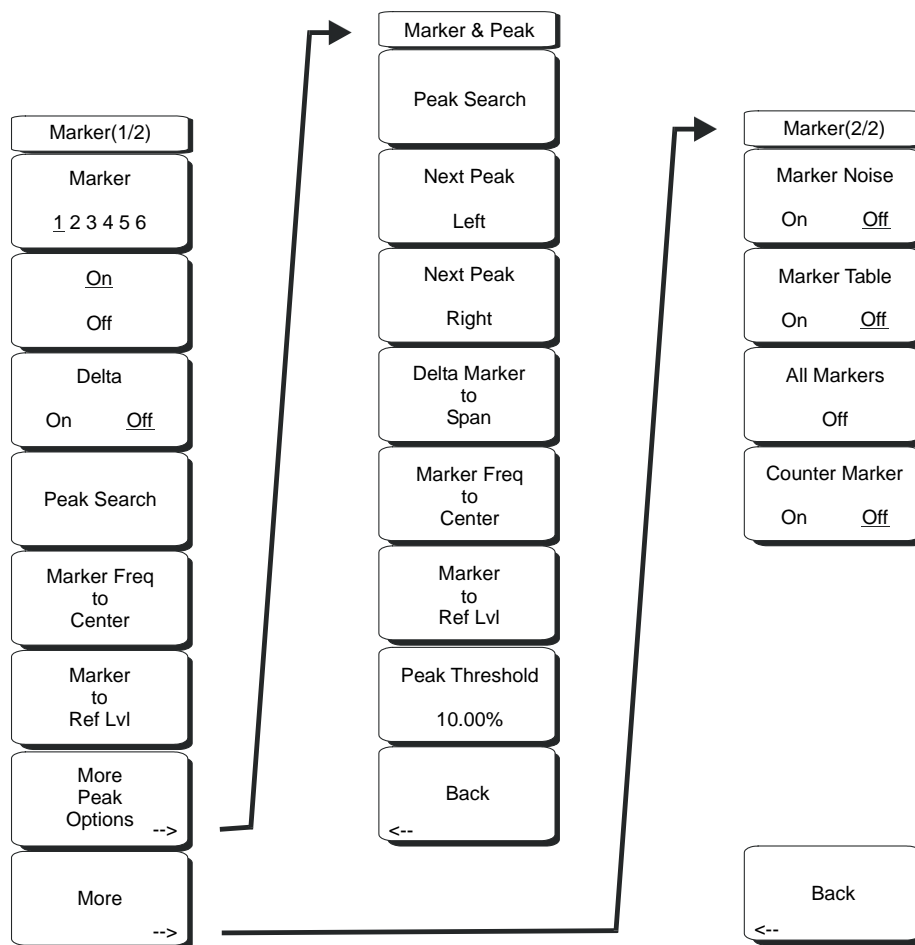

**Figure 9-12.** Interference Analyzer Mode Marker Menu

Markers are available in Spectrum and Spectrogram measurements. Press the **Marker** function hard key to open the Marker menu. The VNA Master is equipped with six markers. Any or all markers can be employed simultaneously.

Marker 1 2 3 4 5 6

Use this soft key to select the active marker. The underlined marker number is the active marker. Each press of the soft key moves the underline to the next marker number.

On/Off

This soft key turns the active marker, selected by the Marker soft key above, on or off.

Delta On/Off

This function turns on a delta marker and prompts for a delta offset frequency, either positive or negative from the frequency of the currently active marker.

**Peak Search**

This soft key places the currently active marker on the highest signal amplitude currently displayed on screen.

**Marker Freq to Center**

This soft key changes the center frequency to place the currently active marker at the center of the display.

**Marker to Ref Level**

This soft key causes the amplitude of the currently active marker to become the reference level, which is the top horizontal line of the display.

**More Peak Options**

This soft key brings up a secondary menu of soft keys for more peak searching options.

**Peak Search**

This soft key places the currently active marker on the highest amplitude signal currently on screen.

**Next Peak Left**

From the current position of the active marker, the instrument searches to the left (toward lower frequencies) for a peak signal that rises at least a certain amount above the average noise level. If no such peak is found, then the marker is placed at the left end of the trace. The Peak Threshold soft key allows the user to specify the performance of peak searching.

**Next Peak Right**

From the current position of the active marker, the instrument searches to the right (toward higher frequencies) for a peak signal that rises at least a certain amount above the average noise level. If no such peak is found, then the marker is placed at the right end of the trace. The Peak Threshold soft key allows the user to specify the performance of peak searching.

**Delta Marker to Span**

Sets the total span width to the value of the delta marker. If the delta marker is zero, then the span is set to 10 Hz. If there is no delta marker, or if the delta marker value is set to less than 10 Hz, then the span will be set to 10 Hz.

**Marker Freq to Center**

Sets the center frequency to the frequency of the currently active marker.

**Marker to Ref Lvl**

Sets the reference level (top graticule line) to the amplitude of the currently active marker.

**Peak Threshold**

This soft key allows the user to specify how far above the average noise floor a signal must rise before it is considered a peak. This feature can be especially useful in noisy environments, where there are a lot of small noise spikes. The default peak threshold is 10%. In noisy environments, increase the peak threshold to avoid stopping on noise spikes or small signals.

**Back**

Returns to the higher-level menu.

**More**

Opens a submenu of further Marker options.

**Marker Noise**

This marker option turns the markers into noise markers with units of dBm/Hz. When this option is selected, the detection method is automatically changed to RMS and the displayed value is compensated for the noise bandwidth of resolution bandwidth filter.

**Marker Table**

Available only in Spectrum view, pressing this soft key causes a table to be displayed below the sweep window. The table is automatically sized for all possible markers and delta markers. In addition to the marker frequency and amplitude, the table also shows delta frequencies and amplitude deltas for all markers that have deltas entered for them.

**All Markers Off**

This soft key turns off all markers and the marker table, if it is on.

**Counter Marker On Off**

Sets the frequency counter mode for all markers. Marker frequency values are normally limited in resolution to individual display pixels. Each pixel may represent multiple frequencies. Using the Counter Marker in association with Marker to Peak will result in the exact frequency of the peak within the pixel to a resolution of 1 Hz.

**Back**

Returns to the previous menu.



# ***Chapter 10 — Channel Scanner, Option 27***

## **10-1 Introduction**

This chapter presents Channel Scanner information and procedures. The Channel Scanner option (Option 27) measures the signal power of multiple transmitted signals. The power can be displayed as either a bar graph or a text display showing the channel power of selected channels for a given air interface standard, or the manually entered channels. Up to 20 channels can be measured.

The operating frequency range for Channel Scanner mode can either be set manually, or the desired air interface standard can be selected from the Signal Standard and channel list in the instrument. When the channels are selected from the Signal Standard list, all frequency related parameters for the standard are automatically set to the appropriate values. The frequency and bandwidth settings can be manually entered using the Scan Frequencies selection if none of the available air interface standards meet the measurement need. A custom channel list can also be created to allow up to 20 independent channels to be defined.

## 10-2 Sample Channel Scanner Setup Procedure

The following procedure demonstrates a common channel scanner setup.

1. On the VNA Master, select the **Shift** key, then the **Mode** (9) key.
2. Use the directional arrow keys or the rotary knob to highlight Channel Scanner and press the **Enter** key to select.
3. Press the **Scanner** key to activate the Scanner menu. The power can be scanned using a signal standard and channel numbers or by entering a start frequency, frequency step size and bandwidth. The channels can be customized using the Scan Custom List or Custom Setup. For this example, select the channels by pressing the Scan Channels soft key, then the Signal Standard soft key. Select the CDMA US PCS signal standard.
4. Select the Number of Channels soft key and enter 20.
5. Select the **Amplitude** key and set the Reference Level and Scale so that the power of all the channels is displayed on the screen.
6. Select the **Measurements** key to activate the Measurement menu.
7. Press the Display soft key and select Graph display to display the measurements in the graph format.
8. Press the Channel Units soft key and select Channel to display the measurements in channel format.
9. Press the Units Display soft key and choose Max to display the maximum measured power for each channel.
10. Press the Color Code soft key and select Dual to display the measurements in dual colors.

**Note**

Measurements can be made when the base station is in service, out of service, or over the air.

## 10-3 Custom Setup

### Procedure

1. On the VNA Master, select the **Shift** key, then the **Mode** (9) key.
2. Use the directional arrow keys or the rotary knob to highlight Channel Scanner and press the **Enter** key to select.
3. Press the **Custom Setup** key.
4. Press the Number of Channels soft key to define how many channels to include in the custom list. This choice can be changed later if needed.
5. Press the Edit List soft key to bring up the list of channels. The channel highlighted in blue is the channel active for editing. Use the up and down arrows to select the channel to edit. Each channel can be set up differently.
6. Press either the Select Signal Standard soft key or the Set Freq soft key. If the Select Signal Standard soft key was selected, then select the desired air interface standard from the dialog box displayed. When a standard is selected, the usual bandwidth for that standard is automatically set. The bandwidth can be changed if desired. After the air interface standard is selected, press the Set Channel soft key to enter the desired channel number.
7. If the Set Freq soft key was selected, then the frequency value of the active channel will be highlighted in a red box. Use the rotary knob or the numeric key pad to enter the desired center frequency in Hz, kHz, MHz, or GHz.
8. Press the Set Bandwidth soft key and use the rotary knob or numeric keypad to enter the desired value in Hz, kHz, MHz, or GHz.
9. Repeat 5. through 8. for all channels.



## Custom Setup Example

This example explains how to monitor several signals, plus a potential intermodulation product, to see if there is a correlation between the nearby signals and an intermittent interference problem.

The signals on or near the rooftop are:

- An FM broadcast station at 106.5 MHz
- A paging transmitter at 157.86 MHz
- Three cellular sites:
  - US CDMA PCS channel 50 (1932.5 MHz)
  - AMP/EIA 553 channel 525 (885.750 MHz)
  - GSM 1800 channel 512 (1805.2 MHz)
- A Ham repeater at 147.36 MHz
- A Ham repeater at 446.5 MHz
- A land mobile repeater at 451.7875 MHz
- A public safety repeater at 485.5625 MHz
- In addition, the site is near the flight path of an airport. The approach frequency is 121.4 MHz.

Set up a measurement channel for each of the signals to be observed plus extra channels for any intermodulation products to be observed. After the channels are set up, press **Shift** and **File**, **Save**, **Recall**, **Delete**, & **Copy**, then **Save Setup**, and name the setup for easy recall later.

## 10-4 Scanner Menu

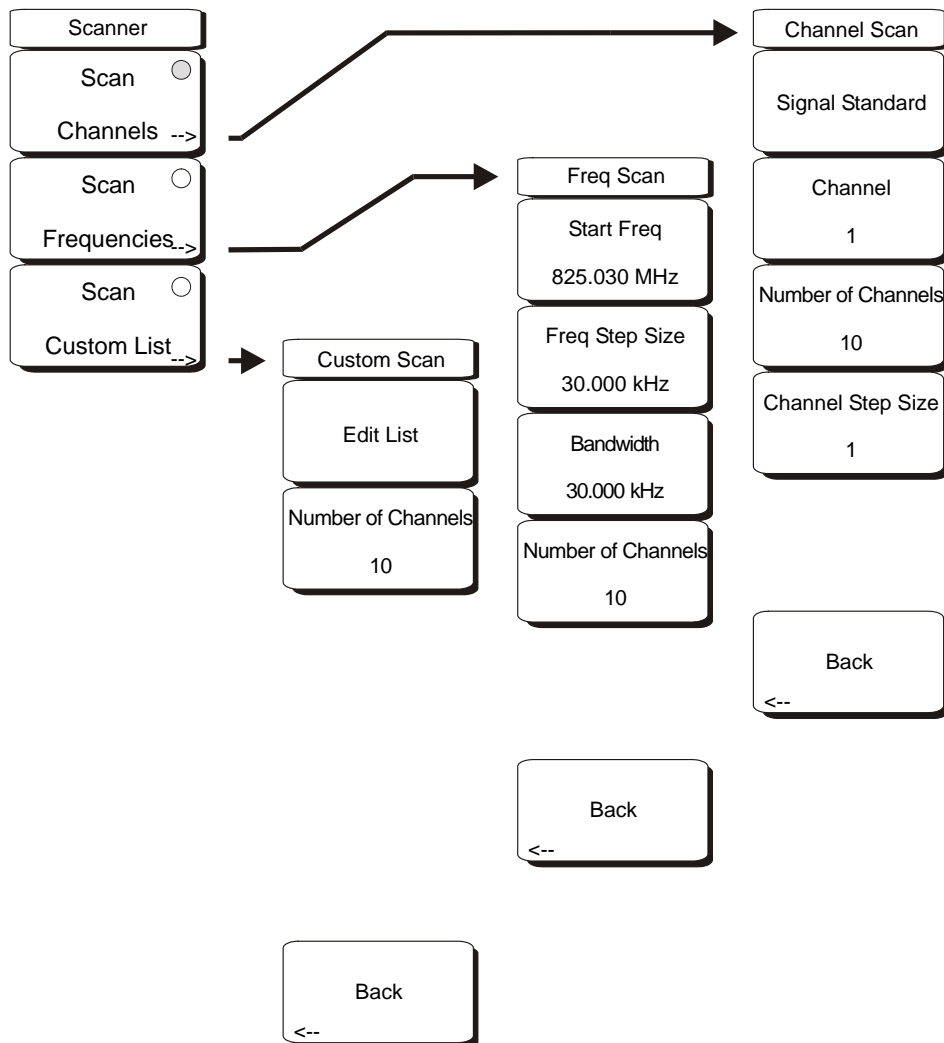

**Figure 10-1.** Channel Scanner Mode Scanner Menu

### Scan Channels

Select scan channels to activate the scan channel menus:

#### Signal Standard

Sets the signal standard.

#### Channel #

Sets the starting channel on the display.

#### Number of Channels ##

Sets the number of channels to be displayed. From 1 to 20 channels can be displayed.

**Channel Step Size #**

Sets the number of channels to skip between displayed channels.

**Back**

Returns to the previous menu.

**Scan Frequencies**

Select scan frequencies to activate the scan frequencies menu:

**Start Freq ###.### GHz, MHz, kHz, Hz**

Sets the center frequency of the first channel to be displayed.

**Freq Step Size**

Sets the spacing between frequencies on the display.

**Bandwidth**

The channel bandwidth can be manually entered in GHz, MHz, kHz, or Hz.

**Number of Channels**

Sets the number of channels to be displayed (1 to 20).

**Back**

Returns to the previous menu.

**Scan Custom List**

Opens the Custom Scan menu.

**Edit List**

Edit the Signal Standard, Channel, Frequency and Bandwidth for a selected standard.

**Number of Channels ##**

Sets the number of channels to be displayed (1 to 20).

**Back**

Returns to the previous menu.

---

## 10-5 Amplitude Menu

---

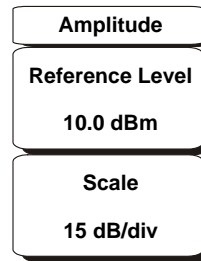

---

**Figure 10-2.** Channel Scanner Mode Amplitude Menu

### Reference Level

Activates the amplitude reference level function which sets the amplitude at the top of the display. Valid reference levels are from +30 dBm to -130 dBm.

### Scale

Activates the scale function which sets the dB/division value from 1 dB/div to 15 dB/div in 1 dB steps.

---

## 10-6 Custom Setup Menu

---

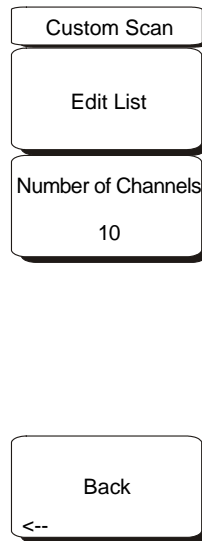

---

**Figure 10-3.** Channel Scanner Mode Custom Setup Menu

**Edit List**

Edit the Signal Standard, Channel, Frequency and Bandwidth for selected item.

**Number of Channels**

Sets the number of channels to be displayed (1 to 20).

**Back**

Returns to the previous menu.

---

## 10-7 Measurements Menu

---

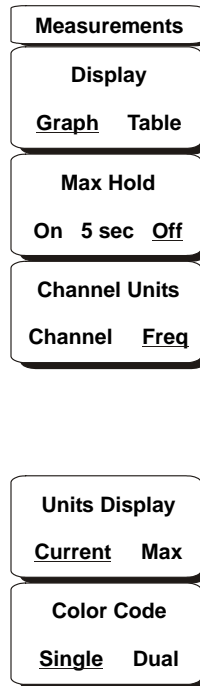

---

**Figure 10-4.** Channel Scanner Mode Measurements Menu

Display Graph/Table

Toggles the display between table and graph formats (refer to [Figure 10-5](#) and [Figure 10-6](#)).

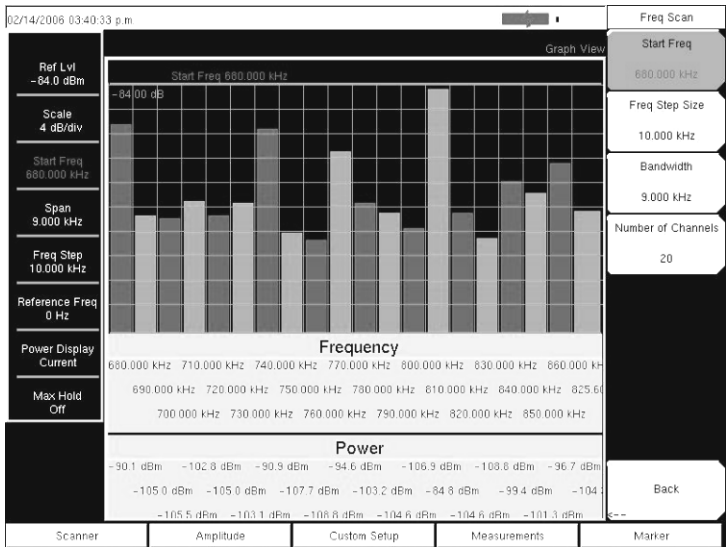

Figure 10-5. Channel Scanner Mode Sample Graph Display

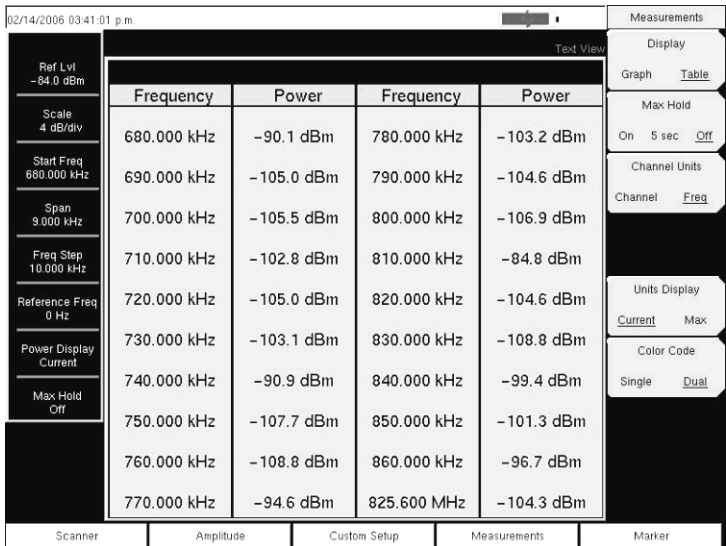

Figure 10-6. Channel Scanner Mode Sample Table Display

**Max Hold On/5 sec/Off**

Turns on or off small yellow lines for every channel/frequency on the display that indicate the highest level that channel or frequency has reached. The 5 sec option holds the small yellow line at the highest level in the last 5 seconds.

**Channel Units Channel/Freq**

Toggles the display channel units between channel number and frequency.

**Units Display Current/Max**

The current power units are displayed at the bottom of the channels, or the maximum power is displayed (activated only when Max Hold is set to On or 5 sec).

**Color Code Single/Dual**

The channels can be represented in one color or two alternating colors.





# Chapter 11 — High Accuracy Power Meter

## 11-1 Introduction

The VNA Master with Option 019 is available on all VNA Master models and sensors PSN50 or MA24106A can be used to make High Accuracy Power Measurements from 50 MHz to 6 GHz. This high performance sensor option provides true RMS measurements with accurate measurements for both CW and complex digitally modulated signals.

**Note**

A power sensor is not included with Option 019. PSN50 or MA24106A sensors must be ordered separately.

The power values are displayed in both dBm and Watts. The Relative Power feature allows the display of power changes with respect to a desired reference value in both dB and % (percent). Limit values can be turned on as needed to indicate if a measurement is within or outside specified limits. Running averaging and a Max/Hold feature are also available.

The VNA Master connects to the PSN50 High Accuracy Power Sensor or MA24106A USB Power Sensor with a standard USB A/mini-B cable (3-2000-1498).

The zeroing feature improves the accuracy at low power levels by removing measured system noise. Calibration factors can be used to correct both efficiency and mismatch loss.

Attenuators can be used to ensure that the power does not exceed the specified measurement range. The Enter Offset feature allows entering offset values for any cables and attenuators.

## 11-2 Getting Started with HAPM

### High Accuracy Power Meter (HAPM) Mode

To prepare for High Accuracy Power Meter measurements, the VNA Master must be configured for High Accuracy Power Meter mode, as follows:

1. Select the **Shift** key, then the **Mode** (9) key.
2. Use the directional arrow keys or the rotary knob to highlight High Accuracy Power Meter and press the **Enter** key to select.

For additional information about the Mode menu, refer to [“Mode Menu” on page 3-47](#).

### Hard Keys and Soft Keys

For a general description of these key functions, refer to section [“Front Panel Keys” on page 2-5](#).

### Required Equipment

- MS202xA or MS203xA VNA Master
- High Accuracy Power Sensor, PSN50 or MA24106A
- USB cable, 3-2000-1498
- 30 dB, 50 W, bi-directional, DC-8.5 GHz, N(m)-N(f), Attenuator, 3-1010-123

## 11-3 HAPM Operation Procedure

### Turn on the VNA Master and the Sensor

1. Connect the USB A/mini-B cable between the High Accuracy Power Sensor and the VNA Master.

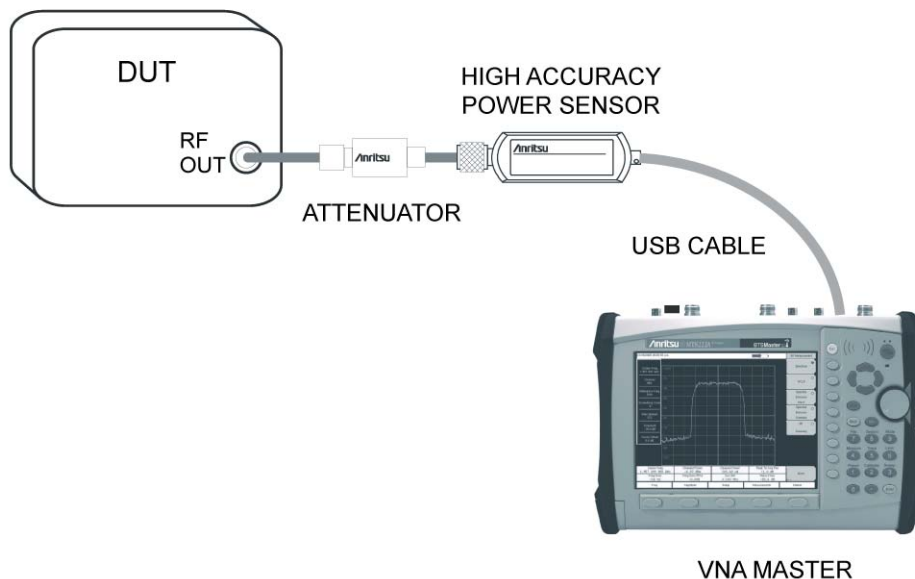

**Figure 11-1.** High Accuracy Power Meter Setup Example

2. Press the **ON/OFF** key on the VNA Master.
3. Press the **Shift** key, then the **Mode** (9) key. Use the **Up/Down** arrow keys or rotary knob to select High Accuracy Power Meter mode and press **Enter**.

### Zero and Cal

1. Press the **Zero/Cal** key and select the Cal Factor soft key. Enter the Center Frequency or select the Signal Standard key and the Up/Down arrow keys to select a particular standard. The Cal Factors will be derived for the corresponding center frequency. The channel number is not required because the cal factor frequencies are rounded to the nearest 500 MHz. The Cal Factor message in the display window will show ON if the Cal Factor command has been properly sent to the sensor.
2. With no power applied to the sensor, press the Zero soft key to zero the sensor. This step is recommended when making power measurements below  $-20$  dBm.

## Changing the Scale of the Analog Display

1. Press the **Amplitude** key.
2. Press the Auto Scale soft key to align the needle in the middle of the analog display. The maximum and minimum values align accordingly.
3. Press the Max soft key and use the numeric key pad to manually set the maximum value of the analog display.
4. Press the Min soft key and use the numeric key pad to manually set the minimum value of the analog display.

**Note**

With no offset, the maximum value for the display is the upper measurement range, which is +20 dBm. With an offset, such as with 10 dB of attenuation, the upper value can be set to +30 dBm. With an offset of xx dB, the upper value can be set to +20 dBm plus xx dB.

## Using Attenuators

1. Press the **Amplitude** key and select the Enter Offset soft key.
2. Enter the offset value for the attenuator at the frequency of operation.

## Displaying Relative Power

1. Press the **Amplitude** key.
2. With the desired base power level input to the sensor, press the Relative soft key. The power reading will show 0 dB and 100%. If measuring a 10 dBm signal, and if the Relative key is selected, then a drop to 7 dBm will show as -3 dB and 50%.

## Averaging/Max Hold/Run Hold

1. Press the **Average** key.
2. Press the Running Averages key. Use the numeric keypad to enter the desired number of averages.
3. Press the Max Hold soft key to toggle between Max Hold On and Max Hold Off. If averaging is selected, then Max Hold will display the maximum value of the non-averaged data.

## Limits

1. Press the **Limit** key.
2. Press the Lower Limit soft key. Enter the lower limit value in dBm or in Watts.
3. Press the Upper Limit soft key. Enter the upper limit value in dBm or in Watts.
4. Press the Limit On/Off soft key to turn the Limits on and off. The number display will turn green or red if the measurement is passing or failing.
5. Press the **Amplitude** key and select the Units soft key to change between dBm and Watts

## Saving the Measurement

1. Press the **Shift** key, then the **File (7)** key.
2. Select the Save soft key.
3. Press the Save Measurement soft key and use the Text Entry soft keys to enter the desired file name.
4. Press the Save Screen as JPEG soft key to save an image of the screen as a JPEG. file.

**Note**

Screen captured images are provided as examples. The image and measurement details shown on your instrument may differ from the examples in this user guide.

## 11-4 HAMP Menu

### Zero/Cal Menus

The Zero/Cal menu choices are shown in the following illustrations.

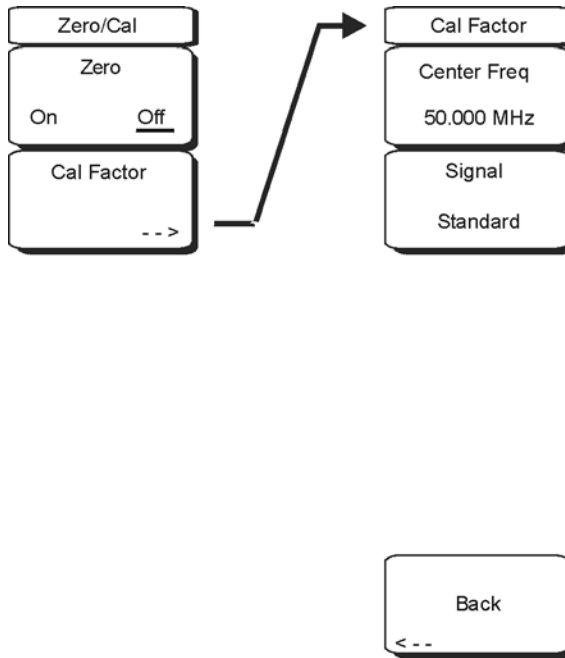

Figure 11-2. Zero/Cal Menu

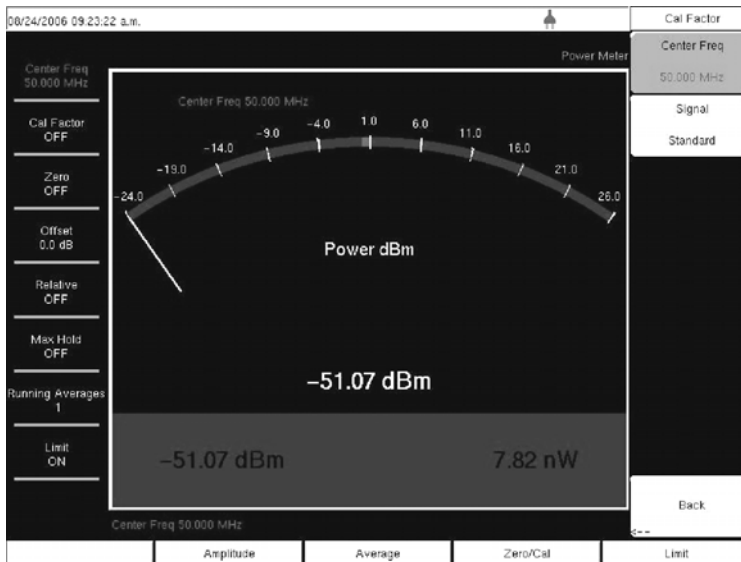
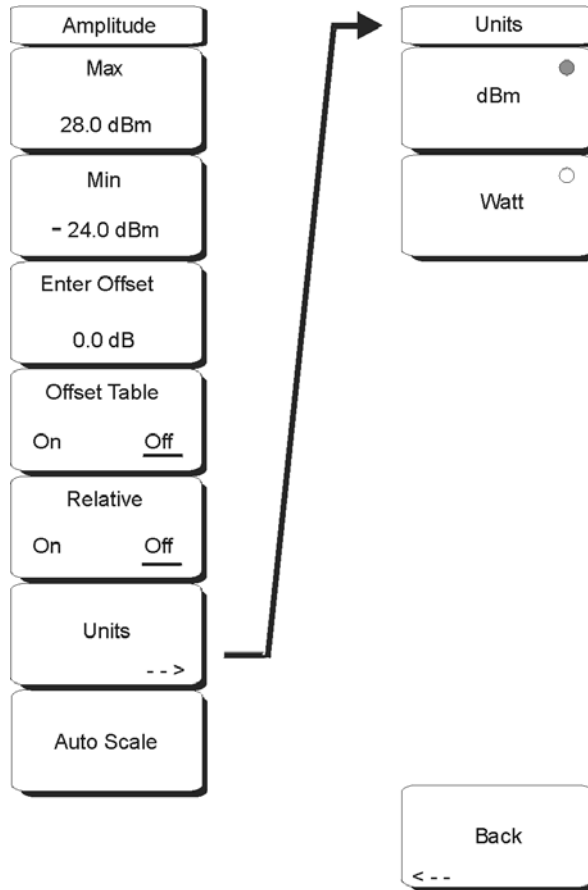

Figure 11-3. Cal Factor Menu

---

**Amplitude Menu**

---



---

**Figure 11-4.** Amplitude and Units Soft Key Menus



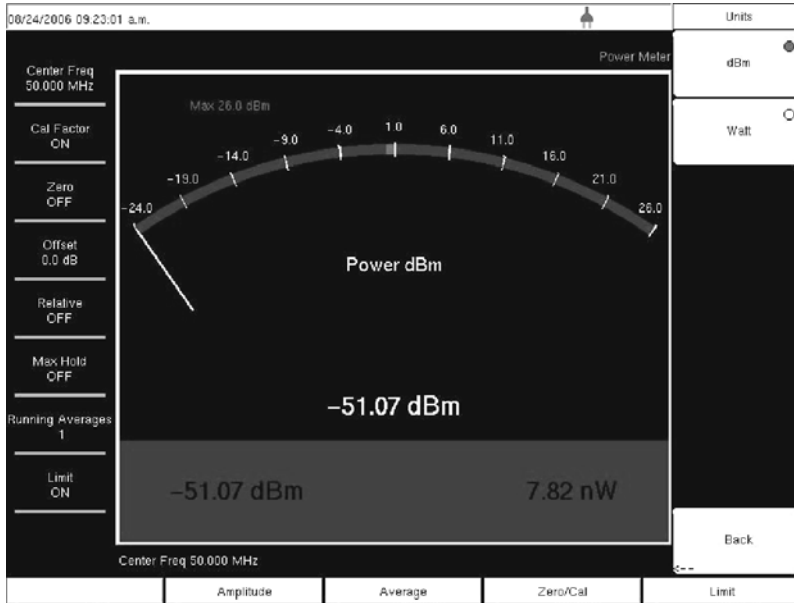

Figure 11-5. Units Menu

Averages Menu

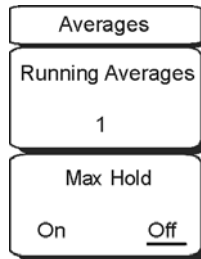

Figure 11-6. Averages Soft Key Menu

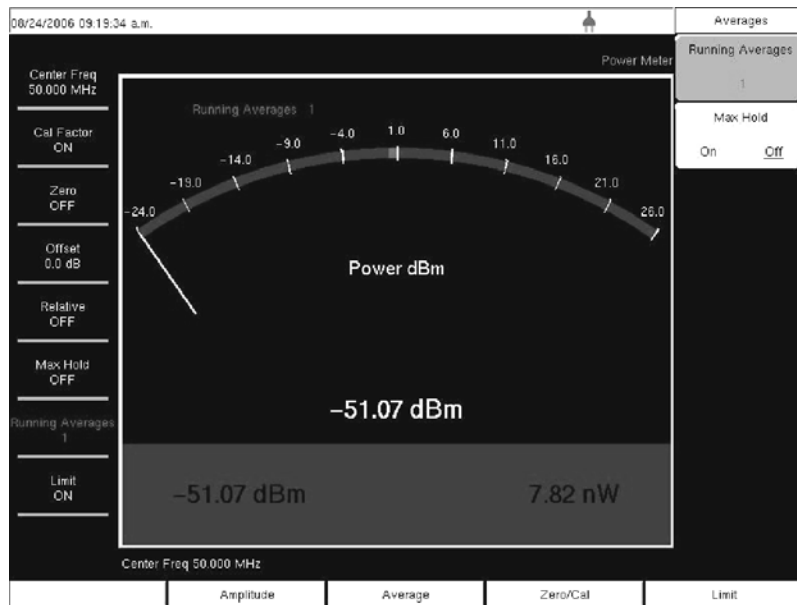

Figure 11-7. Averages Menu

Limits Menu

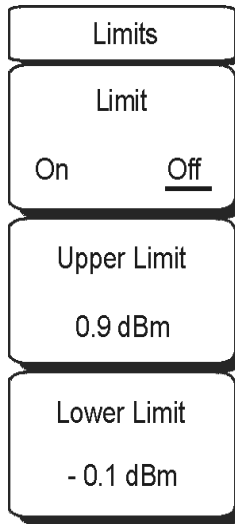

Figure 11-8. Limits Menu

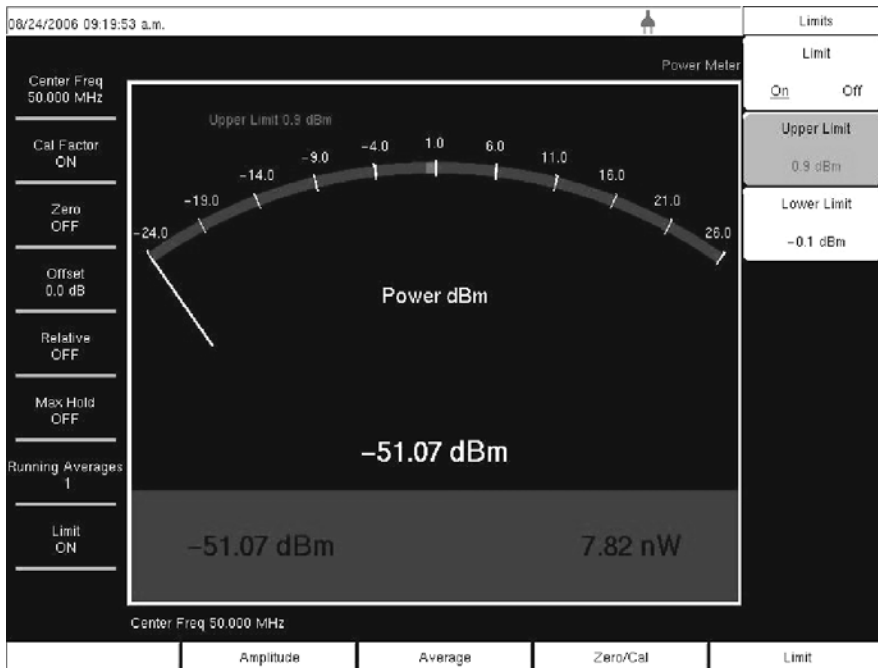

Figure 11-9. Limits Menu

## Mode Menu

To access the functions under the Mode menu, select the **Shift** key, then the **Mode** (9) key. Use the Up/Down arrow keys or the rotary knob to highlight the selection, and press the **Enter** key to select. The list of modes that appears in this menu will vary depending upon the options that are installed and activated in your instrument. The mode menu is described in section [“Mode Menu” on page 3-47](#). Your instrument may not show the same list.



# Chapter 12 — GPS Receiver, Option 31

## 12-1 Introduction

The VNA Master is available with a built-in GPS receiver feature (Option 31) that can provide latitude, longitude, altitude, and UTC timing information. This option also enhances frequency reference oscillator accuracy in spectrum analyzer mode.

Within three minutes of satellite acquisition, the reference oscillator will have an accuracy of better than 25 ppb (parts per billion). The OCXO internal standard accuracy is  $\pm 0.3$  PPM. The correction factor applied to the internal OCXO allows the instrument to maintain GPS frequency accuracy for three days at better than 50 ppb, even when the instrument is obstructed from receiving signals from the GPS satellites.

In order to acquire data from the GPS satellites, the user must have line-of-sight to the satellites or the antenna must be placed outside with out any obstructions. The following GPS antenna is provided with the unit:

- 2000–1410 Magnet Mount GPS Antenna with 15-foot cable

## 12-2 Activating the GPS Feature

Install the Anritsu GPS antenna onto the GPS Antenna connector on the VNA Master.

**Note**

The GPS antenna connection on the VNA Master is fitted with a reverse BNC connector to help prevent damage to the GPS circuitry. There is a DC voltage present on this connector. Do not connect anything other than the Anritsu GPS antenna to this port.

1. Press the **Shift** key, then the **System** (8) key.
2. Press the GPS soft key.
3. Press the GPS On/Off soft key to toggle the GPS feature on or off. When GPS is first turned on, a RED GPS icon will be appear at the top of the display.



**Figure 12-1.** GPS - Red

4. When the GPS receiver has tracked at least three satellites, the GPS icon will change to GREEN. Latitude and Longitude information is displayed in the white bar on top of the display. Acquiring satellites may take as long as three minutes.



**Figure 12-2.** GPS - Green

5. Press the GPS Info soft key to view the number of tracked satellites, latitude, longitude, altitude, and UTC timing information, and so forth.
6. Press the Reset soft key to reset the GPS.
7. The GREEN GPS icon with a RED CROSS through it, as shown below, appears when GPS satellite tracking is lost (after actively tracking 3 or more satellites). The GPS longitude and latitude are saved in the instrument memory until the VNA Master is turned off or until GPS is turned off by using the GPS On/Off soft key.



**Figure 12-3.** GPS - Crossed

<b>Note</b>	When the GPS feature is not enabled, the reference source will display either "Internal Standard Accuracy" or a user-selected external reference frequency in the Status menu on the left side of the screen.
-------------	---

## 12-3 GPS Menu

The GPS soft key menu is shown in [Figure 3-30 on page 3-54](#).

### GPS On/Off

This soft key toggles the GPS feature On and Off.

### GPS Info

The GPS Info soft key opens a window with additional GPS information. Press the **Esc** key to close the window.

### Reset

The Reset soft key sets the tracked number of satellites to 0 and erases any almanac data, along with saved coordinates. The process of searching for and reacquiring satellites will begin again.

## 12-4 GPS Info Window

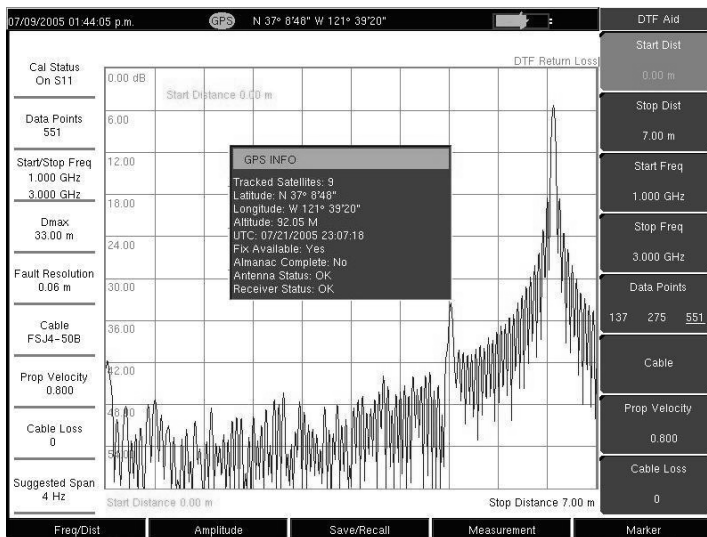

**Figure 12-4.** GPS Info Window

The GPS Info window provides the following GPS information:

### Tracked Satellites

Shows the number of tracked satellites (three are required to retrieve latitude and longitude, four are required to resolve altitude). Generally, the larger number of satellites tracked, the more accurate the information.

### Latitude and Longitude

Shows location in degrees, minutes, and seconds.

### Altitude

Shows altitude information in meters.

### UTC

Universal Coordinated Time.

### Fix Available

The cold start search sets are established to ensure that at least three satellites are acquired within the first couple of minutes. When three satellites are found, the receiver will compute an initial fix (typically in less than two minutes). Fix Not Available means that the initial position has not been established.



## Almanac Complete

The system Almanac contains information about the satellites in the constellation, ionospheric data, and special system messages. In a cold start, the GPS receiver does not have any navigation data so the receiver does not have a current almanac. A complete system almanac is not required to achieve a first position fix. The availability of the almanac, however, can significantly reduce the time to first fix.

## Antenna Status

OK: Antenna is connected properly and antenna is working properly

Short/Open: A short or open exists between the antenna and the connection. If this message is displayed, then remove and replace the GPS antenna. If the message persists, then try another Anritsu GPS antenna (part number 2000–1410). If the message persists, then contact your nearest Anritsu Service Center.

# 12-5 Saving and Recalling Traces with GSP Information

## Saving Traces with GPS Information

The GPS coordinates of a location can be saved along with a measurement trace. Refer to [“Save/Recall Menu” on page 3-49](#) for more information.

The current GPS coordinates will be saved with the measurement traces whenever GPS is on and actively tracking satellites.

## Recalling GPS Information

If the GPS coordinates were saved with a measurement trace, then when the trace is recalled, the coordinates that were saved are recalled as well. Refer to [“Save/Recall Menu” on page 3-49](#) for more information about recalling a saved trace.

# Chapter 13 — Master Software Tools

## 13-1 Introduction

This chapter provides a description of the Anritsu Master Software Tools program. Master Software Tools is a suite of Microsoft Windows programs for transferring saved measurements (along with markers and limit lines) to a PC display. The programs provide the ability to modify display parameters, overlay multiple traces (Spectrum Analyzer mode), upload and download traces, print traces using local or networked printers, create or modify language files, edit the cable and signal standard lists, and convert **.dat** files to the new **.vna** format.

Master Software Tools requires Windows 2000 or Windows XP, and will not function on earlier versions of the Microsoft Windows operating system, as the program relies on the Windows 2000 and Windows XP .NET Framework.

The complete Master Software Tools User Guide (part number 10580-00180) is available under the Help menu within the Master Software Tools program. The latest revision is available for download from the Anritsu website at:

- <http://www.us.anritsu.com/downloads/files/10580-00180.pdf>

## 13-2 Features

The Master Software Tools Suite provides the following features and capabilities:

- Download measurements saved in the instrument memory to the PC for storage and analysis
- Capture live traces from the instrument and view them on the PC
- Upload measurements from the PC to the instrument memory
- Compare multiple traces using drag, drop, and trace overlay features (Spectrum Analyzer mode)
- Add or modify Limit Lines (Spectrum Analyzer mode only) and Markers
- Modify the Signal Standard List and new lists to the instruments using the Cable and Signal Editors
- Display power level, calibration status, and GPS Information along with a trace in one professional report
- Create custom language files that can be uploaded to the instrument
- Export measurement data as text files for use in a spreadsheet (**.txt** and **.dat** file formats)
- Export measurements as graphic files (**.jpg**, **.wmf**, **.bmp**, and **.png** file formats)
- Automatically update the instrument with the latest firmware available from the Anritsu web site

- Handle long file names for easy, descriptive data labeling
- Store an unlimited number of data traces to a PC easing the task of analyzing and monitoring historical performance
- Create and download new signal standards, Pass/Fail Mode custom lists and antenna factors to existing lists into the unit
- Establish a connection to a PC using USB, Ethernet LAN, or Direct Ethernet
- Coordinate cell site locations using Map Point and GPS location mapping

## 13-3 System Requirements

Minimum requirements and recommendations are:

- Microsoft Windows 2000 or Windows XP
- Intel Pentium 233 MHz microprocessor minimum (Pentium II 350 MHz or better recommended)
- 128 MB of RAM minimum (256 MB or above recommended)
- Hard disk drive with approximately 80 MB of available space (An additional 80 MB free space for storage of captured plots is recommended.)
- A USB port (USB 1.2 required, USB 2.0 recommended) or an Ethernet 10/100 T connection for communication with the instrument

## 13-4 Installation

To install the Master Software Tools program, insert the Anritsu Master Software Tools disk in the CDROM drive. Follow the instructions in the installation program to install the software. If the autorun feature is disabled in your computer, then click on the Windows Start menu, and select Run. Type: X:\Setup.exe, where X is the drive letter of the CDROM drive, and follow the instructions in the installation program.

**Note**

Master Software Tools requires Windows 2000 or Windows XP. Master Software Tools will not function on earlier versions of the Microsoft Windows operating system, as the program relies on the Windows 2000 and Windows XP .NET Framework

The readme.doc file on the disk provides updated information about the program, and the Help function provides detailed operating information from within the program.

To start the Master Software Tools program, double-click on the Master Software Tools desktop icon, or select Programs from the Windows Start menu and select Anritsu, then Master Software Tools to launch the program.

# Appendix A — Signal Standards

## A-1 Signal Standards

This appendix provides a list of the signal standards included in the VNA Master. The standards displayed depend upon the operating mode selected.

Signal Standard	Center (MHz)	Span (MHz)	Valid Channels
AMPS / EIA 553 - Uplink	859	70	1-799, 990-1023
AMPS / EIA 553 - Downlink	859	70	1-799, 990-1023
C-450 (P) - Uplink	463.5	21	1-800
C-450 (P) - Downlink	463.5	21	1-800
C-450 (SA) - Uplink	462.5	15	1-247
C-450 (SA) - Downlink	462.5	15	1-247
CDMA US Cellular - Uplink	859	70	1-799, 990-1023
CDMA US Cellular - Downlink	859	70	1-799, 990-1023
CDMA US PCS - Uplink	1920	140	1-1199
CDMA US PCS - Downlink	1920	140	1-1199
CDMA Korea PCS - Uplink	1810	120	1-599
CDMA Korea PCS - Downlink	1810	120	1-599
CDMA Japan / ARIB - Uplink	878.5	93	1-799, 801-1039, 1041-1199
CDMA Japan / ARIB - Downlink	878.5	93	1-799, 801-1039, 1041-1199
CDMA China - 1 - Uplink	916	88	0-1000, 1329-2047
CDMA China - 1 - Downlink	916	88	0-1000, 1329-2047
CDMA China - 2 - Uplink	910	76	0-1000
CDMA China - 2 - Downlink	910	76	0-1000
cdma2000 Class 0, Korea Cellular - Uplink	859	70	1-799, 990-1023
cdma2000 Class 0, Korea Cellular - Downlink	859	70	1-799, 990-1023
cdma2000 Class 0, N.A. Cellular - Uplink	859	70	1-799, 990-1023
cdma2000 Class 0, N.A. Cellular - Downlink	859	70	1-799, 990-1023
cdma2000 Class 1, N.A. PCS - Uplink	1920	140	0-1199
cdma2000 Class 1, N.A. PCS - Downlink	1920	140	0-1199
cdma2000 Class 2, (TACS Band) - Uplink	916	88	0-1100, 1329-2047
cdma2000 Class 2, (TACS Band) - Downlink	916	88	0-1100, 1329-2047
cdma2000 Class 3, (JTACS Band) - Uplink	878.5	93	1-799, 801-1039, 1041-1199
cdma2000 Class 3, (JTACS Band) - Downlink	878.5	93	1-799, 801-1039, 1041-1199
cdma2000 Class 4, Korea PCS - Uplink	1810	120	0-599

Signal Standard	Center (MHz)	Span (MHz)	Valid Channels
cdma2000 Class 4, Korea PCS - Downlink	1810	120	0-599
cdma2000 Class 5, (NMT-450-20 kHz) - Uplink	472.5	43	1039-1473, 1792-2016
cdma2000 Class 5, (NMT-450-20 kHz) - Downlink	472.5	43	1039-1473, 1792-2016
cdma2000 Class 5, (NMT-450-25 kHz) - Uplink	439.5	57	1-300, 539-871
cdma2000 Class 5, (NMT-450-25 kHz) - Downlink	439.5	57	1-300, 539-871
cdma2000 Class 6, IMT-2000 - Uplink	2045	250	0-1199
cdma2000 Class 6, IMT-2000 - Downlink	2045	250	0-1199
cdma2000 Class 7, N.A. 700 MHz Cellular - Uplink	770	48	0-359
cdma2000 Class 7, N.A. 700 MHz Cellular - Downlink	770	48	0-359
ETACS - Uplink	916	88	0-1000, 1329-2047
ETACS - Downlink	916	88	0-1000, 1329-2047
GSM 900 - Uplink	897.4	40	1-124, 975-1023
GSM 900 - Downlink	942.4	40	1-124, 975-1023
GSM 1800 - Uplink	1747.4	80	512-885
GSM 1800 - Downlink	1842.4	80	512-885
GSM 1900 - Uplink	1879.8	80	512-810
GSM 1900 - Downlink	1959.8	80	512-810
JTACS - Uplink	878.5	93	0-1198 (even numbers only)
JTACS - Downlink	878.5	93	0-1198 (even numbers only)
MATS-E - Uplink	925	70	1-1000
MATS-E - Downlink	925	70	1-1000
N-AMPS / IS-88L - Uplink	859	70	1-799, 990-1023
N-AMPS / IS-88L - Downlink	859	70	1-799, 990-1023
N-AMPS / IS-88M - Uplink	859	70	1-799, 990-1023
N-AMPS / IS-88M - Downlink	859	70	1-799, 990-1023
N-AMPS / IS-88U - Uplink	897.5	147	1-799, 990-1023
N-AMPS / IS-88U - Downlink	897.5	147	1-799, 990-1023
NADC IS136 Cellular - Uplink	859	70	1-799, 990-1023
NADC IS136 Cellular - Downlink	859	70	1-799, 990-1023
NADC IS136 PCS - Uplink	1920	140	1-1199
NADC IS136 PCS - Downlink	1920	140	1-1199
NMT-411-25 kHz - Uplink	420.5	19	539-871
NMT-411-25 kHz - Downlink	420.5	19	539-871
NMT-450-20 kHz - Uplink	460.5	19	1039-1473
NMT-450-20 kHz - Downlink	460.5	19	1039-1473

Signal Standard	Center (MHz)	Span (MHz)	Valid Channels
NMT-450-25 kHz - Uplink	459	18	1-300
NMT-450-25 kHz - Downlink	459	18	1-300
NMT-470-20 kHz - Uplink	486.5	15	1972-2016
NMT-470-20 kHz - Downlink	486.5	15	1972-2016
NMT-900 - Uplink	925	70	1-1000
NMT-900 - Downlink	925	70	1-1000
NMT-900 (Offset) - Uplink	925	70	1025-2023
NMT-900 (Offset) - Downlink	925	70	1025-2023
NTACS - Uplink	878.5	93	1-1199
NTACS - Downlink	878.5	93	1-1199
PDC 800 Analog - Uplink	891.5	97	0-1680
PDC 800 Analog - Downlink	891.5	97	0-1680
PDC 1500 (JDC) - Uplink	1513	72	0-960
PDC 1500 (JDC) - Downlink	1513	72	0-960
PHS - Uplink	1906.5	23	1-77
PHS - Downlink	1906.5	23	1-77
SMR 800 - 12.5 kHz - Uplink	836	60	1-1199
SMR 800 - 12.5 kHz - Downlink	836	60	1-1199
SMR 800 - 25 kHz - Uplink	836	60	1-600
SMR 800 - 25 kHz - Downlink	836	60	1-600
SMR 1500 - Uplink	1483	60	1-479
SMR 1500 - Downlink	1483	60	1-479
TACS - Uplink	925	70	1-1000
TACS - Downlink	925	70	1-1000
UMTS/WCDMA - Uplink	1920	70	9600-9900
UMTS/WCDMA - Downlink	2110	70	10550-10850
UMTS/Region 2 - Uplink	1850	70	9250-9550
UMTS/Region 2 - Downlink	1930	70	9650-9950
802.11a	5170	84	34-161 (not all valid)
802.11b	2442	84	1-14
802.11 DS	2448	72	1-14
802.11 FH	2448.5	93	2-95
802.11g	2442	84	1-14



# Appendix B — Error Messages

## B-1 Introduction

This appendix provides a list of information and error messages that could be displayed on the VNA Master. If any error condition persists, then contact your local Anritsu Service Center.

## B-2 Self Test or Application Self Test Error Messages

### ADC Self Test FAILED

The Analog to Digital converter failed to return an answer. Insure that the battery level is adequate for operation or that the temperature is within acceptable limits. Reset to factory defaults with either Factory Defaults, ESC+ON, or MASTER RESET, System+ON. Caution: Use of MASTER RESET, System+ON, will erase all user saved setups and measurement traces and return the unit to a fully Factory Default condition. If the error persists, then contact your Anritsu Service Center.

### DDC FAILED

The Digital Down Converter failed to return a value. Insure that the battery level is adequate for operation or that temperature is within acceptable limits. Reset to factory defaults with either Factory Defaults, ESC+ON, or MASTER RESET, System+ON. Caution: Use of MASTER RESET, System+ON, will erase all user saved setups and measurement traces and return the unit to a fully Factory Default condition. If the error persists, then contact your Anritsu Service Center.

### Lock Test FAILED

One or more Phase Lock Loops Failed to properly achieve Lock Status. Insure that the battery level is adequate for operation or that temperature is within acceptable limits. Reset to factory defaults with either Factory Defaults, ESC+ON, or MASTER RESET, System+ON. Caution: Use of MASTER RESET, System+ON, will erase all user saved setups and measurement traces and return the unit to a fully Factory Default condition. If the error persists, then contact your Anritsu Service Center.

### Mixer Saturation: Increase Attenuation or Mixer Overdrive FAILED

Too much power applied with too little Attenuation. Increase attenuation. Sometimes even out of band frequencies may be present that would cause a Mixer Overdrive Error. In highly rich RF environments it may be necessary to add an external band pass filter to reduce unwanted interference. See the accessories section for a list available band pass filters from Anritsu. Out of band frequencies can often be detected by increasing the SPAN to maximum in peak detect mode of operation. Another resolution may be to Reset to factory defaults with



either Factory Defaults, ESC+ON, or MASTER RESET, System+ON. Caution: Use of MASTER RESET, System+ON, will erase all user saved setups and measurement traces and return the unit to a fully Factory Default condition. If the error persists, then contact your Anritsu Service Center.

### **Overall Status FAILED**

One or more elements of the System or Application Self Test has failed. Refer to the other pass fail tests listed below to determine which specific test failed.

### **Over Power FAILED**

RF Power applied to the input connector is too high. Remove or reduce the input power or add additional attenuation. Sometimes out of band frequencies may be present that can cause an Over Power Error. In highly rich RF environments it may be necessary to add an external band pass filter to reduce unwanted interference. See the accessories section for a list of available band pass filters from Anritsu. Out of band frequencies can often be detected by increasing the Span to maximum in the peak detect mode of operation. Another resolution may be to reset to factory defaults with either Factory Defaults, ESC+ON, or MASTER RESET, System+ON. Caution: Use of MASTER RESET, System+ON, will erase all user saved setups and measurement traces and return the unit to a fully Factory Default condition. If the error persists, then contact your Anritsu Service Center.

### **Over Power Start FAILED**

RF Power applied to the input connector is too high at turn on. See Over Power FAILED error above.

## B-3 Operation Error Messages

### **ADC Over range: Increase Reference Level**

Input signal is too large for the Analog to Digital converter to process. Increase the internal or external attenuation or, if using Auto attenuation, increasing the Reference Level should resolve the error. See also the Mixer Overdrive error above for information on Out of band RF power.

### **Calibrator Reading Error**

Calibration reference source is not providing quality signal. Insure that the battery level is adequate for operation or that temperature is within acceptable limits. Reset to factory defaults with either Factory Defaults, ESC+ON, or MASTER RESET, System+ON. Caution: Use of MASTER RESET, System+ON, will erase all user saved setups and measurement traces and return the unit to a fully Factory Default condition. If the error persists, then contact your Anritsu Service Center.

### **Cannot change average for Recalled/Inactive Traces**

Cannot set Delta Detection modes or other elements like RBW/VBW, averaging etc. cannot be altered on a recalled trace. The trace is displayed with the same parameters in which it was saved.

### **Cannot change Modes for Recalled/Inactive Traces**

Detection modes or other elements like RBW/VBW, averaging etc. cannot be altered on a recalled trace. The trace is displayed with the same parameters in which it was saved.

### **Cannot change scale in Linear mode**

Linear display mode of operation does not support a scaling change like the Log display mode.

### **Cannot set Delta Mkr Freq to Demod Freq**

Marker to Demod frequency is only available with a primary marker as the selected marker.

### **Cannot turn on delta marker because Ref Marker is a counter Marker**

Delta markers cannot be enabled unless the primary marker is NOT a counter Marker. Turn off the Counter Marker mode of marker operation to use Delta Marker.

### **Cannot turn on delta marker because Ref Marker is invalid**

Delta markers cannot be enabled unless the primary marker is within the displayed span.

### **Copy failed. Please check External Card**

Attempt to copy user saved data to external the Compact Flash Card has failed. Do not attempt to remove or power down the unit before the copy has completed. Be sure that the CF is not already full and that it is fully inserted into the CF-Card slot.

**Current Marker is not ON**

Attempted to use a marker mode or feature for a marker that is not enabled. Turn on the appropriate marker to use this function or switch to a marker that is already enabled.

**DSP Memory Failure, Address, Ext High, Ext Middle, Ext low, Ext1, Ext2**

One of the DSP memory locations has failed. The DSP will attempt to resolve the memory Failure location and Byte. There are two external memory banks (Ext1 = bank one, Ext2 = Bank 2) with three bytes wide (Ext High, Ext Middle and Ext Low. Byte).

**DSP version different from released version**

May occur during firmware update. Likely cause is incomplete firmware package installation. Finish the complete firmware update with Master Code Loader.

**EEPROM TEST: FAIL**

Hardware communications between modules has failed. Insure that the battery level is adequate for operation or that temperature is within acceptable limits. Reset to factory defaults with either Factory Defaults, ESC+ON, or MASTER RESET, System+ON. Caution: Use of MASTER RESET, System+ON, will erase all user saved setups and measurement traces and return the unit to a fully Factory Default condition. If the error persists, then contact your Anritsu Service Center.

**EEPROM TEST: UNKNOWN ERROR**

Hardware communications between modules has failed. Insure that the battery level is adequate for operation or that temperature is within acceptable limits. Reset to factory defaults with either Factory Defaults, ESC+ON, or MASTER RESET, System+ON. Caution: Use of MASTER RESET, System+ON, will erase all user saved setups and measurement traces and return the unit to a fully Factory Default condition. If the error persists, then contact your Anritsu Service Center.

**Fan Failure**

The system has determined that the fan should be running due to the internal temperature of the unit, but cannot detect that the fan is actually running.

It is important to keep the fan inlet and exhaust ports clear of obstructions. The cooling fan will vary the speed in relation to the internal temperature of the instrument. The fan will turn on at low speed when the internal temperature of the instrument reaches 44°C, and will increase the fan speed to maximum at 54°C. As the internal temperature of the instrument decreases, the fan will reduce speed until the temperature reaches 39°C, at which point the fan will turn off.

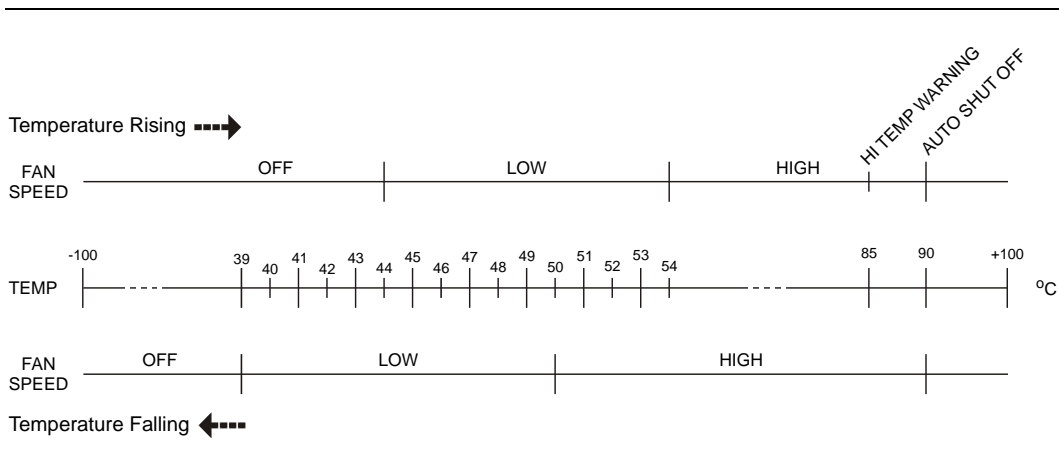

**Figure B-1.** Fan Speed vs. Temperature

## Fatal Error

Usually caused by a failure to communicate with one section or another. Sometimes resolved by restarting the unit or by Factory Defaults, ESC+ON, resetting of the unit. Under extreme cases the use of MASTER RESET, System+ON, may resolve the issue. Caution: Use of MASTER RESET, System+ON, will erase all user saved setups and measurement traces and return the unit to a fully Factory Default condition. If the error persists, then contact your Anritsu Service Center.

### Fatal error, EEPROM failed

Hardware communications between modules has failed. Insure that the battery level is adequate for operation or that temperature is within acceptable limits. Reset to factory defaults with either Factory Defaults, ESC+ON, or MASTER RESET, System+ON. Caution: Use of MASTER RESET, System+ON, will erase all user saved setups and measurement traces and return the unit to a fully Factory Default condition. If the error persists, then contact your Anritsu Service Center.

### Fatal error, no SPA board connected

Hardware communications between modules has failed. Insure that the battery level is adequate for operation or that temperature is within acceptable limits. Reset to factory defaults with either Factory Defaults, ESC+ON, or MASTER RESET, System+ON. Caution: Use of MASTER RESET, System+ON, will erase all user saved setups and measurement traces and return the unit to a fully Factory Default condition. If the error persists, then contact your Anritsu Service Center.

### **Fatal error not decoded by DSP**

Hardware communications between modules has failed. Insure that the battery level is adequate for operation or that temperature is within acceptable limits. Reset to factory defaults with either Factory Defaults, ESC+ON, or MASTER RESET, System+ON. Caution: Use of MASTER RESET, System+ON, will erase all user saved setups and measurement traces and return the unit to a fully Factory Default condition. If the error persists, then contact your Anritsu Service Center.

### **Fatal error, Unknown**

Hardware communications between modules has failed. Insure that the battery level is adequate for operation or that temperature is within acceptable limits. Reset to factory defaults with either Factory Defaults, ESC+ON, or MASTER RESET, System+ON. Caution: Use of MASTER RESET, System+ON, will erase all user saved setups and measurement traces and return the unit to a fully Factory Default condition. If the error persists, then contact your Anritsu Service Center.

### **High Temp Warning**

The internal temperature has reached an excessive level, 85°C. Verify that the ventilation openings are unobstructed and that the fan is running. Internal temperatures may be manually verified by using the SELF TEST function. Turn off the unit and allow the temperature to cool down. If the fault is not resolved and the internal temperature reaches 90°C, then a countdown of 10 seconds will begin to give the user a chance to save the current setup before it will turn itself off before internal temperatures can cause any damage. If the error persists after removing any obstructions and allowing the unit to cool, then reset to the factory defaults with either Factory Defaults, ESC+ON. Caution: Use of MASTER RESET, System+ON, will erase all user saved setups and measurement traces and return the unit to a fully Factory Default condition. If the error persists, then contact your Anritsu Service Center.

### **IF Cal is OFF**

Factory Calibration is OFF. Insure that the battery level is adequate for operation or that the temperature is within acceptable limits. Reset to factory defaults with either Factory Defaults, ESC+ON, or MASTER RESET, System+ON. Caution: Use of MASTER RESET, System+ON, will erase all user saved setups and measurement traces and return the unit to a fully Factory Default condition. If the error persists, then contact your Anritsu Service Center.

### **Invalid Attenuation for Preamp**

The only valid attenuation settings while the Preamp is operational are 0dB and 10dB. All other settings attempted by the user will result in this message. Select 0dB or 10dB or select AUTO Attenuation to let the system determine the correct setting based on the reference level selected.

**Lock failed during initialization**

One or more of the Phase Lock Loops failed to achieve lock status during startup. Insure that the battery level is adequate for operation or that temperature is within acceptable limits. Reset to factory defaults with either Factory Defaults, ESC+ON, or MASTER RESET, System+ON. Caution: Use of MASTER RESET, System+ON, will erase all user saved setups and measurement traces and return the unit to a fully Factory Default condition. If the error persists, then contact your Anritsu Service Center.

**Lock failure**

One or more of the Phase Lock Loops cannot keep the frequency controlled accurately. Insure that the battery level is adequate for operation and that the temperature is within acceptable limits. Reset to factory defaults with either Factory Defaults, ESC+ON, or MASTER RESET, System+ON. Caution: Use of MASTER RESET, System+ON, will erase all user saved setups and measurement traces and return the unit to a fully Factory Default condition. If the error persists, then contact your Anritsu Service Center.

**Locking to External Ref failed; Lock attempt Failed**

Switching from an internal frequency reference to the external reference has failed. Verify that the correct external reference frequency value has been selected from the list of valid external reference frequencies. Verify that the level of the external reference frequency is at least 1vp-p.

**Locking to Internal Ref failed**

Switching from an external frequency reference to the internal reference has failed. Some additional warm up time may be needed if the unit has been on external reference for a long time or the unit is not warmed up enough.

**Lock Test FAILED**

One or more Phase Lock Loops Failed to properly achieve Lock Status. Insure that the battery level is adequate for operation or that temperature is within acceptable limits. Reset to factory defaults with Factory Defaults, ESC+ON.

**Marker must be ON to Use the feature**

Attempted to use a marker mode or feature for a marker that is not enabled. Turn on the appropriate marker to use this function or switch to a marker that is already enabled.

**Measurement not valid in Zero Span**

Attempt was made to make an automated measurement that requires more than ZERO SPAN to accomplish. An example would be Occupied Bandwidth measurement.

**Minimum permitted Sweep time is 50 $\mu$ s**

An attempt was made to set the minimum Sweep time to less than 50us.

**Operation not Permitted in Recall Mode**

Attempted to perform an operation on a recalled trace. Many operations are valid only on a live or active trace.

**OTC Error**

Input signal is too large for the Analog to Digital converter to process. Increase the internal or external attenuation or, if using Auto attenuation, increasing the Reference Level should resolve the error. See also the Mixer Overdrive error above for information on Out of band RF power.

**Overall Status FAILED**

One or more elements of the System or Application Self Test has failed. Refer to the other pass fail tests listed below to determine which specific test failed.

**PLL Lock Fail**

Phase Lock Loop failed to lock.

**PMON PLD Fail**

Unable to communicate with the Power Monitor PCBA.

**Power Supply**

Power Supply failed. Charge the battery.

**Pretune Calibration Table fault.**

Insure that the battery level is adequate for operation or that temperature is within acceptable limits. Reset to factory defaults with either Factory Defaults, ESC+ON, or MASTER RESET, System+ON. Caution: Use of MASTER RESET, System+ON, will erase all user saved setups and measurement traces and return the unit to a fully Factory Default condition. If the error persists, then contact your Anritsu Service Center.

**Reference LVL Cal is OFF**

Factory Calibration is OFF. Insure that the battery level is adequate for operation or that the temperature is within acceptable limits. Reset to factory defaults with either Factory Defaults, ESC+ON, or MASTER RESET, System+ON. Caution: Use of MASTER RESET, System+ON, will erase all user saved setups and measurement traces and return the unit to a fully Factory Default condition. If the error persists, then contact your Anritsu Service Center.

**The Freq range of the Antenna is invalid for this setup. Please select another Antenna**

Choose a start and stop frequency that is within the defined frequency range for the selected antenna compensation table. See also Master Software Tools for creation and Upload of Antenna correction files.

**Trace A/B/C has no data to view**

Attempt to turn on or VIEW a trace that has never had data recalled into this trace location. Refer to Recall Trace section for instructions on how to recall stored measurement traces into either Trace A, B or C.

**Trace not saved. Please wait for complete sweep and try again.**

Attempted to save a measurement trace before the sweep had completed at least once. Wait for at least one complete sweep and try to save again.

**Triggering valid only in Zero Span**

External triggering can only be used while the SPAN is set to 0 (zero)

**Unable to add additional limit points. 41 points is the maximum.**

Attempted to add an additional limit line point beyond the maximum number of allowed points.

**UNKNOWN ERROR In SPA**

Hardware communications between modules has failed. Insure that the battery level is adequate for operation or that temperature is within acceptable limits. Reset to factory defaults with either Factory Defaults, ESC+ON, or MASTER RESET, System+ON. Caution: Use of MASTER RESET, System+ON, will erase all user saved setups and measurement traces and return the unit to a fully Factory Default condition. If the error persists, then contact your Anritsu Service Center.

**Use Demod type USB or LSB to use Beat Frequency Osc**

An attempt to use the Beat Frequency Oscillator while not in Upper or Lower Sideband Demodulation mode.

**Valid Attenuations with Preamp on are 0dB and 10dB**

An attempt to use the Beat Frequency Oscillator while not in Upper or Lower Sideband Demodulation mode.

**VNA EEPROM Fail**

Writing and reading of test data to and from the VNA EEPROM failed.

**VNA FPGA Fail**

Unable to communicate with the VNA PCBA.

**VNA Board ID Fail**

Readings and voltages associated with the VNA board failed.



## **B-4 Interference Analyzer Information Messages**

**ADC Over range: Increase Reference Level**

**Attempting to lock to ext ref**

**Attempting to lock to External ref**

**Attempting to lock to Internal ref**

**Attenuation has been changed**

**Cannot change scale in Linear mode**

**Cannot turn on delta marker because Ref Marker is a counter Marker**

**Changing Active trace to A**

**Connect Carrier\Press Enter to Measure or Escape to Exit**

**Current Marker is not ON**

**Disconnect Carrier\Press Enter to Measure or Escape to Exit**

**IF Cal is OFF**

**Minimum permitted Sweep time is 10 $\mu$ s**

**Mixer Saturation: Increase Attenuation**

**Preamp has been turned off**

**Preamp has been turned on**

**Press ESC to clear Recall Trace**

**Press Escape to keep old settings, or Enter to use Recalled Values**

**Reference Level has been changed**

**Reference Locked Successfully**

**Reference LVL Cal is OFF**

**Startup DSP Memory test successful**

**Startup Selftest successful**

**Successfully locked**

**Sweep Stopped After Saving On Event**

**Turning off Delta Marker**

**Units has been changed to dBm**

**Use Min/Max buttons under the Signal Strength Sub-Menu to change display range**

**Use Min/Max buttons under the Signal Strength Sub-Menu to change measure range**

**Valid Attenuations with Preamp on are 0dB and 10dB**

## **B-5 Interference Analyzer Error Messages**

**Auto Save not available when Time Span is Auto**

**Cannot change average for Recalled/Inactive Traces**

**Cannot set Delta Mkr Freq to Demod Freq**

**Current measurement is stopped when Cursor is not zero**

**DDC Failure**

**DSP Memory Failure**

**Fatal error not decoded by DSP**

**Fatal error, EEPROM failed**

**Fatal error, no IA board connected**

**Fatal error, Unknown**

**Hidden inflection points prevent this action. Decrease Span to reveal hidden points.**

**Invalid Attenuation for PreAmp Setting**

**Lock attempt Failed**

**Lock failed during initialization**

**Lock failure %x**

**Locking to External Ref failed**

**Locking to Internal Ref failed**

**Marker must be ON to Use the feature**

**Measurement has been turned OFF**

**Measurement not valid in Zero Span**

**Measurements can not be displayed in Full Screen mode**

**Only HOLD is valid for Trace B**

**Only HOLD is valid for Trace C when trace C is not being updated from A**

**Operation not Permitted in Recall Mode**

**Operation not Permitted in this Mode**

**OVER POWER ERROR**

**Pretune Calibration Failure**

**The Freq range of the Antenna is invalid for this setup. Please select another Antenna**

**The specified Time span is too big to save all measurements. Automatically adjusted Time Span to a valid number**

**Timed Measurement Done. Press Reset/Restart Meas to continue measuring**

**Trace A has no data to view**

**Trace B has no data to view**

**Trace C has no data to view**

**Trace not saved. Please wait for complete sweep and try again.**

**Triggering valid only in Zero Span**

**Turning off Trace Overlay**

**Unable to add additional limit points. %d is the maximum.**

**UNKNOWN ERROR In IA**

## **B-6 Channel Scanner Information Messages**

**Attempting to lock to ext ref**

**Attempting to lock to External ref**

**Attempting to lock to Internal ref**

**Press ESC to clear Recall Trace**

**Reference Locked Successfully**

**Startup DSP Memory test successful**

**Startup Selftest successful**

## **B-7 Channel Scanner Error Messages**

**ADC Over range: Increase Reference Level**

**Error Recalling Measurement**

**Mixer Saturation: Increase Attenuation**

**Not Available when Max Hold is OFF**

**Operation not Permitted in Recall Mode**



# Appendix C — Windowing

## C-1 Introduction

The theoretical requirement for inverse FFT is for the data to extend from zero frequency to infinity. Side lobes appear around a discontinuity due to the fact that the spectrum is cut off at a finite frequency. Windowing reduces the side lobes by smoothing out the sharp transitions at the beginning and at the end of the frequency sweep. As the side lobes are reduced the main lobe widens thereby reducing the resolution.

In situations where there may be a small discontinuity close to a large one, side lobe reduction windowing should be used. When distance resolution is critical windowing can be reduced.

## C-2 Windowing Examples

The types of windowing in order of increasing side lobe reduction are: rectangular, nominal side lobe, low side lobe, and minimum side lobe. Figures C-1 through C-4 show examples of the types of windowing.

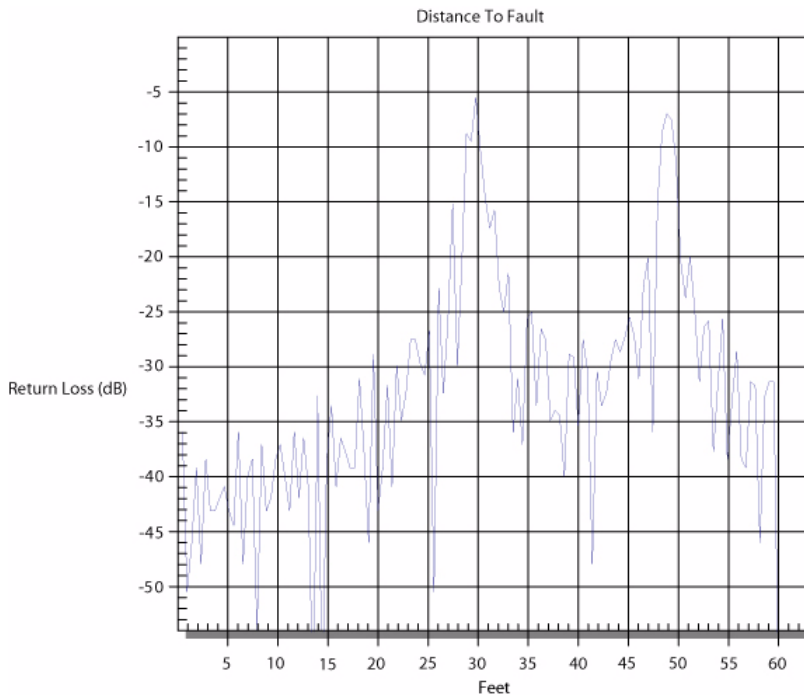

**Figure C-1.** Rectangular Windowing Example



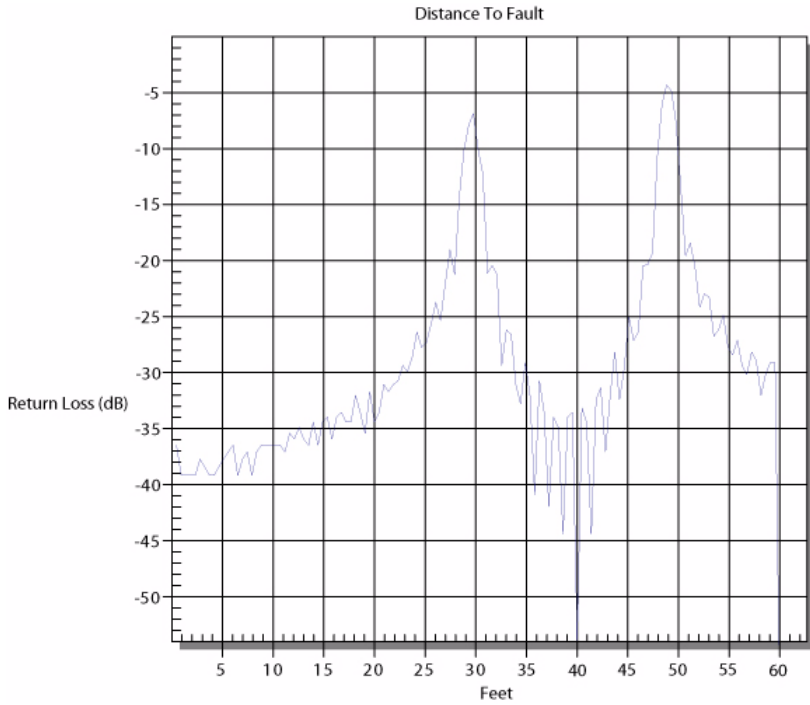

Figure C-2. Nominal Side Lobe Windowing Example

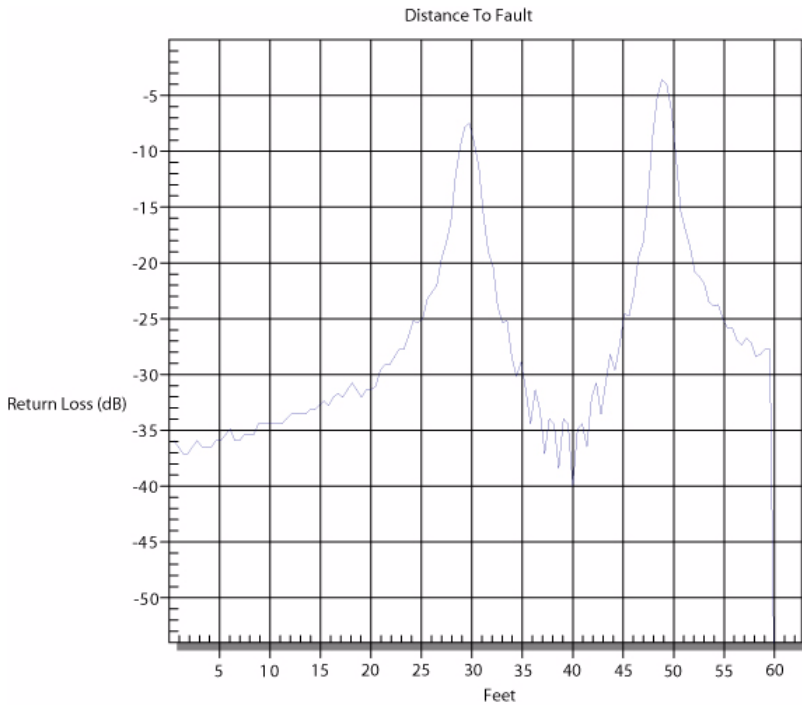

Figure C-3. Low Side Lobe Windowing Example

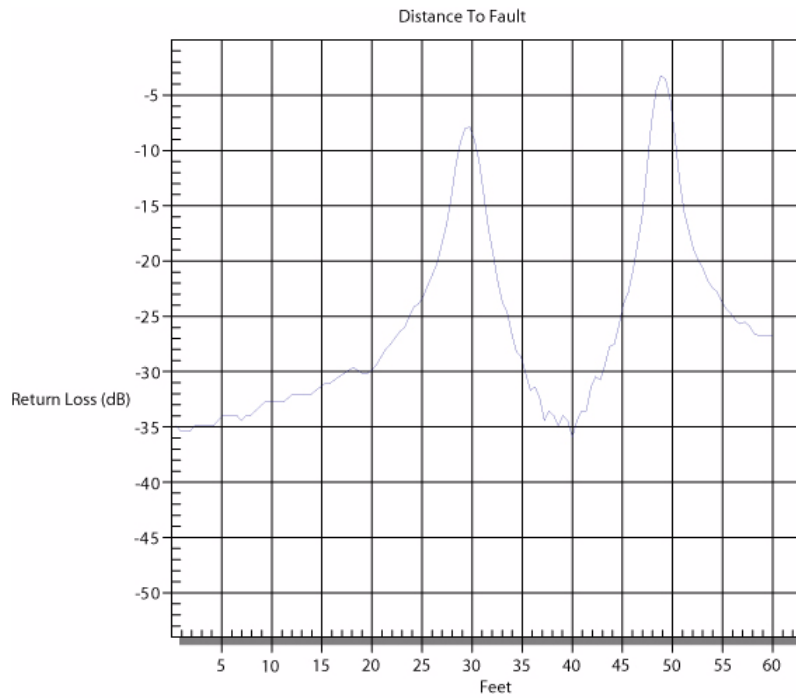

Figure C-4. Minimum Side Lobe Windowing Example



# Appendix D — Tower Mounted Amplifiers

## D-1 Introduction

A Tower Mounted Amplifier (TMA) can be used to amplify the received signal. There are different types of TMA depending on the system requirements. Three commonly used types are:

- TMA-D - A duplex tower mounted amplifier that combines transmit and receive ports from the radio system and connects to a single antenna. This configuration is specific to systems that use a single antenna configuration.
- TMA-S - A receive-only tower mounted amplifier is installed between the receiving antenna and the radio to boost weak signals. This configuration is common on systems that implement separate antennas for transmitting and receiving.
- TMA-DD - A dual-duplex tower mounted amplifier used for radios systems with a single transmission line connection for transmit and receive. These systems are commonly called transceivers.

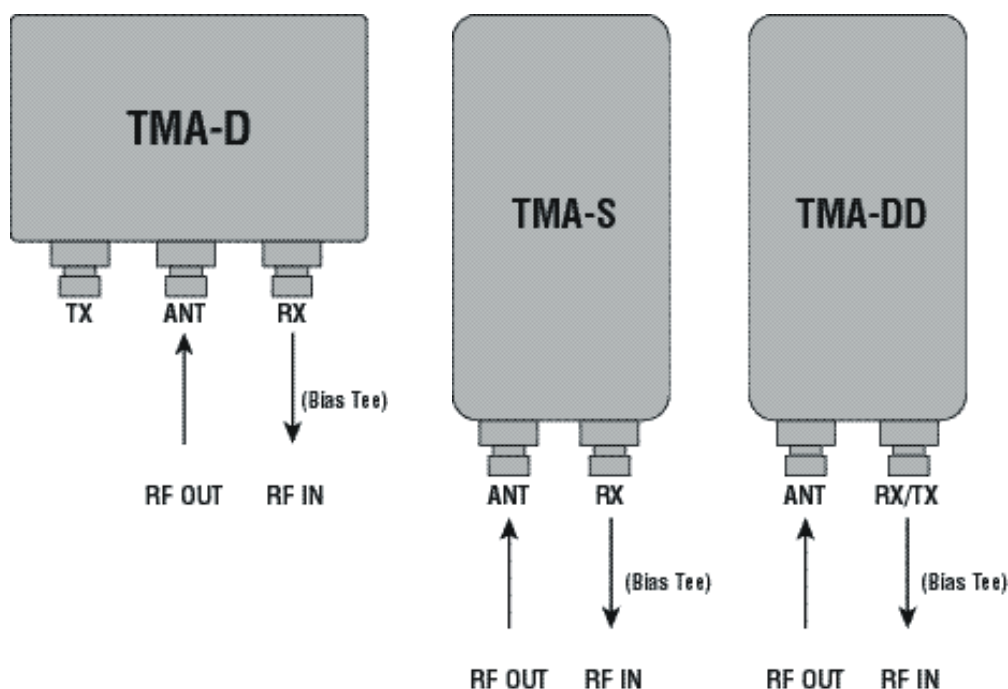

Figure D-1. Tower Mounted Amplifiers



# Appendix E — Coaxial Cable Technical Data

## E-1 Coaxial Cable Technical Data

The table below provides a list of common coaxial cables.

Mfgr.	Cable	Prop. Vel	Freq 1	Loss 1	Freq 2	Loss 2	Freq 3	Loss 3
Andrew	FSJ1-50A (6 GHz)	0.84	1000	0.196	2500	0.313	6000	0.532
Andrew	FSJ2-50 (6 GHz)	0.83	1000	0.133	2500	0.223	6000	0.374
Andrew	FSJ4-50B (6 GHz)	0.81	1000	0.118	2500	0.201	6000	0.348
Andrew	EFX2-50 (6 GHz)	0.85	1000	0.121	2500	0.202	6000	0.341
Andrew	LDF1-50 (6 GHz)	0.86	6000	0.306	6000	0.306	6000	0.306
Andrew	LDF2-50 (6 GHz)	0.88	6000	0.323	6000	0.323	6000	0.323
Andrew	LDF4-50A (6 GHz)	0.88	1000	0.073	2500	0.121	6000	0.218
Andrew	HJ4-50 (6 GHz)	0.914	1000	0.092	2500	0.156	6000	0.257
Andrew	HJ4.5-50 (6 GHz)	0.92	1000	0.054	2500	0.089	6000	0.148
Andrew	AVA5-50 7/8	0.91	1000	0.038	2000	0.055	2500	0.063
Andrew	AVA7-50 1-5/8	0.92	1000	0.022	2000	0.034	2500	0.038
Andrew	EFX2-50	0.85	1000	0.121	2000	0.177	2500	0.202
Andrew	FLC 12-50J	0.88	1000	0.075	2000	0.11	2500	0.134
Andrew	FLC 38-50J	0.88	1000	0.115	2000	0.169	2500	0.19
Andrew	FLC 78-50J	0.88	1000	0.041	2000	0.061	2500	0.072
Andrew	FLC 114-50J	0.88	1000	0.033	2000	0.05	2500	0.059
Andrew	FLC 158-50J	0.88	1000	0.025	2000	0.038	2500	0.042
Andrew	FSJ1-50A	0.84	1000	0.196	2000	0.285	2500	0.313
Andrew	FSJ2-50	0.83	1000	0.133	2000	0.196	2500	0.223
Andrew	FSJ4-50B	0.81	1000	0.118	2000	0.176	2500	0.201
Andrew	HJ4-50	0.91	1000	0.092	2000	0.137	2500	0.156
Andrew	HJ4.5-50	0.92	1000	0.054	2000	0.079	2500	0.089
Andrew	HJ5-50	0.916	1000	0.042	2000	0.063	2500	0.071
Andrew	HJ7-50A	0.921	1000	0.023	2000	0.034	2500	0.039
Andrew	HJ12-50	0.931	1000	0.019	2000	0.029	2000	0.029
Andrew	HL4RP-50A	0.88	1000	0.074	2000	0.109	2500	0.123
Andrew	LDF4-50A	0.88	1000	0.073	2000	0.107	2500	0.12
Andrew	LDF4.5-50	0.89	1000	0.054	2000	0.08	2500	0.091
Andrew	LDF5-50A	0.89	1000	0.041	2000	0.061	2500	0.07

Mfgr.	Cable	Prop. Vel	Freq 1	Loss 1	Freq 2	Loss 2	Freq 3	Loss 3
Andrew	LDF5-50B	0.91	1000	0.041	2000	0.061	2500	0.07
Andrew	LDF6-50	0.89	1000	0.028	2000	0.042	2500	0.048
Andrew	LDF7-50A	0.88	1000	0.024	2000	0.037	2500	0.043
Andrew	LDF12-50	0.88	1000	0.021	2000	0.033	2000	0.033
Andrew	VXL5-50 7/8	0.88	1000	0.045	2000	0.066	2500	0.075
Andrew	VXL6-50 1-1/4	0.88	1000	0.032	2000	0.048	2500	0.055
Andrew	VXL7-50 1-5/8	0.88	1000	0.024	2000	0.037	2500	0.043
Belden	RG-8/8A	0.86	1000	0.132	2000	0.33	2500	0.22
Belden	RG-9/9A	0.659	1000	0.289	1000	0.289	1000	0.289
Belden	RG-17/17A	0.659	1000	0.18	1000	0.18	1000	0.18
Belden	RG-55/55A/55B	0.659	1000	0.541	1000	0.541	1000	0.541
Belden	RG-58/58B	0.77	1000	0.356	2000	0.528	2500	0.6
Belden	RG-58A/58C	0.73	1000	0.594	1000	0.594	1000	0.594
Belden	RG-142	0.7	1000	0.43	2000	0.663	2500	0.713
Belden	RG-174	0.66	1000	1.115	1000	1.115	1000	1.115
Belden	RG-178B	0.695	1000	1.509	1000	1.509	1000	1.509
Belden	RG-188	0.69	1000	0.951	1000	0.951	1000	0.951
Belden	RG-213	0.66	1000	0.262	1000	0.269	1000	0.269
Belden	RG-214	0.659	1000	0.229	1000	0.292	1000	0.292
Belden	RG-223	0.66	1000	0.476	1000	0.478	1000	0.478
Cablewave	HCC 12-50J	0.915	1000	0.087	2000	0.126	2500	0.137
Cablewave	HCC 78-50J	0.915	1000	0.041	2000	0.061	2500	0.066
Cablewave	HCC 158-50J	0.95	1000	0.022	2000	0.031	2500	0.033
Cablewave	HCC 300-50J	0.96	1000	0.015	1000	0.015	1000	0.015
Cablewave	HCC 312-50J	0.96	1000	0.013	1000	0.013	1000	0.013
Cablewave	HF 4 1/8 Cu2Y	0.97	1000	0.01	1000	0.01	1000	0.01
Cablewave	HF 5 Cu2Y	0.96	1000	0.007	1000	0.007	1000	0.007
Cablewave	HF 6 1/8 Cu2Y	0.97	1000	0.006	1000	0.006	1000	0.006
Cellflex	LCF78-50JA	0.9	1000	0.039	2000	0.058	2500	0.066
Cellflex	LCFS114-50JA	0.9	1000	0.029	2000	0.044	2500	0.051
Cellflex	LCF158-50JA	0.9	1000	0.024	2000	0.036	2500	0.042
Cellflex	LCF214-50JA	0.88	1000	0.021	2000	0.033	2000	0.033
Cellflex	UCF114-50JA	0.89	1000	0.031	2000	0.047	2000	0.047
Comscope	CR50 540PE	0.88	1000	0.069	2000	0.103	2500	0.116
Comscope	CR50 1070PE	0.88	1000	0.037	2000	0.055	2500	0.064
Comscope	CR50 1873PE	0.88	1000	0.022	2000	0.034	2500	0.04
Eupen	EC4-50-HF 1/2	0.82	1000	0.108	2000	0.161	2500	0.183
Eupen	EC4-50 1/2	0.88	1000	0.074	2000	0.109	2500	0.121

Mfgr.	Cable	Prop. Vel	Freq 1	Loss 1	Freq 2	Loss 2	Freq 3	Loss 3
Eupen	EC4.5-50 5/8	0.88	1000	0.056	2000	0.083	2500	0.094
Eupen	EC5-50 7/8	0.88	1000	0.04	2000	0.058	2500	0.066
Eupen	EC6-50 1-1/4	0.88	1000	0.028	2000	0.043	2500	0.048
Eupen	EC7-50 1-5/8	0.88	1000	0.024	2000	0.037	2500	0.042
Eupen	EC7-50A 1-5/8	0.89	1000	0.023	2000	0.035	2500	0.039
Eupen	EC12-50 2-1/4	0.88	1000	0.022	2000	0.034	2500	0.039
Nk Cables	RF1/2-50	0.88	1000	0.073	2000	0.107	2500	0.127
Nk Cables	RF1/2-50GHF	0.88	1000	0.073	2000	0.107	2500	0.127
Nk Cables	RF1/2-50BHF	0.88	1000	0.073	2000	0.107	2500	0.127
Nk Cables	RF5/8-50	0.88	1000	0.051	2000	0.075	2500	0.087
Nk Cables	RF5/8-50GHF	0.88	1000	0.051	2000	0.075	2500	0.087
Nk Cables	RF5/8-50BHF	0.88	1000	0.051	2000	0.075	2500	0.087
Nk Cables	RF7/8-50	0.88	1000	0.04	2000	0.059	2500	0.07
Nk Cables	RF7/8-50GHF	0.88	1000	0.04	2000	0.059	2500	0.07
Nk Cables	RF7/8-50BHF	0.88	1000	0.04	2000	0.059	2500	0.07
Nk Cables	RF1 5/8-50	0.88	1000	0.024	2000	0.036	2500	0.042
Nk Cables	RF1 5/8-50GHF	0.88	1000	0.024	2000	0.036	2500	0.042
Nk Cables	RF1 5/8-50BHF	0.88	1000	0.024	2000	0.036	2500	0.042
Nk Cables	RF2 1/4-50	0.88	1000	0.021	2000	0.032	2500	0.041
Nk Cables	RF2 1/4-50GHF	0.88	1000	0.021	2000	0.032	2500	0.041
Nk Cables	RF2 1/4-50BHF	0.88	1000	0.021	2000	0.032	2500	0.041
Nk Cables	RFF3/8-50	0.81	1000	0.147	2000	0.218	2500	0.25
Nk Cables	RFF3/8-50GHF	0.81	1000	0.147	2000	0.218	2500	0.25
Nk Cables	RFF3/8-50BHF	0.81	1000	0.147	2000	0.218	2500	0.25
Nk Cables	RFF1/2-50	0.82	1000	0.112	2000	0.167	2500	0.19
Nk Cables	RFF1/2-50GHF	0.82	1000	0.112	2000	0.167	2500	0.19
Nk Cables	RFF1/2-50BHF	0.82	1000	0.112	2000	0.167	2500	0.19
Nk Cables	RFF7/8-50	0.88	1000	0.04	2000	0.066	2500	0.076
Nk Cables	RFF7/8-50GHF	0.88	1000	0.04	2000	0.066	2500	0.076
Nk Cables	RFF7/8-50BHF	0.88	1000	0.04	2000	0.066	2500	0.076
Times	LMR100	0.66	1000	0.789	2000	1.15	2500	1.31
Times	LMR200	0.83	1000	0.342	2000	0.49	2500	0.554
Times	LMR240	0.84	1000	0.261	2000	0.377	2500	0.424
Times	LMR400	0.85	1000	0.135	2000	0.196	2500	0.222
Times	LMR500	0.86	1000	0.109	2000	0.159	2500	0.18
Times	LMR600	0.87	1000	0.087	2000	0.128	2500	0.145
Times	LMR900	0.87	1000	0.059	2000	0.086	2500	0.098
Times	LMR1200	0.88	1000	0.044	2000	0.065	2500	0.074



<b>Mfgr.</b>	<b>Cable</b>	<b>Prop. Vel</b>	<b>Freq 1</b>	<b>Loss 1</b>	<b>Freq 2</b>	<b>Loss 2</b>	<b>Freq 3</b>	<b>Loss 3</b>
Times	LMR1700	0.89	1000	0.033	2000	0.049	2500	0.057
	310801	0.821	1000	0.115	1000	0.115	1000	0.115
	311201	0.82	1000	0.18	1000	0.18	1000	0.18
	311501	0.8	1000	0.23	1000	0.23	1000	0.23
	311601	0.8	1000	0.262	1000	0.262	1000	0.262
	311901	0.8	1000	0.377	1000	0.377	1000	0.377
	352001	0.8	1000	0.377	1000	0.377	1000	0.377

# Appendix F — Formulas

## F-1 VNA Master Formulas

The following formulas can be used with the VNA Master.

### Reflection Coefficient

Reflection coefficient is the ratio of the amplitude of the reflected wave to the incident wave.

$$\text{Reflection Coefficient} = \rho$$

$$\text{where: } 0 \leq \rho \leq 1$$

### Return Loss

$$\text{Return Loss (dB)} = -20 \log |\rho|$$

$$\text{where: } 0 \leq \text{Return Loss} < \infty$$

### VSWR

$$\text{VSWR} = \frac{(1 + \rho)}{(1 - \rho)}$$

$$\text{where: } 1 \leq \text{VSWR} < \infty$$

### Smith Chart

$$\text{Smith Chart: } z = r + jx$$

$$\rho = \frac{(z - 1)}{(z + 1)}$$

### Electrical Length

The length of the cable as seen by the electrical signal. The electrical length is always greater than 1 for practical dielectric materials.

$$\text{Electrical Length} = L_{el} = L_{mech} \times \sqrt{\epsilon}$$

## Propagation

Propagation is the propagation velocity expressed as a ratio to the speed of light.

$$\text{Propagation Constant} = v_p = \frac{1}{\sqrt{\epsilon}}$$

where:  $0 \leq v < 1$

## Cable Loss

$$\text{Cable Loss} = \frac{\text{Return Loss (dB)}}{2}$$

$$\text{Cable Loss Average} = \frac{(\text{Peak} + \text{Valley})}{2}$$

## Fault Resolution

Fault resolution or distance-to-fault (DTF) is the system's ability to separate two closely spaced discontinuities.

$$\text{Fault Resolution (m)} = \frac{1.5 \times 10^8 \times v_p}{\Delta F}$$

where:  $F =$  Frequency in Hertz (Hz)

## Maximum Horizontal Distance

$D_{\max}$  is the maximum horizontal distance that can be analyzed in DTF.

$$D_{\max(m)} = (\text{Datapoints} - 1) \times \text{Fault Resolution}$$

## Suggested Span

Suggested Span is the span needed to get Stop Distance to equal Max Distance

$$\text{Suggested Span (Hz)} = \frac{(\text{Datapoints} - 1) \times 1.5 \times 10^8 \times v_p}{\text{Stop Distance}}$$

# Appendix G — More About DHCP

## G-1 Introduction

DHCP stands for Dynamic Host Configuration Protocol. This protocol allows a server to dynamically assign IP addresses to devices that are connected to the network. Most networks include a DHCP server to manage IP addresses. When a DHCP server is available on the network, DHCP is the preferred IP address mode.

## G-2 Using DHCP

When using DHCP, no setup is required to lease and use a dynamic IP address. In a dynamic IP operation, the assigned IP address may change from use to use. The DHCP server assigns IP addresses on a time rotation basis. As soon as the device is disconnected from the network, the IP address that it was using becomes available to lease to the next unit requesting an IP address. Normally, some amount of lag time occurs on the DHCP server end, so if the device is connected again reasonably soon, it may receive the same address.

**Note**

The VNA Master must be connected to the network *before* it is turned on in order to allow DHCP to work. Key elements of the DHCP lease are performed only during the instrument startup operations or when switching from manual to DHCP.

## G-3 Static IP Address

When a DHCP server is not available, a Static IP address can be used. A Static IP address is a fixed address. After being set, it will always remain the same, and care must be taken to avoid conflict with other equipment on the network.

When using a static IP address on an established network, always request a Static IP address from the network administrator. Randomly choosing a Static IP address on an established network may result in duplicate IP addresses or other conflicts.

Three parameters must be set prior to using a Static IP address:

### IP Address

This is the Static IP address on the network.

### Default Gateway

Often when a static IP address is assigned, a default gateway is also identified. If the default gateway is unknown, then type in the Static IP address so that the Static IP address and Default Gateway are the same number.

## Subnet Mask

This parameter is usually extracted from the Static IP address based upon the class of the address. It determines the destination of any broadcast messages that might be sent from the instrument. It can be customized if necessary. The subnet mask may also be provided with the Static IP address.

### Example 1

In this example, a Static IP address has been chosen because no network is available. The instrument is connected to the network port on the PC with a crossover Ethernet cable (not included). This is also referred to as Direct Connect:

```
IP Address: 10.0.0.2
Default Gateway: 10.0.0.2
Subnet Mask: 255.255.0.0
```

### Example 2

In this example, the Static IP address has been assigned with an associated gateway and subnet mask:

```
IP Address: 153.56.100.42
Default Gateway: 153.56.100.1
Subnet Mask: 255.255.252.0
```

## G-4 Operating System Tools

A few tools that are built into the Microsoft Windows operating system can assist in making some determinations about the network that the PC is plugged into.

### Ipconfig Tool

Typing ipconfig at a command prompt will display information about the in-use parameters of the PC and its network connection. Below is an example of the typical results expected.

**Note** The ipconfig display does not report if the information is from a DHCP server or a Static IP setup

```
Y:\>ipconfig
Windows 2000 IP Configuration
Ethernet adapter Local Area Connection:
Connection-specific DNS Suffix. : us.anritsu.com
IP Address . . . . . : 172.26.202.172
Subnet Mask . . . . . : 255.255.252.0
Default Gateway . . . . . : 172.26.200.1
```

## Ping Tool

Another tool that can find out if a selected IP address is already on the network is ping. Ping is a harmless way to determine if an address is found on the network and, if it is found, for it to reply. Greatly simplified, ping sends out a request to a specific address to determine if it is there. If the specific address is found, then it will respond by sending back the same message that was received. If it is not found, then the response will be “request timed out.” This means that no reply was received from that IP address.

```
Y:\>ping 172.26.202.172
Pinging 172.26.202.172 with 32 bytes of data:
Reply from 172.26.202.172: bytes=32 time<10ms TTL=128
Reply from 172.26.202.172: bytes=32 time<10ms TTL=128
Reply from 172.26.202.172: bytes=32 time<10ms TTL=128
Reply from 172.26.202.172: bytes=32 time<10ms TTL=128
Ping statistics for 172.26.202.172:
    Packets: Sent = 4, Received = 4, Lost = 0 (0% loss),
    Approximate round trip times in milliseconds:
    Minimum = 0ms, Maximum = 0ms, Average = 0ms
```



# Index

---

## A

ACPR .....9-18  
ACPR measurement  
    interference analyzer .....9-18  
ACPR, adj channel power ratio .....4-49  
adapter  
    AC-DC .....1-16  
add point  
    with limit lines .....3-11  
Adjacent Channel Power Ratio (ACPR)  
    field measurement .....4-8  
    spectrum analyzer .....4-1  
adjacent channels .....9-18  
almanac  
    complete, GPS .....12-4  
    GPS data, reset .....12-2  
AM/FM .....4-8, 4-18  
AM/FM demodulation .....4-49  
    Interference Analyzer Mode .....9-18  
amplitude .....10-7  
    SPA Auto Atten coupling .....4-3  
    SPA setting .....4-2  
Amplitude menu  
    interference analyzer mode .....9-12  
amplitude menu  
    cable & antenna analyzer .....3-26  
antenna  
    calculations .....4-17  
    connection, GPS .....2-14  
    status .....12-4  
application  
    self test .....3-55, B-8  
application options  
    Field vs VNA menu .....3-1  
    soft key, field measurement menu or VNA  
        menu .....3-41  
    System menu .....3-55  
    VNA measurement .....3-1  
attenuation .....4-6, 9-12  
    amplitude menu .....4-24  
    attenuator part numbers .....1-9  
    high input power .....6-1  
    S21 measurement VNA .....3-19  
    VNA DTF .....3-16  
attenuation error  
    ADC over range .....B-3, B-8  
    additional over power failed .....B-2  
    additional over power start failed ... B-1  
    interference analyzer messages .... B-10  
    Invalid Attenuation for Preamp .... B-6

attenuation S21 measurement  
    Bias Tee .....7-2  
attenuation VNA  
    cable loss, field meas .....3-45  
attenuation, VNA  
    cable loss level .....3-14  
attenuator functions .....4-6  
Auto RBW  
    BW menu .....4-26  
Auto VBW, BW menu .....4-26

## B

bandwidth .....10-6  
battery  
    charging .....1-16, 2-12  
    replacement .....1-15  
    status information .....3-55  
beat frequency oscillator .....4-50  
bias tee  
    S21 attenuation example .....7-2  
    Sweep Menu .....3-52, 7-4  
bias tee 2-port gain  
    VNA measurement .....7-2  
bias tee, 2-port gain  
    VNA measurement .....3-19  
brightness  
    System menu, VNA .....3-56  
brightness, system menu .....4-59

## C

C/I  
    measure menu .....4-50  
C/I (carrier to interference)  
    spectrum menu, interference analyzer 9-19  
C/I see Carrier to Interference Ratio  
cable loss  
    Field Menus description .....3-14  
    VNA Field Measurement menu .... 3-40  
calibration  
    1-port .....3-4  
    2-port .....3-5  
    before field measurement .....1-14  
    high accuracy power meter .....11-1  
    menu, functions overview .....3-27  
    requirements .....1-14  
    status, Master Software Tools .... 13-1  
calibration procedure  
    OSL .....3-4  
    OSLIT .....3-5  
Carrier to Interference Ratio (C/I)



## D to F

---

- field measurement . . . . . 4-8
- measurement description . . . . . 4-19
- spectrum analyzer . . . . . 4-1
- Carrier to Interference ratio (C/I) . . . . . 4-50
- cautions
  - ESD damage . . . . . 1-15
- center frequency . . . . . 3-2
- center frequency, freq menu . . . . . 4-36
- channel power . . . . . 9-17
  - channel scanner display . . . . . 10-1
  - interference analyzer . . . . . 9-17
  - SPA . . . . . 4-9
- channel power, measure menu . . . . . 4-48
- channel spacing . . . . . 9-18
- charging the battery . . . . . 1-16
- CISPR
  - radio interference standard . . . . . 4-25
- compact flash memory card . . . . . 2-15
- compact flash module . . . . . 4-29
- connectors . . . . . 2-11
- continuous sweep . . . . . 3-51
- current
  - bias tee . . . . . 3-52, 7-4
- custom setup . . . . . 10-3

## D

- data points
  - DTF, VNA measurement . . . . . 3-16
  - VNA Sweep menu . . . . . 3-52
- date and time . . . . . 3-55
- default gateway
  - functions overview . . . . . G-1
- defaults
  - factory . . . . . 3-56, 4-60, B-7
- demod
  - AM/FM, measure menu . . . . . 4-49
  - frequency . . . . . 9-19, B-3
  - frequency, measure menu . . . . . 4-49
  - time . . . . . 9-19
  - time, measure menu . . . . . 4-49
- detection
  - amplitude menu . . . . . 4-24
  - detection, sweep menu . . . . . 4-55
- detector
  - RF . . . . . 2-14
  - RF, power monitor . . . . . 6-1
- DHCP Ethernet address . . . . . 2-12
  - VNA configuration . . . . . 3-55
- DHCP, dynamic IP Address selection . . 4-59
- display overview . . . . . 2-4
- distance
  - horizontal D-Max VNA . . . . . 3-19
  - resolution, windowing . . . . . C-1
  - stop, span formula . . . . . F-2
  - VNA log magnitude fault location . . 3-43

- VNA stop, DTF measurement . . . . . 3-17
- distance VNA
  - DTF field meas menu . . . . . 3-46
- Distance-To-Fault (DTF)
  - VNA field measurements . . . . . 3-2
  - VNA measurements . . . . . 3-15
- DMax
  - defined as VNA measurement . . . . . 3-19
  - DTF, VNA measurement . . . . . 3-16

## E

- ESD damage, cautions . . . . . 1-15
- Ethernet address
  - functions overview . . . . . 2-12
  - VNA configuration . . . . . 3-55
- Ethernet configuration, system menu . . 4-59
- export measurement data
  - Master Software Tools . . . . . 13-1
- external reference frequency . . . . . 4-58

## F

- fault resolution
  - defined, VNA . . . . . 3-18
  - DTF, example formula . . . . . F-2
  - DTF, VNA . . . . . 3-16
- FDMA . . . . . 4-10
- FHSS
  - Frequency Hopping Spread Spectrum 4-50
- FHSS carrier signal type
  - interference analyzer . . . . . 9-20
- field measurement menu
  - field menu versus VNA menu . . . . . 3-41
- field menu
  - VNA measurement . . . . . 3-1
- field strength . . . . . 4-16, 9-17, 9-24
- field strength characteristics
  - interference analyzer . . . . . 9-17, 9-24
- field strength, measure menu . . . . . 4-47
- frequency
  - center . . . . . 3-2
  - center, signal standard . . . . . 4-3
  - center, signal standard, VNA . . . . . 3-34
  - external reference . . . . . 2-14
  - span . . . . . 3-2
  - start . . . . . 4-2
  - stop . . . . . 4-2
- frequency center . . . . . 9-10
- frequency menu
  - center . . . . . 4-36
  - range . . . . . 4-34
- frequency range
  - tuning, interference analyzer . . . . . 9-8
  - VNA tuning . . . . . 3-33
- front panel keys . . . . . 2-5

function overview	2-11	IP address	2-12, 4-59
functions overview		VNA configuration	3-55
battery	2-12	<b>J</b>	
DHCP	2-12	JPEG	4-32
headset	2-14	export using Master Software Tools	13-1
IP address	2-12	Save screen as	4-30
LAN	2-12	<b>K</b>	
subnet mask	2-12	keys	2-5
USB	2-13	front panel keys	2-5
<b>G</b>		soft key types	2-7
gain	9-17, 9-24	<b>L</b>	
external, ref level	9-12	LAN connection	2-12
log magnitude, S21	3-43	VNA configuration	3-55
gain, 2-port		language	
Bias Tee	7-2	system options, VNA	3-55
VNA Field measurement	3-40	language selection	
VNA field measurement	3-2	Spectrum Master	4-59
VNA general	3-19	limit	
gain, 2-port, VNA		menu, functions overview	3-35
Field measurement	3-46	limit alarm	
gateway address		limit lines, VNA	3-10
LAN connection	2-12	on/off soft key	3-37
general instrument specifications	1-14	limit lines	
battery	1-15	Limit menu	3-35
ESD damage	1-15	Smith Chart, VNA	3-22
verification	1-14	VNA	3-10
general instrument specs		limit menu	
calibration	1-14	limit lines	3-10
GMSK		<b>M</b>	
SPA channel power	4-10	maintenance, preventive	1-14
GPS		Marker	4-43
Master Software Tools	13-1	Noise	4-45
option 31	12-1	Table	4-45
GSM		marker	
SPA channel power	4-10	interference analyzer menu	9-27
<b>H</b>		noise, interference analyzer	9-29
headset jack	2-14	Smith chart, VNA	3-22
High Accuracy Power Meter		table, interference analyzer	9-29
relative power feature	11-1	Marker function hard key	4-43
required equipment	11-2	marker menu	4-43
USB A/mini-B cable	11-1	Marker soft key menu	4-43
hold	3-51	master reset	4-60, B-4
<b>I</b>		measure menu	4-47
impedance selection for adaptors	4-58	measurements	
integration bandwidth		HiAcc Pwr Mtr averaging	11-4
interference analyzer	9-17	HiAcc Pwr Mtr limits	11-4
integration bandwidth, measure menu	4-48	HiAcc Pwr Mtr rel power	11-4
interference analyzer		HiAcc Pwr Mtr scale change	11-4
signal strength menu	9-24	HiAcc Pwr Mtr zero & cal	11-3
spectrum menu	9-17		
intermodulation product	10-4		

SPA introduction ..... 4-2  
 SPA set amplitude ..... 4-2  
 measurements SPA  
   C/I ratio ..... 4-19  
   demodulation ..... 4-18  
   field strength ..... 4-16  
   GSM Adj Ch Pwr ..... 4-11  
   GSM ch pwr ..... 4-9  
   in-band ..... 4-14  
   OBW ..... 4-8  
   out-of-band ..... 4-12  
   select signal std ..... 4-3  
   set BW ..... 4-3  
 memory  
   DSP ..... B-4  
   trace math, VNA ..... 3-8  
 memory card ..... 2-15  
 memory compact flash card ..... 2-15  
 mode  
   Hi Accuracy Pwr Mtr ..... 11-2  
 mode menu ..... 4-51

O

occupied bandwidth ..... 4-8  
 occupied bandwidth (OBW)  
   interference analyzer soft key ..... 9-17  
 occupied bandwidth, measure menu ..... 4-48  
 offset interference analyzer ..... 9-12  
 option soft key, system menu ..... 4-58  
 oscillator, beat frequency ..... 4-50  
   interference analyzer ..... 9-19  
 OSL (Open/Short/Load) calibration ..... 3-4  
 OSLIT (Open/Short/Load/Isolation/Through)  
 calibration ..... 3-5

P

panel, keys on front panel ..... 2-5  
 peak search  
   DTF, VNA ..... 3-17  
 phase  
   VNA measurement ..... 3-1  
 phase measurements, VNA ..... 3-21  
 power ..... 9-17  
   built-in power supply ..... 7-4  
   Cal Power soft key, VNA ..... 3-6  
   external ..... 2-12  
   high and low output, VNA ..... 3-52  
   internal power meter ..... 5-1  
   Meter, mode menu ..... 3-47  
   monitor, option 5 ..... 6-1  
   over power error ..... B-2  
   phase measurement settings ..... 3-21  
   power-on cycle ..... 2-2  
   reflected, VNA ..... 3-45

relative ..... 5-1, 6-2  
 Relative soft key, Power Monitor ..... 6-2  
 RF detector ..... 2-14  
   soft key, VNA ..... 3-20  
   supply failure ..... B-8  
   sweep menu, VNA ..... 3-52  
 power level  
   2-port gain, Bias Tee ..... 7-2  
   2-port gain, VNA ..... 3-19  
   master software tools ..... 13-1  
 power, reflected  
   return loss/VSWR, VNA ..... 3-12  
 preamplifier ..... 4-6  
   amplitude menu ..... 4-24  
 preamplifier amplitude menu  
   interference analyzer ..... 9-12  
 preset menu ..... 4-51  
   functions overview ..... 3-48  
 preventive maintenance ..... 1-14  
 propagation velocity  
   DTF, VNA measurement ..... 3-16

Q

quasi-peak  
   amplitude menu ..... 4-25

R

RBW ..... 4-3, 4-6  
   interference analyzer ..... 9-13  
   spectrogram measurement ..... 9-1  
 recall  
   GPS information ..... 12-4  
   Save/Recall menu, VNA ..... 3-49  
 reference level  
   amplitude menu ..... 4-23  
   interference analyzer ..... 9-12  
 relative power ..... 11-1  
 reset ..... 4-59  
   GPS soft key ..... 12-2  
   master ..... 4-60  
   master reset soft key, VNA ..... 3-56  
   sweep ..... 4-55  
   system menu soft key, VNA ..... 3-56  
 resolution ..... C-1  
   bandwidth ..... 4-5, 4-15  
   fault, DTF, VNA, description ..... 3-16  
   fault, DTF, VNA, example ..... 3-18  
 resolution bandwidth  
   BW menu ..... 4-26  
   menu, interference analyzer ..... 9-13  
 return loss  
   cable loss, VNA ..... 3-14  
   DTF, VNA ..... 3-15  
   return loss/VSWR, VNA ..... 3-12

VNA field measurement ..... 3-40  
 RSSI ..... 9-1, 9-6, 9-25  
 run/hold, sweep menu, VNA ..... 3-51

## S

S11 Reflection measurements ..... 3-40  
 S21 Transmission measurements ..... 3-40  
 safety symbols  
   for safety ..... 1-2  
   in manuals ..... 1-1  
   on equipment ..... 1-1  
 save  
   Save/Recall menu, VNA ..... 3-49  
 scale ..... 10-7  
 selecting  
   frequency signal stanard ..... 4-3  
 self test  
   VNA system menu ..... 3-55  
 self test, system menu ..... 4-58  
 setting IP Address ..... 2-12  
 setup  
   recall, spectrum analyzer ..... 3-48  
   save and recall, preset menu ..... 4-51  
   save, spectrum analyzer ..... 3-48  
 signal standard  
   setting, channel scanner ..... 10-5  
   setting, interference analyzer ..... 9-10  
 signal standard, interference analyzer .. 9-10  
 signal standard, selecting  
   High Accuracy Power Meter ..... 11-3  
   spectrum analyzer ..... 4-3  
 signal strength ..... 9-1, 9-23  
 single sweep ..... 3-51  
 Smith Chart  
   VNA ..... 3-22  
 soft key types ..... 2-7  
 span ..... 9-9  
   frequency ..... 3-2  
   frequency, DTF, VNA measurement . 3-16  
 span menu ..... 4-52  
 spectrogram ..... 9-1, 9-22  
 spectrum menu  
   interference analyzer ..... 9-17  
 SSB ..... 4-18  
 Start ..... 4-2  
 start frequency ..... 4-2  
 stop frequency ..... 4-2  
 subnet mask ..... 2-12  
 sweep ..... 4-6  
   external trigger ..... 2-14  
   group delay ..... 3-23  
   key, 2-port gain ..... 3-19  
   menu, VNA ..... 3-51  
   power monitor detectors ..... 1-10  
   preset resets sweep conditions ..... 3-48

sweep menu ..... 4-54  
 system  
   menu ..... 3-55  
   menu, functions overview .... 3-54, 3-55  
   options ..... 4-58  
   options soft key ..... 2-12  
   requirements ..... 13-2  
 system menu ..... 4-57

## T

TDMA ..... 4-10  
 test panel connectors  
   function overview ..... 2-11  
 tilt bail  
   MS203xA use and storage ..... 1-13  
 time cursor ..... 9-22  
 time span ..... 9-21  
 trace math  
   menu, VNA ..... 3-8  
 trace menu ..... 4-61  
 trigger  
   external connector ..... 2-14  
   external sweep ..... 2-14  
   external, sweep menu ..... 4-56  
   manual, sweep menu ..... 4-54  
   position, sweep menu ..... 4-56

## U

units ..... 6-2  
   display ..... 9-12  
   DTF, VNA measurement ..... 3-16  
 update OS ..... 3-56  
 USB  
   connection to PSN50 ..... 11-1  
   port, system requirements ..... 13-2  
   updating OS, VNA ..... 3-56  
 USB interface ..... 2-13  
 UTC ..... 12-3

## V

VBW ..... 4-3, 4-5  
   menu, interference analyzer ..... 9-13  
 vector network analyzer  
   display overview ..... 2-4  
 verification  
   performance, annual ..... 1-14  
 video bandwidth ..... 4-5  
 VNA  
   EEPROM Fail error ..... B-9  
   measurement menu, Field versus VNA 3-40  
   reflection, RF Out connector ..... 2-14  
   scale menu ..... 3-49  
 VNA measurement  
   application options ..... 3-55

## Z to Z

---

selection (Field versus VNA) . . . . .	3-1
volume	
screen display, spectrum menu . . . . .	9-19
setting, interference analyzer . . . . .	9-5
setting, VNA . . . . .	3-56
volume, measure menu . . . . .	4-50
volume, system menu . . . . .	4-59
VSWR	
DTF, VNA . . . . .	3-15
field measurement menu, VNA . . . . .	3-40
S11 reflection, VNA . . . . .	3-1

## Z

zero . . . . .	6-1
Zero/Cal menu	
High Accuracy Pwr Mtr . . . . .	11-7