



INSTRUCTION MANUAL

harmony convertible car seat

FROM 0 TO 4*#
MONTHS YEARS



Illustrations and designs may vary.

IMPORTANT: KEEP THIS BOOKLET IN THE PLACE PROVIDED ON THE CHILD RESTRAINT.



motherschoice.com.au



*Rearward-facing



*Forward-facing



Service



*Suitability



Australian Standard
AS/NZS 1754:01-2011
S44 03044



REARWARD-FACING USING SEATBELT

NEWBORN UP TO 12 MONTHS, APPROX.



ATTACH TOP TETHER

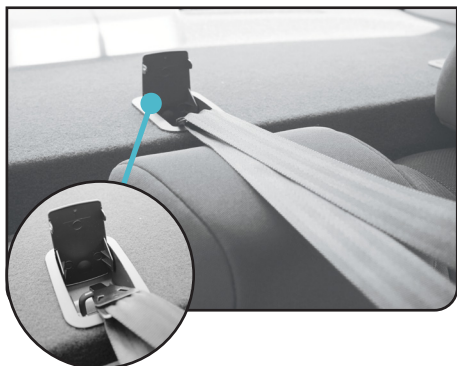

FORWARD-FACING USING SEATBELT

12 MONTHS UP TO 4 YEARS, APPROX.

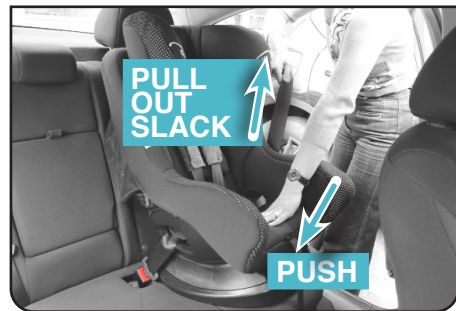
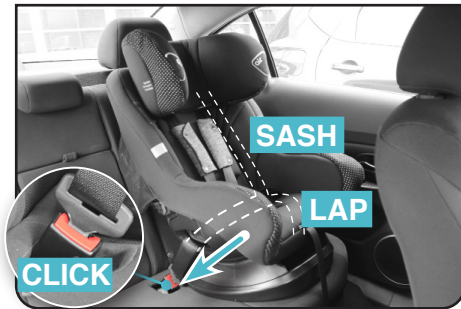

ATTACH TOP TETHER

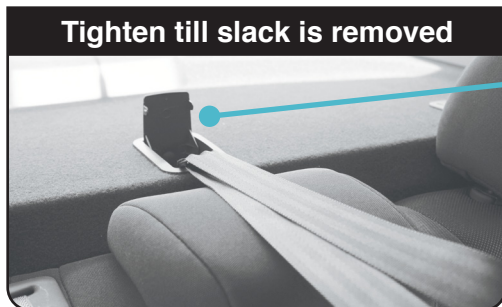

contents

Quick start installation	2-3
Before you start	5
Warnings	6-8
VEHICLE INFORMATION	
Rearward-facing vehicle position	9
Forward-facing vehicle position	10
Anchor fitting locations	11
Anchor installation	12-14
Angle requirements	15
SEAT OPERATION AND ADJUSTMENT	
Components list	16-17
Shoulder Height Markers	18-19
Loosening and fastening harness straps	20
Adjusting harness and seat configurations	21
Buckle fastening and operation	22
INSTALLATION	
Adjusting top tether strap	23
Rearward-facing installation	24
Forward-facing installation	25
The next car seat for your child	26
CARE AND MAINTENANCE	
Buckle maintenance	27-28
Fabric care instructions	29
Removing and fitting the seat trim	29
Removing and fitting accessories	30-31
CONTACTS	
Warranty	32
Notes	33
Customer service	35-36



Before you start:

Thank you for purchasing this child seat. This product is suitable for newborns to children approximately 4 years old. We welcome you as a valued customer, and trust that your child will enjoy many years of comfort and safety.

No child restraint can guarantee absolute protection from a crash. However proper use of this restraint may reduce the risk of injury or death!

Please read and follow all of the instructions outlined in this manual for maximum protection.

If you have any questions regarding the installation or use of this child restraint in Australia or New Zealand, please contact our customer service numbers provided. An alternative option is to also contact any registered child fitting station authorised by your local transport authority.

need assistance?

Call our Customer Service Team: 1300 809 526
Monday to Friday (8:30am - 5:00pm AEST)
or send an email: customerservice@dorel.com.au

www.motherschoice.com.au  **mother's choice**

 **WARNINGS**

- To be used only in a rearward-facing position until the infant's shoulders reach the lower shoulder height marker (approximately 12 months of age). Then to be used in a forward-facing position until the child's shoulders reach the upper shoulder height marker (approximately 4 years of age).
- Continue to use this child restraint until the child reaches this limit.
- Do not use forward facing until child's shoulders are above the lower shoulder height marker.
- Infants are at risk of serious injury if they face forward too early.
- Children are at risk of serious injury if they move to booster seats too early.
- Children who have outgrown this restraint are safest in a larger child restraint with an in-built harness or a booster seat until their shoulders reach the upper shoulder height marker of the restraint.

GENERAL:

- Use the restraint exactly as shown in the instructions.
- Supervision of children is needed because they may be able to undo the buckles.
- **DO NOT LEAVE CHILDREN UNATTENDED IN THE CAR.**
- Do not alter or modify this restraint.
- Repairs must only be done by the manufacturers or agent.
- Do not allow the restraint to come into contact with polishes, oils, bleach and other chemicals.
- Destroy the restraint if it has been in a severe crash, even if no damage is visible

 **WARNINGS**

- **DO NOT USE THIS RESTRAINT WITHOUT THE COVER.**
- To ensure infant's back is evenly supported, do not put more than one nappy on the baby and make sure the nappy is not thickly folded at the back.
- **DO NOT USE A REAR- FACING CHILD RESTRAINT WHERE AN AIRBAG IS FITTED IN FRONT OF THE SEATING POSITION.**
- Fit the restraint firmly to the car seat.
- Fit the harness firmly to the child.
- A loose restraint or harness is dangerous.
- Do not harness an infant wrapped in a blanket or swaddled. Any blanket or wrap must only be placed over the harness and infant.
- Seatbelt extenders are not recommended to be used if the seatbelt is not long enough to secure the child restraint. If seatbelts are too short then advice should be sought from a child restraint fitter and their recommendation be considered before using a seatbelt extender.
- Always secure the loose end of the top tether strap. Do not use the child restraint where this strap may fall into a split in the seat back or off the side of the seat.
- Always secure the loose end of the top tether strap to prevent it hanging out of the car or being accessible by the child.
- **ALWAYS ATTACH HOOK AND REMOVE SLACK.**
- THIS RESTRAINT IS NOT SUITABLE FOR USE WHERE THE TOP TETHER STRAP MAY FALL INTO A SPLIT IN THE SEAT BACK OR OFF THE SIDE OF THE SEAT.
- **THIS RESTRAINT MUST BE ATTACHED TO A CHILD RESTRAINT UPPER ANCHORAGE POINT IN THE CAR. REFER TO CAR OWNER'S HANDBOOK FOR LOCATION OF UPPER ANCHORAGE POINTS. REFER TO A CHILD RESTRAINT FITTING STATION IF NO UPPER ANCHORAGE POINTS ARE IN THE MOTOR CAR.**
- Always check the measurements between the front of the seat back of the rear seat and all front seats in the car in which the child restraint is intended to be used, to ensure that the space is sufficient.
- Care and attention be given to ventilation and shading of the occupant.
- **TO BE USED WITH A LAP-SASH/LAP-ONLY SEATBELT IN THE FRONT / BACK OF MOST CARS WITH FORWARD FACING SEATS.**

 **WARNINGS**

- The use of child restraints in the front seat may be restricted for children of specific ages by local legislation. Please check with your local legislation regarding any restriction for child restraint. If a car has two or more rows of seats, children under four must not travel in the front seat. If all seats, other than the front seats, are being used by children under seven years, children aged between four and six years (inclusive) may travel in the front seat, provided they use an approved child restraint or booster seat.
- This child restraint is not approved for use with any connectors that connect to the car's ISOFIX low anchorages.
- Use of aftermarket accessories (i.e. items not provided in the box with the child restraint), can reduce the safety provided by child restraint and may cause injury or death. For approved aftermarket accessories please refer to page 11.
- Please contact Dorel Australia Customer Service with any questions or concerns.

Correct Rearward-Facing Vehicle Position

Some seating positions in your vehicle may NOT be safe for this safety seat. Some vehicles do not have any seating positions that can be used safely with the seat. If you are not sure where to place the infant seat in your vehicle, consult your vehicle's owner's handbook.

Vehicle Seat Location Requirements

Children are safer when properly restrained in rear vehicle seating positions. Whenever possible, secure the infant seat in the centre position of the seat directly behind the front seats.

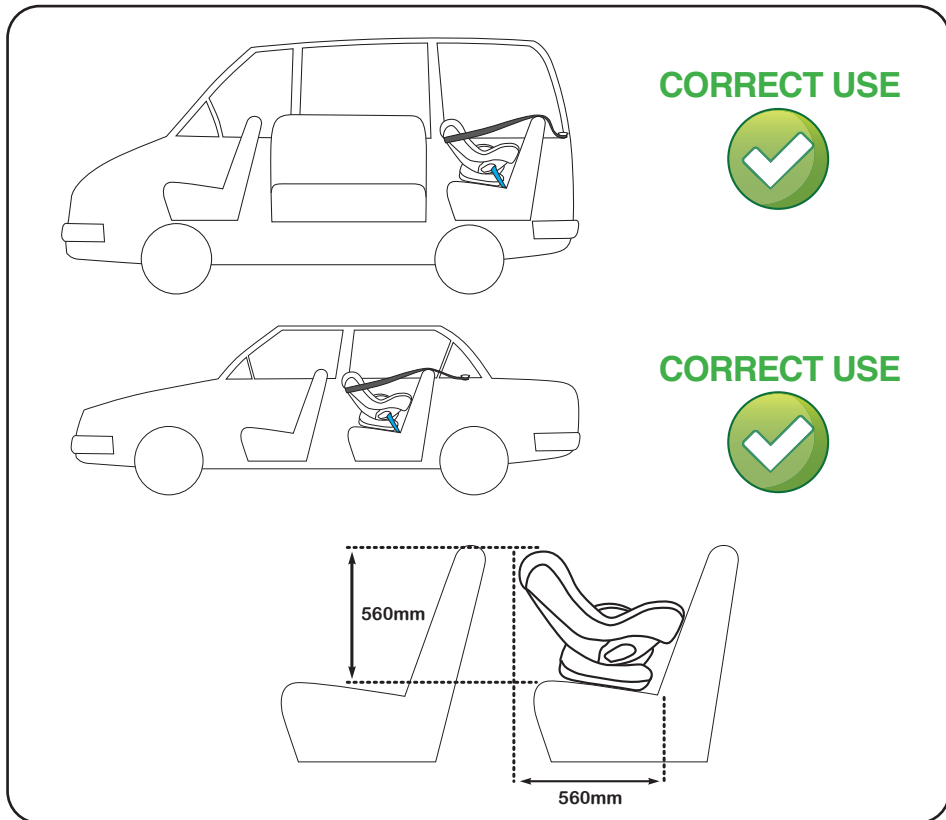

Correct Forward-Facing Vehicle Position

CORRECT USE

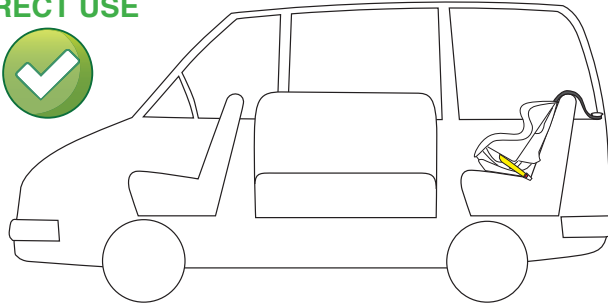

CORRECT USE

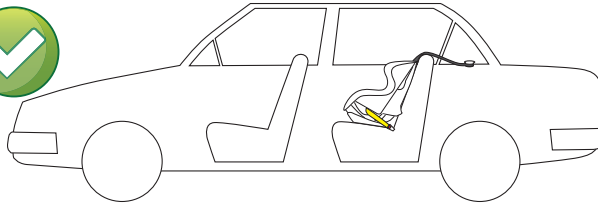

INCORRECT USE

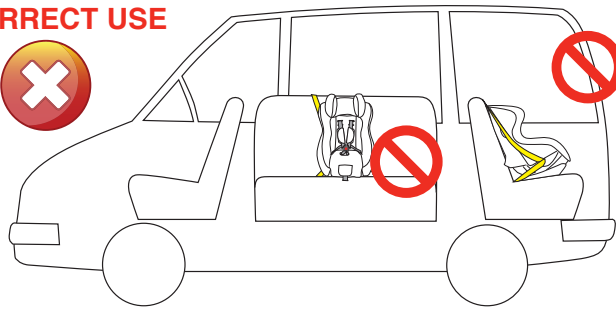

WARNING

IMPROPER PLACEMENT OF THE SAFETY SEAT INCREASES THE RISK OF SERIOUS INJURY DEATH.

Anchor Fitting Locations

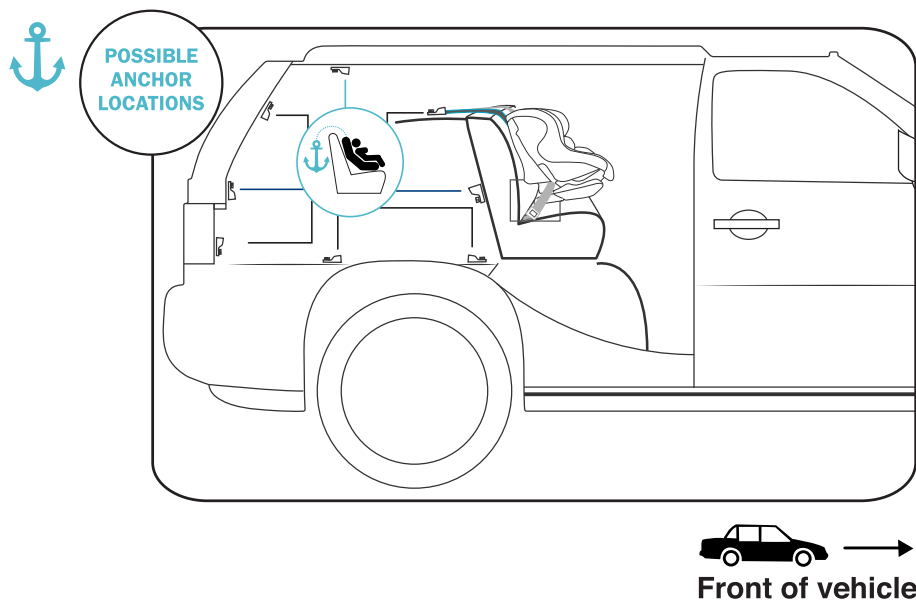

NOTE:

- The anchor point can be found in different locations in different cars. The illustration above shows possible locations of anchor points. Sometimes it is on the parcel shelf in sedans, and on the floor area in station wagons, vans and hatchbacks. Make sure that you do not confuse the luggage hook in the back of a station wagon with anchor points. Refer to your owner's manual.
- An extension strap may be needed for vehicles without a fixed parcel shelf. Extension straps and extra fittings are available from various stores.
- Use of aftermarket accessories (i.e. items not provided in the box with the child restraint), can reduce the safety provided by the child restraint and may cause injury or death.

Extension straps 300mm ref no. 015057	Extension straps 600mm ref no. 015058
Anchor bolt kit ref no. 014400	Belt converter ref no. 015059

Correctly Connecting the Top Tether

Child restraints must be used correctly to provide proper protection for your child. The anchorage system on child restraint must be used in the correct way.

CORRECT

Make sure there is no slack in the top strap and the attachment clip is upright in the anchorage fitting.

INCORRECT

The clip must not lie flat on the anchorage fitting.

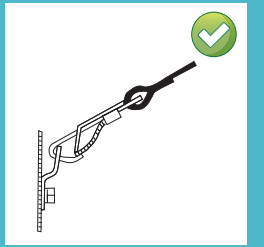
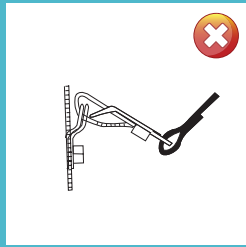
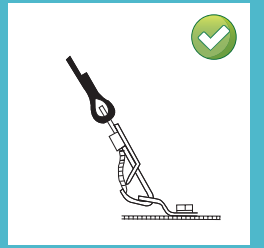
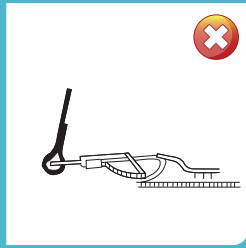
INSTALLATION	CORRECT	INCORRECT
<p>FIGURE 1</p> <p>ANCHORAGES IN VERTICAL PANEL AT REAR OF VEHICLE</p>		
<p>FIGURE 2</p> <p>FLOOR MOUNTED ANCHORAGES</p>		

Anchorage Fitting Installation

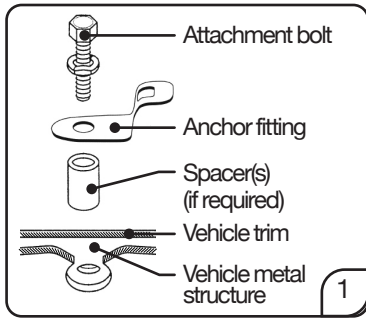

For cars fitted with a child restraint upper anchorage point:

Locate the upper anchorage point behind the rear seating position (consult the car owner's handbook for the location of the upper anchorage point).

Remove the thread plug from the parcel shelf/floor/roof and install the attachment bolt as shown in Figure 1.

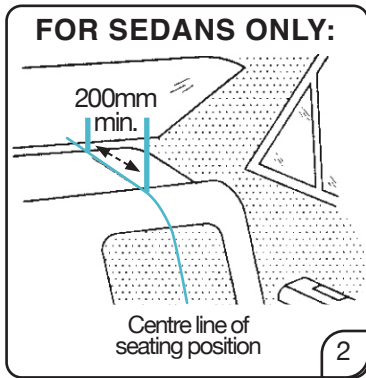

CAUTION: DO NOT OVERTIGHTEN THE ATTACHMENT BOLT. OVERTIGHTENING MAY FRACTURE OR BREAK BOLT. MAXIMUM TORQUE IS 20 Nm.

For cars not fitted with a child restraint upper anchorage point:

For sedans only:

Drill a 9mm diameter hole in the parcel shelf on the centre-line of the seating position as shown in Figure 2. Install the anchor bolt as shown in Figure 3. It is recommended that this installation be carried out by a child restraint fitting station or licenced motor mechanic.

For vehicles other than sedans:

In Australia, consult your nearest child restraint fitting station or traffic authority for vehicle inspection to find the best, correct position for the placement of the upper anchorage point, and for the correct attachment bolt length and use of spacers. In New Zealand, consult the agent for the vehicle.

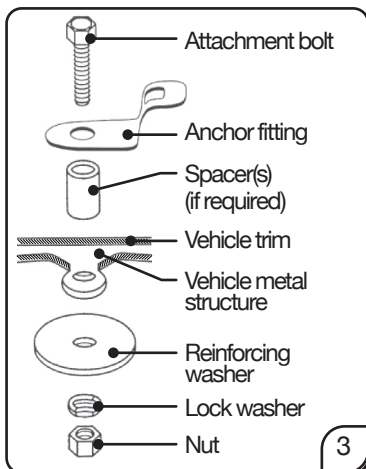

 **WARNINGS**

- CHILD RESTRAINTS MUST NOT BE ATTACHED TO UNSOUND METAL OR TO WOOD OR SYNTHETIC STRUCTURES. WHEN DRILLING THE 9mm HOLE DO NOT DRILL THROUGH FUEL LINES, FUEL TANKS, ELECTRICAL WIRING, OR RADIO SPEAKERS. WEBBING STRAPS MUST BE PROTECTED FROM SHARP CORNERS AND EDGES.
- THE ANCHOR FITTING MUST BE USED ONLY AS DESCRIBED ABOVE. IT MUST NOT BE HOOKED ONTO ANY OTHER OBJECT.

Seat Angle



Position seat ensuring that the angle is no greater than 53° from horizontal plane.



WARNINGS

- DO NOT install convertible child restraints excessively reclined, ensure the angle is no greater than 53°.
- DO NOT adjust harness or tether strap hardware such that it sits too close to the occupant.
- Ensure that correct seatbelt path is used and that the restraint is installed in the correct direction for rearward facing application (Refer to page 24).
- DO NOT wrap baby in a blanket or swaddled as infant can be ejected and killed in an accident.
- Ensure the harness fits the baby firmly.
- Ensure that any blanket or other covering may only be placed over the harness after the harness is adjusted firmly.
- The infant's legs and arms are not to be bounded or wrapped together.

Components List



- | | |
|---------------------------------------|----------------------------------|
| 1 Headrest Insert (if fitted) | 8 Belt Path Opening (both sides) |
| 2 Seat Insert | 9 Adjuster Strap |
| 3 Belt Mates (x2) | 10 Seat Base |
| 4 Harness (under belt mate) | 11 Base Recline Adjuster |
| 5 Buckle (under crotch buckle pad) | |
| 6 Crotch buckle pad | |
| 7 Centre Front Adjuster (under cover) | |

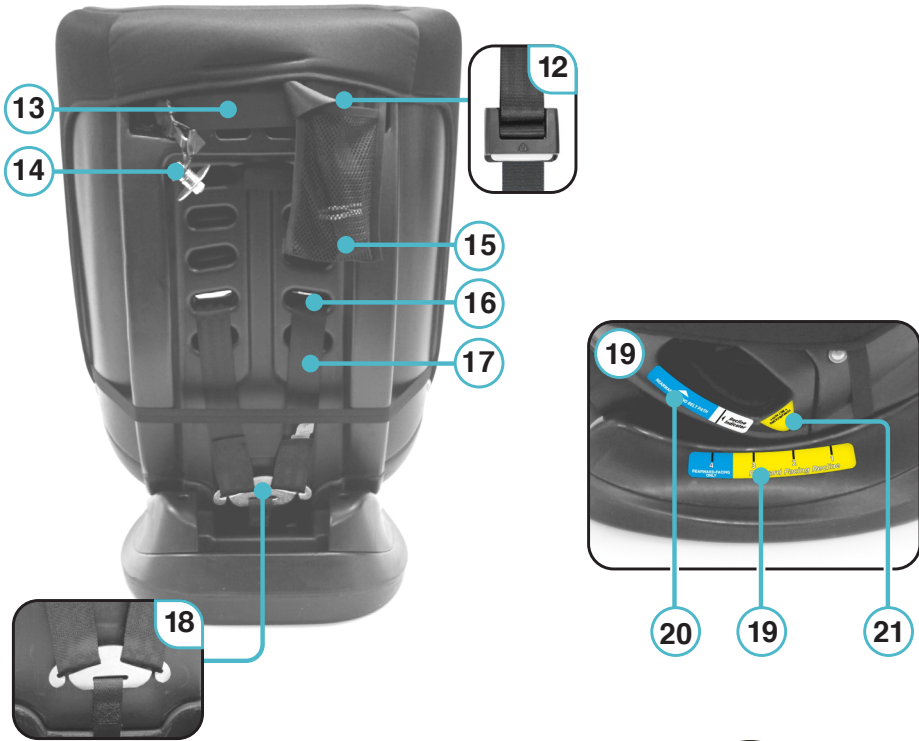

20 REARWARD-FACING BELT PATH



21 FORWARD-FACING BELT PATH

- | | |
|---|------------------------------|
| 12 Top Tether Strap Adjuster | 17 Harness Straps |
| 13 Top Tether Strap | 18 Splitter Plate |
| 14 Anchor Kit | 19 Recline Indicator |
| 15 Top Tether / Instruction Manual storage pocket | 20 Rearward-Facing Belt Path |
| 16 Harness Slots | 21 Forward-Facing Belt Path |

Shoulder Height Markers

Marker A



Marker B



UPPER HEIGHT MARKER

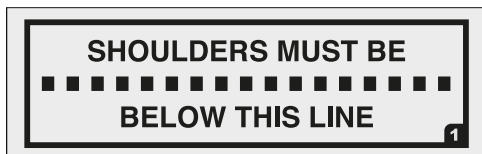

Upper Shoulder Height Marker

For toddler use up to approx 4 years old or when the child's shoulders reach the shoulder height marker at which point you must move to the next car seat.

LOWER HEIGHT MARKER

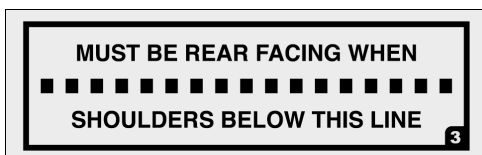

Lower Shoulder Height Marker

For newborn use up to approx 12 months old or when the child's shoulders reach the shoulder height marker at which point you must turn the seat forward-facing.

 **WARNINGS**

- Continue to use this child restraint until the child reaches this limit.
- Do not use forward facing until child's shoulders are above the lower shoulder height marker.
- Infants are at risk of serious injury if they face forward too early.
- Children are at risk of serious injury if they move to booster seats too early.
- Children who have outgrown this restraint are safest in a larger child restraint with an in-built harness or a booster seat until their shoulders reach the upper shoulder height marker of the restraint.
- The child restraint is unsuitable for the occupant when the shoulders are below the lower marker or above the upper marker. The child needs to be moved into the next form of child restraint (booster seat) when they reach the top shoulder height marker.

NOTE:

- **If the baby's neck muscles are unable to support their head, then the child should remain rear facing.**

Preparing Harness for Child Fitment

You **MUST** make these adjustments with your child before you install the child restraint in the vehicle. Please adjust harness according to the infant's shoulder height prior to installation.



CONFIGURING THE HARNESS STRAPS FOR CORRECT CHILD FITMENT

1. Push the harness release lever at the front of seat.
2. Pull the shoulder strap to loosen
3. Press red button to release buckle assembly for ease of child fitment. Pull harness straps over sides of infant seat. Place child in seat.
4. Fasten buckle assembly. Listen for "click!".
5. Pull strap to tighten.

IMPORTANT: ALWAYS ENSURE THAT THE HARNESS ADJUSTER IS FREE FROM ANY OBSTRUCTIONS TO AVOID HARNESS STRAPS LOOSENING.



REARWARD-FACING

(Newborn to approximately 12 months)

The shoulder straps must be in the slots which are nearest to the child's shoulders, but not lower than the child's shoulders.

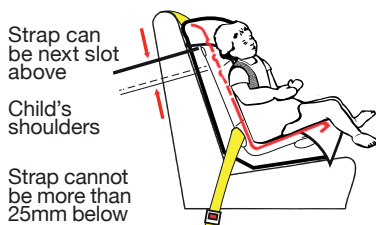

FORWARD-FACING

(12 months to 4 years)

The shoulder straps must be in the slots which are nearest to the child's shoulders, but not more than 25 mm below the child's shoulders.

Headrest and Harness Height Adjustment



TO ADJUST SHOULDER STRAP HEIGHT:

1. Place thumb or finger through cover opening and press the harness release lever at the front of seat.
2. Pull both shoulder straps simultaneously to loosen.
3. Undo the straps from the splitter plate located on the back of the child restraint.
4. Re-thread the shoulder straps through the desired slots. Reconnect the straps to the splitter plate.

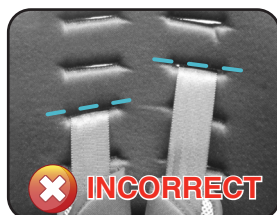
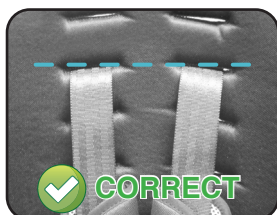

NOTE: Ensure the harness heights are of equal length.



Adjusting seat recline:

The seat is fitted with **3** forward-facing recline positions. The **4th** and most reclined position is for rearward-facing use **ONLY**.

To adjust, place hand under seat and squeeze the **RED** lever to select the desired position.

NOTE:

Never use **Position 4** for forward-facing.

WARNINGS

- Always adjust the height of the shoulder straps as the child grows.
- Failure to fasten and tighten the harness system correctly can result in serious injury or death.

Fastening the Buckle Assembly

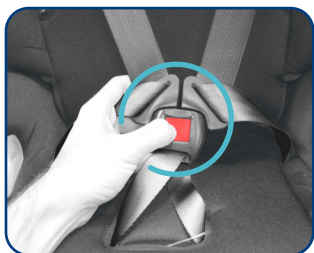

1. To release press the red button to release the buckle.



2. Insert one buckle tongue as shown in image. You will not hear a click.



3. Insert the second buckle tongue as shown. Now listen for a “click!”.

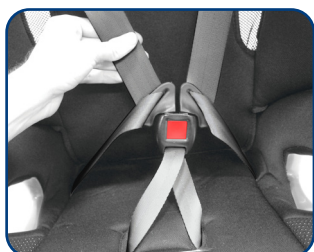

4. Remember to always pull up on the harness straps to make sure buckle is locked tightly.



WARNING

DO NOT LEAVE CHILDREN UNATTENDED IN THE CAR.

To adjust the Top Tether Strap

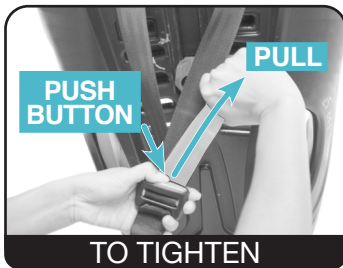
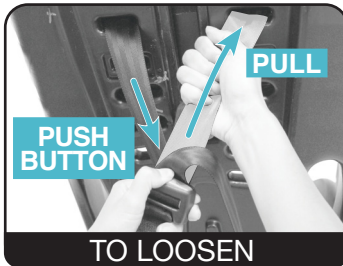

TO LOOSEN:

Press on the adjuster button with thumb and pull strap back through to loosen top tether strap using strap which is attached to the seat.

TO TIGHTEN:

Adjust top tether strap and remove slack. Pull loose end of strap to tighten.

NOTE: Store the excess webbing in the pocket provide on the side of the child restraint.



WARNINGS

Always secure the loose end of the top tether strap to prevent it hanging out of the car or being accessible by the child. When not in use, fold hanging tether strap and place in storage pocket provided.

CAUTION: CHILDREN CAN BE INJURED OR RESTRAINTS AND TOP TETHER STRAP DAMAGED BY UNSECURED CARGO IN A COLLISION. SECURE OR REMOVE HAZARDOUS CARGO BEFORE USING THIS CHILD RESTRAINT.

Rearward-Facing Installation

1. Set seat to position 4 (full recline) for rearward-facing.
2. Loosen full length of the top tether.
3. Place restraint facing rearwards on back seat of vehicle in line with a top tether strap anchorage point.
4. Thread the vehicle seat belt through the **BLUE** belt path at the bottom of the restraint and fasten buckle.
5. Press the child restraint firmly down into the vehicle seat and remove belt slack.
6. Attach the top tether strap to the anchorage point. Adjust until all the slack is removed. Ensure Base of seat is not lifted.

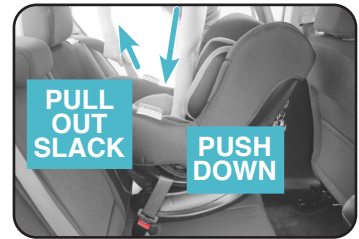

Front of vehicle →

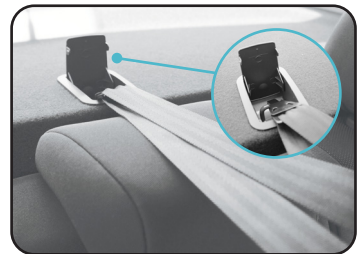

NOTE: There is an option to install seat using seat belt with accessory locking clip. Please see instructions provided with locking clip for installation.

WARNING

DO NOT LEAVE CHILDREN UNATTENDED IN THE CAR.

Forward-Facing Installation

NOTE: Before you start installation, adjust the shoulder straps to fit your child.

Refer to pages 20-21.

1. Select the desired recline angle (1, 2 or 3).

NOTE: Never use position 4 for forward-facing.

2. Place restraint on back seat of vehicle in line with a top tether strap anchorage point.
3. Thread the vehicle seat belt through the back of the seat through the **YELLOW** forward-facing belt path.



4. Place one hand on seat and firmly press the child restraint down into the vehicle seat and pull on seatbelt to remove slack.

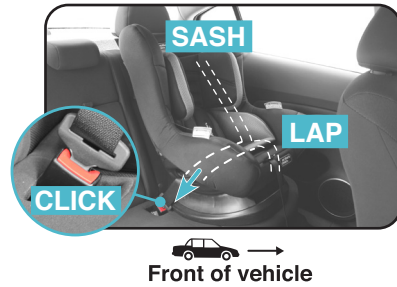

5. Attach the top tether strap to the anchorage point. Adjust until all the slack is removed. Ensure Base of seat is not lifted.



NOTE: If the car seatbelt is not long enough to secure the child restraint, **DO NOT USE SEAT BELT EXTENDERS.**



NOTE: There is an option to install seat using seat belt with accessory locking clip. Please see instructions provided with locking clip for installation.

The Next Seat for Your Child

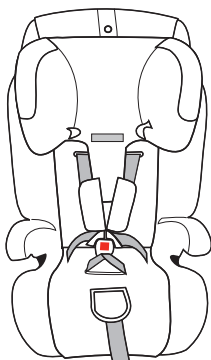

Option 1: Harnessed forward-facing car seat

To be used only in a forward-facing position by a child whose shoulders are above the lower shoulder height marker (approximately 6 months of age) until the child's shoulders reach the upper shoulder height marker (approximately 8 years of age).

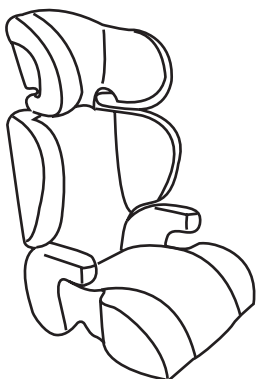

Option 2: Booster seat

To be used with a lap-shoulder seatbelt by a child whose shoulders are above the lower shoulder height marker (approximately 4 years of age) until the child's shoulders reach the upper shoulder height marker (approximately 6 to 8 years of age). Can also be used with child harness that is approved for use with this booster seat.

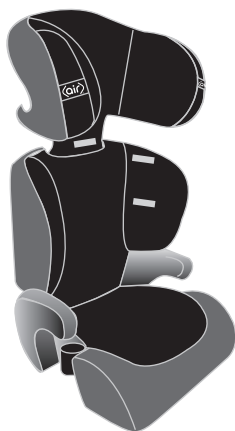

Option 3: Larger booster seat

To be used with a lap-shoulder seatbelt by a child whose shoulders are above the lower shoulder height marker (approximately 4 years of age) until the child's shoulders reach the upper shoulder height marker (approximately 8 to 10 years of age). Can also be used with child harness that is approved for use with this booster seat.



for more information, visit:
www.motherschoice.com.au

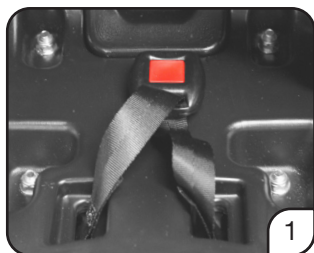

CARING FOR THE BUCKLE

When caring for your restraint's buckle follow the manufacturer's instructions at all times. Before removal, ensure you have carefully noted the way which the various parts are attached to the seat so as to facilitate reassembly.

Your child car seat is equipped with a buckle designed to give your child maximum protection during proper use (**Figure 1**). When working properly, your buckle should always fasten with an audible 'CLICK'.

If sticky liquids (such as baby food, fruit juice, etc.) get into the buckle it may become sluggish and you will not hear a CLICK'.

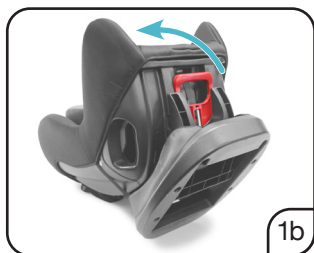

REMOVING BUCKLE:

1. Set seat in position 4 (full recline) (**Figure 1a**).
2. Lay seat on its back to access crotch adjustment (**Figure 1b**).
3. Using a flat object (such as a flat-head screwdriver, not included) gently lift one end of the **Metal Plate** to loosen (**Figure 1c**), repeat on the other side.
4. Push the metal plates through the top opening to release crotch buckle for cleaning (**Figure 1d**).

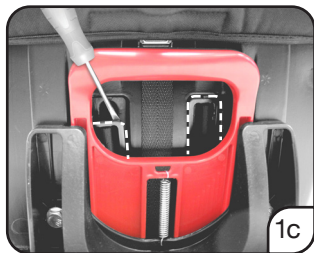

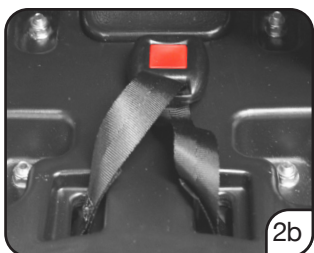
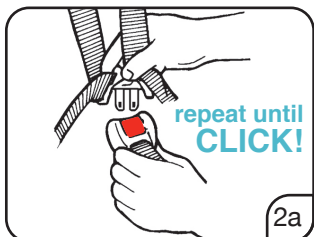
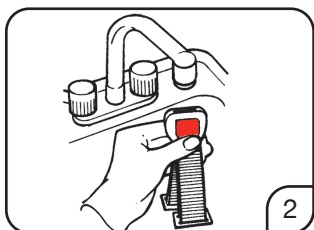

CLEANING BUCKLE:

1. Place the buckle unit under running water (40 degrees Celsius), (**Figure 2**). Let the water flow through the mouth of the buckle for one minute.
2. Simultaneously latch and unlatch the tongues into the buckle several times until a strong audible click is heard (**Figure 2a**).
3. If you still cannot hear a strong audible click after latching the buckle several times. Repeat steps above.
4. DO NOT oil any part of the buckle.
5. Allow buckle to completely dry.

REFITTING BUCKLE:

1. Refit crotch buckle ensuring **RED** button is facing out (**Figure 2b**).
2. Place the two metal plates back through openings.
3. Pull up on each side of the crotch straps firmly to snap the metal plates back into place (**Figure 2c**).

- If the buckle does not return to original working order, contact Dorel Australia Customer Service on **1300 809 526**.
- If you are a New Zealand customer, please contact IGC Dorel New Zealand Customer Service on **0800 628 000**.

CARING FOR THE SEAT FABRICS

- Seat trim may be removed for cleaning. Don't forget to remove the instruction manual.
- Machine washable on lukewarm setting - delicate cycle.
- Tumble dry 10-15 minutes on low heat.
- Do not dry clean.
- All other surfaces should be cleaned with a mild soap and water.
- Never clean with bleach or spirit-type cleaners.
- Do not use the restraint without the cover.
- Check the webbing for fraying.



TO REMOVE SEAT TRIM:

1. Loosen the harness by pressing down on centre front adjuster.
2. Turn seat around and undo shoulder straps from the splitter plate (**Figure 3**).
3. Pull straps through the cover.
4. Undo the buckle and remove the seat trim.

TO REPLACE SEAT TRIM:

1. Pull the seat trim on the seat.
2. Feed the shoulder straps through the harness slots.
3. Attach the shoulder straps to the splitter plate.

NOTE: ENSURE HARNESS IS NOT TWISTED

Take extra care to be sure the harness is reinstalled correctly and the shoulder straps are of equal height through both the trim and the harness slots of the seat.



TO REMOVE THE HEADREST INSERT (IF FITTED):

To remove the headrest insert, simply undo the velcro tabs located on the back of the seat from the harness slots.



TO REPLACE HEADREST INSERT (IF FITTED):

Fit headrest insert to seat by threading the two straps through the harness slots (**Figure 4a**) and fasten the velcro tabs firmly at rear of seat (**Figure 4b**).

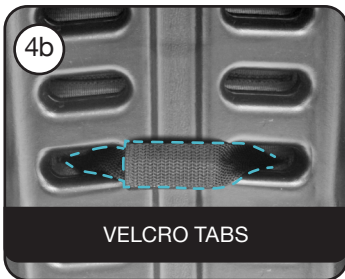

The headrest insert is only for use when child is in rearward-facing mode.

**TO REMOVE BELT MATES:**

To remove the belt mates, simply undo press studs and unwrap from harness straps.

TO REPLACE BELT MATES:

Fit belt mates to harness straps by wrapping around straps and closing press studs.

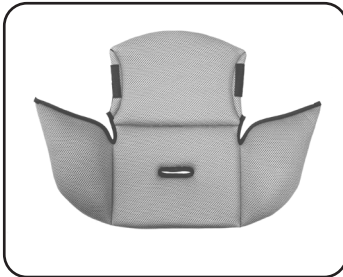
**TO REMOVE SEAT INSERT:**

To remove the seat insert, undo the buckle and pull the insert out.

TO REPLACE SEAT INSERT:

Feed the buckle through the opening slot in the seat insert and fasten buckle assembly.

**WARNING****VERY IMPORTANT:**

Only replace the cover with a manufacturer's supplied replacement cover with identical shoulder height markers or a replacement cover meeting AS/NZS 8005.

Warranty

Dorel Australia Pty Ltd warrants your new product to be free from defects in materials and workmanship for 6 years on the seat & 2 years on the trim, from the date of purchase, provided that the product is used in accordance with accompanying recommendations or instructions where provided. The benefit of this warranty is in addition to your rights under the Australian consumer law and to other rights and remedies of the consumer under a law in relation to the goods or services to which the warranty relates.

Dorel Australia Pty Ltd will provide you with your choice of a refund, repair or exchange (where possible) for this product if it becomes defective within the warranty period. Dorel Australia Pty Ltd will bear the reasonable expense of claiming the warranty. This warranty will no longer apply where the defect is a result of alteration, accident, misuse, abuse or neglect.

Please retain your receipt as proof of purchase and contact our Customer Service Team on ph: 1300 809 526 or alternatively, via our website at www.dorel.com.au for any difficulties with your product. Warranty claims and claims for expense incurred in returning this product can be addressed to our Customer Service Team at 655-685 Somerville Road, West Sunshine, Vic, 3020.

For New Zealand please contact Customer Service Centre, 14 Sir William Avenue, East Tamaki, Auckland, 2013. Auckland: (09) 274 1040 NZ wide: 0800 628 000 (toll free). Hours: 8:00am - 4:00pm, Monday to Friday.

Our goods come with guarantees that cannot be excluded under the Australian consumer law. You are entitled to a replacement or refund for a major failure and compensation for any other reasonably foreseeable loss or damage. You are also entitled to have the goods repaired or replaced if the goods fail to be of acceptable quality and the failure does not amount to a major failure.

**IMPORTANT: KEEP THIS INSTRUCTION MANUAL
IN THE POCKET PROVIDED AT THE REAR OF
THE SEAT.**





motherschoice.com.au

mother's choice tip...

Visit us online to register your new Mother's Choice product.
www.motherschoice.com.au/product-registration

benefits of registration

- Your safety - allows us to contact you with important product notifications.
- Confirmation of ownership - provides a record in case of product loss or theft.
- Improved product development - helps us continue to design products that meet your needs.

**to prevent loss or fading,
please attach your receipt here:**



DOREL AUSTRALIA PTY LTD

655-685 Somerville Road
Sunshine West Victoria 3020
Hours: 8:30 am - 5:00 pm Mon-Fri

Email: customerservice@dorel.com.au

Phone: 1300 809 526 (toll free)

IGC DOREL NEW ZEALAND LTD

14 Sir William Avenue
East Tamaki Auckland 2013
Hours: 8:00 am - 5:00 pm Mon-Fri

Email: customerservice@dorel.co.nz

Phone: 0800 628 000 (toll free)



Specifications are subject to change without notice. Copy or reproduction without permission is prohibited. © 2020 Dorel Australia Pty Ltd. All Rights Reserved.

www.dorel.com.au