

from the Publishers of **POPULAR COMMUNICATIONS**

CB Radio Buyer's Guide No. 1

CB Radio

1996 BUYER'S GUIDE

- **Theft-proofing Your Mobile CB Radio**
- **Emergency Help On Channel 9**
- **The "In's-and-Out's" Of GMRS**
- **Sideband: Is It For You?**
- **Buying A CB—Tips From The Experts**
- **Antenna Safety—Doing It Right The First Time**



Product photos,
specifications and
prices you
NEED to know!

U.S. \$3.95 Canada \$4.95



Plus a complete CB manufacturer and dealer listing

J. PERRY
JR '95

CB Radio

1996 BUYER'S GUIDE



14

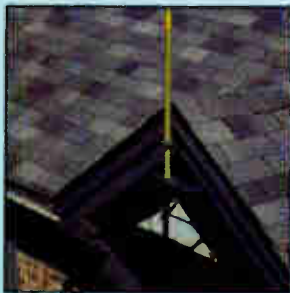

59



65



30

FEATURES

The New CB—It's Not Your Father's RadioLarry Miller, KCZ-8847	6
Getting Ready to Buy a New CB Radio? Here's Some Help.....Allen C. Lorentson, N3DCX	11
Getting and Giving Help on CB Channel 9Jock Elliott	14
Talkin' That "Good CB".....Tom Kneitel, K2AES	18
CB Handles: A Chance to Undo What Your Parents Did.....Bill Price, N3AVY a/k/a The Chiseler	22
CB Not Working? Here Are Some Troubleshooting Tips.....Harold Ort, N2RLL	24
The General Mobile Radio Service—GMRS At Your Service.....Bill Simpson	28
REACT Volunteers Respond to Oklahoma City Bombing.....Gayland Kitch	30
Scanners: Radios That Go Hand-In-Hand With CB.....Chuck Gysi, N2DUP	38
Freebanding—An Adventure Beyond the Ends of the Citizens Band.....Jock Elliott	44
The CVS Samaritans—The Albany, New York Patrol.....Dave Plouff, 41 Albany	46
Installing Your Mobile CB Radio, The Right WayBill Price, N3AVY	48
(Don't) Open Mouth: Insert Foot—CB Operating Habits Make You a Big Deal or a Big DoofusTom Kneitel, K2AES/SSB-13 ("TOMCAT")	54
Eight Steps to Antenna SafetyEdward V. Hammond, WN1I	59
Keeping Your CB Radio—A Quick Guide to Theft-Proofing Your Mobile.....Ken Watson	65
Single-Sideband, Is It For You?Jock Elliott, SSB-734	67
Truckin'.....Bill Simpson a/k/a "Chicago Rebel"	69

PRODUCT LISTINGS

CB Base/Mobile.....	72
CB Walkie-Talkies.....	77
Scanners-Base/Mobile.....	79
Scanners-Handheld.....	83
GMRS Transceivers.....	86
Miscellaneous.....	88
Manufacturers.....	99
Dealers.....	106

EDITORIAL STAFF

Harold Ort, N2RLL
Editor
 Nancy Barry
Assistant Editor
 Jock Elliott
 Chuck Gysi, N2DUP
 Edward V. Hammond, WN1I
 Gayland Kitch
 Tom Kneitel, K2AES/SSB-13
 Allen C. Lorentson, N3DCX
 Larry Miller, KCZ-8847
 Dave Plouff
 Bill Price, N3AVY
 Bill Simpson
 Ken Watson
Contributing Editors

BUSINESS STAFF

Richard A. Ross, K2MGA
Publisher
 John Dorr, K1AR
General Manager
 Donald Allen, N9ALK
National Advertising Manager
 Frank V. Fuzia
Controller
 Simon Schatzmann
Circulation Director
 Catherine Ross
Circulation Manager
 Melissa Nitschke
Operations Manager
 Denise Pyne
Customer Service

PRODUCTION STAFF

Dorothy Kehrwieler
Production Manager
 Emily Kreutz
Assistant Production Manager
 Elizabeth Ryan
Art Director
 Barbara Terzo
Associate Art Director
 Susan Reale
Assistant Art Director
 Edmond Pesonen
Electronic Composition Manager
 Pat Le Blanc
Electronic Composition
 Hai Keith
Illustrator
 Janine Perry
Cover Painting

A publication of

 CQ Communications, Inc.
 76 North Broadway
 Hicksville, NY 11801-USA.

Offices: 76 North Broadway, Hicksville, NY 11801. Telephone: 516 681-2922. FAX: 516 681-2926. CB Radio Buyer's Guide (ISSN 1084-8894) is published annually by CQ Communications, Inc. Entire contents copyrighted 1996 by CQ Communications, Inc. CQ Communications, Inc., has extended its best efforts to create a useful and accurate CB Radio Buyer's Guide. We recognize, however, that despite this, errors and omissions may occur. Should any be observed, please inform us so that we may correct them in the next edition. CQ Communications, Inc. disclaims any and all liability resulting from such errors or omissions.

Printed in the United States of America.

Postmaster: Please send change of address to CQ Communications, Inc., 76 North Broadway, Hicksville, NY 11801.

CQ Communications, Inc. is publisher of CQ The Radio Amateurs Journal, Popular Communications, MicroComputer Journal, Electronic Servicing & Technology, CQ Radio Amateur (Spanish CD), Communications Quarterly, CQ Amateur Radio Equipment Buyer's Guide, CQ Amateur Radio Beginner's Guide, Popular Communications Communications Guide, and CB Radio Buyer's Guide.

Kenwood's TH-22AT/42AT: The Compact Solution!

144 MHz/450 MHz single band HTs

See Your Dealer
For Details

Join The FM Club!



Features

- 3-watt output from MOS FET power module and supplied 6-volt battery (TH-22AT: approx. 3 watts, TH42AT: approx. 2.5 watts), and 5-watt output with optional PB-34!
- Compact design: 2-3/16 x 4-5/3 x 1 in.
- Built-in DTMF keypad with monitor
- Built-in DTSS page system ■ Large 1-7/16" speaker
- 41 EPROM channel memories (including 1 call channel)
- Multiple scan functions (VFO, call & memory)
- Carrier-operated & time-operated scan stop modes
- Tone alert with elapsed time indicator
- Battery-saver circuit and auto power-off function to extend battery life ■ Selectable squelch configuration
- RF output power control (Hi/Low/EL)
- Built-in CTCSS encoder, optional TSU-8 decoder (any tone can be stored in any channel)
- User-friendly menu system to customize your operating preferences ■ Easy to program and use
- Modifiable for MARS and CAP. Specifications guaranteed for amateur bands only. Permits required for MARS and CAP use
- Wide range of accessories to enhance operating convenience and enjoyment

Slim, compact, lightweight. These words describe the exterior of the new TH-22AT Series HTs. Rugged, innovative, sturdy. These words describe what is on the inside. Because, along with the beauty, this new series of HT has all the things you want in a portable communications package. Like a streamlined, easy to program interface, one touch controls and a simplified menu of functions that you can customize to suit your needs. Even a DTMF memory that stores five of your favorite 15-digit telephone numbers for autopatch use. Wide band receive - 136 to 173.99 MHz. A new, innovative microprocessor and final amplifier circuit enables a full five watts, while conserving battery power. (The supplied battery provides 3 watts.) Easy mobile operation with optional PG-3H cable.

As always, a full line of accessories is available to enhance your operating enjoyment!

See your favorite Authorized Kenwood Amateur Radio Dealer for all the details!

Modifiable for MARS/CAP use.
Permits required. Specifications
guaranteed for Amateur band only.

KENWOOD COMMUNICATIONS CORPORATION
AMATEUR RADIO PRODUCTS GROUP
P.O. Box 22745, 2201 East Dominguez St.
Long Beach, California 90801-5745

KENWOOD

1996 CB Radio Buyer's Guide

A lot has been said about Citizens Band radio over the decades. But one thing's for certain, our love for CB—the Citizen's Band Radio—has never really gone away.

Look closely. CB has survived—and survived in a big way. Just ask the CB electronics retailer and the folks who get help on channel 9 and the college student who drives home late at night while

talking to her family on the newly-installed mobile CB. In fact, sales of CB radios have recently soared.

While Jock Elliott's "CB Scene" column in our monthly *Popular Communications* magazine continues to be widely read and supported by CBers from around the world, we believe there are enough fellow CBers out there who would enjoy a CB-only magazine.

Welcome to our first *CB Buyer's Guide*. It's the only national magazine devoted entirely to CB. We've asked Jock and other top-notch CBers like Tommy Kneitel, Ron McCracken, Bill Price and others to be part of our *CB Buyer's Guide* simply because they know CB radio from top to bottom. To give you a well-rounded *CB Buyer's Guide*, we've included an exhaustive CB product line-up in the back of the *Guide*; information and specifications, photos and suggested retail prices of CB transceivers, antennas, power supplies, switches, microphones and much more.

And because many CBers, particularly those of you who use your radio on the road, enjoy scanner monitoring, there's a complete scanner product listing.

An annual usually lacks reader involvement and a voice in its ultimate direction. We want to know what your interests are, and how you use your CB. Why not take a couple of minutes to complete our postage paid questionnaire? Your answers will help us determine the future direction of your *CB Buyer's Guide*.

In the meantime, I'd really appreciate your comments and suggestions for improving the *CB Buyer's Guide*. If you really feel strongly about something, drop us a letter. While you're at it, how about sending along photos of your CB shack, mobile CB installation, QSL cards, and antennas? Thanks and 73's.



Editor



World's Most Powerful CB and Amateur Mobile Antenna*

Lockheed Corp. Test Shows **Wilson 1000** CB Antenna Has **58% More Gain Than The K40 Antenna (on channel 40).**

In tests conducted by Lockheed Corporation, one of the world's largest Aerospace Companies, at their Rye Canyon Laboratory and Antenna Test Range, the Wilson 1000 was found to have 58% more power gain than the K40 Electronics Company, K40 CB Antenna. This means that the Wilson 1000 gives you 58% more gain on both transmit and receive. Now you can instantly increase your operating range by using a Wilson 1000.

Guaranteed To Transmit and Receive Farther Than Any Other Mobile CB Antenna or Your Money Back**
New Design

The Wilson 1000 higher gain performance is a result of new design developments that bring you the most powerful CB base loaded antenna available.

Why Wilson 1000 Performs Better

Many CB antennas lose more than 50% of the power put into them. The power is wasted as heat loss in the plastic inside the coil form and not radiated as radio waves.

We have designed a new coil form which suspends the coil in air and still retains the rigidity needed for support. This new design eliminates 95% of the dielectric losses. We feel that this new design is so unique that we have filed a patent application on it.

In addition, we use 10 Ga. silver plated wire to reduce resistive losses to a minimum.

In order to handle higher power for amateur use, we used the more efficient direct coupling method of matching, rather than the lossy capacitor coupling. With this method the Wilson 1000 will handle 3000 watts of power.

The Best You Can Buy

So far you have read about why the Wilson 1000 performs better, but it is also one of the most rugged antennas you can buy. It is made from high impact thermoplastics with ultraviolet protection. The threaded body mount and coil threads are stainless steel; the whip is tapered 17-7 ph. stainless steel. All of these reasons are why it is the best CB antenna on the market today, and we guarantee to you that it will outperform any CB antenna (K40, Formula 1, you name it) or your money back!

*Inductively base loaded antennas
**Call for details.

Lockheed - California Company

A Division of Lockheed Corporation
Burbank, California 91520

Aug. 21, 1987

Wilson Antenna Company Inc.
3 Sunset Way, Unit A-10
Green Valley Commerce Center
Henderson, Nevada 89015

Subject: Comparative Gain Testing of Citizen's Band Antennas
Ref: Rye Canyon Antenna Lab File #870529

We have completed relative gain measurements of your model 1000 antenna using the K-40 antenna as the reference. The test was conducted with the antennas mounted on a 16" ground plane with a separation of greater than 300" between the transmit and test antennas. The antennas were tuned by the standard VSWR method. The results of the test are tabulated below:

FREQUENCY (MHZ)	RELATIVE GAIN (dB)	RELATIVE POWER GAIN (%)
26.965	1.30	35
27.015	1.30	35
27.065	1.45	40
27.115	1.60	45
27.165	1.50	41
27.215	1.60	45
27.265	1.75	50
27.315	1.95	57
27.365	2.00	58
27.405	2.00	58

58% MORE POWER GAIN THAN THE K40

Individual test results may vary upon actual use.

CALL TODAY
TOLL FREE: 1-800-542-6116
FOR YOUR NEAREST DEALER
Wilson 1000
DEALERS Exclusive dealer areas still open

- Roof Top Mount.....59⁹⁵ Little Wil.....29⁹⁵
- Trunk Lip Mount.....69⁹⁵ Wilson 2000 Trucker .59⁹⁵
- Magnetic Mount79⁹⁵ Wilson 5000 Trucker .79⁹⁵
- 500 Magnetic Mount .59⁹⁵

Wilson
ANTENNA INC.
1181 GRIER DR., STE. A
LAS VEGAS, NV 89119

R&R COMMUNICATIONS INC.

2312 CARPENTER ROAD
WILMINGTON, DE 19810

(302) 475-1351 OR (302) 475-1352

***SPECIALIZING IN SALES, SERVICE AND MODIFICATIONS.
*CUSTOM WORK AVAILABLE***

***WE HAVE 27 YEARS EXPERIENCE IN THE CB, MARINE, POLICE AND FIRE SCANNERS AND 2 WAY RADIO BUSINESS. THERE ARE 2 FULL TIME FCC LICENSED TECHNICIANS ON DUTY TO HELP YOU WITH ANY QUESTION OR PROBLEM YOU NEED SOLVED.**

***WE ARE A FACTORY LICENSED WARRANTY REPAIR STATION FOR:
COBRA, MIDLAND, K40**

***WE CARRY A FULL LINE OF CB AND 10 METER RADIOS SUCH AS:
COBRA, UNIDEN, MIDLAND, RANGER, GALAXY, CONNEX, MAXON.**

***WE CARRY THE BEST IN SCANNING RADIOS SUCH AS:
UNIDEN BEARCAT, AOR(ACE)**

***WE CARRY A FULL LINE OF METERS, ANTENNAS AND ACCESSORIES SUCH AS:
WAWASEE, VALOR, PARA DYNAMICS, ANTENNA SPECIALIST, GIZMOTCHY, MACO,
WILSON, K40, HUSTLER, SHAKESPEAR, SKIPSHOOTER, FIRESTICK, FRANCIS, ANTRON,
MIDLAND, JBC, TRUCK SPEC, WORKMAN, ETC.**

***WE CARRY A FULL LINE OF MICROPHONES SUCH AS:
ASTATIC, TELEX, COBRA, GALAXY, SADELTA**

***WE CARRY THE BEST AND ONLY THE BEST IN RADAR DETECTORS:
B.E.L. TRONICS #1 AND AMERICAN MADE**

**AMPHENOL CONNECTORS, COAX ALL 99% SHIELD
POWER SUPPLIES SUCH AS: ASTRON AND PYRAMID
ANTENNA TUNERS SUCH AS: MFJ, MACO AND PDC**

**FREQUENCY COUNTERS, EXTERNAL SPEAKERS, SWR METERS,
SWITCH BOXES, DUMMY LOADS 10-1500 WATTS, TVI FILTERS,
PHONE FILTERS, HOOK UP WIRE FROM 24 AWG TO 4 AWG,
MOUNTING BRACKETS FOR ALL MODELS**

AND ALL ACCESSORIES POSSIBLY NEEDED!

**NO SALES TAX IN DELAWARE - UPS SHIPPING ANYWHERE IN THE
CONTINENTAL U.S., CARRIBEAN I.S., SOUTH AMERICA, CANADA, MEXICO**

ADD YOURSELF TO OUR MAILING LIST

R&R COMMUNICATIONS INC.

HOURS ARE:

**MONDAY 10AM - 8PM
WED. THURS. FRI. 10AM - 5:30PM
SATURDAY 10AM - 4PM
SUNDAY AND TUESDAY - CLOSED**

Name: _____

Address: _____

Phone# _____

Interests _____



**SEND TO: R&R COMMUNICATIONS INC.
2312 CARPENTER ROAD
WILM. DE. 19810**

The New CB—It's Not Your Father's Radio

To know where CB is going, it's important to know where it's been . . .

BY LARRY MILLER, KCZ-8847

No marketing person could have put together a more potent plan of action. In 1945, World War II was winding down. Millions of men would soon be heading home to start families, producing the population spurt known forever as the "baby boom." That very same year, planners in Washington, D.C. began the task of looking toward the country's peacetime radio future. These plans, which laid the groundwork for today's Citizens Band radio, would become reality some 25 years later, just as the baby boomer would also come of age. The result would be a CB mania that would engulf the nation, dominate the media, and put a radio in the hands of nearly every man, woman and child from First Lady Betty Ford ("First Mamma") to the average "goodbuddy" in a Volkswagen Beetle. It even spawned its own language, 10-4? ("Breaker, breaker, breakity broke. This here's the Gear Jammer. We got us a convoy!") Back in '45, however, it was clear that the boys in

Washington had anything but this sort of thing in mind.

The Citizens Radio What?

For the most part, the pre-war use of radio extended only into the 100 MHz range. During the war, however, the demands of the military and the new technology it had created had pushed the edges of spectrum usage dramatically. And the U.S. Federal Communications Commission knew that in the foreseeable future, the sky would be the limit. So when officials came out with their "Report of Proposed Allocations" in January of 1945, no one was surprised to see that the report covered frequencies all the way up to the unheard of 30 GHz. Few people noticed—nor cared—about a relatively thin slice of future spectrum allocated to the Citizens Radio Service.

CB radio began its life at the unlikely address of 460—470 MHz. Indeed there

was some priority given to finding a more suitable space for such a service, but with the pressing needs of public safety, broadcasters, and the growing aviation industry, 460 was the lowest part that could be found.

The truth be known—460—470 MHz appealed to the technical-types in D.C. because it would be skip-free and because civilian manufacturers, it was felt, could easily convert over from the manufacture of military communications equipment to the new civilian Citizens Radio Service. As for the Citizens Radio Service itself, the FCC saw it as a way to allow non-technical people access to the airwaves. There would be no Morse code test, no questions about tubes and resistors—just a relatively simple application form to complete, write a check and send it in. In exchange, the FCC expected that licensees would use the airwaves for serious—"substantive" in their words—communications between different units of the same license.



E.C.I.'s Courier 1M transceiver didn't look like much, but was a dream CB radio with a great reputation back in 1960. (Courtesy Tom Kneitel)

Compare the size of that 1960's CB behemoth 'neath the dashboard with even the largest of today's mobile CBs. (Courtesy Tom Kneitel)





The Browning 23/S-Nine deluxe transmitter was a popular unit during the 1960's. The rig was expensive and extremely successful. (Courtesy Tom Kneitel)



This accomplished 1960's CBER sorts through his DX cards as he monitors the band on his International Crystal Executive Model 100. (Courtesy Tom Kneitel)

The First License

According to legend, the first official "CB" license was issued on March 22, 1948 to a man named Al Gross. His call sign was 19W0001. That year, Gross had been given the FCC's go-ahead to manufacture and sell a transceiver for the Citizens Radio Service. Back then, the Citizens Radio Service was divided into two parts, Class A and Class B. Class A had higher technical standards and was allowed 50 watts. The technical standards for Class B were more lax, but power was restricted to a mere 10 watts. Gross chose to go with the Class B. He immediately sold 25,000 units to the Montgomery Ward department store chain. For the next five years or so, Gross had the market virtually to himself. When the FCC relaxed some of its technical standards, others joined the game. Names like Vocaline Company of America and Stewart-Warner tried their luck. But the American public was not biting. No one ever heard of the Citizens Radio Service. And the equipment—well, it was—how would you say it? Lousy. The whole idea was a commercial disaster. Tom Kneitel, then Citizens Radio Service licensee 2A0305, remembers that "the equipment was as expensive as it was temperamental and unreliable. The communications range was too short to make the cost and effort worthwhile. Besides, most of the general public had never heard of the Citizens Radio Service. Those who had couldn't have cared less." This was no way to launch one of the most

popular and service-oriented radio services in history, 10-4?

Birth Pains

You'll still hear many ham radio operators grumble bitterly about the year 1958. That was the year—the dark deed actually occurred on July 3—that the FCC took a portion of the 11 meter band from amateur operators and awarded it to CB Radio. Actually, CB's move from 460-470 MHz to 26.96-27.23 MHz was more of a shuffle than any outright looting of airspace. For a reason that has been lost to history, but which had something to do with allocating space on the high frequency spectrum, the FCC actually took more than 6 MHz from CB's 460 MHz range. At the same time, it took the space between 26.96 and 27.23 MHz from the hams and created a new "Class D" citizens band. The FCC would regret the action every hour of every day that it lived. Ham operators would never forget.

Like A Rocket

Interest in the new type of CB was fast and furious. While only a few stations were licensed in 1958, the numbers began to grow with alarming speed; 600 per month in January of 1959, 5,500 per month four months later. Soon 27 MHz equipment began rolling off the assembly line to match demand. Names like Hallicrafters, Heathkit, Gonset and others began to fill the shelves of stores.

That same year, *Popular Electronics* magazine began its first CB column. CB was off and running and it would never look back. By mid-1961, the license count for stations in all classes of the CB Service had skyrocketed to some 200,000! A mania, a love affair, a hobby to top all hobbies had been officially set off at the starting gate. In a little more than a decade, TV shows like the "Dukes of Hazard" soon made CB radio part of every episode. Movies touted the CB "lifestyle," linking it forever with the trucking industry. There was even a Top-40 single, the sugar-coated "Convoy," that raced up the charts. Ordinary citizens rushed to join in the fun, using their radios to make friends, get directions and find a fully-juiced gas pump in a nation strangled by the Arab Oil Embargo. Even the state police belatedly jumped into the pool, posting signs on the nation's highways advising that "State Police Monitors CB-9. KNN 3083." All of this was happening as the first wave of the Baby Boom began to come of age—and into a lot of disposable income. And, of course, everyone had a "handle." Candyman. Cuddles. Tomcat. Gear Jammer. Macho Man and the Roach. And on, and on and on. The cast of characters and the fun, was unending.

Meet The Boss, Uncle Charlie

The party was just starting to gather steam when another "handle" made its way into the CB dictionary: "Uncle



Tram's name on any piece of early CB equipment meant it was something special. Here's the company's Model TR-70C transceiver from about 1963. During the 1970's, they made spectacular CB sideband equipment. (Courtesy Tom Kneitel)

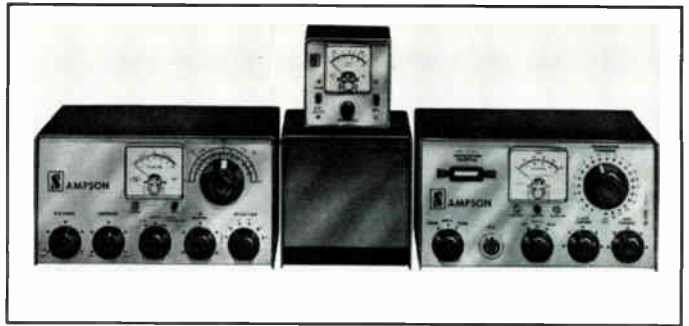

During the late 1970's, this Sampson modular station appeared on the market. This was a fine station, but costly. Not many were sold. (Courtesy Tom Kneitel)

Charlie." Uncle Charlie was the boogeyman—the bad guy. Uncle Charlie was the FCC and he was anything but happy about what was going on with his Citizens Radio Service. But Uncle Charlie didn't enter the picture only in the heyday of the national CB party line. Uncle Charlie was expressing concern about its errant child almost from the birth of the service. It was a classic case of a government agency being utterly out of touch with what the people wanted or needed, and then responding aloof, from on high. It was also, in the end, a classic case of the general public ignoring a set of rules so absurd that they virtually invited challenge.



Here's a look at the new Cobra 148F GTL. It's a top-of-the-line mobile CB that also operates on SSB. (Photo Courtesy Cobra Electronics)

Substantive and Useful Messages

According to the FCC, CB was created "to provide a means of transmitting substantive and useful messages, in connection with either business or personal activities, of private citizens who may not be eligible in any other radio service except amateur." Once the rules were set, that was it. The public was expected to obey. Or so thought the FCC. Unfortunately, the rules, according to Kneitel, "contained so many operating restraints that (they) seemed to have been deliberately rigged so as to rule out any possible full legal use of the service." The most confusing aspect of the rules was the use of the word "substantive" in describing allowable communications. Substantive means, according to the dictionary, important or essential. But who was to decide what was substantive? The FCC was listening. They alone decided. Anyone sending what the government considered to be a frivolous communication could be fined. But that wasn't all. You had to use call letters, talk only for a specific amount of time, talk only to specific people and NO calling CQ. Meanwhile, ingenious CBers who were hoping to

expand their 23 legally allotted channels and trying to find some private space in the increasingly crowded channels, were discovering that by switching the receive and transmit crystals in the average CB, they could add some new, although illegal, channels to the fun. Anyone who ever listened to CB can never forget the seemingly round-the-clock voices coming out of the American south and southwest, shooting skip in search of that elusive long, long-distance contact.

Free At Last As FCC Cries "Uncle"

The FCC was, in fact, eventually overwhelmed by the sheer numerical force of CB. First to fall was the FCC's licensing system. Originally, licenses were issued in the same manner as ham radio licenses; certain digits indicated the district office where the licensee was located. That was scrapped in favor of a standard alphabetical rotation. But even that failed in time. At one point, the FCC's computer began hiccuping, issuing already-issued call letters to other CBers. According to some reports, as many as 100,000 duplicate call letters were issued before someone in Washington gave the

computer a hit in the side with the palm of their hand. Eventually, the FCC dropped licensing altogether. They even dropped some of their more onerous CB rules restricting hobby use of the frequencies. To alleviate overcrowding, 17 additional channels were added to the original 23, effectively legalizing the bootleg use of what operators jokingly called "Channels 22A and 22B."

Changing Times

CB continues to change and grow. Wear a lime green leisure suit to a formal affair and you'll probably be ignored. Get on the CB and talk in the phony corn pone accent of the CB 70's and you'll probably be ignored, too. Even the use of jargon has changed. You'll hear less of it and some of your old favorites don't mean the same thing anymore. "Goodbuddy," now means a homosexual lover in some areas. The difference is that CB, like many of its operators, has matured. Gone is much of the silliness. Gone, too are the over-anxious people in yellow rain slickers with flashlights that seemed to turn out at every gathering of over two people either offering coffee or

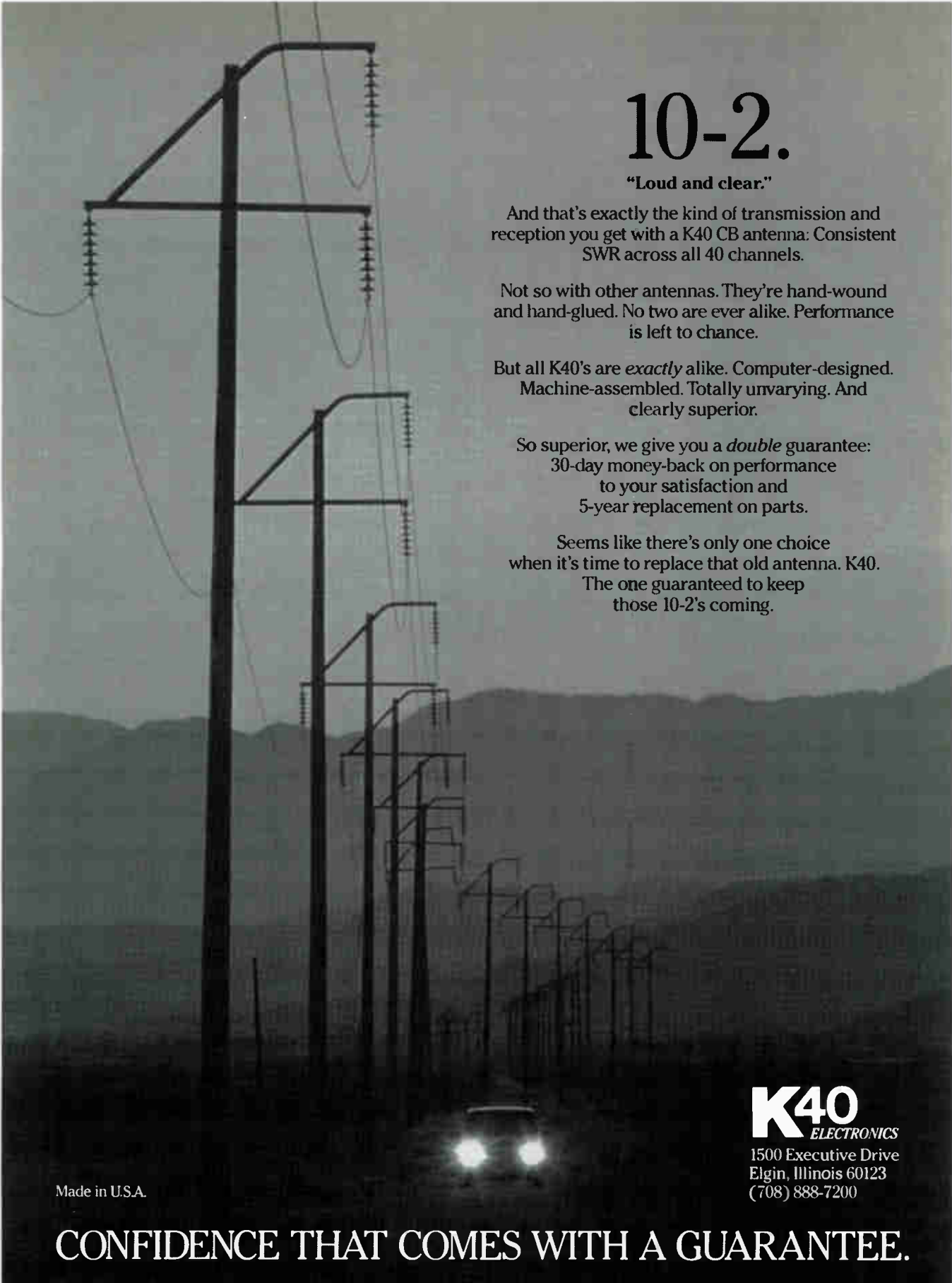

10-2.

"Loud and clear."

And that's exactly the kind of transmission and reception you get with a K40 CB antenna: Consistent SWR across all 40 channels.

Not so with other antennas. They're hand-wound and hand-glued. No two are ever alike. Performance is left to chance.

But all K40's are *exactly* alike. Computer-designed. Machine-assembled. Totally unvarying. And clearly superior.

So superior, we give you a *double* guarantee: 30-day money-back on performance to your satisfaction and 5-year replacement on parts.

Seems like there's only one choice when it's time to replace that old antenna. K40. The one guaranteed to keep those 10-2's coming.

Made in U.S.A.

K40
ELECTRONICS
1500 Executive Drive
Elgin, Illinois 60123
(708) 888-7200

CONFIDENCE THAT COMES WITH A GUARANTEE.

UNITED STATES OF AMERICA
FEDERAL COMMUNICATIONS COMMISSION
WASHINGTON, D.C. 20554

CB RADIO SERVICE STATION LICENSE (SUBPART D)
OR
R/C RADIO SERVICE STATION LICENSE (SUBPART C)

CONDITIONS OF GRANT

The licensee's authority under this license is subject to the provisions of the Communications Act of 1934, as amended, subsequent statutes, treaties, current and future regulations issued by this Commission and the conditions set forth herein. This license does not permit the licensee to operate the station or use the frequencies (channels) beyond the term of the license or in any manner not authorized herein.

This license authorizes the person named herein, members of the licensee's immediate family residing in the same household, and the licensee's employees, while acting within the scope of their employment (95.265, 95.465) to operate a CB or R/C radio station in accordance with Part 95 of the Commission's Rules. Violations of the Communications Act may result in license revocation, monetary forfeiture, and criminal prosecution. It is a federal offense under the Communications Act punishable by a fine of \$10,000 or one year in jail, or both, to operate a CB or R/C radio transmitter without temporary permit or a license from the Commission. Violations of the Commission's Rules are punishable by a fine of not more than \$500 for each and every day during which such offense occurs (Section 302 Communications Act).

The operating authority granted by this license shall not be transferred, directly or indirectly, to any other person.

This license must be posted at the principal fixed location of the station, or retained in the station records. A photocopy may be posted at the principal fixed location, provided you note on it the location of the original license. Photocopies must be posted at other fixed locations. The station and all station records must be made available for inspection upon request of an authorized Commission representative. A current copy of Part 95, Subpart C (R/C) or Subpart D (CB), as appropriate, must be kept in the station records (95.305, 95.305).

The licensee must share the channels and agree to tolerate all radio interference caused by other stations or equipment operating in accordance with applicable laws, treaties and regulations.

This license is issued on the licensee's certification that all statements contained in the application are true.

This license is subject to the right of use or control by the Government of the United States conferred by Section 406 of the Communications Act. This license replaces and supersedes any previous license in accordance with the following: An R/C license replaces a Class C license and a CB license replaces a Class D license.



NOT TRANSFERABLE

FEDERAL COMMUNICATIONS COMMISSION

PART 95 SUBPART	NO. TRANSMITTERS	CALL SIGN
CB	25	
EFFECTIVE DATE	EXPIRATION DATE	
10-10-80	10-10-85	

SPECIAL CONDITIONS D UPLICATE
DUE TO PROCESSING ERROR YOU WERE
ISSUED TWO LICENSES.
CALL SIGN KBRH0409 ISSUED ON
10/10/80 IS YOUR CORRECT LICENSE.
CALL SIGN KBRI2079 ISSUED ON
10/20/80 IS INCORRECT AND IS
HEREBY CANCELLED. PLEASE DESTROY.

SORRY FOR ANY INCONVENIENCE THIS MAY
HAVE CAUSED.

Here's a 1980 version of an FCC "processing error." With their computer system on meltdown, thousands of duplicate licenses were issued, prompting the immediate re-issuing of licenses.

trying to direct traffic and shouting hysterically, "I'm with the local CB club. Get out of my way." In its place is a spirit of camaraderie, of genuine service. Experts believe that CB is well on its way to fulfilling the promise of the original "Citizens Radio Service." No doubt about it, there's an excitement about it that's been unseen since the mid 70's. And the equipment? It's hot as a firecracker. Said one CBer, "most of the new radios are really good. The rest are excellent."

Jock Elliott, *Popular Communications* CB Scene columnist, agrees with the assessment of the new CB. "These people are good folk. And they see the honor of service to their fellow man." In fact, Elliott proudly points out, CB is the only radio service with a channel devoted entirely to giving people a hand on the road in times of emergency. "There's no frequency like 27.065 when you've got a problem," says Elliott. Even cell phones have spotty coverage in many areas of the country. But so long as there's a CBer with his "ears on", you can be certain that you'll get help, even if its just directions to the next gas station.

One of the many excellent local organizations serving the public is Tri County Assistance. Tri County Assistance is an independent CB service organization in



Emergency?

Broadcast key details over and over
(WHO • WHERE exactly • WHAT)
without regard for a reply

REACT International, Inc., P.O. Box 998,
Wichita, KS 67201 (316)263-2100



REACT logo.

the capitol region of New York. They handle some 3,800 incidents each year; half on CB. These range from simple disabled vehicle calls to more serious accidents involving life-and-death situations. CVS, the pharmacy chain, sends "Samaritan" vans equipped with CBs onto the nation's highways in 12 states. Recently Cobra, the scanner manufacturer, announced that it has become an official sponsor of REACT (Radio Emergency Associated Communications Teams International). REACT has thousands of members divid-

ed into hundreds of local chapters, all of which are dedicated to ensuring your on-road safety.

In the end, CB is a community. Whether you're monitoring channel 9 for emergency action or hanging out on Channel 35 with a bunch of CBers talking about women or Channel 22 where the sports freaks listen, it's good people. And it's a chance to make a difference. "For me," says one local CBer, "that 's what matters. I can make a difference in someone's life. Just me and my CB."

Getting Ready to Buy a New CB Radio? Here's Some Help

Before you buy, take a few minutes to think about what you really want . . .

BY ALLEN C. LORENTSON, N3DCX

So you've decided to buy a new CB radio. Maybe this is your first CB and you're not sure what you really need. Perhaps you already own a CB and you want to know what features would be really useful. Whether you're just starting out or you're an experienced CBer, this article will help you determine the right CB for you.

We'll review what the ratings mean, what's significant, whether you need a portable, mobile or base unit, and what controls/features are really useful and which items can make using your CB radio easier.

I've been a CBer since the early '70's. In high school I became a ham operator as well. Since then I've designed commercial two-way radio systems and have recently worked in management for one of the nation's largest electronics retailers. Through the years I've experienced hours of enjoyment from my CB, and know you will too. Let's get started . . .

First, you need to decide what type of CB you want to use. There are a few basic types: portable, emergency, mobile, "all-in-ones" and bases. The confusing part is that many of these models can be interchanged for different needs. For example, you can use a mobile in your home by connecting it to an appropriate DC power supply. More on that later, though. We'll start with portables and work our way to base stations.

Portables

If you're going to use a CB to keep in touch while hiking, biking, walking or working outside or doing anything else where there is no electrical power or place for a big antenna, you should consider a portable CB, also known as a handie-talkie. Portables are designed to operate without an external antenna or power source. They run off some sort of battery pack and have either a telescoping whip or shorter "rubber duck" antenna which makes them convenient, but also reduces their range.



The Uniden Pro 520XL is a compact AM CB that features instant channel 9 access. (Courtesy Uniden Corp.)

Portables are great for their intended purpose; walking or when you're on a bike or horse and operate in a range of 1/4 to 2 miles, depending on terrain and power. They can also become mobiles or base stations by using external power supplies and antennas, however by the time you pay for all the add-ons, a regular mobile or base could be the better buy.

If you're considering a portable, remember that they use batteries; typically the "AA" alkaline or NiCd rechargeable variety. The louder you keep the volume and the more frequently you use the high power setting, the more frequently you'll be replacing or recharging the batteries. There really isn't any way around this simple fact. Many CBers who use portables keep an extra set of batteries handy in case the ones in the radio suddenly go dead. Most CBers will use rechargeable NiCds. Initially they'll cost a bit more than alkalines, but in the long run they pay for themselves because they can be used over and over.

Emergency CBs

If you want a CB just for peace of mind

in the car in the event of a breakdown or emergency, this type of CB radio might be for you. These radios are typically contained in a hard plastic case with a compartment for the radio, collapsible antenna and power cord. Most folks store the emergency CB under the seat or in the glove compartment where its ready for emergency use. They are rated for full legal output power. These radios are designed to be easy to use and quick to set up. Some of the better models include instant channel 9, built-in battery packs and the NOAA weather channels. Since they are meant for temporary emergency use, they are not built for continuous mobile use. If you are looking into CB as a hobby, this CB is not the style you want. However, if you just want some security and peace of mind for your family, these emergency CBs are great.

Mobiles

A mobile CB radio connects to the 12 volt power system in your vehicle and works with an externally-mounted antenna designed for CB use. This is typically the most cost-effective CB for use



Radio Shack's TRC-465 is a full-featured AM/SSB CB radio that can also be used as a base by using a DC power supply. (Courtesy Radio Shack)

in the car. They are also the most popular and come in a variety of sizes. Their features vary from extremely simple and small, to radios with more gadgets and controls than you can imagine. Some useful options on a mobile include: noise reduction circuits, a good meter, NOAA weather channels, weather alert tone and instant channel 9. Mobile CBs can also be used as a base station by using a 120 Vac to 12 Vdc converter (power supply) and a base station antenna.

Sometimes I hear prospective CBers being concerned that mobiles aren't quite as "powerful" as base CBs. NOT TRUE. Legal output power is legal output power.

You also need to determine how much room you have for a radio in your car and then see how much radio your budget can handle. Expect to pay from \$50 to \$300 for a mobile CB radio.

One special type of mobile CB radio deserves some special attention. These radios have the mic and controls "all-in-one". The main box of the radio is tucked away wherever there is room, such as in the trunk of your vehicle. All that's visible in the car is an elaborate mic. This kind of radio is very convenient in today's crowded cars and for CBers concerned about theft. It also saves lots of space. However there are some drawbacks. The

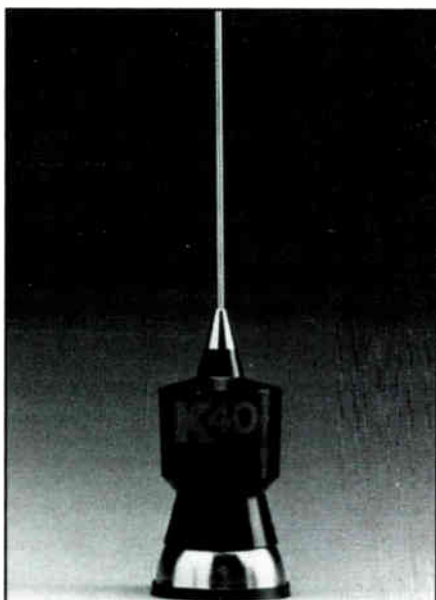

Every CB needs a good antenna to perform at peak efficiency. This K-40 mag-mount antenna is ideal for mobile radio users who want to prevent theft.



The HCB-30 by Maxon features all 40 channels and access to three NOAA weather frequencies. (Courtesy Maxon Systems)

controls and displays must be small to fit on the mic. Dropping the mic can mean expensive damage to the radio.

Base Stations

Base stations are the big daddies of CB radio. They typically have most of the best features of the mobiles, but also include a built-in power supply and larger speaker. Most base stations also have a more stylish look than the mobiles. Examples include wood grain to high-tech looking chrome cases. While base stations very often look better and stronger than their mobile cousins, performance is usually the same. In fact, sometimes it is just the same radio with a different case and power supply.

Controls, Features and Options

In this section I'll do an overview of these items. Some of the explanations are simplifications of how things really work. This is done so more readers can get the information they need, so bear with me if the explanations aren't very technical.

All CBs today have 40 channels (except some portables). If someone is trying to sell you an old 23 channel radio, be forewarned that it is about 20 years old. With that in mind, let's talk about some of the different controls, jacks, etc. that you might find on the CB you're considering.

Universal to almost all CB radios are the volume and squelch controls. The volume control is self explanatory. Sometimes it's in the form of a rotary or thumbwheel-type control, while other times it's an up/down pushbutton. It's your preference.

The squelch control is used to allow only signals of a certain strength and higher go to the speaker. This allows you to listen to people and not the static in between transmissions. The RF Gain is used in a similar way to "extend" the squelch control. It essentially desensitizes the receiver to allow only the strongest signals through. Use caution with both of these controls! If you raise them too high you may miss hearing stations with slightly lower signals. You could end up talking on top of them. On older radios you may find a delta-tune knob or on single sideband CBs, a clarifier. These both adjust the receive frequency of the CB for better sounding reception. While this is still important for single sideband, it is unnecessary for today's regular CB radios. All of these controls are used for receiving CB signals.

There is primarily only one for transmit—the modulation control or mic gain. This allows you to adjust for how far you hold the mic from your mouth when speaking. If you hold the mic away from

you, turn it up some. Be careful, because too high a level will pick up background noise and may even cause distortion from overmodulation. Set it too low and you'll hardly be heard.

Noise is a common enemy in many mobile (and even base) situations. There are various ways to deal with this problem. Most common are the noise blanker (or NB) and the automatic noise limiter (or ANL). Both go after different kinds of noises. The noise blanker attacks pulsating noises such as ignition noise. The automatic noise limiter attacks continuous noises such as alternator whine. Both can do a fair job, but they are by no means perfect. In the past few years a new kind of noise protection circuit has come out. It's called the Digital Signal Processor or DSP. This circuit is built into some radios, but is also available in a separate box that hooks up to your external speaker jack. My experience with DSP on CB radios has been very positive. The DSP removes the heterodynes and whistles quite well and makes listening to the CB so pleasurable that my wife didn't complain about having the radio on during one of our long trips. When you keep the noise levels down, listening is certainly more enjoyable and productive.

Extra Jacks

On the back of a CB radio you may find several jacks. The antenna jack is obviously required to operate the CB in the first place. On a portable CB you may find an external antenna jack. This is used to connect a base- or mobile-type antenna to your handie-talkie.

Then there's the external speaker jack. It is used to hook up a larger or possibly amplified speaker to your CB radio. It is also used to hook up a DSP unit to your radio. Sometimes you'll also find a PA (public address) speaker jack. This allows you to use your CB as a PA amplifier. I have found this to be handy, especially at public service events.

The Display and Meter

On the front of the CB radio along with the controls, you'll find the channel display and possibly a meter. There are primarily three kinds of displays: backlit dials, LEDs and LCDs. Backlit dials are not used very much anymore. This type of display uses a tiny light bulb behind a small window. The light shines through a clear dial that has numbers printed on it. LEDs are popular, especially on the less expensive CBs. The main drawback with LEDs is that they tend to get washed out in bright light, making them difficult, if not impossible to read.

New higher end radios are using LCD displays because they are more flexible than any other displays. It is possible to build the meters and words into the display. However at some angles they are hard to read.

The most popular meters are the S-meter, power meter, modulation meter and SWR meter. Each has a completely different function. The S-meter tells you the strength of the received signal. The lower the number, the weaker the received signal. You'll use this meter to properly set your squelch and RF gain.

The power meter lets you know the strength of your transmitted signal.

The SWR meter lets you know how well your antenna system is performing. This information is crucial. Nothing will kill your range like a bad antenna system. Keeping your SWR as low as possible is your goal.

Weather Reception and Frequency Counters

Two newer options on some CB radios are NOAA weather channel reception and frequency counters. If you do much traveling or live in an area prone to sudden nasty changes in weather, having NOAA weather available at the push of a button is great. It saves time trying to find a local radio station giving a weather report right when you need one.

A frequency counter tells you your transmit frequency along with the channel number. You really shouldn't need this with modern CB radios; they are extremely stable and shouldn't drift.

Ratings

The rating numbers the manufacturer provides are used to give you some idea of that CB radios' performance. For reception there's sensitivity, distortion and image rejection. You want the sensitivity to be the smallest negative number, distortion the lowest and rejection the highest negative number.

The primary rating for transmit is power, expressed in watts or milliwatts. Five watts input power is the maximum allowed by U.S. law. Using a CB radio rated higher could cost you the equipment, fines and possibly jail. Single sideband CBs have a maximum peak envelope power of 12 watts. Today the ratings are typically very similar from radio to radio. Many times it's difficult to even get specs on them.

Antennas

A good antenna is absolutely essential to a good performing CB radio system.

There are many out there. The longer the whip, the better the performance. However a 102" whip is not practical for most people. There are specialty antennas for just about any need. Some are glass, magnet, mirror and bumper mount; there are ones for fiberglass vehicles, cellular look-alike antennas, marine and combination AM/FM/CB antennas. Pick the one that meets your needs and buy the best quality you can afford.

Assess Your Needs



In selecting a CB radio, you need to take a few factors into consideration:

- what you want
- what you need
- what you can afford

If you buy a CB that is too complicated for your interests, you could become frustrated with the radio and not get much enjoyment or satisfaction from it. There's danger in going too far in the other direction as well. There may be times where NOAA reception or a DSP would come in handy. Always try to buy the best CB radio you can afford and understand. You'll never be disappointed.

If you have questions about shopping for your CB radio, drop me a line. See you on the air! 73's. ■

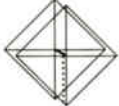
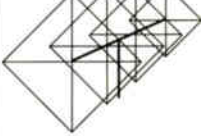
SE SIGNAL ENGINEERING'S
High Performance CB Antennas

SUPERHAWK 	Goldenrod 45 Spyder A+ Broadband Hi powered MOBILE
WHITE LIGHTNING The Four Element Antenna 	THUNDER 8 Hi Gain Bi-Directional OMNI Electronically Steerable
LIGHTNING 6 	And, also, NEW QUAD LIGHTNING 8 THE most POWERFUL CB base in the world today!

ALL SE PATENTED rotary beams are true quads and OUTPERFORM their counterparts (quad/yagi types). SE's patented SFS matching system makes SE QUADS the most technologically advanced antennas in the world today.
If your dealer doesn't have SIGNAL ENGINEERING, write or call for full specs. DEALER inquiries invited.
MasterCard, VISA, AMEX, Discover

SIGNAL ENGINEERING
155 San Lazaro Ave, Sunnyvale, CA 94086
(408) 733-1580

Getting and Giving Help on CB Channel 9

When you need assistance, Channel 9 monitors are just a call away . . .

BY JOCK ELLIOTT,
CB Editor, *Popular Communications* magazine

The following is a true story. It was a little after 9 p.m. on a Fall evening several years ago. My wife and I were returning from a class. As we crossed the four-lane bridge that connects Troy, New York with Green Island, we spotted a car parked at an angle across two lanes. Nearby, one woman was holding another near the railing of the bridge.

I stopped our car and yelled to the women, "Do you need assistance?"

The woman who was restraining the other replied, "This woman has a note on her that says she is an epileptic and has heart failure."

I keyed the microphone on my CB. "Break channel 9, This is Tri-County 56. We have a medical emergency on the Green Island Bridge." Judy, Tri-County 942, monitoring the channel from a base station, came back to my call. "I'll get help," she said. Within two minutes, police and ambulances from Troy and Green Island arrived, and we drove off. Once again, emergency CB channel 9 had fulfilled its promise.

It's a Fact!

Citizen's Band channel 9 is the *only* emergency and traveler's assistance frequency readily available to the general public. Thousands of Cbers in hundreds of REACT and independent teams across the U.S. monitor channel 9 to respond to people who call for help.

Channel 9 monitors handle everything from disabled vehicles to life-threatening accidents, from bears and other wild animals on the highway to (once!) a fire in a port-a-john at a highway construction site. They even respond to domestic disputes, knifings, and other crimes. For the most part, channel 9 monitors do not get directly involved, but provide instead a vital communications link between the people who need help and the authorities who can provide it.

It's important to remember that channel 9 is not just the emergency channel; FCC rules state clearly that channel 9 is for *both* emergencies and traveler's assistance. That means it is perfectly okay to use channel 9 to request directions or the location of a place to stay. It saddens me when I occasionally hear some retro-grouch attempt to chase someone off channel 9 because "it's for emergencies only." I've even heard people who were reluctant to use channel 9 to ask for help because they thought they didn't have a "big enough emergency."

If a call is not appropriate for channel 9, or if it appears that answering the call will take considerable time during which additional calls for help might come in, a courteous channel 9 monitor may ask you to accompany him to another channel where the call can be handled.

How To Give Help on Channel 9

If you are in your car and hear an unanswered call for help on channel 9, carefully listen to the call, then repeat the information back to the caller to make sure you have heard the message correctly. Make sure you know who is calling, where they are, what the problem is, and what assistance is required. If the information is incomplete, ask some questions to help fill in the blanks.

Then relay the call to a base station if one is available, or use the alternative communications (cellular phone, 2-meter ham radio, GMRS radio or even pay phone) to pass the message to the appropriate authorities. Again, the authorities will want to know: who you are, what the incident is, where it is, and what assistance is required. Once you know that help is on the way, you can relay that information back to the original caller on channel 9.

CB base station operators who monitor channel 9 should make sure their stations are equipped with a list of local authori-



Ed Barnat of the Tri County Assistance Group provides traffic reports to a local broadcaster from information he has gathered from his CB. (Photo by Jock Elliott)

ties and their phone numbers and a detailed map of the local area. Calls are handled in the same way as in mobile operations, except that base station operators usually call the appropriate authorities directly instead of relaying the call.

Incidentally, being a base or mobile channel 9 monitor doesn't mean you have to listen to static for hours on end. Simply squelch out the noise and go about your business. When a call breaks the



New York State Police respond to an accident scene. The initial report of the mishap was aired on CB channel 9. (Photo by Jock Elliott)



During this severe storm season, a mobile CB operator reports damage from his pick-up truck in this heavily-damaged residential area. (Photo by Jennifer Ort)

squelch, turn the squelch down so you can clearly hear the signal, and handle the call. It's just that easy.

The first time that you need help on the

road and are able to get it through CB channel 9, you'll be glad that you have a CB in your car. But the first time that you respond to a call for help using your

Experts
secrets
on
how-to
fix
CB
radios

**THE
"SCREWDRIVER
EXPERT'S" GUIDE**



CBR

\$21.95

plus shipping \$4.50 US Mail - \$7.50 Foreign

Free Catalog Packed with all kinds of books for Amateur Radio, SWL, CB and electronics professionals.

(800) 457-7373

Radio Bookstore



PO Box 209



Rindge, NH 03461-0209

603-899-6826 24 hour FAX

Helpful Hints

If you want increased range from your CB walkie-talkie, consider buying one that accepts a full-size telescoping antenna. The flexible rubber duck antenna is fine for close-in communications. It won't get snapped off by low-hanging tree branches or backyard obstacles, but you compromise longer range communications for the convenience of a short antenna.

Treat your new CB purchase with care. Remember, it's a delicate piece of electronic gear. Dropping, knocking or abusing it can cause intermittent operation and void your warranty.

Got a cellular phone? Maybe you've just bought a new ham radio, too. Very often cell phones have dead spots, and even though you've programmed all the latest repeater frequencies in that new ham radio, you still can't get assistance on the highway. It won't hurt to get a small mobile CB. Tuck it in the glove compartment. When you need it, it's there.

The CB Jamboree Calendar

1995

November 4-5, 1995

Haines City, Florida
Traveling Knights CB Radio Club
Contact: Donald & Hazel Darrin
813-421-4989

November 4-5, 1995

Tipton, Indiana
Tipton CB Club
Contact: Walter Baker,
1300 S. Washington Street,
Kokomo, IN 46962

1996

February 16-18

Yuma, Arizona
Contact: Ted Green,
12672 Tanja Drive,
Yuma, AZ 85364

March 16

Brownsville, Kentucky
Edmonson County CB Club, Inc.
Contact: Lo-Bo,
P.O. Box 245, Sweeden, KY 42285
502-286-4250

May 18-19

Decatur, IL
Soy City Breakers CB Club
Contact: P.O. Box 113, Decatur, IL
62525 217-428-1608

June 21-23

Tipton, Indiana
National Top-20 Jamboree
(sponsored by Muncie Maniacs)
Contact: Larry (T-Bone) White,
11 Center Drive, Muncie, IN 47302
317-288-6759

The above listing was provided courtesy The CB News Voice, 719 North Grant, Bloomington, IN 47408 812-336-7387 or 336-0363.



Stranded or out of gas? No problem. With your handy portable CB radio on channel 9, help is usually just a call away. (Photo courtesy Radio Shack)

mobile or base station CB, you'll find the only thing that is more fun than CB'ing is CB'ing and helping people!

How To Get Help on 9

- Select channel 9, key the microphone and say "Break channel 9." Then clearly broadcast your ID (your handle, name or callsign), the location of the incident (Route 87, a mile south of Exit 12, etc.), the nature of the problem (an accident,

disabled vehicle), and what assistance is required (an ambulance, tow truck, the police)

- If there are injuries, state what they are, if possible.

- Even if no one comes back to your call, repeat your full message every minute or so, pausing to listen for a response, for at least 10 minutes. It may well be that an assistance monitor can hear you, but you can't hear them.

- If you need to, try other active CB channels for assistance. ■

If you need help on the highway, remember "CLIP."

- C** — **Call sign.** Repeatedly give your call or identify yourself clearly.
- L** — **Location.** Repeatedly give your exact location; road number, direction of travel, city and state.
- I** — **Injuries.** Are there injuries? Repeat this information as well.
- P** — **Problem.** What is the problem? (Accident, out of gas, dangerous situation, etc.)

Be sure to repeat the above information several times, pausing a few seconds between each group of information and at the end of your transmission, listening carefully for a response. YOU MAY NOT hear a response, even though a monitor has heard your call.



(Courtesy REACT)

Talkin' That "Good CB"

Open the box, connect the power cord, and plug in the mic, but you're not an official CBer just yet . . .

BY TOM KNEITEL, K2AES

CB is a wonderful way to become introduced to the hobby aspects of two-way radio. With only a small investment, and no need for an FCC exam, a person can be on the air very quickly from a car or home base station. In general, Cbers tend to be warm and friendly folk, always pleased to welcome newcomers to their ranks.

The owner's manuals supplied with CB radios explain everything you need to know about installing the sets and what the different controls do. But it's not in the scope of the owner's manuals to point out the various CB operating traditions, practices, and taboos that help the Cber assimilate easily into the world of CB. These are important things to know. We'll give you the inside track on the basics of being a good AM mode operator, whether you're a newcomer or a seasoned old-timer.

Getting a Handle on Things

AM mode operators identify themselves and others using "CB handles," or nicknames. In fact, a handle not only identifies the station, but also the operator—personally. Each operator has the opportunity to select his or her own CB handle, so some thought must be put into its creation. Sadly, it doesn't appear that all handles are well chosen, and end up making some operators sound rather silly to others.

For instance, just within the past few weeks I've heard the CB handles "Horse Thief," "Fathead" and "Rhino Breath." These are handles that may have seemed hilarious when first conceived, but not much thought had been given to how their owners would be perceived by others. Hardly the best way to begin a CB career.

The best CB handles are based on the occupations, hobbies, names, or some accomplishment of the operators. And, sure, there are some clever or funny CB handles that come from left field or were even phoned in from another dimension. After nearly 20 years of CB handle history, it's virtually impossible to come up with anything that hasn't been thought of before. I've hooked up with about a hundred other "Tomcats" in the many years it's been my CB handle.

A few excellent handles I recently heard include "Shutter Bug," "Gear Jammer," "Jim Dandy," "Flying Nun," "Wild Bill," "California Kid," "Doctor Strangelove," "Road Runner," "E-Z Rider," "Grandpa Joe," and even "Neon Cactus."

Ready, Set . . .

Once you've selected a CB handle, you should know that one of CB radio's unofficial traditions and courtesies is for operators in AM mode to use channels 1 through 35. Channels 36 through 40, in most areas, are voluntarily used on an exclusive basis by single sideband (SSB) operators. This is because AM and SSB modes interfere with one another when they share

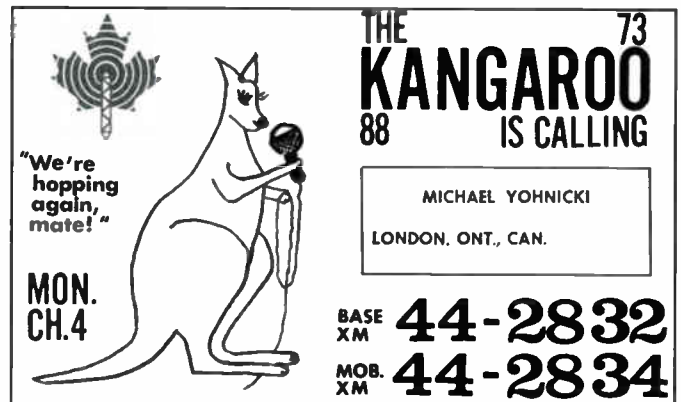

"We're hopping again, mate!"

MON. CH.4

THE KANGAROO 73 88 IS CALLING

MICHAEL YOHNICKI
LONDON, ONT., CAN.

BASE XM 44-2832
MOB. XM 44-2834

Mike, "The Kangaroo," notes on his attractive QSL that he monitors Channel 4.

channels. Your communications will be best served if you continue this practice and encourage others to do so, too.

Channel 9 is reserved exclusively for emergency use and by mobile units seeking road information. In many areas of the nation, there are volunteer CB groups monitoring channel 9 for these calls. This is a useful feature of CB, but it requires that the channel be kept clear of hobby chatter.

Channel 19 is the unofficial primary mobile in-transit channel where drivers exchange highway information. While mobile units are encouraged to use this channel, base stations are welcomed like foxes at a chicken convention.

Most communities and neighborhoods have one especially popular CB channel where local operators congregate. Tune around the band to find this channel because that's the channel to monitor to seek out and meet new CB friends.

. . . Now Go!

Many operators think they need to "break a channel" or ask for a break before using a channel. For years, the practice has been promoted in all movies and songs relating to CB. I have heard hapless Cbers spend more than five minutes begging for someone to come back and grant them permission for a break on an otherwise quiet channel. Obviously, the logic of such a break managed to get itself lost somewhere between Nashville and Hollywood, so let's see if we can find it.

If a channel is actively in use, it's courteous to ask for a break if you want to join in on the conversation, or if you need to interrupt to make a brief contact ("short-shot") with another station. If a channel is quiet and not in use, however, there's absolutely no reason to announce a break, nor to ask for one from an

JGAR PISTOL

UPS SHIPPABLE



JG 3 + 3 STAR

UPS SHIPPABLE



WE'VE GOT THE FIELD COVERED!

JO
GUNN
Antennas

JG-4
CONVENTIONAL

UPS SHIPPABLE

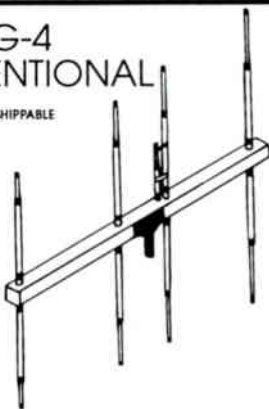

Route 1 Box 32C, Old Hwy 82
Ethelsville, Alabama 35461
(205) 658-2229
fax (205) 658-2259

Hours: 9am - 5pm (CST)
Tuesday - Friday



JG 4 + 4 CROSS

UPS SHIPPABLE

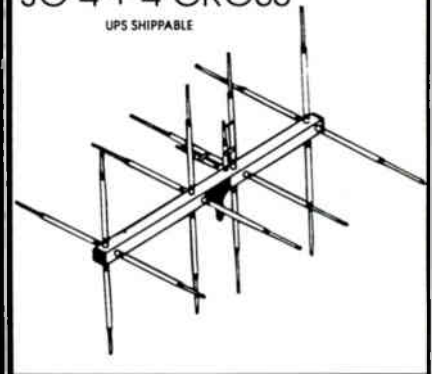

Other Models & Sizes Available in 10 or 11 Meters

Call or send \$2 for Complete Catalog and Pricing of Antenna

DEALER INQUIRIES, PLEASE CALL



"Charlie Delta" is the handle of a CBer whose name is (you guessed it) Charlie. His QSL card shows that he enjoys fishing.

apparent net control station. Courtesy and common sense should prevail.

Certainly, new CBers shouldn't be bashful. While it isn't a good idea to attempt to inject yourself into a contact on an obviously private matter, most CB contacts are hobby chit-chat and will welcome those who ask to join in. CBers love to chatter about CB itself, as well as sports, their jobs, the weather, cars, TV programs, scanners, vacations, and dozens of other topics. It's easy to stir up a spirited round-table on practically any subject, with as many as a dozen CBers joining in. Moreover, every possible viewpoint is expressed, from the serious to wisecracks.

Pushing the Envelope

As free-form as CB can get, there are a few things that annoy more operators than they amuse. Things to steer clear of include on-air arguments with other CBers, barnyard sound effects, music, causing deliberate interference, and locker-room language.

CBers who repeatedly ask for "radio checks" or "10-36" (the correct time) rapidly wear out the patience of other local operators. Also, CBers intending to engage in a lengthy chat would be best advised to hold it on a normally unused channel rather than tying up the local monitoring channel.

"Shooting Skip" (working distant stations at those times when they can be heard due to ionospheric signal reflection) is not allowed in the U.S. or Canada. On the surface, this may appear to be harmless fun. But given that the AM mode CB hobby takes place on only 33 channels, the practice creates enormous interference and can block local CB contacts. Luckily for those who really want to work distant stations, an amateur radio license is now easier to get than ever. Amateur radio encourages this type of operation on bands especially established for long-distance communications, and a great many operators enjoy both hobbies.



The walls of a well-appointed CB radio room are perfect for displaying club membership certificates as well as QSL cards. This is John's station, in Pennsylvania.



Lisbeth, a CBer from Lulea, Sweden, posed for this photo when she visited a CB/ham station in California.

Every CBer will observe annoying practices, to one extent or another. The trick is to avoid them because they work against the enjoyment and usefulness of CB radio.

The Lingo, by Jingo

Thank goodness, much of that corny pseudo-trucker CB lingo the media was pushing 20 years ago has been filtering out of the essential vocabulary of the AM CBer. Seldom do you hear a "negatory," a "pedal to the metal," or "mercy." The once-popular term "good buddy" has gone through several changes of meaning over the years. Nobody seems exactly certain what it means any longer. Whatever it may be, these days most CBers appear distinctly unamused when addressed with the words.

In reality, there are about two dozen terms in CB lingo that

Essential CB Lingo Directory

Big 10-4	I agree with you 100%.
Bring it on back	I'm listening for your reply.
County Mountie	Deputy sheriff.
Crystal clear	Your signals sound good.
Evel Knievel	Motorcyclist.
Four wheeler	A passenger car.
Got your ears on?	If you heard me, please reply.
Granny lane	Right (slow) lane of a highway.
Greenstamps	Money (also speeding fines).
Hammer Lane	Left (passing) lane of a highway.
Home 20	An operator's base station.
How about it?	If you heard me, please reply.
Landline	Telephone
Picture taker	Police radar.
Piggy bank	Toll plaza.
Plain wrapper	Unmarked police car.
Rig	The CB radio.
Roger-D	I agree with you 100%
Sandwich lane	Center lane of a multi-lane highway.
Smokey	State trooper.
Super slab	Interstate highway.
Tijuana taxi	Marked police car.
Walk it on back	I'm listening for your reply.
What am I hitting you with?	Give me an S-meter reading.
What's your 20?	Where are you located?

are heard all the time on the AM channels and should be considered essential. Other terms are heard, but not to the same extent. My intention is to give you the basics (see box) so that, once familiar with these terms, you'll be able to mix it up like a pro on any channel where AM mode is in use.

The QSL Card

Some operators like to swap or exchange "QSL," or station, cards. Very often this is done as a sideline to the hobby, where the cards are swapped with other operators and collected like baseball cards. Or, in a more traditional sense, they can also be exchanged in response to actual on-air contacts.

These cards are designed by the operators, and show their CB handle and any other relevant information such as monitoring channels. They are usually colorful, interesting, very personal, and lots of fun to exchange, collect, and display.

All the Good Numbers

At the end of a contact, CBers traditionally wish one another "all the good numbers." There are several good numbers in CB-land when it comes to finishing a conversation on the AM channels. The number "30" means "the end," while "73" means "best regards." Those are the best numbers and are a fitting end to a pleasurable CB contact.

Let me just leave you with a reminder that the information presented here relates only to operations in the AM mode. SSB operation is used by far fewer stations than AM mode. SSB operators use operating techniques that differ considerably from those described in this article and should be explored separately.

For now, I wish my readers the good numbers! ■

INCREASE AVERAGE TALKPOWER TO APPROXIMATELY 90%

Now The SP-1a Used In The Ranger
AR-3300 & AR 3500 Is Available
For CB!

\$49.95 + shipping

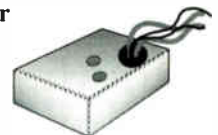

- Variable Compression Up To 110dB Dynamic Range
- Works Well With Stock Or Amplified Mic
- Improves Tone Quality
- Processor Completely Bypassed When Turned Off
- Easily Installed In Most CB And Amateur Radios
- Professional Quality, Made & Tested In The USA
- Variable Input Control – Reduces Background Noise
- Dimensions 2 1/2" x 1 3/4" x 7/8"

Easily Installed Inside The Radio, Simply Cut The Mic Input Line
At The Mic Connector And Locate The 12 Volt DC Line.

Visit Our Retail Store

• Anttron • Astatic • Connex • Galaxy • Hustler • Midland • Uniden •
• President • Pyramid • Ranger • Road Noise • Sadelta • Solarcon •
• Valor • Wilson • Yosan • & More...

Bob's CB

72 Eastern Avenue
Malden, MA 02148
(800) 473-9708

CB Handles: A Chance to Undo What Your Parents Did

Your CB handle is something YOU create—it's yours, so choose it well . . .

BY BILL PRICE, N3AVY A/K/A THE CHISELER

By now you know how to pick a CB radio, how to install it, how to pick an antenna, how to use the radio and how to keep it all performing year after year. When you have it all ready to go and get to the big moment where you ask for your first "radio check," whaddya gonna say when they ask you, "What's your handle?"

You might not assign a high priority to selecting your CB moniker—"I'll think of something later on," you'll say, but don't count on it. Everyone I know who just grabbed the first handle that came to his mind has been stuck with that handle *forever*—some to their eternal dismay—just ask my friend, *Stinky!*

I became *The Chiseler* because I am a sometimes woodcarver. I once met another *Chiseler*, so while we traveled the same highway I used my full nom-de-mike, *The Underhanded Chiseler*. My friend Al has a similar problem with his handle, *The Virginia Creeper*—it's a popular handle in these parts, because it's a popular vine in this state, and because many professional drivers like Al are indeed *creepers* when they're pulling a heavy load on the uphill side of the Blue Ridge Mountains. One of my CB listening pleasures is to run into two professional drivers with the same handle heading in the same direction.

"Well, I was the *Virginia Creeper* when Noah was puttin' his animals on the Ark," one *Creeper* says.

"Oh, yeah?? Well a couple hundred pages before that, *this Virginia Creeper* was pickin' apples in the orchards at Eden! I am the gen-yoo-wine bona fide, original, firstborn one-of-a-kind *deeluxe Virginia Creeper*, and you, sir, are merely a cheap imitation of the original—and not a very eloquent one at that!"

If either of these professional drivers knew how much entertainment they provided to the hundreds of "fans" listening to their good-natured wit, they'd probably start selling commercials. Be advised, though, *Virginia Creeper* has been taken many times over, so unless you are willing to join the competition to see who is the *gen-yoo-wine Virginia Creeper*, per-

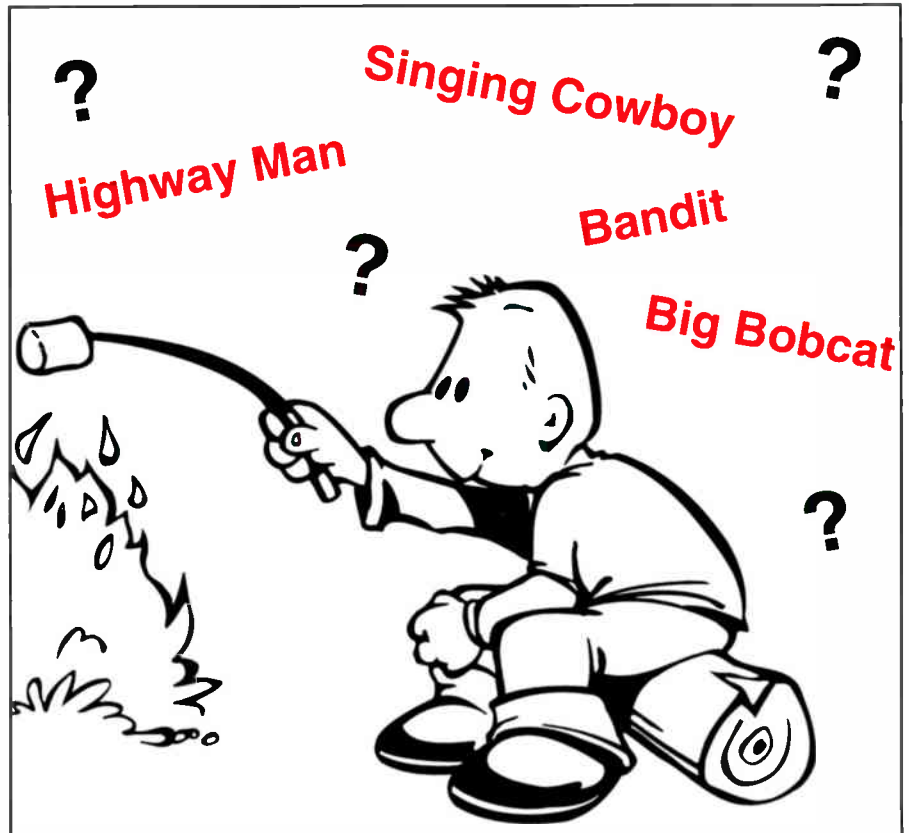

haps you'd make a good *Kudzu*, if you must name yourself after a southern vine.

Modify a Popular State Name

If you think you're the first Okie or North Caroliner to call yourself *The Sooner*, or *The Tarheel*, better pick a more definitive sobriquet like the *Red-Headed Tarheel* or the *Tulsa Sooner* if you're from the town Hoyt Axton calls the "Cultural Center of the Universe." If you're a Minnesotan, it might be safe to call yourself *The Gopher*, since not many folks use that state's alternate nickname, *The Gopher State*. Throw in something about yourself that sets you apart from the thousands of other *Lone Star* Cbers—make yourself the *Under-Par*

Lone Star if you hit your tee shot from Texarkana to El Paso. You can bet that there's already enough *Lone Star Diesel-Cars* on channel 19, so scratch a little deeper. Drop a couple bucks on a rhyming dictionary to work on your new handle—I'll bet some folks would pay you good money to work them up a classy handle like the *Under-Par Lone-Star Take-You-Far Diesel-Car*, though I wouldn't quit my day job 'til the checks clear.

A Psychologist's Field Day?

Somehow, self-deprecating humor—making fun of yourself—is used quite a bit on the radio. I guess the anonymity of the microphone makes it OK to call your-

self *Baldy* or *Fatso*, *Beanpole* or *Ugly Mug* on the air, though unless you're what the shrinks call *really comfortable* with yourself—warts and all—then I'd pick one a little less painful. I also heard a young woman I knew to be very attractive call herself *Ugly Mug*—she explained it kept her from being "hit-on" so often.

An Adjective and A Noun

A modifier and the name of a person, place or thing. *The Green Gizzard*—*The Big Bobcat*—*The Little Leprechaun*. That's the easiest way to make up a handle—a good handle. No imagination? Drop by your bookstore and pick up a copy of J. I. Rodale's *The Synonym Finder*. It's better than many thesauri, and you can use it to find the best word for any occasion (my copy listed over 130 alternatives to *big*, including such tongue-twisters as *Brobdingnagian*, *voluminous*, *stalwart* and *gargantuan*). I wouldn't recommend these adjectives—they're hard to say and to understand—but they give you an idea of the choices you'll have when you want another way to say *big*.

The Double Entendre

Okay—so I lapsed into my native tongue—call it a double *meaning*. It's an area where you can be wryly suggestive, or downright silly—but please—be thoughtful of some of the younger and more naive listeners, and if you pick a name with an off-color meaning, make sure it's well concealed. First names such as *Ima*, *Izzy*, *Betty*, *Woody*, and *Willy* can pair up cleverly with last names such as *Looker*, *Ready*, *Wood*, *Tryit*, and *Getter*, but I'm sure you can do better than those (my wife just read this and *she's* sure too!). If you're a credit manager, you might call yourself *Helen Waite*.

Good Old Fargo

Eons ago, in a world far away, I worked with a fellow whose last name was *North*. At that same time, on *Sesame Street*, there was a character named *Fargo North*, *Decoder*. I'm sure my friend wasn't the only *North* who got called *Fargo*, but it was sure better than his previous handle, which was *Balloon Tooth*. No—I haven't the slightest idea *where* he got it or what it meant, but I can tell you no one he ever spoke to forgot *that* handle.

Be sure not to offend anyone who might be listening, and pick a good handle—one that's fun, easy to understand on the crowded airways—maybe even one that makes people laugh. Life's supposed to be fun. And please—don't pick *Balloon Tooth*!

Don't let your antenna kit or accessories be the weakest link in your system.

BLAST the AIRWAVES



Speakers

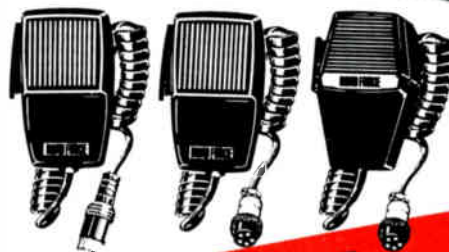

Microphones



Coaxial Cable

Antenna Kits



Mounts

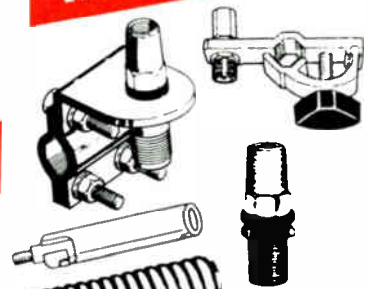

ROAD FORCE™

Dealer Inquiries
Dragon Distributing
800-825-3746

ROAD FORCE products are available where CB Radios are sold.

CB Not Working? Here Are Some Troubleshooting Tips

Keep your cool when it comes to being your own troubleshooter. You'd be surprised how many problems you can fix yourself. . .

STORY AND PHOTOS BY HAROLD ORT, N2RLL

If the darned thing works, leave it alone. While that's sometimes good advice, there are those times when you just can't control yourself and taking action to get that old, tired CB working again is your only choice.

Over the past few years, I've learned a few radio things by "doing"; sometimes doing the wrong thing, sometimes the right thing. But after doing all these radio things; including dropping, watering, reverse-polarity totaling, over-modulating, and others I can't (and don't want to) remember, my two CBs and assorted ham gear looks and operates like new. Why? Because unlike many radio enthusiasts and general tinkerers, I know when to quit and call in a professional.

Lots of times though, that "dead" radio isn't really dead after all. Many times it's something you CAN fix yourself—without too much sweat.

Live Long Enough To Buy Lots of Radios!

It's important to remember a key point when it comes to tracking down a radio problem. Electricity. It's a killer. There probably isn't a CBer or ham alive (no pun intended) that hasn't received at least a jolt or two doing something that he or she shouldn't have been doing. So, please remember that it doesn't take much electric current to pass through your heart to kill you. Even your car's battery, which produces lots of amps quickly, can kill you if you aren't careful.

A Few Basic Safety Tips To Keep You Alive

- Always disconnect equipment and power supplies BEFORE opening the cabinet
- DON'T open the cabinet if you (like most of us) don't know what you're doing

- Cover exposed wiring, either with electrical tape or heat-shrink tubing
- Connect your equipment to a good earth ground
- Consider putting your radio equipment on a separate circuit breaker, even with a manual shut-off located in your shack
- Don't get in over your head. Know when to take your radio to the repair shop.

Tracking Down Problems

Fixes to some of the more common CB problems are often easier than you think—many are, in fact, very simple and sometimes the problems are our own fault in the first place. To begin our troubleshooting we must first identify the problem, and then consider the proper course of action as outlined in the following paragraphs:

1. No power, no lights, it's dead. Have you checked the in-line fuse? If it's blown, there's always a reason. Perhaps the power wires themselves have cut or exposed wiring. When replacing the in-line fuse, always be certain to follow the manufacturer's recommendation for the fuse. Also, never use a "slow-blow" fuse. Most power cords are fused; if it isn't in-line, carefully unscrew the cigarette lighter tip to locate the fuse. Remember, the fuse is there to protect your equipment.

Is your power source dead? If mobile, how have you wired the radio? Perhaps you should turn on the ignition.

If you're using NiCd batteries, they typically lose their charge (from full) at the approximate rate of 1 percent a day. So, if it's been 3-4 months since you last used your NiCd-equipped walkie-talkie, it's a good bet they need to be recharged.

If you're at your base, is the wall outlet working properly? Older outlets frequently develop problems. Many times, I've unplugged my equipment prior to an electrical storm, only to forget to plug it in

a couple of days later. What a relief when you realize it's a simple problem.

Have you observed the correct polarity when inserting the batteries?

Check the power cord again. Is it tightly plugged into the back of your rig?

2. Intermittent power. The radio turns on and off. If you're operating from your vehicle's cigarette lighter receptacle, try cleaning the socket with a large swab. Sometimes, especially if you smoke, all kinds of junk accumulates on the contacts, making a good electrical connection nearly impossible.

If your radio is smoking and sputtering more than you are, unplug it and take it to your nearest CB repair center. Don't open the unit and attempt to fix it yourself. This is a blueprint for disaster. Let's face it, the radio cost \$50-300 brand new. If it's new and smoking, return it to your dealer. If it's well out of warranty, you probably deserve a new radio anyway. Go for it, unless it can be repaired for a few bucks.

Have you dropped the CB? Those tiny solder joints (that's assuming they were perfectly soldered to begin with) and circuit boards can, and do break.

3. The lights are on, but there's no receiver volume. Aren't you lucky. Maybe it's simply that you've set the squelch too high. Try adjusting the squelch counterclockwise.

Is your mic plugged in? Some radios only power the lights/meters, etc. until the mic is plugged in.

Is your antenna connected to the CB? If not, most of the time you'll hear a faint hiss, but the noise gets much louder when the antenna is connected, even if the channel is unoccupied.

Are you using the PA function? Simply switch back to CB.

If your radio has a headphone jack, are the headphones plugged in? If not, the wires connected to the speaker might be loose or broken.

4. The CB works, but when the vol-

Strict Quality Standards To Guarantee The Best Performance

For over 20 years Sirio has worked to develop a hi-tech product line, which includes the best quality components at very competitive prices. If you want your company to have a big quality improvement, change to Sirio, the leading edge of technology.

SIRIO 827

SIRIO
antenne

46049 VOLTA MANTOVANA - MANTOVA - ITALY - Tel. (39) 376/801515 - Fax (39) 376/801254

Products include wide range of antennas and accessories CB-VHF-UHF

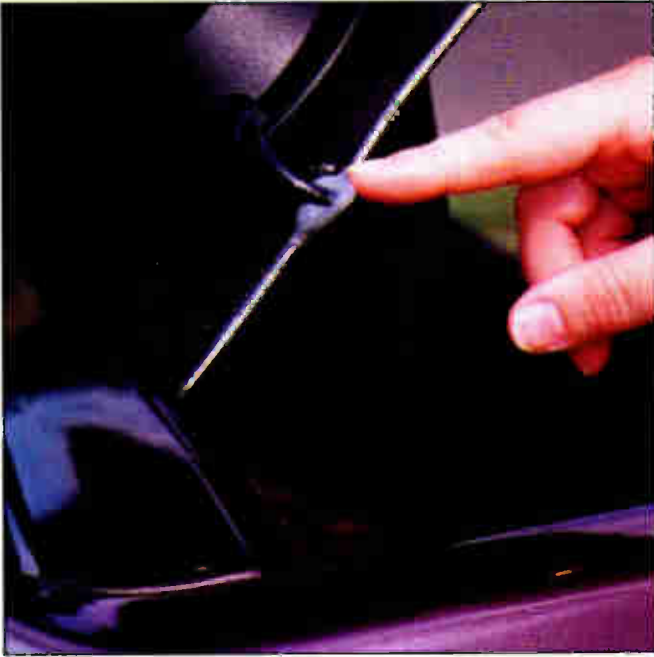

Keep your coax from getting crunched by a car door or trunk by carefully examining how the coax fits through an opening, BEFORE you decide on a final antenna location. Then, try covering the coax with some sealant where the cable comes in close contact with the vehicle. Intermittent operation or abnormally high SWR are signs of broken or loose coax cable.

Clean the moisture from under the magnet every few days. You'll be surprised how your SWR will improve. ▼



ume is adjusted the noise is unbearable. Chances are you've got an older CB and the volume control needs cleaning or replacement. Cleaning the control is easy. Run down to your local electronics

retailer and get a can of contact cleaner. Nothing else will do; not alcohol (it contains WATER), or over-the-counter alcohol-based anything. DISCONNECT THE POWER! The can of contact cleaner has



Ensure the power cord is tightly and properly connected to your CB. A loose-fitting cord is a cause of touch and go operation.

Make sure you use the correct size fuse and adhere to the manufacturer's recommended rating. Remember, the fuse is there to protect your equipment and shouldn't be eliminated from ANY power connection to your radio. While you're at it, inspect all your power cables and cigarette plug assemblies for proper operation. ▼

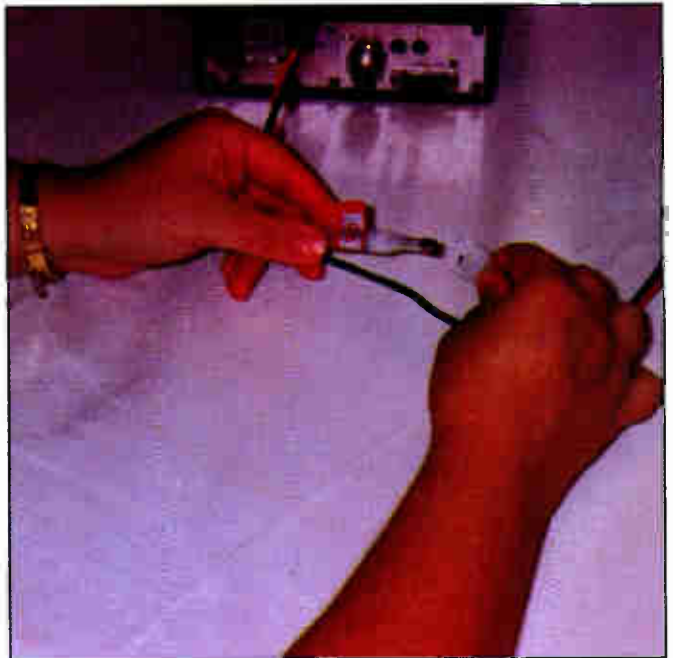

a long plastic nozzle. Use it, spraying ONCE into a tiny hole of the control. (Of course you've already opened the case) Turn the control fully each way, and if possible blow gently on the control. (Some

folks use a spray can of air that's available at the local stationery store. It's used for cleaning dust from keyboards, etc. You can also use it to clean the dust from your radios!

Sometimes the control is simply shot. This is usually an easy fix that your nearby repair shop should be able to handle relatively inexpensively.

5. The SWR is REALLY high, according to the built-in meter. Stop transmitting right away. While there's a remote chance the meter is defective, it's more likely you've got a serious antenna or cable problem. If you haven't mounted your magnetic-mount antenna in the center of your vehicle's roof, now is a good time to do so. If the SWR is better than before, but still not ideal (1.5:1 or so) inspect the coax cable. Have you taken care of it, or when storing the antenna, have you tossed the antenna in the garage where the kids will trample over the cable and the dog will chew the PL-259?

Did you just finish soldering the PL-259? If you did, there's a really good chance you botched the job. Cut the PL-259 off and try again. Better yet, have a friend who's an expert at soldering show you how. It takes some patience, and experience to do it the right way. How about the coax "jumper" cable. Is it new? If not, try another one; all jumper cables are NOT created equally.

As crazy as it sounds, is the antenna connected to the CB? Don't laugh, it happens. At least you didn't keep the mic keyed for five minutes while you tried to figure out the problem, did you? Good-bye radio if you did.

If you've connected a gutter-mount antenna or trunk lip-mount, is there a good connection where the set screws contact your vehicle? It always pays to scrape the paint from where the screws will make contact.

Using a magnet-mount antenna? Be sure to tilt (NOT slide) the magnet and wipe away any moisture from time to time. Dampness and dirt cause high SWR.

If you're operating from your base station, is your CB antenna in very close proximity to your TV or ham antenna? Is anything touching the antenna? I once had a standard vertical CB antenna mounted on a couple of 10-foot poles. Trouble was, the metal rain gutters caused a fairly high SWR. The choice is simple. Since we're not about to give up our CB, either replace the gutters or move the antenna to another location away from metal gutters, siding, antennas, etc.

6. Other operators say your signal is good, but report your voice crackles and there are other unusual sounds. It's possible you have a mic problem; maybe the mic cable is shorting out or the mic itself needs replace-

ment. After replacement, if the problem persists, it could be a technician's problem inside your radio.

7. You turn on the CB and receiving stations groan, howl and sound otherwise terrible. If you're using an AM/SSB rig, chances are you're receiving AM stations with your mode selector switch in either LSB or USB. The same is true if your

CB is misaligned or has an internal defect that's a technician's problem.

These are by no means ALL the fixes for all your radio problems, but it's a good start. Most dealers, including the ones we've talked to, will always tell you that most problems you'll encounter are problems you can correct yourself. Good luck and 73's. ■

CANADIANS ONLY!

Canada's Largest (and best) CB
mail-order store gives you
seven good reasons to buy from us.



No... Long Waits

(All in-stock items ordered by noon are shipped same-day. No delays at Canada Customs. We ship via Post and UPS.)

No... Duty fees

(Know the exact total when you order not when you receive it.)

No... Warranty Hassles

(We repair or replace defective items right on the premises.)

No... Hidden Charges

(The price quoted is the only price you pay. We include services the other guys can't provide or charge extra for.)

No... Prepayment Required

(We accept Visa and Mastercard or for a small fee you can have your order shipped C.O. D. and pay for it when it arrives.)

Best Prices in Canada

We will meet or beat any advertised price in Canada.

Best Selection in Canada

Over 2000 brand-name items for you to choose from.

****NEW** 50 PAGE '96 GIANT CB CATALOG!**

Full illustrations and descriptions of all kinds of CB radio equipment, scanners, marine radios, and more. **ONLY \$3.00!**

Check out our web site! <http://durhamnet.com>

Durham Radio
Sales & Service Inc.

350 Wentworth St. E. Unit #7
Oshawa, Ontario, L1H 7R7
Phone: (905) 436-2100
Fax: (905) 436-3231

The General Mobile Radio Service—GMRS At Your Service

Here's the latest on an ever-growing personal communications service . . .

STORY AND PHOTOS BY BILL SIMPSON

The General Mobile Radio Service (GMRS), originally known as Class A CB radio, operates on FM (Frequency modulation) in the UHF band at 462 MHz. In contrast, CB radio operates AM (amplitude modulation) in what is essentially the high frequency band at 27 MHz. GMRS gives the same type of communications heard in many of the police bands, allowing very little inter-modulation, "skip" or DX. Some ducting or band openings, similar to skip, can be experienced during abnormal weather conditions, but interference is normally not a problem. Typical range on "simplex" is comparable to that of CB, while range on "duplex" extends beyond 40 miles, depending on terrain.

Simplex or Talk Around

The term "simplex" or "talk-around" signifies two or more GMRS stations operat-

ing on the same frequency, for example 462.600 MHz in direct line-of-sight communications. Ranges of one-half to one mile are common for handheld walkie-talkies, while ranges between mobiles typically are between six and 10 miles. The key to the range is the terrain and the antenna's height above ground, rather than power of the stations.

Duplex

While the term "duplex" is commonly used while discussing repeater operation, the correct term should be "half-duplex". The telephone lines are considered "full-duplex" since we are able to hear and talk at the same time. Using a repeater, which is nothing more than another radio mated to a very high antenna, radio users can either talk or listen, but may not do both simultaneously. Radio user "George" speaks into his

GMRS radio transmitting a signal on frequency 467.600 MHz. The repeater "hears" the signal and retransmits on 462.600 MHz to "Jacki". As Jacki speaks, the entire process is reversed. Each radio transmits on the 467 MHz and receives on 462 MHz. This is called a frequency pair. The eight GMRS frequency pairs in MHz are:

Transmit	Receive	Transmit	Receive
467.550	462.550	467.575	462.575
467.600	462.600	467.625	462.625
467.650	462.650	467.675	462.675
467.700	462.700	467.725	462.725

In addition, there are seven other GMRS frequencies available for low power simplex use. These frequencies, called interstitials are:

462.5625, 462.5875, 462.6125, 462.66375, 462.6625, 462.6875 and 462.7125 MHz.

While the process sounds complicat-



Tom and Tina Davis, KAE 7107 using their GMRS radio.



Mary Lou Hiltibran chatting using KAE 5313.



Race corner workers Barbara, KAE 9576 and Carron, KAD 9669 using GMRS and VHF to communicate during a recent race.



ed, it all happens automatically and users are never conscious of the change. The five MHz offset is programmed, (or controlled by crystals) within the transceiver, and does not require conscious effort on the part of the user.

One Repeater At A Time

In areas where several repeaters could be in operation, such as Chicago, New York City, Los Angeles, Detroit, Milwaukee, etc., it is essential to allow only one repeater to operate at a time. Each repeater is equipped with a special circuit which allows only signals which are accompanied by a specific sub-audible tone to be retransmitted. Again, this may sound complicated, but happens automatically. This function is called by various manufacturers: "Channel Gard", "Private Line", "PL", and even implies that communications are not overheard by other radio users on the specific frequency.

In fact nothing could be further from the truth! Every radio, and even cell or mobile phone users should assume that their communications are being heard by someone at all times. We are accessing the airwaves and radio signals can be intercepted. The entire concept here is to control the stations able to access any specific repeater, rather than control the stations able to receive transmissions.

What's Available Out There

GMRS users did not enjoy transceivers

dedicated to GMRS until late 1993, when Tandy Company introduced a low power, simplex unit that was incapable of either duplex or PL. Prior to that time, GMRS licensees used radios that were either synthesized for the 450-512 MHz band, were diode-programmable, or were crystal-controlled. GMRS handheld radios have remained rather expensive, ranging from about \$300 for a crystal-controlled walkie-talkie to \$500 and up for a five watt synthesized unit. There are newer, less expensive units available from several companies, but no information is available to this writer at this time. Mobiles available are generally designed for the 450-512 MHz band and have 30 or more programmed frequencies with multiple tone combinations available. Prices start around \$400 and can exceed \$1,000. Base stations tend to be a mobile attached to a 13.8 Vdc power supply and either an omni or "yagi" type antenna, with rather significant gain characteristics is used.

Some GMRS radios aren't capable of accessing a repeater or having the CTCSS (PL) tones installed.

While current rules do not require any test of radio knowledge, the FCC requires completion of a Form 574, and a \$60 fee for the five year license. The licensee is granted operation on two channel pairs, the seven interstitial frequencies, AND the 462.675/467.675 MHz pair for emergency and motorist assistance.

The granting of the license by the FCC allows every member of a licensee's family living within the same household to use the equipment. Obviously, all usage must be within the scope of the FCC Rules, Part

95A, and the stations must be identified periodically during conversations. Typical transmissions between family members, between friends or any combination are allowed. Many public service organizations use GMRS during neighborhood watches and community service activity that requires communications. Please note that each member of an organization must obtain a license to be in compliance with the FCC's rules.

As this is written, an amendment concerning the de-licensing of GMRS, along with certain forms of marine and aviation radio is being considered with a bill in the House of Representatives and a Notice of Proposed Rulemaking (NPRM 95-102) awaits a decision by the FCC. ■

For more information on GMRS, please contact:

REACT International
P.O. Box 998
Wichita, KS 67201

The Personal Radio Steering Group
P.O. Box 2851
Ann Arbor, MI 48186

W.F. Simpson
12276 Tyler Avenue
Waukegan, IL 60087

REACT Volunteers Respond to Oklahoma City Bombing

They've spent years training, preparing for such a disaster. The test came in April . . .

BY GAYLAND KITCH
Emergency Manager City of Moore and REACTer

A force of trained radio-equipped local citizens provided skilled assistance alongside national professionals during the response to the bombing of the Federal Building in Oklahoma City. These volunteers are members of REACT—Radio Emergency Associated Communications Teams—a worldwide organization made up of citizen radio operators. As with REACTers worldwide, the Oklahoma City area volunteers have spent years training and equipping for community emergencies, in addition to providing assistance to motorists via Citizens Band emergency channel 9. This planning paid great benefits by giving REACT members the tools they needed to provide a professional service to their communities.



Fire rages from a simulated crash between a mass transit bus and military attack fighter. (Courtesy Richard Feinberg, University of Oklahoma REACT)

The Teams

REACT members are organized into local independent teams. In the Oklahoma City metro area, there are two such teams: Oklahoma County Emergency REACT Team #2620, and University of Oklahoma REACT Team #3916.

Oklahoma County REACT was formed in 1974, and has approximately 40 members. These volunteers monitor CB channel 9 for emergencies and travelers assistance, operate safety breaks at local interstate rest stops on holiday weekends, and provide communications and logistics support for a myriad of community events in and around Oklahoma City. The Oklahoma County REACT Team also serves as the emergency management (civil defense) volunteers for the City of Moore, just south of Oklahoma City. In this capacity, members are responsible for providing observation and warning of Oklahoma's severe weather, and for traffic/crowd control, damage assessment, and communications support during local emergencies.

The University of Oklahoma REACT Team is based in nearby Norman, and

consists of about 20 volunteers from both the community and the college. Like the Oklahoma County team, OU REACTers provide their community with assistance for many community events and are emergency management volunteers for the City of Norman. As a practical matter, both teams work extensively with each other, sharing manpower, communications, training, and response equipment.

Team Communication

Along with CB radio equipment, both teams own and operate commercial-grade communications networks. These networks are licensed by the FCC in the General Mobile Radio Service (GMRS), and operate at 462 MHz. The OU team operates a repeater on 462.675 MHz, which is located on a 60-foot tower on top of a twelve story dormitory at the university. With an antenna height of about

185 feet above the terrain and a 50 watt repeater, REACTers have a communications radius of 15-20 miles using hand held radios, and up to 75 miles with mobile equipment. Similarly, Oklahoma County REACT operates a repeater on 462.600 MHz, located in Oklahoma City. In addition, the Oklahoma County group has a mobile repeater which can operate on either REACT frequency. The repeater is mounted in a disaster response trailer, allowing repeater communications outside the normal coverage area, or as a backup to the fixed repeaters.

When close-area communications are needed, the teams have the capability to switch from repeater operations to simplex, or radio-to-radio transmissions. All radios in the system are configured so that operations can be conducted on either team's frequency, so communications during events where members of both teams are working pose no problem. This also allows for personal communi-



Oklahoma County REACT President Bob Kaster coordinating crowd control and exercise security via GMRS radio. Also notice the pager on his shoulder. (Courtesy Richard Feinberg, University of Oklahoma REACT)

cations between members of both teams, increasing the versatility and reliability of the system, and promotes a spirit of friendship and cooperation between the volunteer teams.

Many of the Oklahoma City area REACTers have taken advantage of a low-cost alphanumeric paging system offered via the local emergency management community. Up to the minute weather information is broadcast to these pagers from the Oklahoma County Emer-

gency Operations Center, in addition to group-page capability for REACT and Red Cross, and personal use.

Other than the repeater equipment, most of the radios used by the REACT volunteers are owned by individual members. In addition to the GMRS equipment, REACTers will also use CB radios, cellular phones, and multi-band scanners. A few members are also amateur radio operators. Experience has shown that the diversity of the REACT radio capabilities



OU REACT President Shirley Kitch and Oklahoma County REACT President Bob Kaster conferring with City of Moore Emergency Manager, Gayland Kitch. (Courtesy Richard Feinberg, University of Oklahoma REACT)

allows for nearly 100 per cent dependable radio communications.

Constant Training

REACTers assist with many community events, primarily providing communications support, traffic and crowd control, and other logistics and manpower functions. All these tasks require the teams to provide professional training. This training comes primarily from local 9-1-1, police, fire, and emergency management instructors; a few of whom are REACT members themselves. Events generally allow a forum to put the classroom training into on-the-job experience. For instance, for many years the University REACT team has provided assistance to incoming traffic at concert events held at O.U.'s Lloyd Noble Center. This continuing project allows members to become proficient in traffic control, which in addition to being an asset for community events, is an important emergency management task. These events provide numerous training opportunities in logistics, decision-making and leadership, in addition to plugging REACT into the network of community leaders.

The teams also participate in emergency exercises with local response agencies. As an example, the Transportation Safety Institute conducted a life/safety exercise with the City of Moore last year. Acting under the direction of the city's Emergency Management Department, both teams participated in the event and also provided site security. During the exercise, REACTers assisted with taking simulated victims of a bus/aircraft accident to a nearby triage area and provided ground assistance for medical helicopter operations. After a break, REACT also handled crowd control for a second exercise, in which the bus and aircraft were set on fire.

The combination of this extensive planning, training, and experience were to prove of utmost value on April 19, 1995 and the following days.

The Bombing

Wednesday, April 19 began as a gorgeous spring day in Oklahoma City. The skies were clear, temperatures were pleasant, and even the normally-gusty Oklahoma winds were moderate. Downtown Oklahoma City was its normal self, with the business day just beginning.

At 9:02 a.m., a tremendous explosion rocked the entire area. Responders from all emergency professions, and citizen volunteers from all walks of life, soon found the north side of the Alfred P. Murrah Federal Building gone. There was

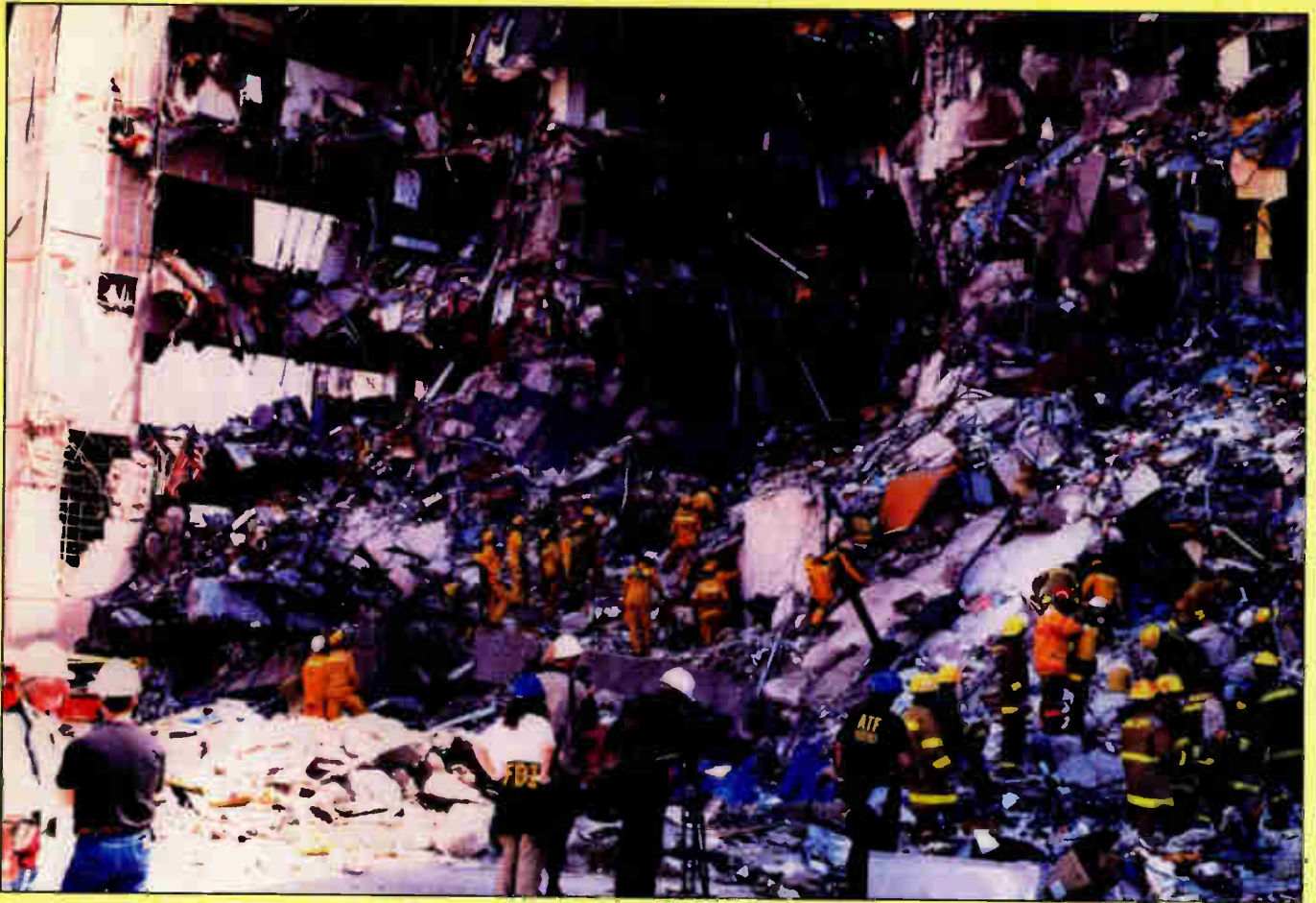

Massive destruction of the Murrah Building in downtown Oklahoma City. (Courtesy FEMA)

extensive damage to many other buildings in the area.

Cars in the parking lot across the street were burning, covering the scene with thick, black smoke. Glass blanketed the streets and sidewalks for several miles.

University REACT President Shirley Kitch was at work on the 15th floor of the Kerr-McGee Center, one and a half blocks from the Murrah Building, when the blast occurred. Her and her co-workers thoughts were that an airplane had struck their 29-story building. They immediately left their work area and proceeded to the first floor, where they found glass surrounding their building and security guards scrambling to keep order.

Ten miles southwest, Bob Kaster, President of the Oklahoma County REACT Team and a retired federal law enforcement officer, felt the blast while working in his yard. Upon learning of the event from local news media, Kaster began a quick rundown of preparing his members for a possible emergency response.

As a 20-year REACT veteran of the O.U. team and Emergency Manager for the City of Moore, I was also preparing for an emergency response. Sharing time for

concern of my wife's safety with my immediate duties as a dispatcher for the police and fire services of Moore, I along with Jeffery Haralson, initiated an alert of the O.U. team and coordinated with Kaster and the Oklahoma County team.

Members of these teams, even with their communications and disaster oriented training, did not immediately respond to the downtown area. One of the keys to the success of both REACT teams and REACT in general, is that the volunteer members provide a professional level-headed service when needed, but do not rush to scenes just to be there. Both Oklahoma City area groups have a good working relationship with their local law enforcement agencies—a relationship that in both cases took many years of work overcoming a stigma of being "ambulance chasers."

Radio Contact Established

Radio contact was established with the Oklahoma County Emergency Management Department (OCEMD), who requested the trained REACT volunteers respond to assist their activities. Official

emergency callout of both teams was made immediately. Members were asked to stage at the Moore Emergency Operations Center for assignment.

As members arrived, they were briefed on the latest information available, issued hard hats and emergency management identification, and grouped into teams of four. They would respond to Oklahoma City. By 11:30 a.m., 26 REACTers, including six from Grady County REACT based in the southwest Oklahoma town of Chickasha, were on-scene at the OCEMD Mobile Command Post.

The disaster response trailer of Oklahoma County REACT was also activated, responding to the OCEMD command post. This provided an on-scene staging area for REACT near the EM command post. It also provided a base GMRS radio used to coordinate the REACT members activities.

Numerous Tasks Performed

REACT members worked under the auspices of the Oklahoma County Emergency Management Department for the first two days of the incident, and per-

Save up to 44% on POPULAR COMMUNICATIONS

Get fast home delivery of Popular Communications and save \$15.40 a year over the newsstand price. Save even more on 2 or 3 year subs.

- 1 year—12 issues: \$22.95
(Save \$12.45)
- 2 years—24 issues: \$41.00
(Save \$29.80)
- 3 years—36 issues: \$60.00
(Save \$46.20)

Canada/Mexico—One year \$32.95 (\$22.95 + \$10 postage), two years \$61.00 (\$41.00 + \$20 postage), three years \$90.00 (\$60.00 + \$30 postage). Foreign—one year \$34.95 (\$22.95 + \$12 postage), two years \$65.00 (\$41.00 + \$24 postage), three years \$96.00 (\$60.00 + \$36 postage). Foreign Air Mail—one year \$82.95 (\$22.95 + \$60 postage), two years \$161.00 (\$41.00 + \$120 postage), three years \$240.00 (\$60.00 + \$180 postage). Payable in U.S. dollars only.

(Please Print Clearly)

Name _____

Address _____

City _____

State _____

Zip _____ 2CBG6

Check or Money Order Enclosed

Please charge my:

MasterCard 

Visa 

American Express 

Discover 

My account number is: _____ Expiration date: _____

--	--	--	--

Note: Allow 6-8 weeks for delivery of first issue.

For Faster Service Call:
1-800-853-9797
or FAX: 516-681-2926

Listening is only half the fun.

POPULAR COMMUNICATIONS is the other half.

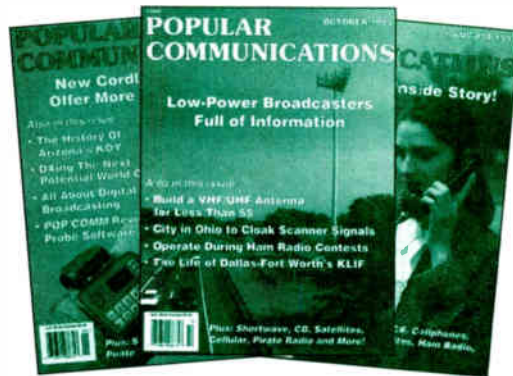

IMPORTANT: BE SURE TO ENCLOSE YOUR CHECK

FOLD HERE

The World's largest,
most authoritative
monthly magazine
for Short Wave Listening
and Scanner Monitoring.

Read by more
active listeners than
all other listening
publications combined!

If you enjoy radio
communications you'll love
Popular Communications.

**Subscribe now
and save!**

TEAR ALONG DOTTED LINE, FOLD OVER, AND SEAL

When sealing, please do not cover shaded area

NAME _____

ADDRESS _____

CITY _____

STATE _____

Zip _____

RETURN ADDRESS (Please Print)



BUSINESS REPLY MAIL
 FIRST CLASS MAIL PERMIT NO. 2055, HICKSVILLE, NY 11801

POSTAGE WILL BE PAID BY ADDRESSEE

**POPULAR
 COMMUNICATIONS**

*76 North Broadway
 Hicksville, NY 11801-9962*

NO POSTAGE
 NECESSARY
 IF MAILED
 IN THE
 UNITED STATES



SUBSCRIBE

TODAY

Let Popular Communications bring every facet of the radio hobby directly to your mailbox each and every month!

Popular Communications is the only widely read monthly magazine that covers the Citizens Band world with the user in mind. **POP'COMM's** own CB Scene columnist, Jock Elliott, keeps in contact with the manufacturers of CB gear just so we can keep our readers up-to-date on the latest in CB communications products.

POP'COMM also takes a look at what CBers are doing on the air in their communities not only in the US and Canada, but also abroad. The 27-megahertz CB band is truly an international band around the world and **POP'COMM** brings you the exciting news that keeps you current with the CB hobby.

In addition, **POP'COMM** will be featuring a look at the "other CB," GMRS, or the general mobile radio service, over the coming months. With the ready availability of these UHF handheld radios, more and more CBers are escaping from the crowded 40 channels to this virtually quiet FM band for personal communications. Read along as we check out what radios are available for this exciting band that compliments CB.

Popular Communications covers every aspect of hobby radio with columns on topics such as:

Scanning
CB Scene
VHF and UHF Bands

Amateur Radio
Pirate Broadcasting
Shortwave Listening

Cellular Telephones
AM/FM Broadcasting
Nostalgia

Antennas
Satellites
Digital Signals

We'll also bring you the latest news from the **Federal Communications Commission** that affects the radio hobbyist! And our **Shortwave Tuning Schedule** keeps you on time for your favorite international broadcasts.

If you enjoy radio communications - you'll love **Popular Communications** - **Subscribe today and save!** Use the handy postage-paid envelope bound into this issue; phone in your order to the 800 number below or complete this coupon below and mail or fax it in. We'll get your subscription started immediately!

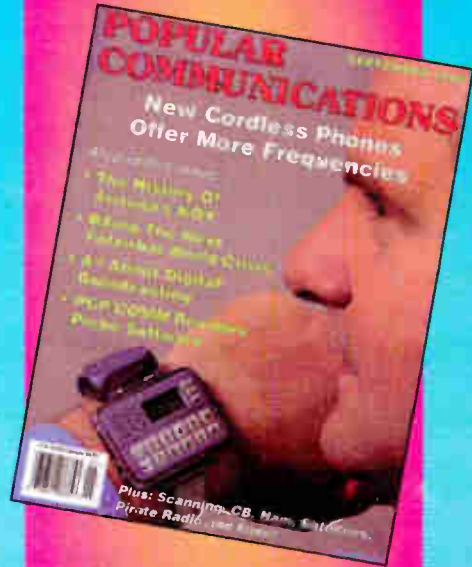

To Order Call Toll FREE 1-800-853-9797

Name _____ Call _____

Address _____

City _____ State _____ Zip _____

1 year 12 issues\$22.95 2 years 24 issues....\$41.00 3 years 36 issues\$60.00

Canada/Mexico—One year \$32.95, two years \$61.00, three years \$90.00;

Foreign—one year \$34.95, two years \$65.00, three years \$96.00,

Foreign Air Mail—one year \$82.95, two years \$161.00, three years \$240.00. Payable in US dollars only

Allow 6 to 8 weeks for delivery

--	--	--	--

Exp Date: _____

Check Money Order MasterCard VISA AMEX Discover

Mail your order to:

Popular Communications, 76 North Broadway, Hicksville, NY 11801 Telephone 516 681-2922; FAX 516 681-2926



REACT volunteer groups manned several locations near the Murrah Federal Building.

formed a variety of tasks. These included liaison with the command posts of the Oklahoma City Police and Fire Departments, monitoring weather conditions, building of evidence-sifting screens, and operation of the OCEMD command post.

The GMRS radios of the REACTers performed extremely well during the response. The downtown location, with many large buildings, made repeater access difficult, as did a tremendous amount of RF interference due to the great amount of emergency radio communications in the area. However, the majority of REACT communications was between members who were in the immediate vicinity of each other, so REACTers switched to simplex, finding considerably less difficulty talking.

Cellular telephones have been touted by many as the cause of decline in use of CB radio. While cellular may provide excellent service for everyday personal communications, it was found to be highly undependable during the initial response to the bombing. Use demands on both the cellular and wire telephone systems was tremendous, causing both to overload. It was estimated during the response that only about one in three cellular call attempts actually made the system. The system dependability increased later in the day as the emergency load on it decreased, fewer non-emergency related people remained in the downtown

area and citizens heeded pleas by emergency officials to curtail their non-emergency use of the systems. A mobile cell site was also brought in to assist in meeting the demand for service.

By evening the next day, most of the response tasks related to the initial event had been completed, and it appeared that the REACT volunteers would be released. However, that all changed after a call from the Oklahoma County Sheriff's Office. Among other duties, the Sheriff had taken charge of providing an inside and outside perimeter around the area, and was finding that it's staff of deputies and reserves was rapidly being depleted. Could REACT help in performing traffic and crowd control functions on the outside perimeter?

REACT members came through! From about 5 p.m. on Thursday, April 20, through 5 p.m. on Friday, May 5th—16 days—REACTers manned several intersections on the outside perimeter. These volunteers denied public access to the area, provided control for the tremendous volume of traffic in the area, and answered many questions from onlookers. Although a Sheriff's Deputy or Oklahoma City police officer was initially assigned to assist the volunteers, it was soon shown that the REACTers could handle the task alone. The police manpower was made available for other duties.

The primary intersection REACT con-

trolled was NE 6th and Oklahoma. Six blocks east of the bombing site and just off Interstate 235, the location served as the primary entrance to the FBI's command center. Agents soon found that the REACT members took their instructions seriously and learned to have their identification ready for inspection.

Military Partnership Too

Oklahoma City is home to Tinker Air Force Base, where several REACTers are stationed or employed. Thanks to the military's partnership with the local community, the REACTers stationed there are generally allowed to respond to emergencies with the volunteer organization. During the bombing response, four air-men members received temporary assignment to REACT for response to the emergency. Along with President Bob Kaster, these four—Louis VanDyke, Chuck Newsom, Darryl Glenn and Antony Holliday—provided the backbone of the REACT operations.

Three Days After The Bombing

The first Saturday following the bombing provided an opportunity for an exercise in decision making and command. Early that morning, the roof of a building a block west of the primary REACT intersection collapsed, leaving a small radio tower standing without support. Fearing the tower would fall into nearby power lines on NW 6th, police and fire officials ordered the street totally closed. This left no access to the FBI's command center, particularly from I-235. After quickly studying the options, REACT leaders decided to change Oklahoma to two-way traffic, routing FBI traffic north on Oklahoma and then west into the back of their command center. Relying on knowledge and experience gained through the working of parades and other events, traffic barricades and cones were set up, and personnel locations were adjusted to accommodate the new plan. Within minutes, the new traffic corridor was in place and functioning.

The same day, metro OKC REACTers were supplemented by eight members of the Sedgwick County REACT team from Wichita, Kansas. Again, advance coordination paid off, as the GMRS frequency used by REACT in the O.U. system is the same as that used in Wichita, and by many other REACT teams nationwide. Braving a cold, steady rain and two minor hail storms, the Wichita REACTers stepped right into the tasks assigned, providing Oklahoma City personnel with an opportunity for some much needed

rest. It's all about teamwork; back in April 1991 personnel from the University REACT team, with equipment from the Oklahoma County team, traveled to Andover, Kansas to assist the Sedgwick REACTers in response to a killer tornado. Similar tasks were provided then, primarily in controlling access to the emergency operations center area.

Many REACTers from around the country called to offer assistance to the two teams. Donations were received in the mail. A REACTer from Michigan called to offer equipment and even assistance with obtaining temporary FCC licenses, if needed. And a local family who also has a GMRS system on 462.675 MHz in Oklahoma City reprogrammed several personal radios to allow access on the O.U. system, and brought them to the REACT responders within an hour of the initial event.

Concern for family members was naturally widespread. Oklahoma County REACT member Laura Newsom was due with her first child at the time of the bombing. She delivered on the Friday following the event. Husband Chuck—also a REACTer—took a day to spend with Laura, then returned to REACT duty and was active until operations were ended.

Closure

July 4th was a very special day in Oklahoma City this year. In addition to celebrating Independence Day, it also provided a time to celebrate the "closing" of an immediate, professional, caring response to an event tragic to the city, state and country. Thousands of people from Oklahoma City and surrounding areas turned out to watch an annual parade honoring the fire, police, medical and volunteer personnel who successfully responded to the bombing.

Oklahoma County and O.U. REACTers were a part of this event. A parade normally worked by the Oklahoma County team, REACTers were there early, assisting with traffic control, and with staging the more than 100 parade entries. When it was over, the REACTers added their vehicles to the end of the parade, bearing American flags and playing "Proud to Be An American" through their public address speakers. Later, both teams assisted with fireworks displays in Oklahoma City, Moore and Norman.

Over the span of 17 days, a force of 40 REACT citizen-volunteers provided over 3,000 hours of community assistance during a time of dire need. Using their radios and training, these volunteers provided a unique service to their local community, living up to their motto—"Public Service through Communications." ■

Ham Radio Horizons The Book



Written by Peter O'Dell, WB2D, this is a book about ham radio that every beginner can enjoy! If you want to get in on the fun and excitement of Amateur Radio, Ham Radio Horizons is the perfect way to get started. HRH is full of tips from expert hams in: DXing, Contesting, Serving the Public, Ham Radio in Space, Experimenting, Digital Communications — you name it! This exciting book is an excellent gift to a prospective ham or for use in your club's licensing classes and library.

Order No. BHOR..... \$12.95

Order Toll-Free
1-800-853-9797

CQ Communications
76 North Broadway
Hicksville, NY 11801
FAX 516-681-2926

Stewart Electronics

Orders & info **314-949-8890**

Hours 9:30 - 6:00 Mon - Fri / 9:00 - 3:00 Sat
1411C First Capitol Drive So.
St. Charles, Missouri 63303

YOUR ONE STOP CB RADIO SHOP!



CB Radio



Scanners



Ham Radio



Marine

CB's

Cobra
Uniden
Midland
Galaxy
RCI
Ranger
Maxon
Emperor
K-40

Antennas

K-40
American Antenna
Wilson
Firestik
Hustler
Solarcon
Valor
Maco
Antenna Specialists

Microphones

Astatic
Telex
Sadelta
Merry
Road Noise
Para - Dynamics
Echo Mics
Cobra

Accessories

Echo Boards
Royer Beeps
Noise Toys
Antenna Mounts
Coax & Connectors
CB Parts
Power Meters
Frequency Counters
Antenna Tuners

Scanners

Uniden Bearcat

Shakespeare

Francis

GMRS & Land Mobile

Maxon, RCI, Midland, & Uniden

Marine

Uniden
Midland
Ranger

Much more call ...

New & Used Equipment

- * Sales & Service
- * FCC Licensed Technicians
- * Knowledgeable Sales Staff
- * Large Inventory
- * Fast Shipping

Master, Visa, Disc, COD



Call or write for price catalog!

Scanners: Radios That Go Hand-In-Hand With CB

Stay on top of what's going on in your community with a mobile or handheld scanner. Here's how . . .

BY CHUCK GYSI, N2DUP

Editor, *Popular Communications* magazine

Scanners allow you to monitor not only your local police and fire departments when sirens scream around the corner, but also offer an entirely separate hobby that meshes very well with CB.

Scanners allow the radio hobbyist the capability to tune in VHF and UHF radio signals. If you use your CB radio for community service such as REACT or community watch activities, a scanner could become an essential addition to your radio gear. After calling in reports or requests for police assistance on your CB radio, you can monitor the appropriate public safety services to ensure your call is handled. Sometimes, monitoring public safety calls can offer an additional element of help to an agency when they are having trouble responding to your call or request for help. If you hear a police officer having trouble locating your stalled vehicle on the highway, you can call in additional information that will allow officers or troopers to find you easier.

However, if you are considering buying a new scanner, the radios are unlike CB radios, yet they also can be similar in some aspects. For instance, CB radios and scanners offer a squelch feature to eliminate static heard between calls. They also both may have channel numbers for indicating the various frequencies you use for talking on or monitoring. If you are considering buying a scanner, learn as much as you can about the various features available on new radios. If there is something you really like, it will help narrow your search for a new scanner.

What's Scanning?

Scanning, also known as monitoring, is a great hobby. Those who really like the hobby refer to themselves as scanners, monitors, or even scannists. While the term "scanner" is derived from using scanners (also misnamed "police radios"), "monitor" goes back before scanners made their



This wide-coverage scanner from AOR offers not only the VHF and UHF scanner bands, but also extended coverage of 800 and 900 MHz for newer radio systems.

debut in the late 1960s. Single-channel or tunable receivers allowed listeners to monitor a specific police or fire frequency.

Not until scanners, which scanned through a series of four to eight channels when first introduced, could one "monitor" more than one channel at a time.

Decisions, Decisions

Two important decisions that need to be made when selecting a scanner are the number of channels necessary for your listening pleasure or needs and the bands that the scanner will offer. After you make those two decisions, it will be so much easier to narrow your selection.

The Scanner Bands

When you start shopping for a scanner, you need to know what bands you need. A local scanner shop will know the active frequencies for your locale and can offer suggestions. All scanners will include VHF low from 30 to 50 MHz, VHF high from 137

to 174 MHz and UHF from 406–512 MHz. These three bands offer most of the scanning action to keep up with activity in your neighborhood. However, in some metro areas and larger regions, public safety services are migrating to 800 MHz. If city agencies or state police in your listening area are moving or already have moved to 800 MHz, you'll want to include this band on your new scanner. However, if the 800 MHz system being installed in your area is what is known as a digital radio system, you will be out of luck trying to monitor it because scanners are analog receivers and there are no digital scanners available to monitor this new technology. Your local scanner shop or neighborhood public servants may be able to offer you help in trying to determine this information. All receivers now manufactured or imported exclude the cellular portions of the 800 MHz band, however, so don't be concerned when you see a chunk of the 800 MHz band missing from your new scanner's receive capabilities. That's because it is illegal to monitor cellular, as well as cordless telephone conversations.

Aviation Listening

If aviation is interesting to you, you may want to see that your scanner includes the 108–137 MHz band. Most two-way radio communications in other bands are narrowband FM, while aero communications are AM and need to have either a separate band to receive these AM communications or allow the receiver to toggle between AM and narrowband FM for various frequencies you might program into the scanner's memory. Another possible aviation band that is intriguing is the 225–400 MHz military aviation and satellite communications band, however, not too many scanners include this segment of frequencies.

And if you live along various inland waterways such as the Mississippi River, the 217-MHz band offers marine tele-



Here's one Canadian's scanner listening post. It's compact and quite efficient.



Handheld scanners allow you to take emergency calls with you wherever you go.

phone calls in narrowband FM, while hams can be monitored on the 222–225 MHz segment.

What to Hear?

After you start playing around with the local police and fire frequencies, you may want your scanner to bring you other exciting communications. For the most part, scanners can tune in police departments to pizza parlors, fire departments to FedEx and ambulance services to news services.

Just like you need TV listings to decide what to watch on the tube each week, you need a scanner directory for your area. Most radio stores sell a regional scanner directory of one kind or another. Some better-done scanner guides will include information not only on frequencies, but also radio codes and unit-numbering schemes so you can decipher what you're hearing on the airwaves.

Choosing Channel Capacity

While scanners allow you to tune in virtually any two-way user, if you only want to hear fire and police calls in your commu-

nity, a 16-channel scanner probably is sufficient unless you live in a very large city with many frequencies in use. While 16-channel scanners may offer enough for keeping tab on the neighborhood, you may find yourself wanting to upgrade to a scanner with more channels, such as 50 or 100 channels, especially when the bug bites and you start finding lots of interesting scanner frequencies to monitor.

If you program in all your community's emergency services frequencies, you may find that you have extra channels left over. It is here where you can program in the frequencies used by surrounding communities for good scanning action.

Metro, Suburban or Rural?

Residents of large cities with emergency services that use more than a dozen or so frequencies may find themselves with an information overload if they attempt to monitor all those channels. After programming your local precinct police and fire dispatch channels for your section of the city, you may have more than enough for your ears to handle. Using various scanner directories, you can even aug-

ment your scanner listening by programming frequencies such as the local community watch channel or security operations for your apartment complex or a nearby hotel. In rural or remote areas, a scanner with only 16 channels may prove adequate for keeping tab on the Joneses. After programming in frequencies for local police, fire, sheriff, ambulance and the highway patrol, you'll have more than enough to keep you apprised of the news around town. You might consider listening to frequencies for neighboring towns and counties, or even large businesses and farms in and around town.

Suburban dwellers shouldn't buy a scanner with less than 50 channels, and, they probably should have 100 channels or more. That allows you to not only monitor the activity in nearby towns, but perhaps big cities near your community, too. For instance, most communications from communities and cities surrounding your locale will be easily heard from your home or car.

Using the Search Function

After learning how to program fre-

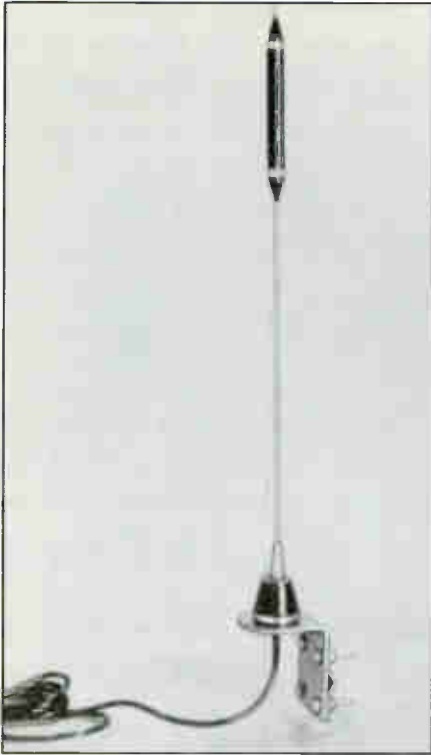

Mobile scanner antennas come in a variety of configurations. This antenna is designed to be mounted on mirror mounts, such as on a truck.

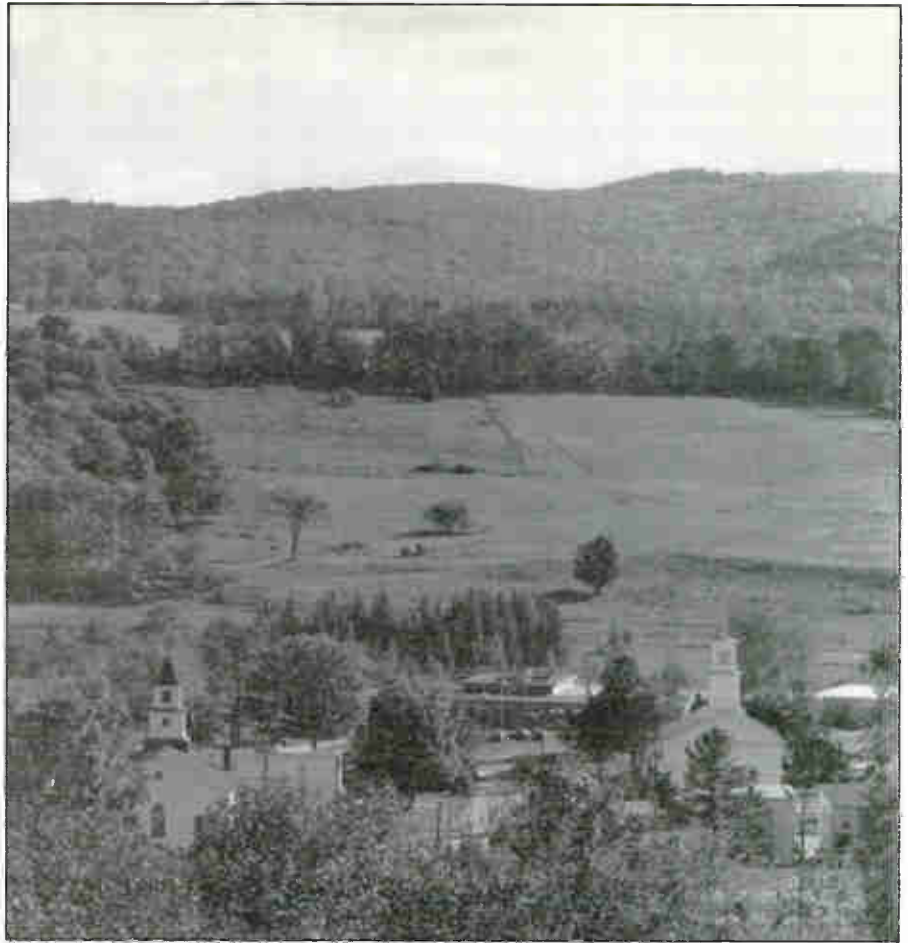

Even in rural towns across the map, there can be plenty to listen to on your scanner, if you know where to listen.

quencies into your scanner's memory, you should try the search feature most scanners include. The search feature automatically scans all frequencies between two given frequencies for any possible action. For instance, you might set your scanner to search for communications on frequencies between 460 and 465 MHz. Your scanner might stop on 460.250 for a police call, 460.575 for fire activity, 461.325 for business calls, 462.675 for REACT units and 465.000 MHz for paging. As long as there are com-

munications on those frequencies, a scanner will catch the action for you. That's an easy way to find new frequencies in your area.

A Variety of Versions

Much like CB radios, scanners come in

a variety of shapes and sizes. You can buy handheld models, or you can buy base or mobile versions. Again, like CB radios, many mobile scanners can be used as base radios with power packs and 12-volt power supplies.

Handheld scanners offer you the best flexibility, especially if you want to have your scanner with you wherever you go.



The scanning action can get quite intense in the nation's larger cities. There are always emergency calls to monitor.

Hot Frequencies for ANYWHERE in the U.S.A.

BY CHUCK GYSI, N2DUP
Editor, *Popular Communications* magazine

No matter where you live in the United States, you should be able to find something to monitor at any given time. Here's a list of scanner frequencies that you ought to be able to hear just about anywhere:

47.42	American National Red Cross
52.525	Ham 6-meter calling
121.500	Aeronautical distress (AM)
146.520	Ham 2-meter calling
151.625	Itinerant business
154.570	Low-power business
154.600	Low-power business
155.340	Ambulance-to-hospital
155.370	Police point-to-point
155.475	Police emergency mutual aid
156.800	VHF Marine Channel 16-calling/emergency
162.400	NOAA weather broadcasts
162.475	NOAA weather broadcasts
162.550	NOAA weather broadcasts
166.5125	Secret Service, presidential protection
167.050	Federal Communications Commission
167.5625	FBI, nationwide Channel 4, car-to-car
223.500	Ham 222 MHz calling
446.000	Ham 440 MHz calling
462.675	REACT emergency teams
464.500	Itinerant business
464.550	Itinerant business
465.000	Business paging

Cordless Telephones

Channel	Base	Handset
1	43.720	48.760
2	43.740	48.840
3	43.820	48.860
4	43.840	48.920
5	43.920	49.020
6	43.960	49.080
7	44.120	49.100
8	44.160	49.160
9	44.180	49.200
10	44.200	49.240
11	44.320	49.280
12	44.360	49.360
13	44.400	49.400
14	44.460	49.460
15	44.480	49.500
16	46.610	49.670
17	46.630	49.845
18	46.670	49.860
19	46.710	49.770
20	46.730	49.875
21	46.770	49.830
22	46.830	49.890
23	46.870	49.930
24	46.930	49.990
25	46.970	49.970

You even may consider buying a spare battery pack if you find yourself using a handheld scanner a lot. The nice thing about a handheld scanner is that you can monitor it not only in your home, or while hanging on your belt or in your purse, but you also can take it in the car with you! Handheld scanners offer the best bet in many situations.

Mobile Scanning Laws

Some states or cities have laws restricting scanner usage in vehicles by private citizens. Be sure to check with your local police department or state police post before installing a scanner in your car. It also is noteworthy that many states exempt licensed ham radio operators from mobile scanner laws. That in itself might be an incentive for you to get a ham license to cover your mobile scanning if your state restricts such use.

Spec-tacle

Two numbers should be looked at by scanner buyers. Check the sensitivity and selectivity of the receiver before buying. It can help you stay away from a real dog, if you pay attention.

Sensitivity probably is the most important number to look at while comparing spec—or specification—sheets. This number is shown in microvolts and tells the scanner's ability to detect weak signals. A smaller number would mean greater sensitivity.

Selectivity also is important. It determines the receiver's ability to block out unwanted signals on adjacent frequencies. In selectivity, higher numbers that are positive or negative are more selective in blocking out signals on those adjacent frequencies.

Features and Their Attractions

There are features offered on some models of scanners, but not others. And, like anything in life, you'll find that as you are willing to spend more on a scanner, the features on the radios increase in abilities to make the radios perform.

Here is a listing of some features to help you figure out whether you really need some of those bells and whistles:

• **Audio output**—If you plan to use your scanner mobile, you'll need to get as much sound as possible. The higher the wattage, the louder your scanner will be in noisy situations. If you have a choice

between a scanner that offers 1.5 watts and 4 watts, go for the power.

• **Banks**—Scanners with 100 or even several hundred channels can be unwieldy to monitor. If your new scanner has 400 channels, one option in programming is to set up a group of channels for an area you visit frequently, while another group of channels is for your community's police, fire and emergency services. In order to accomplish this, you set up your scanner channels in "banks," or groups of frequencies. For instance, channels 1 through 40 in a 400-channel scanner could be used just for fire departments, while channels 41 through 80 could be used for police channels. Just like individual channels can be locked out during scanning, each of the scanner banks can be locked out en masse, too. During a big fire, for instance, you may want to hear only fire frequencies. By locking out all the banks except the 40-channel fire bank, you'll hear only fire communications without locking out several dozen or even several hundred individual channels.

• **Scan and search speed**—Scanners will be capable of routine scanning, or searching between two frequencies at various speeds. On some scanners, the

CB REPAIR SERVICE

AM's \$25 SSB \$35

Plus Parts & \$10 shipping
Sorry: No repairs on exports or
converted ham radios

THE CB SHOP

Since 1975 Phone: (217) 342-3054
410 E. Fayette, Effingham, IL 62401

New York's CB Store

Radios, Antennas, Meters, Mikes,
Speakers, Power Supplies, Etc.

CRS Communications

1692 Central Park Avenue
Yonkers, New York (914) 961-7887

Electric City Electronics, Inc.

- **Amateur Radio**
ANLI, Cushcraft, Wilson
- **Citizens Band**
Cobra, Uniden, Wilson,
Valor, Firestik, Turner,
Astatic, Sadelta, Connex
- **Scanners**
Uniden, Cobra
- **Service**
Complete in
house service on
all brands we sell!

WE SHIP COD

521 Duaneburg Road, Store #3
Schenectady, NY 12306

Phone: (518) 356-7839 FAX: (518) 356-7873
Orders Only: (800) 489-7839

Ham Radio Horizons The Video

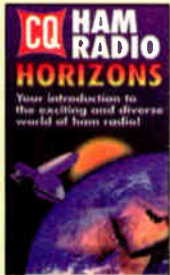

Video
Available in
PAL format

This introduction to Amateur Radio is an excellent complement to the Ham Radio Horizons book. Enjoy seeing all aspects of ham

radio ranging from what it takes (and costs) to get started to how you can get your ham license. Designed for the general public, HRH is ideal for public events, presentations to community groups and as an opening to your club's licensing courses! There's no better way to introduce someone to ham radio.

Order No. VHOR.....\$19.95

Order Toll-Free

1-800-853-9797

CQ Communications
76 North Broadway
Hicksville, NY 11801
FAX 516-681-2926



The hottest scanning action is on frequencies reserved for fire departments. Whenever fire strikes, scanner listeners keep an ear to their radios for all the action. (Photo courtesy of Philadelphia Fire Department)

scan or search speed is selectable between slow and fast. If you want a scanner that has hundreds of channels, you better get one that has a very fast scan rate, otherwise, while your scanner is scanning channels 1 through 200, something interesting could be happening on channel 358, but you'll miss the call.

• **Attenuators**—Usually offered as a slide switch either behind or under the scanner, it allows the listener to decrease the range of transmitters being heard. It's somewhat opposite of having a power booster. If you live in an area with many different towers, the transmitters on those towers can overpower your scanner, much like an over-powered CB operator whose signal splatters all across the channels. The attenuator decreases the capability of the scanner to receive so

many signals. As an added tip, this trick also works well if you only want to hear communications in your own community and not those of other nearby towns sharing the same frequencies.

Any Antenna?

Scanners installed in vehicles or homes should have an external antenna to help tune in the scanning action. For handheld scanners, the rubber antennas that come with the radio should prove satisfactory as you move around. You might want to connect a mobile scanner antenna while you use the handheld scanner in your car to increase your reception range.

For mobile installations, a scanner antenna should be mounted outside the



By using a mobile scanner, you can keep abreast of traffic conditions such as accidents. Knowing such information allows you to reroute and avoid such situations. (Photo by Chuck Gysi, N2DUP)

vehicle. Typical types of mobile antennas include those permanently mounted on the roof, trunk-lid mounts with set screws, magnetic mount, or even on-glass mount. The magnetic mount is popular because

the antenna can be hidden in the car while in parking lots. This keeps from advertising to thieves that there's a scanner inside your car.

For base station scanning, discones are

a popular antenna because they cover such a wide frequency range. While discones offer no gain, they do offer wide frequency coverage, typically 40 to 900 MHz. This is good if you like not only the normal scanner bands, but also, for instance, the military aircraft band at 225-400 MHz. By sacrificing gain on any given band, you are gaining an antenna that covers all frequencies inclusive, instead of only certain designated segments.

When choosing a place to mount your base scanner antenna, try to keep the cable length as short as possible. It's best to use a cable that exhibits low-loss characteristics so most of the signal isn't lost in the cable before it even gets to the scanner. Belden 9913 (or an equivalent) has proven to be popular with many scanner listeners.

If you only want to know what's going on around your neighborhood, don't go crazy putting up a good antenna. You may wind up receiving more signals than you care to hear. If the neighborhood is all you want to hear, the telescoping metal whip antenna supplied with your scanner will prove satisfactory. But whatever you do, have fun listening. Those calls you hear on your scanner may prove to be a lifesaver some day! ■

"WANTED"

DEALERS OF: CB RADIO EQUIPMENT

MAIL OR FAX PHOTO COPY OF RETAIL TAX
CERTIFICATE TO :
DNA DISTRIBUTING, INC.
2885 MELLONVILLE AVE.
SANFORD, FL 32773
FAX (407) 321-2487
(WHOLESALE ONLY TO DEALERS.)
(NO MEMBERSHIP DUES!)

WOW

HAVE YOU SEEN U.S. SCANNER NEWS

The ONLY National Monthly
Magazine Devoted Entirely To the
Hobby of VHF-UHF Monitoring.
No Shortwave, No Broadcast!!

Each Month You Get:

- Outstanding Feature Articles
- In-depth, unbiased reviews
- The latest FCC actions
- Accurate frequency information
- Helpful scanning and technical hints
- Plus regular monthly columns

1YR \$20.00; 2YR \$35.00; 3YR \$49.00
Sample \$3.00 1st Class or \$1.00 3rd Class (4-6 wks)





Dealer
Sales
Available

Mail Check or Money Order or Call **1-800-890-6999**

US SCANNER PUBLICATIONS
PO BOX 14923
PORTLAND OR 97214-4923
(503) 230-6999 FAX (503) 233-5176

Freebanding—An Adventure Beyond the Ends of the Citizens Band

It seems there's always an urge to see what's over the horizon. And so it is with CB . . .

BY JOCK ELLIOTT
CB Editor, *Popular Communications* magazine

Ordinary CB radio starts at channel 1 (26.965 MHz) and extends at fairly regular intervals to channel 40 (27.405 MHz). As you click the channel selector from 1 to 40, you'll hear all sorts of things: personal conversations, people conducting business, group discussions, truckers and travelers enroute, folks making fools of themselves with electronic noise toys, and much more.

But what if that channel selector would take you above channel 40 or below

channel 1? What would you hear then? Quite a bit, it turns out.

Pushing the Limits

Ever since the earliest days of CB as we now know it, CBers have been pushing the limits. When 23-channel CBs were controlled by discrete plug-in crystals, many CBers would reverse the receive and transmit crystals so they could cre-

ate an "extra" channel beyond the officially authorized channels.

When 40-channel, synthesized CBs that no longer relied on crystals were introduced, it wasn't long before curious CB operators found a way to persuade the synthesizer to receive and transmit on frequencies outside the 40 legal channels. Thus the freeband was born.

The CBers who entered the freeband found it offered several opportunities. On the one hand, operating above channel

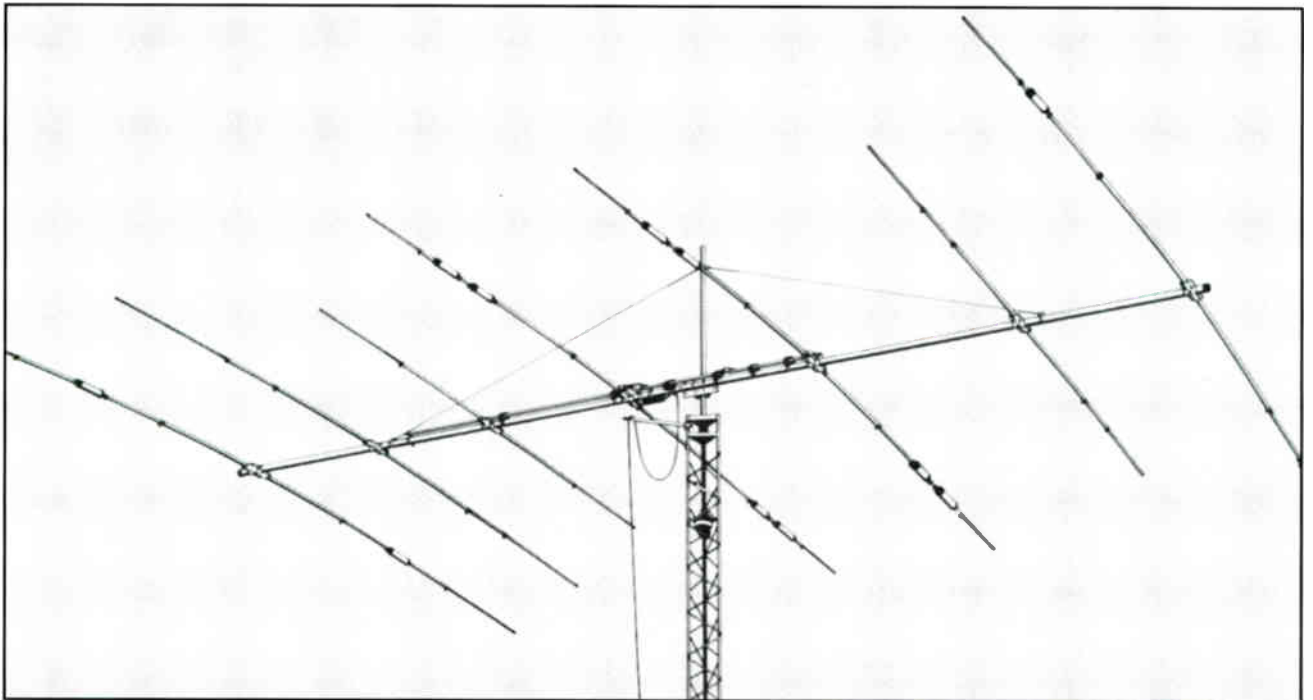

Freebanders typically take their radio hobby very seriously. Many freebanders are also amateur operators and sometimes use high-performance tri-band beams such as this TH7DX 7-element broadband beam for 10, 15 and 20 meters by Telex Hy-Gain.

40 or below channel 1 offered somewhat more privacy and less noise for local communications than the 40 legal channels. On the other hand, freebanding often offered the ability to communicate more easily with distant (DX) stations, including those overseas.

Since communicating outside the 40 channels was illegal anyhow, many radio operators decided that they might as well run additional power—either in the form of a modified CB with a power-boosting linear amplifier or an outright ham radio rig with modifications that would allow it to operate outside the authorized amateur radio frequencies.

Above all, what these radio operators discovered is that freebanding is very entertaining. In a short while, as national and international freebanding organizations sprang up, some with their own "special achievement" awards, the entire enterprise took on a life of its own.

FCC Takes A Dim View Of It All

The fact that operating in the freeband frequencies is strictly illegal in many parts of the world seems to be only a minor consideration for most freeband operators. In the United States, the Federal Communications Commission takes an extremely dim view of this "unlicensed operation" and periodically makes attempts to catch and find U.S. freebanders. The penalties can be hefty—a \$2,000 fine for the first offense, but most freebanders know the chances of getting caught are quite low.

It's difficult to see why the FCC is so concerned about freebanders. In more than 20 years of listening to freeband frequencies, I have never heard a legitimate station (like the Coast Guard, Civil Air Patrol, or what-have-you) operating there. So there doesn't seem to be any real harm done. Perhaps, by pursuing freebanders, the FCC is seeking to set an example for those operators who might try unlicensed activities elsewhere in the radio spectrum.

Despite their scofflaw operations, many freebanders take pains to operate technically-sophisticated stations with ultra-clean signals. One freebander I know operated a ham transceiver, a 1,000 watt linear which he re-designed for better performance, and a six-element dual-polarity beam. Any ham examining his station would find it comparable to a high-level amateur contest station.

So, Why Do Freebanders Do It?

It's difficult to figure out why freebanders do what they do. Some claim that, by moving above channel 40 or below channel 1, they are escaping the congestion on the



Amid a rat's nest of wires at a secret location in the Northeast, a freebander's tools of the trade: a Cobra 2010 (top right) on top of a Cobra 2000, and (at lower left) a Kenwood TS-850. At upper left, a 20-amp power supply and antenna control box.

existing legal CB channels. But in many parts of the country, clear legal CB channels are easy enough to find.

Others, evidently licensed amateur radio operators themselves, say they are frustrated with the stuffiness of the ham community. They admire the fact that, (unlike the 10-meter ham band just above the freeband) whenever there is a whiff of long-distance propagation, freebanders

can be heard straining to make contact. Still others say they are exercising their right of free speech, a shaky claim at best.

But perhaps the answer is more simple. Take a general coverage receiver and listen to the freebanders for a while, and you'll come away with one incontrovertible fact: The freebanders are having an enormous amount of FUN. So long as that is true, freebanding is here to stay. ■



THE BEST...



**RMS
INTERNATIONAL**

HIGH PERFORMANCE ACCESSORIES FOR CB & AMATEUR RADIO

TUNERS * METERS * FILTERS * MATCHERS * DUMMY LOADS * PRE-AMPS

IMPORTED & DISTRIBUTED BY:

ADVANCED SPECIALTIES INC.

**PO BOX 1099R
LODI, NJ 07644
201-VHF-2067**



SEND AN S.A.S.E. FOR
INFORMATION & LIST OF
AUTHORIZED DEALERS



*DEALERS/DISTRIBUTOR
INQUIRIES INVITED*

The CVS Samaritans—The Albany, New York Patrol

When you need help, who are you going to call? The CVS Samaritans, of course . . .

BY DAVE PLOUFF, 41 ALBANY

The general thought of using a citizen's band radio creates all kinds of emotions, but in Albany, New York it has become a mainstay and mainstream for communications in helping motorists of the Capital District.

It's done a number of ways. The first and most direct way is by simply asking for help from the CVS Samaritans on both CB channel 9 and 19. In the Albany area alone, there are two CVS vehicles covering approximately 40 miles of limited access highway.

Motorists in the Capital District who are CB radio-equipped have become very familiar with identifying fellow travelers who are either disabled or have become involved in a traffic accident, or simply need general travel information. They simply contact the vans directly and relay the information, which allows the Samaritans to prioritize their response, or determine whether police, fire or EMS crews are needed at the scene.

The Tri-County Assistance Network

The second way the CB-equipped motorist interacts with the Samaritans in the Albany area is with the Tri-County Assistance Network. This radio group consists of travelers and home-based operators that monitor channel 9 for distress calls. In fact, the Samaritans have one base station operator who is on duty weekdays for both morning and evening rush hours. This gentleman, Mr. Ed Barnat (Tri-County 44) has become an invaluable asset to the traveling public by receiving distress calls and relaying the information to the appropriate patrol van. The overall



A CVS Samaritan uses CB radio to summon help. Listen for them on Channel 9 and 19. If you need help, give them a call.



The Samaritans are able to communicate with the motorist on the scene, providing invaluable information that allows them to provide rapid assistance.

Schenectady, NY 12309
January 5, 1995

Gentlemen:

I returned the postcard to you but I felt that there is more I must say concerning the service you provide through the CVS/Samaritan.

On Thursday, December 29, 1994 I was on my way home from work via Rte. 787, a limited access highway in the City of Albany. My car stalled but I was able to maneuver my car onto the shoulder of the road. I examined the engine compartment not even knowing what to look for and on this cold blustery evening decided to put on the hazard lights and wait inside my car for help to arrive. After 15-20 minutes (which felt like hours) the flashing lights of the CVS/Samaritan appeared behind my car. Within 15 minutes I was on my way.

I cannot tell you how much I appreciated that service. Since I could not get your representative to take money I feel that I can repay your kindness by patronizing your pharmacies and telling my friends this story. I used to go to the nearest pharmacy, but now I will seek out only yours. You deserve to be repaid for the service you provide.

Thank you.

SWB:th

March 7, 1994

RECEIVED

MAR 09 1994

CVS
Attn.:
P.O. Box E
Woonsocket, RI 02895-9988

Re: CVS/Samaritan

Dear Ms.

On March 3, 1994 at approximately 4:45 p.m. I hit a patch of black ice and ended up in the snow bank going southbound on the northbound lanes of 787. Within ten minutes your CVS/Samaritan was there, dug me out, pulled me out of the snow bank, stopped traffic so I could turn my car around and proceed home.

Please extend my deepest **THANK YOU** to your CVS/Samaritan, Dave Plouff, for his excellent service.

Very truly yours,

/cjt

Letters from thankful motorists.

goal accomplished in the system is to get the motorist rapid help, eliminating unnecessary simultaneous activation of both local and state police. This radio network has been used to transmit information from the CVS Samaritans during road closures, major accidents and lane restrictions caused by disabled vehicles in traffic.

The Bottom Line

The Samaritans have found that by using citizen's band radios in their vans, they are contacted frequently and are able to communicate directly with the motorist on the scene, providing invaluable information that allows the dispatching of aid, whether it involves an overheated vehicle, flat tire or a life-threatening situation.

If you're traveling through the Capital District area of New York State and need assistance, or see a hazardous condition, report it to the CVS Samaritans!

Other areas where they operate include: throughout the Massachusetts area; Providence, Rhode Island; Southern Connecticut; Westchester County, New York; Central Long Island, New York; Philadelphia, Pennsylvania; Washington, D.C.; Indianapolis, Indiana; Cincinnati, Ohio; and Northern Kentucky. ■

More Distance Over More Channels

The Patented 'Bare-Hands' Tunable Tip

'Firestik' II

40-Channel Plus, Professional CB Antenna

Settle for the best. Demand Firestik!

- ★ Works with every CB radio ever made.
- ★ Fastest and easiest tuning method available.
- ★ Bandwidth exceeds 40 channels.
- ★ Power accelerating coil design.
- ★ Large heat-sink at tip for high wattage use.
- ★ Proven design for more than 15 years.
- ★ Made in the USA.

5 YEAR WARRANTY*

*replacement due to defects in workmanship and/or materials to original purchaser with dated proof of purchase.

Call or write for a FREE Firestik catalog: 602-273-7151 or write to:
Firestik Products, 2614 East Adams St, Phoenix, AZ 85034-1495

Installing Your Mobile CB Radio, The Right Way

Here's how to do it right the first time—with no sweat . . .

BY BILL PRICE, N3AVY

I know it's a *ham* call sign, but I started with CB in 1964—the Lafayette Comstat 25s are still in my dad's attic. When you installed one of those in a car, you spent the day at it, but I plan to get you through this one without working up a sweat. In case you don't already have one, lets start with:

Choosing a Radio

This is not the page where you'll find out which radio has the most Joules per gigaHenry—this is where we consider the features that make a particular radio right for your vehicle in the first place—the one that makes installation easy, and operation safe and convenient.

Controls

Instead of sensitivity and selectivity, this is the section where we'll talk about an easy-to-read channel indicator (easy at night and in bright sunlight) so your eyes are back on the road after the briefest glance. It's where you consider a rig with controls and display on the mike, or a channel selector knob with the clicks that makes it easy to change channels by counting clicks while you're watching the road. Now that we're thinking about controls, think too about a volume and

squelch control that are smooth, but offer enough physical resistance to let you set them easily on a bumpy road, and try those push-button controls, such as noise blanker and ANL to be sure they're easy to identify and operate by feel.

Size and Weight

Once you've narrowed your choice down to four or five radios based on your favorite features and convenient controls, you'll probably want the smallest, lightest radio of the group you've selected, unless of course, you're still driving a 1968 Checker Marathon.

Where and How?

Before you even dig out the toolbox, there are two major considerations for installing a CB radio in your car:

- Where will you mount the radio?
- How will you mount the radio?

You should know what choices are available for the "how" before you decide on the where—it makes the whole process easier. The basic "how" options are:

- Brackets
- Hump Mount
- Beverage-Tray Hump Mount
- Hook-and-Loop Fasteners

Note that nowhere on our list will you

find "tossing the radio on the front seat or floor and allowing the wires to tangle among your feet," and you can bet (up to a nickel) that none of the communication professionals here in the editorial offices has ever done such a thing. Let's look at the four proper methods:

Brackets

There are custom brackets which come with some radios, and there are universal brackets available at discount stores, mail-order outlets, and Radio Shack. I'm biased here, and with good reason: the Radio Shack universal mounting bracket set costs less than a good cheeseburger and is as universal as you can get. In the photos, my neighbor Al and I show two of many possibilities using just one pair of the brackets, and each kit contains three different pair of brackets and a rear mounting strap. These are the brackets I've used to mount mobile ham rigs, mobile scanners, cassette players and my prized Kraco CB, which I bought used in 1978. I've mounted scanners under kitchen cabinets using these brackets, and I've even fixed those same kitchen cabinets using the brackets. To be fair, though, every good discount chain offers some kind of universal bracket kit, though prices vary considerably.

Hump Mount

Even front-wheel-drive cars have vestigial transmission humps—that's where we put our combination drink-holder/dirt-catchers. Several CB accessory manufacturers make metal mounts which attach to the floor with screws, but if you see what Al and I did in the photos, you'll note our final installation ended up using my favorite universal brackets to mount the radio to the floor of his truck. I honestly couldn't see a reason to spend more on a special hump mount.

Beverage-Tray Hump Mount

Once an easy item to find, you'll have to dig through all the combination bever-

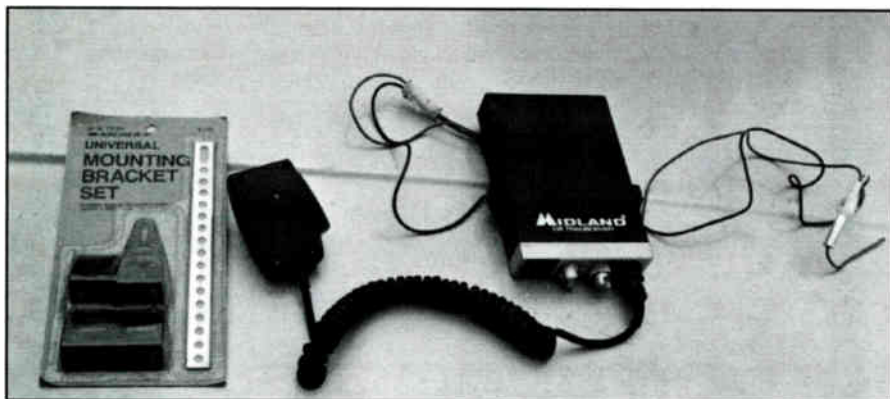

The universal mounting bracket set typically costs less than a good cheeseburger, and is ideal for mounting your mobile CB radio. When you're done, you're still left with a metal bracket or two that's perfect for another radio project.

NATION'S LARGEST RADIO OUTLET

In our 25th years of service to the communication world. You can count on EEB for: 1. Discount pricing (we'll match any advertised deal), 2. Fast, friendly service from knowledgeable sales personnel, 3. Factory authorized service for many of our suppliers, 4. We have four show rooms crammed with radios on demo so our walk-in customers can try before they buy. (some competitors are not open to the public) 5. Complete one stop radio shopping; antennas, power meters, radios, counters, power supplies, cable, connectors, books, we have it all! 6. Compare our prices, service, (before, during and after the sale) and our freight policy. You see why we're number one.

CB Radio is coming back in a big way. We carry Cobra, Maxon, Realistic and Uniden. There are over 50 CB radios on today's market, most do the same thing: 40 channels & 4 watts. After that there are portables, mobile, base, weather channels, single side band etc. No supplier can carry all the models. We have a few listed here. We carry more and can order all the rest.

Uniden's Professional 40 channel CB Radio

- 3 instant weather channels
 - Instant channel 9 push button
 - Signal and RF LED meter
 - Multi-Function LED - Signal and RF Meter, TX & RX indicator
- PRO538W



list \$99.95 **\$77.95**

Compact and ready to travel UNIDEN CB, yet performs like the big boys. LED display of channels (full 40 chs.). TX and low battery. Also features easy up/down channel selectors, Hi (4w) or Lo (1 watt) switch to conserve battery. **PRO340XL...SAVE 30%**



list \$99.95 **\$67.95**



The Ultimate Remote Mount CB
Controls and mic, call-in-one compact, handy unit with backlit LCD display for channel and RFI Signal strength, simple 2 wire installation to remote hideaway unit. 4 watt RF output, Instant ch. 9 . push key lock and more!

HH-70 list \$149.95
\$117.95

40 Ch. Base Station Weather Monitor 93LTD



At the push of a button you can keep abreast of travel advisories and natural disasters through 24 hr a day weather alert on 7 channels. AC/DC operation, 4 watts output, dynamike boost & switchable RF gain control are just a few features.

list \$199.95 **\$129.95**

The Ultimate 40 Channel AM/SSB CB Base With Weather Alert!



- Includes Dynamic Base Station Mic
- Receive emergency alert WX tone even when CB is off 24 hrs. a day.
- LED indicator with 5 digital frequencies for AM & SSB
- Meters for MOD/SWR and RFPWR signal • Much More!

2010GTL list \$599 **\$399.95**

Your personal UHF 2 way radio for keeping in touch

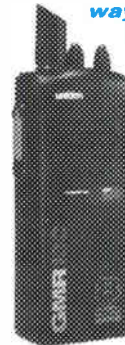

GMRS, VHF, 8ch., FM for clear, crisp audio. Range up to 1 mile or 20 miles thru a repeater. Join the professional communicators on react.

SAVE \$100
GMR100

list \$279.95 **\$177.95**

Daiwa Power Supplies



Turn that mobile into a base. The most popular Daiwa the PS50TM. Volt & Amps, S meter. Adjust

9-15V. Binding post and cig lighter jack, Over current protection. Regulated to < 1% wt. 5lbs

list \$59.95 **\$47.95**

RF POWER METER

Cross needle shows forward and reverse power and SWR at the same time. 15, 150, 1500 watts. 1.8-150MHz



CN101 **\$77.95**

Shortwave Radio

EEB is known as the world number one shortwave radio supplier.



There is lots more to the HF spectrum from around the globe. News, Music, Discussion, Amateur, Governments, Hear what they are saying about us. Hear the news without our medias' slant. New digital receivers start under \$100. Portables, Laptop, Table-Top...EEB carries them all!

Amateur Radio

The ultimate hobby! Many of today's Hams got their first radio experience in CB. Ham Radio offers unlimited possibilities. HF world Radio, Packett computer link via Radio, VHF/UHF repeaters, slow and fast scan TV even satellite repeaters and more! EEB is one of the east coast's largest Ham dealers. Get started today in the ever expanding world of Ham Radio. Starter books \$5 & up



Binoculars

Tasco combines high quality optics and superior construction to provide remarkable viewing...all at a bud-



get price! Light weight, field glasses up to 7X50, Marine with built-in compass are offered at a discount price at EEB.



Night Vision

Imagine seeing in the dark. This state of the art scope allows you to observe by starlight, superior optics produce brilliant images. Ideal for hunting, neighborhood watch, security, wildlife, law enforcement and star gazing.



NV100 List \$449 **EEB \$339.95**
NV100-1 w/Illuminator List \$499 **EEB \$379.95**
NV100C compact List \$349 **EEB \$299.95**
NV100C-1 w/Illuminator **EEB \$329.95**

GPS Global Positioning System

It's sweeping the industry and now prices start under \$200. Perfect gift for the Hunter, Camper, Boater, Outdoorsmen and fun for all! Know your location and altitude to within 300ft anywhere in the world. We carry all major GPS brands.



Magellen GPS2000 Only **\$199.95**

All new expanded 1996 catalog. Hundreds of new items, you should have a copy by now...if not...get one!

CATALOG 1996

- SW
- Scanner
- Amateur
- Books
- Comm/Govt.



323 Mill St.
Vienna, VA. 22180
FAX: 703-938 3350

Orders: 800 368 3270
INFO/Metro: 703 938 3350
BBS: 703 938 3781
Internet: eeb@access.digex.net

- We'll match anyone's deal
- Prices subject to change
- Prices do not include freight
- Returns subject to 20% restock fee
- Sorry no COD's



If you can convince your spouse (or indeed, yourself!) that drilling a couple of holes—be careful!—in the floor board is right for your mounting installation, the universal mounting bracket set works just fine. Remember to position your CB out of the driver's way, and at the appropriate angle for proper operation.



A perfect fit! Today, many vehicles have special places for things like maps, soda cans, and CB radios. If you're lucky enough to own a vehicle like the one in this photo, you can use the famous hook-and-loop fasteners to keep it in place.

age/CD/cassette/change/tissue holders 'til you find one made to hold a radio. They're not expensive, and they do double duty, but they have a few drawbacks.

- They can be top-heavy and tip over on hard turns.
- They invite you to spill soda or coffee on your radio.
- They appear to invite theft.

On the positive side, they are a snap to remove and toss into the trunk when you disconnect antenna and power from the radio, and you can attach a radio to one using hook-and-loop fasteners, screws, or chewing gum.

Hook-and-Loop Fasteners

Velcro is the brand name that everyone associates with these burr-like fasteners with the incredible shear-strength. Use them to mount lighter-weight radios on top of a dash or console, on the side of a console, or as Al and I show in our pictures, inside some of the shallow openings you'll find in today's small cars and trucks. If these fasteners were perfect, we'd have skipped the other methods, so here's the downside of hook-and-loop:

The adhesive backing often gives out in summertime parking lot heat. If you want to beat that, buy the fasteners that

are made to be sewn-on to fabric, and attach them to the radio and the car's mounting surface with a good grade of contact cement.

If you mount a radio under a dashboard using hook-and-loop fasteners—it will most likely come loose when you hit a bump. Use the hook-and-loop method to secure a radio on top of something, or inside an opening, as shown in the photos, and you'll be fine.

Where to Mount it

Take your radio and microphone to the car, sit in the car, and look all around you. If the radio's light-weight, take some double-faced tape to give it a temporary trial mount while you're sitting in the driveway, or ask someone to sit there with you and try various locations. Mounting situations to avoid are:

Locations that don't allow you to fasten the radio securely. You don't want your radio attacking you when you accelerate or brake hard.

Locations that would require you to reach through your steering wheel, take your attention from your driving, or lean away from your normal driving position.

If your car has room between two front bucket seats, consider mounting the

radio there, with the controls facing upwards. Remember to take into account seat-movement (yours and the car's) when positioning the set.

Empowerment

And you thought I wasn't a nineties person! Once the radio is installed, you can find several ways to get 12 Volt DC power to it. You have two wires attached to the back of that radio, and they are almost universally a red one and a white one. The red one is positive (+), and the white one (sometimes it's another neutral color such as grey or black) is negative (-). With the exception of a few heathen vehicles that you shouldn't be driving anyway, all vehicles today use a negative ground. That means that the (-) terminal of the battery is connected to the chassis or frame of the car, and indirectly to most metal parts of the car.

You'll need to connect the (-) wire to some metal part of the car that is eventually connected to the (-) side of the battery, then you need to complete the circuit by connecting the red (+) wire to something that is eventually connected to the (+) side of the battery. If all this is more than you want to deal with, there are simple cigarette-lighter plugs which you can

connect to your radio and plug in.

Assuming you decide to "hard-wire" the radio to your car's electrical system, a DC voltmeter is handy to have—it tells you when you have successfully connected two wires, one to a (+) source and one to a (-) source. You can make a substitute by cutting the cigarette lighter plug off the end of a low-cost 12 Volt "trouble-light" and connecting crimp-on alligator clips to the exposed wires. Prove it works by connecting one wire to each terminal of your car's battery, then move the lead from the (-) terminal to other unpainted metal parts of the car to see which are "ground" and which are not.

The red (+) wire from your radio should have a fuse holder built in to it. If not, pick one up at your favorite radio store or auto store. You want an "in-line fuse holder," and a fuse that's equal to the rating marked on the back of your radio. This is a good time to pick up some spare fuses.

If you don't solder very well, buy some crimp-on connectors and a crimper—they're efficient and handy. Detachable connectors are available, as are little gadgets you can slip in behind your car's fuses to allow you to use a slip-on connector to connect your red (+) wire to the car's fuse panel. If you do this, remember that a fuse has two ends. Connecting your red (+) wire to one of them will add the load of your radio to that fuse—something you shouldn't do. Use the "hot" (unfused) end—the end connected to the car's battery. Not sure? Find a friend who is.

Remember, some things, such as your dome lights work all the time—whether the ignition key is on or off. If you want your radio to work with the key off, choose a fuse for one of those items to attach your (+) lead. If you want your radio to shut off with the key, choose a fuse—such as the one for the car's AM/FM radio—which is wired to turn off with the key. Wiring your (+) lead directly to the battery means your radio will operate whether the ignition key is on or off.

Antenna

Before you ever "key the mike," make sure you have a functional antenna connected to your radio (you could do instantaneous damage to it if you don't). There are antennas that require you to drill holes in your fender or roof, clamp them to a non-existent rain-gutter, chain them to an inaccessible bumper, or pop them onto the roof with a magnet mount. Guess which is easiest?

There are places you can't put a mag-mount antenna, and those places are all made of fiberglass or some miracle plastic. The matching truck-cap shown in the photos is an example of a non-magnetic surface, as are fiberglass cars and certain

Your CB Headquarters!

CB Radios By:

- Cobra
- Uniden
- Ranger
- Emperor
- Maxon, Midland, Yosan

Antennas By:

- Wilson
- K40
- Firestick
- Whiskey Still
- Antron and more!



Cobra's 148GTL is a consistent top performer, year after year.... and always a value at Quement's!





Quement Communications

Ph:408-998-2355

969 S. Bascom Ave, San Jose, Ca 95128

When you're on the road
it's nice to have a pal...

ROAD PAL

CB ANTENNAS

- Quality Communication
- Affordable Price
- Compatible with all CB radios

There is no need to travel
alone anymore.

Call or write for a FREE Firestick catalog:
Tel: 602-273-7151 or write to:
Firestick Products, 2614 East Adams St,
Phoenix, AZ 85034-1495



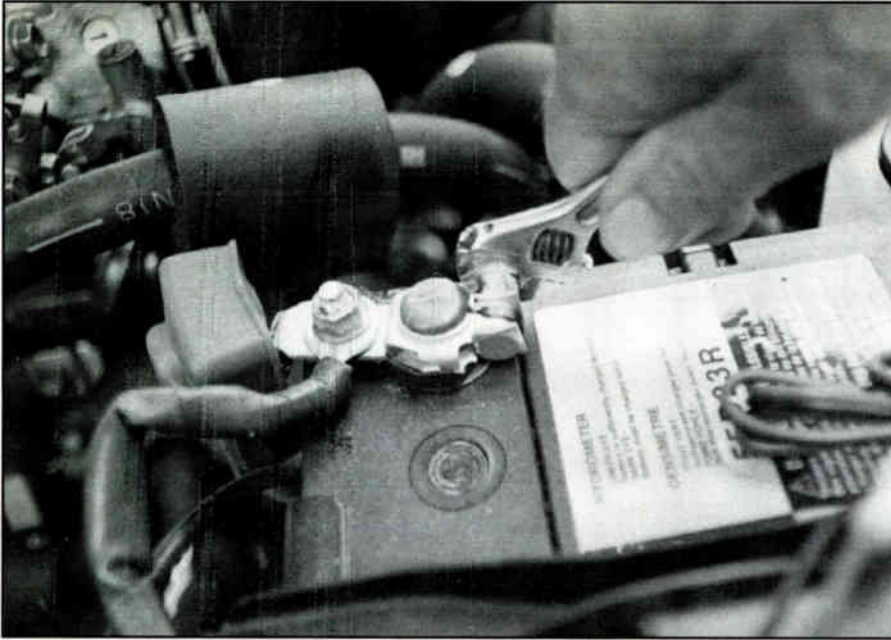

Consider connecting your radio's 12 Vdc power lines directly to the battery. You must, however, then remember to turn off the radio so you don't drain the car's battery. Here, Al loosens the battery terminal connection in preparation to connect the power cord.

vans which make increasing use of plastic and fiberglass body parts. If you have such a critter and can't figure out how to deal with it, the manufacturers or dealers may offer solutions, but if not, drop me a line with an SASE and I'll try to help.

In the meantime, remember to NEVER place the mag-mount (or any other antenna) on the hood or front fenders. Even if it's way off to the side, it'll be distracting to the driver, and no matter where you live, you don't need any more distractions when you drive.

If you have one of those really nice fiberglass pickup-cabs like Al has, you'd have to glue an old engine block to the inside of the cap before a magnet would stick to it, so you're limited to either the roof, or the trunk lid if you've got one. No matter which you choose, it's best to mount your antenna in the center. It not only looks nicer, but it WORKS better. You get a more evenly distributed radiation pattern (equal coverage in all directions) and in most instances your SWR will be lower. If you drive one of those new plastic cars (you'll know because a magnet won't stick anywhere) contact the manufacturer so they can tell you why you probably shouldn't use a radio anyway. Seriously, there are ways to put an antenna on plastic cars, and if enough of you are interested, we'll see what we can do about an article dealing with them (but it's a tough subject and you'll really make us work on that one!)

If you have a nice metal car (as Henry

Ford, Maurice Chevrolet and Mr. Belvedere Plymouth intended), be sure to wipe the roof and base of the magnet clean of all gunk when you install the antenna and every month or so thereafter.

Hiding the Wires

Only a really messy person would allow wires to lay all over the seats and floor of the car, that's why we showed Al's installation instead of mine. Wires can be safely and neatly tucked under the edge trim around doors, under the edges of carpets (not under the area where your feet rub) and held in place up under the dashboard or consoles using screw-on and adhesive wire clips available at your favorite radio store or auto parts store.

I can only remain serious for a few seconds at a time, but this is one of those times. No wire should ever be allowed to rest anywhere near a driver's feet. Your favorite radio store has spiral-wrap plastic to hold wires together. It's wonderful stuff—you can hold your newly-installed wires to existing wires under the dash and route them to side kick-panels where you can loosen a panel, tuck the wires under, and tighten the panel again. You can also 'loosen the "running-board" and tuck the wires under the edge of that or under the edge of the carpet, then tighten the running board again. That favorite radio store of yours will also have about six other really clever methods of holding wires where

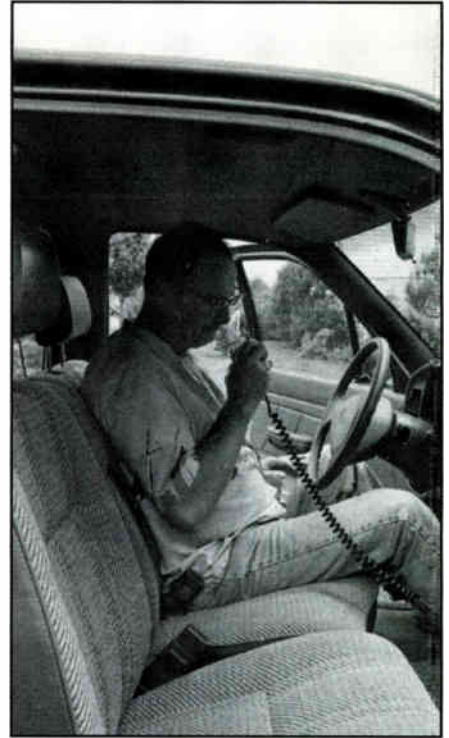

Al, The Virginia Creeper, has the cleanest, neatest pickup on the highway! It's been said that the best sounding mobile CB radio results when your vehicle is in good operating condition, your radio is readily accessible and doesn't interfere with the proper operation of your vehicle. Whatever you do, don't simply place the radio on the seat or floor, especially under the driver's seat.

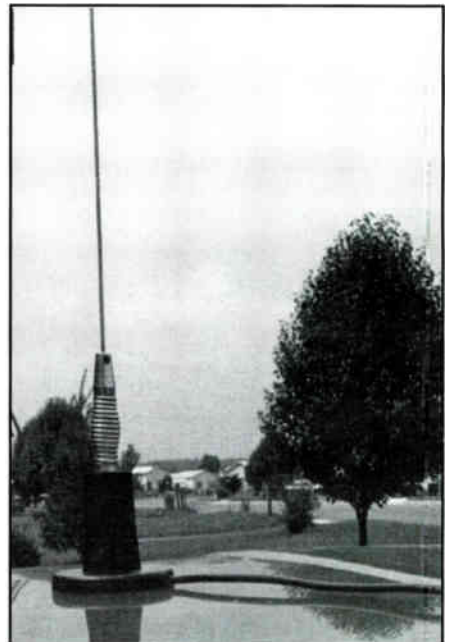

Here's the magnetic-mount CB antenna. It's easy to install, puts out a great signal and doesn't require you to drill any holes.



Once in a while, it's okay to shut the door on your coax cable, but a steady dose of door-slamming can gradually destroy your coax and your signal. It's best to route, if possible, your coax through an opening that gives it the least amount of physical strain.

you want the, if spiral-wrap isn't for you.

When you install your antenna, you can usually hide most of the coax in the same ways mentioned above. A one-inch slit in your carpet will nearly vanish if you fluff the nap, and your wires can enter and exit through such slits without the need to remove connectors from the ends.

You can run your coax out through a door or window, but if it's pinched too hard and too often, you end up having to replace the wire. When your coax gets squashed into an oval, its characteristic impedance—the part that makes it 50 ohms—changes. That can have an adverse effect on its performance. So for the most part, roll-up windows do more damage to coax than doors, but “flip-open” windows like Al has on his truck (see photo) are pretty gentle to coax. You can find the best (least squashing) area around a door or flip-open window by closing it on a small sample of coax and trying to move the wire with your fingers. Route the cable through the part where you experience the least resistance (that's friction, not ohms). If you tuck the cable under the back seat and route it into the trunk, the same test goes for finding

the best area to close the trunk lid onto your cable.

If you must remove antenna connectors and you're not an expert solderer, consider the crimp-on solderless connectors shown in the photo. If you are an expert solderer, consider the butane-powered soldering iron—it's great when you're a hundred feet from an AC outlet.

What if You Hear “Engine Noise?”

Some cars and trucks create a lot of electrical interference (called “engine-noise”) which covers up the signals you're trying to hear on your radio. You can find out if yours does by listening to the radio with the engine off, then starting the engine and listening for any new noise. It wouldn't be fair to let you make the mistake I once made, so for your own sanity, close the hood completely before listening for interference caused by the car's engine! The area under a car's hood is loaded with electrical interference, but it is almost entirely sealed off when the hood is closed.

If you have engine noise, the solutions are “bolt-on” fixes that you buy at your favorite radio store or auto parts store. They include:

- Resistor Spark Plugs
- Resistor Spark Plug Wires
- Noise Suppressor Kits for Spark Plug Wires
- Noise Suppressor Kits for the Spark Coil
- Noise Suppressor Kits for the Generator

Always try the cheapest fix first. Before you try any of them, though, you might want to try connecting the radio's 12V power wires directly to the car's battery (see photo). Remember, this bypasses the ignition key and means you must remember to turn off the radio each time you leave the car. Naturally, you must still fuse the (+) wire if you install your radio this way.

If you're not sure of something, ask the person at your favorite radio store. Along those lines, I'd like to thank the Bealeton, VA *Radio Shack*, for their assistance with parts and photos. Stay safe so you can catch the next issue, and drop a line if you'd like. ■

Scheduled Maintenance To Keep You On The Air

BY BILL PRICE, N3AVY

About once a month—or each time you clean out the peanut shells and candy wrappers from under the seats—perform a few simple checks.

- Are all the screws on the brackets still tight? If they work themselves loose someday, I guarantee it will be at the wrong moment.
- Is the coax connector (PL-259) screwed in firmly to the socket on the back of your CB? Hand-tight is fine—really!
- If you plug your radio into the cigarette lighter for power, is the plug reasonably clean? Have you looked into the socket? Those things are usually filthy—particularly those on rental cars. NEVER USE STEEL WOOL TO CLEAN A CIGARETTE LIGHTER SOCKET—IT WILL CATCH FIRE INSTANTLY, BURN YOUR HAND AND POSSIBLY YOUR CAR! Use a stiff plastic brush or a piece of 3M Scotch-Brite™ pad or its generic equivalent—they're plastic, therefore they're non-conductive—an important consideration when you need to use an abrasive around electrical equipment.

Now just one more bit of nagging and I promise I'll let you enjoy the rest of the magazine. I'd like to talk for a moment about those neat little portable CB sets made to store under the seat or in the trunk until you need to call for help.

They are good little radios, and they have been designed to do just what they're sold to do—sit dormant until you need to plug them in and use them WHILE YOU ARE PARKED AT THE SIDE OF THE ROAD. The manufacturers tell you clearly that the antennas are not meant to withstand highway speeds. They are not lying! Most of them are not meant to withstand as vehicle moving at any speed. The manufacturers tell you this because the antenna will blow off the car when you drive! Trust me; I'm an antenna doctor.

These emergency-type CB radios also have another drawback—they're not really designed for one-handed operation. They're big, and they're not made to hold up to your face when you're driving. Most of them have wonderful controls, a nice built-in mic and speaker, but they are NOT designed to use while you're driving. Take one along in a rental car. Take one as a spare in your everyday car. Put one in the trunk of each of your loved ones (unless you're dating a pachyderm), but please—don't use one when you're driving. Thanks!

(Don't) Open Mouth: Insert Foot—CB Operating Habits Make You a Big Deal or a Big Doofus

Unpack the radio, plug it in and start talking, right? Wrong!—Take a few days to learn the ropes. Here's how . . .

BY TOM KNEITEL, K2AES/SSB-13 ("TOMCAT")

CB has the potential for being a lot of fun, an exciting and wonderful hobby, which also happens to be useful as a highway aid. In short order, you can press a mic button and have the privilege of connecting with a lot of absolutely great folks who share your interest in communications. Ultimately, you may meet many of these people in person ("have an eyeball," as it's known on CB), and form genuine friendships that will last for years. I got into CB radio in 1959 and met people on the channels who are still among my closest friends.

There's a catch. A reasonable amount of thought, self-control, maturity, and consideration for others must be part of a person's CB operations if they hope to be welcomed and accepted by other operators. True, it's possible to get on the air without dealing with these factors, just like it's possible to drive a car that way. But, how many drivers welcome being on the road near an inconsiderate driver weaving in and out of traffic, cutting them off, and becoming a general nuisance? You've got the idea, so let's pick through a couple of things to be dealt with on CB channels, and offer up opinions for dealing with them.

For starters, it's best to spend at least a few days doing nothing more than only *listening* to the CB activity in your area. Do not even try to transmit. Get a feel for who the operators are, which channels are most in use, and other relevant things about local practices.

Handles

For local communications on the AM channels, CB'ers usually identify by nicknames, known as handles. You are welcome to pick any CB handle you like. Most CB'ers seem to select handles that have

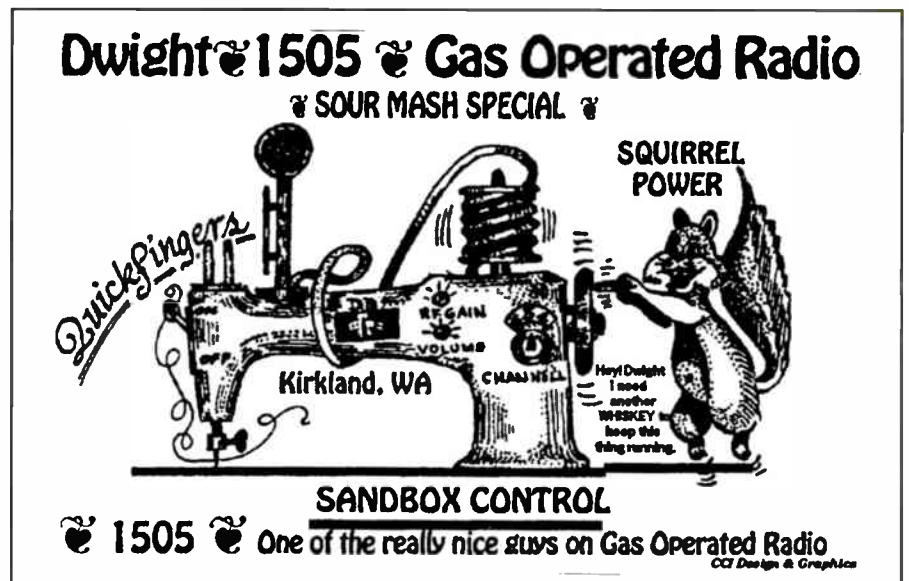

Dwight 1505 sent us this QSL card. Some operators hand out QSLs at jamborees, club meetings or to CB'ers they meet when traveling. Many others send them to other operators they've contacted on the air.

a direct tie-in with their real names, occupations, astrological sign, hobbies, vehicles, or something else with a personal significance. Some are quite clever and humorous. But, remember, handles have been in use for 20 years.

Even though you may be certain you have cooked up an appropriate and absolutely original handle, it's unlikely that you'll have concocted one that hasn't been used before by hundreds of others. Surely, every pharmacist who picked the handle Pill Pusher is certain nobody else ever thought of that one. Same with every attorney known as Legal Eagle, every farmer thinks he's the first one to be the Plow Boy, and so on.

No problem, but don't get all bent out of shape if some dim bulb should become

annoyed and accuse you of "stealing" his handle. It occasionally happens. Some folks entertain the preposterous fantasy that they invented a handle, and/or "own" the thing. Don't argue the point. If you're mobile and unlikely to meet up with that CB'er again, just ignore the whole incident. If you're at home and it appears that you are stepping on the ego of a local, then consider that discretion actually is the better part of valor. Either add the suffix "2" to your handle (Pill Pusher-2), or else apologize and pick a completely new handle.

Remember, a handle is an important factor in the way an operator is perceived by other CB'ers. Therefore, it should be selected with thought as to the image it projects. You don't want to be Prune Face, or McNasty, nor would you want the instant

YOU'LL LOVE THE FREQUENCY ALMANAC®

Simplified Frequency format listed by county.
Each county lists public safety by state, county and city agencies,
including 800MHz, followed by business and all other services.

- ▶ Direct From FCC Data Files
- ▶ Covers All Land Mobile and Fixed Services Between 30MHz and 2GHz
- ▶ Books For Each Of The Fifty States
- ▶ From The Publishers of Frequency Directories for over 15 Years

\$19.95ea
AK, AL, AR, AZ, CO,
CT, GA, ID, IN, IA,
KS, KY, LA, MA, MD,
MN, MO, MS, MT,
NC, ND, NE, NJ, NM,
NV, OH, OK,
OR, PA, SC, TN,
UT, VA, WA,

\$24.95ea
CA, FL,
IL, MI,
NY, TX, WI

\$9.95ea
DE, HI, ME,
NH, PR&VI,
RI, SD, VT,
WV, WY,

For 1st Book Add:

\$3.95 S&H For
4th Class or
\$5.95 S&H For
Priority Mail
2-3 Days
**(\$6.95 For CA, FL,
IL, MI, NY, TX, WI)**

For More
Than 1 Book
Add **\$1.00 S&H**
Per Book

Dealer
Inquiries
Welcome

▶ California Book
is 820 Pages

Compare The Page Counts
To Other Directories

State	Pages	State	Pages
AK	96	MT	136
AL	208	NC	334
AR	184	ND	115
AZ	176	NE	206
CA	829	NH	88
CO	224	NJ	272
CT	100	NM	94
DC	See MD	NV	96
DE	48	NY	504
FL	472	OH	480
GA	336	OK	230
HI	56	OR	127
IA	272	PA	464
ID	128	PR&VI	116
IL	520	RI	56
IN	320	SC	164
KS	252	SD	121
KY	223	TN	261
LA	212	TX	840
MA	231	UT	104
MD	152	VA	270
ME	120	WV	72
MI	420	WA	172
MN	292	WI	301
MO	280	WY	136
MS	170		128



1-800-890-6999
US SCANNER PUBLICATIONS
PO BOX 14923
PORTLAND OR 97214-4923
FAX (503) 233-5176 (503) 230-6999



U.S. Scanner News

Published By
U.S. Scanner Publications
The ONLY national
monthly magazine
devoted entirely to the
hobby of VHF-UHF
monitoring.
**No Shortwave,
No Broadcast!!**

Each Month You Get:
**NOW WITH FCC MONTHLY
FREQUENCY UPDATES**

- ▶ Monthly FCC Frequency Updates
 - ▶ Outstanding feature articles
 - ▶ In-depth, unbiased reviews
 - ▶ Accurate frequency information
 - ▶ The latest FCC actions
 - ▶ Helpful scanning and technical hints
 - ▶ Plus regular monthly columns
- 1yr \$20.00; 2yr \$35.00;
3yr \$49.00**
Sample
\$3.00 1st Class

**NINE
ZERO
MIKE
SEATTLE, WA**

SSB-90M



MARK REDFOX
814 COLUMBIA ST APT 1
SEATTLE, WA 98104-1961

Confirming QSO with:

STATION	MO	DAY	YR	UTC	REPORT	MODE
						TWO WAY
				FREQ		

This full-data type QSL card from Nine Zero Mike in Seattle has room for pertinent data confirming a contact (QSO) with another station.

image I got yesterday when I heard the handle Sneaky Pete. And, keep it clean!

Speaking of Your Image

Remember, CB is a hobby. As such, it's supposed to be fun and relaxing. That's why most people become CB'ers. Still, there are always a few people who think CB radio is the place to be testy or vent their frustrations.

If you want to enjoy CB to the max, go into it with the notion of having a good time. Expect that once in a while, you'll have days where there will be interference and noise, or other reasons why you can't complete a desired exchange of

communications with a base or mobile station. Don't get all steamed up and put your blood pressure into a snit. That's the nature of CB comms. Take it easy. Try again later, or the next day.

Enjoy communicating with your friends. Be yourself, and speak as if you were talking to your neighbor on the telephone. Don't feel pressured into using what you assume to be what CB'ers are expected to sound like based on what you have heard in songs, or seen on TV shows or in movies. Some folks still like that corny 1970's CB "goodbuddy" lingo, but if it's not your thing, don't bother. Make sparing use of the "10-code" and the "Q-code", or else ignore them.

Unless you come from Dixie, please

don't think anyone else will be impressed if you suddenly try speaking as if you did. While everyone enjoys hearing those to whom the dialect comes naturally; imitations produce only snickers. CB'ers from Maine to Montana, and all areas in between are prone to paying this poor homage to Dixie.

Channels

Channel 9 is officially dedicated for highway emergency and traveler's assistance usage. Unless you are mobile and requesting aid, or are a base station monitoring in order to provide emergency or other assistance to mobile units, you are not permitted to use Channel 9.

Channel 19 has long been the mobile in-transit channel used by truckers and car drivers to exchange traffic information, road conditions, and chit-chat. Its use for other purposes is discouraged.

Channels 32 through 40 are generally used by CB stations operating in single sideband (SSB) mode. Because of their technical differences, SSB and standard AM mode operations can't coexist locally on the same channels without causing severe interference to one another. SSB stations therefore restrict their operations to these channels so as not to disrupt standard AM CB'ing. AM-only CB'ers are therefore asked to operate only between Channels 1 and 31.

Many local areas have established a favorite neighborhood or community call, club, or chit-chat channel. Everyone monitors it, and that's where you can hook up with any local operator. These channels invariably welcome newcomers to check in and make friends. What they don't like on such a channel is an operator who likes to hog its use, shoot skip (work DX), or gets involved in a long-winded discussion. The idea is to make an initial contact on this channel, then quickly take your chat to a secondary or other mutually agreed-upon channel so the call channel remains available for ready access to all operators.

On The Air!

What's all this business about "breakers"? Sure, if you want to interrupt someone else's contact, for whatever reason, then you should announce a "break."

However, unless you want to literally "break" onto a channel that other stations are actively using, there seems no logic to using the word "break," or identifying yourself as a "breaker." Makes no sense at all to use either term when getting ready to use an otherwise quiet channel. What's worse yet, announcing on a quiet channel that you are a "breaker," and are



Chip "The Judge" of Ridgewood, New Jersey has quite a collection of radio gear in his neat-looking radio room.



Channel 9 is the official highway assistance/emergency channel. You'll find that many public safety agencies monitor the channel to provide assistance to motorists. Don't use channel 9 unless, of course, you're reporting a problem or need other assistance.

seeking to be granted permission from some unknown station to use your radio.

Nobody "owns" a silent CB channel and needs to be sought out for permission to

use the frequency. If there are no local stations using it, then forget all of that ridiculous "breaker" nonsense and make your call (or "shout") to the station you are try-

ing to reach. Give the other station's handle, followed by your own, "Pineapple, Pineapple, here's Tomcat calling. Come back." Listen for a response. If the other station doesn't reply, try calling once or twice more, then quit.

If you're not looking for a specific station, but you would like to hook up with any other random station on the channel, simply say so, identifying yourself. Like, "Anybody on the channel today? It's Tomcat here. C'mon back!" If you want to enter a social conversation between other stations, then wait for the brief period between transmissions and announce that you're a "breaker." They'll ask you to identify yourself, and will normally invite you into the chat.

For lack of knowing how to solicit random contacts, some lazy CB'ers resort to using two old ploys that were annoying and dumb, even when they first came into vogue 20 years ago. These have not improved with age, so a great many present day operators regard them with utter scorn. Therefore, avoid seeking random contacts by asking for a "10-36," which pretends asking anyone to let you know what time it is. Furthermore, never call out for a "radio check." The response will be a half dozen enraged operators shouting,

RF Limited The Leader In CB Radio Technology

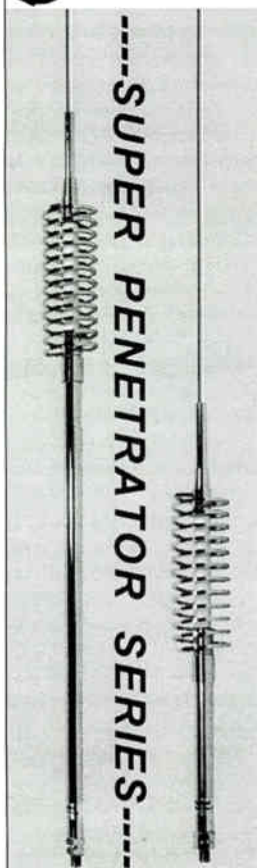

The Super Penetrator Antennas

- Super Wide Band, 25-30 MHz
- Quad-Angular Helical Coil (BIC-11 and BIC-11S Antennas Shown)
- Brass and Stainless Steel Construction
- 3500 Watt Power Rating
- Two Shaft Lengths: 16 or 25 Inch



HANDS FREE TX'ing FOR CB!

Handsfree/Voice Activated Headset For CB Transceivers!

- Plugs into CB like a standard microphone
- Fully adjustable speaker/microphone headset with folding headband
- Handsfree or manual PTT switching
- Adjustable VOX sensitivity
- Control box has belt/lapel clip
- Adjustable Talk Back feature to monitor transmitted audio
- Prewired for Cobra, Uniden 4pin radios

For The Name Of Your Nearest Distributor Call : 206-222-4295

Land Matic™ CB Accessories



LM-300

5 Digit Frequency Counter

- Perfect for radios without frequency counters!
- Know your exact frequency at all times!
- Frequency Ranges: 1 - 99MHz (LO) 1 - 250MHz (HI)



LM-50

SWR/Power Meter with Antenna Matcher

- Measure SWR and power output (0-10 or 0-100 watts)
- Keep your radio and antenna matched at all times!
- Price Breakthrough! Call For Pricing!



LM-830

Multi-Meter Measures -- RF Power, AM Modulation, FM Deviation,

SWR, Field Strength, and 5 Digit Frequency Counter!

Land Matic Products at Unbeatable Prices! Call RF Limited at 206-222-4295

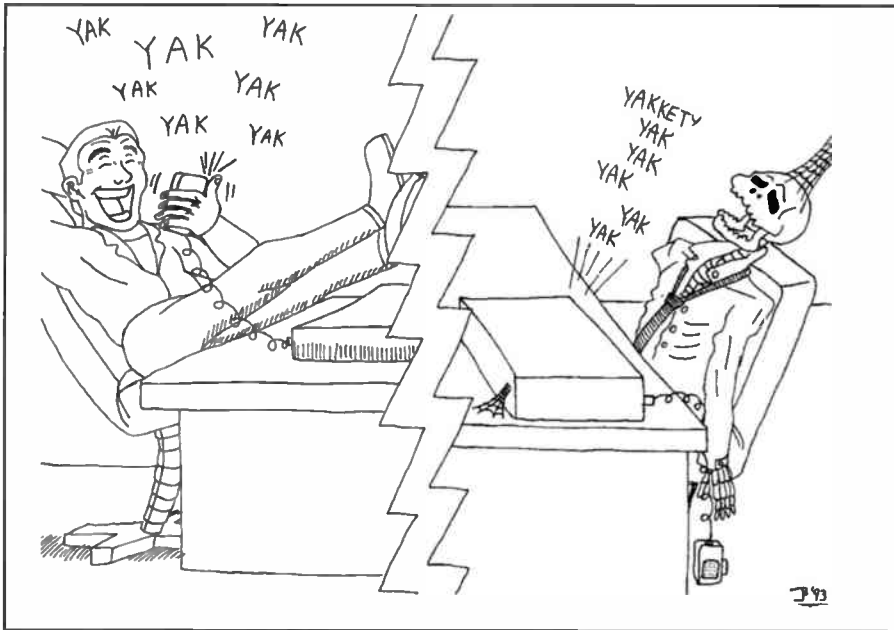

Since you'll have your CB a long, long time, give others a chance to talk. A long-winded operator or "ratchet jaw" quickly becomes well-known on the channels.

"Your radio's working fine, buddy."

Most chat topics are fair game on CB, but operators prefer not to become involved in discussions relating to politics, religion or sexual matters. Only the sleaziest of operators think they need to resort to smutty remarks and jokes, use racial or bigoted epithets. Favorite talking topics include CB radio itself, scanners,

jobs, sports, hobbies, food, cars, kids, vacations, and the big one that got away. There's a lot of good-natured kidding around, too. This is a friendly crew.

The day you get started on CB, curb your natural inclination to yak until the swallows come back to Capistrano. You're going to have CB radio available every day, don't quickly wear out your



Trevor Fletcher of Edmonton, Alberta, Canada sent us a photo of his shack. Would anyone guess that Trevor enjoys building model airplanes and gets the whole family involved in CB?

welcome on the channels by being an ever-present, ever-talking, all-knowing, "ratchet jaw," and general pain in the antenna to all of the other locals. The idea is to start off gently and blend gradually into the fabric of the local CB community during a period longer than the first week you have the CB set. You'll get used to them, and they'll get to know you. This is as it should be.

Ending the Contact

When the time comes to end a CB contact, simply say that you've enjoyed the conversation. You can add you'll be back on the air in an hour, or later in the day, or tomorrow, or whatever. You can explain you have a phone call ("a land-line"), or an appointment. No elaborate excuses are needed. Say your good-byes, and back out with some courteous words looking towards your next contact with that operator, even if you aren't.

A Few More Tips

Here are a few more basic operating guidelines you may find useful to enjoy a long and pleasant CB career: never speak badly of another operator, or CB club. Don't become a person who establishes him/herself as the apparent "owner" or controller of any channel; and lastly, don't inject yourself into someone else's contact when it's obviously a personal or family matter.

You now know enough to show up on the AM CB channels and get the most use and enjoyment from the equipment you purchased. It's just as easy to do it right and get the maximum, as it is to do it wrong and end up with a brief, thoroughly miserable, stint on the channels. They're your channels, you bought the radio, and the choice is yours! ■

Helpful Hints

Treat your new CB purchase with care. Remember, it's a delicate piece of electronic gear; dropping, knocking or abusing it can cause intermittent operation and void your warranty.

Got a cellular phone? Maybe you've just bought a new ham radio, too. Very often cell phones have dead spots, and even though you've programmed all the latest repeater frequencies in that new ham radio, you still can't get assistance on the highway. It won't hurt to get a small mobile CB. Tuck it in the glove compartment. When you need it, it's there.

Eight Steps to Antenna Safety

Every year fatal mistakes have cost radio hobbyists their lives and their equipment. It doesn't have to happen . . .

BY EDWARD V. HAMMOND, WN1I

Safely constructing, erecting and ultimately enjoying the use of your Citizen's Band base antenna should be your primary objective whenever you tackle an antenna project.

Having worked several years as the amateur sales manager for a large New England-based amateur antenna manufacturer, I stress that SAFETY MUST be your primary concern when erecting ANY antenna. Too often, all of us get caught up in the euphoric rush to get the antenna up and cooking without safely planning each phase of antenna construction and safe installation.

Rule No. 1: Plan, Plan and then Plan Some More

A good start is to survey the intended site or sites where you wish to position the CB antenna. What equipment will you need? Make a list of hardware, tools and equipment, of course not forgetting your helpers. Like any project, the more, the merrier. Proper planning for anything in life takes into account all possible variables. In the case of any antenna, the weather, good equipment and an experienced person to help oversee the project cannot be stressed enough.

Rule No. 2: Think Safety FIRST.

Just as one of the major concerns of most manufacturers is minimizing industrial accidents, you have to be concerned about your own (and others) safety. The last thing you want to happen on antenna day is a mishap that could easily injure or kill you or your friends. Some key things to consider are:

1. Avoid ANY possible contact or potential contact with power lines. Despite changes in CB antenna construction, where verticals are insulated, but quads or beams are metal, there are still too many electrocution deaths of

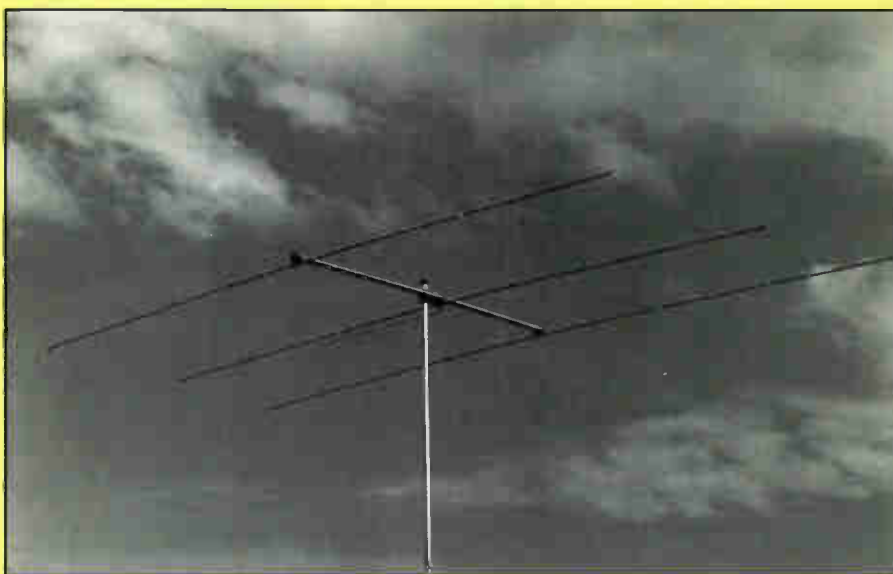

Always get a helping hand when installing ANY antenna. This large Cushcraft yagi is a snap to erect, as long as you plan your installation before "Antenna day." (Photo Courtesy Cushcraft Corp.)



A fast-acting gas discharge lightning arrester is an absolute MUST on your antenna installation. Pictured here is the LAC-4H with SO-239 connectors.

CBers and hams alike each year. In the CB heyday of the late 70's, scores of CBers met a violent death by high-voltage electrocution in their rush to get on the air.

My rule of thumb when speaking to amateur clubs or radio shows is "measure the total height from the tip of your antenna to ground, always maintaining a distance of 1 1/2 times that height away from any power lines."

2. Cover your head and eyes. People might laugh at construction helmets, but one quick whack to the head and you or your helpers could be rendered unconscious, or even worse. Your eyes are indeed a vital necessity in life and a rather vulnerable area when it comes to potential injury. ALWAYS wear safety glasses when working on towers, with power tools or even soldering a connector. I have been made painfully aware of this rule I recently violated when erecting a tower. A swinging guy wire hit me directly in the left eye, resulting in a rush to the emergency room. A scratched cornea and blurred vision for a few weeks was bad enough. The bill for my stupidity exceed-



WORLD FAMOUS RADIO COMMUNICATIONS MICROPHONES

SIMPLY A CLASSIC

The Famous Crystal D104 Family!

SILVER EAGLE NIGHT EAGLE

The ASTATIC SILVER EAGLE features the original D104 Super Talk-Power microphone with a rugged transistor amplifier. The D104 uses a metal sealed crystal, combined with an extra large diaphragm that gives the D104 a distinctive sound that has been the standard which all others have been compared for many years. The Silver Eagle is solidly constructed of brass and die cast zinc, and features an American Eagle embossed on the back of the D104 head. The mic is then polished to mirror finish and bright chrome plated.

The ASTATIC NIGHT EAGLE has all of the features of the SILVER EAGLE with a unique new finish. The main mic body is done in a luxurious black, while the press bars, locking clamp, and grille screen are polished and bright brass plated. The NIGHT EAGLE also features an American Eagle embossed on the back of the D104 head.



SILVER K EAGLE NIGHT K EAGLE

Equipped With ETS Circuitry

The Silver K Eagle and the Night K Eagle are new versions of the amplified D104 microphone. These microphones feature a unique End of Transmission Signal (ETS) with two different and distinctive sounds. The first sound is a Morse code "K" which is the universal telegraph abbreviation for "over". The second switch selectable sound is a multi-tone burst. The unique ETS circuitry has the following features:

DUAL RELAYS: Eliminates the annoying receiver pop that other "roger beep" microphones cause on electronics switching radios.

LONG BATTERY LIFE: The ETS circuit is only engaged when the microphone is un-keyed.

FAIL SAFE DESIGN: When battery power becomes low, the microphone automatically reverts to normal non-ETS operation to allow time to replace the battery.

SWITCHABLE 20 dB PAD: Useful to prevent over modulation and feedback on "hot" radios.

1104C

Dependable Base Station

The ASTATIC 1104C is an amplified high gain ceramic desk microphone. It features easily accessible tone and volume controls to help customize the sound of your voice for best results on any radio. The 1104C uses a standard 9 volt battery and has a rugged die cast zinc base and ABS upper housing. The 1104C amplifier and 6 wire cable make it compatible with all modern radio transceivers.



SILVER SIDEBANDER



Specially designed for single side band but capable of excellent performance on all communication equipment. The base is attractive high polished chrome finish with grip-to-talk and push-to-talk operation. The 10DAL head is capable of a 90 degree head tilt with adjustable tension.

A TRADITION OF EXCELLENCE SINCE 1933



636L

Dynamic Noise Cancelling

The ASTATIC 636L is a microphone that was designed for use in situations where there is high background noise levels, such as in trucks. Our commercial version of this mic is used in public service agencies, such as fire departments all over the United States. The 636L has a rugged ABS housing, polyurethane coated steel grille screen, and a dependable low impedance dynamic element.



RD104E



ROAD DEVIL



The Ultimate In Noise Cancelling



The ASTATIC Road Devil (Model RD-104E) is an amplified noise cancelling microphone for close talking, hand held applications in CB, Amateur Radio, and SSB communications. The Road Devil features a high

gain amplifier with electronic equalization to provide maximum talk power and intelligibility even under noisy conditions. The Road Devil amplifier and 6 wire cable make it compatible with all modern radio transceivers.

BUM-1

So Rugged It Has a 3 Year Warranty!

For years this microphone has been used in places like factories and oil fields. Now ASTATIC is introducing a new version of this microphone to the communications world. The model number of this new microphone is the BUM-1 (Big Ugly Mic!). It has been rewired to work with virtually all C.B. radios and we even threw in a transformer to make it hotter. The microphone still retains all of the best features of the original design. Who says they don't build them like they use to!



Virtually indestructible housing made from Lexan®.

Specially tailored frequency response for aximum talk power with maximum reduction of background noise.

All stainless steel hardware.

Heavy duty leaf switch that is rated for a minimum of one million operations!

Large press-to-talk bar that can even be configured to lock on if desired.

Two way mounting either using a built in retractable steel loop or an included quick release hang up bracket.

Heavy duty, long life coil cord.

The microphone cartridge is protected with a Mylar barrier. If you spill a cup of coffee on the front of this microphone, it won't even notice!

Guaranteed to be really UGLY! So ugly only a mother trucker could love....

NEW!!

- Amplified Noise Cancelling
- Electronic Equalization for Maximum Talk Power
- Large External Volume Control
- Soft Molded "No-Stain" Vinyl Lip Guard
- Steel Grille Screen
- Rugged ABS Housing in Fire Red or Black
- Heavy Duty 6 Wire Cable
- Uses Standard 9 Volt Battery (Not included)
- Works with ALL modern transceivers

D104M6 B D104M6 C

Ceramic Power Mic

The ASTATIC D104M-6B/C is the hand-held version of the D104 desk mic. Ruggedized for harsh mobile environments, the D104M-6B/C has an attractive chrome plated grille just like it's "big brother" with a tough ABS housing, transistor, amplifier and external gain control. It uses a standard 9 volt battery. The D104M6C has a polished chrome front housing.



575M-6

Amplified Power Mic With Volume & Tone Controls

The ASTATIC 575M-6 is a transistorized ceramic handheld microphone that features a unique combination of tone and volume controls mounted on the front housing. These controls help customize the sound of your voice for the best results on any radio. It uses a standard 9 volt battery, has a rugged ABS housing, and has a polyurethane coated steel grille screen.



Improved

(216) 593-1111 FAX (216) 593-5395



The MFJ-931, Artificial RF Ground device is ideal for apartment dwellers who live on upper floors where no earth ground is possible. (Photo Courtesy MFJ Enterprises)

na safety to protect you from the horrors of lightning and storm static, but for proper antenna operation. CB antennas manufactured today must offer a good match to your CB transceiver, or the whole concept of putting your CB signal into the airwaves is off.

A proper SWR match of antenna to transceiver is VITAL. Always use good quality RG-58A/U or RG8 cable if the distance is over 50 feet!

A good earth ground is constructed by obtaining a high quality ground rod from a local ham store, Radio Shack or farm supply. Tying into a steel grid like sewer pipes, radial wires, etc. all aid in making a reflective ground shield that's so essential to proper radio wave propagation. If you're in an apartment, some manufacturers, like MFJ (800-647-8324) make an artificial ground device.

ed \$300. It could have been far worse!

3. Finally, ALWAYS avoid risky high areas unless you have seasoned veterans with top-notch climbing gear helping you. Steep pitched roofs and poorly-guyed towers are a major concern. Remember, you're supposedly thinking SAFETY FIRST. If inclement weather is

coming your way, simply delay your antenna project until the next day.

Rule No. 3: A Good Earth Ground is Essential

You need the ground not only for anten-

Rule No. 4: Always Test The Antenna On the Ground

Before erecting the antenna, it only takes a few minutes to "field test" the aerial. It could save you a lot of grief if you're



Here's an installation that is both unsafe—it's unguyed for more than 40 plus feet, and illegal because it's over 50 feet tall.



Here's a shining example of a poorly-maintained tower. It's completely rusty and has been erected too close to metal objects, including power lines. It's a disaster waiting to happen.



There are a multitude of antenna mounts available to CBers. Whatever method you use, be sure to properly and securely guy your antenna. It won't be long before Mother Nature tests your efforts, so those extra few minutes spent during your installation phase will prevent needless damage and costly repairs. (Photos Courtesy Radio Shack)

mounting it in a difficult spot or one that requires lots of manpower. A standing wave check on a vertical mounted 4-6 feet above ground or on a beam (point it straight up) should give you a ROUGH indication of antenna SWR performance. Believe me, the grief I got on the phone from angry customers—some of whom were older hams who had paid a small fortune to tower companies to erect a large high frequency array—could have been avoided IF they had only double-checked the construction and SWR on the ground. An antenna 20 feet above a three story peak is tough to analyze once in place!

Rule No. 5: Properly Mount and Guy the Antenna Once in Position

A good practice is to secure the base in a minimum of three points; brackets, guy wires or tie-down points. Wind loading and potential for storm blast will test your antenna installation at some future

date. Do it right the first time and you won't suffer the expense of a new antenna, not to mention some mighty expensive property damage to you or your neighbors.

Rule No. 6: Are You Legal?

Although the old rule of 20 feet above the height of mounting structure (usually a rooftop) for CB antennas still applies (See your FCC Rules and Regulations for CB operation, Part 95D), several factors must be taken into account.

The 20 foot rule is superseded if the building is more than a few stories high. According to the FCC's height rule then, your antenna may not exceed 60 feet above ground level.

Secondly, are you near an airport? Anyone within a few miles of any air strip, airport, military air base, etc. must meet and exceed FAA Rules and Regulations. If you're in doubt, call your local airport for more information.

Lastly, even if you meet all of the above requirements, towns and cities these days may have strict antenna restrictions.

City zoning officials are much more difficult to deal with if they catch you in the act, than if you call them for some friendly advice beforehand.

Rule No. 7: Follow-Through!

Just as any good game of tennis, golf or skeet shooting requires the proper amount of follow-through, so does antenna construction. Make a basic checklist and maintenance check sheet, just like the big boys are required to do at broadcast stations. A monthly checklist for guy wires, mounting brackets, corrosion, SWR, etc. will assure you maintain top CB antenna performance.

Rule No. 8: Protect Your Gear From New Unseen Enemies

Lightning and power surges are two arch-enemies of modern solid state communications equipment. When I was working for the Palm Beach, Florida Sheriff's



This CB dealership base antenna is a nice neat installation, approx. 40 feet tall and well-guyed.



No, it's not a tryout for a TV sitcom, but a crew of seasoned veterans that are a necessity for tower construction. (We haven't figured out what Bill is doing with the axe!). Pictured are (left to right) Bill Price, N3AVY; Ed Hammond, WN1I; Jim Webb, N1LOE; Joe Reisert, W1JR; and Bill's son, Scott Price.

Office as a two-way radio technician, there were certainly many weekends spent in the everglades after lightning storms.

Good movistor surge protection on the power line side and a fast-acting gas discharge lightning arrestor in your coax line

(as near to the antenna as possible) are your best bets!

So, as you plan your antenna installation, keep THINKING SAFETY, and you'll live long enough to enjoy your CB radio. Good luck, have fun and 73's. ■

Put Your Antenna Up Last

BY EDWARD V. HAMMOND, WN1I

The amount of time, effort and expense a radio enthusiast spends installing an antenna, completely disregarding long-term antenna life amazes me.

Yes, as in any other product, the antenna has a certain life expectancy, but you CAN push it well into its golden years with just a little thought.

Just as tower and mounting surfaces must be constantly examined for changes like loosening, corrosion, and wear and tear, so must the antenna surface itself be periodically checked. Insulated vertical CB antennas could be prone to ultra-violet (UV) breakdown. Metal beam antennas like yagis and quads could corrode if you're in an area near the ocean coastline region or near industrial air pollution.

Here's a handy antenna checklist to help you:

- In the case of most metal antennas, an annual cleaning and coat of good old fashioned marine varnish can go a long way to protect your investment.
- The use of high quality stainless steel components, instead of some older zinc-plated hardware will also go a long way toward increasing longevity of your antenna system.
- Many unfortunate ham operators go to great lengths to have the most wonderful antennas, only to have the bird of paradise bend or twist his antenna array. An inexpensive insurance policy to protect against troublesome birds if you have a CB beam are the nice BIG Owls sold by L.L. Bean. It's available from them by mail order at 800-221-4221 or your local Ham Radio Outlet store at 800-854-6046.

Finally, think in system terms of the antenna-rotor-coax-switch-transceiver as one unit. Are they all protected from the environment? A dollar's worth of Coax Seal™ on outside connections and a penny's worth of silicone on PL-259 connector threads at the time of construction can save you a million dollars in grief and aggravation at some later date. Keep your investment factory-fresh.

Keeping Your CB Radio— A Quick Guide to Theft-Proofing Your Mobile

Now that you've spent your hard-earned money on a CB radio, here's how to keep it . . .

BY KEN WATSON

So you've just purchased that brand new CB radio and it's proven to be a great acquisition for you—much better than expected. With the aid of your new CB, you've been able to avoid sitting in huge traffic jams, bad accidents and you've even been able to report traffic tie-ups yourself.

The new friends you've met share similar interests; your CB has become your traveling companion wherever you drive.

Like Magic, It's Gone!

One day you go out to your vehicle, get in, and—OH NO! It's GONE! Your CB has been stolen. How? Why? Your highway companion has suddenly been taken away from you.

Could this have been prevented? Did you do everything within your power to stop it from happening? Perhaps the most important question to ask is: Did you do ANYTHING? Let's find out.

Preventing Theft

The first thing that you have to do to prevent CB theft from happening is very simple: Lock your vehicle every time you're away from it. Close all of the windows and lock ALL the doors. Sounds simple, doesn't it? This is probably the number one way things get stolen from vehicles; owners leave the vehicle unattended with the doors unlocked. It's an invitation to theft! When you leave the vehicle like this, you've made the crooks' job very easy. You might just as well have handed the crook your valuable possessions from your vehicle.

Always lock your vehicle—not sometimes, but EVERY TIME. The one time you don't, you may wind up like thousands of



A typical slide-mount is an excellent way to install your CB. All the connections, including the coax, are connected to the part that remains in the vehicle. The other part of the slide-mount attaches to your radio. When you park your vehicle, simply slide out the transceiver and take it with you. (Photo by Harold Ort)

other folks, regretting the fact that you've lost your valuable electronic equipment.

It's also important to consider where you park your vehicle. Try to park in well lighted areas. Crooks don't like recognition, especially when they are on the job.

Out of Sight!

The next step in preventing the risk of theft is to keep your CB out of sight from would-be thieves who will be looking in your vehicle. Car stereos are now being made that are either entirely removable

or where their faceplates or control panels are easily removable to prevent theft. There are similar options for CB owners who are concerned about theft.

The first option is to mount your CB using a temporary method. Instead of hard wiring the CB into the vehicles' power, you can use a temporary wiring method. An example of this option would be to install a cigarette lighter plug onto the CB's power wires. To use your CB, simply reconnect the antenna and plug in the cigarette lighter plug. When not in use, you can place your CB in the trunk of your vehicle or under the seat simply by



Is your vehicle "theft-proof?" Nothing ever guarantees your vehicle won't be broken into, but if you follow a few simple suggestions, you decrease your chances of becoming a victim. (Photo by Harold Ort)



The ever-popular magnet-mount antenna being hidden from view in this CBers trunk. Eliminating the temptation for would-be thieves goes a long way in preventing theft. (Photo by Harold Ort)

unplugging it and disconnecting the antenna. The approximate cost of this method is under \$5.

Another option is to use a temporary mounting device. This device is usually called a slide mount and consists of two parts. One part is permanently mounted in your vehicle and is hard-wired to your vehicles' power. The second part is physically attached to your CB, including the power connections.

The part that has the CB attached easily slides in and out of the vehicle-mounted part. Again, this option allows you to remove your CB from sight and costs you less than \$20. Is it worth it? You bet. Just ask the folks who didn't use one!

Your Antenna Is a BIG Clue To What's Inside

Another important, yet often overlooked anti-theft technique is removing your highly visible antenna. Many CBers today use a magnetic-mount antenna, simply because it's easily removed when parking in unfamiliar areas, such as malls and parking garages. Tucked away in your trunk, the antenna is ready to use in a few seconds, but out of sight of nearby

thieves. You might also consider an on-glass or AM/FM/CB disguise antenna.

Keep Your Investment!

The CB you have invested in is worth protecting. Take a few extra minutes to evaluate your individual situation.

Are you doing everything you can to protect your investment? It is a very bad, sinking feeling when you find out that something you value and enjoy has been stolen from you, especially when it could have been prevented.

Think about this for a moment: When you've taken the time to secure your CB and removed it from plain sight of would-be thieves, you've decreased the odds of your vehicle being broken into. Would-be thieves "shop" where they see value. Take away some of the value, and you will decrease the odds of theft.

The main points again are: 1. Lock your car, 2. Make sure the windows are closed, 3. Park in well lighted areas whenever possible, and 4. Don't leave your CB in plain sight.

These precautions will not guarantee your CB won't be stolen. Sadly, there is no method that stops all thieves. But if you



Consider buying a new CB with a removable anti-theft control, such as this Cobra HH-70. (Photo Courtesy Cobra.)

practice some common sense, recognize the fact that no area is crime-free, and try some of these suggestions, you will stand less chance of having your CB stolen. ■

Single-Sideband, Is It For You?

A whole new CB world is waiting for you—more power, increased range and plenty of fun . . .

BY JOCK ELLIOTT, SSB-734
CB Editor, *Popular Communications* magazine

Have you ever noticed how the hero in a martial arts movie always scrunches his knuckles up into a little tiny square or uses the side of his hand when he is subduing the bad guy? That's because, by reducing the size of the striking surface, he can concentrate more force into a smaller area.

For the same reason, if someone throws a one-pound pillow at you, it will bounce off harmlessly. But if the same person throws a much smaller one-pound object at you—a can of soup, for example—it could seriously hurt you. (Caution: Do not try these experiments on your friends!) The lesson is clear: concentrate force into a smaller area and you get much more impact.

The SSB Secret!

That is precisely the secret behind single-sideband CB; it concentrates the power of the CB signal to deliver nearly twice as much range under identical conditions as an ordinary AM CB signals. Single-sideband (SSB) is simply another mode of operating on the 40 legal CB channels. The vast majority of CBs are designed to operate only in the AM mode and are thus limited to 4 watts legal power, but CB's equipped with sideband mode can legally put out as much as 12 watts peak power when operating in the SSB mode.

Here's why sideband works so well: an ordinary AM signal consists of a center carrier and two sidebands. The only reason for transmitting a carrier is to give the CB receiver at the other end of the communications something to lock onto. The carrier does not contain any of the transmitted audio of the operator's voice. In fact, when you press the transmit button in the AM mode, 50% of the power goes into the carrier which means that two of your four watts are essentially wasted.

The actual information in an AM signal (the sound of your voice, for example) is contained in the two sidebands (the upper sideband and the lower sideband), and they carry exactly the same informa-

tion. That means the remaining two watts of your AM signal are split between the two sidebands! (See Fig. 1).

A Concentrated Signal

By now, I'm sure you're ahead of me; if you could get rid of the carrier and transmit only one sideband, you would concentrate your signal, and just like a karate blow, it would pack more wallop so you could talk much farther.

That's exactly what a sideband CB rig does. Switch it to upper sideband (USB) or lower sideband (LSB) and key the mike, and nothing happens until you say something. That's because there's no carrier, just the signal of your voice being transmitted—with full power—on the sideband of your choice as you speak (Fig. 2).

But because there is no carrier for a receiver to lock onto, that means a sideband transceiver must be built with another



Well known logo of the SSB Network, founded in 1964.

er control, the clarifier, which is used to adjust the receiver so that it is exactly on the same frequency as the transmitted signal. Otherwise, the voice may sound unnaturally high, like Donald Duck, or unnaturally low, a bit like Baby Huey.

That also means that sideband CBs, because of their additional circuitry, are more expensive than AM-only CBs. Figure on spending at least \$100–200 for



This fine shack belongs to Ed Barnat in upstate New York. As you can see, on SSB Ed uses his Cobra 2000 GTL. A multitude of scanners rounds out Ed's shack.

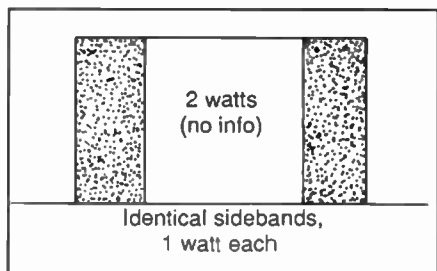

Figure 1.

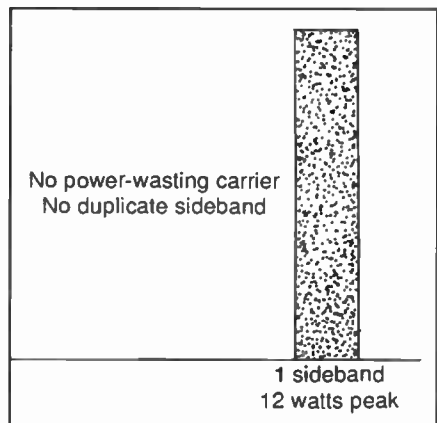

Figure 2.

an SSB mobile rig, and a top-of-the-line base station, like the Cobra 2010 will cost you hundreds. Fortunately, most sideband rigs deliver sparkling performance, even when they are used in AM mode.

It's Another Culture, too

It's not only the sideband radios that are different—you'll find a different CB culture as well. Sidebanders, for example, generally identify themselves using a number assigned by one sideband network or another, and they use their own first names on the air instead of handles. I find sidebanders to be, in general, a pretty civilized group, whose members are often interested in the more technical aspects of CBing. As a rule, I've found sidebanders are more apt to put up large beam antennas that allow communications over longer distances.

The only downside of sidebanding is that there are fewer of them to talk to than AM CB'ers. All single sideband CBs sold in the U.S. have both AM and SSB modes, so, with the flip of a switch, you can still talk with AM CB'ers. SSB operation does not require any special antennas or other changes to CB equipment.

The Federal Communications Commission has steadfastly refused to assign SSB operation to any particular channel or group of channels. As a result, it is legal

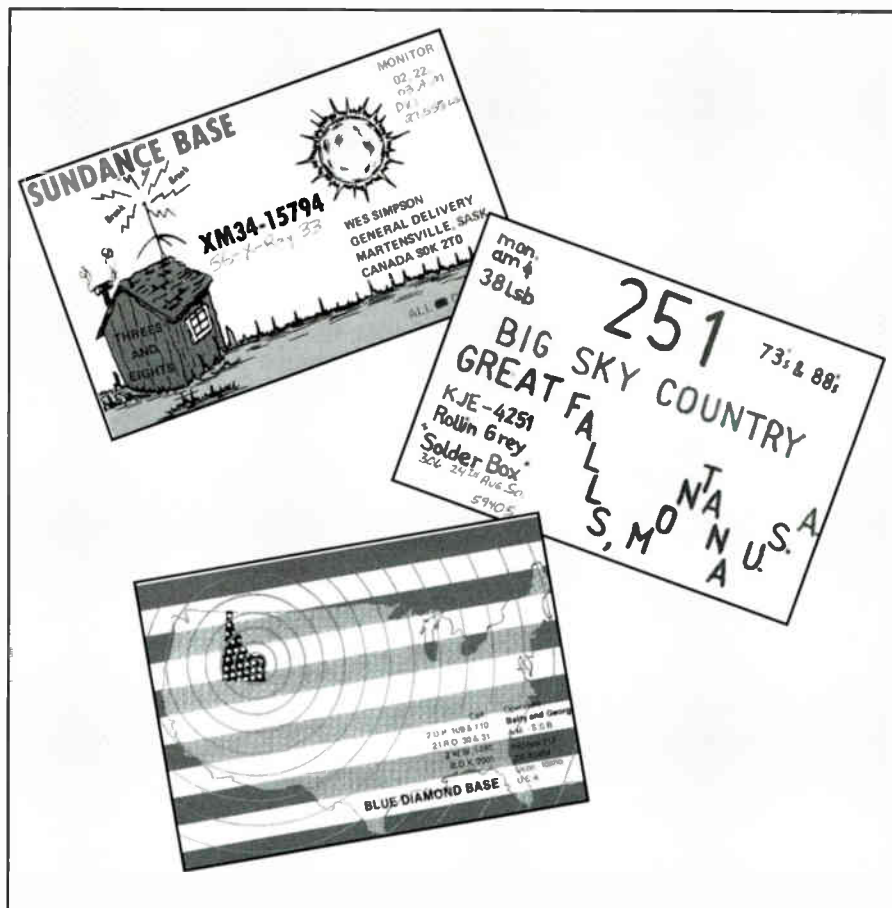

These three QSL cards attest to the fact that SSB is alive and well. Notice that "251" from Great Falls, Montana uses channel 38 LSB.

to operate in SSB anywhere on the 40 CB channels. However, by custom, most sidebanders operate on channels 36-40 LSB and sometimes on channel 16, LSB.

Most sidebanders eventually become part of a local or national network and identify themselves with the numbers issued by one of those networks. The SSB Network, P.O. Box 908, Smithtown, NY 11787 is the largest organization of 11 meter single-sideband operators, representing some 125,000 sidebanders

around the world. If you write to the SSB Network at that address and enclose a self-addressed, stamped envelope with U.S. postage on it, you will get information about the network and an application form. There is a small fee for lifetime registration.

So, is single-sideband CB for you? If you're willing to pay a bit more for longer range communications and the opportunity to talk with a different and exciting group of CB'ers, you bet!

Helpful Tips

It's always a good idea to listen before you talk, so why not take some time to tune across the CB channels, listening for local activity. Then, when you learn the ropes, you'll be surprised the friends you'll make who share your same interests.

Remember the Golden Rule when using your CB radio; keep channel 9 open for emergency and assistance communications. If you want to be a big help to your local public safety officials, consider joining OR STARTING a group of channel 9 monitors that listens for emergency assistance calls. Tying up channel 9 for idle chit-chat, or using illegal power amplifiers can cost lives. Someday YOU could be the person who needs assistance on the nation's only emergency frequency!

The '90s Convoy: "We've got a mighty convoy, rockin' through the night" . . .C.J. McCall

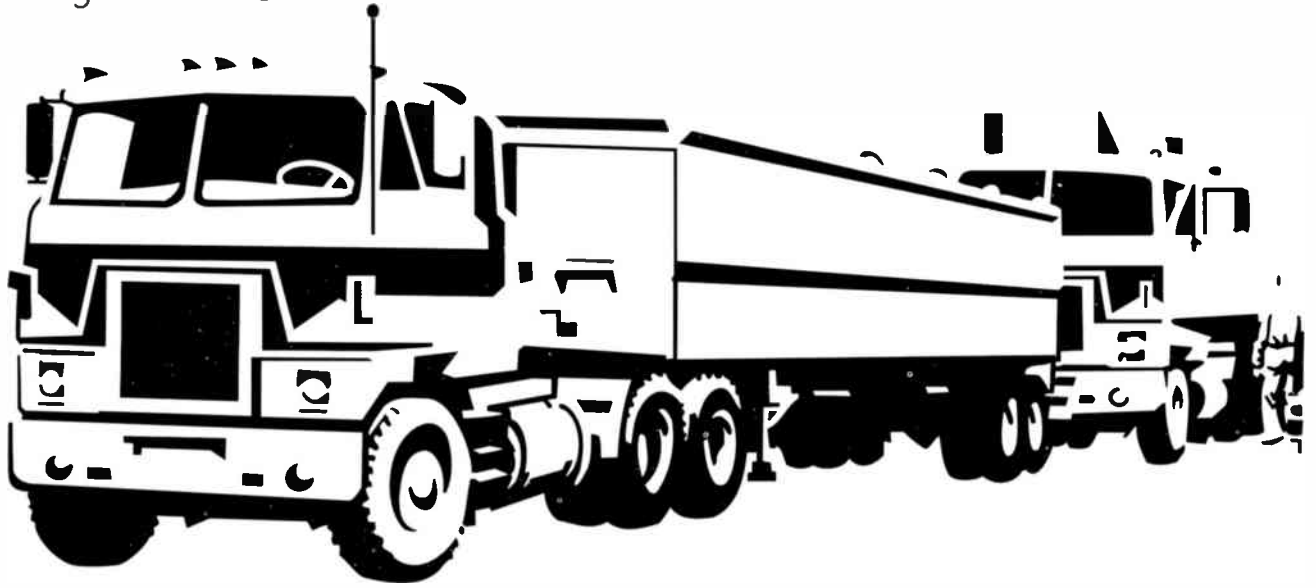

Truckin'

Mileposts disappear into the setting sun, but professional drivers—truckers—and CB go on forever . . .

STORY AND PHOTOS BY BILL SIMPSON AKA "CHICAGO REBEL"

For many of us, these words have a special meaning, from the '70s right through the '90s. These words helped immortalize the "Knights of the Road" . . . the road driver . . . the long haul driver that picks up in Chicago on Monday, makes Spokane on Tuesday, LA on Wednesday and is back in Tampa for dinner on Friday. Yeah, I know, all the professional drivers are coming unglued now, but let's face it guys and gals, that IS the way the media circus portrayed us then. We were SUPER TRUCKER—able to leap continents in a single eight-hour stretch, stop a speeding Smokey, and be a friend to all damsels in distress.

First CB Exposure

My first exposure to a CB was climbing in a rig headed for the "cities"—Minneapolis/St. Paul. For the old-timers, the rig was an old six-channel crystal-controlled rig that seemed to talk three days past forever. I absolutely had a blast with this radio. Back in the '60s there

weren't many stations on the air. We didn't have to worry about interference, bleed-over, adjacent channel rejection, or any of the myriad of things that CB users worry about today.

In the early '70s I retired the EFJ, and bought my first Cobra; a 23-channel model 19, I think. We simply used the radios to chat—as a toy. But we were stuck in the middle of the fuel shortage coupled with the speed limits, suddenly facing reality nose-to-nose. We simply needed a source to find fuel whenever we needed it. The CB became a valuable tool; a way to locate fuel, regardless of the price. As soon as a truck stop received a load of diesel, you could put serious money on the delivery immediately hitting the airwaves! We really didn't care about price, just location. Our other use for the CB, quite honestly, was to locate the "Smokies" as we nicknamed them (for the hats most state police wear). The newly instituted 55 mph speed limit didn't allow us to make a financial living, so we had to find a way to circumvent it.

Suddenly we saw the ultimate "Road

Warrior" (with apologies to Mel Gibson), movies: Smokey and the Bandit, I, II, III etc. with Burt Reynolds, Jerry Reed and Sally Field, and "The Great One"—songs like "Convoy" and even two TV series; "Rollin On" and "BJ and The Bear." I don't remember who starred in either series, but I almost crashed into that big green Kenworth on I-10 near Mobile when he pulled out in front of me on the causeway. I always felt that the chimp "Bear" was underrated as an actor—should have received more lines.

On a more serious note, we were using the CB as an important tool at the time; fuel reports, Smokey reports, directions to our stops, and of course the ultimate "Helpmestayawake!" calls at two in the morning. The trucking industry probably could have survived without CB, but we would not have had as much fun.

The Emergency Channel

After REACT managed to have channel 9 designated by the FCC as an emer-



Recognize the highway? Traffic rushes by on I-94 near the Chicago Loop during morning rush hour. The multi-lane highway, like many others around the country, is shared by four-wheelers and truckers, alike.



This All American Transport rig's antenna puts out a hefty signal.



Joe, a.k.a. "Stranger," a driver with Arrow Moving Co., uses his Cobra CB which is mounted near his visor.



Joe pulls into a "TA" near the border of Wisconsin and Illinois.

agency channel, we even had a way to call for assistance, directions or emergencies. The state police installed CB in most of the cruisers so we could talk to them on the road. Everyone was into CB radio! It was the ultimate thing to do. Every household had two mobiles and a base, it seemed.

As most fads go, so went the CB radio, except for a few individuals who simply

enjoyed the no cost, short range ability to chat with a neighbor within a five mile radius.

And, the Truckers . . .

For the truckers, CB radio continued to be the wave of the future. All the radio systems available either involved a test,

which we had no time to review, or simply did not have sufficient stations in order to be reliable. We could use the CB to talk to each other on the road and could always find someone willing to give instructions (along with fourteen other drivers screaming about smokies) and even had a source to contact for accidents. Best of all, we already had the CB radio installed in the truck! Why should we even

consider any other radio? We even had truckstops sending messages about truck washes and fuel.

Enter—The Nineties

Here we are using the same technology used in the late '70s and early '80s. By the way, don't blame the CB manufacturers; they have advanced technology, but the FCC (I'm from the federal government and I'm here to help you!) will not allow the technology to be placed into use.

For over-the-road drivers, CB still plays a very important part in our lives. We still use Smokie reports, still ask for directions to our next stop (I once made six stops across Illinois, Indiana, and Michigan with only a CB and six addresses and NO MAPS). As recently as July 28 this year, I spoke to a driver entering Chicago with only a company name and phone number, hoping to find the address and directions from the CB radio. This IS optimism! That driver would be a true Chicago Cub fan! Always the optimist.

We will always need to know where the state police are, even though every driver and most of the smokies know that a favorite trick is to pull into the median at some prominent location, stay for 30 minutes, while completing some paperwork, and move to a different location. The reports will continue for several hours, even after the cop is gone.

Another common CB use is to see if the weigh stations, or scales are open, and to discover if the DOT are checking for logbooks, or for safety violations. I think that most drivers today are running at least close to legal logbooks, but tend to fall behind in actually writing down every place they've been. It makes little sense to try to hide previous stops, or destinations; the penalties can be too great. But I digress. . . the bottom line . . . we just want to know which scales are open, and which ones will let us skate.

The Language Situation

While we're on the subject of the slightly illegal, have you listened to some of the language we use on the road? Holy suffering succotash folks, would you use that language if you knew your mother was listening? Yeah, I know, it's the '90s, and yeah, I've heard—and used—most of the words myself. Years ago, we discovered that we could hide behind the mike and say anything we wanted. Suddenly it became a habit we couldn't break. If we're supposed to be the Knights of the Road, how do we sound to a young mother with three small children heading across country to see Grandma? And for Pete's sake, how do we sound to

Grandma, who grew up in the '60s, and still believes in us?

Checkin' In With CB Today

Anyway, back to current CB use. Most of us know which truck stops are CB users; we check on mechanics, CB shops, truck washes, fuel prices, and even the restaurant or a particular waitress that MIGHT be working. The regulars might check for another driver that could be refueling or simply stopping for a cuppa. Many of the truck stops will advertise over the air for specials on fuel, a truck wash or even freshly-made lemon meringue pie. Company drivers will check with other company drivers to see if other loads are available.

Then there's MY personal favorite—the dreaded "Construction" which normally starts January 1, and finally finishes December 31. Notice I didn't specify a particular year. We must slow down to precisely seven miles below the posted speed limit in the one lane, no passing zone-14 mile stretch of highway. Don't worry about the line of traffic behind you, 'cause there's another truck 200 yards ahead with his own string of traffic. If a four-wheeler gets around you, he's got at least 90 other cars to pass before he reaches the next truck.

In reality, if we spot construction, or hear of it on the local traffic reports, we can usually find someone to direct us around the problem. We all have stories about the four-wheeler that flipped his (travel trailer, U-Haul, boat or camper) during the road construction at (your favorite location) and stopped traffic for several hours.

We all know about contacting channel 9 for emergencies, motorist assistance and directions. Unfortunately, during recent years, REACT, the only nationwide organization consistently making an effort to answer calls on channel 9, has suffered a decline in membership, creating a possible delay in answering a call. They request drivers trying to report an accident to simply continue to broadcast the problem, location, and state for several minutes. Someone will normally hear your call and send assistance. You might pop back up to the road channel and have another driver warn approaching vehicles of the problem.

Another favorite use for CB is to solve the problems of the world, the U.S., the state, local government, the guy two doors down, or our own. We'll get to chatting with someone, and really get into an interesting discussion, totally forgetting that maybe someone else wants to get directions. I've participated in legitimate discussions on just about everything imaginable, and have suddenly discovered that a hundred miles have vanished.

It's Not A Truckstop Anymore!

BY BILL SIMPSON

It's a travel center!

Two decades ago, as we drove across this great country, the rule of thumb was to always stop for meals at a place where the truckers stopped. The food was guaranteed to be great, since the truckers knew ALL the good places. I don't think anyone realized that truckers used the establishments that had the big parking lots and fuel available. Normally the restaurant had adequate food, and the service was fast, since even then the truckers had schedules.

The shop was dark, and usually stained with oil and grease to a three foot level. The mechanic was named "Buford" or "Joe" and swapped grease from hands to overalls with suave aplomb. Truck wash? Sure, the hose is out back . . . help yourself. Showers? Sure, the hose is out back . . . help yourself.

Welcome to the 21st Century!

While traveling in the area between Chicago and Milwaukee, we stopped in at the "TA" and chatted with Karen Seivert, Store Coordinator, about the changes occurring in the industry. The "TA", as Truckstops of America are known, is typical of the facilities utilized by the drivers—and by travelers and the local population, too.

"We have every item that truckers could want; clothes, snacks, logbooks, electronics, boots, sandwiches, fuel, and even showers," said Karen. "This is the ultimate in one-stop shopping—road service, repairs, and even telephones to contact the brokers," she added.

Glancing around at the airy, spacious restaurant, the fully-stocked store and video games and TV with VCR along with rental information, we agree.

Best of all, I was awake and alert, had learned something new and had a good time while driving. No, we really didn't solve many major problems, but did learn how to check the timing in a lawn tractor, grow much bigger roses and about 12 new baits for catfish. I was also told that some guy's sister was leaving her husband 'cause he was staying out late. (I really didn't care about THAT one.)

I'm sure I've missed several uses for the CB that truckers have today, so I'm depending on YOU to tell me some more. I normally travel only the midwest now, so Knights of the Road, how 'bout sending me your favorite? There simply has to be more, even if they are some local uses.

Send me your favorite CB story, or just express your ideas on something about truckin' and CB. Nope, there aren't any prizes—I can't even promise to use your ideas. I will promise to write back, though.

73's and keep 'em rollin'.

Chicago Rebel

CB Base Mobiles

In this section, listed alphabetically, are Citizens Band radios. Where available, retail/suggested list prices are given. They vary considerably from "street" prices so shop around for the best deal. Today's CB radios are all 40-channel transceivers except some walkie talkies. Remember that most CB radios come with a microphone and internal speaker, but most don't include an antenna or coaxial cable. Be sure to check our "accessories" listing for antennas and other accessories.

Cobra Electronics Corp.

19 LTDII Classic

CB radio features detachable front-panel microphone, rotary tuning, LED channel indicator, S/RF meter, non-switchable noise limiter, volume/squelch controls and external speaker jack. Power requirement 13.8 Vdc. Dimensions (HWD) 1 3/4" x 5 3/8" x 7". Weight 2 1/3 lbs.\$90

21 LTDWX Classic

CB radio features include same basic features of 19 LTD Classic, except includes RF gain switch, mic gain control, transmit indicator and switchable auto noise limiter. Power requirement 13.8 Vdc. Dimensions (HWD) 1 3/4" x 5 3/8" x 7". Weight 2 1/3 lbs.\$110

25 LTD Classic

CB radio features include microphone, RF gain control, mic gain control, rotary tuning, LED channel indicator, transmit/receive indicator, S/RF meter, non-switchable noise limiter, bright/dim switch, noise



blanker, instant channel 9, PA function, volume/squelch controls, external speaker jack and PA speaker jack. Power requirement 13.8 Vdc. Dimensions (HWD) 2 1/8" x 6 1/4" x 8 5/8". Weight 3 5/8 lbs. 25 LTD Classic\$160

29 LTD Classic

CB radio features include same basic features of the 25 LTD Classic, except with SWR calibrate control, S/RF-SWR-MOD meter, switchable noise limiter, antenna warning indicator. Power requirement 13.8 Vdc. (HWD) 2 1/4" x 7 1/4" x 8 5/8". Weight 4 3/8 lbs.\$200

19DX

CB radio features 40 channel operation, LED channel display, LED bar graph signal strength meter, red transmit indicator, instant channel 9 and rotary controls for volume and squelch. Tuning is via push-button up/down control. Also features ANL, CB/PA switch, external speaker jack, PA speaker jack and front-mounted PTT mic.

Power requirement 13.8 Vdc. Dimensions (HWD) 1 3/4" x 4 1/2" x 6 5/8"\$80

7DX

CB radio features 40 channel operation, transmit indicator, electronic push-button up/down tuning. Power requirement 13.8 Vdc.\$63

148 GTL

CB radio features 40 channels in AM/SSB modes. Features include: mic gain control, SWR calibrate control, S/RF-SWR-MOD meter, tone control, meter function switch and bright/dim switch. Power requirement 13.8 Vdc. Dimensions (HWD) 2 3/8" x 7 7/8" x 9 1/4". Weight 5 lbs. 148 GTL\$330

148F GTL

CB radio features 40 channels in AM/SSB modes. Features include rotary volume/squelch, mic gain, RF gain/SWR calibrate, mode selector switch and channel selector. Separate displays indicate channel in use and frequency. Also includes two-color LED transmit/receive LED, high/low tone control, ANL, dim/bright switch, noise blanker control, PA control and outputs and mounting bracket/hardware. Audio output 4 watts. Power requirement 13.8 Vdc.\$370

7 Ultra

CB radio features 40 channels, rotary volume and squelch controls, transmit indicator, channel display window, and front-mounted mic. Also features up/down channel selector buttons, external speaker jack and mounting bracket/hardware. Audio output 4 watts. Power requirement 13.8 Vdc. Dimensions (HWD) approx. 1 1/4" x 4 1/2" x 6 1/4". Weight 1 lb 10 oz.\$63

7 Ultra AT

CB radio features 40 channel operation, front-mounted PTT mic, rotary volume and squelch controls and 24" magnet-mount antenna. Also features transmit indicator. Power requirement 13.8 Vdc.\$79

Cobra 18 Ultra

CB radio with front-mounted microphone, front-mounted speaker, instant



Channel 9 access and National Weather Service (NOAA) instant access. Features push-button up/down channel tuning, rotary volume and squelch controls and LED signal strength meter. Includes mobile mounting bracket. Power requirement 13.8 Vdc. Includes external speaker jack.

Dimensions: (HWD) 2" x 7 1/2" x 6 3/4". Weight approx. 2 1/2 lbs.\$110

Cobra 19 Ultra

CB radio with front-mounted microphone, bottom-mounted speaker, instant Channel 9 access, external speaker and PA jacks, LED display shows channel number, signal strength and transmit mode. Includes mobile mounting bracket. Power requirement 13.8 Vdc. Dimensions: (HWD) 1 3/4" x 4 1/2" x 6 1/2". Weight approx. 3 lbs.\$80

HH-70

Remote-mount mobile CB features 40 channels and maximum legal power. Other features include one-piece handheld operation, two-wire remote installation, instant channel 9 selection, pushbutton keylock, backlit LCD (shows RF/signal strength, key lock or transmit), on/off volume control, squelch, 10-foot coiled cord, microphone, external speaker jack and key lock\$170

29-LTD WX

CB radio features nearly identical to 29 LTD Classic, except includes reception of seven weather channels and includes weather alert tone feature\$220

25-LTD WX

CB radio features nearly identical to 25-LTD Classic, except includes reception of seven weather channels and includes weather alert tone feature\$180

93LTD WX

CB radio features 40 channels, rotary volume, squelch and volume/on/off controls. Also includes switchable RF gain control, ANL, large LED channel indicator, illuminated signal strength meter, instant Channel 9 control with LED indicator, weather channel selector, and oversized channel selector control. Power requirement 120 Vac. Audio output 4 watts. 93LTD WX\$180

CB Base Mobiles



2010 GTL WX

CB radio features 40 channels in AM/SSB modes. Features include five-digit frequency counter (measures both modes), weather channel reception with alert mode, instant channel 9, dynamic front-mounted base station mic, separate meters for signal strength and SWR/MOD, ANL, noise blanker, channel indicator with mode and counter; rotary volume, squelch, RF gain, mic gain, voice lock and SWR calibrate controls. Power requirement 120 Vac or 13.8 Vdc. Dimensions (HWD) approx. 4 1/2" x 13" x 9 1/2". Weight approx. 9 1/2 lbs\$660

10 SOS

CB radio features include 40 channel operation and maximum legal power. Other features include on/off/volume control, transmit/receive indicator light, channel up/down button, LED channel display, squelch and microphone. Kit designed as emergency radio system and equipped with mic hanger clip, magnet-mount antenna, emergency flag and user's guide.

10SOS\$90

23 SOS Kit

CB radio features 40 channels, separate transmit/ receive indicators, LED signal strength meter, LED channel display, rotary tuning, squelch, instant weather channels, ANL, and front-mounted mic. Also includes cigarette lighter power cord, magnetic mount antenna, mounting bracket, emergency flag and hardware for permanent or temporary installation.....\$120

GE Communications Products

3-5807

Compact mobile CB transceiver features 40 channels, receive/transmit LED, electronic scan tuning, quick-release mounting bracket, front panel mic connection, built-in ANL.\$55

3-5920

CB mobile radio with 40 channels, magnetic-mount antenna, and DC cigarette lighter cord. Ready-to-use unit features full legal limit power output, collapsible antenna, electronic scan channel selection, instant channel-9 access. Controls: on/off/power/volume control, push-to-talk bar, local/distant setting. Built-in ANL, LED channel display, transmit light, built-in speaker and jacks for external DC power and antenna.\$60

K40 Electronics

Speech Processor CB System

Mobile CB radio and antenna with the



following features. Speech processor circuitry, full time ANL, transmit/S/RF LED meter, and K40 antenna. Power output 4W. Speech Processor.....\$160

Maxon Systems

27-MCB

CB mobile radio with 40 channels. Features include instant-Channel 9 switch, last channel recall, volume and squelch controls, LCD with backlight, jacks for optional ear microphone and remote PTT button, bar-type signal strength display, built-in speaker and microphone, (unit fits in users hand, while antenna connection unit/power assembly mounts under dash, etc.) Dimensions (HWD) 5 1/4" x 2 1/2" x 1 1/2". Weight approx. 1 lb.....\$140

MCB-10A

CB radio features 40 channel operation and maximum legal power. Transceiver housed in single cabinet size and shape of handheld microphone. Features include LED display, transmit indicator light, last channel memory, instant channel 9 access, PTT mic, up/down channel selector buttons, top-mounted on/off volume and squelch controls. Attached antenna/power connector box contains CB antenna jack, external speaker jack and 12 Vdc fused wiring. Mounting hardware included. Antenna not included MCB-10A.....\$120

MCB-20

CB radio features 40 channel operation and maximum legal power. Features similar to MCB-10 except LCD display and also shows signal strength. CB transceiver can be moved between vehicles equipped with optional MCB-20A antenna/power connector boxes. Installation hardware included\$140

MCB-25

CB radio features 40 channel operation and maximum legal power. Standard features include front-mounted microphone with modular jack, coiled cord and PTT bar. Receiver is dual conversion superheterodyne with tuned RF stage, built-in ANL, PLL circuitry. Green LED readout, last channel memory, up/down channel

selector buttons, variable squelch control, transmit indicator, power on/off, volume control, external speaker jack. Includes mounting bracket, mic hanger and installation hardware. Dimensions (HWD) approx. 1 3/8" x 5" x 6 1/4" ...\$60

MCB-30

CB radio features 40 channel operation and maximum legal power. Features nearly identical to above MCB-25, except mic jack is 5-pin.....\$70

MCB-40

CB radio features 40 channel operation and maximum legal power. Includes front-mounted 4-pin screw-on microphone with locking ring, coiled cord and PTT bar. Features include CB/PA function switch,



ANL, 18-segment multi-colored S/R/F meter, transmit indicator light, dual conversion superheterodyne receiver with tuned RF stage, PLL circuitry, green LED readout, last channel memory, channel selector knob, squelch, volume, on/off control, external speaker and PA jacks. Includes mounting bracket, mic hanger and installation hardware. MCB-40\$80

MCB-50

CB radio features 40 channels, instant channel 9 access, analog signal/power meter and front-mounted mic. Also switchable ANL/PA, noise blanker, meter bright-



ness control. Rotary controls for volume, squelch, MIC and RF gain. Display indicates channel number. Last channel memory recalls last channel displayed. Includes jack for external speaker. Requires 13.8 Vdc. Dimensions (HWD) 2" x 6 1/4" x 7"\$140

MCB-55

CB radio features 40 channels, instant

CB Base Mobiles

channel 9 access, signal/power meter, front-mounted mic and speaker, volume, squelch, RF gain, noise blanker and ANL controls. Also features reception of three NOAA weather broadcasts. Last channel memory recalls last channel displayed. Display indicates channel (or flashes channel 9 or indicates PA). Requires 13.8 Vdc. Dimensions (HWD) 2 1/8" x 7 3/8" x 7". Weight approx. 3 lbs 3 oz.\$140

MCB-60A

CB radio features 40 channel operation and maximum legal power. Includes front-mounted 4-pin microphone with locking ring, coiled cord and PTT bar. Also includes multi-function analog meter indicates SWR, RF output power and receiving signals; direct access to channels 9 and 19, ANL, noise blanker, CB and PA switches, transmit and receive indicators, bright/dim switch and control knobs for volume, power on/off, channel selector and squelch. Equipped with external speaker and PA jacks. Includes mounting bracket, mic hanger and installation hardware. Dimensions (HWD) approx. 2 1/4" x 7 3/4" x 8"\$160

Midland

77-092

CB Radio features separate LED system for transmit/receive, green LED channel indicator, adjustable squelch and volume control, preset automatic noise limiter, quick disconnect mounting bracket, external speaker jack and front-mounted condenser mic. Channels selected by pushbuttons. Power requirement 13.8 Vdc. Dimensions (HWD) 1 5/8" x 4 7/8" x 6 1/2". Weight approx. 2 lbs.\$100

77-099

CB radio features LED channel indicator, full-time noise limiter, front-panel microphone, volume/squelch control, quick-disconnect mounting bracket and external speaker jack. Power requirement 13.8 Vdc. Dimensions (HWD) 1 1/2" x 4 1/4" x 6 1/4". Weight approx. 2 lbs.\$100

77-099X

Same as 77-099 except includes center-loaded magnetic mount antenna with cable and connector.\$150

77-104XL

CB radio features LED channel indicator, automatic noise limiter, volume/squelch control, and external speaker jack. Power requirement 13.8 Vdc. Dimensions (HWD) 1 1/4" x 4 1/2" x 6 11/16". Weight approx. 3 lbs.\$100

77-106

CB radio features LED channel indicator, up/down channel selection buttons on front-panel microphone, volume/squelch control, instant channel 9 button, multi-colored S/R/F meter, automatic noise limiter, external speaker and PA speaker jacks, and quick disconnect power cord and mounting bracket. Power requirement 13.8 Vdc. Dimensions (HWD) 1 1/4" x 4 1/2" x 6 11/16". Weight approx. 2 lbs.\$130

77-116

CB radio features LED channel indicator, volume/squelch controls, instant channel 9 switch, receives NOAA weather broadcasts, noise limiter switch, S/R/F meter and quick disconnect bracket and DC cord. Power requirement 13.8 Vdc. Dimensions (HWD) 1 1/4" x 5 1/2" x 6". Weight approx. 3 lbs.\$150

77-116Z

Same as 77-116 except includes glass mount antenna with cable and connector 77-116Z\$200

77-117

CB mobile radio features 40 channel operation with 7-channel weather and alert feature. Receives all U.S. and Canadian VHF weather channels. (Alert circuit is switchable) CB features green LED readout, memory channel 9, remote control channel change on mic, signal output and "S" meter. Also includes variable volume and squelch and noise elimination circuitry. Requires 13.8 Vdc, negative ground. Includes remote control mic, DC cord, mounting bracket and hardware. Dimensions (HWD) 1 1/4" x 5 1/2" x 6"\$200

77-118

CB radio features LED channel indicator, switchable noise limiter, instant channel 9 switch, volume/squelch controls, receives NOAA weather broadcasts, noise limiter switch, front mounted speaker,



memory-hold circuit (retains last channel used when unit is turned off), channel access via front panel or microphone switches and quick-disconnect bracket and DC cord. Power requirement 12 Vdc. Dimensions (HWD) 2" x 6 3/4" x 6". Weight approx. 4 lbs.\$170

77-130 "Star Max"

CB mobile radio features 40 channel operation, green LED channel readout, backlighted multi-color S/R/F meter system. Also local/distant RF gain control, memory channel 9, chrome front with silver/chrome knobs. All metal cabinet with mic (four pin screw-on connector), and external speaker jack. Requires 13.8 Vdc, negative ground. Dimensions (HWD) 2" x 6" x 7"\$170

77-160XLT

CB radio features LED channel indicator, volume/squelch controls, RF gain control, bright/dim switch, multi-colored metering system, rubberized overlay on control knobs, instant channel 19 access, external speaker and PA jacks, and quick release bracket and DC cord. Power requirement 13.8 Vdc. Dimensions (HWD) 1 7/8" x 5 3/8" x 6 7/8". Weight approx. 4 lbs.\$180

77-225A

CB radio features LED channel indicator, all microphone-mounted controls (to allow user to mount radio portion under seat, in trunk, etc.) on/off/volume, squelch, up/down channel selector, local/distant switch, channel 9 switch. Also includes two-speed channel scan, memory retention circuit, automatic noise limiter, and jacks for external speaker and PA. Includes mounting bracket and quick disconnect power cord. Power requirement 13.8 Vdc. Dimensions (HWD) 1 1/4" x 4 3/4" x 6 1/2". Weight approx. 3 1/2 lbs.\$250

77-250C

CB radio features LED channel indicator, front mounted microphone with long cord, volume/squelch controls, mic gain switch, bright/dim switch, RF gain control, chrome front panel control SWR calibration control, multi-colored S/R/D/modulation/SWR bar meter, switchable noise blanker, switchable noise filter, instant channel 9 and 19 access, slide-in/out mounting system, rubberized shock mounts, and quick disconnect power cord. Power requirement 13.8 Vdc. Dimensions (HWD) 2 1/4" x 7 1/4" x 7 1/4". Weight approx. 5 lbs. 77-250C\$230

77-285

CB radio features 40 channel operation and maximum legal power. Standard features include backlighted controls, self-adjusting CPU, instant channel 9 and 19, four user-selectable "memory" channels, dual watch mode, last channel recall, full-stage noise blanker, local/DX switch, external speaker jack and 4-pin screw-on mic connector. Requires 13.8 Vdc.

CB Base Mobiles



Includes power cord, mounting bracket, microphone and manual. Weight approx. 2 1/2 lbs. Dimensions (HWD) approx. 1 7/8" x 6 1/4" x 8"\$250

77-909

CB radio features LED channel indicator, magnetic mount antenna, instant channel 9 access, volume/squelch controls, built-in condenser microphone, carrying case, telescopic antenna, separate up/down channel selection buttons (with two speeds) and cigarette lighter plug. Power requirement 12 Vdc. Dimensions (HWD) 7" x 2 1/4" x 1 3/8". Weight approx. 2 lbs.\$150

77-912

CB radio features basically same as model 77-909, except includes snap-on battery-pack, LED bar graph metering system, LED off switch to conserve battery power, high-low power switch, battery-low indicator, carrying case, flexible rubber duck antenna with magnetic mount. Power requirement 12 Vdc or 8 AA batteries for battery pack. Dimensions (HWD) 6 1/2" x 2 1/4" x 1 1/2". Weight approx. 4 lbs.\$190

79-290

CB mobile radio features 40 channel operation with SSB, detachable security panel and weather radio with alert function. Also features 4" x 2" black matrix LCD panel, surface mount construction, 12-segment signal and power meter. User choice of channel or frequency readout. Also features four user selected memory channels, instant channel 9 access, mic preamp boost circuit, RF gain, dual watch operation. Also separate TX visual indicator. LCD panel indicates channel frequency, memory 1-4, plus seven other functions. Detachable front panel has built-in rechargeable battery that retains previous settings up to five days. Built-in noise blanker/limiters. Mic is four-pin screw-on type. Includes mobile bracket, DC cord and hardware. 79-290\$400

Radio Shack

TRC-438

Mobile CB radio features 40 channels and is similar to TRC-437 above, except includes dual ceramic filters, 4-step signal/RF power meter. Dimensions (HWD) 1 6/16" x 4 1/2" x 7"\$70

TRC-443

CB radio features 40 channels, PLL frequency synthesizer, two ceramic filters, rotary channel selector, RF gain control,

squelch, ANL, lighted analog signal/power meter and LED display. PTT mic is front-mounted. Includes mounting bracket/hardware. Requires 12-16 Vdc. Audio output 4.5 watts max. Dimensions (HWD) approx. 2" x 5 1/8" x 7 1/2". Weight approx 2 lbs 5 oz.\$80

TRC-444

CB radio features 40 channels, similar to TRC-443, except includes MIC gain control, noise blanking control, meter brightness control, and instant channel 9



access. Audio output 5.5 W max. Dimensions (HWD) approx. 2" x 6" x 7 1/2". TRC-444\$100

TRC-463

CB mobile radio with 40 channels. Features include instant channel 9 control, two ceramic filters, ANL circuit, auto-modulation control, magnetic-mount telescoping antenna, cigarette lighter adapter cord, built-in mic and speaker, digital channel readout, volume and squelch controls. Power is full legal limit.

Specifications: Sensitivity 0.7µV or better for 10dB S+N/N. Adjacent channel rejection 60dB at 10 kHz. Dimensions (HWD) 6 5/8" x 2 11/16" x 1 7/16". Weight 12 oz.\$70

TRC-464

CB radio features 40 channels and maximum legal power. Also equipped with ANL circuit, digital channel display, remote speaker jack, two ceramic filters, and uni-

versal mounting bracket.

Specifications: Sensitivity 0.7µV or better for 10dB (S+N/N). Selectivity 60dB at 10 kHz. Audio output 4W max.\$60

TRC-465

CB radio features AM/SSB, LED channel indicator, with switchable noise limiter/noise blanker, RF gain control, volume/squelch controls, side-mounted microphone, 5-step LED power/signal meter, jacks for external speaker and PA, and mounting bracket. Power requirement 12 Vdc. Dimensions (HWD) 2" x 6 1/4" x 8 1/8". Weight approx. 2 1/2 lbs\$170

TRC-483

CB radio features 40 channels and receives all U.S. and three international weather channels. Features include channel 9 priority switch, ANL, RF gain, rotary volume and squelch. Display indicates channel and bar-type S-meter. Requires 13.8 Vdc. Jack for adding external and PA speakers. Includes mounting bracket/hardware. Dimensions (HWD) 1 3/4" x 8" x 5 7/8".\$100

TRC-484

CB radio features 40 channel operation with mic/up/down channel selector. Also features on-radio rotary channel selector, volume, squelch and RF gain controls. Includes channel 9 and 19 priority switches and mic. Power requirement 13.8 Vdc. TRC-484\$80

TRC-486

CB radio features 40 channel operation, front-mounted mic, rotary volume and squelch controls with analog signal strength/power meter, and LED channel display. Features rotary channel selector and is water-resistant (designed for open-air type vehicles). Includes mic,

HWY 155 GB Shop

Largest In East Texas!

New & Used CB Radio Equipment Only

Repair & Installation On Cars, Trucks, RV's & Boats

Antennas, Meters, Accessories

**Radars
Detector's
Scanners**



Monday - Friday 8am - 7pm

Saturday 9am - 3pm

Closed Sundays

(903) 825-2070

1-800-582-0426

Visa, MC, AE, Discover/Novus

**9 Miles South Of Tyler Texas On Hwy 155
18884 Hwy 155 South**

CB Base Mobiles



fused DC power cord and mounting hardware. Dimensions (HWD) 2" x 5 1/2" x 7 1/2". Power requirement 13.8 Vdc. ...\$90

TRC-489

CB radio features 40 channel operation, LED channel display, transmit indicator, rotary volume and squelch controls and sliding on/off control. Also features ANL and dual ceramic filters and rotary channel selector and mic. Power requirement 13.8 Vdc.\$50

TRC-493

CB mobile radio with 40 channels features DSP (digital signal processor) circuit. Includes DSP switch, instant channel 9 access, PA capability, PLL freq. synthesizer, two ceramic filters, squelch, auto modulation control circuit, ANL, LED



channel display, RF gain control, tone control, 4-step LED receiver signal/transmit power meter, modulation indicator, external speaker jack and universal mounting hardware.

Specifications: Full legal output power. Sensitivity 1µV for 10dB S+N/N. Audio output max 6W. Power requirements: 120 Vac or 12-16 Vdc positive/negative ground.\$150

TRC-494

Same as TRC-463 above, plus includes 3-channel NOAA weather receiver, battery pack and removable telescoping antenna for portable use.\$100

TRC-495

CB radio features 40 channel operation with ANL and noise blanker circuitry. Scan feature, analog meter, rotary-type channel selector, channel 9 priority button, RF gain, external speaker and headphone jacks also featured. Power requirement 13.8Vdc or 120 Vac. Dimensions (HWD) approx. 3" x 11 1/8" x 8 1/4".\$150

TRC-499

CB radio features 40 channels, PLL frequency synthesizer, squelch, ANL, up/down channel selector, LED display and mounting bracket/hardware. Audio output 3 watts max. Power requirement 13.8 Vdc, negative ground. Dimensions (HWD) approx. 1 3/8" x 4 1/2" x 6 1/4". Weight approx. 1 3/4 lbs.\$50

Uniden

PC66XL

CB radio features side-mounted microphone, LED channel indicator, lighted analog S/RF meter, volume/squelch controls, RF gain control, transmit/receive indicator, instant channel 9 access, switchable noise blanker, auto noise limiter, mic gain control, dimmer control, jacks for remote speaker and PA, and mounting bracket. Power requirement 13.8 Vdc. Dimensions (HWD) 2 1/4" x 6 1/2" x 8 2/3". Weight approx. 2 1/2 lbs.\$130

PC122XL

CB radio features front-mounted microphone, AM/SSB, LED channel indicator, volume/squelch controls, RF gain and clarifier controls, switchable noise limiter, transmit indicator, S/RF indicator, jacks for external speaker and PA, and mounting bracket. Power requirement 13.8 Vdc. Dimensions (HWD) 2" x 6" x 7 9/16". Weight approx. 2 1/2 lbs.\$200

PRO501XL

CB radio features 40 channels and maximum legal power. LED display, built-in auto noise limiter, phase locked loop circuitry, volume and squelch control, up/down channel selector, PTT mic and mounting hardware.\$50

501AXL

CB radio features LED channel indicator, volume/squelch controls, front-mounted microphone, 4-segment bar LED meter, transmit indicator, automatic noise limiter, mounting bracket, magnetic mount antenna, and cigarette lighter plug. Power requirement 13.8 Vdc. Dimensions (HWD) 1 3/8" x 4 1/2" x 6 3/4". Weight approx. 1 1/2 lbs.\$70

510XL

CB radio features basically same as 510AXL, except does not include antenna or cigarette lighter plug. Power requirement 13.8 Vdc. Dimensions and weight same as 510AXL\$70

520XL

CB radio features LED channel indicator, front-mounted microphone, volume/squelch and RF gain controls, transmit indicator, LED S/RF meter, switchable noise limiter, instant channel 9 access, jacks for external speaker and PA, mounting bracket. Power requirement 13.8Vdc. Dimensions same as 510XL. Weight approx. 1 1/2 lbs. 520XL\$90

PC76XL

Mobile CB radio features LED channel



indicator, front-mounted microphone, volume/squelch and RF gain controls, transmit indicator, LED S/RF meter, auto noise limiter, instant channel 9 access, jacks for external speaker and PA, rotary channel selector and includes mounting bracket. Power requirement 13.8 Vdc.\$180

PC76XLW

Same as PC76XL except includes NOAA weather and tone alert.\$190

PRO-538W

Mobile CB radio features include instant channel 9, front-mounted, S/RF meter, TX/RX indicator and LED channel indicator. Also RF gain control, PA switch and mounting hardware included, except without channel 19 access. Includes access to NOAA weather broadcasts. Dimensions (HWD) 2" x 6 3/4" x 8 1/4". Weight approx. 2 lbs.\$110

Grant XL

CB radio features LED display, side-mounted microphone and USB/LSB. Features also include mic gain control, RF gain, clarifier control, switchable noise blanker, PA/CB switch, S/RF/SWR meter shows relative RF output power, instant channel 9 switch, dimmer, rotary volume and squelch controls and TX/RX indicator. Also includes high/low tone switch. Audio output 3W. Power requirement 13.8 Vdc. Includes mounting hardware. Dimensions (HWD) 2 3/8" x 9 1/2" x 7 7/8". Weight 6 lbs. Grant XL\$270

Washington

Base CB radio features USB/LSB operation with analog S/RF/MOD meter, instant channel 9, noise blanker switch, clarifier, RF and microphone gain, rotary volume and squelch and headphone jack. Power requirement 120 Vac. Dimensions: (HWD) 5" x 11" x 13 1/2". Weight approx. 13 lbs.\$350



CB Walkie/Talkies ■ ■ ■ ■ ■ ■ ■ ■ ■ ■

The following section features handheld CB radio/walkie talkies. As with other communications products listed in this book remember that the prices are suggested retail/list and that the "street" prices are considerably lower. Shop around for the best deals.

Cobra

HH-35

Handheld CB radio features 40 channels and full legal power output. Other features include antenna with BNC connector, on/off volume control, PTT mic, AC charger jack (enables recharging of optional Nicd batteries), cigarette lighter cord for vehicle power, and belt clip. Equipped with channel up/down tuning, squelch control, high/low power control, LED channel display and transmit/receive indicators. Weight 1 lb. 7 oz.\$90

HH-35WX

Handheld CB radio features 40 channel operation, green LED channel indicator, transmit/receive indicator, and 12 Vdc power jack for operation from vehicle or boat. Also features reception of three NOAA weather channels and includes weather alert tone reception. Other features include red LED charge indicator light, low battery indicator, high/low power setting control, detachable flexible rubber antenna with BNC connector, belt clip and five foot fused cigarette lighter power cord. Dimensions (HWD) approx. 8" x 3 1/2" x 2 1/4". Weight (with batteries) 1 lb. 7 oz. HH-35WX \$110

HH-40

Handheld CB radio features 40 chan-



nels, instant channel 9 access, full LCD status display, snap-on rechargeable battery system (requires 10 rechargeable AA NiCds or 8 AA alkaline batteries-not included), AC charger, belt clip, battery contact cover, cigarette lighter plug with 5' cord for vehicle operation, built-in mic high/low power switch (high provides 4 watts), push button up/down channel select, charge indicator, light button, and detachable rubber duck antenna with BNC connector. Power requirements 10 rechargeable AA or 8 alkaline AA batteries (not included) or 12 Vdc. Dimensions (HWD)(with battery case attached) 7 5/8" x 2 1/2" x 17/16". Weight 1 lb.\$160

GE Communications Products

3-5979

Handheld CB with maximum legal power on 40 channels. Features include volume/squelch controls, LCD channel display, 3-position power saver switch,



telescoping antenna, LED battery check and jacks for 12 Vdc power and earphone. Power requirement 13.8 Vdc or 8 AA batteries. Dimensions (HWD) 12 1/2" x 3 1/2" x 3". Weight 1 3/4 lbs.\$55

Maxon Systems

HCB-10

Handheld CB radio features 40 channel operation and maximum legal power. Equipped with two separate jacks for optional ear speaker/mic and remote PTT accessory and optional VOX-operated headset/bloom accessory use. Includes battery charging and 12 Vdc power jacks. A 12 Vdc power cord with cigarette lighter plug is supplied. Features high/low power switch, LED channel display, LED transmit and battery low indicator,

last channel memory. Power requirement 8 "AA" or 10 rechargeable "AA" NiCd batteries (not included) Includes rubber duck antenna, two "dummy" cells and belt clip.\$120

HCB-30

Handheld CB radio features 40 channel operation and maximum legal power. Features similar to HCB-10 except the HVCB-30 includes three separate National Weather Service frequencies. HCB-30\$140

27-KC

Handheld CB radio features 40 channels with high/low power switch. High is full 4W. Features include power on/off volume control, rubber duck antenna, battery-low LED



indicator, charge jack (for input from optional charger), back-of-unit belt clip, adjustable squelch control, microphone hanger, external antenna connector, power connections for vehicle power supply. Power requirement 8 AA batteries or 10 NiCds (not included). Unit mounts on cradle and includes handheld microphone. Dimensions (HWD) 7 1/4" x 2 7/8" x 2". Cradle 5 1/2" x 4 1/4" x 2 3/4". Weight approx. 1 lb.\$160

27-LP

Handheld CB radio features 40 channels and full legal power, LED channel display, transmit and battery-low indicator, high/low power control and detachable rubber flexible antenna. Also includes metal belt clip, 12 Vdc cigarette lighter power cord, antenna and "dummy" cells for use with alkaline batteries. Power requirement 12 Vdc or 8 "AA" or 10 rechargeable "AA" batteries (not included).....\$90

CB Walkie/Talkies

Midland

75-784

Handheld CB radio features 40 channel operation, maximum legal power and the following standard features: on/off/volume, range/squelch controls, high/low power switch, instant channel 9, power save mode, pushbutton up/down



channel selection, built-in mic, external power jack, charge jack and sequential four-stage bar-graph LED metering system. Includes flexible rubber antenna with BNC connector, 12 Vdc power cord with cigarette lighter socket plug, metal belt clip and manual. ("AA" batteries not included)\$150

75-800

Handheld CB radio features 40 channel operation, external antenna jack, flexible rubber antenna is stud mount, dual watch mode, instant channel 9 and multi-function LCD. Includes 12 Vdc power cord with cigarette lighter socket plug, carry strap and manual. Requires 9 "AA" batteries (not included)\$200

75-805

Handheld CB radio features 40 channels and full legal power, 7-channel weather with alert feature and FM (88-108 MHz) receiver built-in with 8 user-selectable station memories. Features surface-mount construction, large LCD info panel, multi-segment S/Rf meter, dual watch, memory channel 9, high/low power switch, back-lighted panel, rotary volume and squelch control, accessory jack for external antenna, power, mic/earphone or speaker mic. Includes flexible antenna. Power require-

ment optional "AA" batteries or NiCds or included power cord, 12 Vdc. Includes belt clip.\$250

Radio Shack

TRC-222

Handheld CB radio features 40 channels and full legal output power. Features include: Red LCD channel display, ANL, ceramic filter, adjustable squelch, center-loaded telescoping antenna, high/low power switch and jacks for external antenna, AC charger and DC power. Power requirement: 8 AA or 10 rechargeable batteries or DC adapter.\$80

TRC-223

Handheld CB radio nearly identical to TRC-91 (above) except includes separate speaker and microphone, power is max. 2W, low battery indicator and adjustable squelch. Jacks included for external antenna, AC charger and DC power. Comes equipped with crystal for Channel 14. Dimensions (HWD) 7 1/2" x 2 1/2" x 1 5/16". Weight approx. 14 oz.\$50

TRC-225

Handheld CB radio features 40 channel operation and maximum legal power. Features include auto modulation limiter, ANL, power selection, power-saver display, battery low indicator and transmit indicator. Antenna included. Audio output 400mW (10% THD)\$100

TRC-230

Handheld CB radio features 40 channels, with features similar to TRC-231 except push-button channel selection, display shows only channel number TRC-230\$130

TRC-231

Handheld CB radio features 40 channels and maximum legal power. Features include PLL frequency synthesizer, ceramic filters, auto modulation control, ANL circuitry, squelch, rotary channel selector, LCD display (shows channel number, signal strength and battery condition), two power levels and flexible BNC antenna. Power requirement 12 Vdc (8 "AA" alkaline or 10 "AA" NiCds—not included).\$150

TRC-232

Handheld CB radio features 40 channel operation and dual channel watch (switches to active channel at touch of button). Also features last-channel and channel 9 recall, high/low power saver. LCD display



TRC-230



TRC-231

with rotary squelch and volume controls, ANL, transmit/receive LED and flexible antenna. Power requirement 6 "AA" alkaline batteries (not included) or 10 rechargeable NiCds.....\$170

TRC-233

Handheld CB radio features three channel operation, ceramic filter and low-battery indicator. Also features high/low power control, rotary squelch and volume controls. Includes jacks for charger, antenna and power. Power requirement 8 "AA" alkaline batteries (not included) or 10 NiCds or DC adapter.\$60

Uniden

PRO340XL

Handheld CB features 40 channel operation, LED display, channel up/down keys, volume and squelch control, Nicd or alkaline battery compatible, high/low power switch, internal mic, battery low LED, transmit LED, belt clip, rubber antenna and cigarette lighter adapter PRO340XL\$90

Scanners/Base Mobile

In this section, listed alphabetically, are currently available base/mobile scanners. A separate section features handheld models. Remember, the prices given are the suggested retail/list prices; they vary considerably from actual "street" prices. Shop around for the best deals.

A new law, effective April 26, 1994 makes it illegal to manufacture a scanner capable of receiving cellular telephone frequencies or converters to receive the same. However, stocks of cellular-reception capable scanners can be sold indefinitely. It is NOT illegal to use and own such equipment.

AOR, Ltd.

AR3000A

Programmable scanner covers continuous from 100 kHz to 2036 MHz in 400 channels. AM, FM, WFM, LSB, USB, and CW modes; attenuation programmable by channel; manual tuning knob; tuning increments down to 50Hz; 4 scan and search banks, lockout in search; 4 priority channels, RS232 control through DB25 connector; delay, hold features; 15 band pass filter, RF amp; sleep and alarm features; telescopic antenna; AC adapter/charger, DC power cord.

Specifications: Sensitivity .35µV NFM, 1.0µV WFM, 1.0µV AM/SSB/CW; Selectivity FM and NFM 12 & 20 kHz at -6dB and 60dB, SSB 2.4 kHz -6dB and 4.5 kHz -60dB, WFM 180 kHz/1000 kHz at -6dB and -60dB; Audio output 1.2W at 4 ohms; Antenna, BNC; Display, LCD; Scan speed 20 ch/sec. scan and search; IF 736.23 (352.23)(198.63) 45.0275, 455 kHz, Increments, 50Hz and greater. Power 120 Vac, 13.8 Vdc, 500mA. Dimensions (HWD) 3 1/8" x 5 2/5" x 7 7/8".....**\$1,299**

AR5000

Programmable scanner covers 10 kHz to 2600 MHz in 650 channels (10 banks of 65 channels each). Features include surface-mount technology throughout, multi-mode reception—FM, AM, LSB, USB, and CW. Also features four IF bandwidths, triple-conversion IF and programmable steps from 1 Hz to 999.999 kHz. Entry mode is auto dial, manual dial, dial search, programmed search, memory recall, memory channel scan and priority. Scanner is totally computer controllable with local and remote control of all functions, seven IF bandwidth filters, four antenna inputs computer/front panel control, switchable attenuator.

Specifications: Sensitivity AM 10dB S/N 1500 kHz .6µV, 5 MHz .6µV, 15 MHz

.5µV and 30 MHz .6µV. FM (N) 12 dB SINAD 40–1000 MHz .3µV, 1 GHz – 2.1 GHz .2µV, 2.6 GHz .25 µV and SSB from 2–30 MHz .15µV. Antenna impedance is 50 ohms (UHF, N, BNC). Scan speed 50 ch/sec, search speed 50 steps/sec. Audio output 1W. Power requirement 12 Vdc, 120 Vac adapter included or 220 Vac (adapter available). Dimensions (HWD) 3 1/2" x 8 1/2" x 10". **\$TBA**

ICOM

IC-R100

Programmable scanning receiver covering 100 kHz–1856 MHz AM, FM & WFM modes, in 100 memory channels. Features include RF attenuator, preamplifier, priority channel, built-in clock/timer with sleep function. Also includes automatic noise limiter, mobile mounting bracket, DC power cable, wire and telescoping antenna. Optional items include AC adapter, cigarette lighter cable with noise filter and external speakers.

Specifications: Sensitivity 500 kHz–1.6295 MHz AM 3.2µV; 1.63–49.99 MHz AM 1.6µV, FM 0.56µV; 50–904.995 MHz AM 0.56µV, FM 0.2µV & WFM 0.63µV, 905–1380.487 MHz AM 1.0µV, FM 0.32µV, & WFM 0.79µV; 1380.5–1800 MHz AM 1.4µV, FM .045µV, & WFM 1.1µV. Selectivity AM more than 6 kHz -6dB, FM more than 15 kHz -6dB, and WFM more than 180 kHz -3dB; Audio output more than 2.5W, Power 13.8 Vdc (or AC with optional adapter). Dimensions (HWD) approx. 2" x 6" x 7". Weight approx. 3 lbs. IC-R100**\$935**

R7000A

VHF/UHF receiver covering 25 MHz to 2 GHz in AM, FM, WFM, and SSB modes. Available for government and qualifying telecommunications only. Features include 99 memory channels, variable scan speed, selectable scan delay time, noise blanker, attenuator, Voice Scan Control function (enables user to skip frequencies with inaudible voice signals), keyboard entry, dial lock, selectable display intensity, headphone and recording jacks, optional wireless remote control, optional TV receive capability, optional voice synthesizer unit and optional system for computer control.



Specifications: Sensitivity 25–999.99 MHz SSB less than 0.3µV for 10dB S/N; AM less than 1.0µV for 10dB S/N; FM less than 0.5µV for 12dB SINAD; and WFM less than 1.0µV for 12dB SINAD: 1240.0–1300.0 MHz SSB less than 0.3µV for 10dB S/N; AM less than 2.0µV for 10dB S/N; FM less than 0.5µV for 12dB SINAD. Selectivity SSB more than 2.8 kHz -6dB and less than 11 kHz -40dB; AM & FM more than 150 kHz -6dB and less than 380 kHz -20dB; Audio output more than 2.5W. Power 117 Vac. Dimensions (HWD) 4 3/10" x 11 3/10" x 10 9/10" Weight 17 6/10 lbs.**\$2200**

R7100A

Programmable scanner receiver covers 25–2000 MHz in 900 memory channels, continuous coverage. Available for government and qualifying telecommunications only. Features include LCD readout, selectable tuning steps, USB/LSB/AM/FM modes and wide/narrow selectivity. Also includes keypad frequency or dial entry, scan rate of 5 or 12 ch/sec in 9 banks, lockout and priority feature, squelch, delay, search and 24-hour clock with on/off timer. Five basic scans or "window scan" capability that watches for two signals alternately. Features an analog-type S-meter and includes DC power cord. Power requirement 117/240 Vac or 13.8 Vdc. Options include voice synthesizer, CT17 computer interface, external speaker and TV/FM adapter.

Specifications: Sensitivity SSB 0.2µV, Am 1.6µV, FM 0.35µV, WFM 1.0µV. Selectivity SSB more than 2.4 kHz/-6dB, AM and NFM more than 6.0 kHz/-6dB, FM and wide AM more than 15 kHz/-6dB, and WFM more than 150 kHz/-6dB. Audio output 2W. Power requirement 117/240 Vac or 13.8 Vdc. Dimensions: (HWD) approx. 3 3/4" x 9 1/2" x 9 1/2". Weight approx 13 lbs.**\$2035**

Radio Shack

PRO-2026

Programmable scanner covers 29–54, 108–174, 406–512, 806–823.9375, 851.0–868.9375 and 896.1125–956 MHz in 100 channels in five memory banks. Features include service search, two-second scan delay, lockout function, user-selected priority channel and one monitor memory.

Specifications: Sensitivity (20 dB S/N with 60% modulation for AM; 3 kHz deviation for FM): 29–54 MHz 0.5µV, 108–136.975 MHz 1.6µV, 137–174 MHz 0.7µV, 406–512 MHz 0.7µV and 806–956 MHz

Scanners/Base Mobile



0.8 μ V. Selectivity \pm 9 kHz -6dB; \pm 15 kHz -50dB. Scan speed is 14 channels per second, search speed 19 steps per second. Audio output 1.1W max. Power requirement 12 Vdc. Includes jacks for external speaker and antenna and mobile mounting bracket. Dimensions (HWD) 1 5/8" x 6 5/16" x 7 3/8". Weight 2 lbs. 3 oz. PRO-2026\$230

PRO-2033

Programmable scanner covers 137-174 and 406-512 MHz in 10 channels. Also features one-touch weather, auto scan delay, lockout and memory backup.

Specifications: Double conversion IF system. Scan rate 12 ch/sec. Power requirement 120 Vac; includes AC adapter. Also features detachable indoor antenna and jack for external antenna (Motorola-type jack). Dimensions (HWD) 2 5/8" x 9 15/16" x 6 7/8".\$120

PRO-2034

Programmable scanner covers 29-50, 50-74, 108-137, 137-144, 144-148, 148-174 and 406-512 MHz in 80 channels. Features include priority channel, instant weather, memory back up, scan delay, 10 monitor memories, display backlight and lockout function.

Specifications: Sensitivity (20dB S+N/N) with 60% modulation for AM, 3 kHz deviation for FM; 29-54 MHz 0.5 μ V, 108-137 MHz 2.0 μ V, 137-174 MHz 0.7 μ V and 406-512 MHz 1.0 μ V. Scanning rate 12 channels/sec. Search rate is 16 steps/sec. Audio output max. 1.3W, nominal 1.0W. Power requirement 120 Vac. Weight approx. 19 oz. Dimensions (HWD) approx. 2 5/16" x 9 9/16" x 7".\$160

PRO-2037

Programmable scanner covers same frequencies as PRO-2036 above in 200 channels. Features include HyperScan, headphone jack, triple conversion superheterodyne receiver, 10 channel storage banks, 10 monitor memories, two-second delay, lockout function, priority channel, AM/FM mode, attenuator switch, memory backup and LCD display (shows selected channel and frequency).



Specifications: Sensitivity FM (20dB S+N/N at 3 kHz deviation) 30-54, 118-137, 137-174, 380-512 MHz 1 μ V; 806-960 MHz 2 μ V; AM (20dB S+N/N at 60% modulation) 2 μ V, except 806-960 MHz 4 μ V. Selectivity \pm 10 kHz -6dB, \pm 20 kHz -50dB. Scanning rate 25 channels/sec., searches 50 steps/sec. Audio output 1W nominal. Power requirement 120 Vac or 13.8 Vdc. Dimensions (HWD) approx. 3 1/4" x 8 7/16" x 6 13/16"....\$300

PRO-2038

Pre-programmed scanner covers 30-54, 108-137, 137-174, 380-450, 450-512 and 806-890 MHz in 50 channels. Features include five service scan banks (lets user scan pre-set frequencies in separate banks), private scan bank (user can store 20 frequencies found while scanning or searching), 12 frequency bands (lets user search pre-set frequency ranges), two second scan delay, lockout function, memory backup, and backlit display.



Specifications: Scan rate up to 100 frequencies or channels/second; search rate 100 steps/sec. Audio output max 1.8W, nominal 1.5W. Power requirement 120 Vac or 13.8Vdc adapter. Dimensions (HWD) approx. 2" x 5" x 7".....\$200

PRO-2039

Programmable scanner covers same frequencies as PRO-2038, above, features nearly identical except 2039 has 200 channels, priority channel and scans at 50 channels/second and searches at 25 steps/sec. (selectable). Equip- ped with 10 monitor memories, lockout function, external speaker jack and LCD (shows selected channel and frequency).

Specifications: Sensitivity (20dB S+N/N, Modulation=60% at 1 kHz) 30-54 MHz 5 μ V; 108-137 MHz 2 μ V; 137-174 MHz 1 μ V; 380-512 MHz 1 μ V and 806-960 MHz 2 μ V. Selectivity \pm 10 kHz -6dB and \pm 20kHz -50dB. Audio output (10% THD) 1.0W nominal. Power requirement 120 Vac. Weight approx. 9 oz. PRO-2039\$230

PRO-2040

Programmable scanner covers 29-54, 108-174, 406-512 and 806-956 MHz in 100 channels, AM, FM, WFM modes. Features include 10 bank storage, user-

specified priority channel, data detection, 10 monitor memories, search function, selectable scan/search speeds, manual or scan channel select and search skip (lets user select up to 50 frequencies for scanner to skip during a limit or direct search to avoid unwanted frequencies). Also includes weather band key, squelch, back-lighted LCD display, audio output jack, external antenna (BNC) connection and lockout function. PRO-2040\$220

PRO-2042

Programmable scanner covers 25-520, 760-823.995, 849.005-868.995 and 894.005-1300 MHz in 1,000 channels. Features include selectable NFM, FM, WFM, FM or AM modes, lockout, sound squelch, auto-store function (loads active frequencies into specified memory banks while preventing duplications), HyperScan, one-touch weather, and RF attenuator.

Specifications: Triple conversion IF system. Scans/searches at 50 ch/sec. Power requirement 120 Vac or 12 Vdc. Also features detachable indoor antenna and jacks for external antenna (BNC type), external DC power, tape-out, external speaker and headphone.

Dimensions (HWD) 3 13/16" x 9 1/8" x 7 7/8".....\$500

PRO-508

Programmable scanner covers 30-54, 137-174, and 380-512 MHz in 20 channels. Features include search mode, channel lockout, selectable scan delay, top-mounted speaker, and memory backup.

Specifications: Double conversion IF system. Scan and search rate 16 ch/sec. Power requirement: 120 Vac; includes AC adapter. Also features detachable indoor antenna and jack for external antenna (Motorola-type jack). Dimensions (HWD) 2 1/16" x 8 1/4" x 6 7/8".

PRO-508.....\$150

Standard

CCR708A

Programmable scanner/re-ciever covering 50 to 904.995 MHz in 100 channels, AM, NFM, and WFM modes. Features include 10 bands and a spectrum display, 20dB attenuator switch, jacks for external speaker and record, brightness control, LCD frequency display, tone, dimmer control and headphone jack.

Specifications: Sensitivity AM (10dB S/N) 3 μ V, NFM (12dB SINAD) less than 1.5 μ V, WFM (12dB SINAD) less than 1 μ V. Audio output 2W. Power 13.8 Vdc. Di-

Scanners/Base Mobile

mensions (HWD) approx. 3" x 7" x 7".
Weight approx. 4 1/2 lbs.\$899

Uniden

BC-144XL

Programmable scanner covers 29-54, 136-174 and 406-512 MHz in 16 channels. Features include LED display, lockout, priority channel, one-touch weather, auto delay, review, volume and squelch control.\$160

BC 147XLT

Programmable scanner covering 29-29.7, 29.7-50, 50-54, 136-144, 144-148, 148-174, 406-420, 420-450, 450-470, 470-512 MHz in 16 channels. Includes LED display, review, channel 1 priority, memory backup retains frequencies more than 3 days without batteries during a power failure, lockout, direct channel access, weather scan, built-in 2-second delay and "track tuning."

Specifications: Sensitivity 29-54 MHz 0.4µV for 12dB SINAD, 136-174 MHz 0.5µV for 12dB SINAD, 406-512 MHz, 0.7µV for 12dB SINAD; Selectivity -50dB



±15 kHz; Scan speed 15 ch/sec.; Audio output, 0.9W maximum. Power 117 Vac. Dimensions (HWD) 2 3/4" x 9" x 6 1/2". Weight 1 1/4lbs. BC 147XLT\$170

BC 148XLT-1

Programmable scanner covering 29-54, 136-174 and 406-512 MHz in 20 channels with Weather Alert. Features include 10 bands with Weather Alert, LED display, priority, NOAA weather search, lockout, review, built-in delay, volume and squelch control.

Specifications: Sensitivity 29-54 MHz 0.3 µV (12dB SINAD), 136-174 MHz 0.4µV (12dB SINAD), and 406-512 MHz 0.6µV (12dB SINAD). Selectivity ±20 kHz, -50dB. Audio output 1.2W max. Scan



speed is 15 ch/sec. Includes telescoping antenna, external antenna, and DC power jack. Power requirement 117 Vac. Dimensions: (HWD) approx. 2 5/16" x 9 9/16" x 7 7/8". Weight approx. 1 1/2 lbs. BC 148XLT-1.\$180

BC-178XLT

Programmable scanner covers 29-54, 108-174 and 406-512 MHz in 100 channels, five banks. Features include five priority channels, weather alert, full frequency LCD display, preprogrammed service search, programmable search, channel lockout, one-touch weather, and auto squelch.\$250

SERIOUS OPERATORS JOIN THE

National Citizens Band Center

1-800-423-1331

The National Citizens Band Center (NCBC) is the fastest growing CB operator's organization in the United States. NCBC operators are known throughout the world for their professionalism and service.

All NCBC Members get:

- + Officially registered call letters and identification documents for emergency and public safety work.
- + Free subscription to CB America, the bimonthly journal that covers everything from new products to power-pushing tips and techniques.
- + Free access to the Center's toll-free 800 number
- + As the nations largest, The National Citizens Band Center passes its enormous purchasing power directly to you. Chances are that you'll save the cost of membership with your next CB purchase!
- + Best of all, The National CB Center is the only organization that represents the needs of the professional CB operators in Congress.

Join now. Send \$29.95 to the National Citizens Band Center, Box 291849, Kettering, OH 45429 or call toll-free

1-800-423-1331

NEW!!
SCANCAT GOLD
IMPROVED!

Since 1989, The Recognized Leader in Computer Control

Once you use SCANCAT with YOUR radio, you'll NEVER use your radio again WITHOUT SCANCAT!

SCANCAT supports most receivers/transceivers by:
AOR, DRAKE, KENWOOD, ICOM, YAESU and JRC (NRD)
Plus PRO-2005.6 & 2035/OS456, Lowe HF-150, and Watkins-Johnson HF-1000

SCANCAT 6.0 FEATURES

- Search between any 2 frequencies.
- Log found frequencies to files while scanning.
- Search by ANY increment.
- Scan Disk Files Frequencies.
- Create Disk files.
- Spectrum Analysis to Screen OR Printer.
- Import from most text formats to a working SCANCAT file.

SCANCAT - GOLD FEATURES

We simply don't have the space to tell you ALL the new GOLD features
SCANCAT-GOLD includes ALL ABOVE 6.0 FEATURES PLUS

- Link up to 15 frequency disk files.
- Link up to 15 search banks.
- D-BASE IMPORT w/DUPLICATE filters.
- IMPORT virtually any database.
- Scan HF & VHF Icom's simultaneously.
- Search by CTCSS & DCS TONES with PRO2005.6/2035 (& ICOM/DC440).
- PRINT to ANY printer, or Disk File.
- MULTIPLE search filters.
- Automatic BIRDIE LOCKOUT.

PLUS - POWERFUL COMMERCIAL FEATURES SUCH AS:

- Demographic search for frequency co-ordination and 2-way Usage Analysis.
- Detailed logging to ASCII type files with DATE, TIME, Sig Str, Air Time
- UNLIMITED file sizes with our exclusive SCANCAT filing method.
- Exclusive "MACRO" control by frequency of Dwell, Hang, Resume, Sig. Threshold and even 6 separate programmable, audible alarms.
- Command line options for TIMED ON/OFF (Unattended) logging/searches.

SCANCAT IS NOT COPY PROTECTED - USE ON AS MANY COMPUTERS AS YOU NEED
SCANCAT will run on virtually ANY 640K computer, EVEN HP-100XLT PALMTOP!

SCANCAT comes ready to run ALL supports radios within only ONE program. SCANCAT makes your listening hobby a breeze! Plus, the included SCANCAT allows you to convert your favorite BBS, D Base or Text Files to a running SCANCAT file: 100+ Page manual included. Requires a 640K MS-DOS computer w/RS-232C serial port - hard disk recommended. Manufacturer's Interface not included.

CALL or WRITE for FREE information or our \$5.00 FULLY OPERATIONAL DEMO DISK (includes shipping/handling). ORDER NOW & RECEIVE as a BONUS, FOUR SCANCAT FREQUENCY FILES!

SCANCAT GOLD	\$94.95	UPGRADE	\$24.95
SCANCAT 6.0	\$69.95	from any version	
SQUELCH DETECT CABLES	\$24.95	PLUS \$5.00 SHIPPING & HANDLING \$7.50 FOREIGN	
OPTOScan456 kit	\$299 (\$10 s/h)		

COMPUTER AIDED TECHNOLOGIES

P.O. Box 18285, Dept. C, Shreveport, LA 71138
Orders Only (318) 636-1234 - FAX (318) 686-0449 (24 hrs)
Live Tech Support - (318) 687-2555 (9 a.m. - 1 p.m. Central M-F)
NiteTime BBS (SCANCAT File Area) (318) 631-3082 (7 p.m. - 6 a.m. Central)
Online support available on GEnie. • E-mail - j.springer7@qgis.com

FREE DEMO ON BBS

Scanners/Base Mobile ■ ■ ■ ■ ■ ■ ■ ■

BC 560XLA

Programmable scanner covering 29–54, 136–174, 406–512 MHz in 16 channels. Includes review key, LED display, Channel 1 priority, memory backup allows channel frequencies to be retained for up to 2 months without batteries or external power, lock out function, direct channel access, weather search, built-in delay (automatically adds two-second delay to transmissions received), and mobile mounting bracket.

Specifications: Scan speed 15 ch/sec. Audio output, 3W maximum. Power 13.8 Vdc (or optional AC adapter). Dimensions (HWD) 1 3/4" x 5 1/2" x 6 7/8" Weight approx. 1 3/4 lbs\$170

BC 760XLT

Programmable/preprogrammed scanner covering same frequencies as 590XLT, but additionally covers 806–956 MHz (excluding 823.9875–849.0125 and 868.9875–894.0125 MHz) in 100 channels (five 20-channel banks). Includes single button access to preprogrammed

frequencies for police, fire, emergency services, aircraft, and marine frequencies. Weather search, channel one priority, lockout function, programmable three second delay function, LCD shows current frequency, channel and other features and operating modes; direct channel access and memory lock.

Specifications: Sensitivity 29–54 and 136–174 MHz 0.4µV (nominal), 118–136 MHz 0.8µV, 806–956 MHz 1.0µV; Selectivity –55dB at ±25 kHz; Scan speed 15 ch/sec. Audio output, 3W maximum. Power 13.8 Vdc (or AC adapter) two AA batteries for memory backup. Dimensions (HWD) 1 5/8" x 6 5/16" x 7 3/8". Weight approx. 1 1/4 lbs\$370

BC-860XLT

Programmable scanner covers 29–54, 108–174, 406–512 and 806–956 MHz (less cellular) in 100 channels in 10 banks. Includes lockout, programmed delay, 10 priority channels, one-touch weather, and full LCD\$320

BC 890XLT

Programmable scanner covers 29–956 MHz (except cellular band) with 200 channels in 10 banks. Includes 10 priority channels, auto store, VFO control, weather search, aux tape output, weather alert, LCD display, reception counter and step select, channel lockout key, speed selection, delay, CTCSS key (optional), and auto sorting feature.



Specifications: Sensitivity 12 dB SINAD 29–54 MHz 0.5µV, 137–174 MHz 0.7µV, 216–244 MHz 0.8µV, 406–512 MHz 0.8µV, 108–137 MHz 1.0µV, 225–400 MHz 1.2µV and 806–956 MHz 0.8µV. Audio output max. 2.7W. Includes telescopic antenna, AC adapter, DC power and cigarette lighter cords. Scan rate: up to 100 ch/sec. Scan delay: 2 sec ...\$440

BC 9000XLT

Programmable scanner covers 25 MHz to 1.3 GHz including 760–824, 849–869, 894–1300 MHz. Features include 500 channels in 20 banks with 20 priority channels, dot matrix-alphanumeric illuminated display, auto store, VFO control,

weather search, aux tape output, weather alert, selectable delay, reception counter and step select. Also includes speed key (up to 100 ch/sec.), auto sorting, squelch and external antenna (BNC) jack. Power requirement: 13.8 Vdc or AC adapter.

Specifications: Audio output max 2.2W. Dimensions (HWD) 3 3/8" x 10 1/2" x 7 1/2". Weight 6 lbs 5 oz\$770

BC 350A

Programmable/preprogrammed scanner includes 50 user-programmable channels in addition to 2193 preprogrammed channels of police, fire, EMS, air, marine and weather. Coverage is: 29–30, 30–50, 50–54, 108–137, 137–144, 144–148, 148–174, 406–420, 420–450, 450–470 and 470–512 MHz. Also includes 11 search banks, LCD display, lockout and mobile mounting bracket, AC adapter, telescopic antenna, volume and squelch control, memory lock switch and external jacks for antenna (BNC) and speaker. Power requirement 13.8 Vdc and includes vehicle cigarette power cord and DC power cord.



Specifications: Sensitivity at 12dB SINAD: 29–54 MHz 0.5µV, 137–174 MHz 0.7µV, 406–512 MHz 0.7µV and 108–137 MHz 1.2µV. Audio output 3W max. Scan rate up to 100 ch/sec. Dimensions: (HWD) 1 5/8" x 5 1/5" x 6 15/16". Weight 1 lb 11 oz\$200

BC 700A

Programmable/preprogrammed scanner similar to BC 350A, except includes additional search bank (total 12 search banks), and 806–956 MHz uninterrupted coverage.\$300

BCT-7

Programmable scanner covers 29–50, 118–174, 406–512 and 806–956 MHz (less cellular) in 100 channels. Includes preset service search, 40-channel CB scan and band search, full frequency LCD, channel lockout, one-touch weather. Includes AC adapter and cigarette lighter adapter\$320

Letters to the Editor ... And Replies

Q. How can I get more than 100 per cent modulation out of my mobile?

John—Idaho

A. John, modulation is one of the most misunderstood things in CB. When 100 per cent of the carrier is modulated, that's it. In the standard AM modulator, trying to go beyond 100 per cent causes clipping and actually reduces your power out. Think of trying to drive your car cross-country on 125 per cent of the gas in the gas tank. When you've used it all, you've used it all.

I can already see the letters coming, saying "But my friends modulation meter (built by Chinese political prisoners and sold on the wholesale market for \$1.63) shows that his rig runs 125 per cent modulation." The simple peak reading volt meters sold as "modulation meters" are approximate at best. The meters only look at the peaks of the RF carrier and miss the holes in the carrier.

Q. I see lots of claims on mobile antennas. What should I look for?

Steven—New Jersey

A. Almost all mobile antennas are quarter-wave verticals. On 27 MHz this works out to 108", so your radio thinks all mobile antennas are 108" long. By putting some of that 108" in a coil, the antenna can be shortened. The problem is coil loss. More coil, more loss. Less coil, less loss. So, a four foot antenna works better than a three foot one; a five foot antenna better than a four foot one. Use the longest whip you can live with. By the way, those 102" whips allow 6" for the spring.

Handheld Scanners

In this section, listed alphabetically, are currently available handheld scanners. Remember, the prices given are the suggested retail/list prices; they vary considerably from actual "street" prices. Shop around for the best deals.

A new law, effective April 26, 1994 makes it illegal to manufacture a scanner capable of receiving cellular telephone frequencies or converters to receive the same. However, stocks of cellular-reception capable scanners can be sold indefinitely. It is NOT illegal to use and own such equipment.

AOR, Ltd.

AR2700

Programmable handheld scanner covering 500 kHz-1300 MHz no gaps in NFM, WFM and AM modes, 500 channels (10 banks of 50 channels each). Features include search/scan rate of 30 increments/sec., programmable step size, auto-mode tuning, variety of search/scan facilities, programmable delay timer (0-9.9 secs.), pause timer, programmable priority interval timer (1-19 secs or off), 10 programmable search banks, on-screen battery indicator, sleep timer and switchable illuminated keypad/beep. Unit includes NiCds, charger, hand strap, belt hook and screws, telescopic whip antenna, DC power cord with cigarette plug, and operating manual. Options include a voice recording chip (RU2700) for up to 20 seconds of digital recording and play back of transmissions with LCD on-screen bar graph providing record indicator, adapter for copy (clone) between two AR2700 units, computer control port connected via optional adapter and interface (IF-ADP & CU8232) to computer for remote control of receiver (requires control software). Audio output 110mW
AR2700\$450

AR8000

Handheld scanner covering 500 kHz to 1900 MHz. Features include all mode reception, 1000 memory channels, rotary tuning dial, 20 search banks, priority channel, frequency pass, step sizes are programmable between 50 Hz and 995 Hz in 50 Hz steps, scan & search speed up to 30 increments/sec., signal strength meter, band scope, backlit LCD (keypad and side panel), battery save facility, separate controls for volume, squelch & dial, attenuator, keypad beep on/off, keypad lock, top panel earphone jack, monitor switch, password protected banks, programmable scan & search, delay, select

scan list, clone data facility between two AR8000 units, computer control, EEPROM memory backup (no battery required).

Specifications: Selectivity, SSB 4 kHz (-6dB), 15 kHz (-50dB); AM/NFM 12 kHz (-6dB), 25 kHz (-60dB); WFM 180 kHz (-6dB), 800 kHz (-50dB). Antenna impedance 50 ohm BNC. Scan/search rate: approx 30 channels/sec. max. Audio output 120mW. Computer control using optional CU-8232 interface. Unit includes NiCds, charger, hand strap, belt hook & screws, semi-flexible antenna, 12 Vdc cigarette lighter plug, operating manual and over 50 LCD illustrations.
AR8000\$800

ICOM

IC-R1

Programmable handheld scanner covering 100 kHz to 1300 MHz in 100 channels. Available for government and qualifying telecommunications only. Features include small size, power saver function, keyboard lock, sleep timer and auto-on timer, low battery indicator, line out jack for tape re-cording, manual tuning control, search function, built-in NiCd batteries, well charger, antenna and belt clip.

Specifications: Sensitivity: 2-24.99 MHz AM, 1.6µV; FM 0.79µV; WFM 6.3µV, 25-905 MHz AM 1.26µV; FM 0.63µV, 25-905 MHz AM 0.63µV; FM 0.32µV. Selectivity AM more than 15 kHz -S6dB, FM more than 15kHz -6dB, and WFM more



than 150 kHz -6dB. Audio output 150mW; Power 7.2 Vdc (from internal battery)(or optional battery pack) or external DC power source from 6-16 Vdc. Dimensions (HWD) approx. 4" x 2" x 1 2/5". Weight approx. 5/8 lb\$635

Radio Shack

PRO-24

Programmable handheld scanner covering 29-54, 137-174, 406-512, 806-823, 851-868 and 896-1125 MHz in 16 channels. Features include instant weather, memory backup, auto scan delay, keylock function, low battery alarm, and flexible antenna (BNC connector). LCD display shows selected channel and frequency.

Specifications: Sensitivity FM (20dB signal-to-noise ratio at 3 kHz deviation) 29-54 MHz 0.4µV; 137-174 MHz 0.5µV; 406-512 MHz 0.8µV and 806-956 MHz 0.7µV. Selectivity ± 10 kHz, -6dB and ± 17 kHz -50dB. Scanning rate: 10 ch/sec. Delay time 2 sec. Power requirement 4 "AA" batteries (not included) or rechargeable Nicds (not included) or DC adapter. Weight approx. 8 oz. Dimensions (HWD) approx. 7" x 2 1/2" x 1 1/2"\$180

PRO-25

Programmable handheld scanner covering 30-54, 108-136, 137-174, 380-512 and 806-960 MHz in 100 channels. Features include HyperScan—scans 50 channels/sec and searches 100 frequencies/sec. Equipped with two-second delay, lockout function, priority chan-



Handheld Scanners

nel, weather band key, frequency search, 10 monitor channel memories, display backlight, flexible antenna (with BNC connector) and memory backup (up to one hour).

Specifications: Sensitivity FM (20dB S/N with 60% modulation, 3 kHz deviation) 29–54 MHz 0.5 μ V; 108–137 MHz 1.3 μ V, 137–174 MHz 0.6 μ V, 406–512 MHz 0.5 μ V and 806–956 MHz 0.7 μ V. Samples priority channel every two seconds. Audio output 230mW max. on FM and 250mW max. on AM. Power requirement 6 Vdc—4 “AA” batteries (not included) or rechargeable Nicds or AC adapter or universal DC adapter. Weight approx. 8 oz. Dimensions (HWD) approx. 6” x 2 1/2” x 1 1/2”**\$250**

PRO-26

Programmable handheld scanner covering 25 MHz to 1.3 GHz continuous in 200 channels, 10 banks. Features include hyperscan (scan rate 50 ch/sec.), limit search, direct search, 10 monitor memories, search skip (lets user select up to 50 frequencies for unit to skip during search), auto sort, hypersearch (searches up to 300 steps/sec. –5 kHz steps only), auto store, two or four second delay, data skip, lockout function, auto modulation mode, selectable frequency step, weather band key, attenuator, low battery indicator, and memory back-up.**\$400**

PRO-28

Programmable handheld scanner covering 29-54, 137-174, and 406-512 MHz in 30 channels. Features include seven preset frequency bands and search-start with one button push. Also includes search-skip, one-touch NOAA weather, scan delay, selectable lockout, audible low-battery indicator, key lock and memory back-up. Includes jacks for external speaker/headphone, BNC-type antenna, external power, charger.

Specifications: Double IF conversion system. Power requirement 4 “AA” batteries or rechargeable batteries (not included), AC or DC adapter (optional). Scans at 15 ch/sec, searches at 10 ch/sec. Includes flexible antenna, and detachable belt clip.**\$180**

PRO-29

Programmable handheld scanner covers 29-54, 108-174, 406-512, 806-823.9375 and 896.1125-956 MHz in 60 channels. Features include larger scan/manual buttons, search mode, one-touch NOAA weather, selectable priority mode, lockout function, key lock, backlit display, audible low-battery indicator and memo-

ry backup. External jacks for external earphone, antenna, DC power, charger.

Specifications: Double IF conversion system. Power requirement 4 “AA” alkaline batteries or rechargeable batteries (not included), or AC or DC adapter (optional). Scans at 12 ch/sec, searches at 19 ch/sec. Includes flexible antenna and belt clip.**\$240**

PRO-50

Programmable handheld scanner covering 30–54, 137–174, 380–450, 450–470 and 470–512 MHz in 20 channels. Features include priority channel, instant weather, memory backup, scan delay, LCD display showing channel number plus frequency (and other indicators), lockout function, monitor memory and frequency search.



Specifications: Sensitivity (20dB Signal-to-Noise ratio) 1 μ V overall. Selectivity \pm 10kHz –6dB and \pm 20kHz –50dB. Scans and searches at 16 channels/steps per second. Delay time 2 seconds. Audio output 200mW. Weight approx. 9 oz. Dimensions (HWD) approx. 6 5/16” x 2 3/8” x 1 3/4”**\$140**

PRO-51

Programmable handheld scanner covers same frequencies as PRO-29, above, except features 200 channels divided into 10, 20-channel banks. Features include 50-channel per sec. scanning and 100 ch/sec search rate. Also features one-touch band search for preprogrammed air, VHF-marine, fire and weather frequencies in addition to direct and limit search, separate 10-channel bank holds frequencies found during search mode, priority mode,

channel lockout, backlit display, key lock and memory backup.

Specifications: Double IF conversion system. Power requirement 4 “AA” alkaline batteries or rechargeable batteries (not included) or AC or DC adapter (optional). Jacks provided for earphone, antenna, external power and charger. Includes flexible antenna and belt clip.**\$320**

PRO-60

Programmable handheld scanner covering 30-512, 760-824, 849-869 and 894-999.9875 MHz in 200 channels (10 banks). Features include triple conversion superheterodyne receiver, hyper-scan (searches at 50 steps/sec or scans at 25 ch/sec.), monitor memory allows storage of up to 10 frequencies found during search for later recall or transfer to permanent channels, direct frequency search, two-second scan delay and memory backup. LCD display shows selected channel, frequency and selected functions. Also features lockout, key-lock, user-designated priority channel and battery-saving circuitry.

Specifications: Sensitivity (FM 20dB (S+N/N at 3 kHz deviation) 30–512 MHz 1 μ V; 760–999.9875 MHz 1 μ V.; AM 20dB (S+N/N at 60% modulation 2 μ V. Selectivity: FM/AM \pm 10 kHz –6dB; \pm 15 kHz–30dB. WFM mode \pm 100 kHz –6dB; \pm 200 kHz –50dB. Audio output 180 mw nominal. Power requirement 9 Vdc (6 “AA” batteries, not included) or suitable adapter. Includes flexible antenna and manual. Dimensions (HWD) 6 5/16” x 2 7/16” x 2 1/8”. Weight approx. 8 oz.

PRO-60.....**\$350**

PRO-62

Programmable handheld scanner covering 30–54, 118–136, 137–174, 380–



Handheld Scanners

512, 806-823 and 849-960 MHz in 200 channels. Features include HyperScan, triple conversion superheterodyne tuning, monitor memory, two-second delay, 10 channel storage banks, LCD display (showing selected channel, frequency and mode), memory backup, lockout function, keylock, priority channel, AM/FM mode operation, battery-save circuit, Nicd battery charging circuit.

Specifications: Sensitivity FM (20dB S+N/N at 3 kHz deviation) 1µV (806-960 Mhz 2µV) AM (20dB S+N/N at 60% modulation) 2µV (806-960 Mhz 4µV). Selectivity ±10kHz -6dB and ±20kHz -50dB. Scan rate 25 channels/sec. Search rate 50 steps/sec. Priority sampling every two seconds. Audio output (10% THD) 180mW nominal. Power requirement 9 Vdc (6 "AA" batteries, not included) or suitable adapter (negative ground only). Weight approx. 8 oz. Dimensions (HWD) approx. 5 3/4" x 2 1/4" x 1 3/4"**\$300**

Uniden

BC60XLT

Programmable handheld scanner covers 29-54, 136-174 and 406-512 MHz in 10 channels. Features include 2-digit LCD display, lockout, auto delay, volume and squelch control, review key, keypad lock, belt clip, one-touch weather, AC adapter/charger and headphone jack**\$170**

BC80XLT

Programmable handheld scanner covers 29-54, 136-174, 406-512 and 806-956 MHz (less cellular) in 50 channels. Includes manual channel access, channel lockout, built-in scan delay, one-touch weather, 5 priority channels, band search, full frequency LCD, illuminated display, AC adapter/charger and headphone jack**\$310**

BC120XLT

Programmable handheld scanner covers 29-54, 108-174, and 406-512 MHz in 100 channels. Features include 10 priority channels, preprogrammed service search, programmable search, one-touch weather, data lockout, rechargeable nicd battery, illuminated LCD, lockout, programmable delay, volume and squelch control and headphone jack. BC120XLT**\$250**

SC150Y/B (SportCat)

Programmable handheld sport scanner covers 29-54, 108-174, 406-512 and 806-956 MHz (less cellular) in 100 channels. Features include 10 one-touch direct

access channels with 10 corresponding channel identifiers, band search, data skip, headphone jack, one-touch weather, rechargeable nicd, illuminated LCD, lockout, programmable delay, volume and squelch control. Available in black or yellow**\$320**

BC220XLT

Programmable handheld scanner covers 29-54, 108-174, 406-512 and 806-956 MHz (less cellular) in 200 channels. Features include 10 priority channels, preprogrammed service search,



one-touch weather, data skip, rechargeable nicd battery, illuminated LCD, programmable search and headphone jack BC220XLT**\$440**

BC230XLT

Same as 220XLT except includes charger and spare NiCd battery.**\$460**

BC 3000XLT

Programmable handheld scanner covering 25 MHz to 1.3 GHz in 400 memory channels (except cellular). Features include 20 banks and 10 priority channels, auto store, VFO control, weather search, illuminated LCD display, reception counter, step select, rechargeable NiCd battery and AC adapter. Also includes delay, count, and step keys.

Specifications: Rechargeable NiCd pack supplies up to 5 hrs use. Scan rate up to 100 ch/sec. Audio output max 320mW. Includes AC adapter, rubber antenna, belt clip, earphone and leatherette case.**\$700**

(800) 619-9527
Far and away, the best CB antenna



K40
 Tomorrow's CB Technology Today
 Consistent SWR across all 40 channels. Super-easy tuning.
 The K40 can be purchased at Loveland CB along with CB repairs, tune-ups, and installations

Dealers for
 Cobra • Uniden • K-40 C.B. Radios
 Wilson and K-40 Antennas

LOVELAND CB
 329 E. 5th Street, Unit 2 Loveland, CO 80537
 (970) 667-9527

CB's
Order New Tricks III
CB Books
 Shows Tune Ups In CB's, Amplifiers, Export CB's.



ONLY \$19.95
 J.L. Hamerlin
 Contact Technical

Medicine Man CB
 P.O. Box 37, Clarksville, AR 72830
 Send \$19.95 with order

CB RADIO OWNERS!
 We specialize in a wide variety of technical information, parts and services for CB radios. 10-Meter and FM conversion kits, repair books, plans, high-performance accessories. Thousands of satisfied customers since 1976! Catalog \$3.

CBC INTERNATIONAL, INC.
 P.O. BOX 31500G, PHOENIX, AZ 85046
 FAX 602/996-8700

SCANNER CRYSTALS
 Send long SASE for ordering information to:
G.E. JONES ELECTRONICS
 P.O. Box 467
 Buckeye Lake, OH 43008-0467

VIDEO SYNC GENERATOR



Restores Horizontal and Vertical Sync Lines from Distorted Analogue Video Formats

For Free Information Package on Completed Units and Pricing
 VISA • Call 219-236-5776 • M.C.
 R.C. Distributing • PO Box 552 • South Bend, IN 46624

GMRS Transceivers

FM Transceivers listed in this section require the user to complete the FCC Form 574 that accompanies each radio and send the \$60 first-time license fee to the FCC. When the license arrives, you may begin using the transceiver. Prices listed are suggested retail prices; shop around for the best deal.

Maxon Systems, Inc.

GMRS-10

Handheld GMRS transceiver features single channel operation and 100 mW power. Controls are top-mounted on/off-volume control. Speaker and mic jacks are also top-mounted. Side-mounted controls include PTT and VOX controls (for optional VOX mode), squelch and monitor. Also features belt clip and rubber flex antenna. VOX options include headset with boom mic (PCA-1) and ear speaker/mic with remote PTT (WTA-9).

Specifications: Transmits 462.625 MHz. Requires 3 "AA" batteries (not included). Dimensions (HWD) approx. 6" x 2 1/2" x 1 1/2". Weight approx. 1/2 lb. **\$130**

GMRS-21A

Handheld GMRS transceiver features two channel operation and 1 watt power output. Controls are top-mounted volume/squelch and channel selector switch. Side controls are PTT button, monitor control, and battery pack release. Also features NiCd battery pack with wall charger, belt clip and rubber flex antenna. Front of battery pack features charge indicator LED. (charging jack is on rear of unit). Transmit/battery low LED indicator is on top of unit. Options include speaker/mic (WTA-10G) and VOX/PTT mini-headset (WTA-13G).

Specifications: Transmits 462.575 and 462.625 MHz. Dimensions (with battery pack) (HWD) approx. 5 1/2" x 2 1/2" x 1". Weight (with battery pack) approx. 12 oz. GMRS-21A **\$260**

GMRS-210+3

Handheld GMRS transceiver features 10 channel operation and 2 watt power output (up to five watts with vehicle power cord). Features include two dealer-programmable channels, one for emergency/safety comms, and seven non-programmable set on interstitial frequencies for all-purpose GMRS radio use. Eight button keypad selects programmable features. Controls include volume/on/off, squelch and tune/M-Ch, low-power switch; illuminated LCD (displays channel, frequency and radio status); channel



scan, priority channel scan and "call" channel capability; CTCSS capability; user-programmable scan delay time option with channel lockout and transmit time-out-timer. Includes jacks for external DC power cord use, belt clip and vehicle DC cigarette lighter power cord. Options include speaker/mic or VOX PTT mini headset.

Specifications: Dimensions approx. (HWD) 6 1/2" x 2 1/2" x 1 1/2". Weight approx. 1 lb. 2 oz. Power output 2-5 watts depending upon source voltage up to 13.8 Vdc. **\$300**

Midland International Corp.

75-900

GMRS handheld transceiver features eight channel operation and two watt power output. Features include synthesized frequency operation, lower power switch, volume/squelch controls. Also includes visual indicator for "busy" and transmit modes. Jacks for external antenna, earphone or speaker mic. Includes rechargeable battery pack with wall charger and flex antenna. Dimensions (HWD) 6" x 2" x 1 1/3". Weight approx. 1 lb. **\$350**

Radio Shack

19-901, PRS-101

GMRS handheld transceiver features 10-channel operation with two watt output. Features include hi/low power switch, one-touch access to GMRS emergency channel and user-programmable frequencies. Includes NiCd battery pack,



AC charger, belt clip, and detachable flex antenna. Dimensions (HWD) approx. 6" x 2 1/2" x 1 1/2". **\$220**

Uniden

GMR-100

Handheld GMRS transceiver features eight channel operation and one watt power output. Features include "Busy" LED, busy alert tone, transmit/battery low indicator, external mic/speaker jack, removable belt clip and NiCd battery (with charger), and flex antenna. Dimensions (HWD) approx. 6" x 2 3/8" x 1 5/8". **\$290**





PRESENTS

An Exciting New Introduction To Amateur Radio!

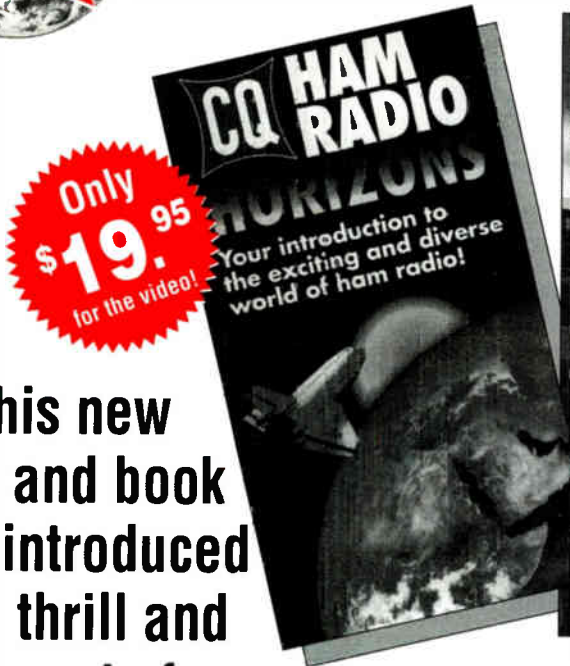

Only \$19.95 for the video!

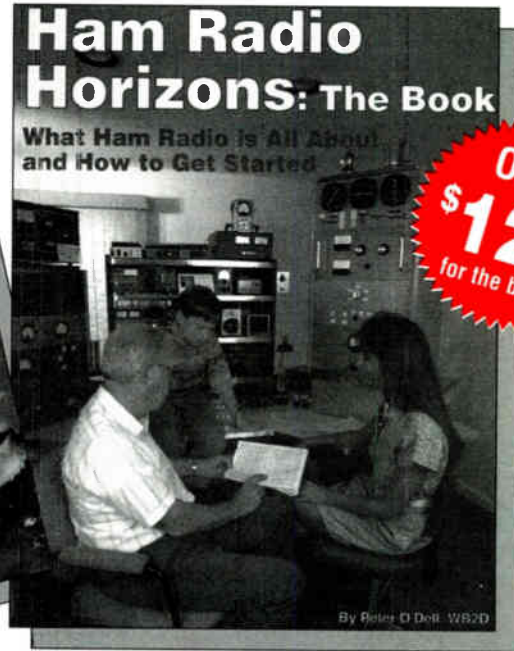

Only \$12.95 for the book!

Use this new video and book to be introduced to the thrill and enjoyment of Amateur Radio!

HERE'S WHAT'S IN OUR NEW VIDEO AND BOOK

- Hams talking to the space shuttle crews
- What it takes (and costs) to get started
- How to get your ham radio license
- Who hams are and what they do with their stations
- Ham radio for the young and old
- Women in ham radio
- Ham radio for the disabled
- How ham radio can help your career
- How hams talk around the world
- Hams using satellites and computers on the air

This informative book and video will give you all the support you need to introduce prospective hams to the wonderful ways they can enjoy amateur radio! These products give first-hand tips from the leaders in the hobby. Future hams will see how we talk to the space shuttle and hear about some of ham radio's famous celebrities.

For faster service call our order department at **(800) 853-9797**

THEY'LL WANT TO BE INVOLVED WHEN THEY SEE THESE

Ham Radio Horizons products can get you in on the fun and excitement of Amateur Radio—from talking to friends across town to making new acquaintances in foreign countries. It's the perfect way to get started, and with terminology that everyone can understand!

Send for your video and book today—the exciting world of Amateur Radio awaits!

HAM RADIO HORIZONS VIDEO & BOOK ORDER FORM

YES! I want to receive all the information in **HAM RADIO HORIZONS Video & Book** by writing the number of copies I want below.

- # of copies **HAM RADIO HORIZONS: THE VIDEO \$19.95**, plus \$3.50 shipping and handling.
 # of copies **HAM RADIO HORIZONS: THE BOOK \$12.95**, plus \$4.00 shipping and handling.
 Complete video and book set **\$30.95**, plus \$4 shipping and handling.

Name _____

Address _____

City _____ State _____ Zip _____

Send \$7.00 each for overseas shipment. Tapes available in VHS format only.

Payment: Mastercard Visa American Express
 Discover Money Order Check

Card # _____ Exp. Date _____

Mail orders to: **CQ Communications, Inc. 76 North Broadway, Hicksville, NY 11801**

For Faster Service Call (516) 681-2922 or Fax (516) 681-2926. Dealer inquiries welcome.

Club quantity discounts available

Miscellaneous



The following alphabetized section includes manufacturers of accessories from antennas to software packages. In many instances the products are available directly from the manufacturer. In other cases the products may be purchased from dealers. Be sure to check the listings of Manufacturers and Dealers in the back of our Guide for their addresses and phone numbers. Remember, prices given are suggested retail/list prices and can vary considerably from actual "street" prices. Of course, shipping charges are usually extra. Every attempt has been made to include a reasonable variety of products to enhance your listening/talking pleasure. Naturally all products, from all manufacturers could not be included.

ACE Communications

GW 2 Preamp

Preamp improves receiver sensitivity. Offers variable -3 to +25dB gain over 100 kHz to 1500 MHz range. GaAsFET design gives noise figure better than 1.5dB. BNC connectors male and female connectors for mounting even on handheld. Comes with 9 Vdc battery. Dimensions (HWD) 3" x 1/8" x 1 1/8" Weight 5 oz.\$79

AEA

SWR Antenna Analyzer

Features graphic display to show user antenna performance (SWR vs. frequency). Microprocessor-controlled frequency synthesizer with low-power SWR bridge. Full-featured keypad allows user to select center fre-



quency, frequency range, and step size. LCD readout displays antenna's SWR curve over an entire range. Power requirement: 8 "AA" batteries or 12-16 Vdc external. SWR measurement range: 1:1 to 65.5:1. With optional software features include remote control of

analyzer, display plots on computer, save plots to disk and control unit from keyboard. SWR-121 HF (For 1-32 MHz)\$399
Carrying case w/belt loop\$29

AEA Hamlink

Gives user access to CB radio using a Touch Tone™ phone. Talk and listen with your CB radio. Features password protection. Connects to existing phone line (no need for second phone line). Works even if answering machine is connected to line.....\$269

Antenna Specialists Co., a Division of Allen Telecom Group, Inc.

AV-240 Moon Fantom

On-glass mount 1/2 wave CB antenna. No tools needed. Works on metal or fiberglass vehicles. Stainless steel whip with center load. AV-240\$54

M 904 Black Stallion

Magnetic mount CB antenna with 42" long stainless steel whip. Comes with 12 feet coax cable and connector. (not for vinyl roofs) All-black finish\$26

M R306 Mobile CB Antenna

Designed for motorcycles, snowmobiles, fiberglass vehicles where no ground plane is needed. Antenna is base-loaded with fiberglass whip. Tunable for maximum of 15 channels with better than 2.0:1 VSWR. Includes whip, spring, cable and attached connector. Not recommended where ground plane is available.\$68

M-1D

Full quarterwave 102" whip for mobile CB operation. Chrome-plated professional-grade swivel ball mount plus heavy duty stainless steel spring\$58

MS119 Super Scanner

Base CB antenna. Selectable omni or high gain beam. Gain 5.75dB in beam mode. Height 18 feet. Width 6 feet. Uses standard 50 ohm cable (not supplied) and accepts standard PL-259 connector. Weight 17 lbs. Requires 1 1/2-2" outside diameter mast (not supplied).....\$325

AV-140 Moonraker 4

Four dual-element dual polarity beam CB antenna with forward gain of 14.5dBi. Uses PDL-type reflector for increased gain and rejection of unwanted signals. VSWR 1.3:1 across all 40 channels. Aluminum construction. Boom length 16'5". Weight 24lbs. Connector is SO-239 (cable not included) AV-140 Moonraker 4.....\$400

Alpha Delta Communications, Inc.

Transi Trap Surge Protectors

Gas surge arresters designed to protect sensitive electronic equipment from damage due to excess voltages or currents generated by lightning or static build-up. Replaceable

Arc-Plug cartridge. Model R-T, 200W thru 500 MHz (all UHF connectors); Model HV 2000W thru 500 MHz; and Model LT, T-type 200W thru 30 MHz.

Model R-T\$33
Model HV\$36
Model LT.....\$23
(replacement cartridges cost between \$13 and \$18 each)

Delta-2

Lightning surge protected 2-position RF coax switch, with internal 50 ohm micro-strip cavity construction, similar to Delta-4.

Delta-2\$50
Delta-2N (N-connectors)\$65

Aluma Tower Company, Inc.

Lightweight aluminum towers, including crank-up towers, stack sections, mobile van-mounted towers and trailer towers. Crankups range from 35 to 100 feet. Lightweight, durable units are for ham, CB radio, TV and similar communication. T-140 (is comprised of 2, 20-foot triangular sections weighs approx. 59 lbs. Includes 5 foot mast,(less antenna) Comes with safety stop device and includes crank arm that acts as locking device.\$1550

AMC Sales, Inc.

AMC Model 2712 Recorder

Long playing (record up to 12 hours—6 hours per side using a TDK cassette) Features include one-touch recording, cue/review, lockable pause control, built-in condenser microphone, digital tape counter, separate volume control, one TDK 120 tape, auto stop function. Powered by 4 C size batteries (not included) or 110 Vac cord, included. Jacks for remote mike and speaker. Dimensions (HWD) 2 1/16" x 5 1/2" x 9 7/8". Weight (without batteries) approx. 2 lbs.\$119

ANLI International Corp.

Power Station SB-752

Portable power for communications equipment, cellular telephones and TV's. Features include LED charging indicator, DC 3-6-9 Vdc selector switch, charge input cigarette socket, voltmeter, LED power-on indicator, main power on/off switch, 12 Vdc output cigarette socket and ± output terminal. Power output 12 Vdc, 15 amps 120 watts. Also 3-6-9 Vdc, 50 Hz or 12 Vdc with supplied cigarette lighter plug. Also offers quick recharge (3 hrs. approx. from 12 Vdc while driving vehicle). Recharges in approx. 8 hrs. from 110 Vac adapter, included, with automatic full-charge shut-off circuit. Weight approx. 7 1/2 lbs. Dimensions (HWD) approx. 8" x 8" x 2 1/2"\$60

Astatic

Night Eagle Model TUP9-D104-NE Microphone

Amplified crystal microphone includes all

Miscellaneous



features of Silver Eagle with new finish. Main mic body is done in black using polyurethane coating. Press bar, locking clamp and grille screen are polished then bright brass plated. Also features an American Eagle embossed on back of the D-104 head. Includes heavy duty coiled cord. Uses standard 9V battery (not included)

TUP9-D104-NE.....\$130

Road Devil Noise Canceling Power Microphone

Amplified handheld mic includes 6-wire cable. Features include large external volume control, ABS housing in fire red or black, steel grille screen. Operates on 9 Vdc battery (not included).....\$55

Amplified Ceramic Microphone

Handheld ABS plastic housed mic. Features include heavy duty coiled cord, external volume control on back of mic, chrome-plated brass grille screen, and chrome-plated front housing. Power requirement 9 Vdc battery. Mic is the handheld version of D-104 Desk Mic.

Model D104M-6B.....\$55

Astron Corporation

Heavy duty power supplies to operate 13.8 Vdc equipment from 120 Vac, featuring solid state electronically regulated, fold-back current limiting, low ripple, heavy duty heat sink, chassis mount fuse, three-conductor power cord. All units (except one) available in 220 Vac.

SL Series price range.....\$91-132

RS-L Series (built-in cigarette lighter receptacle).....\$58-64

Austin Antenna Ltd.

Spectra

Four-band tuned antenna for mobile or base

scanner use. For mobile use 1/2 wave elements provide coverage on UHF and 800-1000 MHz. Low and high band coverage provided by offset fed 1/4 wave elements. Length is 33 inches. Includes Motorola connector. Thru hole body mounts and magnet mounts available. Pole mount is also available for base station use. Enhances performance on low and high band by increasing those elements to 1/2 wave length. Pole mount is 48 inches long. With Spectra attached, overall length is approx. 7 feet.....\$85
Spectra with pole mount.....\$140
Spectra for mobile CB use.....\$60

Azimuth Communications Corporation

Grand 24 Liquid Crystal Clock

24-hour see-thru LCD clock. Window is 2 1/4" high and 3 1/8" wide. Brushed black metal stand, 4 1/2" high. Battery operated (included). Grand 24 Crystal Clock.....\$30

Butternut Electronics

1011 Butterfly

Base antenna for CB operation. Adjustable frequency coverage 27-30 MHz. Includes two elements. Boom length 4 feet. SWR at resonance 1.5:1 or less. Front-to-side 20dB, front-to-back 15dB+. Polarization: Horizontal. Forward gain over dipole 5dB. Wind survival 80 mph.....\$160

Cellular Security Group

MAX System Scanner Antennas

Receiving antennas mount on scanner with BNC mounts.

46-49 MHz Dipole.....\$50

46-49 MHz Halfwave.....\$30

MAX 800 Base Antenna.....\$36

Charles Radio Company

Charles Gizmotchy 3-Element Vertical/Horizontal Beam

CB beam antenna with following features: Transmits/receives in uni-directional pattern, using two feed lines. Antenna can be used in either vertical or horizontal mode with any standard coax switch. Antenna is gamma-matched, both vertical and horizontal to 50 ohms. Forward gain approx. 12dB, front-to-back ratio 28dB. Handles up to 1kW and weighs 12 lbs.....\$300

Cobra Electronics Corp.

Dual Platinum Series CB Antennas

ATW-480 mobile dual band antenna tunable for CB and NOAA reception. Center-loaded and features extra tip rod for low frequency usage. Whip is fiberglass. Includes 15 feet RG-58 coax and PL-259 connector.

ATW-480 Antenna.....\$30

ATW-1000 mobile dual band magnetic-mount antenna for CB and NOAA reception. Ideal for trunk or roof mounting. Overall length is 60". Includes heavy duty magnet and 16 feet 8240 cable with PL-259 connector. Antenna is tapered stainless steel whip and is tunable for 10-meter ham band with 2 MHz bandwidth; tunable 26.5 to 30.0 MHz.....\$90

ATW-93 Indoor Antenna

Pre-tuned dual-band indoor CB base antenna receives/transmits CB and receives NOAA weather broadcasts. Antenna magnetically mounts on special pad. Includes 15 feet coax with attached PL-259 connector.....\$45

AT-70 Magnetic-Mount Antenna

Base loaded CB mobile antenna features 38 1/2" stainless steel whip. Mount is charcoal gray, molded ABS. Includes 17 feet RG-58 coax with PL-259 connector.....\$30

CA-72 Base Station Microphone

Fits all Cobra CB models with 5-pin connector. Features omnidirectional dynamic mic with built-in voice compression amp for consistent gain and less distortion. Features PTT bar, lock switch and pre-wired connector with seven foot coiled cord. Requires 9 Vdc battery, not included. Weight approx. 2 lbs...\$80

Connect Systems, Inc.

CD-2 Decoder Unit

Decodes and displays 50 CTCSS codes, 104 DCS codes and all 16 DTMF digits. Used in conjunction with scanners, receivers and service monitors to decode communications codes. Displays data on front LED panel with all decoded data available on RS-232 serial port. Optional PC compatible software applications program (CD-2P) allows user to view all decoded data on computer and also acquire time, date, and hits per CTCSS or DCS code, plus usage graphs. DTMF characters are decoded in strings up to 128 characters in length. Internal pre-amp with level control allows input levels from 10mV to 4 volts. Power requirement 12 Vdc. Dimensions (HWD) approx. 2" x 5" x 4 3/4". Weight approx. 1 lb.

CD-2 Decoder Unit.....\$313

CD-1 Decoder Unit (same as CD-2 less RS-232 port).....\$255

Create

Log Periodic Antenna CLP 5130 Series

High gain, wideband VHF and UHF log peri-

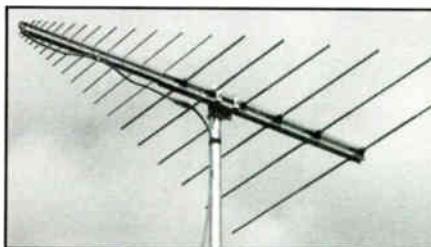

Miscellaneous



odic type beam antenna. Useable in amateur bands 50-1300 MHz and suitable for FM BC reception, all band scanning, VHF/UHF television, air band communications. Forward gain from 50-1300 MHz is 10 to 12dBi. Additional features and specifications include: 25 elements, front-to-back ratio 15dB, connector is female "N", power rating 500W PEP. Boom length is 6' 8". Requires mast 1 1/2"-2". Weight 11 lbs. Wind survival 90 mph\$420

Design EQ

Guide to The AR1000

A 90-page guide to understanding and using AOR AR1000 family of wide-range handheld scanners. Covers all models of the AR1000 and also appropriate for the AR2800 mobile/desktop scanner. Four sections (Operations, Applications, Accessories and Reference) in book helps user get most out of this scanner. Includes templates and Quick Reference Card. Guide to The AR1000\$15

E.H. Yost & Co.

Full line of batteries-rechargeable NiCd, sealed lead acid, lithium, computer, alkaline, zincair, silveroxide, solar, nickel hydrite and solar panels. Batteries include standard charge, high capacity and fast charge types. New lithium batteries. Sanyo NiCd- 600 MaH AA batteries.....**Call for prices**

FBenterprises

Repeater Maps

Plastic laminated color maps for each state showing amateur radio repeater frequencies. each.....\$3.95
North American Repeater Atlas includes all 50 states, Canada, Mexico, Central America and Caribbean.each.....\$10.00
Regional Repeater MapGuide is color, spiral-bound, 6-state guide.....\$9.95
Canadian set (all provinces) each.....\$19.95

Firestik Antenna Company

Firestik CB antennas; copper coil design with standard 3/8"-24 thread includes 18 feet coax cable.

KW Series (five models 2, 3, 4, 5, and 7 feet).....\$16-20
KW Series (custom colors).....\$18-22

Firestik II Tunable Tip

Same as above, except tip is tunable to allow use on multiple vehicles.

FS2 Series (four models 2, 3, 4, and 5')\$18-21
FS2 Series (custom colors)\$20-23

Indoor Antenna System IBA-5

Five-foot high antenna includes 18 feet of coax. Ideal for apartment or office use.\$50

Motorcycle "Firestik II" CB/AM/FM Antenna Kit

Four-foot model 5/8 wave tunable tip antenna constructed of heavy gauge stainless steel strut or rack mount w/hardware, 9 feet of coax and Match Maker antenna splitter. Kit also includes spring and mic hanger. Works with all CB or CB/AM/FM radio combinations. Mounts to tubular motorcycle struts, rack supports or motorcycle frames. Available in black, red or white antenna.

MCK-4\$00

Macho-Magnet Mount

Heavy-duty mag mount specially designed for heavy duty antennas. Pre-assembled with 18 feet coax. Recommended user get medium duty spring with this mount. Standard 3/8 inch-24 thread accepts all "Firestik" antennas. Model K-11\$35

"Speak Easy" Miniature CB Extension Speaker

Features waterproof speaker cone material and six foot cord with standard 1/8 inch mini-plug. Also includes mic type hang button for alternate mounting option.

SE-SS Speaker.....\$18

GAP Antenna Products

Discovery DX II Antenna

Base three-element 10 and 11 meter beam antenna. Forward gain nominally 6dB. Requires a low-cost TV-type rotor. Can be mounted on 30 foot push pole if properly guyed. Constructed of aluminum and sections are pre-drilled. Hardware is stainless steel and U-bolts are zinc-plated. Includes mounting plate to interface with mast. Center frequency is 28.4 MHz on 10 meters and 27.2 MHz on 11 meters (pre-tuned). Boom length is 10 feet. Weight 8 lbs. Turning radius 8 1/2'\$129

GRE America, Inc.

Super Amplifier

Compact pre-amp designed for use on handheld scanners and amplifies reception of frequencies 100 MHz-1 GHz as high as 20dB. Gain is adjustable. Powered by 9V battery. Features include LED power indicator. Connectors: BNC. Dimensions (HWD) 2 5/8" x 1 9/16" x 1 7/16"

Super Amplifier (Handheld Version).....\$60
Super Amplifier (Base Version)\$70

Gamber-Johnson

Super Slide™ Series

Series SS-100 mounts are used for frequencies up to 512 MHz. They are equipped with Type UHF connectors to mate with radio's antenna receptacle and the antenna cable.

Series SS-500 mounts are used with UHF radios equipped with Type UHF connectors. The mounts have a Teflon® filled, soldered PL-259 connector to the radio and a female Type N connector to the antenna lead.

Series SS-800 mounts have Type N antenna connectors and a greater input current capacity. Recommended for frequencies above 512 MHz.

All models have low VSWR and can be mounted either above or below the radio using the radio's own mounting screws. Brackets adjust to the width and height of nearly all dash-mount mobiles and marine transceivers. Correct antenna connectors are installed at the factory.

Series SS-100\$78
Series SS-500\$103
Series SS-800\$112

Grove Enterprises, Inc.

Hidden Antenna

Covers 30-1000 MHz for scanner use. Indoor antenna,66-inch flexible.....\$20

No-Tenna

Eight foot antenna for user who doesn't want visible receiving antenna on vehicle. Receives 1 to 1000 MHz. Uses entire car body as antenna. Connects to single upholstery screw (use moulding screw or sun visor screw). Includes instructions and universal connectors.....\$20

Hamtronics, Inc.

Broadband Preamp

Used to improve sensitivity of scanners. Provides 10-15dB gain with low noise figure over 20-950 MHz range without tuning 50 or 75 ohms. Has BNC jack and requires regulated 12 Vdc power. Noise figure avg. 1dB. (LNG-WB).....\$59

Hustler, Inc.

DCX

Scanner discone antenna for 40-999 MHz. Solid aluminum rod, hardware and mounting assembly included. Mounts on vertical support to 1 1/4" OD. Cone elements 55", disc elements 20". Weight 2 1/2 lbs.....\$24

HQ-27M CB Antenna

Center loaded mobile trunk lip mount antenna features swivel ball for proper positioning and 17 feet coax.....\$37

MOT Trunk Lip Mount Scanner Antenna

Center-loaded stainless steel brackets fits most vehicles. Covers same as MOG above. Includes 17' coax with BNC connector.\$20

RTM Antenna

Magnetic mount CB antenna. Height 25" and includes 15 feet coax.\$17

HQT Antenna

Designed for professional drivers, antenna features mirror-mount. All fittings are 3/8" x 24 thread. Height 51". Includes 12 feet coax and PL-259 connectors.....\$28

Miscellaneous

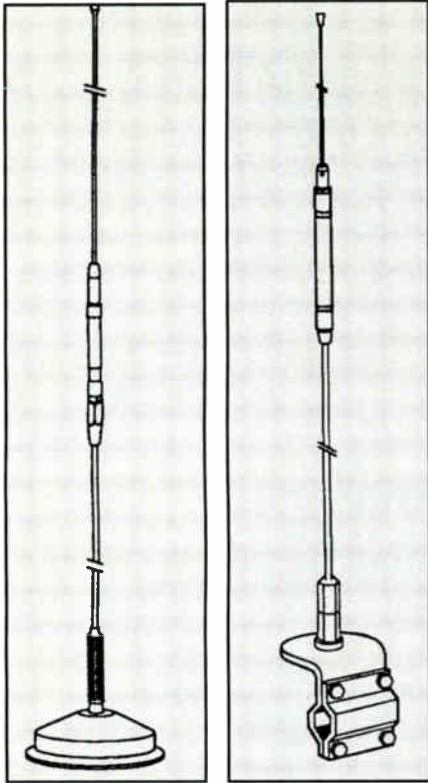

RTM

HQT

1C-56 Antenna

Mobile CB whip antenna constructed of stainless steel. Standard 3/8" x 24 threaded mount.....\$15

RVM Recreational Vehicle Mount

Heavy duty mount for vertical side panel or roof mounting on RV. Features 180 degree swivel for optimum vertical positioning. Includes 17 feet coax. Includes grommet and mounting hardware. Accepts most flexible antennas to 55" long with 3/8" x 24 threaded base. Weight approx. 2 lbs.\$21

MRM Scanner Antenna

Magnetic-mount scanner antenna with heavy duty magnet and 12 feet coax. Available with BNC or pin plug. Covers 30-50, 148-174 and 800-950 MHz. Features center-loaded coil.....\$20

Index Publishing Group, Inc.

Publisher of "Scanners & Secret Frequencies." Book is 320-pages of authoritative information about scanners and scanning. Includes 300 illustrations. Topics range from antennas and types of scanners to advanced scanning techniques. Written by Henry L. Eisenon.

Book.....\$19.95

Also publishes "Emergency Radio!" Written by Norm Schrein, the President of Bearcat Radio Club. The book covers scanning and why we scan.....\$14.95

"The Ultimate Scanner" written by Bill Cheek. Book includes most sophisticated scanner modifications made easy with step-by-step instructions and detailed illustrations.

.....\$29.95

JPS Communications, Inc.

ANC-4 Antenna Noise Canceler

Cancels locally-generated noise from power lines, computers, TV and electrical equipment. Features include front-panel controls for adjustment of both phase and magnitude of interference. Unit connects between main station antenna and receiver. DC power mating connector supplied. SO-239 mates with a PL-259 plug for the outside antenna and output to receiver. Short wire antenna and collapsible whip supplied to act as noise pickup antenna. May be used as active antenna by plugging noise antenna (or longer wire antenna) into noise antenna jack and using noise gain control to increase antenna output. Power requirement: 12 Vdc at 150mA (adapter available from JPS). Unit is NOT designed to be used at output of high power linear amp, but must be installed at lower RF level of transceiver if transmitting is anticipated. Handles 150W. Dimensions approx. (HWD) 1.7" x 6" x 4". Noise cancellation typically 40dB or better. Signal loss, main antenna to radio 6dB. Operates 100 kHz to 80 MHz.\$175
Power pack.....\$16

Jo Gunn Enterprises

JG 3+3 Star

CB base antenna with horizontal and vertical polarization. Gain 14.5dB. Front to-back ratio 40dB, side rejection 40-45dB, back rejection 40dB. Wind survival 100 mph and SWR 1.1. Length 8 feet, Weight 28 lbs....\$285

JG AR-Pistol

Vertical Omni Antenna Covers 26-29 MHz. Height 10'; weight 8 lbs. Gain 4.75dB....\$139

JG - Skip Jack

CB horizontal or vertical polarized antenna. Gain 12.5dB, front-to-back ratio 35dB, side rejection 40dB. SWR 1.1. Length 5' and weight 15 lbs. Wind survival 100 MPH. JG - Skip Jack (10 meter cut optional)....\$219

JG - 4V

CB base antenna with either horizontal or vertical polarization. Single feed. Gain 15.5dB on DX. Front-to-back ratio is 50dB. Side rejection 45-50dB. Back rejection 35dB. Length is 12 feet. Wind survival 100 mph.\$285

Smoking Gun II

Dual polarity (with twin feeds) two-element CB (26.5-28.5 MHz) beam antenna. Features include 12dB gain. Boom is five feet. Wind survival 80 mph. Constructed of aluminum. Handles up 3,000 watts (12kW with optional power package). Weight is 14 lbs.\$259

Horizontal/Vertical Antenna - JGAR Hillbilly

CB/10 meter omni-directional antenna covers 26.0-29.50 MHz with 4.75dB. Height is 11 feet and weight 10 lbs. Constructed of anodized aircraft aluminum tubing. Same power rating as above. Requires two separate coaxial cables for hook-up.\$195

K40 Electronics

K40 Antenna

CB antenna with quarter-turn quick release, 30 degree rotating base. Comes fully assembled with 18 feet RG-59 coax.\$50

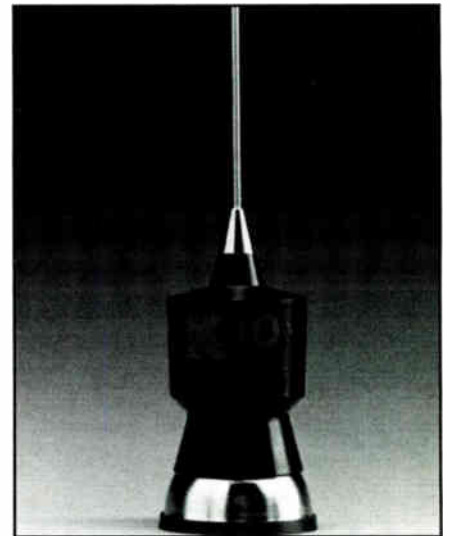

Tunable Fiberglass

CB Whip Antennas

Patented tuning sleeve for fast easy installation. Available in 2 to 4 1/2 foot lengths. Price range\$19 to \$29

K30 Magnamount Mobile CB Antenna

Features include base-loaded coil, 35" stainless steel whip antenna and 15 feet pre-wired cable. Magnet is 3" heavy duty type K30 Magnamount.\$25

MM40 Mount

Mirror mount assembly allows K40 antenna to mount to many truck and RV mirrors.....\$16

Lakeview Company, Inc.

Discone Scanner Antenna

Eight cone elements and 8 disk elements. All aluminum. Mount attaches to 1-1 1/2" mast. Receives all frequencies on AM, SSB and FM from 100 MHz-2.5 GHz. Can be used for transmitting on 2 meters and 70 cm. D-16 Plus.\$37

Magnetic Mount Antenna

Mobile magnetic-mount CB antenna (tunable for 10 and 11 meters). Rated at 500 watts. Includes 12 feet RG-58 coax and PL-259 connector.\$22

Miscellaneous

On-Glass CB Antenna

Mobile on-glass antenna rated at 25 watts and includes PL-259 connector.\$22

Triple Magnet Mount

Over 400 lbs holding strength. Constructed of 6061/P6 aluminum. Comes with coax and vinyl magnet pads\$37

Larsen Electronics, Inc.

10-Meter Mobile Antenna

Loaded quarter wave 27-30 MHz mobile antenna rated at 200 watts. Requires 3/4" hole for permanent mount. Height 52 1/4".

NMO-27 CO (coil only)\$24

NMO-27 (coil and whip)\$33

NMO-27 K (coil, whip, mount, 17 feet coax and PL-259)\$46

NMO-MM (Mag-mount for coil/whip above)\$29

Low Electronics Ltd.

Airmaster

Decoder unit plugs into user's PC comm port. All ACARS data stream is handled by software running on the PC. Some analysis of ACARS messages possible before displayed on screen. Requires at least a 386 PC to operate. Airmaster decoder and software\$180

MFJ Enterprises, Inc.

Heavy Duty Coax Antenna Switch

Four-position S0-239 switch. Allows user to select any of four antennas or the center ground position. Provides replaceable lightning surge protection to protect against distant

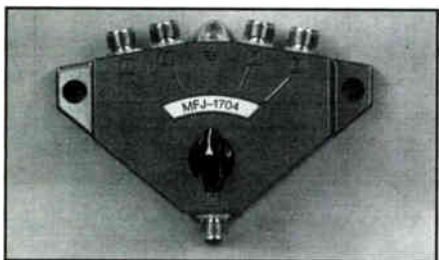

lightning-induced surges and static. Handles 2.5KW PEP. Low SWR. Isolation rated from better than 60dB at 30 MHz to better than 50dB isolation at 500 MHz. 50 ohm.\$60

Outdoor Active Antenna

Mounts outdoors away from electrical noise for maximum signal, minimum noise. Covers 50 kHz to 30 MHz. Remote unit has 54 inch whip, 50 feet of coax and connector. 12 Vdc or 110 Vac (with optional adapter) On-LED, 20dB attenuator and gain control. MFJ-1024\$130

Receiver Antenna Tuner/Preamplifier

Provides proper impedance matching to transfer maximum signal from antenna to

receiver. Covers 1.6-30 MHz. A 20dB preamp with gain control boosts weak stations. A 20dB attenuator prevents overload. Select from 2 antennas, 2 receivers. Use 9-18 Vdc or 110 Vac (with optional adapter) Dimensions (HWD) 2" x 9" x 6".

MFJ-959B\$90

Maco Manufacturing

Audio Specialty Sounds

Features a variety of specialty sounds including teletype, tweets, siren-like sound, ding-dong, etc.\$15

Super Laser 500 Base Antenna

CB base antenna features directional dual polarity with gain of 18dB. Handles up to 2 kW. Mounted on 40-foot boom, 16-element antenna uses 14 yagi-type elements, plus quad

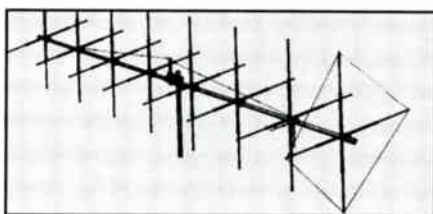

reflector. Adjustable gamma match to obtain lowest SWR for both vertical and horizontal polarization. Front-to-back ratio is up to 46dB; weight 70 lbs (by truck delivery). Turning radius 21 feet.\$934

Shooting Star

CB base station antenna features 8-element dual-polarity with gain of 14dB. Antenna is mounted on 16-foot boom with six elements plus quad reflector. Handles up to 2 kW. Front-to-back separation is 38dB; weight 31 lbs. Turning radius 13 feet.\$336

Maco M107C Beam

CB base station antenna is 7-element beam constructed of telescoping aluminum tubing, pre-drilled holes and handles up to 2 kW. Boom length 37.5 feet; gain 17.5dB; front to-back separation 36dB. Turning radius is 22 feet. Weight 44 lbs.\$504

Maco M103C Beam

CB base station antenna is a 3-element beam with 11dB gain. Boom length 11 1/2 feet; front-to-back separation 25dB. Turning radius is 10 feet. Weight 14 lbs.\$143

Maco 45 Switch

Coax three-position switchbox with rotary switch. Handles up to 1 kW.\$19

Marvel Communications Co., Inc. (Everhardt Antennas)

MM-1001 Deluxe Mag Mount

CB magnetic-mount antenna includes 18 feet RG-58/U coax and PL-259 connector. Stainless steel spring and 45" whip. Available in black or white.\$40

800 MHz+ Mobile Scanner Antenna

Receive only antenna for 25-1000 MHz, preset for maximum gain at 850 MHz. Antenna is 24" high and features standard 3/8" x 24 threaded base. Available in red, white, blue or black.

MS-1\$13

MS-2 (Includes MS-1, horizontal aluminum mirror mount, 12 feet coax and PL-259 to male Motorola plug)\$29

Master Blaster MB-1 Mobile Antenna

Base-loaded, 59" mobile CB antenna features 2,000 watts power handling capability and low SWR on all 40 channels. Constructed of stainless steel with frequency range of 26.0-29.0 MHz. Capacitive hat radial design. Also available in elevated base load, (67"), center-load (48") and 54" center-load.\$42

MM-2098 "Shorty" Center Load

Mobile CB antenna (mag mount) with weatherband trap for improved reception of all seven NOAA weather channels. Antenna is 27" high and includes stainless steel whip and spring, 18 feet coax with PL-259 connector.\$46

TSMCCBWB Antenna

Superflex CB mobile antenna is 48" high, rated at 1,000 watts and features weatherband trap for improved reception of all seven NOAA weather channels.\$19

MetroWest, Inc.

Pro Charge 7

Drop-in charge controller for the Pro Pack PP-1200 battery. Keeps NiCds at 100 percent charge. Adds time charge control and taper charging to your charger module, stand-up design for parking scanner. Features seven hour recharge, and auto taper charge with two-color LED charge status indicator. Powered by your Bearcat recharge module or auto lighter cord. Dimensions (HWD) 1 3/4" x 4 1/2" x 3 1/4" Pro Charge 7\$39

Pro-Power Drop-In Charger Stand

(For Bearcat 100, 200 or 205XLT, Regency 4020 and 4030 and Radio Shack PRO-35, Regency HX-1000, 1200 or 1500, Radio Shack 30-37, and PRO-43, and AOR 1000 series). Price range\$65-\$75

Taper Box (T-102)

Plugs into recharge jack on scanner. Plugs into scanner; control circuitry limits charge time to the proper 15 hours for AA NiCds, then switches to a true phase modulated trickle charge to keep batteries at full charge. LED flashes to indicate charging, and is on solid during trickle charge, alerting user that scanner is fully charged.\$23

Midland International Corp.

Window Mount CB Antenna

Mobile 27 MHz antenna with prewired coax and all installation material. Black-color finish. Whip removable.\$30

Miscellaneous

Deluxe Trunk/Deck Mount Mobile CB Antenna

Mounts on trunk lip or can be hole-mounted. Shock relief spring included. Length approx. 32". Whip is black thin fiberglass and is adjustable. Waterproof construction. All metal is chromed. Includes prewired coax assembly.

18-2903 Mobile CB Antenna\$30
18-2983 (similar to above, except magnetic mount)\$30

Mobile Mark, Inc.

Broad Stick Heliwhip

Top-loaded CB antenna features nearly constant VSWR across all channels. Features include heavy gauge wire, space-wound top load, 7/8 wavelength, heavier gauge wire in matching coil, separate loading and matching coils. Design tested for 700 watts. Mount is standard 3/8" x 24 thread. Standard model available in four lengths and also in heavy duty model comes in three lengths.

HW-11-SB3 (Three foot model)\$11
HW-11-SB4 (Four foot model
26.6-27.8 MHz)\$11

Mosley Electronics, Inc.

A311-S

CB 3-element beam antenna. Boom length 12 feet. Maximum element length 18' 5". Front-to-back ratio 20dB. Vertical wind load 60 lbs. Forward gain 8dB compared to reference dipole. Feed point impedance is 52 ohms, radiation is uni-directional. Shipping weight 14 lbs.\$186

AMPLP-HF Log

Nine element mini-log antenna for 20, 17, 15, 12, 11 and 10 meters. Features include stainless steel hardware. Constructed of aircraft-grade drawn tubing. Parts are color-coded; no measuring and no hose clamps. Items are pre-drilled. Gives user broad frequency coverage and comes with a balun and coax line connector (PL-259 standard, N is optional). Boom length is 18 feet. Weight 58 lbs. Max gain at 28 MHz 7.9dBd. Longest element length is 35 feet. Turning radius approx. 20 feet. Average VSWR at 50 ohms is 1.5:1. AMLP-14-28-18.....\$550

MoTron Electronics

TM-16A & TM-16A Plus DTMF/Rotary Test Decoders

Decodes all 16 DTMF digits from nearly any audio source. Now also decodes and displays either DTMF or rotary from a telephone. Hyphen is automatically inserted between number groups. Each device can display up to 16 digits at one time on LCD display. Internal memory and left to right scroll functions allow user to decode, capture and display up to 80 characters, including hyphens without loss of information. Both units completely portable in black metal enclosure. Includes speaker with

built-in amplifier and volume control and two decoder speed settings. TM-16A Plus also has RS-232C ASCII serial output (9600 baud) and can be connected to computer for auto logging or remote data entry. Both models include three audio cables, 9 Vdc battery and manual with schematic.

TM-16A Standard Decoder\$179
TM-16A Plus Decoder\$249

NCG Company

Power Pocket

Lead acid sealed battery rated at 12 Vdc, nominal capacity 2.0 AH/20 hour rate. User's HT/scanner plugs in female cigarette lighter socket. Includes UL approved charger with male cigarette adapter plug. Battery in soft bag with belt loop with shoulder strap/waist belt included. Charge rate: 6-8 hours from complete discharge. Standby life expectancy: 3-5 years. Weight 30 oz. (approx.) Dimensions (HWD) approx. 6 1/2" x 3 1/2" x 1".\$67

Naval Electronics

HTS-3 Amplified Speaker

For use with handheld radios, model is compact with heavy duty 3 1/2 inch speaker and 12dB internal amplifier. Includes built-in NiCd battery charger and auto shut-off feature. Includes Tape Trigger feature that turns cassette recorder on when audio signal is detected, and off again when audio disappears. When manually switched off, amplifier is bypassed and input jack is connected directly to speaker. Uses positive or negative ground and includes remote jack for recording. Also has level control, which, once adjusted, is set by transceiver volume control. Powered by 4 AA internal batteries (not included) or any external 6-15 Vdc. Dimensions (HWD) 4 1/2" x 2 1/2" x 2 3/4"\$35

Nevada

Nevada-1300 Discone

Wideband omni-directional antenna covers 25-1300 MHz and can be used by amateurs to transmit up to 200 W on 50, 144, 430, 900 and 1200 MHz. Stainless steel construction with weather protected feedpoint. Connector is "N" type. Includes mounting kit and short mast section. Height 5'6", weight 2.2 lbs.

Nevada-1300 Discone
(cable not included)\$90
Nevada-2200 Baby Discone
(coverage 200 MHz-2.2 GHz, similar to above 1300 model except 24" high)....\$100

Optoelectronics, Inc.

3300 MiniCounter

Pocket-sized frequency counter, 1 MHz to 2.8 GHz range. Six selectable gate times. Ten-digit LCD display. Accuracy 1PPM, 10 MHz industry standard timebase. Includes NiCd and adapter/charger.....\$139

Scout

Records and stores into memory 400 unique frequencies within a 10 MHz to 1.4 GHz range while being able to record up to 255 hits on each channel in memory. Digital filter/auto capture allows unit to record frequencies automatically. Unit automatically Re-action Tunes or Memory Tunes the following receivers: AOR8000/2700, Icom R7000, R7100 and R9000, PRO 2005/6 (when equipped with OS456) and PRO 2035 (when equipped with OS535). Scout features 10 digit LCD, EL backlight and 16-segment signal strength bargraph, NiCd batteries, AC Adapter/charger and PC utility disk\$449

OptoScan 456

Add-on computer interface board designed to fit into Radio Shack PRO 2005/6 receivers. Unit gives complete computer control of receiver while increasing scanning speed up to 65 channels/sec. (depending on software used). It receives VHF/UHF signals in the fol-

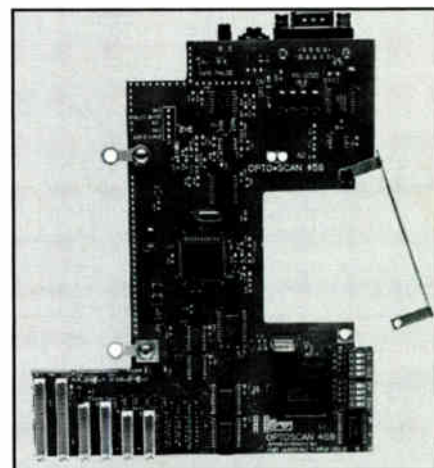

lowing ranges: 25-519.995 MHz and uninterupted 760-1299.995 MHz. Supports AM, FM narrow and FM wideband modes. Also decodes CTCSS, DCS and DTMF. Can be used with Scout for Reaction Tune. Supported by the following software programs: Probe, Scanstar, Scancat, Scannerwear for Windows, and Radio Manager for Windows.....\$299

Palomar Engineers

Amplifier

Connects between antenna and receiver. Designed for use with antennas fed with coax feedline. Works with random wire antennas and those fed with twinline. Features include an amplifier with 20dB gain, 3 MHz highpass filter, a 30 MHz lowpass filter and 20dB attenuator. May be used separately or in any combination. Also 20dB attenuator reduces overload from in-band signals. For short antenna users, the 20dB amplifier boosts signals. All functions except amplifier and lamps work without optional power supply. Connectors: SO-239 for receiver and antenna. Dimensions (HWD) 1 3/4" x 4 1/2" x 4 1/4". Cabinet is brushed aluminum panel with black vinyl cover. Amplifier frequency range is 0.1-1000 MHz.

Miscellaneous

Model PA-360 Amplifier.....\$80
 Model PS-90 115 Vac Adapter.....\$10

ParaDynamics, a Division of Valor Enterprises, Inc.

PDC6000 Meter

Meter features three separate meters in one unit for simultaneous readings of all functions for mobile, bench or base station installation. Reads SWR, RF power in watts and modula-

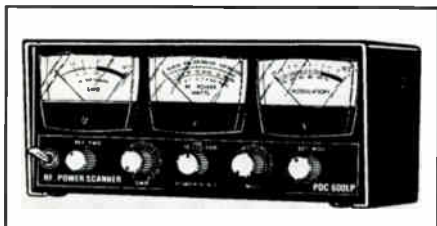

tion. Rated at 5,000 watts. Dimensions same as above meter. Includes earphone jack and earphone. Frequency range 25-30 MHz.\$190

PDC256 Frequency Counter

Six-digit continuous readout counter allows user to read operating frequency without transmitting. Designed to interface with most frequency synthesized SSB/CB radios. Field programmable; one model fits all. Green LED displays and reads 20,000-29,999 MHz. \$200

PDC268 CB/AM/FM Coupler

Coupler converts ungrounded CB antenna to be used with CB and AM/FM radios.\$30

PDC Sound Modules

User-installable modules. Can be wired directly to mic key wires or used with momentary push button.\$40-45

PDC704 4-Way Lighter Plug Adapter

Item allows multiple use of cigarette lighter for accessories when going mobile. Attaches to side of console or under dash with supplied adhesive tape. For use in all vehicles with 12 Vdc. Full use of all four sockets at once should not exceed 180 watts (15 amps).\$23

PDC57 Pro-King Power Microphone

Mobile handheld power microphone features dual OP/AMP controlled speech amplifier, automatic roger beep upon PTT release. Fits Cobra/Uniden 4-pin standard mic plug. Uses standard 9 Vdc battery, not included.\$50
 PDC59 (Same, except echo repeating, talk-back and four emergency sounds)\$90

PDC66 Base Pro-King Microphone

Features roger beep, echo controls, VU meter, talk-lock, swivel head. Uses standard 9 Vdc battery, not included.\$140

PDC1089 Low-Pass TVI Filter

Suppresses TV interference at the source. Rated at 1,000 watts and covers 0-30 MHz. Impedance 50 ohms.\$40
 PDC1090 (Rated 1,500 watts).....\$80

PerCon Corporation

Master Frequency-Regional Series

Extracted from FCC database and organized by individual regions/groups for PC and Macintosh compatible computers. Each region contains an average of 700,000 records with 61 fields of information per record. NE Region (ME, VT, NH, MA, RI, NY, DE, CT, NJ, MD, DC, PA, OH, VA, WV); SE Region (WV, VA, KY, TN, NC, SC, MS, AL, GA, FL); NC Region (MI, WI, MN, ND, SD, MT, WY, NE, IA, IL, IN); SC Region (MO, KS, CO, NM, TX, OK, AR, LA); WE Region (WA, OR, ID, CA, NV, UT, AZ, AK, HI).

Regional CDROM\$100

Master Frequency-US Index

Entire FCC MFDB on single CDROM. Consists of 11 fields with over 3 million frequency records.\$100

Spectrum

Nationwide frequency database with over 3 million records of 15 fields of information including: frequency, callsign, radio service and class of station codes, transmitter city/county/state/lat & long and number of units for vehicles, marine, aircraft, portables and pagers. Program has seven fill in blank style searches. Data can be displayed on screen, printed to an 80 or 132 column report or exported to a UFDBF file.

Spectrum (Win/Dos/Mac)\$30

Periphex Inc.

Replacement Batteries

Highest capacity for amateur HT's. Many offer twice capacity of original battery. BP-8 (for HTX-202/404) and others. Call for free catalog.

Pouch, The

Washable "quick-draw" holster made for handie talkies, scanners, cordless phones and pagers. Constructed of neoprene and nylon with web belt-loop over top of unit to secure radio with a Velcro™ tab. Standard in black with quick-release belt loop. Nine sizes available. Over 300 dealers.

Price range..... under \$20

Quantum Instruments, Inc.

Quantum Ham Battery

Industrial sealed lead acid battery rated at 12 Vdc at 2.1 AH. Designed for high drain currents. Cannot be overcharged; charging circuit is fully regulated. Features include two outlets in parallel to allow user to power two HTs. Operates any device that can be run off 12 Vdc and draws less than 3 amps. Includes back belt clip and wall charger. Life expectancy is between 250 and 1000 recharge cycles. LED indicators alert user to battery status. Options include slide-on adapter and shoulder strap and cables/plugs to fit specific radios.

Quantum Ham Battery\$150

Custom cables to connect to user's radio (price range)\$35-45
 HB-36 Vehicle Fast Charger.....\$81

RF Limited

Voice Activated Headset for CB Transceivers

Adjusts to any size and folds for storage. Choose between voice activated or manual PTT. Connects into transceiver mic jack. Pre-wired for popular radios. Talk-back feature allows user to monitor own transmissions through headset speaker.

VX-33\$125

DM-313P Power Microphone With Roger Beep

Features include slowly releasing PTT switch engages Roger Beep. Switchable from power to non-power dynamic mic in event of battery failure. Constructed of polystyrene, matte finish. Coiled six-conductor cord. Battery life approx. 75-80 hours continuous use. Factory-wired for all popular radios. Requires 9 Vdc battery, not included.....\$40

EC-2020 Power Microphone With Robot Voice and Talk Back

Features include front panel slide control which selects level of Robot Voice. Switchable from robot sound to standard power mic. Requires 9 Vdc battery, not included.....\$64

RP-007 Power Microphone With Roger Beep

Features include switchable, fully automatic Roger Beep, front panel slide control adjusts power level. Cord is six-conductor coiled type. Requires 9 Vdc battery, not included.....\$52

TP-902M Power Microphone With 8 Melodies and Talk Back

Features include push button selector switch for melodies, locking PTT switch. Melodies include: Greensleeves, Home on The Range, Aloetta, Happy Birthday and four others. Requires 9 Vdc battery, not included. TP-902M\$80

ES-100 Remote External Speaker

Features include switchable talk back feature, switchable noise filter. Fits all transceivers. Unit is 8 ohm (frequency response is 300-3,000 Hz). Weight 1 lb. Dimensions (HWD) approx. 4 1/4" x 4 1/4" x 2 1/2".....\$26

DS-2040 Agitator In-Line Control Box

Installs in-line with microphone and transceiver (no hard wiring required). Unit accepts over 140 sound modules (interchangeable) that plug in using surface mount technology. (Custom modules available with user's own personalized message). Requires 9 Vdc battery, not included. Dimensions (HWD) approx. 1 3/4" x 2 1/4" x 3 1/4".....\$50
 Modules.....\$50

LM-300 Frequency Counter

Five-digit counter constructed of metal and

Miscellaneous

comes with mounting bracket and hardware. Can be used as both standard digital frequency counter and as counter for checking transmitter frequency. Power requirement 13.8 Vdc supply. Covers 1-99 MHz and 1-250 MHz.

LM-300\$92

LM-50 SWR/Power Meter With Antenna Tuner

Three-function test meter indicates SWR or RF power of any 52 ohm antenna and coax used for CB radio. Also contains antenna matcher (tuner). Use in base or mobile applications without any measurable power loss. RF power 0-10 watts and 0-100 watts. SWR accuracy: 5 percent. Power requirement 13.8 Vdc supply.\$40

RMS (Advanced Specialties, Inc.)

HT-808

Dual-meter base power/SWR meter. Features built-in tuner/matcher (500W AM/1kW SSB), illuminated meters, built-in A/B antenna switch. Reads wattage and SWR to 1.5kW on 10 or 11 meters. Shielded metal cabinet.\$159

MB-30

Antenna tuner/matchbox for CB and 10 meters. Covers 26-30 MHz, 500 watts AM and 1kW PEP SSB. Dual controls, metal cabinet.\$69

A-27

Receive booster pre-amp for CB and 10 meter ham. Gain is 26dB. Includes LED indicator A-27.\$55

RD-6

Power reducer with built-in watt meter. Six-step switch reduces power output of radio at six levels. Input 1-10 watts AM and 1-30 SSB.\$75

W-301

Deluxe watt/SWR dual meters. Features shielded metal cabinet. Reads 1.5kW on 26-30 MHz.\$79

Radio Shack

CB Whip With Weatherband

Fiberglass 49" whip with VHF weather band reception. Requires mount and cable assembly.

21-986\$17

Crossbow Base Station CB Antenna

Omni-directional 16-foot 1/2 wave antenna. Fiberglass radiator. Fits masts up to 1 5/8" diameter. Accepts PL-259 connector. Requires coax assembly.

21-967\$80

Slide Mount

Includes under-dash mounting hardware. Helps prevent theft of mobile CB rig. Connects antenna coax, power and external speaker wires.

21-566\$20

Communications Headset with VOX

Accommodates Radio Shack, Icom, Yaesu and Standard amateur HT's for hands-free operation of rig. Can also be used with GMRS, business band and CB transceivers that have external mic/speaker jacks. Features include PTT button that lets user manually switch between transmitting and receiving when voice control feature is not appropriate; adjustable headband and flexible mic boom. Operates on one "AAA" battery (not included) for approx. 500 hours.

19-312\$50

SWR/Power Meter

Digital display meter features 3-30 MHz operation. Measures peak/average power. Remote sensor lets user place digital display in convenient location. Rated at 2,000 watts. 21-527 Meter\$120

Regulated Power Supply

Converts 120 Vac to 12 Vdc to operate mobile radios, etc. from house current. Features push-to-reset circuit breaker, large heat sink. Rated at 2.5 amps continuous. 22-120 Power Supply\$40

"No Ground" CB Mobile Antenna

For RV's and other fiberglass vehicles/boats. Features 34" length and includes 16 foot cable with PL-259 connector.

21-977 Antenna\$40

Magnet-Mount CB Antenna

Features 54" stainless steel whip and 16 foot cable with connector.

21-960 Antenna\$39

Discone Scanner Antenna

Omnidirectional receiving antenna with 25-1300 MHz coverage. Has eight, 33" lower elements and eight 11" upper elements. Fits masts up to 1 1/2" diameter. Accepts PL-259 connector.

20-013 Discone\$60

Through-Glass CB Antenna

Includes 17 foot cable and connector.

21-985 Antenna\$40

Monaural Headset

Mono headset for CB, scanner, SW, ham use. Includes 1/4" and 1/8" plugs.

20-210 Headset\$10

Ramsey Electronics, Inc.

AR-1 Aircraft Receiver Kit

Tunes 118-136 MHz. With AGC, superhet circuitry, squelch, varactor tuning. Requires 9 volt battery, not included.

AR-1 Kit\$30

CAR (Case and knob set)\$15

QT-1 Subaudible Tone Encoder/Decoder Kit

Encodes and decodes any of 39 standard CTCSS tones with quartz crystal accuracy. Jumpers allow frequency programming and built-in digital audio filtering eliminates falsing

and interference from normal speech. Unit uses single chip CMOS technology, operates on 5 to 15 volts.

QT-1 Encoder/Decoder Kit\$40

Fully wired/tested with

1 year warranty\$70

CQT Matching case set\$15

ScanWare Associates

FCC Frequency Retrieval System Version 2.0

Database manager for IBM/Intel compatible computer. User can add, delete, search, sort, extract and prepare reports. User can output to disk files of several types and define own custom databases. Includes complete FCC Database for state of choice. Frequencies covered: DC to daylight. Database includes all 11 FCC Subsets. Supplied on 3 1/2" HD disks. Version 2.0\$40-45 (depending on state needed)

Shakespeare Electronics and Fiberglass Division

Gold Band Big Stick

Base CB antenna made of 3-sectioned fiberglass. Total 18 feet. Trimmable for exacting performance. Accepts PL-259 connector. Coax and connectors extra.

376-GB\$98

PogoStick

Three-sectioned 18 foot base CB antenna, tunable (no cutting needed) for minimum SWR, fiberglass construction and aluminum tip section is telescoping. Inverted Tri-radial broadens bandwidth.

318-GBT\$89

5210 Antenna

Co-phased four-foot CB antenna with heavy duty mirror mounts, connectors and nine feet co-phasing harness. Base is 3/8" x 24 threads. Mount fits horizontal or vertical mirror bars up to 3/4". Available in white or black.....\$52

5217 Quick Disconnect Mirror Mount

Heavy duty mount designed for use on horizontal mirror bars or tubing up to 1 3/8" diameter. Clamp is adjustable; foot swivels for maximum contact with bar for positive grip.\$14

5016-3 Magnetic Mount Antenna

Twenty-inch center-loaded stainless steel whip with pre-wired 2" magnetic mount, 12 feet coax with PL-259 connector. Rated 200 watts. Overall height 22".\$25

176 GBS Super Big Stick Gold Band Antenna

Base antenna is 18 feet long, constructed of two-section fiberglass. Pre-tuned to CB frequencies. Handles 1000 watts.\$100

176 GBSU Base Antenna

Same as above, except 16 feet.

176 GBSU Antenna\$85

Miscellaneous

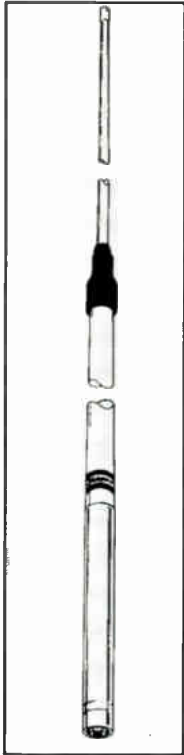

176 GBSU

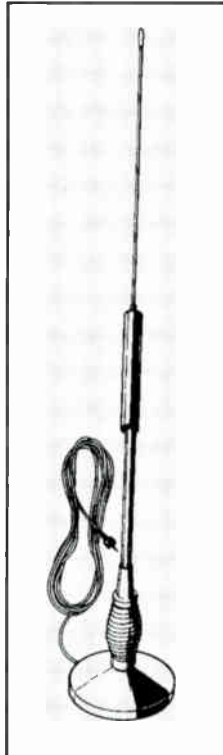

5016-3 Magnetic Mount

4050-B Little Giant Mobile Antenna

Continuous-load three-foot, end-fed 1/2 wave antenna designed for maximum range and performance on fiberglass vehicles. Antenna is DC grounded with 7-foot matching cable with PL-259 connector. Coil is permanently sealed in fiberglass.....\$77

4036-GM Mirror Mount

Mount is designed for GM-type mirrors. Includes SO-239 adapter and connector to fit any 3/8" x 24 thread antenna. Mounts left or right side.....\$11

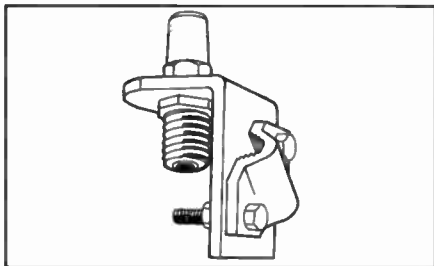

341 Ball Mount

Chrome plated adjustable ball mount for fender top or side installation. Swivels for vertical. Accepts antenna with 3/4" x 24 threaded base. Requires approx. 1" center hold and three 1/4" holes in vehicle.....\$26

Signal Engineering

White Lightning

Four-element true quad base CB antenna

with 14.6dB gain. Front-to-back ratio 38dB. Front-to-side ratio 38dB. VSWR 1.4:1, vertical or horizontal polarization. Weight 20 lbs. Wind survival 100 mph. Boom is 15' long, 2" diameter aluminum. Spreaders constructed of fiberglass, and elements are full-length enamel-protected copper wire. Fasteners are all plated for corrosion resistance. Turning radius: 10' 1". Requires rotor assembly.....\$250

Lightning 6

Base CB antenna, 6-element true quad, with 17.4dB gain, front-to-back ratio of 44dB, front-to-side ratio 50dB, VSWR: 14.:1. Total boom length is 30'. Aluminum construction, spreaders constructed of fiberglass and elements are full-length enamel-protected copper wire. Turning radius: 16' 5". Weight: 37 lbs. Wind survival is 100 mph. (Requires rotor assembly).....\$450

Lightning 8 (8-elements).....\$685

Golden Rod 45A+ Spider

Mobile CB antenna with 4.5dB gain, covers 26.5-28.5 MHz with VSWR of 1.5:1 max. Rated at 5kW. Height above mount 4'3". Mount is 3/8" x 24 stud. Constructed of aircraft alloy aluminum with gold alodine finish.....\$53

Golden Rod 180S

Mobile CB antenna is full size half wave. Designed for mobile homes, apartments, and portable applications. Covers 26.5-28.5 MHz and 10 meter amateur band with VSWR of 1.5:1 typ. Rated at 5kW. Height above mounting plate is 9 feet. Upper section is 6" x wide, lower section is 18" wide. Wind survival 100 mph Golden Rod 180S.....\$60

Sirio Antenna

3000 PL Mobile CB Antenna

Base-loaded and specially designed 26-28 MHz antenna for higher power applications up to 3000 W PEP. Stainless steel whip. Mount is black chromed brass with waterproof connection. Features include UHF-PL 259 connection. Can be used with optional mag mount assembly. Antenna requires mount and coax. Gain 5dBd and VSWR less than 1.1:1.....\$35

HP4000R

Mobile CB antenna. Covers 26-28 MHz base loaded. Handles 3000 watts PEP.....\$40

CELL 33SM

Mobile CB antenna. Covers 26-28 MHz. Handles 30 watts PEP available in mag-mount. CELL 33SM.....\$30

Miri-Mag 27

Mag mount CB mobile antenna with center loaded coil and black base. Whip angle is adjustable. Includes coax and PL-259.....\$25

Solarcon Antenna Research

A99 Base Antenna

Fiberglass omnidirectional CB base antenna (operates 10 through 17 meters with tuner).

Features include power rated at 2,000 watts PEP, 9.9 dBi gain and lightning protected, DC grounded. Antenna comes in three sections, total length 17'4". Connector is SO-239. Optional radial kit (GPK-1) fits bottom sleeve of antenna. Radials in kit are 70" long.....\$70

Thru-Glass CB Mobile Antenna

Half wave voltage fed antenna requires no ground. Range is 10-11 meters and is tunable for lowest SWR. Includes 16 feet of RG-58U cable with soldered PL-259 connector. Removable 24" composite-wound whip....\$66

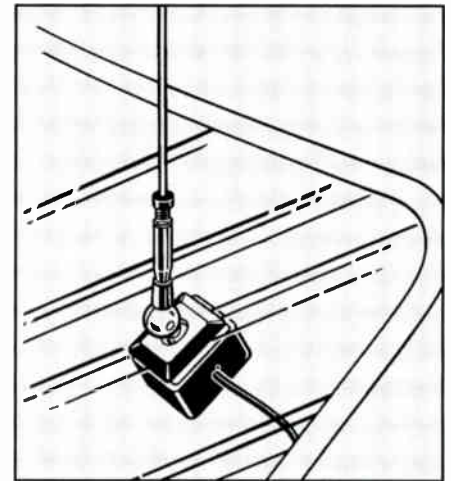

Prowler Whip Antenna

Top-loaded 5/16" fiberglass quarter-wave wound copper wire whip with anti-static UV resistant PVC jacket. Base is standard 3/8" x 24 thread. Rated at 750 watts. Available in four lengths, 24", 36", 48" and 60". Prowler Classic (36" or 48" rated at 1,000 watts).....\$10

A-3000 Antenna

Wideband mobile antenna covers 26-29 MHz. Antenna is 24k gold-plated and features tunable whip. Features open air helix coil, plated stainless steel whip and rated at 2,000 watts. Length is 59"......\$71

2 + 2 Antenna

Top-loaded mobile quarter wave antenna tunable 25 to 28.5 MHz. Features clear anti-static jacket, tunable tip, wound with four 22-gauge wires and rated at 1,500 watts PEP. Thread is standard 3/8" x 24 mount. Overall length 52".....\$21

TRX-1011 Antenna

Base-loaded mobile quarter wave antenna tunable 10-11 meters. Features stainless steel whip and 3/8" x 24 thread. Available in white or black. Adjustable stainless steel whip raised or lowered for best SWR.....\$15

Startek International, Inc.

ATH-Bar Graph Counters

Units feature instant reading, integrated signal strength bar graph, high sensitivity, auto

Miscellaneous

trigger & hold and more. Portable battery operated units can automatically trigger and read, display and hold an input signal in less than 8% of a sec. Unit is shirt-pocket size. Other standard features include auto-polarity power input, manual & auto hold switch and indicator, two ranges, six gate times, high capacity NiCds, anodized aluminum cabinet, glass-epoxy PC boards, bright LED digits and optional high stability TSCO timebase and more. Requires 9-12 Vdc.

ATH-10 (no bargraph)	\$149
ATH-15	\$189
ATH-30	\$249
ATH-50	\$289
HST-15	
High Accuracy Time Base	\$100

Systems & Software International, Ltd.

Remote Computer Scanning System (RCSS)

Provides automated PC control over Icom receivers (R7000, R7100 and R9000) for scanning, logging and memory functions. Features include automatic detection and storage of active frequencies while scanning; scanning of user-specified tuning steps (10Hz to 100 MHz); scan by mode, class of service or type of unit, user-adjustable scan rate; unattended frequency monitoring by time and date; memory expansion in excess of 3,500 frequencies; laptop compatible operation and display; and documented "flat file" data format allows use of own or existing/future frequency data bases. Mouse/keyboard driven graphic user interface.

Includes interface and all cables.	
RCSS For R7000	\$200
RCSS For R7100	\$250
RCSS For R9000	\$500

Telex Communications, Inc.

HG-37SS

Antenna tower with two sections. Crank-up and self supporting. Requires concrete base. Tower is constructed of all steel and is 37 feet high. Retracted height is 20 1/2' Base width is 13 3/4". Shipping weight 265 lbs. Towers come complete with base hinge, foundation steel cage and a pre-drilled rotator mounting plate. Requires no guying and conforms to EIA specifications and Uniform Building Code. Includes freight.....**\$1,739**

Timewave Technology Inc.

DSP-59+ Noise Filter

Unit uses digital signal processing technology to provide optimum filters for random noise reduction, heterodyne elimination, highpass filtering, lowpass filtering, and bandpass filtering. Typical noise reduction ranges from 5 to 20dB for random noise and up to 50dB for heterodynes. Features include CW, data and speech filters, remodulator for RTTY, variable noise reduction, new noise reduction software, improved data filters, and SSTV/WEFAX filters.

Also includes built-in self test and audio generator. Compatible with all amateur transceivers and receivers. Connects between radio and its speaker/headphones. Power requirement 12-16 Vdc.....**\$299**

Transtel Technologies

Model 82-FL CB Antenna

Three-foot plastic base-loaded CB magnetic mount antenna includes 17 feet cable, pre-wired. Rated 50 watts.....**\$16**

Model CB 27 Glass Mount Antenna

Two-foot colinear whip glass-mount CB antenna includes 17 feet RG58 cable and PL-259 connector. Includes all hardware and installation instructions.....**\$30**

Model TS8 Speaker

Sun visor clip-on extension speaker. Includes bracket, plug and visor clip.....**\$13**

Model TAB5 Antenna

Mobile HF antenna is 4 feet high and includes auto bandswitching. Resonators available for 10, 15, 20, 40 and 75 meters. Rated at 250 watts. Constructed of solid aluminum.....**\$90**

Model T655 Mount

Bumper mount constructed of non-corrosive aircraft aluminum flat bar with standard 3/8 inch 24 thread. Includes mounting hardware.....**\$8**

Trylon Manufacturing Co. Ltd.

Titan towers

Modular design towers shipped in kit form or in factory assembled 8 foot sections. Requires crane or boom truck to erect. Contact company for details.

T200 Tower is 96'	\$1,800
T400 Tower is 80'	\$1,725
T600 Tower is 64'	\$1,600
T800 Tower is 48'	\$1,400

Universal Radio Inc.

M-400

Self-contained data decoder and tone reader. Text is displayed to the 40-character, two line, super-twist LCD and sent to printer port. No computer or monitor required. SWL can copy: Baudot, SITOR A & B, FEC-A, ASCII and SWED-ARQ. Weather FAX can also be decoded to the printer port. The scanner user can copy the ACARS VHF aviation teletype mode plus GOLAY and POCSAG, Super PSOCASAG digital pager modes. Off-air decoding of DTMF, CTCSS (PL) and DCS is also supported. Unit operates on 12 Vdc or with supplied adapter.....**\$400**

ACT-1 ACARS Decoder

Used in conjunction with scanner and PC, decodes Aircraft Communications Addressing and Reporting System (ACARS) message traffic. Plugs into PC computer's serial port. Software includes mouse support. View, filter, print and save text. Also view, search and print previously logged data files. Minimum system requirements 8088 CPU, 25 pin serial port, hard drive recommended.....**\$150**

(Book "Understanding ACARS" is free upon request with ACT-1 purchase)

Universal Manufacturing Company

Free-standing aluminum towers from 30-100' high. Bases, flat roof mounts and rotor mounts are extra.
Towers (price range).....**\$335-\$2375**
(Heavy duty towers up to..... **\$3884**)

Valor Enterprises, Inc.

Model 120 Hump Mount

Sawtooth design and is steel with baked black finish. Unit is adjustable.....**\$7**

Model 235 Bracket

Universal adjustable mounting bracket.

For an Exciting Challenge in Community Service!

Contact:

REACT International, Inc.

P.O. Box 998

Wichita, KS 67201

Tel: (316) 263-2100

FAX: (316) 263-2118

Electronic Mail - react@wichita.fn.net

Volunteer Emergency & Safety Communications

Providing assistance for over 30 years with the aid of
CB's, Cellular Phones, Computers, Business and Amateur Radios



Miscellaneous

Adjusts from 0"-9". Constructed of 14 gauge steel, 1 1/4" wide, black finish. Includes mounting hardware.\$6

Black Magic Mobile Antennas

Features 3/8" x 24 thread. Constructed of 20-gauge solid copper wire, top-loaded fiberglass. Rated at 500 watts. Four models available 24"-48". Available in red, white, black, white/gold, and black/gold. Must specify color.\$12

Double CB Mirror-Mount Antenna Kit

Model 833 Black Magic antenna (24") with cable and mirror-mount assembly.\$50

Model VMT536B Mag-Mount Kit

Includes one 530 36" Dial-A-Match antenna, one pre-wired 3" mag-mount with 12' coax and PL-259 connector. Black.\$26

Model 82FL Magnetic-Mount CB Antenna

Features 36" stainless steel whip with plastic base-loaded magnet-mount kit and 17 feet coax with PL-259 connector. Available in black or white.\$20

Model CB27 Thru-Glass CB Antenna

Glass-mount CB antenna is 21" long with 15 feet coax with PL-259 connector. Includes fine tuning tool, hardware and installation instructions.\$40

Model VS1 Sun Visor CB Extension Speaker

Speaker mounts on sun visor with included clips. Features six-foot cord with mini plug. VS1\$16

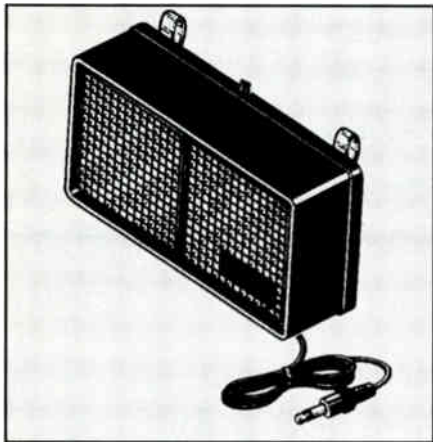

Weather Band/CB Antenna

Mobile CB antenna system receives NOAA weather when installed in-line with existing CB antenna. Whip is 20" and also features 3, 1 1/2" radials. Black powder coated.\$25

VO18 Mobile Microphone

Pre-wired, electronic condenser 5-pin replacement mic for Cobra and Uniden radios (5-pin) with locking ring and coiled seven foot cord.\$33

Viking International

10-Hour Recorder

Professional recorder also available in 12, 14 and 16-hour models. Works with Opto 456 board. Dimensions (HWD) 2 3/4" x 7" x 1 1/2". 10-Hour Recorder.\$149
(with built-in voice activation, add \$25)

W & W Associates

Replacement batteries for most amateur radios. For most battery packs/inserts prices range from \$18-\$80. Also custom-made battery packs and inserts.

WaWasee Electronics

JB2002SW Wattmeter/SWR Bridge

Peak-reading type meter with three ranges; 0-20, 0-200 and 0-2000 watts. Covers all operating frequencies in 10-80 meter bands. SWR bridge shows voltage standing wave ratios of 1.5, 2 and 3. Dimensions (HWD) approx. 4 1/2" x 8 1/2" x 5 1/2".\$96

JF1004/B Frequency Counter

Shows transmitter frequency when mic is keyed. Operates on 12 Vdc with AC/DC converted included for base operation. LED is 5" red display. Range is 1 to 50 MHz (typical). JF1004/B.\$156

JF4000/SW Wattmeter and Switch

Unit measures RF watts to 4kW in frequency range of 10-80 meters. Both RMS and peak measures SWR and modulation percentage without changing cables. Earphone jack and four-position antenna coax switch included. JF4000\$168

Wilson Antenna Inc.

Wilson 1000

CB and amateur antenna (mobile) handles 3500W, silver-plated coil and internal connections, stainless steel trunk mount. Frequency range 26-30 MHz. Includes 17 foot coax cable and PL-259.

1000 Trunk Lip Series.\$70
1000 Magnetic Series (white or black)\$80
1000 Roof Top Series (white or black)\$60

Wilson Silver Load

5/8 wave fiberglass mobile antenna for 26-30 MHz. 2' through 6' (red, white or black). Wilson Silver Load.\$22-35

"Little Wil" Mag Mount

Mobile CB antenna, 39" high.\$30

Wilson 2000 and 5000 Series Antennas

Trucker type and also Standard mirror mount. Handles 3,500-20,000 watts. Available in red, white, black and blue. 5" to 22" shaft 2000 and 5000.\$60-85

Wilson 500

Mag-mount black only CB mobile antenna. Handles up to 1 kW.\$60

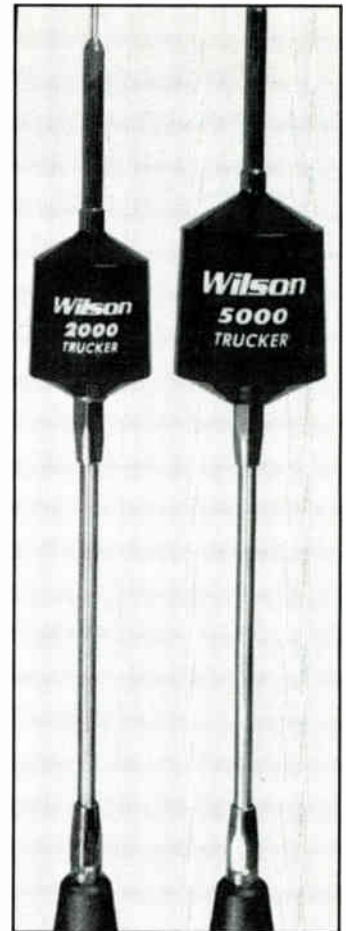

Wintenna, Inc.

Slimline CB Antennas/Kits

Magnetic-mount CB/cellular look-a-like mobile antenna is 28" high with 2" magnet. Available in black or white. Includes coax and PL-259 connector.\$23

CB Through-Glass Antenna Kit

Mobile CB antenna is approx. 18" high and includes 15 feet coax with all hardware and mounting instructions.\$38

Standard Flame Stik Antenna

Fiberglass mobile CB antenna rated at 500 watts. Features tunable stainless steel tip. Available as single antenna, single mirror mount kit or dual mirror mount kit. Single is available in 2-, 3-, and 4 foot heights. Kit includes coax and mount. Single Kit w/mount 4-ft. model\$32

Scan Master Scanner Antenna

Mobile four-foot fiberglass antenna fits standard 3/8" x 24 mounts and covers 30-1200 MHz.

Model 190 (antenna only)\$17
Model 191 (magnet-mount, antenna and coax)\$40
Model 192 (trunk-mount kit, antenna and coax)\$33
Model 195 (mirror-mount kit, antenna and coax)\$30

Manufacturers

The following directory gives valuable information on manufacturers and/or importers of radio equipment and supplies.

Beyond being a handy source of phone numbers and addresses, it also gives you insight to a company's business longevity and size, the latter by number of employees. Moreover, you'll learn which companies sell their own products directly to end users, usually through mail order, rather than only to dealers for resale.

Another directory that follows, "Who's Who in Dealers," presents retail operations that sell radio products made or imported by companies listed here.

Company names in color have display ads in this Guide. See them for added product and services information. Many will also send free literature upon written request.

A

ARRL

225 Main Street
Newington, CT 06111
Phone: 203 666-1541
FAX: 203 665-1166
Established: 1914; Employs 120
Sells direct and through dealers.
Major Products: Publications, including QST, QEX, National Contest Journal, ARRL Letter.

A.M.C. Sales, Inc.

193 Vaquero Drive
Boulder, CO 80303
Phone: 800 926-2488
Sales: 303 499-5405
Established: 1970; Employs 3
Sells direct and through dealers.
Major Products: 12 hr. long play recorders, tel. recording adapter, VOX switches, RF detectors, tel. scramblers, micro recorders, microphones

ANLI

20277 Valley Blvd., #J
Walnut, CA 91789
Phone: 909 869-5711; 800 666-2654
Established: 1965; Employs 15
Sells through dealers.
Major Products: Antennas, battery packs, and power station.

Ace Communications

10707 E.106th Street
Fishers, IN 46038
Phone: 800 445-7717; 317 842-7115
FAX: 317 849-8794
Established: 1986; Employs 12
Sells direct and through dealers.
Major Products: SW receivers, scanners, computer products.

Action Communications

1705 Westminster Drive
Greensboro, NC 27410
Phone: 919 299-1298 or (orders only) 800-647-0564
Established: 1993; Employs 2
Sells direct.
Major Products: ERA MicroReader and other ERA products.

Advanced Electronic Applications Inc.

AEA
2006 196th St. SW
PO Box C-2160
Lynnwood, WA 98036
Phone: 206 774-5554
FAX: 206 775-2340
Tech. Support: 206 775-7373
Established: 1977
Sells through dealers.
Major Products: Packet controllers, multi-mode data controllers, HF/UHF/NHF antennas, UHF/VHF handheld antennas, high speed radio modems, keyboard keyers, handheld antenna analyzers, loop antennas, remote control products.

Advanced Specialties, Inc.

P.O. Box 1099R
Lodi, NJ 07644
Phone/Fax: 201 843-2067
Sells through distributors and dealers.
Major Products: U.S. importer and distributor of the RMS international line of watt meters, tuner-matchboxes, receive boosters, switchboxes, etc. for CB and amateur use.

AIWA America Inc.

800 Corporate Drive
Mahwah, NJ 07430-2048
Phone: 201 512-3600
Tech: 201 512-3600
Established: 1978; Employs 87
Sells through dealers.
Major Products: Headphone stereos, mini stereo systems, portable audio, care stereos, DAT
Branch: 14821 E. Northam Street,
La Mirada, CA 90638
Phone: 714 522-2492

Alden Electronics, Inc.

40 Washington Street
Westborough, MA 01581
Phone: 508 366-8851
FAX: 508-898-2427
Established: 1946; Employs 140
Sells direct and through dealers.
Major Products: HF RadioFAX, Weather chart, receivers, weather and satellite pictures via fax.

Alexander Batteries

Box 1508
Mason City, IA 50401
Phone: 800 247-1821
Tech: 515 423-8955
FAX: 515 423-1644
Established: 1967; Employs 310
Sells through dealers.
Major Products: Portable two-way radio batteries; battery chargers; battery analyzers conditioners; portable two-way radio antennas.

Allen Telecom Group

30500 Bruce Industrial Pkway.
Cleveland, OH 44139
Phone: 216 349-8400
FAX: 216 349-8407
Established: 1953; Employs 500
Sells through dealers.
Major Products: Two-way mobile and base communications antennas for CB, VHF, UHF, 800 MHz, 900 MHz cellular, marine, amateur, monitor.

Alliance Rotators

Philips ECG
Baldwin Green Comman, #110
Woburn, MA 01801
Phone: 617 932-9070
FAX: 617 932-3553
Established: 1950; Employs 175
Sells direct and through dealers.
Major Line: Manufacturers of antenna rotators

Alpha Delta Communications, Inc.

P.O. Box 620
Manchester, KY 40962
Phone: 606 598-2029
Established: 1981
Sells direct and through dealers.
Major Products: Lightning/EMP ceramic gas tube Transi-Trap surge protectors, lightning/emp protected DELTA-4 precision coaxial switches, HF (160 through 10 meter) NO-TRAP space-limited sloper and dipole DX SERIES wire antennas.

Aluma Tower Co., Inc.

PO Box 2806
Vero Beach, FL 32961
Phone: 407 567-3423
FAX: 407 567-3432
Established: 1974; Employs 25
Sells direct and through dealers.
Major Products: Aluminum crank-up towers, aluminum stack towers, aluminum trailer towers, aluminum mobile van towers, tower accessories.

American Antenna Corp.

1500 Executive Drive
Elgin, IL 60123
Phone: 800 323-6768; 708 888-7200
FAX: 708 888-7094
Established: 1977; Employs 125
Sells direct and through dealers.
Major Products: Manufacturers of HF & VHF mobile antennas and accessories.

Antenna Mart

PO Box 699
Loganville, GA, 30249
Phone: 404 466-4353
Major Products: Antenna remote switch, rotating side mount.

Antenna Supermarket

PO Box 563
Palatine, IL 60078
Phone: 708 359-7092
FAX: 708 359-8161
Established: 1974
Sells: direct and through dealers.
Major Products: SWL antennas, multi-band SWL antennas, lightning surge arrestors.

Antennas West

1500 North 150
West Provo, UT 84605
Phone: 801 373-8425
Sales: 800 926-7373
FAX: 801 375-4664
Established: 1987; Employs 10
Sells direct and through dealers.
Major Products: Antennas for shortwave and scanner reception, quicklaunch antenna installation systems, high-frequency antennas, emergency antenna packs, 160-10 dipole, inverted-V, sloper & shortened trapless antennas, solar power supplies for repeaters and remote portable operation.

Antique Radio Classified

PO Box 802-C11A
Carlisle, MA 01741
Phone: 508 371-0512
FAX: 508 371-7129
Established: 1984 Sells direct
Major Lines: Antique radio monthly magazine, books on collecting old radios.

Artsci Inc.

P.O. Box 1428
Burbank, CA 91507
Phone: 818 843-4080
FAX: 818 846-2298
Established: 1978; Employs 6
Sells direct and through dealers.
Major Products: Modification books, license manuals, frequency book and repeater map books.

Ashton ITC

PO Box 830
Dandridge, TN 37725-0830
Phone: 615 397-0742
FAX: 615 397-0466
Established: 1969; Employs 7
Sells direct.
Major Products: SWL and amateur radio software.

Astatic/CTI Audio, Inc.

PO Box 120
Harbor & Jackson
Conneaut, OH 44030
Phone: 216 593-1111
Sells through dealers.
Major Line: Complete line of microphones.

Astron Corporation

9 Autry
Irvine, CA 92718
Phone: 714 458-7277
Established: 1976; Employs 50
Sells direct and through dealers.
Major Products: Power supplies, inverters and converters.

Austin Antenna Ltd.

10 Main Street
Gonic, NH 03839
Phone: 603 335-6339;
FAX: 603 335-1756
Established: 1973; Employs 18
Sells direct and through dealers.
Major Products: VHF/UHF fixed and mobile antennas, microwave and multiband-design antennas.

Autek Research

P.O. Box 8772
Madeira Beach, FL 33738
Phone: 813 886-9515
Sells direct.
Major Products: Audio filters, wattmeters, and antenna analyzer.

Azimuth Communications Corporation

3612 Alta Vista Avenue
Santa Rosa, CA 95409-4049
Phone: 800-882-7388
Tech: 707 577-8007
FAX: 707 573-1482
Established: 1980; Employs 6
Sells direct and through selected dealers.
Major Products: Azimuth WeatherStar Computerized Weather Stations, Azimuth Awards QSL Library Albums, and Azimuth grand 24 hour station clocks.

Manufacturers



B

Bearcat Radio Club
PO Box 291918
Kettering, OH 45429
Phone: 513 299-7226

Belden Wire and Cable
PO Box 1980
Richmond, IN 47375
Phone: 800-BELDEN-1
Tech: 317 983-5200
Established: 1902; Employs 3500
Sells: direct and through dealers.
Major Products: Broadcast cable and connectors.

Benjamin Michael Industries, Inc (BMI)
9445 Seven Mile Road
Caledonia, WI 53108
Phone: 414-835-4299
FAX: 414 835-4298
Established: 1980
Sells direct and through dealers.
Major Products: "NiteLogger" automatic recorder activator and military time format clocks.

Bilal Company
137 Manchester Drive
Florissant, CO 80816
Phone: 719 687-0650
Established: 1980
Sells direct and through dealers.
Major Line: Reduced-space HF Antennas.

Boedecker, Shawn
1653 Parkside Trail
Lewisville, TX 75067
Phone: 214 221-7213
Sells direct.
Major Products: Scanner enhancements and add-ons.

Butternut Manufacturing Co.
831 N. Central Ave.
Woodale, IL 60191
Phone: 708 238-1183
Established: 1974; Employs 20
Sells direct and through dealers.
Major Line: Antennas.

C

CQ Communications, Inc.
76 N. Broadway
Hicksville, NY 11801
Phone: 516 681-2922
FAX: 516 681-2926
Established: 1979; Employs 41
Sells direct and through dealers.
Major Products: Publishers of CQ magazine, Popular Communications, MicroComputer Journal, Electronic Servicing & Technology, CQ Amateur Radio Equipment Buyer's Guide, CQ Beginner's Guide, PopComm Communications Guides, CQ Radio Amateur (Spanish CQ) various amateur radio books, T-shirts, and the "Getting Started" video series.

CRB Research Books, Inc.
PO Box 56
Commack, NY 11725
Established: 1967
Sells direct.
Major Products: Communications books and frequency guides.

CABLE X-PERTS, Inc.
113 McHenry Road, Suite 240
Buffalo Grove, IL 60089
Phone: 800 828-3340
Tech: 708 506-1886
Established: 1989; Employs 7
Sells direct and through dealers.
Major Products: Coax cable, rotor cable, antenna wire, antennas and accessories, baluns and traps, connectors and adapters.

Cellular Security Group
4 Gerrard Road
Gloucester, MA 01930
Phone: 508 281-8892 800 487-7539
FAX: 508 768-7486
Established: 1990; Employs 3
Sells direct.
Major Line: VHF/UHF antennas.

Charles Radio Co.
6836 W. Pearl City Rd.
Freeport, IL 61032
Phone: 815 235-7733
Established: 1960; Employs 2
Sells direct and through dealers.
Major Products: Gizmotchy antennas, Gizmotchy power boosters, coaxial cable, support kits, coaxial switches, CB radios, antennas, connectors, guy wire, etc.

ClearTek
P.O. Box 1123
Crystal Beach, FL 34681
Phone: 615 954-9221
Sells direct.
Major Products: Signal Tracker 6000 shortwave receiving antenna.

Cleveland Inst. of Electronics
1776 East 17 Street
Cleveland, OH 44114
Phone: 216 781-9400; 800 321-2155
Established: 1934
Major Line: Electronics education.

Cobra Electronics Corp.
6500 W. Cortland Street
Chicago, IL 60635
Phone: 312 889-8870; 1 800 262-7222
FAX: 312 794-1930
Established: 1965; Employs 200
Sells through dealers.
Major Products: CB radios, CB antennas (magnetic & lip), radio receiver scanners and radar and laser detectors.

CDMMtronics Engineering
PO Box 262478
San Diego, CA 92196-2478
Phone/FAX: 619 578-9247

Communications Specialists
426 W. Taft Avenue
Orange, CA 92665-4296
Major Products: Programmable tone encoder/decoders.
Phone: 800 854-0547

Computer Aided Technologies
PO Box 18285
Shreveport, LA 71138
Phone (tech): 318-687-2555;
(orders) 318-636-1234
FAX: 318-686-0449
Major Products: Computer scanning software, HOKA demodulator systems, OptoScan 456.
Sells direct and through dealers.

Connect Systems, Inc.
2259 Portola Road
Ventura, CA 93003
Phone: 805 642-7184;
FAX: 805 642-7271

Cushcraft, Inc.
PO Box 4680
48 Perimeter Road
Manchester, NH 03108
Phone: 603 627-7877
FAX: 603 627-1764
Established: 1950
Sells through dealers.
Major Products: HF/VHF/UHF antennas and accessories.

D

DGM Electronics, Inc.
13654 Metric Road
Roscoe, IL 61073
Phone: 815 389-2040
Established: 1971; Employs 6
Sells direct.
Major Products: Radio facsimile (Weather Fax) converter, radioteletype and Morse code communications products.

DX Computing
232 Squaw Creek Road
Willow Park, TX 76087
Phone: 817 441-9188
FAX: 817 441-5555
Established: 1988; Employs 1
Sells direct.
Major Products: Software for the Macintosh computer (Shortwave Navigator/Frequency Valet).

DAIWA Ind. Co. Japan
(See Electronic Distributors Corp.)

Dalong
(See Electronic Distributors Corp. and Gilfer Shortwave in dealer listing.)

Delta Loop Antennas, Inc.
PO Box 274
Weston, VT 05161
Phone: 802 824-8161
Established: 1987
Sells direct.
Major Line: HF antennas.

Delta Research
PO Box 13677
Wauwatosa, WI 53213
Phone: 414 353-4567; Tech: Ext. 22
FAX: 414 353-4567 Ext. 11
Established: 1980; Employs 7
Sells via mail order.
Major Products: Software and interfaces for complete communication control of receivers, scanners and transceivers (MS-DOS version); repeater controller DTMF programmer software and interface (MS-DOS version).

Digital Electronic Systems
P.O. Box 1073
Englewood, FL 34295-1073
Phone: 813 474-9518
Tech: 813 474-9518
FAX: 813 474-9519
Established: 1975; Employs 6
Sells through dealers.
Major Products: Digital demodulators, commercial phone patch and custom designs.

Drake Company, R. L.
P.O. Box 3006
Miamisburg, OH 45343
Phone: 800 937-2534
Service: 513 746-6990
Sells direct and through dealers.
Major Line: R8 and SW8 Worldband Communications Receiver.

E

Eavesdropping Detection Equipment (EDE)
P.O. Box 337
Buffalo, NY 14226
Phone: 716 691-3476
Sells direct (retail and wholesale).
Major Products: Surveillance equipment, counter surveillance and covert video equipment.

Electronic Distributors Corp. (EDCO)
325 Mill St. NE
Vienna, VA 22180
Phone: 703 938-8105
FAX: 703 938-6911
Established: 1989; Employs 8
Sells through dealers.
Major Products: CREATIVE DESIGN log periodic antennas, roof top towers, rotators; DAIWA coax switches, SWR/PWR meters, duplexers, power supplies, amplifiers; DATONG audio filters; EMOTO rotators and accessories; NOVEX speaker mics, SWR/PWR meters, chargers; SIGMA disccone antenna.

Emoto
(See Electronic Distributors Corp.)

Enterprise Radio Applications, Inc.
PO Box 3144
Charlotte, NC 28210
Phone: 800 925-4735
Tech: 704 543-4766
Established: 1987; Employs 10
Sells direct.
Major Products: Design and manufacture of Data Communications Equipment.

F

FB Enterprises
23801 NW 1st Avenue
Ridgefield, WA 98642-8830
Phone: 800 377-2339
Established: 1991; Employs 1
Sells direct and through dealers.
Major Products: Ham and shortwave radio publications; ham repeater maps; repeater map book; and shortwave broadcast frequency guides.

Firestik Antenna Company
2614 E. Adams Street
Phoenix, AZ 85034-1495
Phone: 602 273-7151;
Tech: 602 273-7152
Established: 1963; Employs 25
Sells through dealers.
Major Products: CB antennas, antenna mounts, coaxial cable, accessories.

Frequency Printout Service
P.O. Box 1239
Charleston, SC 29402
Phone: 803 723-5061
Sells direct.
Major Products: Custom FCC reports on disk or printout.

Manufacturers

G

GAP Antenna Products Inc.

6010 N. Old Dixie Hwy.
Vero Beach, FL 32967
Phone: 407 778-3728
Established: 1989; Employs 6
Sells direct and through dealers.
Major Line: HF vertical and beam antennas utilizing GAP technology.

GRE America, Inc.

425 Harbor Blvd.
Belmont, CA 94002
Phone: 415 591-1400; 800 233-5973
FAX: 415 591-2001
Established: 1979; Employs 25
Sells direct and through dealers.
Major Products: Scanner accessories, pre-amplifiers, frequency converters, all band antennas, 900 MHz spread spectrum products and other wireless telecommunications products.

Gamber-Johnson

801 Francis Street
Stevens Point, WI 54481
Phone: 1 800 456-6868;
FAX: 1 800 934-3577
Established: 1954
Sells direct and through dealers.
Major Products: Slide mounts, stacking mounts, mounting hardware for all types of mobile voice and data communications equipment.

Gilfer Shortwave

52 Park Avenue
Park Ridge, NJ 07656
Phone: 201 391-7887; 800 GILFER 1
Established: 1953; Employs 6
Sells direct and through dealers.
Top Lines: Japan Radio Company, Datong, Dressler, Yaesu, Kenwood, Sony, Kantronics, CQ and ARRL Publications.

Gillin, Scott

86-29 155th Avenue, Suite 5N
Howard Beach, NY 11414
Phone: 718 738-8943
Established: 1991
Sells direct and through dealers.
Major Products: Frequency Management IBM compatible software for shortwave, scanning, utility, and ham monitoring.

Grove Enterprises, Inc.

300 South, Hwy. 64 West
Brasstown, NC 28902
Phone: 800 438-8155 (orders only)
Sales: 704 837-9200
Tech: 704 837-7081
FAX: 704 837-2216
Established: 1979; Employs 25
Sells direct and through dealers.
Major Products: Shortwave receivers, scanners, antennas, software, receiver preselectors, preamplifiers, books and *Monitoring Times* magazine.

Grundig (Lextronix, Inc.)

3520 Haven Avenue, Unit L
Redwood City, CA 94063
Phone: 415 361-1611
FAX: 415 361-1724
Established: 1945; Employs 60
Sells through dealers.
Major Line: Shortwave receivers.

H

Hamstuff, 7-Mike

P.O. Box 14455
Scottsdale, AZ 85267-4455
Phone: 602 998-2418
Established: 1990; Employs 1
Sells direct.
Major Products: QSL card boxes, index dividers, wooden covers for Bencher paddles, and assorted ham accessories.

Hamtronics, Inc.

65 Moul Road
Hilton, NY 14468-9535
Phone: 716 392-9430
FAX: 716 392-9420
Established: 1961
Sells direct.
Major Products: VHF/UHF FM exciters, receivers, repeaters, PA's, preamps, RCVG & XMTG converters, autopatches & other repeater accessories, computer data links.

Heil Sound Ltd.

2 Heil Drive
Marissa, IL 62257
Phone: 618 295-3000
FAX: 618 295-3030
Established: 1966
Sells direct and through dealers.
Major Products: Specialized audio equipment, equalizer microphones, boomset, speakers, remote base intertie, ten meter FM kits.

HighText Publications, Inc.

P.O. Box 1489
Solana Beach, CA 92075
Phone: 619 793-1955
FAX: 619-693-3225
Established: 1990; Employs 4
Sells via mail order.
Key Employees: Harry, AA6FW; Carol and Dawn.
Top Lines: Publisher of the DX/SWL Press series of books for radio hobbyists. Current titles include *Shortwave Listening Guidebook*, *All About Ham Radio*, and *Joe Carr's Receiving Antenna Handbook*.

Hustler Antennas

One Newtronics Place
Mineral Wells, TX 76067
Phone: 817 325-1386; 800 949-9490
FAX: 817 328-1409
Established: 1968; Employs 100
Sells through dealers.
Major Products: Vertical base station antennas, mobile antennas, mounts, springs and accessories.

I

ICOM America, Inc.

2380 116th Avenue NE
Bellevue, WA 98004
Phone: 206 454-8155
Tech: 206 454-7619
Established: 1979
Sells through dealers.
Major Products: HF/VHF/UHF base and mobile/handheld transceivers, 1.2 GHz/144 MHz/220 MHz/440 MHz repeaters, accessories, amplifiers, power supplies, antenna tuners.
Branch: Regional Sales/Service center 1777 Phoenix Pkwy., Suite 201 Atlanta, GA 30349
Phone: 404 991-6166
Branch: 18102 Skypark South, #52B Irvine, CA 92714
Phone: 714 852-8026
Branch: 3071 #S Road Unit 9, Richmond BC, Canada
Phone: 604 273-7400

INDEX Publishing Group

3368 Governor Drive, Ste. 273F
San Diego, CA 92122
Phone: 800 546-6707; Tech: 619 281-2957; FAX: 619 281-0547
Established: 1992; Employs 4
Sells direct and through dealers.
Major Products: Books on communication (scanners, shortwave, frequency guides, electronic encryption, decryption, privacy).

Industrial Comm. Engineers

P.O. Box 18495
Indianapolis, IN 46218-0495
Orders: 1 800 423-2666
FAX: 317 545-9645
Customer Svc.: 317 547-1398
Established: 1990; Employs 34
Sells direct and through dealers.
Major Products: Receive preamplifiers and splitters, metal chassis, lightning arrestors, grounding blocks, grounding equipment, BCB filters, low-pass filters, high-pass filters, and RF switches, cables and transformers.

International Electronic Wire & Cable Co.

891/2 O'Leary Drive
Bensenville, IL 60106
Phone: 800 323-0210
FAX: 708 298-8433
Tech: 708 299-0021
Sells through dealers.
Major Products: Electronic wire and cable, coaxial cable, antenna wire and rotor cable.

International Shortwave Awards Congress

P.O. Box 66
Hanover, MI 49241
Phone: 517 563-9022
Major Products: Shortwave and scanner awards and certificates.

J

JPS Communications, Inc.

5720 Capital Blvd.
Raleigh, NC 27604
Phone: 919 790-1011
Tech: 919 790-1048
Established: 1988; Employs 25
Sells direct and through dealers.
Major Products: Commercial/Governmental radio enhancement equipment and amateur radio equipment.

JSC Wire & Cable

PO Box 248
Wayne, NJ 07474-0248
Phone: 800 572-9473;
Tech: 201 694-6200
FAX: 201 694-8297
Established: 1942; Employs 50
Sells: through dealers/distributors.
Major Products: Electronic wire & cable: coaxial, 450 ohm open line, audio, instrumentation, multiconductor cables.

Japan Radio Company Ltd.

430 Park Avenue, 2nd Floor
New York, NY 10022
Phone: 212 355-1180
FAX: 212 319-5227
Established: 1915
Sells through dealers.
Major Products: HF transceivers, general-coverage receivers, linear amplifiers.

Jo Gunn Enterprises

Route 1, Box 32C, Hwy. 82
Ethelsville AL 35461
Phone: 205 658-2229
FAX: 205 658-2259
Established: 1976; Employs 5
Sells direct, through distributors and dealers.
Major Products: Mobile and base CB antennas, 10M amateur antennas, coax and accessories.

K

K40 Electronics

1500 Executive Drive
Elgin, IL 60123
Phone: 1-800-323-6768
Tech: 1-800-323-4458
Established: 1977; Employs 75
Sells through dealers.
Major Products: Radar and laser detectors, CB radios, CB antennas.

KIWA Electronics

612 South 14th Avenue
Yakima, WA 98902
Phone: 509 453-5492; 800 398-1146
Established: 1989
Sells direct and through dealers.
Major Products: IF Filters (455 kHz); air-core loop antennas, and receiver accessories.

Kantronics, Inc.

1202 E. 23rd Street
Lawrence, KS 66046
Phone: 913 842-7745
Tech: 913 842-4476
FAX: 913 842-2021
Established: 1971; Employs 45
Sells through dealers.
Major Products: Digital data interfaces between radios computers/terminals for packet, CW, RTTY, AMTOR, ASCII, PACTOR, and G-TOR, and WEFAX on HF and VHF.

Manufacturers

Kenwood Communications Corporation

Amateur Radio Products Group
2201 E. Dominguez Street
PO Box 22745

Long Beach, CA 90801

Phone: 310 639-5300

Tech: 310 639-7140

BBS: 310 761-8284

(8N1, 300/1200/2400)

Established: 1975

Sells through dealers.

Major Products: HF/VHF/UHF base, mobile, portable transceivers and receivers, amplifiers, power supplies, manual and automatic antenna tuners, external speakers for base and mobile use, SWR and RF power meters, HF mobile antenna, dual band (2m/70cm) mobile antenna, headphones, microphones, and accessories.

L

Lakeview Co. Inc.

3620-9A Whitehall Road
Anderson, SC 29624

Phone: 803 226-6990

FAX: 803 225-4565

Established: 1979; Employs 7

Sells direct and through dealers.

Major Products: WD4BUM mobile antennas and mounts for HF, VHF and UHF. Fixed station ground plane antennas for 10 M, UHF and VHF.

Larsen Electronics, Inc.

3611 NE 112th Avenue
Vancouver, WA 98668

Phone: 360 944-7551

Established: 1965; Employs 110

Sells direct and through dealers.

Major Products: antennas.

Branch: Canadian Larsen Electronics Ltd.

5049 Still Creek Avenue

Burnaby, BC, Canada, V5C 5V1

Phone: 604 299-8517; 800 663-6734

M

M² Enterprises

7560 N. Del Mar Avenue
Fresno, CA 93711

Phone: 209 432-8873

FAX: 209 432-3059

Established: 1985; Employs 8

Sells direct and through dealers.

Major Products: HF, VHF and UHF antennas and antenna related products.

MFJ Enterprises, Inc.

PO Box 494

Mississippi State, MS 39762

Phone: 800 647-1800;

Tech: 1 800 647-8324;

FAX: 601 323-6551

Established: 1972; Employs 160

Sells direct and through dealers.

Major Products: Antenna tuners, keyers, wattmeters, packet controllers, dummy loads, antenna bridge, noise bridge, antenna current probe, clocks, coaxial switches, filters, speaker mics, mobile speaker, telescoping antennas, interfaces, code oscillators, books, licensing, code and theory programs.

Branch: 921 Louisville Road (antenna & metal shop).

Starkville, MS 39759

Branch: 106 Willow Road (Ameritron amplifiers).

Starkville, MS 39759

Phone: 601 323-5869;

FAX: 601 323-6551

Maco Manufacturing a Division of Majestic Communications, Inc.

4091 V Street

Memphis, TN 38118

Phone: 901 794-9494;

Tech: 901 794-9497

Established: 1962; Employs 10

Sells direct and through dealers.

Major Products: CB antennas, power supplies, CB accessories.

Martin Engineering, Glen

Rt. 3 Box 322

Booneville, MO 65233

Phone: 816 882-2734

Established: 1917; Employs 12

Sells direct.

Major Products: Aluminum communications towers and the "Hazer" tower elevator system.

Marvel Communications Co., Inc.

6000-D Old Hemphill Road

Fort Worth, TX 76134

Phone: 817 568-0177

Established: 1982; Employs 90

Sells direct and through dealers.

Major Products: communications antennas and accessories.

Maxcom, Inc.

1309 SW 5th Court

PO Box 502

Ft. Lauderdale, FL 33302

Phone: 305 527-5172, 305 523-6369

FAX: 305 522-8159

Established: 1982; Employs 5

Sells direct and through dealers.

Major Line: Automatic antenna matchers and antenna systems.

Maxon Systems, Inc.

10828 N.W. Air World Drive

Kansas City, MO 64153

Phone: 816 891-1093

Established: 1985; Employs 50

Sells through dealers.

Major Products: 49 MHz 2-way radios, CB radios, weather receivers, video door phones, GMRS two-way radios, portable car alarms.

Medicine Man CB

P.O. Box 37

Clarksville, AR 72830

MetroWest

822 N. Spring Avenue

LaGrange Park, IL 60525-1475

Phone: 708 354-2125

Established: 1988; Employs 4

Sells direct and through dealers.

Major Products: Handheld scanner chargers and accessories, antennas, cords, books, batteries and Bearcat scanners.

Microcraft Corporation

PO Box 513

Thiensville, WI 53092

Phone: 414 241-8144

Established: 1978; Employs 10

Sells direct.

Major Products: Code Readers: CODE*STAR, CODE SCANNER, Personal Code Explorer, all mode decoders, Professor Morse CW trainer, digital signal processing development system, Chip Checker in circuit IC tester, tri-voltage power supply, TELESCAN, tele-radiology system.

Midland International Corp.

1690 N. Topping Avenue

Kansas City, MO 64120

Phone: 800 669-4567 x1691

Major Products: CB radios, amateur radios, VHF marine radios, anti-theft devices, weather monitors, antennas.

Mirage Communications

P.O. Box 1000

Morgan Hill, CA 95038

Phone: 408 779-7363

FAX: 408 779-8845

Established: 1979; Employs 40

Sells through dealers.

Major Products: Amateur radio amplifiers and antennas.

Mobile Mark, Inc.

3900-B River Road

Schiller Park, IL 60176

Phone: 708 671-6690

FAX: 708 671-6715

Established: 1984

Sells through distributors and dealers.

Major Products: Mobile and base station antennas for Cellular, UHF, VHF, Low Band, 220, CB, Amateur & PCS/PCN frequencies.

Mosley Electronics, Inc.

1344 Baur Blvd.

St. Louis, MO 63132

Phone: 800 966-7539; 800 325-4016

Tech: 314 994-7872

Established: 1946

Sells direct and through international dealers.

Major Products: Antennas, antenna accessories, amateur, commercial and military.

MoTron Electronics

310 Garfield Street, Suite 4

Eugene, OR 97402

Phone: 800 338-9058

Tech: 503 687-2118

Sells direct.

Major Products: Touch-Tone Decoder/Display and ASCII converter board.

MultiFAX

Route 1, Box 27

Pulewood Yard Road

Peachland, NC 28133

Phone: 704 272-9028; BBS: 716 425-

8759 (no charge).

Established: 1986

Sells direct and through dealers.

Major Products: High resolution plug-in or external WEFAX demodulators for IBM PC compatibles. Works with GOES, METEOSAT, NOAA, Meteor, and HF FAX

N

NCG Companies

1275 N. Grove Street

Anaheim, CA 92806-2114

Phone: 714 630-4541; 800 962-2611

FAX: 714 630-7024

Established: 1968; Employs 7

Sells through dealers.

Major Products: US and Canadian distributor of the COMET Multi-Band Antenna Line. 900-MHz FM transceivers. Exclusive distributor for Comet Co. Ltd. antennas.

National Amateur Radio Association (NARA)

P.O. Box 201407

Arlington, TX 76006

Phone: 1 800 468-2426

FAX: 817 860-0979

Established: 1989; Employs 5

Sells direct and through dealers.

Major Products: Amateur Radio licensing aids, computer software, books, cassette tapes, and *Amateur Radio Communicator* magazine, *Amateur Radio Catalog* and *Resource Directory*.

National Scanning Report

PO Box 291918

Kettering, OH 45429

Phone: 1 800 423-1331

Major Product: *National Scanning Report Magazine*.

Naval Electronics, Inc.

5417 Jetview Circle

Tampa, FL 33634

Phone: 813 885-6091

FAX: 813 885-3789

Established: 1984; Employs 6

Sells direct and through dealers.

Major Products: Audio booster, voice operated squelch.

Nemal Electronics Int., Inc.

12240 NE 14th Avenue

N. Miami, FL 33161

Phone: 305 893-3924

FAX: 305 895-8178

Established: 1977; Employs 15

Sells direct and through dealers.

Major Products: Coaxial cable, connectors, transmission lines, crimping tools.

O

OFS WeatherFAX

6404 Lakerest Court

Raleigh, NC 27612

Phone/FAX: 919 847-4545

Established: 1990; Employs 4

Sells direct and through dealers.

Major Products: PC-Based Fax and Satellite Imagery Products.

Optoelectronics, Inc.

5821 NE 14th Avenue

Ft. Lauderdale, FL 33334

Phone: 800 327-5912; 305 771-2050

FAX: 305 771-2052

Established: 1974; Employs 20

Sells direct and through dealers.

Major Line: Frequency counters, Universal timer-counters, active pre-selectors, cellular filters and PC-Based Universal timer-counters, OptoScan 456 scanner interface.

Outbacker Antenna Sales

330 Cedar Glen Circle

Chattanooga, TN 37412

Phone: 615 899-3390

Sells direct and through dealers.

Major Products: Importers of mobile HF, multiband vertical antennas manufactured by Terlin Aerials of Australia.

Manufacturers

P

P.C. Electronics

2522 Paxson Lane
Arcadia, CA 91007
Phone: 818 447-4565
FAX: 818 447-0489
Established: 1965; Employs 10
Sells direct.

Major Products: Fast scan amateur television equipment, transmitters, transceivers, down converters, antennas, linear amps, accessories.

Pac Comm Packet Radio Systems, Inc.

4413 N. Hesperides Street
Tampa, FL 33614-7618
Phone: 813 874-2980
Tech: 813 875-6417
Purch: 81 3 876-0351
FAX: 81 3 872-8696
Established: 1985; Employs 22
Sells direct and through dealers.

Major Products: A broad range of packet equipment for both amateur and commercial use. Packet controller models for both RS-232 and TTL computers, both VHF and VHF/HF use, miniaturized controllers for integration in laptop computers, and several styles of PC card controllers. A complete line of 9000 baud packet equipment including modems, digital transceivers, and integrated packet radios.

Palomar Engineers

PO Box 462222
Escondido, CA 92046
Phone: 619 747-3343
FAX: 619 747-3346
Established: 1965; Employs 7
Sells direct and through dealers.
Major Products: HF whip antenna, HF directional antenna, HF preamplifiers, VLF, MF and HF loop antennas; and VLF converters.

Panasonic Company

One Panasonic Way
Secaucus, NJ 07094
Phone: 201 348-7000
Established: 1960; Employs 1,137
Sells through dealers.
Major Line: Multi-band portable radios.

ParaDynamics (Valor Enterprises, Inc.)

1711 Commerce Drive
Piqua, OH 45356-0601
Phone: 513 836-0594

Passport To World Band Radio

c/o IBS, Ltd.
Box 300, Penns Park, PA 18943
Phone: 215 794-3410;
FAX: 215 794-3396
Major Line: "Passport To World Band Radio" SWL Guide.

PerCon Corporation

4906 Maple Springs/
Ellery Road, Bemus Point, NY 14712
Phone: 716 386-6015
FAX: 716 386-6013

Periphex, Inc.

300 Centre Street
Holbrook, MA 02343
Phone: 617 767-5516;
FAX: 617 767-4599
Established: 1982; Employs 14
Sells direct and through dealers.
Major Products: Replacement batteries and battery packs, featuring super packs for longer operating time, for hand held radios and scanners.

Phillips Consumer Electronics Corp.

One Philips Drive
Knoxville, TN 37914
Phone: 615 521-4316
Tech: 615 475-8869
Established: 1974; Employs 6,000
Sells through dealers.
Major Products: Televisions, VCRs and audio equipment for home and portable.

Phillips-Tech Electronics

5420 E. Sahuro Drive
Scottsdale, AZ 85252
Phone: 602 947-7700
Established: 1982; Employs 3
Sells direct.
Major Products: Wireless cable TV, amateur TV, microwave TV antennas, and other equipment.

Pouch, The

535 Suffolk Drive
Tucson, AZ 85704
Phone: 800-72-POUCH
Sells direct and through dealers.
Major Line: Nine sizes of holsters made of neoprene and nylon for hand-held two-way radios, scanners, cordless and cellular phones, pagers and small computers. Cross index available w/SASE.

Q

QSL'S by W4MPY

682 Mt. Pleasant Rd.
Monetta, SC 29105
Phone: 803 685-7117 (Phone or FAX)
Established: 1981; Employs 2
Sells direct.
Major Products: QSL cards, logbooks.

R

R.C. Distributing

PO Box 552
South Bend, IN 46624
Phone: 219 236-5776

RF Concepts, Div. of Kantronics

PO Box 11039
Reno, NV 89510-1039
Phone: 702 324-3290
FAX: 702 324-3289
Established: 1987
Sells through dealers.
Major Products: VHF all mode RF amplifiers 144-148 MHz, UHF all mode RF amplifiers 432-450 MHz, dual-band amplifiers.

RF Limited/Clear Channel Corp.

P.O. Box 1124
Issaquah, WA 98027
Phone: 206 222-4295
FAX: 206 222-4294
Established: 1976; Employs 15
Sells direct and through dealers.
Major Products: Amateur and CB accessories. Antennas for amateur, CB, SWL and stereo. N. America Diamond Antenna agent, mobile and base microphones. Digital voice recorders and speech processors.

R.F. Parts Co.

1320 Grand Avenue
San Marcos, CA 92069
Phone: 800 854-1927; 619 744-0728
Tech: 619 744-0720
Established: 1968; Employs 10
Sells direct.
Major Products: Diamond Antennas VHF/UHF antennas, duplexers, wattmeters, accessories, RF power transistors for transmitters, amplifiers.

RMS

(See Advanced Specialties, Inc.)

Radio Accessories

PO Box 168
Melvin Village, NH 03850
Phone: 603 544-8401
Established: 1992; Employs 7
Sells direct.
Major Products: Message Catcher and monitoring Accessories.

Radio Amateur Callbook Inc.

1695 Oak Street
PO Box 2013
Lakewood, NJ 08701
Phone: 908 905-2961
Established: 1920
Sells direct and through dealers.
Major Products: North American and International Callbooks, Gordon West Radio School, maps, and atlas.

Radio Bookstore

P.O. Box 209
Rindge, NH 03461
Phone: 800 457-7373;
FAX: 603 899-6826
Established: 1970; Employs 2
Sells direct and through dealers.
Major Line: ARRL, CQ and SAMS Books and software.

Radio Shack

1500 One Tandy Center
Ft. Worth, TX 76102
Phone: 817 390-3011
Established: 1921; Employs 39,000
Nearly 7,000 stores in the U.S.
Major Products: Computers, scanners, antennas, transceivers, coax, plugs, jacks, parts and supplies.

Radioware Corp.

P.O. Box 1478
Westford, MA 01886-4978

Ramsey Electronics, Inc.

793 Canning Parkway
Victor, NY 14564
Phone: 716 924-4560
Established: 1976; Employs 27
Sells direct and through dealers.
Major Products: Frequency counters, oscilloscopes, service monitors, hobby kits.

REACT International, Inc.

242 Cleveland
Wichita, KS 67214
Phone: 316 263-2100

ROBOT Research Inc.

5636 Ruffin Road
San Diego, CA 92123
Phone: 619 279-9430
FAX: 619 279-7931
Established: 1969
Sells direct.
Major Line: Color SSTV converter (model 1200C only).

ROHN

PO Box 2000
Peoria, IL 61656
Phone: 309 697-4400
FAX: 309 697-5612
Established: 1948
Sells direct and through dealers.
Major Line: Towers.

S

SGC, Inc.

P.O. Box 3526
Bellevue, WA 98009-3526

Sangean America, Inc.

2651 Troy Ave.
South El Monte, CA 91733
Phone: 818 579-1600
FAX: 818 579-6806
Established: 1974; Employs 20
Sells through dealers.
Major Line: Multi-band SW radio receivers, pocket-size AM/FM/stereo/TV receivers.

ScanWare Associates

7910 N.E. Double Hitch Court
Bremerton, WA 98311-3801
Phone: (Sales/Info.): 360 698-1383;
FAX: 360 698-8207;
Tech: (Voice/FAX): 360 871-3751
Established: 1992; Employs 4
Sells direct and through dealers.
Major Products: Custom Computer Software; FCC Frequency Retrieval System; BCD Broadcast Database; US_RR-US Railroads Database; FCC Metro-Call Database; ABD Airband Database; and MBD Marine Band Database.
Branch: 2196 California St., E. Port Orchard, WA 98366
Phone: 206 871-3751;
BBS: 206 871-4228
Key Employees: Gene, KG7X; Matt, AA7LP

Manufacturers



Scanner Master

P.O. Box 428
Newton Highlands, MA 02161
Phone: 800 722-6701
Established: 1978; Employs 5
Major Line: Scanner/Communications Guides, computer software services

Shakespeare Company

PO Box 733
Newberry, SC 29108
Phone: 803 276-5504
Established: 1965; Employs 300
Sells through dealers.
Major Products: CB & VHF Antennas, VHF Radios, Loran, Cellular Antennas.

Shure Brothers

222 Hartrey Avenue
Evanston, IL 60202
Phone: 708 866-2200
FAX: 708 866-2279
Established: 1925
Sells through dealers.
Major Products: Base station microphones, mobile communications microphones, hands-free cellular microphone systems, DTMF microphones.

Signal Engineering & Communications

155 San Lazaro Avenue
Sunnyvale, CA 94086
Phone: 408-733-1580
FAX: 408-732-4456

Software Systems Consulting

615 S. El Camino Real
San Clemente, CA 92672
Phone: 714 498-5784
FAX: 714 498-0568
BBS: 619 259-5554
Established: 1981; Employs 4
Sells direct and through dealers.
Major Products: FAX, SSTV, RTTY interfaces and software, shortwave receivers, scanners and antennas.

SolarCon Inc.

PO Box 176
Holland, OH 43528
Phone: 419 865-5877;
Tech: 419 865-5877
Established: 1985
Sells through dealers.
Major Products: Antennas

Somerset Electronics Inc.

1290 Highway A1A
Satellite Beach, FL 32937
Phone: 1 800 678-7388
Tech./FAX: 1 407 773-8097
Sells direct and through dealers.
Major Products: Multi Mode Decoder video/printer interface, standard and portable (battery operated).

Sony Electronics, Inc.

1 Sony Drive
Park Ridge, NJ 07656
Phone: 201 930-1000

Startek

398 NE 38 Street
Ft. Lauderdale, FL 33334
Phone: 305 561-2211
Tech: 305 537-5577
Established: 1988
Sells direct and through dealers.
Major Products: Frequency counters (frequency finders).

Systems and Software International, Ltd.

4639 Timber Ridge Drive
Dumfries, VA 22026
Phone: 703 680-3559
FAX: 703 878-1460
Established: 1985; Employs 5
Sells direct and through dealers.
Major Products: HF/VHF/UHF receivers, software (Macintosh + MS Windows) for communications systems, direct finding systems and automatic satellite tracking systems.

T

TRS Consultants

PO Box 2275
Vincentown, NJ 08088-2275
Phone: 609 859-2447
FAX: 609 859-3226
Established: 1986; Employs 2
Sells direct and through dealers.
Major Products: IBM PC software for receiver control of Japan Radio Company, Kenwood and Lowe, and other SWL-related software.

Telex Communications Inc.

Hy-Gain Division
8601 E. Cornhusker Hwy.
Lincoln, NE 68505
Phone: 402 465-7021 (rotator parts);
402 465-7022 (antenna parts)
Established: 1936; Employs 1,800
Sells through dealers.
Major Products: HF & VHF beams, HF & VHF verticals, HF dipoles, antenna accessories, antenna rotators, crankup towers and accessories, log antennas, and headsets.

Timewave Technology Inc.

2401 Pilot Knob Road
St. Paul, MN 55120
Phone: 612 452-5939;
FAX: 612 452-4571
Established: 1982; Employs 15
Sells through dealers.
Major Line: Digital signal processing equipment.

Tri-Ex Tower Corp.

7182 Rasmussen Avenue
P.O. Box 5009
Visalia, CA 93278
Phone: 209 651-7860; Tech: 209 651-7859; FAX: 209 651-5157
Established: 1951; Employs 80
Sells direct.
Major Products: Manufactures and designs communication towers.

U

U.S. Scanner Publications

P.O. Box 14923
Portland, OR 97214-4923
Phone: 800 890-6999; 503 230-6999;
FAX: 503 233-5176
Sells via mail order.
Major Products: Scanner frequency lists and The Frequency Almanac.

US Tower Corporation

1220 Marcin Street
Visalia, CA 93291
Phone: 209 733-2438
FAX: 209 733-7194
Established: 1985; Employs 25
Sells direct and through dealers.
Major Products: Mobile and free standing Crank-up towers, tubular and lattice towers, all sizes and accessories.

Uniden Corporation of America

4700 Amon Carter Blvd.
Ft. Worth, TX 76155
Phone: 817 858-3300
Tech: 317 842-2483
Established: 1979; Employs 470
Sells through dealers and distributors.
Major Products: Cordless telephones, cellular telephones, scanners, radar detectors, citizen band radios, satellite receivers & dishes, 2-way commercial radios, marine radios, and pagers.

Universal Electronics, Inc.

4555 Groves Road, Suite 12
Columbus, OH 43232
Phone: 614 866-4605; Sales: 1 800 241-8171; Tech: 614 866-4605
Established: 1976; Employs 13
Sells direct and through dealers.
Major Products: SCPC Satellite audio receivers. SCPC-100 receiver, SCPC 300-C commercial broadcast receiver.

Universal Manufacturing

43900 Groesbeck Hwy.
Clinton Twp., MI 48036
Phone: 800 542-3450; 810 463-2560
FAX: 810 463-2964
Established 1969; Employs 9
Sells direct and through dealers.
Major Line: Freestanding aluminum towers.

V

Valor Enterprises, Inc.

1711 Commerce Drive
Piqua, OH 45356
Phone: 1 800 543-2197
Established: 1974; Employs 130
Sells through dealers.
Major Products: Full line manufacturer of mobile antennas and accessories, CB, cellular, amateur, land mobile, TV, chrome accessories and test meters. (Para Dynamics, Pro-Am and Vectorics are divisions of Valor Enterprises, Inc.)

Viking International

150 Executive Park Blvd., Ste. 4600
San Francisco, CA 94134
Phone: 415 468-2066;
FAX: 415 468-2067
Established: 1971
Sells direct and through dealers.
Major Products: Long-playing cassette recorders, electronic counter measures equipment, scramblers and wireless video systems, and dialed number decoders.

W

W5Y1 Group

PO Box 565101
Dallas, TX 75356
Phone: 817 461-6443
Established: 1982; Employs 6
Sells direct and through dealers.
Major Products: License study guides and practice tapes, The W5Y1 Report newsletter.

W & W Associates

29-11 Parsons Blvd.
Flushing, NY 11354
Phone: 800 221-0732, 718 961-2103
Established: 1975
Sells direct and through dealers.
Major Products: Replacement battery packs for hand-held radios, cordless telephones, cellular phones, and camcorders.

Watkins-Johnson Company

Electronic Equipment Division
700 Quince Orchard Road
Gaithersburg, MD 20878-1794
Phone: 800 954-3577; 301 948-7550
Established: 1957; Employs 2400
Sells through dealers.
Major Products: HF-1000 digital shortwave receiver.

Wawasee Electronics

P.O. Box 36
400 S. Sycamore Street
Syracuse, IN 46567
Phone: 219 457-3191;
Tech: 219 457-3191
Established: 1994; Employs 2
Sells direct and through dealers.
Major Products: CB accessories; wattmeters, frequency counters, monitor scope.

West Radio School, Gordon

Published by: Radio Amateur Callbook Inc.
PO Box 2013
Lakewood, NJ 08701
Phone: 908 905-2961
FAX: 714 434-0666
Established: 1976
Sells direct and through dealers.
Major Products: Amateur radio code courses on cassette tapes, radio theory books, theory cassette tapes, and Ham Classroom Instruction.

Will-Burt Co.

PO Box 900
Orrville, OH 44667
Phone: 216 682-7015
FAX: 216 684-1190
Established: 1918; Employs 250
Sells direct.
Major Line: Pneumatic telescoping antenna masts.

Wilson Antenna, Inc.

1181 Grier Dr., Suite A
Las Vegas, NV 89119
Phone: 800 541-6116, 702 896-0399
FAX: 702 896-0409
Established: 1985
Sells through dealers.
Major Products: Amateur and CB mobile antennas.

Manufacturers

Wintenna, Inc.

911 Amity Road
Anderson, SC 29621
Phone (Sales): 1 800 845-9724;
Phone (Tech.): 803 261-3965
Established: 1975; Employs 30
Sells through dealers.
Major Products: mobile multi-purpose antennas and accessories for TV, CB, scanners, ham radio, cellular and cordless phones.

X

Xandi Electronics

201 E Soughern Ave., Suite 205
Tempe, AZ 85282
Phone: 800 336-7389
Tech: 602 894-0992
Sells direct.
Major Products: Super-miniature FM transmitters, FM stereo transmitter kits, scanner converter kits and more.

Y

Yost E.H., & Company, Mr. Nicad

2211-D Parview Road
Middleton, WI 53562
Phone: 608 831-3443
Major Line: Batteries—NiCd sealed lead, gel cells, mercury, alkaline, lithium, etc.

Z

Zihua Software

PO Box 51601
Pacific Grove, CA 93950
Phone: 408 372-0155
Established: 1986; Employs 2
Sells direct and through dealers.
Major Line: Macintosh software.

CANADA

North Atlantic Radio Service

PO Box 1
Marion Bridge, Nova Scotia BOA 1PO
Canada
Phone: 902 727-2913
Established: 1990; Employs 3
Sells direct
Major Products: Shortwave receivers.
North American distributor for Lowe Electronics, U.K.

Trylon Mfg. Co. Ltd.

PO Box 186
21 Howard Avenue
Elmira, ON N3B 2Z6, Canada
Phone: 519 669-5421
Established: 1960; Employs 50
Sells direct.
Major Products: Self-support and guyed towers, Titan series, safety fall arrest systems, safety cable, safety rail.

FOREIGN

Lowe Electronics

Chesterfield Road
Matlock, Derbyshire DE4 5LE
ENGLAND
Phone: 629 580800; FAX: 629 580020
Established: 1974; Employs 32
Sells through dealers.
Major Line: Shortwave receivers, pre-selectors and other related accessories.

Maldol Antennas

Hokushin Industry Co., Ltd.
1111-1 Nagasaki Cho
Hanamigawa-ku
Chiba City, Chiba, -pref. Japan
Phone: 043-257-1581
FAX: 043-259-6000
Sells through dealers.
Major Products: mobile and base station antennas, mounting bases for mobile stations, duplexers, SWR meters, speaker microphones, extension speakers, roof towers.

SIRIO Antenna

Strada dei Colli Sud, 1/Q
46049 Volta Mantovana
Mantova, ITALY
Phone: 011 39 376-801515
FAX: 011 39 376-801254

subscribe to POPULAR COMMUNICATIONS

See page 35 for
order form.

Don't Delay
order your
subscription
today!!!!



FCC CB Station Information

(Editor's note: The following information is reprinted from the FCC's Fact Sheet PR-5000, Number 200, dated April, 1993. We have not included in-depth information about R/C Rules.)

Can I get a CB or R/C (Radio Control) License?

No. The FCC ceased issuing licenses for CB and R/C in 1983 because licenses were no longer serving a useful purpose. CB Rule 3 authorizes you to operate your Citizens Band (CB) Radio Service Station, and R/C Rule 3 authorizes you to operate your Radio Control (R/C) Radio Service station, from places where the FCC regulates communications. There is no age or citizenship requirement. CB Rule 9 prohibits anyone from using a CB station, if the transmitter is not type accepted for that function. CB Rule 3 and R/C Rule 3 prohibit the following from operating a CB or R/C station: foreign governments; representatives of foreign governments, federal government agencies; or persons who have been issued a cease and desist order which is still in effect.

Where Can I Get A Copy of the CB or R/C Rules?

Contact the U.S. Government Printing Office, Superintendent of Documents, Mail Stop SSOP, Washington, DC 20402-9328 (Phone 202-512-1800) for price and ordering information. The rules are published annually in the Code of Federal Regulations, Title 47, Telecommunications, Part 80 to End. While operating a CB or R/C station, you need to know the FCC's Rules for proper use. Violation of these rules can result in a fine and loss of your authority to use the CB or R/C Radio Services. Violation of the Communications Act, moreover, can result in a fine and imprisonment.

For What Purposes May I Use A CB or R/C Station?

You may use your CB station for two-way, short-distance voice communications for your personal or business activities. (CB Rule 1.) You may use your R/C station for one-way, short-distance non-voice communications to operate devices by remote control. (R/C Rule 1.) Expect to reach about one to five miles.

Can I Raise The Power Output of My CB?

Absolutely not. You may not attach a radio frequency power amplifier (linear or linear amplifier) to your CB transmitter. (CB Rule 11.) When your transmitter is modified internally, its type acceptance is canceled and you forfeit your authority to use it. (CB Rule 10 and R/C Rule 10.)

How High May I Put My Antenna?

The highest point of your CB or R/C station antenna must not be more than 20 feet above the highest point of the building or tree on which it is mounted, or 60 feet above the ground. There are lower height limits if your station is located within two miles of an airport. No height restrictions apply to an antenna mounted on a vehicle or a hand-held transmitter. (CB Rule 8 and R/C Rule 8.)

On Which Channels May My CB Station Transmit?

Channel 9 may be used only for emergency communications or for traveler assistance. Your CB station is authorized to transmit on any of 39 CB channels when it is clear of on-going communications with which your station could interfere. CB channels must be shared by all CB stations. No CB or R/C channel is assigned to any specific individual or organization. (CB Rule 7 and R/C Rule 7). These radio services depend upon all operators being cooperative. Keep your communications short. Never talk with another station for more than 5 minutes continuously. Wait at least one minute before starting another communication. (CB Rule 16).

Which CB Channel May I Use For Emergency Communications?

You may use any CB channel. A CB station transmitting messages concerning the immediate safety of life or the immediate protection of property must be given priority regardless of the channel. (CB Rule 7) However, because CB channel 9 is reserved for emergency communications and for traveler assistance, it may be your best choice.

Must I Identify My CB or R/C Station?

You are not required to identify your station. The FCC encourages you to identify your CB station while you are using it. If you once held a CB license, you can use that call sign. Otherwise, you can use the letter K followed by your initials and residence zip code or an organizational name and unit number. (CB Rule 17)

May I Use My CB or R/C Station in Canada?

Yes. When in Canada, however, you are subject to the rules of the Canadian Department of Communications, not those of the FCC.

Is There Another Personal Radio Service For Short Distance Two-Way Voice Communications?

Yes. The General Mobile Radio Service (GMRS) is available to individuals. You will need a license for a GMRS system comprised of one or more stations. GMRS systems are used to facilitate the activities of the licensees and their family members. See Part 95, Subpart A of the Commission's Rules, 47 C.F.R. Section 95.1-95.181.

The above are general answers to the questions most frequently asked about the Citizens Band (CB) and Radio Control (R/C) Radio Services. For complete information, see the Commission's Rules for the Citizens Band (CB) Radio Service, 47 C.F.R. Section 95.401-95.428, and the Commission's Rules for the Radio Control (R/C) Radio Service, located in 47 C.F.R. Section 95.201-95.225.

Dealers

The following directory consists of retailers who sell other makers' brands of radio products either through a retail store(s) or by mail order, or both. (Manufacturers or importers who sell only their own brands to end users are listed in the previous section, "Who's Who in Manufacturers/Importers.")

Top lines they carry are noted, as well as information concerning equipment trade-ins and on-site repairs. Additionally, the year the company was established, the number of employees, and branch store information, if any, are also indicated. Furthermore, key employee names and call signs are shown, enabling you to personalize your buying contacts.

Note that toll-free "800" telephone numbers should only be used to place a purchase order, not to gather general information, for repairs, etc. This reduces the time that other callers have to wait (it might be you!) for someone to take their order.

Company names in color have display ads in this Guide. See them for added product and services information. Many will also send free literature upon request.

A

A-B-C Communications

17550 15th Avenue NE
Seattle, WA 98155
Phone: 206 364-8300
Sells via showroom.
Top Lines: ICOM, books, and all major antenna lines.

A-TECH Electronics

2210 W. Magnolia Blvd.
Burbank, CA 91506
Phone: 818 845-9203
FAX: 818 846-2298
Established: 1987; Employs 5
Sells via showroom and mail order.
Key Employees: Bill, N6MQS; Ted, KD6HGA.
Top Lines: Alinco, Larsen, Comet, Mirage, Kenwood, Yaesu, ICOM, NCG, ArtSci.
Accepts trade-ins and provides repairs.

AXM Incorporated

11791 Loara St., Suite B
Garden Grove, CA 92640-2321
Phone: 714 638-8807; 1 800 755-7169
FAX: 714 638-9556
Established: 1976; Employs 3
Sells via mail order and direct.
Key Employee: Susan, N6ORA.
Top Lines: TAD, Ranger (RCI), Ritron, Jobcom, Mobile-Mark Antennas, Larsen antennas and Centurion batteries.
Provides repairs.

Ack Radio Supply Company

3101 4th Avenue
South Birmingham, AL 35233
Phone: 205 322-0588; 800-338-4218
FAX: 205-322-0580
Established: 1947; Employs 5
Sells via showroom and mail order.
Key Employees: Larry N4HYX; Mike, KC4OIT; Bill; Kirk, N4WYC.
Top Lines: ICOM, Ten-Tec, MFJ, ARRL, Vibroplex, Bencher, Hustler, DAIWA.
Accepts Trade-Ins.
Branch: 554 Deering Road
Atlanta, GA 30367
Phone: 404 351-6340;
FAX: 404 351-1879
Key Employees: Tommy W4RRW; Jim WA4APG.

Advanced Specialties, Inc.

114 Essex Street
Lodi, NJ 07644
Phone: 201 843-2067
Sells via showroom & mailorder.
Top Lines: Cobra, Astatic, RMS, Anttron, Uniden, Para Dynamics, Midland, Maxon, K40, Turner, JBC & more.
Accepts trade-ins and provides repairs.

Alfa Electronics

741 Alexander Road
Princeton, NJ 08540
Phone: 800 526-2532
FAX: 609 520-2007
Established: 1988; Employs 8
Sells via mail order.
Key Employee: Jeff Kao
Top Lines: Alfa, Fluke.
Provides repairs.

All Electronics

PO Box 567
Van Nuys, CA 91408
Phone: 800 826-5432; Tech: 818 904-0524; FAX: 818 781-2653
Established: 1967; Employs 35
Sells via showroom and mailorder.
Top Lines: Full line of parts—rechargeable batteries, capacitors, semi-conductors, fuses, switches, fasteners, lamps, optoelectronics, etc. Free Catalog.
Branches: 905 S. Vermont Avenue
Los Angeles, CA 90006
Phone: 213 380-8000
14928 Oxnard Street
Van Nuys, CA 91411
Phone: 818 997-1806

Amateur & Advanced Communications

3208 Concord Pike, Rt 202
Wilmington, DE 19803
Phone: 302 478-2757
Established: 1977; Employs 2
Sells via showroom and mail order.
Key Employees: Gisele, K3WAJ; Bill, WB3DPJ.
Top Lines: ARRL, Alinco, Ameritron, Cushcraft, MFJ, Ten-Tec, Alpha Delta, Hustler, Butternut, Larsen, Rohn, ProAm, Bencher, Henry, Kantronics, Astron, Shortwave Equipment, Ham Classes.
Provides repairs.

Amateur Communications, Etc.

263 Mink
San Antonio, TX 78213-3949
Phone: 512 733-0334;
512 734-7793,-7794
Established: 1969; Employs 2
Sells via showroom and mail order.
Key Employees: Frank, WD5GZU;
Steven, KA5SWI.
Top Lines: Ten-Tec, Tempo, Alinco, MFJ, Valor, Azden, William Nye, Hustler, Ranger.
Accepts trade-ins and provides repairs.

Amateur Electronic Supply, Inc.

5710 Good Hope Road
Milwaukee, WI 53223
Phone: 800 558-0411, 414 358-0333
Established: 1957; Employs 39
Sells via showroom and mail order.
Key Employees: Paul, W9KHO.
Top Lines: Kenwood, Yaesu, ICOM, Cushcraft, Hy-Gain, AEA, Kantronics, Nye-Viking, MFJ, Ten-Tec, Hustler.
Large used gear inventory.
Accepts trade-ins and provides repairs.

Amateur Electronic Supply, Inc.

28940 Euclid Avenue
Wickliffe, OH 44092
Phone: 800 321-3594; 216 585-3278
Employs 8
Sells via showroom and mail order.
Key Employees: Dave, WB8BAG Bob, WB8WEN; Phil, WD8AAN; Ed, N8FIN; Sam, N8UZN; and John, WA8PKB.
Top Lines: Kenwood, Yaesu, ICOM, Alinco, Cushcraft, MFJ, Hy-Gain, AEA, Kantronics and Ten-Tec.
Accepts trade-ins and provides repair.

Amateur Electronic Supply, Inc.

621 Commonwealth Avenue
Orlando, FL 32803
Phone: 800 327-1917; 407 894-3238
Employs 11
Sells via showroom and mail order.
Key employees: Grant, K41QW.
Top Lines: Kenwood, Yaesu, ICOM, Cushcraft, Hy-Gain, AEA, Kantronics, Nye-Viking, MFJ, Ten-Tec. Hustler.
Large used gear inventory.
Accepts trades-in and provides repairs.

Amateur Electronic Supply, Inc.

1898 Drew Street
Clearwater, FL 34625
Phone: 813 461-4267
FAX: 813 443-7893
Employs 3
Sells via showroom and mail order.
Key Employees: Len, K4BDP.
Top Lines: Kenwood, Yaesu, ICOM, Cushcraft, Hy-Gain, AEA, Kantronics, Nye-Viking, MFJ. Large used gear inventory.
Accepts trade-in and provides repairs.

Amateur Electronic Supply, Inc.

1072 N. Rancho Drive
Las Vegas, NV 89106
Phone: 800 634-6227; 702 647-311 4
FAX: 702 647-3412
Employs 6
Sells via showroom and mail order.
Key Employees: Squeak, AD7K.
Top Lines: Kenwood, Yaesu, ICOM, Cushcraft, Hy-Gain, AEA, Kantronics, Nye-Viking, M MFJ, Ten-Tec. Large used gear inventory.
Accepts trade-ins and provides repairs.

Amateur Radio Supply, Co.

5963 Corson Avenue S. Suite #140
Seattle, WA 98108-2707
Phone: 206 767-3222;
FAX: 206 763-8176
Established: 1956; Employs 5
Sells via showroom and mail order.
Key Employees: Marlo, N7TQU; Eric, N7DLV; and Floyd, KB7PLW.
Top Lines: Kenwood, ICOM, Rohn, AEA, Cushcraft, Bird Wattmeters, Kantronics, Yaesu, Comet, Alinco, Nye, Hustler and Larsen.

Amateur Radio Team Of Spokane

S.25 Girard
Spokane, WA 99212
Phone: 509 928-3073
Established: 1976; Employs 2
Sells via showroom and mail order.
Key Employees: Art, WB7AUK and Joann, KA7SUZ.
Top Lines: ICOM, Astron, International Wire, MFJ, ARRL, Van Gordon, Bencher, AEA.
Accepts trade-ins.

American Electronics

PO Box 301
173 East Broadway
Greenwood, IN 46142
Phone: 317 888-7265; 1 800 872-1373
FAX: 317 888-7368
Established: 1965; Employs 8
Sells via showroom and mail order.
Key Employees: Win, K9EMV; Mike, N9LPJ; Jon, N9KZB; John, N9KZG.
Top Lines: Professional 2-way, CB, scanners, tools and electronic equipment.
Provides repairs.

Antenna Service

165 Olympia Street
Pittsburgh, PA 15211
Phone: 412 431-5171; 412 431-9330
FAX: 412 341-4116
Established: 1959; Employs 5
Sells via mail order.
Key Employees: Joe, KA3TDQ; Joe, Jr.
Top Lines: Philips ECG, Channel Master, South River, Blonder Tongue, Wine Guard, Life Master.
Provides repairs.

Antennas Etc.

PO Box 4215
Andover, MA 01810-4215
Phone: 508 475-7831; 508 975-2711
FAX: 508 474-8949
Established: 1986; Employs 16
Sells direct and through dealers.
Top Lines: Unadilla antennas, James Millen equipment.

Associated Radio Comm.

PO Box 4327 8012 Conser
Overland Park, KS 66204
Phone: 913 381-5900;
FAX: 913 648-3020.
Established: 1945.
Sells via showroom and mail order.
Top Lines: Kenwood, ICOM, Alinco, Ten-Tec, Yaesu, Kantronics, R.F. Concepts, Cushcraft, Maxrad, Hustler, B&W, Nye-Viking, Panasonic, Sangean, Uniden-Bearcat, Drake, Collins, Comet, AEA, Daiwa, Vectronics, MFJ, W5YI, Valor, ARRL, Butternut, Astron.
Accepts trade-ins and provides repairs.

Dealers

Atlantic Ham Radio, Ltd.

(See Canada Listing)

Austin Amateur Radio Supply

5325 North IH-35
Austin, TX 78723
Phone: 512 454-2994; 800 423-2604.
Established: 1986.
Sells via showroom and mail order.
Top Lines: Kenwood, ICOM, Yaesu, AEA, MFJ, Astron, Cushcraft, Hustler, Butternut, Larsen, Telex-HyGain.
Provides repairs.

B

BCB

72 Eastern Avenue
Malden, MA 02148
Phone: 617 321-2550

B.C. Communications, Inc.

The 211 Bldg.-Depot Road
Huntington Station, NY 11746
Phone: 516 549-8833; 516 549-1277;
800 924-9884
FAX: 516 549-8820.
Established: 1972; Employs 12
Sells via showroom and mail order.
Key Employees: William, W2ZBY.
Top Lines: Yaesu, MFJ, Larsen, William Nye-Viking, DAIWA, Kantronics, Astatic, Hustler, Newtronics, Valor, Mobile Mark, Bearcat, Uniden, Maxon, Mirage, B&W.
Accepts trade-ins and provides repairs.

B & H Sales and Service

707 North Baltimore
Derby, KS 67037
Phone: 316 788-4225
Established: 1989; Employs 5
Sells via showroom and mail order.
Key Employees: Mark, KBØMOF; Norm, NIØS; and Shawn, KBØMNY.
Top Lines: MFJ, Hustler, ARRL, Comet, Astron, AEA, Kantronics, Radio Shack, Smiley, and The Pouch.
Accepts trade-ins.

Barry Electronics, Corp.

512 Broadway
New York, NY 10012
Phone: 212 925-7000;
FAX: 212 925-7001
Established: 1950; Employs 8
Sells via showroom and mail order.
Key Employees: Kitty, WA2BAP; Emil, N2EZZ.
Top Lines: Kenwood, Yaesu, ICOM, Bird, Nye-Viking, Hy-Gain, Motorola, AEA, MFJ, Larsen, Hy-Gain, Maxon, Uniden, Astron, B&W, Sony, Panasonic.
Provides repairs.

Base Station, Inc.

1839 East Street
Concord, CA 94520
Phone: 510 685-7388
Established: 1976; Employs 5
Sells via showroom and mail order.
Key Employees: Art, AB6HB.
Top Lines: Cobra, Midland, Uniden, Maxon, K40, Wilson, Firestik, Valor, Francis, ParaDynamics, Echomics, Antenna Specialists, Ranger.
Accepts trade-ins and provides repairs.

Boucher Electronics

4813 Lexington Avenue
Erie, PA 26509

Burghardt Amateur Center, Inc.

PO Box 73, 182 N. Maple St.
Watertown, SD 57201-0073
Phone: 605 886-7314; 605 886-7382
FAX: 605 886-3444
Established: 1931; Employs 10
Sells via showroom and mail order.
Key Employees: Darrell, WDOGDF; Tim, WDOFKC; Stan, W01T; Jim, WB0MJY and David, KA0JDN,
Top Lines: Kenwood, ICOM, Yaesu, AEA, Kantronics, Astron, Ten-Tec, Barker & Williamson, Cushcraft, Telex, MFJ.
Accepts trade-ins and provides repairs.

Burk Electronics

35 N. Kensington
LaGrange, IL 60525
Phone: 708 482-9310
Established: 1983; Employs 5
Sells via mail order.
Key Employees: Wayne NA9B; Ann, KA9TAC, Jeff, Maria, James.
Top Lines: AEA, Ameritron, Ameco, Antenna Specialist, Antler, ARRL Publications, Bencher, Butternut, Comet, Diamond, Hustler, Larsen, Lunar, Maxrad, Mobile Mark, MFJ, Radio Amateur Callbook, Radio Publications, Pyramid, Sam's Smiley Antenna, TAB Books, Valor, Wintenna, Yaesu.
Accepts trade-ins, provides repairs and technical assistance.

C

C.A.T.S

7368 S. R. 105
Pemberville, OH 43450
Phone: 419 352-4465
Established: 1980; Employs 2
Sells via mail order.
Key Employee: Craig, N8DJB.
Major Lines: Parts and service on all American rotators, Hy-Gain/CDE, Alliance and Channel Master, cable, wire and rotator accessories.
Accepts trade-ins.

CB Shop, The

410 E. Fayette Avenue
Effingham, IL 62401
Phone: 217 342-3054

CBC International, Inc.

PO Box 31500
Phoenix, AZ 85046
FAX: 602 996-8700
Established: 1976; Employs 3
Sells via mail order.
Key Employees: Lou, K6NH.
Top Lines: CB-to-ham radio modification, plans and hardware; FM conversion kits, books, plans, high-performance CB accessories.

C-Comm

6115 15th Avenue NW
Seattle, WA 98107
Phone: 800 426-6528; 206 784-7337
FAX: 206 784-0541
Established: 1976; Employs 8
Sells via showroom and mail order.
Key Employees: Frank, K7DS; George, K7HBN; Joe, NY7X; Dan, N7PSH and Dale, W7GAB.
Top Lines: ICOM, Kenwood, Yaesu, Ten-Tec, AEA, Cushcraft, Telex-Hy-Gain, Astron, Hustler, Larsen.
Provides repairs.

CRS Communications

1692 Central Park Avenue
Yonkers, NY 10710
Phone: 914 961-7887

C. Crane Company

558 10th Street
Fortuna, CA 95540
Phone: 800 522-8863;
FAX: 707 725-9060
Sells via showroom and mail order.
Top Lines: Drake, Grundig, and Sangean shortwave receivers, Uniden and AOR scanners, AM/FM radio, antennas, and other communications equipment and accessories.

C & S Sales

1245 Rosewood Avenue
Deerfield, IL 60015
Phone: 800 292-7711; 708 541-0710
FAX: 708 520-0085
Established: 1985; Employs 5
Sells via mail order.
Key Employees: Jim, Nate.
Top Lines: John Fluke, B&K Precision, Elenco, Hitachi test equipment and standard, amateur radio products.
Provides repairs.

Chilton Pacific Limited

5632 Van Nuys Blvd., Suite 222
Van Nuys, CA 91401
Phone: 818 780-2730
Established: 1983; Employs 2
Sells direct.
Major Products: Portable shortwave receivers, AM/FM DXing accessories, Indoor and Outdoor antennas, and headphones. Catalog available.

ComDac Radio

1051 Main Street
St. Joseph, MI 49085
Phone: 616 982-0404; 800 382-2562
FAX: 616 982-0433
Established: 1982; Employs 6
Sells via showroom and mail order.
Key Employees: Duane, KX8D; Barb, N8JML.
Top Lines: Yaesu, Alinco, VoCom, Vibroplex, Comet, Hustler, Ameritron, Astron, MFJ, various computer products.

Com-West Radio Systems, Ltd.

(See Canada Listing)

Communications Electronics Inc.

Emergency Operations Center
P.O. Box 1045
Ann Arbor, MI 48106-1045
Phone: 313 996-8888;
FAX: 313 663-8888
Established: 1923; Employs 38
Sells via showroom and mail order.
Key Employees: Ken, WB8LIT; Paul, W8UO.
Top Lines: Uniden, Cobra, Shinwa, Motorola, RELM, Ranger Communications, Grundig, Sangean, Midland, Super Disk.
Provides repairs.

Comm-Pute, Inc.

1057 East 2100 South
Salt Lake City, UT 84106
Phone: 801 484-7388; 801 467-8873;
800 942-8873
Established: 1988; Employs 5
Sells via showroom and mail order.
Key Employees: Preben, K7KMZ; Tim, W71QY. Dave, KD7UM.
Top Lines: Kenwood, Yaesu, ICOM, Cushcraft, Larsen, AEA, Kantronics, Hustler, Bencher, Diamond.
Accepts trade-ins and provides repairs.

Copper Electronics, Inc.

3315 Gilmore Industrial Blvd.
Louisville, KY 40213
Phone: 502 968-8500; 800 626-6343
FAX: 502 968-0449
Established: 1974; Employs 36
Sells via showroom and mail order.
Top Lines: Cobra, Uniden, Maxon, Antenna Specialists, Valor, Computer Equipment, PC, Shortwave receivers, 2-way radio, Watt Meters.

D

DNA Distributing, Inc.

2885 Mellonville Avenue
Sanford, FL 32773
Phone: 407 321-1088

DX Radio Supply

PO Box 360
Wagontown, PA 19376
Phone: 610 273-7823
Established: 1980
Sells via mail order.
Key Employees: Larry and Robin Miller
Top Lines: National Scanning Report Magazine, complete line of all monitoring-related books. Catalog available 25 cents.

DANDYS

120 North Washington
Wellington, KS 67152
Phone: 316 326-6314
Established: 1985; Employs 5
Key Employees: Norm, NIØS; Dana, NOFYQ.
Sells via showroom, hamfests, and mail order.
Top Lines: Ameritron, ARRL, Astron, Butternut, Kantronics, MFJ, RF Concepts, Radio Shack, TEN-TEC, Valor, AEA, Comet, Diamond and Larsen.
Accepts trade-ins.

De La Hunt Electronics

Highway 34E
Park Rapids, MN 56470
Phone: 218 732-3306
Top Line: ICOM.
Accepts trade-ins.

Dentronics

6102 Deland Road
Flushing, MI 48433
Phone: 810 659-1776; 800 722-5488
FAX: 810 659-1280
Established: 1978; Employs 4
Sells via showroom and mail order.
Key Employee: Dennis, WB8QWL; Mark, WA8VNZ; and Jim, WD8QPF.
Top Lines: Kantronics, AEA, MFJ, DRSI, R.F. Concepts, Pac Comm, Diamond, Sierra Computers, CD ROM and software.
Accepts trade-ins.

Doc's Communications

702 Chickamauga Avenue
Rossville, GA 30741
Phone: 706 866-2302; 706 861-5610
FAX: 706 866-6113
Established: 1975; Employs 6
Sells via showroom and mail order.
Key Employees: Maxine, N4ECA; Doc, KC4EV; John, WD4AQO; Pat; Jim and Darrel.
Top Lines: ICOM, Kenwood, Yaesu, MFJ, Larsen, Astron.
Accepts trade-ins.

Dealers

Dragon Distributing

411 Kansas City Avenue
Excelsior Springs, MO 64024
Phone: 816 630-6011

Durham Radio

(See Canada Listing)

E

Electric City Electronics, Inc.

521 Duanesburg Road
Schenectady, NY 12306
Phone: 518 356-7839;
Orders: 1 800 489-7839
Established: 1991; Employs 2
Sells via showroom and mail order.
Key Employees: Pete, WZ2X; Bill, N2UIE, Gary, WA2IQC.
Top Lines: Uniden, Cobra, Wilson, Ranger, Astatic, Cushcraft, ANLI, Valor, Firestik, Tripplite.
Accepts trade-ins and provides repairs.

Electronic Distributors Corp. (EOCO)

325 Mill St. NE
Vienna, VA 22180
Phone: 703 938-8105
FAX: 703 938-6911
Established: 1989; Employs 8
Sells through dealers.
Major Products: CREATIVE DESIGN log periodic antennas, roof top towers, rotators; DAIWA coax switches, SWR/PWR meters, duplexers, power supplies, amplifiers; DATONG audio filters; EMOTO rotators and accessories; NOVEX speaker mics, SWR/PWR meters, chargers; SIGMA disccone antenna.

El Original Electronics

1257 East Levee
Brownsville, TX 77520
Phone: 512 546-9846; 512 542-8507
Established: 1979; Employs 4
Sells via showroom.
Key Employee: Emilio, XE2XES.
Top Lines: Alinco, Azden, Kenwood, ICOM, Tempo, Yaesu, Regency, Uniden.

Electro-Comm

961 E.65th Street
Tacoma, WA 98404-2237
Phone: 206 473-9225; 800 821-9150
FAX: 206 473-9225
Established: 1984; Employs 3
Sells via showroom and mail order.
Key Employees: Joe, KA7DEX; Dick, WB7CRR.
Top Lines: Alinco radios, Larsen antennas, Mirage amplifiers, Astron Dower supplies.

Electronic Center, Inc.

2809 Ross Avenue
Dallas, TX 75201
Phone: 214 969-1936
Established: 1960; Employs 2
Sells via showroom, hamfest, and mail order.
Key Employees: Mike, WB5E; George, N5AXR; and Matt, KE5BJ.
Top Lines: Kenwood, ICOM, Yaesu, Rohn, Hustler, AEA, ARRL, Encomm, Larsen, M FJ, Mirage/KLM.
Accepts trade-ins and provides repairs.

Electronic Equipment Bank (EEB)

323 Mill Street NE
Vienna, VA 22180
Phone: 800 368-3270, 703 938-3350
FAX: 703 938-6911
Established: 1971; Employs 27
Sells via showroom and mail order.
Key Employees: Bob, K7RDH; Allen, KD4CGR; Dave, KE4TZ; Martha, N7KBG; and Ted, AA6GM.
Top Lines: ICOM, Sony, Kenwood, Yaesu, Panasonic, Sangean, AOR, Bearcat, Fairmate, Daiwa, Cushcraft, Antenna Specialists, Hustler, Create and EMOTO.
Accepts trade-ins and provides repairs.

Eleven Meter Communications

PO Box 3569
Poughkeepsie, NY 12603
Phone: 914 452-1614; 1 800 955-5960
Established: 1990
Sells via mail order.
Top Lines: Cobra, Uniden (Bearcat), Midland, Ranger, Regency, Maxon, Astatic, Para Dynamics, Antenna Specialists, JoGunn.
Accepts trade-ins.

Eli's Amateur Radio, Inc.

2513 SW Ninth Avenue
Ft. Lauderdale, FL 33315
Phone: 305 525-0103, 305 944-3383;
800 780-0103; FAX: 305 944-3383
Established: 1980; Employs 5
Sells via showroom and mail order.
Key Employees: Eli, M4BK; Al, N4AXQ; Jose, WT4G; and Len, AB4LV.
Top Lines: ICOM, Kenwood, Cushcraft, Hustler, AEA, Kantronics, Bird, DAIWA, MFJ, Antenna Specialists.
Accepts trade-ins and provides repairs.

Erickson Communications

5456 N. Milwaukee Avenue
Chicago, IL 60630
Phone: 800 621-5802; 312 631-5181
Established: 1969; Employs 4
Sells via showroom and mail order.
Key Employees: Vince, KA9ZDM; Verne, K9TMR; Scott, N9GLL; and Ron, N9VEB.
Top Lines: Kenwood, Yaesu, ICOM, Cushcraft, Hy-Gain, AEA, Kantronics, Nye-Viking, MFJ, Ten-Tec, Hustler.
Accepts trade-ins.

F

F & M Electronics

P.O. Box 21
Sale City, GA 31784-0021
Phone: 919 299-3437
Established: 1978; Employs 6
Sells via showroom and mail order.
Key Employees: Mae, KB4LMX; Frank, N4AZM.
Top Lines: ICOM, Ten-Tec, Bencher, Callbook, Ameco, MFJ, Antenna Specialists, Hustler, Lunar, Barker & Williamson, Alinco, Uniden, Alliance, Ranger, Wilson, Sangean, Butternut.
Accepts trade-ins and provides repairs.

First Call Communications (FCC)

3 Chestnut Street
Suffern, NY 10901
Phone: 800 426-8693, 914 357-7339
Top Line: US Towers.

G

G and G Electronics of Maryland

8524 Dakota Drive
Gaithersburg, MD 20877
Phone: 301 258-7373
Established: 1975; Employs 1
Sells via showroom and mail order.
Key Employee: Jeff, K3PUA
Accepts trade-ins and provides repairs.

Galaxy Electronics

PO Box 1202, 67 Eber Avenue
Akron, OH 44309
Phone: 216 376-2402
Established: 1982; Employs 6
Sells via mail order.
Key Employees: Robert, KA8VWR; Al, WD8KTR; Mary, Rose, Steve.
Top Lines: Uniden, AOR, Regency, Cobra, ICOM, Kenwood, Yaesu, Sony, Grundig, Sangean.
Accepts trade-ins.

Gilfer Shortwave

52 Park Avenue
Park Ridge, NJ 07656
Phone: 201 391-7887, 800 GILFER 1
Established: 1953; Employs 6
Sells via showroom and mail order.
Key Employee: Paul, N2HIE; and Tom, N2ONK.
Top Lines: Japan Radio Company, Datong, Dressler, Yaesu, Kenwood, Sony, Kantronics, CQ and ARRL Publications.

H

H.R. Electronics

722-24 Evanston Avenue
Muskegon, MI 49442
Phone: 616 722-2246
Established: 1978; Employs 3
Sells via showroom and mail order.
Key Employees: Russ, W8BXS; Sue, N8MMH; Allen.
Top Lines: Ten-Tec, ICOM, Alinco, Cushcraft, DAIWA, Hustler, Mirage/KLM, Van Gorden, Butternut, Rohn, B&W, Astron, Larsen, Spi-ro, MFJ, A/S, Grundig, ARRL, Callbooks, Bencher, Vibroplex, AEA.
Accepts trade-ins and provides repairs.

H.S.C. Electronic Supply

6819 Redwood Blvd.
Cotati, CA 94931
Phone: 707 792-2277; 707 792-2357
FAX: 707 792-0146
BBS: 707 527-7734 8N1 (300-2400)
Established: 1963; Employs 7
Sells via showroom and mail order.
Key Employee: George, KS6W.
Top Lines: MFJ, Larsen, Antenna Specialists, ARRL, Ameco, Call Books, software.

Ham Buerger, Inc.

417 Davisville Road
Willow Grove, PA 19090
Phone: 215 659-5900;
FAX: 215 659-5902
Established: 1956; Employs 6
Sells via showroom and mail order.
Key Employees: Jeff, WB3HOF; Bob, WA3ZID.
Top Lines: ICOM, Ten-Tec, MFJ, Astatic, Hustler, Antenna Specialist, Uniden Bearcat, B&W, W2AW Baluns, RF Concepts, Bencher, Larsen, Astron, Alliance Rotators, Sangean, LMB Boxes, Code Alarm, Crime Stopper, Chemtronics, Nutone, Ademco, Cushcraft.
Accepts trade-ins and provides repairs.

Ham Radio Outlet

933 N. Euclid Street
Anaheim, CA 92801
Phone: 800 854-6046;
Local: 714 533-7373
FAX: 714 533-9485
Established: 1971; Employs 15
Sells via showroom and mail order.
Key Employee: Janet, WA7WMB.
Top Lines: Kenwood, ICOM, Yaesu, Alinco, US Tower, RFC, Cushcraft, MFJ, Ameritron, Standard.
Accepts trade-ins and provides repairs.

Ham Radio Outlet

6071 Buford Highway
Atlanta, GA 30340
Phone: 404 263-0700; 800 444-7927
FAX: 404 263-9548
Established: 1971; Employs 9
Sells via showroom and mail order.
Key Employee: Mark, KJ4VO.
Top Lines: Kenwood, ICOM, Yaesu, Alinco, US Tower, RFC, Rohn, AEA, Cushcraft, Hy-Gain, Butternut, Ten-Tec, Bird.
Accepts trade-ins.

Ham Radio Outlet

2210 Livingston Street
Oakland, CA 94606
Phone: 415 534-5757, 800 854-6046
FAX: 415 534-0729
Established: 1971; Employs 4
Sells via showroom and mail order.
Key Employee: Rich, WA9WYB.
Top Lines: Kenwood, ICOM, Yaesu, US Tower, RFC, Rohn, AEA, Cushcraft, Hy-Gain, Butternut, Ten-Tec, Bird.
Accepts trade-ins.

Ham Radio Outlet

1702 W. Camelback Road, Suite 4
Phoenix, AZ 85015
Phone: 602 242-3515, 800 854-6046
FAX: 602 242-3481
Established: 1971; Employs 6
Sells via showroom and mail order.
Key Employee: Gary, WB7SLY.
Top Lines: Kenwood, ICOM, Yaesu, US Tower, RFC, Rohn, AEA, Cushcraft, Hy-Gain, Butternut, Ten-Tec, Bird.
Accepts trade-ins.

Dealers

Ham Radio Outlet

224 N. Broadway
Salem, NH 03079
Phone: 603 898-3750, 800 444-0047
FAX: 603 898-1041

Established: 1986; Employs 8
Sells via showroom and mail order.

Key Employee: Paul, NW1U
Top Lines: Kenwood, ICOM, Yaesu, Cushcraft, HyGain/Telex MFJ, Alinco, Ten-Tec, Rohn, Mosley, Mirage/KLM, Alliance, Kantronics, RF Concepts, TE Systems, Nye-Viking, Ameritron, AEA, Bird.

Ham Radio Outlet

5375 Kearny Villa Road
San Diego, CA 92123
Phone: 619 560-4900, 800 854-6046
FAX: 619 560-1705

Established: 1971; Employs 5
Sells via showroom and mail order.

Key Employee: Tom, KM6K.
Top Lines: Kenwood, ICOM, Yaesu, US Tower, RFC, Rohn, AEA, Cushcraft, Hy-Gain, Butternut, Ten-Tec, Bird.
Accepts trade-ins.

Ham Radio Outlet

6265 Sepulveda Blvd.
Van Nuys, CA 91411
Phone: 818 988-2212; 800 854-6046
FAX: 818 988-4326

Established: 1971; Employs 5
Sells via showroom and mail order.

Key Employee: Jon, KB6ZBI.
Top Lines: Kenwood, ICOM, Yaesu, US Tower, RFC, Rohn, AEA, Cushcraft, Hy-Gain, Butternut, Ten-Tec, Bird.
Accepts trade-ins.

Ham Radio Outlet

14803 Build America Drive, Bldg B
Woodbridge, VA 22191
Phone: 800 444-4799, 703 643-1063
FAX: 703 494-3679

Established: 1977; Employs 9
Sells via showroom and mail order.

Key Employee: Curtis, WB4KZL.
Top Lines: Kenwood, ICOM, Yaesu, Cushcraft, Telex/Hy-Gain, MFJ, Alinco, Ten-Tec, Rohn, Mosley, Mirage, Alliance, Kantronics, RF Concepts, TE Systems, Nye-Viking, Ameritron, AEA, Bird.
Accepts trade-ins and provides repairs.

Ham Station, Inc.

220 N. Fulton Avenue
Evansville, IN 47710
Phone: 800 729-4373, 812 422-0231
FAX: 812 422-4253

Established: 1979; Employs 6
Sells via showroom and mail order.

Key Employees: Dan, N9APA; Rick, WB9SAN; Russ, Ruth, and Jeff, KA9YKA.
Top Lines: ICOM, Yaesu, Ten-Tec, Hy-Gain, Cushcraft, Hustler, AEA, MFJ, Astron, Kenwood, Alinco, Alliance, Diamond, Heil, Ameritron, Comet, Standard, Larsen, RFC, Kantronics, Butternut, Daiwa.
Accepts trade-ins and provides repairs.

Hamtronics/Trevoze

4033 Brownsville Road
Trevoze, PA 19053
Phone: 215 357-1400
FAX: 215 355-8958

Established: 1954; Employs 11
Sells via showroom and mail order.

Key Employees: Dave, N3TS; Mike, KA3WVZ; Sam, N3DFV; Dave Jr., KA3BKG; Gene, WA3STW, Eva, WA3USJ; Marrion, WA3VEP; Jim, N3IIG.
Top Lines: Kenwood, Yaesu, ICOM, AEA, MFJ, Cushcraft, Hustler, Astron, Ten-Tec, JRC.
Accepts trade-ins and provides repairs.

Hardin Electronics

5635 E. Rosedale Street
Ft. Worth, TX 76112
Phone: 817 429-9761, 817 457-2200;
800 433-3203 FAX: 817 457-2429

Established: 1965; Employs 20
Sells via showroom and mail order.

Key Employees: Jane, WB5JYN; Richard, K5ZIM; Rick, N5QKB; Lee, N5RAT, and Beth, KB5N EH.
Top Lines: Kenwood, ICOM, Cushcraft, Kantronics, MFJ, Larsen, ANLI, Yaesu, Spiro, Diamond, Ameco.
Accepts trade-ins and provides repairs.

Hatry Electronics

500 Ledyard Street
Hartford, CT 06114
Phone: 203 296-1881
FAX: 203 296-7110

Established: 1928; Employs 20
Sells via showroom and mail order.

Key Employees: Lenny, WA1VPT; Spiro, KJ1R.
Top Lines: ICOM, MFJ, B&W, Alinco, Ameco, Sangean, Van Gorden, Cushcraft, Larsen, Hustler.
Accepts trade-ins.

Heaster, Inc., Harold

84 North Timber Creek Road
Ormond Beach, FL 32174
Phone: 904 672-2878

Established: 1984; Employs 4
Sells via showroom and mail order.

Key Employees: Harold, KE8MR; Barb, KA8RRD; Lewis, KC4DSQ; Jeff, KA8RRE.
Top Lines: Kenwood, ICOM, Tokyo Hy-Power, Larsen Antennas & Accessories.
Accepts trade-ins and provides repairs.

Henry Radio Inc.

2050 Bundy Drive
Los Angeles, CA 90025
Phone: 800 877-7979, 310 820-1234
FAX: 310 826-7790

Established: 1941; Employs 51
Sells via showroom.

Key Employees: Ray, WW6X; David, N6YGH; Paul, N6VLV; Leo, KJ6HI; Nate, K16IK; and Ted, W6Y6Y.
Top Lines: Kenwood, ICOM, Yaesu, Henry Amps, Tempo, Astron, Bird, Hy-Gain, Cushcraft, MFJ.
Accepts trade-in and provides repairs.

Hialeah Communications

801 Hialeah Drive
Hialeah, FL 33010
Phone: 305 885-9929; 305 888-5040
FAX: 305 888-8768

Established: 1978; Employs 13
Sells via showroom and mail order.

Key Employees: Sara, Juvenal, Glenn & Patrick.
Top Lines: Motorola, ICOM, Kenwood, Yaesu, Mirage/KLM, CES, Larsen, Hustler, Cushcraft, Decibel, Bird, MFJ, Hy-Gain and all major brands.
Provides repairs.

Highway 155 CB Shop

18888 State Highway 155 South
Flint, TX 75762
Phone: 800 582-0426; 903 825-2070

Hirsch Sales Corporation

219 California Drive
Williamsville, NY 14221
Phone: 716 632-1189; 716 634-0634,
FAX: 716 632-6304

Established: 1961; Employs 12
Sells via showroom and mail order.

Key Employees: Jerry, WA2ZFA; Joe, N2FEO; Rick; Mike, Ken and Tom.
Top Lines: All popular brands stocked.
Accepts trade-ins and provides repairs.

Honolulu Electronics

870 Kawaiahao Street
Honolulu, HI 96813-5208
Phone: 808 949-5564, 808 949-5565
FAX: 808 949-1209

Established 1932; Employs 20
Sells via showroom and mail order.

Key Employees: Tom, KH6BM; Richard, AH610; Dennis, Melvin.
Top Lines: Kenwood, ICOM, Yaesu, Tri-Ex Towers, Belden Cables, Eimac Tubes, Alexander Nicad Batteries, Astron Power Supplies, KLM Antennas, AEA, Hy-Gain, MFJ, Cushcraft, Larsen, Fluke Meters, Maxrad Antennas
Provides repairs.

Hooper Electronics

1702 Pass Road
Biloxi, MS 39531
Phone: 601 432-1100; 601 432-0584
FAX: 601 432-7651

Established: 1960; Employs 110
Sells via showroom and mail order.

Key Employees: Dave, WB5KDV; Bill, W5WWJ; Joyce, WB5LKC; Wayne, KB5JCI.

Top Lines: ICOM, Kenwood, AEA, MFJ, Cushcraft, Hustler, Astron, Bird, Larsen. Antenna Specialist.

Accepts trade-ins.
Branch: 1700 Terry Road
Jackson, MS 38204

Phone: 601 353-0922, 601 354-4531
FAX: 601 948-3807

Key Employee: Dave Anderson, WB5KDV

International Radio & Computer

3804 South US #1
Fort Pierce, FL 34982-6620
Phone: 407 489-5609;
FAX: 407 464-6386

Established: 1979; Employs 5
Sells via showroom and mail order.

Top Lines: IRLCI and Fox Tango Crystal Filters, Icom, Kenwood, Yaesu Newsletters, Original Kits/ modifications, Authorized Kenwood Service Center.
Accepts Trade-ins.

J-Com

PO Box
194 Ben Lomond, CA 95005
Phone: 408 335-9120;
FAX: 408 335-9121

Established: 1990; Employs 3
Sells via mail order.

Key Employees: Peter, VE3SUN; and Susan, WA60CV
Top Lines: Magicnotch Ventriloquist, Hambase, Stealth Antennas, Personal Autopatch.
Provides repairs.

J.R.S. Distributors, Inc.

646 W. Market Street
York, PA 17404
Phone: 717 854-8624;
1 800 JRS-HAM-1
FAX: 717 854-8624

Established: 1925; Employs 4
Sells via showroom and mail order.

Key Employees: Jim, K3JFL; Jean, K30AU; and Jimmy, N3KWZ.
Top Lines: Kenwood, ICOM, Yaesu, Alinco, AEA, Bencher, Cushcraft, B&W, Butternut, Larsen, Nye-Viking, MFJ, Astron, ARRL Publications.
Provides repairs.

Jeremy Communications

169 Jeremy Hill Road
Pelham, NH 03076
Phone: 603 635-3048
Established: 1989; Employs 2

Sells via mail order.
Key Employee: Carl, KM1 H.

Top Lines: B&W, LMB, Hammond, JW Miller, Cardwell, Jackson Brothers, Micrometals, Orion Rotators, Rohn Towers, Van Gorden, Eimac and Penta tubes, International Wire, Radio Kit plate and filament transformers, QRP Kits.
Provides HF amplifier repairs.

Jones, G.E. Electronics

PO Box 467
Buckeye Lake, OH 43008-0467
Phone: 614 928-8961

K

KComm, Inc.

5730 Mobud
San Antonio, TX 78238
Phone: 512 680-6110, 1 800 344-3144
Established: 1988; Employs 12

Sells via showroom and mail order.
Key Employees: Craig, KB5BI; Gary, WD5DUL, Ed, K5SV, Oscar, AA5DB.
Top Lines: Kenwood, Yaesu, ICOM, Alinco, Cushcraft, Hustler, Mirage, AEA, Kantronics, DAIWA, Genesys.
Accepts trade-ins and provides repairs.

Dealers



L

LaRue Electronics

1112 Grandview Street
Scranton, PA 18509
Phone: 717 343-2124
Established: 1976; Employs 3
Sells via showroom and mail order.
Key Employees: Gene, K3HAM; Les, W3LPZ.
Top Lines: ICOM, Cushcraft, Bird, Astron, Amphenol, Belden, Larsen, Alpha Delta, AEA, Beckman, Weller/Xcelite.
Provides repairs.

Lentini Communications

21 Garfield Street
Newington, CT 06111
Phone: 203 666-6227; 800 666-0908
FAX: 203 667-3561
Established: 1954; Employs 8
Sells via showroom and mail order.
Key Employees: Alex, N1EBU; Mike, W1VLA; Martin, N1FOC; Bill, N1JBS; Jim, N1JYH.
Top Lines: Yaesu, ICOM, Alinco, Standard, MFJ, Diamond, Cushcraft, Astron, AEA, Sony, Sangean, Kenwood, Comet, Kantronics.
Accepts trade-ins and provides repairs.

Lindsay Publications, Inc.

PO Box 12
Bradley, IL 60915
Phone: 815 468-3668

Longs Electronics

2630 South Fifth Avenue
Irondale, AL 35210
Phone: 800 633-3410; 800 292-8668
Established: 1971
Sells via showroom and direct mail.
Key Employees: Erich, KD4GUQ; Clay, KD4GVK; Charles, KD4GUS; John, KD4GUU; Ricky, KA4LIA; Karen, KD4GVH; Steve, KD4GUZ; Tracy, KD4GVB.
Top Lines: Kenwood, ICOM, MFJ, Cushcraft, Hy-Gain, Ameritron, Uniden, Rohn Towers, Sony, Panasonic, Simpson, B&K, Maxon, Hakko.

Loveland CB

329 East 5th Street, #2
Loveland, CO 80537
Phone: 970 667-9527

M

Madison Electronics

12310 Zavalla Street
Houston, TX 77085
Phone: 713 729-7300, 800 231-3057
FAX: 713 358-0051
Established: 1956; Employs 10
Sells via mail order.
Key Employees: Max, W5GJ; Don, K5MD; Jim, N5DC, Ken, K5YCP; and Dave, N5LHA.
Top Lines: Kenwood, ICOM, Belden, Bird, Amphenol, B&W, industrial surplus.
Accepts trade-ins.

Marine Electronics, Inc.

Route 33, Box 160
Hartfield, VA 23071
Sales: 800 654-9251
Tech: 804 776-9500
Established: 1977; Employs 18
Sells via showroom and mail order.
Key Employees: Howard Rock III, WA4UBZ, Kim Blake, and Kevin Fay.
Top Lines: Motorola, Magnavox, Furuno, Trimble, SEA, ICOM Marine.
Accepts trade-ins and provides repairs.
Branch: 5760 Northampton Blvd. Suite 110
Virginia Beach, VA 23455
Phone: 804 363-2002
Sales: 800 344-6388
Key People: Lynn Gardiner, Bryan Finkel.
Branch: Annapolis Marine Electronics 303B Second Street Annapolis, MD 20403

Maryland Radio Center

8576 Laureldale Drive
Laurel, MD 20707
Phone: 301 725-1212, 800 447-7489;
FAX: 301 725-1198
Established: 1986; Employs 9
Sells via showroom.
Key Employees: Jerry, WA3WZF; Steve, KD3EH; Mike, WA8MCQ; Ike, WB3LRM; John, N3FNG.
Top Lines: Kenwood, Ten Tec, ICOM.
Accepts trade-ins and provides repairs.

MaryMac Industries, Inc.

Radio Shack Dealer
22511 Katy Freeway
Katy, TX 77450
Phone: 713 392-0747; Orders: 1 800 231-3680
Sells via showroom and mail order.
Key Employees: Joe and Richard.

McCarthy, N6C10, Loraine

2775 Mesa Verde Dr. E., Ste E101
Costa Mesa, CA 92626
Phone: 714 979-CODE
Established: 1979; Employs 3
Sells via showroom and mail order.
Key Employee: Loraine, N6C10.
Top Lines: Gordon West Radio School training materials, ARRL training materials, AMECO material.

McClaran Sales, Inc.

PO Box 2513
Vero Beach, FL 32961
Phone: 407 778-7584
Established: 1977; Employs 2
Sells via mail order.
Key Employees: Bob, W4ZGG; Lolly.
Top Lines: "Aluma" crank-up towers, mobile van towers, trailer towers, G.A.P. verticals, G.A.P. beams, phone identifiers.
Accepts trade-ins.

Medicine Man CB

PO Box 37
Clarksville, AR 72830
Phone: 501 754-2076
Established: 1980
Sells via mail order.
Key Employee: J.L. Richardson
Major Line: Books

Memphis Amateur Electronics, Inc.

1465 Wells Station Road
Memphis, TN 38108
Phone: 800 238-6168; 901 683-9125
Established: 1966; Employs 8
Sells via showroom and mail order.
Key Employees: Bill, W4TNP; Marshall, KU40; Stan, W4RMW; Ken, W4UFH.
Top Lines: Kenwood, ICOM, Ten-Tec, MFJ, Butternut, Cushcraft, Hustler, Larsen, Grundig, Van Gorden, Astron, Hy-Gain.
Accepts trade-ins and provides repairs.

Miami Radio Center Corp.

5590 W. Flagler Street
Miami, FL 33134
Phone: 305 264-8406
Established: 1980; Employs 6
Sells via showroom.
Key Employees: Mario, KC4DLP; Esteban, KC4DWJ; Jimi.
Top Lines: ICOM, Kenwood, Yaesu, Motorola, Azden, Tempo, Uniden Scanners, Cobra, Citizen Band, Bird, Cushcraft.
Provides repairs.

Michigan Radio

23040 Shoenherr
Warren, MI 48089
Phone: 313 771-4711; 800 878-4266;
Service: 313 771-4712
FAX: 313 771-6546
Established: 1980; Employs 6
Sells via showroom and mail order.
Key Employees: Dave, M8DH; Chris, N8FZT; Jerry, W8MR; Tom, KA8LSW.
Top Lines: ICOM, Yaesu, Kenwood, Alinco, Cushcraft, DAIWA, AEA, Sangean, Vibroplex, Ten-Tec.
Accepts trade-ins and provides repairs.

Mike's Electronics

1001 NW 52nd Street
Ft. Lauderdale, FL 33309
Phone: 305 491-7110;
FAX: 305 491-7011
Established: 1980; Employs 3
Sells via showroom and mail order.
Key Employees: Walt, KN4SL; Mike, WB4RFC.
Top Lines: ICOM, Sony, Rohn, Astron, Yaesu, Cushcraft, Hustler, AEA, Kantronics, MFJ, Comet.
Accepts trade-ins.

N

N & G Electronics Corp.

1950 NW 94th Avenue
Miami, FL 33126
Phone: 305 592-9685;
FAX: 305 592-2330
Established: 1975; Employs 10
Top Lines: Heathkit, ICOM, Kenwood, Yaesu, Interconnect Spec., Astron, Hy-Gain, Cushcraft, AEA, C.E.S., Hustler, and many more.
Provides repairs.

National Tower Company

PO Box 15417
Shawnee Mission, KS 66215
Phone: 913 888-8864

North American Radio

719 Grafton Street
Shrewsbury, MA 01545
Phone: 508 799-5516

O

Oklahoma Comm Center

9500 Cedar Lake Avenue., Suite 100
Oklahoma City, OK 73114
Phone: 405 478-2866; 800 765-4267
FAX: 405 478-4202
Sells via showroom and mail order.
Key Employees: Craig, WE51; Glen, WN5J; Jim, KA5PSF; Rod, N5QKK.
Top Lines: ICOM, Ten-Tec, Yaesu, Kantronics, Cushcraft, TelexHy-Gain, Hustler, Diamond.

Omar Electronics

2130 GA Hwy. 81 SW
Loganville, GA 30249
Phone: 404 466-3241, 404 466-1952
FAX: 404 466-9013
Established: 1974; Employs 4
Sells via showroom and mail order.
Key Employees: Omar, WA8FON; Mark, N4YHM.
Top Lines: MFJ, Alinco, ARRL-connectors, AEA, Drake, Kantronics.
Accepts trade-ins.

Omega Electronics

101-D Railroad Street
PO Box 579
Knightdale, NC 27545
Phone: 919 266-7373
FAX: 919 250-0073
Established: 1988; Employs 3
Sells via showroom and mail order.
Key Employee: Bill, K4BWC; Sherry, KB4EXL.
Top Lines: Ten-Tec, JPS, COM, Centurion, Maxrad, Omega Antennas, Jolida (Penta), Peter Dahl, consignment sales.
Provides amplifier repair.

Omni Electronics

1007 San Dario
Laredo, TX 78040
Phone: 512 722-5195, 512 722-6664,
1 800 827-6664; FAX: 512 722-8184
Established: 1984; Employs 8
Sells via showroom and mail order.
Key Employee: Eduardo, XE2HHC.
Top Lines: Alinco, ICOM, Kenwood, Yaesu, Antenna Specialists, Tempo, CES, CSI, Astron, Azden, Centurion, Hustler, Trip-Lite, Standard, Max Rad, Solarex.
Provides repairs.

P

Phillips-Tech Electronics

5420 E. Sahuro Drive
Scottsdale, AZ 85252
Phone: 602-947-7700
Top Lines: Wireless cable, amateur television, and microwave television antennas.

Portland Radio Supply

234 SE Grand Avenue
Portland, OR 97214-1115
Phone: 503 233-4904
Established: 1932; Employs 5
Sells via showroom and mail order.
Key Employees: Ken, WR7D; Stan, WB70KN; Jesse, KB7LPO; Stephanie.
Top Lines: ICOM, Kenwood, Yaesu, Rohn, Astron, Larsen, Hustler, B&W, ARRL, RF Concepts, MFJ.
Accepts trade-ins and provides repairs.

Dealers

Q

Quement Electronics

1000 S. Bascom Avenue
San Jose, CA 95128
Phone: 408 998-5900.
FAX: 408 292-9920
Established: 1933
Sells via showroom and mail order.
Top Lines: ICOM, Yaesu, Larsen, Cushcraft, Telex/Hy-Gain, MFJ, Alpha Delta, B&W, Butternut, Rohn, Alinco.

R

R&R Communications, Inc.

2312 Carpenter Road
Wilmington, DE 19810
Phone: 302 475-1351
Established: 1968; Employs 4
Sells via showroom and mail order.
Key Employees: Russ Prince, Dustin P. Clea P.
Top Lines: Cobra, Uniden, Bearcat, Midland, Ranger Comm., Galaxy, Sadelta, BelTronics, Maxon, Wilson.
Provides repairs.

R.F. Connection, The

213 N. Frederick Ave. Suite 11
Gaithersburg, MD 20877
Phone: 301 840-5477; 800 783-2666
FAX: 301 869-3680
Established: 1979; Employs 3
Sells via showroom and mail order.
Key Employee: Joel, KA3QPG; Don.
Top Lines: RF connectors and coax.

R.F. Enterprises

HCR Box 43
Merrifield, MN 56465
Phone: 218 765-3254; 800 233-2482
FAX: 218 765-3308
Established: 1982; Employs 7
Sells via showroom and mail/telephone order.
Key Employees: George, AD0S; Ralph, K01R.
Top Lines: Yaesu, Ten-Tec, Rohn, Cushcraft, Mirage/KLM, Butternut, Hustler, MFJ, Kantronics, ICOM, Heath, Alinco, AEA, Telex/HyGain, Ameritron, Belden, Andrew, Amphenol, Astron, Heil, Diamond and Alpha Delta.
Accepts trade-ins and provides repairs.

R & L Electronics

1315 Maple Avenue
Hamilton, OH 45011
Phone: 800 221-7735; 513 868-6399
FAX: 513 868-6574
Established: 1980; Employs 18
Sells via showroom and mail order.
Key Employees: Larry, N8CHL; Rita, WD8POC; Troy, N8ASZ; Roger, N8EKG.
Top Lines: Yaesu, Kenwood, ICOM, MFJ, TenTec, Rohn, AEA, DAIWA, Cushcraft, Hustler.
Accepts trade-ins.
Branch: 8524 E. Washington St.
Indianapolis, IN 46219
Phone: 800 524-4889; 317 897-7362
FAX: 317 898-3027.

Radio Bookstore

P.O. Box 209
Rindge, NH 03461-0209
Phone: 800 457-7373; 603 899-6957;
FAX: 603 899-6826
Established: 1970; Employs 2
Sells via mail order and phone sales.
Key Employee: J. Craig Clark, Jr.
Top Lines: ARRL, SAMS, CQ, Tiare, McGraw Hill, W5Y1, Gordon West, Artsci, Grove, Universal.

Radio Center

525 E. 70th Ave Suite 1W
Denver, CO 80229
Phone: 800 227-7373; 303 288-7373
Established: 1984; Employs 4
Sells via showroom and mail order.
Key Employees: Craig, KM0Q; Joel, KJ01.
Top Lines: Kenwood, Yaesu, ICOM, AEA, MFJ, Alinco, Astron.
Accepts trade-ins and provides repairs.

Radio Center USA

630 N.W. Englewood Road
Kansas City, MO 64110-3473
Phone: 800 821-7323; 816 741-8118
Established: 1980; Employs 9
Sells via showroom and mail order.
Key Employees: Larry, W0YY; Bill,
Top Lines: Kenwood, Yaesu, ICOM, AEA, MFJ, Hy-Gain, Cushcraft, Butternut, Kantronics, RF Concepts.
Accepts trade-ins and provides repairs.

Radio City, Inc.

2663 Country Road I
Minneapolis, MN 55112
Phone: 800 426-2891, 612 786-4475
Established: 1986; Employs 10
Sells via showroom and mail order.
Key Employees: Dan, KB0XC; Louis, KA01PN; John, N01SL; Quent, N0ZJZ; Jim, KB0JZF; Maline, Denise, Dorothy, KB0JPS.
Top Lines: Yaesu, MFJ, Butternut, Larsen, Spi-Ro, ICOM, AEA, Kantronics, Astron, Vibroplex, Bencher, Cushcraft, Daiwa, Sony, Panasonic, Kenwood, Alinco, cable and connectors.
Accepts trade-ins and provides repairs.

Radio City Communications

55 East Main Street, Route 6
Terryville, CT 06798
Phone: 203-585-9751

Radio Communications

Box 212
Royal Oak, MI 48068-3308
Phone: 800 551-1955;
FAX: 810 546-2010
Established: 1971; Employs 4
Sells via showroom and mail order.
Key Employees: Gil, K8COM; Gloria, Jason and Paul, Jr.
Top Lines: Kenwood, Larsen, Uniden, Comet, Butternut, Hustler, NYE-Viking, Callbook, Universal Tower.
Accepts trade-ins and provides repairs.

Radio Comm. of Charleston, Inc.

102 Farm Road
Goose Creek, SC 29445
Phone: 803 553-4101;
FAX: 803 553-3564

Radio Place, The

5675A Power Inn Road
Sacramento, CA 95824
Phone: 916 387-0730;
FAX: 916 387-0744
Established: 1976; Employs 6
Sells via showroom and mail order.
Key Employees: Glenn, WR60; Paul, KA6MHT; Roger, WD6CLZ; Craig, N6YUV; and Steve, KB6VVF.
Top Lines: Cobra, Uniden, Firestick, K40, Wilson, Yaesu, Alinco, Sony, Grundig, Sangean, AEA, AOR.
Accepts trade-ins and provides repairs.

RadioWare

P.O. Box 1478
Westford, MA 01886
Phone: 800 950-9273; 508 452-5555
Established: 1992; Employs 4
Sells via mail order.
Key Employee: John, WA1KYH
Top Lines: Radioware, Flex-Weave™, Davis RF wire and cable, Austin, M2 Enterprises, Daiwa, Palomar, Unadilla, ICE, Timewave.

Radio Wholesale Marketing

3132 Mercury Drive
Columbus, GA 31906
Phone: 706 561-7000;
FAX: 706 568-4504
Established: 1974; Employs 15
Key Employee: John, WB4JUN.
Top Lines: Motorola, Maxon, Kenwood.
Accepts trade-ins and provides repairs.

Radio Works

PO Box 6159
Portsmouth, VA 23703
Phone: 804 484-0140
Established: 1984; Employs 4
Sells via mail order.
Key Employees: Jim, W4TH U; Judy.
Top Lines: MFJ, B&W, Heil, Metz, ARRL and Radio Publications books, Spi-Ro, Ameco, Alpha-Delta, ProAm, Van Gorden, Smiley.

Rivendell Electronics

8 Londonderry Road
Derry, NH 03038
Phone: 603 434-5371;
FAX: 603 432-3674
Established 1982; Employs 5
Sells via showroom and mail order.
Key Employees: Joe, KC1D; Peter, KI1M; Nancy, N1CXC; Herb, AK1V; Rob, N1ORI.
Top Lines: ICOM, AEA, Astron, B&W, Cushcraft, Larsen, MFJ, Rohn, Bencher, Alinco.
Accepts trade-ins and provides repairs.

Rogus Electronics

250 Meriden-Waterbury Turnpike
Southington, CT 06489
Phone: 203 621-2252
Established: 1979
Key Employees: John, WA1JKR; Frank, W1FD; Joe, N1ECB; Jan, KA1NXX.
Sells via showroom and mail order.
Top Lines: Rohn Towers, Alinco, Kantronics, MFJ, Cushcraft, Butternut, B&W, Diamond, Comtelco, ProAm, Ameritron and Astron.

Rosen's Electronics, Inc.

104 E. 2nd Avenue
Williamson, WV 25661
Phone: 304 235-3677;
FAX: 304 235-8038
Established: 1980; Employs 2
Sells via showroom and mail order.
Key Employees: Larry, WR8M; and Liz, KB8GDG.
Top Lines: MFJ, Tandy Computers, Relm & Shinwa.
Accepts trade-ins and provides repairs.

Ross Distributing, Co.

78 S. State Street
Preston, ID 83263
Phone: 208 852-0830, 208 852-0832
FAX: 208 852-0833
Established: 1952; Employs 7
Sells via showroom and mail order.
Key Employees: Ross, WB7BYZ; Karen, KA7BLB; Kathy, Gae, Shannon, Randon, and Wally.
Top Lines: Kenwood, ICOM, Yaesu, AEA, Larsen, Kantronics, Cushcraft, Telex, MFJ, Astron, Butternut.
Accepts trade-ins and provides repairs.

S

S.B.H. Enterprises

1678 53rd Street
Brooklyn, NY 11204
Phone: 718 438-1027
Sells via mail order.
Top Lines: Bearcat, Sony, and Uniden.

Scanner World USA

10 New Scotland Avenue
Albany, NY 12208
Phone: 518 436-9606

Scan Communications Co.

PO Box 911
Burlington, IA 52601-0911
Phone: 319 752-3000;
Orders: 800 SAV-SCAN
Established: 1983; Employs 4
Sells via mail order.
Key Employees: Chuck Gysi, N2DUP and Janet, KA0TPA
Top Lines: AOR, Uniden, Icom, Yaesu, Kenwood, Ritron, Alinco and commercial radios and antennas.

Slep Electronics

P.O. Box 100
Otto, NC 28763-0100
Phone: 704 524-7519
Established: 1955; Employs 6
Sells via mail order and world-wide export.
Key Employee: Bill, W4FHY.
Top Lines: Astron, Ten-Tec, ICOM, Collins, military surplus radios and test equipment, technical manuals, surplus parts, antique and Early American radios.
Accepts trade-ins and provides repairs.

Soundnorth Electronics

1802 Highway 53
International Falls, MN 56679
Phone: 218 283-9290, 800 932-3337
Established: 1976; Employs 7
Sells via showroom and mail order.
Key Employees: Terry, WV0G; Gale, WV0O; Dan, WZ0A; Jami, WY0D; Mike, KB0DXW.
Top Lines: Alinco, DAIWA, NCG, Valor, ANTECO, Maxrad, JRC, T.E. Systems Amps, MFJ and all used gear.
Accepts trade-ins and provides repairs.

Helpful Hints

Before returning your handheld CB to the dealer or manufacturer for service, always be sure to check the batteries. Too many times radios are returned, when the cause of the problem was dead or improperly charged batteries. Other common "problems" include improperly set RF gain and squelch controls, and poor antenna connections.

Did you know that you can hear stations hundreds and often thousands of miles away on your scanner? With a little patience and a good outside discone antenna, you'll hear "skip" from around the world.

It's always a good idea to listen before you talk, so why not take some time to tune across the CB channels, listening for local activity. Then, when you learn the ropes, you'll be surprised the friends you'll make who share your same interests.

Always remember to observe safety precautions and common sense when putting up ANY antenna. Keep it away from power lines! ALWAYS do a basic site survey first to ensure, among other things, if the antenna falls, it won't touch power lines. While you're putting up that new antenna, keep your coax cable runs as short as possible to cut down on loss.

Remember the Golden Rule when using your CB radio; keep channel 9 open for emergency and assistance communications. If you want to be a big help to your local public safety officials, consider joining OR STARTING a group of channel 9 monitors that listens for emergency assistance calls. Tying up channel 9 for idle chit-chat, or using illegal power amplifiers can cost lives. Someday YOU could be the person who needs assistance on the nation's only emergency frequency!

Are you after increased range and more "talk power" on the CB band? Why not consider buying a beam antenna and rotor assembly? It's legal, and it's lots of fun talking to another CBER with your legal CB radio, knowing you're pumping out the equivalent of big watts in a pinpoint signal. Another excellent way of getting more "talk power" is to invest (it really isn't THAT much more money) in a SSB CB.

Concerned about losing your CB to theft? Get a slide-mount assembly for your vehicle. One part attaches to your radio, the other bracket attaches to your vehicle; complete with all connections. When you leave the vehicle, simply slide out your radio and take it with you or put it in the trunk.

It's a good idea to buy an SWR meter and install it in-line between your CB and antenna. At the flick of a switch you'll be able to tell the condition of your antenna system.

If you're hunting, backpacking, hiking, biking or simply like to stay in touch while walking around your neighborhood, get a CB walkie-talkie. They're small, inexpensive and there's no air-time charge.

Use your mobile CB as a base station. It's as easy as installing a base antenna and using a DC power supply to convert the household AC power to DC used by your mobile rig. Remember to observe correct polarity when hooking up the power cords.

Steer clear of linear amplifiers. Not only are they illegal, but their use ruins communications for other users. Save your money and stay legal.

Dealers



Spectronics Inc.

1009 Garfield Street
Oak Park, IL 60304
Phone: 708 848-6777
FAX: 708 848-3398
Established: 1967; Employs 5
Sells via showroom and mail order.
Top Lines: Standard, Maxon, and used commercial 2-way equipment.

Sports Comm. Dist.

P.O. Box 36
Scotts Mills, OR 97375
Phone: 800-573-2256
FAX: 503-873-2051
Sells via mail order
Top Lines: Icom, Uniden, Maxon, Maxrad.

Stewart Electronics, Inc.

1411C First Capital Drive
St. Charles, MO 63303
Phone: 314 949-8890

Surplus Sales of Nebraska

1315 Jones Street
Omaha, NE 68102
Phone: 402 346-4750;
FAX: 402 346-2939
Established: 1978 Employs 3
Sells via showroom and mail order.
Key Employee: Bob, WD0FDE.
Top Lines: B&W, RF transmitting components, connectors, Collins parts, AEA, Jackson Brothers, MicroMetals.

Systems And Software, International, Ltd.

4639 Timber Ridge Drive
Dumfries, VA 22026-1059
Phone: 703 680-3559; 703 878-1460
Established: 1985; Employs 5
Sells via mail order.
Key Employees: Watts Hill, KC4WVM; Mike McClure, K4ALG; Shirley Hill.
Top Lines: RCSSTM Software; Seeker™ Receiver, DTI Direct Finding Systems.

T

Ten-Tec, Inc.

1185 Dolly Parton Parkway
Sevierville, TN 37862
Phone: 800 833-7373; 615 453-7172
Established: 1968; Employs 100
Sells via showroom and mail order.
Key Employees: Eric, AC4LS and Paul, WD4EBR.
Accepts trade-ins and provides repairs.

Texas Towers

1108 Summit Avenue Ste. 4
Plano, TX 75074
Phone: 800 272-3467; 214 422-7306
FAX: 214 881-0776
Established: 1976; Employs 6
Sells via showroom and mail order.
Key Employees: Gerald, K5GW; Matt, N5VQT; Neil, M6TR.
Top Lines: Kenwood, ICOM, Yaesu, US Towers, Rohn, Telex/Hy-Gain, Cushcraft, Mirage/ KLM, Butternut, Astron, AEA, Ameritron, MFJ, Kantronics, RF Concepts.

Tiare Publications

P.O. Box 493
Lake Geneva, WI 53147
Phone: 414 248-4845
Established: 1986
Sells via mail order.
Key Employees: Gerry L. Dexter
Top Lines: books relating to SWLing, ham radio, and scanner/satellite monitoring.

Tranrel Technologies/LJ Electronic Inc.

123 E. South Street
Harveysburg, OH 45032
Phone: 800 829-8321; 513 897-3442
Established: 1981; Employs 5
Sells via showroom and mail order.
Key Employees: Darrell, N801B; and Charles, KB8RQF.
Top Lines: Tranrel Tech., Tranrel Corp., Centurion, Pack-It.
Accepts trade-ins and provides repairs.

Tucker Electronics

1717 Reserve Street
Garland, TX 75042
Phone: 800 527-4642; 214-348-8800;
FAX: 214 348-0367
Sells via showroom and mail order.
Top Lines: AEA, ANLI, AOR, Alinco, Astron, Bearcat, Create, DRSI, Daiwa, Datong, EDCO, EMOTO, Grundig, Heil Sound, Hustler, ICOM, JIM, JPS, MFJ, Novex, Tucker, Sangean, Sigma, Sony, and others. Also, test equipment.

U

USRadio

377 Plaza
Granbury, TX 760048
Phone: 1-800-433-7283 (SAVE)
Established: 1981
Sells via mail order
Top Line: Radio Shack scanners and radios.

U.S. Scanner Publications

Portland Radio Supply
234 S.E. Grand Avenue
Portland, OR 97214
Phone: 503 233-4904

Universal Radio Inc.

6830 Americana Parkway
Reynoldsburg, OH 43068
Phone: 614 866-4267; 800 431-3939
FAX: 614 866-2339
Established: 1942; Employs 18
Sells via showroom and mail order.
Key Employees: Steve, N18F; Fred, N8EKU; Sam, N8JYV; Dave, N8FVL; Scott, KB2ARL; Jim, KC8XZ; Jerry, N8XMV.
Top Lines: Kenwood, ICOM, Yaesu, Japan Radio, AEA, Kantronics, Sony, Alinco, Standard, Drake, MFJ, Cushcraft, Larsen, Sangean, Lowe, JPS, Vectronics, Diamond, Ameritron & Uniden.
Accepts trade-ins and provides repairs.

Dealers



V

VHF Communications

280 Tiffany Avenue
Jamestown, NY 14701
Phone: 716 664-6345
800 752-8813 (orders only)
FAX: 716 487-0310
Established: 1971

Sells via showroom, mail order and hamfests.

Key Employees: Gary, W2UCZ; Loretta.
Top Lines: ICOM, Unadilla, AEA, Van Gorden, Nye-Viking, Hamtronics, Leading Edge, RFCConcepts, ACE Systems, ARRL, Larsen, Kantronics
Accepts trade-ins and provides repairs.

Valley Radio Center

1522 N. 77 Sunshine Strip
Harlingen, TX 78550
Phone: 210 423-6407; 800 869-6439
FAX: 210 423-1705

Established: 1959; Employs 8

Sells via showroom and mail order.

Key Employees: Bob, WD5KBZ; Rick, WD5ADC.

Top Lines: Kenwood, ICOM, Yaesu, Motorola, Larsen, Astron, Hustler, ARRL, CES, Connect Systems, B&W, AEA, Cushcraft.

Accepts trade-ins and provides repairs.

Van Valzah Company, H.C.

1140 Hickory Trail
Downers Grove, IL 60515
Phone: 708 852-0472; Orders: 800 HAM-0073 FAX: 708 852-1469; Tech line: 708 852-1469

Established: 1981; Employs 3

Sells via mail order.

Key Employees: Howard, WB91PG; Casey, Susan.

Top Lines: Cushcraft, Hustler, Antenna Specialists, Mobile Mark, Butternut, Alpha Delta, B&W.

W

W5YI Group, Inc.

2000 E. Randol Mill Road, Suite 608-A
Arlington, TX 76011

Phone: 817 461-6443, 817 274-0400, 800 669-9594; FAX: 817 548-9594

Established: 1979; Employs 10

Sells via mail order.

Key Employees: Fred, W5YI; Joe, AA5LD; Susan, N41EC; Stew, AA5LX; Steve, NS51, Arlene, N5YLT.

Top Lines: Amateur Radio Operator License Preparation material, code tapes, study manuals, educational ham software, video ham courses, part 97 rulebooks, etc.

Williams Radio Sales

600 Lakedale Road
Coffax, NC 27235

Phone: 919 993-5881

Established: 1974; Employs 3

Sells via showroom, hamfests and mail order.

Key Employees: Wayne, K4MOB; Gerry, KB4SEL; and Chris, KE4FUP.

Top Lines: Alinco, Larsen, Hustler, Pyramid, Callbook, and ARRL books.
Accepts trade-ins.

The Wireman, Inc. (Certified Communications)

261 Pittman Road
Landrum, SC 29356
Phone: 800 727-WIRE, 803 895-4195
FAX: 803 895-5811

Established: 1975; Employs 8

Sells via mail order.

Key Employee: Press, N8UG.

Top Lines: Wire & cable, wire antennas and accessories, baluns, kits, noise bridges, and *The Wirebook*.

Provides technical assistance.

Canada

Atlantic Ham Radio, Ltd.

368 Wilson Avenue
Downsview, ONT M3H 1S9

Phone: 416 636-3636

FAX: 416 631-0747

Established: 1979; Employs 14

Sells via showroom and mail order.

Key Employees: Lutz; Mike, VA3MW; Nick, VE3SEC; Mario, VE2MBZ; Howard, VE2HNL; and Alan, VE3XAG.

Top Lines: Kenwood, ICOM, Yaesu, Sony, JRC, AEA, Kantronics, Hy-Gain, Cushcraft, MFJ, Grundig, Panasonic, Uniden-Bearcat, Yupiteru, AOR.

Accepts trade-ins and provides repairs.

Com-West Radio Systems, Ltd.

8179 Main Street
Vancouver, BC V5X 3L2

Phone: 604 321-3200;

FAX: 604 321-6560

Sells via showroom and mail order.

Key Employees: Ron, VE7XR; Bill, VE7CIM; Michael, VE7CIP; Fred, VE7EE; Stan, VE7STN; Chris, VE7FKS.
Service: Brian, VE7BWM; Robert, VE7HBG; Doug, VE7HDL.

Top Lines: ICOM, Kenwood, Yaesu, Cushcraft, Mirage/KLM, Larsen, AEA, Butternut, Hustler, Heil, Unadilla, Kantronics, ARRL, Astron, B&W, MFJ, Telex/HyGain, Alinco.

Accepts trade-ins and provides repairs.

Durham Radio Sales and Service, Inc.

350 Wentworth Street, East, Unit #7
Oshawa, ON L1H 7R7 CANADA

Phone: 905 428-3746;

FAX: 905 436-3231

Sells via showroom and mail order.

Top Lines: Amateur radio, CB radios, scanners, HF receivers, marine radios, and other equipment.

ADVERTISER'S INDEX

Advanced Specialties, Inc.....	45
Astatic	60,61
Bob's CB	21
Bearcat Radio Club.....	81
CB Shop, The	42
CBC International, Inc.....	85
CRS Communications.....	42
CTI Audio, Inc.	60,61
Cobra Electronics.....	Cover IV
Computer Aided Technologies	81
Copper Electronics, Inc.	Cover III
DNA Distributing, Inc.....	43
Durham Radio Sales & Service, Inc.....	27
Dragon Distributing	23
Electric City Electronics	42
Electronic Equipment Bank.....	49
Firestik Antenna Co.....	57
Highway 155 CB Shop.....	75
Jo Gunn Enterprises, Inc.	19
Jones, G.E. Electronics.....	85
K-40 Electronics.....	9
Kenwood Communications Corp.	3
Loveland CB	85
MACO Manufacturing Div./ Majestic Comm.	114
Medicine Man CB.....	85
North American Radio.....	17
Para Dynamics.....	1
Quement Communications	51
RF Limited.....	57
R & R Communications.....	5
R.C. Distributing.....	85
REACT International.....	97
Radio Bookstore	15
Signal Engineering.....	13
SIRIO antenne s.r.l.....	25
SolarCon	Cover II
Stewart Electronics, Inc.	37
U.S. Scanner Publications	55,43
Valor Enterprises, Inc.....	1
Wilson Antenna, Inc.	4

Reach this dynamic audience with your advertising message, contact Don Allen, N9ALK at 217-344-8653, FAX 217-344-8656

- ANTENNAS •
- POWER SUPPLIES •
- CABLE ASSEMBLIES •



4091 Viscount St.
 Memphis, TN 38118
 (901) 794-9494
 Fax: (901) 366-5736

HIGH PERFORMANCE and MADE IN U.S.A.

ALL MACO BASE STATION ANTENNAS are made of aircraft alloy 6056-T6 aluminum tubing—.050 guage.

NOTE! To prevent fatigue failure, no holes are made in any boom or element.

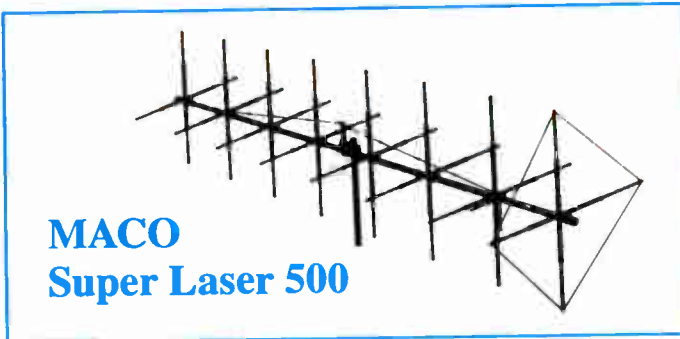

**MACO
 Super Laser 500**



**MACO
 Shooting Star**

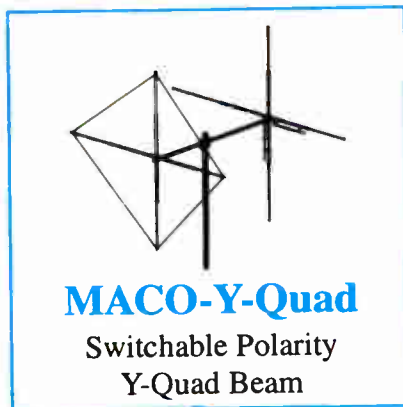

MACO-Y-Quad
 Switchable Polarity
 Y-Quad Beam

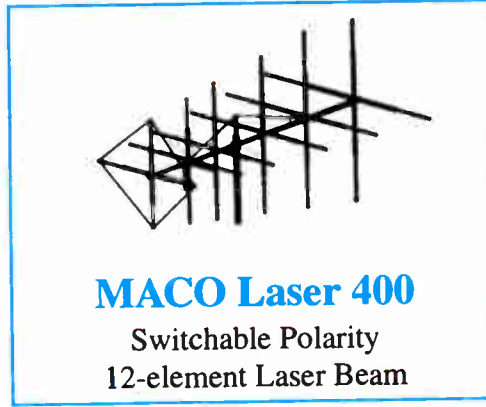

MACO Laser 400
 Switchable Polarity
 12-element Laser Beam

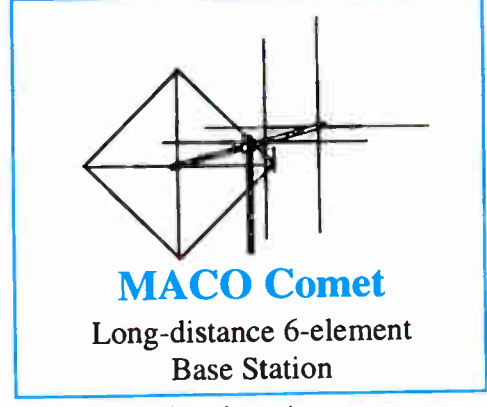

MACO Comet
 Long-distance 6-element
 Base Station

MAXIMUM BEAMS—Directional, Single Polarity, Yagi CB Base Station Antennas
 available in 3,4,5,6,7 & 8 element for CB or 10 meters; vertical or horizontal.

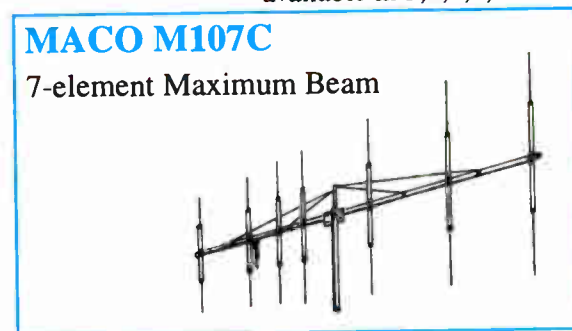

MACO M107C
 7-element Maximum Beam



**MACO
 M103C**
 3-element
 Maximum
 Beam

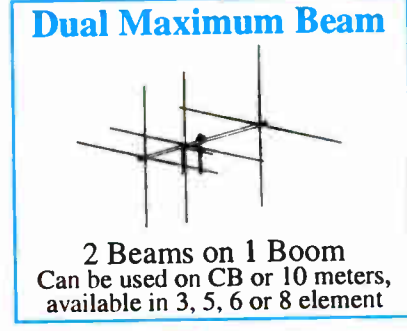

Dual Maximum Beam
 2 Beams on 1 Boom
 Can be used on CB or 10 meters,
 available in 3, 5, 6 or 8 element

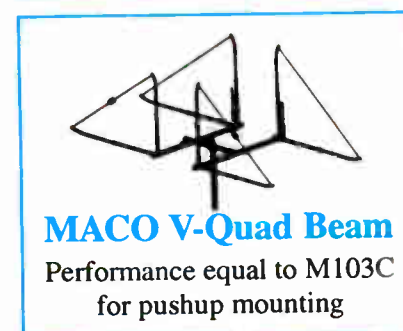

MACO V-Quad Beam
 Performance equal to M103C
 for pushup mounting



MBSK
 Maximum Beam Stacking
 Kit for M103C thru M107C

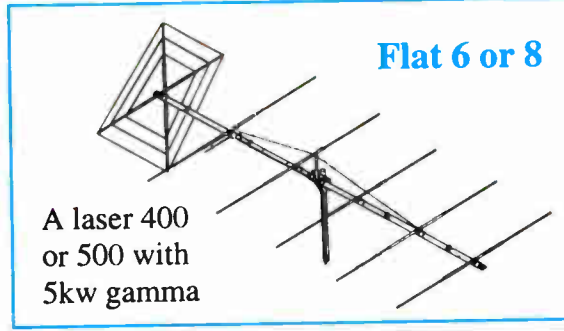

Flat 6 or 8
 A laser 400
 or 500 with
 5kw gamma

Call or write for free catalog and name of reseller near you.

THE *ULTIMATE* AM / SSB CB BASE STATION AT AN *ULTIMATE* PRICE...



Dynamic Ultra
Base Station Mic

**MODEL
2010 GTL WX**

\$339.⁹⁹ C.O.D.

**IF YOU LIKE THIS
ULTIMATE PRICE
CALL:**

1-800-626-6343

FOR A FREE CATALOGUE

Cobra[®]
40 CHANNEL

40 Channel Base Station
Instant Channel 9 Button
Automatic Noise Blanker and Noise Limiter
WX Emergency warning, Phase Lock Loop: 1050Hz
Monitors 7 National Weather Service Channels
Exclusive COBRA DYNAMIKE Control
Frequency Range 26.965 to 27.405 MHz
Frequency Tolerance: 0.005%
Antenna Connector: UHF, SO-239
Transmitter Output: AM, 4 watts SSB , 12 watts, PEP
SSB Carrier Suppression 55db
Frequency Response AM and SSB: 300 to 2500 Hz



COPPER ELECTRONICS, INC.

3315 GILMORE INDUSTRIAL BLVD. * LOUISVILLE, KY 40213

"The Legend Lives On..."

Jock Elliott - Contributing Editor, Popular Communications, September 1995

Introducing Cobra's new 2010 GTL WX 40 Channel AM/SSB/WX CB base station



Everybody knows about the
Legendary 2000GTL 
It was simply the best
am/ssb cb base
station....until now!

The new standard, the
2010 GTL WX is everything
the 2000GTL was and a
whole lot more.

At Cobra, we build
products that
Legends are
made of!

Cobra
WE ARE CB

Features

2010 GTL WX

- Selectable 7 channel NOAA Weather Receiver
- Receives Emergency NOAA Weather Alert Warnings. Sounds weather alert tone during NOAA Emergencies
- Large LCD Displays Channels, Frequency, 24 HR Clock, Rx/Tx, Antenna Mismatch, AM/USB/LSB
- Separate HEADPHONE and EXT speaker jacks
- Includes 2 panel meters for convenient monitoring of POWER, SWR, MODULATION, and SIGNAL STRENGTH
- Switchable ANL, NB
- Dual range VoiceLock for convenient SSB operation
- Dynamic Base Station power microphone included
- FCC/UL listed



Official
Sponsor