

# USER MANUAL



## CONTENTS

1. SAFETY INFORMATION.....	2
2. SAFETY INSTRUCTIONS.....	4
3. PRODUCT DESCRIPTION.....	7
4. OPERATING THE APPLIANCE.....	8
5. BEFORE FIRST USE.....	9
6. DAILY USE.....	9
7. CLOCK FUNCTIONS.....	15
8. USING THE ACCESSORIES.....	16
9. ADDITIONAL FUNCTIONS.....	19
10. HINTS AND TIPS.....	19
11. CARE AND CLEANING.....	34
12. TROUBLESHOOTING.....	36
13. ENERGY EFFICIENCY.....	38

## FOR PERFECT RESULTS

Thank you for choosing this AEG product. We have created it to give you impeccable performance for many years, with innovative technologies that help make life simpler features you might not find on ordinary appliances. Please spend a few minutes reading to get the very best from it.

Visit our website for:



Get usage advice, brochures, trouble shooter, service information:

**[www.aeg.com/webselfservice](http://www.aeg.com/webselfservice)**



Register your product for better service:

**[www.registeraeg.com](http://www.registeraeg.com)**



Buy Accessories, Consumables and Original spare parts for your appliance:

**[www.aeg.com/shop](http://www.aeg.com/shop)**

## CUSTOMER CARE AND SERVICE

Always use original spare parts.

When contacting our Authorised Service Centre, ensure that you have the following data available: Model, PNC, Serial Number.

The information can be found on the rating plate.

 Warning / Caution-Safety information

 General information and tips

 Environmental information

Subject to change without notice.

### 1. SAFETY INFORMATION

Before the installation and use of the appliance, carefully read the supplied instructions. The

manufacturer is not responsible for any injuries or damages that are the result of incorrect installation or usage. Always keep the instructions in a safe and accessible location for future reference.

## 1.1 Children and vulnerable people safety

- This appliance can be used by children aged from 8 years and above and persons with reduced physical, sensory or mental capabilities or lack of experience and knowledge if they have been given supervision or instruction concerning the use of the appliance in a safe way and understand the hazards involved.
- Do not let children play with the appliance.
- Keep all packaging away from children and dispose of it appropriately.
- Keep children and pets away from the appliance when it operates or when it cools down. Accessible parts are hot.
- If the appliance has a child safety device, this should be activated.
- Children shall not carry out cleaning and user maintenance of the appliance without supervision.
- Children aged 3 years and under must be kept away from this appliance when it is in operation at all times.

## 1.2 General Safety

- Only a qualified person must install this appliance and replace the cable.
- **WARNING:** The appliance and its accessible parts become hot during use. Care should be taken to avoid touching heating elements. Children less than 8 years of age shall be kept away unless continuously supervised.
- Always use oven gloves to remove or put in accessories or ovenware.
- Before carrying out any maintenance, disconnect the appliance from the power supply.

- Ensure that the appliance is switched off before replacing the lamp to avoid the possibility of electric shock.
- Do not use a steam cleaner to clean the appliance.
- Do not use harsh abrasive cleaners or sharp metal scrapers to clean the glass door since they can scratch the surface, which may result in shattering of the glass.
- If the mains power supply cable is damaged, it must be replaced by the manufacturer, its Authorised Service Centre or similarly qualified persons to avoid an electrical hazard.
- Excessive spillage must be removed before the pyrolytic cleaning. Remove all parts from the oven.
- To remove the shelf supports first pull the front of the shelf support and then the rear end away from the side walls. Install the shelf supports in the opposite sequence.
- Use only the food sensor (core temperature sensor) recommended for this appliance.

## 2. SAFETY INSTRUCTIONS

### 2.1 Installation



#### **WARNING!**

Only a qualified person must install this appliance.

- Remove all the packaging.
- Do not install or use a damaged appliance.
- Follow the installation instruction supplied with the appliance.
- Always take care when moving the appliance as it is heavy. Always use safety gloves and enclosed footwear.
- Do not pull the appliance by the handle.
- Keep the minimum distance from the other appliances and units.
- Make sure that the appliance is installed below and adjacent safe structures.
- The sides of the appliance must stay adjacent to appliances or to units with the same height.

- The appliance is equipped with an electric cooling system. It must be operated with the electric power supply.

### 2.2 Electrical connection



#### **WARNING!**

Risk of fire and electrical shock.

- All electrical connections should be made by a qualified electrician.
- The appliance must be earthed.
- Make sure that the parameters on the rating plate are compatible with the electrical ratings of the mains power supply.
- Always use a correctly installed shockproof socket.
- Do not use multi-plug adapters and extension cables.
- Make sure not to cause damage to the mains plug and to the mains cable. Should the mains cable need

to be replaced, this must be carried out by our Authorised Service Centre.

- Do not let mains cables touch or come near the appliance door, especially when the door is hot.
- The shock protection of live and insulated parts must be fastened in such a way that it cannot be removed without tools.
- Connect the mains plug to the mains socket only at the end of the installation. Make sure that there is access to the mains plug after the installation.
- If the mains socket is loose, do not connect the mains plug.
- Do not pull the mains cable to disconnect the appliance. Always pull the mains plug.
- Use only correct isolation devices: line protecting cut-outs, fuses (screw type fuses removed from the holder), earth leakage trips and contactors.
- The electrical installation must have an isolation device which lets you disconnect the appliance from the mains at all poles. The isolation device must have a contact opening width of minimum 3 mm.
- This appliance complies with the E.E.C. Directives.

### 2.3 Use



#### **WARNING!**

Risk of injury, burns and electrical shock or explosion.

- This appliance is for household use only.
- Do not change the specification of this appliance.
- Make sure that the ventilation openings are not blocked.
- Do not let the appliance stay unattended during operation.
- Deactivate the appliance after each use.
- Be careful when you open the appliance door while the appliance is in operation. Hot air can release.
- Do not operate the appliance with wet hands or when it has contact with water.
- Do not apply pressure on the open door.

- Do not use the appliance as a work surface or as a storage surface.
- Open the appliance door carefully. The use of ingredients with alcohol can cause a mixture of alcohol and air.
- Do not let sparks or open flames to come in contact with the appliance when you open the door.
- Do not put flammable products or items that are wet with flammable products in, near or on the appliance.



#### **WARNING!**

Risk of damage to the appliance.

- To prevent damage or discoloration to the enamel:
  - do not put ovenware or other objects in the appliance directly on the bottom.
  - do not put aluminium foil directly on the bottom of cavity of the appliance.
  - do not put water directly into the hot appliance.
  - do not keep moist dishes and food in the appliance after you finish the cooking.
  - be careful when you remove or install the accessories.
- Discoloration of the enamel or stainless steel has no effect on the performance of the appliance.
- Use a deep pan for moist cakes. Fruit juices cause stains that can be permanent.
- This appliance is for cooking purposes only. It must not be used for other purposes, for example room heating.
- Always cook with the oven door closed.
- If the appliance is installed behind a furniture panel (e.g. a door) make sure the door is never closed when the appliance is in operation. Heat and moisture can build up behind a closed furniture panel and cause subsequent damage to the appliance, the housing unit or the floor. Do not close the furniture panel until the appliance has cooled down completely after use.

## 2.4 Care and cleaning



### WARNING!

Risk of injury, fire, or damage to the appliance.

- Before maintenance, deactivate the appliance and disconnect the mains plug from the mains socket.
- Make sure the appliance is cold. There is the risk that the glass panels can break.
- Replace immediately the door glass panels when they are damaged. Contact the Authorised Service Centre.
- Be careful when you remove the door from the appliance. The door is heavy!
- Clean regularly the appliance to prevent the deterioration of the surface material.
- Clean the appliance with a moist soft cloth. Only use neutral detergents. Do not use any abrasive products, abrasive cleaning pads, solvents or metal objects.
- If you use an oven spray, follow the safety instruction on it's packaging.
- Do not clean the catalytic enamel (if applicable) with any kind of detergent.

## 2.5 Pyrolytic cleaning



Risk of Injury / Fires / Chemical Emissions (Fumes) in Pyrolytic Mode.

- Before carrying out a Pyrolytic self-cleaning function or the First Use please remove from the oven cavity:
  - any excess food residues, oil or grease spills / deposits.
  - any removable objects (including shelves, side rails etc., provided with the product) particularly any non-stick pots, pans, trays, utensils etc.
- Read carefully all the instructions for Pyrolytic cleaning.
- Keep children away from the appliance while the Pyrolytic cleaning is in operation.

The appliance becomes very hot and hot air is released from the front cooling vents.

- Pyrolytic cleaning is a high temperature operation that can release fumes from cooking residues and construction materials, as such consumers are strongly advised to:
  - provide good ventilation during and after each Pyrolytic cleaning.
  - provide good ventilation during and after the first use at maximum temperature operation.
- Unlike all humans, some birds and reptiles can be extremely sensitive to potential fumes emitted during the cleaning process of all Pyrolytic Ovens.
  - Remove any pets (especially birds) from the vicinity of the appliance location during and after the Pyrolytic cleaning and first use maximum temperature operation to a well ventilated area.
- Small pets can also be highly sensitive to the localized temperature changes in the vicinity of all Pyrolytic Ovens when the Pyrolytic self cleaning program is in operation.
- Non-stick surfaces on pots, pans, trays, utensils etc., can be damaged by the high temperature Pyrolytic cleaning operation of all Pyrolytic Ovens and can be also a source for low level harmful fumes.
- Fumes released from all Pyrolytic Ovens / Cooking Residues as described are not harmful to humans, including infants or persons with medical conditions.

## 2.6 Internal light

- The type of light bulb or halogen lamp used for this appliance is only for household appliances. Do not use it for house lighting.



### WARNING!

Risk of electrical shock.

- Before replacing the lamp, disconnect the appliance from the power supply.
- Only use lamps with the same specifications.

## 2.7 Disposal



### WARNING!

Risk of injury or suffocation.

- Disconnect the appliance from the mains supply.
- Cut off the mains electrical cable close to the appliance and dispose of it.

- Remove the door catch to prevent children or pets from becoming trapped in the appliance.

## 2.8 Service

- To repair the appliance contact an Authorised Service Centre.
- Use original spare parts only.

# 3. PRODUCT DESCRIPTION

## 3.1 General overview

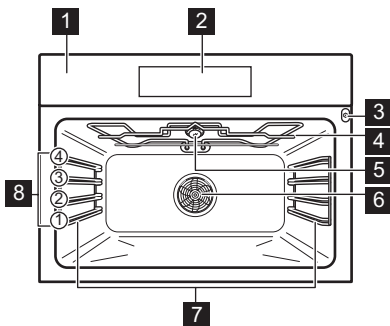

- 1 Control panel
- 2 Electronic programmer
- 3 Socket for the food sensor
- 4 Heating element
- 5 Lamp
- 6 Fan
- 7 Shelf support, removable
- 8 Shelf positions

## 3.2 Accessories

### Wire shelf

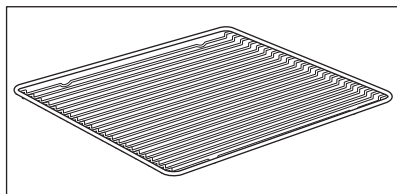

For cookware, cake tins, roasts.

### Baking tray

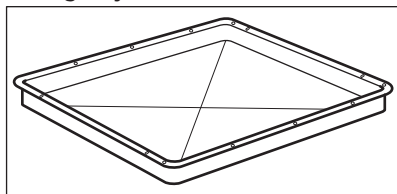

For cakes and biscuits.

### Grill- / Roasting pan

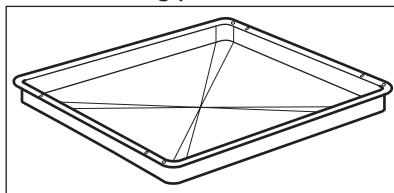

To bake and roast or as a pan to collect fat.

### Trivet

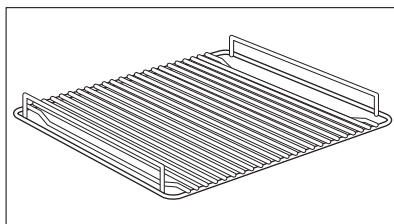

For roasting and grilling.



Use the trivet only with the Grill- / Roasting pan.

To measure the temperature inside the food.

### Food Sensor

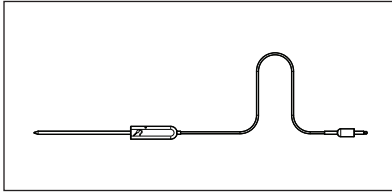

## 4. OPERATING THE APPLIANCE

### 4.1 Control panel

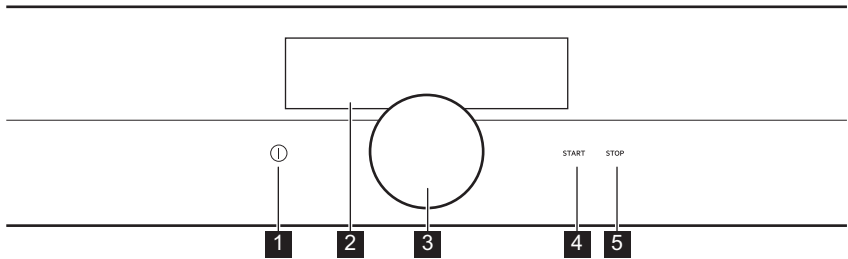

Function	Comment
<b>1</b> On / Off	To turn the appliance on and off.
<b>2</b> Display	Shows the current settings of the appliance.
<b>3</b> Rotary knob	To adjust the settings and navigate through the menu. Press ① to turn the appliance on. Hold the rotary knob to turn on the setting screen. Hold and turn the rotary knob to navigate through the menu. Hold and press the rotary knob to confirm a setting or enter the selected submenu. To return to the previous menu find the option Back in the menu list or confirm a selected setting.
<b>4</b> START	To turn on selected function.
<b>5</b> STOP	To turn off selected function.

### 4.2 Display

After turning on, the display shows the last selected heating function mode.





The display with maximum number of functions set.

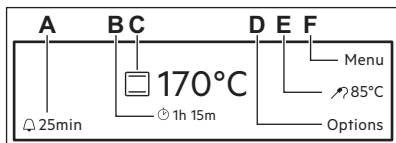

- A. Reminder
- B. Up Timer
- C. Heating function and temperature
- D. Options or Time of Day
- E. Duration time and End time of a function or Food Sensor
- F. Menu

## 5. BEFORE FIRST USE



**WARNING!**  
Refer to Safety chapters.

### 5.1 Initial Cleaning

Remove all accessories and removable shelf supports from the appliance.



Refer to "Care and cleaning" chapter.

Clean the appliance and the accessories before first use.

Put the accessories and the removable shelf supports back to their initial position.

### 5.2 First Connection

After the first connection the software version will appear for 7 seconds.

You have to set the language, the Display Brightness and the Time of Day.

## 6. DAILY USE



**WARNING!**  
Refer to Safety chapters.

### 6.1 Heating Functions

Turning the heating functions on and off.

1. Turn on the oven.
2. Hold the rotary knob.  
The last used function is underlined.
3. Press the rotary knob to enter the submenu and turn it to select a heating function.
4. Press the rotary knob to confirm.

5. Set the temperature and confirm.
6. Press **START**. Food Sensor can be plugged at any time before or during cooking process. Some functions contain a sequence of pop-ups. Press the rotary knob to go to the next pop-up. After the last confirmation the function starts.







To turn off a function press **STOP**.







The lamp may turn off automatically at a temperature below 60 °C during some oven functions.



### Heating Functions: Specials

Heating function	Application
 Slow Cooking	To prepare tender, succulent roasts.

Heating function	Application	
	Keep Warm	To keep food warm.
	Plate Warming	To preheat plates for serving.
	Preserving	To make vegetable preserves such as pickles.
	Drying	To dry sliced fruit (e.g. apples, plums, peaches) and vegetables (e.g. tomatoes, zucchini, mushrooms).
	Dough Proving	For controlled rising of yeast dough before baking.
	Defrost	This function can be used for defrosting frozen foods, such as vegetables and fruits. The defrosting time depends on the amount and size of the frozen food.
	Bread Baking	Use this function to prepare bread and bread rolls with a very good professional-like result in terms of crispiness, colour and crust gloss.

## Heating functions: Standard

Heating function	Application	
	True Fan Cooking	To bake on up to two shelf positions at the same time and to dry food. Set the temperature 20 - 40 °C lower than for the function: Conventional Cooking.
	True Fan + Bottom	To bake food on one shelf position for a more intensive browning and a crispy bottom. Set the temperature 20 - 40 °C lower than for the function: Conventional Cooking.
	Conventional Cooking (Top / Bottom Heat)	To bake and roast food on one shelf position.
	Bottom + Grill + Fan	To make convenience food like e.g. french fries, potato wedges or spring rolls crispy.
	Grill	To grill flat food and to toast bread.

Heating function	Application
 Grill + Fan	To roast larger meat joints or poultry with bones on one shelf position. Also to make gratins and to brown.
 Bottom Heat	To bake cakes with crispy bottom and to preserve food.
 Moist Fan Baking	To bake breads, cakes and cookies. To save energy during cooking. This function must be used in accordance with the Moist Fan Baking table in order to achieve the desired cooking result. To get more information about the recommended settings, refer to the Hints and Tips chapter, Moist Fan Baking table. This function was used to define the energy efficiency class acc. to EN 60350-1.

## 6.2 Menu - overview

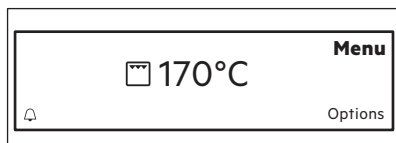

### Menu

Menu item	Application
Assisted Cooking	Contains a list of automatic programmes.
Cleaning	Contains a list of cleaning programmes.
Basic Settings	Used to set the appliance configuration.

### Submenu for: Cleaning

Submenu	Description
Quick	Pyrolytic cleaning. 1 h for a low degree of dirt.
Normal	Pyrolytic cleaning. 1 h 30 min for a usual degree of dirt.
Intense	Pyrolytic cleaning. 2 h 30 min for a high degree of dirt.

## Submenu for: Basic Settings

Submenu	Description
Child Lock	When the Child Lock is on, the oven cannot be activated accidentally. You can activate and deactivate this function via Basic Setting Menu. Once activated, Child Lock appears on the display when you turn on the appliance. To enable the oven use, choose the code letters with the rotary knob in the following order: A B C.
Fast Heat Up	Decreases heat up time as a default. Note that it is available only for some of the heating functions.
Heat + Hold	Keeps the prepared food warm for 30 minutes after a cooking is finished. To turn it off earlier press the rotary knob. When this function is active the message "Keep warm started" appears on the display. Note that it is available only for some of the heating functions.
Time Extension	To extend predefined cooking time. Note that it is available only for some of the heating functions.
Setup	To set the oven configuration.
Service	Shows the software version and configuration.

## Submenu for: Setup

Submenu	Description
Language	Sets the language for the display.
Time of Day	Sets the current time and date.
Key Tones	Activates and deactivates the tone of the touch fields. It is not possible to deactivate the tone of the ON / OFF and STOP.
Alarm/Error Tones	Activates and deactivates the alarm tones.
Buzzer Volume	Adjusts the volume of press-tones and signals by degrees.
Display Brightness	Adjusts the display brightness by degrees.

## Submenu for: Service

Submenu	Description
DEMO	Activation / deactivation code: 2468
Show Licenses	Information about licenses.
Show Software Version	Information about software version.
Factory Settings	Reset to factory settings.

## Submenu for: Assisted Cooking

Every dish in this submenu has a proposed function and temperature. Those parameters can be adjusted manually according to the user's preference.

For some of the dishes You can also choose way of cooking:

- Weight Automatic
- Food Sensor

The level to which a dish is cooked:

- Rare or Less
- Medium
- Well Done or More

Food Category: Meat and Fish

Meat		
Beef	Sirloin	
	Roast	
	Meat Loaf	
	Scandinavian Beef	
Pork	Tenderloin	Fresh
		Smoked
	Roast	
	Ham	
	Knuckle	
Rib		
Veal	Tenderloin	
	Roast	
	Knuckle	
Lamb	Roast	
	Saddle	
	Leg	
Game	Venison	Saddle
		Haunch
	Hare	Saddle
		Leg

Poultry	
Chicken	Whole
	Half
	Legs
	Wings
Duck	
Goose	
Turkey	Whole:
	Breast

Fish	
Whole Fish	Small
	Medium
	Large
Fish Bakes	
Fish Fingers	

Food Category: Side / Oven Dishes

Dish	
Side Dishes	French Fries
	Croquettes
	Wedges
	Hash Browns
Oven Dishes	Lasagne
	Potato Gratin
	Pasta Bake
	Vegetables au Gratin
	Casserole, savoury
Casserole, vegetable	

## Food Category: Savoury Baking

Dish		
Pizza	Fresh	Thin
		Thick
	Frozen	Thin
		Thick
		Snacks
Chilled		
Quiche	Thin	
	Thick	
Bread	Fresh	Baguette
		Ciabatta
		White Bread
		Dark Bread
		Rye Bread
		All Grain Bread
		Unleavened Bread
	Frozen	Baguette
		Bread
	Pre-baked	
	Rolls	Fresh
Frozen		
Pre-baked		

## Food Category: Desserts / Baking

Dish		
Cake in Tin	Almond Cake	
	Apple Pie	
	Cheese Cake	
	Apple Cake, covered	
	Short Pastry Base	
	Sponge Flan Base	
	Madeira Cake	
Sponge Cake		
	Tarts	
Cake on Tray	Froz. Apple Strudel	
	Brownies	
	Cheese Cake	
	Christmas Stollen	
	Fruit Flan	Short Pastry
		Sponge Dough
		Yeast Dough
	Sponge Cake	
	Sugar Cake	
	Swiss Roll	
	Swiss Tarte, sweet	
Yeast Cake		

Dish	
Small Pastry	Cakes, small
	Cream Puffs
	Eclairs
	Macaroons
	Muffins
	Pastry Stripes
	Puff Pastry
	Short Pastry
	Biscuits

Dish
Casserole, sweet

## 6.3 Options



Options	Description
Timer Settings	Contains a list of clock functions.
Fast Heat Up	To decrease heat up time in the currently running heating function. On / Off
Set + Go	To set a function and turn it on later. Once set, the message "Set&Go active" appears on the display. Press Start to turn it on. When this function is active the message disappears from the display and the oven starts to work. Note that it is available only for some of the heating functions and if Duration / End Time is set.
Light	On / Off





## 6.4 Residual heat

When you turn off the oven, the display shows the residual heat. You can use the heat to keep the food warm.

# 7. CLOCK FUNCTIONS

## 7.1 Timer Settings

Clock function	Application
 Up Timer	Automatically monitors how long the function operates. The visibility of the Up Timer can be turned on and off.

Clock function		Application
	Duration	To set the length of an operation. <sup>1)</sup>
	End Time	To set the switch-off time for a heating function. This option is available only when the Duration is set. Use the functions Duration and End Time at the same time to automatically turn on and off the oven on a given time later. <sup>1)</sup>
	Reminder	To set a countdown. <sup>1)</sup> This function has no effect on the operation of the oven. Choose  and set the time. When the time ends the signal sounds. Press the rotary knob to stop the signal. The Reminder can be also used when the oven is turned off.

<sup>1)</sup> Maximum 23 h 59 min

## 8. USING THE ACCESSORIES



### WARNING!

Refer to Safety chapters.

### 8.1 Food Sensor

Food Sensor measures temperature inside the food. When the food is at the set temperature, the appliance deactivates.

There are two temperatures to be set:

- the oven temperature (minimum 120 °C),
- the food core temperature.



### CAUTION!

Use only the accessory supplied and the original replacement parts.

Directions for the best results:

- Ingredients should be at room temperature.
- The Food Sensor cannot be used for liquid dishes.
- During cooking the Food Sensor must remain in the dish and the plug in the socket.

- Use recommended food core temperature settings.



### WARNING!

Refer to "Hints and tips" chapter.



The appliance calculates an approximate end of cooking time. It depends on the quantity of food, the set oven function and temperature.

### Food categories: meat, poultry and fish

1. Activate the oven.
2. Insert the tip of the Food Sensor into the centre of meat or fish, in the thickest part if possible. Make sure that at least 3/4 of the Food Sensor is inside of the dish.
3. Put the plug of the Food Sensor into the socket at the front of the oven.



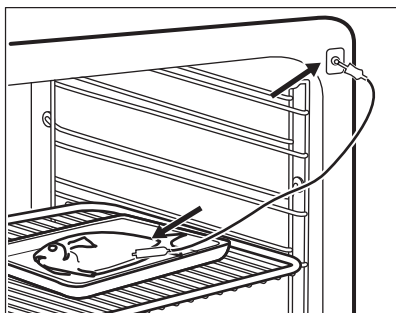
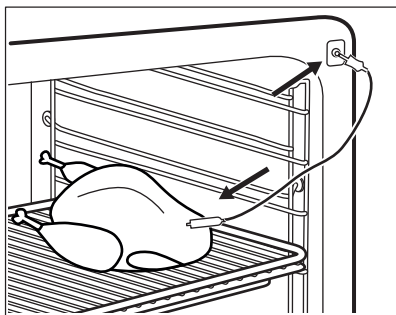

The display shows: Food Sensor.

4. Set the core temperature.
5. Set a heating function and, if necessary, the oven temperature.

When the dish reaches the set temperature the signal sounds. The oven turns off automatically.

6. Press the rotary knob to stop the signal.
7. Remove the Food Sensor plug from the socket and remove the dish from the oven.



#### **WARNING!**

There is a risk of burns as the Food Sensor becomes hot. Be careful when you unplug it and remove it from the food.

### **Food category: casserole**

1. Activate the oven.
2. Place half of the ingredients in a baking dish.
3. Insert the tip of the Food Sensor exactly in the centre of the casserole. The Food Sensor should be stabilized in one place during baking. Use a solid ingredient to achieve that. Use the rim of the baking dish

to support the silicone handle of the Food Sensor. The tip of the Food Sensor should not touch the bottom of a baking dish.

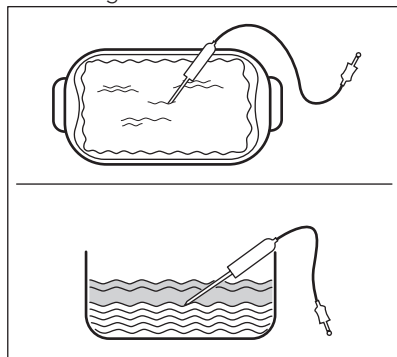

4. Cover the Food Sensor with the remaining ingredients.
5. Put the plug of the Food Sensor into the socket at the front of the oven.

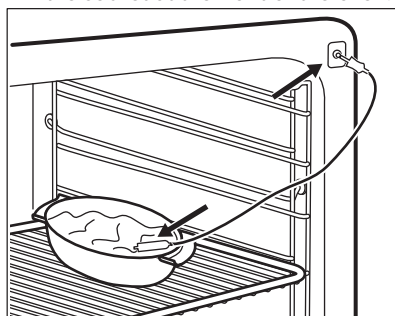

The display shows: Food Sensor.

6. Set the core temperature.
7. Set a heating function and, if necessary, the oven temperature. When the dish reaches the set temperature, an acoustic signal sounds. The oven turns off automatically.
8. Press the rotary knob to stop the signal.
9. Remove the Food Sensor plug from the socket and remove the dish from the oven.



#### **WARNING!**

There is a risk of burns as the Food Sensor becomes hot. Be careful when you unplug it and remove it from the food.

## Changing the core temperature

You can change the core temperature and the oven temperature at any time during cooking.

1. Select  on the display.
2. Turn the rotary knob to change the temperature.
3. Press to confirm.

## 8.2 Inserting the accessories

Wire shelf:

Push the shelf between the guide bars of the shelf support and make sure that the feet point down.

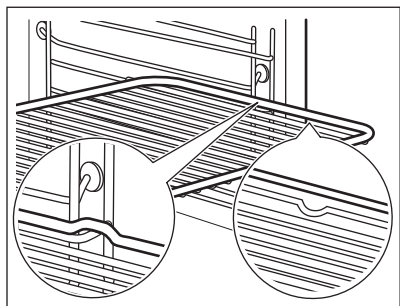

Baking tray / Deep pan:

Push the baking tray / deep pan between the guide bars of the shelf support.

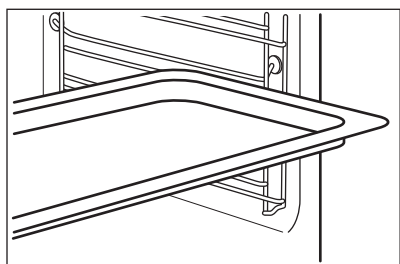

Wire shelf and baking tray / deep pan together:

Push the baking tray / deep pan between the guide bars of the shelf support and the wire shelf on the guide bars above.

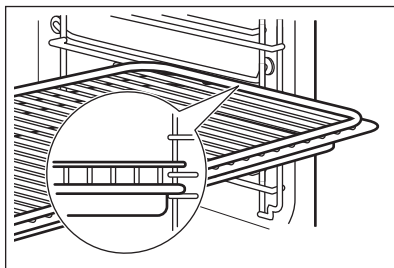

-  Small indentation at the top increase safety. The indentations are also anti-tip devices. The high rim around the shelf prevents cookware from slipping of the shelf.

## 8.3 Trivet and Grill- / Roasting pan



### WARNING!

Be careful when you remove the accessories from a hot appliance. There is a risk of burns.

You can use the trivet to roast larger pieces of meat or poultry on one shelf position.

1. Put the trivet into the deep pan so that the supports of the wire shelf point up.

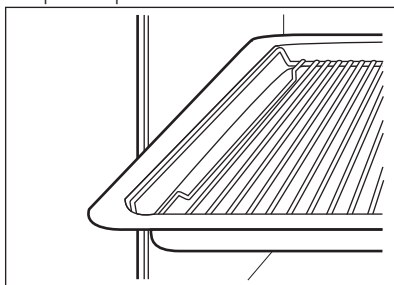

2. Put the deep pan into the oven on the necessary shelf position. You can use the trivet to grill flat dishes in large quantities and to toast.

1. Put the trivet into the deep pan so that the supports of the wire shelf point down.

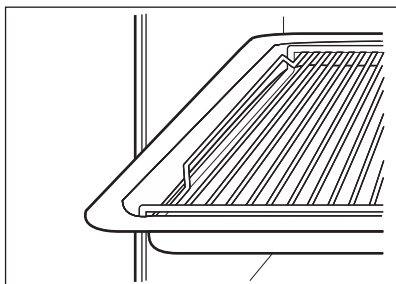

- Put the deep pan into the oven on the necessary shelf position.

## 9. ADDITIONAL FUNCTIONS

### 9.1 Automatic Switch-off

For safety reasons the appliance turns off automatically after some time if a heating function operates and you do not change any settings.

Temperature (°C)	Switch-off time (h)
30 - 115	12.5
120 - 195	8.5
200 - 245	5.5

Temperature (°C)	Switch-off time (h)
250 - maximum	1.5

- i** The Automatic switch-off does not work with the functions: Light, Food Sensor, Duration, End Time.

### 9.2 Cooling fan

When the appliance operates, the cooling fan activates automatically to keep the surfaces of the appliance cool. If you deactivate the appliance, the cooling fan can continue to operate until the appliance cools down.

## 10. HINTS AND TIPS



**WARNING!**  
Refer to Safety chapters.



The temperature and baking times in the tables are guidelines only. They depend on the recipes and the quality and quantity of the ingredients used.

### 10.1 Advice for special heating functions of the oven

#### Keep Warm

Use this function if you want to keep food warm.

The temperature regulates itself automatically to 80 °C.

#### Plate Warming

For warming plates and dishes.

Distribute plates and dishes evenly on the wire shelf. Move stacks around after half of the warming time (swap top and bottom).

The automatic temperature is 70 °C.  
Recommended shelf position: 3.

### 10.2 Baking

- Your oven may bake or roast differently to the appliance you had before. Adapt your usual settings

- such as temperature, cooking time and shelf position to the values in the tables.
- Use the lower temperature the first time.
  - If you cannot find the settings for a special recipe, look for the similar one.
  - You can extend baking times by 10 – 15 minutes if you bake cakes on more than one shelf position.
  - Cakes and pastries at different heights do not always brown equally at first. If this occurs, do not change the temperature setting. The differences equalize during the baking procedure.
  - Trays in the oven can twist during baking. When the trays become cold again, the distortions disappear.

### 10.3 Tips on baking

Baking results	Possible cause	Remedy
The bottom of the cake is not browned sufficiently.	The shelf position is incorrect.	Put the cake on a lower shelf.
The cake sinks and becomes soggy, lumpy or streaky.	The oven temperature is too high.	The next time you bake, set a slightly lower oven temperature.
The cake sinks and becomes soggy, lumpy or streaky.	The baking time is too short.	Set a longer baking time. <b>You cannot decrease baking times by setting higher temperatures.</b>
The cake sinks and becomes soggy, lumpy or streaky.	There is too much liquid in the mixture.	Use less liquid. Be careful with mixing times, especially if you use a mixing machine.
The cake is too dry.	The oven temperature is too low.	The next time you bake, set a higher oven temperature.
The cake is too dry.	The baking time is too long.	The next time you bake, set a shorter baking time.
The cake browns unevenly.	The oven temperature is too high and the baking time is too short.	Set a lower oven temperature and a longer baking time.
The cake browns unevenly.	The mixture is unevenly distributed.	Spread the mixture evenly on the baking tray.
The cake is not ready in the baking time given.	The oven temperature is too low.	The next time you bake, set a slightly higher oven temperature.

## 10.4 Baking on one oven level

### Baking in tins

Food	Function	Temperature (°C)	Time (min)	Shelf position
Ring cake or brioche	True Fan Cooking	150 - 160	50 - 70	1
Madeira cake / Fruit cakes	True Fan Cooking	140 - 160	70 - 90	1
Sponge cake / Sponge cake	True Fan Cooking	140 - 150	35 - 50	1
Sponge cake / Sponge cake	Conventional Cooking	160	35 - 50	1
Flan base - short pastry <sup>1)</sup>	True Fan Cooking	170 - 180	10 - 25	2
Flan base - sponge mixture	True Fan Cooking	150 - 170	20 - 25	2
Apple pie / Apple pie (2 tins Ø 20 cm, diagonally off set)	True Fan Cooking	160	70 - 90	2
Apple pie / Apple pie (2 tins Ø 20 cm, diagonally off set)	Conventional Cooking	180	70 - 90	1
Cheesecake, tray <sup>2)</sup>	Conventional Cooking	160 - 170	70 - 90	2

<sup>1)</sup> Preheat the oven.

<sup>2)</sup> Use a deep pan.

### Cakes / pastries / breads on baking trays

Food	Function	Temperature (°C)	Time (min)	Shelf position
Plaited bread / bread crown	Conventional Cooking	170 - 190	30 - 40	1
Christmas stollen <sup>1)</sup>	Conventional Cooking	160 - 180	50 - 70	1
Bread (rye bread) <sup>1)</sup>	Conventional Cooking			1
first		230	20	
then		160 - 180	30 - 60	
Cream puffs / eclairs <sup>1)</sup>	Conventional Cooking	190 - 210	20 - 35	2

Food	Function	Temperature (°C)	Time (min)	Shelf position
Swiss Roll <sup>1)</sup>	Conventional Cooking	180 - 200	10 - 20	2
Cake with crumble topping (dry)	True Fan Cooking	150 - 160	20 - 40	2
Buttered almond cake / sugar cakes <sup>1)</sup>	Conventional Cooking	190 - 210	20 - 30	2
Fruit flans (made with yeast dough / sponge mixture) <sup>2)</sup>	True Fan Cooking	150 - 160	35 - 55	2
Fruit flans (made with yeast dough / sponge mixture) <sup>2)</sup>	Conventional Cooking	170	35 - 55	2
Fruit flans made with short pastry	True Fan Cooking	160 - 170	40 - 80	2
Yeast cakes with delicate toppings (e.g. quark, cream, custard) <sup>1)</sup>	Conventional Cooking	160 - 180	40 - 80	2

<sup>1)</sup> Preheat the oven.

<sup>2)</sup> Use a deep pan.

#### Biscuits

Food	Function	Temperature (°C)	Time (min)	Shelf position
Short pastry biscuits	True Fan Cooking	150 - 160	10 - 20	2
Short bread / Short bread / Pastry Stripes	True Fan Cooking	140	20 - 35	2
Short bread / Short bread / Pastry Stripes <sup>1)</sup>	Conventional Cooking	160	20 - 30	2
Biscuits made with sponge mixture	True Fan Cooking	150 - 160	15 - 20	2
Pastries made with egg white, meringues	True Fan Cooking	80 - 100	120 - 150	2
Macaroons	True Fan Cooking	100 - 120	30 - 50	2
Biscuits made with yeast dough	True Fan Cooking	150 - 160	20 - 40	2

Food	Function	Temperature (°C)	Time (min)	Shelf position
Puff pastries <sup>1)</sup>	True Fan Cooking	170 - 180	20 - 30	2
Rolls <sup>1)</sup>	True Fan Cooking	160	10 - 25	2
Rolls <sup>1)</sup>	Conventional Cooking	190 - 210	10 - 25	2
Small cakes / Small cakes <sup>1)</sup>	True Fan Cooking	160	20 - 35	2
Small cakes / Small cakes <sup>1)</sup>	Conventional Cooking	170	20 - 35	2

<sup>1)</sup> Preheat the oven.

## 10.5 Bakes and gratins

Food	Function	Temperature (°C)	Time (min)	Shelf position
Pasta bake	Conventional Cooking	180 - 200	45 - 60	1
Lasagne	Conventional Cooking	180 - 200	25 - 40	1
Vegetables au gratin <sup>1)</sup>	Grill + Fan	160 - 170	15 - 30	1
Baguettes topped with melted cheese	True Fan Cooking	160 - 170	15 - 30	1
Sweet bakes	Conventional Cooking	180 - 200	40 - 60	1
Fish bakes	Conventional Cooking	180 - 200	30 - 60	1
Stuffed vegetables	True Fan Cooking	160 - 170	30 - 60	1

<sup>1)</sup> Preheat the oven.

## 10.6 Moist Fan Baking

Food	Temperature (°C)	Time (min)	Shelf position
Pasta gratin	200 - 220	45 - 60	1

Food	Temperature (°C)	Time (min)	Shelf position
Potato gratin	180 - 200	70 - 85	1
Moussaka	180 - 200	75 - 90	1
Lasagne	180 - 200	70 - 90	1
Cannelloni	180 - 200	65 - 80	1
Bread pudding	190 - 200	55 - 70	1
Rice pudding	180 - 200	55 - 70	1
Apple cake, made with sponge mixture (round cake tin)	160 - 170	70 - 80	1
White bread	200 - 210	55 - 70	1

## 10.7 Multilevel baking

Use the function: True Fan Cooking.

Cakes / pastries / breads on baking trays

Food	Temperature (°C)	Time (min)	Shelf position
Cream puffs / Eclairs <sup>1)</sup>	160 - 180	25 - 45	1 / 4
Dry streusel cake	150 - 160	30 - 45	1 / 4

<sup>1)</sup> Preheat the oven.

Cakes / small cakes / breads on baking trays

Food	Temperature (°C)	Time (min)	Shelf position
Short pastry biscuits	150 - 160	20 - 40	1 / 4
Short bread / Short bread / Pastry Stripes	140	25 - 45	1 / 4
Biscuits made with sponge mixture	160 - 170	25 - 40	1 / 4
Pastries made with egg white, meringues	80 - 100	130 - 170	1 / 4
Macaroons	100 - 120	40 - 80	1 / 4
Biscuits made with yeast dough	160 - 170	30 - 60	1 / 4



## 10.8 Slow Cooking

Use this function to prepare lean, tender pieces of meat and fish. This function is not applicable to such recipes as pot roast or fatty roast pork. You can use the Food Sensor to guarantee that the meat has the correct core temperature.



### WARNING!

Refer to "Hints and tips" chapter.

In the first 10 minutes you can set an oven temperature between 80 °C and 150 °C. The default is 90 °C. After the temperature is set, the oven continues to cook at 80 °C. Do not use this function for poultry.



Always cook without a lid when you use this function.

1. Sear the meat in a pan on the hob on a very high setting for 1 - 2 minutes on each side.
2. Put the meat together with the hot roasting pan on the wire shelf in the oven.
3. Put the core temperature sensor into the meat.
4. Select the function: Slow Cooking and set the correct end core temperature.

Food	Quantity (kg)	Temperature (°C)	Time (min)	Shelf position
Roast beef	1 - 1.5	150	120 - 150	1
Fillet of beef	1 - 1.5	150	90 - 110	1
Roast veal	1 - 1.5	150	120 - 150	1
Steak	0.2 - 0.3	120	20 - 40	1

## 10.9 True Fan + Bottom

Food	Temperature (°C)	Time (min)	Shelf position
Pizza (thin crust) <sup>1)</sup>	200 - 230	15 - 20	2
Pizza (with a lot of topping) <sup>2)</sup>	180 - 200	20 - 30	2
Tarts	180 - 200	40 - 55	1
Spinach flan	160 - 180	45 - 60	1
Quiche Lorraine (Savoury flan)	170 - 190	45 - 55	1
Swiss Flan	170 - 190	45 - 55	2
Cheesecake	140 - 160	60 - 90	1
Apple cake, covered	150 - 170	50 - 60	1
Vegetable pie	160 - 180	50 - 60	1
Unleavened bread <sup>1)</sup>	230 - 250	10 - 20	2

Food	Temperature (°C)	Time (min)	Shelf position
Puff pastry flan <sup>1)</sup>	160 - 180	45 - 55	2
Flammekuchen <sup>1)</sup>	230 - 250	12 - 20	2
Piroggen (Russian version of calzone) <sup>1)</sup>	180 - 200	15 - 25	2

1) Preheat the oven.

2) Use a deep pan.

## 10.10 Roasting

- Use heat-resistant ovenware to roast. Refer to the instructions of the ovenware manufacturer.
- You can roast large roasting joints directly in the deep pan or on the wire shelf above the deep pan.
- Put some liquid in the deep pan to prevent the meat juices or fat from burning on it's surface.
- All types of meat that can be browned or have crackling can be roasted in the roasting tin without the lid.
- If necessary, turn the roast after 1/2 to 2/3 of the cooking time.
- To keep meat more succulent:
  - roast lean meat in the roasting tin with the lid or use roasting bag.
  - roast meat and fish in pieces weighting minimum 1 kg.
  - baste large roasts and poultry with their juices several times during roasting.

## 10.11 Roasting tables

Beef

Food	Function	Quantity	Temperature (°C)	Time (min)	Shelf position
Pot roast	Conventional Cooking	1 - 1.5 kg	230	120 - 150	1
Roast beef or fillet: rare <sup>1)</sup>	Grill + Fan	per cm of thickness	190 - 200	5 - 6 per cm of thickness	1
Roast beef or fillet: medium	Grill + Fan	per cm of thickness	180 - 190	6 - 8 per cm of thickness	1
Roast beef or fillet: well done	Grill + Fan	per cm of thickness	170 - 180	8 - 10 per cm of thickness	1

1) Preheat the oven.

## Pork

Food	Function	Quantity	Temperature (°C)	Time (min)	Shelf position
Shoulder, neck, ham joint	Grill + Fan	1 - 1.5 kg	160 - 180	90 - 120	1
Chop, spare rib	Grill + Fan	1 - 1.5 kg	170 - 180	60 - 90	1
Meat loaf	Grill + Fan	750 g - 1 kg	160 - 170	50 - 60	1
Pork knuckle (precooked)	Grill + Fan	750 g - 1 kg	150 - 170	90 - 120	1

## Veal

Food	Function	Quantity	Temperature (°C)	Time (min)	Shelf position
Roast veal	Grill + Fan	1 kg	160 - 180	120 - 150	1
Knuckle of veal	Grill + Fan	1.5 - 2 kg	160 - 180	120 - 150	1

## Lamb

Food	Function	Quantity	Temperature (°C)	Time (min)	Shelf position
Leg of lamb, roast lamb	Grill + Fan	1 - 1.5 kg	150 - 180	100 - 120	1
Saddle of lamb	Grill + Fan	1 - 1.5 kg	160 - 180	40 - 60	1

## Game

Food	Function	Quantity	Temperature (°C)	Time (min)	Shelf position
Saddle of hare, leg of hare 1)	Conventional Cooking	up to 1 kg	230	30 - 40	1
Saddle of venison	Conventional Cooking	1.5 - 2 kg	210 - 220	35 - 40	1
Haunch of venison	Conventional Cooking	1.5 - 2 kg	180 - 200	60 - 90	1

1) Preheat the oven.

## Poultry

Food	Function	Quantity	Temperature (°C)	Time (min)	Shelf position
Chicken, spring chicken	Grill + Fan	200 - 250 g each	200 - 220	30 - 50	1
Chicken half	Grill + Fan	400 - 500 g each	190 - 210	35 - 50	1
Poultry pieces	Grill + Fan	1 - 1.5 kg	190 - 210	50 - 70	1
Duck	Grill + Fan	1.5 - 2 kg	180 - 200	80 - 100	1

## Fish (steamed)

Food	Function	Quantity	Temperature (°C)	Time (min)	Shelf position
Whole fish	Conventional Cooking	1 - 1.5 kg	210 - 220	45 - 60	1

## 10.12 Grill

- Always grill with the maximum temperature setting.
- Set the shelf into the shelf position as recommended in the grilling table.
- Always set the pan to collect the fat into the first shelf position.

- Grill only flat pieces of meat or fish.
- Always preheat the empty oven with the grill functions for 5 minutes.

**CAUTION!**

Always grill with the oven door closed.

## Grill

Food	Temperature (°C)	Grilling time (min)		Shelf position
		1st side	2nd side	
Roast beef, medium	210 - 230	30 - 40	30 - 40	1
Filet of beef, medium	230	20 - 30	20 - 30	1
Back of pork	210 - 230	30 - 40	30 - 40	1
Back of veal	210 - 230	30 - 40	30 - 40	1
Back of lamb	210 - 230	25 - 35	20 - 35	1
Whole Fish, 500 - 1000 g	210 - 230	15 - 30	15 - 30	1

## Fast Grilling

Food	Grilling time (min)		Shelf position
	1st side	2nd side	
Burgers / Burgers	9 - 13	8 - 10	3
Pork fillet	10 - 12	6 - 10	3
Sausages	10 - 12	6 - 8	3
Fillet steaks, veal steaks	7 - 10	6 - 8	3
Toast / Toast	1 - 3	1 - 3	3
Toast with topping	6 - 8	-	3

**10.13 Bottom + Grill + Fan**

- Remove the food packaging. Put the food on a plate.

- Do not cover it with a bowl or a plate. This can extend the defrost time.

Food	Temperature (°C)	Time (min)	Shelf position
Pizza, frozen	200 - 220	15 - 25	2
Pizza American, frozen	190 - 210	20 - 25	2
Pizza, chilled	210 - 230	13 - 25	2
Pizza Snacks, frozen	180 - 200	15 - 30	2
French Fries, thin	200 - 220	20 - 30	2
French Fries, thick	200 - 220	25 - 35	2
Wedges / Croquettes	220 - 230	20 - 35	2
Hash Browns	210 - 230	20 - 30	2
Lasagne / Cannelloni, fresh	170 - 190	35 - 45	2
Lasagne / Cannelloni, frozen	160 - 180	40 - 60	2
Oven baked cheese	170 - 190	20 - 30	2
Chicken Wings	190 - 210	20 - 30	2

## Frozen ready meals

Food	Function	Temperature (°C)	Time (min)	Shelf position
Frozen pizza	Conventional Cooking	as per manufacturer's instructions	as per manufacturer's instructions	2
Chips <sup>1)</sup> (300 - 600 g)	Conventional Cooking or Grill + Fan	200 - 220	as per manufacturer's instructions	2
Baguettes	Conventional Cooking	as per manufacturer's instructions	as per manufacturer's instructions	2
Fruit cake	Conventional Cooking	as per manufacturer's instructions	as per manufacturer's instructions	2

<sup>1)</sup> Turn chips 2 or 3 times during cooking.

### 10.14 Defrost

- Remove the food packaging and put the food on a plate.
- Use the first shelf position from the bottom.
- Do not cover the food with a bowl or a plate, as this can extend the defrost time.

Food	Quantity	Defrosting time (min)	Further defrosting time (min)	Comments
Chicken	1 kg	100 - 140	20 - 30	Put the chicken on an upturned saucer in a big plate. Turn halfway through.
Meat	1 kg	100 - 140	20 - 30	Turn halfway through.
Meat	500 g	90 - 120	20 - 30	Turn halfway through.
Trout	150 g	25 - 35	10 - 15	-
Strawberries	300 g	30 - 40	10 - 20	-
Butter	250 g	30 - 40	10 - 15	-
Cream	2 x 200 g	80 - 100	10 - 15	Whip the cream when still slightly frozen in places.
Gateau	1.4 kg	60	60	-

### 10.15 Preserving

- Use only preserve jars of the same dimensions available on the market.
- Do not use jars with twist-off and bayonet type lids or metal tins.
- Use the first shelf from the bottom for this function.

- Put no more than six one-litre preserve jars on the baking tray.
- Fill the jars equally and close with a clamp.
- The jars cannot touch each other.
- Put approximately 1/2 litre of water into the baking tray to give sufficient moisture in the oven.
- When the liquid in the jars starts to simmer (after approximately 35 - 60 minutes with one-litre jars), stop the oven or decrease the temperature to 100 °C (see the table).

## Soft fruit

Food	Temperature (°C)	Cooking time until simmering (min)	Continue to cook at 100 °C (min)
Strawberries / Blueberries / Raspberries / Ripe gooseberries	160 - 170	35 - 45	-

## Stone fruit

Food	Temperature (°C)	Cooking time until simmering (min)	Continue to cook at 100 °C (min)
Pears / Quinces / Plums	160 - 170	35 - 45	10 - 15

## Vegetables

Food	Temperature (°C)	Cooking time until simmering (min)	Continue to cook at 100 °C (min)
Carrots <sup>1)</sup>	160 - 170	50 - 60	5 - 10
Cucumbers	160 - 170	50 - 60	-
Mixed pickles	160 - 170	50 - 60	5 - 10
Kohlrabi / Peas / Asparagus	160 - 170	50 - 60	15 - 20

<sup>1)</sup> Leave standing in the oven after it is deactivated.

## 10.16 Drying

Food	Temperature (°C)	Time (h)	Shelf position
Beans	60 - 70	6 - 8	2
Peppers	60 - 70	5 - 6	2
Vegetables for soup	60 - 70	5 - 6	2
Mushrooms	50 - 60	6 - 8	2
Herbs	40 - 50	2 - 3	2
Plums	60 - 70	8 - 10	2

Food	Temperature (°C)	Time (h)	Shelf position
Apricots	60 - 70	8 - 10	2
Apple slices	60 - 70	6 - 8	2
Pears	60 - 70	6 - 9	2

## 10.17 Bread Baking

Preheating is not recommended.

Food	Temperature (°C)	Time (min)	Shelf position
White Bread	180 - 200	40 - 60	2
Baguette	200 - 220	35 - 45	2
Brioche	160 - 180	40 - 60	2
Ciabatta	200 - 220	35 - 45	2
Rye Bread	180 - 200	50 - 70	2
Dark Bread	180 - 200	50 - 70	2
All Grain bread	170 - 190	60 - 90	2

## 10.18 Food Sensor table

Beef	Food core temperature (°C)		
	Rare	Medium	Well done
Roast beef	45	60	70
Sirloin	45	60	70

Beef	Food core temperature (°C)		
	Less	Medium	More
Meat loaf	80	83	86

Pork	Food core temperature (°C)		
	Less	Medium	More
Ham, Roast	80	84	88
Chop (saddle), Smoked pork loin, Smoked loin poached	75	78	82



<b>Veal</b>	<b>Food core temperature (°C)</b>		
	<b>Less</b>	<b>Medium</b>	<b>More</b>
Roast veal	75	80	85
Knuckle of veal	85	88	90

<b>Mutton / lamb</b>	<b>Food core temperature (°C)</b>		
	<b>Less</b>	<b>Medium</b>	<b>More</b>
Leg of mutton	80	85	88
Saddle of mutton	75	80	85
Leg of lamb, Roast lamb	65	70	75

<b>Game</b>	<b>Food core temperature (°C)</b>		
	<b>Less</b>	<b>Medium</b>	<b>More</b>
Saddle of hare, Saddle of venison	65	70	75
Leg of hare, Whole hare, Leg of venison	70	75	80

<b>Poultry</b>	<b>Food core temperature (°C)</b>		
	<b>Less</b>	<b>Medium</b>	<b>More</b>
Chicken (whole / half / breast)	80	83	86
Duck (whole / half), Turkey (whole / breast)	75	80	85
Duck (breast)	60	65	70

<b>Fish (salmon, trout, zander)</b>	<b>Food core temperature (°C)</b>		
	<b>Less</b>	<b>Medium</b>	<b>More</b>
Fish (whole / large / steamed), Fish (whole / large / roasted)	60	64	68

<b>Casseroles - Precooked vegetables</b>	<b>Food core temperature (°C)</b>		
	<b>Less</b>	<b>Medium</b>	<b>More</b>
Zucchini Casserole, Broccoli Casserole, Fennel Casserole	85	88	91

Casseroles - Savoury	Food core temperature (°C)		
	Less	Medium	More
Cannelloni, Lasagne, Pasta bake	85	88	91

Casseroles - Sweet	Food core temperature (°C)		
	Less	Medium	More
White bread casserole with / without fruits, Rice porridge casserole with / without fruits, Sweet noodle casserole	80	85	90

## 11. CARE AND CLEANING



**WARNING!**  
Refer to Safety chapters.

### 11.1 Notes on cleaning

- Clean the front of the appliance with a soft cloth with warm water and a cleaning agent.
- To clean metal surfaces, use a dedicated cleaning agent.
- Clean the appliance interior after each use. Fat accumulation or other food remains may result in a fire. The risk is higher for the grill pan.
- Clean stubborn dirt with a special oven cleaner.
- Clean all accessories after each use and let them dry. Use a soft cloth with warm water and a cleaning agent.
- If you have nonstick accessories, do not clean them using aggressive agents, sharp-edged objects or a dishwasher. It can cause damage to the nonstick coating.

### 11.2 Removing the shelf supports

To clean the oven, remove the shelf supports.

1. Pull the front of the shelf support away from the side wall.

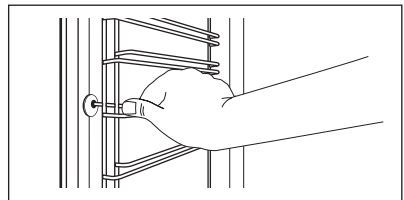

2. Pull the rear end of the shelf support away from the side wall and remove it.

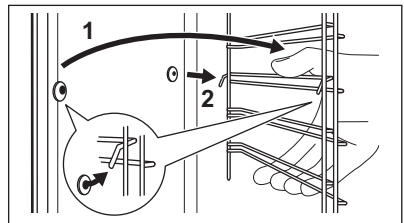

Install the shelf supports in the opposite sequence.

### 11.3 Pyrolytic cleaning



**CAUTION!**  
Remove all accessories and removable shelf supports.



**The pyrolytic cleaning procedure cannot start:**

- if you did not remove the core temperature sensor plug from the socket.
- if you did not fully close the oven door.

Remove the worst dirt manually.



### CAUTION!

If there are other appliances installed in the same cabinet, do not use them at the same time as the function: Pyrolytic Cleaning. It can cause damage to the appliance.

1. Clean the inner side of the door with hot water, so that the residues do not burn from the hot air.
2. Turn the appliance on.
3. Select the Menu and press the rotary knob to confirm.
4. Select Pyrolytic Cleaning and press the rotary knob to confirm.
5. Select the duration of the cleaning procedure:

Option	Description
Quick	1 h for a low degree of dirt
Normal	1 h 30 min for a usual degree of dirt
Intense	2 h 30 min for a high degree of dirt

6. Press the rotary knob to confirm.



When the pyrolytic cleaning starts, the appliance door is locked and the lamp does not work. The cooling fan works at a high speed.



To stop the pyrolytic cleaning before it is completed, turn the appliance off.



### WARNING!

After the function is completed, the appliance is very hot. Let it cool down. There is a risk of burns.



After the function is completed, the door stays locked for the cool down phase. Some of the appliance functions are not available during the cool down phase.

## 11.4 Cleaning Reminder

When reminder is displayed cleaning is necessary. Perform the function Pyrolytic Cleaning.

## 11.5 Removing and installing the door

You can remove the door and the internal glass panels to clean it. The number of glass panels is different for different models.



### WARNING!

Be careful when you remove the door from the appliance. The door is heavy.

1. Open the door fully.
2. Fully press the clamping levers (A) on the two door hinges.

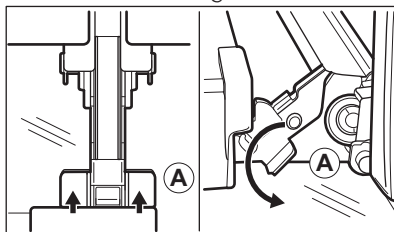

3. Close the oven door to the first opening position (approximately 70° angle).
4. Hold the door with one hand on each side and pull it away from the appliance at an upwards angle.
5. Put the door with the outer side down on a soft cloth on a stable surface. This is to prevent scratches.

6. Hold the door trim (B) on the top edge of the door at the two sides and push inwards to release the clip seal.

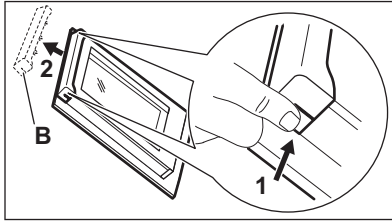

7. Pull the door trim to the front to remove it.
8. Hold the door glass panels on their top edge one by one and pull them up out of the guide.

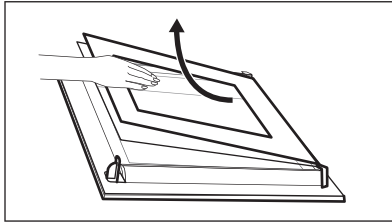

9. Clean the glass panel with water and soap. Dry the glass panel carefully. When the cleaning is completed, do the above steps in the opposite sequence. Install the smaller panel first, then the larger and the door.



**WARNING!** Make sure that the glasses are inserted in the correct position otherwise the surface of the door may overheat.

## 12. TROUBLESHOOTING



**WARNING!** Refer to Safety chapters.

## 11.6 Replacing the lamp

Put a cloth on the bottom of the interior of the appliance. It prevents damage to the lamp glass cover and the cavity.



**WARNING!**

Danger of electrocution! Disconnect the fuse before you replace the lamp. The lamp and the lamp glass cover can be hot.

1. Deactivate the appliance.
2. Remove the fuses from the fuse box or deactivate the circuit breaker.

### The top lamp

1. Turn the lamp glass cover counterclockwise to remove it.

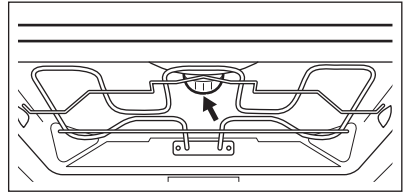

2. Clean the glass cover.
3. Replace the lamp with a suitable 300 °C heat-resistant lamp.
4. Install the glass cover.

## 12.1 What to do if...

Problem	Possible cause	Remedy
You cannot activate or operate the oven.	The oven is not connected to an electrical supply or it is connected incorrectly.	Check if the oven is correctly connected to the electrical supply (refer to the connection diagram if available).
The oven does not heat up.	The oven is deactivated.	Activate the oven.
The oven does not heat up.	The clock is not set.	Set the clock.
The oven does not heat up.	The necessary settings are not set.	Make sure that the settings are correct.
The oven does not heat up.	The automatic switch-off is activated.	Refer to "Automatic switch-off".
The oven does not heat up.	The door is not closed correctly.	Fully close the door.
The oven does not heat up.	The fuse is blown.	Make sure that the fuse is the cause of the malfunction. If the fuse is blown again and again, contact a qualified electrician.
The lamp does not operate.	The lamp is defective.	Replace the lamp.
The display prompts to set: Language	There was a power cut longer than 3 days.	Refer to "Before first use" chapter.
The display prompts to set: Language		
The display shows F111.	The plug of the core temperature sensor is not correctly installed into the socket.	Put the plug of the core temperature sensor as far as possible into the socket.
The display shows an error code that is not in this table.	There is an electrical fault.	<ul style="list-style-type: none"> <li>Deactivate the oven with the house fuse or the safety switch in the fuse box and activate it again.</li> <li>If the display shows the error code again, contact the Customer Care Department.</li> </ul>
Steam and condensation settle on the food and in the cavity of the oven.	You left the dish in the oven for too long.	Do not leave the dishes in the oven for longer than 15 - 20 minutes after the cooking process ends.

## 12.2 Service data

If you cannot find a solution to the problem yourself, contact your dealer or an Authorised Service Centre.

The necessary data for the service centre is on the rating plate. The rating plate is

on the front frame of the appliance cavity. Do not remove the rating plate from the appliance cavity.

We recommend that you write the data here:	
Model (MOD.)	.....
Product number (PNC)	.....
Serial number (S.N.)	.....

## 13. ENERGY EFFICIENCY

### 13.1 Product Fiche and information according to EU 65-66/2014

Supplier's name	AEG
Model identification	KPE842220M
Energy Efficiency Index	80.8
Energy efficiency class	A+
Energy consumption with a standard load, conventional mode	0.89 kWh/cycle
Energy consumption with a standard load, fan-forced mode	0.59 kWh/cycle
Number of cavities	1
Heat source	Electricity
Volume	43 l
Type of oven	Built-In Oven
Mass	32.7 kg

EN 60350-1 - Household electric cooking appliances - Part 1: Ranges, ovens, steam ovens and grills - Methods for measuring performance.

### 13.2 Energy saving



The oven contains features which help you save energy during everyday cooking.

#### General hints

Make sure that the oven door is closed properly when the appliance operates. Do not open the door too often during cooking. Keep the door gasket clean and make sure it is well fixed in its position.

Use metal dishes to improve energy saving.

When possible, do not preheat the oven before you put the food inside.

When the cooking duration is longer than 30 minutes, reduce the oven temperature to minimum 3 - 10 minutes before the end of the cooking time, depending on the duration of the cooking. The residual heat inside the oven will continue to cook.

Use the residual heat to warm up other dishes.

Keep breaks between baking as short as possible when you prepare few dishes at one time.

### **Cooking with fan**

When possible, use the cooking functions with fan to save energy.

### **Residual heat**

If a programme with the Duration or End Time selection is activated and the cooking time is longer than 30 minutes, the heating elements automatically deactivate earlier in some oven functions.

The fan and lamp continue to operate.

### **Keep food warm**

Choose the lowest possible temperature setting to use residual heat and keep a meal warm. The residual heat indicator or temperature appears on the display.

### **Cooking with the lamp off**

Turn off the lamp during cooking. Turn it on only when you need it.

### **Moist Fan Baking**

Function designed to save energy during cooking. It operates in such a way that the temperature in the oven cavity may differ from the temperature indicated on the display during a cooking cycle and cooking times may be different from the cooking times in other programmes.

When you use Moist Fan Baking, the lamp automatically turns off after 30 seconds. You may turn on the lamp again but this action will reduce the expected energy savings.

## 14. ENVIRONMENTAL CONCERNS

Recycle the materials with the symbol . Put the packaging in applicable containers to recycle it. Help protect the environment and human health and to recycle waste of electrical and electronic appliances. Do not dispose appliances

marked with the symbol  with the household waste. Return the product to your local recycling facility or contact your municipal office.

[www.aeg.com/shop](http://www.aeg.com/shop)



867335711-C-192017



**AEG**