

# Weva

# OCTO / OCTO +



# ProSwell

by PROCOPI

## Installation instructions

To be read carefully and kept for future reference



PROCOPI  
Les Landes d'Apigné  
B.P.45328  
35650 LE RHEU Cedex  
FRANCE

Installation instructions Weva Octo, Octo+ 07/2017  
GB - Revision: E - Code : 97149997

## WOOD, A NATURAL MATERIAL.

Being a natural material, wood will have some imperfections. These are normal and have no impact on the service life of the product. A certain number are superficial and are not covered within the scope of the guarantee.



### » COLOUR VARIATIONS

Colour variations are common to every species of wood. Treatment brings them out because the depth of penetration of the product will depend on the wood density and grain. Weathering of wood outdoors will significantly attenuate these colour variations.



### » GREYING

Wood exposed to sunlight is susceptible to greying. Some people like the silvery sheen of this natural patina. If, however, you would prefer the wood to keep its original colour with brown tones, apply a protective coating (lasure, oil) when the product is assembled.



### » SURFACE MOULD

Mould, caused by microscopic fungi, can grow on wood, particularly on resinous species, on which the growth can appear as «blueing». It is a surface phenomenon, exacerbated by heat, humidity and inadequate aeration and is characterised by stains ranging from light to dark blue. They can be removed by wiping the surface. Remember that class IV treated wood is protected against attack by fungi that could destroy the physical and mechanical properties of the wood. For further information, please refer to Procopi's guarantees concerning the types of wood and their treatment.



### » RESIN BEADS

When resinous wood species are autoclaved, the alternating pressure and vacuum can cause sticky resin residues to rise to the surface. To remove them, scrape them carefully with an appropriate tool, being careful not to touch the wood. Turpentine spirits could also be effective, but could stain the wood if too much is applied.

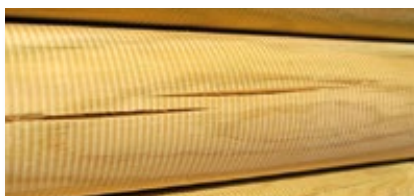

### » SPLITTING AND CRACKING

Wood expands and contracts when exposed to variations in humidity and temperature. As it dries, wood contracts unevenly resulting in the appearance of cracks. While these can seem to be cause for concern, they have no impact on the mechanical properties of the product and therefore do not fall within the scope of the guarantee.



### » SALT STAINS

Small green stains are frequently found on the surface of autoclaved wood. These can be removed with light sanding. Otherwise, this colour will disappear over time.



### » KNOTS

Knots mark the places where branches were attached. The quantity and size depends on the species of wood and the sorting process. For outdoor installations, small adherent knots are acceptable. The more stringent the sorting process to limit the number and size of knots, the more expensive the wood will be.



### » JOINED WOOD

To ensure the highest quality in the selection of our wood, it is sorted meticulously before planing. Planks that feature defects on both sides are taken out. Defects (knots, cracks, flashes) are removed and the planks are joined together (see the image above).

This is why it is not unusual to find joined elements in a wooden pool, it in no way penalises the mechanical properties of the wood. For the same reason, imperfections on the interior surface of the pool (knots, cracks, flashes) are entirely acceptable.

## CAUTION

■ **storage.** If you do not intend to assemble your pool immediately, you should store it without opening it in a well-ventilated room, or failing this, in an area protected from humidity and sunlight. If, however, you were obliged to unpack your pool, redo and restrap the pallet. Once the pallets are undone, the kit must be assembled within 24 to 48 hours.

proswell.fr



## CONTENTS

Foreword .....	p-4
Storage & time required for assembly .....	p-4
Siting and preparation of the ground for Octo & Octo + pools.....	p.5-6
Assembly of the Octo pool structure .....	p.7-9
Assembly of the Octo+ pool structure .....	p.10-14
Gaskets, laying and cutting out the liner .....	p.15-17
Assembling coping on Octo pools.....	p.18
Assembling coping on Octo+ pools .....	p.19
Assembling and installing ladders .....	p.20-21
Installation of in-ground and partially in-ground pools ...	p.22-24
Maintenance and use.....	p.25-26
Safety .....	p.27
Guarantee.....	p.28-29
Exploded view of the wooden structure .....	p.30-31

## » FOREWORD

Congratulations on acquiring your pool. We have taken great care with the design and manufacture of your pool to provide you with a top quality product.

The wood used to make the various elements (interlocking walls, coping, ladder, etc.) was carefully selected. Outdoors, these wooden elements are subject to constant weathering: contact with the ground, temperature variations, exposure to sunlight, rain and frost, insect attack, etc. The wood's ability to withstand this aggression depends on the origin of the wood and the method used to treat it.

For this reason, we choose pine from extensive, sustainably managed forests in northern Europe. Why do we insist on this? Because the more rigorous climates above the 57th parallel favour very slow tree growth, making the wood stronger and more resilient.

The wood is autoclaved, this involves subjecting the wood alternately to pressure and vacuum in order to drive the treatment chemicals into the heart of the wood as opposed to other more superficial treatment techniques such as soaking.

Class IV treated wood in contact with the ground is immune to insect attack and rotting caused by humidity. Autoclave treatment is guaranteed 10 years, in accordance with standards currently in effect.

The pool coping is made of treated PINE.

Wood is a living material, variations in temperature and humidity can cause it to expand or contract so take care to follow the storage and assembly instructions concerning the wooden structure. Similarly, prolonged exposure to UV light can cause wood to grey. These are natural phenomena that in no way effect the service life of the products.

Do not apply any product to the wood (for example: lazure, micro-porous products, etc.)

## » STORAGE & TIME REQUIRED FOR ASSEMBLY

We shall now explain how to assemble your pool, but first some instructions before you begin.

Please read these instructions carefully, this will allow you to prepare each stage to achieve optimum efficiency. Please keep these instructions for future reference.

You should take the time to go through the components using the nomenclature page enclosed with the accessories kit and make sure that no items are missing.

Keep the following documents;

- the productions sheets for the various kits
- proofs of purchase

### STORAGE

If you do not intend to assemble your pool immediately, you should store it without opening it, in a well ventilated room, or failing this, in an area protected from humidity and sunlight. Once the pallets are undone, the kit must be assembled within 24 hours. Once work has begun, try to avoid leaving the structure exposed to significant climatic variations that could cause the wood to "work" too quickly. This could lead to deformations that could render the item unusable. By preference, the wooden structure should be assembled in one go on a day that is not too hot. The liner should be stored at a minimum of 20°C for at least 24 hours before it is fitted. This is to render the liner more supple and thus facilitate fitting. The liner should only be fitted if the ambient temperature is higher than 20 °C.

### TOOLS AND TIME REQUIRED TO MOUNT AN OCTO POOL

- To prepare the ground (does not include pouring a concrete slab): shovel, rake, pick axe, cord, aluminium ruler and a spirit level.
- To assemble the structure: spirit level, screw gun, mallet, measuring tape, stanley knife, metal saw, flat head and cross head screw drivers, sanding paper and a fine grain file.
- The time taken for assembly is 2 days for 2 people (does not include excavation, pouring the slab or filling of the pool).

keep on hand: sand and cement for tamping the soil

### TOOLS AND TIME REQUIRED TO MOUNT AN OCTO+ POOL

- To prepare the ground (does not include pouring a concrete slab): shovel, rake, pick axe, cord, aluminium ruler and a spirit level.
- To assemble the structure: spirit level, screw gun, mallet, measuring tape, stanley knife, metal saw, flat and socket wrenches, flat head and cross head screw drivers, sand paper and a fine grain file.
- The time taken for assembly is 3 days for 2 people (does not include excavation, pouring the slab or filling of the pool).

keep on hand: sand and cement to support the cradles and tamp the soil

## » SITING AND PREPARATION OF THE GROUND FOR OCTO & OCTO+ POOLS

This is the most important step in the procedure as the pool site will determine the service life of your pool. There are some rules that must be respected.

Given the vast number of possible variations (slope, type and homogeneity of the ground, possible issues with drainage, etc) we cannot provide recommendations for every possible permutation here. Some optional steps, such as pouring a concrete slab, laying foundations, footing, laying drains, etc will require assistance from professionals who will be able to advise you on solutions best suited to your configuration.

We will explain how to prepare the ground without any concrete, the objective being to achieve a flat, level bearing surface. In as far as possible, avoid siting your pool under trees (to stop you pool from being filled with leaves) or near rises or dips in the ground that could expose children to danger. Do not assemble your pool under electrical cables. The pool should be at least 3.50 m from any electrical source (French safety standard C15-100). On a slope, never back fill under your pool to bring the bearing surface level, always cut into the upward slope. Lastly, avoid preparing the ground and assembling the pool while a strong wind is blowing.

How should the pool be oriented? Ideally, the pool should be oriented so that the skimmers are facing into the prevailing wind. This will determine the final orientation of your pool and the manner in which it will lie in your garden, notably in the case of elongated pools.

## » OCTO POOLS

(ABOVE GROUND CONFIGURATION ONLY. ADVISE AND INSTRUCTIONS FOR IN-GROUND OR PARTIALLY SUNKEN CONFIGURATIONS ARE ILLUSTRATED AT THE END OF THIS DOCUMENT).

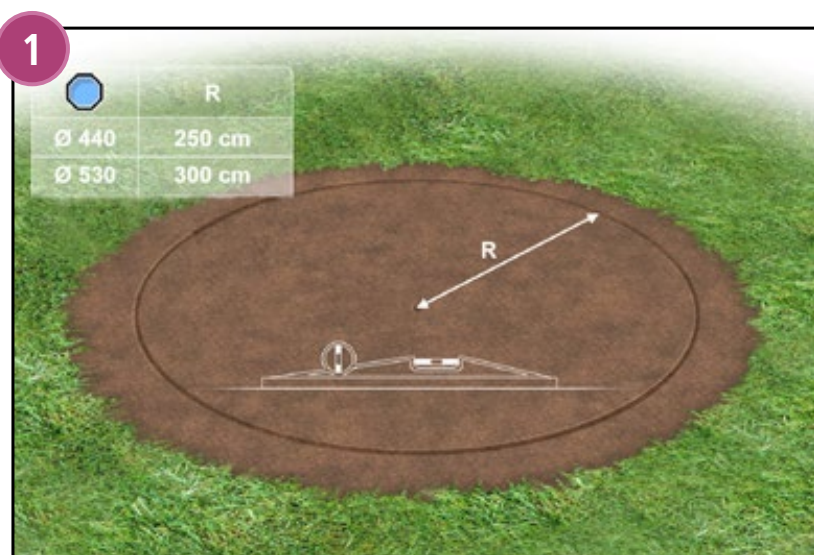

### Soil with a good constitution:

That is properly consolidated soil that has not been subject to recent backfill. Even after 15 years, the backfill may not be completely stabilised.

To begin, clear the ground of plants and other miscellaneous objects. Next, level and smooth the surface using a spade, rake and a pickaxe (if necessary). Make sure that you smooth out any bumps or rough areas that could damage the underlay, or more seriously, the liner.

After a rough preparation of the surface, plant a stake in the centre of the circle and mark the point where it comes into contact with the ground.

Next, using a flat, straight piece of wood longer than the radius of your pool, go around the circle checking that the ground is level. This operation requires two people (one to make sure that the bottom of the wood corresponds to the mark on the stake, and the other to check the level and move the wood around the entire circumference to ensure that the surface is perfectly level).

## » OCTO+ POOLS

(ABOVE GROUND CONFIGURATION ONLY. ADVISE AND INSTRUCTIONS FOR IN-GROUND OR PARTIALLY SUNKEN CONFIGURATIONS ARE ILLUSTRATED AT THE END OF THIS DOCUMENT).

Trace out site of the pool and clear the ground of plants, grass and other miscellaneous objects. Next, level and smooth the surface using a spade, rake and a pickaxe (if necessary). Make sure that you smooth out any bumps or rough areas that could damage the underlay, or more seriously, the liner.

Make sure that the bearing surface is completely flat and perfectly level.

Once the ground has been prepared, use string to mark out the longitudinal axis (A1) of your pool and then the transversal axis (A2) perpendicular to the axis A1.

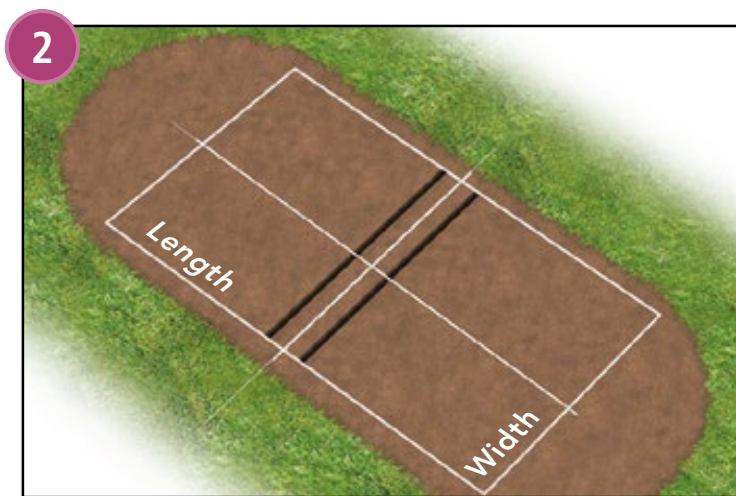

OCTO+ footprint

### Pool sizes

	length	width
+460	460	330
+540	540	330
+640	640	400
+840	840	490

The dimensions shown in this table do not take the footprint of the access steps or plant housing into consideration.

## » ASSEMBLY OF THE OCTO POOL STRUCTURE

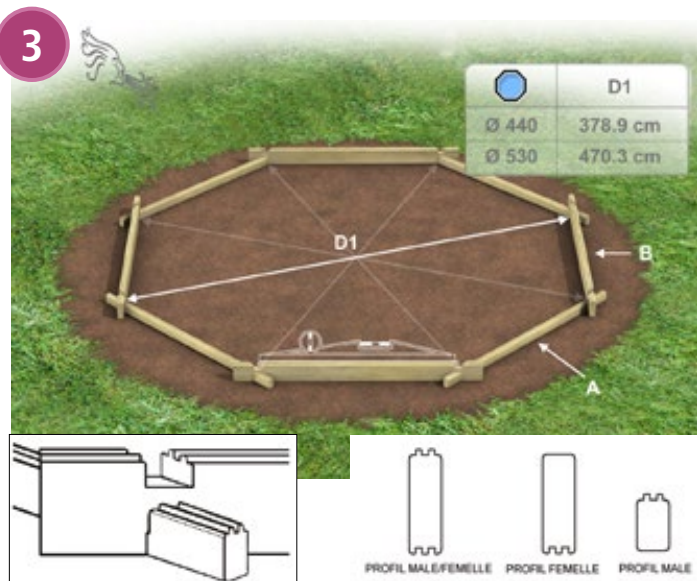

- Before you begin, familiarise yourself with the nomenclature enclosed in the "Accessories" kit and the exploded view (at the end of this notice) that corresponds to your pool.
- Determine the final orientation of your pool, by preference, the skimmers should be oriented so that they are facing into the prevailing winds. Skimmers must be mounted on a side that starts with a type A slat.
- While assembling the walls, make sure that each slat is fully engaged before starting on the next.
- You may need to use a hammer and a clamp to remedy any slight warping of the slats. Do not strike the wood directly, use the protective brace (provided).
- During assembly, check regularly that the walls are level and the 4 diagonals are equal in length.
- To avoid the risk of injury or damage to the liner, take care to eliminate any splinters during and after assembly.
- If you intend to fit your pool with a counter swim unit, you will need to incorporate the 2 slats specially prepared to mount this option.

Fit the 4 half slats (type A - smooth side facing down) together with 4 male/ female slats (type B), grooves facing down, double tongues facing up (see the detail above).

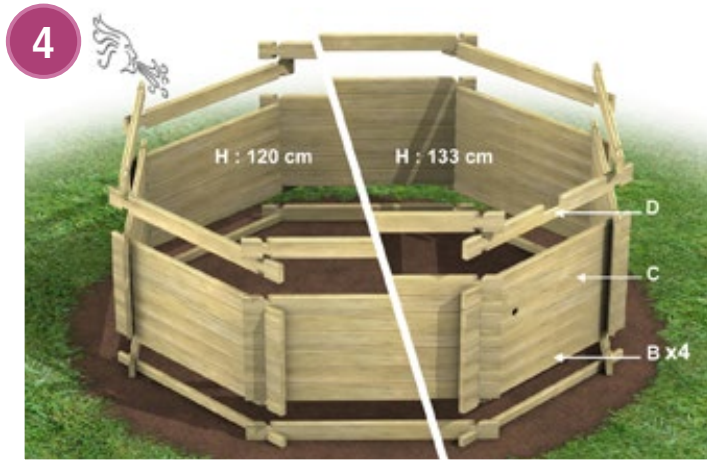

Fit together the remaining slats (type B) taking care to position the slat that will hold the return fitting (type C) and the machined slat (type D) correctly. The slat that will hold the return fitting (type C) should be positioned over 4 type B slats + 1 type A slat in the case of a skimmer and in the case of an autonomous filtration unit. The slat that will hold the return fitting slat (type C) should be positioned just underneath the machined slats. The type D slat is positioned on the same side in the last row of this step.

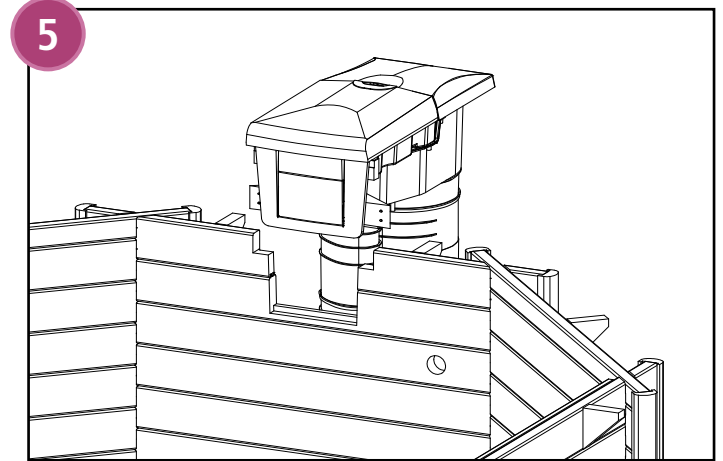

At this point, fit the skimmer or filtration unit into the bottom machined slat (type D).



In the case of a filtration unit, fit the 2 slats on either side of the filtration unit, otherwise, fit the top skimmer slat (type E) over the bottom skimmer slat (type D). Continue around the pool with 3 type F slats and 4 type G half-slats as illustrated.

Paint the ends of the slats in the corners with a wood stabiliser to limit deformation over time.

This product is white on application, but becomes colourless when dry. Drying time is 2 to 3 hours. Apply a second layer if the temperature is high or if the product dries too quickly.

Follow the safety instructions printed on the container. Rinse the brush after use.

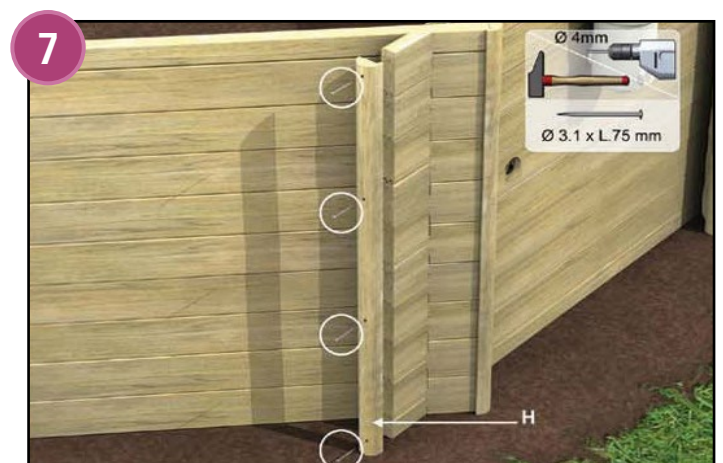

Attach the finishing profiles (type H) to the exposed edge of each wall using 4 equally spaced SS rivets (3.1x75 mm) inserted into holes pre-drilled in the axis.

## >> ASSEMBLY OF THE OCTO POOL STRUCTURE (contd.)

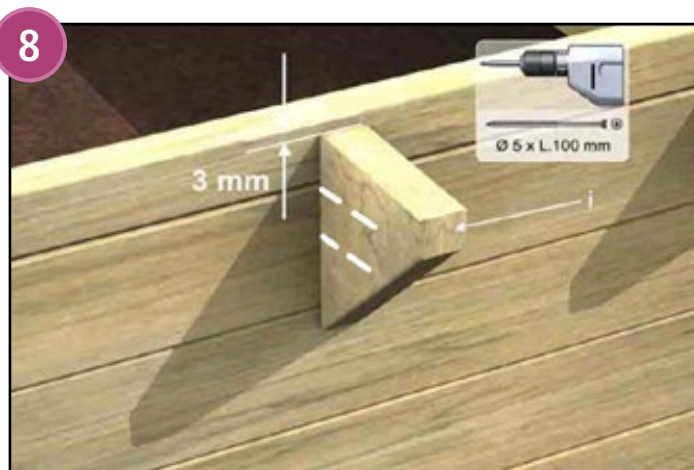

The wooden brackets will support the coping that will be mounted after the pool is filled. Pre-drill the wall from inside the pool then attach each wooden bracket (type I) using 2 screws (5x100 mm sachet I) taking care to position them 3 mm below the top of the structure. Remove any splinters that may have been raised during this process.

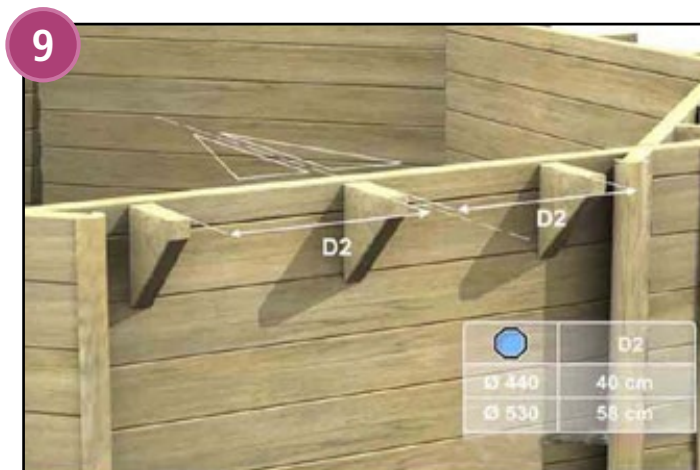

There are 3 wooden brackets per side (except the side holding the skimmer). Position 1 wooden bracket in the centre of the slat, the other 2 equidistant on either side of it (distance D2 in the table).



Mount 2 wooden brackets on the wall holding the skimmer or filtration unit. In the case of a skimmer they should be positioned 75.5 cm apart and equidistant from the skimmer axis. In the case of a filtration unit, they should be 50 cm apart.

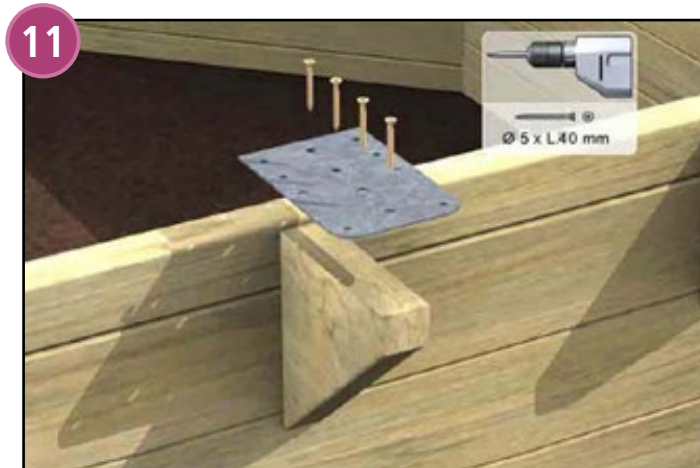

Screw a mounting plate to the top of each wooden bracket (wooden bracket kit). Make sure that each plate is flush with the top of the walls.

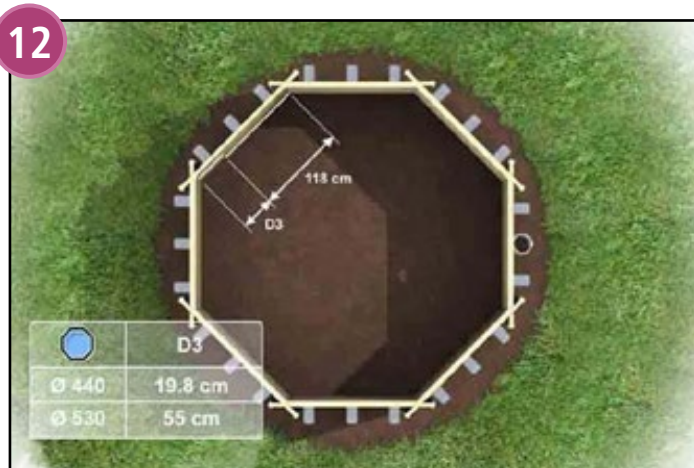

### IMPORTANT !

Check that the structure is correctly assembled before mounting the liner locking track.

To do this:

- use a spirit level to check that the structure is horizontal around the entire periphery.
- check that the 4 diagonals are equal in length.

Fix any imperfections before continuing. The liner locking track should be flush with the top of the wooden structure.

Before mounting the liner locking track, pre-drill using a Ø 3 mm drill bit.

Avoid over tightening, this could cause the screws to break through the track.



## » ASSEMBLY OF THE OCTO POOL STRUCTURE (contd.)

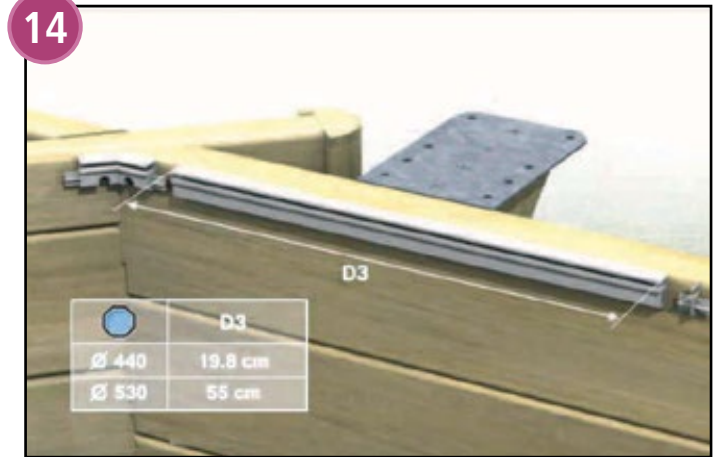
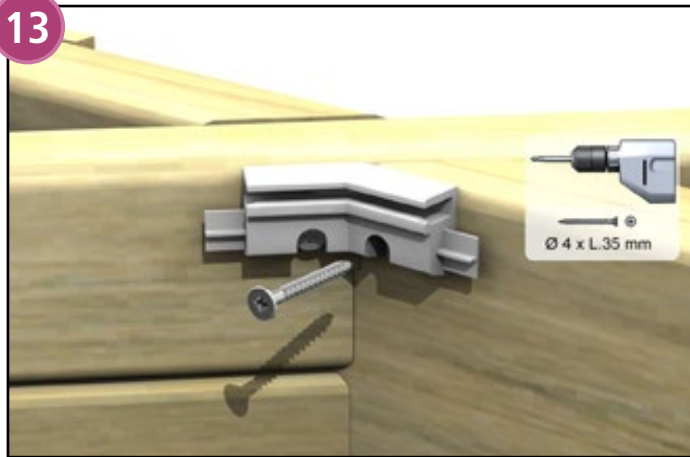

Mount a corner junction piece (junction+corner blister pack) in each corner using 2 SS screws (bag E) inserted through the notches intended for this purpose. Make sure that these parts are flush with the top of the pool wall. Each wall will take a 1.18 m length of track and an additional length that will need to be trimmed to size. Prepare the 8 additional pieces of track according to the table below. Before making the cuts, check that the total length of the track is equal to the distance between two corner pieces less 2 mm to allow for the corner pieces. Make sure that the cuts are straight and clean. Deburr the cuts using the fine grain file.

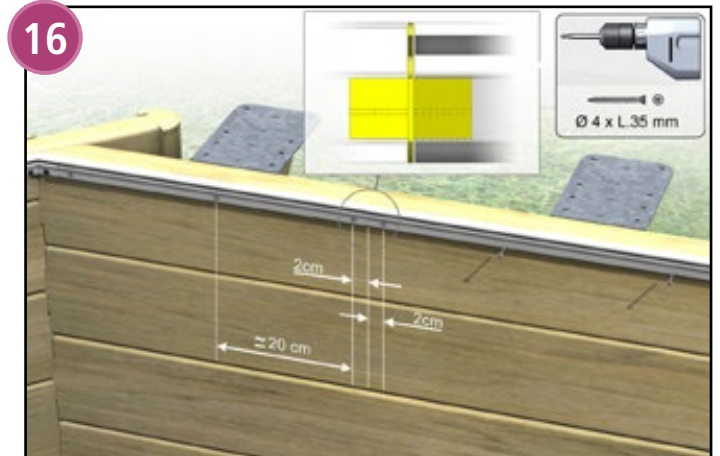
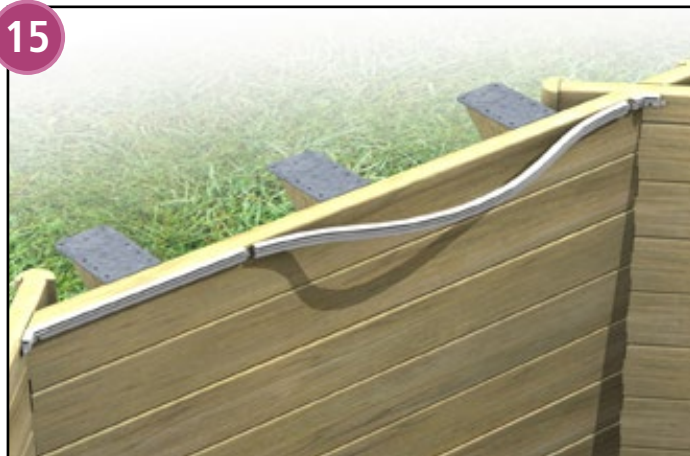

Fit the long section into the corner piece. Bend the track to facilitate fitting onto the junction piece. Hold the track in position using a screw 2 cm from each end. Then complete attachment of the track by inserting screws at 20 cm intervals.

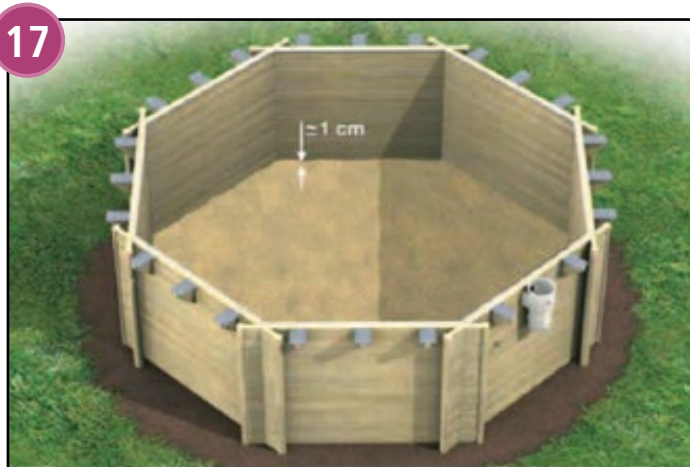

### FITTING THE UNDERLAY:

**Important!** The ground underneath the underlay should be absolutely flat and free of any bumps or rough areas. Because of the pressure exerted by the water, even the smallest bump will be visible underneath the liner. After clearing the ground, spread a layer of sand mixed with cement (1 part cement to 7 parts sand) over the floor of the pool and compact it. This layer should be no more than 1 cm deep. (The sand and cement are not supplied). Unfold the underlay in the pool taking care to line it up correctly with the corners. Smooth out any wrinkles. The underlay will be slightly smaller than the pool structure.

## >> ASSEMBLY OF THE OCTO+ POOL STRUCTURE

The pool structure is mounted in two stages:

- Stage 1, excavation of the site and installation of the cradles designed to reinforce the lateral walls. A cradle comprises a cross beam, vertical posts and metallic plates to be bolted together.
- Stage 2, assembly of the wooden structure and fitting of the additional items (liner, coping, etc.).

We recommend that the pool structure be assembled by two people. Before you begin, familiarise yourself with the nomenclature page (enclosed with the Accessories kit) and the main exploded view (at the end of this document) that corresponds to your pool.

Cross section of the cement slab  
In the case of a cement slab, it is better to seal the cradles into the slab and create a peripheral drain.

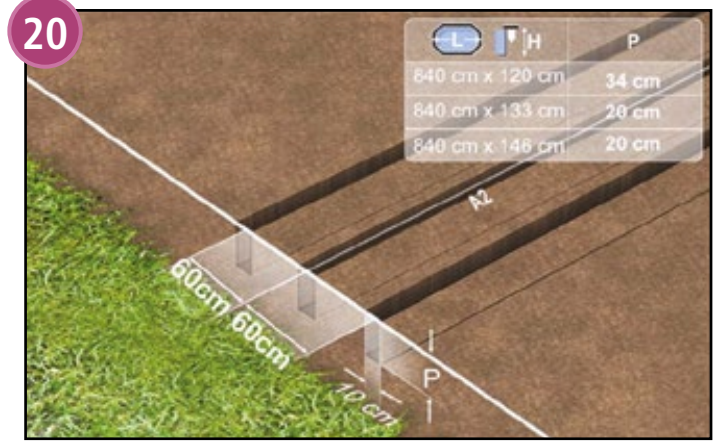
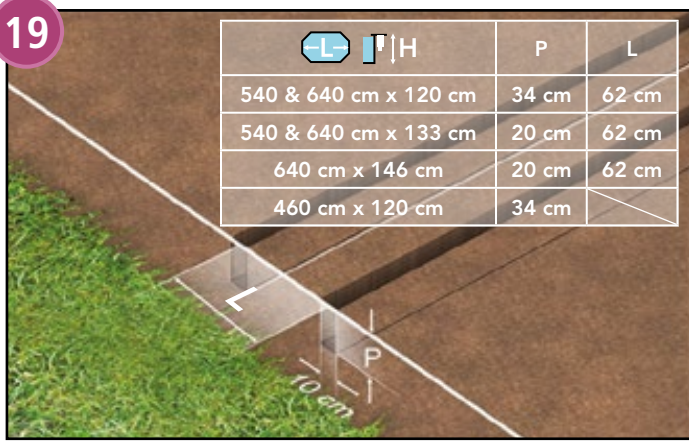
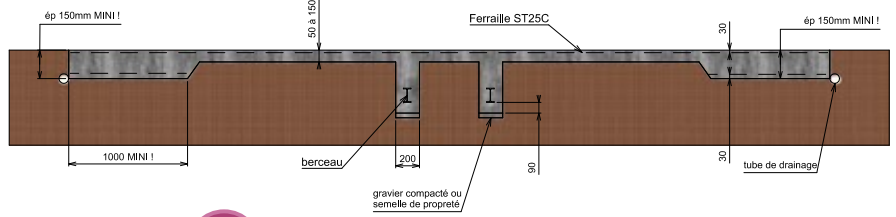

You will need to dig shallow trenches to hold the cradles. Make sure that these are parallel to each other and to the A2 axle. The number of trenches required will depend on the pool model, refer to the illustrations corresponding to your pool. Trenches should be regular and sized to hold the cradles in the right position. Only one trench is required for the Octo 460.

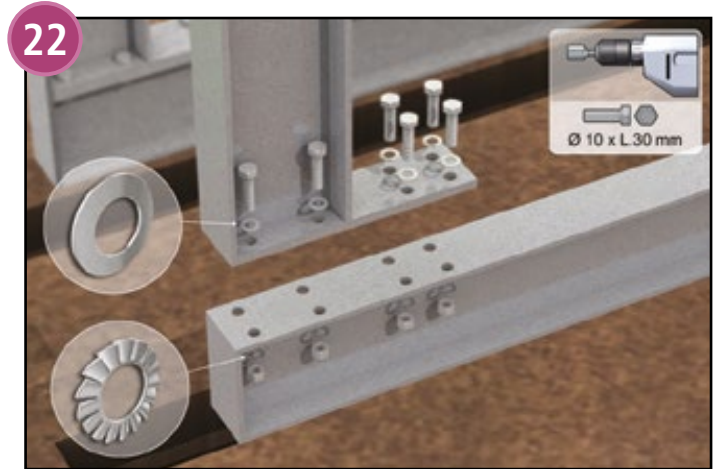
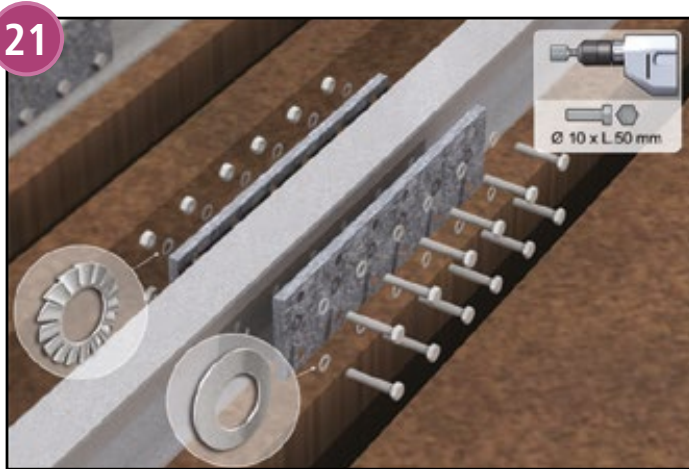

Lay the cradle components out beside the trench and fit them together (using the cradle kit).

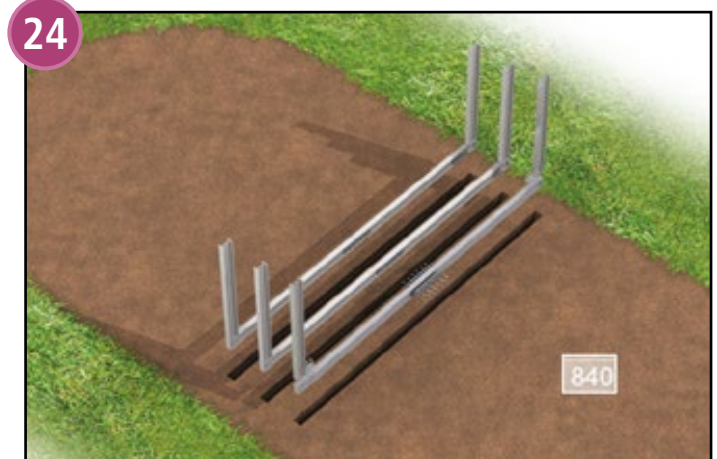
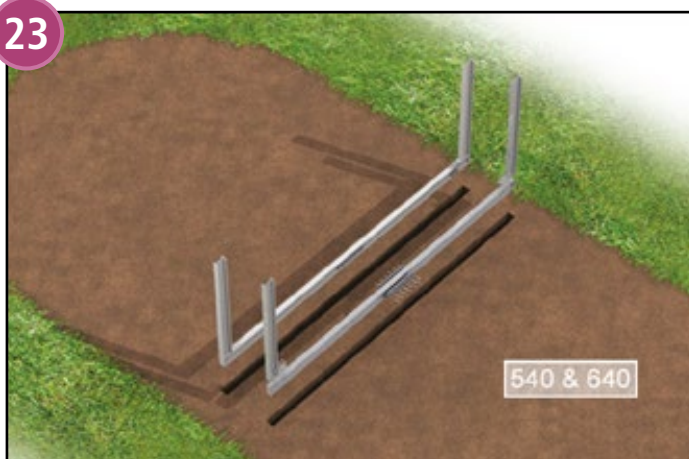

Once the cradles have been assembled, place them in the trenches and block them in position using wet compacted sand if necessary. During this operation, check that the cradles are level, straight, aligned and parallel. Fill the trenches with wet, compacted sand. Important ! Make sure that the cradles are buried to the correct depth.

## » ASSEMBLY OF THE OCTO+ POOL STRUCTURE (CONTD.)

### Recommendations and advice:

- Before beginning assembly, identify the various slat types with reference to the exploded view at the end of this document.
- Establish the final orientation of your pool, the skimmer should be oriented facing into prevailing winds. The skimmer should be mounted on a side that starts with a type A slat.
- While assembling the walls, make sure that each slat is fully engaged before starting on the next.
- You may need to use a hammer and a clamp to remedy any slight warping of the slats. Do not strike the wood directly, use the protective brace (provided).
- During assembly, check regularly that the walls are level and the 4 diagonals are equal in length.
- To avoid the risk of injury or damage to the liner, take care to eliminate any splinters during and after assembly.
- Please refer to the various illustrations provided in this document.
- If you intend to fit your pool with a counter swim treadmill, you will need to incorporate the 2 slats specially prepared to mount this option.

### Layout

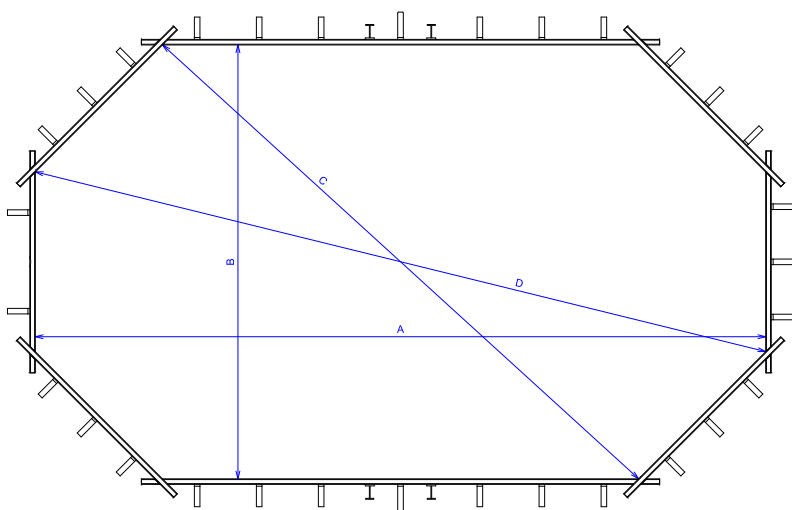

### Pool measurements

	A	B	C	D
+460	4.28	2.78	3.84	4.43
+540	4.88	2.78	4.28	5.01
+640	5.89	3.50	5.20	6.07
+840	7.89	4.35	6.89	8.09

Fit 2 type A half-slats and 2 type C half slats together with 4 type B wall slats according to the illustration above. The male side (double tongue) should face upwards (see the detail below).

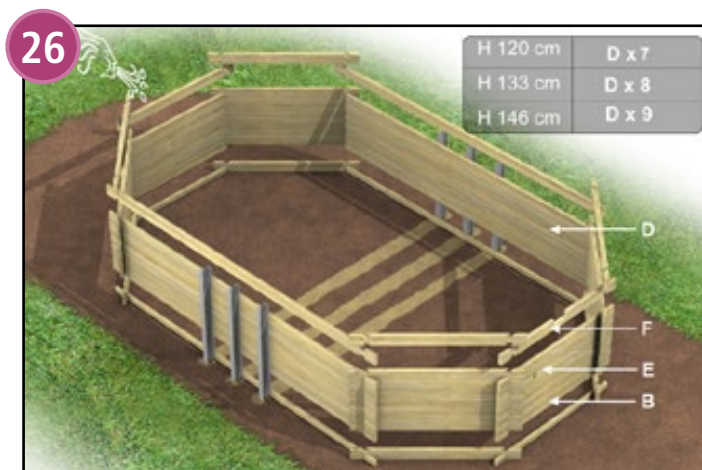
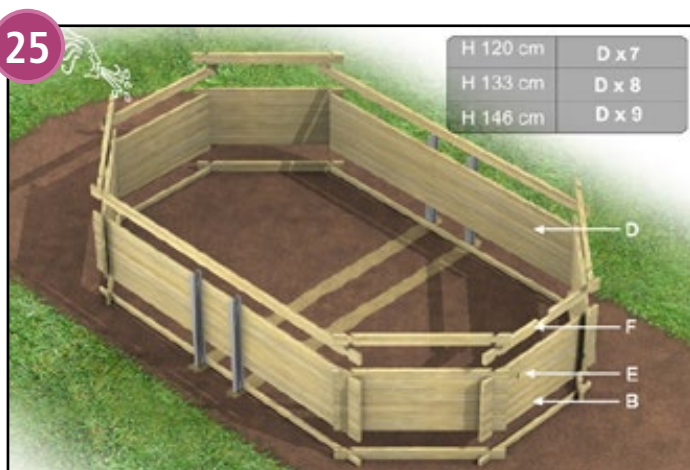

Fit the remaining slats together using type B slats on the short sides and type D slats on the long walls. Take care to correctly position the pierced slats (type E) that will hold the return and vacuum fittings, the bottom skimmer slat (type F) and, if necessary, the 2 optional slats from the counter swim unit kit. (Refer to the exploded view at the end of this document for the position of these slats). In the case of a skimmer, the slat that will hold the return fitting (E) should be positioned above 4 type B slats + 1 type A slat. The type F slat should be located on the same side in the last row of this step. Note the position of the type E slat.

## >> ASSEMBLY OF THE OCTO+ POOL STRUCTURE (contd.)

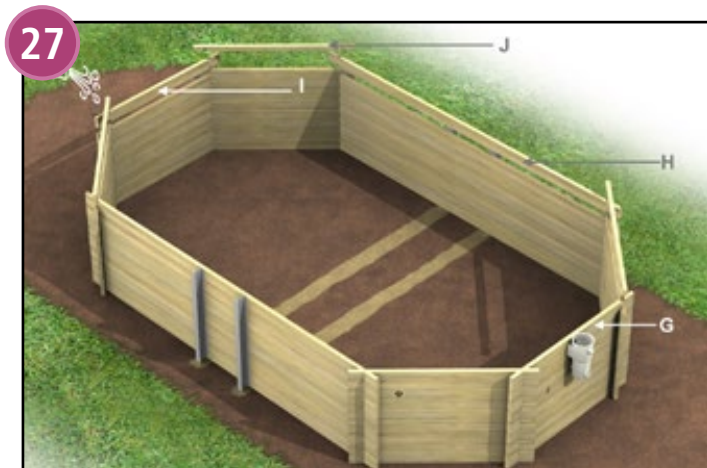

At this point, fit the filtration system into the machined slat (F). Slot the top skimmer slat (G) over slat F and continue around the pool, fitting 2 type H slats, 1 type I slat and 4 type J half-slats into position as shown.

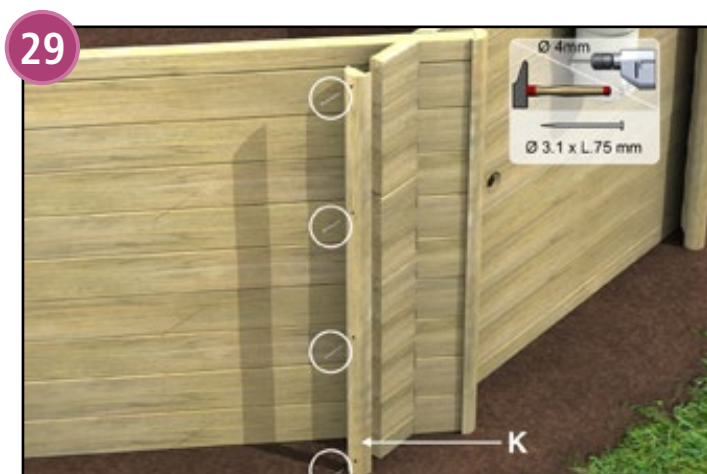
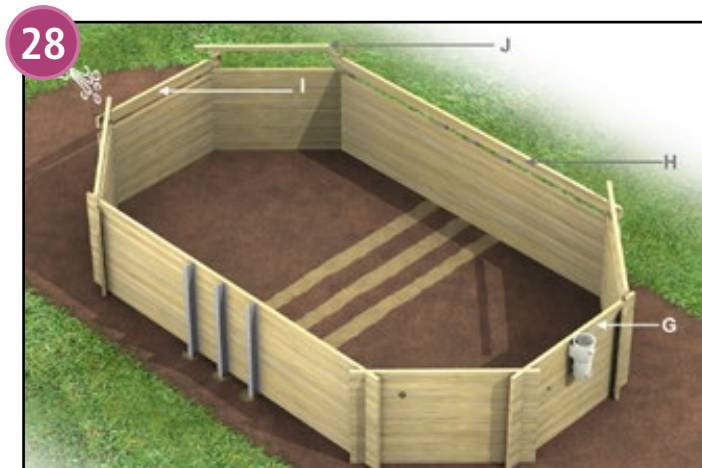

Attach a decorative trim (type K) to the end of each wall using 4 3.1x75 mm screws (bag L) inserted through holes pre-drilled at regular intervals along the axis.

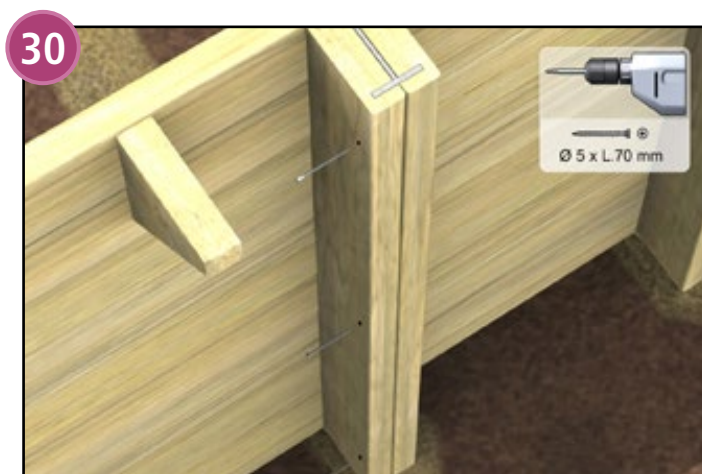

Working from the outside, screw the metallic posts (pre-drilled) onto the wooden walls using 6x40 mm screws from bag C. Check their verticality. Position two decorative profiles (Q) on either side of each post and fasten them together using 3 5x70 screws (bag C) as shown.

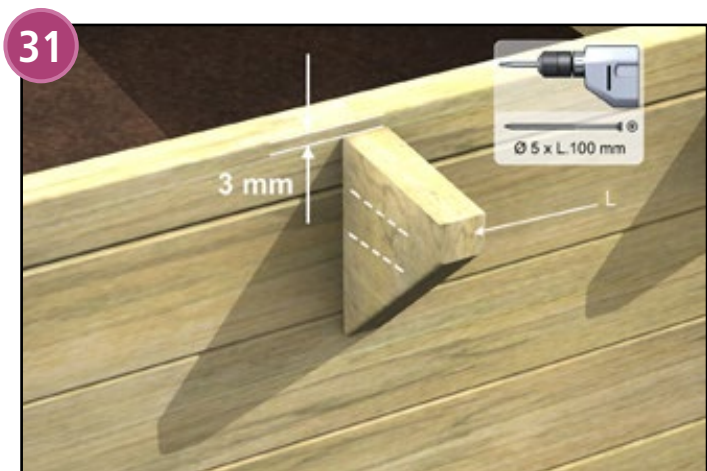

The wooden brackets are designed to support the coping after the pool is filled. Pre-drill the wall, then, working from inside the pool, fasten each coping support bracket (L) in position using 2 5x100 mm screws (bag I), taking care to ensure that each bracket is 3 mm beneath the top of the pool structure. Check the verticality of each support bracket.

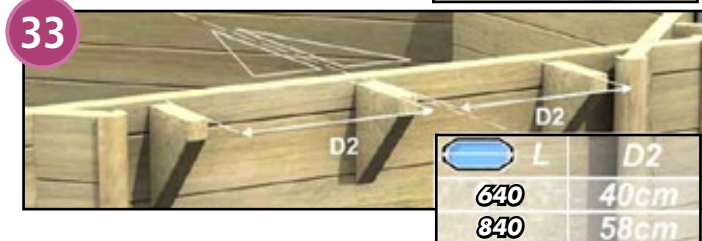
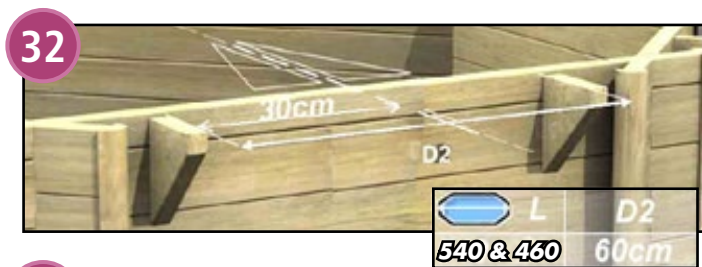

The short sides of the 460 and 540 pools should be fitted with 2 coping support brackets. The short sides of the 640 and 840 pools should be fitted with 3 coping support brackets, except for the side holding the filtration system which should be fitted with 2 coping support brackets. (illustration 38).

## » ASSEMBLY OF THE OCTO+ POOL STRUCTURE (contd.)

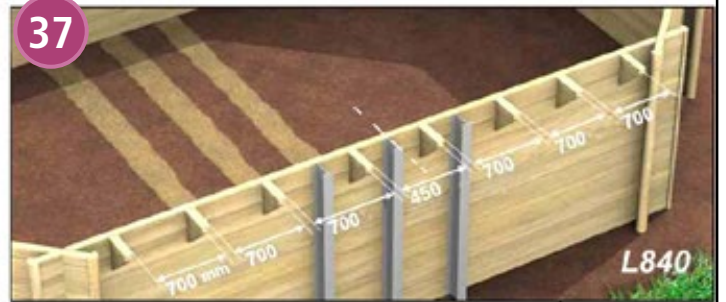
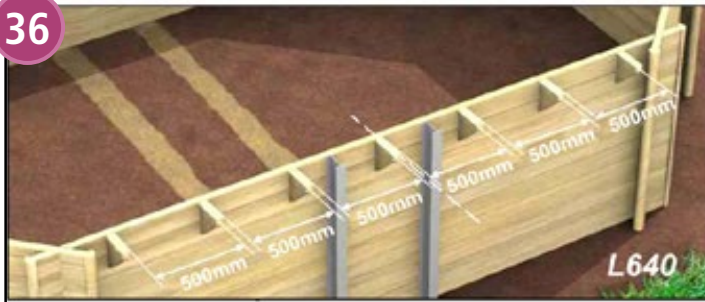
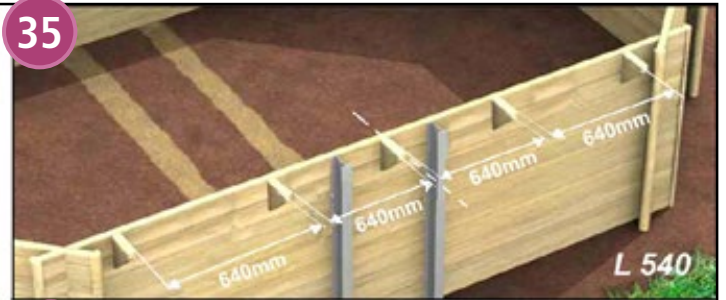
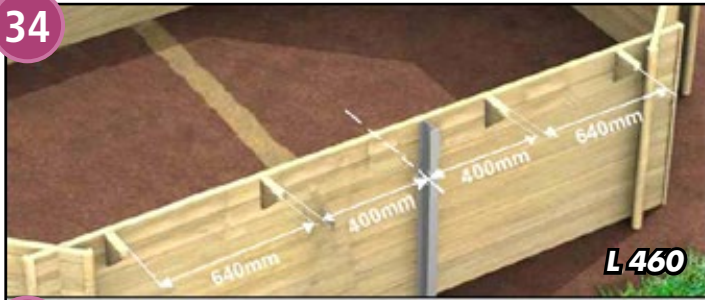

Attach the wooden brackets along the lengths as shown.

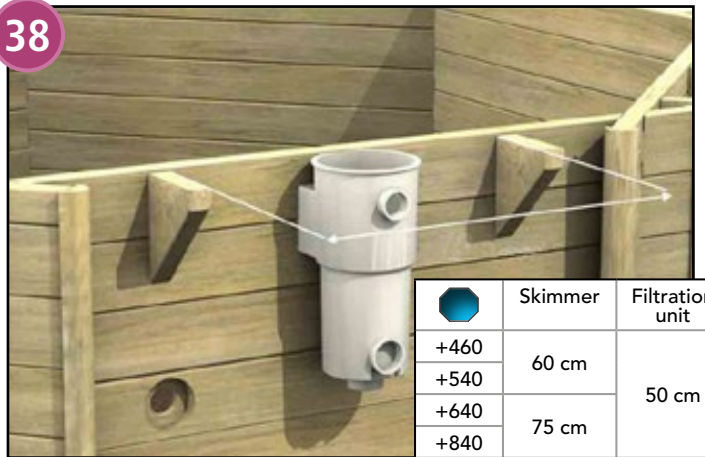

On the wall holding the skimmer, position 1 coping support bracket on either side of the skimmer equidistant from the skimmer axis as shown.

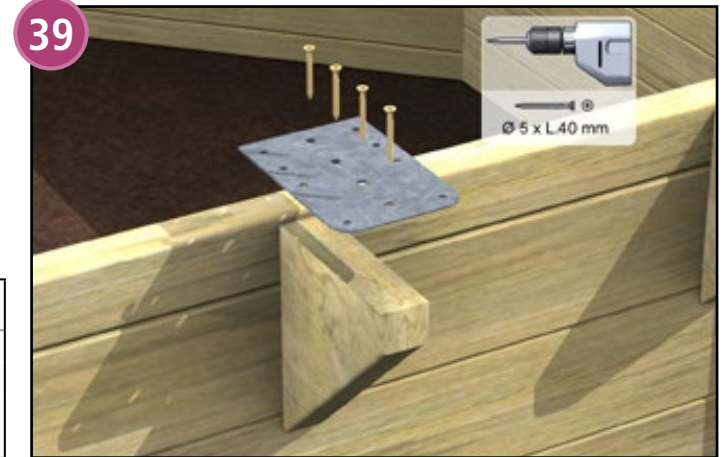

Mount an anchoring plate (coping support bracket kit) on each support bracket. Make sure that each plate is flush with the top of the pool structure. Bevel the holes in the plate before fixing the plates in position.

## » ASSEMBLY OF THE OCTO+ POOL STRUCTURE (contd.)

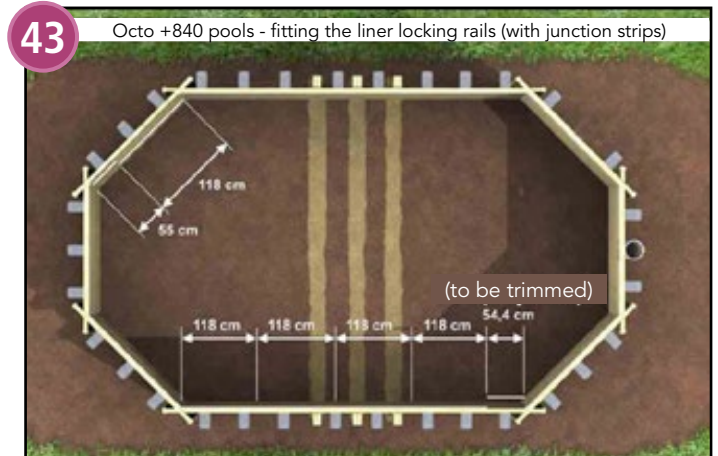
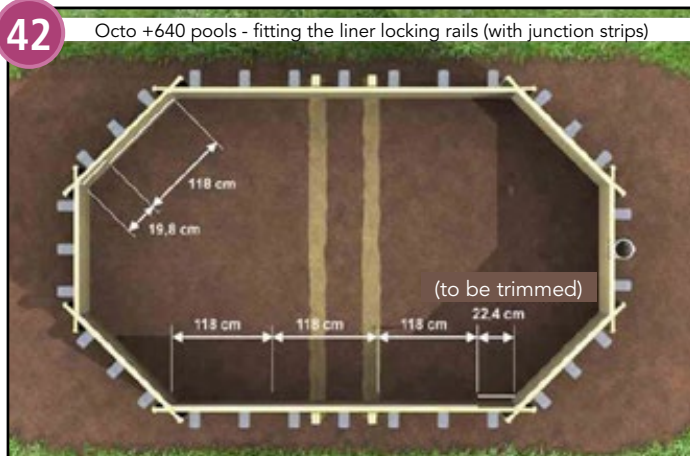
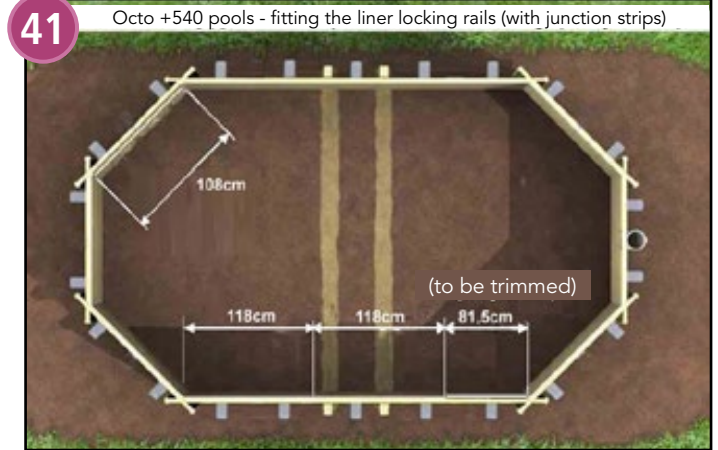
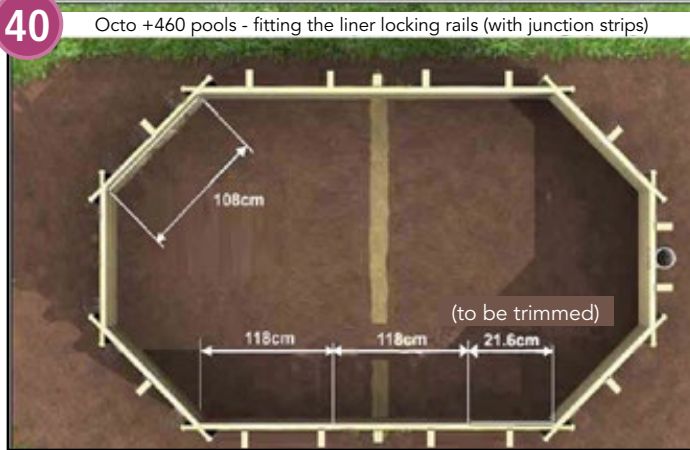

### IMPORTANT !

Before you begin to install the liner locking track, check that the structure was correctly assembled.

- Using a spirit level, go around the entire structure checking that it is horizontal.
- Check that the four diagonals are equal in length.
- Correct any defects.

### Recommendations:

- The liner locking track should be fitted such that it is flush with the top of the wooden structure.
- Use junction pieces between each liner locking track section.
- Check the length of liner locking track required before trimming it.
- Pre-drill the walls using a  $\varnothing$  3 mm drill bit and fix the liner locking track in position.
- Avoid over tightening, this could cause the screws to break through the track.

Refer to the illustrations on page 9.



**IMPORTANT!** The ground underneath the underlay should be absolutely smooth flat and free of any foreign bodies. Because of the pressure exerted by the water, even the smallest bump will be visible underneath the liner. After clearing the ground, spread a layer of sand mixed with cement (1 part cement to 7 parts sand) over the floor of the pool and tamp it down. Unfold the underlay in the pool taking care to line it up correctly with the corners. Smooth out any wrinkles.

## » GASKETS FOR POOL FITTINGS

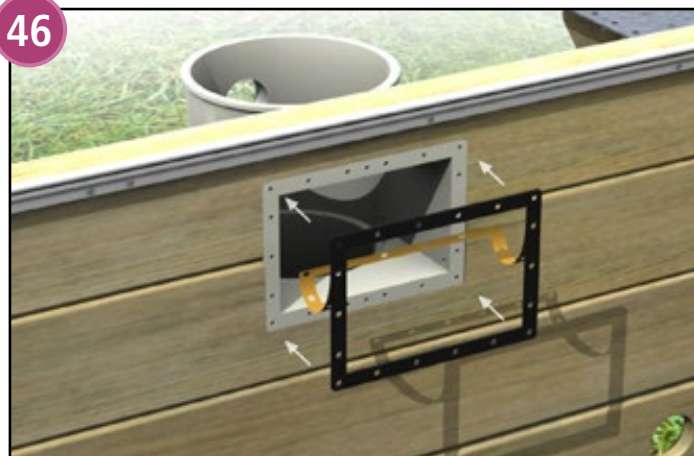

Before fitting the liner, glue one of the 2 rectangular self-adhesive gaskets (pool fitting skin pack) around the mouth of the skimmer or filtration unit.

Make sure that the holes in the gasket are correctly aligned with the holes in the skimmer.



From the pool side, insert return fitting throughwall flange (pool fitting pack) into the opening in the pierced slats. Fix it in position using countersunk self-tapping 3x25 screws. Fit a self-adhesive gasket to each throughwall flange. Screw carefully by hand to avoid damaging the wood.



## » FITTING & CUTTING OUT THE LINER

**IMPORTANT !** The ideal temperature for laying liner is between 18° and 25°C. Outside this range, the liner will be either too rigid or too pliant and will be difficult to fit. On very hot days, lay the liner early in the morning. During cold weather (less than 18°C), store the liner somewhere warm for as long as possible to increase its suppleness and do not take it out until the last minute.

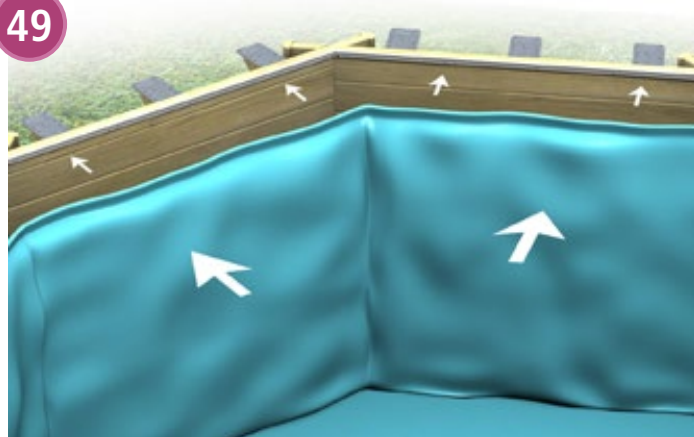

Place the liner in the centre of the pool and unfold it. When it is unfolded, the liner will form either an octagon or an elongated octagon on the ground, depending on the pool model. Line the corners up with the corners of the pool structure. Working in bare feet from inside the pool, fit the liner lip into the liner locking track, continue around the pool.

**CAUTION:** The vertical seam that joins the band that covers the walls should not be on the wall that holds the skimmer. If this is the case, turn the liner.

While fitting the liner, insert wooden half pegs (provided) in the liner locking track to hold it in position in the corners and at regular intervals around the periphery. This will help position the liner and stop it from slipping in the track. Keep the pegs in position until the pool has been filled with water.

Make sure that the bottom corners of the liner correspond to the corners of the pool structure. You will note that the liner is slightly smaller than the structure, this is normal and necessary to ensure correct tension on the liner after the pool has been filled with water. The liner is approximately 1% smaller around the periphery, height is approximately 5% shorter. Make sure that the liner is spread out over the entire surface of the pool.

Leave the liner as is until the warmth of the sun eases out the creases caused by folding (this will take a few hours).

**CAUTION:**

In the event that you need to move the liner, do not slide it in the track. Take it out of the track by pulling upwards on the lip and reposition it. Sliding the liner in the track can cause it to tear just below the lip (this type of damage will not be covered by any guarantee).

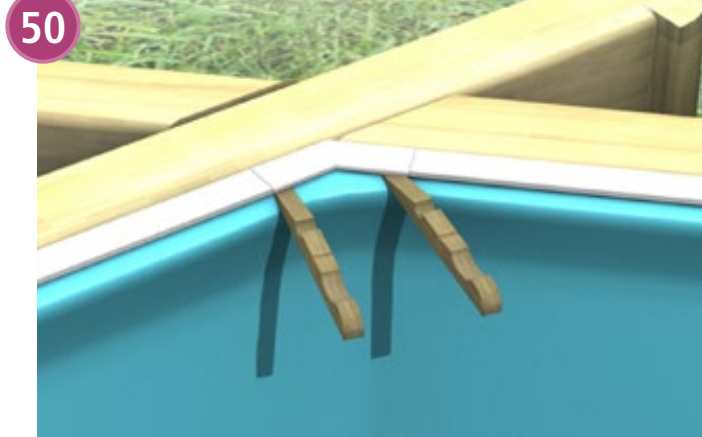

## >> FITTING & CUTTING OUT THE LINER (contd.)

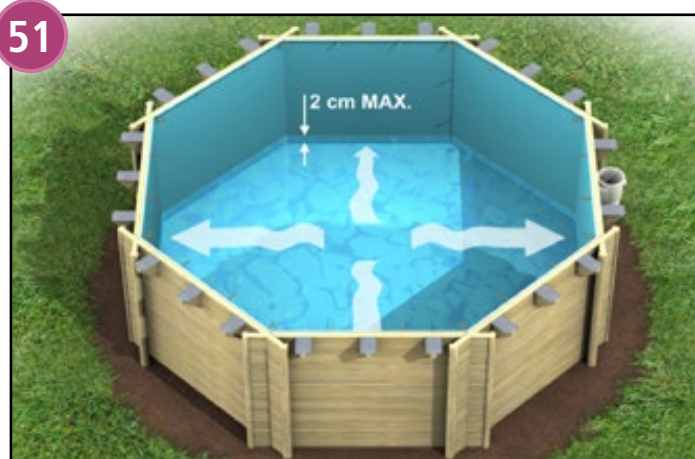

Once the liner has been hung and is correctly positioned, fill the pool with 2 cm of water. Push any creases towards the walls smoothing out the liner as much as possible.

This operation will not be possible if the pool is empty or overfilled (contains more than 2 cm of water).

Once the liner is correctly hung and positioned and creases have been eliminated, continue filling the pool until the water level is 10 cm below the first pool fitting (underwater light or return fitting depending on their position).

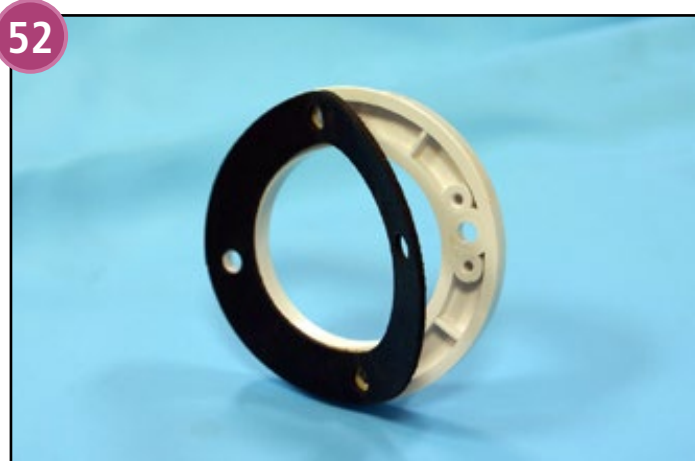

Stick the self-adhesive gaskets to the return fitting and vacuum fitting flanges.



Locate the holes in the throughwall flange and mark them.

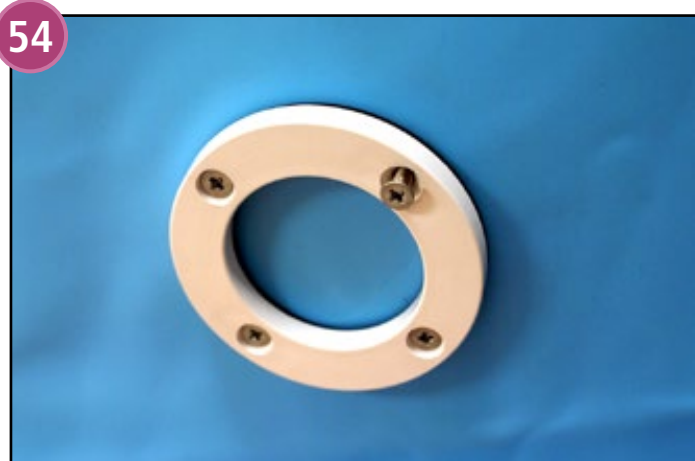

Screw the flange (fitted with its gasket) into place using the countersunk SS screws M5x16 from the pool fitting skin pack. Tighten the screws alternately to ensure a leaktight fit. Hand tighten, over tightening could damage the flange.



Cut out the liner inside the vacuum fitting and return fitting flanges.



56

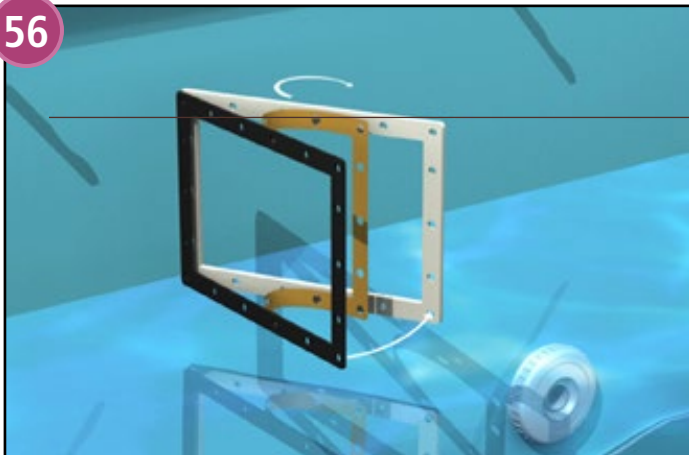

57

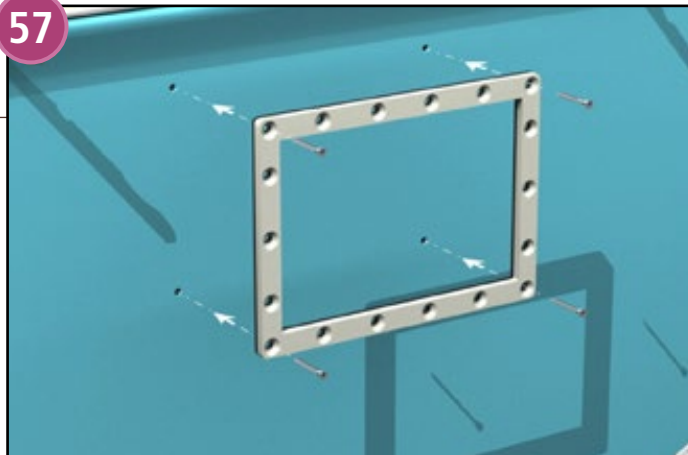

Glue the second skimmer gasket to the interior surface of the skimmer or filtration unit flange. Locate the 4 corner holes of the mouth and mark them with a pen. Position the flange such that its corner holes are aligned with the points marked in pen. Use a small screw driver or punch to pierce the liner at the 4 points marked and fix the flange in position with the gasket against the liner. Once the 4 corner screws are in place, continue, inserting a screw through each hole. Avoid over tightening, this could deform the flange. Tighten the screws alternately to ensure an even and leaktight fit.

58

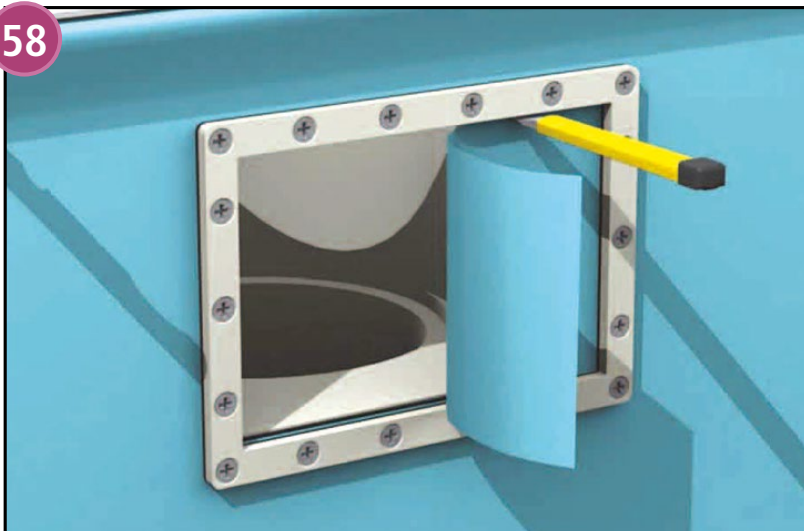

Cut away the liner inside the flange. Keep the off-cuts for future repairs. In the case of skimmers, clip the weir into place, smooth surface facing the pool. The weir should be able to swing freely. Mount the skimmer face plate. The skimmer basket is passed through the skimmer mouth, swing the weir towards the pool to make space. Place the lid on the skimmer.

(these parts can be found in the Pool Fitting skin pack)

In the case of a filtration unit, refer to the installation instructions enclosed with the unit.

59



Screw the multi-directional eyeball assembly into the return fitting body. The eyeball should be pointed left to facilitate the flow of water necessary for efficient filtration. (Prior to assembly, apply a layer of silicon grease to the eyeball and its housing to facilitate its movement and subsequent removal).

## >> FITTING THE COPING ON OCTO POOLS

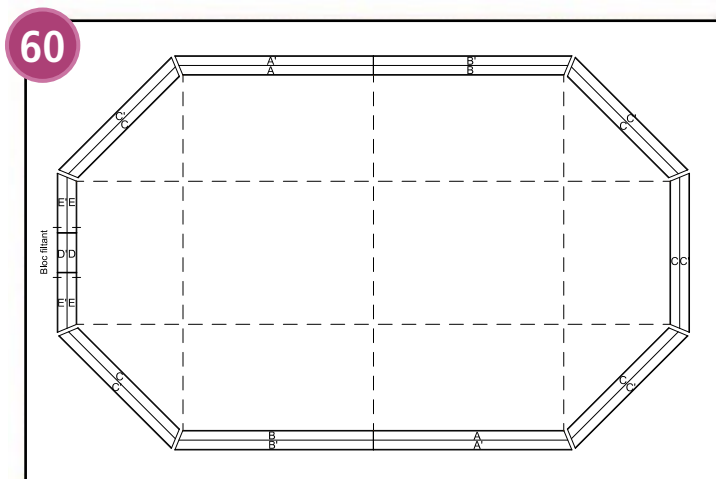

The coping comprises 8 interior planks and 8 exterior planks. Arrange the planks on the the support brackets as shown. The interior planks overlap the pool by approximately 25 mm from the edge of the wall. Make sure that the elements are correctly positionned around the periphery of the pool.

The coping is approximately 295 mm wide with a gap of around 5 mm between the interior and exterior planks

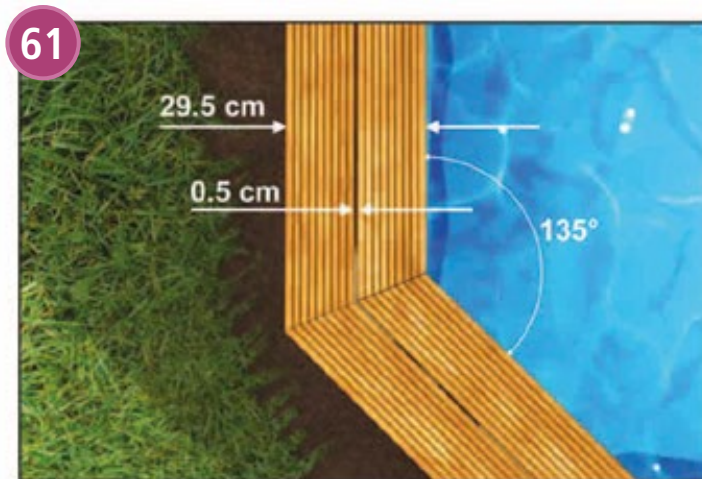

Attach the coping elements to the mounting plates on the support brackets using roofing screws (bag G and H) as shown. Pre-drill lightly to ease driving of the screws. Check continuously that the coping elements are correctly aligned.

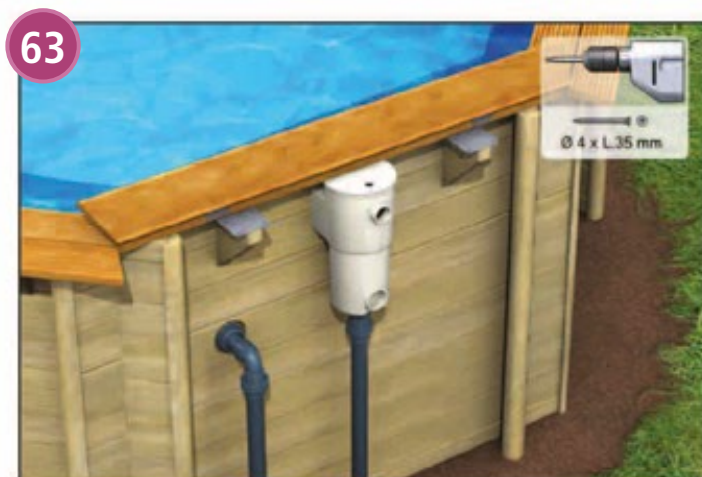

In the case of a skimmer, the outer coping plank above the skimmer is attached to the inner plank by means of 2 hinges (bag A). It is not screwed to the support brackets. The hinge allows access to the skimmer basket. After use, secure the latches. (See below).



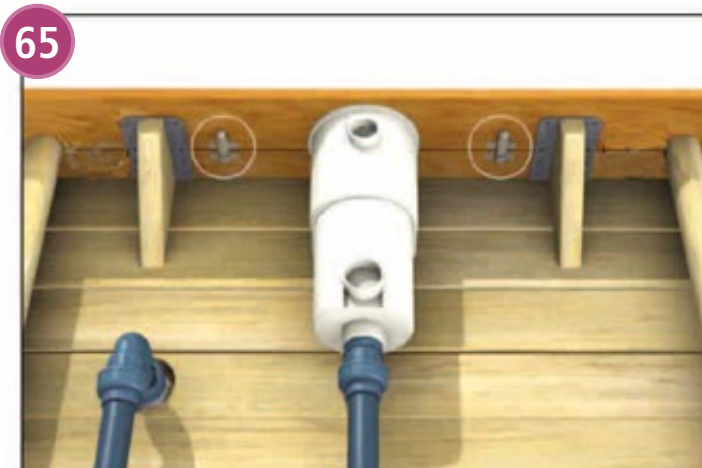

All that remains is to attach the 8 coping corner connecting brackets (mounting kit in the coping pack) as shown above, taking care to position the brackets correctly .

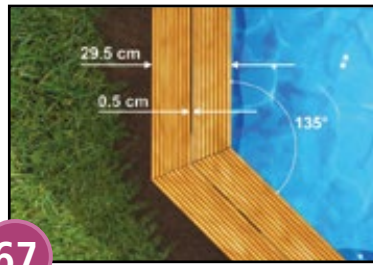
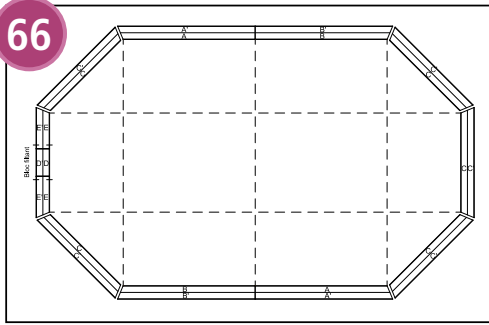

In the case of a skimmer, mount the latches (bag N) as shown.

## » FITTING THE COPING ON OCTO+ POOLS



	A or B	A' or B'	between A & B	C	C'	Filtration unit	
						E	E'
							
440				1550	1677	573	637
530				1905	2029	750	812
+460	1377	1429		1254	1378	425	487
+540	1677	1739		1254	1378	425	487
+640	1971	2033		1550	1677	573	637
+840	1971	2033	1500	1905	2029	750	812

For instructions on mounting the coping, please refer to pages 18. On the 460+, 540+ & 640+ models it may be necessary to add additional coping support plates.

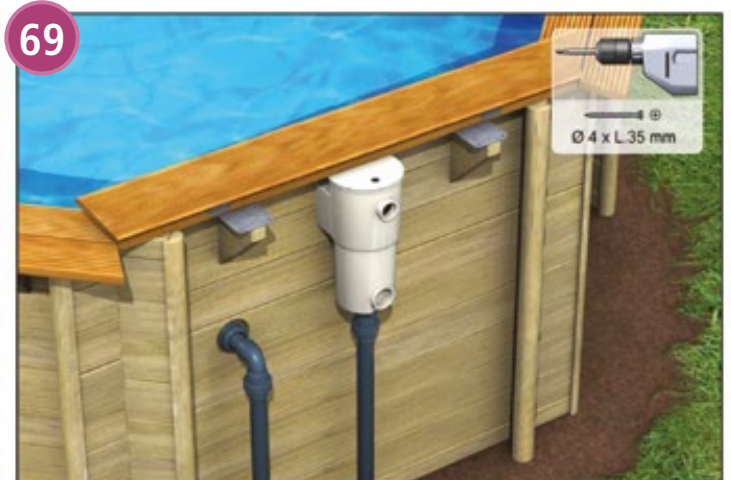

Skimmer version

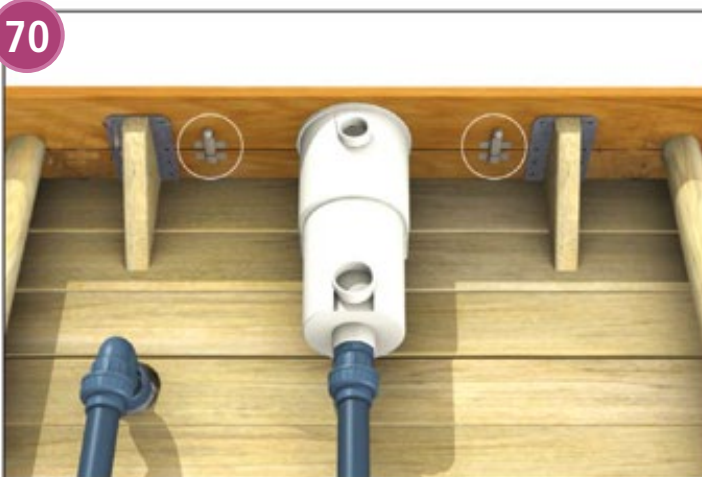

Skimmer version



## >> ASSEMBLING AND INSTALLING THE STAINLESS STEEL LADDER

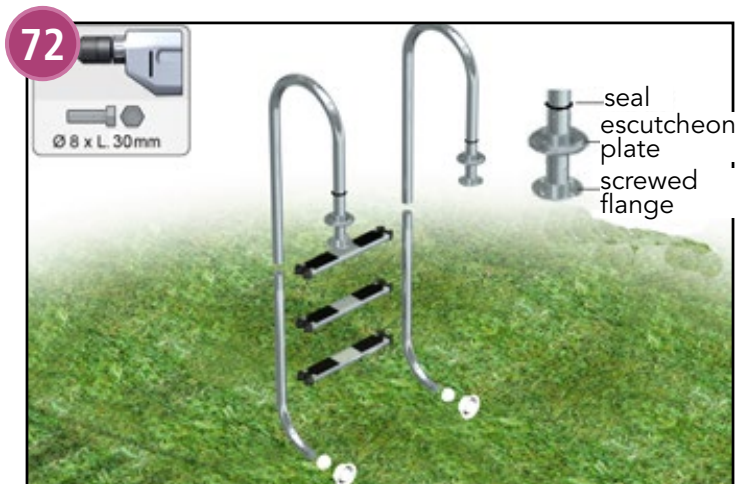

Assemble the various parts of the ladder referring to the installation instructions provided. When mounting the hand rails, do not forget the two rubber seals that will be used to hold the decorative escutcheon plates in position.

If the pool is fitted with in-pool corner steps, refer to the installation instructions enclosed with this item.

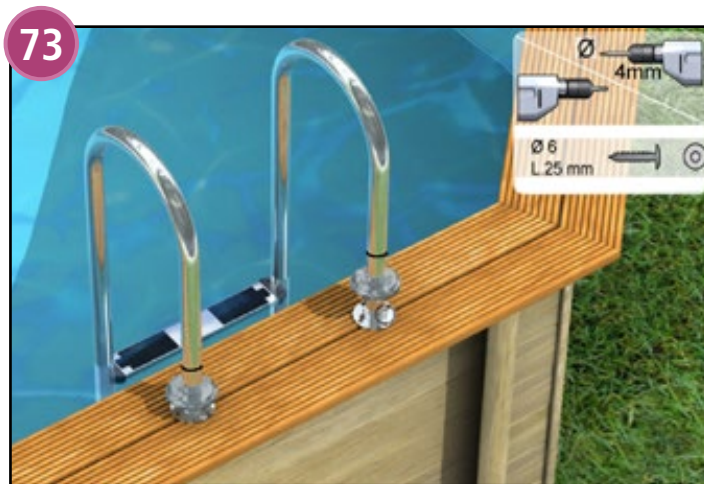

Position the ladder in the pool on the coping module of your choice (except the wall holding the filtration system and counter swim module), remember that it should be opposite the wooden ladder.

Adjust the position of the ladder paying particular attention to ensure that it is vertical and that the bumpers are pressed firmly against the inside wall.

Mark the positions for drilling. Remove the ladder and drill.

Fix the ladder in place according to the instructions provided, the counter plate should be positioned under the coping. Tighten moderately. Slide the 2 rubber seals along the tubes so that they hold the escutcheon plates in position.

## >> ASSEMBLING AND POSITIONING THE WOODEN LADDER

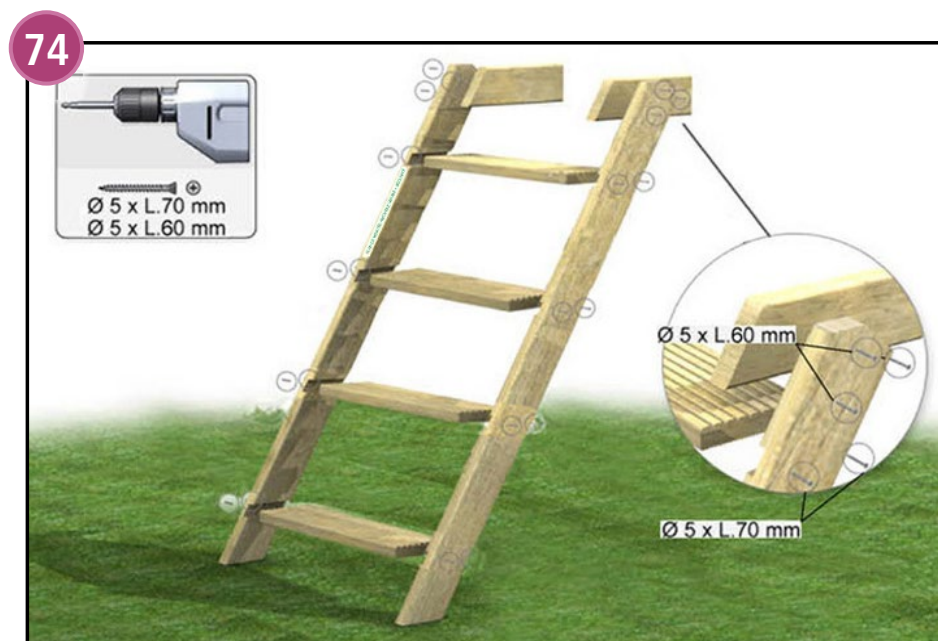

The stringers and the treads for the wooden steps are in the Wood kit. Assemble the wooden steps using the SS screws (bag K). For cleaner, more efficient assembly, we recommend that you pre-drill the various elements (4 mm drill bit) and mill the holes to avoid splitting the wood and raising splinters.

## » ASSEMBLING AND POSITIONING THE WOODEN LADDER (contd.)



The wooden ladder is fitted with two lever latches that lock it into position. The lever sections are fitted to the ladder supports and the hooks are mounted under the coping (these parts are enclosed in bag K). Observe how these 2 parts interact together to understand how the mechanism works and establish the travel necessary for the ladder to be locked correctly into position.

Position the assembled ladder under the coping. Insert the blocking parts between the wooden supports and the coping. These should be positioned in line with the lever latches. Trace the position of the various elements. Remove the ladder, screw the blocking parts into position and attach the lever elements to the ladder supports. Put the ladder in place and lock it in position.

The locking mechanism might differ from that illustrated here, but will function according to the same principal.



### For your children's safety !

Don't forget to stick the safety label to the pool wall stating that the ladder must be removed while the pool is not in use.

## » INSTALLATION OF PARTIALLY IN-GROUND OR IN-GROUND POOLS

**CAUTION:** This type of configuration must be protected by one of the four safety systems that comply with French safety standards concerning safety of in-ground pools; safety barrier, alarm, safety cover or a shelter. The decree no. 2003-1389 dated 31/12/2003 renders it mandatory for clients of pools installed after the 1st of January to have the pool fitted with a system to prevent drowning before it is filled with water. Said system must comply with either the French safety standards, or with those standards, technical specifications or manufacturing procedures set out in the regulations of a member state of the European Community or another state party to the Agreement on the European Economic Area, providing for an equivalent level of safety. These provisions apply to open air pools that are partially or fully in-ground.

Below, we suggest implementation configurations that show basic recommendations for non-humid ground. You should adapt these to your installation, notably, in humid areas (stagnant water, water source, zone subject to flooding, etc.) a sump drain pump may be required for efficient drainage.

In any case, the drainage system must be adequate to prevent the stagnation of water that could cause the wood to rot. We recommend that you follow the installation instructions to the letter; failure to abide by these instructions will render the usual guarantees null and void.

Should you have any questions, and to ensure a quality installation, do not hesitate to contact a specialist.

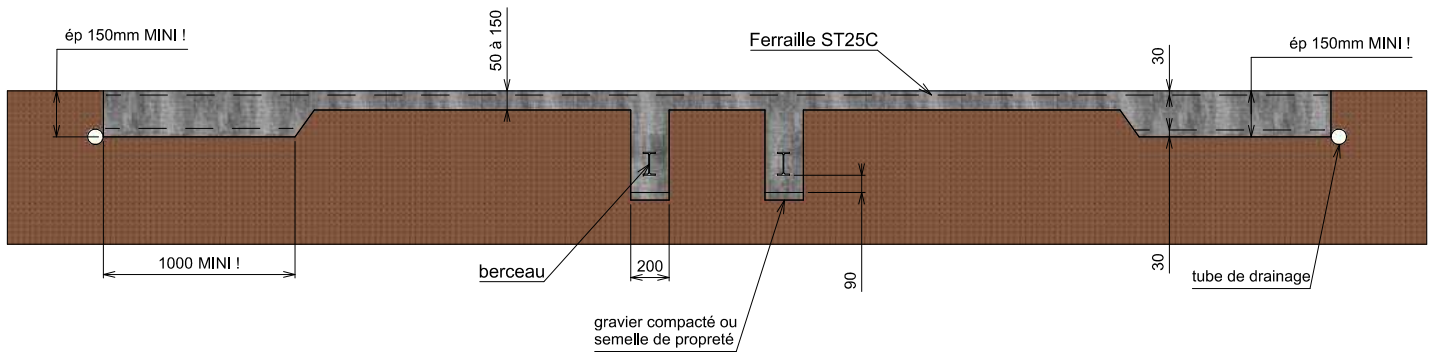

## » EXCAVATION

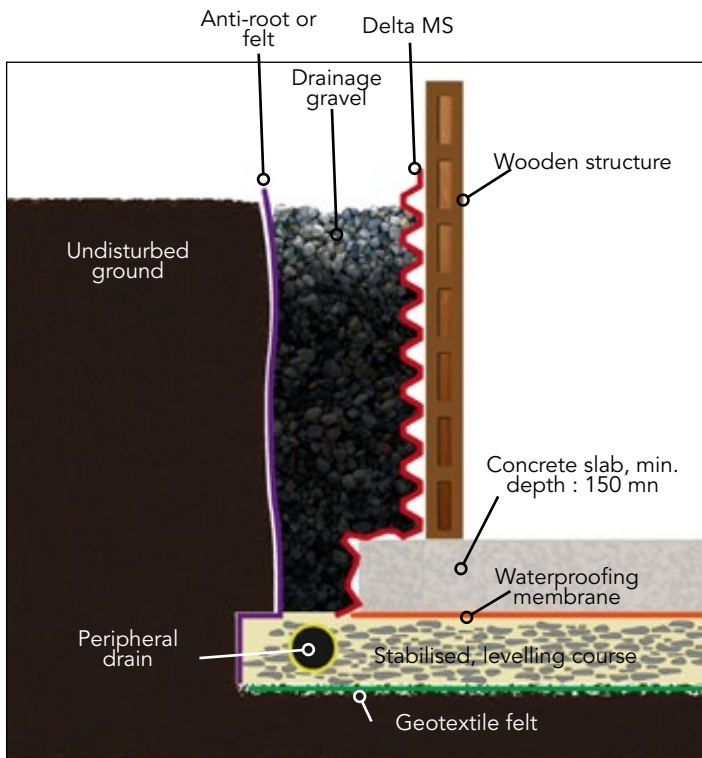

## » RELIEF WELL

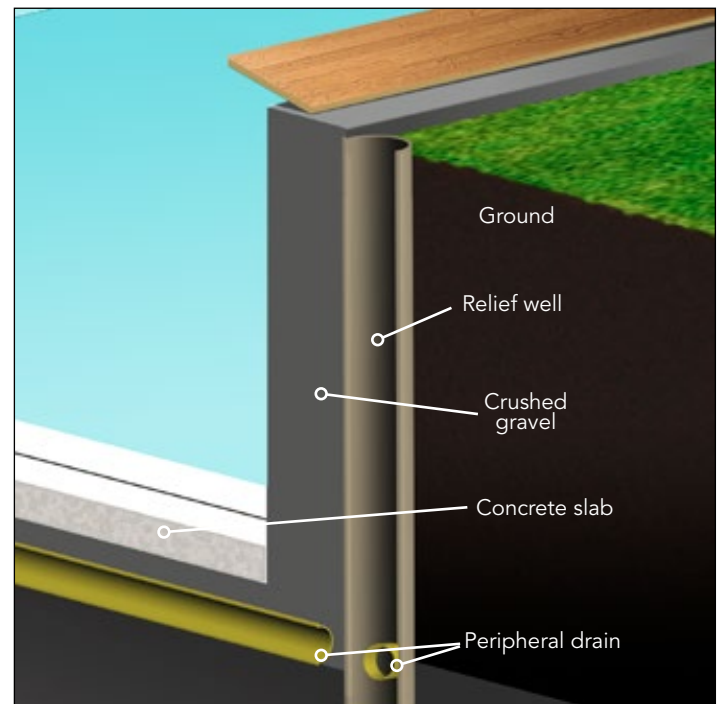

The Delta MS membrane allows ventilation of the wooden pool structure. This is necessary to prevent rotting of the wood.

## » OCTO POOLS

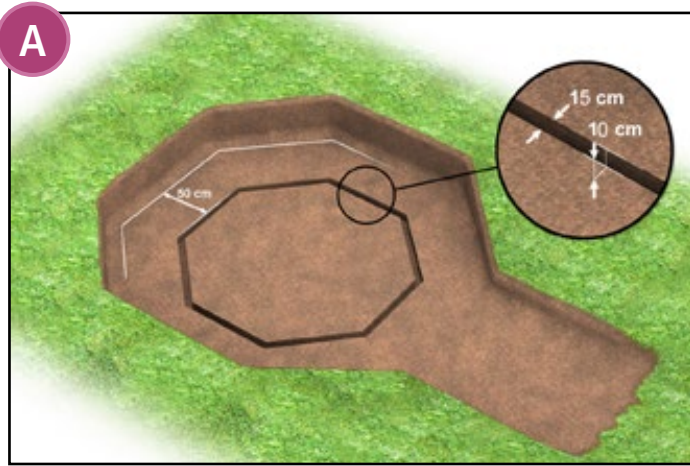

For selection of the site, refer to the instructions at the beginning of this document.

Once the excavation is at the required depth, make sure that the surface is perfectly flat and level. Next, dig a trench to allow drainage under the walls of the pool. Trace the shape of the trench, to assist this process you may temporarily assemble the first row of slats (illustration 5). It should be wide enough to extend beyond each side of the wall once it is built.

If you intend to install the filtration system in a box adjoined to the pool, remember to dig a trench to run the power cable. Similarly, if the filtration system is to be installed at a distance from the pool, dig a trench to accommodate passage of the suction and return lines.

Max. depth of the excavation:  
 pool height 120 cm = 116 cm  
 pool height 133 cm = 129 cm

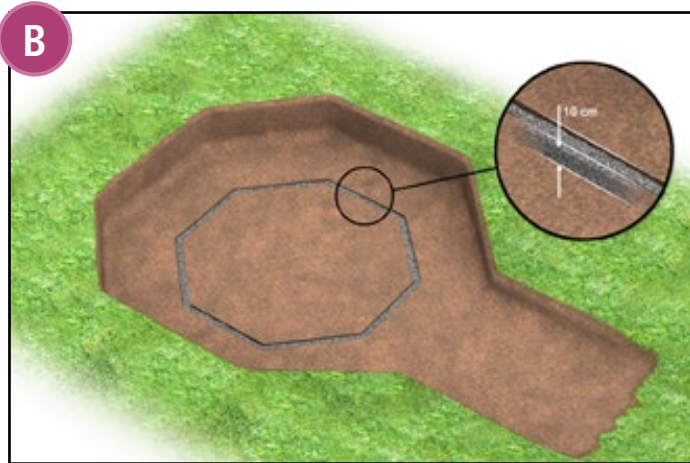

After the trench under the pool wall is dug, fill it to a depth of approximately 10cm using small sized gravel. Make sure that the gravel is well compacted to avoid future subsidence that will impact the pool structure. Finish filling the trench with compacted sand, the filled trench should be level with the ground.

**CAUTION!** We strongly recommend that you install the filter below the water line. If the filter is installed above the water line, there is a risk of deformation due to depressurisation. At most, the filter should be installed level with the coping. In the event that the filter is installed above the water line, mount a check vent on the return line and an easily accessible check valve on the suction line.

Illustrations shown in this document are valid for a filtration system housed in a box buried at the same level as the pool. Should you choose another configuration, abide by the instructions above.



Assemble your pool as described in the installation instructions.  
 Cover the portion of the wooden structure that will be buried with Delta MS membrane.



Back fill around the pool, taking care not to damage the structure.

## >> FOR OCTO+ POOLS

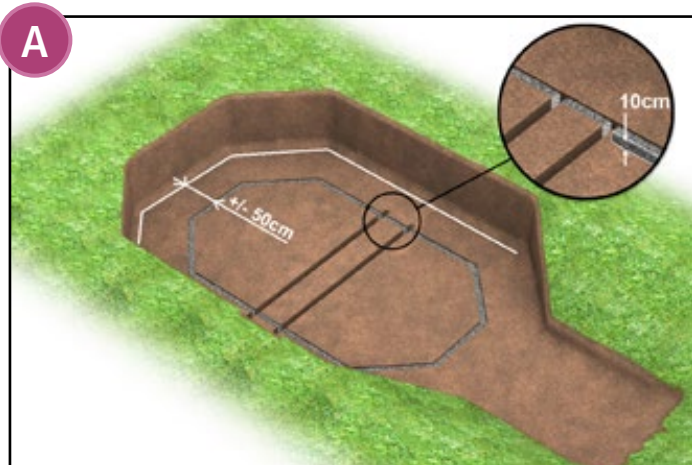

For selection of the site, refer to the instructions at the beginning of this document.

Once the excavation is at the required depth, make sure that the surface is perfectly flat and level. Next, dig a trench to allow drainage under the walls of the pool. Trace the shape of the trench, to assist this process you may temporarily assemble the first row of slats (illustrations 27 and 28, depending on the model). It should be wide enough to extend beyond each side of the wall once it is built. The cradle trenches are dug as described previously (illustrations 21 to 26). If you intend to install the filtration system in a box adjoined to the pool, remember to dig a trench to run the power cable. Similarly, if the filtration system is to be installed at a distance from the pool, dig a trench to accommodate passage of the suction and return lines.

Max. depth of the excavation:

Pool height 120 cm = 116 cm Pool height 133 cm = 129 cm  
 Pool height 146 cm = 142 cm

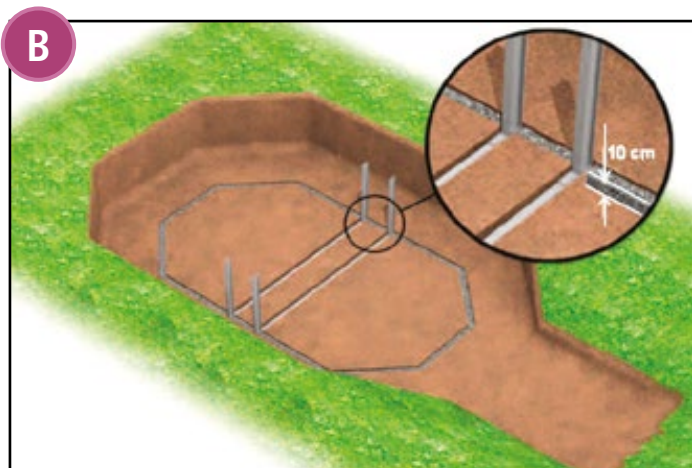

After the trench under the pool wall is dug, fill it to a depth of approximately 10cm using small sized gravel. Make sure that the gravel is well compacted to avoid future subsidence that will impact the pool structure. Finish filling the trench with compacted sand, the filled trench should be level with the ground.

**CAUTION!** We strongly recommend that you install the filter below the water line. If the filter is installed above the water line, there is a risk of deformation due to depressurisation. At most, the filter should be installed level with the coping. In the event that the filter is installed above the water line, mount a check vent on the return line and an easily accessible check valve on the suction line.



Assemble your pool as described in the installation instructions. Cover the portion of the wooden structure that will be buried with Delta MS membrane.



Back fill around the pool, taking care not damage the structure.



## » MAINTENANCE & OPERATION

Wood is a living material that responds to changes in temperature and humidity; cracks and splits may appear; this is natural and in no way impacts the service life of our products.

The wooden components of this pool are subjected to a Class IV autoclave treatment that complies with standards in effect, they present no danger to people or animals that may come into direct contact with the wood.

Over time, the wood will inevitably get dirty. Clean it once a year with a high pressure jet to remove dirt trapped in the pores of the wood. Take care to regulate the water pressure to avoid damaging the finish or raising wood fibres.

Do not apply any product to the wood (for example: lazure, micro-porous products, etc.)

This pool is delivered as a kit and is not designed to be dismantled.

This pool is designed to be used by persons 3 years of age and older. It is understood that young children and non-swimmers using the pool will wear flotation devices. For your safety and that of your children, we recommend that you read and apply the safety recommendations on page 27.

**Use of a pool kit implies adherence to safety recommendations outlined in the maintenance and operating instructions.**

octo 440 & +460	maximum 4 people allowed in the pool at any one time.
octo 530	maximum 5 people allowed in the pool at any one time.
octo +540 and +640	maximum 6 people allowed in the pool at any one time.
octo+ 840	maximum 8 people allowed in the pool at any one time.

Ladders should only be used to enter and exit the pool. Any other use is prohibited and could be dangerous.

The wooden access ladder should be taken away and stored systematically after the last person leaves the pool. This is to prevent the risk of drowning. We have designed a fast efficient locking system, use it!! Store the ladder in a dry place during the winter. There should be no means of access to the pool while it is not in use. The ladder wood should be treated in the same way as the other wooden elements.

**We recommend that you secure access to the finished pool with one of the measures set out in the French pool safety standard NF P 90-306, 307, 308 & 309 that is: Safety barrier - Alarm - Safety cover - Shelter.**

Inspect the accessible nuts and bolts regularly and carry out any maintenance required (re-tighten, treat traces of rust, etc.).

Take care with the liner of your pool, do not treat it roughly. Make sure that correct tension is maintained on the liner, failure to do so could result in tears and leaks. See the guarantee conditions at the end of these instructions.

During the life of your pool it may be necessary to empty it totally. In this event, take every precaution necessary to avoid accidents and danger (falls, etc.). Avoid leaving the pool empty for more than 48 hours, this could result in deformation of the structure.

**REMINDER: No diving - No walking on the coping - Never leave an empty pool uncovered**

### WATER TREATMENT & MAINTENANCE OF THE FILTRATION SYSTEM

To ensure the comfort of pool users, you will need to treat the pool water. Follow the recommendations concerning operation of the filtration group: commissioning, frequency of use for regeneration of the water, maintenance, inspections (pipes, nuts and bolts), etc. Monitor the build up of dirt in the sand filter (see the section on filter back washing).

During the pool season, the filter should be run every day for long enough to renew the entire pool water volume at least three times every 24 hours.

To ensure optimal efficiency of the filtration system, make sure that the water level remains correct and constant. The water level should be 2/3 of the way up the skimmer mouth.

To fill your pool, use tap water, its pH is close to the ideal pH. If you use water from a well or some other private source you must have it analysed beforehand. You will need to test the pH of your pool at regular intervals and adjust it if necessary to keep it between 7.2 and 7.6. Treatment chemicals for this purpose are widely available.

To preserve the quality of the pool water, it will need to be tested and treated regularly. Frequency will depend on a number of conditions; pool situation, bather load, weather conditions, etc.

As pool water cannot be directed into the sewage system, it must be directed as rain run-off. Familiarise yourself with the regulations concerning disposal of pool waste water in effect in the area in which the pool is located

**Failure to abide by maintenance instructions may entail serious risks to health and safety, notably of children.**

## » MAINTENANCE & OPERATION (contd.)

### ACCESSORIES

Electrical equipment such as underwater lights that require an electrical supply must be fitted and wired in according to the standards in effect. We recommend that you take great care in this matter and that you call on the services of qualified specialists.

Some models come with a bubble cover that is spread over the pool while it is not in use. The action of sunlight on the cover heats the water below and the cover helps maintain the water temperature at night. Upon removing the cover from the pool, turn it over to allow it to dry, then roll it up and store it out of the way. Never fold the bubble cover, this could cause it to tear. Wipe it down from time to time with a damp cloth. This cover should under no circumstances be considered a safety device. A safety winter cover (that complies with the French safety standard NF P90-308) is available as an option to protect the pool. This high quality product is extremely hard-wearing and attractively finished. For storage and upkeep, follow the same instructions as for the bubble cover.

### WINTERIZING THE POOL

Carry out a prolonged back wash of the filter.

The pool should not be emptied during winter (or prolonged periods while the pool is not use). The liquid mass plays a several roles, providing thermal insulation, holding the liner and pool structure in position.

Lower the water level to about 10 cm below the bottom of the skimmer mouth.

Water can be siphoned from the pool or allowed to drain by gravity by moving the multiport valve to DRAIN. Water will run through the waste line. Do not run the pump during this operation.

Next, disconnect the pipe underneath the skimmer so that it can act as an overflow in the event the water level rises due to precipitation. Remove any water treatment chemicals from the skimmer (chlorine tablets, flocculents, etc.).

Unscrew the return fitting face ring from inside the pool.

Use a threaded winterizing plug or rubber plug (not provided) to block the return fitting from inside the pool.

Add an algicide and a winterizing product (not supplied) to the water.

Remove the stainless steel ladder.

Place a winter cover over the surface of the pool.

NOTE: Winterizing is not mandatory, especially if the weather is clement and temperatures remain positive. In this case, maintain a correct water level in the pool and run filtration 2 to 3 hours per day. Check the water level in the pool regularly.

### WINTERIZING THE HYDRAULIC INSTALLATION

Disconnect the return line.

Allow water to drain from the suction and return lines.

Open the plug at the bottom of the filter and allow water to drain away. Do not replace the plug before putting the filter back into service.

Open the drain plugs on the pump and pre-filter.

Leave the plugs open.

Cut the power supply to the filtration control panel.

In as far as possible, store the filtration group in a location protected from humidity. In the case of an unprotected outdoor installation, remove the pump and store it.

We think that we have provided you with main information you required to use and maintain your pool, however you will find more information in specialised guides and reviews. Don't hesitate to consult these.

### HYGIENE

As regards hygiene, there are no official regulations for family pools. However, for your health and that of your family and friends, there are some rules that you should respect!

This begins with good personal hygiene.

Next, to maintain water purity, respect the instructions set out in the section "maintenance and operation". Pay particular attention to treatment cycles, water testing, filtration and cleaning. The balance of your pool water depends mainly on you. Do not hesitate to inform yourself and follow the advice of the professionals.

## » SAFETY

**DO NOT PLAY WITH SAFETY ! ! !**

In this fun environment you need to watch your children! You alone are responsible for their safety ! Children should be closely supervised at all times. The risk is at its greatest when children are less than 5 years old.

- ▶ Accidents don't just happen to others. Be ready to act !!
- ▶ Never leave a child alone close to the pool.
- ▶ Children must be closely supervised at all times.
- ▶ Children who don't know how to swim, or children not supervised by adults, should wear a flotation device (vest or arm bands). Without these precautions, access to the pool should be strictly denied.
- ▶ The access ladder must be removed while the pool is not in use irrespective of the length of time for which the pool will not be used.
- ▶ Designate one person responsible for watching non-swimmers and children.
- ▶ Be particularly attentive when there are several people in the pool.
- ▶ Keep a pole and/or life ring close to the pool in case of necessity.
- ▶ Teach young children how to swim as early as possible!
- ▶ Before getting into the pool, wet the back of the neck, legs and arms to prevent irreversible thermal shock! This warning also applies to older pool users who frequently disregard this safety tip.
- ▶ Jumping or diving should be prohibited. The same applies to violent games.
- ▶ Do not stand or walk on the coping! No diving.
- ▶ Be careful not to leave toys in or around an unwatched pool, these could attract children...
- ▶ Keep the water clean and sanitary during the pool season.
- ▶ Water treatment chemicals should be kept out of reach of children; store them in a safe, inaccessible place. Never leave cleaning accessories near the pool.
- ▶ Some equipment can contribute to pool safety:
  - safety barrier, with a gate that is always kept closed (for example, a hedge could not be considered a safety barrier).
  - a manual or automatic safety cover correctly installed and fixed in position.
  - a functional alarm to detect proximity to the pool or falls into the water.

Safety equipment will under no circumstances replace close surveillance.

- ▶ Outside the pool season, the pool should be covered with a winter cover correctly positioned and attached. This serves an additional function in that it renders the pool less attractive.
- ▶ Make sure that there is a telephone (land line or mobile) within easy reach of the pool to avoid leaving children alone in the event of a problem.
- ▶ Learn first aid, especially those techniques applicable to children, to provide assistance in the case of an accident.
- ▶ Take steps to prevent access to the pool if the filtration system is damaged and during maintenance operations.
- ▶ **In the event of an accident :**
  - ▶ Get the child out of the water as quickly as possible.
  - ▶ Call for help immediately and follow the advice given.
  - ▶ Remove the wet clothes and wrap the child in warm blankets.

**MEMORISE EMERGENCY SERVICE NUMBERS AND DISPLAY THEM CLOSE TO THE POOL**

Fire: Ambulance: Poison centre:

## » GUARANTEES

**WOODEN COMPONENTS:** 10 year guarantee from the manufacturer against insect infestation and rotting (wood is high pressure autoclaved in accordance with the standards in effect).

This guarantee does not cover natural warping of the wood (appearance of cracks, splits that in no way impact the mechanical strength of the wood) or changes in colour attributable to weathering. Defects resulting from errors in mounting or storage are also excluded from the scope of this guarantee: deformed wall slats (exposure to sunlight, assembly deferred after opening the package), slats altered or broken due to assembly in a manner other than that set out in the installation instructions. It should also be noted that the any cutting of wood elements, for any reason whatsoever, will cancel the guarantee against insect infestation and rotting for the altered element.

**ACCESSORIES:** according to the conditions of coverage against manufacturing defects and assembly defects effecting the various accessories comprising the pool and that could impinge upon its normal use. The guarantee conditions stipulate specific periodic inspections and maintenance that must be carried out for the pool to run correctly. The successful outcome of any claim made under the aforementioned guarantee will be contingent on strict adherence to its conditions. This guarantee does not cover corrosion that may occur over time, nor does it cover damage caused by inappropriate handling during assembly or use of accessories (impacts, scratches, etc) or incidents not directly related to normal usage of the pool or its accessories. All of these guarantees apply to parts recognised as defective by our services and are limited to replacement of the implicated item(s). **The costs of dismantling and reassembly are not covered.**

### GUARANTEE CONDITIONS COVERING ITEMS FROM THE ACCESSORIES AND OPTIONAL EQUIPMENT KIT

All of the components of the accessories kit are guaranteed 2 years (except the bubble cover and winter cover).

ARTICLE	Subject and scope of the guarantee	Term of the guarantee as of the date of purchase	Conditions governing acceptance of a claim
LINER	- Leaktightness of welds. - The guarantee is limited to replacement or repair of the liner recognised as defective without any other damages or interest.	10 years against leaks 2 years against stains	Adherence to conditions governing fitting, use and maintenance.

**CAUTION!** The following problems, associated with inappropriate use or maintenance of the membrane, are not covered in the scope of the guarantee

- folds that appear after the liner has been fitted, these can be caused by sliding of the membrane on loose soil or an uneven surface, or physico-chemical properties of the pool water that are outside the acceptable ranges: water temperature should be less than 28°C, pH should be between 7.2 and 7.6 and the concentration of the sterilising agent should be within the range recommended by the manufacturer of the water treatment products.

- Folds that remain despite following all the instructions regarding fitting of the liner should be reported immediately to your Procopi agent.

The appearance of yellow stains or discolouration along the water line.

These may be the result of deposition of organic compounds floating on the water surface (sun creams and oils, residue of hydrocarbon combustion or smoke from wood fires). To prevent this from happening, clean the water line regularly using products designed for this purpose. (not supplied) and a non-abrasive sponge.

Very hard water can also be the cause of this type discolouration due to the build up of calcium deposits on the membrane. Hard water (TH greater than 250 ppm) should be treated with a product to eliminate calcium and suitable for use in pools (not supplied).

- Stains caused by the growth of algae and micro-organisms: the pool water should be treated regularly with an appropriate dose of algicide.

- Stains, discolouration and wrinkles caused by direct contact with oxidizing agents (thrown directly into the pool) or pockets of excessively high concentrations of oxidising agents (frequently associated with failure to run filtration while the oxidising agents are dissolving).

- Stains caused by stagnation and/or decomposition of a foreign body in direct contact with the liner (dead leaves, oxidizable metallic objects, miscellaneous detritus, etc.)

- Damage caused by direct contact with incompatible materials such as bitumen, tar, oils, polystyrene panels, polyurethane. Never apply adhesive tape or glue to the membrane.

- Tears that occur while fitting the liner caused by shifting the liner without releasing it from the liner locking track first.

## » GUARANTEES (contd)

ARTICLE	Subject and scope of the guarantee	Term of the guarantee as of the date of purchase	Conditions governing acceptance of a claim
POOL FITTINGS	Leaktightness and durability of the pool fittings	10 years	

ARTICLE	Subject and scope of the guarantee	Term of the guarantee as of the date of purchase	Conditions governing acceptance of a claim
FILTER + CONNECTIONS	Leaktightness of the filter tank. Leaktightness of the connection elements.	5 years on the filter tank	The hydraulic installation and notably the pump, should generate an operating pressure less than 1.2 bar. Regular back washes to clean the filter to avoid clumping of the filter medium.

**CAUTION!** The following problems, associated with inappropriate use of the filtration components, are not covered under the terms of this guarantee:

- Leaks caused by running the filter at an operating pressure greater than 1.2 bar (use of a pump that is too powerful, clogged filter medium, etc.), or installing the filter above the water level without a vent and check valve. (see the installation instructions)
- "stress-cracking" of ABS parts (valve, nuts) caused by surface reactants found in some types of grease: grease should not be used on these types of components.
- The continuous expulsion of sand if sand with a grain size of less than 0.6 mm is used. (the sand supplied has the correct grain size).

ARTICLE	Subject and scope of the guarantee	Term of the guarantee as of the date of purchase	Conditions governing acceptance of a claim
PUMP	Motor operation Operation and leaktightness of the hydraulic components.	2 years	See below and regular cleaning

**CAUTION!** The following problems, associated with inappropriate use of the pump, are not covered under the terms of this guarantee:

- Running the pump 'Dry' (absence of water, clogging of the pre-filter)
- Running the pump without the pre-filter

ARTICLE	Subject and scope of the guarantee	Term of the guarantee as of the date of purchase	Conditions governing acceptance of a claim
SUMMER COVER	Fit for purpose on delivery	2 years	

**RECOMMENDATION!** While the cover is not rolled out over the surface of the water, it should be dried, rolled up and stored out of the sunlight.

ARTICLE	Subject and scope of the guarantee	Term of the guarantee as of the date of purchase	Conditions governing acceptance of a claim
WINTER COVER	Fit for purpose on delivery	2 years	

**RECOMMENDATION !** Avoid placing too much traction on the bungee cord, this could pull out the eyelets.

Monitor water quality during the winter. Excessively high concentrations of treatment chemicals, a pH that is too low or too high, could result in discoloration or damage to the cover material

To prevent the development of mould during periods while the cover is not in use, take care to dry and fold the cover carefully before storing it.

ARTICLE	Subject and scope of the guarantee	Term of the guarantee as of the date of purchase	Conditions governing acceptance of a claim
MAINTENANCE ACCESSORIES	Fit for purpose on delivery	2 years	

## » EXPLODED VIEW OF THE OCTO+ STRUCTURE (AUTONOMOUS FILTRATION UNIT)

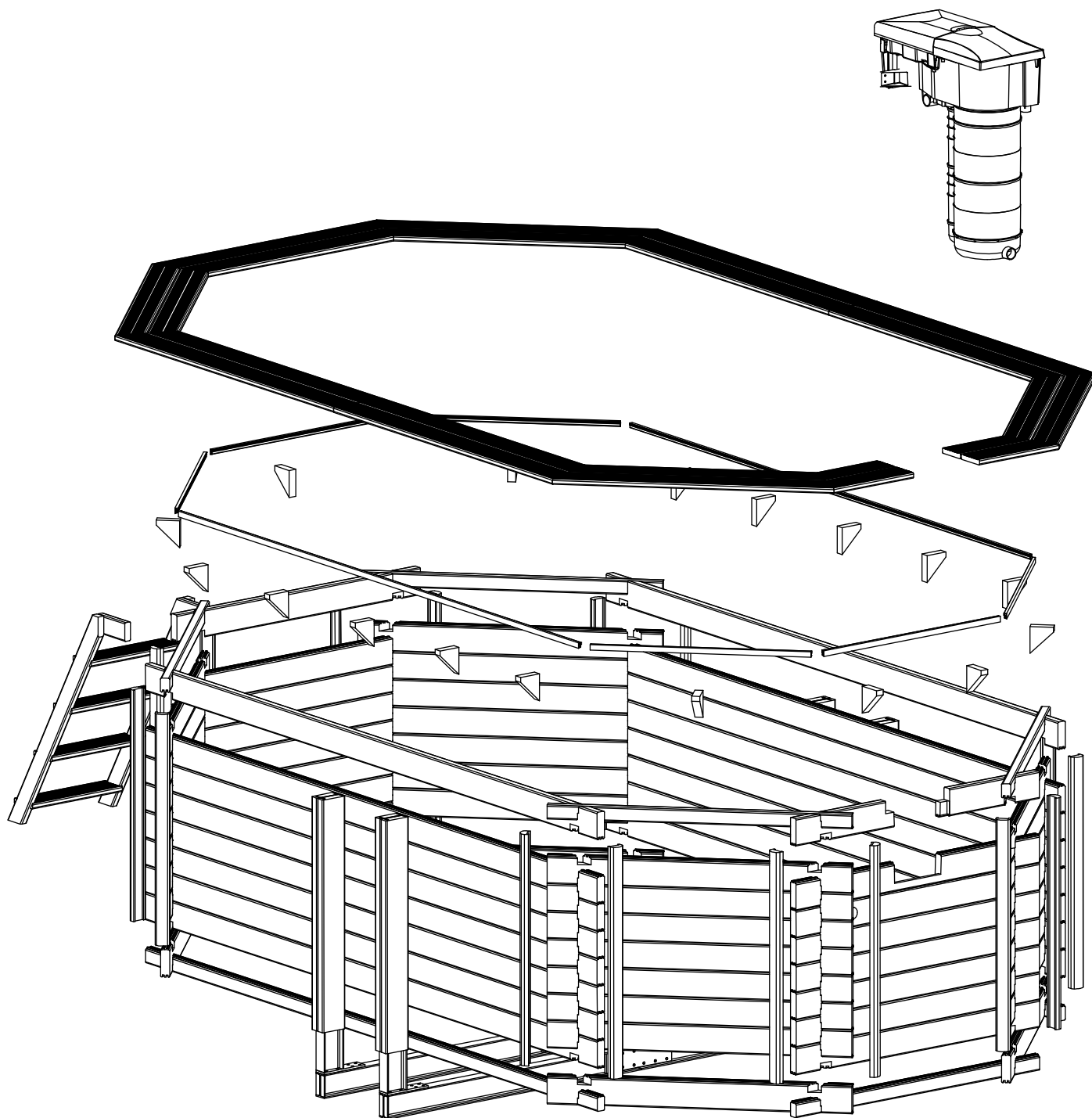

## » EXPLODED VIEW OF THE OCTO STRUCTURE (SKIMMER)

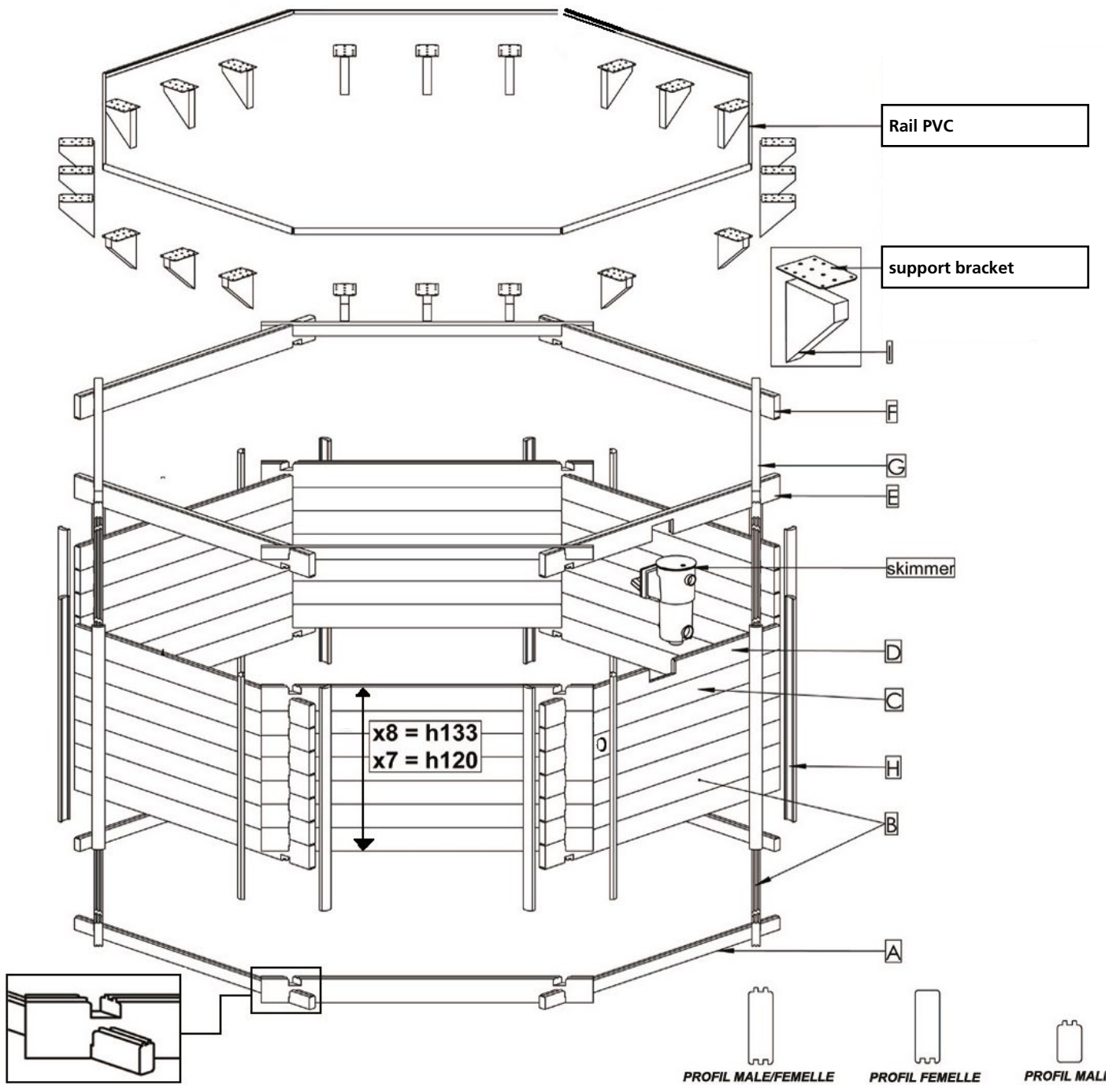



QUALITY CERTIFICATE

PEFC CONTROL CHAIN

Company

**PROCOPI**  
35650 LE RHEU

Control chain no.

**FCBA/12-01382**

The chain of custody of the company designated hereinover complies with the PEFC\* stipulations in effect.

This certificate was issued in accordance with the PEFC reference governing chain of custody of wood, FCBA MQ CERT 11-360.

Scope	Method used
Manufacture and distribution of wooden equipment for pools at the Pleumeleuc site	Average percentage method

This certificate attests chain of custody certification based on continuous monitoring. It cannot prejudice changes or decisions that could be made during the year. The list of certified companies is available on line [www.fcba.fr](http://www.fcba.fr) and <http://register.pefc.cz>



ACCREDITATION  
N°5-011  
PORTÉE  
DISPONIBLE SUR  
[WWW.COFRAC.FR](http://WWW.COFRAC.FR)

\* appendices 15 and 16 of the french forestry certification scheme, translation of appendices PEFC ST 2002: 2012 and PEFC ST 2001: 2008 of the international technical document issued by the PEFC council.



50, avenue de Saint-Mandé  
75012 Paris  
Tél. : +33 (0)1 40 19 49 19  
Fax : +33 (0)1 43 40 85 65  
[www.fcba.fr](http://www.fcba.fr)

Certificate No.  
0226/2012  
Date: 13th February 2012  
Valid up until 01/02/2017

LE RESPONSABLE CERTIFICATION  
Alain HOCQUET

2017

