

OXYGEN SYSTEMS

AEROX HIGH-DURATION AVIATION OXYGEN SYSTEMS



Add to your flying comfort by using oxygen at altitudes as low as 5000 ft. Aerox Oxygen Systems include lightweight aluminum cylinders, regulators, all hardware, flow meter, and nasal cannulas (masks available as option). Oxsaver oxygen saving cannulas & Aerox Flow Control Regulators increase the duration of oxygen supply about 4 times, and prevent nasal irritation and dryness. Complete brochure available on request.

500 SERIES REGULATOR - AN AIRCRAFT SPRUCE EXCLUSIVE!

- Low profile
- 1, 2, & 4 place
- Standard Aircraft filler for easy filling
- Convenient top mounted ON/OFF valve
- Equipped with Aerox standard plug sockets
- Over pressure safety valve
- Built in cylinder pressure gauge

COMPLETE AEROX SYSTEMS (ADJUSTABLE FLOW)

Part No.	Model	Description	Price
13-18895	1A	1 outlet, 6 Cu Ft. Cyl. w/Flow Meter & Cannula	\$378.00
13-18896	1C	1 outlet, 9 Cu. Ft. Cyl. w/Flow Meter & Cannula	\$425.00
13-18897	1D	1 outlet, 13 Cu Ft. Cyl. w/Flow Meter & Cannula	\$421.00
13-18898	2A	2 outlet, 6 Cu. Ft. Cyl. w/Flow Meters & Cannulas	\$487.00
13-18899	2C	2 outlet, 9 Cu Ft. Cyl. w/Flow Meters & Cannulas	\$513.00
13-18900	2D	2 outlet, 13 Cu. Ft. Cyl. w/Flow Meters & Cannulas	\$549.00
13-18901	2E	2 outlet, 22 Cu Ft. Cyl. w/Flow Meters & Cannulas	\$575.00
13-18902	2M	2 outlet, 22 Cu. Ft. Cyl. w/Flow Meters & Cannulas	\$565.00
13-18903	4C	4 outlet, 9 Cu Ft. Cyl. w/Flow Meters & Cannulas	\$580.00
13-18904	4D	4 outlet, 13 Cu. Ft. Cyl. w/Flow Meters & Cannulas	\$652.00
13-18950	4E	4 outlet, 22 Cu Ft. Cyl. w/Flow Meters & Cannulas	\$686.00
13-18906	4M	4 outlet, 22 Cu. Ft. Cyl. w/Flow Meters & Cannulas	\$714.00
13-18915	6M	6 outlet, 22 Cu Ft. Cyl. w/Flow Meters & Cannulas	\$848.80
13-18905	6F	6 outlet, 33 Cu. Ft. Cyl. w/Flow Meters & Cannulas	\$1,011.20

AEROX ACCESSORIES

Part No.	Description	Price
13-18910	CC Oxsaver Cannula	\$30.50
13-18920	CR-A Regular Cannula	\$9.50
13-18970	Metal Clamp Bracket for 13 or 22Cft cyl	\$43.50
13-18930	CR-C Reg. Cannula (Child)	\$8.50
13-18940	MSK-A Rebreather Mask	\$13.90
13-03271	Aerox Oxsaver Pendant	\$46.75
13-08023	MSK-A Rebreather Mask Child	\$9.65
13-07737	1 Place Regulator With Gauge For 540 Valve	\$197.50
13-07735	2 Place Regulator With Gauge For 540 Valve	\$254.95
13-07736	4 Place Regulator With Gauge For 540 Valve	\$391.00
13-05250	Glo-tec Pressure Gauge	\$29.55
13-04683	Flowmeter with needle valve	\$67.75

AEROX RETROFIT KITS FOR BUILT-IN SYSTEMS OR OTHER PORTABLES



FITTING IDENTIFICATION CHART (Not Sold Separately)

1.) Oxsaver® Cannula—this comfortable device may be used in place of your mask up to 18,000 ft. MSL. It has a conserving feature which can extend your oxygen supply by up to four times. 2.) Aerox Flowmeter/Indicator—this combination device conveniently reads both mask and cannula flow rates in MSL altitude. 3.) Aerox Adjustable Flow Restrictor—a thumb screw operated needle restrictor valve allows you to precisely control flow. Shown are most of the connectors for general aviation. If you want us to supply the connector, be sure to indicate which is your type.

Model	Retrofit Kits	Part No.	Price
RK-SC	Retrofit Kit plus Scott type fitting SC	13-18992	\$112.00
RK-PB-1	Retrofit Kit plus Puritan-Bennett type fitting	13-18994	\$103.85
RK-PB-2	Retrofit Kit plus Puritan-Bennett type fitting	13-18995	\$103.85
RK-SK	Retrofit Kit plus Sky-Ox fitting (new style) SK	13-18996	\$98.75
RKPCPC	Kit with CPC fitting for Cirrus	13-05152	\$107.75
RK-PB1	Retrofit Kit with RK-PB1 Fitting FMNV (Aerox Flow meter Needle Valve) Mask to 25,000 ft	13-05582	\$110.75
---	Retrofit Kit for Aerox 350/400 Regulators	13-00787	\$84.95
RK-SC	Retrofit Kit with Scott Type Fitting FMNV (Aerox Flow meter Needle Valve) Mask to 25,000 ft	13-19711	\$109.75
RK-MS	Retrofit Kit With Military Type Fitting	13-07739	\$128.75

AEROX PRO-O2 EMERGENCY HANDHELD OXYGEN SYSTEMS



Provides oxygen until the aircraft can reach a lower altitude. And because Pro-O2 is refillable, there is no need to purchase replacement O2 cartridges. During short flights at altitudes between 12,500ft. MSL and 14,000ft. MSL where maneuvering over mountains or turbulent weather is necessary, the Pro-O2 emergency handheld oxygen system provides oxygen to extend these brief legs. Included with the refillable Pro-O2 is a regulator with gauge, mask and a refillable cylinder. Pro-O2-2 (2 Cu. Ft./1 mask).....P/N 13-02735\$340.00 Pro-O2-4 (2 Cu. Ft./2 masks).....P/N 13-02736\$366.00 PrO2-Plus Portable Oxygen System.....P/N 13-23658\$399.00

AEROX EMT-3 PORTABLE OXYGEN SYSTEM



A small portable system designed for the occasional user who wants something smaller and less costly than a full portable system. The EMT-3 is also ideal for use as an emergency oxygen system. The system lasts 25 minutes at 2.5 LPM @ 25,000 FT.....P/N 13-12773\$404.00

AEROX 4110-712 SERIES OXYGEN MASK WITH MICROPHONE



The 4110-712 Series continuous flow oxygen mask with microphone is intended for crew and passengers in the general aviation industry at a maximum altitude of 25,000 feet. Optional equipment includes industry standard fittings for connection to portable and built-in oxygen systems.FAA 8130 Provided.

Description	Aerox No.	Part No.	Price
Small Without Microphone	4110-711-1	13-06652	\$248.95
Medium Without Microphone	4110-711-2	13-06653	\$240.95
Large Without Microphone	4110-711-3	13-06654	\$246.95
Small	4110-712-1	13-06655	\$543.00
Medium	4110-712-2	13-06656	\$516.00
Large	4110-712-3	13-06657	\$516.00

AEROX SMOKE GOGGLES



Aerox has introduced Smoke Goggles with face forming elastomer seals to keep smoke out. Aerox Smoke Goggles are the choice of the U.S. Special Forces. The case features reflective tape to make goggles easy to locate as well as a velcro strip on the back for mounting.

GogglesP/N 13-06173\$113.75
Soft CaseP/N 13-06174\$102.80

BR-M AEROX BRACKET



Bracket Assembly, SS, with Lock, or Cyl Diameter (2 needed per system).....P/N: 13-04033\$56.75

AEROX FBO-1 FILLING STATION



Whether making money or saving it, the Aerox FBO-1 Cascade Filling System makes it easy to fill all types of aviation systems, from portables to jets. The FBO-1 comes complete with 2 CGA 540 cylinder connectors, 6' high-pressure (3000 psi) braided stainless filler line, contents gauge, flow restrictor and adapters to fit Puritan-Bennett, Scott, and CGA 540 filler ports.....P/N 13-04534\$360.00

AEROX CGA-540 SINGLE CYLINDER FILLING STATION
Transfills between cylinders quickly and easily. 6' braided stainless line, gauge, restrictor, and CGA 540 filler.....P/N 13-04535\$219.95

OPTIONAL BUILT-IN ADAPTERS

Image	Description	Part No.	Price
	Aerox Scott Built-in Adapter Option (Piper, Beech, Mooney)	13-04536	\$62.80
	Aerox Puritan-Bennett Built-in Adapter Option (all other makes)	13-04537	\$81.75
Portable System Filling adaptors for standard CGA 540 supply cylinders:			
	Aerox Scott Portable Filling Adaptor	13-04538	\$65.00
	Aerox Puritan-Bennett Portable Adapter Option	13-04540	\$87.00



AEROX SEAT BACK DELUXE CARRIER

Fitted case with quick release, all point webbing. Available for "A", "C", "D", "E", and "M" cylinders. Doubles as a carrier with built in rubber handle. Webbing can remain on the seat when the case is detached. Internal velcro strap holds cylinder securely. Accessory pocket on side holds webbing for easy storage. Available in black.

Complete Part no. with: -A, -C, -D, -E, or -M.
P/N 13-18990\$62.99

PS

OXIMETERS - FACE MASKS



AEROX DILUTER DEMAND MASK

Comes standard with an electret microphone and an inflatable Quick Comfort head harness that provides maximum comfort. The mask features a carbon fiber construction, and soft silicon rubber. Connectors are available for most built in systems. This mask is easily mounted with the available carbon fiber stowage cup, aerox® is also able to manufacture a walk around system with the same outlet plug that is on your aircraft, so you can easily disconnect from the on-board system and plug directly into a portable system allowing mobilityP/N 13-12359**\$3,950.00**



PULSE OXIMETER CO DETECTOR 455

Designed for all aircraft with limited panel space. This small pulse Oximeter with CO Detector mounts easily in most panels and transmits data to the MFD'S via RS232. Current MFD manufacturers include Electronics International, Advanced Flight Technologies, Grand Rapids Instruments and on upcoming releases of Avidyne Entegra Release 9.

The unit transmits the pilot's blood oxygen levels, heart rate statistics, CO Level, Cabin temperature and Cabin Altitude to the MFD's display units. The pilot inserts an index finger in the unit and quickly gets readouts so he/she can determine his/her general physical and his environmental condition. Aero-455 reminds the pilot when he/she passes 10K and every 30 minutes above 10KP/N 11-07993**\$999.00**



IOXIMETER SMARTPHONE PULSE OXIMETER

Pulse Oximeter for Smart Phones. Reads Oxygen Saturation. Reads Pulse Rate. No batteries required. Powered through the headphone jack on your phone.

P/N 13-17632**\$48.75**



FINGER PULSE OXIMETER

MD300 C201 is intended for noninvasive spot-check measurement of function oxygen saturation of arterial hemoglobin(SpO2). It can be used with adult and pediatric and widely used in family, clinic and hospital.

Features: • SpO2%, PR are displayed on screen • Simple and convenient operation • Light, compact (the weight is 50g including batteries) Low power consumption, two AAA batteries can be continuously Operated for 30 hours • Indication of low power consumption • Two display modes P/N 13-05666**\$89.95**



AITHRE ALTUS PORTABLE OXYGEN TANK MONITOR

The first portable oxygen tank monitor that wirelessly pairs to your iOS device for pressure, flow rate, and time-remaining monitoring. Features Siri voice notifications via a paired headset when pressure drops below 500 psi or when threshold altitudes are crossed. The Altus removable straps to your oxygen tank and includes a high pressure T-fitting so you can keep your manual pressure gauge for backup P/N 11-17393**\$189.95**

AITHRE ILLYRIAN SMART OXIMETER



The Illyrian smart oximeter is usable in aviation, sleep, and mountaineering to provide constant, always on pulse oximeter readings to an iOS device and Apple Watch. SPO2 readings are obtained using a thin sensor pad worn

near the ear or on the forehead and then broadcast wirelessly using BLE (Bluetooth Low Energy) to your Apple phone, tablet, watch using the free Aithre Connect app and your experimental avionics when using the companion product Shield EX 3. Power is provided via USB plug and the included long lasting portable power bank.

Use up to 6 Illyrian oximeters simultaneously on the App to monitor you and your passenger SPO2 and BPM data throughout the flight.

P/N 11-17595**\$130.00**



AITHRE OXYGEN BOTTLE WITH FIXED FLOW REGULATOR 47L

The Aithre personal oxygen bottle is constructed from lightweight composite carbon fiber with an aluminum lining and is designed for low altitude and short duration mid-altitude use. Offering a 2000 PSI working pressure, simple on-off gauge, and preset 0.5 LPM flow rate, this bottle is ideal for pilots in private GA aircraft for refreshing before an approach and supporting brief climbs above terrain or weather at altitudes of 5k MSL - 15k MSL. Small enough and light enough to fit in your flight bag, the Aithre oxygen bottle is 100% refillable and can store 47L of compressed oxygen at 2000 PSI. If you don't already fill your own oxygen, filling your own bottles is easy and very cost-effective. You can easily fill the bottle yourself for about \$0.50 - \$1.00 per fill (\$0.02 per liter of compressed oxygen) using the following parts from AEROX and an oxygen supply tank. The oxygen supply tank can be either a large cylinder from your gas company (e.g. NORCO) OR another portable oxygen tank (e.g. another portable oxygen cylinder) filled by your FBO.

BOTTLE SHIPPED EMPTY • No oxygen is contained in the bottle when shipped • Filling port is 3/8"-24 UNF (FAM-PB3 adaptor from Aerox) • Fill yourself using Aerox transfilling equipment (FA540-72-G hose/gauge from Aerox)P/N 13-23419**\$395.00**



MOUNTAIN HIGH OXYMIZER CANNULA

The Oxymizer 'M' type (mustache-style) oxygen-conserving cannula is the most popular version. The Oxymizer is standard issue with our XCR and XCP systems and may work with almost any adjustable constant flow regulatorP/N 13-11592**\$34.85**



MH E-Z BREATHE II BOOM CANNULA EDS FOR PULSE DEMAND

Mountain High has redesigned their Boom Cannula system to make it even better. The redesigned nylon boom arm affixes to your headset with a ball mount and adhesive pad. It can swivel about and slides in and out for best fit. The new improved arm incorporates an adjustable friction lock to eliminate slippage. The nasal tips and the entire feed-tube assembly are easily replaceable, as well as the aluminum mount ball. The arm can be easily removed from the headset when not in use.....P/N 13-13067**\$99.75**



MH E-Z BREATHE II BOOM CANNULA FOR XCP - FLOWMETER

The E-Z Breathe Boom Cannula II™ kit for use with Mountain High XCP portable constant-flow systems. This model will also work with most all constant flow systems that use a Flow-Meter..P/N 13-23358**\$99.75**



MOUNTAIN HIGH ALPS FACE MASK

MH ALPS FaceMask and the MH ALPS-M (for microphone) FaceMask. The ALPS-M is outfitted with an electronic "Clear-Speak" ambient noise-canceling microphone that enables pilots to fly with safety and comfort with clear, crisp voice communication and is compatible with most aircraft systems. The mask is easy to put on and exceptionally comfortable as it does not require a polyvinyl bag. The ALPS or the ALPS-M FaceMask can be used with any of the MH oxygen systems.

Alps Constant Flow Feed Tube Use with MH-4 Flowmeter only

P/N 13-11388**\$4.95**

Alps EDS Style Feed Tube.....P/N 13-13098**\$4.85**

Description	Part No.	Price	Description	Part No.	Price
Med.	13-04155	\$173.75	w/ Mic Small	13-05134	\$473.00
Small	13-05136	\$173.80	w/ Mic Med.	13-05135	\$475.00
Large	13-05137	\$169.75	w/ Mic Large	13-04156	\$475.00



AITHRE ALTUS MESO PORTABLE OXYGEN TANK PRESSURE MONITOR - WITH IOS APP

The Altus Meso is the second generation Altus smart tank monitor from Aithre with all the same innovative functionality now packaged in a miniature form factor. Altus Meso wirelessly pairs to your iOS device and Apple Watch to display pressure, flow rate, and time remaining, including oxygen trend graphing and much more, now using only USB power (optional 5V hardwired experimental aircraft installed version available upon request). This small device makes your portable oxygen tank more usable and accessible without the expense and hassle of a traditional built-in system. (Black)P/N 11-18407**\$195.00**



AITHRE SHIELD EDOT 5.0 CARBON MONOXIDE DETECTOR WITH IOS APP

The Aithre Shield 5.0 eDot CO Detector - FAA Part 23 Approved - Panel Led Indicator with iOS App. FAA approved for Certified Aircraft but also available for experimental Aircraft builders: The Aithre Shield eDot 5.0 is the first behind-the-panel device that puts carbon monoxide readings output to panel mounted LED light and to iOS device. Features a simple wiring installation, a small footprint, iOS app, WatchOS app, and 10 years without recalibration for the CO ppm.....P/N 11-18408**\$450.00**



AITHRE OXYGEN BOTTLE WITH FIXED FLOW REGULATOR 152L

The Aithre personal oxygen bottle is constructed from lightweight composite carbon fiber with an aluminum lining and is designed for low altitude and short duration mid-altitude use. Offering a 2000 PSI working pressure, simple on-off gauge, and preset 0.5 LPM flow rate, this bottle is ideal for pilots in private GA aircraft for refreshing before an approach and supporting brief climbs above terrain or weather at altitudes up to 15k MSL.

Small enough and light enough to fit in your flight bag, the Aithre oxygen bottle is 100% refillable and can store 152L of compressed oxygen at 2000 PSI. If you don't already fill your own oxygen, filling your own bottles is easy and very cost-effective. You can easily fill the bottle yourself for about \$0.50 - \$1.00 per fill (\$0.02 per liter of compressed oxygen) using the following parts from AEROX and an oxygen supply tank. The oxygen supply tank can be either a large cylinder from your gas company (e.g. NORCO) OR another portable oxygen tank (e.g. another portable oxygen cylinder) filled by your FBO.

P/N 13-23716**\$595.00**

PS

OXYGEN SYSTEMS

MOUNTAIN HIGH XCP SYSTEMS



The MH-XCP Constant Flow series is our most economical single and multi-place, portable oxygen system for general aviation. Weight is kept to a minimum by our low profile, light weight regulators, MH-3 or MH-4 Flowmeters and Cylinders. The XCP systems come complete with Cylinder (of your choice), Regulator, Mountain High MH-3 or MH-4 Flowmeter, Oxymizer™ cannula, facemask, tote bag and cylinder carry case for easy transport and seat back mounting. Full-Pack The XCP System can be used up to 25,000 ft. with the MH-4 Flowmeter and Facemask. Choose the MH-3 Flowmeter for flights up to 18,000 ft. Each XCP

System Includes: • Instructions • Cylinder with Valve, Gauge and carry case. • Pressure reducing Regulator with self sealing outlet for each user. • MH3 or MH4 Flow-Meter (Your choice when ordering) • Oxymizer (oxygen conserving) Cannula. • Facemask • Tote-Bag.

Models include Full-Pack padded cylinder carry/strap-down case

Model	Description	Part No.	Price
00XCP-0064-34	682 liter (24 cu. ft.) 4-place carry-on system	13-03657	\$1,037.00
00XCP-0064-32	682 liter (24 cu. ft.) 2-place carry-on system	13-03658	\$847.00
00XCP-0064-31	682 liter (24 cu. ft.) 1-place carry-on system	13-03659	\$652.00
00XCP-0060-34	415 liter (15 cu. ft.) 4-place carry-on system	13-03660	\$904.00
00XCP-0060-32	415 liter (15 cu. ft.) 2-place carry-on system	13-03661	\$737.00
00XCP-0060-31	415 liter (15 cu. ft.) 1-place carry-on system	13-03662	\$566.00
00XCP-0054-31	180 liter (6 cu. ft.) 1-place carry-on system	13-03663	\$536.00

MOUNTAIN HIGH EDS O2D2 OXYGEN SYSTEMS



The MH EDS-O2D2 Pulse Demand Oxygen Delivery System is the only single unit, portable, two-place oxygen system currently available for general aviation. A variety of options allow you, the pilot, to customize a system to your specific needs. The O2D2 kit comes with (3) AA batteries, 2 standard cannulas, 2 flare tip cannulas, and 2 face masks all in a handy carry bag.

Note: Our EDS O2D2 and O2D1 are portable systems designed and calibrated to be used with our regulators (~15 psig. dynamic to 25 MAX. psig. static). However, if you wish to operate from the outlets of a built-in system, we offer the EDS-STR stabilizing regulator. This will allow our portable EDS systems to operate with built-in systems that supply up to 90 psig. to the outlets in the aircraft.

Model	Description	Part No.	Price
00EDS-2060-02	with AL-415 Aluminum cylinder and XCR-540 regulator - 2 Place	13-05068	\$1,199.00
00EDS-2062-02	with AL-647 Aluminum cylinder and XCR-540 regulator - 2 Place	13-05069	\$1,287.00
00EDS-2053-02	with AL-180 Aluminum cylinder and XCR-540 regulator with holster pack	13-07313	\$1,126.00
00EDS-2060-04	(2) units with AL-415 Aluminum cylinder, FPR-540 regulator - 4 Place	13-07315	\$2,121.00
00EDS-2062-04	(2) units with AL-647 Aluminum cylinder, FPR-540 regulator - 4 Place	13-07316	\$2,193.00
00EDS-2064-02	with AL-682 Aluminum cylinder and XCR-540 regulator - 2 Place	13-07317	\$1,228.00
00EDS-2064-04	(2) with AL-682 Aluminum cylinder, FPR-540 regulator - 4 Place	13-07319	\$2,140.00
00EDS-2002-02	with KF-011 Kevlar cylinder and XCR-540 regulator - 2 Place	13-07321	\$1,670.00
00EDS-2004-02	with CFFC-022 carbon fiber cylinder, XCR-540 regulator - 2 Place	13-07323	\$2,383.00
00EDS-2084-02	with CFF-480 Silica cylinder, XCR-540 regulator - 2 Place	13-07324	\$1,917.00
00EDS-2000-00	Kit only- Regulator or Cylinder Not Included	13-07312	\$893.00
00EDS-2084-02	with CFF-480 Silica cylinder, XCR DIN-477 (Euro Inlet) regulator.	13-07326	\$1,862.00
00EDS-02D2-26	Oxygen Controller	13-18720	\$895.00

MOUNTAIN HIGH TRANSFILLER UNITS



TR-55 00GSE-1008-00 Standard length 18 inches. The TR-55 is the most economical way to fill your cylinder. One side has a CGA-540 nut & nipple with an O-ring seal, while the other end is equipped with a large hand nut with bare nipple. This allows you to slowly and safely bleed the line so the fittings can be easily removed from the cylinder.
P/N 13-03923 \$170.00

TR-75B 00GSE-1012-00 Standard length 24 inches. The TR-75b is our most popular personal transfiller. It is equipped with O-ring seals on both of the CGA-540 (oxygen) ends for a positive and air-tight fit by hand. A handy bleed valve is included to relieve the pressure in the system so that the fittings can be easily removed from the cylinder without damage to the O-ring seals. P/N 13-03924 \$359.00

TR-95B 00GSE-1016-00 Standard length 48 inches. The TR-95b is an economical transfilling system for soaring and flying clubs where many cylinders are serviced frequently. Both connecting ends have O-ring seals for a positive air-tight fit. The pressure/contents gauge shows how much oxygen remains in the master (rental) cylinder P/N 13-03925 \$424.00

O2 TRANSFILLER FBO KIT - The standard kit comes with a non-venting style regulator, and the four most common fill adapters that you will need. Incorporates a flow restrictor to prevent filling too fast, as well as built-in filters. All Components are cleaned and ready for Oxygen use. With 8 ft. Hose P/N 13-14949 \$1,289.00
Without Hose P/N 13-12735 \$1,155.00

TA-916-S Adapts CGA-540 to the Scott fitting (9/16-18 threads). Commonly known as the Scott 26875, 5020-1 Airline or AS1046 fitting. A socket is on the CGA-540 end to attach to transfiller lines P/N 13-14773 \$177.75

MOUNTAIN HIGH EDS O2D1 OXYGEN SYSTEMS



The EDS-O2D1 System enables the general aviation pilot to fly at pressure altitudes up to 25,000 feet with safety and comfort. The EDS-O2D1 digital Pulse-Demand™ system reduces Oxygen consumption dramatically. Different from the "standard" constant flow systems, the EDS-O2D1 Pulse-Demand™ system wastes no Oxygen during the breathing cycle when oxygen is not being delivered to the lungs. The average user will enjoy a duration increase of two to three times compared to the constant flow systems. The built in Barometer adjusts for Altitude increase while reducing the pilots work load. The unit operates for up to 100 hours on two AA batteries. The EDS-O2D1 should be used with any of our XCR, XCP, or 4-place FPR regulator. for correct pressure and oxygen delivery. The low-pressure service line is a high quality polyurethane line that is kink-resistant and flexible under varying temperatures. The cannula, face mask and service line connect to the EDS unit via color-coded "Quick-Connects" providing an air-tight fitting by hand. These fittings can be connected and disconnected many times. With the optional XCP connecting kit, the EDS can be used with an XCP system at the same time flow meters are being used. In addition, the optional ALPS Facemask with or without microphone, is the perfect addition to any EDS system. All systems are shipped empty.

Model	Description	Part No.	Price
00EDS-0084-01	with CFF-480 Silica Cylinder and XCR-540 regulator with tote bag - 1 Place	13-02387	\$1,664.00
00EDS-0054-01	with AL-180 Aluminum Cylinder and XCR-540 Regulator with tote bag - 1 Place	13-03668	\$921.00
00EDS-0002-01	with KF-011 Kevlar cylinder and XCR-540 regulator with tote bag - 1 Place	13-03666	\$1,611.00
00EDS-0004-01	with CFFC-022 carbon fiber cylinder, XCR-540 regulator with tote bag - 1 Place	13-03665	\$2,337.00
00EDS-0004-02	(2) with CFFC-022 carbon fiber cylinder, XCR-540 regulator with tote bag - 2 Place	13-03670	\$3,054.00
00EDS-0060-02	(2) units with AL-415 Aluminum cylinder, FPR-540 regulator with tote bag - 2 Place	13-03671	\$1,662.00
00EDS-0084-02	(2) and CFF-480 Silica cylinder, XCR-540 regulator with tote bag - 2 Place	13-03672	\$2,419.00
00EDS-1052-00	with XCR-540 regulator	13-02390	\$822.00
00EDS-1054-01	with XCR-540 regulator with gauge	13-02391	\$847.00
00EDS-1062-02	with XCR DIN-477 (Euro Inlet) Regulator with gauge	13-02392	\$919.00
00EDS-02D1-26	Oxygen Controller	13-18719	\$767.00

MOUNTAIN HIGH AVIATOR STANDARD CANNULA



Calibrated for use with the MH-4 flowmeter or any other device calibrated to the standard protocol of 1 liter per minute per 10,000 ft. per FAA-FAR 23.1447. This Cannula works great with a headset!..P/N 13-11590 \$6.50

MOUNTAIN HIGH FLOWMETER MH-4



The MH-4 has two altitude flow scales. The left (compressed) scale is calibrated for the Oxymizer™ cannula and is limited to flight of 18,000 ft. and below. The right scale is calibrated for a standard cannula or facemask up to 25,000 ft.
Plastic P/N 13-06128 \$79.85
Metal P/N 13-23410 \$115.75

MOUNTAIN HIGH MH-3 XCP FLOWMETER WITH CPC FITTING AND TUBING



The MH-3 Flowmeter is calibrated for use with the Oxymizer™ cannula for flight up to 18,000 ft. The left (compressed) scale is calibrated for the Oxymizer™ cannula and is limited to flight of 18,000 ft. and below.
Plastic P/N 13-23408 \$67.71
Metal P/N 13-23409 \$81.43

NATURAL BOOST OXYGEN



Boost Oxygen is a convenient, lightweight, and portable 95% pure Aviator's Breathing Oxygen. Perfect for hikers, athletes, and GA pilots flying at high altitude (but still below 12,000 feet), Boost can help you out on your next trip.

Instructions for use:

- Place mask under the nose and over the mouth.
- Press trigger down to activate flow.
- Breathe deeply through the mouth.

Pocket Size - 2 Liters P/N 13-12975 \$7.50
(case of 12) P/N 13-12975-1 \$77.65
Medium Size - 5 Liters P/N 13-21167 \$9.80
(case of 12) P/N 13-21167-1 \$109.75
Large Size - 10 Liters P/N 13-12976 \$14.95
(case of 12) P/N 13-12976-1 \$154.75

NORAL OXYGEN CANNULA CARRIERS



See www.aircraftspruce.com for our full line of Noral Oxygen Canula Carriers.

PS

OXYGEN SYSTEMS



SOLOPACK PERSONAL OXYGEN PACK

The ALL-IN-ONE SOLO Pack with A-5 Flow Meter and ALL-IN-ONE Connector Kit is a complete and simple oxygen kit for the pilot and/or passenger. The Connector Kit allows you to connect to virtually all general aviation aircraft. This package includes a standard face mask, Oxymizer Cannula, A-5 Flow Meter, and FLOWGLOW to illuminate your flow meter in the dark. Includes all necessary tubing and connectors.

P/N 05-14888\$195.75



PILOTPACK PERSONAL OXYGEN PACK

The PILOTPack with ALL-IN-ONE Connector Kit is the perfect solution for the pilot who needs complete breathing gear AND a Mic Mask. The ALL-IN-ONE Connector Kit allows you to connect to virtually all general aviation aircraft, and the comfortable silicone Mic Mask ensures crystal clear communication when flying at high altitudes. This convenient ALL-IN-ONE package includes: the Comfort Mic Mask, Oxymizer Cannula, the popular A-5 Flow Meter, and a FLOWGLOW to illuminate your flow meter in the dark. Includes all necessary tubing and connectors.

P/N 05-14890\$669.00



PLANE PACK - 4 PERSON

The PLANEpack with ALL-IN-ONE Connector Kits is a versatile kit that fits a number of passengers and/or pilots with all the breathing gear they need. The Connector Kits allow you to connect to the majority of General Aviation planes flying today. In the box: • 4 - A-5 Oxygen Flow Meter With Tubing • 2 - Comfort Microphone Mask with Premium Mic • 4 - Oxymizer Cannula For Use With Flow Meters • 2 - Standard Face Mask - Certified to 25,000 Feet • 4 - ALL-IN-ONE Connector Kit • 4 - FLOWGLOW for use with A-5 Flow Meter • 2 - Oxygen Equipment Bag - PFI • 1 - Pulse Oximeter..P/N 05-14896\$1,751.00



PLANE PACK - 6 PERSON

The PLANEpack with ALL-IN-ONE Connector Kits is a versatile kit that fits a number of passengers and/or pilots with all the breathing gear they need. The Connector Kits allow you to connect to the majority of General Aviation planes flying today. In the box: • 6 - A-5 Oxygen Flow Meter With Tubing • 2 - Comfort Microphone Mask with Premium Mic • 6 - Oxymizer Cannula For Use With Flow Meters • 4 - Standard Face Mask - Certified to 25,000 Feet • 6 - ALL-IN-ONE Connector Kit • 6 - FLOWGLOW for use with A-5 Flow Meter • 3 - Oxygen Equipment Bag - PFI • 1 - Pulse Oximeter.

P/N 05-14897\$2,102.00



PLANE PACK - 8 PERSON

In the box: • 8 - A-5 Oxygen Flow Meter with Tubing • 2 - Comfort Microphone Mask with Premium Mic • 8 - Oxymizer Cannula for use with Flow Meters • 6 - Standard Face Mask - Certified to 25,000 Feet • 8 - ALL-IN-ONE Connector Kit • 8 - FLOWGLOW for use with A-5 Flow Meter • 4 - Oxygen Equipment Bag - PFI • 1 - Pulse Oximeter.....P/N 05-14898\$2,195.00

OXYGEN CHARGE FILL ADAPTER WITH DUST CAP

1/4 JIC/AN-4 to 9/16-18 UNF-2B aircraft connection. Includes dust cap/protective nipple with chain/lanyard. Shipped certified clean for immediate useP/N 12-04870\$109.75

OXYGEN CHARGE FILL ADAPTER 30° BEND

1/4 JIC/AN-4 "Male Flared Tube" connected by 1-inch tube with AN800-3 (3/8-24 UNF-2B) aircraft connection. Includes dust cap/protective nipple with chain/lanyard. Shipped certified clean for immediate useP/N 12-04869\$129.85



OXYPACK1 - 2 PERSON OXYGEN SYSTEM

In the box: • 1 - 6.3 CU. Ft. Aluminum Oxygen Cylinder • 1 - 6.3 Cubic Foot Case With Shoulder Strap • 2 - A-5 Oxygen Flow Meter With Tubing And CPC Connector • 2 - Oxymizer Cannula For Use With Flow Meters • 2 - Standard Face Mask - Certified to 25,000 Feet • 1 - Two-Person Oxygen Pressure Regulator..P/N 05-14892\$801.00



OXYPACK2 - 2 PERSON OXYGEN SYSTEM

In the box: • 1 - 15 CU. Ft. Aluminum Oxygen Cylinder • 1 - Carrying Case With Seatback Harness • 2 - A-5 Oxygen Flow Meter With Tubing And CPC Connector • 2 - Oxymizer Cannula For Use With Flow Meters • 2 - Standard Face Mask - Certified to 25,000 Feet • 1 - Four-Person Oxygen Pressure Regulator..P/N 05-14893\$800.00



OXYPACK3 - 2 PERSON OXYGEN SYSTEM

In the box: • 1 - 22 CU. Ft. Aluminum Oxygen Cylinder • 1 - Carrying Case With Seatback Harness • 2 - A-5 Oxygen Flow Meter With Tubing And CPC Connector • 2 - Oxymizer Cannula For Use With Flow Meters • 2 - Standard Face Mask - Certified to 25,000 Feet • 1 - Four-Person Oxygen Pressure Regulator..P/N 05-14894\$1,095.00



OXYPACK4 - 2 PERSON OXYGEN SYSTEM

In the box: • 1 - 22 CU. Ft. Aluminum Oxygen Cylinder • 1 - Carrying Case With Seatback Harness • 4 - A-5 Oxygen Flow Meter With Tubing And CPC Connector • 4 - Oxymizer Cannula For Use With Flow Meters • 4 - Standard Face Mask - Certified to 25,000 Feet • 1 - Four-Person Oxygen Pressure Regulator • 4 - FLOWGLOW for use with A-5 Flow Meter.....P/N 05-14895\$1,301.00

X3 SOLO PACK

Pilot tested and pilot approved! The X3 Demand Converter is the best demand converter in the aviation industry. The X3 Demand Converter is the only fully mechanical demand converter (no batteries required). By giving you oxygen only when you "demand" it, the X3 will extend the duration of your oxygen supply by at least 300%. The X3 Solo Pack includes everything you need, including a dual lumen cannula, dual lumen mask, connectors, and tubing. The X3 is STC'd for Cirrus and certified up 25,000 feet.

P/N 05-14889\$999.00



X3 PILOT PACK

This package includes the X3 Demand Converter PLUS a Comfort Mic Mask certified up to 25,000 feet! The X3 Demand Converter is the only fully mechanical demand converter (no batteries required). By giving you oxygen only when you "demand" it, the X3 will extend the duration of your oxygen supply by at least 300%. This X3 Pack includes everything you need PLUS a Comfort Mic Mask for crystal clear communications at high altitudes. Includes: dual lumen cannula, dual lumen Mic Mask, connectors, and tubing. The X3 is STC'd for Cirrus and certified up 25,000 feet.

P/N 05-14891\$1,326.00



GROUND SUPPORT TOW BARS

CESSNA - This two piece telescoping tow bar fits all Cessnas with 5/8" lugs on nosegear. Overall length 42.5", collapsed 24".
P/N 13-01800 **\$68.95**

MOONEY - A simple "T" handle design for the Mooney axle. Overall length 33.5".
P/N 13-02000 **\$63.95**

CHEROKEE - This one piece tow bar has a retractable locking mechanism that gives a positive lock when installed. Overall length 31" P/N 13-01600 **\$66.75**

BEECHCRAFT - The compact design of this tow bar makes it very popular among Beech owners. Overall length 38", collapsed 21.5".
P/N 13-01900 **\$65.95**

ARROW - This offset "T" handle design fits into the Arrow axle making it a simple and easy design to use. Overall length 33".
P/N 13-01700 **\$64.75**

TWIN CESSNA - The extra length provides extra nose clearance and leverage for Twin Cessnas and remains very compact. Overall length 55", collapsed 34".
P/N 13-01850 **\$68.75**

TWIN PIPER - (HH-007) Piper Twin Comanche, Apache, Aztec, and Navajo Towbar. Two section until 28" collapsible, 49-1/2" overall length.
P/N 13-01778 **\$61.75**

COMANCHE - The same as our P/N HH-007 except one piece construction. Overall length 33" P/N 13-02100 **\$66.95**

DELUXE CESSNA - The deluxe Cessna towbar is very popular and designed for those who demand the ultimate in convenience and durability. Spring loaded forks allow easy one handed engagement without getting on your hands and knees. Length 45.5" extended, 26" collapsed. Wt. 3.75 lbs. Ideal for Cessna RGs Including 210 series.
P/N 13-01540 **\$77.75**

DUTCHESS/PIPER - Fits Dutchess and Piper nose gear axle. Telescoping design provides extra nose gear clearance. Overall length 48", collapsed 28" P/N 13-02210 **\$68.85**

RV-A M-340-026 - Two piece spring loaded design. 26" collapsible, 43" overall. Code 7.
P/N 13-18476 **\$79.95**

DELUXE PIPER - The deluxe Piper towbar offers all the features of a standard Piper towbar plus the convenience of a two-piece design. When extended, this model provides additional propeller clearance and leverage. Length: 42" extended, 23" collapsed. Wt. 3.5 lbs. P/N 13-01550 **\$79.95**

UNIVERSAL TOW BAR WITH CLEVIS HITCH

CESSNA/ BEECH/ MOONEY - This universal tow bar is excellent for use with tug, tractor, or by hand. It fits most Cessna singles & twins with 5/8" lugs, Beech singles and twins with 1/4" lugs, all Mooneys, Twin Commanders, Lake and Comanche. Slide lock quickly adjusts and holds firmly P/N 13-02350 **\$204.95**

PIPER - Same design as the universal tow bar above, this towbar fits Piper single fork design, Arrow, Malibu, Lance, Seneca, and Seminole. Slide lock quickly adjusts and holds firmly.
P/N 13-02351 **\$204.95**

SCOTT TAILWHEEL - A tow bar designed for aircraft using a Scott 3000 series tailwheel. Overall length 48", collapsed 28".
P/N 13-02205 **\$81.75**

BEECHCRAFT AXLE - Its collapsible design makes it easy to fit in the baggage area. Collapsible Length: 26" Overall Length: 43".
P/N 13-02215 **\$74.50**

CHEETAH/CIRRUS - This tow bar is designed to fit Grumman aircraft. Its collapsible design makes it easy to fit in the baggage area. Overall length 43", collapsed 26".
P/N 13-02200 **\$78.85**

ERCOUPE - Specially designed for Ercoupe. This tow bar has a spring loaded lever action for ease of operation. Overall length 46.5", collapsed 28.5" P/N 13-01580 **\$78.75**

1-1/8" AXLE - This is a universal tow bar designed for aircraft with 1-1/8" axles such as Cessna Skymaster and Piper Seneca. Overall length 56", collapsed 33".
P/N 13-02110 **\$82.75**

COMMANDER - This model fits Rockwell 112 and 114. Spring loaded forks for ease of operation. Overall length 46.5", collapsed 28.5".
P/N 13-01570 **\$79.75**

DELUXE MOONEY - The deluxe Mooney towbar is a longer, two piece version of a standard Mooney towbar. Attractive black caps accentuate deluxe appearance. Length: 38", collapsed 21". Wt. 3 lbs. P/N 13-01560 **\$69.95**

UNIVERSAL - For the FBO this is an ideal hand held universal tow bar. Fits Cessna, Beech, Piper, Scott Tailwheel and many others. Overall length 57", collapsed 34". Fits aircraft with 5/8" lug on the nose gear strut.
P/N 13-02250 **\$108.95**

VIKING - Designed especially for Bellanca Viking axle. Collapsible design and spring loaded fork. Overall length 46.5", collapsed 28.5" P/N 13-02220 **\$92.75**

DELUXE BEECHCRAFT - Spring loaded forks for ease of operation. Overall length 47", collapsed 28" P/N 13-01905 **\$82.75**

AERO-TOW CIRRUS TOWBAR - This Cirrus Towbar is designed specifically to fit the gear of the Cirrus Aircraft. At just 6 lbs and a shipping box of 1-3/4" x 12" x 39" you will find this to be a quick and easy stowaway.
P/N 13-17597 **\$185.00**

FBO UNIVERSAL TOW BAR WITH RING HITCH T-100

This heavy duty universal tow bar is standard equipment for FBOs. Fits most Piper, Cessna, Beech, Mooney, AeroCommander, and many others. The adjustable fork allows you to extend the fork assembly from 3" to 10". This tow bar is extra long at 7 ft. 6 inches. The T-100 is not made for specific aircraft. It has spring loaded adapters that will fit and 1/4" to 5/8" towpins on the aircraft axle. This will not work with aircraft that have tow pins on the landing gear P/N 13-02355 **\$279.95**

AIRCRAFT WINCH & MOUNTING KIT

AIRCRAFT WINCH - Floor mounting aircraft winch with hook cable to tail tie-down ring and press button operation. Easily moves aircraft up to 3,000 lbs. rolling weight on smooth, flat surfaces. If uphill, on gravel, or there is a large hangar lip, most aircraft will require the Heavy Duty variant. Comes with 100' of cable and 75' of control cord and has an automatic safety shut off. Cable speed is 30 feet per minute. Voltage 100 AC. Floor mount is required for operation (sold separately), Part No. 13-06124.
P/N 13-01764 **\$490.00**

HEAVY DUTY AIRCRAFT WINCH - Winch includes metal wind up drum, 100' of cable 125' of control cord. Moves aircraft up to 6,000lbs. Includes a wall mount. If floor mount is desired P/N 13-06124 must be ordered. Code 7
P/N 13-06125 **\$496.00**

AIRCRAFT WINCH MOUNTING KIT - Aircraft Winch Mounting Kit Everything you need to secure the winch to the floor. Mounting kit only. Can be used with P/N's 13-01764 and 13-06125 in a floor mount is desired.
P/N 13-06124 **\$71.75**

PS

TOW BARS

BOGERT TOW BARS (BOGI-BARS)



Light enough to stow Built from a combination of steel for maximum durability comfort grips on the handle and spreader bar chip resistant red bar will look great for years. Operation: extend the handle easily with high shear wick release pin apply forward pressure on the spreader bar to open the wishbone jays. Line up the Bogi-Bar attachment at the tow points or axle depending on model. Release the tension on the spreader bar and you are locked on! The tow bar will not slip off the plane. Reverse for removal.

TAIL WHEEL AIRCRAFT				
Model	Fits	Extended Length	Part No.	Price
4-API	Aircraft Products Tailwheel	48"	12-02097	\$225.00
4-ABI	Alaskan Bushwheel 3400B	48"	13-06106	\$225.00
04M-XP	Cessna XP Modification	48"	13-06107	\$225.00
4-TDG	Scott 3200 & 3400/ABI 3200/3400	48"	13-10000	\$225.00
4-F24	Fairchild 24, Beech Stagger Wing	48"	13-02410	\$152.75
4-RV	Vans RV3, RV4, RV6, RV8, RV9	48"	13-02408	\$241.95
NOSE WHEEL AIRCRAFT				
Model	Fits	Extended Length	Part No.	Price
4-35	Beechcraft- Bonanza, Debonair, Duchess, Duke & Skipper	49"	13-10030	\$225.00
4-19/23B	Beechcraft-Musketeer, Sport, Super, Sierra & King Air	48"	13-01808	\$225.00
4-17/30	Bellanca-Viking Series	48"	13-01809	\$225.00
4-172	Cessna 150, 152, 172, 175, 177, 182, 310R, RV-4	48"	13-10040	\$225.00
4-206	Cessna 205, 206 & 207	48"	13-10060	\$225.00
4-210	Cessna 172RG, 177RG, 182RG & 210 Series	48"	13-10050	\$281.00
4-182-XL	Cessna 182 S (1996 and up) and T (2001 and up) models with long nose.	55"	13-11389	\$248.00
4-SR	Cirrus SR 20 & 22	48"	13-06108	\$225.00
4-AA	Gulfstream American AA1 & AA5	48"	13-02407	\$225.00
4-Lake	Lake Amphibian	48"	13-02411	\$291.00
4-Moon	Mooney Aircraft	48"	13-01810	\$225.00
4-24/30	Piper Comanche PA-24, PA-30 & PA-39 Also the Cherokee Six axle w/pants if tabs above wheel are broken	48"	13-10010	\$225.00
4-22/28	Piper PA-22, & PA-28 Series (Not PA-28R)	48"	13-10020	\$225.00
4-28R	Piper PA-28R Series - Hand Pull for dog-leg style	49"	13-02098	\$34.95
4-34	Piper Seneca PA34 200/220/220T, and Aerostar 601P *handle extends to 78"	78"	13-01812	\$379.00
4-PA46	Piper Malibu & Mirage -Vehicle Pull	72"	13-06112	\$399.00
4-28R, 4-PA46	Piper PA-28R, PA- 32R, PA-46 Hand Pull Towbar. Malibu, Mirage, Meridian and Saratoga Aircraft.	60"	13-11203	\$399.00
4-RVA	Vans - RV6A, RV7A, RV8A, & RV9A	48"	13-01811	\$225.00
4-LANCE	Lance Towbar	48"	12-03546	\$379.00
4-20	Diamond DA20	--	13-06111	\$225.00
4-DA40	Diamond DA40	--	13-06110	\$225.00
4-DA42	Diamond DA42	--	13-06109	\$399.00
4-RV10	Vans - RV10	48"	13-04282	\$225.00
4-Socata	Socata Style Bogi Bar	49"	13-06113	\$225.00
4-Navion	Navion Aircraft	48"	13-21892	\$225.00

BOGI BAR EXTENDED T-HANDLE

Includes new grips and is 7" longer than the standard Bogi Bar T-Handle. The extra length can be quite beneficial for aircraft with extra-long noses like the Cessna 182 S (1996 and up) and T (2001 and up) models. Tall customers will find this T-Handle easier on the back since it lowers that overall angle of the tow. The Extended T-Handle works with any of the standard Bogi-Bars and will increase the overall length to about 55". Model 4-TXL.

P/N 13-11199 \$75.00

BRACKET TOW BARS



MODEL TR-6

Excellent for towing aircraft such as the T-6, P-51, Stearman, Staggerwing Beech, or any aircraft with 3/4" or larger eye bolts. Length: 12' Spread: 12 ft. Weight: 62 lbs.

Ring Hitch P/N 13-10131 \$1,049.00
Ball Hitch P/N 13-10130 \$939.00



BRACKET TH-6 TOWBARS

The TH-6 is a light-weight universal towbar designed primarily for hand towing. The TH-6 eliminates the mad hunt for the proper towbar when moving a hangar full of singles and light twins. This towbar also has a good handle for pulling and a ring ,ball or clevis hitch for occasional light towing. NOTE: The piper manual states that the tow pins are for hand towing.

For powered towing we suggest adapter set P/N 13-15488.

Ring Hitch P/N 13-18547 \$463.00
Ball Hitch P/N 13-18548 \$456.00
Clevis Hitch P/N 13-18722 \$456.00
Piper Adapter - Qty 2 Required P/N 13-15488 \$17.85

MODEL TR-34



The TR-34 has the light weight of the TR-3, and the strength of the TR-4. It has the same universal features that fit most aircraft from C-150 through aircraft up to 14,500 lbs. Wt: 35lbs. Available in 3 hitch styles. .
Ring Hitch (TR-34R) P/N 13-10085 \$738.00
Ball Hitch (TR-34B) P/N 13-10086 \$738.00
Clevis Hitch (TR-34C) P/N 13-10087 \$662.00
TWA-10 Scott Tail Wheel Adapter (2 pcs. req) P/N 13-10089 \$22.95

MODEL TH-53

Features a tow bar length of 80" to 94" (extended). Wt: 22 lbs., Max. aircraft Wt: 7,000 lbs.

TH-53R Towbar w/Ring hitch P/N 13-03338 \$638.00
TH-53B Towbar w/Ball hitch P/N 13-03339 \$638.00
TH-53C Towbar w/Clevis hitch P/N 13-03340 \$638.00



MODEL TR-71, 72, & 73

Lightweight aluminum designed for Waco, Stearman, & Cessna 195 type aircraft. Length: 100", Spread: 90", Wt: 22 lbs. Hook dia: TR-71 (.850), TR-72 (1.25)

TR-71B Towbar w/Ball hitch P/N 13-01907 \$586.00
TR-72B Towbar w/Ball hitch P/N 13-01908 \$586.00
TR-73B Towbar w/Ball hitch P/N 13-01909 \$586.00
TR-71R Towbar w/Ring hitch P/N 13-01910 \$795.00
TR-72R Towbar w/Ring hitch P/N 13-01911 \$586.00

CUSTOM TOWBARS & OPTIONS FOR UNIVERSAL TOW BARS

Model	Description	Part No.	Price
TWA-10	Scott Tail Wheel Adapter (2 pcs. req.)	13-10089	\$22.95
T-MU2-10	Kit-Crank & head assembly for converting TR-34 to TR-44	13-01890	\$144.75
TWA-11	Tail Wheel Adapter for DGA-Staggerwing (2 pcs. req.)	13-01891	\$22.95
T-4W	Wheel Set (Set of 2) for TR-34	13-01892	\$122.75
T-375	Adapter .375" for Aerospatiale-Trinidad, Tabago (2 pcs.)	13-01893	\$17.85
T-475	Adapter .475" Outer Diameter (2 pcs. req.)	13-01894	\$17.00
T-625	Adapter .625" for Augusta 109 & Others (2 pcs. req.)	13-01895	\$17.00
T-750	Adapter .750" for Commander 114, S-76 & Other	13-01896	\$17.85
T-Maule	Adapter for Maule Tail Spring (1 pc. req.)	13-01897	\$83.95
T-34-04	Shock Absorbing Ring Hitch (1 pc. req.)	13-01899	\$189.95
TR-PC	Towbar; Pilatus PC-12, 3 pcs., 30 lbs.	13-01686	\$598.00
TR-PCS	Towbar; Pilatus PC-12, 1 pc., 19 lbs.	13-01903	\$972.00
TR-S2	Towbar; Ayres; 3 pcs., 18 lbs.	13-01755	\$335.00

VISIT WWW.AIRCRAFTSPRUCE.COM
FOR MORE TOWBARS AND ADAPTERS.

PS

TOW BARS – TUGS



THE TAIL-DRAGGER DRAGGER

This manual tow bar has heavy-duty solid rubber 8-inch wide tread wheels and will move most tail-draggers up to 2,000 lbs. and tail wheel tires up to 10 inches in diameter. Options Available: 3rd Wheel for heavier ships, and RV tail wheel lift pin.

Tail-Dragger Dragger™

Features:

- Patented Design
- No Winches
- No Hydraulics
- No Metal To Metal Contact
- No Adapters Required
- Superior Traction

- 5 Second Loading & Unloading
- Will fit Almost Any Aircraft
- Tail Wheel Stays In Trailing Position
- Lifting Pins Grip & Lift Tail Wheel
- Maneuver In Any Direction
- Operator Has Good View Of Wingtips

Description	Part No.	Price
Standard tail Dragger	13-01510	\$219.00

ACCESSORIES

Descriptions	Part No.	Prices
RV Tail Wheel Lift Pin	13-04936	\$7.85

BOGERT UNIVERSAL BIG BOGI TOWBAR



The 04M-BBU is unique because it can attach to virtually any aircraft. It has interchangeable "Feet" that can be matched to any aircraft. Each of the "Feet" typically adapts to several models or series of aircraft and several sizes can be carried right on the tow bar. This is perfect for FBO's that deal

with a variety of aircraft or aircraft owners that have more than one plane or shared hangars. "Interchangeable feet sold separately".

Description	Part No.	Price
Universal Big Bogi Bar	12-03168	\$495.00
Jabiru Sport; Kit Fox	11-11815	\$78.00
Cessna 150, 152, 172, 182, Vans, and many more	12-03172	\$78.00
Cirrus SR20, 22	12-03174	\$98.00
PA22, 28, 32, Cherokee Six	12-03175	\$78.00
Aerostar 601, Bellanca, Mooney	12-03176	\$78.00
Glaster, Legend Cub, Rockwell	12-03177	\$78.00
Alaskan Bushwheel, Scott 3200, 3400	12-03178	\$78.00
Diamond DA-40	12-03179	\$78.00
Diamond DA-20	12-03180	\$98.00
Cessna 172RG, 177RG, 182RG, 210	12-03181	\$98.00
Beechcraft Bonanza, 35	12-03183	\$98.00

See www.aircraftspruce.com for complete application list



2" HITCH BALL RECEIVER

For the 12-03168 Universal Big Bogi Bar.
With Ring P/N 11-11516 \$86.75
With Clevis..... P/N 11-11517 \$86.75

BRACKETT MULTI-LINK TOW BARS



User benefits: All tow bars and heads are interchangeable with other popular tow bar systems such as tronair® warranty on all materials and workmanship money saving alternative to multiple tow bars.

Brackett aircraft's multi-link tow bar line consists of tow bars that utilize changeable heads which allow you to tow a large variety of turbo prop and jet aircraft. The tyga line offers a standard multi-link system for aircraft with maximum tow weights of up to 125,000 pounds. All heads and tow bars are interchangeable with many widely used multi-head tow bar systems. You now have a high quality and competitive source for tow bars, changeable heads, and accessories.

Description	Part No.	Price
TY-TB125 Multi-Link Towbar	13-04157	\$1,742.00
TY-TB75 Multi-Link Towbar	13-04158	\$1,541.00
TY-TB-FTD Flat Tire Dolly T/B	13-04159	\$3,485.00
King Air/Queen Air Head Only	13-16150	\$658.00

SEE WWW.AIRCRAFTSPRUCE.COM
FOR COMPLETE MULTI-LINK SELECTION.

NOSE WHEEL DRAGGER DRAGGER



The Nose-Dragger Dragger features a swing gate front roller (for easy loading), 10 ball bearing rollers (which push and guide the nose wheel), and does not require the use of adapters, winches, or hydraulics. Effortless ground handling is accomplished by its lightweight design and slow walking speed. The Nose-Dragger Dragger accepts nose wheels up to 600 x 6 (with or without wheel fairings), and no metal-to-metal or metal-to-fiberglass contact. Available in gas or electric power models. The 12V electric powered Nose-Dragger Dragger will accept aircraft up to 3,000 lbs. The Nose-Dragger Dragger Gas powered model accepts aircraft up to 6,000 lbs. Please call 1-877-477-7823 for freight quote.

Gas Powered, 6.5HP (up to 12,000 lbs)..... P/N 13-05103 \$1,895.00

ACCESSORIES

Snow Chains	P/N 13-04932	\$69.00
Battery Charger - 24V	P/N 13-04934	\$105.95
Mag-Light / Head Lamp.....	P/N 13-04935	\$58.75

ELECTRIC DRAGGER® NOSE-DRAGGER



This powerful 24-volt electric aircraft tug will fit and move any nose wheel airplane up to 4,000 lbs. without wheel fairings as well as those with wheel fairings that have 3" or greater of clearance from the fairing to the ground. It utilizes a smooth thumb throttle speed control for precise forward and reverse movements. The built in differential allows for easier turning and even better control! Comes with batteries and smart charger! Ships fully assembled!

P/N 13-18726 \$2,395.00

ELECTRIC DRAGGER® TAIL-DRAGGER



This powerful 24-volt electric tug has heavy-duty 11 1/2 -inch air wheels and will move tail-draggers up to 5,000 lbs., tail wheel tires up to 16 inches in diameter. It utilizes a smooth thumb throttle speed control for precise forward and reverse movements. Uses 2 batteries hooked up in series that are supplied with the unit and on-board smart charger. The built in differential allows for easier turning and even better control! Ships on a skid. Comes with batteries and smart charger!

P/N 13-18727 \$2,395.00

TAILDRAGGER PICKER 1



The PICKER-1 is for tail-dragger/conventional gear aircraft and has 100% fully adjustable Picker-Pins on ((1)) side only. This towbar fits all Van's RV tail draggers and J3-Cubs thru 450 Stearmans. The PICKER you see here is a rugged built and powder coated tail dragger tow-bar made with heavy duty materials and hardware. A benefit of the design truly enables the pilot or ground crew to literally make an infinite number of adjustments to ensure a perfect fit every single time for a multitude of aircraft with tail wheels

P/N 13-14774 \$269.95

BABY BUSH PICKER 1A



The Baby Bush PICKER-1A is for tail-dragger/conventional gear aircraft and has 100% fully adjustable Picker-Pins on ((1)) side only. This PICKER is intended for tail wheels up to 6-inches wide and up to 15-inches in diameter. Those dimensions just mentioned exceed the size of a 500 x 5.0 nose wheel. This towbar must be used for aircraft with over 10 inches of ground clearance FWD of the tail wheel. The PICKER you see here is a rugged built and powder coated tail dragger tow-bar made with heavy duty materials and hardware.

P/N 13-16047 \$326.00

X - TENSION - 12 INCH - Consider this ADD-ON product when the reach to your tail wheel is just too far away. Works good and needed for Stearman, WACO, Swift etc. Also works with the "Sport Picker-3" for smaller aircraft with tailwheels too far away from the back side of the rudder. P/N 13-21072 \$48.85

HEAVY DUTY BABY PUSH PINS - As popularity grows for the BUSH tail wheels, so does the need for the BUSH pins when used with a Baby Push Picker. These longer pins reach 8". Alaska Bush tail wheels are wider and these Extra Long HD AK Bush pins will fit a Bush Plane, and even with the use of the collars have a fully contained 7-inch width.

P/N 13-21073 \$31.65

TOW BARS – TUGS

ROBOTOW PORTABLE TOW BAR



The all weather Robotow 24SL is lightweight (33 lbs.) and portable, making it ideal for carrying onboard your aircraft. When the Robotow's heavy duty all weather knurled drive drum is held against the nose wheel, the aircraft is easily moved. A trigger on the handle controls the speed while a switch reverses direction on command. Powerful, portable, and dependable, Robotow is an ideal power towbar for the aircraft listed.

The Robotow 24SL includes: a comfort grip handle with variable speed switch settings of forward, reverse and locked, a black oxide coated knurled drive drum for non-slip operation with maximum torque transfer, a 5 amp 24 volt durable sealed lead acid detachable battery pack with simple wire harness connections (no memory effect problems), 3 amp charger which can be connected to battery while it is mounted to Robotow frame, and a 24 volt permanent magnet motor for maximum battery life with high torque output.

This unit fits all existing Robotow adapters which are sold separately.

Description	Part No.	Price
Robotow 6420 24V Towbar Cordless Kit with International Charger	13-03896	\$1,426.00
Robotow 6426 24V Towbar Cordless Kit with U.S. Charger	13-04222	\$1,350.00
Robotow 6351 corded 120V, with 80ft. extension cord.	13-03897	\$1,195.00
ACCESSORIES		
Rowbotow 5 Amp/18V Battery	13-03898	\$266.95
Robotow 6425 24SL 5 amp Battery	13-11264	\$339.00
Robotow 6427 24SL 3 amp Charger	13-11265	\$173.75
Robotow Dolly Wheel	13-22378	\$196.00
Robotow Extension Cord - 100 ft.	13-22379	\$70.95
Robotow Ground Fault Interrupter	13-22380	\$80.00
AIRPLANE ADAPTERS (SOLD SEPARATELY)		
Robotow Adapter Beech 1 / Baron / Bonanza / Debonair Duke	13-03905	\$119.75

AIRPLANE ADAPTERS (SOLD SEPARATELY) - CONT'D		
Description	Part No.	Price
Robotow Adapter Beech 2 / Queen Air / Twin Bonanza / Trigear 18	13-03906	\$194.75
Robotow Adapter Cessna 1 / 150, 172, 182, 310, 340	13-03907	\$120.75
Robotow Adapter Cessna 2/ 310R, 401, 414, 421	13-03908	\$119.75
Robotow Adapter Cessna 3 / 182RG (Pre-1962), 206, 210 (Pre-1962)	13-03909	\$119.75
Robotow Adapter Cessna 4 / 337, 303	13-03910	\$193.75
Robotow Adapter Cessna 5 / 182RG and 210 (1962-1986)	13-03911	\$194.75
Robotow Adapter Piper 1 / Apache, Comanche, Aztec, Navajo, Twin Comanche, Bellanca	13-03912	\$119.75
Robotow Adapter Piper 2 / Colt, Cherokee, Tri-pacer	13-03913	\$193.75
Robotow Adapter T28 Trainer	13-03914	\$194.75
Robotow Adapter Navion	13-03915	\$194.75
Robotow Adapter Cessna Caravan	13-03917	\$194.75
Robotow Adapter Trinidad	13-03918	\$194.75

CESSNA TOWBAR EXTENSION



The "QUICK-FOLD COMPACT TOWBAR" also known as the "QFC--TowbarTM". No more back breaking, bend over towing. Simply attach the QFC-TowbarTM extension to your already existent Cessna tow bar and stand up straight. An added extension of 33". Folds flat and is stowed securely along side the factory tow bar.

P/N 13-06722 **\$99.75**

POCKET TOW TAILWHEEL LEASH



Pocket tow makes tail wheel aircraft maneuvering easy. Made with one-inch heavy-duty nylon webbing, the lightweight tow bar alternative is small enough to fit in your pocket and works on tail wheel aircraft with a 360-degree full-swivel tail wheel assemblies. The small end loops around the tail wheel leaf spring and cinches up tightly to pull and steer the aircraft backwards without pushing or pulling on any flight surfaces.

Black P/N 13-04681 **\$19.95**
Red..... P/N 13-04682 **\$19.95**

GENERAL AVIATION TOWBAR



This aircraft tow bar attaches to tow vehicle, or you can move by hand with the convenient handles. Improved with powder coating. This tow bar has been used on the following aircraft: Cessna 150, 172, 182, 205, 210, Cirrus SR-22, Mooney M20, Vans RV-9A. Check your aircraft owner's manual, some aircraft manufacturers warn against towing with a bar attached to a vehicle. Make sure you do not exceed the tow limits of your aircraft.

P/N 13-19787 **\$309.00**

BEECH TOWBAR ADAPTER



Beech Adapter. With this adapter you can move Beech Aircraft with the little tow pin. This adapter fits any towbar with a 3/4" or larger hole. Note: The grip length; (distance from nut to bolt head) is 1 1/2". With this adapter you can move Beech series aircraft with the small pin.

P/N 13-19793 **\$35.80**

DELUXE TAILWHEEL TOWBAR



The Deluxe Tail wheel Towbar uses a positive locking control cable to attach to the wheel from a straight-on position. No extra maneuvering or lifting is required, and it can be adjusted for various tail wheel sizes. Towbar Weight: 26 lbs.

Note: Maximum weight to lift is 1,200 to 1,500 lbs.....P/N 13-04918 \$295.00

STEARMAN TOWBAR



This towbar easily captures your tailwheel. Just push down on the bar and latch the pental hook or drawbar ball. It makes moving the Stearman from the rear quick and easy. Made with heavy duty wheels and pump up tires. Powder coated black.

P/N 13-11618 **\$398.00**

BOGERT ATC GROUND OPS KIT



ATC Ground OPS Kit. This Kit includes Bogert Tow Bars Bogi-Bars For Nosewheel, Rubber Wheel Chocks, Molded Wheel Chocks and Nylon Tie-Down Rope. **In the box:** • 1-Bogert Tow Bars Bogi-Bars For Nosewheel • 1-Rubber Wheel Chocks • 1-Molded Wheel Chocks • Nylon Tie-Down Rope.

P/N 01-01149 **\$1,674.00**

NOSE PICKER HEAVY DUTY AIRCRAFT TUG



Recommended for up to a 4,000 pound aircraft. Entire chassis can be raised or lowered, and three different sized front wheels can be used to create exact measurements for aircraft. The 24-volt, ships assembled inside a wooden crate, Batteries not included.

P/N 13-21166 **\$2,250.00**



REDLINE / AERO TECH TOW BARS

REDLINE SIDEWINDER POWER DRIVER

Powerful and portable, the Sidewinder will forever change the way you move your aircraft. Powered by Milwaukee's top of the line 28V power unit with a long-lasting, lithium ion battery pack, Sidewinder weighs less than 22 pounds, collapses to 27" and stows easily in your baggage compartment. Made in the USA using 4130 Chromoly material. Comes with battery and charger.



Sidewinder attached securely to the front wheel.



Sidewinder collapsed.



Sidewinder extended.

Part No.	Models	Description	Part No.	Price
Cessna				
S.E Cessna 2	172 RG, 182 RG, 210	Sidewinder Powerdriver Twin Cessna 2 with 15" Extension	13-23666	\$1,987.50
Twin Cessna 2	310R, 414, 421	Sidewinder Powerdriver Twin Cessna 2 with 15" Extension	13-23667	\$1,987.50
Diamond				
DA-42	DA-42	Sidewinder Diamond DA-42 with 15" Extension	13-22200	\$1,988.00
DA-62	DA-62	Sidewinder Diamond DA-62 with 30" extension	13-22201	\$1,991.00
Diamond Eclipse				
EC-01	Eclipse - All Models	Sidewinder Eclipse with 15" Extension	13-23672	\$1,987.50
Piper				
PI-01	Malibu, Matrix, Mirage	Sidewinder Power Driver Piper 2 with 15" Extension	13-23668	\$1,987.50
PI-01S	Meridian	Sidewinder Power Driver Piper 3 with 30" Extension	13-23669	\$1,987.50
PI-02	With DLX Jet Prop Conversion	Sidewinder Power Driver Piper with Dlx Jet Prop Conversion with 30" Extension	13-23670	\$1,987.50

REDLINE ACCESSORIES

Sidewinder Carry Bag.....	13-06839	\$76.75
Sidewinder Replacement Battery	13-06840	\$214.95

REDLINE ST-1 TOWBARS

If you own models 33, 35 or 55, the ST-1 is the least expensive, most versatile option for hand or vehicle towing. With an overall length of 38.5" and 3 pound 8 ounce weight, it fits neatly on the floor of your baggage compartment. This is our recommended tow bar for the STIFFY. For attachment to a golf cart, tractor or other powered vehicle, please use the ST-1 Vehicle Adaptor. Length is 38.5" and weighs 3 pounds 8 ounces. Made in the USA using 4130 Chromoly material.

FITS THESE BEECHCRAFT MODELS: Bonanza, Baron, Travel Air, T-34P/N 13-06848 **\$235.00**
ST-1 Vehicle AdapterP/N 13-04066 **\$59.50**

REDLINE BE-4 TOWBARS

2-piece design for hand or powered use for heavier airplanes. Extends to 61.5" and collapses to 33" and weighs 5 pounds. For attachment to a golf cart, tractor or other powered vehicle, please use the ST-1 Vehicle Adaptor. Made in the USA using 4130 Chromoly material.

Application	Part No.	Price
BE-4 Eclipse - Fits All	13-06852	\$389.95
ST-1 Vehicle Adapter	13-04066	\$59.50

REDLINE BE-3 TOWBARS

2-piece design for hand or powered use. Extends to 43.5", collapses to 24.5" and weighs 4 pounds. For attachment to a golf cart, tractor or other powered vehicle, please use the S-3 Vehicle Adaptor. Made in the USA using 4130 Chromoly material.

Application	Part No.	Price
BE-3 Beechcraft - Fits Bonanza, Baron, Travel Air, T-34	13-06841	\$295.00

REDLINE UL TOWBARS

Very light weight, 2-piece design for hand towing only. Extends to 43.5" and stows to 25.5" and weighs 3 pounds 4 ounces. Made in the USA using 4130 Chromoly material.

Application	Part No.	Price
UL - Beechcraft - Fits Bonanza, Bonanza, Baron, Travel Air, T-34	13-01914	\$235.00
UL - Piper - Fits Arrow, Lance, Saratoga (RG).	13-01915	\$235.00

REDLINE STIFFY

A 1-pound, spring-loaded, reversible-ratcheting mechanism that greatly increases the "leverage" available to help move your plane. Must be used with either the ST-1 or BE-3 Towbar, purchased separately. Made in the USA using 4130 Chromoly material. **Application:** Beechcraft - Bonanza, Baron, Travel Air, T-34.....P/N 13-04064 **\$265.00**

AERO TECH TOW HITCH ASSEMBLIES

1 3/4" TOW HITCH ASSEMBLY - (SINGLE HITCH)

Tow Hitch Assembly - Single for Piper. Fits tail wheel leaf Springs 1.75" wide.
P/N 13-23399 **\$1,495.00**

1 3/4" TOW HITCH ASSEMBLY - (3 HITCH)

Tow Hitch Assembly - (3 Hitch) for Piper. Fits tail wheel leaf Springs 1.75" wide.
P/N 13-23400 **\$1,950.00**

1 1/2" TOW HITCH ASSEMBLY - (3 HITCH)

Tow Hitch Assembly - (3 Hitch) for Piper. Fits tail wheel leaf Springs 1.5" wide.
P/N 13-23403 **\$1,950.00**

1 1/2" TOW HITCH ASSEMBLY - (SINGLE HITCH)

Tow Hitch Assembly - Single for Piper. Fits tail wheel leaf Springs 1.5" wide.
P/N 13-23402 **\$1,495.00**

1 1/2" TOW HITCH ASSEMBLY - (5 HITCH)

Tow Hitch Assembly - (5 Hitch) for Piper. Fits tail wheel leaf Springs 1.5" wide.
P/N 13-23404 **\$2,495.00**

1 3/4" TOW HITCH ASSEMBLY - (5 HITCH)

Tow Hitch Assembly - (5 Hitch) for Piper. Fits tail wheel leaf Springs 1.75" wide.
P/N 13-23401 **\$2,495.00**

PS

AIRCRAFT TUGS

TRACE TOWBOTS REMOTE CONTROL AIRCRAFT TUG



The iTowBot's loading sequence is as easy as driving the unit directly under the nosewheel of your aircraft. It is engineered so that when the aircraft loads, the weight of the loaded aircraft does not inhibit its zero-turn capability. This allows the operator to articulate the aircraft in a manner that places it ahead of all other towing equipment. Releasing the aircraft is just as easy. A foot-operated release allows the operator to unlock the swivel carriage and merely back out from beneath the nosewheel. Can tow in any direction, allowing the user to position aircraft in close quarters with ease. It has the ability to rotate the aircraft inside of its own wingspan. The powerful 24VDC motors are regulated for smooth starts and stops while delivering the power you need to put your aircraft asset out on the ramp or back in the hangar. Specifically designed to provide adequate distance for the operator to tow an aircraft while stepping back to visually clear the areas around the aircraft.

Specifications:

- Measures 38" Wide x 46" Long x 12" High • Powerful Reversible 24 Volt DC Motors • Rugged Steel Construction • Powder-Coated Frame • Virtually Zero Maintenance • Easy Ergonomic Remote Control Handset • Max Towing Speed 1.7 Feet Per Second • Overvoltage Thermally Protected • Tows Aircraft up to 15,000+ Pounds Gross Weight • Trouble Free Cast Iron Rims with Non-Marking Moldon • Solid State Heavy Duty Fully Articulating Motor Control Wheels • Hybrid Zero Turn Capability about Stationary Nosewheel • Equipped with Solid State Battery Charger/Maintainer • Also available with built-in 24V Auxiliary Power Plug (APU) & Power Cord

Description	Part No.	Price
Standard Model (No APU) Up to 15,000 lbs.	13-05252	\$9,386.00
Standard Model (With APU) Up to 15,000 lbs	13-05253	\$10,873.00
Heavy Duty - Incorporates Gear Reduction and is 36V (No APU) up to 30,000 Lbs.	13-05734	\$11,681.00
Heavy Duty - Incorporates Gear Reduction and is 36V (With APU) up to 30,000 Lbs.	13-05735	\$12,900.00

PRICELESS TRANSAXLE BATTERY OPERATED TUG



Easily move small aircraft quickly and safely in tight areas. The model 701 is collapsible for compact stowing. Optional ball hitch attachment for movement of small trailers and campers. **Model 701** - Move aircraft weighing up to 4,500 lbs. Max Tow. Tug performance data based on level, smooth, paved surfaces. **Features:** • 400W effective power • 24 V DC Electric motor • Dual Battery Pack - 24v system • Operator can easily control steering • Rocker switch for forward/reverse • Adjustable speed • Virtually silent when moving • Environmentally friendly - no exhaust • Average battery life: 1 hr • 2 - 12V lead-gel batteries • Easily replace batteries • Collapsible design • Easy adjust handle for user comfort • Universal adapter attachment for quick tool-free connection to a wide range of aircraft. • Warranty Electrical: 6 months or 250 hours of use • Warranty Mechanical: 12 months or 500 hours of use.

P/N 11-10807 **\$4,038.00**

TUGMAXXE®SM 2.0 TWIN ENGINE AIRCRAFT TUG



Small, versatile, powerful, and reliable. Applicable for large single engine and twin-engine aircraft up to 8,800 lbs (2t) MOTW. Powerful high-torque rotary drive 24V 500W DC effective power electric motor resourcefully applied. Allows noiseless silent maneuvering and movement of single- and small twin-engine aircraft up to max 8,800 lbs (4t) quickly and safely in tight areas. Environmentally friendly - no exhaust. **Features:** • Ergonomic Height Adjustment • Comfortable Lever for easy Coupling and De-Coupling • Easy and simple Steering • Forward and Reverse • Adjustable Speed Control • Smooth Acceleration • Universal Adapter for a wide Range of Aircraft • High Capacity Battery Pack with long Service Life • Extended Charging Cycle Time • Maintenance Free • Environmentally friendly • No Exhaust • No Noise - Silent • Easy to operate • Weatherproof..... P/N 13-18770 **\$2,465.00**

TUGMAXXE®SM2.2 HELICOPTER TUG



Small, powerful, and reliable. Especially designed for Robinson Helicopters (R22, R44, and R66). 13-19496: TOWFLEXX Universal Adapter Required information: Aircraft Make, Model & Serial No. Attention: Adapter required / sold separately
ELECTRICAL MOTOR
• Powerful high-torque rotary drive 24V 500W DC effective power electric motor resourcefully applied.
• Allows noiseless silent maneuvering and movement of Robinson helicopter rotary aircraft up to max 8,800 lbs (4t) quickly and safely in tight areas. Environmentally friendly - no exhaust.
EASY HANDLING
• Ergonomic height adjustment mechanism of the control handle, allowing fast adaptation matching the operators height for user comfort. • Easy and simple steering by hand, via raising and guiding into the steering direction. Operation is a breeze because of the forward and reverse acceleration rocker switch mechanism with adjustable speed control. • Universal adapter (fit's Robinson Helicopters) for quick tool-free attachment, fast and simple guidance.

ERGONOMIC MULTIFUNCTIONAL THREE-AXIS HANDLE

• In basic configuration the tug is equipped with the standard handlebar control.

REMOVABLE BATTERY BOX

• The rechargeable 24V 33Ah maintenance free led-gel battery pack is designed for approx. 3 hours part time operation (fully charged) including short-circuit protection. Can be easily removed from the tug and also to be used as ground power supply for the aircraft.

BATTERY CHARGER

• Advanced timer circuit battery charger for uninterrupted service and continuous operation incl. auto-shutdown function.

P/N 13-18771 **\$3,395.00**

TUGMAXXE® ACCESSORIES

Description	Part No.	Price	Description	Part No.	Price
2 Light Aircraft Adapter Diamond DA42	13-20669	\$149.00	Power Outlet	13-20674	\$119.00
2 Light Aircraft Adapter Diamond DA40	13-20670	\$149.00	Three-Axis Tiller Control Handle	13-20673	\$495.00
2 Light Aircraft Adapter Beech Bonanza B33 to B36	13-20671	\$149.00	Heavy Duty All Terrain Tires	13-20675	\$242.00
2 Light Aircraft Adapter Socata TB20 and TB21	13-20672	\$149.00	Snow Chains	13-20676	\$290.00



AIRTUG® 6-S GAS POWERED



The AIRTUG Model 6-S model is extremely easy to use because of its' unique "Throttle Grip Control" system utilizing a hydrostatic transmission as the heart of the Airtug, a heavy duty variable speed , 6 horsepower gas engine. They guarantee your safety with their "Return to Brake" feature that absolutely prevents any unintentional movement of the plane when the throttle grip is released. There is no metal to metal contact, no gears to shift and no jerky clutching systems to quickly wear out. Finally, its' pinpoint handling makes this unit a great choice. All of these features simply make this aircraft tug the best in the industry! **Specifications:** • 11 Gauge Heavy Steel Frame • Hydrostatic Transaxle 16"x 6" - 6 ply on 8" Drive Wheels • Drive wheels capable of handling nosewheel weights up to 2000 lbs. • Welded load platform mounted between the drive wheels for added traction.....P/N 13-07284**\$3,895.00**

AIRTUG® 6-H GAS POWERED



The 6-H aircraft tug model is the tug of choice for those who need to lower the tail to enter a hangar, and might also need to handle nose-wheel fairing aircraft. The nose-wheel is loaded the same as the Model 6-H, and then it can be raised by a hydraulic jack up as much as needed to a maximum of roughly 9", thus lowering the tail by approximately double this amount. Additionally, it is easy to use because of its' unique "Throttle Grip Control" system utilizing a hydrostatic transmission and a 6HP variable speed gasoline engine. They guarantee your safety with their "Return to Brake" feature that absolutely prevents any unintentional movement of the plane when the throttle grip is released. There is no metal to metal contact, no gears to shift and no jerky clutching systems to quickly wear out. Finally, its' pinpoint handling makes this unit a great choice. **Specifications:** • 2 Ton Hydraulic Jack for Lift Shoe • 11 Gauge Heavy Steel Frame • Hydrostatic Transaxle • 16"x 6" - 6 ply on 8" Drive Wheels • Drive Wheels Capable of Handling Nosewheel Weights up to 2000 lbs. • Low Profile unit for avoiding low aircraft hulls and flight controls with low axle and optional 13" Drive Wheels.....P/N 13-07285**\$3,995.00**

AIRTUG® 10-S GAS POWERED



Extremely easy to use because of its' unique "Throttle Grip Control" system utilizing a hydrostatic transmission as the heart of the Airtug, a heavy duty variable speed gas engine, with a built in electric starter. They guarantee your safety with their "Return to Brake" feature that absolutely prevents any unintentional movement of the plane when the throttle grip is released. There is no metal to metal contact, no gears to shift and no jerky clutching systems to quickly wear out. Finally, its' pinpoint handling makes this unit a great choice. A light is built in for ease of seeing under the fuselage at night.P/N 13-07288**\$4,895.00**

AIRTUG® NFE-6 ELECTRIC AIRCRAFT TUG

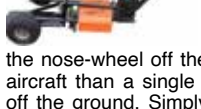

This quiet electric model makes moving the aircraft a simple task for a single person by lifting the nose-wheel off the ground! Much easier to hookup and control the aircraft than a single wheel tug that is not able to lift the nose wheel off the ground. Simply attach the small towbar by hand to the aircraft and then winch the tow-bar / nose-wheel onto the raised platform for total control by the tug. The NFE-6 model AirTug® is extremely easy to use because of its' unique "Thumb Throttle" system utilizing an electric transaxle with differential and on board Smart Battery Charger. For your safety, "Return to Brake" feature prevents any unintentional movement of the plane when the thumb throttle is released. There is no metal to metal contact, no gears to shift and no jerky clutching systems to quickly wear out. Its' pinpoint handling allows the operator to pivot as tight as desired as a result of the differential transmission. All of these features simply make this quiet, aircraft tug a good value in the industry!
P/N 13-21612**\$3,995.00**

AIRTUG NFE-4 ELECTRIC FOR CIRRUS



Moves the CIRRUS Aircraft and other castering nose-wheel aircraft easily and makes moving the aircraft a simple task for a single person! The BEST TUG for CIRRUS aircraft or any other castering or non-castering nose- fairing aircraft. Simply attach the small towbar by hand to the aircraft and then winch the tow-bar / nose-wheel onto the raised platform for total control by the tug. Much easier to hookup and control the aircraft than a single wheel tug that is not able to lift the nose wheel off the ground. Can move most nose-fairing aircraft including the Diamond and other aircraft weighing less than 4,000 lbs. Easy to Use and Economical with pin point handling allowing the operator to pivot as tight as desired as a result of the transmission Differential. 24 Volt Electric motor so no need to worry about gas going bad.

AIRTUG® 10-H GAS POWERED



The 10-H aircraft tug model is the tug of choice for those who need to lower the tail to enter a hangar, and might also need to handle nose-wheel fairing aircraft. The nose-wheel can be raised by a hydraulic jack up as much as needed to a maximum of roughly 9", thus lowering the tail by approximately double this amount. Additionally, it is easy to use because of its' unique "Throttle Grip Control" system utilizing a hydrostatic transmission, electric starter and a heavy duty variable speed gasoline engine. They guarantee your safety with their "Return to Brake" feature that absolutely prevents any unintentional movement of the plane when the throttle grip is released. There is no metal to metal contact, no gears to shift and no jerky clutching systems to quickly wear out. A light is built in to ease seeing under the fuselage at night. **Features:** • Loading System: Hydraulic Lift Shoe with Winch Strap/ Strut Strap • Parts Warranty: 1 Year • Type of Starter: Electric • Engine: Four Stroke 10-HP or greater, electric or recoil start • Tow Weight: Up to 16,000 lbs. • Turning Radius: 360 Degree **Specifications:** • 2 Ton Hydraulic Jack for Lift Shoe • 11 Gauge Heavy Steel Frame • Hydrostatic Transaxle • 16"x 6" - 6 ply on 8" Drive Wheels • Drive Wheels Capable of Handling Nosewheel Weights up to 2000 lbs. • Low Profile unit for avoiding low aircraft hulls and flight controls with low axle and optional 13" Drive Wheels.....P/N 13-07289**\$4,995.00**

AIRTUG® EL3-S ELECTRIC POWERED



Same great power and moving capacity as the larger gas powered unit, but in a QUIET electric model! Extremely easy to use because of its' unique "Throttle Grip Control" system utilizing a Hydrostatic Transmission, Heavy Duty Electric Motor, powerful Batteries, and built-in Battery Charger. They guarantee your safety with their "Return to Brake" feature that absolutely prevents any unintentional movement of the plane when the throttle grip is released. There is no metal to metal contact, no gears to shift and no jerky clutching systems to quickly wear out. Finally, its' pinpoint handling combining twist grip control with a large, handle-mounted Caster makes this walk-behind Airtug a great choice. A light is also built in for ease of seeing under the fuselage at night. **Features:** • Loading System: Winch Strap/Strut Strap with Accessories • Parts Warranty: 1 Year • Engine: Heavy Duty 3HP Permanent Magnet Motor • Tow Weight: Up to 16,000 lbs. • Turning Radius: 360 Degree **Specifications:** • 11 Gauge Heavy Steel Frame • Hydrostatic Transaxle • 16"x 6" - 6 ply on 8" Drive Wheels • Drive wheels capable of handling nosewheel weights up to 2000 lbs. • Low Profile unit for lower axle clearances and 13" Drive Tires option.....P/N 13-07286**\$5,495.00**

AIRTUG® EL3-H ELECTRIC POWERED



Same great power and moving capacity as the larger gas powered unit, but in an electric model! The choice for those who need to lower the tail to enter a hangar, and might also need to handle nose-wheel fairing aircraft. The nose-wheel can be raised by a hydraulic jack up to a max. of 9". It is easy to use because of its' unique "Throttle Grip Control" system. They guarantee your safety with their "Return to Brake" feature that absolutely prevents any unintentional movement of the plane when the throttle grip is released. There is no metal to metal contact, no gears to shift and no jerky clutching systems to quickly wear out. A light is also built in for ease of seeing under the fuselage at night. **Features:** • Loading System: Hydraulic Lift Shoe with Winch Strap/ Strut Strap • Parts Warranty: 1 Year • Engine: Heavy duty 3HP Permanent Magnet Motor • Tow Weight: Up to 16,000 lbs. • Turning Radius: 360 Degree. **Specifications:** 2 Ton Hydraulic Jack for Lift Shoe • 11 Gauge Heavy Steel Frame • Hydrostatic Transaxle • 16"x 6" - 6 ply on 8" Drive Wheels • Drive Wheels Capable of Handling Nosewheel Weights up to 2000 lbs.P/N 13-07287**\$5,695.00**

ADDITIONAL ADAPTERS

Description	Part	Price
Airtug NFE-4 Cirrus Adapter	13-14975	\$285.00
Airtug NFE-4 Diamond Da20 Adapter	13-14976	\$285.00
Airtug NFE-4 Diamond Da40 Adapter	13-14977	\$285.00
Airtug NFE Adapter for Non-Cowling Aircraft	13-21625	\$248.95

TIE-DOWNS

FLY TIES TIE DOWNS

FlyTies Tie Downs Rated "Top Choice" by Aviation Consumer



FlyTies® unique design allows quick insertion and quick removal using the easy-out extraction tool provided. Rugged, die-cast steel rods are 3/8" x 14" for deeper penetration into harder ground. Cumulative load capacity is 3,600 lbs. Kit includes • 3 ea. aluminum hubs w/ forged steel eyebolt • 9 ea. 3/8" dia. x 14" steel stakes • 1 ea. extractor tool • 1 ea. heavy duty canvas tote bag • 1 ea. set of instructions • 3 ea. polypropylene ropes and has a lifetime warranty..... P/N 13-22751\$99.95

TIE-DOWN EYE BOLT



For non-structural applications. The 7/16" dia. threaded shaft is 7/8" long. Hole is 5/8" dia. Overall length 2-1/2". Furnished with AN365-720 elastic stop nut and wide-area AN970-7 washer P/N 13-04303\$9.75

AIRCRAFT TIE-DOWNS



These Aircraft Tie-Downs offer strong, durable, and easy to use tie downs for any weather condition. These tie downs are rated up to 3,000lbs. and tighten up with one quick pull. A sliding cap protects the buckle from freezing during cold weather and keeps grit out during windy field conditions. Each kit comes with: • Three 9 foot long tie down straps • Choice of tie down strap colors: black, red, or royal blue • A Dupont Cordura carrying bag with choice of colors; black, forest green, red, royal blue or navy. Embroidery is available for an additional \$5. Color is Red. P/N 13-06328\$89.75

TAIL TIE DOWN GUARD 162TG



Fits Cessna 162 And Other Light Aircraft. P/N 05-08294\$131.95

AIRCRAFT TIE-DOWN WITH EMBROIDERY



Aircraft Tie-Down offer strong, durable, and easy to use tie down for any weather condition. Rated up to 3,000lbs. and tighten up with one quick pull. A sliding cap protects the buckle from freezing during cold weather and keeps grit out during windy field conditions. Kit Contains: A Dupont Cordura matching carrying bag. **Specifications:** • Strap Color: Red • Embroidery Color: White. P/N 13-12672\$92.90

SHOCKSTRAP™



ShockStraps™ are a unique shock absorbing tie down that incorporates three of the most versatile tie down principals into one superior system. It is quick and easy like a motorcycle tie down, has the reliability of a ratchet system, and versatility of a shock cord. ShockStrap™ stretches acting like a shock absorber and contracts with the load keeping it secure.

- 6' Red Single Strap..... P/N 13-18502\$25.50
- 6' Red Double Strap..... P/N 13-18501\$47.50
- 7' Black Single Strap..... P/N 13-20707\$34.50
- 7' Black Double Strap..... P/N 13-20706\$64.98
- 10' Red Single Strap..... P/N 13-18504\$26.60
- 10' Red Double Strap..... P/N 13-18503\$45.99
- 15' Red Single Strap..... P/N 13-20709\$37.99
- 15' Red Double Strap..... P/N 13-20708\$74.99

TIE DOWN STRAPS



LARGE STRAP KIT - 3000 lb. universal, 14 foot tie-down straps with 3000 lb. spring clip climbing type carabiners and 3000 lb. ground stakes. P/N 13-11229\$238.95

HEAVY STRAP KIT - 5000 lb. universal, 14 foot tie-down straps with 5000 lb. spring clip climbing type carabiners and 5000 lb. ground stakes P/N 13-11230\$265.95



16" CORKSCREW TIEDOWN KIT

A versatile, general-purpose spiral anchor made from cold, rolled steel. Design for lightweight applications. Folding ring reduces profile to minimize obstruction in high traffic areas. Bright orange color powder coating resists corrosion and helps provide added visibility. Use to secure small tents, trees, recreational use and patio furniture.

Features: • High pull force performance; 500 pounds per anchor (results may vary dependent on soil types) • Installs in most soils in minutes • Lightweight, individual weight of 1 lb 13 oz. or 5 lbs. 7 oz. per kit • This kit includes: three 16" corkscrew tiedown anchor, one 3/8" nylon tiedown rope, and one tiedown bag - all complete with a manual including installation instructions! P/N 13-09652\$67.95

PIPER/BEECH TIE DOWN RINGS



45° Angled Stainless Steel Tie-Down Rings Gold Titanium Nitrite Coat Stainless Safe to 230 mph Wind. Also 45° Angled Aircraft Aluminum Tie-Down Rings. With Stainless Strike Plate: 6 X Stronger than OEM. Also offered in Nickel Plated Aircraft Aluminum (+Great for Fueling Ground). Nickel Plated with White Powder Coat (190+MPH Wind Speeds). Parts Look Streamline and Attractive. FAA-PMA Certified - Directly Interchangeable with all OEM Parts. Sold as Pair.

Description	Part No.	Price
Piper Tie Down Rings - aluminum painted - white	13-11221	\$198.00
Piper Tie Down Rings - aluminum plated - white	13-11220	\$198.00
Piper Tie Down Rings - buffed stainless	13-11996	\$198.00
Piper Tie Down Rings - stainless - gold	13-17626	\$236.95
Beech Tie Down Rings plated - white	13-11222	\$198.00
Beech Tie Down Rings painted - white	13-11223	\$198.00
Beech Tie Down Rings stainless steel	13-11994	\$198.00
Beech Stainless Steel Tie Down Rings - gold	13-17628	\$236.95

PIPER/BEECH SKID & STRIKE PLATES



45° Angled Stainless Steel Tie-Down Skids. Gold Titanium Nitrite Coat Stainless Safe to 230 mph Wind. Also 45° Angled Aircraft Aluminum Tie-Down Skids. With Stainless Strike Plate: 6 X Stronger than OEM. Also offered in Nickel Plated Aircraft Aluminum (+Great for Fueling Ground). Nickel Plated with White Powder Coat (190+MPH Wind Speeds). Parts Look Streamline and Attractive. FAA-PMA Certified- Directly Interchangeable with all OEM Parts. Sold as Pair.

Description	Part No.	Price
Piper Tail Skid - aluminum w/Stainless Steel plate painted - white	13-11225	\$198.00
Piper Tail Skid - aluminum w/Stainless Steel plate plated - white	13-11224	\$198.00
Piper Tail Skid - aluminum w/Stainless Steel plate - gold	13-17627	\$236.95
Beech Stainless Steel Tail Skid & Strike Plate painted - white	13-11227	\$198.00
Beech Stainless Skid (no plate necessary)	13-11995	\$198.00
Beech Stainless Skid - gold (no plate necessary)	13-17629	\$236.95
Beech Stainless Steel Tail Skid & Strike Plate - buffed & plated	13-11226	\$198.00

HOOK-N-PULL TIE DOWNS



Hook-N-Pull Tie downs feature closed end "s" hooks made from high quality steel with heavy plating, and tie down bards are made from high grade aluminum, hardened for strength and ball burnished and anodized. Furnished with 3/8" diameter nylon rope.

Tie-down bar is guaranteed for 10 years under normal use. When making your own length of tie-downs, add at least 30" for rope reversal and knots.

- High wing..... P/N 13-00448\$25.00
- Low wing or tail..... P/N 13-00449\$23.75

STORMFORCE TIE DOWN ANCHORS



The Storm Force Aircraft Tie Down System is the STRONGEST, LIGHTTEST, and BEST aircraft tie down available, and is compatible with all types of small aircraft. The Storm Force Tie Down Kit is perfect for aircraft under 3500lbs gross weight; for twin engine aircraft and aircraft above 3500lbs gross weight checkout our Storm Force XL. Storm Force Aircraft Tie Downs are manufactured using lightweight yet extremely durable materials in order to provide pilots with exactly what they need to secure their aircraft with confidence. Capable of supporting 4200 lbs or more of force per unit, the Storm Force Aircraft Tie Down leaves the competition in the dust. Durable Powder Coating Light-Weight Design..... P/N 13-21608\$97.75

AEROSPOILER KIT,

AEROSPOILER EXTENSION KIT



Kit contains 10 cup/receiver assemblies and 8 30"X3" inch blade assemblies. Each kit contains 20' of wing coverage. The Aero Spoiler will reduce the lift producing capability of your aircraft wing by as much as 96% on the area of wing covered by the Spoiler. Extension kits are available for aircraft requiring more than 20' of wing coverage.

- Aero Spoiler Kit..... P/N 13-06505\$179.00
- Extension Kit..... P/N 13-06506\$99.00



TIE-DOWNS

“THE CLAW” TIE-DOWN SYSTEM



Features: Easy installation...Easy removal. No more struggling with screw-in anchors. The “Claw” is designed exclusively for aircraft. The “Claw” system has a 3600 lb. combined capacity. The last tie down you will ever have to buy - Lifetime Warranty, Tremendous holding strength. The harder you pull, the more The “Claw” grips. Ideal for all aircraft, Works in hard clay, sandy soil or anything in between Large foot

print spreads the load over a larger area for maximum holding power, Low profile will not puncture tires, Complete System weighs only 8 lbs (Including Hammer), Light-weight aircraft aluminum with hardened corrosion resistant die cast zinc plated steel spikes 25 ft 3/8” dia. solid braid polyester rope, Anchoring System hammer doubles as removal tool The “Claw” includes: Bag that is easy to carry and store that contains: 3 Anchors; 9 spikes; 1 hammer; 25-ft rope Wt: 8 lbs.

P/N 13-02448\$99.75

AIRCRAFT TIE DOWNS



Three 17” x 3/8” plated steel cork screw stakes. Three 10’ x 3/8” polypropylene ropes. Cloth draw string bag.

P/N 13-06634\$35.80

E-Z LOCK TIE DOWNS



EZ-Lock Tie Downs allow for simple, one-person tie-down of aircraft, with no knots to tie. Features weather-, oil- and gas-resistant polypropylene rope for long product life. 72” Fully Extended.

P/N 13-00159\$16.50

SLIDEDOWN AIRCRAFT TIE DOWN



Made as a “one size fits most aircraft”, the SlideDown is easily adjustable to reach most anchor points. Maximum reach on the wings are approximately 100 inches and the maximum reach on the tail is approximately 54 inches. The SlideDown can be shortened to accommodate just about any length. The SlideDown is proudly Made in the USA and available in a variety of colors. **Features:** Powder Coated Aircraft Grade Aluminum Slide, 7/16” Kernmantle Braided Rope available in a variety of colors, Vinyl Coated

Hooks, and a maximum Reach: Wings 100”, Tail 54”. Sold in sets of 3.

Color	Part No.	Price	Color	Part No.	Price
Orange/Blue	13-14797	\$82.75	Red/White	13-14804	\$82.75
Yellow	13-14799	\$82.75	Red	13-14805	\$82.75
Green/Blue	13-14801	\$82.75	Blue/White	13-14806	\$82.75
Blue	13-14807	\$82.75	Black	13-14808	\$82.75

CARAVAN TAIL TIEDOWN HANDLE



Airforms P/N AF2612035-1, Tail tie down handle, rear. Direct replacement for Cessna P/N 2612035-1. Eligible for all S/N aircraft, Cessna models 208 and 208B. FAA PMA Approved.

Specifications: • Precision fit – drop in replacement for the original part • Aircraft interface unchanged • Tail stand interface unchanged – works with your existing tail stand

• Comes primed and ready for installation • FAA PMA Approved • All S/N aircraft, Cessna models 208 and 208B P/N 05-12267\$489.00

RANS TIE DOWN SHACKLE



This stainless steel tiedown shackle will fit any 1 inch wide attach point, but is made special for most RANS aircraft that have RANS aluminum lift struts. The shackle is designed to accept chain or rope without marring the struts.

P/N 13-10435\$9.80

NELSON AIRCRAFT TIE-DOWNS



• Three 15” welded (not bent) steel anchors with sharp tips for easy installation • Three 15’ nylon ropes • Cordura, Int'l. Orange, 8”x15” case • Wt: 4 lbs

P/N 13-00663\$100.00

NYLON TIE-DOWN ROPE



American-made 100% duPont filament fiber nylon rope. Over twice the strength of manila. Highly resistant to sunlight, rot & mildew. Don't be fooled by foreign imitations.

3/8” (4000 lb. test) P/N 13-05400\$0.31 /Ft.
1/2” (6250 lb. test) P/N 13-05500\$0.69 /Ft.

15% Discount on 100 ft.

GENUINE VELCRO



5819 Genuine Velcro Two 4 1/2” pressure sensitive hook and loop strips.

P/N 13-06404\$2.75

TRACK CARGO ANCHORS



A series of anchors specially designed for “T” type tracks. FAA-PMA approved to fit most G.A. aircraft seat rails. Quality constructed from solid aluminum alloy anodized per MIL-A-8625 and permanently fitted with a stainless threaded sleeve and welded stainless steel ring with heat treated steel alloy stud.

Aircraft	L	Description	Part No.	Price
Piper	1.5”	T Type Track Cargo Anchor Blue 5501	13-20137	\$116.85
Cessna	1.5”	T Type Track Cargo Anchor Purple 5502	13-20139	\$109.75
Cessna	2.5”	HD T Type Track Cargo Anchor Black 5502-1	13-20140	\$132.75
Beech	1.5”	T Type Track Cargo Anchor Green 5503	13-20141	\$109.75

TOUGHMAN TIE-DOWN



Incorporates the patent protected Toughman™ Rope Clamp which has only two moving parts and is manufactured from high performance engineered nylon resin. It is very easy to use, extremely lightweight, high strength and permanently corrosion proof. The Toughman™ Tie-Down product package includes one rope clamp, ten or fifteen feet of rope and one corrosion resistant steel hook. Military Tough: The Toughman™ Rope Clamp has undergone rigorous testing by the US Army Soldier Systems Center, “Natick” test labs and has been approved for use on cargo nets and rope support lines on military tents.

3/8” Camo 10’ P/N 13-05115\$11.75
3/8” Red & Yellow 10’ P/N 13-06142\$11.75

BIG SCREW EZ TIE DOWN



Big-Screw EZ Tie-Down is an innovative tie down system combining a lightweight 18” cast aluminum ground screw, and a custom aviation designed attachment strap. The 18-inch long cast aluminum screw provides stronger ground holding in all soil types. The screw penetrates deeply into compacted soils resulting in superior holding strength.

This exclusive design provides two to three times the holding strength of spike type angled-in tie-downs. Large 1 1/4” Wide screw provides 80 Square inches of Ground Contact Area, 40 times more than a spike. The screw can be positioned either directly below or set out from aircraft attachments. Quick easy installation and removal using a 1” ratchet, 1” socket, or a portable impact wrench (not included).

P/N 13-21308\$159.95
Big Screw Straps (3 each 9 Ft.) P/N 13-21309\$69.95

PS

CHOCKS

ASA WHEEL CHOCKS



These tire stops are for keeping aircraft securely parked. A pair of black molded plastic wheel stops are connected with 22" bright yellow and black braided nylon rope that won't rot or retain water. The bottom cleats keep aircraft securely parked. Lightweight; 7-3/4" x 2-1/2" x 4-1/2"; concave design fits any aircraft tire. One pair is needed for each wheel.

P/N 13-05752 **\$33.75**

MOLDED WHEEL CHOCKS



The "Perfect" lightweight orange urethane aircraft wheel chocks. Oil and chemical resistant and connected by a 22-inch nylon rope. Concave design that fits into tire. Larger sizes available.

Yellow P/N 13-11857 **\$58.30**

PARK IT PLATES



Park It Plate™ "Standard Series" Plates are made from 100% HDPE and come in a thickness of 1/4". They are designed to be used on solid, flat surfaces found in hangars, garages, showrooms, and are resistant to most chemicals. They protect your investment in your finished floor coatings from stains and permanent tire marks and will greatly reduce the possibility of paint blistering and delamination. Most importantly, they do all this and make your aircraft, look good at the same time!

24x24 P/N 13-18429 **\$53.95**
30x30 P/N 13-18430 **\$83.95**

HANDY CHOCKS



One pair of 8 oz. lightweight wheel red or yellow chocks with adjustable cords ensure a snug fit for a wide range of aircraft. Easy storage and portability. Note: 1 set per Package

Red P/N 13-06405 **\$23.95**
Yellow P/N 13-06406 **\$23.95**

SAFE T CHOCKS



"Safe T Chock Line" pull rope is a new patented product invented to prevent injuries while chocking wheels on aircraft, GSE, trucks and trailers. The Safe T Chock Line is a high visibility poly braided rope with a vinyl tube sleeve for a handle that will not freeze or cause

rope burns. It is also sleeved to slide thru the center hole in the chock blocks. It can easily be modified to fit almost any type of chock block. This type of chock block pull rope is designed to reduce wrist, hand and finger injuries as well as making it safer to chock and un-chock aircraft and vehicles.

Description	Part Number	Price
Safe T Chock Line 12" Set	05-12011	\$29.95
Safe T Chock Line 24" Set	05-12012	\$34.75
Safe T Chock Line 36" Set	05-12013	\$39.95
Safe T Chock Line 48" Set	05-12014	\$43.85

CUSTOM WHEEL CHOCKS FOR LARGE JETS



These custom wheel chocks are lightweight aluminum for large corporate jets. These wheel chocks are carefully fabricated, engraved and then covered with durable powder coating available in grey, black, or orange. In addition to being stylish, these wheel chocks are very durable, long lasting and won't corrode. These are offered as a single pair for nosewheel or as two pair (one for each main wheel). Designed for single main wheel aircraft and are 12" long and made of .25" thick aircraft grade aluminum.

Description	Part Number	Price
Bare Aluminum - 1 Set	13-16051	\$99.95
Bare Aluminum - 2 Sets	13-16052	\$174.95
Powdercoat Black - 1 Set	13-16053	\$149.95
Powdercoat Black - 2 Sets	13-16054	\$249.95
Powdercoat Orange - 1 Set	13-16055	\$149.95
Powdercoat Orange - 2 Sets	13-16056	\$249.95
Powdercoat Grey - 1 Set	13-16057	\$149.95
Powdercoat Grey - 2 Sets	13-16058	\$249.95

TRAVEL CHOCKS



Very light weight wheel chock designed for airplanes and other vehicles. Compact and easily stored. Powder coated in durable red, blue, or yellow finish. Available in 3 sizes. Chock set is for one wheel only. **Small** - 1 1/2" angle x 6" long x 1/8" Thick Heat Treated Alum. **Medium** - 2" x 2" x 8" 1/8 Thick Angle Heat Treated Alum. **Large** - 3 1/2" x 3 1/2" x 8" Heat Treated 3/16" Thick Alum.

Description	Part No.	Price	Description	Part No.	Price
Sm. Bare Alum.	13-01120-A	\$23.50	Med. Red	13-01130-R	\$25.50
Sm. Blue	13-01120-B	\$23.50	Med. Yellow	13-01130-Y	\$25.50
Sm. Red	13-01120-R	\$23.50	Lg. Bare Alum.	13-01140-A	\$36.50
Sm. Yellow	13-01120-Y	\$23.50	Lg. Red	13-01140-R	\$36.50
Med. Bare Alum.	13-01130-A	\$25.50	Lg. Yellow	13-01140-Y	\$36.50
Med. Blue	13-01130-B	\$25.50			

LIGHTWEIGHT CUSTOM ALUMINUM WHEEL CHOCKS



Extremely lightweight compared to chocks made out of steel. Very Durable Powdercoat finish that will withstand the elements. Extremely corrosion resistant. The chocks include a front and rear chock, connected with a lightweight cable. Small Wheel Chocks- 1.5" angle and 8" wide. Available in Black Powdercoat, Orange Powdercoat, and Grey Powdercoat....Weight is only 9oz per pair, or 18oz for complete set of two pair. These wheel chocks are designed for aircraft up to approximately 3,000 lbs. They are low profile and will fit under the wheel pants of aircraft such as RVs.

Large Wheel Chocks- 2.5" angle and 10" wide. Available in Black Powdercoat, Orange Powdercoat, and Grey Powdercoat- 24oz per pair, 48 oz for two pairs.

Description	Part No.	Price
1.5 inch Bare Aluminum - 1 Set	13-13118	\$57.75
1.5 inch Bare Aluminum - 2 Sets	13-13120	\$105.75
1.5 inch Powdercoated - 1 Set	13-13119	\$119.75
1.5 inch Powdercoated - 2 Sets	13-13089	\$153.75
2.5 inch Bare Aluminum - 1 Set	13-13121	\$84.75
2.5 inch Bare Aluminum - 2 Sets	13-13123	\$126.75
2.5 inch Powdercoated - 1 Set	13-13122	\$140.75
2.5 inch Powdercoated - 2 Sets	13-13124	\$186.75

Specify color for Powdercoated Chocks.

WOOD WHEEL CHOCKS



These chocks feature heavy duty wood construction and are finished in bright safety yellow. Connected with 18" of braided nylon rope.

Attention: Total of characters may not exceed 6. **Example:** (N#) xxxxx - (Text) abcdef

Standard chocks P/N 13-01765 **\$36.50**
Chocks w/ your N# or company name P/N 13-01766 **\$65.75**

RUBBER WHEEL CHOCKS



These ribbed rubber wheel chocks measure 4"x4"x8" and have reflective tape on all three sides. Connected with nylon rope. Very popular with corporate operations & FBOs.

P/N 13-01767 **\$39.95**

AIRGIZMOS WHEEL CHOCKS



These chocks are unique because they are stackable. Cuts down on the amount of space required to carry them in the plane. Durable plastic sides are lightweight, but are made to take a lot of abuse. There is space on the sides to put your airplane's n-number (you supply the vinyl lettering). The edges of these chocks are made of non-skid material, so they stay where you put them.

P/N 13-04298 **\$17.95**

VECTOR CHOCKS



Hangar rash is the leading cause of ground handling insurance claims. Vector Chocks reduces the chance of hangar rash and will save you a considerable amount of money.

Vector Chocks cradle the wheel with their unique ramp design and the energy yellow colored industrial grade safety tape will help guide you from the hangar door to your safe parking place. Installation is a snap with the peel-n-place feature, which sticks to asphalt as well as concrete.

Vector Chocks come as a complete kit, each kit containing two Vector Chocks and a roll of industrial grade energy yellow safety tape.

P/N 13-11694 **\$39.95**



WINDSOCKS

SCOTT'S WINDSOCKS



Scott's windsocks are manufactured of long-life polyester fabric that is treated to resist the effects of wind and weather. All seams are double stitched with polyester thread for strength. The windsock throat is reinforced and has solid brass grommets for easy attachment and corrosion resistance. Nylon ties are included with each windsock to attach it to the frame. Windsocks are available in high visibility orange, white or alternate orange and white stripes. Fully extended at 20 MPH or 15 Knots.

BRIGHT ORANGE

Throat Dia.	Length	Part No.	Price
8"	30 inches	13-04147	\$41.85
10"	36 inches	13-02026	\$45.50
13"	55 inches	13-04145	\$57.95
18"	5 feet	13-20200	\$66.85
18"	8 feet	13-20202	\$79.90
24"	8 feet	13-20204	\$99.75
28"	7 feet	13-20205	\$104.75
36"	10 feet	13-20206	\$179.95

INTENSE WHITE

Throat Dia.	Length	Part No.	Price
18"	5 feet	13-20210	\$66.85
18"	8 feet	13-20212	\$81.75
24"	8 feet	13-20214	\$97.99

WHITE/ORANGE STRIPE

Throat Dia.	Length	Part No.	Price
18"	5 feet	13-20220	\$82.75
18"	8 feet	13-20222	\$89.95
24"	8 feet	13-20224	\$115.75
28"	7 feet	13-20225	\$125.75
36"	10 feet	13-20226	\$193.75
36"	12 feet	13-20228	\$226.95

SCOTT'S STANDARD WINDSOCK FRAMES



These very popular frames are constructed of welded steel for strength & durability. They have 2 ball bearings for easy swiveling and are painted for corrosion resistance. The frame is mounted to a 1-inch diameter support pipe threaded to fit a 3/4" size pipe or conduit. Order windsocks separately.

8".....	P/N 13-20229	\$66.75
24".....	P/N 13-20232	\$129.75
10".....	P/N 13-20005	\$75.90
13".....	P/N 13-20231	\$93.75
36".....	P/N 13-20235	\$128.75
18".....	P/N 13-20230	\$89.95

SCOTT'S EXTENDED WINDSOCK FRAMES

The extended frame turns much easier and keeps the windsock headed into the wind like a weathervane. The frame holds the windsock open fully so it will "fly" in lighter winds. Constructed of all welded steel with 2 ball bearings. The frame is mounted to a 1-inch diameter support pipe threaded to fit a 3/4-inch size pipe or conduit. **ORDER WINDSOCKS SEPARATELY**

18" P/N 13-20244..... \$116.75 24" P/N 13-20245..... \$142.75

STANDARD WINDSOCK FRAMES



These windsock frames are perfect for both our "long life" and "extra long-life" series windsocks. The "Long Life" windsock is made of 100% nylon and is very durable. Even in tough weather conditions, this windsock can hold its own. Order windsocks Separately.

The "Extra Long Life" windsock is a heavy-duty cross-woven Aviation blend Poly. Nylon material with special Rip-Stop characteristics, Medium-weight for more flexibility, chemically resistant treated, and Polyurethane coated for bonding strength and water repellency. Ultra-violet dyed for best retention. Nylon support webbing on intake opening with brass grommets. Colorfast International Bright Orange in color. "Extra Long Life" windsocks have an estimate 50% longer life and color retention.

Size (in)	Part No.	Price
12 x 48	13-04318	\$95.75
13 x 48	13-04319	\$98.90
15 x 55	13-04320	\$98.75

Size (in)	Part No.	Price
18 x 60	13-04326	\$133.75
20 x 60	13-04327	\$121.75
24 x 96	13-04328	\$183.75

MINIATURE 15" WIND SOCK



For home, office, hangar or workshop. The 15" long wind cone of Flame-Orange sailcloth material swivels on 23" high steel shaft. Wind directionals are cast aluminum with flat black finish.

Furnished with mounting hardware and instructions.
Complete Kit..... P/N 13-03747 \$59.75
Replacement Sock P/N 13-03748 \$14.50

NYLON WINDSOCKS



These socks are windtunnel tested and designed for conditions in which safety and wind direction are of greatest importance. They are constructed

of nylon oxford cloth for strength and flyability and dyed a bright orange for higher visibility. The throat and tail bands are stitched with multiple rows of tough synthetic thread. The throat band is finished with #1 brass grommets and nylon ties are included. Unlike canvas or vinyl, these Socks fly in the slightest breeze.

Part No.	Throat Diameter	Length	Price Each
13-20040	10"	36"	\$43.85
13-20045	18"	48"	\$62.75
13-20060	36"	144"	\$213.95
13-20050	18"	60"	\$66.85

LONG LIFE WINDSOCKS



All Long Life Windsocks are made of heavyweight cross-woven Aviation blend material having special Rip-Stop characteristics, flexible, chemically resistant treated, Polyurethane Coated for bonding strength and water repellency, Ultra-violet dyed, with Nylon Web support and brass grommets. Color: Colorfast

International Orange. Estimated 50% longer life and color retention. Aviation sized windsocks. FAA approved sizes per FAA Advisory Circular #AC 150/5345-27C dated 07/85. Estimated wind speeds: Fully extended shape for all sizes listed below, (wind tunnel tested) to be special cut Specification of 15 knots = 16.5 mph. 18" - 28" diameter windsocks 96" in length. 36" diameter 144" in length.

Size (in)	Part No.	Price
6 x 18	13-04306	\$37.50
9 x 30	13-04307	\$43.50
10 x 36	13-04308	\$51.75
12 x 48	13-04309	\$56.99
13 x 48	13-04314	\$60.95

Size (in)	Part No.	Price
15 x 55	13-04315	\$61.90
18 x 60	13-04321	\$69.95
20 x 60	13-04323	\$71.75
24 x 96	13-04324	\$131.75

EXTRA LONG LIFE WINDSOCKS



"Extra Long Life" is a heavy-duty cross-woven Aviation blend Poly./Nylon material with special Rip-Stop characteristics, Medium-weight for more flexibility, chemically resistant treated, and Polyurethane coated for bonding strength and water repellency. Ultra-violet dyed for best retention. Nylon support webbing on intake

opening with brass grommets. Colorfast International Bright Orange in color. "Extra Long Life" windsocks have an estimate 50% longer life and color retention.

Size (in)	Part No.	Price
6 X 18	13-20110	\$41.50
9 X 30	13-20111	\$45.50
10 X 36	13-20112	\$54.95
13 X 48	13-20113	\$64.95
18 X 60	13-20114	\$72.99
20 X 60	13-20115	\$79.75
12 X 48	13-04316	\$61.75

Size (in)	Part No.	Price
15 X 55	13-04317	\$64.90
20 X 96	13-02039	\$125.75
18 X 96	13-02038	\$113.85
24 X 96	13-02040	\$134.75
28 X 96	13-02041	\$155.75
36 X 144	13-02042	\$255.95

PS

WINDSOCKS

AIRPORT WINDSOCKS



What makes these aviation windsocks different?

Two major things make a windsock, its material and its construction. Starting off with a premium nylon fabric that is made right here in the USA to exact standards. Nylon offers unparalleled windsock durability to the elements and will not become rigid in cold weather, keeping these windsocks extremely responsive in even the slightest of wind. From there it gets urethane coated and UV protected, giving the windsock superior fade resistance and color retention. The material is subjected to a variety of tests by an independent lab to verify its structural integrity and UV resistance. This superior material is then cut and sewn. Our reinforced double stitched hems and heavy duty brass grommets, assures these windsocks long life reliability.

The added expense of a superior material and manufacturing process meets the needs of even the most demanding windsock customers. Such as: US Military, US Coast Guard, US Embassies, State Airports, Offshore Oil Rigs, Nuclear Power Plants, Medical Heliports, Government Bio Hazard Units.

ORANGE WINDSOCKS

Description	Size	Part No.	Price
Orange Windsock	4" x 15"	13-06386	\$17.80
Orange Windsock	6" x 24"	13-06387	\$18.50
Orange Windsock	8" x 36"	13-06388	\$24.70
Orange Windsock	10" x 36"	13-06389	\$36.50
Orange Windsock	13" x 54"	13-06465	\$41.75
Orange Windsock	18" x 48"	13-22400	\$48.50
Orange Windsock	18" x 60"	13-06466	\$51.80
Orange Windsock	18" x 72"	13-06467	\$64.75
Orange Windsock	18" x 96"	13-06468	\$62.75
Orange Windsock	20" x 96"	13-06469	\$69.75
Orange Windsock	24" x 96"	13-06470	\$74.75
Orange Windsock	36" x 144"	13-06471	\$141.75

ORANGE AND WHITE WINDSOCKS

Description	Size	Part Number	Price
Orange & White Windsock	4" x 15"	13-06472	\$25.50
Orange & White Windsock	8" x 36"	13-06473	\$37.65
Orange & White Windsock	10" x 36"	13-06474	\$47.50
Orange & White Windsock	13" x 54"	13-06475	\$53.85
Orange & White Windsock	18" x 60"	13-06476	\$69.50
Orange & White Windsock	18" x 72"	13-06477	\$75.95
Orange & White Windsock	18" x 96"	13-06478	\$79.85
Orange & White Windsock	24" x 96"	13-06479	\$94.75

BALL BEARING FRAMES



The ball bearing windsock frames are a rugged design constructed of a welded steel construction and then a powder coated finish for corrosion protection. They incorporate a two bearing pivoting design for effortless pivoting. These frames are ready to be mounted on a 3/4" female pipe thread for the 8", 13", 18" and 24" and a 1" pipe thread for the 36".

Description	Size	Part No.	Price
Ball Bearing Frames	8"	13-06481	\$46.50
Ball Bearing Frames	13"	13-06482	\$65.90
Ball Bearing Frames	18"	13-06483	\$73.75
Ball Bearing Frames	24"	13-06484	\$76.85
Ball Bearing Frames	36" Non Collapsible	13-06485	\$139.75

EXTENDED BALL BEARING FRAMES



These windsock ball bearing extended frames are a rugged design constructed of a welded steel construction and then a powder coated finish for corrosion protection. They incorporate the same high quality construction as our standard ball bearing frames with the added performance of an extended frame. They incorporate a two bearing pivoting design for effortless pivoting. These frames are ready to be mounted on a 3/4" female pipe thread for the 13" and 18" frames. Use 1" female pipe thread for mounting the 24" and 36" frames.

Description	Size	Part No.	Price
Extended Ball Bearing Frames	13"	13-06487	\$89.95
Extended Ball Bearing Frames	18"	13-06488	\$105.75
Extended Ball Bearing Frames	24"	13-06489	\$122.75

VERTICAL SOCK KITS



These complete kits include our standard frame, windsock, windsock ties, pole, and brackets. They are a stand alone unit for mounting on a flat vertical surface or they can be installed right onto an existing 3/4" pipe thread pole.

Description	Size	Part No.	Price
Vertical Mount Windsock Kit	8" x 36"	13-06491	\$92.75
Vertical Mount Windsock Kit	13" x 54"	13-06494	\$98.85
Vertical Mount Windsock Kit	18" x 60"	13-06495	\$112.75
Vertical Mount Windsock Kit	18" x 96"	13-06496	\$122.75



TRIPOD MOUNT WINDSOCK KIT

These complete kits include our standard frame, windsock, windsock ties, pole, and tripod. They are a stand alone unit for mounting on a flat horizontal or peaked roof surface or they can be installed right onto an existing 3/4" pipe thread pole.

Description	Size	Part No.	Price
Tripod Mount Windsock Kit	8" x 36"	13-06497	\$97.85
Tripod Mount Windsock Kit	13" x 54"	13-06498	\$124.95
Tripod Mount Windsock Kit	18" x 60"	13-06499	\$124.75
Tripod Mount Windsock Kit	18" x 96"	13-06501	\$128.75



PORTABLE WINDSOCK KIT

This rugged, stand alone unit comes complete with the pole, frame, windsock and windsock ties. This free standing system measures over 7' tall in its assembled configuration. • It features an extremely rugged design that incorporates a pole with a foot lug and handle for easy installation and removal. The two part pole disassembles for easy transportation. • The frame conveniently screws onto the top of the pole.

Its aluminum hoop and bail pivot on a stainless steel shaft for years of reliable and responsive action. These high quality socks are constructed from U.S. made nylon fabric that is urethane coated and UV protected.

Description	Size	Part No.	Price
Portable Windsock Kit	6" x 24"	13-06502	\$132.85
Portable Windsock Kit	8" x 36"	13-06503	\$132.85
Portable Windsock Kit	13" x 54"	13-06504	\$148.75



AVIATION UNLIGHTED WINDSOCK FRAMES

Non-lighted, heavy duty ball-bearing frame, with 1-75 to 300W lamp, extended to 30" double hoop frameworks. (3/8" round metal frameworks) FAA approved sizes per FAA Advisory Circular #AC150/5345-27C dated 07/19/85. Furnished complete with windsocks.

Description	Part No.	Price
13" w/ Windsock	13-04330	\$203.95
18" w/ Windsock	13-04331	\$385.00
20" w/ Windsock	13-04332	\$391.00
24" w/ Windsock	13-04333	\$423.00
36" w/ Windsock	13-04334	\$1,317.00
Windsock Stationary Base	13-04335	\$93.75
Windsock Hinged Base	13-04336	\$207.95
Windsock Heavy Duty Pole	13-04337	\$151.75
Windsock Galvanized Pole	13-04338	\$50.75

AVIATION LIGHTED WINDSOCK FRAMES

Internally lighted, heavy duty ball-bearing frame, with 1-75 to 300W lamp, extended to 30" double hoop frameworks. (3/8" round metal frameworks) FAA approved sizes per FAA Advisory Circular #AC150/5345-27C dated 07/19/85. Furnished complete with windsocks.

18" dia	P/N 13-02043	\$1,233.00
20" dia	P/N 13-05729	\$1,239.00
24" dia	P/N 13-05730	\$1,367.00
36" dia	P/N 13-05731	\$2,243.00



WINDSOCK FRAMES

Totally enclosed housing prevents heavy duty ball-bearing from lock-ups, corrosion, and excessive premature wear. Bearings are grease packed, metal shielded. Self contained unit easily attaches with 3/4" standard threaded pipe.

6" dia	P/N 13-20120	\$76.75
9" dia	P/N 13-20121	\$82.75
10" dia	P/N 13-20122	\$92.75

PS

WINDSOCKS

WINDCONES



Windcones come in 3 different materials, Vinyl, Nylon or Cotton Duck. The standard color for all windcones is International Orange. Windcone Material: Vinyl - This

material is heavy duty and works well in coastal environments. We use vinyl coated polyester that does not delaminate as laminated vinyls can. This material is oxidation resistant. Windcones 12" and smaller are made of 7 oz. vinyl. All other windcones are made of 9 oz. vinyl. Nylon - This is a light weight (6 oz.), easily inflatable material that is UV coated. Cotton Duck - A heavy duty (9 oz.) cotton army duck which is water repellent and mildew resistant.

Throat Dia (TD)	End Dia (ED)	Length	Material	Part No.	Price
6"	3"	24"	Cotton	13-17649	\$23.50
8"	4"	42"	Cotton	13-17652	\$24.65
10"	5"	42"	Cotton	13-17655	\$30.80
12"	6"	48"	Cotton	13-17658	\$35.50
13"	6.5"	48"	Cotton	13-17661	\$41.75
15"	7.5"	48"	Cotton	13-17664	\$52.75
18"	9"	48"	Cotton	13-17667	\$61.75
18"	9"	60"	Cotton	13-17670	\$66.75
18"	9"	96"	Cotton	13-17673	\$70.80
20"	10"	96"	Cotton	13-17676	\$80.00
22"	11"	96"	Cotton	13-17679	\$89.75
24"	12"	96"	Cotton	13-17682	\$102.75
28"	14"	96"	Cotton	13-17685	\$127.95
36"	18"	144"	Cotton	13-17688	\$198.75
6"	3"	24"	Nylon	13-17648	\$17.75
8"	4"	42"	Nylon	13-17651	\$21.55
10"	5"	42"	Nylon	13-17654	\$21.55
12"	6"	48"	Nylon	13-17657	\$23.50
13"	6.5"	48"	Nylon	13-17660	\$23.85
15"	9"	48"	Nylon	13-17663	\$29.50
18"	9"	48"	Nylon	13-17666	\$49.65
18"	9"	60"	Nylon	13-17669	\$52.75
18"	9"	96"	Nylon	13-17672	\$55.90
20"	10"	96"	Nylon	13-17675	\$61.95
22"	11"	96"	Nylon	13-17678	\$69.75
24"	12"	96"	Nylon	13-17681	\$72.90
28"	14"	96"	Nylon	13-17684	\$84.75
36"	18"	144"	Nylon	13-17687	\$146.75
6"	3"	24"	Vinyl	13-17647	\$23.50
8"	4"	42"	Vinyl	13-17650	\$25.50
10"	5"	42"	Vinyl	13-17653	\$26.50
12"	6"	48"	Vinyl	13-17656	\$30.80
13"	6.5"	48"	Vinyl	13-17659	\$32.80
15"	9"	48"	Vinyl	13-17662	\$44.65
18"	9"	48"	Vinyl	13-17665	\$59.95
18"	9"	60"	Vinyl	13-17668	\$63.75
18"	9"	96"	Vinyl	13-17671	\$67.95
20"	10"	96"	Vinyl	13-17674	\$73.90
22"	11"	96"	Vinyl	13-17677	\$86.85
24"	12"	96"	Vinyl	13-17680	\$89.75
28"	14"	96"	Vinyl	13-17683	\$112.75
36"	18"	144"	Vinyl	13-17686	\$183.75

WINDCONE WINDSOCK FRAMES



Small Frames (12" and smaller) - Lightweight frames made of galvanized steel wire. Large Frames (18" and larger) - These are heavy duty frames designed to withstand storm force winds and harsh environmental conditions. Large frames are made of galvanized steel (WCF18) or a combination of steel and cast aluminum (WCF20, WCF22, WCF24).

Manufacturer No.	Hoop Dia.	Mounting Collar ID	Max Pipe OD	Part No.	Price
WCF6	6"	1"	7/8"	13-17689	\$21.50
WCF8	8"	1"	7/8"	13-17690	\$25.80
WCF10	10"	1"	7/8"	13-17691	\$27.50
WCF12	12"	1"	7/8"	13-17692	\$29.50
WCF18	18"	1 5/8"	1 1/2"	13-17693	\$137.75



STANDARD WINDSOCKS

These windsocks are fabricated with doubly sewn seams and brass grommets for attachment. Bright red/orange nylon provides good long distance visibility.

Description	Part No.	Price
8" x 30"L Sock	05-05222	\$31.70
13" x 55"L Sock	05-05223	\$46.70
18" x 71"L Sock	05-05224	\$61.75
24" x 120"L Sock	05-05225	\$84.85
36" x 120"L Sock	05-05226	\$146.75



STANDARD FRAMES

Internally supports the windsock for more accuracy. Frames are finished using a powder coated weather guard finish. Smooth free swiveling movement with low maintenance. Mounts on standard pipe.

Description	Part No.	Price
8" Frame requires 3/8" pipe mount	05-05227	\$61.95
13" Frame requires 1/2" pipe mount	05-05228	\$67.75
18" Frame requires 3/4" pipe mount	05-05229	\$86.80
24" Frame requires 3/4" pipe mount	05-05230	\$72.99
36" Frame requires 1-1/4" pipe mount	05-05231	\$219.95

REPLACEMENT WINDSOCK FOR LIGHTED FRAME

Description	Part No.	Price
13" x 55" long Sock	05-06249	\$29.95

13" WINDSOCK & FRAME



Made of bright red-orange Nylon and a white powder coated frame. P/N 05-05232 \$82.75

36" COMMERCIAL/ MILITARY WINDSOCK



Designed to conform to rigid Federal Standard #595 with International Orange Mil Spec CCC-C-476 nylon. This sock has a four-fold reinforced collar, throat, and tail, with double-stitching. Incorporates precipitation drain, and has direct frame attach clinch fastener. Includes fastening hardware. 135" mounted length. Frame not included...P/N 05-05233 \$308.00

INTERNATIONAL EUROSOCK™



Multi-panel sock of bright red/orange and white provides very distinctive visibility, both from air and ground. Fits the standard frames (sold separately). 13" Eurosock x 55"LengthP/N 05-05234 \$51.75
18" Eurosock x 71"LengthP/N 05-05235 \$72.75

PS

MONTAGUE FOLDING BICYCLES / ECO SCOOTER

MONTAGUE CROSSTOWN BIKE



Color: Ghost White/Black. Frame: Custom drawn 7005 Series, Aluminum tubing with FIT System. Fork: Rigid Unicrown, with CLIX™ Rims: Alex. Alloy, 36 hole, Silver. 700c. Tires: Kenda Kwick. Spokes: 14 Gage Saddle: Performance comfort with Internal Springs and "Center Gap". Seatpost: 27.2 X 300mm

Alloy. Handlebars: Riser style 30mm rise. 600mm wide. Alloy, Black. Stem: Octagon™ height adjustable stem. No tools required. Crankset: Single chainwheel. Alloy 170mm crank arm. Speeds: 7 Pedals: Trekking pedal with all-weather non-slip tread Folded Size: 36" x 28" x 12" Approx Weight: 27lbs

17 in Frame: 4'8" - 5'2" 700C.....P/N 13-07241\$745.00
19 in Frame: 5'3" - 5'10" 700C.....P/N 13-07242\$745.00
21 in Frame: 5'11" - 6'4" 700 C.....P/N 13-07243\$745.00

MONTAGUE PARATROOPER PRO



Color Matte Black. Frame Custom drawn 7005 Series Aluminum with FIT System. Alloy one piece lower. Disc Compatible. Rims Alloy, 32 hole. Double Wall. Black Tires CST Critter. Knobby. 26 x 1.95". Hubset Formula Disc. Black, Alloy. Sealed front & rear with CLIX™ front quick release. Spokes 14 Gauge Stainless. Shifters Shimano RAPIDFIRE Plus Trigger Shifters. 27 Speeds. Brakeset Tektro Novela. Front & rear mechanical disc w/ pad adjustment. Alloy Levers. Pedals Platform pedal with steel cage. Bottom Bracket Sealed Cartridge. Frame Sizes 18", 20". Stand over heights 30", 31". Folded Size 36" x 28" x 12". Approx Weight 29lbs.

18 in Frame: 5'3" - 5'10".....P/N 13-12970\$1,179.00
20 in Frame: 5'11" - 6'4".....P/N 13-12971\$1,179.00

MONTAGUE BOSTON BIKE



Color: Matte Black Frame: Custom drawn 7005 Series. Aluminum tubing with horizontal dropouts and FIT System. Fork: Full Cro-Mo, with CLIX™ Rims: Alex. Alloy, 36 hole, Black. 700c. Tires: Kenda Kwick Roller Sport 700c x 28mm slick. Rear. Spokes: 14 Gage

Handlebars: Riser style 30mm rise. 530mm wide. Crankset: SR Suntour. Alloy 42T chainwheel with integrated chain guard. Alloy 170mm crank arm. Speeds: Single Speed Pedals: Platform trekking pedal. Aluminum Cage. Folded Size: 36" x 28" x 12" Approx Weight: 24lbs

19 in Frame: 5'3" - 5'10" 700C.....P/N 13-07244\$779.00
21 in Frame: 5'11" - 6'4" 700C.....P/N 13-07245\$779.00

MONTAGUE PARATROOPER ELITE BIKE



The Paratrooper Elite is the highest performance folding mountain bike in the world, an aggressive hard tail built for technical single track. Larger 27.5-inch wheels roll over any obstacle while a full Shimano XT drivetrain, Shimano XT hydraulic disc brakes, and Rockshox Reba suspension provide performance never before seen

from a folding bike. Built upon the heritage of Montague's Swissmilitary® folding bikes, the Elite takes the mountain line to new heights.

18 inch FrameP/N 13-21867\$2,695.00
20 inch FrameP/N 13-21868\$2,695.00

MONTAGUE NAVIGATOR BIKE



Color: Midnight Blue/Black Frame: Custom drawn 7005 Series Aluminum with FIT System. Fork: Full Cro-Mo, with CLIX™ Rims: Alex. Alloy, 32 hole, Silver. Tires: Kenda Kwick Roller Sport 700c x 26mm semi-slick. Spokes: 14 Gage Handlebars: Alloy, 30mm rise. Stem: Octagon™ height adjustable stem. No tools required. Shifters: Shimano Rapid Fire Road for Flat Handlebar. 3-Speed

Left. 9-Speed Right Crankset: SR Suntour. 48/38/28. Alloy 170mm crank arm. Black. Speeds: 27 Speeds Folded Size: 36" x 28" x 12" Weight: 27lbs
19 inch Frame.....P/N 13-07246\$1,085.00
21 inch Frame.....P/N 13-07247\$1,085.00

MONTAGUE FIT BIKE



Hunter: Green/Black Frame: Custom drawn 7005 Series Aluminum with FIT System. Fork: Full Cro-Mo, with CLIX™ Rims: XERO 700c. 28c hole rear, 24 hole front. Silver. Tires: Kenda Kwick Roller Sport 700c x 26mm slick. Spokes: 14 Gage Saddle: Double Density

Performance, with "Center Gap" Comfort Technology. Handlebars: Kalloy. Alloy, double butted. 25mm rise, 8 degree backsweep. Stem: Octagon™ height adjustable stem. No tools required. Shifters Shimano trigger shifters. Speeds: 27 Speeds Pedals: Aluminum trekking pedal. Cro-Mo Spindle. Silver Aluminum Body. Folded Size: 36" x 28" x 12" Approx Weight: 26.5lbs
19 in FrameP/N 13-07248\$1,499.00
21 in FrameP/N 13-07249\$1,499.00

MONTAGUE PARATROOPER™



The Paratrooper is one of the many folding mountain bikes that Montague offers. Its patented folding design was developed to allow airborne soldiers to drop out of airplanes and helicopters and into combat. The Paratrooper offers advanced features with 24 speeds and front and rear mechanical disc brakes. Known

for its durability and load bearing capabilities, this folding bike has also developed a following with everyday commuters and weekend warriors. The Folding Integrated Technology (F.I.T.) is based around frame construction concepts designed for serious full suspension downhill bikes.

18 in FrameP/N 13-01068\$1,075.00
20 in FrameP/N 13-01069\$1,075.00

MONTAGUE PARATROOPER HIGHLINE MOUNTAIN BIKE



The Paratrooper Highline Mountain Bike is a true cross country machine. 27.5 inch wheels provide superior rolling ability over obstacles and rough terrain. A Rockshox fork and hydraulic disc brakes satisfy the true XC rider looking for convenience. Like all Montagues, the Highline is designed to fit on the bus or train, and easily in your airplane, car trunk or boat. The Paratrooper Highline is a rugged 27.5" wheel folding mountain bike with a 2x10 drivetrain. With fat tires and a wide range cassette, the Highline is built for after-work rides on your favorite trails and full-on weekend excursions in the mountains.

18 in FrameP/N 13-19002\$1,395.00
20 in FrameP/N 13-19003\$1,395.00

MONTAGUE PARATROOPER EXPRESS BIKE



Like all Montagues, the Paratrooper Express is designed to fold and fit anywhere. With front suspension and semi-knobby tires, the Express is at home on and off-road. It makes for the perfect light trail bike or rugged commuter. With Shimano derailleurs, Suntour suspension, and Tektro brakes, the Paratrooper Express offers components from the industry's top manufacturers, carrying on the Swissbike® tradition of performance and portability.

16 in FrameP/N 13-21864\$699.00
18 in FrameP/N 13-21865\$699.00
20 in FrameP/N 13-21866\$699.00

MONTAGUE ALLSTON BIKE



The Allston is a folding bike that combines standard 700c wheels with a Gates carbon belt drive and Shimano Alfine 11 internal gear hub. Grease-less and virtually maintenance free, it's perfect for urban riding and can be stowed until your next ride. Hydraulic disc brakes provide

superb stopping power, a RackStand offers cargo carrying capacity, and extra wide 38mm tires make it comfortable on even the roughest roads.
19 in FrameP/N 13-21862\$2,140.00
21 in FrameP/N 13-21863\$2,140.00

MONTAGUE URBAN BIKE



The Urban is a folding bike with standard 700c wheels that delivers road performance on a budget. A 21-speed Shimano drivetrain provides ample gearing for hilly roads while wide 35mm tires cushion the ride over rough terrain and potholes. The patented RackStand offers cargo carrying capacity and has a built in fender, acts as a kickstand, and serves as a stand for the folded bike.

17 in FrameP/N 13-21859\$845.00
19 in FrameP/N 13-21860\$845.00
21 in FrameP/N 13-21861\$845.00

ECO RECO ELECTRIC SCOOTERS

EcoReco M3 scooter is an eco-friendly, efficient, portable, and smart electric vehicle, designed for your everyday urban use. In the form of a kick scooter, it is the most practical and economical last mile solution on the market. EcoReco M3/M5 can be easily stored under chairs or a desk, in a car trunk, in a gym locker, and it also works well with public transportations. Whether you're going the distance or just that extra mile, EcoReco M3 provides a convenient and economical ride for you, and cleaner air for all.



M3 ScooterP/N 13-18595\$999.00
M5 ScooterP/N 13-18594\$1,250.00



PARA-CUSHION PARACHUTES



PARA-CUSHION 311 - WEDGE

The Para-Cushion 311 Wedge measures 24" (61cm) tall by 16" (40.5cm) wide by 1" (2.5cm) at the shoulders and 3" (7.5cm) at the lower back, and weighs approximately 16 lbs. (7.3 kg). This unique configuration allows for maximum comfort for the pilot by using the shape of the parachute system to put you in a slightly reclined position. The parachute assembly is designed to be used in airplanes where headroom is at a minimum and the backrest is at a straight upright angle with the seat bottom, such as a Pitts S1, Pitts Model 12, Christen Eagle, RV-4, RV-6, Harmon Rocket, and many others.

System Comes Complete with: Harness/Container, Mid-Lite Parachute, Ripcord, Lil Grabber Pilot Chute, Carry Bag, and Manual. TSO - C23c cat. B P/N 13-14779 **\$2,628.00**



PARA-CUSHION 304 - SEAT

The Para-Cushion 304 Seat, measures 12" (30.5 cm) tall by 16" (40.5 cm) wide by 1/2" (1.3 cm) thick throughout the back, and 3" (7.5 cm) thick in the seat cushion, and weighs approximately 18.5 lb. (8.4 kg). The 304 is designed to be used in place of a seat cushion. By using an additional Confor© Foam cushion the seat thickness of the pack may be from 1" (2.5 cm) to 6" (15 cm) thick depending on the type of airplane and how high the user desires to be in the cockpit. The parachute assembly is designed to be used in airplanes where head room is not restricted or moving forward in the cockpit is not possible

including: Skybolt, Yak 52, Yak 55, CJ-6, Stearman, Great Lakes, Pitts S 2B, Decathlon, RV-4 and many others. For RV-4 and RV-8 aircraft the seat container is modified slightly to fit the exact size of the seat pan. The options for the RV version remain the same as the standard version. System Comes Complete with: Harness/Container, Mid-Lite Parachute, Ripcord, Lil Grabber Pilot Chute, Seat Cushion, Carry Bag, and Manual. TSO - C23c cat. B P/N 13-03441 **\$2,269.00**

PARA-CUSHION 306 - SQUADRON SEAT

The Para-Cushion 306 Squadron Seat measures 16.5" (42 cm) tall by 13" (33 cm) wide by 6.5" (16.5 cm) thick and weighs approximately 19.5 lbs. (8.8 kg). Color Options: Stock Colors are Black, Red, Navy Blue, Royal Blue, and Olive Drab. This applies to Container, trim, and harness colors. Color Choices: Black, Red, Navy Blue, Royal Blue, and Olive Drab. The pack and cushion combination are shaped to fit fully into the seat to provide a large stable, and comfortable seating area for the pilot. The harness is fully adjustable in the main lift webs (vertical straps), as well as in the lumbar area to ensure proper fit, provide support, and remain comfortable. The

parachute assembly is designed to be used with the bucket style seat pan found in most warbirds such as: SN-J, T-6, Harvard, T-34, T-28, P-51, Stearman, and many others. TSO - C23c cat. B.

Strong 306 Seat P/N 13-14781 **\$2,269.00**
Strong 306 Harness Container Only P/N 13-15946 **\$1,349.00**



ACROPRO PARACHUTE

The AcroPro is designed with Aerobatic pilots in mind. At just 16 lbs., this lightweight, thin, and comfortable pack supports the pilot during high G maneuvers while maintaining comfort and safety. The AcroPro, measures 24" (60 cm) tall by 16" (40 cm) wide by 3" (7 cm) thick and weighs approximately 16 lbs (6.5 kg). In many cases, by removing the back cushion of the seat pan, the pilot may place the AcroPro in its place. Choose our Standard Harness or the Aerobatic Harness at no additional charge. AcroPro comes with: Harness/Container, Mid-Lite Parachute if desired or C-9 (call for price), Ripcord, Lil Grabber Pilot Chute, Carry Bag, and DVD Manual. TSO - C23c cat. B & SAE AS-8015A.

Standard Harness - Harness/Container Only P/N 13-21184 **\$1,499.00**
Standard Harness - Complete Mid-Lite P/N 13-21186 **\$2,599.00**
Aerobatic Harness - Harness/Container Only .. P/N 13-21185 **\$1,499.00**
Aerobatic Harness - Complete Mid-Lite P/N 13-21187 **\$2,499.00**



PARA-CUSHION 305 - CHAIR

The Para-Cushion 305 Chair measures 42" long (105 cm) by 16" (40 cm) wide by 2.5" (6cm) to 1" (2.5cm) thick and weighs approximately 16.5 lb. (7.5 kg).

This back mounted container is built to extend from the shoulders of the user to just above the knees. This long design allows the parachute to be packed in a larger area keeping the system as thin as possible. Confor© Foam padding throughout the system allows the user to comfortably sustain flight for many long hours. The parachute assembly is designed to be used in airplanes where your seat is reclined such as a Grob, Giles 202, the rear seat of an Extra, and many others. System Comes Complete with: Harness/Container, Mid-Lite Parachute, Ripcord, Lil Grabber Pilot Chute, Carry Bag, and Manual.

TSO - C23c cat. B P/N 13-03442 **\$2,127.00**



PARA-CUSHION 303 - BACK

The Para-Cushion 303 measures 24" (60 cm) tall by 16" (40 cm) wide by 3" (7 cm) thick and weighs approximately 15 lbs (6.5 kg). In many cases, by removing the back cushion of the seat pan, the pilot may place the 303 in it's place. The 303 Back is recommended for use in airplanes where head room is at a minimum and moving forward in the cockpit is not a problem. Recommended for use in airplanes such as: ASW-27, PW-5, Cap-10, Zlin 50, and Christen Eagle.

System Comes Complete with: Harness/Container, Mid-Lite Parachute, Ripcord, Lil Grabber Pilot Chute, Carry Bag, and Manual. TSO - C23c cat. B.

P/N 13-03440 **\$2,265.00**



PARA-CUSHION L-39

The Para-Cushion L-39, measures 27" (68.6 cm) tall by 17" (43.2 cm) wide by 3.5" (8.9 cm) thick and weighs approximately 25.9 lb. (11.7 kg). The L-39 is designed exclusively for the L-39 Albatross. The design incorporates existing Russian designed pilot restraint system found on the original assembly, including shoulder roller guide for inertial reel and seat belt buckles at the hips. This provides you with fit-and-fly technology that

perfectly replaces the original equipment and gives you peace of mind knowing that you have a comfortable, top of the line system.

System Comes Complete with: Harness/Container, 28" C-9 Parachute, Ripcord, Travel Cushion, G-Pad, Static Line, Lil Grabber Pilot Chute, Carry Bag, and Manual. TSO - C23c cat. B. P/N 13-15068 **\$3,500.00**



MID-LITE CANOPY

The 26' Mid-Lite is the finest reserve canopy available! It is a highly reliable 24 gore canopy. It is tested and approved to FAA TSO C23c Category B.

The canopy has been tested to withstand a 5000lb shock load, which means it is built to withstand the rigors of an emergency bail-out. In production since 1987 the Mid-Lite has proven time and time again that it is the most rugged and reliable reserve you can own!

Canopy Shape	Conical	Canopy Cloth	30-50 cfm (PIA-C-44378d)
Size	26'	Turn Speed	Approx. 7 sec
Number of Gores	24	Forward Speed	6 - 8 mph (10-12 km/h)
Line Length	17' 6"	Opening Time	1.1 - 2.3 sec
Panels Per Gore	4	Rate of Descent	18.5 fps @ 225 lbs (5.7 mps)
Suspension Line Material	Type 1A	Canopy Weight	Approx. 7 lbs
Suspension Line Strength	400 lbs	Maximum Weight	254 lbs (115 kg)

P/N 13-14782 **\$1,112.00**

PS

ACCESSORIES

CUSTOM MONOGRAMMING - Monogram your name, N number, or anything that space will allow on the front of your container.

P/N 13-04907 **\$43.60**

CAPEWELL RISER RELEASE - For landing in high wind conditions allows the pilot to release the parachute, to prevent dragging. Disadvantages -- Heavy and expensive hardware. P/N 13-04908 **\$482.00**

LUMBAR SUPPORT PAD - A rounded Tempore® foam pad that attaches in existing channel. Adjustable to just the right position in the small of your back. P/N 13-15065 **\$106.80**

PARA-CUSHION G-PAD CUSHION - An auxiliary pad that attaches to the back pad of any Para-Cushion. G-pad is formed to snugly fit around the pilot's sides providing extra support during high G maneuvers.

P/N 13-15066 **\$136.75**

ELT POCKET - This external pocket snaps onto the system and holds the pilots ELT system. P/N 13-15949 **\$114.75**

SHEEPSKIN BACK PAD - Sheepskin pads keep you cool in the summer and warm in the winter.

Smoke P/N 13-11307 **\$168.75**

Natural P/N 13-11309 **\$168.75**

Black P/N 13-04911 **\$195.00**

QUICK EJECTOR SNAPS - This is the Military type hardware that can be used in place of the standard B-12 snaps. Works best for former military pilots who have become accustomed to this type of hardware.

Snaps P/N 13-04909 **\$144.75**

Aerobatic Snaps P/N 13-04910 **\$108.75**

AERO PAD - A zip-on seat pad held in place by the pilot's weight to restrain the Para-Cushion and prevent shifting during high G maneuvers. P/N 13-15067 **\$91.85**

CHECKMATE CHECKLISTS

CHECKMATE CHECKLISTS



Checkmate is the only checklist that contains virtually all data desired by pilots to fly the airplane while excluding the extraneous information which leads to inefficiency, confusion and even refusal to use. They eliminate the tedious and cluttered 15-page flip-book that pilots quickly become discouraged from using.

Checkmate contains the most comprehensive V-speed section in the industry. V-speeds are listed in Knots and MPH. Checkmate not only makes a dramatic difference in everyday use, but also in critical situations. Emergency procedures are right there! Every time! With most of the emergencies there is no time to flip pages looking for the correct procedures.

Available for over 300 single and twin engine aircraft. All follow a standard format. Used by some of the best flight schools in the country. Checkmate Standard Checklists is 6.5" x9" size. Checkmate Compact Checklist 5"x7" size.

Description	Part No.	Price
Alarus/Zenith CH2000	13-04627	\$17.95
Aviat Husky A1-B	13-05490	\$17.95
Aviat Husky A1-B Amphibian	13-05491	\$17.95
Beechcraft Baron B55 64'-76'	13-04649	\$20.95
Beechcraft Baron B55 77'-82'	13-04650	\$20.95
Beechcraft Baron 58 285 HP	13-04651	\$20.95
Beechcraft Baron 58 300 HP	13-04652	\$20.95
Beechcraft Baron 58P 310 HP	13-04653	\$20.95
Beechcraft Baron 58P 325 HP	13-04654	\$20.95
Beechcraft G58 G100	13-04655	\$20.95
Beechcraft Bonanza A36 '84 & On	13-08699	\$17.95
Beechcraft Bonanza F33A	13-04601	\$17.95
Beechcraft Bonanza G36 G1000	13-04608	\$17.95
Beechcraft Bonanza NP35	13-04604	\$17.95
Beechcraft Bonanza V35TC	13-04606	\$17.95
Beechcraft Bonanza A36 thru '83	13-04607	\$17.95
Beechcraft Debonair CEF33	13-08697	\$17.95
Beechcraft Duchess 76	13-04648	\$20.95
Beechcraft Bonanza S35	13-08698	\$17.95
Beechcraft Sundowner	13-08696	\$17.95
Cessna 150 D-K	13-08605	\$17.95
Cessna 150 '59-'63 Quickmate	13-00708	\$12.95
Cessna 150 '59-'63	13-07301	\$17.95
Cessna 150L	13-08606	\$17.95
Cessna 150M	13-08607	\$17.95
Cessna 152	13-08610	\$17.95
Cessna 172 F, G, H	13-08612	\$17.95
Cessna 172 I, K, L	13-08613	\$17.95
Cessna 172 M	13-08615	\$17.95
Cessna 172 N	13-08620	\$17.95
Cessna 172 P	13-08625	\$17.95
Cessna 172 P 6.5"x4"	13-08630	\$11.95
Cessna 172 R G1000	13-04575	\$17.95
Cessna 172 RG	13-08635	\$17.95
Cessna 172 S	13-04576	\$17.95
Cessna 172 S G1000	13-04577	\$17.95
Cessna 177	13-08636	\$17.95
Cessna 177 RG	13-08637	\$17.95
Cessna 182 E-M	13-08638	\$17.95
Cessna 182 P	13-08639	\$17.95
Cessna 182 Q	13-08640	\$17.95
Cessna 182 R	13-08641	\$17.95
Cessna 182 RG	13-08645	\$17.95
Cessna 182 S	13-04578	\$17.95
Cessna 182 T	13-04579	\$17.95
Cessna 182 T G1000	13-04580	\$17.95
Cessna T182T	13-04581	\$17.95
Cessna 206H	13-04583	\$17.95
Cessna 206H G1000	13-04584	\$17.95
Cessna T206H G1000	13-04585	\$17.95
Cessna T206H G1000,GFC700 C	13-05638	\$17.50
Cessna T206H G1000 Amphibian	13-05394	\$17.95
Cessna 210M	13-05476	\$17.95
Cessna T210M	13-05483	\$17.95
Cessna 210N	13-05482	\$17.95
Cessna T210N	13-05484	\$17.95
Cessna 303 Turbo Crusader S	13-05635	\$17.95
Cessna 303 Turbo Crusader C	13-05636	\$15.95
Cessna 310Q	13-04629	\$20.95
Cessna 310R	13-04630	\$20.95
Cessna 340A	13-04631	\$20.95
Cessna 402B	13-04632	\$20.95
Cessna 421B	13-04634	\$20.95

Description	Part No.	Price
Cessna 421C	13-04637	\$20.95
Cirrus SR20-Electric	13-04614	\$17.95
Cirrus SR22	13-04615	\$17.95
Citabria 7ECA / 7KCAA	13-07991	\$17.95
Citabria 7KCAB	13-11860	\$17.95
Diamond DA20 C1	13-04621	\$17.95
Diamond DA20-100	13-04622	\$17.95
Diamond DA40-180	13-04623	\$17.95
Diamond DA40-180 G1000	13-04624	\$17.95
Diamond DA40-180 FP	13-04625	\$17.95
Diamond DA40-180 FP G1000	13-04626	\$17.95
Diamond A42 G1000	13-04656	\$20.95
Maule MT 7-235	13-04613	\$17.95
Mooney 201 (M20J)	13-08700	\$17.95
Mooney Encore M20K	13-05492	\$17.95
Mooney M20K-231	13-04616	\$17.95
Mooney M20K-252	13-04617	\$17.95
Mooney M20M/Bravo	13-04618	\$17.95
Mooney M20R/Ovation	13-05493	\$17.95
Mooney M20R/Ovation G1000	13-04620	\$17.95
Mooney M20S/Eagle	13-05494	\$17.95
Mooney M20TN/Acclaim	13-04714	\$17.95
Mooney M20TN/Acclaim Compact	13-04715	\$17.50
J3 CUB 65	13-16432	\$17.95
Super Cub 1750 LB GW	13-16433	\$17.95
Super Cub 2000 LB GW	13-16434	\$17.95
Piper 6X	13-04586	\$17.95
Piper 6XT	13-04587	\$17.95
Piper Archer II	13-08670	\$17.95
Piper Arrow II	13-08675	\$17.95
Piper Arrow III	13-08680	\$17.95
Piper Arrow 180	13-04592	\$17.95
Piper Arrow 200	13-04593	\$17.95
Piper Aztec E	13-04643	\$20.95
Piper Aztec F	13-04644	\$20.95
Piper Cherokee 140	13-08655	\$17.95
Piper Cherokee 180	13-08656	\$17.95
Piper Cherokee 235	13-08685	\$17.95
Piper Cherokee Six/30	13-05486	\$17.95
Piper Lance	13-04594	\$17.95
Piper Lance II Turbo	13-05488	\$17.95
Piper Malibu 310	13-04598	\$17.95
Piper Mirage 350	13-04599	\$17.95
Piper Navajo 310	13-04645	\$20.95
Piper Navajo 350 Chieftan	13-04647	\$20.95
Piper Saratoga FG	13-04595	\$17.95
Piper Saratoga SP	13-05489	\$17.95
Piper Saratoga II HP	13-04596	\$17.95
Piper Saratoga II TC	13-04597	\$17.95
Piper Seminole	13-08690	\$20.95
Piper Seneca I	13-04639	\$20.95
Piper Seneca II	13-08695	\$20.95
Piper Seneca III	13-04640	\$20.95
Piper Seneca IV	13-04641	\$20.95
Piper Seneca V	13-04642	\$20.95
Piper Tomahawk	13-08650	\$17.95
Piper Twin Comanche	13-04638	\$20.95
Piper Warrior	13-04588	\$17.95
Piper Warrior II	13-08665	\$17.95
Piper Warrior III	13-04590	\$17.95
Piper Warrior III with Avidyne Entegra	13-05640	\$17.50
Symphony SA160	13-04628	\$17.95

Checkmate Universal SingleP/N 13-08705\$17.95



CHECKMATE CHECKLISTS

CHECKMATE IFR



In the IFR environment organization and management lead to smoother, stress-free and safer outcomes. CheckMate IFR will assist you through preflight planning to touch-down on the IFR flight. Whether you are cleared for the complete approach or radar vectored to the FAF, CheckMate IFRs format will help keep the flight business orderly and functional. It is precise & specific to the different phases of those sometimes precarious flights. You will be reminded when to prepare and look ahead to each phase. A quick review of CheckMate IFR before flight will help you determine pilot and aircraft preparedness and legalities, how to give those greatly appreciated pilot reports on icing and turbulence, and what ATC expects you to do after radio failure; Professional information in a concise and orderly manner.

Standard (6" x 9.5") P/N 13-08805 **\$17.95**
 Compact (5" x 7") P/N 13-08810 **\$17.50**

CHECKBOOK CHECKLISTS



Aviation Checkbook is a high quality, multi-page laminated checklist utilizing factory type information for FAA Part 141 and 61 schools. Designed as a primary checklist giving all details and responses needed by new students or pilots wanting a multi-page checklist without the usual bulk. Shirt pocket size with mark and erase surface for notes. The various checklists for your aircraft are stacked and color tabs allow you to locate the checklist you need.

Part No.	Description (Checkbook Checklist for:)	Price
13-03091	Cessna150 D-K	\$21.95
13-01262	Cessna 150M	\$13.95
13-01264	Cessna 172FGH	\$13.95
13-01270	Cessna 172P	\$13.95
13-03102	Cessna 172RG	\$21.95
13-01272	Cessna 182E-M	\$21.95
13-01273	Cessna 182N	\$13.95
13-01288	Piper Seminole	\$13.99
13-01291	Piper Seneca I	\$13.95
13-01275	Cessna 182Q	\$13.95
13-01276	Cessna 182R	\$13.95
13-01277	Cessna 182S	\$13.95
13-01278	Cessna 182RG	\$13.95
13-01280	Cherokee160	\$13.95
13-01282	Piper Warrior	\$13.95
13-01283	Piper Warrior II	\$13.95
13-01284	Piper Archer II	\$13.95
13-01286	Piper Arrow II	\$17.95
13-01287	Piper Arrow III	\$13.95

SURVIVING THE FIRST 24 HOURS CHECKMATE®



Surviving the First 24 Hours CheckMate® clearly details the procedures and equipment that you will need to survive a forced landing and the subsequent 24 hours. The preparation before a flight can easily make the difference between surviving or not surviving. This is one of the most important pieces of equipment in a pilot's pre-flight planning.

Available in three sizes.
 Standard (6.5"x 9") P/N 13-00444 **\$17.95**
 Compact (5"x 7") P/N 13-00446 **\$17.85**
 Pocket (3.75"x 3.25") P/N 13-00447 **\$12.70**

FLYWRITE COCKPIT WRITING PAD

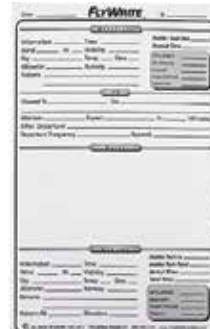

FlyWrite™ is not another "flight planning" layout. It is designed to give you a dedicated place for all the information that flows while in the cockpit of the aircraft. Convenient top-bound writing pad. Each pad contains 50 5" x 8" sheets and can be used with or without standard junior legal vinyl binders. IFR clearances, ATIS, AWOS, frequencies, flight times, hobbys times, tach times, airport information , frequency changes, hand-off's, altitude changes, weather, etc, now have a home. There is also an area for random information or diagrams. FlyWrite™ also contains a handy vertical scale which measures mileage for WAC, SEC, TAC, NOS, JEPP, & ELA charts, eliminating the need for that ruler you can never find..... P/N 13-03307 **\$8.60**

MOUNTAIN FLYING CHECKMATE



CheckMate Aviation's new Mountain Flying CheckMate™ is a full color, plastic card that is a compilation of the special knowledge required for mountain flying. Competent flying in mountainous terrain requires knowledge far beyond what is taught in standard flight courses; and as most pilots discover, sooner or later, flying in mountainous terrain is inevitable. CheckMate Aviation's Mountain Flying CheckMate™ covers both the rules and common sense of flying that are critical when in this aspect of flight. Available in 3 sizes.

Standard (6.5"x9") P/N 13-02713 **\$17.95**
 Compact (5"x7") P/N 13-02714 **\$17.50**
 Pocket (6.75"x3.25") P/N 13-02716 **\$11.95**

PS

CHECKLISTS

THRU-VIEW EMERGENCY CHECKLISTS



The Thru-View Emergency Checklist is a heads-up, emergency checklist made of high quality, transparent static cling vinyl that adheres to a window or clear sun visor without the use of adhesive for quick, convenient reference.

Features:

- Engine Failure After Take Off Checklist
- Engine Failure In
- Flight Checklist
- Engine Fire In Flight Checklist
- Transponder Codes

And Two of the More Commonly used Checklists:

- The Before Takeoff Checklist and
- The Before Landing Checklist

Aircraft	Part No.	Price
Cessna 172 with Carb	13-21467	\$16.85
Cessna 172SP	13-21468	\$16.85
Cessna 182 with Carb	13-21469	\$16.85
Cessna 182T	13-21470	\$16.85
Bonanza A36/G36	13-21471	\$16.85
Bonanza F33	13-21475	\$16.85
Bonanza V-Tail	13-21476	\$16.85
Piper Cherokee Warrior	13-21472	\$16.85
Diamond DA40	13-21473	\$16.85
Cirrus SR20 SR22	13-21474	\$16.85

THE PRECLIGHT CHECKLIST



Normal Procedures - Before Start, Start-up, Run-up, Before Takeoff, Climb, Cruise, Descent, Before Landing, After Landing, & Shutdown. Emergency Procedures - Engine Failures (Takeoff Roll, After Liftoff, & In Flight), Fires (During Start, In Flight, Electrical, Cabin, & Wing), Electrical, & Power-Off Landing. Communications Template. Includes V speeds & light gun signals. Durable lamination. Fits on any kneeboard or inside any iPad case. Made by full-time Certified Flight Instructors.

Description	Part No.	Price
Cessna 152	13-20156	\$9.95
Cessna 172	13-20157	\$9.95
Cessna 172SP	13-20159	\$9.95
Piper	13-20160	\$10.00

E.S.P. CHECKMATE™

E.S.P. CheckMate™ is a 1st for Aviation, and the only product of its kind available. Our new "Emergency Substitute Pilot"™ could save the lives of you and your passengers by providing the most basic and simplest of terms and procedures to the NON-PILOT, in the unfortunate event the real pilot becomes incapacitated. E.S.P. CheckMate™ assists the NON-PILOT in controlling the aircraft, reaching help on the radio, and if necessary, landing the aircraft. The graphical format makes it easy and comfortable to follow. E.S.P. CheckMate™ can easily be the difference in the outcome of this most serious type of emergency. For safety and readability, we are publishing only in 7.5" x 10" size.....P/N 13-01834.....**\$17.95**



QREF CHECKLISTS



Qref Books - Topics Covered: Preflight, Takeoff/ Cruise, Landing, Comprehensive Abnormals and Emergencies, V-speed list, cruise performance chart.

Qref Cards - Topics Covered: Preflight, Takeoff/Cruise, Landing, Abnormals and Emergencies, V-speed list.

Description	Part No.	Price
Cessna 150 Qref 0	13-15560	\$19.95
Cessna 152 Qref Book	13-15561	\$19.95
Cessna 172 Universal Qref Book	13-15562	\$24.95
Cessna 172RG Qref Book	13-15567	\$24.95
Cessna 172S G1000 Qref Book	13-15569	\$24.95
Cessna 182R Qref Book	13-15571	\$24.95
Cessna R182 Skylane RG Qref Book	13-15572	\$24.95
Cessna Turbo 182T Qref Book	13-15575	\$29.95
Cessna 150 Qref Card	13-15625	\$12.95
Cessna 172 Universal Qref Card	13-15627	\$12.95
Cessna R182 Skylane RG Qref Card	13-15635	\$12.95
Cessna 185H-K QRef Book	13-17523	\$18.95
Cessna Turbo 182T Qref Card	13-15640	\$12.95
Cessna Turbo 182T G1000 Qref Card	13-15641	\$12.95
Cessna Turbo 206H Qref Card	13-15642	\$12.95
Cessna Turbo 210M Centurion Qref Card	13-15643	\$12.95
Cessna 210/210A Qref Book	13-17524	\$18.95
Cessna 210G/H/J Qref Book	13-17526	\$18.95
Cessna 210L/M Qref Book	13-17527	\$18.55
Cessna Turbo 210M Qref Book	13-17528	\$18.50
Cessna 210N Qref Book	13-17529	\$18.50
Cessna Turbo 210N Qref Book	13-17531	\$18.95
Cessna Pressurized P210N Qref Book	13-17532	\$23.95
Cessna Pressurized P210R Qref Book	13-17533	\$23.50
Cirrus SR20 Analog Qref Book	13-15578	\$29.95
Cirrus SR20 G1-G2 Qref Book	13-15579	\$29.95
Cirrus SR22 G3 Qref Book	13-15583	\$29.95
Cirrus SR22 Perspective Qref Book	13-15584	\$29.95
Cirrus SR22 G3 Turbo Qref Book	13-15585	\$29.95
Cirrus SR20 Perspective Qref Card	13-15646	\$12.95
Cirrus SR22 G3 Turbo Qref Card	13-15650	\$12.95
Mooney M20C Mark 21	13-15589	\$19.95
Piper Archer II PA-28-181 Qref Book	13-15590	\$19.95
Piper Arrow 180 PA-28R-180 Qref Book	13-15592	\$24.95
Piper Arrow II PA-28R-200 Qref Book	13-15593	\$24.95
Piper Arrow III PA-28R-201 Qref Book	13-15594	\$24.95
Piper Cherokee 140 PA-28-140 Qref Book	13-15598	\$24.95
Piper Cherokee 150 PA-28-150 Qref Book	13-15599	\$24.95
Piper Cherokee 160 PA-28-160 Qref Book	13-15600	\$24.95
Piper Saratoga SP PA-32R-301 Qref Book	13-15603	\$24.95
Piper Warrior 151 PA-28-151 Qref Book	13-15606	\$19.95
Beechcraft Bonanza C D 35 QREF CARD	13-15621	\$12.95
Piper Archer II PA-28-181 Qref Card	13-15654	\$12.95
Piper Arrow III Turbo PA-28R-201T Qref Card	13-15659	\$12.95
Piper Cherokee 180 PA-28-180 Qref Card	13-15663	\$12.95
Piper Navajo PA-31-310 B C Qref Card	13-15665	\$12.95
Piper Tomahawk PA-38-112 Qref Card	13-15667	\$12.95
Beechcraft Bonanza J K M 35 QREF CARD	13-15622	\$12.95
Beechcraft Bonanza N P 35 QREF CARD	13-15623	\$12.95

SEE WWW.AIRCRAFTSPRUCE.COM FOR COMPLETE LISTING OF QREF CHECKLISTS.

PS

PLOTTERS

FLIGHT COMPUTERS



E6-B METAL FLIGHT COMPUTER - The best slide-rule-style flight computer on the market, with solid aluminum construction and easy-to-read lettering. ASA's E6-B features a wind component grid and comprehensive crosswind correction chart, and on the other side the slide computes time, speed, distance, altitude, true airspeed, and density altitude problems as well as conversions. Nautical and statute scales are included.
P/N 13-00813 **\$33.50**



E6B PAPER FLIGHT COMPUTER - Made from solid, heavyweight fiberboard, an economical version of the aluminum model described above including all its problem-solving features. P/N 13-02298 **\$12.65**



MICRO E6-B - This pocket-sized, brushed aluminum E6-B is a full function aviation computer. Popular among military pilots, it features a high-speed and low-speed wind correction slide, high-speed compressibility table, and instruction manual. Micro E6-B performs all the standard manual flight computer functions, and it conveniently fits in a shirt pocket or glove box.
P/N 13-02299 **\$31.95**



E6-B HIGH SPEED SLIDE - A companion product, this slide picks up where the traditional metal flight computer leaves off (ASA-E6B), providing calculations for the high-speed realm of flight (in the range of 220-700 knots or miles per hour). Pilots simply replace their current slide with this one, which then continues to use the circular computer from traditional E6-Bs. The slide also includes compressibility correction chart, ICAO Standard Atmosphere reference table, worldwide time conversion table, speed limits for the United States, and most frequently-used weight & balance formulas. All of the pertinent formulas & information required for high-altitude, high-speed operations. Meets both FAR & JAR (international) requirements..... P/N 13-02301 **\$14.75**

E6-B CIRCULAR FLIGHT COMPUTER



The E6B Circular Flight Computer combines high-quality construction with easy-to-read lettering to deliver the most efficient, accurate, and convenient manual flight computer available. Perform multiple calculations ranging from basic arithmetic and flight planning problems to complex in-flight computations. The E6B Circular Flight Computer is a great tool to use during flight planning, flight training or studying, and may be used during FAA written knowledge exams. Pilots flying faster aircraft at higher altitudes will find this computer useful in gaining insight to the external atmospheric conditions and the effects they have on in-flight performance. P/B 13-16352 **\$24.95**

PROFLIGHT FIXED AZIMUTH PLOTTER



The ProFlight Fixed Azimuth Plotter is:
• Manufactured & Packaged in the U.S.A.
• Made from Premium Clear 8010 Polycarbonate
• More Flexible & Warp Resistant than Acrylic or PVC
• Printed using Ultra Violet Resistant Ink
• Laminated for Lifetime Scratch Protection
• Clearly Distinguishable White, Sectional/Terminal Side & on Reverse, a Blue WAC Scale
ProFlight PF-AP-1 Plotter - Your PF-AP-1 is a premium Fixed Azimuth Plotter designed for measuring distances and courses on VFR navigational Sectional, Terminal & World Aeronautical Charts. This plotter has been designed to exacting standards and slight variations with chart scales may exist as a result of the instability of paper charts in certain temperature and humidity conditions..... P/N 13-11676 **\$8.75**

SQUARE AVIATION PLOTTER

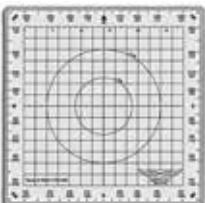

Constructed of durable Lexan®, this plotter won't melt, warp or break in extreme temperatures. Its convenient 5-1/8" square size and ease of use make this plotter a pilot favorite for simple, accurate flight planning. Uses a 1:500,000 scale and includes 5 NM and 10 NM radius rings for quick and easy measurement. The 2 NM grid makes alignment with parallels simple. Plus, it's guaranteed for life!
P/N 13-08056 **\$5.95**

PLOTTERS

Durable Lexan® resin won't melt, warp or break in extreme temperatures - guaranteed! Each plotter features 8 scales to meet the needs of all VFR aeronautical charts - nautical on one side, statute on the flip. Nautical-Statute conversion scale also included. Made in USA.



ULTIMATE ROTATING PLOTTER - 13-1/4" long. Rotating azimuth eases flight planning with direct readout of course. Made in USA.
P/N 13-02302 **\$14.95**



ULTIMATE FIXED PLOTTER - 13-1/4" long. Quick scale reference is provided for both statute and nautical miles. Made in USA.
P/N 13-02424 **\$12.95**



ULTIMATE MICRO PLOTTER - 8" long. Convenient for flight bag, shirt pocket, or airplane storage. Made in USA.
P/N 13-02303 **\$7.95**

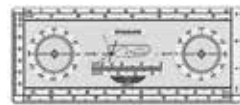

INSTRUMENT PLOTTER - ASA's instrument plotter features: 12 scales to accommodate both NOS & Jepp instrument charts, including a conversion scale for Nautical and Statute miles; holding patterns depicted for both Standard and Nonstandard entries; compass roses allowing quick course & bearing information; and professional layout enabling easy reading during en route spot checks.
P/N 13-02306 **\$10.95**



FIXED PLOTTER - Constructed of sturdy clear plastic with easy-to-read numbers and scales. It includes WAC, Sectional, and Terminal Area scales, and is checked and approved by the Weights and Measures Department. Quick scale reference is provided for both statute and nautical miles.
P/N 13-02304 **\$8.55**



ASA ROTATING PLOTTER - Features a nonslip rotating azimuth made from strong plastic for quick course readout. Constructed of sturdy, clear plastic with easy-to-read numbers and scales.
P/N 13-02307 **\$12.65**

THE PILOT POCKET PEN HOLDER



The Pilot Pocket PEN holder is the easy solution to stowing pens, pencils and sunglasses in the cockpit. The compact design and suction cup mounting over a variety of placement options in any type of cockpit. A convenient temperature conversion chart is printed on the front for quick reference. Secures firmly to any smooth plastic or glass window surface with its 3 suction cup design. Each suction cup has a pull-off tab, making it easy to detach and reattach. It's perfect for airplane renters. Built-in pen slots. Convenient holder for your sunglasses. Constructed of high quality, transparent acrylic that is strong, resistant to scratches and won't discolor in sunlight. A convenient temperature conversion chart is printed on the front for quick reference. 4" high, 1.25" wide and 1.25" front to back.
Pilot Pocket..... P/N 13-16371 **\$16.95**



PEN AND TOUCH PAD STYLUS

A dual-purpose, twist action (black ink) ballpoint pen featuring a soft stylus end for use with touch-screen mobile devices such as iPads, tablets, smartphones, etc. Black barrel with chrome accents.
P/N 13-12066 **\$3.95**

PS

ASA PILOT SUPPLIES

APPROACH PLATE BINDER



Made of durable black vinyl with a reinforced spine, it has easy-to-open, 1-1/2" steel rings that accommodate the drill pattern of the approach plates. ASA wings tastefully silver-foiled on the front cover. Choose from either 4-ring NACO or 7-Ring design.

7-Ring.....P/N 13-02316\$10.95

ASA 4 RING FLIP BINDER



Perfect for Instrument Pilots who carry a smaller number of approach charts. One-inch rings are attached to a sturdy poly backing, with a loose poly cover. Scoring on front and back covers allows you to flip charts completely around the rings and display the one you want on top. Compact, convenient, and practical.

.....P/N 13-02321\$10.95
Replacement Rings.....P/N 13-12055\$4.95

7 RING BINDER KIT



Contains 1 binder, 10 sheet protectors, 5 color side dividers and a sheet of area stickers.

7-Ring.....P/N 13-02322\$19.95

ASA DELUXE RING BINDER



The Deluxe 2" 7-Ring Binder is made of richly-grained simulated leather with edge stitching. It's bound for maximum durability and equipped with a ring system that will keep your approach plates securely organized and easily accessible. Convenient 8.5" x 9" size makes it easy to fit in almost any flight bag.

ASA Deluxe 1" 7-Ring Binder.....P/N 13-05759\$25.80
ASA Deluxe 2" 7-Ring Binder.....P/N 13-05760\$29.95

ASA 1 INCH 7 RING TRIP BINDER



The 7-Ring Trip Binder is made of durable poly. It's bound for maximum durability and equipped with a ring system that will keep your approach plates securely organized and easily accessible. The three rings are spaced to match the 7-hole approach plate drill pattern. Convenient 7" x 9" size makes it easy to fit in almost any flight bag.

P/N 13-05825\$11.95

ASA POLY SHEET PROTECTOR FOLDERS



These durable, translucent plastic covers protect your most frequently used 4-ring or 7-ring style approach plates from wear and tear. These open on three sides. Sold in an envelope containing 10 sheets.

NACO Poly Folders pk of 10/P/N 13-05820\$3.95
7-Ring Vinyl Pocket pk of 10.....P/N 13-02318\$5.95
7-Ring Poly Folders pk of 10.....P/N 13-05821\$4.35

5 COLOR DIVIDERS



For quick reference of various sections of both types of approach plate charts, these five distinctly-colored dividers extend out beyond the side of the charts. Set of 5.

7-Ring.....P/N 13-02323\$6.95

ASA 4 RING NOTEPAD



Compact, convenient writing pad that fits in your approach plate binder. 100 sheets per pad. Weight .80lbs

4-Ring.....P/N 13-05822\$4.90



FLIGHT PLANNER SHEETS

Cross-country planning sheets contain a flight plan section, weight & balance calculation chart, special equipment suffix chart, fuel management, space for radio frequencies, & more. Sold in pads of 48.

P/N 13-18431\$3.95

STUDENT FLIGHT RECORDS



ASA Flight Record Folders provide areas to record pertinent student information, stage checks passed, lesson content, lesson performance, flight hours, instructor notes & endorsements, solo endorsements or aircraft checkout records, and

are current to both Part 61 & Part 141 program requirements. Sturdy & durable, these flight records are available separately, as part of ASA's pre-packaged training kits, or as part of an ASA PACK - Personalized Aviation Custom Kit.

SFR Private.....P/N 13-01548\$2.35
SFR Commercial.....P/N 13-01549\$2.35
SFR Instrument.....P/N 13-01551\$2.35
SFR Helicopter.....P/N 13-01547\$2.35

CERTIFICATES AVIATION ACHIEVEMENT AWARDS



Authentic, full-color certificates are perfect for framing yet sturdy enough to slip into the student's flight record as a pleasant surprise to be discovered on their next visit to the airport. Mark progress with style, while further motivating students. 9"x12". Sold in packs of 10.

Private Ground School Certificate.....P/N 13-02327\$11.50



HOLDING PATTERN VISUALIZER

This useful tool shows a pilot which entry is appropriate given the assigned holding radial, making it a superb learning tool.....P/N 13-06940\$11.95



LANDING PATTERN COMPUTER

Easily helps determine appropriate headings for each leg when landing or departing the airport - great teaching aid! Color may vary

P/N 13-06935\$13.95

YOKE CLIP



ASA's new yoke clip holds all the necessary flight paperwork right where pilots need it, leaving their hands free to fly. Simple to install, the black plastic, I-Beam construction is strong enough to serve as a pilot's third hand. The clip is higher than other yoke clips, holding sectionals, approach plates, flight logs, checklists, flight computers, and pens in easy view. The unique, over-centering cam easily adjusts to fit all general aviation aircraft yokes without modification.

P/N 13-01043\$12.75

ASA PILOT HAT



Pilot cap featuring comfort headband and classic wings logo. Stylish baseball cap. Black with neatly embroidered white ASA wings. Adjustable headband for maximum comfort. No button to interfere with headset band. Long bill for sun protection. Perfect for cross-country flying, lounging with friends or on the tarmac hangar flying. Wear it proudly!.....P/N 13-12964\$10.95

PS

ATIS WHEEL PRO



The Atis Wheel™ PRO is a mechanical device designed to help the airplane pilot in recording all ATIS information while presenting the data as a graphic depiction. The Atis Wheel™ PRO is presented on a 3.5"x 5.5" rectangular durable format with seven individual 1.5" wheels positioned about the perimeter of the device along with two, 3" concentric wheels positioned in the center. The Atis Wheel™ PRO information follows the sequential presentation of the ATIS information, providing the pilot the

following data: • The ATIS information phonetic letter identifying this specific ATIS report, named sequentially after a phonetic letter of the alphabet. • Example: This is Providence ATIS information ALPHA. • The time the ATIS information was recorded - in ZULU (GMT) time. • In as much as all ATIS information should be current, there is no wheel on the Atis Wheel™ PRO to record the ZULU time. • The DIRECTION from which the wind is blowing. • The VELOCITY of the wind, and wind GUSTS, if any. • The VISIBILITY and SKY condition. • The CEILING of the sky (if any) and cloud height, if OVERCAST. • The TEMPERATURE and DEW POINT. • The RUNWAY in use for LANDING and TAKEOFF. • The instrument APPROACH in use for landing. • The BAROMETRIC pressure, in order to calibrate the altimeter Additional tower comments (i.e., notice of closed taxies, etc.)
P/N 13-05003\$3.49

EZ ATIS REMINDER PILOT TOOL



The EZ ATIS Reminder makes it easy to communicate the ATIS identifier. No more fumbling through papers for the ATIS identifier - or worse yet, having to recall the prefix from memory! The 1-5/8" diameter knob with 1/2" pointer has a peel and stick adhesive tape on the back that can be easily mounted on your instrument panel, knee board, or anywhere you need a quick ATIS recall.
P/N 13-04920\$12.95

ATIS-MINDER



Designed in 2000, the ATIS-MINDER™ solved several issues for many pilots and those involved in regular use of the phonetic alphabet. The ATIS-MINDER™ meets this demand with precision and adds efficiency to any cockpit. Excellent teaching tool for the student pilot preparing for their licensing criteria. Can be mounted on the yoke, panel, or kneeboard with the hook and loop fastener provided in the purchased package.

Left HandP/N 13-16442\$34.95
Right HandP/N 13-16441\$34.95

RADIALMATE COMPASS ROSE

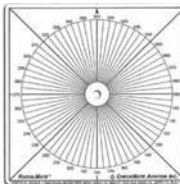

RadialMate™, a 3.5" clear 20 mil plastic compass rose allows you to instantly read a desired course by placing the product over any sectional, chart, or graphic. There are no reciprocals to calculate. RadialMate™ comes with a hole in the middle, allowing additional use as a string compass. It is conveniently sized to fit in your pocket. RadialMate™ also contains Safe Flight's vertical scale which measures mileage for WAC, SEC, TAC, NOS, JEPPI and ELA charts eliminating the need for that ruler you can never find.
P/N 13-08799 \$6.75

EXPERIMENTAL AIRCRAFT CERTIFICATION KIT



A new amateur-built aircraft certification kit created by the Experimental Aircraft Association (EAA) gives builders a simplified way to complete the required FAA paperwork for their new projects. The Amateur-Built Aircraft Certification Kit includes everything you need to register and certify a new experimental amateur-built aircraft in the United States. The 15-page, step-by-step guide walks

you through the entire process from getting an N-number to the aircraft inspection, and provides samples to help complete each required form. The kit includes all FAA forms, Experimental sticker (in black), data plate, and a convenient placard decal sheet.....P/N 13-04244\$20.50

SPORT PILOT PRE-PRINTED LOGBOOK ENDORSEMENTS

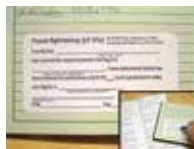

The Instructors Endorsement Pack contains 14 sheets of labels. Each sheet of labels contains 10 copies of a specific endorsement. Each 2" x 4" endorsement label is identified by title and FAR number, has the exact wording as required by the regulations, and has data-prompted blanks for the students' name, your name, CFI cert.#, Biennial Flight Review Certification 61.56(a).

Description	Part No.	Price
Instructor Endorsment Pack Enpak	09-01310	\$18.75
Pre-Solo Aeronautical Knowledge 61.87B	09-01311	\$1.95
Pre-Solo Flight Training 6187C	09-01312	\$1.95
Pre-Solo Training & 90 Day Renewal	09-01313	\$1.95
Solo at Another Airport 6193B	09-01314	\$1.95
1St Solo X-C 61.93(C)(1) 6193C	09-01315	\$1.95
Solo X-C 61.93 (C)(2) 6193C2	09-01316	\$1.95
Repeated Solo X-C <=50Nm6193b2	09-01317	\$1.95
Solo in Class B,C & D 6194A	09-01318	\$1.95
Solo to/from Class B,C Or D	09-01319	\$1.95
Taking Knowledge Test 6135A	09-01320	\$1.95
Proficiency Check 61321	09-01321	\$1.95
Passing Flight Test 61309	09-01322	\$1.95
Taking Sport Pilot Practical Test 61313	09-01323	\$1.95

ASA CX-3 ELECTRONIC FLIGHT COMPUTER



Note: To mount the CX-3 flight computer, use the MGF Sport Stratus mount combined with any MGF Sport yoke, suction, glare shield mount. (See Accessories)

The CX-3 Flight Computer provides a fast, accurate flight computing solution and takes confusion out of the equation for ground school study, preflight planning, and enroute navigation. Fast, versatile and easy to use, the CX-3 delivers accurate results quickly and efficiently through an intuitive menu structure designed to follow typical flight planning sequences with a minimum of keystrokes. It can be used on all FAA and Canadian pilot, mechanic, and dispatcher knowledge exams.

A multitude of aviation functions can be performed on the CX-3 flight computer including those related to time, speed, distance, heading, wind, fuel, altitude, cloud base, standard atmosphere, glide, climb & descent, weight & balance, as well as a holding pattern function to help determine entry method and holding details. A calculator, clock, timer and stopwatch are also built in along with multiple settings for lighting, backlighting, themes, scrolling speed, time zones and more. Weight: 0.70 lbs. Dimensions: 3-1/3" W x 6-1/2" H x 3/4" D

P/N 13-01040\$99.95

PN-1 NAVIGATION PLOTTER



Allows easy identification of WAC and Sectional chart scales. Calibrated in statute & nautical miles. (Size: 12.25" x 4")

P/N 13-21724\$12.00

PJ-1 ROTATING AZIMUTH



Measure the true course or to determine the magnetic course. Includes scales for sectional terminal area & WAC charts in statute & nautical miles. Size: 3.25 x 13"; 3-3/8" Dia.P/N 13-21726\$15.85

BLIND SPOT'S ALL-IN-ONE PILOT'S RULER



The Blind Spot's Original Pilot's Ruler has been designed to offer pilots maximum support, in the simplest way. The concept enables the pilot to solve VFR navigation problems and provide useful information, both at a glance, in only a few seconds and with only one instrument! The use of the ruler is extremely simple & fast. The pilot can concentrate more on flying, less on calculating, thus fly more relaxed and safer. Blind Spot's Original Pilot's Ruler (for USA airspace) is a two-sided pilot's ruler designed for flight preparation and use in flight. Size: 1.8" x 12".....P/N 13-11733\$19.95

PS

FLIGHT COMPUTERS – PLOTTERS



JEPPESEN STUDENT CSG COMPUTERS

This computer made of composite materials works just like an aluminum computer with all the same functions and features, but at a lower cost. Ideal for new students or as an extra to keep in your desk at home. Printed numbers are sharp, clear, and easy to read. Like all Jeppesen products, the quality is superior.
Plastic.....P/N 3866 **\$14.49**



ASA E6B METAL FLIGHT COMPUTER

STANDARD

The best slide-rule-style flight computer on the market, with solid aluminum construction and easy-to-read lettering. ASA's E6-B features a wind component grid and comprehensive crosswind correction chart, and on the other side the slide computes time, speed, distance, altitude, true airspeed, and density altitude problems as well as conversions. Nautical and statute scales are included. Standard (9-3/4" x 5")P/N 13-00813 **\$33.50**



MINI

This pocket-sized, brushed aluminum E6-B is a full function aviation computer. Popular among military pilots, it features a high-speed and low-speed wind correction slide, high-speed compressibility table, and instruction manual. Micro E6-B performs all the standard manual flight computer functions, and it conveniently fits in a shirt pocket or glove boxP/N 13-02299 **\$31.95**



ASA COLOR E6-B COMPUTER

ASA's color E6-B is enhanced with color for quick identification of key elements and easier readability. The new color E6-B is based on ASA's most popular model: slide-rule-style flight computer, the ASA-E6B. It's identical in size to the venerable favorite, made with the same solid aluminum construction and featuring all the functionality pilots have relied on for decades. On the circular side, black is used for the rate arrow and units to be calculated, red is used for weight and volume and blue is used for distance, time and temperature scales. On the wind side, colors are used to identify wind variation: blue identifies west (or right wind correction angle) and red identifies east (or left wind correction angle). Measures 9-3/4" x 5". In The Box: Vinyl case, and Instruction booklet.
P/N 13-10288 **\$38.99**

APR PLOTTERS



DNP-13

13" Deluxe Navigation Plotter with nautical and statute scales, sawtooth graduated color-coded scales for Sectional, WAC, and Terminal Charts. PVC plastic 13-5/16" x 4"P/N 13-06696 **\$10.75**

VOR FLASH CARDS



Designed to show any pilot how to look at a VOR receiver and read it at a glance. There's no time in the cockpit to spend slowly analyzing the CDI needle and To/From indicator! VOR-At-A-Glance flash cards will teach you: • The difference between VOR courses and VOR radials • What the VOR does not show you • The best way to think about the course deviation indicator • Inbound vs. outbound course indications • How to instantly know your position relative to the VOR • Tricks for reading interception courses right off the VOR • Pilots need to be able to look at a VOR and read the information off immediately. It's just like when you first learned how to read. There is a big difference between the ability to sound the words out and the ability to look at a work and just read it. Pilots need to be able to "read" the VOR!
P/N 13-05773 **\$39.95**

VOR TRAINING AID



The VOR Training Aid Includes a rotating OBS and a heading indicator dial. Both the glide slope and localizer CDI needles are movable and have an adjustable ON/OFF, NAV flag. The TO/FROM indicator is also adjustable. List, depict and erase VOR intercept instructions and holding clearances in the top practice area.
P/N 13-16037 **\$18.95**

ADF TRAINING AID



The ADF Training Aid features realistic rotating ADF bearing indicator needle and a heading indicator dial. List, depict and erase NDB intercept instructions and holding clearances in the practice area.....P/N 13-16038 **\$15.95**

APR INTERNATIONAL NAVIGATION PLOTTERS

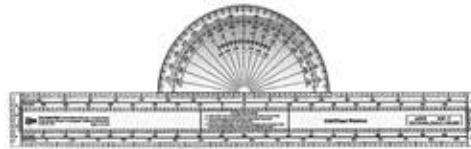

Scales on white background for easy readability set on see-through "clear vision" vinyl. Statute and nautical scales are parallel, making conversion easy. One side scaled for WAC charts, one for Sectional charts. "How-to-Use" instructions printed on plotter. Includes illustrated practice problems.

Plotter/Protractor CPP-5 Douglas International
Combination Plotter/Protractor13-03506 **\$5.95**

E6-B HIGH SPEED SLIDE

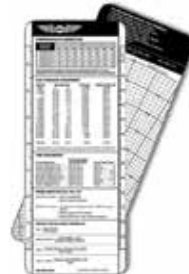

A companion product, this slide picks up where the traditional metal flight computer leaves off (ASA-E6B), providing calculations for the high-speed realm of flight (in the range of 220-700 knots or miles per hour). Pilots simply replace their current slide with this one, which then continues to use the circular computer from traditional E6-Bs. The slide also includes compressibility correction chart, ICAO Standard Atmosphere reference table, worldwide time conversion table, speed limits for the United States, and most frequently-used weight & balance formulas. All of the pertinent formulas & information required for

high-altitude, high-speed operations. Meets both FAR & JAR (international) requirements.
E6-B High Speed SlideP/N 13-02301 **\$14.75**

RUNWAY SELECTOR



Runway Selector is a simple tool pilots use to select the best runway based on prevailing winds. Runway Selector is a quick easy visual reference for all pilots! As an added bonus, the tool can also be used to confirm your take-off runway as well! Together, all the features of Runway Selector serve to provide multiple quick references for any pilot. The tool is also an excellent tool for instructors to use in teaching a new student pilot in a myriad of situations and teaching situations!.....P/N 13-14811 **\$19.95**

JEPPESEN PV-5 IFR ENROUTE PLOTTER



Size 3-3/16" x 8-1/2".....P/N 13-21718 **\$12.50**

PS

FLIGHT ACCESSORIES



ERASABLE HIGHLIGHTERS

These erasable highlighters allow you to highlight all necessary information. They also allow you to erase any marks you've made by mistake! With dual ends, these highlighters will make everything you do in the cockpit easier and more efficient.

Pink.....P/N 14-01638**\$4.35**

CHINA MARKER WHITE



The economical solution for marking on porous and non-porous surfaces such as paper, cardboard, plastic, wood, glass, ceramics, and some metal.

Product Details:

- Moisture Resistant
- Smooth Writing
- Non-toxic Pigments.....P/N 14-01625**\$0.88**

PILOTS FREQUENCY REMINDERS



This little prompter is designed to allow the pilot (especially students) to pre-plan which frequencies will be used during a flight and hang this handy item close at hand in the cockpit. This is ideal when operating in a high density airport area. Helps eliminate cockpit clutter and searching for often used frequencies.....P/N 13-04391**\$5.50**

THE PILOT POCKET PRO



The Pilot Pocket PRO, upgraded design of the popular Pilot Pocket is the best fit yet for all your cockpit storage needs. If you are looking to keep a device within easy reach during flight - such as your smartphone (small or large) or your aviation Bluetooth device -the Pilot Pocket PRO has you covered. In addition to the main storage compartment, the Pilot Pocket PRO provides a convenient holder for your sunglasses and two pens. Do you need quick and easy access in the cockpit? Put it in your pocket!

Features: • Secures firmly to any smooth plastic or glass window surface with its 3 suction cup design. Each suction cup has a pull-off tab, making it easy to detach and reattach. It's perfect for airplane renters. • Built-in pen slots • Convenient holder for your sunglasses • Constructed of high quality, transparent acrylic that is strong, resistant to scratches and won't discolor in sunlight • A convenient temperature conversion chart is printed on the front for quick reference

Specifications: • Total Dimensions: 4-3/16" W x 4-3/4" H x 1-3/4" D
• Holds phone or accessory up to 3-3/8" W x 1-1/2" D
P/N 13-23279**\$29.95**

PS



PILOT & COPILOT SEAT HEIGHT PLACEMENT TOOL

This tool is a must have for any pilot and/or Flight School. Here are a few questions to ask yourself that will help explain why a pilot should use this Seat Height Placement Tool before every flight. This cockpit tool gives the pilot the advantage of consistency in their seat height placement in any airplane they fly. Industry wide, landing accidents have been on the rise. A majority of these can be attributed to improper seat height adjustment and sight picture. The Eye Aligner takes the guesswork out of where to adjust your seat, as well as where the proper Eyleline should be. As an aviator, you know all too well that there are flights where your landings are spot on, and flights where your landings are well.....let's just say not anything to brag about.

Through research, pilot surveys, and over 45 years of instruction, the Eye Aligner manufacturer has come to the conclusion that improper seat height adjustment and sight picture is the main contributing factor to this inconsistency. Made in the U.S.A.P/N 13-19015**\$89.95**

TOLD CARDS

TAKEOFF		LANDING	
QAT	PA	MDA	MSA
MAP/RPM	X-WIND	NORMAL	
NORMAL	OBSTACLE	V _{APP}	V _{REF}
V _{ROT}	V _{ROT}	SHORT FIELD	
V _Y	V _X	V _{APP}	V _{REF}
MIN REQD CLIMB	DTK	RWY	GND ROLL

WWW.TOLDCARDS.COM ©2012 WEBBAIR LLC

Told Cards are a great cockpit accessory for pilots flying in VFR and IFR conditions.

Description	Part No.	Price
Told Cards SE VFR 3x5 Double Sided Cards 25 Pack	13-12011	\$12.25
Told Cards SE IFR 3x5 Sticky Note Pad 50 Cards	13-12012	\$8.49
Told Cards ME IFR 2.5x3 Double Sided Cards 25 Pack	13-12013	\$8.49
Told Cards ME Take off 3x3 Sticky Note Pad 50 Cards	13-12015	\$8.99
Told Cards IFR Approach 3x3 Sticky Note Pad 50 Cards	13-12016	\$8.99

UNBREAKABLE SUPER PLOTTER



Here's a special flight planning tool we really like. A colorful little plotter with a rotating azimuth that makes it much easier to plot a course line.

Place the compass rose over your departure point and rotate the straight edge towards destination. Presto.. an instant readout of your course! Reads distance in statute miles or nautical miles for both sectional and WAC charts. Made of bullet proof Lexan. Won't crack, break, or warp in extreme heat or cold.P/N 13-03473 **\$18.95**



HIGHLIGHTER TAPE

A removable alternative to highlighter pens for all kinds of valuable permanent documents. Sticks securely, yet removes easily without damage to most surfaces. Vivid colors can't be missed, yet transparent feature allows you to see what is underneath. Economical - use as much or as little as you want.

Pink.....P/N 14-00889**\$4.95**
Yellow.....P/N 14-01860**\$4.95**
Green.....P/N 14-01861**\$4.95**
Orange.....P/N 14-01862**\$4.95**

CHART CLIPS - TOOL BAGS



PUT-IT SUCTION CLIP

This clip is strong enough to hold an approach plate, chart, or checklist. Attaches by a suction cup to the instrument panel, yoke or any other nonporous surface.

P/N 8197\$5.85



NO CLUTTER CLIPS

No Clutter Clips • Holds checklists, approach plates, charts, etc. • Stick on most slick surfaces • UV Resistant
1 Small clip per packageP/N 13-06636\$5.35
2 Small clips per packageP/N 13-06408\$9.50
1 Large clip per package.....P/N 13-06409\$6.80



WATCH-IT ACCESSORY HOLDER

"World's most versatile holding device". Lets you mount time pieces and calculators exactly where you want-on the wheel, the yoke tube of clipboard. An ingenious bracket, an adjustable holding loop, and a little Velcro is all it takes. Once positioned, can be mounted & removed repeatedly. Non-reflecting, black materials, weighs less than 1oz.....P/N 8265\$10.90



YOKE CHART CLIP

When you want the chart or approach plate right in front of you - this clip will hold it on the yoke. Adjustable band wraps around the yoke and holds the clip firmly. Fits all general aviation aircraft controls. Non-reflective black finish.....P/N 8135\$9.95



CESSNA YOKE CLIP

Yoke Mount Combo Clip (Large). Fits 1" - 1 1/2" Diameter ShaftP/N 13-02845\$9.50



IFR CHART CLIP

Make IFR flying simpler by keeping vital instrument approach plates and charts in place. Attached to the yoke rather than in your lap or on the floor, this chart clip comes in various models designed to install easily on the yoke of your aircraft. Insures that your navigational charts stay in front of your eyes when you need them most. Handy for VFR charts as well. We'll be happy to assist you in determining what model chart clip will best fit your aircraft.

1.5" Post Standard Clamp.....P/N 8131\$21.75
1.5" Post Wide ClampP/N 8487\$22.75
2" Post Standard Clamp.....P/N 8690\$22.75
2" Post Wide ClampP/N 8822\$21.95
3" Post Standard Clamp.....P/N 8674\$21.95
3" Post Wide ClampP/N 8915\$21.75



YOKE CLIPS

Clip this yoke on your aircraft so it does not interfere with movement of controls. Spring may be adjusted for smaller diameter shafts by pinching with pliers.

Large - Used on 1" tubeP/N 13-04392\$12.75
Small - Used on 3/4" tubeP/N 13-04393\$12.75



APPROACH PLATE HOLDER

• 10 leaf • Flip-over (not accordion) • Size: 6"x 9" • Vinyl.
P/N 13-02772\$5.95



CARRY-IT CORDURA TOTE CASE

This multi-functional tote case is made from black Cordura fabric and features 8 pockets and velcro closures. Holds radios, flashlights, pens, pocket PC, maps, charts & more.
P/N 13-01757\$21.50



PROFLIGHT BOOSTER SEAT POUCH

• End cockpit clutter • Made of durable Cordura • Stores flashlight, fuel tester, flight guides, approach plates, charts, plotter, E6-B, sunglasses and more. • Available in black, AF blue & red.

Black.....P/N 13-31871\$21.50
Blue.....P/N 13-03005\$33.50
Red.....P/N 13-31870\$18.85



23 POCKET BIGMOUTH BAG

17 Multi-use pockets inside and 6 outside organize tools and accessories. Opens wide for easy access to bag's contents. Padded reinforced web carrying handles. 12"L x 8 1/2"W x 8"H
P/N 12-00329\$23.85

12 POCKET TRAYTOTE BAG

- This bag has 2 pockets inside and 10 pockets outside with a 11"x 6" multi-compartment tray which slides securely into bottom of bag. Opens wide for easy access to contents and has reinforced web carrying handles. 12"L x 8"W x 12"H.....P/N 12-00163.....\$49.50



14 POCKET TRAYTOTE BAG

- This bag features 2 pockets inside, 12 pockets outside, with a 13.5" x 6" multi-compartment plastic tray slides securely into bottom of bag. Opens wide for easy access. 16"L x 9"W x 12"HP/N 12-00164\$68.75



MILITARY STYLE TOOL BAGS

These tool bags are made of heavy-duty military-type tough 18oz./sq.yd. cotton duck with a water repellent mildew-resistant treatment. The mechanics Tool Bags have compartmentalized side pockets with flaps. Hardboard bottoms are completely sewn into each bag and are unexposed. All stitching is of heavy duty nylon thread and the handles are made from heavy military spec. webbing. All inside seams are bound to eliminate raveling of the fabric. Long-tab, self-locking slider. Color: O.D. Green. Available in 2 sizes:
O.D. Green Small: 6" x 6" x 12" Bag.....P/N 13-02500\$69.50
O.D. Green. Large: 5" x 5" x 16" Bag.....P/N 13-02600\$77.50



UNIVERSAL BEVERAGE HOLDER

This Universal Beverage Holder made of billet aluminum installs easily in any thickness dash or instrument panel. Available in two styles, with square or oval face-polished surfaces, its compact design permits vast installation possibilities.

Features: • Billet Face, Tray & Stirrup • Easy to Install with Simple Tools • In Dash or Under Dash Installation • Will Install in Any Thickness of Material • Two Styles of Face Plates, Square or Oval • Holds Cans, Bottles & Tapered Cups to 32oz. • Eliminate Face Plate for Stealth Appearance
Oval FaceP/N 13-03792\$139.00



AIRMAN CERTIFICATION HOLDER WITH FAA SYMBOL

Airman Certificate holder with imprinted FAA symbol.....P/N 13-19713\$23.95



LICENSE HOLDERS

Black leatherette with clear plastic window to display ownership certificates. P/N 13-07900 only includes eyelet holes for mounting and metal plates to keep corners from fraying.

4-7/8" X 6-7/8".....P/N 13-07900\$9.95
7-1/2" X 8".....P/N 13-17904\$14.50
7.5" x 5.5".....P/N 13-17905\$14.75
14" x 5.5".....P/N 13-17906\$17.75



NELSON AIRCRAFT DOCUMENT CASE

This durable, flexible blue cordura pouch is an ideal way to keep aircraft registration, insurance, log books, operating manuals, and other important documents all in one safe location. Measures 18"W x 12"H. Features top quality zipper along front side for easy access and location to mark your aircraft number on front. • Made of Cordura • Two compartments
Red.....P/N 13-02934\$32.75

PS

KNEEBOARDS

SOFT-G PLUS KNEEBOARD



This kneeboard is originally designed for high performance fighter & attack aircraft. Standard features include: reversible clip board which allows pocket and document loops to be reversed right or left side, 1-1/2" wide adjustable plastic strap, clear plastic information pocket, removable document loops, 4 elastic pen/pencil slots, side release buckle, durable wire clip, and

NEG-G strap.....P/N 13-12655.....\$59.75

The performance package includes: information cards, clear document protectors, removable document protectors, and releasable cable ties (holds document protectors securely to kneeboard).

P/N 13-12656.....\$73.75

TRIFOLD KNEEBOARD



The standard features include: right and left light pockets that double as pen/pencil pockets, 1.5" wide adjustable plastic strap, 4 clear plastic information pocket, right & left document loops, side release buckle, durable wire clip, and padded backing.

P/N 13-12660.....\$58.75

The performance package includes: information cards, clear document protectors, flex light with fixed or adjustable beam, and releasable cable ties (holds document protectors securely to kneeboard) optional.

P/N 13-12661.....\$69.95

9-G PLUS KNEEBOARD



This kneeboard is originally designed for high performance fighter and attack aircraft. The standard features include: right and left light pockets that double as pen/pencil pockets, 1.5" wide adjustable plastic strap, 3 clear plastic information pocket, right and

left removable document loops, side release buckle, easy access pocket, durable wire clip, and padded backing..... P/N 13-12650.....\$55.75

The performance package includes: information cards, clear document protectors, removable document protectors, & releasable cable ties (holds document protectors securely to kneeboard).

P/N 13-12651.....\$70.85

MINI TRIFOLD KNEEBOARD



This mini trifold kneeboard measures 8" x 16.5". The standard features include: reversible clip board which allows pocket and document loops to be reversed right or left side, 1-1/2" wide adjustable plastic strap, clear plastic information pocket, removable

document loops, 4 elastic pen/pencil slots, side release buckle, durable wire clip, and NEG-G strap.....P/N 13-12665.....\$49.95

The performance package includes: information cards, clear document protectors, removable document protectors, and releasable cable ties (holds document protectors securely to kneeboard).

P/N 13-12666.....\$69.95

JEPPESEN IFR THREE-RING TRIFOLD



The Jeppesen three ring trifold is great for holding approach charts and features three approach chart pockets, collapsible rings, elastic pen / pencil / penlight holders, and valuable IFR flight information the clip board. Includes free U.S. Low altitude planning chart. Size: 10"x 20" open.

Kneeboard/Clipboard.....P/N 13-06956.....\$40.90

ASA IFR & VFR KNEEBOARDS



These IFR and VFR Kneeboards are an attractive, light gray, brushed aluminum. Instrument and visual information is clearly silkscreened on the boards so pilots can quickly reference rules at a glance when operating a cyclic or stick. All information on the Kneeboards match current Federal Aviation Regulations. The Kneeboards feature a comfortable, 1.5" wide elastic legband that hugs the leg without binding. Velcro fasteners can be adjusted without removing the kneeboard and fits all leg sizes. A pencil/pen holder is designed into the leg for fast note taking. The Kneeboards also feature a 4-3/4" wide metal clip that is easy to lift

and strong enough to hold NOS charts and other necessary papers. Paper-protector elbows secure material, yet papers won't rip when pulled out.

VFR Kneeboards.....P/N 13-06925.....\$16.50

IFR Kneeboards.....P/N 13-06930.....\$16.50

VFR KNEEBOARD



Jeppesen's VFR Trifold Kneeboard places information at your fingertips. It organizes and holds charts, flight computers/plotters, flashlight, pen, pilot notes and more. An elastic leg strap sewn to the kneeboard holds this unit comfortably in place with a

Velcro closure. Additionally, the foam-cradled back allows for added comfort and leg positioning. The metal clipboard includes valuable information for your VFR and IFR flight needs. Also includes a leg strap that allows you to use the clipboard independent of the kneeboard. Designed for superior strength, abrasion resistance and durability.

(Size: 21" x 11 1/2" open.).....P/N 13-06955.....\$40.95

FORCE PROTECTOR GEAR KNEEBOARD



Go full electronic with the ability to use an iPad, or old school.

Perfect companion for any COCKPIT OR VEHICLE. "FPG Knee Chocks" lock down the Kneeboard from slipping with less tension on the leg strap. They are adjustable to any size leg and any position needed. Retention strap to keep pages neat and tidy. Removable writing station with a clipboard

that you place as needed. Cell phone pocket. Plenty of small item storage with Velcro enclosure.

Color	Part No.	Price
Black	13-20221	\$104.95
Multi-Camo	13-20633	\$101.85
ABU Camo	13-20635	\$101.85
Coyote	13-20636	\$99.95

TRI-FOLD KNEEBOARD



This elongated 3-panel kneeboard accommodates aeronautical charts without additional folding. The center section of the 3-panel cordura-like jacket holds the included brushed aluminum kneeboard in place, while the two side pockets offer storage for charts, notes, a flight computer, pencil, pen and more. Quick VFR reference information

is tooled into the brushed aluminum kneeboard offering resources for weather and flight planning, VFR ceilings, visibility, cloud clearance, cruising altitudes, pilot weather reports, light gun signals, a crosswind component graph, and more. A wide, sturdy clip on the kneeboard holds papers on place. The left inside panel of the jacket has two pockets for flight plans and notes, as well as elastic straps for holding a flight computer or other flight accessory. The right hand panel has a see-through pocket for easy chart viewing and storage. The hook-and-loop fasteners on the elastic leg band allow the kneeboard to adjust to a variety of leg sizes. Closed Dims: 10-1/4" Length x 6-1/2" Width. Open Dims:10-1/4" Length x 21" Width **Note:** Includes metal clipboard shown in center of the photo. Does not include E6B Flight Computer or charts in the right and left pockets.....P/N 13-06950.....\$42.50

MYCLIP MULTI KNEEBOARD STRAP



The MyClip Multi works on all Apple® iPads including the iPad Pro, iPad Air, iPad Mini and the iPhone 11! The updated product design securely holds almost any tablet with a thickness of .85 inches or less. This innovative product will even hold smartphones over 3 inches in width like the Galaxy Note. Uniquely engineered clips will securely hold a bare iPad as well as one in an armored case.

P/N 13-22441.....\$34.95

FLIGHT DESK TRI-FOLD KNEEBOARD



Flight Desk Kneeboard greatly improves cockpit organization of charts & accessories. Unlike some other kneeboards with limited utility, will hold sectional charts, a large E6B type computer, and has two elastic loops on either side of the clipboard to hold a goose-neck type flashlight. If the

middle loop is not used for a computer, it can be used to hold a handheld transceiver.....P/N 13-03474.....\$16.75

INSTRUMENT MANUAL AND CHARTS BAG



It will hold all your required instrument manuals and charts. This bag has a flap with velcro closure, two handle straps for added strength, and outside pockets perfect for pen and pencil supplies.

Small Dimensions: 9.5"H x 5"D x 6.5" W

P/N 13-19813.....\$12.95

Large Dimensions: 9.5"H x 5"D x 7"W

P/N 13-19814.....\$14.95

KNEEBOARDS



W-2 KNEEBOARD

Kneeboard is made from highly durable and water resistant nylon. Removable strap for the checklist on the left side and two pockets on the right side- one pocket for an E6B and the other for a flashlight. RTwo pencil pockets. RFastened to the leg using an adjustable elastic strap complete with buckle and quick release clip.

P/N 13-19805\$46.65

W-4 KNEEBOARD

Kneeboard is made from highly durable and water resistant nylon. Removable strap for the checklist on the left side and pencil holders, a small pocket for CEPs, and a larger pocket for an E6B on the right side. An added feature is the clear strap that goes across the clipboard to keep pages from flying around. Fastened to the leg using an adjustable elastic strap complete with buckle and quick release clip.

P/N 13-19806\$32.65

W-4 KNEEBOARD WITH FLIP POCKETS

Kneeboard is made from highly durable and water resistant nylon. Removable strap for the checklist on the left side and pencil holders, a small pocket for CEPs, and a larger pocket for an E6B on the right side. An added feature is the clear strap that goes across the clipboard to keep pages from flying around. Fastened to the leg using an adjustable elastic strap complete with buckle and quick release clip. 6 clear pockets that flip up and down.....P/N 13-19807\$37.95



NELSON KNEEBOARDS

MILITARY TRI-FOLD

- Size: 19.5"x11.5" (open), 11.5"x7" (closed)
- Holds sm E6-B, stopwatch, pencils • Supplied w/pad of 50 flight logs • Aluminum board holds approach plates

GrayP/N 13-06910\$21.75

LARGE TRIFOLD KNEEBOARD

Kneeboard is made from highly durable and water resistant nylon. One pocket on the front (when closed), two pockets on the left, two pencil holders, and a plastic pocket on the right. An elastic band to hold a flight computer and a plastic clipboard in the center. When closed, the kneeboard is held together with velcro fasteners. Fastened to the leg using an adjustable elastic strap complete with buckle and quick release clip. Dimensions: 7" x 9 1/2" when closed, 20" x 9 1/2" when open.

P/N 13-19812\$32.95

EFB CADDY

In a word it is all about "SAFETY"! With the advent of Electronic Flight Bag(EFB) software, Tablet technology and ADS-B receivers, today's GA pilot has access to reasonably priced, portable technology that greatly improves the safety conditions, under which they can now operate. Enhanced situational awareness and reduced pilot workload, both preflight and in-flight, are but two of the several benefits. EFB CADDY was designed to further improve the pilot experience, by addressing the deficiencies found in many of the current Tablet holder products. Secure physical attachment and head-up, unobstructed panel and outside view are critical features.

Description	Part No.	Price
Model: A - Cradle / Size: Large, Height 8.25" - 11.25", Width 7.75" Max., Depth 0.56" Max.	11-14025	\$224.95
Model: B - Cradle / Size-Small, Height 8.25" - 11.25", Width 6.80" Max., Depth 0.50" Max.	11-14026	\$224.95
Model: C - No Cradle	11-14027	\$210.95



SECRET POCKET PHONE CASE GENUINE LEATHER

This travelers accessory is made of light-weight / flexible genuine leather. Capacity for a phone up to 3-1/4" in width x 5" in length. The extended secret pocket 6" in depth fits smoothly along side your hip underneath clothing to easily hide: Passport, Money, Credit Cards, Small Valuables, and much more.

P/N 13-15692\$33.75

TRIFOLD WITH POCKET KNEEBOARD



Kneeboard is made from highly durable and water resistant nylon. Compact kneeboard made with the small cockpit in mind. One pocket on the front, two pockets on the left, two pencil holders, and a plastic pocket on the right. An elastic band to hold a flight computer and a plastic clipboard in the center. When closed, the kneeboard is held together with velcro fasteners. Fastened to the leg using an adjustable elastic strap complete with buckle and quick release clip.

Small Dimensions: 5" x 8" when closed, 14 1/2" x 8" when open
P/N 13-19810\$27.65
Large Dimensions: 7" x 9 1/2" when closed, 20" x 9 1/2" when open
P/N 13-19811\$32.65

ULTIMATE KNEEBOARD IPAD HOLDERS



The Ultimate Kneeboard iPad® holder has a seven ring design so it will fit both models of the Ultimate Kneeboard®. It is also designed to fit all models of the iPad® and iPad® mini. The Ultimate Kneeboard iPad® holder is made from the same durable materials as the Ultimate Kneeboard®. It is held in place at each corner with heavy-duty elastic and offers easy access to the Home button and connector port. Just like the Ultimate Kneeboard®, the iPad® holder comes with a money back guarantee and is made in the USA by folks from Boise, Idaho.

Mini iPad.....P/N 13-16345\$37.50
See Website for custom embroidery.....P/N 13-16348\$10.00

HARPER KNEEBOARDS



FIXED RING ULTIMATE KNEEBOARD™

The fixed-ring model is the most popular kneeboard. The convenience of the snap-open, ring binder design makes it ideal for quickly changing pages, charts and checklists. Pilots flying into multiple airports or flying a variety of planes will find the fixed-ring design perfectly suited for them.

P/N 13-07022\$46.50



LOOSE RING ULTIMATE KNEEBOARD™

Our loose-ring model has seven independent rings which are not bound together. The result is a kneeboard that molds perfectly to the shape of the pilot's leg. It is ideal for pilots who primarily fly the same airplane in and out of the same airport.

P/N 13-07023\$46.50

AVIATE PILOT KNEEBOARD



- Removable Clipboard – black non-glaring clip with rubber corners secure your contents on the lightweight but removable durable plastic clipboard which allows you to write on your knee
- Fully Adjustable – easy to use elastic strap adjusts to any size leg and hold strong with Velcro
- Convenient Design – holds pens, pencils, tire pressure gauge and a pocket to hold ear plugs and other small items

• Includes 7 Rings – accommodates your approach plates, checklists, manuals or any other 7 hole pilot documents
• Kneeboard Details – made of rugged canvas, 11.5" wide and flexes around the leg, 8.5" long, clipboard is 5.2" X 8.3"

P/N 13-21477\$37.95

PS

IPAD KNEEBOARDS – ACCESSORIES

THE APPSTRAP FOR IPAD



Converts the iPad or iPad2 into a pilot kneeboard. iPad™ instantly detachable from leg strap via Velcro™ joint. Great for flight crews who must share or stow device. Change between portrait & landscape effortlessly. Made of high-quality Aluminum & professional grade webbing. **For iPad 2, 3, and 4** & allows for power plug or GPS booster.....P/N 11-10399**\$54.75**

APPSTRAP IPAD GEL CASE 2/3



The original AppStrap now with a Gel case. TPU Gel Case. Fits the iPad2 & iPad3. Instantly share, stow or reposition.....P/N 13-12952**\$44.95**

APPSTRAP FOR IPAD AIR



This clip is approximately .75 inches thick. The original AppStrap archi-ecture now with a full skin instead of clips. Works well with both the iPad Air 1 and the new iPad Air 2. Product includes black, form-fitting protective gel case, adjustable leg strap and buckle, and 2 Tilt Pads for glare reduction and stability. P/N 13-15458**\$45.75**

THE APPSTRAP 5



Fits most tablets (8" - 10") when used with large protective case (Not Included) Devices: iPad1-4, iPad mini, Fire 8.9, Galaxy 10.x, Nexus. Cases: Otterbox Defender, Gumdrop Droptech, Griffin Survivor. Larger clip accommodates most heavy-duty cases. Fits cases 3/4" thick or less P/N 13-14753**\$47.85**

G-FORCE MOUNT FOR APPLE IPAD



The G-Force GF260 iPad Mount is everything you need to re-take control of your cockpit and restore confidence to your passengers. Your passengers? You bet! What are they thinking while you're fiddling with that thing in your lap. The G-Force GF260 iPad Mount comes complete: with a custom-designed cradle, tailored to your iPad-1 or iPad-2, secured to the remarkable G-Force GF2 Twin base. In lab tests, the GF2 Mount holds 53.25 gross pounds and withstands a shear force of 16.38Gs. In real time, that means one GF260 Mount Will Support Thirty-Nine iPads.

Rest assured, the G-Force iPad Mount will hold up your window to the world. User Guide includedP/N 11-10741**\$66.75**

EXECUTIVE IPAD KNEEBOARD KIT



This is the premium iPad kneeboard for the executive aviator on the go. Take it with you on land or in the air. This innovative, 3-in-1 iPad mount can be used as a standalone, or be clipped onto a kneeboard band to be used as a kneeboard. Use the optional RAM adapter and clip onto your RAM mount without changing mounting cases! P/N 13-12765**\$59.95**

EXECUTIVE IPAD MINI KNEEBOARD KIT



This is the premium iPad Mini kneeboard for the executive aviator on the go. Take it with you on land or in the air. This innovative, 3-in-1 iPad mount can be used as a standalone, or be clipped onto a kneeboard band to be used as a kneeboard. Use the optional RAM adapter and clip onto your RAM mount without changing mounting cases! P/N 13-12766**\$47.95**

EXECUTIVE IPAD KNEEBOARD KIT ACCESSORIES



Includes strap and Ram adapter. P/N 13-12776**\$18.95**

ASA IPAD MINI / AIR ROTATING KNEEBOARD



Designed by pilots for pilots, the high-quality iPad Rotating Kneeboard is covered with soft, leatherlike material and features a wide hook-and-loop leg strap to hold the kneeboard in place during flight.

Inside, the rotating iPad frame holds the device securely and allows for 360-degree rotation of the iPad. An easel is built into the kneeboard for adjustable tilted viewing, in and out of the cockpit. The power port is accessible with the cover closed, a window exposes the camera lens for easy picture taking, and a small elastic loop securely holds a pencil, pen or stylus.

Features: • Functional - Elastic strap makes for a secure fit in the cockpit; sturdy clips hold device in place • Versatile - Rotates 360 degrees to provide both profile and landscape options. Variable tilt feature allows for flat or pitched positioning in the cockpit or on the desktop • Multitasking Binder and Kneeboard - Window for camera. Elastic loop securely holds a pencil, pen or stylus. Strap kneeboard to your leg in profile or landscape position.

iPad Mini.....P/N 13-22232**\$45.50**
iPad Air.....P/N 13-22233**\$45.50**

IPAD AVIATION ACCESSORY KITS



This affordable accessories kit contains products you will need to start using your iPad in the cockpit. Our kit includes a Dual Universal XGPS150 receiver, a Genesis iPad nylon kneeboard and case, and a Lonestar 2 amp 12V/24V charger. We supply a premium charger which charges iPads, iPhones, iPods, etc. even during heavy use.

iPad 1 Kit.....P/N 11-10452**\$209.69**
iPad 2 Kit.....P/N 11-10453**\$215.70**

AIRGIZMOS IPAD PANEL DOCK (GEN 1, 2, & 3)



If you need to mount your iPad in your plane this might be the solution you are looking for. The base mount is designed to be screwed to a panel using a standard instrument mounting holes. The iPad snaps in and is held securely.

P/N 11-10830**\$59.75**

MGF IPAD PRO 11 SPORT KNEEBOARD / MOUNTABLE CASE



The iPad Kneeboard/Mountable Case is the perfect aviation kneeboard, mount and everyday case for the iPad. It is designed for the pilot looking to secure their iPad to their leg or for the pilot that prefers to mount their iPad. The black, smooth polycarbonate adds protection and great feel to the iPad. Take your iPad from air to office to home. It is perfect for pilots of all aircraft. This product fits the iPad Pro 11". Mounts Sold Separately

Features: • Cockpit Ready • Quick Connect • 360° Rotation • Sport Mount CompatibleP/N 13-22347**\$124.00**

EXECUTIVE IPAD CASE



This is the premium iPad case for the executive aviator on the go. Take it with you on land or in the air. Rotating case - view your iPad in landscape or portrait mode. Landscape folding cover - the cover closes even in landscape mode. P/N 13-12774**\$32.95**

EXECUTIVE IPAD MINI CASE

This is the premium iPad Mini case for the executive aviator on the go. Take it with you on land or in the air. Rotating case - view your iPad in landscape or portrait mode. Landscape folding cover - the cover closes even in landscape mode.....P/N 13-12775**\$32.95**

PS

IPAD KNEEBOARDS – IPAD HOLDERS

THE APPSTRAP FOR IPAD MINI



The original AppStrap architecture now with a full skin instead of clips. Compatible with the iPad Mini 1, 2, and 3. TPU Skin Protects iPad-mini. Functional & Protective. Instantly share, stow, or reposition. Note: Product received will be strap & skin only. This is not a kneeboard, only a strap & skin that your iPad mini fits in.

P/N 13-12709 **\$38.95**

APPSTRAP TILT PADS



The original tilt-pad will convert any device or case into a kneeboard. Heavy-duty leg strap. Velcro joint. 2 Tilt Pads. P/N 13-12954 **\$15.95**

APPSTRAP CONVERSION KIT



Turn any tablet into a kneeboard with our DIY kit! Die cut velcro joint. Compatible with most covers/skins. Portrait or Landscape. Instantly share or stow P/N 13-12953 **\$29.95**

APPSTRAP FOR THE IPAD MINI 4



The AS-mini 4 maintains AppStrap's commitment to excellence and pilot-approved design. The form-fitting gel-case adds protection to the damageable device and mates to the elastic leg strap using a unique and secure Velcro mating system. This allows the iPad to be repositioned with ease, stowed during flight, or adjusted to portrait/landscape mode. The unique modular tilt pad allows the device to be positioned at the optimum viewing angle and helps reduce annoying glare.

As with all of AppStrap's product offerings, the AS-mini 4 employs most-needed features for routine cockpit use. These tablet kneeboard devices maintain a low-profile design without sacrificing on quality or durability.

P/N 13-18750 **\$38.95**

GENESIS X IPAD ROTATING KNEEBOARD / CASE



Made to fit all generations of iPads and port locations. Main frame is made of tough ABS and the corners made of Polyurethane. The frame is contoured around the rear camera and the front camera is completely unobstructed to allow access for Facetime TM, photos or video. Size: 10" x 7.8" x 1" P/N 13-12391 **\$34.75**

GENESIS IPAD CLIPBOARD ADD-ON



A sturdy 3001 grade aluminum clipboard is riveted to a soft velvet backing to protect your iPad touch screen. Pen holder at the top. This is an add-on accessory for the genesis and genesis 2 iPad cases. Not a standalone kneeboard.

P/N 13-14734 **\$24.75**

W-4 IPAD MINI KNEEBOARD FOR USE WITHOUT CASE



Kneeboard is made from highly durable and water resistant nylon. Has a pocket for your E6B, 5 pencils holders, a pouch for your CEPs/earplugs, a removable grommet for your checklist, and a clear plastic strap that goes across your paper to keep them from flying away. One removable flip-up page with two pockets and a clipboard for PPC and notes. The middle of the kneeboard has 4 elastic bands at each corner to hold your mini iPad firmly in place. Fastened to the leg using an adjustable elastic strap complete with buckle and quick release clip.

P/N 13-19808 **\$47.50**

W-4 IPAD MINI KNEEBOARD FOR USE WITH CASE



Kneeboard is made from highly durable and water resistant nylon. Has a pocket for your E6B, 5 pencils holders, a pouch for your CEPs/earplugs, a removable grommet for your checklist, and a clear plastic strap that goes across your paper to keep them from flying away. One removable flip-up page with two pockets and a clipboard for PPC and notes. The middle of the kneeboard has 4 elastic bands at each corner to hold your mini iPad firmly in place. Fastened to the leg using an adjustable elastic strap complete with buckle and quick release clip.

P/N 13-19809 **\$47.50**

AIRGIZMOS IPAD 1 / 2 / 3 KNEEBOARD



The AirGizmo iPad Kneeboard allows accessing charts and apps on the iPad or iPad2 while flying easier and safer than ever. Molded plastic and a wide velcro strap allow for a secure, comfortable fit. Fold over tablet holder drops out of the way when not in use. Ability to adjust the angle of the iPad for best viewing angle and the ability to cut down glare. Designed to work with both the iPad and the iPad2. Width: 7.93 in. Height: 9.79 in. Depth: 3.75 in. Weight: 13.1 ounces.

P/N 13-11218 **\$78.85**

CLASSIC TORCHGRIP®



TORCHGRIP® is a patented, made-in-the-USA, universal computer tablet accessory that functions as both a versatile stand and handle providing secure and comfortable handling of your device. Compatible with all iPads and most other tablets. Its durable and stylish design is ergonomically crafted and lightweight. Every time you set down

your tablet, TORCHGRIP® is a stand. The handle rotates 360 degrees allowing multiple viewing angles in both portrait and landscape positions.

Black/Black P/N 13-19321 **\$59.95**

White/White P/N 13-19322 **\$59.95**

ASA IPAD PORTFOLIO KNEEBOARD



The iPad Portfolio Kneeboard is the ideal stylish multitasking kneeboard, binder, and versatile cover. It is functional and durable and protects your iPad in flight and on the ground making it your favorite cockpit companion.

Fits the iPad, iPad 2, and New iPad (iPad 3).

The inside sleeve holds your iPad securely on the right side with full access to iPad controls and button. The left side has pockets to store your documents and provides a writing surface. The elastic strap secures the binder-like case to your leg for inflight use and is easily removable for everyday use. The cover folds into a flap to serve as a vertical or horizontal desktop stand providing easy landscape viewing and full keyboard access. Beautiful black leatherette with embossed wings. Height: 9-11/16", Width (closed) 7-15/16", Width (open) 15-15/16" P/N 13-11337 **\$49.95**

Replacement Strap P/N 13-19794 **\$4.35**

ASA IPAD KNEEBOARD WITH COVER



The iPad Kneeboard is a versatile case and kneeboard that helps pilots protect and use their iPad in flight and on the ground. The elastic strap secures the case to the pilot's leg for in-flight use. The unique plastic cover keeps the iPad screen safe while maintaining full viewing and complete touch-screen functionality, and opens easily to

insert or remove your device. The easel folds to position the iPad at a convenient "wedged" viewing angle; alternatively, it can lay flat. The pocket on the back offers room for papers and maps. Openings are provided for charger and headphone/earbuds. Made of durable fabric with embossed wings. Fits the iPad, iPad 2, and New iPad (iPad 3). **Features:** • Easel folds up or down for optimal viewing and pocket provides access to charts and papers • Dock connector / power port accessible with the cover closed • Openings are provided for charger and headphone/earbuds • Fits both iPad, iPad 2, and New iPad (iPad 3) • Pocket on back offers room for papers and maps P/N 13-11701 **\$24.95**

ASA IPAD AIR ROTATING KNEEBOARD



Designed by pilots for pilots, our high-quality iPad Rotating Kneeboard is covered with soft, leather-like material and features a wide hook-and-loop leg strap to hold the kneeboard in place during flight. Inside, the rotating iPad frame holds the device securely and allows for 360-degree rotation of the iPad. An easel is built into the kneeboard for adjustable tilted viewing, in and out of the cockpit. Fits iPad 9.7" models. Measures: W 7" (closed) x H 10" x D 1"; W 14-3/4" (opened) P/N 13-21889 **\$42.95**

FLIGHT OUTFITTERS SLIMLINE IPAD KNEEBOARD



The Flight Outfitters Slimline Kneeboards take cockpit organization to a whole new level. Loaded with innovative, pilot-friendly features, these kneeboards provide a sturdy mounting bracket for an iPad. The updated design uses expandable loops to securely hold the corners of the iPad to the bracket. This allows you to keep your iPad in your case instead of removing it for every flight. The bracket rotates for both portrait and landscape orientation. The unique design is completely reversible for use on either leg, and a heavy-duty elastic leg strap securely holds the kneeboard in place. Two mesh pockets on the side of the kneeboard provide storage for cleaning cloths and other accessories. Includes a drawstring bag for storage.

Large (Fits all iPad, iPad Air, and iPad Pro editions, 11" and smaller)

P/N 13-22756 **\$49.95**

Small (Fits all iPad Mini editions) P/N 13-22757 **\$49.95**



MGF PRODUCTS

MGF IPAD MINI / AIR SPORT KNEEBOARD



The iPad Kneeboard Sport™ is the perfect aviation kneeboard, mount and everyday case for the iPad Air. It is designed for the pilot looking to secure their iPad on either leg, who needs the minimal case, but still wants a very secure fit, or for the pilot that wants to mount their iPad. In black, smooth polycarbonate, the Sport™ adds protection and great feel to the iPad. The iPad Kneeboard Sport™ was designed for pilots by pilots. It is designed to work in aircraft where space is tight or where there is a cyclic, or control stick being used between the legs. It is perfect for pilots of helicopters, sport

aircraft, and when there is tight yoke clearance or when mounting is desired. **NOTE:** This is the iPad Kneeboard only. Mounts sold separately. **Compatible iPad Aviation Mounts:** The iPad Kneeboard Sport™ is designed to mate using a quick-connect Sport™ Adapter wmounting system and an iPad Sport™ Mount. Mounting options include a iPad yoke mounts, panel/glare shield, or suction cup mounting system offering flexibility in its use in different aircraft and are sold separately. For more information, go to the Mounts category.

Mini Sport P/N 13-16366 **\$124.00**

IPAD 2/3 KNEEBOARD SPORT



The iPad Kneeboard /Mountable Case is the perfect aviation kneeboard, mount and everyday case for the iPad. It is designed for the pilot looking to secure their iPad to their leg or for the pilot that prefers to mount their iPad. The black, smooth polycarbonate adds protection and great feel to the iPad. Take your iPad from air to office to home. It is perfect for pilots of all aircraft. This product fits the iPad 2, 3, and 4.

Features: • Cockpit Ready: Smartphone secured, viewable, and operable with one hand during critical phases of flight • iPad Kneeboard: Secure

your iPad on either leg for use with either hand • Quick Mount Ring: Convert your case into a desktop stand for use on desk, table or lap • Sport Mount Compatible: VFR/IFR clipboard adheres magnetically for secure note taking • 360 Rotation: Rotate iPad between portrait and landscape mode while still in the case • Multi Use: Take your iPad from air to home to office and everywhere in between with just one case • Smart Cover Compatible: Use with an Apple Smart Cover for the complete iPad Kneeboard case

NOTE: This is the iPad Kneeboard only. Mounts sold separately. P/N 13-11310 **\$119.00**

MGF IPAD MINI 4 KNEEBOARD SPORT



The iPad Kneeboard Sport™ is the perfect aviation kneeboard, mount and everyday case for the iPad Mini 4. It is designed for the pilot looking to secure their iPad on either leg, who needs the minimal case, but still wants a very secure fit, or for the pilot that wants to mount their iPad. In black, smooth polycarbonate, the Sport™ adds protection and great feel to the iPad. The iPad Kneeboard Sport™ was designed for pilots by pilots. It is designed to work in aircraft where space is tight or where there is a cyclic, or control stick being used between the legs. It is perfect for

pilots of helicopters, sport aircraft, and when there is tight yoke clearance or when mounting is desired.

NOTE: This is the iPad Kneeboard only. Mounts sold separately. P/N 13-18845 **\$124.00**

MYGOFLIGHT IPAD PRO 11 SPORT COOLING CASE (KNEEBOARD / MOUNTABLE)



The iPad Sport Cool Case is the first iPad case to add high-end gaming laptop cooling technology engineered to provide maximum airflow with minimum noise powered from the iPad itself in a cool, sleek design. No extra batteries, minimal extra weight.

The iPad Sport Cool Case can be used either as a mountable case or kneeboard and can be used in direct sun. Used in cockpits of planes, trucks and cars and outside when flying a drone or at the beach.

Note: Mounts Sold Separately.
Generation 1 - Air 4 P/N 13-22140 **\$329.00**
Generation 2 P/N 13-23576 **\$329.00**

MGF ARMORGLAS SCREEN PROTECTORS



When it comes to screen protection, nothing is better than the feel and clarity of pure glass. ArmorGlas™ is like having no screen protector on at all - you won't even realize it's there. ArmorGlas™ is made of premium, ultra-thin tempered glass. It is designed to preserve the feel and clarity of the standard screen on your device while adding a substantial level of protection. ArmorGlas™ is made to protect the screen of your device from fingerprints and scratches and is very effective at absorbing impact to minimize the chance of shattering your display.

Model	Anti-Glare No.	Price	Crystal No.	Price
iPad Mini	13-16362	\$49.99	--	--
iPad Mini 4/5	13-18743	\$49.99	--	--
iPad 2/3/4	13-16364	\$49.99	13-16486	\$49.99
iPad Pro	13-19554	\$59.99	--	--
iPad Pro 10.5	13-20668	\$49.99	--	--
iPad Pro 11	13-22079	\$49.99	--	--
iPhone X	13-22080	\$24.99	--	--

MGF IPAD PRO 12.9 / 11-13 INCH TABLET KNEEBOARD FOLIO C



The iPad Pro Universal Kneeboard Folio™ C (including clipboard) is the perfect high-quality leather, rotating aviation kneeboard, lapboard and everyday case for your iPad Pro, and all other 11-13" tablets. Now you can bring any 11-13" iPad/Tablet with you into the cockpit of any airplane, train, car or truck where it can be held secure on your knee and lap. High quality, rich leather wraps the outside while soft and protective micro-fiber material lines the inside. The iPad/Tablet is held by four adjustable clips that are attached to a rotating cradle.

All of the ports and controls remain accessible so the iPad/Tablet can be charged, synced and controlled when it is in its case.

Features: • Tablet secured, view-able, and operable with one hand during critical phases of flight as required by the FAA • Secure your iPad/Tablet on either leg for use with either hand • Rotate iPad/Tablet between landscape and portrait positions while in flight • Convert your case into a desktop stand for use on desk, table or lap • VFR/IFR clipboard adheres magnetically for secure note taking. Detach clipboard from inside of case before closing P/N 13-19537 **\$174.00**

MGF IPAD MINI UNIVERSAL 7-8 INCH TABLET KNEEBOARD FOLIO C



The iPad Mini Universal Kneeboard Folio™ C (including clipboard) is the perfect high quality leather, rotating aviation kneeboard, lapboard and everyday case for your iPad Mini 1/2/3/4, and all other 7-8" tablets. Now you can bring any 7-8" iPad/Tablet with you into the cockpit of any airplane, train, car or truck where it can be held secure on your knee and lap. High quality, rich leather wraps the outside while soft and protective

micro-fiber material lines the inside. The iPad/Tablet is held by four adjustable clips that are attached to a rotating cradle. All of the ports and controls remain accessible so the iPad/Tablet can be charged, synced and controlled when it is in its case P/N 13-19535 **\$154.00**

MGF UNIVERSAL FLEX CLIP KIT



This is the first and only mount that you can secure anywhere you wish with four screws of an AMPs pattern or with semi-permanent VHB adhesive. Since the Flex Clip uses Flex Arms, it is infinitely adjustable so pilots are able to mount their device in the exact position they wish that was thought not possible before. Simply take the metal base and secure it in the desired location with screws or adhesive. Then take the Flex Arm with the clip base and slide it into the base and lock it down by tightening the knob P/N 13-21196 **\$312.00**

MGF APPLE CERTIFIED PREMIUM LIGHTNING CABLE (3FT)



This premium Charge + Sync cable makes it easy to connect your Apple portable to a computer, USB charger, or compatible car receiver. It features high end aluminum casing around the heads for added durability. The cable is wrapped in a high quality braided fabric that resists tangles, kinks and knots. **Nylon Sleeve:**

The cable is wrapped in a high quality braided fabric that resists tangles, kinks and knots. **Metal Connectors:** High end aluminum connectors ensure you'll have a snug, reliable connection every time. 3 Feet: 3.28 feet of cable. **Lightning Connector:** For use with any iPhone, iPad, or iPod that uses the lightning connector P/N 13-19558 **\$24.99**

PS

MGF PRODUCTS



MGF FLIGHT BAG PLC LITE

MGF Flight Bag PLC Lite - Created to be the perfect bag for pilots looking for a light iPad ready flight bag. The PLC Lite is a high quality flight bag built to the same high standards as all other MGF products. Designed by pilots to meet the exacting needs of the cockpit environment. The PLC Lite is built from the ground up to be the ultimate solution for storing and protecting the essentials you will need while flying, with a special focus on your most important tool, the iPad. It has a specially designed, protective pouch to hold an iPad, laptop computer or many other electronic flight bag devicesP/N 13-19545 **\$114.00**



MGF IPAD FLIGHT BAG PLC SPORT

A smaller version of the Flight Bag PLC Pro is finally here. The Flight Bag PLC Sport. Enough room to carry one headset, an iPad/EFB, a hand held radio, and other gear. Same industry leading quality, in a compact size. Headset Storage: Storage for 1 headset or overnight gear. iPad Storage Pocket: Padded pocket designed to protect the iPad or other tablets. Protects Laptop: Padded pocket can also store and protect up to a 13" laptop. Radio Storage: Large side pocket is designed to hold a hand held radio securely. Mesh Pockets: Interior pockets are made out of mesh to easily locate and access your gear. Water Resistance: Exterior of the bag is made of sail cloth making it water resistant. P/N 13-18712 **\$179.00**



MGF FLIGHT BAG PLC PRO TRAVELER

Perfect for an overnight trip or a week out of town the PLC Traveler is tough, lightweight and smart. Engineered from durable sail cloth, this bag comes equipped with multiple pockets for storage, a telescoping handle and easy-rolling wheels that make it a cinch to maneuver. Built from the ground up to be the premium solution to store and protect all your gear while flying and traveling. Designed by pilots for pilots to be the ultimate flight bag for all aviators. This bag gives you the style, storage, organization, compact size and functionality like never offered before. P/N 13-22025 **\$329.00**



MGF FLIGHT BAG PLC PRO 2020 FLIGHT BAG

The redesigned PLC™ PRO 2020 is the latest addition to MYGOFIGHT's amazing line of flight bags. Made from rugged ballistic nylon, this bag is engineered to fit the lifestyles of aviators and travelers that bring both style and durability. This flight bag is the ultimate solution for storing and protecting the essentials needed for any destination. Mesh pockets allow you to see your items inside, while a self-standing shell allows for perfect positioning for easy access. Re-engineered detachable backpack & shoulder straps bring versatility & comfort to a whole new level. The Flight Bag PLC™ Pro Flight Bag is designed by pilots for pilots to be the ultimate travel companion P/N 13-22439 **\$299.00**



MGF HEADSET BAG

Micro-fiber lining cleans and protects the screen while the durable diamond stitch fabric on the outside prevents ripping and tearing. The Headset Bag is made out of durable mesh with a soft, padded lining on the inside, perfect for holding anything you don't want scratched: sunglasses, phones, iPads, and eReaders. The drawstring closure makes holding all of your small items secure and easy to find P/N 13-12407 **\$14.99**



MGF BACKPACK STRAP

MGF Backpack Strap is intended for use with the Flight Bag PLC Pro, PLC Sport, and PLC Lite. Maximum comfort with much less pain on the shoulders which helps minimize fatigue. Helps items feel much lighter than actual weight. Padding and grip prevent straps from sliding off of shoulders. Clips onto bag with three easy hooks. Rotating hook heads make sure you never get tangled straps ever again! Fully adjustable for all sizes P/N 13-19546 **\$30.00**



MGF KNEEBOARD STRAP

A Strap made to go with MGF kneeboards for additional security while in-flight. This strap is made out of a heavy duty, wide elastic and a generous amount of Velcro to provide long-lasting use and comfortable wear P/N 13-19564 **\$9.00**



MGF PEN HOLDER

Add this self-stick pen holder to your MGF clipboard or any other clipboard to provide a convenient and secure place to store your pen. * **Not designed to work the MGF Mini Clipboard.** Securely hold a variety of pen and pencil sizes with this unique little holder. Attaches with a strong 3M VHB tape. P/N 13-19562 **\$7.00**



MGF IPAD AIR 1-2 / PRO 9.7 SPORT CASE (KNEEBOARD / MOUNTABLE)

The iPad Kneeboard Sport™ is the perfect aviation kneeboard, mount and everyday case for the iPad Air or Pro 9.7. It is designed for the pilot looking to secure their iPad on either leg, who needs the minimal case, but still wants a very secure fit, or for the pilot that wants to mount their iPad. In black, smooth polycarbonate, the Sport™ adds protection and great feel to the iPad. The iPad Kneeboard Sport™ was designed for pilots by pilots. It is designed to work in aircraft where space is tight or where there is a cyclic, or control stick being used between the legs. It is perfect for pilots of helicopters, sport aircraft, and when there is tight yoke clearance or when mounting is desired. NOTE: This is the iPad Kneeboard only. Mounts sold separately P/N 13-19539 **\$124.00**



MGF NIGHT VISION CLIP

The Night Vision Clip Light is designed to put green, eye protecting light exactly where you need it when you need it. The batteries are replaceable. P/N 13-12404 **\$19.99**



MGF WATER BOTTLE

The MGF Bottle – a double walled, stainless steel bottle that will keep drinks cold for 24 hours and hot for 12 without any condensation on the outside ever. It is beautiful, fits in the side pocket of the Flight Bag PLC Pro or Sport, will never sweat, helps rid the world of plastic bottles and is beautiful to hold and to see P/N 13-18887 **\$35.00**



MGF SPORT™ MOUNT GPS ADAPTER FOR GARMIN PORTABLES

Sport - GPS Adapter is the perfect solution for mounting all Garmin Portable Avionics, as well as any other device that uses the AMPs hole pattern. The Sport - AMPs Adapter securely connects to all Garmin portables including the aera® 660, aera® 796, aera® 795, aera® 510 GPsMAP® 696, GPsMAP® 695, and more. Once the GPS Adapter is connected to the GPS you can quickly and securely mount the portable avionics using any MGF Sport Mount (Sold Separately). P/N 13-19526 **\$49.00**



MGF SPORT™ CAMERA ADAPTER

The Sport - Puck Adapter is designed to work with almost any digital camera or any other device that has a 1/4"-20 screw on it. As a mountable, it connects and easily rotates when paired with MGF Sport Mounts. No matter how you use it, the Sport - Puck Adapter meets the demands of pilots and other individuals operating in extreme motion. Compatible with most cameras and devices that have a 1/4"-20 hole on them. P/N 13-19527 **\$39.00**



MGF FOLDKEY - BLUETOOTH MINI KEYBOARD

MGF proudly presents a cross platform Bluetooth Ultra-Slim Keyboard with foldable keyboard. Users can enjoy creating and communicating across multiple platforms on bluetooth supported devices wirelessly. Travel anywhere portably without the hassle of tangling wires. Allows you to get work done from anywhere. Only folding keyboard that has all keys including numbers. Performs any task necessary P/N 13-19561 **\$49.99**



MGF DUAL MICRO CHARGER

Handles up to 35 Volts! DualMicro is a 12 to 35 Volt airplane/auto charger and an extra charging cable in one convenient bundle. It has two USB ports that can both be used at the same time. NOTE: For 12-35 volt DC systems. P/N 13-15538 **\$49.99**



MGF PRODUCTS



MGF SPORT™ MOUNT FLEX CLIP

• Fits Monorails sized, 5/16" - 1/2". The infinitely articulating and adjustable arm attaches to the Universal Cradle to hold any iPad or Tablet, or to the iPad Sport Case for a specific iPad fit. This feature makes this mount future proof. Once attached, the iPad can be viewed in either portrait or landscape modes simply by rotating the device, nothing has to be loosened or tightened to make this happen. **Note:** You must have a Device Holder to use this mount.....P/N 13-19518\$164.00

MGF SPORT™ MOUNT FLEX SUCTION PRO



This one mount can operate as a compact suction cup, allowing a close position to the glass of 3.25 inches. It can also operate as a standard suction cup mount extending to 10.5 inches. The Mount utilizes one vacuum suction cup with a built-in finger pump that informs you if the mount is losing suction. Give it a couple pumps and it is quickly back to full strength. **Note:** You must have a device holder to use this mount.....P/N 13-19509\$194.00

MGF SPORT™ MOUNT COMPACT SUCTION CUP



The Sport Mount - Compact Suction Cup is the most versatile mounting solution for pilots that would like to install a device on almost any flat, smooth surface. The high strength suction cup twist and locks to provide a secure hold to the windshield or metal panel. The mount is portable and can easily fit in your flight bag or can be positioned and left on-board. Perfect for owners and renters alike. (**Note:** You must have a device holder to use this mount).....P/N 13-19510\$144.00

MGF SPORT™ MOUNT FLEX DOUBLE SUCTION



This one mount can operate as a compact suction cup, allowing a close position to the glass of 3.25 inches. It can also operate as a standard suction cup mount extending to 10.5 inches. Portable and can easily fit in your flight bag or can be positioned and left on-board. Perfect for owners and renters alike. **Note:** You must have a Sport Case/Cradle to use this mount.....P/N 13-19511\$194.00

MGF SPORT™ MOUNT FLEX YOKE COLLAR FOR BEECH WIDE YOKE



Attaches to control columns with a diameter between 1 5/8" - 1 3/4". This mount attaches to the thick yoke shaft on Beechcraft aircraft that have two yoke tubes coming out of the panel. **Note:** You must have a Device Holder to use this mount.....P/N 13-19513\$164.00

MGF SPORT™ MOUNT FLEX GLARE SHIELD



The Sport Mount - Flex Glare Shield is for pilots who want to mount their iPad or other device off of the glare shield of their airplane or similar shelf-like surface. Can be configured to hang down, or push the iPad/Device up above the glare shield. This mount comes with the Generation 3 Sport Adapter. This is a perfect mounting solution in cockpits where space is tight. **NOTE:** You must have a Device Holder to use this mount.....P/N 13-19514\$144.00

MGF SPORT™ MOUNT FLEX PANEL



Sport Mount - Flex Panel is the perfect mounting solution for pilots that would like to install a iPad/Tablet directly into their panel. Same hole pattern as existing instrument gear. This is a perfect mounting solution in cockpits where space is tight. **Note:** You must have a Device Holder to use this mount. P/N 13-19515\$164.00

MGF SPORT™ MOUNT FLEX YOKE BEECH CENTER COLLAR



Attaches to the retaining clamp (Silver Metal Piece) on the center yolk arm. The way it attaches is by removing the screws that hold the retaining clamp on, putting our mount on top of the retaining clamp, and then securing it with the same screws. **Note:** You must have a Device Holder to use this mount... P/N 13-19512\$164.00

MGF SPORT ADAPTER



This accessory is used to mate Sport™ and Sport™ NR cases to any existing RAM mount or RAM equivalent installation that will accept a 1" ball. P/N 13-12419\$69.00



MGF SPORT™ MOUNT FLEX STUD

The iPad Mount - Flex Stud is the perfect mounting solution for pilots that would like to install an iPad directly into their panel, such as in many experimental aircraft. The stud secures easily to any hole in the panel for easy mounting. **NOTE:** You must have a Device Holder to use this mount. .P/N 13-19516\$124.00

MGF SPORT™ UNIVERSAL CRADLE XL



The Sport™ Universal Cradle XL (10"-13" Tablets) is designed to work with almost any tablet in virtually any case, or no case at all. As a mountable, it connects and easily rotates when paired with MGF Sport Mounts. Compatible with many tablets from 10 inches to 13 inches.....P/N 13-19521\$154.00

MGF SPORT™ PHONE CRADLE



Phone Cradle is designed to work with almost any smartphone in virtually any case, or no case at all. As a mountable, it connects and easily rotates when paired with MGF Sport Mounts. Compatible with many smartphone as small as the iPhone 5 and as big as the iPhone 6 Plus (Minimum width = 2 3/8" | Maximum width = 3 15/16"). P/N 13-19524\$54.00

MGF SPORT™ GOPRO® / GARMIN VIRB ADAPTER



Mounting your GoPro® with the Sport - GoPro® Adapter and MGF Flex Arms allows you the ability to position your GoPro® camera anywhere you would like. MGF Flex Arms are infinitely adjustable so you can mount your GoPro® camera anywhere and everywhere. Something that you are not able to accomplish with any other mounting system. Sport - GoPro® Adapter works with all GoPro® models and all Garmin Virb models.....P/N 13-19525\$49.00

MGF SPORT MOUNT - FLEX YOKE MOUNT FOR IPAD / ANDROID



The Sport Mount - Flex Yoke is for pilots who want to mount their iPad Sport, iPad Kneeboard Sport™ or Nexus 7 Sport case on a yoke, rail, or support strut. This mount comes with a Sport™ Adapter - Generation 2.....P/N 13-16369\$144.00

MGF SPORT FLEX SUCTION CUP MOUNT FOR IPAD



The Sport Mount - Flex Suction is for pilots who want to mount their iPad Sport, iPad Kneeboard Sport™ or Nexus 7 Sport case off a glass windshield, side window or other smooth surface. This mount comes with a Sport™ Adapter - Generation 2. For pilots looking for more articulation and distance from the iPad to the mounting surface, choose the Flex Suction EX.P/N 13-16370\$144.00

MGF UNIVERSAL CRADLE SPORT MOUNT



The Sport - Universal Cradle is designed to work with almost any tablet in virtually any case, or no case at all. As a mountable, it connects and easily rotates when paired with MGF Sport Mounts. The arms of the cradle are adjustable via quick release knobs making it easy to insert and remove your tablet. No matter how you use it, the Sport Cradle meets the demands of pilots operating in extreme motion.....P/N 13-16447\$144.00

MGF FLEX CLIP EXTRA BASE



Flex Clip Mount by MGF. This is the first and only mount that you can secure anywhere you wish with four screws of an AMPs pattern or with semi-permanent VHB adhesive. Since the Flex Clip uses Flex Arms, it is infinitely adjustable so pilots are able to mount their device in the exact position they wish that was thought not possible before.....P/N 13-19528\$29.00

MGF SPORT™ MOUNT AMPs SWIVEL



The Sport™ Mount AMPs Swivel is for pilots who want to mount any size iPad or Tablet in any size or type of case to the AMPs bracket found in many jets. This mount comes with a Sport™ Adapter mounting system and an adjustable tilt plate which adds flexibility in how the iPad/Tablet is positioned. The adapter can tilt up to 15 degrees. The iPad/Tablet can rotate between landscape and portrait mode while attached to the mount. All together, this system gives you the ultimate flexibility while keeping spaced used to a minimum. **NOTE:** You must have a Device Holder to use this mount.P/N 13-19534\$124.00

PS

IPAD MOUNTS – LIGHTNING CABLES

GUARDIAN INSTRUMENT PANEL FLUSH MOUNT FOR IPHONE 6 / 7



The iFDR Panel Mount series is a flush mounting system to easily dock and seamlessly integrate your Apple iPhone 6 or iPhone 7 into your aircraft instrument panel -- giving it a clean, professional appearance in an easy to view position! Once installed, the iFDR mount allows your iPhone to be docked in seconds, fully connected to power and audio with built-in cable ports. Removal is just as easy -- just slide, push, and remove!

P/N 13-18917 **\$99.00**

GUARDIAN INSTRUMENT PANEL FLUSH MOUNT FOR IPHONE 6+ / 7+



The iFDR Panel Mount series is a flush mounting system to easily dock and seamlessly integrate your Apple iPhone 6+ or iPhone 7+ into your aircraft instrument panel -- giving it a clean, professional appearance in an easy to view position! Once installed, the iFDR mount allows your iPhone to be docked in seconds, fully connected to power and audio with built-in cable ports. Removal is just as easy -- just slide, push, and remove!.....P/N 13-18918 **\$148.00**

GUARDIAN INSTRUMENT PANEL FLUSH MOUNT FOR IPAD MINI



The iFDR Panel Mount for Apple iPad Mini is a flush mounting system to easily dock and seamlessly integrate your existing iPad Mini into your aircraft instrument panel -- giving it a clean, professional appearance in an easy to view position! Once installed, the iFDR mount allows your iPad to be docked in seconds, fully connected to power and audio with built-in cable ports. Removal is just as easy -- just slide, push, and remove!.....P/N 13-18919 **\$149.75**

GUARDIAN INSTRUMENT PANEL FLUSH MOUNT FOR IPAD AIR PRO 9.7 INCHES



The iFDR Panel Mount for Apple iPad Air (1 & 2) and iPad Pro 9.7-in is a flush mounting system to easily dock and seamlessly integrate your existing iPad into your aircraft instrument panel -- giving it a clean, professional appearance in an easy to view position! Once installed, the iFDR mount allows your iPad to be docked in seconds, fully connected to power and audio with built-in cable ports. Removal is just as easy -- just slide, push, and remove!...P/N 13-18921 **\$199.75**

GUARDIAN INSTRUMENT PANEL FLUSH MOUNT FOR IPAD PRO



The iFDR Panel Mount for Apple iPad Pro is a new flush mounting system to easily dock and seamlessly integrate your existing iPad Pro into your aircraft instrument panel -- giving it a clean, professional appearance in an easy to view position! Once installed, the iFDR mount allows your iPad to be docked in seconds, fully connected to power and audio with built-in cable ports. Removal is just as easy -- just slide, push, and remove!.....P/N 13-18922 **\$248.95**

GUARDIAN LIGHTING CABLES



Decription	Part No.	Price
Apple MFI Certified Lighting Cable for iFDR Panel Mounts 4-wire 3 Feet	13-18963	\$32.50
Apple MFI Cert. Lighting Cable-3	13-18964	\$31.65
3.5mm Audio Cable 3 Male Jack	13-18968	\$28.50
Braided Leather Apple Lightning USB Charging / Sync Cable for iPad / iPhone - MFI Certified	11-14111	\$22.75

GUARDIAN IPAD/IPHONE IFDR PANEL MOUNTS



The iFDR Panel Mount Packages are a flush mounting system to easily dock and seamlessly integrate your existing device into your aircraft instrument panel, giving it a clean, professional appearance in an easy to view position! Once installed, the iFDR mount allows your device to be docked in seconds, fully powered and ready for use, and able to be removed in seconds when done! This package gives you the mount along with a panel mounted single 2.7 amp USB-A port that also features a hard-wired 2.7 amp connection from the rear to power the device mount! This way you can provide power to an external component like a phone or GPS/ADS-B receiver while keeping your device is charged! Choose from a Single USB Round Faceplate or Single USB Square Faceplate. Can be mounted either horizontally or vertically.

Description	Part No.	Price
iFDR Panel iPad Pro 12.9 Inch Mount Round	13-20272	\$489.95
iFDR Panel iPad Air/Pro 9.7 Inch Mount Round	13-20271	\$449.95
iFDR Panel iPad Air/Pro 9.7 Inch Mount Square	13-20599	\$439.95
iFDR Panel iPad Mini Mount Round	13-20270	\$409.00
iFDR Panel iPhone 6+/7+ Mount Round	13-20269	\$379.95
iFDR Panel iPhone 6+/7+ Mount Square	13-20597	\$369.95
iFDR Panel iPhone 6/7 Mount Round	13-20268	\$339.95
iFDR Panel iPhone 6/7 Mount Square	13-20596	\$339.95

GUARDIAN IPAD SMARTPANEL MOUNTS



The SmartPanel Mount for Apple iPads is a flush mounting system to easily dock and seamlessly integrate your existing iPad into your aircraft instrument panel -- giving it a clean, professional appearance in an easy to view position! Once installed, the smartPanel mount allows your iPad to be docked in seconds, fully connected to power and audio with built-in cable ports. Each mount has a built-in Fan Blower (14 or 28V).

Description	Part No.	Price
iPad Pro 10.5 Inch Smart Panel Mount and Power Supply Package 12V	13-20272	\$489.95
iPad Pro 10.5 Inch Panel Mount 12V	13-21188	\$465.00
iPad Pro 10.5 Inch Panel Mount 24V	13-21190	\$449.00
iPad Pro 10.5 Inch Panel Mount And USB Package 12V	13-21193	\$499.00
iPad Pro 10.5 Inch Panel Mount And USB Package 24V	13-21194	\$499.00
iPad Mini Panel Mount Round	13-20270	\$409.00

X-NAUT ACTIVE COOLING MOUNT FOR IPAD AIR



The Active Cooling Mount was created with the safety of pilots and iPad™ users in mind. Works with iPad Air™ Versions 1 | 2 | Pro 9.7". Switch between using Micro USB or power by battery (8AA Air Version). Battery test button shows status of batteries. Green indicates high battery life, yellow indicates low battery life and red indicates battery replacement. Spring loaded latch makes loading your iPad easy and secure. Low noise fans (26 DBA) Weight: 9.7 oz (no batteries no iPad™) Dimensions: 9.17in x 7in x 1.5in.P/N 13-19502 **\$199.95**

X-NAUT ACTIVE COOLING MOUNT FOR IPAD MINI



The Active Cooling Mount was created with the safety of pilots and iPad™ users in mind. Works with iPad™ mini Versions 1 | 2 | 3 | 4. Switch between using Micro USB or power by battery (4AA Mini Version). Battery test button shows status of batteries. Green indicates high battery life, yellow indicates low battery life and red indicates battery replacement. Spring loaded latch makes loading your iPad easy and secure. Low noise fans (26 DBA). Weight: 7 oz (no batteries no iPad™). Dimensions: 8.3in x 5.6in x 1.7in.P/N 13-19503 **\$179.95**

X-NAUT ACTIVE COOLING MOUNT FOR IPAD PRO - 10.5



The Active Cooling Mount was created for iPad™ users in extreme conditions. Works with works with iPad Pro 10.5". *iPad™, AA batteries and micro USB cord are not includedP/N 13-21626 **\$199.95**

PS

X-NAUT iPad ACCESSORIES



X-NAUT KNEEBOARD KIT

Kneeboard rotates 360° and mounts to your leg with a universally adjustable strap. One size fits all elastic Velcro strap. Mounting hardware included. Work with both Mini and Air versions. *Active Cooling Mount not included.....P/N 13-19504**\$39.95**

X-NAUT CARRYING CASES



Carrying Case comes in iPad™ Mini & iPad™ Air sizes. Adjustable and removable shoulder strap. Large zippered pocket houses the Active Cooling Mount. A small outer Velcro pocket stores accessories. X-naut embroidered logo. *Battery pouch and Active Cooling Mount not included. MiniP/N 13-19506**\$34.50**

X-NAUT 25MM BALL AND SOCKET EXTENSION KIT



The X-naut 25MM Extension Kit allows you to connect and extend mounts and pedestals with a 25mm (1 inch) mounting pattern to other 25mm mounts.

This includes the 25mm Ball Adapter and 3.75" Shaft (mounts, holders, and devices sold separately.) Secure the adapter onto any mount or pedestal accommodating the 25mm (1 inch) ball pattern.

Specifications: Compatible with the Flexgrib Series P/N 13-22316**\$39.99**

X-NAUT CLAW YOKE MOUNT



Mount your X-naut Active Cooling Case to a yoke shaft or exposed tube. The Claw base fits yoke shafts measuring 0.625" to 1.5" in diameter. Infinitely adjustable. P/N 13-22317**\$56.99**

X-NAUT SINGLE SUCTION MOUNT



The X-naut single suction cup base is designed to have a stronghold on glass and non-porous plastic surfaces. Infinite adjustment to obtain optimum viewing angles. P/N 13-22318**\$39.99**

X-NAUT DUAL SUCTION MOUNT



The X-naut dual suction cup base is designed to have an extra strong hold on glass and non-porous plastic surfaces. Infinitely adjustable to obtain the optimum viewing angles. P/N 13-22319**\$56.95**

X-NAUT DRONE BRACKET CONTROLLER



- Compatible with the DJI Mobile Device Holder for Phantom and Inspire Remote Controller
- Rugged Metal Bracket- Powder Coated
- Metal Bracket Can be Used as a Handheld Fixture

Note: iPad Cooling Case not included. P/N 13-22325**\$39.95**

X-NAUT FLEXGRIP ROTATING HANDSTRAP WITH KICKSTAND



Take your iPad and iPad Cooling Case everywhere with the X-Naut Rotating Handstrap with Kickstand. Engineering specifically for the X-Naut, this gives you the flexibility to work, travel, and play in extreme conditions. Supports your iPad in both landscape and portrait mode.

Note: *iPad Cooling Case not included. P/N 13-22315**\$59.95**

X-NAUT HOODMAN COCKPIT TABLET VISOR IPAD AIR



Eliminate glare and see your screen better with The Hoodman Cockpit Visor!

The Hoodman Cockpit Visor universally mounts in portrait or landscape orientation, with a size for the iPad mini and another for normally-sized iPads.

Attaching via adhesive Velcro strips, the visors are easily added and removed from your X-naut

Pilot Series iPad Cooling Case. Simply attach the Velcro strips to the perimeter of your case and you're ready for flight!

MiniP/N 13-22321**\$34.99**
Standard (Air, Pro, etc.).....P/N 13-22320**\$34.95**

X-NAUT HOOD FOR IPAD MINI / AIR / PRO



Monitor Hood - iPad Mini and Air/Pro 9.7" from HOODMAN

The X-naut & HoodMan aviator hood for drone pilots mounts to your iPad Mini and Air/Pro 9.7" for improved outdoor viewing.

The HAV2 aviator hood for drone pilots mounts to your Mini and Air/Pro 9.7" for improved outdoor viewing. The bottom panel of the aviator hood has

a unique pierceable feature to aid in touchscreen access. Two adjustable mounting straps make hood mounting quick and easy. A horizontal safety strap prevents iPad from falling forward out of its mount. Hood mounts on the front of iPad Mini and Air/Pro 9.7"

MiniP/N 13-22322**\$44.99**
9.7"P/N 13-22324**\$49.99**
10.5"P/N 13-22323**\$49.99**

X-NAUT ACTIVE COOLING MOUNT FOR IPAD PRO - 11 INCH



The Active Cooling Mount was created for iPad™ users in extreme conditions.

- Switch between using Micro USB or power by battery (8AA Air Version).
- Battery test button shows status of batteries. Green indicates high battery life, yellow indicates low battery life and red indicates battery replacement.
- Spring loaded latch makes loading your iPad easy and secure.
- Low noise fans (26 DBA)

- Compatible with RAM Mounts
- Compatible with MGF© mounts when used with the Sport - GPS Adapter by MGF©
- Kneeboard accessory mounts Active Cooling Mount to your leg. P/N 13-22326**\$199.95**

G1000 TRAINING COVER



G1000 partial panel simulators are used for training to fail certain instruments.

The product is held in not using a static cling but a backing of micro suction cups, allowing you to use this for years to come, including a storage case when not in use.

P/N 13-22141**\$25.70**

STEAM GAUGE COVER



Steam gauge cover is a high-quality inoperable cover using a micro suction cup pad on the back. Great for flight training or covering an inoperable gauge.

P/N 13-22142**\$7.75**

PS

FLYBOYS GEAR FOR PILOTS



FLY BOYS PUBS BAG

Top opening flap gives access to the main pockets. Additional smaller external pockets are located in the front, rear as well. Handy for smaller items or for sliding enroute charts and maps for quick access. Top, front and back are secured with sturdy Velcro™. Pocket on one side for a water bottle or sunglass case. Slots on the opposite side for 2 pens or pencils. The most popular choice of most fighter and trainer pilots no matter what the airframe. Also, an excellent option for civilians looking for a no frills - priced right bag. Measures 8 1/2" x 11" x 1" empty. Fully loaded it will expand out to 8 1/2" wide!
Black FB1020P/N 13-05566**\$27.95**



FLY BOYS HELMET BAG

420 Denier Cordura Nylon with 1/2" cloth poly-fill to cushion your helmet. Heavy duty nylon zipper - resists snags. Two interior pockets WITH VELCRO CLOSURE that fit your DTC, VTR tapes, sunglasses or water bottle. This super tight knit nylon shell is extremely water resistant and provides superior protection for YOUR expensive equipment. Oversized from standard issue versions, it is superior for helmets with with NVG or HMS mounts! Two NEW pockets for smaller items. Adjustable shoulder strap fitted with a gripping contouring rubber shoulder pad. Inside Dimensions (FLAT): 19 1/2" Wide 20" Tall.

BlueP/N 13-05571**\$39.95**
Black.....P/N 13-05572**\$39.95**
Green.....P/N 13-05573**\$39.95**

FLY BOYS IFR/VFR KNEEBOARD

Features seven eyelets for securing checklists, plastic checklist pages or your in-flight guide - (every base has different spacing. Includes the new flexible plastic clipboard (FB1060). Eyelets also correspond to JEPPESEN approach plates and chart protectors!

Folded: 6.5" X 1.5" X 9.5"
Unfolded: 10" X 8.5" X 1
Writing Surface Area: 8" X 5"
BlueP/N 13-05568**\$39.95**
Black.....P/N 13-05569**\$39.95**
Green.....P/N 13-05570**\$39.95**



FLYBOYS REMOVE BEFORE FLIGHT KEY CHAIN

This nylon strap streamer with the REMOVE BEFORE FLIGHT rubber patch is an instant reminder of the real warning flags that hang off of airplanes on the flight line. They're supposed to be visible and easy to find during the walk-around inspection. Well, now you won't have to "walk around" your house or fish through your gym bag trying to find it!P/N 13-05626**\$4.99**



FLYBOYS MAPSTRAP THIGH STRAP

adjustable to fit just about anyone and features a see-through strap with a healthy portion of hook-and-loop to keep paperwork secure. The leading and trailing edges of the lower strap feature non-slip PVC material to help keep the strap secure on your leg.P/N 13-14943**\$14.95**



FLYBOYS PILOT LOGBOOK

If you are serious about keeping track of your flight time, and operate Army or USAF rotary aircraft - this is the book you need with no question. Record your own flying history of missions, upgrades, checkrides and awards right in this beautiful and durable logbook. This book will hold at least 10 years worth of flight history. Dimensions: 9" tall x 7 7/8" wide x 1" thick
Airforce Pilots Fly Logbook.....P/N 13-05625**\$29.95**
Army Pilots fly Logbook.....P/N 13-06410**\$29.95**



FLYBOYS CHECKLIST PAGES

Heavy-uty plastic FlightCrew checklist pages. Sturdy construction extends the life of these pages. Easy to use at made at a thickness that helps prevent the pages from becoming brittle or tearing in cold environments.

Pages are top loading and are great for protecting your local approaches or condensed aircraft checklist. No covers included.
Sheet Size: 8" X 5"P/N 13-05627**\$0.70**
Bulk back (25 Pk.) w/ CoversP/N 13-05629**\$14.95**
Duty Covers For Checklist Pages OnlyP/N 13-22013**\$8.95**

OVERSIZED CHECKLIST PAGES

These are great if you are ready to start putting originals in the pages instead of shrunken copies! As you can see, a full size Jeppesen chart slides right in! Now your mission data cards fit, your target photos can get more detail in them, and your attack cards slide right in without making a trip to the copier to shrink or the paper cutter to trim! These are the same construction as the regular, just bigger. Great in extreme temperatures and long lasting. Spacing on the holes matches up with the FlyBoys KneeBoard with Eyelets and Jeppesen charts. Size is 5 1/2" X 8 1/2" - really makes a difference.
Sheet Size: 8-1/2" X 5-1/2"PN 13-05628**\$0.95**



EXTRA TALL PAGES FOR BIG CHECKLIST

Heavy duty plastic FlightCrew checklist pages. Sturdy construction leads to a long life. Easy to use but heavy enough to not get brittle or tear in extremely cold environments. Pages are top loading and are excellent for protecting your local approaches or condensed aircraft checklist. USABLE interior dimensions: 5"x11", overall width including checklist ring holes 5 7/8"
Sheet Size: 5" X 11"PN 13-05630**\$0.73**



FLYBOYS HARD PLASTIC COVE SET FOR EXTRA PAGES

The new Cover Set for the FB2203 pages are great. They are perfect for protection of the pages as well as providing structure for these tall pages. Without these covers, they tend to sag due to their height. Buy as many pages as you need, as many cover sets as you need. Sheet Size: 5" X 11"PN 13-05632**\$6.95**



OVER SIZED FLIP CHART PAGES

Over sized top loading pages with three ring holes in the top for those checklists and situations that flow better than the normal "book format." Dimensions: 9.25" x 6".
Sheet Size: 8" X 5"PN 13-05633**\$0.79**



FLYBOYS CHECKLIST RINGS

Durable. Unbreakable. Multi-Purpose. Safe. Opaque nylon ring to hold your checklists and in-flight guides. Or use them for outdoor use where metal rings would rust or wear out. Patented ball-lock design to prevent FOD out on the flight line. The nylon ring is very low resistance as well. Once they are closed, they stay closed. When closed, they are a 1.5" diameter ring. Opened, they stretch to 5". For most applications 4 rings is plenty for keeping your checklists or inflight guides secure. 10 per pack.
Opaque.....P/N 13-05621 **\$10.50/ Pack**
Black.....P/N 13-08644 **\$10.50/ Pack**
Red.....P/N 13-08643 **\$10.85/ Pack**



IFR TRAINING HOODS

BLOCKALLS TRAINING GLASSES



Designed by pilots for pilots. Blockalls™ resolve problems with existing view limiting devices. Weighing in at just under 1oz, it's easy to forget you are wearing them. Engineered to easily penetrate the seal of your headset eliminating the hassle of having to remove it first and can

be worn for extended periods of time without discomfort, thanks to the soft rubber nose piece and streamlined temple tips. Tailored off center viewing also keeps more of your time inside the flight deck rather than outside. Recommended by AOPA/ Flight Training.

Description	Part Number	Price
Black	13-06240	\$20.95
Silver	13-06241	\$20.95
CFI Right Seat	13-20135	\$22.95
Helicopter	13-18969	\$21.95

OLD FOGGIES™ IFR TRAINING GLASSES



IFR Glasses' Old Foggies™ brand view limiting device was developed in order to balance the training value of a view limiting device without further limiting the pilot from being able to read his/her charts. Old Foggies™ blend of precision fogging and custom

powered corrective lenses allows for the precise amount of the instrument panel viewing without any view of the horizon. Old Foggies™ are available in customizable powers with no need for a prescription. Available in Clear and Light Mirrored Tint (a reflective coating that eliminates glare without further limiting visibility). Available Powers: 1.5, 2.0, 2.5

Description	Part No.	Price
Clear Lens Fog 1.0	13-05004	\$29.95
Clear Lens Fog 1.5	13-05005	\$29.95
Clear Lens Fog 2.0	13-05006	\$29.95
Clear Lens Fog 2.5	13-05007	\$29.95
Clear Lens Fog 3.0	13-05008	\$29.95
Tint Lens Light Mirrored Tint Fog 1.5	13-05009	\$29.95
Tint Lens Light Mirrored Tint Fog 2.0	13-05010	\$29.95
Tint Lens Light Mirrored Tint Fog 2.5	13-05011	\$29.95
Tint Lens Tinted Fog 1.5	13-05012	\$32.95
Tint Lens Tinted Fog 2.0	13-05013	\$29.95
Tint Lens Tinted Fog 2.5	13-05014	\$29.95

THE HOODY



Provides a complete view of even the most sophisticated instrument panel. Weighs less than 2 oz. Stores easily in a flight bag with the flaps folded in. The Hoody® fits most caps. No hooks, no clips, just slips on and off. Easily molds to the bill of your favorite capP/N 13-12753\$19.95

OVERCASTERS



Overcasters is a unique IFR training tool which clips to glasses (sunglasses or RX) in seconds. Flip-up in one easy motion for easy transition. Feather light with no straps, helmets, or hoods. Accepted by IFR examiners for checkriders.

P/N 13-33799\$16.95

CLOUD-EEZE™ IFR TRAINING GLASSES



Developed in order to balance the training value of a view limiting device without further limiting the pilot from being able to read his/her charts. Old Foggies™ blend of precision fogging and custom powered corrective lenses allows for the precise amount of the instrument panel viewing without any view of the horizon. Old Foggies™ are available in customizable powers with no need for a prescription. Available in Clear and Light Mirrored Tint (a reflective coating that eliminates glare without further limiting visibility). Available Powers: 1.5, 2.0, 2.5

Cloud-eeze Clear Lens.....P/N 13-05015\$17.50
Cloud-eeze Tint LensP/N 13-05016\$18.95

BEST HOOD: IFR TRAINING HOOD



The 'Best Hood' is a sturdy paper hood which is amazingly simple yet very effective. Its inexpensive, it folds flat for the flight bag and is an excellent vision limiting device for instrument pilot training. Easy to use, the hood has a comfortable elastic headband and it fits easily over glasses.

P/N 17-00020\$15.85

JIFFYHOOD



A lightweight plastic hood that does the job inexpensively, Jiffyhood stows rolled up in a flight case, or even in your pocket. Has an adjustable elastic headband for comfortable fit.

P/N 13-03457\$10.95

FRANCIS IFR HOOD



Francis hood restricts your vision totally to your instruments & because its small, will not block any part of an instructor's vision. Made of lightweight, shock-resistant plastic, and has cushioned face pad for comfort. Adjustable elastic headband.

P/N 3362\$54.75

JEPP SHADES



Replaces bulky, hard-to-use instrument training hoods. The improved design allows better student/instructor interaction. The Cockpit proven design works conveniently under headsets and the universal adjusting strap reduces pressure on the ears and temple. The Velcro™ strap fits comfortably and flip-up lens allows convenient IFR/VFR flight transition. The high quality polycarbonate lens is impact resistantP/N 13-404311\$25.85

FOGGLES



A creative solution to the problems caused by wearing a large hood on your head. Foggles fit and feel like glasses, but the opaque frosting on the top and sides let you see only the instrument panel. Your out the window view is always foggy. Wear

them with headsets and microphone with no interference or discomfort. They come with a protective carrying case and weigh only two ounces.
ClearP/N 13-06500\$18.95
YellowP/N 17-00039\$22.95

SUPER HOOD



Ideal with eye glasses or headsets it slides in under the headset without relinquishing control of the aircraft and it can be instantly removed at any time for a safe approach or landing. Blocks outside reference but provides a full panel view to reduce vertigo. Light weight (3 oz.) and comfortable.

P/N 13-30200\$21.75

IFR TRAINING GLASSES



Polycarbonate Lenses (UV Protected). Adjustable frames High brow area to prevent "peeking". Opaque frosting to simulate actual IFR conditions. Protective carrying bag included.

P/N 13-12050\$17.95

VIBAN



Weighs only 2 oz., making it easy to put on and take off during flight. Provides a perfect view of the instrument panel while providing complete occlusion forward and to the side. Even more, ViBAN folds compactly to fit in its own durable case and is easily stored in your flight bag.

Without NosepieceP/N 13-02022\$38.95
With NosepieceP/N 13-02023\$38.95

PS

AIRCRAFT LOG BOOKS

AERO PRODUCTS AIRCRAFT LOGS



Permanent, hard cover, logs with leatherette cover printed in gold. Pages are updated to current FAA requirements. Generous line spacing. Size: 5.75"x7.75"; 74 pgs; Green cover. Comprised of 9 sections: Aircraft Description, Installed Equipment, Major Alterations, Life Limited Parts or Overhaul Requirements, AD or Factory Bulletin Compliance Record, Altimeter and Static System Checks, Radio and Electronic Checks, Maintenance Record (FAR 43.9), Inspection Record (FAR 43.11-91.217).

AF-5 Hard Cover P/N 13-32385 **\$18.50**
AL-12P Soft Cover P/N 13-04670 **\$12.65**

CUSTOM-BUILT AIRCRAFT OWNERS & OPERATORS MANUAL

Contains spaces for listing of aircraft description, specifications, construction data, weight and balance calculations, operating limitations, operating instructions and servicing information. (L. Pazmany).

P/N 13-20100 **\$24.95**

ASA AIRCRAFT LOG BOOKS

Designed to keep records of the entire aircraft in order: inspections, tests, repairs, alterations, ADs, service bulletins, and equipment additions, removals or exchanges.

SA-1 soft cover-hunter green; 7.25"x 4"; 64 pgs
P/N 13-32375 **\$4.75**
SA-2 Hard cover-Hunter Green; 7.75"x 5-5/8"; 96 pgs.
P/N 13-32384 **\$9.95**

ASA AIRCRAFT FLIGHT LOG/ LOGBOOK (SP-FLT)

Spiral-bound and perfectly sized to fit in an aircraft glove box or chart pocket, this logbook is a quick reference to the recent history of the airplane so pilots have immediate access to the airplane's records. P/N 13-03163 **\$9.50**

PLANEVIEW AIRCRAFT FLIGHT LOGS

Compact and can be easily stored in a glove box or side pocket. You only have to use the categories that are important to you. The owner of a Piper Cub would not use the logbook to the extent that a Piper Mirage owner/operator would, but it can easily accommodate the needs of both aircraft. Multiple pilots can use the book, so it can be used in an aircraft that is used in partnerships, flight schools, charter and many other operations where there are a number of different pilots flying the aircraft.

Single engine log P/N 13-01946 **\$7.95**
Multi-engine log P/N 13-01947 **\$7.95**

AIRCRAFT TECHNICAL LOG POST BINDER

Basic Binder: Single and twin-engine airplanes have fewer maintenance logs which can be easily managed with these basic Chicago-screw type binders. This binder can hold four to eight maintenance logs, enough for the typical twin, with plenty of space remaining. These high density poly binders are fuel and solvent resistant, almost indestructible, and will protect your tech logs in any shop environment. Binder package includes envelope for service tags and airworthiness forms P/N 13-12324 **\$28.50**

EAA EXPERIMENTAL AIRCRAFT - AIRFRAME LOGBOOK

General Aircraft Record, Record of Ownership, Initial Condition, FAA Airworthiness Inspection pages. Entry pages that the owner fills in the information. Soft Cover 54 pages. Revised 2012. This logbook was developed to meet the special requirements of experimental aircraft P/N 13-12860 **\$7.50**

CULHANE AME PERSONAL LOGBOOK

This Culhane aviation training product AME personal logbook in hardcover format, fully meets CARs requirements. Those wishing to qualify for a Canadian Aircraft Maintenance Engineer license must successfully complete approved maintenance tasks appropriate to the rating sought in accordance with Part V of the CARs. This AME personal logbook is durable with a 4 mm textured imitation leather hardcover and Smyth-sewn binding. Also includes a bookmark ribbon. 128 pages, measures 5.75" X 8.75".

P/N 13-18988 **\$29.95**

AERO PRODUCTS ENGINE LOGS



Permanent, hard cover, logs with leatherette cover printed in gold. Pages are updated to current FAA requirements. Generous line spacing. Overall dimensions: 5.75"x 7.75"; 74 pages; Red cover. Comprised of 8 sections: Engine Description, Installed Record, Life Limited Parts or Overhaul Requirements, AD or Factory Bulletin Compliance Record (propeller or rotor only), Repair and Inspection Record (propeller or rotor only)

EF-5 Hard Cover P/N 13-32390 **\$17.50**
EL-13P Soft Cover P/N 13-03811 **\$9.95**

ASA ENGINE LOG BOOKS

Keep track of engine inspections, tests, repairs and alterations, airworthiness directives, manufacturers' mandatory service bulletins & equipment removal or exchange. Color: Burgundy

Hard Cover (7.75" x 5-5/8") 96 pages P/N 13-32382 **\$9.95**
Soft Cover (7.25" x 4") 64 pages P/N 13-32380 **\$4.75**

EAA LOGBOOKS

Engine Log P/N 13-02253 **\$6.50**
Propeller Log P/N 13-02255 **\$4.60**

ASA AIRCRAFT FLIGHT LOG

The ASA Flight Log is the perfect tool for aircraft owners and aircraft flown by multiple pilots to keep track of the care and use of an individual aircraft. Spiral bound and perfectly sized to fit in an aircraft glove box or chart pocket. Logbook pilots will have quick reference to the recent history of the airframe without digging through those usually kept in the maintenance hangar P/N 13-03163 **\$9.50**

ASA PROPELLER LOGBOOK

Record data for hub & blade inspections, repairs and alterations, airworthiness directives, & factory bulletins. Soft cover, Black, 7-1/4" x 4", 20 pages.

P/N 13-32370 **\$3.95**

ASA AVIONICS LOG BOOK

Includes entries for avionics equipment, VOR accuracy, transponder & ELT checks, AD & SB compliance, maintenance records. Soft cover, blue/gray, 7.25"x4", 64 pgs P/N 13-02315 **\$5.95**

ASA AMT LOG BOOK

Designed for Maintenance Technicians, IA-qualified mechanics, and students to log training and educational requirements, work performed, and experience for the purpose of tracking for future certification, recurrence, employment applications, school records, or insurance applications. Plastic coil binding stays open on current page. Soft cover, 6 1/2" X 11", 192 pages.

P/N 13-02313 **\$14.95**

AIRCRAFT JOURNEY LOG

This is the full-size, hard-cover format (8.5" x 11") new Journey Log. 25% more pages! It has been designed to meet the requirements of the Canadian Aviation Regulations. As permitted by the CARs. There is now a page for Weight & Balance data at the front of the log. When open, the Journey Log pages lie flat to allow for easy data entry P/N 13-12323 **\$36.65**

AIRCRAFT TECHNICAL LOG SECTION 1 AIRFRAME

The Airframe Log (Section 1) is used to record details of airframe flight hours and related maintenance tasks. Three-hole drilled for keeping in a ring binder or Tech Log Book. Vary the number of engine and prop volumes for multi-engine aircraft. The 5 sections are ordered separately, depending on the number of engines, props, etc. Each tech record can be bound with all the others into the Tech Log Binder to make up the complete aircraft Technical Record. When bound together, the entire log is almost indestructible, yet each record can be removed easily for updating at any time.

Log Section 1 Airframe P/N 13-12325 **\$13.85**
Log Section 2 Record Of Installations P/N 13-12326 **\$8.75**
Log Section 3 Engine P/N 13-12327 **\$12.50**
Log Section 4 Propeller P/N 13-12328 **\$12.50**
Log Section 5 Component P/N 13-12329 **\$7.95**
Log Post Binder P/N 13-12324 **\$28.50**

PILOT LOG BOOKS

JEPPESEN PROFESSIONAL LOGBOOK



This professional log book from Jeppesen, measuring 6-1/2" x 11" is constructed of sturdy, easy-to-read ledger paper & includes an elegant cover.

P/N 13-21728 **\$26.75**

JEPPESEN PROFESSIONAL EUROPEAN LOGBOOK



Complies with JAR 1.080 regulations for logging flight time in Europe. handles 10 years of data. Size: 17.1 x 28.6 cm P/N 13-02212 **\$30.90**

JEPPESEN PILOT LOGBOOK



Our 96-page permanent record offers large flight time category spaces, arranged according to FAA regulations. Printed on "easy-eye" green pages that resist "bleed through". Size: 8-5/16" x 5-5/16" P/N 13-21732 **\$11.95**

LITTLE PILOT LOGBOOK



The Little Pilot Logbook is the perfect gift for the aviation enthusiast. Record treasured stories and precious favorites, display adorable pictures and store mementos in this spiral bound 8.75" x 5.75" hard cover book that lays flat for easy entry and portable enough to carry with our on your next journey. This keepsake will be treasured not only by the parent but also by the future aviator that receives it as a record of childhood memories of flight.

P/N 13-08051 **\$24.95**

STUDENT PILOT LOGBOOK



This Logbook is designed for Student Pilots preparing for Private, Sport, and/or Recreational Pilot licenses. The student's learning progress is comprehensively tracked from his first flight to his last prior to his completion ride. This Logbook was designed for 14 CFR Section 61 (FAR Part 61) flight training requirements using 14 CFR Section 141 (FAR Part 141) documentation methods. There are upwards of fifty (50) critical areas of airmanship presented and tracked per flight. These areas range from take-offs, flight maneuvers, to landings. Discussion time is also tracked along with ground school briefing subjects. The Student Pilot and Flight Instructor can quickly identify problem areas or areas which do not need to be stressed to help the student in progressing towards the license. P/N 13-12957 **\$19.95**

CANADIAN LOGBOOKS



A reprinted version of the now defunct Transport Canada AME log book.

Description	Part No.	Price
Professional Large Logbook Black	13-12345	\$37.95
Small Student Logbook Black	13-12346	\$16.95
Pilot Training Record Helicopter Logbook	13-12348	\$12.95
Pilot Training Record Logbook	13-12347	\$5.70

STANDARD LOGBOOKS



Standard Layout spacing allows for organized handwritten entries. Large Pages Allow for multiple entries per page. Pre-punched for easy 3 Ring Organizing.

Part no.	Description	Price
13-18059	Single Airframe Logbook	\$10.95
13-18060	Single Engine Logbook	\$10.95
13-18061	Single Prop Logbook	\$10.95
13-18062	Single Avionics Logbook	\$10.95
13-18063	Single Engine Logbook Kit	\$33.95
13-18064	Twin Engine Logbook Kit	\$44.95

FLIGHT SCHEDULE LOG



Essential for smooth dispatching, features include: a replaceable perpetual aircraft/instructor entry panel; standby request section; and time in 15-minute blocks. Charcoal Gray binder is 17-1/4" x 13-5/8" with 15" x 12" pages for easy viewing. 60 pages included, refill packs available.

P/N 13-02308 **\$39.75**

FLIGHT SCHEDULE REFILL PACK - Can be used over and over with this 60-day refill.

P/N 13-02309 **\$21.95**

POWDER PUFF PINK LOGBOOK



The Powder Puff Pilot standard logbook has a pink, protective hard cover with the Powder Puff Pilot logo on the front. It's standard size (8 1/4 by 6 1/4 inches) with 52 pages of all the record keeping, endorsements, and flight log information that every pilot needs. Inspirational quotes from the famous pioneers of women aviation sprinkled throughout to keep you motivated, inspired, and flying high.

P/N 13-06342 **\$17.95**

POWDER PUFF PILOT AVIATRIX LOGBOOK



This logbook-scrapbook hybrid documents a youngster's early flying experiences. Its removable, card-stock pages record their First Flight Plan, First Pilot Report, and a flight log. It also has pages for listing favorite pilots, future aspirations, thoughts and quotes about flying, photos, and drawings.

Pink P/N 13-11471 **\$23.95**

Blue P/N 13-11472 **\$23.95**

Green P/N 13-11473 **\$23.95**

STANDARD PILOT MASTER LOG BLACK



The finest and most versatile logbooks for aviators. ASA's logbooks have been "The Standard" of the industry for over 30 years and comply with the FAA's recordkeeping requirements. With so many options, there is a logbook that's right for you. Versatile, easy-to-use and flexible enough to fit any pilot's needs, student or ATP. Columns provide standardization, but are flexible enough to allow pilots to customize to fit their needs. Summary pages allow pilots to track experience, aircraft types, currency, medical dates, flight review, and more for quick reference. Hard cover, black, 11" x 6-1/2", 278 pages.

P/N 13-32392 **\$19.95**

PILOT LOGBOOK (ASA-SP-10)



Blue, soft cover, 7-3/4" x 4-1/8", 16 pages. Ideal as a pilot's first logbook and for introductory flight give-away.

The finest and most versatile logbooks for aviators. ASA's logbooks have been "The Standard" of the industry for over 30 years and comply with the FAA's recordkeeping requirements. P/N 13-05670 **\$2.95**

ASA FLIGHT CREW LOGBOOK POCKET SIZE



Created with the input of airline pilots and instructors, these shirt-pocket size logs are designed for long-lasting and comprehensive recordkeeping on the road. Options are provided for tracking flight time, currency requirements, expenses, duty times, layovers, and much more. Soft cover. Black. Spiral bound. 108 pages. 3-1/2" x 4-1/4".

P/N 11-08801 **\$7.50**

ULTRALIGHT PILOT'S LOGBOOK



This small logbook is perfect for the ultralight pilot. Includes sections for flight time, airframe repairs, and engine repairs, plus metric/inch conversion table and fuel/oil ratio chart. Measures 4 1/4" x 7".

P/N 13-11509 **\$1.95**

GLEIM PILOT LOGBOOK



The Gleim Pilot Logbook provides detailed entries for all inflight information, sections for certificates, ratings, and operating privilege endorsement section, table of contents, room for up to 450 entries, and much more. High quality paper and hard cover binding. 112 pgs. 5"x9. P/N 13-01822 **\$9.75**

CULHANE PILOT LOGBOOK



This Canadian pilot logbook by Michael Culhane fully meets CARs requirements and can be used by student pilots through professional pilots alike having all of the proper columns for flight times, dual, PIC, copilot, single engine, multi-engine, cross country etc. Page count: 160 pages with room for 852 separate entries. Actual size is 6 1/4" X 9 1/4" P/N 13-17634 **\$9.95**

ASA STANDARD UAS OPERATOR LOG



The Standard UAS Operator Log meets the needs of civilian, military, hobbyists, and professional operators alike so that critical flight details can be tracked. It provides record-keeping for flight operations of small and large unmanned aircraft systems (UAS) or unmanned aerial vehicles (UAV), remote-control aircraft (R/C), remotely piloted aircraft (RPA), and drones. Color : Grey

P/N 13-18544 **\$10.95**

PS

PILOT LOG BOOKS



PROFESSIONAL PILOT LEATHER LOGBOOKS

These are designed and made to last a lifetime. Available in Aviation leather and brown leather which are styled to look like a log book dating back to the early days of aviation, as well as black leather which is standard in modern log books. This logbook is bound from true leather. The log pages are designed to keep traditional logging info but to provide more flexibility. It has customary Date, Aircraft, Pilots, Route & Remarks sections. Each page is 8.5"x 9"; 20 entries per page; 288 pages which allows for 2600 entries.

Aviation Brown leatherP/N 13-02139**\$99.95**
 Antique - Brown leather.....P/N 13-02141**\$99.95**
 Black leather.....P/N 13-02140**\$99.95**



STANDARD PILOT LOG BLACK

The finest and most versatile logbooks for aviators. ASA's logbooks have been "The Standard" of the industry for over 30 years and comply with the FAA's recordkeeping requirements. With so many options, there is a logbook that's right for you. Versatile, easy-to-use and flexible enough to fit any pilot's needs, student or ATP. Includes all instructor endorsements. Hard cover, black, 8" x 4 1/2", 100 pages.

Black.....P/N 13-32365**\$7.95**
 Burgundy.....P/N 13-32360**\$9.75**
 Pink.....P/N 13-18545**\$8.75**



STANDARD PILOT LOG

The finest and most versatile logbooks for aviators. ASA's logbooks have been "The Standard" of the industry for over 30 years and comply with the FAA's recordkeeping requirements. With so many options, there is a logbook that's right for you. Versatile, easy-to-use and flexible enough to fit any pilot's needs, student or ATP. Includes all instructor endorsements.....P/N 13-32355**\$9.95**

easy-to-use and flexible enough to fit any pilot's needs, student or ATP. Includes all instructor endorsements.....P/N 13-32355**\$9.95**



PROFLIGHT STUDENT PILOT LOG BOOK

Here is a great way to record a first flight experience for yourself or friends. The "Student Pilot Logbook" has a page for recording a name, address, airport and instructor or pilot's name. It has 4 standard pilot log book pages for recording all of the standard flight information. It has 2 pages of Instructor Endorsements and the "Notes Section" on the last page is a great place to record first impressions. With room for 32 flight entries and a place to record Instructor Endorsements, these logbooks are great for students, flight schools, or those who like to give their guests a way to record their flight. Softcover. Size: 4" x 7 3/4".

Single.....P/N 13-10445**\$2.95**
 13 PackP/N 13-10446**\$38.35**



ASA STANDARD EASA FCL-COMPLIANT PILOT LOG

The EASA FCL-Compliant Pilot Log meets European Aviation Safety Agency record keeping requirements and complies with Flight Crew Licensing rules, EU-FCL.050. A profile page in the front of the logbook provides room to include personal info such as licenses held, date issued, license number, ratings, and aircraft type ...P/N 13-21068**\$9.50**

provides room to include personal info such as licenses held, date issued, license number, ratings, and aircraft type ...P/N 13-21068**\$9.50**



ASA DRONE LOGBOOK

This Drone Logbook is the perfect place for hobbyists and drone operators to begin recording their flight time and experience. Log flight or mission details including date, make & model of aircraft being flown, aircraft identification, takeoff location, landing location, aircraft category (multi-rotor, single rotor, fixed wing), flight conditions, types of operating time, instruction received, PIC time, number of flights, number of takeoffs and landings, and total duration of flight. There is also a column to record special remarks related to the mission. A ground instruction log and maintenance log are also included, as well as a summary page to record flight time specific to make, model, dual instruction, and PIC time. Gray, soft cover, 7-3/4" x 4-1/8", 16 pages.

P/N 13-22748**\$2.35**

FLIGHT CREW LOG BOOK



This shirt-pocket-sized crew log has 216 pages for recording flight times, expenses, duty rigs, crew names, phone numbers, door codes, and more. 12 monthly schedule pages, plus a provision for year totals in the appendix. Meets FAA & IRS record keeping requirements. Durable high quality vinyl cover. Red. 4.25" X 3.25".

P/N 14-00066**\$6.55**

CULHANE CANADIAN AME LOGBOOK



This AME personal logbook designed by Michael Culhane ATPL BSc BA JD is logically organized based on CARs requirements with separate sections for M1/M2, Avionics (E) and Structures (S) ratings, along with separate columns for completion dates and certifications by the supervising AME. Additional sections are provided for personal data, education, training and employment history.

P/N 13-18041**\$19.95**



MASTER LOGBOOK CASE

Durable nylon logbook cover sized to hold master logbook, charts, and other aviation essentials. Loop for pen or pencil, hook and loop closure, clear pockets for license and medical certificate. 7.5"x12"; hold logbooks up to 6.5"x11".

P/N 13-02311**\$19.95**



LOG BOOK COVERS

These nylon logbook covers are very light weight but cover and protect your logbook very effectively. The nylon material is extremely durable and is washable. The cover features a holder for two pens and a velcro pocket on the back for licenses, gas receipt, and other documents.

Color	Size	Description	Part No.	Price
Black	Medium	JEPP	13-04402	\$21.50
Black	Medium	ASA	13-04403	\$21.50
Black	Medium	Sporty's/Stafford	13-04404	\$21.50
Blue	Medium	JEPP	13-04405	\$21.50
Blue	Medium	ASA	13-04406	\$21.50
Blue	Medium	Sporty's/Stafford	13-04407	\$21.50
Red	Medium	JEPP	13-04408	\$21.50
Red	Medium	ASA	13-04409	\$21.50
Red	Medium	Sporty's/Stafford	13-04410	\$21.50
Black	Large	JEPP	13-04411	\$23.95
Black	Large	ASA	13-04411	\$23.95
Black	Large	Sporty's/Stafford	13-04412	\$23.95
Blue	Large	JEPP	13-04413	\$23.95
Blue	Large	ASA	13-04413	\$23.95
Blue	Large	Sporty's/Stafford	13-04414	\$23.95
Red	Large	JEPP	13-04415	\$23.95
Red	Large	ASA	13-04415	\$23.95
Red	Large	Sporty's/Stafford	13-04416	\$23.95

LOGBOOK ENDORSEMENT STICKERS



Can be used for Flight Reviews and Instrument Proficiency Checks, and comply with FAR 61.56 and FAR 61.57 on PIC recent flight experience and flight reviews. Each sticker measures 2" H x 4"L. 10 stickers per sheet on white paper.

P/N 13-06585**\$2.35**



BRIGHTLINE FLIGHT BAGS

BRIGHTLINE B2 COMPUTE BAG



The B2 Compute starts with the 2" Center Section, which is designed to hold 13" laptops. Add a Front and Rear End Cap and you have an extraordinary laptop bag. The Front End Cap allows you to store items such as power cords, backup drives, flash drives, digital cameras, smart phones, tools, keys, etc. Meanwhile, the Rear End Cap allows you to store your manilla folders and documents. This can be used daily or you can attach the 2" Center Section to any other FLEX module. For example, you can zip it in between the Front Bag and the Rear Bag when traveling. This bag also includes the Portfolio Handle which can be attached to the Front End Cap. This will only be used when you decide to remove the Center Section Two and zip the Front End Cap and the Rear End Cap together to make a "Portfolio Bag"P/N 13-11848**\$149.00**

BRIGHTLINE FLEX B4 SWIFT FLIGHT BAG



The B4 SWIFT makes a perfect VFR Flight Bag with room for one or two headsets, an iPad, a handheld radio, and organization for all the little tech accessories. Remove the 4-inch Center Section and end up with the B-zero SLIM. Two different bags for the price of one. The B4 SWIFT is often recommended as the ideal VFR flight bag. It's designed to hold one or two full-sized headsets plus a handful of charts, and/or an iPad, plus all the small stuff you'll want along for the ride. It also serves as an unbeatable carry-on personal bag when traveling on commercial flights, or just as a terrific daily bag for a wide variety of personal and professional uses. ...P/N 13-19653**\$196.00**

BRIGHTLINE B7 PILOT FLIGHT BAG



The B7 FLIGHT is the FLEX version of our award-winning original Pilot Flight Bag updated by now being configured with End Caps and Center Sections to allow even more flexibility. The B7 FLIGHT is perhaps the most useful flight bag ever designed. It's a fact that some days you need more gear than others. The B7 lets you carry a full set of flight gear for cross country and basic IFR flight. And then it lets you downsize to a smaller bag for those days when you're just going to take a quick VFR flight.P/N 13-16012**\$242.00**

BRIGHTLINE FLEX B18 HANGAR FLIGHT BAG



A Flight Bag or Travel Bag that can handle all your gear. Adaptable by adding or removing center sections as needed. Eight different bags can be built with the included modules. Eight bags for the price of one. Designed primarily for aviators who need a Pilot Flight Bag to pack multiple overnight items, such as clothes, shoes, coolers, etc., the B18 HANGAR fits the bill when maximum space is required. Also excellent for those in the Law Enforcement and Emergency Medical field. The B18 is 13.5" x 10.5" x 22" with interior storage capacity of 18 inches. (And remember, it is a soft bag so it can expand slightly in every direction.) P/N 13-19654**\$389.00**

BRIGHTLINE FLEX PACK CAP REAR



This specialized Rear End Cap turns any BrightLine Bag into a backpack (with limitations). This End Cap has backpack straps built in, but doesn't look like a backpack when the straps are not in use. It's easy to deploy the straps in less than 20 seconds. Use both shoulders to carry the load and be hands free when necessaryP/N 13-18166**\$54.00**

BRIGHTLINE FLEX SIDE POCKET ECHO



This new SIDE POCKET ECHO is an infinitely-adjustable insulated water bottle pocket. It will securely hold anything from a small 0.5 liter size, up to a huge 1.5 liter size. The pocket can be adjusted to exactly the size of any container in that range. Secures with two clips on two straps. Allows one-hand removal and replacement of the bottle. P/N 13-18167**\$22.00**

Brightline Bag Shoulder Strap Extension Set ..P/N 13-19489**\$12.00**
 Brightline Flex HolsterP/N 13-19495**\$19.00**
 Brightline Flex Array Base Plate.....P/N 13-19493**\$9.00**
 Brightline Flex Array Kit - Tall.....P/N 13-19492**\$60.00**
 Brightline Flex Array Kit - Short.....P/N 13-19491**\$54.00**
 Brightline Bag Luggage Works Adapter Set P/N 13-19490**\$16.00**

BRIGHTLINE SIDE POCKET DELTA



The Side Pocket Delta is a double pocket designed to provide greater outside storage with a larger pocket. Installs onto any two side-by-side attachment bays. Even bridges the gap between two modules. P/N 13-11989**\$22.00**

BRIGHTLINE SIDE POCKET CHARLIE

The Side Pocket Charlie is a pen pocket designed to hold pens and pencils in flight. In addition, it will hold eyeglasses and larger markers in the pocket behind the slots. P/N 13-11988**\$15.00**



BRIGHTLINE SIDE POCKET BRAVO

The Side Pocket Bravo is a small radio pocket designed for the small aviation radio. There is also room for extra batteries and smaller items.....P/N 13-11987**\$15.00**



BRIGHTLINE SIDE POCKET ALPHA

The Side Pocket Alpha is a radio pocket that is designed to hold a large radio or water bottle. The zipper conceals an expansion flapP/N 13-11986**\$15.00**



BRIGHTLINE REAR END CAP

The Rear End Cap is designed to mimic the outside of the Rear Bag. It is used to finish the exposed rear area of a bag, center section, or end cap by zipping on to the exposed area. By adding a Rear End Cap, not only do you add functionality, you protect the exposed zipper, preventing possible damage. The Rear End Cap is 13.5" x 10.5". The Rear End Cap does not come with a Main Handle or a Shoulder Strap. P/N 13-11985**\$30.00**

BRIGHTLINE FRONT END CAP

This is the Front End Cap that mimics the front of the Front Bag. It is 13.5" x 10.5" x 1.5". The Front End Cap is designed to hold your cell phone, wallet, Multi-Tool, cords, cables, etc. It is not designed to be used alone as the zippers are exposed and could be damaged. Works well with a Rear End CapP/N 13-11984**\$58.00**



BRIGHTLINE CENTER SECTION 11 INCH

The CS11 was designed primarily for pilots that frequently travel overnight. It will swallow several changes of clothes, a 13" laptop with room for binders and documents, or a small cooler. The CS11 is 13.5" x 10.5" x 11". (And remember, it is a soft bag so it can expand slightly in every direction.) The CS11 comes with a handle and a shoulder strap.....P/N 13-11983**\$110.00**



BRIGHTLINE CENTER SECTION 5 INCH

The CS5 was developed primarily for our IFR Flight Customers. With the B10, you get enough storage for VFR to light IFR flying. By adding a CS5, you can now add IFR Binders and documents, without changing the setup of the B10. Also, perfect for a couple days worth of clothes, two more sets of headsets, or a 13" laptop. The CS5 is 13.5" x 10.5" x 5". (And remember, it is a soft bag so it can expand slightly in every direction.)P/N 13-11982**\$63.00**



BRIGHTLINE CENTER SECTION 2 INCH

The CS2 is designed for carrying 13" laptops, iPads and assorted documents. This center section is 13.5" x 10.5" x 2". Not designed to be used by itself due to the possibility of damaging the exposed zippers. Can be added to any configuration to add storage for your 13" laptop. Simply zip the CS2 into a B10, B16, or B25 to get added storage for your 13" laptop, iPad, or folders and documents. P/N 13-11981**\$41.00**



BRIGHTLINE BAGS O-RINGS

Slide the two pairs of o-rings onto the main handle of the BrightLine Bag and nestle the J-hook from your main suitcase in between the two pairs of o-rings to keep the J-hook from sliding side-to-side on the main handle of the BrightLine Bag as you pull your main suitcase around. Includes two pairs of o-rings (total of 4).....P/N 13-11991**\$2.00**



PS

BRIGHTLINE FLIGHT BAGS

BRIGHTLINE FLEX B4 SWIFT - ECHO



The B4 SWIFT-ECHO makes a perfect VFR Flight Bag for Airline Captains as there is room for one or two headsets, one or two iPad, a full-sized water bottle, plus all the small stuff you'll want along for the ride. The B4 SWIFT-ECHO includes our unique Main Handle J-Hook that is designed to fit onto the J-Hook of most rolling suitcases. It also serves as an unbeatable carry-on personal bag when traveling on commercial flights, or just as a terrific daily bag for a wide variety of personal and professional uses. The B4 consists of the POCKET CAP FRONT, CENTER SECTION 4, FLAT CAP REAR, along with two Side Pockets, Echo and Charlie. It

also includes the MHJ and SS. It does NOT include a SLIM HANDLE KIT. If you ever think you'd like to remove the CS4 and zip just the two End Caps together to make the B0 SLIM, you'll need to make sure you also order an SLIM HANDLE KIT.P/N 13-21547**\$199.75**

BRIGHTLINE FLEX B7 FLIGHT - ECHO



The B7 FLIGHT is perhaps the most useful flight bag ever designed. It's a fact that some days you need more gear than others. The B7 lets you carry a full set of flight gear for cross country and basic IFR flight. And then it lets you downsize to a smaller bag for those days when you're just going to take a quick VFR flight.

The B7E consists of the POCKET CAP FRONT, CENTER SECTION 4, FLAT CAP REAR, along with two Side Pockets, Echo and Charlie. It also includes the MHJ and SS. It does NOT include a SLIM HANDLE KIT. If you ever think you'd like to remove the CS4 and zip just the two End Caps together to make the B0 SLIM, you'll need to make sure you also order an SLIM HANDLE KIT.

.....P/N 13-21548**\$249.00**

BRIGHTLINE FLEX B-ZERO SLIM



The B0 SLIM is obviously the thinnest possible FLEX SYSTEM configuration. The "iPad bag" because works so well as an ultra-thin computing and personal bag - a "man purse" if you will. The B0 is simply the POCKET CAP FRONT and the FLAT CAP REAR modules zipped together. It has no definable interior storage dimensions since it is just two End Caps put right against each other, but the flexible nature of the parts allows one-half inch to three-quarters inch of flat items to fit inside between the modules.

.....P/N 13-21546**\$120.00**

BRIGHTLINE POCKET CAP REAR



PCR: The POCKET CAP REAR module offers a variety of pockets organized into three "main" pockets, each one with two "secondary" pockets, for a total of nine small pockets on the Rear panel. There is also a flat half-height slip pocket on the inner surface of the module where you can stow an important document or two.

The key benefit of this PCR module is that you can put a second set of exterior pockets on the Rear of your bag, to go along with the ones that you already have on the Front of your bag. More pockets - More organization.

.....P/N 13-21549**\$58.00**

BRIGHTLINE FLAT CAP FRONT



The FLAT CAP REAR attaches to the Rear Surface of all Center Sections as well as directly to a Front End Cap.

The FLAT CAP REAR module offers one flat pocket on the outside, and one flat half-height slip pocket on the inner surface of the module. The primary outer pocket is accessed from the top and has a cover flap that is secured with Velcro. This where you'll likely store your iPad (as long as it's not in a thick case), or a manilla folder or two for some documents, or a magazine.

.....P/N 13-21550**\$30.00**

BRIGHTLINE CENTER SECTION TWO - TALL



The CS2-Tall is designed for carrying 15" laptops, iPads etc.

This center section is 15" x 10.5" x 2" and it can attach to all of the FLEX System modules including other center sections.

This item does not include a Main Handle or Shoulder Strap. If building a custom bag, make sure your order includes one or both.

The CS2-Tall can be used in any configuration and is not designed to be used by itself due to the possibility of damaging the exposed zippers. You will always want to have something (either another module or an End Cap) zipped onto both sides of the CS2-Tall to protect the zippers.

.....P/N 13-21551**\$46.00**

BRIGHTLINE CENTER SECTION THREE



The Center Section Three offers 3 inches of storage and easily carries 13" laptops, some 14" laptops, tablets as well as documents, folders, clipboards, etc.

There is one small accessory pocket on the side panel, accessible with a vertical zipper. It's a good size for pens, markers, highlighters, or spare reading glasses.

The Main Compartment of the CS3 has locking zipper sliders.P/N 13-21552**\$46.00**

BRIGHTLINE CENTER SECTION FOUR



The Center Section Four offers four inches of storage depth and comes with a divider shelf attached to the side walls of the main compartment with Velcro. This shelf can be positioned right where you need it or removed for full access storing one or two headsets or GPS.

This item does not include a Main Handle or Shoulder Strap. If building a custom bag, make sure your order includes one or both.

The interior of the CS4 is 13.5" tall, 10.0" wide, 4.0" deep.P/N 13-21553**\$58.00**

BRIGHTLINE ACCESSORIES

Description	Part No.	Price
Brightline Main Handle	13-21554	\$9.00
Brightline Main Handle - Jhook	13-21555	\$8.95
Brightline Shoulder Strap	13-21556	\$11.00
Brightline Adapter Loops (2)	13-21557	\$5.00
Brightline Adapter Kit	13-21558	\$14.00
Brightline D3 Clips (4)	13-21559	\$9.00
Brightline Slim Handle	13-21560	\$7.00

Description	Part No.	Price
Brightline Slim Handle Kit	13-21561	\$214.00
Brightline Array 4 X 3 - Short	13-21562	\$6.50
Brightline Array 4 X 3 - Tall	13-21563	\$7.50
Brightline Array 6 X 3 - Short	13-21564	\$7.50
Brightline Array 6 X 3 - Tall	13-21565	\$8.50
Brightline Array 6 X 4 - Short	13-21566	\$8.50
Brightline Array 6 X 4 - Tall	13-21567	\$9.50

PS

FLIGHT BAGS

AERO SQUADRON LEATHER BAGS



AERO SQUADRON LEATHER DUFFLE BAG
Carry on Bag
Dimensions: 119" Length, 10" Height, 9.5" Width
Color: Walnut
P/N 13-07202**\$329.00**



AERO SQUADRON LEATHER BRIEF CS
Satchel Brief.
Dimensions: 16.5" Length, 12" Height, 4" Width
Color: Walnut
P/N 13-07199**\$386.00**



AERO SQUADRON LEATHER CARRY-ON
Lambskin wheeled carry-on. Telescoping handle with in-line skate wheels. Exterior front zip compartment with file section & pockets for discs. Exterior back zip pockets. Roomy main compartment with support straps. Compartment for laptop. Import.
Dimensions: 13L x 18H x 7W.
P/N 13-07206**\$490.00**

AERO SQUADRON LEATHER TRAVEL SLING

Travel Sling.
Dimensions: 13.5" Width 9.75" Height, 6.75D
Color: Walnut..... P/N 13-07204..... **\$187.75**



AERO SQUADRON LEATHER HANDBAG

Handbag Collection
Dimensions: 8.25" Length, 10.5" Height, 3" Width
Color: Walnut.....P/N 13-07207**\$170.00**



AERO SQUADRON LEATHER SHAVE KIT

Shave Kit
Dimensions: 10" Length, 6" Height, 4" Width
Color: Walnut.....P/N 13-07198**\$115.75**



AERO SQUADRON LEATHER SHIELD TOTE

Man Bag w/Shoulder Strap
Dimensions: 6-1/2" x 9" x 4"
Color: Walnut
P/N 13-07201**\$128.75**

FLIGHTLINE FLIGHT BAGS



LARGE DELUXE FLIGHT BAG
The top of the line Flight Bag by Flightline boasts an incredible array of features for the price. This heavy-duty bag is double stitched and ideal for large loads.
Dimensions: 12"H x 7-1/4"W x 14-1/2" L
P/N 13-04255**\$64.75**



MEDIUM DELUXE FLIGHT BAG
This Flight Bag is ideal for pilots who have a lot to carry but not a lot of space to put the bag. It is currently any pilot's favorite flight gear!
Dimensions: 10"H x 6-3/4"W x 12-1/2" L
P/N 13-04256**\$56.80**



DELUXE HEADSET BAG
It is the perfect bag to protect and organize any fragile and expensive equipment. Not only will this bag hold a headset, but other necessary items as well!
Dimensions: 10"H x 4-1/4"W x 10 " L
P/N 13-01416**\$31.75**

BISON FLIGHT BAGS



MOUNTAIN ULTIMATE FLIGHT BAG

Taller than most bags, it makes more use of the vertical room in your narrow baggage compartment or cockpit. At 19.5 inches long, 9 inches wide, and 14 inches tall you can pack everything you need to fly with and there is enough room left over for a couple days worth of clothes. The interior compartment is 14 inches long, 7.5 inches wide, and 14 inches tall. A removable interior divider velcros in place to increase storage options. There are nine exterior pockets. Exterior pockets include a padded headset pocket, padded pocket specifically for Garmin 496 or similar GPS's (or handheld radios), cellphone pocket, pocket for magazines or newspapers, water bottle pocket, chart pocket, 8.5 inch by 7 inch pocket for logbooks or aircraft manuals and pen, pencil, flashlight holder. Large padded laptop compartment that measures 14 inches long, 12 inches high, and 1.5 inches wide. A clear plastic identification card holder. There is a place for military or civilian wings that attach with velcro. It comes with sturdy carrying handles that velcro together and a removable carrying strap.

Color	Part No.	Price
Black Curdura	13-05329	\$157.75
Grey Curdura	13-05331	\$157.75
Black Leather	13-05333	\$196.85
Grey Leather	13-05334	\$196.85
Brown Leather	13-05336	\$196.85



MOUNTAIN RV FLIGHT BAG

A practical solution to organizing the cargo area of your RV-6, RV-7 or RV-9. Also makes a great overnight bag! The RV Flight Bag was designed to fit behind the pilots and co-pilots seat of the RV-6/7/9. It fits over the flap actuator bar and makes maximum use of the area behind your seat. 18 inches high and 12.5 inches wide. There are two side pockets, one 10" x 4 " and a 7" x 5.5" map pocket. The rear side of the bag has a pencil /flashlight/fuel tester pocket, a 10 inch x 7 inch headset pocket, and a 6"x 5 1/4" pocket for small tools. It has a nice carrying handle and comes with two straps that can be attached to your seat back to clip the bag to your seat to minimize movement. It also comes with a removable shoulder strap.

Color	Part No.	Price
Black Curdura	13-05321	\$125.75
Grey Curdura	13-05323	\$125.75
Black Leather	13-05324	\$194.75
Grey Leather	13-05326	\$192.85
Brown Leather	13-05328	\$192.85

PS

NORAL FLIGHT BAGS



NORAL EXPRESS FLYER BAG

The swing hook for the adjustable shoulder strap is made of metal to ensure heavy load resistance. The shoulder strap has a soft rubber pad for your comfort and to keep the bag in fixed position while carrying on shoulder. Made of 1680 Denier Ballistic water repellant material. Its interior is fully padded and covered with the liner of water repellant taffeta.

Black P/N 13-11441 **\$61.75**
 Grey P/N 13-11440 **\$61.95**



NORAL TRIPLE HEADSET BAG

The Noral Triple Headset Bag is made of 1680 Denier Ballistic water repellant material. Interior is fully padded and covered with the liner of water repellant taffeta.

Black P/N 13-11430 **\$63.75**
 Grey P/N 13-11433 **\$63.75**



NORAL FLYING CLUB BAG

This bag is designed for all pilots, especially for the compact cockpit airline pilot, Military pilot and for private and student pilots. This bag can hold most essential instruments efficiently. The main compartment of this bag can hold a large headset, logbook and/or any other similar items. The rear pocket works well to hold books, boards, charts or similar items. There is also a small front pocket with zipper closure and two side pouches

for Transceiver/ GPS etc. Made of 1680 Denier Ballistic water repellant material. Its interior is fully padded and covered with the liner of water repellant taffeta.

Black P/N 13-11442 **\$55.95**
 Grey P/N 13-11444 **\$55.99**



NORAL ATTACHE FLIGHT BAG

This bag has two side pouches for large headsets. One of these side pouches has a flap pocket with zipper closure to store pens, flashlights, ID card and/or license etc. Inside the main compartment there is two removable pouches for GPS/Transceiver and two dividers. The dividers can be adjusted to different positions and are removable. The front of the bag has a large open pocket for easy access. The back of the bag has a large zippered pouch with piano type opener and three dividers. At the bottom floor of this bag is a removable plastic board to reinforce it and to keep the bag from sagging when fully loaded. Made of 1680 Denier Ballistic water repellant material. Its interior is fully padded and covered with the liner of water repellant taffeta.

Black P/N 13-11446 **\$267.95**
 Grey P/N 13-11448 **\$216.95**



NORAL IPILOT BAG

This bag can hold most instruments and is compact to save cockpit space. There are a total of 13 pockets inside and one large pocket outside for a headset. The main compartment of this bag can hold a large headset or other equipment. It has another zippered pocket in the front for a logbook or any other similar item. This bag also has some small rear pockets.

Grey P/N 13-12432 **\$142.75**
 Black P/N 13-12433 **\$139.75**

NORAL AVIATOR FLIGHT BAG (DETACHABLE)

The main compartment of this bag has a removable divider which can be adjusted to a different position. The bottom floor has a removable plastic board to reinforce.

The swing hook for the adjustable shoulder strap is made of metal to ensure heavy load resistance. The shoulder strap has a soft rubber pad for your comfort and to keep the bag in fixed position while carrying on shoulder. Made of 1680 Denier Ballistic water repellant material. Black P/N 13-11428 **\$165.95**
 Grey P/N 13-11429 **\$176.75**

NORAL AIRCRAFT DOCUMENT HOLDER

This durable document holder is made of strong fabric with two clear pockets to hold your aircraft document secure and visible. It comes with two inches of velcro to be placed anywhere that velcro can be applied to. Velcro P/N 13-01134 **\$28.50**

NORAL ANGELS TOOL BAG

Two side pouches and over one of the side pouches is an open pocket for easy access. In the front of the bag is a large zippered pocket and both the front and back of the bag have reflector bands that can be seen at night time. The back of the bag can be opened like a portfolio and there are 21 elastic loops to keep organized. Also, inside this portfolio is a large zippered pocket. The main compartment has 10 more elastic loops for small tools and 3 easy access pockets. The main compartment also has a removable and adjustable divider to keep instruments organized.

Color: Grey P/N 13-11421 **\$153.75**



NORAL SINGLE HEADSET BAG

This bag is ideal for the pilot that wants to carry a passenger headset or his own, separate from his flying bag. It is constructed with genuine DuPont® Cordura® 1000 Deniers, water resistant, fully padded with a 1/4" foam and backed with a layer of tricot. Features separate zippered compartment along with an extra side pocket.

Grey P/N 13-00286 ... **\$36.50** Black P/N 13-00288 **\$34.60**



NORAL STUDENT PILOT BAG

The Student Pilot Bag has plenty of room for everything a student pilot needs to carry and more. It has 2 extra large zippered headset pouches plus another zippered section to store pens, flashlight, fuel tester, E6B computer and more! Access to the main compartment is through a double zipper flap with a pull cord. In addition to the carrying handles, a detachable padded shoulder strap is included. Size: 11"H x 10.5"W x 12"L.

Grey P/N 13-00294 ... **\$79.95** Black P/N 13-00297 **\$76.75**



NORAL PRIVATE PILOT BAG

Fits all the goodies and gadgets a pilot needs and wants to carry. It has two extra large zippered headset pouches plus another zippered section to store pens, flashlight, fuel tester, E6B computer and more! Access to the main compartment is through a double zipper flap with a pull cord. In addition to the carrying handles, a detachable padded shoulder strap is included. Size: 11"H x 10.5"W x 15.5"L.

Black P/N 13-00313 **\$102.85**



NORAL MACH 1 FLIGHT BAG

The Mach 1 flight bag is compact yet roomy. The bag features a wide 5" double zippered access flap with a pen and pencil holder. There are two end compartments 6"x10". On the front, a zippered 11"x6" compartment. On the back is a 4"x8"x8" headset compartment which will accommodate the largest of headsets. The Mach 1 is made of US Made Nylon with 1/4" Foam Padded, 1000 Denier and is water resistant. It comes equipped with a GPS/Transceiver Pouch that can be worn on your belt. Also included is a shoulder strap and carry handle. Dimensions: 15"LX11"WX10 1/2H

Black P/N 13-04088 ... **\$131.75** Grey P/N 13-04092 ... **\$131.75**



NORAL MACH 2 FLIGHT BAG

A divider in the main compartment. can be adjusted in different position and can be removed if you want so. The shoulder strap has a soft rubber pad for your comfort and to keep the bag in fixed position while carry on shoulder. This bag is made of 1680 Denier Ballistic water repellant material. Its interior is fully padded and covered with the liner of water repellant taffeta to protect your instrument. All our Flight Bags have 7 years Warranty on Manufacturing defects.

Black P/N 13-11425 ... **\$190.75** Grey P/N 13-11424 ... **\$199.95**



AIRCRAFT SPRUCE SINGLE HEADSET BAG

Safe and convenient way to protect a single headset. Features foam padded single zipper compartment with convenient webbing handle. Made in USA. Size: 7"L x 4"W x 9"H. Color: Black...P/N 13-55010 **\$19.95**



NORAL HEADSET FLIGHT BAG

The main compartment of this bag can hold a large headset and another space with divider for logbook and/or any other similar item. This bag has a rear pocket with secure touch fastener. It also has a small front pouch with touch fastener and one pouch in the left side for Transceiver/GPS. The right side has holders for pen and small flash light. The main compartment is H9" X W9" X G4.5".

Black P/N 13-07468 ... **\$41.95** Grey P/N 13-11356 **\$42.55**



NORAL CFI/IFR PILOT FLIGHT BAG

This bag has two side pouches equipped for large sized headsets. One of these side pouches has a flap pocket with a zipper closure to store pens, flashlight, ID card and/or license etc. Inside the main compartment is two removable pouches for GPS/Transceiver. The dimension of main compartment is H11" X W14.5" X G10". In the front of the bag is a large open pocket for easy access. The back of the bag has two open pockets and the bottom floor of the bag is a removable plastic board to reinforce it and to keep the bag from sagging when fully loaded. Also has two dividers in the main compartment that can be adjusted to a different position and can be removed if desired..... P/N 13-15768 **\$167.99**



NORAL AIR MAP CASE 1000

The Noral Air Map Case 1000 is made of 1680 Denier Ballistic water repellant material. Interior is fully padded and covered with the liner of water repellant taffeta.

Black P/N 13-11434 **\$28.50**



FLIGHT BAGS

ASA AIRCLASSICS FLIGHT BAG



ASA has brought pilot gear to a new level with the AirClassics series of pilot bags. Focusing on a clean, sophisticated and professional look, they have been designed and engineered to be supremely functional. Padded 600D nylon for superior durability. Comfort Grip connectable handles. Non-slip detachable carry strap. Reinforcing straps around bag for strength. #10 zippers for easy handling. Headset pockets on both ends. Large single-pull, zippered & dividable main compartment. 18"L x 11"H x 7"WP/N 13-02336**\$68.95**

ASA AVIATOR FLIGHT BAGS



The Pilot Flight Bag and the Trip Bag, are made of fully padded nylon for extreme durability. They feature wraparound carry straps for strength, a non-slip detachable shoulder strap, and high-quality zippers on the main compartments.

Pilot Bag.....P/N 13-04057**\$37.95**
Trip Flight Bag.....P/N 13-04058**\$59.75**

PROFLIGHT PREMIUM HEADSET BAG



Three small individual pockets. It is made to resist water and tears. Padded protection for an individual headset with a dual zipper on top makes access very easy. Will fit most ANR headsets. Size: 10-3/4" x 11-3/4" x 5"

P/N 13-06936**\$19.95**

ASA TABLET BAG



The Tablet Bag is the perfect size for student and professional pilots alike! This conveniently sized bag, handy for pilots and aviation professionals alike, holds a tablet, headset and other small personal items for your flight. This bag will hold a lot more than just a tablet, in fact, it has plenty of room for a 13" laptop and a tablet. It will also hold a headset, charts, a plotter, logbook, radio, or gps unit, and all of those other small items a pilot may need to carry. The outside of the bag has a spot for a flashlight or fuel tester and a zip pocket for a radio, GPS, or water bottle. The padded, adjustable shoulder strap can be worn cross body for a comfortable fit, and easy portability. Focusing on a clean, sophisticated and professional look, the ASA AirClassics® Tablet Bag is designed and engineered to be supremely functional, able to stand up to the toughest treatment possible, yet still look great at the end of the day.

P/N 13-18460**\$69.95**

ASA FLIGHT BRIEFCASE



The Pilot Briefcase features an expandable, zippered main compartment with room for all ground and flight school necessities. The outer flap provides easy access to a chart pocket with multiple accessory storage areas to store everything from pencils and pens, to flashlights and flight computers. Also perfect for laptop computers. Each bag is black with the ASA wings logo tastefully silver-embroidered on the top. Count on ASA's AirClassics Flight Bags to bring many years of utility and pride. 15-1/2"L x 11"H x 3"W.

P/N 11-08805**\$29.50**

ASA AIRCLASSICS PILOT BACKPACK



The ASA AirClassics® Pilot Backpack is made of durable fabric and supported by a heavy-duty water-resistant bottom, this backpack keeps books and supplies organized and protected. Four zippered compartments provide ample room for just about anything a pilot-on-the-go needs. The front pocket will accommodate most aviation headsets, including the HS-1A Headset and Single Headset Bag (both sold separately). The second level interior compartment has a lanyard for keys, a zippered containment pouch, and plenty of pockets and slots for pens, pencils, flight computers and plotters. The spacious main compartment supports textbooks and manuals, and the checkpoint-friendly fold-down back panel contains a padded pocket for a laptop, and a felt-lined pocket for a tablet. The backpack's interior contrasting-color lining makes it easy to find things inside.

P/N 13-18424**\$83.95**

AEROCOAST PRO SLIM NOTEBOOK BAG



A great addition to the 13-12894 Pro Cooler Bag sold separately. Shoulder strap connection points on both modular sections. Easy X-ray screening at TSA checkpoints so you will never take out your laptop again. You will save time and you will protect your laptop, iPad or EFB from physical damage. iPad compartment dimensions 15 x 11 x 1.5 inches.

P/N 13-12895**\$27.80**

AEROCOAST PRO COOLER I



Eat healthy on the road and save money. This cooler bag has two separate insulated compartments with silver lining to keep your food warm or cold. Tired of lugging around more than you have to? Do you want to eat healthier and save money while on the road?

You can eliminate a lot of day to day hassle at the TSA checkpoints. Ergonomically designed snap handle for quick, easy, and comfortable use. Four additional pockets for easy storage of accessories. Rigid case construction for added durability. A great addition to the 13-12895 Pro Slim Notebook Bag sold separately.....P/N 13-16281**\$94.95**

AEROCOAST PRO EFB & INSULATED COOLER BAG



Top pocket for sunglasses. Shoulder strap connection points on both modular sections. Modular design lets the EFB & Cooler portion to be used independently or used in unison. Easy X-ray screening at TSA checkpoints so you will

never take out your laptop again. Two separate insulated compartments to keep your food warm or cold. Four additional pockets for easy storage of accessories. Leak resistant main compartment design. Fits under aircraft seats for easy stowage on travel. Outside dimensions: 15 x 11 x 10 inches. Laptop compartment dimensions 15 x 11 x 3 inches

P/N 13-12893**\$119.95**

AEROCOAST PRO CREW I FLIGHT BAG



The Next-Gen airline pilot flight bag. You can breeze through and eliminate a lot of the stress at TSA checkpoints.

YKK Zippers and rigid composite construction to increase durability. Ergonomically designed snap handle for quick, easy, and comfortable carrying. Quick access top compartment for extra storage has been added, in addition to 5 pockets for easy organization and storage of accessories. Interior padded compartment makes for a great way to carry and protect your laptop, EFB, or iPad, etc. with additional room to bring books and manuals and all of your necessary trip accessories.

Specifications: • Outside: 16 x 11 x 9.5 inches • Interior Compartments: Main: 15.5x11x7 inches • Second forward: 15.5 x 11 x 1.5 inches • Most forward: 15.5 x 11 x 1 inches.....P/N 13-22309**\$117.14**

AEROCOAST PRO CREW I-W FLIGHT BAG



YKK Zippers and rigid composite construction to increase durability. Ergonomically designed snap handle for quick, easy, and comfortable carrying. This bag has quick access top compartment for extra storage, in addition to 5 pockets for easy organization and storage of accessories. Interior padded compartment makes for a great way to carry and protect your laptop, EFB, or iPad, etc. with additional room to bring books and manuals and all of your necessary trip accessories.

Specifications: • Outside 15.5 x 13 x 11 inches • Interior Compartments: Main: 15.5 x 11 x 7 inches • Second forward: 15.5 x 11 x 1.5 inches • Most forward: 15.5 x 11 x 1 inches.....P/N 13-22310**\$160.00**

AEROCOAST PRO JETPACK I BACKPACK



This ultimate bag has 3 primary compartments and multiple usable organizational pockets for easy organization and storage of required equipment such as headsets, EFB's, laptop, glasses, and all the associated accessories.

Interior padded compartment makes for a great way to carry and protect multiple EFB's laptops, tablets, etc. with additional room to bring food, and all of your necessary trip accessories.

Specifications: • Outside: 16"x13"x8" • Main compartment: 15"x12"x5" • Main Laptop compartment: 14"x12"x2" • Front iPad/ EFB sleeves: 12"x11"x.5" • Sunglass compartment: 10"x3"x2.8"

P/N 13-22311**\$154.29**

PS

FLIGHT BAGS



AIRCLASSICS™ SINGLE HEADSET BAG

For those who like to fly with minimum baggage, this holds one headset, has extra pockets, and all-around padding.

P/N 13-02333\$16.95



VOYAGER II FLIGHT ATTACHE FOR IPAD

The Voyager II has upgraded metal snap hooks and d-rings to attach the stretchy, comfortable Air Lift shoulder strap. There is a separate pocket inside to carry your iPad1, 2 or 3 and will fit most iPad cases. The outer side pocket features a removable AND adjustable strap. The handles are now made of 1680D

and the entire bag is accented with Leatherette. All the same organizing features including the Co-Pilot organization flap, chart pockets and battery sleeves are all still where they were before. If you fly with an iPad, this is a great case to help organize during your pre-flight.

Size: 17.0 X 11.5 X 5.5in. Weight: 2lbs 13oz.....P/N 13-11877\$63.85

FLIGHT BAG 1 V2



This bag is like the hard flight cases airline pilots use. There's no maze of compartments, just efficient, sensible storage. Maybe that's why a major US airline flight training academy chose Bag1 as standard issue for their students. This Cockpit Bag is simple, practical, and cockpit friendly. Perhaps its ease of use is a Brighter idea. Enjoy the simplicity of well thought out storage, just right for most pilots.

Color: Black.....P/N 13-20149\$64.95

PORTABLE FOLDING LUGGAGE CART



3-Way portable luggage cart (folding cart) in black plastic with 37.5" extension handle. Load up to 66 lbs. Store flat. Makes moving items easy. Fits the Brightline Bag perfectly!

To attach the bag, place the front of the bag (pocket-side) flush against the telescoping handle. Take the handle and clip it into the front buckle. Wrap the handle around the telescoping handle and reattach it to the opposite front buckle. The bag is now securely attached to the cart..... P/N 13-10007\$48.00

POWDER PUFF PILOT PINK FLIGHT BAG



In response to customers who lamented not being able to find a pink flight bag – here you are! A padded handle and gray shoulder strap makes it easy and convenient to tote – even when it's full. The main compartment is roomy enough to carry headsets, charts, and flight gear for a cross-country adventure; or clothes, toiletries, and makeup for a weekend getaway.

It also has two exterior pockets for easy access to your wallet, keys, and cell phone, as well as a mesh pocket for your water bottle. Bag dimensions: 10½ by 17½ by 10½ inchesP/N 13-11469\$29.95

AVCOMM DELUXE DUFFLE FLIGHT BAG



AvComm Pilot Deluxe Flight Bag with 7 Compartments. Great for your flight gear, travel or any overnight stay.

Features: • Seven compartments with shock resistant padding • Dual zippered flap on center compartment has a Velcro® strip making it easy to zip • Inside, a Velcro® partition and pouch with Velcro® closure secures radios and gear • Outside features a large compartment, two zippered end pockets for headsets, and two additional gusseted pouches.

Specification: • Dimensions: 18"L x 10.5"H x 9"W • Weight: 2 lbs. P/N 11-02277\$39.00

FORCE PROTECTOR GEAR HELMET BAG



FPG HelmetBag design! This bag features a much larger storage capability without taking up too much cabin space in aircraft. The pleated bag design expands and contracts with your loadout to easily fit your helmet and accessories. Dimensions: 21.5" Wide x 19" Tall x 3.25" D (54.6cm Wide x 48cm Tall x 8.3cm D). Capacity: 1226 cubic inches internal / 20 liters / 676 cubic inches external pockets / 11 liters. Weight: 2 lbs / .9kg.

Color	Part No.	Price
Black	13-20223	\$181.75
Multi-Camo	13-20637	\$181.75
ACU Camo	13-20638	\$181.75
ABU Camo	13-20639	\$181.75
Coyote	13-20640	\$181.75

THE AVIATOR BAG



Slightly smaller than the Navigator Bag, but still spacious enough for all your flight materials. Includes 1 exterior front pocket as well as detachable headset & transceiver cases. Constructed with durable PVC backed with 600 denier poly. 15"x 6.5" x 12" (black only).

P/N 13-00998\$72.75

THE STUDENT PILOT



A great first bag for the student pilot. Numerous outside pockets organize charts, flight computer, fuel tester, plotter, pens and pencils, flashlight and much more. Comfortable, wide removable shoulder strap; double zipper opening for easy access. Reinforced bottom. Constructed with durable PVC backed 600 denier poly. 10"x 5.5"x17" (black only).

P/N 13-00997\$32.85

JEPPESEN STYLE FLIGHT BAG



Student/Book Bag: Same great bag Jeppesen uses for its training kits. The bag is made from heavy-duty 6000 denier Cordura for superior strength and with a PVC coating on one side for added water resistance. Includes outside pockets, removable shoulder strap, reinforced bottom. Size 10" x 5.5" x 17"

P/N 13-06280\$29.95

AIRCRAFT DOCUMENT CASE



This durable, flexible blue cordura pouch is an ideal way to keep aircraft registration, insurance, log books, operating manuals, and other important documents all in one safe location. Measures 18"W x 12"H. Features top quality zipper along front side for easy access and location to mark your aircraft number on front.

Color	Part No.	Price
Blue	13-20065	\$27.50
Black	13-11883	\$32.50
Red	13-02934	\$32.75

WWP-102 HEADSET BAG



This padded carry bag provides inexpensive insurance against headset damage. Featuring dual zipper openings, inside pocket sectionals, computers, glasses, etc. Bag is constructed of black waterproof nylon with carry handle.

P/N 17-00231\$15.95

GELFLEX "CREW" LUGGAGE TAG DUAL SIDED



The Gelflex Crew Luggage Tag is a great version of a traditional Crew Tag. Black letters (CREW) on vibrant background. And best of all, it comes with a special flexible cord that enables you to attach it to your luggage or equipment without worrying about whether it will break or tear. 3-3/4" x 2-1/4".

White TagP/N 14-02963\$5.80
Blue TagP/N 14-02960\$6.50

PS

FLIGHT BAGS

FLIGHT OUTFITTERS PROPACK BAG



The Pro Pack is an optional insulated bag that is designed to fit inside one of the hide away pockets of the Flight Level Bag. This handy pack provides extra protection for delicate items or an insulated place to put your snack out of the way of your flying gear. FLIGHT LEVEL Pro Series bag is not included..... P/N 13-18539**\$12.95**

FLIGHT OUTFITTERS LIFT PRO FLIGHT BAG



The Flight Outfitters Lift Bag is offered in all-black. This sturdy bag has room for all the essentials, but won't get in your way. Includes a large headset pocket, iPad pocket and multiple organizer sections with room for all your accessories. A helpful exterior pocket makes it easy to grab your backup radio in an emergency. Steel-reinforced carrying handles will haul even the heaviest load, and the reinforced sides offer additional protection. Signature orange interior makes it easy to find the flashlight or pen in the dark.....P/N 13-22022**\$99.95**

FLIGHT OUTFITTERS LIFT XL FLIGHT BAG



The Lift XL is a larger version of the top-rated Lift Bag, adding more room for storage (ex. two headsets, not included) and more organization options, all while retaining the signature design features that make Flight Outfitters bags so useful in the cockpit. For

professional pilots who prefer an understated, all-black look, the Lift XL Pro is ideal. Features a solid black exterior but with the signature orange interior so items are easy to find in the dark. Slides over your rolling luggage for easy transport.

Specifications: • Weight (empty): 2 lbs. • External: 18" w x 10.5" h x 9" d
• Main Internal Pockets (front to back).....P/N 13-22020**\$129.95**

FLIGHT OUTFITTERS LIFT XL PRO BAG



The Lift XL Pro is ideal for professional pilots who prefer an understated, all-black look. As a larger version of the top-rated Lift Pro Bag, the Lift XL Pro adds more room for storage (ex. two headsets, not included) and more organization options, all while

retaining the signature design features that make Flight Outfitters bags so useful in the cockpit. Features a solid black exterior but with the signature orange interior so items are easy to find in the dark. Slides over your rolling luggage for easy transport.

Specifications: • Weight (empty): 2 lbs. • External: 18" w x 10.5" h x 9" d
• Main Internal Pockets (front to back).....P/N 13-22021**\$129.95**

FLIGHT OUTFITTERS WAYPOINT BACKPACK



This thoughtfully-designed backpack has room for all your aviation gear but is flexible enough to work as an overnight bag or an everyday laptop case. The large center compartment accommodates a headset and kneeboard, with plenty of room left over for a change of clothes. Two interior mesh

side pockets are perfectly sized for an ADS-B receiver or GoPro, and a large zippered pocket organizes your charging cords and battery packs. Signature orange interior makes it easy to find your gear, even at night. P/N 13-23256**\$49.95**

GARMIN EXECUTIVE BLACK FLIGHT BAG



This Garmin executive ballistic nylon shoulder bag was designed with the pilot in mind and includes custom-made pouches to hold Garmin portable devices, such as the aera 796, VIRB action camera and GDL 39. Some of these pouches are even removable.

Special pass-through areas are included throughout the bag to allow you to charge your devices from a separate battery charger without having to take them out of the bag.....P/N 10-05882**\$115.00**

FLIGHT OUTFITTERS LIFT FLIGHT BAG



This sturdy bag has room for all the essentials, but won't get in your way. Includes a large headset pocket, iPad pocket and multiple organizer sections with room for all your accessories. A helpful exterior pocket makes it easy to grab your backup radio in an emergency. Steel-reinforced carrying handles will haul even the heaviest load, and the reinforced sides offer additional protection. Signature orange interior makes it easy to find the flashlight or pen in the dark. BrownP/N 13-18181**\$99.95**

FLIGHT OUTFITTERS BUSH PILOT BAG



The Bush Pilot bag is canvas with leather accents, and carries an embossed leather flight outfitters patch on the front. The inside of the Flight Level has the signature Flight Outfitters orange, making it easy to find gear in a dark cockpit. There are two large padded side pockets for headsets. The large front zip pocket has 4 organization pockets, for

chargers and other smaller items that tend to find their way to the bottom of other bags. The Bush Pilot Bag also features a pass through strap on the back to slide over rolling luggage handles and a leather shoulder strap padP/N 13-19105**\$165.00**

FLIGHT OUTFITTERS BUSH PILOT FOLIO BAG



Whether you're soaring above the clouds in your Cirrus or closing a big deal in your desk chair, this Folio Bag looks like it just left the flight deck of a DC-3. But while the Bush Pilot Folio has plenty of style, it's also a very practical bag, storing a surprising amount of gear without looking bulky or weighing you down. It has separate pockets for your tablet and laptop, plus a large center compartment

and plenty of exterior pockets. You can keep everything separated but easy to find. For further utility, the Folio Bag has a rear strap to securely attach it to your roll-aboardP/N 13-20713**\$165.00**

FLIGHT OUTFITTERS SEAPLANE DUFFELS



These rugged, water-resistant duffel bags are made for remote fishing trips, cross-country flights in old taildraggers, and any other adventures you can dream up. The huge center compartment can haul almost anything, from clothes to hunting gear, and features a padded bottom layer for protection. Best of all, the Seaplane Duffel remains flexible enough to stuff into cramped luggage compartments. You can even roll it up and pack it away in another bag when not in use. It's your go-anywhere, do-anything bag—whether you're flying or not.

Description	Part Number	Price
40L Duffel	13-23559	\$49.95
60L Duffel	13-23558	\$69.95
40L & 60L Combo	13-23572	\$99.95

FLIGHT OUTFITTERS FLIGHT CART



One of a kind patented design and function makes sure the Model 700 lives up to its moniker. An impressive 400lb capacity and generous loading tray (16" w x 13.5" d) allows you to move anything from presentation and display equipment to a washer/dryer. Easy single-motion squeeze handle telescopes the cart open and closed. Sleek design and limited lifetime warranty put the Super Cart in a league of its own. P/N 13-19651**\$179.95**

ASA DISPATCH BAG



Adjustable comfort shoulder that can also be worn cross-body. Top grab-and-go handle. Contrast lining, to find items more easily. Made of durable, 600D Polyester. Spacious main compartment fits headset. 2 pockets within main compartment keep headset accessories or smaller items organized. Front interior compartment organizer with slots and pockets to store phone, keys, wallet, pens. Padded compartment to protect a tablet. Exterior slide-in back slot to store charts or

easy access items. Exterior slots for flightline supplies like a fuel tester, flashlight, and pen. Side pocket with adjustable strap to secure, radio, gps unit, or water bottleP/N 13-18458**\$48.95**

PS

FLIGHT BAGS



SKY HIGH GEMINI

The Gemini flight bag is a fully padded duffel designed to protect the pilot's important gear. It is made with full sized compartment flaps, allowing easy organization of flight materials and access during flight - there is even a special stow-a-way pocket designed to hold most kneeboards. Everything is right where it should be - especially important during IFR flights. The center compartment

has a double zipper opening with a padded quad-modular divider to segment the compartment for custom organization and easy access.

P/N 13-04254 **\$83.95**

SKY HIGH EXPLORER PRE FLIGHT POUCH



Our preflight pouch is made of durable 600D Polyester. It is designed to organize and hold your basic items for your preflight - Mini Mag size flashlight, fuel tester, pen/pencil, tire pressure gauge, and pliers or wrench. We have also included a grommet on the corner so you can attach a towel for wiping your hands clean. The Explorer will fit easily into any bag and has a Velcro strap to attach to your waist belt for convenience during the preflight.

P/N 13-03276 **\$9.95**

PROFLIGHT STUDENT PILOT BAG



The ProFlight Student Pilot bag is a great value! Black Cordura type material, carry strap. Great for students; use alone or as an accompaniment to your travel luggage. This bag is similar to the Jeppesen Student Pilot Bag in style and materials with multi side pockets. Size: (L)17" x (W)6" x (H)10".

P/N 13-06280 **\$29.95**

SCHEYDEN LUGGAGE VERY LIGHT KIT ENSEMBLE



The finest 3-piece flight crew luggage ensemble in the world. Manufactured in the USA using the finest materials and hardware available. Our ensemble is taller with a more slender profile (similar to that of a beverage cart) that allows you to slip down aisles of any aircraft to the flight deck with ease. Black.

VLK (Very Light Kit): • 12"H x 14"W x 5"D (2.8 lbs) • For pilots who have gone paperless • Perfect for iPads, laptops, or both • Ample storage for headset, flashlight, water bottle and gear • Removable padded shoulder

pad • 1 Exterior zippered pocket • 1 Interior zippered pocket • 2 Interior breathable mesh pockets • 2 Interior side elastic loops to hold gear • Interior key holder • Interior ID holder • Made with Invista™ CORDURA® brand 1000 d water resistant nylon fabric up to 3x stronger and lasts up to 5x longer than standard polyester • Reliable and durable YKK® zippers and ITW Nexus® Buckles • Integrated Train Reaction™ luggage connecting system (Patent Pending Ser#12/348,857). Dimensions: 22.5. Weight: 13.2 Lbs. Limited lifetime warranty optional 5-Year NQA warranty upgrade.....P/N 13-14968 **\$599.00**
Embroidery P/N 13-14972 **\$20.00**
NQA 5 Year Warranty.....P/N 13-14973 **\$149.00**

SCHEYDEN LUGGAGE FLIGHT KIT ENSEMBLE



The finest 3-piece flight crew luggage ensemble in the world. Manufactured in the USA using the finest materials and hardware available. Our ensemble is taller with a more slender profile (similar to that of a beverage cart) that allows you to slip down aisles of any aircraft to the flight deck with ease. Black.

FK (Flight Kit): • 12"H x 14"W x 8"D • Ample storage for headset, flashlight, water bottle and gear • Removable padded shoulder pad • Two removable mesh clothing

organizers • Interior horizontal clothing divider • Mesh zippered interior accessory pocket • One outside zippered pocket • Auxiliary side handle • Made with Invista™ CORDURA® brand 1000 d water resistant nylon fabric up to 3x stronger and lasts up to 5x longer than standard polyester • Reliable and durable YKK® zippers and ITW Nexus® Buckles • Integrated Train Reaction™ luggage connecting system(Patent Pending Ser#12/348,857). Dimensions: 22.5. Weight: 13.2 Lbs. Limited lifetime warranty optional 5-Year NQA warranty upgrade.

P/N 13-14970 **\$529.00**

Embroidery P/N 13-14972 **\$20.00**
NQA 5 Year Warranty.....P/N 13-14973 **\$149.00**



WEEKENDER COMBO FLIGHT BAG

The swing hook for the adjustable shoulder strap is made of metal to ensure heavy load resistance. The shoulder strap has a soft rubber pad for your comfort and to keep the bag in fixed position while carrying on shoulder. This bag is made of 1680 Denier Ballistic water repellant material. Its interior is fully padded and covered with the liner of water repellant taffeta.

Grey.....P/N 13-11385 **\$106.95**
Black.....P/N 13-01434 **\$106.95**

NORAL EXTRA PADDED HELMET BAG



The swing hook for the adjustable shoulder strap is made of metal to ensure heavy load resistance. The shoulder strap has a soft rubber pad for your comfort and to keep the bag in fixed position while carrying on shoulder. This bag is made of 1680 Denier Ballistic water repellant material. Its interior is fully padded and covered with the liner of water repellant taffeta.

Grey.....P/N 13-11382 **\$126.75**
Black.....P/N 13-00262 **\$143.75**

CFI / IFR PILOT FLIGHT BAG



This bag has two side pouches equipped for large sized headsets. One of these side pouches has a flap pocket with a zipper closure to store pens, flashlight, ID card and/or license etc. Inside the main compartment is two removable pouches for GPS/ Transceiver. The dimension of main compartment is H11" X W14.5" X G10". In the front of the bag is a large open pocket for easy access. The back of the bag has two open pockets. Has two dividers in the main compartment that can be adjusted to a different position and can be removed if desired. Size: 11" x 23" x 12"

Black.....P/N 13-00186 **\$248.95**
Grey.....P/N 13-11375 **\$247.95**

BALLISTIC NYLON FLIGHT CASE 18"



Many RJ pilots requested a flight case design to fit the RJ cockpit. Using input from RJ pilots, CrewGear® created an RJ specific flight case. It has been flight tested by RJ line pilots who rated it an A+. Outside dimensions: 18.75" x 14.25" x 8.75" Color: Black. Fits most RJ flight case compartments.....P/N 13-11599 **\$114.95**

HARDSIDE CARBON FIBER BRIEFCASE



Large-capacity attache. Styled in sleek carbon fiber frame. Patented Right-Side-Up feature prevents accidental upside-down opening. Accordion-style legal size portfolios and multiple compartments for all your pilot essentials. Secure combination lock. Body Dimensions: 18.2" x 12.7" x 5.2". Overall Dimensions: 18.2" x 12.7" x 5.2".....P/N 13-18537 **\$879.00**

ROLLING BALLISTIC NYLON FLIGHT CASE



Now roll your way through airports, crew parking lot, and down those eternally long concourses easily with CrewGear®'s Rolling Ballistic Nylon flight case. This flight case is loaded with unique features. Best of all, IT ROLLS! Color: Black. Inside dimensions: 18" x 13 1/2" x 8". Outside dimensions: 19 1/2" x 15 1/2" x 10 1/2".....P/N 14-00831 **\$234.95**

ULTIMATE "MULTI-TASKER" FLIGHT BAG PLUS



It's a Flight Case, an Overnight Bag, a Brief Case and Computer Bag all in one! Proudly designed by CrewGear®, this bag will accommodate a 2" JEP binder, pilot headset and all related work gear. There is a padded compartment for your Laptop Computer (14" or less), Net Book or iPad. The clothing compartment is perfectly sized for one pair of slacks, one shirt, and all your undergarments. The file-folder compartment is perfectly sized to hold documents, magazines and newspapers. That's not all; this bag also comes with a toiletry pouch, and a shock-absorbing shoulder strap. Weight: 5.15 lbs. (Empty) 6.10 lbs. (w/Accessories). Exterior Dimensions: 18" x 13.5" x 9.5". Color: BlackP/N 13-11598 **\$168.75**

PS

FLIGHT BAGS – AVIATION CASES



SCULLY AEROSQUADRON LEATHER DUFFLE BAG

2 Zip Carry-On lambskin duffle bag with Exterior zip pocket. This bag has two roomy center zip compartments. One compartment includes garment straps and the other compartment includes pockets for cell phone and pens. 2 roomy center zip compartments.

Removable and adjustable shoulder strap w/faux shearling pad. Cotton lining shows schematics of aircrafts. Color: Walnut. 23" Width 13.5" Height x 6.5" Depth.....P/N 13-18001\$239.95



SCULLY AEROSQUADRON MESSENGER BRIEF BAG

Lambskin messenger brief bag for laptop. This bag comes with a front outer zip pocket under flap and a single gusset inside zip pocket in back and small open pockets in front.....P/N 13-18002\$149.85



SCULLY AEROSQUADRON LEATHER TRAVEL KIT

Leather travel kit with exterior dual zip entry compartment. It has a roomy main compartment w/open pockets to hold travel bottles, toothbrush, etc. Removable zip mesh pocket. Elastic loop for brush. Rear zip compartment includes hanger. 12.25" Length x 7.5" Height x 4" Width.

P/N 13-18004\$83.85



ASA AIRCLASSICS FLIGHT BAG PRO

1000D Nylon for extreme durability and gear protection. Large, zippered side pockets. Unique detachable chart wallet. A zippered, mesh interior pocket. Smaller mesh compartment on the outside of the bag. Black with the ASA wings logo tastefully silver-embroidered on the top. Dimensions: 20"L x 10"H x 8"W.

P/N 11-08804\$99.95



LIGHTSPEED ADVENTURE FLIGHT BAG - THE GANN

Ready for a true journey, the Gann is imbued with the same insatiable thirst for adventure as the novelist it is named for. Spacious but cabin-friendly, this carpenter-style bag is a great companion to the pilot who has everything — and likes to take it along.

Dimensions: 16"W x 6"D x 13.5"H.
P/N 11-13505\$299.00



LIGHTSPEED ADVENTURE FLIGHT BAG - THE MARKHAM

Ready for a true journey, the Gann is imbued with the same insatiable thirst for adventure as the novelist it is named for. Spacious but cabin-friendly, this carpenter-style bag is a great companion to the pilot who has everything — and likes to take it along. Dimensions: 16"W x 6"D x 13.5"H.

P/N 11-13506\$249.00



LIGHTSPEED ADVENTURE FLIGHT BAG - ORGANIZER INSERT

Designed to help organize the interior of all of our flight bags, the organizer insert is made from 210 Denier polyester. Perfectly sized to hold a headset, camera, and other essential gear, it features padded, sewn-in dividers, multiple accessory pockets and woven bindings to protect the edges. Dimensions: 11"W x 4.5"D x 9"H.

P/N 11-13508\$30.00



DOUBLE HEADSET BAG

Double-sided, 1/4" padding everywhere; can hold two headsets.....P/N 13-02334\$24.95



GATOR WATERPROOF AVIATION CASES

Gator Cases new line of water proof, dust proof, sand proof, crush proof, injection molded cases feature impact-proof light weight NK-7 resin and have a ATA-300 flight safe rating. Every case has a Auto Pressure equalizer valve with a Mil-Std-810F Immersion test certification. Available in both NO FOAM and DICED FOAM version, all Gator Injection Molded Cases have Soft Grip carry handles, and unique easy relase Powerclaw(TM) latching system.

PS

Part No.	Item Number	Description	Interior Dimensions	Price
13-17861	GU-0705-03-WPNF	Black Waterproof Injection molded case, with NO FOAM	7.4" x 4.9" x 3.1"	\$39.99
13-17862	GU-0806-03-WPNF	Black Waterproof Injection molded case, with NO FOAM	8.4" x 6" x 3.7"	\$34.99
13-17863	GU-0907-05-WPNF	Black Waterproof Injection molded case, with NO FOAM	9.4" x 7.4" x 5.5"	\$69.99
13-17864	GU-1309-03-WPNF	Black Waterproof Injection molded case, with NO FOAM	13.2" x 9.2" x 3.8"	\$59.99
13-17865	GU-1309-06-WPNF	Black Waterproof Injection molded case, with NO FOAM	13.8" x 9.3" x 6.2"	\$69.99
13-17866	GU-1510-06-WPNF	Black Waterproof Injection molded case, with NO FOAM	15" x 10.5" x 6.2"	\$84.99
13-17867	GU-1711-06-WPNF	Black Waterproof Injection molded case, with NO FOAM	17" x 11.8" x 6.4"	\$94.99
13-17868	GU-1813-06-WPNF	Black Waterproof Injection molded case, with NO FOAM	18" x 13" x 6.9"	\$109.99
13-17869	GU-2011-07-WPNF	Black Waterproof Injection molded case, with pullout handle and inline wheels and NO FOAM	20.5" x 11.3" x 7.5"	\$139.99
13-17870	GU-2014-08-WPNF	Black Waterproof Injection molded case, with NO FOAM	20" x 14" x 8"	\$114.99
13-17871	GU-2015-10-WPNF	Black Waterproof Injection molded case, with pullout handle and inline wheels and NO FOAM	20.5" x 15.3" x 10.1"	\$199.99
13-17872	GU-2217-08-WPNF	Black Waterproof Injection molded case, with NO FOAM	22" x 17" x 8.2"	\$144.99
13-17873	GU-2217-13-WPNF	Black Waterproof Injection molded case, with pullout handle and inline wheels and NO FOAM	22" x 17" x 12.9"	\$229.99
13-17874	GU-1510-06-WPDF	Black waterproof injection molded case with DICED FOAM	15" x 10.5" x 6.2"	\$94.99
13-17875	GU-1711-06-WPDF	Black waterproof injection molded case with DICED FOAM	17" x 11.8" x 6.4"	\$124.99
13-17876	GU-1813-06-WPDF	Black waterproof injection molded case with DICED FOAM	18" x 13" x 6.9"	\$149.99
13-17877	GU-2011-07-WPDF	Black waterproof injection molded case with pullout handle, inline wheels and DICED FOAM	20.5" x 11.3" x 7.5"	\$179.99
13-17878	GU-2014-08-WPDF	Black waterproof injection molded case with DICED FOAM	20" x 14" x 8"	\$159.99
13-17879	GU-2015-10-WPDF	Black waterproof injection molded case with pullout handle, inline wheels, and DICED FOAM	20.5" x 15.3" x 10.1"	\$249.99
13-17880	GU-2217-08-WPDF	Black waterproof injection molded case with DICED FOAM	22" x 17" x 8.2"	\$194.99
13-17881	GU-2217-13-WPDF	Black waterproof injection molded case with pullout handle, inline wheels, and DICED FOAM	22" x 17" x 12.9"	\$279.99
13-17882	GX-20	Cargo Case w/ Lift-Out Tray, Wheels, Retractable Handle	13.5"X12.75"X14"	\$179.99
13-17883	GxX-22	Cargo Case w/ Lift-Out Tray, Wheels, Retractable Handle	12"X24"X30"	\$269.99

SEAT FOAM - FLIGHT SEATS

BACKSAVER FOAM



Backsaver foam is temperature sensitive, softening when it comes in contact with a warm surface; thus, in a seat cushion, the foam softens and conforms to the person's body. This provides even pressure distribution and unconstricted blood circulation, significantly reducing discomfort, even over long periods. In addition, Backsaver foam has excellent energy absorption properties, which have made it excellent for use in the U. S. space shuttle program and in military aircraft and helicopters. Pilots find that Backsaver cushions reduce their discomfort and fatigue, even on missions of 8 hours or more. Aircraft Spruce now makes Backsaver foam available to the homebuilt and general aviation market. Backsaver Foam 16" X 18" P/N 01-09325 **\$99.95**
Backsaver Foam 36" X 80" P/N 01-09330 **\$27.00**

CONFOR FOAM SEAT CUSHION

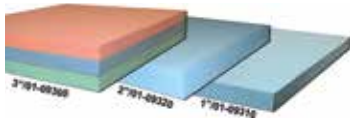

Tempofoam is the conforming foam cushion that was developed for the "Astronaut's Couch" back in the Apollo space program. Seat foam has the capability of absorbing a tremendous amount

of impact shock compared to common polyfoam and it is flame resistant. It is an excellent product that will give your seats enduring comfort that you never thought possible. It is not a soft seat, but it adapts to you for pressure-point-free comfort that is really incredible. The best universal cushion for aircraft use is a 3" T/38/T41/T47 laminate. Tempofoam is not currently FAA approved for certificated aircraft but is excellent for homebuilts. Some special sizes in 1", 2" or 3" thicknesses are available on special request.

Foam Size	Foam Type	Color	Part No.	Price
1" X 16" X 18"	CF45 Medium	Blue	01-09310	\$37.75
1" X 16" X 18"	CF47 Firm	Green	01-01632	\$35.75
1" X 18" X 24"	CF47 Firm	Green	01-01662	\$51.85
1" X 16" X 18"	CF42 Soft	Pink	01-01633	\$34.50
1" X 18" X 24"	CF45 Medium	Blue	01-01634	\$52.75
1" X 18" X 24"	CF42 Soft	Pink	01-01635	\$51.85
2" X 16" X 18"	CF45 Medium	Blue	01-09320	\$68.75
3" X 16" X 18"	CF42/CF45/CF47 (1" Soft, 1" Medium, 1" Firm)	Pink, Blue, Green	01-09300	\$113.95

SKWOOSH™ PILOT SEAT



SKWOOSH™ fluidized gel cushions relieve pressure on the "sitz" bones to help maintain circulation, and reduce numbness and lower back discomfort caused by prolonged sitting. The non-skid bottom makes SKWOOSH™ stay put, ensuring no movement during use while the low profile (1/2") allows for normal seat position. SKWOOSH™ cushions are made in the USA and are guaranteed for performance and workmanship. Weight: 8 oz. Open Dimensions: 10 1/2" L x 15" W x 1/2" H. Folded Dimensions: 10 1/2" L x 7 1/2" W x 1" H..... P/N 13-05827 **\$39.99**

SKWOOSH PRO TRAVELER



SKWOOSH™ fluidized gel cushions relieve pressure on the "sitz" bones to help maintain circulation, and reduce numbness and lower back discomfort caused by prolonged sitting. Non-skid bottom and is maintenance free. SKWOOSH™ cushions are made in the USA and are guaranteed for performance and workmanship. Weight: 8 oz. Open Dimensions: 10 1/2" L x 15" W x 1/2" H. Folded Dimensions: 10 1/2" L x 7 1/2" W x 1" H..... P/N 13-10284 **\$49.99**

SKWOOSH EZ SWIVEL CUSHION



The SKWOOSH™ All Purpose with EZ Swivel Capability is lightweight, folds for portability, is less than 1" high and is almost invisible when in use. The low friction top fabric allows you to swivel freely with little effort while the Non-Skid bottom keeps the All Purpose locked in place. You turn with less effort while the All Purpose stays put. SKWOOSH™ is made in the USA and is guaranteed for workmanship and performance..... P/N 13-18496 **\$39.95**

SKWOOSH LUMBAR CRADLE



The SKWOOSH™ LUMBAR CRADLE uses a cutting edge SPLIT LUMBAR DESIGN, TekPad® FLUIDIZED GEL and AIR-FLO3D breathable fabric to provide the best in back comfort. The "gel comfort-cradle" contours and cradles the back exactly as nature intended. SKWOOSH™ products are made in the USA and are guaranteed for performance and workmanship..... P/N 13-18497 **\$49.99**

RAM SEAT WEDGE WITH PUMP



The Tough-Wedge™ is a mount that fits in the gap between the vehicle seat and center console or potentially a center seat. This allows for easy access and operation of a mobile device. The Tough-Wedge™ can also be used for back-seat applications by inserted into the pockets located on the back of the front seats. Included diamond adapter attaches to a variety of RAM mounts. Length: 13.25". Height: 8.25". Depth: 1". Inside Wedge Depth: 0.375" - 0.875"..... P/N 11-14362 **\$68.75**

PROFLIGHT SEATS



Sit higher, and sit softer on 2 or 3 inches of high-density foam covered with durable, "breathable" Cordura. Made of USAF specifications, with segmented backrest. Really makes a difference on a long flight. Also available: 3 or 4-inch thick child's cushion that finally lets kids see outside, keeps them interested as well as comfortable during long trips. Both seat and cushion are available in either Air Force blue or red. Add B (blue), or R (red) after part number to indicate color.

Dimensions for all Seats: Back: Width - 16" Height - 17" Seat: Width - 15" Depth - 12"

Description	Part No.	Price
Blue 2" Booster seat w/ 1-1/2" back	13-02916	\$98.95
Red 2" Booster seat w/ 1-1/2" back	13-02917	\$104.00
Blue 3" Booster seat w/ 1-1/2" back	13-02918	\$106.95
Red 3" Booster seat w/ 1-1/2" back	13-02919	\$99.90
Blue 3" Booster seat w/ 3" back	13-02920	\$98.75
Blue 4" Booster seat w/ 1-1/2" back	13-31855	\$99.95
Red 3" Booster seat w/ 3" back	13-02922	\$100.75
Child's Blue 3" Booster cushion	13-02923	\$66.95
Child's Red 3" Booster cushion	13-02924	\$71.75
Child's Blue 4" Booster cushion	13-02925	\$69.75
Child's Red 4" Booster cushion	13-31861	\$68.95
Blue - 4" Seat x 3" back	13-31845	\$115.95
Red - 4" Seat x 3" back	13-31850	\$112.00
Red - 4" x 1-1/2" back	13-31860	\$110.75
Blue - Cut for flight stick 4" Seat w/ 1-1/2" back	13-12077	\$112.95

NORAL SEATS



This cushion is made with the finest materials available. It features a high back with a Lumbar Support for added comfort. The foam inside meets FAA FAR regarding fire materials. A strap is present for easy carrying and securing the cushion to the back of the seat when installed. Available in 2 sizes marked Type 'A' & Type 'B'.

Label 'A' is intended for larger aircraft such as Cessna 172, 182, 210, or Cardinal.
Label 'B' fits Intended for smaller aircraft such as Cessna 150, 152, Piper Cherokee or Warrior.

Available only in Black & Smoke Grey.

Color	Part No.	Price	Color	Part No.	Price
2" Seat Cushion - Type A			2" Seat Cushion - Type B		
Black	13-00327	\$109.75	Black	13-00323	\$88.75
Grey	13-00329	\$108.95	Grey	13-00326	\$90.75
3" Seat Cushion - Type A			3" Seat Cushion - Type B		
Black	13-00334	\$129.90	Black	13-00331	\$117.80
Grey	13-00337	\$128.75	Grey	13-00333	\$117.80
4" Seat Cushion - Type A			4" Seat Cushion - Type B		
Black	13-00342	\$140.75	Black	13-00338	\$130.90
Grey	13-00344	\$140.75	Grey	13-00341	\$129.80

Description	Color	Part No.	Price
2" Cushion With No Back	Black	13-00346	\$51.75
2" Cushion With No Back	Grey	13-00348	\$51.75
3" Cushion With No Back	Black	13-00221	\$57.75
3" Cushion With No Back	Grey	13-00223	\$57.75
4" Cushion With No Back	Black	13-00224	\$61.95
4" Cushion With No Back	Grey	13-00227	\$61.95

BLACK MAX COMFORTLITE SEAT



- 18" Wide X 19" Deep x 26" High
- 6061-T6 Aluminum Base and tubing.
- Assembled with AN Hardware. Material made from durable cordura nylon
- Includes a large storage pocket in the back
- Additional storage between pan and seat
- Pivots down to make it easier to get in behind the seat on a tandem P/N 13-05554 **\$258.95**

INFLATABLE LUMBAR SUPPORT



This inflatable air pillow can be installed just under the seat material and will give you the customized support just where you need it. A convenient palmsize pump and a release valve control the firmness of the lumbar support. The In-Flight Back Support is made of a heavy duty self-extinguishing neoprene rubber, specially designed to pass FAR 23.853 flame-test requirements.

Quantity One P/N 13-01501 **\$52.85**
Quantity Two P/N 13-01821 **\$86.75**



OREGON AERO® SEATING SYSTEMS

Oregon Aero® VK SmartCushion™ Systems for Experimental and Homebuilt aircraft offer maximum-comfort seating designed for your particular aircraft. The VK SmartCushion™ System shifts the hips, pelvis and back into a comfortable sitting position. At the same time, the seat cushions support occupants over as large an area of the seat surface as possible, preventing painful "hot spots." Pilot and passengers fly in comfort-no matter how long the flight. Simply put, Oregon Aero® offers the most comfortable seat in the industry **All Oregon Aero® Seating Systems are 100% Satisfaction Guaranteed.**



OREGON AERO® SEAT CUSHION GLASAIR I, II, III

GlasAir I (Pilot), II, III Left or Right Cushion Set un-upholstered cushion core.

NOTE: Cushion set includes: (1) back and (1) bottom cushion. Price per set.

Description	Part No.	Price
GlasAir I Pilot Left or Right Cushion Set	13-07474	\$396.00
GlasAir II or III Left or Right Cushion Set	13-07475	\$408.00



OREGON AERO® SEAT CUSHION GLASTAR

GLASTAR Left & Right Front Cushion Set un-upholstered cushion core.

Description	Part No.	Price
GLASTAR Left Front Cushion Set	13-07476	\$453.95
GLASTAR Right Front Cushion Set	13-07477	\$453.95



OREGON AERO® SEAT CUSHION LANCAIR 320/360/IV PILOT/LEGACY

Lancair 320/360/IV Pilot/Legacy Left or Right Cushion Set un-upholstered cushion core.

Description	Part No.	Price
Lancair 320/360 Left Front Cushion Set	13-07478	\$550.00
Lancair 320/360 Right Front Cushion Set	13-07479	\$550.00
Lancair IV Pilot or Co-Pilot Cushion Set	13-07480	\$321.95
Lancair Legacy Left or Right Cushion Set	13-07481	\$637.00



OREGON AERO® SEAT CUSHION RV-4

RV-4 Front & Rear Cushion Set un-upholstered cushion core

Description	Part No.	Price
RV-4 Front Cushion Set	13-07482	\$358.00
RV-4 Rear Cushion Set	13-07483	\$468.00



OREGON AERO® SEAT CUSHION RV-6

RV-6 Left or Right Cushion Set un-upholstered cushion core.

Description	Part No.	Price
RV-6 Left or Right Cushion Set 2"	13-07484	\$359.00
RV-6 Left or Right Cushion Set 3"	13-07485	\$358.00



OREGON AERO® SEAT CUSHION RV-7

RV-7 Pilot or Co-Pilot Cushion Set un-upholstered cushion core.

P/N 13-07486 **\$382.00**



OREGON AERO® SEAT CUSHION RV-8

RV-8 Front and Rear Cushion Set un-upholstered cushion core.

Description	Part No.	Price
RV-8 Front Cushion Set	13-07488	\$399.95
RV-8 Rear Cushion Set	13-07489	\$504.00

1 INCH PORTABLE UNIVERSAL SOFTSEAT® CUSHION SYSTEMS



Shifts your hips, pelvis and back into the proper, pain-free position. Helps minimize lower back pain from prolonged sitting. Eliminates pain from "hot spots." Can raise or move you forward. Zippered and interchangeable parts. 100% satisfaction guaranteed.

Two anchor options available: (1) Non-Skid Strips (most popular option) Two 1" wide x 10" long strips of black webbing with black non-skid rubber are hand sewn to the bottom of the cushion. (2) Straps - Best option if using Cushion Base for one purpose, such as in an aircraft. One-inch straps with adjustable buckle are hand sewn from side-to-side. Two hook and loop fasteners are hand sewn to the back.

1" Cushion is the most commonly used thickness. 1/2" Cushion is available for individuals with limited headroom. 2" Cushion available for individuals who need raised up. See www.aircraftspruce.com for additional sizes.

Color	Non-Skid Strips	Price	Straps	Price
Burgundy	13-08611-1	\$224.95	13-08614-1	\$224.95
Blue	13-08611-2	\$224.95	13-08614-2	\$224.95
Teal	13-08611-3	\$224.95	13-08614-3	\$224.95
Beige	13-08611-4	\$224.95	13-08614-4	\$225.95
Gray	13-08611-5	\$225.95	13-08614-5	\$224.95
Charcoal	13-08611-6	\$224.95	13-08614-6	\$224.95
Black	13-08611-7	\$224.95	13-08614-7	\$224.95

OREGON AERO® SEAT CUSHION VELOCITY

Velocity Cushion Set un-upholstered cushion core.

Description	Part No.	Price
Velocity Cushion Set	13-07490	\$352.95

OREGON AERO® SEAT CUSHION ZENITH/ZENAIR

Zenith/Zenair Left and Right Cushion Set un-upholstered cushion core.

Description	Part No.	Price
Un-upholstered CH701 Left cushion	13-07491	\$298.00
Un-upholstered CH701 Right cushion	13-07492	\$298.00
Un-upholstered CH601 Left cushion	13-07493	\$301.95
Un-upholstered CH601 Right cushion	13-07494	\$301.95

PS

SEAT COVERS – JET SHADES

SUPERLAMB SHEEPSKIN SEAT COVERS: NATURE'S OWN THERMOSTAT



The magic of 100% genuine sheepskin is quite simply that it will keep you cool in summer and warm in winter. No other natural or man-made fiber possesses the qualities of sheepskin. Whatever the temperature in your cockpit, sheepskin covers remain almost the identical temperature. Additionally, each hollow fiber absorbs up to 30% of its own weight in moisture. It keeps you dry, yet never feels wet itself. You avoid the heat and clamminess of vinyl, or even leather, because there's free flow of air between you and seat. Every cover is hand-made by master craftsmen from the finest chrome-tanned pelts, in colors to match or coordinate with any interior. Sold in pairs only, in 11 colors (request color samples when ordering). FAA Approved.

Available for the following planes: Beechcraft: Baron B-55, E-55, B-58, Bonanza V-35 (A or B), A-33, A-36, F-33A, A36TC. Cessna: 150, 152, 172, 177, 180, 182, 185, 210, 310, 340, 402, 414, 421. Aero Commander: 500, 600, 900, Piper: Archer, Cherokee, Warrior Tomahawk.

Specify year, make model and color choice when ordering. Car seat covers also available in same colors. Call for a price.
Superlamb Sheepskin Seat Covers (pair)..... P/N 7736..... **\$513.00**

Sheepskin Samples - Order a sample then return it for a full credit after you have selected a color and ordered your seat cover..... P/N 13-05553..... **\$0.00**

COLORS AVAILABLE



Mushroom



Latte



Coffee



Navy



Burgundy



Silver



Steel



Charcoal



Black



Palomino



Tawney



Sand



Cream



White



JET SHADES™ TINTED WINDOW PANELS

Unlike foil aircraft sun shades, Jet Shades are removable tinted window panels and visors designed to block harmful UV and sun glare in your aircraft cockpit both DURING FLIGHT & WHILE PARKED!

Inspired by an engineer and private pilot who was always hot in the cockpit and wrestled with sun glare on him and the instrument panel in the hot Florida sun, Jet Shades solve the problem of hot, sunny cockpits that are uncomfortable for both pilot and passengers.

- Blocks 99.9% harmful UV (See JAMA article on harmful effects of UV radiation for pilots)
- Provides instant relief from solar energy
- Reduces glare by 70% for better contrast and visibility on instrument panels, smartphones and tablet devices.
- Minimizes eye strain and pilot fatigue caused by prolonged sun exposure
- Maintains pilot & passenger comfort during high sun glare flights
- Effortless removal with patented friction-tab design
- Protects aircraft interior from cracking and discoloration while parked
- Enhances ramp appeal by giving your aircraft a "tinted windows" look
- Eliminates the need for removing and storing foil sun shades before and after flights

Specifications:

- Made with optical quality polycarbonate for clearest visibility
- Blocks 72% visible light/ 99.9% UV/ 79% infrared light/ 44% solar energy
- Provides 70% glare reduction
- Lightweight, high impact strength, virtually unbreakable
- Highly engineered product stops glare while allowing enough light in for easy navigation
- Patent-pending design
- Made in the USA



Description	Part No.	Price
Total Cirrus Solution SR-22/SR-22T/SR-GTS22 G3 - G6	13-22073	\$2,000.00
Cirrus Cockpit Solution SR-22/SR-22T/SR-GTS22 G3 - G6	13-22074	\$1,300.00
Cirrus Rear Skylight Shade G2-G6 Premium	13-22075	\$400.00
Cirrus Upper Windshield Shade Premium	13-22082	\$249.00
Total Columbia Solution 400/TTX	13-22083	\$1,198.00
Total Columbia Solution 400/TTX Upgrade Rear Window to Premium	13-22084	\$400.00
Columbia Cockpit Solution 400/TTX	13-22085	\$800.00
Total Diamond Da 40 Solution	13-22086	\$1,595.00
Total Diamond Da40 Solution Upgrade	13-22087	\$400.00
Diamond DA 40 Canopy Solution	13-22088	\$1,000.00
Diamond DA 40 Canopy Solution Upgrade	13-22089	\$200.00
Eclipse 500/550 Cockpit Solution	13-22090	\$799.00
Eclipse 500/550 Cockpit Solution Upgrade	13-22091	\$302.00

PS

SUN VISORS

ROSEN SUN VISOR SYSTEM

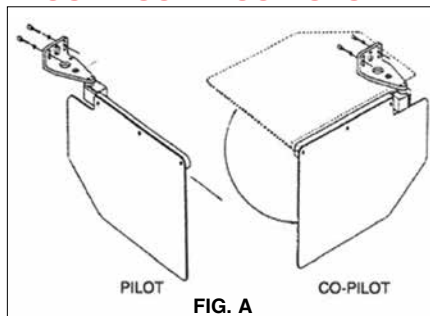

Attention: Products noted in "Application Guide" with an (*) are sold in pairs.

Don't fly blind! Give yourself and your passengers that extra margin of safety. These are transparent sun visors which rotate and extend to offer complete cockpit protection from the sun. The oversize, tinted lens filters out 95% of the ultraviolet rays, reduces glare by 94% and heat by 86%. Distortion free. Fully STC'd and PMA'd. The system, which includes pilot and co-pilot visors, installs in minutes (exceptions: Cessna non-pressurized 210 requires 1-1/2 hours, Cessna 152 requires rivnut installation by an A&P).

Aircraft	Part No.	Price
BEECH - Bonanza/Baron, standard	7568*	\$415.00
Bonanza/Baron, 2- Axis replacement lens	13-18718	\$83.75
Bonanza/Baron, 3rd Axis option	7311*	\$485.00
Duke	7738*	\$397.00
King Air	13-01927*	\$482.00
King Air 200 Monorail with visors (not for A200)	13-12787	\$1,315.00
MOONEY - 1968 and later models original visors mounted on right or left side (not on center post)	7762*	\$465.00
PIPER - Comanche, All models, standard	7809*	\$409.00
Comanche, Third Axis option	7924*	\$485.00
Aerostar Monorail System	13-15027	\$1,285.00
Cheyenne Monorail system w/visors	13-15028	\$1,188.00
Malibu Mirage Monorail System	13-15030	\$1,445.00
Malibu Meridian Monorail System	13-15031	\$1,445.00
Arapaho Comanche	13-07454*	\$477.00
Cherokee, Center mount	13-01315*	\$475.00
Cherokee, swivel stud	13-01316*	\$475.00
Seneca	13-01317*	\$471.00
CESSNA 1980 and later - 170's to 206's (except 177's) Center Mount	7629*	\$415.00
All 150's and 152's. Prior to 1980 - 170's - 206's (except 177's) Side Mount	7006*	\$415.00
Cessna 2- Axis replacement lens	13-18343	\$83.75
210's w/o air cond. (Older 210's, see above)	7152*	\$445.00
P210's and 210's w/air conditioning	7426*	\$445.00
177's	7582*	\$445.00
T303	13-01928*	\$516.00
310s & 340s, special order to replace units with ball-joint cover style visor only (shown)	7687*	\$489.00
337	13-01308*	\$531.00
320	13-01311*	\$516.00
350/400	13-06044*	\$619.00
400	13-01312*	\$483.00
400 Monorail with visors	13-14937	\$926.00
412B	13-05180*	\$516.00
Citation 500/501 Monorail with Visors SN>213/	13-14938	\$1,264.00
Citation 3rd Axis Visor Assy.	13-14940*	\$448.00
Citation III Monorail with visors	13-14941	\$1,495.00

Aircraft	Part No.	Price
Mustang Monorail System	13-14942	\$1,385.00
Mustang w/ 3rd Axis Visor Assy.	13-15008	\$448.00
GRUMMAN - Cheetah	13-01313*	\$515.00
RV-10 - Rosen Sun Visor Set - RV-10	13-05695*	\$475.00
Rosen Sun Visor - Pilot Side	13-05696	\$208.95
MAULE	13-02471*	\$475.00
Rockwell Commander 114	13-03328	\$476.00
OTHERS*		
Cirrus SR20 / SR22	13-03258*	\$477.00
Lancair IV	13-01934*	\$477.00
Aero Commander Monorail System w/ Visors	13-14850	\$1,184.00
Aero Commander Replacement Lens Only	13-14928*	\$84.99
Aero Commander Visor Assy. Only	13-14930*	\$374.00
Bell 206 Jet Ranger Monorail w/ Visors	13-14931	\$1,362.00
Bell 206 Long Ranger Monorail w/ Visors	13-14932	\$1,362.00
Bell 206 Jet Ranger with AC Monorail System	13-14933	\$1,362.00
Bell 222 Monorail System w/ Visors	13-14934	\$1,361.00
BK117 Monorail System w/ Visors	13-14935	\$2,081.00
BAC1/11 Monorail System w/ Visors	13-14936	\$2,337.00
Challenger 600,601, 604 Monorail System w/ Visors	13-15009	\$2,156.00
Challenger 600, 601, 604 Replacement Lens	13-15010	\$133.75
Challenger 600, 601, 604 Visor Assy Only	13-15011	\$425.00
Falcon 20 Monorail System w/ Visors	13-15012	\$1,744.00
Falcon 50 200 Monorail System w/ Visors	13-15016	\$1,744.00
Gulfstream I, II Monorail System w/ Visors	13-15017	\$1,731.00
Gulfstream III Monorail System w/ Visors	13-15018	\$2,295.00
Gulfstream IV Long Beach Monorail System w/ Visors	13-15019	\$2,295.00
Gulfstream IV Savannah Monorail System w/ Visors	13-15020	\$2,295.00
Gulfstream 200 Galaxy Monorail System w/ Visors	13-15022	\$2,400.00
Hawker 700 Monorail System w/ Visors	13-15023	\$1,592.00
Hawker 750, 800, 850, 800XP, 850XP, 900XP, 1000 Monorail	13-15024	\$1,591.00
Lear 45 Monorail System w/ Visors Standard Size Lens	13-15025	\$1,488.00
Lear 45 Monorail System w/ Visors Small Size Lens	13-15026	\$1,488.00
Homebuilders Universal surface mount	13-03175*	\$436.00
Homebuilders Universal tube mount	13-03176*	\$429.00

Homebuilders Universal systems are specific order & built to your specs

ROSEN THIRD AXIS UPDATE KIT: This update kit will fit any Rosen system that does not come standard with third axis option (Piper systems, for examples, come with third axis stanard)..... P/N 13-04014..... **\$85.65**



ROSEN RED KNOB KIT
Red Knob Kit 99-701-KIT includes Red tensioning knob (99-701), spring (B-19679), and washer (90295A110).

Notes: Parts not sold separately, only as a kit. The kit is compatible with any of Rosen Sunvisor Systems' New Swinging Arm (NSA) systems. P/N 13-22304..... **\$8.50**

ROSEN LSA ACCORDION SHADES

Rosen LSA Accordion Shades. **Specifications:** • Accordion Shade - Single 18'W X 21'L • Accordion Shade - Double - 30'W X 25'L
Single.....P/N 13-22938..... **\$196.75** Double.....P/N 13-22994..... **\$262.95**

SUN VISORS

KENNON SUPER SUN SHIELDS



The most durable sun shield on the market has a clear polyester coating to protect the plexiglass windows. Heat can permanently damage the interior and avionics in your aircraft. The secret is a material with two surfaces of aluminum separated by trapped air. This combination reflects 97% of radiant heat, an insulation value of R-9 equivalent to two inches of fiberglass. Kennon Extra Firm shields fit snugly, and maintain their shape for a tight fit. They install in no time, and roll up for storage in compact, water-repellent bags. Weight is 1Lb. Available for most aircraft, specify year, make and model. For custom shields, specify exact size of windshield & windows. Also available for cars. Fabric edging insures snug fit & durability.

Developed for the US Military and used on most aircraft deployed to the desert where temperatures often exceed 115F degrees.

General Aviation: Single engine pistons (ie Cessna 172, Piper PA-28, etc)
Business: Twin turboprops, corporate jets (ie Beech King Air, Cessna Citation, etc)

General Aviation P/N 7672 **\$199.95**
Business Class P/N 13-01071 **\$248.95**

SUN-FOIL SUNSCREENS



Sun-Foil aircraft sunscreens protect the Aircraft Interior - 97% of radiant heat is reflected, and UV protection prevents cracking and discoloration. The Gold Standard Since 1989!

The Sun-Foil Difference

Protects Aircraft Interior - 97% of radiant heat is reflected, and UV protection prevents cracking and discoloration

Keeps Cockpit Cooler - Drop cockpit temperatures as much as 68 degrees compared to an unprotected cockpit

Prevents Heat Related Avionics Failure - Protects sensitive components from heat and enhances pilot comfort.

Integrated Protection - Our exclusive layer of hand-rolled gold or silver Mylar laminate provides additional rigidity and durability. Strategically placed suction cups combine with a friction fit to ensure your Sun-Foils are always in place, protecting your expensive investment.

Secures Avionics Panel - Complete screen sets are an effective deterrent to common avionics theft

Built-In Storage - Sun-Foils roll easily and are secured with an attached Velcro strap. They are easily stored in a custom-fit bag (included with each set) with a personalized ID tag.

Lifetime Workmanship Guarantee - Sun-Foil stands behind their products. Sun-Foils will be replaced at no charge in the event of damage due to defects in materials or workmanship. Suction cups are replaced at no charge throughout the lifespan of your Sun-Foils, at no charge.

Features: • Strategically placed suction cups that work with a friction fit to ensure Sun-Foils always stay in place. • Double stitched protective border • Military grade double layer bubble insulation • Exclusive added layer of highly polished gold or silver Mylar enhances appearance and reflectivity
Front Only P/N 13-22381 **\$185.00**
Cockpit Set P/N 13-22382 **\$300.00**
Full Set P/N 13-22383 **\$300.00**

DIM-IT MOVEABLE VISOR

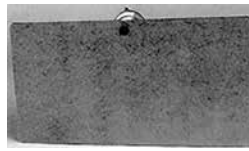

You can keep moving your head to stay in the shade of your visor, or you can get a DIM-IT visor and move it to where you want it. It's a 6"x12" sheet of tinted Lexan that can be positioned on any window in the cockpit by means of the attached vinyl suction cup. (An optional self-adhesive adapter plate lets you attach it to porous surfaces as well.) Completely transparent and distortion-free.

DIM-IT Moveable Visor P/N 7172 **\$8.75**
Adapter (for porous surfaces) P/N 7113 **\$4.65**

MINI DIM-IT



Diminishes the intensity of direct sunlight, glare, and reflections. This little visor is made of high strength tinted Lexan and is distortion-free. Place the suction cup on window/windshield and press. P/N 13-01758 **\$6.95**

ADJUSTAVISOR



The Adjustavisor, a clip-on unit that virtually doubles the effective range of stock visors, adds contrast, and reduces glare and fatigue. Available with smoke polycarbonate lens with UV protection. There's also a suction cup model for aircraft with canopies. The cups are strong enough and the visor assemblies light enough that they stay attached to any window through most any maneuver. Size: 3.5"x 12".

Clip-on (smoke) P/N 13-03263 **\$134.75**
Suction (smoke) P/N 13-03261 **\$119.75**

ROSEN VANS RV 6-7-9 ARC SUNVISOR



The Van's RV 6-7-9 Sliding Canopy ARC Sunvisor System design provides Van's

RV 6-7-9 aircraft owners flexible, multi-axis sun attenuation, glare reduction and pilot comfort during standard cockpit flight operations.

Description	Part No.	Price
Rosen Vans Rv 6-7-9 ARC Sunvisor Assembly	13-16034	\$454.00
Rosen Vans Rv 6-7-9 ARC Pilot Replacement Lens	13-16035	\$75.95
Rosen Vans Rv 6-7-9 Co-pilot ARC Replacement Lens	13-16036	\$75.95

RV-10 SUN VISOR



Blue Sky Sun Visors were specifically designed for the RV-10. The RV-10 visors retain all of the features of those that have been produced for certified aircraft since 2001. The visors provide improved visibility in hazy or cloudy conditions while still being out of the pilot's view when not in use. In addition to retaining the superior functionality, durability, and strength of the original Blue Sky Sun Visor, they provide sun and heat screening, whether coming from the front or side for both pilot and co-pilot. Installation is quick and requires only basic tools and mechanical ability.

P/N 13-07444 **\$223.00**

UNIVERSAL SUNVISOR FOR HOMEBUILT AIRCRAFT

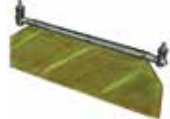

Universal Swivel Mounts - simplify installation into most homebuilt aircraft! Lightweight hardware and optical quality bronze acrylic visor. Designed, and visor tint specified, by eye doctor/pilot Dr. Steven DeGroff, to reduce, high-altitude and ocular media small-particle scatter and enhance vision at dusk, after sunset, when scotopic vision is used. Hundreds of same class visors are field-approved and in use in the Comanche fleet.

P/N 13-07443 **\$329.00**

ROSEN MONORAIL IPAD / IPAD MINI UNIVERSAL MOUNTS



Designed to attach to any Rosen Monorail, the Rosen Universal iPad mount system provides a convenient and adjustable deployment. The large version will accommodate iPads in OtterBox or similar sized cases, while the standard model is delivered with two hook choices to fit all regular-sized cases as well as bare iPads. Note: it will accommodate all of size iPads except the new iPad Pro 12.9. Currently it won't open up far enough for the larger Pros. The Mini and Standard models, however, are no problem. Designed to attach to any Rosen monorail. Convenient and fully adjustable. Quick and easy stowage against the headliner.

Lage Cases P/N 13-20666 **\$229.95**
Standard Cases/Bare P/N 13-20667 **\$242.95**

PS

SUN SHIELDS – SUN VISORS

RAM MOUNT DARK GREEN SUN VISORS



The precision laser cut cast acrylic 8"x13" sun visor offers ideal blockage of glare while ensuring no obstruction or distortion of view. The dark green 50% tint is ideal for blocking sun and glare in a variety of applications. The RAM-B-166-326-VIS-G1U includes a 1" ball and complete suction cup mounting kit. The double ball and socket arm with a swivel feature in the center makes adjustment simple

and effortless. This mount can be easily configured for left or right handed use as well as pilot and co-pilot use.

Ball and Suction Cup.....P/N 11-13584**\$59.90**
1" Ball Only.....P/N 11-14911**\$36.75**

PIPER SUNVISOR CATCHES



Many Piper aircraft have the same problem. The sun visor catches lose to stability, because the UV effect allows the plastic to become porous. These Piper Sunvisor Catches are made from a blended poly-plastic with a UV additive that will prevent UV corrosion. A set contains two pieces with the required plastic rivets. They are available in white and black

(used in Piper PA-38 Tomahawk). The set for the Piper Tomahawk contains two extra rivets.

WhiteP/N 13-04187**\$33.85**
Black.....P/N 13-04188**\$33.85**

KENNON COWL PLUGS



Kennon cowl plugs are constructed from red Aqualon over 2" thick foam and feature a binding around the outer edge of each plug so there is a tight seal which fits snugly in the cowl. This lip prevents the plugs from slipping inside the opening. A safety strap goes around the prop so if by chance you forget to remove

the plugs, the prop will remove them for you. These cowl plugs install easily and comes with their own storage bag. Specify aircraft make, model & year when ordering. Include aircraft registration number to be printed on plugs at no extra charge.

Single engine plugs.....P/N 13-14111**\$150.00**

CUSTOM FIT COWL PLUGS



Cowl plugs are tailored to fit popular Cessna single engine aircraft. High visibility yellow closed cell foam will not retain moisture. Printed on one side is "Remove Before Starting Engine", and the other is blank for the N number. They are joined by a nylon strap with a

fluorescent orange "Remove Before Flight" flag.
C-172 (1965+)P/N 13-02625**\$50.80**
C-182 (1972.5 - 1989).....P/N 13-02630**\$54.75**
Universal kit w/square inlets (Sqr blocks you cut to fit)
P/N 13-02645**\$49.95/pr**

UNIVERSAL TINT - TRAVELING PLANE KIT



This Universal Kit is the perfect choice for everyone! The shape is a rectangle with rounded edges. 10" X 15.5". It will stick to any window that you want to protect yourself from the bright sunlight glare, damaging UV rays while blocking out heat. Includes Carrying Kit.

P/N 13-21878**\$49.95**

FLEXIBLE COCKPIT SUN SHADES



The CRAZEdpilot Sun Shade is a highly portable, easy to store, and easy to use for pilots with only one hand available for placement. Easily conforms to various curvatures of windscreen or side windows. A great lowcost investment to save your interior and panel, without the expense of custom made sunshades! 14.5" x 17" rounded oval shape. Coils/folds to a 6" dia. that can be stored in a seat pouch. Secures to any smooth

surface (glass, plastic, metal, etc.) with one central suction cup. Easily installed with one hand, and moved quickly. Package contains TWO sun shades and TWO suction cups Place two sun shades under one Sunction cup for extra sun protection!.....P/N 11-13316**\$7.95**

PILOT ARMOR™ GENERAL PURPOSE SUNSHADES



This general purpose sunshade provide "spot relief" on windows of any size. They are easily attached and removed to provide sun and glare protection wherever you need it. Made of commercial grade exterior polyester blended Sun Protection screen

that has been treated and sealed with a reflective polymer which gives the fabric its protective features. It is very durable, will not mildew, or fade. Tear and dirt resistant, the fabrics stand up to tough conditions and continue to look fresh for years. It is easily maintained with a mild detergent or a cockpit "wet-nap".

• Excellent solar protection-eliminates up to 86% of the sun's rays, excellent thermal reflective features • Ideal compromise between solar protection and light transparency • Provides significant external visibility • For use on the ground or in the air • Will not damage acrylic windows

Size	Part No.	Price
9.5"x6"	13-09666	\$22.85
11"x6"	13-09665	\$35.50
16"x9"	13-09664	\$31.95
15"x22"	13-09662	\$43.80
16"x16"	13-09663	\$38.50

BONANZA/BARON ADJUSTABLE SUN VISORS



Aerospace construction means they work flawlessly, plus they are very adjustable. Rotate them up and down, turn to cover the side windows and slide them in and out for coverage where you want.

P/N 05-03434**\$432.00**

SUNGUARD SLAP ON SUN VISOR



Sunguard is a transparent polymer, that will statically attach to any smooth surface (windows in cars, boats, aircraft, RV's and homes). It is available in "olive green" tinted shade and absorbs approximately 78% of the light spectrum.

6X9.....P/N 13-08666**\$5.70**
9X12.....P/N 13-08667**\$9.50**

JUST PLANE TINT SLAP SHADE



This is a full Block Off Kit, it is the same size as the Universal Kit, made to be put anywhere and block the sunlight 100%, includes carrying case.
15" X 10.5"

GreyP/N 13-22143-2**\$35.70**
Tan.....P/N 13-22143-1**\$35.70**
BlackP/N 13-22143**\$35.70**

BRUCES INSULATED HANGAR BLANKET



Insulated Hangar Blanket, Interior use for 2-place high wing aircraft.

This item comes in red only. Protect your airplane's engine inside a cold winter hangar with reasonably priced Insulated Hangar Blankets.

Excellent protection against the cold when used indoors with an engine warming heat source.

The Original and World's Finest Aircraft Covers for Airplanes, Jets, Helicopters, Gliders and QEC Off-link Jet Engines.

Once the material for each order is cut into its appropriate parts, highly trained sewing machine operators meticulously assemble the products with durable thread, rivets, and canvas trim.

High Wing, 2 Place.....P/N 13-21100**\$289.95**
High Wing, 4 Place.....P/N 13-21103**\$290.00**
Low Wing, 2 PlaceP/N 13-21102**\$245.00**
Low Wing, 4 PlaceP/N 13-21104**\$290.00**

PS

BRUCE'S CUSTOM COVERS

BRUCES CUSTOM CANOPY COVERS



Canopy Covers help reduce damage to your airplane's upholstery and avionics caused by excessive heat, and they can eliminate problems caused by leaking door and window seals. They keep the windshield and window surfaces clean and help prevent vandalism and theft. When requested, it is also sometimes possible to design Canopy covers that can attach to the aircraft fuselage using pop-riveted snap-heads at the rear and snap-head screws on the engine cowling. The Canopy Cover is custom sewn and the corners are trimmed to match the colors of the airplane. The airplane's registration number can be imprinted onto both sides of the cover for an additional charge. A duffie bag is included with all Canopy Covers. Made from Silver Acrylic Sunbrella or Silver Solution-Dyed Polyester and is lined 100% with a soft and smooth microfiber. The outer material is medium-weight and treated for water resistance, UV resistance and anti-static buildup. The inner lining is a very soft and smooth microfiber to prevent scratching. Does not contain hydrocarbon compounds that can harm Plexiglas windshields and acrylic finishes. Other colors are available. Please contact us for availability and price. Light weight material available.

Description	Part No.	Price
C350 & C400 CoRValis, CoRValis TT	13-15233	\$614.00
Cessna 150 & 152 Wrap-around Style	13-15126	\$425.00
Cessna 170 Wrap-around Style	13-15141	\$470.00
Cessna 172 & 175 (T-41, T-41a/c) Wrap-around Style	13-15157	\$470.00
Cessna 177 Cardinal Wrap-around Style	13-15172	\$588.00
Cessna 180/185 Skywagon Wrap-around Style	13-15185	\$470.00
Cessna 182 Skylane Wrap-around Style	13-15210	\$480.00
Cessna 206 Stationair Wrap-around Style	13-15217	\$480.00
Cessna 210 Centurion Wrap-around Style	13-15226	\$480.00
Travel Canopy Cover C350 & C400	13-15234	\$492.00
Travel Canopy Cover Cessna 150 & 152 Wrap-around Style	13-15127	\$340.00
Travel Canopy Cover Cessna 170 Wrap-around Style	13-15142	\$375.00
Travel Canopy Cover Cessna 172 & 175 Wrap-around Style	13-15159	\$374.00
Travel Canopy Cover Cessna 177 Cardinal Wrap-around Style	13-15173	\$375.00
Travel Canopy Cover Cessna 180/185 Skywagon Wrap-around Style	13-15186	\$365.00
Travel Canopy Cover Cessna 182 Skylane Wrap-around Style	13-15211	\$380.00
Travel Canopy Cover Cessna 206 Stationair Wrap-around Style	13-15218	\$384.00
Travel Canopy Cover Cessna 210 Centurion Wrap-around Style	13-15227	\$380.00
Beech Bonanza/Debonair	13-15089	\$576.00
Beech Bonanza 36 Models	13-15099	\$599.00
Beech Baron 58	13-15111	\$647.00
Travel Canopy Cover Beech Bonanza/Debonair	13-15090	\$460.00
Travel Canopy Cover Beech Bonanza 36 Models	13-15101	\$485.00
Travel Canopy Cover Beech Baron 58	13-15112	\$518.00
Diamond DA20, Katana, Eclipse	13-15263	\$439.00
Diamond DA40	13-15270	\$550.00
Travel Canopy Cover Diamond DA20, Katana, Eclipse	13-15264	\$353.00
Travel Canopy Cover Diamond DA40	13-15271	\$439.00
Grumman AA1	13-15277	\$443.00
Grumman AA5	13-15286	\$550.00

Description	Part No.	Price
Travel Canopy Cover Grumman AA1	13-15278	\$353.00
Travel Canopy Cover Grumman AA5	13-15287	\$439.00
Lancair Columbia 300, 350, 400	13-15296	\$614.00
Lancair Models 320, 360	13-15307	\$443.00
Lancair IV	13-15317	\$550.00
Travel Canopy Cover Lancair Columbia 300, 350, 400	13-15297	\$492.00
Travel Canopy Cover Lancair Models 320, 360	13-15308	\$353.00
Travel Canopy Cover Lancair IV	13-15318	\$438.00
Mooney Early M20 Series	13-15327	\$575.00
Mooney 201, 205, 231, 252 & MSE	13-15337	\$575.00
Mooney Ovation	13-15347	\$614.00
Mooney TLS, Bravo, Acclaim TN, Type S, & Porsche Powered Models	13-15367	\$614.00
Travel Canopy Cover Mooney Early M20 Series	13-15328	\$460.00
Travel Canopy Cover Mooney 201, 205, 231, 252 & MSE	13-15338	\$460.00
Travel Canopy Cover Mooney Ovation	13-15357	\$492.00
Travel Canopy Cover Mooney TLS, Bravo, Acclaim TN, Type S, & Porsche Powered Models	13-15368	\$460.00
Piper PA-24 Comanche	13-15377	\$515.00
Piper PA-28	13-15388	\$525.00
Piper PA-32	13-15399	\$647.00
Travel Canopy Cover Piper Pa-24 Comanche	13-15378	\$410.00
Travel Canopy Cover PA-28	13-15389	\$415.00
Travel Canopy Cover Piper PA-32	13-15401	\$520.00
Vans Aircraft RV-10	13-15409	\$415.00
Vans Aircraft RV-12	13-15420	\$415.00
Vans Aircraft RV-6/6A	13-15429	\$415.00
Vans Aircraft RV-7/7A	13-15436	\$415.00
Vans Aircraft RV-8/8A	13-15443	\$415.00
Vans Aircraft RV-9/9A	13-15451	\$415.00
Travel Canopy Cover Vans Aircraft RV-10	13-15410	\$415.00
Travel Canopy Cover Vans Aircraft RV-12	13-15421	\$332.00
Travel Canopy Cover Vans Aircraft RV-6/6A	13-15430	\$360.00
Travel Canopy Cover Vans Aircraft RV-7/7A	13-15437	\$332.00
Travel Canopy Cover Vans Aircraft RV-7/7A	13-15444	\$332.00
Travel Canopy Cover Vans Aircraft RV-9/9A	13-15452	\$315.00



BRUCES CUSTOM WING COVERS

The Wing Covers are a perfect solution to protect your paint from sun damage and prevent winter frost, snow, ice buildup, and corrosion. They are made from Solution-Dyed Polyester or Acrylic Sunbrella and form-fit to slip around each wing tip, cover the entire upper surface of the wing and wrap around the leading and trailing edges. The covers secure under the wing with adjustable straps from the trailing edge to the leading edge. The wing covers can also attach to each other with adjustable straps at the leading and trailing edges of the wing under the belly of the plane. We have the ability to also accommodate wing tip modifications, such as STOL kits, droop tips, and vortex generators. Labeled LEFT and RIGHT for your convenience. Hail Protection version can be made. Set of 2.

Description	Part No.	Price
Cessna 150 & 152	13-15134	\$465.00
Cessna 170	13-15147	\$503.00
Cessna 172 & 175	13-15164	\$503.00
Cessna 177 Cardinal	13-15178	\$503.00
Cessna 180/185 Skywagon	13-15192	\$503.00
Cessna 182 Skylane	13-15193	\$503.00
Cessna 206 Stationair	13-15194	\$503.00
Cessna 210 Centurion	13-15196	\$503.00
C350 & 400 Corvallis, Corv Tt	13-15198	\$503.00
Beech Bonanza/Debonair	13-15094	\$503.00
Beech Bonanza 36 Models	13-15105	\$503.00
Beech Baron 58	13-15117	\$1,195.00
Cirrus SR20	13-15199	\$503.00
Cirrus SR22	13-15201	\$503.00
Diamond DA-20, Katana, Eclipse	13-15202	\$465.00
Diamond DA-40	13-15203	\$503.00
Grumman AA5:tiger,cheetah,traveler	13-15291	\$503.00
Horizontal Stabilizer Covers Grumman AA	13-15292	\$283.95
Grumman AA1	13-15205	\$465.00

Description	Part No.	Price
Lancair Columbia 300,350,400	13-15302	\$503.00
Lancair Models 320,360	13-15312	\$465.00
Lancair Iv	13-15322	\$503.00
Mooney Early M20 Series	13-15332	\$503.00
Mooney 201,205,231,252 & Mse	13-15342	\$496.00
Mooney Ovation	13-15362	\$503.00
Mooney Tls, Bravo, Acclaim Tn, Type S, & Porsche Powered Models	13-15372	\$503.00
Piper PA-24 Comanche	13-15383	\$503.00
Piper PA-28	13-15393	\$504.00
Piper PA	13-15405	\$503.00
Vans Aircraft RV-4-WCW	13-16013	\$395.00
Vans Aircraft RV-10	13-15414	\$503.00
Vans Aircraft RV-12	13-15425	\$465.00
Vans Aircraft RV-6/6a	13-15434	\$465.00
Vans Aircraft RV-7/7a	13-15441	\$435.00
Vans Aircraft RV-8/8a	13-15448	\$465.00
Vans Aircraft RV-9/9a	13-15456	\$610.00



BRUCE'S CUSTOM COVERS

BRUCES CUSTOM HORIZONTAL STABILIZER COVERS



Horizontal Stabilizer Covers are a perfect solution to protect your paint from sun damage and prevent frost, snow, ice buildup, and corrosion. They are made from Solution-Dyed Polyester or Acrylic Sunbrella. They cover the entire upper surface of the stabilizers and overlap around the leading and trailing edges as well as the wing tip. The covers secure under each stabilizer with adjustable straps. In some instances, cut-outs are made in the trailing edge of the wing covers to accommodate for static wicks. Horizontal Stabilizer Covers for winter use or long-term all year use are usually available, and are normally made from Solution-Dyed Polyester or Acrylic Sunbrella. A Hail Protection version can be made. Although these covers are bulky, they do help protect your wing and control surfaces against small to medium-size hail. **Set of 2 - Winter Use**

Description	Part No.	Price
C150 & 152	13-15136	\$149.85
C170	13-15148	\$267.95
C172 & 175	13-15166	\$256.95
C177 Cardinal	13-15179	\$283.95
Cessna 180/185 Skywagon	13-15206	\$283.95
Cessna 182 Skylane	13-15214	\$283.95
C206 Stationair	13-15222	\$283.95
C210 Centurion	13-15230	\$267.95
C350 & C400	13-15238	\$283.95
Beech Bon/deb	13-15095	\$283.95
Beech Bon 36	13-15106	\$283.95
Beech Baron 58	13-15118	\$293.95
Cirrus SR20	13-15247	\$283.95
Cirrus SR22	13-15256	\$283.95
DA20, Katana, Eclipse	13-15268	\$149.80
Diamond DA40	13-15275	\$283.95
Grumman AA1	13-15282	\$149.80

Description	Part No.	Price
Grumman AA5	13-15292	\$283.95
Lan C300,350,400	13-15303	\$256.95
Lancair Models 320,360	13-15313	\$149.80
Lancair IV	13-15323	\$283.95
Mooney Early M20 Series	13-15333	\$283.95
M201,205,231,252 & Mse	13-15343	\$283.95
Mooney Ovation	13-15363	\$283.95
Mooney TLS, Bravo, Acclaim TN, Type S, & Porsche Powered Models	13-15373	\$283.95
Piper PA-24 Comanche	13-15384	\$283.95
Piper PA-28	13-15394	\$284.95
Vans Aircraft RV-10	13-15415	\$256.95
Vans Aircraft RV-12	13-15426	\$149.80
Vans Aircraft RV-6/6a	13-15435	\$235.95
Vans Aircraft RV-7/7a	13-15442	\$236.95
Vans Aircraft RV-8/8a	13-15449	\$149.80
Vans Aircraft RV-9/9a	13-15457	\$235.95



BRUCES CUSTOM ENGINE COVERS

Once the material for each order is cut into its appropriate parts, highly trained sewing machine operators meticulously assemble the products with durable thread, rivets, and canvas trim.

Description	Part No.	Price
Cessna 150 & 152	13-15132	\$347.00
Cessna 170	13-15144	\$326.00
Cessna 172 & 175	13-15162	\$384.00
Cessna 177 Cardinal	13-15176	\$385.00
Cessna 180/185 Sky Wagon	13-15189	\$332.00
Cessna 182 Skylane	13-15212	\$415.00
Cessna 206 Stationair	13-15220	\$385.00
Cessna 210 Centurion	13-15228	\$347.00
C350 & C400 Corvalis, Corvalis TT	13-15236	\$326.00
Beech Bonanza/debonair	13-15092	\$385.00
Beech Bonanza 36 Models	13-15103	\$385.00
Beech Baron 58	13-15114	\$646.00
Cirrus SR20	13-15245	\$385.00
Cirrus SR22	13-15254	\$385.00
Diamond DA20, Katana, Eclipse	13-15266	\$326.00
Diamond DA40	13-15273	\$385.00
Grumman AA1	13-15280	\$326.00
Grumman AA5	13-15289	\$385.00
Lancair Columbia 300, 350, 400	13-15299	\$396.00
Lancair Models 320, 360	13-15310	\$326.00
Lancair IV	13-15320	\$385.00
Mooney Early M20 Series	13-15330	\$326.00
Mooney 201, 205, 231, 252 & MSE	13-15340	\$460.00
Mooney Ovation	13-15360	\$326.00
Mooney TLS, Bravo, Acclaim TN, Type S, & Porsche Powered Models	13-15370	\$326.00
Piper PA-24 Comanche	13-15381	\$385.00
Piper PA-28	13-15391	\$444.00
Piper PA-32	13-15403	\$465.00
Vans Aircraft RV-10	13-15412	\$385.00
Vans Aircraft RV-12	13-15423	\$326.00
Vans Aircraft RV-6/6A	13-15432	\$385.00
Vans Aircraft RV-7/7A	13-15439	\$386.00
Vans Aircraft RV-8/8A	13-15446	\$326.00
Vans Aircraft RV-9/9A	13-15454	\$412.00
Insulated/cold Weather Engine Cover Beech Bon/Deb	13-15093	\$530.00
Insulated/cold Weather Engine Cover Beech Bonanza 36	13-15104	\$533.00
Insulated/cold Weather Engine Cover Beech Baron 58	13-15116	\$998.00
Insulated/cold Weather Engine Cover Cessna 150 & 152	13-15133	\$465.00

Description	Part No.	Price
Insulated/cold Weather Engine Cover Cessna 170	13-15146	\$503.00
Insulated/cold Weather Engine Cover Cessna 172 & 175	13-15163	\$540.00
Insulated/cold Weather Engine Cover 177 Card	13-15177	\$540.00
Insulated/cold Weather Engine Cover Cessna 180/185	13-15190	\$349.00
Insulated Cold Weather Engine Cover C182 Skylane	13-15213	\$540.00
Insulated Cold Weather Engine Cover C206 Stationair	13-15221	\$540.00
Insulated Cold Weather Engine Cover C210 Centurion	13-15229	\$540.00
Insulated Cold Weather Engine Cover C350 & C400	13-15237	\$572.00
Insulated Cold Weather Engine Cover Cirrus SR20	13-15246	\$540.00
Insulated Cold Weather Engine Cover Cirrus SR22	13-15255	\$540.00
Insulated Cold Weather Engine Cover DA20	13-15267	\$443.00
Insulated Cold Weather Engine Cover DA40	13-15274	\$503.00
Insulated Cold Weather Engine Cover Grumman AA1	13-15281	\$443.00
Insulated Cold Weather Engine Cover Grumman AA5	13-15290	\$499.00
Insulated Cold Weather Engine Cover Lan C300,350,400	13-15301	\$572.00
Insulated Cold Weather Engine Cover L320 & L360	13-15311	\$444.00
Insulated Cold Weather Engine Cover Lancair IV	13-15321	\$503.00
Insulated Cold Weather Engine Cover M20	13-15331	\$503.00
Insulated Cold Weather Engine Cover M201, 205, 231, 252	13-15341	\$503.00
Insulated Cold Weather Engine Cover Mooney Ovation	13-15361	\$503.00
Insulated Cold Weather Engine Cover Mooney Tls, Bravo, Acclaim, Tn, Type S & Porche Powered Models	13-15371	\$327.00
Insulated Cold Weather Engine Cover Piper PA-24 Comanche	13-15382	\$503.00
Insulated Cold Weather Engine Cover Piper PA-28	13-15392	\$540.00
Insulated Cold Weather Engine Cover Piper PA-32	13-15404	\$540.00
Insulated Cold Weather Engine Cover Vans A/C RV-10	13-15413	\$503.00
Insulated Cold Weather Engine Cover Vans A/C RV-12	13-15424	\$443.00
Insulated Cold Weather Engine Cover Vans RV-6	13-15433	\$502.00
Insulated Cold Weather Engine Cover Vans A/C RV-7	13-15440	\$503.00
Insulated Cold Weather Engine Cover Vans A/C RV-8	13-15447	\$443.00
Insulated Cold Weather Engine Cover Vans A/C RV-9	13-15455	\$528.00

PS

BRUCE'S CUSTOM COVERS



BRUCES CUSTOM HEATSHIELDS

Heatshield Interior Reflectors are made of a special laminate of metallized polyester film and closed cell foam. Less than 1/8" thick, the Reflector can roll up and store in a sleeve, yet is stiff enough when flat to stand up against the windshield using the sun visors and window framing only. On some designs no Velcro or suction cups are necessary. Heatshields are an excellent short-term remedy for cockpit overheating, but use the Canopy Cover for more effective and practical long term protection. Heatshields should not be used on polarized windows.

Description	Part No.	Price
Heatshield Set Cessna 150 & 152	13-15138	\$256.95
Heatshield Set Cessna 170	13-15151	\$241.95
Heatshield Set Cessna 172 & 175	13-15168	\$256.95
Heatshield Set Cessna 177 Cardinal	13-15182	\$261.95
Heatshield Set Cessna 180/185 Skywagon	13-15208	\$261.95
Heatshield Set Cessna 182 Skylane	13-15216	\$261.95
Heatshield Set Cessna 206 Stationair	13-15224	\$261.95
Heatshield Set Cessna 210 Centurion	13-15232	\$261.95
Heatshield Set C350 & C400 Corvalis, Corvalis TT	13-15240	\$277.95
Windshield Heatshield Cessna 150 & 152	13-15137	\$100.00
Windshield Heatshield Cessna 170	13-15149	\$100.00
Windshield Heatshield Cessna 172 & 175	13-15167	\$104.99
Windshield Heatshield Cessna 177 Cardinal	13-15181	\$100.00
Windshield Heatshield Cessna 180/185 Skywagon	13-15207	\$100.00
Windshield Heatshield Cessna 182 Skylane	13-15215	\$100.00
Windshield Heatshield Cessna 206 Stationair	13-15223	\$100.00
Windshield Heatshield Cessna 210 Centurion	13-15231	\$100.00
Windshield Heatshield C300 & C450	13-15239	\$106.75
Heatshield Set Beech Bonanza/Debonair	13-15097	\$261.95
Heatshield Set Beech Bonanza 36 Models	13-15108	\$261.95
Heatshield Set Beech Baron 58	13-15122	\$277.95
Windshield Heatshield Beech Bonanza/Debonair	13-15096	\$100.00
Windshield Heatshield Beech Bonanza 36 Models	13-15107	\$100.00
Windshield Heatshield Beech Baron 58	13-15119	\$106.75
Heatshield Set Cirrus SR20	13-15249	\$261.95
Heatshield Set Cirrus SR22	13-15258	\$261.95
Windshield Heatshield Cirrus SR20	13-15248	\$100.00
Windshield Heatshield Cirrus SR22	13-15257	\$100.00

Description	Part No.	Price
Heatshield Set Grumman AA1	13-15284	\$251.95
Heatshield Set Grumman AA: Tiger, Cheetah, traveler	13-15294	\$240.95
Windshield Heatshield Grumman AA1	13-15283	\$106.75
Windshield Heatshield Grumman AA5	13-15293	\$106.75
Heatshield Set Lancair Columbia 300, 350, 400	13-15305	\$275.95
Heatshield Set Lancair IV	13-15325	\$267.95
Windshield Heatshield Lancair Columbia 300, 350, 400	13-15304	\$106.75
Windshield Heatshield Lancair Models 320,360	13-15314	\$133.80
Windshield Heatshield Lancair IV	13-15324	\$106.75
Heatshield Set Mooney Early M20 Series	13-15335	\$259.95
Heatshield Set Mooney 201, 205, 231, 252 & MSE	13-15345	\$261.95
Heatshield Set Mooney Ovation	13-15365	\$277.95
Heatshield Mooney TLS, Bravo, Acclaim TN, Type S, & Porsche Powered Models	13-15375	\$277.95
Windshield Heatshield Mooney Early M20 Series	13-15334	\$100.00
Windshield Heatshield Mooney 201, 205, 231, 252 & MSE	13-15344	\$100.00
Windshiled Heatshield Mooney Ovation	13-15364	\$106.75
Windshield Heatshield Mooney TLS, Bravo, Acclaim TN, Type S, & Porsche Powered Models	13-15374	\$106.75
Heatshield Set Piper PA-24 Comanche	13-15386	\$251.95
Heatshield Set Piper PA-28	13-15397	\$218.95
Heatshield Set Piper PA-32	13-15407	\$277.95
Windshield Heatshield Piper PA-24 Comanche	13-15385	\$100.00
Windshield Heatshield Piper PA-28	13-15395	\$100.00
Windshield Heatshield Piper PA-32	13-15406	\$106.75
Heatshield Set Vans Aircraft RV-10	13-15418	\$251.95
Windshield Heatshield Vans Aircraft RV-10	13-15416	\$100.00



BRUCES CUSTOM ENGINE INLET PLUGS

Engine Inlet Plugs are custom fit for your intakes, made with heavy-duty vinyl material, and stuffed with a single block of sculpted urethane foam. Each plug has a zipper that allows the foam to be removed and dried if necessary. Engine plugs have warning flags that are visible from the cockpit or 'remove before flight' streamers sewn onto the face of the plugs.

Description	Part No.	Price
Cessna 150 & 152	13-15131	\$122.75
Cessna 170	13-15143	\$138.75
Cessna 172 & 175	13-15161	\$128.00
Cessna 177 Cardinal	13-15174	\$128.00
Cessna 180/185 Skywagon	13-15187	\$128.00
Bruces Engine Inlet Plug Cessna 182 Skylane	13-15070	\$135.00
Bruces Engine Inlet Plug Cessna 206 Stationair	13-15072	\$130.00
C350 & C400 Corvalis, Corvalis TT	13-15235	\$128.00
Beech Bonanza/Debonair	13-15091	\$138.75
Beech Bonanza 36 Models	13-15102	\$144.00
Beech Baron 58	13-15113	\$235.95
Cirrus SR20	13-15244	\$128.00
Cirrus SR22	13-15253	\$128.00
Diamond Da20, Katana, Eclipse	13-15265	\$122.75
Diamond Da40	13-15272	\$138.75
Grumman AA1	13-15279	\$128.00
Grumman AA5	13-15288	\$138.75

Description	Part No.	Price
Lancair Columbia 300,350,400	13-15298	\$128.00
Lancair Models 320,360	13-15309	\$122.75
Lancair IV	13-15319	\$128.00
Mooney Early M20 Series	13-15329	\$128.00
Mooney 201, 205, 231, 252 & MSE	13-15339	\$128.00
Mooney Ovation	13-15359	\$138.75
Mooney TLS, Bravo, Acclaim TN, Type S, & Porsche Powered Models	13-15369	\$144.00
Piper PA-24 Comanche	13-15379	\$138.75
PA-28	13-15390	\$128.00
Piper PA32	13-15402	\$128.00
Vans Aircraft RV-10	13-15411	\$133.75
Vans Aircraft RV-12	13-15422	\$133.75
Vans Aircraft RV-6/6A	13-15431	\$128.00
Vans Aircraft RV-7/7A	13-15438	\$133.75
Vans Aircraft RV-8/8A	13-15445	\$128.00
Vans Aircraft RV-9/9A	13-15453	\$133.75



FUEL MATS – FUEL INDICATORS

POLYURETHANE WING FUEL MAT



This polyurethane wing fuel mat can be easily cleaned with soap and water. Avoid spraying product with silicone or wd-40 type products because this material will cause dust and dirt to attach to pad possibly scratching wing surface. Color fading will not affect the integrity of the polyurethane material. Color options available at point of purchase. Dimensions: 18" x 24" x 0.30 Length and width dimensions are subject to +/- 1/8 tolerance Service range: -20F - 200F. Fuel port: 5" diameter. Durable impact absorbing polyurethane. Non-Marking and Non-Abrasive, UV stable. Exposure to direct sunlight will cause color fading. Fuel Resistant and chemical resistant with the exception of MEK.

Blue	P/N 01-01284	\$69.75
Orange.....	P/N 01-01285	\$69.75
Black.....	P/N 01-01286	\$69.75
Red.....	P/N 01-01287	\$69.75

FUEL STIKS



Extremely light, high impact plastic tubing with aluminum rings resist damage. Available "Aircraft Specific Scales" Can be downloaded and printed from the website. Can easily be calibrated to any tank using the "Universal" scale. A worksheet, written instructions and even an instructional video are available at the website. We will generate an "Aircraft Specific Scale" from your calibration It's shipping tube doubles as a "Vented Storage Tube". This allows any remaining fuel to evaporate between uses, provides a protection for the life of the unit and reduces manufacturing waste. It's design gives consistent readings even when the fuel in the tank is sloshing around. It's upper and lower rings aide in handling. Large Easy-to-Read numbers observed outside the tank. Quantities given in both Gallons and Pounds! Color coded sections represent approx. 1/3 cruise consumption. It's not limited to your aircraft. Works in tractors, small motors, etc. Will not fall into fuel tank on most aircraft. 100% Made in the USA

Description	Usable Fuel Tank Size	Part No.	Price
Cessna 150-152	12.5 Gal.	05-12341	\$29.50
Cessna 172-A	18.5 Gal.	05-12343	\$29.50
Cessna 172	19 Gal.	05-12344	\$29.50
Cessna 172	21.5 Gal.	05-12345	\$29.50
Cessna 172 N-Q (Long Range)	25 Gal.	05-12346	\$29.50
Cessna 172 R-S	26.5 Gal.	05-12348	\$29.50
Cessna 177	25 Gal.	05-13076	\$29.50
Cessna 177 Cardinal A-B (Including RG)	30.5 Gal.	05-12350	\$26.95
Cessna 182 A-D	27.5 Gal.	05-12351	\$29.50
Cessna 182 P	30 Gal.	05-13078	\$29.50
Cessna 182 Q	37 Gal.	05-12352	\$29.50
Cessna 210 G-N (Including Turbo)	44.5 Gal.	05-12353	\$26.95
Cessna 182 T	43.5 Gal.	05-12355	\$29.50
Grumman-American General AA (AG)-5A-5B	26.3 Gal.	05-12356	\$29.50
Piper PA 12	19 Gal.	05-13081	\$29.50
Piper PA 22 160	18 Gal.	05-13082	\$29.50
Piper PA 28 151-181	24 Gal.	05-12357	\$29.50
Piper PA 28 150-180	24 Gal.	05-12358	\$29.50
Piper PA 28 200-235B	24 Gal.	05-12359	\$29.50
Piper 34 200 Seneca II	61.5 Gal.	05-13083	\$29.50
RV RV6A	19 Gal.	05-12360	\$26.95
RV RV7	20 Gal.	05-13084	\$29.50
RV RV8	21 Gal.	05-13085	\$29.50
RV RV10	31 Gal.	05-13086	\$29.50
Master (10.75") Includes: Ship/Storage Tube, Use and Calibration Instructions, Universal Scale Installed in Float Tube	10.75"	05-12361	\$29.50

CESSNA HIGH-WING FUEL VENT SCREEN



Fuel flow to your aircraft's engine can be compromised by insects or debris entering fuel tank vents. This remove-before-flight Fuel Vent Screen prevents contaminants from obstructing or contaminating the fuel system. The attached foot-long, florescent, and weather-resistant reflective streamer stands out equally well in daylight or darkness under all weather conditions, so it won't be forgotten during your pre-flight. Fits Cessna piston engine aircraft. Inside diameter of PVC sleeve is 0.365" 3/8 InchP/N 13-10437**\$18.75** 1/2 InchP/N 13-12390**\$19.75**

FUELING / ENGINE ACCESS WING MATS



Please specify color when ordering: Red, Light Blue, Royal Blue, Black, Green, Yellow and Safety Orange. **Features:** • Protective and durable impact absorbing Urethane-polymer • UV • Fuel

• Chemical resistant • Non-marking • Non-abrasive • Exceeds FAA and military standards • -20° F to 200° F service integrity • Standard 5-inch diameter service port • Special design and private labeling available • Approved by all major oil companies, airlines, military and fuel service operations • 3 year warranty

Color	Size	Part No.	Price	Size	Part No.	Price
Red	18" x 24"	13-11206	\$107.75	18" x 36"	13-11212	\$139.95
Royal Blue		13-11207	\$108.85		13-11213	\$139.95
Orange		13-11208	\$107.75		13-11214	\$139.95
Yellow		13-11209	\$107.75		13-11215	\$138.95
Black		13-11210	\$107.75		13-11216	\$139.75
Green		13-11211	\$105.85		13-11217	\$138.85

WING MAT



This navy blue carpet can be placed on the wing prior to boarding which will protect both the wing and the aircraft interior. This mat rolls up easily for storage in the aircraft and an attached elastic band keeps it rolled up. The rubber backing is perfect for use on low wing aircraft. Two sizes available.

Small Wing 10.5" x 36".....	P/N 13-07195	\$19.70
Large Wing 21" x 48".....	P/N 13-07196	\$48.65

DIRECT FUEL LEVEL INDICATORS



These Direct Fuel Level Indicators are quality made of acrylic PVC tube with an aluminum scale. They are available calibrated to individual tanks or uncalibrated for custom calibration to home built tanks. These Indicators allow an accurate check of on board fuel level indicators and eliminate the guess work.

Description	Part No.	Price
Fuel Level Indicator C-150/C-152 +	12-21200	\$16.95
Fuel Level Indicator C-150 LONG 19	12-21205	\$18.50
Fuel Level Indicator C-170 / C-172	12-21210	\$16.95
Fuel Level Indicator C-172 34G	12-21215	\$18.50
Fuel Level Indicator C-182 42G	12-21230	\$16.95
Fuel Level Indicator C-210 45G	12-21240	\$16.95
Fuel Level Indicator PA-24 30G	12-21245	\$18.50
Fuel Level Indicator 7KCAB	12-21250	\$18.50
Fuel Level Indicator PA-28	12-21255	\$16.95
Home Built Universal Fuel Level Indicator CK Rod	12-21260	\$18.50

FUEL HAWK FUEL GAUGES



The Fuelhawk is just 11" long, clear lightweight and unbreakable. It's easy to use and gives an instant readout in gallons usable. No more guessing. These handy devices offer the answers to these very important questions: 1.How many gallons of usable fuel are remaining in the tank? 2.How much fuel can be added without going over gross weight? 3. Are the aircraft fuel gauges working & accurate?

Application	Part No.	Price
Cessna 152 (standard 12 gal. tanks)	13-00443	\$12.95
Cessna 172 (standard 19 gal. tanks)	13-00442	\$12.95
New Cessna 172 Skyhawk (26.5 gal.)	13-01468	\$12.95
New Cessna 182 Skylane (43.5 gal.)	13-01469	\$12.95
Cessna 182LR (42 gal. Long range tanks)	13-00441	\$12.95
Universal for any aircraft, w/graph & calibration chart	13-00439	\$12.95
Universal XL Fuel Gauge (16" long)	13-00949	\$17.95
Universal Gauge 26"	13-11189	\$19.95

THE ORIGINAL FUEL STOP

The Fuel Stop is a simple tool that snaps onto a standard straw fuel gauge and prevents the gauge from ever slipping into the tank. Works with FuelHawk, or any other 1/2" diameter fuel gauge tube. It also becomes extremely handy when it's necessary to set the gauge on the wing, as it will stay put and not roll off to disappear into the grass or onto the pavement. Shaped like a set of red pilot wings which makes finding the gauge a snapP/N 13-17631**\$7.95**



GOCHECK PREFLIGHT 6 IN 1 MULTI-TOOL

Designed for single-engine propeller pilots and aviation mechanics; the GoCheck PreFlight Multi-Tool combines six functions in one device. Features a stall horn tester that is unique for preflight inspection and compact to store in your flight bag or clip to your belt. Fuel Tester with Strainer, Stall Horn Tester, Dipstick Wiper, Red/White Flashlight, Phillips/flathead Screwdriver, and Checklist Reminder CardP/N 05-15254**\$49.95**

PS

COWL PLUGS - AIRCRAFT COVERS

COWL PLUGS



Cowl Plugs with attached "remove before flight" streamer for general aviation aircraft. Prevents bird and foreign objects from entering through the cowl. Comes complete with a linking lanyard and remove before flight streamer. Heavy duty cross linked construction and durable nylon hand sewn stitching complete the set. Please specify aircraft make, model, & serial number when ordering. Plugs are furnished with free embroidery and pitot tube cover.

Single engine.....P/N 13-01742\$80.75
Twin engine.....P/N 13-01743\$168.95

PROPELLER SLINGS EXHAUST COVERS



Propeller Slings & Exhaust Covers keep your propeller secure and in place, eliminating any bearing damage caused by a free-spinning propeller with no lubrication. The integral exhaust covers protect the costly turbine wheel from debris & birds. Simple, quick one man operation. Please specify aircraft make, model, serial no. when orderingP/N 13-01744\$123.75

INLET PLUGS



These protect your engine from foreign object damage, blowing dust and sand, birds and debris. Complete with remove before flight flag and easy pull handle for insertion and removal. Please specify aircraft make, model, & serial no. when ordering.P/N 13-01745. \$106.75/eng

JET ENGINE COVERS



Made of extremely durable, water-proof and fire resistant Herculite, our covers are guaranteed for 10 yrs. Each set is hand crafted and sewn to order. Complete with storage bag and remove before flight flags. Please specify aircraft make, model, & serial no. when ordering.
P/N 05-04077CALL FOR QUOTE

ENGINE INTAKE COVER



Protect your engine from natural hazards which could cause serious in-flight problems. This economical design fits practically every single or twin, even homebuilts. The lightweight, fire-retardant mesh fabric will not blister or melt. After simple one-time installation of mounting hardware, cover snaps into place and secured with Velcro. Folds for easy storage. Complete with mounting hardware & "Remove Before Starting Engine" streamers. Also available: Bib that allows you to cover additional intakes. Engine Intake Cover.....P/N 7148\$64.85

KUVR**IT WHEEL COVERS



A vinyl-coated polyester that is fade resistant and California State Fire Marshall approved (#F-2310). The weave breathes and yet provides 85% shade factor from the suns damaging ultra violet rays. It is easy to care for. Simply machine wash and just hang it to dry. The KUVR**IT II Wheel Cover is easy to use. Simply place the cover over your tires and adjust the strap to the desired tightness and lock into place. There are 2 sizes for your convenience: Small fits tire size: 5.00 - 5/15 x 00-6.....P/N 13-03158\$39.95

REDWING TRAILING EDGE PROTECTIVE FOAM



RedWing helps prevent aircraft damage and head injuries. Just slide the foam onto the trailing edges of ailerons, elevators, rudders or flaps to protect these surfaces while tied down or in the hangar.. RedWing is also ideal for protecting landing gear doors, avionics antennas, and winglets. The bright red color reminds the pilot to remove RedWing before flight, and RedWing is reuseable and unaffected by UV, water, or oils. Furnished in 3ft. sections which can be easily cut to smaller sections.

P/N 13-02566\$31.50

WICKSHIELD



Warning type cover for aircraft, wire/rod & "whisker" type, Static Wicks. These are very simple to use, economical, and conveniently packaged in 8 packs. They offer practical protection for the wicks, charter/corporate passengers, crew, and maintenance staff! They have been well received by corporate fleets. Features: One size fits all static wicks. Lightweight-will not stress static wicks - will not scratch airplane finish. Quick "Attach - Release" Clasp - will not stick to wicks - will not freeze in place.

P/N 13-11708\$35.90

STEARMAN COCKPIT DUST AND RAIN COVER



One of the problems with traveling in your Stearman is the lack of space to haul necessities. This Cockpit Cover weighs about 1 pound in it's storage bag, which is the size of a quart carton.

The cover is made from back-packing tent material which is rain proof and light weight. Installs with two Velcro straps and four elastic cords using plastic fasteners. There is no metal to scratch your finish. Available in Federal Yellow.P/N 13-11616\$219.95

KOGER SUNSHADES



The Koger Sunshade was developed to provide protection from the sun while flying an airplane that has a large bubble plastic canopy like the RV-6, RV-7, RV-8, RV-9 and many other types of aircraft.

Key Benefits:

- Retractable to front or rear.
- Lightweight (9oz. for side by side RV models)
- Install in 1/2 to 1-1/2 hours depending on the model.
- Makes instruments more visible, and the cockpit more comfortable.

Fits	Description	Part No.	Price
RV-8	Special 15" W x 46" L	13-05657	\$249.95
RV-6, 6A, 7, 7A, 9, 9A	Standard RV TIP-UP 30" W x 25" L	13-05658	\$195.00
RV-6, 7, 9	Super RV Slider - 34" W x 35" L	13-09609	\$229.00
RV-6, RV-6A, RV-7, RV-7A, RV-9, RV-9A, RV-14, Lancair 320, 360, Pulsar - Plusar III, Sonex, Swift	Designed for the RV-14. 35"Wx 25"L	13-20710	\$195.00
Arion Aircraft - Lighting, Breezer, Cirrus, Classic Sport - S-18 & S-18T, Europa Evektor - Eurostar, Glasair-320 and 360 Lancair - Legacy, Mustang II Sequoia Falco - F9L, Skylark Sting Sport, Texan, Zenith - Zodiac	Large Universal for larger clear bubble canopies with no center structural members 34" W x 35" L	13-05660	\$229.00
Air Tourer AESL T-6, Alisport LLC Sailplane, American Champ 8GGGBC, Apis INC Sailplane, Citabria, Cozy III & IV, Dynamic WTP, Evektor Sportstar, Fasanation D4, Glasair, Nuventure Questair, Rans Coyote II, Rans S-7S & S-6, T-18, Team Rocket F-1, Vans RV 4	Custom made to order shades	13-05661	\$286.95

TRISOFT WINGTIP BUMPER



Trisoft Bumpers provide protection for the trailing edge of the wing, delta fins and ventral fins. Each Trisoft Bumper is made of chemical resistant EVA foam and provides ultimate aircraft protection. The Trisoft Bumpers also work great as wing edge indentifiers. This helps protect your employees while they are working or walking under the wing.
P/N 13-08263\$31.75

TRISOFT WINGTIP/PROP TIP COVERS



• Avoid Accidents • Protect Employees and Aircraft • Reduce Insurance Claims • Remain In Compliance Trisoft Aircraft Covers • Can Be Used As a Safety and Warning Device on Prop Tips. Trisoft is a simple foam triangular cover that slips onto the corners of the prop tips, gear doors, wing flaps (in the lowered position), wing tips, and dorsal antennas. Trisoft can be used on personal aircraft, corporate aircraft, commercial aircraft, military aircraft and helicopters.
P/N 13-06003\$21.85



PLANE SIGHTS REMOVE BEFORE FLIGHT

PLANE SIGHTS PITOT TUBE COVERS

Extremely obvious, very durable, and weather resistant pitot tube covers for every aircraft.



ANGLED PITOT TUBE COVER - Aircraft Type: Piston Powered Plane This durable, weather-resistant orange and yellow reflective cover fits virtually any size pitot tube. It stands out in daylight or darkness under all weather conditions, so it can't be missed. Large sewn-on Velcro tabs keep it securely in place under all conditions. Weight: 0.14 kg If length of the tube exceeds 6.75" and the diameter exceeds 7/8", then the Universal Pitot tube cover would be a better choice. As seen on the 2009 AOPA 'Let's Go Flying' Cirrus SR22 P/N 13-05611 **\$16.95**



UNIVERSAL PITOT TUBE COVER - Aircraft Type: Piston Powered Plane. This durable, weather-resistant orange and yellow reflective cover fits virtually any size pitot tube. It stands out in daylight or darkness under all weather conditions, so it can't be missed. Universal covers fit any length of tube from the smallest home built 1/4" tubes up to 7/8" jet probes. The versatile hook/loop Velcro strap with sewn-in rubberized trim allows the cover to be quickly and securely fastened to the pitot tube. Weight: 0.00 kg The inside diameter of the cover is 7/8". Works with a variety of aircraft including: Cessna, Beechcraft, Cirrus, Diamond, Grumman or Mooney aircraft, as well as most Pipers and many light sport aircraft..... P/N 13-05610 **\$16.95**



BLADE PITOT COVER - Aircraft Type: Piston Powered Plane Forgetting to remove a faded, dull and worn-out pitot tube cover can jeopardize the safety of you and your passengers. And when cold weather prevents you from installing your pinch-and-insert style blade pitot cover, ice and snow can contaminate your pitot system. Some blade pitot covers also cause damage to paint when the sleeve is being forced on and off. The highly conspicuous and very durable Plane Sights Blade Pitot Cover is a perfect fit for any aircraft with a blade-type pitot tube or piper gear extension mast. Properly installed, it's guaranteed not to blow off, fade in the sun or wear out for at least two years. Fits Piper, Katana, some Rockwell, late Grumman, Lake 250, and all other aircraft with a blade-type pitot tube. (As seen on the 2008 AOPA "Get Your Glass" sweepstakes aircraft) Weight: 0.15 kg Fits Piper, Katana, some Rockwell, late Grumman, Lake 250, and most other aircraft with a blade type of pitot tube..... P/N 13-06016 **\$17.95**



PITOT TUBE PLUG (5/8") - Aircraft Type: Piston Powered Plane 5/8" inside diameter vented pitot plug with its unmistakably conspicuous Remove-before-Flight Streamer. ANSI-compliant and weather-resistant reflective streamer stands out equally well in daylight or darkness under all weather conditions. The plug is attached to the streamer's rugged black oxide coated zinc grommet with a galvanized steel ring, and is vented to prevent pressurization damage. This 5/8" Plug Fits Aero Commander, Twin Beach, Bonanza, Cessna 300/400/500, Conquest Series, Grumman, Lear, Mooney, Piper Cheyenne and Navajo aircraft. Weight: 0.04 kg 5/8" / 0.625" (15.875mm) ID x 1.85" (38.10mm) P/N 13-06019 **\$14.95**



PITOT TUBE PLUG (3/4") - Aircraft Type: Piston Powered Plane. 3/4" inside diameter vented plug with its unmistakable Remove-before-Flight Streamer provides a perfect easy-on, easy-off solution. ANSI-compliant and weather-resistant reflective streamer stands out equally well in daylight or darkness under all weather conditions. The poly plug is attached to the streamer's rugged black oxide coated zinc eyelet with a stainless steel ring. This 3/4" plug Fits Cessna 150, 152, 172, 177, 182, 200 series, and 337 models. Weight: 0.04 kg 3/4"/0.75" (19.05mm) ID x 2" (50.80mm) useable length..... P/N 13-06018 **\$14.95**



LIGHT SPORT PITOT PLUG KIT - Aircraft Type: Piston Powered Plane. Light Sport/Homebuilt Pitot Plug Kit provides a perfect fit for many homebuilt pitot tubes, light sport pitot tubes, and aircraft fuel vents. The kit includes several vented plugs so it even works with double-tube systems and is guaranteed not to pressurize your pitot static system. ANSI-compliant and weather-resistant reflective remove-before-flight streamer stands out equally well in daylight or darkness under all weather conditions. The kit comes complete with three different-sized pitot tube plugs, a unique streamer, and two rust-resistant coated triangle rings. **WARNING: CHECK WITH YOUR AIME AND CONSULT YOUR OWNER'S MANUAL BEFORE USING A FUEL VENT PLUG** P/N 13-06020 **\$14.95**



DIAMOND STALL WARNING PLUG

Aircraft Type: Piston Powered Plane Diamond recommends that operators of their DA40 and DA20 aircraft plug the stall warning air inlet holes on these aircraft while they're parked on the ground. Fits any Diamond DA40 or DA20, one way or the other. ANSI-compliant and weather-resistant reflective remove-before-flight streamer stands out equally well in daylight or darkness under all weather conditions. P/N 13-06830 **\$39.95**

STATIC WICK COVERS

Prevent hangar rash and broken static wicks



STATIC WICK COVER SET (TUBE STYLE 7")

Aircraft Type: Jet. A lower priced alternative to Static Wick Markers. They protect static wicks from damage on the ground and make wing/elevator tips more obvious, preventing hangar rash. Slide these round style covers on for a tight weather resistant fit on Citations and other jets. Weight: 0.04 kg Round, tubular poly cover, 0.310" x 0.450" x 7.000" Long. *Shock cord lanyard not included. P/N 13-06888 **\$42.75**



STATIC WICK COVERS (SMALL ID 7")

Aircraft Type: Jet. Installed and removed in seconds, Static Wick Covers help prevent delays and inconvenience due to hangar rash. Extremely obvious and very durable Static Wick Covers make these vulnerable parts highly visible by day or night. Slide these round style covers on for a tight weather resistant fit on your Bombardier (Challenger & Global Express) or Hawker/Beechcraft and many other jets. If necessary cut with scissors to desired length. Weight: 0.20 kg Fit's over static wick part #'s: Chelton 2-17SC-1, Chelton 2-11SC-1, MIL-9129D, DG17770. Fits Bombardier, Hawker/Beachcraft and others..... P/N 13-06777 **\$59.95**



STATIC WICK COVER (SQUARE STYLE)

Aircraft Type: Jet These Square Style Static Wick Covers protect, usually yellow pronged static wicks from damage on the ground and make wing/elevator tips more obvious, thereby preventing hangar/ramp rash. Slide these rectangle covers on for a tight weather resistant fit on Falcon, Hawker, Beechjet, older Lear Jet and many other static wicks. Weight: 0.21 kg Includes three (3) Static Wick Covers per package Square Poly, 0.75"x0.25"ID x 3.50" Long. (in stock) (also available by special request, 5.25" length sleeves) Standard two year warranty applies. *Shock cord lanyard not included P/N 13-06776 **\$42.85**



UNIVERSAL AIRCRAFT MARKER

Aircraft Type: Piston Powered Plane. Highly reflective markers make vulnerable wing and elevator tips clearly visible under all conditions, and their projecting "proximity fuses" warn that something is too close before damage occurs. Fit all aircraft from Airliners to light sport aircraft, including models with static wicks and strobe lights. For aircraft with tip tanks, the wing marker opening fits over one end of the tank. A full set stows easily under most aircraft seats. Once initial fitting is done, the markers can be installed and removed in seconds during routine pre- and post-flight walk-arounds. Weight: 0.08 kg Package Contents: Two (2) corner marker pieces, two (2) harness pieces, two (2) marker fuses, four (4) 54" lengths of shock cord with cord hook ends, and four shock cord hook ends for assembly. P/N 13-05603 **\$159.95**



REMOVE BEFORE FLIGHT STREAMER

Blazing yellow color stands out equally well in daylight or darkness under all weather conditions. A cord can be attached to the streamer to the rugged black oxide coated zinc eyelet. Ideal for any remove-before-flight application. Weight: 0.03 kg. Streamer - 12.25" long x 2" wide, two metal rings included. P/N 13-05612 **\$13.95**



HI VISIBILITY BOOTIE PITOT COVER

Features: • Long Life Clip - Hook and loop closure • Bright Yellow Sock - More visible against aircraft finishes • Softer Vinyl Banner - Less abrasive to paint and aluminum • Bright White Letters - High visibility lettering, Fuel resistant (won't chip off), Non-abrasive. **Applications:** • Specially designed for use with pylon mounted Pitot Probes, fits Nose, Fuselage, or under wing locations • VL jets, and regional service airline aircraft (Boeing, Beechcraft, Bombardier, Cessna Jets, Cirrus, CRJ, Piper, Grob, Grumman, Gulfstream, Lear, Embraer, Hawker, Honda, Sabliner, Swearingen, and others) • Warbirds with "arrow head" type Pitot Tubes (North American, most AT-6, SNJ, Vultee BT-13, Grumman F4F Wildcat, F6F Hellcat, B-25 Mitchell, P-47 Thunderbolt, and many others) • TAT Probes • Dynon Angel of Attack - Pitot Probes, Pylon mount • Rosemount Pitot Probes. P/N 13-12349 **\$11.50**

PS

BANNERS – PITOT TUBE COVERS

AIRCRAFT FOR SALE BANNERS



Designed specifically for aircraft use, these banners slip right over your prop blades, moving in the breeze to attract attention-but will not rub against painted surfaces. Each banner is 9" x 23", made of heavyweight rubberized Nylon that is weather-repellent and resists tearing. Sold as a set of 2.....
P/N 5412 **\$34.50**

PROPELLER MOUNTED BANNERS



Two 28" x 8", white printing on red reinforced vinyl. Yellow, blue and white pennants, slides over prop, fastens with velcro.
For Sale P/N 13-06402 **\$36.50**
For Rent P/N 13-06635 **\$34.50**

FOR SALE PROP BANNER



Consists of three pieces. Each prop banner is 11" high X 22" long when mounted. Made of RED vinylized polyester with BOLD WHITE lettering. Unlike prop banners that are a sleeve which must be slipped over the prop blade only, these banners are split at the bottom and are held together with velcro. This allows the banner to be opened up and then wrapped around virtually ANY structural member of the aircraft..... P/N 13-06014 **\$38.50**

AIRCRAFT SPRUCE PROPELLER CARD



These prop cards are great when displaying your aircraft at a fly-in or event. There's room to fill in your personal information as well as large notes instructing onlookers to enjoy the views of your beautiful aircraft, but keep their hands off. They easily slide on and off the blades of your propeller. If you are organizing an event, these are affordable enough to pick up in bulk and pass them out to all who attend. 8-1/2"x 11". Semi-Gloss P/N 13-12320 **\$1.35**

PITOT TUBE COVERS



Feature an authentic, soft, bright red vinyl - will not fade, mildew resistant, made to Mil-C-20696. "Remove before Flight" streamer. Attaches simply with a velcro strap to 5/8" or 11/16" diameter L-shaped pitot tubes. P/N 15210 **\$5.95**

SLIP ON PITOT COVER

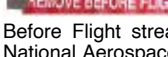

Slip fit over 1/4" or 1/2" dia. pitot. Red Remove Before Flight streamer attached. Made of flame-proof/weather-resist. National Aerospace material..... P/N 15220 **\$6.95**

ROUND CESSNA PITOT COVER

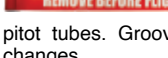

This red pitot cover fits round, high-wing Cessna pitot tubes. Grooved fitting releases air pressure as the barometer changes..... P/N 5139 **\$9.90**

PIPER PITOT COVER

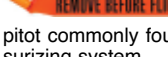

This pitot cover is designed to fit the blade style pitot commonly found on piper aircraft. Small vent hole prevents pressurizing system..... P/N 5740 **\$15.85**

REMOVE BEFORE FLIGHT RIBBON



This 3"x24" bright orange streamer with black letters features a grommet for a C ring to attach to anywhere on the aircraft. High visibility, fire resistant material..... P/N 15200 **\$18.50**

DO NOT TOW STREAMER



17" Streamer, attach with Velcro, Color international orange..... P/N 13-02004..... **\$12.85**

ASA REMOVE BEFORE FLIGHT BANNER



A bright red heavy nylon banner that can be fastened to anything that needs removing before flight. Comes with a grommet and wire ring that can be attached to everything from gear pins to gust locks and pitot covers. Heavy duty vinyl is tear resistant. 2" X 17" P/N 13-02380 **\$6.95**

ASA PITOT TUBE COVERS



Fit snugly over standard aircraft pitot tubes, and are vented to avoid pressurizing the pitot static system. Critical to safe operations, the cover keeps dirt, contamination, and insects from entering the pitot tube. A "remove before flight" streamer hangs off the cover as a prominent preflight reminder to pilots. Molded in the United States, the cover uses a heavy duty plastic material.
Pitot Tube Cover 5/8" (small) P/N 13-02378 **\$12.95**
(Fits: Cessna 300/400 series, Citation & Conquest, Beech singles & twins, Piper Navajo & Cheyenne, Mooneys, Mitsubishi, Lear Jets & Cirrus)
Pitot Tube Cover 3/4" (large)..... P/N 13-02377 **\$13.95**
(Fits: Cessna 150,152,172,177,182, 200 series, Skymaster & the Falcon Jet)

FUEL CAP COVER



The STAY SEALED cap is a patented fuel cap cover that locks onto the existing factory cap and seals to the surface of the wing. Designed and tested against heavy rains, strong winds, high temperatures, and extreme cold. It sealed out melting snow and ice, blowing rain and water from aircraft washing. *To be used anytime the aircraft is stored outside. The device MUST be REMOVED BEFORE FLIGHT.

Model SSCC fits the following: Cessna Series: 152, 172, 182, 206, 207, 210. Fitted with the raised metal fuel cap.... P/N 05-03662 **\$48.85**

Model SSCP fits the following: Cessna 120,140,150,172 with recessed fuel filler opening P/N 05-03668 **\$48.85**

"REMOVE BEFORE FLIGHT" PITOT COVERS



Universal cover P/N 13-04396 **\$12.75**
Piper blade cover P/N 13-02946 **\$12.75**
3/4 pitot cover P/N 13-04395 **\$12.75**
5/8 pitot cover P/N 13-04394 **\$12.75**
Sm RBF streamer P/N 13-02818... **\$3.95**
Lrg RBF streamer P/N 13-02819... **\$6.50**
Nelson RBF Streamer... P/N 13-04397 **\$13.75**

FUEL VENT COVER



The fuel vent cover is designed to fit most fuel vents, and will not pressurize the fuel system. The ribbon is nylon with a vinyl coating and silkscreened letters..... P/N 13-02817 **\$11.95**

REMOVE BEFORE FLIGHT STREAMERS



Red "REMOVE BEFORE FLIGHT" Streamer with white lettering.
3" X 31" P/N 13-11731 **\$8.50**
3" X 21" White on Orange
P/N 13-16572 **\$6.95**
3: X 21" Black on Yellow
P/N 13-16573 **\$7.50**

ASA PITOT TUBE COVER - BLADE



This pitot tube cover fits snugly over blade-type pitot systems typically found on Piper Cherokee, Warrior, and Arrow aircraft. They are vented to prevent pressurization of the pitot-static system. Critical to safe operations, the cover keeps dirt, contamination, and insects from entering the pitot tube. A "remove before flight" streamer hangs off the cover as a prominent preflight reminder to pilots. The cover uses a heavy-duty plastic material; the 2" x 17" banner is bright red with white screen-printing for maximum visibility..... P/N 13-02379 **\$14.95**

KEY CHAINS



Remove before flight key chain with white letter REMOVE BEFORE FLIGHT on red banner
P/N 13-02836 **\$3.95**



Key ring with a white printed "I'D RATHER BE FLYING" on blue banner.
P/N 13-02949 **\$2.95**



Key ring with blue writing "I LOVE FLYING" on off-white banner .. P/N 13-02950 **\$2.95**

PROFLIGHT AIRCRAFT KEY CHAINS



ProFlight aircraft personal streamer with attached ring and slogan "I LOVE FLYING".
P/N 13-10448 **\$1.95**



ProFlight aircraft personal streamer with attached ring and slogan "HAVE YOU CLOSED YOUR FLIGHT PLAN".
P/N 13-10449 **\$1.99**

PS

PITOT TUBE COVERS – EZ FLAP

REMOVE BEFORE FLIGHT STREAMER



2-1/4" wide, 17" long red polyester fabric with white writing: "Remove Before Flight"
P/N 13-01458 \$5.35

UNIVERSAL STATIC PORT COVERS



SPC-101



SPC-102

An inexpensive, yet very effective alternative to other covers and plugs. The SPC-101 is designed to fit an aircraft with one static port on each side of the aircraft and the SPC-102 is designed to fit an aircraft with two static port on each side of the aircraft.

Features: • Universal design to fit most aircraft • Lightweight entire assembly weighs less than 1/2 pound • Attaches with heavy duty lever cups designed to lift up to 40 pounds each • No fuselage modification required • Prevents the possibility of any damage to static ports by being and externally mounted cover • Malleable lightgauge red anodized aluminum easily conforms to virtually any surface contour • Adjustable to allow for attaching lever cups on or around decals and pin striping • Installed at temperatures from -20°F to 110°F

SPC-101 P/N 13-06723 \$199.85
SPC-102 P/N 13-06724 \$219.95

PITOT COVERS

Avoid costly damage to your pitot-static system. Protects from dust, insects, wind and other foreign matter. Will not pressurize pitot-static system.



MODEL 4602 - Fits Piper, Katana, some Rockwell, and late Grumman aircraft..... P/N 13-06395 \$10.50

MODEL 4935 - Bootie Type, all Naughahyde, white boot, red with white printing, 2" x 16"..... P/N 13-06397 \$10.50

STREAMERS



5811 "OUT OF SERVICE" - 3" x 24", yellow printing on red reinforced vinyl with grommet and ring. 2" securing strap with grommet and velcro. P/N 13-06399 \$11.50



5813 "DO NOT TOW" - 3" x 16", yellow printing on red reinforced vinyl with grommet and ring. 2" securing strap with grommet and velcro. P/N 13-06401 \$10.60



4604 "REMOVE BEFORE FLIGHT" - 2" x 16", white printing on red reinforced vinyl with grommet and ring..... P/N 13-06396 \$5.35

EZ FLAP HANDLE EXTENSION



Because EZ Flap puts the flap control at the correct location close to the yoke (instead of down on the floor under the panel), pilots can finally remain upright while using the flaps, and stay focused on takeoff/landing, obstacles, terrain, traffic, and instrument scan. No more bending over - no more loss of visibility. EZ Flap improves the performance of the pilot! EZ Flap mounts to the existing aircraft flap handle with no disassembly and no de-rigging in 20-40 minutes, with only two small screw holes. The original aircraft flap control remains fully functional. 100% made in the USA. Full FAA STC-PMA approval on 95% of all US manual flap aircraft.

CESSNA/PIPER FLAP HANDLE EXTENSION APPLICATIONS: Cessna: 170 / 172 / 175 / 180 / 182 / 185. Piper: PA-28 / PA-32 Cherokee Family. Piper: PA-34 / PA-44 Seneca / Seminole. Beech: 19/23/24 Musketeer Family P/N 13-06946 \$499.00

SUPERCUB HANDLE EXTENSION APPLICATIONS: Piper: PA-18 Super Cub. Piper: PA-20 / PA-22 Pacer / Tri-Pacer. Maule: M-5 thru M-9 Family. Stinson: 108 Family P/N 13-07438 \$499.00

BRUCES UNIVERSAL CUSTOM PITOT TUBE COVERS



The Original and World's Finest Aircraft Covers for Airplanes, Jets, Helicopters, Gliders and QEC Off-link Jet Engines.

Once the material for each order is cut into its appropriate parts, highly trained sewing machine operators meticulously assemble the products with durable thread, rivets, and canvas trim.

Pitot Tube Covers, made of Naughahyde vinyl, are designed to cover the entire pitot assembly. Slipping on over the tube, the cover tightens around the base with a special Velcro strap detail. A "remove before flight" streamer is attached to the cover. Non-burning Pitot Covers are designed to withstand more than 500° Fahrenheit, and will prevent the pitot cover from melting onto the tube if the pitot heat is accidentally turned on with the pitot cover attached

Pitot Tube Cover for the following applications: • Beech: Bonanza B35, Bonanza B36, Baron B58 • Cessna: Cardinal 177, Centurion 210, Corvallis 350 • Cirrus: SR20, SR22 • Grumman: American AA5 • Piper: Comanche PA24, Cherokee Six PA32 • Lancair: IV, Columbia 300, Columbia 350, Columbia 400, Lancair 320, Lancair 360 • Mooney: Ovation, M20, 201, 205, 231, 252 & MJ20 MSE

P/N 13-15994 \$35.95

Pitot Tube Cover for the following applications: • Cessna: 150, 152, 172, 175, 180/185 Skywagon, 182 Skylane, and 206 Stationair. • Grumman AA1..... P/N 13-15995 \$28.75

PS

PITOT TUBE COVERS



REMOVE BEFORE FLIGHT STREAMER

Red Streamer with white print. Aid as a reminder of preflight for pilots. Ideal for landing gear pins.

P/N 13-18382\$13.75



ROSEMONT TEMPERATURE PROBE COVER

High Quality Cover for Temperature Probe.

Applications:

- Cessna Citation Bravo: 650
- Learjet: 31, 35, 40, 45, 70, 75
- Hawker: 4000
- Bombardier Challenger: 601, 604, 300.....P/N 13-18383\$21.90



PITOT COVER FOR PIPER AIRCRAFT

High Quality Cover for Pitot Tube. Protects and prevents contamination of the Pitot Tube providing safety to the aircraft systems.

Applications: Piper aircraft, and small general aviation.

P/N 13-18385\$21.95



UNIVERSAL PITOT COVER

High Quality Cover for Pitot Tube. Protects and prevents contamination of the Pitot Tube providing safety to the aircraft systems.

Applications: Small general aviation aircrafts. Cessna Citation, Beechcraft King Air, Cirrus, Diamond, Grumman Mooney, Cessna, Piper.

LeftP/N 13-18384\$21.85
Right.....P/N 13-18384-R\$21.85



LEARJET PITOT COVERS

High Quality Cover for Pitot Tube. Protects and prevents contamination of the Pitot Tube providing safety to the aircraft systems.

Learjet 25,31,35,36 series

LeftP/N 13-18386\$31.90
Right.....P/N 13-18386-R\$29.95

Learjet: 40, 45, 60, 70, 75

Bombardier Challenger: 300, 601, 604

LeftP/N 13-18387\$30.95
Right.....P/N 13-18387-R\$28.95



CIRCULAR STATIC WICK COVER

Circular Tube Static Wick Covers with streamer remover before flight. Protects aircraft static wicks and personnel from injuries on ground and makes wings elevator more obvious preventing hangar rash.

Applications:

- Embraer Phenom 100
 - Phenom 300
 - Learjet series
 - Citation series and more.
- P/N 13-18388\$49.50

PILATUS PC-12 COVERS

High Quality Cover for Pitot Tube. Protects and prevents contamination of the Pitot Tube providing safety to the aircraft systems.

Pitot Covers

LeftP/N 13-18393\$28.90
Right.....P/N 13-18393-R\$28.90

Angle of Attach Covers

LeftP/N 13-18392\$21.80
Right.....P/N 13-18392-R\$21.80



PLANE SIGHTS REFLECTIVE GEAR PIN FLAG



The Plane Sights 3x18" lime green or red orange reflective XL Remove-Before-Flight banner is designed for long medium to long range business jet gear pins and replacement wide body remove before flight flags. Plane Sights is the only brand of remove before flight flags that are made from ultra violet resistant microprismatic reflective. The brilliantly reflective PVC can also be easily cleaned of landing gear grease with any mild soap and water.

Lime Green.....P/N 13-21613\$28.35
Red Orange.....P/N 13-21614\$28.35

PLANE SIGHTS FLASHFLAG



This 4x32" flag is designed to meet the abrasion resistance, weatherability, and self extinguishing/flame retardant requirements of wide body and other long range business jet OEM customers.

The materials and construction meet NAS-1756 / NAS-1091 technical specifications for remove before flight flags. The color specifications, for obvious reasons do not meet the standard. If you're looking for a very durable gear pin flag that's designed for the abuse of quick turns and tight stowage, this is the right product.

3" X 20".....P/N 13-21623\$29.90
4" X 32".....P/N 13-21622\$42.90

REMOVE BEFORE FLIGHT PITOT TUBE COVERS



Before Flight Pitot Tube Covers. 5/8" or 3/4" ID Vinyl Cover.

5/8"P/N 05-12646\$8.95
3/4"P/N 05-12645\$8.95

UNIVERSAL REMOVE BEFORE FLIGHT PC-100U PITOT COVER



Before Flight Pitot Cover. Universal size, All Vinyl. - Fits All Tube Type Pitots.....P/N 05-12660\$16.85

REMOVE BEFORE FLIGHT



Before Flight 10" Flag with Ring.....P/N 05-12661\$7.95

REMOVE BEFORE FLIGHT PITOT COVER



Before Flight Pitot Tube Cover. 6" Red Vinyl Sleeve Fits D.G. # 16920. 16" Flag. Wick-Tector (3/Pack).....P/N 05-12655\$29.50

FUEL CAP COVERS



This easy to use removable product will help keep water and debris from getting inside your fuel tank, all you do is peel and stick it right on top your fuel cap after landing and remove before your next flight. Set of 2

P/N 13-21885\$49.95

STATIC PORT COVER



This easy to use stick on product will provide full coverage for your Static Port and protect it from all the natural elements.

P/N 13-21884\$27.95



CONTROL LOCKS



UNIVERSAL CONTROL LOCK

This Control Lock is of all stainless steel construction with silicone rubber to protect aircraft interior and folds into small package for easy storage. Installs in seconds from the pilot seat and fits most aircraft with a control column. Other control locks are not required like the one Cessna provides. It's virtually impossible to try to take off with this lock in place, as you cannot get your feet on the Pedals to taxi aircraft and keep the elevator in the nose down position.....P/N 13-13075\$369.00

AMC AIRPLANE CONTROL LOCK



Rather than tying your seat belt to your controls, try AMC's new Airplane Control Lock. This lightweight control lock will stop your control surfaces from moving with the winds and will also prevent damage to your controls such as bending. This new Control Lock is lightweight and easily stored.

Mooney.....P/N 13-03164\$77.95
 Cessna 210P/N 13-03165\$81.95
 Cessna 206P/N 13-03166\$81.95
 Skymaster.....P/N 13-03167\$77.95



PAD-LOK CONTROL SURFACE LOCK

Like it says, a padded lock. Effectively locks control surfaces while the padding compresses to the proper configuration and protects the surface finish. Padding won't absorb water. Hard-to-miss Dayglo color, plus yarn streamers. Wt. 10 oz.

P/N 13-22700\$17.95

THE CONTROL SAVER



The Control Saver control lock was designed for Piper and Mooney aircraft to protect aircraft controls in high wind gusts. It holds the ailerons in the neutral position and stabilizer in the down position. This control lock is light weight, easy to use and fits in an area as small as your shirt pocket. Sold to thousands of Piper and Mooney owners worldwide.

P/N 13-15505\$39.95

SAF-T-STOP



Saf-T-Stop is an auxiliary seat stop mechanism approved by the FAA for use with Cessna seat track A.D. #87-20-03. Installs easily, sliding over seat track. Approved for: Cessna 150, 152, 170, 170B, 172, R172, 175, 180, 182, 185, 190, 205, 206, 207, 210, 303, 337. Not a seat lock, Saf-T-Stop is designed to restrict rearward motion if the seat lock fails.

P/N 13-18510\$58.75/pr

AILERON & RUDDER SOFT LOCK



The Aileron & Rudder Soft Lock is made out of a durable foam that will not scratch your paint. Slides in gap between rudder and vertical stab. Keeps rudder from moving while plane is on the ground. Comes with "Remove Before Takeoff" flag. Patent Pending.

P/N 13-11615\$38.95

LIGHT SPORT CONTROL LOCKS



These control lock is easy to install and positively locks the ailerons and elevator of the aircraft models listed below. Gust lock is manufactured using 6061T3 aluminum. The control stick clamping portion has a protective sleeve to prevent damage to special control handles. The latching mechanism is tow locking buttons that cannot come loose until released by the pilot which insures the owners that

their ailerons and elevators are safe from wind damage. The control lock is red anodized with a "Remove Before Flight" decal, and each unit comes complete with instructions in a 4" x 4" x 12" box. Only weighs 3 1/2 ounces.

PIPERSPORT / SPORTCRUISER CONTROL LOCK CL200 LONG

Eligible Aircraft Models: Eligible Aircraft Models: Pipersport and SportCruiser only.P/N 13-11304\$79.75

VANS RV12 CONTROL LOCK CL230 LONG

Eligible Aircraft Models: Vans RV12 only ...P/N 13-11319\$79.75

VANS RV LSA CONTROL LOCK CL100 SHORT

Eligible Aircraft Models: most Van's RV's and many other LSA aircraft, as well as the Stearman PT17.....P/N 13-11269\$79.75

CITABRIA / DECATHLON CONTROL LOCK CL210 LONG

Eligible Aircraft Models: Aerotrek A220 & A240, AirCam, Alto 100, Breezer ELSA, Bristol, Champion Scout, Citabria, Decathlon, Diamond DA20 & TC100, Evector Harmony & Sportstar, KitFox Super Sport 7, Lightning LS1, Luscombe, Peregrine FK-9, Phoenix, Ran's SL-19, Coyote 2, S-7LS, Remos LSA, SeaRay, Spirit, Sting S4, Tecnam P2002 P/N 13-11318\$79.75

HUSKY CONTROL LOCK CL110 SHORT

Eligible Aircraft Models: Husky only.....P/N 13-21226\$79.75

ULTIMATE GUST LOCKS FOR RVS



This revolutionary product "The Ultimate Gust Lock" is a solution to this rather troublesome and sometimes challenging task. This product will definitely calm the fears of many RV owners and builders of these wonderful aircraft. After watching, reading, analyzing, researching and waiting for someone to offer up a solution we decided to go to work on this problem.

Aircraft	Part Number	Price
RV-6, 6A, 7, 7A, 9, 9A	05-12368	\$189.00
RV-8, 8A	05-12483	\$189.90
RV-10, 10A	05-12484	\$209.95

REMOVE BEFORE FLIGHT AIRPLANE CONTROL LOCK



Piper and Mooney aircraft do not have control locks. That's why there is now a Control Saver control lock to meet the needs of pilots who fly these planes.

PA-28 1968-97P/N 13-12726\$39.95
 PA28 1997-CurrentP/N 13-12727\$39.95
 PA32 1968-97P/N 13-12728\$39.95
 PA32 1997-CurrentP/N 13-12729\$39.95
 PA-28-61 BowtieP/N 13-15505\$39.95
 Mooney.....P/N 13-20663\$39.95

RANS CONTROL LOCK



RANS has developed a control lock that attaches to most models. The lock consists of a bungee cord, a couple of hooks and cap that slips over the top of the control stick. Allows for bungee tension to be set for a particular model. Not hard bolted so if an outside force against the control surfaces occur, the bungees will absorb the load.

P/N 13-10434\$35.50

PS

AIRCRAFT LOCKS



WHEEL CHOCK LOCK

This innovative aircraft security device clamps to the wheel which prevents theft of the aircraft, while the built-in chock prevents the wheel from rolling forward when parked. The lock and chock are yellow, while the red rubber coated arms protect the finish of the wheel. Fits any type of wheel up to 12" wide. Lifetime warranty. P/N 13-06141**\$88.75**



YORK GUST-LOK™

The York Gust Loks the ultimate protection for your plane from wind and theft. It locks the control surfaces in a neutral position and prevents damage to control surfaces and tail caused by wind gust loads. It is welded steel, fully adjustable, is lightweight, and features a powder coat finish. The York Gust Lok is compact for easy storage and is quick and easy to use. Wt: 2.2 lbs.

CONTROL WHEEL AIRCRAFT

Aircraft	Part No.	Price
PA-28, PA-32, PA-24, PA-30 & PA-39, PA-32R, PA-34 & PA-44	13-00855	\$285.00
Commander 112 / 114	13-32730	\$281.95
Mooney, Grumman Goose, Maule (Tricycle gear & Seaplane) PA-23, & Grumman American, Myers 200 & Commander 200	13-00863	\$285.00
Cessna Single engine 150' & 172's, Helio Courier, 295/395	13-00864	\$282.95
Cessna Single engine 180, 206 & 210's fixed & retract gear & Cessna 337	13-00865	\$282.95
Cessna Twins except 337 & 310	09-00329	\$308.00
Aerostar, Commander 500, Beech Baron, Bonanza, Duke & 18/C-45, Lake L-A-4 (except Renegade)	13-32790	\$285.00
Cessna Tailwheel, Stinson, Beech Staggerwing	13-32800	\$281.95
Lake Amphibian	13-32820	\$325.00
Beech King Air	13-32830	\$309.00
Cessna 310's	13-32840	\$281.95
Aeronca Chief 508, Taylorcraft BC 12-D, Stinson 108 & 108-1	13-32850	\$281.95
PA-38	13-32860	\$281.95
Maule (Tailwheel)	13-32871	\$281.95
Piper PA-31, Chieftain, Navajo, Chyenne	13-32880	\$281.95
Socata (Trinidad), Grumman Widgeon	13-32890	\$295.95
Seawind	13-32885	\$295.95
Dehaviland Beaver	13-00866	\$331.00
Cessna Twins (except 337 & 310)	13-00867	\$308.00
Piper Malibu	13-00868	\$309.00

STICK CONTROL AIRCRAFT

Aircraft	Part No.	Price	Aircraft	Part No.	Price
Bellanca	13-06114	\$348.00	Piper PA-14	13-00875	\$348.00
Champ & Citabria	13-00879	\$348.00	Piper PA-15/17	13-00876	\$348.00
Huskie, Pitts	13-00880	\$348.00	Piper PA-16	13-00873	\$348.00
J3 with Shin Klocker Tubes	13-00871	\$348.00	Piper PA-18 & J3 Shin Knockers	13-00877	\$348.00
J4	13-11870	\$348.00	Piper PA-20	13-00878	\$320.00
Kit Fox	13-00886	\$321.00	RV-6	13-00884	\$321.00
Lancair IV	13-00888	\$321.00	RV-8	13-11868	\$266.95
Luscombe	13-11869	\$348.00	Swift (only for stick)	13-00883	\$321.00
Micco	13-00881	\$348.00	Waco	13-00887	\$321.00
Nanchang CJ-6	13-11872	\$321.00	Yak 52	13-11871	\$321.00
Piper PA-12	13-00872	\$348.00			



YORK DO NOT TOW WARNING FLAG

Red and white vinyl warning flag reading "DO NOT TOW". It has a metal ring with a velcro strap for easy attachment and removal on any wind gust lock. P/N 13-00869**\$26.50**



PROLOCK

PropLock is a simple, yet effective anti-theft device that can be easily installed on any single or twin engine aircraft. Made of high quality steel wire rope coated with bright red PVC, PropLock provides effective protection against unauthorized use of your aircraft.

Included: • 1 PropLock • 1 Remove Before Flight Carrying Pouch.
Features: • Hardened Steel Components • Red PVC Coating • Rust proof • High Visibility • Easily Installed • Nickel Plated Lock Assembly • Effective.P/N 13-20147**\$279.00**



PROP LOCK CHAIN

The THEX50 is a "T-HEX" maximum security chain 5 ft in length with hardened 10mm hexagon shaped links. Hexagon shaped case hardened trip heat treated super chain. This heavy duty Prop Lock Chain is the perfect way to insure the security of your aircraft, particularly at remote or foreign airports. The hexagon shaped, heat treated heavy duty chain can endure over 10 tons of cutting force, insuring your aircraft against theft. A black nylon cover over the chain protects your aircraft from the chain when in place. The Prop Lock Chain is 5 feet long and weighs 12lbsP/N 13-05182**\$54.90**



THE PLANE LOCK

For Cessna C-172-210s, except for the C-177. Prevents the wind from popping your doors open and provides an added measure of security against break-ins. No tools or STC required. From outside the aircraft, the pilots door is locked by reaching through the window (prior to closing it) and pushing down the door safety handle. Then, slip the Plane Lock over the window sill and lock the window shutP/N 13-03386**\$100.95**



NELSON AILER-LOCKS

• 13" RBF streamer
• Locks flaps, ailerons, elevators, or rudder. Ailer-Lock Large (10")
P/N 13-22705**\$35.25**



SKYLOK

Skylock is an inexpensive throttle lock for aircraft with Cessna type push-pull throttles. The device will accept shafts up to .375" diameter, and is made of heavy-gauge cadmium plated steel. Skylock affords great peace of mind to aircraft owners at very little cost. Just put in place after every flight, secure with your own favorite padlock, and your throttle cannot be moved! Simple, but it works.....P/N 13-18500**\$13.95**



ANTI-THEFT LOCK FOR BONANZAS

Built for those incomparable Beechcraft. All have FAA STC/PMA as applicable. The rugged, locksmith quality key lock combines forces with hardened steel pins embedded in the lock body that roll to defeat cutting. Bright red color, easy to use, installs in just seconds. Patent Pending.
P/N 05-03435**\$309.00**

AIRGIZMO UNIVERSAL GUST LOCK



The AirGizmos Gust Locks are designed to quickly lock virtually any control surface securely. Its bright color and integrated flag reminds you to remove before flight. The rubber cushions ensure that your finish will be protected. They are lightweight and portable. Perfect for carrying in the plane wherever you go.
SingleP/N 13-06139**\$37.50**
3 PackP/N 13-18457**\$109.75**



FIRE EXTINGUISHERS – RESCUE EQUIPMENT

H3R AVIATION FIRE EXTINGUISHERS



The FAA recommends and/or requires Halon fire extinguishers on aircraft. H3Rs Halon fire extinguishers are the extinguishers of choice in the aviation industry. They cause no mess or damage, and do not require taking a plane out of service for clean-up; a costly process for both the aircraft owner and insurance carrier. The heat-seeking quality of the Halon gas makes it a superior fire fighting agent.

DISPOSABLE, LOW-MAINTENANCE HALON 1211-1301 BLEND

Contain a proprietary blend of the "liquid streaming agent," Halon 1211, and the gaseous "total flooding agent," Halon 1301. The blend's power lies in the Halon 1301, which is both a firefighting agent and a propellant. Low maintenance and non-rechargeable. Lightweight aluminum canister Disposable. Tested to ANSI/UL 711 and UL 1093. Meets DOT requirements Meets the requirements in Advisory Circular 20-42C, "Hand Held Extinguishers for Aircraft" and/or NFPA 408, "Standard for Aircraft Hand Portable Fire Extinguishers" 12-year shelf life. Fire extinguishers include a mounting bracket.

RECHARGEABLE, STURDY INDUSTRY-STANDARD HALON 1211

Required on commercial transport aircraft. Although classified a "liquid streaming agent," Halon 1211 also performs remarkably well as a "total flooding agent," seeking out and extinguishing fires in inaccessible places. A 6-year maintenance and 12-year hydrostatic test are required. Rugged steel cylinder. Pressure gauge enables easy confirmation of charge. Tested to ANSI/UL 711 and UL 1093. Meets DOT requirements. Meets the requirements in Advisory Circular 20-42C, "Hand Held Extinguishers for Aircraft" and/or NFPA 408, "Standard for Aircraft Hand Portable Fire Extinguishers". Fire extinguishers include a mounting bracket or a wall hook.

Protection RT Extinguishers			
Protection R.T. Extinguishers	Part No.	Range	Price
RT A400 - 14 oz. (UL Rating 2B:C)	13-07650	4-6 ft	\$166.99
RT A600 - 1.2 lb. (UL Rating 2B:C)	13-07655	6-8 ft	\$223.95
RT A1200 - 2.5 lb. (UL Rating 5B:C)	13-07660	7-9 ft	\$395.00
A1600 - 3.5 lb. (UL Rating 1A:5B:C)	13-07665	8-10 ft	\$536.00

H3R Extinguishers			
HALON 1211 UNITS	Part No.	Range	Price
A344T - 1.3 lb. (UL Rating 2B:C)	13-01993	9-12 ft	\$222.99
A344TC - 1.3 lb. (UL Rating 2B:C)	13-02546	9-12 ft	\$265.95
C352TS - 2.5 lb. (UL Rating 5B:C)	13-01966	9-15 ft	\$343.99
C352TSL - 2.5 lb. (UL Rating 5B:C)	13-02547	9-15 ft	\$347.00
C354TS - 3.0 lb. (UL Rating 5B:C)	13-02548	9-15 ft	\$399.30
B355T - 5.0 lb. (UL Rating 10B:C)	13-02545	9-15 ft	\$522.24
B369 - 15.7 lb. (UL rating 1A:10B:C)	13-02557	12-18 ft.	\$899.17
B371 - 19.9 lb. (UL rating 2A:40B:C)	13-02558	12-18 ft.	\$1,231.09
674 - 460.0 lb. (UL rating 10A:80B:C)	13-02562	30-45 ft.	\$9,821.17
B394TS - 9.3 lb. (UL rating: 5B:C)	13-02549	9-15 ft.	\$539.00
347 - 6.0 lb. (UL rating: 5B:C)	13-23573	~10 ft.	\$1,097.15
349 - 6.0 lb. (UL rating: 5B:C)	13-23574	~10 ft.	\$1,110.00

FIRE EXTINGUISHER BRACKETS

- BKT400** - Brackett for the RT-A400 Fire Extinguisher P/N 13-06166 **\$16.50**
- BKT600** - Brackett for the RT-A600 Fire Extinguisher P/N 13-06167 **\$16.50**
- BKT1200** - Brackett for the RT-A1200 fire Extinguisher P/N 13-06168 **\$16.50**
- 845** - Brackett for the A344T Fire Extinguisher P/N 13-06170 **\$12.75**
- 845** - Brackett for the A344TC Fire Extinguisher P/N 13-06171 **\$12.50**
- 817S** - Brackett for the C352TS, C352TSC, C354TS Fire Extinguisher..... P/N 13-06172 **\$18.50**

FIRE EXTINGUISHER BRACKETS 325 - RED

Designed for use with H3R Aviation fire extinguisher models 347 and 349. BKT325 has been tested to ensure that it can meet the most demanding aviation requirements..... P/N 13-23575 **\$235.97**

H3R BILLET MOUNTS

H3R Performance hand held 1 lb. and 2.5 lb. fire extinguishers come standard with aviation style mounting brackets. Stylish and versatile billet mounting accessories are also available. Band clamps fit 2.6" or 3.0" diameter fire extinguishers, and can be combined with the flat surface mount or either of the two roll bar mounts. Available in polished and brushed finishes. One year limited warranty. Brushed - Band clamp for 2.5 lb. fire extinguishers P/N 13-06067 **\$63.85**

RESCUE LASER FLARE MAGNUM™



Ahand-held nighttime laser signaling device that provides a convenient, effective way to signal a rescue party up to 20 miles (32 km) away, depending on atmospheric conditions. It's ease of operation, long life and waterproof design makes it the perfect survival signaling device. Unlike conventional pyrotechnic flares, the Rescue Laser Flare™ is non-flammable, non-hazardous and can operate continuously for 72 hours on two replaceable AA batteries.

72 Hour..... P/N 13-01924 **\$83.75**
 15 Hour..... P/N 13-01923 **\$89.95**



EMERGENCY STROBE

• Waterproof • USCG approved • Operates up to 60 hours
 • Uses D battery • Red lens available
 Strobe P/N 13-02811 **\$19.95**

OCEAN SIGNAL SAFESEA GMDSS HANDHELD VHF RADIO



The Ocean Signal range of survival craft VHF hand portable radiotelephones exceed the requirements of IMO, SOLAS and GMDSS. Lithium Polymer rechargeable battery option available with rapid charger, for everyday normal use. Fully waterproof, even 40C thermal shock. High efficiency transmitter for maximum battery life. Rugged design exceeds GMDSS environmental requirements. Lithium primary battery for emergency use. Novel battery protection tab protects from inadvertent use. Battery classified as non-hazardous for shipment. Battery provides in excess of 16 hours typical operation, even at -20°C. (10% Tx, 10% Rx, 80% Squelched) . Laser etched key legends for durability. High contrast, backlit LCD and keypad. Rugged accessory socket option; waterproof to IP68 for use with headsets, helmets, fist mikes, etc. 4 scanning modes, D/W, T/W, scan and memory scan. 21 simplex channels according to IMO SOLAs requirements.

Unit Only..... P/N 13-20261 **\$696.00**
 Kit P/N 13-20262 **\$885.00**

ACTIVE EXTINGUISHING LINE



Active Extinguishing Line is totally independent, 1kg, fire extinguishing system from any power source. Its main secret lies in the heat detector in a form of a line made out of special laser predriller polymer, which will react instantly to any source of heat or fire. This line (heat detector) is connected to reservoir containing fire-extinguishing agent: hexafluoropropane FE-36. Inside of the protected device (equipment) a loop made out of the heat detector breaks, creating a mini sprinkler, directly over source of fire or heat, extinguishing it instantly. In a moment of activation the system closed circuit switch collapses sending a signal informing of fire. For experimental aircraft only. Ask for status of pending STCs.

P/N 13-03266 **\$698.00**

H3R QUICK RELEASE FIRE EXTINGUISHER BRACKET



Fire extinguisher quickly releases from bracket. Fiberglass reinforced nylon construction and corrosion resistant hardware. Designed to meet MIL SPEC 810G (test in progress). Tested to withstand inertial loads in excess of 27G in all directions. Fire extinguisher cannot be accidentally disengaged from bracket. Fits H3R Performance fire extinguishers with 4.25" diameter cylinders (B355T). "Pull to Release" flag enhances visibility. Does not obscure fire extinguisher nameplate. Designed for use with H3R Performance vehicle seat mount. Weighs a scant 15 oz!

3" Bracket..... P/N 13-18452 **\$75.95**
 4-1/4" Bracket..... P/N 13-18453 **\$75.95**
 5" Bracket P/N 13-18454 **\$75.95**

RECHARGEABLE, DURABLE EPA-APPROVED HALOTRON 1™



While it is less powerful pound for pound than Halon 1211, Halotron 1 offers all of Halon 1211's clean agent benefits, and Halotron 1 is less damaging to the ozone layer. H3R Aviation offers two Halotron 1 fire extinguishers: one FAA-approved unit for aircraft use and one wheeled unit for the flight line/ramp. These rechargeable extinguishers have pressure gauges and require a 6-year maintenance and a 12-year hydrostatic test P/N 13-02562 **\$9,821.17**

PS

SMOKE HOODS - LIFE VESTS



PROVITA SMOKE HOOD

The Provita Smoke Hood provides 20 vital minutes of life-saving evacuation time. It is proven to protect from smoke and 98% of toxins created by fire, including: Chlorine, Ammonia, Acrolein, Hydrogen Chloride, and Hydrogen Sulfide. Lightweight and compact. One size fits all. Smoke hood easily comes out of its 8" x 6" x 1" vacuum sealed bag - ready for use in seconds. There is no front or back which allows the smoke hood to be put on quickly for panic situations. The rubber seal easily slips over your head and seals - not allowing any smoke through. The smoke hood provides 360 degree vision and 20 vital minutes to escape a smoke-filled room.

P/N 13-11343\$189.00



POCKET SMOKE MASK

NASA graded high temperature resistance Polyamide Film resists heat up to 932 degrees. The seven layer filter stops and blocks toxic gases made from non-woven and activated carbon fibers Filters more than 20 minutes of toxic smoke from fire. One size fits all: Adults, Children and Infants. Designed to protect user from smoke in the event of a fire. Simple to use, easy to store. Fits in brief case, purse, carry on luggage. Hood allows full 360 degree sight, talk and hearing capability. Heat Resistant - resists heat up to 932 degrees F. Provides 20 minutes of filtered breathable air. Five year shelf life.

P/N 13-17891\$39.95



IEVAC SMOKE MASK / FIRE HOOD

The iEvac Smoke Mask/Fire Escape Hood is the only smoke/fire hood certified to the American Standard ASTM E2952-14. It protects against fire-related gases including carbon monoxide, hydrogen cyanide, smoke, & hydrogen sulfide. The iEvac contains a HEPA filter that removes more than 99.97% of sub-micron particles such as ebola, anthrax, smallpox, and radioactive particles.

One universal size can be put on in under 30 seconds. The hood features easy-to-breathe dual filters and is compact, lightweight, and vacuum sealed in a foil bag for a long shelf life. Its unobstructed field of view can be used with eyeglasses, beards, and long hair.

MaskP/N 13-18188\$189.99
Belt PouchP/N 13-18482\$17.99

EAM AIC-35 UNIVERSAL LIFE PRESERVER



EAM's Universal Series Life Preserver is designed with an open area collar to be placed over the head and onto the neck and shoulder area, so that the vest rest onto the chest of the wearer over 35 lbs.

The vest is secured to the wearer using a harness strap. Inflation is accomplished by either CO2 or oral inflation. Each vest is equipped with a light system assembly. The AIC-35 life preserver is also designed for use on infants and small children weighing under 35 lbs.

10 YearP/N 13-19006\$63.85

EAM XF-35 LIFE VEST



Only 1.13 lbs. (513 grams). The XF-35 offers significant fuel savings to operators wishing to stay with the added security of a twin-cell vest. 5 year frequency of inspection standard. Inflated Buoyancy: 35 lbs. minimum. Approvals: USA FAA TSO-C13f; German LBA Approval No. 40.321/33; United Kingdom CAA Approval No. AR01445. Storage Range: 0 to 120°F (-17.8 to 48.9°C) Humidity: Functional Range: Up to 95% Relative Humidity; Storage Range: Up to 70% Relative Humidity Altitude: -2000 to 45,000 feet above sea level

5 yr. Passenger Yellow.... P/N 13-12677...\$59.75

10 yr. Passenger Yellow.. P/N 13-12685...\$66.75

5 yr. Crew Orange P/N 13-12678...\$61.80

EAM UXF-35 LIFE VEST



This single cell vest is the lightest weight aviation vest in the world, weighing only .9 lbs (410 grams). 5 year frequency of inspection comes standard, 10 year version available. TSO-C13f Approved. Inflated Buoyancy: 35 lbs. min. Temperature: Functional Range: -40 to 140°F (-40 to 60°C); Storage Range: 0 to 120°F (-17.8 to 48.9°C) Humidity: Functional Range: Up to 95% Relative Humidity; Storage Range: Up to 70% Relative Humidity Altitude: -2000 to 45,000 feet above sea level.

UXF-35P/N 13-12679\$51.75

UXF-35 (10 year)P/N 13-12684\$59.75



EAM BRAVO LIFE VEST

This continuous wear, yoke style life vest is ideal for helicopter pilots or anyone flying long distances over open water. Includes a 2-inch, extra wide, waist strap for comfort and security. Equipped with water-activated light, retro-reflective tape and a whistle. Optional storage pouches attach to the waist strap to hold signal kit or EPIRB. Easy fold lines for repackaging. Functional Range: -40 to 140 oF (-40 to 60 oC); Storage Range: 0 to 120 oF (-17.8 to 48.9 oC) Humidity Functional Range: Up to 95% Relative Humidity Storage Range: Up to 70% Relative Humidity Altitude -2000 to 45,000 feet above sea level.

P/N 13-12680\$250.95

REVERE AQUA LIFE JACKET LIGHT



The AQ40S is a compact flashing life jacket light, automatically water activated by its integral sensors or manually. Its unique size and shape, makes the AQ40S ideal for a variety of life jackets.

Sensor ActivatedP/N 11-14272\$20.00

Lead ActivatedP/N 11-14273\$19.50



EAM INFANT LIFE VEST

This specially designed and affordable life vest is made exclusively for children less than 35 lbs. (16 kg). EAM infant vests come in USA and European versions, for the constantly changing safety markets of commercial carriers.

5 Yr. Vest w/Co2.....P/N 13-12681\$95.75

10 Yr. Vest w/Co2.....P/N 13-23269\$109.75

Without Co2.....P/N 13-12778\$95.75

SURVIVAL PRODUCTS LIFE RAFTS



Perfect for general aviation. Small and compact it fits in a lightweight valise 4" x 12" x 14" and weighs only 12 lbs. But don't be fooled by its size, price or weight. This raft will do the job for you under the most adverse condition. It provides a fresh water buoyancy of 190 lbs. per person and a deck area of 3.6' per person which exceeds all Govt. standards. Inflated, the raft is 46' inside and 68' outside and every square inch has been meticulously made from raw materials and components tested for their durability and life expectancy. Every raft is pressure tested and all seams and adhesive bonds rigorously checked prior to release. Raft includes sea anchor, bailing bucket, hand inflation pump, and CO inflation system. Optional survival equipment shown below. 6-13 person raft is 5' x 12' x 14' and weighs 18 lbs. Available in non-TSO'd and TSO'd versions.

Non-TSO:

4-6 Person Life RaftP/N 13-31610\$1,899.00

6-13 Person Life RaftP/N 13-31660\$2,449.00

4-6 Person Basic Raft w/o canopy.....P/N 13-31670\$3,499.00

8-12 Person Basic Raft w/o canopy.....P/N 13-31715\$4,799.00

TSO Certified:

4-6 Person Raft w/91 equip.....P/N 13-31690\$3,699.00

4-6 Person Raft w/121 equip.....P/N 13-31700\$4,599.00

8-12 Person Raft w/91 equip.....P/N 13-31735\$4,999.00

8-12 Person Raft w/135 equip.....P/N 13-31755\$6,199.00

Raft with FAR91 kit 6MP/N 13-05861\$6,495.00

REVERE COASTAL COMPACT RAFT



Double 200 lb. SuperRev™ ballast pockets, it enhances stability in rough sea conditions. Its light weight allows for easy deployment and the compact size makes stowage easy in the smallest of spaces. Operation is easy. Just open the red flap on the valise and extend the painterline. Give a hard pull and the raft inflates automatically in less than 30 seconds. Coastal Compact Raft is not recommended for offshore use.

Raft	Part No.	Price	With Canopy	Price
2	11-07471	\$1,084.00	---	---
4	11-07472	\$1,314.00	11-07473	\$1,427.00
6	11-07474	\$1,549.00	11-07475	\$1,597.00



LIFE RAFTS – LIFE VESTS

REVERE AERO COMPACT LIFE RAFTS



Ideal for general aircraft, the Aero Compact series offers an enhanced level of safety for over-water flights. With double 200 lb. ballast pockets, the Aero Compact enhances stability in the roughest of sea conditions. Equipment Pack Contains: 2 Red Hand Flares - USCG/SOLAS, Bailer, Signal Mirror, Paddles, Repair Kit, Seasick Tablets, Water Tight Flashlight, Extra Flashlight Batteries, Whistle, Sponges, Floating Knife.

Specifications: • Weight: 13 lbs • Dimensions - Packed (L"xW"xH"): 14 x 9 x 5. *Neither Canopies or Equipment Packs are available for 2-Person Aero Compacts.

- 2 Person P/N 11-09399 **\$1,190.00**
- 4 Person P/N 11-09401 **\$1,574.00**
- 4 Person Canopy P/N 11-09402 **\$1,733.00**
- 4 Person Canopy and Standard Kit P/N 11-09403 **\$2,014.00**
- 4 Person Canopy and Standard Kit Plus P/N 11-09404 **\$2,026.00**
- 4 Person Canopy and Deluxe Kit P/N 11-09405 **\$2,468.00**

REVERE AERO ELITE LIFE RAFTS



The Aero Elite offers both crew and passengers easy usage when facing the stress of a life threatening situation as opposed to other life rafts that can be difficult to lift and transport at the time of need. Vertical bulkheads inside divide the tube into two independent air-holding compartments. If one compartment is punctured, the other keeps you afloat. Offers a spacious 4 square feet per person. Inflatable floor, stowage pockets, zippered windows, flashing strobe, extra large ballast pockets, an extensive equipment pack including USCG/SOLAS flares plus much more. If serviced according to manufacturer's specs, the Aero Elite offers a 12 year warranty.

- 4 Person P/N 11-09409 **\$3,054.00**
- 6 Person P/N 11-09411 **\$3,250.00**
- 8 Person P/N 11-09412 **\$3,364.00**

SWITLIK INFLATABLE LIFE RAFTS



The Switlik ISPLR brings advanced military design and mission-proven durability to a single place life raft available for mariners and pilots who are serious about their personal lifesaving equipment. Fully reversible. The unique U-shaped design allows the raft to be fully reversible, allowing quick, easy entry from the water - whichever side is up when it automatically inflates. The ISPLR's low slung floor design allows seating at a slight recline lowering the center of gravity well below the waterline, increasing stability in rough waters. Zip to the elements. Twin zippers, located on either side, allow you to partially close the canopy, keeping the elements out while providing great ventilation.

- Brick Valise, Hermetically Sealed w/Floor... P/N 13-18417 **\$1,395.00**
- Brick Valise, Hermetically Sealed P/N 13-18418 **\$1,195.00**
- Soft Valise, Loose Pack P/N 13-16033 **\$1,150.00**
- Soft Valise, Loose Pack w/Floor P/N 13-18419 **\$1,350.00**
- Belt Pack, Hermetically Sealed P/N 13-18420 **\$1,450.00**

REVERE COMFORTMAX™

INFLATABLE PFD - RED TYPE III



Features: •USCG approved for persons at least 16 years of age weighing 80 lbs. and above with a chest size between 30" and 52" • Dual waist belt stainless steel adjusters. Provides for easy adjustment with both hands and a more custom fit • Exterior inflation system access flap. Allows for clear, direct access to the CO2 cylinder for rearming. CO2 cylinder can be replaced without opening and unfolding the entire PFD • Waist strap and back strap attachment points fully connected and reinforced from inside for added strength • Heavy duty 420 denier nylon packcloth outer cover • Twin 2" wide back straps for comfort and security • Comfortable neck. The neck area has no Velcro or edge binding to cause chafing or abrasion for all-day comfort. Red P/N 13-04373 **\$94.75**
Navy Blue P/N 13-04372 **\$97.75**

REVERE PFD RE-ARMING KIT



This manual PFD Rearming Kit for Comfortmax Inflatable PFDs is an instant CO2 manual inflation system. P/N 13-08831 **\$21.50**

REVERE COMFORT MAX MANUAL BELT PACK



Specifications: Model: 45-61098-101N. Sizing: Adult Universal. User Weight: More than 90 lbs (> 41kg) Chest Size: 30"-52". Buoyancy: 35 lbs (156 Newtons). Approx. Unit Dimension: 10"x4"x3". Approx. Weight: 2 lbs
Navy P/N 13-08826 **\$77.95**
Red P/N 13-23257 **\$74.29**

REVERE SPORT MAX MANUAL REARM KIT



Revere Sport Max re-arm kit, Reverses smallest and lightest inflatable PFD. For use with the Portable Floating Device 61225 P/N 13-08829 **\$20.50**

EAM TITAN XF LIFE VEST



The TITAN XF is carefully designed to offer advanced protection for crew aboard an aircraft during over-water flight. Created with a heavy-duty front zipper and a fixed mesh back, the TITAN XF remains securely fastened throughout flight.

- Blue With D Rings P/N 13-12961 **\$364.00**
- Blue Without D Rings P/N 13-12959 **\$350.00**
- Orange With D Rings P/N 13-12961 **\$364.00**
- Orange Without D Rings P/N 13-12959 **\$350.00**

SWITLIK CPR LIFE RAFT WITH PART 91 KIT



SWITLIK's CPR is designed to be a high quality, light weight, best in class coastal life raft, with a convertible canopy system, large, fast deploying water ballast bags and heat sealed construction. The CPR provides 1,140 lbs of inflated buoyancy and 19.6 sq. ft of floor area and offers excellent ventilation as well as total protection from the elements. P/N 13-19317 **\$4,899.00**

SEE WWW.AIRCRAFTSPRUCE.COM FOR A COMPLETE SELECTION OF EAM SURVIVAL KITS

EAM SURVIVAL RAFTS



Each product is manufactured with the highest quality craftsmanship and are proudly FAA-TSO approved. In addition, EAM is proud to offer customizable raft packaging to meet any client's specifications. When deployed and in the water, the raft may be boarded on either side. Survival items are contained in a kit tied to the raft. Select raft models include a raft canopy, located inside the accessories case, which features two (2) roll-up doors and a rain water collector in the top of the roof panel. The VIP and SAM Series life rafts have auto self-erecting canopies, which have two (2) doors which can be sealed closed with Velcro. Also, the VIP and SAM series canopies are affixed to the life raft with Velcro so if needed the canopy can be removed and reinstalled.

USA: FAA TSO-C70a, Type II

Germany: LBA No. 40.320/12

Japan: JCAB No. 535

• For Air Taxi, Corporate and General Aviation • Single Tube • Compact, lightweight. Constructed of neoprene coated nylon • High tech inflation system • Competitively priced.

Part No.	Canopy	Survival Kit	Rated Capacity	Dimensions (LxWxH)/Wt.	Price
13-16560	Radar Reflective	FAR 121	4	15x13x7/36 lbs.	\$4,122.00
13-16561	Radar Reflective	FAR135	4	15x13x8/39lbs.	\$4,833.00
13-16562	Standard	FAR 121 Special	4	22x13x5/36lbs.	\$3,788.00
13-16565	N/A	N/A	5	15x13x5/20.5lbs.	\$2,986.00
13-16558	Radar Reflective	FAR 121	2	27x8.5x8.5/45lbs.	\$3,496.00
13-16564	Radar Reflective	FAR 121	6	33x16x7/57.5lbs.	\$4,563.00
13-16566	N/A	N/A	12	30x10x9/41.5lbs	\$6,324.00

PS

SURVIVAL EQUIPMENT



SWITLIK TSO-C70A TYPE II OPR 8 PERSON LIFE RAFT

SWITLIK's OPR is designed to be a high quality, light weight, offshore life raft, with a convertible canopy system, 5-Year Service and heat sealed construction. The OPR provides 1,350 lbs. of inflated buoyancy and 24 sq. ft. of floor area and offers excellent ventilation as well as total protection from the elements. Quality materials, superior construction.

Part 91 P/N 13-21122 **\$5,999.00**
Part 135 P/N 13-21123 **\$6,199.00**



EAM HELICOPTER LIFE VEST

This twin cell vest comes in a standard or heavy-duty pouch engineered especially for use in helicopter tour operations. Pouch pack design buckles around the waist for constant wear. The life preserver can easily be pulled out and donned over the head with one quick motion, using a single hand.

P/N 13-22367 **\$99.75**

MUSTANG INFLATABLE PFD REARMING KIT

Designed to rearm your Mustang inflatable after deployment. This is a 1F Automatic and 3F Manual Inflatable PFD Re-Arm Kit E.

P/N 13-20153 **\$32.50**



INFLATABLE BELT

Features include reflective tape on the bladder for greater visibility, 2" deluxe web belt with buckle, and single point indicator window. Inflates in seconds to over 35 lbs. of buoyancy. One size fits adults over 80 lbs. with 30 - 52" chest size. Will not inhibit your range of motion while hunting or fishing. U S Coast Guard approved Type III. Rearm kit 38MRK.

Specifications: 35 lbs. of buoyancy (over 150 newton) • Equipped with single point indication of arming status • Reflective tape on cover and bladder for greater visibility • Safety whistle attached to bladder • 2" deluxe web belt with buckle • USCG Approved Type III • One size fits adults over 80 lbs. P/N 14-00681 **\$138.95**

THROWRAFT INFLATABLE PERSONAL FLOTATION DEVICE



The TD2401 can be inflated manually with the pull tab or automatically by fully submerging it underwater. The device inflates quickly yet gently by filling itself with compressed air in a controlled manner. Once inflated, the TD2401 provides a sturdy, buoyant surface that's easy to maneuver. After it's been used, it can be easily repacked and recharged using a standard PFD re-arming kit.

Specifications:

- Packed Dimension: 11" x 4"
- Inflated Dimension: 22" x 21"
- U.S. Coast Guard Approved P/N 13-21511 **\$127.75**

CLOSED CELL NEOPRENE HOOD

BREATHABLE CONSTANT WEAR AVIATION COVERALL

The MA7348 Closed Cell Neoprene Hood offers increased protection against the elements when worn with Mustang Survival anti-exposure gear. Designed for easy integration with the MSD900, MSD901, MSD585, MAC200 and MAC300, the hood provides exceptional head and neck insulation and includes a lanyard to tether hood to suit, an adjustable mouth guard for protection from spray and a velcro attachment point for an emergency light.

Sizes: N/A or Universal Colors: RED
P/N 13-06380 **\$60.75**



NOMEX FLIGHT SUITS

This Nomex flight suit is built to military specification FNS/PD 96-17 (MIL-C-83141A) as worn by all U.S. flight crews. Constructed of 92% Meta Aramid, 5% Para Aramid and 3% conductive fiber fabrics, which makes this garment flame-resistant. Features a two-way zipper with pull, six primary pockets, adjustable waist belt with VELCRO® brand fasteners, knife pocket on the left inseam, pencil pocket on the left sleeve and a gusseted back.

Features: • Made with DuPont™ Nomex® N303 Fiber: Its thermal technology helps protect against hazards associated with electric arcs and flash fires including intense heat and flame. It is protection that's built into the fiber itself. So, it can never be washed out or worn away. • Sewn to Military Specification FNS/PD96-17(MIL-C-83141A) • As Worn By All US Flight Crews • Flame-Resistant Material • Two-Way Zipper with Pull • Six Primary Pockets • Adjustable Waist Belt with Velcro Fastener • Knife Pocket on Left Inseam • Pen/Pencil Pocket on Left Sleeve • Gusseted Back • Sage Green and Tan Flight Suits are Near Infrared (NIR) Compliant

Color	Part No.	Prices starting at
Sage	Call or visit our website for sizes and part numbers	\$199.99
Black		\$199.99
Tan		\$199.99

EAM GENERAL SURVIVAL KIT



This kit contains equipment for survival and search/rescue aids for use by aircraft crew and passengers after an emergency landing in uninhabited terrain. Collection of equipment designed for survival and search & rescue situations in case of an emergency P/N 13-12823 **\$384.00**

SNUGPAK CHRYSALIS SLEEPING BAGS



Chrysalis is a sleeping bag that has evolved to the next level; putting you in control of temperature and comfort by transforming from a warm, snug sleeping bag, into a cool and spacious one, with a built in LED light to assist you. The bag boasts all the features of a quality Snugpak® mummy-style sleeping bag but the jumbo zip baffle can be opened out to give much more room within the sleeping bag by opening the expander panel. The extra space within the bag allows air to move around, keeping the bag cooler. And if the temperature drops, just zip the bag tighter and instantly boost the warmth around you. The Chrysalis is the ideal sleeping bag for unpredictable conditions. LED Light. Expander Panel System (EPS). Chisel Shaped Foot - For Extra Comfort. Zip Baffle. Anti-Snag Two-Way Zipper. Snugfit Hood. Hanging Dry Tabs.

EXPEDITION - Temperature rating: Comfort: -12°C, Extreme: -17°C • Compact pack size: 14 in. (36 x 36 cm.) • Open Size: Length: 86 in. (218 cm.) • Weight: 92 Oz. (2608 Grams) • Width: 152 cm.

P/N 13-17697 **\$108.75**

MODEL 1 - Temperature Rating: 45°F to 36°F (7°C to 2°C) • Length: 87" • Weight: 35 oz. • Width: 30-24" • Pack Size: 6 x 8" • Fill: Softie® • Shell: Paratex (micro) with Reflectatherm • Liner: Paratex (light)

P/N 13-12457 **\$119.00**

MODEL 2 - Temperature Rating: 36°F to 27°F (2°C to -3°C) • Length: 87" • Weight: 46 oz. • Width: 30-34" • Pack Size: 7 x 9" • Fill: Softie® • Shell: Paratex (micro) with Reflectatherm • Liner: Paratex (light)

P/N 13-12458 **\$139.00**

MODEL 3 - Temperature Rating: 23°F to 14°F (-5°C to -10°C) • Length: 87" • Weight: 56 oz. • Width: 30-34" • Pack Size: 9 x 10"

P/N 13-12459 **\$159.00**

MODEL 4 - Temperature Rating: 14°F to 5°F (-10°C to -15°C) • Length: 87" • Weight: 69 oz. • Width: 30-34" • Pack Size: 9 x 11"

P/N 13-12460 **\$179.00**

PS

SURVIVAL GEAR



SWITLIK AVIATOR LIFE VEST

The Switlik Aviator Life Vest is supremely more comfortable to wear, and specifically designed for the seated position in your aircraft. It's the vest you'll forget you're wearing. The new interior cell folding technique combined with our open V-Neck design allows the Aviator to lay over your shoulders relieving the pressure on your neck during those long flights. We have located our new beaded handle in the center of the vest allowing for an easier approach for deployment. The breakaway safety feature eliminates the risk of snagging. The red handle also offers the best visibility in low light conditions. The Switlik Zipper closure keeps your inflatable vest secure at all times. The simple reliable dual breakaway design provides immediate inflation when activated. Backup oral inflation tubes are conveniently located on either side of the vest and easily reached through the side access flaps.

EV-35 Blue P/N 13-12687 **\$259.00**
 EV-35 Orange P/N 13-16185 **\$259.00**



SWITLIK X BACK AIR CREW LIFE VEST

The aptly named X-Back is ergonomically fitted to your shoulder contour for a perfect fit. As accessories are added the weight is distributed over your shoulders and off your neck for vastly improved comfort. The adjustable X-Back straps provide enough range making it one size fits all. The MOLLE (Modular Lightweight Load-Carrying Equipment) system lets you customize your vest with the accessories you need. The contoured cut of the MOLLE side panels locates the accessories away from your midsection. The simple reliable dual breakaway design provides immediate inflation when activated. Backup oral inflation tubes are conveniently located on either side of the vest and easily reached through the side access flaps. High visibility red beaded handles are found on both sides of the vest making for simple activation. They incorporate a breakaway safety feature to prevent snagging.

X Back Blue P/N 13-12688 **\$396.00**
 X Back Orange P/N 13-16186 **\$402.00**



SWITLIK AVIATION LIFE VEST AV-35H

AV-35H Double Cell Airline Passenger Vest. The AV-35H donning style features a single waist strap and adjusting buckle without a back panel. The AV-35H donning style features a single waist strap and adjusting buckle without a back panel.

Standard P/N 13-16031 **\$71.99**
 5 Year P/N 13-18410 **\$74.99**
 10 Year P/N 13-18413 **\$78.99**



SWITLIK AVIATION LIFE VEST AV-200

The Switlik AV-200 is the latest advancement in airline life vests. Offering airlines a lightweight, compact and inexpensive vest while meeting all the safety features required by the FAA. The AV-200 donning style features a single waist strap with a single adjusting buckle. Meets FAA/TSO C-13f Approval: 2 Year TBO.

Standard P/N 13-16032 **\$47.99**
 5 Year P/N 13-18411 **\$50.99**
 10 Year P/N 13-18414 **\$56.99**



SWITLIK INFANT LIFE

The ILV-20 is a dual chamber, 23-pound buoyancy Infant Life Vest, (FAA/TSO-C13d defines "infant" as a wearer with a weight less than 35 pounds). The underarm configuration allows this vest to be used by wearers whose shorter necks prevent use of the standard "yoke-type" vest.

2 Year P/N 13-18409 **\$91.99**
 5 Year P/N 13-18412 **\$95.99**
 10 Year P/N 13-18415 **\$99.99**



EAM UXF-35 LIFE VEST (10 YEAR)

This single cell vest is the lightest weight aviation vest in the world, weighing only .9 lbs (410 grams). 10 year frequency of inspection. Standard 5 year version also available (P/N 12-02355). TSO-C13f Approved.

Passenger Yellow P/N 13-12684 **\$59.75**
 Crew Molten Orange P/N 13-21624 **\$59.75**



SWITLIK X-BACK BASIC LIFE VEST BLUE

The X-Back Basic incorporates the same fit, adjustment and overall comfort users have come to expect from the Switlik X-Back, with the addition of two permanently attached all-in-one pockets in lieu place of the MOLLE vest attachment loops. This new vest is intended to be a modern version of SWITLIK's previous HV-35 Helicopter Vest. This vest is for users who do not need the MOLLE system and all its accessories. The pockets attached to the vest are intended to fit your essentials "keys, phone, sunglasses & wallet" (and yes, the newest smart phones will fit!) Color: Blue..... P/N 13-18416 **\$359.00**

SWITLIK ALL PAX LIFE PRESERVER BLUE

Whether outfitting a personal aircraft, or a fleet of passengers, the SWITLIK ALL-PAX life preserver is a perfect solution. The ALL-PAX Life preserver has maximum adjustment capability to fit the largest range of size, and provides sufficient flotation for children and adults making it a great product solution for a variety of passengers. Designed for easy donning and constant wear, the ALL-PAX passenger life preserver is perfect for over-water flight protection. Color: Blue.

P/N 13-18741 **\$295.00**



SWITLIK X BACK LEG STRAPS

Quick donning adjustable leg straps are neatly stored using the Velcro™ ties making them a clean and simple accessory to have P/N 13-12691 **\$49.99/pr.**



SWITLIK X BACK MOBILE PHONE POCKET

Safe, secure and easily accessible cell phone holster fits all popular models. P/N 13-12692 **\$26.99**



SWITLIK X BACK BUDDY CLIP

When ditching your aircraft it's important for survivors to stay together. The Switlik Buddy Clip allows you to quickly tether yourselves together via a 6 foot (1.8 m) 550 lb (250 kg) test line with a CRES snap hook. When not in use it is neatly packed into a nylon pouch. The pouch is designed to be attached with snaps to the MOLLE system and by dead ending the buddy line loop directly to the MOLLE Loops as a back up.

P/N 13-12693 **\$27.99**



SWITLIK X BACK ALL IN ONE POCKET

The All-In-One pocket allows you to organize all your equipment into one area. Complete with two zipper pockets, interior MOLLE straps, interior compartments, and a conveniently located pen holder on the outside. Available in left and right.

Right Side P/N 13-12694 **\$54.99**
 Left Side P/N 13-12695 **\$54.99**



SWITLIK X BACK BOTTLE HOLSTER

The Switlik HEEDS/HABD Holsters are specifically designed to be mounted on an angle, readily accessible and unobstructed by safety restraints. This ideal location reduces fatigue by keeping weight off your neck.

HEEDS P/N 13-12689 **\$74.99**
 HABD P/N 13-12690 **\$52.99**



ION FLASHLIGHT FIRESTARTER™

During outdoor adventures, flights over remote areas, or in any emergency survival situation, there are two pieces of equipment that you never want to be without, a flashlight and a firestarter. Solo Scientific combined the two into one lightweight, compact, powerhouse of a product called the ion Flashlight Firestarter™!



The ion Flashlight Firestarter™ is a flashlight, a firestarter, a magnetic tool, has a safety mechanism, is knurled for grip, water proof, shock resistant, and can even be used to cauterize wounds in the field (by qualified medical personnel only).

The energy efficient ion Flashlight Firestarter™ will work in any environment that will support life and uses a super bright (but energy efficient) white LED for illumination. P/N 13-11695 **\$118.75**

PS

PROFORCE SURVIVAL PRODUCTS

SNUGPAK SOFTIE ELITE 3 SLEEPING BAG



Equipped with the unique easy to deploy EPS Expanda Panel System and its own sturdy compression stuff sack. **Specifications:** • Temp. Rating: Comfort 23°F / Low 14°F (-5°C / -10°C) • Weight: 56oz • Length: 86" • Chest: 65" + EPS • Pack Size: 9" x 9" (fully compressed)
 Black P/N 13-08780 **\$194.65**
 Olive P/N 13-08779 **\$194.65**

SNUGPAK SOFTIE 9 HAWK SLEEPING BAG



Temp. Rating: Comfort 23°F / Low 14°F (-5°C / -10°C) • Weight: 53oz • Length: 86" • Chest: 60"
 • Color: Olive • Pack Size: 9" x 9" (fully compressed)
 P/N 13-08777 **\$319.00**

SNUGPAK JUNGLE BAG SLEEPING BAG



The Jungle Bag is an ideal sleeping bag for tropical conditions. Travelsoft Insulation was selected and chosen for its exceptional performance in hot and humid conditions. Concealed roll away mosquito netting which can be zipped over the face. **Specifications:** • Temp. Rating: Comfort 45°F / Low 36°F (7°C / 2°C) • Weight: 27oz • Length: 86" • Chest: 60" • Pack Size: 6" x 6" (fully compressed)
 Black P/N 13-08783 **\$75.65**
 Olive P/N 13-08782 **\$75.65**
 Desert Tan P/N 13-10258 **\$75.65**

PROFORCE DRI-SAK



Store your sleeping bag, clothing, and any other items you want to keep dry in a Dri-Sak™. They are seam taped, nylon with a TPU Film Lamination to ensure protection if your gear takes an unexpected dive into the water. They are a great addition that can be used in conjunction with any of the Snugpak® backpacks or any other backpacks. Not intended to be submerged for extended periods of time. Roll-top closure must be closed correctly (recommended rolling 3 times and buckled to keep contents dry). Contact with abrasive or sharp objects can damage and/or compromise the integrity and waterproofness of our Dri-Sak bags. D-Rings for securing if necessary.

Medium - Dimensions: 6.75" x 18.125" / 17 x 46 cm. Volume: 8 liters. Weight: 2.29 oz. / 60 g
 Olive P/N 13-08784 **\$19.95**
 Black P/N 13-08785 **\$19.95**
 Coyote P/N 13-08786 **\$19.95**
 Large - Dimensions: 8.5" x 20.75" / 22 x 53 cm. Volume: 13 liters. Weight: 3.17 oz. / 90 g
 Olive P/N 13-08787 **\$23.95**
 Black P/N 13-08788 **\$23.95**
 Coyote P/N 13-08789 **\$23.95**

PROFORCE PORTABLE WATER FILTRATION RADIOLOGICAL REPLACEMENT FILTER



Portable water filtration system replacement filter for the 28oz and 38oz portable water bottle and canteen. P/N 13-12002 **\$47.85**

MULTIMAT SUPERLITE MAT

Offering the lightest and most compact options, using the very latest ultra light materials, meeting the highest standards for quality and reliability. Ultra-lightweight 20D rip-stop polyester top and base fabric. Quality ultra-lightweight, vertically drilled 14kg/m3 PU foam core for lasting performance and full inflation. TPU membrane for air-tight seal. Easy valve can be locked while adding air by mouth. Mats supplied with stuff sack matching upper fabric, retaining band and repair kit. Size: 72" x 20" x 1" (1830 x 510 x 25mm). Weight: 18 oz (530g).

Specifications: • Temp Range: 5°F to 130°F (-15°C to +55°C) • Color: Olive/Black (reversible) • Compactness: 10.25" x 4.75" mid-folded (260 x 120mm) P/N 13-10253 **\$84.15**

PROFORCE EMERGENCY SURVIVAL BAG



The NDûR Emergency Survival Bag comes in a small compact packable size but yet opens into a full sized sleeping bag that will fit a fully clothed adult. It is made of a strong insulating material which reflects back 90% of the user's body heat. It not only helps to provide protection in various weather conditions but also prevents and assists treatment of Hypothermia.
 P/N 13-08798 **\$10.50**

PROFORCE LENSATIC COMPASS



Lensatic Compass is great for anyone's survival bag to help one if the situation arises where they are separated from their group, lost their way on the trail or find yourself in a dire drastic survival situation.
 P/N 13-12003 **\$24.95**

PROFORCE MAP COMPASS



Map Compass features include: 3 scales, Liquid Filled, Map Symbol Drawing Holes, Lanyard included, Acrylic clear base w/ruler, Rotating Rings, Index lines, and Magnifier. 1.52oz. 5.51x2.36x.41.
 P/N 13-12004 **\$9.50**

SNUGPAK® IONOSPHERE



The Ionosphere 2™ by Snugpak® is an extremely small and compact 1 person tent. The Ionosphere™ has a very low profile and is great for those looking for a 1 person tent to keep out of the elements. Just like The Bunker™, the Scorpion 3™ and Scorpion2™ the Ionosphere™ also too has a 5000mm PU Coated Fly. The Ionosphere™ has a single entry point, No-See-Um-Mesh and all seams are seam taped. A very impressive small compact tent by anyone's standard. 1 Door, All seams are taped sealed Alloy Stakes (14 + 2 Spare Stakes), Comes with a Repair Kit to allow for repairs while on the move if needed. P/N 13-10260 **\$194.65**

SNUGNUT



The Snugnut is an insulated hat and earmuffs in one. Constructed from the same high performance fabrics and Softie insulation used in our high performance sleeping bags this UK made deerstalker style hat is the ultimate in both day and night cold weather protection for your nut (AKA, Head) and ears.
 Black P/N 13-10267 **\$44.25**
 Olive P/N 13-10266 **\$44.25**

PILE PANTS



Temperature: 23°F / 14°F -5°C / -10°C. Team up these pile lined Paratex Light pants with either the Snugpak® Pile Smock or Pile Elite Smock for an exceptionally warm wicking base layer system. Designed to be worn next to the skin to maximize the moisture management properties. Weights: 23oz to 27oz (Depending on Size).

Size	Olive	Price	Black	Price
Small	13-10264	\$179.25	13-10265	\$179.25
Medium	13-10264-M	\$179.25	13-10265-M	\$179.25
Large	13-10264-L	\$179.25	13-10265-L	---
X-Large	13-10264-XL	\$179.25	13-10265-XL	\$179.25
XX-Large	13-10264-XXL	\$179.25	13-10265-XXL	\$179.25



PROFORCE SURVIVAL PRODUCTS



PROFORCE ARMY FIRE STEELS & STRIKER

Easy and safe to use – Used by Swedish Special Forces – Will light a fire or ignite the fuel in a camping stove in rain or snow – Generates a 3000 C spark – Approved, preferred and recommended by Survival Experts Worldwide. Approx. 12,000 Strikes

P/N 13-08794\$10.20



PROFORCE COMMANDO WIRE SAW

The strongest (over 100 lbs breaking strain) and most effective wire saw available. Cuts through wood, plastic, bone and even soft metals. Constructed using 8 strands of interwoven stainless steel wire, will easily reach inaccessible places. Attach rope to split rings on each end to cut higher branches. 24" sawing edge. Can also be used as a snare. Many uses for the outdoor and house. Retail PackagedP/N 13-08795\$6.95



PROFORCE MARINE SAFETY WHISTLE

High pitched signaling whistle. NATO approved. One piece construction with lanyard hole. Bright Orange. Made in the UK. Ideal for Survival KitsP/N 13-08801\$1.35



PROFORCE HEAVY DUTY BUNGEE CORDS

Ideal for securing cargo, packs and just about anything. Great for shelter building. Heavy duty 30" long x 5/16" in diameter with black plastic coated hooks. Sold in 4 packs. Color: Olive P/N 13-08803\$7.65



PROFORCE EMERGENCY SIGNAL MIRROR

Robust high impact plastic. Easy to use with one hand. Sun's reflection can be seen for many miles. Floats if accidentally dropped in water. Retail Packaged. Measures 2" x 3". P/N 13-08796\$6.80



PROFORCE COMBAT SURVIVAL TIN

Originally designed for the British SAS. Tightly packed in a useful metal tin. Contents include compass, whistle, candle, fishing kit, waterproof survival instructions, wind & waterproof matches, pencil, sewing kit, multi use flexible wire saw w/ split rings (can be used

as a bow saw or snare wire), water tablets, safety pins, fire lighting flint and striker and multifunctional knife w / fold out scissors. Assembled in the US. Contents may vary.....P/N 13-08802\$29.75

BRITE STRIKE BRITE-RESCUE SIGNALING SYSTEM



Brite-Rescue™ is an emergency lighted signaling system. Its ultra-compact size of 1.5" x 5" easily fits into the neoprene pouch and unrolls to 10' long. It has 6 international amber APALS-AIR® light strips, 2 photoluminescent tape strips, 2 Solas radar reflective tape strips, and offers over 200 hours of signalling capabilities, or a total of 1200 hours if used individually. The APALS-AIR® has two strobe modes, a steady on and can be turned off and reused. The LED's can be seen for 2 horizontal miles and 3 miles by air. It can be used on land

and floats on water, so don't take off on your outdoor adventure without one.....P/N 13-21092\$69.95



RESPONSE PACK

When travelling light, or when you may need to move out in a hurry, it pays to keep all your essential items together, with a place for everything this multifunctional carry case also doubles as a fanny pack, or as the British would call it, a bum bag. We use the same heavy duty materials in the Response Pak as we do in our series of backpacks. The Response Pak has a multitude of hidden internal storage pockets. The Response Pak has quickly become a favorite among military members as a great little med bag, perfect for those vital items each soldier needs. Supplies are NOT included.

OliveP/N 13-10261\$24.65
Black.....P/N 13-10262\$26.50



THE SNAPPER CANOPY ESCAPE TOOL

The Snapper (Tool for canopy escape to break shards of plastic after flip-over for escape). This tool was developed specifically for the RVs. This little tool could really save the day in the event of a flip over in your RV. We learned that almost all flip overs result in the canopy being broken and cracked. At first glance one would say that is a good thing, and should help facilitate a speedy exit.....P/N 05-12378\$8.95



TRUE NO-TOUCH CARABINER TOOL

The No-Touch Carabiner Tool works as an extension of your hand. With this antimicrobial, brass plated tool, you can use public touchscreens, keypads, and even open doors and bottles without leaving a fingerprint behind or taking a germ with you. The uniquely designed locking clip remains open to ensure it will never get stuck on any door handle. This multi-functional Carabiner Tool also includes a built-in box opener, flat head driver, bottle opener, and a stylus tip for touchscreen devices. Now you can do it all without touching a thingP/N 13-23258\$9.50



FLIGHT OUTFITTERS PILOT SURVIVAL KNIFE

The Pilot Survival Knife is more than just a blade. This knife was designed to be the perfect side-kick accessory for pilots. In addition to the two-in-one blade design, there is a built-in LED flashlight on the top of the knife. The handle also features a seatbelt cutter, a glass breaker tool, and a clip to secure the knife on a belt or bag. All of these features are neatly contained within the rugged yet attractive grey and black handle. Two-in-one blade design, Integrated LED Flashlight, Seatbelt cutter, Glass breaker tool, and Belt ClipP/N 13-20665\$29.95

BRITE STRIKE SURVIVAL LIGHT PACK



Brite Strike Survival Pack. This pack lasts for 200 plus hours, can be seen up to 1 mile and has 3 different modes. These are waterproof, dustproof and shockproof. Comes with a heavy duty 3m® Adhesive Back. Six different colors. Includes: 2 Green, 2 Red 2 White, 1 Blue, and 1 Amber.....P/N 13-16429\$49.95

BRITE STRIKE EXECUTIVE PRECISION LIGHTING INSTRUMENT



The EPLI™ is the perfect lighting instrument for any outdoor adventure. Super bright, waterproof and shockproof, it slips easily in a day pack or pocket. The EPLI™ has a strobe setting that can be used for SOS signaling and runs on easy to find low cost AAA batteries. Slim and sleek LED penlight made of high grade aircraft aluminum with a graphite anodized finish. The EPLI™ has the heart of a true rugged outdoor flashlight.....P/N 13-16430\$69.99

PS

GLOVES – SURVIVAL KITS

GENERAL UTILITY PLUS GLOVES



All-purpose and abrasion-resistant. This is the ideal performance work glove. Heavy duty non-slip reinforcement on the palm, fingers and thumb ensures lasting durability and grip. The ergonomic design reduces hand fatigue while enhancing wrist support. Features a terry cloth brow wipe on the thumb. This glove is ideal for any number of rugged applications.

Features: • Durable non-slip reinforcement on palm, fingers and thumb • Neoprene cuff adds support and secures fit; click here for more detailed sizing instructions • Breathable stretch nylon on top of hand wicks moisture and heat • Terry cloth thumb for wiping sweat and debris • Machine washable/air dry

Large P/N 13-09814 **\$22.50**
X-Large..... P/N 13-09815 **\$22.50**

PRO XT GLOVES



Pro XT is an extra heavy duty glove designed for rugged applications and total hand protection. The non-slip reinforced palm, fingers and thumb ensures lasting durability and grip. The unique 'one-piece saddle' reinforces this critical wear area. The top of hand features double knuckle protection and moisture wicking fabrics. It also features a terry cloth thumb wipe and

supportive, velcro cuff and closure. If you are doing heavy duty work like logging, landscaping, demolition or farming - this is the glove for you.

Features: • Durable non-slip reinforcement on palm, fingers and thumb • Extra grip saddle extends over index finger and thumb • Double knuckle protection on top of hand • Extended cuff protects wrist bone and adds support • Extensive reinforcement and protection for rugged applications • Machine washable/air dry • Click here for more detailed sizing instructions

Medium..... P/N 13-09819 **\$24.95**
Large P/N 13-09820 **\$25.50**
X-Large..... P/N 13-09821 **\$25.50**

WATERPROOF WINTER PLUS GLOVES



Waterproof Winter Plus is the ultimate winter work glove. 100% Waterproof and windproof, this glove is designed to keep your hands warm and dry without sacrificing dexterity. Triple layer technology of micro-fleece liner, waterproof membrane, and form-fit outer shell. Durable, dexterous, comfortable and warm - if you work or live in cold, wet winters you need this glove.

Features: • Waterproof, windproof and breathable inner membrane keeps hands warm and dry • Durable and form-fit outer shell maintains dexterity • Flexible Clarino™ non-slip palm reinforcement • Grips in wet and dry conditions and increases durability • Internal knuckle protection on top of hand • Double-stitched bonded nylon thread for extended life • Terry cloth thumb for wiping sweat and debris (or nose) • Machine wash/line dry

Medium..... P/N 13-09822 **\$35.50**
Large P/N 13-09823 **\$35.50**
X-Large..... P/N 13-09824 **\$35.50**

MAGID ROC GP110 GREY GLOVES



Made from an ultra-soft, grey, high-density, 13-gauge, seamless machine knit nylon blend, the ROC GP110 Work Gloves feature a full black micro foam coating offering exceptional comfort, flexibility, dexterity and added protection to the palm and back of the hand.

Micro foam nitrile coating improves upon the softness of standard nitrile while delivering a superior grip in dry or oily conditions. The nylon blended shell is ultra-soft and breathable. In addition to its comfort-enhancing properties, the ROC GP110 Gloves provide protection against cuts and abrasions, offering ANSI Cut Level 1 protection and ANSI Level 4 abrasion resistance.

ROC GP110 Gloves have color coded knit wrists with matching color overcasts for easy sorting and dispensing and incorporate a rubber band edge finish to help prevent unraveling.

Size 11..... P/N 13-09638 **\$4.95**

FLIGHT LEVEL 220 SURVIVAL KITS

Flight Level 220 is a brand built on the importance of having the proper equipment in an emergency situation. Safety and survival start with preparedness; we make this easier by providing high quality first aid and survival products incased in durable materials to survive the elements.

Our products are designed by pilots with many hours of experience, with the understanding of safety in the forefront of all operations. Our team also consists of emergency and medical professionals that are on the front lines for first responders. Together we designed FL220 family of products to meet or exceed all aviation regulations.

Quality and integrity in our products and service are the most important part of our business. We stand behind our products and support our customers around the world. Aviation safety is our passion and mission. We strive to make your next flight better prepared with more confidence in your safety.



STANDARD

Flagship kit from Flight Level 220. Combining a jungle kit, first aid and survival kit in to one practical unit. Over 100 item to assist you in any challenge, including rendering first aid, signaling, fire, shelter, and fluid, food replacement. All items in a water tight, dust proof, crush proof Pelican Case. Essential for over water or over jungle flights. Safety comes with preparation for any situation. Meets and exceeds INAC requirements.

Specifications:
• 10.62" L x 9.68" W x 4.87" D.
• 7 lbs (3.2 Kg Approx.)
P/N 13-15955 **\$375.00**



LITE

The FL220 Survival Kit Lite is the perfect fit for the pilot that invest in safety. General aviation can only be safe with the right safety equipment on board. FL220 has put together and array of essential and "what if" items in a small durable case to cover any situation. Pilots think safety first and Flight Level agrees. Meets and exceeds FAA Far 91 requirements.

Specifications:
• 9.12" L x 7.56" W x 4.37" D.
• 8.5 lbs (3.9 Kg Approx.)
P/N 13-15956 **\$215.00**



FAA

The FL220 First Aid Kit is built to ensure its integrity in any situation. The Pelican case gives its users confidence in the content when needed most. Design to meet and exceed FAA Far 91 • 121 • 135 requirements as well as other aviation authorities. Each Kit is inspected and secured with a numbered break-away tag.

Specifications:
• 11.64" L x 8.34" W x 3.78" D.
• 3.5 lbs (1.6 Kg Approx.)
P/N 13-15957 **\$149.00**



FAA DELUXE

The FL220 Expanded Survival Kit was design to exceed all expectations for safety and survival. Equipped for commercial or general aviation aircraft, it stands ready for any situation. FAA FAR 91, 121, 135 - INAC.

Specifications:
• 10.62" L x 9.68" W x 6.87" D.
• 8.5 lbs (3.9 Kg Approx.)
P/N 13-15958 **\$475.00**

PS

SURVIVAL KITS - FIRST AID KITS

TWO-MAN V.I.P. SURVIVAL PACK



It's staggering just how much useful equipment comes out of this 10" x 11" w x 4" d backpack. Everything arranged logically and available the way you'd want it. Organized into 6 major divisions: medical/first aid, food & water, shelter & protection, fire & cooking, signals & lights, & "emergency devices." Wt; 20 lbs.
P/N 9217 **\$282.95**

NYLON CASE FIRST AID KITS

MODEL A FIRST AID KIT



International Orange Case Velcro Hold-Downs 10 FA Unit Kit Contents:
• 1" X 3" Adhesive Bandages (16 Bandages) • First Aid Instruction Book • Adhesive Tape (2 Rolls) 1/2" x 2-1/2" yards each • 24" X 72" Gauze Compress • 4" Bandage Compress • Scissors • 2 Triangular Bandages 40" x 40" x 56" • Ammonia Inhalants (10 Capsules) • 6 Burn Gel Packets • Wire Splints 3-3/4" x 27" • PVP Iodine Wipes (10 Wipes) • Orange First Aid Case P/N 13-02944 **\$86.50**

MODEL B FIRST AID KIT



International Orange Case Velcro Kit Contents:
• Burn Gel Packets • Aluminum Thermal Blanket • Sissors • Emergency Strobe • Hema-Flex 4" Bandage Compress • 36" X 48" Gauze Compress • 1" X 3" Adhesive Strips • 1/2" Adhesive Tape (2 Rolls) • 2 Triangular Bandages • Ammonia Inhalants • Wire Splints • PVP Iodine Wipes P/N 13-02945 **\$133.95**

FIRST-AID SAFETY SCISSORS



Angle Kit Plastic Handle Scissors 4 1/2" can be used in all first aid kits.
P/N 13-12036 **\$1.95**

AIRCRAFT EMERGENCY SURVIVAL KIT



This is an ideal emergency support kit for plane, boat, home, office or school. This kit will sustain a person for 3 days. Includes: 2400 calories of ready-to-eat US Coast Guard approved food, sterile Coast Guard approved water, a lightweight (54" x 48") durable, waterproof blanket, & assorted first aid supplies, matches etc.
P/N 9641 **\$35.75**

ODEO LED FLARE



Traditional flares will illuminate for around 30 seconds before extinguishing: the Odeo Flare™ illuminates for around 6 hours at full illumination. Because no pyrotechnics are used, the Odeo Flare™ is totally safe when switched off, and because it uses battery power (high power Lithium or Alkaline cells), it can even be safely posted or carried in baggage on flights.
P/N 13-18207 **\$146.75**

3M™ ULTRATHON INSECT REPELLANT



Unique, time-release technology allows you to enjoy the outdoors longer. Provides lasting protection — up to eight hours against mosquitoes, gnats, chiggers, biting flies and ticks. Helps reduce the risk of contracting West Nile Virus and Lyme Disease.
2 oz. Lotion P/N 09-01723 **\$6.90**

FIXR 20 IN 1 POCKET UTILITY TOOL



The FIXR™ features an easy, portable solution for all of your everyday tools. Equipped with a quick release clip, this tool easily attaches to your key ring or belt loop. A gold plated revolving disc allows tools to be exposed while in use, so they are never in the way when you don't need them. P/N 13-18339 **\$14.99**

SMARTKNIFE 7 IN 1 UTILITY KNIFE



Much more than just a pocket knife...it's a bottle opener, screwdriver, belt cutter, glass breaker, multi-size spanner and a knife all wrapped up in a high-grade stainless steel body. Handy belt clip and lanyard attachment included.
P/N 13-18552 **\$16.99**

SPACE EMERGENCY BLANKETS



This "two ounces of protection that fits in the palm of your hand" is about the size of a deck of cards when folded, but opens into a 56" (142cm) by 84" (214cm) tough and durable thermal reflective blanket. The Space Emergency Blanket has helped save countless lives, by providing needed personal protection from the harsh elements of Mother Nature. Available in orange on one side and silver on the other, a combination providing greater air-to-ground visibility, particularly against a snow or water background. P/N 13-06933 **\$4.35**

TRAFFIC WAND



This lighted traffic directing wand comes with 6 colored lens discs that change the color glow of the white tapered top. **Features:** GSA compliant for US military use • Made in the USA of sturdy gray plastic • O-ring sealed for waterproof operation in rainy weather • Lenses (2-red, 1 ea. amber, white, blue, & green), as well as a spare light bulb are conveniently stored in the end cap.
P/N 14-00902 **\$22.85**

LIGHTED LINEMAN WANDS



• Used by US Air force • Up to 400 hours operation • 17" long • Waterproof • Uses 2 D batteries (not included) • Fluorescent coated diffuser enhances red light output.
P/N 13-08959 **\$29.75**

LED AIRCRAFT PARKING WAND 22" RED LED



Mini LED Signal Lite with 6 LED's. 500+ Hours Runtime with 2 D Batteries. Great for Cars or for Security Uses. LED Bulb Signal/Traffic Lite. 6 Sets of LED Lites. Ultra High Visibility. 21 Inches length. Tough ABS construction. 400 Hour battery life.
22" Red P/N 11-10803 **\$17.95**
22" White P/N 11-10804 **\$42.50**

STROBEWAND LIGHT



The Strobewand is a hand held, battery powered warning light wand. Designed as a durable, quality-built, essential for traffic control. The Strobewand quickly attracts attention on the ramp. This Strobewand can be operated in the steady state or, with a flip of the switch, produce up to 120 flashes per minute. And readily tucked in a trunk or hung from the belt..... P/N 14-00833 **\$42.70**

PS

SURVIVAL KITS – FIRST AID KITS



EMERGENCY SURVIVAL KIT

Specially designed by a focus group, the ESK-02 makes it easy to be prepared for life's little surprises. Each kit contains over 40 medical and general supply items including a guidebook that offers survival tips and basic information. Designed to support one person for up to three days, the ESK-02 carries a five-year shelf life on food and water. Its affordable price makes it a great choice as a premium/incentive item, corporate gift, or employee award.

P/N 13-03606\$36.50



THE TRAVELER KIT

The Traveler Kit - Personal Care Package is appreciated by everyone from busy executives to sports enthusiasts. It's the perfect addition to any car as the "other spare" to have on hand for life's unexpected moments. Designed to support one person for up to three days, it contains over 50 support items in a custom nylon carrying bag with reinforced straps. "The Traveler" is ready to go anywhere.

P/N 13-03607\$65.75



2-PERSON EMERGENCY SURVIVAL KIT

This deluxe 2 PERSON EMERGENCY SURVIVOR KIT could mean the difference between disaster and survival in an emergency situation. It contains a complete 3-day supply of food, water, medical & other emergency supplies for 2 people.

Over 60 Emergency Items! • Emergency Drinking Water Metallic Sachets • 2400 Calorie Emergency Food Rations • Instant Cold Pack • Medical Kit • Disposable Flashlights • Thermal Blankets • AM/FM Portable Radio w/ Batteries • The Wallace Emergency GuidebookP/N 13-03608\$86.75



EMERGENCY BLANKET

This Emergency Blanket (52" x 82.5", 1.5 oz.) provides personal protection from rain, wind, heat, and cold. It's manufactured from extremely lightweight, flexible, space-age material, and retains up to 90% body heat in cold weather. It even deflects heat in hot climates and can be used to offset hypothermic reactions. The Emergency Blanket is waterproof, reusable, and portable. It's perfect for camping trips and sporting events in addition to emergencies. Keep several on hand for the unexpected!

P/N 13-03604\$2.95



FIRST AID 'N TRAVEL KIT

Finally—a compact, complete travel unit for the person on the go! This kit fits perfectly in a purse, briefcase, or glove compartment, and is ready when you need it in first aid situations. This kit is very special because it's the only one of its kind to include a 4 oz. sterile water packet with a five-year shelf life. Ask us about using this kit for fundraisers or corporate promotions! We can customize the kit to include your company's logo.....P/N 13-03605\$12.50



ELMRIDGE® FIRE ESCAPE CAPE™

The Fire Escape Cape's™ inherently flame resistant material and ease of use can help protect your body from harmful flames and can make you easily visible to first responders. With its built in hood, the Fire Escape Cape™ also adds protection for your head and neck. A Velcro opening and built in ties help you secure the hood in place for easy maneuverability when fleeing an emergency. **Note:** Due to the nature of this product, this product cannot be returned.

Height	Part No.	Price	Height	Part No.	Price
3' 5" to 4'	13-22442	\$39.98	5' 4" - 5' 9"	13-22446	\$79.98
4' to 4' 6"	13-22443	\$49.98	5' 9" - 6' 2"	13-22447	\$89.98
4' 6" to 5"	13-22444	\$59.98	6' 2" + +	13-22448	\$99.97
5' to 5' 4"	13-22445	\$69.98			



COCOON SLEEPING BAG

The All Weather Pocket Size Sleeping Bag The Cocoon Sleeping Bag (84" x 36") provides personal protection from rain, wind, heat, and cold. It's manufactured from extremely lightweight, flexible, space-age material, and retains up to 90% body heat in cold weather. It even deflects heat in hot climates and can be used to offset hypothermic reactions. The Cocoon is waterproof, reusable, and portable. Keep several on hand for the unexpected!

P/N 13-03603\$3.85

EMERGENCY FOOD RATIONS



Individualized portions eliminate the messy breaking-up that occurs with other bars. Allows for on-land emergency consumption in a high-stress active situation. Contains no cholesterol or tropical oils. Enriched with vitamins and minerals exceeding the RDA requirements. Pleasant lemon flavor which appeals to everyone. 5 year Shelf Life. Non-Thirst Provoking. Withstands Temperatures of -40° F to 300°F (-40°C to 149°C)

- **13-03602:** Ready to Eat- Each package contains 3 pre-measured 400 calorie meals.
 - **13-03601:** Ready to Eat: Each package contains 6 pre-measured 400 calorie meals.
 - **13-03599:** Ready to Eat: Each package contains 9 pre-measured 400 calorie meals.
- Mainstay™ 3600P/N 13-03599\$7.90
Mainstay™ 2400P/N 13-03601\$6.50
Mainstay™ 1200P/N 13-03602\$3.95



EMERGENCY WATER PACKETS

Mainstay™ Water Packets - All water is not created equal! Here at Survivor Industries we have spent years perfecting our Mainstay™ Water Packets. The final result is a portable product with a 5-year shelf life. Other Key Benefits: • U.S. Coast Guard approved • No Oxygen Transfer (In other words, no chance of bacterial contamination) • Pre-Measured Packets make the water easy to dispense, and potential for loss is minimized. If a packet is destroyed, only 4.224 ounces (125 ml) would be lost • Easy to Transport - just 18 lbs. (8.17 kg) per case of 60 packets • No special storage required - it can withstand temperatures from (-40°F to 210°F) (-40°C to 99°C) • Very Low Cost • No Cups Needed!

P/N 13-03598\$17.60



THE WALLACE GUIDEBOOK

For Emergency Care & Survival - When you're faced with a disaster, you can often face physical and psychological strain. It's often hard to remember what to do in an emergency situation, and this is exactly why we've written the Wallace Guidebook. This book is specifically designed to present the basics of survival in an extremely easy-to-understand manner. This book discusses the following topics, plus many more: Choking, Heart Attack, CPR, Shock, Burns, Emotional Trauma, Bleeding, Fainting, Wounds, Broken Bones, Fractured Bones, Back Injury, Childbirth, Auto Breakdown, Temperature Extremes, and the 1st and 2nd Rules of Survival. It's not fun to be in one of these situations, but having a book like this nearby gives you a better chance of a happy ending.....P/N 13-03597\$11.50

RESCUEME EDF1 OCEAN SIGNAL FLARE



The rescueME EDF1 electronic distress flare offers users a safe and long-lasting solution to visual signalling in an emergency. The light output is a beam of over 30° throughout the full 360° azimuth, providing in excess of 6 times more light coverage than other electronic flares*. Light is also distributed throughout the hemisphere above the unit to ensure visibility from the air. Unlike single use pyrotechnic flares the rescueME EDF1 can be used repeatedly in any of its four modes, ensuring continued visibility is maintained over a longer period. The unit is both safe to store and operate while also eliminating any worries associated with disposal. The compact size and rugged design means the rescueME EDF1 is the perfect safety product for a grab bag, life raft or hiker's backpack.

P/N 13-20241\$165.75
Replacement Battery PackP/N 13-20243\$45.50



SURVIVAL KITS

Crashkit Personal and Professional Flight Line Series aviation survival kits are quickly becoming an industry leader in top quality aviation survival kits. Numerous kits are available to suit you piloting and survival needs.

CRASHKIT BRAVO SURVIVAL KIT



The 'Bravo' Personal Aviation Kit is designed for you. The Bravo Crashkit is small and compact, and includes 76 of the most essential items needed to survive. Kit includes basic first aid, light, fire, signal, shelter and methods for providing clean water and food procurement.

The kit is slightly thicker than the Crashkit 'Alpha', but still small enough to be carried easily in small flight bags, jacket pocket, glove compartment, map pouch or cargo pants pocket. Crashkit 'Bravo' weighs in at 1.6 Kilos or 3.52lbs.

While water resistant, crushproof and relatively small, this kit still exceeds all Transport Canada requirements for aviation survival. And with every item tried and tested to ensure it will work flawlessly for you when you need it most, you can count on the tools you need, when you need them P/N 13-04685 **\$268.95**

CRASHKIT CHARLIE SURVIVAL KIT



Including 71 of the most essential items, this kit is extensive in its coverage of necessary tools and supplies. Packaged in a Pelican 1120 case, 'Charlie' is still compact and lightweight enough for easy transport and storage. Every item in this kit has been thoroughly tested and approved to ensure it performs flawlessly when needed, as well as to ensure the ease of use for each individual piece. This kit meets or exceeds Transport Canada's Canadian Aviation Regulations to facilitate survival and rescue. This kit now contains Aquatabs Water Purification and

The Spark-Lite Flint and Tinder Kit. Each package of Mainstay Food Rations contains pre-measured 400 calorie individualized portions, non-thirst provoking lemon flavor daily meals, and suitable from -40F to 300F and ready to eat. The tasty bars contain no cholesterol or tropical oils. Meets all guidelines set by the Department of Defense (SOLAS 74/83). Exceeds the RDA requirements. In an emergency situation, ration to one portion per day or less. Dimensions : 20.6 x 16.7 x 9 cm (8.12" x 6.56" x 3.56") Weight : 1.85 kg (4.07 lbs)..... P/N 13-04686 **\$344.95**

CRASHKIT 10:7 SURVIVAL KIT



The Crashkit 10: 7 is intended for commercial aircraft. The Crashkit 10:7 has enough supplies to sustain ten people for seven days in the event of a crash. Various means of food, fire, water and shelter allow for multiple options; for example, this kit includes not only Mainstay water, but the means for purification, as well as hot chocolate, and tea. Within this indestructible, crushproof and waterproof Pelican 1520 case, 733 of the most essential items needed in a survival situation are packaged and ready for easy use. Every item included in this kit has been thoroughly tested and approved to ensure it performs flawlessly when needed, and meets or exceeds Transport Canada's Canadian Aviation Regulations to facilitate survival and rescue.

P/N 13-22469 **\$1,683.93**

GOGIRL SINGLE TUBE



Includes re-usable tube, baggie and tissue. It's a kit in a tube ready to go! Made from Medical Grade Silicone. Lavender with Pink Tube P/N 13-08566 **\$10.50**

GOGIRL TRAVEL COOLIE



Important Note: GoGirl products can only be shipped within the USA. Cannot ship internationally. A simpler way to store the GoGirl. Just fold your GoGirl in half and insert into the GoGirl Travel Coolie. Makes carrying in a pocket easier than before. Great for fishing and camping.

Note: *GoGirl funnel sold separately. P/N 13-22449 **\$5.98**

CRASHKIT 2-7 SURVIVAL KIT



As a pilot with a professional responsibility to others, we know you will want only the best survival options. The 'Crashkit 2:7' has been designed for use in a typical GA light aircraft and contains over 200 essential items needed to sustain two people for seven days. This Aviation kit contains multiple options for the provision of food, fire and water, including Aquatabs Water Purification Tablets and the Spark-Lite Flint and Tinder kit. The kit is packaged in a Pelican 1200 case and remains

lightweight and compact for ease of storage. As with all Crashkits, all products have satisfied rigorous testing to ensure they surpass Transport Canada regulations for aviation. Crashkit 2:7 exceeds all Transport Canada and Federal Aviation Administration regulations for both survival and first aid, 1-6 person. Dimensions: 27 x 24.6 x 12.4 cm (10.62" x 9.68" x 4.87") Weight: 4.31 kg or 9.50 lbs..... P/N 13-04690 **\$529.95**

CRASHKIT 4-7 SURVIVAL KIT



The Crashkit 4-7, designed for use in typical GA light aircraft and commercial aircraft, contains the materials necessary to sustain four people for seven days in the event of a crash. The variation of items within the kit allows for multiple options for food, fire, water and shelter; for example, in addition to the Mainstay packaged food, a fishing kit and snare are also included. This kit contains 232 of the most essential items needed in a survival situation, packaged within an indestructible Pelican 1400 case. Every item included in this kit has been thoroughly tested and approved to ensure it performs flawlessly when needed, and meets or exceeds Transport Canada's Canadian Aviation Regulations to facilitate

survival and rescue. Dimensions: 13.37" x 11.62" x 6.00" (34 x 29.5 x 15.2 cm) Weight: 17.55lbs Contents: 232 items covering food, fire, water, shelter, and first aid Case: Pelican 1400 case - tough, watertight, polycarbonate case Kit Coverage: 4 people for 7 days (or longer dependent on situation) Optional Acc's: Parachute deployment system; Warranty: Lifetime.

P/N 13-04691 **\$926.00**

CRASHKIT 6-7 SURVIVAL KIT



Intended for commercial aircrafts, our Crashkit 6-7 has enough materials to sustain six people for seven days in the event of a crash. Various means of food, fire, water and shelter allow for multiple options; for example, this kit includes not only Mainstay water, but the means for purification, as well as hot chocolate or tea. Within this indestructible, crushproof and waterproof Pelican 1450 case, 261 of the most essential items needed in a survival situation are

packaged and ready for easy use. Every item included in this kit has been thoroughly tested and approved to ensure it performs flawlessly when needed, and meets or exceeds Transport Canada's Canadian Aviation Regulations to facilitate survival and rescue. Dimensions: 16" x 13" x 6.88" (40.6 x 33 x 17.5 cm) Weight: 22.80lbs Contents : 261 items covering food, fire, water, shelter, and first aid Case: Pelican 1450 case - tough, watertight, polycarbonate case Kit Coverage: 6 people for 7 days (or longer dependent on situation) Optional Acc's: Parachute deployment system; Warranty: Lifetime..... P/N 13-04692 **\$1,195.00**

PERSONAL SIGNALING REFLECTOR



The "Automatic Personal Signaling Reflector" works continuously and automatically 24-7, day and night. You can work on your shelter, gather food/water or rest if injured. Rescuers will not walk by you if you're asleep or if you are unable to respond. The highly reflective silver-coated plastic works with Sunlight, Search Lights and Flashlights. It's always working .

P/N 13-08662 **\$9.70**

PS

SURVIVAL EQUIPMENT



REVERE PARAHATCHET SURVIVAL CUTTING TOOL

Paracord handle unwraps to provide 8.2ft. (25m) of heavy duty cord for emergency use. Lanyard can be removed for additional 1.6 ft. (0.5m) of cord. 5mm black oxide-finished stainless steel blade. Includes nylon sheath with belt loop. Multi-sized hex wrenches. Quick-action rope cutter on back of blade. Built-in wrist lanyard included. Size: 10" x 4" x 0.5". Weight: 11 oz.

P/N 13-15540\$17.50



REVERE SEE-ME STROBE

Both automatic and manual modes. Fast activation in water. Far exceeds USCG requirements for light output and duration. Waterproof/Weatherproof. For use with lithium (5 year) or alkaline (1 year) batteries (not included). Available with lifesteak clip and lanyard. USCG Approved/SOLAS compliant. Typical Light Output is up to 5 cd (min. requirement by USCG is .75 cd). Typical Operation Time is 120 hrs (min. requirement by USCG is 8 hrs).

P/N 10-04580\$26.55



SNOW BROOM

The SNO BRuM offers pilots a way to quickly sweep snow off aircraft wings and away from the user. Great for high wing aircraft. The oversized head (6" x 17") is the largest snow remover available. The aluminum telescoping handle has special cold resistant nylon threads and extends from 27" to 46". Also great for cars, trucks, SUV's, and awnings.

P/N 13-04055\$19.65

ACR FIREFLY PRO SOLAS EMERGENCY DISTRESS STROBE LIGHT



The Firefly PRO emergency strobe light boasts a light output power management system that produces over 41 candela of light per strobe for up to 56 hours of use with AA lithium batteries. Using wide light emission LEDs, it cuts through the foulest conditions creating a super-bright flash visible for over 3.5 miles. **Specifications:** • Size: 4.4 x 2.2 x 1.2 inches / 11.7 x 5.7 x 2.8 cm • Weight: 2.39 oz (68 g) (without batteries) • Operation: Manual ON/OFF switch • Waterproof: Factory tested to 33 feet. (10 m) Lamp: LED - cool white • Strobe Intensity: 41 Candela (Strobe) • Strobe Visibility: Over 3 miles • Strobe Flash Rate: 60 P/M +/- • Strobe Operation: 56 hours • Certification: SOLAS, USCG, MED, IMO LSA, CEP/N 11-14786\$61.75

NEBO POPPY LANTERN AND SPOT LIGHT



Poppy is a combination 300 lumen C-O-B (Chip on Board) LED lantern and bright LED spot light. Poppy is the perfect light for indoor or outdoor use when versatility and powerful lighting are critical. With a rubberized impact-resistant body, Poppy is both rugged and soft to the touch. Poppy easily changes from spot light to lantern with just a slide of its top, revealing a full 360° C-O-B lantern. The handle is designed to easily adjust to conveniently serve both light modes. 4 Assorted Colors (Yellow, Dark Grey, Red, Green). Lantern color is shipped randomlyP/N 13-20219\$19.99

REVERE SURVIVAL TOOL CARD



Thirteen tools protected by a hard plastic credit card-size case: • Attachment loop • Mini Phillips screwdriver • Large flathead screwdriver • Magnifying glass • 8-sided bolt head wrench • Position wrench (4 different sizes) • Butterfly wrench • Large flathead screwdriver • Bottle opener • File edge • Sharp knife edge • Can opener • 2 inch/5cm ruler • Mini compass*. Size closed: 3.3"x2.2"x.5" Weighs 1.6 oz. *For optimum compass performance, separate compass portion from main unit.....P/N 13-15544\$5.35

AURORA FIRE STARTER



Made in the U.S.A. Self contained fire starter. Made of knurled anodized aluminum. Includes a cylinder with built in stainless steel blade at the outside base which is struck by the 1/4" thick ferromagnesium rod, creating a spark. The cylinder and rod screw together and meet at an o-ring creating a waterproof seal to protect the rod from corrosion.

P/N 14-02701\$19.75

G.I. AVIATION SURVIVAL FIRE STARTER



Magnesium shaving edge and sparking insert. Government issue.

P/N 14-02700\$11.50

AVIATION SAFETY HORN



The CRAZEDpilot Aviation Safety Horn is for the pilot who values options - the aviation safety horn is extremely helpful on the ramp to get someone's attention over the roar of a propeller - to off-airport landing preparedness.

But what makes this horn EXACTLY what you need? The CRAZEDpilot Aircraft Safety Horn is completely electronic - it can run on a 9 volt battery for hours of use! Stop and think about the alternative - compressed cans of air are simply DANGEROUS inside an aircraft. A punctured can could become a projectile, or a huge annoyance screaming in your ear during flight.

For all these reasons, the CRAZEDpilot Electronic Safety Horn is the perfect solution pumping out a huge 112 decibels of ear piercing pulsating tones!P/N 11-12917\$28.99

TINDER HOT BOX SOLAR FIRE STARTER SURVIVAL KIT



The Tinder HOT Box Solar Fire Starter™ is a tinder storage box that can start a fire using solar energy, and the inside top cover is also a signal mirror! The Tinder HOT Box Solar Fire Starter™ is used to store fire starting tinder in the air/water tight tinder box portion of the unit that is sealed from the elements using an o-ring seal. This keeps the damp air/water out so your tinder always stays dry! The Tinder HOT Box Solar Fire Starter™ is also a solar powered fire starter. It is designed to function in any environment that will support life; the Tinder HOT Box Solar Fire Starter™ will literally function for as long as our Sun will shine and there is tinder to be found! As a matter of fact our Tinder Hot Box Solar Fire Starter will even function on other planets. 2.625 inches in diameter. .725 inches thick. weighs only 4 oz. can easily fit in your pocket.P/N 13-13091\$39.95

PS

EAR PLUGS-PORTABLE RESTROOMS-CO² DETECTORS

PILOT RELIEF TUBES



HORN
Black molded plastic horn fits into horizontal or vertical brackets. Measures 2-3/8" diameter and weighs 1.3 oz
P/N 13-04168 **\$23.85**



HORIZONTAL BRACKET
Black molded plastic bracket for underseat installation.
P/N 13-04169 **\$24.50**



VERTICAL BRACKET
Black molded plastic bracket for vertical installation.
P/N 13-04170 **\$16.50**



VENTURI
Black molded plastic venturi mounts on fuselage bottom and produces required suction to horn and outlet tubes for fluid ejection P/N 13-04171 **\$31.50**



HORN AND VALVE ASSEMBLY
Dimensions: Length: 8-31/64"; Top opening: 2-21/64"; Bottom opening: 3/16"; Weight: 4 ounces
P/N 13-04167 **\$108.75**



TEE AN8019-1
The material is RTP 152 black. 2-1/32" wide and 1" length..... P/N 13-04172 **\$10.50**

ULTRAFIT™ UNCORDED EAR-PLUGS 340-4001 IN CARRYING CASE



• Patented, premolded, triple-flange design inserts easily. • No rolling or sizing needed to get a comfortable, protective fit. • Hypoallergenic polymer is washable and reusable. • Carrying case keeps plugs clean and accessible for re-use. • NRR 25dB. • ANSI S3.19-1974; CSA Z94.2; CSA Class AL..... P/N 13-02194 **\$1.74**

EZ FIT EAR PLUGS WITH CORD



The E-Z Fit line of EAR plugs was designed specifically for smaller ear canals, providing comfort and a secure fit. The self-adjusting foam and bell shape allow for easy insertion and help to keep the earplug from shifting or dislodging P/N 14-00051 **\$0.86**

CLASSIC™ UNCORDED EARPLUGS 312-1201 IN A POLY BAG



• Slow-recovery foam helps ensure comfort and minimize pressure. • Bright yellow color provides a quick visual compliance check. • Dermatologically safe foam is non-irritating, nonflammable, and moisture-resistant. • NRR 29dB. • ANSI S3.19-1974; CSA Class AL
P/N 9134 **\$0.40/pair**

PRESSURE REGULATING EAR PLUGS FOR CHILDREN



EarPlanes are a patented pressure-regulating earplug inserted in the ear to help reduce discomfort often associated with air travel. They were developed by Cirrus Healthcare Products LLC in conjunction with the House Ear Institute in Los Angeles, and have been tested by US Navy aviators at the Miramar Naval Air Station in San Diego P/N 14-02837 **\$7.95**

OZIUM AIR SANITIZER / FRESHENER



Eliminates smoke and offensive malodors caused by airborne bacteria. OZIUM is a product that sanitizes the air you breathe. It is clinically proven to eliminate odors, unlike current products that just mask odors. OZIUM combats airborne contaminants and eliminates odors with glycol-ized action...dispensing micron sized particles that linger in the air, attach to airborne bacteria and malodors to drastically reduce air pollution, purify and sanitize the air..... P/N 14-00061 **\$11.80**

THE BIFFY BAG



Personal disposable toilet system is a complete toilet that fits in the palm of your hand. Allows for a natural position. It has everything you need for a sanitary, discrete and comfortable experience.
3pk P/N 13-12354 **\$13.50**
10pk P/N 13-12355 **\$36.75**



LITTLE JOHN

Positively the least expensive accessory you can buy to extend your range. One authenticated case reports a Piper Malibu's range extended by 500 miles. Durable plastic, won't crack under any normal handling and temperature conditions. A tight screw-on cap makes it spill proof. Standard issue in hospitals for years..... P/N 9741 **\$10.95**



LADY J ADAPTER

The anatomically designed funnel snaps in and out of the little John. It can be used sitting or even standing. Clean white plastic..... P/N 9745 **\$8.99**



G FUNNEL ADAPTER

The G-Funnel is a portable urinal adapter which simply screws on to any plastic pop or water bottle that will be used as a container for those situations where a washroom facility is not available. Can be attached and used together with any sized plastic pop or water bottle that most people have on hand. A very useful relief device for those emergency situations P/N 13-01974 **\$7.99**



FORENSICS CARBON MONOXIDE DETECTOR

A Small carbon monoxide detector for aircraft for aircraft that triggers alarms in line with air quality regulations, particularly important for health and occupational concerns for pilots. This product remains on calibration for 3 years P/N 13-22019 **\$99.00**



TRAVEL JOHN

Absorbent pouch turns urine into gel instantly while destroying bacteria and odor. Specially designed collar works for men women and children; spill guard prevents back guard during use. Convenient, sanitary and compact, TravelJohn is easy to use while sitting or standing. Will not leak or spill, even if punctured. Holds 28 fl. oz. Includes antiseptic hand wipe. 3-pack.
P/N 13-00894 **\$5.50**



CONVENIENCE BAG

Disposable urine & vomit bag. • Wide mouth. • No spill, cleanup, or odors • One-hand use
P/N 13-02821 **\$2.25**



MOTION EAZE

Whether you want to prevent occasional motion sickness or relieve its symptoms, after the fact, Motion Eaze does the job. No matter, if it's sea sickness, car sickness, air sickness or any activity where motion sickness poses a problem, Motion Eaze really works. Contains no drugs, artificial additives, or stimulants of any kind. Only the freshest, highest quality, natural oils are used in its production. Motion Eaze is an oil that is applied to, and absorbed through, the skin, just behind the ear..... P/N 13-02732 **\$16.50**

SEABAND WRIST BAND



The Sea-Band has been clinically tested against nausea and vomiting in travel, pregnancy, anesthesia, chemotherapy and all conditions which induce nausea. The Sea-Band is a knitted elasticized wrist band, which operates by applying pressure on the Nei Kuan acupressure point on each wrist.
Adult Band..... P/N 9411..... **\$8.75/**
Child Band..... P/N 13-23252 **\$8.75/pr**

SIC-SAC™



Use these for air sickness emergencies. Moisture proof and tear resistant even under extreme temperature changes. 10 sacks, individually packaged, each with attached tie band.
Pack of 10 P/N 9296 **\$9.50**
Pack of 100 P/N 9296-100 **\$98.00**



FLIGHT DATA SYSTEMS GD-40 CARBON MONOXIDE DETECTOR

Integrates with most EFIS Systems - Connect via RS232 or a Switched Input. Audio Voice Alerts. LED and Discrete Warning/Status Outputs - Two color LED included. Monitors Cabin Altitude - Aural Alerts to remind you to don your Oxygen Mask. Calibrated Using Precision Gas - Each unit is individually calibrated and tested before shipping. Built in Self Test Monitors Sensor Quality - Continuous self testing for reliability. Altitude and Temperature Compensated - Has an internal Altimeter and Thermometer. Remote Mounting Takes No Panel Space Dimensions: 4.7 X 3.1 X 1.0 inches. Weight: 4.1 oz..... P/N 11-09843 **\$295.00**

PS

CO DETECTORS

CO GUARDIAN CARBON MONOXIDE DETECTORS



AERO 353-101/201 - The AERO 353 has a built-in state-of-the-art CO sensor that immediately reacts to the presence of CO. It was designed for pilots who want the unit to be small, so it takes up a minimum of panel space, and provides pilots a peace of mind. Detector will go into alarm mode within five minutes if CO level is greater than 50 PPM. The unit has dual light LED alarm; Amber less than 99 PPM and Red 100 PPM and above. Very simple installation (2-4 hours). For experimental aircraft only.

Aero Model 353	P/N 13-16423	\$289.00
Aero Model 353 w/ Pressure Sensor	P/N 13-16424	\$389.00
Aero Model 353 Display Only	P/N 13-16427	\$289.00
CO2 Detector for MVP and CGR	P/N 10-03188	\$289.00
353P-201 Remote Mount	P/N 13-06917	\$399.00



MODEL AERO 553 - Replaces the 2.25" clock and provides the latest CO protection that displays 30 to 999 ppm in the cockpit, as well as aircraft high and low voltage alarms, pressure density altitude readout for takeoff. Cabin altitude alerts to remind you to go on oxygen. CO level, cabin pressure and temperature to be displayed on the UPS AT CNX80.....

P/N 13-02569	\$689.00	
Aero 553 OAT Probe	P/N 13-06165	\$140.75



MODEL AERO 451 - The CO Guardian 451-101 panel mounted Carbon Monoxide (CO) detector is designed especially for FAA certified Part 23 aircraft and Part 27 and 29 rotorcraft. A compact and lightweight unit meant to use as little panel space as possible, the 451-101 combines highly accurate CO detection for the cockpit in a small package. This CO detection unit is perfect for builders and pilots looking for basic protection from the dangers of carbon monoxide in their certified aircraft or helicopter.

Model 451-101 Panel Mount	P/N 13-21110	\$478.00
Model 451-201 Remote Mount	P/N 13-21111	\$399.00



MODEL AERO-452 - Input Power-14 / 28 V DC. Power Usage-Less than 1 Watt, 10 Watts with heater ON. Temp Range - -20° C to 55° C. Inspection - Each Unit 100 % tested. Humidity - 5% to 95% RH (non-condensating). Circuit Breaker-2 Amp. Design-Meets TSO-C48A. Weight-3.5 Oz. Sensor-Tested to 25,000 Ft. Calibration-100 and 500 PPM. Output-Dual Relay Output for, Panel Warning light / Annunciator. WARRANTY: The Aero 452 comes with a 1 year limited warranty. The warranty will be void if the unit has been opened or tampered with.....

P/N 13-07102	\$479.00
--------------------	-----------------



MODEL AERO 452-201-011 - Aero 452-201-011 is the first TSO certified remote-mountable Carbon Monoxide detector for use in General Aviation. This unit is a derivative of Aero 452 (Panel Mount). This unit comes standard with remote re-set switch and a remote light and can be installed behind a panel. This unit is pre-wired for connecting to an external annunciator warning lamp on your panel. Different light models can be purchased separately.....

P/N 13-06918	\$479.00
--------------------	-----------------



MODEL AERO 455 - CO Guardian proudly announces aviation's first built-in pulse oximeter for airplane panels. This Life Guardian Aero-455 has been designed for all aircraft with limited panel space. This small pulse Oximeter with CO Detector mounts easily in most panels and transmits data to the MFD'S via RS232. Current MFD manufacturers include Electronics International, Advanced Flight Technologies, Grand Rapids Instruments and on upcoming releases of Avidyne Entegra Release 9

P/N 11-07993	\$999.00
--------------------	-----------------



AERO-551 - Is fast responding to CO threat detector that is designed to standard 2 1/4 hole. This unit is our most sophisticated CO detector that has an extremely fast response when CO is present. The 551 unit shows continuous CO Level from 10PPM to 999 PPM.

P/N 13-06919	\$589.00
--------------------	-----------------

HONEYWELL BW SOLO WIRELESS BLUETOOTH CARBON MONOXIDE MONITOR



Honeywell BW™ Solo is a easy to service single-gas detector with BLE connectivity that provides real-time visibility into the status and safety of hazardous-area workers, helping companies respond faster, more knowingly and decisively to safety incidents.

Features: User-friendly operation • Easy-to-read display for multiple languages • Lightweight convenience • Ease of maintenance • Serviceability • The new 1-Series sensor for enhanced reliability • Connected Bluetooth Low Energy (BLE) capabilities.....

P/N 13-22414	\$436.38
--------------------	-----------------

AITHRE SHIELD 4.0 CARBON MONOXIDE DETECTOR WITH IOS APP - WHITE



The Aithre Shield 4.0 auto-pairs to your iOS device using the free Aithre Connect app. Readings are collected and graphed in the background and Siri notifies you via your iOS-paired headset when thresholds are crossed. In addition to the app, the Aithre Shield 4.0 itself also has a glowing light indication of the CO levels and an alarm that is triggered at 50 ppm.

Detector Only.....	P/N 11-17141	\$150.00
Detector with Altus Bundle ...	P/N 11-17598	\$487.00

AITHRE SHIELD EX 3.0 BEHIND - THE - PANEL CARBON MONOXIDE DETECTOR



Note: For Experimental Aircraft Only. The Aithre Shield EX 3.0 is the first behind-the-panel device that puts carbon monoxide readings AND tank PSI from your Aithre Altus portable oxygen tank gauge directly on your Dynon SkyView, MGL, Garmin G3X, and Advanced Flight Avionics.

Detector Only	P/N 11-17497	\$400.00
Detector w/Altus Bundle...P/N 11-17597		\$722.65

GASALERT CLIP EXTREME CARBON MONOXIDE MONITOR TWO YEAR BATTERY LIFE



Simply press the start/test button and the GasAlertClip Extreme is ready to use, providing continuous, reliable protection. This carbon monoxide detector requires no calibration, sensor replacement, battery replacement or battery charging. The simplicity of the GasAlertClip Extreme combined with minimal training requirements and negligible maintenance costs make the GasAlertClip Extreme one of the most cost-effective gas detection solutions for facility workers and onsite contractors. Standard Package Contents: Detector complete with specified sensor, stainless steel alligator clip and concussion-proof housing, Test cap and hose, Manual, Multi-language CD manual.

Gas Alert Clip Extreme II CO (2 Years).....	P/N 13-09667	\$159.95
Gas Alert Clip Extreme III CO (3 Years).....	P/N 13-09668	\$428.00

STANDARD CARBON MONOXIDE DETECTOR



Toxic, odorless, tasteless gas produced by incomplete combustion or gasoline, kerosene, natural gas, butane, fuel oil, wood, coal or anywhere fossil fuels are burned. Dangerous levels of CO come from internal combustion engines such as cars, airplanes, and lawn mowers or from any poorly vented or improperly adjusted fuel burning appliance.....

P/N 09-35600	\$3.85
Discount on 5	\$17.33

ASA CARBON MONOXIDE DETECTOR



Carbon Monoxide (CO) is a toxic, odorless, and tasteless gas produced by the incomplete combustion of gasoline, kerosene, natural gas, butane, propane, fuel oil, wood, coal, and other fossil fuels. Dangerous levels of CO can be produced by internal combustion engines or from any poorly vented or improperly adjusted fuel-burning appliance. Exposure to CO may cause sickness, headaches, or even death.....

P/N 13-05755	\$3.95
--------------------	---------------

DIGITAL CO2 DETECTOR



The extremely affordable DCO 1001 has a measuring range of 0-1000 ppm and comes complete with a soft case, a wrist strap, 3 "AAA" batteries and an instruction manual.

Features: • Adjustable co warning level • LCD dual digital display • Bright backlight • self test • Low battery indication • °F/°C selectable • Auto power off • Auto zero • CO range: 0-999ppm • Resolution: 1ppm • Battery life is 250 hours when the backlight is off and 35 hours with the backlight on.

P/N 12-01895	\$174.75
--------------------	-----------------

AITHRE SHIELD EX 2.0 CARBON MONOXIDE DETECTOR



The Aithre Shield EX 2.0 Carbon Monoxide Detector is the first analog output carbon monoxide detector for experimental aircraft that pairs with an iOS app for trend data. Compatible with Dynon Skyview and Garmin G3X

P/N 11-17143	\$300.00
--------------------	-----------------



PROTECTIVE GEAR FOR PETS

MUTT MUFFS



The inner foam that we use is the exact same ester resin foam that is used in many high end commercial head sets designed for humans. Based on the materials used, the estimated decibel reduction is between 21 and 24, assuming proper fit and a good seal against your pup's head.

Specifications:

- Over-the-Head Hearing Protector for animals.
- Specially Designed Wide Foam Filled Ear Seals for Maximum Comfort.
- Engineered specifically to properly meet the contour of a dog's head
- Comfortable and Lightweight
- Adjustable Straps for Optimum Fit.
- Inner sound-deadening foam is the same density found in pilot's high-end headsets
- Made entirely in the United States of America
- Patent Pending

Muff Size	Typical Dog Weight	Head Circumference	Maximum Inner Shell		Weight	Part No.	Price
			Width	Height			
X-Small	5-10 lbs	7-9"	1.5"	1.625"	1.5 oz	13-05536	\$55.75
Small	10-20 lbs	9-13"	1.75"	1.75"	1.7 oz	13-05537	\$55.75
Medium	20-50 lbs	13-18"	2.5"	2.5"	3.0 oz	13-05538	\$59.75
Large	50-95 lbs	18-23"	3.25"	3.25"	4.0 oz	13-05539	\$59.75
X-Large	95+ lbs	23+	4"	4"	5.8 oz.	13-05540	\$59.75

SIZE CHART - The overall circumference measurement of your dog's noggin at the largest point is the best determination of size, because if you choose a size too large, the muffs won't seal well against his head, and you lose all the sound-reducing properties you were shooting for. Your dog's weight is also a good indicator of which size to choose.

CUSTOM COLORS - Ever-classic "Mutt Muff® Black". But now, Mutt Muffs® are available in three additional colors! Red! Blue! and Pink!
P/N 13-05541\$62.75

CO-PILOT - TRIANGLE BANDANA FOR DOGS



The proper uniform for the distinguished canine aviator. Sewn on all three sides. Finished Sizes: Large: 21.5" x 21.5" x 29", Small: 14" x 14" x 20"
Large.....P/N 13-05547\$6.65
Small.....P/N 13-05548\$6.65

HYDRO-BOWL FOR DOGS



Next time your pooch is pantin' for a drink, pull out the convenient, collapsible Hydro Bowl. Waterproof and made of a high-tech, durable plastic canvas, the Hydro Bowl folds up and snaps closed into a compact triangle for storage. Attach it to a leash, backpack, bicycle, or a variety of other places for easy storage. Hold 5 cups
P/N 13-05546\$9.50

DOG IS MY CO-PILOT - BUMPERSTICKER



"Dog Is My Co-Pilot" is the trademarked motto of Bark magazine - accept no substitute. As seen on dog-friendly cars from coast to coast!
P/N 13-05545\$2.85

BARK BAGS

If you take passengers, sooner or later, you're going to need one. 9-3/4" x 4-1/4" to hold alot of chunks. Sold in a package of 3. There could be sympathy heaves.
P/N 13-05543\$4.50



4 PAWS K-9 EAR MUFFS



4 Paws Aviation has come out with hearing protection for your pet. Average of 15 dBHL greater sound reduction than what's on the market today. These Ear Muffs hearing protection is made of nylon, aircraft approved sound deadening foam, non-toxic "gel" cups, webbing, and a safety "break a way" clip.

They can be used with the only oxygen hood delivery system for your pet also offered by 4 Paws Aviation.

Small (5 - 25 pounds 7" & 13" head size)....P/N 13-08288\$61.95
Medium (20 - 85 pounds 9" & 19" head size)..P/N 13-08289\$65.95
Large (Over 85 Pounds & 19" head size)....P/N 13-12807\$71.85

4 PAWS K-9 OXYGEN HOODS



Fight the effects of Hypoxia on your four legged family members by using the only oxygen delivery hood for animals when flying at high altitudes. Keep your pets safe and healthy when flying high.

Hood comes with 7-foot long oxygen supply tubing with a common push on female end. Attaches to a stand-alone bottle or in place oxygen system.

Oxygen hoods are available in five sizes, measurements' include the collar (around the neck) and the length from the nap of the neck to the end of the nose, then add two more inches for clearance.

Size	Collar Size	Hood Depth	Part No.	Price
Small	7.5" To 9.5"	8.5"	13-08290	\$126.75
Medium	9.5" To 13.25"	10"	13-08291	\$127.75
Large	13.25" To 15.75"	12"	13-08292	\$127.75
X-Large	15.75" To 20"	14"	13-08293	\$127.75
XX-Large	20" To Over	17"	13-08294	\$127.75

AEROX PET MASK



Take your pet with you at altitude thanks to AEROX and their line of Canine O2 Mask supplemental oxygen system certified to 25,000 feet. The Aerox® Canine O2 supplemental oxygen system is currently available in 5 sizes:

Small - (Poodles, Shelties, Yorkies, Cavalier, Bichon Frise)

Medium - (Beagles, Keeshounds, Jack Russels, Standard Poodle)

Large - (Cockers Spaniels, Springers, Beagles, Boston Terriers)

X-Large - (Huskies, Labradors, Retrievers, Dobermans)

Giant - (Great Danes, Newfies, St Bernards, 90-160 LBS)

The muzzle incorporates a medium concentration continuous flow oxygen mask and frontal mesh area for best ventilation and oxygen delivery to your pets mouth and nose.

Size	Part No.	Price
Small	13-07460	\$106.85
Medium	13-07461	\$116.75
Large	13-07462	\$118.75
X-Large	13-07463	\$109.95
Giant	13-07464	\$105.75

PS

WEATHER STATIONS – WINDMETERS

WINDSCRIBE HANDHELD WIND METER



A precise, handheld wind meter (anemometer). Also measures maximum headwind, maximum tailwind, a five-second average wind, and a running average wind. Speeds can be displayed in both U.S. and metric units, and the unit also records temperature and wind chill. The WindScribe weighs 3.5 ounces and comes with a lanyard. A velcro strap and mounting bracket are included.

P/N 13-04019\$179.99

WIND WIZARD WIND SPEED INDICATOR ECONOMY MODEL – ACCURATE & COMPACT



Conveniently calibrated in miles/hour, meters/ second and Beaufort. Expanded in the lower wind speed range of 0-20 MPH (0-8.9 meters/sec). Slips easily into a shirt or coat pocket. Safety wrist strap gives added security in stronger winds, and stores out of the way in the folding handle. Constructed of high impact plastic and corrosion resistant metals. It comes with leather-like carrying case. No Batteries needed.....P/N 13-18520\$49.99

SKYWATCH GEOS 11 HANDHELD WEATHER STATION



Features: • Electronic Compass - analogical and digital • Three Data Recording Modes: Manual Recording by pressing two buttons, Automatic Recording at selected intervals (when unit is off or on), and Automatic Recording (when unit is on only) • Bright LED Light - operates on separate battery • Replaceable Ball Impeller - rotates to protect impeller blades • Exposed Sensors - for instant readings

Kit includes: Geos Unit, USB Interface with software, Metallic Support, and Carrying Pouch.....P/N 13-04757\$759.95
Unit OnlyP/N 11-11297\$614.95

SKYWATCH HANDHELD WIND METERS



Designed for consumer and professional use, the Xplorer does not include complicated and seldom-used features such as downloading and storing. Press one button, and instant readings are at your fingertips. Dimension: 3.5 x 1.5 x 0.75 in, 2 oz. (41 x 93 x 17 mm, 50 g) • One button operation • EL Backlight • Completely sealed; internal sensors, • Weatherproof (can be submerged 6 feet) • Replaceable Lithium battery (included and installed) • Stainless steel back • Auto-off after one minute (can be disabled to remain on) • Included lanyard • One year warranty.

Handheld Weather 4P/N 13-04762\$139.95

XPLORER 2 WINDMETER BY SKYWATCH



Dimension: 3.5 x 1.5 x 0.75 in, 2 oz. (41 x 93 x 17 mm, 50 g). One button operation. EL Backlight. Completely sealed; internal sensors. Weatherproof (can be submerged 6 feet). Replaceable Lithium battery (included and installed). Stainless steel back. Auto-off after one minute (can be disabled to remain on). Included lanyard. One year warranty. Designed in Switzerland.....P/N 13-12440\$59.95

XPLORER 3 WINDMETER BY SKYWATCH



Dimension: 3.5 x 1.5 x 0.75 in, 2 oz. (41 x 93 x 17 mm, 50 g). One button operation. EL Backlight. Completely sealed; internal sensors. Weatherproof (can be submerged 6 feet). Replaceable Lithium battery (included and installed). Stainless steel back. Auto-off after one minute (can be disabled to remain on). Included lanyard. One year warranty. Designed in Switzerland P/N 13-12441\$99.95

WEATHER FLOW WIND METER



The WeatherFlow Wind Meter is an anemometer that fits in your pocket. It's the first hardware product we have created for the general wind- & weather-addicted community. It's compatible with iPhone, iPad, iPod, and all major Android (coming soon) devices. And you are going to love it. It's operating range extends from the smallest puff (2 mph) to well over hurricane force winds (125 mph).

P/N 13-14788\$34.95

WIRELESS VANTAGE PRO2 WEATHER STATION



Uses frequency hopping spread spectrum radio technology to transmit data wirelessly up to 1000' (300 m). Console/receiver, integrated sensor suite, and mounting hardware.

Integrated sensor suite includes rain collector, temperature and humidity sensors, anemometer, 40' (12 m) anemometer cable, and solar panel. Sensor suite is solar powered. AC-power adapter included for console, or use with three C batteries (not included). Wireless range is up to 1000' outdoors, line of sight. Typical range through walls 200' to 400'. Add wireless repeaters for distances up to 1.7 miles. Not available in EU (Europe).
Vantage Pro2 (U.S.)P/N 13-05532\$595.00
Vantage Pro2 Plus with UV & Solar Radiation ..P/N 13-05586\$869.00
Mounting TripodP/N 13-04569\$103.75
Replacement Anemometer for Vantage Pro2 & Pro
P/N 13-13073\$128.75



SKYWATCH WINDOO 1 OMNI DIRECTIONAL WEATHER STATION

SKYWATCH® Windoo 1 is an anemometer-thermometer for your smartphone. It measures and indicates the following information. Windspeed. Temperature – Wind chill factor. Measured data can be stored and shared on facebook, twitter or windoo.ch Materials: Housing: anodised aluminium, Protective case: carbon. Wind: Units: km/h, mph, m/s, fps and knots, Resolution: 0.1 unit, Accuracy: ± 2%, Measuring range: from 0 to 150 km/h. Temperature: Units: °C and °F, Resolution: 0.1 unit, Accuracy: ± 0.3 °C, Measuring range: from -25 °C to +60 °C.....P/N 13-16357\$69.95



SKYWATCH WINDOO 2 OMNI DIRECTIONAL WEATHER STATION

SKYWATCH® Windoo 2 is a measuring instrument for your smartphone. It indicates the following information. Windspeed. Temperature – Wind chill factor. Humidity – Dew point. Measured data can be stored and shared on facebook, twitter or windoo.ch. Materials: Housing: anodised aluminium, Protective case: carbon. Wind: Units: km/h, mph, m/s, fps and knots, Resolution: 0.1 unit, Accuracy: ± 2%, Measuring range: from 0 to 150 km/h. Temperature: Units: °C and °F, Resolution: 0.1 unit, Accuracy: ± 0.3 °C, Measuring range: from -25 °C to +60 °C. Humidity: Units: %RH, Resolution: 0.1 unit, Accuracy: ± 4.5 %RH, Measuring range: from 0 to 100 %RH.....P/N 13-16358\$94.95



SKYWATCH WINDOO 3 OMNI DIRECTIONAL WEATHER STATION

SKYWATCH® Windoo 3 is a weather station for your smartphone. It measures and indicates the following information. Windspeed. Temperature – Wind chill factor. Humidity – Dew point. Pressure. Measured data can be stored and shared on facebook, twitter or windoo.ch. Materials: Housing: anodised aluminium, Protective case: carbon. Wind: Units: km/h, mph, m/s, fps and knots, Resolution: 0.1 unit, Accuracy: ± 2%, Measuring range: from 0 to 150 km/h. Temperature: Units: °C and °F, Resolution: 0.1 unit, Accuracy: ± 0.3 °C, Measuring range: from -25 °C to +60 °C. Humidity: Units: %RH, Resolution: 0.1 unit, Accuracy: ± 4.5 %RH, Measuring range: from 0 to 100 %RH. Pressure: Units: hPa, mbar, inHg, Resolution: 0.1 unit, Accuracy: ± 0.2 hPa, Measuring range: from 300 to 1100 hPa.....P/N 13-16359\$114.95

AVIATION WEATHERVANES



The weathervanes are made of 14 gauge steel and come with a one year warranty on the finish and a lifetime warranty on all workmanship. Dimension: 17-3/4" x 6-1/2" Weathervanes are shipped standard with a 60" garden stake. Weathervanes may also be ordered with a different stand as a special order only. No additional charge will apply. The different stands that are available are: 15" Roof Mount, 15" Deck Mount, or a 15" Post Mount.

Description	Part No.	Price
Lo Wing Garden Weathervane	13-07217	\$60.75
Cessna Garden Weathervane	13-07215	\$58.95
Helicopter Garden Weathervane	13-07220	\$59.95
Hi Wing Garden Weathervane	13-07216	\$60.75
Cessna Roof Weathervane	13-08142	\$58.95
Cessna Deck Weathervane	13-08143	\$60.75
P-51 Roof Weathervane	13-11256	\$60.75
P-51 Garden Weathervane	13-11305	\$60.75
B-17 Garden Weathervane	13-07213	\$60.75
Bi Plane Garden Weathervane	13-07214	\$58.95
Tri Motor Garden Weathervane	13-07218	\$60.75
B-17 Roof Weathervane	13-08078	\$60.75
Bi Plane Roof Weathervane	13-08139	\$58.95
Bi Plane Deck Weathervane	13-08140	\$60.75
Bi Plane Post Weathervane	13-08141	\$58.95

SEE OUR WEBSITE FOR A COMPLETE LIST.



COCKPIT COOLERS

THE ICEBOX PORTABLE AIR CONDITIONER



The IceBox is a portable air conditioning system, for your airplane cabin, car, or boat. For Pilots: No more flying in a scorching hot cabin! Turn ON the IceBox during preflight and cool your cabin down before engine start. Jump in and experience a comfortable taxi and departure to a cooler altitude. Enjoy hours of IceBox cooling power and control your comfort with the wireless remote Pump and Fan controls. TIP: During cruise flight, Turn OFF the water pump at altitude to sustain the longest A/C possible. In Cruise Flight Mode -- Keep the fan running to push cooler air through the cabin
For General Use: Use the IceBox portable air conditioner in any environment, with or without available electrical power. Cool down the car or boat with the IceBox, and keep your engines off in the process.

Specifications:

- Electrical: 12V or 24V. Max Power Consumption 4.5 Amps
- Dimensions: 10"x13"x18"
- Weight Empty: 10lbs

Voltage	Description	Part No.	Price
12V	Wireless Unit	08-16237	\$395.00
12V	Full System	08-16242	\$536.00
24V	Wireless Unit	08-16238	\$439.00
24V	Full System	08-16243	\$578.00



ICEBOX PILOT CABLE

Pilot's Cable to switch between ship's power and Aux Battery (useful for preflight, fuel stops and post-flight draining of the IceBox).....P/N 08-16241**\$59.99**

COOL MOVE TRAVEL COOLER



Soft sided electric travel cooler with cigarette lighter car plug in. Cools without ice which leaves you more room for food and drink. Quiet, long lasting motor powered by 12V vehicle outlet. 14 quart capacity that holds up to 20 cans plus snacks. Collapsible cooler takes up minimal space and allows

for easy storage. Iceless cooling performance powered by thermoelectric technology that allows you to travel without the mess and inconvenience of ice. Digital Thermometer indicates ambient cooler temperature. Made with high quality materials for durability and toughness that's built to last. Plug in A/C adapter for use in the office, hotel room, camper, or dorm (not included).....P/N 08-14007**\$59.75**

B-KOOL PORTABLE COOLING SYSTEMS



Using a combination of ice and water, B-Kool™ provides up to an hour of 40° cool air using just 10 lbs of ice and a minimal amount of water. B-Kool™ is NOT an evaporative cooler and works well in high Humidity areas. Capacity is 20 lbs of ice giving you over 2 hours of cool air. Kool-Flex, a flexible and expandable air duct. Can be expanded to over 2 feet and positioned so air can be ducted where you want it. Because the B-Kool™ weighs less than 10 lbs empty, you can easily move it from your Camper, Airplane, Boat or any area where either 12 or 24v DC current is available.

12V Base Unit.....P/N 13-16043**\$325.00**
24V Base Unit.....P/N 13-16044**\$351.00**

KEWLFLOW PORTABLE COOLER



The ice cooler or backpack that holds the ice and water can be easily refilled for continuous cooling over extended periods. Includes 12V Adapter. 4 quarts. 6429C includes 6429 Vest and Cooler. 100% Nylon Carrying Case with spill proof inner cooler. Unit includes water reservoir, pump, and power source. Insulated tubing and manifolds enable maximal cooling. Easy to use quick connectors allow for convenient operation. Can operate with variable power sources (battery, 12V, 110AC). Cooling Duration: Up to 3 hours. Typical users include surgeons, motorcyclists, and others needing personal cooling relief.P/N 13-15509**\$307.00**

KEWLFLOW PORTABLE BACKPACK



KewlFlow™ products use a combination of ice water and pumps to push cold water through special tubes built into vests. This allows for a continuous flow of cool water around the upper body, keeping the user cool and comfortable in any condition. The backpack that holds the ice and water can be easily refilled for continuous cooling over extended periods. Includes battery pack. 4 liters. 100% Nylon Back Pack with integrated water reservoir, pump, and power source. Padded shoulder straps with variable sizing adjustments. Insulated tubing and manifolds enable maximal cooling. Easy to use quick connectors allow for convenient operation. Can operate with variable power sources (battery, 12V, 110AC). Cooling Duration: Up to 3 hours. Typical users include motorcyclists, welders, painters, and others requiring a portable cooling solution.P/N 13-15510**\$475.00**

CIRCULATORY COOLING VEST WITH STATIC COOLER



Includes 12V Adapter. Includes Vest and Cooler. 100% Nylon Carrying Case with spill proof inner cooler. Unit includes water reservoir, pump, and power source. Insulated tubing and manifolds enable maximal cooling. Easy to use quick connectors allow for convenient operation. Can operate with variable power sources (battery, 12V, 110AC). Cooling Duration: Up to 3 hours. Color: Black, Size: 9 Quart Cooler. Typical users include surgeons, motorcyclists, and others needing personal cooling relief.

Size	Part No.	Price	Size	Part No.	Price
Small	13-15507	\$661.00	X-Large	13-15507-XL	\$661.00
Medium	13-15507-M	\$661.00	XX-Large	13-15507-2XL	\$661.00
Large	13-15507-L	\$661.00			

CIRCULATORY COOLING VEST WITH PORTABLE BACKPACK



Includes Vest and Backpack. 100% Nylon Back Pack with integrated water reservoir, pump, and power source. Padded shoulder straps with variable sizing adjustments Insulated tubing and manifolds enable maximal cooling. Easy to use quick connectors allow for convenient operation. Can operate with variable power sources (battery, 12V, 110AC). Cooling Duration: Up to 3 hours. Typical users include motorcyclists, welders, painters, and others requiring a portable cooling solution.

Size	Part No.	Price	Size	Part No.	Price
Small	13-15508	\$799.00	X-Large	13-15508-XL	\$801.00
Medium	13-15508-M	\$677.00	XX-Large	13-15508-2XL	\$775.00
Large	13-15508-L	\$677.00			

VISIT WWW.AIRCRAFTSPRUCE.COM FOR MORE KEWLFLOW HEATING AND COOLING VESTS.

PS

COOLERS

YETI® TUNDRA® COOLERS

YETI makes the world's best coolers. Extreme design and construction assure you a lifetime of extreme performance. No other cooler is as durable. No other cooler keeps ice longer. No other cooler compares.



FATWALL™ DESIGN

Extra-thick walls hold up to two inches of insulation for unmatched ice retention.

ROTOMOLDED CONSTRUCTION

Makes it armored to the core and virtually indestructible.

PERMAFROST™ INSULATION

Pressure-injected commercial grade polyurethane foam in the walls and lid makes sure your ice stays ice.

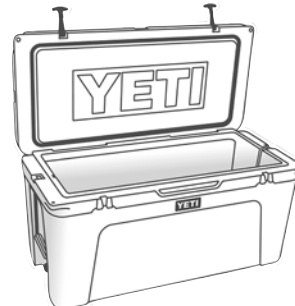

Cooler	Part No.	Price	Weight	Exterior		Interior	
				Height	Top	Height	Top
Tundra 35							
White	13-19106	\$249.99	20 lbs	15-1/2"	L 21" W 16"	10"	L 15" W 10-1/2"
Tan	13-19107	\$249.99					
Seafoam	13-22129	\$249.99					
Tundra 45							
White	13-19109	\$299.99	23 lbs	15-1/2"	L 25-1/2" W 16"	9-7/8"	L 19-1/2" W 10-1/2"
Tan	13-19111	\$299.99					
Tundra 65							
White	13-19117	\$349.99	29 lbs	16"	L 30-1/2" W 17-1/2"	10-1/8"	L 24-1/2" W 12"
Tan	13-19118	\$349.99					
Seafoam	13-22131	\$349.99					
Tundra 75							
White	13-19120	\$449.99	34 lbs	18"	L 33-1/4" W 18"	12"	L 27-1/4" W 12-1/2"
Tan	13-19121	\$449.99					
Tundra 105							
White	13-19122	\$479.99	36 lbs	20"	L 30-1/2" W 19-1/2"	14-1/4"	L 24-1/2" W 14"
Tan	13-19123	\$479.99					
Tundra 110							
White	13-19124	\$499.99	39 lbs	20"	L 37" W 18"	13-3/4"	L 31" W 12-1/2"
Tundra 125							
White	13-19125	\$549.99	48 lbs	20"	L 40" W 19-1/2"	14-1/4"	L 34" W 14"
Tundra 160							
White	13-19126	\$679.99	54 lbs	21-1/2"	L 45" W 19-1/2"	15-1/2"	L 39" W 14"
Tundra 210							
White	13-19127	\$799.99	62 lbs	24"	L 39-3/8" W 25-1/2"	19-3/4"	L 33-3/8" W 19-5/8"
Tundra 250							
White	13-19128	\$899.99	70 lbs	21-1/4"	L 55" W 22-5/8"	15-1/2"	L 49" W 17"
Tundra 350							
White	13-19129	\$1,299.99	89 lbs	23-1/4"	L 63-1/4" W 24-1/2"	18-3/8"	L 57-1/4" W 18-1/2"

YETI® HOPPER™ FLIP SOFT COOLERS



Meet the leakproof, tough-as-nails, carry-the-day soft cooler. Its wide-mouth opening makes for easy loading and access to your food and drinks. Its compact, cubed body means ultimate portability — go off road, onto the water, and back again with this personal cooler. And its extreme insulation means your ice is staying ice.

DRYHIDE™ SHELL

The Hopper's high-density fabric is waterproof and resistant to mildew, punctures, and UV rays. The liner is made from an FDA-approved food-grade material.

COLDCELL™ INSULATION

Closed-cell rubber foam offers far superior cold-holding to ordinary soft coolers.

HYDROLOK™ ZIPPER

The toughest, highest-performing waterproof and leakproof cooler zipper in the world.

Hopper Soft Cooler	Part No.						Price	Weight	Outside	Inside
	Fog Gray/Tahoe Blue	Charcoal	River Green	Coral	Navy	Sagebrush Green				
FLIP 8	---	13-22252	---	13-22490	---	---	\$199.99	2.8	8" x 10-1/2" x 11-1/2"	6-1/4" x 7-1/2" x 9-3/4"
FLIP 12	13-21090	13-22068	13-22254	13-22491	13-23246	13-23315	\$249.99	3.1	10" x 11-1/2" x 12-5/8"	8" x 9" x 11"
FLIP 18	---	13-22253	---	13-22492	---	13-23316	\$299.99	5.1	10-3/4" x 13" x 16-1/4"	8-1/2" x 10-1/4" x 14-1/4"

VISIT WWW.AIRCRAFTSPRUCE.COM FOR MORE YETI PRODUCTS!

WWW.AIRCRAFTSPRUCE.COM



COOLERS - RV ACCESSORIES

YETI® TANK®



The best times in life seem to involve good friends, family, and a healthy supply of ice-cold drinks nearby. So we designed the YETI TANK to be the perfect centerpiece of all the fun. This nearly indestructible party machine is packed with our patented cold-holding insulation to keep your next backyard barbecue, tailgate, or beach side bonfire wilder, longer. ROTOMOLDED CONSTRUCTION - Makes it armored to the core and virtually indestructible. NO SWEAT™ DESIGN - Keeps it dry on the outside.

Cooler	Part No.	Price	Weight	Exterior		Interior	
				Height	Top	Height	Top
TANK 45							
White	13-19133	\$199.99	13 lbs	16-1/4"	L 21" W 21"	13 7/8	L 17-1/8" W 17 -1/8"
DesertTan	13-19134	\$199.99					
Seafoam	13-22133	\$199.99					
TANK 85							
White	13-19137	\$249.99	20 lbs	19-1/2 "	L 25-1/2" W 25-1/2"	16	L 20-1/2" W 20-1/2"
DesertTan	13-19138	\$249.99					
Seafoam	13-22134	\$249.99					

YETI® RAMBLER™ DRINKWARES

The Rambler series of drinkware is the first line of YETIs you can fit in your hand. And, yeah, they over-engineered them to be virtually indestructible and keep your drink as cold (or hot) as science allows. With 18/8 stainless steel construction, double-wall vacuum insulation, and No Sweat™ Design, they're perfect for the deer lease, cleaning table, or just the times in between your outdoor adventures. 18/8 STAINLESS STEEL - Made with kitchen-grade stainless steel, so they're puncture- and rust-resistant. DOUBLE-WALL VACUUM INSULATION - Keeps cold drinks cold and hot drinks hot until the last sip. NO SWEAT™ DESIGN - Keeps fingers dry and unfrostbitten.



Rambler	Size	Outside	Stainless	White	Seafoam	Black	Navy	Graphite	Copper	Northwood Green	Price
Lowball	10 oz.	4 1/8" x 3 1/2"	13-19154	--	13-19828	13-19830	13-21529	13-23325	13-23326	--	\$19.99
Bottle with Hotshot Caps	12 oz.	7 1/8" x 3"	--	13-22249	13-21054	13-21056	13-22126	--	--	--	\$29.99
Mugs	14 oz.	3 3/4" x 5"	13-20981	13-21235	13-21058	13-21060	--	--	13-23167	13-23327	\$24.99
Tumbler	20 oz.	6 7/8" x 3 1/2"	13-20686	13-21236	13-20682	13-20684	13-21531	13-23164	13-22763	13-23318	\$29.99
Bottle with chug cap	26 oz.	10 1/4" x 3-3/8"	13-20985	13-22789	13-20992	13-20990	13-21534	--	13-22793	13-23341	\$39.99
Tumbler	30 oz.	7 7/8" x 4"	13-20691	13-21239	13-20687	13-20689	--	--	13-22764	13-23337	\$34.99
Bottle	18 oz.	9 1/2" x 3"	13-19157	--	13-19832	13-19834	--	--	--	--	\$29.99
Bottle	36 oz.	10 3/4" x 3 3/4"	13-19158	13-21246	13-19836	13-19838	13-21535	13-22794	13-22796	13-23343	\$49.99
Colster	12 oz.	4 7/8" x 3-1/8"	13-19167	13-21247	13-19824	13-19826	13-21528	13-22761	13-22798	13-23344	\$24.99
Colster Slim	12 oz.	6-1/8" x 3-3/4"	13-22800	13-23159	--	13-23157	13-23158	13-23346	13-23347	--	\$24.99
Colster	16 oz.	6" x 3"	13-23160	13-23163	13-23162	13-22762	13-23161	--	--	--	\$29.99



Rambler	Outside	Stainless	Price
Half Gallon Jug	13 1/2" x 5 7/8"	13-19760	\$99.99
One Gallon Jug	15" x 6 3/8"	13-19761	\$129.99



Rambler	Size	Outside	White	Seafoam	Navy	Black	Price
Wine Tumbler	10 oz.	4-1/2" X 3-1/2"	13-22135	13-22137	13-22246	--	\$99.99
Wine Tumbler (2 pack)	10 oz.	4-1/2" X 3-1/2"	13-21786	13-21787	--	13-22138	\$129.99

VISIT WWW.AIRCRAFTSPRUCE.COM FOR MORE YETI PRODUCTS!

THE NOSE JOB 1 FOR RV NOSE GEAR



Anti-Splat-Aero is very proud to offer this revolutionary product (THE NOSE JOB 1) as a partial solution to the nose gear leg fears of many RV-A model builders, current owners and potential buyers of these wonderful aircraft. After watching, reading, analyzing, researching and waiting for someone to offer up a solution we decided to go to work on the problem. This product allows the Van's nose gear leg to function as designed without interfering with its dynamics or operation in any way. The product only comes into play when the forces on the gear leg, if allowed to increase further, would become greater than the gear leg was designed to see or handle without permanent damage to itself or the aircraft. When operating your aircraft from an unimproved surface i.e. grass, dirt, poor runway surface or in an emergency off field landing this device could help prevent a costly repair, a propeller strike, engine disassembly for inspection or other damage may be avoided not to mention a dreaded possible flip over we have seen so many times.
P/N 05-12363**\$379.00**

THE NOSE JOB 2 FOR RV NOSE GEAR



After many requests and making dozens of custom units, we are proud to offer this variation of our product "THE NOSE JOB TWO" as a partial solution to the nose gear leg fears of many RV-A model builders, current owners and potential buyers of these wonderful aircraft. Many of you requested a kit that would not require the fitting of a new fairing.
The preparation and fitting of the new fairing is a complex problem for a non-builder and most don't wish to deal with it. Also many finished airplanes have very expensive and elaborate paint jobs and this is a deterrent to many people as well. So in response to the demand here is a "NOSE JOB TWO" kit that will fit under the stock Vans fairing and provide the same protection as our original unit. We now feel our product is the most logical, simple and inexpensive device that can be manufactured and installed in an effort to address these gear leg concerns.
P/N 05-12364**\$339.00**

THE LIP SKID

Prevents nose gear from digging into turf on dirt and grass runways. This device was created to help prevent flip-overs of the Vans RV-A Models on irregular surfaces. It installs in the bottom of the nose gear, providing surface area to keep the gear leg from digging in on contact. Installation only takes a few minutes and can possibly prevent a flip-over and serious damage to your aircraft. The center post is precision machined from 4130 grade aircraft steel as is the skid plate. Assembled and heat treated to a 45 rockwell, then zinc plated to provide a lifetime of protection for your aircraft. This comes with a vibration preventing O-ring for inside the gear leg and complete installation instructions to install inside the wheel pants out of sight. Total weight of this installed is 7 oz.

P/N 05-12365 **\$95.00**

PS

FLASHLIGHTS

MAGLITE LED FLASHLIGHTS



MAG-LED™ Technology known for their obsession with precision engineering, craftsmanship and commitment to perfection, was not satisfied with the performance of a "regular" LED as a usable light source. They set their sights on producing a light source that would not only incorporate longer battery life, but would also have the kind of durability, reliability, and performance Maglite® flashlights are known for. With an emphasis on uncompromising performance, MAG-LED™ Technology is the result of that quest.

LED Mini Maglight 2-cell AA - Black P/N 13-04722 ..\$19.95
LED Mini Maglight 2-cell AA, w/Holster - Grey Pewter

P/N 13-04917 ..\$19.95
LED Maglight 2 Cell D hang pack- Black..... P/N 13-04724 ..\$31.75
LED Maglight 2 Cell D hang pack- Grey Pewter P/N 13-04880 ..\$34.95
LED Maglight 3 Cell D hang pack- Black..... P/N 13-04725 ..\$32.50
LED Maglight 3 Cell D hang pack- Grey Pewter.... P/N 13-04881 ..\$32.80

ACCESSORIES PACK - Includes: Pocket clip, lanyard wrist strap with key ring, anti-roll device, red, clear, and blue lenses.
P/N 13-04727\$3.95

MAGLITE XL 200 LED FLASHLIGHTS



This XL™ SERIES of COMPACT FLASHLIGHTS offers FIVE BASIC, EASY-TO-USE FUNCTIONS plus Advanced Features and the STUNNING BRIGHTNESS of a Next-Generation LED. By the simple "QuickClick" method introduced with our popular Maglite® XL50™ flashlight, the XL200™ lets the user select the desired function. Motion-controlled variable power level and strobe rate. Easy to use. Powerful Projecting LED Beam. Pushbutton tailcap switch. Compact, Pocket Size Design.

Color	Part No.	Price
Black	13-16539	\$43.50
Red	13-16540	\$36.50
Gray	13-16541	\$36.50
Blue	13-16542	\$39.50



MAGLITE D CELL ACCESSORY PACK
Mounting Brackets (Fit D-Cell Only) Mount your Mag-Lite® flashlight on a wall, in a vehicle, boat, airplane or home. Lens Holder / Anti-Roll Device This item both retains a colored lens and helps prevent the flashlight from rolling off irregular surfaces. Note: The Lens Holder and Lenses may also be used on "C" cell Mag-Lite® flashlights.

P/N 13-04886\$8.50

MAGLITE FLASHLIGHTS



Mini Maglight AA - Black...P/N 13-04913\$11.75
Maglight 2 Cell D - Black.....P/N 13-04915\$22.50
Replacement Bulb for 2D Cell..P/N 13-13594\$3.65

MAGLITE XL50 LED FLASHLIGHT BLACK



Features: Compact, pocket sized design (every day carry). Adjustable LED Beam (Spot-to-Flood). Durable, rugged, machined aluminum case Anodized for corrosion resistance and durability. Intelligent energy source management - continuously monitors the balance between high brightness and efficient power usage allowing for prolonged battery life. Powered by three (3) AAA alkaline batteries (included). Individually serial numbered

Color	Part No.	Price
Black	13-08982	\$33.55
Red	13-08989	\$31.95
Gray	13-08990	\$33.55
Silver	13-08991	\$32.50
Blue	13-08992	\$32.50

NEBO CHAMELEON TRI COLOR FLASHLIGHT



No color filters...no separate heads...and no extra attachments. The Chameleon™ by NEBO offers 3 vibrant colors all in one convenient, compact flashlight. One color changing LED switches from white to green to red with the touch of the glow-in-the-dark On/Off button. The Chameleon™ features a 4x adjustable zoom to change the beam from spot light to flood light with the simple twist of the head.

P/N 13-17163\$20.65

VANTAGE VUE WIRELESS WEATHER STATION



Includes: • Integrated Sensor Suite: Wireless, Rain Collector, Anemometer, Weather Proof Cover, Radiation Shield, Wind Direction, Solar Panel, Bubble Level. • Console: Time & Date, Moon Phase, Forecast Icons, Temperature Icons, Temperature & Humidity, Retransmits, Barometer, Variable Display Options, Rain Totals, "Change in Weather" Feature, Weather

Center, User-Friendly Keypad, Graphs, "This Time Yesterday" Feature, Alarms, Wind Speed • Mounting hardware (mounting pole sold separately) Weather Station.....P/N 13-11572\$357.00
Mount Pole Kit.....P/N 13-11576\$37.50
Mounting Tripod.....P/N 13-04569\$103.75

See www.aircraftspruce.com for additional options.

BEND-A-LIGHT



Bend to any configuration and illuminate hard-to-reach areas where conventional lighting cannot go. The incredibly brilliant light beam penetrates anywhere! A must for electronics, automotive, maintenance, repairs, locksmiths, industrial, hobbies, around the house and more. The only complete line of professional quality high intensity flexible light tools. Available in 3 lengths and 3 different lamps to choose from. Made in USA and come with batteries installed.

Part No.	Description	Length Flex Shaft	Length Overall	Battery	Bulb	Price
12-15005	Mini Pro	6"	11.5"	2-AAA	12100	\$19.95
12-15150	Pro	15.75"	24"	3-AAA	12110	\$39.95
12-10250	Removable Shaft	9.5"	15.75"	2-AA	12100	\$22.65

Part No.	Description	Dia	Bulb Life	Price
12-15020	12100 - Replacement Lamp	5/32"	4 Hours	\$7.50
12-12110	12110- Krypton Lamp	5/32"	20 hours	\$9.50

AVIATOR'S QUIQLITE



Extra Bright LED, available with Red, Green, White or Blue Light. Handy pocket clip and rotating arm. Rotating "light arm" allows you to place the light where you need it. Push-button On-Off switch with convenient 7 minute Auto-Off feature. Over 40 hours of light using replaceable lithium watch batteries (included).

Fits easily into shirt or uniform pocket.

Green LED Quiqlite.....P/N 13-02728\$4.50
White LED Quiqlite.....P/N 13-02730\$4.50

SURE CHECK FUEL LIGHT



Will assist in ensuring your safety every time you strain test your fuel prior to flight. At night, it's safe & easy to use. The Sure Check Fuel Light, when used with your fuel test tube, will light up all the water and debris that might be present. The case is made of durable aluminum, weighs only 2.2 ounces, is 3" long, and uses a 12 volt battery to power a high intensity white LED light bulb. The casing is sealed with a strong neoprene rubber seal to keep any fuel from leaking into the case. Color: Red. Made in USA.....P/N 13-04207\$17.95

FLIGHT OUTFITTERS BUSH PILOT RECHARGEABLE FLASHLIGHT



Illuminate the night with this powerful, rechargeable flashlight. Smart Select Dial provides five unique light modes that can be accessed without scrolling through each one. Blast up to 1,000 lumens of white light for

safe preflight inspections, or provide up to 120 hours of low-level green light so you don't disturb sleeping passengers. An adjustable beam provides spot and flood light modes, and there's even a strobe setting for emergency signalling.

The Bush Pilot Flashlight is charged via a USB port, so you don't have to worry about carrying AA batteries; it will recharge from your cigarette lighter, portable battery pack, or wall plug. Plus, the same charging port can provide output for keeping your phone at 100% (does not charge tablets). Constructed with aircraft-grade aluminum, the Bush Pilot Flashlight is water-resistant and tough enough to survive life in a bush pilot's airplane. A magnetic base makes mounting to crew cars or luggage carts quick and easy—it's perfect around the hangar. No flight bag is complete without this ultimate backup flashlight.

P/N 13-23255\$89.95

PS

PILOT FLASHLIGHTS

SUREFIRE G2X™ PRO

 A polymer-body version of the 6PX Pro, uses a high-efficiency LED—virtually immune to failure since there's no filament to burn out or break—that provides two light output levels: a brilliant, penetrating, perfectly pre-focused 200-lumen beam, and a 15-lumen low-output setting that lets you greatly extend the runtime per set of batteries, an invaluable option when you find yourself miles from civilization. Press the tailcap switch for momentary-on low, press further to click constant-on low, return to off and press or click on again within two seconds for high. A polycarbonate micro-textured reflector delivers a comparatively wider beam with generous peripheral light P/N 13-10290 **\$71.00**

SUREFIRE G2Z-MV COMBATLIGHT® FLASHLIGHT

 SureFire's single-output G2Z™ Combatlight® with Max Vision™ flashlight—designed and built specifically for tactical use—features a proprietary reflector that shapes the high-output LED's 650 lumens of light into a wide, useful MaxVision Beam™ optimized for your field of vision. With its designed 14 mm bezel, the compact G2Z is even shorter and lighter in weight than its predecessor, generates nearly twice the output, and has all of the same features for outstanding tactical performance. P/N 13-20653 **\$119.00**

SUREFIRE LITHIUM BATTERIES

 Optimized for use in SureFire flashlights, SureFire lithium batteries pack a lot of power into a small package. And unlike some other batteries SureFire high-performance lithium batteries boast a ten-year shelf life, which means they will be ready when you need them, every time. For all SureFire Lithium battery powered lights.
12 Pack P/N 13-18714 **\$31.50**
2 Pack P/N 13-18715 **\$5.35**

SEE WWW.AIRCRAFTSPRUCE.COM FOR A COMPLETE SELECTION OF SUREFIRE FLASHLIGHTS.

AVEO THE AVIATOR FLASHLIGHT

 World-Class Aveo™ circuitry. Ni-MH rechargeable batteries. Fixed 25° Lens. Single color light (White). Steady, strobe and SOS function. Dimming – Stepless slide-switch 0-100%. Charge level indicator on the flashlight. DO-160G Environmentally qualified. Anodized aluminum construction. Black anodizing color. IP68 Waterproofness. DC Battery charger included. Charging/Mounting cradle option (not included). Low EMI, low self-discharge, overheat protected. Private logo/label available P/N 11-15181 **\$429.00**

FLIGHTLIGHT™ - PILOT FLASHLIGHT

 A flashlight is a must have for every pilot's flight bag. In or out of the cockpit, this conveniently sized, long lasting, and durable flashlight serves as a great pilot companion. This 3-in-one LED flashlight toggles between red, green, or white depending on your cockpit needs. With an LED life of 100,000 hours, the included alkaline batteries can keep this flashlight illuminated for up to 17 hours in "red" mode and 14 hours in "white". P/N 13-01067 **\$17.95**

WORKBRIGHT INSPECTION LIGHT

 This shop light is perfect for places that a flashlight can't quite illuminate properly. It was originally designed as an inspection light, but has many other uses as well. It is powered through a USB connector, and can be used with a battery pack, wall adapter, computer, etc.
Features: • USB Powered, 250mA (1.25W) • 140 lm • Color Temp: 5000 K • CRI: 80 • Cable Length: 6.5' • Outer Dimensions: 2.5" x 3" x 1" • Meets FCC Class B Requirements • Velcro Cable Tie Included • IP20 (not fluid or dust proof) • Compatible with UD1 Controller. P/N 12-04780 **\$119.95**

NEBO MYPAL PERSONAL ALARM AND LIGHT

 The first NEBO flashlight designed just for women is the MYPAL, a rechargeable personal alarm and light. The various light modes make the MYPAL perfect for any task at hand, and the 400 lumen TURBO mode can light up any space. The MYPAL also features an ear-piercing, 115dB safety alarm and distress strobe to provide safety right at your fingertips. The MYPAL's compact size fits perfectly in a purse or on a key chain.
* 2 Assorted Colors (Black, Pink)*
* Nebo MYCRO Pocket Light color is shipped randomly. P/N 13-22458 **\$29.99**

SUREFIRE E1B-MV BACKUP™ FLASHLIGHT

 The sleek, ultra-compact E1B-MV was originally developed as backup lights for law enforcement pros. This outstanding everyday-carry light sets itself apart from the rest of the Backup family with its broad, useful MaxVision Beam™, created by a special faceted reflector that shapes the LED's light into a smooth, seamless wall of light that's perfect for closer-range applications and maintaining situational awareness. P/N 13-20652 **\$139.00**

SUREFIRE AVIATOR® DUAL-OUTPUT LED FLASHLIGHT

 The ultra-compact, dual-output Aviator reinvents a classic SureFire design to provide a primary white LED and secondary colored LED in one sealed head, both focused into a useful beam with ample reach and surround light by a proprietary Total Internal Reflection (TIR) lens. Pull and twist Aviator's self-locking selector ring to set it to white or colored light, no filter required.
Blue Light P/N 13-20654 **\$269.00**
Red Light P/N 13-20655 **\$269.00**

SUREFIRE FURY-DFT FLASHLIGHT

 The "DFT" stands for dual fuel tactical, and represents the natural evolution of the best-selling Fury® Tactical flashlight into a single-output 1,500* lumen light that can also function as a searchlight. The dual fuel feature means the light can be powered by either two 123A lithium batteries or a single economical 18650 lithium rechargeable battery. The high-strength aerospace aluminum body and tailcap are knurled for a secure grip and Mil-Spec hard anodized for extreme resistance to abrasion and corrosion P/N 13-21609 **\$199.00**

SUREFIRE SIDEKICK RECHARGEABLE KEY CHAIN FLASHLIGHT

 This ultra-compact, powerful LED illuminator was created so it could be carried and used by everyone. The rechargeable Sidekick was designed to attach to keys so it's always available and, most importantly, ready for everyday use and emergencies. This polymer-bodied light features three levels of output that will provide security and peace of mind, no matter what. On high and operated just like a key FOB, its wide, smooth 300-lumen MaxVision Beam™ illuminates all dark areas at night P/N 13-20658 **\$69.99**

SUREFIRE MINIMUS™ HEADLAMP

 The model that launched SureFire headlamps into best-in-class status. Minimus provides the right amount of light—13 preset outputs up to a max of 300 lumens—precisely where you need it, thanks to its adjustable output knob and rotatable LED housing P/N 13-20659 **\$179.00**

SUREFIRE MAXIMUS™ HEADLAMP

 The SureFire Maximus™ rechargeable variable-output LED headlamp delivers an amazing 1,000 lumens of light—enough to illuminate your entire campsite. If that's too much light, you can dial it down to 1 lumen—or any level in between—for closer work, preserving your dark-adapted vision, or extending the runtime. A large knurled dial permits output control with one hand—even if it's gloved or numbed by cold. One hand can also aim the light right where you want it since the light assembly rotates up and down 90 degrees P/N 13-20660 **\$290.95**

TITAN® ULTRA-COMPACT DUAL-OUTPUT LED KEYCHAIN LIGHT

 Built to SureFire's exacting standards—and created for everyone—the groundbreaking Titan is the world's first professional-grade keychain flashlight. This ultra-compact, dual-output feat of engineering boasts a proprietary faceted reflector that shapes the light from its high-performance LED into a broad, smooth MaxVision Beam™ at both 125 and 15 lumens—astounding levels for a finger-sized light. The beam is perfectly balanced and better preserves your dark-adapted vision since it doesn't have an intense hot spot. And its wide beam pattern was designed to fit your field of view. Because of all these factors, it better maintains your overall situational awareness, crucial for safely navigating in the dark P/N 13-22300 **\$68.56**

TITAN® PLUS ULTRA-COMPACT DUAL-OUTPUT LED KEYCHAIN LIGHT

 The refined, ultra-compact Titan® Plus builds upon groundbreaking Titan, the world's first professional-grade keychain flashlight, by adding several useful "pluses," including more than twice the maximum output—300 lumens of flawless white light! Its high-performance LED also generates two other useful light levels with a simple twist of the head switch: 75 lumens at its medium setting and 15 lumens on low. No matter which output level you select, proprietary faceted reflector shapes the LED's light into wide, smooth MaxVision Beam™. And, because there are no intense hot spots and it's optimized for your field of view, you see things clearly and maintain good situational awareness—crucial for closer-range tasks and safe navigation P/N 13-22301 **\$116.00**

PS

PILOT FLASHLIGHTS

XEVISION PERSONAL LED FLASHLIGHTS



The compact LED flashlights are so small that they fit in the palm of a hand comfortably. They are so bright, even die-hard HID Xenon lighting technology purists can not resist.

Super-bright white light from one small but powerful LED
Our LED flashlights feature the latest commercial Cree LED 7090 XR-E, which delivers unprecedented levels of bright white light. The legendary 7090 XR-E is tested to the highest standards in the LED industry. The white light generated is as cool as HID with around 4000°K to 5000°K. The current draw is quite small while the LED is very efficient with a luminous flux of up to 100 lm min. @ 350 mA, and a luminous efficacy up to 75 lumens/watt.

XeVision personal LED flashlight models - The compact LED flashlights are so small that they fit in the palm of a hand comfortably. They are so bright, even die-hard HID Xenon lighting technology purists can not resist.

XV-C1C

Is their most compact LED flashlight using one long-lasting 3 VDC Lithium CR123A battery. The XV-C1C features six settings, 4 of them being output levels. This flexibility not only allows the user to select the best compromise between brightness and runtime for any given task but also has the ability to aid in an emergency. The XV-C1C offers a remarkably compact size and is extremely solid and reliable with its digitally regulated brightness. One 3 VDC CR123A Lithium battery
XV-C1C (Black)PN 13-05144**\$89.95**
XV-C1C (Iridium)PN 13-05147**\$91.50**

XV-C2C

Features six settings, 4 of them being output levels. This flexibility not only allows the user to select the best compromise between brightness and runtime for any given task but also has the ability to aid in an emergency. The XV-C2C offers a remarkably compact size and is extremely solid and reliable with its digitally regulated brightness. Two 3 VDC CR123A batteries (Lithium), not rechargeable.
XV-C2C (Black)PN 13-05145**\$89.95**
XV-C2C (Iridium)PN 13-05148**\$94.50**

XV-C2A

Features six settings, 4 of them being output levels. This flexibility not only allows the user to select the best compromise between brightness and runtime for any given task but also has the ability to aid in an emergency. The XV-C2A offers a compact size and is extremely solid and reliable with its digitally regulated brightness. Two 1.5 VDC AA (Alkaline, Lithium) or 1.2 V NiMH batteries.
XV-C2A (Black)PN 13-05146**\$89.95**

ACCESSORIES

Model	Description	Part No.	Price
WF-138C Charger for XeVision XV-C2C	Charger for a single or pair of over-discharge protected R-CR123A rechargeable Li-Ion cells. Comes with 2 R-CR123A cells.	13-05141	\$67.95
WF-138 Charger only	Just the charger - for the WF-123 combo package	13-05140	\$31.50
CR123A Single Cell Lithium Technology	1 Titanium 3 V CR123A battery. For the XV-C1C LED flashlight. Prevents excessive discharge that can damage lithium cells and may lead to catastrophic incidents.	13-05142	\$2.21
CR123AX2 Twin Cell Lithium Batteries	2 Titanium CR123A batteries are carefully matched and form one single sealed unit, 3 V but double capacity). Used for the XV-C2C LED flashlight. Prevent excessive discharge that can damage lithium cells and may lead to catastrophic incidents.	13-05143	\$4.50

AIRCRAFT SPRUCE LED PILOT'S FLASHLIGHT



The Aircraft Spruce LED pilots flashlight comes with a lifetime guarantee. Ultra-Bright light is provided with 12 energy saving LED bulbs. Made of aircraft aluminum, the flashlight casing is tough and durable. Attractive presentation box included. Size: 4-5/8" Long. Water and Shock Resistant. Push Button Sealed Rubber Switch. Battery Included.....P/N 13-06922**\$5.95**

LARRY POWER LED WORK LIGHT



The Larry™ is BRIGHTER THAN EVER! Now, equipped with C•O•B LED technology, the Larry™C outputs 170 lumens of intense light. The rotating magnetic clip gives you convenient hands-free lighting by attaching to virtually anything. The reinforced plastic body design is water and impact-resistant, making this light basically indestructible. Powered by 3 AAA batteries (included). Size: (H) 6.375" x (W) 0.55" x (D) 1.25". 0.1870 lbs.....P/N 13-18551**\$9.99**

COAST PX20 DUAL LED FLASHLIGHT



The PX20 Dual Color LED Flashlight combines five super bright white LEDs with one red LED. Each LED is controlled by a separate switch, allowing you to turn on the desired color with one click; no cycling through switch modes to find your color. The white light is for general flashlight use, while the red LED is perfect when you only need minimal light, such as when reading a map. A lightweight aluminum casing offers great durability and will hold up to heavy daily use.P/N 13-12049**\$27.95**



LIGHT BUDDY

Light Buddy its a swivel magnetic mount fits Maglite XL 50 XL 100 or any 1" light. Flashlight not included.....P/N 13-12076**\$19.95**



NEBO PAL™ PLUS

The PaL+ is a 3-in-1 powerbank, flashlight and folding knife that conveniently fits in your pocket, purse or briefcase. This portable, rechargeable 400 lumen flashlight also serves as a backup power source for mobile phones and other USB rechargeable electronic devices. The PaL+ also features 3" folding blade, that can be removed for safe travel.
Benefits: • Accessories: Micro USB to USB cable included • Batteries: Powered by 1 rechargeable battery (included)
P/N 13-22065**\$34.99**

NEBO TORCHY RECHARGEABLE FLASHLIGHT



The rechargeable TORCHY, inch for inch, is the brightest flashlight in the world. Smart Power Control allows the TORCHY to seamlessly transition through the 4 light modes and 1,000 lumen TURBO mode. The powerful magnetic base doubles as the magnetic charging port for the included USB MagCable, and the removable clip provides easy carry or hands-free use as a cap light.
P/N 13-22482**\$34.99**

PILOT'S HANDY LANYARD LIGHT



This emergency light with a break-away neck lanyard is great for use around any aircraft. Ideal for pre-flight inspections after dark, providing you with a small, powerful flashlight which you can simply hang around your neck as you preflight the aircraft. Also makes the perfect cockpit light in an emergency. Furnished with blue-green and red lenses for night flying as well as a standard clear lens. Includes lanyard & 1 AAA battery.
P/N 13-00571 **\$23.50**



FLASHLIGHTS

FLITELITE A1 TACTICAL AVIATOR SERIES FLASHLIGHT



Specially designed for the aviator and tactical operations to avoid being blinded by a flashlight that is too bright in the cockpit. The light starts in a programmable memory mode, which is user programmable to any brightness level desired.

P/N 13-11259\$46.90

NEBO MYCRO POCKET LIGHT



The MYCRO is impossibly bright and unbelievably small. Featuring 6 unique light modes, including the 400 lumen TURBO MODE and 3 LED color options to accommodate any situation. The MYCRO is small enough to conceal in your hand or fit on your key ring. This powerful pocket light even

comes with a stainless steel necklace chain to keep this light with you wherever you go.

3 Assorted Colors (Red, Silver, Black). Nebo MYCRO Pocket Light color is shipped randomly.....P/N 13-21854\$34.99

NVIS FINGER LIGHT PRO



Standard Finger Light Pro lights are available in Red or White. These lights are not NVIS/NVG compatible. The new Pro version powers a 3mm White or Red LED specifically selected to match a laser cut Lexan filter material. The 3mm LED is recessed inside inside the body of the light. This means less lateral visibility, ideal to reduce canopy glare and increase light discipline. It was developed to accommodate the

F-22, and was tested with several rotorcraft types.

WhiteP/N 13-22225\$18.95

RedP/N 13-22226\$18.95

NEBO TELESCOPIC PEN



All of the TelePen essentials plus a magnetic cap...now that's something to write home about.

Features: • Ballpoint pen • Telescopic design • 3 black ink refills included • Magnetic cap • V-clip key ring attachment

P/N 13-22313\$10.50

NEBO SLIM FLASHLIGHT



The NEBO SLIM is a thin, ergonomic rechargeable pocket light that outputs 500 lumens of intense bright light. Equipped with full dimming and Power Memory Recall, the SLIM also features a pocket clip, collapsible hanging hook and powerful magnetic base for convenient hands-free lighting.

3 Assorted Colors (Red, Silver, Black) Nebo MYCRO Pocket Light color is shipped randomly.

P/N 13-22077\$34.99

BRILA™ 550 LED HEADLAMP



The Brila 550 LED Headlamp will stay secure for all your outdoor adventures with its included top stability strap and even weight distribution between the front LED and rear battery pack. The easy-to-use focus control adjustment provides a long-distance spot beam or broad flood beam at up to 550 lumens on high and runs for up to 55 hours on low.....P/N 13-22026\$34.85

MINI LED FLASHLIGHTS



Only 3.5 inches long. NOT water resistant. DUAL Ultra-bright LEDs with lifetimes of 100,000+ hours, never break, and provide smooth illumination. • Thumbwheel Brightness Control • Energy Efficient -- Up to 320+ hours at the dimmest setting, 12+ hours at the brightest, from one 9V Alkaline

• Exclusive brightness regulation circuitry -- keeps the LEDs shining bright as batteries age, • 9 Volt Battery & 20 inch neck strap included
White & RedP/N 13-04696\$32.80
Red & GreenP/N 13-04697\$32.80

BITE-A-LITE FLASHLIGHT MOUTHPIECE



A clever mouthpiece for comfortably holding a flashlight with your teeth. Fits most "AA" or "AAA" size quality aluminum flashlights. Note: flashlight not included. This is the mouth piece only.

AA Flashlight Holder: .465" ID

AAA Flashlight Holder: .675" ID

Size AA.....P/N 14-00020\$3.95

Size AAA.....P/N 14-03292\$3.95

PETZL TACTIKKA CONSTANT HANDSFREE LIGHTING + RED / GREEN / BLUE



The Tactikka +RGB is a compact, 250-lumen headlamp designed for activities where stealth is key. This hybrid headlamp is powered by the included 3xAAA/LR03 batteries or by the optional CORE rechargeable

battery. It features a long burn time, proximity or focused lighting for movement, and red/green/blue lighting which is easier on night vision and remains stealth. Red/green/blue lighting is easier on the user's night vision while remaining stealth. Powerful 250-lumen light has a long burn time. Provides three lighting modes: max autonomy, standard and max power. Single button operation is easy to use, even when wearing gloves while the headband is easy to slip on and off. Tactikka +RGB hybrid headlamps include three standard batteries, and are also compatible with the CORE rechargeable battery.

P/N 11-05096\$66.75

DUO 5 HEADLAMP PETZL LIGHTS E69



The DUO lamps are ideal for use in wet environments, but are not designed for prolonged submersion (i.e. diving).

Features:

• Waterproof with dual light source: focusable halogen bulb and an LED module. • Switching on & off, brightness selection, zooming • The DUO lamps allow the light to be optimized

(distance, duration) according to your needs. • Simultaneous use of both bulbs is not possible. • Unlocking/locking the bezel

Specifications:

• Weight: 200g (not including batteries) • Comes with 6 V halogen spare bulb • Uses 4 AA / LR6 batteriesP/N 11-04996\$99.95

FLIGHT OUTFITTERS DUAL COLOR HEADLAMP



Flying at night can be a daunting task. Having both hands free to handle the workload during these tense situations is extremely important. This dual color headlamp puts the right type of light right where you need it without tying up your hands. Dual switches allow you to turn on just the white light, or just the red light. This means you don't have to scroll through different lights and ruin your night vision. Each color of light

has a high and low setting to maximize battery life. Uses 3AAA batteries (included).....P/N 13-18183\$29.95

PS

FLASHLIGHT HOLDERS - ARM RESTS



MERCURY CLAMP FLASHLIGHT HOLDER

Astro Arm is the perfect device when you need your flashlight directed precisely while having both hands available to perform a task. These holders are great for aviation, marine, automotive, racing, and emergency lifesaving applications. Available in Mercury models for smaller flashlights and Gemini models for larger flashlights.

P/N 13-04005\$24.70



MERCURY-MAGNETIC FLASHLIGHT HOLDER

Astro Arm is the perfect device when you need your flashlight directed precisely while having both hands available to perform a task. These holders are great for aviation, marine, automotive, racing, and emergency lifesaving applications.

P/N 13-04006\$24.70



GEMINI CLAMP FLASHLIGHT HOLDER

Astro Arm is the perfect device when you need your flashlight directed precisely while having both hands available to perform a task. These holders are great for aviation, marine, automotive, racing, and emergency lifesaving applications. Available in Mercury models for smaller flashlights and Gemini models for larger flashlights..

P/N 13-04007\$37.50



GEMINI MAGNETIC FLASHLIGHT HOLDER

Astro Arm is the perfect device when you need your flashlight directed precisely while having both hands available to perform a task. These holders are great for aviation, marine, automotive, racing, and emergency lifesaving applications. Available in Mercury models for smaller flashlights and Gemini models for larger flashlights.

P/N 13-04008\$37.50



GUPPIE MULTI-TOOL

The adjustable wrench jaw opens to 1/2" so you can use it for all kinds of light repair and assembly jobs. Thanks to the carabiner gate, the Guppie is easy to carry on a belt loop, D-ring, pack or rope. (But it is not a weight-bearing carabiner.) The high-carbon stainless steel blade with a Razor-sharp edge can be opened and closed with one hand using the blade slot. The removable bit carrier is also a high-intensity LED light. It has two strong magnets to hold it securely to the Guppie's left side. The stainless steel clip will hold the Guppie in your pocket or on gear, which gives a lot of versatility. One more trick: The Guppie carabiner detent will open bottle caps and metal jar lids.

Specifications: Blade Length: 2.0" (5.1 cm) Blade Steel: 3Cr13, 52-55 HRC Handle Length: 3.5" (8.9 cm) Tool Weight: 4.1 oz. (116 g) Bit Carrier Weight: 1.2 oz. (34 g) Batteries: Two CR327 3V Lithium

P/N 13-07358\$38.95

SIDESTICK CONTROL ARM RESTS



The side stick control arm rests will steady the hand, which improves flying and reduces wrist and arm fatigue. The arm rests were designed by an orthopedic specialist to reduce wrist and hand carpal tunnel syndrome. They can also be used for throttle rests. Color: Black. ABS plastic. Furnished as right/left set.P/N 13-03265\$25.85

CIGPEN



Old Ashtray

CigPen



CIGPEN HOLDER - CigPen installation is as easy as 123. Pull the nasty ashtray out, peel the double stick tape, insert and press in CigPen. CigPen was designed to hold two standard pencils or pens along with a Mini Mag Lite AAA. For a very low cost, you can easily turn your existing ashtray into a useful device. Fits C-150, 172, 182 Cardinal. DOOR LOCK HANDLE - When you order the CigPen, you will also receive the Cessna 150 door lock. The door lock is made from ABS Plastic. It is engraved with lock, un-lock, and indicating arrows. Fits C-150 airplanes.P/N 13-06913\$18.75

MAP, CHECKLIST & LOG BOOK HOLDERS



These holders come in three sizes to store your maps, checklists and log books. They are thermoformed from ABS plastic, and come in either black or gray.

Description	Size	Color	Part No.	Price
Aircraft Log	4-1/2"x7"x1/4"	Black	13-03086	\$21.50
Engine Log	6-1/2"x7"x1/2"	Black	13-03087	\$28.95
Map/Checklist	9"x10"x 5/8"	Gray	13-03088	\$31.50
Aircraft Log	4-1/2"x7"x1/4"	Gray	13-03089	\$21.50
Engine Log	6-1/2"x7"	Gray	13-03090	\$17.85

CIGPEN 2



The Cigpen2 fits in the same space as that used by the ashtray in aircraft such as the Cessna 172, 182, 210, and many other makes and models. An ideal product for experimental aircraft. Provides a holder for two AA batteries, and a loop to hold a pen.

In The Box:

- 1 - Base
- 1 - Battery Holder
- 1 - Pen Holder

Note: Optional install of head set jacks by simply drilling two holesP/N 13-22416\$47.02

PS

LEATHERMAN POCKET TOOLS



LEATHERMAN WINGMAN

The Leatherman Wingman is just that: your go-to tool for projects around the house, on the job, or at the campsite. A great, lightweight, pocket-sized, stainless steel tool; the Wingman features an outside-accessible, one-hand opening blade and newly-designed spring-action jaws. With plenty of handy tools, and backed by a team of designers, assemblers, and manufacturing crew from Portland, Oregon, this is one amazing value. Covered by the Leatherman 25-year warranty.

P/N 13-11705\$59.95



LEATHERMAN SQUIRT PS4

The Leatherman Squirt PS4 is the first miniature pliers multi-tool tough enough to be a Leatherman. Now the Squirt also sports a scissors, making it even more useful than before. The key ring attachment offers the flexibility to place it on your key chain, backpack or even a zipper. Just two ounces, it's light enough to take anywhere. Fits nicely on a key ring. Color: Blue. Weight: 1.9 oz Length (Closed): 2.25 inches / 5.72 cm (Closed) Material: Stainless Steel with anodized aluminum scales.

Features: • Needlenose Pliers • Regular Pliers • Scissors • 420HC Knife • Wire Cutters • Wood/Metal File • Medium Screwdriver • Flat/Phillips Screwdriver • Bottle Opener • Key Ring Attachment

P/N 13-11706\$39.95



LEATHERMAN SKELETOOL, CX

Needlenose Pliers. Regular Pliers. Wire Cutters. Hard-wire Cutters. Bit Storage in Handle. 420HC Stainless Steel Blade. Universal Bit Driver. Carabiner/Bottle Opener. Removable Pocket Clip. Included Bits: Phillips #1 and #2. Screwdriver 3/16" and 1/4". Length: 4 in. / 10 cm closed. Weight: 5 ounces / 142 grams. Materials: 420HC Stainless Steel, Hard-Anodized Aluminum Handle Insert

With sheath.....P/N 13-07071\$79.95



LEATHERMAN SKELETOOL

420HC Stainless Steel Clip Point Combo Straight/Serrated Knife. Needlenose Pliers. Regular Pliers. Wire Cutters. Hard-wire Cutters. Large Bit Driver. Bottle Opener. Carabiner Clip. INCLUDED BITS: Phillips #1 and #2 Bit, Screwdriver 3/16" and 1/4" Bit. Stainless Steel with 6061-T6 Aluminum Handle Insert. Stainless Steel body. Outside-accessible Blade for One-handed Opening. All Locking Blades and Tools. Removable Pocket Clip. Nylon Sheath Sold Separately. 25-year Warranty. 4 in / 10 cm (closed). 5.0 oz / 142 g. 2.6 in l 6.60 cm (blade length)

Skeletool.....P/N 13-07068\$64.95

Skeletool w/sheath ..P/N 13-07069\$64.95

LEATHERMAN MICRA

Spring-action scissors and personal care features that fit on your key chain are just part of what makes the Micra truly unique. Features: Scissors, Clip-Point Knife, Tweezers, Nail File / Cleaner, Flat Phillips, Screwdriver, Extra Small Screwdriver, Medium Screwdriver, Bottle Opener, Ruler (Inch / Metric), Lanyard Attachment, Length: 2.5 in. / 6.35 cm closed, Weight: 1.75 ounces / 50 grams, Materials: 100% stainless steel (Optimum grade hardness for each tool/blade). Color: Blue

P/N 13-07079\$29.95



WAVE TOOL

Needlenose Pliers, Regular Pliers, Wire Cutters, Hard-Wire Cutters, Clip-Point Knife, Serrated Knife, Saw, Scissors, Wood/Metal File, Diamond-Coated File, Large Bit Driver, Small Bit Driver, Large Screwdriver, Ruler (8 inch/19 cm), Bottle/Can Opener, Wire Stripper, Lanyard Attachment, Two Double-Ended Bit.

P/N 13-03289\$99.95



SIDEKICK

Stainless Steel Body, Leather Sleeve, Spring-action Needlenose Pliers, Spring-action Regular Pliers, Spring-action Wire Cutters, 420HC Combo Knife, 420HC Serrated Knife, Saw, Wood/Metal File, Small Screwdriver, Medium Screwdriver, Phillips Screwdriver, Ruler (1 in / 2.54 cm), Bottle Opener, Can Opener, Wire Stripper, Removable Pocket Clip, Lanyard Ring, Carabiner Bottle Opener Accessory...P/N 13-11703\$59.95



SUPER TOOL 300

• Stainless Steel 420HC Handles • All locking blades and tools • Comfort-sculpted Handles w/ Cutouts for Access with Gloves On • 420HC Clip Point Knife with Straight Edge • 420HC Sheepfoot Serrated Knife • Needlenose Pliers • Regular Pliers • 154CM Removable Wire Cutters • 154CM Removable Hard-wire Cutters • Stranded-wire Cutters • Wire Stripper • 19 Tools • Electrical Crimper • 5/16" Screwdriver • 7/32" Screwdriver • 1/8" Screwdriver • Phillips Screwdriver • Wood/Metal File • Saw • Bottle Opener • Can Opener • Ruler (9 inch/22 cm) • Awl with Thread Loop.

P/N 13-11704\$89.95



LEATHERMAN REBAR

Optimized for strength and features: • Needlenose Pliers • Regular Pliers • 154CM Replaceable Wire Cutters • 154CM Replaceable Hard-wire Cutters • Electrical Crimper • 420HC Knife • 420HC Serrated Knife • Wood/Metal File • Saw • Small Screwdriver • Large Screwdriver • Phillips Screwdriver • Awl w/Thread Loop • Ruler (8 inches/20 cm) • Bottle Opener • Can Opener • Wire Stripper.....P/N 13-12777\$69.95



LEATHERMAN CHARGE + TTI

Lightweight and made of premium materials, this upgraded version of the original includes replaceable wire cutters. One of the more popular tools, the Charge Plus TTI is ready for jobs big and small. This practical multi-tool combines some of our most requested features with premium materials and upgraded, replaceable wire cutters. Titanium handles make the tool lightweight and strong and an ultra-sharp S30V steel knife blade resists corrosionP/N 13-21325\$169.95



CRUNCH TOOL

Locking Pliers, Wire Cutters, Hard-Wire Cutters, Serrated Knife, Metal/Wood File, Ruler (Inch/Metric), Bottle Opener, Small Screwdriver, Medium Screwdriver, Large Screwdriver, Phillips Screwdriver (#1/#2), Hex Bit Driver, Wire Stripper, Lanyard Attachmen.....P/N 13-02727\$109.95

PS

VISIT OUR WEBSITE TO VIEW OUR COMPLETE LISTING FOR LEATHERMAN TOOLS.

WIRE MARKERS – SAFETY STEPS

TANA WIRE MARKERS



Tana Wire Markers are large fiberglass balls which can be attached to power lines to warn aircraft of the location of the wires. They meet FAA specifications, feature easy installation and universal attachment, withstand the elements for over 10 years, require no maintenance, do not slip, chafe, oscillate, or cause electrolysis or vibration.

Stocked in 9", 12", and 24" sizes. Larger sizes available on request. Color: international orange. Stocked in Tana marker style JX. Styles SD, KJ, AR, XL, and BN are available by special order. Please Request a Quote.

9" diameter with Tape	P/N 13-18710	\$92.75
9" diameter w/o Tape	P/N 13-18711	\$117.75
12" diameter with Tape	P/N 13-00057	\$148.95
20" diameter with Tape	P/N 13-00058	\$211.95
24" diameter with Tape	P/N 13-00059	\$326.00
12" diameter w/o Tape	P/N 13-00054	\$115.75
20" diameter w/o Tape	P/N 13-00055	\$158.75
24" diameter w/o Tape	P/N 13-00056	\$286.95

BIRD DETERRENT - BIRDXPPELLER PRO



The BirdXPeller PRO is a sonic bird repeller that broadcasts a variety of naturally recorded bird distress signals and predator calls that frighten, confuse and disorient pest birds within the effective range. Pest birds cause damage, liability and health hazards. Sonic bird control is a safe, humane, eco-friendly way to get rid of birds from outdoor areas. Sonic repellers use high-definition digital recordings. Customizable

settings allow for easy, DIY pest control. Real sounds – digital playback of naturally recorded threats. Covers up to 1 acre. Repels: pigeons, starlings, sparrows and gulls.P/N 13-00091

LARGE AIRPORT CONE MARKERS



Avlite's range of airfield cone markers is rotationally-molded using UV-stabilised polyethylene, providing exceptionally long-life without the need for painting.

Large Cone Marker Yellow	P/N 11-14012	\$72.85
Large Cone Marker Orange	P/N 11-14013	\$65.00
Mini Cone Marker Blue	P/N 11-14014	\$37.85

UNIVERSAL SAFETY STEP



Unique Self-Leveling Anti-Tip design. Tubular Aluminum 11" x 14" platform, 8" high. Custom designed non-slip Safety Strips on Platform. Powder coat finish. Rugged All Aluminum Welded Construction – will not corrode. Heat Treated for Maximum Strength. Weight – 4 lbs. Lab Tested to 1000 lbs. Weight: 7 lbs. Dimensions: 19 x 16 x 8 in

P/N 13-18575**\$58.75**

LO-COMMERCIAL 6 INCH SAFETY STEP



Unique Self Leveling Anti-Tip Design. Tubular Aluminum 12" x 19" Platform, 6" High Non-Slip Safety Strips on Platform. Powder Coat Finish. All-Aluminum Welded Construction. Heat Treated for Maximum Strength. Weight – 4 1/2 lbs. Lab Tested to 1000 lbs. Weight: 8 lbs. Dimensions: 27 x 21 x 7 in.

P/N 13-18576**\$59.95**

COMMERCIAL 8 INCH SAFETY STEP



Tubular Aluminum 15"x19" platform, 8" high. Custom Designed Non-Slip Safety Strips on Platform. Powder coat finish. Rugged All Aluminum Welded Construction, will not corrode. Heat Treated for Maximum Strength. Weight – 6 1/2 lbs. Lab Tested to 1000 lbs. Weight: 11 lbs. Dimensions: 27 x 21 x 8 in.

P/N 13-18577**\$74.75**

FOLDING SAFETY STEPS



Unique Self-Leveling Anti-Tip design. Unique Double-Locking Safety Legs. Custom Designed Non-Slip Safety Strips on platform. Powder coat finish. Rugged All Aluminum Welded Construction – Will not corrode. Heat Treated for Maximum Strength. Unique Self-Leveling Anti-Tip design. Unique Double-Locking Safety Legs. Custom Designed Non-Slip Safety Strips on platform. Rugged All Aluminum Welded Construction – Will not Corrode. Heat Treated for Maximum Strength.

Small.....	P/N 13-18578	\$67.99
Large	P/N 13-18579	\$120.75
Extra Large	P/N 13-18580	\$121.75

HANDLE SAFETY STEP



Unique Self Leveling Anti-Tip Design. Lab Tested to Hold 1000 lbs. Weighs Only 10 1/2 lbs. Heavy Duty Tubular Aluminum 15" x 19" Platform With An 8" Step Height. 34" Steel Handle. Safety Strips and Angled Leg Tips to Prevent Slippage. Durable, Textured Powder Coat Finish Will Not Rust. Weight: 18 lbs. Dimensions: 26 x 19 x 16 in. Steel Handle: 34".....P/N 13-18581

INDUSTRIAL SAFETY STEPS



Unique Self Leveling Anti-Tip Design. Lab Tested to Hold 1000 lbs. Weighs Only 10 1/2 lbs. Heavy Duty Tubular Aluminum 15" x 19" Platform With An 8" Step Height. 34" Steel Handle. Safety Strips and Angled Leg Tips to Prevent Slippage. Durable, Textured Powder Coat Finish Will Not Rust. Unique self-leveling Anti-Tip design. Tubular Aluminum 15"x19" platform, 8" high - 15" high. Brackets for increased durability. Custom Designed Non-Slip Safety Strips on Platform. Available Safety Yellow powder coat finish. Rugged All Aluminum Welded Construction, will not corrode. Heat Treated for Maximum Strength. Weight: 8" - 7 1/2 lbs / 10" - 8 lbs / 12" - 8 1/2 lbs / 15" - 9 1/2 lbs. Lab Tested to 1000 lbs.

8 Inches.....	P/N 13-18582.....	\$79.95
10 Inches.....	P/N 13-18583.....	\$89.75
12 Inches.....	P/N 13-18584.....	\$95.75
15 Inches.....	P/N 13-18585.....	\$98.75

SAFETY STEP ACCESSORIES

Description	Part No.	Price
Safety Step Replacement Strips Set for 15x19 Deck Fits Models: 13-18577, 13-18579, 13-18582,13-18583, 13-18584 & 13-18585	13-18589	\$14.95
Safety Step Replacement Strips Set for 12x19 Deck Fits Models: 13-18576	13-18589-1	\$14.95
Safety Step Replacement Strips Set for 11x14 Deck Fits Models: 13-18578 & 13-18575	13-18589-2	\$14.95



PILOT WATCHES

CITIZEN ECO-DRIVE STRAP 180 MENS WATCH



For a rugged look with a comfortable fit, this military-inspired timepiece fits the bill. With a day-date indicator, luminous hands, 37mm screw-back case, and 100M WR. The black dial provides a backdrop for simple Arabic numerals, housed in a stainless steel case along with a woven green strap with patterned stitching and a buckle clasp. P/N 13-19311\$175.00

CITIZEN PROMASTER ALTICHRON WATCH



Climb to new heights with the reinvented Promaster Altichron. Designed with light power technology, the sky is the limit when wearing this innovative, sleek yet sporty timepiece. With an altimeter measuring from 1,000ft - 32,000ft, compass and date, its the absolute timepiece for any semi-professional adventurer. Featured with a gun metal grey ion-plated stainless steel case, comfortable sleek grey polyurethane strap and complimentary black dial with bright orange accents. Featuring Eco-Drive technology – powered by light, any light. Never needs a battery. P/N 13-21902\$416.50

CITIZEN PROMASTER NAVIHAWK GPS WATCH



Travel around the world with the newest addition to the Promaster collection. The Citizen® Promaster Navihawk GPS features Satellite GPS Timekeeping technology with synchronized time adjustment available in 27 cities. Pilot's rotating slide rule bezel, chronograph, perpetual calendar, alarm, light level indicator and dual time. This timepiece features a Super Titanium™ case and bracelet. Citizen's Super Titanium™ is 40% lighter than stainless steel and 5 times harder to resist scratches. Featuring Eco-Drive technology – powered by light, any light. Never needs a battery. P/N 13-21901\$1,466.50

CITIZEN PROMASTER NAVIHAWK A-T WATCH



The Navihawk A-T ensures you are always on time, no matter where your journey takes you. The black-tone stainless steel case and mesh bracelet with black dial features world time in 43 cities, 2 alarms, 1/100-second chronograph, 99-minute countdown timer, UTC display, power reserve indicator, hand correction and shock sensing function. Featuring Eco-Drive technology – powered by light, any light. Never needs a battery. P/N 13-21900\$525.00

CITIZEN PROMASTER SKYHAWK A-T WATCH



With atomic timekeeping in 43 cities, this chronograph watch features a perpetual calendar, dual time, alarms, countdown timer, digital backlight and UTC displays, power reserve and pilot's rotating slide rule bezel. This model appears with a black ion-plated stainless steel case and bracelet, black dial, bright orange details and black bezel with unique case and dial motifs. P/N 13-21898\$486.50

CITIZEN BLUE ANGELS WATCH



This precision and grace is exhibited in the Citizen Blue Angels Nighthawk seen here with a navy blue ion-plated stainless steel case, stainless steel bracelet and navy blue dial with bright yellow accents. A watch powered by any light with Eco-Drive Technology featuring 12/14-hour time, pilots rotating slide ring and date. Stainless Steel Band.....P/N 13-21896\$332.50
Leather Band.....P/N 13-21897\$297.50

CITIZEN BLUE ANGELS WATCH - PROMASTER SKYHAWK A-T



This model appears in a stainless steel case, indigo blue Italian leather strap with yellow contrast stitching, yellow accented dark blue dial and bezel with the Blue Angel's insignia replicated on the case-back. Featuring Eco-Drive technology – powered by light, any light. Never needs a battery.....P/N 13-21894\$455.00

CITIZEN NIGHTHAWK WATCH



Revamped and reinvented, the sport styled Citizen Nighthawk is here to stay. Powered by any light, this watch never needs a battery. Featuring chronograph, 12/24-hour time and date in a stainless steel case and bracelet with black dial and vivid red accents. Featuring Eco-Drive technology – powered by light, any light. Never needs a battery
Stainless SteelP/N 13-21903\$332.50
Granite Ion PlatingP/N 13-21904\$368.00
Black Ion PlatingP/N 13-16301\$368.00

CITIZEN PRIMO WATCH



Time to hit the racetrack with the improved Citizen Primo Chronograph with Eco-Drive technology. A watch that keeps up with your speedy lifestyle, shown here with a men's stainless steel case and bracelet with a midnight blue dial with bright red accents. A 1/5th second chronograph with 12/24-hour time and date.
Blue FaceP/N 13-21905\$262.50
Black FaceP/N 13-21907\$297.95

VIBRALITE MINI BLACK



The smallest, high quality, user friendly Vibration Alarm Watch available. Vibration, Audible or Both Set easily in Option Mode. Text on display prompts you. Button Alert feature will confirm your setting quickly. 12 Daily Alarm Settings Preset for variable reminders. 20 second duration alarm with auto off or can be turned off by pushing any button. Countdown Timer with Auto Repeat.
Black with Nylon Band.....P/N 11-11135\$51.75
Purple Flower Band.....P/N 11-11136\$51.75
Blue w/Hook & Loop Band...P/N 11-11137\$51.75

VISIT OUR WEBSITE FOR OUR COMPLETE PRODUCT LISTING.

ABINGDON WATCHES

In this collection, the function of a rotating bezel slide rule comes together with the classic analog face to present a timeless purity of curves and lines. An elegant chronograph.

Jackie

Elise

Amelia

Katherine



13-11393



13-11399



13-11395



13-18055

Description	Color	Part No.	Price
Jackie Dreamy Watch	White	13-11392	\$535.50
Jackie Sunset Watch	Pink	13-11394	\$535.50
Jackie Seaplane Watch	Green	13-11393	\$535.50
Amelia Cloud Watch	White	13-11396	\$337.50
Amelia Runway Watch	Black	13-11395	\$314.10
Elise Anthenian Watch	Silver	13-11398	\$449.10
Elise Egyptian Watch	Gold	13-11399	\$499.10
Elise Tahitian Watch	Two Tone	13-11397	\$449.10
Katherine Watch	Sky Blue	13-18054	\$495.00
Katherine Watch	Royale	13-18055	\$495.00
Katherine Watch	Storm	13-18056	\$495.00
Katherine Watch	Rose Sun	13-18057	\$495.00
Katherine Watch	Frequent	13-18058	\$495.00

VISIT OUR WEBSITE FOR OUR COMPLETE ABINGDON PRODUCT LISTING.

PS

SUNGLASSES

Ray-Ban RAY-BAN AVIATION SUNGLASSES

Ray-Ban is the leading brand in the high quality sunwear market segment and by far the best-selling sunwear brand in the world. It is an all American Brand created 1937 with the Aviator style, developed for use by the pilots of the U.S Air Force.



Style	Frame	Lens Color	PN	Price
RB 3025	Arista	G-15 XLT 62mm	13-04984	\$154.00
RB 3025	Arista	G-15 XLT 58mm	13-04990	\$154.00
RB 3025	Black	G-15 XLT 58mm	13-04991	\$154.00
RB 3025	Black	Polarized Natural Green 58mm	13-04987	\$204.00
RB 3025	Gunmetal	Polarized Natural Green 58mm	13-04989	\$204.00
RB 3025	Arista	Polarized Natural Green 58mm	13-04985	\$204.00

G-15XLT is a Grey Color

Style	Frame	Lens Color	PN	Price
RB 3026	Black	G-15 XLT	13-04992	\$154.00
RB 3026	Arista	G-15 XLT	13-04993	\$154.00

G-15XLT is a Grey Color

Style	Frame	Lens Color	PN	Price
RB 3030	Arista	G-15 XLT	13-04994	\$154.00
RB 3030	Black	G-15 XLT	13-04995	\$154.00

SCHEYDEN FIXED HYBRID COMPOSITE SUNGLASSES REVELSTROKE



Stylish composite frames have been combined with HiNiHg (High Nickel Silver) temples enabling full wrap frames that fit comfortably under a headset without disturbing the ANR seal. The frames will easily slide down the wearers nose and back up again to adapt to changing light conditions with the push of a finger. Scheyden Deluxe Case Pack is included. **\$259.00/ea.**

Part No.	Description	Part No.	Description
13-06993	Bronze Havana	13-06991	Bronze CR39
13-06994	Gray Havana	13-06992	Gray CR39

SCHEYDEN FIXED GEAR WAYLITE SUNGLASSES

A timeless style mixed with aviation specifications. The Waylite is fashionable and durable. A first of its kind, the Waylite is an ideal fit for a wide range of facial sizes.

Anti-Reflective, Anti-Glare and 100% Protection from UVA & UVB.

Lens Options:

7-Layer Non-Polarized (Aviation, Golf, Driving)

8-Layer Polarized (Fishing, Boating, Driving)

FRAME STYLES



Description	Part No.	Price
Black Bronze	13-19030	\$169.00
Black Bronze Polarized	13-19031	\$199.00
Black Gray	13-19032	\$169.00
Black Gray Polarized	13-19033	\$199.00
Havana Tortoise Bronze	13-19038	\$169.00
Havana Tortoise Bronze Polarized	13-19039	\$199.00
Havana Tortoise Gray	13-19040	\$169.00
Havana Tortoise Gray Polarized	13-19041	\$199.00
Clear Bronze	13-19034	\$169.00
Clear Bronze Polarized	13-19035	\$199.00
Clear Gray	13-19036	\$169.00
Clear Gray Polarized	13-19037	\$199.00



SCHEYDEN FIXED GEAR LIBERATOR SUNGLASSES

The "Liberator" is a titanium version of the iconic aviator sunglasses, originally developed during the WWII era. This timeless, fashionable, and incredibly durable frame is perfect for those who demand the highest level of precision and quality. Anti-Reflective, Anti-Glare and 100% Protection from UVA & UVB.

Bronze.....P/N 13-19042.....**\$289.00**
 Gray.....P/N 13-19043.....**\$289.00**

SCHEYDEN CLASSIC FLIP-UP SUNGLASSES



El Capitan



Avalon



Sonoma



Avalon Small

Scheyden patented FlipUp & locking mechanism, allows you to instantly adapt to constantly changing cockpit light conditions with the flip of a finger. Fabricated in titanium it weighs mere ounces. Offers 100% UVA & UVB protection, and crystal clear, distortion free vision. Backside Triple Anti-Reflective coating acts to diffuse ambient light from behind. Includes a Deluxe Case Pack with a luxurious microfiber cleaning cloth and glasses bag along with an aluminum hard case and leather flip sport case. Lifetime warranty on all titanium frames and the best lens replacement warranty in the eyewear industry. Frames are Natural Titanium.

Model	Lens	Part No.	Price
El Capitan	High Contrast Bronze CR39	13-06947	\$449.00
El Capitan	Neutral Grey CR39	13-06948	\$399.00
Avalon	High Contrast Bronze CR39	13-06949	\$449.00
Avalon	Neutral Grey CR39	13-06951	\$449.00

Lenses are non-polarized as standard. This ensures that there is no distortion or "blacking-out" of glass cockpit instruments or LCD screens. Polarized lenses are available.

SCHEYDEN FIXED GEAR SUNGLASSES



Mustang

Albatross

C-130

The thin titanium ear-pieces fit comfortably under a headset and are small enough that they won't interfere with the ANR seal. Fixed Gear Mavericks are the choice of the US Air Force Thunderbirds. High Contrast Light Bronze lens offers 100% UVA & UVB protection and is recommended for low light conditions.

Model	Frame	Lens	Part No.	Price
Mustang	Natural Titanium	Bronze Polarized	13-11479	\$349.00
Mustang	Natural Titanium	Bronze Non-Polarized	13-11478	\$309.00
Mustang	Natural Titanium	Gray Polarized	13-11481	\$349.00
Mustang	Natural Titanium	Gray Non-Polarized	13-11480	\$309.00
Albatross	Natural Titanium	Bronze Polarized	13-11483	\$349.00
Albatross	Natural Titanium	Bronze Non-Polarized	13-11482	\$309.00
Albatross	Natural Titanium	Gray Polarized	13-11476	\$349.00
Albatross	Natural Titanium	Gray Non-Polarized	13-11477	\$309.00
C-130	Titanium	Gray Polarized	13-16269	\$349.00
C-130	Titanium	Gray Non-Polarized	13-16270	\$309.00
C-130	Stealth Black	Gray Polarized	13-16271	\$349.00
C-130	Stealth Black	Gray Non-Polarized	13-16272	\$309.00
C-130	Swiss Gold	Gray Polarized	13-16273	\$289.00
C-130	Swiss Gold	Gray Non-Polarized	13-16274	\$309.00
C-130	Titanium	Bronze Polarized	13-16275	\$349.00
C-130	Titanium	Bronze Non-Polarized	13-16276	\$309.00
C-130	Stealth Black	Bronze Polarized	13-16277	\$289.00
C-130	Stealth Black	Bronze Non-Polarized	13-16278	\$309.00
C-130	Swiss Gold	Bronze Polarized	13-16279	\$349.00
C-130	Swiss Gold	Bronze Non-Polarized	13-16280	\$309.00

SCHEYDEN FIXED HYBRID COMPOSITE SUNGLASSES REVELSTROKE



Frame	Lens	Part No.	Price
Gloss Black	High Contrast Bronze CR39	13-06991	\$259.00
Gloss Black	Neutral Grey CR39	13-06992	\$259.00
Havana Tortoise	High Contrast Bronze CR39	13-06993	\$259.00
Havana Tortoise	Neutral Grey CR39	13-06994	\$259.00

PS

SUNGLASSES

ROTHCO G.I. TYPE PILOT SUNGLASSES



P/N 14-02118

Carries CE certified symbol on package. Metal-lens: hard coating acrylic. 58mm lenses. Frame: nickel silver finish: tempering, grounded, gold plating, clear plastic tip. Made to mil-std 105. Impact resistant. UV 400 protection. Bayonet temples. With black case. Available in: smoke lens with gold frame, smoke lens with chrome frame, smoke lens with black frame, mirror lens with gold frame, mirror lens with chrome frame and brown lens with gold frame

Color	Part No.	Price	Color	Part No.	Price
Chrome/Smoke	14-02123	\$12.99	Black/Smoke	14-02120	\$12.99
Gold/Brown	14-02118	\$12.99	Gold/Smoke	14-02119	\$12.99
Gold/Mirror	14-02121	\$12.99			

AMERICAN OPTICAL SUNGLASSES

Performance-tested sunglasses with classic aviator styling. The Original Pilot Sunglass® has been a favorite of US military pilots for more than 40 years. Engineered to rigid military specifications and issued to millions of US soldiers, sailors, marines and airmen since 1958. The rugged and sturdy structure and high quality finishing of the steel alloy frame coupled with distortion free, toughened and polished True Color® glass lens have made the AO Flight Gear® Collection the standard bearer of all fine military sunglasses.

ORIGINAL PILOT (SQUARED)



52MM.... P/N 13-03212... \$194.00

GENERAL (OVAL)



52MM.... P/N 13-03214... \$194.00
58MM.... P/N 13-03215... \$194.00

SERENGETI AVIATOR SUNGLASSES

Serengeti Aviators protect your vision while eliminating glare and sharpening details better than other sunglasses. Cloud boundaries are more easily delineated and oncoming traffic is more visible. Unique photochromic spectral controls improve your ability to see in marginal VFR and IFR conditions. In bright sunlight, you'll see the instruments better and ghost images will be eliminated from the cockpit. Wear them late in the day or at sunset to preserve your night vision.



LARGE AVIATOR SUNGLASSES

• Base Curve: 6 • Temple Length: 140mm.
• Lens Size: 61.75 x 55.5 x 68mm, DBL 10.5mm Black

P/N 2121 \$113.75



DANTE SUNGLASSES

• Base Curve: 8 Rx • Temple Length: 130mm • Lens Size: 63 x 38 x 64mm, DBL 15mm • Frame Features: Wire-Flex Technology and Adjustable Nose Pads

P/N 13-15083 \$225.00



MEDIUM AVIATOR HENNA SUNGLASSES

• Base Curve: 6 • Temple Length: 140mm/ Spring Hinges • Lens Size: 59.3 x 51.57 x 67.02mm • Distance Between Lenses (DBL) 12.5mm.....

P/N 14-01823 \$168.00

FLYING EYES HAWK SUNGLASSES

Lightweight, unbreakable Resilamide frames. Soft nose-pad keeps glasses properly positioned and balanced for optimal fit. The included strap and cinch is unnoticeable under headsets. Standard Temples for everyday use. The included micro-thin Temples for use under a helmet or headset. Wraparound style gives a wider viewing angle than most frames. Optically correct, shatterproof polycarbonate lenses with 100% UV400 protection.

Glossy Black Frame/Solid Grey Lens..... P/N 13-16455 \$165.75
Matte Black Frame/Solid Grey Lens..... P/N 13-16456 \$192.75
Matte Black Frame/Gradient Lens..... P/N 13-16454 \$189.00

RANDOLPH®

Randolph Engineering has been a leading supplier of military sunglasses to the U.S. Armed Forces since 1982. These sunglasses are the choice of America's Top Gun pilots and NASA astronauts. They meet demanding U.S. military specifications, provide superior glare protection and UV absorption and can be converted to prescription lenses. All of the sunglasses below feature 23K gold plated, hand polished frames and come with a crush resistant case.



Gold/Gray Gold/AGX Gold/Tan Matte Black/Gray



Gold/Gray Gold/Tan Gold/Green Matte Black/Gray

AVIATOR – Standard issue for military pilots worldwide. (MIL.SPEC. 25948). These lenses sharpen detail and show colors evenly, making them ideal for flying. Bayonet temples provide optimum fit for use with a headset or helmet.

Size	Lens	Part No.	Price
52mm	Gold/Gray	13-00679	\$239.95
52mm	Gold/AGX	13-00680	\$239.00
55mm	Gold/Gray	13-00681	\$239.00
55mm	Gold/Tan	13-00682	\$299.00
55mm	Gold/AGX	13-00683	\$239.00
58mm	Gold/Gray	13-00684	\$239.00
58mm	Gold/Tan	13-00685	\$299.00
58mm	Gold/AGX	14-01848	\$239.00
52mm	MatteBlack/Gray	14-01843	\$219.00
55mm	MatteBlack/Gray	14-01844	\$219.00
58mm	MatteBlack/Gray	14-01849	\$219.00

CONCORDE – The Concorde features the world famous tear drop aviator lens design, monoblock hinge design, skull temple bars, and non-slip silicone nose pads. A very popular sunglasses style with lenses that are convertible for prescription lenses.

Size	Lens	Part No.	Price
57mm	Gold/Gray	13-00687	\$239.00
57mm	Gold /Tan	13-00688	\$299.00
57mm	Gray/Green	13-00689	\$239.00
61mm	Gold/Gray	13-00690	\$239.00
61mm	Gray/Green	13-00691	\$239.00
57mm	MatteBlack/Gray	14-01852	\$219.00
61mm	MatteBlack/Gray	14-01851	\$219.00

VISIT OUR WEBSITE FOR MORE SUNGLASS OPTIONS.

PS

FLIGHT HELMETS - FLIGHT JACKETS

LIFT AVIATION FLIGHT HELMETS



This aviation helmet is made out of a fiberglass composite, utilizing Koroyd® and an anti-microbial comfort liner making it the lightest aviation helmet on the market. Features Fire Retardant trim and a FIDLOCK™ buckle system. Works with any aftermarket in helmet communications devices.

Features: • Airflow Comfort Liner - Is a breathable material that promotes air flow circulation and cooling. Made from FireBlock, a fire resistant composite, and Ariaprene, this moisture wicking liner draws sweat away from the wearers head. • Pure Optics Goggle - The Anti-fog UV lens provides premium optics, reduces glare and supports a wider field of vision. TPR molded Visor Retainers mounted on the shell keep the visor from sliding off the helmet. • Flow-Vents - Promotes ventilation and enhanced cooling with strategically engineered exhaust ports designed to pull cool air in and push hot air out. • Fidlock® - Quick Release Allows the fasteners to be conveniently opened and closed single handedly. • PolyFusion Shell - Is the first line of impact defense and is designed to withstand the impact forces you'll encounter inside the cockpit. In addition, this shell is engineered to maintain structural integrity in extreme temperatures. • Headset integration - The AV-1 KOR's shell is designed to fit a wide variety of communication units to suit the wearers aviation needs. • Snap Lock TPR - This rear mounted TPR strap secures the shield and utilizes a button snap closure system. **\$1,214.10/ea.**

Color	Size	Part No.	Size	Part No.	Size	Part No.
Black	Medium	13-21573	Large	13-21572	X-Large	13-21574
Blue	Medium	13-21576	Large	13-21575	X-Large	13-21577
Matte Black	Medium	13-21583	Large	13-21582	X-Large	13-21584
Matte White	Medium	13-21587	Large	13-21586	X-Large	13-21588

Color	Size	Part No.	Size	Part No.	Size	Part No.
Red	Medium	13-21590	Large	13-21589	X-Large	13-21591
White	Medium	13-21593	Large	13-21592	X-Large	13-21594
Yellow	Medium	13-21598	Large	13-21595	X-Large	13-21599

SEE WWW.AIRCRAFTSPRUCE.COM FOR COMPLETE LIST OF HELMETS AND SIZING CHARTS.

FLIGHT OUTFITTERS BUSH PILOT WALLET



The Bush Pilot Wallet is canvas with leather accents, and has a clear window that can display both a Pilot's License and a Driver's License. The wallet comes in a Flight Outfitters-logged tin box, perfect for storing charger cables and other miscellaneous items in a flight bag. Features include six credit card pockets and a divided bill fold.

Features:

- 6 credit card slots
- 2 clear ID holders
- Divided billfold
- Measures 3.5" x 4.5" x 1"
- Wallet is packaged in a custom tin for gift giving.

P/N 13-21893 **\$29.95**

FLIGHT OUTFITTERS BUSH PILOT JACKET



This jacket is essential equipment for your next adventure, whether you're flying seaplanes in Alaska or splitting wood in your back yard. Its rugged exterior blocks out wind and rain, and can stand up to almost any abuse. But the Bush Pilot jacket is as comfortable on the inside as it is tough on the outside, with a quilted body lining and Sherpa accents to keep you warm. It's the bomber jacket for the modern pilot.

Small.....	P/N 13-21539	\$99.95
Medium.....	P/N 13-21540	\$99.95
Large.....	P/N 13-21541	\$99.95
X-Large.....	P/N 13-21542	\$99.95
XX-Large.....	P/N 13-21543	\$99.95

Classic. Authentic. Quality. Established in 1959 as a defense contractor for the US Government, Alpha Industries remains one of the largest manufacturers of cold weather outerwear. For over 35 years, Alpha Industries has continuously supplied the US Government and military forces throughout the world. Alpha is now recognized as the original and leading manufacturer of authentic military-inspired outerwear. Some jackets are made in the USA and some are imported.

TO ORDER FLIGHT JACKETS:

Choose jacket style and color desired and order by basic part number shown.

Complete the part number with size by adding -1 (Small), -2 (Medium), -3(Large), -4 (X Large), or -5 (XX Large).

MA-1 INTERMEDIATE FLIGHT JACKET



The most popular flying jacket in the world, supplied by Alpha Industries to the U.S. Military for over 40 years. 100% nylon flight satin outer shell with nylon flight lining and polyester batting interlining for warmth. Front closure storm flap. Knit collar, waistband and cuffs. Combination utility pocket on sleeve. Pilot's MA-1 reverses to high visibility Indian Orange for use in emergencies.

Black.....	P/N 13-00544	\$137.75
Navy.....	P/N 13-00546	\$137.75
Sage.....	P/N 13-00547	\$146.95

CWU - 45/P FLIGHT JACKET



A nylon version of the U.S. Air Force current issue flight jacket. 100% nylon flight satin outer shell. Fully lined with quilted flight nylon and polyester fill. Water repellent. Knit cuffs and wristband. Storm flap. Two fully-lined cargo pockets and combination utility pocket on sleeve. Removable Velcro logo patch.

Black.....	P/N 13-00559	\$149.75
Replica Blue.....	P/N 13-05585	\$137.75
Airforce Green.....	P/N 13-00572	\$139.95

CHILDREN'S JACKETS

YOUTH BOMBER JACKETS



These are a Flightline original. They're a reproduction of a classic bomber, complete with simulated fleece collar. They are sturdily made with many special touches that make it unique, such as an airplane zipper pull, authentic aviation patches & colorful graphic map liner.



YOUTH BOMBER JACKETS

These are a Flightline original. They're a reproduction of a classic bomber, complete with simulated fleece collar. They are sturdily made with many special touches that make it unique, such as an airplane zipper pull, authentic aviation patches & colorful graphic map liner.



MA-1 JACKETS WITH PATCHES

This is a well made reproduction of the famous MA-1 green nylon quilted. Same patches as our childrens bomber jacket.

Size	Part Number	Price
Toddler Small	13-06432	\$44.95
Toddler Medium	13-06428	\$41.75
Toddler Large	13-06433	\$41.95
Boys Small	13-06429	\$42.95
Boys Medium	13-06430	\$42.95
Boys Large	13-06435	\$42.85
Youth Small	13-06427	\$43.95
Youth Medium	13-06431	\$43.95
Youth Large	13-06434	\$43.95

Size	Part Number	Price
Toddler Small	13-06447	\$36.50
Toddler Medium	13-06446	\$39.95
Toddler Large	13-06445	\$41.90
Boys Small	13-06454	\$43.95
Boys Medium	13-06451	\$39.60
Boys Large	13-06449	\$43.95
Youth Small	13-06448	\$45.50
Youth Medium	13-06453	\$44.50
Youth Large	13-06452	\$48.95

Size	Part Number	Price
Toddler Small	13-06443	\$42.85
Toddler Medium	13-06442	\$42.85
Toddler Large	13-06444	\$44.85
Boys Small	13-06439	\$43.95
Boys Medium	13-06438	\$43.95
Boys Large	13-06441	\$44.95
Youth Small	13-06437	\$45.50
Youth Medium	13-06436	\$48.50
Youth Large	13-06440	\$41.50

VISIT WWW.AIRCRAFTSPRUCE.COM FOR PINK MA-1 JACKETS.

FLIGHT JACKETS



ULTRA FORCE BLACK MA-1 FLIGHT JACKET

This Black MA-1 Flight Jacket features a fully reversible Orange lining, ribbed collar, 100% Nylon water repellent outer shell, Poly fiberfill lining and 4 front slash pockets. Rothco's Flight Jacket has an extra full cut. Sizes and colors do vary.

Size	Part Number	Price
X-Small	14-03239	\$42.99
Small	14-03240	\$42.99
Medium	14-03241	\$42.99
Large	14-03242	\$45.50
X-Large	14-03243	\$42.99
XX-Large	14-03244	\$44.99
XXX-Large	14-03245	\$46.99



G-1 LEATHER FLIGHT JACKET

Reproduction of the coveted naval leather flying jacket featuring a genuine mouton fur collar. Premium goatskin leather. Bi-swing back for free range of movement. Underarm gussets. Knit waistband and cuffs. Legendary Pilot Jacket.

Color	Size	Part Number	Price
Black	Small	13-14998-S	\$349.00
Black	Large	13-14988-L	\$349.00
Black	X-Large	13-14998-XL	\$364.00



NOMEX 45/P-36/P MIL-SPEC FLIGHT JACKET

Made in USA, this true Mil-Spec flight jacket currently issued to U.S. Air Force pilots. Made from fire-resistant Nomex material, this jacket is engineered to exceed incredibly tight tolerances and military requirements. Color: Sage. NOMEX fire resistant fabric, zipper tape, knit cuffs and waistband. Tonal Velcro patch. Front zipper closure with storm flap. Fully lined double-stitched cargo pockets with Velcro closure. Made to military specification.

Size	Part Number	Price
Small	13-15007-S	\$729.00
Medium	13-15007-M	\$729.00
Large	13-15007-L	\$729.00
X-Large	13-15007-XL	\$729.00



FLIGHT OUTFITTERS LEATHER MA-1 JACKET

Since its introduction in 1949, the Leather MA-1 Jacket has perennially been in style. There have been several adaptations over the years but the original styling, cut and genuine cowhide leather are hard to beat. Perfect for lengthy high altitude missions or cold blustery days. The internal lining of the MA-1 was safety orange so that downed pilots could turn the jacket inside out and be easily seen. The orange in the Flight Outfitters logo is based on the classic jacket.

So iconic in it's look and feel that it's been a mainstay on the big screen for years. From Steve McQueen to "Maverick"... the MA-1 has simply owned cool for more the better part of a century. A leather Flight Outfitters placket is attached to the sleeve and makes a perfect spot for a unit crest or custom embroidered patch.

Size	Part Number	Price
Small	13-23352	\$729.00
Medium	13-23353	\$729.00
Large	13-23354	\$729.00
X-Large	13-23356	\$729.00
XX-Large	13-23357	\$729.00



MA-1 BLOOD CHIT FLIGHT JACKET

The MA-1 BLOOD CHIT jacket is one of a kind to be worn with pride. Alpha's MA-1 flight jacket with "Blood Chit" sewn on the inside lining was a type of flag that contained a message in several languages identifying an airman as a U.S. Aviator if they were shot down, to aid the airman in avoiding capture and in being returned safely to U.S. Forces. A reward was offered for this assistance.

This is a classic flight jacket made for the military for over 40 years and features nylon flight satin outer shell with reversible orange nylon lining with the Blood Chit sewn into it, front closure storm flap, knitted collar, cuffs, and waistband and Alpha signature zippered utility/pencil pocket. If you are looking for a quality jacket that isn't just like the one everyone else has, then this is certainly worthy of your consideration. Just think of all the conversations you can have with this jacket. Color: Sage.

Size	Part Number	Price
Small	13-15005-S	\$139.95
Medium	13-15005-M	\$158.75
Large	13-15005-L	\$139.99
X-Large	13-15005-XL	\$149.95



B-15 FLIGHT JACKET

The B-15 is a classic flight jacket made tough to battle the harsh elements. Features a nylon shell and removable synthetic mouton fur collar. The Alpha B-15 features button tabs once used by pilots to connect oxygen masks and headset wires. Water repellent 100% nylon flight satin outer shell and polyester filled lining. Front zipper closure with storm flap. Knit cuffs and waistband. Alpha signature utility/pencil pocket Color: Black.

Size	Part Number	Price
Small	13-15006-S	\$139.95
Medium	13-15006-M	\$139.95
Large	13-15006-L	\$149.75
X-Large	13-15006-XL	\$139.95



AERO SQUADRON LEATHER FLIGHT JACKET

The leather is treated to make the jacket look as if it were issued to your grandfather in WWII and stored in the attic until this week, soft and comfortable. A great way to outfit Dad, Son and teenage Grandson. Color: Brown Antique Lamb

Size	Part Number	Price
Small	13-07208	\$486.00
Medium	13-07209	\$486.00
Large	13-07210	\$486.00
X-Large	13-07211	\$486.00
XX-Large	13-07212	\$486.00



SCULLY LEATHER BOMBER JACKET

This retro rugged leather bomber jacket features a zip front closure, point collar and two lower flap pockets with snap closures & side entry access. The style has epaulettes on the shoulders and a knit waist and cuffs. Also, interior has quilted lining for warmth with one inside chest pocket. Import. Color: Brown.

Size	Part No.	Price	Size	Part No.	Price
Small	13-22459	\$184.23	XX-Large	13-22463	\$184.23
Medium	13-22460	\$184.23	XXX-Large	13-22464	\$211.88
Large	13-22461	\$184.23	XXXX-Large	13-22465	\$211.88
X-Large	13-22462	\$184.23			

PS

AIRCRAFT SPRUCE APPAREL

AIRCRAFT SPRUCE T-SHIRTS

Top quality 100% cotton shirt available in white or navy blue. These shirts feature Aircraft Spruce logo on the back and a small Aircraft Spruce Logo on the front left chest. A great looking shirt that will last for years. Order size by part no.:



Size	White	Price	Navy	Price
Small	13-02810	\$8.95	13-02047	\$8.95
Med.	13-02910	\$8.95	13-02048	\$8.95
Large	13-03010	\$8.95	13-02049	\$8.95
XL	13-03110	\$8.95	13-02050	\$8.95
XXL	13-03120	\$9.95	13-02051	\$9.95

AIRCRAFT SPRUCE POLO SHIRTS



AIRCRAFT SPRUCE POLO SHIRT - These are the same high quality polo shirts worn by the Aircraft Spruce Staff at Oshkosh, Sun 'N Fun and other airshows. Made from Dry-Excel™ close-hole Micromesh, polyester knit, with a fine gauge rib-trim collar. Three button front, open hem sleeves, and split side welts make these polos great for everyone. These polos feature the Aircraft Spruce logo on the left chest. Machine washable.

MEN'S BLACK		
Size	Part No.	Price
Small	13-04729	\$45.00
Med.	13-04731	\$45.00
Large.	13-04732	\$45.00
X-LRG	13-04733	\$45.00
2XLG	13-04734	\$45.00
MEN'S WHITE		
Size	Part No.	Price
Small	13-04730	\$45.00
Med.	13-01985	\$45.00
Large.	13-01982	\$45.00
XLRG	13-01979	\$45.00
2XLG	13-01976	\$45.00

MEN'S LIGHT BLUE		
Size	Part No.	Price
Small	13-04728	\$45.00
Med.	13-01986	\$45.00
Large.	13-01983	\$45.00
XLRG	13-01980	\$45.00
2XLG	13-01977	\$45.00
MEN'S NAVY BLUE		
Size	Part No.	Price
Med.	13-01984	\$45.00
Large.	13-01981	\$45.00
XLRG	13-01978	\$45.00
2XLG	13-01975	\$45.00

AIRCRAFT SPRUCE WINDBREAKERS



These high quality, golf style pullover windbreakers are perfect for those chilly days on the course or at the airport. Color: Navy blue w/khaki trim and "Aircraft Spruce & Specialty Co" on left chest.

Small..... P/N 13-12018**\$39.95**
 Medium..... P/N 13-01987**\$39.95**
 Large P/N 13-01988**\$39.95**
 X-Large..... P/N 13-01989**\$39.95**
 2XL P/N 13-01990**\$29.95**

AIRCRAFT SPRUCE CAPS



Our heavyweight 100% brushed cotton hat is perfect for aviators. Unlike other caps, ours features a no-button construction for comfort while wearing your headset. Low profile cap has aircraft design on front panel and Aircraft Spruce logo on back. A great looking top quality cap Stretch fit, one size fits all.

Black..... P/N 13-03895**\$17.95**
 Navy P/N 13-11715**\$17.95**

AIRCRAFT SPRUCE WATER BOTTLE



BPA free 20 oz. reusable aluminum Aircraft Spruce water Bottle. Features a leak proof lid and a clip to conveniently attach the bottle to a backpack or belt loop. Size: 8 1/2" x 2 3/4 diameter.

P/N 13-11326**\$4.95**

CUSTOM AIRCRAFT MODELS

Recreate your airplane into a beautifully detailed desktop replica. Our Premium Custom Made Models are built to your exact specifications – no detail will be spared. You can have ANY aircraft recreated into a museum quality desktop model with your paint scheme, logos, registration number or any other details and markings.

Complete your model with a fully customized stand including your choice of logo and a personalized inscription plaque. We offer over 3,000 different models – both military and civilian. Our desktop models are a maximum of 17" in either wingspan or length. Please allow approximately 6-8 weeks for delivery. 100% satisfaction guaranteed.

The Premium Plus Custom Models Include : Full Cockpit and Cabin detail – Instrument panel, yoke, seats, seatbelts and other fine details. Fully Customized Paint Scheme. 17" Maximum Wingspan or Length (whichever is greater). Antennas and Other VERY Fine Details. Premium Plus High Gloss Black Pedestal. Raised Brass Logo on Stand. Personalized Inscription Plaque. Military or Civilian. Your Paint Scheme. Your Registration Number. Your Airplane Recreated into a Beautiful Desktop Model. Built to Exact Specifications.

IMPORTANT INFORMATION : Please fill out the information form online in order to customize your model. Please send the form to contact information listed on the form. Along with information form filled out, we will need 5 photos of the top, front, back, and both sides of your aircraft emailed to us.

Custom Aircraft Models P/N 13-06837**\$549.00**
 Premium Plus Custom Models P/N 13-08050**\$699.00**



PS

FLYING GLOVES – GOGGLES – EPAULETS

NOMEX AVIATOR'S SUMMER FLYING GLOVES



GLOVE SIZING

Hold your hand out with your fingers together and thumb extended out. Start measuring palm from between the index finger and thumb, continue around the outside of the palm and back around on the inside of the palm making a complete circle with the measuring tape. Total inches around entire palm determines the size glove you will need.

- 6 inches or less, order Size 7
- 6 1/2 to 7 inches, order Size 9
- 7 1/2 to 8 inches, order Size 11
- 6 to 6 1/2 inches, order Size 8
- 7 to 7 1/2 inches, order Size 10
- 8 inches or more, order Size 12

Size	Part No.	Price	Size	Part No.	Price
Black			Sage Green		
5	13-17931	\$17.95	5	13-17927	\$17.95
6	13-17932	\$17.95	6	13-17928	\$17.95
7	13-03615	\$17.95	7	13-17929	\$17.95
11	13-17933	\$17.95	11	13-02058	\$17.95
12	13-03620	\$17.95	12	13-17930	\$17.95
Tan			Olive Drab		
5	13-17934	\$17.95	6	13-17938	\$17.95
6	13-17935	\$17.95	12	13-17940	\$17.95
12	13-17936	\$17.95			



MARK 4 SILVER CROSS GOGGLES

All leather face mask, colour matched head bands, Split lenses, bright polished and chrome plated frames, Sliding Nose Bridge Adjustment.

P/N 13-06000 \$99.85

Replacement Lenses for Silver Cross Goggles

- Clear, set of 2 P/N 13-06100 \$36.50
- Smoke, Set of 2 P/N 13-06200 \$46.50



WORLD WAR II RAF FLYING GOGGLES

A faithful Replica incorporating dark brown soft leather face mask stitched to the RAF blue painted solid brass frames. The traditional Split Lenses.

P/N 13-05860 \$94.75

- Replacement Split Lenses - Clear P/N 13-06100 \$36.50
- Replacement Split Lenses - Tinted P/N 13-06200 \$46.50



VINTAGE AVIATOR GOGGLES

Soft Brown or Black Leather face Mask, Hand Stitched to silver or black painted solid brass frames. Screw adjustment on nose bridge P/N 13-06310 \$94.75

- Replacement Split Lenses - Clear P/N 13-06100 \$36.50
- Replacement Split Lenses - Tinted P/N 13-06200 \$46.50

NOMEX TOUCH SCREEN COMPATIBLE FLYING GLOVES



These are the same as the regular Flying Gloves which have been worn by American military aviators since the 1960's, except these have a conductive fabric sewn into the tips (of both the left and right glove) of the middle finger, index finger, and thumb to allow for use with touch screen devices. The palms are made from soft capeskin (hair sheep) that gives you the

fine sense of touch you need for flying. The back is made from soft knit of fire-resistant aramid fiber that stretches so the gloves fit snugly. They remain soft and pliable when they get wet. You can even wash them in warm water and hand soap. Measure in inches around the fullest part of your palm. Order the size closest to your hand measurement. Gloves stretch a little, so the fit should be snug.

Color/Size	Part No.	Price	Color/Size	Part No.	Price
Black/5	13-21297	\$48.50	Black/9	13-21303	\$29.95
Black/6	13-21298	\$42.00	Black/10	13-21304	\$48.50
Black/7	13-21299	\$42.00	Black/11	13-21305	\$29.95
Black/8	13-21301	\$29.95	Black/12	13-21306	\$42.95

VISIT OUR WEBSITE FOR PART NUMBERS FOR NAVY & DESERT TAN GLOVES

GENERAL UTILITY PLUS GLOVES



All-purpose and abrasion-resistant. This is the ideal performance work glove. Heavy duty non-slip reinforcement on the palm, fingers and thumb ensures lasting durability and grip. The ergonomic design reduces hand fatigue while enhancing wrist support. Features a terry cloth brow wipe on the thumb. This glove is ideal for any number of rugged applications.

- Medium P/N 13-09813 \$22.50
- Large P/N 13-09814 \$22.50
- X-Large P/N 13-09815 \$22.50

PROPELLER LETTER OPENER



Put a new spin on opening the bills with this propeller letter opener. With its streamlined design of heavy zinc alloy and brushed-metal finish, it makes a beautiful object d'art for the desktop. Twirl it on its spinning metal base for a bit of fun. P/N 13-16039 \$12.90

PS



PILOT SHIRTS / TIES / EPAULETS

Aircraft Spruce stocks a full line of authentic airline pilot shirts in Aviator, Pilot, and Commander styles. Aviator style is available in short and long sleeve, in white or blue. Pilot and Commander are available in short and long sleeve, in white. Available in a complete selection of sizes for men and women pilots.



VISIT WWW.AIRCRAFTSPRUCE.COM FOR A COMPLETE LISTING OF SIZES AND COLORS OF SHIRTS, PLUS TIES AND EPAULETS

MECHANICS DOLLIES – STEP STOOLS



BONE MECHANICS CREEPER

The Bone™ features a uniquely shaped body which cradles the user between the wheels only an inch or so above the ground. The big, easy rolling wheels are positioned outboard to provide a strong, stable working platform that can't tip or flip the user. The rib-reinforced body is molded of a state-of-the-art, engineering grade co-polymer that resists the effects of common solvents, so cleaning is quick and easy at the end of the job. The smooth, comfortable one-piece design has no cracks, corners or other pinch points, and the outboard wheel pods prevent tipping and flipping. The Bone™ body is a patented design which allows the use of large diameter wheels with specially formulated tires that roll easily over all sorts of obstacles, including rough floors, drop cords and air lines, loose parts and even tools and floor grates. The wheels are fastened to the creeper body with four 5/16" diameter through bolts so they can't pull tear out or break off in any common use situation. One of the most important features of the Bone™ is its wheels. Ordinary creeper wheels are a conventional creeper's weakest point. They're too small, so they get hung up or stopped by even the tiniest obstacles, and they have a real knack for tearing out or breaking off at the worst moment. To add insult to injury, the replacement wheels can cost almost as much as a new creeperP/N 13-12331**\$167.00**

TAIL BONE ROUGH RIDER MECHANICS SEAT



The Tail Bone Rough Rider is a totally new approach to creeper seats, designed from scratch to be easier to use, more comfortable, more durable and a better value than any other mechanic's stool on the market! The base is a uniquely designed tripod, so it's a naturally stable working platform even on uneven floors and surfaces. And because it turns with the user, the legs always stay out of the way and let you tuck your feet under you for comfort or convenience. The tripod design also means fewer wheels to have to roll over obstacles! The Tail Bone Rough Rider uses the casters from the Bone Rough Rider Creeper, which are 5 3/8" diameter and 1 3/8" wide, perfect for using outdoors in less than perfect circumstances. It also has an extra inch of ground clearance over the standard Tail Bone! The bucket seat works just like the ones in high performance vehicles, it lets you use your natural body movements and trunk strength to position yourself and the stool exactly where you can do the job at hand comfortably and easily. Work without fear! The Tail Bone just rolls over obstacles that trip and tip ordinary little wheel stools. P/N 13-12330**\$197.85**

RED VIPER AIRPLANE POSITIONER



Own a small airplane? Having trouble positioning it around in your hangar, garage, etc.? Try RED VIPER Positioners™ they really work! Will hold up to 6000 lbs on a 3 tire airplane. Extremely LOW to the ground (only 1/2 inches ground to dolly) so wheel assembly clearance & tire fenders are never an issue. The side panels are only 3 1/2 inches height. Supports tire thicknesses up to 9 inch & wheel diameter up to 26 inches. Just roll your airplane onto dollies & glide 360 degrees effortlesslyP/N 13-17910**\$215.00**

AEROCREEPER - ADJUSTABLE CREEPER



Caster options include:

- Standard 3" x 13/16" Hard Rubber
- recommended for most uses on smooth cement floors
- 120 lb dynamic load per caster
- keeps the creeper low for low working positions
- smooth operation
- Heavy Duty polyurethane casters
- More resistant to embedding metal chips & rivets
- 250 lb dynamic load per caster
- 1-3/16" wide tread helps rolling on rough surfaces
- Available in 3 diameters

- 3" - Usually the best choice - keeps creeper low for low work
- 4" - better for rolling on rough surfaces but raises creeper 1-5/8" so it's not as good for low work
- 5" - better for rolling on rough surfaces but raises creeper 2-5/8" so it's not as good for low work
- Locking Casters
- Prevents rolling
- Installed on front two casters

Description	Part No.	Price
Aerocreeper - Standard - 3" Hard Rubber Casters	13-21329	\$445.00
Aerocreeper - Heavy Duty - 3" TPU Casters	13-21330	\$480.00
Aerocreeper - Heavy Duty - 4" TPU Casters	13-21331	\$485.00
Aerocreeper - Standard - 3" Front Locking Casters	13-21333	\$498.00
Aerocreeper - Heavy Duty - 3" Front Locking Casters	13-21334	\$495.00
Aerocreeper - Heavy Duty - 4" Front Locking Casters	13-21335	\$499.00



SHURE-STEP® II

The Shure-Step II is a 10 inch high step stool that will not tip or slip during use for aircraft maintenance. This step stool is rated for 500 pounds yet only weighs 10 pounds. Rubber pads on bottom prevent the step from scratching the paint on an aircraft.

Features: • 6 large rubber pads on bottom • Very rough top surface to keep mechanics safe • Ice cleats keep the step from sliding during icy winter conditions • The Shure-Step II is a stackable step stool • Weight: 10 pounds
 Yellow.....P/N 13-11219**\$114.75**
 Black.....P/N 13-23267**\$101.76**



SHURE-STEP® 2-STEP STOOL

The 2-Step stool is 10 inches high, half is 6 inches high.

Features: • Durable, lightweight, and stackable • Shure-Step® will float • All Shure-Step® products are rated at holding 500 lbs.

P/N 13-11585**\$147.75**



SHURE-STEP® SENIOR STEP

The Senior Step is 6 inches tall, weighs 9 lbs., rated at 500 lbs. and measures 24" x 14". Step has a large, 10" x 20" black non-slip sandpaper surface on top of it.

Features: • Durable and lightweight • Senior Step can be stacked on top of the Shure-StepII® • Shure-Step® will float • All Shure-Step® products are rated at holding 500 lbs.

Yellow.....P/N 13-11584**\$106.77**
 Black.....P/N 13-23265**\$105.76**



ALUMINUM AIRCRAFT FUELING LADDER

Heavy duty aluminum fueling ladder perfect for aircraft fueling applications. Just the right height to put you in perfect position for low-wing or high-wing aircraft. Made of high quality aluminum and will stand the test of time. **Features:** • Step Ladder • Ladder Height 5 ft. • Number of Steps 3 • Platform Width (In.) 13-1/2 • Height to Platform (In.) 3 • Bottom Width (In.) 20 • Base Spread (In.) 34 • Step Width (In.) 3 • Shipping Weight: 5.8 lbs • Anti-Slip Tread • Load Capacity (Lb.) 300 • Aluminum, ANSI Type 1A • Includes Heavy Duty Standing Platform.

P/N 13-12017**\$204.00**



HANGARBOT DOOR CONTROLLER

Enjoy the convenience of opening and closing your hangar door from the cockpit with the HangarBot Door Controller! Our premiere door controller system is custom made to the specifications of your hangar door. Compatible with nearly all electric and hydraulic Industrial doors with both momentary and continuous hold models as well, this device provides control and connectivity to your door from anywhere in the world. Tailored to your specific hangar door opening and closing it is as easy as a one-tap or continuous hold feature in our

proprietary mobile application.

Note: This product is NOT compatible with manual latch hangar door.
 Note: Your Door Controller is as unique as you are, and will need additional information in order to fulfill this order.

Specifications: • Battery Life: Internal rechargeable battery MicroUSB Cable included (~6 month battery life) • Mounting: Industrial Velcro • Shipping Dimensions: (L x W x H) 6.625" x 2.375" x 1.625" • Shipping Weight: 0.5 lbs.....P/N 11-18344**\$225.00**



FLIGHT SOUND X - AVIATION HEADSET / USB ADAPTER



Just plug and play ... and you're ready to go! Flight Sound X is designed to be as easy to use as possible - no additional software, no batteries, no external power sources - just one standard USB cable. Just 'plug and play!' When

users have finished with the device, simply unplug it, and the computer will revert to its original audio settings. The Flight Sound X adapter is a great accessory for any pilot!

Features: • USB 1.1 and 2.0 compatible • Plug and Play with Windows 7/ Vista/XP and Mac OS X • Uses standard General Aviation headset connectors (PJ-068 and PJ-055B) • Supports headset impedances of 100 to 600 Ohms • Supports Mono and Stereo Headsets • Compatible with standard microphone types (electret, dynamic and powered dynamic)
Pilots Headset USB AdapterP/N 13-09050**\$116.90**
Chopper / Military Pilots UCB adapterP/N 13-09051**\$115.75**

X-PLANE 11 FLIGHT SIMULATOR - DVD SET



Welcome to the world of props, jets, single- and multi-engine airplanes, as well as gliders, helicopters and VTOLs. X-Plane contains subsonic and supersonic flight dynamics, allowing users to predict the flight characteristics of the slowest aircraft or the fastest. X-Plane includes more than 15 aircraft in the default installation, spanning the aviation industry and its history. Aircraft included range from the Sikorsky S-76 and Cessna 172 to the Space Shuttle and the B-52 Bomber. Additionally, some 2,000 additional aircraft models can be downloaded from the Internet, many of which are completely free. If those aren't enough, users can design their own airplanes and test-fly them!

Included Aircraft: • Cirrus Vision SF50 • North American X-15 • Beechcraft Baron 58 • Boeing 747-400 and 747-100 • Boeing 737-800 • Lockheed SR-71 • Cessna 172SP • McDonnell Douglas KC-10 Extender • Stinson L-5 Sentinel • Beechcraft King Air C90B • ASK-21 Glider • Boeing B-52G Stratofortress • Lockheed C-130 Hercules • Space Shuttle Orbiter • McDonnell Douglas F-4 • McDonnell Douglas MD-80 • Sikorsky S-76 • Columbia 400P/N 17-00348**\$59.99**

GARMIN G1000 TRAINING: IFR PROCEDURES



Advanced, extensive computer-based training program developed with input from Garmin that teaches the skills required to master the operation and confidently fly the G1000 in IFR conditions. Learn how to pull up and fly instrument procedures, load and activate approaches including RNAV and GPS approaches, new WAAS-enabled approaches such as LNAV, LNAV/VNAV, and LPV approaches, departures and arrivals, as well as performing course reversals, holding patterns, and executing missed approaches. Complete and comprehensive training allowing the pilot to become proficient in all advanced functions and tasks required for IFR flight and greatly facilitates the transition to flying the Technically Advance Aircraft and the Garmin glass cockpit.

Garmin G1000 PFD & MFD AdvancedP/N 13-05788**\$149.75**

AIRBORNE RADAR ONLINE TRAINING



Airborne-Radar.Com is an online course that teaches how to use airborne weather radar. But, it goes beyond the use of airborne radar, teaching thunderstorm theory, hazards of thunderstorms, airborne radar theory, and airborne radar techniques. A Final Exam concludes the course, enabling the user to test their knowledge. Airborne-Radar.Com is available to PC and Mac

users. Most seasoned professional pilots will admit that there has always been a lack of adequate weather radar training. The mantra has always been, "fly the airplane, and figure it out as you go." But there's no reason to continue with that mindset. Now Airborne-Radar.Com provides the only source of thorough, interactive online training for airborne weather radarP/N 13-10296**\$199.00**
Download VersionP/N 13-11405**\$199.00**

VOR/NDB SIMULATOR V2.0



While The Navigation CD-ROM™ teaches the theory behind navigation, VOR NDB Simulator™ enables you to practice real-time VOR and NDB navigation on your computer! You don't have to worry about altitude control, radio communications, airspace, traffic, or other major tasks, as you would in real flight. Aircraft are expensive to operate, and they make poor classrooms. With VOR NDB Simulator, you're able to learn navigation techniques on your computer, in an inexpensive and non-distracting environment.

Features: • On-screen instructions are fully-voice-narrated • There's only one Simulator Module—you can choose any array of instru-

ments to use, from the Instrument Manager • The Instrument Manager lets you select flight and nav instruments in an array of combinations (including Directional Gyro, Course Deviation Indicators, Automatic Direction Finder, Horizontal Situation Indicator, and Radio Magnetic Indicator) • Instruments are draggable, allowing you to arrange them as they exist on your aircraft's instrument panel • VOR and NDB navigation can be performed simultaneously on the same screen • "Random" buttons generate random aircraft heading, navaid positions, aircraft position, and wind speed and direction • Aircraft can be turned continuously at standard rate (3° per second) and slower with either the keyboard or mouse • ADF interference causes the ADF or RMI needle to vary its indications, making navigation more difficult • "Show/Hide" buttons allow you to hide and show the aircraft, course lines, path flown, and heading vectors • The instruments and map area can be printed by the default printer configured on your computer • Grid lines on the map area represent square miles • ADF instrument allows fixed-card and rotatable-card methods of use • Precision movement of the course needle on the Course Deviation Indicators and Horizontal Situation Indicator allows greater navigation accuracy • Compass rose symbol on VOR nav aids now remains stationary when the course is changed.

P/N 13-01437**\$69.00**

Download VersionP/N 13-11402**\$64.95**

GETTING AROUND ON THE GROUND



The only interactive, multimedia tool available that teaches the types of airport markings, signage, and lighting. It also goes beyond simple technical knowledge by outlining hazards, safety tips, and procedures that will help keep you aware, knowledgeable, and safe on the ground. A real-time, 3-D, virtual airport taxi simulator. Get the ATIS, exchange communications with Air Traffic Control, and follow taxi instructions including hold short and runway crossing tasks. Two airports and forty challenging taxi scenarios are included. And, there's no need for special hardware such as rudder pedals, because you control your aircraft with just a few keys on your keyboard. It's easy! By completing all the content and taking the Final Exam, you can qualify to obtain credit

for the FAA WINGS program. The WINGS program is a continuing education program for pilots, sponsored by the FAA. You'll not only learn to be a safer pilot on the airport surface—you'll also be able to prove your commitment to flight safety with your WINGS account.

P/N 13-01438**\$99.00**

Download VersionP/N 13-11403**\$99.00**

MULTIMEDIA SOFTWARE FLITESCHOOL



In terms of speed, graphics, clarity, and learning value, FliteSchool from Jeppesen Software is unequaled in its class. Much more than a series of "flash cards" that help you memorize the answers to FAA exams, FliteSchool provides programmed learning modules and Hypertext referencing that leads through a series of associated references to learn more, faster! Flite School's Dynamic Cybernetic Learning enhances your training by analyzing your responses and leading you to new subject areas. You'll find studying with FliteSchool to be more interesting and more effective than

other software programs and many video tapes. Material is organized into 20 categories and monitored by topic. The software takes you step-by-step through each subject area and returns to areas where you need more work. When you've mastered enough material to pass the FAA exam, you receive a graduation certificate for your instructor to sign off.
Private PilotP/N 13-100507**\$69.50**
InstrumentP/N 13-100519**\$79.95**

PS

AVIATION AND SIMULATORS SOFTWARE

VTS MULTIMEDIA TRAINING SOFTWARE



VTS training tools are priced affordably to allow each student to own a personal copy of the software. Each aircraft systems are covered in detail far surpassing the general information provided in Pilots Information Manual. For example, the electrical schematic is presented on-screen just as it appears in the information manual. But instead of just sitting there looking mysterious and intimidating, this virtual schematic comes to life with a click of the mouse. Controls and indicators from the cockpit are also available on-screen, creating an animated simulation of the entire system.

Aircraft Systems - Warrior
P/N 13-03388\$148.95

KITLOG PRO SOFTWARE



KitLog Pro is an organizational tool that allows the builder of any type of aircraft to create, archive, maintain, and display the entire building process. Whether your experimental aircraft is a plans-built EAA bi-plane, a Van's RV, a Glastar, or even a Lancair IV-P, KitLog Pro is the most efficient way to ensure that you meet the requirements of a builder's log for the certification of your homebuilt aircraft.

Features: • Complete Builder's log to satisfy FAA requirements
Detailed Expense Log • Test Flight Log • Maintenance Log • Weight & Balance CalculatorP/N 13-03705\$49.95

MAX TRESMOTT'S G1000™ GLASS COCKPIT HANDBOOK



This edition includes dozens of tips and features for G1000 and Perspective glass cockpits, including Cirrus SR20 and SR22 Aircraft. Chapter 11 on Instrument Flying was completely rewritten to make it easier for pilots to understand the many nuances of using the G1000 and Perspective for instrument flight. There is a revolution sweeping through general aviation. In less than two years, the industry has converted to ship all new aircraft with glass cockpits, rather than traditional instrument panels. The most popular and comprehensive guide to operating these airplanes continues to be

Max Trescott's G1000 and Perspective Glass Cockpit Handbook. This book makes it easy for you to quickly become an expert on operating and programming the G1000 and Perspective systems in any aircraft. Instructors agree that the cockpit is not an ideal learning environment. Reading this book, written by a Master Flight Instructor, is one of the most efficient and cost effective ways to learn the G1000 or Perspective before stepping into the cockpit for your first transition lesson.

PN 13-05533\$36.99

IFLIGHTPLANNER SUBSCRIPTION



This is a subscription only*** Email address required for purchase. iFlightPlanner is general aviation's most comprehensive suite of easy-to-use flight planning tools for private and corporate pilots. Featuring iFlightPlanner.com, mobile.iFlightPlanner.com and iFlightPlanner for iPad, iFlightPlanner allows pilots to intuitively plan routes, retrieve certified weather briefs, calculate weight & balance and file flight plans from any computer or their iPad. Note iFlightPlanner currently supports flight planning within the United States, however iFlightPlanner for iPad does support worldwide GPS tracking and color-coded METARs and TAFs.

AnnualP/N 13-16354\$99.99
Plus AnnualP/N 13-23577\$49.99

VOLAIR SIM COCKPIT CHASSIS



Note: This product is drop shipped direct from the manufacturer. If shipping international, inbound freight from manufacturer to our warehouse will apply in addition to outbound freight from our warehouse to destination. This modern design is intended to take the flight simulator instruments off our desks and put them in a more realistic simulator environment. Although the pre-drilled installation holes are universal in nature they are also specific for the Saitek brand of instruments.

The Volair Sim flight chassis' name was derived as a play on the Spanish / Italian word volare, which means 'to fly'. This futuristic looking layout is the near perfect setup for most of our flight simulations. You can adapt any piece or combination of pieces of flight sim gear to the basic chassis and go even further with a little imagination, a drill and a screwdriver.

The Volair Sim is a quality product that enhances the flight simulation environment to near real-world expectations. The high quality powdered tubular steel chassis built around the adjustable real world car racing seat is a true joy to experience. The pre-drilled mounting holes and innovative design features along with the universal adjustable mounts adds to the flexibility of the unit. The ability to mount up to a single 42 IN VESA spec monitor or three 19 - 30 IN widescreen monitors makes it an instant hit with all flight simmers..... P/N 13-14948\$710.00

ELITE V8.5 FLIGHT TRAINING SOFTWARE



For years, professional pilots had no choice other than to maintain IFR proficiency in an expensive full flight simulator. By introducing the world's first professional PC-based airliner-class simulator, ELITE offers a completely new way to practice IFR procedures to keep skills sharp.

ELITE Pilot Premium version 8.6 allows pilots of all levels of experience to exercise their flying skills using the power of the personal computer for over two decades. Complete startup and shutdown procedures, fly different patterns or approaches, practice with normal or abnormal situations, or maintain proficiency, in a completely controllable virtual environment with new 2011 navigational data.

P/N 13-07341\$199.00

WEATHER STATEMENT GROUND SCHOOL



A CD-ROM-based course on METAR's and TAF's. Nearly 2 hours of stunning, interactive training is provided. Promotes learning through human interaction—not just rote memorization. A remarkable feature is the interactive weather controls, which enable the user to "control the weather." Since weather codes are confusing to interpret, the user can click the "Speak-It" button to hear a verbal translation. This allows the user to correlate codes with a true, visual picture and understanding of the weather. This

tutorial CD is perfect for all pilots, from students to rated pilots who wish to remain sharp and proficient. It's also ideal for airport personnel, dispatchers, and anyone else who needs to view aviation weather information.

SoftwareP/N 13-05575\$59.00

Download VersionP/N 13-11404\$55.00

HELICOPTER MANEUVERS GUIDE



The Maneuvers Guide provides step-by-step guidance with over 2 hours of video and animated media. Each maneuver is introduced by designated pilot examiner Ben Fouts.

A detailed graphical animation follows, explaining the maneuvers step by step. Then there is also a cockpit view available showing the flown maneuver

from pilot's perspective! Additionally you can profit from the "Examiner's Perspective" videos. Here you will get important information about common errors and see what an FAA examiner is looking for during the check ride. The software is a great learning tool for students and CFIs alike. System Requirements: • High Definition image quality • 1280x720pix resolution • Runs on MAC and PC (Mac OSX 10 / Windows Vista, 7) (requires Adobe Flash 11 and Adobe AIR - free downloads) • Note: This Software does not run on iPad or iPhone min. 1 GB RAM recommended.

P/N 13-12737\$199.00

PS

FLIGHT SIMULATORS – SOFTWARE

CH VIDEO GAME JOYSTICKS

Your pulse quickens, your muscles tighten, adrenaline surges through your veins as you engage enemy aircraft in gut wrenching aerial combat. With CH Products simulation controllers, the realism of your next combat mission ascends to new heights.



FLIGHTSTICK PRO

- Windows 98, ME, 2000, XP, XP 64bit, Vista • 3 axes and 12 buttons – X, Y, and Z axes for Aileron, Elevator, and Throttle control – 4 traditional push buttons – 1 eight direction POV HAT switch • Total of 80 programmable functions with Control Manager software (included) • Simple ambidextrous handle • Dual rotary trim wheels for precise adjustment of ailerons and elevators • Side Throttle wheel • Large sturdy base with 7 foot USB cable • Plug and Play driverless USB installation • Quality industrial components and construction • Two year limited warranty

P/N 13-05613\$92.80



FLIGHTSTICK

- Windows 98, ME, 2000, XP, XP 64bit, Vista • 3 axes and 24 buttons – X, Y, and Z axes for Aileron, Elevator, and Throttle control – 3 traditional push buttons – 1 mode switch button – 3 four direction HAT switches – 1 eight direction POV HAT switch • Total of 176 programmable functions with Control Manager software (included) • Three color mode indicator LEDs on base • Realistic F-16 handle • Dual rotary trim wheels for precise adjustment of ailerons and elevators • Side Throttle wheel • Large sturdy base with 7 foot USB cable • Plug and Play driverless USB installation • Quality industrial components and construction • Two year limited warranty.

P/N 13-05615\$142.75



PRO THROTTLE

- Windows 98, ME, 2000, XP, XP 64bit, Vista • 3 axes and 24 buttons – X and Y axes on miniature joystick – Z axis on accurate throttle sliding motion – 3 traditional push buttons – 1 mode switch button – 3 four direction HAT switches – 1 eight direction POV HAT switch • Total of 176 programmable functions with Control Manager software (included) • Three color mode indicator LEDs on base • Ergonomic left hand HOTAS design • Large sturdy base with 7 foot USB cable • Plug and Play driverless USB installation • Quality industrial components and construction • Two year limited warranty

P/N 13-05616\$128.75

PANEL PLANNER INSTRUMENT PANEL DESIGN SOFTWARE



Panel Planner software gives you the power to design and build instrument panels in record time. Simply drag full-color, photo-realistic instruments, avionics, and cockpit controls into place on an aircraft panel template or photograph. Panel Planner tracks total cost, total weight, and peak current, generates an equipment list, and even prints actual-size hole-cutting templates and color mock-ups. Panel Planner is easy to install and use with its continuous context-sensitive help to guide you every step of the way. The updatable database includes equipment from King, Narco, Sigma-Tek, David Clark, P.S. Engineering, Insight, Garmin, IFR, Il Morrow, UMA, Mitchell, Trimble, Arnov, S-Tek, Century, Vision Microsystems, Avidyne, Digifly, Skyforce, and many more; PLUS switches, lights, control cables, vents, circuit breakers, trim indicators, etc. Create labels, color-coded annunciators, or placards.

PANEL PLANNER PRO (2.9 VERSION)

The PPJ 3.4 update has 100's of new panels and instruments. Please download the Excel spreadsheets. Hundreds of hours were spent reworking older panels to bring out more detail. Instrument manufacturers added like Lonestar that represent new, important auxiliary avionics and more smaller aircraft manufacturers' panel added. View 1600 instruments on 600 aircraft panels. Outputs DXF files for CNC, laser/water jet. Updates over the internet. Full-size cutting template printouts Measurement and alignment tools. Edit existing or create new panel templates. Multiple zoom and magnification levels. Actual-size color prints from desktop printers.

Panel Planner Pro for WindowsP/N 13-44415\$495.00

Panel Planner Pro for MacintoshP/N 13-06210\$495.00

LOGITECH EXTREME 3D PRO JOYSTICK



When the pressure is on, your stick performance is the difference between victory and total oblivion. The Extreme 3D Pro twist handle joystick will never let you down. The 12 programmable buttons and 8-way rubber hat switch give you optimum control, personalized to your taste. Whether you're dropping bombs at a distance or firing guns in a dog fight, the stable and precise Extreme 3D Pro will have you dominating the enemy in no time.

Benefits:

- Dominate the skies or the ground with the control of 12 well-placed, fully programmable buttons and a rapid-fire trigger
- Home in on your target with the deadly accurate direction control of the twist handle
- Smooth and accurate throttle settings are a major bonus whether you're entering the fray or bugging out.....P/N 14-03430\$41.95

COMM 1 VFR/FR RADIO SIMULATOR

Learning to fly? Not flown for a few years? Talking on the radio is one of the most important, but least emphasized, skills you need to fly safely in today's busy airspace. COMM1 VFR Radio Simulator is a proven tool for getting you up to speed on communicating professionally with ATC, Flight Services, Flight Watch, and other ground personnel. 6+ hours of training, comprehensive audio-visual tutorials, realistic flight scenarios, Interactive practice exercises w/ ATC, playback your exchange w/ATC, and compare yourself to an expert. Works with MAC and Windows 8. 486/66 MHz PC processor. 16 MB RAM. 6 MB hard drive space. Windows 95. 4x speed CD-ROM drive. Sound Blaster-compatible sound card. Microphone and speakers (or headset). 800 x 600 resolution display with 256 colors. Works with MAC and Windows 8.

Comm1 - VFR Radio Simulator.....P/N 13-32221\$93.95

Comm1 - IFR Radio SimulatorP/N 13-00093\$112.95

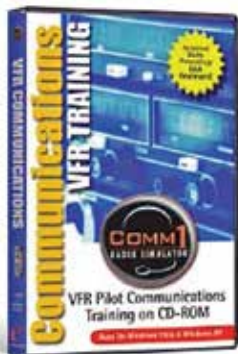

PS

REDBIRD FLIGHT SIMULATORS

THE JAY BY REDBIRD



Start Up-procedure: 1.Put it on a table. 2.Turn it on. 3. Fly. Practicing at home is a great idea for pilots. You can keep your skills sharp and your mind in the cockpit even when you can't make it to the airport. In reality, however, two obstacles deny a majority of pilots effective home flight simulation: purchasing and assembling the right hardware

requires a PhD in computer know-how, and after flying around the virtual world for a bit, most pilots get bored. Redbird Flight Simulations, the world leader in FAA-approved flight simulators for general aviation, has addressed both these issues with the Jay. The Jay contains the monitor, speakers, computer and flight controls—all-in-one unit that is ready to fly right out of the box. It boots up directly to a launch screen where you can select your airplane, airport and weather conditions. Push the green button and you're on a runway and ready to go. **Scenario-based training? It's built in.** The Jay is more than a simulator—it's a flight experience device supporting training, proficiency, and just plain fun! In addition to the free flight mode where you select the aircraft and conditions, the Jay has a scenario mode where you can load a preset scenario and fly it. A scenario could range from a simple flight challenge to a complex flight with multiple potential outcomes. For example, a magazine article on an aircraft accident could be linked to a mission where the Jay owner flies that scenario. Redbird Media, a company specializing in curriculum for simulation, will create many of these scenarios in partnership with AOPA Pilot and other training outlets and magazines. The scenario exchange will be open to any company wishing to create scenarios for the Jay. A one-button update on the Jay will load the latest scenarios available for free or that the owner has purchased. The Jay home screen also has a built-in web browser to access scenario add-ons, such as video, or download simulator extensions such as additional aircraft or scenery. The Jay chassis is metal, not plastic. Control smoothness is paramount. The parts should last indefinitely. In addition, there are pilot-centric touches.....P/N 13-15906**\$2,794.97**

OPTIONS

Description	Part No.	Price
Redbird Wireless Adapter For The Jay	13-15874	\$58.95
Redbird RD1 Rudder Pedals	13-15866	\$549.00
Extended Warranty - Jay (12 Months) S-1105	13-22370	\$299.00
Extended Warranty - Jay (24 Months) S-1106	13-22371	\$399.00

THE JAY VELOCITY EDITION BY REDBIRD



The Jay Velocity Edition contains all of the standard Jay features, while adding upgraded computing power and robust components to allow it to be used in demanding environments like middle and high schools, museums, and public access kiosks. The clean-sheet design prioritizes one thing for the classroom: Get the student learning with a minimum of fuss. There are

no peripherals to configure, no systems to install. Take it out of the box, plug it in, and turn it on. Now say, "preflight complete." The Jay contains the monitor, speakers, computer and flight controls—all-in-one unit that is ready to fly right out of the box. It boots up directly to a launch screen where you can select your airplane, airport and weather conditions. Push the green button and you're on a runway and ready to goP/N 13-20712**\$4,594.97**
 Extended Warranty - Jay Velocity (12 Months) S-1107.....P/N 13-22372**\$399.00**
 Extended Warranty - Jay Velocity (24 Months) S-1108.....P/N 13-22373**\$499.00**

REDBIRD ALLOY SIMULATOR CONTROLS

Part No.	Description	Price
13-19645	Redbird Control Yoke	\$799.00
13-19642	Redbird Single Engine Vernier Throttle Quadrant	\$575.00
13-19643	Redbird Twin Engine Lever Throttle Quadrant	\$599.00

REDBIRD ALLOY FLIGHT SIMULATOR BUNDLE



A good flight simulator is more than just a toy; it can improve your flying skills and keep you current. But many inexpensive yokes and rudder pedals don't accurately simulate what flying is really like.

- Virtually indestructible metal construction – never worry about broken parts
- Accurate feel - full control deflection without increasing spring tension
- Set the perfect height – controls can be attached above or below a table
- Easy setup – plug and play compatibility with Microsoft Flight Sim X, X-Plane, and Prepar3d
- USB connectivity ensures that these controls compatible with most flight simulation software devices running Lockheed Martin Prepar3d, X-Plane, and Microsoft Flight Simulator (including Microsoft Flight Simulator 2020)
- Yoke includes electric trim switch, push-to-talk button, and autopilot disconnect button
- Throttle quadrant includes throttle, propeller, and mixture levers, plus flap and gear handles.

In The Box:

- 1 - Flight Simulation Yoke YK1
 - 1 - Rudder Pedals RD1
 - 1 - Single Engine Vernier Throttle Quadrant TH1
- P/N 13-23275**\$1,999.00**

OTHER REDBIRD SIMULATORS

Part No.	Model Number	Description	Starting Price
13-15889	Redbird LD	Wrap around visuals without cockpit enclosure	\$32,800.00
13-15890	Redbird SD	Enclosed similar to FMX, but no motion	\$42,800.00
13-15891	Redbird FMX	Full motion, enclosed cockpit, flagship model	\$64,800.00
13-15892	Redbird MX2	Full motion, compact for limited space	\$58,800.00
13-15893	Redbird MCX	Full motion, ideal for CFI, CFII, CRM Training	\$89,800.00
13-15902	Redbird XWIND	Full motion, teaches cross wing techniques	\$31,900.00
13-15903	Redbird XWIND SE	Full motion, with more LCD exterior visuals	\$34,900.00
13-15870	Redbird O-1123	TD & TD2 Sims. Come with a single screen. This kit adds 2 side screens for a panoramic view.	\$1,695.00
13-15860	Redbird O-1109	Redbird Table For TD And TD2	\$629.00

PS

SAITEK FLIGHT SIMULATION



SAITEK X52 FLIGHT CONTROL SYSTEM

Enhanced game play through intuitive Multi-Function display (MFD). Illuminated buttons and MFD - ideal for low light environments. Rubber grips and ergonomic design for increased comfort and fatigue-free gaming. Includes Roger Wilco Chat software - the ideal accompaniment for on-line multiplayer gaming. P/N 14-02845\$149.99



SAITEK X52 PRO FLIGHT SYSTEM

The MFD screen is now interactive. Now you can display important in-game information such as the Radio Stack and interact with your games directly. Shipping with support for Microsoft's Flight Simulator X, there's also a Software Development Kit (SDK) included which allows budding programmers to create interactions with their own favorite games. P/N 14-00649\$199.99



SAITEK PRO FLIGHT YOKE SYSTEM

Meets the exacting needs of the true flight simulation enthusiast. Stainless steel shaft, ergonomic controls, integrated chronograph and separate throttle quadrant. Use the integrated USB Hub to easily connect other parts of the Saitek Pro Flight range of products, such as additional Pro Flight Throttle Quadrant or Pro Flight Instrument Panel (sold separately) P/N 14-00598\$169.99

SAITEK PRO FLIGHT INSTRUMENT PANEL 6 PACK



Featuring a stunning 3.5" colour LCD screen, the Instrument Panel can display 6 of the main cockpit instrument panels from Microsoft's Flight Simulator X. Choose between 6 different flight instruments at the touch of a button: Altimeter, Attitude Indicator, Airspeed Indicator, Compass, Turn and Slip indicator, and Vertical Speed.....P/N 14-03010\$885.00



SAITEK PRO FLIGHT ADVANCED PANEL

Advanced Panel offers a cockpit-realistic way to mount Saitek Pro Flight Simulation Instruments and Controls. The Advanced Panel twist-and-remove pre-cut tabs allow you to add Saitek hardware to your Advanced Panel over time and trade simulation devices between slots. Small tabs accommodate up to 10 Pro Flight Instruments. Each Saitek Flight Instrument Panel allows you to digitally switch between simulating eleven flight instruments. Alternatively, mount a Hannspree HL161ABB 16" Screen LED-Lit Monitor in one of several possible Panel face mounting configurationsP/N 13-13088\$239.00

HONEYCOMB ALPHA FLIGHT CONTROL YOKE AND SWITCH PANEL



The Honeycomb Alpha Flight Control is the most advanced flight simulation system available to simmers, flight students, and pilots for setup at home and features a complete backlit switch panel and ignition switch. It was designed and developed in California by pilots and aerospace engineers to ensure the most realistic flight experience. P/N 13-22139\$249.99

SAITEK X-56 PRO FLIGHT RHINO H.O.T.A.S. SYSTEM



Evolving the H.O.T.A.S. Designed to meet the needs of the re-emerging space simulation genre, Saitek introduces the new X-56 Rhino H.O.T.A.S. System. Built to the same exacting standards of Saitek's award-winning Pro Flight accessories range, the X-56 Rhino delivers a multitude of customizable options.

Compatible Simulators: • Elite: Dangerous • Star Citizen • Flight Simulator X • Flight Simulator 2004 • X-Plane 10 • X-Plane 9 • DCS WorldP/N 14-03295\$349.00



SAITEK PRO FLIGHT THROTTLE QUADRANT

Upgrade your flight simulation experience with the Saitek Pro Flight Throttle Quadrant. This makes an ideal addition to the Saitek Pro Flight Yoke System to expand the number of controls for your flight simulation setup.

Set the levers to control aircraft throttles, adjust elevator trim, fuel mixture or even to engage reverse thrust during landing. The Pro Flight Throttle Quadrant will work in any major flight simulation to give you all the control you need.....P/N 14-00601\$59.99



SAITEK PRO FLIGHT RUDDER PEDALS

Complete your virtual pilot's controller setup and take flight simulation reality to the next level with the Pro Flight Rudder Pedals. Control the rudder and toe brakes of your aircraft with your feet - just like real pilots. Adjustable, smooth action gives you optimum control and realism, and brings you even closer to the experience of flying a real aircraft. P/N 14-00602\$174.95



SAITEK PRO FLIGHT SWITCH PANEL

Upgrade your flight simulation experience for Microsoft Flight Simulator X with the Saitek Pro Flight Switch Panel. Whether attached to the Saitek Pro Flight Yoke System, free standing on a desk or mounted into your own cockpit setup, the Pro Flight Switch Panel is an ideal way to expand the number of controls for your flight simulation setupP/N 14-00714\$99.99



SAITEK PRO FLIGHT RADIO PANEL

Upgrade your flight simulation experience for Microsoft Flight Simulator X with the Saitek Pro Flight Radio Panel. LED displays work fully in real time with Flight Simulator X and 2004, removing the need to bring the radio stack up on screen. A set of switches and LED displays for use in controlling various aspects of flight simulation. COM1 / COM2 / NAV1 / NAV2 function. DME / ADF / XPDR functions. P/N 14-00969\$149.99



SAITEK PRO FLIGHT MULTI-PANEL

Upgrade your flight simulation experience for Microsoft Flight Simulator X with the Saitek Pro Flight Multi Panel. LED displays work fully in real time with Flight Simulator X and 2004, removing the need to bring the autopilot up on screen. A set of switches and LED display for use in controlling various aspects of flight simulation. Full Autopilot panel with associated setting controls: Auto Throttle, Flaps, Elevator Trim wheel. P/N 14-00968\$149.99

SAITEK PRO FLIGHT INSTRUMENT PANEL



Featuring a stunning 3.5" colour LCD screen, the Instrument Panel can display 6 of the main cockpit instrument panels from Microsoft's Flight Simulator X. Reacting and updating in real time with events from the game, the Instrument Panel brings an extra level of realism to your flight simulation setup. Choose between 6 different flight instruments at the touch of a button: Altimeter, Attitude Indicator, Airspeed Indicator, Compass, Turn and Slip indicator, Vertical SpeedP/N 14-00870\$171.75



SAITEK PRO FLIGHT SIMULATOR BUNDLE

The Saitek Pro Flight Yoke System is highly engineered to meet the exacting needs of the true flight simulation enthusiast. Stainless steel shaft, ergonomic controls, integrated chronograph and separate throttle quadrant ensure a smooth, accurate and totally realistic flying experience. Use the integrated USB Hub to easily connect other parts of the Saitek Pro Flight range of products, such as additional Pro Flight Throttle Quadrant or Pro Flight Instrument Panel (both sold separately). Complete your virtual pilot's controller setup and take flight simulation reality to the next level with the Pro Flight Rudder Pedals. Control the rudder and toe brakes of your aircraft with your feet - just like real pilots. Adjustable, smooth action gives you optimum control and realism, and brings you even closer to the experience of flying a real aircraft.....P/N 13-23276\$344.90

PS

VINTAGE SIGNS – IFR SIMULATORS

VINTAGE SIGNS



HOMEBUILDERS HEADQUARTERS SINCE 1965 WITH PROP LOGO

This Homebuilders Headquarters since 1965 prop logo vintage metal sign is made in the United States using 24 gauge American steel and a process known as sublimation, where the image is baked into a powder coating for a durable and long lasting finish. A vintaging process is then performed by hand to give this sign an aged look and feel. The edges of this sign are rounded for extra rigidity and the corners are drilled and riveted for easy hanging.
11.5" x 17.5".....P/N 13-17902**\$18.95**



I'D RATHER BE SHOPPING AT AIRCRAFT SPRUCE TREE LOGO

This I'd rather be shopping at Aircraft Spruce tree logo vintage metal sign is made in the United States using 24 gauge American steel and a process known as sublimation, where the image is baked into a powder coating for a durable and long lasting finish. A vintaging process is then performed by hand to give this sign an aged look and feel. The edges of this sign are rounded for extra rigidity and the corners are drilled and riveted for easy hanging.
11.5" x 17.5".....P/N 13-17908**\$12.50**



HONEYCOMB BRAVO THROTTLE QUADRANT

The Bravo Throttle Quadrant is an all-in-one cockpit system featuring a fully configurable throttle setup. Six general aviation and six commercial levers are included and can be arranged from single-engine general aviation all the way up to four-engine commercial aircraft. The commercial levers include flaps, spoilers, and functional thrust reversers while the general aviation levers include power, prop, and mixture and can engage thrust reverse for turbo props as well. The throttle

also features multiple cockpit components including an autopilot panel with backlit buttons, annunciator panel with 14 warning lights, Gear Lever with landing gear indicator lights, general aviation flap lever and a trim wheel. The throttle also comes with Honeycomb's dual mounting system which includes two heavy duty steel clamps and a large 3M® Micro-Suction Pad that can be used as a clamp-free solution. The Honeycomb Bravo Throttle Quadrant was designed to ensure the most versatile flight simulation experience possible.....P/N 13-23178**\$249.99**



HONEYCOMB THROTTLE PACK FOR AIRBUS™

The Throttle Pack is an accessory for the Airbus™ A319-A380.

Note: Bravo Throttle Quadrant Sold Separately*. Model: A319-A380
P/N 13-23173**\$69.99**

HARDWARE OPTIONS FOR ON TOP AND IP TRAINER

FLIGHT SIM YOKE USB



Put yourself behind a set of real controls with the CH Flight Sim Yoke, complete with an authentic 3 lever throttle quadrant and numerous cockpit functions at your fingertips. Now you can control your aircraft like a real pilot would with left hand on the yoke and right hand controlling your throttle, prop and mixture and managing the rest of your cockpit.

P/N 13-00737**\$163.75**

CH ECLIPSE YOKE



Fully programmable fingertip paddles, ideal for flight and racing sims. Programmable trim / scroll wheels with center push function. Two backlit push buttons and a third traditional push button. Two 8-way hat with rocker switch and trigger on both sides of handle. Configurable POV hat for either left or right hand use. Colored handles for throttle / prop / fuel mixture. Three color LED selector dial giving you a total of 240 programmable functions with CH Control Manager software. Six analog 10 bit axes for aileron, elevator, throttle, propeller pitch, fuel and rudder. New and improved industrial grade material / components; indestructible robust plastic, free floating shaft and clamp extenders for the thinnest of desksP/N 13-06127**\$219.95**

CH PRO RUDDER PEDALS USB



Features forward/backward slide motion for real simulation flying. Also works well as gas and brake controls for racing simulators. These 3 axes pedals are ideal with the 5 axes USB Flight Sim yoke.

P/N 13-00738**\$159.95**

Kit #1 - Yoke and Rudder PedalsP/N 13-06766**\$289.95**

CH THROTTLE QUADRANT USB



TWIN ENGINE. Fully programmable and featuring six physical dent axis' and up to 350 buttons. Throttle Quadrant USB takes you from the computer to the cockpit. **Features:** 6 Axis 12 Buttons (24 Button functions w/Control Manager Software (included), 6 Physical Detents, Fully Programmable with CH Control manager, Compatible with Windows 98, Windows ME, Windows 2000 & Windows XP. Compatible with all Windows based GamesP/N 13-03377**\$132.75**



JEPPESEN AIRWAY – ACCESSORIESEPAULETS

JEPPESEN AIRWAY SERVICES

Aircraft Spruce carries the complete Jeppesen Airway Services product line. See our website for part numbers and prices on Jeppesen Enroute Low and Terminal Charts as well as Jeppesen Airway Manual Express.



APPROACH CHART PROTECTOR

Protection plus. Transparent plastic envelopes protect your most frequently used approach charts, while accepting marks from almost any writing instrument. Easy Erase. Set of 10.
P/N 13-21748 \$7.50

JEPPESEN BINDERS



Functional, durable, protects & lasts. Jeppesen's leather binders are made from top-grain cowhide and include steel hinges and safety locks to secure the rings. The sturdy Duraflo binder has the look and the feel of our leather binders. The flo-mold process laminates and binds sturdy, ethylene acetate with a clear tough surlyn outer surface. Available in brown and black.

Standard leather 2" Binder.P/N 13-03250 \$58.90
LB-2 Leather, 2" Rings, Stay-Open Bar.P/N 13-21738 \$88.75

PLASTIC BINDERS

PB-2 Denlon wrapped, 2" Rings, No Stay-Open Bar.
P/N 13-21744 \$34.80
PB-1.5 Denlon wrapped, 1.5" Rings, No Stay-Open Bar.
P/N 13-22792 \$24.95

JEPPESEN PRIVATE PILOT EXAM BOOKLET

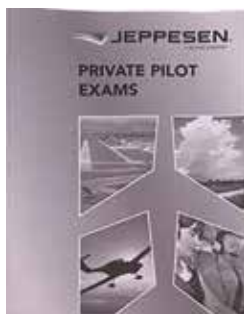

The Private Pilot Exam Booklet is a product that contains all the written exams that are needed to complete the Jeppesen Private Pilot course under 14 CFR Part 141. This booklet combines the Private Pilot Pre-Solo Written Exam, Private Pilot Stage Exams, and Private Pilot End Of Course Exams into one single product.
P/N 13-19627 \$17.90

CHARTTABS



Quick reference tabs labeled, "Departure, Destination and Alternate" help you find your place fast. Plastic color coded.
Set of 3P/N 13-21752 \$6.85

MULTI-TABS



Make your binder work like you do. Write your own labels to separate your contents. Erasable, reusable. Lines for notes. Set/13
P/N 8455 \$7.20

AIRWAY MANUAL ACCESSORY PACK



Each package Contains: • Chart tabs (set of 3) • Approach chart protectors (set of 10) • NavLog/Flight Plan Forms (set of 50) • Multi-tabs (set of 13) • Pilot Notes (set of 25 lined)P/N 13-62604-6 \$23.75

IFR FLIGHT FILE



This handy chart planner and organizer holds NOS or Jeppesen approach plates, SIDs and STARs, and airport diagrams. Easy to load static-hold chart protectors, and fits yoke clips & keenboards. Important reference information relating to IFR departure, enroute, approach, and alternates.
P/N 13-55016 \$19.95

PREMIUM EPAULETS



The board for these epaulets are made of 100% Polyester and the finest braided bars available. Epaulets are available with a Black or Navy base and a Metallic Gold, Metallic Silver, Nylon Gold, or Nylon Silver stripe. Price per pair.

Part No.	Description	Price
14-00421	1 Stripe - Gold Metallic Navy	\$11.85
14-00422	1 Stripe - Gold Nylon Black	\$12.50
14-00423	1 Stripe - Gold Nylon Navy	\$12.50
14-00424	1 Stripe - Silver Metallic Black	\$12.50
14-00425	1 Stripe -Silver Metallic Navy	\$12.50
14-00426	1 Stripe - Silver Nylon Black	\$12.50
14-00427	1 Stripe -Silver Nylon Navy	\$11.60
14-00420	1 Stripe - Gold Metallic Black	\$11.90
14-00412	2 Stripe - Gold Metallic Black	\$12.50
14-00413	2 Stripe -Gold Metallic Navy	\$12.50
14-00414	2 Stripe -Gold Nylon Black	\$12.50
14-00415	2 Stripe -Gold Nylon Navy	\$12.50
14-00416	2 Stripe -Silver Metallic Black	\$12.50
14-00417	2 Stripe - Silver Metallic Navy	\$12.50
14-00418	2 Stripe - Silver Nylon Black	\$12.50
14-00419	2 Stripe - Silver Nylon Navy	\$9.50
14-00241	3 Stripe - Gold Metallic Black	\$12.95
14-00405	3 Stripe - Gold Metallic Navy	\$14.50
14-00406	3 Stripe -Gold Nylon Black	\$11.95
14-00407	3 Stripe -Gold Nylon Navy	\$11.75
14-00408	3 Stripe -Silver Metallic Black	\$12.50
14-00409	3 Stripe -Silver Metallic Navy	\$11.75
14-00410	3 Stripe -Silver Nylon Black	\$13.00
14-00411	3 Stripe -Silver Nylon Navy	\$11.75
14-00397	4 Stripe - Gold Metallic Black	\$13.50
14-00399	4 Stripe - Gold Metallic Navy	\$15.00
14-00401	4 Stripe -Gold Nylon Black	\$13.50
14-00402	4 Stripe -Gold Nylon Navy	\$11.75
14-00398	4 Stripe -Silver Metallic Black	\$13.50
14-00400	4 Stripe -Silver Metallic Navy	\$13.50
14-00403	4 Stripe -Silver Nylon Black	\$13.50
14-00404	4 Stripe -Silver Nylon Navy	\$13.00
14-00397	4 Stripe - Gold Metalic on Black	\$13.50
14-00398	4 Stripe - Silver Metalic on Black	\$13.50
14-03296	4 Stripe - White Nylon on Black	\$11.50
14-00399	4 Stripe - Gold Metalic on Navy	\$15.00

PS

MAPS – CHARTS

WEATHERCYCLER WEATHER SYSTEMS CHART



A durable 8-1/2" x 11" slide chart that uniquely displays map views and vertical cross sections through Highs, Lows, and fronts -- the broad-scale systems and features that dominate our weather. Sky views and changes in temperature and pressure complete the comprehensive chart depictions. By simply pulling the chart insert, the weather systems are put into their typical movements from west to east. Weather changes are

shown for your location as the weather systems pass by. Accompanying four-page instruction booklet describes the basic causes of weather and explains step-by-step how to use The WeatherCycler.

P/N 13-29949\$9.99



FULL-COLOR CLOUD CHART

"Clouds: A Guide to the Sky" shows full-color photos of 30 different cloud formations, (with descriptions) and the weather associated with each. 25" x 37" on heavy stock.

P/N 13-14758\$5.95

SCENIC FLIGHT MAPS



The Scenic Flight Maps give you many different routes for sightseeing to the major landmarks, famous places in Los Angeles and Orange County or San Diego area. The multiple color graphs and route pointers are really easy to read and follow. The map is laminated to keep from daily tears and protects from liquid spill. On the back side, it shows three columns: Route, Need to Know and Sightseeing sections, to better guide you in your travel without confusion or time lost. Scenic Flight Maps L.A./O.C.

P/N 13-05667\$11.95



VFR WALL PLANNING CHART

U.S. VFR Wall Planning Chart is designed for VFR preflight planning and provides aeronautical and topographic information of the conterminous U.S. The aeronautical information includes airports, radio aids to navigation, Class B airspace and special use airspace.

The topographic information includes city tint, populated places, principal roads, drainage patterns and shaded relief. This chart, 59x36 inches flat, is updated annually.P/N 13-14786\$14.75

CANADA FLIGHT SUPPLEMENT IFR CHART



The Canada Flight Supplement is a joint civil/military publication. It contains information on Canadian and North Atlantic aerodromes and is used as a reference for the planning and safe conduct of air operations.

Features: • General: Tables, legends and associated information pertinent to interpretation of the supplement. • Aerodrome Directory • Planning • Radio Navigation and Communications • Military: Flight procedures and data, including sections on procedures for flight in the USA, North Atlantic and Alaska, air/ground communications and military training routes/areas. • Emergency procedures. • The Canada Flight Supplement, measuring 5 1/4 by 8 1/4 inches, is available in English or a bilingual format. Data for the province of Quebec and the National Capital Region are presented in French in the bilingual edition.

English VersionP/N 13-04424\$17.50
Bilingual Version.....P/N 13-04550\$22.95

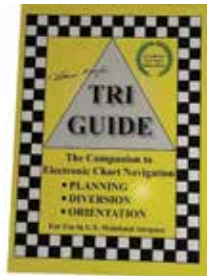

TRI GUIDE THE COMPANION TO ELECTRONIC CHART NAVIGATION

Howie Keefe's Tri Guide is the perfect companion to Electronic Chart Navigation. This guide addresses: • Planning • Diversion • Orientation • Airport & VOR Decode (ID to Name) Plus Contact Frequency • Reservation Numbers and even Hotel & Motel Numbers • For use in U.S. Mainland Airspace P/N 13-12653.....\$27.95

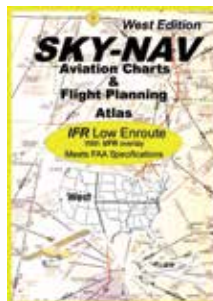

SKY - NAV VFR SECTIONAL ATLAS SOUTHEAST USA

Each VFR Sectional Atlas includes Frequencies for Towers, Approach Control, Restricted Airspace & MOA's.

Easy to read & same size as folded FAA sectional chart.....P/N 13-12127\$49.95

3-D AERONAUTICAL CHARTS



The precisely molded 3D shape allows pilots to see and feel the terrain shape and clearly understand how it relates to the airspace and flight. Pilots will value referencing this chart for flight planning, training, and as a general conversation piece, whether hung on a wall of an office, hangar, or home. This chart is made with a digital inkjet printing process on a rigid plastic film, which is then molded to a precise terrain model.

Los Angeles.....P/N 13-09595\$46.50
Southern Sierra Nevada.....P/N 13-09597\$46.50
San Francisco / TahoeP/N 13-09596\$46.50
Denver.....P/N 13-10006\$46.50
PortlandP/N 13-11714\$46.50
SeattleP/N 13-11713\$46.50



QUICK REFRESHER CHARTS

These Quick Refresher Charts provide a wealth of useful information that every pilot seems to forget over time. Available to "refresh" the pilot on IFR procedures & regulations, Weather info, VFR procedures & regulations, mountain flying, passenger info (the right seat), flying to Canada, and flying to the Bahamas. These

charts are laminated for long life & fit right in your flight bag. Quick Refresher Mtn. Flying.....P/N 13-00422\$5.95

FOLDED PILOT'S MAP



This map measures 3 feet by 2 feet and is encapsulated on both sides by a rugged 3 mil laminate for durability. The map is extremely detailed and includes hundreds of airports (civil and military), vor's, ndb's, terrain features, national parks, cities, time zones, etc. The back of the map has a very detailed AM radio frequency guide for all 50 states, the District of Columbia, Puerto Rico, and the U.S. Virgin Islands. Contains state information including capitals, square mileage, population, and nick names along with each state flag. Great for pilots and aviation enthusiasts. Flight plan information, ATC light gun signals, cruising altitudes, and a crosswind component chart included.

Folded Pilot's MapP/N 13-11247\$18.75
Pilot's Laminated Wall MapP/N 13-11248\$18.75

PS

AERONAV VISUAL NAVIGATION CHARTS

AERONAV SECTIONAL CHARTS

Sectional aeronautical charts are designed for visual navigation of slow to medium speed aircraft. The topographic information featured consists of the relief and a judicious selection of visual checkpoints used for flight under visual flight rules. The checkpoints include populated places, drainage patterns, roads, railroads, and other distinctive landmarks. The aeronautical info on Sectional Charts includes visual and radio aids to navigation, airports, controlled airspace, restricted areas, obstructions, & related data. (Scale 1"=6.86 nm/ 1:500,000. 60"x20" folded to 5"x10") Revised semi-annually, except most Alaskan charts are revised annually.



Sectional & VFR Terminal Charts for conterminous United States, Hawaii, Puerto Rico and Virgin Islands

Sectional Charts P/N 8403 **\$8.50**
 Set of 37 charts (w/o AK & HI) P/N 8557 **\$313.95**

NOTE: When ordering charts, complete part no. with first 3 letters of chart title. Ex.: Seattle sectional is P/N 8403SEA.

For Subscription service: Add -SUB (example: 8403SEA-SUB) and a new chart will be shipped & billed to you automatically at every revision until you cancel the subscription. Subscription chart orders require credit card no. on file.

Seattle	Klamath Falls	Denver	Dallas/Fort Worth	Brownsville	Seward	McGrath
Great Falls	Cheyenne	Wichita	Memphis	Miami	Juneau	Anchorage
Billings	Omaha	St. Louis	Atlanta	Hawaii	Ketchikan	Salt Lake City
Twin Cities	Chicago	Cincinnati	El Paso	Kodiak	Cape Lisburn	Kansas City
Green Bay	Detroit	Washington	San Antonio	Dutch Harbor	Point Barrow	Charlotte
Lake Huron	New York	Los Angeles	Houston	Aleutian Islands	Fairbanks	Cold Bay
Montreal	San Francisco	Phoenix	New Orleans	Western	Dawson	
Halifax	Las Vegas	Albuquerque	Jacksonville	Whitehorse	Bethel	



CHART MASTER

Chart Master is Aircraft Spruce's online chart selection program designed to tell you exactly which aviation charts you will need for the route you intend to fly. Just plug in the 3 letter airport identifiers for your departure and destination airports, and Chart Master will provide you with a list of all of the charts needed for your route. Select VFR (sectional, terminal, WAC, AFD, or IFR (Low altitude enroute) or both and order any or all of the charts listed by Chart Master. This program is available on line at www.aircraftspruce.com.

AERONAV VFR TERMINAL AREA CHARTS

Terminal Area Charts depict the airspace designated as Class B Airspace. The information found on these charts, while similar to that found on Sectional Charts, is shown in much more detail because of the larger scale. These charts should be used by pilots intending to operate from airfield within or near a Terminal Control Area or an Airport Radar Service Area. Locations of Terminal Area Charts are indicated by a • on the Sectional Chart indexes. (Scale 1 inch = 3.43nm/1:250,000. 25 x 20 inches folded to 5 x 10 inches.) Revised semi-annually, except Puerto Rico/Virgin Islands is revised annually.

Terminal Area Charts P/N 8064 **\$6.20**
 Set of 28 Terminal Charts P/N 8524 **\$146.95**

NOTE: When ordering charts, complete part number with first 3 letters of chart title. Ex: Los Angeles terminal chart is P/N 8064LOS.

For Subscription service: Add -SUB (example: 8064LOS-SUB) and a new chart will be shipped and billed to you automatically at every revision until you cancel the subscription. Subscription chart orders require credit card number on file.

Atlanta	Cleveland	Houston	Miami	Phoenix	Seattle
Boston	Dallas	Kansas City	Minneapolis	Pittsburgh	St. Louis
Charlotte	Denver	Las Vegas	New Orleans	Salt Lake City	Orlando/Tampa
Chicago	Detroit	Los Angeles	New York	San Diego	Washington
Cincinnati	Honolulu	Memphis	Philadelphia	San Francisco	Anchorage/Fairbanks

CINCINNATI VFR TERMINAL AREA & FLYWAY CHART

P/N 8064CIN **\$6.20**

PS



AERONAV VISUAL NAVIGATION CHARTS

AERONAV AIRPORT / FACILITY DIRECTORY



The Airport/Facility directory is a pilot's manual which contains data on public and joint use airports, seaplane bases, heliports, VFR airport sketches, NAVAIDS, communications data, weather data sources, airspace, special notices, VFR waypoints and operational procedures. The seven volumes cover the conterminous United States, Puerto Rico, and the Virgin Islands. Includes data that cannot be readily depicted in graphic form; e.g., airport hours of operation, types of fuel available, runway data, lighting codes, etc. **\$4.85 ea.**

Area	Part No.
Southwest U.S.	AFD-SW
Northwest U.S.	AFD-NW
So. Central U.S.	AFD-SC
No. Central U.S.	AFD-NC

Area	Part No.
East Central U.S.	AFD-EC
Southeast U.S.	AFD-SE
Northeast U.S.	AFD-NE

OTHER VFR CHARTS:

VFR-IFR Wall Planning Chart (U.S.) Flat/Wall.....	P/N 13-30703	\$6.50
VFR-IFR Wall Planning Chart (U.S.) Folded.....	P/N 13-06455	\$6.50
U.S. Gulf Coast VFR Chart.....	P/N 13-30704	\$11.95
Grand Canyon VFR Chart.....	P/N 13-30706	\$3.95
Baltimore-Washington Helicopter Route Chart.....	P/N 13-30707	\$12.95
Chicago Helicopter Route Chart.....	P/N 13-30709	\$13.25
Houston Helicopter Route Chart.....	P/N 13-30711	\$13.25
Los Angeles Helicopter Route Chart.....	P/N 13-30712	\$12.85
New York Helicopter Route Chart.....	P/N 13-30713	\$12.95
Pacific Chart Supplement.....	P/N 13-07875	\$6.50

World Aeronautical Charts for Alaska

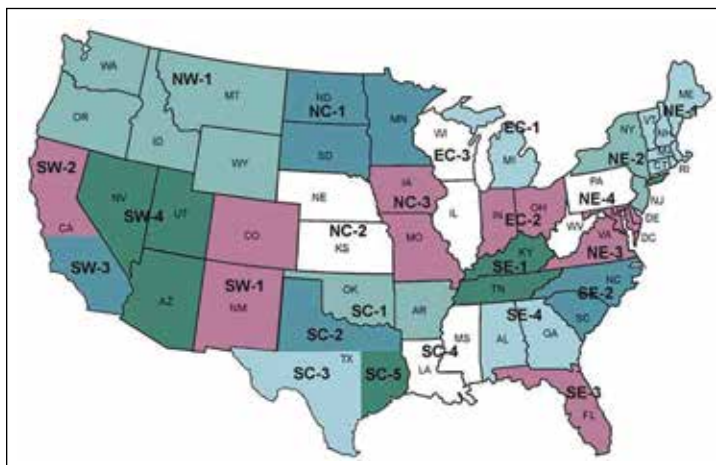

TERMINAL PROCEDURES COVERAGE OF THE CONTERMINOUS U.S.

Includes: • Instrument Approach Procedure (IAP) Charts • Departure Procedure (DP) Charts • Standard Terminal Arrival (STAR) Charts • Charted Visual Flight Procedures (CVFP) • Airport Diagrams
IAP Charts are designed to provide an IFR descent from the enroute environment to a point where a safe landing can be made. DP charts are Air Traffic Control (ATC)-coded departure procedures which have been established at certain airports to simplify clearance delivery procedures. STAR charts are ATC-coded IFR arrival routes established for certain airports to simplify clearance delivery procedures. CVFPs are an operational technique designed to move air traffic safely and expeditiously. In addition to conventional visual approach procedures, it has been necessary to specify routes/altitudes to enhance noise abatement at some locations. CVFPs have been developed to provide a pictorial display of these visual arrival routes. Airport Diagrams are specifically designed to assist in the movement of ground traffic at locations with complex runway/taxiway configurations and provide information for updating geodetic position navigational systems aboard aircraft.

Bound Volumes **\$10.50**
Loose Leaf Volumes..... **\$14.80**

Description	Bound P/N	Loose Leaf P/N	Description	Bound P/N	Loose Leaf P/N
South Central Vol.1	13-01331	13-01364	Southwest Vol. 4	13-00814	13-01546
South Central Vol.2	13-01332	13-01365	East Central Vol. 1	13-01341	13-01354
South Central Vol.3	13-01333	13-00774	East Central Vol. 2	13-01342	13-01355
South Central Vol.4	13-01334	13-00105	East Central Vol. 3	13-01343	13-01356
South Central Vol.5	--	13-02002	North Central Vol. 1	13-01344	13-01357
Southeast Vol. 1	13-01335	13-01366	North Central Vol. 2	13-01345	13-01358
Southeast Vol. 2	13-01336	13-01367	North Central Vol. 3	13-01346	13-01359
Southeast Vol. 3	13-01337	13-01368	Northeast Vol. 1	13-01347	13-01360
Southeast Vol. 4	13-01338	13-00106	Northeast Vol. 2	13-01348	13-01361
Southwest Vol. 1	13-01339	13-01369	Northeast Vol. 3	13-01349	13-01362
Southwest Vol. 2	13-01340	13-01370	Northeast Vol. 4	13-02062	13-02063
Southwest Vol. 3	13-01445	13-01446	Northwest Vol. 1	13-01350	13-01363

Area	Part No.	Price
Caribbean Low Enroute 1/2	13-07902	\$4.85
Caribbean Low Enroute 3/T3	13-07903	\$4.45
Caribbean Low Enroute 5/6	13-07904	\$4.85
Caribbean Low Enroute T1/T2	13-07905	\$4.45



INSTRUMENT NAVIGATION CHARTS

AERONAV ENROUTE LOW ALTITUDE CHARTS

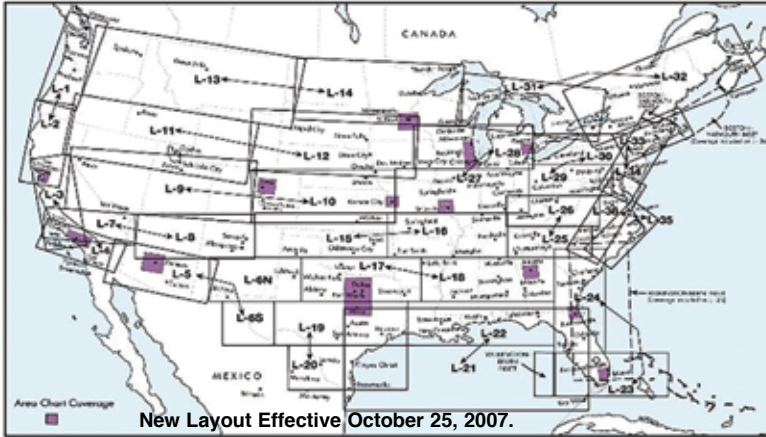

Enroute low altitude charts for conterminous U.S. (includes area charts)

Enroute Low Altitude charts (Conterminous U.S. and Alaska) provide aeronautical information for navigation under instrument flight rules below 18,000 feet MSL. Information includes: airways; limits of controlled airspace; position, identification, and frequencies of radio aids to navigation (Alaska 4-color series includes geographic coordinates); airports with terminal air/ground communications; minimum enroute and obstruction clearance altitudes; airway distances; reporting points; special use airspace areas; military training routes. Scales vary from 1 inch = 5nm to 1 inch = 20nm. 50 x 20 inches folded to 5 x 10 inches. Revised every 8 weeks. Area charts, which show congested terminal areas at a large scale, are included with subscriptions to any conterminous U.S. Set Low (Full set, East or West sets). Chart L-28 covers the Washington-Boston corridor at a scale similar to an Area Chart. Charts are revised every 8 weeks. Enroute Low Altitude Charts ... P/N 8070L **\$4.85/ea.** Full Set (L1/2-L27/28 & Area Chart)

- P/N 13-30714 **\$108.75**
- Western U.S. Set (L1/2-L15/16 & Area Chart) P/N 13-30716 **\$52.50**
- Eastern U.S. Set (L11/12, L13/14, L17/18-L27/28 & Area Chart) P/N 13-30717 **\$57.50**
- Alaskan Set (Alaskan L1/2-Alaskan L3/4) P/N 13-30718 **\$9.25**

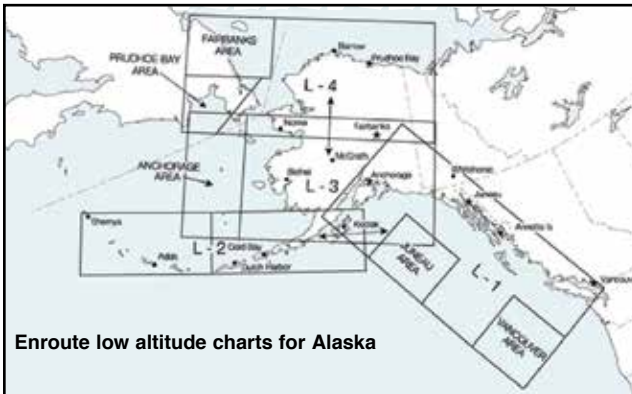

Enroute low altitude charts for Alaska

For individual charts please call 877-4-SPRUCE
or visit our website at:
www.aircraftspruce.com

- IFR GULF OF MEXICO CHART - WEST** P/N 13-08004 **\$16.50**
- IFR GULF OF MEXICO CHART - CENTRAL** P/N 13-08003 **\$17.50**

NOTE: When ordering individual charts, complete part number with the chart number. Example: Enroute Low Altitude Chart L-10 is P/N 8070L-10.

For SUBSCRIPTION service, add -SUB (example: 8070L-10-SUB) and a new chart will be shipped and billed to you automatically at every revision until you cancel the subscription. Subscription chart orders require a credit card number on file.



CHART MASTER

Chart Master is Aircraft Spruce's online chart selection program designed to tell you exactly which aviation charts you will need for the route you intend to fly. Just plug in the 3 letter airport identifiers for your departure and destination airports, and Chart Master will provide you with a list of all of the charts needed for your route. Select VFR (sectional, terminal, WAC, AFD, or IFR (Low altitude enroute) or both and order any or all of the charts listed by Chart Master. This program is available on line at www.aircraftspruce.com.

AERONAV IFR ENROUTE HIGH ALTITUDE CHARTS

IFR Enroute High Altitude Charts (Conterminous U.S. and Alaska) are designed for navigation at or above 18,000 feet MSL. This four color chart series includes: Jet route structure; VHF radio aid to navigation (frequency, ID, channel, geographic coordinates); selected airports; reporting points. (Scales vary from 1" = 78nm to 1" = 30nm. 55 x 20" folded to 5 x 10".) Revised every 8 weeks.

NOTE: When ordering individual charts, complete part no. with the chart no. Ex: Enroute High Altitude Chart H1/2 is P/N 8075-H1/2.

- Full Set (H1/H2, H3/H4, H5/6, H9/H10, H11), (H3/H4, H5/H6, H7/H8-very small area, H9/H10), (H3/H4-very small area, H5/H6, H7/H8, H9/H10, H11) P/N 8075-1 **\$28.75**

For SUBSCRIPTION service: Add -SUB (example: 8075-H1/2-SUB) and a new chart will be shipped and billed to you automatically at every revision until you cancel the subscription. Subscription chart orders require a credit card number on file.

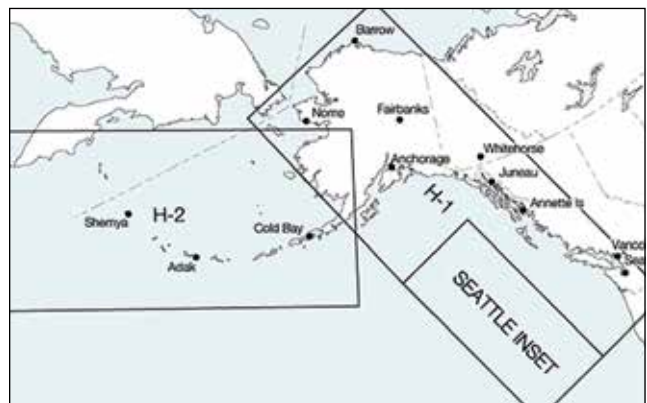

PS

CANADIAN AIA CHARTS

CANADIAN VNC (VFR) CHARTS

The VNC is used by VFR pilots on short to extended cross-country flight at medium altitudes and at low to medium airspeeds. These charts show aerodrome data, airspace information, radio aids to navigation, air/ground communications, and elevation with contour lines, tints and shaded relief.

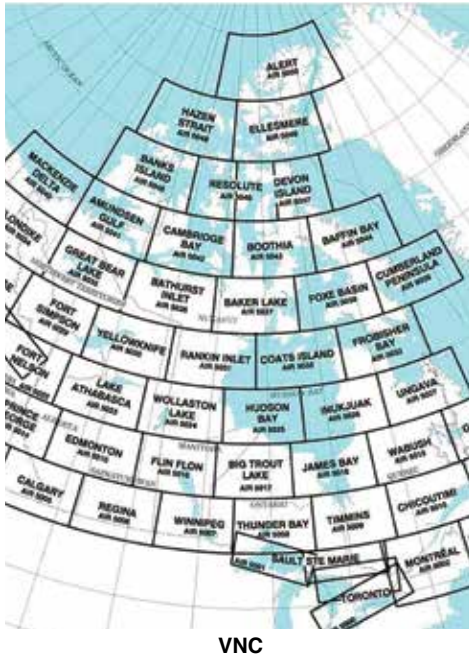

Item	Title	Part No.	Price	Item	Title	Part No.	Price
5000	VNC Toronto	13-04425	\$18.75	5026	VNC Inukjuak	13-04487	\$18.75
5001	VNC Sault Ste Marie	13-04434	\$18.75	5027	VNC Ungava	13-04488	\$18.75
5002	VNC Montreal	13-04433	\$18.75	5028	VNC Whitehorse	13-04489	\$18.85
5003	VNC Moncton	13-04466	\$18.75	5029	VNC Ft Simpson	13-04490	\$18.75
5004	VNC Vancouver	13-04467	\$18.75	5030	VNC Yellowknife	13-04491	\$18.75
5005	VNC Calgary	13-04468	\$18.85	5031	VNC Rankin	13-04492	\$18.75
5006	VNC Regina	13-04469	\$18.75	5032	VNC Coats Isl.	13-04493	\$18.75
5007	VNC Winnipeg	13-04470	\$18.75	5033	VNC Frobisher	13-04494	\$18.75
5008	VNC Thunder Bay	13-04436	\$18.75	5034	VNC Klondike	13-04495	\$18.75
5009	VNC Timmins	13-04435	\$18.75	5035	VNC Great Bear Lake	13-04496	\$18.75
5010	VNC Chicoutimi	13-04471	\$18.75	5036	VNC Bathurst Inlet	13-04497	\$18.75
5011	VNC Anticosti	13-04472	\$19.75	5037	VNC Baker Lake	13-04498	\$18.75
5012	VNC Gander	13-04473	\$18.75	5038	VNC Foxe Basin	13-04499	\$18.75
5013	VNC Kitimat	13-04474	\$18.85	5039	VNC Cumberland	13-04501	\$18.75
5014	VNC Prince George	13-04475	\$18.75	5040	VNC MacKenzie	13-04502	\$18.75
5015	VNC Edmonton	13-04476	\$18.75	5041	VNC Amundsen	13-04503	\$18.75
5016	VNC Flin Flon	13-04477	\$18.75	5042	VNC Cambridge	13-04504	\$18.75
5017	VNC Big Trout	13-04478	\$18.75	5043	VNC Boothia	13-04505	\$18.75
5018	VNC James Bay	13-04479	\$18.75	5044	VNC Baffin Bay	13-04506	\$18.75
5019	VNC Wabush	13-04480	\$18.75	5045	VNC Banks Island	13-04507	\$18.75
5020	VNC Goose Bay	13-04481	\$18.75	5046	VNC Resolute	13-04508	\$18.75
5021	VNC Atlin	13-04482	\$18.85	5047	VNC Devon Island	13-04509	\$18.75
5022	VNC Fort Nelson	13-04483	\$18.85	5048	VNC Hazen Strait	13-04510	\$18.75
5023	VNC Athabasca	13-04484	\$18.75	5049	VNC Ellesmere	13-04511	\$18.75
5024	VNC Wollaston	13-04485	\$18.75	5050	VNC Alert	13-04512	\$18.85
5025	VNC Hudson Bay	13-04486	\$18.75	5099	VNC Alaska Highway	13-04516	\$18.75



CANADIAN WAC CHARTS

Item	Title	Spruce PN	Price
WACB7	C-WAC B-7	13-04518	\$13.75
WACB8	C-WAC B-8	13-04519	\$13.75
WACD14	C-WAC D-14	13-04526	\$16.25

For a complete image of the area map above, please visit www.aircraftspruce.com.

LOW ALTITUDE ENROUTE CHARTS



Enroute Low and High Altitude charts provide aeronautical information for instrument navigation in the low and high airway structure of the Canadian Domestic Airspace. The airspace over foreign territory and international waters in which Canada accepts responsibility for the provision of air traffic services, and other areas required for military use. The primary purpose of Enroute charts is to depict radio navigation data to provide rapid and precise location and identification of information requisite to radio instrument navigation.

Item	Title	Spruce PN	Price
LE12	LE12 Low Enroute Chart 1-2	13-04539	\$4.95
LE34	LE34 Low Enroute Chart 3-4	13-04541	\$4.95
LE56	LE56 Low Enroute Chart 5-6	13-04542	\$4.95
LE78	LE78 Low Enroute Chart 7-8	13-04543	\$4.95
LE910	LE910 Low Enroute Chart 9-10	13-04544	\$4.95

CANADA VTA TERMINAL CHARTS

Terminal area charts provide detailed information in congested air traffic areas. The six charts of the series cover Toronto, Montreal, Vancouver, Winnipeg, Calgary and Edmonton. The latter two are printed back to back. All charts are at a scale of 1:250,000.

Emonton/Calgary	P/N 13-04426	\$18.75
Montreal	P/N 13-04427	\$18.75
Toronto	P/N 13-04428	\$18.75
Winnipeg	P/N 13-04430	\$18.75
Vancouver	P/N 13-04429	\$18.75



CANADA WATER AERODROME SUPPLEMENT (WAS)

Provides tabulated, textual data and graphical information in support of Canadian VFR charts. Contains an Aerodrome/Facilities Directory of all water aerodromes shown on Canadian VFR charts. Updated once a year in March.

P/N 13-04552 \$56.75

PS