

THE ELECTRONIC ENGINEER

a CHILTON publication / October 1972

What's new in digital panel meters?
Prices are down, but failures are up.

Digital readouts course—Part 4
How experts solve their applications problems.

Fifth Connector Symposium wrapup:
Where are connectors going?

The 1972 political World Series: which man will win for electronics?

	CONVERSION	DEFENSE SPENDING	AID TO UNEMPLOYED ENGINEERS	MULTI-NATIONAL ELECTRONICS	R&D SUPPORT	ANTI-DUMPING	TECHNOLOGY ASSESSMENT	PRODUCTIVITY INCENT
McGovern	1	0	1	0				
Nixon		1	0	1				

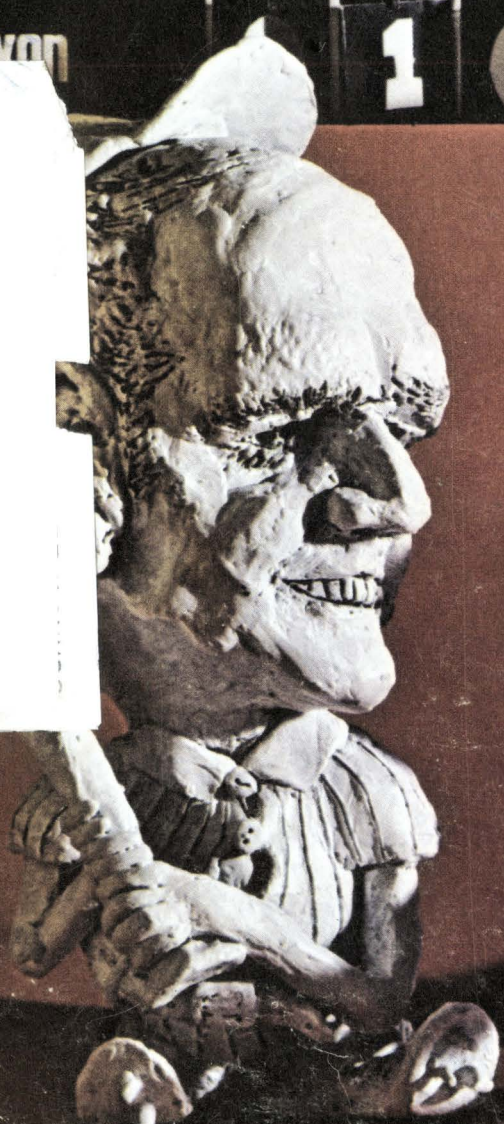



**Crystalonics
has a 4-ohm FET
with a 1-volt threshold
for \$3.69?***

That's almost right.

**The best doesn't cost
any more anymore.**

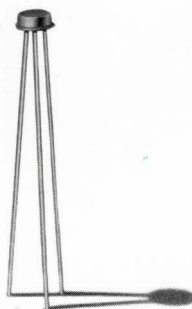

Our 2N5066 has a 4-ohm typical (8-ohm maximum) R_{ON} . We have to admit, it does have an offset voltage, but it's only 300 microvolts typical (1 millivolt maximum). The off-current is still 1 nano-amp maximum, and it takes less than 1 volt to turn it on. The device does draw some current in the on state (less than 1 milliamp), but that's OK in most cases, because the signal source impedance is usually less than 1 ohm.

If you're getting suspicious, you're right. We lied . . . it's an NPN transistor, not a FET . . . but everything else we've said about it is the truth. Besides, do you really care?

If you're not miffed and are still interested, we have a "P-channel" equivalent (the 2N3677) at an even lower price. Both really warrant your investigation if you are designing analog switching circuits. We'll send you one of each to try if you'll drop us a note. If more data would help, circle the reader service number.

P.S. We also make the real McCoy.

*100-piece price

**TELEDYNE
CRYSTALONICS**

147 Sherman St. • Cambridge, Mass. 02140 • TEL: 617-491-1670
1800 N. Highland Ave. • Suite 616 • Hollywood, Calif. 90028 • TEL: 213-469-5871

MDR

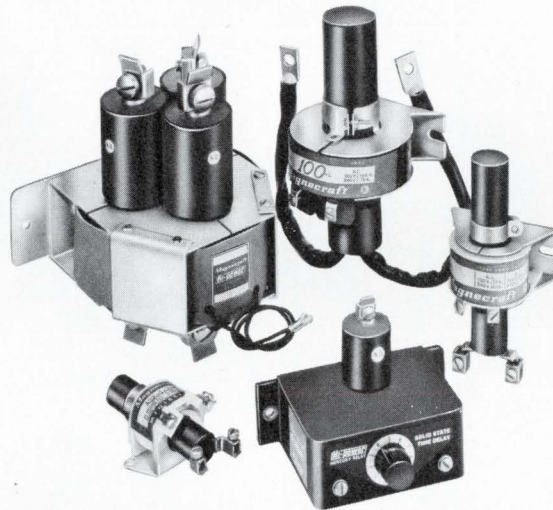

MERCURY DISPLACEMENT POWER RELAYS

Where sealed contact protection is required for explosive, corrosive, dirty or moist ambient conditions; where the use of contactors does not permit contact maintenance; where noiseless operation is required; where weight, size, and cost must be a minimum for contact ratings up to 100 amps,

Mercury Displacement Relays are unsurpassed.

This unique design, which incorporates broad cross-sections of liquid mercury for switching, is what makes the Mercury Displacement relay a high current, high voltage, high power device. Whereas conventional relays, which use hard contacts are destroyed by pitting and sticking under high load conditions, the perpetually self-renewing, mercury-to-mercury contacts insure maximum contact life and in-rush capabilities up to 15 times rated loads.

In a highly competitive business, delivery can be a deciding factor. If delivery is important to you, be aware that Magnecraft ships better than 90% of all incoming orders for stock relays, received before noon, **THE SAME DAY** (substantiated by an independent auditing firm). In addition to our shipping record, most stock items are available off-the-shelf from our local distributor.

FREE!

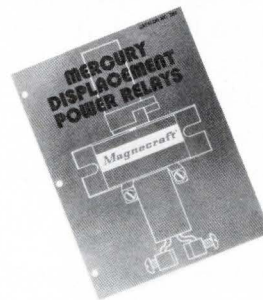

MDR CATALOG

The purpose of this 16-page catalog is to assist the design engineer in specifying the proper relay for a given application. The book completely describes 20, 35, 60, and 100 amp versions with one, two, or three poles as well as Time Delay models of Mercury Displacement Power Relays.

Magnecraft[®] ELECTRIC COMPANY

5575 NORTH LYNCH AVENUE • CHICAGO, ILLINOIS 60630 • 312 • 282-5500 • TWX-910-221-5221

Teradyne's L100 Automatic Circuit Board Test System speaks for itself.

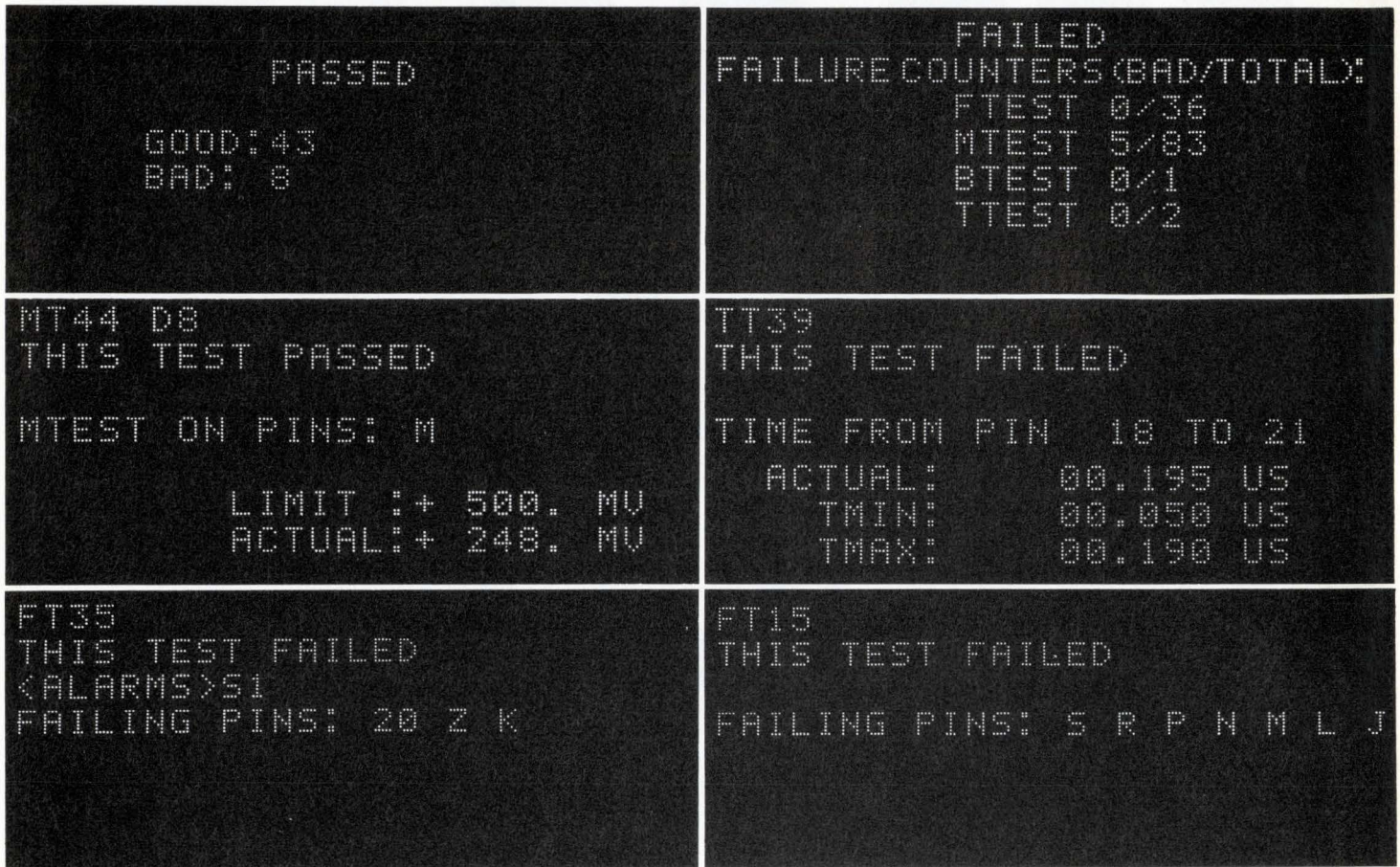

If you test circuit boards, you get the message. The L100 doesn't just tell you a bad board is bad. It helps you find out why. And in a fraction of the time you'd usually spend troubleshooting. We'd like to send you a brochureful of reasons why the L100 is the most money-saving system you can buy.

Write: Teradyne
183 Essex Street
Boston, Mass. 02111

In Europe:
Teradyne Europe
S.A., 11 bis, rue
Roquépine,
75 Paris 8^e, France.
Tel. 265 72 62.

TERADYNE

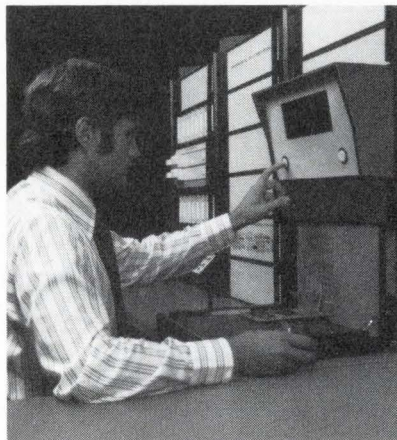

THE ELECTRONIC ENGINEER

October 1972 Vol. 31 No. 10

Cover. It's the World Series of American politics—the presidential election. And the Democrats, a many-time pennant winner who struck out in recent years, are fielding their untried, but promising power hitter, George McGovern. Facing him is Richard Nixon, a veteran of many games who puts his pitches down the middle every time. Both teams have advanced very different policies that directly affect your professional future and that of your industry. For the score on the issues, see p. 58; although you can tell the players without a scorecard, you need a scorecard to pick the winning teams for EEs.

5	Publisher's Comment
7	Editorial
10	Up to Date
15	Digital Readout Course
33	Connector Symposium Preview
58	Cover Story
DC-1	Data Communications
DC-5	Data Communications Feature
DC-12	Data Communications News
DC-14	Data Communications Products
79	The Profit Center
84	New Product Feature
87	System Products
89	Subsystem Products
92	Lab Products
95	Lit Items
102	Consciousness π
103	Advertising Index
104	Samples

15 DIGITAL READOUT COURSE—PART 4

The digital readout story is an applications story. And here are just some of the more significant applications in this dynamic field. Whatever your application—whether automotive or office machines—these problem-solving case studies can help you.

- Introduction** Stephen A. Thompson, **The Electronic Engineer**
- Dial DI S-play for operator assistance** L. A. Deibert, Western Electric Co.
- Brightening up your applications** Dan Rovine, Pinlites Div., REFAC
- Digital displays in digital instruments** Tom Kelly, Weston Instruments, Inc.
- Copiers: a typical office application** Craig Smith, Information Technology Group, Xerox Corp.

33 ELECTRONIC CONNECTOR SYMPOSIUM: MORE, PERHAPS FEWER, CONNECTORS

Will new categories of connectors reduce connector proliferation? Many papers in this Symposium take that approach. In addition, The Symposium looks at advances in connector technology and materials, plus the market for connectors—and for the engineers who use them.

58 MCGOVERN OR NIXON: WHICH CHOICE FOR EES? John McNichol

Can you vote for your own special interests in the presidential contest this year? Incumbent President Nixon and Senator McGovern have some radically different programs when it comes to electronics. Here's an analysis of what this race means to the electronic engineer.

DATA COMMUNICATIONS

DC-5 MOS REVOLUTIONIZES MODEM DESIGN Don W. Lake and William R. Foy

What has interfered with the large-scale use of MOS in modem design? After all, LSI/MOS can offer a five-to-one cost improvement, size and power reductions, and improved performance and reliability. Here's a look at those benefits and the problems of this design bonanza.

79 DPM PRICES TAKE A DIVE Arthur J. Boyle

The under \$100 digital panel meter makes it possible for equipment manufacturers to make the big switch from analog. Yet, misleading specs and reliability problems have sometimes made this a chancy switchover. Here's a straightforward look at some pitfalls.



KEPCO TALKS POWER SUPPLY TECHNOLOGY:

FERRORESONANCE... *the key to simple stabilization*

In this age of high gain, solid-state integrated feedback circuit, it is easy to overlook the simpler ways of controlling voltage and current. The ferroresonant flux-oscillating power transformer, used as the control for a d-c power supply, provides an extremely simple—therefore reliable—stabilizer that suffers no risk of the overvoltage danger to which so many loads are so vulnerable.

A ferroresonant system consists of two coils on a common core separated by a magnetic shunt. The primary coil is permitted to function linearly, while the secondary is paralleled with a resonating capacitor to excite its iron into saturation on alternate half-cycles. The shunt provides a flux path for the secondary so that the primary is not saturated.

The voltage waveform across the tank has a roughly square aspect because the iron transition from unsaturated to saturated state is a rather abrupt phenomenon triggering a rapid discharge from the capacitor (whose energy then builds the flux in the reverse direction).

When rectified, this square waveform presents a much smaller peak/average ratio to a capacitor input filter, resulting in a much lower output impedance and smaller ripple amplitude than would an equivalent sinusoid.

Because the tank's voltage, which controls the output is independent of the driving source amplitude, the load voltage is entirely a function of the magnetic structure with about 30 dB or more isolation from source changes.

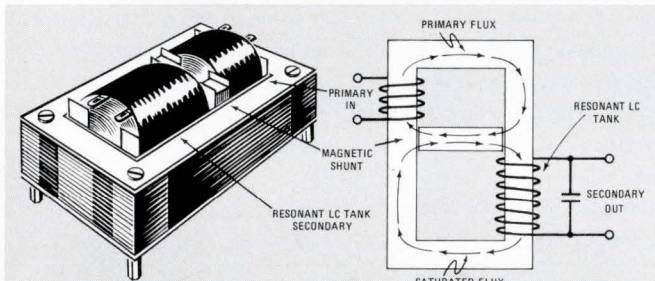

THE FERRORESONANT POWER TRANSFORMER WITH ITS TANK CAPACITOR STABILIZES A d-c OUTPUT WITH A MINIMUM OF FUSS AND BOTHER, AND A MAXIMUM OF RELIABILITY

The ferroresonant approach, in addition to providing stabilization versus the source, and a reduced load effect, through lowered impedance, is also self-protecting for overloads. Short the output and the lowered tank "Q" causes the tank oscillations to diminish and cease. This provides a current limiting effect which protects both supply and load.

Power Supplies with the Kepco ferroresonant transformer, Flux-O-Tran®, range from 60 watt modules to 300 watt supplies in single and dual output configurations. The Kepco PRM Series has 58 models in all from 4.5V d-c to 240V d-c, easily tailored to your application. Check out their advantages in *your* circuit. Get Kepco Catalog B-703.

KEPCO®

Write Department DO-19

KEPCO, INC. • 131-38 SANFORD AVENUE • FLUSHING, N.Y. 11352
(212) 461-7000 • TWX # 710-582-2631

Circle Reader Service 4

THE ELECTRONIC ENGINEER

October 1972
Vol. 31 No. 10

Bernard M. Gittelman.....Publisher
Alberto Socolovsky.....Editor
Arthur J. Boyle.....Managing Editor
John E. Hickey, Jr.....Features Editor
Sheldon Edelman.....Western Editor S. F.
Stephen A. Thompson.....Western Editor L. A.
John McNichol.....New Directions Editor
Deborah P. Wilkins.....Assistant Editor
Christopher P. Kocher.....Assistant Editor
Dr. O. M. Salati.....Consultant
Mae Moyer.....Editorial Reader Service
Ben D'Angio.....Art Director
Phaue Featherson.....Artist
George Baker.....Washington News Bureau
Neil Regeimbal.....Washington News Bureau

Executive and Editorial Offices:
One Decker Square, Bala-Cynwyd, Pa. 19004
Tel: (215) SH 8-2000

Address Mail to:
56th & Chestnut Sts., Philadelphia, Pa. 19139

Western Offices:
Stephen A. Thompson
3727 W. 6th St., #202, Los Angeles, Calif. 90005
Tel: (213) DU 7-1271

Sheldon Z. Edelman
199 First St., Rm. 335, Los Altos, Calif. 94022
Tel: (415) 941-6655

Chilton Officers & Directors: Robert E. McKenna, Chairman; William A. Barbour, President; Richard H. Groves, K. Robert Brink, Executive Vice Presidents; John H. Kofron, Charles W. Hevner, Senior Vice Presidents; James Miades, Vice President, Finance; Thomas J. Casper, Spencer H. Collmann, John P. Kushnerick, Raymond O. Nelson, Eugene C. Beaudet, William A. Phair, David Acton, Donald P. Jones, Richard C. Sorlien, Directors; James A. Naughton, Vice President, Creative Services; Christian H. Miller, Secretary.

Monthly publication of Chilton Company, Chestnut & 56th Sts., Phila., Pa. 19139. (Area Code 215) SHerwood 8-2000. Controlled circulation postage paid at Philadelphia, Pa. \$1 a copy. Subscription rates U.S. and U.S. Possessions: 1 yr. \$12.00; 2 yrs. \$20.00; Canada 1 year \$14.00; 2 yrs. \$25.00. All other countries 1 yr. \$20.00; 2 yrs. \$35.00. Chilton Company 1972. Title Reg. U.S. Patent Office. Reproduction or reprinting prohibited except by written authorization. Microfilm reproductions of **The Electronic Engineer** and its predecessors, **Electronic Industries** and **Tele-Tech**, may be obtained from University Microfilms, 313 N. First St., Ann Arbor, Mich.

The Chilton Electronics and Instrumentation Group
The Electronic Engineer
Instruments and Control Systems
Instrument & Apparatus News
Medical Electronics and Equipment News
Electronic Component News

Chilton

THE ELECTRONIC ENGINEER • Oct. 1972

PUBLISHER'S COMMENT

The only constant is change

Twenty-nine years and 11 months ago, a new magazine appeared: *Electronic Industries*, predecessor of *The Electronic Engineer*. Now, almost 30 years later, *The Electronic Engineer* is busily preparing to celebrate its thirtieth anniversary next month.

These have been years of tremendous change for the magazine and the industry. And, although coincidental, it is nonetheless significant that we'll also be celebrating the twenty-fifth anniversary of the transistor—the invention that can be credited with most of the industry's growth in the past quarter of a century.

The changes in the industry and the changes in component design must be reflected—sometimes anticipated—in the pages of the magazine that serves it. For instance, thumbing through that historic first issue, I came across an article, "Where to sell Uncle Sam." That was certainly on target in 1942 when Uncle Sam (and his military arm in particular) was the most important and fastest growing user of electronics. The problem today is not where to sell Uncle Sam, but how to unlock the application of electronic components and equipment to the automotive, anti-pollution, medical, and the thousands of other markets for our technology.

We are all participating in another change—the evolution from an industry of circuit designers to one of systems engineers. Today, as never before, our readers are comparing components and subsystems—for their specs and cost factors—to not only make a better system, but one that makes a profit.

Truly, the systems engineer is the decision maker—the money engineer. That's why we have a commitment each month to bring you courses on the latest technology, the newest products, components and subsystem comparisons that aren't afraid to tell it as it is, plus the trend reports to help you better assess your future.

Before we start our next 30 years, see our November issue; it's an important anniversary.

Bernie Gittelman

Publisher

**\$650
Solid
State
Angle
Position
Indicator**



Miniaturized—Takes only 5"x1-3/4" Panel Space

astrosystems

asi

astrosystems, inc.
6 Nevada Drive
Lake Success, New York 11040
(516) 328-1600

Circle Reader Service #5

**\$590
(100 piece quantity)
14-bit
Accurate
Synchro
Conversion**



- Solid State miniaturized module
- DTL/TTL compatible
- Digital output register
- 5ms conversion time

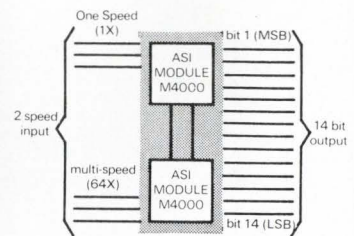

The block diagram shows two ASI modules which form a complete 14-bit 2-speed converter. No external mixing logic or programming is required. For further information contact astrosystems, inc.

astrosystems

asi

astrosystems, inc.
6 Nevada Drive
Lake Success, New York 11040
(516) 328-1600

Circle Reader Service #6

The Sperry eye test for display equipment buyers

ES SP



The above is a printed interpretation of the appearance of the more popular displays. You are encouraged to make the same comparison with actual devices.

The old saying "what you see is what you get" certainly applies to the purchase of equipment incorporating displays — panel meters, DVM's, multimeters, counters, instruments, calculators and other equipment. If you can't clearly and easily read the information being displayed then you're not getting full product value. And, you're obviously not getting equipment supplied with advanced Sperry planar displays†.

How do you tell if they're Sperry displays? Simply take the Sperry eye test.

1. Do the displays appear as uniformly bright, continuous characters with no irritating gaps or filaments and screens to reduce readability?
 YES NO
2. Do the displays remain bright and clearly legible with no glare or appreciable fading even under direct sunlight conditions?
 YES NO
3. Can you quickly, easily and accurately read the displays from 20 to 40 feet away?
 YES NO
4. When the unit is positioned within a 130° viewing angle, can you still clearly read the displayed characters?
 YES NO

If you answered YES to all four questions, you already have your eyes on equipment featuring preferred Sperry displays.

If you answered NO to any of the questions, you owe it to yourself to take a comparison look at products equipped with superior Sperry displays.

FREE BUYER'S GUIDE —

To help you make the right equipment selection, Sperry offers the handy "Buyer's Guide for Equipment featuring Electronic Displays". It's yours for the asking. Order your copy today by checking the reader service card or phone or write: Sperry Information Displays Division, P.O. Box 3579, Scottsdale, Arizona 85257, telephone (602) 947-8371.

SPERRY
INFORMATION DISPLAYS



Sperry 1/3"

Sperry 1/2"

units are available for use with red filters

It's a whole new ball game in displays!

†Patents Pending

"NIXIE is the registered trademark of The Burroughs Corporation.

 SPERRY RAND

Circle Reader Service - 7

The Presidential input

Will there be an "engineering" vote?

Richard Milhaus Nixon is not an electronic engineer, and neither is George Stanley McGovern. Yet the significance that electronics will have for either man goes beyond the medium they both must skillfully modulate to convey their message to millions.

Both President Nixon and Senator McGovern are important to electronics—to our industry, to electronic companies, and to you and me as electronic engineers. And the importance seems to be reciprocal because, for the first time in any election, the candidates, especially Mr. McGovern, seem to be aware of the presence of a technological *bloc*, so much so that comments have been addressed specifically to engineers.

This magazine will not endorse a candidate, because, although acknowledged, technology still lies low in the scant list of issues both candidates have chosen to define, and because technology and the particular interests of our readers and of our industry are but one input in the complex mesh of decisions that leads to a vote. But, although technology maintains a low profile, it's there. Acknowledged by both candidates as an indispensable ingredient to key issues such as military preparedness, ecological measurements and international trade, electronics technology will increase, not decrease, its political importance. We have judged it, therefore, an important issue for our readers, and have analyzed the inputs from both candidates in the article that starts on page 58.

Unfortunately, for all the limelight cast on both candidates, it is extremely hard to unravel the mass of usually self-contradictory statements, plus the few deeds that can serve as the basis to judge them. Or, even after unearthing them, to present them as facts and not as indictments. Speaking with the men responsible in both camps for technology and defense policy helps only a little. The forthrightness of McGovern's advisors and staff impressed our New Directions Editor Jack McNichol as much as their naiveté in technological matters. But it was even more difficult for him in the Nixon camp, which seems to make it a policy of not spelling out policy.

Using dollars as a measurement, the \$3-billion cut, which **The Electronic Engineer** magazine estimates the McGovern alternative defense budget will cost the electronics industry, seems to cast him as its enemy. But that's only because, although nebulous, his plans for conversion of military technology into socially-oriented projects have neither precedent nor parallel in comparison with the present Administration's plans. And the suspiciously grandiose plans Mr. McGovern has for conversion have a sorry counterpart in the lack of technological policy that has characterized the Nixon administration. We can picture the disruptions that a literal application of McGovern's conversion proposals would produce among engineers, simply by remembering the similar disruptions from the defense and aerospace cutbacks Nixon implemented in 1969-70.

Which candidate wins will be determined by issues, not technology. But technology is an increasingly important, albeit poorly understood, tool to implement issues. Electronics people, therefore, must not only understand how one or the other candidate will affect our industry, but must also assume the responsibility of keeping government both honest and informed about the technology. To help you discharge this responsibility, we dedicate our report. *Make your vote count.*

Alberto Socolovsky
Editor



NEW 650-PAGE TTL BIBLE



The most usable TTL Data Book for the most usable TTL Family. 250 circuit functions in plastic or ceramic packages.

Our new TTL data book is like our TTL Family: most comprehensive, practical, easiest to use by far.

The TTL bible is structured to provide the designer with precise data on our TTL family in the most accessible form. He can find what he's looking for quickly and easily, whether he starts with a device number in any well-known series (9300, 5400/7400, etc.) or simply the device functional nomenclature. The indices and selection guides will direct him instantly to those devices suitable for his application, and complete specifications from which he can determine his best choice. A comprehensive industry cross-reference provides an overview of all major sources of TTL devices and their Fairchild equivalents.

The Fairchild TTL Family is a mix of more than 1,000 proprietary and second source device and package combinations selected to give the designer the broadest choice of performance/

cost trade-offs to optimize his system design. Over 100 new devices have been added to the family in the last year alone. There are logic, memory and interface functions in plastic, ceramic or flatpak, commercial or military temperature grade. Together, they provide a comprehensive line of standard off-the-shelf building blocks that can be interfaced directly with each other in the same system for maximum speed/power efficiency.

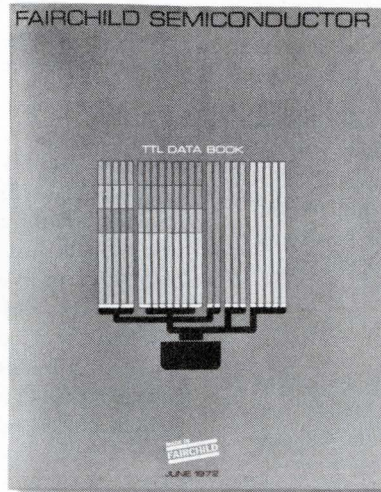

We offer more than 100 MSI devices, both proprietary and second source, that are widely accepted as the keys to optimum TTL system design.

For example: Our proprietary devices include the most complete range of TTL memories available anywhere—from 8-bit scratchpad registers to our new 93415 1024 x 1 bit RAM (made by Isoplanar) that has 60ns access time at 0.5mW/bit.

Our 9344 parallel multiplier eliminates a lot of hardware and software.

For simple solutions for A/D converters, minicomputers and high-speed systems, our 9334 8-bit addressable latch for general purpose storage, our 9338 8-bit multiple port register for high-speed storage in ALUs, and our 93H00 and 93H72 high-speed 4-bit shift registers. Our list of design-time and cost-saving proprietary devices is long and impressive.

250 proprietary and second source circuit functions:

- 54/74 & 9000 Standard SSI
- 74H00 High Speed SSI
- 74S00 Schottky SSI
- 9300 and 54/74 Standard MSI
- 9600 Monostable & Interface devices
- 93400 Memory devices

Book and family are designed for practical use. To get a copy of the former, about the latter, please write us on your company letterhead, giving us your name and title.

**MADE IN
FAIRCHILD**

CMOS goes south . . . Newest entry in the complementary MOS competition is Harris Semiconductor, of Melbourne, Fla. The first products in their line (seven RCA CMOS second sources and one new design) rely on Harris' expertise in dielectric isolation to offer improved performance at competitive pricing. Harris will introduce 11 additional circuits before the end of the year and plans to bring its ion-implant facility on-stream in the near future for further spec improvement.

Circle Reader Service #235

Mil specs for linear ICs . . . The military has added three popular linear ICs, all pioneered by National Semiconductor, to MIL-M-38510. New members are the 101A operational amplifier, voltage regulator 102, and the differential voltage follower 103. For copies of the new specs, contact Naval Publications and Forms Center, 5801 Tabor Ave., Philadelphia, Pa. 19120.

The winner by 1.609 kilometers . . . A survey by ANSI (American National Standards Institute) on metric conversion reveals a favorable attitude towards the change. Probing for opinions on House Joint Resolution 1092, intended to establish a national policy for conversion to the metric system within 10 years, the 383 returned questionnaires showed that 255 favored enactment of the resolution. Enactment was strongly favored (only 61 opposed) even though most of the responding companies don't need the conversion for effective operations in the U.S., and only half do for international operations.

Components make a comeback . . . Following a year-long decline, the United States' \$5 1/2-billion electronic components industry is bouncing back. Shipments of components rose nearly 6% in the fourth quarter of 1971, with an even greater upswing of 10.6% in 1972's first quarter, according to the U.S. Dept. of Commerce. With gains recorded in both defense and non-defense markets, the largest increases were in receiving tubes, quartz crystals, semiconductors, ICs, relays, and TV picture tubes.

Automotive electronics still in low gear . . . The anticipated explosive growth of electronics in automobiles may take another four years to arrive. During this time, predicts consulting firm Darling & Alsobrook, purchases of electronic equipment by the automotive industry will increase more than 50%. The boom of IC usage will be fragmented rather than concentrated, penetrating such varying areas as communications; entertainment; cost, performance, and safety equipment; and diagnostic and measurement instrumentation. The total market is expected to grow from \$652 million in 1971 to \$1016 million in 1976. (See "Automotive electronics is no lemon," *The Electronic Engineer*, Feb. 1972, p. 56.)

ISSCC pulls together at the Philadelphia Marriott . . .

Leaving behind the tradition of a show split between the University of Pennsylvania and the Sheraton Hotel, the entire 1973 International Solid-State Circuits Conference is moving to one location—the Phila. Marriott Motor Hotel. Since it has snowed in Philadelphia during the past three ISSCC's, most attendees will welcome the parking facilities and the end of shuttling between U. of Pa. and the hotel. It may even mean the end of the long lines to register for accommodations! Conference date—Feb. 14-16.

Electronic dollars in military contracts . . . The Dept. of

Defense loosened its purse strings this month, distributing more dollars for electronics in July than we've seen in any other month this year. The Air Force alone issued \$385 million worth of electronics-oriented contracts, the Army, \$225 million, and the Navy, \$100 million. In proportion, however, the allocation of funds by systems remained unchanged: missiles (\$435 million), aircraft and aircraft equipment (\$145 million), computers and computer-related equipment (\$93 million), and radar (\$30 million).

Not so shocking . . . Using an old method, electrical analogs of mechanical systems, and a modern tool, ECAP (electrical circuit analysis program), the Aerospace and Electronic Systems Div. of Westinghouse has solved the complex problem of evaluating elastic shock and vibration mounts for delicate avionics systems. V. M. Foxwell Jr., Project Engineer at the Baltimore, Md. facility, applied the analog method (which, incidentally, was developed at Westinghouse three decades ago) to a system of cascaded, multi-degree-of-freedom isolation mounts. Because shock and vibration isolation is essentially a trial and error approach, the computer becomes a powerful tool for separating the resonant frequencies between attenuating isolation mounts and amplifying structures.

Circle Reader Service #236

Calculating the future of calculators . . . An estimate of worldwide production of pocket and desk top calculators predicts a rosy future for the U.S. Entering the market with 1/2 million units in 1971, production will rise to 5 million by 1974. Japan, the first to enter the market in 1970 with 1/2 million units, will drop behind the U.S. with a 4-million unit production estimated for 1974. European and other countries entering the market for the first time this year will produce a total of 3 million calculators that same year. Based on a market study by Integrated Circuit Engineering Corp., the survey figures an average retail price per calculator of \$60, a factory cost of \$30, and an average semiconductor content of \$12. Creative Strategies Inc.'s thorough analysis of the electronic calculator industry predicts the same leaders and movement within the industry, though not so optimistically in terms of market dollars.

New from Helipot: the lowest trimmer profile in the business.

SHOWN ACTUAL SIZE

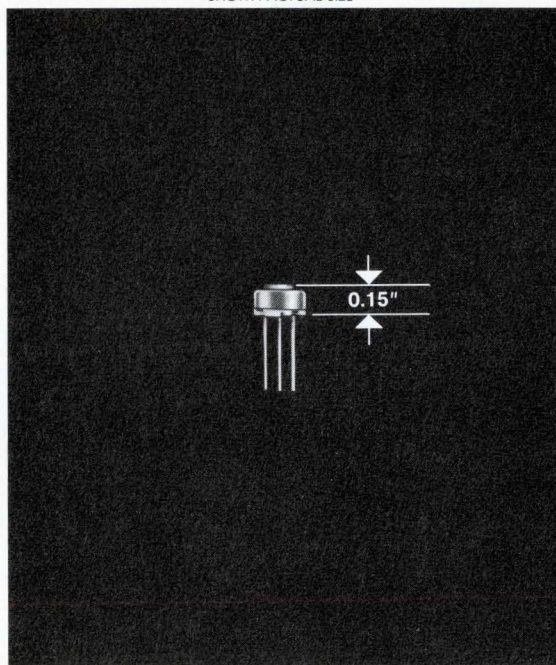

You can't do better than our Series 82 Trimmers for small size and low cost . . . and, of course, Helipot dependability. These ¼" single-turn, general-purpose cermet models have the lowest profile in the industry with a proven cermet resistance element that can be set to any voltage ratio within 0.05% of full scale. Sealed metal housings, solid stops, and essentially infinite resolution. They'll save you space—they'll save you money. (Our prices start at \$1.40 list.) Two good reasons to write for specs and prices today.

Beckman® INSTRUMENTS, INC.

HELIPOT DIVISION

2500 Harbor Blvd., Fullerton, Calif. 92634

HELPING SCIENCE AND INDUSTRY IMPROVE THE QUALITY OF LIFE

Fiber optics: light pipes do heavy jobs

Do you really need thick, heavy, shielded coax to carry a 50-MHz signal? According to fiber optics designers you don't. An inexpensive 0.04-in. diameter plastic fiber can carry at least as much information, and it's lighter, cheaper, and inherently immune to interference and crosstalk.

In a joint presentation at the recent Electro-optics Design Show in New York City, representatives of the Dupont Company and the Electro Fiberoptics Div. of the Valtec Corp. demonstrated some advantages of Dupont's Crofon® fiberoptics for information conveying systems.

In a display illustrating the information-carrying capability of the fiber, a TV signal on a channel 2 carrier frequency (about 60 MHz) modulated a low-power He-Ne laser beam. A 10-ft. length of 0.04-in. plastic light guide transmitted the modulated light to a detector which recovered the impressed signal and fed it to a conventional TV receiver. A spark tester crackling next to the fiber confirmed the fact that optical signals are indeed immune to electrical interference.

A second display, though less dynamic, highlighted an intriguing design concept—what might be the world's simplest multiplexer. At the "transmit" end of the line, key switches controlled three light sources—one red, one green, and one blue. The three different color signals traveled over the same fiber to the easily connected receiver taps, where simple color filters separated out the

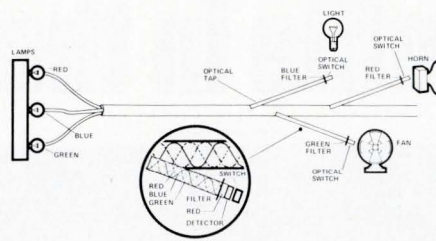

three individual signals. Electro Fiberoptics engineers are now trying to determine just how many different colors can be "multiplexed" over a single line. The possibility of combining the two concepts displayed is impressive: half a dozen 60-MHz signals could be transmitted over a spaghetti-sized cable that costs less than pennies a foot.

The inherent properties of the fiber-optic communication systems immediately suggest a number of potential uses. In an aircraft, much weight could be saved by replacing heavily shielded coax with light plastic fiber, and the cable would no longer have to be routed around rf-sensitive equipment. Since the fiber is an insulator, it can be used to obtain data from a source at a very high electrical potential, where a metallic conductor would be a shock hazard.

According to Electro Fiberoptics spokesmen, automobile manufacturers are also interested in fiber optic systems. They would like to replace the jungle of wires in current automotive wiring harnesses with a system consisting of only a power bus and a control bus. Fiberoptics would be suitable for the control

bus since many signals can be transmitted over a single fiber, and these signals would be immune to ignition noise and rf interference.

The fiber optic systems *do* have limitations: the major drawback for communications systems seems to be the current high cost of light modulators. The advent of more powerful LEDs may obviate this objection, however. Other limitations are tied to the physical properties of the plastic used for the fibers: Crofon light guides may shrink up to 1.5% in length at 80°C, and light guides held at the maximum continuous service temperature of 85°C experience a slow loss in light transmission. Since light loss by absorption within the fiber amounts to 8-10% per foot, fiberoptics will probably not be applicable to long distance communications; links on the order of 50 ft. are currently quite feasible, however. But despite these relatively minor drawbacks, the major advantages of fiberoptics—economy, huge bandwidth capacity, immunity to interference, and the ease with which signals may be multiplexed—indicate many applications for fiber optic techniques in the near future. ■

E. I. Du Pont de Nemours & Co., Wilmington, DE 19898.

Circle Reader Service #237

Electro Fiberoptics Div., Valtec Corp., 99 Hartwell St., W. Boylston, MA 01583.

Circle Reader Service #238

Superconducting above 20°K

For the first time, scientists at RCA Laboratories in Princeton, N.J. have achieved superconductivity in a two-element compound at a temperature above 20 K. The phenomenon occurred in a niobium-gallium compound at 20.3 K or -252.8 degrees Celsius. This marked only the second time that superconductivity has been observed in any material above 20 K.

The niobium-gallium compound not only superconducts at a relatively high temperature, but also can superconduct in far more intense magnetic fields than existing commercial superconductors. These combined attributes could result in superconducting devices operating at

significantly higher temperatures than in the past. The advance gives promise that practical superconductive systems can operate efficiently in magnetic fields larger than 100 kilogauss at 14 K (-259°C), a temperature within the capability of liquid hydrogen refrigeration. This approach is much less costly than helium refrigeration, resulting in a reduction of as much as 75% in the very high cooling costs associated with superconductivity.

In the last several years, high field superconducting magnets have replaced many conventional magnets in research as well as in several high-energy physics applications, but these advantages have

been partially offset by the high costs of cooling practical superconducting systems with liquid helium refrigeration in the temperature range of 3 K to 9 K.

The 20.3 K transition temperature for niobium-gallium was achieved through refinements in the metallurgical techniques used to prepare the material. Key to the success was in obtaining a stoichiometric compound that had exactly three atoms of niobium to each atom of gallium. ■

RCA, David Sarnoff Research Center, Princeton, NJ 08540.

Circle Reader Service #239

G-LINE SCRs

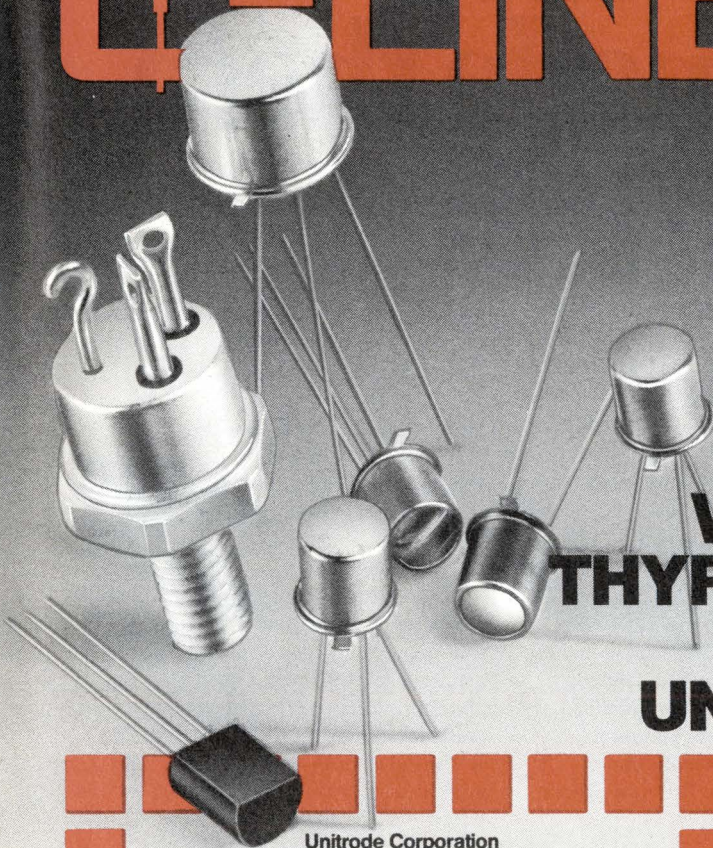

**WE PUT 14 YEARS OF
THYRISTOR EXPERIENCE
INTO EVERY
UNITRODE SCR.**

Unitrode Corporation
Dept. 10W, 580 Pleasant St., Watertown, Mass. 02172

Please send SCR information kit containing detailed specs and application notes.

NAME _____

TITLE _____

CO. _____

ADDRESS _____

CITY _____ STATE _____ ZIP _____

And that means a better industrial product. Our performance record proves it. In industrial/commercial applications, the use of Unitrode SCRs doubled last year and has doubled again this year. For the military, Unitrode supplies more lead-mounted SCRs than everyone else combined. Unitrode is the only SCR supplier with Military Qualification Approval on all TO-5 and TO-18 mil. specs. Why this kind of acceptance? Our experience. It means a lot to people who've had experience with less.

Our broad line of SCRs including plastic and hermetically sealed metal types offers a wide range of choices for literally hundreds of applications. The Unitrode SCR product line ranges from our very popular, rugged 0.8 amp TO-92 plastic package and TO-18 hermetically sealed series to our 1.6 amp TO-5 and TO-39 series and 5 amp TO-59 stud series. Some series are available to 600 volts.

It's what you would expect from a company that makes thyristors a major part of its effort — not just a sideline.

For fast action, call Sales Engineering collect at (617) 926-0404 Unitrode Corporation, 580 Pleasant St., Watertown, Mass. 02172.

See EEM Section 4800 And EBG Semiconductors Section for more complete product listing.

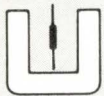

UNITRODE quality takes the worry out of paying less.

First we made them easy to use. Now we've made them easy to get.

Yes, we now have distributors. The best there are around the world. These distributors have in stock our complete line of LED displays, LED lamps, isolators and photo-detectors.

Easy to use. All these products are solid-state and directly DTL-TTL compatible. And they are all designed for ease of application.

A complete LED lamp family. Our LED lamp family offers a complete selection of lens, lead and light output combinations. Our new T-1 Mini-LED is just 0.125" in diameter. This device offers high brightness over a wide viewing angle. And you have a choice of lenses: red diffused, clear, or clear diffused. This little gem, known as the 5082-4480, costs just 45¢ in 1,000 quantities. The T-1 3/4 long lead wire wrappable 5082-4880 lamps start at 55¢ each in 1,000 quantities; the short or bent lead 5082-4440 LEDs start at 49¢ in 1,000 quantities. Higher volume prices on all these devices are even more attractive.

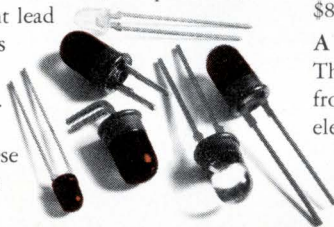

A new low-cost isolator. At 5 MHz bandwidth, it's 25 times faster than any other isolator on the market. It has a high DC isolation voltage of 2500 volts, and a high common mode rejection of 10 volts at 2 MHz, making the 5082-4350 ideal for eliminating ground loops in digital or analog line receivers, floating power supply and feedback networks. Prices start at \$2 each in 1,000 quantities.

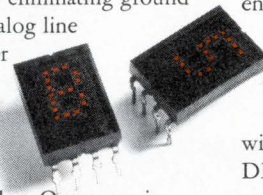

A low-cost LED display. Our numeric and hexadecimal displays have simplified your designs with on-board electronics, standard package configuration, and categorized light outputs. Best of all, the 5082-7300 numeric has a new low price of \$8.25 in 1,000 quantities.

A new 1.5" LED numeric. This new LED display, visible from 60 feet, has on-board electronics, wide viewing angle, and is designed for edge mounting in a standard PC

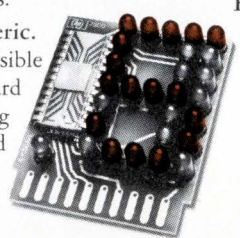

board socket. Solid-state reliability makes the 5082-7500 ideal where dependability is important. The price is \$23.50 each in 500 quantities.

Small character LED displays.

The 5082-7405 is a 5 digit end stackable display. It minimizes power consumption and offers ease of implementation with a standard 14 PIN DIP package. At only 7 mW per digit, this display is ideal for calculators, portable instruments and anywhere that low power and high brightness are important. The 5082-7405 is priced at \$3.20 per digit in 1,000 quantities.

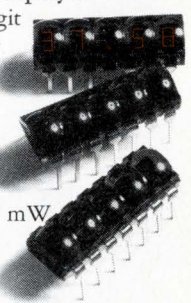

Easy to get. Call the distributor nearest you for immediate delivery. Or write us for more information. Hewlett-Packard, Palo Alto, California 94304.

HEWLETT  PACKARD
COMPONENTS

The Light Source

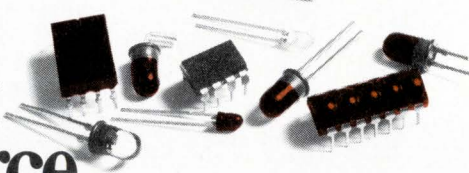

Distributor Stocking Locations:

SCHWEBER ELECTRONICS

Hollywood, Florida (305) 927-0511
Rockville, Maryland (301) 881-2970
Waltham, Massachusetts (617) 890-8484
Rochester, New York (716) 328-4180
Westbury, New York (516) 334-7474

WYLE DISTRIBUTION GROUP

Liberty Electronics/Arizona
Phoenix, Arizona (602) 264-4438
Liberty Electronics
El Segundo, California (213) 322-8100
Elmar Electronics
Mt. View, California (415) 961-3611
Western Radio
San Diego, California (714) 235-6571
Elmar Electronics
Commerce City, Colorado (303) 287-9611
Liberty Electronics/Northwest
Seattle, Washington (206) 763-8200

HALL-MARK ELECTRONICS

Huntsville, Alabama (205) 539-0691
Tulsa, Oklahoma (918) 835-8458
Dallas, Texas (214) 231-6111
Houston, Texas (713) 781-6100

EUROPE

Celdis Ltd.
37-39 Loverock Road, READING, Berks, England
Tel.: READING 58 22 11
I.S.C. France
20, rue Gambetta, 92-Boulogne, France
Tel.: 604.52.75
Ingenieurbüro Dreyer
238 Schleswig, Flensburger Strasse 3, Germany
Tel.: (04621) 2 31 21
EBV Elektronik
8 Munich 2, Augustenstrasse 79, Germany
Tel.: (0811) 52 43 40/48
6 Frankfurt 1, Myliusstrasse 54, Germany
Tel.: (0611) 72 04 16/8



DIGITAL READOUTS COURSE

PART 4

Stephen A. Thompson, Western Editor

We continue with more applications for digital readouts in this chapter. The value of any given parameter depends heavily on the particular application. For instance, telephone, avionic, lab, and office equipment, which function in different environments, have highly diverse users with varying goals. Good design must take these uses and users into account.

In the case of the telephone equipment, reliability is a very large factor. To the operator, any one digit is as important as any other, and when one fails, an expensive piece of Western Electric's equipment is down. This, in turn, leads to customer dissatisfaction and the type of problems to which the Bell System is

most sensitive. In the airborne application, the emphasis is on a combination of reliability and brightness.

Weston is, of course, a leading instrument manufacturer and likes its displays to work, since that is the user's interface with the instruments. However, cost and power consumption also are prime considerations. In contrast, the Xerox copier, a typical example of office equipment, may in many cases function perfectly well without the display. Nevertheless, the evaluation of a readout is complex and second sources and alternative designs assume more importance.

As you follow these designers through their designs, you'll find that some aspect of each of them will almost certainly bear on your application.

Dial DI-S-PLAYS for Operator assistance

L. A. Deibert,

Western Electric, Aurora, Ill.

In 1964, the Traffic Service Position (TSP) cordless switchboard was introduced to expedite handling of the heavy influx of telephone operator-assisted calls. Today, over 5,000 of these units with pushbutton-operated key shelves and recessed numeric display panels are now in service.

These switchboards, which are part of the Traffic

Service Position System (TSPS), permit faster direct customer dialing of special calls by providing access to facilities for automatically recording billing information. Calls are switched automatically through a centrally located control unit up to 50 miles away from the consoles. The 100B TSPS electronic (computer) system is a common system with a stored program control designed to operate with all telephone offices.

(Continued on page 18)

OPCOA sells LED displays and lamps...

lots of them.

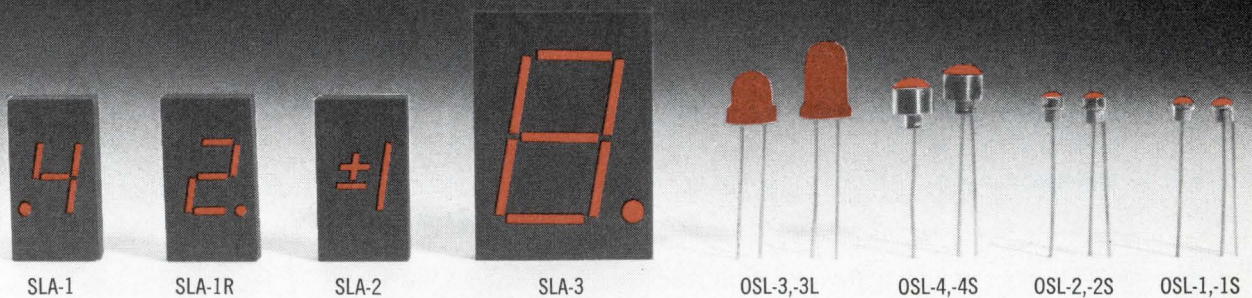

Lots of displays. All use gallium phosphide, the most efficient visible light emitting semiconductor with 200,000 hours typical half life. All are operable from standard low-voltage IC's. Numerals are red on an opaque black background. Choose from:

SLA-1: A seven-segment numeric display with decimal point featuring a large $\frac{1}{3}$ -in. character in a standard 14-pin dual-in-line package. Total power is less than $\frac{1}{4}$ watt. Operates directly from standard TTL decoder/drivers.

SLA-1R: Similar to SLA-1 but with right-hand decimal point.

SLA-2: For use with SLA-1 or -1R seven-segment displays to indicate the overflow numeral one and polarity.

SLA-3: The largest available solid state numeric display with an 0.8-in. character height—readable at distances of over 40 feet. It features a 0.17-in. thin package with 0.100-in. spaced leads for convenient socket mounting or soldering to a p-c board.

Lots of lamps. All use gallium phosphide LED's which emit light in all directions to provide an area light source rather than a pinpoint. All provide typical optical power output of 225 μ watts (4.5 millilumens) at 15 mA. Choose from:

OSL-1 and -1S: Full 0.100-in. sources of light in 0.100-in. diameter packages with good visibility over 180° viewing angle. For coaxial or two-wire hookup.

OSL-2 and -2S: Provide 2.0 millicandelas at 15 mA in 0.100-in. diameter reflector packages. Recommended where high luminosity with more directional viewing is desired. For coaxial or two-wire hookup.

OSL-3 and -3L: Large indicator lamps with 0.200-in. lens diameters offer exceptionally wide viewing angle. Convenient socket or soldered mounting with 0.100-in. lead spacing. Available with short (OSL-3) or long (OSL-3L) dome in either red or clear plastic.

OSL-4 and -4S: Directional 0.175-in. diameter "head-light" type lamps provide 2.7 millicandelas. Particularly useful for panel backlighting. For coaxial or two-wire hookup.

And lots of the model you've chosen. When your design moves from prototype into production, you can count on OPCOA to meet your requirements.

For technical literature or applications assistance, contact OPCOA, Inc., 330 Talmadge Road, Edison, New Jersey 08817; call (201) 287-0355; TWX 710-998-0555.

OPCOA

SOLID-LITE

Speculation is too expensive on the big board.

With pin counts ranging in the hundreds, complex PC Boards are already way into big economies and bigger profits. More components, more functions, less work and less inventory. No question about it; the pay-off from the big board is handsome. Until it develops a glitch.

Isolating the problem is the hook. Once found, repair is comparatively easy. But finding it, with certainty, had been cause enough to doubt the profitability of using big boards. And especially of reclaiming them. With smaller boards, it was often cheaper to throw the board away and replace it with a new unit. But as costs went up with packing densities, that choice began to resemble throwing the baby out with the bathwater.

Fairchild Systems has a better way. Computer controlled SENTRY Systems with fault isolation software can exercise your PC Boards through the complete functional test pattern with program directed probing. Each program is unique to your board's logic topography. And it means you can quickly, automatically, economically isolate the malfunctioning element or elements in the PC Board and make the repairs only where they are needed. Inexpensive. Fast. Efficient. And you'll keep your PC Boards in working, available inventory with a minimum of replacement parts.

It takes a big capability to make the job this simple. And Fairchild has

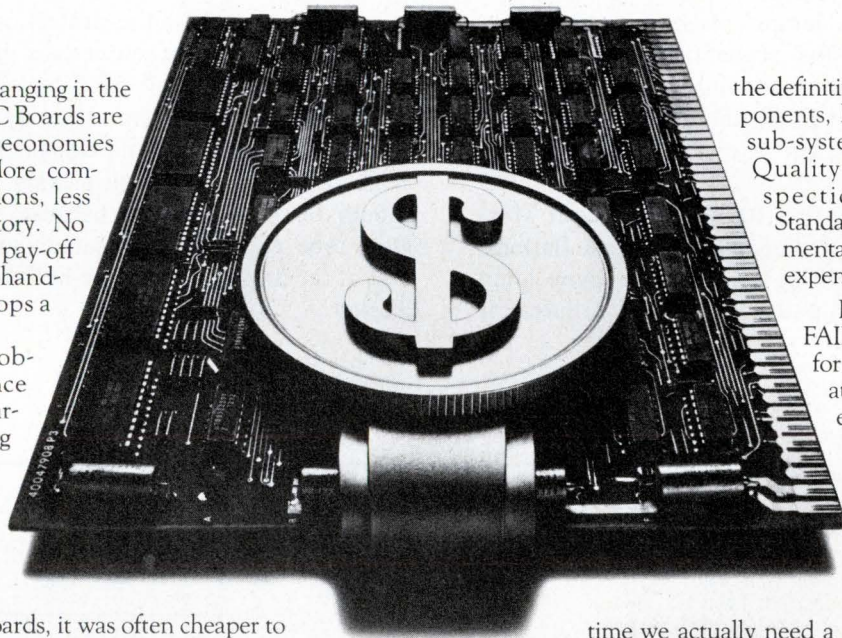

the definitive capability in testing components, PC Boards, modules and sub-systems. For Manufacturing, Quality Control, Incoming Inspection and Performance Standards. Faster, complete documentation of faults makes it less expensive to rework than reorder.

Built around the exclusive FAIRSIM/FAIRGEN software for simulation and test generation, Fairchild Systems has evolved FAIRTEST, the complete software system which develops custom testing and fault isolation programs just from the description of your PC Board content, layout and wiring. The first

time we actually need a physical sample of the PC Board is to final-verify the software. We have fixtures and adapters including load boards where needed to simulate an unusual electrical environment. The whole shooting match, from software through computer-controlled hardware and accessory

fixtures, including maintenance support and updating services, available with cost analysis of the proposed system... only from Fairchild Systems.

If you manufacture systems with large scale digital boards, or if you only inventory them, Fairchild has a system for keeping the profit returns from the big board at their optimum levels. We take the guesswork out of rework.

Fairchild Systems. Fairchild Systems Technology, a division of Fairchild Camera & Instrument Corporation.

FAIRCHILD SYSTEMS TECHNOLOGY

Fairchild Systems
3500 Deer Creek Road
Palo Alto, California 94302

Please send me information on your PC Board Test Systems.

Please send information on your avionic and military test capabilities.

Call immediately.

Name _____

Title _____

Company _____

Street _____

City _____ State _____

Zip _____ Telephone _____

TEE

Fairchild Systems

Fairchild Systems Technology, a division of Fairchild Camera & Instrument Corporation.

Each TSP position contains 12 numeric Nixie™ tubes. They can display operator-requested data such as the originating (calling) telephone number, the terminating (called) number, the charging rate for the call, elapsed time, time of day, special billing number, or any other data obtainable from the control unit.

The Nixies are mounted on a double-sided printed wiring board, along with their control circuitry, consisting of neon glow lamps, resistors, and diodes. The Nixies light in pairs, sequentially from right to left. Pairs are selected by one of the six pair exclude leads, and the digit in each tube by one of ten even tube digit select leads, and one of ten odd tube digit select leads.

Experience with the first 100B TSPS office at Morristown, New Jersey, and at subsequent installations, indicated that false firing of the neon glow lamp caused an excessive number of display failures. It

was necessary to tighten the process controls and to add pulse shaping networks in the control circuits to overcome the inherent instability of the neon glow lamps.

The light-emitting diodes, being used in a new operator display will replace the present indicators soon. The new display uses 7-segment LED numeric indicators, IGFET LED drivers, discrete transistors to interface with the control circuits, and TTL circuitry to provide increased noise protection. It will require +5- and -3-V power sources, six pair exclude leads and two sets of five digit select buses.

The new display system uses only 16 control leads compared to 26 in the old design, because of additional IC decoding and multiplexing. The new display should be more reliable because the troublesome glow tube has been eliminated, and the estimated cost of the display is only one-half that of the present display.

This is the drive scheme for the gas discharge displays in the switchboard. Each Nixie tube has 10 driver circuits of the type shown connected to the numeral five. To display a digit, a pair exclude pulse (-80 V) is applied to all pair exclude leads except the one desired. Then digit select pulses (+80 V) are applied to one lead of the even tube bus and one lead of the odd tube bus. The potential difference of 210 V (+80 V and -130 V) ionizes the selected glow lamps, in turn activating the desired numerical element. All other numbers and tubes are held off, because the coincidence of +80 V and -80 V (pair exclude) is insufficient to light the glow lamp. The +24 V maintains the display once it fires and the digit select pulse is removed. In early versions of the unit, false firing of the glow lamp caused an excessive number of display failures. Corrective action consisted of tighter process control on the lamps themselves, plus the inclusion of pulse shaping networks in the control circuits.

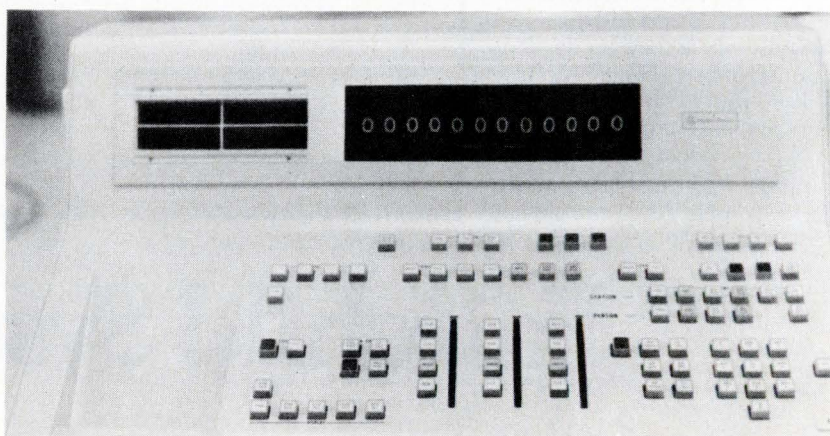
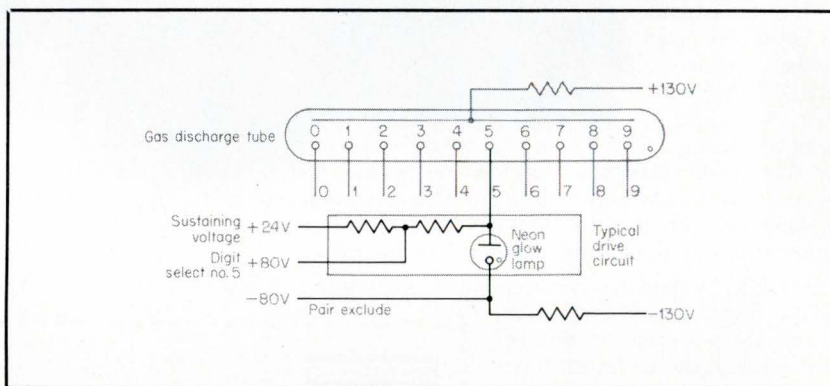

The Traffic Service Position Switchboard with 12-digit Nixie display. There are over 5000 of these units now in service throughout the country. Presently in the development stage, a new version of the switchboard will use seven-segment LED displays.

Brightening up your applications

Dan Rovine, Pinlites Div.

REFAC, Caldwell, N. J.

When you turn on an incandescent filament readout, the principal advantage and the major area of concern are both evident. The strength of the incandescent is its bright, uniform output, easily read in direct sunlight. Because it is brighter than any other readout, the incandescent operates well with all color filters and glare-minimizing, contrast-enhancing circularly polarized filters. This brightness is no illusion—efficiency, measured as light output per power input, is higher than any alternative.

Service life is the major concern. How long will those thin, hot filaments last, and how much banging around can they withstand without breaking? As some airborne and ground communications applications show, service life is fully compatible with the requirements of modern solid-state instrumentation, even in military and airborne shock and vibration environments.

The features of incandescent filament displays that vary among manufacturers include such items as packaging, extent of corner gaps, filament uniformity, and thermal design of support structures, all of which have a bearing on how pleasing and readable the output is.

Communication system control box

Joe Adams is an electronic engineer at Hoffman Electronics, Inc. Hoffman is building a high-frequency single-sideband airborne or vehicular communication system, and Joe Adams is the project engineer for the control box. The system requires a display brightness of 3000 ft-L, with a minimum contrast ratio of 10-20, for use in high ambient light levels. Polarized filters are used for glare reduction. The display had to be serviceable, yet operate and remain properly seated during a 200-g vibration test. An additional design goal was uniform brightness without corner discontinuities.

Rear projection readouts were considered, but did not suit the application. Relatively low brightness is inherent in them, because of the large spacing between the lamp and the readout surface.

Similarly, LED brightness, which is an order of magnitude less than incandescents, was insufficient. In addition, LEDs exhibit a characteristic of many readouts in high ambient light: output figure "8's" can be discerned in all positions with no electrical in-



This Hoffman Model VCS-801 control box contains 5/16-in. character, incandescent filament DIP readouts. It displays a six-digit frequency plus a decimal point in the 2.0000 to 29.9999 Mhz range and uses a 22-bit core memory to achieve non-volatility.

put. The usual solution is to add suitable filtering, but that attenuates an already low illumination.

Liquid crystals that operate from reflected light are candidates for high ambient light applications. Their pricing is suitable, however, in their present stage of development, they cannot meet the temperature requirements of -55 to 100°C .

Adams also checked into the dot-matrix incandescent readouts in which highly efficient fiber-optics conduct light to the viewing surface. While brightness was adequate, it varied among dots, possibly due to geometric factors in arranging the fibers. Much more serious was a three-fold cost increase compared to incandescent filament displays. Further, the fiber-optic readout length requires significant cantilevering on the front panel, increasing vulnerability to vibration.

The Hoffman application made extensive use of strobing to simplify the electronics, and pulse-width modulation to adjust brightness. A photodiode monitors ambient light to provide the "AGC" to regulate brightness by reducing the effective voltage in darker environments.

The incandescents made sense for Hoffman from this point of view, too. It is possible to strobe up to 10-20 incandescent displays. Strobe rate depends

(Continued on page 22)

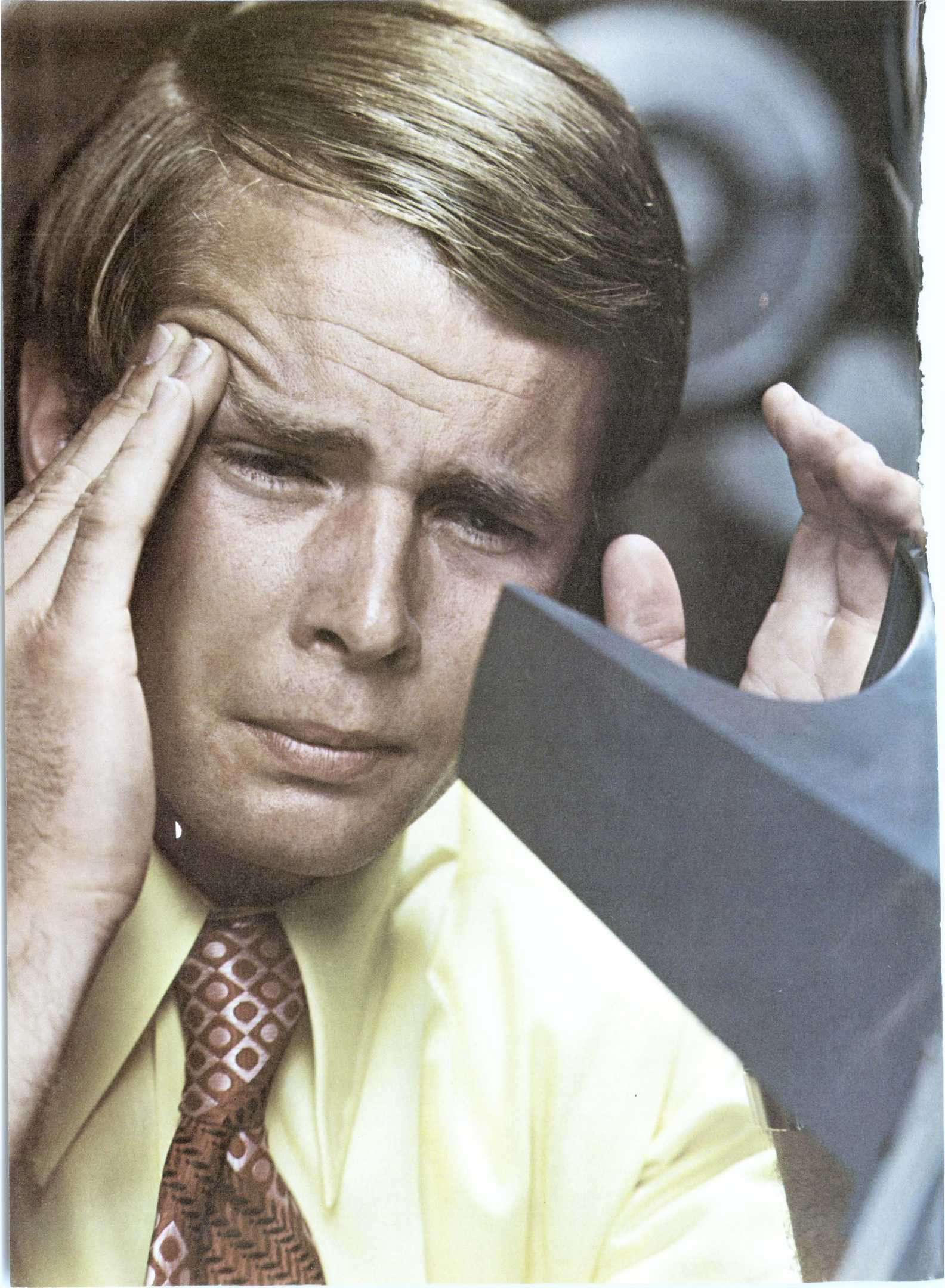

Think Twice:

What's one of the biggest measurement problems in the computer industry today?

Low Duty-Cycle Measurements—

Making timing-pulse adjustments, and finding noise pulses in, or locating missing bits from low duty-cycle digital signals. Countless lost hours and eye-strain have resulted from this problem—trying to view low rep-rate signals like those found in disc, tape, or drum peripheral units. But with your refresh cycle occurring at such long intervals, coupled with short phosphor persistence, it's no wonder that you've spent an inordinate amount of time making such measurements. And it's no wonder that you often came out from under your scope hood rubbing your eyes. Well, no more!

Storage CRT With Unmatched 400 cm/ μ s Writing Speed. Hewlett-Packard just made it possible for you to throw away your scope hood by developing a new bright, burn-resistant, high-speed, variable-persistence CRT—available in either 100 cm/ μ s or 400 cm/ μ s writing speeds. Placing these new CRT's into an all new mainframe that's optimized for high-writing-speed storage measurements, HP now gives you a new dimension in storage scopes—the HP 184A. This unique combination offers the highest writing speed available, and a display with brightness as great as you can find anywhere. For the first time you can find those elusive transients that before were too fast for your storage scope to follow—like nanosecond noise pulses.

Display True Replicas of Your Waveforms. You'll appreciate being able to adjust persistence down to 0.2 seconds; that's 75 times lower than a major competitive unit. For those measurements that require faster sweep times, you'll know you are displaying true replicas of your waveforms when you're using an HP 184A. Capture low duty-cycle pulse trains, through repetitive sweeps, simply by adjusting the persistence to

"maximum," to build up the intensity of dim traces. This feature in the new 184A oscilloscope lets you do many jobs you previously allocated to expensive, single-shot scope/camera systems.

Variable-Persistence Storage and Standard in One Scope. Further, you'll find that your 184A is a true general purpose scope that offers you the capability to choose, by way of plug-ins, all the functional features of the HP 180 Series of oscilloscopes, including such items as selectable-input impedance, and sampling to 18 GHz. And for simplicity of operation, we think you're in for a pleasant surprise when you compare the 184A against the competitive unit.

Superior Technology. HP believes the most important part of a scope system is the CRT—the interface between you and your measurement. As the pioneer in practical applications of dome-mesh magnification, HP was first to expand the size of high-frequency CRT's to 6 x 10 cm; first to 8 x 10 cm; and first to 10.4 x 13 cm—all in high-frequency mainframes. HP was also the first to use dome-mesh technology to substantially lower power requirements for CRT deflection (making possible the only line of 35 and 75 MHz portable scopes with built-in battery packs—scopes that really are portable).

From The Storage Leader. HP was first with variable-persistence mesh storage for commercial applications—to give you a stored trace many times brighter than bi-stable tubes, and without annoying flicker. Variable-persistence, with its ability to build up waveform brightness, was the first CRT innovation that gave you a trace bright enough to let you tackle most single-shot or low rep-rate measurements problems. All you do is adjust persistence until the integrating storage effect brings your waveform up to a bright, clear display.

Burn-Resistant CRT's. HP placed variable-persistence in many of its scopes including the 181A, 1702A, and 1703A storage units. And now HP has developed, for its current line of storage instruments, carefree CRT's so highly burn resistant they require little more care than conventional CRT's. The new 184A high-writing-speed scope also has unprecedented inherent resistance to burns.

Yes, Scopes Are Changing. How many times have you wished for a scope that could display a low rep-rate digital signal brightly and clearly, and one that could also be used for a variety of general purpose measurements. That scope is here now in HP's 184A storage mainframe, \$2200 (for only \$500 more, you can boost your 184A's writing speed to 400 cm/ μ s), with plug-in capability to 100 MHz real time, or 18 GHz sampling. Think twice; put away your scope viewing hood and call your local HP field engineer for a demo today. Or write for our "No Nonsense Guide to Oscilloscope Selection." It covers the other members of HP's variable-persistence storage scopes. Hewlett-Packard, Palo Alto, California 94304. In Europe: P.O. Box 85, CH-1217 Meyrin 2, Geneva, Switzerland. In Japan: YHP, 1-59-1, Yoyogi, Shibuya-Ku, Tokyo, 151.

**Scopes Are Changing;
Think Twice.**

HEWLETT  PACKARD

OSCILLOSCOPE SYSTEMS

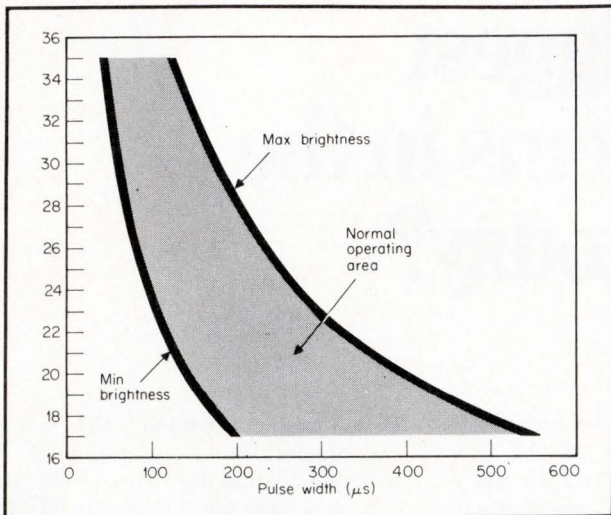

Display pulse width vs voltage. The Hoffman display subsystem typically operates at 27 V and 175 μ s pulse width every 6,400 μ s.

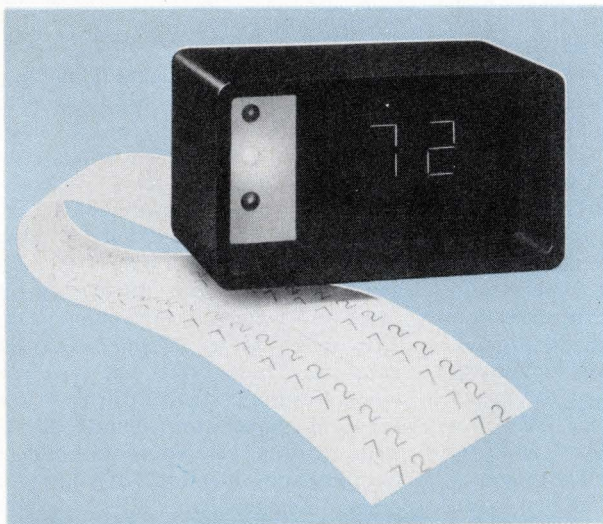

This Rotiform display unit is used in digital speedometers, and to display transducer outputs in shipboard applications.

more on the drive circuitry than the readout and the rate can go as high as 100 kHz. Except for limits imposed by high voltage breakdown and low frequency flicker any voltage or frequency can be used as long as filament temperature is kept within safe limits. High voltage narrow pulse strobing does not affect display life.

Digital speedometers

Clyde Stein is chief engineer at Rotiform, Inc. He recently did an extensive comparison of readouts for digital speedometers in police and commercial vehicles, and for digital displays of transducer outputs in ship-board applications.

The initial selection factor was the requirement for compatibility with the already available IC power supplies, quickly narrowing the options to: (1) LEDs, (2) conventional 7-segment readouts using seven sub-miniature lamps, (3) an incandescent filament display in a vacuum tube package, and (4) a DIP package incandescent filament display. Because DIP packaging was so advantageous, the choice narrowed to the LED and the DIP-packaged incandescent, which are plug-for-plug interchangeable.

The LED caused eye fatigue during extended viewing. This was partially attributed to the localized variations in brightness—high intensity at the diodes alternating with darker areas between diodes. The red filter that was used enhanced these brightness contrasts.

Thermal factors had an effect. The LEDs require dropping resistors to operate from the dc logic supply, increasing the internal temperature rise. Their brightness falls off at higher ambient temperatures. The principal deficiency of the particular incandescent is the thinness of the line, which is accentuated in high ambient light. The final design used the incandescent DIP, with the LED as a backup alternative.

Digital displays in digital instruments

Tom Kelly,

Weston Instruments, Inc., Newark, N.J.

The parameters for evaluating displays for digital panel meters or bench instruments are the same, although the selection criteria may differ, depending on the intended application. Regardless of the instrument or its application, all display evaluations in-

itially focus on cost. This concept of cost must include not only the display but the impact on the instrument of all hardware and circuitry unique to its implementation.

During the past year, LED displays have become widely accepted in instruments where reliability and portability are stressed. Though the price has fallen,

LEDs remain one of the higher priced displays. Monsanto's MAN-1, the first commercially available LED (0.27 in. high, 7-segment), is now offered at \$4.30/digit in 10,000 quantity.

The price of LED displays is quite sensitive to the amount of GaP or GaAsP used to fabricate the segments. Various schemes have been used to reduce the material required. For instance, Opcoa's SLA-1, which can be interchanged with the MAN-1, uses multi-directional light output from GaP in conjunction with reflectors. A display without reflectors uses almost ten times as much semiconductor material. Another tactic that some manufacturers use is to leave large gaps between segments. This creates displays having only marginally acceptable appearance.

The Hewlett-Packard Model 5082-7405 features five digits in a DIP package. An integral molded lens system, having a magnification of two, magnifies the LED character height from 0.055 in. to an apparent 0.11 in. Present pricing by Hewlett-Packard is \$2.70/digit in quantities of 10,000 (2,000 clusters).

Mounting costs

Light-emitting diode displays are normally mounted on a vertical printed circuit board. The display cost must include the additional PC board, the PC connector that connects the display board to the main board, and sockets for the individual LEDs. For a 3½-digit DPM currently in production at Weston, the cost of this unique hardware exceeds \$2/unit, or adds more than 50¢/digit. This represents an additional 10-15% display cost, and will be a correspondingly higher percentage as LED prices drop.

A variety of standard TTL, BCD to 7-segment, LED decoder-drivers are priced similarly to decoder/drivers for other displays. Normally, one resistor/segment, plus one for decimal point, is added externally to an LED decoder/driver to provide current limiting. The resistors, plus labor costs add approximately 40¢/digit to the cost of the display.

The Weston 4440 digital multimeter reduces total display cost by integrating the LED segments and hardware in the front window of the instrument. The segments are mounted directly onto the PC board that plugs vertically into the instrument, eliminating the housing and pin-outs normally required for individual LEDs. An inexpensive, molded red plastic window snaps over the front of the board, covering and protecting the LEDs. Strobing the display achieves an additional cost reduction, because only eight resistors, instead of 26, are needed for 3½ digits.

For over a decade, the gas discharge Nixie™ tube has been the accepted display in digital voltmeters, counters, and panel meters. It may have its short-

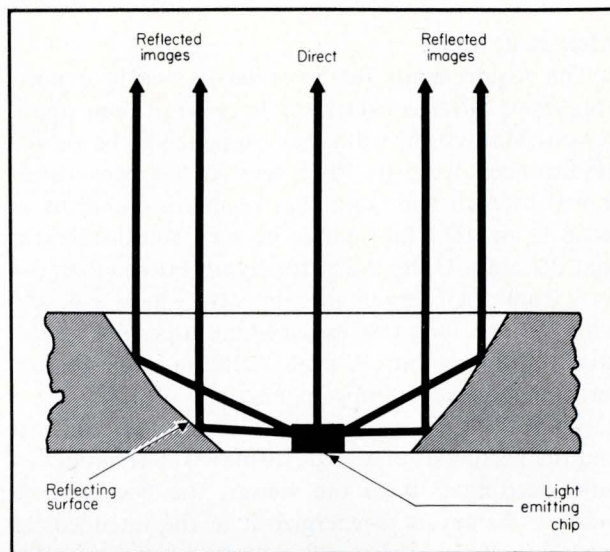

This LED display, the SLA-1 from Opcoa, reflects the multi-directional light output from GaP to reduce the actual amount of semiconductor material in the display. Displays that do not use this technique can require up to 10 times as much semiconductor material.

comings, and not the glamour of newer displays, but it is still a very dependable, competitively priced display. Pricing for 10,000 is around \$2/digit.

Standard full-scale values for DPMs and DVMs are 1,900, 19,000, and 12,000, so that the most significant digit need only display the number 1, or be off. A commercially available neon lamp resembles the size and appearance of the number 1 in a gas discharge tube. This type of neon lamp costs about 50¢ in quantity, saving more than \$1.50 in the cost of a full Nixie digit.

Side-viewing gas discharge tubes have external connections at the bottom of the tube, permitting direct mounting to a horizontal PC board. Typical sockets, used to permit easy tube replacement, cost 30¢/socket in volume.

Another type of gas discharge tube finding acceptance in digital instruments is the Sperry, 7-segment, in-plane display. It is competitively priced at \$2.32 in 10,000 digit quantity. Since it's meant for end viewing, it requires a vertical PC board for mounting, and a means for interconnecting to the main board which is similar to that required of LEDs.

An additional cost of gas discharge tubes is associated with the high voltage requirements. It is quite nominal with ac lines, but increases in importance when battery operation is considered.

During the past year, great things have been promised for liquid crystal displays, including pricing forecasts as low as 50¢/digit. Until the life and temperature problems are resolved, it will remain in the talking stage for digital instruments.

After cost, what?

The requirements for DPMS versus bench or portable DVMS differ considerably because of their application. Many DPMS will mount in panels to be viewed at distances of up to 10-15 feet. It has been determined by trial and error that readouts should be at least ½ in. to 1 in. high to be seen comfortably at that distance. Users are normally no further than 3-4 feet from their bench instruments, which are sold with 5-6 feet long test leads. Some users still prefer larger numbers, but ¼ in. to 0.187-in. high characters normally satisfy this application.

Since the final evaluation of brightness, contrast and the aesthetics of a given display is determined by how pleasing it is to the viewer, the best way to grade a display is to energize it in the intended instrument. This is also particularly true when evaluating the character height of LED displays that nearly always appear larger than their actual specified dimensions. Items affecting the apparent character height include the segment height-to-width ratio, the gaps between segments, the angle of slant of the characters, and whether the character is formed by dots or bars.

Where applicable, don't forget to energize the decimal point and polarity signs. The decimal point may give you quite a shock. Some manufacturers locate it under the character, instead of to the right or left. Instead of configuring the decimal point as a dot, some display it as a comma (vacuum fluorescent), or as a V or an X (incandescent).

Brightness for most displays is normally specified in terms of spot brightness (foot-Lamberts). For gas discharge tubes and incandescent displays, because of their large apparent emitting areas and high foot-Lambert levels, this specification is normally adequate. With LED displays, however, where the source is normally small compared to the viewing distance, brightness specified only in terms of foot-Lamberts is highly deceptive because it is area dependent. To be meaningful, the purchase of LED displays in addition to a specification of spot brightness (foot-Lamberts) should contain a specification of the intensity of the source (millicandelas). The foot-Lamberts specification will essentially provide a measure of the visibility of the display in high ambient lighting, while the millicandelas specification provides a reference for the brightness seen by the eye for a given size numeral. Both specifications should include the operating point in terms of the peak current and duty cycle since the efficiency of the output of LEDs changes with peak current.

A brightness uniformity spec is not required for gas discharge displays. For LEDs, where the bright-

ness can differ widely, it is necessary to specify uniformity to obtain the proper aesthetic value. The different means of specifying this parameter must be considered from an economic viewpoint as well. Some techniques used successfully include specifying comparative brightness in foot-Lamberts, from segment-to-segment in a digit (or a number of digits in an integrated display), and comparative brightness in millicandelas from digit-to-digit.

Power consumption

Power consumption is an important criterion of any instrument. When it is high, it increases the costs of heat sinking and the power supply. Quite often it places an additional restriction on the permissible maximum operating temperature (ambient) of an instrument.

For battery-operated, portable instruments, the implications of higher power consumption are even more direct. Assuming an 8-h battery operation criterion, one 2.3-oz., "C" cell, NiCd battery is required for every additional 250-300 mW of power. The cost in 10,000 quantity is about \$1.50. One watt of additional power increases battery cost by \$5-6, and weight by 7-9 oz. The effects on size and weight reduce the degree of portability.

Since instrument power, not display power, is the concern, specifications must be evaluated in light of the application of the display to a given instrument. In an ac line-operated application, gas discharge tubes normally operate from an unregulated full- or half-wave rectified voltage of approximately 200 V. A Nixie tube consumes 200 V at 3 mA average, or 600 mW/tube. Losses in the power transformer typically run another 100 mW/digit, for a total of 700 mW/digit.

Sperry Rand 750 Series gas-discharge displays, with all segments lit, typically consume 370 mW/digit. This saves 30-40%, compared to a Nixie readout. The Panaplex and Panaplex II gas discharge displays are not applicable to DPMS and DMMS because they have a minimum of eight digits.

Applying LEDs to the example above, power consumption depends upon the character size, light intensity, and mode of operation (dc or strobe). As one example, the MAN-1 typically operates from a 5-V supply, uses a dropping resistor, and requires 105 mA, or 525 mW/digit. In normal ac line operation, the display operates from a regulated 5 V having a typical voltage drop of 4 V, across the regulator. The total power includes that dissipated in the regulator and the transformer, and is approximately 1040 mW/digit.

As a second example, assume an instrument with

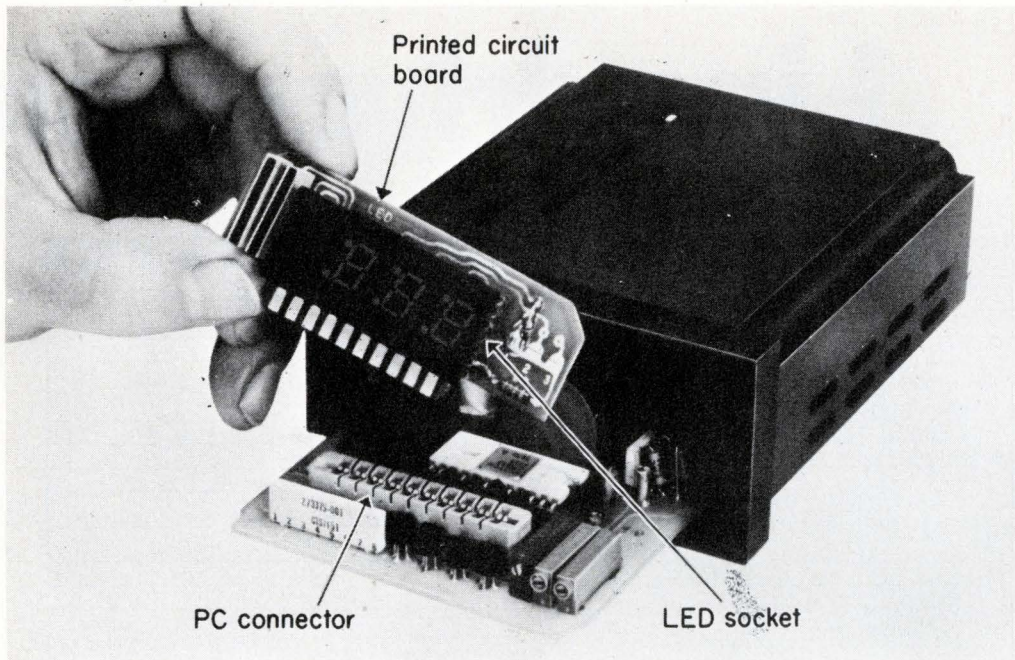

A typical display application is this 3 1/2-digit DPM. The LED displays are mounted on a vertical printed circuit board that is then plugged into the main board. To be realistic, the cost of the display must include the cost of this additional PC board, the PC connector, and the sockets for the individual displays.

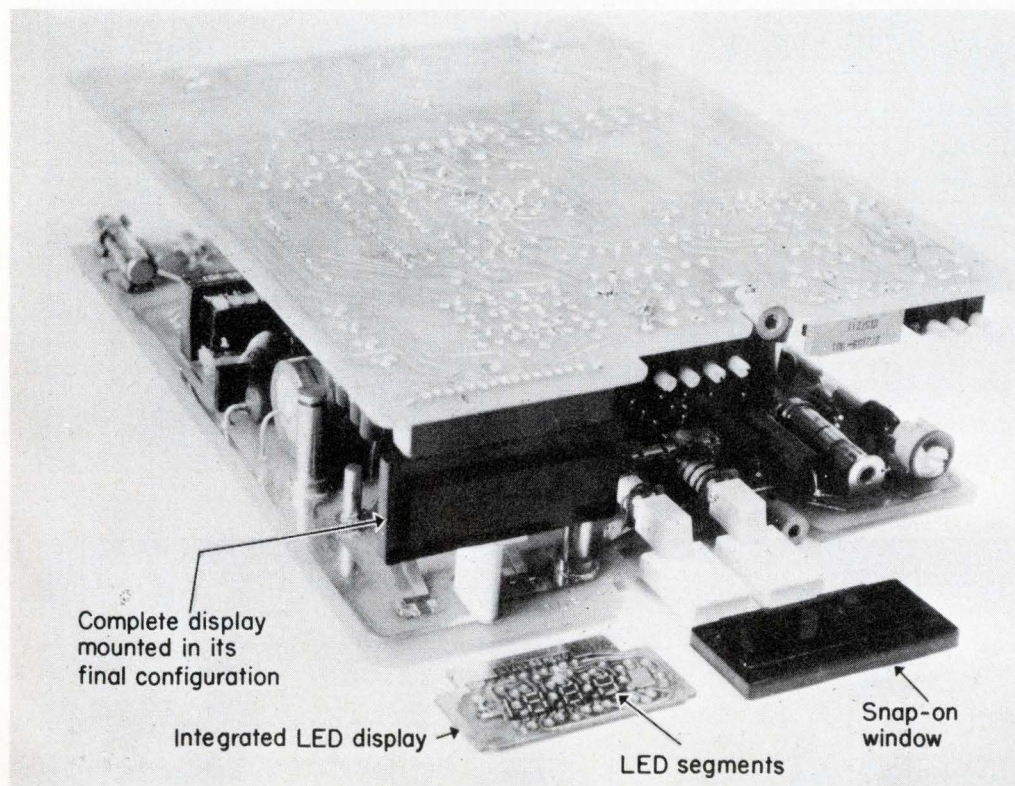

One approach to reducing display costs, used in this multimeter, integrates the actual LED segments and the mounting hardware. The display also includes a snap-on window which serves both as a protective cover during handling, and a viewing window after installation.

3/16-in. high LED characters, 100-200 ft-L brightness, and operation directly from a 5-V supply. This describes the display used in the Weston Model 4440 digital multimeter, which also operates at a 10% duty cycle to improve its efficiency.

In operation, the LED display has a peak current of 20 mA per segment or 140 mA per digit which, at a 10% duty cycle, is 70 mW per digit. Since operation is directly from a battery supply, no additional power is consumed by a regulator.

(Course continues on page 28)

Line drivers and

MOTOROLA LINE DRIVERS

TYPE	MC75109	MC75110	MC75113
BLOCK DIAGRAM			
OPERATING FREQ.	< 10 MHz	< 10 MHz	< 10 MHz
LENGTH OF LINE	< 5000'	< 10,000'	< 20,000'
INPUT	TTL	TTL	TTL
TYPICAL LOAD CURRENT	6 mA	12 mA	± 20 mA
PARTY LINE OPERATION	YES	YES	YES
STROBE	YES	YES	NO
POWER SUPPLIES	± 5 V	± 5 V	± 5 V
FEATURES	INSENSITIVE TO SUPPLY VARIATIONS OVER ENTIRE OPERATING RANGE INHIBITOR AVAILABLE FOR DRIVER SELECTION		CAPABLE OF SOURCING CURRENT WITH ONE OUTPUT AND SINKING CURRENT WITH THE OTHER

TYPE	MC1488	MC1580	MC1582	MC75450	MC75451
BLOCK DIAGRAM					
OPERATING FREQ.	< 2.5 MHz	< 10 MHz	< 10 MHz	1 MHz	1 MHz
LENGTH OF LINE	< 50'	< 5000'	< 5000'	< 500'	< 500'
INPUT	TTL	MECL	TTL	TTL	TTL
TYPICAL LOAD CURRENT	10 mA	8 mA	8 mA	—	—
PARTY LINE OPERATION	NO	YES	YES	YES	YES
STROBE	NO	NO	NO	NO	NO
POWER SUPPLIES	± 9 V	± 5 V	± 5 V	± 5 V	± 5 V
FEATURES	SATISFIES EIA STANDARD RS-232 SIMPLE SLEW-RATE CONTROL	COMMON-MODE INPUT RANGE ± 3.5 V COMMON-MODE OUTPUT RANGE -3 V / +9 V		TWO STANDARD TTL GATES TWO UNCOMMITTED HIGH VOLTAGE NPN TRANSISTORS	POSITIVE "AND" DRIVER OUTPUT TRANSISTORS INTERNALLY CONNECTED

MOTOROLA LINE RECEIVERS

TYPE	MC75107	MC75108	MC1581	MC1583	MC1584	MC1489/89A
BLOCK DIAGRAM						
INPUT SENSITIVITY	25MV MAX	25MV MAX	50MV MAX	50 MV MAX	60MV MAX	ADJUSTABLE FROM -3 V TO +3 V
PROPAGATION DELAY NSEC	25 MAX	25 MAX	20 MAX	30 MAX	37 NSEC	50 MAX
STROBE CAPABILITY	YES	YES	NO	NO	NO	THRESHOLD ADJUST AND RESPONSE CONTROL
OUTPUT	TTL ACTIVE PULL-UP	TTL OPEN COLLECTOR	MECL	TTL OPEN - COLLECTOR	TTL - ACTIVE PULL-UP	RESISTIVE PULL-UP
POWER SUPPLIES	± 5 V	± 5 V	+5 V, -5.2 V	± 5 V	± 5 V	+5 V
FEATURES	DIODE PROTECTED INPUT STAGE HIGH COMMON-MODE REJECTION RATIO HIGH DC NOISE MARGINS		± 3.5 V COMMON-MODE INPUT RANGE HIGH INPUT IMPEDANCE			SATISFIES EIA STANDARD, RS-232 BUILT-IN HYSTERESIS



- Supply variation immunity
- Diode protected inputs
- New design

receivers step ahead.

Line driver and receiver design advances don't come along every day. Now, in three simultaneous strides, two Motorola twisted-pair line drivers offer more than the types they replace, so do two receivers, and a brand new driver is introduced to serve a previously unmet need.

Output sink current is independent of positive and negative supply fluctuations, allowing immunity to supply variations over their entire operating range. Thus the MC55/75109 and 110 are superior to the line drivers they replace. Step one.

MC55/75107 and 108 are superior to the receiver types they replace because diode protection on all input stages preserves data transmitted during power down periods of a particular receiver in

party line applications. Step two.

Step three. The MC75113. A brand new push pull driver designed for high speed data transmission systems using balanced terminated lines. The first one specifically created for party line operation. Output sink current (typ) is 20 mA. Output common-mode voltage range is ± 3 V.

FOR PRICE WATCHERS

Circuit	100-999 \$ Price	Circuit	100-999 \$ Price
MC55107L	4.80	MC55109L	5.15
MC75107L	3.20	MC75109L	3.35
MC75107P	2.65	MC75109P	2.80
MC55108L	4.80	MC55110L	5.15
MC75108L	3.20	MC75110L	3.35
MC75108P	2.65	MC75110P	2.80
MC75113L	3.10		

In late 1969 we introduced the industry's first twisted pair line driver and receiver family, the MC1580 series. Hundreds of thousands of Motorola line drivers and receivers have been delivered since we introduced the industry's first

EIA RS232C drivers and receivers, the MC1488 and MC1489. And our new developments are only the latest steps in Motorola's continuing effort to meet the expanding needs of a dynamic industry.

These new devices are among the many in Motorola's broad line of linear interface circuits available now from Motorola distributors and sales offices. Since you probably want more information before you buy than the selection guide on the opposite page provides, circle the reader service number or write to Motorola Semiconductor Products Inc., Box 20912, Phoenix, AZ. 85036. We'll also send a copy of our handy new Linear IC Pocket Cross Reference as long as the supply lasts.

MOTOROLA LINEAR

— Serving a greater range of analog designs

Copiers: a typical office application

Craig A. Smith,

Information Technology Group,
Xerox Corp.

A numeric readout must be readable in response to the appropriate control, perform reliably, and be available at an overall cost commensurate with the function it performs. The final test will be whether it improves operator performance or causes errors, confusion, annoyance, and loss of efficiency.

At Xerox Corp., Human Factors Design works with Industrial Design, Engineering, and Components Engineering to choose the most efficient display for each task. The result is a design based on experience, emerging information on current or new devices, and a thorough evaluation of the functional value of the display.

When design starts, a rough value is placed on each function, such as a display. While dollars do not insure intelligent design, this value judgement helps to avoid over- or under-designing the display. If the resulting costs do not compare, the design is changed or the function is re-evaluated in light of new information.

Singular approach. When the "start-print" button is pushed on the new Xerox 4000 copier, the Nixie™ display resets to zero and begins counting copies until the selected number is produced.

Dual digits. In Xerox 2400/3600 copier/duplicators, knobs below each digit set the desired quantity which is indicated by the lower set of vendor's backlit numbers. Nixies™ at the top indicate copies produced at any given time. The three gas-switching tubes are used as a three-decade ring counter. The count signal causes the tube to switch electrostatically to the next point in the decade ring until coincidence occurs. More recent machines in this family use monolithic ICs to perform the counting function, to compare the count with the quantity selected, and to interface with Nixie™ tube readouts.

What's in a cost?

All design guidelines affect cost in one of three general categories:

- unit cost of design, procurement and production
- service cost
- market-impact cost

Unit cost includes the cost of the readout and the full or incremental cost of almost everything associated with the display, such as the power source, data conversion (decoding/driving), mounting hardware, panel techniques, handling during manufacturing, and ancillary components that protect the readout. Developmental costs and time constraints, available manpower, and time and money required to interface with Underwriters Laboratory are also cost considerations.

Electrical considerations

Since Xerox is moving toward low-voltage ICs for machine control, high-voltage switching for gas-discharge or electroluminescent displays presents a serious interface problem, requiring pre-biasing or buffering. (High-current switching for multiplexed devices can also cause trouble.) Devices requiring specific frequency for activation must absorb the

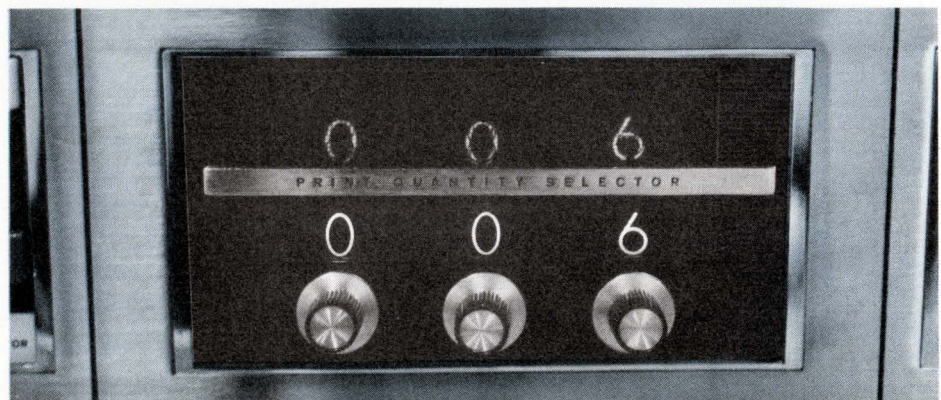

cost burden of an oscillator and power supply. Both can cause noise problems that can harm low-voltage circuitry unless the device is carefully designed.

Complex designs often require components which consume a fair amount of power. Since we want to minimize overall machine power, this limits power available for other machine functions, and may add ventilation costs. Displays that need secondary illumination burden the electrical system and complicate mechanical mounting.

Incoming displays are checked at typical operating levels for general operability, brightness within a given range (generally 2:1), high-current pulse tolerance (approximately 10 times rating for 10 cycles of a few microseconds each), and for tolerance to extreme temperatures and temperature gradients. Units undergo 10 cycles from 0°C to 100°C for 10 minutes at each extreme with a maximum transfer time of 10 seconds.

Since we look for a 5- to 10-year operating life, many devices from each potential supplier are life tested early in the evaluation stage. To simulate five years of field operation we continuously test a statistically appropriate number of devices for 4,000 hours. The second phase of our cost impact begins with service after the machines leave the factory.

Service cost

Service cost is of paramount importance. Most customers lease their copiers from Xerox. Since we charge by the copy, it is in our best interest to keep our machinery in good working order. The greater the availability, the greater the revenue, and the greater the customer's satisfaction. We want a reliable assembly that can be repaired as quickly and as cheaply as possible. Its failure should have a minimal effect on general machine operation.

We look for these specifics:

- at least 5 or 10 year life before failure or serious degradation.
- effects of component failure on the total system
- temperature tolerance—continuous operation between 10-70°C. Readouts producing excess heat affect their own life.
- humidity tolerance—5-95% relative humidity.
- independence—no tweaking or matching required when components are replaced.
- immunity from interaction with silicone oil or toner (dry imager). For instance, vinyl encapsulations would probably discolor, since the toner tends to migrate into vinyl surfaces.
- freedom from surface static charge, which



Convergence. This detail of the electromechanical counter of a Xerox 1000 copier shows the static backlit numbers. When the left-hand number, representing copies produced, reaches parity (coincides) with the right hand number, representing copies requested, the copying mode automatically shuts off.

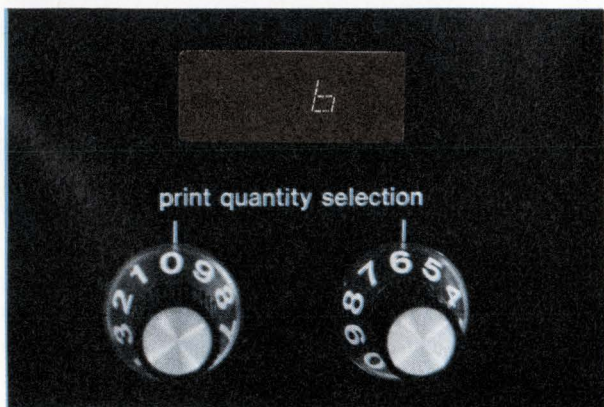

Prototype. Operation of this LED display is the same as on a Xerox 4000 copier. The counter indicates copies selected until the "start-print" button is pushed. Then it resets to zero and counts until that number is reached.

would also interact with the toner.

- indifference to static build-up on nearby plastic panels.

Market-impact cost

An illegible readout may be costly from the standpoint of customer errors and dissatisfaction. We must consider if failures are likely to be catastrophic or partial, and if any false indications result. A blank readout is better than a false indication, which can cause more confusion than no information at all.

The advent of LEDs and liquid crystal displays places more emphasis on apparent brightness than actual brightness. Most Xerox copiers have grey-tinted plastic panels in front of the readouts, reducing a certain amount of the initial brightness. Liquid crystals suffer the most. Reflective ones lose doubly if ambient lighting is used.

Actually, the matter of brightness is really a discussion of contrast; the readout must appear bright enough against its background to be read easily. Ambient light and glare can cause a dark panel to appear so bright that the readout cannot be seen. Expensive special materials and coatings can sometimes help. Apparent contrast is also improved by a sharp readout with minimum blur at the edges. Multiplexing may help (especially with LEDs), because the eye reacts to peak brightness more than average brightness. In addition, readout brightness must be kept in scale with other panel graphics.

We have found that specs, samples, and measurements may all fail to represent actual performance. Manufacturers are making rapid improvements and citing minimum and typical values while leaving specs open at the top. Unless displays are matched to about 2:1 in brightness, one digit of a multi-digit readout may stand out brighter than the rest. This can affect apparent size. An LED can appear almost 50% larger than it is, and within reason, the brighter it is, the larger it seems. With display specifications, parameter values, and even the parameters themselves constantly changing, standardization of terms and measurement techniques would go a long way toward simplifying the design process and reducing its cost.

We strive for an uncluttered appearance in a readout array and a display panel system. Numeral shapes familiar to the operator are preferred (such as in the Helvetica Medium type we use elsewhere) since not all operators have good vision at this distance. Curved sections and corners with a height of about half an inch would make a very readable display that is in scale with the console area of most of our machines. We would like a green-blue readout because it is easier for the operator to view. Further-

more, red is normally reserved for fault indicators. We have even found color blind people who cannot see the narrow spectrum red LED display at all. However, the red and red-orange displays are presently the strongest contenders when all parameters are considered.

Several characteristics we avoid or minimize are:

- Reflections from display surfaces
- Visibility of unused readout elements
- Hot spots or uneven illumination of the display
- Heated surfaces
- Narrow viewing angles
- Motion or apparent motion when characters change
- Visible refresh rate (flicker) (8-13 Hz can cause headaches).

The operator interface

Different types of digital readouts lend themselves to certain general types of character sets.

- Previously prepared graphics selected on command:

- 1) rear projection or illuminated
- 2) flip-card displays

- Groups of simple symbols or pictures composed and controlled electronically (unlimited combinations).

- 1) large dot matrix
- 2) CRT

- Single symbols composed and/or selected electronically (limited to pre-selected set):

- 1) small dot matrix
- 2) segmented display
- 3) character display (Nixie type)

When using a Xerox copier, operators interface with four types of copier displays: 1) general instructions, including the names of the displays and controls, 2) status indicators or specific directives, 3) an indication of the number of copies requested, and 4) an indication of the number of copies produced. In general, types three and four each require a flexible format numeric readout but since they have different specific requirements, the choice of a device to fulfill the function differs.

Before a design is finalized, it is evaluated again by Industrial Design/Human Factors to determine that it adequately fulfills its function. We also call in customer representatives, technical representatives and operators to get the best possible verification of the usefulness of the design before it is issued.

We achieve this utility only if the display provides the user with exactly the information required when it is needed. We strive for easily understood data which is carefully structured—information based on functional requirements. ■

WORLD'S GREATEST OP-AMP?

If you had designed an op amp that guaranteed extremely low noise and drift (like the SSS725) and extremely low input current (like the SSS108A) and was easy to use with internal compensation and complete protection (like the SSS741), would you call it the world's greatest op amp?

WE CALL IT THE **monoOP-05!**

Here are the facts on the new **monoOP-05** Instrumentation Operational Amplifier:

	monoOP-05	monoOP-05EJ	monoOP-05CJ
V _{os} Max (mv)	0.5	0.5	1.3
I _B Max (nA)	3.0	4.0	7.0
R _{in} Min (MΩ)	20.0	15.0	8.0
Noise Voltage Max (μVp-p)	0.6	0.6	0.65
TCV _{os} Max (μV/°C)	1.0	0.6	1.5
CMRR Min (db)	114	110	100
Slew Rate (V/μsec)	0.25	0.25	0.25
Price at 100 pcs.	\$19.95 (TO-99, -55°C to +125°C)	\$14.95 (TO-99, 0° to +70°C)	\$6.95 (TO-99, 0° to +70°C)

The monoOP-05 fits directly into 725, 108A and unnull'd 741 sockets, allowing instant upgrading of your system without redesign. And offset nulling (with a 20KΩ pot) actually improves offset voltage drift. So there it is — could an op amp that combined the very best features of three of the industry's best sellers be called the world's greatest op amp? We'll leave that decision up to you.



UNITS ARE WAITING FOR YOU AT YOUR LOCAL DISTRIBUTOR — OR
CALL US DIRECTLY FOR IMMEDIATE ACTION.

... delivering tomorrow's linear technology today!

A BOURNS Affiliate

WEST

Lee Egberman
Precision
Monolithics, Inc.
1500 Space Park Drive
Santa Clara, Calif. 95050
Tel. # (408) 246-9225

CENTRAL

Ed Raether
Precision
Monolithics, Inc.
605 E. Algonquin Rd.
Arlington Heights, Ill. 60005
Tel. # (312) 437-6697

EAST

Joe Stern
Precision
Monolithics, Inc.
100 Ricefield Lane
Smithtown, N.Y. 11787
Tel. # (516) 864-2666

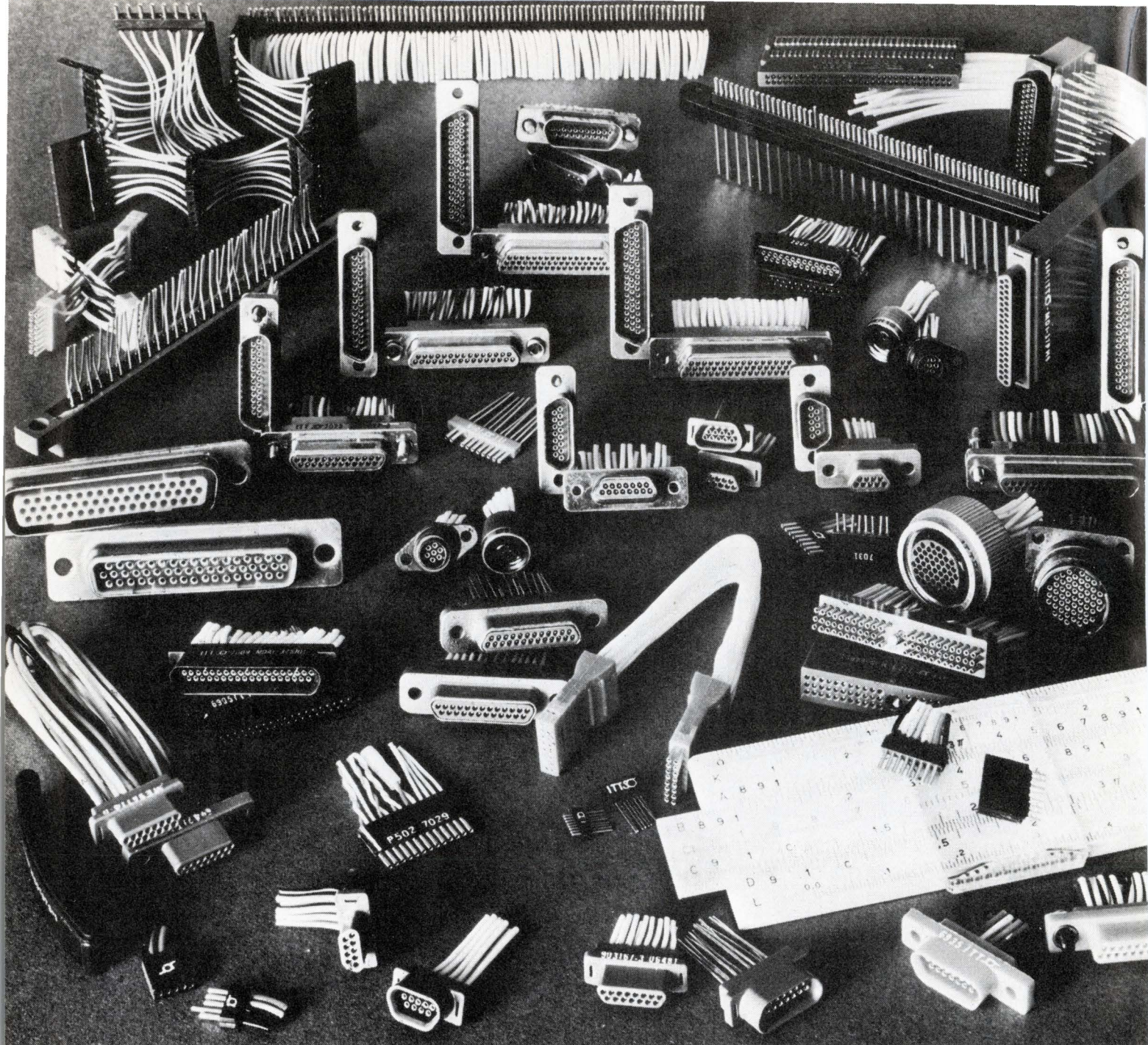

High contact density and light weight. Cannon calls that Centsible.

ITT Cannon's broadest line of microminiature connectors in the industry really give you your money's worth when you need contact centers from .100" down to .025". They're the Centsible choice in any application where space and weight are critical:

MDM Series. Rugged, moisture-sealed metal shell rectangulars — in 7 sizes.

MICRO-D. The smallest rectangular connector in the industry. Clip or screw mounting, 7 sizes.

MICRO-K. 7 and 55 contact microminiature circular connectors.

50-MIL STRIPS. Low profile, light-weight strip, up to 6 inches long with 120 contacts on .050" centers.

Since all the preceding connectors

are sold with wire attached to your requirements, no tooling or training investment is required.

CENTI-LOC STRIPS. Up to 53 size 22 crimp contacts on .075" centers or 60 on .100" centers.

DOUBLE DENSITY D. From 19 to 100 size 22 contacts on .075" centers in 5 shell sizes.

If we don't have the exact one you need (and we produce more types, shapes and sizes than anyone) we'll be glad to discuss creating one for you — at a Centsible price.



Contact the most experienced house in the industry, ITT Cannon Electric, International Telephone and Telegraph Corporation, 666 East Dyer Road, Santa Ana, California 92702. (714) 557-4700.



New horizons for INTERCONNECTION TECHNOLOGY

Summary of the 1972 Connector Symposium

Seeing the need for a dialogue on electronic connectors, a group of components engineers founded in 1958 The Philadelphia Connector Study Group, which later became the Delaware Valley Connector Study Group. Its members, all from the Delaware Valley, represented companies involved in aerospace, military, and commercial electronics, purchasing millions of dollars worth of electrical and electronic connectors each year. Companies represented include Burroughs Corp., Philco-Ford Corp., RCA, G.E., Boeing-Vertol, and Control Data Corp. In 1970, the group changed the organizational name to the Electronic Connector Study Group (ESCG). There are now two chapters of ESCG, one in

Baltimore-Washington, the other in Greater Boston.

Since 1968, ESCG has organized annual connector symposia, the foremost technical meetings on connectors in the country. This year, the Fifth Annual Connector Symposium convenes at the Cherry Hill Inn in Cherry Hill, N.J. on October 18 and 19. The abstracts of papers follow below. A fee of \$10 covers admission to the 32 technical sessions, a copy of the Proceedings, the cost of two lunches, a cocktail party, and one banquet. If you can't attend, you can get a copy of the Proceedings for \$10 by writing to The Electronic Connector Study Group, Box 3104, Philadelphia, PA 19150.

Session 1a—SYSTEMS WIRING CONCEPTS

Chairman: E. T. Derkas

New interconnection for ICs

Allison C. Danzig

Kollmorgen Corp., Glen Cove, N.Y.

The "Multiwire" concept for point-to-point interconnections consists of laying down polyimide-insulated magnet wire on an adhesive coated substrate with a numerically controlled machine. To connect the wires, holes are drilled and metallized through the wire paths. Advantages of this system are: lowered design and tooling costs, fast implementation of new designs and changes, high packaging densities, and low system interconnection costs.

Flat flexible cabling—early design

James A. Henderson

Westinghouse Electric Corp., Baltimore, MD

Flat flexible cabling provides low system cost, high reliability, improved quality control, high volumetric efficiency, and light weight. To realize these advantages, however, you must consider all the factors involved in your system design. Based on our experience, from underwater ordnance and avionics programs, with several forms of collated cabling, we have developed a coordinated systems ap-

proach to evaluate the claims of cable manufacturers. Systems design considerations include location and function of sub-assemblies, cabling standardization and modularization, and selection of connectors.

Production harnesses

Edward Nemeth

Varied Industrial Products, Paterson, N.J.

While fabrication of solid-state devices is becoming more automated and seemingly ever smaller, no similar prospect exists for wiring technology.

Wiring harness technology, therefore, is best improved by more efficient fabrication and by cost reduction. This entails an analysis of all of the operations required to manufacture a wiring harness and to devise means for automating them. The author describes machines which hold the promise of eventually creating a harness fabricating technology. Operations such as cutting, stripping, tinning, heat-shrinking, application of terminals, and quality measurements have been converted into machine operations requiring an operator only for set up, material feed, and monitoring.

New point-to-point wiring system

V. Wulf, AMP Incorporated

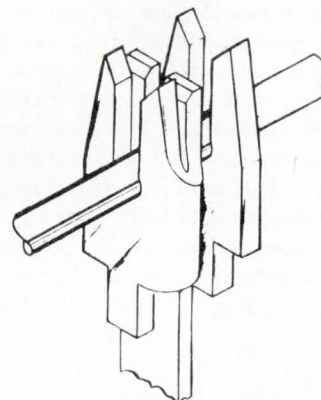

A new point-to-point daughter-board wiring system can be applied by hand or with a tape controlled machine. The inherent ease of wire removal and replacement makes this system especially suited for prototype wiring.

Competitive with welding and soldering techniques, the wires extend only 0.1 in. (2.5 mm) off the board. The heart of this system is a three-legged fork with a wedge-shaped slot. The outer two legs grip the insulation and serve as a strain relief, while the center leg provides the high mechanical forces necessary for a reliable electrical connection.

(continued on next page)

Session 1b—TERMINATION TECHNIQUES

Chairman: W. A. Ruehmling

Tang-termination of Al wires

Allen Warner, Joyal Products, Inc.

(abstract not available)

Integrated wire terminal design

Harold W. Hulst

Cutler-Hammer Inc., Milwaukee, Wis.

Developed for components such as switches, this wire termination accepts the MIL-C-39029/01-20 crimp type pin contact (long nose) and the NAS 1749-20 crimp type pin contact (short nose), both presently used on miniature military switches covered by MS21346 and MS21347. In addition, it provides high **contact force** between the contact pin and the switch terminal, good **contact wiping** action when inserting the contact pin, and **strain relief** for rigid wires.

C-21 environmental connector

N. L. Moulin, Hughes Aircraft Company
Newport Beach, Calif.

C-21 is a new sealing concept for environmental connectors. It consists of an individual conductor seal, attached to the contact, which is pulled into the connector block. The wire passes through the seal and is then crimped in place. The contact is then pulled into the connector block with a Pull-Thru® insertion tool. As the contact with attached seal and wire enters the connector block, they deform the seal

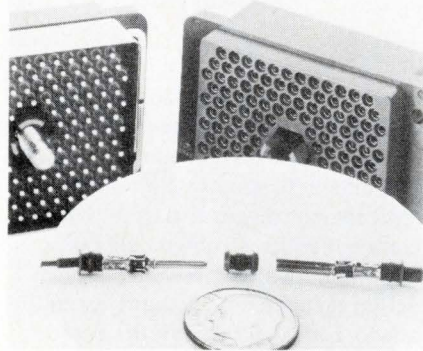

into a cup and lock into the connector block. From the rear or wire side, the seal is now a pressure-sensitive membrane, much like the cup of an air or hydraulic cylinder, which increases its sealing capability as pressure differences between the inside of the con-

tact cavity and the outside increase. Existing seals range for all sizes of wire and insulation diameters from No. 30 to No. 16 gauge.

There is also an interface seal for each contact, installed on the pin contacts after they are locked into the connector blocks. The same pressure-sensitive cup forms on the interface as was described for the contact wire seal. This seal is insensitive to the gap between connector blocks and does not require clamping pressure to maintain its integrity.

Insulation piercing connectors

Gerald N. Smith, AMP, Inc., Harrisburg, Pa.

This technique combines a high deformation crimp and a perforated sleeve to crimp and strip film-insulated Al or Cu conductors. The crimp makes the conductor metal flow, while the perforated sleeve strips the insulation, providing a stressed, hermetically sealed, electrical interface.

Session 2a—CONNECTOR DESIGN GUIDELINES

Chairman: W. H. Taylor III

Designing connectors to ANSI Y 14.5 for interchangeability

Thomas Berilla, Department of Defense
Fort Meade, Md.

ANSI Y 14.5 is a basic specification for mechanical design. This paper will explain its purpose and show how to apply it to achieve functional design, interchangeable fit, and lower costs of fork and blade connectors, PC cards and edge-board connectors, and rack-and-panel or circular (Mil C 81511) connectors. While many existing specifications can reject better quality connectors than those they accept, and accept connectors which should be rejected, application of the general rules of Y 14.5 optimize costs, quality, producibility, performance, and interchangeable assembly.

Low-cost dual-in-line connector

W. G. Klehm, Burroughs Corp., Plymouth, MI

Designed by Burroughs Corp. and tooled by Berg Electronics for Burroughs' electronic accounting machines, these connectors are automatically inserted into printed circuit boards, and allow the DIPs to be

automatically inserted into them. Their contacts consist of two independently sprung simply-supported beams, in contrast to the more conventional cantilever beam.

Headaches solved by design

Richard W. Normann

Bendix/ECD, Sidney, N.Y.

Summary of a NASA-sponsored study intended to eliminate, by design, connector problems such as bent pins; recessed or improper contact insertion; splayed contacts; damaged shells, couplings, inserts, and wire clamps; damaged seals and grommets; and improper mating and clocking. A complete connector design is proposed which incorporates many solutions for a trouble-free product.

New safety in power connectors

Sheldon R. Kinney, Bendix/ECD, Sidney, N.Y.

The Signal Corps is revising MIL-C-22992, Class L, which covers heavy duty, waterproof, arc quenching connectors (in case they are inadvertently uncoupled with full power applied). This revision will yield a much improved standard, for both military and commercial applications, and will assure that both the application and the safety requirements will be met.

Fail-safe breakaway connector

Carl L. Knapp, Bendix/ECD, Sidney, N.Y.

This is a twist-pull, (twist to couple, pull to separate) connector which disengages under any mated position.

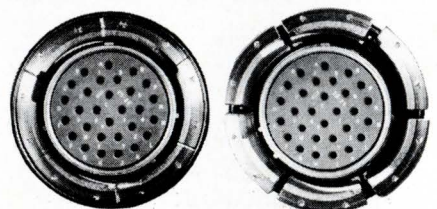

While the twist-pull idea is not new, this fail-safe design (a coupling nut) is. It eliminates the critical need to complete coupling for proper operation.

(continued on page 39)

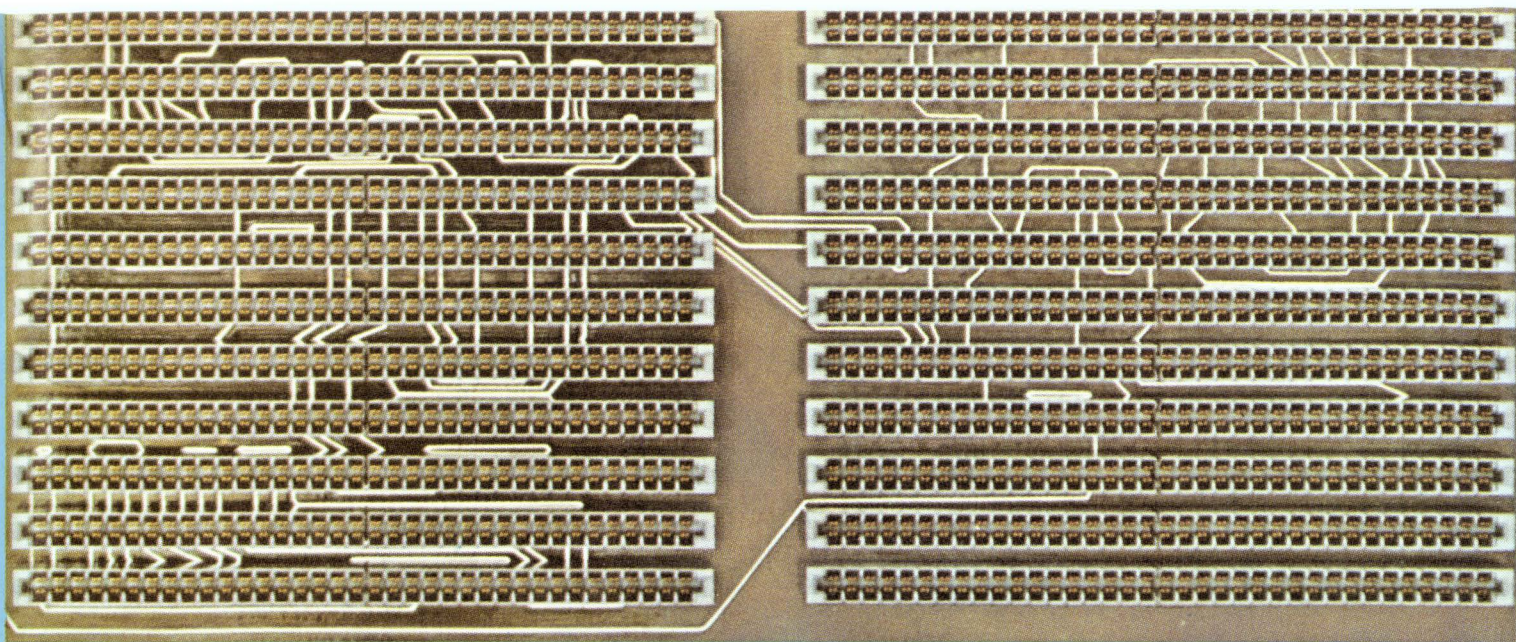

REDUCE INTERCONNECTING COSTS 50-75%

... using Elco's Series 6317*, 6320* and 6321* card edge connector systems. These new problem-solvers from Elco help you beat the "wrap-or-not-to-wrap" syndrome that crops up when you're designing a new circuit. Formerly you had one of two choices. Go the wire-wrapping route for design flexibility. Or choose p.c. wiring for manufacturing economy. Either way, you've had to accept trade-offs.

Wire wrapping lets you make circuit changes throughout the life of your equipment. But, at roughly 10¢ for each pair of terminations, a densely wrapped board can be expensive. On the other hand, committing all signal interconnections to p.c. wiring is the less costly alternative, but you're married to the circuit on your multi-layer board. So when a design change is called for, you have to discard the board and design anew.

That is, up until now.

Because Elco's press-fit card edge connector systems give you the best of both approaches.

In a typical application, you can specify 50 to 75% of your interconnections as p.c. wiring, including all grounds and voltage distributions. And thus cut as much as 75% from your overall interconnecting costs. Your interconnections will be made by press-fitting the contacts of our connectors into the plated-through holes of the board. The remaining interconnections will be made by wire wrapping the appropriate contacts.

Since your p.c. wiring is exposed, you now have the ability to make circuit changes and repairs using the wire wrap tail available on each contact. You're also able to replace damaged contacts without disturbing or removing the insulator or adjacent contacts. And you needn't worry about the integrity of the press-fit connection because it's mechanically stronger and electrically more reliable than the best soldered connection. Furthermore, circuit reliability in general is improved because the p.c. board is not subjected to the heat shock that accompanies most soldering processes.

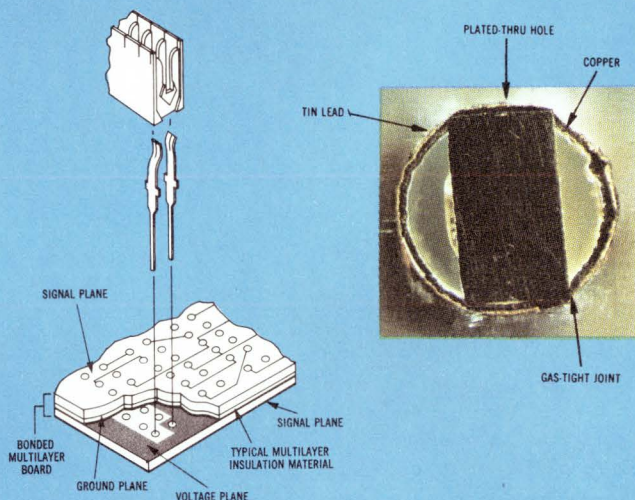

And Elco will go you even two better.

Give us your p.c. back panel laid out to our hole specs (.125" x .125" — Series 6317; .100" x .200" — Series 6320; .125" x .250" — Series 6321), and we'll fill the board with our "Economist" Series connectors. Or send us your specifications, and we'll even supply the board. In either case, we'll also complete the wire wrapping.

Just two more services in keeping with CONNEC-TRONICS, Elco's Total Connector Capability.

For full details and specifications on the "Economist," contact your local Elco representative, or:

Elco, Willow Grove Division,
Willow Grove, Pa. 19090
(215) 659-7000

Elco, Pacific Division,
2200 Park Place,
El Segundo, Calif. 90245
(213) 675-3311



Circle Reader Service #16

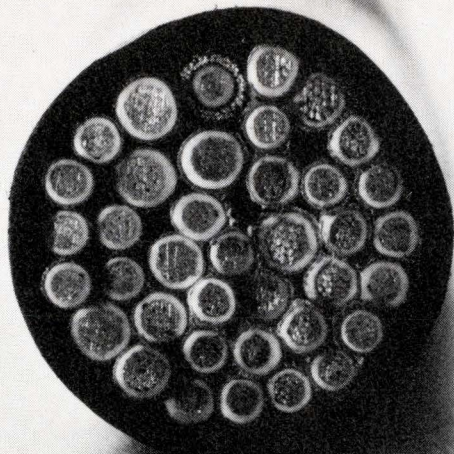

The world was round

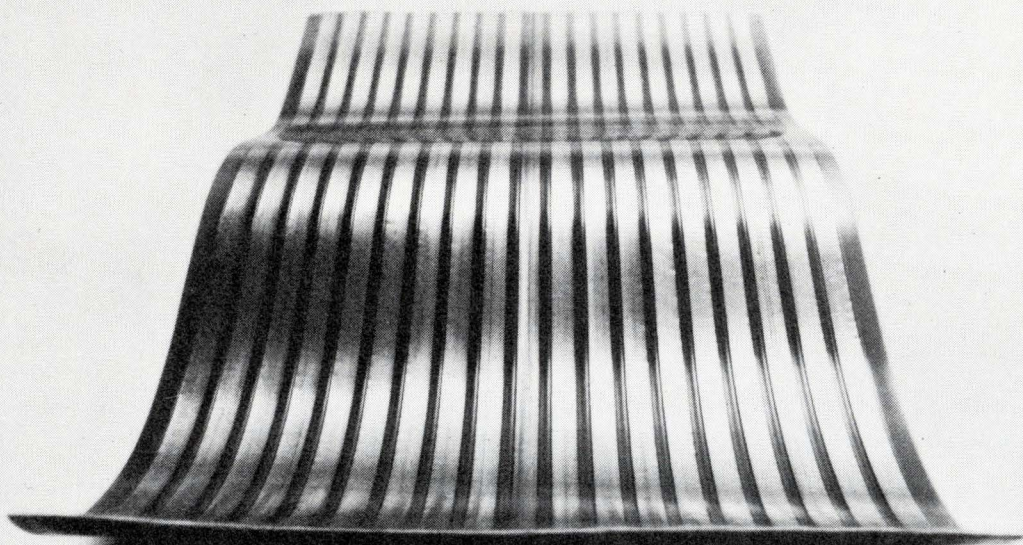

until we flattened it.

When most everybody else was tied up with knotty bundles of cable, Hughes started working on the idea of a flat cable and etched circuits. Instant flexibility.

Since pioneering our Contour™ Cable, we've gone to great lengths to extend our capabilities. Trips to the moon on Surveyor soft lunar landers proved reliability. We

gained a wide range of experience on shipboard and airborne systems, radar, sonar, high-speed computers, missiles, torpedos and space satellites.

Finally, we rounded out our capability by developing a total *inter-connection systems approach*: Hughes is the only company to offer a complete line of flat cable,

etched circuits, and the connectors to terminate them. A single source for your ideas has got to improve design flexibility. Tell us your needs, we'll bend to the task. Write for new 6-page Contour Cable catalog: 500 Superior Ave., Newport Beach, CA 92663.

HUGHES
HUGHES AIRCRAFT COMPANY
CONNECTING DEVICES

™ Contour Cable is a trademark of Hughes Aircraft Company

CABLES, CIRCUITS, CONNECTORS... ONLY HUGHES PUTS IT ALL TOGETHER.

Circle Reader Service #17

THE HUGHES CONNECTION.

**It's a breakthrough, instead of a breakdown.
With C-21 connectors, the greater the
pressure change, the tighter the seal.**

Today's environmental connectors often begin to fail at pressures as low as 5 psi. The new C-21 keeps sealing even at 250 psi.

That's because we make atmospheric pressure changes work for you, not against you.

First, we got rid of the interfacial rubber seal commonly used today. It can take only low pressure changes before it starts leaking. Also, risk of leakage rises as the connector is coupled and uncoupled. And you can't change individual contacts without

endangering the whole seal.

Not good enough. So we developed a true environmental connector with individual pressure seals in front of and behind each contact.

They block out moisture, dust and other contaminants. As pressure rises, these small cup-shape seals, within their own special cavities in the connector body, only grip tighter.

Finger pressure is enough for connector mating. You can change contacts individually. And seals on

individual contacts.

The C-21 is designed for airborne, deep space, shipboard, and undersea applications in a wide range of sizes.

No other connectors with crimp-removable size 16 contacts approach the C-21 in sealing capabilities, versatility, or long life. Yet prices are competitive.

More information? Write: Hughes Connecting Devices, 500 Superior Ave., Newport Beach, CA 92663. Or call (714) 548-0671



CONNECTORS, CABLES, CIRCUITS...ONLY HUGHES PUTS IT ALL TOGETHER.

Our low-cost receptacles give you low-cost pluggability. Automatically.

Three lines for just a fraction more than a penny. That's the cost of our reliable DIP and transistor receptacles. But only the start of savings.

Put our high speed automatic insertion machine to work in your plant, and you've got production rates of up to three thousand mounted transistor receptacles per hour, or up to 18,000 DIP receptacles per hour.

That's the story. You get the pluggability you want at the lowest applied cost available anywhere—a total economy unmatched in the industry.

You also get long life expectancy, dependable performance after repeated insertions and extractions, and special design that accepts a wide variety of lead sizes. Plus, a special feature that prevents solder from entering the contact area. Both DIP and transistor receptacles are available for a wide variety of boards and board thicknesses.

All the cost-saving, convincing details are yours for the asking. Write for Bulletin T50-1 to:

AMP Incorporated, Industrial Division, Harrisburg, Pa. 17105.

AMP INCORPORATED

Manufacturing and direct sales facilities worldwide: Barcelona, Brussels, Buenos Aires, Frankfurt, London, Mexico City, Paris, Puerto Rico, Sao Paulo, s'Hertogenbosch (Holland), Sydney, Stockholm, Tokyo, Toronto, Turin, Vienna.

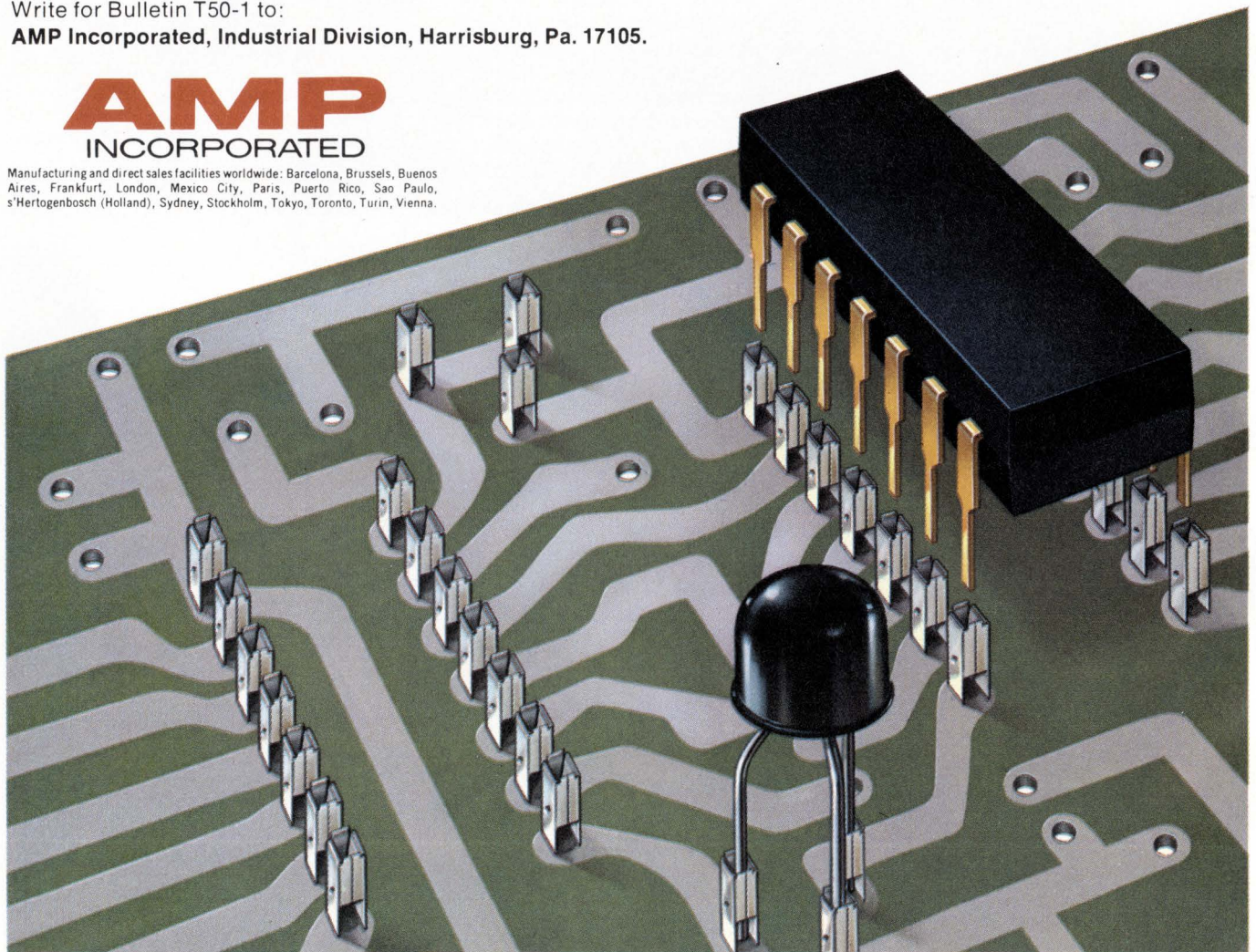

72 Please send literature — Possible Future Interest

73 Please send literature — Immediate Interest

(continued from page 34)

Session 2b—APPROACHES TO STANDARDIZATION

Chairman: E. Dodszeit

Let's start a family

Edward M. French

Martin Marietta Corp., Orlando, Fla.

The goal of this effort was a cost-effective family of miniature circular, rectangular and special electrical connectors and wire terminations for a new military missile system, while keeping the number of types and assembly procedures to a minimum. The result was a universal contact system with standard internal construction, and with common dimensions, materials and assemblies which will permit most of these connectors to be used on other programs with few modifications. To select, out of eleven bidders, the vendor for this connector, we used a very efficient matrix to compare the features they offered.

Universal termination system

Donald H. Gould

Bendix/ECD, Sidney, N.Y.

Many popular connector families, such as MIL-C-26482, MIL-C-26500, and MIL-C-81511 use different contacts and crimp-insertion tools. This has led to a proliferation of connectors, contacts and tools. To correct it, the U.S. Army Electronics Command has issued to Bendix a R&D contract which has produced a new universal termination system.

Connector standards for AEGIS

B. R. Schwartz, M. H. Plofker,

and W. R. Alexander RCA, Moorestown, N.J.

Goals for connector selection and application for the AEGIS Program are high density electronic packaging, extended shipboard and radar environments, enhanced reliability and logistics support and the utilization of proven approaches. These goals were met by the AEGIS MIL-C-81511 connectors for intercabinet signal wiring, a ruggedized water-proof power connector, a modified NAFI connector for the high density plug-in board modules and ultra-stable SMA-cables.

Stop the population explosion

C. E. Shappell

Boeing Co., Vertol Div., Wilmington, Del.

There are now over 145,000 Federal Stock numbers assigned to con-

nectors, and approximately 9,000 more are being added annually. Each one of these items costs the military and us poor tax payers over \$8,000 to become established in the DoD logistic system. Analysis of connector specifications shows that, in some cases, some parts have several different military part numbers. In other cases, many different parts have the same military part numbers. The paper reviews the current military approach to standardizing connector usage, and shows how it would reduce the connector population on helicopters CH-46 & CH-47.

Be-Cu springs for connectors

Morris D. Scott

Kawecki Beryllco Industries, Reading, PA

This paper deals with connectors in terms of the material, which acts as a spring. In selecting the material for connector springs, both the ambient factors and the spring requirements must be known. In addition to beryllium copper, the paper includes special materials such as preplated, in-lays, dual gauge and composite strip. Six design formulas, which assume that length and width will remain constant but that modulus, deflection, force, stress or thickness will change, are included.

Multiwire brush connector

R. S. Nelson

Sandia Laboratories, Albuquerque, N.M.

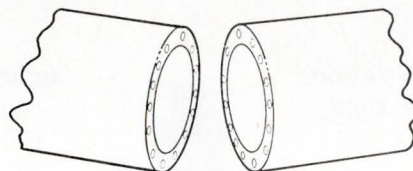

Sandia Labs, with the collaboration of Bendix Corp., developed this connector for a military application. Fourteen of these single-contact connectors, mounted around the ends of two 8-inch dia. cylinders, electrically interconnect the two cylinders and meet the following design requirements: Continuous operation for years at low dc voltage and current; contact resistance no higher than 30 m Ω ; plus stringent mating requirements.

The pin contact consists of a bundle of five chisel-pointed 8-mil dia. wires mechanically crimped into a tubular metal retainer, while the socket contact is similar, but contains approximately 250 5-mil dia. wires.

When mating, the pin wires home in interstices between socket wires.

Thermal releasing connectors

Robert W. Brush, Bendix/ECD, Sidney, N.Y.

Not just a connector, but a connector and a switch, this connector disconnects when the temperature becomes excessive. This paper discusses the design approach, selection of materials and the controls imposed to maintain its reliability.

Diallyl phthalate for connectors

J. J. Moylan

Allied Chemical Corp., Morristown, N.J.

Comparison of performance characteristics of diallyl phthalate, glass-filled phenolic and glass-filled thermoplastic materials, all of them plastics used in connectors, for: flow, strength and rigidity; resistivity and retention of electrical properties; shrinkage and dimensional stability; corrosivity and leachable impurities; continuous use at elevated temperatures; and flammability. The paper also projects future requirements of the connector industry particularly in telecommunications and relates these to the properties of these plastics.

MIL-C-39012—state of the spec

Morton Pomerantz

U.S. Army Electronics Command, Ft. Monmouth, N.J.

After seven years in vigor, it's time to review MIL-C-39012. Although the spec establishes uniform mating faces, spec sheets, performance requirements, and standard crimping tools, it has failed, in many areas, particularly for Category A connectors. It has, in fact, retarded the state of the art of clamp-type connectors. The paper includes a summary of future directions for the specification with specific approaches for resolving the present shortcomings.

Pins & sockets simulate hf coax

Harlow H. Heller, Raytheon Co., Bedford, Mass.

Coax was simulated with a cluster of standard connector pins and sockets. Isolation for this cluster ranged from 74 db of isolation @ 100 MHz to 60 db @ 500 MHz, whereas for multilayer boards transmission line (50 Ω) it ran from 90 db @ 100 MHz to 82 db @ 500 MHz. In all cases, SWR for shielded transmission line multilayer boards was less than 1.2:1.0. For the cluster of pins, it was 1.1:1.0 @ 100 MHz, 1.2:1.0 @ 300 MHz and 1.3:1.0 @ 500 MHz.

(continued on page 41)



The upsetting problems, the roaring frustrations of defining, specifying and procuring the right printed circuit board connectors are over.

Over, because Winchester Electronics offers one of the world's largest, most varied lines of printed circuit connectors. To this purring thought, we'll add another. That Winchester Electronics has the unmatched capability to custom-design and produce special printed circuit connectors, as well. For you and you alone. Even if your order is relatively small and requires special tooling.

Our standard lines include connectors for single and double sided boards. With contact spacing of .100, .125, .150, .156 and .200. With as few as 6 contacts or as many as 100. And with an array of termination types that include wrap-post, solder-eyelet, dip-solder and crimp.

Add to these our ceramic substrate connectors. And our newest standard connector lines, the HSD and HMD*. With .156 contact spacing center-to-center plus .140 contact spacing between rows for double sided 1/16" cards. And add our DW

*The HMD meets performance requirements of MIL-C-21097.

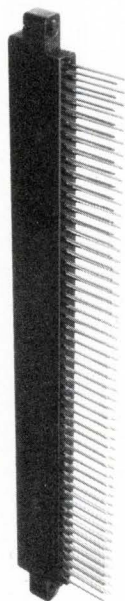

series edgeboard connectors. Featuring .025 square wrappable cantilever contacts on a .125 x .125 grid, 18 to 50 contacts per row.

Yes, add it all up. You'll see why Winchester Electronics has manufactured and delivered more than 15 million printed circuit connectors in the last 10 years. And why Winchester Electronics' record of successful innovations goes back for more than 3 solid decades.

So take the snarls out of your life, tiger. With the all-inclusive line of printed circuit connectors from Winchester Electronics. You'll get what you need. When you need it. And at very competitive prices. Call the Authorized

Distributor near you for details, now. Or, for applications, contact Winchester Electronics Division, Main St. & Hillside Ave., Oakville, Connecticut 06779. Phone(203)274-8891.



WINCHESTER ELECTRONICS

Circle Reader Service #21

(continued from page 39)

Miniature transmission lines

Edgar W. Forney, Jr., AMP Inc., Harrisburg, PA

It is hard to interface SMA miniature coax connectors and miniature semi-rigid coaxial cables (141 and 85-mil dia.) with precision rf connectors and cables, because: SMA connectors must be soldered to semi-rigid cable; and connector and cable are still joined by hand.

To preserve the inherent quality of both cable and connectors, and to reduce the assembly labor, AMP Inc. has developed a crimped connection. Its tooling consists of two units: a cable preparation machine, which strips the outer conductor and dielectric, exposing the center conductor, and knurls the surface of the outer conductor; and a pneumatic crimper.

Hermetic seals for connectors

Daniel Rumsey, Microdot, Inc., Pasadena, CA

Microdot is developing high pressure hermetically sealed circular connectors, using a glass-to-metal compression seal to withstand pressures of > 10,000 psi and temperatures of 400°F. Heating the connector metal shell to 1750°F expands the shell while the glass melts. During cooling, the metal contracts faster than the glass, creating a mechanical seal (as opposed to a chemical bond). These connectors have great application in the atomic and underwater fields.

Session 4a—COMPUTER INTERCONNECTIONS SYSTEMS

Chairman: **W. M. Rees, Jr.**

Pressfits for PC backplanes

David Goodman and Jim Prow

ITT Cannon Electric, Santa Ana, CA

Newest in backplanes is a pressfit interconnect system for double-sided or multi-layer boards. Instead of soldering or staking, the interconnection consists of an interference joint between the contact shank and the walls of the plated-thru hole. The design parameters will be reviewed for a card-edge connector used in conjunction with this system.

Connection to PC board holes

James E. McKeown, Bendix/ECD, Sidney, N.Y.

Capable of mating with plated-thru holes in conventional printed circuit boards, a new connector uses a "laundry tag" contact which has chamfered tines to enter the circuit board hole. These tines can develop

high radial stresses in the hole, lowering the contact resistance. A two-stage spring holds the contact in the circuit board hole without overstressing the spring members.

Plugging DIPs saves money

Max Peel, Texas Instruments Inc., Attleboro, Mass.

When are pluggable interconnection systems used? When *should* they be used? What are the cost tradeoffs involved? To answer these questions, users should consider, early in the design phase, the following factors: serviceability, design changes to the system, repairability, and density.

This paper will show that, although component costs increase with pluggable systems, they are more than offset by savings from reduced cost of service, repair, and design flexibility.

RF shielding in card guides

Anthony D. Calabro

Calabro Plastics, Inc., Upper Darby, PA

Today's electronics, no matter how sophisticated, must still be packaged with practical, easy-to-assemble components such as card guides, card cages, and card brackets. This paper discusses the types available, their function, cost factors, and applications. In addition, it describes a novel method to dissipate heat from power transistors.

Session 4b—NEW CONNECTORS AND DEVICES

Chairman: **H. D. Carnes, Jr.**

High pressure Ti connectors

Dee A. Werth, Bendix/ECD, Sidney, N.Y.

Manned submersible vessels for the advanced Deep Ocean Technology (DOT) program required an electrical connector header to be able to withstand higher pressures than those encountered in glass-sealed stainless steel connectors. Titanium ASTM Grade 5 was chosen for the connectors and bulkhead fittings, because of its excellent strength-to-weight ratio, its resistance to corrosion, and because it is non-magnetic. These characteristics are exceptionally desirable for undersea applications. However, since compression sealing of glass insulators and electrical contacts into a titanium matrix had not been attempted by any of the major electrical connector manufacturers, a glass/titanium hermetic seal for the connector was developed. The end product withstands 20,000 psig and maintains a leak rate of $< 1 \times 10^{-9} \text{ cm}^3 \text{ He/s}$.

Multi-level interconnections

Herbert E. Ruehleman

Elco Corp., Willow Grove, PA

At present, 0.100-in. spacing between adjacent contacts is the practical contact density limit for connectors, which results in 0.050-in. spacing along a module board edge when it has two rows of contacts. Modern computers, using high-speed ICs, demand smaller connectors with higher contact density, but without loss of performance or ruggedness at a comparable price per connection.

Just as in housing, the answer is to build multiple units within the same amount of real estate. Applying this principle to connectors led to multi-level units whose contacts overlap at different levels, and which mate in three dimensions instead of in a plane. This design principle has great versatility and has been implemented already in a connector which has 80 contacts spaced 0.025 in.

Cammed contact for connectors

G. J. Selvin, J. W. Anhalt and J. E. Barr

ITT Cannon Electric, Santa Ana, CA

Rectangular and circular connectors with many contacts have required jack screws, threads or toggles to force engagement of all the contacts. Instead, this new concept uses quarter-turn camming of contacts into high normal force engagement after "zero force" connector mating. Some of the examples, rectangular and circular connectors, are used as the focal point for a technical discussion of selection of insulator materials, contact materials, stress and deflection, cam forces and contact wear.

Low cost interconnections

Jack L. Bowen & Larry G. Fischer

E. F. Johnson Co., Waseca, Minn.

All termination techniques consist of tradeoffs and compromises which gain one set of desirable features at the expense of other features, depending on their applications. This one is again a compromise, but one which provides a unique set of characteristics for industrial communications products, such as a good cable strain relief, UL recognition, crimp or solder contacts, field repairability, rugged but pleasant appearance and low cost. Few Mil-standard tests were used to evaluate this connector.

(continued on next page)

The green connection

Alberto Socolovsky Editor

This is the fifth time this excellent symposium convenes to discuss the latest advances in connectors and interconnections, but it's the first time it includes a "dollars and cents" look at the field. Something must have happened during these five years to make a highly technical conference pay some attention to the economic forces that are shaping the connector field. These are the forces which will affect the sales by manufacturers of connectors, the applications for those connectors in the equipment and systems you build, as well as your paycheck. In short, they'll determine where the money will come from.

What happened was that the decade of the '70s began with both a sharp **warning** and a formidable **challenge** to the electronics industry. The **warning**, precipitated by declining sales and jobs in 1969 and 1970, told the industry that the lush years of the '60s were over. Those were the years when the procurement coming out of the Defense Department fueled the growth of virtually the entire industry. Now the abundant flow of money for new programs has, for most but the strategic programs, come to an abrupt halt. Even though the military is still the industry's major customer for both components and equipment, the growth it provided has virtually ended.

The challenge requires that we find and develop markets other than the military which will provide continuous growth for the electronics industry and full employment for its engineers. And that's what this paper is about: the market for connectors, and for products using connectors, and the employment picture for engineers.

The money engineers

To put it bluntly, it is apparent that marketing is now as important to our growth as is our technology. More than ever before the engineer, the technical catalyst of the industry, must consider profit as one of his design constraints. He must not only be inventive in advancing the technology, but he must develop products that sell—not simply advance the state of the art. And the reason is that, with the decline of the military market as a customer, the importance of commercial, consumer, and industrial applications increases in providing mar-

kets for electronic products. However, unlike the military applications, commercial and industrial users are more sensitive to price and competition.

More sales, less engineering

In addition to presenting us with a tougher design problem, electronic equipment and systems developed for the commercial, consumer, and industrial markets have a lower engineering content than similar equipment developed for military applications. For example, back in 1969, a military or aerospace contract of \$10 million provided jobs for 65 to 70 engineers. Today, because of the new procurement policies of the Department of Defense, the same money for a similar contract provides jobs for only 50 engineers—and there are fewer contracts to boot.

Suppose now that we take the same \$10 million and we put them to work in the commercial or industrial project, such as developing a point-of-sale computerized system for a department store. Those \$10 million allow for only 10 to 15 engineers, because they pay for mass-produced units, instead of few-of-a-kind.

A national study

Did electronics companies learn much as a result of the business decline and the unemployment of 1970? And, if so, what do they plan to do in the foreseeable future? To find out, **The Electronic Engineer** magazine commissioned an exhaustive research study among executives of major electronics companies. This national, industry-wide study was conducted by Chilton Research Services, the second largest industrial research organization in the country. Although the companies studied consisted of manufacturers of electronic components, of materials, instruments, and of subsystems components such as mini-computers and communications products, we are showing here only that part which pertains to connectors. Manufacturers of connectors were asked to provide answers to two kinds of questions:

Which particular markets were you selling in 1970?

How do you expect sales in those markets to vary in the next few years?

After compiling the results of the study, we summed up the findings in

a matrix,* from which we are showing the portion pertaining to connectors in Figure 1.

How it was in 1970

The particular markets connector manufacturers concentrated on in 1970 are represented in the cells of the matrix. The numerals within these cells represent the dollars spent by their users expressed as a percentage (or a range of most common percentages) of the total dollar volume sold by connector manufacturers.

For example, the matrix shows that the connectors bought by manufacturers of computers and peripheral equipment amounted to 30 to 40% of the total sales made by connector manufacturers. Since the connector market in the U.S. in 1970 was about \$390 million, then about \$135 million worth of connectors were used in computers and peripheral equipment.

Those cells within Fig. 1 which represent markets of major importance are outlined with heavy rules lines. They clearly show, for instance, that **MILITARY AND AEROSPACE** accounted for a large part of the sales. And that was true not just for connectors, but for just about every type of manufacturer during 1970. It is equally apparent that the **COMPUTERS AND PERIPHERALS** market was second in importance.

What's ahead?

So much for 1970. Now, let's examine some of the growth markets that head the rows of the matrix. It is important to study them for two reasons: first, because they represent the kinds of equipment and systems which our electronic engineer readers now build. Second, because if these markets, say, double by 1975, and the use of connectors in them remains constant, then the market for connectors will double, too.

For example, connectors accounted for 1.7% of the dollars sold in electronic equipment by American electronic manufacturers in 1970. That means a \$100 piece of equipment made in U.S.A. contained \$1.70 worth of connectors. Based on the predictions for both the output of electronic equipment by American manufacturers, and the U.S. consumption of connectors for 1975, the

(continued on page 45)

only from now - logic panels with decoupling capacitor provisions

for standard applications...

Decoupling efficiency of better than 98% is achieved from 1.34 kHz through 50 mHz by using Scanbe's suggested capacitor array.

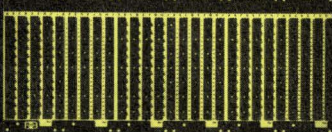

UNIVERSAL MODEL LPU

\$35.50 avg./zone (25 pc. quant.)

- 18, 36 or 54 pin rows
- For 14, 16, 24, 36, 40 LEAD DIPS

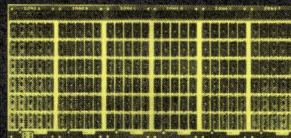

STANDARD MODEL LPS

\$35.00 avg./zone (25 pc. quant.)

- 14 or 16 LEAD DIPS
- 30 to 180 sockets in 30 socket zones

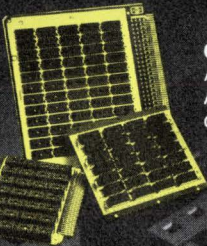

CUSTOM LOGIC PANELS

Available in any shape, size or configuration.
Any number of pins for discretes or decoupling capacitors.



All of our universal, standard and custom series logic panels now incorporate this outstanding advance. All of our models are supported by the best, most complete line of quality accessories (including our ME-2 sockets) to optimize and assure top performance and reliability.

So if your logic panel needs call for quality performance, exclusive features and low price, get the best logic panels... only from Scanbe. Call or write for our latest logic panel brochure.

SCANBE MANUFACTURING CORP.

"The Packaging People"

3445 Fletcher Ave. • El Monte, Calif. 91731
(213) 579-2300 / 686-1202

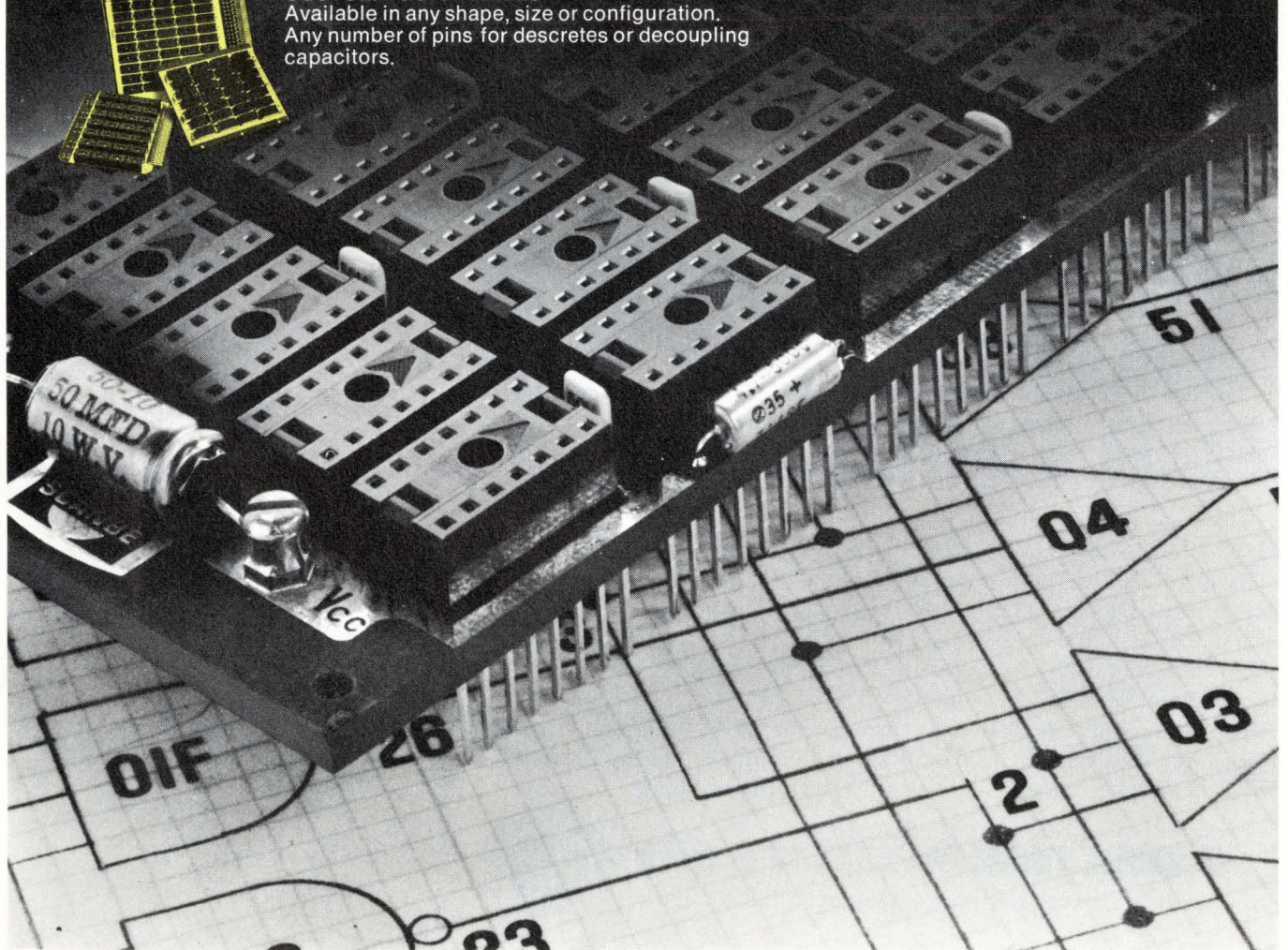



TOP PRODUCTION NUMBER FOR PCB DRILLING!

Gardner-Denver N/C Grid-Drill^(TM) makes 180 hits per minute, with from 4 to 16 individual spindles in a wide choice of arrangements. Handles as many as four stacks of boards as large as 15.5"x22" per stack. Drills hole sizes .010" to .250" with a variety of spindle speeds, including belt drive ball bearing to 50,000 rpm and air bearing to 90,000 rpm. Maintains accuracies of $\pm .0015"$, to random holes measured from common reference, through years of production service. Write for Bulletin AC-35 on this drill and the whole family of Wire-Wrap* equipment and related electronic products.

GARDNER-DENVER

Gardner-Denver Company, Quincy, Illinois 62301

*Wire-Wrap is a registered trademark of Gardner-Denver Company



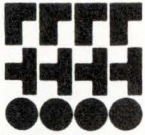

USERS	MFR'S	Connectors
COMPUTERS & PERIPHERALS		30-40
INSTRUMENTATION		8-10
COMMUNICATIONS SYSTEMS		10-20
CONSUMER ELECTRONICS		10-15
INDUSTRIAL CONTROL SYSTEMS		5
COMPONENTS & SUBASSEMBLIES		1
GOVERNMENT (MILITARY & AEROSPACE)		35-50
GOVERNMENT (CIVILIAN)		
MEDICAL ELECTRONICS		2
BUSINESS MACHINES		3
RESEARCH LABORATORIES		2
AUTOMOTIVE		
NON-OEM USERS		
AIRLINES		

Fig. 1. Where did all the connectors go? According to manufacturers, the numbers in the right column represent the % of their dollar sales into the markets shown in the left column. For 1973-75, they expect these percentages to increase (blue), decrease (red) or stay constant (yellow).

penetration of connectors will be about the same as it was in 1970. In other words, the consumption of con-

nectors will increase by the same percentage as the equipment sales by U.S. manufacturers.

However, the unit price for those connectors will be lower than in 1970, indicating that the number of circuits to be connected will increase—a logical consequence of the trend to plug-in modules in modern equipment.

On the other hand, the use of some components, such as the classical military-type of circular connectors, will undoubtedly decrease.

The trend to more, lower-cost connectors, incidentally, spells good tidings for the kind of engineer who can take advantage of inexpensive connectors by partitioning his equipment along the lines of optimum cost and reliability, rather than simply trying to reduce the number of contacts. For connector manufacturers, it means that they have to develop reliable connectors at lower cost.

In answer to the second question mentioned above (where do you expect the sales to be in the next few years?) component manufacturers singled out what they expect to be their growth markets for 1975. The research study we carried analyzes their answers, and compares them with the

expected performance for most of the markets expected to grow.* For connectors, these markets are COMPUTERS AND PERIPHERAL EQUIPMENT, INSTRUMENTATION, COMMUNICATIONS SYSTEMS AND EQUIPMENT, INDUSTRIAL CONTROL SYSTEMS, CONSUMER ELECTRONICS EQUIPMENT, and AUTOMOBILES.

The same areas will offer the employment opportunities for engineers, not in the order of their size, but approximately in the same order listed above.

Summing up, the dollars will come and the jobs will grow only when a determined, aggressive and competitive industry no longer waits for the mailman to bring another RFQ from the Department of Defense; and only if the industry innovates and develops new applications now, to be marketed profitably in the new markets ahead.

And, more than anytime in the history of the industry, its success depends on a special type of engineer. The money engineer. You.

*This study has been summarized in the report "The Challenge of this Decade: Technology or Profit?" published in two parts in *The Electronic Engineer* magazine, January 1972 (pp. 16-22) and February 1972 (pp. 16-23).

LOOKS LIKE A CONNECTOR ACTS LIKE A BUFFER

In fact it's both. A connector and a buffer. And good news for unit connector life.

It's called SAV-CON. A double ended connector with a ONE PIECE CONTACT. It interfaces between the test cable connector and unit connector. Saves your unit connector from engaging and disengaging wear and tear during equipment test and check out phase.

Plug in SAV-CON once and leave it there, even when the equipment is shipped to your customer. When all the pluggers and unpluggers are through, SAV-CON can be removed revealing an UNFATIGUED unit connector ready to perform with ultra reliability.

Available for all popular cylindrical or rectangular connectors.

Test Cable Connector



SAV-CON



Unit Connector

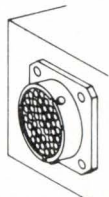

WHERE YOUR SPECIALS ARE OUR STANDARDS

Glenair

Glenair Inc.
1211 Air Way Glendale, Ca. 91201
(213) 247-6000
TWX 910-497-2066 TELEX 67-3485

Circle Reader Service #23

**Could you have found the costly fault
in this IC board in 5 minutes or less?**

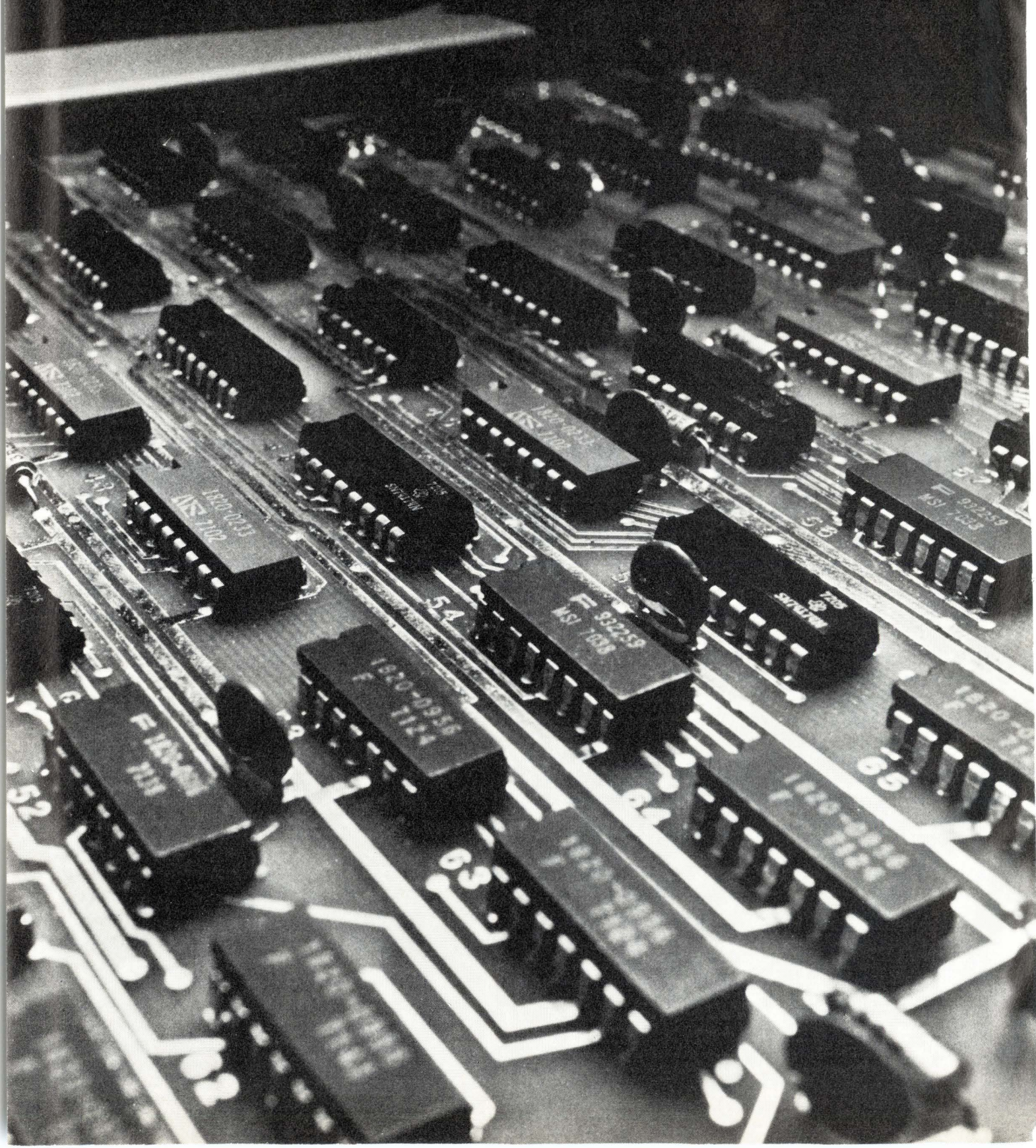

The IC Troubleshooters did.

From Hewlett-Packard, the IC Troubleshooters continue to bring super-sophistication to DTL and TTL troubleshooting. See logic states and pulse activity at a glance. Make a complete functional test on an in-circuit IC in less than 10 seconds. See instantaneously the state of all 14 or 16 pins via easy-to-read LED's. Monitor dynamic and static logic activity as easily as having an oscilloscope at your fingertips. Whether you're in service design or production, the HP IC Troubleshooters can save you time, money and headaches from the moment you start using them. Here's the lineup:

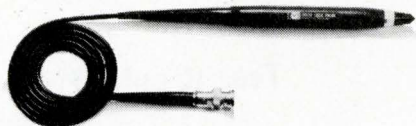

10525T Logic Probe — This brand new device handily picks off a pulse anywhere in the circuit and, via the light in the tip, tells you logic highs, lows, in-between bad levels and open circuits. It captures single pulses as narrow as 10 nsec, pulse trains to 50 MHz. \$95. **10525H** — High threshold model — also \$95.



10526T Logic Pulser — This brand new partner to the Logic Probe and Logic Clip completes a unique stimulus-response team. It injects a pulse into a circuit without trace cutting or unsoldering pins and

automatically drives low nodes high or high nodes low for 300 nsec. Over-rides "clamped" conditions with controlled TTL pulse. A single pulse at each triggering, and probe tip impedance is greater than 1 megohm when off. \$95.



10528A Logic Clip — Eliminating the cumbersome voltmeter route, this unique device clips directly onto an IC and 16 LED's tell you the state of all 14 or 16 pins instantaneously. No cables, no power connections. Auto-seeking of V_{CC} and ground. Only \$125.



10529A Logic Comparator — This device steals stimulus from the circuit under test to exercise a reference IC of the same type. Outputs are compared and differences displayed via LED's in the unit itself, one for each pin, localizing the malfunction to the node. Ten seconds or less completes an IC test, even for dynamic errors as brief as 200 nsec. \$375.



5011T Logic Troubleshooting Maxi-kit — Complete in a convenient case. You get all of the above instruments in order to optimize your stimulus-response monitoring and logic analysis for test purposes. Pulser injects signals to be monitored by Probe and Clip. Pulser can provide synchronizing pulses for test and reference IC's when checking tricky sequential circuits with the Comparator. Complete Maxi-kit, including 10% discount on all instrument prices, \$625.



Mini-kit 5015T also available (without Comparator) for \$285.

Call your local HP field engineering office to get your IC Troubleshooters as quickly as possible. Or write Hewlett-Packard, Palo Alto, California 94304; Europe: P.O. Box 85, CH-1217 Meyrin 2, Geneva, Switzerland; Japan: YHP, 1-59-1, Yoyogi, Shibuya-Ku, Tokyo, 151.

HEWLETT  **PACKARD**

02205

NEW COOL-PAX MODULAR COOLING SYSTEMS FOR PowerSemiconductors

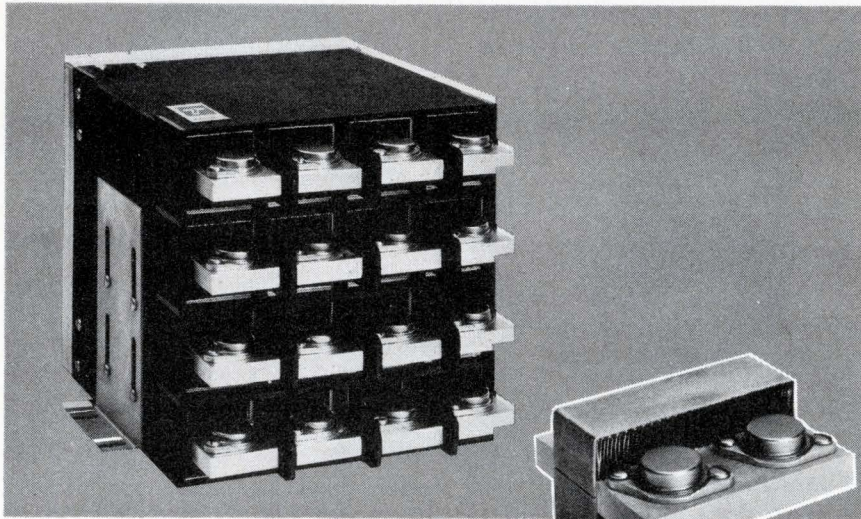

New concept in forced-air cooling using convoluted fin stock in modular assemblies accommodates any number of devices in case-common or single, isolated modules.

Modules are easily removed from system via a simple latching mechanism. Shown, a two-unit module.

Brazed aluminum compact cooling packages:

- Provide $.65^{\circ}\text{C/W}$ cooling for each transistor at 8 CFM
- Provide parallel air flow to all devices
- Greatly reduce volume and weight

The COOL-PAX Modular System is a new generation in electronic cooling. Its superior performance and greatly reduced volume and weight make the heavy extrusion obsolete. COOL-PAX systems improve packaging versatility and lower overall systems costs. Devices are easily accessible and wiring complexity is reduced.

COOL-PAX Systems are simple to specify, to analyze, and to predict performance. For technical applications data to analyze your own system, write for our new COOL-PAX Catalog 72-CP-7.

WRITE FOR FREE CATALOG



Thermalloy*

P.O. BOX 34829
2021 W. VALLEY VIEW LANE
DALLAS, TEXAS 75234
(214) 243-4321 TWX 910-860-5542

Circle Reader Service #25

Here is your
copy of a revised and
updated reference chart
sponsored by
**TELEDYNE
PHILBRICK**



**GUIDE TO
DATA
CONVERTERS**

Tear it out, 

NOW

... and
mount it on
your wall

If the chart has been
removed, Circle Num-
ber 41 on the Inquiry
Card for a copy.

YOU CAN MASTER THE MEMORIES TECHNOLOGY WITH THIS 7-PART COURSE

It took almost one year for the editors of *The Electronic Engineer* to research and compile the most comprehensive memory course available. Seven chapters guide you through this complex field, from delay lines to magnetic bubbles, with schematics and applications all along the way.

Thirty-six top engineering specialists from every phase of memories contributed their expertise. Inter-technological ballyhoo has been stripped away to reveal each aspect on its merits and show where it properly fits. The course covers:

- fundamentals . . . memory types
- . . . magnetic mainframes . . .
- non-magnetic mainframes . . .
- bulk storage . . . systems applications . . . future memories

This Course on Memories costs only \$5.00 postpaid and includes an examination. Those who wish to take the examination will receive a *Certificate of Completion* free of charge. Send the coupon and your check or money order to: Course Editor, *The Electronic Engineer*, One Decker Square, Bala Cynwyd, Pa. 19004. E-10

Send me your new Course on **Memories**. Payment of **\$5.00** is enclosed. Send the Course to me at:

Name _____

Company _____

Address _____

City _____

State _____ Zip _____

E-10
Check here for quantity prices.

Fault Isolation: We've just made it economically practical for commercial/industrial equipment.

Our new Fault Indicators take the high cost out of monitoring circuit performance. With them you can isolate faulty operation, cut troubleshooting time, eliminate costly check-out equipment and procedures, reduce downtime. All at a fraction of what fault indicators have previously cost.

These BITE (Built-In-Test-Equipment) Indicators use an electrically actuated mechanical display that latches into position magnetically. When a circuit malfunction occurs—transient or continuous—the display transfers color and

latches magnetically until reset. This latch memory assures positive isolation/indication regardless of the nature of the fault.

Because of their miniature size (.320" dia.), these indicators can be mounted directly on PC boards or grouped as a system on a remote fault isolation panel. Our application engineers will be glad to assist you in the use of individual units or in the designing of a complete system to your specific requirements.

Write for details. Today.

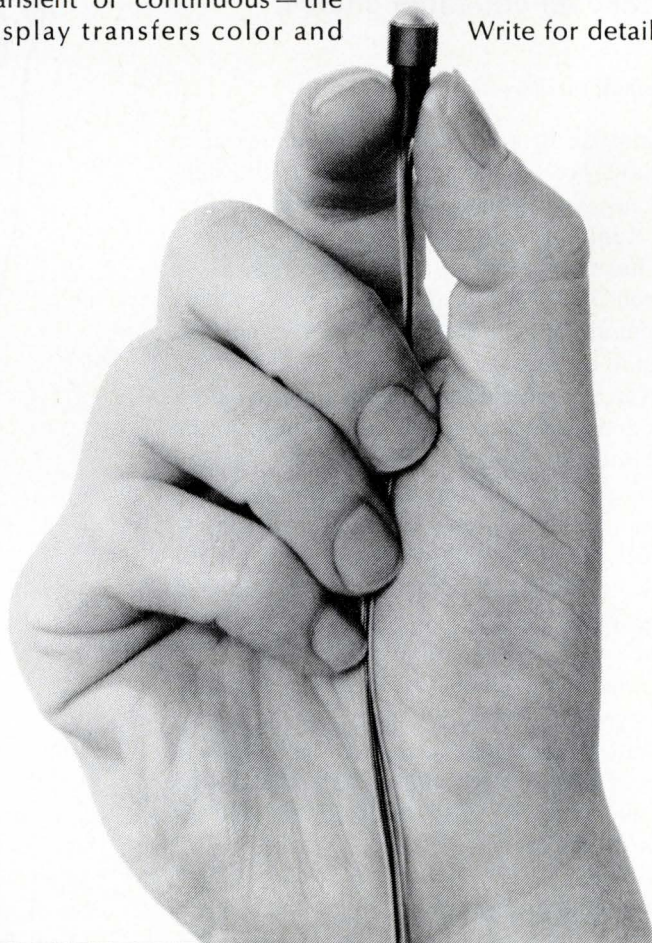

A. W. HAYDON CO. PRODUCTS

NORTH AMERICAN PHILIPS CONTROLS CORP.

A NORTH AMERICAN PHILIPS COMPANY
Cheshire, Conn. 06410 • (203) 272-0301
Circle Reader Service #26

McGovern or

A President who's aware of the special problems of the electronic engineer and his industry? Probably not, but there are enough clues in Nixon's/McGovern's very different programs for you to make an educated choice.

John McNichol, *New Directions Editor*

Whatever the traditional reasons for choosing a President have been—charisma, “to kick the bum out” or because your great-grandfather was the first registered Republican/Democrat in his county—technology has not ranked with the major issues.

It's different in 1972. Not only are the technology issues in general, and the electronic ones in particular, important to engineers and their industry this year, but even the candidates have recognized their importance and have even spelled some out. On the surface, incumbent President Richard Nixon and Senator George McGovern seem to offer vastly different programs, but you must examine them closely before deciding how the industry will fare with the next President. To get the answer, we've taken a look at each candidate's programs and analyzed them for their electronic content in the major areas that affect electronic engineers: defense spending; plans for conversion (that is, the plans for the transition from military to civilian spending), including aid to unemployed and underemployed EEs, R&D, and technology assessment; aerospace programs; and attitudes towards business.

The higher-priced budget or . . .

Probably the most highly publicized difference between the two men has been their stance on defense spending. President Nixon's budget for Fiscal Year (FY) 1973 stands at \$78.3 billion. By 1975, the Nixon defense spending has been estimated at \$85.9 billion. Boosting this increase are such programs as the new missile carrying submarine, the trident (~\$30

billion); the B-1 bomber (~\$11 billion); a fleet of F-14 and F-15 fighter planes; a \$1 billion nuclear aircraft carrier; etc. But, if George McGovern is elected this November, he has promised that his defense budget will stand at \$54.8 billion in 1975—a difference of some \$31.1 billion.

Leaving aside Defense Secretary Melvin Laird's caustic suggestion that “Congress would have to direct that the Defense Department spend \$1 billion on white flags so we can run them up all over the world,” what does such a cut mean to the electronics industry? McGovern aide Larry Goldstein notes such historical precedents as the drop in defense spending

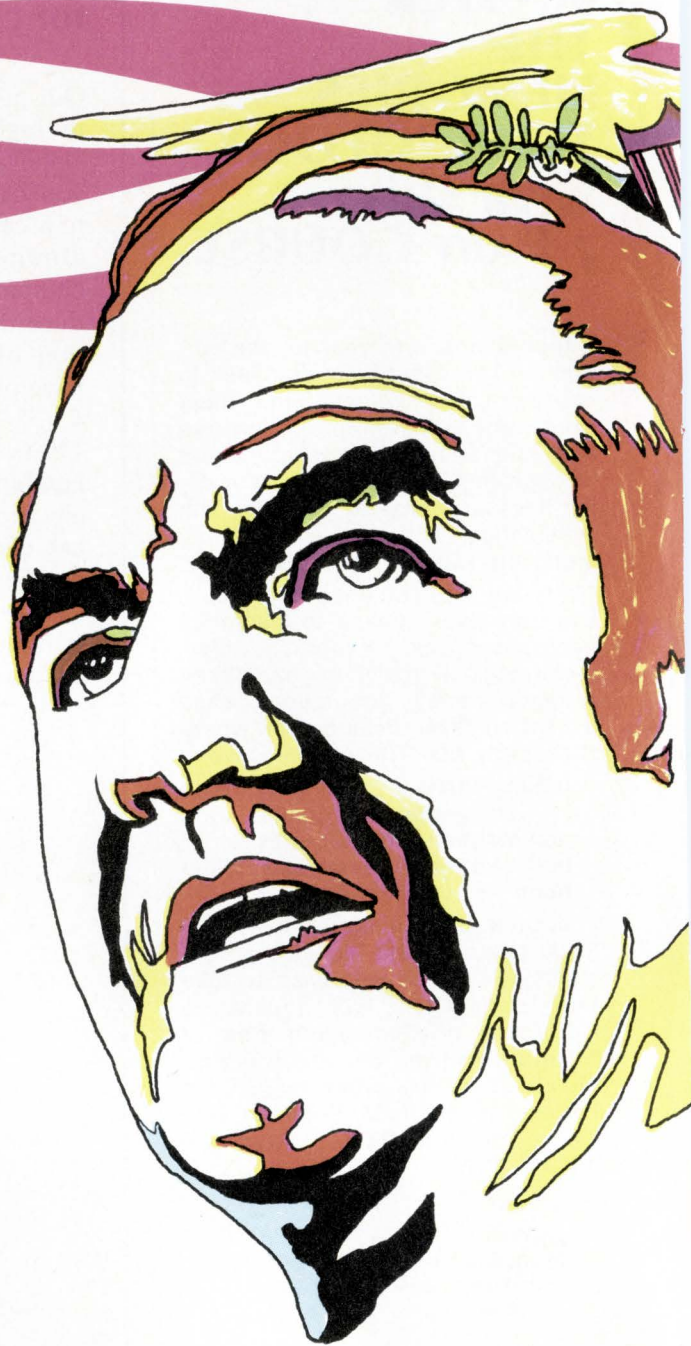

Nixon: which choice for EEs?

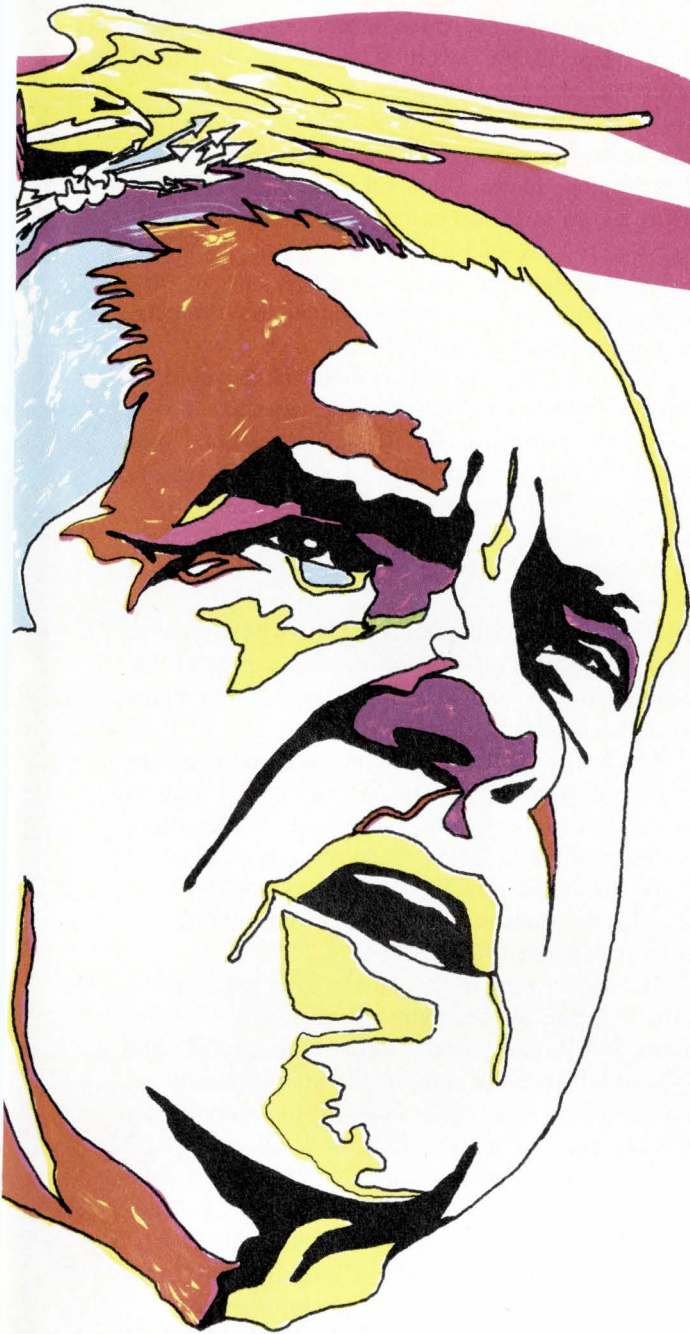

from 1945 (\$79.9 billion) to one-sixth of that war budget by 1950 (\$11.9 billion) and President Eisenhower's 25% cut in defense funds. The fact remains, however, that any major surgery on defense expenditures, which traditionally have a high electronics content*, could have severe consequences. Witness, for instance, what happened to the electronics industry when procurement, RDT&E and construction went from \$40.3 billion to \$22.9 billion between 1968 and 1973 resulting in layoffs of some

10,000 electronic engineers. Interestingly the overall budget only went down \$2.2 billion (from \$80.5 to \$78.3 billion) while inflation, increased benefits, and pay raises ate up most of the technology savings.

According to Caspar Weinberger, who is deputy director of the Office of Management and Budget, "A cut of \$30 billion in the defense budget would mean a reduction in direct employment of approximately 1.8 million jobs nationally, not to mention the indirect effects." Although Weinberger is not exactly an unbiased source, and his estimate probably includes military personnel and civilian employees at the DoD, as well as industry people, this is an imposing figure—one third of all defense-related personnel, who numbered 5.4 million in 1972.

Building an alternative defense budget

George McGovern's alternative defense budget does not offer a rich mother lode for the electronics industry. As he candidly told *The Electronic Engineer**, "If the McGovern military budget were considered in isolation, there would be great cause for concern for the electronics industry. Although the greatest single cutback by far . . . will be in funding for active duty forces, there will be under my proposals severe cutbacks and even cancellations in programs with a high electronics content." *The Electronic Engineer* has estimated that over \$3 billion in business might be lost to the U.S. electronics industry as a result of such a cut.

Although McGovern's alternative defense budget uses the same cornerstone as Nixon's budget—the so-called triad of ballistic missile submarines, land-based intercontinental ballistic missiles, and manned bombers—the resemblance ceases there. What would survive after some carriers, the B-1 bomber, and the F-14 fighter were cancelled, according to Robert Sherman, defense planner for McGovern, would be a fleet of 84 nuclear attack subs, plus 24 Polaris subs altered to the Poseidon configuration, with a hold on the design phase of the Trident; retrenched Safeguard and ABM missile systems; and upgraded

* See "The great military electronics plot: The Carlson curve," *The Electronic Engineer*, Aug., p. 12. According to Bruce Carlson, president of Sprague, the electronic content of DoD budgets is about 15%.

* See *The Electronic Engineer*, Aug. 1972, pp. 20-21.

B-52 and FB-111 air forces, with SRAM (Short Range Attack Missiles) and SCAD (Subsonic Cruise Armed Decoy) missiles.

How does defense R&D fare with such a lean defense posture? According to McGovern aide Goldstein, not well. "We are in favor of trimming current levels of defense research and development, particularly for unneeded weapons systems." McGovern's 1975 estimate runs from \$5.5 to 6 1/2 billion vs Nixon's \$7.9 billion in 1973.

In the McGovern budget, research and development become part of the diplomatic game plan, just as hardware is in Nixon's plans. "If the R&D were completed on the Trident submarine," says Goldstein, "the U.S. could go into actual production within six to 12 months. From our point of view, this is much more of a diplomatic bargaining chip than actually constructing these weapons." Nixon's experts argue that four to six years is more realistic.

McGovern's final word: "Even under the reduced McGovern military budget, military projects will be a major component of the electronics industry, and finding some solution to the boom-and-bust syndrome that attends military procurement will still be virtually important for electronic engineers."

Conversion: fact or fraud?

Are we out of the latest of the boom or bust cycles? According to a spokesman for Dr. Edward David's Office of Science and Technology, which functions as the chief science advisory body to President Nixon, much of the transition from military to civilian projects is well underway. As proof, he points to the federal budget allotting 63% more for civilian-oriented R&D in 1973 than in 1969. Out of this conviction that the corner has been turned, Dr. David insists that Senator Edward Kennedy's bill, S. 32 (National Science Policy and Priorities Act of 1972), would be "disruptive to the whole process."

But it's a different story in the McGovern camp, where aides contend that conversion policies have never been given a chance. "There will be more con-

version planning in the three months following the election," asserts McGovern aide Goldstein, "than has ever been done in U.S. history."

Although McGovern acknowledges that legislation cannot be "a complete solution for scientists and engineers because few civilian industries are as R&D intensive as military work, and even after successful conversion, there would not be jobs for all of the scientists and engineers," he has worked out an ambitious program that combines conversion projects, technology assessment, and job insurance.

An immediate \$10 billion investment would be directed at housing, public transit systems, etc.

Income protection for displaced workers by a program of income support (Senate bill S. 1631) would offer 80% of prior earnings up to \$8944 for a family of four for 18 months. McGovern also advocates a government-insured pension plan that would move with the engineer.

Defense and aerospace contracts would have to prepare for transition by putting aside monies for displaced workers and also make conversion plans for their businesses.

Savings from the defense budget would be applied to peacetime needs. As an example of a company that has successfully made such a transition, McGovern points to TRW Corp., which reduced its military business from 75% to 18% between 1960 and 1972. "In the same period," McGovern notes, "its workforce expanded from 30,000 to 75,000."

Bill S. 32, now in the House after passing the Senate, is aimed at the engineer and scientist. It authorizes \$1.8 billion over a three-year period: \$50 million to advance the state of the art in priority research areas, such as land transportation systems, air traffic control, the energy crisis, and pollution; \$1.2 billion for civil science systems to improve public services; and \$550 million to specifically aid in transition. (This has been cut to \$1.025 billion.)

Guaranteed jobs for those military and aerospace workers who still cannot find employment.

Deeply involved in such plans is the concept of



An electronic engineer's guide to the candidates: which

Defense

Conversion

Aerospace

Technological
assessment

Aid to
unemployed
engineers

Nixon



McGovern





technology assessment, an idea whose time has not yet come in the Nixon Administration, where it is handled on an individual basis, as each government Department sees fit.

Although McGovern had earlier plans for an Office of Technology Assessment, this idea has been dropped. At the moment, the long-range direction of technology will be handled by the Economic Conversion Commission. Day-to-day problems will come under the Action Group on Peacetime Jobs.

On the record

As for aid to the unemployed engineer, the Nixon Administration has set up a variety of programs, some of them under a \$42 million grant to specifically attack the problem. Administration spokesmen point proudly to an unemployment rate of 2% for engineers, about 4% less than the national average. Among the programs have been the Job Bank venture in 60 cities, the National Registry for Scientists and Engineers, a \$1.2 million retraining program to retrain aerospace engineers for work on urban problems, and VEST (to bring industry and engineer together). The \$42 million project, the Technology Mobilization and Reemployment Program, the single largest attempt by the Administration to aid the unemployed engineer, was broken down into \$5 million for job search, \$25 million for retraining, \$10 million for relocation expenses, and \$2 million for a skill conversion fund. Of 42,000 registrants, 17,000 individuals have new jobs.

What may be final word on Nixon's attitude towards technology transfer was spelled out by Weinberger of the Office of Management and Budget. Disagreeing that "we can avoid transition problems of skilled labor by increased spending on the nation's social problems. . . . This Administration has learned that adequate and cost effective solutions to areas of newly identified need inevitably require considerable leadtime, particularly where such solutions have a high technical content."

Weinberger continues with the bleak comment

that, "we cannot now commit large amounts to the solution of any problem where, even though a general need may have been identified, there is little understanding or what solutions are technologically feasible as well as cost-effective, or indeed, whether they will work at all."

Will NASA continue to fly?

The agency of the '60s, NASA, is down almost \$2 billion from its 1966 high. If it were not for the space shuttle award, the prospects would be bleak.

McGovern, however, believes strongly that the space shuttle is a serious mistake. Speaking at the Manned Spacecraft Center in Houston, he advocated a reduced space program with the emphasis on unmanned exploration and the earth resources program. His space budget would be about \$2 billion, compared with the Nixon funding of \$3 billion.

Goldstein speaks of the McGovern attitude on the space shuttle: "When the Nixon Administration went ahead with the shuttle, they cut back on the unmanned probes, which offer far greater scientific benefits to the nation. Senator Mondale has said that the cost will be \$30 to \$40 billion over the next 10 years. With overruns, they are talking about expenditures of at least \$4 billion per fiscal year."

Not anti-business, just anti-special interest

One of the sharpest criticisms of McGovern that recurs constantly is that he is anti-business. Goldstein vehemently denies this: "We are anti-special interest, not anti-big business. Big business has done much for the U.S.; it's put many people to work and created many great products. What we are opposed to are special interest executives who have their foot in the White House door."

Nonetheless, McGovern has plans for depreciation and overseas tax deferrals that will treat businesses, including the electronics industry, differently than the Nixon Administration has.

One point of agreement, however, between both camps is the enforcement of the Anti-Dumping Act

candidate does more for the industry? ★ ★ ★ ★ ★ ★ ★ ★

Multi-national electronic companies

Business policies

Anti-dumping enforcement

Defense R&D

Civilian R&D

Your vote





COMPARISONS OF THE ELECTRONIC CONTENT OF THE McGOVERN/NIXON BUDGETS

	McGovern (\$ billions) by 1975	Nixon (\$ billions) in 1973
Strategic forces	3.5	8.8
Intelligence and communications	5.6	5.8
Research and development	5.5	7.2
Total	14.6	21.8
Electronic content	6.5*	9.6**

*The Electronic Engineer estimate.

**Electronic Industries Association estimate.

TWO VERSIONS OF STRATEGIC FORCES' COSTS: McGOVERN (BY 1975) vs NIXON (1973)

	McGovern (\$ millions) by 1975	Nixon (\$ millions) 1973
Minuteman/Titan	170	857.8
Polaris/Poseidon	1,120	842.2
B-52s/FB-111s	665	*
SRAM/SCAD	100	200
Safeguard	0	1,851.3**
B-1	0	***
Total	2,055	3,771.3

*The Defense Department Appropriations Bill for 1973 shows \$160 million earmarked for the procurement of FB-111s, while the only amounts for the B-52 are maintenance costs.

**The January budget scheduled this amount for the Safeguard program; however, the SALT agreement (the Strategic Arms Limitation Treaty with Russia that was signed later this year) reduced this amount to \$1,206 million.

***Although the B-1 does not show up in the Appropriations Bill for 1973, the best estimate given for the entire program is about \$11 billion.

OVERALL DEFENSE PROGRAMS: McGOVERN (BY 1975) vs NIXON (1973)

	McGovern (by 1975)	Nixon (1973)
MILITARY PERSONNEL		
Army	648,000	841,000
Navy	471,000	602,000
Marine Corps	140,000	198,000
Air Force	476,000	717,000
Subtotal, Active Duty	1,735,000	2,358,000
STRATEGIC FORCES		
Minuteman missiles	1,000	1,000
Polaris missiles	544	544
Poseidon missiles	112	112
Strategic bombers B-52s and FB-111s	200	511
Manned fighter-interceptor squadrons	5	7
Air defense firing batteries	8	21
GENERAL-PURPOSE FORCES		
Land forces		
Army divisions	10	13
Marine divisions	2	3
Tactical air forces		
Air force wings	18	21
Navy attack wings	6	13
Marine Corps double wings	2	
Naval forces		
Attack carriers	6	16
Nuclear attack submarines	69	60
Escort ships	130	207
Amphibious assault ships	56	66
Troop ships, cargo ships, replenishment ships	80	66
AIRLIFT FORCES		
Aircraft squadrons		
C-5A	4	4
C-141 and other	14	13

*Each Poseidon missile has three warheads.

of 1921. Whoever is chosen, the Bureau of Customs of the Department of Treasury will continue to investigate such cases as color TV tubes, deflection yokes, and electronic ceramic packages that are sold in the U.S. for less than the price in the country of origin.

As to the presidential differences, McGovern would repeal the Asset Depreciation Range System (ADR), which was enacted in 1971. The ADR, which allows a quicker rate of depreciation on new equipment, is added to the already existing 7% investment credit. "The ADR is terribly inefficient," asserts Paul Offner, a McGovern expert, "we have a report that showed it cost the Treasury \$1.8 billion to increase investment by \$250 million in 1972." As for the investment credit, it may eventually be substantially reduced when McGovern's aim of full employment is fulfilled.

Multi-national electronic firms may feel the bite of the repeal of the so-called DISC program if McGovern sits in the White House. This 1971 law offers special tax deferrals on foreign export earn-

ings of corporations. In addition, other tax breaks accorded foreign subsidiaries of U.S. corporations would be tightened up. McGovern experts expect about \$1.3 billion in extra revenues in 1975 as a result from both sources.

Which man?

McGovern or Nixon, which man? Of course, no one votes for or against a presidential candidate because of purely professional considerations. How a candidate has handled or would handle one segment of the economy does not necessarily impair or improve his performance as the national leader.

There are, however, clues in the plans for dealing with an industry in transition—the electronics industry. Nixon and McGovern would seem to bring two radically different philosophies to the problems of the electronic engineer and his industry. Nixon, it seems, relies on the patterns of the past while McGovern is attempting to bring a new perspective to the problem. Who'll do the better job? It's your choice.

Nobody has to babysit this OEM strip chart recorder.

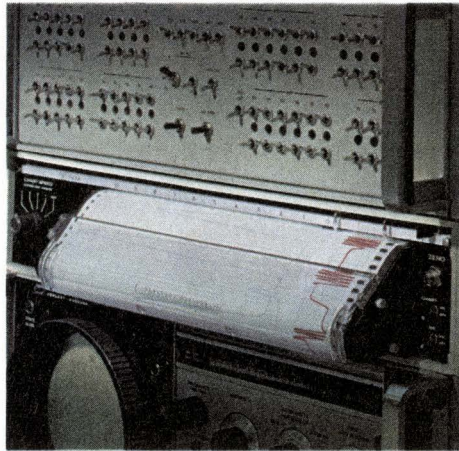

No more 2 a.m. bottles.
Electric writing option makes child's play of long-term unattended operation. Get a crisp clear face without pen and ink.



No more messy early morning pen changes.
Disposable pens make changes quick and clean. (Or electric writing eliminates pens altogether.)

OEM from the ground up.
HP's new 7123 strip chart recorder is built for dedicated OEM applications. You select from nearly 50 options to customize this 3½-inch-high recorder for any end-user system.

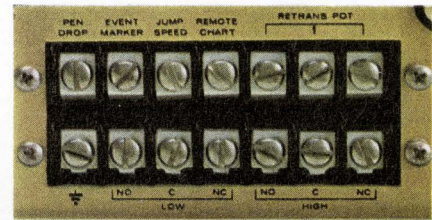

Swing out to reload, half-rack or full-rack.

An electronic integrator is the simplest way yet to measure the area of a curve. Set zero along any point on the main chart.

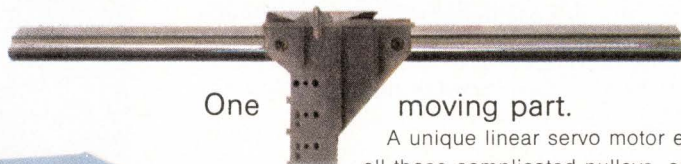

One moving part.
A unique linear servo motor eliminates all those complicated pulleys, cables and slip clutches. No wirewound slidewire or boards full of touchy adjustments.

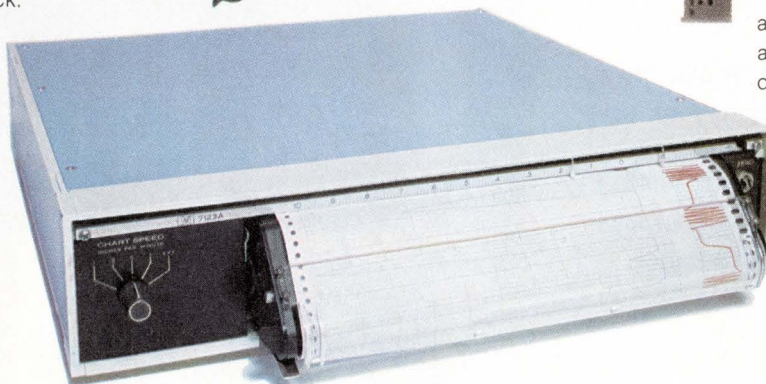

Four-speed incremental chart drive option.

The uncomplicated new Model 7123 never cries for attention. Get details and oem discount data from Hewlett-Packard, Palo Alto, California 94304; Europe: 1217 Meyrin-Geneva, Switzerland.

HEWLETT *hp* PACKARD

111-05

BOURNS LOW COST FAMILY

OF INDUSTRIAL *TRIMPOT*[®]
POTENTIOMETERS

49^{*}¢

OFF THE SHELF AS LOW AS

POWER: 1/2 WATT (or better) AT 70°C.

TEMPCO: AS LOW AS 100PPM/°C OVER TEMPERATURE RANGE
OF -55° TO +125°C AND -55° TO +150°C.

Bourns **LOW-COST FAMILY** was designed specifically to fill the requirements of cost-conscious industrial users — so *were the prices!* Imagine how they reduce on large production-run quantities. As a bonus, you get Bourns TRIMPOT potentiometer quality, reliability and performance.

AVAILABILITY

All models shown are stocked in depth **RIGHT NOW**, so delivery is off-the-shelf from the factory or your local Bourns distributor.

Complete data on all models of the **LOW-COST FAMILY** is available upon request. Just write, or call, your local Bourns Sales office, representative, or distributor.

*1000-piece price Model 3389, U.S. dollars, F.O.B., U.S.A.

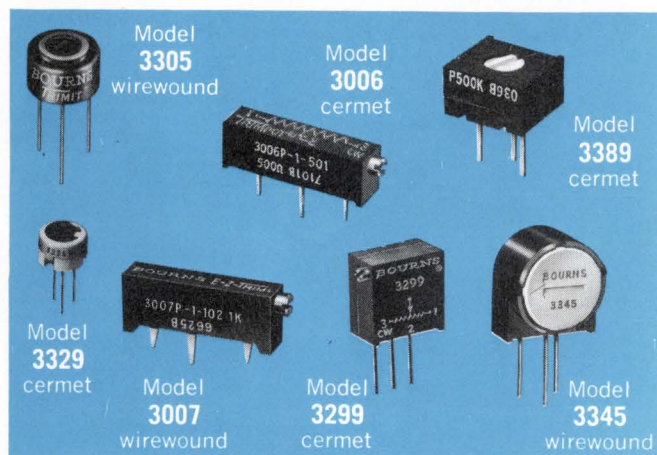

BOURNS, INC., TRIMPOT PRODUCTS DIVISION • 1200 COLUMBIA AVE., RIVERSIDE, CALIF. 92507

OCTOBER 1972

DATA COMMUNICATIONS



The MOS modem story:
Cost, size, performance and
reliability plusses outweigh
the negatives.

Data communications
news and products.

**This looks like
just another
ordinary data
terminal.**

**Until it goes
to work.**



Our new model 38 eight-level data terminal is anything but ordinary.

Because it's loaded with big machine features.

Like a 132 character printing format on a 15-inch wide platen. It's designed to handle computer print-out paper so you can eliminate time-wasting reformatting procedures. And for added versatility, there's a simple modification kit that permits you to use standard friction-feed rolls, too.

More big machine features? The model 38 prints both upper and lower case, in two colors, for maximum visibility and clarity in data presentation. And the four-row keyboard generates all 128 ASCII characters.

Speed? The model 38 moves data at 100 words per minute. For on-line speeds up to 2400 words per minute, it interfaces with the Teletype® solid-state 4210 magnetic tape data terminal.

The model 38 is flexible enough to fit into practically any switched or private-line system. That's why there are three interface options available. You can select from a built-in, factory-tested modem; a current interface; or an EIA interface.

You also get a choice in receive-only, keyboard send-receive, and automatic send-receive configurations.

Finally, the model 38 was designed to offer plug-to-plug compatibility with just about anything—including the model 33.

You'd think that all these big machine features would carry a big machine price tag, right?

Wrong.

We priced the model 38 so low it can be used economically in most applications—even in low usage locations where terminals couldn't be justified before. To offer real-time system up-date,

data entry and retrieval, and inquiry response throughout your operation.

It takes more than manufacturing facilities to build the machines Teletype Corporation offers. It also takes commitment. From people who think service is as important as sales. In terminals for computers and point-to-point communications.

That's why we invented a new name for who we are and what we make. The computer-cations people.



For more information about any Teletype product, write or call TERMINAL CENTRAL: Teletype Corporation, Dept. 55A, 5555 Touhy Avenue, Skokie, Illinois 60076. Phone 312/982-2500

Teletype is a trademark registered in the United States Patent Office.

Circle Reader Service #29



Still paying for oscillator stability you don't need?

Plug in our K1065A instead. Medium stability and price. 1 to 5 MHz range: 3×10^{-8} stability for -20° to $+55^{\circ}\text{C}$; less than 5×10^{-9} aging per day. Prototype quantities available for immediate delivery in 1.0 MHz and 5.0 MHz. Details available from Motorola Component Products Dept., 4545 W. Augusta Blvd., Chicago, Ill. 60651.  **MOTOROLA**

MOS revolutionizes modem design

The application of MOS/LSI is the first real change in modem design in 15 years.

Don W. Lake and William R. Foy

Standard Microsystems Corp., Mountain View, Calif.

The basic modem function, the transmission of digital data through the analog telephone network, requires the marriage of digital and analog techniques in a balance of performance and economy. An MOS/LSI modem shifts this balance to achieve some exciting results.

Modem, which introduced its 202 modem at the 1970 Fall Joint Computer Conference, shipped its first products the following spring. With the subsequent announcements and deliveries of the Penril 202, the Collins 201, and the Modem and Dataserv 103's, the era of the MOS/LSI modem began.

MOS/LSI in modems is attractive . . .

The great lure of MOS/LSI in the commercial electronics markets is the potential of a greatly reduced parts cost; in an all-digital machine, such as a calculator, MOS/LSI offers a five-to-one cost improvement and is therefore very attractive.

In a modem, however, the cost tradeoff is against an analog/digital implementation, not a fully digital one. The control circuitry is always digital, but the filtering, modulation and demodulation, and carrier-detector functions are traditionally analog. Are MOS/LSI implementations of the analog functions cheaper than the equivalent analog implementations? MOS/LSI modem makers have found that they are, but not by a factor of five to one. The cost improvement factor appears to be between two and two-and-a-half to one over the equivalent analog technique.

The second great lure of MOS/LSI is the size and power reductions it offers over any other available technology. While size is not a critical factor in stand-alone units, small size and low power are valuable qualities when modems are to be integrated into terminals or multiple modem racks mounted at a large central site.

A third area of MOS/LSI improvement is that of performance. Performance is a function of the modulation/demodulation technique and, at least for low- and medium-speed Bell-compatible modems, these techniques are fixed. Further, since the transfer functions of the modulator and demodulator are often the same for both the MOS/LSI and analog technologies, one would expect the performance of analog and MOS/LSI modems to be about equal. But the digital MOS/LSI approach has some subtle advantages. For example, frequencies and timing functions are derived from a single, crystal-controlled system time base, and are therefore accurate and stable; slicing operations are ideal and do not drift with time and temperature.

Such characteristics are real considerations to the producers of commercial units who are trying to minimize the time spent selecting parts to make analog circuits meet specifications. They are also important to the customer who finds the performance of the lowest-bidder's equipment deteriorating in production. There's no in-between with MOS/LSI modems—either they work or they don't.

The final MOS/LSI advantage is reliability. There are fewer parts, solder joints, interconnections, and bonds in MOS/LSI modems; the systems are consequently more reliable. After proper burn-in, an MOS/LSI modem will have an MTBF between two and ten times better than an analog modem.

. . . but it has its problems, too

If you could reap the benefits of MOS/LSI for free, or without problems, then MOS/LSI would have had a far greater impact than it has had to date.

The most significant problem is the development cost of an MOS/LSI modem and the relation of that cost to the modem's expected market size and selling price. The development costs for MOS/LSI devices are high—perhaps \$40,000 per chip for random-logic

functions. And modem chip development costs are higher yet because of the statistical nature of the medium in which the modem operates and, therefore, the much-longer-than-usual chip development cycle. (There are, of course, development costs associated with analog modems, but they are less than those of the MOS/LSI modems.)

So in order to get a lower parts cost and minimize the high development costs, the market for MOS/LSI modems must be fairly large. As a rule of thumb, an MOS/LSI modem with a three-year product life must sell at least 5,000 units per year to begin to realize the benefits of MOS/LSI. This translates into a total market size of at least 20,000 units per year for even the most aggressive marketeers. Hence MOS/LSI modems are just now being introduced, and only for those modems with the highest unit volume: the 103, 201, and 202 types.

The second basic limitation is that a modem cannot be all digital. The transmit and receive carriers are analog, and they must be processed in the analog domain in at least a portion of the machine. Moreover, the spectrum of the energy output to the telephone line must be controlled. Now, there are two ways to perform the analog processing: using a digital filter with multi-bit (14- to 16-bit) A/D and D/A converters, or, using analog filtering with a simple limiter for A/D conversion. At present, the cost of the higher-order A/D and D/A converters is too high, and most of today's approaches use analog line filtering and hard limiting.

A third problem area with MOS/LSI modems is in the flexibility of the final machine configuration. In today's modem market, each machine is offered with a wide variety of optional control features, and the list expands daily as communications-systems people find new ways to use modems. The MOS/LSI modem maker either must build all of those functions into his modem or must include as many as possible and provide the capability of adding new features at a future time.

The first solution is the desirable one, but it is difficult, if not impossible, in today's changing industry. New features are almost always added with discrete components because of response times required by the customer. Thus, the inflexibility of the chips themselves limits the flexibility of MOS/LSI modem configurations.

Non-MOS/LSI modems are not so severely limited in this respect since, although they must be redesigned, the maker can directly replace the necessary parts and interconnections required by the various modifications. Of course, where parts must be added, both approaches suffer.

Modem types share similar partitioning

Three basic modem types are actively being pro-

Factor	MOS/LSI modems	Conventional analog modems
Parts cost, high volume	Low	Medium
Parts cost, low volume	High	Medium
Size	Small	Medium
Power	Low	Medium
Performance	As desired	As desired
Long-term stability	Excellent	Good
Reliability	Excellent	Good
Development cost	High	Medium
Flexibility	Limited	Unlimited

Points of comparison between conventional analog modems and MOS/LSI modems. There is another class of modems not mentioned here—conventional digital modems. In such modems, parts cost and power drain so severely limit what the digital designer can afford to do that the analog modem has dominated the commercial modem market. Digital modems have met with some success only where the advantages of digital techniques have overshadowed cost and power considerations. The advantages of conventional digital modems are, with one exception, included in the advantages of MOS/LSI modems. That single exception is the flexibility of design, where the discrete digital modem allies itself with the conventional discrete analog modem.

Function	Technique
Modem Control	Digital
Modulation	Digital
Demodulation	Digital
Carrier Detect	Digital
Time Base	Digital
Crystal Oscillator	Digital
Transmit Filters	Either
Receive Filters	Analog
Limiter	Analog
Line Interface	Analog
Test Modes	Mixed
Adaptive Equalizer	Mixed
DAA Interface	Mixed

Various functional blocks within a modem and the techniques by which they can be built. A digital technique implies the use of MOS/LSI technology.

duced in MOS today. These are the 103, the 201, and the 202. The 103 is a full-duplex, two-wire, 300-b/s, FSK modem; the 201 is a half-duplex, two-wire, 1200-baud, 2400 b/s, PSK modem with reverse channel; and the 202 is a half-duplex, two-wire, 1200-b/s, FSK modem. The basic partitioning for all these modems is similar.

An MOS/LSI modem includes the following functions:

Modem Control circuitry provides the control interplay between the business machine and the telephone line control equipment. To work in the customer's system, a modem must present the proper signals to the proper lines at the proper times; this means that the control circuitry must have both interlocking logic and time delays. Control circuitry must also determine that all conditions are satisfied

TRON*

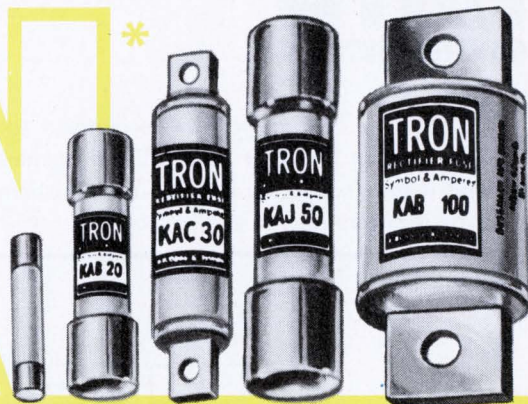

USE TRON RECTIFIER FUSES TO PROTECT

VARIABLE SPEED DRIVES

... as used in machine tools and conveyor controls.

INVERTERS

... wherever it is necessary to produce alternating current from direct current, such as non-interruptable power supplies.

BATTERY CHARGERS

... used to charge batteries of industrial trucks, forklifts, etc.

PLATING POWER SUPPLIES

... used to furnish direct current for electro-plating processes.

POWER CONTROLS

... as used for heating, cooling and temperature control applications.

... or wherever a fast-acting fuse is needed in the protection or isolation of electronic or electrical components.

TRON fuses offer you a complete line— $\frac{1}{2}$ to 1000 amps.—voltages up to 1500.

They are designed for the protection of solid state devices such as semi-conductor rectifiers, thyristors, SCR's—wherever extremely fast opening and great limitation of let-through current is needed.

For full information on TRON Rectifier Fuses and time-current characteristic charts, write for BUSS Bulletin TRFS.

*A member of the "TRON" family of marks, Reg. U.S. Pat. Off.

Bussmann Mfg. Division, McGraw-Edison Co., St. Louis, Mo. 63107

*FOR FUSES AND FUSEHOLDERS
OF UNQUESTIONED HIGH QUALITY
FOR EVERY PROTECTION NEED...*

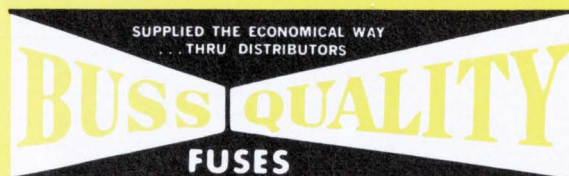

to direct an automatic DAA to connect to the phone line, present a carrier, and tell the business machine that it may send data or that the data being received is or is not valid.

The implementation of such functions depends on a host of customer requirements: whether the system operates on dial-up or private lines, with manual or automatic DAA's, over a point-to-point hook-up or a

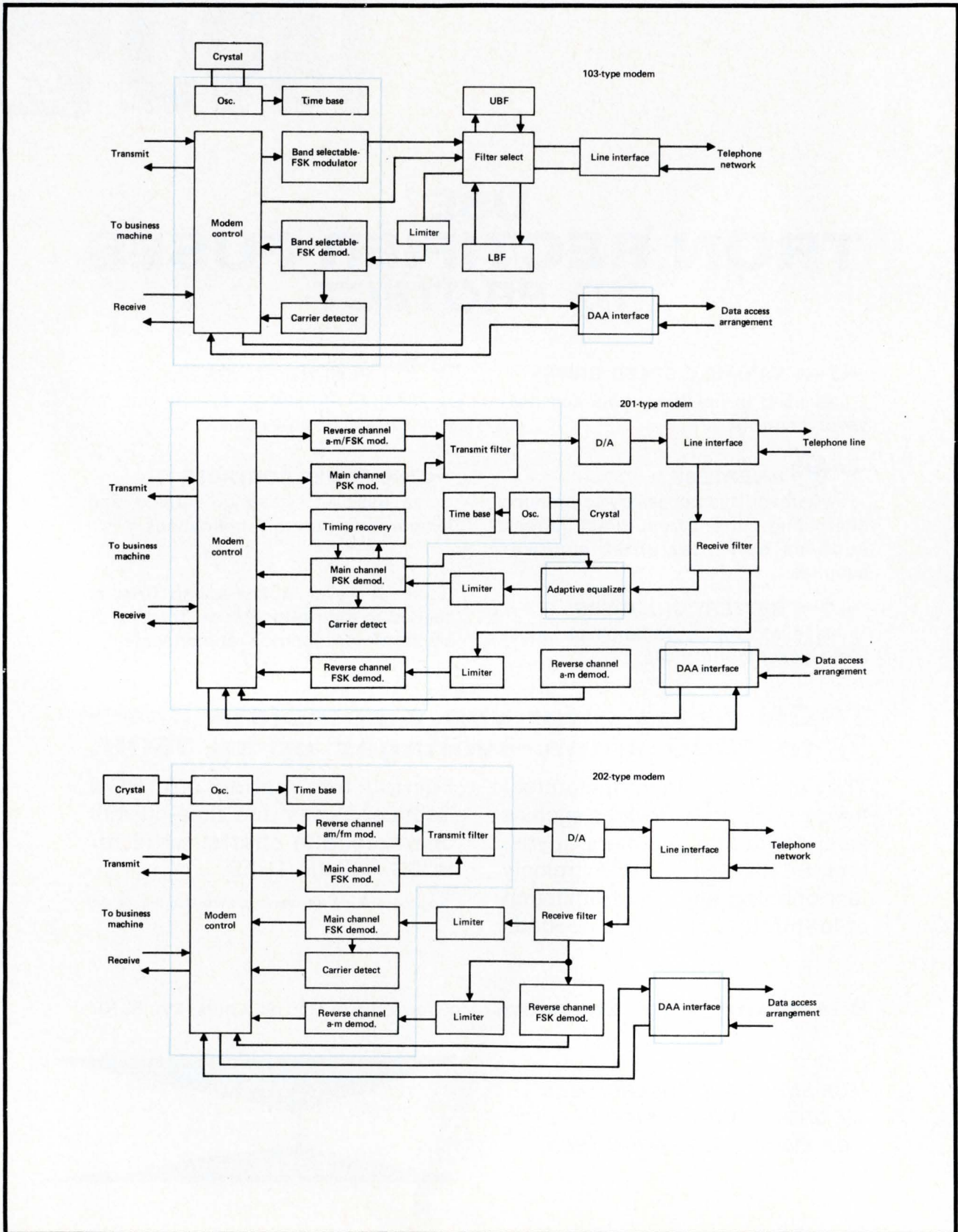

multi-drop polled system, over short- or long-distance lines with or without echo-suppressors . . .

In short, the modem control must be very flexible with many strapping options to allow it to do many different jobs. And the user must be able to easily decipher which straps to change to reconfigure a modem for his various applications. Thus, the control circuitry is possibly the most difficult part of the modem to design because it is really a task in problem definition.

□ **Modulation/Demodulation** is strictly a function of the modem type and the type of reverse channel, if one is used. For the 103, 201, and 202 types, this translates into three different FSK techniques, one PSK technique, and one a-m technique.

□ **Transmit Filtering** shapes the spectrum of the transmitted signal to pass the necessary sideband energies so that data is reliably detected without exceeding telephone company bandwidth restrictions, and without interfering with other usage of the line.

Transmit filtering can be done digitally. In 201 and 202 modems, where the switching of transmit and receive bands doesn't occur, it is practical to do it on the MOS chip. The signal level to the telephone line drive circuit can be constant, so the D/A converter can be of low order and precision needing only slight smoothing to remove amplitude granularity.

In 103-type modems where the transmit and receive bands are interchanged, filters are needed for both bands for the receive filtering, and digital transmit filters would only duplicate the receive filters.

□ The **Carrier Detector** determines whether or not a distant modem is transmitting a signal that the local modem can receive. A modem generally uses such a detector to ENABLE the output of the demodulator so that data is presented to the business machine only when it is meaningful.

ployed depends on the modulation technique used.

The carrier-detect decision varies somewhat from an energy-level detection to a signal-quality detection, depending on the needs of the customer and the price he is willing to pay. With the low cost-per-function of MOS/LSI, it is usually practical to design the carrier detector to detect signal quality, usually by observing how much difficulty the demodulator experiences in detecting the data.

□ The **Time Base** is largely determined by the MOS/LSI technology used, but a crystal oscillator usually drives the time base to provide the stability and accuracy needed by the modem's various functions.

The frequency is a function of the modem implementation; it is often chosen to be the same as, or a multiple of, frequencies used by the manufacturer in other equipment. These frequencies usually require TTL speeds and, in the past, have been generated by discrete oscillators. However, advances in the n-

channel silicon-gate process, which gives TTL speeds to MOS circuitry, mean that crystals will soon work with oscillators that are contained on the LSI chips.

ROM's and mixed functions

The inherent need for flexibility, coupled with the restriction of pin count on an MOS/LSI package, presents a major design problem. Generally, the solution is to build some of the interface and control logic into a small read-only memory included on the chip with other logic functions, and then program the ROM so that only certain functions are available for any given application. If other functions are required, the memory can be reprogrammed for that application. The capability of reprogramming the interface and control logic allows all foreseen and many unforeseen configurations to be produced without external discrete components.

The partitioning for the modem also includes the following non-MOS/LSI functions:

□ The **Receive Filter and Limiter** pass the necessary carrier and sidebands, and reject noise and other interference.

The extreme dynamic range of input signal levels—40 to 50 dB—renders digital filtering impractical by the A/D converter requirements. The receive filters are usually active RC networks. Properly-selected stable resistors and capacitors give both the filtering and the voltage gain needed to retrieve the low-level signals. The output of the receive filter is then hard limited for use in the digital MOS LSI circuit.

□ The **Line Interface** depends on the type of telephone line being used—private or direct-dial, two-wire or four-wire—and the transmission loss of the line from the modem to the local switching office. The line interface usually has a variable-gain line drive amplifier matched to the phone line impedance and a receive amplifier driven either from the receive half of a four-wire or from the receive output of a hybrid bridge on a two-wire line.

Finally, in addition to providing purely digital and purely analog functions, the basic partitioning also furnishes the following mixed functions:

□ **Test Modes.** Since most test modes require special handling of the digital data and control as well as the analog transmit and receive carriers, they are a mixed function, part of which is included in the modem control section of the chip, and part of which is implemented discretely.

□ **Adaptive Equalizer.** The telephone line is essentially a band-pass filter. It limits the bandwidth of the transmitted signal and introduces envelope delay distortion. It is desirable, therefore, to compensate for this effect or to equalize the receive signal. If the equalizer compensates for a nominal telephone line, it is known as a *compromise* or *fixed* equalizer and is considered to be part of the receive filtering.

MONO-KAPSTM

Unique in
Availability,
Price and Quality



* **FREE
Samples**

USCC/Centralab Mono-Kap Ceramic Capacitors have availability, price and quality inherent in every part.

AVAILABILITY. Immediately available from over 150 distributors are stock units in six sizes from .100 x .100 to .500 x .500. Our four dielectrics are NPO, W5R, Z5U and Y5V, with capacitance values from 4.7 pF to 10 Mfd in 50, 100 and 200 VDC ratings.

PRICE. \$.09 average in production quantities. This low price is due to USCC's development of highly automated assembly techniques resulting in large volume production of Mono-Kaps.

QUALITY. USCC is currently under contract to produce chip capacitors (the heart of Mono-Kaps) at the rate of 25,000 per hour, with a failure rate level of only .001% per 1000 hrs.



*Want FREE evaluation samples? Write on company letterhead to USCC/Centralab. For complete technical data on MONO-KAPS and other quality USCC components, circle the information retrieval number below.

USCC

USCC/Centralab

Electronics Division • Globe-Union, Inc.

2151 North Lincoln Street • Burbank, California 91504
(213) 843-4222 • TWX: 910-498-2222



Circle Reader Service #31

But at bit rates of 2400 b/s and higher it becomes desirable, if not necessary, to note the effects of the telephone line and to compensate for what it is doing to the signal at any given time. This adaptive equalization is sometimes done in the demodulation and sometimes prior to demodulation.

When it is included in the demodulation, the adaptive equalization can be all digital, and is considered part of the demodulator. When it is implemented prior to the demodulator, it is essentially a filter whose characteristics vary automatically to complement the characteristics of the telephone line. It can be either a digital or an analog function. But since the adaption algorithms typically depend upon information generated in the demodulation, adaptive equalizers for MOS/LSI modems are usually digital filters. Further, since equalizers operate on an (originally) analog signal, they must include some form of A/D conversion.

DAA Interface. This interface is simply a function of the type of Data Access Arrangement used.

A preview of coming attractions

The advent of MOS/LSI modems will accelerate the trend started by independent modem makers after the historic Carterfone decision of 1968. As MOS/LSI modems develop over the next few years we can expect to see the following events:

There will be a great push toward integral modems. The lower price of the new modems further tips the scale away from the leasing of telephone company equipment. And the smaller size and lower power make such modems much easier to fit into, and be accommodated by, terminals and other peripheral equipment.

The new modems will increase the demand for remote equipment of all types. The lower cost will make remote equipment more attractive and, coupled with the smaller size, will make certain applications—such as point-of-sale equipment—more practical.

MOS/LSI modems will progressively include more and more systems communications capability. As modem makers begin to offer more and more capability within the modem—thereby spreading development cost over many different customers and reaching a broader market—users will find that it is cheaper to have systems capabilities provided in the modem rather than in the terminal. This will have the secondary effect of standardizing a set of communications systems techniques among many different applications.

The techniques of MOS/LSI will be applied to different types of modems and other related communications products. Already in the works are 3600-, 4800-, 7200-, and 9600-b/s modems, as well as such products as autocal and autodial units.

In brief, MOS/LSI brings a set of powerful advantages to modems and to communications equipment in general. It is truly causing a hardware revolution in the communications industry.

DOUBLE-BALANCED MIXERS

With +30 dBm Intercept Points

Reduce your IMD problems with our high intercept point double-balanced mixers. RELCOM Models M1K and M9D Double-Balanced Mixers have a +30 dBm input third order intercept point . . . typically 15 dB greater than the input third order intercept point of low-level double-balanced mixers such as RELCOM Models M1G and M6E.



The Model M1K is believed to be the first commercially available high level mixer with microwave capability. It has a L and R Port

frequency range of 1.0 to 4.0 GHz and an I-Port frequency range DC to 1.0 GHz. Isolation greater than 30 dB. Noise figure and conversion loss typically only 6.5 dB. The advantage obtained by using the Model M1K is shown below where third order products are suppressed greater than 60 dB with 0 dBm input levels. In addition, you can obtain +15 dBm of output power from the Model M1K. In up-converting applications this is particularly important as amplification can be made

prior to mixing in lieu of expensive amplification at microwave frequencies.

The Model M9D is unique among high level mixers. With only +20 dBm of LO drive level it can provide a +30 dBm intercept point. Also, its noise figure and conversion loss performance are not degraded by the fact it is a high level mixer. Instead of a 7 or 8 dB of noise figure, the Model M9D has a 6 dB noise figure which is as good as most low-level mixers.

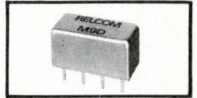

In spectrum analyzer, synthesizer, transceiver and ECM applications, the extremely wide bandwidth and high intercept point of these mixers will provide improved performance.

Both units are hermetically sealed and are guaranteed over a temperature of -54°C to $+100^{\circ}\text{C}$ and after environmental stressing per MIL-STD-202D.

TWO-TONE PERFORMANCE

AT 1600 MHz

Spectrum displays of two-tone IMD suppression taken under the following conditions: Input signals: $f_L = 2000$ MHz, $f_{R1} = 1600$ MHz, $f_{R2} \cong 1600$ MHz. Horizontal Scale: 10 MHz/cm centered at $\cong 400$ MHz. Vertical Scale: 10 dB/cm.

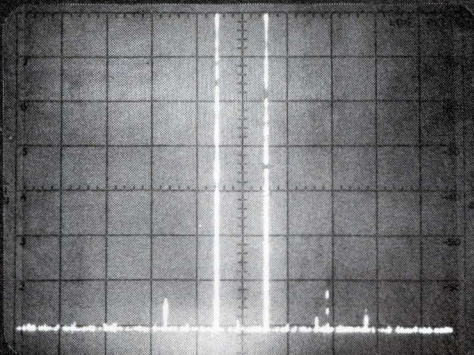

High Level Model M1K: With a +23 dBm f_L drive level and with f_{R1} and f_{R2} at 0 dBm, the Model M1K virtually eliminates all two-tone products from the 70 dB spectrum.

AT 220 MHz

Spectrum displays of two-tone IMD suppression taken under the following conditions: Input signals: $f_L = 250$ MHz, $f_{R1} = 220$ MHz at 0 dBm, $f_{R2} \cong 220$ MHz at 0 dBm. Horizontal Scale: 50 KHz/cm centered at $\cong 30$ MHz. Vertical Scale: 10 dB/cm.

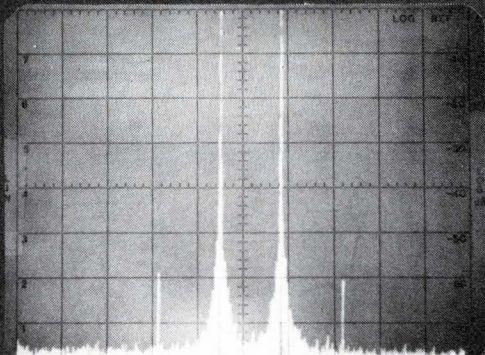

High Level Model M9D: With only a +20 dBm f_L drive level, the Model M9D suppresses the third order product by 60 dB and the fifth order product by more than 70 dB.

Call applications engineering for additional data. Better yet, compare our performance for yourself and requisition your own evaluation unit from our stock.



3333 HILLVIEW AVE., STANFORD INDUSTRIAL PARK, PALO ALTO, CALIF. 94304 • (415) 493-4141

What's new in frequency control?

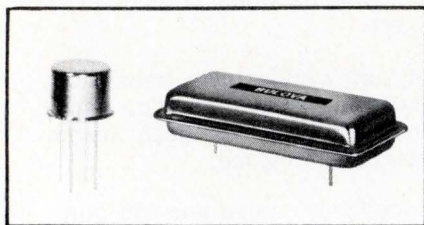

A new series of *highly miniaturized coldwelds* having a broader frequency output is now available. The units — developed by Bulova — feature tolerances as close as 3 ppm of nominal on initial adjustment, and aging rates up to 3 pp 10^8 per week. In the TO-5 can, for example, with a frequency range of 500 KHz to 160 MHz, Bulova coldwelds have a tolerance of $\pm 0.015\%$ (from -55°C to $+105^\circ\text{C}$, or to specs.) Aging is 1×10^{-7} /week after 4 weeks.

Circle No. 42

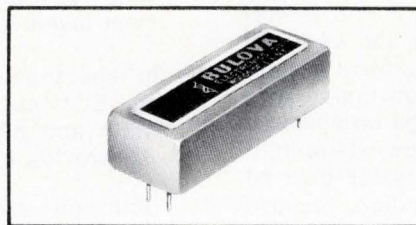

Group delay crystal filters offering perfect phase linearity for optimum data transmission are also available from Bulova. Overshoot is kept to 40 db (1%) below the steady state value. The filters provide distortion-free selectivity, at a maximum speed, and have a reduced error rate. Bulova's complete line of crystal filters meet all transmission specifications from 4 KHz to 150 MHz.

Circle No. 44

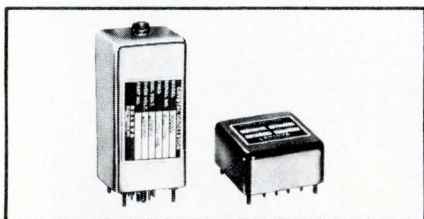

In crystal oscillators, the *temperature compensated TCXO-18* offers a frequency stability of ± 2 ppm over a temperature range of -55°C to $+105^\circ\text{C}$. A voltage variable capacitance diode and thermistor network maintain stability without an oven. The *high stability PCOXO-5* — also by Bulova — has an aging of 5 pp 10^{10} /day. It's a commercial, plug-in package with frequency stability of 2 pp $10^{10}/^\circ\text{C}$ over a range of 0° to $+60^\circ\text{C}$, and short term stability of 11 pp 10^{10} per second.

Circle No. 43

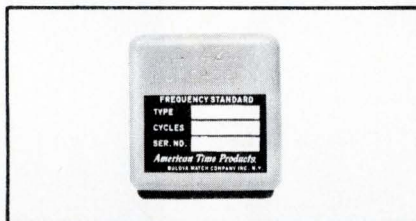

The news in *subminiature fork oscillators* is a unit which uses less than 5 ma. The oscillator, developed by Bulova and designated the FS-11-1, takes up about $\frac{1}{2}$ cu. in. of space and weighs one ounce. Their units have accuracies up to $\pm 0.0005\%$, 90% reliability for 200,000 hrs. and logic circuit compatibility.

Circle No. 45

Bulova has been making frequency control news since 1937. For information on Bulova's complete range of frequency control products, call 212-335-6000, see EEM Section 2300, or write: Bulova Watch Company, Inc., Electronics Division, 61-20 Woodside Ave., Woodside, N. Y. 11377.

Ma Bell goes long distance data . . .

The Federal Communications Commission gave the go-ahead for AT&T to establish its first long-distance channel system designed especially for data. The New York-Chicago route will utilize the DUV (data under voice) approach, that allows data to be transmitted with ordinary telephone traffic. The cost is estimated at \$141,000.

Modem get-together . . .

United Business Communications and Sangamo Electric Co. will combine their data modem enterprises in a new corporation. The new firm, starting with \$6 million backlog, will be operated as a subsidiary of Sangamo. With the combination of the Sangamo and UBC's Rixon data modem lines, the new company will have a full line, ranging from products for the independent telephone industry to 9600 b/s models.

Keep on trucking . . .

Another nationwide carrier is making its appearance. The American Trucking Association (ATA) has begun accepting orders from member companies for a new communications system, resembling Arinc (Aeronautical Radio, Inc., the airlines' industry system). Since ATA regards beginning a private microwave system "from scratch" as a "perilous and difficult" project, they will lease facilities from AT&T and combine them with existing private mobile operations.

Hot standby added . . .

In addition to space and frequency diversity, multiline switching, and single-channel arrangements, GTE Lenkurt has added a hot-standby protection feature to its type 75 long-haul heterodyne microwave radio systems. The systems operate in the 4-, 6-, and 11-GHz common carrier frequency bands. The new feature allows an alternate transmitter to deliver its output to the antenna in case of failure. At a repeater, a standby receiver is switched into the thru path if the noise sample indicates a performance failure.

Circle Reader Service #249

DATA COMMUNICATIONS PRODUCTS

PRINTS 200 LINES/MIN

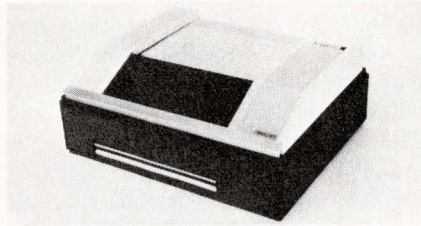

With only two moving parts in the print mechanism, and backed by a one-year warranty, the Tally 2200 can print six copies of full 132-column formats for 1,000 hours of continuous failure-free printing. Available with hardware and software for interfacing with most minis. A serial communication interface, compatible with Bell Series 202C modem is available for 1200-baud systems. With parallel interface, \$4,000 each. Tally Corp., Kent, Wash.

Circle Reader Service #260

1200 BAUD COUPLER

The Design 1200 acoustic data coupler can transmit or receive data at 1200 baud and can be operated in a full-duplex mode to 150 baud. The operator can select reverse channel speeds of 0 to 10 or 0 to 150 baud for compatibility with remote modems. Active filters provide maximum receiver sensitivity, and a fully automatic self adaptive equalizer adjusts coupler for maximum data transmission quality. A signal guard circuit examines the quality of the carrier level signal to determine the validity of the data. George Gerhard, MI² Data Systems, Inc., Design Elements Div., 1356 Norton Ave., Columbus, Ohio 43212.

Circle Reader Service #261

MODEM INTERFACE SPLITTER

The Modem Interface Splitter permits a single modem to service up to four terminals, four computer ports, or even four separate processors. Typical applications include elimination of multiple modems where several polled terminals are located adjacent to each other, or the connection of a standby processor to a modem operating with an on-line processor. Spectron Corp., Suite 212, 1060 Kings Hwy North, Cherry Hill, N.J. 08034.

Circle Reader Service #262

FSK MODEM MODULES

This line of thick-film hybrid modules for FSK modem applications uses switched active resonator circuitry for modulation and demodulation. For a typical 300 b/s 103 compatible modem utilizing the CH1211 demodulator, the CH1212 modulator and the CH1256 bandpass filter, the modules occupy only 2.35 in.² of board space. Combined cost for the three modules in 100 quantity: \$33.55. Individual 100 quantity pricing: CH1211, \$14.50; CH1212, \$10.65; CH1256, \$8.40. Cermetek, Inc., 660 National Ave., Mountain View, CA

Circle Reader Service #263

TOUCH TONE® RECEIVER

Converts standard two-tone signals into one of twelve TTL compatible signals. Provides a TTL logic zero and strobe for a valid input signal. TD-112 accepts all touch pad tone pairs when used in private systems with dedicated lines; TD-113 accepts all valid touch-tone signals over commercial telephone range as well. Applications include data terminals, security systems, private key systems, mobile communications systems, and credit checking systems. Teletron Co., 40 Elliott St., Melrose, MA.

Circle Reader Service #264

MAG TAPE SYSTEM



The Cartrifile 20 with PD20 drive features two independently controllable tape drives and read/write electronics controller, interface for any popular minicomputer, integral power supply, cables, and basic software. It uses Tri-Data 1000 Series endless-loop cartridges up to 150 feet long. Typical prices: \$3,650 with interfaces; \$2025 in small OEM quantities without interface; drive only version for OEMs, \$795 in quantity. Tri-Data Corp., 800 Maude Ave., Mountain View, CA. 94040.

Circle Reader Service #265

Programmable Frequency Synthesizer

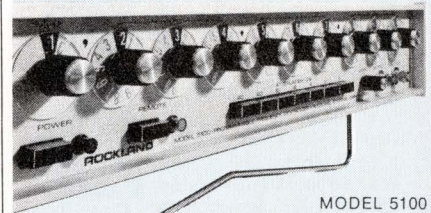

MODEL 5100

- Low cost \$2450
- Covers the range of 0.001 Hz to 2 MHz with 0.001 Hz resolution
- Direct synthesis utilizing digital techniques
- Full programmability using Binary or BCD
- 1.5 usec programming speed
- No switching transients

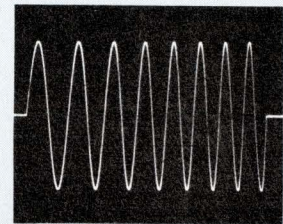

Frequency Sweep from 8 KHz to 15 KHz in 1 KHz increments. Remote programming in Binary mode.

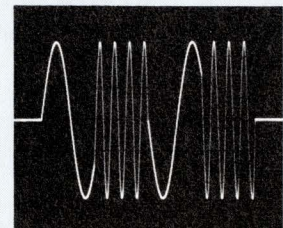

Frequency Hopping between 1 KHz and 4 KHz in Binary programming mode. Note that amplitude and phase continuity is maintained.

Rockland also manufactures a complete line of Analog & Digital Filters and Speech Synthesizers.

ROCKLAND
Rockland Systems Corporation

230 W. Nyack Road, West Nyack, N. Y.
(914) 623-6666 TWX No. 710-575-2631

Circle Reader Service #33

TEC LED LITE

TRANSISTOR CONTROLLED LED INDICATOR SAVES PC BOARD SPACE

If you're driving LED's directly from IC outputs you're wasting valuable PC board space! TEC's new L-1017 Series LED Indicator requires 1/10th the current (only 1.6ma) of ordinary LED's (using 15ma) — lets you drive one L-1017, plus nine other loads from one IC logic circuit. Transistor driver and LED are housed in a .284 dia. x 1" long body that mounts in a 1/4" panel hole on 1/2" centers. Wire-wrap terminals standard. L-1017 Series turns on with "high" input, logic "1" (IC driven LED's indicate logic "0"). L-1017 signals: ON, +2.5 to +5VDC; OFF, 0 to +0.8VDC. Supply: +5VDC @ 15ma, maximum. Special lens design increases LED brilliance and side viewing — available in red or clear, spherical or flat top lens style.

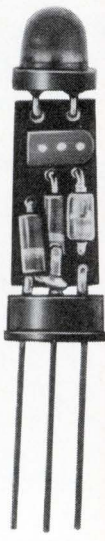

2 X SIZE

Immediate Del. \$2.30 ea., 100-499 qty

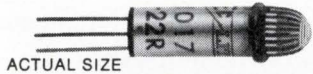

ACTUAL SIZE

DIRECT DRIVE LED INDICATOR

L-1015 Series LED Indicator is identical to L-1017 Series above in all mechanical details. Internal resistors allow operation directly from 5.0, 6.3, 10 and 24 VDC supplies — permit LED indicator substitution for incandescents.



ACTUAL SIZE

Immediate Del. Price, \$1.30 ea., 100-499.

TEC LED LITE INDICATOR PACKAGES

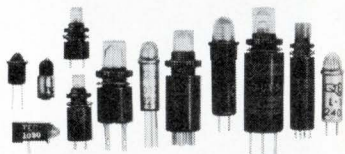

Select a rugged, long life LED indicator or switch/indicator from more than 20 TEC designs. More brilliance, easier mounting, attractive appearance are added to the various LED's packaged by TEC.

See TEC-LITE for the complete line of readouts, indicators, switches, display panels, keyboards, CRT terminals.

TEC, Incorporated; 9800 North Oracle Road, Tucson, Arizona 85704; or phone (602) 297-1111



Circle Reader Service #34

DATA COMMUNICATIONS PRODUCTS

DOCUMENT READER

The 7100 document reader can input documents from 2 x 3 to 6 x 9 in., with data line length and position variable. Data may be OCR-A numeric, or optionally full alpha/numeric OCR-A, or mark sense. Modular add-on options include auto feed, make sense, and check digit features. \$4450.00 (quantities of 100). Computer Entry Systems, 2141 Industrial Pkwy., Silver Spring, MD
Circle Reader Service #266

TIME TRANSLATOR

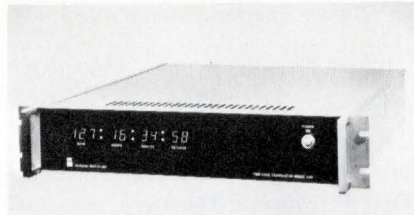

The Model 520 time code translator converts serial input codes to parallel BCD or binary output, and displays day/hour/minute/second. The rack mounted unit houses a power supply and receptacles for 20 standard plug-in time code and interface modules. The unit can be easily expanded or modified to a new or alternate code in the field by changing modules. Codes handled include IRIG A, B, E, H, and G; NASA 28 and 36; AMR-B2, -C2, and -D5, and XR-3. Parallel BCD formats, Slow Code Type B outputs and others optionally available. \$1,000 up. 30 to 120 day delivery. SRC Div./Moxon Inc., 2222 Michelson Dr., Irvine, CA 92664.

Circle Reader Service #267

TAPE FORMATTER FOR OEMS

The Data Path Series 1X00 tape formatters control the generation of tape formats by controlling data between an I/O interface and up to four 7- or 9-track transports with minimum interface control sequences. While the Series 1X00-01 operates with NRZI tape drives only, the 1X00-02 operates with both NRZI and phase encode transports to read and write IBM compatible tapes. \$1400 to \$3000 in single quan. Stock delivery. Information Products, Inc., 4202 Director's Row, Houston, Tex. 77018.

Circle Reader Service #268

LINE ADAPTERS

This line of IBM compatible line adapters is built around two modules, a transmitter and a receiver. For incorporation in remote terminals and data comm systems, the OEM line is available in module form, on standard motherboards, or on customer-specified PC boards, \$225 to OEMs, 30-day delivery. For end users, the VA1616 holds up to 16 intermixed IBM compatible line adapters, \$275/channel, 45 day delivery. Model VA1604 houses up to 4 IBM compatible adapters, \$287.50/modem, 45 day delivery. Stand-alone boxes for one or two channels, from \$375. Vadic Corp., 505 E. Middlefield Rd., Mountain View, Calif. 94040.

Circle Reader Service #269

PRESET DIALER

The Automatic Preset Dialer is designed for use with the Design 103GM, 300-baud, direct access, originate and automatic answer data sets for Teletype® installations. The telephone number can be either preset by the operator with the thumbwheel switches, or hard-wired into the electronics package. Dialing is initiated by pressing the Dial Start pushbutton. MI² Data Systems, Inc., 1356 Norton Ave., Columbus, OH

Circle Reader Service #270

ANSI/ASCII KEYBOARD



The model 7100 low-cost ANSI typewriter keyboard features a dynamically scanned MSI electronic encoding system and redundant gold contact BI-PAC switches. All circuitry and key-switch modules are on a single PC board. Features include full ASCII coding (shifted, unshifted, control and control/shift), 2-key roll-over interlock, and low power consumption (less than 300 mA.). \$49 in 5000 quan., stock to 8 wk. Jim Antrim, Controls Research Corp., 2100 S. Fairview, Santa Ana, CA 92704.

Circle Reader Service #271

DPM PRICES TAKE A DIVE

As manufacturers continue to cut prices, digital panel meters become candidates for more and more applications. On the other hand, experienced users point to serious quality problems as the major stumbling block.

Arthur J. Boyle, Managing Editor

You say you have been thinking about converting some of your equipment from analog displays to the new, low-cost, digital panel meters? Well, if you are cost conscious, there has never been a better time to make the switch. Prices are at an all time low, and the large number of manufacturers will insure healthy competition for your order. On the other hand, six months from now prices will probably be lower yet, and some of the bugs in the current models will have been ironed out. And, if you can afford to wait, the DPM industry will probably be even more of a buyer's market a year from now.

But there is a major road block to the development of this market. Users, who have been attracted by the cost factors and specs, have experienced serious disenchantment as the result of the lack of reliability and misleading specifications. Such a problem, if not corrected quickly, could seriously retard the growth of this very promising market.

Price is going down, but how fast?

The table in this article lists a rather impressive number of DPMs that you can buy for less than \$100 in quantity. Compare this list to similar meters two years ago and you have some idea of what is happening to DPM prices. The price erosion has been dra-

matic, and in all probability it will continue in the near future.

The price of a digital panel meter, like most other components, is very volume dependent. While it is a pretty safe bet that prices will continue to decline, just how much they drop depends on how the market develops. Actually, the DPM market is (or more accurately, it could be) composed of three fairly distinct segments:

- **System applications**, where the user is actually buying an analog-to-BCD converter with an auxiliary readout.

(continued on next page)

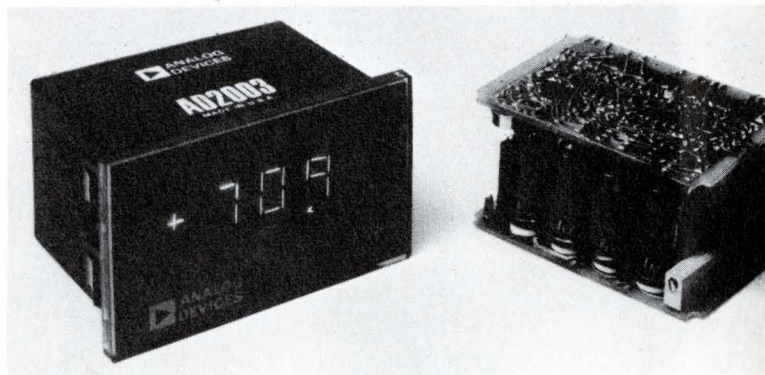

The latest, low-cost DPM from Analog Devices is the AD2003. The meter is aimed specifically at high performance applications such as instrumentation and data collection, and includes such features as a true differential input and latched BCD outputs.

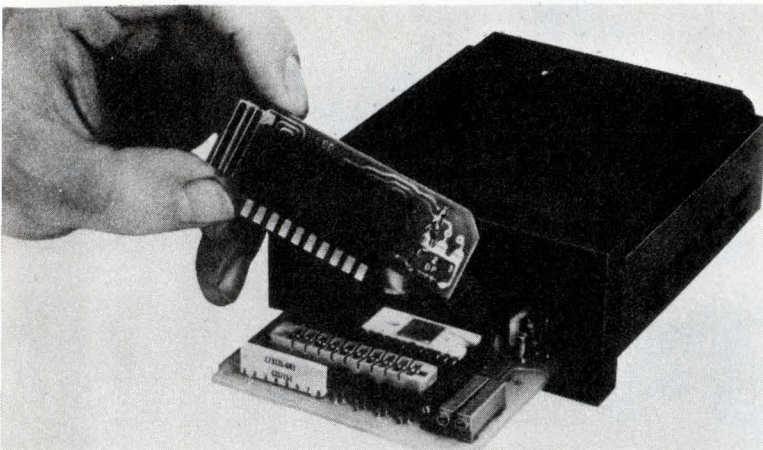

Weston's 1295 is one of the few low-cost DPMs to offer an LED display. The meter also incorporates a custom LSI chip from Mostek in the digital portion.



The 2530, from Analogic, is in the less than \$50 class. It offers a 999 full scale reading and lets you program the display count so that you can scale the inputs, much like an analog meter.

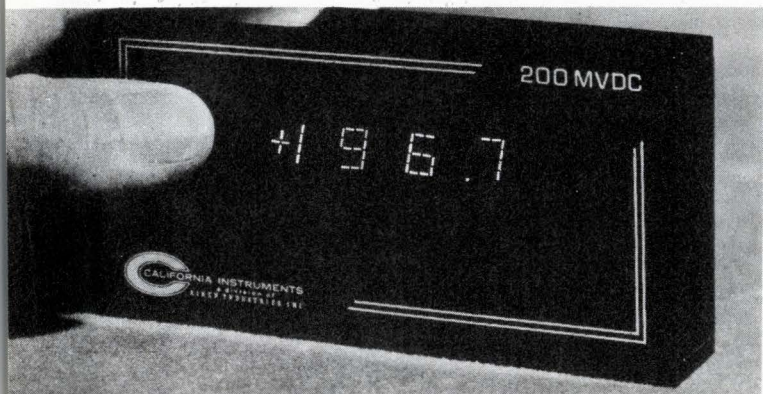

One approach to solving the problems associated with panel cutouts is offered by this unit from California Instruments (see *The Electronic Engineer*, Sept. 1972, p. 70). Available with a full scale reading of 99 for \$90, the meter mounts on the front of the panel with just three drill holes required.

- **Strictly panel meter applications**, where the DPM replaces an analog meter on a one-for-one basis.
- **Sales appeal applications**, where the advantages of a DPM over a moving needle meter produce a tangible increase in the value of the end product and justify the increased cost of the DPM.

Up to now, most of the DPMs sold are in this last category. One good example is medical instrumentation. Here the ultimate customer has demonstrated his willingness to pay a premium for an unambiguous readout.

The second largest segment of the current market is the system user. While relatively modest right now, the system OEM market will probably become the dominant factor in the years ahead. However, don't expect any major impact on DPM prices from the system OEM for some time. Jack Stegenga, product marketing manager for Weston Instruments, estimates that while 95% of the DPMs Weston sells have BCD outputs, probably less than 5% are really required. Stegenga says, "The day when BCD outputs will really be required to sell DPMs is still about two years away."

If you need convincing on this point, take a look at the limitations of BCD outputs in many of today's meters. Only recently have manufacturers started to introduce units in the under \$100 range that have a BCD output suitable for use in any kind of practical system.

Chasing the big carrot

The real dream of every manufacturer is to get his DPM into every panel that now uses an analog meter. But even the most optimistic admit that it is a rather remote possibility. The average selling price of an analog meter is between \$5 and \$10. No one sees DPMs competing in that area on the basis of price alone.

On the other hand, even an average price of \$5 implies a fair number of meters which sell for significantly more than that. This is the segment of the analog meter market that is attracting the DPM people. Larry Sullivan, VP of Marketing for Analog Devices, says, "We feel that when the DPM gets down to the \$30-35 range, you will see a significant analog replacement market develop. Since the DPM itself will eventually become just a CMOS chip and a display, there is no reason why the DPM should not become a serious competitor for a large portion of the analog market."

Weston is, of course, an old line manufacturer of analog meters which has also established itself as a leader in DPMs. When we asked Jack Stegenga about the prospects for analog replacements, he agreed that it was coming but cautioned about looking for it

Model	Full Scale Reading	Display Type	Input Power	Unipolar/Bipolar	BCD Output	Price (\$) 100 Quantity	Manufacturer	Reader Serv. No.
AD2001	1999	RCA Numitron	5 V dc	unipolar	standard	89.00	Analog Devices	201
AD2002	199	RCA Numitron	5 V dc	unipolar	optional	50.00	Analog Devices	202
AD2003	1999	RCA Numitron	5 V dc	unipolar	standard	93.00	Analog Devices	203
AN2530	999	incandescent	5 V dc	bipolar	standard	49.00	Analogic	204
AN2535	1999	incandescent	5 V dc	bipolar	standard	85.00	Analogic	205
8330	99	LED	5 V dc	unipolar	optional	90.00	California Instruments	206
320	199	Nixie	ac	bipolar	optional	88.00	Datascan	207
420	999	Nixie	ac	bipolar	optional	95.00	Datascan	208
610	1999	Nixie	ac	unipolar	optional	95.00	Datascan	209
4311/4312	1999	Sperry gas discharge	ac	unipolar/bipolar	standard	93.00/95.00	Data Technology	210
4211/4212	199	Sperry gas discharge	ac	unipolar/bipolar	standard	77.00/79.50	Data Technology	211
276	999	LED	ac	unipolar	optional	88.00	Digitec	212
277	1999	LED	ac	bipolar	optional	97.00	Digitec	213
300	1999	Nixie	ac	bipolar	standard	99.50	Electro-Numerics	214
370	1999	RCA Numitron	ac	bipolar	standard	99.50	Electro-Numerics	215
301	199	Nixie	ac	bipolar	standard	89.50	Electro-Numerics	216
371	199	RCA Numitron	ac	bipolar	standard	89.50	Electro-Numerics	217
2501-3	199	incandescent	ac	unipolar	standard	65.00	Faratron	218
2501-3-03	199	LED	ac	unipolar	standard	81.50	Faratron	219
2701-27	199*	incandescent	ac	unipolar	standard	68.00	Faratron	220
2701-27-3	199*	LED	ac	unipolar	standard	84.50	Faratron	221
4350	1999	flourescent	ac	unipolar	optional	84.00	LFE Corp., API Inst.	222
200B	1999	Nixie	ac	unipolar	standard	99.00	Newport Labs.	223
4228	199*	neon	ac	unipolar	optional	86.45	Triplet	224
4225	199	neon	ac	unipolar	optional	77.19	Triplet	225
4220	99	neon	ac	unipolar	optional	67.93	Triplet	226
1295	1999	LED	ac	bipolar	optional	97.50	Weston	227
1296	1999	LED	ac	limited bipolar**	optional	95.00	Weston	228
1297	199	LED	ac	bipolar	optional	92.00	Weston	229

*Includes an additional indicator which indicates either 0 or 0.5 in the least significant digit position.

**Displays both positive and negative values, but has reduced accuracy with a negative input.

Less than \$100 in 100 quantity. This table lists those digital panel meters which we have been able to find for less than \$100 in 100 quantity. In an attempt to eliminate some of the confusion, we have rejected the concept that there is any such thing as a 1/2 or a 1/4 digit. The user is only interested in the full scale reading of the meter.

The most difficult area to make a meaningful comparison is the column headed BCD output. The usefulness of this output varies considerably from manufacturer to manufac-

turer, and even between different models from the same manufacturer.

If you are in the market for a DPM, we recommend that you first go on a literature gathering spree with the reader service numbers provided. The data sheets will allow you to narrow your options to a manageable number of vendors and models. At this point we strongly recommend a stringent evaluation phase for both the product and its workmanship before any substantial buy is made.

too soon. He says, "Look, there is more than price involved. Even if we cut the price of a DPM to \$10, it would be a year before you saw the impact. It takes that long for the analog guys to re-orient their thinking and to get the product designed in."

If you like the price, then what?

If you do decide that DPM prices are in your ball

park now, the next step is to carefully evaluate those units that seem to fit your application.

The most noticeable characteristic of a panel meter is, naturally, the display. In the under \$100 class, you can presently select from Nixies™, several incandescents (such as RCA's Numitron), gas discharge display (à la Sperry) and LEDs. The choice of a particular display can only be made by looking at it for

long periods of time and preferably in the environment in which it will be used.

The DPM manufacturers readily admit that no one display is right for all applications. James DiRocco, president of Analogic, says, "We are not locked into any one readout. We are constantly evaluating all types of displays, and we plan to offer the customer more readout options in the future."

DiRocco's sentiments are reflected by most other manufacturers. For example, in addition to the standard LEDs, Weston is planning to offer their meters with an incandescent display from Pinlight. The Sperry display is also gaining popularity, with both Newport Labs and Analogic looking at it very seriously.

Of course, every one is looking at (or at least looking for) liquid crystals. However, none of the vendors we talked to would venture a guess as to when we might see liquid crystal DPMs for \$100.

So, the choice of a display is in the eye of the beholder. We strongly recommend that you "look before you leap" into any kind of DPM commitment.

Don't ignore the other specs

While displays are the most obvious difference between DPMS, the other specs really determine if the meter will fit the application. A relatively new development in DPMS is the 5-Vdc powered units being offered by Analog Devices and Analogic. If such a meter is going into a system with lots of TTL and 5 V all over the place, fine. If not, you better add the cost of a power supply to the price of these units.

Do you need a BCD output from the meter to some other part of your system? If so, look carefully at that output. The most common problem is the lack of any isolation between the analog and digital sections. This, plus the absence of any buffering on the output lines themselves, make many of the meters useful in only very limited applications.

The user's look at DPMs

When we set out to do a survey of digital panel meters, we felt a vital part of that survey consisted of personally talking to as many users as possible throughout the country. Let's face it, the best source of information about any product is the guy who has used it.

Well, we went to users—users who have purchased panel meters from just about every major supplier in the country. Almost every interview had three points in common: users have very strong feelings about the type of display used in their panel meters (although they don't usually agree with each other); users are universally enthusiastic about a standard mechanical configuration for digital panel meters; and, most importantly, just about every user we talked to had experienced what he considered poor quality in the DPMS that he bought.

Consider, for example, the gentleman who buys digital panel meters and incorporates them into calorimeters. His big complaint is the unreliability of the meters which he purchases. He says that although current units are 10 to 15 times more reliable than earlier units, lack of reliability is still his single biggest problem. Price and physi-

cal size are not nearly as important to him as a meter that he can depend on in his end product. Although he has evaluated meters with both NixieTM and seven-segment incandescent displays, he is just as happy with the Nixies. Once again, the main concern is reliability and he feels that the Nixie is the only display which has established a track record in this area. He also cites noise and common-mode rejection as being other primary concerns, and would like very much to see interchangeable cases so that he can change vendors in case of a problem without having to re-do his own panels.

Then there is the fellow who builds medical instrumentation for hospitals, clinics, and doctors' offices. He has bought about 500 digital panel meters so far this year. He also cites quality as being his biggest concern and had already gone through three different vendors before arriving at one which he felt was acceptable. Although presently using Nixie readouts, he has evaluated the Sperry display and likes it very much. He says the digital panel meter is the second most expensive component in most of his instruments. For this reason, he is very cost conscious. However, he is not going to sacrifice quality because of cost. He also is very enthusiastic about the idea of a standard case. He states the problem of finding a capable second source because of the incompatible case and

DPM PRICES TAKE A DIVE 

A couple of other areas which deserve careful scrutiny are:

- Input circuitry.** If you plan to do any range switching, you had better check the input bias current and its behavior with temperature.
- Noise and common mode rejection** of the meter.
- The effects of environment,** particularly temperature, on the accuracy and performance.
- Power drain,** especially for a battery powered instrument. Although Datascan's new Model 820, a 100 mW DPM which uses CMOS and a special scan circuit to save power in both logic and readout, is priced around \$150 in quantity, the day is coming when CMOS and liquid crystals will bring that price under \$100.

Perhaps the best advice of all comes from the manufacturer who warns all his customers: "Try before you buy. A digital panel meter is just not as forgiving as an analog meter." ■

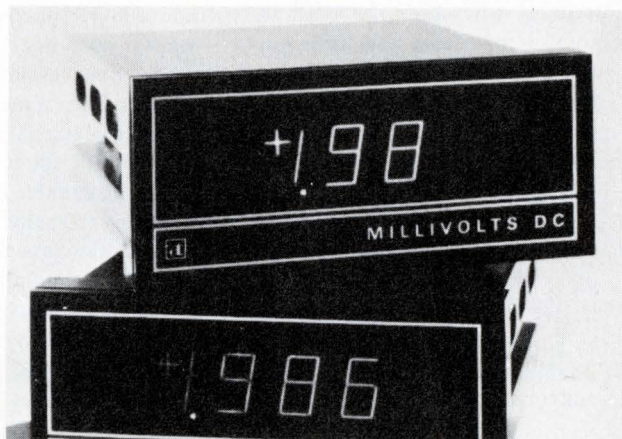

Data Technology's entry is the under \$100 DPM sweepstakes offers full-scale readings of 199 or 1999 and your choice of unipolar or bipolar input. Originally developed for LED displays, Data Technology reports that they changed to the Sperry gas discharge display as a result of a customer preference poll.

mounting problems.

A different set of problems was encountered by the engineer who incorporates digital panel meters into his company's data acquisition systems. His biggest concern was the type of BCD output from the meter. He also says that since some of their more sophisticated systems are used in very noisy environments, they need high common, and normal mode noise rejection. Asking him about price, he noted the type of meter they need is definitely not in the under \$100 class yet; the more common price is about \$200. The gentleman also had a complaint about specmanship of the part of some manufacturers. In particular, he complained about the way they specified temperature range. He was looking for meters to operate in a 50°C ambient. He found one manufacturer who specified the temperature inside the meter, but did not identify it as such. This particular user felt very strongly that this was misleading specmanship on the part of that manufacturer, and won't do business with that company in the future.

One engineer we spoke to was using digital panel meters in instrumentation for examining the content of flue gasses, such as in a power plant or a steel mill. His primary specification was price. He selected his vendor by holding a price competition which narrowed the field down to two finalists. The actual choice went to a manufacturer that used a

Sperry readout, which he liked very much. He does not use meters with BCD outputs in his present application, but he does feel that in a year or two they will become necessary.

Still another DPM specifier used digital panel meters to replace analog meters in pH equipment for laboratories. His big worry was the input circuit of the DPM. Although all the manufacturers specified temperature drift at approximately the same level, he says that after he evaluated them he found that they were not the same. He complains that there is just no standardization on the meaning of the spec.

Another medical electronics firm used panel meters in a gamma counter in their product line. Noise and common load rejection were very important in this application. Once again the complaint was the lack of reliability.

Probably the best summary of user reactions was stated by the engineer at the large westcoast company that incorporated DPMs into their line of industrial instrumentation. He said he uses meters which cost him on the average of \$300 each. "Was he aware of the newer, low-priced instruments on the market?" we asked. "Yes, but those damn inexpensive meters caused us nothing but headaches. We spent half our time on airplanes traveling back and forth across the country trying to fix up all the problems."

Kick the 608 habit!

Some products become classics. For years after their introduction, users cling to them and competitors emulate them in a vain effort to displace the pace-setter as an industry standard.

Hewlett-Packard's Model 608 signal generator has been that kind of a classic. For years it has been the VHF signal generator for many, and users have routinely depended on it to exceed its printed specs. But the days of the 608 are numbered as HP and others introduce quiet, versatile solid-state signal generators suitable for UHF and VHF receiver testing.

Most of these generators cover an even wider frequency range than the 608. The HP 8640 and the Singer 6201 can both go to the GHz region with external doublers, while the 6201 also offers an \$850 plug-in frequency extender that stretches the lower end of its range down to 61 kHz. One instrument that does not have a wider frequency range is the Marconi 2012. It is a special-purpose generator designed specifically for testing narrow band FM receivers, and its frequency range is therefore limited to 400-550 MHz.

The new signal generators all offer integral digital frequency counters, either as standard equipment or as an option.

The obvious advantage is increased accuracy—plus or minus half the resolution of a 5- or 6-digit display as opposed to perhaps half a percent on a dial meter. HP's 8640B features a 10x and 100x expander that lets the user resolve 0.1 Hz in the 0.5-1 MHz range and 100 Hz in the 500-MHz range. A similar expander on the Logimetrics model gives resolution to 1 kHz.

Moreover, some of the counters can be used externally as well. The HP counter will count external signals to 1 GHz; the counter in the Singer 6201 can be used externally to 10 MHz to measure such things as modulation frequency.

Increased stability—approaching synthesizer stability—is another feature vaunted by many of the signal generators. Singer's 6201 and the HP 8640B feature frequency lock circuits that tie the output frequency to the crystal time base of the counter and provide stability of better than 1 ppm over 24 hours. If users require even better stability, both models can be locked to an external standard. Although Logimetrics, who introduced the frequency lock concept, does not offer such a feature on the Model 750, spokesmen say that they are "working on" a model that does. Spokesmen for Marconi, on the other

hand, claim their model 2012 does not need a frequency lock—its stability is good enough without one.

The generators are approaching the spectral purity of synthesizers, too. All the models listed below boast of low close-in noise—typically, 100-140 dB/Hz below the carrier at 10 KHz offset from the carrier. This is important for narrow-band receiver testing where a generator with low close-in noise is essential for adjacent channel selectivity tests.

For many applications, the most outstanding characteristics of the new generators—accuracy, stability, and spectral purity—will allow them to replace not only older signal generators, but frequency synthesizers as well. *Rest in peace, 608.* ■

Hewlett-Packard. Contact D. Abramson, 1501 Page Mill Rd., Palo Alto, CA 94304.

Logimetrics, Inc. Contact F. Sposato, 100 Forest Dr., Greenvale, NY 11548.

Marconi Instruments. Contact K. Elkins, 111 Cedar Lane, Englewood, NJ 07631.

Singer Co., Instrumentation Div., Palo Alto Operation. Contact W. Burton, 3176 Porter Dr., Palo Alto, CA 94304.

VHF-UHF SIGNAL GENERATORS

	Frequency Range	Read-out	Accuracy	RF Output into 50Ω	Frequency Lock	Modulation Capabilities	Simultaneous Modulation	Comments	Price	Reader Service Number
HP 608	10-450 MHz	N.L. dial	0.5%	0.1 μV - 1 V	No	int. AM, ext. AM, pulse	No.		\$1790	
HP 8640 A	.45-550 MHz (to 1100 MHz with ext. doubler)	Dial	0.5%	0.1 μV - 2 V	No.	int. AM, FM; ext. AM, FM pulse	AM/FM		\$3100	275
HP 8640 B	.45-550 MHz (1100 MHz with ext. doubler)	6 digit with 10X, 100X expand	±1 ppm	0.1 μV - 2 V	Yes	int. AM, FM; ext. AM, FM pulse	AM/FM	Stability 5 x 10 ⁻⁸ /hr	\$4450	276
Logimetric 750	9.5-520 MHz	5 digit	.05 - .001%	0.1 μV - 1 V	No	int. AM, FM; ext. AM, FM pulse	AM/FM FM/pulse	Continuously tunable over entire range—no band-switching. Accuracy of externally modulated FM not dependent on ext. level.	\$2785	277
Marconi 2008	10K-510 MHz	Dial (6 digit optional)	0.5%	0.1 μV - 0.1 V	No	AM, FM sweep	any comb. of int. AM & ext. FM + sweep	Both a sweeper and S-G — can perform dynamic tests.	\$5250 \$1425 for the readout	278
Marconi 2012	400 MHz to 550 MHz	Dial (linear)	1%	0.1 μV to 0.1 V	No	Strictly FM (int.)		For mobile radio—low noise (140 dB/Hz.) Stability 3 ppm/15 min.	\$3125	279
Singer 6201	7.75-512 MHz (1024 MHz with ext. doubler)	6 digit	.0005%	.01 μV - 2.2 V	Yes	int. AM, FM; ext. AM, FM pulse	AM/FM FM/pulse	Stability 1 x 10 ⁻⁶ /24 hr	\$4250 \$200 for ext. doubler	280



We have a
"complement"
for you!

SOLITRON'S NEW 5 AMP COMPLEMENTARY NPN/PNP PLASTIC POWER TRANSISTORS

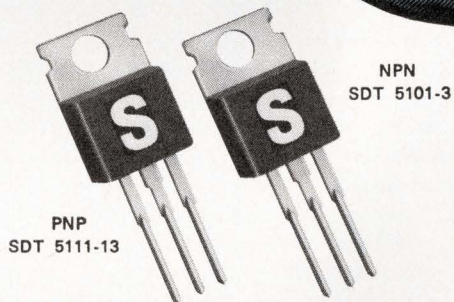

Our new series of 5 Amp Silicon NPN/PNP Plastic Power Transistors are manufactured by the triple diffused planar process, giving you these advantages: low leakage and fast switching times, with f_T typically 8 MHz. Other characteristics include typical gain of 100 @ 1.0 Amp and typical $V_{CE} (sat)$ @ 2.0 Amps of less than 0.5 Volts. They are constructed with tin plated leads to provide optimum solderability and permanent contact with a one piece collector. Intended for complementary use, these low cost devices are recommended for motor speed controls, inverters, series regulators and audio amplifiers. Available in a TO-220 package, the transistors are 80¢ per pair in 100 quantities.

TYPICAL GAIN SPECIFICATIONS

NPN Type Numbers	H_{FE} @ 1.0A, 4V	PNP Type Numbers
SDT 5101	35-70	SDT 5111
SDT 5102	60-120	SDT 5112
SDT 5103	100-300	SDT 5113

Write today for our spec sheets and application information.



1177 BLUE HERON BLVD. / RIVIERA BEACH, FLORIDA / (305) 848-4311
TWX: (510) 952-7610

SAN DIEGO, CALIF.
8808 Balboa Ave.
CMOS, PMOS Circuits
Diodes, Rectifiers, &
Zeners
FET & Dual FET
Transistors
High Voltage Assemblies
Linear & Monolithic IC's

RIVIERA BEACH, FLA.
1177 Blue Heron Blvd.
Hi-Rel Power Transistors
SI & Ge. Power
Transistors
Hi-Rel Power Hybrids
PNP-NPN Industrial
Transistors

PORT SALERNO, FLA.
Cove Road
Microwave Connectors
Plaxial (R) Cable
Precision RF Coaxial
Connectors

JUPITER, FLA.
1440 W. Indiantown Rd.
Microwave Stripline
Components
Microwave Diodes
RF and Microwave
Transistors
Hi-Rel Power
Transistors

TAPPAN, N.Y.
256 Oak Tree Road
Diodes & Rectifiers
Ferrite & Ferrite Devices
High Voltage Assemblies
Power Rectifiers
Thick Film
Hybrid Circuits

KENT, ENGLAND
Tubbs Hill House
London Road,
Sevenoaks
Solidev, Ltd.
Full line of
Solitron devices

BEN BARAQ, ISRAEL
51 Hayarkon Street
AEL Israel, Ltd.
Full line of
Solitron devices

TOKYO 105, JAPAN
Rm. No. 21,
Kyodo Bldg.
No. 4-10, 2 Chome
Higashi Shinbashi
Minato-ku
Full line of
Solitron devices

NEW EL-MENCO Transmitting Dipped Micas take only 1/6 the space, yet cost less than conventional types.

NEW in the industry—El-Menco TDM43 Transmitting Dipped Mica Capacitors are unequalled in small size and low cost for their ratings. Compared to conventional types with similar characteristics, they require only one-sixth as much space... save you 83% of the volume previously required. The superior coating transmits heat more efficiently, so you can use a smaller size for a given rating.

Specify these high-quality TDM43 Capacitors wherever better performance and long, reliable life are critically important... and where space and weight are at a premium. For medium power, moderate-to-high voltage service, TDM43's can be used in tuned amplifier tank circuits, for DC blocking in high frequency amplifiers, in high frequency filter networks needing high Q and RF current capabilities, and in timing circuits requiring a high degree of stability.

Check the table below for representative values among the many standard TDM43 units available... or call or write Electro Motive if you have a special application or one in which pulse conditions are present. Technical literature available on request.



Typical TDM43 Capacitor, actual size

Ideal for high frequency circuits, in military, communication, and industrial portable and airborne equipment... equivalent to RTM 63 in EIA spec. TR-109.

Typical Values Available—TDM43 Transmitting Dipped Mica Capacitors

Capacitance Value in pF	60 Hz Peak W.V.	Characteristic	Rated Current in amps. at Freq. of				Max. Dimens. in Inches		
			3.0 MHz	1.0 MHz	0.3 MHz	0.1 MHz	L	W	T
47	1500	C	0.50	0.10	0.07	0.03	2.010	.850	.220
1200		F	4.90	3.80	1.20	0.42	2.010	.850	.230
2700		F	5.90	5.80	2.20	0.90	2.010	.850	.230
3300	1000	F	6.10	6.20	2.60	1.10	2.010	.850	.230
5600		F	6.50	7.30	4.10	1.80	2.010	.850	.240
9100		F	6.80	8.10	5.50	2.40	2.020	.860	.260
10,000	750	F	6.90	8.40	6.40	2.70	2.020	.860	.260
15,000		F	7.00	8.90	7.80	3.30	2.030	.870	.280
20,000		F	7.10	9.20	8.30	3.50	2.040	.880	.310
22,000	500	F	7.20	9.40	8.80	3.70	2.030	.870	.300
30,000		F	7.20	9.60	9.30	3.90	2.040	.880	.320
36,000		F	7.30	9.80	9.70	4.10	2.040	.890	.340
39,000	250	F	7.30	9.90	10.0	4.20	2.050	.890	.350
68,000		F	7.40	10.3	10.9	4.50	2.050	.900	.370
100,000		F	7.40	10.5	11.5	4.70	2.070	.910	.440



The Electro Motive Mfg. Co., Inc.

WILLIMANTIC, CONNECTICUT 06226

Dipped Mica • Molded Mica • Silvered Mica Films • Mica Trimmers & Padders
Mylar-Paper Dipped • Paper Dipped • Mylar Dipped • Tubular Paper

West Coast Manufacturers contact:

COLLINS & HYDE CO., 900 N. San Antonio Rd., Los Altos, California 94022
5380 Whittier Blvd., Los Angeles, California 90022

ALSO SOLD NATIONALLY THROUGH ARCO ELECTRONIC DISTRIBUTORS

SYSTEM PRODUCTS

MECL LOGIC TRANSLATORS

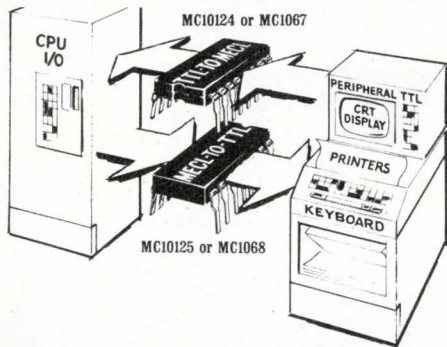

Four TTL/MECL translators convert between the differing logic voltage and current levels. Each handles 4 circuits per package and can be used as inverting/noninverting translators. Propagation delays are typically 5 ns. Power supplies are +5 V and -5.2 V. The MC1067 is similar to the MC1024 and can be used as a differential line driver for feeding twisted-pair cable. The MC1068 offers the quad NOR function rather than the quad line receiver function used in the MC1025. The 1000 Series is rated for the commercial temp. range and the 1200 Series for the military. 100 quantity prices for the 16-pin DIP off-the-shelf units are:

MC1024	TTL to MECL 10,000	\$4.50
MC1025	MECL 10,000 to TTL	4.50
MC1067/1267	TTL to MECL II	4.33/5.42
MC1068/1268	MECL II to TTL	4.33/5.42

Technical Information Ctr., Motorola, Semiconductor Products Div., Box 20924, Phoenix, Ariz. 85036.

Circle Reader Service #240

OFF-LINE DATA LOGGER

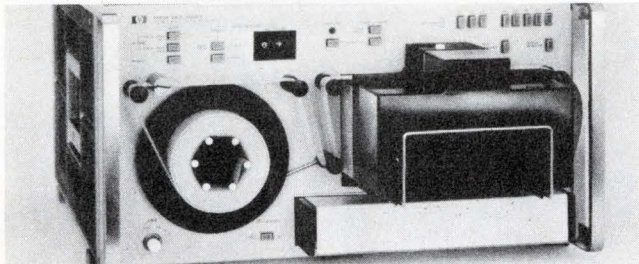

This data tape punch connects to instruments having TTL level, BCD coded outputs. Punched tape data later feeds directly into almost any computer, calculator, or Telex system. Unattended sampling rate is controlled by the built-in timer in intervals from 1-99 s or min. It accepts up to 8 BCD digits of data plus a BCD digit for range, a BCD digit for function, and 1 bit for polarity overload. Speed is 70 cps. Model 3489A, \$3,000; optional bypass card \$170; time input card \$220; stock. Hewlett-Packard, 1601 Calif., Palo Alto, Calif.

Circle Reader Service #241

PROCESS ANALOG SIGNALS

This 7-in. high rack mounted cabinet provides individual amplifiers and filters for up to 64 channels. It also contains a high level multiplexer, gain programmable amplifier, high speed ADC with sample and hold, and DTL/TTL compatible logic. Plug-ins can expand to 256 channels, or 2,048 in a different configuration. Typical 256-channel System 620 is \$37,500 (\$145/channel). Neff Instrument Corp., 1088 E. Hamilton Rd., Duarte, Ca. 91010.

Circle Reader Service #242

THE ELECTRONIC ENGINEER • Oct. 1972

The advertisement for BUSSCO Engineering Inc. features several images of different bussing technologies. At the top left is a 'FINGER BUSS' assembly. To its right is a 'STRIP BUSS' assembly. Below these are 'CLIP-ON BUSS' and 'MULTILAYER LAMINATED BUSS BAR' components. A patent notice 'U.S. Pat. #3,582,864' is visible. The text reads: 'BUSSCO GETS IT ALL TOGETHER... For less. Circuit board busses replace multi layer boards. Clip-on buss eliminates soldering and wrapping. Noisy, bulky wire harnesses are replaced by laminated buss bars. Call Bussco today.' At the bottom, it lists 'BUSSCO ENGINEERING INC. 119 Standard St. • El Segundo, Ca. 90245 • (213) 322-6580 • TWX: 910-348-6295' and 'Circle Reader Service #38'.

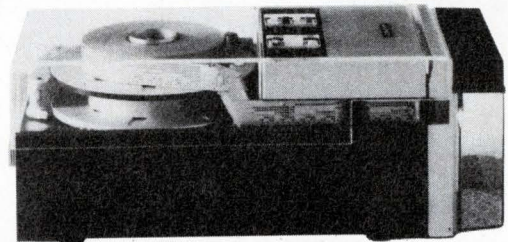

OUR PUNCH FEATURES OUTNUMBER YOUR PROBLEMS

- 75 cps
- 5-8 track standard, 6 track TTS optional
- Automatic tape monitoring system
- Back spacing for accuracy control
- Includes control and drive electronics
- Modular construction
- Powered, wired and space provided for extra PC board
- Built in tape supply and take-up spools
- No routine lubrication necessary
- Very quiet—54 db.
- Lightweight
- Low power consumption
- Immediate delivery from stock

Facit Odhner Inc.
501 Winsor Drive
Secaucus, N.J.

Gentlemen:
I am interested in receiving detailed data on your Tape Punch

Name _____ Title _____
Phone _____
Company _____
Address _____
City _____ State _____ Zip _____



Circle Reader Service #39

Low-cost limit control for OEM's.

With a circuit breaker.

With a circuit breaker?

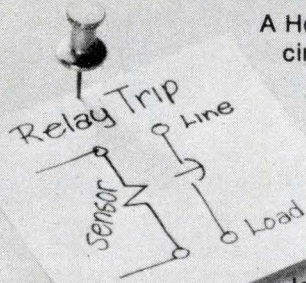

A Heinemann relay-trip circuit breaker.

With this one economical device, you can take a signal from any low-voltage sensor and, at a preselected

level, switch off a massive current load.

As much as 100 amp, to be precise.

There is no end to the uses you can find for this simple little control device. It will work with pressure sensors, voltmeters, ammeters, tachometers, pH sensors, what have you.

For alarm or other purposes, we can include auxiliary switch contacts right inside the breaker. When the circuit

changes state, you can turn on a light, ring a bell, or start another operation.

If you want the security of precision fault protection, as well as the relay-trip action, get our Dual-Control breaker (JA or AM Series). It monitors the critical analog signal, or signals, basic

to the operation, and keeps tabs on the electrical integrity of your equipment at the same time.

Whichever design you choose, you can

get a lot of functional

value for the price of a circuit breaker.

Like to find out more? Send for our Engineering Guide, and we'll include a copy of Bulletin 3352 on Dual-Control breakers. Free, of course. Heinemann Electric Company, 2806 Brunswick Pike, Trenton, N.J. 08602. Or Heinemann Electric (Europe) GmbH, 4 Düsseldorf, Jägerhofstrasse 29, Germany.

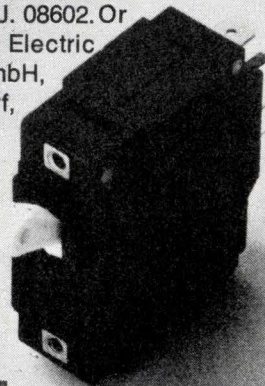
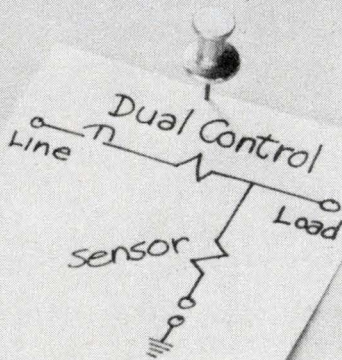
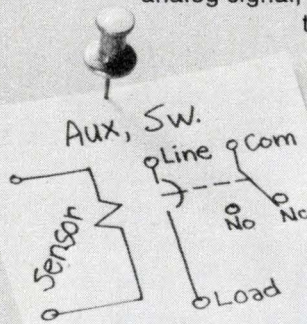

HEINEMANN

5066

HIGH SPEED 741 OP AMP

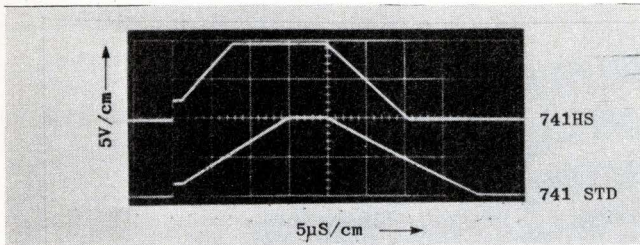

This high-speed version, the 741HS, boasts a 4 to 1 improvement in the standard 741 slew rate, plus improved input offset (I_{OS}) and input bias (I_b) currents.

Device	Temp. range	Slew rate	I_{OS}	I_b
741HS	-55 to 125°C	0.7 V/ μ s	20 nA	0.1 μ A
Std 741	-55 to 125°C	0.2 V/ μ s	300 nA	1.5 μ A
741HS	0 to 70°C	0.7 V/ μ s	70 nA	0.3 μ A
Std 741	0 to 70°C	0.2 V/ μ s	500 nA	0.8 μ A

Price for the Mil-temp version in either a ceramic DIP or TO-5 can is \$3.95 (100-piece quantities). The 100-piece price for the commercial-temp version, packaged in a plastic 8-pin MINIDIP or TO-5 can, is \$0.95. Intersil Inc., 10900 N. Tantau Ave., Cupertino, Calif. 95014.

Circle Reader Service #243

HI-FI STEREO DUAL PREAMP

The total equivalent noise input of the LM381 is 0.45 μ V. Each of its two amplifiers is independent and an internal power supply decoupler/regulator provides 120 dB power supply rejection and 60 dB channel separation. Gain is 112 dB, output swing equals V_{CC} -2 V peak-to-peak, and power bandwidth is 75 kHz. The LM382 is similar but has a built-in resistor network for NAB and RIAA equalization. Gain and equalization are selected by external pins. Both operate from single 9- to 40-V dc supplies, have short circuit protection, and come in 14-pin DIP. LM381A, \$4.95 each in 100 qty.; LM382 is \$2.25; stock. National Semiconductor, 2900 Semiconductor Dr. Santa Clara, Ca. 95051.

Circle Reader Service #244

1/8-IN. DIAMETER LED

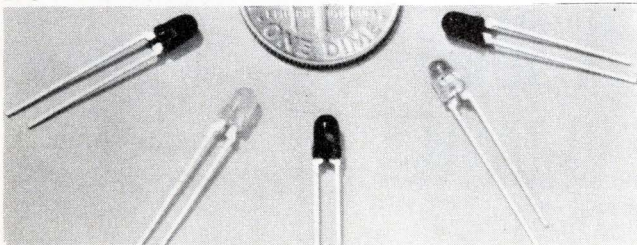

These LEDs conform to the Class T-1 bulb outline. Leads mount to 0.045-in. holes on 0.1-in. centers on PC boards, making them suitable for large scale X-Y addressable arrays. Typical light output is 0.8 mcd. Three lenses are available: red diffused for good on/off contrast; white diffused for masking the red color when the lamp is off; and clear to provide a point source for external lenses, annunciators or photodetectors. Model 5082-4480; 45¢ in 1,000 stock. Hewlett-Packard, 1501 Page Mill Rd., Palo Alto, Calif. 94304.

Circle Reader Service #245

Bevco Offers New Low Cost Upholstered Posture Chair for factory use



Increase production with comfortable, contoured formed plywood seat and back chairs, foam padding as shown, optional. Back floats on springs, adjusts to users back. Heavy Gauge steel frame and sturdy tubular base in scratch resistant baked enamel or chrome.

- Instant 8" center-post seat height adjustment.
- Back adjusts with easy grip locking knob.
- Swivel optional with exclusive torsion control.
- High base models available with footings.
- Foam cushioned seat and back pads optional.

BEVCO Precision Mfg. Co. Write or telephone for literature
831 Chicago Ave., Evanston, Ill. Davis 8-4254

Circle Reader Service #46

PERIPHERAL PERFORMANCE IMPROVERS...

Low-Inertia DC Motors from MCD!

Designed solely for the EDP market, by Control Data®'s own "inside peripheral component experts," our units all offer performance-proved, low-inertia advantages: high resonant frequency, high acceleration, high heat dissipation, and **lower** operating cost!—for the life of your products!

These MCD "Improvers" can be supplied with a performance package option, too: Motor, Capstan, Vacuum Manifold and Tachometer—ready to go—and **keep going** for the goingest peripherals in the field!

DETAILED DATA and performance brochures can be on their way to you fast—Write Now!

MAGNETIC COMPONENTS DIVISION **CONTROL DATA CORPORATION**

7801 Computer Ave. So., Minneapolis, Minn. 55435
(612) 920-8600 TWX 910-576-2978

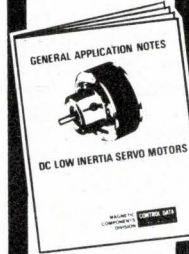
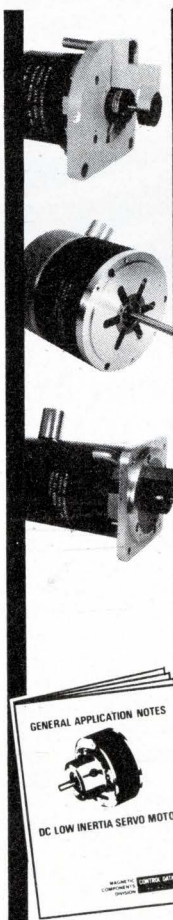

Circle Reader Service #47

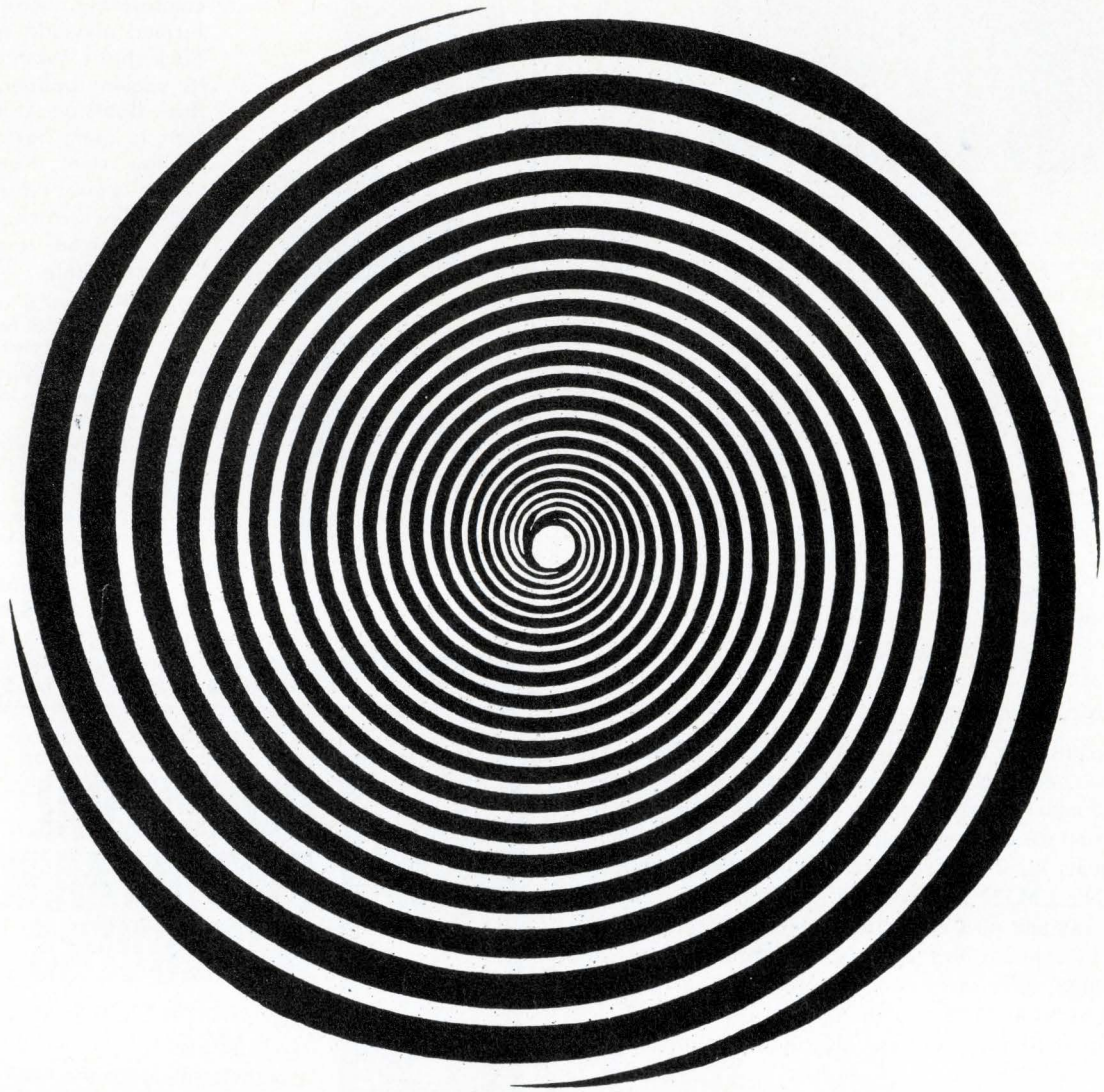

You CAN MASTER THE MEMORIES TECHNOLOGY with this 7-PART COURSE

It took almost one year for the editors of *The Electronic Engineer* to research and compile the most comprehensive memory course available. Seven chapters guide you through this complex field, from delay lines to magnetic bubbles, with schematics and applications all along the way.

Thirty-six top engineering specialists from every phase of memories contributed their expertise. Intertechnological ballyhoo has been stripped away to reveal each aspect on its merits and show where it properly fits. The course covers:

fundamentals . . . memory types . . . magnetic mainframes . . . non-magnetic mainframes . . . bulk storage . . . systems applications . . . future memories .

This Course on Memories costs only \$5.00 postpaid and includes an examination. Those who wish to take the examination will receive a *Certificate of Completion* free of charge. Send the coupon and your check or money order to: Course Editor, The Electronic Engineer, One Decker Square, Bala Cynwyd, Pa. 19004. Department E-9

SUBSYSTEM PRODUCTS

TTL BUS BUFFER GATES

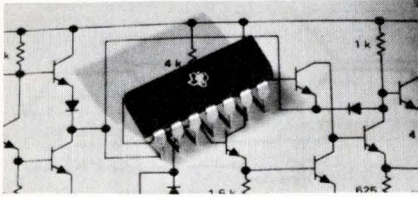

The SN54/74125 and the SN54/74126 are improved versions of two TTL quad bus buffer gates currently on the market. The circuits feature reduced propagation delays and improved output disable times. The average propagation delay time has been reduced 2 ns. Switching speed between disable and enable has been improved 4 ns. This improvement reduces the possibility of two or more outputs overlapping when they are in the low-impedance (on) state. Texas Instruments Inc., Inquiry Answering Service, Box 5012, M/S 308, Dallas, Tex. 75222.

Circle Reader Service #246

CIRCUIT-DECK SWITCHES

Decade, and ratio attenuators combine switching and circuit components on a single monolithic structure. Adding a switch detent provides complete circuit switching. Model 1391-41 decade attenuator provides 4-decade precision ratio division from 1 to 0.0001. Input resistance is 1 MΩ; output constant at 90 kΩ. Model 1391-42 ratio attenuator extends over 3½ decades from 1.0 to 0.0002 in steps of 5, 2, and 1. 25-99 quantities are -41, \$10.80; -42, \$12.60; stock. Helipot Div., Beckman, Box 11866, Santa Ana, Ca. 92711.

Circle Reader Service #247

PROTOTYPING KIT

This kit contains 75 components for prototyping or lab work with semiconductors. Twenty assorted items include heat exchangers, mounting hardware, an IC component carrier, and sockets. Transistor sockets include universal low power units plus TO-33 and TO-66 sockets. The IC sockets are TO-5, 10- and 12-lead types, plus 14- and 16-pin DIPs. Compartments of the 24-drawer cabinet are labeled for identification and reordering. \$63.11 value; \$44 for limited time. International Rectifier, Semiconductor Div., 233 Kansas St., El Segundo, Ca. 90245, or distributors.

Circle Reader Service #248

NEW AUTORANGING DIGITAL MULTIMETER... IN-PROBE DISPLAY, HIGH-SPEED READOUT, BATTERY OPERATION...

\$325.



For AC or DC voltage, resistance and even current, our Model 167 with unique in-probe readout lets you make time-saving measurements directly at the point of measurement. With up to 3-month battery life. The Model 167's combination probe/readout, with 3½ digit LED display, automatically indicates decimal point, polarity, range and function. Front panel terminals and probe receptacle allow alternative use as a bench instrument. The neat, sweet-to-hold 167 Auto-Probe DMM is only \$325 (less in quantity). Check it out and get our latest "How Sweet" button.

Measures easily ... 1 mV to 1000 VDC
• 1 mV to 500 VAC RMS • 1 ohm to 20 megohms
with the convenience of ... 55 megohms input resistance • 2-sec. reading time to rated accuracy • 1200 volts overload protection • Complete choice of accessories.



KEITHLEY INSTRUMENTS
U.S.A.: 28775 AURORA ROAD, CLEVELAND, OHIO 44139
EUROPE: 14, AVENUE VILLARDIN, 1009 PULLY, SUISSE

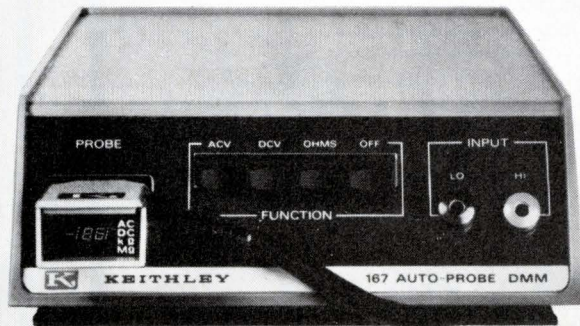

The Model 167... another how-sweet-it-is Keithley Multimeter
Buy now using BankAmericard or Master Charge

100- AND 200-MHz SCOPES

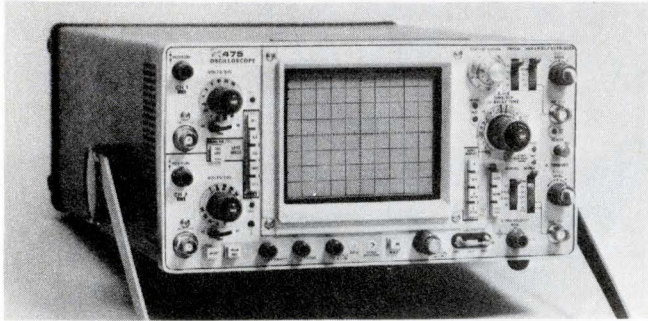

Two new, small (25 lb.) portable oscilloscopes, the 465 and 475 claim significant price/performance breakthroughs. The Model 475 offers 200 MHz at 2 mV/cm, while the 465 has 100-MHz bandwidth at 5 mV/div. The scopes achieve full bandwidth at their highest sensitivity settings. The 465 and 475 contain a 8-cm-by-10-cm display with rise time graticule, the largest CRT display area available in general purpose portable oscilloscopes. The 475's sweep speed at 1 ns with X10 mag. claims the fastest sweep available in any portable oscilloscope. Convenience features include Trig View, operation function pushbuttons, probe ground reference button, battery operation and others. Model 465, \$1725; 475, \$2500. 60 day availability. Tektronix, Inc., Box 500, Beaverton, Ore. 97005.

Circle Reader Service #250

LOW-COST 4½-DIGIT MULTIMETER

A full 4½-digit portable multimeter will be announced shortly. This compact, 21-range DMM, scheduled for first delivery Jan. 1973, will cost \$295. For more information on Model 425, contact Data Precision Co., Audubon Rd., Wakefield, Mass. 01880.

Circle Reader Service #251

26 3½-DIGIT RANGES FOR \$299

The Fluke 8000A measures ac and dc voltages from 100 μ V to 1200 V, ac and dc currents from 100 nA to 2 A, and resistance from 100 m Ω to 20 M Ω . The basic accuracy is 0.1%, and the unit is guaranteed to meet specs for one year. Said to be the first instrument to use both analog and digital LSI, the number of parts is cut by about two-thirds (see "Monolithics shrink DVM Prices," *The Electronic Engineer*, June 1972). It will withstand a fall from bench height without damage. A self-zeroing A/D converter eliminates offset uncertainty. Options include rechargeable battery pack, \$50; BCD data output, \$75; rf probe, \$75; 200-A ac current probe, \$50; HV probe, \$25; and carrying case, \$15. The 8000A offered on a 15-day, "no obligation" trial basis from stock at 50 U.S. locations. Fluke, Box 7428, Seattle, Wash. 98133.

Circle Reader Service #252

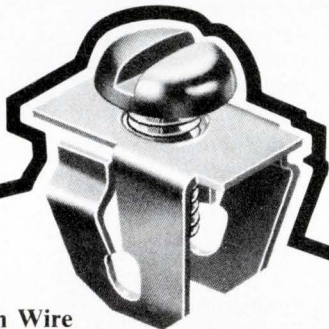

Snap-in!

Fastex® Snap-in Wire Terminal Clips

Speed wire hookups, save on labor and cut production costs. All you do is snap-in this Fastex terminal and attach the inside and outside leads. Simple, easy, fast.

Fastex has a wide variety of styles and sizes to fit your application. The terminal comes pre-assembled with a captive screw. Also available preassembled in terminal boards. Circle that bingo card now for . . .

Free Samples and Literature

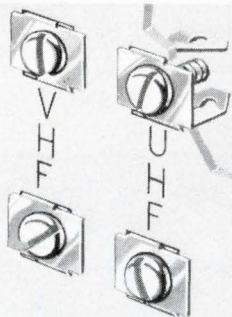

it FASTEX
DIVISION ILLINOIS TOOL WORKS INC.
195 ALGONQUIN ROAD • DES PLAINES, ILLINOIS 60016

Copyright Illinois Tool Works Inc. 1972

Circle Reader Service #50

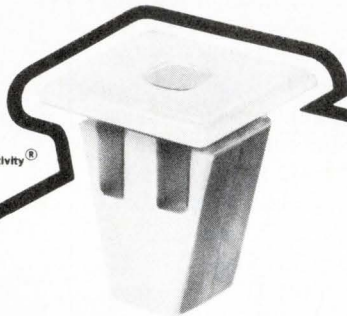
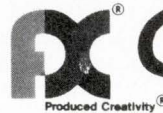

Hole in One!

Fastex® Enclosed Screw Grommet

When is a hole not a hole—when it's in a Fastex enclosed screw grommet. Completely encloses screw point—eliminates abrasion of wires, insulation or probing hands. They snap firmly in place and stay there—then positively lock when screw is driven. Circle that bingo card now for . . .

Free Samples and Literature.

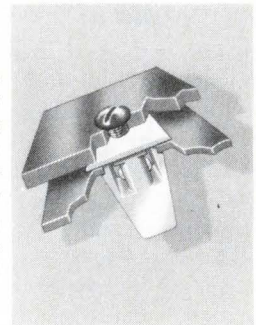

it FASTEX
DIVISION ILLINOIS TOOL WORKS INC.
195 ALGONQUIN ROAD • DES PLAINES, ILLINOIS 60016

Patent Pending
Copyright Illinois Tool Works Inc. 1972

Circle Reader Service #51

THE ELECTRONIC ENGINEER • Oct. 1972

NETWORK ANALYZER SYSTEM

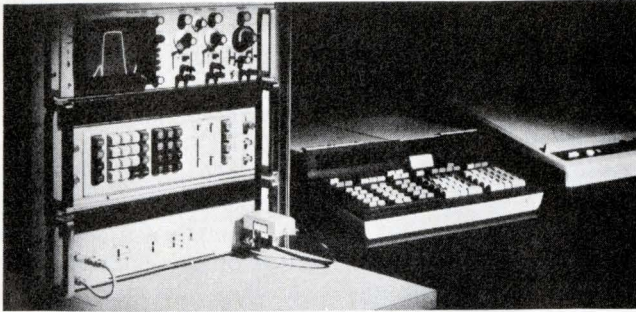

By adding programmable calculator control to a 50Hz-to-13-MHz network analyzer system, the cost of automatic data analysis is claimed to be lowered to a fraction of the price of a computer-based system. The Model 3042A automatic network analyzer consists of an HP Model 3330B automatic synthesizer as a source, a model 3570A tracking detector and a model 9820A desktop calculator. Amplitude level is measured over a 120-dB range. The dynamic display range is 100 dB and amplitude is measured to a resolution of 0.01 dB. Model 3042A, \$22,900. 90-day delivery. Inquiries Manager, Hewlett-Packard Co., 1501 Page Mill Rd., Palo Alto, Calif. 94304.

Circle Reader Service #253

MEASURE MICROWAVES AUTOMATICALLY

Frequencies from 20 Hz to 18 GHz are displayed on an 11-digit display to 1 Hz resolution in 1 s. The center frequency can be read directly with up to 130 MHz of peak-to-peak modulation. The display is sectionalized into GHz, MHz, and Hz, with blanking available. Options include higher stability reference oscillators and complete system interfaces. Model 350C (20 Hz - 12.4 GHz), \$4,250; 351C (20 Hz - 18.0 GHz); \$4,850. 3-4 weeks ARO. EIP Inc., 3130 Alfred, Santa Clara, Calif. 95050.

Circle Reader Service #254

LOW-COST PULSE GENERATOR

This compact pulse generator offers repetition rates from <2 Hz to > 20 MHz in seven overlapping ranges. Other features are a 5-ns rise/fall time, pulsewidth from <20 ms to > 200 ms in seven overlapping ranges, and variable amplitude from <1 V to > 5 V into 50 Ω . The baseline is fixed at 0 ± 0.25 V. Sink current is 40 mA. \$285. Stock delivery. Systron-Donner Corp., Datapulse Div., 10150 W. Jefferson Blvd., Culver City, Calif. 90230.

Circle Reader Service #255

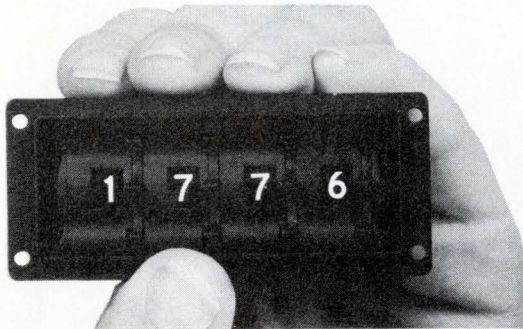

The infinity switch

Series-1776 EECoS WITCHES are rotary thumbwheel switches available in a near-infinite variety of configurations.

Features include:

- 38 standard codes
- 8, 10, and 12 positions
- component mounting provisions
- double-width message switches
- lighting
- black, grey or white colors
- field-adjustable stops
- mother-board compatible terminals
- four standard mother boards
- up to 4 poles per switch
- EECo's exclusive 2-year warranty

And — with prices as low as \$3.00 for single units — the application possibilities are infinite too!

Free For a sample of our Series-1776 switch, and 12-page brochure, check reader service number.

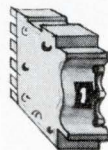

Electronic Products Division
Electronic Engineering Company of California
 1441 East Chestnut Avenue, Santa Ana, California 92701
 Telephone: (714) 547-5651

Dist. by: G.S. Marshall — Hall-Mark — Schweber

Circle Reader Service #52

What do you want in a push button switch?

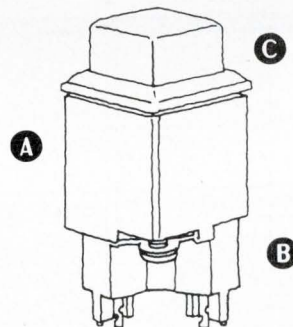

- A Actuation**—Momentary, alternate or snap action.
- B Circuitry**—From single pole, single throw to double pole, double throw; SPDT (2 circuit); make-before-break or break-before-make.
- C Styling**—Square, round, bezel, colors, lighted.

Just a few of the options possible in a wide range of push button switches available from Grayhill. If what you need isn't among them we can design one that is.

For our latest Engineering Catalog write or phone:
 Grayhill, Inc., 543 Hillgrove Ave.,
 La Grange, Illinois 60525
 (312) 354-1040



Circle Reader Service #53

Self-contained, 400 Channel/Second mv Data Logger with Autorange

\$73/Channel*

Hook-up transducers and power-up the new self-contained VIDAR 6403 High Speed, Low-Level Data Logger; you'll get 400 channels/second of extremely accurate data recorded on incremental magnetic tape . . . at \$73/channel! Included is VIDAR's unique AUTORANGE feature which provides automatic switching of gain ranges as varying input levels are sampled; it's accomplished by internal system logic — no computer is necessary!

The data logger requires no customer interface or software and is easy to operate. The heart of the system is the VIDAR 600 MUX/ADC — a 20,000 channel/second multiplexer and 12-bit ADC with 25 microsecond conversion time, plus two or three-pole filtering per channel which results in excellent noise rejection. Ten full scale ranges varying from eight volts to 15 millivolts may be operator-selected or may be designated by AUTORANGE.

Other VIDAR 6403 system features include selection of first and last channels to be recorded, and single or continuous scanning. LED visual display provides

the operator with a base to derive octal or binary data from last channel read.

Computer front-ends The VIDAR 600 MUX/ADC, core of the VIDAR 6403 Data Logger, can function as a computer front-end. It can digitize up to 1024 inputs at 20,000 channels/second, or at 12,000 channels/second with AUTORANGE. Output can be in a serial or parallel binary stream making interfacing to any computer an uncomplicated procedure.

Investigate how the VIDAR 6403, Low-Level Data Logger and VIDAR 600 MUX/ADC can economize and improve the performance of your high speed data acquisition and how VIDAR's vast systems capability relates to total data handling for you. Circle the reader

service number for details or write Dick Kennedy, product manager, 77 Ortega Avenue, Mountain View, Calif. 94040 (415) 961-1000.

Offices in: Atlanta (404) 458-0993 • Boston (617) 922-7192 • Chicago (312) 539-4838 • Cleveland (216) 267-0445 • Denver (303) 986-1000 • Los Angeles (805) 498-6017 • New York (201) 647-5888 • San Francisco (415) 327-9270 • Washington, D. C. (703) 534-6241.



VIDAR
A Member of Continental Telephone System

Circle Reader Service #59

*Based on 1024 channel system

LITERATURE

Monsanto's GaAsLite Catalog

Monsanto, a top manufacturer of light emitting devices as well as a top supplier of basic materials to the LED industry, now offers a top-notch catalog to our readers. The Mid-72 GaAsLite Directory offers 128 pages of technical data and illustrations for LED displays, discretes, and opto-isolator products.

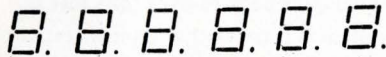

Electro-optical characteristics and absolute maximum ratings are clearly outlined in chart form. And you'll find decoder/driver diagrams, package dimension drawings, truth tables, schematics, and applications information. Monsanto Commercial Products Co., 10131 Bubb Rd., Cupertino, Calif. 95014.

Circle Reader Service #386

Automated wiring data preparation

Here's a handy 28-page booklet that explains the steps in preparing input data for computer-aided wiring of DIP sockets and panels. Discussing three optional computer-entry points, the booklet covers logic diagram, pin list, to-to punched card entries and when to use each. It also explains final documentation and lists the entry plans available from EECO. Electronic Engineering Co. of Calif., 1441 E. Chestnut Ave., Santa Ana, Calif. 92701.

Circle Reader Service #387

How to speak data

Ok, you know your Hertz from a hole in the ground. But what about bit, baud, noise weighting, and other data communications "buzz words"? Let Sherry Moreau, ICC's show girl (you've probably seen her at SJCC and other shows) guide you through this 20-page glossary of indispensable data comm words and phrases. If you've seen Sherry, whose delivery resembles a sexy Phyllis Diller, you know she specializes in a sort of triple entendre on data, exploring such terms as phase jitter, throughput, and response time for every laugh. International Communications Corp., 7620 NW 36th Ave., Miami, Fla. 33147.

Circle Reader Service #388

Precision switch application

Micro Switch offers what is believed to be the first book on the application of precision switches. Compiled from a series of articles and technical bulletins, the 145-page guide discusses the history of the precision switch, electrical and mechanical characteristics, switch resistance, switch life, and applying switches in hostile environments. The technical information is supplemented with photos, charts, graphs, diagrams, and a glossary of switch terms. For your copy, write on company letterhead to Mr. Ronald Beam, Micro Switch, Div. of Honeywell Inc., 11 W. Spring St., Freeport, Ill. 61032.

Minicomputer interface

With RTP (Real-Time Peripheral family of analog/digital interface equipment), interfacing a minicomputer to your process is no longer a custom engineering problem. This booklet explains the company's concept of standard-type, plug-compatible process I/O interface and equipment, and provides technical data and prices for the products comprising this analog/digital line. Computer Products Inc., 1400 NW 70th St., Fort Lauderdale, Fla. 33307.

Circle Reader Service #389

IC multiplier applications

The operation and application of precision IC 4-quadrant multipliers is the subject of this 6-page application note. The note explains analog trans-conductance multiplication and provides a comprehensive circuit description of In-

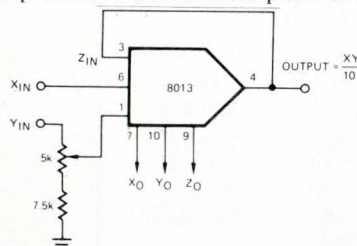

tersil's 8013. Illustrated also is the use of the 8013 in multiplication, division, squaring and square-root applications, and the 8013 as a variable-gain amplifier. Intersil Inc., 10900 N. Tantau Ave., Cupertino, Calif. 95014.

Circle Reader Service #390

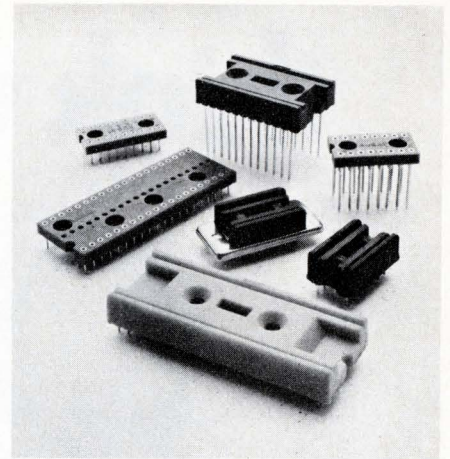

If you've got the circuit, we've got the socket.

We ought to.

After all, Augat conceived and pioneered the socket panel for dual-in-line IC's. So why wouldn't we make other sockets for printed circuit boards as well?

We do. Low profile types, ultra-low profile types, MSI and LSI types, even LED sockets. More important, Augat design and quality standards provide for longer life, better retention and greater reliability.

There's more to Augat than sockets. As the leader in electronic interconnection, we also offer a broad selection of accessories. For quick information on price and delivery, call us at (617) 222-2202. Or write for our catalog. Augat Inc., 33 Perry Ave., Attleboro, Mass. 02703. Our representation and distribution is nationwide and international.

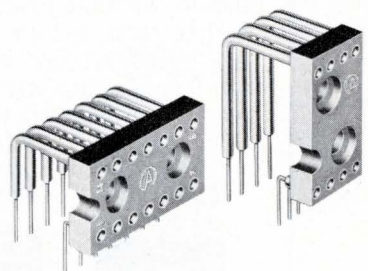

Plug into Augat®

See our new packaging developments at the NEPCON EAST Show, New York, Booths 4521-4523.

Circle Reader Service #70

think woven

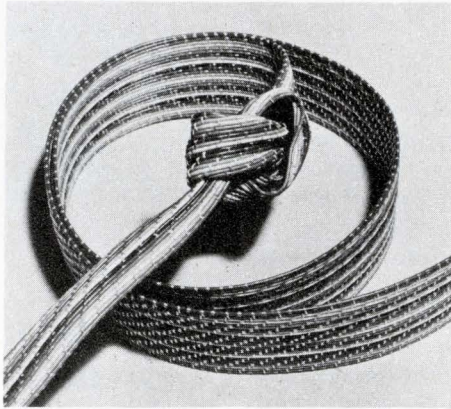

for flexibility

It rolls, bends and folds for turns, tight spots and small spaces, without lead damage or signal distortion. Woven goes from "Point A" to "Point B" like no other cable can!

WOVEN ELECTRONICS

A DIVISION OF SOUTHERN WEAVING COMPANY

P.O. Box 189, Mauldin, S.C. 29662, (803) 288-4411

Circle Reader Service #55

MINI HEATERS

Hotwatt® Miniature Stainless Steel Sheathed Cartridge Heaters for special applications where space is at a premium and heat requirements are high.

Hotwatt Miniature Heaters deliver up to 1250°F. max. surface temp. and are available in these sizes: 1/8", 3/16" round; 1/8", 3/16" square; and 1/8" x 3/8" rectangular. They are manufactured in lengths of 1" — 12" and longer, in all diameters, which makes them readily adaptable to a wide variety of special requirements. Send for the MINI/MAXI Catalog today.

**FREE
CATALOG**
All the facts.



HOTWATT

HOTWATT, INC., 128 MAPLE STREET
DANVERS, MASSACHUSETTS 01923

Circle Reader Service #56

LITERATURE

Data modems

This folder is packed with technical data sheets on data modems and test equipment for modems and communications lines. You'll find diagrams of typical connections of modems to direct

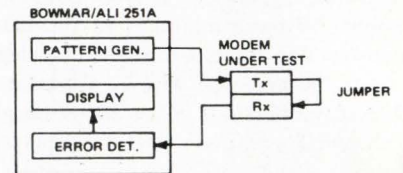

Full duplex back-to-back (one test set)

distance dial networks, typical test connections in use, circuit and block diagrams, as well as data on operation, spec summaries, applications, and more. Bowmar/ALI Inc., 531 Main St., Acton, Mass. 01720.

Circle Reader Service #391

Power semiconductor catalog

Westinghouse's 1972 semiconductor condensed catalog covers rectifiers, thyristors (SCRs), transistors, and prewired heat sink assemblies. Its simple format refers you to individual product line selector guides for more complete information on specific devices. You'll also find dimensional drawings for standard packages. Westinghouse Electric Corp., Semiconductor Div., Youngwood, Pa.

Circle Reader Service #392

Mainframe core memory

ARM-22 memory doubles your computer power, taking your System/360 Model 22 beyond the IBM 32k-byte limit to 64k bytes. This brochure gives you the details, discussing plug compatibility, capacities, and cost. Ampex Corp., Marketing Communications, 13031 W. Jefferson Blvd., Marina del Rey, Calif. 90291.

Circle Reader Service #393

New EIA/JEDEC standard

Copies of "Measurement of small values of transistor capacitance" are now available from the EIA. The new standard treats a three-terminal procedure for capacitance measurement with precautions for shielding of extraneous effects due to terminal leads and metal enclosures. Copies are available for \$3.30 each from the Electronic Industries Assoc., Standards Orders, 2001 Eye St. NW, Washington, D.C. 20006.

LED digital readouts

Here's a booklet describing the new Novalite™ series of LED and incandescent digital and alphanumeric readout display packages. The Nova 3, for example, features plug-in high luminance 7-segment LED displays, plug-in decoder/drivers, mono digit construction, and prewired DTL/TTL compatible interface. All seven models are described and illustrated, with suggested mounting dimensions, photos, and truth table provided. Precision Dynamics Corp., 3031 Thornton Ave., Burbank, Calif. 91504.

Circle Reader Service #394

The three faces of metal finishing

A capabilities brochure, here you'll read about common metal electroplating, metal surface preparation, and precious metal electroplating. Sel-Rex, for example, services applications in communications, computers, aerospace, and instrumentation, working with connectors, computers, printed circuits, ICs, transistors, and other devices in which precious metals enhance reliability. You might call Parker if you're interested in protective coatings, or Udy-lite for electrodeposition of metals on basic materials. They're all a part of Oxy Metal Finishing Corp., 21441 Hoover Rd., Warren, Mich. 48089.

Circle Reader Service #395

Versawatt power transistors

Described in this 12-page catalog are RCA's Versawatt power transistors used in automotive, consumer, industrial, and computer applications. There's a discussion of design (pellet structure, header, lead construction and pattern

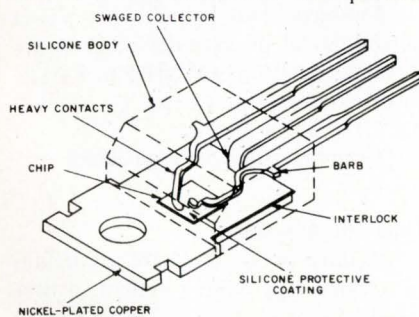

configurations, and thermal-cycling capability) and illustrations show the internal structure of the basic package, lead-configuration options, and device performance ratings. RCA Solid State Div., Box 3200, Somerville, N.J. 08876.

Circle Reader Service #396

NEW

VECTOR-PAK SYSTEM SOLVES PACKAGING PROBLEMS

- CAGES NOW AVAILABLE FULLY OR PARTIALLY ASSEMBLED.
- NEW EASY-TO-ORDER NUMBERING SYSTEM.
- BUILT IN ADJUSTABILITY AND FLEXIBILITY TO SOLVE YOUR PACKAGING PROBLEMS.

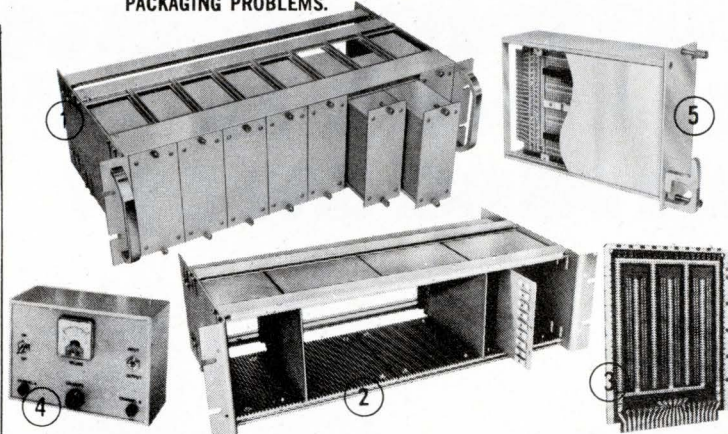

- ① Rack mountable cage and module systems available in 3½", 5¼", 8¾" heights and 9", 12", 15" depths. Immediate availability— assembled or multi purpose kit versions.
- ② Rugged Vector Pak Card Cages with extruded ABS or aluminum guides located on .15", .25", or .3" multiples.
- ③ Dozens of new Plugboards for building Plug-In Cards— IC and discrete types.
- ④ Multi-Mod Cases— sleek functional aluminum cases for instruments and other circuitry. 4 slotted interior surfaces for cards, mounting plates.
- ⑤ EFP modules in 1.6", 2", 3", or 4½" widths have slots for cards 4½" x 6½", 2.7" x 6.5", 8" x 9.6", slide off sides

Send for new specification sheets. NIMS bins and modules also available.

VECTOR ELECTRONIC CO., INC.

12460 Gladstone Ave., Sylmar, California 91342
Phone: (213) 365-9661 ■ TWX (910) 496-1539



72-2

Circle Reader Service #57

Optima 17: how to make your product look as good as it performs.



Optima 17 enclosures combine bold design and quality construction into chassis and case. Hundreds of two-color combinations from classic elegance to the space age, finished in durable vinyl. 4 models in 4 sizes, for bench, desk or 19 inch rack. Write Optima Enclosures, division of Scientific Atlanta, Inc., 2166 Mountain Industrial Blvd., Tucker, Ga. 30084. Or call (404) 939-6340.

OPTIMA

Circle Reader Service #58

Your custom resistor network is only an idea away!

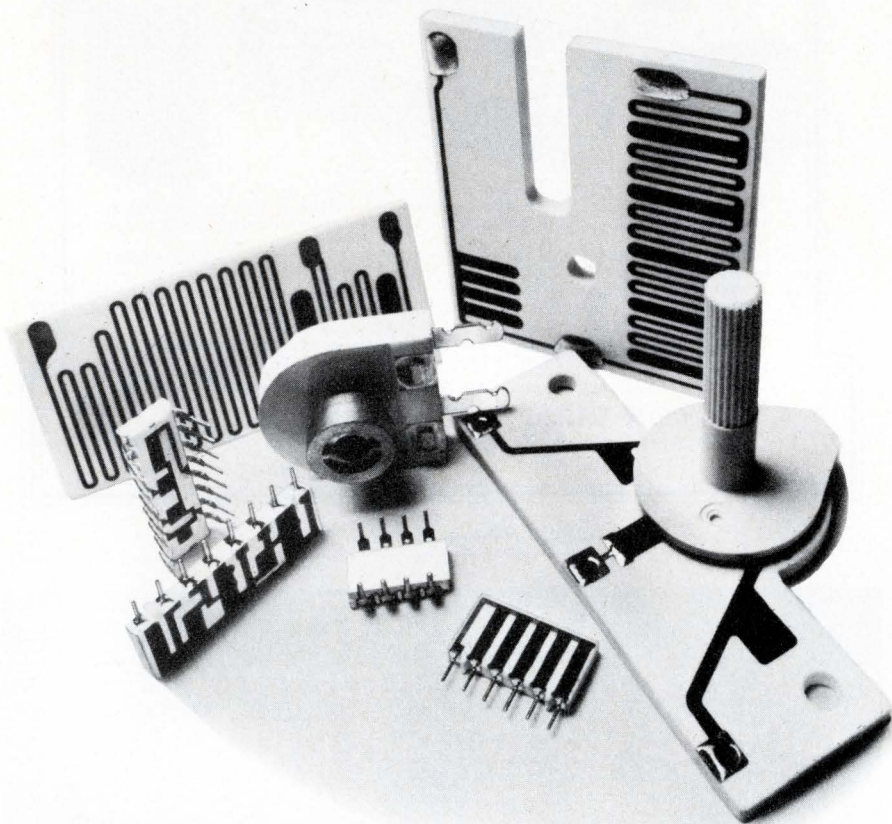

CTS CORPORATION, a pioneer in cermet network packaging, HAS WHAT YOU NEED TO SOLVE "CUSTOM" RESISTOR REQUIREMENTS! Complete thick film facilities save in-house investments: existing tools speed production—cut costs...capabilities you can't afford to overlook. Resistors and resistor networks are our business... not just a sideline.

Whatever your needs, from standard in-line and DIP networks to custom high power/high voltage packages, you can rely on CTS experience and know-how.

Unmatched field reliability, high volume mechanization, and over a decade of cermet thick film-technology make CTS resistors "the engineers' choice". We have what it takes for both standard and custom resistor packages. Call on CTS EXPERIENCE...today! CTS CORPORATION, 905 N. West Boulevard, Elkhart, Indiana 46514, Phone: (219) 293-7511.

CTS CORPORATION
Elkhart, Indiana



A world leader in cermet and variable resistor technology.

Circle Reader Service #54

LITERATURE

Magnetic tape data terminals

A discussion of Teletype's 4210 magnetic tape data terminals calls your attention to the unattended automatic-rewind and local printout option recently added to the set. You'll also

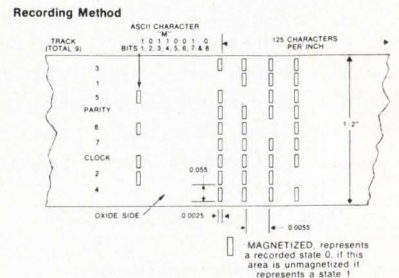

find data on editing, cartridges, data location, optional character recognition expander, and transmission error control as well as a diagram of recording method. Teletype Corp., 5555 Touhy Ave., Skokie, Ill. 60076.

Circle Reader Service #397

Power rectifier catalog

Specifications for a complete line of power rectifiers and rectifier bridge assemblies are provided in this large catalog. The 180-page catalog also includes a full listing of important electrical and mechanical specs. Sensitron Semiconductor Div., RSM Electronic Power Inc., 221 W. Industry Ct., Deer Park, N.Y. 11729.

Circle Reader Service #398

Power vs frequency rating charts

These charts graphically depict power vs frequency ratings for molded and hermetically sealed microwave transistor packages. This includes the power capabilities of discrete device packages at frequencies from 100 MHz to 3 GHz. National Beryllia Corp., Cermetrol Div., Haskell, N.J. 07420.

Circle Reader Service #399

Tape editing system

Available in this brochure are details on a video tape editing system, a time code generator, and an editing time code translator. Diagrams illustrate the control panels of both editing systems, and there's an illustration of one frame of the SMPTE/editing time code used with the system. Datatron Inc., 1562 Reynolds Ave., Santa Ana, Calif.

Circle Reader Service #400

Digital panel meter

Weston tells you about their model 1291 digital panel meter in this data sheet. Since the miniaturized 3 1/2-digit DPM is intended for OEM application, you'll read about available variations: faster sampling rates, circuit adjustments allowing direct readout, suppressed ranges for operating from industrial transmitters, BCD output, and over-range capabilities. Weston Instruments Inc., 614 Frelinghuysen Ave., Newark, N.J. 07114.

Circle Reader Service #401

Photodetector applications

"The use of RCA solid-state photodetectors in small-signal detection systems," is the title of this 6-page application note. It develops the basic equation for noise equivalent power (NEP) and provides two nomographs for determining NEP, rise time, and frequency cut-off for a given system. RCA Commercial Engineering, Harrison, N.J.

Circle Reader Service #402

Microelectronics research microscope

A semiconductor and metallographic research microscope, this instrument is suggested for qualitative and quantitative evaluation of surface finish and film thickness measurements. This 12-page booklet discusses basic features, capabilities, applications, and available accessories. Hacker Instruments Inc., Box 646, W. Caldwell, N.J. 07006.

Circle Reader Service #403

Communications interface

Described in this 8-page brochure is a programmable computer-based interface between computing centers and data communications networks. Information is provided on system features,

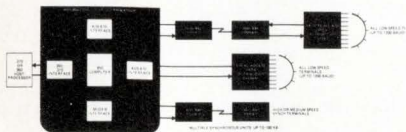

generalized functions, system configurations, hardware and software features, and data management capabilities. American Data Systems, 8851 Mason Ave., Canoga Park, Calif.

Circle Reader Service #404

COMPLETE PACKAGING CAPABILITY

only
from
Vero

CASES
CONNECTORS
CARD FRAMES
MODULE RACKS
VEROBOARD
CARD HANDLES
FRONT PANELS
PANEL HANDLES

ALL
DELIVERED
FROM
STOCK

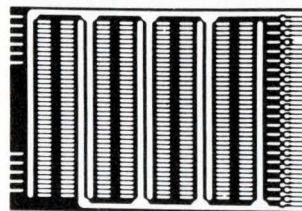

VERO D.I.P. BOARD FOR DUAL IN LINE I.C. PACKAGES

• Accepts D.I.P. socket or direct I.C. plug in • Gold plated contacts with connectors to match • Boards available in epoxy glass 1/16 thick or low cost paper • Complete versatility with continuous isolated pads on .1 centers holds 20 D.I.P.s on 4.5x 6.5 board • Will mount either 14, 16, 24 or 36 pin D.I.P. package.



Vero Electronics Inc.

171 Bridge Road, Hauppauge, N.Y. 11787
Tel.: 516-234-0400 • TWX510-227-8890

Circle Reader Service #60

GET THE **FACTS** ABOUT THE **FAST GROWING MARKET** FOR MEDICAL ELECTRONICS AND EQUIPMENT

The market for medical electronics is booming. Estimated at \$1 billion dollars in 1971, it will reach a whopping \$2.5 billion in 1980 which will be spent for biomedical and analytical equipment, instruments, accessories and computers.

Get to know how you can become an important supplier with a copy of the **1972 DICTIONARY AND BUYERS' GUIDE**. Published by Medical Electronics and Equipment News, the **GUIDE** is invaluable for understanding this growing market. It provides:

- The **names** of all available products
- Clearly **defines** the **function** of each product
- Specifies the **manufacturer** of each product
- Provides a manufacturers' directory which gives names, addresses and products they manufacture

The **DICTIONARY AND BUYERS' GUIDE** gives you 140 fact-filled pages of information available **nowhere else**. To get a copy mail coupon with check or money order for \$5.00 to Medical Electronics and Equipment News, Dept. C, One Decker Square, Bala Cynwyd, Pennsylvania 19004.

Name _____
Address _____
Company _____
City _____ State _____ Zip _____

We've made a new kind of FET op amp.

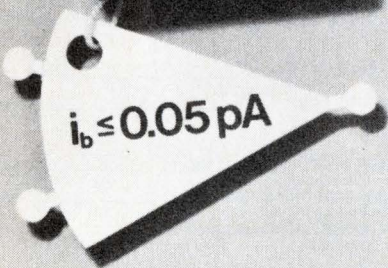

The bias current is $\pm 0.05\text{pA}$ max. And it doesn't double every 10°C ... over 0°C to $+50^\circ\text{C}$ we never exceed $\pm 0.2\text{pA}$. We've also kept the noise down to 0.02pA .

Now you have an alternative to costly and bulky varactor-bridge amplifiers. We designed the 380K for use in your analytical instruments. Gas chromatographs, pH meters, photometers... and anywhere else that you need to turn picoamps into volts.

We made the 380 easy to use...

- It has differential inputs... use it inverting or noninverting.
- The package is $1.12'' \times 1.12'' \times 0.5''$ with a 7 pin layout.
- The cost is low... only \$39 in hundred quantity. And the 380J is even lower priced.

So send for the data sheet... and we'll show you what's new in FET-op amps!

FUNCTION MODULES, INC.
2441 Campus Drive
Irvine, California 92664
(714) 833-8314

Circle Reader Service #62

LITERATURE

Dual monolithic transistors

Efficiently summarizing four families each of dual monolithic FET and bipolar transistors is this 4-page brochure. Included in the summary are general descriptions, spec summaries, performance curves, package outline drawings, pin configuration diagrams, and prices. This handy reference is offered to you by Analog Devices Inc., Box 280, Norwood, Mass. 02062.

Circle Reader Service #413

Communications equipment

High-frequency single-sideband radio equipment is the subject of this 40-page catalog. In addition to product data on transmitters, receivers, antennas, power supplies, controllers, and more, there's useful reference information. You'll find details on systems design, antenna selection, ground and sky-wave propagation, operating modes, radio teletype communication, and much more. Rf Communications Inc., 1680 University Ave., Rochester, N.Y. 14610.

Circle Reader Service #414

Switchlight catalog

Discussed here are snap-in pushbutton switchlights available in three lens cap sizes, two pole or six pole, momentary or alternate action. The 8-page short form catalog also introduces the Monoform line, explains the advantages of snap-in gangswitch assemblies, and reviews available indicators and lens caps. Clare-Pendar Co., Post Falls, Idaho 83854.

Circle Reader Service #415

Accumulating digital printer

Suggested for producing printed records for inventory control and cut-to-length applications such as cable, wire, and steel is the accumulating digital printer described in this data sheet. It covers automatic and remote paper advance, BCD or $\overline{\text{BCD}}$ input, totalize/nontotalize with add/subtract functions in the totalize mood and other features, as well as aperture card printout and other options. Veeder-Root, 70 Sargeant St., Hartford, Conn. 06108.

Circle Reader Service #416

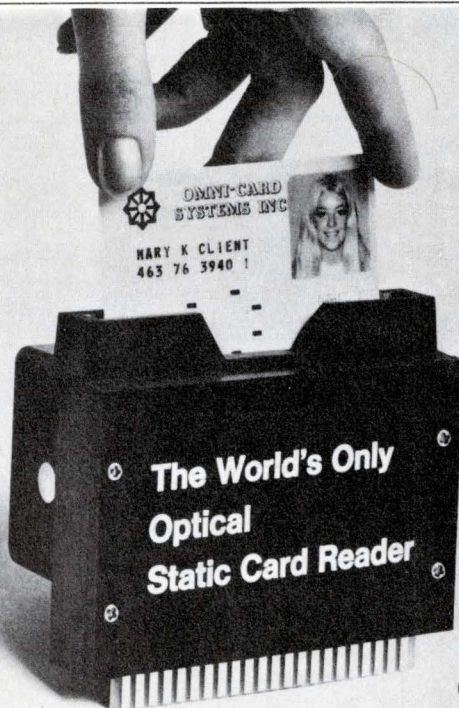

Accepts Hollerith cards or badges.

Extremely reliable, compact.

Easy to operate.

Uses diode-isolated light sensors.

Available from 10x10 to 12x80 matrix.

Prevents improper card insertion.

Plugs into standard connectors.

Horizontal or vertical card insert.

Optional solenoid card ejector.

For further information contact Ken Terasaki, Panasonic Industrial Division, 200 Park Avenue, New York, N.Y. 10017 (212) 973-8907.

Panasonic®

just slightly ahead of our time

Circle Reader Service #63

101

Here's how you
can run a
**Sperry Rand
SP-730** or
any gas-discharge
readout from
a battery!

**E 700
SERIES**
DC POWER SUPPLY



You can forget about high voltage lines, or complex power hook-ups which used to be required to activate such readouts.

This new **DC Power Supply** is especially designed for "glow-type" information displays. Our compact Series 700 does the job! It's fully encapsulated, and features input-output isolation. Pin layout is designed for mounting on most standard mother-boards.

Prices start at \$5.65 each for unregulated models and \$8.75 each for regulated units in quantities of 1,000 units.

For detailed information circle the reader service number below, or write:



Endicott Coil Co., Inc.
30 Charlotte Street
Binghamton, N. Y.

13905 Phone: 607/797-1263

Circle Reader Service #64

Advertisers—October 1972

No liability is assumed for errors or omissions.
This Index is published for a convenience.

AMP, INC. 38 Aitkin-Kynett Co., Inc.	PANASONIC 101 Dentsu Corp. of America
ASTROSYSTEMS, INC. 5 Don Alt & Associates, Inc.	PRECISION MONOLITHICS, INC. 31 Marlborough Assoc., Inc.
AUGAT 95 Creamer, Trowbridge, Case & Basford, Inc.	RCA, Solid State DivisionBC Al Paul Lefton Company, Inc.
BECKMAN INSTRUMENTS-Helipot Div.11-A N. W. Ayer/Jorgensen/MacDonald, Inc.	ROCKLAND LABSDC-13 Rolf Johnson
BEVCO-PRECISION MFG. CO. 89 Mar-Pat Advertising	SCANBE MANUFACTURING CORP. 43 Warren C. Wilson & Associates
BOURNS, INC. 64 Marlborough Assoc., Inc.	SCIENTIFIC-ATLANTA, INC. 97 NOW
BULOVA/FCPDC-12 Caroe Marketing, Inc.	SOLITRON DEVICES INC. 85 William F. Haselmire Advertising
BUSSCO ENG. INC. 87 T. F. Murray & Assoc., Inc.	SPERRY INFORMATION DISPLAYS DIV. 6 N. A. Winter Advertising Agency
BUSSMANDC-7 Henderson Advertising Co.	TEC, INCORPORATEDDC-14 Tec-Ad
CTS CORP. 98 Reincke, Meyer & Finn Inc.	TELEDYNE CRYSTALONICSIFC Gerard J. Gormley Advertising
CONDENSER PRODUCTS CORP. 102 MacMahon Advertising, Inc.	TELEDYNE PHILBRICK49-56 Ingalls Associates
DECCOFELT CORPORATION 104 Peter Ebeling Advertising	TELETYPEDC-2, DC-3 N. W. Ayer & Son, Inc.
EDMUND SCIENTIFIC COMPANY 104 Chittick Advertising	TERADYNE, INC. 2 Quinn & Johnson, Inc.
EECO 93 The Robertson Co.	THERMALLOY 48 Warren Guild
ELCO CORP. 35 Mort Barish Associates, Inc.	U. S. CAPACITOR CORP.DC-10 S. Michelson Advertising
ELECTRO-MOTIVE MFG. CO., INC. 86 Culver Advertising, Inc.	UNITRODE CORP. 13 Impact Advertising Inc.
ENDICOTT COIL CO., INC. 102 Fred Riger Advertising	VECTOR ELECTRONIC CO., INC. 97 Dan Ebberts and Company
FACIT ODHNER 37 Kriegel/Feldman/Stern, Inc.	VERO ELECTRONICS, INC. 99 Adrian E. Clark Jr.
FAIRCHILD SEMICONDUCTOR8, 9 Carson/Roberts, Inc.	VIDAR CORP., Instrumentation Div. 94 Lincoln Assoc.
FAIRCHILD SYSTEMS TECHNOLOGY 17 Hall Butler Blatherwick, Inc.	WATKINS-JOHNSON CO.DC-11 William C. Estler
FASTEX, Div. Illinois Tool Works Inc. 92 Waldie and Briggs Inc.	WINCHESTER ELECTRONICS 40 Renaccio Advertising
FUNCTION MODULES, INC. 101 Leon Richman Design	WOVEN ELECTRONICS 96 Prentiss Court
GARDNER-DENVER COMPANY 44 Buchen Advertising, Inc.	
GENERAL INSTRUMENT CORP.Bet. DC-8 & DC-9	
GLENAIR 45 T. F. Murray and Associates, Inc.	
GRAYHILL, INC. 93 Carr Liggett Advertising, Inc.	
HARSHAW CHEMICAL COMPANY 100 Industry Advertising Co.	
HEINEMANN ELECTRIC COMPANY 88 Thomas R. Sundheim Inc.	
HEWLETT-PACKARD 14 Richardson Seigle Rolfs & McCoy, Inc.	
HEWLETT-PACKARD46, 47 Richardson Seigle Rolfs & McCoy, Inc.	
HEWLETT-PACKARD COLORADO SPRINGS20, 21 Tallant/Yates Advertising, Inc.	
HEWLETT-PACKARD San Diego Div. 63 Phillips Ramsey	
HOTWATT, INC. 96 Sears Advertising Agency, Inc.	
HUGHES AIRCRAFT COMPANY36, 37 Foote, Cone & Belding	
ITT CANNON 32 D'Arcy-MacManus-Intermarco, Inc.	
KEITHLEY INSTRUMENTS, INC. 91 The Bayless-Kerr Co.	
KEPCO, INC. 4 Weiss Advertising	
LAMBDA ELECTRONICSIBC Michel Cather, Inc.	
MAGNECRAFT ELECTRIC CO. 1 Marketronics, Inc.	
MAGNETIC COMPONENTS Div. CDC 89 Kent Dixon Advertising	
MOTOROLA COMMUNICATIONSDC-4 Brand Advertising, Inc.	
MOTOROLA SEMICONDUCTOR26, 27 E. B. Lane & Associates, Inc.	
NORTH AMERICAN PHILIPS CONTROLS CORP. 57 J. B. Rundle Inc.	
NYTRONICS 103 Prentiss Court	
OPCOA, INC. 16 Mort Barish Assoc., Inc.	

WITH OUR CATALOG
YOU MAY NOT NEED
A CUSTOM

CAPACITOR

AND THE CATALOG
IS YOURS
FOR THE ASKING

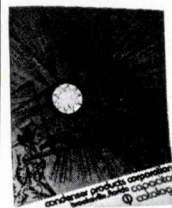

Picture a complete concise composite catalog of over 800 off-the-shelf capacitors, over 1200 variations including some weird and unusual units.

If what you need isn't there, then drop us a line, or give us a call, we'll custom design a capacitor for your circuit, and in most cases there is no charge for customizing. But check the catalog first, what you need may be there and ready for immediate shipment.

TO GET YOUR CATALOG,
JUST DROP US A LINE.

**condenser
products
corporation**

Box 997, Brooksville, Florida 33512
Phone (904) 796-3562

Circle Reader Service #65

**THE
ELECTRONIC
ENGINEER**

DISTRICT SALES MANAGERS

EDWARD G. SHAUD
BALA-CYNWYD, (Pa.) 19004
One Decker Square
(Area Code 215) SHerwood 8-2000

JACK RATTINGER
NEW YORK 10016-600 Third Ave.
(Area Code 212) OXford 7-3400

JOHN W. BERNHARDT
CHICAGO 60606-100 S. Wacker Drive
(Area Code 312) 782-1400

G. T. ALFANO
NEEDHAM HEIGHTS, MASS. 02194-
570 Hillside Ave.
(Area Code 617) 444-0010

TERRENCE D. BUCKLEY
THOMAS R. BORIS
LOS ANGELES 90020-3727 W.
Sixth St. # 202
(Area Code 213) DUnkirk 7-1271

RALPH PETERSEN
JOHN SLY
LOS ALTOS (San Francisco) 94022
199 First St., Room 335
(Area Code 415) 941-6655

RICHARD DUTE
CLEVELAND 44114-601 Rockwell Ave.
(Area Code 216) SUperior 1-2860

NEWTON B. COLLINSON
DOUGLAS B. BRODIE
ATLANTA 30309-1776 Peachtree St.
N.W.
(Area Code 404) 872-4723

HAROLD E. MOTT
RICHARD HERRANEN
Houston 77027
4151 Southwest Freeway
Suite 735
(Area Code 713) 621-7550

INTERNATIONAL BUSINESS OFFICES

London SW1Y 6PB Max F. Holsinger
67 88 Jermyn St. St James's Dir. European Sales
01 839 6318-9 K. J. Hendry S. K. Elliott
Cables WHIP LONDON S W 1

Manchester M22 5RQ D. I. Goulden
Haletop Wythenshawe Civic Centre 061 437 3293

4 Dusseldorf Nord E. Hillerbrandt
Eitelstrasse 32 R. Schomburg H. Habt
Dusseldorf 652031 2 WHIP DUSSELDORF
Cables

75 Paris 8e S. Brown Jousard
70 rue de Pontneuf J. C. Lamone
Paris 359 65 77 UIIP PARIS 8E
Cables

Tokyo Clarence T. Sakaguchi
11-3-2 Chome, Shinbashi
Minato-ku, Tokyo, Japan Tel. 591-6897

BUSINESS STAFF

BERNARD M. GITTELMAN

Publisher

DENNIS J. PERKINS

Promotion Manager

JOHN J. MEEHAN

Marketing Services Manager

KAREN A. CHRISTIAN

Production Mgr.

BEVERLY TATUM

Production Asst.

WILLIAM HOWAT

Circulation Director

DAVID ELY

Circulation Manager

JOSEPH P. BABCOCK

Reader Service Manager

JOHN H. KOFRON

Chilton Research Services

C. R. WILHIDE

Washington Vice-President

**Look
close
or you
may miss**

**the world's
smallest
shielded inductor.**

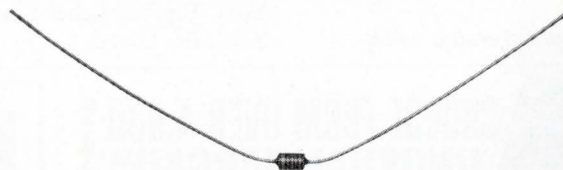

ACTUAL SIZE

New Pee-Wee Ductor
66% smaller
than the previous smallest

Nytronics' new Pee-Wee Ductor for microminiature hybrid circuits is about an 1/8th of an inch from stem to stern . . . or about 1/3rd the size of the previous world's smallest magnetically shielded inductor. Yet its electrical performance is big time. It offers higher L and Q (MIL-C-15305) in ratio to volume than its famous predecessors Wee-Wee and Super Wee-Wee. Values run from .10 to 1000 uh $\pm 10\%$, a low of .025 to a high of 10,000 uh on special order. Minimum Q ranges from 34 to 55 at RF frequencies, and current capability from 43 mA to a whopping 1.5 amps.

Write for additional specs and temperature curves.
Write small.



Nytronics, Inc.

THE QUALITY LINE OF STANDARD COMPONENTS

ORANGE STREET, DARLINGTON, S. C. 29532 • (803) 393-5421 • TWX 810-665-2182
Circle Reader Service #74

Stack and bridge selector

Determine at a glance the correct high-voltage stacks and 1- or 3-phase full-wave bridges with this handy silicon rectifier stack and bridge selector. You simply set the desired voltage rating in an index window, look at the appropriate output current column, and read the type number and package illustration code of the stack or bridge for your application. The handy slide-chart selector is offered to you by Unitrode Corp., 580 Pleasant St., Watertown, Mass.

Circle Reader Service #417

Plastic caps and plugs

Here's a 30-piece sample kit of Cap-plugs—plastic caps and plugs used on electronic components for the protection of products in process, storage, and transit. Easy to apply and remove, they provide inexpensive protection for tubing, threaded fittings, and machined parts. A 54-page catalog and price list is included with the offer. Capplugs Div., Protective Closures Co. Inc., Dept. ECN, 2152 Elmwood Ave., Buffalo, N.Y. 14207.

Circle Reader Service #418

The best dice in the world . . .

. . . AMD claims to make, and they want you to make them prove it. They'll send you ten dice free—five Am741 op amps and five Am9316 counters, so if you're building hybrids or modules you can make them prove what they're saying. All dice are 100% visually inspected to Mil-Std-883, electrically tested to all dc parameters, and 100% slew rate tested. Write on company letterhead for your free dice to Advanced Micro Devices, 901 Thompson Pl., Sunnyvale, Calif. 94086.

Label reference kit

These sample label sheets will give you an idea of the various label stocks and surface finishes available. Make your selection for appearance, abrasion resistance, or adhesive compatibility with material surfaces. They also illustrate printing types, sheeting, die-cutting, and headed strips. For your samples, write on company letterhead to York Tape & Label Corp., Box 1309, York, Pa. 17405.

PC board production aids

This offer will bring you samples of Perm-O-Pads™, molded nylon component mounting pads for printed circuit applications. You'll also receive a catalog giving you complete specs (material, heat resistance, color, and dimensional tolerances), prices, and applications information. Bivar Inc., 1500 S. Lyon St., Santa Ana, Calif. 92705.

Circle Reader Service #419

PC foil board

Here's the first patented backup material for the PC board drilling industry. The core of #3003 foil board is a cellulose hardboard that lubricates the twist drill, but has no binders that might cause hole contamination. The aluminum is a tempered foil which acts as a heat sink, cleans and cools the twist drills. A variety of sizes and thicknesses are available. Samples are available to companies concerned with quality hole production drilling. LCOA Laminating Co. of America, 10612 Midway Ave., Cerritos, Calif. 90701.

Circle Reader Service #420



ASTRONOMY
OPTICS
SCIENCE
ELECTRONICS
FOR HOBBYISTS
SCHOOLS & INDUSTRY

EDMUND
SCIENTIFIC CO.

MORE THAN 4,000 UNUSUAL BARGAINS
FOR HOBBYISTS, SCHOOLS & INDUSTRY

CHOOSE FROM OVER 4,000! UNUSUAL BARGAINS!

OPTICS • SCIENCE
ELECTRONICS

FREE CATALOG!

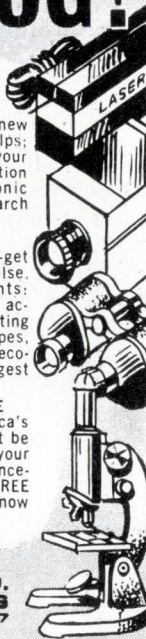

**1,000's OF HARD-TO-FIND
BUYS FOR INDUSTRY**

Brand new 164-page easy-to-read edition packed with new products, charts, diagrams, illustrations. On-the-job helps; quality control aids, unique, exclusive items to speed your work, improve quality, cut development and production costs! Loaded with optical, scientific and electronic equipment available from stock for industry, research labs, design engineers, experimenters, hobbyists.

ONE SOURCE FOR ALL YOUR NEEDS

Tremendous variety. Terrific savings. Countless hard-to-get surplus bargains. Many "one-of-a-kinds" nowhere else. Ingenious scientific tools. Thousands of components: lenses, prisms, wedges, mirrors, mounts, all types of accessories. Hundreds of instruments: pollution testing equipment, lasers, comparators, magnifiers, microscopes, projectors, telescopes, binoculars, photo attachments, ecological items, black light equipment and America's largest collection of unique lighting products.

BUY DIRECT WITH MONEY-BACK GUARANTEE

Edmund ships over 5,000 orders monthly to America's largest industrial — every item guaranteed! You must be satisfied, or return your purchase in 30 days for your money back. Shop the catalog of America's largest Science-Optics-Electronics Mart with confidence! Get your FREE copy without obligation. No salesman will call. Write now for free catalog "EE"

EDMUND SCIENTIFIC CO.
300 EDSCORP BUILDING
BARRINGTON, NEW JERSEY 08007
TELEPHONE: 609-547-3488

Circle Reader Service #66

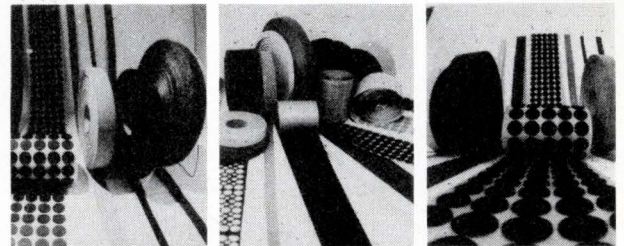

ubiquitous

Omnipresence; being everywhere or in an indefinite number of places at the same time.

In the bulkheads of atomic submarines, inside toys, t.v. sets and electric organs, under ash trays and statues, our adhesive backed materials are found everywhere. We supply

FELT, FOAM, SPONGE, CORK, FOIL, FILM, PLASTIC . . . in die-cut, segmented or bulk form, delivered on special quick releasing paper for whatever use you can think of — cushion, pad, protect, insulate, decorate . . .

Our brochure has samples, specifications and ideas; send for it, you'll like it.

**DECCOFELT
CORPORATION**

500 South Vermont Avenue, Glendora Ca. 91740

Circle Reader Service #67

Do you face
a make or buy decision
on power supplies?

How to use power hybrid voltage regulators to build your own power supplies.

There's another choice now in power-supply design. You're no longer restricted to a supply designed by others, nor to one you have to design from scratch. You can buy the heart of the supply—the voltage regulator—in a hybrid form that offers much more power output than monolithic regulators. Then you can design the rest of the supply and the heat sink, if necessary, using a straightforward procedure.

Hybrid regulators are now available in many models with outputs to 28 V dc and to 5 A. Dissipation at 25°C can reach 85 W—a far cry from the watt or so available in monolithic regulators.

Though there are differences in circuitry, specifications and packaging among regulators available from companies like Lambda, Melville, N. Y.; Micropac, Garland, Tex.; and Tecnetics, Boulder, Colo., you can design with them around your own needs.

A typical unit

This article in Lambda's new hybrid regulator brochure tells you how to use these devices to build your own power supplies. . . . Send for your free copy.

**Announcing:
NEW POWER HYBRID
VOLTAGE REGULATORS**
62W 5V 3A

\$25 ea.
(in quantity
of 1)

\$14 ea.
(in quantity
of 100)

\$11 ea.
(in quantity
of 1000)

**NEW
LOW PRICES ON**
85W 5V 5A

\$30 ea.
(in quantity
of 1)

\$18 ea.
(in quantity
of 100)

\$15 ea.
(in quantity
of 1000)

**100,000 hours MTBF
demonstrated**

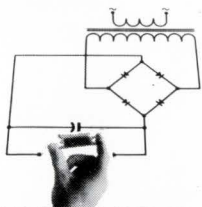

**WHETHER
YOU MAKE
OR BUY...**

**LAMBDA
ELECTRONICS CORP.**
A  Company

MELVILLE, NEW YORK 11746 515 Broad Hollow Road Tel. 516-694-4200 ARLINGTON HEIGHTS, (CHICAGO) ILL. 60005 2420 East Oakton St., Unit Q Tel. 312-593-2550
NORTH HOLLYWOOD, CALIF. 91605 7316 Varna Ave. Tel. 213-875-2744 MONTREAL, QUEBEC 100C Hymus Blvd., Pointe-Claire, Quebec-730 Tel. 514-697-6520

Circle Reader Service #68

CA3118AT
CA3118T

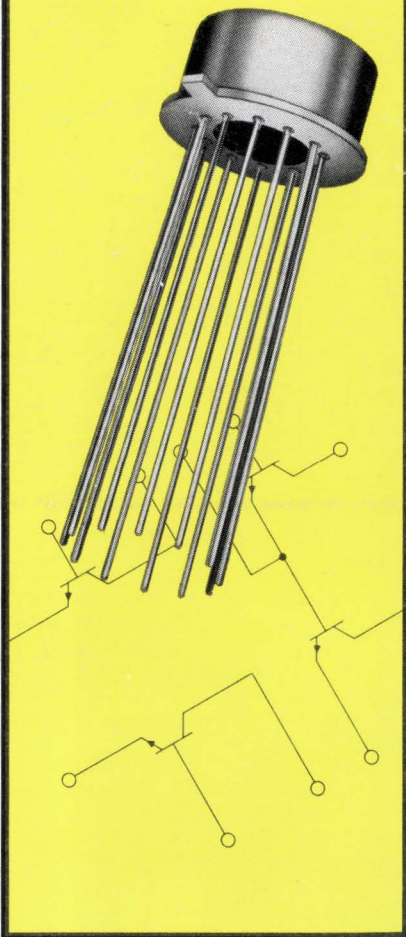

CA3146AE
CA3146E

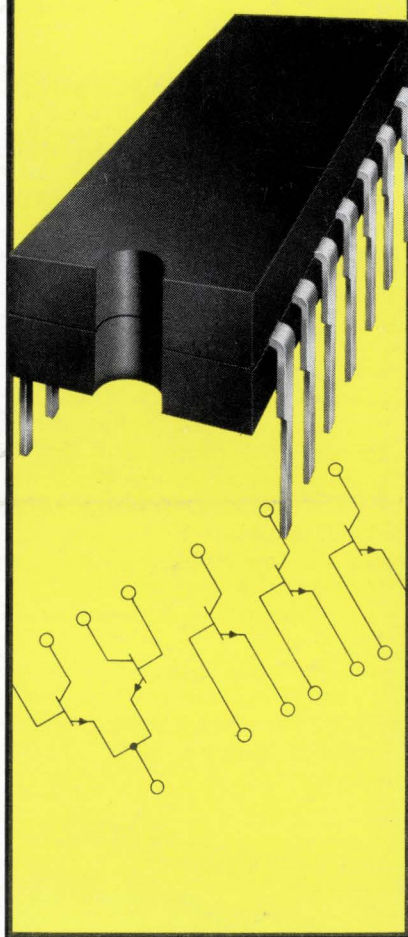

CA3183AE
CA3183E

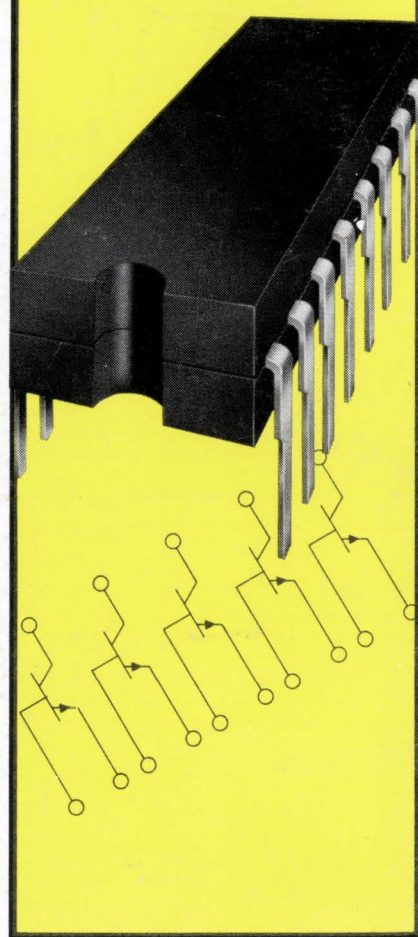

We've UPPED our V_{CEO} to 40 volts... to give you flexibility with extra muscle

We've taken our already popular CA3018, CA3046, CA3083 transistor arrays and upped their V_{CEO} ratings from 15 volts to 30 and 40 volts. The new CA3118AT, CA3118T, CA3146AE, CA3146E, CA3183AE, CA3183A now bring you a new level of design flexibility in our widely accepted line of monolithic transistor arrays.

They offer a broad variety of configurations — Darlington, differential amplifiers and uncommitted transistors — for communication, control, and instrumentation equipment. High-current types CA3183E and CA3183AE offer capability up to 75 mA.

If compact, economical design

and high voltage are important to you... use these new RCA arrays, CA3100 Series. They're the logical choice for lamp and relay drivers, thyristor triggering, and for most signal processing and switching systems from DC to 120 MHz. (If V_{CEO} to 15 volts meets your requirements, specify the standard CA3018, CA3018A, CA3045, CA3046 or CA3083.)

If you have been using discretes, take advantage of RCA's unequalled experience in the design and manufacture of high-quality transistor arrays. If you've been voltage- or current-limited by previous arrays — check RCA's six new types now.

For more information see your

RCA Representative or your local RCA Distributor. All types are available from stock in quantity for new designs. For technical data, write RCA Solid State, Section 59J, Box 3200, Somerville, N.J. 08876.

Type	V_{CEO}	I_C (max.) mA	Package	Price (1000-unit level)
CA3118AT	40	50	12L TO-5*	\$1.40
CA3118T	30	50	12L TO-5*	.98
CA3146AE	40	50	14L DIP**	1.40
CA3146E	30	50	14L DIP**	.98
CA3183AE	40	75	16L DIP**	1.50
CA3183E	30	75	16L DIP**	1.25

*Operates over full military temperature range of -55°C to 125°C

**Operates over ambient temperature range of -40°C to $+85^{\circ}\text{C}$

International: RCA, Sunbury-on-Thames, U.K., or Fuji Building, 7-4 Kasumigaseki, 3-Chome, Chiyoda-Ku, Tokyo, Japan. In Canada: RCA Limited, Ste. Anne de Bellevue 810, Quebec.

RCA Solid State
products that make products pay off