

## FEATURES

- Dual transmitters
- Dual input shared observation receiver
- Maximum tunable transmitter synthesis bandwidth: 450 MHz
- Maximum observation receiver bandwidth: 450 MHz
- Fully integrated fractional-N RF synthesizers
- Fully integrated clock synthesizer
- Multichip phase synchronization for RF LO and baseband clocks
- JESD204B datapath interface
- Tuning range (center frequency): 75 MHz to 6000 MHz

## APPLICATIONS

- 2G/3G/4G/5G macrocell base stations
- Active antenna systems
- Massive multiple input, multiple output (MIMO)
- Phased array radars
- Electronic warfare
- Military communications
- Portable test equipment

## GENERAL DESCRIPTION

The ADRV9008-2 is a highly integrated, RF agile transmit subsystem offering dual-channel transmitters, an observation path receiver, integrated synthesizers, and digital signal processing functions. The IC delivers a versatile combination of high performance and low power consumption required by 2G/3G/4G/5G macrocell base stations, and active antenna applications.

The transmitters use an innovative direct conversion modulator that achieves multicarrier macrocell base station quality performance and low power. In 3G/4G mode, the maximum transmitter large signal bandwidth is 200 MHz. In multicarrier

global system for mobile communications (MC GSM) mode, which has higher inband spurious-free dynamic range (SFDR), the maximum large signal bandwidth is 75 MHz.

The observation path consists of a wide bandwidth direct conversion receiver with state of the art dynamic range. The complete receive subsystem includes dc offset correction, quadrature correction, and digital filtering, thus eliminating the need for these functions in the digital baseband. Several auxiliary functions such as analog-to-digital converters (ADCs), digital-to-analog converters (DACs), and general-purpose inputs/outputs (GPIOs) for power amplifier (PA) and radio frequency (RF) front-end control are also integrated.

The fully integrated phase-locked loops (PLLs) provide high performance, low power fractional-N RF frequency synthesis for the transmitter and receiver sections. An additional synthesizer generates the clocks needed for the converters, digital circuits, and the serial interface. Special precautions have been taken to provide the isolation required in high performance base station applications. All voltage controlled oscillators (VCOs) and loop filter components are integrated.

The high speed JESD204B interface supports up to 12.288 Gbps lane rates, resulting in two lanes per transmitter in the widest bandwidth mode and two lanes for the observation path receiver in the widest bandwidth mode.

The core of the ADRV9008-2 can be powered directly from 1.3 V regulators and 1.8 V regulators and is controlled via a standard 4-wire serial port. Comprehensive power-down modes are included to minimize power consumption in normal use. The ADRV9008-2 is packaged in a 12 mm × 12 mm 196-ball chip scale ball grid array (CSP\_BGA).

**TABLE OF CONTENTS**

Features .....	1	Theory of Operation .....	69
Applications.....	1	Transmitter.....	69
General Description .....	1	Observation Receiver.....	69
Revision History .....	2	Clock Input.....	69
Functional Block Diagram .....	3	Synthesizers.....	69
Specifications.....	4	Serial Peripheral Interface (SPI).....	69
Current and Power Consumption Specifications.....	13	JTAG Boundary Scan.....	69
Timing Diagrams.....	14	Power Supply Sequence .....	69
Absolute Maximum Ratings.....	15	GPIO_x Pins .....	70
Reflow Profile.....	15	Auxiliary Converters.....	70
Thermal Management .....	15	JESD204B Data Interface .....	70
Thermal Resistance .....	15	Applications Information .....	71
ESD Caution.....	15	PCB Layout and Power Supply Recommendations.....	71
Pin Configuration and Function Descriptions.....	16	PCB Material and Stackup Selection .....	71
Typical Performance Characteristics .....	23	Fanout and Trace Space Guidelines .....	73
75 MHz to 525 MHz Band .....	23	Component Placement and Routing Guidelines .....	74
650 MHz to 3000 MHz Band.....	36	RF and JESD204B Transmission Line Layout .....	79
3400 MHz to 4800 MHz Band.....	47	Isolation Techniques Used on the ADRV9008-2W/PCBZ... 83	
5100 MHz to 5900 MHz Band.....	57	RF Port Interface Information.....	85
Transmitter Output Impedance.....	67	Outline Dimensions .....	95
Observation Receiver Input Impedance.....	67	Ordering Guide .....	95
Terminology .....	68		

**REVISION HISTORY**

9/2018—Revision 0: Initial Version

# FUNCTIONAL BLOCK DIAGRAM

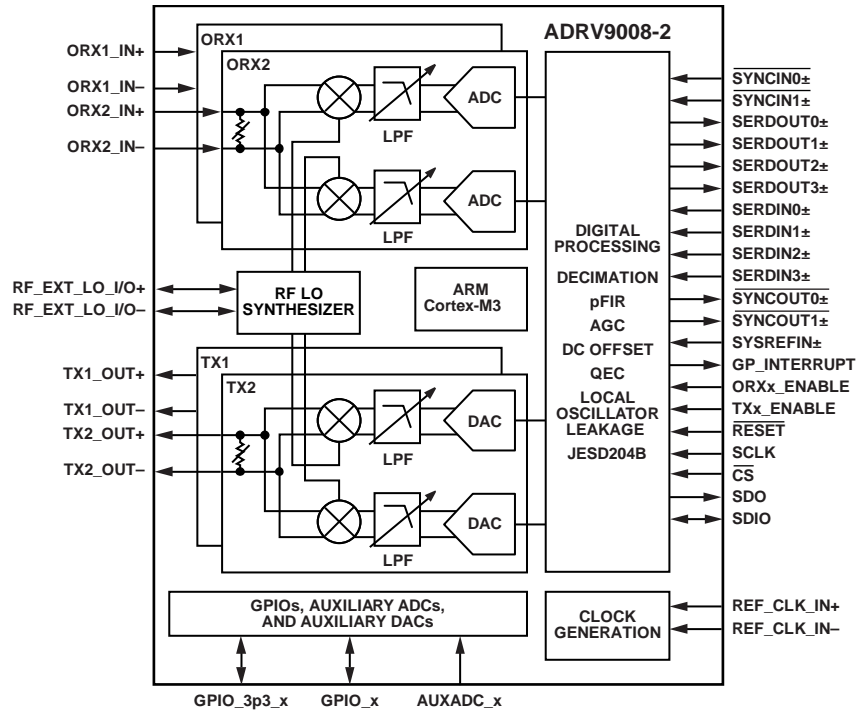

Figure 1.

16833-001

## SPECIFICATIONS

Electrical characteristics at  $V_{DDA1P3}^1 = 1.3\text{ V}$ ,  $V_{DDD1P3\_DIG} = 1.3\text{ V}$ ,  $V_{DDA1P8\_TX} = 1.8\text{ V}$ ,  $T_j =$  full operating temperature range. Local oscillator frequency ( $f_{LO}$ ) = 1800 MHz, unless otherwise noted. The specifications in Table 1 are not de-embedded. Refer to the Typical Performance Characteristics section for input/output circuit path loss. The device configuration profile for the 75 MHz to 525 MHz frequency range is as follows: transmitter = 50 MHz/100 MHz bandwidth (inphase quadrature (IQ) rate = 122.88 MHz), observation receiver = 100 MHz bandwidth (IQ rate = 122.88 MHz), JESD204B rate = 9.8304 GSPS, and device clock = 245.76 MHz. Unless otherwise specified, the device configuration for all other frequency ranges is as follows: transmitter = 200 MHz/450 MHz bandwidth (IQ rate = 491.52 MHz), observation receiver = 450 MHz bandwidth (IQ rate = 491.52 MHz), JESD204B rate = 9.8304 GSPS, and device clock = 245.76 MHz.

Table 1.

Parameter	Symbol	Min	Typ	Max	Unit	Test Conditions/Comments
TRANSMITTERS						
Center Frequency		75		6000	MHz	
Transmitter (Tx) Synthesis Bandwidth (BW)				450	MHz	
Transmitter Large Signal Bandwidth (3G/4G)				200	MHz	
Transmitter Large Signal Bandwidth (MC GSM)				75	MHz	Low intermediate frequency (IF) mode
Peak-to-Peak Gain Deviation			1.0		dB	450 MHz bandwidth, compensated by programmable finite impulse response (FIR) filter
Gain Slope			±0.1		dB	Any 20 MHz bandwidth span, compensated by programmable FIR filter
Deviation from Linear Phase			1		Degrees	450 MHz bandwidth
Transmitter Attenuation Power Control Range		0		32	dB	Signal-to-noise ratio (SNR) maintained for attenuation between 0 dB and 20 dB
Transmitter Attenuation Power Control Resolution			0.05		dB	
Transmitter Attenuation Integral Nonlinearity	INL		0.1		dB	For any 4 dB step
Transmitter Attenuation Differential Nonlinearity	DNL		±0.04		dB	Monotonic
Transmitter Attenuation Serial Peripheral Interface 2 (SPI 2) Timing						See Figure 4
Time from $\overline{CS}$ Going High to Change in Transmitter Attenuation	$t_{SCH}$	19.5		24	ns	
Time Between Consecutive Microattenuation Steps	$t_{ACH}$	6.5		8.1	ns	A large change in attenuation can be broken up into a series of smaller attenuation changes
Time Required to Reach Final Attenuation Value	$t_{DCH}$			800	ns	Time required to complete the change in attenuation from start attenuation to final attenuation value
Maximum Attenuation Overshoot During Transition		-1.0		+0.5	dB	

Parameter	Symbol	Min	Typ	Max	Unit	Test Conditions/Comments
Change in Attenuation per Microstep				0.5	dB	
Maximum Attenuation Change when $\overline{CS}$ Goes High			32		dB	
Adjacent Channel Leakage Ratio (ACLR) (LTE)						20 MHz LTE at -12 dBFS
			-67		dB	75 MHz < f ≤ 2800 MHz
			-64		dB	2800 MHz < f ≤ 4800 MHz
			-60		dB	4800 MHz < f ≤ 6000 MHz
In Band Noise Floor						0 dB attenuation, in band noise falls 1 dB for each dB of attenuation for attenuation between 0 dB and 20 dB
			-147		dBm/Hz	75 MHz < f ≤ 600 MHz
			-148		dBm/Hz	600 MHz < f ≤ 3000 MHz
			-149		dBm/Hz	3000 MHz < f ≤ 4800 MHz
			-150.5		dBm/Hz	4800 MHz < f ≤ 6000 MHz
Out of Band Noise Floor						0 dB attenuation, 3 × bandwidth/2 offset
			-147		dBm/Hz	75 MHz < f ≤ 600 MHz
			-153		dBm/Hz	600 MHz < f ≤ 3000 MHz
			-154		dBm/Hz	3000 MHz < f ≤ 4800 MHz
			-155.5		dBm/Hz	4800 MHz < f ≤ 6000 MHz
Interpolation Images						
MC GSM Mode			-95		dBc	
3G/4G Mode			-80		dBc	
Transmitter to Transmitter Isolation			85		dB	75 MHz < f ≤ 600 MHz
			75		dB	600 MHz < f ≤ 2800 MHz
			70		dB	2800 MHz < f ≤ 4800 MHz
			65		dB	4800 MHz < f ≤ 5700 MHz
			56		dB	5700 MHz < f ≤ 6000 MHz
Image Rejection						
Within Large Signal Bandwidth						Quadrature error correction (QEC) active
			70		dB	75 MHz < f ≤ 600 MHz
			65		dB	600 MHz < f ≤ 4000 MHz
			62		dB	4000 MHz < f ≤ 4800 MHz
			60		dB	4800 MHz < f ≤ 6000 MHz
Beyond Large Signal Bandwidth			40		dB	Assumes that distortion power density is 25 dB below desired power density
Maximum Output Power						0 dBFS, continuous wave (CW) tone into 50 Ω load, 0 dB transmitter attenuation
			9		dBm	75 MHz < f ≤ 600 MHz
			7		dBm	600 MHz < f ≤ 3000 MHz
			6		dBm	3000 MHz < f ≤ 4800 MHz
			4.5		dBm	4800 MHz < f ≤ 6000 MHz
Third-Order Output Intermodulation Intercept Point	OIP3					0 dB transmitter attenuation
			29		dBm	75 MHz < f ≤ 600 MHz
			27		dBm	600 MHz < f ≤ 4000 MHz
			23		dBm	4000 MHz < f ≤ 6000 MHz

Parameter	Symbol	Min	Typ	Max	Unit	Test Conditions/Comments
Third-Order Intermodulation	IM3		-70		dBc	2 × GSMK carriers, $\Sigma P_{OUT} = -12$ dBFS rms The two carriers can be placed anywhere within the transmitter band such that the IM3 products fall within the transmitter band or within 10 MHz of the band edges
Carrier Leakage						With LO leakage correction active, 0 dB attenuation, scales decibel for decibel with attenuation, measured in 1 MHz bandwidth, resolution bandwidth, and video bandwidth = 100 kHz, rms detector, 100 trace average
Carrier Offset from Local Oscillator (LO)			-84		dBFS	75 MHz < f ≤ 600 MHz
			-82		dBFS	600 MHz < f ≤ 4800 MHz
			-80		dBFS	4800 MHz < f ≤ 6000 MHz
Carrier on LO			-71		dBFS	
Error Vector Magnitude (Third Generation Partnership Project (3GPP) Test Signals)	EVM					
75 MHz LO <sup>2</sup>			0.5		%	300 kHz RF PLL loop bandwidth
1900 MHz LO			0.7		%	50 kHz RF PLL loop bandwidth
3800 MHz LO			0.7		%	300 kHz RF PLL loop bandwidth
5900 MHz LO			1.1		%	300 kHz RF PLL loop bandwidth
Output Impedance	Z <sub>OUT</sub>		50		Ω	Differential (see Figure 265)
OBSERVATION RECEIVER	ORx					
Center Frequency		75		6000	MHz	
Gain Range			30		dB	Third-order input intermodulation intercept point (IIP3) improves decibel for decibel for the first 18 dB of gain attenuation, QEC performance optimized for 0 dB to 6 dB of attenuation only
Analog Gain Step			0.5		dB	For attenuator steps from 0 dB to 6 dB
Peak-to-Peak Gain Deviation			1		dB	450 MHz bandwidth, compensated by programmable FIR filter
Gain Slope			±0.1		dB	Any 20 MHz bandwidth span, compensated by programmable FIR filter
Deviation from Linear Phase			1		Degrees	450 MHz RF bandwidth
Observation Receiver Bandwidth				450	MHz	
Observation Receiver Alias Band Rejection		60			dB	Due to digital filters
Maximum Useable Input Level	P <sub>HIGH</sub>					0 dB attenuation, increases decibel for decibel with attenuation, continuous wave corresponds to -1 dBFS at ADC
			-11		dBm	75 MHz < f ≤ 3000 MHz
			-9.5		dBm	3000 MHz < f ≤ 4800 MHz
			-8		dBm	4800 MHz < f ≤ 6000 MHz
Integrated Noise			-58.5		dBFS	450 MHz integration bandwidth
			-57.5		dBFS	491.52 MHz integration bandwidth

Parameter	Symbol	Min	Typ	Max	Unit	Test Conditions/Comments
Second-Order Input Intermodulation Intercept Point	IIP2		62		dBm	Maximum observation receiver gain, ( $P_{HIGH} - 14$ ) dB per tone (see the Terminology section), $75 \text{ MHz} < f \leq 600 \text{ MHz}$
			62		dBm	Maximum observation receiver gain, ( $P_{HIGH} - 8$ ) dB per tone (see the Terminology section), $600 \text{ MHz} < f \leq 3000 \text{ MHz}$
Third-Order Input Intermodulation Intercept Point Narrow Band	IIP3		4		dBm	$75 \text{ MHz} < f \leq 300 \text{ MHz}$ , ( $P_{HIGH} - 14$ ) dB per tone
			11		dBm	$300 \text{ MHz} < f \leq 600 \text{ MHz}$ , ( $P_{HIGH} - 14$ ) dB per tone
			12		dBm	IM3 product $< 130 \text{ MHz}$ at baseband, ( $P_{HIGH} - 8$ ) dB per tone
			12		dBm	$600 \text{ MHz} < f \leq 3000 \text{ MHz}$
			11		dBm	$3000 \text{ MHz} < f \leq 4800 \text{ MHz}$
			11		dBm	$4800 \text{ MHz} < f \leq 6000 \text{ MHz}$
Wide Band			7		dBm	$600 \text{ MHz} < f \leq 3000 \text{ MHz}$
			7		dBm	$3000 \text{ MHz} < f \leq 4800 \text{ MHz}$
			6		dBm	$4800 \text{ MHz} < f \leq 6000 \text{ MHz}$
			6		dBm	$4800 \text{ MHz} < f \leq 6000 \text{ MHz}$
Third-Order Intermodulation Product	IM3					IM3 product $< 130 \text{ MHz}$ at baseband, two tones, each at ( $P_{HIGH} - 12$ ) dB
			-70		dBc	$600 \text{ MHz} < f \leq 3000 \text{ MHz}$
			-67		dBc	$3000 \text{ MHz} < f \leq 4800 \text{ MHz}$
			-62		dBc	$4800 \text{ MHz} < f \leq 6000 \text{ MHz}$
Fifth-Order Intermodulation Product (1800 MHz)	IM5		-80		dBc	IM5 product $< 50 \text{ MHz}$ at baseband, two tones, each at ( $P_{HIGH} - 12$ ) dB, $600 \text{ MHz} < f \leq 6000 \text{ MHz}$
Seventh-Order Intermodulation Product (1800 MHz)	IM7		-80		dBc	IM7 product $< 50 \text{ MHz}$ at baseband, two tones, each at ( $P_{HIGH} - 12$ ) dB, $600 \text{ MHz} < f \leq 6000 \text{ MHz}$
Spurious-Free Dynamic Range	SFDR		70		dB	Non IMx related spurs, does not include HDx, ( $P_{HIGH} - 9$ ) dB input signal, $600 \text{ MHz} < f \leq 6000 \text{ MHz}$
Harmonic Distortion Second-Order Harmonic Distortion Product	HD2		-80		dBc	( $P_{HIGH} - 11$ ) dB input signal
			-80		dBc	( $P_{HIGH} - 11$ ) dB input signal, $75 \text{ MHz} < f \leq 600 \text{ MHz}$
			-80		dBc	( $P_{HIGH} - 9$ ) dB input signal, $600 \text{ MHz} < f \leq 6000 \text{ MHz}$
Third-Order Harmonic Distortion Product	HD3		-70		dBc	In band HD falls within $\pm 100 \text{ MHz}$
			-60		dBc	Out of band HD falls within $\pm 225 \text{ MHz}$
Image Rejection Within Large Signal Bandwidth			65		dB	QEC active
			55		dB	QEC active
Outside Large Signal Bandwidth			55		dB	QEC active

Parameter	Symbol	Min	Typ	Max	Unit	Test Conditions/Comments
Input Impedance			100		$\Omega$	Differential (see Figure 266)
Isolation Transmitter 1 (Tx1) to Observation Receiver 1 (ORx1) and Transmitter 2 (Tx2) to Observation Receiver 2 (ORx2)			100		dB	75 MHz < f ≤ 600 MHz
			65		dB	600 MHz < f ≤ 5300 MHz
			55		dB	5300 MHz < f ≤ 6000 MHz
Tx1 to ORx 2 and Tx2 to ORx 1			105		dB	75 MHz < f ≤ 600 MHz
			65		dB	600 MHz < f ≤ 5300 MHz
			55		dB	5300 MHz < f ≤ 6000 MHz
<b>LO SYNTHESIZER</b>						
LO Frequency Step			2.3		Hz	1.5 GHz to 2.8 GHz, 76.8 MHz phase frequency detector (PFD) frequency
LO Spur			-85		dBc	Excludes integer boundary spurs
Integrated Phase Noise 75 MHz LO			0.014		°rms	2 kHz to 18 MHz Narrow PLL loop bandwidth (50 kHz)
1900 MHz LO			0.2		°rms	Narrow PLL loop bandwidth (50 kHz)
3800 MHz LO			0.36		°rms	Wide PLL loop bandwidth (300 kHz)
5900 MHz LO			0.54		°rms	Wide PLL loop bandwidth (300 kHz)
Spot Phase Noise 75 MHz LO						Narrow PLL loop bandwidth
10 kHz Offset			-126.5		dBc/Hz	
100 kHz Offset			-132.8		dBc/Hz	
1 MHz Offset			-150.1		dBc/Hz	
10 MHz Offset			-150.7		dBc/Hz	
1900 MHz LO						Narrow PLL loop bandwidth
100 kHz Offset			-100		dBc/Hz	
200 kHz Offset			-115		dBc/Hz	
400 kHz Offset			-120		dBc/Hz	
600 kHz Offset			-129		dBc/Hz	
800 kHz Offset			-132		dBc/Hz	
1.2 MHz Offset			-135		dBc/Hz	
1.8 MHz Offset			-140		dBc/Hz	
6 MHz Offset			-150		dBc/Hz	
10 MHz Offset			-153		dBc/Hz	
3800 MHz LO						Wide PLL loop bandwidth
100 kHz Offset			-104		dBc/Hz	
1.2 MHz Offset			-125		dBc/Hz	
10 MHz Offset			-145		dBc/Hz	
5900 MHz LO						Wide PLL loop bandwidth
100 kHz Offset			-99		dBc/Hz	
1.2 MHz Offset			-119.7		dBc/Hz	
10 MHz Offset			-135.4		dBc/Hz	
<b>LO PHASE SYNCHRONIZATION</b>						
Phase Deviation			1.6		ps/°C	Change in LO delay per temperature change



Parameter	Symbol	Min	Typ	Max	Unit	Test Conditions/Comments
EXTERNAL LO INPUT						
Input Frequency	$f_{EXTLO}$	300		8000	MHz	Input frequency must be 2× the desired LO frequency
Input Signal Power		0	3	12	dBm	50 $\Omega$ matching at the source
			6		dBm	$f_{EXTLO} \leq 2$ GHz, add 0.5 dBm/GHz above 2 GHz
External LO Input Signal Differential					dBm	$f_{EXTLO} = 8$ GHz To ensure adequate QEC
Phase Error				3.6	ps	
Amplitude Error				1	dB	
Duty Cycle Error				2	%	
Even-Order Harmonics				-50	dBc	
CLOCK SYNTHESIZER						
Integrated Phase Noise 1966.08 MHz LO			0.4		$^{\circ}$ rms	1 kHz to 100 MHz PLL optimized for close in phase noise
Spot Phase Noise 1966.08 MHz LO						
100 kHz Offset			-109		dBc/Hz	
1 MHz Offset			-129		dBc/Hz	
10 MHz Offset			-149		dBc/Hz	
REFERENCE CLOCK (REF_CLK_IN $\pm$ )						
Frequency Range		10		1000	MHz	
Signal Level		0.3		2.0	V p-p	AC-coupled, common-mode voltage ( $V_{CM}$ ) = 618 mV, for best spurious performance, use <1 V p-p input clock
AUXILIARY CONVERTERS						
ADC						
Resolution			12		Bits	
Input Voltage						
Minimum			0.05		V	
Maximum			VDDA_3P3 - 0.05		V	
DAC						
Resolution			10		Bits	Includes four offset levels
Output Voltage						
Minimum			0.7		V	1 V $V_{REF}$
Maximum			VDDA_3P3 - 0.3		V	2.5 V $V_{REF}$
Output Drive Capability			10		mA	
DIGITAL SPECIFICATIONS (CMOS)—SDIO, SDO, SCLK, $\overline{CS}$ GPIO_x, TXx_ENABLE, ORRx_ENABLE						
Logic Inputs						
Input Voltage						
High Level		VDD_INTERFACE $\times 0.8$		VDD_INTERFACE	V	
Low Level		0		VDD_INTERFACE $\times 0.2$	V	
Input Current						

Parameter	Symbol	Min	Typ	Max	Unit	Test Conditions/Comments
High Level		-10		+10	μA	
Low Level		-10		+10	μA	
Logic Outputs						
Output Voltage						
High Level		VDD_ INTERFACE × 0.8			V	
Low Level				VDD_ INTERFACE × 0.2	V	
Drive Capability			3		mA	
<b>DIGITAL SPECIFICATIONS (CMOS)—GPIO_3p3_x</b>						
Logic Inputs						
Input Voltage						
High Level		VDDA_3P3 × 0.8		VDDA_ 3P3	V	
Low Level		0		VDDA_ 3P3 × 0.2	V	
Input Current						
High Level		-10		+10	μA	
Low Level		-10		+10	μA	
Logic Outputs						
Output Voltage						
High Level		VDDA_ 3P3 × 0.8			V	
Low Level				VDDA_ 3P3 × 0.2	V	
Drive Capability			4		mA	
<b>DIGITAL SPECIFICATIONS (LVDS)</b>						
Logic Inputs (SYSREF_IN±, SYNCINx±)						
Input Voltage Range		825		1675	mV	Each differential input in the pair
Input Differential Voltage Threshold		-100		+100	mV	
Receiver Differential Input Impedance			100		Ω	Internal termination enabled
Logic Outputs (SYNCOUtx±)						
Output Voltage						
High				1375	mV	
Low		1025			mV	
Output Differential Voltage			225		mV	Programmable in 75 mV steps
Output Offset Voltage			1200		mV	
<b>SPI TIMING</b>						
SCLK Period	t <sub>CP</sub>	20			ns	See the <a href="#">UG-1295</a> for more information.
SCLK Pulse Width	t <sub>MP</sub>	10			ns	
CS Setup to First SCLK Rising Edge	t <sub>SC</sub>	3			ns	
Last SCLK Falling Edge to CS Hold	t <sub>HC</sub>	0			ns	
SDIO Data Input Setup to SCLK	t <sub>S</sub>	2			ns	

Parameter	Symbol	Min	Typ	Max	Unit	Test Conditions/Comments
SDIO Data Input Hold to SCLK	$t_H$	0			ns	
SCLK Rising Edge to Output Data Delay (3-Wire or 4-Wire Mode)	$t_{CO}$	3		8	ns	
Bus Turnaround Time, Read After Bits per Pixel (BPP) Drives Last Address Bit	$t_{HZM}$	$t_H$		$t_{CO}$	ns	
Bus Turnaround Time, Read After ADRV9008-2 Drives Last Data Bit	$t_{HVS}$	0		$t_{CO}$	ns	
<b>JESD204B DATA OUTPUT TIMING</b>						AC-coupled
Unit Interval	UI	81.38		320	ps	
Data Rate per Channel Nonreturn to Zero (NRZ)		3125		12,288	Mbps	
Rise Time	$t_R$	24	39.5		ps	20% to 80% in 100 $\Omega$ load
Fall Time	$t_F$	24	39.4		ps	20% to 80% in 100 $\Omega$ load
Output Common-Mode Voltage	$V_{CM}$	0		1.8	V	AC-coupled
Differential Output Voltage	$V_{DIFF}$	360	600	770	mV	
Short-Circuit Current	$I_{DSHORT}$	-100		+100	mA	
Differential Termination Impedance		80	94.2	120	$\Omega$	
Total Jitter			15.13		ps	Bit error rate (BER) = $10^{-15}$
Uncorrelated Bounded High Probability Jitter	UBHPJ		0.56		ps	
Duty Cycle Distortion	DCD		0.369		ps	
SYSREF_IN $\pm$ Setup Time to REF_CLK_IN $\pm$		2.5			ns	See Figure 2
SYSREF_IN $\pm$ Hold Time to REF_CLK_IN $\pm$		-1.5			ns	See Figure 2
Latency	$t_{LAT\_FRM}$		116.5		Clock cycles	REF_CLK_IN $\pm$ = 245.76 MHz Observation receiver bandwidth = 450 MHz, IQ rate = 491.52 MHz, lane rate = 9830.4 MHz, number of converters (M) = 4, number of lanes (L) = 2, converter resolution (N) = 16, number of samples per converter (S) = 1
			237.02		ns	
			89.4		Clock cycles	Observation receiver bandwidth = 200 MHz, IQ rate = 245.76 MHz, lane rate = 9830.4 MHz, M = 2, L = 2, N = 16, S = 1
			364.18		ns	
<b>JESD204B DATA INPUT TIMING</b>						AC-coupled
Unit Interval	UI	81.38		320	ps	
Data Rate per Channel (NRZ)		3125		12288	Mbps	
Differential Voltage	$V_{DIFF}$	125		750	mV	
$V_{TT}$ Source Impedance	$Z_{TT}$		8.9	30	$\Omega$	
Differential Impedance	$Z_{RDIFF}$	80	105.1	120		

Parameter	Symbol	Min	Typ	Max	Unit	Test Conditions/Comments
Termination Voltage	$V_{TT}$	1.267		1.33	V	Device clock = 245.76 MHz, transmitter bandwidth = 200 MHz, IQ rate = 491.52 MHz, lane rate = 9830.4 MHz, M = 2, L = 2, N = 16, S = 1
AC-Coupled Latency	$t_{LAT\_DEFRM}$		74.45		Clock cycles	
			153.5		ns	

<sup>1</sup> VDDA1P3 refers to all analog 1.3 V supplies, including: VDDA1P3\_RF\_SYNTH, VDDA1P3\_BB, VDDA1P3\_RX\_RF, VDDA1P3\_RX\_TX, VDDA1P3\_RF\_VCO\_LDO, VDDA1P3\_RF\_LO, VDDA1P3\_DES, VDDA1P3\_SER, VDDA1P3\_CLOCK\_SYNTH, VDDA1P3\_CLOCK\_VCO\_LDO, VDDA1P3\_AUX\_SYNTH, and VDDA1P3\_AUX\_VCO\_LDO.  
<sup>2</sup> Test equipment phase noise performance limited.

## CURRENT AND POWER CONSUMPTION SPECIFICATIONS

Table 2.

Parameter	Min	Typ	Max	Unit	Test Conditions/Comments
SUPPLY CHARACTERISTICS					
VDDA1P3 <sup>1</sup> Analog Supply	1.267	1.3	1.33	V	
VDDD1P3_DIG Supply	1.267	1.3	1.33	V	
VDDA1P8_TX Supply	1.71	1.8	1.89	V	
VDDA1P8_BB Supply	1.71	1.8	1.89	V	
VDD_INTERFACE Supply	1.71	1.8	2.625	V	CMOS and LVDS supply, 1.8 V to 2.5 V nominal range
VDDA_3P3 Supply	3.135	3.3	3.465	V	
POSITIVE SUPPLY CURRENT					
450 MHz Transmitter Bandwidth, Observation Receiver Disabled					
VDDA1P3 <sup>1</sup> Analog Supply		1978		mA	LO at 2600 MHz Two transmitters enabled
VDDD1P3_DIG Supply		611		mA	Transmitter QEC active
VDDA1P8_TX Supply		455		mA	Transmitter RF attenuation = 0 dB, full scale continuous wave
		135		mA	Transmitter RF attenuation = 15 dB, full scale continuous wave
VDD_INTERFACE Supply		8		mA	VDD_INTERFACE = 2.5 V
VDDA1P8_BB Supply		68		mA	
VDDA_3P3 Supply		3		mA	No Auxiliary DAC x or AUXADC_x enabled, if enabled, AUXADC_x adds 2.7 mA and each Auxiliary DAC x adds 1.5 mA
Total Power Dissipation		4.34		W	Typical supply voltages, 0 dB transmitter attenuation, transmitter QEC active
		3.76		W	Typical supply voltages, 15 dB transmitter attenuation, transmitter QEC active
450 MHz Transmitter Bandwidth, Observation Receiver Enabled					
VDDA1P3 <sup>1</sup> Analog Supply		2059		mA	Two transmitters enabled
VDDD1P3_DIG Supply		1501		mA	Transmitter QEC tracking active, observation receiver QEC enabled
VDDA1P8_TX Supply		455		mA	Transmitter RF attenuation = 0 dB, full scale continuous wave
		135		mA	Transmitter RF attenuation = 15 dB, full scale continuous wave
VDD_INTERFACE Supply		8		mA	VDD_INTERFACE = 2.5 V
VDDA1P8_BB Supply		63		mA	
VDDA_3P3 Power Supply		3		mA	No Auxiliary DAC x or AUXADC_x enabled, if enabled, AUXADC_x adds 2.7 mA and each Auxiliary DAC x adds 1.5 mA
Total Power Dissipation		5.59		W	Typical supply voltages, 0 dB transmitter attenuation, transmitter QEC active
		5.01		W	Typical supply voltages, 15 dB transmitter attenuation, transmitter QEC active

<sup>1</sup> VDDA1P3 refers to all analog 1.3 V supplies, including: VDDA1P3\_RF\_SYNTH, VDDA1P3\_BB, VDDA1P3\_RX\_RF, VDDA1P3\_RX\_TX, VDDA1P3\_RF\_VCO\_LDO, VDDA1P3\_RF\_LO, VDDA1P3\_DES, VDDA1P3\_SER, VDDA1P3\_CLOCK\_SYNTH, VDDA1P3\_CLOCK\_VCO\_LDO, VDDA1P3\_AUX\_SYNTH, and VDDA1P3\_AUX\_VCO\_LDO.

TIMING DIAGRAMS

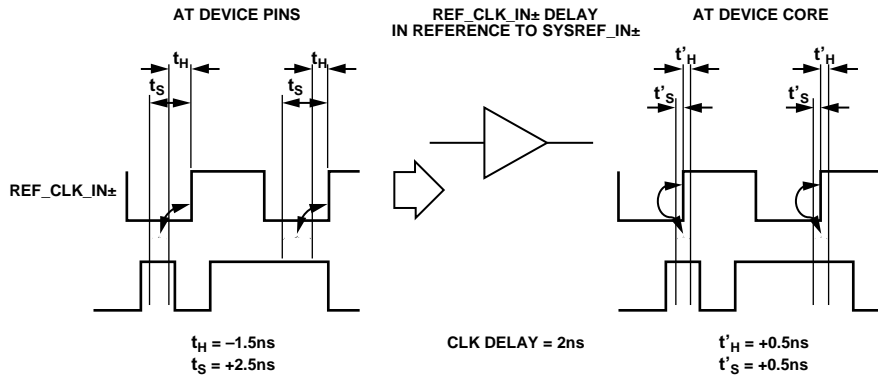

NOTES

1.  $t_H$  AND  $t_S$  ARE THE HOLD AND SETUP TIMES FOR THE REF\_CLK\_IN± PINS.  $t'_H$  AND  $t'_S$  REFER TO THE DELAYED HOLD AND SETUP TIMES AT THE DEVICE CORE IN REFERENCE TO THE SYSREF\_N± SIGNALS DUE TO AN INTERNAL BUFFER THAT THE SIGNAL PASSES THROUGH.

16833-005

Figure 2. SYSREF\_IN± Setup and Hold Timing

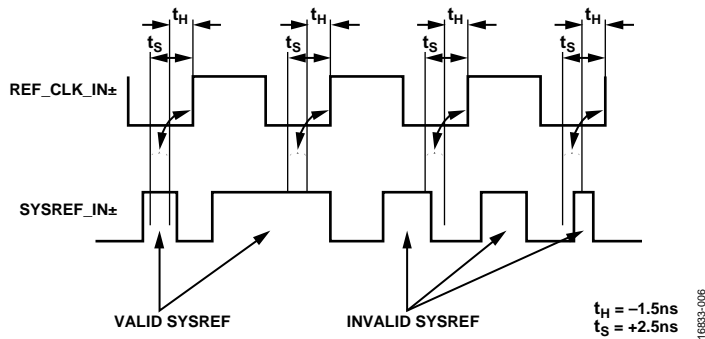

16833-006

Figure 3. SYSREF\_IN± Setup and Hold Timing Examples, Relative to Device Clock

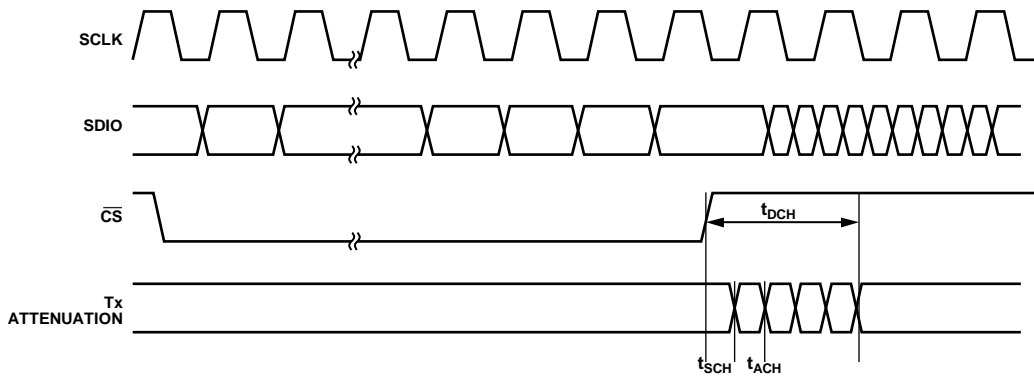

16833-007

Figure 4. Transmitter Attenuation Update via SPI 2 Port

# ABSOLUTE MAXIMUM RATINGS

Table 3.

Parameter	Rating
VDDA1P3 <sup>1</sup> to VSSA	-0.3 V to +1.4 V
VDDD1P3_DIG to VSSD	-0.3 V to +1.4 V
VDD_INTERFACE to VSSA	-0.3 V to +3.0 V
VDDA_3P3 to VSSA	-0.3 V to +3.9 V
VDDA1P8_TX to VSSA	-0.3 V to +2.0 V
VDD_INTERFACE Logic Inputs and Outputs to VSSD	-0.3 V to VDD_INTERFACE + 0.3 V
JESD204B Logic Outputs to VSSA	-0.3 V to VDDA1P3_SER
JESD204B Logic Inputs to VSSA	-0.3 V to VDDA1P3_DES + 0.3 V
Input Current to any Pin Except Supplies	±10 mA
Reflow Profile	260°C
Maximum Input Power into RF Port	23 dBm (peak)
Maximum Transmitter Voltage Standing Wave Ratio (VSWR)	3:1
Maximum Junction Temperature	110°C
Storage Temperature Range	-65°C to +150°C

<sup>1</sup> VDDA1P3 refers to all analog 1.3 V supplies, including: VDDA1P3\_RF\_SYNTH, VDDA1P3\_BB, VDDA1P3\_RX\_RF, VDDA1P3\_RX\_TX, VDDA1P3\_RF\_VCO\_LDO, VDDA1P3\_RF\_LO, VDDA1P3\_DES, VDDA1P3\_SER, VDDA1P3\_CLOCK\_SYNTH, VDDA1P3\_CLOCK\_VCO\_LDO, VDDA1P3\_AUX\_SYNTH, and VDDA1P3\_AUX\_VCO\_LDO.

Stresses at or above those listed under Absolute Maximum Ratings may cause permanent damage to the product. This is a stress rating only; functional operation of the product at these or any other conditions above those indicated in the operational section of this specification is not implied. Operation beyond the maximum operating conditions for extended periods may affect product reliability.

## REFLOW PROFILE

The ADRV9008-2 reflow profile is in accordance with the JEDEC JESD204B criteria for Pb-free devices. The maximum reflow temperature is 260°C.

## THERMAL MANAGEMENT

The ADRV9008-2 is a high power device that can dissipate over 3 W depending on the user application and configuration. Because of the power dissipation, the ADRV9008-2 uses an

exposed die package to provide the customer with the most effective method of controlling the die temperature. The exposed die allows cooling of the die directly. Figure 5 shows the profile view of the device mounted to a user printed circuit board (PCB) and a heat sink (typically the aluminum case) to keep the junction (exposed die) below the maximum junction temperature shown in Table 3. The device is designed for a lifetime of 10 years when operating at the maximum junction temperature.

## THERMAL RESISTANCE

Thermal performance is directly linked to PCB design and operating environment. Careful attention to PCB thermal design is required.

$\theta_{JA}$  is the natural convection junction to ambient thermal resistance measured in a one cubic foot sealed enclosure.  $\theta_{JC}$  is the junction to case thermal resistance.

Thermal resistance data for the ADRV9008-2 mounted on both a JEDEC 2S2P test board and a 10-layer Analog Devices, Inc., evaluation board is listed in Table 4. Do not exceed the absolute maximum junction temperature rating in Table 3. Ten-layer PCB entries refer to the 10-layer Analog Devices evaluation board, which more accurately reflects the PCB used in customer applications.

Table 4. Thermal Resistance<sup>1,2</sup>

Package Type	$\theta_{JA}$	$\theta_{JC\_TOP}$	$\theta_{JB}$	$\Psi_{JT}$	$\Psi_{JB}$	Unit
BC-196-13	21.1	0.04	4.9	0.3	4.9	°C/W

<sup>1</sup> For the  $\theta_{JC}$  test, 100  $\mu$ m thermal interface material (TIM) is used. TIM is assumed to have 3.6 thermal conductivity watts/(meter  $\times$  Kelvin).

<sup>2</sup> Using enhanced heat removal techniques such as PCB, heat sink, and airflow improves the thermal resistance values.

## ESD CAUTION



**ESD (electrostatic discharge) sensitive device.** Charged devices and circuit boards can discharge without detection. Although this product features patented or proprietary protection circuitry, damage may occur on devices subjected to high energy ESD. Therefore, proper ESD precautions should be taken to avoid performance degradation or loss of functionality.

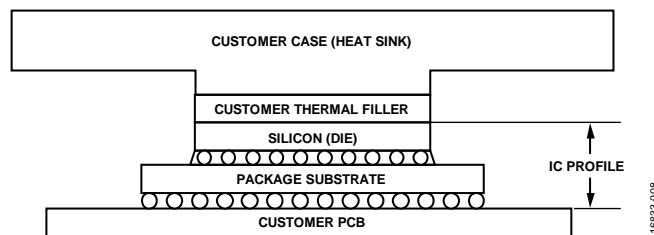

Figure 5. Typical Thermal Management Solution

### PIN CONFIGURATION AND FUNCTION DESCRIPTIONS

	1	2	3	4	5	6	7	8	9	10	11	12	13	14
A	VSSA	ORX2_IN+	ORX2_IN-	VSSA	VSSA	VSSA	VSSA	VSSA	VSSA	VSSA	VSSA	ORX1_IN+	ORX1_IN-	VSSA
B	VDDA1P3_RX_RF	VSSA	VSSA	VSSA	VSSA	VSSA	RF_EXT_LO_I/O-	RF_EXT_LO_I/O+	VSSA	VSSA	VSSA	VSSA	VSSA	VSSA
C	GPIO_3p3_0	GPIO_3p3_3	VDDA1P3_RX_TX	VSSA	VDDA1P3_RF_VCO_LDO	VDDA1P3_RF_VCO_LDO	VDDA1P1_RF_VCO	VDDA1P3_RF_LO	VSSA	VDDA1P3_AUX_VCO_LDO	VSSA	VDDA_3P3	GPIO_3p3_9	RBIAS
D	GPIO_3p3_1	GPIO_3p3_4	VSSA	VSSA	VSSA	VSSA	VSSA	VSSA	VSSA	VDDA1P1_AUX_VCO	VSSA	VSSA	GPIO_3p3_8	GPIO_3p3_10
E	GPIO_3p3_2	GPIO_3p3_5	GPIO_3p3_6	VDDA1P8_BB	VDDA1P3_BB	VSSA	REF_CLK_IN+	REF_CLK_IN-	VSSA	AUX_SYNTH_OUT	AUXADC_3	VDDA1P8_TX	GPIO_3p3_7	GPIO_3p3_11
F	VSSA	VSSA	AUXADC_0	AUXADC_1	VSSA	VSSA	VSSA	VSSA	VSSA	VSSA	AUXADC_2	VSSA	VSSA	VSSA
G	VSSA	VSSA	VSSA	VSSA	VDDA1P3_CLOCK_SYNTH	VSSA	VDDA1P3_RF_SYNTH	VDDA1P3_AUX_SYNTH	RF_SYNTH_VTUNE	VSSA	VSSA	VSSA	VSSA	VSSA
H	TX2_OUT-	VSSA	VSSA	VSSA	VSSA	VSSA	VSSA	VSSA	VSSA	VSSA	GPIO_12	GPIO_11	VSSA	TX1_OUT+
J	TX2_OUT+	VSSA	GPIO_18	RESET	GP_INTERRUPT	TEST	GPIO_2	GPIO_1	SDIO	SDO	GPIO_13	GPIO_10	VSSA	TX1_OUT-
K	VSSA	VSSA	SYSREF_IN+	SYSREF_IN-	GPIO_5	GPIO_4	GPIO_3	GPIO_0	SCLK	CS	GPIO_14	GPIO_9	VSSA	VSSA
L	VSSA	VSSA	SYNCIN1-	SYNCIN1+	GPIO_6	GPIO_7	VSSD	VDDD1P3_DIG	VDDD1P3_DIG	VSSD	GPIO_15	GPIO_8	SYNCOUT1-	SYNCOUT1+
M	VDDA1P1_CLOCK_VCO	VSSA	SYNCIN0-	SYNCIN0+	ORX1_ENABLE	TX1_ENABLE	ORX2_ENABLE	TX2_ENABLE	VSSA	GPIO_17	GPIO_16	VDD_INTERFACE	SYNCOUT0-	SYNCOUT0+
N	VDDA1P3_CLOCK_VCO_LDO	VSSA	SERDOUT3-	SERDOUT3+	SERDOUT2-	SERDOUT2+	VSSA	VDDA1P3_SER	VDDA1P3_DES	SERDIN1-	SERDIN1+	SERDIN0-	SERDIN0+	VSSA
P	AUX_SYNTH_VTUNE	VSSA	VSSA	SERDOUT1-	SERDOUT1+	SERDOUT0-	SERDOUT0+	VDDA1P3_SER	VDDA1P3_DES	VSSA	SERDIN3-	SERDIN3+	SERDIN2-	SERDIN2+

ADRV9008-2

Figure 6. Pin Configuration

16633-900

Table 5. Pin Function Descriptions

Pin No.	Type	Mnemonic	Description
A1, A4 to A11, A14, B2 to B6, B9 to B14, C4, C9, C11, D3 to D9, D11, D12, E6, E9, F1, F2, F5 to F10, F12 to F14, G1 to G4, G6, G10 to G14, H2 to H10, H13, J2, J13, K1, K2, K13, K14, L1, L2, M2, M9, N2, N7, N14, P2, P3, P10	Input	VSSA	Analog Supply Voltage (V <sub>SS</sub> ).
A2	Input	ORX2_IN+	Differential Input for Observation Receiver 2. When this pin is unused, connect to GND.



Pin No.	Type	Mnemonic	Description
A3	Input	ORX2_IN-	Differential Input for Observation Receiver 2. When this pin is unused, connect to GND.
A12	Input	ORX1_IN+	Differential Input for Observation Receiver 1. When this pin is unused, connect to GND.
A13	Input	ORX1_IN-	Differential Input for Observation Receiver 1. When this pin is unused, connect to GND.
B1	Input	VDDA1P3_RX_RF	Observation Receiver Supply.
B7	Input	RF_EXT_LO_I/O-	Differential External LO Input/Output. If this pin is used for the external LO, the input frequency must be 2x the desired carrier frequency. When this pin is unused, do not connect.
B8	Input	RF_EXT_LO_I/O+	Differential External LO Input/Output. If this pin is used for the external LO, the input frequency must be 2x the desired carrier frequency. When this pin is unused, do not connect.
C1	Input/output	GPIO_3p3_0	General-Purpose Inputs and Outputs (GPIO) Pin Referenced to 3.3 V Supply. The alternative function is Auxiliary DAC 4. Because this pin contains an input stage, control the voltage on the pin. When unused, this pin can be tied to ground through a resistor to safeguard against misconfiguration, or this pin can be left floating, programmed as an output, and driven low.
C2	Input/output	GPIO_3p3_3	General-Purpose Inputs and Outputs Pin Referenced to 3.3 V Supply. Because this pin contains an input stage, control the voltage on the pin. When unused, this pin can be tied to ground through a resistor to safeguard against misconfiguration, or this pin can be left floating, programmed as an output, and driven low.
C3	Input	VDDA1P3_RX_TX	1.3 V Supply for Transmitter/Observation Receiver Baseband Circuits. This pin can power the transimpedance amplifier/transmitter (TIA/TX), transconductance/baseband (GM/BB) filter/auxiliary DACs circuits.
C5, C6	Input	VDDA1P3_RF_VCO_LDO	RF VCO LDO Supply Inputs. Connect Pin C5 to Pin C6. Use a separate trace on the PCB back to a common supply point.
C7	Input	VDDA1P1_RF_VCO	1.1 V VCO Supply. Decouple this pin with a 1 $\mu$ F capacitor.
C8	Input	VDDA1P3_RF_LO	1.3 V LO Generator for RF Synthesizer. This pin is sensitive to supply noise.
C10	Input	VDDA1P3_AUX_VCO_LDO	1.3 V Supply.
C12	Input	VDDA_3P3	General-Purpose Output Pull-Up Voltage and Auxiliary DAC Supply Voltage.
C13	Input/output	GPIO_3p3_9	General-Purpose Inputs and Outputs Pin Referenced to 3.3 V Supply. The alternative function is Auxiliary DAC 9. Because this pin contains an input stage, control the voltage on the pin. When unused, this pin can be tied to ground through a resistor to safeguard against misconfiguration, or this pin can be left floating, programmed as an output, and driven low.
C14	Input/output	RBIAS	Bias Resistor. Tie this pin to ground using a 14.3 k $\Omega$ resistor. This pin generates an internal current based on an external 1% resistor.
D1	Input/output	GPIO_3p3_1	General-Purpose Inputs and Outputs Pin Referenced to 3.3 V Supply. The alternative function is Auxiliary DAC 5. Because this pin contains an input stage, control the voltage on the pin. When unused, this pin can be tied to ground through a resistor to safeguard against misconfiguration, or this pin can be left floating, programmed as an output, and driven low.
D2	Input/output	GPIO_3p3_4	General-Purpose Inputs and Outputs Pin Referenced to 3.3 V Supply. The alternative function is Auxiliary DAC 6. Because this pin contains an input stage, control the voltage on the pin. When unused, this pin can be tied to ground through a resistor to safeguard against misconfiguration, or this pin can be left floating, programmed as an output, and driven low.
D10	Input	VDDA1P1_AUX_VCO	1.1 V VCO Supply. Decouple this pin with a 1 $\mu$ F capacitor.

Pin No.	Type	Mnemonic	Description
D13	Input/output	GPIO_3p3_8	General-Purpose Inputs and Outputs Pin Referenced to 3.3 V Supply. The alternative function is Auxiliary DAC 1. Because this pin contains an input stage, control the voltage on the pin. When unused, this pin can be tied to ground through a resistor to safeguard against misconfiguration, or this pin can be left floating, programmed as an output, and driven low.
D14	Input/output	GPIO_3p3_10	General-Purpose Inputs and Outputs Pin Referenced to 3.3 V Supply. The alternative function is Auxiliary DAC 0. Because this pin contains an input stage, control the voltage on the pin. When unused, this pin can be tied to ground through a resistor to safeguard against misconfiguration, or this pin can be left floating, programmed as an output, and driven low.
E1	Input/output	GPIO_3p3_2	General-Purpose Inputs and Outputs Pin Referenced to 3.3 V Supply. Because this pin contains an input stage, control the voltage on the pin. When unused, this pin can be tied to ground through a resistor to safeguard against misconfiguration, or this pin can be left floating, programmed as an output, and driven low.
E2	Input/output	GPIO_3p3_5	General-Purpose Inputs and Outputs Pin Referenced to 3.3 V Supply. The alternative function is Auxiliary DAC 7. Because this pin contains an input stage, control the voltage on the pin. When unused, this pin can be tied to ground through a resistor to safeguard against misconfiguration, or this pin can be left floating, programmed as an output, and driven low.
E3	Input/output	GPIO_3p3_6	General-Purpose Inputs and Outputs Pin Referenced to 3.3 V Supply. The alternative function is Auxiliary DAC 8. Because this pin contains an input stage, control the voltage on the pin. When unused, this pin can be tied to ground through a resistor to safeguard against misconfiguration, or this pin can be left floating, programmed as outputs, and driven low.
E4	Input	VDDA1P8_BB	1.8 V Supply for the ADC and DAC.
E5	Input	VDDA1P3_BB	1.3 V Supply for the ADC, DAC, and auxiliary ADC.
E7	Input	REF_CLK_IN+	Device Clock Differential Input.
E8	Input	REF_CLK_IN-	Device Clock Differential Input Negative.
E10	Output	AUX_SYNTH_OUT	Auxiliary PLL Output. When this pin is unused, do not connect.
E11, F3, F4, F11	Input	AUXADC_0 through AUXADC_3	Auxiliary ADC Inputs. When these pins are unused, connect these pins to GND with a pull-down resistor or connect these pins directly to GND.
E12	Input	VDDA1P8_TX	1.8 V Supply for Transmitter.
E13	Input/output	GPIO_3p3_7	General-Purpose Inputs and Outputs Pin Referenced to 3.3 V Supply. The alternative function is Auxiliary DAC 2. Because this pin contains an input stage, control the voltage on the pin. When unused, this pin can be tied to ground through a resistor to safeguard against misconfiguration, or this pin can be left floating, programmed as an output, and driven low.
E14	Input/output	GPIO_3p3_11	General-Purpose Inputs and Outputs Pin Referenced to 3.3 V Supply. The alternative function is Auxiliary DAC 3. Because this pin contains an input stage, control the voltage on the pin. When unused, this pin can be tied to ground through a resistor to safeguard against misconfiguration, or this pin can be left floating, programmed as an output, and driven low.
G5	Input	VDDA1P3_CLOCK_SYNTH	1.3 V Supply Input for Clock Synthesizer. Use a separate trace on the PCB back to a common supply point.
G7	Input	VDDA1P3_RF_SYNTH	1.3 V RF Synthesizer Supply Input. This pin is sensitive to aggressors.
G8	Input	VDDA1P3_AUX_SYNTH	1.3 V Auxiliary Synthesizer Supply Input.
G9	Output	RF_SYNTH_VTUNE	RF Synthesizer PLL Tuning Voltage (V <sub>TUNE</sub> ) Output.

Pin No.	Type	Mnemonic	Description
H1	Output	TX2_OUT-	Transmitter 2 Negative Output. When unused, do not connect this pin.
H11	Input/output	GPIO_12	Digital GPIO, 1.8 V to 2.5 V. Because this pin contains an input stage, control the voltage on the pin. When unused, this pin can be tied to ground through a resistor to safeguard against misconfiguration, or the pin can be left floating, programmed as an output, and driven low.
H12	Input/output	GPIO_11	Digital GPIO, 1.8 V to 2.5 V. Because this pin contains an input stage, control the voltage on the pin. When unused, this pin can be tied to ground through a resistor to safeguard against misconfiguration, or the pin can be left floating, programmed as an output, and driven low.
H14	Output	TX1_OUT+	Transmitter 1 Positive Output. When unused, do not connect this pin.
J1	Output	TX2_OUT+	Transmitter 2 Positive Output. When unused, do not connect this pin.
J3	Input/output	GPIO_18	Digital GPIO, 1.8 V to 2.5 V. The joint test action group (JTAG) function is test clock (TCLK). Because this pin contains an input stage, control the voltage on the pin. When unused, this pin can be tied to ground through a resistor to safeguard against misconfiguration, or the pin can be left floating, programmed as an output, and driven low.
J4	Input	$\overline{\text{RESET}}$	Active Low Chip Reset.
J5	Output	GP_INTERRUPT	General-Purpose Digital Interrupt Output Signal. When unused, do not connect this pin.
J6	Input	TEST	Pin Used for JTAG Boundary Scan. When unused, connect this pin to GND.
J7	Input/output	GPIO_2	Digital GPIO, 1.8 V to 2.5 V. The user sets the JTAG function to 0. Because this pin contains an input stage, control the voltage on the pin. When unused, this pin can be tied to ground through a resistor to safeguard against misconfiguration, or the pin can be left floating, programmed as an output, and driven low.
J8	Input/output	GPIO_1	Digital GPIO, 1.8 V to 2.5 V. The user sets the JTAG function to 0. Because this pin contains an input stage, control the voltage on the pin. When unused, this pin can be tied to ground through a resistor to safeguard against misconfiguration, or the pin can be left floating, programmed as an output, and driven low.
J9	Input/output	SDIO	Serial Data Input in 4-Wire Mode or Input/Output in 3-Wire Mode.
J10	Output	SDO	Serial Data Output. In SPI 3-wire mode, do not connect this pin.
J11	Input/output	GPIO_13	Digital GPIO, 1.8 V to 2.5 V. Because this pin contains an input stage, control the voltage on the pin. When unused, this pin can be tied to ground through a resistor to safeguard against misconfiguration, or the pin can be left floating, programmed as an output, and driven low.
J12	Input/output	GPIO_10	Digital GPIO, 1.8 V to 2.5 V. Because this pin contains an input stage, control the voltage on the pin. When unused, this pin can be tied to ground through a resistor to safeguard against misconfiguration, or the pin can be left floating, programmed as an output, and driven low.
J14	Output	TX1_OUT-	Transmitter 1 Negative Output. When unused, do not connect this pin.
K3	Input	SYSREF_IN+	LVDS Positive Input.
K4	Input	SYSREF_IN-	LVDS Negative Input.
K5	Input/output	GPIO_5	Digital GPIO, 1.8 V to 2.5 V. The JTAG function is test data output (TDO). Because this pin contains an input stage, control the voltage on the pin. When unused, this pin can be tied to ground through a resistor to safeguard against misconfiguration, or the pin can be left floating, programmed as an output, and driven low.

Pin No.	Type	Mnemonic	Description
K6	Input/output	GPIO_4	Digital GPIO, 1.8 V to 2.5 V. The JTAG function is test rest ( $\overline{\text{TRST}}$ ). Because this pin contains an input stage, control the voltage on the pin. When unused, this pin can be tied to ground through a resistor to safeguard against misconfiguration, or the pin can be left floating, programmed as an output, and driven low.
K7	Input/output	GPIO_3	Digital GPIO, 1.8 V to 2.5 V. The user sets the JTAG function to 1. Because this pin contains an input stage, control the voltage on the pin. When unused, this pin can be tied to ground through a resistor to safeguard against misconfiguration, or the pin can be left floating, programmed as an output, and driven low.
K8	Input/output	GPIO_0	Digital GPIO, 1.8 V to 2.5 V. The user sets the JTAG function to 1. Because this pin contains an input stage, control the voltage on the pin. When unused, this pin can be tied to ground through a resistor to safeguard against misconfiguration, or the pin can be left floating, programmed as an output, and driven low.
K9	Input	SCLK	Serial Data Bus Clock.
K10	Input	$\overline{\text{CS}}$	Serial Data Bus Chip Select, Active Low.
K11	Input/output	GPIO_14	Digital GPIO, 1.8 V to 2.5 V. Because this pin contains an input stage, control the voltage on the pin. When unused, this pin can be tied to ground through a resistor to safeguard against misconfiguration, or the pin can be left floating, programmed as an output, and driven low.
K12	Input/output	GPIO_9	Digital GPIO, 1.8 V to 2.5 V. Because this pin contains an input stage, control the voltage on the pin. When unused, this pin can be tied to ground through a resistor to safeguard against misconfiguration, or the pin can be left floating, programmed as an output, and driven low.
L3	Input	$\overline{\text{SYNCIN1}}$	LVDS Negative Input. When unused, connect this pin to GND with a pull-down resistor or connect this pin directly to GND.
L4	Input	$\overline{\text{SYNCIN1}}$ +	LVDS Positive Input. When unused, connect this pin to GND with a pull-down resistor or connect this pin directly to GND.
L5	Input/output	GPIO_6	Digital GPIO, 1.8 V to 2.5 V. The JTAG function is test data input (TDI). Because this pin contains an input stage, control the voltage on the pin. When unused, this pin can be tied to ground through a resistor to safeguard against misconfiguration, or the pin can be left floating, programmed as an output, and driven low.
L6	Input/output	GPIO_7	Digital GPIO, 1.8 V to 2.5 V. The JTAG function is test mode select input (TMS). Because this pin contains an input stage, control the voltage on the pin. When unused, this pin can be tied to ground through a resistor to safeguard against misconfiguration, or the pin can be left floating, programmed as an output, and driven low.
L7, L10	Input	VSSD	Digital Supplies.
L8, L9	Input	VDDD1P3_DIG	1.3 V Digital Core. Connect L8 and L9 with a separate trace to common supply point.
L11	Input/output	GPIO_15	Digital GPIO, 1.8 V to 2.5 V. Because this pin contains an input stage, control the voltage on the pin. When unused, this pin can be tied to ground through a resistor to safeguard against misconfiguration, or the pin can be left floating, programmed as an output, and driven low.
L12	Input/output	GPIO_8	Digital GPIO, 1.8 V to 2.5 V. Because this pin contains an input stage, control the voltage on the pin. When unused, this pin can be tied to ground through a resistor to safeguard against misconfiguration, or the pin can be left floating, programmed as an output, and driven low.
L13	Output	$\overline{\text{SYNCOUT1}}$	LVDS Negative Output. When unused, do not connect this pin.
L14	Output	$\overline{\text{SYNCOUT1}}$ +	LVDS Positive Output. When unused, do not connect this pin.
M1	Input	VDDA1P1_CLOCK_VCO	1.1 V VCO Supply. Decouple this pin with a 1 $\mu\text{F}$ capacitor.

Pin No.	Type	Mnemonic	Description
M3	Input	SYNCIN0-	JESD204B Receiver Channel 0 Data Link LVDS Input. This pin forms the sync signal associated with observation receiver channel data on the JESD204B interface. When unused, connect this pin to GND with a pull-down resistor or directly to GND.
M4	Input	SYNCIN0+	JESD204B Receiver Channel 0 Data Link LVDS Input. This pin forms the sync signal associated with observation receiver channel data on the JESD204B interface. When unused, connect this pin to GND with a pull-down resistor or connect this pin directly to GND.
M5	Input	ORX1_ENABLE	Observation Receiver 1 Enable Pin. When unused, connect this pin to GND with a pull-down resistor or connect this pin directly to GND.
M6	Input	TX1_ENABLE	Transmitter 1 Enable Pin. When unused, connect this pin to GND with a pull-down resistor or connect this pin directly to GND.
M7	Input	ORX2_ENABLE	Observation Receiver 2 Enable Pin. When unused, connect this pin to GND with a pull-down resistor or connect this pin directly to GND.
M8	Input	TX2_ENABLE	Transmitter 2 Enable Pin. When unused, connect this pin to GND with a pull-down resistor or connect this pin directly to GND.
M10	Input/ output	GPIO_17	Digital GPIO, 1.8 V to 2.5 V. Because this pin contains an input stage, control the voltage on the pin. When unused, this pin can be tied to ground through a resistor to safeguard against misconfiguration, or the pin can be left floating, programmed as an output, and driven low.
M11	Input/ output	GPIO_16	Digital GPIO, 1.8 V to 2.5 V. Because this pin contains an input stage, control the voltage on the pin. When unused, this pin can be tied to ground through a resistor to safeguard against misconfiguration, or the pin can be left floating, programmed as outputs, and driven low.
M12	Input	VDD_INTERFACE	Input/Output Interface Supply, 1.8 V to 2.5 V.
M13	Output	SYNCOUT0-	JESD204B Transmitter Channel Data Link LVDS Output. This pin forms the sync signal associated with transmitter channel data on the JESD204B interface. When unused, do not connect this pin.
M14	Output	SYNCOUT0+	JESD204B Transmitter Channel Data Link LVDS Output. This pin forms the sync signal associated with transmitter channel data on the JESD204B interface. When unused, do not connect this pin.
N1	Input	VDDA1P3_CLOCK_VCO_LDO	1.3 V Separate Trace to Common Supply Point.
N3	Output	SERDOUT3-	RF Current Mode Logic (CML) Differential Negative Output 3. When unused, do not connect this pin.
N4	Output	SERDOUT3+	RF CML Differential Positive Output 3. When unused, do not connect this pin.
N5	Output	SERDOUT2-	RF CML Differential Negative Output 2. When unused, do not connect this pin.
N6	Output	SERDOUT2+	RF CML Differential Positive Output 2. When unused, do not connect this pin.
N8, P8	Input	VDDA1P3_SER	1.3 V Supply for JESD204B Serializer.
N9, P9	Input	VDDA1P3_DES	1.3 V Supply for JESD204B Deserializer.
N10	Input	SERDIN1-	RF CML Differential Negative Input 1. When unused, do not connect this pin.
N11	Input	SERDIN1+	RF CML Differential Positive Input 1. When unused, do not connect this pin.
N12	Input	SERDIN0-	RF CML Differential Negative Input 0. When unused, do not connect this pin.
N13	Input	SERDIN0+	RF CML Differential Positive Input 0. When unused, do not connect this pin.
P1	Output	AUX_SYNTH_VTUNE	Auxiliary Synthesizer V <sub>TUNE</sub> Output.

<b>Pin No.</b>	<b>Type</b>	<b>Mnemonic</b>	<b>Description</b>
P4	Output	SERDOUT1-	RF CML Differential Negative Output 1. When unused, do not connect this pin.
P5	Output	SERDOUT1+	RF CML Differential Positive Output 1. When unused, do not connect this pin.
P6	Output	SERDOUT0-	RF CML Differential Negative Output 0. When unused, do not connect this pin.
P7	Output	SERDOUT0+	RF CML Differential Positive Output 0. When unused, do not connect this pin.
P11	Input	SERDIN3-	RF CML Differential Negative Input 3. When unused, do not connect this pin.
P12	Input	SERDIN3+	RF CML Differential Positive Input 3. When unused, do not connect this pin.
P13	Input	SERDIN2-	RF CML Differential Negative Input 2. When unused, do not connect this pin.
P14	Input	SERDIN2+	RF CML Differential Positive Input 2. When unused, do not connect this pin.

# TYPICAL PERFORMANCE CHARACTERISTICS

The temperature settings refer to the die temperature.

## 75 MHz TO 525 MHz BAND

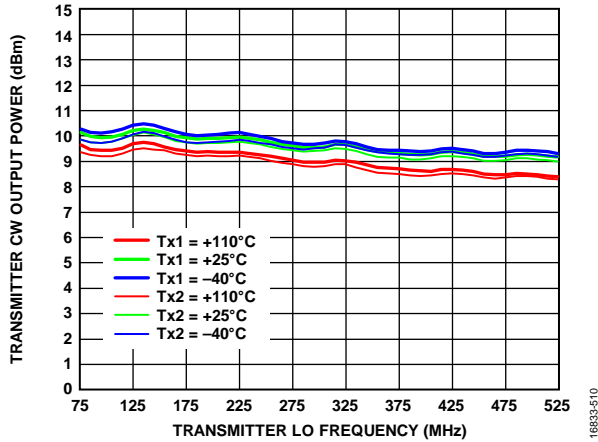

Figure 7. Transmitter Continuous Wave (CW) Output Power vs. Transmitter LO Frequency, Transmitter QEC and External LO Leakage Active, Transmitter 50 MHz/100 MHz Bandwidth Mode, IQ Rate = 122.88 MHz, Attenuation = 0 dB, Not De-Embedded

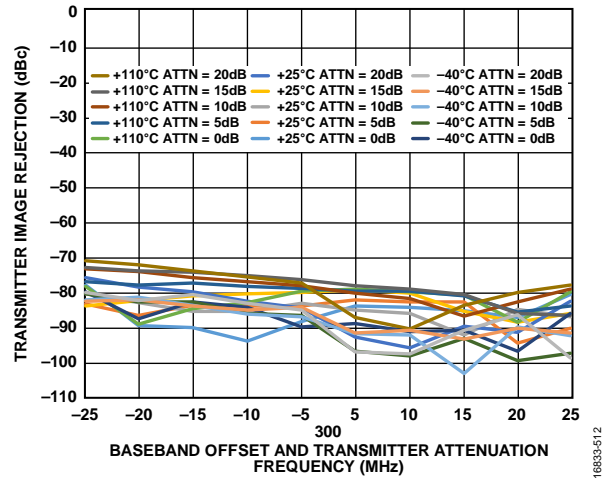

Figure 9. Transmitter Image Rejection vs. Baseband Offset Frequency and Transmitter Attenuation, QEC Trained with Three Tones Placed at 10 MHz, 48 MHz, and 100 MHz (Tracking On), Total Combined Power = -10 dBFS, Correction Then Frozen (Tracking Turned Off), CW Tone Swept Across Large Signal Bandwidth, LO = 300 MHz

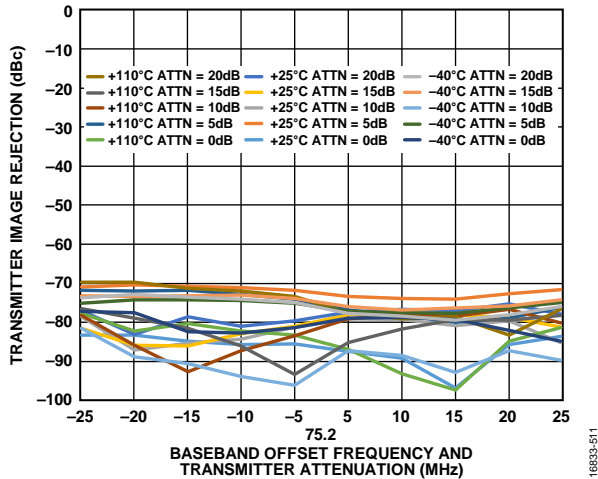

Figure 8. Transmitter Image Rejection vs. Baseband Offset Frequency and Transmitter Attenuation, QEC Trained with Three Tones Placed at 10 MHz, 48 MHz, and 100 MHz (Tracking On), Total Combined Power = -10 dBFS, Correction Then Frozen (Tracking Turned Off), CW Tone Swept Across Large Signal Bandwidth, LO = 75.2 MHz

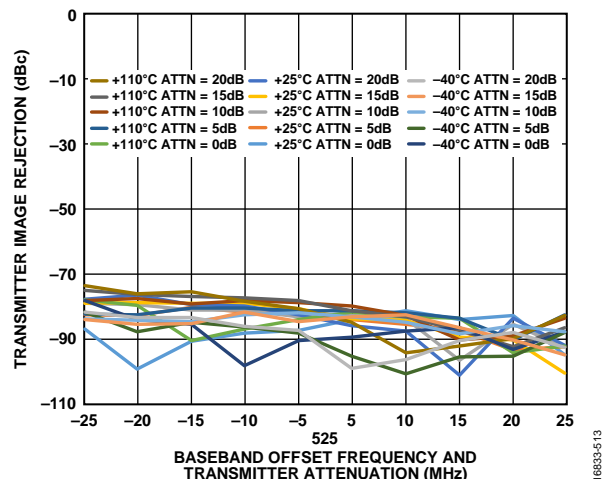

Figure 10. Transmitter Image Rejection vs. Baseband Offset Frequency and Transmitter Attenuation, QEC Trained with Three Tones Placed at 10 MHz, 48 MHz, and 100 MHz (Tracking On), Total Combined Power = -10 dBFS, Correction Then Frozen (Tracking Turned Off), CW Tone Swept Across Large Signal Bandwidth, LO = 525 MHz

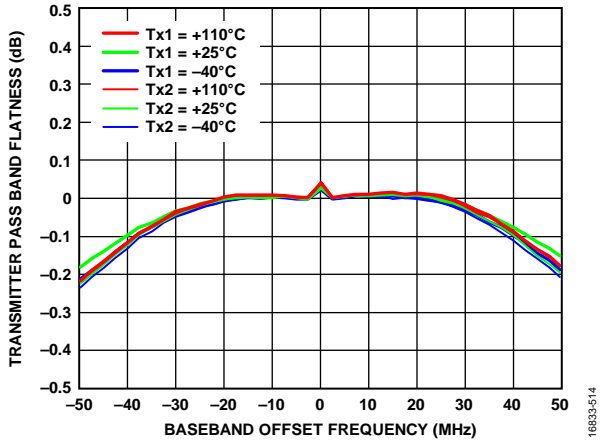

Figure 11. Transmitter Pass Band Flatness vs. Baseband Offset Frequency, Off Chip Match Response De-Embedded, LO = 300 MHz, Calibrated at 25°C

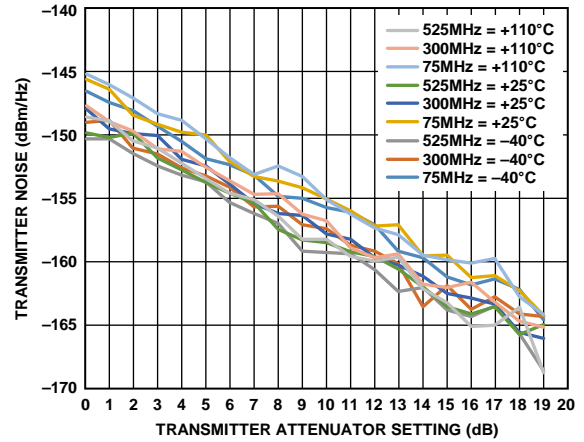

Figure 14. Transmitter Noise vs. Transmitter Attenuator Setting, Offset = 50 MHz

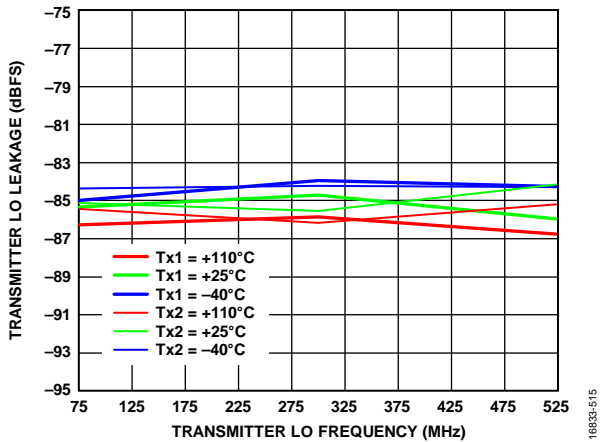

Figure 12. Transmitter LO Leakage vs. Transmitter LO Frequency, Transmitter Attenuation = 0 dB, Baseband Tone Frequency = 10 MHz, Tracked

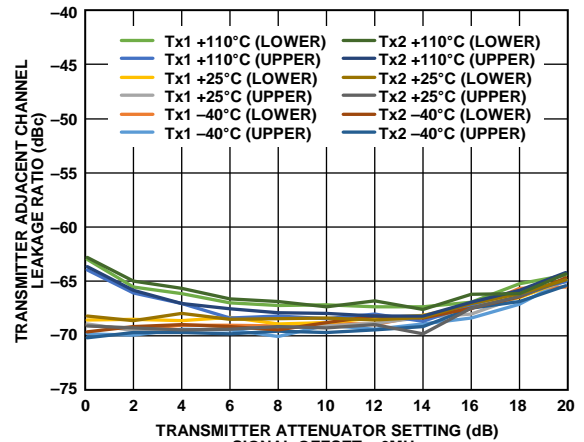

Figure 15. Transmitter Adjacent Channel Leakage Ratio vs. Transmitter Attenuator Setting, Signal Offset = 0 MHz, LO = 75 MHz, LTE = 20 MHz, Peak to Average Ratio (PAR) = 12 dB, DAC Boost Normal, Upper Side and Lower Side, Performance Limited by Spectrum Analyzer at Higher Attenuation Settings

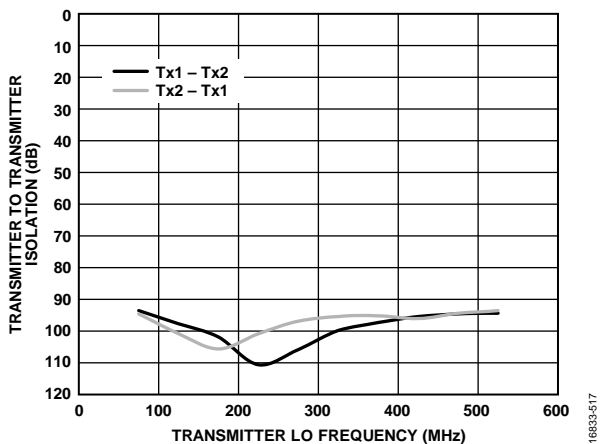

Figure 13. Transmitter to Transmitter Isolation vs. Transmitter LO Frequency, Temperature = 25°C

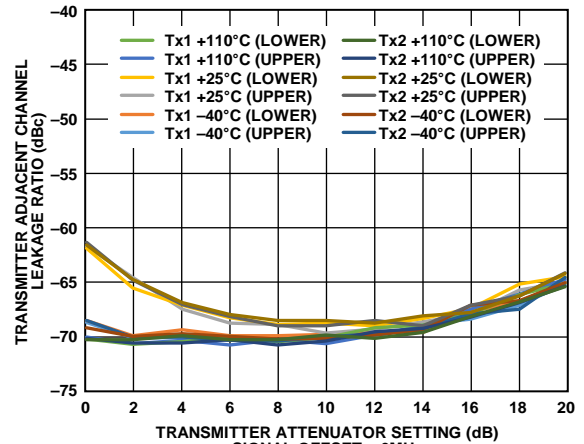

Figure 16. Transmitter Adjacent Channel Leakage Ratio vs. Transmitter Attenuator Setting, Signal Offset = 0 MHz, LO = 300 MHz, LTE = 20 MHz, PAR = 12 dB, DAC Boost Normal, Upper Side and Lower Side, Performance Limited by Spectrum Analyzer at Higher Attenuation Settings



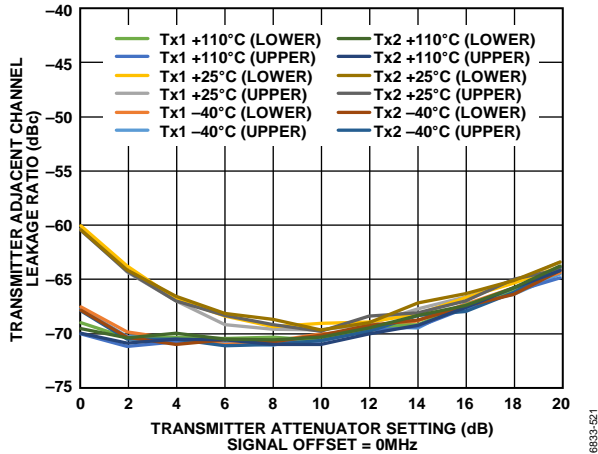

Figure 17. Transmitter Adjacent Channel Leakage Ratio vs. Transmitter Attenuator Setting, Signal Offset = 0 MHz, LO = 525 MHz, LTE = 20 MHz, PAR = 12 dB, DAC Boost Normal, Upper Side and Lower Side, Performance Limited by Spectrum Analyzer at Higher Attenuation Settings

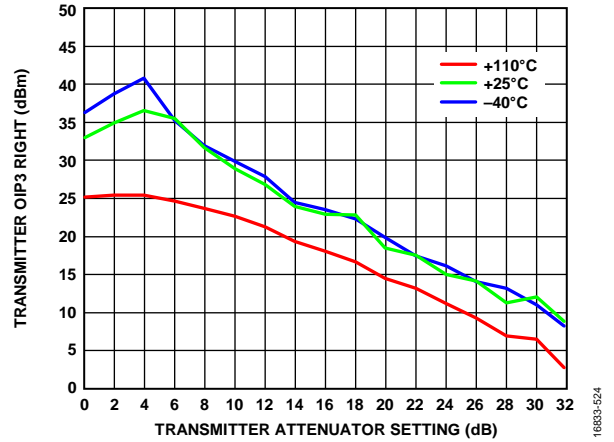

Figure 20. Transmitter OIP3 Right vs. Transmitter Attenuator Setting, LO = 525 MHz, Total RMS Power = -12 dBFS, 20 MHz/25 MHz Tones

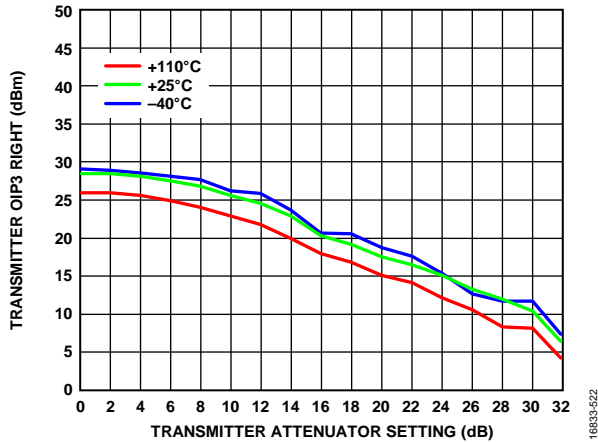

Figure 18. Transmitter OIP3 Right vs. Transmitter Attenuator Setting, LO = 75 MHz, Total Root Mean Square (RMS) Power = -12 dBFS, 20 MHz/25 MHz Tones

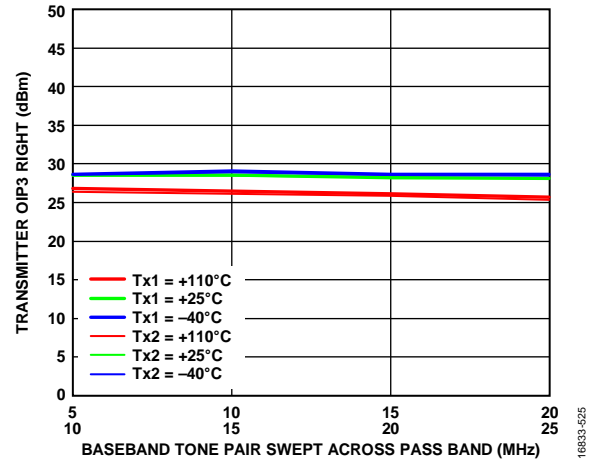

Figure 21. Transmitter OIP3 Right vs. Baseband Tone Pair Swept Across Pass Band, LO = 75 MHz, Total RMS Power = -12 dBFS, Transmitter Attenuation = 4 dB

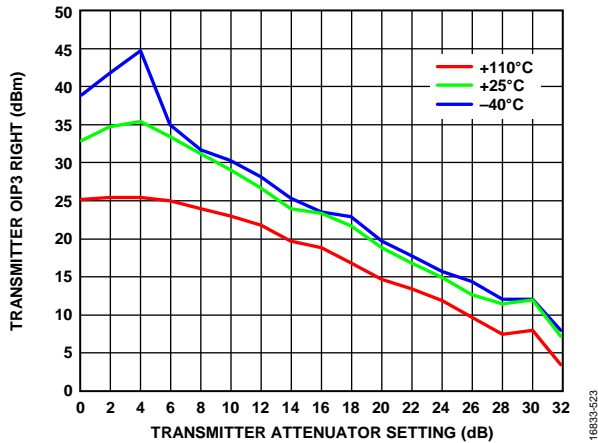

Figure 19. Transmitter OIP3 Right vs. Transmitter Attenuator Setting, LO = 300 MHz, Total RMS Power = -12 dBFS, 20 MHz/25 MHz Tones

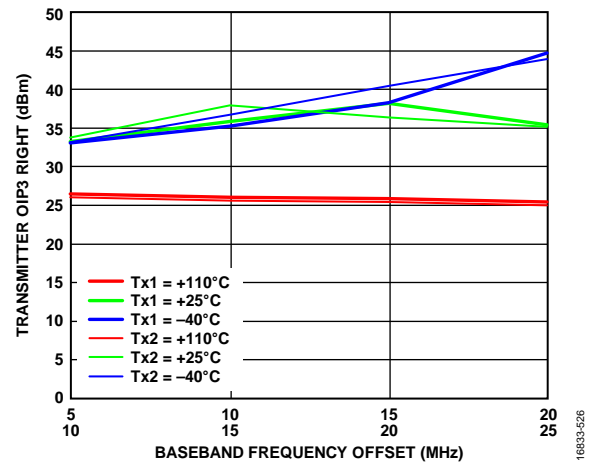

Figure 22. Transmitter OIP3 Right vs. Baseband Frequency Offset, LO = 300 MHz, Total RMS Power = -12 dBFS, Transmitter Attenuation = 4 dB

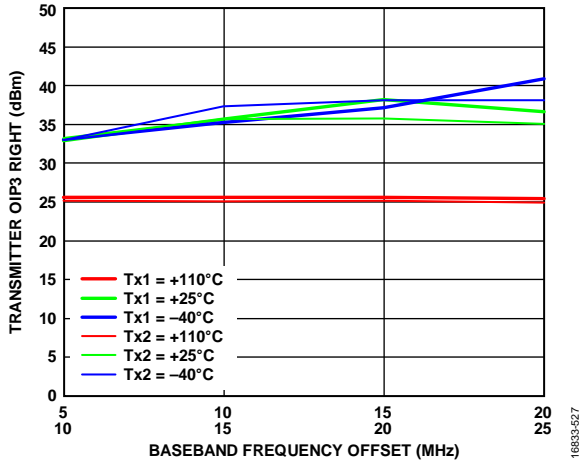

Figure 23. Transmitter OIP3 Right vs. Baseband Frequency Offset, LO = 525 MHz, Total RMS Power = -12 dBFS, Transmitter Attenuation = 4 dB

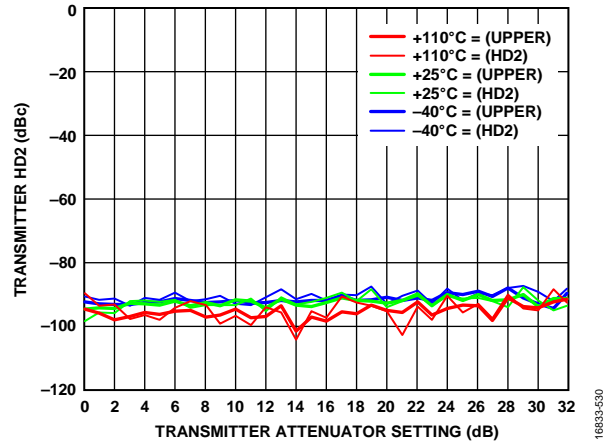

Figure 26. Transmitter HD2 vs. Transmitter Attenuator Setting, Baseband Frequency = 10 MHz, LO = 525 MHz, CW = -15 dBFS

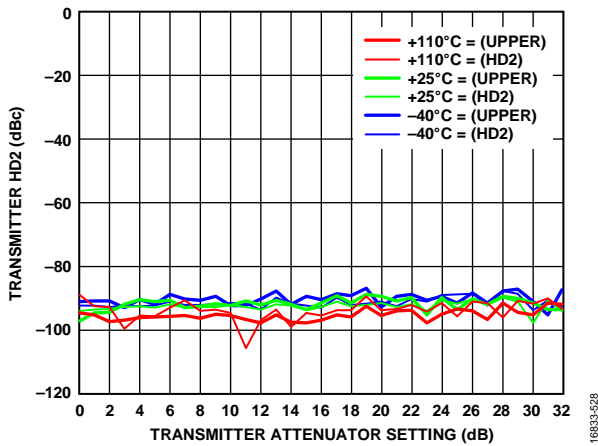

Figure 24. Transmitter HD2 vs. Transmitter Attenuator Setting, Baseband Frequency = 10 MHz, LO = 75 MHz, CW = -15 dBFS

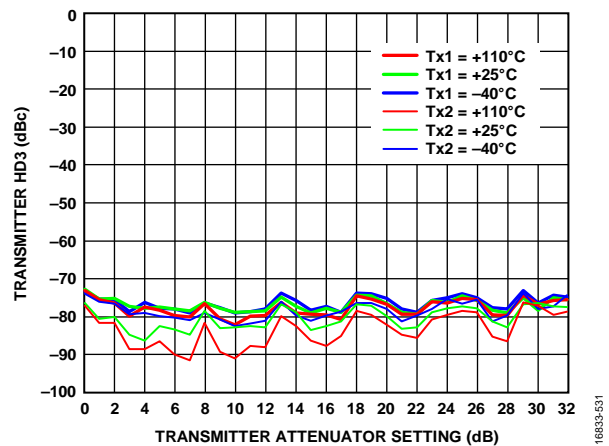

Figure 27. Transmitter HD3 vs. Transmitter Attenuator Setting, LO = 75 MHz, CW = -15 dBFS, Baseband Frequency = 10 MHz

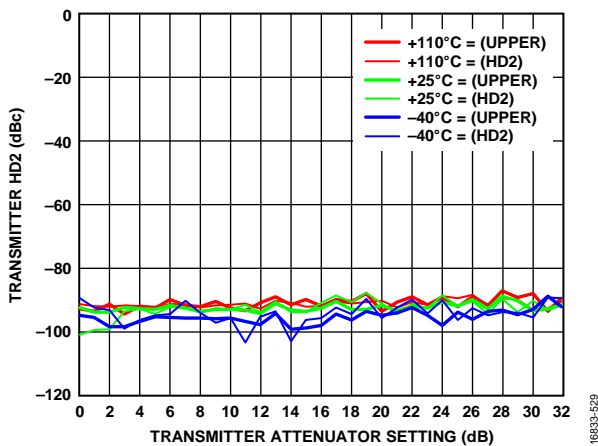

Figure 25. Transmitter HD2 vs. Transmitter Attenuator Setting, Baseband Frequency = 10 MHz, LO = 300 MHz, CW = -15 dBFS

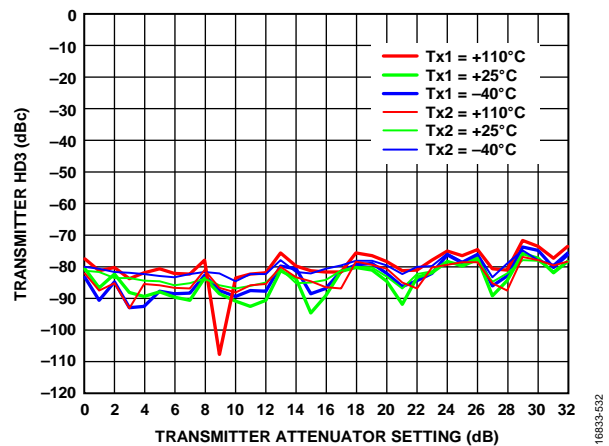

Figure 28. Transmitter HD3 vs. Transmitter Attenuator Setting, LO = 300 MHz, CW = -15 dBFS, Baseband Frequency = 10 MHz

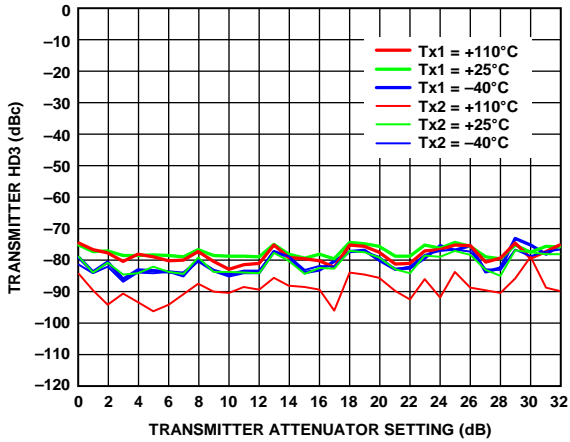

Figure 29. Transmitter HD3 vs. Transmitter Attenuator Setting, LO = 525 MHz, CW = -15 dBFS, Baseband Frequency = 10 MHz

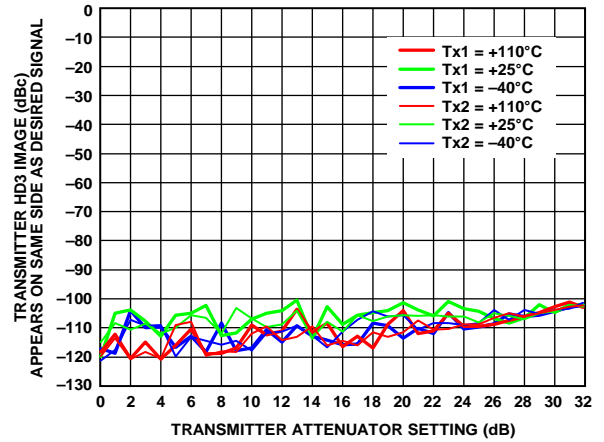

Figure 32. Transmitter HD3 Image Appears on Same Side as Desired Signal vs. Transmitter Attenuator Setting, LO = 525 MHz, CW = -15 dBFS

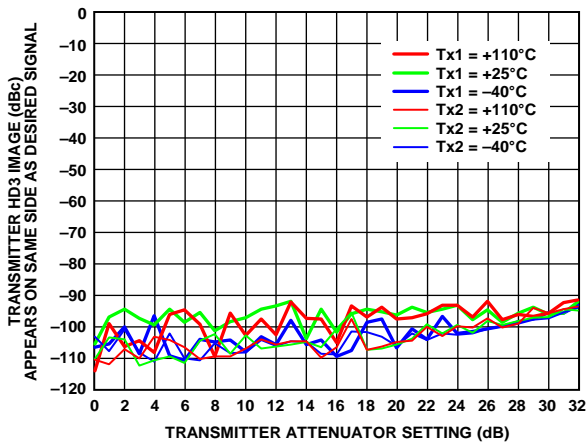

Figure 30. Transmitter HD3 Image Appears on Same Side as Desired Signal vs. Transmitter Attenuator Setting, LO = 75 MHz, CW = -15 dBFS

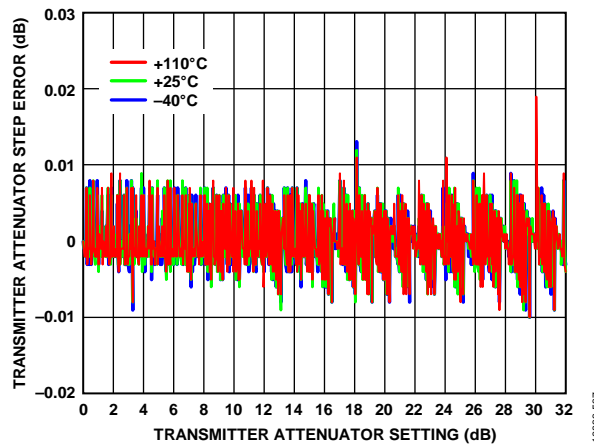

Figure 33. Transmitter Attenuator Step Error vs. Transmitter Attenuator Setting, LO = 75 MHz, Baseband Frequency = 10 MHz, Backoff = 15 dBFS

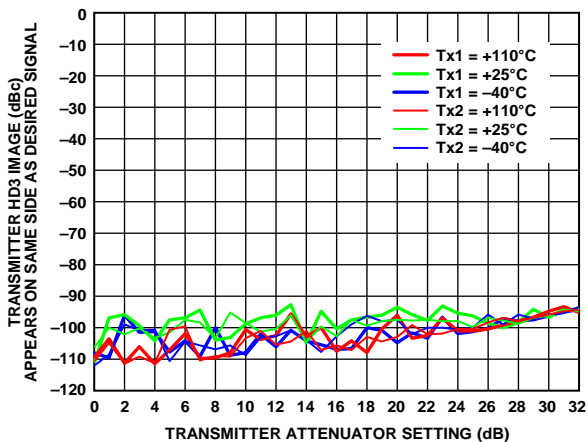

Figure 31. Transmitter HD3 Image Appears on Same Side as Desired Signal vs. Transmitter Attenuator Setting, LO = 300 MHz, CW = -15 dBFS

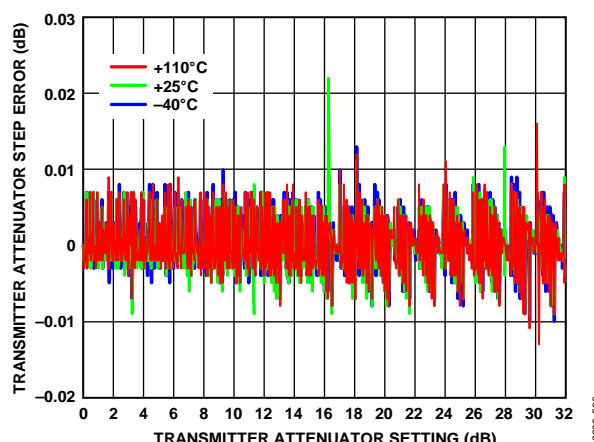

Figure 34. Transmitter Attenuator Step Error vs. Transmitter Attenuator Setting, LO = 300 MHz, Baseband Frequency = 10 MHz, Backoff = 15 dBFS

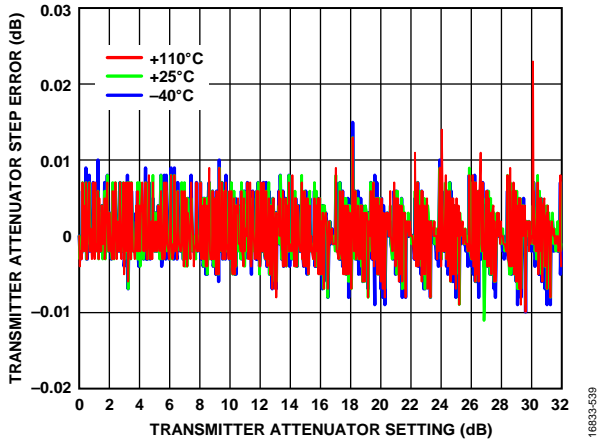

Figure 35. Transmitter Attenuator Step Error vs. Transmitter Attenuator Setting, LO = 525 MHz, Baseband Frequency = 10 MHz, Backoff = 15 dBFS

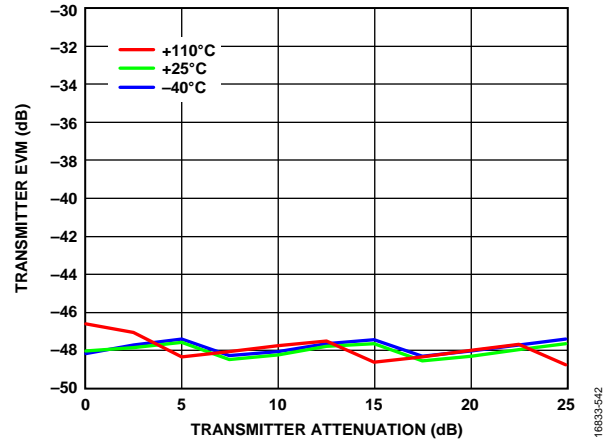

Figure 38. Transmitter EVM vs. Transmitter Attenuation, LTE = 20 MHz, Signal Centered on DC, LO = 525 MHz

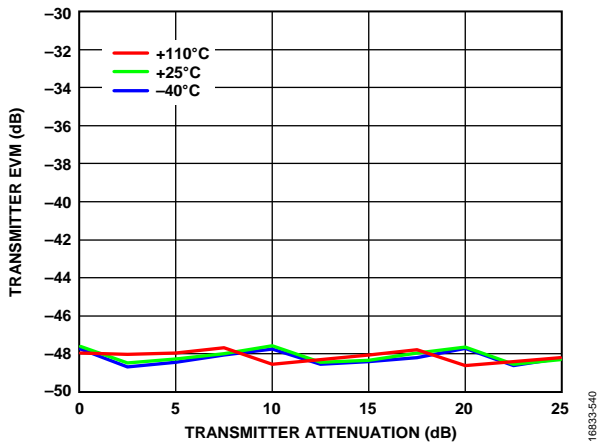

Figure 36. Transmitter EVM vs. Transmitter Attenuation, LTE = 20 MHz, Signal Centered on DC, LO = 75 MHz

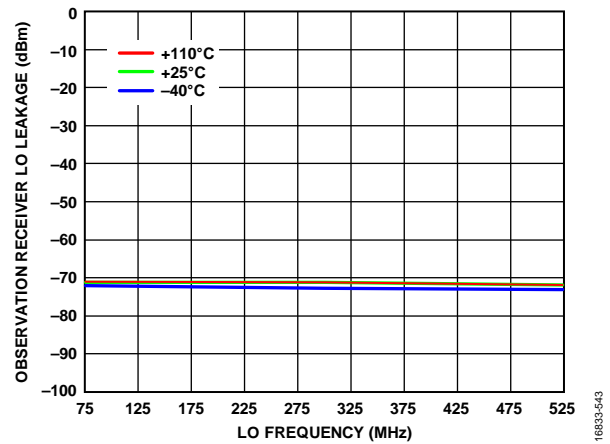

Figure 39. Observation Receiver LO Leakage vs. LO Frequency, 75 MHz, 300 MHz, and 525 MHz, Attenuation = 0 dB

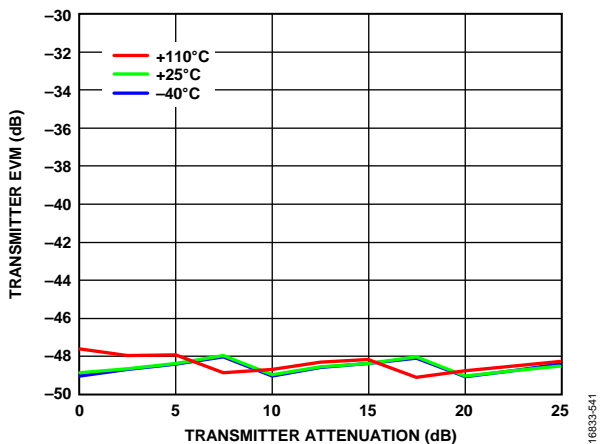

Figure 37. Transmitter EVM vs. Transmitter Attenuation, LTE = 20 MHz, Signal Centered on DC, LO = 300 MHz

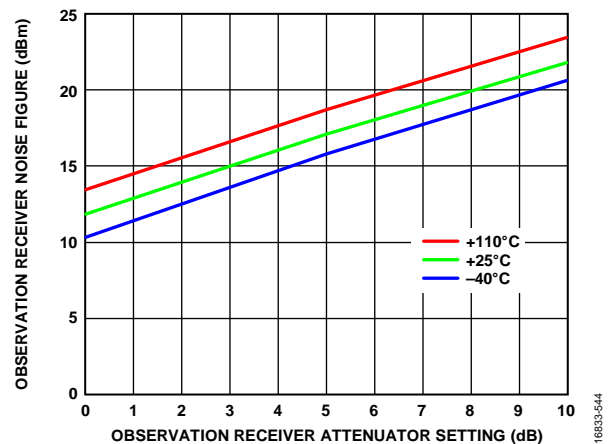

Figure 40. Observation Receiver Noise Figure vs. Observation Receiver Attenuator Setting, LO = 75 MHz, Total Nyquist Integration Bandwidth

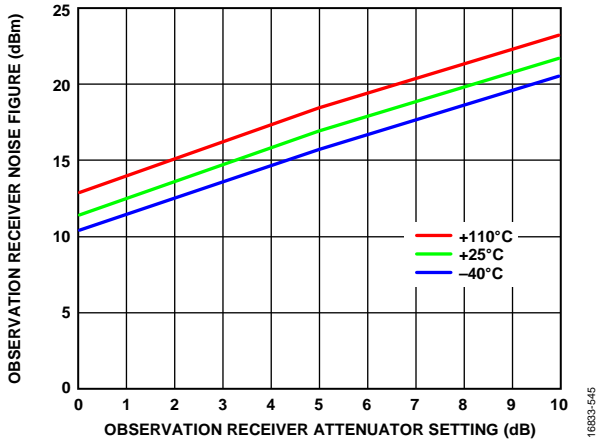

Figure 41. Observation Receiver Noise Figure vs. Observation Receiver Attenuator Setting, LO = 300 MHz, Total Nyquist Integration Bandwidth

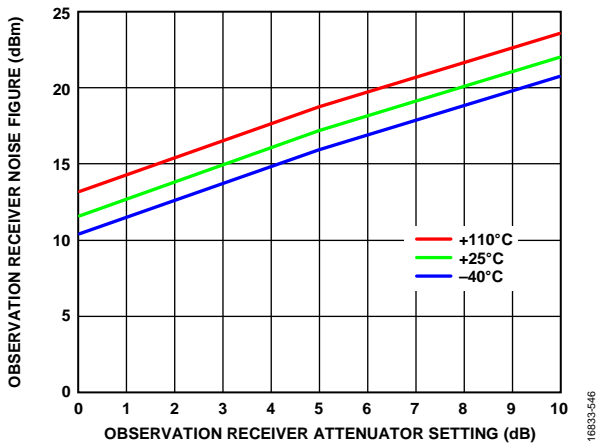

Figure 42. Observation Receiver Noise Figure vs. Observation Receiver Attenuator Setting, LO = 525 MHz, Total Nyquist Integration Bandwidth

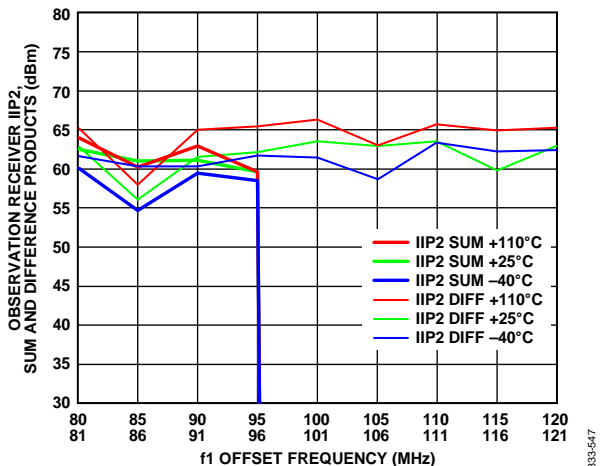

Figure 43. Observation Receiver IIP2, Sum and Difference Products vs. f1 Offset Frequency, Tones Separated by 1 MHz Swept Across Pass Band at -25 dBm Each, LO = 75 MHz, Attenuation = 0 dB

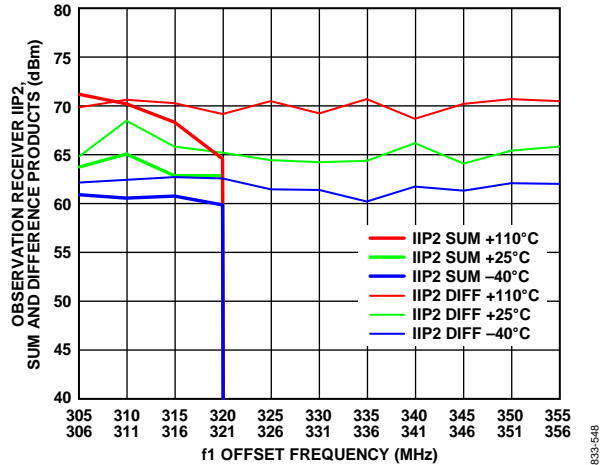

Figure 44. Observation Receiver IIP2, Sum and Difference Products vs. f1 Offset Frequency, Tones Separated by 1 MHz Swept Across Pass Band at -25 dBm Each, LO = 300 MHz, Attenuation = 0 dB

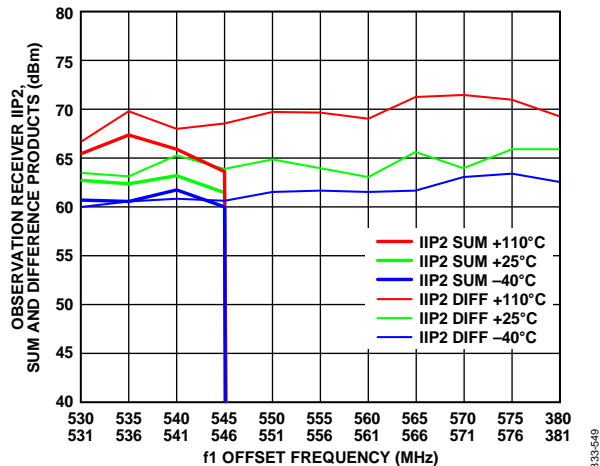

Figure 45. Observation Receiver IIP2, Sum and Difference Products vs. f1 Offset Frequency, Tones Separated by 1 MHz Swept Across Pass Band at -25 dBm Each, LO = 525 MHz, Attenuation = 0 dB

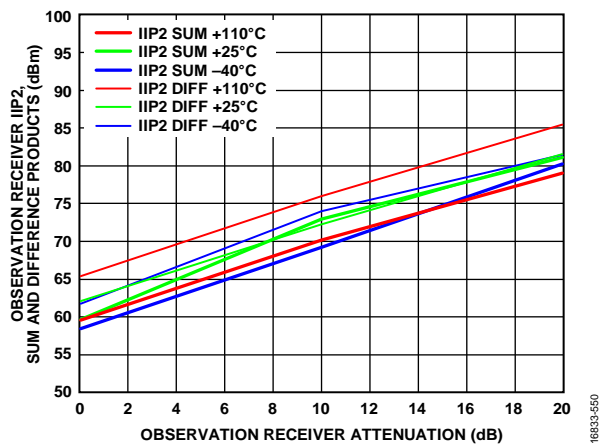

Figure 46. Observation Receiver IIP2, Sum and Difference Products vs. Observation Receiver Attenuation, LO = 75 MHz, Tone 1 = 95 MHz, Tone 2 = 96 MHz at -25 dBm Plus Attenuation

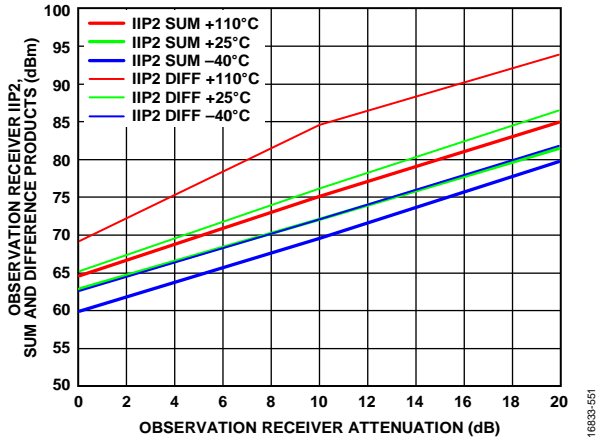

Figure 47. Observation Receiver IIP2, Sum and Difference Products vs. Observation Receiver Attenuation, LO = 300 MHz, Tone 1 = 320 MHz, Tone 2 = 321 MHz at -25 dBm Plus Attenuation

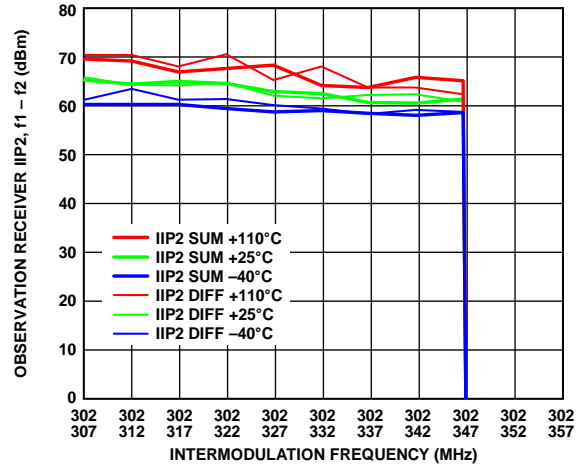

Figure 50. Observation Receiver IIP2,  $f_1 - f_2$  vs. Intermodulation Frequency, LO = 300 MHz, Tone 1 = 302 MHz, Tone 2 = Swept, -25 dBm Each, Attenuation = 0 dB

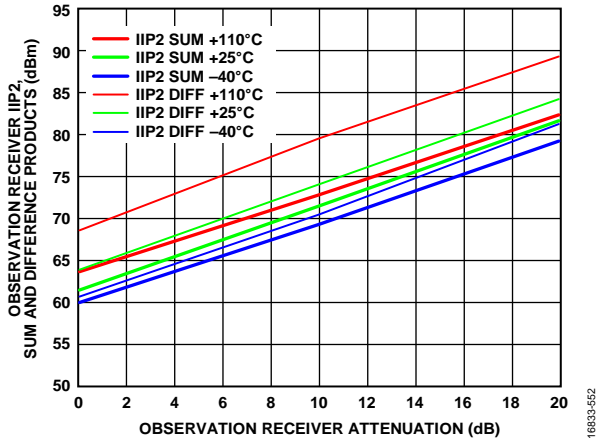

Figure 48. Observation Receiver IIP2, Sum and Difference Products vs. Observation Receiver Attenuation, LO = 525 MHz, Tone 1 = 545 MHz, Tone 2 = 546 MHz at -25 dBm Plus Attenuation

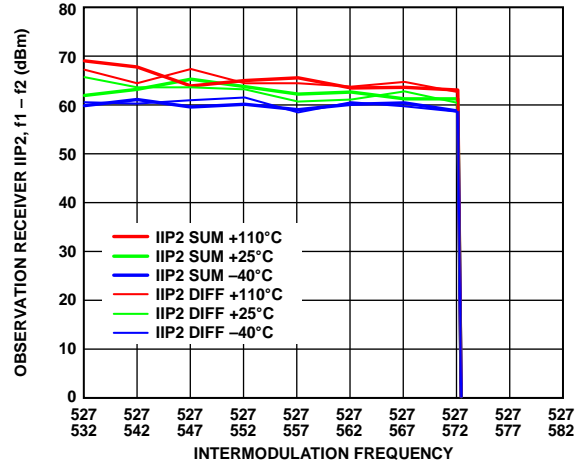

Figure 51. Observation Receiver IIP2,  $f_1 - f_2$  vs. Intermodulation Frequency, LO = 525 MHz, Tone 1 = 527 MHz, Tone 2 = Swept, -25 dBm Each, Attenuation = 0 dB

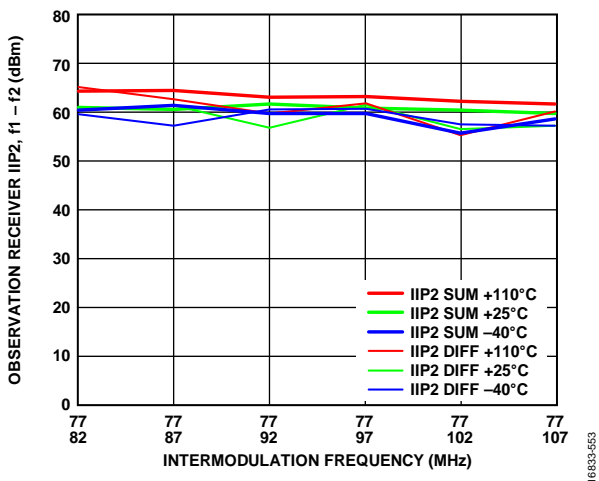

Figure 49. Observation Receiver IIP2,  $f_1 - f_2$  vs. Intermodulation Frequency, LO = 75 MHz, Tone 1 = 77 MHz, Tone 2 = Swept, -25 dBm Each, Attenuation = 0 dB Change

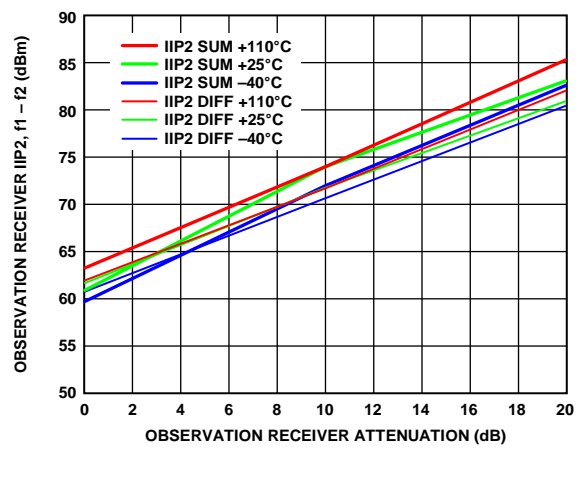

Figure 52. Observation Receiver IIP2,  $f_1 - f_2$  vs. Observation Receiver Attenuation, LO = 75 MHz, Tone 1 = 77 MHz, Tone 2 = 97 MHz at -25 dBm Plus Attenuation

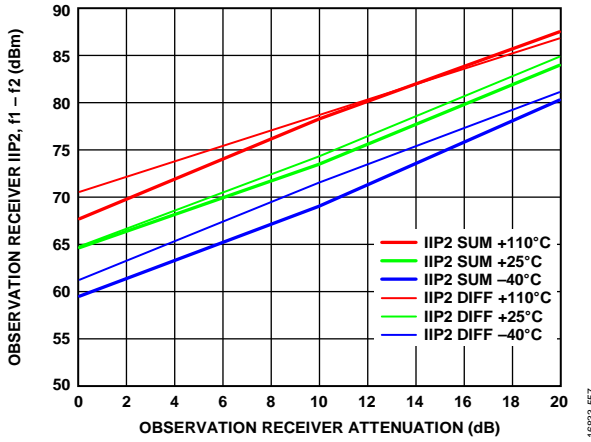

Figure 53. Observation Receiver IIP2,  $f_1 - f_2$  vs. Observation Receiver Attenuation, LO = 300 MHz, Tone 1 = 302 MHz, Tone 2 = 322 MHz at -25 dBm Plus Attenuation

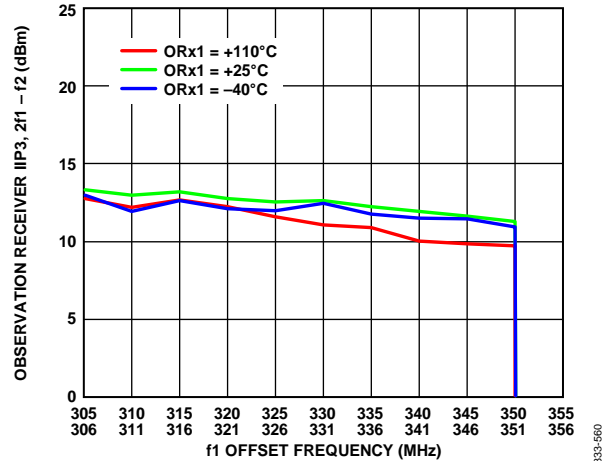

Figure 56. Observation Receiver IIP3,  $2f_1 - f_2$  vs.  $f_1$  Offset Frequency, LO = 300 MHz, Attenuation = 0 dB, Tones Separated by 1 MHz Swept Across Pass Band at -25 dBm Each

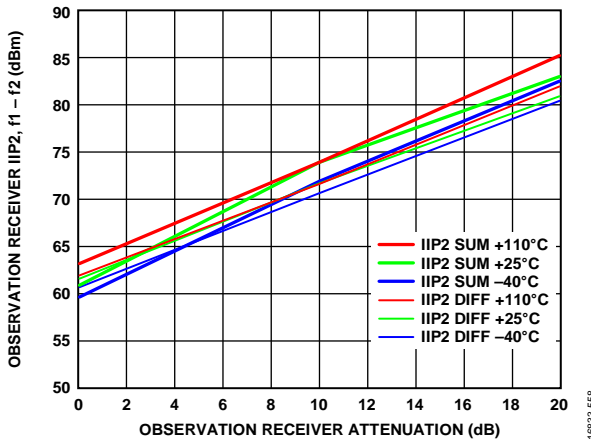

Figure 54. Observation Receiver IIP2,  $f_1 - f_2$  vs. Observation Receiver Attenuation, LO = 525 MHz, Tone 1 = 527 MHz, Tone 2 = 547 MHz at -25 dBm Plus Attenuation

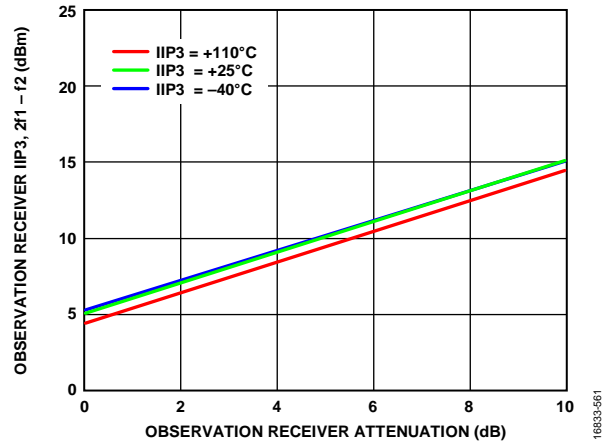

Figure 57. Observation Receiver IIP3,  $2f_1 - f_2$  vs. Observation Receiver Attenuation, LO = 75 MHz, Tone 1 = 100 MHz, Tone 2 = 101 MHz at -24 dBm Plus Attenuation

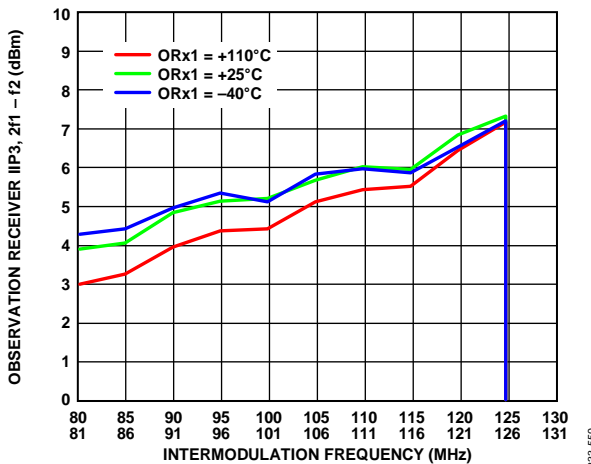

Figure 55. Observation Receiver IIP3,  $2f_1 - f_2$  vs. Intermodulation Frequency, LO = 75 MHz, Attenuation = 0 dB, Tones Separated by 1 MHz Swept Across Pass Band at -25 dBm Each

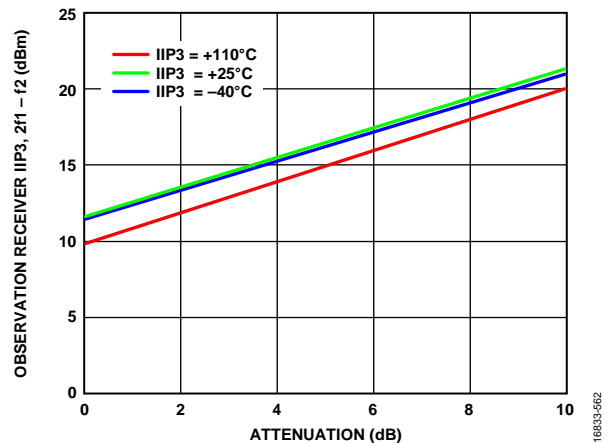

Figure 58. Observation Receiver IIP3,  $2f_1 - f_2$  vs. Attenuation, LO = 300 MHz, Tone 1 = 345 MHz, Tone 2 = 346 MHz at -24 dBm Plus Attenuation

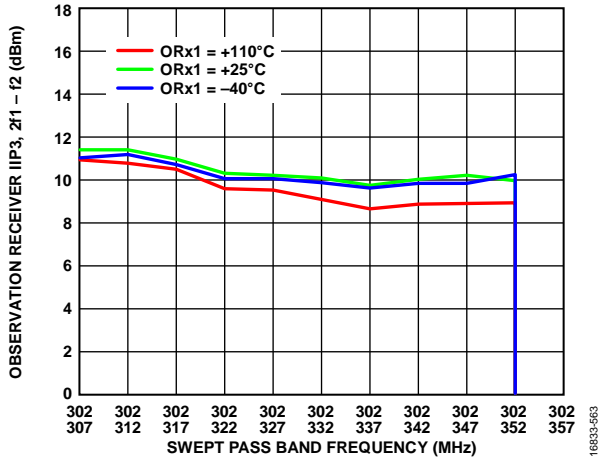

Figure 59. Observation Receiver IIP3, 2f1 – f2 vs. Swept Pass Band Frequency, LO = 300 MHz, Attenuation = 0 dB, Tone 1 = 302 MHz, Tone 2 = Swept Across the Pass Band, Tones Separated by 1 MHz Swept Across Pass Band at –19 dBm Each

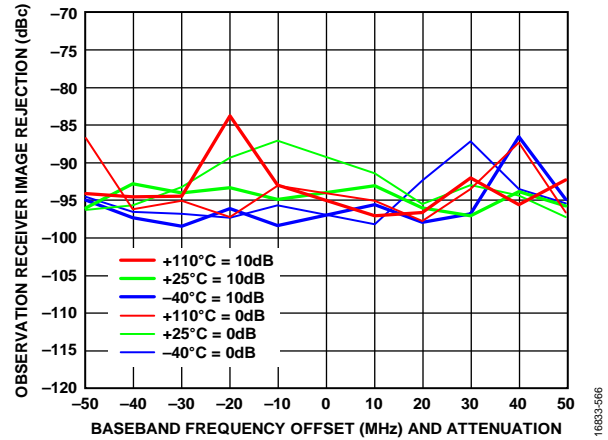

Figure 62. Observation Receiver Image Rejection vs. Baseband Frequency Offset and Attenuation, CW Signal Swept Across the Band, LO = 300 MHz

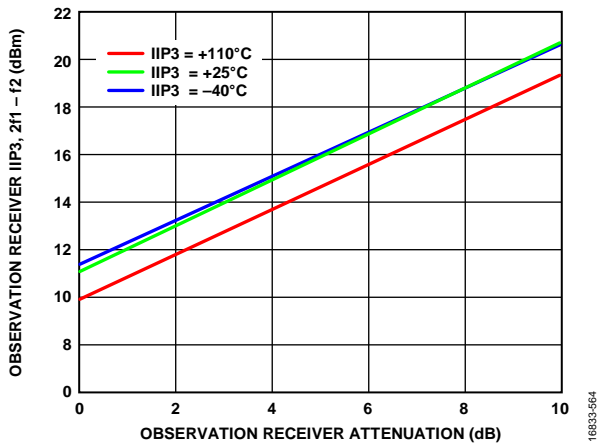

Figure 60. Observation Receiver IIP3, 2f1 – f2 vs. Observation Receiver Attenuation, LO = 300 MHz, Tone 1 = 302 MHz, Tone 2 = 352 MHz at –19 dBm Plus Attenuation

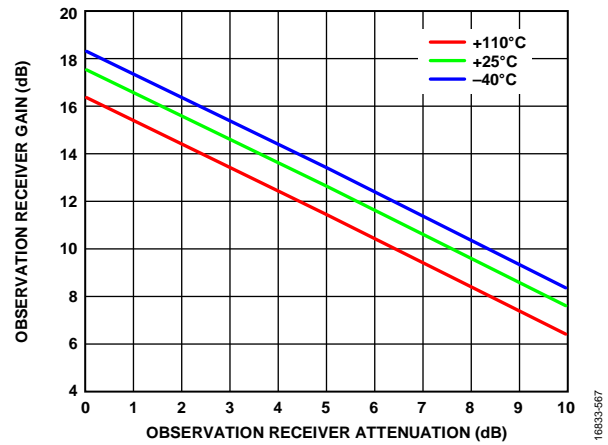

Figure 63. Observation Receiver Gain vs. Observation Receiver Attenuation, LO = 75 MHz

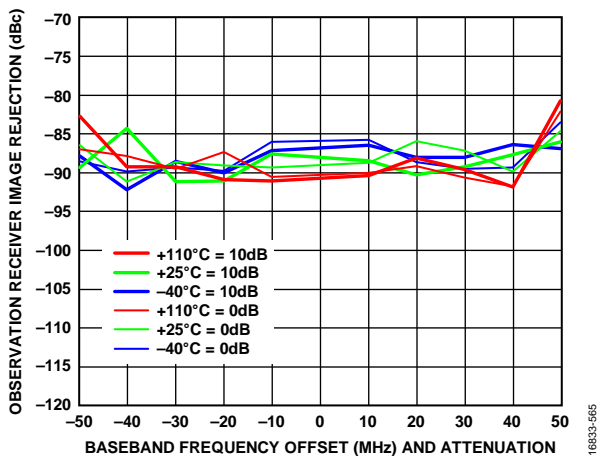

Figure 61. Observation Receiver Image Rejection vs. Baseband Frequency Offset and Attenuation, CW Signal Swept Across the Band, LO = 75 MHz

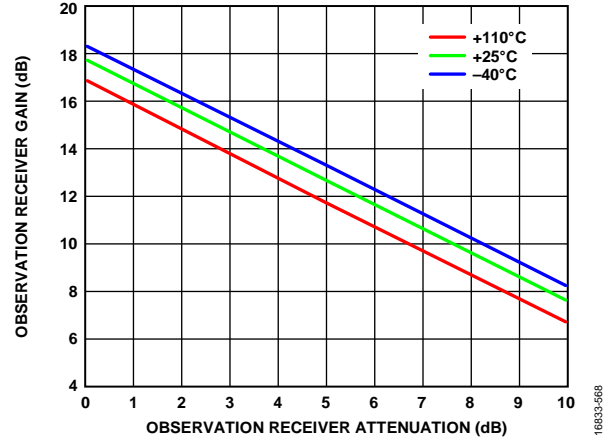

Figure 64. Observation Receiver Gain vs. Observation Receiver Attenuation, LO = 300 MHz



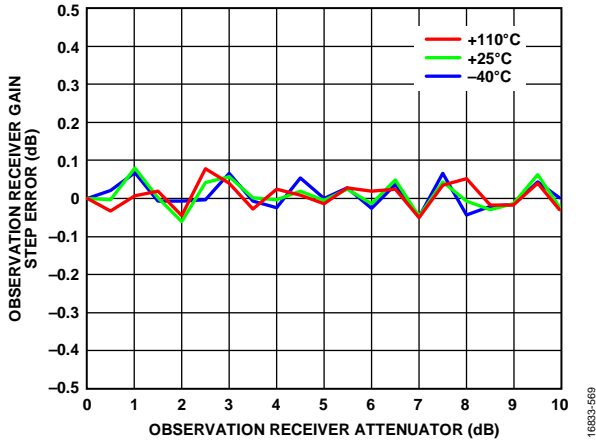

Figure 65. Observation Receiver Gain Step Error vs. Observation Receiver Attenuator, LO = 75 MHz

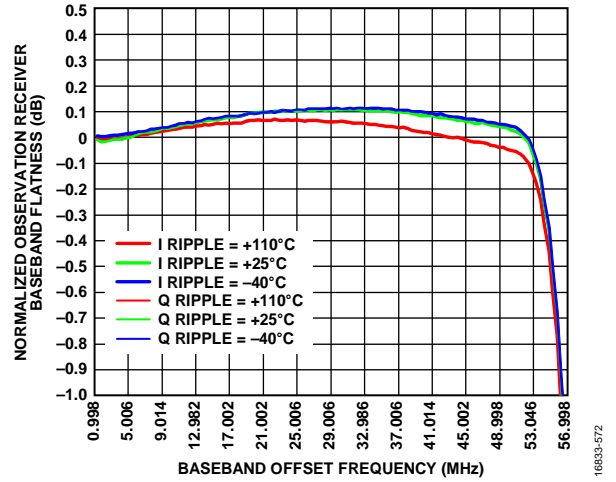

Figure 68. Normalized Observation Receiver Baseband Flatness vs. Baseband Offset Frequency, LO = 75 MHz, Attenuation = 0 dB

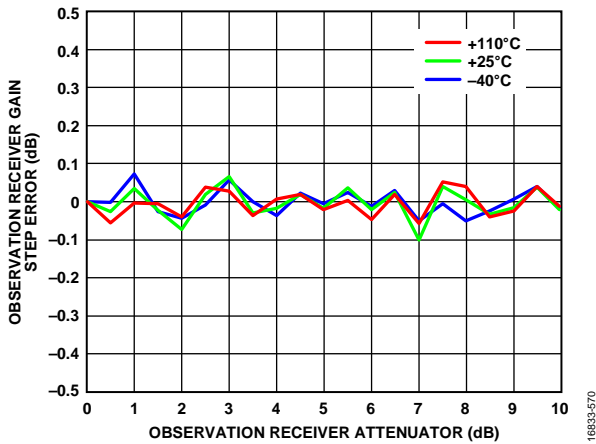

Figure 66. Observation Receiver Gain Step Error vs. Observation Receiver Attenuator, LO = 325 MHz

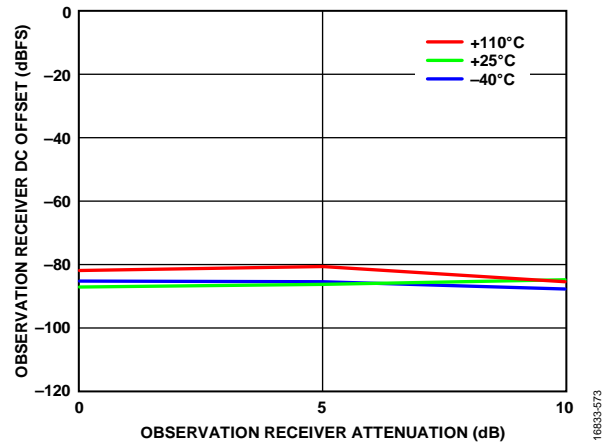

Figure 69. Observation Receiver DC Offset vs. Observation Receiver Attenuation, LO = 75 MHz, Baseband Frequency = 50 MHz

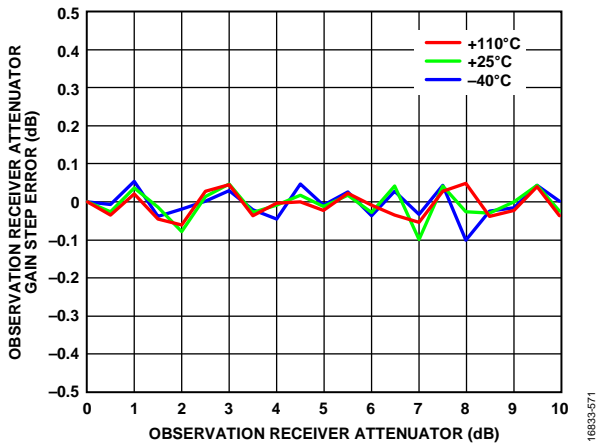

Figure 67. Observation Receiver Attenuator Gain Step Error vs. Observation Receiver Attenuator, LO = 525 MHz

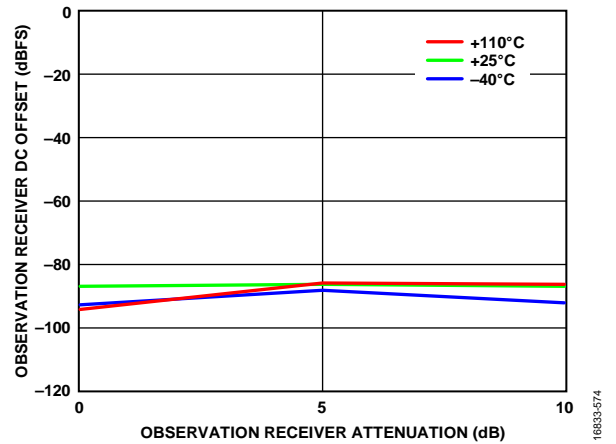

Figure 70. Observation Receiver DC Offset vs. Observation Receiver Attenuation, LO = 325 MHz, Baseband Frequency = 50 MHz

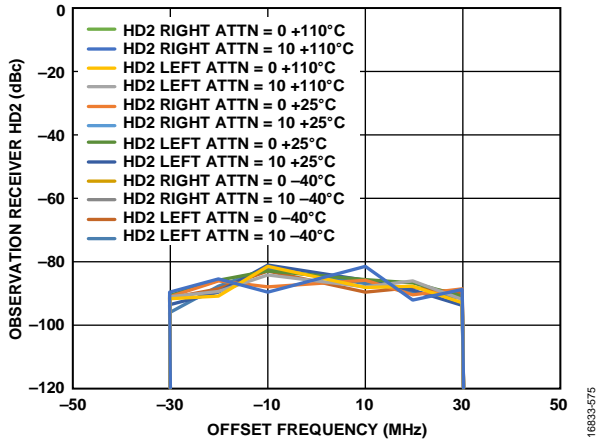

Figure 71. Observation Receiver HD2 vs. Offset Frequency and Attenuation, LO = 75 MHz, Tone Level = -21 dBm Plus Attenuation

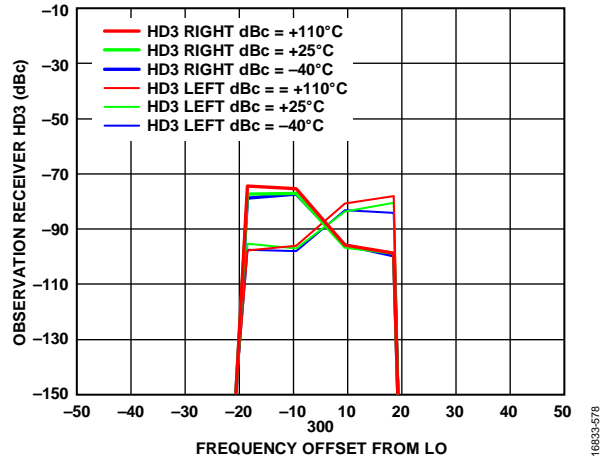

Figure 74. Observation Receiver HD3 Left and Right vs. Frequency Offset from LO, Tone Level = -22 dBm at Attenuation = 0 dB, LO = 300 MHz

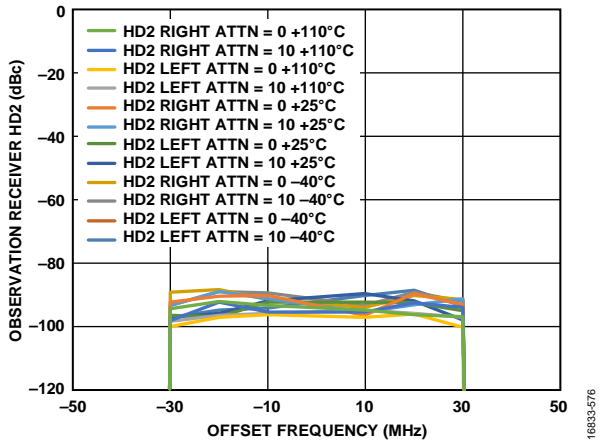

Figure 72. Observation Receiver HD2 vs. Offset Frequency and Attenuation, LO = 300 MHz, Tone Level = -22 dBm Plus Attenuation

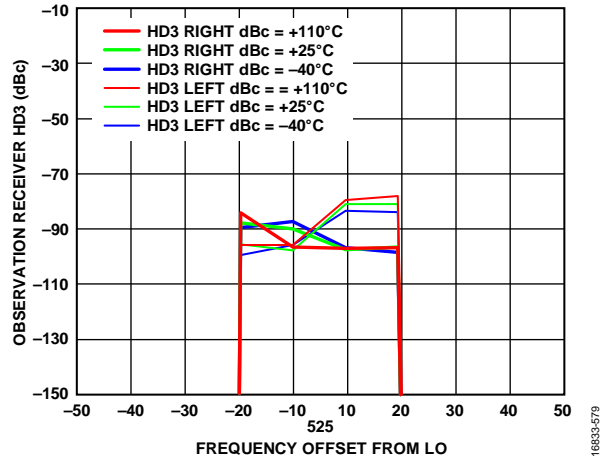

Figure 75. Observation Receiver HD3 Left and Right vs. Frequency Offset from LO, Tone Level -22 dBm at Attenuation = 0 dB, LO = 525 MHz

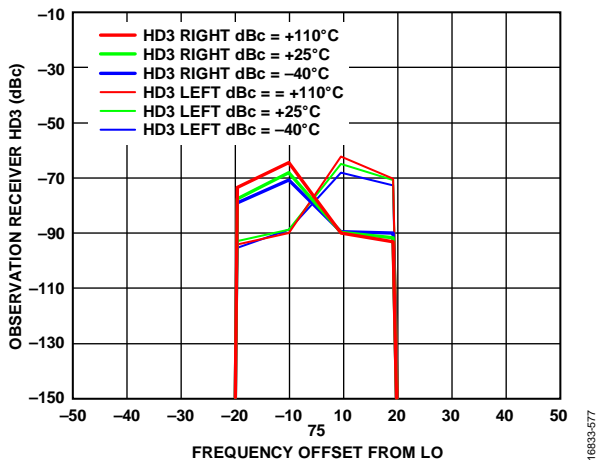

Figure 73. Observation Receiver HD3 Left and Right vs. Frequency Offset from LO, Tone Level = -21 dBm at Attenuation = 0 dB, LO = 75 MHz

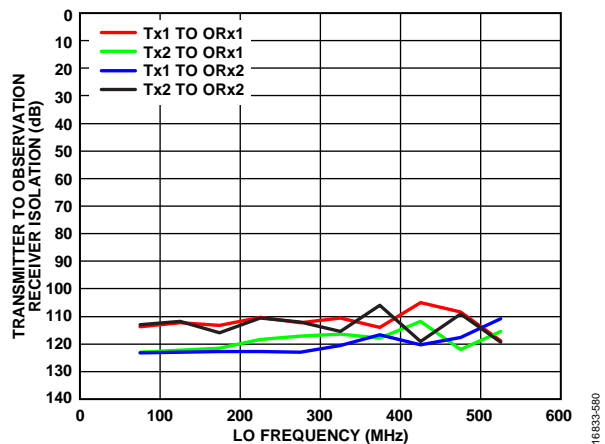

Figure 76. Transmitter to Observation Receiver Isolation vs. LO Frequency, Temperature = 25°C

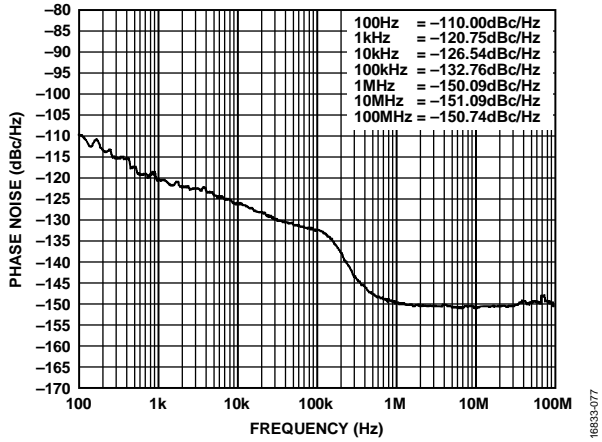

Figure 77. LO Phase Noise vs. Frequency Offset, LO = 75 MHz, PLL Loop Bandwidth = 50 kHz

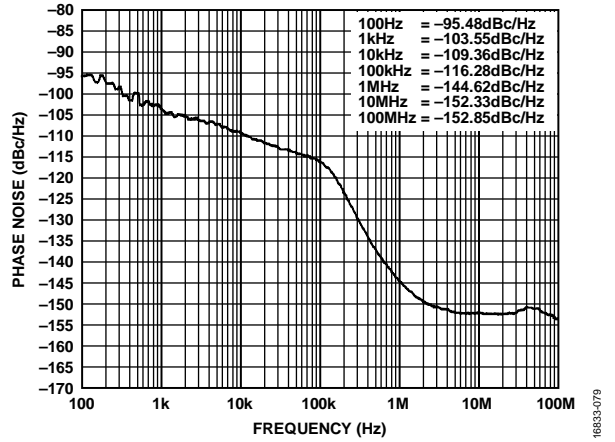

Figure 79. LO Phase Noise vs. Frequency Offset, LO = 525 MHz, PLL Loop Bandwidth = 50 kHz

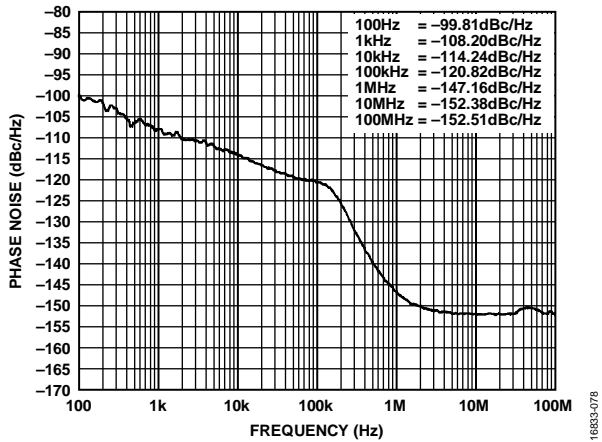

Figure 78. LO Phase Noise vs. Frequency Offset, LO = 300 MHz, PLL Loop Bandwidth = 50 kHz

650 MHz TO 3000 MHz BAND

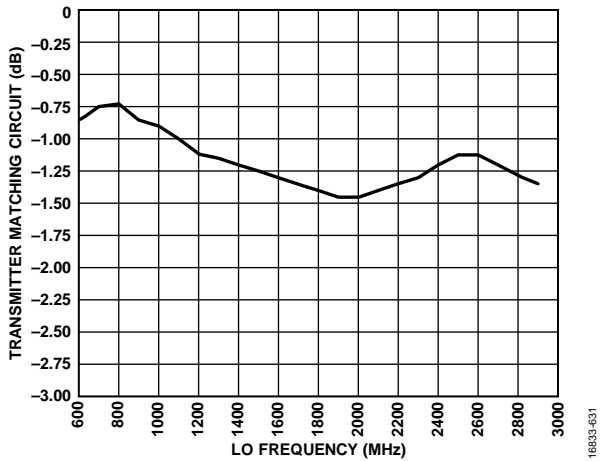

Figure 80. Transmitter Matching Circuit Path Loss vs. LO Frequency (Can be Used for De-Embedding Performance Data)

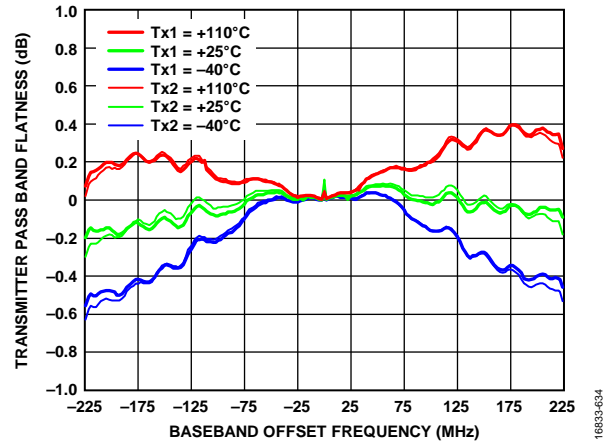

Figure 83. Transmitter Pass Band Flatness vs. Baseband Offset Frequency, LO = 2600 MHz

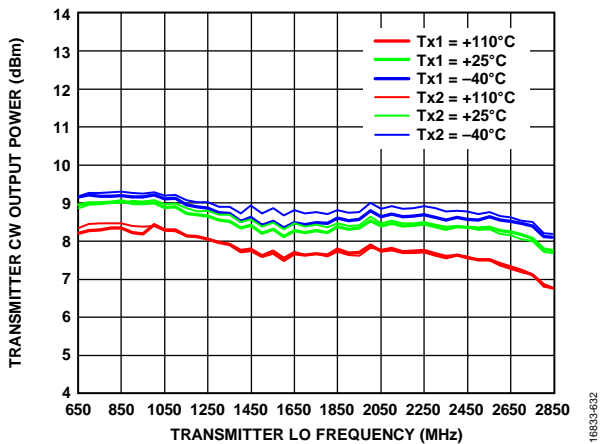

Figure 81. Transmitter CW Output Power vs. Transmitter LO Frequency, Transmitter QEC and External LO Leakage Active, Transmitter in 200 MHz/450 MHz Bandwidth Mode, IQ Rate = 491.52 MHz, Attenuation = 0 dB (Not De-Embedded)

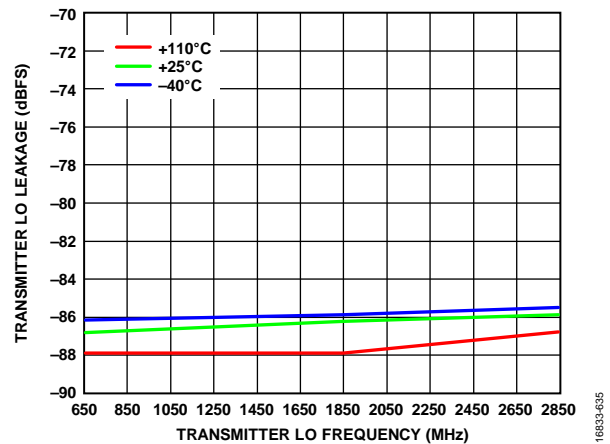

Figure 84. Transmitter LO Leakage vs. Transmitter LO Frequency, Transmitter Attenuation = 0 dB

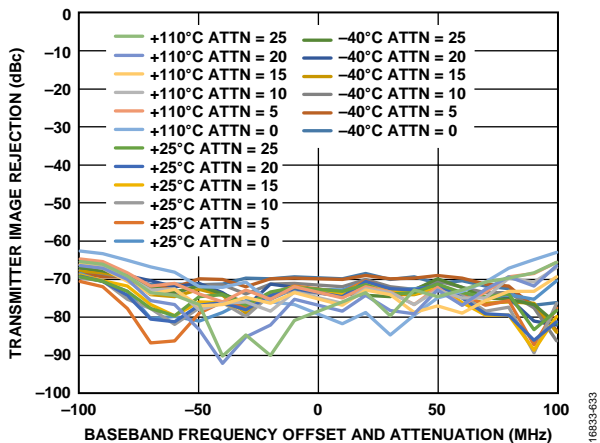

Figure 82. Transmitter Image Rejection vs. Baseband Frequency Offset and Attenuation, QEC Trained with Three Tones Placed at 10 MHz, 50 MHz, and 100 MHz (Tracking On), Total Combined Power = -6 dBFS, Correction Then Frozen (Tracking Turned Off), CW Tone Swept Across Large Signal Bandwidth

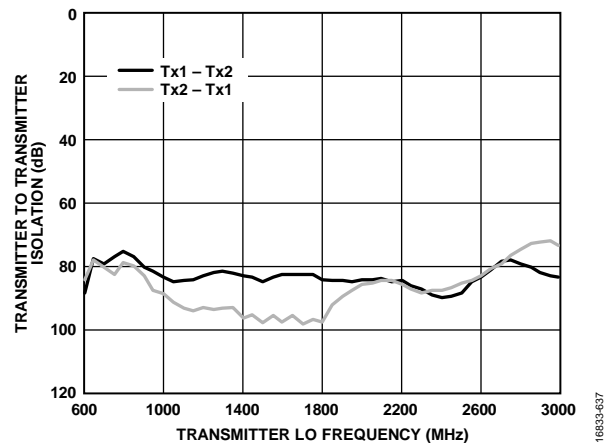

Figure 85. Transmitter to Transmitter Isolation vs. Transmitter LO Frequency, Temperature = 25°C

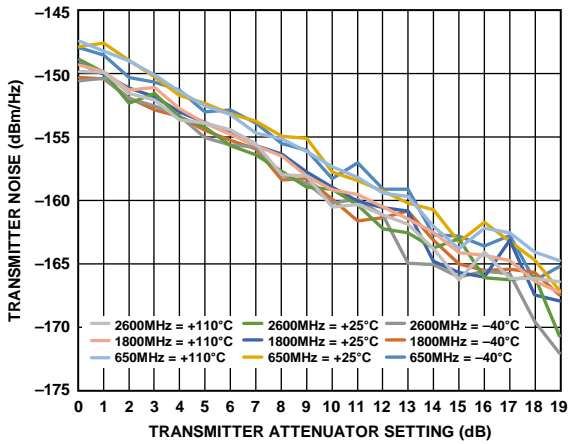

Figure 86. Transmitter Noise vs. Transmitter Attenuator Setting

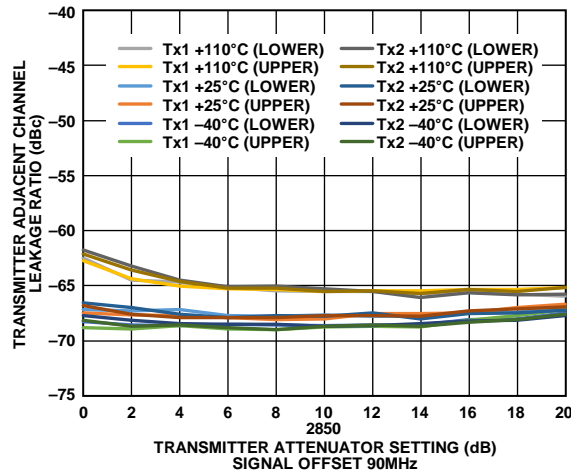

Figure 89. Transmitter Adjacent Channel Leakage Ratio vs. Transmitter Attenuator Setting, Signal Offset = 90 MHz, LO = 2850 MHz, LTE = 20 MHz, PAR = 12 dB, Upper Side and Lower Side

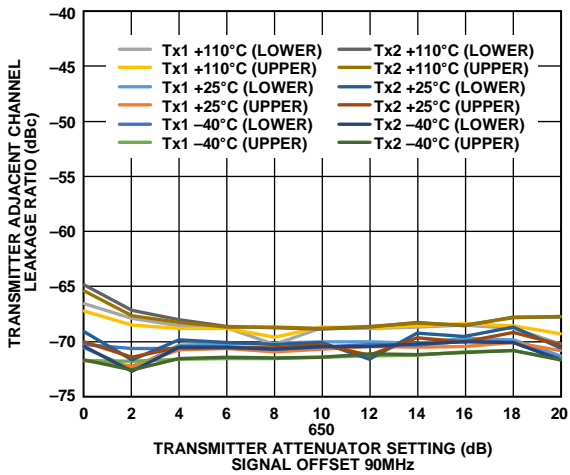

Figure 87. Transmitter Adjacent Channel Leakage Ratio vs. Transmitter Attenuator Setting, Signal Offset = 90 MHz, LO = 650 MHz, LTE = 20 MHz, PAR = 12 dB, Upper Side and Lower Side

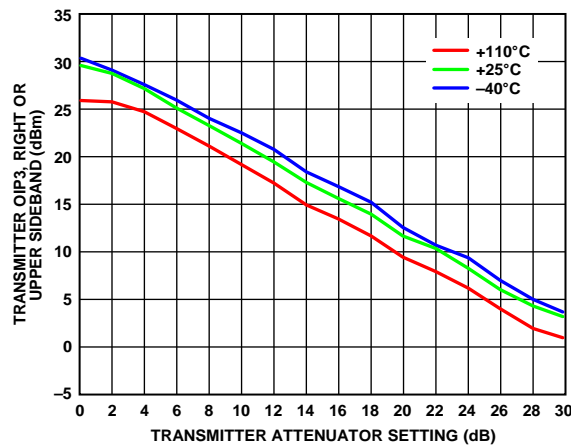

Figure 90. Transmitter OIP3, Right or Upper Sideband Response vs. Transmitter Attenuator Setting, LO = 850 MHz, Digital Backoff per Tone = 15 dB

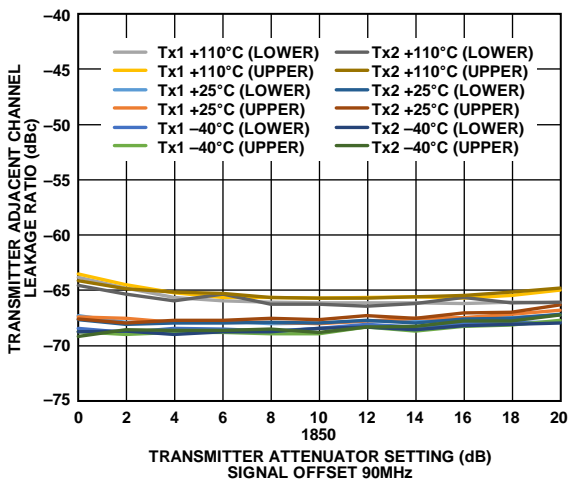

Figure 88. Transmitter Adjacent Channel Leakage Ratio vs. Transmitter Attenuator Setting, Signal Offset = 90 MHz, LO = 1850 MHz, LTE = 20 MHz, PAR = 12 dB, Upper Side and Lower Side

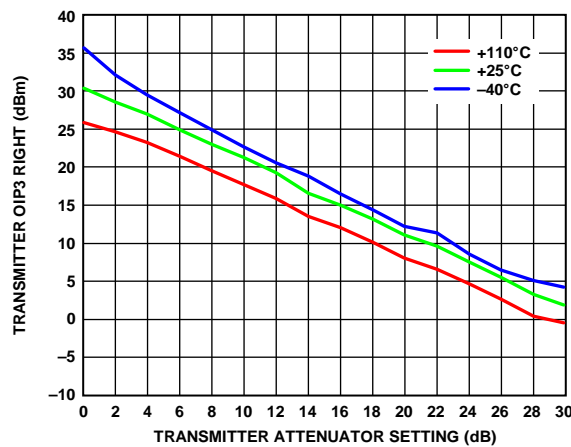

Figure 91. Transmitter OIP3 Right vs. Transmitter Attenuator Setting, LO = 1850 MHz, Digital Backoff per Tone = 15 dB

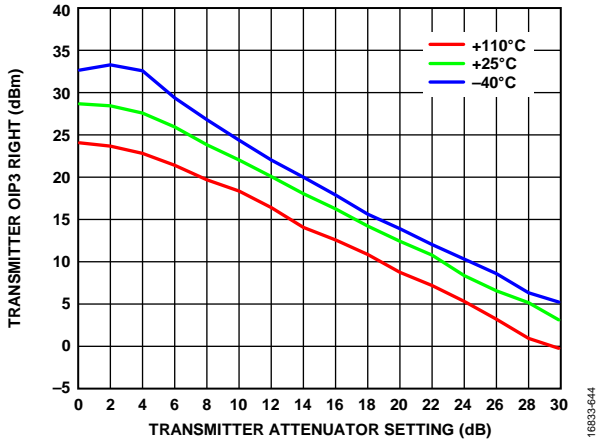

Figure 92. Transmitter OIP3 Right vs. Transmitter Attenuator Setting, LO = 2650 MHz, Digital Backoff per Tone = 15 dB

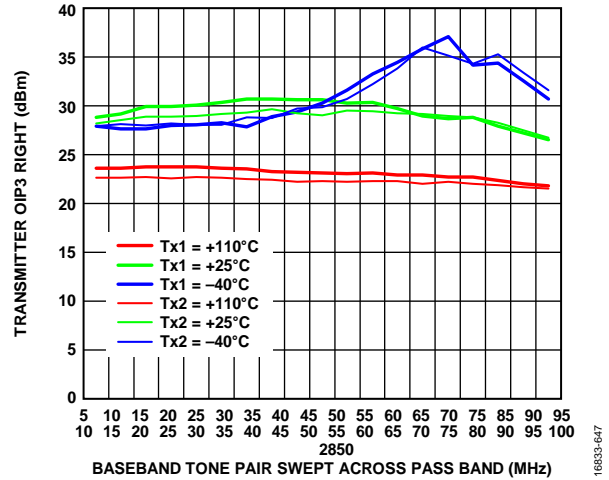

Figure 95. Transmitter OIP3 Right vs. Baseband Tone Pair Swept Across Pass Band, LO = 2850 MHz, Digital Backoff per Tone = 15 dB

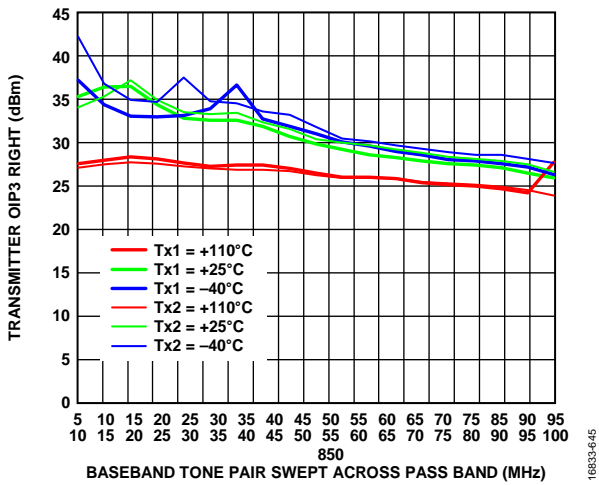

Figure 93. Transmitter OIP3 Right vs. Baseband Tone Pair Swept Across Pass Band, LO = 850 MHz, Digital Backoff per Tone = 15 dB

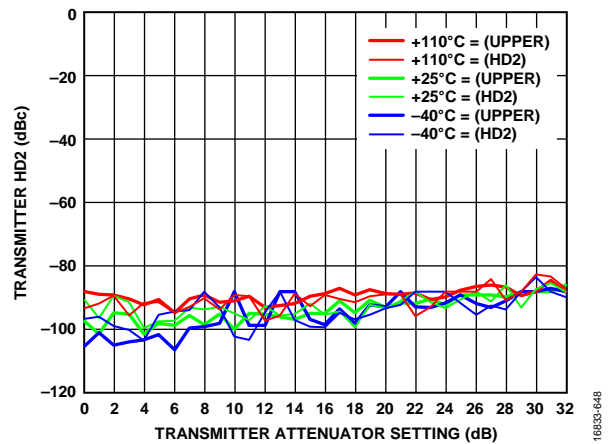

Figure 96. Transmitter HD2 vs. Transmitter Attenuator Setting, Baseband Frequency = 10 MHz, LO = 1850 MHz, Digital Backoff = 15 dB

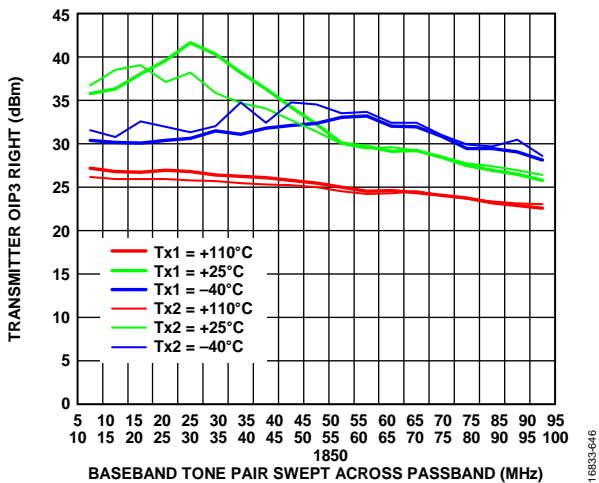

Figure 94. Transmitter OIP3 Right vs. Baseband Tone Pair Swept Across Pass Band, LO = 1850 MHz, Digital Backoff per Tone = 15 dB

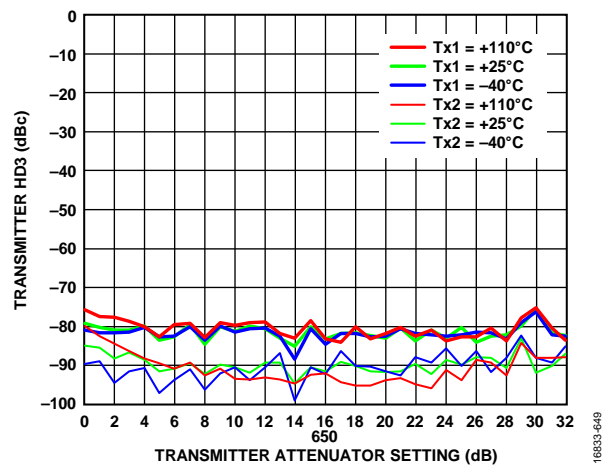

Figure 97. Transmitter HD3 vs. Transmitter Attenuator Setting, LO = 650 MHz, Digital Backoff = 15 dB

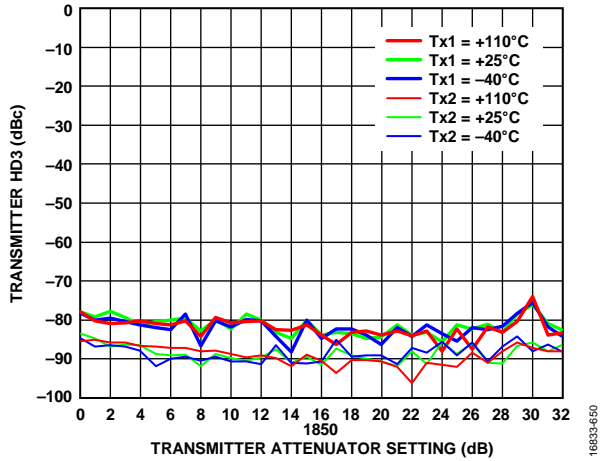

Figure 98. Transmitter HD3 vs. Transmitter Attenuator Setting, LO = 1850 MHz, Digital Backoff = 15 dB,

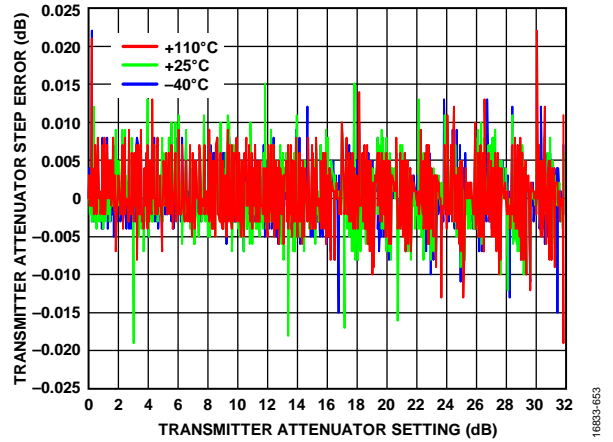

Figure 101. Transmitter Attenuator Step Error vs. Transmitter Attenuator Setting, LO = 650 MHz

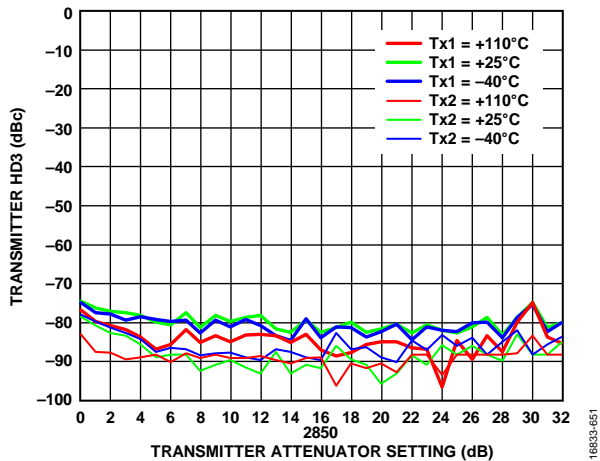

Figure 99. Transmitter HD3 vs. Transmitter Attenuation Setting, LO = 2850 MHz, Digital Backoff = 15 dB

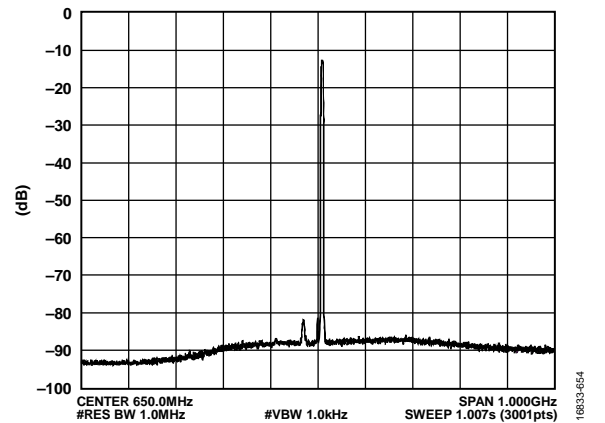

Figure 102. Transmitter Output Spurious, Transmitter 1 = 650 MHz, LTE = 5 MHz, Offset = 10 MHz, RMS = -12 dBFS, Temperature = 25°C

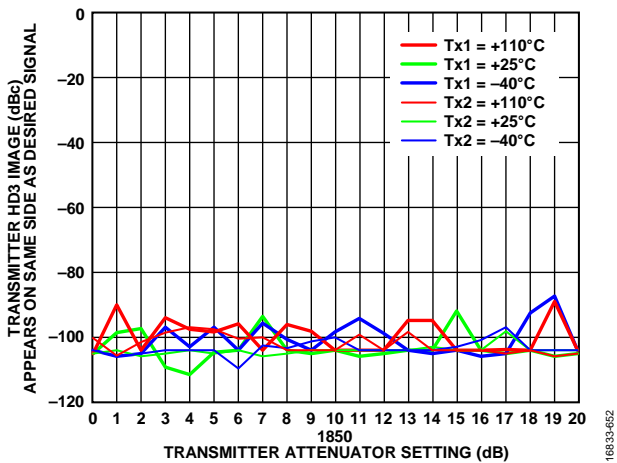

Figure 100. Transmitter HD3 Image Appears on Same Side as Desired Signal vs. Transmitter Attenuation Setting, LO = 1850 MHz, Digital Backoff = 15 dB

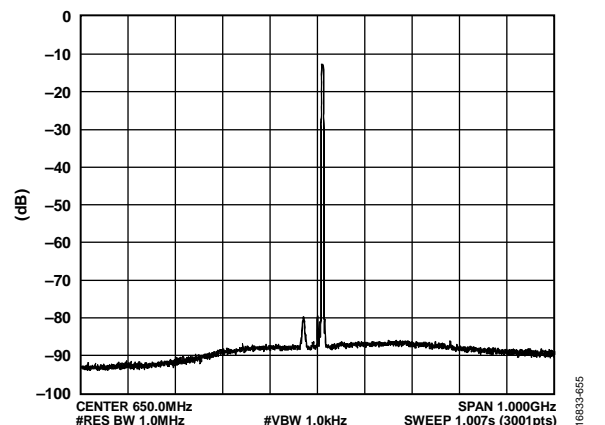

Figure 103. Transmitter Output Spurious, Transmitter 2 = 650 MHz, LTE = 5 MHz, Offset = 10 MHz, RMS = -12 dBFS, Temperature = 25°C

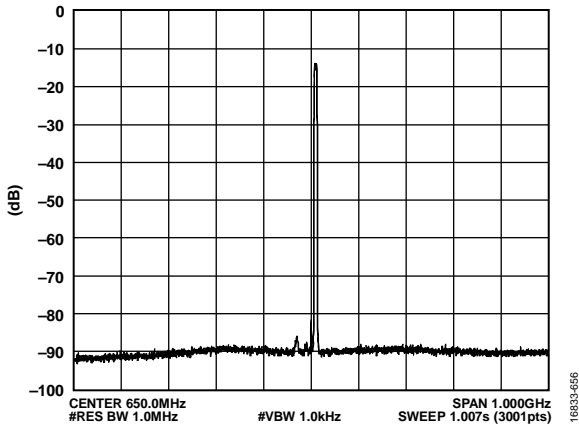

Figure 104. Transmitter Output Spurious, Transmitter 1 = 1850 MHz, LTE = 5 MHz, Offset = 10 MHz, RMS = -12 dBFS, Temperature = 25°C

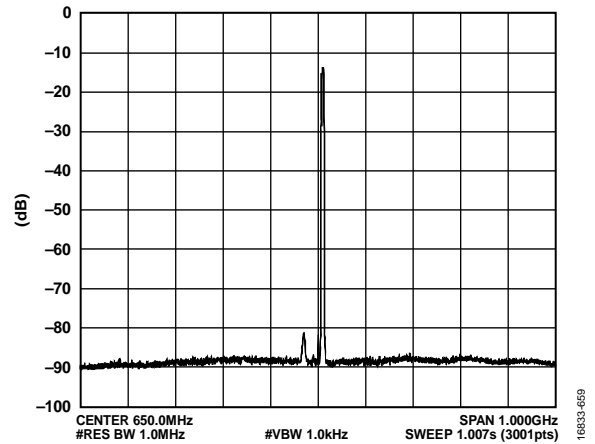

Figure 107. Transmitter Output Spurious, Transmitter 2 = 2850 MHz, LTE = 5 MHz, Offset = 10 MHz, RMS = -12 dBFS, Temperature = 25°C

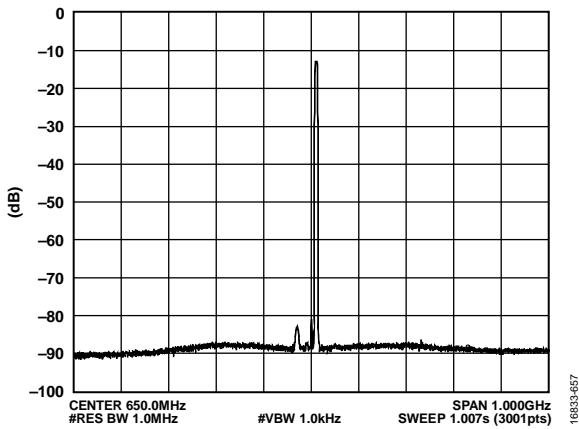

Figure 105. Transmitter Output Spurious, Transmitter 2 = 1850 MHz, LTE = 5 MHz, Offset = 10 MHz, RMS = -12 dBFS, Temperature = 25°C

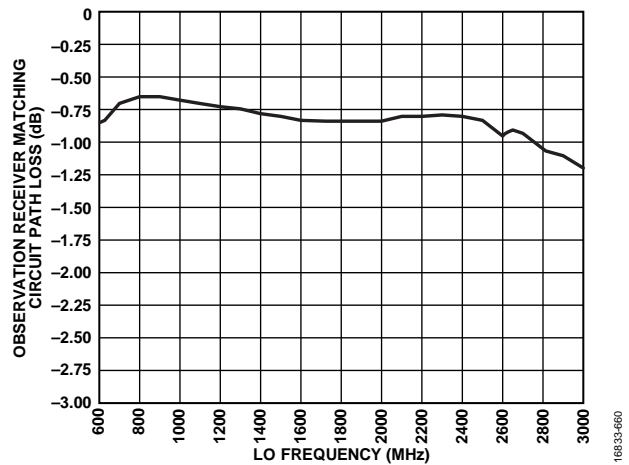

Figure 108. Observation Receiver Matching Circuit Path Loss vs. LO Frequency, Can be Used for De-Embedding Performance Data

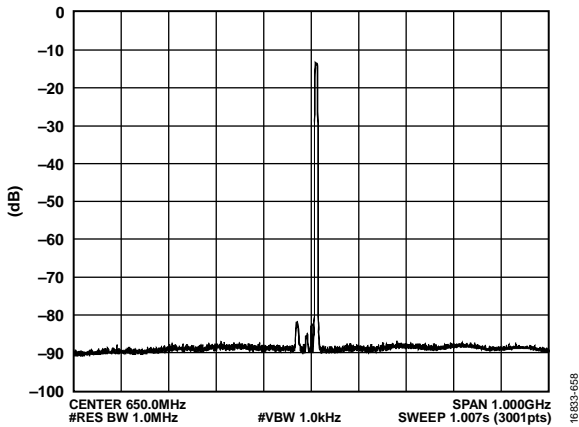

Figure 106. Transmitter Output Spurious, Transmitter 1 = 2850 MHz, LTE = 5 MHz, Offset = 10 MHz, RMS = -12 dBFS, Temperature = 25°C

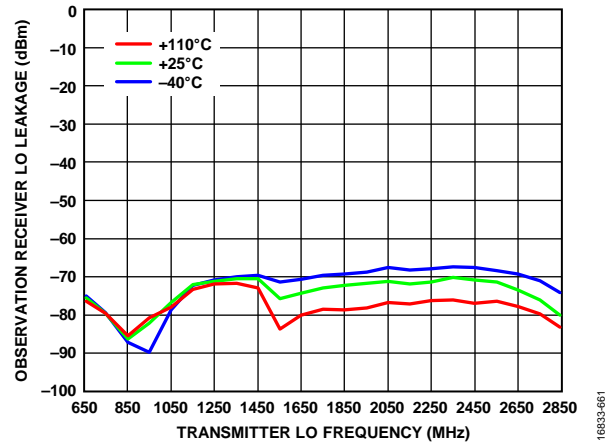

Figure 109. Observation Receiver LO Leakage vs. Transmitter LO Frequency



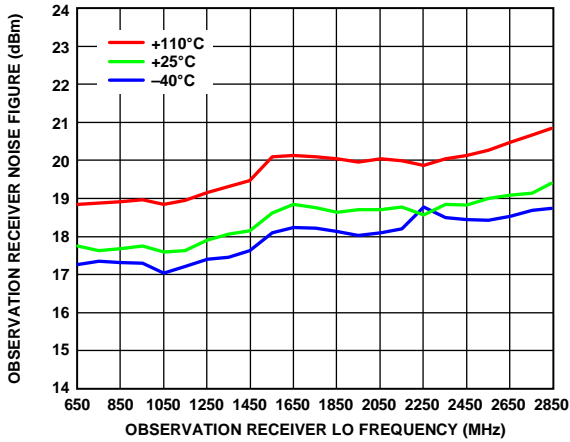

Figure 110. Observation Receiver Noise Figure vs. Observation Receiver LO Frequency, Total Nyquist Integration Bandwidth

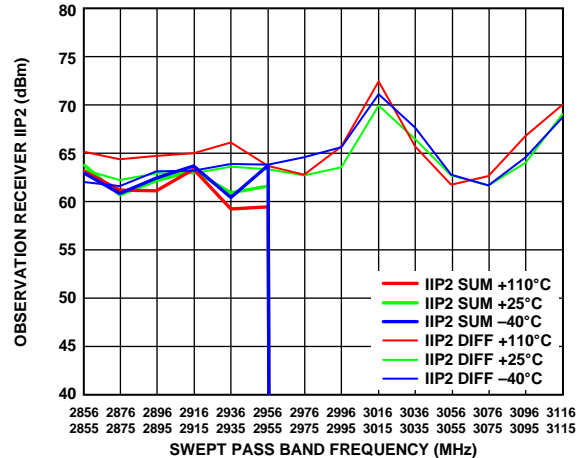

Figure 113. Observation Receiver IIP2, Sum and Difference Products vs. Swept Pass Band Frequency, Tones Separated by 1 MHz Swept Across Pass Band at -19 dBm Each, LO = 2850 MHz, Attenuation = 0 dB,

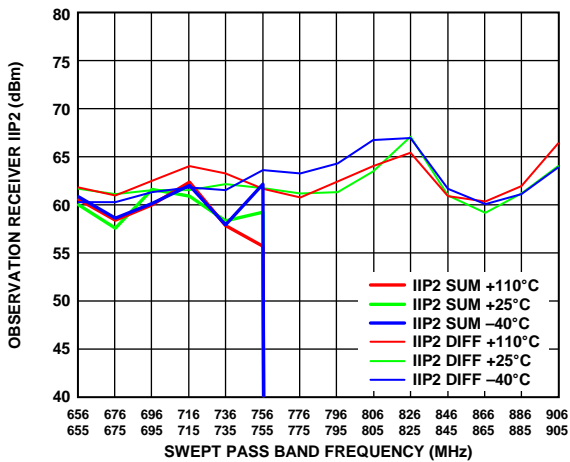

Figure 111. Observation Receiver IIP2, Sum and Difference Products vs. Swept Pass Band Frequency, Tones Separated by 1 MHz Swept Across Pass Band at -19 dBm Each, LO = 650 MHz, Attenuation = 0 dB

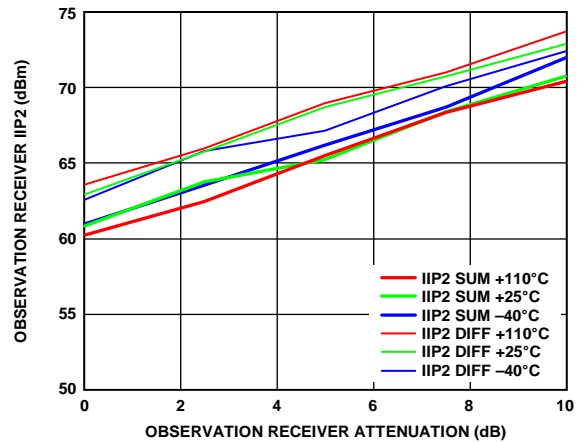

Figure 114. Observation Receiver IIP2, Sum and Difference Products vs. Observation Receiver Attenuation, Tone 1 = 1845 MHz, Tone 2 = 1846 MHz at -19 dBm Plus Attenuation, LO = 1800 MHz

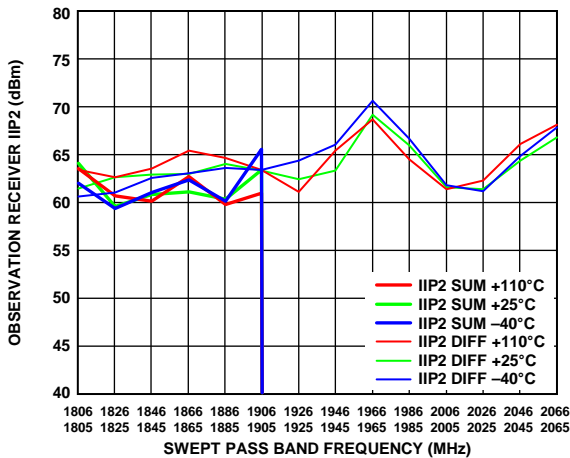

Figure 112. Observation Receiver IIP2, Sum and Difference Products vs. Swept Pass Band Frequency, Tones Separated by 1 MHz Swept Across Pass Band at -19 dBm Each, LO = 1800 MHz, Attenuation = 0 dB

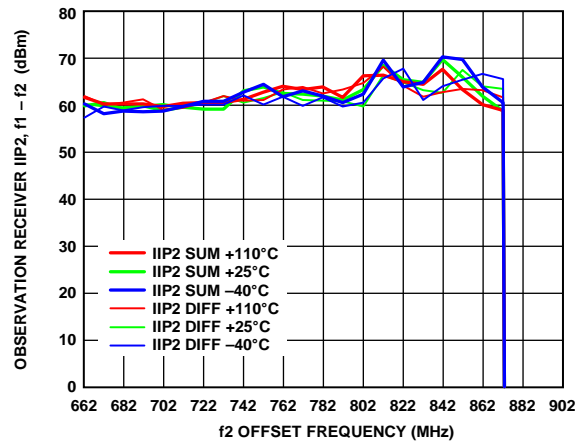

Figure 115. Observation Receiver IIP2, f1 - f2 vs. f2 Offset Frequency, LO = 650 MHz, Tone 1 = 652 MHz, Tone 2 = Swept at -19 dBm Each, Observation Receiver Attenuation = 0 dB

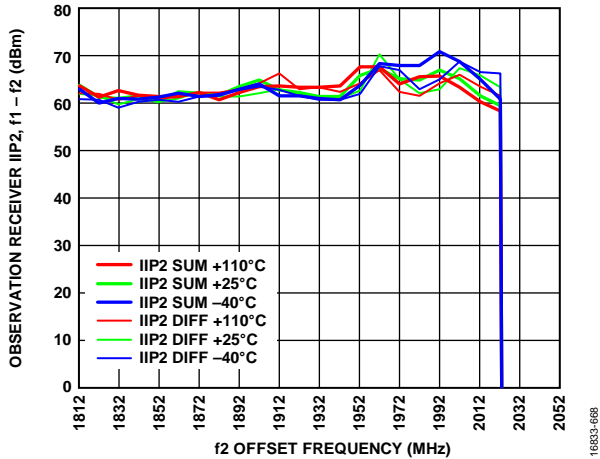

Figure 116. Observation Receiver IIP2,  $f_1 - f_2$  vs.  $f_2$  Offset Frequency, LO = 1800 MHz, Tone 1 = 1802 MHz, Tone 2 = Swept at -19 dBm Each, Attenuation = 0 dB

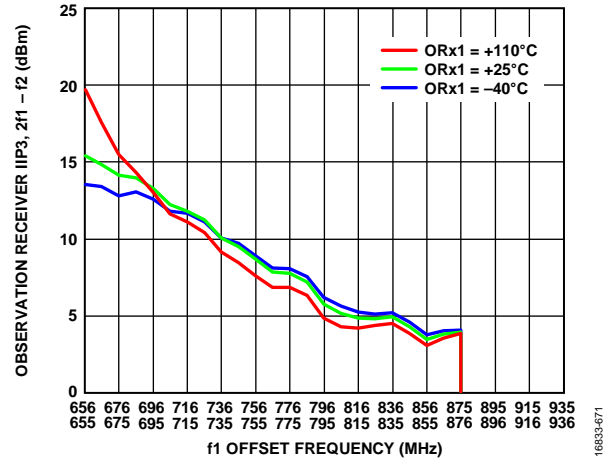

Figure 119. Observation Receiver IIP3,  $2f_1 - f_2$  vs.  $f_1$  Offset Frequency, LO = 650 MHz, Attenuation = 0 dB, Tones Separated by 1 MHz Swept Across Pass Band at -19 dBm Each

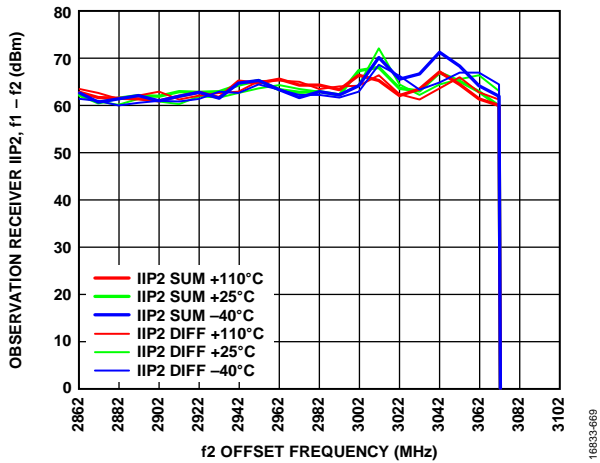

Figure 117. Observation Receiver IIP2,  $f_1 - f_2$  vs.  $f_2$  Offset Frequency, LO = 2850 MHz, Tone 1 = 2852 MHz, Tone 2 = Swept at -19 dBm Each, Attenuation = 0 dB

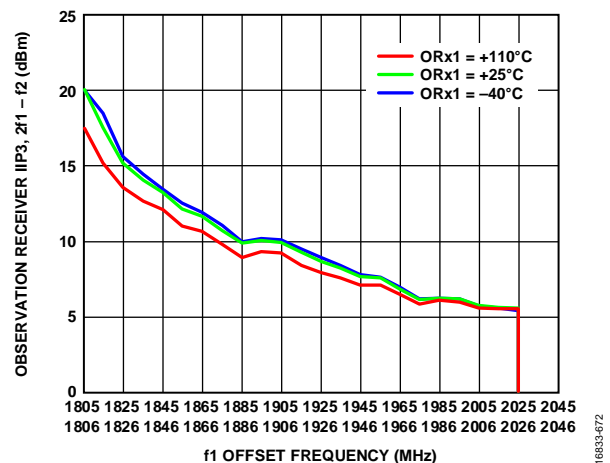

Figure 120. Observation Receiver IIP3,  $2f_1 - f_2$  vs.  $f_1$  Offset Frequency, LO = 1800 MHz, Attenuation = 0 dB, Tones Separated by 1 MHz Swept Across Pass Band at -19 dBm Each

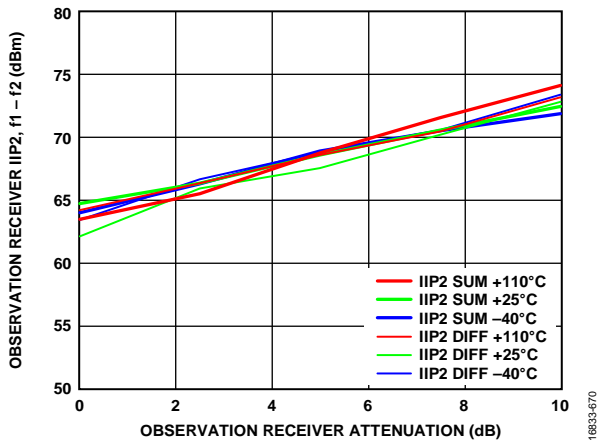

Figure 118. Observation Receiver IIP2,  $f_1 - f_2$  vs. Observation Receiver Attenuation, LO = 1800 MHz, Tone 1 = 1802 MHz, Tone 2 = 1902 MHz at -19 dBm Plus Attenuation

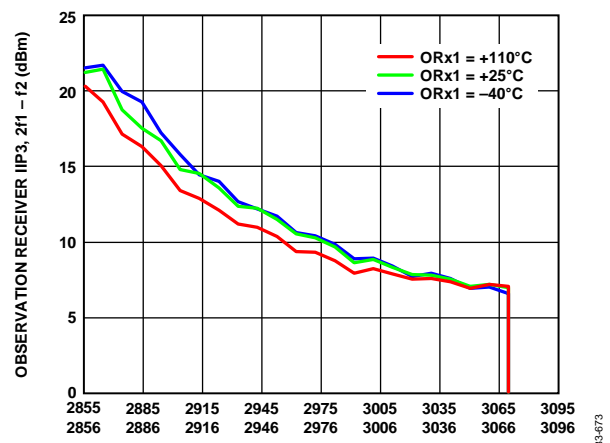

Figure 121. Observation Receiver IIP3,  $2f_1 - f_2$  vs.  $f_1$  Offset Frequency, LO = 2850 MHz, Attenuation = 0 dB, Tones Separated by 1 MHz Swept Across Pass Band at -19 dBm Each

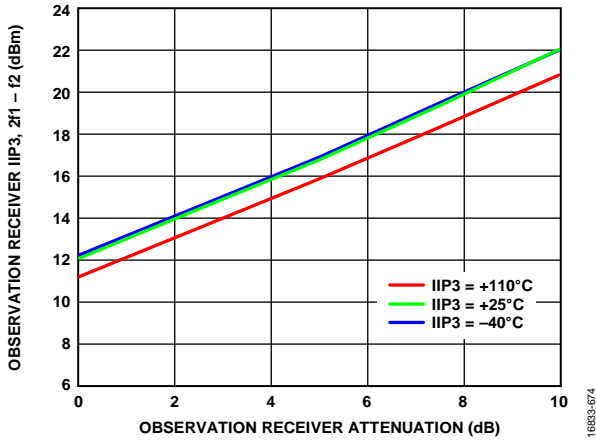

Figure 122. Observation Receiver IIP3, 2f1 - f2 vs. Observation Receiver Attenuation, LO = 1800 MHz, Tone 1 = 1895 MHz, Tone 2 = 1896 MHz at -19 dBm Plus Attenuation

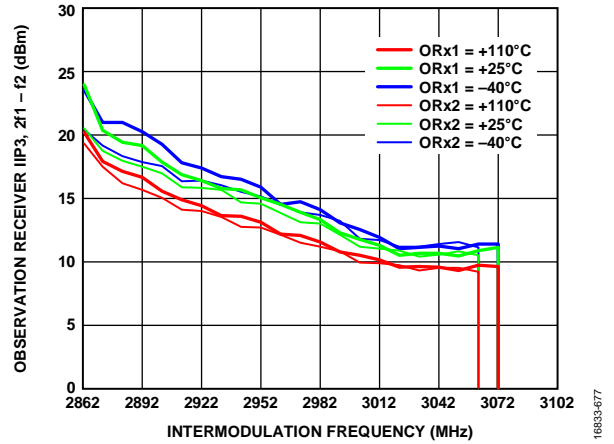

Figure 125. Observation Receiver IIP3, 2f1 - f2 vs. Intermodulation Frequency, LO = 2850 MHz, Tone 1 = 2852 MHz, Tone 2 = Swept at -19 dBm Each

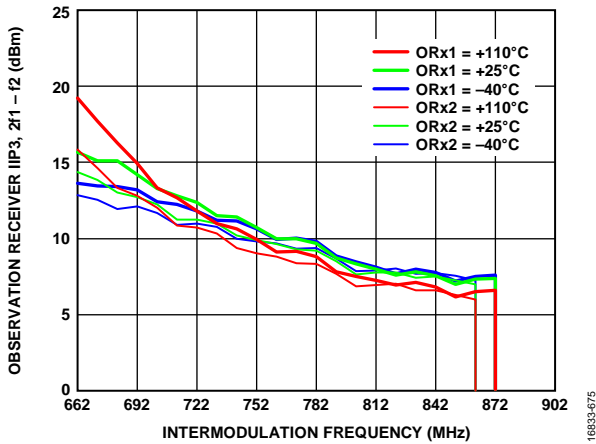

Figure 123. Observation Receiver IIP3, 2f1 - f2 vs. Intermodulation Frequency, LO = 650 MHz, Tone 1 = 652 MHz, Tone 2 = Swept at -19 dBm Each

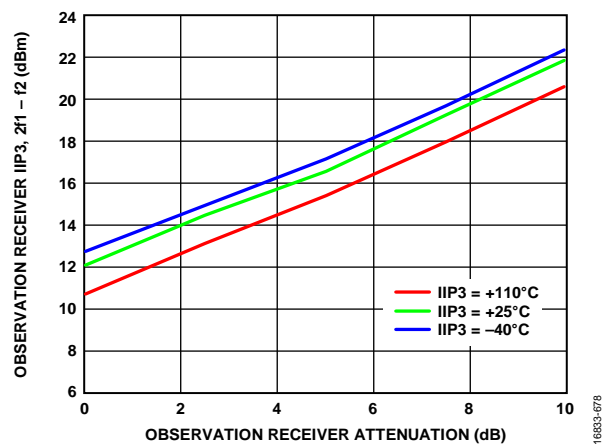

Figure 126. Observation Receiver IIP3, 2f1 - f2 vs. Observation Receiver Attenuation, LO = 1800 MHz, Tone 1 = 1802 MHz, Tone 2 = 1922 MHz at -19 dBm Plus Attenuation

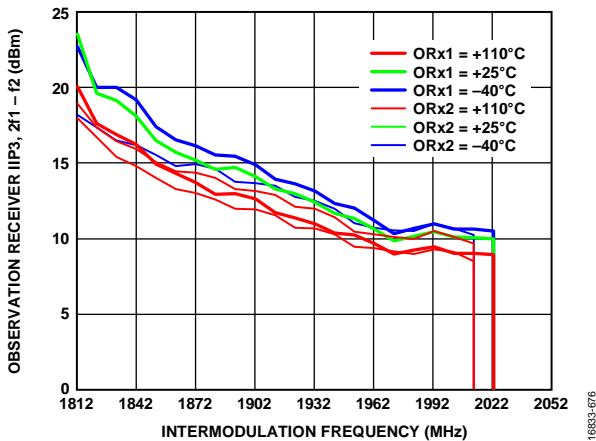

Figure 124. Observation Receiver IIP3, 2f1 - f2 vs. Intermodulation Frequency, LO = 1800 MHz, Tone 1 = 1802 MHz, Tone 2 = Swept at -19 dBm Each

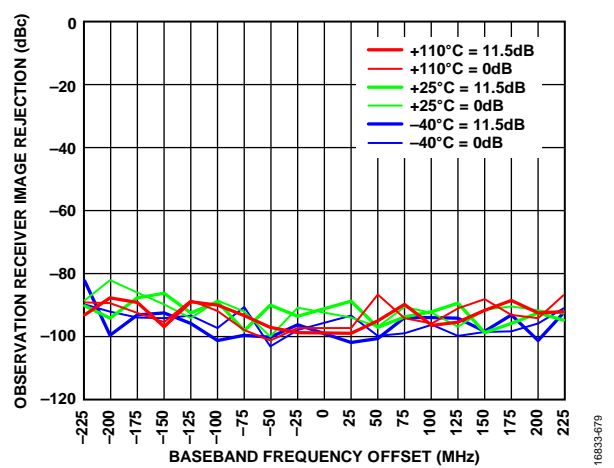

Figure 127. Observation Receiver Image Rejection vs. Baseband Frequency Offset, CW Signal Swept Across the Band, LO = 650 MHz

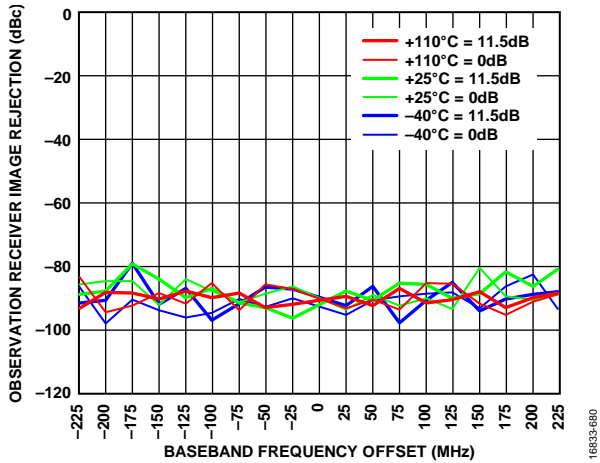

Figure 128. Observation Receiver Image Rejection vs. Baseband Frequency Offset, CW Signal Swept Across the Band, LO = 1850 MHz

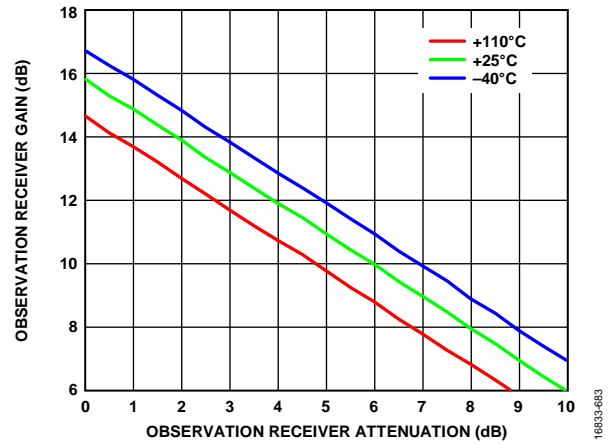

Figure 131. Observation Receiver Gain vs. Observation Receiver Attenuation, LO = 1800 MHz

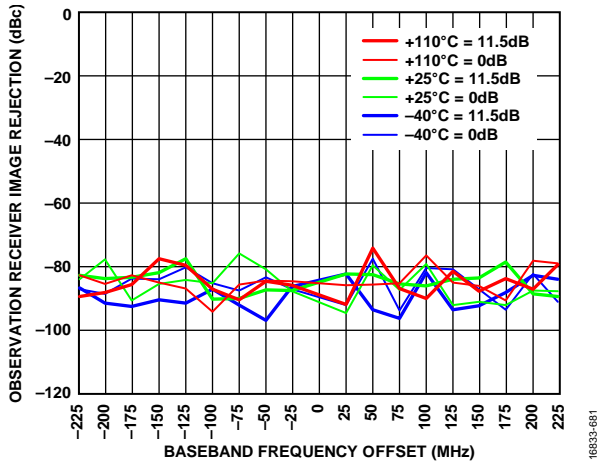

Figure 129. Observation Receiver Image Rejection vs. Baseband Frequency Offset, CW Signal Swept Across the Band, LO = 2850 MHz

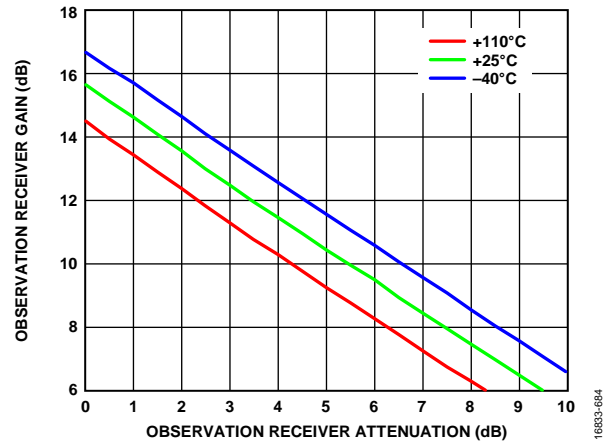

Figure 132. Observation Receiver Gain vs. Observation Receiver Attenuation, LO = 2800 MHz

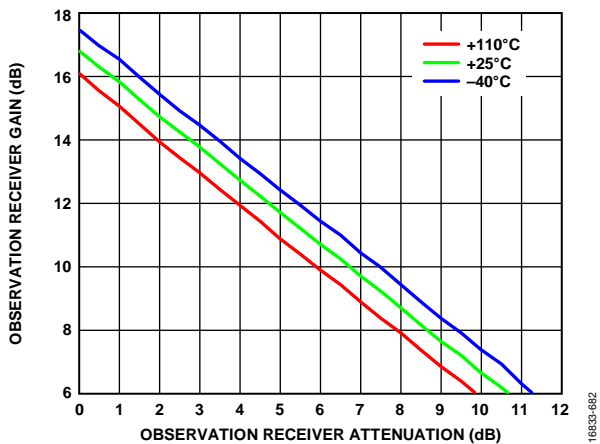

Figure 130. Observation Receiver Gain vs. Observation Receiver Attenuation, LO = 650 MHz

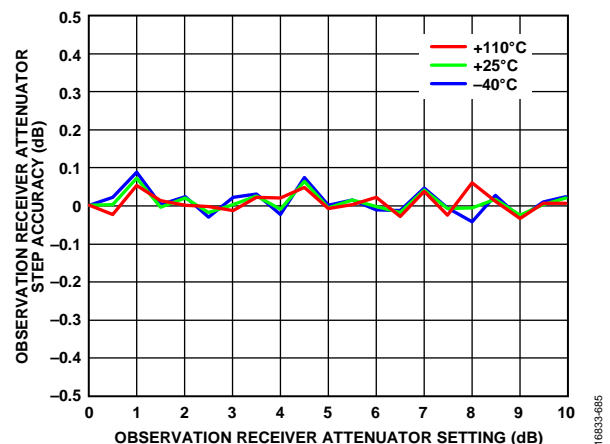

Figure 133. Observation Receiver Attenuator Step Accuracy vs. Observation Receiver Attenuator Setting, LO = 2600 MHz

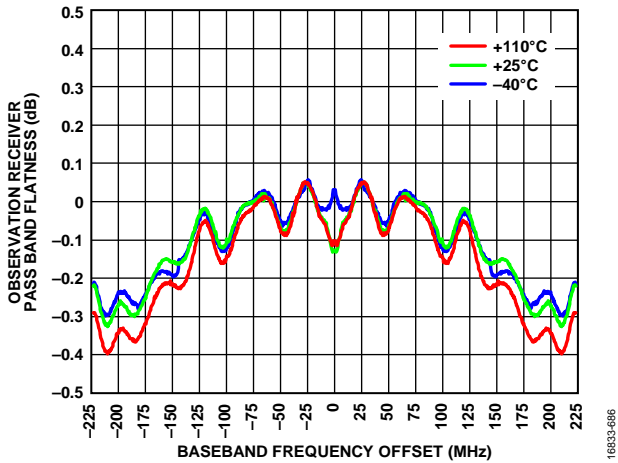

Figure 134. Observation Receiver Pass Band Flatness vs. Baseband Frequency Offset, LO = 1800 MHz

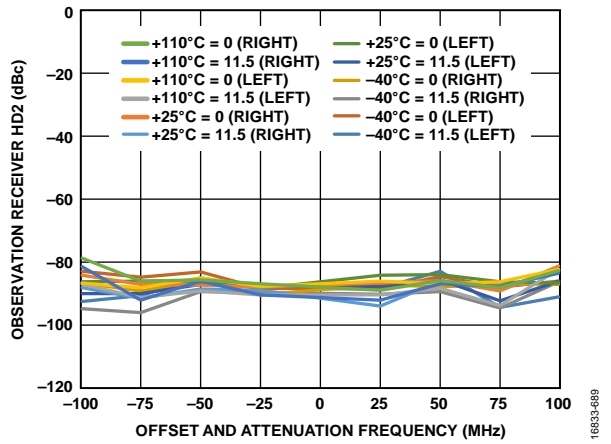

Figure 137. Observation Receiver HD2 vs. Offset Frequency and Attenuation, LO = 1850 MHz, Tone Level = -20 dBm at Attenuation = 0 dB

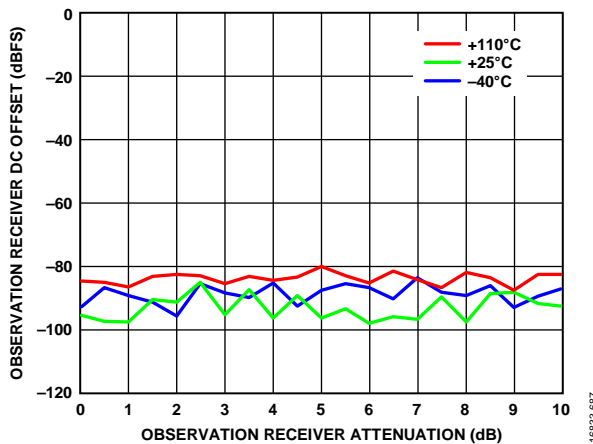

Figure 135. Observation Receiver DC Offset vs. Observation Receiver Attenuation, LO = 1850 MHz

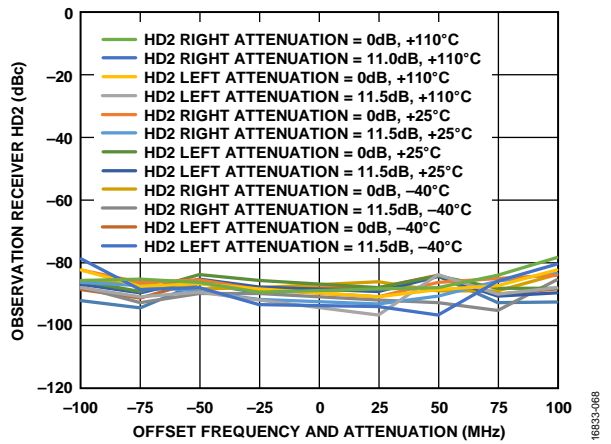

Figure 138. Observation Receiver HD2 vs. Offset Frequency and Attenuation, LO = 2850 MHz, Tone Level = -20 dBm at Attenuation = 0 dB

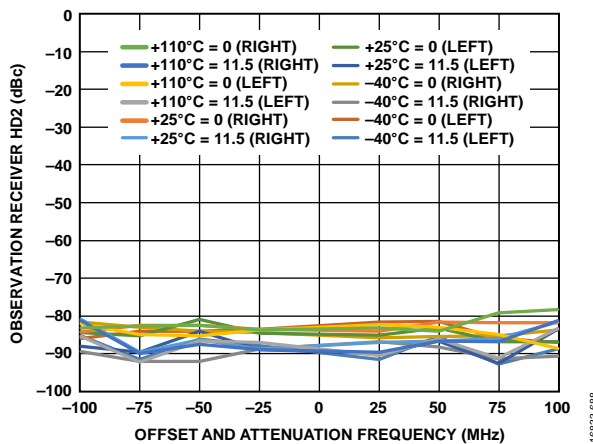

Figure 136. Observation Receiver HD2 vs. Offset Frequency and Attenuation, LO = 650 MHz, Tone Level = -20 dBm at Attenuation = 0 dB

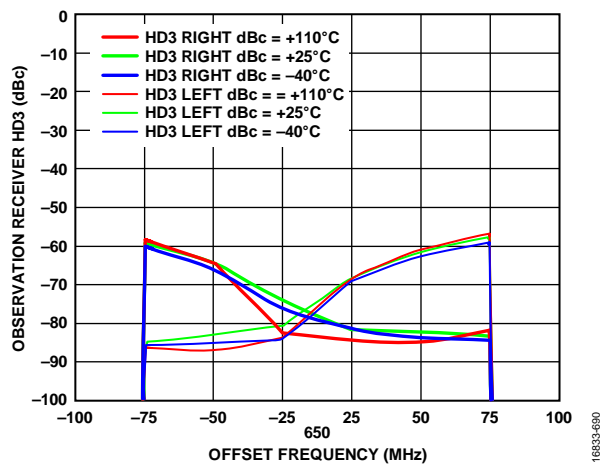

Figure 139. Observation Receiver HD3, Left and Right vs. Offset Frequency, LO = 650 MHz, Tone Level = -20 dBm at Attenuation = 0 dB

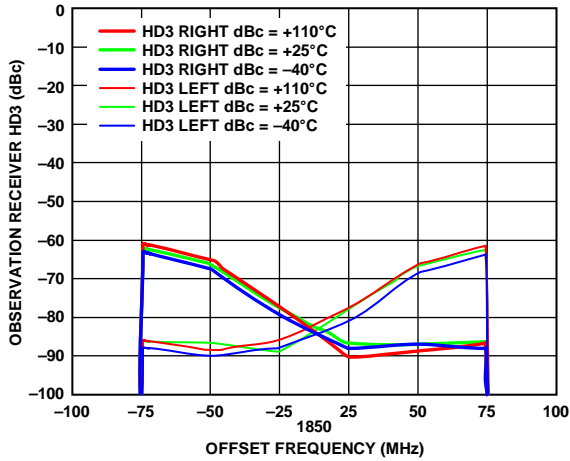

Figure 140. Observation Receiver HD3, Left and Right vs. Offset Frequency, LO = 1850 MHz, Tone Level = -20 dBm at Attenuation = 0 dB

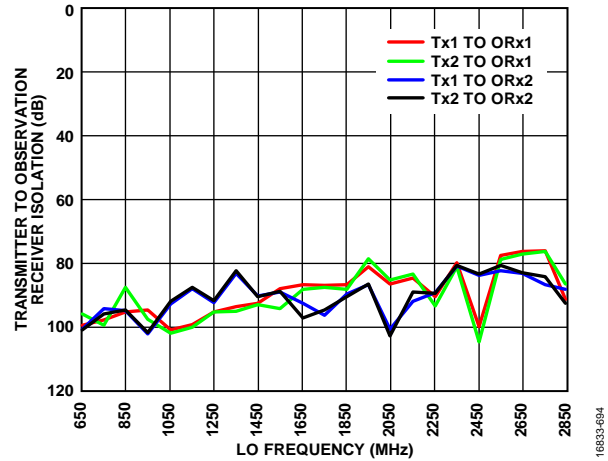

Figure 143. Transmitter to Observation Receiver Isolation vs. LO Frequency, Temperature = 25°C

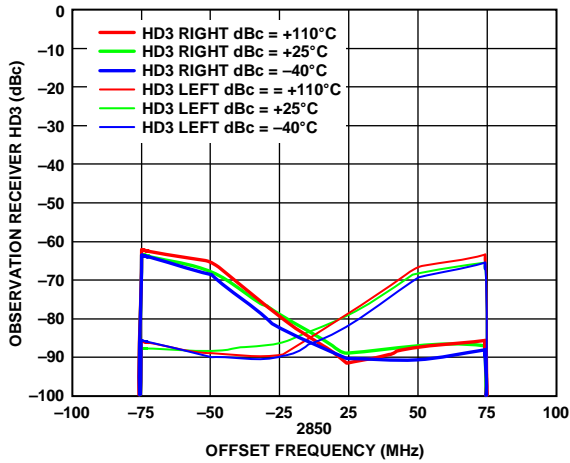

Figure 141. Observation Receiver HD3, Left and Right vs. Offset Frequency, LO = 2850 MHz, Tone Level = -20 dBm at Attenuation = 0 dB

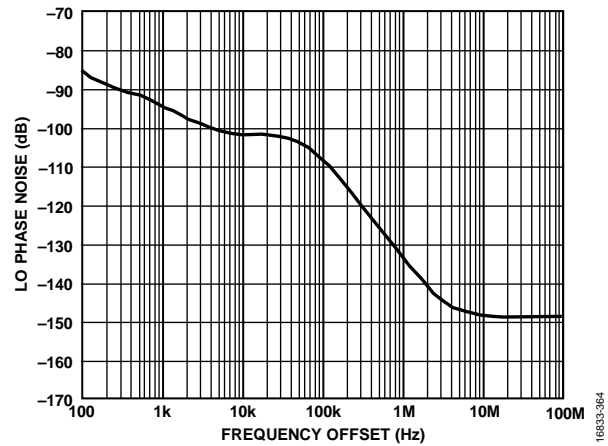

Figure 144. LO Phase Noise vs. Frequency Offset, LO = 1900 MHz, Spectrum Analyzer Limits Far Out Noise

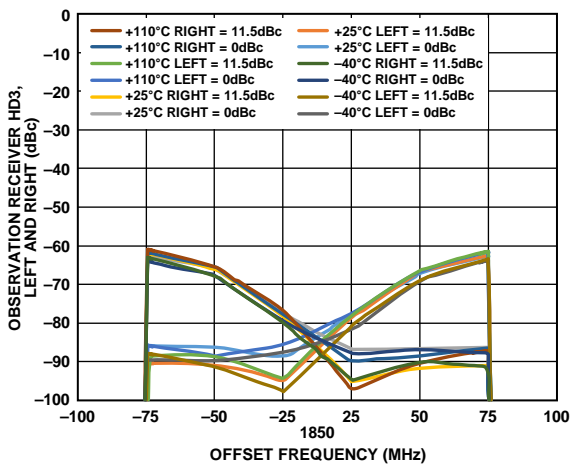

Figure 142. Observation Receiver HD3, Left and Right vs. Offset Frequency, LO = 1850 MHz, Observation Receiver Attenuation = 0 dB and 11.5 dB

3400 MHz TO 4800 MHz BAND

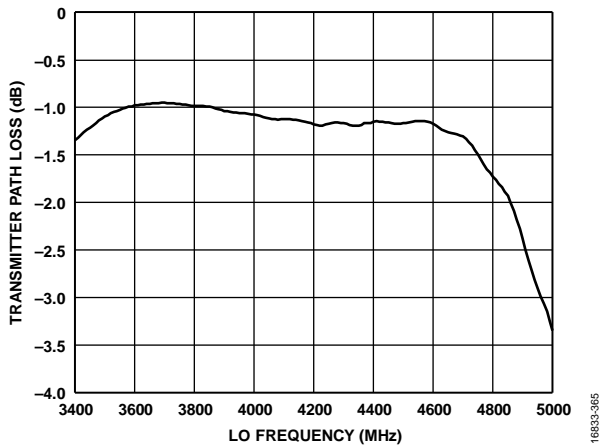

Figure 145. Transmitter Path Loss vs. LO Frequency (Simulation), Can be Used for De-Embedding Performance Data

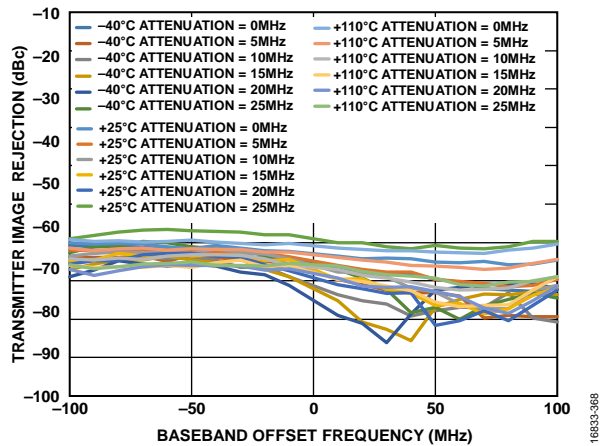

Figure 148. Transmitter Image Rejection vs. Baseband Offset Frequency and Attenuation, QEC Trained with Three Tones (Tracking On), Total Combined Power = -6 dBFS, Correction Then Frozen (Tracking Turned Off), Continuous Wave Tone Swept Across Large Signal Bandwidth, LO = 4600 MHz

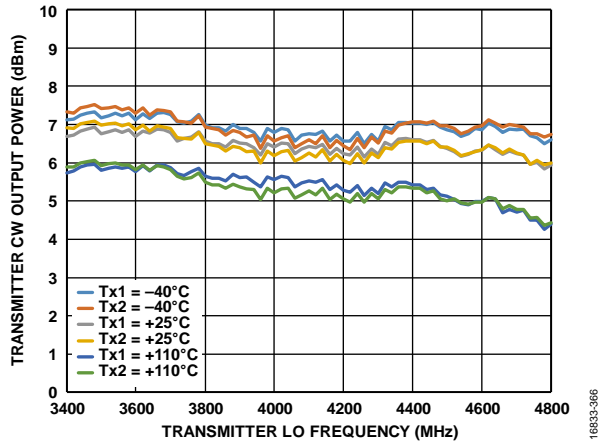

Figure 146. Transmitter Continuous Wave Output Power vs. Transmitter LO Frequency, Transmitter QEC and External LO Leakage Active, Transmitter in 200 MHz/450 MHz Bandwidth Mode, IQ Rate = 491.52 MHz, Attenuation = 0 dB, Not De-Embedded

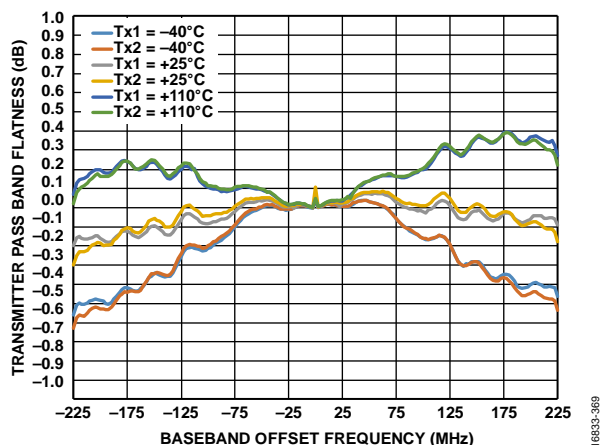

Figure 149. Transmitter Pass Band Flatness vs. Baseband Offset Frequency, Off Chip Match Response De-Embedded, LO = 3600 MHz

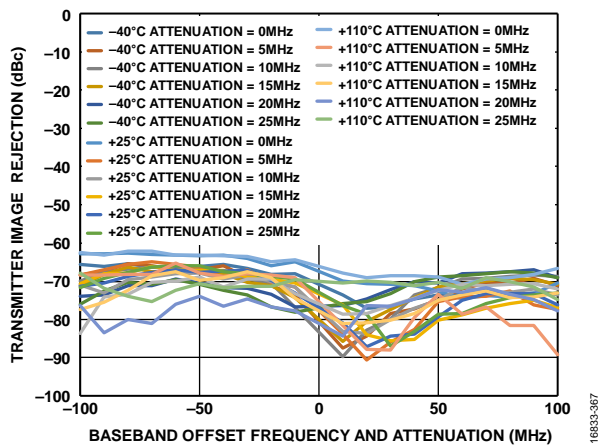

Figure 147. Transmitter Image Rejection vs. Baseband Offset Frequency and Attenuation, QEC Trained with Three Tones Placed at 10 MHz, 50 MHz, and 100 MHz (Tracking On), Total Combined Power = -6 dBFS, Correction Then Frozen (Tracking Turned Off), Continuous Wave Tone Swept Across Large Signal Bandwidth, LO = 3700 MHz

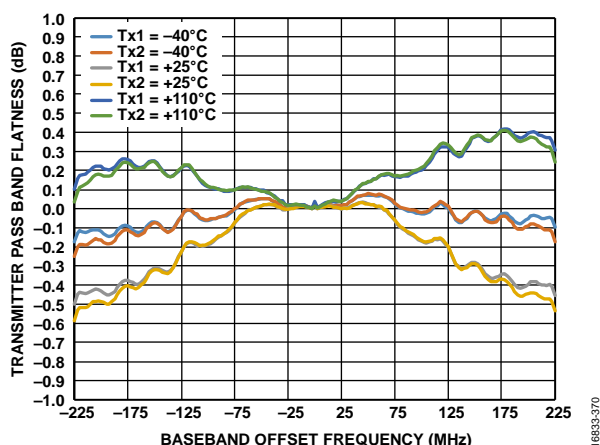

Figure 150. Transmitter Pass Band Flatness vs. Baseband Offset Frequency, Off Chip Match Response De-Embedded, LO = 4600 MHz

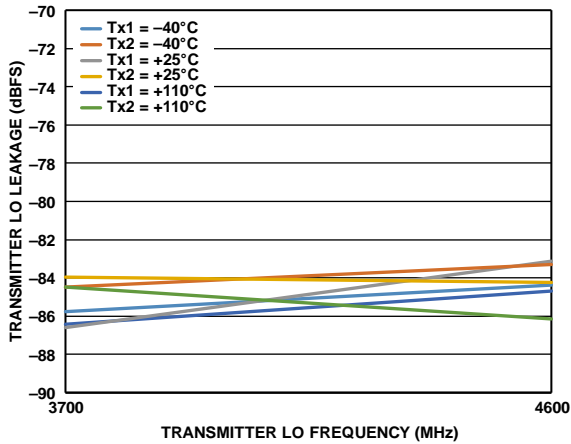

Figure 151. Transmitter LO Leakage vs. Transmitter LO Frequency, Transmitter Attenuation = 0 dB

16833-371

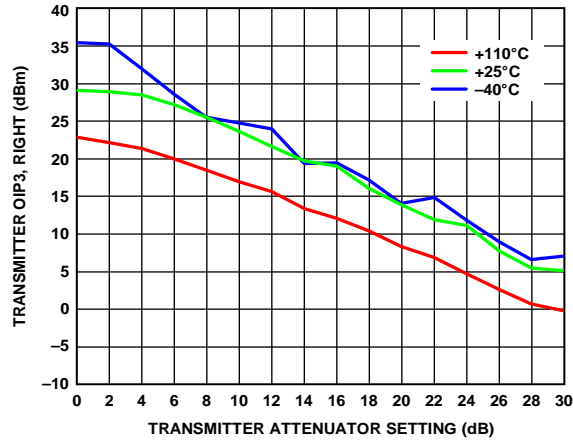

Figure 154. Transmitter OIP3, Right vs. Transmitter Attenuator Setting, LO = 3600 MHz, Total RMS Power = -12 dBFS.

16833-753

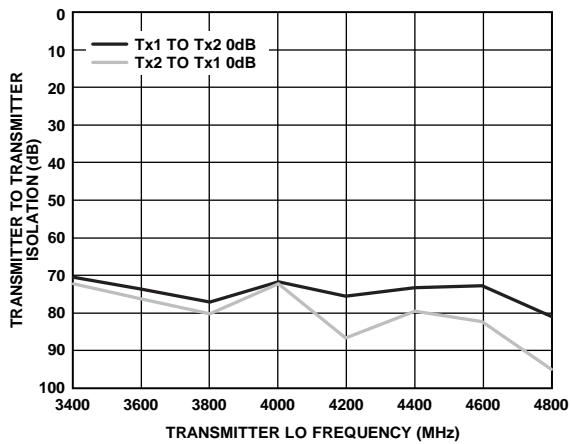

Figure 152. Transmitter to Transmitter Isolation vs. Transmitter LO Frequency, Temperature = 25°C

16833-751

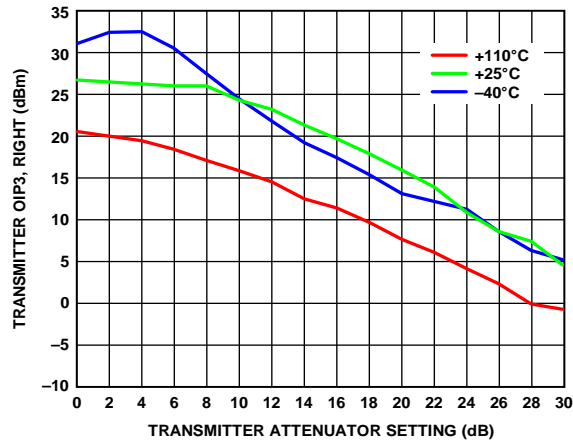

Figure 155. Transmitter OIP3, Right vs. Transmitter Attenuator Setting, LO = 4600 MHz, Total RMS Power = -12 dBFS

16833-754

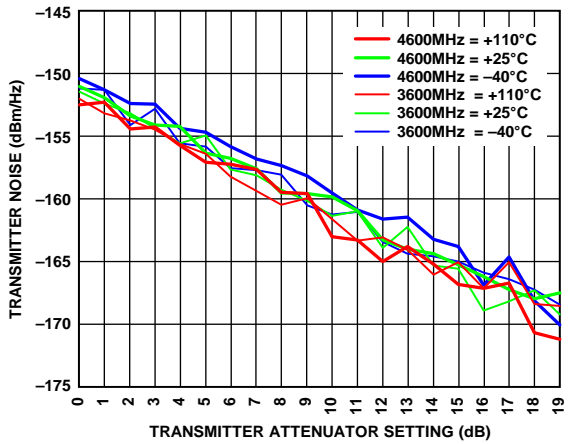

Figure 153. Transmitter Noise vs. Transmitter Attenuator Setting

16833-752

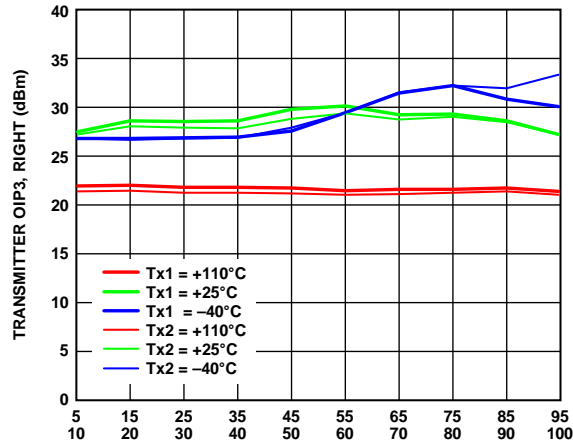

Figure 156. Transmitter OIP3, Right vs. Baseband Tone Pair Swept Across Pass Band, LO = 3600 MHz, Total RMS Power = -12 dBFS

16833-755



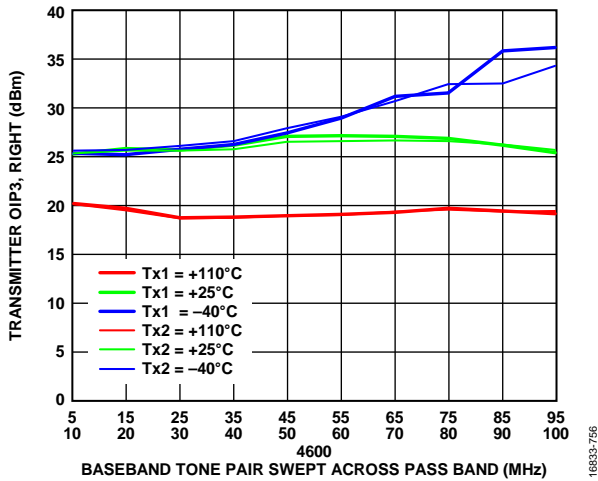

Figure 157. Transmitter OIP3, Right vs. Baseband Tone Pair Swept Across Pass Band, LO = 4600 MHz, Total RMS Power = -12 dBFS

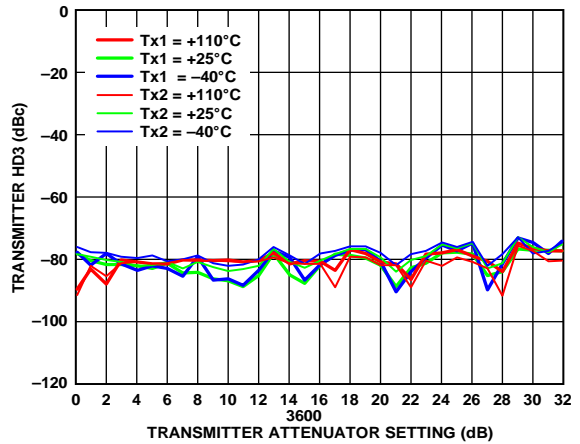

Figure 160. Transmitter HD3 vs. Transmitter Attenuator Setting, LO = 3600 MHz, CW = -15 dBFS, Baseband Frequency = 10 MHz

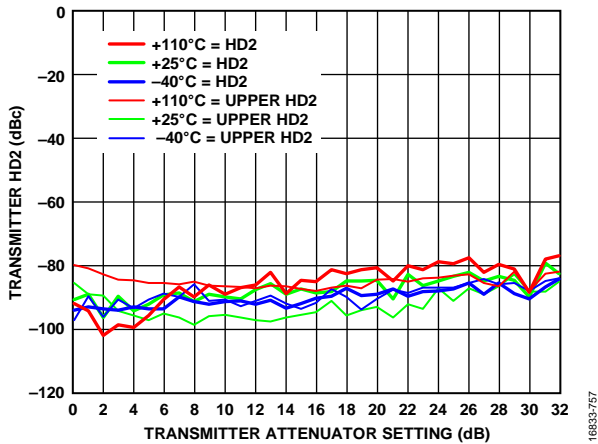

Figure 158. Transmitter HD2 vs. Transmitter Attenuator Setting, Baseband Frequency = 10 MHz, LO = 3600 MHz, CW = -15 dBFS

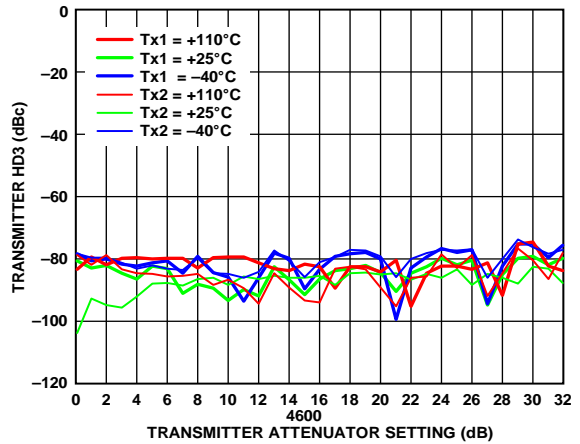

Figure 161. Transmitter HD3 vs. Transmitter Attenuator Setting, LO = 4600 MHz, CW = -15 dBFS, Baseband Frequency = 10 MHz

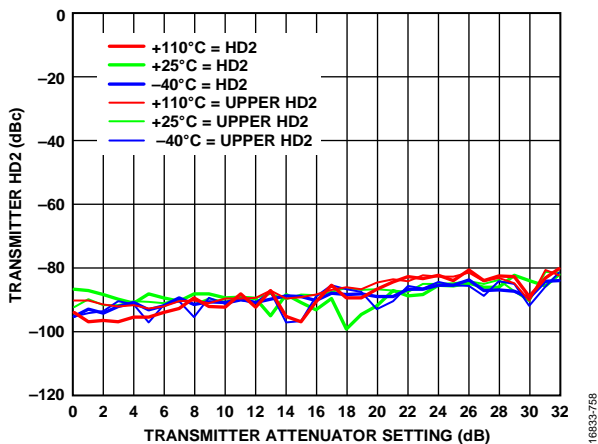

Figure 159. Transmitter HD2 vs. Transmitter Attenuator Setting, Baseband Frequency = 10 MHz, LO = 4600 MHz, CW = -15 dBFS

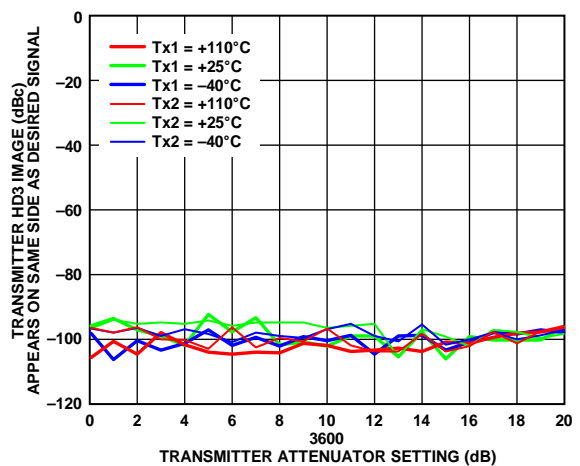

Figure 162. Transmitter HD3 Image Appears on Same Side as Desired Signal vs. Transmitter Attenuator Setting, LO = 3600 MHz, CW = -15 dBFS

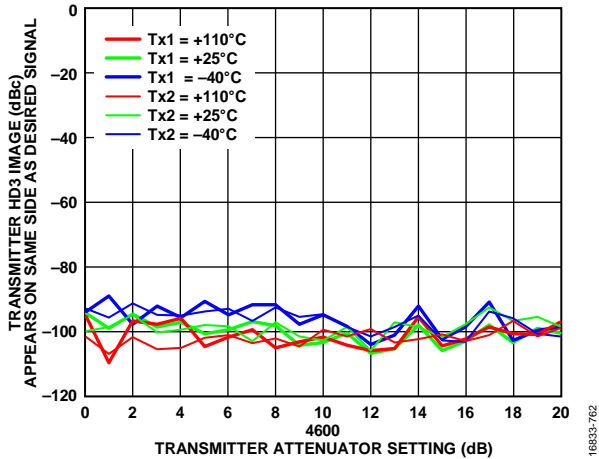

Figure 163. Transmitter HD3 Image Appears on Same Side as Desired Signal vs. Transmitter Attenuator Setting, LO = 4600 MHz, CW = -15 dBFS

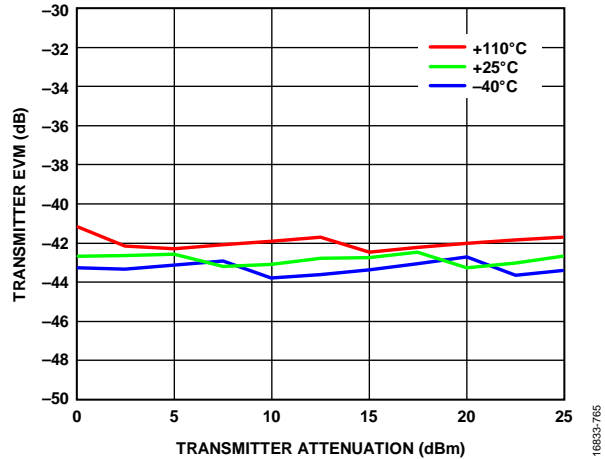

Figure 166. Transmitter EVM vs. Transmitter Attenuation, LTE = 20 MHz, Signal Centered on DC, LO = 3600 MHz

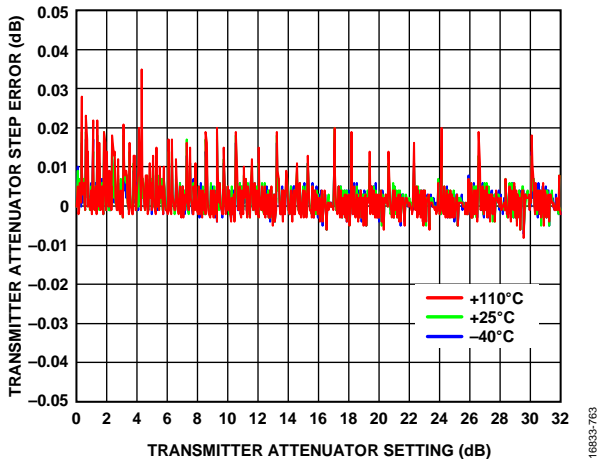

Figure 164. Transmitter Attenuator Step Error vs. Transmitter Attenuator Setting, LO = 3600 MHz

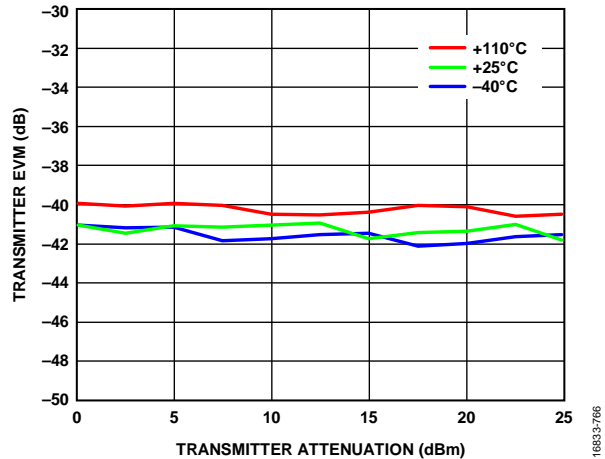

Figure 167. Transmitter EVM vs. Transmitter Attenuation, LTE = 20 MHz, Signal Centered on DC, LO = 4600 MHz

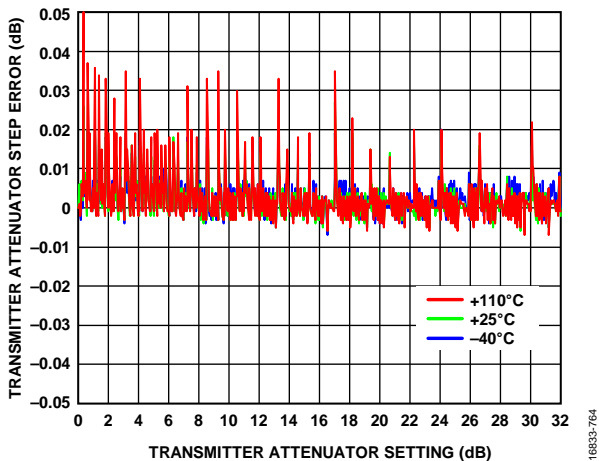

Figure 165. Transmitter Attenuator Step Error vs. Transmitter Attenuator Setting, LO = 4600 MHz

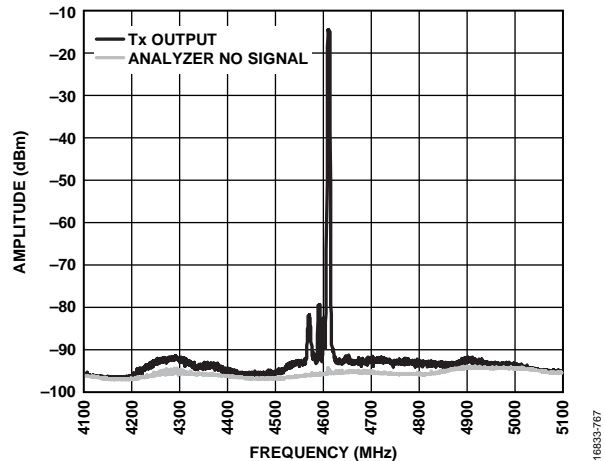

Figure 168. Amplitude vs. Frequency, Transmitter Output Spurious, Transmitter 1 = 4600 MHz, LTE = 5 MHz, Offset = 10 MHz, RMS Ripple in Noise Floor due to Spectrum Analyzer = -12 dBFS, Temperature = 25°C

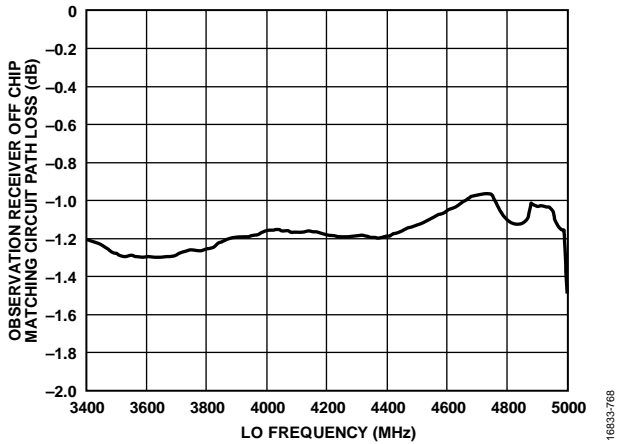

Figure 169. Observation Receiver Off Chip Matching Circuit Path Loss vs. LO Frequency (Simulation), Can be Used for De-Embedding Performance Data

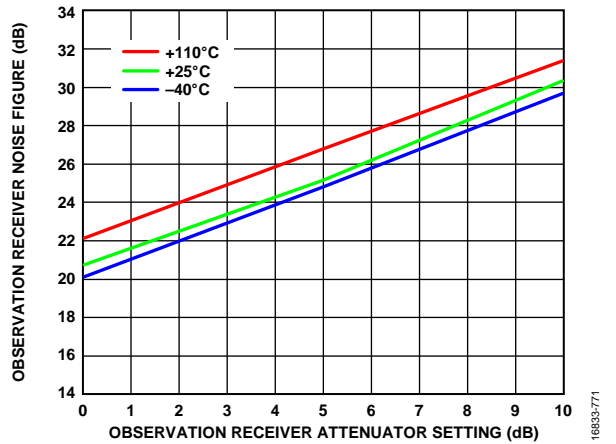

Figure 172. Observation Receiver Noise Figure vs. Observation Receiver Attenuator Setting, LO = 4600 MHz, Total Nyquist Integration Bandwidth

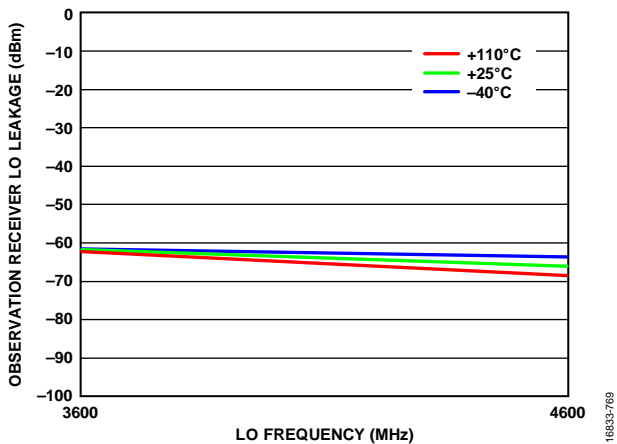

Figure 170. Observation Receiver LO Leakage vs. LO Frequency from 3600 MHz to 4600 MHz

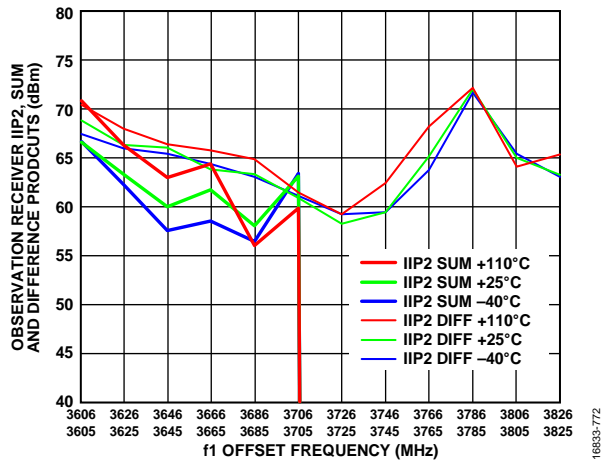

Figure 173. Observation Receiver IIP2, Sum and Difference Products vs. f1 Offset Frequency, Tones Separated by 1 MHz Swept Across Pass Band at -22 dBm Each, LO = 3600 MHz, Attenuation = 0 dB

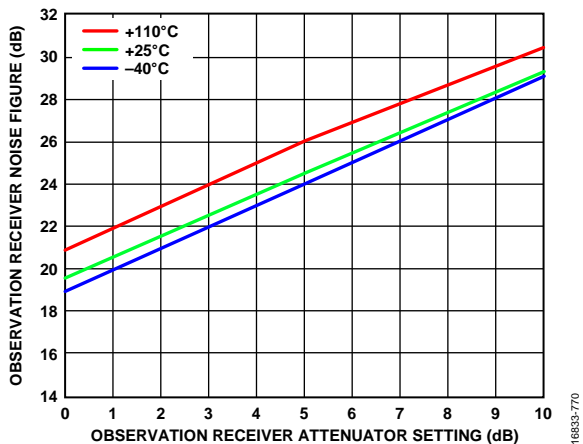

Figure 171. Observation Receiver Noise Figure vs. Observation Receiver Attenuator Setting, LO = 3600 MHz, Total Nyquist Integration Bandwidth

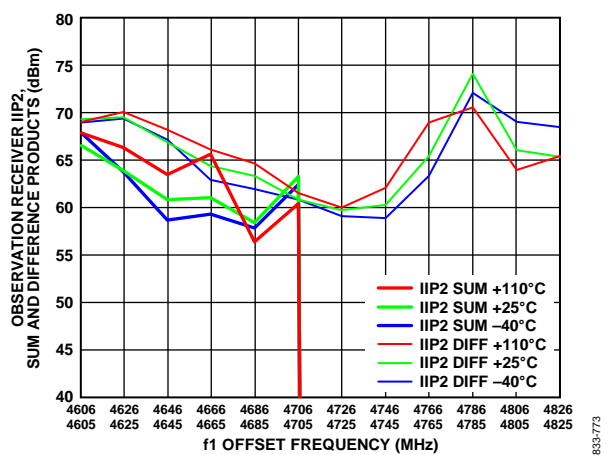

Figure 174. Observation Receiver IIP2, Sum and Difference Products vs. f1 Offset Frequency, Tones Separated by 1 MHz Swept Across Pass Band at -22 dBm Each, LO = 4600 MHz, Attenuation = 0 dB

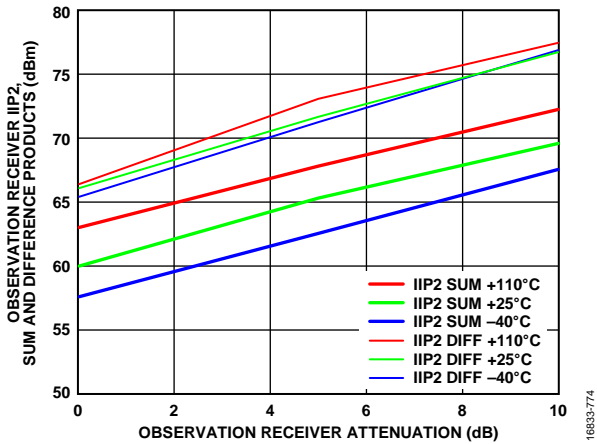

Figure 175. Observation Receiver IIP2, Sum and Difference Products vs. Observation Receiver Attenuation, LO = 3600 MHz, Tone 1 = 3645 MHz, Tone 2 = 3646 MHz at -22 dBm Plus Attenuation

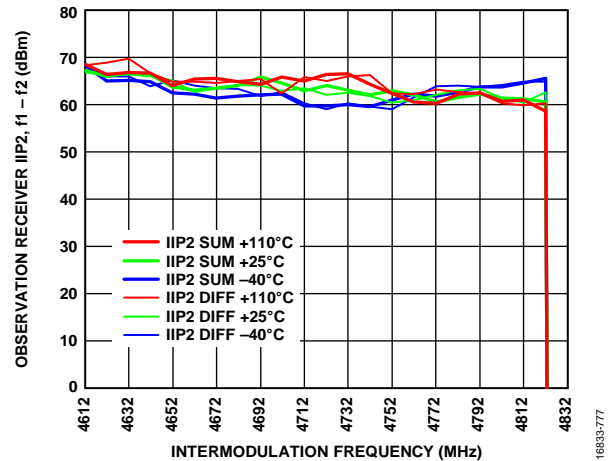

Figure 178. Observation Receiver IIP2, f1 - f2 vs. Intermodulation Frequency, LO = 4600 MHz, Tone 1 = 4602 MHz, Tone 2 = Swept, -22 dBm Each, Attenuation = 0 dB

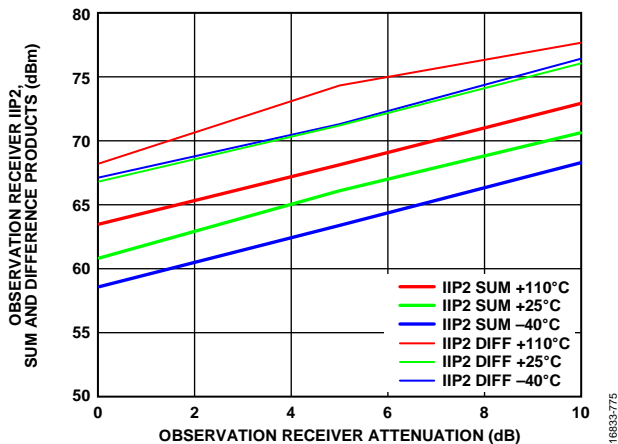

Figure 176. Observation Receiver IIP2, Sum and Difference Products vs. Observation Receiver Attenuation, LO = 4600 MHz, Tone 1 = 4645 MHz, Tone 2 = 4646 MHz at -22 dBm Plus Attenuation

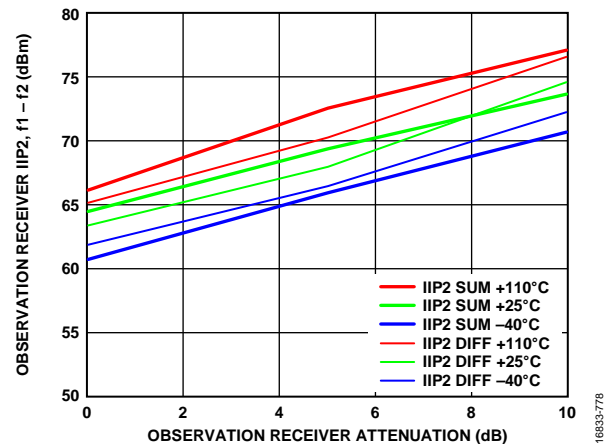

Figure 179. Observation Receiver IIP2, f1 - f2 vs. Observation Receiver Attenuation, LO = 3600 MHz, Tone 1 = 3602 MHz, Tone 2 = 3702 MHz at -22 dBm Plus Attenuation

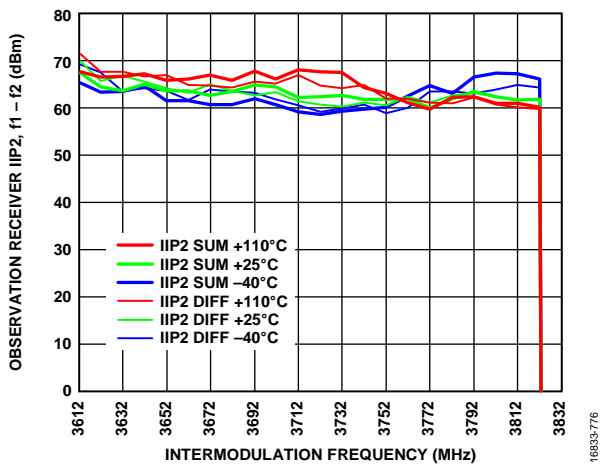

Figure 177. Observation Receiver IIP2, f1 - f2 vs. Intermodulation Frequency, LO = 3600 MHz, Tone 1 = 3602 MHz, Tone 2 = Swept, -22 dBm Each, Attenuation = 0 dB

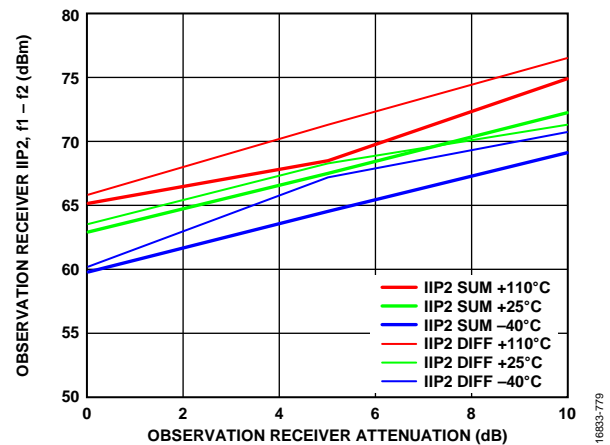

Figure 180. Observation Receiver IIP2, f1 - f2 vs. Observation Receiver Attenuation, LO = 4600 MHz, Tone 1 = 4602 MHz, Tone 2 = 4612 MHz at -22 dBm Plus Attenuation

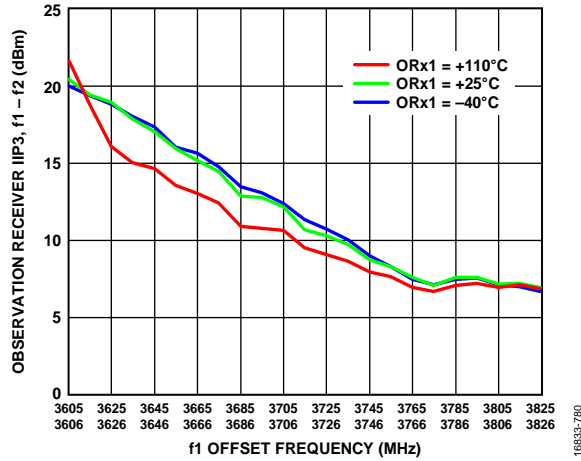

Figure 181. Observation Receiver IIP3,  $f_1 - f_2$  vs.  $f_1$  Offset Frequency, LO = 3600 MHz, Attenuation = 0 dB, Tones Separated by 1 MHz Swept Across Pass Band at -22 dBm Each

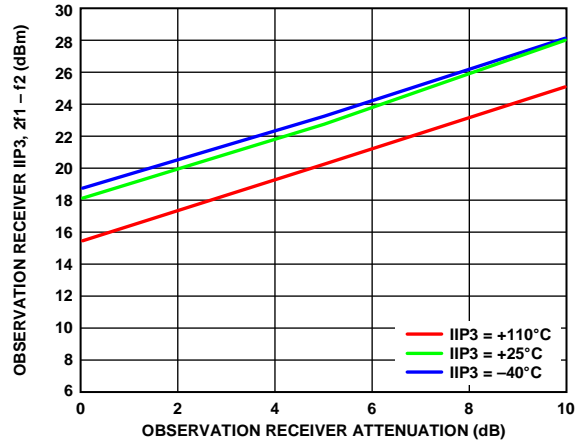

Figure 184. Observation Receiver IIP3,  $2f_1 - f_2$  vs. Observation Receiver Attenuation, LO = 4600 MHz, Tone 1 = 4695 MHz, Tone 2 = 4696 MHz at -22 dBm Plus Attenuation

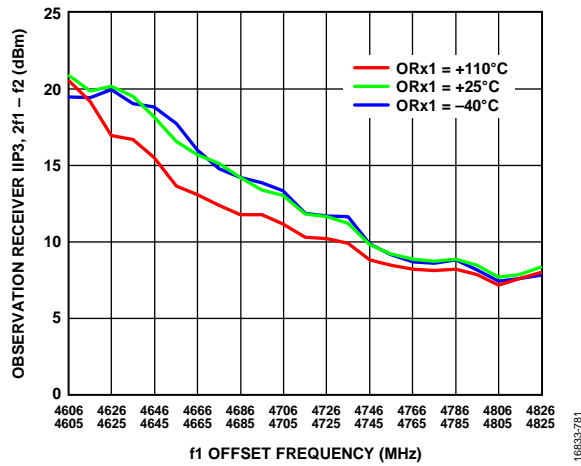

Figure 182. Observation Receiver IIP3,  $2f_1 - f_2$  vs.  $f_1$  Offset Frequency, LO = 4600 MHz, Attenuation = 0 dB, Tones Separated by 1 MHz Swept Across Pass Band at -22 dBm Each

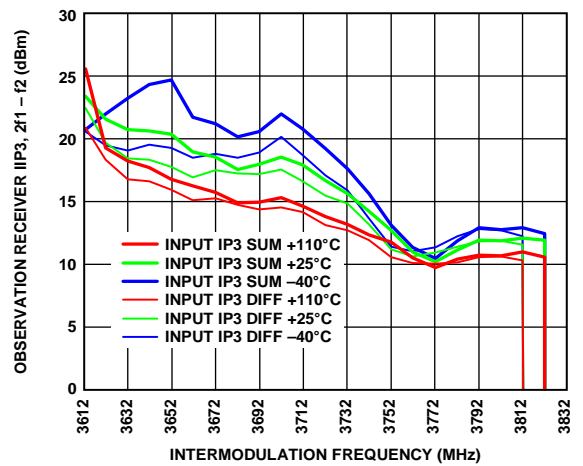

Figure 185. Observation Receiver IIP3,  $2f_1 - f_2$  vs. Intermodulation Frequency, LO = 3600 MHz, Tone 1 = 3602 MHz, Tone 2 = Swept, -22 dBm Each

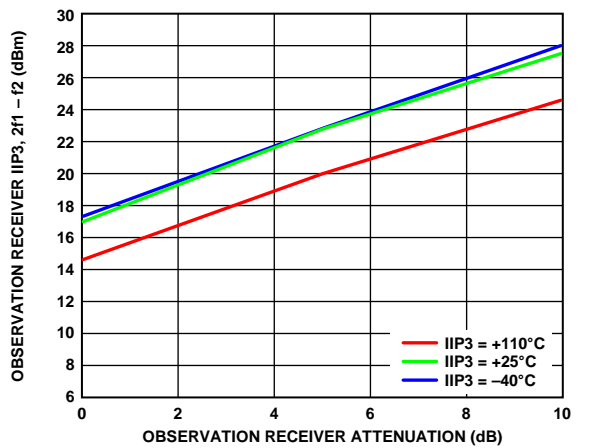

Figure 183. Observation Receiver IIP3,  $2f_1 - f_2$  vs. Observation Receiver Attenuation, LO = 3600 MHz, Tone 1 = 3695 MHz, Tone 2 = 3696 MHz at -22 dBm Plus Attenuation

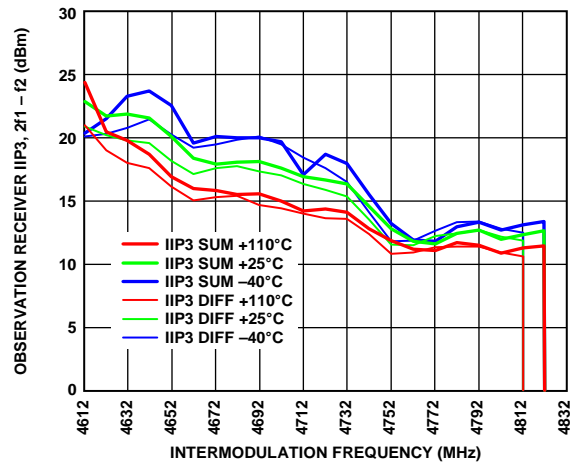

Figure 186. Observation Receiver IIP3,  $2f_1 - f_2$  vs. Intermodulation Frequency, LO = 4600 MHz, Tone 1 = 4602 MHz, Tone 2 Swept, -22 dBm Each

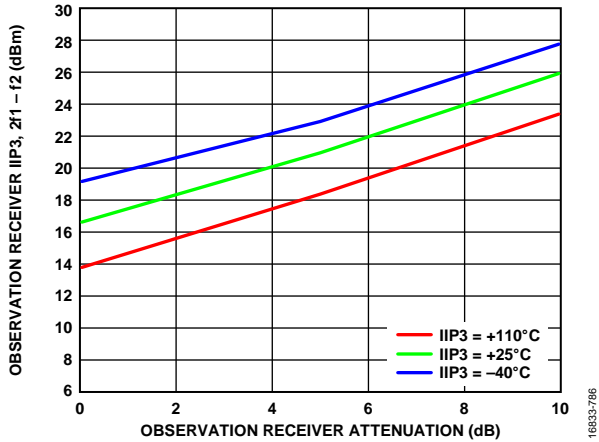

Figure 187. Observation Receiver IIP3, 2f1 to f2 vs. Observation Receiver Attenuation, LO = 3600 MHz, Tone 1 = 3602 MHz, Tone 2 = 3722 MHz, -22 dBm Plus Attenuation Each

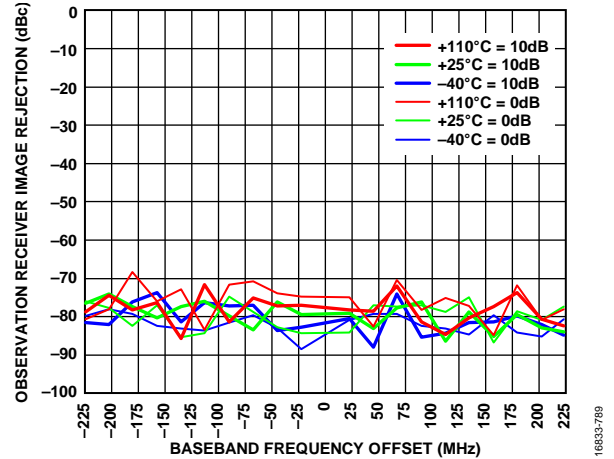

Figure 190. Observation Receiver Image Rejection vs. Baseband Frequency Offset, CW Signal Swept Across the Band, LO = 4600 MHz

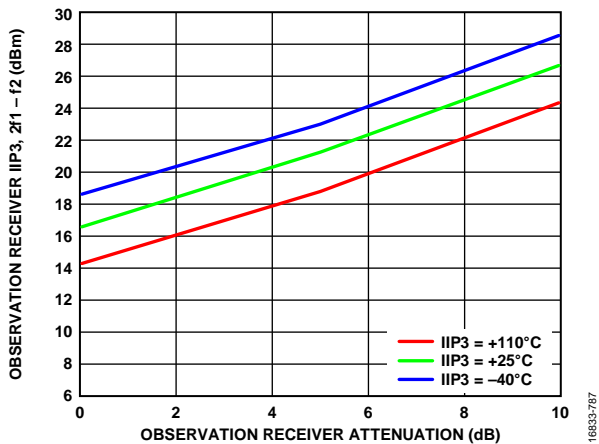

Figure 188. Observation Receiver IIP3, 2f1 - f2 vs. Observation Receiver Attenuation, LO = 4600 MHz, Tone 1 = 4602 MHz, Tone 2 = 4722 MHz at -22 dBm Plus Attenuation Each

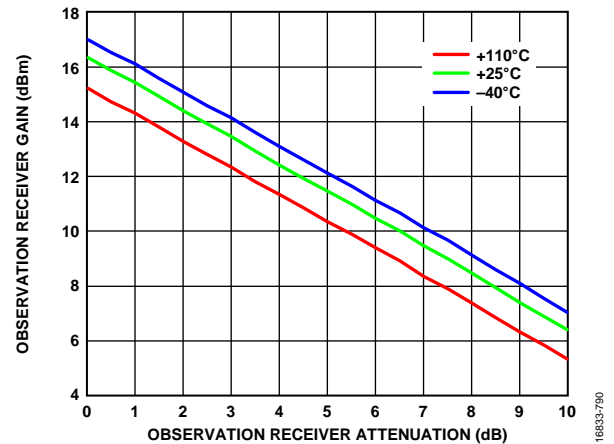

Figure 191. Observation Receiver Gain vs. Observation Receiver Attenuation, LO = 3600 MHz

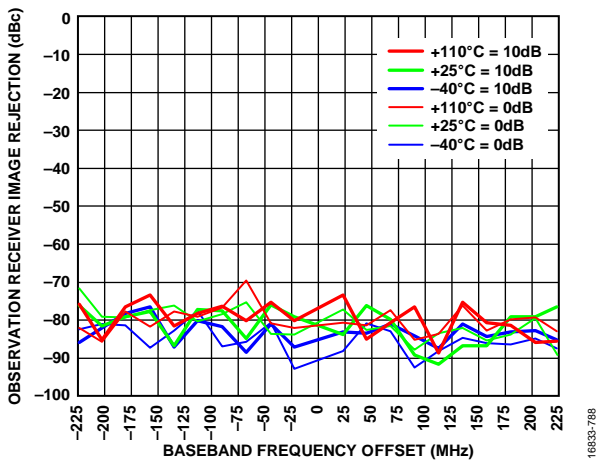

Figure 189. Observation Receiver Image Rejection vs. Baseband Frequency Offset, CW Signal Swept Across the Band, LO = 3600 MHz

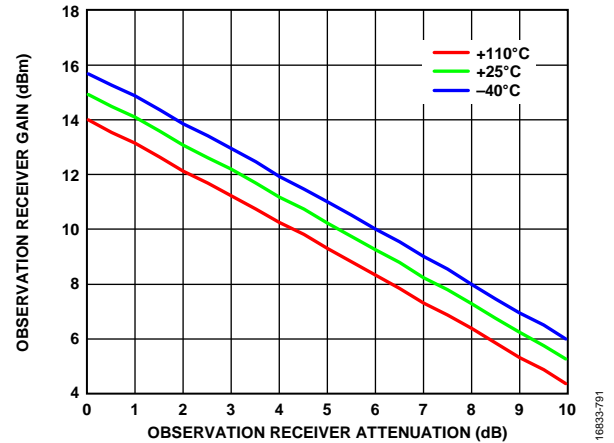

Figure 192. Observation Receiver Gain vs. Observation Receiver Attenuation, LO = 4600 MHz

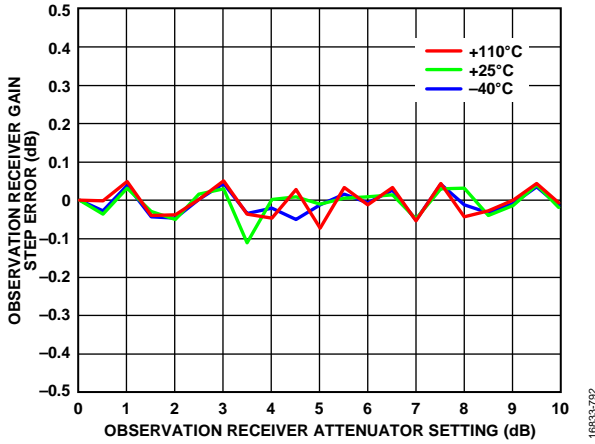

Figure 193. Observation Receiver Gain Step Error vs. Observation Receiver Attenuator Setting, LO = 3600 MHz

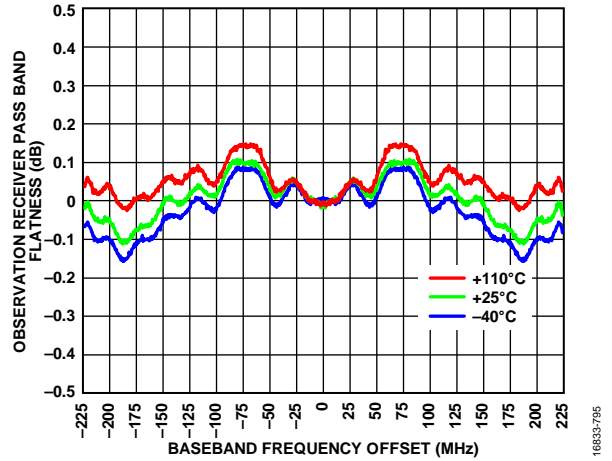

Figure 196. Observation Receiver Pass Band Flatness vs. Baseband Frequency Offset, LO = 4600 MHz

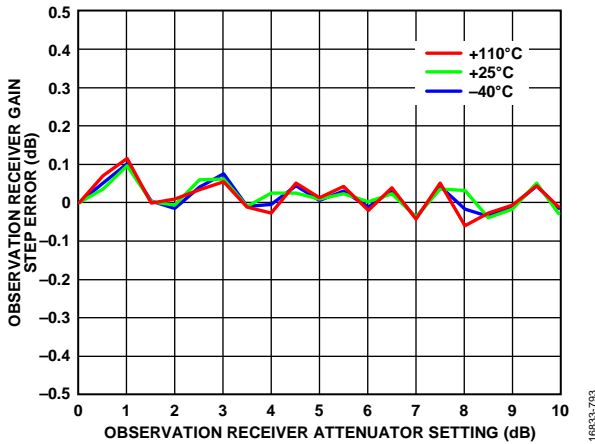

Figure 194. Observation Receiver Gain Step Error vs. Observation Receiver Attenuator Setting, LO = 4600 MHz

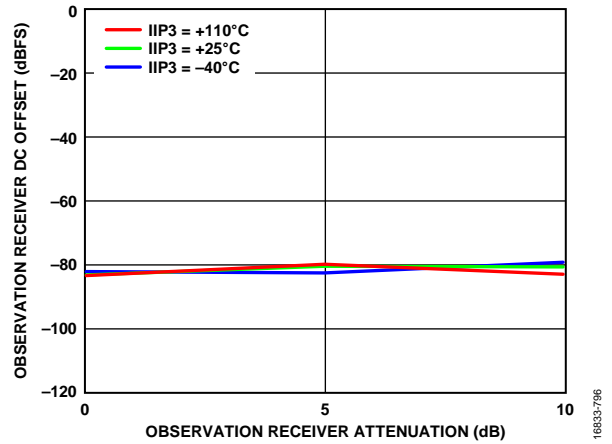

Figure 197. Observation Receiver DC Offset vs. Observation Receiver Attenuation, LO = 3600 MHz

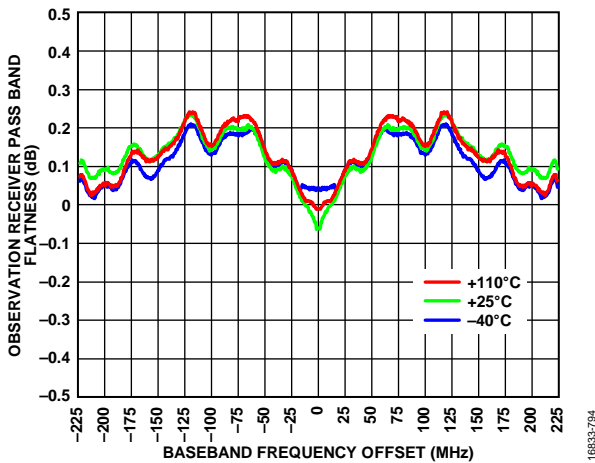

Figure 195. Observation Receiver Pass Band Flatness vs. Baseband Frequency Offset, LO = 3600 MHz

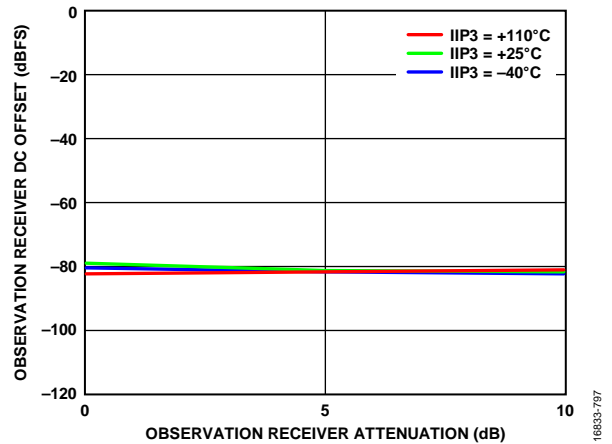

Figure 198. Observation Receiver DC Offset vs. Observation Receiver Attenuation, LO = 4600 MHz

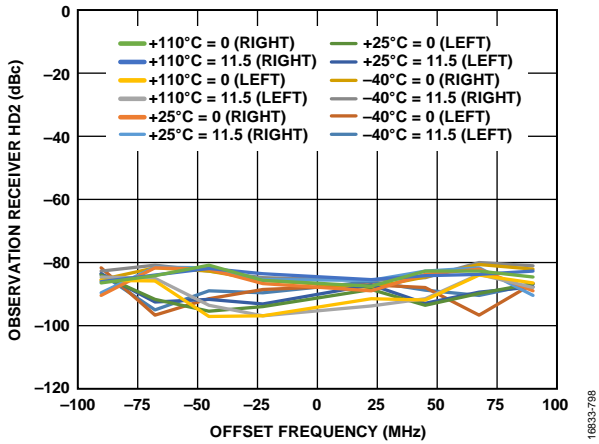

Figure 199. Observation Receiver HD2 vs. Offset Frequency, LO = 3600 MHz, Tone Level = -20 dBm Plus Attenuation

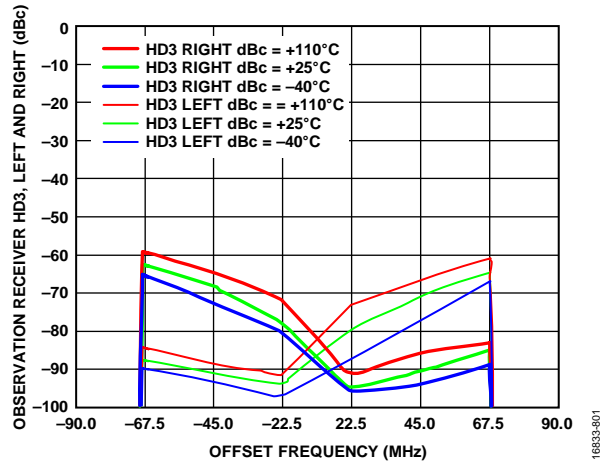

Figure 202. Observation Receiver HD3, Left and Right vs. Offset Frequency, LO = 4600 MHz, Tone Level = -20 dBm

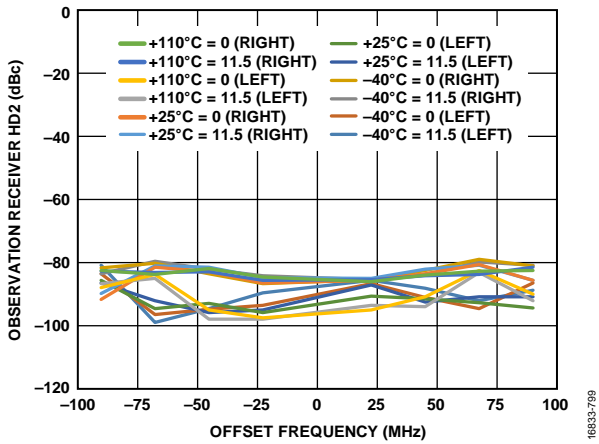

Figure 200. Observation Receiver HD2 vs. Offset Frequency, LO = 4600 MHz, Tone Level = -20 dBm Plus Attenuation

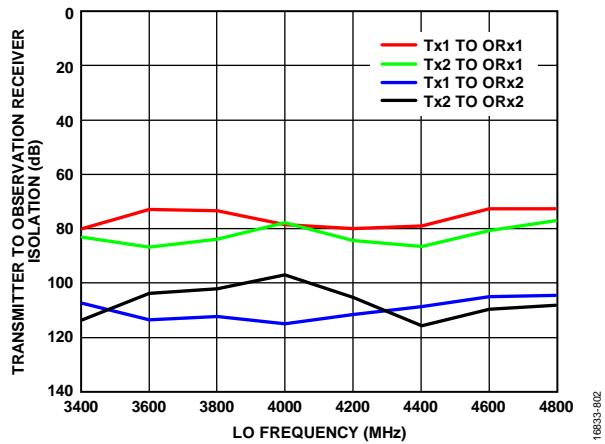

Figure 203. Transmitter to Observation Receiver Isolation vs. LO Frequency, Temperature = 25°C

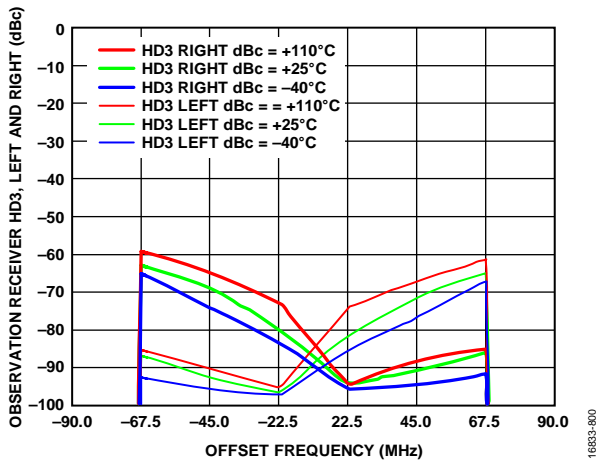

Figure 201. Observation Receiver HD3, Left and Right vs. Offset Frequency, LO = 3600 MHz, Tone Level = -20 dBm

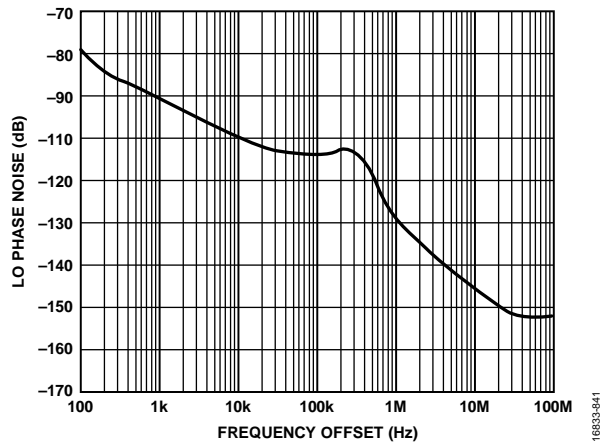

Figure 204. LO Phase Noise vs. Frequency Offset, LO = 3800 MHz, PLL Loop Bandwidth = 300 kHz, Spectrum Analyzer Limits Far Out Noise



5100 MHz TO 5900 MHz BAND

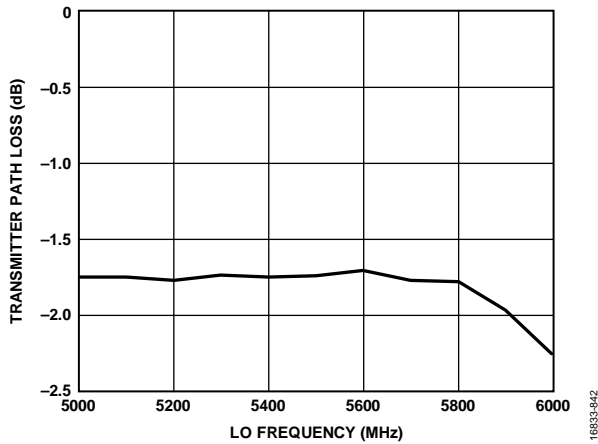

Figure 205. Transmitter Path Loss vs. LO Frequency (Simulation), Useful for De-Embedding Performance Data

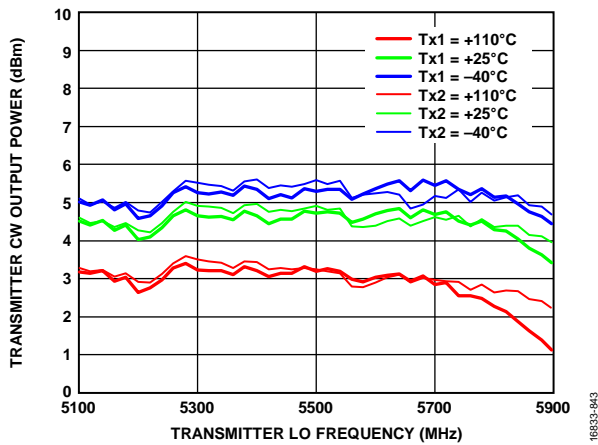

Figure 206. Transmitter CW Output Power vs. Transmitter LO Frequency, Transmitter QEC, and External LO Leakage Active, Bandwidth Mode = 200 MHz/450 MHz, IQ Rate = 491.52 MHz, Attenuation = 0 dB, Not De-Embedded

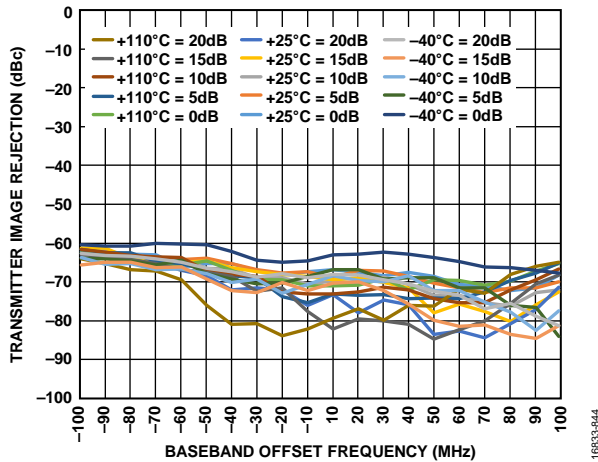

Figure 207. Transmitter Image Rejection vs. Baseband Offset Frequency, QEC Enabled (Tracking On) with Three Tones Placed at 10 MHz, 50 MHz, and 100 MHz Offset from LO, Total Combined Power = -6 dBFS, Correction Then Frozen (Tracking Turned Off), CW Tone Swept Across Large Signal Bandwidth, LO = 5100 MHz

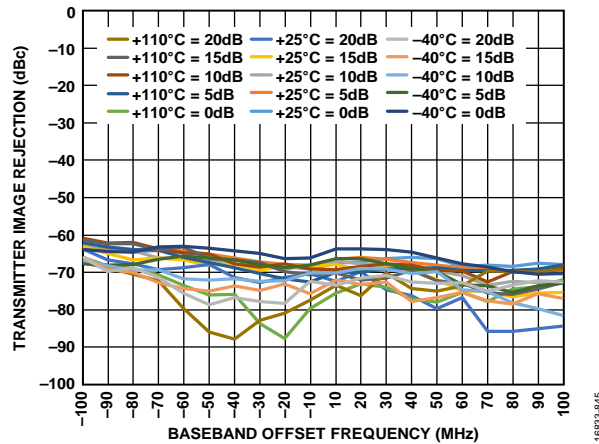

Figure 208. Transmitter Image Rejection vs. Baseband Offset Frequency, QEC Trained with Three Tones Placed at 10 MHz, 50 MHz, and 100 MHz (Tracking On), Total Combined Power = -6 dBFS, Correction Then Frozen (Tracking Turned Off), CW Tone Swept Across Large Signal Bandwidth, LO = 5500 MHz

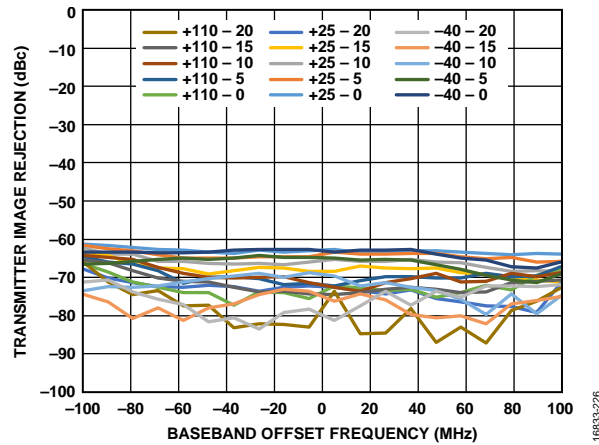

Figure 209. Transmitter Image Rejection vs. Baseband Offset Frequency, QEC Trained with Three Tones Placed at 10 MHz, 50 MHz, and 100 MHz (Tracking On), Total Combined Power = -6 dBFS, Correction Then Frozen (Tracking Turned Off), CW Tone Swept Across Large Signal Bandwidth, LO = 5900 MHz

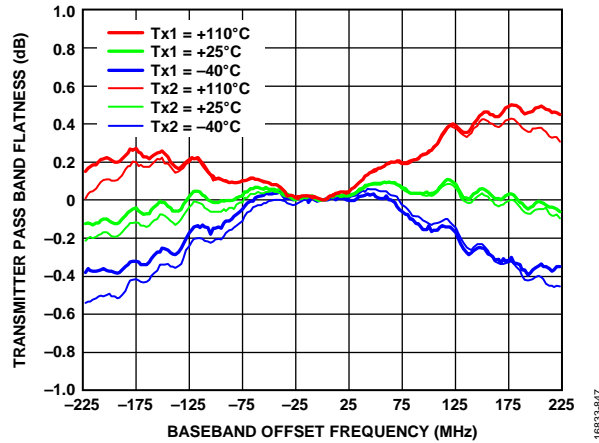

Figure 210. Transmitter Pass Band Flatness vs. Baseband Offset Frequency, Off Chip Match Response De-Embedded, LO = 5700 MHz, Measurements Performed with Device Calibrated at 25°C

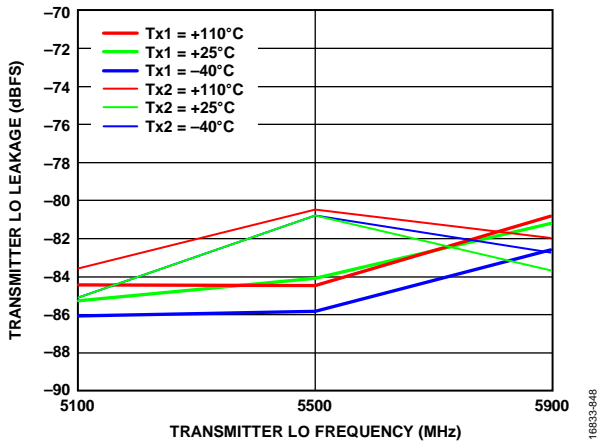

Figure 211. Transmitter LO Leakage vs. Transmitter LO Frequency, Transmitter Attenuation = 0 dB

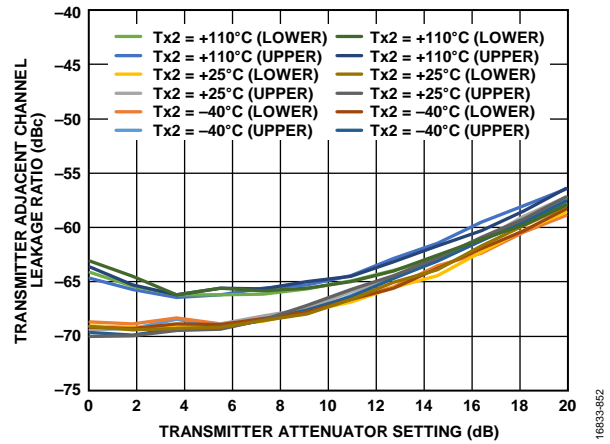

Figure 214. Transmitter Adjacent Channel Leakage Ratio vs. Transmitter Attenuator Setting, LO = 5100 MHz, LTE = 20 MHz, PAR = 12 dB, DAC Boost Normal, Upper Side and Lower Side, Decreasing ACLR at Higher Attenuation due to Spectrum Analyzer Noise Floor

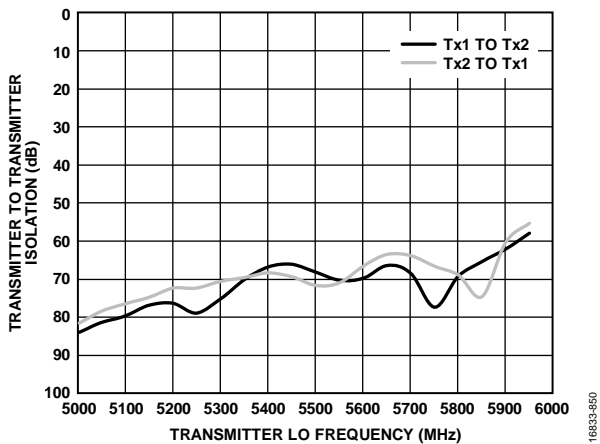

Figure 212. Transmitter to Transmitter Isolation vs. Transmitter LO Frequency, Temperature = 25°C

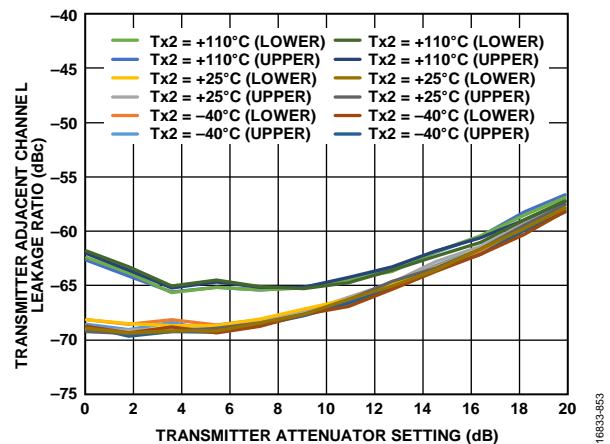

Figure 215. Transmitter Adjacent Channel Leakage Ratio vs. Transmitter Attenuator Setting, LO = 5500 MHz, LTE = 20 MHz, PAR = 12 dB, DAC Boost Normal, Upper Side and Lower Side, Decreasing ACLR at Higher Attenuation Due to Spectrum Analyzer Noise Floor

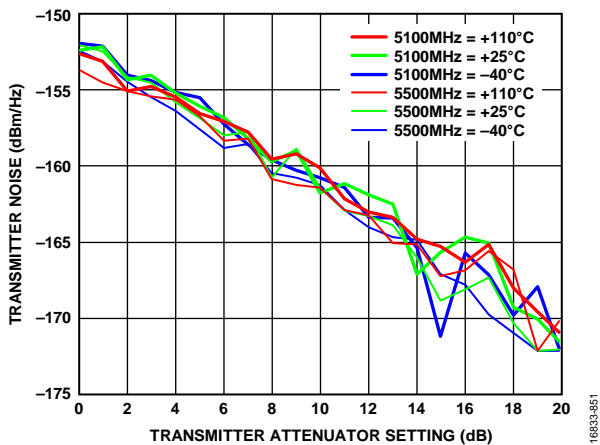

Figure 213. Transmitter Noise vs. Transmitter Attenuator Setting

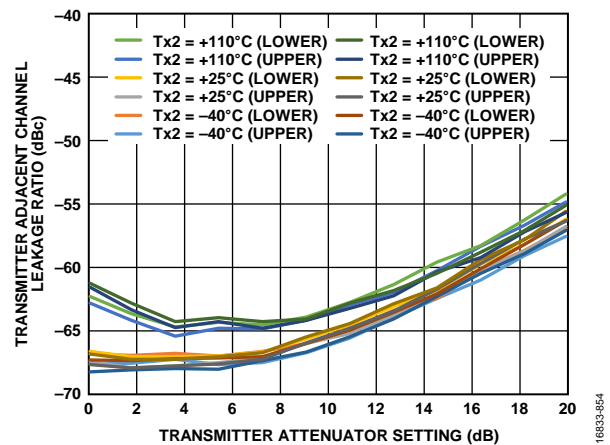

Figure 216. Transmitter Adjacent Channel Leakage Ratio vs. Transmitter Attenuator Setting, LO = 5900 MHz, LTE = 20 MHz, PAR = 12 dB, DAC Boost Normal, Upper Side and Lower Side, Decreasing ACLR at Higher Attenuation Due to Spectrum Analyzer Noise Floor

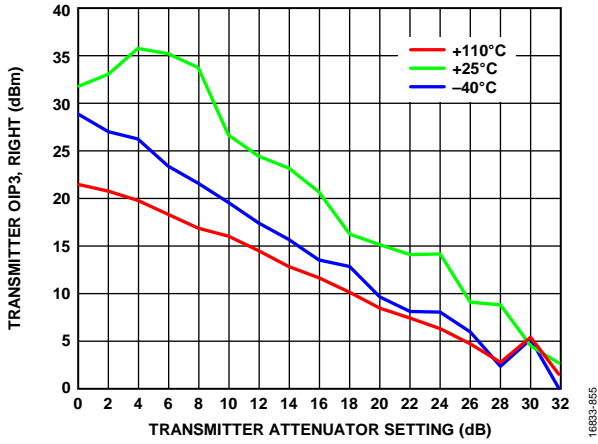

Figure 217. Transmitter OIP3, Right vs. Transmitter Attenuator Setting, LO = 5100 MHz, Total RMS Power = -12 dBFS

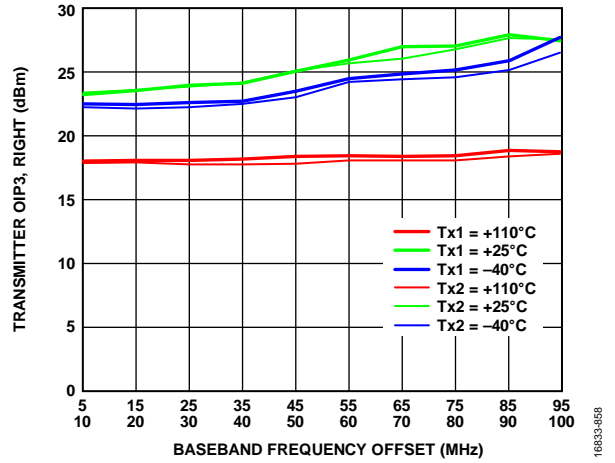

Figure 220. Transmitter OIP3, Right vs. Baseband Frequency Offset, LO = 5100 MHz, Total RMS Power = -12 dBFS Power, Transmitter Attenuation = 4 dB

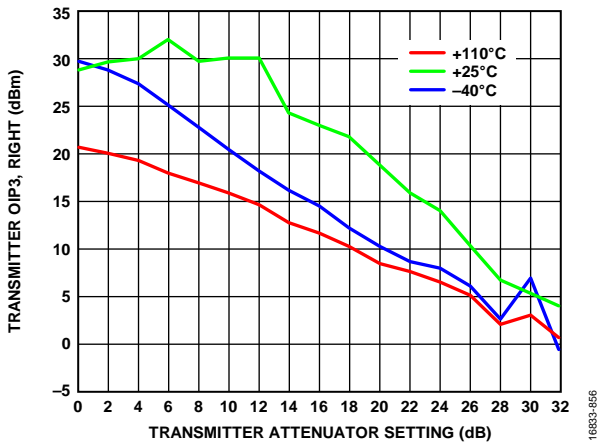

Figure 218. Transmitter OIP3, Right vs. Transmitter Attenuator Setting, LO = 5500 MHz, Total RMS Power = -12 dBFS

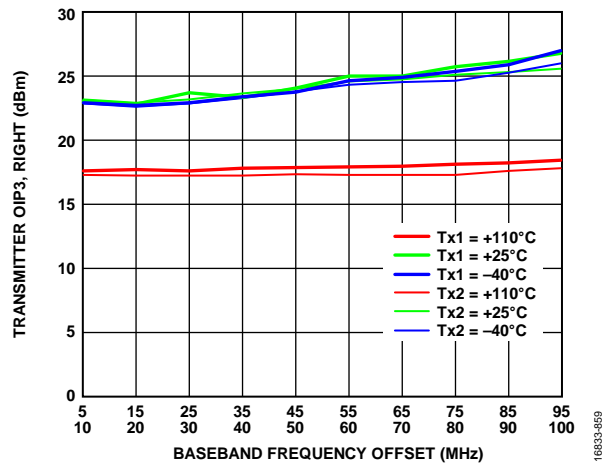

Figure 221. Transmitter OIP3, Right vs. Baseband Frequency Offset, LO = 5500 MHz, Total RMS Power = -12 dBFS, Transmitter Attenuation = 4 dB

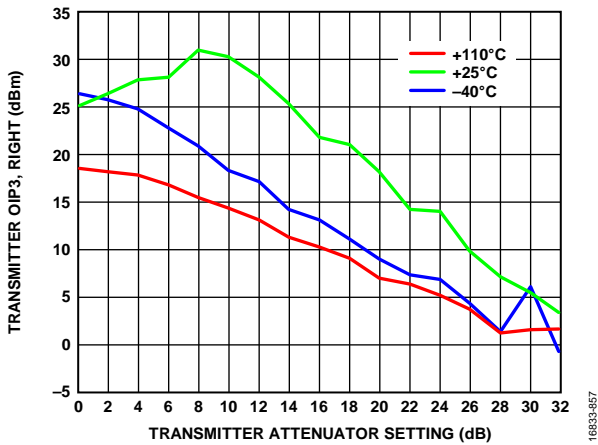

Figure 219. Transmitter OIP3, Right vs. Transmitter Attenuator Setting, LO = 5800 MHz, Total RMS Power = -12 dBFS

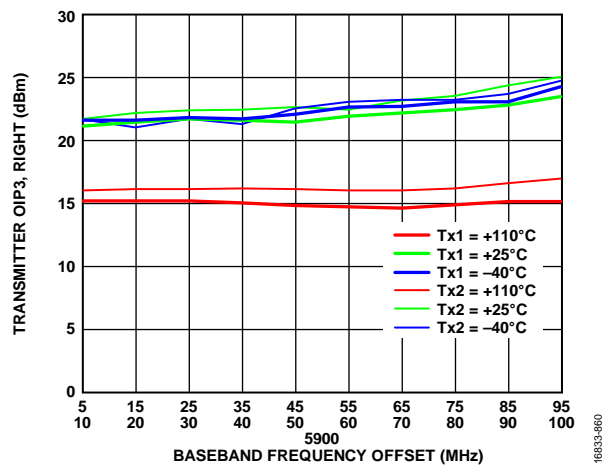

Figure 222. Transmitter OIP3, Right vs. Baseband Frequency Offset, LO = 5900 MHz, Total RMS Power = -12 dBFS, Transmitter Attenuation = 4 dB

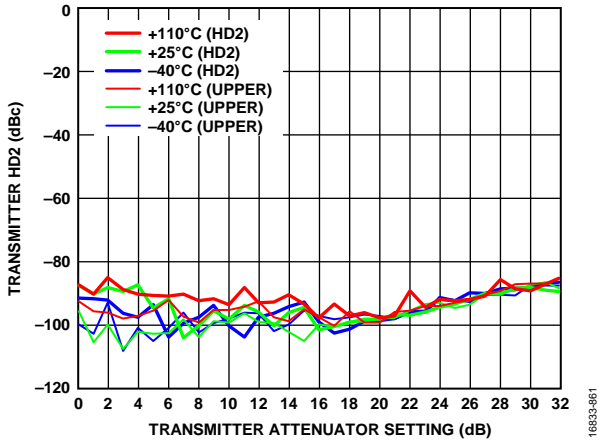

Figure 223. Transmitter HD2 vs. Transmitter Attenuator Setting, Baseband Frequency = 10 MHz, LO = 5100 MHz, CW = -15 dBFS

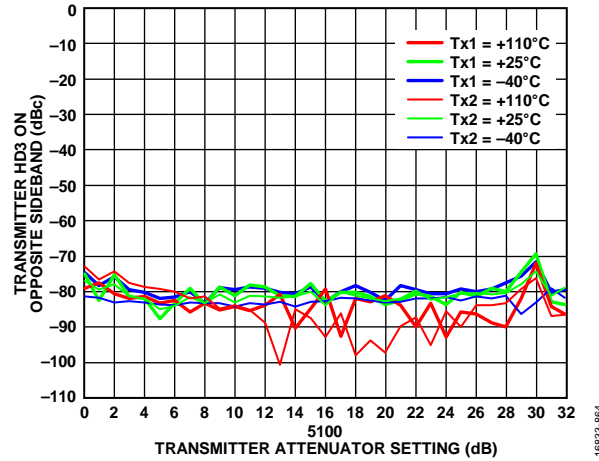

Figure 226. Transmitter HD3 on Opposite Sideband vs. Transmitter Attenuator Setting, LO = 5100 MHz, CW = -15 dBFS, Baseband Frequency = 10 MHz

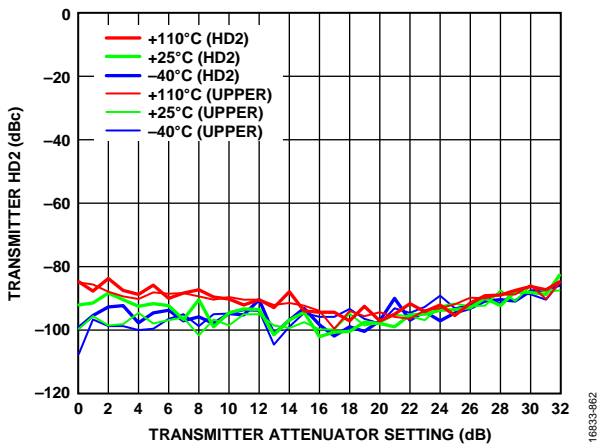

Figure 224. Transmitter HD2 vs. Transmitter Attenuator Setting, Baseband Frequency = 10 MHz, LO = 5500 MHz, CW = -15 dBFS

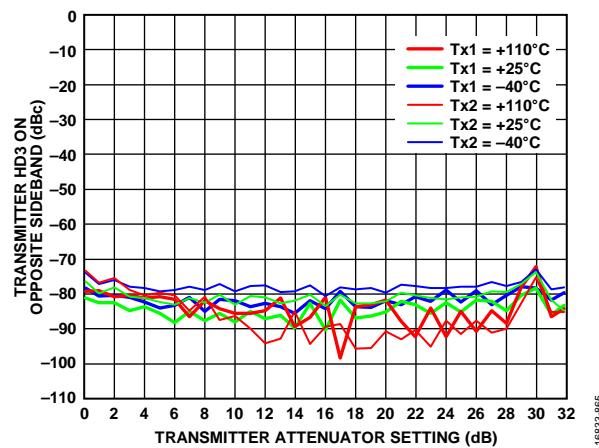

Figure 227. Transmitter HD3 on Opposite Sideband vs. Transmitter Attenuator Setting, LO = 5500 MHz, CW = -15 dBFS, Baseband Frequency = 10 MHz

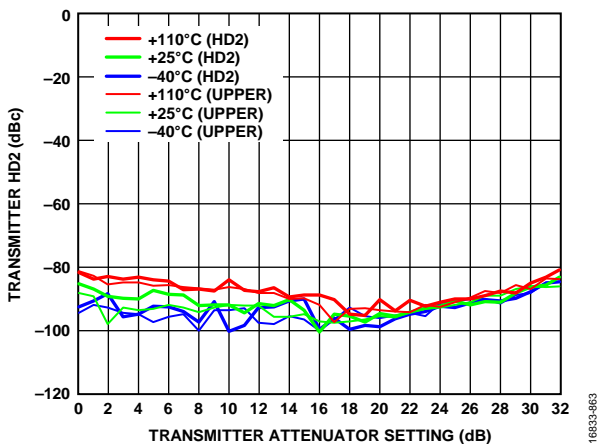

Figure 225. Transmitter HD2 vs. Transmitter Attenuator Setting, Baseband Frequency = 10 MHz, LO = 5900 MHz, CW = -15 dBFS

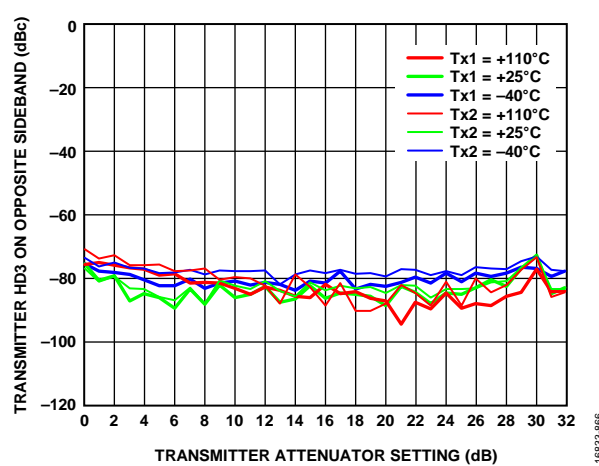

Figure 228. Transmitter HD3 on Opposite Sideband vs. Transmitter Attenuator Setting, LO = 5900 MHz, CW = -15 dBFS, Baseband Frequency = 10 MHz

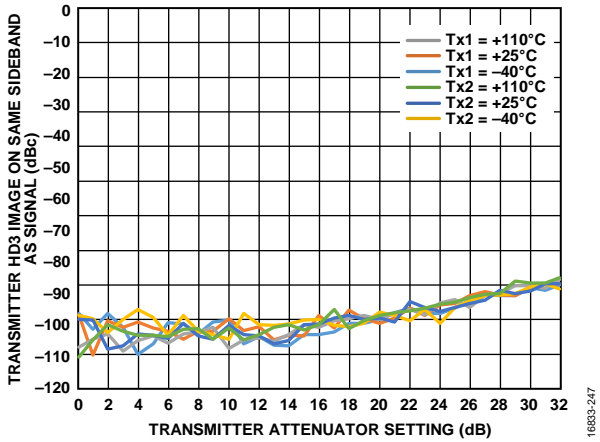

Figure 229. Transmitter HD3 on Same Sideband as Signal vs. Transmitter Attenuation Setting, LO = 5100 MHz, CW = -15 dBFS

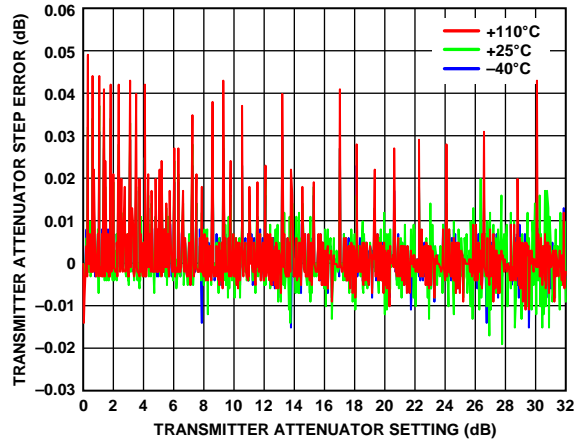

Figure 232. Transmitter Attenuator Step Error vs. Transmitter Attenuator Setting, LO = 5100 MHz

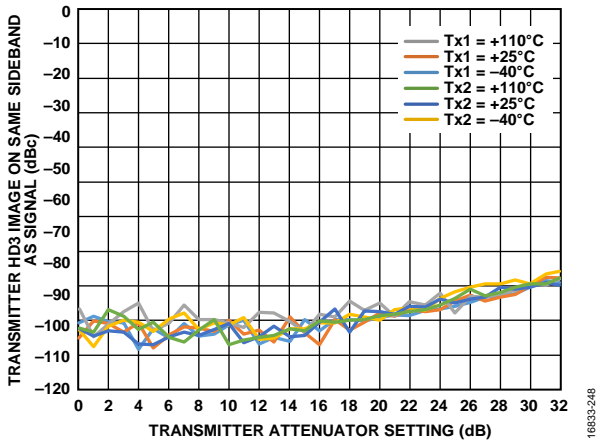

Figure 230. Transmitter HD3 on Same Sideband as Signal vs. Transmitter Attenuator Setting, LO = 5500 MHz, CW = -15 dBFS

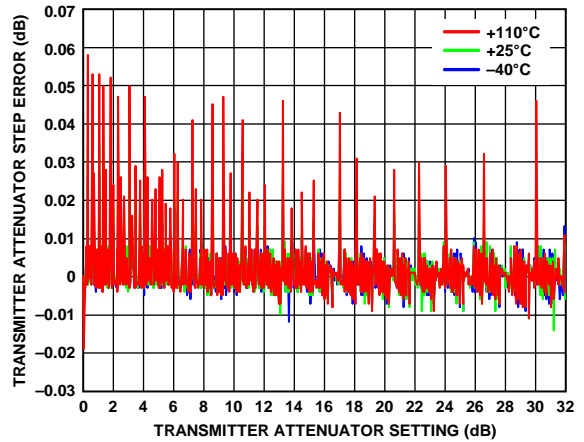

Figure 233. Transmitter Attenuator Step Error vs. Transmitter Attenuator Setting, LO = 5500 MHz

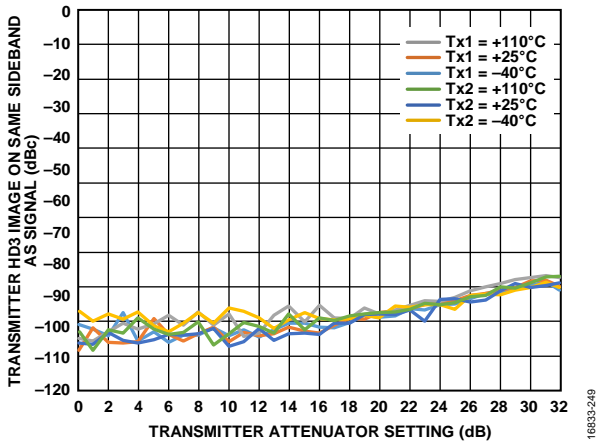

Figure 231. Transmitter HD3 on Same Sideband as Signal vs. Transmitter Attenuator Setting, LO = 5900 MHz, CW = -15 dBFS

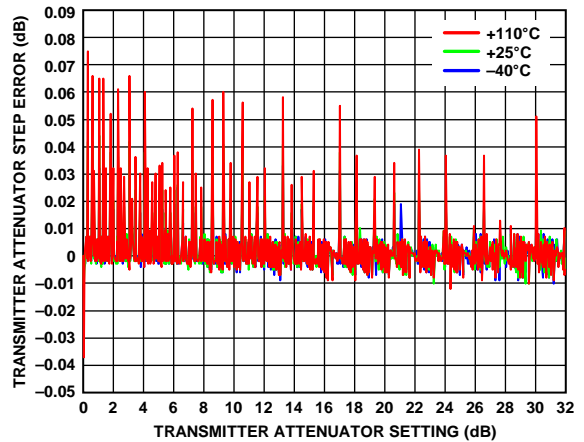

Figure 234. Transmitter Attenuator Step Error vs. Transmitter Attenuator Setting, LO = 5900 MHz

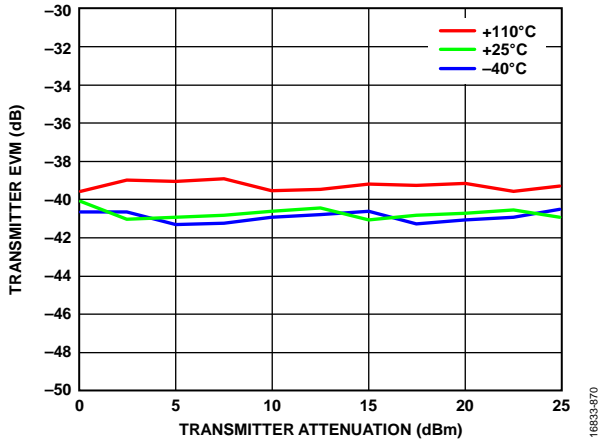

Figure 235. Transmitter EVM vs. Transmitter Attenuation, LTE = 20 MHz, Signal Centered on DC, LO = 5100 MHz

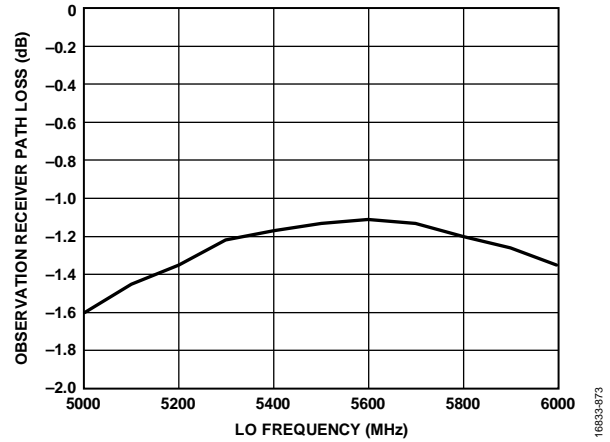

Figure 238. Observation Receiver Path Loss vs. LO Frequency (Simulation), Can be Used for De-Embedding Performance Data

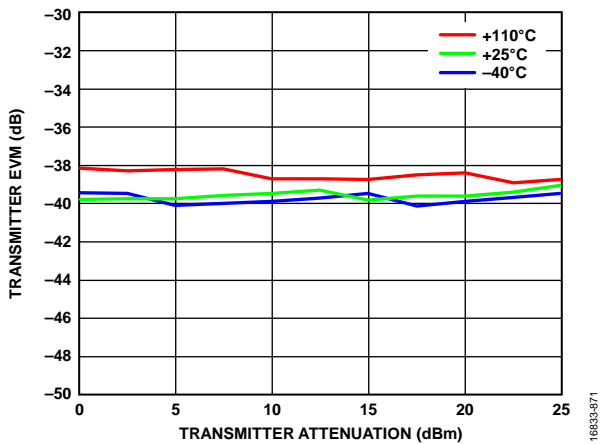

Figure 236. Transmitter EVM vs. Transmitter Attenuation, LTE = 20 MHz, Signal Centered on DC, LO = 5500 MHz

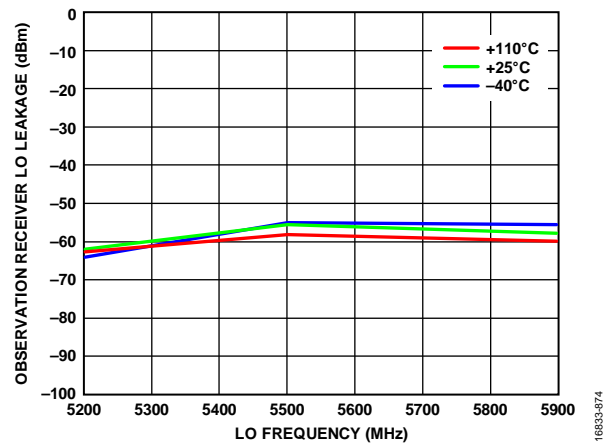

Figure 239. Observation Receiver LO Leakage vs. LO Frequency, 5200 MHz, 5500 MHz, and 5900 MHz

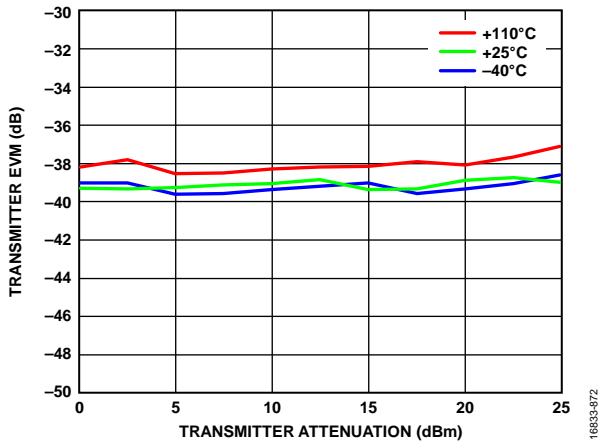

Figure 237. Transmitter EVM vs. Transmitter Attenuation, LTE = 20 MHz, Signal Centered on DC, LO = 5900 MHz

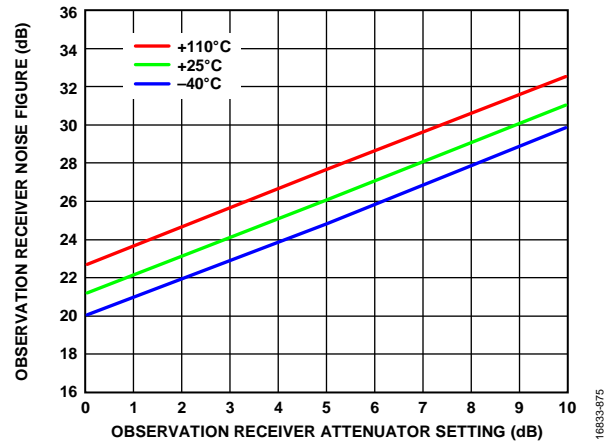

Figure 240. Observation Receiver Noise Figure vs. Observation Receiver Attenuator Setting, LO = 5200 MHz, Total Nyquist Integration Bandwidth

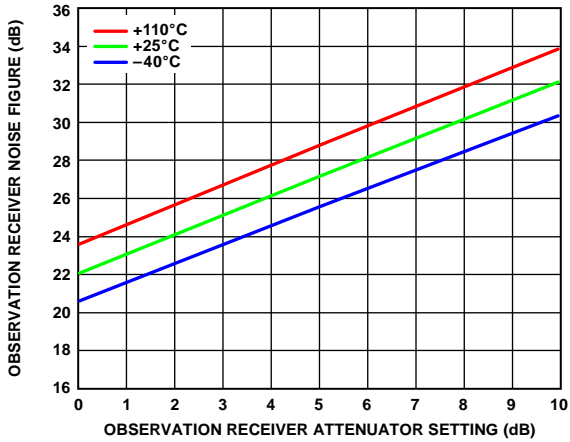

Figure 241. Observation Receiver Noise Figure vs. Observation Receiver Attenuator Setting, LO = 5500 MHz, Total Nyquist Integration Bandwidth

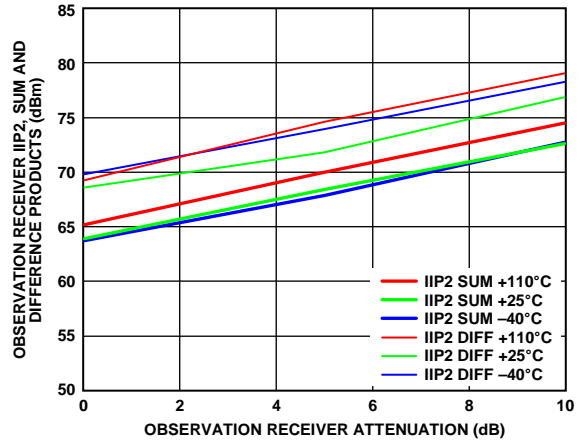

Figure 244. Observation Receiver IIP2, Sum and Difference Products vs. Observation Receiver Attenuation, LO = 5700 MHz, Tone 1 = 5725 MHz, Tone 2 = 5726 MHz at -19 dBm Plus Attenuation

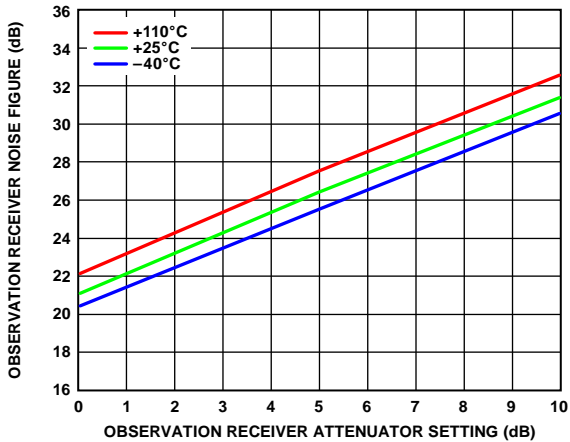

Figure 242. Observation Receiver Noise Figure vs. Observation Receiver Attenuator Setting, LO = 5800 MHz, Total Nyquist Integration Bandwidth

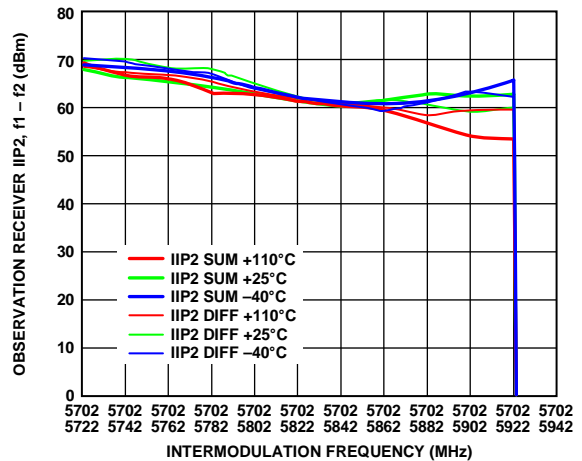

Figure 245. Observation Receiver IIP2,  $f_1 - f_2$  vs. Intermodulation Frequency, LO = 5700 MHz, Tone 1 = 5702 MHz, Tone 2 Swept, -19 dBm Each, Attenuation = 0 dB

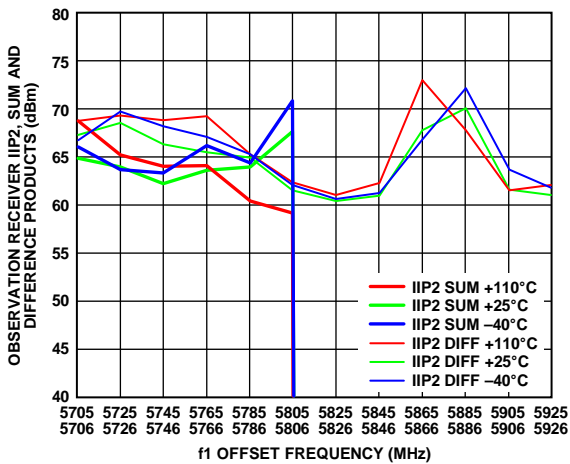

Figure 243. Observation Receiver IIP2, Sum and Difference Products vs.  $f_1$  Offset Frequency, Tones Separated by 1 MHz Swept Across Pass Band at -19 dBm Each, LO = 5700 MHz, Attenuation = 0 dB

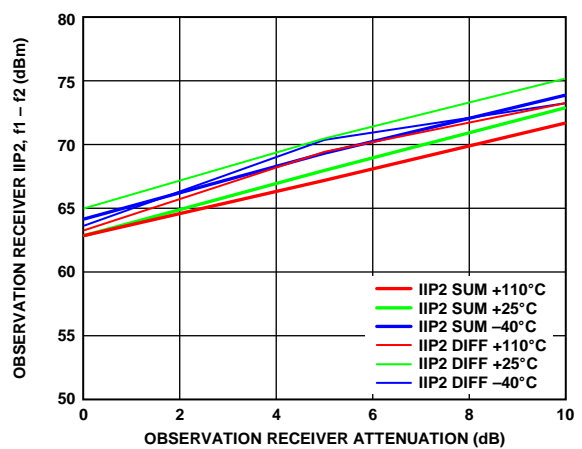

Figure 246. Observation Receiver IIP2,  $f_1 - f_2$  vs. Observation Receiver Attenuation, LO = 5700 MHz, Tone 1 = 5702 MHz, Tone 2 = 5802 MHz at -19 dBm Plus Attenuation

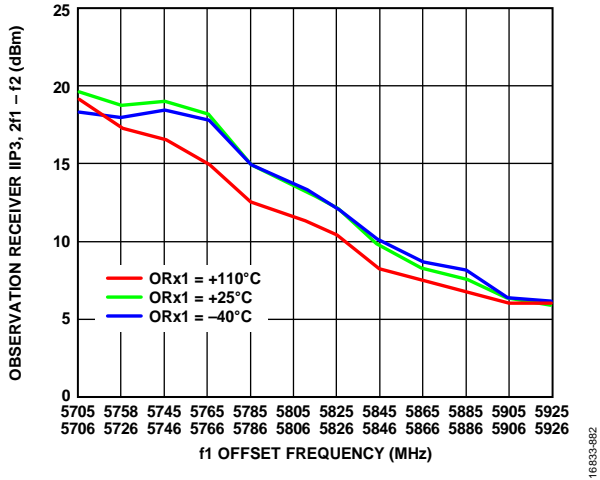

Figure 247. Observation Receiver IIP3, 2f1 - f2 vs. f1 Offset Frequency, LO = 5700 MHz, Attenuation = 0 dB, Tones Separated by 1 MHz Swept Across Pass Band at -19 dBm Each

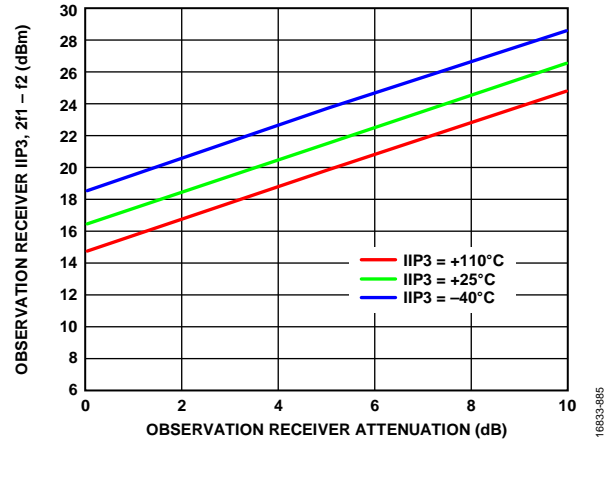

Figure 250. Observation Receiver IIP3, 2f1 - f2 vs. Observation Receiver Attenuation, LO = 5700 MHz, Tone 1 = 5702 MHz, Tone 2 = 5822 MHz at -19 dBm Plus Attenuation

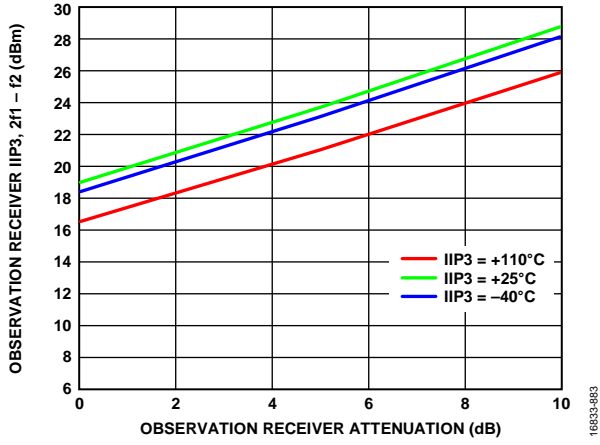

Figure 248. Observation Receiver IIP3, 2f1 - f2 vs. Observation Receiver Attenuation, LO = 5700 MHz, Tone 1 = 5745 MHz, Tone 2 = 5746 MHz at -19 dBm Plus Attenuation

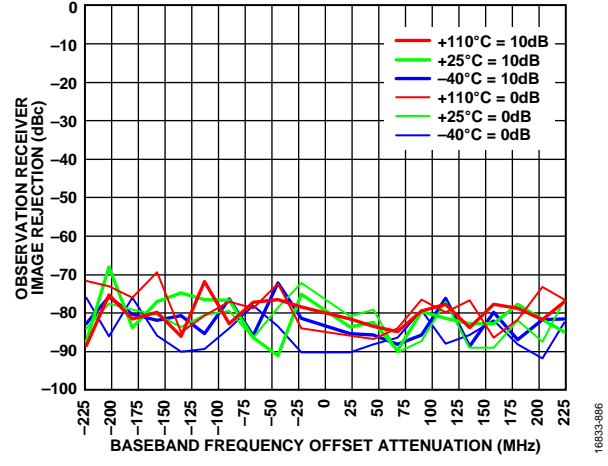

Figure 251. Observation Receiver Image Rejection vs. Baseband Frequency Offset Attenuation, CW Signal Swept Across the Band, LO = 5200 MHz

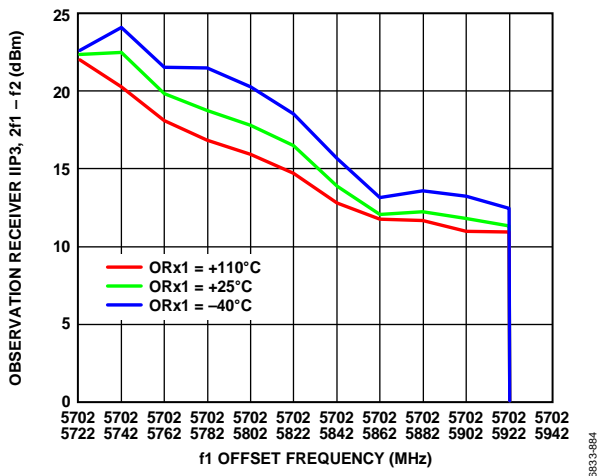

Figure 249. Observation Receiver IIP3, 2f1 - f2 vs. f1 Offset Frequency, LO = 5700 MHz, Tone 1 = 5702 MHz, Tone 2 = 5722 MHz at -22 dBm Plus Attenuation Each

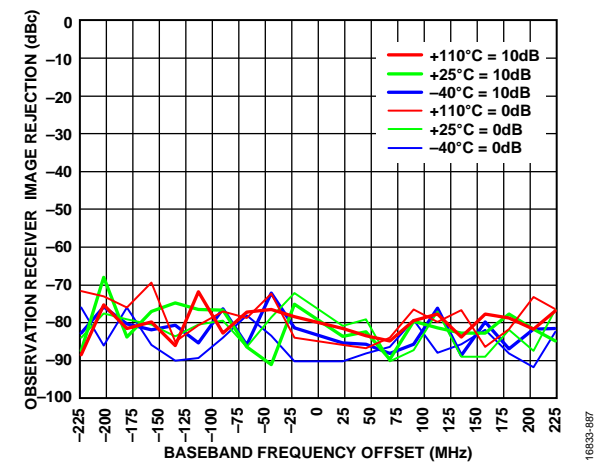

Figure 252. Observation Receiver Image Rejection vs. Baseband Frequency Offset, CW Signal Swept Across the Band, LO = 5700 MHz



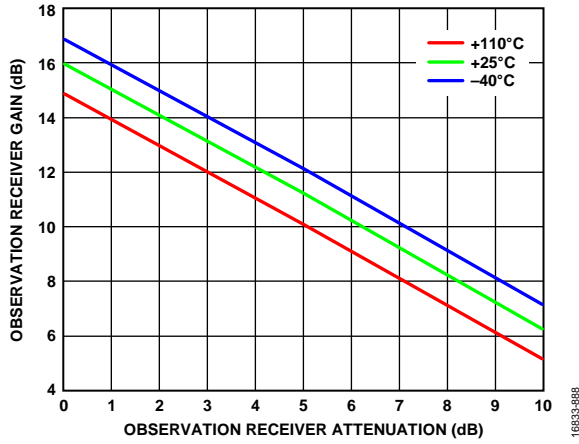

Figure 253. Observation Receiver Gain vs. Observation Receiver Attenuation, LO = 5200 MHz

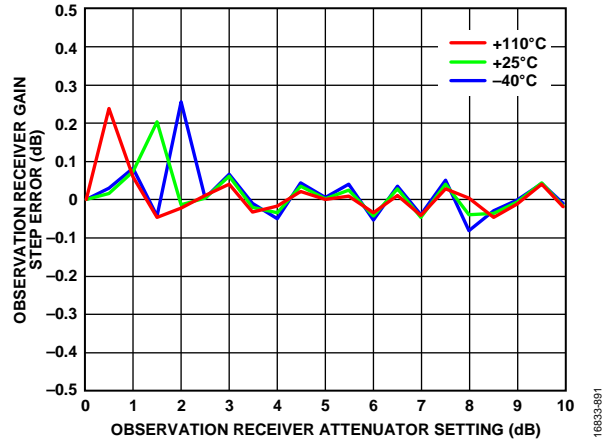

Figure 256. Observation Receiver Gain Step Error vs. Observation Receiver Attenuator Setting, LO = 5600 MHz

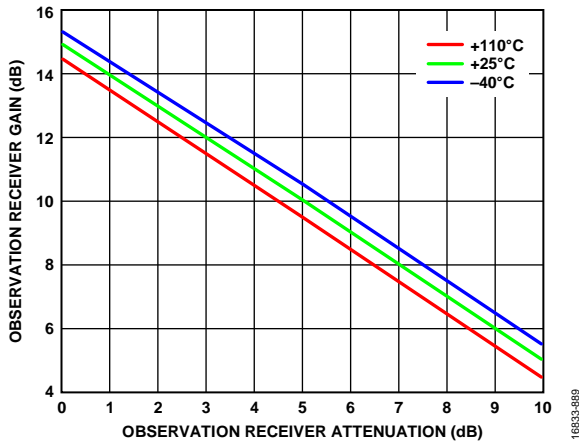

Figure 254. Observation Receiver Gain vs. Observation Receiver Attenuation, LO = 5700 MHz

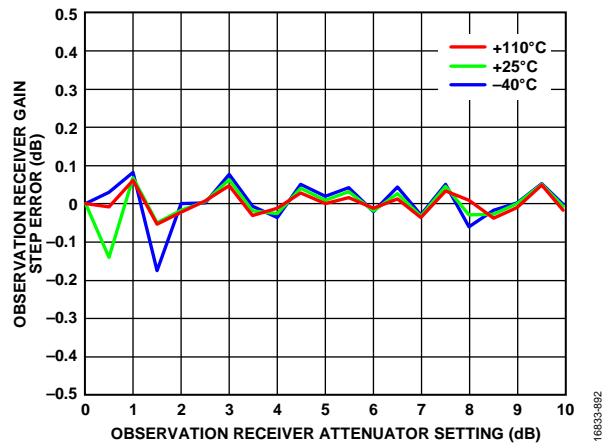

Figure 257. Observation Receiver Gain Step Error vs. Observation Receiver Attenuator Setting, LO = 5600 MHz

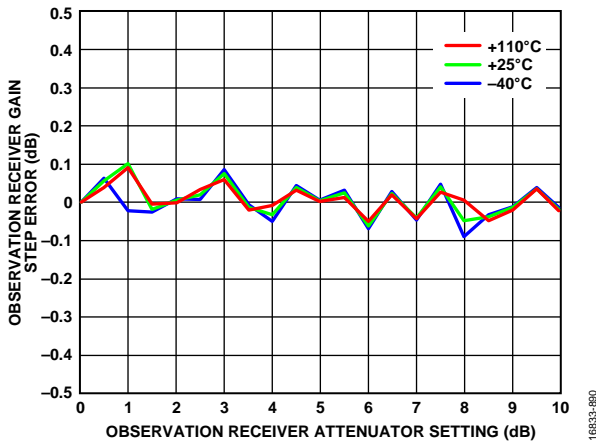

Figure 255. Observation Receiver Gain Step Error vs. Observation Receiver Attenuator Setting, LO = 5200 MHz

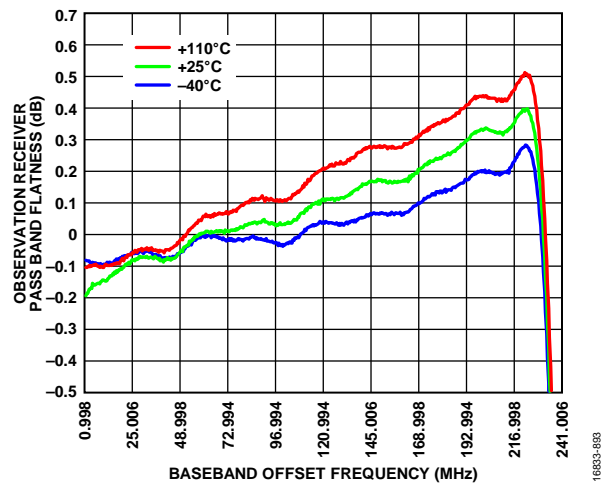

Figure 258. Observation Receiver Pass Band Flatness vs. Baseband Offset Frequency, LO = 5700 MHz

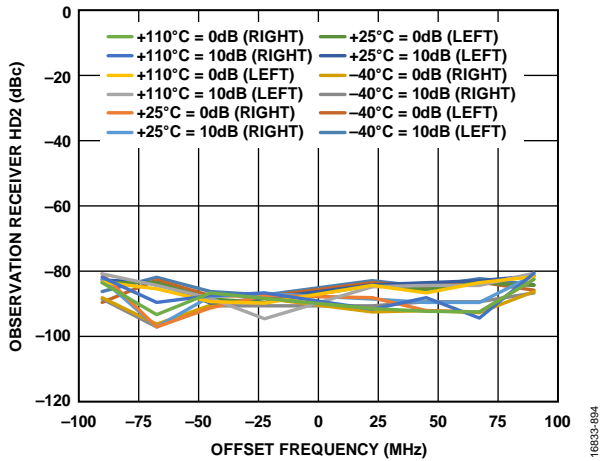

Figure 259. Observation Receiver HD2 vs. Offset Frequency, LO = 5200 MHz, Tone Level = -20 dBm Plus Attenuation

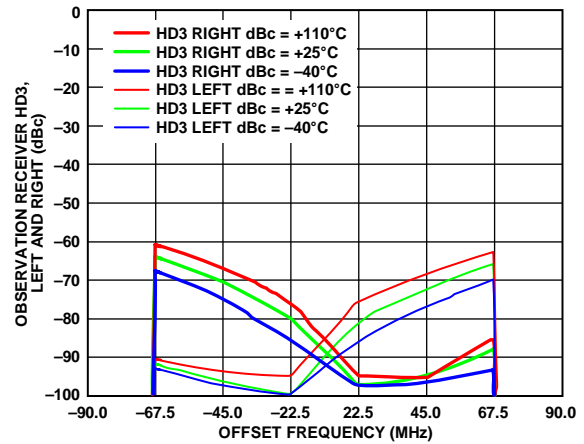

Figure 262. Observation Receiver HD3, Left and Right vs. Offset Frequency, LO = 5700 MHz, Tone Level = -20 dBm

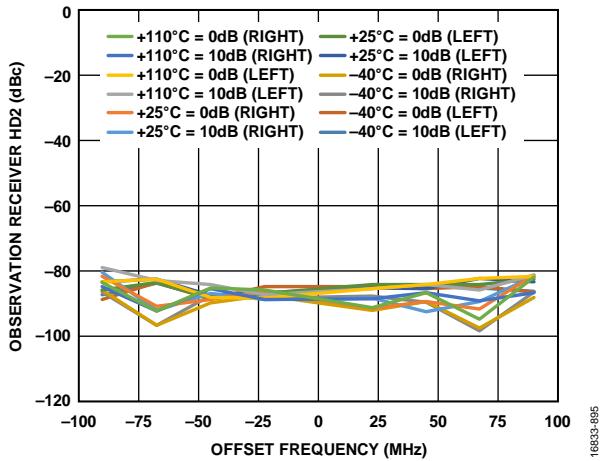

Figure 260. Observation Receiver HD2 vs. Offset Frequency, LO = 5700 MHz, Tone Level = -20 dBm Plus Attenuation

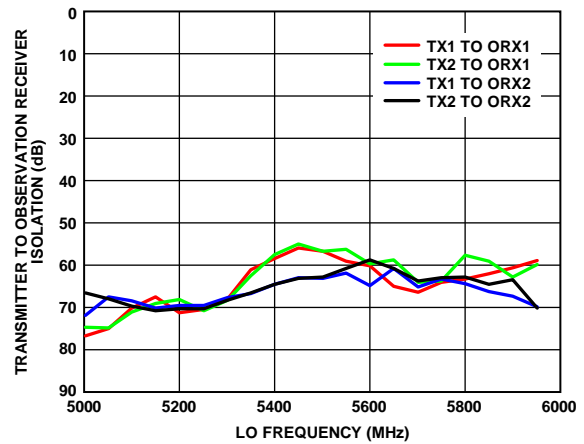

Figure 263. Transmitter to Observation Receiver Isolation vs. LO Frequency, Temperature = 25°C

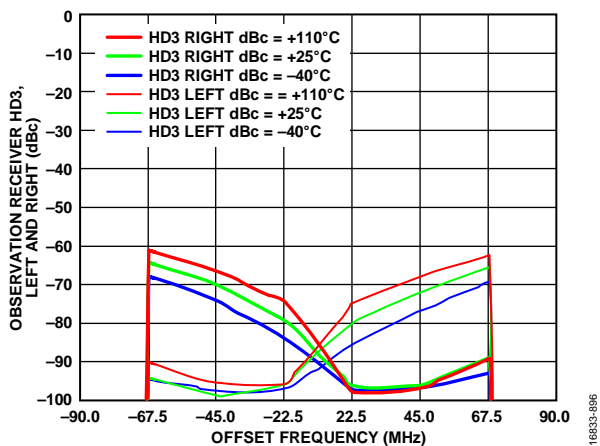

Figure 261. Observation Receiver HD3, Left and Right vs. Offset Frequency, LO = 5200 MHz, Tone Level = -20 dBm

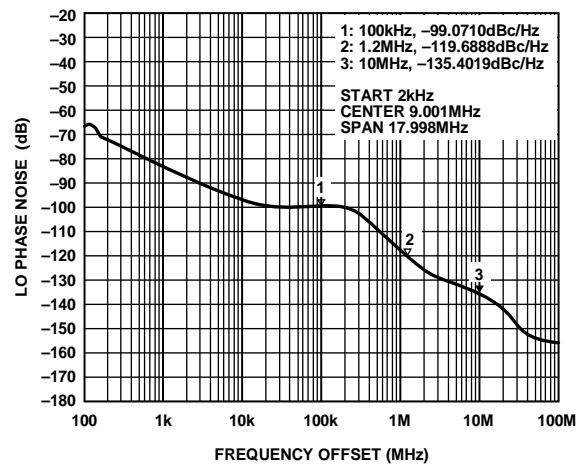
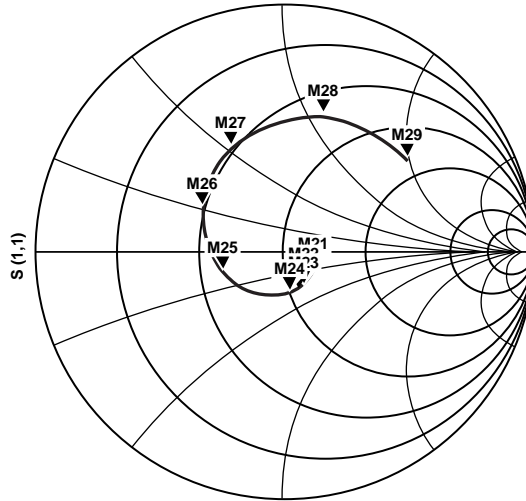

Figure 264. LO Phase Noise vs. Frequency Offset, LO = 5900 MHz, PLL Loop Bandwidth > 300 kHz, Spectrum Analyzer Limits Far Out Noise

TRANSMITTER OUTPUT IMPEDANCE

TX PORT SIMULATED IMPEDANCE: SEDZ

<b>M21</b> FREQUENCY = 100.0MHz S (1,1) = 0.143 / -7.865 IMPEDANCE = 66.439 - j2.654
<b>M22</b> FREQUENCY = 300.0MHz S (1,1) = 0.141 / -25.589 IMPEDANCE = 64.063 - j7.987
<b>M23</b> FREQUENCY = 500.0MHz S (1,1) = 0.145 / -42.661 IMPEDANCE = 60.623 - j12.201
<b>M24</b> FREQUENCY = 1.000GHz S (1,1) = 0.164 / -84.046 IMPEDANCE = 49.000 - j16.447
<b>M25</b> FREQUENCY = 2.000GHz S (1,1) = 0.247 / 155.186 IMPEDANCE = 31.131 - j6.860



<b>M26</b> FREQUENCY = 3.000GHz S (1,1) = 0.368 / 150.626 IMPEDANCE = 24.355 + j10.153
<b>M27</b> FREQUENCY = 4.000GHz S (1,1) = 0.484 / -107.379 IMPEDANCE = 25.118 + j30.329
<b>M28</b> FREQUENCY = 5.000GHz S (1,1) = 0.569 / 70.352 IMPEDANCE = 35.932 + j56.936
<b>M29</b> FREQUENCY = 6.000GHz S (1,1) = 0.614 / 36.074 IMPEDANCE = 81.032 + j94.014

FREQUENCY (0Hz TO 6.000GHz)

Figure 265. Transmitter Output Impedance Series Equivalent Differential Impedance (SEDZ)

16833-002

OBSERVATION RECEIVER INPUT IMPEDANCE

ORX PORT SIMULATED IMPEDANCE: SEDZ

<b>M15</b> FREQUENCY = 100.0MHz S (1,1) = 0.391 / -1.848 IMPEDANCE = 114.099 - j3.397
<b>M16</b> FREQUENCY = 300.0MHz S (1,1) = 0.389 / -5.601 IMPEDANCE = 112.639 - j10.091
<b>M17</b> FREQUENCY = 500.0MHz S (1,1) = 0.385 / -9.396 IMPEDANCE = 109.556 - j16.156
<b>M18</b> FREQUENCY = 1.000GHz S (1,1) = 0.362 / -19.087 IMPEDANCE = 97.259 - j26.513
<b>M19</b> FREQUENCY = 2.000GHz S (1,1) = 0.267 / -39.928 IMPEDANCE = 70.189 - j25.940

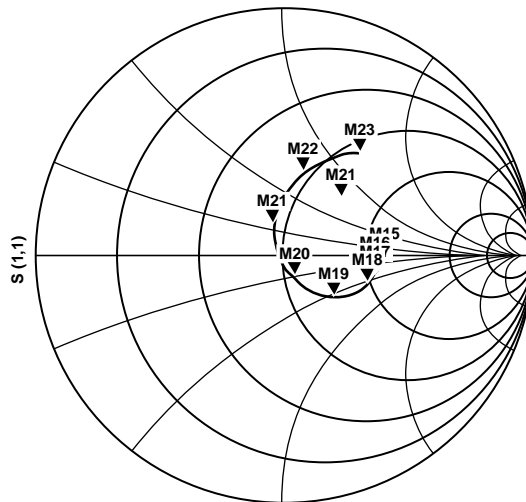

<b>M20</b> FREQUENCY = 3.000GHz S (1,1) = 0.104 / -66.720 IMPEDANCE = 53.262 - j10.292
<b>M21</b> FREQUENCY = 4.000GHz S (1,1) = 0.116 / -104.276 IMPEDANCE = 46.060 + j10.522
<b>M22</b> FREQUENCY = 5.000GHz S (1,1) = 0.342 / 75.761 IMPEDANCE = 46.551 + j34.914
<b>M23</b> FREQUENCY = 6.000GHz S (1,1) = 0.525 / 53.007 IMPEDANCE = 56.249 + j65.146

FREQUENCY (0Hz TO 6.000GHz)

Figure 266. Observation Receiver Input Impedance SEDZ

16833-003

## TERMINOLOGY

### Large Signal Bandwidth

Large signal bandwidth, otherwise known as instantaneous bandwidth or signal bandwidth, is the bandwidth over which there are large signals. For example, for Band 42 LTE, the large signal bandwidth is 200 MHz.

### Occupied Bandwidth

Occupied bandwidth is the total bandwidth of the active signals. For example, three 20 MHz carriers have a 60 MHz occupied bandwidth, regardless of where the carriers are placed within the large signal bandwidth.

### Synthesis Bandwidth

Synthesis bandwidth is the bandwidth over which digital predistortion (DPD) linearization is transmitted. Synthesis bandwidth is the 1 dB bandwidth of the transmitter. The power density of the signal outside the occupied bandwidth is assumed to be 25 dB below the signal in the occupied bandwidth, which also assumes that the unlinearized power amplifier (PA) achieves 25 dB ACLR.

### Observation Bandwidth

Observation bandwidth is the 1 dB bandwidth of the observation receiver. With the observation receiver sharing the transmitter LO, the observation receiver sees similar power densities, such as those in the occupied bandwidth and synthesis bandwidth of the transmitter.

### Backoff

Backoff is the difference (in dB) between full scale and the rms signal power.

### $P_{\text{HIGH}}$

$P_{\text{HIGH}}$  is the largest signal that can be applied without overloading the ADC for the observation receiver input. This input level results in slightly less than full scale at the digital output because of the nature of the continuous time  $\Sigma$ - $\Delta$  ADCs, which, for example, exhibit a soft overload in contrast to the hard clipping of pipeline ADCs.

## THEORY OF OPERATION

The ADRV9008-2 is a highly integrated RF transmitter subsystem capable of configuration for a wide range of applications. The device integrates all RF, mixed-signal, and digital blocks necessary to provide all transmitter traffic and DPD observation receiver functions in a single device. Programmability allows the transmitter to be adapted for use in many time division duplexes (TDDs) and 2G/3G/4G/5G cellular standards. The ADRV9008-2 contains four high speed serial interface links for the transmitter chain, and four high speed links for the observation receiver chain. The links are JESD204B, Subclass 1 compliant.

The ADRV9008-2 also provides tracking correction of dc offset QEC errors, and transmitter LO leakage to maintain high performance under varying temperatures and input signal conditions. The device also includes test modes that allow system designers to debug designs during prototyping and to optimize radio configurations.

### TRANSMITTER

The ADRV9008-2 transmitter section consists of two identical and independently controlled channels that provide all digital processing, mixed-signal, and RF blocks necessary to implement a direct conversion system while sharing a common frequency synthesizer. The digital data from the JESD204B lanes pass through a fully programmable, 128-tap FIR filter with variable interpolation rates. The FIR output is sent to a series of interpolation filters that provide additional filtering and interpolation prior to reaching the DAC. Each 14-bit DAC has an adjustable sample rate.

When converted to baseband analog signals, the inphase (I) and quadrature (Q) signals are filtered to remove sampling artifacts and are fed to the upconversion mixers. Each transmitter chain provides a wide attenuation adjustment range with fine granularity to optimize SNR.

### OBSERVATION RECEIVER

The ADRV9008-2 contains an independent DPD observation receiver front end. The observation receiver shares the common frequency synthesizer with the transmitter.

The observation receiver is a direct conversion system that contains a programmable attenuator stage, followed by matched I and Q mixers, baseband filters, and ADCs.

The continuous time  $\Sigma$ - $\Delta$  ADCs have inherent antialiasing that reduces the RF filtering requirement.

The ADC outputs can be conditioned further by a series of decimation filters and a programmable FIR filter with additional decimation settings. The sample rate of each digital filter block is adjustable by changing decimation factors to produce the desired output data rate.

### CLOCK INPUT

The ADRV9008-2 requires a differential clock connected to the REF\_CLK\_IN\_± pins. The frequency of the clock input must be between 10 MHz and 1000 MHz and must have very low phase noise because this signal generates the RF LO and internal sampling clocks.

### SYNTHESIZERS

#### RF PLL

The ADRV9008-2 contains a fractional-N PLL to generate the RF LO for the signal paths. The PLL incorporates an internal VCO and loop filter, requiring no external components. The LOs on multiple chips can be phase synchronized to support active antenna systems and beamforming applications.

#### Clock PLL

The ADRV9008-2 contains a PLL synthesizer that generates all the baseband related clock signals and serialization/deserialization (SERDES) clocks. This PLL is programmed based on the data rate and sample rate requirements of the system.

### SERIAL PERIPHERAL INTERFACE (SPI)

The ADRV9008-2 uses an SPI interface to communicate with the baseband processor (BBP). This interface can be configured as a 4-wire interface with dedicated receiver and transmitter ports, or it can be configured as a 3-wire interface with a bidirectional data communications port. This bus allows the BBP to set all device control parameters using a simple address data serial bus protocol.

Write commands follow a 24-bit format. The first five bits set the bus direction and the number of bytes to transfer. The next 11 bits set the address where data is written. The final 8 bits are the data to be transferred to the specific register address.

Read commands follow a similar format with the exception that the first 16 bits are transferred on the SDIO pin and the final eight bits are read from the ADRV9008-2, either on the SDO pin in 4-wire mode or on the SDIO pin in 3-wire mode.

### JTAG BOUNDARY SCAN

The ADRV9008-2 provides support for JTAG boundary scan. Five dual function pins are associated with the JTAG interface. Use these pins, listed in Table 5, to access the on-chip test access port. To enable the JTAG functionality, set the GPIO\_3 pin through the GPIO\_0 pin to 1001, and then pull the TEST pin high.

### POWER SUPPLY SEQUENCE

The ADRV9008-2 requires a specific power-up sequence to avoid undesired power-up currents. In the optimal power-up sequence, the VDDD1P3\_DIG and the VDDA1P3 supplies (VDDA1P3 includes all 1.3 V domains) power up first and at the same time. If these supplies cannot be powered up simultaneously, the VDDD1P3\_DIG supply must power up first. Power up the

VDDA\_3P3, VDDA1P8\_BB, VDDA1P8\_TX, VDDA1P3\_DES, and VDDA1P3\_SER supplies after the 1.3 V supplies. The VDD\_INTERFACE supply can be powered up at any time. Note that no device damage occurs if this sequence is not followed. However, failure to follow this sequence may result in higher than expected power-up currents. It is also recommended to toggle the RESET signal after power stabilizes, prior to configuration. The power-down sequence is not critical. If a power-down sequence is followed, remove the VDDD1P3\_DIG supply last to avoid any back biasing of the digital control lines.

**GPIO\_x PINS**

The ADRV9008-2 provides 19, 1.8 V to 2.5 V GPIO signals that can be configured for numerous functions. When configured as outputs, certain pins can provide real-time signal information to the BBP, allowing the BBP to determine observation receiver performance. A pointer register selects the information that is output to these pins. Signals used for manual gain mode, calibration flags, state machine states, and various observation receiver parameters are among the outputs that can be monitored on these pins. Additionally, certain pins can be configured as inputs and used for various functions, such as setting the observation receiver gain in real time.

Twelve 3.3 V GPIO\_x pins are also included on the device. These pins provide control signals to external components.

**AUXILIARY CONVERTERS**

**AUXADC\_x**

The ADRV9008-2 contains an auxiliary ADC that is multiplexed to four input pins (AUXADC\_x). The auxiliary ADC is 12 bits with an input voltage range of 0.05 V to VDDA\_3P3 – 0.05 V. When enabled, the auxiliary ADC is free

running. The SPI reads provide the last value latched at the ADC output. The auxiliary ADC can also be multiplexed to a built in, diode-based temperature sensor.

**Auxiliary DAC x**

The ADRV9008-2 contains 10 identical auxiliary DACs (auxiliary DAC x) that can be used for bias or other system functionality. The auxiliary DACs are 10 bits, have an output voltage range of approximately 0.7 V to VDDA\_3P3 – 0.3 V, and have an output drive of 10 mA.

**JESD204B DATA INTERFACE**

The digital data interface for the ADRV9008-2 uses JEDEC JESD204B Subclass 1. The serial interface operates at speeds of up to 12.288 Gbps. The benefits of the JESD204B interface include a reduction in required board area for data interface routing, resulting in smaller total system size. Four high speed serial lanes are provided for the transmitter, and four high speed lanes are provided for the observation receiver. The ADRV9008-2 supports single-lane or dual-lane interfaces as well as fixed and floating point data formats for observation receiver data.

**Table 6. Observation Path Interface Rates**

Bandwidth (MHz)	Output Rate (MSPS)	JESD204B	
		Lane Rate (Mbps)	Number of Lanes
200	245.76	9830.4	1
200	307.2	12288	1
250	307.2	12288	1
450	491.52	9830.4	2
450	491.52	4915.2	4

**Table 7. Transmitter Interface Rates (Other Output Rates, Bandwidth, and JESD204B Lanes Also Supported)**

Bandwidth (MHz)	Input Rate (MSPS)	Single-Channel Operation		Dual-Channel Operation	
		JESD204B Lane Rate (Mbps)	JESD204B Number of Lanes	JESD204B Lane Rate (Mbps)	JESD204B Number of Lanes
200	245.76	9830.4	1	9830.4	2
200	307.2	12288	1	12288	2
250	307.2	12288	1	12288	2
450	491.52	9830.4	2	9830.4	4

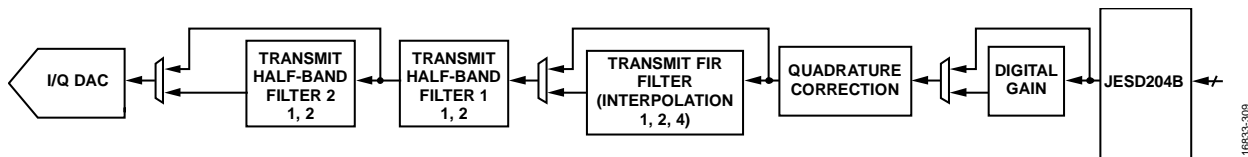

Figure 267. Transmitter Datapath Filter Implementation

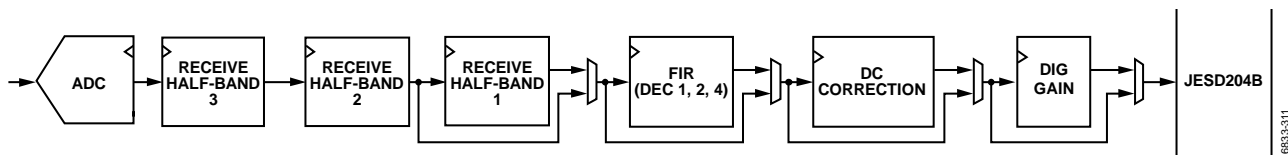

Figure 268. Observation Receiver Datapath Filter Implementation

# APPLICATIONS INFORMATION

## PCB LAYOUT AND POWER SUPPLY RECOMMENDATIONS

### Overview

The ADRV9008-2 device is a highly integrated RF agile transceiver with significant signal conditioning integrated on one chip. Due to the increased complexity of the device and its high pin count, careful PCB layout is important to get the optimal performance. This data sheet provides a checklist of issues to look for and guidelines on how to optimize the PCB to mitigate performance issues. The goal of this data sheet is to help achieve the optimal performance from the ADRV9008-2 while reducing board layout effort. This data sheet assumes that the reader is an experienced analog and RF engineer with an understanding of RF PCB layout and RF transmission lines. This data sheet discusses the following issues and provides guidelines for system designers to achieve the optimal performance for the ADRV9008-2:

- PCB material and stack up selection
- Fanout and trace space layout guidelines
- Component placement and routing guidelines
- RF and JESD204B transmission line layout
- Isolation techniques used on the [ADRV9008-2W/PCBZ](#)
- Power management considerations
- Unused pin instructions

### PCB MATERIAL AND STACKUP SELECTION

Figure 269 shows the PCB stackup used for the [ADRV9008-2W/PCBZ](#). Table 8 and Table 9 list the single-ended and differential impedance for the stackup shown in Figure 269. The dielectric material used on the top and the bottom layers is 8 mil Rogers 4350B. The remaining dielectric layers are FR4-370 HR. The board design uses the Rogers laminate for the top and the bottom layers for the low loss tangent at high frequencies. The ground planes under the Rogers laminate (Layer 2 and Layer 13) are the reference planes for the transmission lines routed on the outer surfaces. These layers are solid copper planes without any splits under the RF traces. Layer 2 and Layer

13 are crucial to maintaining the RF signal integrity and, ultimately, the ADRV9008-2 performance. Layer 3 and Layer 12 are used to route power supply domains. To keep the RF section of the ADRV9008-2 isolated from the fast transients of the digital section, the JESD204B interface lines are routed on Layer 5 and Layer 10. Those layers have impedance control set to a 100 Ω differential. The remaining digital lines from the ADRV9008-2 are routed on Inner Layer 7 and Inner Layer 8. RF traces on the outer layers must be a controlled impedance to get the best performance from the device. The inner layers on this board use 0.5 ounce copper or 1 ounce copper. The outer layers use 1.5 ounce copper so that the RF traces are less prone to peeling. Ground planes on this board are full copper floods with no splits except for vias, through-hole components, and isolation structures. The ground planes must route entirely to the edge of the PCB under the Surface-Mount Type A (SMA) connectors to maintain signal launch integrity. Power planes can be pulled back from the board edge to decrease the risk of shorting from the board edge.

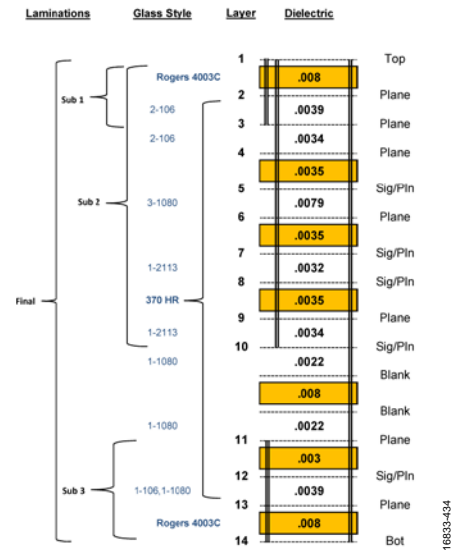

Figure 269. ADRV9008-2W/PCBZ Trace Impedance and Stackup

Table 8. Evaluation Board Single-Ended Impedance and Stackup<sup>1</sup>

Layer	Board Copper %	Starting Copper (oz.)	Finished Copper (oz.)	Single-Ended Impedance	Designed Trace Single-Ended (inches)	Finished Trace Single-Ended (inches)	Calculated Impedance (Ω)	Single-Ended Reference Layers
1	N/A	0.5	1.71	50 Ω ±10%	0.0155	0.0135	49.97	2
2	65	1	1	N/A	N/A	N/A	N/A	N/A
3	50	0.5	1	N/A	N/A	N/A	N/A	N/A
4	65	1	1	N/A	N/A	N/A	N/A	N/A
5	50	0.5	0.5	50 Ω ±10%	0.0045	0.0042	49.79	4, 6
6	65	1	1	N/A	N/A	N/A	N/A	N/A
7	50	0.5	0.5	50 Ω ±10%	0.0049	0.0039	50.05	6, 9
8	50	0.5	0.5	50 Ω ±10%	0.0049	0.0039	50.05	6, 9
9	65	1	1	N/A	N/A	N/A	N/A	N/A
10	50	0.5	1	50 Ω ±10%	0.0045	0.0039	49.88	9, 11
11	65	0.5	1	N/A	N/A	N/A	N/A	N/A
12	50	1	1	N/A	N/A	N/A	N/A	N/A
13	65	1	1	N/A	N/A	N/A	N/A	N/A
14		0.5	1.64	50 Ω ±10%	0.0155	0.0135	49.97	13

<sup>1</sup> N/A means not applicable.

Table 9. Evaluation Board Differential Impedance and Stackup<sup>1</sup>

Layer	Differential Impedance	Designed Trace (inches)	Designed Gap Differential (inches)	Finished Trace (inches)	Finished Gap Differential (inches)	Calculated Impedance (Ω)	Differential Reference Layers
1	100 Ω ± 10%	0.008	0.006	0.007	0.007	99.55	2
	50 Ω ± 10%	0.0032	0.004	0.0304	0.0056	50.11	2
2	N/A	N/A		N/A		N/A	N/A
3	N/A	N/A		N/A		N/A	N/A
4	N/A	N/A		N/A		N/A	N/A
5	100 Ω ±10%	0.0036	0.0064	0.0034	0.0065	99.95	4, 6
6	N/A	N/A		N/A		N/A	N/A
7	100 Ω ±10%	0.0036	0.0064	0.0034	0.0066	100.51	6, 9
8	100 Ω ±10%	0.0038	0.0062	0.0034	0.0066	100.51	6, 9
9	N/A	N/A		N/A		N/A	N/A
10	100 Ω ±10%	0.0036	0.0064	0.003	0.007	100.80	9, 11
	N/A	N/A		N/A		N/A	N/A
	N/A	N/A		N/A		N/A	N/A
11	N/A	N/A		N/A		N/A	N/A
12	N/A	N/A		N/A		N/A	N/A
13	100 Ω ±10%	0.008	0.006	0.007	0.007	99.55	13
14	50 Ω ±10%	0.032		0.004		50.11	13

<sup>1</sup> N/A means not applicable.



**FANOUT AND TRACE SPACE GUIDELINES**

The ADRV9008-2 device uses a 196-ball chip scale package ball grid array (CSP\_BGA), 12 × 12 mm package. The pitch between the pins is 0.8 mm. This small pitch makes it impractical to route all signals on a single layer. RF pins are placed on the outer edges of the ADRV9008-2 package. The location of the pins helps route the critical signals without a fanout via. Each digital signal is routed from the BGA pad using a 4.5 mil trace. The trace is connected to the BGA using a via in the pad structure. The signals are buried in the inner layers of the board for routing to other parts of the system.

The JESD204B interface signals are routed on two signal layers that use impedance control (Layer 5 and Layer 10). The spacing between the BGA pads is 17.5 mil. After the signal is on the inner layers, a 3.6 mil trace (50 Ω) connects the JESD204B signal to the field programmable gate array (FPGA) mezzanine card (FMC) connector. The recommended BGA land pad size is 15 mil.

Figure 270 shows the fanout scheme of the [ADRV9008-2W/PCBZ](#). As mentioned before, the [ADRV9008-2W/PCBZ](#) uses a via in the pad technique. This routing approach can be used for the ADRV9008-2 if there are no issues with manufacturing capabilities.

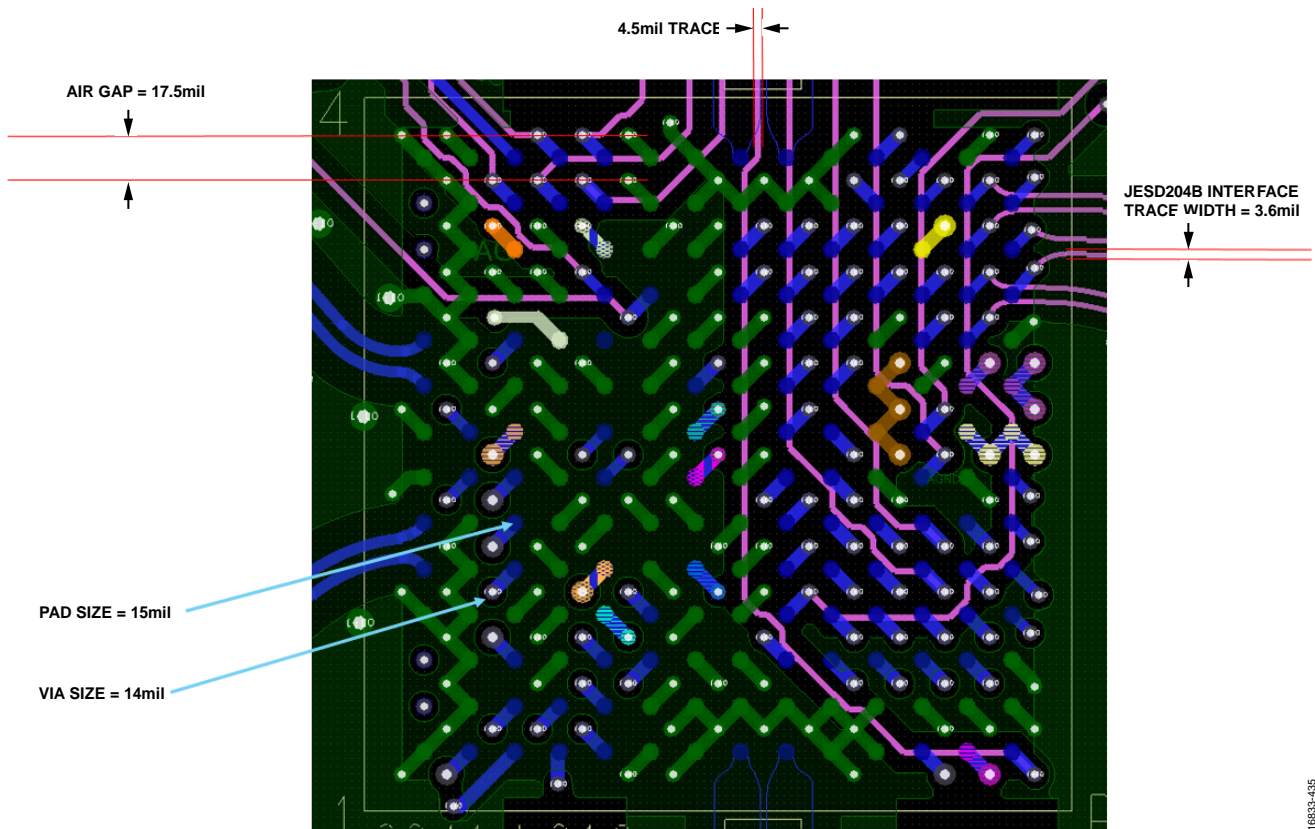

Figure 270. Trace Fanout Scheme on the [ADRV9008-2W/PCBZ](#) (PCB Layer Top and Layer 5 Enabled)

16833-425

**COMPONENT PLACEMENT AND ROUTING GUIDELINES**

The ADRV9008-2 transceiver requires few external components to function, but those that are used require careful placement and routing to optimize performance. This section provides a checklist for properly placing and routing critical signals and components.

**Signals with Highest Routing Priority**

RF lines and JESD204B interface signals are the signals that are most critical and must be routed with the highest priority.

Figure 271 shows the general directions in which each of the signals must be routed so that they can be properly isolated from noisy signals.

The observation receiver and transmitter baluns and the matching circuits affect the overall RF performance of the ADRV9008-2 transceiver. Make every effort to optimize the component selection and placement to avoid performance degradation. The RF Routing Guidelines section describes proper matching circuit placement and routing in more detail. Refer to the RF Port Interface Information section for more information.

To achieve the desired level of isolation between RF signal paths, use the technique described in the Isolation Techniques Used on the [ADRV9008-2W/PCBZ](#) section in customer designs.

In cases in which ADRV9008-2 is used, install a 10  $\mu$ F capacitor near the transmitter balun(s) VDDA1P8\_TX dc feed(s) for RF transmitter outputs. This acts as a reservoir for the transmitter supply current. The Transmitter Balun DC Feed Supplies section discusses more details about the transmitter output power supply configuration.

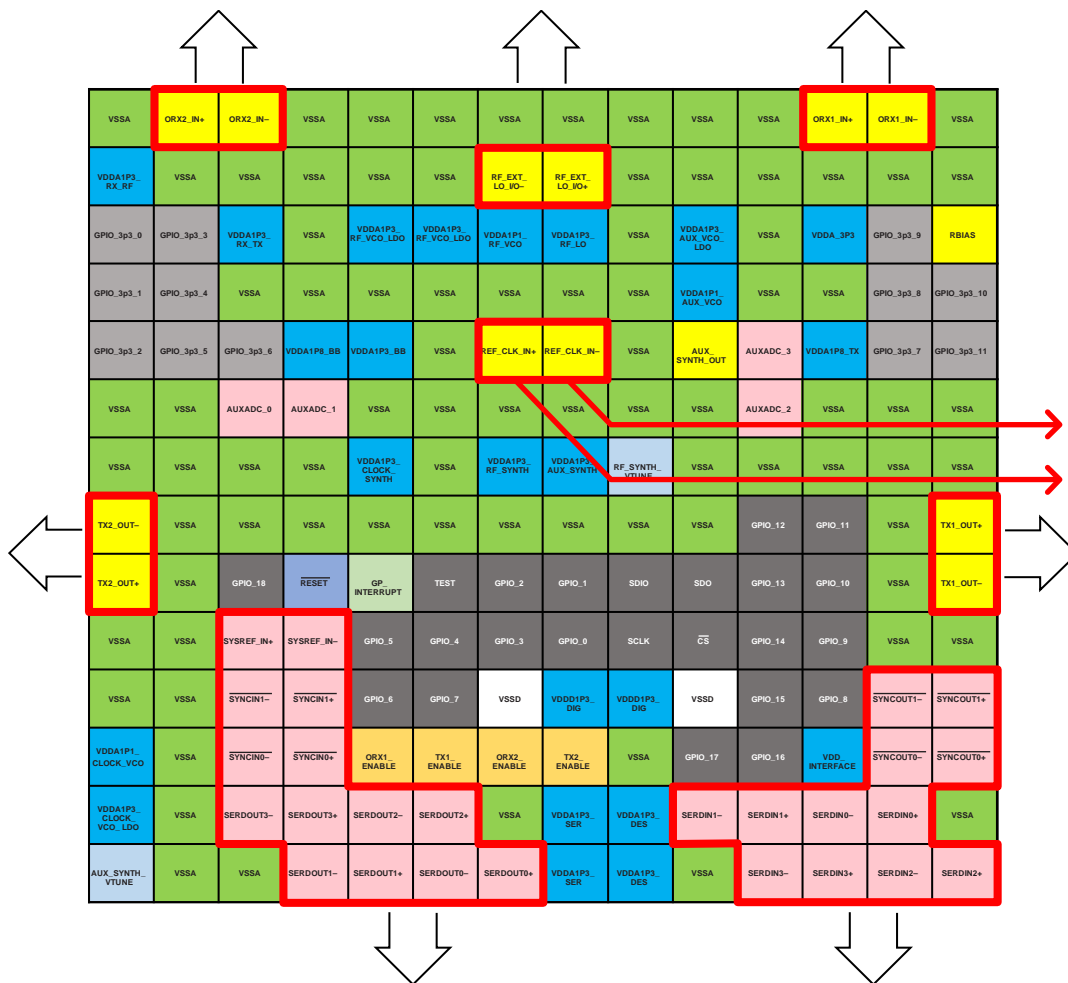

Figure 271. RF Input/Output, REF\_CLK\_IN±, and JESD204B Signal Routing Guidelines

16833-436

Figure 272 shows placement for ac coupling capacitors and a 100  $\Omega$  termination resistor near the ADRV9008-2 REF\_CLK\_IN $\pm$  pins. Shield the traces with ground flooding that is surrounded with vias staggered along the edge of the trace pair. The trace pair creates a shielded channel that shields the reference clock from any interference from other signals. Refer to the [ADRV9008-2W/PCBZ](#) layout, including board support files included with the evaluation board software, for exact details.

Route the JESD204B interface at the beginning of the PCB design and with the same priority as the RF signals. The RF

Routing Guidelines section outlines recommendations for JESD204B interface routing. Provide appropriate isolation between interface differential pairs. The Isolation Between JESD204B Lines section provides guidelines for optimizing isolation.

The RF\_EXT\_LO\_I/O- pin (B7) and the RF\_EXT\_LO\_I/O+ pin (B8) on the ADRV9008-2 are internally dc biased. If an external LO is used, connect it via ac coupling capacitors.



Figure 272. REF\_CLK\_IN $\pm$  Routing Recommendation

**Signals with Second Routing Priority**

Power supply quality has direct impact on overall system performance. To achieve optimal performance, users should follow recommendations regarding ADRV9008-2 power supply routing. The following recommendations outline how to route different power domains that can be connected together directly and that can be tied to the same supply, but are separated by a 0 Ω placeholder resistor or ferrite bead (FB).

When the recommendation is to use a trace to connect power to a particular domain, ensure that this trace is surrounded by ground.

Figure 273 shows an example of such traces routed on the [ADRV9008-2W/PCBZ](#) on Layer 12. Each trace is separated from any other signal by the ground plane and vias. Separating the traces from other signals is essential to providing necessary isolation between the ADRV9008-2 power domains.

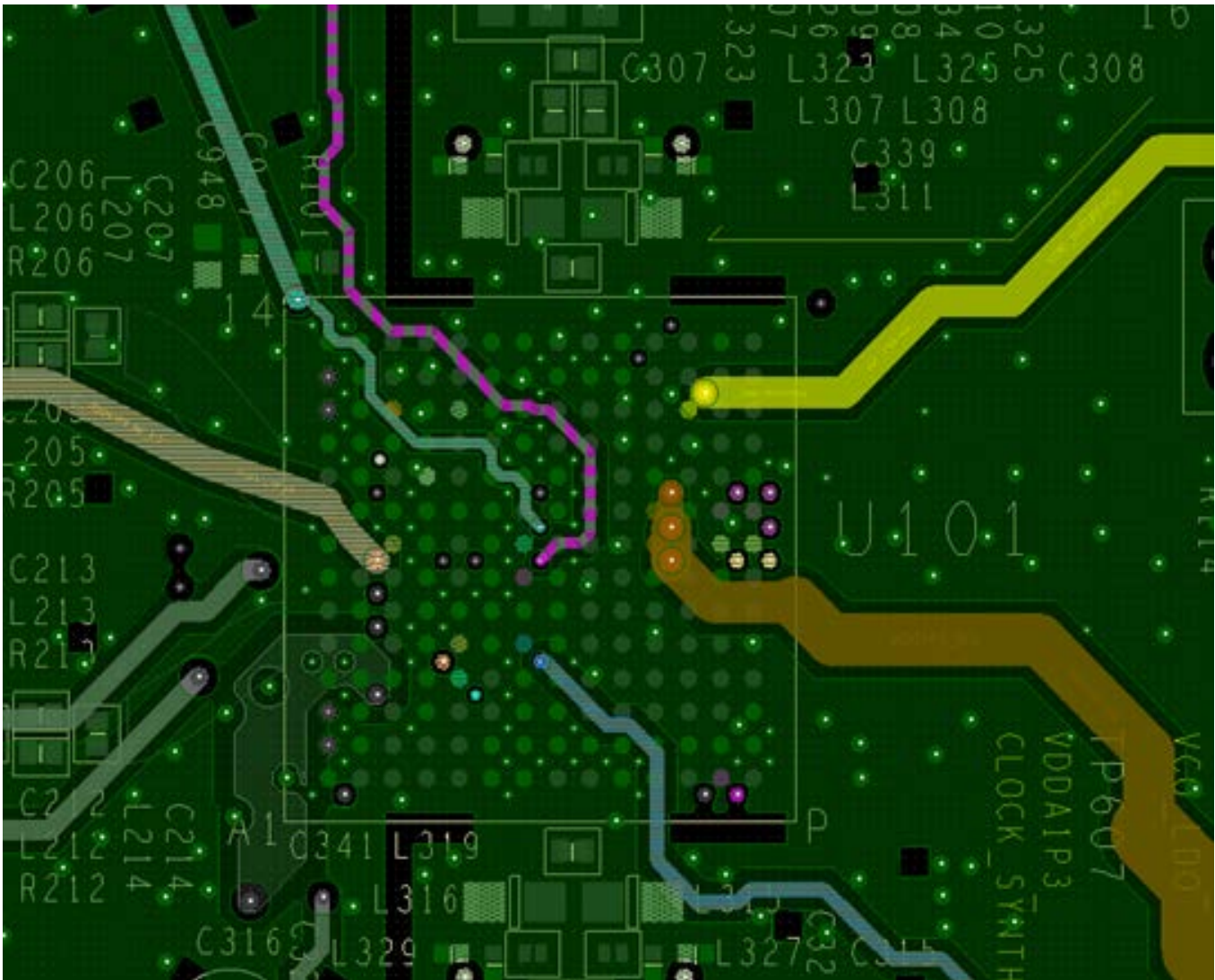

Figure 273. Layout Example of Power Supply Domains Routed with Ground Shielding (Layer 12 to Power)

16893-440

Each power supply pin requires a 0.1 μF bypass capacitor near the pin at a minimum. Place the ground side of the bypass capacitor so that ground currents flow away from other power pins and the bypass capacitors.

For the domains shown in Figure 274, like the domains powered through a 0 Ω placeholder resistor or ferrite bead, place the 0 Ω placeholder resistors or ferrite beads further away from the device. Space 0 Ω placeholder resistors or ferrite beads apart from each other to ensure the electric fields on the ferrite beads do not influence each other. Figure 275 shows an example of how the ferrite beads, reservoir capacitors, and decoupling

capacitors are placed. The recommendation is to connect a ferrite bead between a power plane and the ADRV9008-2 at a distance away from the device. The ferrite bead and the reservoir capacitor provide stable voltage to the ADRV9008-2 during operation by isolating the pin or pins that the network is connected to from the power plane. Then, shield that trace with ground and provide power to the power pins on the ADRV9008-2. Place a 100 nF capacitor near the power supply pin with the ground side of the bypass capacitor placed so that ground currents flow away from other power pins and the bypass capacitors.

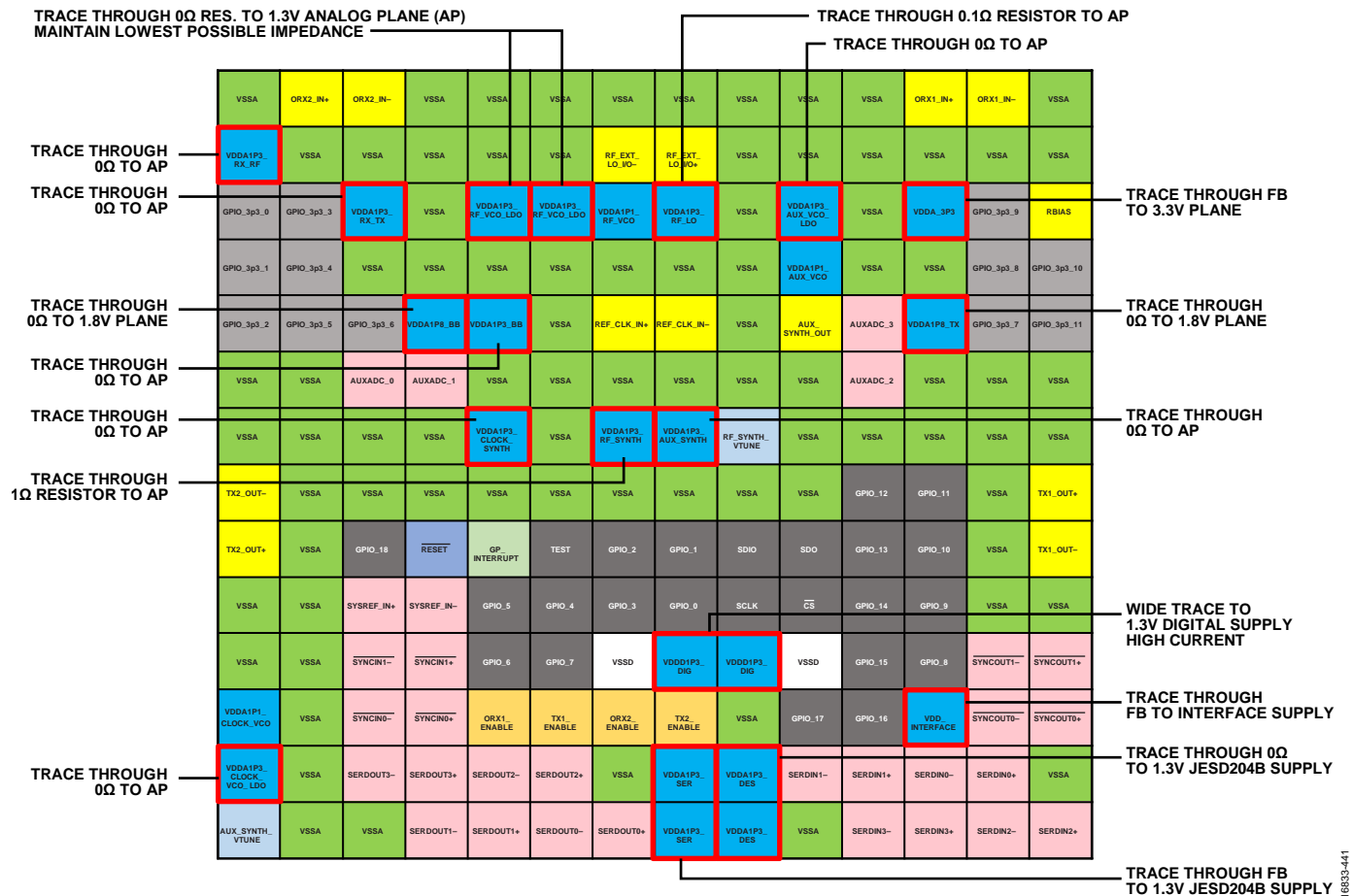

Figure 274. Power Supply Domains Interconnection Guidelines

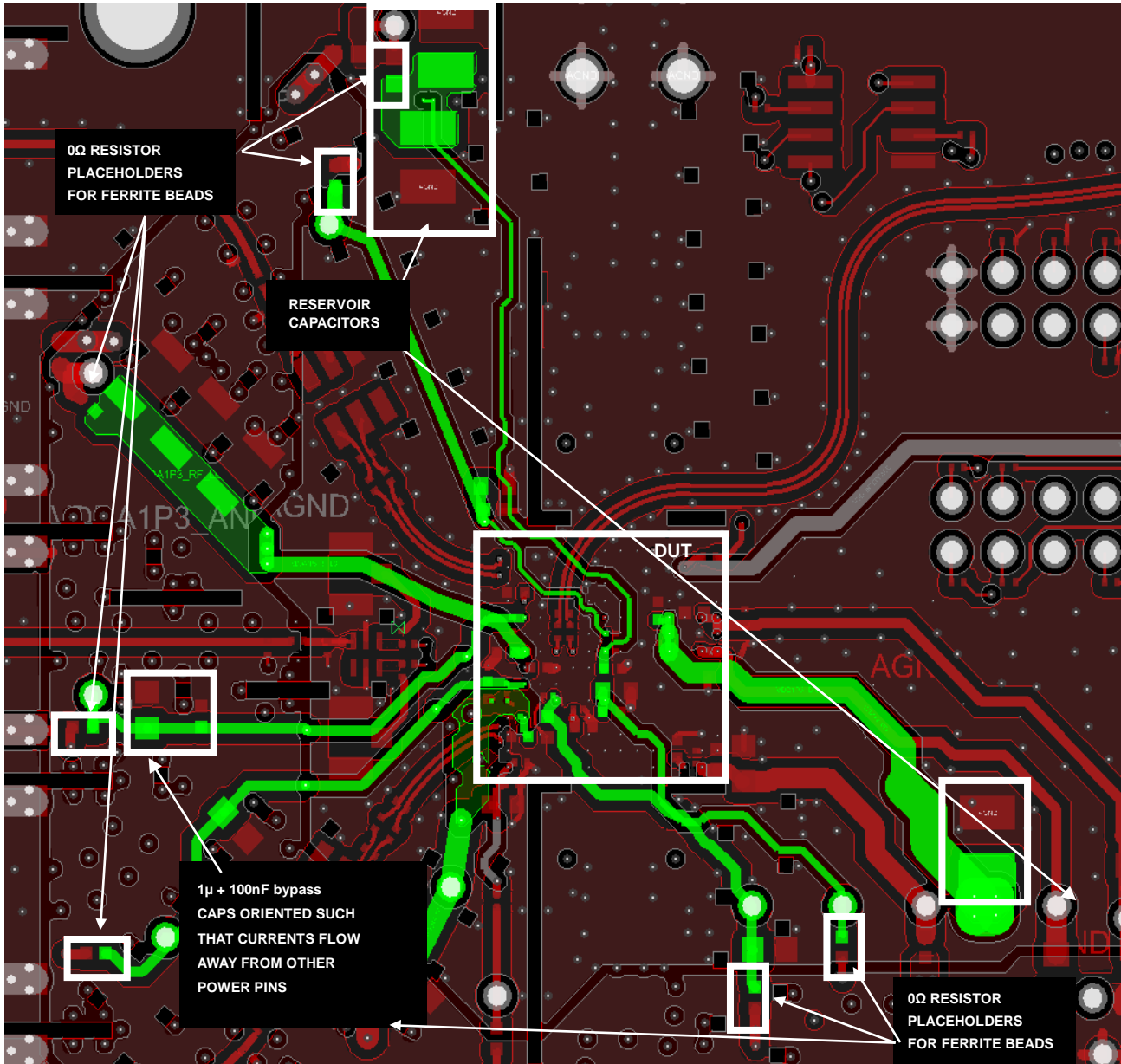

Figure 275. Placement Example of 0 Ω Resistor Placeholders for Ferrite Beads, Reservoir and Bypass Capacitors on the ADRV9008-2W/PCBZ (Layer 12 to Power Layer and Bottom Layer)

16633-444

**Signals with Lowest Routing Priority**

As a last step while designing the PCB layout, route signals shown in Figure 276. The following list outlines the recommended order of signal routing:

1. Use ceramic 1  $\mu$ F bypass capacitors at the VDDA1P1\_RF\_VCO, VDDA1P1\_AUX\_VCO, and VDDA1P1\_CLOCK\_VCO pins. Place them as close as possible to the ADRV9008-2 device with the ground side of the bypass capacitor placed so that ground currents flow away from other power pins and the bypass capacitors, if at all possible.
2. Connect a 14.3 k $\Omega$  resistor to the RBIAS pin (C14). This resistor must have a 1% tolerance.
3. Pull the TEST pin (J6) to ground for normal operation. The device has support for JTAG boundary scan, and this pin is used to access that function. Refer to the JTAG Boundary Scan section for JTAG boundary scan information.
4. Pull the RESET pin (J4) high with a 10 k $\Omega$  resistor to VDD\_INTERFACE for normal operation. To reset the device, drive the RESET pin low.

When routing analog signals such as GPIO\_3p3\_x/Auxiliary DAC x or AUXADC\_x, it is recommended to route them away from the digital section (Row H through Row P). Do not cross the analog section of the ADRV9008-2 highlighted by a red-dotted line in Figure 276 by any digital signal routing.

When routing digital signals from rows H and below, it is important to route them away from the analog section (Row A through Row G). Do not cross the analog section of the ADRV9008-2 highlighted by a red-dotted line in Figure 276 by any digital signal routing.

**RF AND JESD204B TRANSMISSION LINE LAYOUT**

**RF Routing Guidelines**

The ADRV9008-2W/PCBZ use microstrip type lines for observation receiver and transmitter RF traces. In general, Analog Devices, Inc. does not recommend using vias to route RF traces unless a direct line route is not possible.

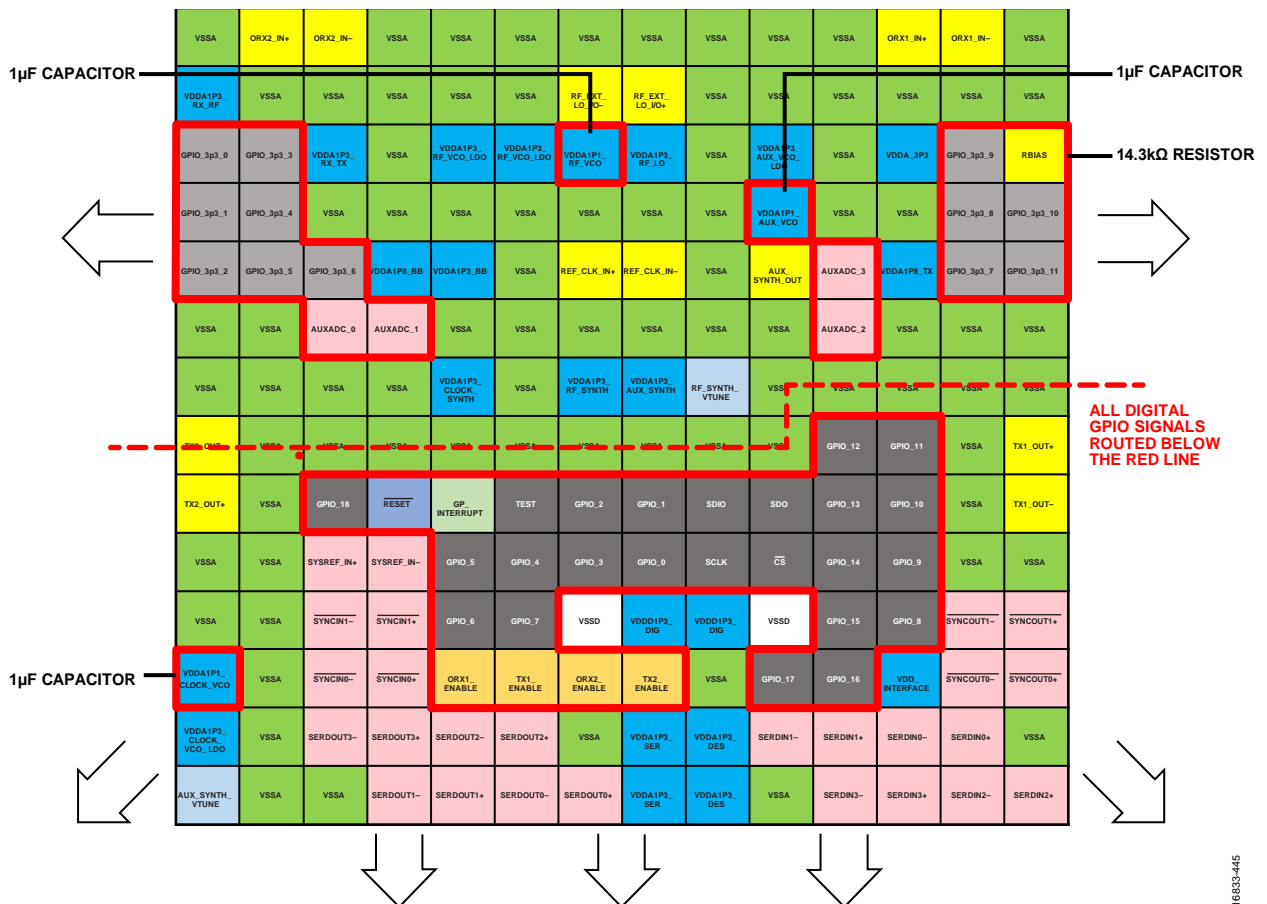

Figure 276. Auxiliary ADC, Analog, and Digital GPIO Signals Routing Guidelines

16E93-445

Differential lines from the balun to the observation receiver and transmitter pins need to be as short as possible. Make the length of the single-ended transmission line also short to minimize the effects of parasitic coupling. It is important to note that these traces are the most critical when optimizing performance and are, therefore, routed before any other routing. These traces have the highest priority if trade-offs are needed.

Figure 277 and Figure 278 show pi matching networks on the single-ended side of the baluns. The observation receiver front end is dc biased internally, so the differential side of the balun is ac-coupled. The system designer can optimize the RF performance with a proper selection of the balun, matching components, and ac coupling capacitors. The external LO traces and the REF\_CLK\_IN± traces may require matching components as well to ensure optimal performance.

All the RF signals mentioned previously must have a solid ground reference under each trace. Do not run any of the critical traces over a section of the reference plane that is discontinuous. The ground flood on the reference layer must extend all the way to the edge of the board. This flood length ensures signal integrity for the SMA launch when an edge launch connector is used.

Refer to the RF Port Interface Information section for more information on RF matching recommendations for the device.

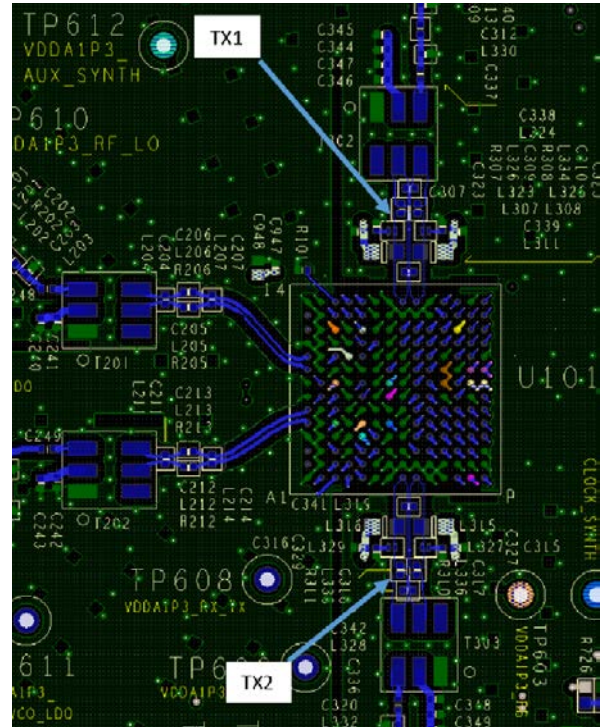

Figure 277. Pi Network Matching Components Available on Transmitter Outputs

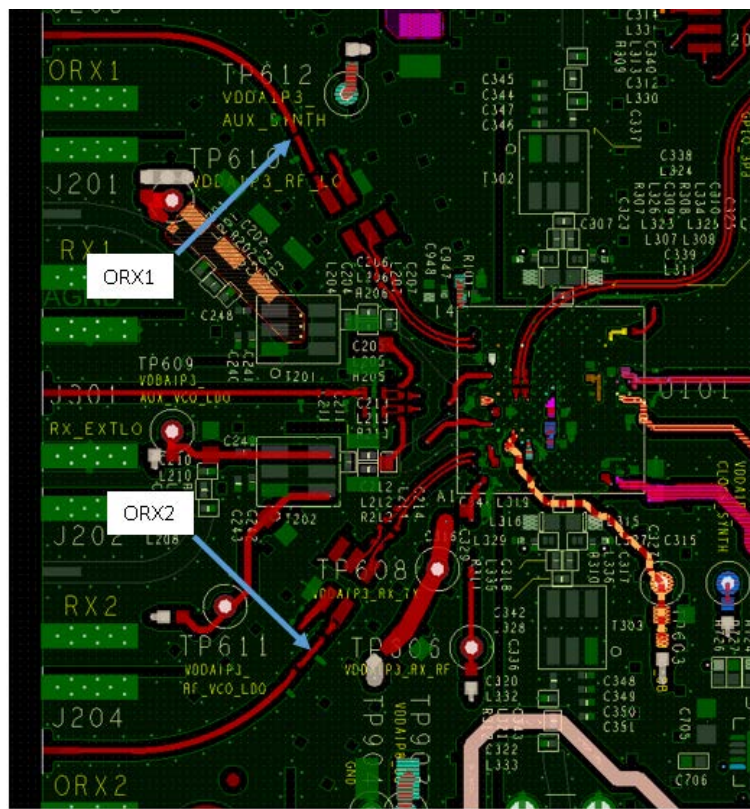

Figure 278. Pi Network Matching Components Available on Observation Receiver Inputs



### Transmitter Balun DC Feed Supplies

Each transmitter requires approximately 200 mA supplied through an external connection. On the ADRV9008-2 and ADRV9009 evaluation boards, bias voltages are supplied at the dc feed of the baluns. Layout of both boards allows the use of external chokes to provide a 1.8 V power domain to the ADRV9008-2 outputs. This configuration is useful in scenarios where a balun used at the transmitter output is not capable of

conducting the current necessary for the transmitter outputs to operate. To reduce switching transients when attenuation settings change, power the balun dc feed or transmitter output chokes directly by the 1.8 V plane. Design the geometry of the 1.8 V plane so that each balun supply or each set of two chokes is isolated from the other. This geometry can affect transmitter to transmitter isolation. Figure 279 shows the layout configuration used on the ADRV9008-2W/PCBZ.

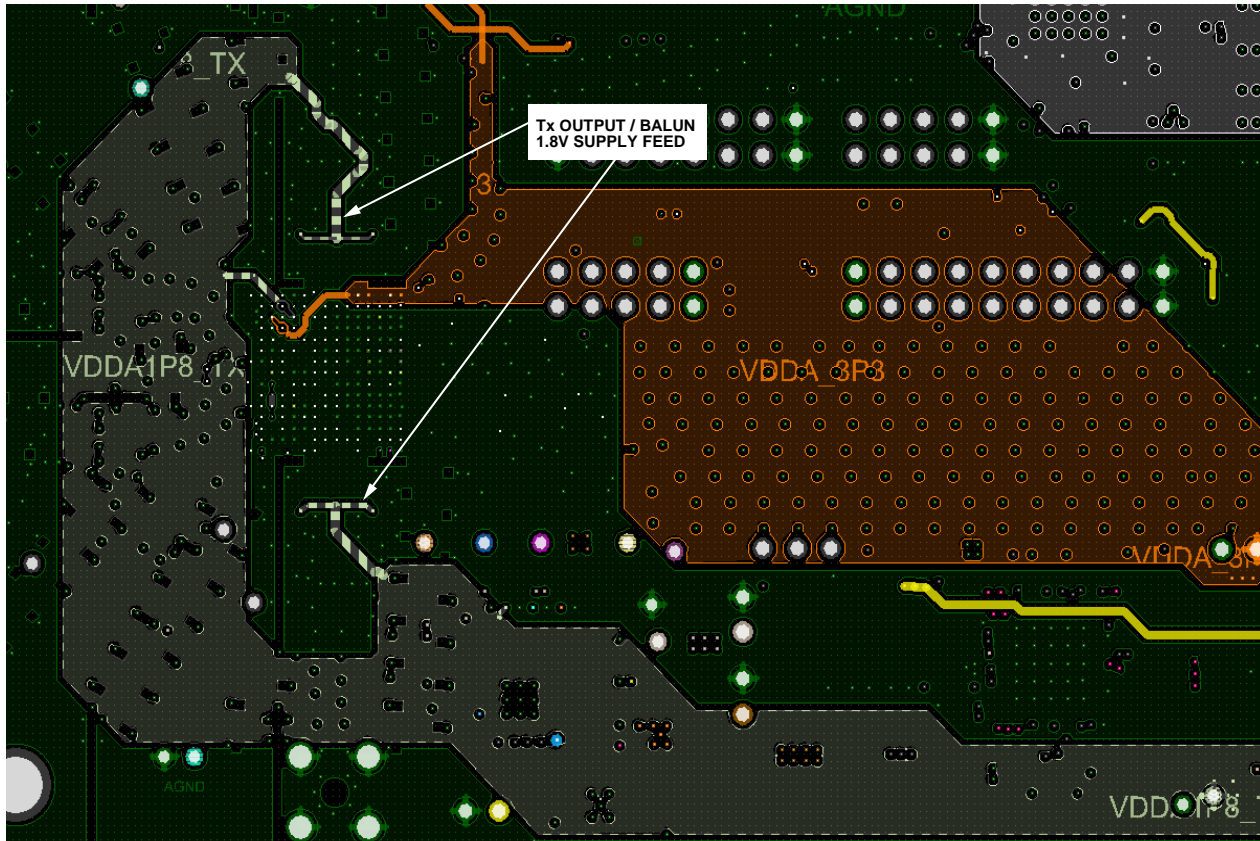

Figure 279. Transmitter Power Supply Planes (VDDA1P8\_TX) on the ADRV9008-2W/PCBZ

Both the positive and negative transmitter pins must be biased with 1.8 V. This biasing is accomplished on the evaluation board through dc capacitors chokes and decoupling capacitors, as shown in Figure 280. Match both chokes and their layout to avoid potential current spikes. A difference in parameters between both chokes can cause unwanted emission at transmitter outputs. Place the decoupling capacitors that are near the transmitter balun as close as possible to the dc feed of the balun or the ground pin. Make orientation of the capacitor perpendicular to the device so that the return current forms as small a loop as possible with the ground pins surrounding the transmitter input. A combination network of capacitors is used to provide a wideband and low impedance ground path and helps to eliminate transmitter spectrum spurs and dampens the transients.



Figure 280. Transmitter DC Chokes and Balun Feed Supply

**JESD204B Trace Routing Recommendations**

The ADRV9008-2 transceiver uses the JESD204B, high speed serial interface. To ensure optimal performance of this interface, keep the differential traces as short as possible by placing the ADRV9008-2 as close as possible to the FPGA or BBP, and route the traces directly between the devices. Use a PCB material with a low dielectric constant (< 4) to minimize loss. For distances greater than 6 inches, use a premium PCB material, such as RO4350B or RO4003C.

**Routing Recommendations**

Route the differential pairs on a single plane using a solid ground plane as a reference on the layers above and/or below these traces.

All JESD204B lane traces must be impedance controlled to achieve 50 Ω to ground. It is recommended that the differential pair be coplanar and loosely coupled. An example of a typical configuration is a 5 mil trace width and 15 mil edge to edge spacing, with the trace width maximized as shown in Figure 281.

Match trace widths with pin and ball widths while maintaining impedance control. If possible, use 1 oz. copper trace widths of at least 8 mil (200 μm). The coupling capacitor pad size must match JESD204B lane trace widths. If trace width does not match pad size, use a smooth transition between different widths.

The pad area for all connector and passive component choices must be minimized due to a capacitive plate effect that leads to problems with signal integrity.

Reference planes for impedance controlled signals must not be segmented or broken for the entire length of a trace.

The REF\_CLK\_IN± signal trace and the SYSREF signal trace are impedance controlled for characteristic impedance (Z<sub>0</sub>) = 50 Ω.

**Stripline Transmission Lines vs. Microstrip Transmission Lines**

Stripline transmission lines have less signal loss and emit less electromagnetic interference than microstrip transmission lines. However, stripline transmission lines require the use of vias that add line inductance, increasing the difficulty of controlling the impedance.

Microstrip transmission lines are easier to implement if the component placement and density allow routing on the top layer. Microstrip transmission lines make controlling the impedance easier.

If the top layer of the PCB is used by other circuits or signals, or if the advantages of stripline transmission lines are more desirable over the advantages of microstrip transmission lines, follow these recommendations:

- Minimize the number of vias.
- Use blind vias where possible to eliminate via stub effects, and use micro vias to minimize via inductance.
- When using standard vias, use a maximum via length to minimize the stub size. For example, on an 8-layer board, use Layer 7 for the stripline pair.
- Place a pair of ground vias in close proximity to each via pair to minimize the impedance discontinuity.

Route the JESD204B lines on the top side of the board as a differential 100 Ω pair (microstrip). For the [ADRV9008-2W/PCBZ](#), the JESD204B differential signals are routed on inner layers of the board (Layer 5 and Layer 10) as differential

100 Ω pairs (stripline). To minimize potential coupling, these signals are placed on an inner layer using a via embedded in the component footprint pad where the ball connects to the PCB. The ac coupling capacitors (100 nF) on these signals are placed near the connector and away from the chip to minimize coupling. The JESD204B interface can operate at frequencies of up to 12 GHz. Ensure that signal integrity from the chip to the connector is maintained.

**ISOLATION TECHNIQUES USED ON THE ADRV9008-2W/PCBZ**

**Isolation Goals**

Significant isolation challenges were overcome in designing the ADRV9008-2W/PCBZ. The following isolation requirements are used to accurately evaluate the ADRV9008-2 transceiver performance:

- Transmitter to transmitter, 75 dB out to 6 GHz
- Transmitter to observation receiver, 65 dB out to 6 GHz

To meet these isolation goals with significant margin, isolation structures are introduced.

Figure 282 shows the isolation structures used on the ADRV9008-2W/PCBZ. These structures consist of a combination of slots and square apertures. These structures are present on every copper layer of the PCB stack. The advantage of using square apertures is that signals can be routed between the openings without affecting the isolation benefits of the array of apertures. When using these isolation structures, make sure to place ground vias around the slots and apertures.

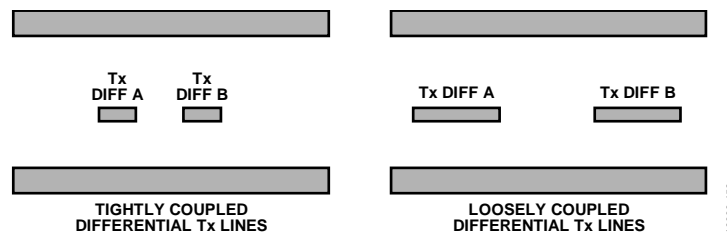

Figure 281. Routing JESD204B, Differential A and Differential B Correspond to Differential Positive Signals or Negative Signals (One Differential Pair)

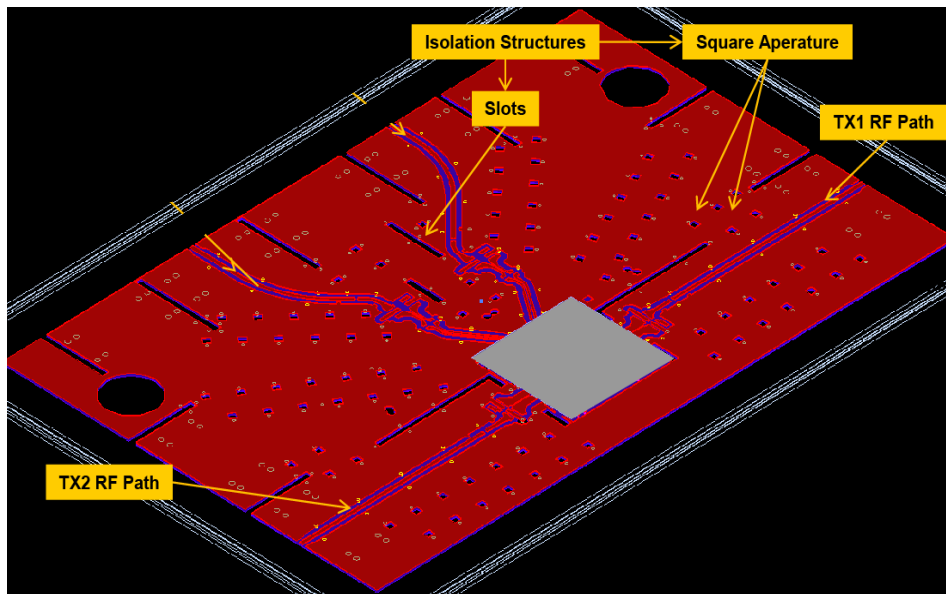

Figure 282. Isolation Structures on the ADRV9008-2W/PCBZ

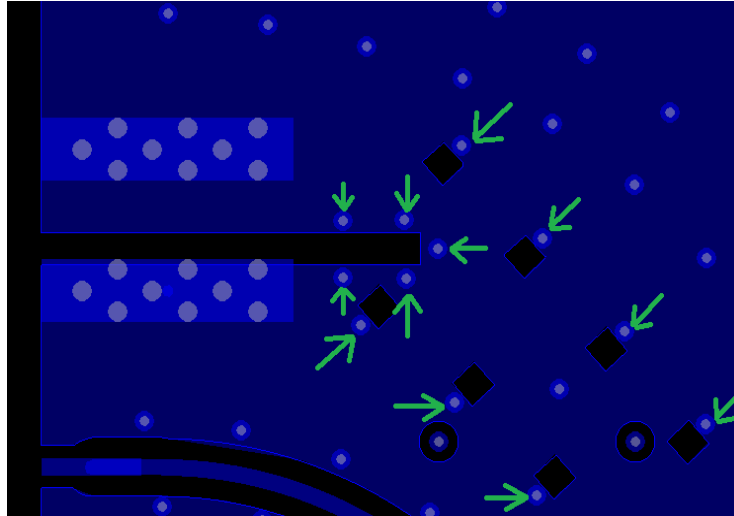

Figure 283. Current Steering Vias Placed Next to Isolation Structures

Figure 283 outlines the methodology used on the [ADRV9008-2W/PCBZ](#). When using slots, ground vias must be placed at the ends of the slots and along the sides of the slots. When using square apertures, at least one single ground via must be placed adjacent to each square. These vias must be through-hole vias from the top to the bottom layer. The function of these vias is to steer return current to the ground planes near the apertures.

For accurate slot spacing and square apertures layout, use simulation software when designing a PCB for the ADRV9008-2 transceiver. Spacing between square apertures must be no more than 1/10 of a wavelength. Calculate the wavelength using Equation 1:

$$Wavelength (m) = \frac{300}{Frequency (MHz) \times \sqrt{E}} \quad (1)$$

where  $E_R$  is the dielectric constant of the isolator material. For RO4003C material, microstrip structure (+ air)  $E_R = 2.8$ . For FR4-370HR material, stripline structure  $E_R = 4.1$ .

For example, if the maximum RF signal frequency is 6 GHz, and  $E_R = 2.8$  for RO4003C material, microstrip structure (+ air), the minimum wavelength is approximately 29.8 mm.

To follow the 1/10 wavelength spacing rule, square aperture spacing must be 2.98 mm or less.

### Isolation Between JESD204B Lines

The JESD204B interface uses eight line pairs that can operate at speeds of up to 12 GHz. When configuring the PCB layout, ensure these lines are routed according to the rules outlined in the JESD204B Trace Routing Recommendations section. In addition, use isolation techniques to prevent crosstalk between different JESD204B lane pairs.

Figure 284 shows a technique used on the [ADRV9008-2W/PCBZ](#) that involves via fencing. Placing ground vias around each JESD204B pair provides isolation and decreases crosstalk. The spacing between vias is 1.2 mm.

Figure 284 shows the rule provided in Equation 1 JESD204B lines are routed on Layer 5 and Layer 10 so that the lines use stripline structures. The dielectric material used in the inner layers of the [ADRV9008-2W/PCBZ](#) PCB is FR4-370HR.

For accurate spacing of the JESD204B fencing vias, use layout simulation software. Input the following data into Equation 1 to calculate the wavelength and square aperture spacing:

- The maximum JESD204B signal frequency is approximately 12 GHz.
- For FR4-370HR material, stripline structure,  $E_R = 4.1$ , the minimum wavelength is approximately 12.4 mm.

To follow the 1/10 wavelength spacing rule, spacing between vias must be 1.24 mm or less. The minimum spacing recommendation according to transmission line theory is 1/4 wavelength.

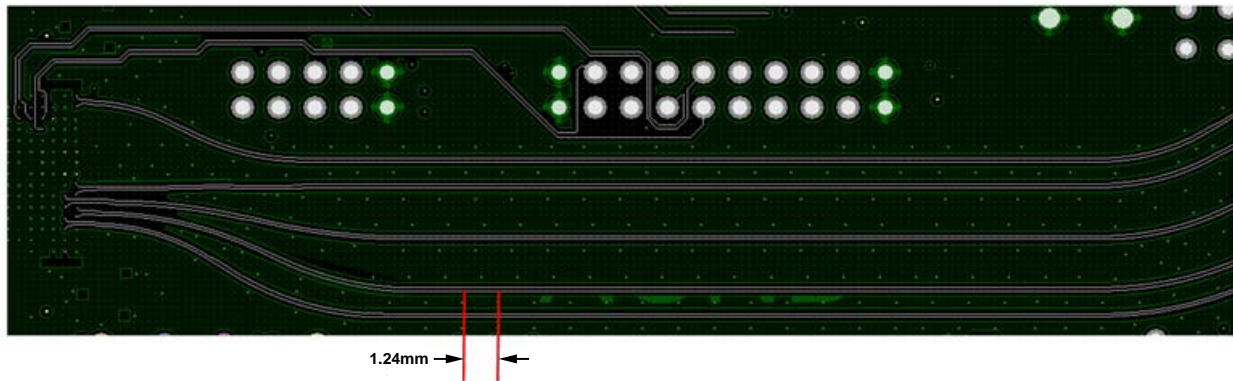

Figure 284. Via Fencing Around JESD204B Lines, PCB Layer 10

16833-455

### RF PORT INTERFACE INFORMATION

This section details the RF transmitter and observation receiver interfaces for optimal device performance. This section also includes data for the anticipated ADRV9008-2 RF port impedance values and examples of impedance matching networks used in the evaluation platform. This section also provides information on board layout techniques and balun selection guidelines.

The ADRV9008-2 is a highly integrated transceiver with transmit and observation (DPD) receive signal chains. External impedance matching networks are required on transmitter and observation receiver ports to achieve performance levels indicated on the data sheet.

Analog Devices recommends the use of simulation tools in the design and optimization of impedance matching networks. To achieve the closest match between computer simulated results and measured results, accurate models of the board environment, surface-mount device (SMD) components (including baluns and filters), and ADRV9008-2 port impedances are required.

### RF Port Impedance Data

This section provides the port impedance data for all transmitters and observation receivers in the ADRV9008-2 integrated transceiver. Please note the following:

- $Z_0$  is defined as  $50 \Omega$ .
- The ADRV9008-2 ball pads are the reference plane for this data.
- Single-ended mode port impedance data is not available. However, a rough assessment is possible by taking the differential mode port impedance data and dividing both the real and imaginary components by 2.
- Contact Analog Devices applications engineering for the impedance data in Touchstone format.

m21  
 FREQUENCY = 100MHz  
 $S(1,1) = 0.143/-7.865$   
 IMPEDANCE = 66.439 - j2.654

m22  
 FREQUENCY = 300MHz  
 $S(1,1) = 0.141/-25.589$   
 IMPEDANCE = 64.063 - j7.987

m23  
 FREQUENCY = 500MHz  
 $S(1,1) = 0.145/-42.661$   
 IMPEDANCE = 60.623 - j12.201

m24  
 FREQUENCY = 1GHz  
 $S(1,1) = 0.164/-84.046$   
 IMPEDANCE = 49.000 + j16.447

m25  
 FREQUENCY = 2GHz  
 $S(1,1) = 0.247/-155.186$   
 IMPEDANCE = 31.131 - j6.860

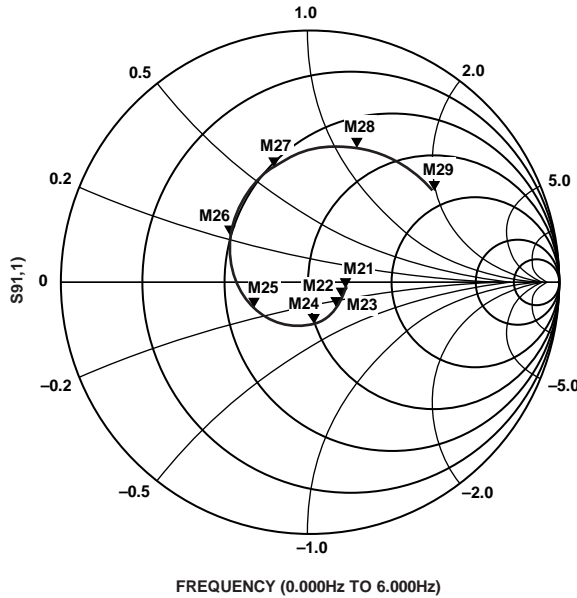

m26  
 FREQUENCY = 3GHz  
 $S(1,1) = 0.368/150.626$   
 IMPEDANCE = 24.355 + j10.153

m27  
 FREQUENCY = 4GHz  
 $S(1,1) = 0.484/107.379$   
 IMPEDANCE = 25.118 + j30.329

m28  
 FREQUENCY = 5GHz  
 $S(1,1) = 0.569/70.352$   
 IMPEDANCE = 35.932 + j56.936

m29  
 FREQUENCY = 6GHz  
 $S(1,1) = 0.614/36.074$   
 IMPEDANCE = 81.032 + j94.014

Figure 285. Transmitter 1 and Transmitter 2 SEDZ and Parallel Equivalent Differential Impedance (PEDZ) Data

m15  
 FREQUENCY = 100MHz  
 $S(1,1) = 0.391/-1.848$   
 IMPEDANCE = 114.099 - j3.397

m16  
 FREQUENCY = 300MHz  
 $S(1,1) = 0.389/-5.601$   
 IMPEDANCE = 112.639 - j10.091

m17  
 FREQUENCY = 500MHz  
 $S(1,1) = 0.385/-9.396$   
 IMPEDANCE = 109.556 - j16.156

m18  
 FREQUENCY = 1GHz  
 $S(1,1) = 0.362/-19.087$   
 IMPEDANCE = 97.259 - j26.513

m19  
 FREQUENCY = 2GHz  
 $S(1,1) = 0.267/-39.928$   
 IMPEDANCE = 70.789 - j25.940

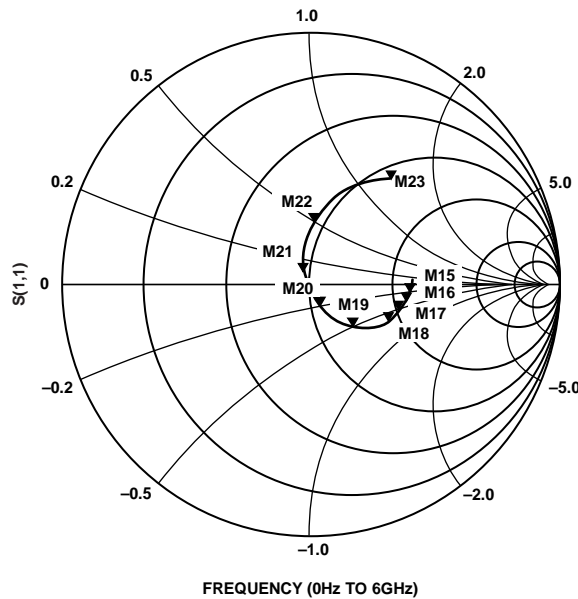

m20  
 FREQUENCY = 3GHz  
 $S(1,1) = 0.104/-66.720$   
 IMPEDANCE = 53.262 - j10.292

m21  
 FREQUENCY = 4GHz  
 $S(1,1) = 0.116/104.276$   
 IMPEDANCE = 46.060 + j10.522

m22  
 FREQUENCY = 5GHz  
 $S(1,1) = 0.342/75.761$   
 IMPEDANCE = 46.551 + j34.914

m23  
 FREQUENCY = 6GHz  
 $S(1,1) = 0.525/53.007$   
 IMPEDANCE = 56.249 + j65.146

Figure 286. Observation Receiver 1 and Observation Receiver 2 SEDZ and PEDZ Data

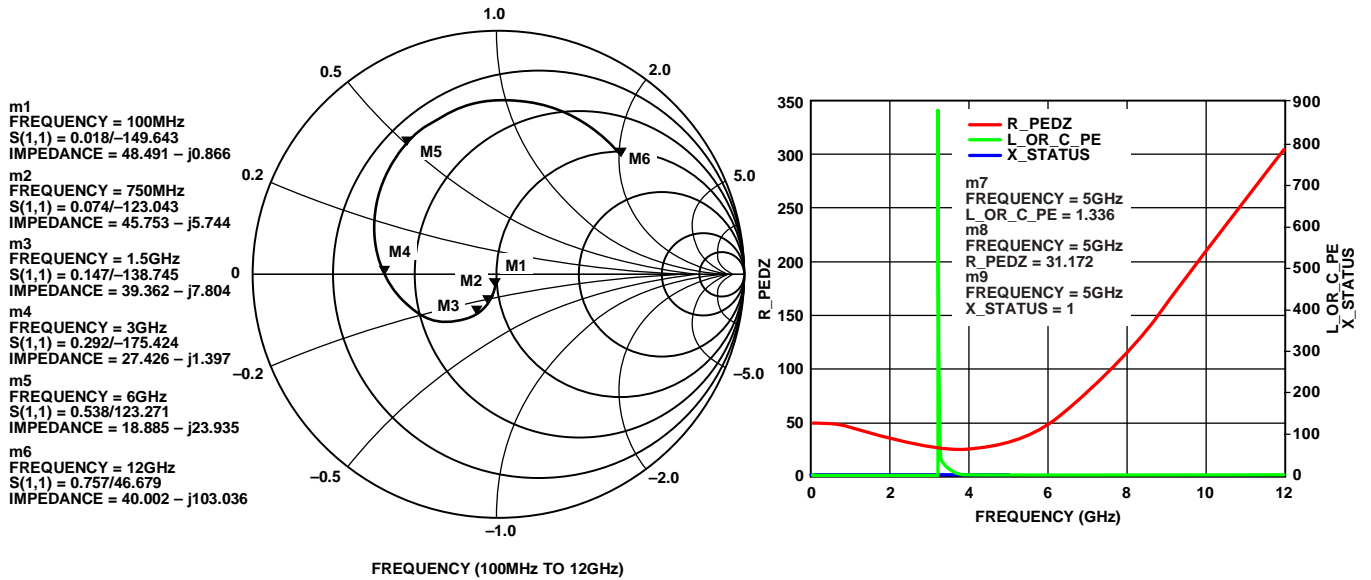

Figure 287. RF\_EXT\_LO\_I/O± SEDZ and PEDZ Data

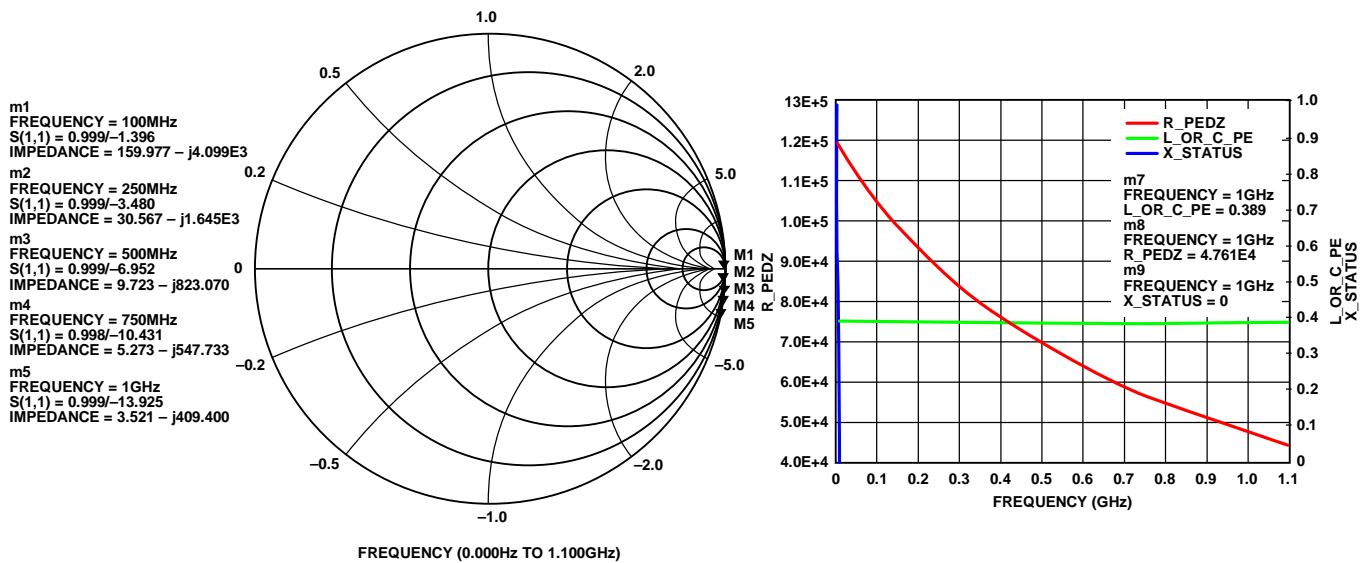

Figure 288. REF\_CLK\_IN± SEDZ and PEDZ Data, On Average, the Real Part of the Parallel Equivalent Differential Impedance (R<sub>P</sub>) = ~ 70 kΩ

**Advanced Design System (ADS) Setup Using the DataAccessComponent and SEDZ File**

Analog Devices supplies the port impedance as an **.s1p** file that can be downloaded from the ADRV9008-2 product page. This format allows simple interfacing to the ADS by using the DataAccessComponent. In Figure 289, Term 1 is the single-ended input or output, and Term 2 is the differential input or output RF port on the device. The pi on the single-ended side and the differential pi configuration on the differential side allow maximum flexibility in designing matching circuits. The pi configuration is suggested for all design layouts because the pi configuration can step the impedance up or down as needed with appropriate component population.

The mechanics of setting up a simulation for impedance measurement and impedance matching is as follows:

1. The DataAccessComponent block reads the RF port **.s1p** file. This file is the device RF port reflection coefficient.
2. The two equations convert the RF port reflection coefficient to a complex impedance. The result is the RX\_SEDZ variable.
3. The RF port calculated complex impedance (RX\_SEDZ) is used to define the Term 2 impedance.
4. Term 2 is used in a differential mode, and Term 1 is used in a single-ended mode.
5. Setting up the simulation this way allows one to measure the input reflection (S11), output reflection (S22), and through reflection (S21) of the three-port system without complex math operations within the display page.

For the highest accuracy, electromagnetic momentum (EM) modelling result of the PCB artwork, S11, S22, and S21 of the matching components and balun must be used in the simulations.

**Transmitter Bias and Port Interface**

This section considers the dc biasing of the ADRV9008-2 transmitter outputs and how to interface to each transmitter port. The ADRV9008-2 transmitters operate over a range of frequencies. At full output power, each differential output side draws approximately 100 mA of dc bias current. The transmitter outputs are dc biased to a 1.8 V supply voltage using either RF chokes (wire wound inductors) or a transformer center tap connection.

Careful design of the dc bias network is required to ensure optimal RF performance levels. When designing the dc bias network, select components with low dc resistance to minimize the voltage drop across the series parasitic resistance element with either of the suggested dc bias schemes suggested in Figure 290. The R<sub>DCR</sub> resistors indicate the parasitic elements. As the impedance of the parasitics increases, the voltage drop ( $\Delta V$ ) across the parasitic element increases, which causes the transmitter RF performance (P<sub>O,1dB</sub>, P<sub>O,MAX</sub>, and so on) to degrade. The choke inductance (L<sub>C</sub>) must be at least 3× times higher than the load impedance at the lowest desired frequency so that it does not degrade the output power (see Table 10).

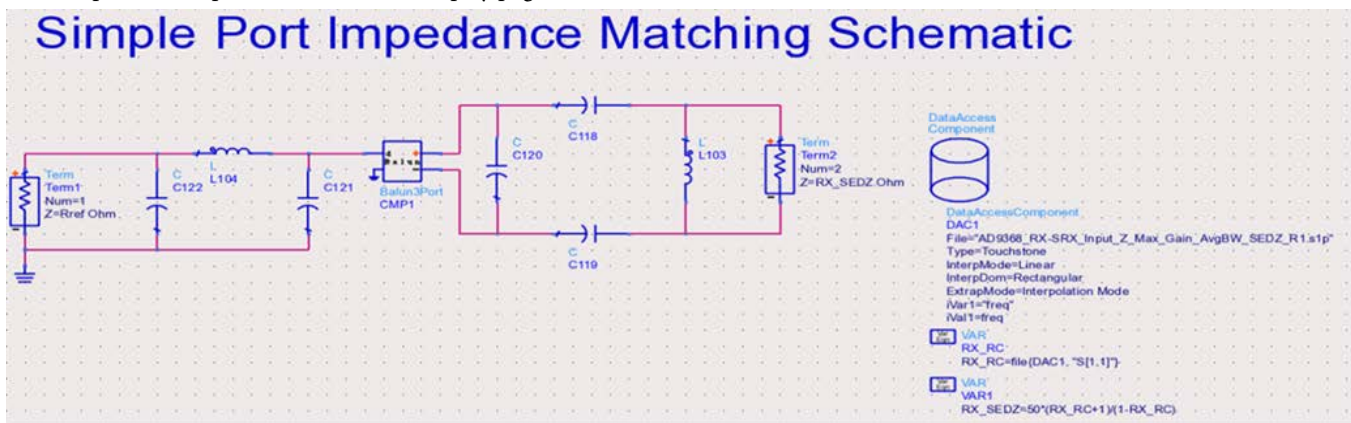

Figure 289. Simulation Setup in ADS with SEDZ .s1p Files and DataAccessComponent

**Table 10. Sample Wire Wound DC Bias Choke Resistance vs. Size vs. Inductance**

Inductance (nH)	Resistance (Size: 0603) (Ω)	Resistance (Size: 1206) (Ω)
100	0.10	0.08
200	0.15	0.10
300	0.16	0.12
400	0.28	0.14
500	0.45	0.15
600	0.52	0.20



The recommended dc bias network is shown in Figure 291. This network has fewer parasitics and fewer total components.

Figure 292 through Figure 295 identify four basic differential transmitter output configurations. Except in cases in which impedance is already matched, impedance matching networks (balun single-ended port) are required to achieve optimum device performance. In applications in which the transmitter is not connected to another circuit that requires or can tolerate dc bias on the transmitter outputs, the transmitter outputs must be ac-coupled because of the dc bias voltage applied to the differential output lines of the transmitter.

The recommended RF transmitter interface is shown in Figure 290 to Figure 295, featuring a center tapped balun. This configuration offers the lowest component count of the options presented.

Descriptions of the transmitter port interface schemes are as follows:

- In Figure 292, the center tapped transformer passes the bias voltage directly to the transmitter outputs.
- In Figure 293, RF chokes bias the differential transmitter output lines. Additional coupling capacitors ( $C_C$ ) are added in the creation of a transmission line balun.
- In Figure 294, RF chokes are used to bias the differential transmitter output lines and connect to a transformer.
- In Figure 295, RF chokes bias the differential output lines that are ac-coupled to the input of a driver amplifier.

If a transmitter balun that requires a set of external dc bias chokes is selected, careful planning is required. It is necessary to find the optimum compromise between the choke physical size, choke dc resistance, and the balun low frequency insertion loss. In commercially available dc bias chokes, resistance decreases as size increases. As choke inductance increases, resistance increases. It is undesirable to use physically small chokes with high inductance because small chokes exhibit the greatest resistance. For example, the voltage drop of a 500 nH, 0603 choke at 100 mA is roughly 50 mV.

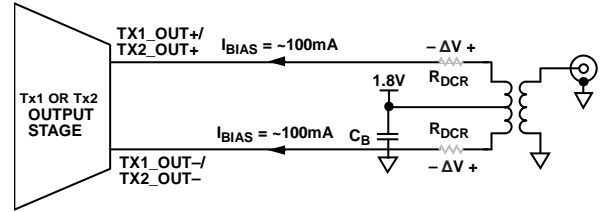

Figure 291. RF DC Bias Configurations Showing Parasitic Losses Due to Center Tapped Transformers

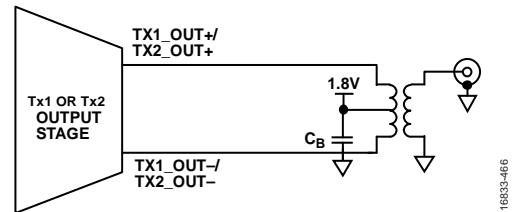

Figure 292. RF Transmitter Interface Configurations

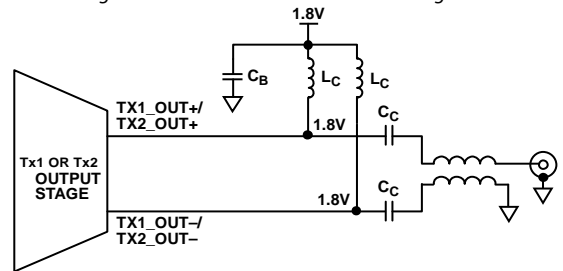

Figure 293. RF Transmitter Interface Configurations

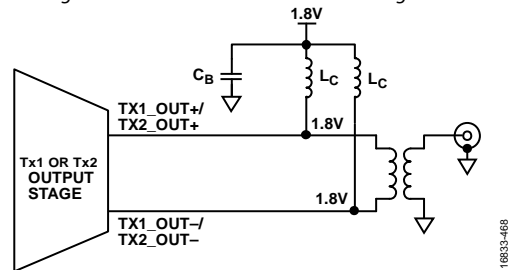

Figure 294. RF Transmitter Interface Configurations

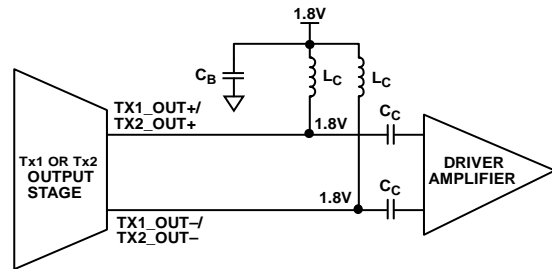

Figure 295. RF Transmitter Interface Configurations

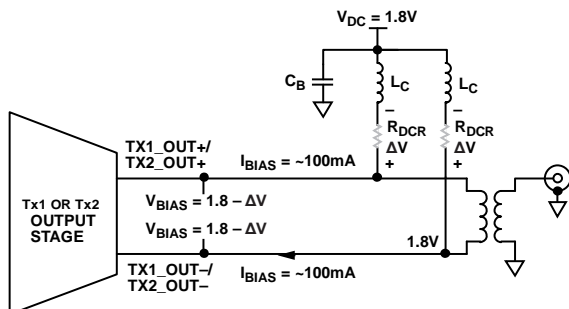

Figure 290. RF DC Bias Configurations Showing Parasitic Losses Due to Wire Wound Chokes

**General Observation Receiver Path Interface**

The ADRV9008-2 has two observation, or DPD, receivers (Observation Receiver 1 and Observation Receiver 2). The observation receivers can support up to 450 MHz bandwidth. The observation receiver channels are designed for differential use.

The ADRV9008-2 differential signals of the observation receivers interface to an integrated mixer. The mixer input pins have a dc bias of approximately 0.7 V and may need to be ac-coupled, depending on the common-mode voltage level of the external circuit.

Important considerations for the observation receiver port interface are as follows:

- The device to be interfaced (filter, balun, transmit/receive (T/R) switch, external low noise amplifier (LNA), external PA, and so on).
- The observation receiver maximum safe input power is 23 dBm (peak).
- The observation receiver optimum dc bias voltage is 0.7 V bias to ground.
- The board design (reference planes, transmission lines, impedance matching, and so on).

Figure 296 and Figure 297 show possible differential observation receiver port interface circuits. The options in Figure 296 and Figure 297 are valid for all observation receiver inputs operating in differential mode, although only the Observation Receiver 1 signal names are indicated. Impedance matching may be necessary to obtain the performance levels.

Given wide RF bandwidth applications, SMD balun devices function well. Decent loss and differential balance are available in a relatively small (0603, 0805) package.

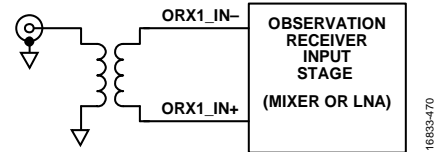

Figure 296. Differential Observation Receiver Interface Using a Transformer

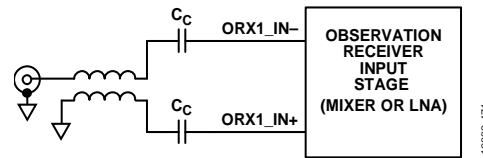

Figure 297. Differential Observation Receiver Interface Using a Transmission Line Balun

**Impedance Matching Network Example**

Impedance matching networks are required to achieve the ADRV9008-2 data sheet performance levels. This section provides a description of matching network topologies and components used on the [ADRV9008-2W/PCBZ](#).

Device models, board models, and balun and SMD component models are required to build an accurate system level simulation. The board layout model can be obtained from an EM simulator. The balun and SMD component models can be obtained from the device vendors or built locally. Contact Analog Devices applications engineering for ADRV9008-2 modeling details.

The impedance matching network provided in this section is not evaluated in terms of mean time to failure (MTTF) in high volume production. Consult with component vendors for long-term reliability concerns. Consult with balun vendors to determine appropriate conditions for dc biasing.

Figure 299 and Figure 300 show that in a generic port impedance matching network, the shunt or series elements may be a resistor, inductor, or capacitor.

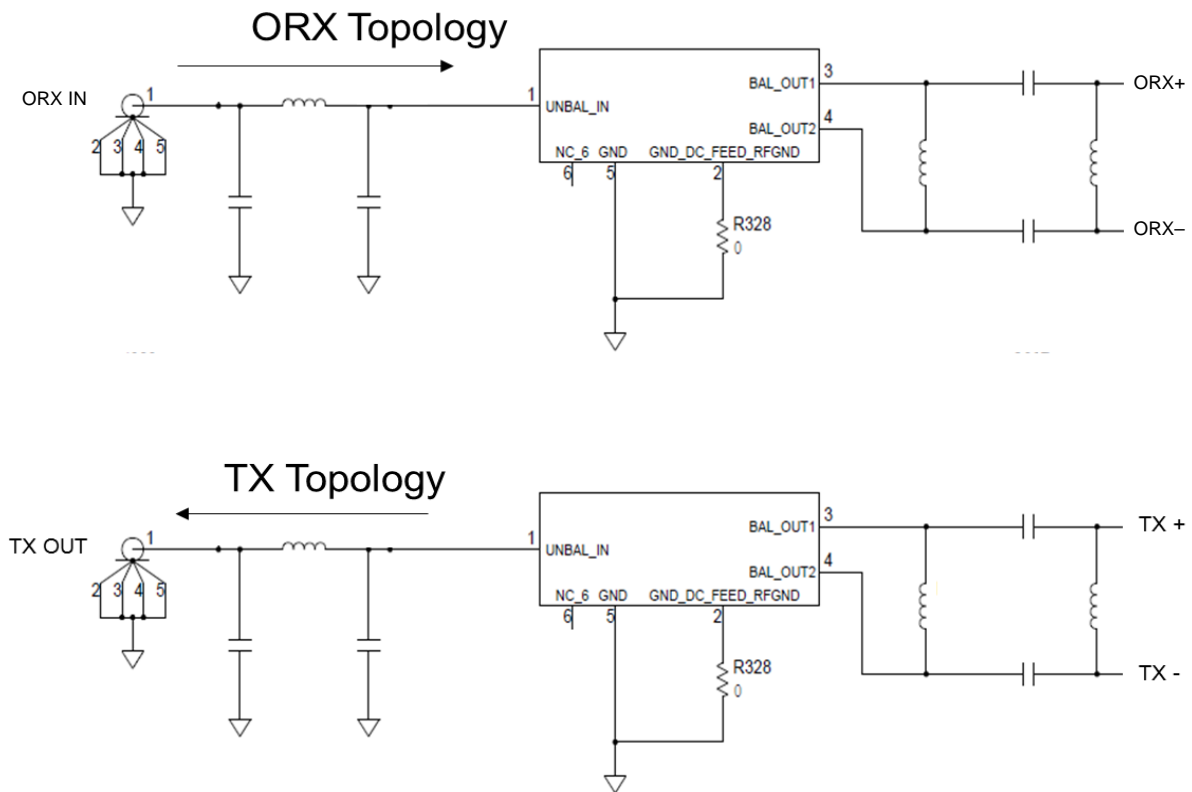
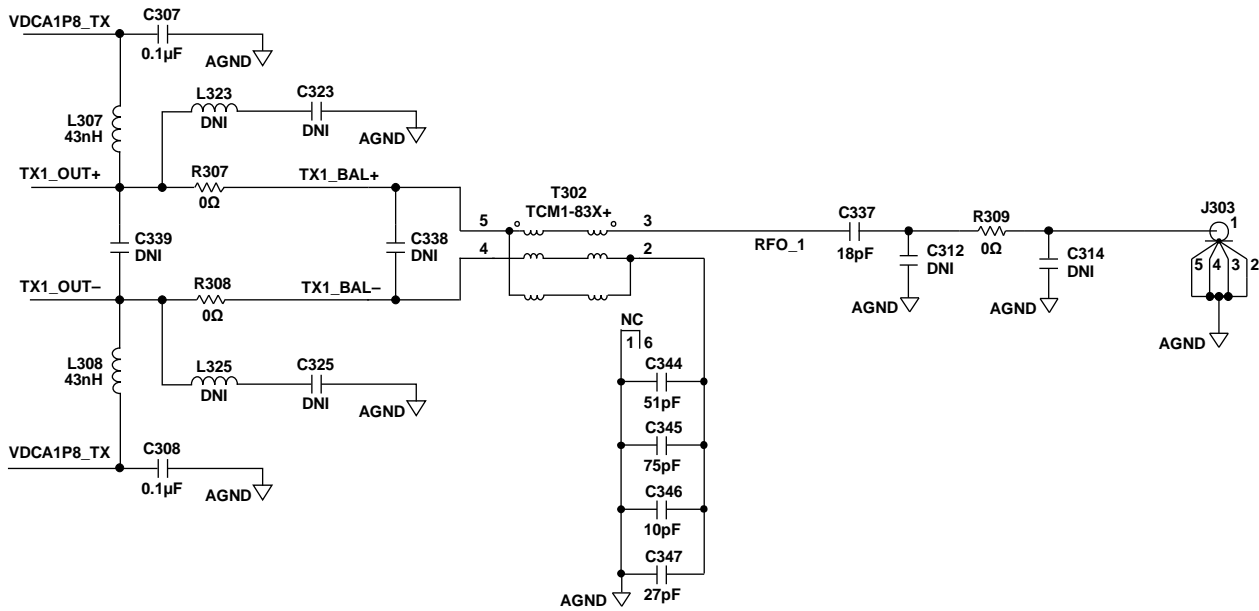

Figure 298. Impedance Matching Topology

16833-472

RF OUTPUT 1



RF OUTPUT 2

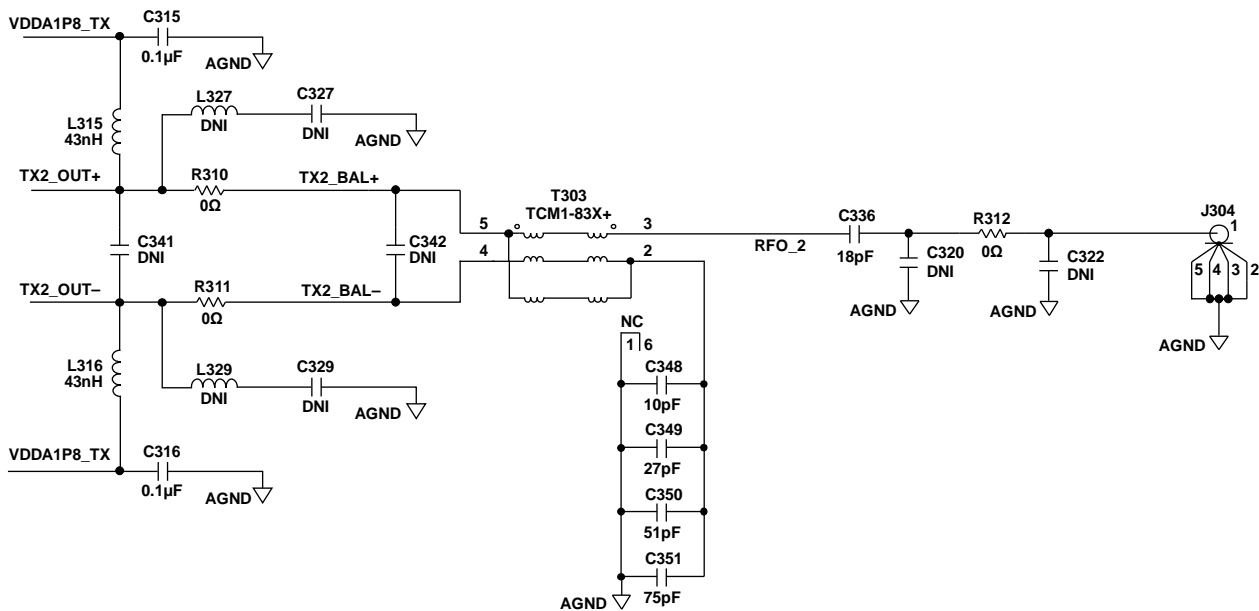

Figure 299. Transmitter 1 and Transmitter 2 Generic Matching Network Topology

16833-401

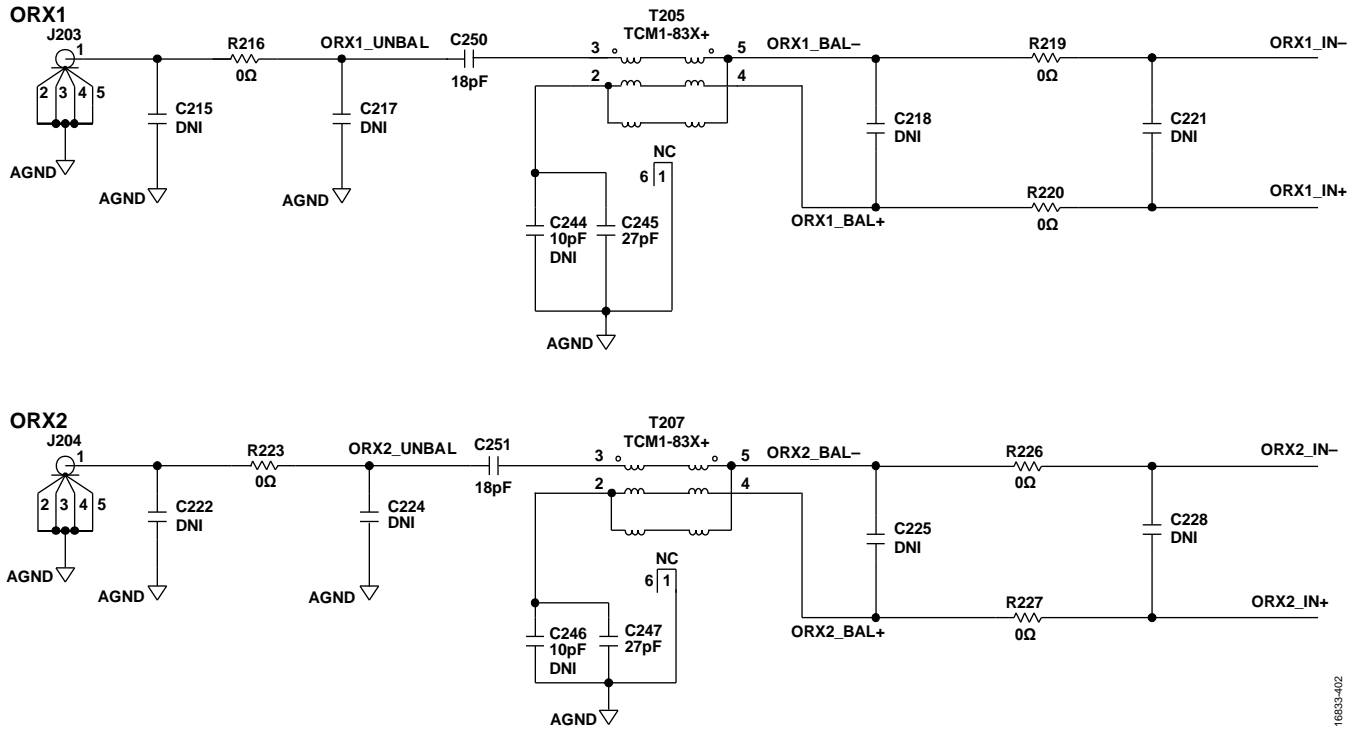

Figure 300. Observation Receiver 1 and Observation Receiver 2 Generic Matching Network Topology

16833-402

Table 11 and Table 12 show the selected balun and component values used for the matching network sets. Refer to the ADRV9008-2 schematics for a wideband matching example that operates across the entire device frequency range with somewhat reduced performance.

The RF matching used in the [ADRV9008-2W/PCBZ](#) allows the ADRV9008-2 to operate across the entire chip frequency range with slightly reduced performance.

**Table 11. Observation Receiver 1 and Observation Receiver 2 Evaluation Board Matching Components for Frequency Band 75 MHz to 6000 MHz**

Component	Value
C215, C22	Do not install (DNI)
R216, R223	0 Ω
C217, C224	DNI
C250, C251	18 pF
C218, C225	DNI
R219/R220, R226/R227	0 Ω
C221, C228	DNI
T205, T207	Mini circuits TCM1-83X+

**Table 12. Transmitter 1 and Transmitter 2 Evaluation Board Matching Components<sup>1</sup> for Frequency Band 75 MHz to 6000 MHz**

Component	Value
C314, C322	DNI
R309, R312	0 Ω
C312, C320	DNI
C337, C336	18 pF
C338, C342	DNI
R307/R308, R310/R311	0 Ω
C339, C341	DNI
T302, T303	Mini circuits TCM1-83X+

<sup>1</sup> These matches provide VDDA1P8\_TX to the TXx\_OUT± pins through the balun.

# OUTLINE DIMENSIONS

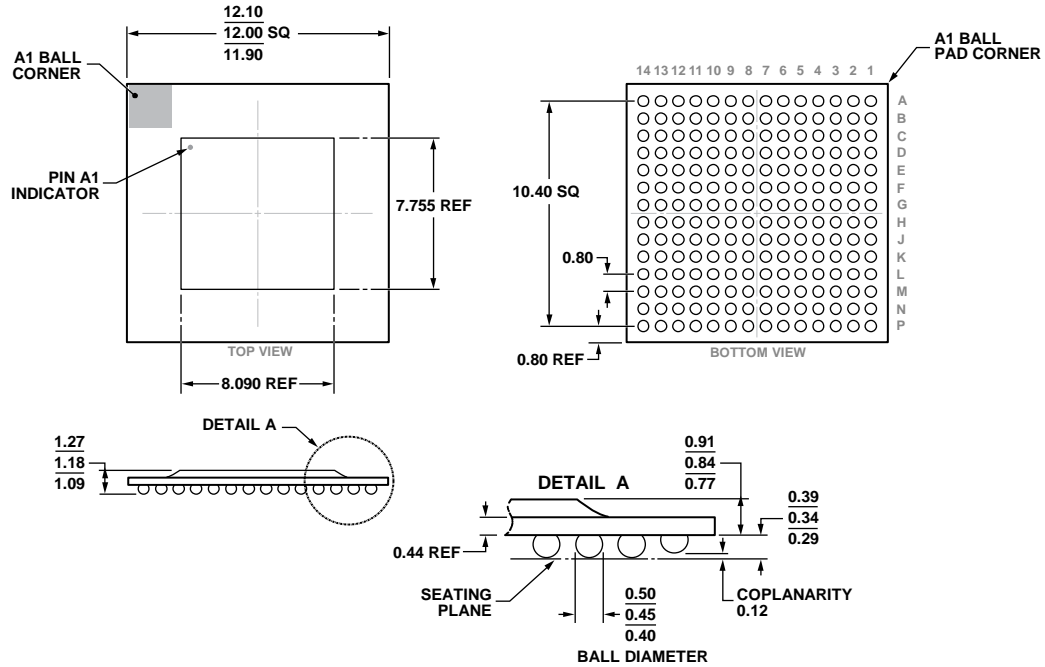

COMPLIANT TO JEDEC STANDARDS MO-275-GGAB-1.

Figure 301. 196-Ball Chip Scale Package Ball Grid Array [CSP\_BGA] (BC-196-13)  
Dimensions shown in millimeters

## ORDERING GUIDE

Model <sup>1</sup>	Temperature Range <sup>2</sup>	Package Description	Package Option
ADRV9008BBCZ-2	-40°C to +85°C	196-Ball Chip Scale Package Ball Grid Array [CSP_BGA]	BC-196-13
ADRV9008BBCZ-2REEL	-40°C to +85°C	196-Ball Chip Scale Package Ball Grid Array [CSP_BGA]	BC-196-13
ADRV9008-2W/PCBZ		Pb-Free Evaluation Board, 75 MHz to 6000 MHz	

<sup>1</sup> Z = RoHS Compliant Part.  
<sup>2</sup> See the Thermal Management section.