

Σ -7-Series AC Servo Drive Digital Operator Operating Manual

Model: JUSP-OP05A-1-E

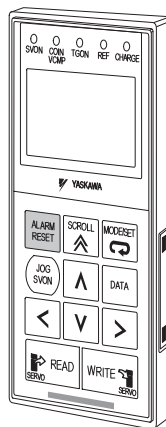

Introduction **1**

Parameter/Monitor Functions **2**

Utility Functions **3**

Parameter Copy Functions **4**

Copyright © 2014 YASKAWA ELECTRIC CORPORATION

All rights reserved. No part of this publication may be reproduced, stored in a retrieval system, or transmitted, in any form, or by any means, mechanical, electronic, photocopying, recording, or otherwise, without the prior written permission of Yaskawa. No patent liability is assumed with respect to the use of the information contained herein. Moreover, because Yaskawa is constantly striving to improve its high-quality products, the information contained in this manual is subject to change without notice. Every precaution has been taken in the preparation of this manual. Nevertheless, Yaskawa assumes no responsibility for errors or omissions. Neither is any liability assumed for damages resulting from the use of the information contained in this publication.

About this Manual

This manual describes the connection methods and provides the operating procedures for a Digital Operator for a Σ -7-Series Servo System.

Read and understand this manual to ensure correct usage of the Σ -7-Series AC Servo Drives.

Keep this manual in a safe place so that it can be referred to whenever necessary.

Outline of Manual

The contents of the chapters of this manual are described in the following table.

Refer to these chapters as required.

Chapter	Chapter Title	Contents
1	Introduction	Describes the names of Digital Operator parts, how to change between functions, and the status indications.
2	Parameter/Monitor Functions	Describes operating procedures for the parameter/monitor functions.
3	Utility Functions	Provides an outline of the utility functions and describes the operating procedures for them.
4	Parameter Copy Functions	Describes operating procedures for the parameter copy functions.

Related Documents

The relationships between the documents that are related to the Servo Drives are shown in the following figure. The numbers in the figure correspond to the numbers in the table on the following pages. Refer to these documents as required.

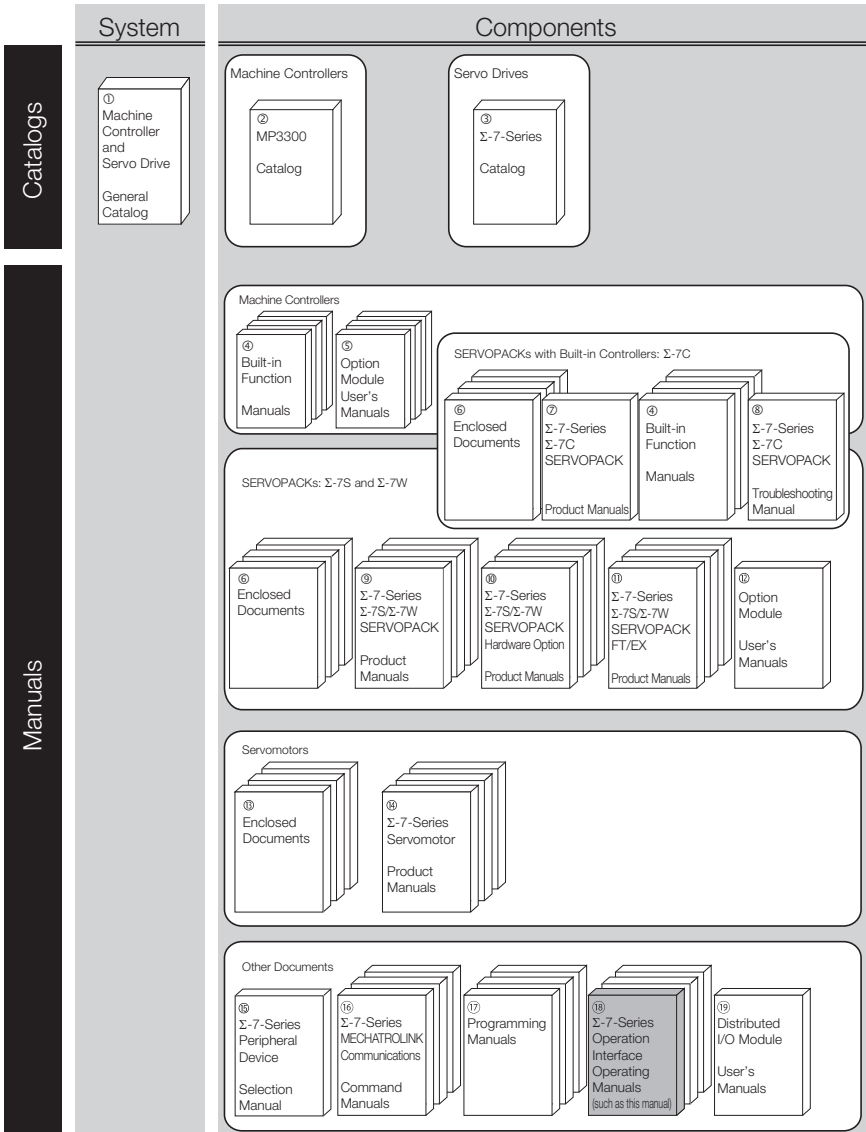

Classification	Document Name	Document No.	Description
① Machine Controller and Servo Drive General Catalog	Machine Controller and AC Servo Drive Solutions Catalog	KAEP S800001 22	Describes the features and application examples for combinations of MP3000-Series Machine Controllers and Σ -7-Series AC Servo Drives.
② MP3300 Catalog	Machine Controller MP3300	KAEP C880725 03	Provides detailed information on MP3300 Machine Controllers, including features and specifications.
③ Σ -7-Series Catalog	AC Servo Drives Σ -7 Series	KAEP S800001 23	Provides detailed information on Σ -7-Series AC Servo Drives, including features and specifications.
④ Built-in Function Manuals	Σ -7-Series AC Servo Drive Σ -7C SERVOPACK Motion Control User's Manual	SIEP S800002 03	Provides detailed information on the specifications, system configuration, and application methods of the Motion Control Function Modules (SVD, SVC4, and SVR4) for Σ -7-Series Σ -7C SERVOPACKs.
	Machine Controller MP3000 Series Communications User's Manual	SIEP C880725 12	Provides detailed information on the specifications, system configuration, and communications connection methods for the Ethernet communications that are used with MP3000-Series Machine Controllers and Σ -7-Series Σ -7C SERVOPACKs.

Continued on next page.

Continued from previous page.

Classification	Document Name	Document No.	Description
⑤ Option Module User's Manuals	Machine Controller MP2000 Series Communication Module User's Manual	SIEP C880700 04	Provide detailed information on the specifications and communications methods for the Communications Modules that can be mounted to MP3000-Series Machine Controllers and Σ -7-Series Σ -7C SERVOPACKS.
	Machine Controller MP2000 Series 262IF-01 FL-net Communication Module User's Manual	SIEP C880700 36	
	Machine Controller MP2000 Series 263IF-01 EtherNet/IP Communication Module User's Manual	SIEP C880700 39	
	Machine Controller MP2000 Series I/O Module User's Manual	SIEP C880700 34	Provide detailed information on the specifications and communications methods for the I/O Modules that can be mounted to MP3000-Series Machine Controllers and Σ -7-Series Σ -7C SERVOPACKS.
	Machine Controller MP2000 Series Analog Input/Analog Output Module AI-01/AO-01 User's Manual	SIEP C880700 26	
	Machine Controller MP2000 Series Counter Module CNTR-01 User's Manual	SIEP C880700 27	

Continued on next page.

Continued from previous page.

Classification	Document Name	Document No.	Description
© Enclosed Documents	Σ-7-Series AC Servo Drive Σ-7S, Σ-7W, and Σ-7C SERVOPACK Safety Precautions	TOMP C710828 00	Provides detailed information for the safe usage of Σ-7-Series SERVOPACKs.
	Σ-V-Series/Σ-V-Series for Large-Capacity Models/ Σ-7-Series Safety Precautions Option Module	TOBP C720829 00	Provides detailed information for the safe usage of Option Modules.
	Σ-V-Series/Σ-V-Series for Large-Capacity Models/ Σ-7-Series Installation Guide Command Option Module	TOBP C720829 01	Provides detailed procedures for installing the Command Option Module in a SERVO-PACK.
	Σ-V-Series/Σ-V-Series for Large-Capacity Models/ Σ-7-Series Installation Guide Fully-closed Module	TOBP C720829 03	Provides detailed procedures for installing the Fully-closed Module in a SERVO-PACK.
	Σ-V-Series/Σ-V-Series for Large-Capacity Models/ Σ-7-Series Installation Guide Safety Module	TOBP C720829 06	Provides detailed procedures for installing the Safety Module in a SERVO-PACK.
	Σ-V-Series/Σ-V-Series for Large-Capacity Models/ Σ-7-Series Installation Guide INDEXER Module	TOBP C720829 02	Provides detailed procedures for installing the INDEXER Module in a SERVO-PACK.
	Σ-V-Series/Σ-V-Series for Large-Capacity Models/ Σ-7-Series Installation Guide DeviceNet Module	TOBP C720829 07	Provides detailed procedures for installing the DeviceNet Module in a SERVO-PACK.

Continued on next page.

Continued from previous page.

Classification	Document Name	Document No.	Description
⑦ Σ-7-Series Σ-7C SERVOPACK Product Manual	Σ-7-Series AC Servo Drive Σ-7C SERVOPACK Product Manual	SIEP S800002 04	Provides detailed information on selecting Σ-7-Series Σ-7C SERVOPACKs; installing, connecting, setting, testing in trial operation, and tuning Servo Drives; writing, monitoring, and maintaining programs; and other information.
⑧ Σ-7-Series Σ-7C SERVOPACK Troubleshooting Manual	Σ-7-Series AC Servo Drive Σ-7C SERVOPACK Troubleshooting Manual	SIEP S800002 07	Provides detailed troubleshooting information for Σ-7-Series Σ-7C SERVOPACKs.

Continued on next page.

Continued from previous page.

Classification	Document Name	Document No.	Description
© Σ-7-Series Σ-7S/Σ-7W SERVOPACK Product Manuals	Σ-7-Series AC Servo Drive Σ-7S SERVOPACK with MECHATROLINK-4 Communications References Product Manual	SIEP S800002 31	Provide detailed information on selecting Σ-7-Series Σ-7S or Σ-7W SERVOPACKs and information on installing, connecting, setting, performing trial operation for, tuning, monitoring, and maintaining the Servo Drives.
	Σ-7-Series AC Servo Drive Σ-7S SERVOPACK with MECHATROLINK-III Communications References Product Manual	SIEP S800001 28	
	Σ-7-Series AC Servo Drive Σ-7S SERVOPACK with MECHATROLINK-II Communications References Product Manual	SIEP S800001 27	
	Σ-7-Series AC Servo Drive Σ-7S SERVOPACK with Analog Voltage/ Pulse Train References Product Manual	SIEP S800001 26	

Continued on next page.

Continued from previous page.

Classification	Document Name	Document No.	Description
⑨ Σ-7-Series Σ-7S/Σ-7W SERVOPACK Product Manuals	Σ-7-Series AC Servo Drive Σ-7S SERVOPACK Command Option Attachable Type with INDEXER Module Product Manual	SIEP S800001 64	Provide detailed information on selecting Σ-7-Series Σ-7S or Σ-7W SERVOPACKs and information on installing, connecting, setting, performing trial operation for, tuning, monitoring, and maintaining the Servo Drives.
	Σ-7-Series AC Servo Drive Σ-7S SERVOPACK Command Option Attachable Type with DeviceNet Module Product Manual	SIEP S800001 70	
	Σ-7-Series AC Servo Drive Σ-7W SERVOPACK with MECHATROLINK-III Communications References Product Manual	SIEP S800001 29	
⑩ Σ-7-Series Σ-7S/Σ-7W SERVOPACK with Hardware Option Specifications Product Manuals	Σ-7-Series AC Servo Drive Σ-7S/Σ-7W SERVOPACK with Hardware Option Specifications Dynamic Brake Product Manual	SIEP S800001 73	Provide detailed information on Hardware Options for Σ-7-Series SERVOPACKs.
	Σ-7-Series AC Servo Drive Σ-7W/Σ-7C SERVOPACK with Hardware Option Specifications HWBB Function Product Manual	SIEP S800001 72	

Continued on next page.

Continued from previous page.

Classification	Document Name	Document No.	Description
⑩ Σ-7-Series Σ-7S/Σ-7W SERVOPACK FT/EX Product Manuals	Σ-7-Series AC Servo Drive Σ-7S SERVOPACK with FT/EX Specification for Indexing Application Product Manual	SIEP S800001 84	Provide detailed information on the FT/EX Option for Σ-7-Series SERVOPACKs.
	Σ-7-Series AC Servo Drive Σ-7S SERVOPACK with FT/EX Specification for Tracking Application Product Manual	SIEP S800001 89	
	Σ-7-Series AC Servo Drive Σ-7S SERVOPACK with FT/EX Specification for Application with Special Motor, SGM7D Motor Product Manual	SIEP S800001 91	
	Σ-7-Series AC Servo Drive Σ-7S SERVOPACK with FT/EX Specification for Press and Injection Molding Product Manual	SIEP S800001 94	
	Σ-7-Series AC Servo Drive Σ-7S SERVOPACK with FT/EX Specification for Transfer and Alignment Application Product Manual	SIEP S800001 95	

Continued on next page.

Continued from previous page.

Classification	Document Name	Document No.	Description
⑩ Σ-7-Series Σ-7S/Σ-7W SERVOPACK FT/EX Product Manuals	Σ-7-Series AC Servo Drive Σ-7S SERVOPACK with FT/EX Specification for Torque/Force Assistance for Conveyance Application Product Manual	SIEP S800002 09	Provide detailed information on the FT/EX Option for Σ-7-Series SERVOPACKS.
	Σ-7-Series AC Servo Drive Σ-7S SERVOPACK with FT/EX Specification for Cutting Application Feed Shaft Motor Product Manual	SIEP S800002 10	
⑪ Option Module User's Manual	AC Servo Drives Σ-V Series/Σ-V Series for Large-Capacity Models/ Σ-7 Series User's Manual Safety Module	SIEP C720829 06	Provides detailed information required for the design and maintenance of a Safety Module.
⑫ Enclosed Documents	AC Servo Drive Rotary Servomotor Safety Precautions	TOBP C230260 00	Provides detailed information for the safe usage of Rotary Servomotors and Direct Drive Servomotors.
	AC Servomotor Linear Σ Series Safety Precautions	TOBP C230800 00	Provides detailed information for the safe usage of Linear Servomotors.

Continued on next page.

Continued from previous page.

Classification	Document Name	Document No.	Description
⑭ Σ-7-Series Servomotor Product Manuals	Σ-7-Series AC Servo Drive Rotary Servomotor Product Manual	SIEP S800001 36	Provide detailed information on selecting, installing, and connecting the Σ-7-Series Servomotors.
	Σ-7-Series AC Servo Drive Linear Servomotor Product Manual	SIEP S800001 37	
	Σ-7-Series AC Servo Drive Direct Drive Servomotor Product Manual	SIEP S800001 38	
⑮ Σ-7-Series Peripheral Device Selection Manual	Σ-7-Series AC Servo Drive Peripheral Device Selection Manual	SIEP S800001 32	Provides the following information in detail for Σ-7-Series Servo Systems. <ul style="list-style-type: none"> • Cables: Models, dimensions, wire materials, connector models, and connection specifications • Peripheral devices: Model, specifications, diagrams, and selection (calculation) methods

Continued on next page.

Continued from previous page.

Classification	Document Name	Document No.	Description
⑥ Σ-7-Series MECHATROLINK Communications Command Manuals	Σ-7-Series AC Servo Drive MECHATROLINK-II Communications Command Manual	SIEP S800001 30	Provides detailed information on the MECHATROLINK-II communications commands that are used for a Σ-7-Series Servo System.
	Σ-7-Series AC Servo Drive MECHATROLINK-III Communications Standard Servo Profile Command Manual	SIEP S800001 31	Provides detailed information on the MECHATROLINK-III communications standard servo profile commands that are used for a Σ-7-Series Servo System.
	Σ-7-Series AC Servo Drive MECHATROLINK-4 Communications Standard Servo Profile Command Manual	SIEP S800002 32	Provides detailed information on the MECHATROLINK-4 communications standard servo profile commands that are used for a Σ-7-Series Servo System.
⑦ Programming Manuals	Machine Controller MP3000 Series Ladder Programming Manual	SIEP C880725 13	Provides detailed information on the ladder programming specifications and instructions for MP3000-Series Machine Controllers and Σ-7-Series Σ-7C SERVOPACKs.
	Machine Controller MP3000 Series Motion Programming Manual	SIEP C880725 14	Provides detailed information on the motion programming and sequence programming specifications and instructions for MP3000-Series Machine Controllers and Σ-7-Series Σ-7C SERVOPACKs.

Continued on next page.

Continued from previous page.

Classification	Document Name	Document No.	Description
[®] Σ-7-Series Operation Interface Operating Manuals	Machine Controller MP2000/MP3000 Series Engineering Tool MPE720 Version 7 User's Manual	SIEP C880761 03	Describes in detail how to operate MPE720 version 7.
	Σ-7-Series AC Servo Drive Digital Operator Operating Manual	This manual (SIEP S800001 33)	Describes the operating procedures for a Digital Operator for a Σ-7-Series Servo System.
	AC Servo Drive Engineering Tool SigmaWin+ Operation Manual	SIET S800001 34	Provides detailed operating procedures for the SigmaWin+ Engineering Tool for a Σ-7-Series Servo System.
[®] Distributed I/O Module User's Manual	MECHATROLINK-III Compatible I/O Module User's Manual	SIEP C880781 04	Describes the functions, specifications, operating methods, and MECHATROLINK-III communications for the Remote I/O Modules for MP2000/MP3000-Series Machine Controllers.
	MECHATROLINK-4 Compatible I/O Module User's Manual	SIEP C880782 01	Describes the functions, specifications, operating methods, and MECHATROLINK-4 communications for the Remote I/O Modules for MP3000-Series Machine Controllers.

Using This Manual

◆ Technical Terms Used in This Manual

The following terms are used in this manual.

Term	Meaning
Servomotor	A Σ -7-Series Rotary Servomotor, Direct Drive Servomotor, or Linear Servomotor.
Rotary Servomotor	A generic term used for a Σ -7-Series Rotary Servomotor (SGM7M, SGM7J, SGM7A, SGM7P, SGM7G, or SGM7E) or a Direct Drive Servomotor (SGM7D, SGM7E, SGM7F, SGM7G, SGM7H, or SGM7I). The descriptions will specify when Direct Drive Servomotors are excluded.
Linear Servomotor	A Σ -7-Series Linear Servomotor (SGLG, SGLF, or SGLT).
SERVOPACK	A Σ -7-Series Servo Amplifier.
Servo Drive	The combination of a Servomotor and SERVOPACK.
Servo System	A servo control system that includes the combination of a Servo Drive with a host controller and peripheral devices.
servo ON	Supplying power to the motor.
servo OFF	Not supplying power to the motor.
base block (BB)	Shutting OFF the power supply to the motor by shutting OFF the base current to the power transistor in the SERVOPACK.
servo lock	A state in which the motor is stopped and is in a position loop with a position reference of 0.
Main Circuit Cable	One of the cables that connect to the main circuit terminals, including the Main Circuit Power Supply Cable, Control Power Supply Cable, and Servomotor Main Circuit Cable.
SigmaWin+	The Engineering Tool for setting up and tuning Servo Drives or a computer in which the Engineering Tool is installed.

◆ Differences in Terms for Rotary Servomotors and Linear Servomotors

There are differences in the terms that are used for Rotary Servomotors and Linear Servomotors. This manual primarily describes Rotary Servomotors. If you are using a Linear Servomotor, you need to interpret the terms as given in the following table.

Rotary Servomotors	Linear Servomotors
torque	force
moment of inertia	mass
rotation	movement
forward rotation and reverse	forward movement and reverse movement
CW and CCW pulse trains	forward and reverse pulse trains
rotary encoder	linear encoder
absolute rotary encoder	absolute linear encoder
incremental rotary encoder	incremental linear encoder
unit: min^{-1}	unit: mm/s
unit: N·m	unit: N

◆ Notation Used in this Manual

■ Notation for Reverse Signals

The names of reverse signals (i.e., ones that are valid when low) are written with a forward slash (/) before the signal abbreviation.

Notation Example

$\overline{\text{BK}}$ is written as /BK.

■ Notation for Parameters

The notation depends on whether the parameter requires a numeric setting (parameter for numeric setting) or requires the selection of a function (parameter for selecting functions).

• Parameters for Numeric Settings

The control methods for which the parameters apply are given.
 [Speed]: Speed control [Position]: Position control [Torque]: Torque control

Pn100	Speed Loop Gain				
	Setting Range	Setting Unit	Default Setting	When Enabled	Classification
	10 to 20,000	0.1 Hz	400	Immediately	Tuning

Parameter number: Pn100

This is the setting range for the parameter.

This is the minimum unit (setting increment) that you can set for the parameter.

This is the parameter setting before shipment.

This is when any change made to the parameter will become effective.

This is the parameter classification.

• Parameters for Selecting Functions

Parameter	Meaning	When Enabled	Classification
Pn002	n.□0□□ (default setting)	After startup	Setup
	n.□1□□		
	n.□2□□		

Parameter number: Pn002

The notation "n.□□□□" indicates a parameter for selecting functions. Each □ indicates the setting for one digit. The notation shown here means that the third digit from the right is set to 2.

This column explains the selections for the function

Notation Example

Notation Examples for Pn002

Notation	Digit Notation		Numeric Value Notation	
	Notation	Meaning	Notation	Meaning
n.0000	Pn002 = n.□□□X	Indicates the first digit from the right in Pn002.	Pn002 = n.□□□1	Indicates that the first digit from the right in Pn002 is set to 1.
	Pn002 = n.□□X□	Indicates the second digit from the right in Pn002.	Pn002 = n.□□1□	Indicates that the second digit from the right in Pn002 is set to 1.
	Pn002 = n.□X□□	Indicates the third digit from the right in Pn002.	Pn002 = n.□1□□	Indicates that the third digit from the right in Pn002 is set to 1.
	Pn002 = n.X□□□	Indicates the fourth digit from the right in Pn002.	Pn002 = n.1□□□	Indicates that the fourth digit from the right in Pn002 is set to 1.

◆ Trademarks

- MECHATROLINK is a trademark of the MECHATROLINK Members Association.
- Other product names and company names are the trademarks or registered trademarks of the respective company. “TM” and the ® mark do not appear with product or company names in this manual.

◆ Visual Aids

The following aids are used to indicate certain types of information for easier reference.



Indicates precautions or restrictions that must be observed.
Also indicates alarm displays and other precautions that will not result in machine damage.



Indicates definitions of difficult terms or terms that have not been previously explained in this manual.

Example Indicates operating or setting examples.

Information Indicates supplemental information to deepen understanding or useful information.

Safety Precautions

◆ Safety Information

To prevent personal injury and equipment damage in advance, the following signal words are used to indicate safety precautions in this document. The signal words are used to classify the hazards and the degree of damage or injury that may occur if a product is used incorrectly. Information marked as shown below is important for safety. Always read this information and heed the precautions that are provided.



DANGER

- Indicates precautions that, if not heeded, are likely to result in loss of life, serious injury, or fire.



WARNING

- Indicates precautions that, if not heeded, could result in loss of life, serious injury, or fire.



CAUTION

- Indicates precautions that, if not heeded, could result in relatively serious or minor injury, or in fire.

NOTICE

- Indicates precautions that, if not heeded, could result in property damage.

◆ Safety Precautions That Must Always Be Observed

■ General Precautions



DANGER

- Read and understand this manual to ensure the safe usage of the product.
- Keep this manual in a safe, convenient place so that it can be referred to whenever necessary. Make sure that it is delivered to the final user of the product.
- Do not remove covers, cables, connectors, or optional devices while power is being supplied to the SERVOPACK.
There is a risk of electric shock, operational failure of the product, or burning.



WARNING

- Use a power supply with specifications (number of phases, voltage, frequency, and AC/DC type) that are appropriate for the product.
There is a risk of burning, electric shock, or fire.
- Connect the ground terminals on the SERVOPACK and Servomotor to ground poles according to local electrical codes (100 Ω or less for a SERVOPACK with a 100-VAC or 200-VAC power supply, and 10 Ω or less for a SERVOPACK with a 400-VAC power supply).
There is a risk of electric shock or fire.
- Do not attempt to disassemble, repair, or modify the product.
There is a risk of fire or failure.
The warranty is void for the product if you disassemble, repair, or modify it.



CAUTION

- The SERVOPACK heat sinks, regenerative resistors, External Dynamic Brake Resistors, Servomotors, and other components can be very hot while power is ON or soon after the power is turned OFF. Implement safety measures, such as installing covers, so that hands and parts such as cables do not come into contact with hot components.
There is a risk of burn injury.
- For a 24-VDC power supply, use a power supply device with double insulation or reinforced insulation.
There is a risk of electric shock.
- Do not damage, pull on, apply excessive force to, place heavy objects on, or pinch cables.
There is a risk of failure, damage, or electric shock.
- The person who designs the system that uses the hard wire base block safety function must have a complete knowledge of the related safety standards and a complete understanding of the instructions in this document.
There is a risk of injury, product damage, or machine damage.
- Do not use the product in an environment that is subject to water, corrosive gases, or flammable gases, or near flammable materials.
There is a risk of electric shock or fire.

NOTICE

- Do not attempt to use a SERVOPACK or Servomotor that is damaged or that has missing parts.
- Install external emergency stop circuits that shut OFF the power supply and stops operation immediately when an error occurs.
- In locations with poor power supply conditions, install the necessary protective devices (such as AC reactors) to ensure that the input power is supplied within the specified voltage range.
There is a risk of damage to the SERVOPACK.
- Use a Noise Filter to minimize the effects of electromagnetic interference.
Electronic devices used near the SERVOPACK may be affected by electromagnetic interference.
- Always use a Servomotor and SERVOPACK in one of the specified combinations.
- Do not touch a SERVOPACK or Servomotor with wet hands.
There is a risk of product failure.

■ Storage Precautions



CAUTION

- Do not place an excessive load on the product during storage. (Follow all instructions on the packages.)
There is a risk of injury or damage.

NOTICE

- Do not install or store the product in any of the following locations.
 - Locations that are subject to direct sunlight
 - Locations that are subject to ambient temperatures that exceed product specifications
 - Locations that are subject to relative humidities that exceed product specifications
 - Locations that are subject to condensation as the result of extreme changes in temperature
 - Locations that are subject to corrosive or flammable gases
 - Locations that are near flammable materials
 - Locations that are subject to dust, salts, or iron powder
 - Locations that are subject to water, oil, or chemicals
 - Locations that are subject to vibration or shock that exceeds product specifications
 - Locations that are subject to radiation
- If you store or install the product in any of the above locations, the product may fail or be damaged.

■ Transportation Precautions



CAUTION

- Transport the product in a way that is suitable to the mass of the product.
- Do not use the eyebolts on a SERVOPACK or Servomotor to move the machine.
There is a risk of damage or injury.
- When you handle a SERVOPACK or Servomotor, be careful of sharp parts, such as the corners.
There is a risk of injury.
- Do not place an excessive load on the product during transportation. (Follow all instructions on the packages.)
There is a risk of injury or damage.

NOTICE

- Do not hold onto the front cover or connectors when you move a SERVOPACK.
There is a risk of the SERVOPACK falling.
- A SERVOPACK or Servomotor is a precision device. Do not drop it or subject it to strong shock.
There is a risk of failure or damage.
- Do not subject connectors to shock.
There is a risk of faulty connections or damage.
- If disinfectants or insecticides must be used to treat packing materials such as wooden frames, plywood, or pallets, the packing materials must be treated before the product is packaged, and methods other than fumigation must be used.
Example: Heat treatment, where materials are kiln-dried to a core temperature of 56°C for 30 minutes or more.

If the electronic products, which include stand-alone products and products installed in machines, are packed with fumigated wooden materials, the electrical components may be greatly damaged by the gases or fumes resulting from the fumigation process. In particular, disinfectants containing halogen, which includes chlorine, fluorine, bromine, or iodine can contribute to the erosion of the capacitors.
- Do not overtighten the eyebolts on a SERVOPACK or Servomotor.
If you use a tool to overtighten the eyebolts, the tapped holes may be damaged.

■ Installation Precautions



CAUTION

- Install the Servomotor or SERVOPACK in a way that will support the mass given in technical documents.
- Install SERVOPACKs, Servomotors, regenerative resistors, and External Dynamic Brake Resistors on nonflammable materials. Installation directly onto or near flammable materials may result in fire.
- Provide the specified clearances between the SERVOPACK and the control panel as well as with other devices.
There is a risk of fire or failure.
- Install the SERVOPACK in the specified orientation.
There is a risk of fire or failure.
- Do not step on or place a heavy object on the product.
There is a risk of failure, damage, or injury.
- Do not allow any foreign matter to enter the SERVOPACK or Servomotor.
There is a risk of failure or fire.

NOTICE

- **Do not install or store the product in any of the following locations.**
 - Locations that are subject to direct sunlight
 - Locations that are subject to ambient temperatures that exceed product specifications
 - Locations that are subject to relative humidities that exceed product specifications
 - Locations that are subject to condensation as the result of extreme changes in temperature
 - Locations that are subject to corrosive or flammable gases
 - Locations that are near flammable materials
 - Locations that are subject to dust, salts, or iron powder
 - Locations that are subject to water, oil, or chemicals
 - Locations that are subject to vibration or shock that exceeds product specifications
 - Locations that are subject to radiation

If you store or install the product in any of the above locations, the product may fail or be damaged.

- **Use the product in an environment that is appropriate for the product specifications.**

If you use the product in an environment that exceeds product specifications, the product may fail or be damaged.
- **A SERVOPACK or Servomotor is a precision device. Do not drop it or subject it to strong shock.**

There is a risk of failure or damage.
- **Always install a SERVOPACK in a control panel.**
- **Do not allow any foreign matter to enter a SERVOPACK or a Servomotor with a Cooling Fan and do not cover the outlet from the Servomotor's cooling fan.**

There is a risk of failure.

■ Wiring Precautions



DANGER

- Do not change any wiring while power is being supplied. There is a risk of electric shock or injury.



WARNING

- Wiring and inspections must be performed only by qualified engineers. There is a risk of electric shock or product failure.
- Check all wiring and power supplies carefully. Incorrect wiring or incorrect voltage application to the output circuits may cause short-circuit failures. If a short-circuit failure occurs as a result of any of these causes, the holding brake will not work. This could damage the machine or cause an accident that may result in death or injury.
- Connect the AC and DC power supplies to the specified SERVOPACK terminals.
 - Connect an AC power supply to the L1, L2, and L3 terminals and the L1C and L2C terminals on the SERVOPACK.
 - Connect a DC power supply to the B1/⊕ and ⊖ 2 terminals and the L1C and L2C terminals on the SERVOPACK. There is a risk of failure or fire.
- If you use a SERVOPACK with the Dynamic Brake Hardware Option, connect an External Dynamic Brake Resistor that is suitable for the machine and equipment specifications to the specified terminals. There is a risk of unexpected operation, machine damage, burning, or injury when an emergency stop is performed.



CAUTION

- Wait for at least six minutes after turning OFF the power supply (with a SERVOPACK for a 100-VAC power supply input, wait for at least nine minutes) and then make sure that the CHARGE indicator is not lit before starting wiring or inspection work. Do not touch the power supply terminals while the CHARGE lamp is lit after turning OFF the power supply because high voltage may still remain in the SERVOPACK.

There is a risk of electric shock.

- Observe the precautions and instructions for wiring and trial operation precisely as described in this document.
Failures caused by incorrect wiring or incorrect voltage application in the brake circuit may cause the SERVOPACK to fail, damage the equipment, or cause an accident resulting in death or injury.
- Check the wiring to be sure it has been performed correctly.
Connectors and pin layouts are sometimes different for different models. Always confirm the pin layouts in technical documents for your model before operation.

There is a risk of failure or malfunction.

- Connect wires to power supply terminals and motor connection terminals securely with the specified methods and tightening torque.
Insufficient tightening may cause wires and terminal blocks to generate heat due to faulty contact, possibly resulting in fire.
- Use shielded twisted-pair cables or screened unshielded multi-twisted-pair cables for I/O Signal Cables and Encoder Cables.
- The maximum wiring length is 3 m for I/O Signal Cables, and 50 m for Encoder Cables or Servomotor Main Circuit Cables.
- Observe the following precautions when wiring the SERVOPACK's main circuit terminals.
 - Turn ON the power supply to the SERVOPACK only after all wiring, including the main circuit terminals, has been completed.
 - If a connector is used for the main circuit terminals, remove the main circuit connector from the SERVOPACK before you wire it.
 - Insert only one wire per insertion hole in the main circuit terminals.
 - When you insert a wire, make sure that the conductor wire (e.g., whiskers) does not come into contact with adjacent wires.
- Install molded-case circuit breakers and other safety measures to provide protection against short circuits in external wiring.
There is a risk of fire or failure.

NOTICE

- Whenever possible, use the Cables specified by Yaskawa. If you use any other cables, confirm the rated current and application environment of your model and use the wiring materials specified by Yaskawa or equivalent materials.
- Securely tighten cable connector screws and lock mechanisms. Insufficient tightening may result in cable connectors falling off during operation.
- Do not bundle power lines (e.g., the Main Circuit Cable) and low-current lines (e.g., the I/O Signal Cables or Encoder Cables) together or run them through the same duct. If you do not place power lines and low-current lines in separate ducts, separate them by at least 30 cm.
If the cables are too close to each other, malfunctions may occur due to noise affecting the low-current lines.
- Install a battery at either the host controller or on the Encoder Cable.
If you install batteries both at the host controller and on the Encoder Cable at the same time, you will create a loop circuit between the batteries, resulting in a risk of damage or burning.
- When connecting a battery, connect the polarity correctly. There is a risk of battery rupture or encoder failure.

■ Operation Precautions



WARNING

- Before starting operation with a machine connected, change the settings of the switches and parameters to match the machine. Unexpected machine operation, failure, or personal injury may occur if operation is started before appropriate settings are made.
- Do not radically change the settings of the parameters. There is a risk of unstable operation, machine damage, or injury.
- Install limit switches or stoppers at the ends of the moving parts of the machine to prevent unexpected accidents. There is a risk of machine damage or injury.
- For trial operation, securely mount the Servomotor and disconnect it from the machine. There is a risk of injury.
- Forcing the motor to stop for overtravel is disabled when the Jog, Origin Search, or Easy FFT utility function is executed. Take necessary precautions. There is a risk of machine damage or injury.
- When an alarm occurs, the Servomotor will coast to a stop or stop with the dynamic brake according to the SERVOPACK Option and settings. The coasting distance will change with the moment of inertia of the load and the resistance of the External Dynamic Brake Resistor. Check the coasting distance during trial operation and implement suitable safety measures on the machine.
- Do not enter the machine's range of motion during operation. There is a risk of injury.
- Do not touch the moving parts of the Servomotor or machine during operation. There is a risk of injury.



CAUTION

- Design the system to ensure safety even when problems, such as broken signal lines, occur.
For example, the P-OT and N-OT signals are set in the default settings to operate on the safe side if a signal line breaks. Do not change the polarity of this type of signal.
- When overtravel occurs, the power supply to the motor is turned OFF and the brake is released. If you use the Servomotor to drive a vertical load, set the Servomotor to enter a zero-clamped state after the Servomotor stops. Also, install safety devices (such as an external brake or counterweight) to prevent the moving parts of the machine from falling.
- Always turn OFF the servo before you turn OFF the power supply. If you turn OFF the main circuit power supply or control power supply during operation before you turn OFF the servo, the Servomotor will stop as follows:
 - If you turn OFF the main circuit power supply during operation without turning OFF the servo, the Servomotor will stop abruptly with the dynamic brake.
 - If you turn OFF the control power supply without turning OFF the servo, the stopping method that is used by the Servomotor depends on the model of the SERVOPACK. For details, refer to the manual for the SERVOPACK.
 - If you use a SERVOPACK with the Dynamic Brake Hardware Option, the Servomotor stopping methods will be different from the stopping methods used without the Option or with other Hardware Options. For details, refer to the following manual.
 Σ -7-Series Σ -7S/ Σ -7W SERVOPACK with Dynamic Brake Hardware Option Specifications Product Manual
(Manual No.: SIEP S800001 73)
- Do not use the dynamic brake for any application other than an emergency stop.
There is a risk of failure due to rapid deterioration of elements in the SERVOPACK and the risk of unexpected operation, machine damage, burning, or injury.

NOTICE

- When you adjust the gain during system commissioning, use a measuring instrument to monitor the torque waveform and speed waveform and confirm that there is no vibration.
If a high gain causes vibration, the Servomotor will be damaged quickly.
- Do not frequently turn the power supply ON and OFF. After you have started actual operation, allow at least one hour between turning the power supply ON and OFF (as a guideline).
Do not use the product in applications that require the power supply to be turned ON and OFF frequently.
The elements in the SERVOPACK will deteriorate quickly.
- An alarm or warning may occur if communications are performed with the host controller while the SigmaWin+ or Digital Operator is operating.
If an alarm or warning occurs, it may interrupt the current process and stop the system.
- After you complete trial operation of the machine and facilities, use the SigmaWin+ to back up the settings of the SERVOPACK parameters. You can use them to reset the parameters after SERVOPACK replacement.
If you do not copy backed up parameter settings, normal operation may not be possible after a faulty SERVOPACK is replaced, possibly resulting in machine or equipment damage.

■ Maintenance and Inspection Precautions



DANGER

- Do not change any wiring while power is being supplied.
There is a risk of electric shock or injury.



WARNING

- Wiring and inspections must be performed only by qualified engineers.
There is a risk of electric shock or product failure.



CAUTION

- Wait for at least six minutes after turning OFF the power supply (with a SERVOPACK for a 100-VAC power supply input, wait for at least nine minutes) and then make sure that the CHARGE indicator is not lit before starting wiring or inspection work. Do not touch the power supply terminals while the CHARGE lamp is lit after turning OFF the power supply because high voltage may still remain in the SERVOPACK.

There is a risk of electric shock.

- Before you replace a SERVOPACK, back up the settings of the SERVOPACK parameters. Copy the backed up parameter settings to the new SERVOPACK and confirm that they were copied correctly.

If you do not copy backed up parameter settings or if the copy operation is not completed normally, normal operation may not be possible, possibly resulting in machine or equipment damage.

NOTICE

- Discharge all static electricity from your body before you operate any of the buttons or switches inside the front cover of the SERVOPACK.

There is a risk of equipment damage.

■ Troubleshooting Precautions



DANGER

- If the safety device (molded-case circuit breaker or fuse) installed in the power supply line operates, remove the cause before you supply power to the SERVOPACK again. If necessary, repair or replace the SERVOPACK, check the wiring, and remove the factor that caused the safety device to operate.

There is a risk of fire, electric shock, or injury.



WARNING

- The product may suddenly start to operate when the power supply is recovered after a momentary power interruption. Design the machine to ensure human safety when operation restarts.

There is a risk of injury.



CAUTION

- When an alarm occurs, remove the cause of the alarm and ensure safety. Then reset the alarm or turn the power supply OFF and ON again to restart operation.
There is a risk of injury or machine damage.
- If the Servo ON signal is input to the SERVOPACK and an alarm is reset, the Servomotor may suddenly restart operation. Confirm that the servo is OFF and ensure safety before you reset an alarm.
There is a risk of injury or machine damage.
- Always insert a magnetic contactor in the line between the main circuit power supply and the main circuit power supply terminals on the SERVOPACK so that the power supply can be shut OFF at the main circuit power supply.
If a magnetic contactor is not connected when the SERVOPACK fails, a large current may flow, possibly resulting in fire.
- If an alarm occurs, shut OFF the main circuit power supply.
There is a risk of fire due to a regenerative resistor overheating as the result of regenerative transistor failure.
- Install a ground fault detector against overloads and short-circuiting or install a molded-case circuit breaker combined with a ground fault detector.
There is a risk of SERVOPACK failure or fire if a ground fault occurs.
- The holding brake on a Servomotor will not ensure safety if there is the possibility that an external force (including gravity) may move the current position and create a hazardous situation when power is interrupted or an error occurs. If an external force may cause movement, install an external braking mechanism that ensures safety.

■ Disposal Precautions

- Correctly discard the product as stipulated by regional, local, and municipal laws and regulations. Be sure to include these contents in all labelling and warning notifications on the final product as necessary.



■ General Precautions

- Figures provided in this document are typical examples or conceptual representations. There may be differences between them and actual wiring, circuits, and products.
- The products shown in illustrations in this document are sometimes shown without covers or protective guards. Always replace all covers and protective guards before you use the product.
- If you need a new copy of this document because it has been lost or damaged, contact your nearest Yaskawa representative or one of the offices listed on the back of this document.
- This document is subject to change without notice for product improvements, specifications changes, and improvements to the manual itself.
We will update the document number of the document and issue revisions when changes are made.
- Any and all quality guarantees provided by Yaskawa are null and void if the customer modifies the product in any way. Yaskawa disavows any responsibility for damages or losses that are caused by modified products.

Warranty

◆ Details of Warranty

■ Warranty Period

The warranty period for a product that was purchased (hereinafter called the “delivered product”) is one year from the time of delivery to the location specified by the customer or 18 months from the time of shipment from the Yaskawa factory, whichever is sooner.

■ Warranty Scope

Yaskawa shall replace or repair a defective product free of charge if a defect attributable to Yaskawa occurs during the above warranty period.

This warranty does not cover defects caused by the delivered product reaching the end of its service life and replacement of parts that require replacement or that have a limited service life.

This warranty does not cover failures that result from any of the following causes.

- Improper handling, abuse, or use in unsuitable conditions or in environments not described in product catalogs or manuals, or in any separately agreed-upon specifications
- Causes not attributable to the delivered product itself
- Modifications or repairs not performed by Yaskawa
- Use of the delivered product in a manner in which it was not originally intended
- Causes that were not foreseeable with the scientific and technological understanding at the time of shipment from Yaskawa
- Events for which Yaskawa is not responsible, such as natural or human-made disasters

◆ Limitations of Liability

- Yaskawa shall in no event be responsible for any damage or loss of opportunity to the customer that arises due to failure of the delivered product.
- Yaskawa shall not be responsible for any programs (including parameter settings) or the results of program execution of the programs provided by the user or by a third party for use with programmable Yaskawa products.
- The information described in product catalogs or manuals is provided for the purpose of the customer purchasing the appropriate product for the intended application. The use thereof does not guarantee that there are no infringements of intellectual property rights or other proprietary rights of Yaskawa or third parties, nor does it construe a license.
- Yaskawa shall not be responsible for any damage arising from infringements of intellectual property rights or other proprietary rights of third parties as a result of using the information described in catalogs or manuals.

◆ Suitability for Use

- It is the customer's responsibility to confirm conformity with any standards, codes, or regulations that apply if the Yaskawa product is used in combination with any other products.
- The customer must confirm that the Yaskawa product is suitable for the systems, machines, and equipment used by the customer.
- Consult with Yaskawa to determine whether use in the following applications is acceptable. If use in the application is acceptable, use the product with extra allowance in ratings and specifications, and provide safety measures to minimize hazards in the event of failure.
 - Outdoor use, use involving potential chemical contamination or electrical interference, or use in conditions or environments not described in product catalogs or manuals
 - Nuclear energy control systems, combustion systems, railroad systems, aviation systems, vehicle systems, medical equipment, amusement machines, and installations subject to separate industry or government regulations
 - Systems, machines, and equipment that may present a risk to life or property
 - Systems that require a high degree of reliability, such as systems that supply gas, water, or electricity, or systems that operate continuously 24 hours a day
 - Other systems that require a similar high degree of safety
- Never use the product for an application involving serious risk to life or property without first ensuring that the system is designed to secure the required level of safety with risk warnings and redundancy, and that the Yaskawa product is properly rated and installed.
- The circuit examples and other application examples described in product catalogs and manuals are for reference. Check the functionality and safety of the actual devices and equipment to be used before using the product.
- Read and understand all use prohibitions and precautions, and operate the Yaskawa product correctly to prevent accidental harm to third parties.

◆ Specifications Change

The names, specifications, appearance, and accessories of products in product catalogs and manuals may be changed at any time based on improvements and other reasons. The next editions of the revised catalogs or manuals will be published with updated code numbers. Consult with your Yaskawa representative to confirm the actual specifications before purchasing a product.

Contents

About this Manual	iii
Outline of Manual	iii
Related Documents	iv
Using This Manual	xvi
Safety Precautions	xx
Warranty	xxxv

1

Introduction

1.1	Digital Operator Types and Connections	1-2
1.2	Part Names and Functions	1-5
1.3	Changing Functions	1-7
1.4	Status Indications	1-8

2

Parameter/Monitor Functions

2.1	Parameters	2-2
2.1.1	Setting Parameters	2-2
2.1.2	Types of Parameters	2-6
2.2	Monitors	2-7
2.2.1	Monitor Items	2-7
2.2.2	Interpreting the Monitor Displays	2-10
2.2.3	Monitor Display Operations	2-14

3

Utility Functions

3.1	Introduction	3-4
3.1.1	Utility Functions	3-4
3.2	Operating Procedures for Utility Functions	3-7
3.2.1	Display Alarm History (Fn000)	3-8
3.2.2	Jog (Fn002)	3-10
3.2.3	Origin Search (Fn003)	3-13
3.2.4	Jog Program (Fn004)	3-15
3.2.5	Initialize Parameters (Fn005)	3-18
3.2.6	Clear Alarm History (Fn006)	3-20
3.2.7	Reset Absolute Encoder (Fn008)	3-21
3.2.8	Autotune Analog (Speed/Torque) Reference Offset (Fn009)	3-23
3.2.9	Manually Adjust Speed Reference Offset (Fn00A)	3-25
3.2.10	Manually Adjust Torque Reference Offset (Fn00B)	3-27
3.2.11	Adjust Analog Monitor Output Offset (Fn00C)	3-29
3.2.12	Adjust Analog Monitor Output Gain (Fn00D)	3-31
3.2.13	Autotune Motor Current Detection Signal Offset (Fn00E)	3-33
3.2.14	Manually Adjust Motor Current Detection Signal Offset (Fn00F)	3-35
3.2.15	Write Prohibition Setting (Fn010)	3-38
3.2.16	Display Servomotor Model (Fn011)	3-41
3.2.17	Display Software Version (Fn012)	3-44
3.2.18	Multiturn Limit Setting after Multiturn Limit Disagreement Alarm (Fn013)	3-45
3.2.19	Reset Option Module Configuration Error (Fn014)	3-47
3.2.20	Initialize Vibration Detection Level (Fn01B)	3-49
3.2.21	Display SERVOPACK and Servomotor IDs (Fn01E)	3-52
3.2.22	Display Servomotor ID from Feedback Option Module (Fn01F)	3-55
3.2.23	Set Origin (Fn020)	3-58
3.2.24	Reset Motor Type Change Detected Status (Fn021)	3-60
3.2.25	Software Reset (Fn030)	3-61
3.2.26	Polarity Detection (Fn080)	3-64
3.2.27	Tuning-less Level Setting (Fn200)	3-67
3.2.28	Advanced Autotuning without Reference (Fn201)	3-70
3.2.29	Advanced Autotuning with Reference (Fn202)	3-79

3.2.30	One-Parameter Tuning (Fn203)	3-84
3.2.31	Adjust Anti-resonance Control (Fn204)	3-92
3.2.32	Vibration Suppression (Fn205)	3-100
3.2.33	Easy FFT (Fn206)	3-104
3.2.34	Program Table Edit/Save (FnB03)	3-108
3.2.35	ZONE Table Edit/Save (FnB04)	3-114
3.2.36	JOG Speed Table Edit/Save (FnB05)	3-118
3.2.37	Program Table Initialization (FnB06)	3-120
3.2.38	ZONE Table Initialization (FnB07)	3-122
3.2.39	JOG Speed Table Initialization (FnB08)	3-123
3.2.40	Absolute Encoder Origin Setting (FnB09)	3-125
3.2.41	INDEXER Status Monitor (FnB0A)	3-127
3.2.42	INDEXER Parameter Setting Initialization (FnB0B)	3-132
3.2.43	INDEXER Alarm Reset (FnB0C)	3-134
3.2.44	INDEXER Alarm History Display (FnB0D)	3-135

4

Parameter Copy Functions

4.1	Introduction	4-2
4.1.1	Parameter Copy Mode Functions	4-2
4.2	Operating Procedures in Parameter Copy Mode	4-3
4.2.1	Reading Parameters from the SERVOPACK (SERVO→OP)	4-3
4.2.2	Writing Parameters to the SERVOPACK (OP→SERVO)	4-6
4.2.3	Verifying Parameters (VERIFY)	4-10
4.2.4	Parameter Block List Display (LIST)	4-14

Revision History

Introduction

1

This chapter describes the types and connections of Digital Operators that you can use with Σ -7-Series SERVOPACKs, as well as the names of parts, how to change between functions, and the status indications.

- 1.1** Digital Operator Types and Connections . . 1-2
- 1.2** Part Names and Functions 1-5
- 1.3** Changing Functions 1-7
- 1.4** Status Indications 1-8

1.1 Digital Operator Types and Connections

A Digital Operator is used to display and set parameters in a SERVO-PACK.

You can use the following two types of Digital Operators with Σ -7-Series SERVOPACKs.

- Digital Operator for Σ -V-Series and Σ -7-Series SERVOPACKs: JUSP-OP05A-1-E
- Digital Operators for Σ -III-Series SERVOPACKs: JUSP-OP05A and JUSP-OP05A-E

The connection methods between these Digital Operators and Σ -7-Series SERVOPACKs are described below.

Digital Operator for Σ -V-Series and Σ -7-Series SERVOPACKs: JUSP-OP05A-1-E

To use the Digital Operator for Σ -V-Series and Σ -7-Series SERVOPACKs (JUSP-OP05A-1-E), connect it to the CN3 connector on the SERVO-PACK.

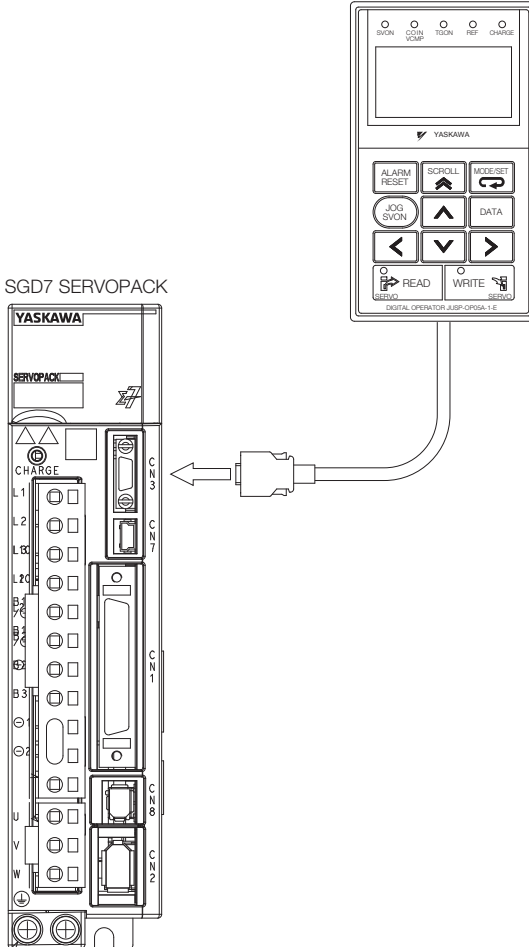

Digital Operators for Σ -III-Series SERVOPACKs: JUSP-OP05A and JUSP-OP05A-E

You can use the Digital Operators for Σ -III-Series SERVOPACKs (JUSP-OP05A and JUSP-OP05A-E) with a Σ -7- Series SERVOPACK. To do so, use the JZSP-CVS05-A3-E Digital Operator Converter Cable to connect to the SERVOPACK. Connect to the CN3 connector on the SERVOPACK.

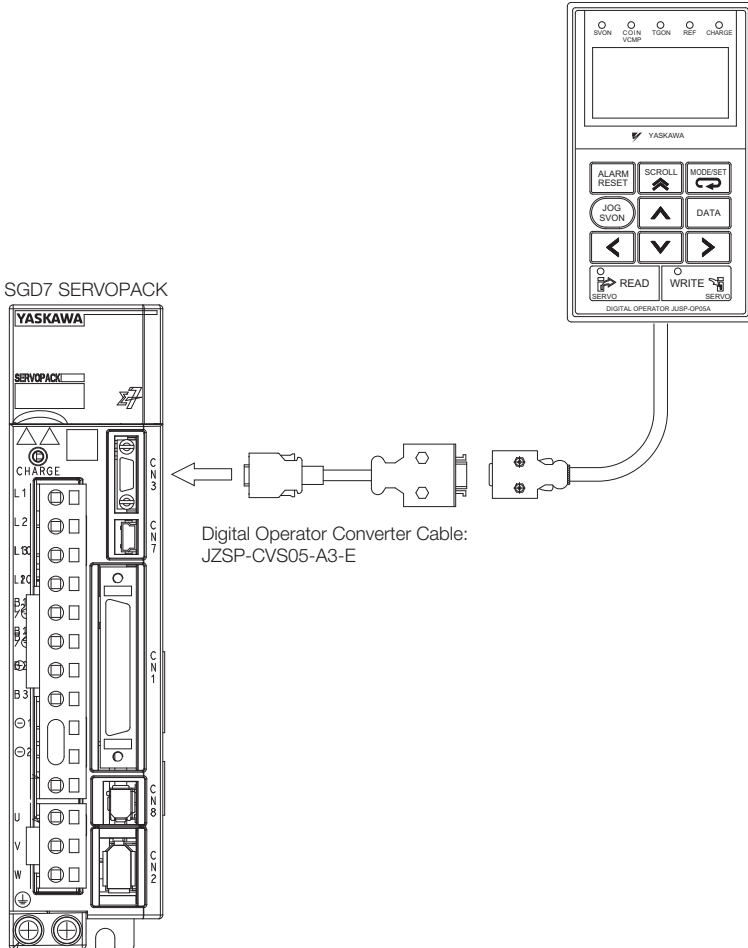

1.2 Part Names and Functions

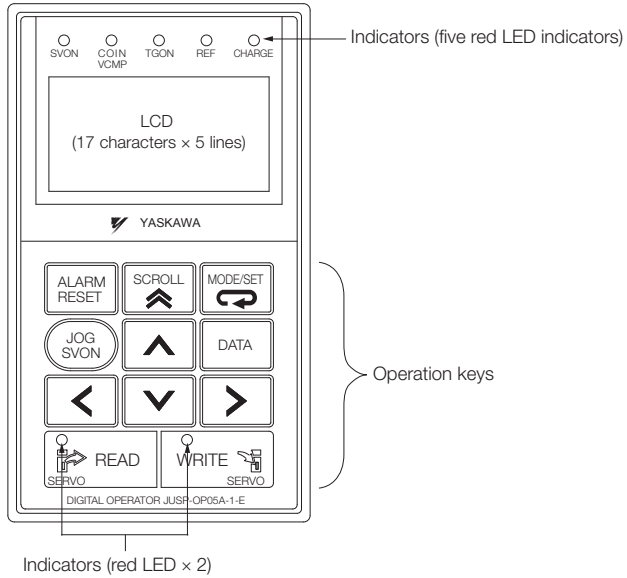









Display and Indicators

The Digital Operator has a display area of five lines with 17 characters per line. (It uses an LCD.) It also has seven indicators that show status, such as the servo ON status and positioning completion status. The indicators are described in the following table.

Indicator	Description
SVON	Lit while the servo is ON. Not lit while the servo is OFF.
COIN VCMP	Lit when positioning is completed. Lit during speed coincidence.
TGON	Lit while the motor is operating.
REF	Lit when the speed reference input is larger than the rotation detection level (Pn502). Position control: Lit while a reference pulse is being input. Torque control: Lit while the torque reference input exceeds 10% of the rated torque.
CHARGE	Lit while the main circuit power supply is ON.
READ	Lit while parameters are being read from the SERVOPACK.
WRITE	Lit while parameters are being written to the SERVOPACK from the Digital Operator.

Operation Keys

Key	Description
	Resets alarms. (An alarm cannot be reset until the cause of the alarm is removed.)
	Changes the mode of the Digital Operator.
	<ul style="list-style-type: none"> When setting parameters, moves the cursor as follows: From the parameter number area to the setting area From the setting area to the parameter number area When setting parameters, saves the settings in the SERVO-PACK. Changes the display to the selected utility function to execute a utility function.
	<ul style="list-style-type: none"> Moves the cursor to the bottom line in Parameter/Monitor Mode. If this key is pressed again, it moves the cursor up one line. In Utility Mode, moves the cursor up four lines at a time.
	Turns the servo ON and OFF as required to execute utility functions. For example, this is necessary to execute jogging or advanced autotuning.
	Move the cursor to the right and left in Parameter/Monitor Mode.
	<ul style="list-style-type: none"> Changes between parameters and monitors as follows: From Un to Pn From Pn to Un Increment/decrement the parameter number, setting, monitor number, or utility number. When jogging, operates the motor in forward or reverse.
	In Parameter Copy Mode, reads the parameters in the SERVO-PACK to the Digital Operator.
	<ul style="list-style-type: none"> In Parameter Copy Mode, writes the parameters in the Digital Operator to the SERVOPACK. In Parameter/Monitor Mode, saves the current display status. When the power is turned OFF and ON again, the same display will appear as the initial display.

Note: "Cursor" indicates the position on the display that is flashing.

1.3 Changing Functions

When you connect the Digital Operator to the SERVOPACK and turn ON the power supply to the SERVOPACK, the Initial Display will appear and then the Parameter/Monitor Mode Main Menu will be displayed. Press the  Key to change the mode.

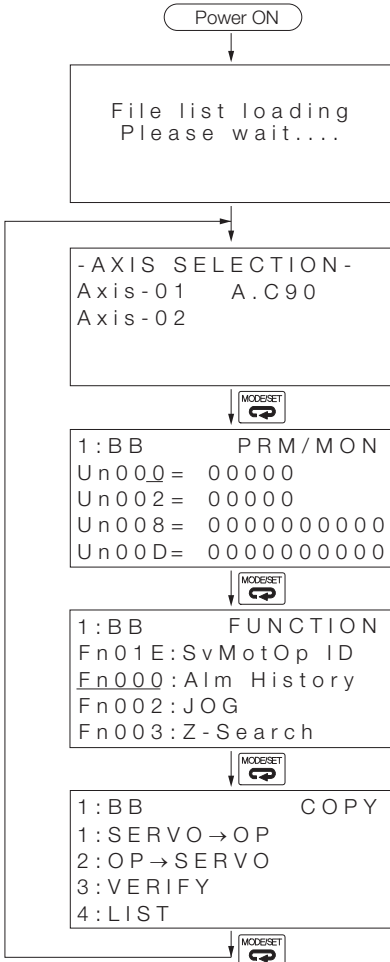

Initial Display

Displayed for approx. two seconds.

Axis Selection Display

This display appears for a Σ -7W SERVOPACK. You can select the axis number. The line for the axis number that you select will flash.

Parameter/Monitor Mode Main Menu Display Parameters

You can display and set the parameters in the SERVOPACK.

Monitors

You can display numeric values and signal status that indicate the speed, position, and torque data in the SERVOPACK. The display on the left shows monitoring.

Utility Mode Main Menu Display

You can set up the SERVOPACK and adjust servo gains, perform maintenance, etc.

Parameter Copy Mode Main Menu Display

You can copy parameters from a SERVOPACK to the Digital Operator or write parameters from the Digital Operator to a SERVOPACK.

1.4 Status Indications

The status of the SERVOPACK is displayed at the upper left of the display. An abbreviation of the current mode is displayed at the upper right of the display.

If you are connected to a Σ -7S SERVOPACK, "1" will be displayed.
 If you are connected to a Σ -7W SERVOPACK, "1" will be displayed if you select axis 1 and "2" will be displayed if you select axis 2.

1	BB	PRM / MON	Mode
U n 0 0 0 =	0 0 0 0 0		PRM/MON: Parameter/Monitor Mode
U n 0 0 2 =	0 0 0 0 0		FUNCTION: Utility Mode
U n 0 0 8 =	0 0 0 0 0 0 0 0 0 0		COPY: Parameter Copy Mode
U n 0 0 D =	0 0 0 0 0 0 0 0 0 0		

Status

- BB: Base-blocked
- RUN: Motor is operating.
- A.□□□: An alarm has occurred (□□□ is the alarm code).
- PT NT: Forward drive and reverse drive prohibited (overtravel status)
- P-OT: Forward drive prohibited (overtravel status)
- N-OT: Reverse drive prohibited (overtravel status)
- NO-OP: Setting disabled or setting error
- HBB: A hard wire base block is active.
- FSTP: Forced stop status

Test without Motor In-progress Display

An asterisk is displayed before the status while a test without a motor is being executed.

1 * BB	PRM / MON
U n 0 0 0 =	0 0 0 0 0
U n 0 0 2 =	0 0 0 0 0
U n 0 0 8 =	0 0 0 0 0 0 0 0 0 0
U n 0 0 D =	0 0 0 0 0 0 0 0 0 0

Example of Display during a Test without a Motor

Alarm Display for Communications Errors

One of the following communications error displays will appear if an error occurs in communications between the SERVOPACK and Digital Operator. There may be a faulty connection at a connector. Check the connections. If you can find no problems, turn the power supply OFF and ON again. If the communications error is still displayed, replace the Digital Operator or SERVOPACK.

<p>CPF00</p> <p>COM-ERR(OP&SV)</p>

<p>CPF01</p> <p>COM-ERR(OP&SV)</p>

Parameter/ Monitor Functions

2

This chapter describes operating procedures for the parameter/monitor functions.

- 2.1 Parameters 2-2**
 - 2.1.1 Setting Parameters 2-2
 - 2.1.2 Types of Parameters 2-6
- 2.2 Monitors 2-7**
 - 2.2.1 Monitor Items 2-7
 - 2.2.2 Interpreting the Monitor Displays . . . 2-10
 - 2.2.3 Monitor Display Operations 2-14

2.1 Parameters

This section describes how to set parameters in the Parameter/Monitor Mode.





There are two types of notations used for parameters, one for parameters that require selection of a function and one for parameters that require numeric settings.

Note: This manual does not provide details on parameters. Refer to the manual for your SERVOPACK.

2.1.1 Setting Parameters



Operation Example 1: Setting a Parameter That Requires Selection of a Function

Some parameters, such as Pn000 (Basic Function Selections 0) and Pn001 (Application Function Selections 1) require you to set each digit. The following example shows how to set Pn000 = n.□□□X (Rotation Direction Selection) to 1 (reverse rotation).

Step	Operation	Result
1	Press the  Key to display the Parameter/Monitor Mode Main Menu.	<pre> 1 : BB PRM / MON Un00<u>0</u> = 00000 Un002 = 00000 Un008 = 0000000000 Un00D = 0000000000 </pre>
2	Press the  Key or  Key to move the cursor to Un .	<pre> 1 : BB PRM / MON Un000 = 00000 Un002 = 00000 Un008 = 0000000000 Un00D = 0000000000 </pre>
3	Press the  Key or  Key to change from Un to Pn .	<pre> 1 : BB PRM / MON Pn000 = n.0000 Un002 = 00000 Un008 = 0000000000 Un00D = 0000000000 </pre>

Continued on next page.











Continued from previous page.

Step	Operation	Result
4	Press the  Key.	<p>The cursor will move from the parameter number to the setting. The first digit on the right in the setting will flash.</p> <div style="border: 1px solid black; padding: 5px; width: fit-content;"> <pre> 1 : BB PRM / MON P n 0 0 0 = n.0 0 0 0 <u>0</u> U n 0 0 2 = 0 0 0 0 0 U n 0 0 8 = 0 0 0 0 0 0 0 0 0 0 U n 0 0 D = 0 0 0 0 0 0 0 0 0 0 </pre> </div>
5	Press the  Key once to set Pn000 = n.□□□X to 1.	<div style="border: 1px solid black; padding: 5px; width: fit-content;"> <pre> 1 : BB PRM / MON P n 0 0 0 = n.0 0 0 0 <u>1</u> U n 0 0 2 = 0 0 0 0 0 U n 0 0 8 = 0 0 0 0 0 0 0 0 0 0 U n 0 0 D = 0 0 0 0 0 0 0 0 0 0 </pre> </div>
6	Press the  Key.	<p>The parameter setting is written to the SERVOPACK and the cursor moves to the parameter number. If you have changed a parameter for which the power supply must be turned OFF and ON again, an A.941 alarm (Change of Parameters Requires Restart) will be displayed.*</p> <div style="border: 1px solid black; padding: 5px; width: fit-content;"> <pre> 1 : A . 9 4 1 PRM / MON P n 0 0 0 = n.0 0 0 0 <u>1</u> U n 0 0 2 = 0 0 0 0 0 U n 0 0 8 = 0 0 0 0 0 0 0 0 0 0 U n 0 0 D = 0 0 0 0 0 0 0 0 0 0 </pre> </div>
7	Turn the SERVOPACK power supply OFF and ON again.	The new parameter settings will be enabled.

* An A.941 alarm is not displayed for SERVOPACKs other than Analog Voltage/Pulse Train Reference SERVOPACKs.







Operation Example 2: Setting a Parameter That Requires a Numeric Setting



The following example shows how to set Pn304 (Jogging Speed) to 1,000 min⁻¹.

Step	Operation	Result
1	Press the  Key to display the Parameter/Monitor Mode Main Menu.	<pre> 1 : B B P R M / M O N U n 0 0 0 = 0 0 0 0 0 U n 0 0 2 = 0 0 0 0 0 U n 0 0 8 = 0 0 0 0 0 0 0 0 0 U n 0 0 D = 0 0 0 0 0 0 0 0 0 </pre>
2	Press the  Key or  Key to move the cursor to Un .	<pre> 1 : B B P R M / M O N U n 0 0 0 = 0 0 0 0 0 U n 0 0 2 = 0 0 0 0 0 U n 0 0 8 = 0 0 0 0 0 0 0 0 0 U n 0 0 D = 0 0 0 0 0 0 0 0 0 </pre>
3	Press the  Key or  Key to change from Un to Pn .	<pre> 1 : B B P R M / M O N P n 0 0 0 = n.0 0 0 0 U n 0 0 2 = 0 0 0 0 0 U n 0 0 8 = 0 0 0 0 0 0 0 0 0 U n 0 0 D = 0 0 0 0 0 0 0 0 0 </pre>
4	Press the  Key once to move the cursor to the right of Pn .	<pre> 1 : B B P R M / M O N P n 0 0 0 = n.0 0 0 0 U n 0 0 2 = 0 0 0 0 0 U n 0 0 8 = 0 0 0 0 0 p u l s e U n 0 0 D = 0 0 0 0 0 0 0 0 0 </pre>
5	Press the  Key or  Key to change the digit and the  Key or  Key to change the numeric value to display Pn304 .	<pre> 1 : B B P R M / M O N P n 3 0 4 = 0 0 5 0 0 U n 0 0 2 = 0 0 0 0 0 U n 0 0 8 = 0 0 0 0 0 0 0 0 0 U n 0 0 D = 0 0 0 0 0 0 0 0 0 </pre>
6	Press the  Key.	<p>The cursor will move from the parameter number to the setting. (The first digit on the right in the setting will flash.)</p> <pre> 1 : B B P R M / M O N P n 3 0 4 = 0 0 5 0 0 U n 0 0 2 = 0 0 0 0 0 U n 0 0 8 = 0 0 0 0 0 0 0 0 0 U n 0 0 D = 0 0 0 0 0 0 0 0 0 </pre>

Continued on next page.

Continued from previous page.

Step	Operation	Result
7	Press the  Key twice to move the cursor to the hundreds digit of Pn304.	<pre> 1 : BB PRM / MON P n 3 0 4 = 0 0 <u>5</u> 0 0 U n 0 0 2 = 0 0 0 0 0 U n 0 0 8 = 0 0 0 0 0 0 0 0 0 0 U n 0 0 D = 0 0 0 0 0 0 0 0 0 0 </pre>
8	Use the  Key,  Key,  Key, and  Key to change the setting from 500 to 1,000.	<pre> 1 : BB PRM / MON P n 3 0 4 = 0 1 <u>0</u> 0 0 U n 0 0 2 = 0 0 0 0 0 U n 0 0 8 = 0 0 0 0 0 0 0 0 0 0 U n 0 0 D = 0 0 0 0 0 0 0 0 0 0 </pre>
9	Press the  Key.	<p>The parameter setting is saved in the SERVOPACK and the cursor moves to the parameter number.</p> <pre> 1 : BB PRM / MON P n 3 0 <u>4</u> = 0 1 0 0 0 U n 0 0 2 = 0 0 0 0 0 U n 0 0 8 = 0 0 0 0 0 0 0 0 0 0 U n 0 0 D = 0 0 0 0 0 0 0 0 0 0 </pre>

Note: Even if you press the  Key without pressing the  Key to move to another mode, such as the Utility Mode, any changes to the parameter settings are stored in the SERVOPACK.

2.1.2 Types of Parameters

There are the following two types of SERVOPACK parameters.

Classification	Meaning
Setup Parameters	Parameters for the basic settings that are required for operation.
Tuning Parameters	Parameters that are used to adjust servo performance.

Information The tuning parameters are not displayed by default when you use the Panel Operator or Digital Operator. To display and set the tuning parameters, set Pn00B to n.□□□1 (Display all parameters).

Parameter	Meaning	When Enabled	Classification
Pn00B	n.□□□0 (default setting)	After restart	Setup
	n.□□□1		

The setting method for each type of parameter is described below.

- Setup Parameters
Setup parameters are set individually.
- Tuning Parameters
Normally the user does not need to set the tuning parameters individually.
Use the various utility tuning functions to set the related tuning parameters to increase the response even further for the conditions of your machine. Refer to the following sections for details.
 - 🔧 3.2.28 *Advanced Autotuning without Reference (Fn201)* on page 3-70
 - 🔧 3.2.29 *Advanced Autotuning with Reference (Fn202)* on page 3-79
 - 🔧 3.2.30 *One-Parameter Tuning (Fn203)* on page 3-84

You can also set the tuning parameters individually to make adjustments.

Refer to the following section for information on the parameter setting procedures.

🔧 2.1.1 *Setting Parameters* on page 2-2

2.2 Monitors

This section describes how to display and operate monitors in the Parameter/Monitor Mode.

2.2.1 Monitor Items

Un No.	Content of Display	Unit
Un000	Motor Speed	min ⁻¹
Un001	Speed Reference	min ⁻¹
Un002	Torque Reference (percentage of rated torque)	%
Un003	Rotary Servomotors: Rotational Angle 1 (number of encoder pulses from origin within one encoder rotation displayed in decimal)	Encoder pulses
	Linear Servomotor: Electrical Angle 1 (linear encoder pulses from the polarity origin displayed in decimal)	Linear encoder pulses
Un004	Rotary Servomotors: Rotational Angle 2 (electrical angle from polarity origin)	deg
	Linear Servomotor: Electrical Angle 2 (electrical angle from polarity origin)	deg
Un005	Input Signal Monitor	–
Un006	Output Signal Monitor	–
Un007	Input Reference Pulse Speed (displayed only during position control)	min ⁻¹
Un008	Position Error Amount (displayed only during position control)	Reference units
Un009	Accumulated Load Ratio (percentage of rated torque: effective torque in cycles of 10 seconds)	%
Un00A	Regenerative Load Ratio (percentage of processable regenerative power: regenerative power consumption in cycles of 10 seconds)	%

Continued on next page.

2.2 Monitors

2.2.1 Monitor Items

Continued from previous page.

Un No.	Content of Display	Unit
Un00B	Power Consumed by DB Resistance (percentage of processable power at DB activation: displayed in cycles of 10 seconds)	%
Un00C	Input Reference Pulse Counter	Reference units
Un00D	Feedback Pulse Counter	Encoder pulses
Un00E	Fully-Closed Loop Feedback Pulse Counter	Encoder pulses
Un010	Upper Limit Setting of Motor Maximum Speed/Upper Limit Setting of Encoder Output Resolution	–
Un011	Polarity Sensor Signal Monitor	–
Un012	Total Run Time	100 ms
Un013	Feedback Pulse Counter	Reference units
Un014	Effective Gain Monitor (gain settings 1 = 1, gain settings 2 = 2)	–
Un015	Safety I/O Signal Monitor	–
Un020	Rated Motor Speed	min ⁻¹
Un021	Maximum Motor Speed	min ⁻¹
Un025	SERVOPACK Installation Environment Monitor	%
Un026*1	Servomotor Installation Environment Monitor	%
Un027	Built-in Fan Remaining Life Ratio	%
Un028	Capacitor Remaining Life Ratio	%
Un029	Surge Prevention Circuit Remaining Life Ratio	%
Un02A	Dynamic Brake Circuit Remaining Life Ratio	%
Un02F	Overheat Protection Input	0.01 V
Un030*2	Current Backlash Compensation Value	0.1 reference units
Un031*2	Backlash Compensation Value Setting Limit	0.1 reference units
Un032	Power Consumption	W
Un033	Consumed Power	0.001 Wh
Un034	Cumulative Power Consumption	Wh
Un040	Absolute Encoder Multiturn Data	–

Continued on next page.

Continued from previous page.

Un No.	Content of Display	Unit
Un041	Position within One Rotation of Absolute Encoder	Encoder pulses
Un042	Lower Bits of Absolute Encoder Position	Encoder pulses
Un043	Upper Bits of Absolute Encoder Position	Encoder pulses
Un084	Linear Encoder Pitch* ³	µm
Un085	Linear Encoder Pitch Exponent* ³	–

*1. This applies to the following motors. The display will show 0 for all other models.
SGM7M, SGM7A, SGM7J, SGM7G, SGM7P, SGMCV, SGM7D, SGM7E, and SGM7F

*2. These monitors cannot be used for Analog Voltage/Pulse Train Reference SERVO-PACKS.

*3. Scale pitch = $Un084 \times 10^{Un085}$ [µm]

2.2.2 Interpreting the Monitor Displays

Input Signal Monitor

The input signal monitor (Un005) is displayed as shown below. The top indicates OFF (high level) and the bottom indicates ON (low level). Undefined digits are always shown as being ON.

```

Un005 = ■■■■■■■■
          | | | | | | |
          8 7 6 5 4 3 2 1 Digit
  
```

■ Σ -7S Analog Voltage/Pulse Train Reference SERVOPACKS

Display Digit Number	Input Pin Number	Signal Name* ¹ (You can change the allocations.)
1	CN1-40	/S-ON (Servo ON) signal
2	CN1-41	/P-CON (Proportional Control) signal
3	CN1-42	P-OT (Forward Drive Prohibit) signal
4	CN1-43	N-OT (Reverse Drive Prohibit) signal
5	CN1-44	/ALM-RST (Alarm Reset) signal
6	CN1-45	/P-CL (Forward External Torque Limit) signal
7	CN1-46	/N-CL (Reverse External Torque Limit) signal
8	CN1-4	SEN (Absolute Data Request) signal* ²

*1. The default settings are given.

*2. You cannot change the allocation.

■ Σ -7S MECHATROLINK-II or MECHATROLINK-III Communications Reference SERVOPACKS

Display Digit Number	Input Pin Number	Signal Name* (You can change the allocations.)
1	CN1-13	/SI0 (General-purpose Sequence Input 0) signal
2	CN1-7	P-OT (Forward Drive Prohibit) signal
3	CN1-8	N-OT (Reverse Drive Prohibit) signal
4	CN1-9	/DEC (Origin Return Deceleration Switch) signal
5	CN1-10	/EXT1 (External Latch Input 1) signal
6	CN1-11	/EXT2 (External Latch Input 2) signal
7	CN1-12	/EXT3 (External Latch Input 3) signal
8	—	Reserved.

* The default settings are given.

■ Σ -7W MECHATROLINK-III Communications Reference SERVOPACKs When Axis 1 Is Displayed

Display Digit Number	Input Pin Number	Signal Name* (You can change the allocations.)
1	CN1-3	P-OT (Forward Drive Prohibit) signal
2	CN1-4	N-OT (Reverse Drive Prohibit) signal
3	CN1-5	/DEC (Origin Return Deceleration Switch) signal
4	CN1-6	/EXT1 (External Latch Input 1) signal
5	CN1-7	/EXT2 (External Latch Input 2) signal
6	CN1-8	/EXT3 (External Latch Input 3) signal
7	–	Reserved.
8	–	Reserved.

* The default settings are given.

■ Σ -7W MECHATROLINK-III Communications Reference SERVOPACKs When Axis 2 Is Displayed

Display Digit Number	Input Pin Number	Signal Name* (You can change the allocations.)
1	CN1-9	P-OT (Forward Drive Prohibit) signal
2	CN1-10	N-OT (Reverse Drive Prohibit) signal
3	CN1-11	/DEC (Origin Return Deceleration Switch) signal
4	CN1-12	/EXT1 (External Latch Input 1) signal
5	CN1-13	/EXT2 (External Latch Input 2) signal
6	CN1-14	/EXT3 (External Latch Input 3) signal
7	–	Reserved.
8	–	Reserved.

* The default settings are given.

Output Signal Monitor

The output signal monitor (Un006) is displayed as shown below. The top indicates OFF (high level) and the bottom indicates ON (low level). Undefined digits are always shown as being ON.

Un006 = 
 | | | | | | | |
 8 7 6 5 4 3 2 1 Digit

■ Σ -7S Analog Voltage/Pulse Train Reference SERVOPACKS

Display Digit Number	Output Pin Number	Signal Name* ¹ (You can change the allocations.)
1	CN1-31 and CN1-32	ALM (Servo Alarm) signal* ²
2	CN1-25 and CN1-26	/COIN (Positioning Completion) signal or /V-CMP (Speed Coincidence Detection) signal
3	CN1-27 and CN1-28	/TGON (Rotation Detection Output) signal
4	CN1-29 and CN1-30	/S-RDY (Servo Ready) signal
5	CN1-37	ALO1 (Alarm Code Output) signal
6	CN1-38	ALO2 (Alarm Code Output) signal
7	CN1-39	ALO3 (Alarm Code Output) signal
8	–	–

*1. The default settings are given.

*2. You cannot change the allocation.

■ Σ -7S MECHATROLINK-II or MECHATROLINK-III Communications Reference SERVOPACKS

Display Digit Number	Input Pin Number	Signal Name* ¹ (You can change the allocations.)
1	CN1-3 and CN1-4	ALM (Servo Alarm) signal* ²
2	CN1-1 and CN1-2	/BK (Brake) signal
3	CN1-23 and CN1-24	/SO2 (General-purpose Sequence Output 2) signal
4	CN1-25 and CN1-26	/SO3 (General-purpose Sequence Output 3) signal
5	–	Reserved.
6	–	Reserved.
7	–	Reserved.
8	–	Reserved.

*1. The default settings are given.

*2. You cannot change the allocation.

■ Σ -7W MECHATROLINK-III Communications Reference SERVOPACKs

Display Digit Number	Input Pin Number	Signal Name* ¹ (You can change the allocations.)
1	CN1-19 and CN1-20	ALM (Servo Alarm) signal for axis 1* ²
2	CN1-21 and CN1-22	ALM (Servo Alarm) signal for axis 2* ²
3	CN1-23 and CN1-24	/BK (Brake) signal for axis 1
4	CN1-25 and CN1-26	/BK (Brake) signal for axis 2
5	CN1-27 and CN1-28	/SO3 (General-purpose Sequence Output 3) signal
6	CN1-29 and CN1-30	/SO4 (General-purpose Sequence Output 4) signal
7	CN1-31 and CN1-32	/SO5 (General-purpose Sequence Output 5) signal
8	–	Reserved.

*1. The default settings are given.

*2. You cannot change the allocation.

Safety I/O Signal Monitor

The safety I/O signal monitor (Un015) is displayed as shown below. The top indicates OFF (high level) and the bottom indicates ON (low level). Undefined digits are always shown as being ON.





Un015 = 
 8 7 6 5 4 3 2 1 Digit

Display Digit Number	Output Pin Number	Signal Name (You cannot change the allocations.)
1	CN8-3 and CN8-4	/HWBB1 (Hard Wire Base Block Input 1) signal
2	CN8-5 and CN8-6	/HWBB2 (Hard Wire Base Block Input 2) signal
3	–	–
4	–	–
5	–	–
6	–	–
7	–	–
8	–	–

2.2.3 Monitor Display Operations



To describe monitor display operations, the following example shows how to display Un000 (Motor Speed) on line 1, Un002 (Torque Reference) on line 2, Un005 (Input Signal Monitor) on line 3, and Un006 (Output Signal Monitor) on line 4, and then how to save the display status. (The example shows how to change the default setting.)

1 : BB	PRM / MON	
Un000 =	00000	← Motor Speed
Un002 =	00000	← Torque Reference
Un005 =	■■■■■■■■■■	← Input Signal Monitor
Un006 =	■■■■■■■■■	← Output Signal Monitor

Step	Operation	Result										
1	Press the  Key to display the Parameter/Monitor Mode Main Menu.	<table border="1"> <tr> <td>1 : BB</td> <td>PRM / MON</td> </tr> <tr> <td>Un00<u>0</u> =</td> <td>00000</td> </tr> <tr> <td>Un002 =</td> <td>00000</td> </tr> <tr> <td>Un008 =</td> <td>0000000000</td> </tr> <tr> <td>Un00D =</td> <td>0000000000</td> </tr> </table>	1 : BB	PRM / MON	Un00 <u>0</u> =	00000	Un002 =	00000	Un008 =	0000000000	Un00D =	0000000000
1 : BB	PRM / MON											
Un00 <u>0</u> =	00000											
Un002 =	00000											
Un008 =	0000000000											
Un00D =	0000000000											
2	Press the  Key once to move the cursor to the bottom line.	<table border="1"> <tr> <td>1 : BB</td> <td>PRM / MON</td> </tr> <tr> <td>Un000 =</td> <td>00000</td> </tr> <tr> <td>Un002 =</td> <td>00000</td> </tr> <tr> <td>Un008 =</td> <td>0000000000</td> </tr> <tr> <td>Un00<u>D</u> =</td> <td>0000000000</td> </tr> </table>	1 : BB	PRM / MON	Un000 =	00000	Un002 =	00000	Un008 =	0000000000	Un00 <u>D</u> =	0000000000
1 : BB	PRM / MON											
Un000 =	00000											
Un002 =	00000											
Un008 =	0000000000											
Un00 <u>D</u> =	0000000000											
3	Use the  Key or  Key to display Un006 .	<table border="1"> <tr> <td>1 : BB</td> <td>PRM / MON</td> </tr> <tr> <td>Un000 =</td> <td>00000</td> </tr> <tr> <td>Un002 =</td> <td>00000</td> </tr> <tr> <td>Un008 =</td> <td>0000000000</td> </tr> <tr> <td>Un00<u>6</u> =</td> <td>■■■■■■■■■</td> </tr> </table>	1 : BB	PRM / MON	Un000 =	00000	Un002 =	00000	Un008 =	0000000000	Un00 <u>6</u> =	■■■■■■■■■
1 : BB	PRM / MON											
Un000 =	00000											
Un002 =	00000											
Un008 =	0000000000											
Un00 <u>6</u> =	■■■■■■■■■											
4	Press the  Key once to move the cursor up one line.	<table border="1"> <tr> <td>1 : BB</td> <td>PRM / MON</td> </tr> <tr> <td>Un000 =</td> <td>00000</td> </tr> <tr> <td>Un002 =</td> <td>00000</td> </tr> <tr> <td>Un008 =</td> <td>0000000000</td> </tr> <tr> <td>Un00<u>6</u> =</td> <td>■■■■■■■■■</td> </tr> </table>	1 : BB	PRM / MON	Un000 =	00000	Un002 =	00000	Un008 =	0000000000	Un00 <u>6</u> =	■■■■■■■■■
1 : BB	PRM / MON											
Un000 =	00000											
Un002 =	00000											
Un008 =	0000000000											
Un00 <u>6</u> =	■■■■■■■■■											

Continued on next page.

Continued from previous page.

Step	Operation	Result
5	Use the  Key or  Key to display Un005 .	<div style="border: 1px solid black; padding: 5px; margin-bottom: 10px;"> <pre> 1 : BB PRM / MON Un000 = 00000 Un002 = 00000 Un00<u>5</u> = ██████████ Un006 = ██████████ </pre> </div> <p>The desired items are now displayed.</p>
6	Press the  Key.	<p>The indicator on the key will flash and the display status will be saved. Note: Do not turn OFF the power supply to the SERVOPACK while the display status is being saved.</p> <div style="border: 1px solid black; padding: 5px; margin-top: 10px;"> <pre> 1 : BB PRM / MON Un000 = 00000 Un002 = 00000 Un00<u>5</u> = ██████████ Un006 = ██████████ </pre> </div>

Utility Functions

3

This chapter provides an outline of the utility functions and describes the operating procedures for them.

3.1 Introduction 3-4

3.1.1 Utility Functions 3-4

3.2 Operating Procedures for Utility Functions . . 3-7

3.2.1 Display Alarm History (Fn000) 3-8

3.2.2 Jog (Fn002) 3-10

3.2.3 Origin Search (Fn003) 3-13

3.2.4 Jog Program (Fn004) 3-15

3.2.5 Initialize Parameters (Fn005) 3-18

3.2.6 Clear Alarm History (Fn006) 3-20

3.2.7 Reset Absolute Encoder (Fn008) . . . 3-21

3.2.8 Autotune Analog (Speed/Torque)
Reference Offset (Fn009) 3-23

3.2.9 Manually Adjust Speed Reference
Offset (Fn00A) 3-25

3.2.10 Manually Adjust Torque Reference
Offset (Fn00B) 3-27

3.2.11 Adjust Analog Monitor Output Offset
(Fn00C) 3-29

3.2.12 Adjust Analog Monitor Output
Gain (Fn00D) 3-31

3.2.13 Autotune Motor Current Detection
Signal Offset (Fn00E) 3-33

3.2.14	Manually Adjust Motor Current Detection Signal Offset (Fn00F)	3-35
3.2.15	Write Prohibition Setting (Fn010)	3-38
3.2.16	Display Servomotor Model (Fn011)	3-41
3.2.17	Display Software Version (Fn012)	3-44
3.2.18	Multiturn Limit Setting after Multiturn Limit Disagreement Alarm (Fn013)	3-45
3.2.19	Reset Option Module Configuration Error (Fn014)	3-47
3.2.20	Initialize Vibration Detection Level (Fn01B)	3-49
3.2.21	Display SERVOPACK and Servomotor IDs (Fn01E)	3-52
3.2.22	Display Servomotor ID from Feedback Option Module (Fn01F)	3-55
3.2.23	Set Origin (Fn020)	3-58
3.2.24	Reset Motor Type Change Detected Status (Fn021)	3-60
3.2.25	Software Reset (Fn030)	3-61
3.2.26	Polarity Detection (Fn080)	3-64
3.2.27	Tuning-less Level Setting (Fn200)	3-67
3.2.28	Advanced Autotuning without Reference (Fn201)	3-70
3.2.29	Advanced Autotuning with Reference (Fn202)	3-79
3.2.30	One-Parameter Tuning (Fn203)	3-84
3.2.31	Adjust Anti-resonance Control (Fn204)	3-92
3.2.32	Vibration Suppression (Fn205)	3-100
3.2.33	Easy FFT (Fn206)	3-104
3.2.34	Program Table Edit/Save (FnB03)	3-108
3.2.35	ZONE Table Edit/Save (FnB04)	3-114
3.2.36	JOG Speed Table Edit/Save (FnB05)	3-118
3.2.37	Program Table Initialization (FnB06)	3-120
3.2.38	ZONE Table Initialization (FnB07)	3-122
3.2.39	JOG Speed Table Initialization (FnB08)	3-123

3.2.40 Absolute Encoder Origin Setting (FnB09)	3-125
3.2.41 INDEXER Status Monitor (FnB0A)	3-127
3.2.42 INDEXER Parameter Setting Initialization (FnB0B)	3-132
3.2.43 INDEXER Alarm Reset (FnB0C) ...	3-134
3.2.44 INDEXER Alarm History Display (FnB0D)	3-135

3.1 Introduction

In Utility Mode, Fn numbers are displayed and you can execute the utility functions to operate and adjust the SERVOPACK.

The following table lists the utility functions.

3.1.1 Utility Functions

Fn No.	Name	Description	Remarks	
Fn000	Display Alarm History	Displays a history of up to the last 10 alarms.	-	-
Fn002	Jog	Used to operate the motor with the keys on the Digital Operator.	Wrt	OFF
Fn003	Origin Search	Used to operate the motor with the keys on the Digital Operator, detect the origin within one rotation, and stop the motor there.	Wrt	OFF
Fn004	Jog Program	Operates the motor according to a pre-set program pattern.	Wrt	OFF
Fn005	Initialize Parameters	Initializes the parameters to the default settings.	Wrt	OFF
Fn006	Clear Alarm History	Clears the alarm history.	Wrt	-
Fn008	Reset Absolute Encoder	Resets any absolute encoder alarms, and resets the multiturn data to zero.	Wrt	OFF
Fn009	Autotune Analog (Speed/Torque) Reference Offset	Automatically adjusts the speed or torque analog reference offset.	Wrt	OFF
Fn00A	Manually Adjust Speed Reference Offset	Used to manually adjust the speed reference offset.	Wrt	-
Fn00B	Manually Adjust Torque Reference Offset	Used to manually adjust the torque reference offset.	Wrt	-
Fn00C	Adjust Analog Monitor Output Offset	Used to manually adjust the analog monitor output offset.	Wrt	-
Fn00D	Adjust Analog Monitor Output Gain	Used to manually adjust the analog monitor output gain.	Wrt	-
Fn00E	Autotune Motor Current Detection Signal Offset	Automatically adjusts the motor current detection signal offsets.	Wrt	OFF
Fn00F	Manually Adjust Motor Current Detection Signal Offset	Used to manually adjust the motor current detection signal offsets.	Wrt	-
Fn010	Write Prohibition Setting	Prohibits or permits changing the settings of the parameters.	-	-
Fn011	Display Servomotor Model	Displays the model of the motor.	-	-

Continued on next page.

Continued from previous page.

Fn No.	Name	Description	Remarks	
Fn012	Display Software Version	Displays the software version of the SERVOPACK.	-	-
Fn013	Multiturn Limit Setting after Multiturn Limit Disagreement Alarm	Resets an A.CC0 alarm that occurred when the multiturn limit was changed and sets a new limit.	Wrt	-
Fn014	Reset Option Module Configuration Error	Clears alarms that have been detected in a specified Option Module.	Wrt	-
Fn01B	Initialize Vibration Detection Level	Automatically adjusts the detection level for vibration alarms and warnings.	Wrt	-
Fn01E	Display SERVOPACK and Servomotor IDs	Displays the models, serial numbers, and manufacturing dates of the SERVOPACK and motor that are stored in the Feedback Option Module.	-	-
Fn01F	Display Servomotor ID from Feedback Option Module	Displays the encoder ID.	-	-
Fn020	Set Absolute Linear Encoder Origin	Uses the current position as the origin and stores the phase information of the motor from the origin in the SERVOPACK.	Wrt	OFF
Fn021	Reset Motor Type Change Detected Status	Deletes detection alarms.	Wrt	-
Fn030	Software Reset	Internally performs a software reset of the SERVOPACK and performs the same calculations as when the power is turned OFF and ON again, including parameter calculations.	-	OFF
Fn080	Polarity Detection	Detects the polarity and stores the phase information of the motor from the origin in the SERVOPACK.	Wrt	OFF
Fn200	Tuning-less Level Setting	Sets the level for the tuning-less function.	Wrt	-
Fn201	Advanced Autotuning without Reference	Uses automatic operation to automatically set the servo gains and filters.	Wrt	OFF
Fn202	Advanced Autotuning with Reference	Automatically sets the servo gains and filters during motor operation.	Wrt	-
Fn203	One-Parameter Tuning	Used to manually adjust the servo during operation using a speed or position reference input from the host controller.	Wrt	-
Fn204	Adjust Anti-resonance Control	Suppresses continuous vibration (oscillation) of approximately 100 Hz to 1,000 Hz.	Wrt	-

Continued on next page.

3.1 Introduction

3.1.1 Utility Functions

Continued from previous page.

Fn No.	Name	Description	Remarks	
Fn205	Vibration Suppression	Suppresses low and transient vibration (oscillation) of approximately 1 Hz to 100 Hz.	Wrt	–
Fn206	Easy FFT	Slightly rotates the SERVOPACK several times for a certain period to cause the machine to vibrate, detects the resonance frequencies, and sets the notch filters.	Wrt	OFF
FnB03	Edit/Save Program Table	Used to edit or save program tables.	Wrt	–
FnB04	Edit/Save ZONE Table	Used to edit or save ZONE tables.	Wrt	–
FnB05	Edit/Save Jog Speed Table	Used to edit or save jog speed tables.	Wrt	–
FnB06	Initialize Program Table	Initializes a program table to the default settings.	Wrt	–
FnB07	Initialize ZONE Table	Initializes a ZONE table to the default settings.	Wrt	–
FnB08	Initialize Jog Speed Table	Initializes a jog speed table to the default settings.	Wrt	–
FnB09	Set Absolute Encoder Origin	Changes the setting of PnB25 (Absolute Position Offset) and overwrites the current position with the specified position.	Wrt	–
FnB0A	INDEXER Status Monitor	Displays the internal status of the INDEXER Module, such as the current position and I/O signal status.	–	–
FnB0B	Initialize INDEXER Parameter Settings	Initializes the parameters in the SERVOPACK and INDEXER Module to the default settings.	Wrt	OFF
FnB0C	Reset INDEXER Alarm	Resets alarms in the SERVOPACK and INDEXER Module and deletes the alarm history from the INDEXER Module.	Wrt	–
FnB0D	Display INDEXER Alarm History	Displays the alarm history from the SERVOPACK and INDEXER Module.	–	–

Note: 1. Utility functions with “Wrt” in the Remarks column cannot be executed if the parameters are write-prohibited (e.g., if Fn010 is set to 0001). (**NO-OP** is displayed if you attempt to change to utility functions from the main menu in Utility Mode while the parameters are write-prohibited.)



2. Utility functions with “OFF” in the Remarks column cannot be executed if the /S-ON (Servo ON) input signal is ON. (**NO-OP** is displayed if you attempt to change to utility functions from the main menu in Utility Mode while the /S-ON signal is ON.)

3. A JUSP-OP05A-1-E Digital Operator is required to use the Fn01E (Display SERVOPACK and Servomotor IDs) and Fn01F (Display Servomotor ID from Feedback Option Module) utility functions.

3.2 Operating Procedures for Utility Functions

This section provides the operating procedures for the Utility Mode execution displays that you can select from the Utility Mode Main Menu.

The Utility Mode Main Menu is displayed when you press the  Key in Parameter/Monitor Mode.

Use the  or  Key to select the utility function you want to execute and press the  Key to change to the execution display for that function.



Press the  Key to scroll four lines at a time. (Three lines will be skipped and the fourth line will be displayed.)

```

1:BB      FUNCTION
Fn207:V-Monitor
Fn000:Alm History
Fn002:JOG
Fn003:Z-Search
  
```

← The selected utility function will flash.

Utility Mode Main Menu Display

If you select a utility function that cannot be executed, the status display will flash **NO-OP** for approximately one second when you press the  Key or  Key.

Example

If you attempt to jog (Fn002) when the parameters are write-prohibited (i.e., when Fn010 is set to 0001), the display will change as shown below.

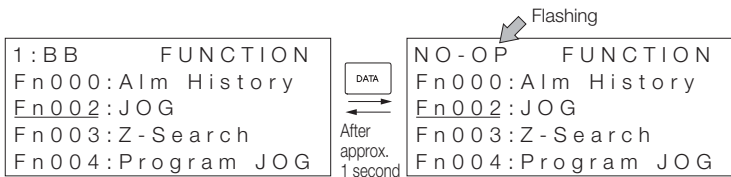

Term

The following term definitions are used in this section.

Servo Ready

- The main circuit power supply is ON.
- There are no alarms.
- There is no hard wire base block (HWBB).
- If an absolute encoder is being used, outputting the position data from the absolute encoder to the host controller has been completed when the SEN (Absolute Data Request) input signal turns ON (high level). However, this condition does not apply to utility functions for which the host controller is not used.

3.2.1 Display Alarm History (Fn000)

You can use this utility function to display a history of up to the last 10 alarms.

You can check the alarm numbers and time stamps of the alarms that have occurred.

A time stamp gives the total operation time to the point at which the alarm occurred in increments of 100 ms from when the control power supply and main circuit power supply were turned ON. The total operating time is recorded continuously for approximately 13 years.

Example

Time Stamp Display Example

If **36000** is displayed,









$3,600,000 \text{ ms} = 3,600 \text{ s} = 60 \text{ min} = 1 \text{ h}$

Therefore, the total operating time in hours is 1 hour.

Preparations

No preparations are required.

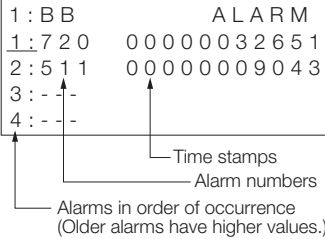
Operating Procedure

Step	Operation	Result
1	Press the  Key to display the Utility Mode Main Menu, and then use the  Key or  Key to select Fn000 .	<pre> 1:BB FUNCTION Fn207:V-Monitor Fn000:Alm History Fn002:JOG Fn003:Z-Search </pre>
2	Press the  Key.	<p>The Fn000 (Display Alarm History) display will appear.</p> <pre> 1:BB ALARM 0:D00 00001207196 1:720 00000032651 2:511 00000009043 3:---- </pre>
3	Press the  Key or  Key to scroll through the alarm history.	<p>The alarms that have occurred will be displayed.</p> <pre> 1:BB ALARM 1:720 00000032651 2:511 00000009043 3:---- 4:---- </pre> <p>  </p>
4	Press the  Key.	<p>The display will return to the Utility Mode Main Menu.</p> <pre> 1:BB FUNCTION Fn207:V-Monitor Fn000:Alm History Fn002:JOG Fn003:Z-Search </pre>

- Note: 1. If the same alarm occurs consecutively within one hour, it is not saved in the alarm history. If it occurs after an hour or more, it is saved.
2. "----" is displayed if no alarm has occurred.
3. You can clear the alarm history with the Fn006 (Clear Alarm History) utility function. The alarm history is not cleared when you reset alarms or turn OFF the power supply to the SERVOPACK.
4. The CPF00 and CPF01 alarms (Digital Operator Communications Error 1 and 2) are Digital Operator alarms. They are not recorded in the alarm history.
5. Warnings are not recorded in the alarm history.

3.2.2 Jog (Fn002)

You can use this utility function to operate the motor in the forward or reverse direction with the keys on the Digital Operator.

For safety, do not jog the motor while the motor is connected to the load (i.e., do not couple the axis to the machine). Also, to prevent the motor from falling over, secure it to the machine.

The range of motion of your machine must be considered when you set the jogging speed. The jogging speed is set in Pn304 (Jogging Speed).

Note: The P-OT (Forward Drive Prohibit) input signal and N-OT (Reverse Drive Prohibit) input signal are disabled during jogging.











Preparations

Always check the following before you execute jogging.

- The parameters must not be write-prohibited (Fn010 must be set to 0000).
- The servo must be OFF.
- The servo must be in ready status.

Operating Procedure

The following procedure shows how to jog the motor at a jogging speed of 1,000 min⁻¹. (The default setting is 500 min⁻¹.)





Step	Operation	Result
1	Press the  Key to display the Utility Mode Main Menu, and then use the  Key or  Key to select Fn002 .	<pre> 1:BB FUNCTION Fn000:Alm History Fn002:JOG Fn003:Z-Search Fn004:Program JOG </pre>
2	Press the  Key.	<p>The Fn002 (Jog) execution display will appear.</p> <pre> 1:BB JOG Pn304=00500 Un000= 00000 Un002= 00000 Un00D= 0000000000 </pre>
3	Press the  Key.	<p>The cursor will move to the setting for Pn304 (Jogging Speed).</p> <pre> 1:BB JOG Pn304=0050<u>0</u> Un000= 00000 Un002= 00000 Un00D= 0000000000 </pre>
4	Use the  Key,  Key,  Key, and  Key to set Pn304 (Jogging Speed) to 1,000.	<pre> 1:BB JOG Pn304=01<u>0</u>00 Un000= 00000 Un002= 00000 Un00D= 0000000000 </pre>
5	Press the  Key.	<p>The setting will be saved and the cursor will move to the parameter number.</p> <pre> 1:BB JOG Pn304=01000 Un000= 00000 Un002= 00000 Un00D= 0000000000 </pre>

Continued on next page.

3.2 Operating Procedures for Utility Functions

3.2.2 Jog (Fn002)

Continued from previous page.

Step	Operation	Result
6	Press the  Key.	<p>The status display will change to RUN and the motor will change to the servo ON state.</p> <pre> 1 : RUN JOG P n 3 0 4 = 0 1 0 0 0 U n 0 0 0 = 0 0 0 0 0 U n 0 0 2 = 0 0 0 0 0 U n 0 0 D = 0 0 0 0 0 0 0 0 0 </pre>
7	<p>Press the  Key to rotate the motor forward at 1,000 min⁻¹.</p> <p>Press the  Key to rotate the motor in reverse at 1,000 min⁻¹.</p> <p>Inspect the Servomotor for the following conditions.</p> <ul style="list-style-type: none"> • Make sure there is no abnormal vibration. • Make sure there is no abnormal noise. • Make sure that the temperature does not increase abnormally. 	-
8	Press the  Key.	<p>The status display will change to BB and the motor will change to the servo OFF state.</p> <pre> 1 : BB JOG P n 3 0 4 = 0 1 0 0 0 U n 0 0 0 = 0 0 0 0 0 U n 0 0 2 = 0 0 0 0 0 U n 0 0 D = 0 0 0 0 0 0 0 0 0 </pre>
9	Press the  Key.	<p>The display will return to the Utility Mode Main Menu.</p> <pre> 1 : BB FUNCTION F n 0 0 0 : Alm History F n 0 0 2 : JOG F n 0 0 3 : Z - Search F n 0 0 4 : Program JOG </pre>
10	Turn the SERVOPACK power supply OFF and ON again.	-

3.2.3 Origin Search (Fn003)

You can use this utility function to operate the motor with the keys on the Digital Operator, move the motor to the origin within one rotation, and clamp the motor there.

Use an origin search when it is necessary to align the origin within one rotation with the machine origin. The following motor speeds are used.

- Rotary Servomotors: 60 min⁻¹
- Direct Drive Servomotors: 6 min⁻¹
- Linear Servomotors: 15 mm/s

Note: 1. Make sure the load is not coupled when you execute an origin search.
2. The POT (Forward Drive Prohibit) input signal and N-OT (Reverse Drive Prohibit) input signal are disabled during an origin search.





Preparations

Always check the following before you execute an origin search.

- The parameters must not be write-prohibited (Fn010 must be set to 0000).
- The servo must be OFF.
- The servo must be in ready status.

Operating Procedure

The following procedure shows how to operate the motor in the forward direction and stop at the origin within one rotation.





Step	Operation	Result
1	Press the  Key to display the Utility Mode Main Menu, and then use the  Key or  Key to select Fn003 .	<pre> 1:BB FUNCTION Fn002:JOG Fn003:Z-Search Fn004:Program JOG Fn005:Prm Init </pre>
2	Press the  Key.	<p>The Fn003 (Origin Search) execution display will appear.</p> <pre> 1:BB Z-Search Un00<u>0</u>= 00000 Un002= 00000 Un003= 0000000774 Un00D= 0000000000 </pre>

Continued on next page.

3.2 Operating Procedures for Utility Functions

3.2.3 Origin Search (Fn003)

Continued from previous page.

Step	Operation	Result
3	Press the  Key.	<p>The status display will change to 1:RUN and the motor will change to the servo ON state.</p> <p>Note: If the Servomotor is already at the origin, Complete will be displayed.</p> <pre data-bbox="650 341 975 480"> 1:RUN Z-Search Un000= 00000 Un002= 00000 Un003= 0000000774 Un00D= 0000000000 </pre>
4	Press the  Key. The Servomotor will rotate in the forward direction and stop at the origin within one rotation. (Press the  Key to operate the motor in the reverse direction and stop at the phase-C position.) Hold down the key until the motor stops.	<p>If the origin search is completed normally, Complete will be displayed in the upper right corner of the display.</p> <pre data-bbox="650 619 975 758"> 1:RUN Complete Un000= 00000 Un002= 00000 Un003= 0000000000 Un00D= 0000001D58 </pre>
5	Press the  Key.	<p>The status display will change to 1:BB and the motor will change to the servo OFF state. The display will change from Complete to Z-Search.</p> <pre data-bbox="650 911 975 1050"> 1:BB Z-Search Un000= 00000 Un002= 00000 Un003= 0000000000 Un00D= 0000001D58 </pre>
6	Press the  Key.	<p>The display will return to the Utility Mode Main Menu.</p> <pre data-bbox="650 1134 975 1273"> 1:BB FUNCTION Fn002:JOG Fn003:Z-Search Fn004:Program JOG Fn005:Prm Init </pre>
7	Turn the SERVOPACK power supply OFF and ON again.	-

3.2.4 Jog Program (Fn004)

You can use this utility function to perform continuous operation with a preset operation pattern, travel distance, movement speed, acceleration/deceleration time, waiting time, and number of movements.

Preparations

Always check the following before you execute program jogging.

- The parameters must not be write-prohibited (Fn010 must be set to 0000).
- The servo must be OFF.
- The servo must be in ready status.
- The range of machine motion and the safe movement speed of your machine must be considered when you set the travel distance and movement speed.
- There must be no overtravel.







Operation

The program for jogging is set in advance with the following parameters. Consider the range of machine motion and the safe movement speed of your machine, and set the travel distance and movement speed correctly.

Program Jogging Element	Parameter
Operation Pattern	Pn530=n.□□□X
Travel Distance	Pn531
Movement Speed	Pn533*
Acceleration/Deceleration Time	Pn534
Waiting Time	Pn535
Number of Movements	Pn536





* Parameter Pn585 is used for a Linear Servomotor.

Operating Procedure

Step	Operation	Result
1	Press the  Key to display the Utility Mode Main Menu, and then use the  Key or  Key to select Fn004 .	<pre> 1:BB FUNCTION Fn003:Z-Search Fn004:Program JOG Fn005:Prm Init Fn006:AlmHist Clr </pre>
2	Press the  Key.	<pre> 1:BB PRG JOG Pn531=00032768 Pn533=00500 Pn534=00100 Pn536=00010 </pre>
3	Check the preset parameters. Press the  Key to display Pn530. Press the  Key to change the display as follows: Pn530 → Pn531 → Pn533 → Pn534 → Pn535 → Pn536	<pre> 1:BB PRG JOG Pn531=00032768 Pn533=00500 Pn534=00100 Pn536=00010 </pre>
4	Press the  Key.	<pre> 1:RUN PRG JOG Pn531=00032768 Pn533=00500 Pn534=00100 Pn536=00010 </pre>

Continued on next page.

Continued from previous page.

Step	Operation	Result
5	Press the  Key (forward movement start) or  Key (reverse movement start) according to the initial direction of the operation pattern.	Operation will start after the waiting time that is set in Pn535. <div style="border: 1px solid black; padding: 5px; margin: 10px 0;"> <pre> 1:RUN PRG JOG P n 5 3 1=0 0 0 3 2 7 6 8 P n 5 3 3=0 0 5 0 0 P n 5 3 4=0 0 1 0 0 P n 5 3 6=0 0 0 1 0 </pre> </div> Note: If you press the  Key again, base block status will be entered and the motor will stop even during operation. When the set program jogging operation has been completed, the status display will change to 1:END for approximately one second. <div style="border: 1px solid black; padding: 5px; margin: 10px 0;"> <pre> 1:END PRG JOG P n 5 3 1=0 0 0 3 2 7 6 8 P n 5 3 3=0 0 5 0 0 P n 5 3 4=0 0 1 0 0 P n 5 3 6=0 0 0 1 0 </pre> </div> It will then return to RUN .
6	Press the  Key.	Base block status is entered and the display will return to the Utility Mode Main Menu.
7	Turn the SERVOPACK power supply OFF and ON again.	-

Note: When you check the parameter settings in step 3, you can change any of the settings.

3.2.5 Initialize Parameters (Fn005)





You can use this utility function to initialize the parameters to the default settings.

Preparations

Always check the following before you initialize the parameter settings.



- The parameters must not be write-prohibited (Fn010 must be set to 0000).
- The servo must be OFF.

Operating Procedure

Step	Operation	Result
1	Press the  Key to display the Utility Mode Main Menu, and then use the  Key or  Key to select Fn005 .	<pre> 1:BB FUNCTION Fn004:Program JOG En005:Prm Init Fn006:AlmHist Clr Fn008:Mturn Clr </pre>
2	Press the  Key.	<p>The Fn005 (Initialize Parameters) execution display will appear.</p> <pre> 1:BB Parameter Init Start : [DATA] Return: [SET] </pre>

Continued on next page.

Continued from previous page.

Step	Operation	Result
3	<p>Press the  Key.</p> <p>Note: Press the  Key to cancel initializing the parameters. The display will return to the Utility Mode Main Menu.</p>	<p>The parameters will be initialized. Parameter Init will flash on the display while the parameters are being initialized. It will stop flashing when processing has been completed and the following status displays will appear.</p> <ul style="list-style-type: none"> • SERVOPACKs with Analog Voltage/Pulse Train References 1:BB → DONE → 1:A.941 • SERVOPACKs with Other References 1:BB → DONE → 1:BB <div style="border: 1px solid black; padding: 5px; margin-top: 10px;"> <pre> 1:A.941 Parameter Init Start : [DATA] Return: [SET] </pre> </div>
4	<p>Turn the SERVOPACK power supply OFF and ON again.</p>	<p>The parameter settings are now enabled.</p>

3.2.6 Clear Alarm History (Fn006)

You can use this utility function to clear the alarm history.







This utility function is the only way to clear the alarm history. The alarm history is not cleared when you reset alarms or turn OFF the power supply to the SERVOPACK.

Preparations

Always check the following before you clear the alarm history.

- The parameters must not be write-prohibited (Fn010 must be set to 0000).

Operating Procedure

Step	Operation	Result
1	Press the  Key to display the Utility Mode Main Menu, and then use the  Key or  Key to select Fn006 .	<pre> 1:BB FUNCTION Fn005:Prm Init Fn006:AlmHist Clr Fn008:Mturn Clr Fn009:Ref Adj </pre>
2	Press the  Key.	<pre> 1:BB Alarm History Data Clear Start : [DATA] Return: [SET] </pre>
3	Press the  Key. Note: Press the  Key to cancel clearing the alarm history. The display will return to the Utility Mode Main Menu.	<p>The alarm history will be cleared. When processing has been completed, the status display will flash DONE for approximately one second and then return to 1:BB.</p> <pre> 1:BB Alarm History Data Clear Start : [DATA] Return: [SET] </pre>

3.2.7 Reset Absolute Encoder (Fn008)

You must reset (initialize) the absolute encoder at the following times.

- When starting the system for the first time
- When an A.810 alarm (Encoder Backup Alarm) occurs
- When an A.820 alarm (Encoder Checksum Alarm) occurs
- When you want to reset the multiturn data in the absolute encoder

Note: 1. You cannot reset alarms from the SERVOPACK to clear the A.810 alarm (Encoder Backup Alarm) or the A.820 alarm (Encoder Checksum Alarm). Always use the operation to reset the absolute encoder to clear these alarms.







2. If an A.8□□ alarm (Internal Encoder Monitoring Alarm) occurs, turn OFF the power supply to reset the alarm.

Preparations

Always check the following before you reset an absolute encoder.

- The parameters must not be write-prohibited (Fn010 must be set to 0000).
- The servo must be OFF.

Operating Procedure

Step	Operation	Result
1	Press the  Key to display the Utility Mode Main Menu, and then use the  Key or  Key to select Fn008 .	<pre>1:A.810 FUNCTION Fn006:AlmHist Clr En008:Mturn Clr Fn009:Ref Adj Fn00A:Vel Adj</pre>
2	Press the  Key.	<pre>1:A.810 Multiturn Clear PGCL1</pre>
3	Press the  Key to go from from PGCL1 to PGCL5 .	<pre>1:A.810 Multiturn Clear PGCL5</pre>
4	Press the  Key.	<p>The absolute encoder will be reset. When processing has been completed, the status display will flash DONE for approximately one second and then return to 1:A.810.</p> <pre>1:A.810 Multiturn Clear PGCL5</pre>
5	Press the  Key.	<p>The display will return to the Utility Mode Main Menu.</p> <pre>1:A.810 FUNCTION Fn006:AlmHist Clr En008:Mturn Clr Fn009:Ref Adj Fn00A:Vel Adj</pre>
6	Turn the power supply OFF and ON again.	The parameter settings are now enabled and the alarm will have been cleared.

3.2.8 Autotune Analog (Speed/Torque) Reference Offset (Fn009)

You can use this utility function to measure the offset to automatically adjust the reference voltage.

The measured offset is saved in the SERVOPACK.

Example







1. The offset does not use a parameter, so it will not change even if the parameter settings are initialized.
2. You cannot use this utility function if a position loop is created with the host controller. Use the Fn00A (Manually Adjust Speed Reference Offset) and Fn00B (Manually Adjust Torque Reference Offset) parameters to adjust the offsets.

Preparations

Always check the following before you automatically adjust the analog (speed/torque) reference offset.

- The parameters must not be write-prohibited (Fn010 must be set to 0000).
- The servo must be OFF.

Operating Procedure

Step	Operation	Result
1	Turn OFF the servo.	–
2	Input a reference voltage of 0 V.	–
3	Press the  Key to display the Utility Mode Main Menu, and then use the  Key or  Key to select Fn009 .	<div style="border: 1px solid black; padding: 5px;"> <pre> 1:BB FUNCTION Fn008:Mturn Clr Fn009:Ref Adj Fn00A:Vel Adj Fn00B:Trq Adj </pre> </div>
4	Press the  Key.	<p>The Fn009 (Autotune Analog (Speed/Torque) Reference Offset) execution display will appear.</p> <div style="border: 1px solid black; padding: 5px;"> <pre> 1:BB Ref Adjust Start : [DATA] Return: [SET] </pre> </div>
5	<p>Press the  Key.</p> <p>Note: Press the  Key to cancel automatically adjusting the analog (speed/torque) reference offsets. The display will return to the Utility Mode Main Menu.</p>	<p>The offsets for the analog voltage references (speed and torque) will be tuned automatically. When processing has been completed, the status display will flash DONE for approximately one second and then return to 1:BB.</p> <div style="border: 1px solid black; padding: 5px;"> <pre> 1:BB Ref Adjust Start : [DATA] Return: [SET] </pre> </div>

3.2.9 Manually Adjust Speed Reference Offset (Fn00A)

You can use this utility function to directly input an offset to adjust the speed reference. The offset is adjusted manually in the following cases.

- When a position loop is created with the host computer and the position deviation when the Servomotor is stopped by a servo lock is to be set to 0
- To intentionally set the offset to a desired value
- To check an offset that was set automatically

Example









The offset does not use a parameter, so it will not change even if the parameter settings are initialized.

Preparations

Always check the following before you manually adjust the speed reference offset.

- The parameters must not be write-prohibited (Fn010 must be set to 0000).

Operating Procedure

Step	Operation	Result
1	Input a reference voltage of 0 V.	–
2	Press the  Key to display the Utility Mode Main Menu, and then use the  Key or  Key to select Fn00A .	<pre>1:BB FUNCTION Fn009:Ref Adj Fn00A:Vel Adj Fn00B:Trq Adj Fn00C:MonZero Adj</pre>
3	Press the  Key.	<p>The Fn00A (Manually Adjust Speed Reference Offset) execution display will appear.</p> <pre>1:BB Velocity Adjust ZADJV= 00000 Vref = 00000</pre>
4	Turn ON the /S-ON (Servo ON) input signal.	<pre>1:RUN Velocity Adjust ZADJV= 00000 Vref = 00000</pre>
5	Press the  Key or  Key to adjust the speed reference offset so that the motor speed goes to 0.	<pre>1:RUN Velocity Adjust ZADJV=+0001<u>2</u> Vref = 00000</pre>
6	Press the  Key.	<p>The speed reference offset is saved in the SER-VOPACK. When the data has been written, the status display will flash DONE for approximately one second and then return to 1:RUN.</p> <pre>1:RUN Velocity Adjust ZADJV=+0001<u>5</u> Vref = 00000</pre>
7	Press the  Key.	<pre>1:RUN FUNCTION Fn009:Ref Adj Fn00A:Vel Adj Fn00B:Trq Adj Fn00C:MonZero Adj</pre>

3.2.10 Manually Adjust Torque Reference Offset (Fn00B)

You can use this utility function to directly input an offset to adjust the torque reference. The offset is adjusted manually in the following cases.

- To intentionally set the offset to a desired value
- To check an offset that was set automatically









Example The offset does not use a parameter, so it will not change even if the parameter settings are initialized.

Preparations

Always check the following before you manually adjust the torque reference offset.

- The parameters must not be write-prohibited (Fn010 must be set to 0000).

Operating Procedure

Step	Operation	Result
1	Input a reference voltage of 0 V.	–
2	Press the  Key to display the Utility Mode Main Menu, and then use the  Key or  Key to select Fn00B .	<pre> 1:BB FUNCTION Fn00A:Vel Adj Fn00B:Trq Adj Fn00C:MonZero Adj Fn00D:MonGain Adj </pre>
3	Press the  Key.	<p>The Fn00B (Manually Adjust Torque Reference Offset) execution display will appear.</p> <pre> 1:BB Torque Adjust ZADJT=-00004 Tref = 00000 </pre>
4	Turn ON the /S-ON (Servo ON) input signal.	<pre> 1:RUN Torque Adjust ZADJT=-00004 Tref = 00000 </pre>
5	Press the  Key or  Key to adjust the torque reference offset so that the motor torque goes to 0.	<pre> 1:RUN Torque Adjust ZADJT=-0000<u>7</u> Tref = 00000 </pre>
6	Press the  Key.	<p>The torque reference offset is written to the SERVOPACK. When the data has been written, the status display will flash DONE for approximately one second and then return to 1:RUN.</p> <pre> 1:RUN Torque Adjust ZADJT=-0000<u>7</u> Tref = 00000 </pre>
7	Press the  Key.	<pre> 1:RUN FUNCTION Fn00A:Vel Adj Fn00B:Trq Adj Fn00C:MonZero Adj Fn00D:MonGain Adj </pre>

3.2.11 Adjust Analog Monitor Output Offset (Fn00C)

You can use this utility function to manually adjust the analog monitor output offsets for the torque reference monitor and motor speed monitor. You can adjust the torque reference monitor and motor speed monitor offsets individually.

These offsets are adjusted at the factory. You normally do not need to use this utility function.





- Note: 1. These offsets are not initialized even if you execute the Fn005 (Initialize Parameters) utility function.
2. When you adjust the offsets, connect to the measuring device that you will actually use when the output voltage is 0 V (e.g., for the speed monitor, when the servo is OFF and the motor shaft is not moving).

Preparations

Always check the following before you adjust offset of the analog monitor output.

- The parameters must not be write-prohibited (Fn010 must be set to 0000).

Operating Procedure







Step	Operation	Result
1	Press the  Key to display the Utility Mode Main Menu, and then use the  Key or  Key to select Fn00C .	<pre> 1:BB FUNCTION Fn00B:Trq Adj Fn00C:MonZero Adj Fn00D:MonGain Adj Fn00E:Cur AutoAdj </pre>
2	Press the  Key.	<p>The Fn00C (Adjust Analog Monitor Output Offset) execution display will appear.</p> <pre> 1:BB Zero ADJ CH1=- 0000<u>2</u> CH2= 00001 Un002= 00000 Un000= 00000 </pre>

Continued on next page.

3.2 Operating Procedures for Utility Functions

3.2.11 Adjust Analog Monitor Output Offset (Fn00C)

Continued from previous page.

Step	Operation	Result
3	Adjust the offset for channel 1 (the torque reference monitor). Press the  Key or  Key to adjust the offset. Adjust the offset so that the value measured by the measuring devices is as close to 0 V as possible.	<pre> 1:BB Zero ADJ CH1=-0000<u>5</u> CH2= 00001 Un002= 00000 Un000= 00000 </pre>
4	Press the  Key.	<p>The cursor will move to channel 2.</p> <pre> 1:BB Zero ADJ CH1=-00005 CH2= 0000<u>1</u> Un002= 00000 Un000= 00000 </pre>
5	Adjust the offset for channel 2 (the motor speed monitor). Press the  Key or  Key to adjust the offset. Adjust the offset so that the value measured by the measuring devices is as close to 0 V as possible.	<pre> 1:BB Zero ADJ CH1=-00005 CH2= 0000<u>6</u> Un002= 00000 Un000= 00000 </pre>
6	Press the  Key.	<p>The adjustment results are written to the SERVOPACK. When the data has been written, the status display will flash DONE for approximately one second and then return to 1:BB.</p> <pre> 1:BB Zero ADJ CH1=-00005 CH2= 0000<u>6</u> Un002= 00000 Un000= 00000 </pre>
7	Press the  Key.	<p>The display will return to the Utility Mode Main Menu.</p> <pre> 1:BB FUNCTION Fn00B:Trq Adj Fn00C:MonZero Adj Fn00D:MonGain Adj Fn00E:Cur AutoAdj </pre>

3.2.12 Adjust Analog Monitor Output Gain (Fn00D)

You can use this utility function to manually adjust the analog monitor output gains for the torque reference monitor and motor speed monitor. You can adjust the torque reference monitor and motor speed monitor gains individually.

These gains are adjusted at the factory. You normally do not need to use this utility function.

The setting range for the analog monitor output gains is -128 to 127 ($\times 0.4\%$).

The center value of the gain adjustment range is 100%.

For example, if you set -125, the gain will be $100\% - (125 \times 0.4\%)$, or 50%. Therefore, the monitor output voltage will be reduced by 1/2. Also, if you set 125, the gain will be $100\% + (125 \times 0.4\%)$, or 150%. Therefore, the monitor output voltage will be increased by a factor of 1.5.





Note: These offsets are not initialized even if you execute the Fn005 (Initialize Parameters) utility function.

Preparations

Always check the following before you adjust gain of the analog monitor output.

- The parameters must not be write-prohibited (Fn010 must be set to 0000).

Operating Procedure







Step	Operation	Result
1	Press the  Key to display the Utility Mode Main Menu, and then use the  Key or  Key to select Fn00D .	<pre> 1:BB FUNCTION Fn00C:MonZero Adj Fn00D:MonGain Adj Fn00E:Cur AutoAdj Fn00F:Cur ManuAdj </pre>
2	Press the  Key.	<p>The Fn00D (Adjust Analog Monitor Output Gain) execution display will appear.</p> <pre> 1:BB Gain ADJ CH1=-0000<u>1</u> CH2=-0000<u>1</u> Un002= 00000 Un000= 00000 </pre>

Continued on next page.

3.2 Operating Procedures for Utility Functions

3.2.12 Adjust Analog Monitor Output Gain (Fn00D)

Continued from previous page.

Step	Operation	Result
3	Adjust the gain for channel 1 (the torque reference monitor). Use the  Key or  Key to change the gain adjustment range.	<pre> 1:BB Gain ADJ CH1= 0012<u>5</u> CH2=-00001 Un002= 00000 Un000= 00000 </pre>
4	Press the  Key.	The cursor will move to channel 2. <pre> 1:BB Gain ADJ CH1= 00125 CH2=-0000<u>1</u> Un002= 00000 Un000= 00000 </pre>
5	Adjust the gain for channel 2 (the motor speed monitor). Use the  Key or  Key to change the gain adjustment range.	<pre> 1:BB Gain ADJ CH1= 00125 CH2=-0012<u>5</u> Un002= 00000 Un000= 00000 </pre>
6	Press the  Key.	The settings are written to the SER-VOPACK. When the data has been written, the status display will flash DONE for approximately one second and then return to 1:BB . <pre> 1:BB Gain ADJ CH1= 00125 CH2=-0012<u>5</u> Un002= 00000 Un000= 00000 </pre>
7	Press the  Key.	The display will return to the Utility Mode Main Menu. <pre> 1:BB FUNCTION Fn00C: MonZero Adj Fn00D: MonGain Adj Fn00E: Cur AutoAdj Fn00F: Cur ManuAdj </pre>

3.2.13 Autotune Motor Current Detection Signal Offset (Fn00E)

The adjustment that is made by this utility function is completed at the factory. There is normally no reason to execute it.

Execute this utility function if you think the torque ripple is abnormally large due to the current detection signal offset.







Note: This offset is not initialized even if you execute the Fn005 (Initialize Parameters) utility function.

Preparations

Always check the following before you automatically adjust the motor current detection signal offset.

- The parameters must not be write-prohibited (Fn010 must be set to 0000).
- The servo must be OFF.
- The servo must be in ready status.

Operating Procedure

Step	Operation	Result
1	Press the  Key to display the Utility Mode Main Menu, and then use the  Key or  Key to select Fn00E .	<pre> 1:BB FUNCTION Fn00D:MonGain Adj Fn00E:Cur AutoAdj Fn00F:Cur ManuAdj Fn010:Prm Protect </pre>
2	Press the  Key.	<p>The Fn00E (Autotune Motor Current Detection Signal Offset) execution display will appear.</p> <pre> 1:BB Auto Offset-ADJ of Motor Current Start : [DATA] Return: [SET] </pre>
3	<p>Press the  Key.</p> <p>Note: Press the  Key to cancel the automatic adjustment. The display will return to the Utility Mode Main Menu.</p>	<p>The offset of the motor current detection signal will be automatically adjusted.</p> <p>When processing has been completed, the status display will flash DONE for approximately one second and then return to 1:BB.</p> <pre> 1:BB Auto Offset-ADJ of Motor Current Start : [DATA] Return: [SET] </pre>

3.2.14 Manually Adjust Motor Current Detection Signal Offset (Fn00F)

The adjustment that is made by this utility function is completed at the factory. There is normally no reason to execute it.

Execute this utility function in the following cases.

- If you think the torque ripple is abnormally large due to the current detection signal offset
 - If you execute the Fn00E (Autotune Motor Current Detection Signal Offset) utility function and the torque ripple is still large.
- Observe the following precautions when you execute this utility function.
- Do not couple the motor shaft to the machine (operate the motor with no load) and operate the motor at 100 min^{-1} .
 - Monitor the torque reference with the SigmaWin+ or the analog monitor and adjust the offset to minimize the torque ripple.
 - Adjust the offsets for the phase-U current and phase-V current of the Servomotor so that they are balanced. Alternately adjust both offsets several times.







Note: These offsets are not initialized even if you execute the Fn005 (Initialize Parameters) utility function.

Preparations

Always check the following before you manually adjust the motor current detection signal offset.

- The parameters must not be write-prohibited (Fn010 must be set to 0000).





Operating Procedure

Step	Operation	Result
1	Press the  Key to display the Utility Mode Main Menu, and then use the  Key or  Key to select Fn00F .	<pre> 1:BB FUNCTION Fn00F:Cur ManuAdj Fn010:Prm Protect Fn011:Motor Info Fn012:Soft Ver </pre>
2	Press the  Key.	<p>The Fn00F (Manually Adjust Motor Current Detection Signal Offset) execution display will appear.</p> <pre> 1:BB Manual Offset-ADJ of Motor Current ZADJIU=-0000<u>9</u> ZADJIV=-00006 </pre>
3	Turn ON the /S-ON (Servo ON) input signal.	<pre> 1:RUN Manual Offset-ADJ of Motor Current ZADJIU=-0000<u>9</u> ZADJIV=-00006 </pre>
4	Adjust the offset for phase U. Use the  Key or  Key to change the offset. Change the offset by about 10 in the direction that reduces the torque ripple. Adjustment range: -512 to 511	<pre> 1:RUN Manual Offset-ADJ of Motor Current ZADJIU=-0001<u>9</u> ZADJIV=-00006 </pre> <p>Note: ZADJIU: Zero adjustment of the phase-U current.</p>
5	Press the  Key.	<p>The cursor will move to the offset for phase V.</p> <pre> 1:RUN Manual Offset-ADJ of Motor Current ZADJIU=-00019 ZADJIV=-0000<u>6</u> </pre>

Continued on next page.

3.2.14 Manually Adjust Motor Current Detection Signal Offset (Fn00F)

Continued from previous page.

Step	Operation	Result
6	Adjust the offset for phase V. Use the  Key or  Key to change the offset. Change the offset by about 10 in the direction that reduces the torque ripple.	<div style="border: 1px solid black; padding: 5px; margin-bottom: 5px;"> <pre>1:RUN Manual Offset-ADJ of Motor Current ZADJIU=-00019 ZADJIV=-0001<u>6</u></pre> </div> Note: ZADJIV: Zero adjustment of the phase-V current.
7	Repeat the above steps (to adjust phase U and then phase V) until the torque ripple cannot be improved any further regardless of whether you increase or decrease the offsets. Then, reduce the amount by which you change the offsets and repeat the same process.	-
8	Press the  Key.	The adjustment results are written to the SERVOPACK. When the data has been written, the status display will flash DONE for approximately one second and then return to 1:RUN . <div style="border: 1px solid black; padding: 5px;"> <pre>1:RUN Manual Offset-ADJ of Motor Current ZADJIU=-00019 ZADJIV=-0001<u>6</u></pre> </div>
9	Press the  Key.	The display will return to the Utility Mode Main Menu. <div style="border: 1px solid black; padding: 5px;"> <pre>1:RUN FUNCTION Fn00F:Cur ManuAdj Fn010:Prm Protect Fn011:Motor Info Fn012:Soft Ver</pre> </div>

3.2.15 Write Prohibition Setting (Fn010)

You can use this utility function to restrict executing the utility functions to prevent careless changes to the parameter settings.

When you prohibit writing, writing parameters and executing utility functions are restricted as described below.

- Parameters: The settings of parameters cannot be changed. If you attempt to change the setting of a parameter, **NO-OP** will flash on the display and the display will return to the Main Menu.
- Utility functions: Some of the utility functions cannot be executed. If you attempt to execute one of these utility functions, **NO-OP** will flash on the display and the display will return to the Main Menu. The following table shows which utility functions cannot be executed.

Fn No.	Function	When Writing Is Prohibited
Fn000	Display Alarm History	Can be executed.
Fn002	Jog	Cannot be executed.
Fn003	Origin Search	Cannot be executed.
Fn004	Jog Program	Cannot be executed.
Fn005	Initialize Parameters	Cannot be executed.
Fn006	Clear Alarm History	Cannot be executed.
Fn008	Reset Absolute Encoder	Cannot be executed.
Fn009	Autotune Analog (Speed/Torque) Reference Offset	Cannot be executed.
Fn00A	Manually Adjust Speed Reference Offset	Cannot be executed.
Fn00B	Manually Adjust Torque Reference Offset	Cannot be executed.
Fn00C	Adjust Analog Monitor Output Offset	Cannot be executed.
Fn00D	Adjust Analog Monitor Output Gain	Cannot be executed.
Fn00E	Autotune Motor Current Detection Signal Offset	Cannot be executed.
Fn00F	Manually Adjust Motor Current Detection Signal Offset	Cannot be executed.
Fn010	Write Prohibition Setting	Cannot be executed.
Fn011	Display Servomotor Model	Can be executed.
Fn012	Display Software Version	Can be executed.
Fn013	Multiturn Limit Setting after Multiturn Limit Disagreement Alarm	Cannot be executed.
Fn014	Reset Option Module Configuration Error	Cannot be executed.

Continued on next page.







Continued from previous page.

Fn No.	Function	When Writing Is Prohibited
Fn01B	Initialize Vibration Detection Level	Cannot be executed.
Fn01E	Display SERVOPACK and Servomotor IDs	Can be executed.
Fn01F	Display Servomotor ID from Feedback Option Module	Can be executed.
Fn020	Set Absolute Linear Encoder Origin	Cannot be executed.
Fn030	Software Reset	Can be executed.
Fn080	Polarity Detection	Cannot be executed.
Fn200	Tuning-less Level Setting	Cannot be executed.
Fn201	Advanced Autotuning without Reference	Cannot be executed.
Fn202	Advanced Autotuning with Reference	Cannot be executed.
Fn203	One-Parameter Tuning	Cannot be executed.
Fn204	Adjust Anti-resonance Control	Cannot be executed.
Fn205	Vibration Suppression	Cannot be executed.
Fn206	Easy FFT	Cannot be executed.
FnB03	Edit/Save Program Table	Cannot be executed.
FnB04	Edit/Save ZONE Table	Cannot be executed.
FnB05	Edit/Save Jog Speed Table	Cannot be executed.
FnB06	Initialize Program Table	Cannot be executed.
FnB07	Initialize ZONE Table	Cannot be executed.
FnB08	Initialize Jog Speed Table	Cannot be executed.
FnB09	Set Absolute Encoder Origin	Cannot be executed.
FnB0A	INDEXER Status Monitor	Can be executed.
FnB0B	Initialize INDEXER Parameter Settings	Cannot be executed.
FnB0C	Reset INDEXER Alarm	Cannot be executed.
FnB0D	Display INDEXER Alarm History	Can be executed.

Preparations

No preparations are required.

Operating Procedure

Step	Operation	Result
1	Press the  Key to display the Utility Mode Main Menu, and then use the  Key or  Key to select Fn010 .	<pre> 1:BB FUNCTION Fn00F:Cur ManuAdj Fn010:Prm Protect Fn011:Motor Info Fn012:Soft Ver </pre>
2	Press the  Key.	<pre> 1:BB Parameter Write Protect P. 0000 </pre>
3	Press the  Key to set 0001. Note: To enable writing the settings of parameters, change the setting to 0000.	<pre> 1:BB Parameter Write Protect P. 0001 </pre>
4	Press the  Key.	<p>The setting is written to the SERVO-PACK. When the data has been written, the status display will flash DONE for approximately one second and then 1:A.941 will be displayed.</p> <pre> 1:A.941 Parameter Write Protect P. 0001 </pre>
5	Turn the SERVOPACK power supply OFF and ON again.	The parameter setting is now enabled.



3.2.16 Display Servomotor Model (Fn011)

You can use this utility function to display the model, voltage, capacity, encoder type, and encoder resolution of the Servomotor that is connected to the SERVOPACK. If the SERVOPACK has custom specifications, the specifications number is also displayed.

Preparations

No preparations are required.

Operating Procedure

Step	Operation	Result
1	Press the  Key to display the Utility Mode Main Menu, and then use the  Key or  Key to select Fn011 .	<pre> 1:BB FUNCTION Fn010:Prm Protect Fn011:Motor Info Fn012:Soft Ver Fn013:MturnLmSet </pre>

Continued on next page.

* The displayed information is as follows for a Linear Servomotor:

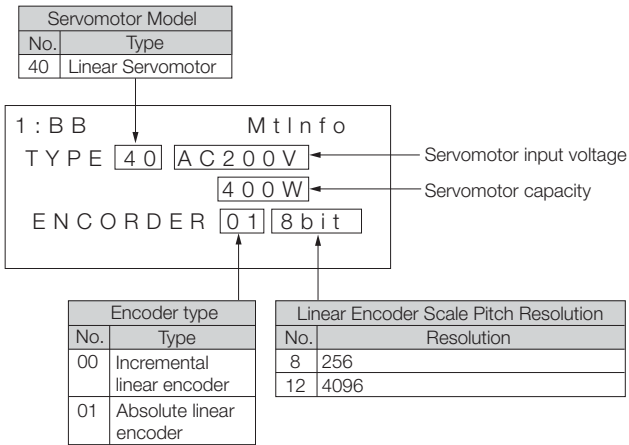





3.2.17 Display Software Version (Fn012)

You can use this utility function to display the software version of the SERVOPACK and the software version of the connected encoder.

Preparations

No preparations are required.

Operating Procedure

Step	Operation	Result
1	Press the  Key to display the Utility Mode Main Menu, and then use the  Key or  Key to select Fn012 .	<pre> 1:BB FUNCTION Fn011:Motor Info Fn012:Soft Ver Fn013:MturnLmSet Fn014:Opt Init </pre>
2	Press the  Key.	<p>The Fn012 (Display Software Version) execution display will appear and the software versions of the SERVOPACK and encoder will be displayed.</p> <pre> 1:BB Soft Ver DRIVER Ver.=0001 ENCODER Ver.=0003 </pre>
3	Press the  Key.	<p>The display will return to the Utility Mode Main Menu.</p> <pre> 1:BB FUNCTION Fn011:Motor Info Fn012:Soft Ver Fn013:MturnLmSet Fn014:Opt Init </pre>

3.2.18 Multiturn Limit Setting after Multiturn Limit Disagreement Alarm (Fn013)









If you change the value of the multiturn limit (Pn205) when an absolute encoder is being used, an A.CC0 alarm (Multiturn Limit Disagreement) will be output. You can use this utility function to reset that alarm and change the value of the multiturn limit.

Preparations

Always check the following before you set the multiturn limit when an A.CC0 alarm (Multiturn Limit Disagreement) alarm has occurred.

- The parameters must not be write-prohibited (Fn010 must be set to 0000).

Operating Procedure

Step	Operation	Result
1	Press the  Key to display the Utility Mode Main Menu, and then use the  Key or  Key to select Fn013 .	<pre>1:A.CC0 FUNCTION Fn012:Soft Ver Fn013:MturnLmSet Fn014:Opt Init Fn01B:ViblvI Init</pre>
2	Press the  Key.	<pre>1:A.CC0 Multiturn Limit Set Start :[DATA] Return:[SET]</pre>
3	Press the  Key. Note: If you press the  Key instead of the  Key, the multiturn limit will not be updated.	<p>The multiturn limit will be set. When processing has been completed, the status display will flash DONE for approximately one second and then return to 1:A.CC0.</p> <pre>1:A.CC0 Multiturn Limit Set Start :[DATA] Return:[SET]</pre>
4	Press the  Key.	<pre>1:A.CC0 FUNCTION Fn012:Soft Ver Fn013:MturnLmSet Fn014:Opt Init Fn01B:ViblvI Init</pre>
5	Turn the SERVOPACK power supply OFF and ON again.	The parameter setting is now enabled and the alarm will have been cleared.

3.2.19 Reset Option Module Configuration Error (Fn014)

If Option Modules are attached to the SERVOPACK, the SERVOPACK detects the presence and models of the connected Option Modules. If it finds any errors, it outputs alarms. You can use this utility function to reset those alarms.









- Note: 1. This utility function is the only way to reset errors for Option Modules. The errors are not reset when you reset alarms or turn OFF the power supply to the SERVOPACK.
2. Always remove the cause of an alarm before you reset the alarm.

Preparations

Always check the following before you reset the Option Module detection alarm.

- The parameters must not be write-prohibited (Fn010 must be set to 0000).

Operating Procedure

Step	Operation	Result
1	Press the  Key to display the Utility Mode Main Menu, and then use the  Key or  Key to select Fn014 .	<pre> 1:BB FUNCTION Fn013:MturnLmSet Fn014:Opt Init Fn01B:VibLvl Init Fn01E:SvMotOp ID </pre>
2	Press the  Key.	<pre> 1:BB Opt Init 01:Command Opt 02:Safety Opt 03:Feedback Opt </pre>
3	Use the  Key or  Key to select the Option Module for which to reset the alarm.	<pre> 1:BB Opt Init 01:Command Opt 02:Safety Opt 03:Feedback Opt </pre>
4	Press the  Key.	<p>The detected alarm will be reset. When processing has been completed, the status display will flash DONE for approximately one second and then return to 1:BB.</p> <pre> 1:BB Opt Init Command Opt Initialize Start :[DATA] Return:[SET] </pre>
5	Press the  Key.	<p>The display will return to the Utility Mode Main Menu.</p> <pre> 1:BB FUNCTION Fn013:MturnLmSet Fn014:Opt Init Fn01B:VibLvl Init Fn01E:SvMotOp ID </pre>
6	Turn the SERVOPACK power supply OFF and ON again.	The parameter settings are now enabled.

3.2.20 Initialize Vibration Detection Level (Fn01B)

You can detect machine vibration during operation to automatically adjust the settings of Pn312 or Pn384 (Vibration Detection Level) to detect A.520 alarms (Vibration Alarm) and A.911 warnings (Vibration Warning) more precisely.

This utility function detects specific vibration components in the Servo-motor speed. If the detected vibration exceeds the detection level calculated with the following formula, an alarm or warning occurs according to Pn310 (Vibration Detection Selections).

- Rotary Servomotors

$$\text{Detection level} = \frac{\text{Vibration detection level (Pn312 [min}^{-1}\text{])} \times \text{Vibration detection sensitivity (Pn311 [\%])}}{100}$$

- Linear Servomotors

$$\text{Detection level} = \frac{\text{Vibration detection level (Pn384 [mm/s])} \times \text{Vibration detection sensitivity (Pn311 [\%])}}{100}$$

Use this utility function if A.520 or A.911 alarms are not output at a suitable time when vibration is detected with the default vibration detection level (Pn312 or Pn384). Otherwise, it is not necessary to execute this utility function.







There will be discrepancies in the detection sensitivity for vibration alarms and warnings depending on the condition of your machine. If there is a discrepancy, use the following formula to adjust Pn311 (Vibration Detection Sensitivity).

Preparations

Always check the following before you initialize the vibration detection level.

- The parameters must not be write-prohibited (Fn010 must be set to 0000).
- The test without a motor function must be disabled (Pn00C = n.□□□0).

Operating Procedure

Step	Operation	Result
1	Press the  Key to display the Utility Mode Main Menu, and then use the  Key or  Key to select Fn01B .	<pre> 1:RUN FUNCTION Fn014:Opt Init En01B:Viblvl Init Fn01E:SvMotOp ID Fn01F:FBOPMot ID </pre>
2	Press the  Key.	<p>The Fn01B (Initialize Vibration Detection Level) execution display will appear.</p> <pre> 1:RUN Vibration Detect Level Init Start : [DATA] Return: [SET] </pre>
3	Press the  Key.	<p>Init will flash on the display and the vibration level will be updated. Note: The vibration detection level will be continuously updated until you press the  Key again.</p> <pre> 1:RUN Vibration Detect Level Init Init </pre>
4	Press the  Key.	<p>The vibration detection level will be initialized. When processing has been completed, the status display will flash DONE for approximately one second and then return to 1:RUN. Also, Pn312 (Vibration Detection Level) will be updated.</p> <pre> 1:RUN Vibration Detect Level Init Done </pre>

Continued on next page.

Continued from previous page.

Step	Operation	Result
5	Press the  Key.	<p>The display will return to the Utility Mode Main Menu.</p> <pre data-bbox="689 272 1016 411"> 1:RUN FUNCTION Fn014:Opt Init Fn01B:Viblvl Init Fn01E:SvMotOp ID Fn01F:FBOpMot ID </pre>

3.2.21 Display SERVOPACK and Servomotor IDs (Fn01E)

You can use this utility function to display ID information on the SERVOPACK and on the Servomotor, encoder, and Option Module that are connected to it. However, ID information for some Option Modules (e.g., the SGD V-OF01A) is not stored in the SERVOPACK. **Not Available** will be displayed for these Option Modules.

You can use this utility function to display the following items.









ID Information	Displayed Items
SERVOPACK ID Information	<ul style="list-style-type: none"> • SERVOPACK model • SERVOPACK serial number • SERVOPACK manufacturing date • SERVOPACK input voltage • Maximum applicable motor capacity [W] • Maximum applicable rated motor current [Arms]
Motor ID Information	<ul style="list-style-type: none"> • Servomotor model • Servomotor serial number • Servomotor manufacturing date • Servomotor input voltage [V] • Servomotor capacity [W] • Rated motor current [Arms]
Encoder ID Information	<ul style="list-style-type: none"> • Encoder model • Servomotor serial number • Encoder manufacturing date • Encoder type/resolution
Safety Option Module ID Information*	<ul style="list-style-type: none"> • Safety Option Module model • Safety Option Module serial number • Safety Option Module manufacturing date • Safety Option Module ID
Feedback Option Module ID information*	<ul style="list-style-type: none"> • Feedback Option Module model • Feedback Option Module serial number (reserved area) • Feedback Option Module manufacturing date • Feedback Option Module ID

* If an Option Module is not connected, **Not connect** will be displayed after the Module name.

Preparations

No preparations are required.

Operating Procedure





Step	Operation	Result
1	Press the  Key to display the Utility Mode Main Menu, and then use the  Key or  Key to select Fn01E .	<pre> 1:RUN FUNCTION Fn01B:Viblvl Init Fn01E:SvMotOp ID Fn01F:FBOPmot ID Fn020:S-Orig Set </pre>
2	Press the  Key.	<p>The Fn01E (Display SERVOPACK and Servomotor IDs) execution display will appear. The SERVOPACK information will be displayed first.</p> <pre> Serial number Model 1:BB SvMtOpID Driver SGD7S-R70A00A D00241234590001 14.02 200V, 50W </pre> <p>Manufacturing date Servomotor input voltage Servomotor capacity</p> <p>Note: Use the  Key or  Key to display hidden information.</p>
3	Press the  Key.	<p>The motor information will be displayed.</p> <pre> Serial number Model 1:BB SvMtOpID Motor SGM7A-A5A7A21 D00245789090001 14.02 200V, 50W </pre> <p>Manufacturing date Servomotor input voltage Servomotor capacity</p> <p>Note: Use the  Key or  Key to display hidden information.</p>

Continued on next page.

3.2 Operating Procedures for Utility Functions

3.2.21 Display SERVOPACK and Servomotor IDs (Fn01E)

Continued from previous page.

Step	Operation	Result
4	Press the  Key.	<p>The encoder information will be displayed.</p> <div style="border: 1px solid black; padding: 5px; margin: 10px 0;"> <pre> Serial number ----- Model ----- 1:BB S v M t O p I D Encoder UTTAI-B24RH ←----- K247-0225E00200 ←----- 14.02 24bit-ABS </pre> <p style="text-align: center;"> ↑ ↑ ↑ Manufacturing date Encoder resolution Encoder type </p> </div> <p>Note: Use the  Key or  Key to display hidden information.</p>
5	Press the  Key.	<p>The display will return to the Utility Mode Main Menu.</p> <div style="border: 1px solid black; padding: 5px; margin: 10px 0;"> <pre> 1:RUN FUNCTION Fn01B:VibIvl Init Fn01E:S v M o t O p I D Fn01F:F B O p M o t I D Fn020:S-Orig Set </pre> </div>

3.2.22 Display Servomotor ID from Feedback Option Module (Fn01F)

You can use this utility function to display the Servomotor and encoder ID information from the Feedback Option Module connected to the SERVOPACK.





You can use this utility function to display the following items.

ID Information	Displayed Items
Motor ID Information	<ul style="list-style-type: none"> • Servomotor model • Servomotor order number • Servomotor input voltage [V] • Servomotor capacity [W] • Rated motor current [Arms]
Encoder ID Information	<ul style="list-style-type: none"> • Encoder model • Servomotor serial number • Encoder type/resolution (The resolution is displayed in number of bits and in rotations/revolution.)
Parameter File ID Information	<ul style="list-style-type: none"> • Parameter file source ID (14 characters) • Parameter file version (4 digits hexadecimal)

Preparations



No preparations are required.

Operating Procedure

Step	Operation	Result
1	Press the  Key, and then use the  Key or  Key to select Fn01F .	<div style="border: 1px solid black; padding: 5px;"> <pre> 1:BB FUNCTION Fn01E:SvMotOp ID Fn01F:FBOPMot ID Fn020:S-Orig Set Fn030:Soft Reset </pre> </div>
2	Press the  Key.	<p>The Fn01F (Display Servomotor ID from Feedback Option Module) execution display will appear. The Servomotor ID information will be displayed first. *1 *2 *3</p> <div style="border: 1px solid black; padding: 5px;"> <pre> 1:BB FBOPMtID Motor SGM-04A312 ← R10419-511-DK5000 ← 200V, 400W ↑ ↑ Voltage Capacity </pre> <p style="text-align: right;">Serial number — Servomotor model —</p> </div>
3	Press the  Key.	<p>The encoder ID information will be displayed. *3</p> <div style="border: 1px solid black; padding: 5px;"> <pre> 1:BB FBOPMtID Encoder UTSTH-U13DB ← C136-1336D00200 ← 13bit-INC ← </pre> <p style="text-align: right;">Serial number — Encoder model — Encoder type/resolution —</p> </div>

Continued on next page.

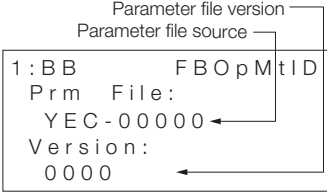
Continued from previous page.

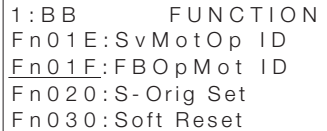
Step	Operation	Result
4	Press the  Key.	<p>The parameter file ID information will be displayed.*3</p> 
5	Press the  Key.	<p>The display will return to the Utility Mode Main Menu.</p> 

*1. The following display will appear if a Feedback Option Module is not connected.



*2. The following display will appear if a Feedback Option Module is connected but there is no Servomotor or encoder information in the Option Module



*3. Use the  Key or  Key to display hidden information.

3.2.23 Set Origin (Fn020)

You can use this utility function to set the current position of the external absolute encoder as the origin when you are using a Linear Servomotor or when you are using an external absolute encoder for fully-closed loop control.

The external absolute encoders from the following manufacturers are supported.

Environmental Resistant Absolute Linear Scale from Mitutoyo Corporation

ABS ST780A Series







Model: ABS ST78□A/ST78□AL

Preparations

Always check the following before you set origin.

- The parameters must not be write-prohibited (Fn010 must be set to 0000).
- The servo must be OFF.
- The servo must be in ready status.

Operating Procedure

Step	Operation	Result
1	Press the  Key to display the Utility Mode Main Menu, and then use the  Key or  Key to select Fn020 .	<pre> 1:BB FUNCTION Fn01F:FBOPMot ID Fn020:S-Orig Set Fn030:Soft Reset Fn080:Pole Detect </pre>
2	Press the  Key.	<pre> 1:BB Scale Origin Set ORGSET1 </pre>
3	Press the  Key or  Key to display ORGSET5 .	<pre> 1:BB Scale Origin Set ORGSET5 </pre>
4	Press the  Key.	<p>Setting the origin will be started. Scale Origin Set will flash on the display while the origin is being set. It will stop flashing when setting the origin has been completed and the following status displays will appear.</p> <ul style="list-style-type: none"> SERVOPACKs with Analog Voltage/Pulse Train References 1:BB → DONE → 1:A.941 SERVOPACKs with Other References 1:BB → DONE → 1:BB <pre> 1:A.941 Scal Origin Set </pre>
5	Turn the SERVOPACK power supply OFF and ON again.	The parameter setting is now enabled.

3.2.24 Reset Motor Type Change Detected Status (Fn021)





After an A.070 (Motor Type Change Detected) alarm occurs, you must reset the Motor Type Change Detected status.

Preparations

Always check the following before you reset the Motor Type Change Detected.

- The parameters must not be write-prohibited (Fn010 must be set to 0000).
- An A.070 (Motor Type Change Detected) alarm must have occurred.

Operating Procedure

Step	Operation	Result
1	Press the  Key to display the Utility Mode Main Menu, and then use the  Key or  Key to select Fn021 .	<pre> 1:A.070 FUNCTION Fn020:S-Orig Set Fn021:Motor Init Fn030:Soft Reset Fn080:Pole Detect </pre>
2	Press the  Key.	<p>The Motor Type Change Detected status will be reset. When processing has been completed, the status display will flash DONE for approximately one second and then return to 1:A.070.</p> <pre> 1:A.070 Motor Connect History Init Start : [DATA] Return: [SET] </pre>
3	Press the  Key.	<p>The display will return to the Utility Mode Main Menu.</p> <pre> 1:A.070 FUNCTION Fn020:S-Orig Set Fn021:Motor Init Fn030:Soft Reset Fn080:Pole Detect </pre>
4	Turn the SERVOPACK power supply OFF and ON again.	<p>The parameter setting is now enabled and the alarm will have been cleared.</p>

3.2.25 Software Reset (Fn030)

You can use this utility function to internally perform a software reset of the SERVOPACK. This utility function is used when resetting alarms and changing the settings of parameters that normally require turning the power supply to the SERVOPACK OFF and ON again. This utility function can be used to change those parameters without turning the power supply to the SERVOPACK OFF and ON again.







Note: 1. Execute this utility function only after confirming that the servo is OFF and that the motor is stopped (including not turning due to inertia or an external force).
2. This utility function resets the SERVOPACK independently of the host controller. The SERVOPACK carries out the same processing as when the power supply is turned ON and outputs the ALM (Servo Alarm) output signal. The status of other output signals may be forcibly changed.

Preparations

Always check the following before you perform a software reset.

- The servo must be OFF.
- The Servomotor must be stopped (including not turning due to inertia or an external force).

Operating Procedure

Step	Operation	Result
1	Press the  Key to display the Utility Mode Main Menu, and then use the  Key or  Key to select Fn030 .	<pre> 1:BB FUNCTION Fn020:S-Orig Set Fn030:Soft Reset Fn080:Pole Detect Fn200:TuneLvl Set </pre>
2	Press the  Key.	<p>The Fn030 (Software Reset) execution display will appear.</p> <pre> 1:BB Software Reset RESET1 </pre>
3	Press the  Key to display RESET5 .	<pre> 1:BB Software Reset RESET5 </pre>
4	Press the  Key.	<p>A software reset will be executed. After the software reset starts, RESET5 will no longer be displayed.</p> <pre> 1:BB Software Reset </pre> <p>After the reset has been completed, the display that appears when the power is turned ON will be displayed. The display will then enter the Parameter/Monitor Mode.</p> <pre> File First Loading Please Wait... </pre>

Continued on next page.

Continued from previous page.

Step	Operation	Result
5	Press the  Key.	<p>The display will return to the Utility Mode Main Menu.</p> <pre data-bbox="692 272 1016 411"> 1:BB FUNCTION Fn020:S- Orig Set Fn030: Soft Reset Fn080: Pole Detect Fn200: TuneLvl Set </pre>

3.2.26 Polarity Detection (Fn080)







You can use this utility function to detect the polarity and store motor phase information in the SERVOPACK. Executing this utility function eliminates the need to detect the polarity every time you turn ON the power supply so that you can start operation immediately.

Preparations

Always check the following before you execute polarity detection settings.

- The parameters must not be write-prohibited (Fn010 must be set to 0000).
- The servo must be OFF.
- The servo must be in ready status.

Operating Procedure

Step	Operation	Result
1	Press the  Key to display the Utility Mode Main Menu, and then use the  Key or  Key to select Fn080 .	<pre> 1:BB FUNCTION Fn030:Soft Reset Fn080:Pole Detect Fn200:TuneLvl Set Fn201:AAT </pre>
2	Press the  Key.	<pre> 1:BB Magnetic Pole Detect Level = 0040 </pre>
3	Press the  Key.	<p>The Fn080 (Polarity Detection) execution display will appear.</p> <pre> 1:BB Magnetic Pole Detect Start :[JOGSVON] Return:[SET] </pre>
4	Press the  Key.	<p>The servo will turn ON automatically and polarity detection will be started. During polarity detection, Magnetic Pole Adjustment will flash on the display. When polarity detection has been completed, the servo will turn OFF automatically.</p> <pre> 1:P DET Magnetic Pole Adjustment Return:[SET] </pre> <p>When polarity detection has been completed, the following display will appear.</p> <pre> 1:BB Magnetic Pole Detect Return:[SET] </pre>

Continued on next page.

3.2 Operating Procedures for Utility Functions

3.2.26 Polarity Detection (Fn080)

Continued from previous page.

Step	Operation	Result
5	Press the  Key.	The display will return to the Utility Mode Main Menu. <div style="border: 1px solid black; padding: 5px; margin-top: 10px;">1:BB FUNCTION Fn030:Soft Reset Fn080:Pole Detect Fn200:TuneLvl Set Fn201:AAT</div>

3.2.27 Tuning-less Level Setting (Fn200)









You can use this utility function to set the tuning-less rigidity and load levels.

Preparations

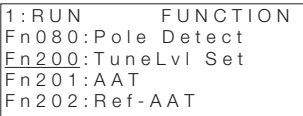
Always check the following before you set the tuning-less rigidity and load levels.

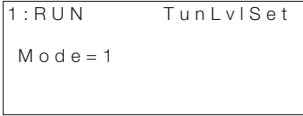

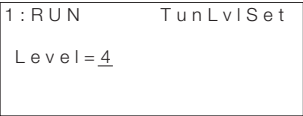

- The parameters must not be write-prohibited (Fn010 must be set to 0000).
- The servo must be in ready status.
- The tuning-less function must be enabled (Pn170 = n.□□□1).
- The test without a motor function must be disabled (Pn00C = n.□□□0).

Operating Procedure

Step	Operation	Result
1	Press the  Key to display the Utility Mode Main Menu, and then use the  Key or  Key to select Fn200 .	
2	Press the  Key.	The display to set the tuning-less load level will appear.  Note: If the display does not change and NO-OP is displayed, writing is prohibited (Fn010 = 0001). Change Fn010 (Write Prohibition Setting) to 0000 to enable writing and repeat the procedure.
3	<ul style="list-style-type: none"> • If there is overshooting in the response waveform or if the allowable load moment of inertia is exceeded (i.e., outside of product specifications), press the  Key to change the mode setting to 2. • If you hear high-frequency noise, press the  Key to change the mode setting to 0. • In all other cases, leave the mode set to 1. Note: You can also change the load level with Pn170 = n.X□□□ (Tuning-less Load Level).	-
4	Press the  Key.	The display to set the tuning-less rigidity level will appear. 

Continued on next page.

Continued from previous page.

Step	Operation	Result
5	<p>Press the  Key or the  Key to select the rigidity level. Set the rigidity level to a value between 0 and 7. The larger the value, the higher the gain and the better the response will be. (The default setting is 4.)</p> <p>Note: 1. Vibration may occur if the rigidity level is too high. Lower the rigidity level if vibration occurs. If you hear a high frequency, press the  Key to automatically set a notch filter to the vibration frequency.</p> <p>2. If you change the rigidity level, automatically set notch filters will be canceled. If vibration occurs, however, the notch filters will be set again.</p> <p>3. You can also change the rigidity level with Pn170 = n.□□□□ (Rigidity Level).</p>	<div data-bbox="698 373 1003 488" style="border: 1px solid black; padding: 5px;"> <pre>1:RUN TunLvlSet Level = 4 NF 2</pre> </div> <p style="text-align: center;">↑ This is displayed when the second notch filter is set.</p>
6	<p>Press the  Key.</p>	<p>The status display will flash DONE and the setting will be saved in the SERVOPACK.</p> <div data-bbox="698 842 1003 957" style="border: 1px solid black; padding: 5px;"> <pre>DONE TunLvlSet Level = 4</pre> </div>
7	<p>Press the  Key.</p>	<p>The display will return to the status shown in step 1. This concludes setting the tuning-less level.</p> <div data-bbox="698 1091 1003 1206" style="border: 1px solid black; padding: 5px;"> <pre>1:RUN FUNCTION Fn030 Fn200 Fn201 Fn202</pre> </div>

3.2.28 Advanced Autotuning without Reference (Fn201)

You can use this utility function to perform automatic round-trip operation within a set range. During the operation, the SERVOPACK will be tuned automatically according to machine characteristics.

You can perform advanced autotuning without connecting the host controller.

Advanced autotuning adjusts the following items.

- Moment of inertia ratio
- Gains (e.g., position loop gain and speed loop gain)
- Filters (torque reference filter and notch filters)
- Friction compensation
- Anti-resonance control
- Vibration suppression (mode = 2 or 3)

Preparations

Always check the following before you perform advanced autotuning. If the settings are not suitable, **NO-OP** will be displayed and advanced autotuning will not be performed.









- The main circuit power supply must be ON.
- There must be no overtravel.
- The servo must be OFF.
- The control method must not be set to torque control.
- The gain selection switch must be set to manual (Pn139 = n.□□□0).
- Gain settings 1 must be selected.
- The test without a motor function must be disabled (Pn00C = n.□□□0).
- There must be no alarms or warnings.
- There must be no hard wire base block (HWBB).
- The parameters must not be write-prohibited (Fn010 must be set to 0000).
- The tuning-less function must be disabled (Pn170 = n.□□□0), or the tuning-less function must be enabled (Pn170 = n.□□□1: default setting) and moment of inertia estimation must be set (Jcalc = ON).

Information

- If you start advanced autotuning while the SERVOPACK is in speed control, the SERVOPACK will change to position control automatically to perform advanced autotuning. The SERVOPACK will return to speed control after completing the adjustment. To perform advanced autotuning in speed control, set the mode to 1.
- Reference pulse input multiplication switching is disabled during advanced autotuning.



For details, refer to the manual for your SERVOPACK.

Operating Procedure

Step	Operation	Result
1	Press the  Key to display the Utility Mode Main Menu, and then use the  Key or  Key to select Fn201 .	<pre data-bbox="661 244 964 360">1:BB FUNCTION Fn200:TuneLvl Set Fn201:AAT Fn202:Ref-AAT Fn203:OnePrmTun</pre>
2	Press the  Key.	<p data-bbox="632 384 969 432">The initial setting display for advanced autotuning will appear.</p> <p data-bbox="677 448 837 464">↓ Status display</p> <pre data-bbox="661 472 964 584">1:BB AAT Jcalc=ON Mode=2 Type=2 Stroke=+00800000 (0003.0)rev</pre> <p data-bbox="632 600 997 703">Note: If the initial setting display does not appear and the status display changes to NO-OP, refer to the following section and correct the problem.</p> <p data-bbox="688 711 975 791"> 3.2.28 Advanced Autotuning without Reference (Fn201) - Preparations on page 3-70</p>
3	Use the  Key,  Key, and  Key to set the items in steps 3-1 to 3-4.	-
3-1	<p data-bbox="253 927 619 951">■ Jcalc (Calculating Moment of Inertia)</p> <p data-bbox="253 951 983 975">Specify whether to calculate the moment of inertia. Normally select ON.</p> <p data-bbox="253 975 790 999">ON: Calculate the moment of inertia (default setting).</p> <p data-bbox="253 999 706 1023">OFF: Do not calculate the moment of inertia.</p> <p data-bbox="253 1023 994 1070">Note: If the moment of inertia ratio is already known from the machine specifications, set the value in Pn103 (Moment of Inertia Ratio) and set Jcalc to OFF.</p>	
3-2	<p data-bbox="253 1086 333 1110">■ Mode</p> <p data-bbox="253 1110 398 1134">Set the mode.</p> <p data-bbox="253 1134 964 1182">1: Tunes the SERVOPACK for response and stability (standard adjustment level).</p> <p data-bbox="253 1182 841 1206">2: Tunes the SERVOPACK for positioning (default setting).</p> <p data-bbox="253 1206 997 1254">3: Tunes the SERVOPACK for positioning, giving priority to suppression of overshooting.</p>	







Continued on next page.

Continued from previous page.

Step	Operation	Result
3-3	<p>■ Type</p> <p>Select the type according to the machine element to drive. If there is noise or if the gain does not increase, better results may be obtained by changing the rigidity type. Select the type according to the following guidelines.</p> <p>1: Belt drive mechanisms 2: Ball screw drive mechanisms (default setting) 3: Rigid systems in which the Servomotor is directly coupled to the machine (without gear or other drive system)</p>	
3-4	<p>■ Stroke (Travel Distance)</p> <p>Set the travel distance.</p> <ul style="list-style-type: none"> • Travel distance setting range: -99,990,000 to 99,990,000 reference units • Minimum setting increment: 1,000 reference units • The negative direction is for reverse rotation, and the positive direction is for forward rotation. The travel distance from the current position is given. • Default setting: Approx. 3 rotations <p>If the Servomotor's encoder resolution is 16,777,216 (24 bits), the stroke (travel distance) will be set to 800,000. If the default electronic gear ratio is used (Pn20E = 64 and Pn210 = 1), then</p> $\frac{800,000}{16,777,216} \times \frac{64}{1} \approx 3 \text{ (revolutions)}$ <p>Note: 1. Set the parameters so that the number of motor rotations is at least 0.5. Otherwise, ERROR will be displayed and advanced autotuning will not be possible. 2. To calculate the moment of inertia and ensure precise tuning, we recommend that you set the number of motor rotations to approximately 3. 3. For an SGMCS or SGMCV Direct Drive Servomotor, the default setting for the number of motor rotations is approximately 0.3.</p>	
4	<p>Press the  Key.</p>	<p>The execution display for advanced autotuning will appear.</p> <div style="border: 1px solid black; padding: 5px; width: fit-content;"> <pre> 1: BB A A T P n 1 0 3 = 0 0 0 0 0 P n 1 0 0 = 0 0 4 0 . 0 P n 1 0 1 = 0 0 2 0 . 0 0 P n 1 0 2 = 0 0 4 0 . 0 </pre> </div>
5	<p>Press the  Key.</p>	<p>The servo will be turned ON and the display will change from BB to RUN. Note: If the mode is set to 2 or 3, Pn141 will be displayed instead of Pn102.</p> <div style="border: 1px solid black; padding: 5px; width: fit-content;"> <pre> 1: RUN A A T P n 1 0 3 = 0 0 0 0 0 P n 1 0 0 = 0 0 4 0 . 0 P n 1 0 1 = 0 0 2 0 . 0 0 P n 1 4 1 = 0 0 5 0 . 0 </pre> </div>







Continued on next page.

Continued from previous page.

Step	Operation	Result
6	<p>Press the  Key if the stroke is set to a positive value, or press the  Key if the stroke is set to a negative value.</p>	<p>Calculation of the moment of inertia will start. While the moment of inertia is being calculated, the setting of Pn103 will flash and 1:ADJ will flash instead of 1:RUN. When calculating the moment of inertia has been completed, the display will stop flashing and the moment of inertia will be displayed. The servo will remain ON, but automatic operation will stop temporarily.</p> <div data-bbox="661 552 966 667" style="border: 1px solid black; padding: 5px; margin: 10px 0;"> <pre>1: RUN A A T P n 1 0 3 = 0 0 3 0 0 P n 1 0 0 = 0 0 4 0 . 0 P n 1 0 1 = 0 0 2 0 . 0 P n 1 4 1 = 0 0 5 0 . 0</pre> </div> <p>Display Example: After Calculating the Moment of Inertia</p> <p>Note: 1. Calculating the moment of inertia will not start if the sign of the stroke does not agree with the key that is pressed ( Key or  Key).</p> <p>2. If Jcalc is set to OFF, calculating the moment of inertia will not start and the setting of Pn103 will be displayed.</p> <p>3. If NO-OP or ERROR is displayed during operation, press the  Key to cancel the operation and refer to the following section to correct the problem.</p> <p> 3.2.28 Advanced Autotuning without Reference (Fn201) - Troubleshooting Problems in the Operation on page 3-76</p>

Continued on next page.

Continued from previous page.

Step	Operation	Result
7	Press the  Key. Note: To end the operation by calculating only the moment of inertia ratio without adjusting the gains, press the  Key.	The calculated moment of inertia will be saved in the SERVOPACK. DONE will flash on the display for one second, and then the status display will return to 1:ADJ .
8	Press the  Key or the  Key.	Automatic operation will start again and the filter and gain will be automatically set. 1:ADJ will flash on the display during autotuning. <div data-bbox="701 480 1003 595" style="border: 1px solid black; padding: 5px; margin: 10px 0;"> <pre> 1:ADJ AAT Pn103=00300 Pn100=0100.0 Pn101=0006.36 Pn141=0150.0 </pre> </div> Note: ERROR will be displayed if there is machine resonance or if the adjustments cannot be made sufficiently for another reason. If that occurs, make adjustments using one-parameter tuning (Fn203). If adjustments are completed normally, the servo will be turned OFF. The status display will flash END as shown below for approximately two seconds and then return to 1:ADJ . <div data-bbox="701 938 1003 1053" style="border: 1px solid black; padding: 5px; margin: 10px 0;"> <pre> END AAT Pn103=00300 Pn100=0100.0 Pn101=0006.36 Pn141=0150.0 </pre> </div>
9	Press the  Key. Note: Press the  Key to cancel saving the settings. The display will return to the status shown in step 1.	The adjusted settings will be saved in the SERVOPACK. The status display will flash DONE as shown below for approximately one second and then return to 1:A.941 . <div data-bbox="701 1241 1003 1356" style="border: 1px solid black; padding: 5px; margin: 10px 0;"> <pre> DONE AAT Pn103=00300 Pn100=0100.0 Pn101=0006.36 Pn141=0150.0 </pre> </div>
10	Turn the power supply OFF and ON again.	The parameter settings are now enabled.

Troubleshooting Problems in the Operation

This section provides information on troubleshooting problems that can occur in the operation.

◆ NO-OP Flashes on the Display

Probable Cause	Corrective Action
The main circuit power supply is OFF.	Turn ON the main circuit power supply.
An alarm or warning occurred.	Remove the cause of the alarm or warning.
Overtraveling occurred.	Remove the cause of overtraveling.
Gain settings 2 was selected with the gain selection.	Disable automatic gain switching.
The HWBB was activated.	Release the HWBB.

◆ ERROR Flashes on the Display

Error	Probable Cause	Corrective Action
The gain adjustment was not successfully completed.	Machine vibration is occurring or the /COIN (Positioning Completion) output signal is turning ON and OFF when the Servomotor stops.	<ul style="list-style-type: none"> • Increase the setting of Pn522 (Positioning Completed Width). • Change the mode from 2 to 3. • If machine vibration occurs, suppress the vibration with the anti-resonance control function and the vibration suppression function.
An error occurred during calculation of the moment of inertia.	Refer to the following section.  3.2.28 <i>Advanced Autotuning without Reference (Fn201)</i> - ◆ <i>Errors during Calculation of Moment of Inertia</i> on page 3-78	
Travel distance setting error	The travel distance is set to approximately 0.5 rotation or less, which is less than the minimum travel distance for adjustment. For a Direct Drive Servomotor (SGMCS or SGMCV), it is set to 0.05 rotations.	Increase the travel distance. (We recommend that you set the number of motor rotations to approximately 3.)

Continued on next page.

Continued from previous page.

Error	Probable Cause	Corrective Action
The /COIN signal did not turn ON within approximately 10 seconds after positioning adjustment was completed.	The positioning completed width is too narrow or proportional control (P control) is being used.	Increase the setting of Pn522. If proportional control is set, turn OFF the /P-CON (Proportional Control) signal.
The moment of inertia was not calculated while the tuning-less function was enabled.	Jcalc was set to OFF when the tuning-less function was enabled.	<ul style="list-style-type: none"> • Disable the tuning-less function. • Set Jcalc to ON.

◆ Errors during Calculation of Moment of Inertia

The following table gives the probable causes of errors that may occur during calculation of the moment of inertia (Jcalc = ON), along with corrective actions for the errors.

Error Display	Probable Cause	Corrective Action
Err1	The SERVOPACK started calculating the moment of inertia but the calculation was not completed.	<ul style="list-style-type: none"> • Increase the setting of Pn100 (Speed Loop Gain). • Increase the setting of the stroke.
Err2	The moment of inertia fluctuated greatly and did not converge within 10 tries.	Calculate the moment of inertia based on the machine specifications, set the value in Pn103, and execute advanced autotuning with the Jcalc set to OFF .
Err3	Low-frequency vibration was detected.	Double the setting of Pn324 (Moment of Inertia Calculation Starting Level).
Err4	The torque limit was reached.	<ul style="list-style-type: none"> • If you are using the torque limit, increase the torque limit. • Double the setting of Pn324 (Moment of Inertia Calculation Starting Level).
Err5	The speed control section changed to proportional control during calculation of the moment of inertia, e.g., the / P-CON (Proportional Control) signal was input.	Use PI control when calculating the moment of inertia.

3.2.29 Advanced Autotuning with Reference (Fn202)

You can use this utility function to automatically achieve optimum tuning of the SERVOPACK in response to operation references (pulse train references) from the host controller. This utility function is normally performed to fine-tune the SERVOPACK after advanced autotuning of the SERVOPACK has been performed.

If the moment of inertia ratio is set correctly in Pn103, this utility function can be performed without performing advanced autotuning.

The following items are adjusted.

- Gains (e.g., position loop gain and speed loop gain)
- Filters (torque reference filter and notch filters)
- Friction compensation
- Anti-resonance control
- Vibration suppression

Preparations









Always check the following before you perform advanced autotuning with a reference input.

If the settings are not suitable, **NO-OP** will be displayed and advanced autotuning will not be performed.

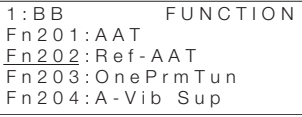
- The servo must be in ready status.
- There must be no overtravel.
- The servo must be OFF.
- Position control must be selected if the Servomotor power is ON (i.e., when the servo is ON).
- The gain selection switch must be set to manual (Pn139 = n.□□□0).
- Gain settings 1 must be selected.
- The test without a motor function must be disabled (Pn00C = n.□□□0).
- There must be no warnings.
- The parameters must not be write-prohibited (Fn010 must be set to 0000).
- Tuning-less function must be disabled (Pn170 = n.□□□0).

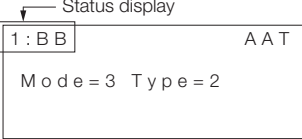
For details, refer to the manual for your SERVOPACK.

Operating Procedure

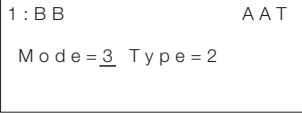
Step	Operation	Result
1	Press the  Key to display the Utility Mode Main Menu, and then use the  Key or  Key to select Fn202 .	 <pre> 1: BB FUNCTION Fn201: AAT Fn202: Ref- AAT Fn203: OnePrmTun Fn204: A- Vib Sup </pre>
2	Press the  Key.	<p>The initial setting display for advanced autotuning with a reference input will appear.</p>  <p>↓ Status display</p> <pre> 1: BB AAT Mode=3 Type=2 </pre> <p>Note: If the initial setting display does not appear and the status display changes to NO-OP, refer to the following section and correct the problem.</p> <p> 3.2.29 Advanced Autotuning with Reference (Fn202) - Preparations on page 3-79</p>
3	Use the  Key,  Key, and  Key to set the items in steps 3-1 and 3-2.	 <pre> 1: BB AAT Mode=3 Type=2 </pre>
3-1	<p>■ Mode</p> <p>Set the mode.</p> <p>1: Tunes the SERVOPACK for response and stability (standard adjustment level).</p> <p>2: Tunes the SERVOPACK for positioning (default setting).</p> <p>3: Tunes the SERVOPACK for positioning, giving priority to suppression of overshooting.</p>	
3-2	<p>■ Type</p> <p>Select the type according to the machine element to drive. If there is noise or if the gain does not increase, better results may be obtained by changing the rigidity type. Select the type according to the following guidelines.</p> <p>1: Belt drive mechanisms</p> <p>2: Ball screw drive mechanisms (default setting)</p> <p>3: Rigid systems in which the Servomotor is directly coupled to the machine (without gear or other drive system)</p>	

Continued on next page.

Continued from previous page.



Step	Operation	Result
4	Press the <input type="button" value="DATA"/> Key.	<p>The execution display for advanced autotuning with a reference input will appear.</p> <pre data-bbox="700 295 1002 406"> 1: BB AAT Pn103=00000 Pn100=0040.0 Pn101=0020.00 Pn141=0040.0 </pre> <p>Note: If the mode is set to 1, Pn102 will be displayed instead of Pn141. If the mode is set to 2 or 3, Pn141 will be displayed.</p>
5	Input the /S-ON (Servo ON) input signal from an external device.	<p>The status display will change from 1:BB to 1:ADJ.</p> <pre data-bbox="700 574 1002 686"> 1: ADJ AAT Pn103=00300 Pn100=0040.0 Pn101=0020.00 Pn141=0050.0 </pre>
6	Input a reference from the host controller and then press the <input type="button" value="▲"/> Key or <input type="button" value="▼"/> Key.	<p>Tuning will be started. 1:ADJ will flash on the display during autotuning.</p> <p>Note: Tuning is not executed while 1:BB is displayed.</p> <pre data-bbox="700 837 1002 949"> 1: ADJ AAT Pn103=00300 Pn100=0100.0 Pn101=0006.36 Pn141=0150.0 </pre> <p>If tuning is completed normally, the status display will flash END as shown below for approximately one second and then return to 1:ADJ.</p> <pre data-bbox="700 1077 1002 1189"> END AAT Pn103=00300 Pn100=0100.0 Pn101=0006.36 Pn141=0150.0 </pre>

Continued on next page.

3.2 Operating Procedures for Utility Functions

3.2.29 Advanced Autotuning with Reference (Fn202)

Continued from previous page.

Step	Operation	Result
7	<p>Press the  Key.</p> <p>Note: Press the  Key to cancel saving the adjusted values. The display will return to the status shown in step 1.</p>	<p>The adjusted settings will be saved in the SERVOPACK. The status display will flash DONE as shown below for approximately one second and then 1:A.941 will be displayed.</p> <div style="border: 1px solid black; padding: 5px; width: fit-content; margin: 10px auto;"> <pre> DONE A A T P n 1 0 3 = 0 0 3 0 0 P n 1 0 0 = 0 1 0 0 . 0 P n 1 0 1 = 0 0 0 6 . 3 6 P n 1 4 1 = 0 1 5 0 . 0 </pre> </div>
8	Turn the power supply OFF and ON again to enable the new settings.	-

Troubleshooting Problems in the Operation

This section provides information on troubleshooting problems that can occur in the operation.

◆ NO-OP Flashes on the Display

Probable Cause	Corrective Action
The main circuit power supply is OFF.	Turn ON the main circuit power supply.
An alarm or warning occurred.	Remove the cause of the alarm or warning.
Overtraveling occurred.	Remove the cause of overtraveling.
Gain settings 2 was selected with the gain selection.	Disable automatic gain switching.
The HWBB was activated.	Release the HWBB.

◆ ERROR Flashes on the Display

Error	Probable Cause	Corrective Action
The gain adjustment was not successfully completed.	Machine vibration is occurring or the /COIN (Positioning Completion) output signal is turning ON and OFF when the Servomotor stops.	<ul style="list-style-type: none"> • Increase the setting of Pn522 (Positioning Completed Width). • Change the mode from 2 to 3. • If machine vibration occurs, suppress the vibration with the anti-resonance control function and the vibration suppression function.
The /COIN signal did not turn ON within approximately 10 seconds after positioning adjustment was completed.	The positioning completed width is too narrow or proportional control (P control) is being used.	Increase the setting of Pn522. If proportional control is set, turn OFF the /P-CON (Proportional Control) signal.

3.2.30 One-Parameter Tuning (Fn203)

You can use this utility function to manually adjust the servo during operation using a speed or position reference input from the host controller. This utility function allows you to automatically set related servo gain settings to balanced conditions by tuning the SERVOPACK with one or two tuning levels.

The following items are adjusted.

- Gains (e.g., position loop gain and speed loop gain)
- Filters (torque reference filter and notch filters)
- Friction compensation
- Anti-resonance control













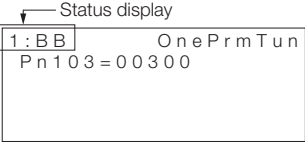

Preparations

Always check the following before you perform one-parameter tuning.

- The parameters must not be write-prohibited (Fn010 must be set to 0000).
- The servo must be in ready status.
- There must be no overtravel.
- If speed control is used, tuning mode 0 or 1 must be set.
- Tuning-less function must be disabled (Pn170 = n.□□□0).
(This is to prevent tuning the SERVOPACK again with the tuning-less function after using one-parameter tuning.)
- The test without a motor function must be disabled (Pn00C = n.□□□0).

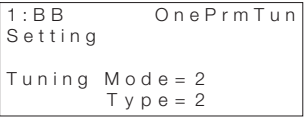
Operating Procedure

◆ Speed Control Mode

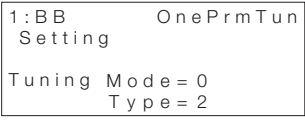
Step	Operation	Result
1	Press the  Key to display the Utility Mode Main Menu, and then use the  Key or  Key to select Fn203 .	<pre> 1:RUN FUNCTION Fn202:Ref-AAT Fn203:OnePrmTun Fn204:A-Vib Sup Fn205:Vib Sup </pre>
2	Press the  Key.	<p>The current setting of Pn103 (Moment of Inertia Ratio) will be displayed.</p>  <p>Note: If the initial setting display does not appear and the status display changes to NO-OP, refer to the following section and correct the problem.</p> <p> 3.2.30 One-Parameter Tuning (Fn203) - Preparations on page 3-84</p>
3	To change the moment of inertia ratio, use the  Key or  Key to move the cursor and use the  Key or  Key to change the value.	—
4	Press the  Key.	<p>The initial setting display for one-parameter tuning will appear.</p> 
5	Use the  Key,  Key, and  Key to set the items in steps 5-1 and 5-2.	

Continued on next page.

3.2 Operating Procedures for Utility Functions









3.2.30 One-Parameter Tuning (Fn203)

Continued from previous page.













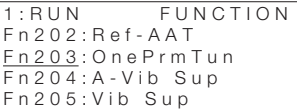

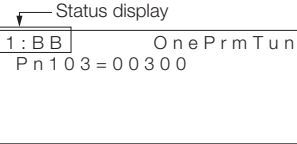
Step	Operation	Result
5-1	<p>■ Tuning Mode</p> <p>Set the tuning mode. Select tuning mode 0 or 1.</p> <p>0: Tunes while giving priority to stability.</p> <p>1: Tunes while giving priority to response.</p>	
5-2	<p>■ Type</p> <p>Select the type according to the machine element to drive. If there is noise or if the gain does not increase, better results may be obtained by changing the rigidity type. Select the type according to the following guidelines.</p> <p>1: Belt drive mechanisms</p> <p>2: Ball screw drive mechanisms (default setting)</p> <p>3: Rigid systems in which the Servomotor is directly coupled to the machine (without gear or other drive system)</p>	
6	<p>Input the /S-ON (Servo ON) input signal from an external device.</p>	<p>The status display will change from 1:BB to 1:RUN.</p> <pre data-bbox="661 619 966 735"> 1:RUN OnePrmTun Setting Tuning Mode = 0 Type = 2 </pre>
7	<p>Input a reference from the host controller and check the response.</p>	<p>–</p>
8	<p>Press the <input type="button" value="DATA"/> Key.</p>	<p>The current setting will be displayed.</p> <pre data-bbox="661 874 966 991"> 1:RUN OnePrmTun Pn100=0040.0 Pn101=0020.00 Pn102=0040.0 </pre>
9	<p>Press the <input type="button" value="DATA"/> Key.</p>	<p>A display to set the tuning level will appear.</p> <pre data-bbox="661 1062 966 1182"> 1:RUN OnePrmTun LEVEL=00<u>5</u>0 NF1 NF2 ARES </pre>

Continued on next page.

Continued from previous page.

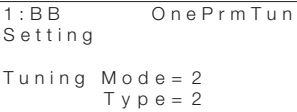
Step	Operation	Result
10	<p>If readjustment is required, input a reference from the host controller, select the digit with the  Key or  Key, change the level with the  Key or  Key, and check the response.</p> <p>If readjustment is not required, go to step 11.</p> <p>Note: The higher the level, the better the response will be. If the value is too large, however, vibration will occur.</p>	<div data-bbox="700 225 1003 339" style="border: 1px solid black; padding: 5px;"> <pre>1: RUN OnePrmTun LEVEL=00<u>5</u>0 NF1 NF2 ARES</pre> </div> <p>Note: If vibration occurs and the vibration is large enough, the SERVOPACK will automatically detect the vibration frequencies and set a notch filter or anti-resonance control. If notch filters are set, NF1 and NF2 will be displayed on the bottom row of the display. If anti-resonance control is set, ARES will be displayed on the bottom row of the display.</p> <p>If the vibration is small, press the  Key to force a search for the vibration frequency.</p> <div data-bbox="700 687 1003 802" style="border: 1px solid black; padding: 5px;"> <pre>1: RUN OnePrmTun LEVEL=00<u>7</u>0 NF1 NF2 ARES</pre> </div>
11	<p>Press the  Key.</p>	<p>A confirmation display for after adjusting the tuning level will appear.</p> <div data-bbox="700 911 1003 1026" style="border: 1px solid black; padding: 5px;"> <pre>1: RUN OnePrmTun Pn100=0050.0 Pn101=0016.0 Pn102=0050.0</pre> </div>
12	<p>Press the  Key.</p> <p>Note: 1. Press the  Key to cancel saving the data. The display will return to the status shown in step 1.</p> <p>2. Press the  Key to readjust the level without saving the values.</p>	<p>The adjusted settings will be saved in the SERVOPACK and DONE will be displayed.</p> <div data-bbox="700 1134 1003 1249" style="border: 1px solid black; padding: 5px;"> <pre>DONE OnePrmTun Pn100=00<u>5</u>0.0 Pn101=0016.0 Pn102=00<u>5</u>0.0</pre> </div>

◆ Position Control Mode

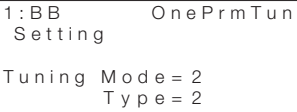
Step	Operation	Result
1	Press the  Key to display the Utility Mode Main Menu, and then use the  Key or  Key to select Fn203 .	 <pre> 1:RUN FUNCTION Fn202:Ref-AAT Fn203:OnePrmTun Fn204:A-Vib Sup Fn205:Vib Sup </pre>
2	Press the  Key.	<p>The moment of inertia ratio that is currently set in Pn103 will be displayed.</p>  <p>← Status display</p> <pre> 1:BB OnePrmTun Pn103=00300 </pre> <p>Note: If the Initial Setting Display does not appear and the status display changes to NO-OP, refer to the following section and correct the problem.</p> <p> 3.2.30 One-Parameter Tuning (Fn203) - Preparations on page 3-84</p>
3	To change the moment of inertia ratio, use the  Key or  Key to move the cursor and use the  Key or  Key to change the value.	-
4	Press the  Key.	<p>The Initial Setting Display for one-parameter tuning will appear.</p>  <pre> 1:BB OnePrmTun Setting Tuning Mode = 2 Type = 2 </pre>
5	Use the  Key,  Key, and  Key to set the items in steps 5-1 and 5-2.	 <pre> 1:BB OnePrmTun Setting Tuning Mode = 2 Type = 2 </pre>







Continued on next page.

Continued from previous page.

Step	Operation	Result
5-1	<p>■ Tuning Mode</p> <p>Set the tuning mode. Select tuning mode 2 or 3.</p> <p>0: Tunes while giving priority to stability.</p> <p>1: Tunes while giving priority to response.</p> <p>2: Tunes the SERVOPACK for positioning.</p> <p>3: Tunes the SERVOPACK for positioning, giving priority to suppression of overshooting.</p>	
5-2	<p>■ Type</p> <p>Select the type according to the machine element to drive. If there is noise or if the gain does not increase, better results may be obtained by changing the rigidity type. Select the type according to the following guidelines.</p> <p>1: Belt drive mechanisms</p> <p>2: Ball screw drive mechanisms (default setting)</p> <p>3: Rigid systems in which the Servomotor is directly coupled to the machine (without gear or other drive system)</p>	
6	<p>Input the /S-ON (Servo ON) input signal from an external device.</p>	<p>The status display will change from 1:BB to 1:RUN.</p> <div style="border: 1px solid black; padding: 5px; width: fit-content; margin: 10px auto;"> <pre>1:RUN OnePrmTun Setting Tuning Mode = 2 Type = 2</pre> </div>
7	<p>Input a reference from the host controller and check the response.</p>	<p>–</p>
8	<p>Press the DATA Key.</p>	<p>The current setting will be displayed.</p> <div style="border: 1px solid black; padding: 5px; width: fit-content; margin: 10px auto;"> <pre>1:RUN OnePrmTun Pn100=0040.0 Pn101=0020.00 Pn141=0050.0</pre> </div>
9	<p>Press the DATA Key.</p>	<p>A display to set the feedforward level and feedback level will appear.</p> <div style="border: 1px solid black; padding: 5px; width: fit-content; margin: 10px auto;"> <pre>1:RUN OnePrmTun FF LEVEL=0050.0 FB LEVEL=0040.0</pre> </div>



Continued on next page.

Continued from previous page.

Step	Operation	Result
10	<p>If readjustment is required, input a reference from the host controller, select the digit with the  Key or  Key, change the FF level and FB level with the  Key or  Key, and check the response. If readjustment is not required, go to step 11.</p> <p>Note: 1. If the FF level is changed when the Servomotor is in operation, the new FF level will not be used immediately. The changes will take effect after the Servomotor comes to a stop with no reference input and then the Servomotor starts operation.</p> <p>2. If the FF level is changed too much during operation, vibration may occur because the response would be changed rapidly when the settings take effect.</p> <p>3. The FF LEVEL will flash until the machine reaches the setting of the FF level. If the Servomotor does not stop within approximately 10 seconds after changing the setting, a timeout will occur. The setting will be automatically returned to the previous value.</p> <p>4. The higher the value of the FF level, the shorter the positioning time will be and the better the response will be. If the level is too high, however, overshooting or vibration may occur. Overshooting will be reduced if the setting of the FB level is increased.</p>	<div data-bbox="664 395 966 512" style="border: 1px solid black; padding: 5px;"> <pre>1:RUN OnePrmTun FF LEVEL=0050.0 FB LEVEL=0040.0</pre> </div> <p>Note: If vibration occurs and the vibration is large enough, the SERVO-PACK will automatically detect the vibration frequencies and set a notch filter or anti-resonance control. If notch filters are set, NF1 and NF2 will be displayed on the bottom row of the display. If anti-resonance control is set, ARES will be displayed on the bottom row of the display.</p> <p>If the vibration is small, press the  Key to force a search for the vibration frequency.</p> <div data-bbox="664 858 966 975" style="border: 1px solid black; padding: 5px;"> <pre>1:RUN OnePrmTun FF LEVEL=0050.0 FB LEVEL=0040.0 NF1 NF2 ARES</pre> </div>
11	<p>Press the  Key.</p>	<p>A confirmation display for after tuning will appear.</p> <div data-bbox="664 1233 966 1350" style="border: 1px solid black; padding: 5px;"> <pre>1:RUN OnePrmTun Pn100=0040.0 Pn101=0020.00 Pn141=0050.0 NF1</pre> </div>

Continued on next page.

Continued from previous page.

Step	Operation	Result
12	<p>Press the  Key.</p> <p>Note: 1. Press the  Key to cancel saving the data. The display will return to the status shown in step 1.</p> <p>2. Press the  Key to readjust the level without saving the values.</p>	<p>The adjusted settings will be saved in the SERVOPACK and DONE will be displayed.</p> <div data-bbox="701 309 1003 421" style="border: 1px solid black; padding: 5px;"> <pre> DONE OnePrmTun Pn100=0040.0 Pn101=0020.00 Pn141=0050.0 NF1 </pre> </div>

3.2.31 Adjust Anti-resonance Control (Fn204)

You can use this utility function to increase the effectiveness of vibration suppression after one-parameter tuning.

This utility function is effective for suppression of continuous vibration frequencies from 100 to 1,000 Hz that occur when the control gain is increased.

Perform one-parameter tuning (Fn203) if required to increase the response after performing this utility function. If the anti-resonance gain is increased, e.g., when one-parameter tuning is performed, vibration may occur again. If that occurs, perform this function again to fine-tune the parameters.

Preparations







Always check the following before you execute anti-resonance control adjustment.

- The parameters must not be write-prohibited (Fn010 must be set to 0000).
- The servo must be in ready status.
- There must be no overtravel.
- The control method must not be set to torque control.
- Tuning-less function must be disabled (Pn170 = n.□□□0).
- The test without a motor function must be disabled (Pn00C = n.□□□0).

Operating Procedure

◆ Adjusting Anti-resonance Control for the First Time

■ Unknown Vibration Frequency

Step	Operation	Result
1	Press the  Key to display the Utility Mode Main Menu, and then use the  Key or  Key to select Fn204 .	<pre> 1:RUN FUNCTION Fn203:OnePrmTun Fn204:A-Vib Sup Fn205:Vib Sup Fn206:Easy FFT </pre>
2	Press the  Key.	<p>The Tuning Mode Selection Display will appear.</p> <p>← Status display</p> <pre> 1:RUN Vib Sup Tuning Mode = 0 </pre> <p>Note: If the initial setting display does not appear and the status display changes to NO-OP, refer to the following section and correct the problem.</p> <p> 3.2.31 Adjust Anti-resonance Control (Fn204) - Preparations on page 3-92</p>
3	Use the  Key or  Key to set Tuning Mode to 0.	<pre> 1:RUN Vib Sup Tuning Mode = 0 </pre>





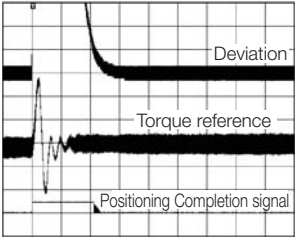





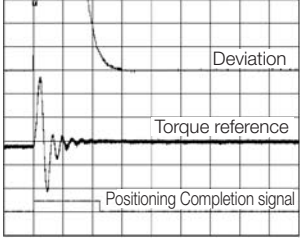

Continued on next page.

Continued from previous page.









Step	Operation	Result
4	Press the DATA Key.	<p>The following display will appear and detection of the vibration frequency will start. During detection, freq will flash on the display. Return to step 3 if vibration is not detected.</p> <div style="border: 1px solid black; padding: 5px; margin: 10px 0;"> <pre>1:RUN Vib Sup freq=---- Hz damp=0000</pre> </div> <p>Note: If vibration is not detected even when vibration is occurring, lower the setting of Pn311 (Vibration Detection Sensitivity). If the setting of this parameter is lowered, the detection sensitivity will be increased. Vibration may not be detected accurately if the setting is too small.</p> <p>The vibration frequency will be displayed at freq if vibration is detected.</p> <div style="border: 1px solid black; padding: 5px; margin: 10px 0;"> <pre>1:RUN Vib Sup freq=0400 Hz damp=0000</pre> </div> <div style="text-align: center; margin: 10px 0;">  <p>Measured Waveform Example</p> </div>
5	Press the DATA Key.	<p>The cursor will move to damp and freq will stop flashing.</p> <div style="border: 1px solid black; padding: 5px; margin: 10px 0;"> <pre>1:RUN Vib Sup freq=0400 Hz damp=000<u>0</u></pre> </div>

Continued on next page.

Continued from previous page.





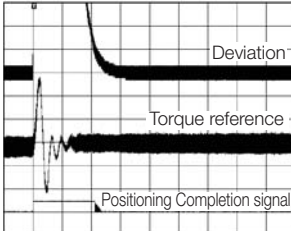





Step	Operation	Result
6	<p>Use the  Key or  Key to move the cursor and the  Key or  Key to set the damping gain.</p> <p>Note: Increase the damping gain by approximately 0% to 200% in 10% increments while checking the effect on vibration. If vibration reduction is still insufficient at a gain of 200%, cancel the setting, and lower the control gain by using a different method, such as one-parameter tuning.</p>	<div data-bbox="701 220 1005 331" style="border: 1px solid black; padding: 5px;"> <pre>1:RUN Vib Sup freq=0400 Hz damp=0120</pre> </div>  <p style="text-align: center;">Measured Waveform Example</p>
7	<p>If fine-tuning of the frequency is necessary, press the  Key. The cursor will move from damp to freq. Go to step 8. If fine-tuning is not required, go to step 9.</p>	<div data-bbox="701 683 1005 794" style="border: 1px solid black; padding: 5px;"> <pre>1:RUN Vib Sup freq=0400 Hz damp=0120</pre> </div>
8	<p>Use the  Key or  Key to move the cursor and the  Key or  Key to fine-tune the frequency.</p>	<div data-bbox="701 855 1005 967" style="border: 1px solid black; padding: 5px;"> <pre>1:RUN Vib Sup freq=0420 Hz damp=0120</pre> </div>
9	<p>Press the  Key.</p> <p>Note: Press the  Key to cancel saving the data. The display will return to the status shown in step 1.</p>	<p>The adjusted settings will be saved in the SERVOPACK. The status display will flash DONE as shown below for approximately one second and then return to 1:RUN.</p> <div data-bbox="701 1136 1005 1248" style="border: 1px solid black; padding: 5px;"> <pre>DONE Vib Sup freq=0420 Hz damp=0120</pre> </div>

■ Known Vibration Frequency

Step	Operation	Result
1	Press the  Key to display the Utility Mode Main Menu, and then use the  Key or  Key to select Fn204 .	<pre>1:RUN FUNCTION Fn203:OnePrmTun Fn204:A-Vib Sup Fn205:Vib Sup Fn206:Easy FFT</pre>
2	Press the  Key.	<p>The Tuning Mode Selection Display will appear.</p> <pre>1:RUN Vib Sup Tuning Mode = 0</pre> <p>Note: If the initial setting display does not appear and the status display changes to NO-OP, refer to the following section and correct the problem.</p> <p> 3.2.31 Adjust Anti-resonance Control (Fn204) - Preparations on page 3-92</p>
3	Use the  Key or  Key to set Tuning Mode to 1.	<pre>1:RUN FUNCTION Tuning Mode = 1</pre>
4	Press the  Key.	<p>The following display will appear and freq will flash.</p> <pre>1:RUN Vib Sup freq=0100 Hz damp=0000</pre>  <p>Measured Waveform Example</p>



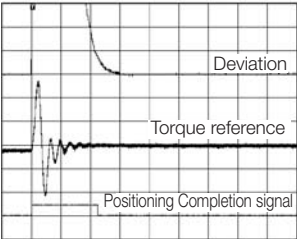



Continued on next page.

Continued from previous page.





Step	Operation	Result
5	Use the  Key or  Key to move the cursor and the  Key or  Key to adjust the frequency.	<pre> 1:RUN Vib Sup freq=01<u>00</u> Hz damp=00<u>00</u> </pre>
6	Press the  Key.	<p>The cursor will move to damp.</p> <pre> 1:RUN Vib Sup freq=040<u>0</u> Hz damp=000<u>0</u> </pre>
7	<p>Use the  Key or  Key to move the cursor and the  Key or  Key to adjust the damping gain.</p> <p>Note: Increase the damping gain by approximately 0% to 200% in 10% increments while checking the effect on vibration. If vibration reduction is still insufficient at a gain of 200%, cancel the setting, and lower the control gain by using a different method, such as one-parameter tuning.</p>	<pre> 1:RUN Vib Sup freq=0400 Hz damp=0020 </pre>  <p>Measured Waveform Example</p>
8	<p>If fine-tuning of the frequency is necessary, press the  Key. The cursor will move from damp to freq. Go to step 9.</p> <p>If fine-tuning is not required, go to step 10.</p>	<pre> 1:RUN Vib Sup freq=040<u>0</u> Hz damp=012<u>0</u> </pre>

Continued on next page.

Continued from previous page.













Step	Operation	Result
9	Use the  Key or  Key to move the cursor and the  Key or  Key to fine-tune the frequency.	<pre> 1:RUN Vib Sup freq=0400 Hz damp=0120 </pre>
10	Press the  Key. Note: Press the  Key to cancel saving the data. The display will return to the status shown in step 1.	<p>The adjusted settings will be saved in the SERVOPACK. The status display will flash DONE as shown below for approximately one second and then return to 1:RUN.</p> <pre> DONE Vib Sup freq=0400 Hz damp=0120 </pre>

◆ Fine-Tuning after Adjusting Anti-resonance Control

Step	Operation	Result
1	Press the  Key to display the Utility Mode Main Menu, and then use the  Key or  Key to select Fn204 .	<pre> 1:RUN FUNCTION Fn203:OnePrmTun Fn204:A-Vib Sup Fn205:Vib Sup Fn206:Easy FFT </pre>
2	Press the  Key.	<p>The following display will appear.</p> <pre> 1:RUN FUNCTION Tuning Mode = 1 </pre> <p>Note: If the initial setting display does not appear and the status display changes to NO-OP, refer to the following section and correct the problem.</p> <p> 3.2.31 Adjust Anti-resonance Control (Fn204) - Preparations on page 3-92</p>

Continued on next page.

Continued from previous page.

Step	Operation	Result
3	Press the  Key.	The following display will appear and damp will flash. <div style="border: 1px solid black; padding: 5px; width: fit-content; margin: 10px auto;"> <pre>1:RUN Vib Sup f r e q=0400 Hz d a m p=0120</pre> </div>
4	Use the  Key or  Key to move the cursor and the  Key or  Key to set the damping gain. Note: Increase the damping gain by approximately 0% to 200% in 10% increments while checking the effect on vibration. If vibration reduction is still insufficient at a gain of 200%, cancel the setting, and lower the control gain by using a different method, such as one-parameter tuning.	<div style="border: 1px solid black; padding: 5px; width: fit-content; margin: 10px auto;"> <pre>1:RUN Vib Sup f r e q=0400 Hz d a m p=01<u>50</u></pre> </div>
5	If fine-tuning of the frequency is necessary, press the  Key. The cursor will move from damp to freq . Go to step 6. If fine-tuning is not required, go to step 7.	<div style="border: 1px solid black; padding: 5px; width: fit-content; margin: 10px auto;"> <pre>1:RUN Vib Sup f r e q=040<u>0</u> Hz d a m p=0150</pre> </div>
6	Use the  Key or  Key to move the cursor and the  Key or  Key to fine-tune the frequency.	<div style="border: 1px solid black; padding: 5px; width: fit-content; margin: 10px auto;"> <pre>1:RUN Vib Sup f r e q=04<u>20</u> Hz d a m p=0150</pre> </div>
7	Press the  Key. Note: Press the  Key to cancel saving the data. The display will return to the status shown in step 1.	The adjusted settings will be saved in the SERVOPACK. The status display will flash DONE as shown below for approximately one second and then return to 1:RUN . <div style="border: 1px solid black; padding: 5px; width: fit-content; margin: 10px auto;"> <pre>DONE Vib Sup f r e q=0420 Hz d a m p=01<u>50</u></pre> </div>

3.2.32 Vibration Suppression (Fn205)

You can use this utility function to suppress transitional vibration at a low frequency from 1 to 100 Hz, which is generated mainly when the machine vibrates during positioning.

Vibration suppression is set automatically when advanced autotuning or advanced autotuning with a reference input is executed. In most cases, this utility function is not necessary. Use this utility function only if fine-tuning is required or readjustment is required as a result of a failure to detect vibration.





Perform one-parameter tuning (Fn203) if required to improve the response after performing this utility function.

Preparations

Always check the following before you execute vibration suppression.

- The parameters must not be write-prohibited (Fn010 must be set to 0000).
- The servo must be in ready status.
- There must be no overtravel.
- Position control must be used.
- Tuning-less function must be disabled (Pn170 = n.□□□0).
- The test without a motor function must be disabled (Pn00C = n.□□□0).

Operating Procedure







Step	Operation	Result
1	Input an operation reference, repeatedly perform a positioning operation, and perform steps 2 on.	—
2	Press the  Key to display the Utility Mode Main Menu, and then use the  Key or  Key to select Fn205 .	<pre>1:RUN FUNCTION Fn204:A-Vib Sup Fn205:Vib Sup Fn206:Easy FFT Fn207:V-Monitor</pre>
3	Press the  Key.	<p>The frequency will be detected and the following display will appear.</p> <pre>1:RUN Vib Sup Measure f=010.4 Hz Setting f=050.0 Hz</pre> <p>The detected frequency is displayed at Measure f. The setting frequency is displayed at Setting f. The default value is the setting of Pn145 (Vibration Suppression 1 Frequency A). Note: 1. If the setting frequency and actual operating frequency are different, Setting will flash. 2. Frequency detection will not be performed if there is no vibration or if the vibration frequency is outside the range of detectable frequencies. The following display will appear.</p> <pre>1:RUN Vib Sup Measure f=---- Hz Setting f=050.0 Hz</pre> <p>If a vibration frequency is not detected, prepare a means of detecting and measuring the vibration. If you measure the vibration frequency, go to step 5 and manually set the measured vibration frequency at Setting f.</p>

Continued on next page.

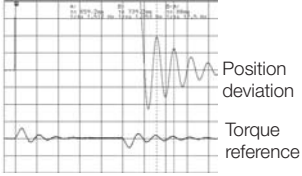
3.2 Operating Procedures for Utility Functions

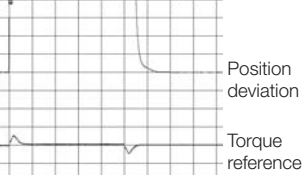

3.2.32 Vibration Suppression (Fn205)

Continued from previous page.

Step	Operation	Result
4	Press the  Key.	<p>The value displayed at Measure f will be set as the Setting f value.</p> <div data-bbox="663 268 965 386" style="border: 1px solid black; padding: 5px;"> <p>1:RUN Vib Sup</p> <p>Measure f = 010.4 Hz</p> <p>Setting f = 010.4 Hz</p> </div>  <p>Measured Waveform Example</p>
5	If the vibration is not completely suppressed, use the  Key or  Key to move the cursor and the  Key or  Key to fine-tune the frequency at Setting f . If fine-tuning the frequency is not necessary, go to step 7.	<div data-bbox="663 646 965 758" style="border: 1px solid black; padding: 5px;"> <p>1:RUN Vib Sup</p> <p>Measure f = 010.4 Hz</p> <p>Setting f = 012.4 Hz</p> </div> <p>Note: If the setting frequency and actual operating frequency are different, Setting will flash.</p>
6	Press the  Key.	<p>The Setting will stop flashing and the currently displayed frequency will be set for the vibration suppression function.</p> <div data-bbox="663 973 965 1085" style="border: 1px solid black; padding: 5px;"> <p>1:RUN Vib Sup</p> <p>Measure f = 010.4 Hz</p> <p>Setting f = 012.4 Hz</p> </div>  <p>Measured Waveform Example</p>

Continued on next page.

Continued from previous page.

Step	Operation	Result
7	<p>Press the  Key.</p> <p>Note: Press the  Key to cancel saving the data. The display will return to the status shown in step 1.</p>	<p>The adjusted setting will be saved in the SERVOPACK. The status display will flash DONE as shown below for approximately one second and then return to RUN.</p> <div data-bbox="700 347 1005 464" style="border: 1px solid black; padding: 5px;"> <p>DONE Vib Sup</p> <p>Measure f=----- Hz</p> <p>Setting f=012.4 Hz</p> </div>

3.2.33 Easy FFT (Fn206)

You can use this utility function to send a frequency waveform reference from the SERVOPACK to the Servomotor and operate the Servomotor at very low speed several times over a certain period to cause machine vibration. The SERVOPACK detects the resonance frequency from the generated vibration and makes notch filter settings according to the detected resonance frequencies. The notch filters are effective for eliminating high-frequency vibration and noise.











Execute this utility function after the Servomotor power is turned OFF if operation of the SERVOPACK results in high-frequency noise and vibration.

Preparations

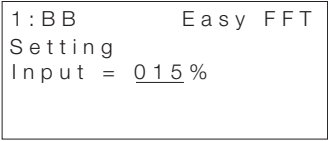
Always check the following before you execute Easy FFT.



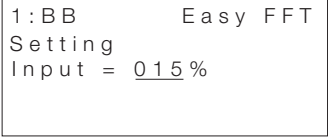

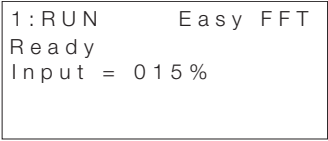
- The parameters must not be write-prohibited (Fn010 must be set to 0000).
- The servo must be OFF.
- The servo must be in ready status.
- There must be no overtravel.
- The test without a motor function must be disabled (Pn00C = n.□□□0).
- An external reference must not be input.

Operating Procedure

Step	Operation	Result
1	Press the  Key to display the Utility Mode Main Menu, and then use the  Key or  Key to select Fn206 .	 <pre> 1:BB FUNCTION Fn205:Vib Sup Fn206:Easy FFT Fn207:V-Monitor Fn000:Alm History </pre>
2	Press the  Key.	<p>The Easy FFT execution display will appear.</p>  <pre> 1:BB Easy FFT Setting Input = 015% </pre> <p>Note: If the initial setting display does not appear and the status display changes to NO-OP, refer to the following section and correct the problem.</p> <p> 3.2.33 Easy FFT (Fn206) - Preparations on page 3-104</p>
3	The cursor will be at the setting of Input . Use the  Key or  Key to set the reference amplitude. Reference amplitude range: 1 to 800 Note: First, execute the utility function with the default value. Increasing the reference amplitude will increase the detection accuracy, but the vibration and noise from the machine will also increase. Increase the reference amplitude a little at a time.	 <pre> 1:BB Easy FFT Setting Input = 015% </pre>
4	Press the  Key.	<p>Power will be supplied to the motor and the display will change as shown below.</p> <p>1:BB → 1:RUN Setting → Ready</p>  <pre> 1:RUN Easy FFT Ready Input = 015% </pre>













Continued on next page.

Continued from previous page.

Step	Operation	Result
5	Press the  Key for forward operation or the  Key for reverse operation.	<p>The motor will repeatedly perform round-trip operation within 1/4th of a rotation and the SERVOPACK will measure the resonance frequency. During detection, Measure will flash on the display.</p> <div data-bbox="651 375 977 512" style="border: 1px solid black; padding: 5px; margin: 10px 0;"> <pre>1:RUN Easy FFT Measure Input = 015%</pre> </div> <p>If detection processing is completed normally, the detected results and notch filter value will be displayed. Measure will change to Result.</p> <div data-bbox="651 663 977 801" style="border: 1px solid black; padding: 5px; margin: 10px 0;"> <pre>1:RUN Easy FFT Result Input = 015% Res = 1250 Hz Filter1 1250 Hz</pre> </div> <p>Note: 1. If a notch filter has been set and is being used, an asterisks will be displayed on the second line. If the first notch filter has already been set, the second notch filter value will be displayed. If the first and second notch filters have already been set, only the result of frequency detection will be displayed.</p> <p>2. If you press the  Key during motor operation, the motor will stop and the frequency will not be detected.</p> <p>3. If the frequency could not be successfully detected, No Measure will be displayed.</p> <p>4. If you press the  Key after the frequency is detected, power is no longer supplied to the motor (base block).</p>

Continued on next page.

Continued from previous page.

Step	Operation	Result
6	Press the  Key. Note: To exit the Easy FFT utility function at this point, press the  Key. The power supply to the Servomotor will be turned OFF and the display will return to the Utility Mode Main Menu.	The display will return to Ready . <div style="border: 1px solid black; padding: 5px; width: fit-content; margin: 10px auto;"> <pre> 1: RUN Easy FFT Ready Input = 015%</pre> </div>
7	Press the  Key.	The optimum notch filter frequencies (Pn408, Pn409, and Pn40C) are automatically changed according to the resonance frequencies and the values are saved in the SERVOPACK. If the first notch filter has already been set, the second notch filter value is set. If the first and second notch filters have already been set, the filter values are not changed. Note: Pn408 = n.     1 (Use first stage notch filter), Pn409 = 1375[Hz] (First Stage Notch Filter Frequency) Pn408 = n.     (Use second stage notch filter), Pn40C = 1375[Hz] (Second Stage Notch Filter Frequency) <div style="border: 1px solid black; padding: 5px; width: fit-content; margin: 10px auto;"> <pre> DONE Easy FFT Result Input = 015% Res = 1250 Hz Filter1 1250 Hz</pre> </div>
8	Press the  Key.	The display will return to the Utility Mode Main Menu. <div style="border: 1px solid black; padding: 5px; width: fit-content; margin: 10px auto;"> <pre> 1:BB FUNCTION Fn205:Vib Sup Fn206:Easy FFT Fn207:V-Monitor Fn000:Alm History</pre> </div>
9	Turn the SERVOPACK power supply OFF and ON again.	The parameter setting is now enabled.

3.2.34 Program Table Edit/Save (FnB03)

This function edits and saves program tables. Saving a program table to flash memory after editing it ensures that the data will be retained even after the control power has been turned off.

◆ Codes Displayed on the Program Table Editing Screen

Refer to the following manual for information on interpreting the displays.

📖 Σ -7-Series Σ -7S SERVOPACK Command Option Attachable Type with INDEXER Module Product Manual (Manual No.: SIEP S800001 64)

PGM-STEP	POS	SPD	RDST	RSPD	ACC	DEC	POUT	EVENT	LOOP	NEXT
0	POS000	SPD000	RDST000	RSPD000	ACC000	DEC000	POUT000	EVT000	LOOP000	NEXT000
1	POS001	SPD001	RDST001	RSPD001	ACC001	DEC001	POUT001	EVT001	LOOP001	NEXT001
⋮	⋮	⋮	⋮	⋮	⋮	⋮	⋮	⋮	⋮	⋮
255	POS255	SPD255	RDST255	RSPD255	ACC255	DEC255	POUT255	EVT255	LOOP255	NEXT255



Preparation

Always check the following before you edit or save a program table.

- The parameters must not be write-prohibited (Fn010 must be set to 0000).
- The program must not be running or on hold.
- A program table save operation must not be in progress for any means other than the digital operator.
- Execution of the RES command must not be in progress.

















Editing Program Table

The operating procedure when setting the acceleration (ACC) in program step 5 is explained here.

Step	Operation	Result
1	Press the  key to open the Utility Function Mode main menu, and move the cursor with the   keys to select FnB03.	<pre> BB FUNCTION Fn207 V-Monitor FnB03 PGM Edit FnB04 ZONE Edit FnB05 JSPD Edit </pre>

Continued on next page.

Continued from previous page.

Step	Operation	Result
2	Press the  key to view the FnB03 operation screen.	<pre> BB P g m E d i t POS000=STOP POS001=STOP POS002=STOP POS003=STOP </pre>
3	Move the cursor using the   keys and   keys (or the  +  and  +  keys) to select the article and program step of the program table to be edited. Refer to the following section for details on the methods to move the cursor.  ◆ <i>Method for Moving the Cursor on page 3-110</i>	<pre> BB P g m E d i t ACC002=: ACC003=: ACC004=: ACC005=: </pre>
4	Press the  key to move the cursor to the setting side of the table.	<pre> BB P g m E d i t ACC002=: ACC003=: ACC004=: ACC005=: </pre>
5	Move the cursor with the   keys, and change the table settings with the   keys.* Refer to the following section for detailed setting methods for each item.  <i>Details on How to Set Table Settings on page 3-111</i>	<pre> BB P g m E d i t ACC002=: ACC003=: ACC004=: ACC005=0000<u>1</u>000 </pre>
6	On pressing the  key, the setting is entered and the cursor returns to the program table article and program step side.	<pre> BB P g m E d i t ACC002=: ACC003=: ACC004=: ACC005=00001000 </pre>
7	Repeat steps 3 to 6 to set the program table. On completing the setting of all the program tables to be used, save the program tables to flash memory by following the procedure in <i>Saving Program Tables</i> on page 3-113.	

* If setting is attempted in an operation prohibited state, it will not be possible to change the setting. In this case, make the setting again by referring to *Preparation* on page 3-108.

◆ Method for Moving the Cursor

The values within the frames in the figure below are the articles and steps of the program table displayed at the digital operator.

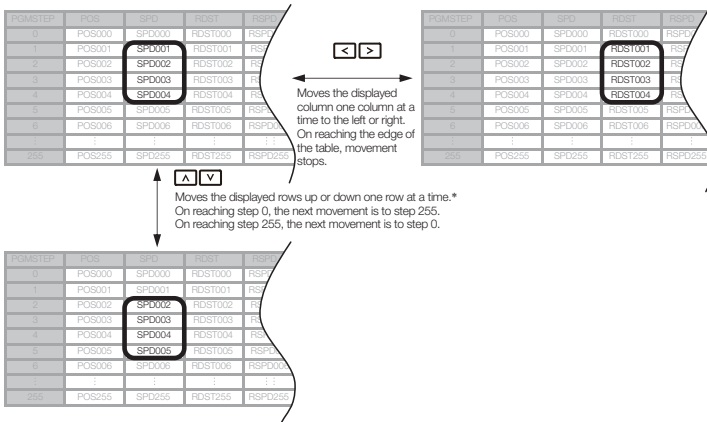

* You can move 4 rows at a time by holding down the or key. By using the key at the same time as these keys, you can move 30 rows at a time.

Details on How to Set Table Settings

Details on the setting method for step 5 in *Editing Program Table* on page 3-108 are shown below.

If the number of display digits is exceeded when Expansion Mode is enabled (PnB54 = 1), the table name will be abbreviated. Refer to the following manual for details.

📖 Σ -7-Series Σ -7S SERVOPACK Command Option Attachable Type with INDEXER Module Product Manual (Manual No.: SIEP S800001 64)

◆ POS: Target Position



◆ SPD: Positioning Speed

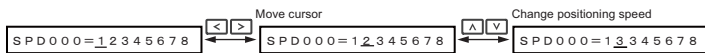

◆ RDST: Registration Distance

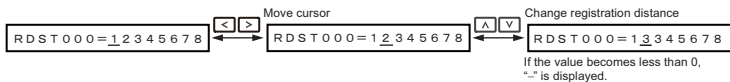

◆ RSPD: Registration Speed

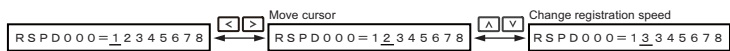

◆ ACC: Acceleration

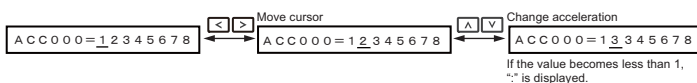

◆ DEC: Deceleration

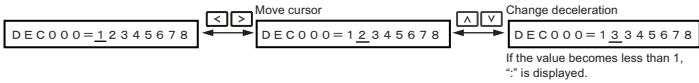

◆ POUT: Programmable Output Signals

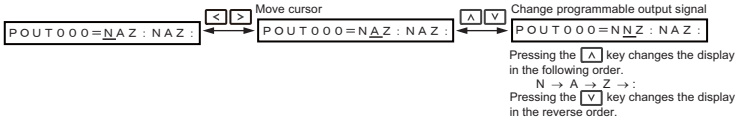

◆ EVENT: Pass Condition

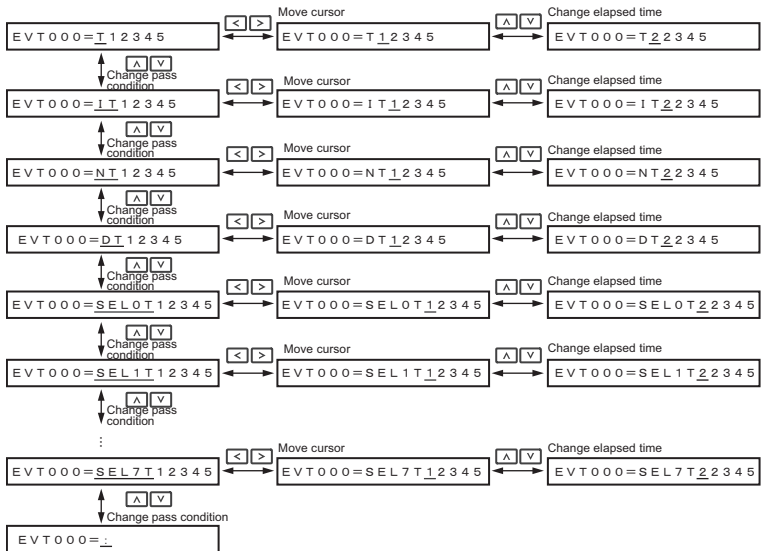

◆ LOOP: Number of Executions

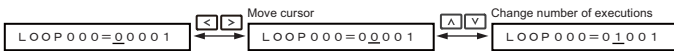



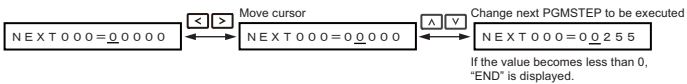



◆ NEXT: PGMSTEP to be Executed Next



Saving Program Tables

The operating procedure for saving program tables is shown below.

Step	Operation	Result
1	Display the program table editing screen.	<pre> BB P g m E d i t <u>POS000=STOP</u> POS001=STOP POS002=STOP POS003=STOP </pre>
2	Press the  key to view the program table save operation screen.	<pre> BB P g m E d i t STORE PGM TABLE? <u>CANCEL</u> STORE </pre>
3	Move the cursor with the   keys to select "STORE". Note: Selecting "CANCEL" and pressing the  key will return the display to the program table editing screen.	<pre> BB P g m E d i t STORE PGM TABLE? CANCEL <u>STORE</u> </pre>
4	Press the  key to start saving the program table to flash memory.* Do not turn off the control power supply until saving has been completed normally.	<pre> BB P g m E d i t <u>Storing now...</u> Please wait. </pre>
5	When saving to flash memory has been completed normally, the display returns to the program table editing screen.	<pre> BB P g m E d i t <u>POS000=STOP</u> POS001=STOP POS002=STOP POS003=STOP </pre>
6	Press the  key to return to the Utility Function Mode main menu.	<pre> BB FUNCTION Fn207 V-Monitor FnB03 <u>PGM Edit</u> FnB04 ZONE Edit FnB05 JSPD Edit </pre>

* If the  key is pressed in an operation prohibited state, "Error." is displayed for approximately 2 seconds and then the display returns to the program table editing screen. In this case, make the setting again by referring to *Preparation* on page 3-108.

3.2.35 ZONE Table Edit/Save (FnB04)

This function edits and saves ZONE tables. Saving a ZONE table to flash memory after editing it ensures that the data will be retained even after the control power has been turned off.

◆ Codes Displayed on the ZONE Table Editing Screen

Refer to the following manual for information on interpreting the displays.

📖 Σ -7-Series Σ -7S SERVOPACK Command Option Attachable Type with INDEXER Module Product Manual (Manual No.: SIEP S800001 64)

ZONE Number	ZONE P	ZONE N
0	ZP000	ZN000
1	ZP001	ZN001
⋮	⋮	⋮
31	ZP031	ZN031





Preparation

Always check the following before you edit or save a ZONE table.

- The parameters must not be write-prohibited (Fn010 must be set to 0000).
- A ZONE table save operation must not be in progress for any means other than the digital operator.











Editing ZONE Tables

The operating procedure when setting ZONE N in ZONE number 5 is explained here.

Step	Operation	Result
1	Press the  key to open the Utility Function Mode main menu, and move the cursor with the   keys to select FnB04.	<pre> BB FUNCTION FnB03 PGM Edit FnB04 ZONE Edit FnB05 JSPD Edit FnB06 PGM Init </pre>
2	Press the  key to view the FnB04 operation screen.	<pre> BB ZoneEdit ZP000=+00000000 ZP001=+00000000 ZP002=+00000000 ZP003=+00000000 </pre>

Continued on next page.

Continued from previous page.



Step	Operation	Result
3	Move the cursor using the   keys and   keys to select the ZONE table number to be edited. Refer to the following section for details on the methods to move the cursor.  ◆ <i>Method for Moving the Cursor on page 3-110</i>	<pre> BB ZoneEdit ZN002=+00000000 ZN003=+00000000 ZN004=+00000000 ZN005=+00000000 </pre>
4	Press the  key to move the cursor to the setting side of the table.	<pre> BB ZoneEdit ZN002=+00000000 ZN003=+00000000 ZN004=+00000000 ZN005=+00000000 </pre>
5	Move the cursor using the   keys and change the ZONE boundary values using the   keys.*	<pre> BB ZoneEdit ZN002=+00000000 ZN003=+00000000 ZN004=+00000000 ZN005=+12345678 </pre>
6	On pressing the  key, the setting is entered and the cursor returns to the ZONE table number side.	<pre> BB ZoneEdit ZN002=+00000000 ZN003=+00000000 ZN004=+00000000 ZN005=+12345678 </pre>
7	Repeat steps 3 to 6 to set the ZONE table. On completing the setting of all the ZONE tables to be used, save the ZONE tables to flash memory by following the procedure in <i>Saving ZONE Tables</i> on page 3-117.	

* If setting is attempted in an operation prohibited state, it will not be possible to change the setting. In this case, make the setting again by referring to *Preparation* on page 3-114.

◆ Method for Moving the Cursor

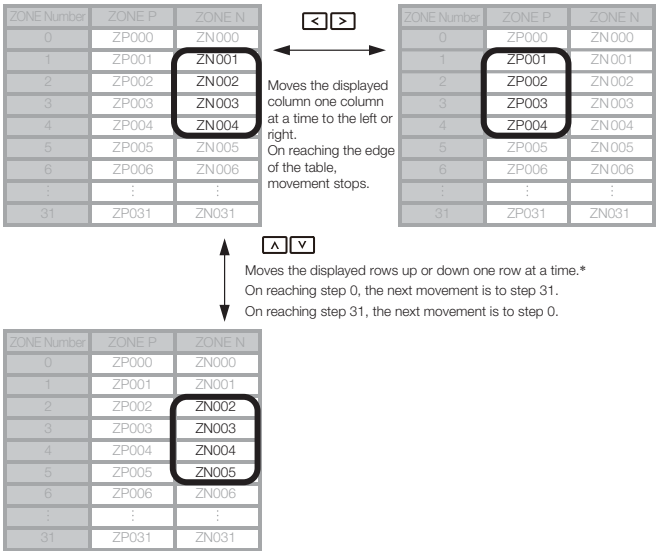





The values within the frames in the figure below are the ZONE table numbers displayed at the digital operator.



* You can move 3 rows at a time by holding down the  or  key.

Saving ZONE Tables

The operating procedure for saving ZONE tables is shown below.

Step	Operation	Result
1	Display the ZONE table editing screen.	<pre> BB ZoneEdit ZP000=+00000000 ZP001=+00000000 ZP002=+00000000 ZP003=+00000000 </pre>
2	Press the  key to view the ZONE table save screen.	<pre> BB ZoneEdit STORE ZONE TABLE? CANCEL STORE </pre>
3	Move the cursor with the   keys to select "STORE". Note: Selecting "CANCEL" and pressing the  key will return the display to the ZONE table editing screen.	<pre> BB ZoneEdit STORE ZONE TABLE? CANCEL STORE </pre>
4	Press the  key to start saving the ZONE table to flash memory.* Do not turn off the control power supply until saving has been completed normally.	<pre> BB ZoneEdit Storing now... Please wait. </pre>
5	When saving to flash memory has been completed normally, the display returns to the ZONE table editing screen.	<pre> BB ZoneEdit ZP000=+00000000 ZP001=+00000000 ZP002=+00000000 ZP003=+00000000 </pre>
6	Press the  key to return to the Utility Function Mode main menu.	<pre> BB FUNCTION FnB03 PGM Edit FnB04 ZONE Edit FnB05 JSPD Edit FnB06 PGM Init </pre>

* If the  key is pressed in an operation prohibited state, "Error." is displayed for approximately 2 seconds and then the display returns to the ZONE table editing screen. In this case, make the setting again by referring to *Preparation* on page 3-114.

3.2.36 JOG Speed Table Edit/Save (FnB05)

This function edits and saves JOG speed tables. Saving a JOG speed table to flash memory after editing it ensures that the data will be retained even after the control power has been turned off.

Refer to the following manual for information on interpreting the displays.

 Σ -7-Series Σ -7S SERVOPACK Command Option Attachable Type with INDEXER Module Product Manual (Manual No.: SIEP S800001 64)









Preparation

Always check the following before you edit or save a jog speed table.

- The parameters must not be write-prohibited (Fn010 must be set to 0000).
- A JOG speed table save operation must not be in progress for any means other than the digital operator.

Editing JOG Speed Tables

The operating procedure when setting the value for JOG speed table number 5 is explained here.

Step	Operation	Result
1	Press the  key to open the Utility Function Mode main menu, and move the cursor with the   keys to select FnB05.	<pre> BB FUNCTION FnB04 ZONE Edit <u>FnB05 JSPD Edit</u> FnB06 PGM Init FnB07 ZONE Init </pre>
2	Press the  key to view the FnB05 operation screen.	<pre> BB JspdEdit <u>JSPD000=00001000</u> JSPD001=00001000 JSPD002=00001000 JSPD003=00001000 </pre>
3	Move the cursor using the   keys to select the JOG speed table number to be edited. Pressing the  key when the cursor is on JOG speed table number 0 moves it to number 15. Pressing the  key when the cursor is on JOG speed table number 15 moves it to number 0.	<pre> BB JspdEdit JSPD002=00001000 JSPD003=00001000 JSPD004=00001000 <u>JSPD005=00001000</u> </pre>

Continued on next page.

Continued from previous page.

Step	Operation	Result
4	Press the DATA key to move the cursor to the setting side of the table.	<pre> BB J s p d E d i t JSPD002=00001000 JSPD003=00001000 JSPD004=00001000 JSPD005=<u>0</u>0001000 </pre>
5	Move the cursor with the < > keys, and change the JOG speed setting with the ▲ ▼ keys.*	<pre> BB J s p d E d i t JSPD002=00001000 JSPD003=00001000 JSPD004=00001000 JSPD005=1234567<u>8</u> </pre>
6	On pressing the DATA key, the setting is entered and the cursor returns to the JOG speed table number side.	<pre> BB J s p d E d i t JSPD002=00001000 JSPD003=00001000 JSPD004=00001000 JSPD005=12345678 </pre>
7	Repeat steps 3 to 6 to set the JOG speed table. On completing the setting of all the JOG speed tables to be used, save the JOG speed tables to flash memory by following the procedure in <i>Saving JOG Speed Tables</i> on page 3-119.	

* If setting is attempted in an operation prohibited state, it will not be possible to change the setting. In this case, make the setting again by referring to *Preparation* on page 3-118.





Saving JOG Speed Tables

The operating procedure for saving JOG speed tables is shown below.

Step	Operation	Result
1	Display the JOG speed table editing screen.	<pre> BB J s p d E d i t JSPD002=00001000 JSPD003=00001000 JSPD004=00001000 JSPD005=00001000 </pre>
2	Press the WRITE key to view the JOG speed table save screen.	<pre> BB J s p d E d i t STORE JSPD TABLE? <u>CANCEL</u> STORE </pre>

Continued on next page.

Continued from previous page.

Step	Operation	Result
3	Move the cursor with the   keys to select "STORE". Note: Selecting "CANCEL" and pressing the  key will return the display to the JOG speed table editing screen.	<pre>BB J s p d E d i t STORE JSPD TABLE? CANCEL S T O R E</pre>
4	Press the  key to start saving the JOG speed table to flash memory.* Do not turn off the control power supply until saving has been completed normally.	<pre>BB J s p d E d i t Storing now... Please wait.</pre>
5	When saving to flash memory has been completed normally, the display returns to the JOG speed table editing screen.	<pre>BB J s p d E d i t JSPD000=00001000 JSPD001=00001000 JSPD002=00001000 JSPD003=00001000</pre>
6	Press the  key to return to the Utility Function Mode main menu.	<pre>BB F U N C T I O N FnB04 ZONE Edit FnB05 JSPD Edit FnB06 PGM Init FnB07 ZONE Init</pre>

* If the  key is pressed in an operation prohibited state, "Error." is displayed for approximately 2 seconds and then the display returns to the JOG speed table editing screen. In this case, make the setting again by referring to *Preparation* on page 3-118.

3.2.37 Program Table Initialization (FnB06)









This function initializes the program tables and restores the settings on shipment from the factory.

Preparation

Always check the following before you initialize a program table.

- The parameters must not be write-prohibited (Fn010 must be set to 0000).
- The program must not be running or on hold.
- A program table save operation must not be in progress for any means other than the digital operator.
- Execution of the RES command must not be in progress.

Operating Procedure

Step	Operation	Result
1	Press the  key to open the Utility Function Mode main menu, and move the cursor with the   keys to select FnB06.	<pre> BB FUNCTION FnB05 JSPD Edit FnB06 PGM Init FnB07 ZONE Init FnB08 JSPD Init </pre>
2	Press the  key to view the FnB06 operation screen.	<pre> BB PgmInit Start : [DATA] Return: [SET] </pre>
3	Press the  key to start program table initialization.* Do not turn off the control power supply until initialization has been completed normally. To cancel the FnB06 operation, press the  key before pressing the  key. The display returns to the Utility Function Mode main menu without executing the operation.	<pre> BB PgmInit Restoring now... Please wait. </pre>
4	When program table initialization has been completed normally, "Done." is displayed.	<pre> BB PgmInit Done. Press [SET] key. </pre>
5	Press the  key to return to the Utility Function Mode main menu.	<pre> BB FUNCTION FnB05 JSPD Edit FnB06 PGM Init FnB07 ZONE Init FnB08 JSPD Init </pre>

* If the  key is pressed in an operation prohibited state, "Error." is displayed for approximately 2 seconds and then the display returns to the FnB06 operation screen. In this case, make the setting again by referring to *Preparation* on page 3-120.

3.2.38 ZONE Table Initialization (FnB07)







This function initializes ZONE tables and restores the settings on shipment from the factory.

Preparation

Always check the following before you initialize a ZONE table.

- The parameters must not be write-prohibited (Fn010 must be set to 0000).
- A ZONE table save operation must not be in progress for any means other than the digital operator.
- Execution of the RES command must not be in progress.

Operating Procedure

Step	Operation	Result
1	Press the  key to open the Utility Function Mode main menu, and move the cursor with the   keys to select FnB07.	<pre> BB FUNCTION FnB06 PGM Init <u>FnB07 ZONE Init</u> FnB08 JSPD Init FnB09 ZSET </pre>
2	Press the  key to view the FnB07 operation screen.	<pre> BB ZoneInit Start : [DATA] Return : [SET] </pre>
3	Press the  key to start ZONE table initialization.* Do not turn off the control power supply until initialization has been completed normally. To cancel the FnB07 operation, press the  key before pressing the  key. The display returns to the Utility Function Mode main menu without executing the operation.	<pre> BB ZoneInit Restoring now... Please wait. </pre>

Continued on next page.

Continued from previous page.

Step	Operation	Result
4	When ZONE table initialization has been completed normally, "Done." is displayed.	<pre> BB Zone Init Done. Press [SET] key.</pre>
5	Press the  key to return to the Utility Function Mode main menu.	<pre> BB FUNCTION FnB06 PGM Init FnB07 ZONE Init FnB08 JSPD Init FnB09 ZSET</pre>

* If the  key is pressed in an operation prohibited state, "Error." is displayed for approximately 2 seconds and then the display returns to the FnB07 operation screen. In this case, make the setting again by referring to *Preparation* on page 3-122.

3.2.39 JOG Speed Table Initialization (FnB08)



This function initializes JOG speed tables and restores the default settings.

Preparation

Always check the following before you initialize a JOG speed table.

- The parameters must not be write-prohibited (Fn010 must be set to 0000).
- A JOG speed table save operation must not be in progress for any means other than the digital operator.
- Execution of the RES command must not be in progress.

Operating Procedure





Step	Operation	Result
1	Press the  key to open the Utility Function Mode main menu, and move the cursor with the   keys to select FnB08.	<pre> BB FUNCTION FnB07 ZONE Init FnB08 JSPD Init FnB09 ZSET FnB0A Monitor</pre>

Continued on next page.

3.2 Operating Procedures for Utility Functions

3.2.39 JOG Speed Table Initialization (FnB08)

Continued from previous page.

Step	Operation	Result
2	Press the  key to view the FnB08 operation screen.	<pre> BB Jsp d I n i t Start : [DATA] Return : [SET]</pre>
3	<p>Press the  key to start JOG speed table initialization.* Do not turn off the control power supply until initialization has been completed normally.</p> <p>To cancel the FnB08 operation, press the  key before pressing the  key. The display returns to the Utility Function Mode main menu without executing the operation.</p>	<pre> BB Jsp d I n i t Restoring now... Please wait.</pre>
4	When JOG speed table initialization has been completed normally, "Done." is displayed.	<pre> BB Jsp d I n i t Done. Press [SET] key.</pre>
5	Press the  key to return to the Utility Function Mode main menu.	<pre> BB FUNCTION FnB07 ZONE Init FnB08 JSPD Init FnB09 ZSET FnBOA Monitor</pre>

* If the  key is pressed in an operation prohibited state, "Error." is displayed for approximately 2 seconds and then the display returns to the FnB08 operation screen. In this case, make the setting again by referring to *Preparation* on page 3-123.

3.2.40 Absolute Encoder Origin Setting (FnB09)

This utility function replaces the current position with a specified position. Also updates PnB25 with the absolute position offset value to achieve the position specified by this utility function.



DANGER

- This function replaces the coordinates of the reference position and is therefore very dangerous. After executing this function, check that the new coordinates match the reference position before starting operation.



Important



- If the settings for any of parameters Pn20E to Pn210, Pn205, or PnB20 to PnB25 have been changed, turn the control power supply off and back on to bring the settings into effect before executing operation.
- The absolute position offset value is saved in parameter PnB25, so do not rewrite this value.

Preparation

Always check the following before you perform the absolute encoder origin setting.

- The parameters must not be write-prohibited (Fn010 must be set to 0000).
- Distribution of position references must not be in progress.
- The absolute position offset value must not be outside the range for PnB25.
- An absolute encoder must be connected and Pn002 must be set to n.□0□□.

Operating Procedure









Step	Operation	Result
1	Press the  key to open the Utility Function Mode main menu, and move the cursor with the   keys to select FnB09.	<pre> BB FUNCTION FnB08 JSPD Init <u>FnB09 ZSET</u> FnB0A Monitor FnB0B Prm Init </pre>

Continued on next page.

3.2 Operating Procedures for Utility Functions

3.2.40 Absolute Encoder Origin Setting (FnB09)

Continued from previous page.

Step	Operation	Result
2	Press the  key to view the FnB09 operation screen.	<pre> BB ZSET Pos=+_00000000 Start : [DATA] Return : [SET] </pre>
3	Move the cursor with the   keys, and change the setting for the position whose current position is to be replaced with the   keys.	<pre> BB ZSET Pos=+0000_1000 Start : [DATA] Return : [SET] </pre>
4	<p>Press the  key to start origin setting.*</p> <p>Do not turn off the control power supply until origin setting has been completed normally.</p> <p>To cancel the FnB09 operation, press the  key before pressing the  key. The display returns to the Utility Function Mode main menu without executing the operation.</p>	<pre> BB ZSET Storing now... </pre>
5	When origin setting has been completed normally, "Done." is displayed.	<pre> BB ZSET Done. Press [SET] key. </pre>
6	Press the  key to return to the Utility Function Mode main menu.	<pre> BB FUNCTION FnB08 JSPD Init FnB09 ZSET FnB0A Monitor FnB0B Prm Init </pre>
7	Check that the current distributed position (PUN) and the current (actual) motor position (PFB) have changed to the specified positions by executing FnB0A.	

* If the  key is pressed in an operation prohibited state, "Error." is displayed for approximately 2 seconds and then the display returns to the FnB09 operation screen. In this case, make the setting again by referring to *Preparation* on page 3-125.









3.2.41 INDEXER Status Monitor (FnB0A)

This function shows the internal status of the INDEXER Module, such as the current position and input/output signals.

Preparation

None

Operating Procedure

Step	Operation	Result
1	Press the  key to open the Utility Function Mode main menu, and move the cursor with the   keys to select FnB0A.	<pre> BB FUNCTION FnB09 ZSET FnB0A Monitor FnB0B Prm Init FnB0C ALM Reset </pre>
2	Press the  key to view the FnB0A operation screen.	<pre> BB Monitor ALM=BB ERR=NONE PFB=+12345678 PGMSTEP=12345 </pre>
3	Use the   keys to change the monitor display content. Note: Press the  key to change the content being displayed in the following order. ALM → ERR → IN2 → OUT2 → STS → PUN → PFB → POS → DST → RPOS → RDST → PGM-STEP → EVTIME → LOOP Press the  key to change the content being displayed in the reverse order.	<pre> BB Monitor STS=■■■■■■■■ PUN=+12345678 PFB=+12345678 POS=+12345678 </pre>
4	Press the  key to return to the Utility Function Mode main menu.	<pre> BB FUNCTION FnB09 ZSET FnB0A Monitor FnB0B Prm Init FnB0C ALM Reset </pre>

◆ Monitor Display Content List

Display Code	Display Content	Display Example	Units	Serial Command
ALM	Alarm or Warning	<ul style="list-style-type: none"> • ALM = A.□□□: A SERVOPACK alarm/warning is in effect (□□□ is the alarm/warning code). • ALM = E□□A: An INDEXER Module alarm is in effect (E□□A is the alarm code). • ALM = HBB: During hard wire base block • ALM = P-OT: Forward run prohibited (Over travel) • ALM = N-OT: Reverse run prohibited (Over travel) • ALM = P-LS: Forward software limit • ALM = N-LS: Reverse software limit • ALM = BB: Base blocked • ALM = HOLD: Positioning interrupted • ALM = INPOS: Positioning completed • ALM = NEAR: Near position status reached in positioning • ALM = RUN: Motor running • ALM = . : Status other than above 	-	ALM
ERR	Most Recent (Closest) Error	<ul style="list-style-type: none"> • ERR = NONE: No error • ERR = E□□E: Error code 	-	ERR

Continued on next page.

Continued from previous page.

Display Code	Display Content	Display Example	Units	Serial Command																								
IN2	INDEXER Module Input Signal	<p>IN2 = </p> <p>1110 9 8 7 6 5 4 3 2 1 digit</p> <p>Upper level: Photocoupler ON Lower level: Photocoupler OFF</p> <table border="1"> <thead> <tr> <th>Display Digit Number</th> <th>Signal Name</th> </tr> </thead> <tbody> <tr> <td>1</td> <td>/MODE0/1</td> </tr> <tr> <td>2</td> <td>/START-STOP; /HOME</td> </tr> <tr> <td>3</td> <td>/PGMRES; /JOGP</td> </tr> <tr> <td>4</td> <td>/SEL0; /JOGN</td> </tr> <tr> <td>5</td> <td>/SEL1; /JOG0</td> </tr> <tr> <td>6</td> <td>/SEL2; /JOG1</td> </tr> <tr> <td>7</td> <td>/SEL3; /JOG2</td> </tr> <tr> <td>8</td> <td>/SEL4; /JOG3</td> </tr> <tr> <td>9</td> <td>/SEL5</td> </tr> <tr> <td>10</td> <td>/SEL6</td> </tr> <tr> <td>11</td> <td>/SEL7</td> </tr> </tbody> </table>	Display Digit Number	Signal Name	1	/MODE0/1	2	/START-STOP; /HOME	3	/PGMRES; /JOGP	4	/SEL0; /JOGN	5	/SEL1; /JOG0	6	/SEL2; /JOG1	7	/SEL3; /JOG2	8	/SEL4; /JOG3	9	/SEL5	10	/SEL6	11	/SEL7	-	IN2
Display Digit Number	Signal Name																											
1	/MODE0/1																											
2	/START-STOP; /HOME																											
3	/PGMRES; /JOGP																											
4	/SEL0; /JOGN																											
5	/SEL1; /JOG0																											
6	/SEL2; /JOG1																											
7	/SEL3; /JOG2																											
8	/SEL4; /JOG3																											
9	/SEL5																											
10	/SEL6																											
11	/SEL7																											

Continued on next page.

Continued from previous page.

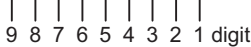
Display Code	Display Content	Display Example	Units	Serial Command																				
OUT2	INDEXER Module Output Signal	<p>OUT2 = </p> <p style="text-align: center;">  9 8 7 6 5 4 3 2 1 digit </p> <p>Upper level: Photocoupler ON Lower level: Photocoupler OFF</p> <table border="1" style="width: 100%; border-collapse: collapse;"> <thead> <tr> <th style="width: 50%;">Display Digit Number</th> <th style="width: 50%;">Signal Name</th> </tr> </thead> <tbody> <tr><td style="text-align: center;">1</td><td>/INPOSITION</td></tr> <tr><td style="text-align: center;">2</td><td>/POUT0</td></tr> <tr><td style="text-align: center;">3</td><td>/POUT1</td></tr> <tr><td style="text-align: center;">4</td><td>/POUT2</td></tr> <tr><td style="text-align: center;">5</td><td>/POUT3</td></tr> <tr><td style="text-align: center;">6</td><td>/POUT4</td></tr> <tr><td style="text-align: center;">7</td><td>/POUT5</td></tr> <tr><td style="text-align: center;">8</td><td>/POUT6</td></tr> <tr><td style="text-align: center;">9</td><td>/POUT7</td></tr> </tbody> </table>	Display Digit Number	Signal Name	1	/INPOSITION	2	/POUT0	3	/POUT1	4	/POUT2	5	/POUT3	6	/POUT4	7	/POUT5	8	/POUT6	9	/POUT7	-	OUT2
Display Digit Number	Signal Name																							
1	/INPOSITION																							
2	/POUT0																							
3	/POUT1																							
4	/POUT2																							
5	/POUT3																							
6	/POUT4																							
7	/POUT5																							
8	/POUT6																							
9	/POUT7																							

Continued on next page.

Continued from previous page.

Display Code	Display Content	Display Example	Units	Serial Command														
STS	Status Flag	<p>STS = </p> <p>Upper level: ON Lower level: OFF</p> <table border="1" data-bbox="469 416 823 965"> <thead> <tr> <th>Display Digit Number</th> <th>Status Flag</th> </tr> </thead> <tbody> <tr> <td>1</td> <td>INPOSITION (Positioning complete)</td> </tr> <tr> <td>2</td> <td>NEAR (Near position)</td> </tr> <tr> <td>3</td> <td>DEN (positioning reference distribution completed)</td> </tr> <tr> <td>4</td> <td>When positioning or program operation is interrupted (on hold)</td> </tr> <tr> <td>5</td> <td>During program operation</td> </tr> <tr> <td>6</td> <td>When the current (torque) is being limited</td> </tr> </tbody> </table>	Display Digit Number	Status Flag	1	INPOSITION (Positioning complete)	2	NEAR (Near position)	3	DEN (positioning reference distribution completed)	4	When positioning or program operation is interrupted (on hold)	5	During program operation	6	When the current (torque) is being limited	-	STS
		Display Digit Number	Status Flag															
		1	INPOSITION (Positioning complete)															
		2	NEAR (Near position)															
		3	DEN (positioning reference distribution completed)															
		4	When positioning or program operation is interrupted (on hold)															
		5	During program operation															
6	When the current (torque) is being limited																	
PUN	Position Reference Current Position	PUN = +12345678	Reference unit	PUN														
PFB	Current (Actual) Motor Position	PFB = +12345678	Reference unit	PFB														
POS	Target Position	POS = +12345678	Reference unit	POS														
DST	Target Distance	DST = +12345678	Reference unit	DST														

Continued on next page.

Continued from previous page.

Display Code	Display Content	Display Example	Units	Serial Command
RPOS	Registration Target Position	RPOS = +12345678	Reference unit	RPOS
RDST	Registration Target Distance	RDST = 12345678	Reference unit	RDST
PGM-STEP	Program Step (PGM-STEP)	PGMSTEP = End: When the program is not running PGMSTEP = 12345: The program step being executed	-	PGMSTEP
EVTIME	Program EVENT Elapsed Time	EVTIME = 12345	ms	EVTIME
LOOP	Loop Pass Through	LOOP = 12345	Times	LOOP

3.2.42 INDEXER Parameter Setting Initialization (FnB0B)

This function restores the default settings and initializes the parameters of both the SERVOPACK and the INDEXER Module.



Important

- Always carry out initialization of the parameter settings in the servo OFF status. It cannot be done in the servo ON status.
- To bring the settings into effect, always turn the SERVOPACK power supply off and back on after this operation.
- When you execute Fn005, only the SERVOPACK parameters are initialized. The INDEXER Module parameters are not initialized. To initialize the INDEXER Module parameters, execute FnB0B.









Preparation

Always check the following before you initialize the INDEXER parameter settings.

- The parameters must not be write-prohibited (Fn010 must be set to 0000).
- The servo OFF status must be established.
- Initializing the parameter settings must not be in progress for any tool.

- The RES command must not be executed.

Operating Procedure

Step	Operation	Result
1	Press the  key to open the Utility Function Mode main menu, and move the cursor with the   keys to select FnB0B.	<pre> BB FUNCTION FnB0A Monitor FnB0B Prm Init FnB0C ALM Reset FnB0D Indexer ALM </pre>
2	Press the  key to view the FnB0B operation screen.	<pre> BB PrmInit Start : [DATA] Return: [SET] </pre>
3	Press the  key to start initialization of the parameters.* Do not turn off the control power supply until initialization has been completed normally. To cancel the FnB0B operation, press the  key before pressing the  key. The display returns to the Utility Function Mode main menu without executing the operation.	<pre> BB PrmInit Restoring now... Please wait. </pre>
4	When parameter initialization has been completed normally, "Done." is displayed.	<pre> BB PrmInit Done. Press [SET] key. </pre>
5	Press the  key to return to the Utility Function Mode main menu.	<pre> BB FUNCTION FnB0A Monitor FnB0B Prm Init FnB0C ALM Reset FnB0D Indexer ALM </pre>
6	To bring the settings into effect, turn the SERVOPACK power supply off and back on.	

* If the  key is pressed in an operation prohibited state, "Error." is displayed for approximately 2 seconds and then the display returns to the FnB0B operation screen. In this case, make the setting again by referring to *Preparation* on page 3-132.

3.2.43 INDEXER Alarm Reset (FnB0C)

This function resets alarms at both the SERVOPACK and INDEXER Module, and clears the alarm history at the INDEXER Module.



Important

- INDEXER Module alarms are not reset by the “ALARM RESET” button of the digital operator. To reset INDEXER Module alarms, execute alarm resetting with FnB0C.
- Eliminate the causes of alarms before resetting them.
- When you execute Fn006, only the SERVOPACK alarm history is cleared. The INDEXER Module alarm history is not cleared. To clear the INDEXER Module alarm history, execute alarm history clearance with FnB0C.

Preparation

◆ When Resetting Alarms





None

◆ When Clearing the Alarm History

Always check the following before you clear the alarm history.









- The parameters must not be write-prohibited (Fn010 must be set to 0000).
- The ALMTRCLR command must not be executed.
- The RES command must not be executed.

Operating Procedure

Step	Operation	Result
1	Press the  key to open the Utility Function Mode main menu, and move the cursor with the   keys to select FnB0C.	<pre>A. AEF FUNCTION FnB0B Prm Init <u>FnB0C ALM Reset</u> FnB0D Indexer ALM Fn000 Alm History</pre>
2	Press the  key to view the FnB0C operation screen.	<pre>A. AEF AlmReset Mode=ALM state Start : [DATA] Return : [SET]</pre>

Continued on next page.

Continued from previous page.

Step	Operation	Result
3-1	<p>■ When Resetting Alarms</p> <p>Use the   keys to select "ALM state".</p>	<pre>A. AEF AlmReset Mode=ALM state Start : [DATA] Return: [SET]</pre>
3-2	<p>■ When Clearing the Alarm History</p> <p>Use the   keys to select "ALM History".</p>	<pre>A. AEF AlmReset Mode=ALM History Start : [DATA] Return: [SET]</pre>
4	<p>Press the  key to reset the alarms or clear the alarm history.*</p> <p>To cancel the FnB0C operation, press the  key before pressing the  key. The display returns to the Utility Function Mode main menu without executing the operation.</p>	<pre>A. AEF AlmReset Resetting...</pre>
5	When alarm resetting or alarm history clearance is completed, the display returns to the Mode selection screen.	<pre>BB AlmReset Mode=ALM state Start : [DATA] Return: [SET]</pre>
6	Press the  key to return to the Utility Function Mode main menu.	<pre>BB FUNCTION FnB0B Prm Init FnB0C ALM Reset FnB0D Indexer ALM Fn000 Alm History</pre>

* If the  key is pressed in an operation prohibited state, "Error." is displayed for approximately 2 seconds and then the display returns to the FnB0C operation screen. In this case, make the setting again by referring to *Preparation*.







3.2.44 INDEXER Alarm History Display (FnB0D)

This function displays the history of alarms that have occurred at the SERVOPACK and INDEXER Module.

Preparation

None

Operating Procedure

Step	Operation	Result
1	Press the  key to open the Utility Function Mode main menu, and move the cursor with the   keys to select FnB0D.	<pre> BB FUNCTION FnB0C ALM Reset FnB0D Indexer ALM Fn000 Alm History Fn002 JOG </pre>
2	Press the  key to view the alarm history. If no alarms occur, "NONE" is displayed.	<pre> BB AlmTrace ALM0=A. F10 ALM1=E19A ALM2=NONE ALM3=NONE </pre>
3	Use the   keys to scroll the alarm history.	<pre> BB AlmTrace ALM0=A. F10 ALM1=E19A ALM2=NONE ALM3=NONE </pre> <pre> BB AlmTrace ALM1=E19A ALM2=NONE ALM3=NONE ALM4=NONE </pre> <pre> BB AlmTrace ALM6=NONE ALM7=NONE ALM8=NONE ALM9=NONE </pre>
4	Press the  key to return to the Utility Function Mode main menu.	<pre> BB FUNCTION FnB0C ALM Reset FnB0D Indexer ALM Fn000 Alm History Fn002 JOG </pre>

Information

To clear the alarm history, execute the Reset INDEXER Alarm (FnBOC) utility function with *Mode* set to *ALM History* (clear alarm history). The alarm history is not cleared when you reset an alarm (*Mode* = *ALM* state) or when the control power supply to the SERVOPACK is turned OFF. Refer to the following section for the procedure.

 **INDEXER Alarm Reset (FnBOC)** on page 3-134

Parameter Copy Functions

4

This chapter describes operating procedures for the parameter copy functions.

4.1	Introduction	4-2
4.1.1	Parameter Copy Mode Functions . . .	4-2
4.2	Operating Procedures in Parameter Copy Mode . .	4-3
4.2.1	Reading Parameters from the SERVOPACK (SERVO→OP)	4-3
4.2.2	Writing Parameters to the SERVOPACK (OP→SERVO)	4-6
4.2.3	Verifying Parameters (VERIFY)	4-10
4.2.4	Parameter Block List Display (LIST)	4-14

4.1 Introduction

The Digital Operator for Σ -7-Series Servo Systems has a storage area of seven blocks of parameters. One block is used for one SERVOPACK. In Parameter Copy Mode, you can use these parameter blocks.

Note: The parameter copy functions are not supported for Σ -7W SERVOPACKs and Σ -7S SERVOPACKs with the MECHATROLINK-4 communications reference. To copy parameters for Σ -7W SERVOPACKs and Σ -7S SERVOPACKs with the MECHATROLINK-4 communications reference, use the parameter editing functions of the SigmaWin+. Refer to the following manual for details.

 AC Servo Drive Engineering Tool SigmaWin+ Operation Manual (SIET S800001 34)

4.1.1 Parameter Copy Mode Functions

You can execute the following four functions in Parameter Copy Mode.



Display	Function
1: SERVO→OP	Copies SERVOPACK parameters to the Digital Operator.
2: OP→SERVO	Writes the parameters saved in the Digital Operator to the SERVOPACK.
3: VERIFY	Compares the parameters in the SERVOPACK and the Digital Operator, and displays the results.
4: LIST	Displays the parameter blocks that are saved in the Digital Operator.

4.2

Operating Procedures in Parameter Copy Mode

This section describes the operating procedures for the functions that you can select from the Main Menu in Parameter Copy Mode.

Press the  Key to display the Parameter Copy Mode Main Menu.

Use the  Key or  Key to select the function you want to execute, and then press the  Key to change to the execution display for that function.

```

1 : BB                COPY
1 : SERVO→OP
2 : OP→SERVO
3 : VERIFY
4 : LIST
  
```

← The selected function will flash.



Parameter Copy Mode Main Menu Display

4.2.1

Reading Parameters from the SERVOPACK (SERVO→OP)

This function reads the parameters saved in the SERVOPACK, and saves them in one of the seven blocks in the storage area in the Digital Operator.

Operating Procedure





Step	Operation	Result
1	Display the Parameter Copy Mode Main Menu, and then use the  Key or  Key to select SERVO→OP .	<pre> 1 : BB COPY 1 : <u>SERVO→OP</u> 2 : OP→SERVO 3 : VERIFY 4 : LIST </pre> <p>The currently selected function will flash.</p>
2	Press the  Key.	<pre> 1 : BB SERVO→OP 00 : * * * * 01 : * * * * 02 : * * * * 03 : * * * * </pre> <p>The Parameter Block Selection Display will appear.</p>

Continued on next page.

4.2 Operating Procedures in Parameter Copy Mode

4.2.1 Reading Parameters from the SERVOPACK (SERVO→OP)

Continued from previous page.

Step	Operation	Result
3	Use the  Key or  Key to select the parameter block (00 to 06) in the Digital Operator in which to save the parameters from the SERVOPACK.	<pre> 1:BB SERVO→OP 00:**** 01:**** 02:**** 03:**** </pre>
4	Press the  Key.	<p>The Parameter Read Execution Display will appear.</p> <pre> 1:BB SERVO→OP 00:**** Start : [READ] Return : [MODE] </pre>
5	<p>Press the  Key.</p> <p>Note: Press the  Key to cancel reading the parameters. The Parameter Block Selection Display will return.</p>	<p>Reading the parameters from the SERVOPACK will start.</p> <pre> 1:BB SERVO→OP 00:**** Reading Parameters.. <<SERVO>> </pre> <p>When the parameters have been read from the SERVOPACK, Completed will be displayed.</p> <pre> 1:BB SERVO→OP 00:**** Completed </pre> <p>After Completed is displayed, the Parameter Block Selection Display will appear. The SERVOPACK model number of the selected block ("SGD7S-R70" in this example) will be displayed.</p> <pre> 1:BB SERVO→OP 00:SGD7S-R70 01:**** 02:**** 03:**** </pre>

Continued on next page.

Continued from previous page.

Step	Operation	Result
6	Press the  Key.	<p>The display will return to the Parameter Copy Mode Main Menu.</p> <div style="border: 1px solid black; padding: 5px; width: fit-content;"> <pre> 1 : BB COPY 1 : <u>SERVO→OP</u> 2 : OP→SERVO 3 : VERIFY 4 : LIST </pre> </div>

Additional Information on Reading Parameters

- If a parameter block that already contains data is selected and the parameters are read, the data in the parameter block is overwritten.
- Press the  Key to cancel the operation while reading parameters. **Canceled** will be displayed and the display will return to the Parameter Block Selection Display.
- If you cancel the reading operation or if the Digital Operator is disconnected from the SERVOPACK during the reading operation, the selected parameter block will become an empty block ("****").
- During the reading operation, the current process will be displayed sequentially on the Digital Operator as shown below. The reading operation requires approximately 10 seconds.
- When the reading operation has been completed, part of the SERVOPACK model number will be registered as the name of block where the parameters are saved. Blocks that contain parameters that were read from the same SERVOPACK will have the same name.

Reading the Parameters from the SERVOPACK

```

1 : BB          SERVO→OP
00 : ****
      Reading
      Parameters..
                    
```

Operation Canceled

```

1 : BB          SERVO→OP
00 : ****
      Canceled
                    
```

Operation Completed









```

1 : BB          SERVO→OP
00 : SGD7S-R70
      Completed
                    
```

4.2.2 Writing Parameters to the SERVOPACK (OP→SERVO)

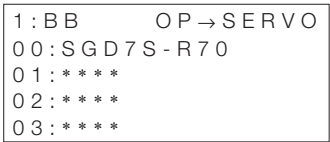

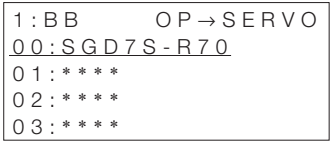
You can use this function to write the parameters that are saved in the selected block in the Digital Operator to a SERVOPACK.

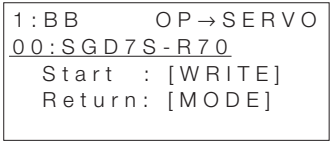
Operating Procedure

Step	Operation	Result
1	Display the Parameter Copy Mode Main Menu, and then use the  Key or  Key to select OP→SERVO .	The currently selected function will flash.  <pre> 1: BB COPY 1: SERVO→OP 2: OP→SERVO 3: VERIFY 4: LIST </pre>
2	Press the  Key.	The Parameter Block Selection Display will appear.  <pre> 1: BB OP→SERVO 00: SGD7S-R70 01: ***** 02: ***** 03: ***** </pre>
3	Use the  Key or  Key to select the parameter block (00 to 06) in the Digital Operator to write to the SERVOPACK.	 <pre> 1: BB OP→SERVO 00: SGD7S-R70 01: ***** 02: ***** 03: ***** </pre>
4	Press the  Key.	The Parameter Write Execution Display will appear.  <pre> 1: BB OP→SERVO 00: SGD7S-R70 Start : [WRITE] Return: [MODE] </pre>

Continued on next page.

Continued from previous page.

Step	Operation	Result
5	Press the  Key.	<p>Writing the parameters to the SERVOPACK will start.</p> <div data-bbox="685 276 1013 414" style="border: 1px solid black; padding: 5px;"> <pre>1 : B B O P → S E R V O 0 0 : S G D 7 S - R 7 0 R e a d i n g P a r a m e t e r s . . < < O P > ></pre> </div> <p>Note: While the power is supplied to the motor (i.e., while RUN is displayed) or while writing the parameters is prohibited, Not Available will be displayed if the  Key is pressed and the parameters will not be written.</p> <p>Completed will be displayed when the parameters have been read from the specified block in the Digital Operator and saved in the SERVOPACK.</p> <p>Also A.941 (Change of Parameters Requires Restart) will be displayed.</p> <div data-bbox="685 790 1013 928" style="border: 1px solid black; padding: 5px;"> <pre>1 : A . 9 4 1 O P → S E R V O 0 0 : S G D 7 S - R 7 0 C o m p l e t e d</pre> </div> <p>After Completed is displayed, the Parameter Block Selection Display will appear.</p> <div data-bbox="685 1034 1013 1173" style="border: 1px solid black; padding: 5px;"> <pre>1 : A . 9 4 1 O P → S E R V O <u>0 0 : S G D 7 S - R 7 0</u> 0 1 : * * * * 0 2 : * * * * 0 3 : * * * *</pre> </div>

Continued on next page.

4.2 Operating Procedures in Parameter Copy Mode

4.2.2 Writing Parameters to the SERVOPACK (OP→SERVO)

Continued from previous page.

Step	Operation	Result
6	Press the  Key.	The display will return to the Parameter Copy Mode Main Menu. <div style="border: 1px solid black; padding: 5px; margin: 10px 0;"><pre>1 : A . 9 4 1 C O P Y 1 : S E R V O → O P 2 : O P → S E R V O 3 : V E R I F Y 4 : L I S T</pre></div>
7	Turn the power supply OFF and ON again.	A.941 (Change of Parameters Requires Restart) will disappear.

Additional Information on Writing Parameters

- Do not disconnect the Digital Operator from the SERVOPACK while the parameters are being written. The writing process will be canceled. If the Digital Operator is disconnected, some of the parameters may not have been written. Repeat the operation. Turning the power OFF and ON again before re-executing the writing operation may cause a A.020 (Parameter Checksum Error) or A.040 (Parameter Setting Error) alarm. To clear an alarm, initialize the parameters (Fn005).
- If an empty block (***) is selected to write parameters, **No Data** will be displayed and nothing will be written.
- If you specify writing a parameter block to a SERVOPACK with a different voltage or capacity, **Unmatched Parameters** will be displayed and the parameters will not be written.
- If writing parameters is prohibited, **Not Available** will be displayed when the servo is turned ON and the parameters will not be written.
- During the writing operation, the current process will be displayed sequentially on the Digital Operator as shown below. The writing operation requires approximately 10 seconds.
- After the parameters have been written to the SERVOPACK, turn the power OFF then ON again. The servo will not turn ON until the power supply is turned OFF and ON again.

Reading Parameters from the Digital Operator

```
1:BB      OP→SERVO
00:SGD7S-R70
  Reading
  Parameters..
<< OP >>
```

Writing Parameters to the SERVOPACK ↓

```
1:A.941   OP→SERVO
00:SGD7S-R70
  Writing
  Parameters..
<< SERVO >>
```

Operation Completed ↓

```
1:A.941   OP→SERVO
00:SGD7S-R70

  Completed
```

Note: You cannot use the  Key during this display to cancel processing.

4.2.3 Verifying Parameters (VERIFY)





You can use this function to compare the parameters that are saved in the selected block in the Digital Operator with the parameters in the SERVOPACK, and display the results.

Operating Procedure

Step	Operation	Result
1	Display the Parameter Copy Mode Main Menu, and then use the <input type="button" value="▲"/> Key or <input type="button" value="▼"/> Key to select VERIFY .	The currently selected function will flash. <pre> 1:BB COPY 1:SERVO→OP 2:OP→SERVO 3:VERIFY 4:LIST </pre>
2	Press the <input type="button" value="DATA"/> Key.	The Parameter Block Selection Display will appear. <pre> 1:BB VERIFY 00:SGD7S-R70 01:***** 02:***** 03:***** </pre>
3	Use the <input type="button" value="▲"/> Key or <input type="button" value="▼"/> Key to select the parameter block (00 to 06) in the Digital Operator to compare with the parameters in the SERVOPACK.	 <pre> 1:BB VERIFY 00:SGD7S-R70 01:***** 02:***** 03:***** </pre>
4	Press the <input type="button" value="DATA"/> Key.	The Parameter Verify Execution Display will appear. <pre> 1:BB VERIFY 00:SGD7S-R70 Start : [READ] Return : [MODE] </pre>

Continued on next page.

Continued from previous page.



Step	Operation	Result
<p>5</p>	<p>Press the  Key.</p> <p>Note: Press the  Key to cancel comparison and return to the Parameter Block Selection Display.</p>	<p>Comparing the parameters will be started.</p> <div style="border: 1px solid black; padding: 5px; margin: 5px 0;"> <pre>1:BB OP→SERVO 00:SGD7S-R70 Reading Parameters.. << OP >></pre> </div> <p>Completed will be displayed when the parameters have been read from the specified block in the Digital Operator, the parameters have been read from the SERVOPACK, and the parameters have been compared.</p> <div style="border: 1px solid black; padding: 5px; margin: 5px 0;"> <pre>1:BB VERIFY 00:SGD7S-R70 Completed</pre> </div> <p>After Completed is displayed, the comparison results will be displayed.</p> <div style="border: 1px solid black; padding: 5px; margin: 5px 0;"> <pre>1:BB VERIFY All Parameters are matched</pre> </div> <p>Note: If any unmatched parameters were found, the numbers of the unmatched parameters are displayed in a list. If there are more than four unmatched parameters, use the  Key or  Key to scroll through the parameter number list. Any parameters displayed as Pn*** in the unmatched parameter list are reserved parameters.</p> <div style="border: 1px solid black; padding: 5px; margin: 5px 0;"> <pre>1:BB VERIFY Pn001 Pn100 Unmatched Pn101 Parameters Pn202</pre> </div>

Continued on next page.



4.2 Operating Procedures in Parameter Copy Mode

4.2.3 Verifying Parameters (VERIFY)

Continued from previous page.

Step	Operation	Result
6	Press the  Key.	The Parameter Block Selection Display will appear. <div style="border: 1px solid black; padding: 5px; margin: 5px 0;"><pre>1:BB VERIFY 00:SGD7S-R70 01:**** 02:**** 03:****</pre></div>
7	Press the  Key.	The display will return to the Parameter Copy Mode Main Menu. <div style="border: 1px solid black; padding: 5px; margin: 5px 0;"><pre>1:BB COPY 1:SERVO→OP 2:OP→SERVO 3:VERIFY 4:LIST</pre></div>

Additional Information on Verifying Parameters

- If an empty block (****) is selected to verify parameters, **No Data** will be displayed and nothing will be compared. (Press the  Key to return to the Parameter Block Selection Display.)
- Press the  Key to cancel the operation while comparing parameters. **Canceled** will be displayed and the display will return to the Parameter Block Selection Display.
- During the comparison operation, the current process will be displayed sequentially on the Digital Operator as shown below. The comparison operation requires approximately 10 seconds.
- If you specify verifying a parameter block with a SERVOPACK with a different model, **Unmatched Parameters** will be displayed and the parameters will not be compared.

Reading Parameters from the Digital Operator

```

1:BB          VERIFY
00:SGD7S-R70
  Reading
  Parameters..
<< OP >>
  
```



Operation Canceled

```

1:BB          VERIFY
00:****
  Canceled
  
```

Comparing Parameters

```

1:BB          VERIFY
00:SGD7S-R70
  Verifying
  Parameters..
<< OP-SERVO >>
  
```

Operation Completed

```

1:BB          VERIFY
00:SGD7S-R70
  Completed
  
```

4.2.4 Parameter Block List Display (LIST)



You can use this function to display the current usage of the seven parameter blocks in the Digital Operator. You can also delete the parameters for a specified block. The procedure to delete a parameter block is given below.

Operating Procedure

Step	Operation	Result
1	Display the Parameter Copy Mode Main Menu, and then use the <input type="button" value="▲"/> Key or <input type="button" value="▼"/> Key to select LIST .	The currently selected function will flash. <pre> 1 : BB COPY 1 : SERVO → OP 2 : OP → SERVO 3 : VERIFY 4 : LIST </pre>
2	Press the <input type="button" value="DATA"/> Key.	The Parameter Block Selection Display will appear. <pre> 1 : BB LIST 00 : SGD7S - R70 01 : * * * * 02 : * * * * 03 : * * * * </pre>
3	Use the <input type="button" value="▲"/> Key or <input type="button" value="▼"/> Key to select the parameter block (00 to 06) to delete in the Digital Operator.	<pre> 1 : BB LIST 00 : SGD7S - R70 01 : * * * * 02 : * * * * 03 : * * * * </pre>
4	Press the <input type="button" value="DATA"/> Key.	The Parameter Block Deletion Execution Display will appear. <pre> 1 : BB LIST 00 : SGD7S - R70 FILE DELETE Start : [WRITE] Return : [MODE] </pre>

Continued on next page.

Continued from previous page.

Step	Operation	Result
5	Press the  Key.	<p>Deleting the parameter block will be started.</p> <div data-bbox="689 274 1016 411" style="border: 1px solid black; padding: 5px;"> <pre>1:BB LIST 00:SGD7S-R70 Deleting Parameters..</pre> </div> <p>Note: If power is supplied to the motor (i.e., if RUN is displayed) when the  Key is pressed, Not Available will be displayed and the parameters will not be deleted. When the selected parameter block has been deleted, Completed will be displayed.</p> <div data-bbox="689 641 1016 778" style="border: 1px solid black; padding: 5px;"> <pre>1:BB LIST 00:SGD7S-R70 Completed</pre> </div> <p>After Completed is displayed, the Parameter Block Selection Display will appear. "****" will be displayed for the deleted block to indicate that it is an empty block.</p> <div data-bbox="689 938 1016 1075" style="border: 1px solid black; padding: 5px;"> <pre>1:BB LIST 00:**** 01:**** 02:**** 03:****</pre> </div>
6	Press the  Key.	<p>The display will return to the Parameter Copy Mode Main Menu.</p> <div data-bbox="689 1161 1016 1299" style="border: 1px solid black; padding: 5px;"> <pre>1:BB COPY 1:SERVO→OP 2:OP→SERVO 3:VERIFY 4:LIST</pre> </div>

Additional Information on Deleting Parameter Blocks

- If an empty block (****) is selected to delete, **No Data** will be displayed and nothing will be done. (Press the  Key to return to the Parameter Block Selection Display.)
- If the Digital Operator is disconnected from the SERVOPACK during the deletion operation, the selected parameter block will become an empty block (****).
- During the block deletion operation, the current process will be displayed sequentially on the Digital Operator as shown below. The deletion operation requires approximately two seconds.

Deleting the Selected Parameter Block

```
1 : B B           L I S T
00 : S G D 7 S - R 7 0
      D e l e t i n g
      P a r a m e t e r s . .
```

Operation Completed



```
1 : B B           L I S T
00 : S G D 7 S - R 7 0

      C o m p l e t e d
```

Revision History

The revision dates and numbers of the revised manuals are given at the bottom of the back cover.

MANUAL NO. SIEP S800001 33A <0>-1
 Web revision number
 Revision number
 Published in Japan November 2015
 Date of publication

Date of Publication	Rev. No.	Web Rev. No.	Section	Revised Contents
February 2020	<6>	1	Preface, 4.1	Partly revised.
			Back cover	Revision: Address
September 2018	0	0	Front cover, 1.1	Deletion: Information on JUSP-OP07A-E
			Preface	Revision: Wiring Precautions
			Preface, 2.2.1, 3.2.16	Addition: Information on Rotary Servomotor (SGM7M)
			Back cover	Revision: Address
October 2017	<5>	0	1.2	Revision: Information on the display and indicators
			Back cover	Revision: Address
March 2017	<4>	0	Preface	Partly revised.
			1.1	Newly added: Digital Operator Types and Connections
			3.2.5, 3.2.23, 3.2.28	Revision: Operating procedure
			3.2.9, 3.2.10, 3.2.14	Revision: Information on preparations
February 2017	<3>	0	1, 3	Revision: Display terms
			3	Addition: Reset Motor Type Change Detected Status (Fn021)
December 2016	<2>	0	Preface	Partly revised.
			2.2.1	Addition: Un02F
			3.2.16	Addition: Information on Direct Drive Servomotors (SGM7D and SGM7E)
June 2016	<1>	0	3.2.33 to 3.2.43	Newly added.
November 2015	<0>	1	Front cover	Revision: Format
			Preface	Revision: Related document (AC Servo Drive Engineering Tool SigmaWin+ Operation Manual)
			4.1	Addition: Note in introduction to parameter copy functions
			Back cover	Revision: Address and format
April 2014	-	-	-	First edition

Σ-7-Series AC Servo Drive Digital Operator Operating Manual

IRUMA BUSINESS CENTER (SOLUTION CENTER)

480, Kamifujisawa, Iruma, Saitama, 358-8555, Japan
Phone: +81-4-2962-5151 Fax: +81-4-2962-6138
www.yaskawa.co.jp

YASKAWA AMERICA, INC.

2121, Norman Drive South, Waukegan, IL 60085, U.S.A.
Phone: +1-800-YASKAWA (927-5292) or +1-847-887-7000 Fax: +1-847-887-7310
www.yaskawa.com

YASKAWA ELÉTRICO DO BRASIL LTDA.

777, Avenida Piraporinha, Diadema, São Paulo, 09950-000, Brasil
Phone: +55-11-3585-1100 Fax: +55-11-3585-1187
www.yaskawa.com.br

YASKAWA EUROPE GmbH

Hauptstraße 185, 65760 Eschborn, Germany
Phone: +49-6196-569-300 Fax: +49-6196-569-398
www.yaskawa.eu.com E-mail: info@yaskawa.eu.com

YASKAWA ELECTRIC KOREA CORPORATION

35F, Three IFC, 10 Gukjegeumyung-ro, Yeongdeungpo-gu, Seoul, 07326, Korea
Phone: +82-2-784-7844 Fax: +82-2-784-8495
www.yaskawa.co.kr

YASKAWA ASIA PACIFIC PTE. LTD.

30A, Kallang Place, #06-01, 339213, Singapore
Phone: +65-6282-3003 Fax: +65-6289-3003
www.yaskawa.com.sg

YASKAWA ELECTRIC (THAILAND) CO., LTD.

59, 1F-5F, Flourish Building, Soi Ratchadapisek 18, Ratchadapisek Road, Huaykwang, Bangkok, 10310, Thailand
Phone: +66-2-017-0099 Fax: +66-2-017-0799
www.yaskawa.co.th

YASKAWA ELECTRIC (CHINA) CO., LTD.

22F, Link Square 1, No.222, Hubin Road, Shanghai, 200021, China
Phone: +86-21-5385-2200 Fax: +86-21-5385-3299
www.yaskawa.com.cn

YASKAWA ELECTRIC (CHINA) CO., LTD. BEIJING OFFICE

Room 1011, Tower W3 Oriental Plaza, No.1, East Chang An Avenue,
Dong Cheng District, Beijing, 100738, China
Phone: +86-10-8518-4086 Fax: +86-10-8518-4082

YASKAWA ELECTRIC TAIWAN CORPORATION

12F, No. 207, Section 3, Beishin Road, Shindian District, New Taipei City 23143, Taiwan
Phone: +886-2-8913-1333 Fax: +886-2-8913-1513 or +886-2-8913-1519
www.yaskawa.com.tw

YASKAWA

YASKAWA ELECTRIC CORPORATION

In the event that the end user of this product is to be the military and said product is to be employed in any weapons systems or the manufacture thereof, the export will fall under the relevant regulations as stipulated in the Foreign Exchange and Foreign Trade Regulations. Therefore, be sure to follow all procedures and submit all relevant documentation according to any and all rules, regulations and laws that may apply. Specifications are subject to change without notice for ongoing product modifications and improvements.

© 2014 YASKAWA ELECTRIC CORPORATION

MANUAL NO. SIEP S800001 33F <6>-1

Published in Japan February 2020

19-10-16

Original instructions