



# OWNER'S MANUAL

Ibiza



## About this manual

This manual contains a description of the **equipment** supplied with the vehicle at the time this manual was published. Some of the units described herein will not be available until a later date or are only available in certain markets.

**Because this is a general manual for the IBIZA, some of the equipment and functions that are described in this manual are not included in all types or variants of the model; they may vary or be modified depending on the technical requirements and on the market; this is in no way deceptive advertising.**

The **illustrations** are intended as a general guide and may vary from the equipment fitted in your vehicle in some details.

The **steering indications** (left, right, forward, reverse) appearing in this manual refer to the normal driving movements of the vehicle except when otherwise indicated.

The **audiovisual material** only is intended to help users to understand certain car functionalities better. It does not replace the instruction manual. Please use the instruction manual to obtain more comprehensive information and indications.

**\*** The **equipment marked with an asterisk\*** is fitted as standard only in certain versions, and is only supplied as optional extras for some versions, or are only offered in certain countries.

**®** All **registered marks** are indicated with **®**. Although the copyright symbol does not appear, it is a copyrighted mark.

**»** The section is continued on the following page.



Important warnings on a given page



Detailed contents on a given page



General information on a given page

**SOS**

Emergency information on a given page



Audiovisual material on a given page

### **WARNING**

Texts preceded by this symbol contain information on safety. They warn you about possible dangers of accident or injury.

### **CAUTION**

Texts with this symbol draw your attention to potential sources of damage to your vehicle.

### For the sake of the environment

Texts preceded by this symbol contain relevant information concerning environmental protection.

### **Note**

Texts preceded by this symbol contain additional information.

This manual is divided into six large parts, which are:

1. The essentials
2. Safety
3. Emergencies
4. Operation
5. Tips
6. Technical data

At the end of this manual, there is a detailed alphabetical index that will help you quickly find the information you require.

## Foreword

This Instruction Manual and its corresponding supplements should be read carefully to familiarise yourself with your vehicle.

Besides the regular care and maintenance of the vehicle, its correct handling will help preserve its value.

**For safety reasons, always note the information concerning accessories, modifications and part replacements.**

If selling the vehicle, give all of the on-board documentation to the new owner, as it should be kept with the vehicle.

You can access the information in this manual using:

- Thematic table of contents that follows the manual's general chapter structure.
- Visual table of contents that uses graphics to indicate the pages containing "essential" information, which is detailed in the corresponding chapters.
- Alphabetical index with many terms and synonyms to help you find information.



### WARNING

**Read and always observe safety information concerning the passenger's front airbag »» page 67, Important information regarding the front passenger's airbag.**



## Related videos



EcoTSI Engine



Fatigue detection

»» page 153



Ambient light and natural light

»» page 109

»» page 113

# Table of Contents

<b>The essentials</b> .....	5	Correct position for passengers .....	52	<b>Communications and multimedia</b> .....	94
<b>Exterior view</b> .....	5	Pedal area .....	56	Steering wheel controls* .....	94
<b>Exterior view</b> .....	6	<b>Seat belts</b> .....	56	Multimedia .....	97
<b>Interior view (left-hand drive)</b> .....	7	Why wear a seat belt? .....	56	<b>Opening and closing</b> .....	98
<b>Interior view (right-hand drive)</b> .....	8	How to properly adjust your seatbelt .....	59	Central locking system .....	98
<b>How it works</b> .....	9	Belt pretensioners* .....	60	Keys .....	102
Opening and closing .....	9	<b>Airbag system</b> .....	61	Radio frequency remote control* .....	102
Before driving .....	11	Brief introduction .....	61	Anti-theft alarm* .....	103
Airbags .....	13	Airbag safety instructions .....	64	Boot hatch .....	105
Child seats .....	15	Deactivating airbags .....	65	Electric windows .....	106
Starting the vehicle .....	20	<b>Transporting children safely</b> .....	67	<b>Lights and visibility</b> .....	108
Lights and visibility .....	20	Safety for children .....	67	Lights .....	108
Easy Connect .....	23	Child seats .....	68	Interior lights .....	113
Driver information system .....	25	<b>Emergencies</b> .....	70	Visibility .....	114
Journey data .....	28	<b>Self-help</b> .....	70	Windscreen wiper and rear window wiper systems .....	114
Cruise control .....	32	Emergency equipment .....	70	Rear view mirrors .....	116
Warning lamps .....	33	Tyre repair .....	71	<b>Seats and head restraints</b> .....	118
Gearbox lever .....	35	Changing the windscreen wiper blades .....	73	Adjusting the seat and head restraints .....	118
Air conditioning .....	36	Towing or tow-starting .....	74	Seat functions .....	119
Fluid Level control .....	36	<b>Fuses and bulbs</b> .....	75	<b>Transport and practical equipment</b> .....	121
<b>Emergencies</b> .....	40	Fuses .....	75	Practical equipment .....	121
Fuses .....	40	Changing bulbs .....	78	Luggage compartment .....	124
Bulbs .....	41	Single headlight bulb change .....	79	Roof rack/roof luggage rack* .....	126
Action in the event of a puncture .....	41	Double headlight bulb change .....	80	<b>Air conditioning</b> .....	127
Changing a wheel .....	43	Changing the AFS headlight bulbs .....	82	Heating, ventilation and cooling .....	127
Snow chains .....	45	Changing the fog light bulbs .....	82	Heating and fresh air .....	129
Emergency towing of the vehicle .....	46	Changing the tail light bulbs .....	83	Air conditioning* .....	131
How to jump start .....	47	Changing the side and interior bulbs .....	84	<b>Driving</b> .....	133
Changing the windscreen wiper blades .....	49	<b>Operation</b> .....	87	Address .....	133
<b>Safety</b> .....	51	<b>Controls and displays</b> .....	87	Starting and stopping the engine .....	135
<b>Safe driving</b> .....	51	General instrument panel .....	86	Braking and parking .....	137
Safety first! .....	51	<b>Instruments and warning/control lamps</b> .....	88	Braking and stability systems .....	140
Advice about driving .....	51	Instruments .....	88	Manual gearbox .....	145
		Warning and control lamps .....	92	Run-in and economical driving .....	146
		<b>Introduction to the Easy Connect system*</b> .....	93	Engine management and exhaust gas purification system .....	149
		System settings (CAR)* .....	93	Driving tips .....	151

<b>Driver assistance systems</b> .....	152	<b>Index</b> .....	201
Start-Stop System* .....	152		
Fatigue detection (break recommendation)* ..	153		
Parking aid* .....	155		
Rear Assist "Rear View Camera"* .....	157		
Cruise speed* (cruise control - GRA) .....	159		
<b>Towing bracket device and trailer</b> .....	161		
Trailer mode .....	161		
Retrofitting a towing bracket* .....	163		
<b>Advice</b> .....	165		
<b>Care and maintenance</b> .....	165		
Accessories and modifications to the vehi- cle .....	165		
Care and cleaning .....	166		
Care of the vehicle exterior .....	167		
Caring for the vehicle interior .....	172		
<b>Checking and refilling levels</b> .....	174		
Refuelling .....	174		
Fuel .....	174		
Working in the engine compartment .....	176		
Engine oil .....	179		
Cooling system .....	182		
Brake fluid .....	184		
Windscreen washer reservoir .....	185		
Vehicle battery .....	185		
<b>Wheels</b> .....	188		
Wheels and tyres .....	188		
Winter service .....	192		
<b>Technical data</b> .....	194		
<b>Technical specifications</b> .....	194		
Important information .....	194		
Information on fuel consumption .....	195		
Trailer mode .....	195		
Wheels .....	196		
Engine data .....	197		
Dimensions .....	200		

## Exterior view

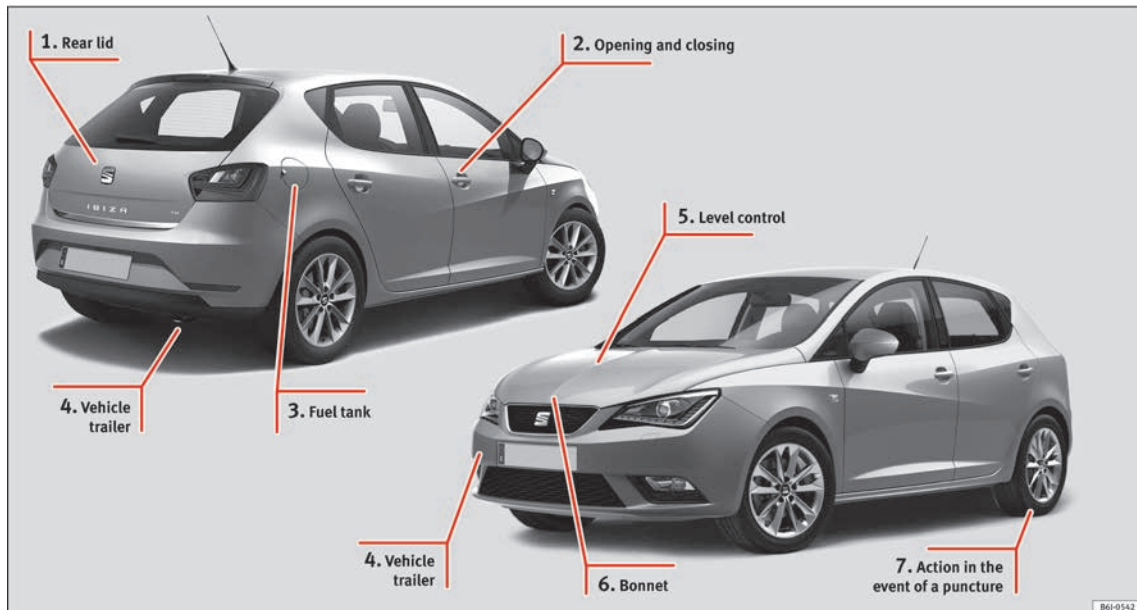

- 1 » page 9
- 2 » page 9
- 3 » page 37

- 4 » page 46
- 5 » page 36

- 6 » page 10
- 7 » page 41

## Exterior view

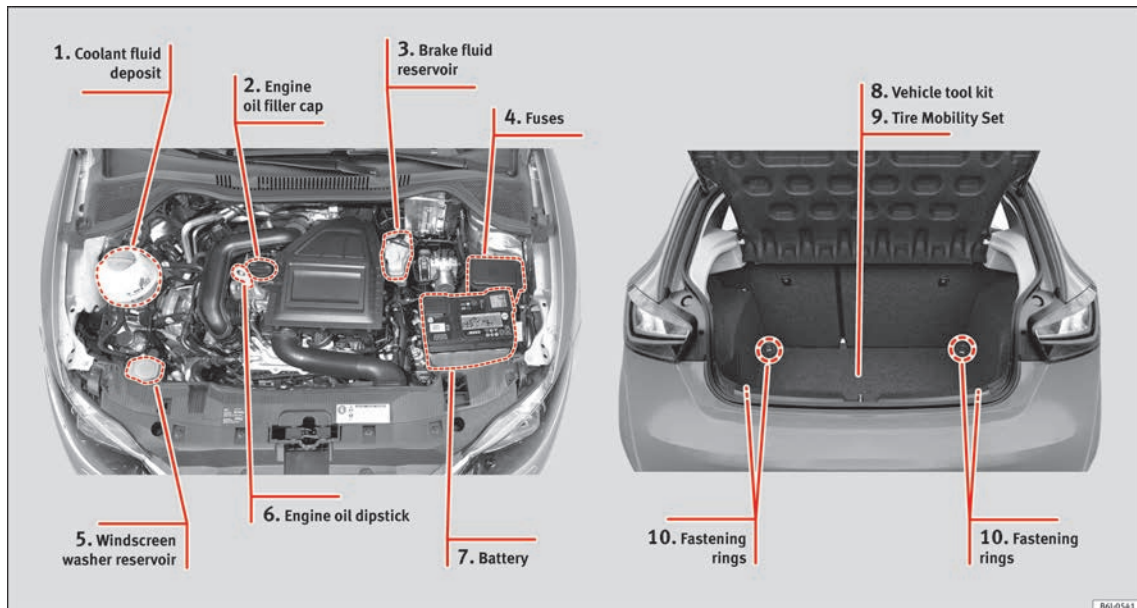

- ① » page 38
- ② » page 37
- ③ » page 39

- ④ » page 40
- ⑤ » page 39
- ⑥ » page 37

- ⑦ » page 39
- ⑧ » page 43
- ⑨ » page 42

- ⑩ » page 125



## Interior view (left-hand drive)

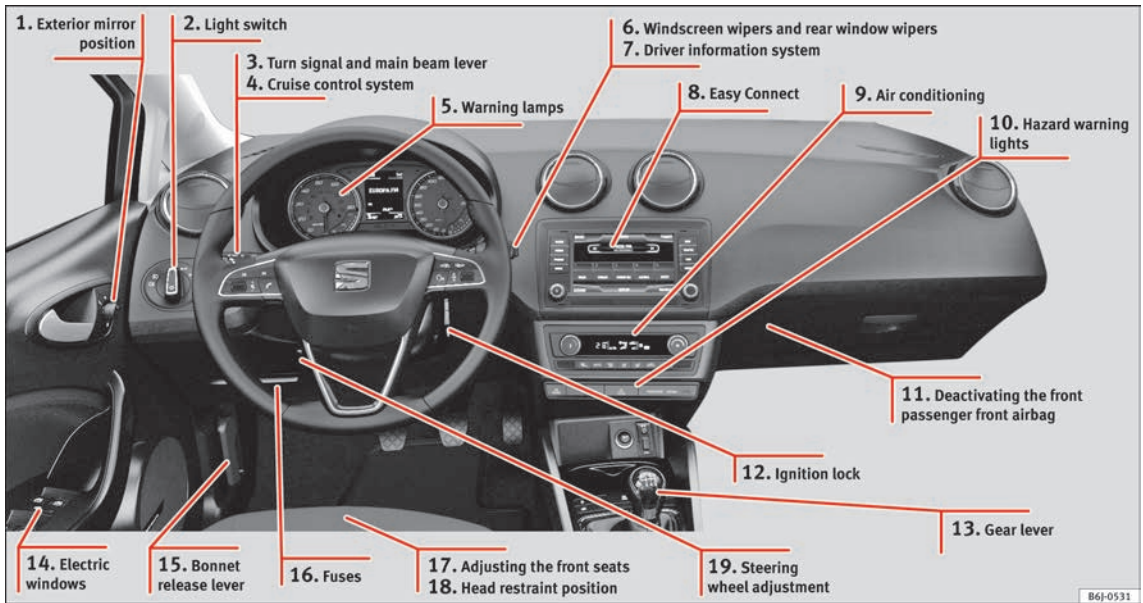

B6J-0531

- ① » page 12
- ② » page 20
- ③ » page 21
- ④ » page 32

- ⑤ » page 33
- ⑥ » page 22
- ⑦ » page 25
- ⑧ » page 23

- ⑨ » page 36
- ⑩ » page 21
- ⑪ » page 14
- ⑫ » page 20

- ⑬ » page 35
- ⑭ » page 11
- ⑮ » page 10
- ⑯ » page 40

- ⑰ » page 11
- ⑱ » page 11
- ⑲ » page 13

## Interior view (right-hand drive)

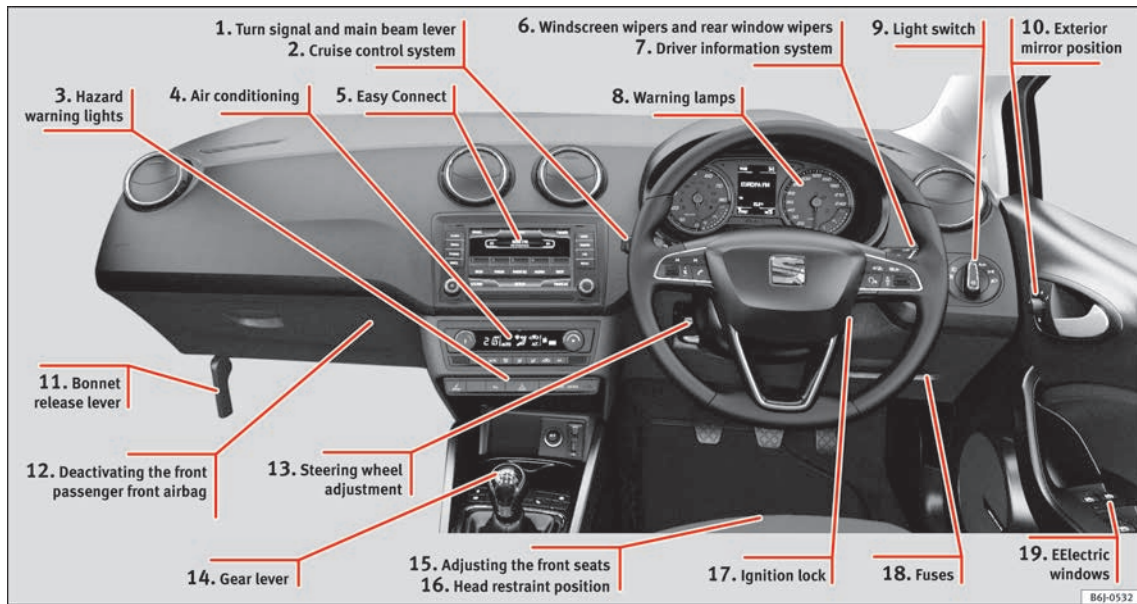

B6J-0532

- ① » page 21
- ② » page 32
- ③ » page 21
- ④ » page 36

- ⑤ » page 23
- ⑥ » page 22
- ⑦ » page 25
- ⑧ » page 33

- ⑨ » page 20
- ⑩ » page 12
- ⑪ » page 10
- ⑫ » page 14

- ⑬ » page 13
- ⑭ » page 35
- ⑮ » page 11
- ⑯ » page 11

- ⑰ » page 20
- ⑱ » page 40
- ⑲ » page 11

## How it works

### Opening and closing

#### Doors





Fig. 1 Remote control key: buttons.





Fig. 2 Centre console: Central lock buttons.

#### Locking and unlocking the vehicle using the key

- Locking: press the  » Fig. 1 button.
- Unlocking: press the  » Fig. 1 button.
- Unlocking the rear lid: press the  » Fig. 1 button until all the turn signals on the vehicle briefly light up.

#### Locking and unlocking with the central locking switch

- Locking: press the  » Fig. 2 button. None of the doors can be opened from the outside. The doors can be opened from the inside by pulling the inside door handle.
- Unlocking: press the  » Fig. 2 button.



»  in Description on page 98



» page 98

#### Rear lid





Fig. 3 Rear lid: opening from the outside.

The rear lid opening system operates electrically. It is activated by using the handle on the boot lid.

This system may or may not be operative, depending on the situation of the vehicle.

If the rear lid is locked then it cannot be opened, however if it is unlocked then the opening system is operative and the rear lid may be opened.

To lock/unlock, press the button  or button  » Fig. 1 on the remote control key.

A warning appears on the instrument panel display if the rear lid is open or not properly closed.\* An audible warning is also given if the boot lid is opened while the vehicle is moving faster than 6 km/h (4 mph)\*.

»

- Opening the rear lid: pull on the release lever and lift it up » **Fig. 3**. The rear lid opens automatically.
- Closing the rear lid: Hold it by one of the handles on the interior lining and close it by pushing gently.



» ⚠ in Opening and closing on page 106

**SOS**

» page 10

### Unlocking the rear lid manually

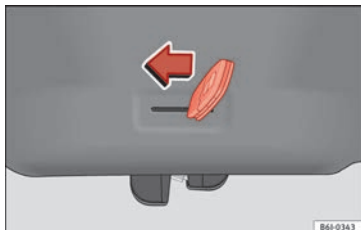

**Fig. 4** Unlocking the rear lid manually.

This allows the vehicle to be opened if the central locking does not work (for example, if the battery is flat).

There is a groove in the luggage compartment allowing access to the emergency opening mechanism.

### Opening the rear lid from inside the luggage compartment

- Insert the key in the groove and unlock the locking system, turning the key from right to left, as shown by the arrow » **Fig. 4**.

### Bonnet

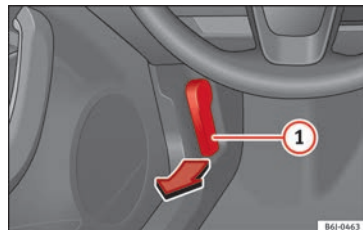

**Fig. 5** Release lever in the driver's footwell area.

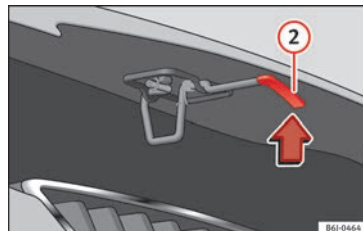

**Fig. 6** Cam under the bonnet

- Opening the bonnet: Pull the lever under the dashboard » **Fig. 5** ①.
- Lifting up the bonnet: press the release catch under the bonnet upwards » **Fig. 6** ②. The arrester hook under the bonnet is released.
- Release the bonnet stay and secure it in the fixture designed for this in the bonnet.



» ⚠ in safety notes for work in the engine compartment on page 176



» page 176

## Electric windows\*

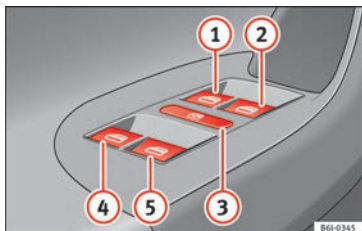

Fig. 7 Detail of the driver door: controls for the windows.

- Opening the window: Press the button.
- Closing the window: Pull the button.

### Buttons on the driver door

- 1 Window on the front left door
- 2 Window on the front right door
- 3 Safety switch for deactivating the electric window buttons on the rear doors (only 5-door vehicles)
- 4 Window on the rear left door (only 5-door vehicles)
- 5 Window on the right rear door (only 5-door vehicles)



» in Opening and closing of the electric windows\* on page 106



» page 106

## Before driving

### Manually adjusting the front seats

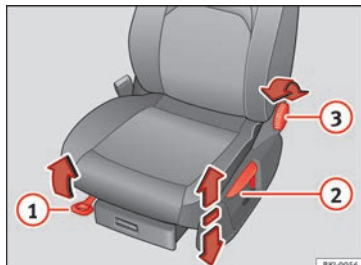

Fig. 8 Front seats: manual seat adjustment.

- 1 Forward/back: pull the lever and move the seat forwards or backwards.
- 2 Raising/lowering: pull/push the lever.
- 3 Tilting the backrest: turn the hand wheel.



» in Adjusting the front seats on page 118

## Adjusting the head restraints

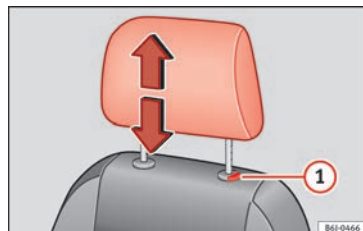

Fig. 9 Front seat: adjustment of the head restraint.

- Grab the sides of the head restraints with both hands and push upwards to the desired position. To lower it, repeat the same action, pressing the button on the side.



» in Adjusting or disassembling the head restraints on page 119



» page 55, » page 118

## Adjustment of the seat belt

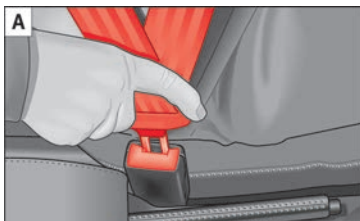

**Fig. 10** Positioning and removing the seat belt buckle.

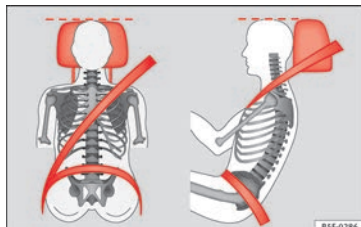

**Fig. 11** Correct seat belt and head restraint positions, viewed from front and the side.

To adjust the seat belt around your shoulders, adjust the height of the seats.

The shoulder part of the seat belt should be well centred over it, never over the neck. The seat belt lies flat and fits comfortably on the upper part of the body.

The lap part of the seat belt lies across the pelvis, never across the stomach. The seat belt lies flat and fits comfortably on the pelvis.



» page 58



» page 59

## Seat belt tensioners

During a collision, the seat belts on the front seats are retracted automatically.

The tensioner can be triggered only once.



» ⚠ in Service and disposal of belt tensioners on page 61



» page 60

## Adjusting the exterior mirrors

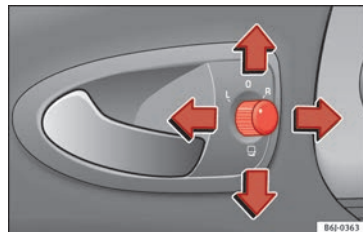

**Fig. 12** Detail of the driver door: control for the exterior mirror.

Adjusting the exterior mirrors: Turn the knob to the corresponding position:

**L/R** Turning the knob to the desired position, adjust the mirrors on the driver

side (L, left) and the passenger side (R, right) to the direction desired.

🔊 Folding in mirrors.



» » ⚠ in Electric exterior mirrors\* on page 117



» » page 117

## Adjusting the steering wheel

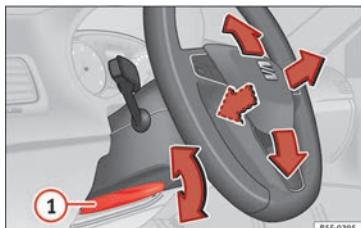

**Fig. 13** Lever in the lower left side of the steering column.

• Adjusting the position of the steering wheel: Pull the » » **Fig. 13** ① lever down, move the steering wheel to the desired position and lift the lever back up until it locks.



» » ⚠ in Adjusting the steering wheel position on page 53

## Airbags

### front airbags

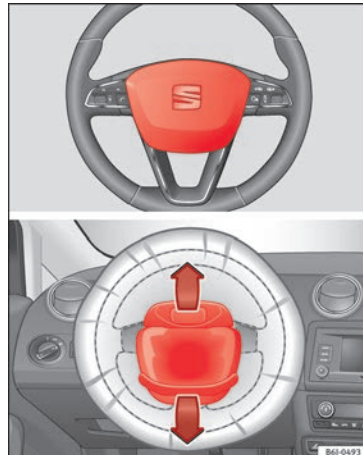

**Fig. 14** Driver airbag located in steering wheel.

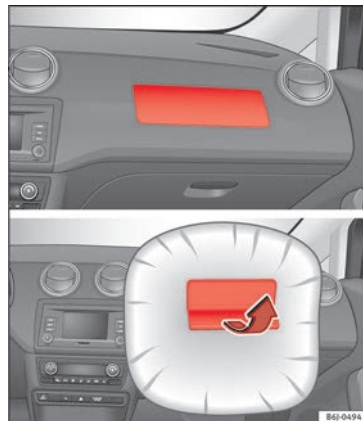

**Fig. 15** Front passenger airbag located in dash panel.

The front airbag for the driver is located in the steering wheel » » **Fig. 14** and the airbag for the front passenger is located in the dash panel » » **Fig. 15**. Airbags are identified by the word "AIRBAG".

When the driver and front passenger airbags are deployed, the covers remain attached to the steering wheel and dashboard, respectively » » **Fig. 14** » » **Fig. 15**.

In conjunction with the seat belts, the front airbag system gives the driver and the front passenger additional protection for the head » »

and chest in the event of a severe frontal collision.

The special design of the airbag allows the controlled escape of the propellant gas when an occupant puts pressure on the bag. Thus, the head and chest are surrounded and protected by the airbag. After the collision, the airbag deflates sufficiently to allow visibility.



» page 64

## Deactivating the front passenger front airbag



Fig. 16 Front passenger front airbag switch.

**To deactivate the front passenger front airbag:**

- Open the glove compartment on the front passenger side.

- Insert the key blade into the slot provided in the deactivation switch.
- Approximately  $\frac{3}{4}$  of the length of the key blade remains inserted (the maximum).
- Turn the key blade, changing its position to **OFF**. Do not force it. If you have difficulty, ensure that you have inserted the key as far as it will go.
- Finally, check the control lamp on the instrument panel where it shows **PASSENGER AIR BAG OFF** ; the following should appear **OFF**.



» in Deactivation of front passenger front airbag\* on page 66



» page 65

## Side airbags\*

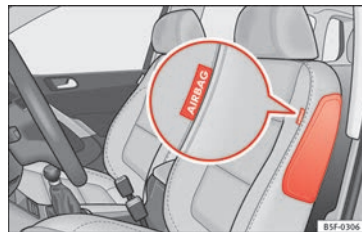

Fig. 17 Side airbag in driver's seat.

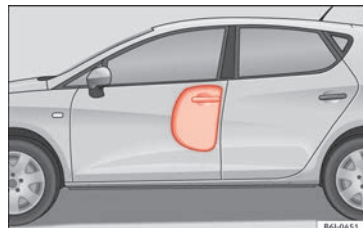

Fig. 18 Illustration of completely inflated side airbag on left side of vehicle.

The side airbags are located in the driver's seat and front passenger seat backrests **» Fig. 17**. The locations are identified by the text "AIRBAG" in the upper region of the backrests.

In conjunction with the seat belts, the side airbag system provides additional protection for the upper body in the event of a severe side collision.

In a side collision, the side airbags reduce the risk of injury to passengers to the areas of the body facing the impact. In addition to their normal function of protecting the occupants in a collision, the front and rear outer seat belts also hold the passengers in the event of a side collision; this is how these airbags provide maximum protection.



» in Side airbags\* on page 64



## Head-protection airbags\*

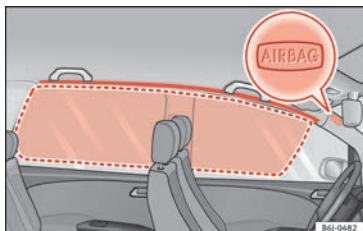

**Fig. 19** Location and deployment area of the head-protection airbag.

There is a head airbag on each side of the interior above the doors » **Fig. 19**. Airbags are identified by the word “AIRBAG”.

The area framed in red is covered by the head-protection airbag when it is deployed » **Fig. 19** (deployment area). Therefore, objects should never be placed or mounted in this area » **⚠ in Curtain airbags\* on page 65**.

In the event of a side collision the curtain airbag is triggered on the impact side of the vehicle.

The head-protection airbags reduce the risk of injury to passengers in the front and rear side seats facing the impact.



» **⚠ in Curtain airbags\* on page 65**

## Child seats

### Important information regarding the front passenger's airbag



**Fig. 20** Passenger's side sun visor: airbag sticker.

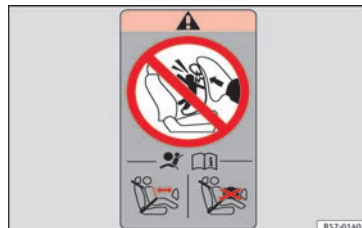

**Fig. 21** On the rear frame of the passenger side door: airbag sticker.

A sticker with important information about the passenger airbag is located on the passenger's sun visor and/or on the passenger side door frame.



» **⚠ in Important information regarding the front passenger's airbag on page 67**



» **page 67**

## Ways to secure a child seat

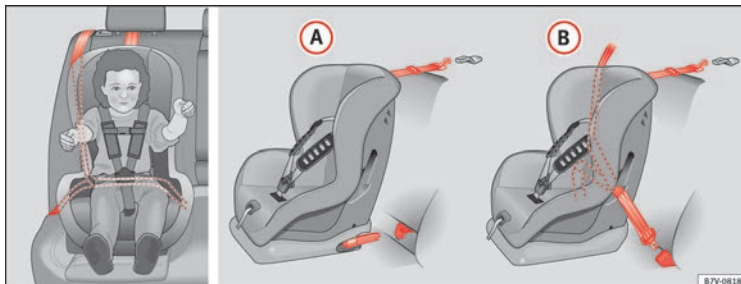

**Fig. 22** On the rear seats: Possible installations for the child seat.

Figure » **Fig. 22 A** shows the basic child restraint system mounting using lower retaining rings and the upper retaining strap. Figure » **Fig. 22 B** shows the child restraint system mounting using the vehicle seat belt.

You can secure a child seat to the rear seat or front passenger seat in the following ways:

- Child seats in groups **0 to 3** can be secured with a seat belt.
- Child seats for groups **0, 0+ and 1** can be fastened without seatbelts, using the “ISOFIX” system, using the “ISOFIX” » **page 17** securing rings.
- During installation of some models of group I, II and III child seats in the rear seat, difficulty may arise in mounting given that the seat comes into contact with the head re-

straint. In this case, adjust the height of the head restraint or remove it from the seat following the instructions in the corresponding chapter » **page 118**. Once you remove the child seat, replace the head restraint in its original position.

Weight group	Seating position		
	Front passenger seat <sup>a)</sup>	Rear side seat	Rear central seat
Group 0 to 10 kg	U*	U	U
Group 0+ to 13 kg	U*	U	U
Group I 9 to 18 kg	U*	U	U
Group II 15 to 25 kg	U*	U	U
Group III 22 to 36 kg	U*	U	U

<sup>a)</sup> Compliance with current national legislation and the manufacturer's instructions is required when using or installing child seats.

- U: Suitable for universal restraint systems for use in this weight group.
- \*: Move the front passenger seat as far back as possible, as high as possible and always disable the airbag.

**The systems include the child restraint system mounting with an upper retaining strap (Top Tether) and lower anchoring points on the seat.**



» » ⚠ in Safety instructions on page 68

### Securing child seats with the "ISOFIX" and Top Tether\* systems

Child seats can be secured quickly, easily and safely on the rear outer seats with the "ISOFIX" and Top Tether\* system.

Two "ISOFIX" retaining rings are fitted on each rear seat. In some vehicles, the rings are secured to the seat frame and, in others, they are secured to the rear floor. The "ISO-

FIX" rings are located between the rear seat backrest and the seat cushioning. The Top Tether\* rings are located at the rear of the backrests of the rear seats (behind the seat backrest or in the boot).

To understand the compatibility of the "ISOFIX" systems in the vehicle, consult the table below.

The body weight permitted and information regarding sizes **A** to **F** is indicated on the label on child seats with "**universal**" or "**semi-universal**" certification. » »

## The essentials

Weight group	Size class	Electrical equipment	Mounting direction	Vehicle Isofix positions
				Rear side seats
Baby carrier	F	ISO/L1	Backward-facing	X
	G	ISO/L2	Backward-facing	X
Group 0 to 10 kg	E	ISO/R1	Backward-facing	IU
Group 0+ to 13 kg	E	ISO/R1	Backward-facing	IU
	D	ISO/R2	Backward-facing	IU
	C	ISO/R3	Backward-facing	IU
Group I 9 to 18 kg	D	ISO/R2	Backward-facing	IU
	C	ISO/R3	Backward-facing	IU
	B	ISO/F2	Forward-facing	IU
	B1	ISO/F2X	Forward-facing	IU
	A	ISO/F3	Forward-facing	IU
Group II 15 to 25 kg	---	---	Forward-facing	---
Group III 22 to 36 kg	---	---	Forward-facing	---

IU: Suitable for ISOFIX universal child restraint systems approved for use in this weight group.

X: ISOFIX position not suitable for ISOFIX child restraint systems for this weight group or size class.



» » ⚠ in Safety instructions on page 68

## Mount the child seat with the “ISOFIX systems”

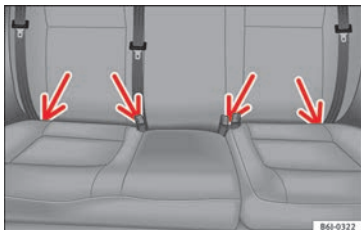

Fig. 23 ISOFIX securing rings.

When removing or fitting the child seat, please be sure to follow the manufacturer's instructions.

- Press the child seat onto the “ISOFIX” retaining rings until the child seat can be heard to engage securely. If the child seat is fitted with any other anti-rotation system, follow the manufacturer instructions carefully.
- Pull on both sides of the child seat to ensure that it is secure.

Child seats with the “ISOFIX” and Top Tether\* attachment system are available from Technical Services.

## Top Tether\* retainer straps

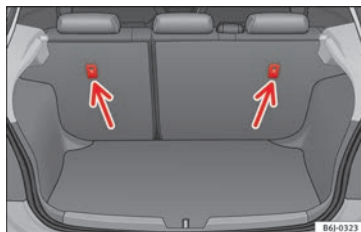

Fig. 24 Position of the Top Tether rings on the back of the rear seat.

Child seats with the Top Tether system come with a strap for securing the seat to the vehicle anchor point, located at the back of the rear seat backrest and provide greater restraint.

The objective of this strap is to reduce the forward movement of the child seat in a crash, to reduce the risk of injuries to the head from hitting the inside of the vehicle.

### Using the Top Tether in rear-facing mounted seats

Currently, there are very few rear-facing child safety seats that have Top Tether. Please carefully read and follow the seat manufacturer instructions to learn the proper way to install the Top Tether strap.

## Securing the Top Tether\* of the child seat to the anchorage point

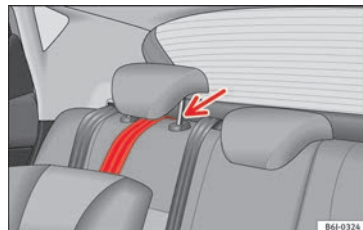

Fig. 25 Retainer strap: correct adjustment and fitting.

### Securing to the anchorage point located on the rear of the backrest

- Follow the manufacturer's instructions to deploy the child seat Top Tether retainer strap.
- Guide the strap under the rear seat head restraint » Fig. 25 (lift the head restraint where necessary).
- Slide the strap and secure it properly with the anchorage of the backrest.
- Firmly tighten the Top Tether belt following the manufacturer's instructions.

### Releasing the retaining strap

- Loosen the strap following the manufacturer's instructions.



- Push the lock and release it from the anchoring support.



» » ⚠ in Safety instructions on page 68

## Starting the vehicle

### Ignition lock

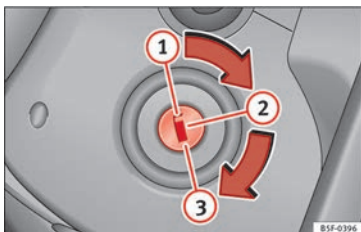

Fig. 26 Ignition key positions.

Switch ignition on: Place the key in the ignition and start the engine.

### Locking and unlocking the steering wheel

- Engaging the steering wheel lock: Remove the key from the ignition and turn the wheel until it locks.
- Unlocking the steering wheel: Put the key into the ignition and turn it at the same time

as the steering wheel in the direction indicated by the arrow. If it is not possible to turn the steering wheel, it may be because it is locked.

### Turning on/switching off the ignition, glow plugs reheating

- Switch ignition on: Turn the key to the ② position.
- Switch ignition off. Turn the key to the ① position.
- Diesel vehicles ∅: The glow plugs reheat when the ignition is switched on.

### Starting the engine

- Press the clutch pedal all the way down and move the gearbox lever into neutral.
- Turn the key to the ③ position. The key automatically returns to the ② position. Do not press the accelerator.

### Start-Stop System\*

When you stop and release the clutch pedal, the Start-Stop system\* turns off the engine. The ignition remains switched on.



» » ⚠ in Ignition key positions on page 135



» » page 135

## Lights and visibility

### Headlight switch

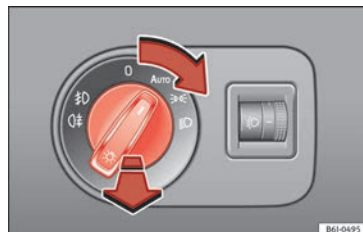





Fig. 27 Dash panel: light control.



- Turn the switch to the required position
- » » Fig. 27.

Symbol	Ignition switched off	Ignition is switched on
0	Fog lights, dipped beam and side lights off.	Light off or daytime driving light on.
AUTO	The "Coming home" and "Leaving home" guide lights may be switched on.	Automatic control of dipped beam and daytime running light.
☞☜	Side light on.	



## The essentials

Symbol	Ignition switched off	Ignition is switched on
	Dipped beam headlight off	Dipped beam switched on.

 **Front fog lights:** move the switch to the first position, from positions **AUTO**,  or .







 **Rear fog light:** move the switch completely from positions **AUTO**,  or .

Switching off fog lights: Push the switch or turn it to the  position.

 »  in Switching lights on and off on page 108

 » page 108

More the lever to the required position:

-  Right turn signal: Right-hand parking light (ignition switched off).
-  Left turn signal: Left-hand parking light (ignition switched off).
-  Main beam switched on: Control lamp  lit up on the instrument panel.
-  Headlight flasher: lit up when the lever is pushed. Control lamp  lit up.

Lever all the way down to switch it off.

 »  in Turn signal and main beam lever on page 110

 » page 110

Switched on, for example:

- When approaching a traffic jam
- In an emergency
- The vehicle has broken down
- When towing or being towed

 »  in Hazard warning lights  on page 113

 » page 112

### Turn signal and main beam lever

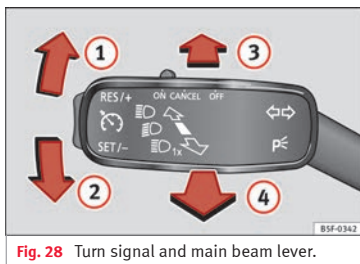

Fig. 28 Turn signal and main beam lever.

### Hazard warning lights



Fig. 29 Dash panel: switch for hazard warning lights.

### Interior lights

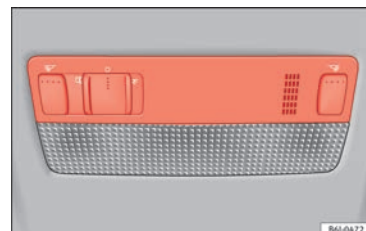





Fig. 30 Detail of headliner: front interior lighting.

Knob	Function
	Switches interior lights off.
	Switches interior lights on.



Knob	Function
	Switches door contact control on (central position). The interior lights come on automatically when the vehicle is unlocked, a door is opened or the key is removed from the ignition. The lights go off a few seconds after all the doors are closed, the vehicle is locked or the ignition is switched on.
	Turning the reading light on and off



» page 113

### Windscreen wipers and window wiper blade

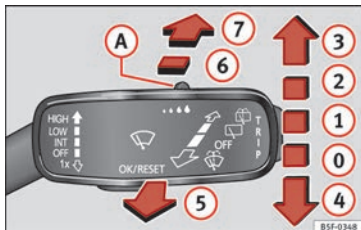

**Fig. 31** Operating the windscreen wiper and rear wiper.

More the lever to the required position:	
0	<b>OFF</b> Windscreen wiper off.
1	Windscreen wipers interval wipe. Using the control » <b>Fig. 31 A</b> adjust the interval (vehicles without rain sensor), or the sensitivity of the rain sensor.
2	<b>LOW</b> Slow wipe.
3	<b>HIGH</b> Continuous wipe.
4	<b>1x</b> Short wipe. Brief press, short clean. Hold the lever down for more time to increase the wipe frequency.
5	Automatic wipe. The windscreen washer function is activated by pushing the lever forwards, and simultaneously the windscreen wipers start.
6	Interval wipe for rear window. The wiper will wipe the window approximately every six seconds.
7	The rear window wash function is activated by pressing the lever, and the rear wiper starts simultaneously.



» ⚠ in Windscreen wipers on page 114



» page 114

**SOS**

» page 49



## Easy Connect

### CAR menu settings (Setup)

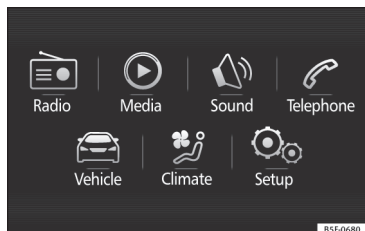

Fig. 32 Easy Connect: Main menu.



Fig. 33 Easy Connect: CAR menu.

To select the settings menus, press the Easy Connect **(CAR)** button and the **(Setup)** function button.

The actual number of menus available and the name of the various options will depend on the vehicle's electronics and equipment.

- Switch the ignition on.
- If the Infotainment System is off, switch it on.

- Press the system's **(MENU)** button and then the system's **(CAR)** button or **(CAR)** button to go to the **CAR** menu »» Fig. 32 button »» Fig. 33.
- Press the function button **(Setup)** to open the menu **Vehicle settings** »» Fig. 33.
- To select a function in the menu, press the desired button.

When you press the menu button, the last selected menu will always be displayed.

When the function button check box is activated , the function is active.

Any changes made using the settings menus are automatically saved on closing the **(BACK <)** menus.

Menu	Submenu	Possible setting	Description
ESC system	–	Activation of the Electronic Stability Programme (ESC)	»» page 140
Tyres	Tyre pressure monitoring	Tyre pressure storing (Calibration)	»» page 191
	Winter tyres	Activation and deactivation of the speed warning. Setting the speed warning value	»» page 192

## The essentials

Menu	Submenu	Possible setting	Description
Driver assistance	Fatigue detection	Activation/deactivation	» page 153
Parking and manoeuvring	ParkPilot	Automatically activate, front volume, front sound settings, rear volume, rear sound settings, adjust volume	» page 155
Vehicle lights	Vehicle interior lighting	Instrument and switch lighting, footrest lighting	» page 113
	Coming home/Leaving home function	Start time for "Coming home" function, start time for "Leaving home" function	» page 110
	Light assist	Turning-on time, automatic lights when raining, convenience turn signals	» page 109
Windscreen wipers	Windscreen wipers	Automatic windscreen wipers, wipe when reversing	» page 22
Opening and closing	Radio-operated remote control	Convenience open function	» page 108
	Central locking system	Unlocking doors, automatic locking/unlocking, audible confirmation	» page 98
Multifunction display	–	Current consumption, average consumption, volume to fill up, convenience consumers, ECOAdvice, travelling time, distance travelled, digital speed display, average speed, speeding warning, oil temperature, coolant temperature, restore data "from start", restore data "total calculation"	» page 25
Date and time	–	Time source, set the time, select time zone, time format, set the date, date format	–
Measurement units	–	Distance, speed, temperature, volume, consumption, pressure	–
Service	–	Chassis number, date of next SEAT service inspection, date of next oil change service	» page 31
Factory settings	–	All settings can be reset: driver assistance, parking and manoeuvring, lights, rear view mirrors, opening and closing, multi-function display	–



» ⚠ in CAR menu (Setup) on page 93



» page 93

## Driver information system

### Introduction

With the ignition switched on, it is possible to read the different functions of the display by scrolling through the menus.

In vehicles with multifunction steering wheel, the multifunction display can only be operated with the steering wheel buttons.

The number of menus displayed on the instrument panel will vary according to the vehicle electronics and equipment.

A specialised workshop will be able to programme or modify additional functions, according to the vehicle equipment. SEAT recommends visiting a SEAT Official Service.

Some menu options can only be read when the vehicle is at a standstill.

As long as a priority 1 warning is displayed, it will not be possible to read the menus. Some warning messages can be confirmed and made to disappear with the windscreen wiper lever button or the multifunction steering wheel button.

The information system also provides the following information and displays (depending on the vehicle's equipment):

### Driving data » page 28

- Vehicle status

- MFD from departure
- MFD from refuelling
- MFD total calculation

### Assist systems » table on page 26

- Reverse (optional)

### Navigation » Booklet Navigation system

### Audio » Booklet Radio or » Booklet Navigation system

### Telephone » Booklet Radio or » Booklet Navigation system

### Vehicle » table on page 26

#### **⚠ WARNING**

**Any distraction may lead to an accident, with the risk of injury.**

- Do not operate the instrument panel controls when driving.

### Operating the instrument panel menus



**Fig. 34** Windscreen wiper lever: control buttons.



**Fig. 35** Right side of multifunction steering wheel: control buttons.

The driver information system is controlled with the multifunction steering wheel buttons » **Fig. 35** or with the windscreen wiper lever » **Fig. 34** (if the vehicle is not equipped with multifunction steering wheel).

### Enabling the main menu

- Switch the ignition on.
- If a message or vehicle pictogram appears, press button **» Fig. 34 1** on the windscreen wiper lever or button **OK** on the multifunction steering wheel **» Fig. 35**.
- *If managed from the windscreen wiper lever:* to display the main screen **» page 26** or to return to the main menu from another menu hold down the rocker button **» Fig. 34 2**.
- *If managed from the multifunction steering wheel:* the main menu list is not displayed. To go from point to point in the main menu, press button **◀** or **▶** several times **» Fig. 35**.

### Select a submenu

- Press the rocker switch **» Fig. 34 2** on the windscreen wiper lever up or down or turn the thumbwheel of the multifunction steering wheel **» Fig. 35** until the desired option appears marked on the menu.
- The selected option is displayed between two horizontal lines. In addition, a triangle is displayed on the right: ◀
- To consult the submenu option, press button **» Fig. 34 1** on the windscreen wiper lever or button **OK** on the multifunction steering wheel **» Fig. 35**.

### Making changes according to the menu

- Make the desired changes with the rocker switch on the windscreen wiper lever or the thumbwheel of the multifunction steering wheel. To increase or decrease the values more quickly, turn the thumbwheel faster.
- Mark or confirm the selection with button **» Fig. 34 1** on the windscreen wiper lever or button **OK** on the multifunction steering wheel **» Fig. 35**.

### Menu

Menu	Function
Driving data	Information and possible configurations of the multifunction display (MFD) <b>» page 28, » page 93</b> .
Assist systems	Information and possible configurations of the driver assistance systems <b>» page 93</b> .
Audio	Station display on the radio. Track name on the CD. Track name in Media mode <b>» Booklet Radio or » Booklet Navigation system</b> .
Telephone	Information and possible configurations of the mobile phone preinstallation <b>» Booklet Radio or » Booklet Navigation system</b> .

Menu	Function
Vehicle status	Display of the current warning or information texts and other system components, depending on the equipment <b>» page 93</b> .

### Outside temperature display

When the outside temperature is below +4°C (+39°F), the “ice crystal” symbol (warning of risk of freezing) is also displayed. At first, this symbol flashes and then it remains lit until the outside temperature rises above +6°C (+43°F) **» Δ in Indications on the display on page 90**.

When the vehicle is at a standstill or when travelling at very low speeds, the temperature displayed may be higher than the true outside temperature as a result of the heat produced by the engine.

The temperatures measured range from -40°C to +50°C (-40°F to +122°F).

## Gear-change indicator

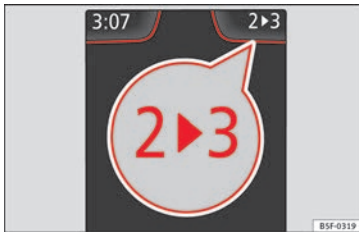

Fig. 36 Instrument panel: gear-change indicator (manual gearbox).

A gear change will be recommended if the gear you are in is not the most economical choice. If no gear-change is recommended, it means that you are already in the most economical gear.

The following display symbols » Fig. 36 mean:

- ▶ **Change to a higher gear:** the suggested gear appears to the **right** of the current gear when a **higher gear is recommended**.
- ◀ **Change to a lower gear:** the suggested gear appears to the **left** of the current gear when a **lower gear is recommended**.

The gear recommendation may occasionally skip a gear (2nd ▶ 4th).

## ⚠ CAUTION

The gear-change indicator is intended to help save fuel, but it is not intended to recommend the right gear for all driving situations. In certain situations, only the driver can choose the correct gear (for instance when overtaking, driving up a steep gradient or towing a trailer).

## i Note

The display disappears from the instrument panel when you press the clutch pedal.

## Bonnet, rear lid and doors open

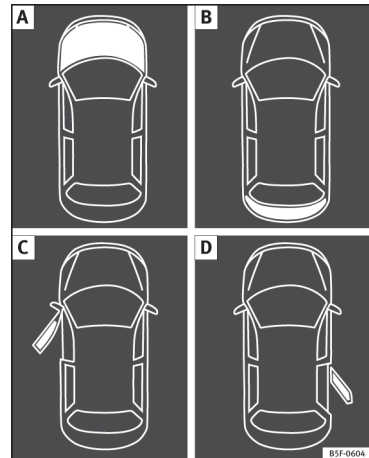

Fig. 37 A: bonnet open; B: rear lid open; C: front left door open; D: rear right door open (5-door vehicles only).

When the ignition is switched on or when driving, the bonnet, rear lid or doors that are open will be indicated on the instrument panel display, and, as applicable, this will be indicated audibly. The display may vary according to the type of instrument panel fitted. »

Illustration	Key to » Fig. 37
A	<b>Do not continue driving!</b> The bonnet is open or is not properly closed » page 176.
B	<b>Do not continue driving!</b> The rear lid is open or is not properly closed » page 9.
C, D	<b>Do not continue driving!</b> A vehicle door is open or is not properly closed » page 98.

### Warning and information messages

The system runs a check on certain components and functions when the ignition is switched on and while the vehicle is moving. Faults in the operation are displayed on the screen using red and yellow symbols and messages on the instrument panel display (» page 92, » page 33) and, in some cases, with audible warnings. The display may vary according to the type of instrument panel fitted.

#### Priority 1 warning (red symbols)

Symbol flashing or lit; partly combined with audible warnings.

**Stop the vehicle!** It is dangerous » in Warning symbols on page 92!

Check the function that is faulty and repair it. If necessary, request assistance from specialised personnel.

#### Priority 2 warning (yellow symbols)

Symbol flashing or lit; partly combined with audible warnings.

A faulty function, or fluids which are below the correct levels may cause damage to the vehicle! » in Warning symbols on page 93

Check the faulty function as soon as possible. If necessary, request assistance from specialised personnel.

#### Informative text

Information relating to different vehicle processes.

### Assist systems submenu

Assist systems menu	Function
Fatigue detection*	Switching the fatigue detection on or off (pause recommendation) » page 153.

### Journey data

#### Memory

The MFD (multifunction display) shows different values for the journey and the consumption.

#### Changing between display modes on the MFD

- *In vehicles without multifunction steering wheel:* Press the rocker switch on the windscreen wiper lever » Fig. 34.
- *Vehicles with a multifunction steering wheel:* turn the thumbwheel » Fig. 35.

#### Multifunction display memory

The multifunction display is equipped with three memories that work automatically: MFD from departure, MFD from refuelling and MFD total calculation. On the screen display, you can read which memory is currently displayed.

#### Toggle between memories with the ignition on and the memory displayed

Press the button on the windscreen wiper lever or the button of the multifunction steering wheel.



Menu	Function
MFD from departure	Display and storage of the values for the journey and the consumption from when the ignition is switched on to when it is switched off. If the journey is continued in less than 2 hours after the ignition is switched off, the new data is added to the data already stored in the memory. The memory will automatically be deleted if the journey is interrupted for more than 2 hours.
MFD from refuelling	Display and storage of the values for the journey and the consumption. By refuelling, the memory will be erased automatically.
MFD total calculation	The memory records the values for a specific number of partial trips, up to a total of 19 hours and 59 minutes or 99 hours and 59 minutes, or 1999.9 km or 9999 km, depending on the model of instrument panel. On reaching either of these limits <sup>a)</sup> , the memory is automatically erased and starts to count from 0 again.

<sup>a)</sup> It varies according to the instrument panel version.

### Erasing a memory manually

- Select the memory that you wish to erase.
- Hold the **OK/RESET** button of the multifunction steering wheel or the **OK** button of the multifunction wheel pressed down for about 2 seconds.

### Personalising the displays

In the Easy Connect system you can adjust which of the possible displays of the MFD can be shown on the instrument panel display with the button **CAR** and the function button **Setup**   page 93.

### Data summary

Menu	Function
Current fuel consumption	The current fuel consumption display operates throughout the journey, in litres/100 km; and with the engine running and the vehicle stopped, in litres/hour.
Average fuel consumption	After turning on the ignition, average fuel consumption in litres/100 km will be displayed after travelling about 100 metres. Otherwise horizontal lines are displayed. The value shown is updated approximately every 5 seconds.
Operating range	Approximate distance in km that can still be travelled with the fuel remaining in the tank, assuming the same style of driving is maintained. This is calculated using the current fuel consumption.
Travelling time	This indicates the hours (h) and minutes (min) since the ignition was switched on.

Menu	Function
Distance covered	Distance covered in km (m) after switching on the ignition.
Average speed	The average speed will be shown after a distance of about 100 metres has been travelled. Otherwise horizontal lines are displayed. The value shown is updated approximately every 5 seconds.
Digital display of speed	Current speed displayed in digital format.
Speed warning at --- km/h or Speed warning at --- mph	If the stored speed is exceeded (between 30 - 250 km/h, or 19 - 155 mph), an audible warning is given together with a visual warning.
Oil temperature	Updated engine oil temperature digital display
Coolant temperature gauge	Digital display of the current temperature of the liquid coolant.



### Storing a speed with the speed warning

- Select the display **Speed warning at --- km/h (--- mph)**
- Press the button **OK/RESET** on the windscreen wiper lever or the button **OK** on the multifunction steering wheel to store the current speed and activate the warning.
- To switch system on: adjust to the desired speed within 5 seconds using the rocker switch **TRIP** on the windscreen wiper lever or 



by turning the thumbwheel on the multifunction steering wheel. Next, press the button **OK/RESET** or **OK** again or wait several seconds. The speed is stored and the warning activated.

- To switch system off: press the button **OK/RESET** or **OK**. The stored speed is deleted.

### Engine oil temperature display

The engine reaches its operating temperature when in normal driving conditions the oil temperature is between **80°C** (178°F) and **120°C** (248°F). If the engine is required to work hard and the outside temperature is high, the engine oil temperature can increase. This does not present any problem as long as the warning lamps  » **table on page 34** or  » **table on page 34** do not appear on the display.



### Vehicles without multifunction steering wheel

- Press the rocker switch » **Fig. 34**  until the main menu appears. Enter into **Driving data**. With the button  move to the oil temperature gauge.

### Vehicles with multifunction steering wheel

- Enter the submenu **Driving data** and turn the thumbwheel until the oil temperature display appears.

### additional electrical appliances

- *Operation with the windscreen wiper lever\**: Press the rocker switch » **Fig. 34**  until the main menu appears. Enter into the section **Driving data**. With the rocker switch, move to the display **Convenience consumers**.
- *Operation with the multi-function steering wheel\**: Move with the buttons  or  to **Driving data** and enter with **OK**. Turn the right thumbwheel until the **Convenience consumers** display appears.

In addition, a scale will inform you of the current sum of all the additional appliances.

### Saving tips



Tips on how to save fuel will be displayed in conditions that increase fuel consumption. Follow them to reduce consumption. The indications appear automatically only with the efficiency programme. After a time, the tips will disappear automatically.

If you wish to hide a saving tip immediately after it appears, press any button on the windscreen wiper lever\*/multifunction steering wheel\*.

#### Note

- If you hide a saving tip, it will reappear after you switch the ignition on again.
- The saving tips do not appear in all situations, but rather with a large separation of time.

### Speed warning device



The speed warning device warns the driver when they have exceeded the pre-set speed limit by 3 km/h (2 mph). An audible warning signal sounds, and the warning lamp  and the driver message **Speed limit exceeded!** will be displayed simultaneously on the instrument panel. The warning lamp  switches off when reducing speed below the stored maximum limit.

Speed warning programming is recommended if you wish to be reminded of a maximum speed, such as when travelling in a country with different speed limits or for a maximum speed for winter tyres.

### Setting speed limit warning

You can use the radio or the Easy Connect\* to set, alter or cancel the speed limit warning.



- **Vehicles with radio:** press the button  **SETUP** > control button  **Driver Assistant** > **Speed warning**.



- **Vehicles with Easy Connect:** press the button **Systems** or else **Vehicle systems** > **Driver assistant** > **Speed warning**.

The warning limit can be set from 30 to 240 km/h (20 to 149 mph). The adjustment is made at 10 km/h (5 mph) intervals.

### Note

- **Please bear in mind that, even with the speed warning function, it is still important to keep an eye on the vehicle speed with the speedometer and to observe the legal speed limits.**
- **The speed limit warning function in the version for some countries warns you at a speed of 120 km/h (75 mph). This is a factory-set speed limit.**

## Service intervals

The service interval indication appears on the instrument panel display   **Fig. 105** .

SEAT distinguishes between services *with* engine oil change (e.g. Oil change service) and services *without* engine oil change (e.g. Inspection).

In vehicles with **Services established by time or mileage**, the service intervals are already pre-defined.

In vehicles with **LongLife Service**, the intervals are determined individually. Thanks to technological progress, maintenance work has been greatly reduced. Because of the technology used by SEAT, with this service you only need to change the oil when the vehicle so requires. To calculate this change (max. 2 years), the vehicle's conditions of use and individual driving styles are considered. The advance warning first appears 20 days before the date established for the corresponding service. The kilometres (miles) remaining until the next service are always rounded up to the nearest 100 km (miles) and the time is given in complete days. The current service message cannot be viewed until 500 km after the last service. Prior to this, only lines are visible on the display.

### Inspection reminder

When the Service date is approaching, when the ignition is switched on a **Service reminder** is displayed.

*Vehicles without text messages:* a spanner  will be displayed on the instrument panel plus an indication in **km**.

The kilometres indicated are the maximum number of kilometres that can be travelled until the next service. After a few seconds,

the display mode changes. A clock symbol appears and the number of days until the next service is due.

*Vehicles with text messages:* **Service in --- km or --- days** will be shown on the instrument panel display.

### Service due

When **the service date is due**, an audible warning is given when the ignition is switched on and the spanner displayed on the screen flashes for a few seconds .

*Vehicles with text messages:* **Service now** will be shown on the instrument panel display.



### Reading a service notification

With the ignition switched on, the engine off and the vehicle at a standstill, the current **service notification** can be read:

Press and hold the button  for more than 5 seconds to consult the service message.

When the **service date has passed**, a minus sign is displayed in front of the number of kilometres or days.

*Vehicles with text messages:* the following message is displayed: **Service --- km (miles) or --- days ago**.

The time can also be set via the  key and  function button in the Easy Connect system  page 93.

## Resetting service interval display

If the service was not carried out by a SEAT dealership, the display can be reset as follows:

- Switch off the ignition, press and hold button »» Fig. 105 ④.
- Switch ignition back on.
- Release the ④ »» Fig. 105 button and press it again for the next 20 seconds.

### Note

- The service message disappears after a few seconds, when the engine is started or when **OK/RESET** is pressed on the windscreen wiper lever, or **OK** on the multifunction steering wheel.
- In vehicles with the LongLife system in which the battery has been disconnected for a long period of time, it is not possible to calculate the date of the next service. Therefore the service interval display may not be correct. In this case, bear in mind the maximum service intervals permitted in the »» Booklet Maintenance Programme.

## Cruise control

### Operating the cruise control system (CCS)\*

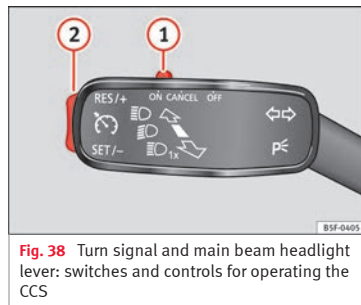

**Fig. 38** Turn signal and main beam headlight lever: switches and controls for operating the CCS

- Switching on the CCS: Move switch »» Fig. 38 ① to **ON**. The system is on. If no speed has been programmed, the system will not control it.
- Activating the CCS: Press button »» Fig. 38 ② in the **SET/-** area. The current speed is memorised and controlled.

- Temporarily switching off the CCS: Move switch »» Fig. 38 ① to **CANCEL** or push the brake. The cruise control system is switched off temporarily.
- Reactivating the CCS: Press button »» Fig. 38 ② in **RES/+**. The memorised speed is saved and controlled again.
- Increasing stored speed during CCS regulation: press button ② in **RES/+**. The vehicle accelerates until the new stored speed.
- Reducing stored speed during CCS regulation: press button ② in **SET/-** to lower the speed by 1 km/h (1 mph). Speed is reduced until reaching the new stored speed.
- Switching off the CCS: Move switch »» Fig. 38 ① to **OFF**. The system is disconnected and the memorised speed is deleted.



»» ⚠ in Operation on page 160



»» page 159

## Warning lamps

## On the instrument panel

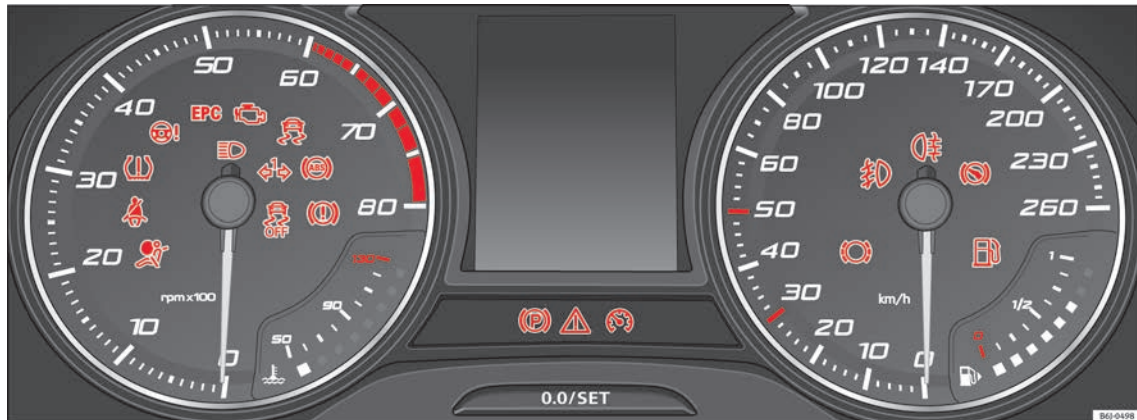

Fig. 39 Instrument panel, on dash panel.

## Red warning lamps

	Central warning lamp: additional information on the instrument panel display	-
	Parking brake on.	» page 137
	<b>Do not continue driving!</b> The brake fluid level is too low or there is a fault in the brake system.	» page 138



Lit up or flashing:

**Do not continue driving!**  
Fault in the steering.

» page 133















Driver or passenger has not fastened seat belt.





» page 57

## Yellow warning lamps

	Central warning lamp: additional information on the instrument panel display	-	»
--	--	---	---

	Front brake pads worn.	
	<i>it lights up:</i> Fault in the ESC, or disconnection caused by the system.	» page 140
	<i>flashes:</i> ESC or ASR activated.	
	ASR manually deactivated. <i>Or else:</i> ESC in Sport mode.	
	ABS faulty or does not work.	
	Front fog lights switched on.	» page 20
	Rear fog light switched on.	» page 20
	<i>lights up or flashes:</i> fault in the emission control system.	» page 151
	<i>it lights up:</i> pre-heating of diesel engine.	» page 151
	<i>flashes:</i> fault in the diesel engine management.	
<b>EPC</b>	fault in the petrol engine management.	» page 150
	<i>lights up or flashes:</i> fault in the steering system.	» page 133
	Tyre pressure too low, or fault in the tyre pressure monitoring system.	» page 191
	Fuel tank almost empty.	» page 91
	Fault in airbag system and seat belt tensioners.	» page 61



### Other warning lamps



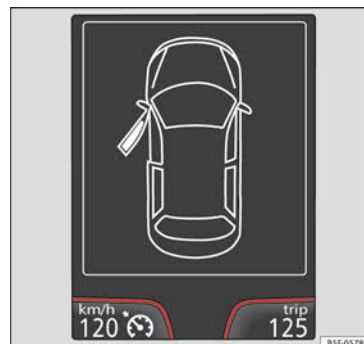







	Left or right turn signal.	» page 21
	Hazard warning lights on.	» page 112
	Trailer turn signals	» page 161
	<i>it lights up:</i> cruise control activated or speed limiter switched on and active.	» page 32
	<i>flashes:</i> the speed set by the speed limiter has been exceeded.	
	Main beam on or flasher on.	» page 21

### On the instrument panel display

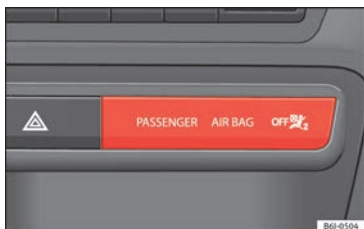

**Fig. 40** On the instrument panel display: door open.

	<b>Do not continue driving!</b> With the corresponding indication: door(s), rear lid or bonnet open or not properly closed.	» page 98 » page 9 » page 176
	<i>Ignition:</i> <b>Do not carry on driving!</b> Engine coolant level too low, coolant temperature too high	» page 182
	<i>Flashing:</i> Fault in the engine coolant system.	
	<b>Do not continue driving!</b> Engine oil pressure too low.	» page 179

	Fault in the battery.	»» page 185
	Driving light totally or partially faulty.	»» page 78
	Fault in the cornering light system.	»» page 108
	Diesel particulate filter blocked	»» page 150
	Level of windscreen washer fluid too low.	»» page 185
	<i>Flashing:</i> Fault in the oil level detection. Control manually.	»» page 179
	<i>Ignition:</i> Insufficient engine oil.	
<b>SAFE</b>	Immobiliser active.	»» page 135
	Service interval display	»» page 31
	Mobile telephone is connected via Bluetooth to the original telephone device.	»» Booklet Radio
	Mobile telephone battery charge meter. Available only for devices pre-installed in factory.	
	Freezing warning. The outside temperature is lower than +4°C (+39°F).	»» page 26
	Start-Stop system activated.	»» page 152
	Start-Stop system unavailable.	

## On the instrument panel



**Fig. 41** Warning lamp for disabling the front passenger airbag.

	Front passenger front airbag is disabled ( <b>PASSENGER AIR BAG OFF</b> ).	»» page 61
---	--	------------



»»  in Warning symbols on page 92



»» page 92

## Gearbox lever

### Manual gearbox

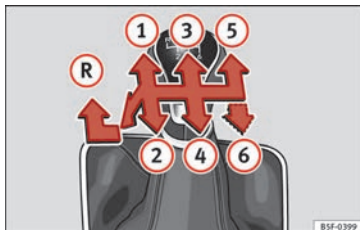

**Fig. 42** Gear shift pattern of a 5 or 6-speed manual gearbox.

The position of the gears is indicated on the gearbox lever »» **Fig. 42**.

- Press the clutch pedal and keep your foot right down.
- Move the gearbox lever to the required position.
- Release the clutch.

### Selecting reverse gear

- Press the clutch pedal and keep your foot right down.
  - With the gearbox lever in neutral, push it downwards, move it to the left as far as it will go and then forwards to select reverse
- »» **Fig. 42** .

- Release the clutch.



» » ⚠ in Driving with manual gearbox on page 146



» » page 145

## Air conditioning

### How does the manual air conditioning work\*?

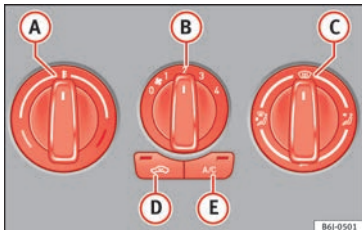

**Fig. 43** In the centre console: Manual air conditioning controls.

- A** Temperature
- B** Blower
- C** Air distribution

 – Air distribution towards the windscreen in order to demist or defrost.



– Air distribution to upper body.



– Air distribution to footwell



– Air distribution to the windscreen and the footwell.

- D** Air recirculation
- E** A/C: Switching the cooling system on



» » ⚠ in General notes on page 127



» » page 131

### How does the heating and the fresh air system work?

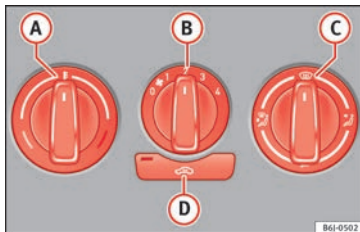

**Fig. 44** In the centre console: heating system and fresh air controls.

- A** Temperature
- B** Blower

- C** Air distribution



– Air distribution towards the windscreen in order to demist or defrost.



– Air distribution to upper body.



– Air distribution to footwell



– Air distribution to the windscreen and the footwell.

- D** Air recirculation



» » ⚠ in General notes on page 127



» » page 129

## Fluid Level control

### Filling capacities

#### Capacities

Fuel tank	45 litres. 7 litre reserve.
Windscreen washer fluid container in vehicles without headlight washer	3 litres
Windscreen washer fluid container in vehicles with headlight washer	4.5 litres

## Fuel

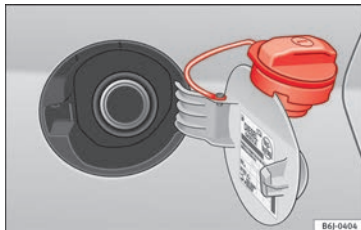

Fig. 45 Fuel tank flap with tank cap attached.

The tank flap is released manually and is located at the rear of the vehicle on the right. The tank holds approximately 45 litres.

### Opening the fuel tank cap

- Lift the lid.
- Hold the cap firmly with one hand, then insert the key into the lock and rotate 180° to the left.
- Unscrew the cap, turning it anticlockwise.

### Closing the fuel tank cap

- Screw the tank cap to the right until it “clicks”.
- Turn the key in the lock, without releasing the cap, clockwise through 180°.

- Remove the key and close the flap until it clicks into place. The tank cap is secured with an anti-loss attachment



» » in Refuelling on page 174



» » page 174

## Oil

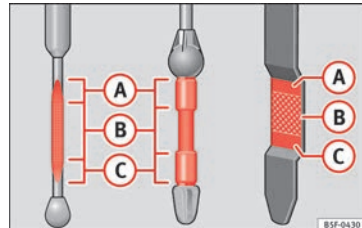

Fig. 46 Engine oil dipstick.



Fig. 47 In the engine compartment: Engine oil filler cap.

The level is measured using the dipstick located in the engine compartment  
» » page 179.

The oil should leave a mark between zones (A) and (C). It should never exceed zone (A).

- Zone (A): Do not add oil.
- Zone (B): You can add oil but keep the level in that zone.
- Zone (C): Add oil up to zone (B).

### Topping up engine oil

- Unscrew cap from oil filler opening.
- Add oil slowly.
- At the same time, check the level to ensure you do not add too much.
- When the oil level reaches at least zone (B), unscrew the engine oil filler cap carefully. »

## Oil properties

Engine type	Specification
Petrol without flexible service interval	VW 502 00/VW 504 00
Petrol with flexible service interval (LongLife)	VW 504 00
Diesel. Engines without Particulate filter (DPF)	VW 505 01/VW 506 01/VW 507 00
Diesel. Particulate Filter Engines (DPF). With or without flexible service interval (with and without LongLife) <sup>a)</sup>	VW 507 00

a) Only use recommended oils, otherwise you may damage the engine.

## Engine oil additives

No type of additive should be mixed with the engine oil. The deterioration caused by these additives is not covered by the warranty.



» ⚠ in Changing engine oil on page 182



» page 179

## Coolant



Fig. 48 Engine compartment: coolant expansion tank cap.

The coolant tank is located in the engine compartment » 📖 page 179.

When the engine is cold, replace the coolant when the level is below **MIN**.

## Coolant specifications

The engine cooling system is supplied from the factory with a specially treated mixture of water and at least 40 % of the additive **G13** (TL-VW 774 J), purple. This mixture gives the necessary frost protection down to -25°C (-13°F) and protects the light alloy parts of the engine cooling system against corrosion. It also prevents scaling and considerably raises the boiling point of the coolant.

To protect the cooling system, the percentage of additive must always be at least 40 %,

even in warm climates where anti-freeze protection is not required.

If for weather reasons further protection is necessary, the proportion of additive may be increased, but only up to 60 %; otherwise antifreeze protection will diminish and this will worsen cooling.

When the coolant is topped up, use a mixture of **distilled water** and at least 40 % of the G13 or G12 plus-plus (TL-VW 774 G) additive (both are purple) to obtain an optimum anti-corrosion protection » ⚠ in **Topping up coolant on page 184**. The mixture of G13 with G12 plus (TL-VW 774 F), G12 (red) or G11 (green-blue) engine coolants will significantly reduce anti-corrosion protection and should therefore be avoided » ⚠ in **Topping up coolant on page 184**.



» ⚠ in Topping up coolant on page 183



» page 182



## Brake fluid



**Fig. 49** Engine compartment: brake fluid reservoir cap.

The brake fluid reservoir is located in the engine compartment »» » page 179.

The level should be between the **MIN** and **MAX** marks. If it is below **MIN**, please visit a Technical Service.



»» » in Changing the brake fluid on page 184



»» » page 184

## Windscreen washer



**Fig. 50** In the engine compartment: windscreen washer reservoir top.

The windscreen washer reservoir is located in the engine compartment »» » page 179.

To top up, mix water with a product recommended by SEAT.

In cold temperatures, add anti-freeze for windows.



»» » in Topping up the windscreen washer reservoir water on page 185



»» » page 185

maintenance. It is checked as part of the Inspection Service.



»» » in Symbols and warnings on handling the battery on page 185



»» » page 185

## Battery

The battery is located in the engine compartment »» » page 179. It does not require

## Emergencies

### Fuses

#### Fuse location



**Fig. 51** On the driver-side dash panel: fuse box cover.



**Fig. 52** In the engine compartment: fuse box cover.

#### Opening and closing the fuse box situated below the dash panel

- Opening: remove the fuse box cover  
» **Fig. 51.**
- Closing: click the cover back into place.

#### To open the engine compartment fuse box

- Raise the bonnet.
- Press the locking tabs to release the fuse box cover » **Fig. 52**
- Then lift the cover out.
- To **fit** the cover, place it on the fuse box. Push the locking tabs down until they click audibly into place.

#### Identifying fuses situated below the dash panel by colours

Colour	Amp rating
Black	1
Purple	3
Light brown	5
Brown	7.5
Red	10
Blue	15
Yellow	20
White or transparent	25

Colour	Amp rating
Green	30
Orange	40



»  in Introduction on page 75



» page 75

#### Replacing a blown fuse

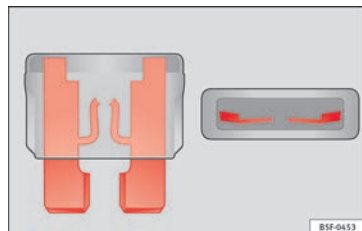

**Fig. 53** Image of a blown fuse.

#### Preparation

- Switch off the ignition, lights and all electrical equipment.
- Open the corresponding fuse box  
»  page 76.

### Identifying a blown fuse

A fuse is blown if its metal strip is ruptured  
 » Fig. 53.

- Point a lamp at the fuse to see if it has blown.

### To replace a fuse

- Remove the fuse.
- Replace the blown fuse by one with an *identical* amperage rating (same colour and markings) and *identical* size.
- Replace the cover again or close the fuse box lid.

## Bulbs

### Bulbs (12 V)

#### Light source used for each function

Double headlights	Type
Dipped beam headlights	H7 Long Life
Main beam headlights	H7
Side lights	W5W Long Life
Turn signal	PY 21W

Double headlights	Type
DRL (day light)	LED <sup>a)</sup>

<sup>a)</sup> In case of a LED failure, go to an authorised workshop to have it replaced.

Single headlight	Type
Dipped/main beam headlights	H4 Long Life
Side lights	W5W Long Life
Turn signal	PY 21W
DRL (day light)	P21W SLL <sup>a)</sup>

<sup>a)</sup> In case of a LED failure, go to an authorised workshop to have it replaced.

Xenon/adaptive headlights*	Type
Dipped/main beam headlights	D1S <sup>a)</sup>
Side lights	LED <sup>b)</sup>
Turn signal	PY 21W
DRL (day light)	LED <sup>b)</sup>

<sup>a)</sup> This light should be changed by an Authorised Service.

<sup>b)</sup> In case of a LED failure, go to an authorised workshop to have it replaced.



» page 78

## Action in the event of a puncture

### What to do first

- Park the vehicle on a horizontal surface and in a safe place as far away from traffic as possible.
- Apply the handbrake.
- Switch on the hazard warning lights.
- Put it in 1st gear.
- If you are towing a trailer, unhitch it from your vehicle.
- Have the vehicle tool kit\* » page 43 and the spare wheel »  page 70 ready.
- Observe the applicable legislation for each country (reflective vest, warning triangles, etc.).
- All occupants should leave the vehicle and wait in a safe place (for instance behind the roadside crash barrier).

### WARNING

- **Always observe the above steps and protect yourself and other road users.**
- **If you change the wheel on a slope, block the wheel on the opposite side of the car with a stone or similar to prevent the vehicle from moving.**

## Repairing a tyre with the anti-puncture kit

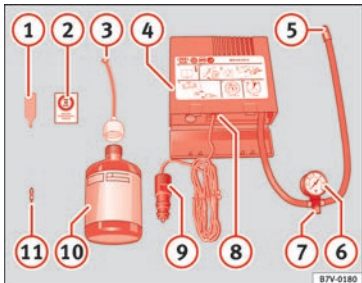

Fig. 54 Standard representation: contents of the anti-puncture kit.

The anti-puncture kit is located under the floor panel in the luggage compartment.

### Sealing the tyre

- Unscrew the tyre valve cap and insert. Use the » Fig. 54 ① tool to remove the insert. Place it on a clean surface.
- Shake the tyre sealant bottle vigorously » Fig. 54 ⑩.
- Screw the inflator tube » Fig. 54 ③ into the sealant bottle. The bottle's seal will break automatically.

- Remove the lid from the filling tube » Fig. 54 ③ and screw the open end of the tube into the tyre valve.
- With the tyre sealant bottle upside down, fill the tyre with the contents of the sealant bottle.
- Remove the bottle from the valve.
- Place the insert back into the tyre valve using the tool » Fig. 54 ①.

### Inflating the tyre

- Screw the compressor tyre inflator tube » Fig. 54 ⑤ into the tyre valve.
- Check that the air bleed screw is closed » Fig. 54 ⑦.
- Start the engine and leave it running.
- Insert the connector » Fig. 54 ⑨ into the vehicle's 12-volt socket » page 124.
- Turn the air compressor on with the ON/OFF switch » Fig. 54 ⑧.
- Keep the air compressor running until it reaches 2.0 to 2.5 bar (29-36 psi/200-250 kPa). **A maximum of 8 minutes.**
- Disconnect the air compressor.
- If it does not reach the pressure indicated, unscrew the tyre inflator tube from the valve.
- Move the vehicle 10m so that the sealant is distributed throughout the tyre.

- Screw the compressor tyre inflator into the valve.
- Repeat the inflation process.
- If the indicated pressure still cannot be reached, the tyre is too badly damaged. Stop and request assistance from an authorised technician.
- Disconnect the air compressor. Unscrew the tyre inflator tube from the tyre valve.
- When the tyre pressure is between 2.5 and 2.0 bars, continue driving without exceeding 80 km/h (50 mph).
- Check the pressure again after 10 minutes » page 73.



» in TMS (Tyre Mobility System)\* on page 71



» page 71

## Changing a wheel

### Vehicle tool kit



**Fig. 55** Underneath the floor panel of the luggage compartment: vehicle tool kit.

- 1 An adapter for the anti-theft wheel bolts\*
- 2 Towline anchorage
- 3 Box spanner for wheel bolts\*
- 4 Jack\*
- 5 Wire hook for pulling off the wheel covers\*/wheel bolt cap clip.



» » ⚠ in Vehicle tools on page 70



» » page 70

### Wheel bolt caps\*

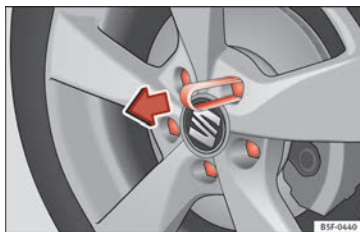
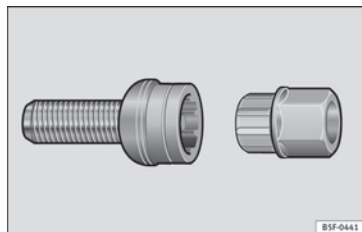

**Fig. 56** Wheel: wheel bolts with caps.

#### Removal

- Fit the plastic clip (vehicle tools) over the cap until it clicks into place » » **Fig. 56**.
- Remove the cap with the plastic clip.

### Anti-theft wheel bolts\*



**Fig. 57** Anti-theft wheel bolt with cap and adapter.

A special adapter (vehicle tools) is required to remove the anti-theft wheel bolts.

- Remove the wheel cover\* or the cap\*.
- Insert the special adapter (vehicle tools) onto the anti-theft wheel bolt and push it on as far as it will go.
- Insert the wheel brace (vehicle tools) onto the adapter as far as it will go.
- Remove the wheel bolt » » page 44.



#### Note

**Make a note of the code number of the anti-theft wheel bolt and keep it in a safe place, but not in your vehicle. If you need a new adapter, you can obtain it from the SEAT Official Service, indicating the code number.**

## Loosening the wheel bolts

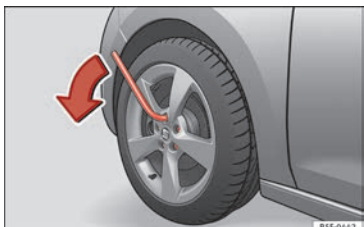

Fig. 58 Wheel: loosen the wheel bolts.

- Insert the box spanner (vehicle tools) onto the wheel bolt as far as it will go. An adapter is required to unscrew or tighten the anti-theft wheel bolts » page 43.
- Turn the wheel bolt approximately one turn to the left » Fig. 58 (arrow). To apply the required torque, hold the wheel brace at the end. If it is not possible to loosen a wheel bolt, carefully apply pressure with one foot on the end of the box spanner. Hold on to the vehicle for support and take care not to slip.

### **⚠ WARNING**

**Slightly loosen the wheel bolts (one turn) before raising the vehicle with the jack\*. If not, an accident may occur.**

## Raising the vehicle

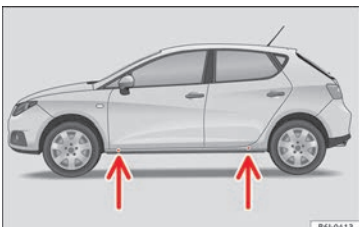

Fig. 59 Jack position points.

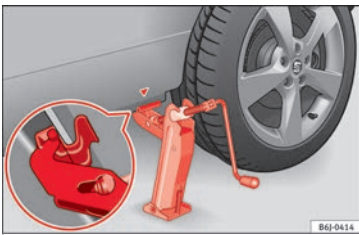

Fig. 60 Fitting the jack.

- Place the jack\* (vehicle tools) on firm ground. If necessary use a large, strong board or similar support. If the surface is slippery (for example tiles) place the jack on a rubber mat or similar to prevent it from slipping » ⚠.

- Find the support point on the strut (sunken area) closest to the wheel to be changed » Fig. 59.
- Place the jack under the jacking point and turn the crank until the arm of the jack is directly below the vertical rib under the door sill.
- Align the jack so that the arm of the jack fits around the rib under the door sill and the movable base plate of the jack is flat on the ground » Fig. 60.
- Continue turning the jack\* until the wheel is slightly lifted off the ground.

### **⚠ WARNING**

- **Make sure that the jack\* remains stable. If the surface is slippery or soft, the jack\* could slip or sink, respectively, with the resultant risk of injury.**
- **Only raise the vehicle with the jack\* supplied by the manufacturer. Other vehicles could slip, with the consequent risk of injury.**
- **Only mount the jack\* on the support points designed for this purpose on the strut, and always align the jack correctly. If you do not, the jack\* could slip as it does not have an adequate grip on the vehicle: risk of injury!**
- **The height of the parked vehicle can change as a result of variations in temperature and loading.**

### ⓘ CAUTION

The vehicle must not be raised on the cross-bar. Only place the jack\* on the points designed for this purpose on the strut. Otherwise, the vehicle may be damaged.

## Removing and fitting the wheel

Change the wheel after loosening the wheel bolts and raising the vehicle with the jack.

### Taking off the wheel

- Unscrew the wheel bolts using the box spanner and place them on a clean surface.
- Take off the wheel » ⓘ.

### Putting on the spare wheel

When fitting tyres with a compulsory rotation direction, observe the instructions in » page 45.

- Mount the wheel.
- Screw on the wheel bolts in position and tighten them loosely with a box spanner.
- Carefully lower the vehicle using the jack\*.
- Tighten the wheel bolts in diagonal pairs using the wheel brace.

The wheel bolts should be clean and turn easily. Before fitting the spare wheel, inspect the wheel condition and hub mounting surfa-

ces. These surfaces must be clean before fitting the wheel.

### ⓘ CAUTION

When removing/fitting the wheel, the rim may hit and damage the brake disc. For this reason, please take care and get a second person to assist you.

## Tyres with compulsory rotation direction

A directional tread pattern can be identified by the arrows on the sidewall that point in the direction of rotation. Always observe the direction of rotation indicated when fitting the wheel to guarantee optimum properties of this type of tyres with regard to grip, noises, wear and aquaplaning.

If it is absolutely necessary to fit the spare tyre\* against the direction of rotation, drive with care as this means the tyre does not offer optimum driving properties. This is of particular importance when the road surface is wet.

To return to directional tread tyres, replace the punctured tyre as soon as possible and restore the obligatory direction of rotation of all tyres.

## Subsequent work

- Replace the wheel bolt caps.
- If the replaced wheel does not fit in the spare wheel housing, store it safely in the luggage compartment » ⓘ page 124.
- Check the tyre pressure of the newly mounted tyre as soon as possible.
- In vehicles fitted with a tyre pressure indicator, adjust the pressure and store it in memory » ⓘ page 191.
- Have the tightening torque of the wheel bolts checked as soon as possible with a torque wrench (it should be 120 Nm). Meanwhile, drive carefully.
- Have the flat tyre replaced as quickly as possible.

## Snow chains

### Use

Snow chains should only be used on the *front* wheels.

- Check that they are correctly seated after driving for a few yards; correct the position if necessary, in accordance with the manufacturer's fitting instructions.
- Keep your speed below 50 km/h (30 mph). »

• If there is a danger of being trapped despite having mounted the chains, it is best to disable the driving wheels (ASR) in the ESC **»»**  page 140.

Snow chains will improve *braking ability* as well as *traction* in winter conditions.

For technical reasons snow chains may only be used with the following wheel rim/tyre combination.

185/60R15	Chains with links not exceeding 15 mm (including the chain closure)
-----------	---

Remove wheel covers and any integral trim ring before fitting snow chains.

Remove the chains when roads are free of snow. Driving characteristics worsen, and the wheels become damaged quickly and may even be rendered unusable.

#### WARNING

**Snow chains should be correctly tightened in accordance with the manufacturer's instructions. This will prevent the chains coming in contact with the wheel housing.**

## Emergency towing of the vehicle

### Towing



**Fig. 61** Right side of the front bumper: Towing ring.

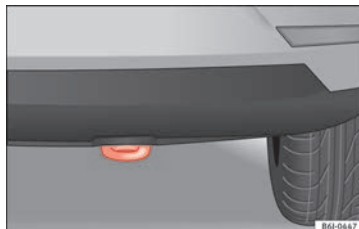

**Fig. 62** Right side of the rear bumper: Towing ring.

### Towline anchorages

Attach the bar or rope to the towline anchorages.

The towline anchorages are located under the floor panel in the luggage compartment, next to the vehicle tools **»»** page 43.

Screw the front towline anchorage into the screw connection **»»** Fig. 61 and tighten it with the wheel brace. The rear towline anchorage is under the rear bumper, on the right.

### Tow rope or tow bar

It is easier and safer for the vehicle to be towed using a tow bar. You should only use a tow-rope if you do not have a tow-bar.

A tow rope should be slightly elastic to reduce the loading on both vehicles. It is advisable to use a tow rope made of synthetic fibre or similarly elastic material.

Attach the tow rope or the tow bar only to the towline anchorages provided or a towing bracket.

### Notes for the driver of the towing vehicle

- The tow rope must be taut before you drive off.
- Release the clutch very carefully when starting the vehicle.



## Driving style

Towing requires some experience, especially when using a tow *rope*. Both drivers should realise how difficult it is to tow a vehicle. Inexperienced drivers should not attempt to tow.

Do not pull too hard with the towing vehicle and take care to avoid jerking the tow rope. When towing on an unpaved road, there is always a risk of overloading and damaging the anchorage points.

The ignition of the vehicle being towed must be switched on to prevent the steering wheel from locking and also to allow the use of the turn signals, horn, windscreen wipers and washers.

Place the gear lever in neutral on vehicles with a manual gearbox.

The brake servo only works when the engine is running. When not running, you must apply considerably more pressure to the brake pedal.

As the power assisted steering does not work if the engine is not running, you will need more strength to steer than you normally would.



» » in Notes on page 74



» » page 74

## Tow-starting

If the engine will not start, first try starting it using the battery of another vehicle

» » page 47. You should only attempt to tow-start a vehicle if charging the battery does not work. This is done by leveraging wheel movement.

When tow-starting a vehicle with a **petrol engine**, do not tow it more than a *short* distance, otherwise unburned fuel can enter the catalytic converter.

**However, if your vehicle has to be tow-started:**

- Engage 2<sup>nd</sup> or 3<sup>rd</sup> gear.
- Keep the clutch pressed down.
- Switch the ignition on.
- Once both vehicles are moving, release the clutch.
- As soon as the engine starts, press the clutch and move the gear lever into neutral. This helps to prevent driving into the towing vehicle.



» » in Notes on page 74



» » page 74

## How to jump start

### Jump leads

The jump lead must have a sufficient wire cross section.

If the engine fails to start because of a discharged battery, the battery can be connected to the battery of another vehicle to start the engine.

### Jump leads

Jump leads must comply with standard **DIN 72553** (see cable manufacturer's instructions). The wire cross section must be at least 25 mm<sup>2</sup> for petrol engines and at least 35 mm<sup>2</sup> for diesel engines.



### Note

- **The vehicles must not touch each other, otherwise electricity could flow as soon as the positive terminals are connected.**
- **The discharged battery must be properly connected to the on-board network.**

## How to jump start: description

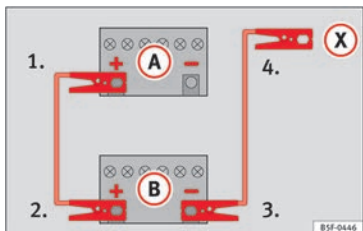

Fig. 63 Diagram of connections for vehicles without Start-Stop system.

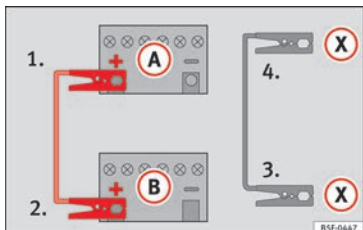

Fig. 64 Diagram of connections for vehicles with Start-Stop system.

### Jump lead terminal connections

1. Switch off the ignition of both vehicles  
»» ⚠.

2. Connect one end of the *red* jump lead to the positive (+) terminal of the vehicle with the flat battery (A) »» Fig. 63.
3. Connect the other end of the *red* jump lead to the positive terminal (+) in the vehicle providing assistance (B).
4. *For vehicles without Start-Stop system:* connect one end of the *black* jump lead to the negative terminal (-) of the vehicle providing the current (B) »» Fig. 63.
- *For vehicles with Start-Stop system:* connect one end of the *black* jump lead (X) to a suitable ground terminal, to a solid piece of metal in the engine block, or to the engine block itself »» Fig. 64.

5. Connect the other end of the *black* jump lead (X) to a solid metal component bolted to the engine block or to the engine block itself of the vehicle with the flat battery. Do not connect it to a point near the battery (A).
6. Position the leads in such a way that they cannot come into contact with any moving parts in the engine compartment.

### Starting

7. Start the engine of the vehicle with the boosting battery and let it run at idling speed.

8. Start the engine of the vehicle with the flat battery and wait for 2 or 3 minutes until the engine is running.

### Removing the jump leads

9. Before you remove the jump leads, switch off the dipped beam headlights if they are switched on.
10. Turn on the heater blower and heated rear window in the vehicle with the flat battery. This helps minimise voltage peaks which are generated when the leads are disconnected.
11. When the engine is running, disconnect the leads in reverse order to the details given above.

Make sure the battery clamps have sufficient metal-to-metal contact with the battery terminals.

If the engine fails to start, switch off the starter after about 10 seconds and try again after about a minute.

### ⚠ WARNING

- Please note the safety warnings referring to working in the engine compartment  
»» 📖 page 176, Working in the engine compartment.
- The battery providing assistance must have the same voltage as the flat battery (12 V)

and approximately the same capacity (see imprint on battery). Failure to comply could result in an explosion.

- Never use jump leads when one of the batteries is frozen. Danger of explosion! Even after the battery has thawed, battery acid could leak and cause chemical burns. If a battery freezes, it should be replaced.
- Keep sparks, flames and lighted cigarettes away from batteries, danger of explosion. Failure to comply could result in an explosion.
- Observe the instructions provided by the manufacturer of the jump leads.
- Do not connect the negative cable from the other vehicle directly to the negative terminal of the flat battery. The gas emitted from the battery could be ignited by sparks. Danger of explosion.
- Never attach the negative cable to fuel system components or the brake lines in the other vehicle.
- The non-insulated parts of the battery clamps must not be allowed to touch. The jump lead attached to the positive battery terminal must not touch metal parts of the vehicle, this can cause a short circuit.
- Position the leads in such a way that they cannot come into contact with any moving parts in the engine compartment.
- Do not lean on the batteries. This could result in chemical burns.

**Note**

The vehicles must not touch each other, otherwise electricity could flow as soon as the positive terminals are connected.

## Changing the windscreen wiper blades

### Changing the wiper blades

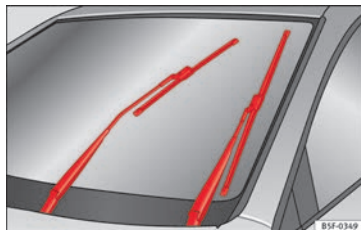

Fig. 65 Wipers in service position.

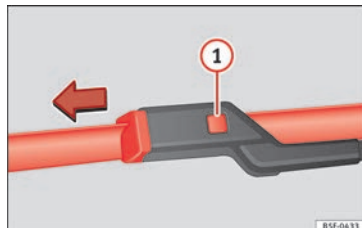

Fig. 66 Changing the windscreen wiper blade.

To change the blades it is necessary to move the wipers from the rest position into the service position.

Do not change the windscreen wipers when out of the service position, as it could cause paint to flake off the bonnet due to friction with the windscreen wiper arm.

### Service position (for changing wiper blades)

- Ensure that the wiper blades are not frozen.
- Turn the ignition on and off and then (with approximately 9 seconds) push the windscreen wiper lever down (short wipe). The windscreen wipers will move to the service position » Fig. 65.

### Removing the wiper blade

- Lift the windscreen wiper arm.
- Press the securing tab down **1** » Fig. 66. »

- Extract the wiper blade from the wiper arm.

### Fitting the wiper blade

- Insert the wiper blade onto the windscreen wiper arm until it clicks into place.
- Place the windscreen wiper arms to their initial position.



» » ⚠ in Changing the windscreen and rear window wiper blades on page 73



» » page 73

- Slide the blade adapter in the direction of the arrow and remove the blade » » **Fig. 67 A.**

### Fitting the wiper blade

- With one hand, hold the top end of the wiper arm.
- Place the blade as shown in » » **Fig. 67 B** and slide the adapter along until it engages.



» » ⚠ in Changing the windscreen and rear window wiper blades on page 73



» » page 73

## Changing the rear window wiper blade

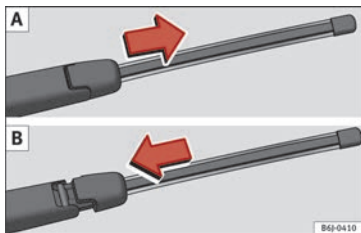

**Fig. 67** Removing and fitting the rear window wiper blade.

### Removing the wiper blade

- Lift the wiper arm away from the glass

## Safety

### Safe driving

#### Safety first!

This chapter contains important information, tips, suggestions and warnings that you should read and consider for both your own safety and for your passengers' safety.

#### WARNING

- This manual contains important information about the operation of the vehicle, both for the driver and the passengers. The other sections of the on-board documentation also contain further information that you should be aware of for your own safety and for the safety of your passengers.
- Ensure that the on-board documentation is kept in the vehicle at all times. This is especially important when lending or selling the vehicle to another person.

### Advice about driving

#### Before setting off

For your own safety and the safety of your passengers, always note the following points before every trip:

- Make sure that the vehicle's lights and turn signals are working properly.
- Check tyre pressure.
- Ensure that all windows provide a clear and good view of the surroundings.
- Ensure that all luggage is correctly secured **»» page 124**.
- Make sure that no objects can interfere with the pedals.
- Adjust front seat, head restraint and mirrors properly according to your size.
- Ensure that the passenger in the central rear seat always has the head restraint in the correct position for use.
- Instruct passengers to adjust the head restraints according to their height.
- Protect children with appropriate child seats and properly applied seat belts **»» page 67**.
- Assume the correct sitting position. Instruct your passengers also to assume a proper sitting position **»» page 52**.
- Fasten your seat belt securely. Instruct your passengers also to fasten their seat belts properly **»» page 56**.

#### What affects driving safety?

As a driver, you are responsible for yourself and your passengers. When your concentration or driving safety is affected by any circumstance, you endanger yourself as well as others on the road **»» **, for this reason:

- Always pay attention to traffic and do not get distracted by passengers or telephone calls.
- Never drive when your driving ability is impaired (e.g. by medication, alcohol, drugs).
- Observe traffic laws and speed limits.
- Always reduce your speed as appropriate for road, traffic and weather conditions.
- When travelling long distances, take breaks regularly - at least every two hours.
- If possible, avoid driving when you are tired or stressed.

#### WARNING

**When driving safety is impaired during a trip, the risk of injury and accidents increases.**

#### Safety equipment

Never put your safety or the safety of your passengers in danger. In the event of an accident, the safety equipment may reduce the **»»**

risk of injury. The following list includes most of the safety equipment in your SEAT:

- three-point seat belts,
- Belt tension limiter for the front and rear side seats
- Belt tensioners for the front seats,
- front airbags,
- Side airbags in the front seat backrests, with chest and head protection
- “ISOFIX” anchor points for “ISOFIX” rear child seat system
- height-adjustable front head restraints,
- Rear-centre head restraints with in-use position and non-use position
- adjustable steering column.

The safety equipment mentioned above works together to provide you and your passengers with the best possible protection in the event of an accident. However, these safety systems can only be effective if you and your passengers are sitting in a correct position and use this equipment properly.

### Safety is everyone's business!

## Correct position for passengers

### Correct sitting position for driver

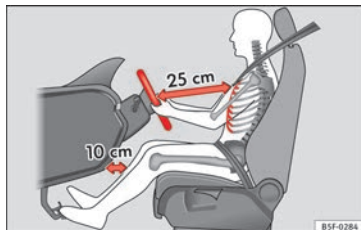

**Fig. 68** The proper distance between driver and steering wheel.



**Fig. 69** Correct head restraint position for the driver.

For your own safety and to reduce the risk of injury in the event of an accident, we recom-

mend the following adjustments for the driver:

- Adjust the steering wheel so that there is a distance of at least 25 cm between the steering wheel and the centre of your chest » **Fig. 68.**
- Move the driver's seat forwards or backwards so that you are able to press the accelerator, brake and clutch pedals to the floor with your knees still slightly angled » **△.**
- Ensure that you can reach the highest point of the steering wheel.
- Adjust the head restraint so that its upper edge is at the same level as the top of your head, or as close as possible to the same level as the top of your head » **Fig. 69.**
- Move the seat backrest to an upright position so that your back rests completely against it.
- Fasten your seat belt securely » **page 56.**
- Keep both feet in the footwell so that you have the vehicle under control at all times.

Adjustment of the driver's seat » **page 118.**

### ⚠ WARNING

- **An incorrect sitting position of the driver can lead to severe injuries.**

- Adjust the driver's seat so that there is at least 25 cm distance between the centre of the chest and the centre of the steering wheel » Fig. 68. If distance is less than 25 cm, the airbag system may not protect you properly.
- If your physical constitution prevents you from maintaining the minimum distance of 25 cm, contact a specialised workshop. The workshop will help you decide if special specific modifications are necessary.
- When driving, always hold the steering wheel with both hands on the outside of the ring at the 9 o'clock and 3 o'clock positions. This reduces the risk of injury when the driver airbag is triggered.
- Never hold the steering wheel at the 12 o'clock position, or in any other manner (e.g. in the centre of the steering wheel). In such cases, if the airbag is triggered, you may sustain injuries to the arms, hands and head.
- To reduce the risk of injury to the driver during sudden braking manoeuvres or an accident, never drive with the backrest tilted far back! The airbag system and seat belts can only provide optimal protection when the backrest is in an upright position and the driver is wearing his or her seat belt correctly.
- Adjust the head restraint properly to achieve optimal protection.

## Adjusting the steering wheel position

Read the additional information carefully

»  page 13

### WARNING

- Never adjust the position of the steering wheel when the vehicle is moving, as this could cause an accident.
- Move the lever up firmly so the steering wheel position does not accidentally change during driving. risk of accident!
- Make sure you are capable of reaching and firmly holding the upper part of the steering wheel: risk of accident!
- If you adjust the steering wheel so that it points towards your face, the driver airbag will not protect you properly in the event of an accident. Make sure that the steering wheel points towards your chest.

## Correct sitting position for front passenger

For your own safety and to reduce the risk of injury in the event of an accident, we recommend the following adjustments for the front passenger:

- Move the front passenger seat back as far as possible » .

- Move the seat backrest to an upright position so that your back rests completely against it.
- Adjust the head restraint so that its upper edge is at the same level as the top of your head, or as close as possible to the same level as the top of your head » page 55.
- Always keep both feet in the footwell in front of the front passenger seat.
- Fasten your seat belt securely » page 56.

It is possible to deactivate the front passenger airbag in **exceptional circumstances** » page 65.

Adjusting the front passenger seat »  page 11.

### WARNING

- An incorrect sitting position of the front passenger can lead to severe injuries.
- Adjust the front passenger seat so that there is at least 25 cm between your chest and the dash panel. If distance is less than 25 cm, the airbag system may not protect you properly.
- If your physical constitution prevents you from maintaining the minimum distance of 25 cm, contact a specialised workshop. The workshop will help you decide if special specific modifications are necessary.

»

- Always keep your feet in the footwell when the vehicle is moving; never rest them on the dash panel, out the window or on the seat. An incorrect sitting position exposes you to an increased risk of injury in case of a sudden braking or an accident. If the airbag is triggered, you could sustain severe injuries due to an incorrect sitting position.

- To reduce the risk of injury to the front passenger in events such as sudden braking manoeuvres or an accident, never travel with the backrest tilted far back! The airbag system and seat belts can only provide optimal protection when the backrest is in an upright position and the front passenger is wearing his or her seat belt properly. The further the seat backrests are tilted to the rear, the greater the risk of injury due to incorrect positioning of the belt web or to the incorrect sitting position!

- Adjust the head restraint correctly in order to achieve maximum protection.

### Correct sitting position for rear seat passengers

To reduce the risk of injury in the event of a sudden braking manoeuvre or an accident, passengers on the rear seat bench must consider the following:

- Sit up straight.
- Adjust the head restraint to the correct position » page 55.

- Always keep both feet in the footwell in front of the rear seat.
- Fasten your seat belt securely » page 56.
- Use an appropriate child restraint system when you take children in the vehicle » page 67.

### WARNING

- If the passengers in the rear seats are not sitting properly, they could sustain severe injuries.
- Adjust the head restraint correctly in order to achieve maximum protection.
- Seat belts can only provide optimal protection when seat backrests are in an upright position and the vehicle occupants are wearing their seat belts correctly. If passengers in the rear seats are not sitting in an upright position, the risk of injury due to incorrect positioning of the seat belt increases.

### Examples of incorrect sitting positions

Seat belts can provide optimal protection only when the belt webs are properly positioned. Incorrect sitting positions substantially reduce the protective function of seat belts and increase the risk of injury due to incorrect seat belt position. As the driver, you are responsible for all passengers, especially children.

- Never allow anyone to assume an incorrect sitting position in the vehicle while travelling » .

The following list contains examples of sitting positions that could be dangerous for all vehicle occupants. The list is not complete, but we would like to make you aware of this issue.

### Therefore, whenever the vehicle is in motion:

- Never stand in the vehicle.
- Never stand on the seats.
- Never kneel on the seats.
- Never tilt your seat backrest far to the rear.
- Never lean against the dash panel.
- Never lie on the rear bench.
- Never sit on the front edge of a seat.
- Never sit sideways.
- Never lean out of a window.
- Never put your feet out of a window.
- Never put your feet on the dash panel.
- Never put your feet on the surface of a seat.
- Do not allow anyone to travel in the footwell.
- Never travel without wearing the seat belt.
- Do not allow anyone to travel in the luggage compartment.



**⚠ WARNING**

- Any incorrect sitting position increases the risk of severe injuries.
- Sitting in an incorrect position exposes the vehicle occupants to severe injuries if airbags are triggered, by striking a vehicle occupant who has assumed an incorrect sitting position.
- Before the vehicle moves, assume the proper sitting position and maintain it throughout the trip. Before every trip, instruct your passengers to sit properly and to stay in this position during the trip » page 52, Correct position for passengers.

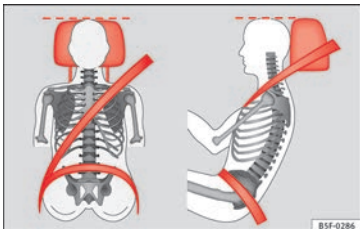
**Correct adjustment of front head restraints**

**Fig. 70** Correctly adjusted head restraint as viewed from the front and the side.

Properly adjusted head restraints are an important part of passenger protection and can reduce the risk of injuries in most accident situations.

- Adjust the head restraint so that its upper edge is, as far as possible, at the same level as the top of your head, or at the very least, at eye level » **Fig. 70**.

**⚠ WARNING**

- Travelling with the head restraints removed or improperly adjusted increases the risk of severe injuries. An improper adjustment of the head restraints may cause death in an accident and increase the risk of suffering injuries during abrupt braking actions or unexpected manoeuvres.
- The head restraints must always be adjusted according to the height of the passenger.

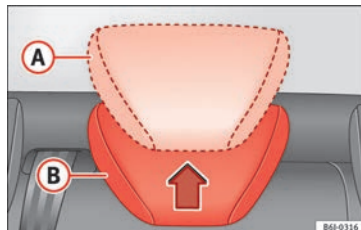
**Correct adjustment of rear head restraints**

**Fig. 71** Rear head restraint adjustment.

The rear head restraints have 2 positions:

- Raised position or position for use **(A)** » **Fig. 71**. In this position, the head restraint is used normally, protecting the occupant of the rear seats, along with the rear seat belts.
- Rest position, not in use **(B)** » **Fig. 71**. This position improves the driver's rear visibility.

To fit the head restraint in position for use **(A)**, pull on the edges with both hands in the direction of the arrow. To place it in rest position **(B)**, lower the head restraint.

**⚠ WARNING**

- Whenever a passenger is seated on the rear seats, the head restraint should be placed in the position for use **(A)**.

- Do not swap the centre rear head restraint with either of the outer seat rear head restraints. Risk of injury in case of an accident!

#### Note

Note the instructions on the head restraints adjustment.

## Pedal area

### Pedals

- Ensure that you can always press the accelerator, brake and clutch pedals unimpaired to the floor.
- Ensure that the pedals can return unimpaired to their initial positions.
- Ensure that the floor mats are securely fastened during the trip and do not obstruct the pedals »» » ⚠.

Only use floor mats which leave the pedals clear and which are secured to prevent them from slipping. You can obtain suitable floor mats from a specialised dealership.

If a brake circuit fails, the brake pedal must be pressed down thoroughly in order to stop the vehicle.

### Wear suitable footwear

Always wear shoes which support your feet properly and give you a good feeling for the pedals.

#### ⚠ WARNING

- If the pedals are obstructed, an accident may occur. Risk of serious injuries.
- Never lay or fit floor mats or other floor coverings over the original floor mats. This would reduce the pedal area and could obstruct the pedals. Risk of accident.
- Never place objects in the driver footwell. An object could move into the pedal area and impair pedal operation. In the event of a sudden driving or braking manoeuvre, you will not be able to operate the brake, clutch or accelerator pedal. Risk of accident!

## Seat belts

### Why wear a seat belt?

#### Number of seats

Your vehicle has **five** seats, two in the front and three in the rear. Each seat is equipped with a three-point seat belt.

In some versions, your vehicle is approved **only** for four seats. Two front seats and two rear seats.

#### ⚠ WARNING

- Never transport more than the permitted amount of people in your vehicle.
- Every vehicle occupant must properly fasten and wear the seat belt belonging to his or her seat. Children must be protected with an appropriate child restraint system.

## Seat belt lamp\*



**Fig. 72** Warning lamp on the instrument panel.

The control lamp illuminates to remind the driver to fasten his seat belt.

Before starting the vehicle:

- Fasten your seat belt securely.
- Instruct your passengers to fasten their seat belts properly before driving off.
- Protect children by using a child seat according to the child's height and weight.

When the ignition is switched on, the control lamp  in the instrument panel lights up\* if the driver or passenger\* have not fastened their seat belts.

An audible warning signal will sound for a few seconds if the seat belts are not fastened as the vehicle drives off and reaches a speed of more than approximately 25 km/h

(15 mph) or if the seat belts are unfastened while the vehicle is in motion. The warning lamp will also flash .

The  lamp goes out when the driver and passenger seat belts are fastened with the ignition switched on.

## The protective function of seat belts



**Fig. 73** Drivers with properly worn seat belts will not be thrown forward in the event of sudden braking.

Properly worn seat belts hold the occupants in the proper position. These also help prevent uncontrolled movements that may result in serious injury and reduce the risk of being thrown out of the vehicle.

Vehicle occupants wearing their seat belts correctly benefit greatly from the ability of the belts to absorb kinetic energy. In addition, the front part of your vehicle and other pas-

sive safety features (such as the airbag system) are designed to absorb the kinetic energy released in a collision. Taken together, all these features reduce the releasing kinetic energy and consequently, the risk of injury. This is why it is so important to fasten seat belts before every trip, even when "just driving around the corner".

Ensure that your passengers wear their seat belts as well. Accident statistics have shown that wearing seat belts is an effective means of substantially reducing the risk of injury and improving the chances of survival when involved in a serious accident. Furthermore, properly worn seat belts improve the protection provided by airbags in the event of an accident. For this reason, wearing a seat belt is required by law in most countries.

Although your vehicle is equipped with airbags, the seat belts must be fastened and worn. The front airbags, for example, are only triggered in some cases of head-on collision. The front airbags will not be triggered during minor frontal or side collisions, rear-end collisions, rollovers or accidents in which the airbag trigger threshold value in the control unit is not exceeded.

Therefore, you should always wear your seat belt and ensure that all vehicle occupants have fastened their seat belts properly before you drive off!

## Safety instructions on using seat belts

- Always wear the seat belt as described in this section.
- Ensure that the seat belts can be fastened at all times and are not damaged.

### ⚠ WARNING

- If seat belts are worn incorrectly or not at all, the risk of severe injuries increases. The optimal protection from seat belts can be achieved only if you use them properly.
- Fasten your seat belt before every trip - even when driving in town. Other vehicle occupants must also wear the seat belts at all times, otherwise they run the risk of being injured.
- The seat belt cannot offer its full protection if the seat belt is not positioned correctly.
- Never allow two passengers (even children) to share the same seat belt.
- Always keep both feet in the footwell in front of your seat as long as the vehicle is in motion.
- Never unbuckle a seat belt while the vehicle is in motion. Risk of fatal injury.
- The seat belt must never be twisted while it is being worn.
- The seat belt should never lie on hard or fragile objects (such as glasses or pens, etc.) because this can cause injuries.

- Do not allow the seat belt to be damaged or jammed, or to rub on any sharp edges.
- Never wear the seat belt under the arm or in any other incorrect position.
- Loose, bulky clothing (such as an overcoat over a jacket) impairs the proper fit and function of the seat belts, reducing their capacity to protect.
- The slot in the seat belt buckle must not be blocked with paper or other objects, as this can prevent the latch plate from engaging securely.
- Never use seat belt clips, fastening rings or similar items to alter the position of the belt webbing.
- Frayed or torn seat belts or damage to the connections, belt retractors or parts of the buckle could cause severe injuries in the event of an accident. Therefore, you must check the condition of all seat belts at regular intervals.
- Seat belts which have been worn in an accident and stretched must be replaced by a specialised workshop. Renewal may be necessary even if there is no apparent damage. The belt anchorage should also be checked.
- Do not attempt to repair a damaged seat belt yourself. The seat belts must not be removed or modified in any way.
- The belts must be kept clean, otherwise the retractors may not work properly.

## Head-on collisions and the laws of physics



**Fig. 74** A driver not wearing a seat belt is thrown forward violently.



**Fig. 75** The unbelted passenger in the rear seat is thrown forward violently, hitting the driver who is wearing a seat belt.

It is easy to explain how the laws of physics work in the case of a head-on collision: when a vehicle starts moving, a type of energy

called “kinetic energy” is created both in the passengers and inside the vehicle.

The amount of “kinetic energy” depends on the speed of the vehicle and the weight of the vehicle and its passengers. The higher the speed and the greater the weight, the more energy there is to be “absorbed” in an accident.

The most significant factor, however, is the speed of the vehicle. If the speed doubles from 25 km/h (15 mph) to 50 km/h (30 mph), for example, the corresponding kinetic energy is multiplied by four.

Because the vehicle occupants in our example are not restrained by seat belts, in the event of crashing against a wall, all of the occupants’ kinetic energy will be absorbed solely by said impact.

Even at speeds of 30 km/h (19 mph) to 50 km/h (30 mph), the forces acting on bodies in a collision can easily exceed one tonne (1000 kg). At greater speed these forces are even higher.

Vehicle occupants not wearing seat belts are not “attached” to the vehicle. In a head-on collision, they will move forward at the same speed their vehicle was travelling just before the impact. This example applies not only to head-on collisions, but to all accidents and collisions.

Even at low speeds the forces acting on the body in a collision are so great that it is not possible to brace oneself with one’s hands. In a frontal collision, unbelted passengers are thrown forward and will make violent contact with the steering wheel, dash panel, windscreen or whatever else is in the way  
» Fig. 74.

It is also important for rear passengers to wear seat belts properly, as they could otherwise be thrown forward violently through the vehicle interior in an accident. Passengers in the rear seats who do not use seat belts endanger not only themselves but also the front occupants » Fig. 75.

## How to properly adjust your seatbelt

### Fastening and unfastening the seat belt

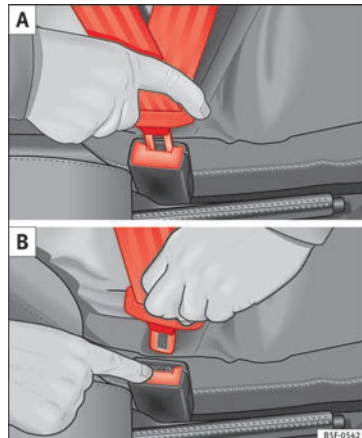

Fig. 76 Positioning and removing the seat belt buckle.



**Fig. 77** Position of seat belt during pregnancy.

### Fasten your seat belt

The seat belt cannot offer its full protection if the seat belt is not positioned correctly.

- Adjust the seat and head restraint correctly.
- To fasten the belt, take hold of the latch plate and pull it slowly across your chest and lap.
- Insert the latch plate into the buckle for the appropriate seat and push it down until it is securely locked with an audible click  
» **Fig. 76.**
- Pull the belt to ensure that the latch plate is securely engaged in the buckle.

The seat belts are equipped with an automatic retractor on the shoulder strap. Full freedom of movement is permitted when the shoulder belt is pulled slowly. However, dur-

ing sudden braking, during travel in steep areas or bends and during acceleration, the automatic retractor on the shoulder belt is locked.

The automatic belt retractors on the front seats are fitted with seat belt tensioners  
» page 60.

### Releasing the seat belt

- Press the red button on the belt buckle  
» **Fig. 76.** The latch plate is released and springs out » .
- Guide the belt back by hand so that it rolls up easily and the trim is not damaged.

### Positioning seat belts

Seat belts offer their maximum protection only when they are properly positioned.

#### WARNING

- The seat belts offer best protection only when the backrests are in an upright position and the seat belts have been fastened properly.
- Never put the latch plate in the buckle of another seat. If you do this, the seat belt will not protect you properly and the risk of injury is increased.
- Never unbuckle a seat belt while the vehicle is in motion. If you do, you increase the risk of sustaining severe or fatal injuries.

- An incorrectly worn seat belt can cause severe injuries in the event of an accident.

- The shoulder part of the seat belt must lie on the centre of the shoulder, never across the neck. The seat belt must lie flat and fit comfortably on the torso

- The lap part of the seat belt must lie across the pelvis, never across the stomach. The seat belt must lie flat and fit comfortably on the pelvis Pull the belt tight if necessary to take up any slack.

- For pregnant women, the lap part of the seat belt must lie as low as possible over the pelvis, never across the stomach, and always lie flat so that no pressure is exerted on the abdomen » **Fig. 77.**

- Always engage the retractor lock when you are securing a child seat in group 0, 0+ or 1  
» page 67.

- Read and observe the warnings » page 58.

## Belt pretensioners\*

### How the seat belt tensioner works

Read the additional information carefully  
»  page 12

The seat belts for the occupants in the front seats are equipped with belt tensioners. Sensors will trigger the belt pretensioners during severe head-on, lateral and rear collisions

only if the seat belt is being worn. This retracts and tightens the seat belts, reducing the forward motion of the occupants.

The belt tensioners will not be triggered in the event of minor collisions, if the vehicle overturns, or in accidents where no major forces act on the vehicle.

#### Note

- If the seat belt tensioners are triggered, a fine dust is produced. This is normal and it is not an indication of fire in the vehicle.
- The relevant safety requirements must be observed when the vehicle or components of the system are scrapped. Specialised workshops are familiar with these regulations, which are also available to you.

### Service and disposal of belt tensioners

The belt tensioners are components of the seat belts that are installed in the seats of your vehicle. If you work on the belt tensioners or remove and install parts of the system when performing other repair work, the seat belt may be damaged. The consequence may be that, in the event of an accident, the belt tensioners function incorrectly or may not function at all.

So that the effectiveness of the seat belt tensioner is not reduced and that removed parts

do not cause any injuries or environmental pollution, regulations, which are known to the specialised workshops, must be observed.

#### WARNING

- **Improper use or repairs not carried out by qualified mechanics increase the risk of severe or fatal injuries. The belt tensioners may fail to trigger or may trigger in the wrong circumstances.**
- **Never attempt to repair, adjust, remove or install parts of the belt tensioners or seat belts.**
- **The seat belt tensioner, seat belt and automatic retractor cannot be repaired.**
- **Any work on the belt tensioners and seat belts, including the removal and refitting of system parts in conjunction with other repair work, must be performed by a specialised workshop only.**
- **The belt tensioners will only provide protection for one accident and must be changed if they have been activated.**

## Airbag system

### Brief introduction

#### Why is it so important to wear a seat belt and to sit correctly?

For the inflating airbags to achieve the best protection, the seat belt must always be worn properly and the correct sitting position must be assumed.

The airbag system is not a substitute for seat belts, but it is an integral part of the vehicle's overall passive safety system. Please bear in mind that the airbag system can only work effectively when the vehicle occupants are wearing their seat belts correctly and have adjusted the head restraints properly. Therefore, it is most important to properly wear the seat belts at all times, not only because this is required by law in most countries, but also for your safety » page 56, **Why wear a seat belt?**

The airbag inflates in a matter of seconds, so if you are not properly seated when the airbag is triggered, you may sustain fatal injuries. Therefore, it is essential that all vehicle occupants assume a correct sitting position while travelling.

Sharp braking before an accident may cause a passenger not wearing a seat belt to be thrown forward into the area of the deploying »

airbag. In this case, the inflating airbag may inflict critical or fatal injuries on the occupant. This also applies to children.

Always maintain the greatest possible distance between yourself and the front airbag. This way, the front airbags can completely deploy when triggered, providing their maximum protection.

The most important factors that will trigger an airbag are: the type of accident, the angle of collision and the speed of the vehicle.

Whether or not the airbags are triggered depends primarily on the vehicle deceleration rate resulting from the collision and detected by the control unit. If the vehicle deceleration occurring during the collision and measured by the control unit remains below the specified reference values, the front, side and/or curtain airbags will not be triggered. Take into account that the visible damage in a vehicle involved in an accident, no matter how serious, is not a determining factor for the airbags to have been triggered.

#### WARNING

- Wearing the seat belt incorrectly or assuming an incorrect sitting position can lead to critical or fatal injuries.
- All vehicle occupants, including children, who are not properly belted can sustain critical or fatal injuries if the airbag is triggered. Children up to 12 years old should always

**travel on the rear seat. Never transport children in the vehicle if they are not restrained or the restraint system is not appropriate for their age, size or weight.**

- If you are not wearing a seat belt, or if you lean forward or to the side while travelling or assume an incorrect sitting position, there is a substantially increased risk of injury. This increased risk of injury will be further increased if you are struck by an inflating airbag.
- To reduce the risk of injury from an inflating airbag, always wear the seat belt properly.
- Always adjust the front seats properly.

#### Description of airbag system

**The airbag system mainly comprises (as per vehicle equipment):**

- an electronic control and monitoring system (control unit)
- frontal airbags for driver and passenger,
- side airbags,
- curtain airbags,
- a control lamp  on the dash panel » page 63.
- key-operated switch for front passenger airbag,
- a control lamp for disabling/enabling the front passenger airbag.

The airbag system operation is monitored electronically. The airbag control lamp will illuminate for a few seconds every time the ignition is switched on (self-diagnosis).

**There is a fault in the system if the control lamp :**

- does not light up when the ignition is switched on » page 63,
- turns off after 4 seconds after the ignition is switched on,
- turns off and then lights up again after the ignition is switched on,
- illuminates or flashes while the vehicle is moving.

**The airbag system is not triggered if:**

- the ignition is switched off
- there is a minor frontal collision
- there is a minor side collision
- there is a rear-end collision
- the vehicle turns over.

#### WARNING

- The seat belts and airbags can only provide maximum protection if the occupants are seated correctly » page 52, Correct position for passengers.
- If a fault has occurred in the airbag system, have the system checked immediately by a specialised workshop. Otherwise, during a



**frontal collision the system might not trigger correctly or may fail to trigger at all.**

### Airbag activation

The airbags deploy extremely rapidly, within thousandths of a second, to provide additional protection in the event of an accident. A fine dust may develop when the airbag deploys. This is normal and it is not an indication of fire in the vehicle.

The airbag system is only ready to function when the ignition is on.

In special accidents instances, several airbags may activate at the same time.

In the event of minor head-on and side collisions, rear-end collisions, overturning or roll-over of the vehicle, airbags **do not activate**.

### Activation factors

The conditions that lead to the airbag system activating in each situation cannot be generalised. Some factors play an important role, such as the properties of the object the vehicle hits (hard/soft), angle of impact, vehicle speed, etc.

Deceleration trajectory is key for airbag activation.

The control unit analyses the collision trajectory and activates the respective restraint system.

If the deceleration rate is below the predefined reference value in the control unit the airbags will not be triggered, even though the accident may cause extensive damage to the car.

### The following airbags are triggered in serious head-on collisions

- Driver airbag.
- Front passenger front airbag

### The following airbags are triggered in serious side-on collisions

- Front side airbag on the side of the accident.
- Rear side airbag on the side of the accident.
- Curtain (head) airbag on the side of the accident.

### In an accident with airbag activation:

- the interior lights switch on (if the interior light switch is in the courtesy light position);
- the hazard warning lights switch on;
- all doors are unlocked;
- the fuel supply to the engine is cut.

### Airbag control lamp and seat belt tensioner

The control lamp monitors all airbags and seat belt tensioners in the vehicle, including control units and wiring connections.

### Monitoring of airbag and belt tensioner system

Both the airbag and belt tensioner systems operation is constantly monitored electronically. The control lamp  will light up for a few seconds every time the ignition is switched on (self-diagnosis).

### The system must be checked when the control lamp :

- does not light up when the ignition is switched on,
- turns off after 4 seconds after the ignition is switched on,
- turns off and then lights up again after the ignition is switched on,
- illuminates or flashes while the vehicle is moving.

In the event of a malfunction, the warning lamp remains on continuously. Have the airbag system inspected immediately by a specialised workshop. **»**

If any of the airbags are disabled by a Technical Service, the warning lamp flashes for several more seconds after verification and will turn off if there is no fault.

#### WARNING

- If there is a malfunction, the airbag and belt tensioner system cannot properly perform its protective function.
- If a malfunction occurs, have the system checked immediately by a specialised workshop. Otherwise, in the event of an accident, the airbag system and belt tensioners may not be triggered, or may not be triggered correctly.

## Airbag safety instructions

### Front airbags

Read the additional information carefully  
»  page 13.

#### WARNING

- The seat belts and airbags can only provide maximum protection if the occupants are seated correctly » page 52, Correct position for passengers.
- The deployment space between the front passengers and the airbags must not in any case be occupied by other passenger, pets and objects.

- The airbags provide protection for just one accident; replace them once they have deployed.
- It is also important not to attach any objects such as cup holders or telephone mountings to the surfaces covering the airbag units.
- Do not attempt to modify components of the airbag system in any way.

### Side airbags\*

Read the additional information carefully  
»  page 14.

#### WARNING

- If you do not wear a seat belt, if you lean forward, or are not seated correctly while the vehicle is in motion, you are at a greater risk of injury if the side airbag system is triggered in an accident.
- In order for the side airbags to provide their maximum protection, the prescribed sitting position must always be maintained with seat belts fastened while travelling.
- Occupants of the outer seats must never carry any objects or pets in the deployment space between them and the airbags, or allow children or other passengers to travel in this position. It is also important not to attach any accessories (such as cup holders) to

the doors. This would impair the protection offered by the side airbags.

- The built-in coat hooks should be used only for lightweight clothing. Do not leave any heavy or sharp-edged objects in the pockets.
- Great forces, such as hard blows or kicks, must not be exerted upon the backrest bolster because the system may be damaged. In this case, the side airbags would not be triggered.
- Under no circumstances should protective covers be fitted over seats with side airbags unless the covers have been approved for use in your vehicle. Because the airbag deploys from the side of the backrest, the use of conventional seat covers would obstruct the side airbag, seriously reducing the airbag's effectiveness.
- Any damage to the original seat upholstery or around the seams of the side airbag units must be repaired immediately by a specialised workshop.
- The airbags provide protection for just one accident; replace them once they have deployed.
- Any work on the side airbag system or removal and installation of the airbag components for other repairs (such as removal of the front seat) should only be performed by a specialised workshop. Otherwise, faults may occur during the airbag system operation.
- Do not attempt to modify components of the airbag system in any way.

- The side and head airbags are managed through sensors located in the interior of the front doors. To ensure the correct operation of the side and curtain (head) airbags neither the doors nor the door panels should be modified in any way (e.g. fitting loudspeakers). If the front door is damaged, the airbag system may not work correctly. All work carried out on the front door must be done in a specialised workshop.
- In a side-on collision the side airbags will not work if the sensors do not correctly measure the pressure increase on the interior of the doors, due to air escaping through the areas with holes or openings in the door panel.
- Never drive if the interior door panels have been removed or if the panels have not been correctly fitted.
- Never drive the vehicle if the loudspeakers in the door panels have been removed, unless the holes left by the loudspeakers have been closed properly.
- Always check that the openings are closed or covered if additional loudspeakers or other equipment are fitted inside the door panels.
- Any work carried out to the doors should be made in an authorised specialised workshop.

### Curtain airbags\*

Read the additional information carefully  
 »  page 15.

### WARNING

The airbag is deployed at high speed in fractions of a second.

- Do not obstruct the head-protection airbag deployment areas.
- Never secure objects over the curtain airbag cover or in its deployment area.
- Occupants of the front seats and rear side seats must never carry any other people, animals or objects in the deployment space between them and the airbags. Make sure that all the vehicle occupants, including children, observe this.
- The clothes hangers are intended only for light articles of clothing. Do not leave any heavy or sharp-edged objects in the pockets.
- Do not mount accessories on the doors.
- Use only sun blinds which have been expressly approved for use in your vehicle.
- Do not turn the sun blinds towards the windows if there are objects, e.g. pens or garage remote controls, secured to them.

## Deactivating airbags

### Deactivation of front passenger front airbag\*



**Fig. 78** In the glove compartment: Switch for activating and deactivating the front passenger airbag



**Fig. 79** Centre side of dash panel: control lamp for deactivated front passenger airbag in centre console.



### Read the additional information carefully

»»  page 14

If you fit a rear-facing child seat to the front passenger seat, the front passenger front airbag must be de-activated.

When the front passenger airbag is **deactivated**, this means that only the front passenger front airbag is deactivated. All the other airbags in the vehicle remain activated.

### Activating the front passenger front airbag

- Switch the ignition off.
- Open the glove compartment on the front passenger side.
- Insert the key into the slot of the switch for deactivating the front passenger airbag  
»» **Fig. 78**. About 3/4 of the key should enter, as far as it will go.
- Then turn the key gently to the **ON** position. Do not force it if you feel resistance, and make sure you have inserted the key fully.
- When the ignition is switched on, check whether the control lamp **PASSENGER AIR BAG OFF**  on the dash panel does  
»» **Fig. 79** not light up  
»» .

### WARNING

- It is the driver's responsibility to ensure that the key-operated switch is set to the correct position.

- You should deactivate the front passenger front airbag only if you have to use a rear-facing child seat in exceptional cases  
»» page 67, Transporting children safely.
- Never install a child seat facing backwards on the front passenger seat unless the front passenger front airbag has been disabled. Otherwise, there is a risk of death.
- As soon as the child seat is no longer needed on the front passenger seat, enable the front passenger front airbag again.
- Only deactivate the front passenger front airbag when the ignition is off, otherwise a fault may occur in the airbag system, which could cause the airbag to not deploy properly or not deploy at all in case of an accident.
- Never leave the key in the airbag disabling switch as it could get damaged or enable or disable the airbag during driving.
- When the passenger airbag is deactivated, if the control lamp **PASSENGER AIR BAG OFF**  is not continuously lit up when the front passenger airbag is disabled, there may be a fault in the airbag system:
  - Have the airbag system inspected immediately by a specialised workshop.
  - Do not use a child seat on the front passenger seat! The front passenger front airbag could be triggered in the event of an accident, even if there is a fault in the system and, as a result, a child could sustain serious or fatal injuries.
  - It is unpredictable whether the front passenger airbag will deploy in the event of

an accident. Warn all your passengers of this.

## Transporting children safely

### Safety for children

#### Introduction

For safety reasons, as we have learned from accident statistics, we recommend that children under 12 years of age travel in the rear seats. Depending on their age, height and weight, children travelling in rear seats must use a child seat or a seat belt. For safety reasons, the child seat should be installed in the rear seat, behind the front passenger seat or in the centre back seat.

The physical laws involved and the forces acting in a collision apply also to children » page 58. But unlike adults, children do not have fully developed muscle and bone structures. This means that children are subject to a greater risk of injury.

To reduce the risk of injuries, children must always use special child restraint systems when travelling in the vehicle.

We recommend the use of child safety products from the SEAT Original Accessories Programme, which includes systems for all ages made by “Peke” (not for all countries).

These systems have been especially designed and approved, complying with the ECE-R44. regulation.

Follow the manufacturer's instructions and observe any statutory requirements when installing and using child seats. Always read and note » page 67.

We recommend you always carry the manufacturer's Child Seat Instruction Manual together with the on-board documentation.

#### Important information regarding the front passenger's airbag

Read the additional information carefully »  page 15.

Read and always observe the safety information included in the following chapters:

- Safety distance with respect to the passenger airbag » page 61.
- Objects between the passenger and the passenger side airbag »  **Δ** in Front airbags on page 64.

The passenger side front airbag, when enabled, is a serious risk for a child that is facing backward since the airbag can strike the seat with such force that it can cause serious or fatal injuries. Children up to 12 years old should always travel on the rear seat.

Therefore we strongly recommend you to transport children on the rear seats. This is the safest location in the vehicle. Alternatively, the front passenger airbag can be dis-

abled with a key-operated switch » page 65. When transporting children, use a child seat appropriate to the age and size of each child.

#### WARNING

- If a child seat is secured to the front passenger seat, the risk to the child of sustaining critical or fatal injuries in the event of an accident increases.
- An inflating front passenger airbag can strike the rear-facing child seat and project it with great force against the door, the roof or the backrest.
- Never install a child seat facing backwards on the front passenger seat unless the front passenger front airbag has been disabled. Risk of potentially fatal injuries to the child! However, if it is necessary, in exceptional cases, to transport a child in the front passenger seat, the front passenger front airbag must always be disabled » page 65, Deactivation of front passenger front airbag\*. If the front passenger seat has a height adjustment option, move it to the highest position.
- For those vehicles that do not include a key lock switch to deactivate the airbag, the vehicle must be taken to a technical service.
- All vehicle occupants, especially children, must assume the proper sitting position and be properly belted in while travelling.
- Never hold children or babies on your lap, this can result in potentially fatal injuries to the child!

»

- Never allow a child to be transported in a vehicle without being properly secured, or to stand up or kneel on a seat while travelling. In an accident, the child could be flung through the vehicle, causing possibly fatal injuries to themselves and to the other vehicle occupants.

- If children assume an improper sitting position when the vehicle is moving, they expose themselves to greater risk of injury in the event of a sudden braking manoeuvre or in an accident. This is particularly important if the child is travelling on the front passenger seat and the airbag system is triggered in an accident; as this could cause serious injury or even death.

- A suitable child seat can protect your child!
- Never leave a child alone in the child seat or inside the vehicle because depending on the season, very high temperatures may be reached inside a parked vehicle, which could be fatal.

- Children who are less than 1.5 metres tall must not wear a normal seat belt without a child seat, as this could cause injuries to the abdominal and neck areas during a sudden braking manoeuvre or in an accident.

- Do not allow the seat belt to become twisted and the seat belt should be properly in place »» page 56.

- Only one child may occupy a child seat »» page 68, Child seats.

- When a child seat is mounted in the rear seats, the door child-proof lock should be activated »» page 101.

## Child seats

### Safety instructions

Read the additional information carefully »»  page 15.

#### WARNING

When travelling, children must be secured in the vehicle with a restraint system suitable for age, weight and size.

- Read and always observe information and warnings concerning the use of child seats »» page 67.

#### WARNING

The retaining rings are designed only for use with "ISOFIX" and Top Tether\* system child seats.

- Never secure other child seats that do not have the "ISOFIX" or Top Tether\* system, or retaining belts or objects to the fastening rings - this can result in potentially fatal injuries to the child.
- Ensure that the child seat is secured correctly using the "ISOFIX" and Top Tether\* securing rings.

#### WARNING

An undue installation of the safety seat will increase the risk of injury in the event of a crash.

- Never tie the retainer strap to a hook in the luggage compartment.
- Never secure or tie luggage or other items to the lower anchorages (ISOFIX) or the upper ones (Top Tether).

### Categorisation of child seats into groups

Only use child seats that are officially approved and suitable for the child.

Child seats are subject to the regulation ECE-R 44. ECE-R stands for: Economic Commission for Europe Regulation.

The child seats are grouped into 5 categories:

**Group 0:** Up to 10 kg (up to around 9 months)

**Group 0+:** Up to 13 kg (up to around 18 months)

**Group 1:** from 9 to 18 kg (up to approx. 4 years old)

**Group 2:** from 15 to 25 kg (up to approx. 7 years old)

**Group 3:** From 22 to 36 kg (over around 7 years old)

Child seats that have been tested and approved under the ECE R44 standard bear the test mark on the seat (the letter E in a circle with the test number below it).

Follow the manufacturer's instructions and observe any statutory requirements when installing and using child seats.

We recommend you to always include the manufacturer's Child Seat Instruction Manual together with the on-board documentation.

SEAT recommends you use child seats from the **Original Accessories Catalogue**. These child seats have been designed and tested for use in SEAT vehicles. You can find the right child seat for your model and age group at SEAT dealers.

 **WARNING**

**Read and always observe information and warnings concerning the use of child seats**  
»» page 67.

## Emergencies

### Self-help

#### Emergency equipment

##### Emergency warning triangle\*

The use of reflective warning triangles is obligatory in emergencies in some countries. As are the first aid kit and a set of spare light bulbs.

The warning triangle is under the storage compartment which is located under the luggage compartment floor.

##### Note

- The warning triangle is not part of the vehicle's standard equipment.
- The warning triangle should meet legal requirements.

##### First-aid kit and fire extinguisher\*

The first-aid kit can go in the storage compartment which is located under the luggage compartment floor.

The fire extinguisher\* is attached to the luggage compartment carpet with Velcro.

##### Note

- The first-aid kit and the fire extinguisher are not part of the vehicle's standard equipment.
- The first aid kit must comply with legal requirements.
- Observe the expiry date of the contents of the first aid kit. After it has expired you should purchase a new one.
- The fire extinguisher must comply with legal requirements.
- Ensure that the fire extinguisher is fully functional. The fire extinguisher should, therefore, be checked regularly. The sticker on the fire extinguisher will inform you of the next date for checking.
- Before acquiring accessories and emergency equipment see the instructions in "Accessories and spares" » page 165.

#### Vehicle tools

Read the additional information carefully  
»  page 43

Some of the items listed are only provided in certain model versions, or are optional extras.

##### WARNING

- The factory-supplied jack is only designed for changing wheels on this model. On no ac-

count attempt to use it for lifting heavier vehicles or other loads. Risk of injury.

- Use the jack only on a firm, level ground.
- Never start the engine when the vehicle is on the jack. Risk of accident.
- If work is to be carried out underneath the vehicle, this must be secured by suitable means. Otherwise, there is a risk of injury.

##### Note

The jack does not generally require any maintenance. If required, it should be greased using universal type grease.

#### Spare wheel (temporary spare wheel)\*

The temporary spare wheel is stored under the floor panel in the luggage compartment and is attached by a thumbnut.

##### How to use the temporary spare wheel

If you ever have a punctured tyre or loss of pressure, the temporary spare wheel is only intended for temporary use until you reach a workshop. Change it for a duty wheel as soon as possible.

Please note the following restrictions when using the temporary spare wheel. This temporary spare wheel has been specially designed for your vehicle, thus, it cannot be



changed with the temporary spare wheel from another vehicle.

No other type of tyre (normal summer or winter tyre) may be fitted on the compact temporary spare wheel rim.

### Snow chains

For technical reasons, snow chains must not be used on the temporary spare wheel.

If you have a puncture on one of the front wheels when using snow chains, fit the temporary spare wheel in place of one of the rear wheels. Fit the snow chains on the rear wheel that you have removed and replace the punctured front wheel with this wheel.

### Extraction of the spare wheel in vehicles with SEAT SOUND 6 speakers (with *subwoofer*)\*

- Disassemble the *subwoofer's* floor panel (carpet) as follows:
- Pull the carpet upwards to remove it.
- Disconnect the *subwoofer's* speaker cable.
- Turn the securing wheel anti-clockwise.
- Remove the *subwoofer* speaker and the spare wheel.
- When replacing the spare wheel, place the *subwoofer* speaker in the direction indicated by the arrow and with the word "FRONT" facing forward.

- Reconnect the speaker cable and firmly rotate the securing wheel clockwise so that the *subwoofer* system and wheel are firmly in place.

#### WARNING

- After fitting the temporary spare wheel, check the tyre pressures as soon as possible. Failure to do so may cause an accident. The tyre pressures are listed on the inside of the fuel tank flap.
- Do not drive at over 80 km/h (50 mph) when the temporary spare wheel is fitted on the vehicle: risk of accident!
- Avoid heavy acceleration, hard braking and fast cornering: risk of accident!
- Never use more than one temporary spare wheel at the same time, risk of accident.
- No other type of tyre (normal summer or winter tyre) may be fitted on the compact temporary spare wheel rim.

## Tyre repair

### TMS (Tyre Mobility System)\*

Read the additional information carefully  
»  page 42

The Anti-puncture kit\* (Tyre Mobility System) will reliably seal punctures caused by the penetration of a foreign body of up to about

4 mm in diameter. **Do not remove foreign objects, e.g. screws or nails, from the tyre.**

After inserting the sealant residue in the tyre, you must again check the tyre pressure about 10 minutes after starting the engine.

You should only use the tyre mobility set if the vehicle is parked in a safe place, you are familiar with the procedure and you have the necessary tyre mobility set! Otherwise, you should seek professional assistance.

**Do not use the tyre sealant in the following cases:**

- If the wheel rim has been damaged.
- In outside temperatures below -20°C (-4°F).
- In the event of cuts or perforations in the tyre greater than 4 mm.
- If you have been driving with very low pressure or a completely flat tyre.
- If the sealant bottle has passed its use by date.

#### WARNING

Using the tyre mobility system can be dangerous, especially when filling the tyre at the roadside. Please observe the following rules to minimise the risk of injury:

- Stop the vehicle safely as soon as possible. Park it at a safe distance from surrounding traffic to fill the tyre.

»

- Ensure the ground on which you park is flat and solid.
- All passengers and particularly children must keep a safe distance from the work area.
- Turn on the hazard warning lights to warn other road users.
- Use the tyre mobility system only if you are familiar with the necessary procedures. Otherwise, you should seek professional assistance.
- The tyre mobility set is intended for temporary emergency use only until you can reach the nearest specialised workshop.
- Replace the repaired tyre with the tyre mobility set as soon as possible.
- The sealant is a health hazard and must be cleaned immediately if it comes into contact with the skin.
- Always keep the tyre mobility set out of the reach of small children.
- Never use a jack, even if it has been approved for your vehicle.
- Always stop the engine, apply the hand-brake lever firmly and engage gear if using a manual gearbox, in order to reduce the risk of vehicle involuntary movement.

### **⚠ WARNING**

A tyre filled with sealant does not have the same performance properties as a conventional tyre.

- Never drive faster than 80 km/h (50 mph).

- Avoid heavy acceleration, hard braking and fast cornering.
- Drive for only 10 minutes at a maximum speed of 80 km/h (50 mph) and then check the tyre.

 For the sake of the environment

Dispose of used or expired sealant observing any legal requirements.

 Note

- A new bottle of sealant can be purchased at SEAT dealerships.
- Take into account the separate instruction manual of the tyre mobility set\* manufacturer.

### Contents of the tyre mobility system\*

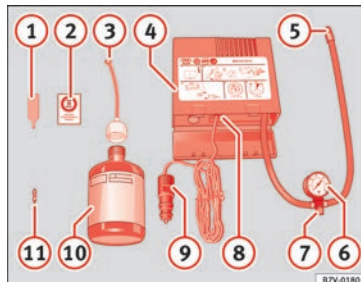

**Fig. 80** Standard representation: contents of the anti-puncture kit.

The anti-puncture kit is located underneath the floor covering in the luggage compartment. It includes the following components

» **Fig. 80:**

- ① Tyre valve remover
- ② Sticker indicating maximum speed “max. 80 km/h” or “max. 50 mph”
- ③ Filler tube with cap
- ④ Air compressor
- ⑤ Tube for inflating tyres
- ⑥ Warning provided by tyre pressure monitoring system (it can also be integrated in the compressor).

- 7 Air bleed screw (in its place, the compressor may have a button).
- 8 ON/OFF switch
- 9 12 volt connector
- 10 Bottle of sealant
- 11 Spare tyre valve

The **valve insert remover** 1 has a gap at the lower end for a valve insert. The valve insert can only be screwed or unscrewed in this way. This also applies to its replacement part 11.

#### WARNING

**When inflating the wheel, the air compressor and the inflator tube may become hot.**

- Protect hands and skin from hot parts.
- Do not place the hot flexible inflator tube or hot air compressor on flammable material.
- Allow them to cool before storing the device.
- If it is not possible to inflate the tyre to at least 2.0 bars (29 psi / 200 kPa), the tyre is too badly damaged. The sealant is not in a good condition to seal the tyre. Do not continue driving. Seek specialist assistance.

#### CAUTION

Switch off the air compressor after a maximum of 8 operational minutes to avoid overheating! Before switching on the air compressor again, let it cool for several minutes.

### Check after 10 minutes of driving

Screw in the inflator tube » Fig. 80 5 again and check the pressure on the gauge 6.

#### 1.3 bar (19 psi / 130 kPa) and lower:

- **Stop the vehicle!** The tyre cannot be sealed sufficiently with the tyre mobility set.
- You should obtain professional assistance » .

#### 1.4 bar (20 psi / 140 kPa) and higher:

- Set the tyre pressure to the correct value again.
- Carefully resume your journey, without exceeding 80 km/h (50 mph), until you reach the nearest specialised workshop and replace the tyre.

#### WARNING

**Driving with an unsealed tyre is dangerous and can cause accidents and serious injury.**

- Do not continue driving if the tyre pressure is 1.3 bar (19 psi / 130 kPa) and lower.
- Seek specialist assistance.

## Changing the windscreen wiper blades

### Changing the windscreen and rear window wiper blades

#### Read the additional information carefully

»  page 49.

Perfect wiper blade condition is essential for clear vision. Damaged wiper blades should be replaced immediately.

The windscreen wiper blades are supplied as standard with a layer of graphite. This layer is responsible for ensuring that the wipe is silent. If the graphite layer is damaged, the noise of the water as it is wiped across the windscreen will be louder.

Check the condition of the wiper blades regularly. **If the wipers scrape across the glass**, they should be changed if they are damaged, or cleaned if they are dirty » .

If this does not produce the desired results, the setting angle of the windscreen wiper arms might be incorrect. They should be checked by a specialised workshop and corrected if necessary.

#### WARNING

**Do not drive unless you have good visibility through all windows!** »

- Clean the windscreen wiper blades and all windows regularly.
- The wiper blades should be changed once or twice a year.

#### ⓘ CAUTION

- Damaged or dirty windscreen wipers could scratch the glass.
- Never use fuel, nail varnish remover, paint thinner or similar products to clean the windows. This could damage the windscreen wiper blades.
- Never move any windscreen wiper by hand. This could cause damage.
- To prevent damage to the bonnet and the windscreen wiper arms, the latter should only be lifted off the windscreen when in service position.

#### ⓘ Note

- The windscreen wiper arms can be moved to the service position only when the bonnet is properly closed.
- You can also use the service position, for example, if you want to fix a cover over the windscreen in the winter to keep it clear of ice.

## Towing or tow-starting

### Notes

#### Read the additional information carefully

»  page 46

Please observe the following points if you use a tow rope:

#### Notes for the driver of the towing vehicle

- Move the vehicle slowly until the cable is taut. Then accelerate gradually.
- Begin and change gears cautiously. If you are driving an automatic vehicle, accelerate gently.
- Remember that the brake servo and power steering are not working in the vehicle you are towing. Brake sooner than normal and pressing the pedal gently.

#### Notes for the driver of the towed vehicle

- Ensure that the tow rope remains taut at all times when towing.

#### ⚠ WARNING

If the vehicle has no electrical power, the brake lights, turn signals and all other lights will no longer function. Do not have the vehicle towed away. Failure to follow this instruction could result in an accident.

#### ⚠ WARNING

Vehicle handling and braking capacity change considerably during towing. Please observe the following instructions to minimise the risk of serious accidents and injury:

- As the driver of the vehicle being towed:
  - You should depress the brake much harder as the brake servo does not operate. Pay the utmost attention to avoid crashing into the towing vehicle.
  - More strength is required at the steering wheel as the power steering does not operate when the engine is switched off.
- As the driver of the towing vehicle:
  - Accelerate with particular care and caution.
  - Avoid sudden braking and manoeuvres.
  - Brake earlier than usual and more smoothly.

#### ⓘ CAUTION

When tow-starting, fuel could enter the catalytic converter and damage it.

#### ⓘ Note

- Observe legal requirements when towing or tow-starting.
- Switch on the hazard warning lights of both vehicles. However, observe any regulations to the contrary.

- For technical reasons, vehicles with an automatic gearbox must not be tow-started.
- If there is no lubricant in the gearbox as the result of a fault, you must raise the driven wheels while the vehicle is being towed.
- If the vehicle has to be towed more than 50 km (30 miles), the front wheels should be raised during towing, and towing should be carried out by a qualified person.
- The steering wheel is locked when the vehicle has no electrical power. The vehicle must then be towed with the front wheels raised. Towing should be carried out by a qualified person.
- The towline anchorage should always be kept in the vehicle.

### Towline anchorages



**Fig. 81** Towline anchorage at the front of the vehicle

### Read the additional information carefully

» page 46

### Fitting the front towline anchorage

- Take the towline anchorage from the on-board tool set.
- Remove the front cover by pressing down on its left-hand side.
- Bolt the anchorage to its limit to the *left*, in the direction of the arrow » **Fig. 81**.

### Rear towline anchorage

There is a towline anchorage at the rear on the right below the rear bumper.

## Fuses and bulbs

### Fuses

#### Introduction

Due to the constant updating of vehicles, fuse assignments based on equipment and the use of the same fuse for various electrical components, it is not possible to provide an up-to-date summary of the fuse positions for the electrical components at the time this manual was printed. For detailed information about the fuse positions, please consult a technical service.

In general, a fuse can be assigned to various electrical components. Likewise, an electrical component can be protected by several fuses.

Only replace fuses when the cause of the problem has been solved. If a newly inserted fuse blows after a short time, you must have the electrical system checked by a specialised workshop as soon as possible.

#### WARNING

The high voltages in the electrical system can give serious electrical shocks, causing burns and even death!

- Never touch the electrical wiring of the ignition system. »

- Take care not to cause short circuits in the electrical system.

### **⚠ WARNING**

Using unsuitable fuses, repairing fuses or bridging a current circuit without fuses can cause a fire and serious injury.

- Never use a fuse with a higher value. Only replace fuses with a fuse of the same amperage (same colour and markings) and size.
- Never repair a fuse.
- Never replace a fuse by a metal strip, staple or similar.

### **ⓘ CAUTION**

• To prevent damage to the vehicle's electric system, before replacing a fuse always turn off the ignition, the lights and all electrical elements and remove the key from the ignition.

- If you replace a fuse with higher-rating fuse, you could cause damage to another part of the electrical system.
- Protect the fuse boxes when open to prevent the entry of dust or humidity as they can damage the electrical system.
- Always carefully remove the fuse box covers and refit them correctly to avoid problems with your vehicle.

### **ⓘ Note**

- One component may have more than one fuse.
- Several components may run on a single fuse.
- In the vehicle, there are more fuses than those indicated in this chapter. These should only be changed by a specialised workshop.
- Positions not containing a fuse do not appear in the following tables.
- Some of the equipment listed in the tables below pertain only to certain versions of the model or are optional extras.
- Please note that the above lists, while correct at the time of printing, are subject to change.

### Fuses to the left of the instrument panel

Read the additional information carefully  
 »  page 40

Only replace fuses with a fuse of the same amperage (same colour and markings) and size.

#### Control box 1

No.	Consumer/Amps	
1	Left lights	40
2	Central locking	40

No.	Consumer/Amps	
3	Power C63 (30 Power)	30
4	PTC Relay (Engine glow)	50
5	Left pillar connector A pin 22 (motor for closing window on driver's side)	30
6	For closing back left window (motor)	30
7	Horn	20
10	Active suspension	7.5
11	Headlight washer system relay	30
12	MIB display	5
13	(RL-15) SIDO Kl.15 supply (inputs 29 and 55)	30
14	Removing ignition key, diagnostics, headlight lever (flashers), switching on dipped /side beams (rotating lights)	7.5
15	Air and heat control (supply)	7.5
16	Instrument panel	5
17	Dwa Sensor, Alarm horn	7.5
23	Dual windscreen cleaner pump	7.5
24	Engine heater, heating control box (supply)	30
26	12V Relay socket	20
27	Rear window wiper motor	15
28	Lighter	20

## Fuses and bulbs

No.	Consumer/Amps	
29	Airbag control unit, airbag deactivation warning lamp	10
30	Reverse, Mirror joysticks, RKA, switching on heated seats, int. pressure A.C, heating A.C. controls (supply), electrochromic mirror, PDC control, switching on front and rear fog lights (rotating lights).	7.5
31	Petrol gauge	5
32	AFS headlights, headlight regulator (signal and adjustment), LWR Cent, diagnostics, front headlight lever (switch on), Dimmer (headlight adjustment)	7.5
33	Start-Stop relay, clutch sensor	5
34	Heated jets	5
35	Soundaktor control feed, GRA feed, Kühlerlüfter central feed	5
36	Heated seats	10
37	Additional diagnostics	10
38	Right hand lights A/66 feed	40
39	ABS Pump (rear battery)	40
41	Heated rear window	30
42	Passenger side window controls	30
43	Rear right window control	30
44	Reversing camera	10

No.	Consumer/Amps	
45	Windscreen wiper feed lever, diagnostics	10
47	ABS Ventil (rear battery)	25
49	EKP TDI relay (fuel pump feed)	30
	EKP MPI relay (fuel pump feed)	20
	TFSI pump gauge control	15
50	Multimedia Radio (power supply)	20
51	Heated mirrors	10
53	Rain sensor	5
54	30 ZAS (ignition switch)	5
55	Heated seats	10

### Fuse arrangement in engine compartment

#### Read the additional information carefully

»  page 40

Only replace fuses with a fuse of the same amperage (same colour and markings) and size.

No.	Consumer/Amps	
1	Fan, condenser	40
	TK8 fan, condenser	50

No.	Consumer/Amps	
2	Glow plugs	50
3	ABS Pump	40
	EMBOX2-13 (TA8)	20
4	PTC glow phase 2	40
5	PTC glow phase 3	40
6	BDM, 30 ReF	5
7	MSG (KL30)	7.5
8	Windscreen wipers	30
10	ABS Ventil	25
	EMBOX2-11 (TA8)	5
11	Vacuum pump motor	20
12	Injectors	10
	TDI fuel metering adjuster, TA8 exhaust temperature sensor	
13	Servo sensor	5
14	Coolant pump high/low temperature, gauge (relay EKP)	10
15	50 controls motor diag	5
16	Starter motor	30
17	Controls motor (MSG KL87)	20
18	PTC Relays, TOG sensor, engine valves, PWM fan	10

»

No.	Consumer/Amps	
19	Lambda probes	15
20	Glow plug relay, Heizrohr	5
	Ignition coil	20
	Pre-wired motor (coolant pump, variable valve distributor, active carbon solenoid valve filter, pressure valve, secondary air inlet valve)	10

## Changing bulbs

### General notes

#### Read the additional information carefully

»  page 41

Before changing any bulb, first turn off the failed device.

Do not touch the glass part of the bulb with your bare hands. The fingerprints left on the glass will vaporise as a result of the heat generated by the bulb, reducing bulb life and causing condensation on the reflector surface, thus reducing effectiveness.

A bulb must only be replaced by one of the same type. The type is indicated on the bulb, either on the glass part or on the base.

### Xenon headlights

With this type of headlight, the user can replace the turn signal bulb. Replacement of the dipped/main beam bulb must be done by Technical Services, given that complex elements must be removed from the vehicle and the automatic control system that incorporates it must be reset.

The Xenon bulbs discharge 2.5 times the light flux and have an average lifespan of 5 times more than that of halogen bulbs, this means that, except due to unusual circumstances, there is no need to change the bulbs for the whole life of the vehicle.

#### WARNING

- Take particular care when working on components in the engine compartment if the engine is warm, there is a risk of burns.
- Bulbs are highly sensitive to pressure. The glass can break when you touch the bulb, causing injury.
- The high voltage element of gas discharge bulbs\* (xenon light) must be handled correctly. Otherwise, there is a risk of death.
- When changing bulbs, please take care not to injure yourself on sharp parts in the headlight housing.

#### CAUTION

- Remove the ignition key before working on the electric system. Otherwise, a short circuit could occur.
- Switch off the lights or parking lights before you change a bulb.

#### For the sake of the environment

Please ask your specialist retailer how to dispose of used bulbs in the proper manner.

#### Note

- Depending on weather conditions (cold or wet), the front lights, the fog lights, the tail lights and the turn signals may be temporarily misted. This has no influence on the useful life of the lighting system. By switching on the lights, the area through which the beam of light is projected will quickly be demisted. However, the edges may continue to be misted.
- Please check at regular intervals that all lighting (especially the exterior lighting) on your vehicle is functioning properly. This is not only in the interest of your own safety, but also that of all other road users.
- Before changing a bulb, make sure you have the correct new bulb.
- Do not touch the glass part of the bulb with your bare hands, use a cloth or paper towel instead. The residue left by the fingerprints



would vaporise as a result of the heat generated by the bulb, they will be deposited on the reflector and will impair its surface.

## Single headlight bulb change

### Position of the bulbs

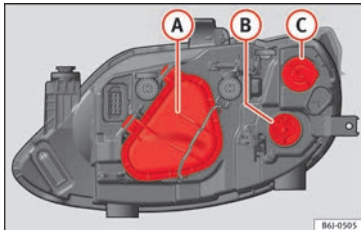

Fig. 82 Single headlight.

- Ⓐ Side lights - Dipped beam/main beam.
- Ⓑ Turn signal light.
- Ⓒ DRL (day light)

### Turn signal and DRL (day light) light

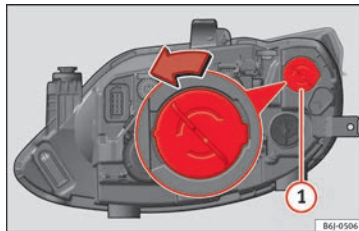

Fig. 83 Single headlight DRL light (day light).

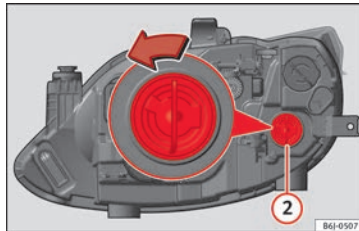

Fig. 84 Single turn signal lamp.

- Raise the bonnet.
- Turn the bulb holder » Fig. 83 ① or » Fig. 84 ② to the left and pull.
- Remove the bulb by pressing on the bulb holder and turning it anti-clockwise at the same time.

– Installation involves all of the above steps in reverse sequence.

### Dipped/main beam headlights and side light

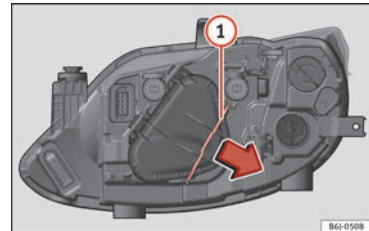

Fig. 85 Single headlight.

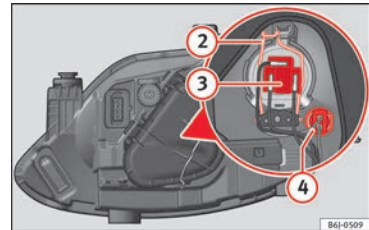

Fig. 86 Dipped beam/main beam and side light of the single headlight.

### Remove the cover

- Raise the bonnet.
- Move the loop » Fig. 85 ① in the direction of the arrow and remove the cover.

### Changing the dipped/main beam headlight

- Remove connector » Fig. 86 ③ from the bulb.
- Unclip the retainer spring » Fig. 86 ② pressing inwards to the right.
- Extract the bulb and fit the replacement so that the lug on the base fits into the recess on the reflector.
- Fit the connector.
- Fit the cover and close the strap. Make sure that the gasket sits well on the casing cover during the operation.
- Check whether the new bulb is working.

### Changing the side light

- Extract the bulb holder » Fig. 86 ④ outwards.
- Remove the bulb by pulling it out and fitting the new one.
- Installation involves all of the above steps in reverse sequence.
- Fit the cover and close the strap. Make sure that the gasket sits well on the casing cover during the operation.

- Check whether the new bulb is working.

## Double headlight bulb change

### Position of the bulbs

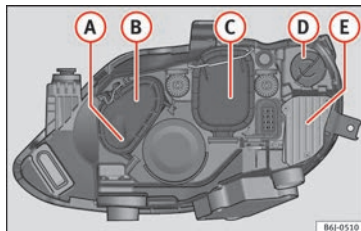

Fig. 87 Double headlight.

- Ⓐ Side lights
- Ⓑ Main beam headlights
- Ⓒ Dipped beam headlights
- Ⓓ Turn signal
- Ⓔ DRL (LED day light)

### Side light and main beam

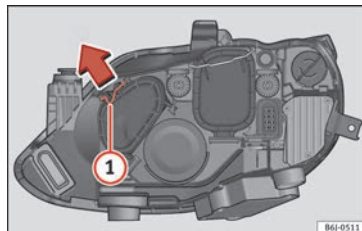

Fig. 88 Double headlight.

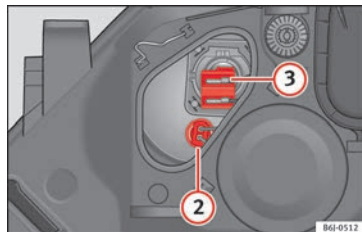

Fig. 89 Side light and main beam headlights.

### Remove the cover

- Raise the bonnet.
- Move the loop ① in the direction of the arrow and remove the cover » Fig. 88.

### Changing the side light

- Remove connector »» Fig. 89 ② by pulling outward.
- Remove the bulb by pulling it out and fitting the new one.
- Installation involves all of the above steps in reverse sequence.
- Fit the cover and close the strap. Make sure that the gasket sits well on the casing cover during the operation.
- Check whether the new bulb is working.

### Changing the main beam bulb

- Remove connector »» Fig. 89 ③ by pulling outward.
- Extract the bulb and fit the replacement so that it sits correctly into the cut-out on the reflector.
- Installation involves all of the above steps in reverse sequence.
- Fit the cover and close the strap. Make sure that the gasket sits well on the casing cover during the operation.
- Check whether the new bulb is working.

### Dipped beam headlight

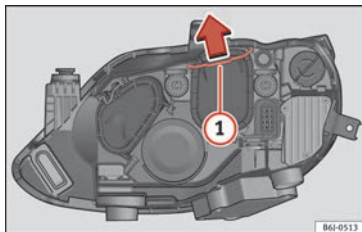

Fig. 90 Double headlight.

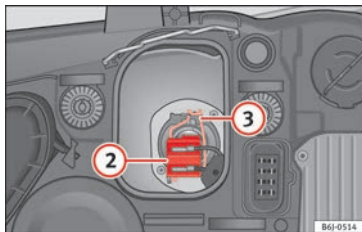

Fig. 91 Dipped beam headlights.

- Raise the bonnet.
- Move the loop »» Fig. 90 ① in the direction of the arrow and remove the cover.
- Remove connector »» Fig. 91 ② from the bulb.

- Unclip the retainer spring »» Fig. 91 ③ pressing inwards to the right.
- Extract the bulb and fit the replacement so that the lug on the base fits into the recess on the reflector.
- Fit the connector.
- Fit the cover and close the strap. Make sure that the gasket sits well on the casing cover during the operation.
- Check whether the new bulb is working.

### Turn signal light

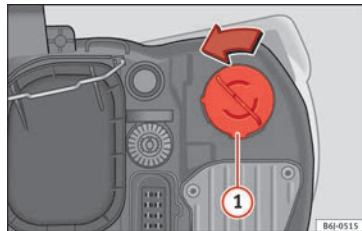

Fig. 92 Turn signal light.

- Raise the bonnet.
- Turn the bulb holder »» Fig. 92 ① to the left and pull. »»

- Remove the bulb by pressing on the bulb holder and turning it anti-clockwise at the same time.
- Installation involves all of the above steps in reverse sequence.

## Changing the AFS headlight bulbs

### Position of the bulbs

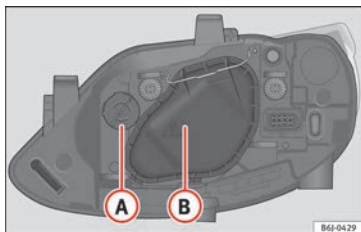

Fig. 93 AFS headlight bulbs.

- A** Turn signal
- B** Xenon headlight (dipped beam/main beam)

## Changing the xenon bulb

The procedure for changing the bulb is the same on both sides of the vehicle.

### ⚠ WARNING

This type of bulb should be changed at a specialised workshop.

## Turn signal bulb

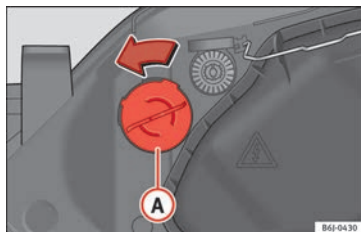

Fig. 94 Turn signal light.

- Raise the bonnet.
- Turn bulb holder»» Fig. 94 **A** to the left and pull.
- Remove the bulb by pressing on the bulb holder and turning it anti-clockwise at the same time.
- Installation involves all of the above steps in reverse sequence.

## Changing the fog light bulbs

### Front fog light bulb

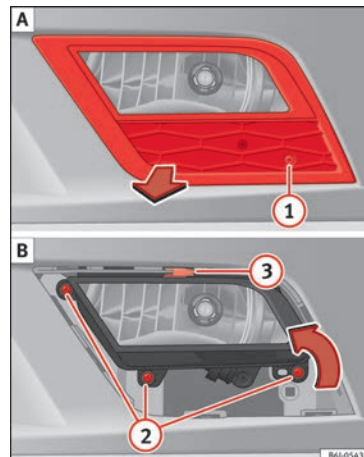
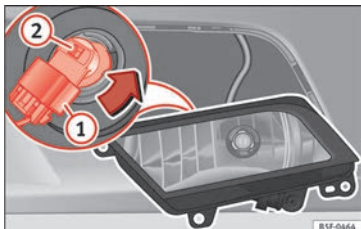

Fig. 95 Fog light: extracting the grille.



**Fig. 96** Fog light: Remove the bulb holder.

- Remove the bolt » **Fig. 95** ① from the fog light grille with a screwdriver.
- Subsequently, remove the clips located on the edge of the grill with gentle leverage.
- Remove the 3 bolts ②.
- Remove the metal clip situated on the upper part of the fog light by pulling away from the vehicle ③ and extract the fog light.
- Remove connector » **Fig. 96** ① from the bulb.
- Turn the bulb holder » **Fig. 96** ② to the left and pull.
- Remove the bulb by pressing on the bulb holder and turning it counter-clockwise at the same time.
- Installation involves all of the above steps in reverse sequence.

– Check that the bulb works properly.

## Changing the tail light bulbs

### Summary of LED tail lights

#### LED

- Brake lights
- Side lights

#### Bulbs

- Retro fog light
- Reverse lights
- Turn signal

### Access to tail lights

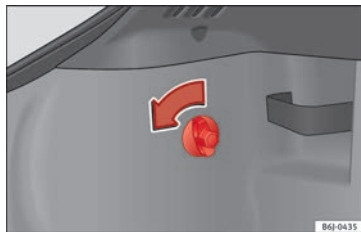

**Fig. 97** Access to tail lights.

- Open the rear lid.
- Turn the bolt in the direction of the arrow, by hand or with a screwdriver » **Fig. 97**.
- Remove the tail light, by pulling it outwards.

## Changing the tail light bulbs

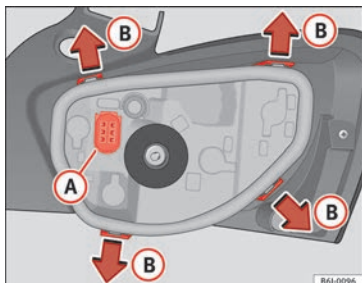

Fig. 98 Changing the tail light bulbs

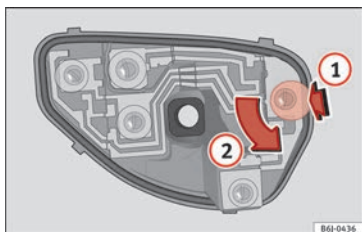

Fig. 99 Changing the tail light bulbs

- Remove the connector from housing (A) » Fig. 97.
- Remove the bulb holder, separating it from the casing. To do this, press tabs (B) in the direction of the arrows » Fig. 98.

- When the bulb holder has been removed, press in the direction of the arrow (1) and at the same time, turn in the direction of the arrow (2) » Fig. 99

### Changing bulbs. LED lamps

Carry out the same operations as in lights fitted with bulbs.

If necessary, remove the socket, as if it were a bulb.

If the brake light and/or side light with LEDs have to be replaced, the tail light must be replaced.

## Changing the side and interior bulbs

### Turn signals

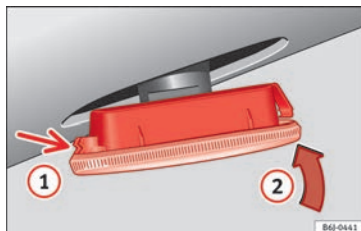

Fig. 100 Turn signals.

- Press the turn signal to the left or to the right to remove the bulb.
- Remove the bulb holder from the turn signal.
- Remove the failed bulb and replace with a new bulb.
- Insert the bulb holder in the turn signal guide until it clicks into place.
- First fit the turn signal in the opening in the chassis, fastening the tabs (1) » Fig. 100, and then fit in the bulb as shown by the arrow (2) » Fig. 100.

### Number plate light

- Insert the flat part of a screwdriver into the special slot and remove the bulb.
- Remove the bulb holder, by turning it until it is free.
- Change the bulb.
- Replace the bulb holder, by turning it until it fits fully.
- Fit the light into the space and press until you hear a “click”.

### Additional brake light\*

Given the difficulty involved in the replacement of this light it should be done by Technical Services.

### Interior light and front reading lights

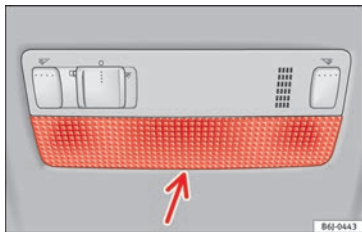

Fig. 101 Front reading light.

#### To remove the glass

- Insert a fine screwdriver between the casing and the glass » Fig. 101.
- Carefully remove the glass, levering it to avoid possible damage.

#### To replace the bulbs

- Pull the bulbs outwards.
- To remove the central bulb, hold and press to one side.

### Assembly

- Proceed in the reverse order, pressing gently on the outer edge of the side light.
- First fit the glass with the fastening tabs over the frame of the switch. Next press the front part until the two long tabs click on the support.

### Luggage compartment light\*

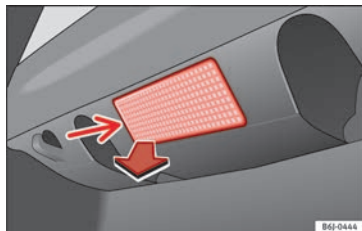

Fig. 102 Boot light.

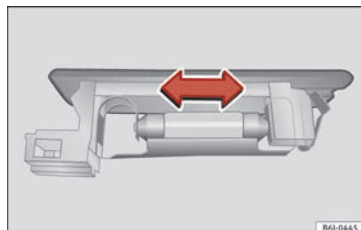
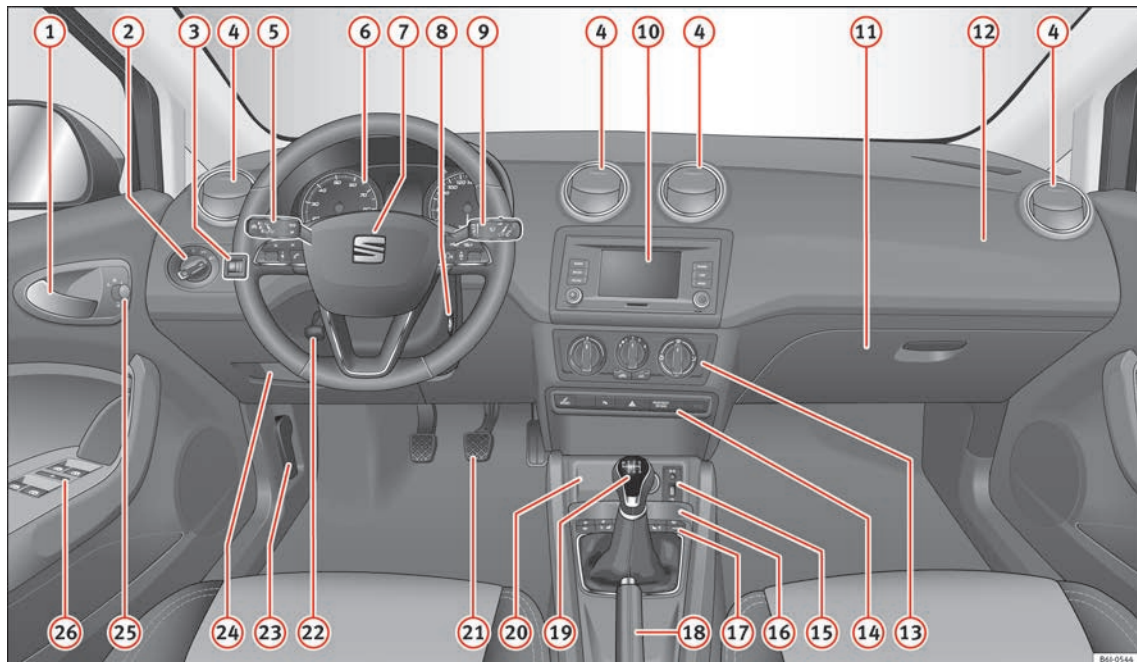

Fig. 103 Boot light.

- Extract the bulb by pressing on its inside edge -arrow- using the flat side of a screwdriver » Fig. 102.
- Press the bulb sideways and remove it from its housing » Fig. 103.



**Fig. 104** Dash panel.

86J-0544



# Operation

## Controls and displays

### General instrument panel

1	Door release lever	
2	Light switch	108
3	Headlight range control*	112
4	Air vents	
5	Lever for:	
	– Turn signals/main beam head-lights	110
	– Cruise control*	159
6	Instrument panel and warning lamps:	
	– Instruments	88
	– Warning and indication lamps	33
7	Steering wheel with horn and	
	– Driver airbag	61
	– On-board computer controls	25
	– Controls for radio, telephone, navigation and speech dialogue system » <b>Booklet Radio</b>	

8	Steering and starter lock	135
9	Lever for:	
	– Windscreen wipers and washer	114
	– Window washer-wiper system*	114
	– Multi-function display control*	25
10	Infotainment system:	
11	Depending on the equipment, glove compartment with:	121
	– CD player* and/or SD card* » <b>Booklet Radio</b>	
12	Passenger airbag*	13
13	Switches for:	
	– Heating and ventilation	129
	– Air conditioning*	131
14	Depending on the equipment, buttons for:	
	– Park assist system	155
	– Hazard warning lights	112
	– Airbag off warning lamp*	63, 65
15	Depending on the equipment:	
	– USB/AUX-IN input	97
	– Cigarette lighter/Power socket	123
16	Drink holder/Ashtray	122

17	Controls in the centre console:	
	– Start-Stop operation button	152
	– Tyre pressure monitoring*	191
	– Heated rear window	114
	– Heated seats*	119
	– Central locking*	100
18	Handbrake lever	137
19	Gear lever	
	– Manual	145
20	Storage space	
21	Pedals	56
22	Steering column control lever*	13
23	Bonnet release lever	177
24	Fuse housing	75
25	Control for adjusting electric exterior mirrors*	117
26	Electric window controls*	106

**Note**

Some of the items of equipment listed here are fitted only on certain model versions or are optional extras.

## Instruments and warning/control lamps

### Instruments

#### General instrument panel

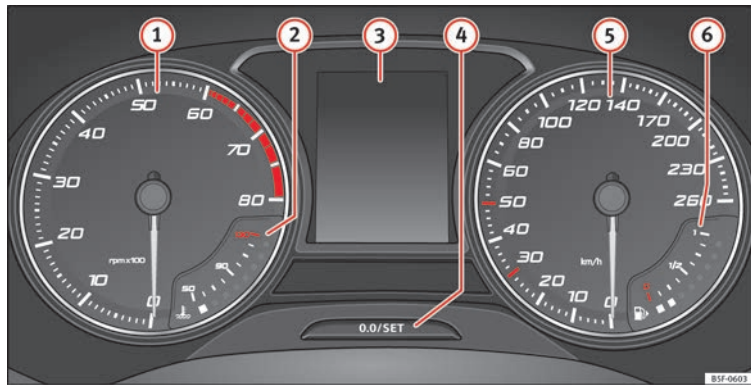

Fig. 105 Instrument panel, on dash panel.

The layout of the instruments depends upon the model and the engine.

- ① **Rev counter** (with the engine running, in hundreds of revolutions per minute) » page 89.

The beginning of the red zone of the rev counter indicates the maximum speed in any gear after running-in and with the engine hot. However, it is advisable to

change up a gear or lift your foot off the accelerator before the needle reaches the red zone » ①.

- ② **Engine coolant temperature display** » page 91.
- ③ **Displays on the screen** » page 89.
- ④ **Adjuster button and display** » page 90.

- ⑤ **Speedometer.**
- ⑥ **Fuel gauge** » page 91.

#### **⚠ WARNING**

Any distraction may lead to an accident, with the risk of injury.

- Do not operate the instrument panel controls when driving.

**ⓘ CAUTION**

- When the engine is cold, avoid high revs and heavy acceleration and do not make the engine work hard.

**Rev counter**

The rev counter indicates the number of engine revolutions per minute » **Fig. 105 ①**.

Together with the gear-change indicator, the rev counter offers you the possibility of using the engine of your vehicle at a suitable speed.

The start of the red zone on the dial indicates the maximum engine speed which may be used briefly when the engine is warm and after it has been run in properly. Before reaching this range, you should change to a higher gear for vehicles with a manual gearbox or for automatic gearboxes put the selector lever in “D” or take your foot off the accelerator pedal.

We recommend that you avoid high revs and that you follow the recommendations on the gear-change indicator. Consult the additional information in » **📖 page 27, Gear-change indicator.**

**ⓘ CAUTION**

Never allow the rev counter needle **①** » **Fig. 105** to go into the red zone on the scale for more than a very brief period, otherwise there is a risk of engine damage.

**🌱 For the sake of the environment**

**Changing up a gear early will help you to save fuel and minimise emissions and engine noise.**

**Indications on the display**

A variety of information can be viewed on the instrument panel display » **Fig. 105 ③** depending on the vehicle equipment:

- Bonnet, rear lid and doors open » **📖 page 27.**
- Information and warning texts.
- Mileage.
- Time.
- Outside temperature.
- Compass.
- Recommended gear » **📖 page 27.**
- Multifunction display (MFD) and menus with different setting options » **📖 page 25.**
- Service interval display » **📖 page 31.**
- Second speed display » **📖 page 25.**

- Speed warning function » **📖 page 30.**
- Start-Stop system status display » **page 152.**
- Identifying letters on engine (MKB).

**Distance travelled**

The *odometer* registers the total distance travelled by the car.

The *odometer (trip)* shows the distance travelled since the last odometer reset. The last digit of the trip recorder indicates distances of 100 metres or one tenths of a mile.

- Briefly press the button » **Fig. 105 ④** to reset the trip recorder to 0.
- Keep the button **④** pressed for about 3 seconds and the previous value will be displayed.

**Time**

- To set the time, keep the button » **Fig. 105 ④** pressed for more than 3 seconds to select the hour or minute display.
- To continue setting the time, press the upper or lower part of the button **④**. Hold button down to scroll through the numbers quickly.
- Press the button **④** again in order to finish setting the time. **»**

The time can also be set via the **(CAR)** key and **(Setup)** function button in the Easy Connect system »» page 93.

### Recommended gear

The recommended gear in order to save fuel is displayed on the instrument panel while you are driving »»  page 27.

### Second speed display (mph or km/h)

In addition to the speedometer, the speed can also be displayed in a different unit of measurement (in miles or in km per hour).

This option cannot be deactivated in models destined for countries in which the second speed must always be visible.

The second speed display can be adjusted in the Easy Connect system via the **(CAR)** key and the **(Setup)** function button »» page 93.

### Speed warning

When the speed setting is exceeded, this will be indicated on the instrument panel display. This is very useful, for example when using winter tyres that are not designed for driving at the maximum speed of the vehicle »»  page 30.

The speed warning settings can be adjusted in the Easy Connect system via the **(CAR)** key and the **(Setup)** function button »» page 93.

### Start-Stop operating display

Updated information relating to the status is displayed on the instrument panel »» page 152.

### Identifying letters on engine (MKB)

Hold the button »» **Fig. 105**  down for more than 15 seconds to display the identifying letters of the vehicle engine (MKB). To do this, the ignition must be switched on and the engine switched off.

#### WARNING

Observe the safety warnings »»  in Warning symbols on page 92.

#### WARNING

Even though outside temperatures are above freezing, some roads and bridges may be icy.

- At outside temperatures above +4°C (+39°F), even when the “ice crystal symbol” is not visible, there may still be patches of ice on the road.
- Do not rely on the outside temperature indicator!

#### Note

• Different versions of the instrument panel are available and therefore the versions and instructions on the display may vary. In the case of displays without warning or informa-

tion texts, faults are indicated exclusively by the warning lamps.

- Depending on the equipment, some settings and instructions can also be carried out in the Easy Connect system.
- When several warnings are active at the same time, the symbols are shown successively for a few seconds and will stay on until the fault is rectified.

### Odometer



**Fig. 106** Instrument panel: odometer and reset button.

The distance covered is displayed in “kilometres” or miles “m”. It is possible to change the measurement units (kilometres “km”/miles “m”) in the radio/Easy Connect\*. Please refer to the Easy Connect\* Instructions Manual for more details.

### Odometer/trip recorder

The odometer shows the total distance covered by the vehicle.

The trip recorder shows the distance that has been travelled since it was last reset. It is used to measure short trips. The last digit of the trip recorder indicates distances of 100 metres or tenths of a mile.

The trip recorder can be set to zero by pressing **0.0/SET** » **Fig. 106**.

### Fault display

If there is a fault in the instrument panel, the letters **DEF** will appear in the trip recorder display. Have the fault repaired immediately, as far as is possible.

### Coolant temperature gauge

For vehicles with no coolant temperature gauge, a control lamp **⚡** appears for high coolant temperatures » **page 182**. Please note » **!**.

The coolant temperature gauge **②** » **Fig. 105** only works when the ignition is switched on. In order to avoid engine damage, please read the following notes for the different temperature ranges.

### Engine cold

If only the diodes in the lower part of the scale light up, this indicates that the engine has not yet reached operating temperature. Avoid high revs and heavy acceleration and do not make the engine work hard.

### Normal temperature

If in normal operations, the diodes light up until the central zone, it means that the engine has reached operating temperature. At high outside temperatures and when making the engine work hard, the diodes may continue lighting up and reach the upper zone. This is no cause for concern, provided the control lamp **⚡** does not light up on the instrument panel digital display.

### Heat range

When the diodes light up in the upper area of the display and the control lamp appears **⚡** on the instrument panel display, the coolant temperature is excessive » **page 182**.

#### ⓘ CAUTION

• To ensure a long useful life for the engine, avoid high revs, driving at high speed and making the engine work hard for approximately the first 15 minutes when the engine is cold. The phase until the engine is warm also depends on the outside temperature. If necessary, use the engine oil temperature\* » **📖** page 30 as a guide.

• Additional lights and other accessories in front of the air inlet reduce the cooling effect of the coolant. At high outside temperatures and high engine loads, there is a risk of the engine overheating.

• The front spoiler also ensures proper distribution of the cooling air when the vehicle is moving. If the spoiler is damaged this can reduce the cooling effect, which could cause the engine to overheat. Seek specialist assistance.

### Fuel level

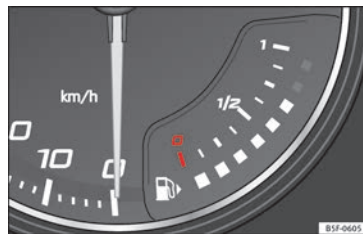

**Fig. 107** Fuel gauge.

The display **⑥** » **Fig. 105** only works when the ignition is switched on. When the display reaches the reserve mark, the lower diode lights up in red and the control lamp **⚡** appears » **page 88**. When the fuel level is very low, the lower diode flashes in red. »

The distance to empty fuel level is displayed on the instrument panel  **Fig. 105**.

You can consult the tank capacity of your vehicle in the  page 36 section.

#### CAUTION

Never run the fuel tank completely dry. An irregular fuel supply could cause misfiring. In this way the unburned fuel can reach the exhaust system, which could cause the catalytic converter to overheat resulting in damage.

## Warning and control lamps

### Warning symbols

Read the additional information carefully  page 33

There are red warning symbols (priority 1) and yellow warning symbols (priority 2).

#### Warning messages, Priority 1 (red)



If one of these faults occurs, the warning lamp will light up or flash and will be accompanied by **three audible warnings**. This is a **danger** warning. Stop the vehicle and switch off the engine. Check the fault and correct it. Obtain professional assistance if necessary.

If several priority 1 faults are detected at the same time, the symbols will be displayed one

after the other for about 2 seconds at a time and will continue until the fault is corrected.

No menus will be shown in the display for the duration of a priority 1 warning message.

#### Examples of priority 1 warning messages (red)

- Brake system symbol  with the warning message **STOP BRAKE FLUID INSTRUCTION MANUAL** or **STOP BRAKE FAULT INSTRUCTION MANUAL**.
- Coolant symbol  with the warning message **STOP SEE COOLANT INSTRUCTION MANUAL**.
- Engine oil pressure symbol  with the warning message **STOP ENGINE OIL PRESSURE LOW! INSTRUCTION MANUAL**.

#### Warning messages, Priority 2 (yellow)

If one of these faults occurs, the corresponding warning lamp lights up and is accompanied by **an audible warning**. Check the corresponding function as soon as possible although the vehicle may be used without risk.

If several priority 2 warning messages are detected at the same time, the symbols are displayed one after the other for about 2 seconds at a time. After a set time, the information text will disappear and the symbol will be shown as a reminder at the side of the display.

**Priority 2** warning messages will not be shown until all **Priority 1** warning messages have been dealt with!

#### Examples of priority 2 warning reports (yellow):\*

- Fuel warning light with the information text **PLEASE REFUEL**.

#### WARNING

If the warning lamps and messages are ignored, the vehicle may stall in traffic, or may cause accidents and severe injuries.

- Never ignore the warning lamps or text messages.
- Stop the vehicle safely as soon as possible.
- Park the vehicle away from traffic and ensure that there are no highly flammable materials under the vehicle that could come into contact with the exhaust system (e.g. dry grass, fuel).
- A faulty vehicle represents a risk of accident for the driver and for other road users. If necessary, switch on the hazard warning lamps and put out the warning triangle to advise other drivers.
- Before opening the bonnet, switch off the engine and allow it to cool.
- In any vehicle, the engine compartment is a hazardous area and could cause severe injuries  page 176.

**ⓘ CAUTION**

Failure to heed the control lamps and text messages when they appear may result in faults in the vehicle.

## Introduction to the Easy Connect system\*

### System settings (CAR)\*

#### CAR menu (Setup)

Read the additional information carefully

»  page 23

To select the settings menus, press the Easy Connect **(CAR)** button and the **(Setup)** function button.

The actual number of menus available and the name of the various options in these menus will depend on the vehicle's electronics and equipment.

Pressing the menu button will always take you to the last menu used.

When the function button check box is activated , the function is active.

Pressing the menu button  will always take you to the last menu used.

Any changes made using the settings menus are automatically saved on closing those menus.

Function buttons in the vehicle settings menu	Page
ESC system	» page 140
Tyres	» page 191
Driver assistance	» table on page 23
Parking and manoeuvring	» page 155
Vehicle lights	» table on page 23
Mirrors and windscreen wipers	» table on page 23
Opening and closing	» table on page 23
Multifunction display	» table on page 23
Date and time	» table on page 23
Units	» table on page 23
Service	» page 89
Factory settings	» table on page 23

#### **WARNING**

**Any distraction may lead to an accident, with the risk of injury. Operating the Easy Connect system while driving could distract you from traffic.**

## Communications and multi-media

### Steering wheel controls\*

#### General information

---

The steering wheel includes multifunction modules from which the audio and telephone functions can be controlled without the driver being distracted.

There are two versions of the multifunction module:

- **Audio system + telephone without voice control version (MID):** for controlling the audio functions available (radio, audio CD, MP3, iPod<sup>®1)</sup>, USB<sup>1)</sup>, SD<sup>1)</sup>) and Bluetooth system from the steering wheel.
- **Audio system + telephone with voice control version (HIGH):** for controlling the audio functions available (radio, audio CD, MP3, iPod<sup>®1)</sup>, USB<sup>1)</sup>, SD<sup>1)</sup>) and Bluetooth system from the steering wheel.

---

<sup>1)</sup> Depending on the vehicle equipment.



## Operating the telephone and audio system without voice control (MID)

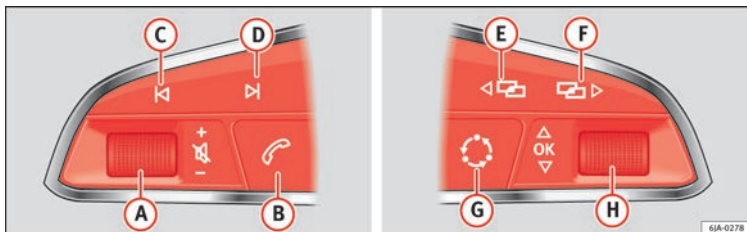

Fig. 108 Controls on the steering wheel.

Button	Radio	Media (except AUX)	AUX	Telephone
A	Turn: Turn volume up/down Press: Mute	Turn: Turn volume up/down Press: Mute	Turn: Turn volume up/down Press: Mute	Turn: Turn volume up/down Press: Mute
B	Short press: access to the telephone menu in the instrument panel <sup>a)</sup> .	Short press: access to the telephone menu in the instrument panel <sup>a)</sup> .	Short press: access to the telephone menu in the instrument panel <sup>a)</sup> .	Short press: answer/hang up calls, enable/open the telephone menu. Hold down: reject an incoming call/switch to private mode/redial <sup>a)</sup> .
C	Search for last station	Short press: switch to the previous song Hold down: quick rewind	No function	No function
D	Search for the next station	Short press: switch to the next song Hold down: fast forward	No function	No function
E, F	Change menu on instrument panel <sup>a)</sup>	Change menu on instrument panel <sup>a)</sup>	Change menu on instrument panel <sup>a)</sup>	Change menu on instrument panel <sup>a)</sup>
G	MID: change source	MID: change source	MID: change source	MID: change source
H	Turn: Next/previous preset <sup>b)</sup> Press: Acts on the MFD	Turn: Next/previous song <sup>b)</sup> Press: Acts on the MFD	Turn: No function Press: Acts on the MFD	Turn: Acts on the MFD Press: Confirm

<sup>a)</sup> According to the vehicle's equipment package.

<sup>b)</sup> Only if the dash panel is in audio menu.

Operating the telephone and audio system with voice control (HIGH)

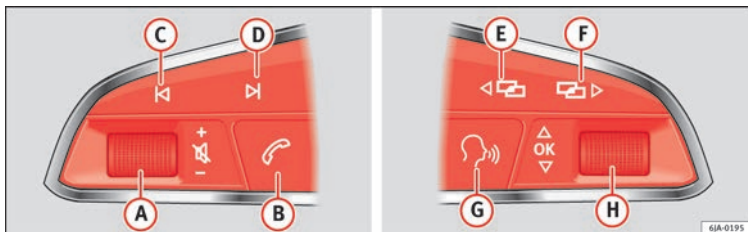



Fig. 109 Controls on the steering wheel.

Button	Radio	Media (except AUX)	AUX	Telephone <sup>a)</sup>
A	Turn: Turn volume up/down Press: Mute	Turn: Turn volume up/down Press: Mute	Turn: Turn volume up/down Press: Mute	Turn: Turn volume up/down Press: Mute
B	Short press: access to the telephone menu on the dash panel <sup>a)</sup> . Hold down: redial <sup>a)</sup>	Short press: access to the telephone menu on the dash panel <sup>a)</sup> . Hold down: redial <sup>a)</sup>	Short press: access to the telephone menu on the dash panel <sup>a)</sup> . Hold down: redial <sup>a)</sup>	Short press: answer/hang up calls, enable/open the telephone menu. Hold down: reject an incoming call/switch to private/redial mode
C	Search for last station	Short press: switch to the previous song Hold down: quick rewind	No function	No function <sup>b)</sup>
D	Search for the next station	Short press: switch to the next song Hold down: fast forward	No function	No function <sup>b)</sup>
E, F	Change menu on instrument panel	Change menu on instrument panel	Change menu on instrument panel	Change menu on instrument panel
G	Enable/disable voice control <sup>a)</sup>	Enable/disable voice control <sup>a)</sup>	Enable/disable voice control <sup>a)</sup>	No function <sup>b)</sup>

Button	Radio	Media (except AUX)	AUX	Telephone <sup>a)</sup>
	Turn: Next/previous preset <sup>c)</sup> Press: Acts on the MFD or confirms the menu option of the dash panel depending on the menu option	Turn: Next/previous song <sup>c)</sup> Press: Acts on the MFD or confirms the menu option of the dash panel depending on the menu option	Turn: Acts upon the dash panel menu depending on where it is located Press: Acts on the MFD or confirms the menu option of the dash panel depending on the menu option	Turn: Acts upon the dash panel menu depending on where it is located Press: Acts on the MFD or confirms the menu option of the dash panel depending on the menu option

- a) According to the vehicle's equipment package.
- b) When a call is being made, radio/media functionality (except AUX).
- c) Only if the dash panel is in audio menu.

## Multimedia

### USB/AUX-IN input



**Fig. 110** USB/AUX-IN input.

Depending on the features and the country, the vehicle may have a USB/AUX-IN connection.

The USB/AUX-IN input is located above the storage compartment in the front centre console » **Fig. 110**.

The operating description is located in the respective Instruction Manuals of the audio system or the navigation system.

## Opening and closing

### Central locking system

#### Description

#### Read the additional information carefully

»  page 9.

The central locking system enables you to lock and unlock all doors and the rear lid by just pushing the button.

Central locking can be activated by using any of the following options:

- **the key**, by inserting it into the driver door cylinder and rotating it in the opening direction. Depending on the vehicle version, either all doors will be unlocked or only the driver door will be unlocked. All doors will be locked on locking the vehicle using the key.
- **the interior central lock button**  
» page 100.
- **the radio frequency remote control**, using the buttons on the key » page 102.

Various functions are available to improve the vehicle safety:

- Locking system “Safe\*\*”
- Selective\* unlocking system
- Self-locking system to prevent involuntary unlocking

- Automatic speed dependent locking and unlocking system\*
- Emergency unlocking system

#### Unlocking the vehicle\*

- Press button  » **Fig. 114** on remote control to unlock all the doors and rear lid.

#### Locking the vehicle\*

- Press button  » **Fig. 114** on the remote control to lock all doors and the rear lid or turn the key in the door to lock all doors and the rear lid.

#### WARNING

- **Locking from the outside carelessly or without good visibility may lead to bruising, particularly in the case of children.**
- **When locking a vehicle, never leave children unaccompanied inside, as from the outside it will be difficult to provide assistance if required.**
- **Having the doors locked prevents intruders from getting in, for example when stopped at a traffic light.**

#### Note

**For anti-theft security, only the driver door is fitted with a lock cylinder.**

#### “Safe” security system\*\*

This is an anti-theft device which consists of a double lock for the door locks and a deactivation function for the boot in order to prevent forced entry.

#### Activation

The “safe” system is activated when the vehicle is locked using the key or the remote control.

To activate it with the key, rotate once it is inserted in the door lock cylinder in the locking direction.

To activate the system using the remote control, press the lock button once  on the remote.

Once this system is activated, opening doors from the outside and the inside is not possible. The rear lid can not be opened. The central lock button does not work.

When the ignition is switched off, the instrument panel display indicates that the “Safe” system is on.

#### Deactivation

Rotate the key inserted in the lock cylinder twice towards the locking direction.

To activate the system using the remote control, press the lock button on the remote twice  in less than five seconds.

On deactivating the “Safe” system, the alarm volumetric sensor is also deactivated.

With the “Safe” switched off, doors can be opened from the interior but not from the exterior.

See “Selective unlocking system\*”

### “Safe” status

On the driver door, there is warning lamp visible from outside the vehicle through the window which shows the “Safe” system status.

We will know that “Safe” system is activated by the flashing warning lamp. The indicator will flash on all vehicles, fitted and not fitted with an alarm, until they unlock.

Remember:

**Safe activated with or without an alarm:** warning lamp flashes continuously.

**Safe deactivated without an alarm:** the warning lamp stays off.

**Safe deactivated with an alarm:** the warning lamp stays off.

### WARNING

No one should remain inside the vehicle if the “Safe” system is activated because opening the doors will not be possible in the event of an emergency neither from the inside nor the outside and help from the outside is made

**difficult. Danger of death. Passengers could become trapped inside in case of emergency.**

### Selective unlocking system\*

This system allows to unlock either just the driver door or all the vehicle.

#### Driver door unlock button

Unlock once. Use either the key or the remote control.

**Once the key** is inserted in the lock cylinder, rotate once in the unlock direction. The driver door will remain without “Safe” and unlocked. In vehicles fitted with an alarm, see the Anti-theft Alarm section » page 103.

**Using the remote control**, press the unlock button on the remote  once. The “Safe” system for all the vehicle is deactivated, only the driver door is unlocked and both the alarm and the warning lamp are also turned off.

#### Unlocking all doors and the luggage compartment

The unlock button on the remote control must be pressed twice  so that all doors and the luggage compartment can be opened.

Press twice within 5 seconds to deactivate the “Safe” system for all vehicle, to unlock all

doors and to use the luggage compartment. The warning lamp and the alarm (only vehicles fitted with one) are turned off.

#### Unlocking the luggage compartment



See »  page 9.

#### Activating the selective unlocking system\*

With the door open, insert a key into the start cylinder and start the ignition. Insert the other key into the driver door lock and turn in the opening direction for at least 3 seconds. The turn signals will flash twice.

#### Deactivating the selective unlocking system\*

With the door open, insert a key into the start cylinder and start the ignition. Insert the other key into the driver door lock and turn in the locking direction for at least 3 seconds. The turn signals will flash once.

You can also activate or deactivate the system in Easy Connect with the  button and the  function button »  page 23.

#### Self-locking system to prevent involuntary unlocking

It is an anti-theft system and prevents the unintentional unlocking of the vehicle. »

If the vehicle is unlocked and none of the doors (including the boot) are opened within 30 seconds, it re-locks automatically.

### Automatic speed-dependent locking and unlocking system\*

This is a safety system which prevents access to the vehicle from the outside when it is running (e.g. when stopped at a traffic light).

#### Locking

The doors will lock automatically if the speed of 15 km/h (9 mph) is exceeded. The rear lid will lock automatically if the speed of 6 km/h (4 mph) is exceeded.

If the vehicle is stopped and any of its doors open, when starting again and exceeding the mentioned speed, all doors will lock again.

#### Unlocking

On withdrawing the ignition key, the vehicle will return to its status prior to self-locking.

Each door can be unlocked and opened independently from the inside (for example, when a passenger gets out). To do it, simply operate the lever inside the door.



#### Activating the system\*

With the ignition on, press the locking key on the central locking system within 3 to 10 seconds.

#### Deactivating the system\*

With the ignition on, press the unlocking key on the central locking system within 3 to 10 seconds.

In both cases, if the operation has been carried out correctly, the locking lamp will flash  **» Fig. 111.**

You can also activate or deactivate the system in Easy Connect with the  button and the  function button **»  page 23.**

#### WARNING

**The door handles must not be operated when the vehicle is running; the door would open.**

#### Note

**If the airbags are triggered during an accident, the vehicle is unlocked, except for the luggage compartment. It is possible to lock the vehicle from inside with the central locking, after turning the ignition off and back on again.**

### Central lock button\*



**Fig. 111** Central lock button.

#### Read the additional information carefully **» page 9**

The central lock button allows you to lock and unlock the vehicle from the inside.

The central lock button also works with the ignition switched off, except when the “safe” system is activated.

Please note the following if you lock your vehicle with the central lock button:



- Locking the doors and rear lid prevents access from the *outside* (for safety reasons, e.g. when stopped at a traffic light).
- The driver door cannot be locked while it is open. This avoids the user from forgetting his key inside the vehicle.

• All doors can be unlocked separately from inside the vehicle. To do so, pull the door release lever *once*.

#### **⚠ WARNING**

- If the vehicle is locked, children and disabled people may be trapped inside it.
- Repeated operation of central locking will prevent the central lock button from working for a few seconds. Then, it can only be unlocked in case it has been previously locked. After few seconds, the central locking becomes operative again.
- The central lock button is not operative when the vehicle is locked from the outside (with the remote control or the key).

#### **i Note**

- Vehicle locked,  button.
- Vehicle unlocked,  button.

### Childproof lock



**Fig. 112** Childproof lock on the left hand side door.

The childproof lock prevents the rear doors from being opened from the inside. This system prevents minors from opening a door accidentally while the vehicle is running.

This function is independent of the vehicle electronic opening and locking systems. It only affects rear doors. It can only be activated and deactivated manually, as described below:

#### Activating the childproof lock

- Unlock the vehicle and open the door in which you wish to activate the childproof lock.
- With the door open, rotate the groove in the door using the ignition key, anti-clockwise for the right-hand side doors and clockwise for the left-hand side doors »» **Fig. 112**

and clockwise for the right-hand side doors.

#### Deactivating the childproof lock

- Unlock the vehicle and open the door whose childproof lock you want to deactivate.
- With the door open, rotate the groove in the door using the ignition key, anti-clockwise for the right-hand side doors, and clockwise for the left-hand side doors »» **Fig. 112**.

Once the childproof lock is activated, the door can only be opened from the outside. The childproof lock can be activated or deactivated by inserting the key in the groove when the door is open, as described above.

## Keys

### Set of keys



Fig. 113 Set of keys.

The set of keys may consist of the following, depending on the version of your vehicle:

- a remote control key » Fig. 113 (A)
- a key without remote control (B),
- a plastic key tab\* (C).

### Duplicate keys

If you need a replacement key, go to a Technical Service with your vehicle identification number.

#### **WARNING**

- An incorrect use of the keys can cause serious injuries.

- Never leave children or disabled persons in the vehicle. In case of emergency, they may not be able to leave the vehicle or manage on their own.

- An uncontrolled use of the key could start the engine or activate any electric equipment (e.g. electric windows), causing risk of accident. The doors can be locked using the remote control key. This could become an obstacle for assistance in an emergency situation.

- Never forget the keys inside the vehicle. An unauthorised use of your vehicle could result in injury, damage or theft. Therefore always take the key with you when you leave the vehicle.

- Never remove the key from the ignition if the vehicle is in motion. Otherwise, the steering could suddenly block and it would be impossible to steer the vehicle.

#### **CAUTION**

There are electronic components in the remote control key. Avoid wetting and hitting the keys.

## Radio frequency remote control\*

### Unlocking and locking the vehicle

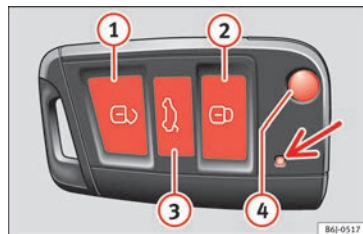

Fig. 114 Assignment of buttons on the remote control key.

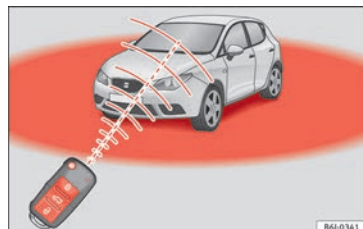

Fig. 115 Range of the radio frequency remote control.







The radio frequency remote control key is used to lock and unlock the vehicle from a distance.

By using button  **Fig. 114** on the control, the key shaft is released.

Unlocking the vehicle  **Fig. 114** .

Locking the vehicle  **Fig. 114** .

Unlocking the rear lid. Press button  **Fig. 114**  until all the turn signals on the vehicle flash briefly. When the unlocking button   is pressed, you have 2 minutes to open the door. Once this time has passed, it will lock again.

Moreover, the battery indicator on the key **Fig. 114** (arrow), will flash.

The remote control transmitter and the batteries are integrated in the key. The receiver is inside the vehicle. The maximum range depends on different factors. The range is reduced as the batteries start to lose power.

#### WARNING

Read and observe the relevant warnings  in Set of keys on page 102.

#### Note

• The radio frequency remote control key functions only when you are within range **Fig. 115**.

• If the vehicle cannot be unlocked or locked by using the radio frequency remote control, the remote control key will have to be resynchronised. For this, go to your technical services.

### Replacing the battery

If the battery indicator does not flash when the buttons are pushed, the battery must be replaced.

#### CAUTION

The use of inappropriate batteries may damage the radio frequency remote control. For this reason, always replace the dead battery with another of the same size and power.



#### For the sake of the environment

Used batteries must be disposed of at an appropriate waste facility or through an authorised service, given that their components can affect the environment.



### Synchronising the remote control key

If it is not possible to unlock or lock the door with the remote control, it should be resynchronised.

#### While the vehicle is open:

- Press the  button  **Fig. 114** on the remote control.
- Then close the vehicle using the key shaft **within one minute**.

#### While the vehicle is closed:

- Press the  button  **Fig. 114** on the remote control.
- Then close the vehicle using the key shaft **within one minute**.

It is possible that the vehicle could no longer be opened and closed with the remote control if the button  is repeatedly pressed outside of the effective range of the radio frequency remote control. The remote control key will have to be resynchronised.

Spare remote control keys are available at your Technical Service, where they must be matched to the locking system.

Up to five remote control keys can be used.

### Anti-theft alarm\*

#### Description of anti-theft alarm system\*

The anti-theft alarm makes it more difficult to break into the vehicle or steal it. The system **»**

will initiate acoustic and optical warning signals when your vehicle is tried to be forced.

The anti-theft alarm system is automatically switched on when locking the vehicle. The system is immediately activated and the turn signal light located on the driver door will flash along with the turn signals, indicating that the alarm and the locking security system (double lock) have been turned on.

If any of the doors or the bonnet are open, they will not be included in the protection zones of the vehicle when the alarm is connected. If the door or the bonnet are subsequently closed, they will be automatically included in the protection areas of the vehicle and the turn signals will flash accordingly when the doors close.

- The turn signal light will flash twice on opening and deactivating the alarm.
- The turn signal light will flash once on closing and activating the alarm.

### When does the system trigger an alarm?

The system triggers an alarm, if the following unauthorised actions are carried out when the vehicle is locked:

- Mechanical opening of the vehicle with the vehicle key without switching on the ignition in the next 15 seconds (in certain markets,

such as the Netherlands, the alarm is activated immediately).

- A door is opened.
- Opening the bonnet.
- The rear lid is opened.
- Ignition switched on with a non-validated key.
- Movements in the driving compartment (vehicles with a volume sensor).
- Towing of the vehicle<sup>1)</sup>.
- Vehicle tilt angle<sup>1)</sup>.
- Undue manipulation of the alarm.
- Battery handling.

In this case, the acoustic signals will go off and the turn signal will flash for approximately 30 seconds. This cycle may be repeated up to 10 times depending on the country.

### Opening all the doors in manual mode

In vehicles without an alarm, when opening the driver door manually, all doors are opened.

### How to switch the alarm off

To deactivate the anti-theft alarm, turn the key in the opening direction, open the door

and switch the ignition on, or press the unlock button  on the remote control.

In vehicles equipped with an anti-theft alarm system, you have 15 seconds to insert the key in the ignition lock and activate the ignition if the vehicle is opened using the driver door key.

Otherwise, the alarm will trigger for 30 sec. and the ignition will be blocked.

### Note

- **After 28 days, the indicator light will be switched off to prevent the battery from draining if the vehicle has been left parked for a long period of time. The alarm system remains activated.**
- **The alarm will trigger again if attempts are made to open another protection zone.**
- **The alarm system can be activated or deactivated using the radio frequency remote control » page 102.**
- **The anti-theft alarm is not activated when the vehicle is locked from within using the central locking button .**
- **If the vehicle battery is run down or flat then the anti-theft alarm will not operate correctly.**
- **Vehicle monitoring remains active even if the battery is disconnected or not working for any reason.**

<sup>1)</sup> With vehicles fitted with a tow-away protection

- The alarm is triggered immediately if one of the battery cables is disconnected while the alarm system is active.



### Vehicle interior monitoring and anti-tow system\*

Monitoring or control function incorporated in the anti-theft alarm\* which detects unauthorised vehicle entry by means of ultrasound.

#### Activation

- It is automatically switched on when the anti-theft alarm is activated.

#### Deactivation

- Open the vehicle with the key, either mechanically or by pressing the  button on the remote control. The time period from when the door is opened until the key is inserted into the contact should not exceed 15 seconds, otherwise the alarm will be triggered.
- Press the button  on the remote control twice. The volumetric sensor and tilt sensors will be deactivated. The alarm system remains activated.

The vehicle interior monitoring and the anti-tow system are automatically switched on again next time the vehicle is locked.

The vehicle interior monitoring and anti-tow sensor (tilt sensor) are automatically switched on when the anti-theft alarm is switched on. In order to activate it, all the doors and the rear lid must be closed.

If you wish to switch off the vehicle interior monitoring and the anti-tow system, it must be done each time that the vehicle is locked; if not, they will be automatically switched on.

The vehicle interior monitoring and the anti-tow system should be switched off if animals are left inside the locked vehicle (otherwise, their movements will trigger the alarm) or when, for example, the vehicle is transported or has to be towed with only one axle on the ground.

#### False alarms

Interior monitoring will only operate correctly if the vehicle is completely closed. Please observe related legal requirements.

#### The following cases may cause a false alarm:

- Open windows (partially or fully),
- Tilting panoramic sunroof open (partially or completely),
- Movement of objects inside the vehicle, such as loose papers, items hanging from the rear vision mirror (air fresheners), etc.

#### Note

- If the vehicle is relocked and the alarm is activated without the volumetric sensor function, relocking will activate the alarm with all its functions, except the volumetric sensor. This function is reactivated when the alarm is switched on again, unless it is deliberately switched off.

- If the alarm has been triggered by the volumetric sensor, this will be indicated by a flashing of the warning lamp on the driver door when the vehicle is opened. The flash is different to the flash indicating the alarm is activated.

- The vibration of a mobile phone left inside the vehicle may cause the vehicle interior monitoring alarm to trigger, as both sensors react to movements and shakes inside the vehicle.

- If on activating the alarm, any door or the rear lid is open, only the alarm will be activated. The vehicle interior monitoring and the anti-tow system will only be activated once all the doors are closed (including the rear lid).

## Boot hatch

### Opening and closing

Read the additional information carefully

»  page 9



**⚠ WARNING**

- Always close the rear lid properly. Risk of accident or injury.
- The rear lid must not be opened when the reverse or rear fog lights are lit. This may damage the tail lights.
- Do not close the rear lid by pushing it down with your hand on the rear window. The glass could smash. Risk of injury!
- Ensure the rear lid is locked after closing it. If not, it may open unexpectedly while driving.
- Never allow children to play in or around the vehicle. A locked vehicle can be subjected to extremely high and low temperatures, depending on the time of year, thus causing serious injuries/illness. It could even have fatal consequences. Close and lock both the rear lid and all the other doors when you are not using the vehicle.
- Closing the rear lid without observing and ensuring it is clear could cause serious injury to you and to third parties. Make sure that no one is in the path of the rear lid.
- Never drive with the rear lid open or half-closed, exhaust gases may enter into the interior of the vehicle. Danger of poisoning!
- If you only open the rear lid, do not leave the key inside. The vehicle cannot be opened if the key is left inside.

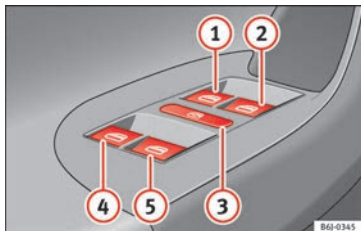
**Electric windows****Opening and closing of the electric windows\***

**Fig. 116** Detail of the driver door: controls for the front and rear windows (5-door vehicles with front and rear electric windows).

**Read the additional information carefully** » page 11

The front and rear electric windows can be operated by using the controls on the driver door. The other doors each have a switch for their own window.

Always close the windows fully if you park the vehicle or leave it unattended » .

You can use the electric windows for approx. 10 minutes after switching off the ignition if neither the driver door nor the front passenger door has been opened and the key has not been removed from the ignition.

Safety switch not pressed: buttons on rear doors are activated.

Safety switch pressed: buttons on rear doors are deactivated.

**⚠ WARNING**

Observe the safety warnings » in Set of keys on page 102.

- Incorrect use of the electric windows can result in injury.
- Never close the rear lid without observing and ensuring it is clear, to do otherwise could cause serious injury to you and third parties. Make sure that no one is in the path of a window.
- If the ignition is switched on, the electric equipment could be activated with risk of injury, for example, in the electric windows.
- The doors can be locked using the remote control key. This could become an obstacle for assistance in an emergency situation.
- Therefore always take the key with you when you leave the vehicle.
- The electric windows will work until the ignition has been switched off and one of the front doors has been opened.
- If necessary, use the safety switch to disable the rear electric windows. Make sure that they have been disabled.

**Note**

If the window is not able to close because it is stiff or because of an obstruction, the window will automatically open again »» page 107. If this happens, check why the window could not be closed before attempting to close it again.

**One-touch opening and closing\***

One-touch opening and closing means you do not have to hold down the button.

Buttons »» Fig. 116 ①, ②, ④ and ⑤ have two positions for opening windows and two for closing them. This makes it easier to open and close windows to the desired position.

**One-touch closing**

– Pull up the window button briefly up to the second position. The window closes fully.

**One-touch opening**

– Push down the window button briefly up to the second position. The window opens fully.

**Resetting one-touch opening and closing**

– The automatic open and close function will not work if the battery has been temporarily disconnected. The function can be restored as follows:

- Close the window as far as it will go by lifting and holding the electric window switch.
- Release the switch and then lift it again for 1 second. This will re-enable the automatic function.

If you push (or pull) a button to the first stage, the window will open (or close) until you release the button. If you push or lift the button briefly to the second stage, the window will open (one-touch opening) or close (one-touch closing) automatically. If you operate the button while the window is opening or closing, it stops at this position.

**Roll-back function**

The roll-back function reduces the risk of injury when the electric windows close.

- If a window is obstructed when closing automatically, the window stops at this point and lowers immediately »» ⚠.
- Next, check why the window does not close before attempting it again.
- If you try within the following 10 seconds and the window closes again with difficulty or there is an obstruction, the automatic closing will stop working for 10 seconds.
- If the window is still obstructed, the window will stop at this point.

- If there is no obvious reason why the window cannot be closed, try to close it again by pulling the tab within ten seconds. The window closes with maximum force. **The roll-back function is now deactivated.**

If more than 10 seconds pass, the window will open fully when you operate one of the buttons. One-touch closing is reactivated.

**⚠ WARNING**

- **Incorrect use of the electric windows can result in injury.**
- **Always take the ignition key with you when leaving the vehicle, even if you only intend to be gone for a short time. Please ensure that children are never left alone inside the vehicle.**
- **The electric windows will work until the ignition has been switched off and one of the front doors has been opened.**
- **Closing the windows without observing and ensuring it is clear could cause serious injury to you and third parties. Make sure that no one is in the path of a window.**
- **Never allow people to remain in the vehicle when you close the vehicle from the outside. The windows cannot be opened even in an emergency.**
- **The roll-back function does not prevent fingers or other parts of the body getting pinched against the window frame. Risk of accident.**

## Convenience opening/closing\*

### Using the door lock\*

- Hold the key in the door lock of the driver door in either the locking or the unlocking position until all windows are either opened or closed.
- Release the key to interrupt this function.





### Using the remote control

- Keep the locking/unlocking button pressed for the electric window risers to open/close; if you stop pressing the button, the window raising/lowering function is stopped.
- If the automatic raising is stopped and immediately after, the opening button is kept pressed, the window risers will lower.
- Once the windows are completely closed, the turn signals will flash.

## Lights and visibility

### Lights

#### Control lamps

	It lights up
Rear fog light switched on »» page 109.	
	It lights up
Front fog lights* switched on »» page 109.	
	It lights up
Left or right turn signal. The control lamp flashes twice as fast when a turn signal is faulty.	
	It lights up
Main beam on or flasher on »» page 110.	

Several warning and control lamps light up for a few seconds when the ignition is switched on, signalling that the function is being verified. They will switch off after a few seconds.

#### WARNING

Observe the safety warnings »»  in Warning symbols on page 92.

## Switching lights on and off

Read the additional information carefully »»  page 20

The driver is personally responsible for the correct use and adjustment of the lights in all situations.

#### WARNING

**Never drive with just the side lights on, there is a risk of accident. The side lights are not bright enough to illuminate the road ahead and to ensure that other road users are able to see you. Always use your dipped beam headlights if it is dark or if visibility is poor.**

#### Note

- The legal requirements regarding the use of vehicle lights in each country must be observed.
- The dipped beam headlights will only work with the ignition on. The side lights come on automatically when the ignition is turned off.
- If the lights are left on after the key has been taken out of the ignition lock, an audible warning sounds while the driver door remains open. This is a reminder to switch the lights off.
- The rear fog light can dazzle drivers behind you. You should use the rear fog light only when visibility is very poor. For this reason, if you exceed approximately 60 km/h (38 mph), the instrument panel will display the

following warning: Switch off the fog light!

- The use of the lighting described here is subject to the relevant statutory requirements.

### Automatic lighting\*

#### Activation

- Rotate the switch to the **AUTO** position, this indication will light up.

#### Deactivation

- Turn the light switch to **0**.

#### Automatic lighting

If automatic headlight control is switched on, dipped beam headlights are automatically switched on by a photosensor if you drive into a tunnel, for example.

### ⚠ WARNING

- Even if the automatic headlight control is switched on, the dipped beam headlights will not be switched on with fog. Therefore, the dipped beam must be switched on manually.

### i Note

- For those vehicles with the automatic headlight system, when the key is removed from

the ignition, the audible warning will only sound if the light knob is in position  $\Rightarrow$  or  $\Rightarrow$ .

- If the daylight driving automatic light function is switched on, the front fog lights or rear fog light cannot be switched on in addition.
- The use of the lighting described here is subject to the relevant statutory requirements.
- Do not put stickers on the windscreen in front of the sensor. This may cause disruptions or faults in the automatic lighting system.
- The rain sensor switches on the dipped beam headlights when the windscreen wipers have been operating continuously for a few seconds and it switches the lights off when the continuous or interval wipe is switched off for some minutes.

### Daytime running lights

»» table on page 2

The daytime running lights are enabled automatically when the ignition is switched on.

Daytime running lights are signalling devices for improving road safety. The lights are built into the headlights and come on each time the ignition is turned on if the light switch is in position **0** or **AUTO**. It is automatically switched off when the dipped beam lights are turned on.

### ⚠ WARNING

The side lights or daytime driving lights are not bright enough to illuminate the road ahead and to ensure that other road users are able to see you.

- Always use your dipped beam head lights if it is raining or if visibility is poor.
- The rear lights do not come on with the daytime driving light. A vehicle which does not have the rear lights on may not be visible to other drivers in the darkness, if it is raining or in conditions of poor visibility.

### i Note

See legal requirements for each country.

### Fog lights

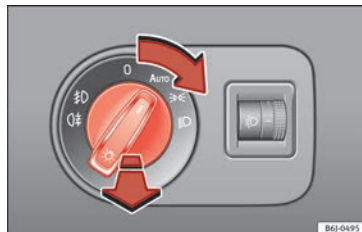









Fig. 117 Dash panel: light control.



## Switching on the front fog lights\*

- Turn the switch from position **AUTO**  or  to the first stop and pull it. The symbol  in the light switch lights up.

## Switching on the rear fog light (vehicles with front fog lights)

- Turn the lights control from position **AUTO**  or  to the second stop and pull it   **in Switching lights on and off on page 108.** A lamp on the control and warning lamps panel lights up.

## Switching on the rear fog light (vehicles with no front fog lights)

- Turn the light control to the end from position  or  and pull it. A lamp on the control and warning lamps panel lights up.

## Turn signal and main beam lever

Read the additional information carefully  page 21

### Parking lights

- Switch the ignition off.
- Move the turn signal lever up or down to the right or left-hand parking lights on, respectively.

## Convenience turn signals

For the convenience turn signals, move the lever as far as possible upwards or downwards and release the lever. The turn signal will flash three times.



The convenience turn signals are activated and deactivated in the **Easy Connect** system via the **CAR** key and the **Setup** function button  page 93.

In vehicles that do not have the corresponding menu, this function can be deactivated in a specialised workshop.



### **WARNING**

The main beam can dazzle other drivers. Risk of accident! Never use the main beam headlights or the headlight flasher if they could dazzle other drivers.

### **Note**

- If the convenience turn signals are operating (three flashes) and the other convenience turn signals are switched on, the active part stops flashing and only flashes once in the new part selected.
- The *turn signals* only work when the ignition is switched on. The corresponding warning lamp  or  flashes in the instrument panel. The control lamp  flashes when the turn signals are operated, provided a trailer is correctly attached and connected to the vehicle. If a turn signal bulb is defective, the con-

trol lamp flashes at double speed. If the trailer turn signal bulbs are defective, the control lamp  does not light up. Change the bulb.

- The *main beam headlights* can only be switched on if the dipped beam headlights are already on. The warning lamp  then comes on in the instrument panel.
- The *headlight flasher* comes on for as long as you pull the lever – even if no other lights are switched on. The warning lamp  then comes on in the instrument panel.
- When the *parking lights* are switched on, the headlight and the tail light on the corresponding side of the vehicle light up. The parking lights will only work if the key is removed from the ignition. If said light is on, an audible warning will be emitted while the driver door is open.
- If the turn signal lever is left on after the key has been taken out of the ignition lock, an acoustic signal sounds when the driver door is opened. This is intended as a reminder to switch off the turn signal, unless you wish to leave the parking light on.

## Coming Home/Leaving Home Function\*

The Coming Home function is controlled manually. The Leaving Home function is controlled with a photosensor.

If the Coming Home or Leaving Home function is connected, the front side and dipped



lights, the tail lights and the number plate light will light up to provide assistance.

### Coming home function

The Coming Home function is activated by switching off the ignition and briefly flashing the lights. When the driver door is opened, the Coming Home lighting comes on. If the driver door is already open when the lights are flashed briefly, the Coming Home lighting comes on **immediately**.

When the last door of the vehicle or the rear lid is closed, the Coming Home function starts and the switching off the headlights is delayed.

The Coming Home lighting switches off in the following cases:

- On completion of the time period established for the delay in switching off the lights after all the vehicle doors and the rear lid have been closed.
- If, 30 seconds after being connected, any doors or the rear lid remain open.
- If the light switch is turned to position 0.
- If the ignition is switched on.

### Automatic Leaving Home function

The Leaving Home function is activated when the vehicle is unlocked if:

- the light control is in position **AUTO** and

- the photosensor detects “darkness”.

The Leaving Home lighting switches off in the following cases:

- If the time period for the delay in switching off the headlights has ended
- If the vehicle is locked again.
- If the light switch is turned to position 0.
- If the ignition is switched on.



### Manual Leaving Home function

In vehicles without an automatic headlight system (light sensor), if the manual Coming Home function is activated when leaving the car, upon returning to the car and unlocking it the manual Leaving Home function will be activated automatically.

You can also activate or deactivate the Coming Home/Leaving Home system in Easy Connect with the **(CAR)** button and the **(Setup)** function button  page 23.

#### Note

- **To activate the Coming/Leaving home function, the rotary light switch must be in position AUTO and the light sensor must detect darkness.**
- **If the ignition key is removed while the lights are on, the lights flash briefly and the driver door opens, no audible warning is heard, since with the Coming Home function**

**on, the lights are automatically switched off after a period of time (except when the light switch is in position  or .**

### Adaptive headlights\* (for driving round bends)

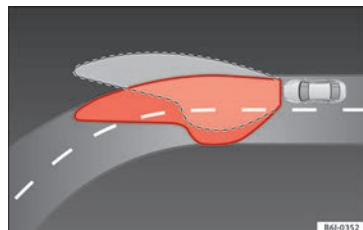

**Fig. 118** Cornering lighting using adaptive headlights.

When driving around bends, the headlights will light the most important areas of the road.

This cornering light gives better illumination of the side of the road and the corner area. The dynamic lighting is controlled automatically according to speed and the steering wheel angle.

The two main headlights move at different angles to avoid that the front of the vehicle is left completely in the dark. 

**Note**

The system operates from a speed of about 10 km/h (6 mph).

**Fog lights with cornering function\***

This is an additional light source to dipped beam headlights to light up the road as a bend is taken.

The cornering light operates with the lights switched on and when driving at less than 40 Km/h (25 mph). Ignition occurs by turning the steering or connecting the turn signal.

**Forward gear**

- If the steering wheel is turned to the right, or the right-hand turn signal operated, the right-hand fog light turns on.
- If the steering wheel is turned to the left, or the left-hand turn signal operated, the left-hand fog light turns on.

In reverse, both fog lights turn on.

**Note**

When the fog lamps are on, the cornering function is activated and both headlights are continuously on.

**Instrument and switch lighting, headlight range control**

Fig. 119 Dash panel: headlight range control.

**Instrument and switch lighting**

The lighting level of instruments, controls and displays can be adjusted through the infotainment system with the **(CAR)** button and the **(SETUP)** function button »»  page 23.

The instrument lighting (some dials and needles), the centre console lighting and the lighting of the displays are regulated by a photodiode incorporated in the instrument panel.

The instrument lighting (needles) is switched on when the ignition is on and the **light is off**. The instrument lighting is dimmed automatically as the daylight starts to fade. It goes out completely when ambient light is very low. This function is intended to remind the driver to switch on the dipped beam

headlights in good time when light conditions become poor.

**Headlight range control**

By using the electrical headlight range control you can adjust the headlight range to the load level that is being carried in the vehicle »» **Fig. 119**. This way, it is possible to avoid dazzling oncoming traffic more than necessary. At the same time, by using the correct headlight settings, the driver has the best possible lighting for the road ahead.

The headlights can only be adjusted when the dipped beam is switched on. Turn the wheel downwards to lower the headlight beam from the basic setting **0**.

**Dynamic headlight range control**

Vehicles with **gas discharge bulbs** (xenon bulbs) are equipped with **dynamic headlight range control**. When you switch on the lights, their range regulates itself according to the vehicle load.



Vehicles with gas discharge bulbs do not have headlight range control.



**Hazard warning lights** 

Read the additional information carefully »»  page 21

The hazard warning lights are used to draw the attention of other road users to your vehicle in emergencies.

If your vehicle breaks down:

1. Park your vehicle at a safe distance from moving traffic.
2. Press the button to switch on the hazard warning lights  .
3. Switch the ignition off.
4. Apply the handbrake.
5. Put it in 1st gear.
6. Use the warning triangle to draw the attention of other road users to your vehicle.
7. Always take the vehicle key with you when you leave the vehicle.

All turn signals flash simultaneously when the hazard warning lights are switched on. The two turn signal turn signal lamps  and the turn signal lamp in the switch  will flash at the same time. The simultaneous hazard warning lights also work when the ignition is switched off.

### WARNING

• **The risk of an accident increases if your vehicle breaks down. Always use the hazard warning lights and a warning triangle to draw the attention of other road users to your stationary vehicle.**

• **Due to the high temperatures that the catalytic converter can reach, never park in an area where the catalytic converter could come into contact with highly inflammable materials, for example dry grass or spilt petrol. This could start a fire.**

### Note

- **The battery will run down if the hazard warning lights are left on for a long time, even if the ignition is switched off.**
- **The use of the hazard warning lights described here is subject to the relevant statutory requirements.**

## Interior lights

### Interior and reading lights

Read the additional information carefully  page 21

#### Luggage compartment lighting

The light is activated when the rear lid is open, even when the ignition and lights are turned off. For this reason, ensure that the rear lid is always closed.

#### Glove compartment light

When opening the glove compartment on the passenger side, the glove compartment light

will automatically turn on and will turn off upon closure.

#### Ambient light\*

  table on page 2

The ambient lighting lights up the central console area and the footwell area.

They will switch on fully when the doors are opened and will decrease in intensity while driving when the dipped beam headlight is on.

The intensity of the ambient light\* can be adjusted using the Easy Connect menu (see **Adjusting Lights > Interior Lighting**  page 23).

### Note

**If not all the vehicle doors are closed, the interior lights will be switched off after approx. 10 minutes, providing the ignition key has been removed and the courtesy light position selected. This prevents the battery from discharging.**

## Visibility

### Heated rear window



**Fig. 120** Centre console: heated rear window switch.

The heated rear window consumes a lot of power and should only be used when the engine is running. When it is switched on, a lamp lights up on the switch.

After approximately 8 minutes, the heating device of the rear window switches off automatically.

#### For the sake of the environment

**The heated rear window should be switched off as soon as the glass is demisted. By saving electrical power you can also save fuel.**

#### Note

To avoid possible damage to the battery, an automatic temporary disconnection of this function is possible, coming back on when normal operating conditions are re-established.

### Sun visors

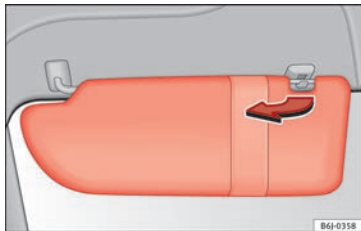

**Fig. 121** Sun visor on the driver side.

The sun visors for the driver and the front passenger can be pulled out of their central supports and turned towards the doors in the direction of the arrow **»» Fig. 121**. Never pull them downwards.

The driver sun visor has compartments for cards, and the passenger sun visor has a vanity mirror with a cover\*.

#### Note

Incorrect use of the sun visor (e.g. pulling them downwards once they are open) may result in broken hinges. This damage is not covered by the vehicle warranty.

## Windscreen wiper and rear window wiper systems

### Control lamp\*



It lights up

Windscreen wiper fluid level too low

This serves as a reminder to fill up the reservoir at the earliest opportunity **»» page 185**.

### Windscreen wipers

Read the additional information carefully **»»  page 22**

#### WARNING

- Worn and dirty wiper blades reduce visibility and safety levels while driving.
- In cold conditions you should not use the wash/wipe system unless you have warmed the windscreen with the heating and ventilation system. The windscreen washer fluid

could otherwise freeze on the windscreen and obscure your view of the road.

- Always note the corresponding warnings  
»»  page 49.

### WARNING

The rain sensor\* may not detect enough rain to switch on the wipers.

- If necessary, switch on the wipers manually when water on the windscreen obstructs visibility.

### CAUTION

In icy conditions, always check that the wiper blades are not frozen to the glass before using the wipers for the first time. If you switch on the windscreen wipers when the wiper blades are frozen to the windscreen, you could damage both the wiper blades and the wiper motor.

### Note

- The windscreen wipers will only work when the ignition is switched on.
- The heat output of the heated jets\* is controlled automatically when the ignition is switched on, depending upon the outside temperature.
- In certain versions of vehicles with alarms, the windscreen wiper will only work in interval/rain sensor mode when the ignition is on and the bonnet closed.

- When the interval wipe function is on, the intervals are directly proportional to the speed. This way, the higher the vehicle speed the shorter the intervals.

- If you stop the vehicle with the windscreen wiper in position 1 or 2, it will automatically change to a lower position speed. The set speed will be resumed when the vehicle pulls away.

- The windscreen will be wiped again after approximately five seconds once the “automatic wash/wipe system” has been activated, provided the vehicle is moving (drip function). If you activate the wipers less than 3 seconds after the drip function, a new wash sequence will begin without performing the last wipe. For the “drip” function to work again, you have to turn the ignition off and then on again.

- Do not put stickers on the windscreen in front of the rain sensor\*. This may cause sensor disruption or faults.

## Rear window wiper

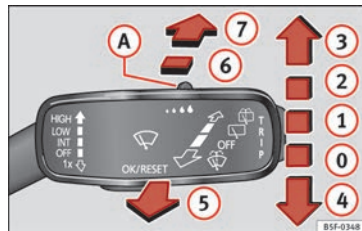

Fig. 122 Windscreen wiper lever: rear window wiper.

### Switching on the interval wipe

- Press the lever forward to position **6**  
»» Fig. 122. The wiper will wipe the window approximately every 6 seconds.

### Switching off the interval wipe function

- Pull the lever back from position **6** toward the steering wheel. The wiper will continue to function for a short period if you switch off whilst the wipers are in motion.

### Switching on the window wiper and washer system

- Press the lever fully forwards to position **7**  
»» Fig. 122. The wiper and washer operate at the same time. The rear window wash system will function as long as you hold the lever in this position. »»

- Release the lever. The washer system stops and the wipers continue until the end of the cycle.
- Move the lever towards the steering wheel to switch off.

### WARNING

- **Worn and dirty wiper blades reduce visibility and safety levels while driving.**
  - **Always note the corresponding warnings**
- »  page 49.

### CAUTION

In icy conditions, always check that the wiper blade is not frozen to the glass before using the wiper for the first time. If you switch on the wiper when the wiper blade is frozen to the glass, this could damage both the wiper blade and the wiper motor.

### Note

- The rear window wiper will only work when the ignition is switched on.
- Depending on the version of the model, when you engage reverse gear and with the headlight wiper activated, this can start a wipe.

### Headlight washer\*

The headlight washers clean the headlight lenses.

The headlight washers are activated automatically when the windscreen washer is used and the window wiper lever is pulled towards the steering wheel for at least 1.5 seconds – provided the dipped beam headlights or main beams are switched on. Clean off stubborn dirt (insects, etc.) from the headlights at regular intervals, for instance when filling the fuel tank.

### Note

- To ensure that the headlight washers work properly in winter, keep the nozzle holders in the bumper free of snow and remove any ice with a de-icer spray.
- To remove water, the windscreen wipers will be activated from time to time, the headlight washers will be activated every three cycles.

## Rear view mirrors

### Interior mirror

It is dangerous to drive if you cannot see clearly through the rear window.

### Interior mirror with automatic anti-dazzle function\*

The anti-dazzle function is activated every time the ignition is switched on.

When the anti-dazzle function is enabled, the interior rear vision mirror will darken **automatically** according to the amount of light it receives. The anti-dazzle function is cancelled if reverse gear is engaged.

### Note

- **The automatic anti-dazzle function will only work properly if the sun blind\* for the rear window is retracted and there are no other objects preventing light from reaching the interior rear vision mirror.**
- If you have to stick any type of sticker on the windscreen, do not do so in front of the sensors. Doing so could prevent the anti-dazzle function from working well or even from working at all.

### Folding in the exterior mirrors manually

The exterior mirrors of the vehicle may be folded in. For this, press the mirror housing towards the vehicle.

**Note**

Before washing the vehicle with an automatic car wash, fold in the exterior mirrors to avoid damage.

**Electric exterior mirrors\***

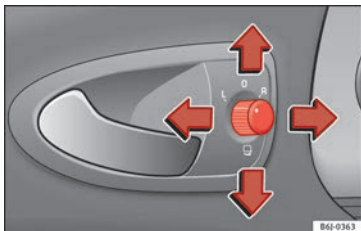

**Fig. 123** Exterior mirror controls.

**Read the additional information carefully**  
» page 12

The exterior mirrors can be adjusted using the rotary knob in the driver door.

**Basic setting of exterior mirrors**

1. Turn knob » **Fig. 123** to position **L** (**left exterior mirror**).
2. Turn the rotary knob to position the exterior mirror so that you have a good view to the rear of the vehicle.

3. Turn the knob to position **R** (**right exterior mirror**).
4. Swivel the rotary knob to position the exterior mirror so that you have a good view to the rear of the vehicle » .

**Heated exterior mirrors\***

- Press the demisting button » **Fig. 120**
- The mirrors demist for some minutes to prevent draining the battery unnecessarily.
- If necessary, press the button again to repeat the function.
- The exterior mirror heating is not activated in temperatures above approximately +20°C (+68°F).

**Folding in the exterior mirrors electrically\***

- Turn the control » **Fig. 123** to position to fold in the exterior mirrors. You should always fold in the exterior mirrors if you are driving through an automatic car wash. This will help prevent damage.

**Folding exterior mirrors back out to the extended position\***

- Turn the knob to position L or R to return the exterior mirrors to their original position » .

**WARNING**

- Convex or aspheric mirrors increase the field of vision however the objects appear smaller and further away in the mirrors. If you use these mirrors to estimate the distance to vehicles behind you when changing lane, you could make a mistake. Risk of accident.
- If possible, use the rear vision mirror to estimate distances to vehicles behind you.
- Make sure that you do not get your finger trapped between the mirror and the mirror base when folding back the mirrors. Risk of injury!

**For the sake of the environment**

The exterior mirror heating should be switched off when it is no longer needed. Otherwise, it is an unnecessary fuel waste.

**Note**

- If the electrical adjustment ever fails to operate, the mirrors can be adjusted by hand by lightly pressing the edge of the mirror glass.
- In vehicles with electric exterior mirrors, the following points should be observed: if, due to an external force (e.g. being knocked while manoeuvring), the adjustment of the mirror housing is altered, the mirror will have to be fully folded electrically. Do not readjust the rear vision mirror housing by hand, as this will interfere with the mirror adjuster function.

»

- The rear vision mirrors can be adjusted separately or simultaneously, as described above.
- The fold-in function on the exterior mirrors will not activate at speeds over 40 km/h (25 mph).

## Seats and head restraints

### Adjusting the seat and head restraints

#### Adjusting the front seats

Read the additional information carefully  
»  page 11

#### WARNING

The safe driving chapter contains important information, tips, suggestions and warnings that you should read and observe for your own safety and the safety of your passengers  
» page 51.

#### WARNING

- Never adjust the driver or front passenger seat while the vehicle is in motion. While adjusting your seat, you will assume an incorrect sitting position. Risk of accidents. Adjust the driver or front passenger seat only when the vehicle is stationary.
- To reduce the risk of injury to the driver and front passenger in case of a sudden braking or an accident, never drive with the backrest tilted towards the rear. The maximum protection of the seat belt can be achieved only when the backrests are in an upright position and the driver and front passenger have properly adjusted their seat belts. The further the

backrests are tilted to the rear, the greater the risk of injury due to improper positioning of the belt web!

- Exercise caution when securing the seat height into forwards/backwards position. Injuries can be caused if the seat height is adjusted without due care and attention.
- To move the seat forwards and backwards, pull upwards and not sideways on the lever, as the force exerted on it in that direction could damage it.

#### Adjusting or disassembling the head restraints

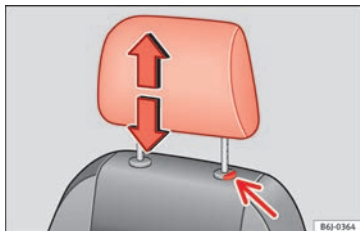



Fig. 124 Adjusting and removing the head restraints.

Read the additional information carefully  
»  page 11



### Adjusting height (front seats)

- Press the button on the side and pull upwards to the desired position.
- To lower the head restraint, press the button and push head restraint downwards.
- Make sure that it engages securely into one of its positions.

### Adjusting height (rear seats)

- Press the button on the side and pull upwards to the desired position.
- To lower the head restraint, press the button and push head restraint downwards.
- Make sure that the head restraint engages securely in one of its positions »» page 55.

### Removing the head restraint

- Push the head restraint up as far as it will go.
- Press the button »» Fig. 124 (arrow).
- Pull head restraint out of fitting without releasing the button.

### Fitting the head restraint

- Insert the head restraint into the guides on the corresponding backrest.
- Push head restraint down.
- Adjust the head restraint to suit body size »» page 55.

#### ⚠ WARNING

- Never drive if the head restraints have been removed. Risk of injury.
- Never drive if the head restraints are in an unsuitable position (the lowest position) as there is a risk of serious injury.
- After refitting the head restraint, you must always adjust it properly for height to achieve optimal protection.
- Please observe the safety warnings in »» ⚠ in Correct adjustment of front head restraints on page 55.

#### i Note

- To fit and remove the rear head restraints, gently tilt the seat backrest forwards.
- When fitting the head restraints again, insert the tubes as far as possible into the guides without pressing the button.

## Seat functions

### Heated seats\*

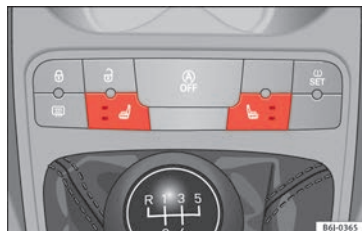

Fig. 125 Front seat heating switch.

The front seat cushions and backrests can be heated electrically.

- Press the corresponding switch »» Fig. 125 to switch on the seat heating.
- Press once to connect the heating at maximum force. The two LEDs illuminate »» Fig. 125. After 15 minutes of high intensity, the upper LED goes out, the system is deactivated for 2 minutes and is then reactivated at low intensity (the lower LED remains on permanently).
- Press the switch again to set the heating to minimum force. (The lower LED lights up).
- To disconnect the heating, press the switch again. »»

### ⚠ CAUTION

To avoid damaging the heating elements, please do not kneel on the seat or apply sharp pressure at a single point to the seat cushion and backrest.

### i Note

The seats are only heated electrically when the engine is running.

### Folding down the back seat

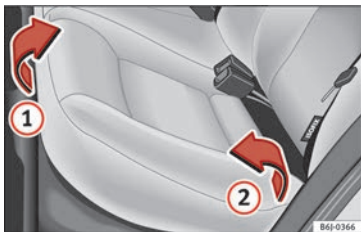

Fig. 126 Folding up the rear seat cushion.

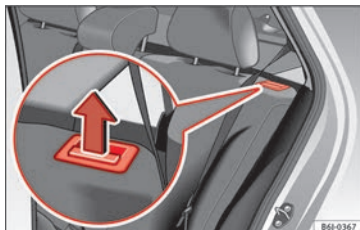

Fig. 127 Button for unlocking the rear backrest.

### Folding seat down

- Remove the head restraint » page 118.
- Pull the front edge of the seat cushion » Fig. 126 ① upwards in the direction of the arrow.
- Lift the cushion ② forwards in the direction of the arrow.
- Pull the release button » Fig. 127 in the direction of the arrow and fold the backrest forwards.
- Insert the head restraints in the spaces on the rear of the seat cushion which are visible when the seat cushion is lowered.

### Folding seat forward

- Remove the head restraints from the spaces in the seat cushion.

- Lift the backrest, and before securing it, replace the head restraints in the seat cushion, and then click the seat correctly onto the locking rails.
- Once the backrest is locked, pull on the central seat belt or directly on the backrest to check that the backrest has properly engaged in position.
- Check that the position lever is in neutral position.
- Lower the cushion and push it backwards below the seat belt buckles.
- Press the front part of the cushion downwards.

On split rear seats\*, the backrest and cushion can be lowered and raised respectively in two sections.

### ⚠ WARNING

- Please be careful when folding back the backrest! Injuries can be caused if the seat height is adjusted without due care and attention.
- Do not trap or damage seat belts when raising the backrest.
- After raising the backrest, check it has engaged properly in position. Do this by pulling on the central seat belt or directly on the backrest and check that the position lever is in the neutral position.

- The three point automatic seat belt only works correctly when the backrest of the central seat is correctly engaged.

## Transport and practical equipment

### Practical equipment

#### Glove compartment



**Fig. 128** Passenger side: glove compartment.



**Fig. 129** Glove compartment: storage compartment for instruction manual.

The compartment can be opened by pulling the lever»» **Fig. 128.**

This compartment can hold documents in A4 format, a water bottle of 1.5 L, etc.

Depending on the vehicle equipment, the CD player is located in the glove compartment. Separate operating instructions are enclosed for this equipment in the corresponding Instruction Manual.

#### **⚠ WARNING**

**Always keep the storage compartment cover closed while the vehicle is in motion in order to reduce the risk of injury caused by a sudden braking or by an accident.**

#### Storage compartment on the driver side

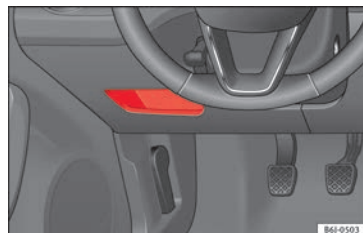

**Fig. 130** Compartment on the driver side

There is a storage compartment on the driver side

### Storage compartment under the front seats\*



**Fig. 131** Storage compartment under the right front passenger seat.

#### To open

- The compartment is opened by pulling on the lever and guiding it with your hand.

#### To close

- Press the cover inwards until the closed drawer “clicks” into position.

#### Note

The storage drawer will hold a maximum weight of 1.5 kg.

### Storage pocket in the seat\*

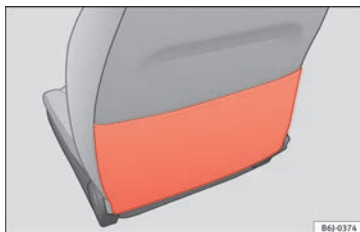

**Fig. 132** Storage pocket.

There is a storage pocket on the rear of the front seats.

### Storage compartment in front door panel\*

In this storage compartment a 1.5l water bottle, etc. can be stored.

### Front drink holder\*

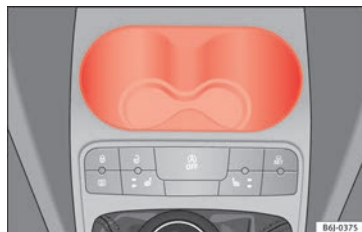
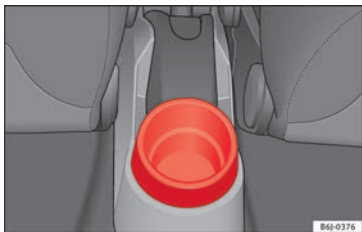

**Fig. 133** Front drink holders in the centre console.

In the central console, in front of the gear lever, there are two drinks holders » **Fig. 133**.

#### WARNING

- Do not put hot drinks in the drink holders. During sudden or normal driving manoeuvres, when braking suddenly or in case of an accident, the hot drink could spill. Risk of scalding.
- Never use rigid materials (for example, glass or ceramic), since they could cause injury in the case of an accident.

**Rear drink holder\***

**Fig. 134** Drinks holder in the centre console.

On the rear part of the centre console, behind the handbrake, there is a drink holder\* installed » **Fig. 134**.

This drinks holder has a capacity for a bottle of up to 1 litre.

**Front ashtray\***

**Fig. 135** Front ashtray.

**Opening and closing the ashtray**

- To open the ashtray, lift the cover » **Fig. 135**.
- To close, push the cover down.

**Emptying the ashtray**

- Extract the ashtray and empty it.

**⚠ WARNING**

**Never put paper in the ashtray. Hot ash could ignite the paper in the ashtray and cause a fire.**

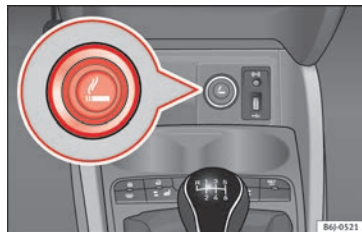
**Cigarette lighter\***

**Fig. 136** Lighter.

- Press on the cigarette lighter » **Fig. 136** to activate it » **⚠**.
- Wait for the lighter to spring out.
- Pull out the cigarette lighter and light the cigarette on the glowing coil.

**⚠ WARNING**

- Improper use of the cigarette lighter can lead to serious injuries or start a fire.
- Using the lighter carefully. Carelessness or negligence when using the cigarette lighter can cause burns and serious injuries.
- The lighter only works when the ignition is turned on or the engine is running. To avoid the risk of fire, never leave children alone inside the vehicle.

## Electrical power socket

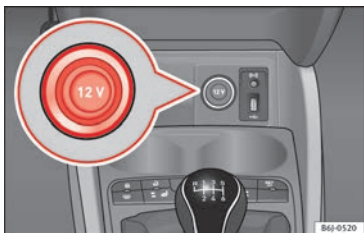

Fig. 137 Front power socket.

The 12 Volt cigarette lighter power socket can also be used for other electrical components with a power rating of up to 120 Watt. When the engine is switched off, however, the vehicle battery will discharge. For further information see »» page 165.

### ⚠ WARNING

The power sockets and the connected accessories will only operate when the ignition is on or when the engine is running. Improper use of the sockets or electrical accessories can lead to serious injuries or cause a fire. To avoid the risk of injury, never leave children alone inside the vehicle.

### ⓘ CAUTION

Always use the correct type of plugs to avoid damaging the sockets.

### ⓘ Note

- The use of electrical appliances with the engine switched off will cause a battery discharge.
- Before using any electrical accessories, see the instructions in »» page 165.

## Luggage compartment

### Loading the luggage compartment

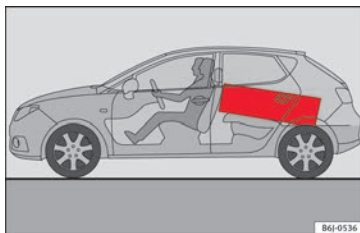

Fig. 138 Position heavy items as far forward as possible.

All luggage and other loose objects must be safely secured in the luggage compartment. Unsecured objects which shift back and forth could affect safety or driving characteristics of the vehicle by shifting the centre of gravity.

- Distribute the load evenly in the luggage compartment.

- Place heavy objects as far forward as possible in the luggage compartment »» Fig. 138.
- Place the heavy objects first.
- Secure heavy objects to the fitted fastening rings\* »» page 125.
- Secure loose loads with a luggage net\* or with non-elastic straps secured to the fastening\* rings.

### ⚠ WARNING

- Loose luggage and other objects in the luggage compartment could cause serious injuries.
- Always stow objects in the luggage compartment and secure them with the fastening rings\*.
- During sudden manoeuvres or accidents, loose objects can be thrown forward, injuring vehicle occupants or even third parties. This increased risk of injury will be further increased if a loose object is struck by an inflating airbag. If this happens, objects may shoot outward like a missile. Risk of fatal injury.
- Always keep all objects in the luggage compartment and use appropriate grips to secure them, particularly in the case of heavy objects.
- Never exceed the allowed axle weights or allowed maximum weight. If said weights are exceeded, the driving characteristics of the

vehicle may change, leading to accidents, injuries and damage to the vehicle.

- Please note that the centre of gravity may shift when transporting heavy objects; this may affect vehicle handling and lead to an accident. Therefore, it is essential to adjust your speed and driving style accordingly, to avoid accidents.
- Never leave your vehicle unattended, especially when the rear lid is open. Children could climb into the luggage compartment, closing the door behind them; they will be trapped and run the risk of death.
- Never allow children to play in or around the vehicle. Close and lock all the doors and rear lid when you leave the vehicle. Before you lock the vehicle, make sure that there are no adults or children in the vehicle.
- Please observe the notes on the »» page 51.

#### ⓘ CAUTION

Hard objects on the rear shelf could chafe against the wires of the heating element in the heated rear window and cause damage.

#### ⓘ Note

- The tyre pressure must be adjusted according to the load. When necessary check the tyre pressures on the label located on the inside fuel tank flap »» page 188.
- Air circulation in the vehicle helps reduce fogging of the windows. Used air escapes

through ventilation slits in the side trim of the luggage compartment. Ensure that the ventilation slots are never covered.

- Straps for securing the load to the fastening rings\* are commercially available from accessory shops.

### Fastening rings\*

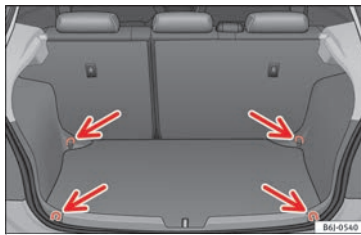

Fig. 139 Location of fastening rings in luggage compartment.

There may be four fastening rings included in the luggage compartment for fastening luggage and other objects »» Fig. 139 (arrows).

- Always use suitable and undamaged straps to secure luggage and other objects to the fastening rings »» ⚠ in Loading the luggage compartment on page 124.
- Pull up the fastening rings to attach the straps.

Example: An object weighing 4.5 kg is lying unsecured in the vehicle. During a frontal collision at a speed of 50 km/h (31 mph), this object generates a force corresponding to 20 times its weight. That means that the effective weight of the object increases to approximately 90 kg. You can imagine the severity of the injuries which might be sustained if this “object” strikes an occupant as it flies through the interior of the vehicle. This increased risk of injury will be further increased if a loose object is struck by an inflating airbag.

#### ⚠ WARNING

- If pieces of baggage or other objects are secured to the fastening rings with inappropriate or damaged retaining cords, injuries could result in the event of braking manoeuvres or accidents.
- Never secure a child seat on the fastening rings.

## Rear shelf

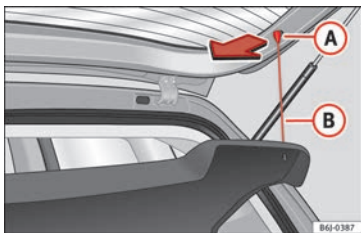

Fig. 140 Rear shelf.

## Removing the shelf

- Unhook the loops » Fig. 140 (A) from housings (A).
- Extract the cover from its slot, in its rest position and pull outwards.

**⚠ WARNING**

Do not place heavy or hard objects on the rear shelf, because they will endanger the vehicle occupants in case of sudden braking.

**ⓘ CAUTION**

- Before closing the rear lid, ensure that the rear shelf is correctly fitted.
- An overloaded luggage compartment could mean that the rear shelf is not correctly seated and it may be bent or damaged.

- If the luggage compartment is overloaded, remove the tray.

**ⓘ Note**

- Ensure that, when placing items of clothing on the luggage compartment cover, rear visibility is not reduced.

## Roof rack/roof luggage rack\*

## Introduction

Please observe the following points if you intend to carry loads on the roof:

- For safety reasons, only luggage racks and accessories supplied by SEAT Official Services are recommended.
- It is essential that you follow the assembly instructions included with the bars exactly, being especially careful to position front and rear luggage compartment cover bars on the special housings in the longitudinal bars. You must also respect their position according to the direction of travel indicated in the assembly manual. Not following these instructions may damage the bodywork.
- Pay special attention to the tightening torque of the attachment bolts and check them following a short journey. If necessary, re-

tighten the bolts and check them at regular intervals.

- Distribute the load evenly. A maximum load of 40 kg is permitted for each roof rack system support bar, the load must be distributed evenly along the entire length. However, the maximum load permitted for the entire roof (including the support system) of 75 kg must not be exceeded nor the total weight recommended for the entire vehicle. See the “Technical Data” section.
- When transporting heavy or large objects on the roof, any change in the normal vehicle behaviour due to a change in the centre of gravity or an increased wind resistance must be taken into account. For this reason, a suitable speed and driving style must be used.
- On vehicles fitted with a sliding/tilting sunroof\*, make sure it does not hit the load on the roof upon opening.



## Attach the cross bars and the roof carrier system

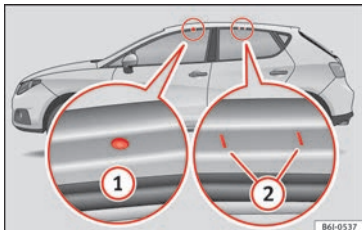

**Fig. 141** Attachment points for the roof railings for the roof carrier system.

The crossbars are the basis of a series of special roof carrier systems. For safety reasons, special fixtures must be used to safely transport luggage, bicycles, skis, surf boards or boats on the roof. Suitable accessories can be acquired at SEAT dealerships.

Always secure the crossbars and the roof carrier system properly. Always take the assembly instructions that come with the crossbars and the roof carrier system in question into account.

The front and rear attachment points ① and ② are only visible when the doors are open  
 »» Fig. 141.

### **⚠ WARNING**

Incorrect attachment and use of the crossbars and the roof carrier system may cause the whole system to detach from the roof and cause an accident and injuries.

- Always take the manufacturer assembly instructions into account.
- Use only crossbars and the roof carrier system when they are in perfect condition and are properly secured.
- Secure the crossbars and the roof carrier system properly.
- Check threaded joints and attachments travelling and if necessary tighten them after you have travelled a short distance. When making long trips, check the threaded joints whenever you stop for a rest.
- Always fit the special roof carrier systems correctly for wheels, skis and surfboards, etc.
- Do not modify or repair the crossbars or roof carrier system.

### **i Note**

Always read the assembly instructions that come with the crossbars and the roof carrier system carefully and keep them in the vehicle.

## Air conditioning

### Heating, ventilation and cooling

#### General notes

Read the additional information carefully  
 »» page 36

#### Pollution filter

The pollution filter (a combined particulate filter and active carbon filter) serves as a barrier against impurities in the outside air, including dust and pollen.

For the climate control system to work with maximum efficiency, the pollution filter must be replaced at the specified intervals in the Maintenance Programme.

If the filter loses efficiency prematurely due to use in areas reaching very high pollution levels, the pollen filter must be changed more frequently than stated in the Service Schedule.

### **⚠ WARNING**

Reduced visibility through the windows increases the risk of serious accidents.

- Always ensure that all windows are free of ice and snow, and that they are not fogged,

so as to maintain good visibility of everything outside.

- The maximum heat output required to defrost windows as quickly as possible is only available when the engine has reached its normal running temperature. Only drive when you have good visibility.
- Always ensure that you use the heating system, fresh air system, air conditioner and the heated rear window to maintain good visibility to the outside.
- Never leave the air recirculation on for a long period of time. If the cooling system is switched off and air recirculation mode switched on, the windows can mist over very quickly, considerably limiting visibility.
- Switch air recirculation mode off when it is not required.

### WARNING

Stuffy or used air will increase fatigue and reduce driver concentration possibly resulting in a serious accident.

- Never leave the fresh air fan turned off or use the air recirculation for long periods of time; the air in the vehicle interior will not be refreshed.

### CAUTION

- If you suspect that the air conditioner is damaged, switch it off with the **(A/C)** button to

prevent further damage and have it checked by a specialised workshop.

- Repairs to the air conditioner require specialist knowledge and special tools. Therefore, we recommend you to take the vehicle to a specialised workshop.

### Note

- If the humidity and temperature outside the vehicle are high, condensation can drip off the evaporator in the cooling system and form a pool underneath the vehicle. This is normal and does not indicate a leak.
- Keep the air intake slots in front of the windscreen free of snow, ice and leaves to ensure heating and cooling are not impaired, and to prevent the windows from misting over.
- The air from the vents flows through the vehicle interior and is extracted by slots in the luggage compartment designed for this purpose. Therefore, you should avoid obstructing these slots with any kind of object.
- The air conditioner operates most effectively with the windows and the sliding/tilting sunroof\* closed. However, if the temperature inside the vehicle is excessive because of the sun, the air inside can be cooled faster by opening the windows for a short time.
- Do not smoke while air recirculation mode is on, as smoke drawn into the air condition-

ing system leaves residue on the evaporator, producing a permanent unpleasant odour.

- At low outside temperatures, the compressor switches off automatically and cannot be switched on even with the **(AUTO)** button.
- It is advisable to turn on the air conditioning at least once a month, to lubricate the system gaskets and prevent leaks. If a decrease in the cooling capacity is detected, a Technical Service should be consulted to check the system.
- To ensure correct operation, the grilles on both sides of the screen must not be obstructed.
- When the engine is under extreme strain, switch off the compressor for a moment.

### Economic use of the air conditioning

When the air conditioning is switched on, the compressor consumes engine power and has influence on fuel consumption. Consider the following points in order to have the system operating in the minimum possible time.

- If the vehicle interior has overheated due to an excessive solar radiation, it is best to open the windows or doors to allow the hot air to escape.
- While in motion, the air conditioning should not be switched on if the windows or the sunroof\* are open.

## Air outlets

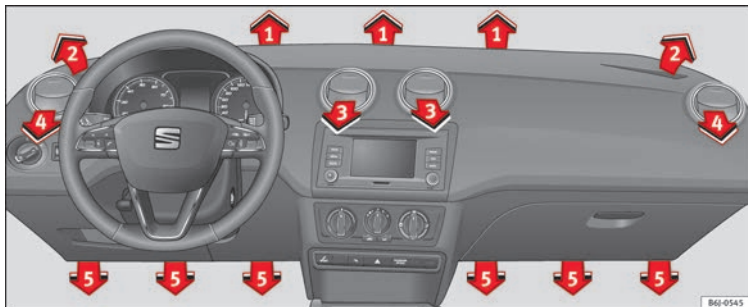

Fig. 142 Air vents.

## Air distribution

Symbol » page 129	Main air output through outlets
	1, 2
	5
	1, 2, 5
	3, 4

Outlets ③ and ④ can be closed or opened separately using the slats and the air flow directed as required.

## Heating and fresh air

## Controls

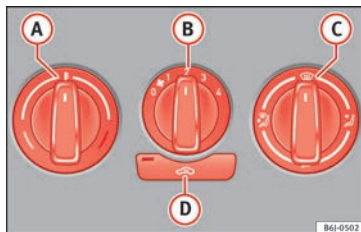

Fig. 143 Heating controls on the dash panel.

- Use turn controls **A**, **B** and **C** » Fig. 143 to adjust the temperature, blower speed and air distribution.

- Press the **D** button to switch air recirculation mode on or off. When the function is activated, a warning light on the button is turned on.

## Temperature

Switch **A** adjusts temperature. The desired temperature inside the vehicle cannot be lower than the ambient temperature. Maximum heat output, which is needed to defrost the windows quickly, is only available when the engine has reached its operating temperature.

## Blower

The air flow can be set at four speeds with switch **(B)**. The blower should always be set at the lowest speed when driving slowly.

## Air distribution

Control **(C)** for setting the flow of air in the required direction.

 – Air distribution towards the windscreen in order to demist. For safety reasons, **it is not recommended** to switch air recirculation on.

 – Air distribution to upper body.

 – Air distribution to footwell

 – Air distribution to the windscreen and the footwell.

### WARNING

- For your safety, the windows should never be fogged up or covered with snow or ice. This is essential to ensure good visibility. Please familiarise yourself with the correct operation of the heating and ventilation system, including the demist/defrost functions for the windows.

### Note

- Please consider the general notes  page 127.

## Air recirculation

Air recirculation prevents unpleasant smells from entering the interior.

### Connecting the recirculation

In any position of rotary switch **(C)** except thaw:

- Press button **(D)**  Fig. 143 and the lamp in the button will illuminate.

### Disconnecting the recirculation

- If the lamp is on, press button **(D)** and the lamp will go off, indicating that the entry of outside air has been activated.

If the rotary switch **(C)**  Fig. 143 is in the thaw position, the recirculation flap will always be open and air will always enter from the outside.

If the rotary switch **(C)** is switched from any position to the thaw position, recirculation will be automatically deactivated.

### WARNING

- In air recirculation mode, no cold air from the outside enters the vehicle interior. The windows can quickly fog over if the heating is switched off. Therefore, never leave the air recirculation mode switched on for a long time (risk of accident).

## Vehicle ventilation or heating



### Ventilating the vehicle interior

- Turn the temperature selector  Fig. 143 **(A)** anticlockwise.
- Turn blower switch **(B)** to any of the head settings 1-4.
- Set the airflow to the desired direction using air distribution control **(C)**.
- Open the relevant air outlets.

### Interior heating

- Turn the temperature selector  Fig. 143 **(A)** clockwise to select the desired temperature.
- Turn blower switch **(B)** to any of the head settings 1-4.
- Set the airflow to the desired direction using air distribution control **(C)**.
- Open the relevant air outlets.

### Defrosting the windscreen

- Turn the temperature selector  Fig. 143 **(A)** clockwise to reach the maximum temperature.
- Turn the blower switch **(B)** to setting 4.
- Turn air distribution control to .
- Close outlet **(3)**.

- Open and turn outlet **(4)** towards the side windows.

### Keeping the windscreen and the side windows demisted

- Turn the temperature selector **»» Fig. 143 (A)** to the heating area.
- Turn blower switch **(B)** to any of the head settings 2-3.
- Turn air distribution control to .
- Close outlets **(3)**
- Open and turn outlets **(4)** towards side windows.

Once the windows are demisted and as a preventive measure, the control **(C)** can be set in position , thus obtaining greater comfort while preventing the windows from misting again.

### Heating

Maximum heat output, which is needed to defrost the windows quickly, is only available when the engine has reached its operating temperature.

#### Note

**Remember that the temperature of the engine coolant should be optimum to ensure that the heating system functions correctly (except in vehicles fitted with additional heating\*).**

## Air conditioning\*

### Controls

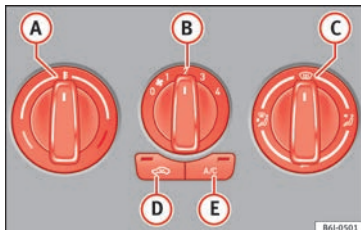

**Fig. 144** Air conditioning controls on the dash panel.

- (A)** Temperature selector **»» page 132**
- (B)** Blower control. There are four speed settings for the blower. At low speed, it is recommended to set the blower to a minimum of 1 to improve the intake of fresh air.
- (C)** Air distribution control **»» page 132**
- (D)** Air recirculation button  **»» page 132**
- (E)** **A/C** button – Switches on the cooling system **»» page 132**

The air conditioning system only works when the engine is running and the fan is switched on.

- Using the rotary switches **(A)**, **(B)** and **(C)** **»» Fig. 144** you can adjust temperature, blower speed and air distribution.
- To switch a function on or off, press the appropriate button **(D)** or **(E)**. When the function is activated, a red warning light on the button is turned on.

### To demist the windscreen

- Turn air distribution to .
- Turn the fan control to one of the two levels depending on the speed required.
- Rotate the temperature control to the desired level of comfort.
- Close outlets **(3)**
- Open and turn outlets **(4)** towards side windows.

#### WARNING







**For your safety, the windows should never be fogged up or covered with snow or ice. This is essential to ensure good visibility. Please familiarise yourself with the correct operation of the heating and ventilation system, including the demist/defrost functions for the windows.**

#### Note





**Please consider the general notes.**

## Vehicle interior heating or cooling system

### Interior heating

- Turn off the cooling system using the **» Fig. 144**  button (the button light turns off).
- Turn the temperature selector  to set the desired temperature inside the vehicle.
- Turn the blower switch to any of the settings 1-4.
- Set the air distribution control  to the air flow configuration desired:  (towards the windscreen),  (towards the chest),  (towards the footwell) and  (towards the windscreen and footwell areas).

### Interior cooling

- Turn off the cooling system using the  button (the button light turns on).
- Turn the temperature control switch until the desired interior temperature is reached.
- Turn the blower switch to any of the settings 1-4.
- Set the air distribution control to the air flow configuration desired:  (towards the windscreen),  (towards the chest),  (towards the footwell) and  (towards the windscreen and footwell areas).

### Heating

Maximum heat output, which is needed to defrost the windows quickly, is only available when the engine has reached its operating temperature.

### Coolant system

When the air conditioning is switched on, the temperature and the air humidity go down. This way, if the outside humidity is extreme, the air conditioning prevents the misting of the windows and therefore, comfort is improved.

If the air conditioning does not work, this may be due to the following reasons:

- The engine is stationary.
- The fan blower is switched off.
- The outside temperature is lower than approximately +3°C (+37°F).
- The air conditioning system compressor has been temporarily switched off because of an increased engine coolant temperature.
- The air conditioner fuse is faulty.
- Another fault in the vehicle. Have the air conditioning checked by a specialised workshop.

### Air recirculation

Air recirculation prevents unpleasant smells, e.g. when passing through a tunnel or in queuing traffic, from entering the interior.

If the rotary switch  **» Fig. 144** is in the thaw position, the recirculation flap will always be open (button light off).

If the rotary switch  is switched from any position to the thaw position, recirculation will be automatically deactivated.

### Connecting the recirculation

In any position of rotary switch  except thaw:

- Press button  **» Fig. 144**, the switch's lamp will light up, indicating that air recirculation inside the vehicle has been activated.

### Disconnecting the recirculation

In any position of rotary switch  except thaw:



- Press button  again and the button's lamp will go off, indicating that air recirculation from the outside has been activated.

In the thaw position of rotary switch , the entry of air into the vehicle interior is always from the outside.

**⚠ WARNING**

In air recirculation mode, no cold air from the outside enters the vehicle interior. If the air conditioner is switched off, the windows can quickly mist over. Therefore, never leave the air recirculation mode switched on for a long time (risk of accident).

**i Note**

- When engaging reverse gear, the air recirculation is connected automatically to prevent the entrance of exhaust gases in the vehicle on travelling backwards. The control lamp on the button  does not light up.
- If the temperature control is turned to the coldest setting (blue point) and the  button is on, the "Air recirculation" function is automatically activated in order to cool the vehicle faster using less energy, and its function control lamp will light up.
- If the function is not deactivated by pressing the button, it will deactivate after approximately 20 minutes.

## Driving

### Address

#### Introduction

The power steering is not hydraulic but electromechanical. The advantage of this steering is that it does not need flexible hydraulic pipes, hydraulic oil, pump, filter or other parts. The electromechanical system saves fuel. Whereas a hydraulic system needs continuous oil pressure, electromechanical steering only needs power when it is used.

In vehicles with electromechanical steering, the assisted steering function automatically adjusts according to vehicle speed, steering wheel torque and wheel orientation. The power steering only works when the engine is running.

**⚠ WARNING**

**If the power steering does not work, you will need much more strength to turn the wheel. This has a considerable effect on vehicle safety.**

- The power steering only works when the engine is running.
- Never allow the vehicle to move when the engine is switched off.
- Never remove the key from the ignition while the vehicle is moving. The steering lock

could be engaged and vehicle steering would not work.

**i Note**

The ignition of the vehicle being towed must be switched on to prevent the steering wheel from locking and also to allow the use of the turn signals, horn, windscreen wipers and washers.

#### Control lamp

The control lamp should light up for a few seconds when the ignition is switched on. It should go out once the engine is started.

	It lights up red
The electromechanical steering is damaged.	Have the steering checked immediately by a specialised workshop.

	It lights up yellow
Electromechanical steering operation is limited.	See a specialised workshop immediately and have the steering checked. If the yellow warning lamp does not light up again after the engine is restarted and the vehicle has travelled a short distance, you do <b>not</b> need to take it to a specialised workshop.





### It lights up yellow

The 12-volt battery was disconnected and has been reconnected.

Take the vehicle for a short run at 15-20 km/h (9-12 mph).



### It flashes yellow

The steering column is tight.

Turn the wheel a little to both sides.

The steering column does not unlock or lock.

Remove the key from the ignition and switch the ignition back on. If necessary, check the messages displayed on the instrument panel display.  
**Do not drive on** if the steering column remains locked after the ignition has been switched on. Seek specialist assistance.

### WARNING

**If the warning lamps and the corresponding messages are ignored when they light up, the vehicle may stall in traffic and cause accidents and severe injuries.**

- Never ignore the warning lamps or messages.
- Stop the vehicle at the next opportunity and in a safe place.



### Note

**Failure to heed the control lamps and corresponding text messages when they light up may result in damage to the vehicle.**

### Information relating to different vehicle processes.

In order to make the vehicle more difficult to steal, you should always lock the steering before leaving the vehicle.

#### Mechanical steering lock

The steering column is locked when the key is removed from the ignition lock and the vehicle is stationary.

#### Activating the steering lock

- Park the vehicle »» page 137.
- Remove the ignition key.
- Turn the steering wheel slightly until the steering lock has engaged.

#### Deactivating the steering lock

- Turn the steering wheel slightly to release the lock.
- Insert the key in the ignition lock.
- Hold the steering wheel in this position and switch on the ignition.

#### Electromechanical steering

In vehicles with electromechanical steering, the assisted steering function automatically adjusts according to vehicle speed, steering wheel torque and wheel orientation. The power steering only works when the engine is running.

You should take into account that you will need considerably more power than normal to steer the vehicle if the power steering is not working correctly or at all.

#### Power-assisted steering

Power-assisted steering helps the driver in critical situations. In counter-steering, it assists by applying additional torque »»

### WARNING

**Power-assisted steering, together with the ESC, helps the driver to control vehicle steering in critical situations. However, the driver is ultimately responsible for steering the vehicle at all times. Power-assisted steering does not remove this responsibility.**



## Starting and stopping the engine

### Ignition key positions

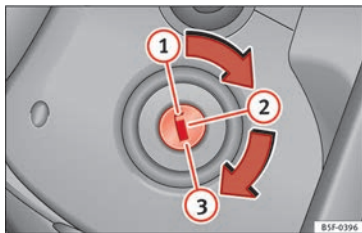

Fig. 145 Ignition key positions.

Read the additional information carefully  
» page 20

### Ignition switched off, steering lock ①

In this position » Fig. 145, the ignition and the engine are OFF and the steering may be locked.

For the **Steering lock** to operate without the ignition key, turn the steering wheel until it locks with an audible sound. You should always lock the steering wheel when you leave your vehicle. This will help prevent vehicle theft » .

### Switching the ignition or the glow plug system on ②

Turn the ignition key to this position and release it. If the key cannot be turned or it is difficult to turn from position ① to position ②, move the steering wheel from one side to the other; this will release it.

### Starting ③

The engine is started when the key is in this position. Electrical devices with high power consumption are switched off temporarily at the same time.

Each time that the vehicle is restarted, the ignition key must be turned to position ①. The **repetitive start prevention lock** of the ignition prevents possible damage to the starter motor if the engine is already running.

### WARNING

- The ignition key must **NOT** be removed from the lock until the vehicle comes to a standstill. Otherwise, the steering could be immediately blocked- Risk of accident!
- Always remove the key from the ignition when leaving the vehicle, even if only for a short period. This is especially important if children or disabled people are left alone in the vehicle. They could accidentally start the engine or work electrical equipment such as the electric windows, resulting in an accident.

- Unsupervised use of the key could start the engine or any electrical system, such as the electric windows. This could result in serious injury.

### CAUTION

The starter motor will only work when the engine is stopped (ignition key position ③).

### Electronic immobiliser “SAFE”

The electronic immobiliser prevents unauthorised persons from driving the vehicle.

Inside the key there is a chip that deactivates the electronic immobiliser automatically when the key is inserted into the ignition.

The electronic immobiliser will be activated again automatically as soon as you pull the key out of the ignition lock.

The engine can only be started using a genuine SEAT key with its correct code.

If the following message\* is shown on the instrument panel display: **SAFE**, the vehicle cannot be started.

The engine can, however, be started if the appropriate coded SEAT genuine key is used. »

 Note

A perfect operation of the vehicle is ensured if genuine SEAT keys are used.

### Starting petrol engines

The engine can only be started using a genuine SEAT key with its correct code.

- Move the gearbox lever to the neutral position and depress the clutch pedal thoroughly and hold it in this position for the starter to turn the engine on.
- Turn the ignition key to the starting position **»» page 135**.
- Let go of the ignition key as soon as the engine starts; the starter motor must not run on with the engine.

After starting a very hot engine, you may need to slightly press down the accelerator.

When starting a cold engine, it may be a little noisy for the first few seconds until oil pressure has built up in the hydraulic valve compensators. This is quite normal, and no cause for concern.

If the engine does not start immediately, switch the starter off after 10 seconds and try again after half a minute. If the engine still does not start, the fuel pump fuse should be checked **»» page 75, Fuses**.

 WARNING

- Never start or run the engine in unventilated or closed rooms. The exhaust gases contain carbon monoxide, an odourless and colourless poisonous gas. Risk of fatal accidents. Carbon monoxide can cause loss of consciousness and result in death.
- Never leave the vehicle unattended if the engine is running.
- Never use “cold start sprays”, they could explode or cause the engine to run at high revs. Risk of injury.

 CAUTION

- When the engine is cold, you should avoid high engine speeds, driving at full throttle and over-loading the engine. Risk of engine damage.
- The vehicle should not be pushed or towed more than 50 metres to start the engine. Unburnt fuel could enter the catalytic converter and damage it.
- Before attempting to push-start or tow a vehicle in order to start it, you should first try to start it using the battery of another vehicle. Please observe and follow the notes on the **»»  page 47, How to jump start**.

 For the sake of the environment

Do not warm-up the engine by running the engine with the vehicle stationary. Start off immediately, driving gently. This helps the

engine reach operating temperature faster and reduces emissions.

### Starting diesel engines

The engine can only be started using a genuine SEAT key with its correct code.

- Move the gearbox lever to the neutral position and depress the clutch pedal thoroughly and hold it in this position for the starter to turn the engine on.
- Turn the ignition key to position **»» Fig. 145 ②**. The warning lamp  will light for engine pre-heating.
- When the lamp turns off, turn the ignition key to position **③** to start the engine. Do not press the accelerator.
- Release the ignition key as soon as the engine starts. The starter motor should not turn at the same time.

When starting a cold engine, it may be a little noisy for the first few seconds until oil pressure has built up in the hydraulic valve compensators. This is quite normal, and no cause for concern.

If there are problems starting the engine, see the **»»  page 47**.

### Glow plug system for the diesel engine

To avoid unnecessary discharging of the battery, do not use any other major electrical equipment while the glow plugs are pre-heating.

Start the engine as soon as the glow plug warning lamp goes out.

### Starting a diesel engine after the fuel tank has been completely run dry

If the fuel tank has been completely run dry, it may take longer than normal (up to one minute) to start a diesel engine after refuelling. This is because the fuel system must eliminate air first.

#### WARNING

Observe the safety warnings  in Starting petrol engines on page 136.

#### CAUTION



- When the engine is cold, you should avoid high engine speeds, driving at full throttle and over-loading the engine. Risk of engine damage.
- The vehicle should not be pushed or towed more than 50 metres to start the engine. Unburnt fuel could enter the catalytic converter and damage it.
- Before attempting to push-start or tow a vehicle in order to start it, you should first try to start it using the battery of another vehicle.

Please observe and follow the notes on the  page 47, How to jump start.

#### For the sake of the environment

Do not warm-up the engine by running the engine with the vehicle stationary. You should drive off as soon as you start the engine. This helps the engine reach operating temperature faster and reduces emissions.

### Switching off the engine

- Stop the vehicle.
- Turn the ignition key to position  **Fig. 145** .

After switching the engine off, the radiator fan may run on for up to 10 minutes. It is also possible that the fan turns itself on once more if the coolant temperature increases due to the heat accumulated in the engine compartment or due to its prolonged exposure to solar radiation.

#### WARNING

- Never switch the engine off until the vehicle is completely stationary.
- The brake servo works only when the engine is running. With the engine switched off, more strength is needed to brake. As normal

brake operation cannot be performed, risk of accidents and serious injury may exist.

- The steering lock can be immediately blocked once the key is removed from the ignition. The vehicle cannot be steered. Risk of accident.
- Power-assisted steering does not work when the engine is off, and more strength is needed to turn the wheel.
- If the key is removed from the ignition lock the steering lock could be engaged and vehicle steering would not work.

#### CAUTION

When the engine has been running under a heavy load for a long period, heat can accumulate in the engine compartment and cause engine damage. For this reason, idle the engine for approximately 2 minutes before switching it off.

## Braking and parking

### Braking capacity and braking distance

The efficiency of the brakes depends directly on the **brake pad** wear. This wear depends to a great extent on the conditions under which the vehicle is operated and the way the vehicle is driven. If you often drive in town, drive short distances or have a sporty driving style, we recommend that you have the thickness 

of your brake pads checked by technical services more frequently than recommended in the Maintenance Programme.

If you drive with **wet brakes**, for example, after crossing areas of water, on days of heavy rainfall or even after washing the car, the effect of the brakes is reduced as the brake discs are wet or even frozen (in winter): in this case, the brakes should be “dried” by pressing the brake pedal several times.

### WARNING

Longer braking distances and faults in the brake system increase the risk of accidents.

- New brake pads must be run in and do not have the correct friction during the first 200 km. This reduced braking capacity may be compensated for by pressing on the brake pedal a little harder, which also applies when the brake pads have to be changed further on.
- If brakes are wet or frozen, or if you are driving on roads which have been salted, braking power may be lower than normal.
- On steep slopes, if brakes are excessively used, they will overheat. Before driving down a long steep slope, it is advisable to reduce speed and change down into a lower gear or range (depending on the type of transmission). Thus, make use of engine braking and relieve the brakes.
- Never let the brakes “drag” by applying light pressure. Continuous braking will cause

the brakes to overheat and the braking distance will increase. Apply and then release the brakes alternately.

- Never let the vehicle run with the engine switched off. The braking distance is increased considerably when the brake servo is not active.
- If the brake fluid loses its viscosity and is subjected to heavy use, vapour bubbles can form in the brake system. This reduces the efficiency of the brakes.
- Non-standard or damaged front spoilers could restrict the airflow to the brakes and cause them to overheat. Before purchasing accessories please observe the relevant instructions » page 165, Modifications.
- If a brake system circuit fails, the braking distance will be increased considerably. Contact a specialised workshop immediately and avoid unnecessary journeys.



### Control lamp

Situations in which the warning lamp lights up \*

- the brake fluid level is too low » page 184.
- there is a fault in the brake system.

This warning lamp can light up together with the ABS system warning lamp.

### WARNING

- If the brake warning lamp does not go out or if it lights up when driving, the brake fluid level in the reservoir is too low so there is a risk of an accident » page 184, Brake fluid. Stop the vehicle and do not drive on. Obtain technical assistance.
- If the brake warning lamp lights up  together with the ABS lamp  this could be due to an ABS fault. This could cause the rear wheels to lock quickly when you brake. This could cause the rear to break away. Risk of skidding. Stop the vehicle and seek technical assistance.

### Handbrake

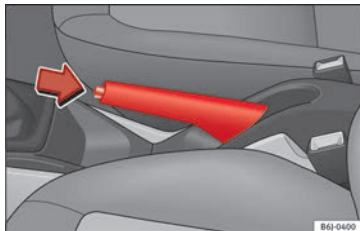

Fig. 146 Handbrake between the front seats.

The handbrake should be applied firmly to prevent the vehicle from accidentally rolling away. Always apply the handbrake when you leave your vehicle and when you park.

### Applying the handbrake

- Pull the handbrake lever up firmly  
»» **Fig. 146.**

### Releasing the handbrake

- Pull the lever up slightly and press the release knob in the direction of the arrow  
»» **Fig. 146** and guide the handbrake lever down fully »» **△.**

Always pull the handbrake *all the way up*, so there is less risk of driving off with it still engaged »» **△.**

The handbrake warning lamp **(P)** lights up when the handbrake is applied and the ignition switched on. The warning lamp turns off when the handbrake is released.

#### **△ WARNING**

- **Never use the handbrake to stop the vehicle when it is in motion. The braking distance is considerably longer, because braking is only applied to the rear wheels. Risk of accident!**
- **If the handbrake is only partially released, this will cause the rear brakes to overheat, which can impair the function of the brake system and could lead to an accident. This also causes premature wear on the rear brake pads.**

#### **ⓘ CAUTION**

**Always apply the handbrake before you leave the vehicle. Put it in 1st gear as well.**

### Parking

The handbrake should always be firmly applied when the vehicle is parked.

Always note the following points when parking the vehicle:

- Use the brake pedal to stop the vehicle.
- Apply the handbrake.
- Put it in 1st gear.
- Switch the engine off and remove the key from the ignition. Turn the steering wheel slightly to engage the steering lock.
- Always take your keys with you when you leave the vehicle »» **△.**

#### **Additional notes on parking the vehicle on gradients:**

Turn the steering wheel so that the vehicle rolls against the kerb if it started to roll.

- If the vehicle is parked facing **downhill**, turn the front wheels so that they point *towards the kerb*.

- If the vehicle is parked facing **uphill**, turn the front wheels so that they point *away from the kerb*.
- Secure the vehicle as usual by applying the handbrake firmly and putting it in 1st gear.

#### **△ WARNING**

- **Take measures to reduce the risk of injury when you leave your vehicle unattended.**
- **Never park where the hot exhaust system could ignite inflammable materials, such as dry grass, low bushes, spilled fuel etc.**
- **Never allow vehicle occupants to remain in the vehicle when it is locked. They would be unable to open the vehicle from the inside, and could become trapped in the vehicle in an emergency. In the event of an emergency, locked doors will delay assistance to vehicle occupants.**
- **Never leave children alone in the vehicle. They could set the vehicle in motion, for example, by releasing the handbrake or the gearbox lever.**
- **Depending on weather conditions, it may become extremely hot or cold inside the vehicle. This can be fatal.**

## Braking and stability systems

### Electronic Stability Control (ESC)\*

This Electronic Stability System reduces the risk of skidding and improves the vehicle's stability and ability to hold the road.

The Electronic Stability Control (ESC) contains the electronic differential lock (EDL) and the traction control system (ASR). The ESC works together with the ABS. Both control lamps will light up if the ESC or ABS systems are faulty.

The ESC system is started automatically when the engine is started.

The ESC system is always active and cannot be switched off. With the Easy Connect system it is only possible to deactivate the ASR or else select Sport mode.

The ASR can be deactivated when wheel spin is desirable » page 141.

For example:

- When driving with snow chains.
- When driving in deep snow or on loose surfaces.
- When the vehicle is stuck, to rock it backwards and forwards.

Press the button to switch the ASR back on when you no longer need wheel spin.



### Electronic Stability Control (ESC)\*

The ESC reduces the risk of skidding by braking the wheels individually.

The system uses the steering wheel angle and road speed to calculate the changes of direction desired by the driver, and constantly compares them with the actual behaviour of the vehicle. When irregularities occur, for example, if the vehicle begins to skid, the ESC brakes the appropriate wheel automatically.

The forces acting on the braked wheel bring the vehicle back to a stable condition. If the vehicle tends to oversteer (the rear end slides out), the system will act on the front wheel on the outside of the turn.

### Control lamp

There are two control lamps for the electronic stability control. The lamp  provides information concerning function and  disconnection status.

Both control lamps light up together when the ignition is switched on and should turn off after approximately 2 seconds. This is the time taken for the function check.

This programme includes the ABS, EDL and ASR. It also includes emergency braking assistance (BAS).

The control lamp  has the following functions:

- It flashes whilst driving when the ASR/ESC is activated.
- It will light up if there is a fault in the ESC.
- As the ESC operates in conjunction with the ABS, the ESC light will also come on if a fault should occur in the ABS.

If the ESC control lamp  lights up and stays on after the engine is started, this may mean that the control system has temporarily switched off the ESC. In this case the ESC can be reactivated by switching the ignition off and then on again. If the control lamp goes out, this means the system is fully functional.

The  lamp provides information about the disconnection status of the system:

- It stays lit when the ASR is disconnected on pressing the switch  or if we select ESC Sport mode, only by means of Easy Connect.

### WARNING

- **Do not forget that the electronic stability control ESC cannot defy the laws of physics. This should be kept in mind, particularly on slippery and wet roads and when towing a trailer.**
- **Always adapt your driving style to suit the condition of the roads and the traffic situation. The greater safety provided by the ESC should not encourage you to run any risks.**

**ⓘ CAUTION**

- To ensure that the ESC works correctly, all four wheels must be fitted with the same tyres. Any differences in the rolling radius of the tyres can cause the system to reduce engine power when this is not desired.
- Any modifications made to the vehicle (for example, to the engine, brake system, running gear or to the combination of wheels and tyres) may affect the operation of the ABS, EDL, ESC and ASR.

**Traction control system (ASR)\***

The traction control system prevents the driven wheels from spinning when the vehicle is accelerating. This system always includes ABS.

**Description and operation of the traction control system during acceleration (ASR)**

On front-wheel drive vehicles, the ASR system intervenes, reducing engine power and preventing the driven wheels from slipping during acceleration. The system works in the entire speed range in conjunction with ABS. If a failure occurs in the ABS, the ASR will also stop working.

TCS helps the car to start moving, accelerate and climb a gradient in slippery conditions where this may otherwise be difficult or even impossible.



The ASR automatically switches on when the engine is started. If necessary, it could be connected or disconnected by means of the Easy Connect system.

When the ASR is off, the warning lamp lights up . The ASR should normally be left on. Only in exceptional circumstances, when wheel spin is required, can they be turned off using the ESC button, for example:

- With compact temporary spare wheel.
- When using the snow chains.
- When driving in deep snow or on soft terrain.
- When the vehicle is bogged-down, to free it “by rocking it.”

The ASR should be switched on again as soon as possible.

**Control lamp**

There are two control lamps for the traction control system:  and . Both control lamps light up together when the ignition is switched on and should turn off after approximately 2 seconds. This is the time taken for the function check.

**The  lamp has the following function:**

- It flashes when the ASR is working if the vehicle is moving.

If the system is deactivated or if it has any fault, the warning lamp will remain lit. The warning lamp will also light up if a fault should occur in the ABS because the ASR operates in conjunction with the ABS. For further information, see **»» page 141**.

**The  lamp provides information about the disconnection status of the system:**

- It stays lit when the ASR is disconnected via Easy Connect.

By means of Easy Connect, the ASR function is reactivated and the warning lamp switched off.

**⚠ WARNING**

- Remember that not even the ASR can defy the laws of physics. This should be kept in mind, particularly on slippery and wet roads and when towing a trailer.
- Always adapt your driving style to suit the condition of the roads and the traffic situation. The greater safety provided by the ASR should not encourage you to run any risks.

**ⓘ CAUTION**

- To ensure that the ASR works correctly, identical tyres should be fitted on all four wheels. Any differences in the rolling radius of the tyres can cause the system to reduce engine power when this is not desired.

»

- Any modifications made to the vehicle (for example, to the engine, brake system, running gear or to the combination of wheels and tyres) may affect the operation of the ABS and ASR.

## Connecting/disconnecting ESC and ASR

The ESC is switched on automatically when the engine is started, and only works when the engine is running and includes the ABS, EDS and ASR systems.

The ASR and ESC function should only be switched off in situations in which traction is insufficient, among others:

- When driving in deep snow or on surfaces that are not very firm.
- To “free” the vehicle if it gets stuck.

Then switch the ASR and ESC function back on.

Depending on finishes and versions, it is possible either to disconnect only the ASR or else activate ESC Sport mode.

### ESC in “Sport” mode

Sport mode can be connected via the Easy Connect » page 93 system menu. The ability of the ESC to stabilise the vehicle is limited;

the traction control system (ASR) becomes disabled » .

The control lamp  lights up. For vehicles with a driver information system\*, the driver will be shown the **electronic stability control (ESC) option: sport. Warning! Limited stability.**

### Disable ESC “Sport” mode

Through the Easy Connect system menu » page 93. The warning lamp  will switch off. For vehicles with a driver information system\*, the driver will be shown the **electronic stability control (ESC) option: on.**

### Disable ASR



The Easy Connect system menu is used to switch off the ASR » page 93. The traction control system will be disabled.

The control lamp  lights up. For vehicles with a driver information system\* the driver will be informed that **ASR is disabled.**

### Activate ASR

The Easy Connect system menu » page 93 is used to switch on the ASR. The traction control system will be enabled.

The control lamp  switches off. For vehicles with a driver information system\* the driver will be informed that **ASR is enabled.**

- Activate or deactivate the ASR or ESC function in the Easy Connect system by means of the button  and the function buttons  and .

### WARNING

You should switch on the ESC Sport mode only if the traffic conditions and your driving ability allow you to do so safely: risk of skidding!

- With ESC in Sport mode, the stabilising function will be limited to allow for a sportier drive. The driving wheels could spin and the vehicle could skid.

### Note

If the ASR is disconnected or the ESC's Sport mode is selected, cruise control\* will be switched off.

## Electronic differential lock (EDS)\*

The EDL operates along with the ABS in vehicles equipped with Electronic Stability Control (ESC)\*.

EDL helps the vehicle to start moving, accelerate and climb a gradient in slippery conditions where this may otherwise be difficult or even impossible.

It uses the ABS sensors to monitor the speed of the driven wheels.



At speeds of up to approximately 80 km/h (50 mph), it is able to balance out differences in the speed of the driven wheels of approximately 100 rpm/min caused by a *partially* slippery road surface. It does this by braking the wheel which has lost traction and distributing more driving force to the other driven wheel via the differential.

To prevent the disc brake of the braking wheel from overheating, the EDL cuts out automatically if subjected to excessive loads. The vehicle will continue to function normally without EDL. For this reason, the driver is not informed that the EDL has been switched off.

The EDL will switch on again automatically when the brake has cooled down.

### Control lamp

A malfunction in the EDL is indicated by the ABS control lamp  **»»» page 143**. Take the vehicle to a specialised workshop as soon as possible.

#### WARNING

- When accelerating on a slippery surface, for example on ice and snow, press the accelerator carefully. Despite EDL, the driven wheels may start to spin. This could impair the vehicle's stability.
- Always adapt your driving style to suit road conditions and the traffic situation. Do not let the extra safety afforded by EDL tempt you in-

**to taking any risks when driving, this can cause accidents.**

#### CAUTION

**Modifications to the vehicle (e.g. to the engine, the brake system, running gear or any components affecting the wheels and tyres) could affect the efficiency of the EDL**  
**»» page 165.**

### Hydraulic Brake Assist (HBA)\*

The function (Hydraulic Brake Assist HBA) is only included in vehicles with ESC.

In an emergency, most drivers brake in time, but not with maximum force. This results in unnecessarily long braking distances.

This is when the brake assist system comes into action. When pressing the brake pedal rapidly, the assistant interprets it as an emergency. It very quickly builds up the full brake pressure so that the ABS can be activated more quickly and efficiently, thus reducing braking distance.

Do not reduce the pressure on the brake pedal, since the brake assist system switches off automatically as soon as you release the brake.

### Automatic hazard warning lights activation

The brake lights flash automatically to indicate that the vehicle is braking suddenly or in an emergency situation. If the emergency braking continues until the vehicle comes to a standstill, the hazard warning lights will then come on and the brake lights will remain on permanently from that moment. The warning lights will automatically switch off when the vehicle begins to move again or when the "warning" light button is pressed.

#### WARNING

- The risk of accident is higher if you drive too fast, if you do not keep your distance from the vehicle in front, and when the road surface is slippery or wet. The increased accident risk cannot be reduced by the brake assist system.
- The brake assist system cannot defy the laws of physics. Slippery and wet roads are dangerous even with the brake assist system! Therefore, it is essential that you adjust your speed to suit the road and traffic conditions. Do not let the extra safety features tempt you into taking any risks when driving.

### Anti-lock brake system (ABS)

The anti-lock brake (ABS) system prevents the wheels from locking during braking and is an important part of the vehicle's active safety system.

### How the ABS works

If one of the wheels turns too slowly in relation to the vehicle's speed, and is close to locking, the system will reduce the braking pressure to this wheel. The driver is made aware of this control process by a **pulsating of the brake pedal** and audible noise. This is a deliberate warning to the driver that one or more of the wheels is tending to lock and the ABS control function has intervened. In this situation it is important to keep the brake pedal fully depressed so the ABS can regulate the brake application. Do not "pump".

If you brake hard on a slippery road surface, the best possible control is retained as the wheels do not lock.

However, ABS will not necessarily guarantee shorter braking distances in *all* conditions. Braking distance could even be further if you brake on gravel or on fresh snow on a slippery surface.

### Control lamp

The control lamp  lights up for a few seconds when the ignition is switched on. It goes out again after the system has run through an automatic test sequence.

### There is a fault in the ABS if:



- The control lamp  does not light up when the ignition is switched on.

- The control lamp does not go out again after a few seconds.
- The control lamp lights up when the vehicle is moving.

The vehicle can still be braked in the normal way, without the ABS function. Take the vehicle to a specialised workshop as soon as possible.

If there is a fault in the ABS, the ESC\* and the tyre pressure control lamp will also light up.



### Brake system fault

If the ABS warning lamp  lights up together with the brake warning lamp , there is a fault in the ABS function and in the brake system **»»** .

### WARNING

- **The anti-lock brake system cannot defy the laws of physics. Slippery and wet roads are dangerous even with ABS! If you notice that the ABS is working (to counteract locked wheels under braking), you should reduce speed immediately to suit the road and traffic conditions. Do not let the extra safety features tempt you into taking any risks when driving.**
- **The effectiveness of ABS is also determined by the tyres fitted »» page 188.**
- **If the running gear or brake system is modified, the effectiveness of the ABS could be severely limited.**

### WARNING

- **Before opening the bonnet, read and observe the warnings »» page 176, Working in the engine compartment.**
- **If the brake system warning lamp  should light up together with the ABS warning lamp , stop the vehicle immediately and check the brake fluid level in the reservoir »» page 184, Brake fluid. If the brake fluid level has dropped below the "MIN" mark you must not drive on. Risk of accident. Obtain technical assistance.**
- **If the brake fluid level is correct, the fault in the brake system may have been caused by a failure of the ABS system. This could cause the rear wheels to lock quickly when you brake. This could cause the rear to break away. Risk of skidding. Stop the vehicle and seek technical assistance.**

### Electronic differential lock (XDS)\*

When taking a curve, the driveshaft differential mechanism allows the outer wheel to turn at a higher speed than the inner wheel. In this way, the wheel that is turning faster (outer wheel) receives less drive torque than the inner wheel. This may mean that in certain situations the torque delivered to the inner wheel is too high, causing the wheels to spin. On the other hand, the outer wheel is receiving a lower drive torque than it could transmit. This causes an overall loss of lateral

grip on the front axle, resulting in understeer or “lengthening” of the trajectory.

The XDS system can detect and correct this effect via the sensors and signals of the ESC.

Via the ESC, the XDS will brake the inside wheel and counter the excess driving torque of that wheel. This means that the driver's desired trajectory is much more precise.

The XDS system works in combination with the ESC and is always active, even when ASR traction control is disconnected or the ESC is in Sport mode.

### Brake servo

The brake servo increases the pressure you apply to the brake pedal. It works **only when the engine is running**.

If the brake servo is not functioning, e.g. due to a malfunction, or if the vehicle is being towed, you will have to press the brake pedal considerably harder to make up for the lack of servo assistance.

#### WARNING

The braking distance can also be affected by external factors.

- Never let the vehicle coast with the engine switched off. Failure to follow this instruction could result in an accident. The braking dis-

tance is increased considerably when the brake servo is not active.

- If the brake servo is not working, for example when the vehicle is being towed, you will have to press the brake pedal considerably harder than normal.

### Hill driving assistant\*

This function is only included in vehicles with ESC.

The hill driving assistant helps the driver to move off and upward on a hill when the vehicle is stationary.

The system maintains brake pressure for approximately two seconds after the driver takes his foot off the brake pedal to prevent the vehicle from lurching backward when it is started. During these 2 seconds, the driver has enough time to release the clutch pedal and accelerate without the vehicle moving and without having to use the handbrake, making start-up easier, more comfortable and safer.

These are the basic operation conditions:

- being on a ramp or hill/slope,
- doors closed,
- vehicle completely stationary,
- engine running and foot on the brake,

- having a gear engaged or being in neutral.

This system is also active when reversing uphill.

#### WARNING

- If you do not start the vehicle immediately after taking your foot off the brake pedal, the vehicle may start to roll back under certain conditions. Depress the brake pedal or use the hand brake immediately.
- If the engine stalls, depress the brake pedal or use the hand brake immediately.
- When following a line of traffic uphill, if you want to prevent the vehicle from rolling back accidentally when starting off, hold the brake pedal down for a few seconds before starting off.

#### Note

The Official Service or a specialist workshop can tell you if your vehicle is equipped with this system.

## Manual gearbox

### Driving with manual gearbox

Read the additional information carefully

»  page 35



Certain versions of the model may include a 6-speed manual gearbox, and its diagram is shown on the gearbox lever.

The reverse gear can only be engaged when the car is stationary. When the engine is running and before engaging this gear, wait about 6 seconds with the clutch pressed down thoroughly in order to protect the gearbox.

The reverse lights switch on when the reverse gear is selected and the ignition is on.

### WARNING

- When the engine is running, the vehicle will start to move as soon as a gear is engaged and the clutch released.
- Never select the reverse gear when the vehicle is in motion. Risk of accident.

### Note

- Do not rest your hand on the gear lever while driving. The pressure of your hand could cause premature wear on the selector forks in the gearbox.
- When changing gear, you should always depress the clutch fully to avoid unnecessary wear and damage.
- Do not “slip” the clutch to hold the vehicle on a hill. This causes premature wear and damage to the clutch.
- Do not leave your foot on the clutch pedal; although the pressure may seem insignifi-

cant, it can cause the premature wear of the clutch plate. Use the foot rest when you do not need to change gear.

### Gear-change indicator

The recommended gear for saving fuel is indicated on the dash screen of certain vehicles during driving.

Display	Meaning
3	The optimal gear is selected.
4 ▲	Changing to a higher gear is recommended.
2 ▼	Changing to a lower gear is recommended.

### Information regarding the “cleanliness” of the diesel particulate filter

The exhaust system manager detects that the diesel particulate filter is nearly saturated and contributes to self-cleaning by recommending the optimal gear. For this purpose, it might be necessary to drive momentarily with a high rpm »» page 150.

### WARNING

The gear change indicator is only an auxiliary function and in no case should be a substitute for careful driving.

- The responsibility of choosing the correct gear depending on the situation (e.g. overtaking, driving up or down a slope or towing a trailer) lies with the driver.

### For the sake of the environment

Selecting the correct gear can help to save fuel.

### Note

The recommended gear display is switched off when the clutch pedal is pressed.

## Run-in and economical driving

### Running in a new engine

The engine needs to be run-in over the first 1500 km (900 miles).

#### For the first 1,000 kilometres (600 miles)

- Do not drive at speeds of more than 2/3 the maximum speed.
- Do not accelerate hard.
- Avoid high engine revolutions.
- Do not tow a trailer.

### From 1,000 kilometres (600 miles) to 1,500 kilometres (900 miles)

- Speeds can be *gradually* increased to the maximum road speed or maximum permissible engine speed (rpm).

During its first few hours of running, the internal friction in the engine is greater than later on, when all the moving parts have bedded in.

#### For the sake of the environment

**If the engine is run in gently, its life will be increased and its oil consumption reduced.**

### Tyre and brake pad run-in

New tyres should be run in carefully for the first 500 km (300 miles) and new brake pads should be run in carefully for the first 200 km (125 miles).

During the first 200 km (125 miles) you have to compensate for the reduced braking effect by applying more pressure to the brake pedal. In case of a sharp braking, the braking distance will be longer with new brake pads than with brake pads which have been run-in.

#### WARNING

- **At first, new tyres do not give maximum grip, and require running-in. This may cause an accident. Drive particularly carefully in the first 500 km (300 miles).**
- **New brake pads must be “run in” and do not have the correct friction properties during the first 200 km (125 miles). However, the reduced braking capacity may be compensated by pressing on the brake pedal a little harder.**

### Environmental compatibility

Environmental protection is a top priority in the design, choice of materials and manufacture of your new SEAT.

#### Constructive measures to encourage recycling

- Joints and connections designed for easy dismantling.
- Modular construction to facilitate dismantling.
- Increased use of single-grade materials.
- Plastic parts and elastomers are marked in accordance with ISO 1043, ISO 11469 and ISO 1629.

#### Choice of materials

- Use of recycled materials.

- Use of compatible plastics in the same part if its components are not easily separated.
- Use of recycled materials and/or materials originating from renewable sources.
- Reduction of volatile components, including odour, in plastic materials.
- Use of CFC-free coolants.

**Ban on heavy metals, with the exceptions dictated by law (Annex II of ELV Directive 2000/53/EC):** cadmium, lead, mercury, hexavalent chromium.

#### Manufacturing methods

- Reduction of the quantity of thinner in the protective wax for cavities.
- Use of plastic film as protection during vehicle transport.
- Use of solvent-free adhesives.
- Use of CFC-free coolants in cooling systems.
- Recycling and energy recovery from residues (RDF).
- Improvement in the quality of waste water.
- Use of systems for the recovery of residual heat (thermal recovery, enthalpy wheels, etc.).
- The use of water-soluble paints.

## Economical and environmentally-friendly driving

Fuel consumption, environmental pollution and wear to the engine, brakes and tyres depends in large part on your driving style. By adopting an economical driving style and anticipating the traffic situation ahead, you can easily reduce fuel consumption by 10-15%. Some tips on how to help you reduce pollution while saving money are listed below.

### Drive anticipating the traffic situation

A vehicle uses most fuel when accelerating. When you anticipate situations, you have to brake less often and, thus, accelerate less. If it is possible, let the vehicle roll with a **gear engaged**, for example, if you see a red light ahead. The braking effect achieved in this way helps to reduce the wear of brakes and tyres; emissions and fuel consumption are reduced to zero (disconnection due to inertia).

### Change gear early to save energy

An effective way of saving fuel is to change up *quickly* through the gears. Running the engine at high rpm in the lower gears uses an unnecessary amount of fuel.

**Manual gearbox:** shift up from first to second gear as soon as possible. We recommend that, whenever possible, you change to a higher gear upon reaching 2000 rpm. Follow

the “recommended gear” indication that appears on the instrument panel »» page 146.

### Avoid driving at high speed

We advise you not to drive at the top speed permitted by the vehicle. Fuel consumption, exhaust emissions and noise levels all increase very rapidly at higher speeds. Driving at moderate speeds will help to save fuel.

### Avoid idling

It is worthwhile switching off the engine when waiting in a traffic jam, at level crossings or at traffic lights with a long red phase. The fuel saved after only 30 - 40 seconds is greater than the amount of fuel needed to restart the engine.

The engine takes a long time to warm up when it is idling. Mechanical wear and pollutant emissions are also especially high during this initial warm-up phase. It is therefore best to drive off immediately after starting the engine. Avoid running the engine at high speed.

### Periodic maintenance

Periodic maintenance work guarantees that, before beginning a journey, you will not consume more than the required amount of fuel. A well-serviced engine gives you the benefit of **improved fuel efficiency** as well as maxi-

mum reliability and an enhanced resale value.

A badly serviced engine can consume up to 10% more fuel than necessary.

### Avoid short journeys

To reduce the consumption and emission of polluting exhaust gases, the engine and the exhaust gas filtration systems should reach the optimum **operating temperature**.

With the engine cold, fuel consumption is proportionally higher. The engine does not warm up and fuel consumption does not normalise until having driven approximately *four* kilometres (2.5 miles). This is why we recommend avoiding short trips whenever possible.

### Maintain the correct tyre pressures

Bear in mind that keeping the tyres at an adequate pressure saves fuel. If the tyre pressure is just one bar (14.5 psi/100 kPa) too low, fuel consumption can increase by as much as 5%. Due to the greater rolling resistance, under-inflation also increases tyre **wear** and impairs handling.

The tyre pressures should always be checked when the tyres are *cold*.

Do not use **winter tyres** all year round as they increase fuel consumption by up to 10%.

### Avoid unnecessary weight

Given that every kilo of **extra weight** will increase the fuel consumption, it is advisable to always check the luggage compartment to make sure that no unnecessary loads are being transported.

A roof rack is often left in place for the sake of convenience, even when it is no longer needed. At a speed of 100 km/h (62 mph) and 120 km/h (75 mph) your vehicle will use about 12% more fuel as a result of the extra wind resistance caused by the roof rack even when it is not in use.

### Save electricity

The engine activates the alternator, which produces electricity. With the need for electricity, fuel consumption also increases. Because of this, always turn off electrical devices when you do not need them. Examples of devices that use a lot of electricity are: the blower at high speeds, the rear window heater or the seat heaters\*.

#### Note

- If your vehicle has *Start-Stop*, it is not recommended that you switch this function off.
- It is recommended that you *close the windows* when driving at more than 60 km/h (37 mph).
- Do not drive with your foot resting on the *clutch pedal*, as the pressure can make the

plate spin, more fuel will be used and it can burn the clutch plate lining, causing a serious fault.

- Do not hold the car on a hill with the clutch, use the foot brake or hand brake, using the latter to start. The fuel consumption will be lower and you will prevent the clutch plate from being damaged.
- On descents, use the engine brake, changing to the gear that is more suitable for the slope. Fuel consumption will be “zero” and the brakes will not suffer.



## Engine management and exhaust gas purification system

### Introduction

#### WARNING

- Because of the high temperatures which can occur in the exhaust purification system (catalytic converter or diesel particulate filter), do not park the vehicle where the exhaust can come into contact with flammable materials under the car (e.g. on grass or at the forest edge). Fire hazard!
- Do not apply wax underneath the vehicle around the area of the exhaust system: Fire hazard!

#### Note

While the control lamps , , **EPC** or  remain lit, there may be engine problems, fuel consumption may increase and the engine may lose power.

### Catalytic converter

#### To maintain the useful life of the catalytic converter

- Use only unleaded petrol with petrol engines, as lead damages the catalytic converter.
- Do not let the fuel get too low in the tank.
- For engine oil changes, do not replenish with too much engine oil » page 181, **Top-up engine oil**.
- Never tow the vehicle to start it, use jump leads if necessary »  page 47.

If you notice misfiring, uneven running or loss of power when the vehicle is moving, reduce speed immediately and have the vehicle inspected at the nearest specialised workshop. In general, the exhaust warning lamp will light up when any of the described symptoms occur » page 92. If this happens, unburnt fuel can enter the exhaust system and escape into the environment. The catalytic converter can also be damaged by over-heating.



### ⓘ CAUTION

Never run the fuel tank completely dry because the irregularity of the fuel supply may cause ignition problems. This allows unburnt fuel to enter the exhaust system, which could cause overheating and damage the catalytic converter.

### 🌿 For the sake of the environment

Even when the emission control system is working perfectly, there may be a smell of sulphur from the exhaust gas under some conditions. This depends on the sulphur content of the fuel used. Quite often the problem can be solved by changing to another brand of fuel.

### Diesel engine particulate filter\*

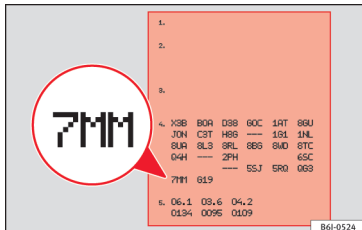

**Fig. 147** Vehicle data sticker on back cover of the Maintenance Programme.





Your vehicle is fitted with a DPF (Diesel Particulate Filter) if the vehicle data sticker (back cover of the “Maintenance Programme”) lists the code PR 7GG » **Fig. 147**.

The diesel engine particulate filter eliminates most of the soot from the exhaust gas system. Under normal driving conditions, the filter cleans itself. If this is not possible (for example, multiple short trips) the filter will be obstructed by soot and  the diesel engine particulate filter warning lamp will light up. This does not represent a fault, it is a warning that indicates that the filter has not been able to regenerate automatically and that you must perform a cleaning cycle, as indicated below.

### Accumulation of soot in the diesel engine particulate filter\*

If the control lamp  lights up you should help the filter clean itself by driving in the appropriate manner.

You should drive at a speed of at least 60 km/h (37 mph) for about 15 minutes in 4th or 5th gear at an engine speed of around 2,000 rpm. In this way, the soot build up in the filter is burned. When cleaning is successful, the control lamp turns off.

If the lamp  does not turn off, or the three lamps turn on (particulate filter , fault in the emission control system  and glow plugs ), drive the vehicle to a specialised

workshop and have the fault repaired at the earliest opportunity.

### ⚠️ WARNING

Always drive according to the road weather conditions, the terrain and traffic. Driving recommendations should never lead to illegal manoeuvres in surrounding traffic.

### ⓘ CAUTION

- Your vehicle is not designed to use biodiesel fuel. Never, under any circumstances refuel with biodiesel. The use of biodiesel fuel could damage the engine and the fuel system. The addition of biodiesel to diesel by the diesel producer in accordance with standard EN 590 is authorised and will not cause damage to the engine or the fuel system.
- Using diesel fuel with a high sulphur content may significantly reduce the useful life of the diesel particulate filter. Your Technical Service will be able to tell you which countries have diesel with a high sulphur content.

### Engine management\* EPC

This warning lamp monitors the engine management system for petrol engines.

The warning lamp **EPC** (Electronic Power Control) lights up when the ignition is switched on while system operation is being verified. It should go out once the engine is started.



If there is a fault in the electronic engine management system while you are driving, this warning lamp will light up. Take the vehicle to a specialised workshop as soon as possible and have the engine checked.

### Emission control system\*

#### Control lamp flashes:

When there is misfiring that can damage the catalytic converter. Reduce speed and drive carefully to the nearest specialised workshop to have the engine checked.

#### The control lamp lights up:

If a fault has developed during driving which has reduced the quality of the exhaust gas (e.g. lambda probe fault). Reduce speed and drive carefully to the nearest specialised workshop to have the engine checked.

### Engine pre-heating/fault system\*

The warning lamp lights up to show that the glow plugs are preheating the diesel engine.

#### The control lamp lights up

If the control lamp  lights up when the engine is started it means that the glow plugs are preheating. The engine can be started straight away when the lamp switches off.

#### Control lamp flashes

If a fault develops in the engine management system while you are driving, the glow plug system lamp will flash . Take the vehicle to a specialised workshop as soon as possible and have the engine checked.

## Driving tips

### Driving abroad

To drive abroad, the following must be taken into consideration:

- For vehicles fitted with a catalytic converter ensure that unleaded petrol is available for the journey. See the chapter “Refuelling”. Automobile organisations will have information about service station networks selling unleaded fuel.
- In some countries, it is possible that your car model is not sold, and therefore some spare parts are not available or the technical services may only be able to carry out limited repairs.

SEAT importers and distributors will gladly provide information about the technical preparation that your vehicle requires and also about necessary maintenance and repair possibilities.

#### Adhesive strips for headlights

In countries where vehicles drive on the other side of the road to your home country, the asymmetric dipped beam may dazzle drivers of oncoming vehicles.

To prevent dazzling, you must apply stickers to certain parts of the headlight lenses. Further information is available at any Technical Service.

### Driving on flooded roads

To prevent damage to the vehicle when driving through water, for example, along a flooded road, please observe the following:

- The water should never come above the lower edge of the bodywork.
- Drive at pedestrian speed.

#### WARNING

**After driving through water, mud, sludge, etc., the braking effect can be delayed slightly due to moisture build-up on the discs and brake pads. Applying the brakes carefully several times will remove the moisture and restore the full braking effect.**



**ⓘ CAUTION**

- Driving through flooded areas may severely damage vehicle components such as the engine, transmission, running gear or electrical system.
- Whenever driving through water, the Start-Stop system\* must be switched off  
»» page 152.

**ⓘ Note**

- Check the depth of the water before entering the flooded zone.
- Do not stop in the water, drive in reverse, or stop the engine in any situation.
- Note that vehicles travelling in the opposite direction may splash water that could exceed the maximum permitted water height for your vehicle.
- Avoid driving through salt water (corrosion).

## Driver assistance systems

### Start-Stop System\*

#### Description and operation

The Start-Stop function stops the engine when the vehicle is stopped and starts it automatically when required.

#### Vehicles with a manual gearbox

- When the vehicle is stopped, put it into neutral and release the clutch pedal. The engine will switch off. The warning lamp (A) will appear on the instrument panel display.
- When the clutch pedal is pressed the engine will start up again. The warning lamp will switch off.

#### Start-Stop function conditions

- The driver seat belt must be buckled.
- The bonnet must be closed.
- The engine must be at operating temperature.
- The steering wheel must be straight.
- The vehicle must be on flat ground.
- The vehicle must not be in reverse.
- A trailer must not be connected.

- The temperature of the interior must be within the comfort limits (A/C button should be selected).
- The windscreen de-mist function must be off.
- If an increase in airflow is **not** requested.
- The temperature must not be set to **HI** or **LO**.
- The driver door must be closed.
- The diesel particulate filter must not be in regeneration mode, for diesel engines.
- The battery charge must not be low for the next start.
- Battery temperature must be between -1°C (+30°F) and +55°C (+131°F).

#### Start-Stop function interruption

In the following situations, the Start-Stop function will be interrupted and the engine will automatically start:

- The vehicle starts moving.
- The brake pedal is pressed several times in a row.
- The battery has been discharged excessively.
- The Start-Stop System is manually deactivated.
- The windscreen de-mist function is turned on.

- The temperature of the interior exceeds the comfort limits (A/C) button).
- If the airflow is increased by more than 3 presses.
- Temperature setting **HI** or **LO** is selected.
- The engine coolant temperature is insufficient.
- The alternator is faulty, for example the V-belt has ruptured.
- If any of the conditions described in the previous section are not fulfilled.

When the engine is turned off by the Start-Stop function, this is displayed on the instrument panel.

If the Start-Stop system is not switched on, the  warning lamp will appear on the instrument panel.

### WARNING

Never allow the vehicle to move with the engine off for any reason. You could lose control of your vehicle. This could cause an accident and serious injury.

- The brake servo does not work with the engine off. You need more force to stop the vehicle.
- Power steering does not work when the engine is not running. That is why it is much more difficult to turn the steering wheel.
- Turn off the Start-Stop system when driving through water (fording streams, etc.).

### Note

- For vehicles with the Start-Stop function and a manual gearbox, when the engine is started, the clutch must be pressed.
- When the conditions for the Start-Stop function are not fulfilled, the instrument panel displays the Start-Stop indicator dimmed.
- If the steering wheel is turned more than 270°, it will not be possible to start the vehicle again. To start the vehicle, straighten the steering wheel so that it is turned less than 270°.
- There are different versions of the dash panel; the display of indications on the screen may differ.

## Activating and deactivating the Start-Stop function



**Fig. 148** The Start-Stop function button.

Every time the ignition is switched on, the Start-Stop function is automatically activated.

### Manually deactivating the Start-Stop function

- Press the  **Fig. 148** button located on the centre console. When the Start-Stop function is switched off, the warning lamp comes on.
- If the Start-Stop function is operating then the engine starts immediately.

### Switching the Start-Stop function on manually

- Press the  **Fig. 148** button located on the centre console. The warning lamp will switch off.

## Fatigue detection (break recommendation)\*

### Introduction

 **»»** table on page 2

The Fatigue detection informs the driver when their driving behaviour shows signs of fatigue.

**WARNING**

Do not let the comfort afforded by the Fatigue detection system tempt you into taking any risks when driving. Take regular breaks, sufficient in length when making long journeys.

- The driver always assumes the responsibility of driving to their full capacity.
- Never drive if you are tired.
- The system does not detect the tiredness of the driver in all circumstances. Consult the information in the section » page 154, System limitations.
- In some situations, the system may incorrectly interpret an intended driving manoeuvre as driver tiredness.
- No warning is given in the event of the effect called microsleep!
- Please observe the indications on the instrument panel and act as is necessary.

**Note**

- Fatigue detection has been developed for driving on motorways and well paved roads only.
- If there is a fault in the system, have it checked by a specialised workshop.

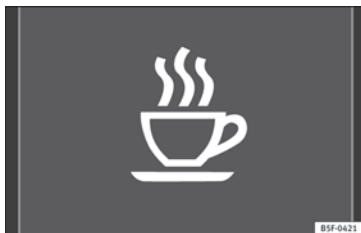
**Function and operation**

**Fig. 149** On the instrument panel display: fatigue detection symbol.

Fatigue detection determines the driving behaviour of the driver when starting a journey, making a calculation of tiredness. This is constantly compared with the current driving behaviour. If the system detects that the driver is tired, an audible warning is given with a sound and an optic warning is shown with a symbol and complementary message on the instrument panel display » **Fig. 149**. The message on the instrument panel display is shown for approximately 5 seconds, and depending on the case, is repeated. The system stores the last message displayed.

The message on the instrument panel display can be switched off by pressing the **OK/RESET** button on the windscreen wiper lever or the button **OK** on the multi function steering wheel » **page 25**.

The message can be recalled to the instrument panel display using the multifunction display » **page 25**.

**Conditions of operation**

Driving behaviour is only calculated on speeds above about 65 km/h (40 mph) up to around 200 km/h (125 mph).

**Switching on and off**

Fatigue detection can be activated or deactivated in the Easy Connect system with the **CAR** button and the **Setup** function button » **page 93**. A mark indicates that the adjustment has been activated.

**System limitations**

The Fatigue detection has certain limitations inherent to the system. The following conditions can limit the Fatigue detection or prevent it from functioning.

- At speeds below 65 km/h (40 mph)
- At speeds above 200 km/h (125 mph)
- When cornering
- On roads in poor condition
- In unfavourable weather conditions
- When a sporty driving style is employed
- In the event of a serious distraction to the driver

Fatigue detection will be restored when the vehicle is stopped for more than 15 minutes, when the ignition is switched off or when the driver has unbuckled their seat belt and opened the door.

In the event of slow driving during a long period of time (below 65 km/h, 40 mph) the system automatically re-establishes the tiredness calculation. When driving at a faster speed the driving behaviour will be recalculated.

## Parking aid\*

### General information

Assorted assistance systems – which vary depending on the equipment fitted in the car – will help you when parking or manoeuvring.

The **rear parking aid** is an audible assistant that warns about obstacles located *behind* the vehicle » page 156.

### WARNING

- Always pay attention, also when looking straight ahead, to traffic and the vehicle surroundings. The assistance systems are not a replacement for driver awareness. When inserting or removing the vehicle from a parking space, or when performing similar ma-

noeuvres the driver always assumes the responsibility.

- Adapt your speed and driving style at all times to suit visibility, weather, road and traffic conditions.
- The ultrasound sensors have blind spots in which obstacles and people are not registered. Pay special attention to children and animals.
- Always keep visual control of the vehicle surroundings: use the mirrors for additional help.

### CAUTION

Parking Aid functions may be negatively affected by different factors that may lead to damage to the vehicle or its immediate surroundings:

- Under certain circumstances, the system does not detect or display certain objects:
  - Objects such as chains, trailer draw bars, fences, posts and thin trees.
  - Objects that are located above the sensors, such as protrusions in a wall.
  - Objects with certain surfaces or structures, such as wire mesh fences or powder snow.
- Certain surfaces of objects and garments do not reflect the ultrasound sensors' signals. The system cannot detect, at least correctly, these objects or people wearing such clothes.

- Ultrasound sensor signals may be affected by external sound sources. In certain circumstances this may prevent them from detecting people or objects.

- Please note that low obstacles detected by the system may no longer be registered by the sensors as the car moves closer, so the system will not give any further warning. In certain circumstances, objects such as high kerbs that could damage the bottom of the vehicle are not detected either.

- If the first warning from the ParkPilot is ignored, the vehicle could suffer considerable damage.

- The knocks or damage on the radiator grille, bumper, wheel arch and vehicle underbody can adjust the orientation of the sensors. This can affect the parking aid function. Have the function checked by a specialised workshop.

### Note

- In certain situations, the system can give a warning even though there is no obstacle in the detected area, e.g.:
  - with rough or cobbled floors or ground with long grass;
  - with external ultrasound sources, such as cleaning vehicles or other vehicles;
  - In downpours, intense snow or dense exhaust gases;



- if the registration plate (front or rear) is not properly affixed to the bumper surface;
- or in locations such as the brow of a hill.
- In order to guarantee good system operation, keep the ultrasound sensors clean, free of snow or ice, and do not cover them with adhesives or other objects.
- If you use high-pressure or vapour equipment to clean the ultrasound sensors, apply it directly only very briefly and always from a distance of more than 10 cm.
- Retrofitting of accessories to the vehicle, such as a bicycle rack, may interfere with the operation of the Parking Aid.
- In order to familiarise yourself with the system, it is advised that you practice parking in an area or car park that is free from traffic. There must be good weather and light conditions.
- The volume and tone of the warnings can be modified, in addition to the indications »» page 156.
- In vehicles *without* a driver information system, these parameters can be modified in a SEAT Official Service or in a specialised workshop.
- Please observe information on towing a trailer »» page 157.
- The display on the Easy Connect screen shows a slight time delay.

### Rear parking aid\*

The rear Parking Aid assists the driver in parking by means of audible warning sounds.

#### Description

There are sensors integrated in the rear bumper. When the sensors detect an obstacle, you are alerted by audible warnings.

Make particularly sure that the sensors are not covered by adhesives, residues and the like, as this could affect the system's operation. Cleaning instructions »» page 169.

The approximate measurement range of the rear sensors is:

side area	0.60 m
central area	1.60 m

As you approach the obstacle, the time interval between the audible warnings will be reduced. When you reach around 0.30 m the warning will be constant: Do not continue to move forward (or backward) »» ⚠ in General information on page 155, »» 📢 in General information on page 155 !

If you maintain separation from the obstacle, the volume of the warning begins to reduce after four seconds (does not affect the tone of the constant warning).

### Activating/Deactivating

When engaging reverse gear, the parking aid is automatically switched on. This is confirmed with a short warning.

On disengaging reverse gear, the Parking Aid system is disconnected immediately.

### Adjusting the display and audible warnings

The settings for the display and audible warnings are controlled via the Easy Connect\*.

#### Rear volume\*

Volume in the rear area.

#### Rear sound settings/sharpness\*

Frequency (tone) of the sound in the rear area.

#### Adjust volume

With the parking aid switched on, the active audio/video source volume will be reduced to the intensity of the selected setting.

## Error messages

When the Parking Aid is activated or when it is switched on, if a message reporting a Parking aid error is displayed on the instrument panel, there is a fault in the system.

If the fault doesn't disappear before disconnecting the ignition, next time that parking aid is engaged in reverse, it will not be indicated.

## Towing bracket

In vehicles equipped with a towing bracket device from the factory, when the trailer is connected electrically, the Parking Aid rear sensors will not be activated when reverse gear is engaged.

## Rear Assist “Rear View Camera”\*

### Operating and safety warnings

#### WARNING

• The Rear Assist does not make it possible to precisely calculate the distance from obstacles (people, vehicles, etc.) and nor can it overcome the system's own limits, hence using it may cause serious accidents and inju-

ries if used negligently or without due care. The driver should be aware of his/her surroundings at all times to ensure safe driving.

- The camera lens expands and distorts the field of vision and displays the objects on the screen in a different, vague manner. The perception of distances is also distorted by this effect.
- Due to the screen resolution or insufficient light conditions, some items may be displayed in an unsatisfactory manner or not at all. Take special care with thin posts, fences, railings or trees that might not be displayed on screen and could damage the vehicle.
- The rear assist has blind spots where it is not possible to represent people or objects (small children, animals and certain objects cannot be detected in its field of vision). Monitor the vehicle's surrounding area at all times.
- Keep the camera lens clean, free of ice and snow, and do not cover it.
- The system is not a replacement for driver awareness. Supervise the parking operation at all times, as well as the vehicle's surrounding area. Adapt your speed and driving style at all times to suit visibility, weather, road and traffic conditions.
- Do not be distracted from the traffic by looking at the screen.
- The images on the rear assist screen are only two-dimensional. Due to a lack of spatial depth, protruding parts or holes in the road, for example, are more difficult to detect or may not be seen at all.

- Vehicle load modifies the representation of the orientation lines displayed. The width represented by the lines diminishes with vehicle load. Pay special attention to the vehicle's surroundings when the inside of the vehicle of the luggage compartment is carrying a heavy load.

- In the following situations, the objects or other vehicles shown in the navigation system display appear to be further away or closer than they really are: Pay special attention:

- On moving from a horizontal plane to a slope.
- On moving from a slope to a horizontal plane.
- If the vehicle is heavily loaded at the rear.
- When the vehicle approaches objects that are not on the ground surface or are jutting out from it. These objects may also be outside the camera's angle of vision when reversing.

#### Note

- It is important to take great care and pay special attention if you are not yet familiar with the system.
- Rear assist will not be available if the vehicle's rear lid is open.

## Instructions for use

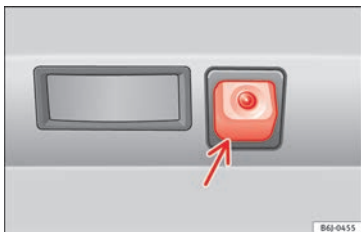

**Fig. 150** On the rear bumper: location of the rear assist camera.

### »» table on page 2

A camera on the rear bumper aids the driver during reverse parking or manoeuvring. **»» Fig. 150.** The camera image is viewed together with orientation lines projected by the system on the Infotainment system screen. The bottom of the screen displays part of the bumper corresponding to the number plate area that will be used as reference by the driver.

### Rear assist settings

Rear assist offers the user the possibility to change the image's *brightness*, *contrast* and *colour* settings.

To change these settings:

- Park the vehicle in a safe place.

- Apply the parking brake.
- Switch the ignition on.
- If necessary, switch on the Infotainment system.
- Select reverse gear.
- Press the  function button displayed on the right of the image.
- Make the desired adjustments on the menu by pressing the  $-/+$  function buttons or by moving the corresponding scroll button.

### Necessary conditions for parking and manoeuvring with the rear assist

The system should not be used in the following cases:

- If the image displayed is not very reliable or is distorted, for example low visibility or dirty lens.
- If the area behind the vehicle is not displayed very clearly or is incomplete.
- If the vehicle is heavily loaded at the rear.
- If the position and installation angle of the camera have been changed, e.g. after a rear-end collision. Have the system checked by a specialised workshop.

### Familiarising yourself with the system

To familiarise yourself with the system, the orientation lines and their function, SEAT recommends practising parking and manoeu-

vring with the rear assist in a place without too much traffic or in a car park when there are good weather and visibility conditions.

### Cleaning the camera lens

Keep the camera lens clean and clear of snow and ice:

- Moisten the lens using a normal alcohol-based glass cleaning product and clean the lens with a dry cloth.
- Remove snow using a small brush.
- Use de-icing spray to remove any ice.

### ⓘ CAUTION

- **Never use abrasive cleaning products to clean the camera lens.**
- **Do not use hot or warm water to remove ice or snow from the camera lens. Doing so could damage the camera.**



## Parking and manoeuvring with the rear assist

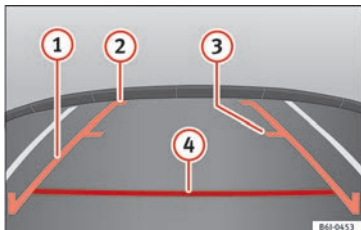

**Fig. 151** Display on the Infotainment system screen: orientation lines.

### Switching the system on and off

- The rear assist will switch on when reverse gear is engaged, provided the ignition is on or the engine is running.
- The system switches off 8 seconds after disengaging reverse gear. The system will also disconnect immediately after the ignition is switched off.
- The camera will stop transmitting images above the speed of 15 km/h (9 mph) with reverse engaged.

### Meaning of the orientation lines

» **Fig. 151**

- ① **Side lines:** extension of the vehicle (the approximate width of the vehicle plus the rear view mirrors) on the road surface.
- ② **End of the side lines:** the area marked in green ends approximately 2 m behind the vehicle on the road surface.
- ③ **Intermediate line:** indicates a distance of approximately 1 m behind the vehicle on the road surface.
- ④ **Red horizontal line:** indicates a safe distance of approximately 40 cm at the rear of the vehicle on the road surface.

### Parking manoeuvre

- Stop the vehicle in front of a parking space and select reverse gear.
- Reverse slowly, and turn the steering wheel so that the side orientation lines lead towards the parking space.
- Guide the vehicle into the parking space so that the side orientation lines run parallel to it.

## Cruise speed\* (cruise control - GRA)

### Operation

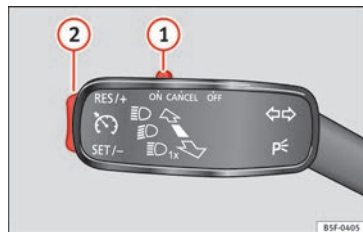

**Fig. 152** Turn signal and main beam headlight lever: switch and rocker switch for the cruise control.

### Read the additional information carefully

» page 32

The CCS is able to maintain the set speed in the range from approx. 30 km/h (19 mph) to 180 km/h (112 mph).

Once the speed setting has been saved, you may take your foot off the accelerator.

When the cruise control is on and a speed is programmed, the indicator on the instrument panel\* is lit.

If the cruise control system is *switched off*, the symbol is switched off. The system will »

also be switched off fully when the **1st** gear is engaged.\*

### Switching on the cruise control system

- Move the switch » **Fig. 152** ① towards the left to **ON**.

### Setting speed

- Briefly press the lower part of the rocker switch **SET-** » **Fig. 152** ② once when you have reached the speed you wish to set.

When you release the rocker switch, the current speed is set and held constant.

### Switching off the cruise control system

- Move the control ① towards the right to **OFF** or turn the ignition off if the vehicle is stationary.

#### **WARNING**

**It could be dangerous to use the cruise control system if it is not possible to drive at constant speed.**

- **Do not use the cruise control system when driving in dense traffic, on roads with lots of bends or on roads with poor conditions (with ice, slippery surfaces, loose grit or gravel), as this could cause an accident.**
- **Always switch the cruise control system off after using it in order to avoid involuntary use.**

- **It is dangerous to use a set speed which is too high for the current road, traffic or weather conditions. Risk of accident.**

#### **Note**

**The cruise control cannot maintain a constant speed when descending downhill. It will increase due to its own weight. Use the foot brake to slow the vehicle.**

### Adjusting the stored speed\*

The speed can be altered without touching the accelerator or the brake.

#### Setting a higher speed

- Press the upper part of the rocker switch **RES+** » **Fig. 152** ② to increase the speed. The vehicle will continue to accelerate as long as you keep the rocker switch pressed. When you release the switch, the new speed is stored.

#### Setting a lower speed

- Press the lower part of the rocker switch **SET-** » **Fig. 152** ② to reduce the speed. The vehicle will automatically reduce its speed for as long as you keep the switch pressed. When you release the switch, the new speed is stored.

When you increase speed with the accelerator and then release the pedal, the system will automatically restore the set speed. This will not be the case, however, if the vehicle speed exceeds the stored speed by more than 10 km/h (6 mph) for longer than 5 minutes. The speed will have to be stored again.

Cruise control is switched off if you reduce speed by depressing the brake pedal. Reactivate the control by pressing once on the upper part of the rocker switch **RES+** » **Fig. 152** ②.

### Deactivation of cruise control

#### Temporary deactivation of the system\*

The cruise control system will be switched off in the following situations:

- if the brake pedal is depressed,
- if the clutch pedal is depressed,
- if the vehicle is accelerated to over 180 km/h (112 mph),
- when the lever ① is moved in the direction of **OFF** without being fully engaged.

To resume cruise control, release the brake or clutch pedal or reduce the vehicle speed to less than 180 km/h (112 mph) and press once on the upper part of the rocker switch **RES+** » **Fig. 152** ②.

### Completely switching off the system

The system is **completely turned off** by moving the control » Fig. 152 ① all the way to the right hand side (set into the OFF position), or when the vehicle is stationary, switching off the ignition.

## Towing bracket device and trailer

### Trailer mode

#### What do you need to bear in mind when towing a trailer?

Your vehicle may be used to tow a trailer when fitted with the correct equipment.

If the car is supplied with a **factory-fitted** towing bracket it will already have the necessary technical modifications and meet the statutory requirements for towing a trailer. If you wish to **retrofit** a towing bracket, consult » page 163.

#### Connectors

Your vehicle is fitted with a 12-pin connector for the electrical connection between the trailer and the vehicle.

If the trailer has a **7-pin plug** you will need to use an adapter cable. It is available at any Technical Service.

#### Trailer weight/drawbar load

Never exceed the authorised trailer weight. If you do not load the trailer up to the maximum permitted trailer weight, you can then climb correspondingly steeper slopes.

The maximum trailer weights listed are only applicable for **altitudes** up to 1000 m above sea level. With increasing altitude the engine power and therefore the vehicle climbing ability are impaired because of the reduced air density. The maximum trailer weight has to be reduced accordingly. The weight of the vehicle and trailer combination must be reduced by 10% for every further 1000 m (or part thereof). The gross combination weight is the actual weight of the laden vehicle plus the actual weight of the laden trailer. When possible, operate the trailer with the maximum permitted **drawbar load** on the ball joint of the towing bracket, but do not exceed the specified limit.

The figures for **trailer weights** and **drawbar loads** that are given on the data plate of the towing bracket are for certification purposes only. The correct figures for your specific model, which may be *lower* than these figures for the towing bracket, are given in the vehicle documentation or in » chapter **Technical Data**.

#### Distributing the load

Distribute loads in the trailer so that heavy objects are as near to the axle as possible. Loads carried in the trailer must be secured to prevent them moving.

»

## Tyre pressure

Set tyre pressure to the maximum permissible pressure shown on the sticker on the inside of the fuel tank flap. Set the tyre pressure of the trailer tyres in accordance with the trailer manufacturer's recommendations.

## Exterior mirrors

Check whether you can see enough of the road behind the trailer with the standard rear vision mirrors. If this is not the case, you should have additional exterior mirrors fitted. Both exterior mirrors should be mounted on hinged extension brackets. Adjust the mirrors to give sufficient vision to the rear.

### WARNING

**Never transport people in a trailer. This could result in fatal accidents.**

### Note

- **Towing a trailer places additional demands on the vehicle. We recommend additional services between the normal inspection intervals if the vehicle is used frequently for towing a trailer.**
- **Find out whether special regulations apply to towing a trailer in your country.**

## Ball coupling of towing bracket\*

The ball coupling is provided with instructions on fitting and removing the ball coupling of the towing bracket.

### WARNING

**The towing bracket ball coupling must be stored securely in the luggage compartment to prevent them being flung through the vehicle and causing injury.**

### Note

- **By law, the ball coupling must be removed if a trailer is not being towed if it obscures the number plate.**

## Driving tips

Driving with a trailer always requires extra care.

### Weight distribution

The weight distribution of a loaded trailer with an unladen vehicle is very unfavourable. However, if this cannot be avoided, drive extra slowly to allow for the unbalanced weight distribution.

## Speed

The stability of the vehicle and trailer is reduced with increasing speed. For this reason, it is advisable not to drive at the maximum permissible speed in an unfavourable road, weather or wind conditions. This applies especially when driving downhill.

You should always reduce speed immediately if the trailer shows the slightest sign of **snaking**. Never try to stop the “snaking” by increasing speed.

Always brake in due course. If the trailer has an **overrun brake**, apply the brakes *gently at first* and then, firmly. This will prevent the jerking that can be caused by locking of trailer wheels. Select a low gear in due course before going down a steep downhill. This enables you to use the engine braking to slow down the vehicle.

### Reheating

At very high temperatures and during prolonged slopes, driving with a low gear and high engine speed; always monitor whether the excessive coolant temperature gauge is activated »» page 182.

## Retrofitting a towing bracket\*

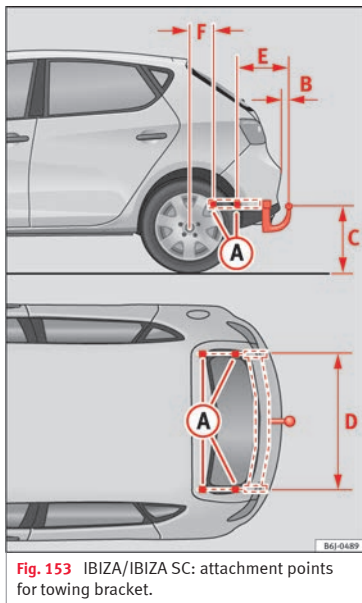

If a towing bracket is to be fitted after the vehicle is purchased, this must be completed according to the instructions of the towing bracket manufacturer.

The attachment points **A** for the towing bracket are underneath the vehicle.

The distance between the centre of the ball coupling and the ground should never be lower than the indicated value, even with a fully loaded vehicle and including the maximum drawbar load.

## Elevation values for securing the towing bracket:

Fig. 153	IBIZA/IBIZA SC
<b>B</b>	65 mm (minimum)
<b>C</b>	350 mm to 420 mm (fully laden vehicle)
<b>D</b>	959 mm
<b>E</b>	438 mm
<b>F</b>	209 mm

## Fitting a towing bracket

- Driving with a trailer involves an extra effort for the vehicle. Therefore, before fitting a towing bracket, please contact a Technical Service to check whether your cooling system needs modification.
- The legal requirements in your country must be observed (e.g. the fitting of a separate control lamp).
- Certain vehicle components, for example the rear bumper, must be removed and reinstalled. The towing bracket securing bolts must be tightened using a torque wrench,

and a power socket must be connected to the vehicle electrical system. This requires specialised knowledge and tools.

- Figures in the illustration show the elevation value and the attachment points which must be considered if you are retrofitting a towing bracket.

**⚠ WARNING**

The towing brackets should be fitted at a specialised workshop.

- If the towing bracket is incorrectly installed, there is a serious danger of accident.
- For your own safety, please observe the tow bracket manufacturer's instructions.

**ⓘ CAUTION**

• If the power socket is incorrectly installed, this could cause damage to the vehicle electrical system.

**i Note**

- SEAT recommends that the towing hooks be fitted at a specialised workshop. In certain versions this may entail fitting a heat insulating plate, which is why it is recommended that you go to a SEAT Dealer. In the event that the plate is not installed correctly, SEAT is exempt from any liability.
- Due to the specific design of the exhaust, the fitting of a conventional towing hook is

»

**not recommended for some sportier versions.  
Please consult your Technical Service.**

## Advice

### Care and maintenance

#### Accessories and modifications to the vehicle

##### Accessories, replacement of parts and modifications

Your vehicle is designed to offer a high standard of active and passive safety.

Before purchasing accessories and parts, and before making technical changes to your vehicle, we recommend that you consult your Technical Service.

SEAT dealerships will be happy to provide you with the latest information about the use, legal requirements and recommendations from the manufacturer regarding accessories and spare parts.

We recommend you use only **SEAT Approved Accessories®** and **SEAT Approved Spare Parts®**. This way, SEAT can guarantee that the product in question is suitable, reliable and safe. SEAT Technical Services have the necessary experience and facilities to ensure that parts are correctly and professionally installed.

Despite a continuous observation of the market, SEAT is not able to assess the reliability, safety and suitability of parts that **SEAT has not approved**. For this reason, SEAT cannot assume responsibility for any non-genuine parts used, even if these parts have been approved by an official testing agency or are covered by an official approval certificate.

Any **retro-fitted equipment** which has a direct impact on the driver's control of the vehicle, such as a cruise control system or electronically-controlled suspension, must be approved by SEAT for use in your vehicle and bear the **e** mark (the European Union's authorisation symbol).

If **any additional electrical devices** are fitted which do not serve to control the vehicle itself, such as refrigerator boxes, laptops or ventilator fans, they must bear the **CE** mark (European Union manufacturer conformity declaration).

##### WARNING

**Accessories, for example telephone holders or cup holders, should never be fitted on the covers, or within the working range, of the airbags. Otherwise, there is a danger of injury if the airbag is triggered in an accident.**

##### Modifications

Modifications must always be carried out according to our specifications. Unauthorised modifications to the electronic components or software in the vehicle may cause malfunctions. Due to the way the electronic components are linked together in networks, other indirect systems may be affected by the faults. This can seriously impair safety, lead to excessive wear of components, and also invalidate your vehicle registration documents.

SEAT Technical Services cannot be held liable for any damage caused by modifications and/or work incorrectly performed. For this reason, we recommend having all work performed by a SEAT Technical Service using **SEAT®** Original Spare Parts.

##### WARNING

**Any type of work or modification performed incorrectly on your vehicle can lead to malfunctions and can cause accidents.**

##### Roof aerial\*

The vehicle can be fitted with a foldable\* and anti-theft\* roof aerial which can be folded backwards, for example when going through an automatic car wash. »

**To fold**

Unscrew the aerial rod, tilting it backwards into a horizontal position and then screw in again.

**To return to working position**

Continue in the reverse order to the previous instruction.

**ⓘ CAUTION**

If an automatic car wash tunnel is used, before entering the tunnel, put the aerial down parallel to the roof and do not tighten to avoid damage.

**Mobile phones and two-way radios**

SEAT has approved for your vehicle the use of mobile telephones and two-way radios providing under the following conditions:

- The external aerial should be correctly installed.
- The transmitting power should be a maximum 10 watts.

The optimal reach of the equipment is only achieved with an external aerial.

First consult your Technical Service if you wish to use a mobile telephone or a two-way radio with a transmitting power output in excess of 10 watts. Here you will receive infor-

mation concerning the technical possibilities for retrofitting this equipment.

Mobile telephones and two-way radios should be only fitted by a specialised workshop, for example a SEAT dealership.

**⚠ WARNING**

- Always concentrate primarily on driving. If you are distracted while driving you could have an accident.
- Never attach the telephone mountings to the surfaces covering the airbag units or within the range of the airbags. There is a high danger of injury if the airbag is triggered.
- Using your mobile telephones or two-way radios in the vehicle without an external aerial, electromagnetic radiation in the vehicle could exceed authorised limits. This also may occur to external aerials that have not been correctly installed.

**ⓘ CAUTION**

Failure to consider the above-mentioned conditions could cause the electronics to malfunction. The most common causes of faults are:

- no external aerial,
- external aerial incorrectly installed,
- transmitting power output in excess of 10 watts.

**ⓘ Note**

Please observe the operating instructions of your mobile telephone/two-way radio.

**Care and cleaning****General notes****Vehicle maintenance**

Regular care and washing help to **maintain the value** of the vehicle. This may also be one of the requirements for acknowledging warranty claims in the event of bodywork corrosion or paint defects.

The best way to protect your vehicle against the harmful effects of the environment is through correct maintenance and *frequent* washing. The longer substances such as insect remains, bird droppings, resinous tree sap, road dirt, industrial deposits, tar, soot or road salt and other aggressive materials remain on the vehicle, the more damage they do to the paintwork. High temperatures, for instance in strong sunlight, further intensify the corrosive effect.

After winter, a period when salt is put on the roads, it is important to have the **underside** of the vehicle washed thoroughly.



## Products for vehicle maintenance

Car-care products are available in your Technical Services. Keep the product instructions until you have used them up.

### ⚠ WARNING

- Car-care products can be toxic. Because of this, they must always be kept closed in their original container. Keep them out of the reach of children. Failure to comply could result in poisoning.
- Always read and observe the instructions and warnings on the package before using car-care products. Improper use could cause health problems or damage the vehicle. The use of certain products may produce noxious vapours; they should be used in well ventilated areas.
- Never use fuel, turpentine, engine oil, nail varnish remover or other volatile fluids. These are toxic and highly flammable. Risk of fire and explosion.
- Before washing your vehicle, or carrying out any maintenance, switch the engine off, apply the handbrake firmly and remove the key from the ignition.

### ⓘ CAUTION

Never attempt to remove dirt, mud or dust if the surface of the vehicle is dry. Never use a dry cloth or sponge for cleaning purposes. This could damage the paintwork or the windows of your vehicle. Soak dirt, mud or dust with plenty of water.

### ♻ For the sake of the environment

- When purchasing car care products, try to select ones that are not harmful to the environment.
- The waste from car-care products should not be disposed of with ordinary household waste. Observe the disposal information on the package.

## Care of the vehicle exterior

### Automatic car wash tunnel

The vehicle paintwork is so durable that the vehicle can normally be washed without problems in an automatic car wash tunnel. However, the paintwork wear depends to a large extent on the kind of the car wash tunnel, the brushes used, its water filtering and the type of cleaning and preservative products.

Before going through a car wash, be sure to take the usual precautions such as closing the windows and sunroof. There is nothing to note apart from that.

If the vehicle has special accessories such as spoilers or a roof rack or two-way radio aerial, etc., it is advisable to consult the car wash tunnel operator first.

After washing, **the brakes** could take some time to respond as the brake discs and pads could be wet, or even frozen in winter. "Dry" the brakes by braking several times.

### ⚠ WARNING

Water, ice and salt on the brake system can reduce braking effectiveness. Risk of accident.

### ⓘ CAUTION

Before putting the vehicle through the car wash, do not tighten the aerial if it is folded because it can be damaged.

### Hand-washing

#### Vehicle washing

- First soften the dirt and rinse it off with water.
- Clean your vehicle from top to bottom with a soft sponge, a glove or a brush. Use very light pressure.
- Rinse the sponge or glove often with clean water.
- Special car shampoo should only be used for very stubborn dirt.
- Leave the wheels, sill panels etc. until last, using a different sponge or glove.

- Rinse the vehicle thoroughly with water.
- Dry the vehicle surface gently with a chamois leather.
- In **cold temperature**, dry the rubber seals and their surfaces to prevent them from freezing. Apply silicone spray to the rubber seals.

#### After washing the vehicle

- After washing, avoid sudden and sharp braking. “Dry” the brakes by braking several times.

#### WARNING

- Wash your vehicle with the ignition switch off.
- Protect your hands and arms from cuts on sharp metal edges when cleaning the underbody, the inside of the wheel housings etc. Risk of injury.
- Water, ice and salt on the brake system can reduce braking effectiveness. Risk of accident.

#### CAUTION

- Never remove dirt, mud or dust if the vehicle surface is dry. Never use a dry cloth or sponge for cleaning purposes. This could scratch the paintwork or glass on your vehicle.

- **Washing the vehicle in low temperatures: when washing the vehicle with a hose, do not direct water into the lock cylinders or the gaps around the doors, rear lid, or sunroof. Risk of freezing.**

#### For the sake of the environment

To protect the environment, the vehicle should be washed only in specially provided wash bays, to prevent toxic, oil-laden waste water from entering the sewer system. In some places, washing vehicles outside wash bays is prohibited.

#### Note

Do not wash the vehicle in direct sunlight.

#### Washing the vehicle with a high pressure cleaner

Be particularly careful when using a high pressure cleaner!

- Always observe the instructions for the high-pressure cleaner, particularly those concerning the **pressure** and the **spraying distance**.
- Increase the spraying distance for soft materials and painted bumpers.

- Do not use a high pressure cleaner to remove ice or snow from windows »» page 170.
- Never use concentrated jet nozzles (“rotating jets”) »» .
- After washing, avoid sudden and sharp braking. “Dry” the brakes by braking several times »» page 137.

#### WARNING

- Never wash tyres with a concentrated jet (“rotating nozzle”). Even at large spraying distances and short cleaning times, damage can occur to the tyres. This may cause an accident.
- Water, ice and salt on the brake system can reduce braking effectiveness. Risk of accident.

#### CAUTION

- Do not use water hotter than +60°C (+140°F). This could damage the vehicle.
- To avoid damage to the vehicle, keep a sufficient distance from sensitive materials such as flexible hoses, plastic, soundproofing material, etc. This also applies to bumpers painted in the colour of the bodywork. The closer the nozzle is to the surface, the greater the wear on the material.

## Factory-fitted adhesive sheets

The following indications should be taken into account to avoid damaging adhesive sheets:

- Do not use high-pressure cleaners.
- Do not use scrapers to remove ice or snow from the sheets.
- Do not polish the adhesive sheets.
- Do not use dirty cloths or sponges.
- It is preferable to wash them with a soft sponge and gentle neutral soap.

## Sensors and camera lenses

- Use a small brush to remove snow and a de-icer spray to remove ice.
- Clean the sensors with a solvent-free product and a soft, dry cloth.
- Moisten the camera lens using a standard alcohol-based glass cleaning agent and clean the lens with a dry cloth.

### ⓘ CAUTION

- **When you clean the vehicle with a pressure washer:**
  - Stay a suitable distance from the sensors on the front and rear bumpers.
  - Do not clean the camera lenses or surrounding area with the pressure washer.

- **Never use warm or hot water to remove snow and ice from the reverse camera lens, as it could crack the lens.**
- **Never use abrasive cleaning agents on the lens.**

## Vehicle paint maintenance

Regular waxing protects the paintwork.

You need to apply wax to your vehicle if water does not form small drops and run off the paintwork when it is *clean*.

Good quality *hard wax products* are available at your Technical Service.

Regular wax applications help to protect the paintwork from environmental contaminants **» page 166**. It is also effective in protecting against minor scratches.

Even if a **wax solution** is used regularly in the vehicle washing tunnel, it is advisable to protect the paint with a hard wax coating at least twice a year.

## Polishing the paintwork

Polishing is only necessary if the paint has lost its shine, and the gloss cannot be brought back by applying wax. Polishing products can be purchased in your Technical Service.

The vehicle must be waxed after polishing if the polish used does not contain wax compounds to seal the paint **» page 169, Vehicle paint maintenance**.

### ⓘ CAUTION

**To prevent damage to the paintwork:**

- **Do not use polishes and hard wax on painted parts with a matt finish or on plastic parts.**
- **Do not polish your vehicle in a sandy or dusty environment.**

## Caring for plastic parts

If normal washing fails to clean plastic parts, clean them with approved **solvent-free** plastic cleaning and care products.

### ⓘ CAUTION

- **The use of liquid air freshener directly over the air vents of the vehicle may damage the plastic parts if the liquid is accidentally spilled.**
- **Cleaning products which contain solvents will damage the material.**

## Cleaning of windows and mirrors

### Cleaning windows

- Moisten the windows with commercially available, alcohol based glass cleaner.
- Dry the windows with a clean chamois leather or a lint-free cloth.

### Removing snow

- Use a small brush to remove snow from the windows and mirrors.

### Removing ice

- Use a de-icer spray.

Use a clean cloth or chamois leather to dry the windows. The chamois leathers used on painted surfaces are not suitable to clean windows because they are soiled with wax deposits which could smear the windows.

If possible, use a de-icing spray to remove ice. If you use an ice scraper, push it in one direction only without swinging it.

Use window cleaner or a silicone remover to clean rubber, oil, grease and silicone deposits off.

Wax deposits can only be removed with a special cleaner available at your Technical Service. Wax deposits on the windscreen could cause the wiper blades to judder. Adding a window cleaner that dissolves wax to

the windscreen washer fluid prevents wiper blades from juddering, but wax deposits are not removed.

#### ⓘ CAUTION

- **Never use warm or hot water to remove snow and ice from windows and mirrors. This could cause the glass to crack!**
- **The heating element for the rear window is located on the inner side of the window. To prevent damage, do not put stickers over the heating elements on the inside of the window.**

## Cleaning windscreen wiper blades

Clean wiper blades improve visibility.

1. Use a soft cloth to remove dust and dirt from the windscreen wiper blades.
2. Use window cleaner to clean the windscreen wiper blades. Use a sponge or a cloth to remove stubborn dirt.

## Care of rubber seals

If rubber seals are well looked after, they will not freeze so quickly.

1. Use a soft cloth to remove dust and dirt from the rubber seals.

2. Apply a specialist care product to the rubber seals.

The rubber strips on the doors, windows, etc. will remain pliable and last longer if they are treated with a suitable rubber care product from time to time (for example silicone spray).

Caring for rubber seals will also prevent premature ageing and leaks. The doors will be easier to open. If rubber seals are well looked after, they will not freeze so quickly in winter.

## Door lock cylinder

The door lock cylinders can freeze up in winter.

To de-ice the lock cylinders you should only use spray with lubricating and anti-corrosive properties.

## Cleaning chrome parts

1. Clean chrome parts with a damp cloth.
2. Polish chrome parts with a soft, dry cloth.

If this does not provide satisfying results, use a specialist **chrome cleaning product**. Chrome cleaning products will remove stains from the surface.

**ⓘ CAUTION**

To prevent scratching chrome surfaces:

- Never use an abrasive cleaning product on chrome.
- Do not clean or polish chrome parts in a sandy or dusty environment.

**Steel wheel rims**

- Clean steel wheel rims regularly using a separate sponge.

Use an industrial cleaner to remove brake dust. Any damage to the paint on steel wheel rims should be repaired before starting to rust.

**⚠ WARNING**

- Never wash tyres with a cylindrical jet. Even at large spraying distances and short cleaning times, damage can occur to the tyres. This may cause an accident.
- Water, ice and salt on the brake system can reduce braking effectiveness. Risk of accident. Directly after washing, avoid sudden and sharp braking. "Dry" the brakes by braking several times » page 137, Braking capacity and braking distance.

**Alloy wheel rims****Every two weeks**

- Wash salt and brake dust from alloy wheels.
- Use an acid free detergent to clean the wheel rims.

**Every 3 months**

- Apply a hard wax compound to the wheels.

Alloy wheels require regular attention to preserve their appearance. If road salt and brake dust are not often removed, the aluminium finish will be impaired.

Always use an acid-free detergent for alloy wheel rims.

Car polish or other abrasive agents should not be used for maintaining the rims. If the protective coating is damaged, e.g. by flying stones, the damaged area should be repaired immediately.

**⚠ WARNING**

Observe the safety warnings » ⚠ in Steel wheel rims on page 171.

**Vehicle underbody protection**

The vehicle underbody is coated to protect it from chemical and mechanical damage.

The protective coating can be damaged when driving. We recommend that you check the protective coating under the body and on the running gear, and retouch it if necessary, before and after the winter season.

We recommend that you go to your Technical Service to carry out repair work and additional anti-corrosion work.

**⚠ WARNING**

Do not apply underseal or anti-corrosion coatings to the exhaust pipes, catalytic converter or the heat shields on the exhaust system. The heat of the exhaust system or the engine could cause them to ignite. Risk of fire.

**Cleaning engine compartment**

Take special care when cleaning the engine compartment.

**Anti-corrosion treatment**

The engine compartment and the surface of the power unit are given anti-corrosion treatment at the factory.

Good corrosion protection is particularly important in winter when the vehicle is frequently driven on salted roads. To prevent the salt corroding the vehicle, the entire engine compartment should be thoroughly cleaned before and after winter.



**Technical Services** have the proper products for cleaning and preservation as well as the necessary workshop equipment. For this reason, we recommend having this work performed by them.

The anti-corrosion protection is usually removed if the engine compartment is cleaned with grease removing solutions, or if you have the engine cleaned. On commissioning this work, ensure that all surfaces, seams, joints and components in the engine compartment are given anti-corrosion treatment.

#### WARNING

- When working in the engine compartment, always observe the safety warnings »» page 176.
- Before opening the bonnet, switch the engine off, apply the handbrake firmly and always remove the key from the ignition.
- Allow the engine to cool before you clean the engine compartment.
- Do not clean, for example, the vehicle underbody, wheel arches or wheel trims without protecting your hands and arms. You may cut yourself on sharp-edged metal parts. Failure to comply could result in injury.
- Moisture, ice and salt on the brake system may affect braking effectiveness. Risk of accident. Directly after washing, avoid sudden and sharp braking.
- Never touch the radiator fan. It is temperature-controlled and could start automatically,

even when the key is removed from the ignition!

#### For the sake of the environment

Fuel, grease and oil deposits can be removed when the engine is washed. The polluted water must be cleaned in an oil separator. For this reason, engine washing should be carried out only by a specialised workshop or a petrol station.

## Caring for the vehicle interior

### Cleaning plastic parts and the dash panel

- Use a clean, damp cloth to clean plastic parts and the dash panel.
- If this does not provide satisfactory results, use a special **solvent-free** plastic cleaning product.

#### WARNING

Never clean the dash panel and the airbag module surface with cleaners containing solvents. Solvents cause the surface to become porous. If the airbag triggered, plastic parts could become detached and cause injuries.

#### CAUTION

Cleaning products which contain solvents will damage the material.

### Cleaning wooden trim\*

- Clean the wooden trim with a water-moistened clean cloth.
- If this does not provide satisfactory results, use a *gentle* soap solution.

#### CAUTION

Cleaning products which contain solvents will damage the material.

### Cleaning upholstery and fabric trim

Cloth seat covers and fabric trim on the doors, headlining etc. can be cleaned with a special interior cleaner or with dry foam and a soft brush.

### Cleaning the radio and climate controls

To clean the radio and/or climate controls, use a soft damp cloth. For more resistant dirt, a neutral soap solution may be used.

## Cleaning leather\*

### Normal cleaning

- Moisten a cotton or woollen cloth with water and wipe over the leather surfaces.

### Cleaning stubborn stains

- More stubborn dirt can be removed using a mild soap solution (pure liquid soap; two tablespoons diluted in one litre of water) and a cloth.
- Do not let the water soak through the leather or soak into the seams.
- Then wipe off with a soft, dry cloth.

### Leather maintenance

- The leather should be treated twice a year with a special leather-care product, available at Technical Services.
- Apply these products very sparingly.
- Then wipe off with a soft cloth.

SEAT does everything possible to preserve the genuine qualities of this natural product. Due to the natural properties of the specially selected hides employed, the finished leather has a certain sensitivity to grease and dirt, etc. so a degree of care is required in everyday use and when looking after the leather.

Dust and grit in the pores and seams can scratch and damage the surface. If the vehi-

cle is under solar radiation for long periods, the leather should be protected to prevent it from fading. However, slight colour variations in high-quality natural leather are normal.

#### ⓘ CAUTION

- Do not use solvents, wax polish, shoe cream, spot removers or similar products on leather.
- To avoid damage, stubborn stains should be removed by a specialised workshop.

### Seat belt cleaning

A dirty belt may not work properly. Check all seat belts regularly and keep them clean.

#### Seat belts cleaning

- Pull the dirty seat belt right out and unroll it.
- Clean dirty seat belts with a *gentle* soap solution.
- Allow it to dry.
- Do not roll the seat belt up until it is dry.

If large stains form on the belts, the automatic belt retractor will not work correctly.

#### ⚠ WARNING

- Do not use chemical cleaning agents on the seat belts, as this can impair the strength of the webbing. Ensure that seat belts do not come into contact with corrosive fluids.
- Check the condition of the seat belts at regular intervals. If you notice that the belt webbing, fittings, retractor mechanism or buckle of any of the belts is damaged, the belt must be replaced by a specialised workshop.
- Do not attempt to repair a damaged seat belt yourself. The seat belts must not be removed or modified in any way.

#### ⓘ CAUTION

After cleaning, allow seat belts to dry completely before rolling them up. Otherwise, the belt retractors could become damaged.

## Checking and refilling levels

### Refuelling

#### Refuelling

Read the additional information carefully

»  page 37

If the automatic filler nozzle is operated correctly, it will switch itself off as soon as the tank is “full”. Never attempt to fill beyond this point, as this will fill the expansion chamber. Fuel may leak out if ambient conditions are warm.

The correct fuel grade for your vehicle is given on a sticker on the inside of the fuel tank flap.

#### WARNING

- Fuel is highly flammable and can cause serious burns and other injuries.
  - Never smoke or come into contact with sparks when filling the fuel tank of the vehicle or a spare fuel canister with fuel. This is an explosion hazard.
  - Follow legal requirements for the use of spare fuel canisters.
  - For safety reasons we do not recommend carrying a spare fuel canister in the vehicle. The canister could be damaged in an accident and leak.

• If, in exceptional circumstances, you have to carry a spare fuel canister, please observe the following:

- Never fill the spare fuel canister inside the vehicle or on it. An electrostatic charge could build up during filling, causing the fuel fumes to ignite. This could cause an explosion. Always place the canister on the ground to fill it.
- Insert the fuel nozzle into the mouth of the canister as far as possible.
- If the spare fuel canister is made of metal, the filling nozzle must be in contact with the canister during filling. This helps prevent an electrostatic charge building up.
- Never spill fuel in the vehicle or in the luggage compartment. Fuel vapours are explosive. Danger of death.

#### CAUTION

- Fuel spills should be removed from the paintwork immediately.
- Never run the tank completely dry. Irregular fuel supply can cause misfiring. As a result, unburnt fuel could enter the catalytic converter and cause damage.
- When filling the fuel tank after having run it completely dry on a vehicle with a diesel engine the ignition must be switched on for at least 30 seconds before starting the engine. Subsequently, when you start the engine it may take longer than normal to start firing

(up to one minute). This is due to the fact that the fuel system has to purge itself of air before starting.

 For the sake of the environment

Do not try to put in more fuel after the automatic filler nozzle has switched off, this may cause the fuel to overflow if it becomes warm.

## Fuel

### Types of petrol

The correct grade of petrol is listed inside the fuel tank flap.

The vehicle is equipped with a catalytic converter and must only be run on **unleaded petrol**. The petrol must comply with European Standard EN 228 or German standard DIN 51626-1 and must be **unleaded**. You can refuel with a maximum ethanol proportion of 10 % (E10). The types of petrol are differentiated by their **octane rating (RON)**.

The following titles appear on the corresponding adhesive on the fuel tank flap:



### Super unleaded 95 octane or normal 91 octane unleaded petrol

We recommend you use super 95 octane petrol. If this is not available: normal 91 octane petrol, with a slight decrease in power.

### Super unleaded petrol with a minimum of 95 octanes

You should use super petrol with a minimum of 95 octanes.

If super is not available, *in an emergency* you may refuel with normal 91 octane petrol. In this case only use moderate engine speeds and a light throttle. Refuel with super as soon as possible.

### Super unleaded 98 octane or super 95 octane unleaded petrol

We recommend you use super plus 98 octane petrol. If this is not available: super 95 octane petrol, with a slight decrease in power.

If super is not available, *in an emergency* you may refuel with normal 91 octane petrol. In this case only use moderate engine speeds and a light throttle. Refuel with super as soon as possible.

### Petrol additives

The quality of the fuel influences the behaviour, power and service life of the engine. This is why the petrol you use should carry suitable additives already included by the

petrol industry, free of metals. These additives will help to prevent corrosion, keep the fuel system clean and prevent deposits from building up in the engine.

If good-quality petrol with metal-free additives is not available or engine problems arise, the necessary additives must be added when refuelling » ⓘ.

Not all petrol additives have been shown to be effective. The use of unsuitable petrol additives may cause significant damage to the engine and the catalytic converter. Metal additives should never be used. Metal additives may also be contained in petrol additives for improving anti-detonation ratings or octane ratings » ⓘ.

SEAT recommends “genuine Volkswagen Group Fuel Additives for petrol engines”. These additives can be bought at SEAT dealers, where information on how to use them can also be obtained.

#### ⓘ CAUTION

- Do not refuel if the filler indicates that the fuel contains metal. LRP (*lead replacement petrol*) fuels contain high concentrations of metal additives. Using them may damage the engine!
- Never refuel with fuels containing a large proportion of ethanol (for example, E50, E85). This could damage the fuel system.

- Just filling one full tank of leaded fuel or fuel containing other metal additives would seriously impair the efficiency of the catalytic converter.

- Only use fuel additives that have been approved by SEAT. Octane boosting or anti-knock additives may contain metal additives that could seriously damage the engine or the catalytic converter. These additives must not be used.

- High engine speed and full throttle can damage the engine when using petrol with an octane rating lower than the correct grade for the engine.

#### ⓘ Note

- You may use petrol with a high octane number than the one recommended for your engine.

- In those countries where unleaded petrol is not available, you may refuel with a fuel with a low lead content.

### Diesel fuel

Please note the information on the inside of the fuel tank flap.

We recommend the use of **diesel** fuel which complies to European standard EN 590. If diesel fuel which meets European standard EN 590 is not available, the Cetane number (CZ) must, at minimum, be 51. If the engine »

is equipped with a particulate filter, the sulphur content of the fuel must be below 50 parts per million.

### Winter-grade diesel

Summer fuel becomes thicker in winter and it is more difficult to start the engine. For this reason, petrol stations in some countries also offer winter diesel with improved fluidity when cold (winter-grade diesel).

#### ⓘ CAUTION

- **The vehicle is not designed for the use of FAME fuel (biodiesel). The fuel system would be damaged if you used biodiesel.**
- **Do not mix fuel additives, the so-called “thinners”, petrol or similar additives with diesel fuel.**
- **If poor-quality diesel fuel is used, it may be necessary to drain the fuel filter more frequently than is specified in the Maintenance Programme. We recommend having this done by a specialised workshop. If water is allowed to collect in the filter, this can cause engine performance problems.**

## Working in the engine compartment

### safety notes for work in the engine compartment

#### Read the additional information carefully

»  page 10

Before starting any work on the engine or in the engine compartment:

1. Switch off the engine and remove the key from the ignition.
2. Apply the handbrake.
3. Place the gear lever into neutral.
4. Wait for the engine to cool down.
5. Keep children away from the vehicle.
6. Raise the bonnet »  page 177.

You should not do any work in the engine compartment unless you know exactly how to carry out the jobs and have the correct tools! Have the work carried out by a specialised workshop if you are uncertain.

All service fluids and consumables, e.g. coolant, engine oil, spark plugs and batteries, are under constant development. SEAT provides a constant flow of information to Technical Services concerning modifications. For this reason, we recommend you have service fluids and consumables replaced by a Techni-

cal Service. Please observe the relevant instructions » page 165. The engine compartment of the vehicle is a hazardous area » .

#### WARNING

**All work on the engine or in the engine compartment, e.g. checking and refilling fluids, involves the danger of injury and burns, accidents and even fire.**

- **Never open the bonnet if you see steam, smoke or coolant escaping from the engine compartment. Otherwise, there is a risk of sustaining burns. Wait until no more steam or coolant is emitted, then allow the engine to cool before carefully opening the bonnet.**
- **Switch off the engine and remove the key from the ignition.**
- **Apply the handbrake and position the gear-box lever in neutral.**
- **Keep children away from the vehicle.**
- **Never touch hot engine parts. There is a risk of burns.**
- **Never spill liquids on a hot engine or on a hot exhaust gas system. This is a fire hazard.**
- **Avoid causing short-circuits in the electrical system, particularly at the points where the jump leads are attached »  page 48. The battery could explode.**
- **Never touch the radiator fan. It is temperature controlled and could start automatically, even when the engine has been switched off and the key removed from the ignition!**

- Never cover the engine with additional insulating materials such as a blanket. Risk of fire!
- Do not unscrew the cap on the coolant expansion tank when the engine is hot. If the coolant is hot, the cooling system will be pressurised!
- Protect face, hands and arms by covering the cap with a large, thick cloth to protect against escaping coolant and steam.
- Always make sure you have not left any objects, such as cleaning cloths or tools, in the engine compartment.
- If you have to work underneath the vehicle, you must use suitable stands additionally to support the vehicle, there is a risk of accident!. A hydraulic jack is insufficient for securing the vehicle and there is a risk of injury.
- If any work has to be performed when the engine is started or with the engine running, there is an additional, potentially fatal, safety risk from the rotating parts, such as the drive belts, alternator, radiator fan, etc., and from the high-voltage ignition system. You should also observe the following:
  - Never touch the electrical wiring of the ignition system.
  - Ensure that jewellery, loose clothing and long hair do not get trapped in rotating engine parts. Danger of death. Before starting any work remove jewellery, tie back and cover hair, and wear tight-fitting clothes.

- Never accelerate with a gear engaged without taking the necessary precautions. The vehicle could move, even if the handbrake is applied. Danger of death.
- If work has to be carried out on the fuel system or on electrical components, you must observe the following safety notes in addition to the above warnings:
  - Always disconnect the battery from the on-board network. The vehicle must be unlocked when this is done, otherwise the alarm will be triggered.
  - Do not smoke.
  - Never work near naked flames.
  - Always have a fire extinguisher on hand.

### WARNING

If the bonnet is not correctly closed, it could suddenly open while driving leaving the driver without visibility. This could result in a serious accident.

- After closing the bonnet, always check that it is properly secured by the locking mechanism in the lock carrier piece. The bonnet must be flush with the surrounding body panels.
- While driving, if you notice that the bonnet is not correctly closed then stop immediately and close it correctly.
- Only open and close the bonnet when there is nobody within its range.

### CAUTION

When topping up service fluids, make sure not to mistake them. Using the wrong fluids could cause serious malfunctions and engine damage!

### For the sake of the environment

Service fluids leaks are harmful to the environment. For this reason you should make regular checks on the ground underneath your vehicle. If you find spots of oil or other fluids, have your vehicle inspected in a specialised workshop.

## Opening the bonnet

Read the additional information carefully  
 page 10

The bonnet is released from inside the vehicle.

Before opening the bonnet ensure that the windscreen wipers are in rest position.

### WARNING

Hot coolant can scald!

- Never open the bonnet if you see steam, smoke or coolant escaping from the engine compartment.

- **Wait until no more steam, smoke or coolant is emitted from the bonnet, then carefully open the bonnet.**
- **When working in the engine compartment, always observe the safety warnings**  
»» page 176.

### Closing the bonnet

- Slightly lift the bonnet.
- Release the bonnet stay and replace it in its support.
- At a height of approximately 30 cm let it fall so it locks.

If the bonnet does not close, do not press downwards. Open it again and let it fall as mentioned above.

#### **WARNING**

**If the bonnet is not closed properly, it could open while you are driving and completely obscure your view of the road. Risk of accident.**

- **After closing the bonnet, always check that it is properly secured. The bonnet must be flush with the surrounding body panels.**
- **If you notice that the bonnet latch is not secured when the vehicle is moving, stop the vehicle immediately and close the bonnet properly. Risk of accident.**

## Checking levels

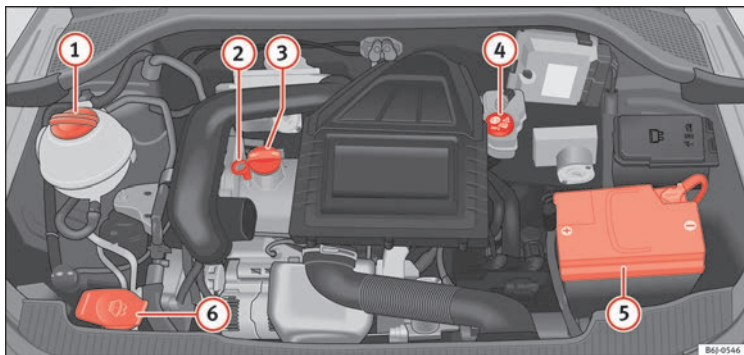

Fig. 154 Diagram for the location of the various elements.

From time to time, the levels of the different fluids in the vehicle must be checked. Never fill with incorrect fluids, otherwise serious damage to the engine may be caused.

- ① Coolant expansion tank
- ② Engine oil level dipstick
- ③ Engine oil filler cap
- ④ Brake fluid reservoir
- ⑤ Vehicle battery
- ⑥ Windscreen washer reservoir

The checking and refilling of service fluids are carried out on the components men-

tioned above. These operations are described in » page 176.

#### Overview

You will find further explanations, instructions and restrictions on the technical specifications as of » page 194.

#### Note

The layout of parts may vary depending on the engine.

## Engine oil

### General notes

The engine comes with a special, multi-grade oil that can be used all year round.

Because the use of high-quality oil is essential for the correct operation of the engine and its long useful life, when topping up or changing oil, use only those oils that comply with VW standards.

The specifications (VW standards) set out in the following page should appear on the container of the service oil; when the container displays the specific standards for petrol and »

diesel engines together, it means that the oil can be used for both types of engines.

We recommend that the oil change indicated in the Maintenance Programme, be performed by a technical service or specialised workshop.

The correct oil specifications for your engine are listed in the  **page 38**.

### Service intervals



Service intervals can be flexible (LongLife service) or fixed (dependent on time/distance travelled).

If the PR code that appears on the back of the Maintenance Programme booklet is PR Q16, this means that your vehicle has the LongLife service program. If it lists the codes Q11, Q12, Q13, Q14 or Q17, the interval service is dependent on the time/distance travelled.



### Flexible service intervals (LongLife service intervals\*)

Special oils and processes have been developed which, depending on the characteristics and individual driving profiles, enable the extension of the oil change service (LongLife service intervals).

Because this oil is essential for extending the service intervals, it **must only** be used observing the following indications:

- Avoid mixing it with oil for fixed service intervals.
- Only in exceptional circumstances, if the engine oil level is too low  **page 181** and LongLife oil is not available, it is permitted to top up (once) with oil for **fixed service intervals**  **page 38** (up to a maximum of 0.5 litres).

### Fixed service intervals\*

If your vehicle does not have the “LongLife service interval” or it has been disabled (by request), you may use oils for **fixed service intervals**, which also appear in  **page 38**. In this case, your vehicle must be serviced after a fixed interval of 1 year/15,000 km (10,000 miles)(whatever comes first)  **Booklet Maintenance Programme**.

- In exceptional circumstances, if the engine oil level is too low  **page 181** and you cannot obtain the oil specified for your vehicle, you can add a small quantity of oil conforming to the specification ACEA A2 or ACEA A3 (petrol engines) or ACEA B3 or ACEA B4 (diesel engines) (up to 0.5 l).

### Vehicles with diesel particulate filter\*

The Maintenance Programme states whether your vehicle is fitted with a diesel particulate filter.

Only VW 507 00 engine oil, with reduced ash formation, may be used in diesel engines equipped with particulate filter. Using other types of oil will cause a higher soot concentration and reduce the life of the DPF. Therefore:

- Avoid mixing this oil with other engine oils.
- Only in exceptional circumstances, if the engine oil level is too low  **page 181** and you cannot obtain the oil specified for your vehicle, you can use a small quantity of oil (once) conforming to the VW 506 00, VW 506 01, VW 505 00, VW 505 01 or ACEA B3/ACEA B4 specification. (up to 0.5 l).

#### Note

**Before a long trip, we recommend finding an engine oil that conforms to the corresponding VW specifications and recommend keeping it in the vehicle. This way, the correct engine oil will always be available for a top-up if needed.**

### Warning lamp

If this warning lamp  is red it indicates that the engine oil pressure is too low.

If this warning symbol starts to flash, and is accompanied by three **audible warnings**, switch off the engine and check the oil level. If necessary, add more oil  **page 181**.

If the warning lamp flashes although the oil level is correct, *stop driving*. Do not even run the engine at idle speed! Obtain technical assistance.

### Checking oil level

If the warning lamp is yellow  the engine oil level should be checked as soon as possible. Top up the oil at the next opportunity **» page 181**.

### Oil level sensor faulty\*

If the  yellow warning lamp flashes, take the vehicle to a specialised workshop to have the oil level sensor checked. Until then it is advisable to check the oil level every time you refuel.

### Check engine oil level

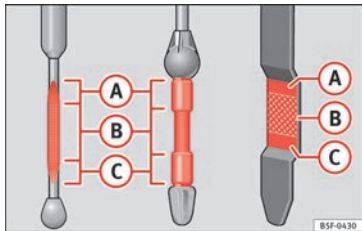

**Fig. 155** Engine oil dipstick.

### Read the additional information carefully

**»  page 37**

### Checking oil level

- Park the vehicle in a horizontal position.
- Briefly run the engine at idle speed until the operating temperature is reached and then stop.
- Wait for about two minutes.
- Pull out the dipstick. Wipe the dipstick with a clean cloth and insert it again, pushing it in as far as it will go.
- Then pull it out again and check the oil level. Top up with engine oil if necessary.

Depending on how you drive and the conditions in which the vehicle is used, oil consumption can be up to 0.5 l/1000 km. Oil consumption is likely to be higher for the first 5,000 km. For this reason the engine oil level must be checked at regular intervals, preferably when filling the tank and before a journey.

### WARNING

Any work carried out in the engine compartment or on the engine must be carried out cautiously.

- When working in the engine compartment, always observe the safety warnings **» page 176**.

### CAUTION

If the oil level is above the area **A** do not start the engine. This could result in damage to the engine and catalytic converter. Contact a Technical Service.

### Topping up engine oil

#### Read the additional information carefully

**»  page 37**

Before opening the bonnet, read and observe the warnings **»  in safety notes for work in the engine compartment on page 176**.

The position of the filler neck is shown in the corresponding engine compartment image **» page 179**.

Engine oil specification **»  page 38**.

### WARNING

Oil is highly inflammable! Ensure that no oil comes into contact with hot engine components when topping up.

### CAUTION

If the oil level is above the area **A** do not start the engine. This could result in damage to the engine and catalytic converter. Contact a specialised workshop. **»**

 For the sake of the environment

The oil level must never be above area **A**. Otherwise oil can be drawn in through the crankcase breather and escape into the atmosphere via the exhaust system.

## Changing engine oil

Read the additional information carefully  
»  page 37

The engine oil must be changed at the intervals given in the service schedule.

We recommend that you have the engine oil changed by a Technical Service.

The oil change intervals are shown in the Maintenance Programme.

 **WARNING**

Only change the engine oil yourself if you have the specialist knowledge required!

- Before opening the bonnet, read and observe the warnings » page 176, safety notes for work in the engine compartment.
- Wait for the engine to cool down. Hot oil may cause burn injuries.
- Wear eye protection to avoid injuries, such as acid burns, caused by splashes of oil.
- When removing the oil drain plug with your fingers, keep your arm horizontal to help prevent oil from running down your arm.

- Wash your skin thoroughly if it comes into contact with engine oil.
- Engine oil is poisonous! Oil must be stored in a safe place out of the reach of children.

 **CAUTION**

No additives should be used with engine oil. This could result in engine damage. Any damage caused by the use of such additives would not be covered by the factory warranty.

 For the sake of the environment



- Because of disposal problems and the special tools and specialist knowledge required, we recommend that you have the engine oil and filter changed by a Technical Service.
- Never pour oil down drains or into the ground.
- Use a suitable container when draining the used oil. It must be large enough to hold all the engine oil.

## Cooling system

### Control lamp

There is a fault if:

- The  lamp does not go out again after a few seconds.

- The  lamp lights up or flashes while the vehicle is running, and three **acoustic warning signals are emitted** » .

This means that either the coolant level is too low or the coolant temperature is too high.



### Coolant temperature too high

If the  lamp lights up, **stop the vehicle, turn off the engine and wait for it to cool down**. Check the coolant level.

If the coolant level is correct, the overheating may be caused by a malfunction of the radiator fan. Check the radiator fan fuse and have it replaced if necessary » page 75.

If the control lamp lights up again after driving on for a short distance, **stop the vehicle and switch the engine off**. Contact a Technical Service or a specialised workshop.

### Coolant level too low

If the  lamp lights up, **stop the vehicle, turn off the engine and wait for it to cool down**. First check the coolant level. If the level of the coolant is below the “MIN” mark, top up with coolant liquid » .

 **WARNING**

- If your vehicle is immobilised for technical reasons, move it to a safe distance from traffic. Turn the engine off, turn the hazard lights on and place the warning triangle.



- Never open the bonnet if you can see or hear steam or coolant escaping from the engine compartment. Risk of scalding. Wait until you can no longer see or hear escaping steam or coolant.
- The engine compartment is a dangerous area. Before carrying out any work in the engine compartment, switch off the engine and allow it to cool down. Always note the corresponding warnings » page 176.

### Topping up coolant

Read the additional information carefully »  page 38



Top up coolant when the level is below the MIN (minimum) mark.

### Checking coolant level

- Park the vehicle in a horizontal position.
- Switch the ignition off.
- Read off the coolant level on coolant expansion tank. When the engine is cold, the coolant level should be between the marks. When the engine is hot, it may be slightly above the upper mark.

### Topping up coolant

- Wait for the engine to cool down.

- Cover the coolant expansion tank cap with a cloth and carefully unscrew it to the left » .
- Top up the coolant only if there is still coolant in the expansion tank, otherwise you could **damage the engine**. If there is no coolant in the expansion tank, do not continue driving. You should obtain professional assistance » .
- If there is still some coolant in the expansion tank, top up to the upper mark.
- Top up with coolant until the level becomes stable.
- Screw the cap back on correctly.

Any loss of coolant fluid normally indicates a leak in the cooling system. Take the vehicle straight to a specialised workshop to have the cooling system examined. If there are no leaks in the engine cooling system, a loss of coolant can only occur if the coolant boils and is forced out of the system as a result of overheating.

### WARNING

- The cooling system is under pressure. Do not unscrew the cap on the coolant expansion tank when the engine is hot: risk of burns!
- The antifreeze and coolant fluid can be a health hazard. Therefore, the antifreeze should be stored in the original container in a

safe place out of reach of children. Failure to comply could result in poisoning.

- If working inside the engine compartment, remember that, even when the ignition is switched off, the radiator fan may start up automatically, and therefore there is a risk of injury.

### WARNING

If there is not enough anti-freeze in the coolant system, the engine may fail leading to serious damage.

- Please make sure that the percentage of additive is correct with respect to the lowest expected ambient temperature in the zone in which the vehicle is to be used.
- When the outside temperature is very low, the coolant could freeze and the vehicle would be immobilised. In this case, the heating would not work either and inadequately dressed passengers could die of cold.

### CAUTION

Do not top up the expansion tank with coolant fluid if it is empty! Air could enter the cooling system. In this case, stop driving. Seek specialist assistance. Otherwise, there is a risk of engine damage. »

**ⓘ CAUTION**

The original additives should never be mixed with coolants which are not approved by SEAT. Otherwise, you run the risk of causing severe damage to the engine and the engine cooling system.

- If the fluid in the expansion tank is not purple but is, for example, brown, this indicates that the G13 additive has been mixed with an inadequate coolant. The coolant must be changed as soon as possible if this is the case! This could result in serious faults and engine damage.

**♻️ For the sake of the environment**

Coolants and additives can contaminate the environment. If any fluids are spilled, they should be collected and correctly disposed of, with respect to the environment.

**Brake fluid****Checking the brake fluid level**

Read the additional information carefully  
»  page 39

The position of the brake fluid reservoir is shown in the corresponding engine compartment image » page 179. The brake fluid reservoir has a black and yellow cap.

The brake fluid level drops slightly when the vehicle is being used as the brake pads are automatically adjusted as they wear.

However, if the level goes down noticeably in a short time, or drops below the “MIN” mark, there may be a leak in the brake system. A display on the instrument panel will warn you if the brake fluid level is too low » page 92.

**⚠️ WARNING**

Before opening the bonnet to check the brake fluid level, read and observe the warnings » page 176.

**Changing the brake fluid**

The Maintenance Programme indicates brake fluid change intervals.

We recommend that you have the brake fluid changed by a Technical Service.

Before opening the bonnet, please read and follow the warnings »  in safety notes for work in the engine compartment on page 176 in section “Safety notes for working in the engine compartment”.

In the course of time, brake fluid becomes hygroscopic and absorbs water from the ambient air. If the water content in the brake fluid is too high, the brake system could corrode. This also considerably reduces the boiling point of the brake fluid. Heavy use of the

brakes may then cause a vapour lock which could impair the braking effect.

Be sure to always use the correct brake fluid. Only use brake fluid that expressly meets the VW 501 14 standard.

You can buy VW 501 14 standard brake fluid in a SEAT dealership or a SEAT Official Service. If none is available, use only high-quality brake fluid that meets DIN ISO 4925 CLASS 4 standards, or USA Standards FMVSS 116 DOT 4.

Using any other kind of brake fluid or one that is not of a high quality may affect operation of the brake system and reduce its effectiveness. Never use a brake fluid if the container does not state that it complies with VW 501 14, DIN ISO 4925 CLASS 4 standards, or USA standards FMVSS 116 DOT 4.

**⚠️ WARNING**

Brake fluid is poisonous. Old brake fluid impairs the braking effect.

- Before opening the bonnet to check the brake fluid level, read and observe the warnings » page 176.
- Brake fluid should be stored in the closed original container in a safe place out of reach of children. There is a toxic risk.
- Perform the brake fluid change according to the Maintenance Programme. Heavy use of the brakes may cause a vapour lock if the brake fluid is left in the brake system for too

long. This would seriously affect the effectiveness of the brakes and the safety of the vehicle. This may cause an accident.

#### ⓘ CAUTION

Brake fluid damages the vehicle paintwork. Wipe off any brake fluid from the paintwork immediately.

#### ♻️ For the sake of the environment

The brake pads and brake fluid must be collected and disposed of according to the applicable regulations. The SEAT Technical Service network has the necessary equipment and qualified personnel for collecting and disposing of this waste material.

## Windscreen washer reservoir

### Topping up the windscreen washer reservoir water

Read the additional information carefully  
»  page 39

The **windscreen washer** and the **headlight washers** are supplied with fluid from the windscreen washer fluid container in the engine compartment. The container holds approx. 3 litres; in vehicles with headlight washers\* it holds approx. 4.5 litres.

The tank is in the engine compartment.

Plain water is not enough to clean the windscreen and headlights. We recommend that you always add a product to the windscreen washer fluid. Approved windscreen cleaning products exist on the market with high detergent and anti-freeze properties, these may be added all-year-round. Please follow the dilution instructions on the packaging.

#### ⚠️ WARNING

Any work carried out in the engine compartment or on the engine must be carried out cautiously.

- When working in the engine compartment, always observe the safety warnings  
» page 176.





#### ⓘ CAUTION

- Never put radiator anti-freeze or other additives into the windscreen washer fluid.
- Always use approved windscreen cleaning products diluted as per instructions. If you use other washer fluids or soap solutions, the tiny holes in the fan-shaped nozzles could become blocked.

## Vehicle battery

### Symbols and warnings on handling the battery

Read the additional information carefully  
»  page 39

	Wear eye protection
	Battery acid is extremely corrosive. Wear protective gloves and eye protection!
	Fires, sparks, open flames and smoking are prohibited!
	A highly explosive mixture of gases is released when the battery is under charge.
	Keep children away from acid and batteries!

#### ⚠️ WARNING

Always be aware of the danger of injury and chemical burns as well as the risk of accident or fire when working on the battery and the electrical system:

- Wear eye protection. Protect your eyes, skin and clothing from acid and particles containing lead.
- Battery acid is extremely corrosive. Wear protective gloves and eye protection. Do not tilt the batteries. This could spill acid through the vents.
- Rinse battery acid from eyes immediately for several minutes with clear water. Then

»

seek medical care immediately. Neutralise any acid splashes on the skin or clothing with a soapy solution, and rinse off with plenty of water. If acid is swallowed by mistake, consult a doctor immediately.

- Fires, sparks, open flames and smoking are prohibited. When handling cables and electrical equipment, avoid causing sparks and electrostatic charge. Never short the battery terminals. High-energy sparks can cause injury.
- A highly explosive mixture of gases is released when the battery is under charge. The batteries should be charged in a well-ventilated room only.
- Keep children away from acid and batteries.
- Before working on the electrical system, you must switch off the engine, the ignition and all electrical devices. The negative cable on the battery must be disconnected. When a light bulb is changed, you need only switch off the light.
- Deactivate the anti-theft alarm by unlocking the vehicle before you disconnect the battery! The alarm will otherwise be triggered.
- When disconnecting the battery from the vehicle on-board network, disconnect first the negative cable and then the positive cable.
- Switch off all electrical devices before reconnecting the battery. Reconnect first the positive cable and then the negative cable. Never reverse the polarity of the connections. This could cause an electrical fire.

- Never charge a frozen battery, or one which has thawed. This could result in explosions and chemical burns. Always replace a battery which has frozen. A flat battery can also freeze at temperatures close to 0°C (+32°F).
- Ensure that the vent hose is always connected to the battery.
- Never use a defective battery. This could cause an explosion. Replace a damaged battery immediately.
- For vehicles with the battery in the luggage compartment: Check that the battery gas ventilation hose is securely attached.

#### CAUTION

- Never disconnect the battery if the ignition is switched on or if the engine is running. This could damage the electrical system or electronic components.
- Do not expose the battery to direct sunlight over a long period of time, as the intense ultraviolet radiation can damage the battery housing.
- If the vehicle is left standing in cold conditions for a long period, protect the battery from “freezing”. If it freezes it will be damaged.

## Warning lamp



It lights up

Alternator fault.





The control lamp  lights up when the ignition is switched on. It should go out when the engine has started running.

If the control lamp  lights up while driving, the alternator is no longer charging the battery. You should immediately drive to the nearest specialised workshop.

You should avoid using electrical equipment that is not absolutely necessary because this will drain the battery.

## Checking the battery electrolyte level

The electrolyte level should be checked regularly in high-mileage vehicles, in hot countries and in older batteries.

- Open the bonnet and open the battery cover at the front   in safety notes for work in the engine compartment on page 176   in Symbols and warnings on handling the battery on page 185. For vehicles with the battery under the spare wheel, open the rear lid and lift the floor covering. The battery is located next to the spare wheel.

- Check the colour display in the "magic eye" on the top of the battery.
- If there are air bubbles in the window, tap the window gently until they disperse.

The position of the battery is shown in the corresponding engine compartment diagram »» page 179.

The "magic eye" indicator, located on the top of the battery changes colour, depending on the charge state and electrolyte level of the battery.

There are two different colours:

- Black: correct charge status.
- Transparent/clear yellow: the battery must be replaced. Contact a specialised workshop.

### Charging or changing the battery

The battery is maintenance-free and is checked during the inspection service. All work on the vehicle battery requires specialist knowledge.

If you often drive short distances or if the vehicle is not driven for long periods, the battery should be checked by a specialised workshop between the scheduled services.

If the battery has discharged and you have problems starting the vehicle, the battery might be damaged. If this happens, we rec-

ommend you have the vehicle battery checked by a Technical Service where it will be re-charged or replaced.

### Charging the battery

The vehicle battery should be charged by a specialised workshop only, as batteries using special technology have been installed and they must be charged in a controlled environment.

### Replacing a vehicle battery

The battery has been developed to suit the conditions of its location and has special safety features.

Genuine SEAT batteries meet the maintenance, performance and safety specifications of your vehicle.

#### WARNING

- We recommend you use only maintenance-free or cycle free leak-proof batteries which comply with standards T 825 06 and VW 7 50 73. This standard applies as of 2001.
- Before starting any work on the batteries, you must read and observe the warnings »»  in Symbols and warnings on handling the battery on page 185.



For the sake of the environment

**Batteries contain toxic substances such as sulphuric acid and lead. They must be disposed of appropriately and must not be disposed of with ordinary household waste.**

## Wheels

### Wheels and tyres

#### General notes

##### Avoiding damage

- If you have to drive over a kerb or similar obstacle, drive very slowly and at a right angle.
- Keep grease, oil and fuel off the tyres.
- Inspect the tyres regularly for damage (cuts, cracks or blisters, etc.). Remove any foreign objects embedded in the treads.

##### Storing tyres

- When you remove the tyres, mark them in order to maintain the same direction of rotation when they are installed again.
- When removed, the wheels and/or tyres should be stored in a cool, dry and preferably dark location.
- Store tyres in a vertical position, if they are not fitted on wheel rims.

##### New tyres

New tyres must be run in » page 147.

The tread depth of new tyres may vary, according to the type and make of tyre and the tread pattern.

##### Concealed damage

Damage to tyres and rims is often not readily visible. If you notice unusual vibrations or the vehicle pulling to one side, this may indicate that one of the tyres is damaged. They should be checked immediately by a Technical Service.

##### Tyres with directional tread pattern

An arrow on the tyre sidewall indicates the direction of rotation on tyres with directional tread. Always observe the direction of rotation indicated when fitting the wheel. This guarantees optimum grip and helps to avoid aquaplaning, excessive noise and wear.

#### ⚠ WARNING

- **New tyres do not have maximum grip during the first 500 km. Drive particularly carefully to avoid possible accidents.**
- **Never drive with damaged tyres. This may cause an accident.**
- **If you notice unusual vibrations or if the vehicle pulls to one side when driving, stop the vehicle immediately and check the tyres for damage.**

##### Tyre pressure monitoring system

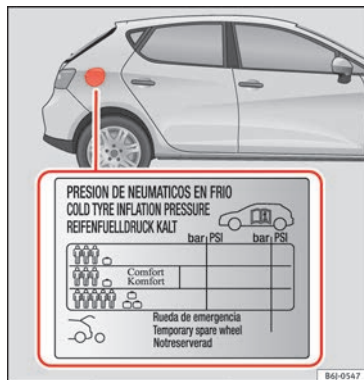

Fig. 156 Location of the tyre pressure sticker.

The correct tyre pressure can be seen on the sticker on the inside of the fuel tank flap » Fig. 156.

1. Read the required tyre inflation pressure from the sticker. The values refer to Summer tyres.
2. The tyre pressures should only be checked when the tyres are cold. The slightly raised pressures of warm tyres must not be reduced.
3. Adjust the tyre pressure to the load you are carrying.

## Tyre pressure

The correct tyre pressure is especially important at high speeds. The pressure should therefore be checked at least once a month and before starting a journey.

Depending on the vehicle, tyre pressure can be adjusted to medium load to improve driving comfort ("comfort" tyre pressure). When driving with comfort tyre pressure fuel consumption may increase slightly.

### ⚠ WARNING

**A tyre can easily burst if the pressure is too low, causing an accident!**

- At continuously high speeds, a tyre with insufficient pressure flexes more. In this way it becomes too hot, and this can cause tread separation and tyre blow-out. Always observe the recommended tyre pressures.
- If the tyre pressure is too low or too high, the tyres will wear prematurely and the vehicle will not handle well. Risk of accident!

🌿 For the sake of the environment

**Under-inflated tyres will increase fuel consumption.**

## Tyre useful life



Fig. 157 Tyre tread wear indicators.

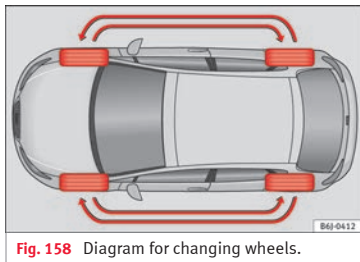

Fig. 158 Diagram for changing wheels.

The useful life of tyres is dependent on tyre pressure, driving style and fitting.

### Wear indicators

The original tyres on your vehicle have 1.6 mm high "tread wear indicators" » Fig. 157, running across the tread. De-

pending on the make, there will be 6 to 8 of them evenly spaced around the tyre. Markings on the tyre sidewall (for instance the letters "TWI" or other symbols) indicate the positions of the tread wear indicators. The minimum tread depth required by law is 1.6 mm (measured in the tread grooves next to the tread wear indicators). Worn tyres must be replaced. Different figures may apply in export countries » ⚠.

### Tyre pressure

Incorrect tyre pressure causes premature wear and could cause tyre blow-out. For this reason, the tyre pressure should be checked at least once per month » page 188.

### Driving style

Fast cornering, heavy acceleration and hard braking all increase tyre wear.

### Changing wheels around

If the front tyres are worn considerably more than the rear ones it is advisable to change them around as shown » Fig. 158. The useful life of all the tyres will then be about the same time.

### Wheel balance

The wheels on new vehicles are balanced. However, various factors encountered in normal driving can cause them to become unbalanced, which results in steering vibration. »

Unbalanced wheels should be rebalanced, as they otherwise cause excessive wear on steering, suspension and tyres. A wheel must also be rebalanced when a new tyre is fitted.

### Incorrect wheel alignment

Incorrect running gear alignment causes excessive tyre wear, impairing the safety of the vehicle. If tyres show excessive wear, you should have the wheel alignment checked by a Technical Service.

#### WARNING

**There is a serious danger of accidents if a tyre bursts during driving!**

- **The tyres must be replaced at the latest when the tread wear indicators are worn** »» page 189. **Failure to follow this instruction could result in an accident. Worn tyres do not grip well at high speeds on wet roads. There is also a greater risk of “aquaplaning”.**
- **At continuously high speeds, a tyre with insufficient pressure flexes more. This causes it to overheat. This can cause tread separation and tyre blow-out. Risk of accident. Always observe the recommended tyre pressures.**
- **If tyres show excessive wear, you should have the running gear checked by a Technical Service.**
- **Keep chemicals such as oil, fuel and brake fluid away from tyres.**
- **Damaged wheels and tyres must be replaced immediately!**

#### For the sake of the environment

**Under-inflated tyres will increase fuel consumption.**

### New tyres and wheels

New tyres and wheels have to be run in.

The tyres and wheel rims are an essential part of the vehicle's design. Those approved by SEAT are specially matched to the characteristics of the vehicle and make a major contribution to good road-holding and safe handling »» .

Tyres should be replaced at least in pairs and not individually (i.e. both front tyres or both rear tyres together). A knowledge of tyre designations makes it easier to choose the correct tyres. Radial tyres have the tyre designations marked on the sidewall, for example:

**195/65 R15 91T**

This contains the following information:

195 Tyre width in mm  
 65 Height/width ratio in %  
 R Tyre construction: Radial  
 15 Rim diameter in inches  
 91 Load rating code  
 T Speed rating

The tyres could also have the following information:

- A direction of rotation symbol
- “Reinforced” denotes heavy-duty tyres.

The manufacturing date is also indicated on the tyre sidewall (possibly only on the inner side of the wheel).

“DOT ... 1103 ...” means, for example, that the tyre was produced in the 11th week of 2003.

We recommend that work on tyres and wheels be carried out by a Technical Service. They are familiar with the procedure and have the necessary special tools and spare parts as well as the proper facilities for disposing of the old tyres.

Any technical service has full information on the technical requirements when installing or changing tyres, wheels or wheel trims.

#### WARNING

- **We recommend that you use only wheels and tyres which have been approved by SEAT for your model. Failure to do so could impair vehicle handling. Risk of accident.**
- **Avoid running the vehicle on tyres that are more than 6 years old. If you have no alternative, you should drive slowly and with extra care at all times.**



- Never use old tyres or those with an unknown "history of use".
- If wheel trims are retrofitted, you must ensure that the flow of air to the brakes is not restricted. This could cause the brake system to overheat.
- All four wheels must be fitted with radial tyres of the same type, size (rolling circumference) and the same tread pattern.

#### For the sake of the environment

Old tyres must be disposed of according to the laws in the country concerned.

#### Note

- A SEAT Service Centre should be consulted to find out whether wheels or tyres of different sizes to those originally fitted by SEAT can be fitted, and to find out about the combinations allowed between the front axle (axle 1) and the rear axle (axle 2).
- For technical reasons, it is not generally possible to use the wheels from other vehicles. This can also apply to wheels of the same model. The use of wheels or tyres which have not been approved by SEAT for use with your model may invalidate the vehicle's type approval for use on public roads.
- If the spare tyre is not the same as the tyres that are mounted on the vehicle (e.g. winter tyres) you should only use the spare tyre for a short period of time and drive with

extra care. Refit the normal road wheel as soon as possible.

### Wheel bolts

The design of wheel bolts is matched to the rims. If different wheel rims are fitted, the correct wheel bolts with the right length and correctly shaped bolt heads must be used. This ensures that wheels are fitted securely and that the brake system functions correctly.

In certain circumstances, you should not use wheel bolts from a different vehicle, even if it is the same model » page 165.

#### WARNING

If the wheel bolts are not tightened correctly, the wheel could become loose while driving. Risk of accident.

- The wheel bolts must be clean and turn easily. Never apply grease or oil to them.
- Use only wheel bolts which belong to the wheel.
- If the prescribed torque of the wheel bolts is too low, they could loosen whilst the vehicle is in motion. Risk of accident! If the tightening torque is too high, the wheel bolts and threads can be damaged.

#### CAUTION

The prescribed tightening torque for wheel bolts for steel and alloy wheels is 120 Nm.

### Tyre pressure



Fig. 159 Centre console: tyre monitoring system button.

The tyre monitoring lamp (⚠)\* compares wheel revolutions and with it, using the ESC, the wheel diameter of each wheel. If the diameter of a wheel changes, the tyre control lamp (⚠) lights up. The wheel diameter changes when:

- Tyre pressure is insufficient.
- The tyre structure is damaged.
- The vehicle is unbalanced because of a load.

- The wheels of one axle are under more pressure (for example, driving with a trailer or on steep slopes).
- The vehicle is fitted with snow chains.
- The temporary spare wheel is fitted.
- The wheel on one axle is changed.

### Tyre pressure adjustment

After modifying tyre pressure or changing any wheels, the new tyre pressure must be stored in the Easy Connect system with the **CAR** button and the **SETTINGS** function button  
 »»  page 23.

In vehicles without a radio, press and hold down the »» **Fig. 159** button, with the ignition on, until an acoustic signal is heard.

If the wheels are under excessive load (for example, driving with a trailer or heavy load), the tyre pressure must be increased to the recommended value for a full load (see the sticker on the inside of the fuel flap). If the tyre monitor system button is pressed down, the new tyre pressures are confirmed.

### The tyre pressure control lamp lights up

If the tyre pressure of a wheel is much lower than the value set by the driver, then the tyre pressure control lamp »»  will light up.

### WARNING

- When the tyre pressure control lamp lights up, reduce speed immediately and avoid any sudden turning or braking manoeuvre. Stop when possible, and check the tyre pressure and status.
- The driver is responsible for maintaining correct tyre pressures. For this reason, tyre pressure must be regularly checked.
- Under certain circumstances (e.g. when driving in a sporty manner, in winter conditions or on a dirt track) the tyre control lamp may light up belatedly or may function incorrectly.

### Note

If the battery is disconnected, the yellow warning lamp  lights up after turning the ignition on. This should turn off after a brief journey.

## Winter service

### Winter tyres

In winter conditions winter tyres will considerably improve the vehicle's handling. The design of summer tyres (width, rubber compound, tread pattern) gives less grip on ice and snow.

**Winter tyres must be inflated to a pressure of 0.2 bar (2.9 psi/20 kPa) higher than the pressures specified for summer tyres (see sticker on fuel tank flap).**

Winter tyres must be fitted on all four wheels.

Information on permitted **winter tyre sizes** can be found in the vehicle's registration documentation. Use only radial winter tyres. All tyre sizes listed in the vehicle documentation also apply to winter tyres.

Winter tyres lose their effectiveness when the tread is worn down to a depth of 4 mm.

The speed rating code »» **page 190, New tyres and wheels** determines the following **speed limits** for winter tyres: »» 

Q	max. 160 km/h (99 mph)
S	max. 180 km/h (112 mph)
T	max. 190 km/h (118 mph)
H	max. 210 km/h (130 mph)

In some countries, vehicles which can exceed the speed rating of the fitted tyre must have an appropriate sticker in the driver's field of view. These stickers are available from your technical service. The legal requirements of each country must be followed.

Do not have winter tyres fitted for unnecessarily long periods. Vehicles with summer tyres handle better when the roads are free of snow and ice.

If you have a flat tyre, please refer to the notes on the spare wheel »» page 190, New tyres and wheels.

### **WARNING**

The maximum speed for the winter tyres must not be exceeded. Otherwise, this could lead to damage and risk of accident.

### For the sake of the environment

Fit your summer tyres again as soon as possible. They are quieter, do not wear so quickly and reduce fuel consumption.

## Technical data

### Technical specifications

### Important information

#### Important

The information in the vehicle documentation always takes precedence over the information in this Instruction Manual.

All technical specifications provided in this documentation are valid for the standard model in Spain. The vehicle data card included in the Maintenance Programme or the vehicle registration documents shows which engine is installed in the vehicle.

The figures may be different depending whether additional equipment is fitted, for different models, for special vehicles and for other countries.

#### Abbreviations used in the technical specifications section

kW	Kilowatt, engine power measurement.
PS	Pferdestärke (horsepower), formerly used to denote engine power.
rpm	Revolutions per minute - engine speed.
Nm	Newton metres, unit of engine torque.
CZ	Cetane number, indication of the diesel combustion power.
RON	Research octane number, indication of the knock resistance of petrol.

#### Vehicle identification data

1	1. VSSZZZXXXXXXXXXXXX
2	2. XXX XXX XXXX X.X XXX XXXXXXXX XX XXXXXX
3	3. XXXX XXXX XX
4	4. X3B B0A D38 80C 1AT 8GJ J1D CGA HH7 -- 1G6 1NL 8YM 8L7 8RM 8BG 8WD 8TC -- 27G 2B2 5SJ 5RQ QG1 7MG 639

Fig. 160 Vehicle data sticker (luggage compartment).



Fig. 161 Chassis number.

Vehicles for certain export countries do not have an identification plate.

#### VIN in the Easy Connect

- Select: **CAR** button > **SETTINGS** function button > **Service** > **Chassis number**.

#### Chassis number

The VIN is located in the Easy Connect, on the vehicle data sticker and under the windscreen, on the driver side »» Fig. 161. Additionally, the chassis number is located in the engine compartment, on the right-hand side. The number is engraved on the top side rail, and is partially covered.

#### Identification plate

The identification plate is located on the rear pillar of the right-hand front door.

### Vehicle data sticker

The data sticker is placed on the inside of the spare wheel well, in the boot and on the rear cover of the Maintenance Programme.

The following information is provided on the vehicle data sticker: » Fig. 160

- ① Vehicle identification number (chassis number)
- ② Vehicle type, model, capacity, engine type, finish, engine power and gearbox type
- ③ Engine code, gearbox code, external paint code and internal equipment code
- ④ Optional extras and PR numbers

## Information on fuel consumption

### Fuel consumption

Approved consumption values are derived from measurements performed or supervised by certified EU laboratories, according to the legislation in force at the time (for more information, see the Publications Office of the European Union on the EUR-Lex website: © European Union, <http://eur-lex.europa.eu/>) and apply to the specified vehicle characteristics.

The values relating to fuel consumption and CO<sub>2</sub> emissions can be found in the documentation provided to the purchaser of the vehicle at the time of purchase.

Fuel consumption and CO<sub>2</sub> emissions depend on the equipment/features of each individual vehicle, as well as on the driving style, road conditions, traffic conditions, environmental conditions, load or number of passengers.

#### Note

**In practice, and considering all the factors mentioned here, consumption values can differ from those calculated in the current European regulations.**

### Weights

Kerb weight refers to the basic model with a fuel tank filled to 90% capacity and without optional extras. The figure quoted includes 75 kg to allow for the weight of the driver.

Special versions, optional equipment fittings or retro-fitting accessories will increase the weight of the vehicle » ⚠.

#### WARNING

**• Please note that the centre of gravity may shift when transporting heavy objects; this may affect vehicle handling and lead to an accident. Always adjust your speed and driving**

**style to suit road conditions and requirements.**

**• Never exceed the gross axle weight rating or the gross vehicle weight rating. If the permissible axle load or the permissible total weight is exceeded, the driving characteristics of the vehicle may change, leading to accidents, injuries and damage to the vehicle.**

## Trailer mode

### Trailer weights

#### Trailer weight

The trailer weights and drawbar loads approved are selected in intensive trials according to precisely defined criteria. The approved trailer weights are valid for vehicles in the EU for maximum speeds of 80 km/h (50 mph) (in certain circumstances up to 100 km/h (62 mph)). The figures may be different in other countries. All data in the official vehicle documentation takes precedence over these data at all times » ⚠.

#### Drawbar loads

The *maximum* permitted drawbar load on the ball joint of the towing bracket must not exceed **75 kg**.

»

In the interest of road safety, we recommend that you always tow approaching the maximum drawbar load. The response of the trailer on the road will be poor, if the drawbar load is too small.

If the maximum permissible drawbar load cannot be met (e.g. with small, empty and light-weight single axle trailers or tandem axle trailers with a wheelbase of less than 1 metre), a minimum of 4% of the actual trailer weight is legally required for the drawbar load.

**⚠ WARNING**

- For safety reasons, you should not drive at speeds above 80 km/h (50 mph) when towing a trailer. This also applies in countries where higher speeds are permitted.
- Never exceed the maximum trailer weights or the drawbar load. If the permissible axle load or the permissible total weight is exceeded, the driving characteristics of the vehicle may change, leading to accidents, injuries and damage to the vehicle.

## Wheels

### Tyre pressure, snow chains, wheel bolts

#### Tyre pressures

The sticker with the tyre pressure values can be found on the inside of the fuel tank flap. The tyre pressure values given there are for cold tyres. Do not reduce the slightly raised pressures of warm tyres »» ⚠.

The pressure for winter tyres is 0.2 bar higher than that of summer tyres (2.9 psi / 20 kPa).

#### Snow chains

Snow chains may be fitted only to the front wheels, and only for the following tyres:

185/60R15	Chains with links not exceeding 15 mm (including the chain closure)
-----------	---

#### Wheel bolts

After the wheels have been changed, the **tightening torque** of the wheel bolts should be checked as soon as possible with a torque wrench »» ⚠. The tightening torque for steel and alloy wheels is **120 Nm**.

**⚠ WARNING**

- Check the tyre pressure at least once per month. Checking the tyre pressure is very im-

portant. If the tyre pressure is too high or too low, there is an increased danger of accidents - particularly at high speeds.

- If the tightening torque of the wheel bolts is too low, they could loosen while the vehicle is in motion. Risk of accident! If the tightening torque is too high, the wheel bolts and threads can be damaged.

**Note**

We recommend that you ask your Technical Service for information about appropriate wheel, tyre and snow chain size.

## Engine data

### Petrol engine 1.0 MPI 55 kW (75 PS)

Power output in kW (PS) at rpm	Maximum torque (Nm at rpm)	No. of cylinders/displacement (cm <sup>3</sup> )	Fuel
55 (75)/6,200	95/3,000-4,300	3/999	Super 95 RON/Normal 91 RON <sup>a)</sup>

<sup>a)</sup> Slight power loss.

Outputs and weights	IBIZA
Top speed (km/h)	172
Acceleration from 0-80 km/h (seconds)	9.5
Acceleration from 0-100 km/h (seconds)	14.3
Maximum authorised weight (kg)	1,530
Weight in running order (with driver) (kg)	1,043
Maximum authorised weight on front axle (kg)	790
Maximum authorised weight on rear axle (kg)	790
Permitted roof load (kg)	75
Maximum trailer weight without brakes (kg)	520
Weight of trailer with brakes, gradients up to 8% (kg)	1,000
Weight of trailer with brakes, gradients up to 12% (kg)	800

## Technical data

### Petrol engine 1.6 MPI 66 kW (90 PS)

Power output in kW (PS) at rpm	Maximum torque (Nm at rpm)	No. of cylinders/displacement (cm <sup>3</sup> )	Fuel
66 (90)/4,250-6,000	155/3,800-4,000	4/1,598	Super 95 RON/Normal 91 RON <sup>a)</sup>

a) Slight power loss.

Outputs and weights	IBIZA
Top speed (km/h)	185
Acceleration from 0-80 km/h (seconds)	7.0
Acceleration from 0-100 km/h (seconds)	10.6
Maximum authorised weight (kg)	1,570
Weight in running order (with driver) (kg)	1,079
Maximum authorised weight on front axle (kg)	830
Maximum authorised weight on rear axle (kg)	790
Permitted roof load (kg)	75
Maximum trailer weight without brakes (kg)	530
Weight of trailer with brakes, gradients up to 8% (kg)	1,000
Weight of trailer with brakes, gradients up to 12% (kg)	1,000



## Technical specifications

### Diesel engine 1.4 TDI 66 kW (90 PS)

Power output in kW (PS) at rpm	Maximum torque (Nm at rpm)	No. of cylinders/displacement (cm <sup>3</sup> )	Fuel
66 (90)/2,750-3,500	230/1,500-2,500	3/1,422	Min, diesel acc. to DIN EN 590 51 CN

Outputs and weights	IBIZA Start-Stop
Top speed (km/h)	182
Acceleration from 0-80 km/h (seconds)	7.4
Acceleration from 0-100 km/h (seconds)	10.9
Maximum authorised weight (kg)	1,640
Weight in running order (with driver) (kg)	1,155
Maximum authorised weight on front axle (kg)	910
Maximum authorised weight on rear axle (kg)	780
Permitted roof load (kg)	75
Maximum trailer weight without brakes (kg)	570
Weight of trailer with brakes, gradients up to 8% (kg)	1,200
Weight of trailer with brakes, gradients up to 12% (kg)	1,100

## Dimensions

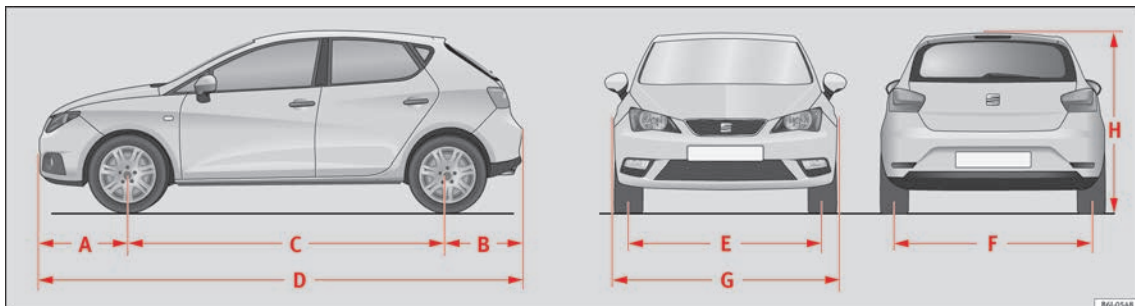

Fig. 162 Dimensions.

Fig. 162		IBIZA
A/B	Front and rear projections (mm)	857/735
C	Wheelbase (mm)	2,469
D	Length (mm)	4,061
E/F	Front/rear <sup>a)</sup> track width (mm)	1,465/1,457
G	Width (mm)	1,693
H	Height at kerb weight (mm)	1,445
	Turning radius (m)	10.7

<sup>a)</sup> This data will change depending on the type of wheel rim.

## Index

## A

- ABS ..... 143
  - control lamp ..... 144
- Accessories ..... 165
- Additional electrical appliances (efficiency programme) ..... 30
- Adjusting
  - front head restraints ..... 55, 118
  - lights ..... 112
  - rear head restraints ..... 55
- Adjusting the front seats
  - adjusting the lumbar support ..... 118
- Adjusting the head restraints
  - front head restraints ..... 118
  - rear head restraints ..... 55
- Adjusting the seat ..... 118
- Adjustment
  - CAR menu ..... 93
  - seats ..... 52
- AFS headlight bulbs ..... 82
- Airbag covers ..... 13
- Airbags ..... 61
  - description ..... 62
- Airbag system ..... 13, 61
  - activation ..... 63
  - control lamp ..... 63
  - deactivation of front airbag ..... 65
  - description ..... 62
  - front airbags ..... 13, 64
  - functioning ..... 63
  - head-protection airbags ..... 15
  - side airbags ..... 14
- Air conditioning ..... 36, 131
  - controls ..... 131
  - general notes ..... 127
  - manual air conditioning ..... 36
- Air outlets ..... 129
- Air recirculation
  - air conditioning ..... 132
  - heating and fresh air ..... 130
- Alarm system ..... 103
  - switching off ..... 104
- Alloy wheel rims ..... 171
- Alternator
  - warning lamp ..... 186
- Ambient lighting ..... 113
- Anti-freeze ..... 38
- Anti-lock brake system ..... 140, 142, 143
  - control lamp ..... 144
- Anti-puncture ..... 42, 71
  - check after 10 minutes ..... 73
- Anti-puncture set ..... 71
- Anti-theft alarm ..... 103
  - switching off ..... 104
- Aquaplaning ..... 190
- Aspects to note before setting off ..... 51
- ASR ..... 141
  - control lamp ..... 141
- Assistance systems
  - parking aid ..... 155, 156
- Assistance Systems
  - fatigue detection ..... 153
- Assisted starting ..... 47
- Audible warning signal
  - seat belt not fastened ..... 57
  - warning and control lamps ..... 92
- Automatic car wash tunnel ..... 167
- Automatic lighting ..... 109
- AUX-IN ..... 97

## B

- Back seat
  - folding down and raising the back seat backrest ..... 120
- Ball coupling ..... 162
- Battery ..... 103
- Before setting off ..... 51
- Belt pretensioners ..... 60
- Biodiesel ..... 175
- Bonnet ..... 10, 176, 179
  - closing ..... 178
  - opening ..... 177
- Boot hatch ..... 105
- Boot lid ..... 105
- Brake assist ..... 140
- Brake fluid ..... 39, 184
  - changing ..... 184
- Brake pads ..... 137, 147
- Brakes
  - brake fluid ..... 184
  - new Brake pads ..... 137
- Brake servo ..... 137, 145
- Brake system ..... 184
- Braking
  - brake assist ..... 140
- Braking distance ..... 137
- Braking system
  - warning lamp ..... 138
- Bulbs
  - changing the bulbs ..... 78
- Buzzer ..... 110

- C**
- Capacities ..... 36
    - fuel tank ..... 91
  - Car care ..... 167
    - exterior ..... 167
  - Catalytic converter ..... 149
    - malfunction ..... 149
  - CCS ..... 32
  - Central locking ..... 103
    - anti-theft alarm ..... 103
    - automatic speed-dependent locking ..... 100
    - central locking button ..... 100
    - electric windows ..... 108
    - key by remote control ..... 102
    - selective unlocking system ..... 99
    - self-locking system to prevent involuntary un-  
locking ..... 99
    - unlocking system ..... 100
  - Central locking system ..... 98
    - safe security system ..... 98
  - Cetane number (diesel fuel) ..... 175
  - Changing a
    - DRL light bulb ..... 79
  - Changing a bulb ..... 85
    - additional brake light ..... 85
    - luggage compartment light ..... 85
    - tail light bulbs ..... 83
    - turn signal light ..... 81
  - Changing a double headlight bulb ..... 81
    - dipped beam headlights ..... 81
    - double headlight bulbs ..... 80
  - Changing an AFS headlight bulb ..... 82
    - turn signal light ..... 82
    - xenon light ..... 82
  - Changing a single headlight bulb ..... 80
    - side light ..... 80
    - single headlight bulbs ..... 79
    - turn signal light ..... 79
  - Changing a wheel ..... 43
    - subsequent work ..... 45
  - Changing double headlight bulb ..... 80
    - side light ..... 80
  - Changing settings ..... 23
    - CAR menu ..... 23
  - Changing the blades ..... 73
  - Changing the bulbs ..... 82
    - AFS headlight bulbs ..... 82
    - fog light bulbs ..... 82
    - general notes ..... 78
    - interior light and reading light ..... 85
    - number plate light ..... 84
    - turn signals ..... 84
  - Changing the double headlight bulb ..... 81
    - main beam ..... 81
  - Changing the single headlight bulbs ..... 79
    - dipped/main beam ..... 79
  - Charging the battery ..... 47
  - Checking levels ..... 179
    - engine compartment ..... 179
  - Child-proof locking ..... 106
    - electric windows ..... 106
  - Child seat ..... 68
    - categorisation in groups ..... 68
  - Child seats ..... 15, 68
    - ISOFIX system ..... 17
    - safety instructions ..... 15, 67
    - securing with the seat belt ..... 16
    - Top Tether system ..... 17, 19
  - Chrome parts ..... 170
    - cleaning ..... 170
  - Cigarette lighter ..... 123
  - Cleaning ..... 166
    - adhesive sheets ..... 169
    - alloy wheel rims ..... 171
    - chrome parts ..... 170
    - engine compartment ..... 171
    - fabric ..... 172
    - high pressure cleaners ..... 168
    - leather ..... 173
    - plastic parts ..... 169, 172
    - radio and climate controls ..... 172
    - rubber seals ..... 170
    - seat belts ..... 173
    - steel wheel rims ..... 171
    - upholstery ..... 172
    - washing the vehicle ..... 167
    - windows and exterior mirrors ..... 170
    - windscreen wiper blades ..... 170
    - wooden trim ..... 172
  - Climatronic ..... 127
    - general notes ..... 127
  - Close ..... 98
  - Closing ..... 98
    - bonnet ..... 178
    - windows ..... 106
  - Coming Home ..... 110
  - Coming Home Function ..... 110
  - Contact key ..... 135
  - Control and warning lamps ..... 186
    - alternator ..... 186
    - Anti-lock brake system (ABS) ..... 144
    - ASR ..... 141
    - braking system ..... 138
    - coolant ..... 182
    - diesel particulate filter ..... 149, 150
    - EDL ..... 143
    - emission control ..... 151
    - engine oil ..... 180

- ESC ..... 140  
 instrument panel ..... 35  
 lights ..... 108  
 steering column lock ..... 133  
 windscreen washer fluid ..... 114
- Controls and displays  
 general instrument panel ..... 87
- Controls on the steering wheel  
 operating the audio system ..... 95  
 operating the telephone and audio system ... 96
- Convenience closing  
 windows ..... 108
- Convenience opening  
 windows ..... 108
- Coolant  
 checking level ..... 183
- Coolant level  
 control lamp ..... 182
- Coolant temperature  
 control lamp ..... 182  
 safety instructions ..... 183
- Cooling system  
 checking coolant ..... 182, 183  
 coolant temperature gauge ..... 91  
 topping up coolant ..... 182, 183
- Correct position ..... 52
- Correct sitting position  
 front passenger ..... 53  
 rear seat passengers ..... 54
- Cruise control ..... 32, 159  
 adjusting the stored speed ..... 160  
 control lamp ..... 159  
 temporary deactivation ..... 160  
 turning off the cruise control system ..... 160
- Current ..... 124
- D**
- Dangers in not using the seat belt ..... 58
- Dash panel ..... 33
- Data sticker ..... 194
- Deactivating the front passenger front airbag ... 14
- Deactivation of front airbag ..... 65
- Diesel  
 diesel particulate filter ..... 149  
 refuelling ..... 175
- Diesel engine particulate filter ..... 150
- Diesel particulate filter  
 malfunction ..... 149
- Digital clock ..... 88
- Dimensions ..... 200
- Direction of rotation  
 tyres ..... 45
- Display ..... 88, 89
- Disposal  
 seat belt tensioners ..... 61
- Door handle  
 de-icing ..... 170
- Door lock  
 de-icing ..... 170
- Door lock cylinder  
 de-icing ..... 170
- Door release lever ..... 87
- Doors  
 childproof locks ..... 101  
 opening and closing ..... 9
- Double headlight bulbs ..... 80
- Driver  
 see Correct sitting position ..... 52, 53, 54
- Driver information system  
 additional electrical appliances ..... 30  
 assist systems ..... 28  
 bonnet, rear lid and doors open ..... 27  
 engine oil temperature ..... 30
- gear-change indicator ..... 27
- journey data ..... 28
- menu ..... 26
- operation ..... 25
- outside temperature ..... 26
- saving tips ..... 30
- service intervals ..... 31
- speed warning ..... 30
- warning and information messages ..... 28
- Driving  
 driving abroad ..... 151  
 driving through water ..... 151  
 economical driving ..... 148  
 with a trailer ..... 162
- Driving abroad  
 headlights ..... 151  
 petrol ..... 151
- Driving assistance systems  
 cruise control ..... 159
- Driving data  
 data summary ..... 29  
 memory ..... 28
- Driving on flooded roads ..... 151
- Driving safety ..... 51
- Driving with a trailer ..... 161
- Duplicate keys ..... 102
- Dust and pollen filter ..... 127
- Dynamic headlight range control ..... 112
- E**
- E10  
 see Ethanol (fuel) ..... 174
- Easy Connect ..... 23, 93
- EDL  
 see Electronic differential lock ..... 142
- EDS ..... 142

- Efficiency programme  
 additional electrical appliances ..... 30  
 saving tips ..... 30
- Electrical power socket ..... 124
- Electric windows ..... 11, 106  
 convenience opening/closing ..... 108
- Electrolyte ..... 186
- Electronic differential lock ..... 140, 142  
 control lamp ..... 143, 144
- Electronic differential lock (XDS) ..... 144
- Electronic immobiliser ..... 135
- Electronic stability control (ESC) ..... 142
- Electronic Stability Control (ESC) ..... 140
- Emergencies ..... 70  
 bulbs ..... 41  
 changing a wheel ..... 43  
 changing the battery ..... 187  
 emergency towing of the vehicle ..... 46  
 emergency warning triangle ..... 70  
 fire extinguisher ..... 70  
 first-aid kit ..... 70  
 fuses ..... 40  
 hazard warning lights ..... 112  
 jump leads ..... 47  
 puncture ..... 41  
 replacing a blown fuse ..... 40  
 spare wheel ..... 70  
 vehicle tools ..... 70
- Emergency warning triangle ..... 70
- Emission control system  
 control lamp ..... 151
- Emissions data ..... 194
- Engine  
 assisted starting ..... 47  
 Running in ..... 146  
 Start-Stop system ..... 152
- Engine compartment ..... 10, 176, 179  
 battery ..... 185  
 brake fluid ..... 184  
 closing ..... 178  
 coolant ..... 182, 183  
 engine oil ..... 181  
 opening ..... 177  
 safety notes ..... 176  
 windscreen washer liquid ..... 185
- Engine coolant ..... 38  
 checking level ..... 182  
 G12 plus-plus ..... 38  
 G13 ..... 38  
 specifications ..... 38
- Engine data ..... 197
- Engine fault  
 control lamp ..... 151
- Engine management ..... 149  
 control lamp ..... 150
- Engine oil ..... 37, 179  
 changing ..... 179, 182  
 check oil level ..... 181  
 consumption ..... 181  
 diesel ..... 179  
 engine oil dipstick ..... 181  
 inspection service ..... 179  
 maintenance intervals ..... 179  
 oil properties ..... 37  
 specifications ..... 179  
 temperature display ..... 30  
 topping up ..... 181
- Engine oil pressure  
 control lamp ..... 180
- Environment  
 ecological driving ..... 148  
 environmental compatibility ..... 147
- Environmental tips  
 refuelling ..... 174
- Equipment ..... 165
- ESC ..... 140  
 electronic stability control ..... 140, 142  
 Sport Mode ..... 142  
*see also* Electronic Stability Control (ESC) ... 140
- Ethanol (fuel) ..... 174
- Exhaust gas emission control system ..... 149
- Exhaust gas purification system  
 catalytic converter ..... 149  
 diesel particulate filter ..... 149
- Extending  
 the luggage compartment ..... 120
- exterior lighting  
 changing the bulbs ..... 78
- Exterior mirrors ..... 116  
 adjusting ..... 12  
 control ..... 117  
 folding in electrically ..... 117  
 folding in manually ..... 116  
 heated ..... 117
- Exterior view ..... 5, 6
- F**
- Fabric: cleaning ..... 172
- Fastening rings ..... 125
- Fatigue detection ..... 153
- Fault in electronic differential lock (EDL)  
 control lamp ..... 143
- Faulty bulbs  
 changing the bulbs ..... 78
- Filling the fuel tank ..... 174
- Filling the tank ..... 174  
 fuel gauge ..... 91
- Fire extinguisher ..... 70
- First-aid kit ..... 70

- Floor mats ..... 56
- Fluid Level control ..... 36
- Fog light bulb ..... 82
- Front airbags ..... 13, 64  
safety instructions ..... 64
- Front ashtray ..... 123
- Front drink holder ..... 122
- Front passenger front airbag  
control lamp ..... 63  
deactivation ..... 14
- Front seat  
manual adjustment ..... 11
- Fuel ..... 37, 174  
consumption ..... 195  
diesel ..... 175  
ethanol ..... 174  
fuel gauge ..... 91  
refuelling ..... 174  
saving ..... 148
- Fuel consumption ..... 148  
why does fuel consumption increase? ..... 149
- Fuel tank cap  
opening and closing ..... 37
- Fuel tank flap  
opening and closing ..... 37
- Fuses ..... 40, 75  
fuse box ..... 76  
identifying blown fuses ..... 41  
identifying by colours ..... 40  
preparation before replacing ..... 40  
replacing ..... 40
- G**
- Gear-change indicator ..... 27, 146
- Gearbox lever ..... 35
- Gear change ..... 35  
changing gears (manual gearbox) ..... 145  
manual ..... 35  
manual gear change ..... 145
- Gear engaged ..... 35
- Gear recommendation ..... 27
- General instrument panel  
controls and displays ..... 87  
turn signal and main beam lever ..... 110  
warning and indication lamps ..... 33
- General overview of the engine compartment .. 179
- Glove compartment ..... 121
- Glow plug system ..... 137
- H**
- Handbrake ..... 137, 138  
warning lamp ..... 139
- Hazard warning lights ..... 21, 112
- HBA ..... 143
- Head-on collisions and the laws of physics .... 58
- Head-protection airbags  
description ..... 15  
safety instructions ..... 15
- Headlight range control ..... 112
- Headlights  
driving abroad ..... 151  
fog lights ..... 110  
headlight washer ..... 116
- Head restraints ..... 11  
adjustment ..... 118  
front head restraints ..... 55  
rear head restraints ..... 55
- Headrests ..... 11  
adjustment ..... 118  
front ..... 55  
rear ..... 55
- Heated rear window  
heating element wires ..... 170  
switch ..... 114
- Heating ..... 130  
defrosting the windscreen ..... 130  
demisting the windscreen and side windows 131
- Heating and fresh air ..... 36, 129
- Heating and fresh air system  
controls ..... 129
- Heating system ..... 130
- Hill driving assistant ..... 145
- Horn ..... 87
- How to jump start ..... 47  
description ..... 48
- Hydraulic Brake Assist  
automatic hazard warning lights activation .. 143
- I**
- Identification plate ..... 194
- Identifying letters on engine ..... 194
- Ignition ..... 20, 135
- Ignition lock ..... 20, 135
- Incorrect sitting position ..... 54
- Indications on the display ..... 89  
assist systems submenu ..... 28  
distance travelled ..... 89  
doors, bonnet and rear lid open ..... 27  
driver information system ..... 25  
journey data ..... 28  
MKB ..... 90  
outside temperature ..... 26  
recommended gear ..... 90  
second speed display ..... 90  
service intervals ..... 31  
speed warning ..... 90  
Start-Stop ..... 90

- time ..... 89  
 warning and information messages ..... 28
- Infotainment system ..... 23
- Inspection ..... 179
- Inspection service ..... 179
- Instrument cluster ..... 88
- Instrument panel ..... 88  
 display ..... 88, 89  
 instruments ..... 88  
 odometer ..... 90  
 service interval indication ..... 31  
 warning and control lamps ..... 92
- Interior lights ..... 21
- Interior mirror ..... 116  
 anti-dazzle ..... 116
- Interior view  
 left guide ..... 7  
 right-hand drive ..... 8
- ISOFIX ..... 17, 19
- ISOFIX system ..... 17
- ISOFIX System ..... 19
- J**
- Jack ..... 43  
 mounting points ..... 44
- Journey data ..... 25
- Jump leads ..... 47
- K**
- Key-operated switch ..... 65
- Key by remote control  
 unlocking and locking ..... 102
- Keys  
 replacing the battery ..... 103  
 spare key ..... 102  
 synchronise ..... 103
- unlocking and locking ..... 102  
 vehicle key ..... 102
- L**
- Leaving Home ..... 110
- Leaving Home Function ..... 110
- Lifting the vehicle ..... 44
- Lighting of the instrument panel, ..... 112
- Lights ..... 20, 108  
 adaptive headlights ..... 111  
 additional brake light ..... 85  
 automatic lighting ..... 109  
 changing the bulbs ..... 78  
 coming home ..... 110  
 Control and warning lamps ..... 108  
 daytime running lights ..... 109  
 fog lights ..... 109  
 fog lights with cornering function ..... 112  
 headlight range control ..... 112  
 interior light and front reading lights ..... 85  
 interior lights ..... 113  
 leaving home ..... 110  
 lighting of the instrument panel ..... 112  
 light switch ..... 108  
 luggage compartment light ..... 85  
 main beam lever ..... 110  
 main beams ..... 21  
 number plate light ..... 84  
 parking lights ..... 110  
 reading lights ..... 113  
 turn signal lever ..... 110  
 turn signals ..... 84
- Light switch ..... 20
- Load compartment in the luggage compartment  
*see* Loading the luggage compartment ..... 124
- Loading the luggage compartment ..... 124
- Loading the vehicle  
 fastening rings ..... 125  
 luggage compartment ..... 9  
 roof luggage rack ..... 126
- Locking and unlocking  
 with the central lock button ..... 100
- Luggage ..... 124
- Luggage compartment ..... 9, 124  
 luggage compartment lighting ..... 113  
 store the rear shelf ..... 126  
 unlocking manually ..... 124  
*see also* Loading the luggage compartment ..... 124
- Luggage compartment lid ..... 10
- M**
- Main beam lever ..... 110
- Maintenance and cleaning ..... 165
- maintenance intervals ..... 179
- Malfunction  
 catalytic converter ..... 149  
 diesel particulate filter ..... 149
- Manual gearbox ..... 145
- Mobile ..... 166
- Mobile phones ..... 166
- Modifications ..... 165
- Multimedia ..... 97
- N**
- Noises  
 tyres ..... 45
- Number of seats ..... 56
- O**
- Octane rating (petrol) ..... 174



- Odometer ..... 90
    - reset button ..... 90
    - total ..... 88
    - trip recorder ..... 88
  - Oil change ..... 182
  - Oil properties ..... 37
  - One-touch opening and closing
    - electric windows ..... 107
  - Open and close ..... 98
    - rear lid ..... 105
  - Opening ..... 98
    - bonnet ..... 10
    - fuel tank flap ..... 174
    - windows ..... 106
  - Opening and closing
    - bonnet ..... 10
    - by remote control ..... 102
    - fuel tank flap ..... 174
    - in the lock cylinder ..... 9
    - rear lid ..... 105
    - rear lid of the luggage compartment ..... 9
    - windows ..... 106
    - with the central lock button ..... 100
  - Outside temperature ..... 26
- P**
- Parking ..... 139
  - Parking aid ..... 155
  - Parking Aid
    - adjusting the display and audible warnings ..... 156
    - fault ..... 157
    - rear parking aid ..... 156
    - sensors and camera: cleaning ..... 169
    - towing bracket ..... 157
  - Parking distance warning system
    - see Parking aid ..... 155
  - ParkPilot
    - see Parking aid ..... 155
  - Particulate filter (diesel) ..... 149
  - Parts ..... 165
  - Passenger
    - see Correct sitting position ..... 52, 53, 54
  - Pedals ..... 56
  - Petrol
    - additives ..... 174
    - refuelling ..... 174
  - Plastic parts: cleaning ..... 169, 172
  - Pollution filter ..... 127
  - Positioning seat belts
    - during pregnancy ..... 60
    - seat belts ..... 60
  - Power-assisted steering ..... 134
  - Power steering ..... 133
  - Pre-heating system
    - control lamp ..... 151
  - Products for vehicle maintenance ..... 166
  - Puncture
    - action ..... 41
- R**
- Radio frequency remote control ..... 102
  - Raising the vehicle ..... 44
  - Rear Assist ..... 157
    - instructions for use ..... 158
    - parking ..... 159
    - screen ..... 158
    - special characteristics ..... 158
  - Rear Assist system ..... 157
  - Rear drink holder ..... 123
  - Rear fog light
    - control lamp ..... 108
  - Rear lid ..... 9, 10
  - Rear seat passengers
    - see Correct sitting position ..... 52, 53, 54
  - Rear shelf
    - store ..... 126
  - Rear View Camera ..... 157
  - Rear view mirror ..... 116
  - Rear view mirrors ..... 116
  - Rear window automatic wiper-washer ..... 115
  - Rear window wiper ..... 115
  - Rear Window wiper ..... 114
  - Rear window wiper blade
    - changing ..... 50
    - cleaning ..... 50
  - Refuelling ..... 174
    - opening fuel tank flap ..... 174
  - Repair work ..... 165
  - Replacement
    - parts ..... 165
  - Replacement keys ..... 102
  - Replacement parts ..... 165
  - Replacing the battery
    - of the vehicle key ..... 103
  - Reset the trip recorder ..... 90
  - Rev counter ..... 88, 89
  - Rims
    - changing a wheel ..... 43
  - Roll-back function
    - windows ..... 107
  - Roof aerial ..... 165
  - Roof carrier system ..... 126
  - Roof luggage rack ..... 126
    - attach the cross bars ..... 127
  - Roof rack ..... 126
  - Rubber seals
    - care ..... 170

- Run-in ..... 188  
 brake pads ..... 147  
 tyres ..... 147
- running in  
 engine ..... 146
- S**
- Safe ..... 98  
 driving safe ..... 51
- Safe Security system ..... 98
- Safety ..... 51  
 child safety ..... 67  
 child seats ..... 67  
 deactivating the front passenger airbag ..... 14  
 safe driving ..... 51
- Safety equipment ..... 51
- Safety instructions  
 coolant temperature ..... 183  
 front airbags ..... 64  
 head-protection airbags ..... 15  
 side airbags ..... 64  
 using child seats ..... 15, 67
- Safety notes  
 seat belt tensioners ..... 61  
 using seat belts ..... 58
- Saving tips (efficiency programme) ..... 30
- Seat  
 heating ..... 119
- Seat belt position  
 for pregnant women ..... 12  
 seat belts ..... 12
- Seat belts ..... 56  
 adjustment ..... 12, 59  
 control lamp ..... 57  
 protective function ..... 57  
 purpose ..... 56, 61
- safety notes ..... 58  
 unfastened ..... 58
- Seat belt tensioners ..... 12  
 control lamp ..... 63
- Seat heating ..... 119
- Selective opening ..... 99
- Service intervals ..... 31
- Service notification: read ..... 31
- Side airbags  
 description ..... 14  
 safety instructions ..... 64
- Side and interior bulbs ..... 84
- Signal lever ..... 21
- Single headlight bulbs ..... 79
- Sitting position  
 driver ..... 52
- Snow chains ..... 45, 196
- Spanner symbol ..... 31
- Spare wheel ..... 70
- Speed limiter ..... 159
- Speed warning ..... 30
- Speed warning device ..... 30
- Sport Mode ..... 142
- Start-Stop  
 activating and deactivating ..... 153  
 function ..... 152
- Start-Stop System ..... 152
- Starting the engine ..... 136  
 after the fuel tank has been run dry ..... 137  
 diesel ..... 136  
 petrol ..... 136
- Starting the vehicle ..... 20
- Steel wheel rims  
 cleaning ..... 171
- Steering ..... 53, 135  
 control lamp ..... 133  
 electromechanical ..... 134
- power ..... 134  
 power-assisted steering ..... 134  
 steering column lock ..... 134
- Steering wheel  
 adjustment ..... 13
- Steering wheel controls ..... 94
- Steering wheel height adjustment ..... 53
- Storage compartment  
 glove compartment lighting ..... 113  
 of front door panel ..... 122  
 on the driver side ..... 121  
 on the front passenger side ..... 121  
 right front seat ..... 122  
 storage pocket in the seat ..... 122
- Storage compartments ..... 121
- Sun visors ..... 114
- Switch  
 hazard warning lights ..... 112
- Switching off the engine ..... 137
- Switching off the lights ..... 108
- Switching on the lights ..... 108
- Switching the ignition on and off ..... 20, 135
- System Easy Connect ..... 93
- T**
- Tail light bulbs ..... 83
- Tail lights  
 access ..... 83  
 change ..... 84  
 summary ..... 83
- Taking care of your vehicle ..... 166
- Technical specifications ..... 194
- Temperature display  
 engine oil ..... 30  
 outside temperature ..... 26
- Tightening the belt ..... 60
- Tightening torque of wheel bolts ..... 196

- Tire Mobility Set  
 inflating a tyre ..... 72
- Top speed ..... 30
- Top Tether ..... 17, 19
- Top Tether system ..... 17
- Top Tether System ..... 19
- Tow-starting ..... 47, 74
- Towing bracket  
 ball coupling ..... 162  
 retrofitting ..... 163
- Towing bracket device ..... 161
- Towing the vehicle ..... 46, 74
- Towline anchorage  
 front ..... 75  
 rear ..... 75
- Towline anchorages ..... 46, 75
- Traction control system ..... 140, 141, 142  
 control lamp ..... 141
- Trailer ..... 161  
 mode ..... 161, 195  
 parking Aid ..... 157
- Trailer turn signals  
 control lamp ..... 110
- Trailer weights ..... 195
- Transporting children ..... 67
- Transporting items  
 fastening rings ..... 125
- Transporting objects  
 roof carrier system ..... 126  
 roof luggage rack ..... 126
- Turn signal lever ..... 110
- Turn signals  
 control lamp ..... 110
- Two-way radios ..... 166
- Tyre mobility set ..... 42  
 components ..... 72  
 sealing a tyre ..... 72
- Tyre Mobility System  
*see* Anti-puncture kit ..... 71
- Tyre pressure monitoring system ..... 189
- Tyre pressures ..... 196
- Tyre profile ..... 189
- Tyre repair ..... 71
- Tyre repair kit  
*see* Anti-puncture kit ..... 71
- Tyres ..... 188  
 changing ..... 43  
 new tyres ..... 190  
 pressure ..... 188, 189, 191  
 useful life ..... 189  
 wear indicators ..... 189  
 with directional tread ..... 45  
 with directional tread pattern ..... 188
- Tyre tread depth ..... 189
- Tyre wear ..... 189
- U**
- Unfastening the seat belt ..... 12, 59
- Unlocking and locking  
 by remote control ..... 102  
 with the central lock button ..... 100
- Unlocking manually  
 rear lid ..... 10
- Upholstery: cleaning ..... 172
- USB/AUX-IN input ..... 97
- V**
- Vanity mirror ..... 114
- Vehicle  
 data sticker ..... 194  
 identification data ..... 194  
 identification number ..... 194  
 raising ..... 44  
 vehicle identification number ..... 194
- Vehicle battery ..... 39, 185  
 assisted starting ..... 47  
 changing ..... 187  
 charging ..... 187  
 connecting and disconnecting ..... 185  
 disconnect and connect ..... 32  
 electrolyte level ..... 186  
 winter conditions ..... 185
- Vehicle care  
 windscreen wipers service position ..... 49
- Vehicle documentation compartment ..... 121
- Vehicle interior heating or cooling system ..... 132
- Vehicle interior monitoring and anti-tow system  
 activation ..... 105
- Vehicle paint  
 code ..... 194
- Vehicle paintwork  
 maintenance ..... 169  
 polishing ..... 169  
 products for vehicle maintenance ..... 167
- Vehicle seats ..... 56
- vehicle tools ..... 43
- Vehicle tools  
 housing ..... 70
- Vehicle underbody  
 protection ..... 171
- Vehicle washing ..... 167
- Ventilation ..... 130
- Ventilation slits ..... 125
- W**
- Warning and control lamp  
 cruise control ..... 159
- Warning and control lamps  
 audible warning signal ..... 92  
 engine management ..... 150

- engine pre-heating/fault system ..... 151
- instrument panel display ..... 34
- Warning and indication lamps
  - airbags ..... 65
  - instrument panel ..... 33
  - seat belt ..... 57
  - tyres ..... 191
- Warning messages
  - red ..... 92
  - yellow ..... 92
- Warning symbols ..... 92
  - see also* Warning and control lamps ..... 92
- Warning triangle ..... 112
- Washing
  - care of the vehicle exterior ..... 167
- Washing the vehicle ..... 167
  - adhesive sheets ..... 169
  - high pressure cleaners ..... 168
- Weights ..... 195
- Wheel balance ..... 189
- Wheel bolts ..... 196
  - anti-theft ..... 43
  - caps ..... 43
  - loosening ..... 44
  - tightening torque ..... 191
- Wheel cover
  - removing ..... 43
- Wheels ..... 188, 196
  - anti-theft bolts ..... 43
  - chains ..... 196
  - changing ..... 43
  - new wheels ..... 190
  - removing and fitting ..... 45
  - snow chains ..... 45
- Windows
  - electric ..... 11, 106
  - removing ice ..... 170
- Window wiper blade ..... 22
- Windscreen and rear window wiper blades ..... 73
- Windscreen defrosting ..... 130
- Windscreen washer ..... 39, 114
- Windscreen washer fluid
  - control lamp ..... 114
- Windscreen washer water
  - check ..... 185
  - filling amounts ..... 185
  - topping up ..... 185
- Windscreen wiper blades
  - cleaning ..... 170
- Windscreen wipers ..... 22, 114
  - lifting the wiper blades ..... 49
  - replacing the wiper blades ..... 49
  - service position ..... 49
- Winter conditions
  - battery ..... 185
  - diesel ..... 175
  - snow chains ..... 45
  - thawing windows ..... 170
  - tyres ..... 192
- Winter tyres
  - sizes ..... 192
- X**
- XDS ..... 144





SEAT S.A. is permanently concerned about continuous development of its types and models. For this reason we ask you to understand, that at any given time, changes regarding shape, equipment and technique may take place on the car delivered. For this reason no right at all may derive based on the data, drawings and descriptions in this current handbook.

All texts, illustrations and standards in this handbook are based on the status of information at the time of printing. Except for error or omission, the information included in the current handbook is valid as of the date of closing print.

Re-printing, copying or translating, whether total or partial is not allowed unless SEAT allows it in written form.

SEAT reserves all rights in accordance with the "Copyright" Act.

All rights on changes are reserved.

 This paper has been manufactured using bleached non-chlorine cellulose.

© SEAT S.A. - Reprint: 15.05.17

Inglés 6P0012720BE (05.17)



6P0012720BE



SEAT recommends  
SEAT **GENUINE OIL**



SEAT recommends  
Castrol EDGE Professional